

XPS 15

Service Manual

Computer Model: XPS 9550
Regulatory Model: P56F
Regulatory Type: P56F001



Notes, cautions, and warnings



NOTE: A NOTE indicates important information that helps you make better use of your computer.



CAUTION: A CAUTION indicates either potential damage to hardware or loss of data and tells you how to avoid the problem.



WARNING: A WARNING indicates a potential for property damage, personal injury, or death.

Copyright © 2015 Dell Inc. All rights reserved. This product is protected by U.S. and international copyright and intellectual property laws. Dell™ and the Dell logo are trademarks of Dell Inc. in the United States and/or other jurisdictions. All other marks and names mentioned herein may be trademarks of their respective companies.

2015-09

Rev. A00

Contents

Before working inside your computer.....	8
Before you begin	8
Safety instructions.....	8
Recommended tools.....	9
After working inside your computer.....	10
Removing the base cover.....	11
Procedure.....	11
Replacing the base cover.....	13
Procedure.....	13
Removing the battery.....	14
Prerequisites.....	14
Procedure.....	14
Replacing the battery.....	16
Procedure.....	16
Post-requisites.....	16
Removing the hard drive.....	17
Prerequisites.....	17
Procedure.....	17
Replacing the hard drive.....	21
Procedure.....	21
Post-requisites.....	21

Removing the solid-state drive (half-length).....	22
Prerequisites.....	22
Procedure.....	22
Replacing the solid-state drive (half-length).....	25
Procedure.....	25
Post-requisites.....	25
Removing the solid-state drive (full-length).....	26
Prerequisites.....	26
Procedure.....	26
Replacing the solid-state drive (full-length).....	28
Procedure.....	28
Post-requisites.....	28
Removing the speakers.....	29
Prerequisites.....	29
Procedure.....	29
Replacing the speakers.....	31
Procedure.....	31
Post-requisites.....	31
Removing the wireless card.....	32
Prerequisites.....	32
Procedure.....	32
Replacing the wireless card.....	34
Procedure.....	34
Post-requisites.....	34

Removing the fans.....	35
Prerequisites.....	35
Procedure.....	35
Replacing the fans.....	38
Procedure.....	38
Post-requisites.....	38
Removing the heat-sink assembly.....	39
Prerequisites.....	39
Procedure.....	39
Replacing the heat-sink assembly.....	41
Procedure.....	41
Post-requisites.....	41
Removing the memory modules.....	42
Prerequisites.....	42
Procedure.....	42
Replacing the memory modules.....	44
Procedure.....	44
Post-requisites.....	45
Removing the system board.....	46
Prerequisites.....	46
Procedure.....	46
Replacing the system board.....	50
Procedure.....	50
Post-requisites.....	50



Removing the keyboard.....	52
Prerequisites.....	52
Procedure.....	52
Replacing the keyboard.....	56
Procedure.....	56
Post-requisites.....	56
Removing the display assembly.....	57
Prerequisites.....	57
Procedure.....	57
Replacing the display assembly.....	61
Procedure.....	61
Post-requisites.....	61
Removing the power-adapter port.....	62
Prerequisites.....	62
Procedure.....	62
Replacing the power-adapter port.....	64
Procedure.....	64
Post-requisites.....	64
Removing the antenna cover.....	65
Prerequisites.....	65
Procedure.....	65
Replacing the antenna cover.....	67
Procedure.....	67
Post-requisites.....	67

Removing the display hinges.....	68
Prerequisites.....	68
Procedure.....	69
Replacing the display hinges.....	71
Procedure.....	71
Post-requisites.....	71
Removing the antenna module.....	72
Prerequisites.....	72
Procedure.....	72
Replacing the antenna module.....	74
Procedure.....	74
Post-requisites.....	74
Removing the palm-rest assembly.....	75
Prerequisites.....	75
Procedure.....	75
Replacing the palm-rest assembly.....	77
Procedure.....	77
Post-requisites.....	77
Flashing the BIOS.....	78
Getting help and contacting Dell.....	79
Self-help resources.....	79
Contacting Dell.....	80

Before working inside your computer

 **NOTE:** The images in this document may differ from your computer depending on the configuration you ordered.

Before you begin

- 1 Save and close all open files and exit all open applications.
 - 2 Shut down your computer.
 - Windows 10: Click or tap **Start** →  **Power** → **Shut down**.
 - Windows 8.1: On the **Start** screen, click or tap the power icon  → **Shut down**.
 - Windows 7: Click or tap **Start** → **Shut down**.
-  **NOTE:** If you are using a different operating system, see the documentation of your operating system for shut-down instructions.
- 3 Disconnect your computer and all attached devices from their electrical outlets.
 - 4 Disconnect all cables such as telephone cables, network cables and so on, from your computer.
 - 5 Disconnect all attached devices and peripherals, such as keyboard, mouse, monitor, and so on, from your computer.
 - 6 Remove any media card and optical disc from your computer, if applicable.

Safety instructions

Use the following safety guidelines to protect your computer from potential damage and ensure your personal safety.

 **WARNING:** Before working inside your computer, read the safety information that shipped with your computer. For more safety best practices, see the Regulatory Compliance home page at www.dell.com/regulatory_compliance.

 **WARNING:** Disconnect all power sources before opening the computer cover or panels. After you finish working inside the computer, replace all covers, panels, and screws before connecting to the power source.

 **CAUTION:** To avoid damaging the computer, ensure that the work surface is flat and clean.

 **CAUTION:** To avoid damaging the components and cards, handle them by their edges and avoid touching pins and contacts.

 **CAUTION:** You should only perform troubleshooting and repairs as authorized or directed by the Dell technical assistance team. Damage due to servicing that is not authorized by Dell is not covered by your warranty. See the safety instructions that shipped with the product or at www.dell.com/regulatory_compliance.

 **CAUTION:** Before touching anything inside your computer, ground yourself by touching an unpainted metal surface, such as the metal at the back of the computer. While you work, periodically touch an unpainted metal surface to dissipate static electricity, which could harm internal components.

 **CAUTION:** When you disconnect a cable, pull on its connector or on its pull tab, not on the cable itself. Some cables have connectors with locking tabs or thumb-screws that you must disengage before disconnecting the cable. When disconnecting cables, keep them evenly aligned to avoid bending any connector pins. When connecting cables, ensure that the ports and connectors are correctly oriented and aligned.

 **CAUTION:** Press and eject any installed card from the media-card reader.

Recommended tools

The procedures in this document may require the following tools:

- Philips screwdriver
- Flat-head screwdriver
- Torx #5 (T5) screwdriver
- Plastic scribe

After working inside your computer



CAUTION: Leaving stray or loose screws inside your computer may severely damage your computer.

- 1 Replace all screws and ensure that no stray screws remain inside your computer.
- 2 Connect any external devices, peripherals, and cables you removed before working on your computer.
- 3 Replace any media cards, discs, and any other parts that you removed before working on your computer.
- 4 Connect your computer and all attached devices to their electrical outlets.
- 5 Turn on your computer.

Removing the base cover

 **WARNING:** Before working inside your computer, read the safety information that shipped with your computer and follow the steps in [Before working inside your computer](#). After working inside your computer, follow the instructions in [After working inside your computer](#). For more safety best practices, see the Regulatory Compliance home page at www.dell.com/regulatory_compliance.

Procedure

- 1 Close the display and turn the computer over.
- 2 Turn the system badge over and place it on the base cover.
- 3 Remove the screws that secure the base cover to the palm-rest assembly.

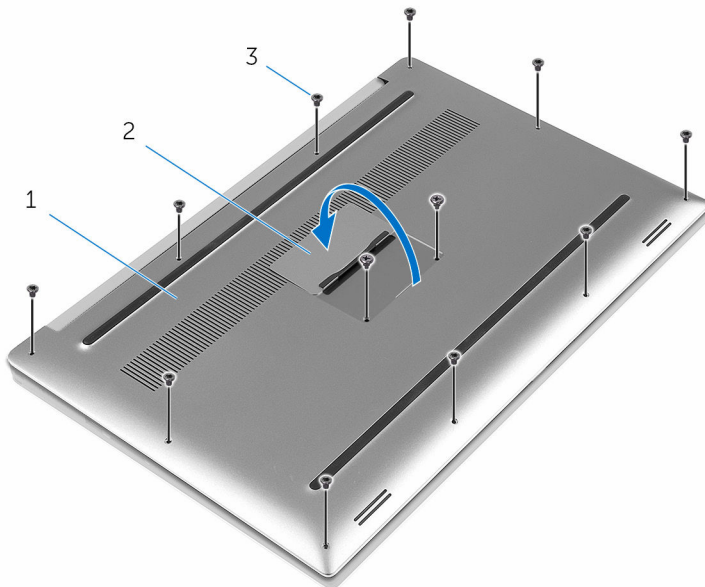

1 base cover
3 screws (12)

2 system badge

- 4 Using your fingertips, gently pry the base cover off the palm-rest assembly.

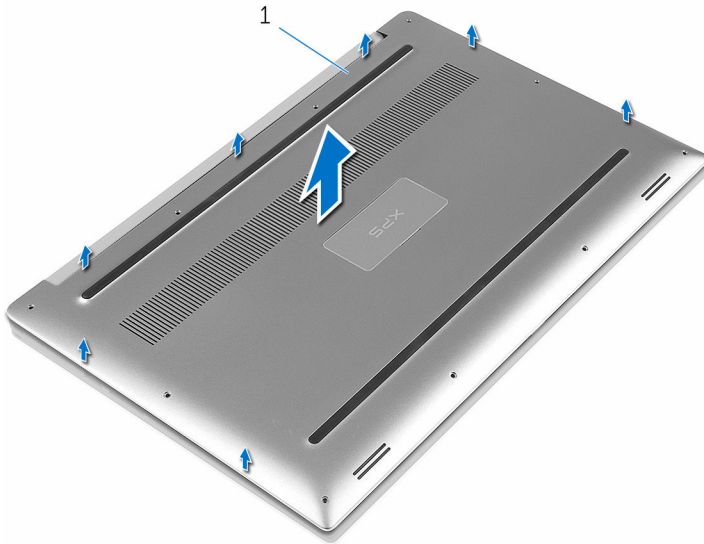

1 base cover

Replacing the base cover



WARNING: Before working inside your computer, read the safety information that shipped with your computer and follow the steps in [Before working inside your computer](#). After working inside your computer, follow the instructions in [After working inside your computer](#). For more safety best practices, see the Regulatory Compliance home page at www.dell.com/regulatory_compliance.

Procedure

- 1 Place the base cover on the palm-rest assembly and snap it into place.
- 2 Replace the screws that secure the base cover to the palm-rest assembly.
- 3 Turn the system badge over and snap it into place.
- 4 Turn the computer over.

Removing the battery



WARNING: Before working inside your computer, read the safety information that shipped with your computer and follow the steps in [Before working inside your computer](#). After working inside your computer, follow the instructions in [After working inside your computer](#). For more safety best practices, see the Regulatory Compliance home page at www.dell.com/regulatory_compliance.

Prerequisites

Remove the [base cover](#).

Procedure



NOTE: The images in this document may differ from your computer depending on the configuration you ordered.

- 1 Remove the screws that secure the battery to the palm-rest assembly.
- 2 Disconnect the battery cable from the system board.

3 Lift the battery off the palm-rest assembly.

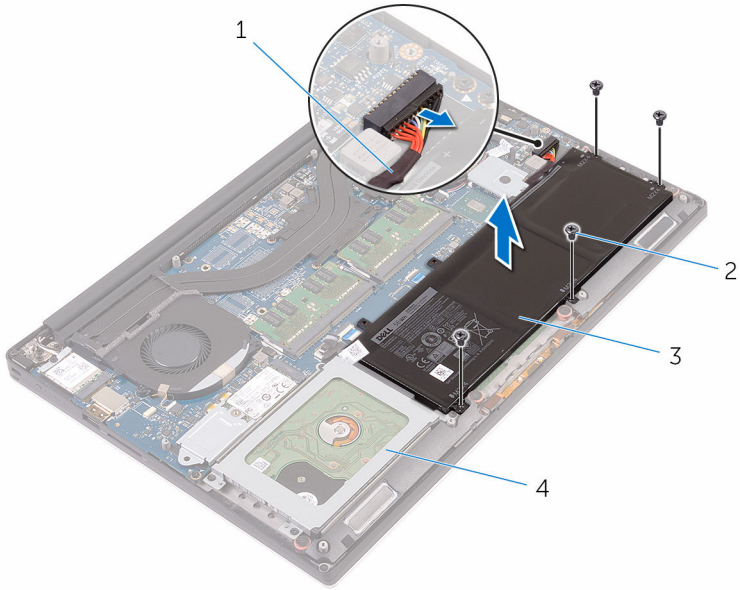

1 battery cable

2 screws (4)

3 battery

4 palm-rest assembly

4 Turn the computer over, open the display, and press the power button for five seconds to ground the system board.

Replacing the battery



WARNING: Before working inside your computer, read the safety information that shipped with your computer and follow the steps in [Before working inside your computer](#). After working inside your computer, follow the instructions in [After working inside your computer](#). For more safety best practices, see the Regulatory Compliance home page at www.dell.com/regulatory_compliance.



Procedure

- 1 Align the screw holes on the battery with the screw holes on the palm-rest assembly.
- 2 Replace the screws that secure the battery to the palm-rest assembly.
- 3 Connect the battery cable to the system board.

Post-requisites

Replace the [base cover](#).

Removing the hard drive

-  **WARNING:** Before working inside your computer, read the safety information that shipped with your computer and follow the steps in [Before working inside your computer](#). After working inside your computer, follow the instructions in [After working inside your computer](#). For more safety best practices, see the Regulatory Compliance home page at www.dell.com/regulatory_compliance.
-  **CAUTION:** Hard drives are fragile. Exercise care when handling the hard drive.
-  **CAUTION:** To avoid data loss, do not remove the hard drive while the computer is in sleep or on state.

Prerequisites

- 1 Remove the [base cover](#).
- 2 Remove the [battery](#).

Procedure

- 1 Remove the screws that secure the hard-drive assembly to the palm-rest assembly.

- 2** Lift the hard-drive cage off the hard-drive assembly.

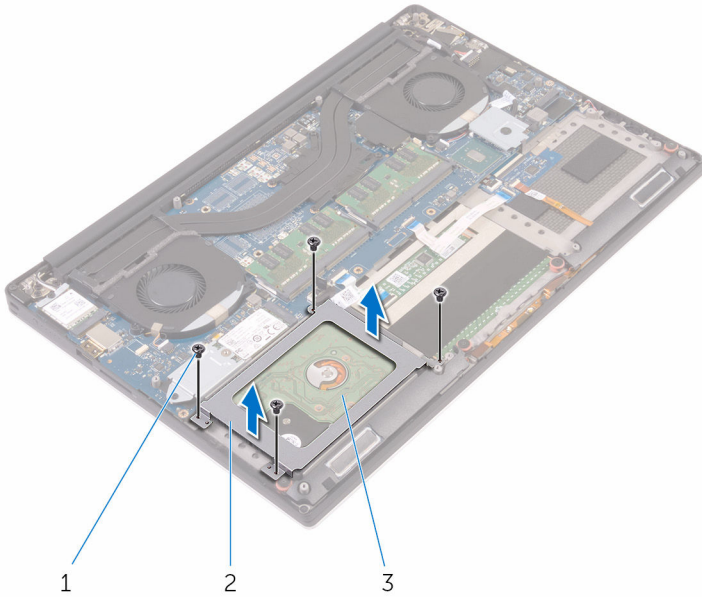

1 screws (4)

2 hard-drive cage

3 hard-drive assembly

- 3** Using the pull tab disconnect the hard-drive cable from the system board.

- 4 Lift the hard-drive assembly off the palm-rest assembly.

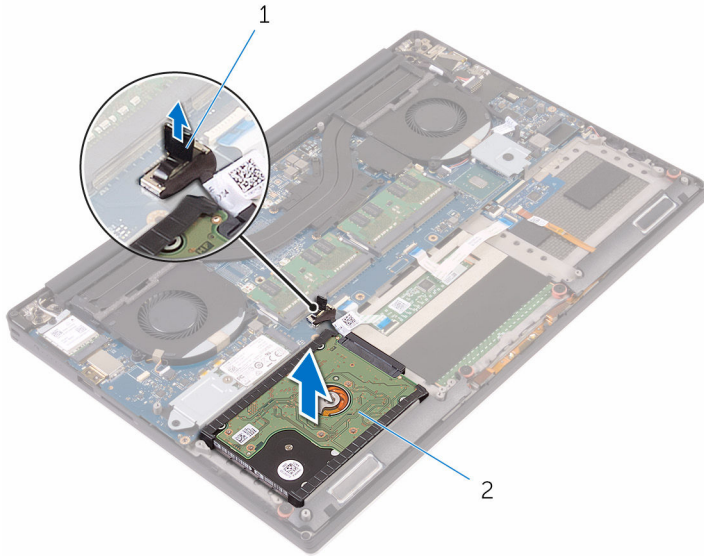

1 pull tab

2 hard-drive assembly

- 5 Disconnect the hard-drive interposer from the hard-drive assembly.

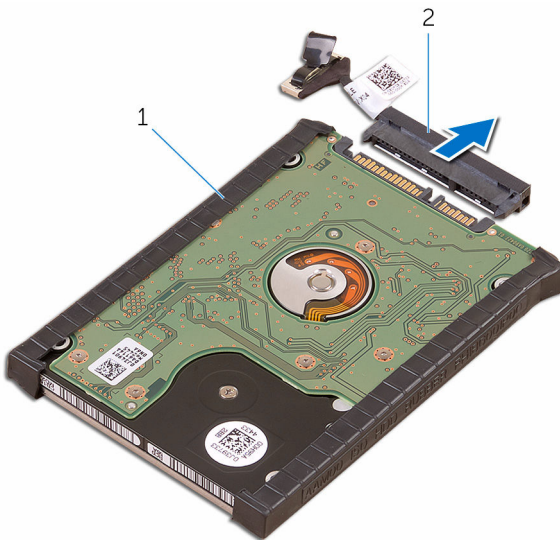

1 hard-drive assembly

2 hard-drive interposer

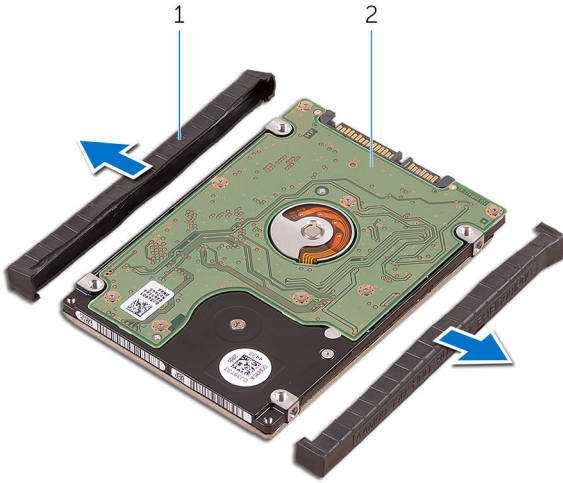

6 Remove the hard-drive covers away from the hard drive.



1 hard-drive covers (2)

2 hard drive

Replacing the hard drive

-  **WARNING:** Before working inside your computer, read the safety information that shipped with your computer and follow the steps in [Before working inside your computer](#). After working inside your computer, follow the instructions in [After working inside your computer](#). For more safety best practices, see the Regulatory Compliance home page at www.dell.com/regulatory_compliance.
-  **CAUTION:** Hard drives are fragile. Exercise care when handling the hard drive.

Procedure

- 1 Replace the hard-drive covers on the hard drive.
- 2 Connect the hard-drive interposer to the hard-drive assembly.
- 3 Place the hard-drive assembly on the palm-rest assembly.
- 4 Connect the hard-drive cable to the system board.
- 5 Align the screw holes on the hard-drive cage with the screw holes on the hard-drive assembly.
- 6 Replace the screws that secure the hard-drive cage to the palm-rest assembly.

Post-requisites

- 1 Replace the [battery](#).
- 2 Replace the [base cover](#).

Removing the solid-state drive (half-length)

 **WARNING:** Before working inside your computer, read the safety information that shipped with your computer and follow the steps in [Before working inside your computer](#). After working inside your computer, follow the instructions in [After working inside your computer](#). For more safety best practices, see the Regulatory Compliance home page at www.dell.com/regulatory_compliance.

 **CAUTION:** Solid-state drives are fragile. Exercise care when handling the hard drive.

 **CAUTION:** To avoid data loss, do not remove the solid-state drive while the computer is in sleep or on state.

Prerequisites

- 1 Remove the [base cover](#).
- 2 Remove the [battery](#).

Procedure

- 1 Remove the screw that secures the solid-state drive assembly to the system board.

- 2** Lift and slide the solid-state drive assembly from the system board.

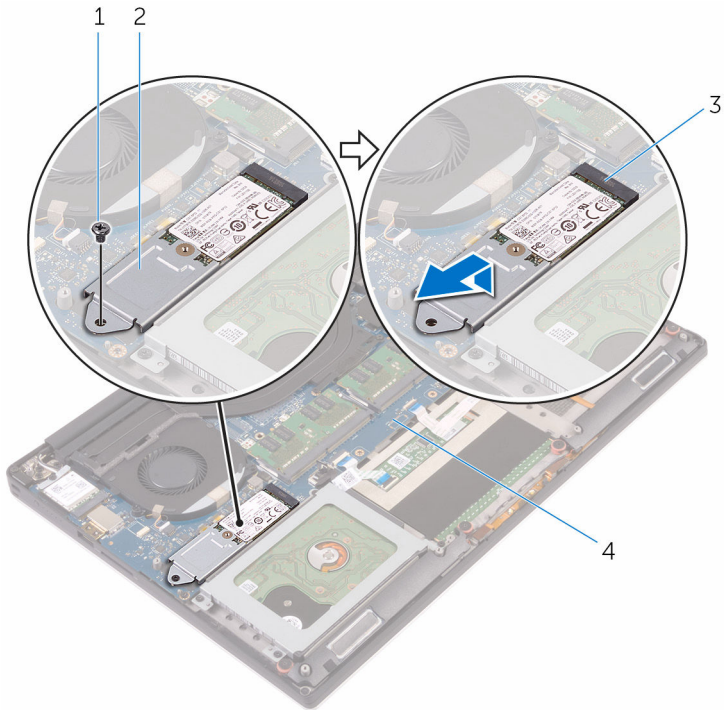

- | | | | |
|---|------------------------|---|----------------------------|
| 1 | screw | 2 | solid-state drive assembly |
| 3 | solid-state drive slot | 4 | system board |

- 3** Remove the screw that secures the solid-state drive to the solid-state drive bracket.

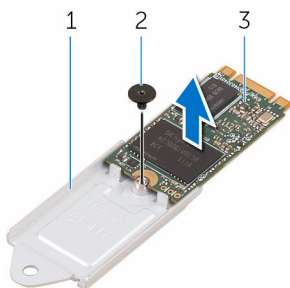

- | | | | |
|---|---------------------------|---|-------|
| 1 | solid-state drive bracket | 2 | screw |
| 3 | solid-state drive | | |

- 4 Lift the solid-state drive off the solid-state drive bracket.

Replacing the solid-state drive (half-length)

 **WARNING:** Before working inside your computer, read the safety information that shipped with your computer and follow the steps in [Before working inside your computer](#). After working inside your computer, follow the instructions in [After working inside your computer](#). For more safety best practices, see the Regulatory Compliance home page at www.dell.com/regulatory_compliance.

 **CAUTION:** Solid-state drives are fragile. Exercise care when handling the hard drive.

Procedure

- 1 Align the screw hole on the solid-state drive bracket with the screw hole on the solid-state drive.
- 2 Replace the screw that secures the solid-state drive to the solid-state drive bracket
- 3 Align the notches on the solid-state drive assembly with the tabs in the solid-state drive slot.
- 4 Slide the solid-state drive assembly at an angle into the solid-state drive slot.
- 5 Press the other end of the solid-state drive down and replace the screw that secures the solid-state drive to the system board.

Post-requisites

- 1 Replace the [battery](#).
- 2 Replace the [base cover](#).

Removing the solid-state drive (full-length)

 **WARNING:** Before working inside your computer, read the safety information that shipped with your computer and follow the steps in [Before working inside your computer](#). After working inside your computer, follow the instructions in [After working inside your computer](#). For more safety best practices, see the Regulatory Compliance home page at www.dell.com/regulatory_compliance.

 **CAUTION:** Solid-state drives are fragile. Exercise care when handling the hard drive.

 **CAUTION:** To avoid data loss, do not remove the solid-state drive while the computer is in sleep or on state.

Prerequisites

- 1 Remove the [base cover](#).
- 2 Remove the [battery](#).

Procedure

- 1 Remove the screw that secures the solid-state drive to the system board.

2 Lift and slide the solid-state drive from the system board.

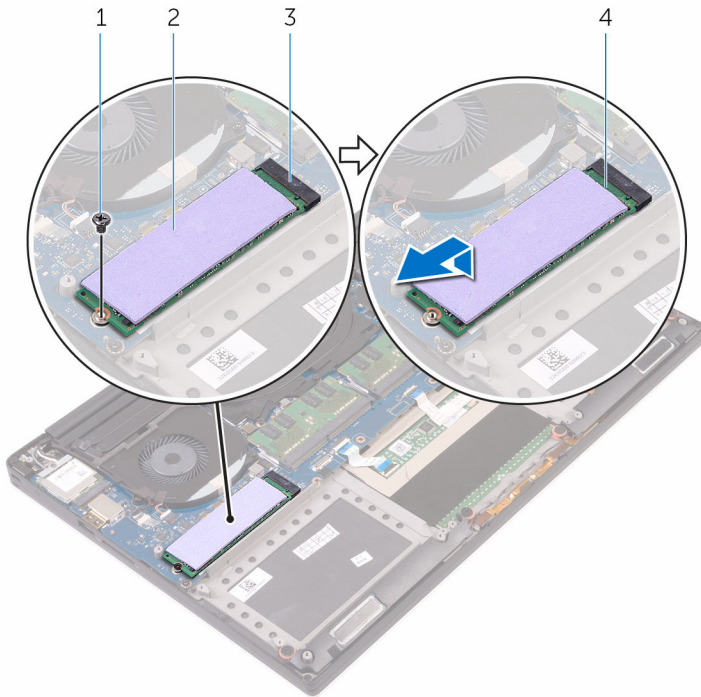

1 screw

2 thermal pad

3 solid-state drive slot

4 solid-state drive

3 Peel the thermal pad off the solid-state drive.

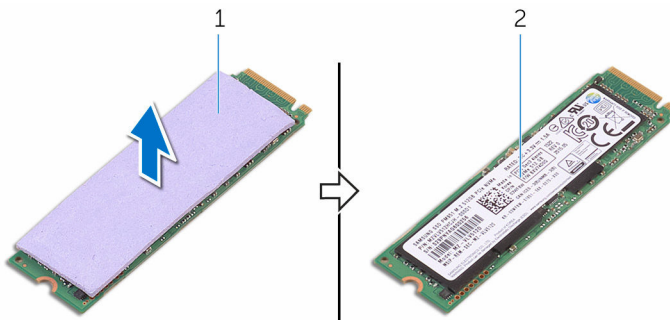

1 thermal pad

2 solid-state drive

Replacing the solid-state drive (full-length)

 **WARNING:** Before working inside your computer, read the safety information that shipped with your computer and follow the steps in [Before working inside your computer](#). After working inside your computer, follow the instructions in [After working inside your computer](#). For more safety best practices, see the Regulatory Compliance home page at www.dell.com/regulatory_compliance.

 **CAUTION:** Solid-state drives are fragile. Exercise care when handling the hard drive.

Procedure

- 1 Adhere the thermal pad to the solid-state drive.
- 2 Slide the solid-state drive at an angle into the solid-state drive slot.
- 3 Press the other end of the solid-state drive down and replace the screw that secures the solid-state drive to the system board.

Post-requisites

- 1 Replace the [battery](#).
- 2 Replace the [base cover](#).

Removing the speakers



WARNING: Before working inside your computer, read the safety information that shipped with your computer and follow the steps in [Before working inside your computer](#). After working inside your computer, follow the instructions in [After working inside your computer](#). For more safety best practices, see the Regulatory Compliance home page at www.dell.com/regulatory_compliance.

Prerequisites

- 1 Remove the [base cover](#).
- 2 Remove the [battery](#).

Procedure

- 1 Disconnect the speaker cable from the system board.
- 2 Note the speaker-cable routing and remove the cable from the routing guides.
- 3 Remove the screws that secure the speakers to the palm-rest assembly.

4 Lift the speakers, along with the speaker cable, off the palm-rest assembly.

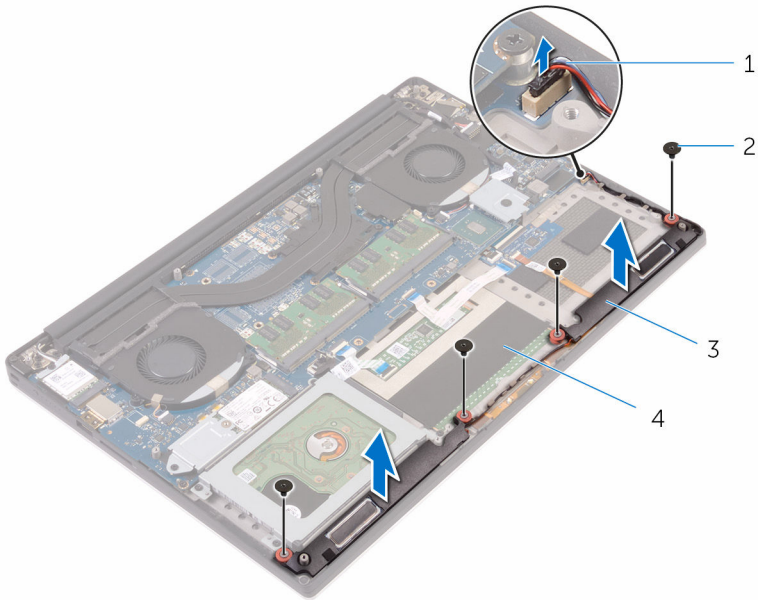

1 speaker cable

2 screws (4)

3 speakers (2)

4 palm-rest assembly

Replacing the speakers



WARNING: Before working inside your computer, read the safety information that shipped with your computer and follow the steps in [Before working inside your computer](#). After working inside your computer, follow the instructions in [After working inside your computer](#). For more safety best practices, see the Regulatory Compliance home page at www.dell.com/regulatory_compliance.

Procedure

- 1 Using the alignment posts, place the speakers on the palm-rest assembly.
- 2 Replace the screws that secure the speakers to the palm-rest assembly.
- 3 Route the speaker cables through the routing guides on the palm-rest assembly.
- 4 Connect the speaker cable to the system board.

Post-requisites

- 1 Replace the [battery](#).
- 2 Replace the [base cover](#).

Removing the wireless card



WARNING: Before working inside your computer, read the safety information that shipped with your computer and follow the steps in [Before working inside your computer](#). After working inside your computer, follow the instructions in [After working inside your computer](#). For more safety best practices, see the Regulatory Compliance home page at www.dell.com/regulatory_compliance.

Prerequisites

- 1 Remove the [base cover](#).
- 2 Remove the [battery](#).

Procedure



NOTE: The images in this document may differ from your computer depending on the configuration you ordered.

- 1 Remove the screw that secures the wireless-card bracket to the wireless card.
- 2 Lift the wireless-card bracket off the wireless card.
- 3 Disconnect the antenna cables from the wireless card.

4 Slide and remove the wireless card out of the wireless-card slot.

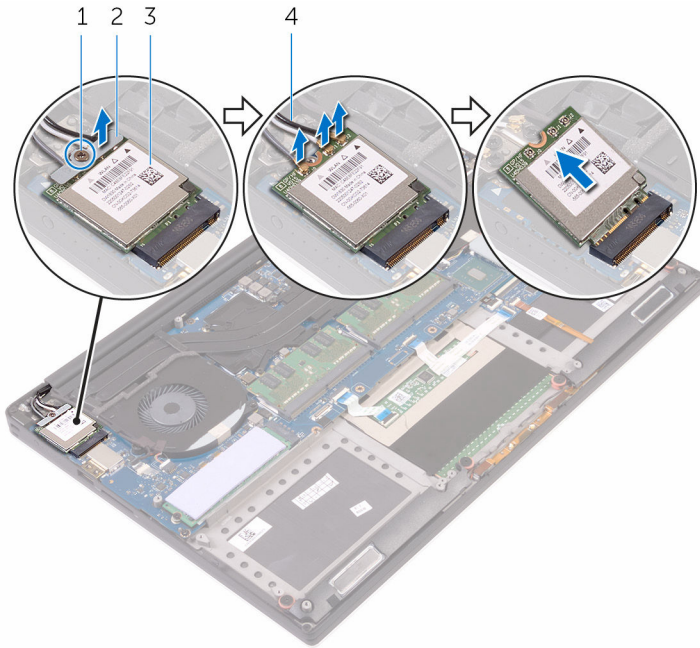

1 screw

2 wireless-card bracket

3 wireless card

4 antenna cables (3)

Replacing the wireless card

 **WARNING:** Before working inside your computer, read the safety information that shipped with your computer and follow the steps in [Before working inside your computer](#). After working inside your computer, follow the instructions in [After working inside your computer](#). For more safety best practices, see the Regulatory Compliance home page at www.dell.com/regulatory_compliance.

Procedure

 **CAUTION:** To avoid damage to the wireless card, do not place any cables under it.

- 1 Align the notch on the wireless card with the tab on the wireless-card slot and slide the card into the slot.
- 2 Connect the antenna cables to the wireless card. The following table provides the antenna-cable color scheme for the wireless card supported by your computer:

Connectors on the wireless card	Antenna-cable color
Main (white triangle)	White
Auxiliary (black triangle)	Black
Multiple input, multiple output (grey triangle)	Grey (optional)

- 3 Align the screw hole on the wireless-card bracket with the screw-hole on the wireless card.
- 4 Replace the screw that secures the wireless-card bracket to the wireless card.

Post-requisites

- 1 Replace the [battery](#).
- 2 Replace the [base cover](#).

Removing the fans



WARNING: Before working inside your computer, read the safety information that shipped with your computer and follow the steps in [Before working inside your computer](#). After working inside your computer, follow the instructions in [After working inside your computer](#). For more safety best practices, see the Regulatory Compliance home page at www.dell.com/regulatory_compliance.

Prerequisites

- 1 Remove the [base cover](#).
- 2 Remove the [battery](#).

Procedure

- 1 Remove the screws that secure the video fan (JFAN_2) to the system board.
- 2 Disconnect the touch-screen cable from the system board.
- 3 Peel off the tape that secures the touch-screen cable to the video fan (JFAN_2).
- 4 Note the routing of the touch-screen cable and remove the cable from the routing guides on the video fan (JFAN_2).
- 5 Disconnect the video fan (JFAN_2) cable from the system board.

- 6** Lift the video fan (JFAN_2) away from the palm-rest assembly.

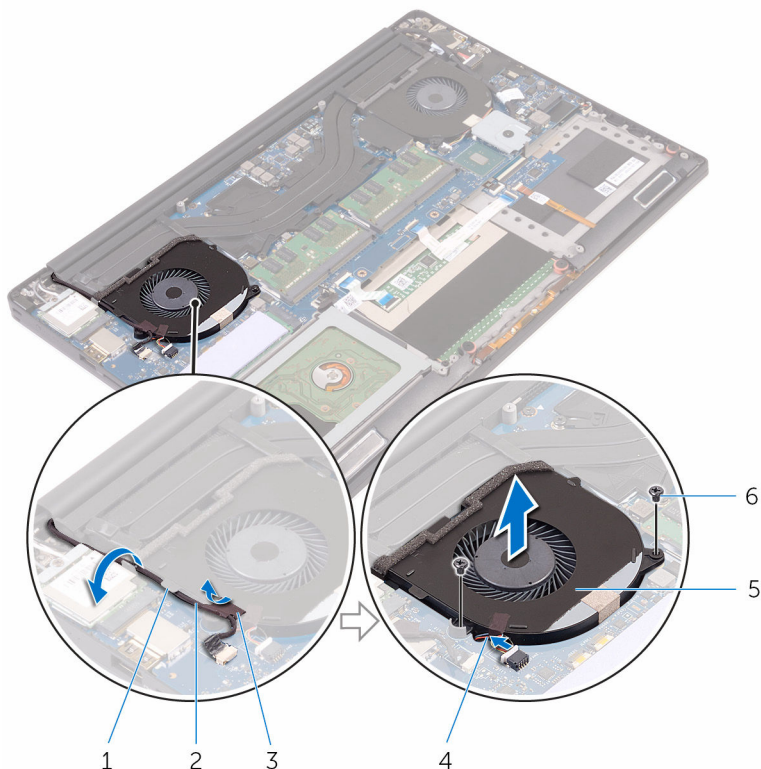

- | | | | |
|---|--------------------|---|-------------------------------|
| 1 | routing guide | 2 | touch-screen cable (optional) |
| 3 | tape | 4 | fan cable |
| 5 | video fan (JFAN_2) | 6 | screws (2) |

- 7** Remove the screws that secure the processor fan (JFAN_1) to the system board.
- 8** Note the routing of the display cable and remove the cable from the processor fan (JFAN_1).
- 9** Disconnect the processor fan (JFAN_1) cable from the system board.

10 Lift the processor fan (JFAN_1) away from the palm-rest assembly.

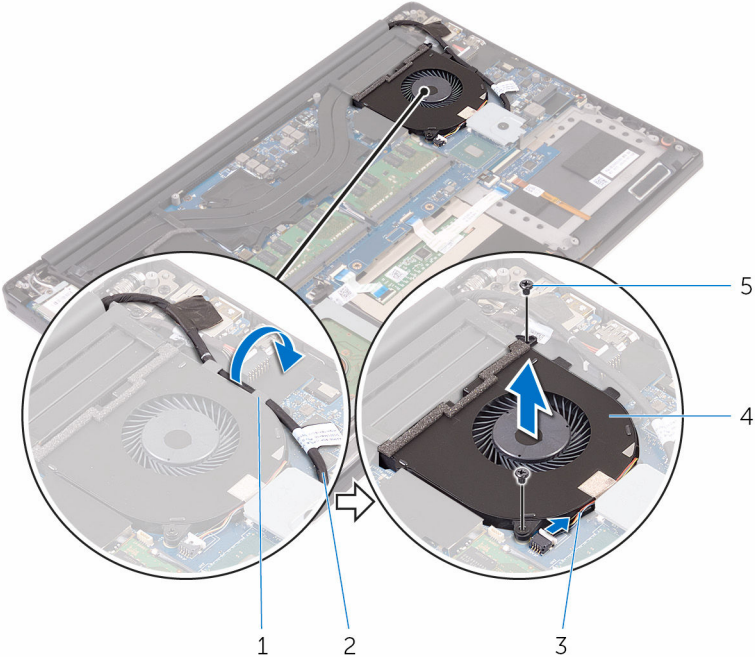

- 1 routing guide
- 3 fan cable
- 5 screws (2)

- 2 display cable
- 4 processor fan (JFAN_1)

Replacing the fans



WARNING: Before working inside your computer, read the safety information that shipped with your computer and follow the steps in [Before working inside your computer](#). After working inside your computer, follow the instructions in [After working inside your computer](#). For more safety best practices, see the Regulatory Compliance home page at www.dell.com/regulatory_compliance.



Procedure

- 1 Align the screw holes on the processor fan (JFAN_1) with the screw holes on the palm-rest assembly.
- 2 Connect the processor fan (JFAN_1) cable to the system board.
- 3 Route the display cable through the routing guides on the processor fan (JFAN_1).
- 4 Replace the screws that secure the processor fan (JFAN_1) to the system board.
- 5 Align the screw holes on the video fan (JFAN_2) with the screw holes on the palm-rest assembly.
- 6 Connect the video fan (JFAN_2) cable to the system board.
- 7 Route the touch-screen cable through the routing guides on the video fan (JFAN_2).
- 8 Adhere the tape that secures the touch-screen cable to the video fan (JFAN_2).
- 9 Connect the display cable to the system board.
- 10 Replace the screws that secure the video fan (JFAN_2) to the system board.

Post-requisites

- 1 Replace the [battery](#).
- 2 Replace the [base cover](#).

Removing the heat-sink assembly

-  **WARNING:** Before working inside your computer, read the safety information that shipped with your computer and follow the steps in [Before working inside your computer](#). After working inside your computer, follow the instructions in [After working inside your computer](#). For more safety best practices, see the Regulatory Compliance home page at www.dell.com/regulatory_compliance.
-  **WARNING:** The heat sink may become hot during normal operation. Allow sufficient time for the heat sink to cool before you touch it.
-  **CAUTION:** For maximum cooling of the processor, do not touch the heat transfer areas on the heat sink. The oils in your skin can reduce the heat transfer capability of the thermal grease.

Prerequisites

- 1 Remove the [base cover](#).
- 2 Remove the [battery](#).

Procedure

-  **NOTE:** The images in this document may differ from your computer depending on the configuration you ordered.
- 1 Remove the screws that secure the heat-sink assembly to the system board.

2 Lift the heat-sink assembly off the system board.

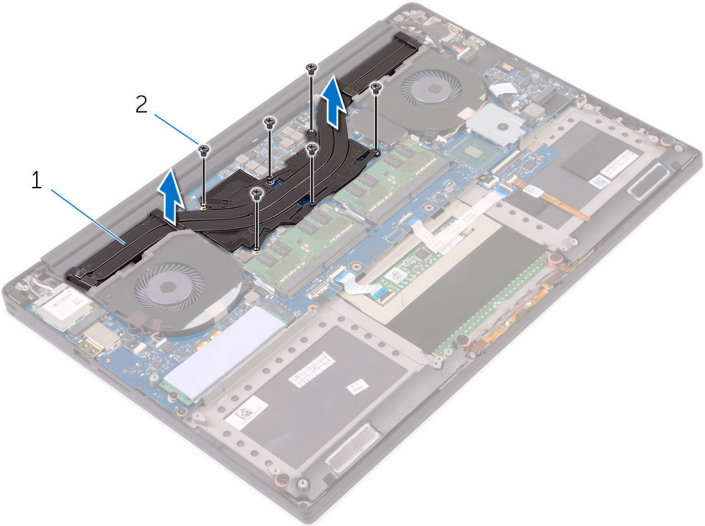



1 heat-sink assembly

2 screws (6)

Replacing the heat-sink assembly

 **WARNING:** Before working inside your computer, read the safety information that shipped with your computer and follow the steps in [Before working inside your computer](#). After working inside your computer, follow the instructions in [After working inside your computer](#). For more safety best practices, see the Regulatory Compliance home page at www.dell.com/regulatory_compliance.

 **CAUTION:** Incorrect alignment of the heat sink can damage the system board and processor.

 **NOTE:** The original thermal grease can be reused if the original system board and fan are reinstalled together. If either the system board or the fan is replaced, use the thermal pad provided in the kit to ensure that thermal conductivity is achieved.

Procedure

- 1 Align the screw holes on the heat-sink assembly with the screw holes on the system board.
- 2 Replace the screws that secure the heat-sink assembly to the system board.

Post-requisites

- 1 Replace the [battery](#).
- 2 Replace the [base cover](#).

Removing the memory modules

 **WARNING:** Before working inside your computer, read the safety information that shipped with your computer and follow the steps in [Before working inside your computer](#). After working inside your computer, follow the instructions in [After working inside your computer](#). For more safety best practices, see the Regulatory Compliance home page at www.dell.com/regulatory_compliance.

Prerequisites

- 1 Remove the [base cover](#).
- 2 Remove the [battery](#).

Procedure

- 1 Using your fingertips, spread apart the securing clips on each end of the memory-module slot until the memory module pops up.

2 Slide and remove the memory module from the memory-module slot.

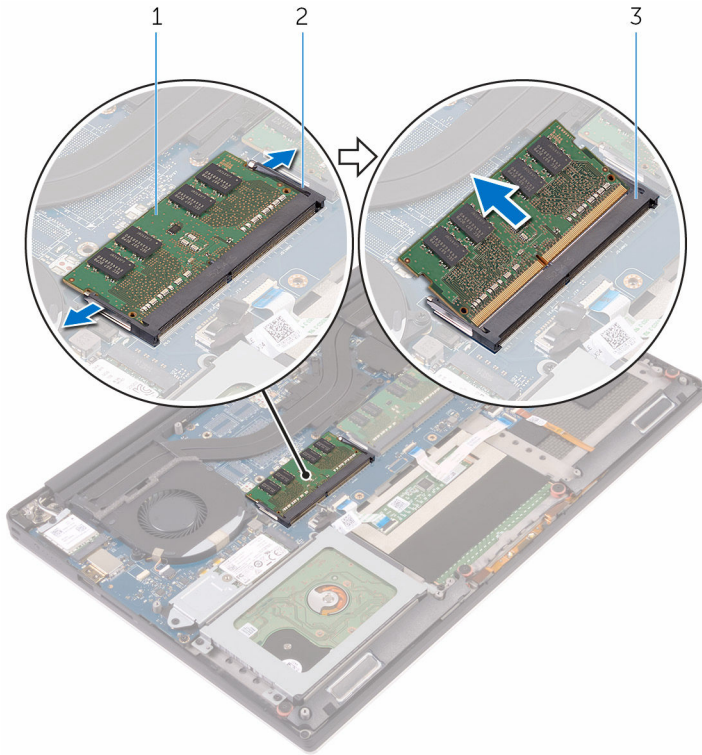

1 memory module

2 securing clips (2)

3 memory-module slot

Replacing the memory modules

 **WARNING:** Before working inside your computer, read the safety information that shipped with your computer and follow the steps in [Before working inside your computer](#). After working inside your computer, follow the instructions in [After working inside your computer](#). For more safety best practices, see the Regulatory Compliance home page at www.dell.com/regulatory_compliance.

Procedure

- 1 Align the notch on the memory module with the tab on the memory-module slot.

- Slide the memory module firmly into the slot at an angle and gently press the memory module down until it clicks into place.

 **NOTE:** If you do not hear the click, remove the memory module and reinstall it.

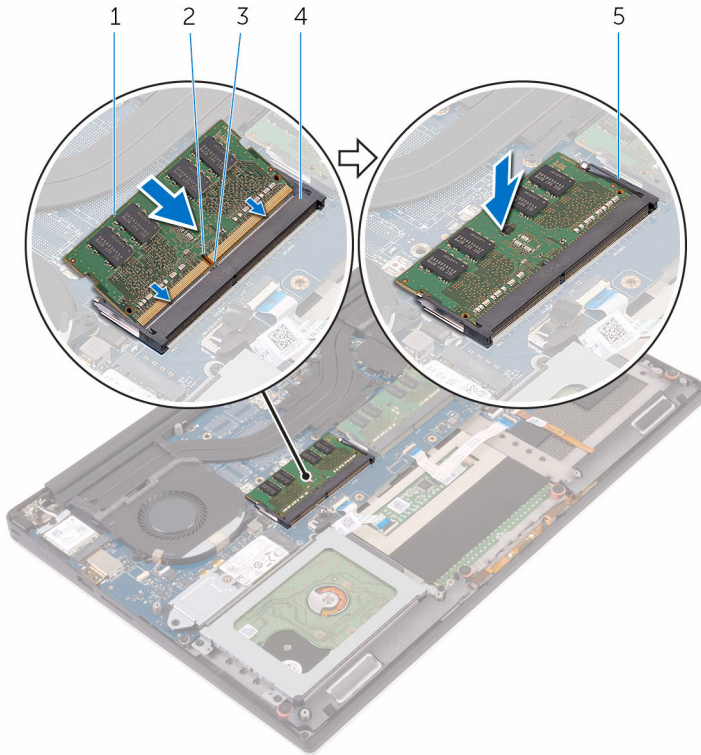

- memory module
- notch
- tab
- memory-module slot
- securing clips

- memory module
- notch
- tab
- memory-module slot
- securing clips

Post-requisites

- Replace the [battery](#).
- Replace the [base cover](#).

Removing the system board



WARNING: Before working inside your computer, read the safety information that shipped with your computer and follow the steps in [Before working inside your computer](#). After working inside your computer, follow the instructions in [After working inside your computer](#). For more safety best practices, see the Regulatory Compliance home page at www.dell.com/regulatory_compliance.



NOTE: Your computer's Service Tag is stored in the system board. You must enter the Service Tag in the BIOS setup program after you replace the system board.



NOTE: Replacing the system board removes any changes you have made to the BIOS using the BIOS setup program. You must make the desired changes again after you replace the system board.



NOTE: Before disconnecting the cables from the system board, note the location of the connectors so that you can reconnect the cables correctly after you replace the system board.

Prerequisites

- 1 Remove the [base cover](#).
- 2 Remove the [battery](#).
- 3 Remove the [wireless card](#).
- 4 Remove the [hard drive](#).
- 5 Remove the [solid-state drive \(half-length\)](#).
- 6 Remove the [solid-state drive \(full-length\)](#).
- 7 Remove the [fans](#).
- 8 Remove the [heat-sink assembly](#).
- 9 Remove the [memory modules](#).

Procedure

- 1 Remove the screw that secures the display-cable bracket to the system board.
- 2 Lift the solid-state drive bracket to access the display cable.

3 Disconnect the display cable from the system board.

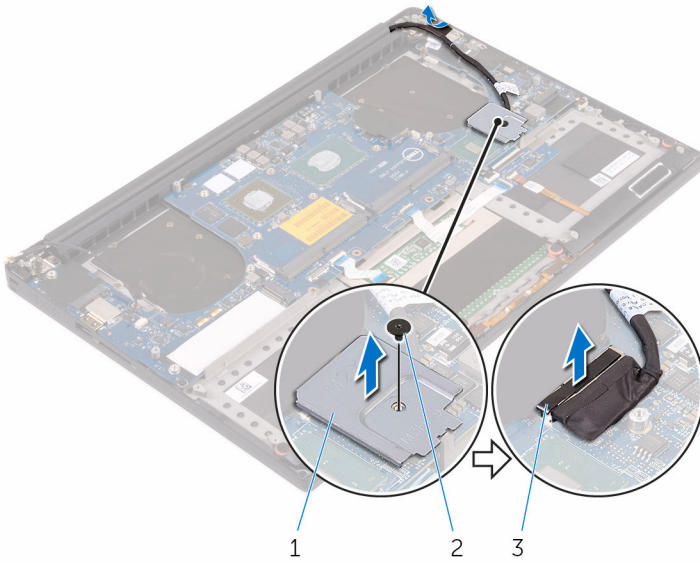

1 display-cable bracket

2 screw

3 display cable

- 4 Disconnect the power-adaptor port cable, speaker cable, keyboard-control board cable, touch-pad cable, and touch-screen cable from the system board.

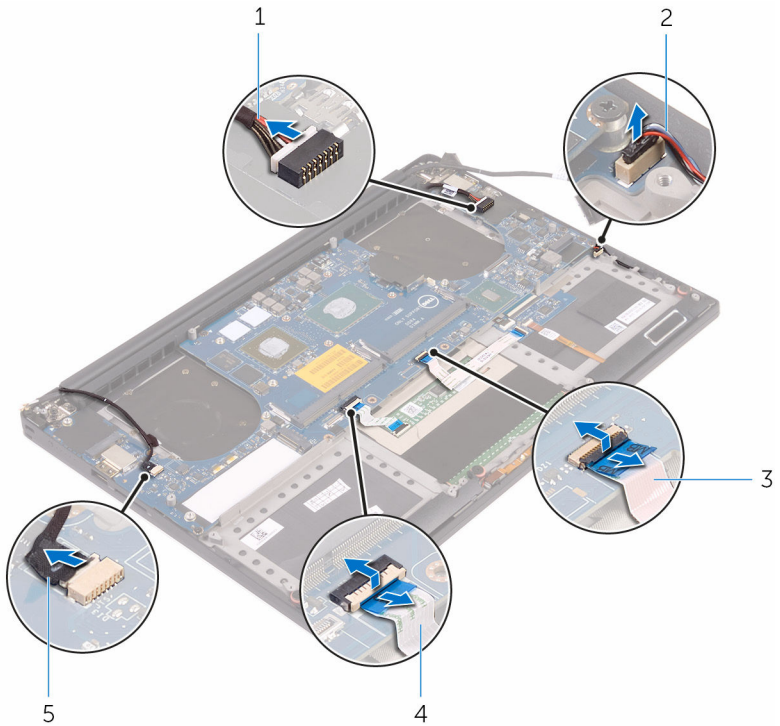

- | | | | |
|---|-------------------------------|---|-----------------|
| 1 | power-adaptor port cable | 2 | speaker cable |
| 3 | keyboard-control board cable | 4 | touch-pad cable |
| 5 | touch-screen cable (optional) | | |

- 5 Remove the screws that secure the system board to the palm-rest assembly.

6 Lift the system board off the palm-rest assembly.

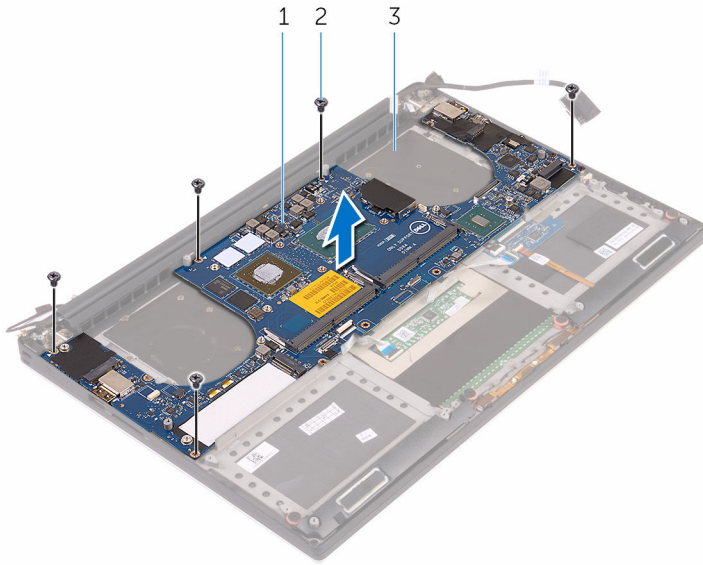

- 1 system board
- 3 palm-rest assembly

2 screws (5)

Replacing the system board



WARNING: Before working inside your computer, read the safety information that shipped with your computer and follow the steps in [Before working inside your computer](#). After working inside your computer, follow the instructions in [After working inside your computer](#). For more safety best practices, see the Regulatory Compliance home page at www.dell.com/regulatory_compliance.



NOTE: Your computer's Service Tag is stored in the system board. You must enter the Service Tag in the BIOS setup program after you replace the system board.



NOTE: Replacing the system board removes any changes you have made to the BIOS using the BIOS setup program. You must make the desired changes again after you replace the system board.

Procedure

- 1 Align the screw holes on the system board with the screw holes on the palm-rest assembly.
- 2 Replace the screws that secure the system board to the palm-rest assembly.
- 3 Connect the power-adaptor port cable, speaker cable, keyboard-control board cable, touch-pad cable, and touch-screen cable to the system board.
- 4 Connect the display cable to the system board.
- 5 Align the screw hole on the display-cable bracket with the screw hole on the system board.
- 6 Replace the screw that secures the display-cable bracket to the system board.

Post-requisites

- 1 Replace the [memory modules](#).
- 2 Replace the [heat-sink assembly](#).
- 3 Replace the [fans](#).
- 4 Replace the [solid-state drive \(half-length\)](#).
- 5 Replace the [solid-state drive \(full-length\)](#).

- 6 Replace the [hard drive](#).
- 7 Replace the [wireless card](#).
- 8 Replace the [battery](#).
- 9 Replace the [base cover](#).

Removing the keyboard



WARNING: Before working inside your computer, read the safety information that shipped with your computer and follow the steps in [Before working inside your computer](#). After working inside your computer, follow the instructions in [After working inside your computer](#). For more safety best practices, see the Regulatory Compliance home page at www.dell.com/regulatory_compliance.

Prerequisites

- 1 Remove the [base cover](#).
- 2 Remove the [battery](#).
- 3 Remove the [hard drive](#).
- 4 Remove the [system board](#).

Procedure

- 1 Lift the latches and disconnect the keyboard cable and keyboard-backlight cable from the keyboard-controls board.

2 Peel off the Mylar to access the screws that secure the keyboard to the palm-rest assembly.

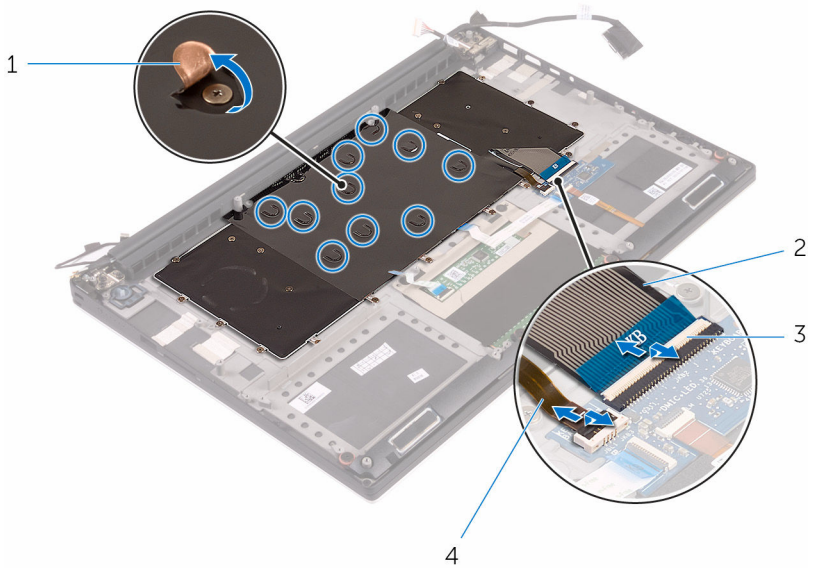

- 1 Mylar
- 3 latches (2)

- 2 keyboard cable
- 4 keyboard-backlight cable

3 Remove the screws that secure the keyboard to the palm-rest assembly.

4 Lift the keyboard off the palm-rest assembly.

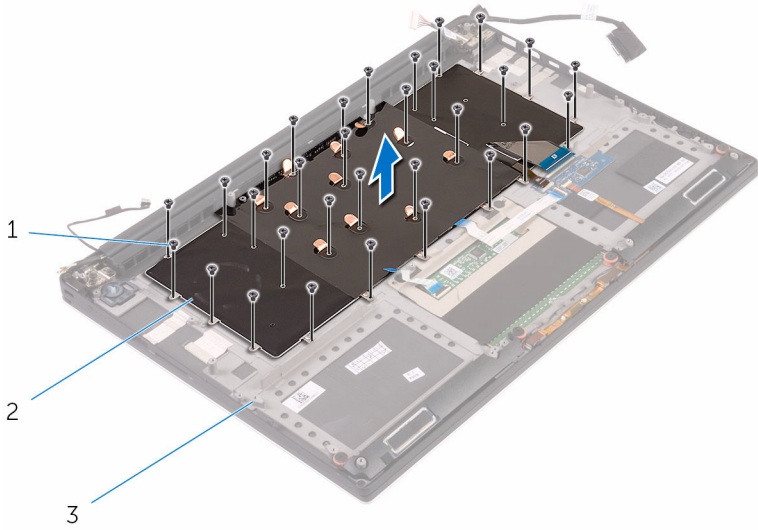

1 screws (31)

2 keyboard

3 palm-rest assembly

5 Peel off the Mylar from the keyboard.

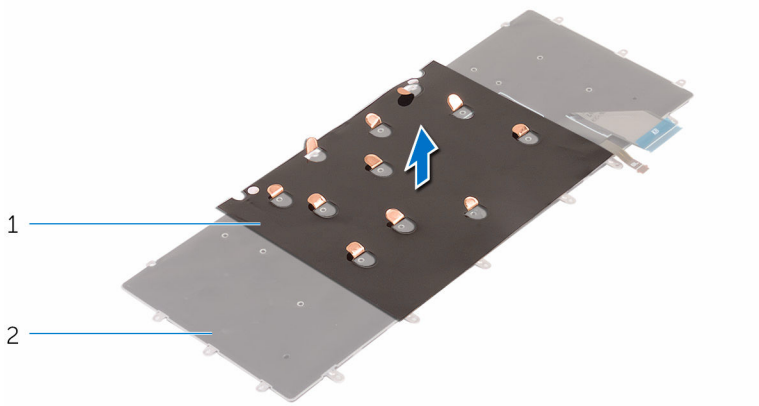

1 mylar

2 keyboard



1 keyboard

Replacing the keyboard



WARNING: Before working inside your computer, read the safety information that shipped with your computer and follow the steps in [Before working inside your computer](#). After working inside your computer, follow the instructions in [After working inside your computer](#). For more safety best practices, see the Regulatory Compliance home page at www.dell.com/regulatory_compliance.

Procedure

- 1 Adhere the Mylar to the keyboard.
- 2 Align the screw holes on the keyboard with the screw holes on the palm-rest assembly.
- 3 Replace the screws that secure the keyboard to the palm-rest assembly.
- 4 Adhere the Mylar to the screws that secure the keyboard to the palm-rest assembly.
- 5 Connect the keyboard cable and keyboard-backlight cable to the keyboard-controls board.

Post-requisites

- 1 Replace the [system board](#).
- 2 Replace the [hard drive](#).
- 3 Replace the [battery](#).
- 4 Replace the [base cover](#).

Removing the display assembly



WARNING: Before working inside your computer, read the safety information that shipped with your computer and follow the steps in [Before working inside your computer](#). After working inside your computer, follow the instructions in [After working inside your computer](#). For more safety best practices, see the Regulatory Compliance home page at www.dell.com/regulatory_compliance.

Prerequisites

- 1 Remove the [base cover](#).
- 2 Remove the [battery](#).
- 3 Remove the [wireless card](#).

Procedure

- 1 Remove the screw that secures the display-cable bracket to the system board.
- 2 Disconnect the touch-screen cable and display cable from the system board.

- 3 Peel off the tape and remove the touch-screen cable from the routing guides on the fan.

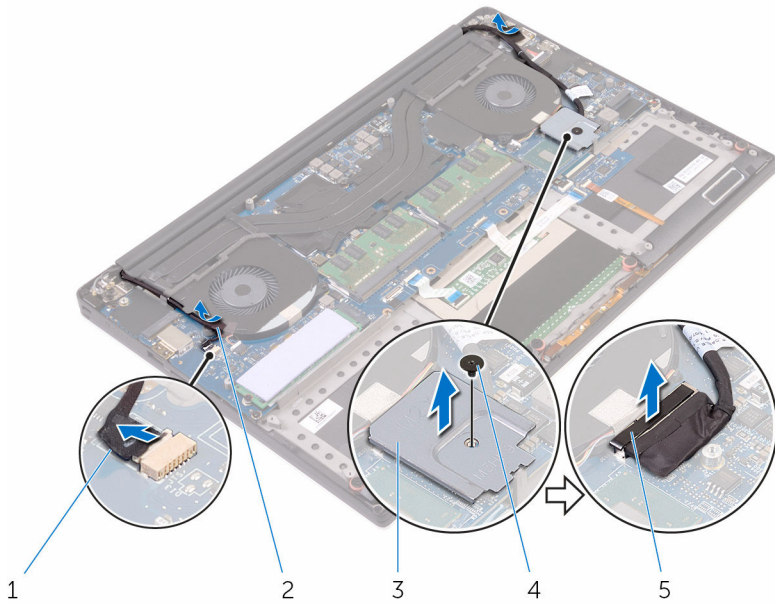

- | | | | |
|---|-------------------------------|---|-------|
| 1 | touch-screen cable (optional) | 2 | tape |
| 3 | display-cable bracket | 4 | screw |
| 5 | display cable | | |

- 4 Turn the computer over and open the display at an angle of 90 degrees.
- 5 Rotate the computer and place it on the edge of the table in a position that allows access to the screws on the display hinges.
- 6 Remove the screws that secure the display hinges to the palm-rest assembly.

7 Carefully lift the display assembly from the palm-rest assembly

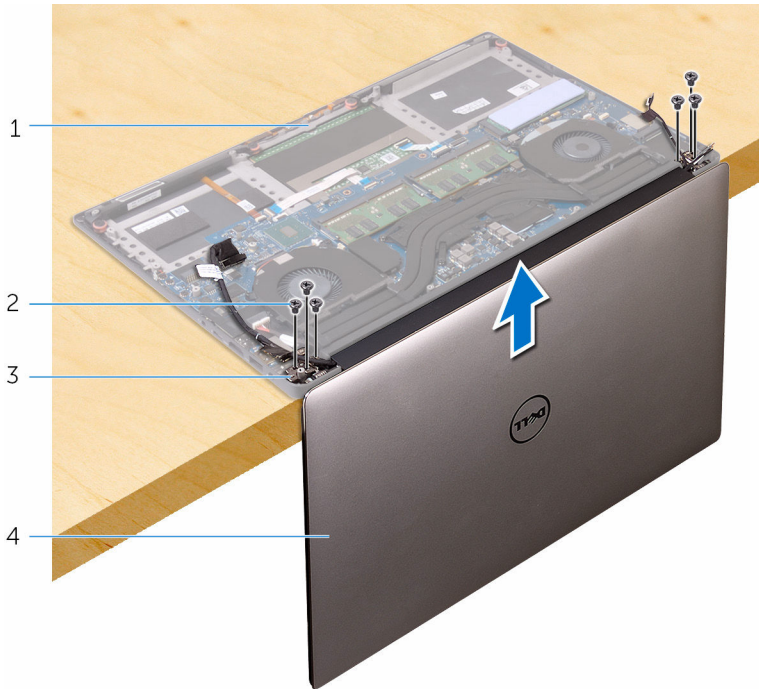

1 palm-rest assembly

2 screws (6)

3 display hinges (2)

4 display assembly

- 8** Carefully place the display assembly on a clean, flat surface.



- 1 display assembly

Replacing the display assembly

 **WARNING:** Before working inside your computer, read the safety information that shipped with your computer and follow the steps in [Before working inside your computer](#). After working inside your computer, follow the instructions in [After working inside your computer](#). For more safety best practices, see the Regulatory Compliance home page at www.dell.com/regulatory_compliance.

Procedure

- 1 Place the palm-rest assembly at the edge of the table with the speakers facing away from the edge.
- 2 Align the screw holes on the palm-rest assembly with the screw holes on the display hinges.
- 3 Replace the screws that secure the display hinges to the palm-rest assembly.
- 4 Adhere the tape and route the touch-screen cable through the routing guides on the fan.
- 5 Connect the touch-screen cable and display cable to the system board.
- 6 Replace the screw that secures the display-cable bracket to the system board.

Post-requisites

- 1 Replace the [wireless card](#).
- 2 Replace the [battery](#).
- 3 Replace the [base cover](#).

Removing the power-adapter port

 **WARNING:** Before working inside your computer, read the safety information that shipped with your computer and follow the steps in [Before working inside your computer](#). After working inside your computer, follow the instructions in [After working inside your computer](#). For more safety best practices, see the Regulatory Compliance home page at www.dell.com/regulatory_compliance.

Prerequisites

- 1 Remove the [base cover](#).
- 2 Remove the [battery](#).
- 3 Remove the [display assembly](#).

Procedure

- 1 Disconnect the power-adapter port cable from the system board.
- 2 Remove the screw that secures the power-adapter port to the palm-rest assembly.

- 3** Lift the power-adapter port along with its cable, off the palm-rest assembly.

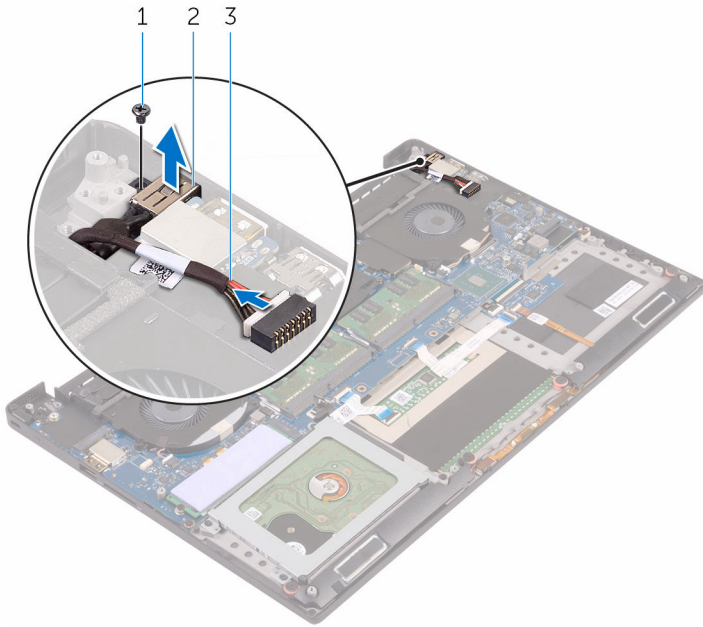

1 screw

2 power-adapter port

3 power-adapter port cable

Replacing the power-adapter port

 **WARNING:** Before working inside your computer, read the safety information that shipped with your computer and follow the steps in [Before working inside your computer](#). After working inside your computer, follow the instructions in [After working inside your computer](#). For more safety best practices, see the Regulatory Compliance home page at www.dell.com/regulatory_compliance.

Procedure

- 1 Place the power-adapter port into the slot on the palm-rest assembly.
- 2 Route the power-adapter port cable through its routing guides on the palm-rest assembly.
- 3 Replace the screw that secures the power-adapter port to the palm-rest assembly.
- 4 Connect the power-adapter port cable to the system board.

Post-requisites

- 1 Replace the [display assembly](#).
- 2 Replace the [battery](#).
- 3 Replace the [base cover](#).

Removing the antenna cover

⚠ WARNING: Before working inside your computer, read the safety information that shipped with your computer and follow the steps in [Before working inside your computer](#). After working inside your computer, follow the instructions in [After working inside your computer](#). For more safety best practices, see the Regulatory Compliance home page at www.dell.com/regulatory_compliance.

Prerequisites

- 1 Remove the [base cover](#).
- 2 Remove the [battery](#).
- 3 Remove the [wireless card](#).
- 4 Remove the [display assembly](#).

Procedure

- 1 Carefully turn the display hinges at an angle.

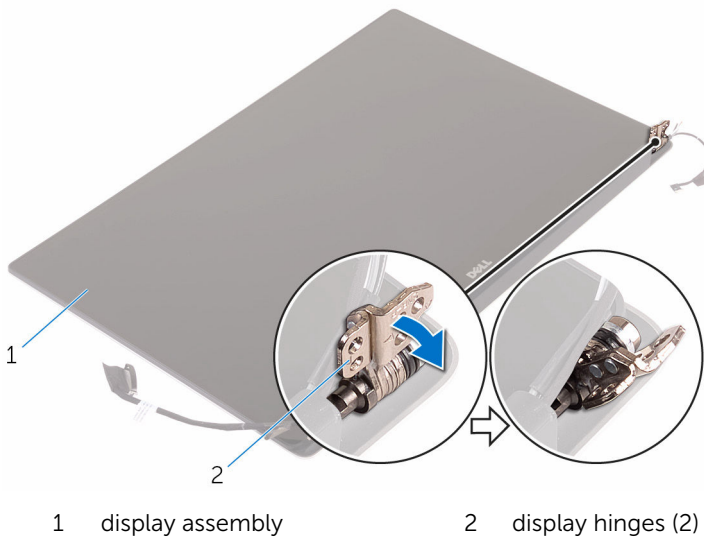

2 Slide and lift the antenna cover away from the display assembly.

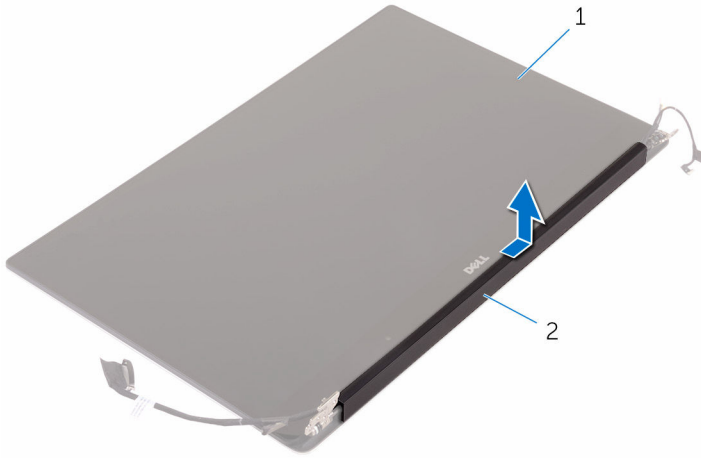

1 display assembly

2 antenna cover

Replacing the antenna cover



WARNING: Before working inside your computer, read the safety information that shipped with your computer and follow the steps in [Before working inside your computer](#). After working inside your computer, follow the instructions in [After working inside your computer](#). For more safety best practices, see the Regulatory Compliance home page at www.dell.com/regulatory_compliance.

Procedure

- 1 Replace the antenna cover on the display assembly.
- 2 Turn the display hinges to the normal position.

Post-requisites

- 1 Replace the [display assembly](#).
- 2 Replace the [wireless card](#).
- 3 Replace the [battery](#).
- 4 Replace the [base cover](#).

Removing the display hinges



WARNING: Before working inside your computer, read the safety information that shipped with your computer and follow the steps in [Before working inside your computer](#). After working inside your computer, follow the instructions in [After working inside your computer](#). For more safety best practices, see the Regulatory Compliance home page at www.dell.com/regulatory_compliance.

Prerequisites



NOTE: These instructions are applicable only for laptops with a non-touchscreen display.

- 1 Remove the [base cover](#).
- 2 Remove the [battery](#).
- 3 Remove the [wireless card](#).
- 4 Remove the [display assembly](#).
- 5 Remove the [antenna cover](#).

Procedure

- 1 Peel off the tape to access the screws on the display hinges.

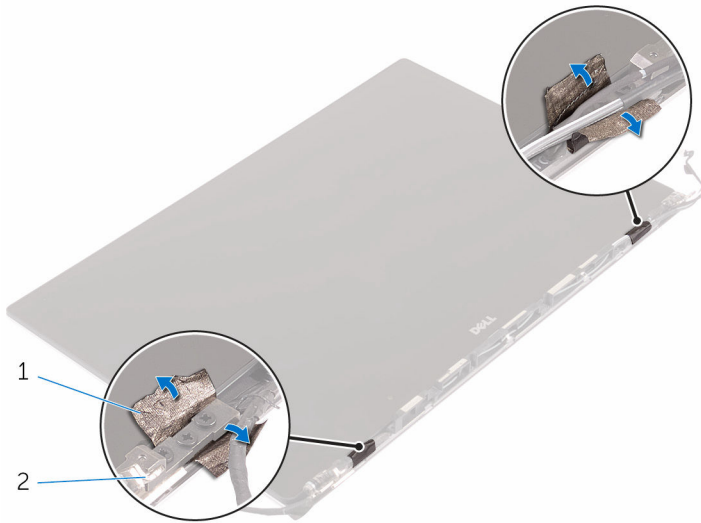

1 tape

2 display hinges (2)

- 2 Remove the screws that secure the display hinges to the display assembly.

3 Carefully lift the display hinges off the display assembly.

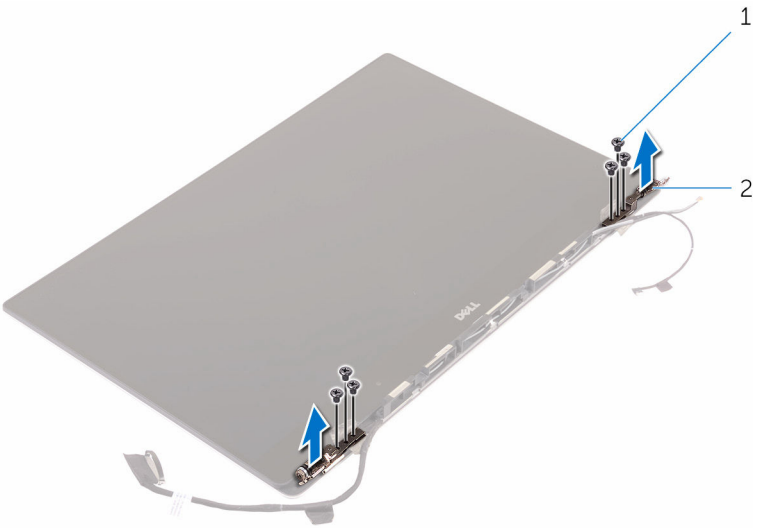

1 screws (6)

2 display hinges (2)

Replacing the display hinges



WARNING: Before working inside your computer, read the safety information that shipped with your computer and follow the steps in [Before working inside your computer](#). After working inside your computer, follow the instructions in [After working inside your computer](#). For more safety best practices, see the Regulatory Compliance home page at www.dell.com/regulatory_compliance.

Procedure

- 1 Align the screw holes on the display hinges with the screw holes on the display assembly.
- 2 Replace the screws that secure the display hinges to the display assembly.
- 3 Adhere the tape to the display hinges.

Post-requisites

- 1 Replace the [antenna cover](#).
- 2 Replace the [display assembly](#).
- 3 Replace the [wireless card](#).
- 4 Replace the [battery](#).
- 5 Replace the [base cover](#).

Removing the antenna module

 **WARNING:** Before working inside your computer, read the safety information that shipped with your computer and follow the steps in [Before working inside your computer](#). After working inside your computer, follow the instructions in [After working inside your computer](#). For more safety best practices, see the Regulatory Compliance home page at www.dell.com/regulatory_compliance.

Prerequisites

 **NOTE:** These instructions are applicable only for laptops with a non-touchscreen display.

- 1 Remove the [base cover](#).
- 2 Remove the [battery](#).
- 3 Remove the [wireless card](#).
- 4 Remove the [display assembly](#).
- 5 Remove the [antenna cover](#).
- 6 Remove the [display hinges](#).

Procedure

- 1 Peel the tape that covers the antenna cables.
- 2 Remove the screws that secure the antenna module to the display assembly.

3 Lift the antenna module away from the display assembly.

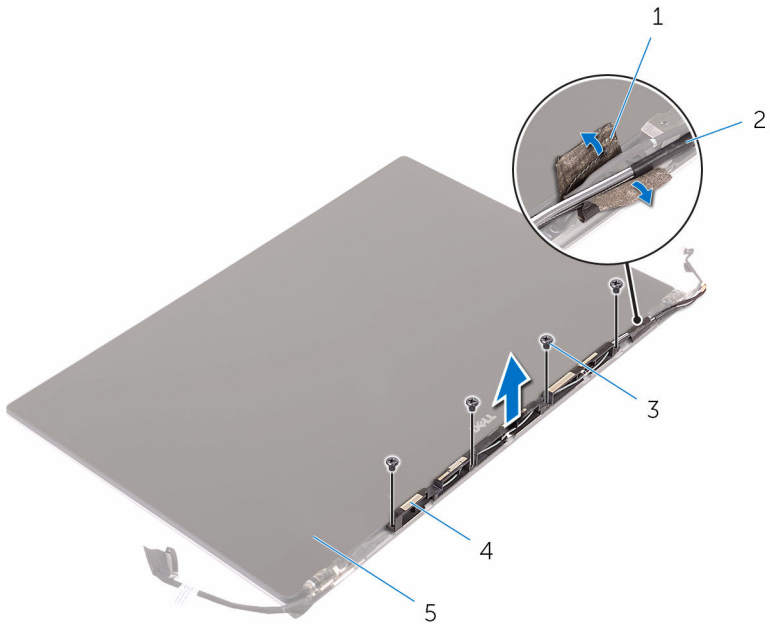

1 tape

2 antenna cable

3 screws (4)

4 antenna module

5 display assembly

Replacing the antenna module



WARNING: Before working inside your computer, read the safety information that shipped with your computer and follow the steps in [Before working inside your computer](#). After working inside your computer, follow the instructions in [After working inside your computer](#). For more safety best practices, see the Regulatory Compliance home page at www.dell.com/regulatory_compliance.

Procedure

- 1 Align the screw holes on the antenna module with the screw holes on the display assembly.
- 2 Replace the screws that secure the antenna module to the display assembly.
- 3 Adhere the tape that covers the antenna cable.

Post-requisites

- 1 Replace the [display hinges](#).
- 2 Replace the [antenna cover](#).
- 3 Replace the [display assembly](#).
- 4 Replace the [wireless card](#).
- 5 Replace the [battery](#).
- 6 Replace the [base cover](#).

Removing the palm-rest assembly



WARNING: Before working inside your computer, read the safety information that shipped with your computer and follow the steps in [Before working inside your computer](#). After working inside your computer, follow the instructions in [After working inside your computer](#). For more safety best practices, see the Regulatory Compliance home page at www.dell.com/regulatory_compliance.

Prerequisites

- 1 Remove the [base cover](#).
- 2 Remove the [battery](#).
- 3 Remove the [memory modules](#).
- 4 Follow the procedure from step 1 to step 4 in "[Removing the hard drive](#)".
- 5 Remove the [wireless card](#).
- 6 Remove the [speakers](#).
- 7 Remove the [heat-sink assembly](#).
- 8 Remove the [fans](#).
- 9 Remove the [display assembly](#).
- 10 Remove the [power-adapter port](#).
- 11 Remove the [system board](#).
- 12 Remove the [keyboard](#).

Procedure

After performing the steps in the prerequisites we are left with the palm-rest assembly.



1 palm-rest assembly

Replacing the palm-rest assembly



WARNING: Before working inside your computer, read the safety information that shipped with your computer and follow the steps in [Before working inside your computer](#). After working inside your computer, follow the instructions in [After working inside your computer](#). For more safety best practices, see the Regulatory Compliance home page at www.dell.com/regulatory_compliance.

Procedure

Place the palm-rest assembly on a clean and flat surface.

Post-requisites

- 1 Replace the [keyboard](#).
- 2 Replace the [system board](#).
- 3 Replace the [power-adapter port](#).
- 4 Replace the [display assembly](#).
- 5 Replace the [fans](#).
- 6 Replace the [heat-sink assembly](#).
- 7 Replace the [speakers](#).
- 8 Replace the [wireless card](#).
- 9 Follow the procedure from step 3 to step 6 in "[Replacing the hard drive](#)".
- 10 Replace the [memory modules](#).
- 11 Replace the [battery](#).
- 12 Replace the [base cover](#).

Flashing the BIOS

You may need to flash (update) the BIOS when an update is available or when you replace the system board. To flash the BIOS:

- 1 Turn on the computer.
- 2 Go to **www.dell.com/support**.
- 3 Click **Product Support**, enter the Service Tag of your computer and click **Submit**.
 **NOTE:** If you do not have the Service Tag, use the auto-detect feature or manually browse for your computer model.
- 4 Click **Drivers & downloads**.
- 5 Select the operating system installed on your computer.
- 6 Scroll down the page and expand **BIOS**.
- 7 Click **Download File** to download the latest version of the BIOS for your computer.
- 8 Save the file and, once the download is complete, navigate to the folder where you saved the BIOS update file.
- 9 Double-click the BIOS update file icon and follow the instructions on the screen.

Getting help and contacting Dell

Self-help resources

You can get information and help on Dell products and services using these self-help resources:

Information about Dell products and services

www.dell.com

Windows 8.1 and Windows 10

Dell Help & Support app



Windows 10

Get started app



Windows 8.1

Help + Tips app



Accessing help in Windows 8, Windows 8.1, and Windows 10

In Windows search, type **Help and Support**, and press **Enter**.

Accessing help in Windows 7

Click **Start** → **Help and Support**.

Online help for operating system

www.dell.com/support/windows
www.dell.com/support/linux

Troubleshooting information, user manuals, setup instructions, product specifications, technical help blogs, drivers, software updates, and so on

www.dell.com/support

Learn about your operating system, setting up and using your computer, data backup, diagnostics, and so on.

See *Me and My Dell* at www.dell.com/support/manuals.

Contacting Dell

To contact Dell for sales, technical support, or customer service issues, see www.dell.com/contactdell.



NOTE: Availability varies by country and product, and some services may not be available in your country.



NOTE: If you do not have an active internet connection, you can find contact information on your purchase invoice, packing slip, bill, or Dell product catalog.