

Dell Precision Mobile Workstation M6800 Owner's Manual

Regulatory Model: P30F
Regulatory Type: P30F001



Copyright © 2015 Dell Inc. All rights reserved. This product is protected by U.S. and international copyright and intellectual property laws. Dell™ and the Dell logo are trademarks of Dell Inc. in the United States and/or other jurisdictions. All other marks and names mentioned herein may be trademarks of their respective companies.

2012 - 08

Rev. A00

Contents

1 Working on Your Computer.....	6
Before Working Inside Your Computer.....	6
Recommended Tools.....	7
Turning Off Your Computer.....	7
After Working Inside Your Computer.....	8
2 Removing and Installing Components.....	9
System Overview.....	9
Inside view – back.....	9
Inside view – front.....	9
Removing the Secure Digital (SD) Card.....	10
Installing the SD Card.....	10
Removing the ExpressCard.....	11
Installing the ExpressCard.....	11
Removing the Battery.....	11
Installing the Battery.....	12
Removing the Micro Subscriber Identity Module (SIM) Card.....	12
Installing the Micro Subscriber Identity Module (SIM) Card.....	13
Removing the Base Cover.....	13
Installing the Base Cover.....	14
Removing the Wireless Local Area Network (WLAN) Card.....	15
Installing the Wireless Local Area Network (WLAN) Card.....	15
Removing Wireless Wide Area Network (WWAN) Card (Optional).....	15
Installing the Wireless Wide Area Network (WWAN) Card (Optional).....	16
Removing the Optical Drive.....	16
Installing the Optical Drive.....	18
Removing the Primary Hard Drive.....	18
Installing the Primary Hard Drive.....	19
Removing the Secondary Hard Drive.....	20
Installing the Secondary Hard Drive.....	20
Removing the Coin-Cell Battery.....	21
Installing the Coin-Cell Battery.....	21
Removing the Processor Fan.....	21
Installing the Processor Fan.....	22
Removing the Video-Card Fan.....	22
Installing the Video-Card Fan.....	23
Removing the Keyboard Trim.....	23
Installing the Keyboard Trim.....	24
Removing the Keyboard.....	25

Installing the Keyboard.....	27
Removing the Primary Memory.....	28
Installing the Primary Memory.....	28
Removing the Secondary Memory.....	29
Installing the Secondary Memory.....	29
Removing the Display Bezel.....	30
Installing the Display Bezel.....	31
Removing the Camera.....	32
Installing the Camera.....	32
Removing the Display Panel.....	32
Installing the Display Panel.....	35
Removing the Palmrest.....	35
Installing the Palmrest.....	40
Removing the ExpressCard Module.....	41
Installing the ExpressCard Module.....	42
Removing The Heat Sink.....	42
Installing the Heat Sink.....	43
Removing the Processor.....	43
Installing the Processor.....	44
Removing The Video-Card Heat Sink.....	44
Installing the Video-Card Heat Sink.....	45
Removing the Video Card.....	46
Installing the Video Card.....	46
Removing the Input/Output (I/O) Board.....	47
Installing the I/O Board.....	47
Removing the Display Assembly.....	48
Installing the Display Assembly.....	50
Removing the Hinge Cover.....	50
Installing the Hinge Cover.....	51
Removing the System Board.....	51
Installing the System Board.....	53
Removing the Power-Connector Port.....	54
Installing the Power Connector Port.....	54
Removing the Switch Board.....	55
Installing the Switch Board.....	55
3 System Setup.....	56
Boot Sequence.....	56
Navigation Keys.....	56
System Setup Options.....	57
Updating the BIOS	67
System and Setup Password.....	68

Assigning a System Password and Setup Password.....	68
Deleting or Changing an Existing System and/or Setup Password.....	69
4 Diagnostics.....	70
Enhanced Pre-Boot System Assessment (ePSA) Diagnostics.....	70
5 Troubleshooting Your Computer.....	71
Device Status Lights.....	71
Battery Status Lights.....	72
6 Specifications.....	73
Technical Specification.....	73
7 Contacting Dell.....	80
Contacting Dell.....	80

Working on Your Computer

Before Working Inside Your Computer

Use the following safety guidelines to help protect your computer from potential damage and to help to ensure your personal safety. Unless otherwise noted, each procedure included in this document assumes that the following conditions exist:

- You have read the safety information that shipped with your computer.
- A component can be replaced or--if purchased separately--installed by performing the removal procedure in reverse order.

 **WARNING:** Before working inside your computer, read the safety information that shipped with your computer. For additional safety best practices information, see the Regulatory Compliance Homepage at www.dell.com/regulatory_compliance

 **CAUTION:** Many repairs may only be done by a certified service technician. You should only perform troubleshooting and simple repairs as authorized in your product documentation, or as directed by the online or telephone service and support team. Damage due to servicing that is not authorized by Dell is not covered by your warranty. Read and follow the safety instructions that came with the product.

 **CAUTION:** To avoid electrostatic discharge, ground yourself by using a wrist grounding strap or by periodically touching an unpainted metal surface, such as a connector on the back of the computer.

 **CAUTION:** Handle components and cards with care. Do not touch the components or contacts on a card. Hold a card by its edges or by its metal mounting bracket. Hold a component such as a processor by its edges, not by its pins.

 **CAUTION:** When you disconnect a cable, pull on its connector or on its pull-tab, not on the cable itself. Some cables have connectors with locking tabs; if you are disconnecting this type of cable, press in on the locking tabs before you disconnect the cable. As you pull connectors apart, keep them evenly aligned to avoid bending any connector pins. Also, before you connect a cable, ensure that both connectors are correctly oriented and aligned.

 **NOTE:** The color of your computer and certain components may appear differently than shown in this document.

To avoid damaging your computer, perform the following steps before you begin working inside the computer.

1. Ensure that your work surface is flat and clean to prevent the computer cover from being scratched.
2. Turn off your computer (see Turning Off Your Computer).
3. If the computer is connected to a docking device (docked) such as the optional Media Base or Battery Slice, undock it.

 **CAUTION: To disconnect a network cable, first unplug the cable from your computer and then unplug the cable from the network device.**

4. Disconnect all network cables from the computer.
5. Disconnect your computer and all attached devices from their electrical outlets.
6. Close the display and turn the computer upside-down on a flat work surface.

 **NOTE:** To avoid damaging the system board, you must remove the main battery before you service the computer.

7. Remove the main battery.
8. Turn the computer top-side up.
9. Open the display.
10. Press the power button to ground the system board.

 **CAUTION: To guard against electrical shock, always unplug your computer from the electrical outlet before opening the display.**

 **CAUTION: Before touching anything inside your computer, ground yourself by touching an unpainted metal surface, such as the metal at the back of the computer. While you work, periodically touch an unpainted metal surface to dissipate static electricity, which could harm internal components.**

11. Remove any installed ExpressCards or Smart Cards from the appropriate slots.



Recommended Tools

The procedures in this document may require the following tools:

- Small flat-blade screwdriver
- #0 Phillips screwdriver
- #1 Phillips screwdriver
- Small plastic scribe

Turning Off Your Computer

 **CAUTION: To avoid losing data, save and close all open files and exit all open programs before you turn off your computer.**

1. Shut down the operating system:
 - In Windows 8:
 - Using a touch-enabled device:
 - a. Swipe in from the right edge of the screen, opening the Charms menu and select **Settings**.
 - b. Select the  and then select **Shut down**
 - Using a mouse:
 - a. Point to upper-right corner of the screen and click **Settings**.
 - b. Click the  and select **Shut down**.
 - In Windows 7:

1. Click **Start** .
2. Click **Shut Down**.

or

1. Click **Start** .
2. Click the arrow in the lower-right corner of the **Start** menu as shown below, and then click



Shut Down..

2. Ensure that the computer and all attached devices are turned off. If your computer and attached devices did not automatically turn off when you shut down your operating system, press and hold the power button for about 4 seconds to turn them off.

After Working Inside Your Computer

After you complete any replacement procedure, ensure you connect any external devices, cards, and cables before turning on your computer.

 **CAUTION: To avoid damage to the computer, use only the battery designed for this particular Dell computer. Do not use batteries designed for other Dell computers.**

1. Connect any external devices, such as a port replicator, battery slice, or media base, and replace any cards, such as an ExpressCard.
2. Connect any telephone or network cables to your computer.

 **CAUTION: To connect a network cable, first plug the cable into the network device and then plug it into the computer.**

3. Replace the battery.
4. Connect your computer and all attached devices to their electrical outlets.
5. Turn on your computer.

Removing and Installing Components

This section provides detailed information on how to remove or install the components from your computer.

System Overview

Inside view — back

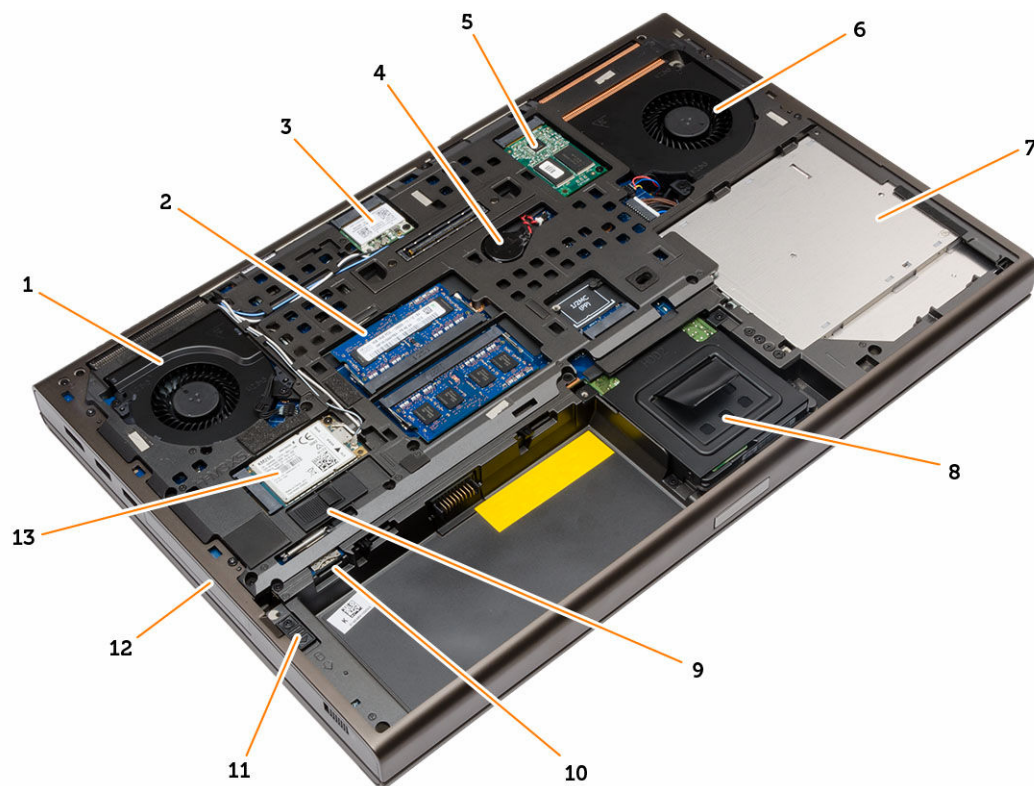

- | | | | |
|-----|------------------|-----|----------------------|
| 1. | system fan | 2. | primary memory |
| 3. | WLAN card | 4. | coin-cell battery |
| 5. | mSATA SSD card | 6. | video-card fan |
| 7. | optical drive | 8. | secondary hard drive |
| 9. | battery latch | 10. | micro SIM card slot |
| 11. | hard drive latch | 12. | primary hard drive |
| 13. | WWAN card | | |

Inside view — front



- | | |
|-----------------------|------------------------|
| 1. processor heatsink | 2. secondary memory |
| 3. wi-fi switch board | 4. Express Card Cage |
| 5. I/O Board | 6. video-card heatsink |

Removing the Secure Digital (SD) Card

1. Follow the procedures in *Before Working Inside Your Computer*.
2. Press in on the SD card to release it from the computer. Slide the SD card out of the computer.



Installing the SD Card

1. Push in the SD card into its slot until it clicks into place.
2. Follow the procedures in *After Working Inside Your Computer*.

Removing the ExpressCard

1. Follow the procedures in *Before Working On Your Computer*.
2. Push in on the ExpressCard.
3. Slide the ExpressCard out of the computer.

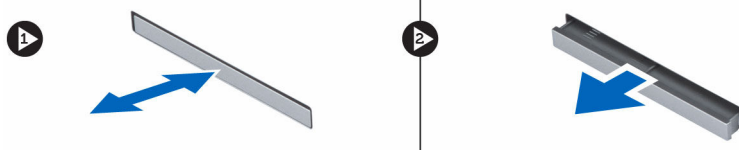

Installing the ExpressCard

1. Insert the ExpressCard into the slot and press till it clicks into place.
2. Follow the procedures in *After Working Inside Your Computer*.

Removing the Battery

1. Follow the procedures in *Before Working Inside Your Computer*.
2. Slide the release latch to unlock the battery.



3. Lift and remove the battery from the computer.



Installing the Battery

1. Slide the battery into its slot until it clicks into place.
2. Follow the procedures in *After Working Inside Your Computer*.

Removing the Micro Subscriber Identity Module (SIM) Card

1. Follow the procedures in *Before Working Inside Your Computer*.
2. Remove the battery.
3. Slide the micro SIM card out from the slot .

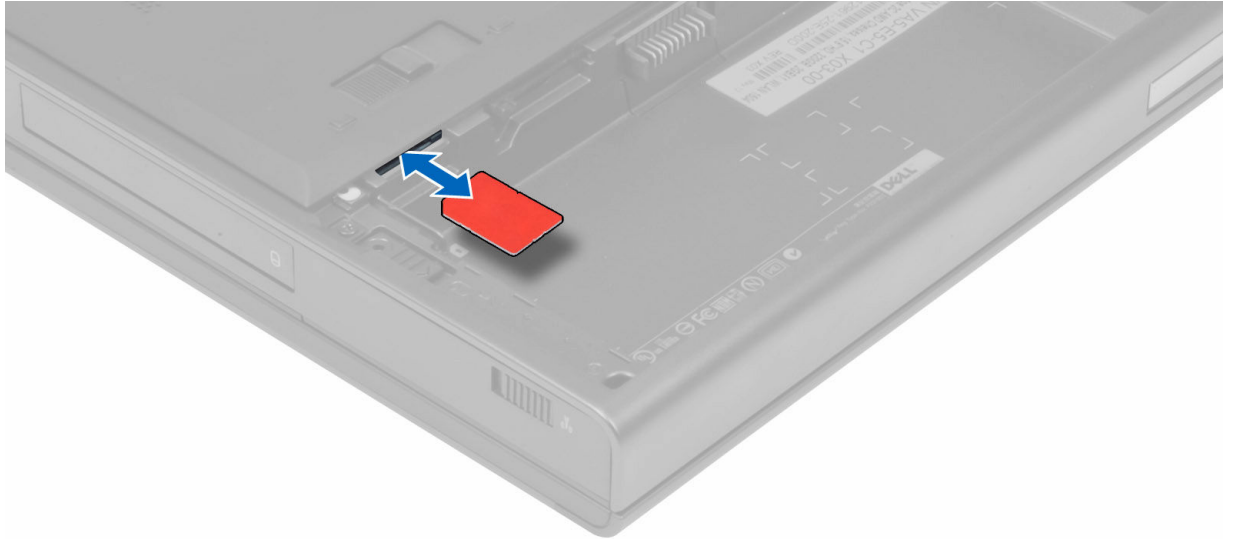

Installing the Micro Subscriber Identity Module (SIM) Card

1. Push in the micro SIM card into its slot.
2. Install the battery.
3. Follow the procedures in *After Working Inside Your Computer*.

Removing the Base Cover

1. Follow the procedures in *Before Working Inside Your Computer*.
2. Remove the battery.
3. Remove the screws that secure the base cover to the computer. Press the rubber tabs towards the rear of the computer to disengage the base cover.



4. Lift and remove the base cover from the computer.



Installing the Base Cover

1. Slide in and place the base cover to align with the screw holes correctly on the computer.
2. Tighten the screws to secure the base cover to the computer.
3. Install the battery.

4. Follow the procedures in *After Working Inside Your Computer*.

Removing the Wireless Local Area Network (WLAN) Card

1. Follow the procedures in *Before Working Inside Your Computer*.
2. Remove the:
 - a. battery
 - b. base cover
3. Please perform the following steps to remove the WLAN card from the computer:
 - a. Disconnect and un-route the antenna cables connected to the WLAN card.
 - b. Remove the screw that secures the WLAN card to the computer.
 - c. Remove the WLAN card from the computer.

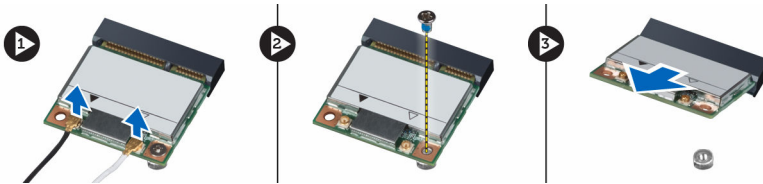

Installing the Wireless Local Area Network (WLAN) Card

1. Insert the WLAN card in its slot in the computer.
2. Press down the WLAN card and tighten the screw to secure the WLAN card to the computer.
3. Route the antenna cables through the routing channel and connect them to the WLAN card.
4. Install the:
 - a. base cover
 - b. battery
5. Follow the procedures in *After Working Inside Your Computer*.

Removing Wireless Wide Area Network (WWAN) Card (Optional)

1. Follow the procedures in *Before Working Inside Your Computer*.
2. Remove the:
 - a. battery
 - b. base cover
3. Please perform the following steps to remove the WWAN card:
 - a. Disconnect and un-route and remove the antenna cables connected to the WWAN card.
 - b. Remove the screw that secures the WWAN card to the computer.
 - c. Remove the WWAN card from the computer.



NOTE: The location of the WWAN card may vary from what is displayed in the illustrations.

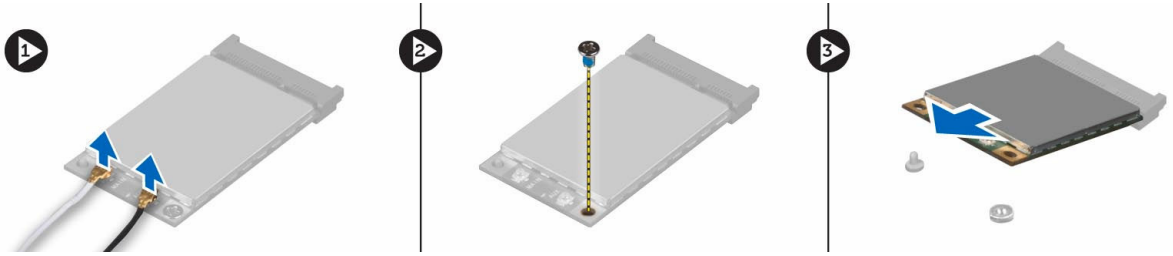

Installing the Wireless Wide Area Network (WWAN) Card (Optional)

1. Slide the WWAN card in the WWAN card slot.
2. Press down the WWAN card and tighten the screw to secure the WWAN card to the computer.
3. Route the antenna cables through the routing channels and connect them to the WWAN card.
4. Install the:
 - a. base cover
 - b. battery
5. Follow the procedures in *After Working Inside Your Computer*.

Removing the Optical Drive

1. Follow the procedures in *Before Working Inside Your Computer*.
2. Remove the:
 - a. battery
 - b. base cover
3. Remove the screw that secures the optical drive to the computer.

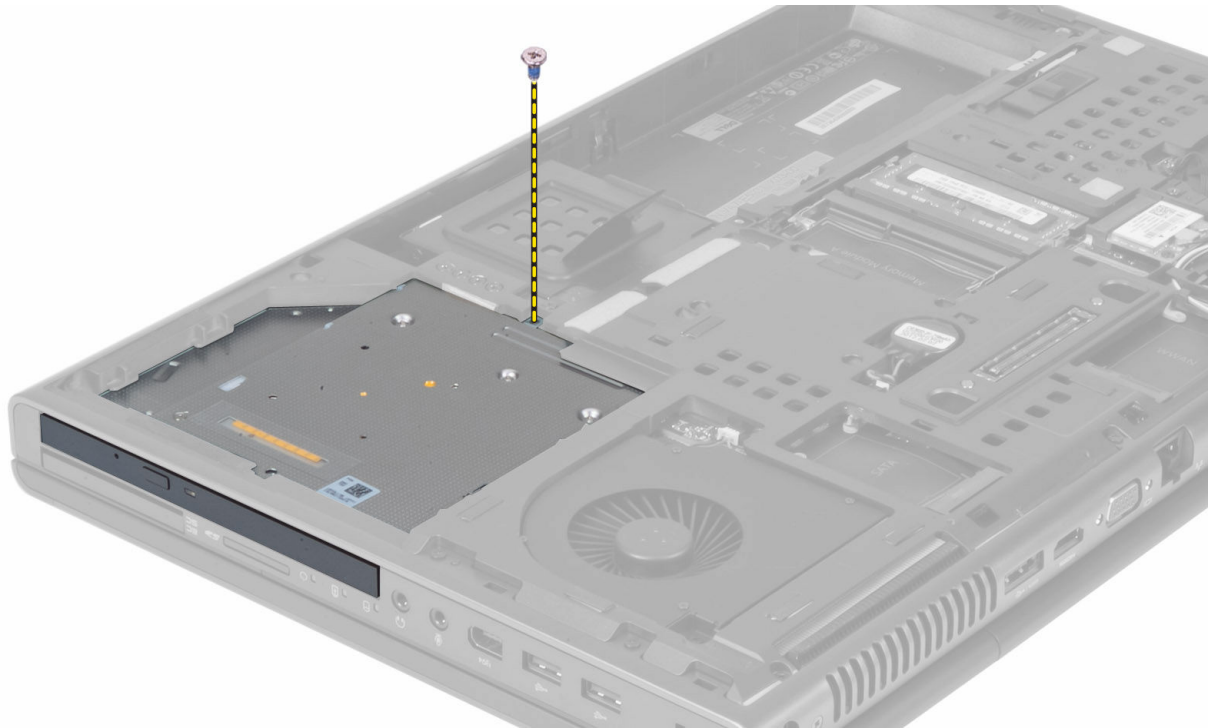

4. Pry and slide out the optical drive to remove it from the computer.



5. Remove the screws that secure the drive-latch bracket to the optical drive and remove the bracket.

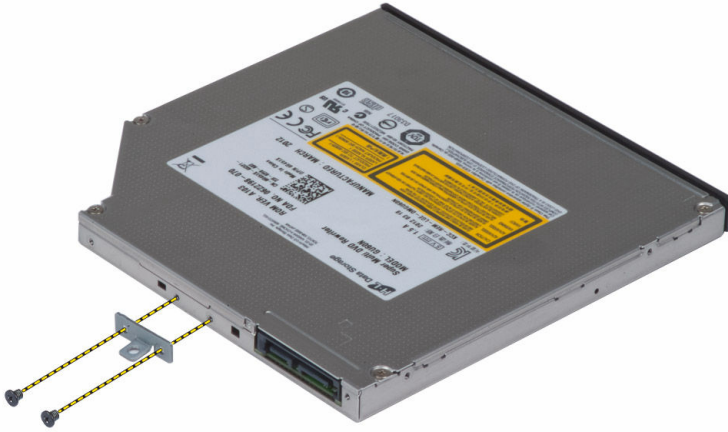

Installing the Optical Drive

1. Tighten the screws to secure the drive-latch bracket to the optical drive.
2. Slide the optical drive into its slot and tighten the screw to secure the optical drive to the computer.
3. Install the:
 - a. battery
 - b. base cover
4. Follow the procedures in *After Working Inside Your Computer*.

Removing the Primary Hard Drive

1. Follow the procedures in *Before Working Inside Your Computer*.
2. Remove the:
 - a. battery
 - b. base cover
3. Remove the screws that secure the primary hard drive to the computer. Slide the primary hard -drive latch to the unlock position and pull out the hard drive from the computer.

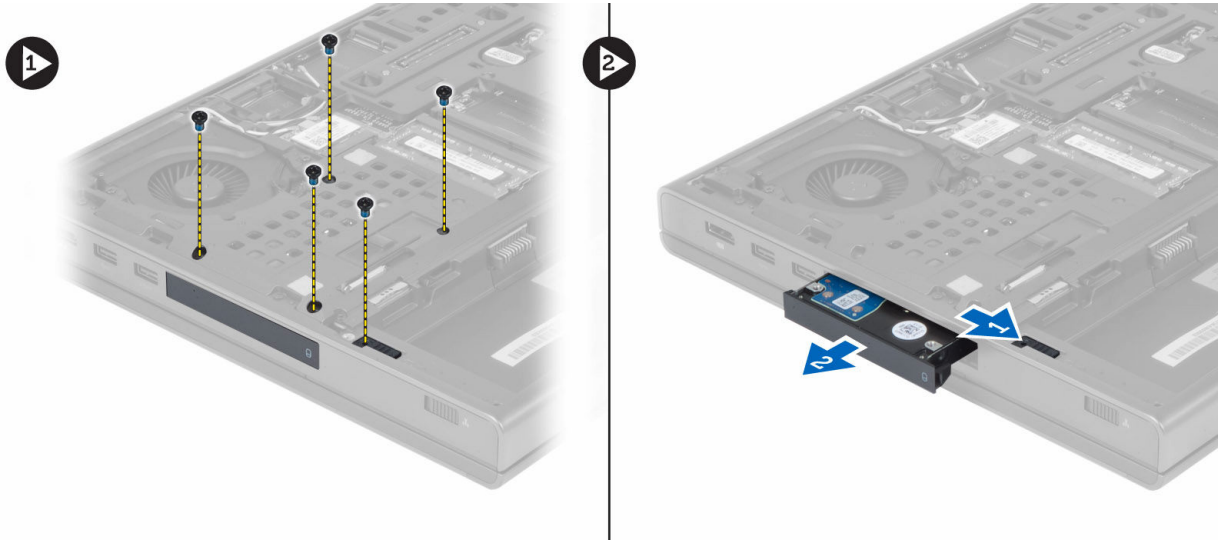

4. Flex the hard-drive bracket outward and pull out the hard drive from the bracket.



 **NOTE:** A rubber filler is installed to the hard-drive bracket for 7 mm hard drives. It is designed to prevent vibrations and for correct installation of the 7 mm hard drives. 9 mm hard drives do not require the filler when installed into the hard-drive bracket.

Installing the Primary Hard Drive

1. Engage the primary hard -drive bracket to the primary hard drive.
2. Insert the primary hard drive into its slot in the computer till it clicks in place.
3. Tighten the screws to secure the primary hard drive to the computer.
4. Install the:
 - a. base cover
 - b. battery
5. Follow the procedures in *After Working Inside Your Computer*.

Removing the Secondary Hard Drive

1. Follow the procedures in *Before Working Inside Your Computer*.
2. Remove the:
 - a. battery
 - b. base cover
3. Remove the screw that secure that secondary hard drive in place.
4. Pull the tab upward and remove the secondary hard drive from the computer.

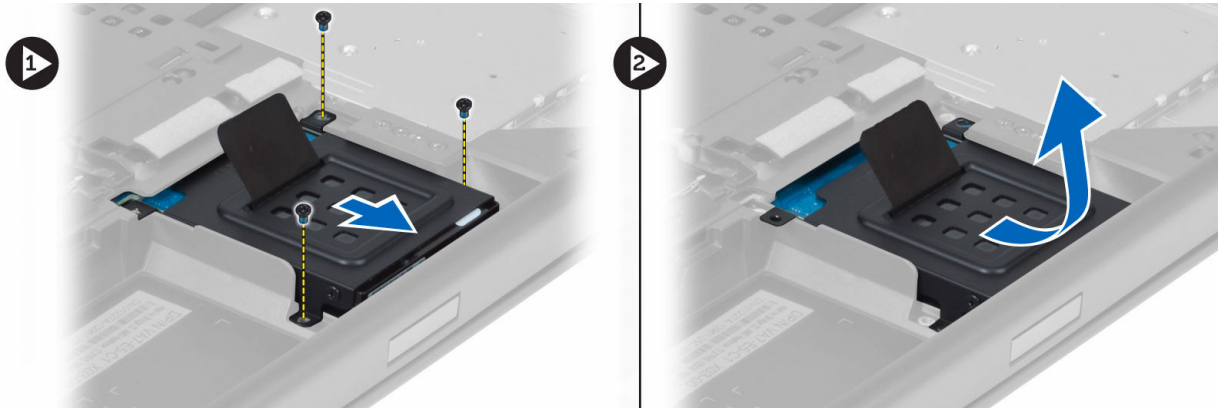

5. Remove the screw that secure secondary hard drive to the bracket.
6. Remove the secondary hard drive from the bracket.



Installing the Secondary Hard Drive

1. Engage the secondary hard drive bracket to the secondary hard drive.
2. Tighten the screw that secure the secondary hard drive bracket.
3. Install the secondary hard drive into the computer.
4. Tighten the screw that secure the secondary hard drive in the computer.

5. Install the:
 - a. base cover
 - b. battery
6. Follow the procedures in *After Working Inside Your Computer*.

Removing the Coin-Cell Battery

1. Follow the procedures in *Before Working Inside Your Computer*.
2. Remove the:
 - a. battery
 - b. base cover
3. Disconnect the coin-cell battery cable. Pry the coin-cell battery upward and remove it from the computer.

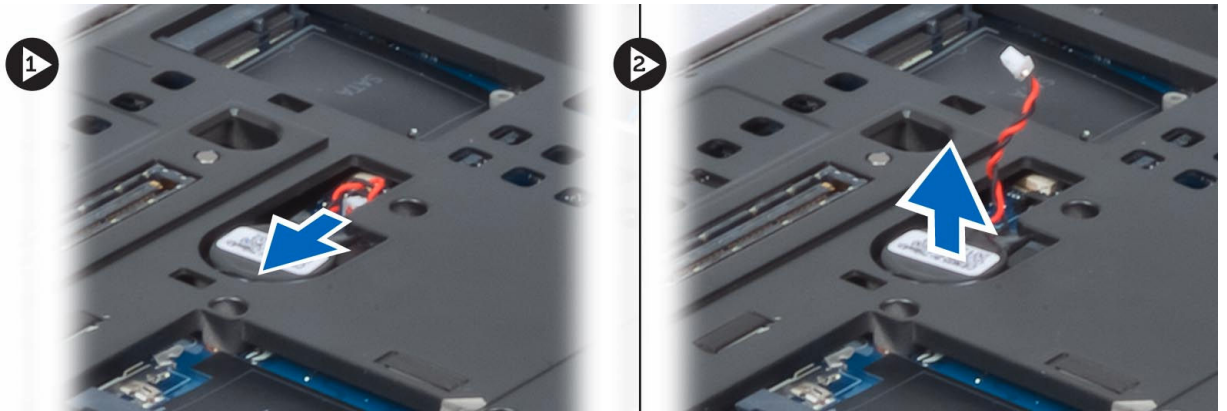

Installing the Coin-Cell Battery

1. Replace the coin-cell battery in its slot in the computer.
2. Connect the coin-cell battery cable.
 **NOTE:** Ensure that the coin-cell battery cable does not protrude outside its compartment.
3. Install the:
 - a. base cover
 - b. battery
4. Follow the procedures in *After Working Inside Your Computer*.

Removing the Processor Fan

1. Follow the procedures in *Before Working Inside Your Computer*.
2. Remove the:
 - a. battery
 - b. base cover
3. Remove the screws that secure the processor fan to the computer. Remove the processor fan from the computer.

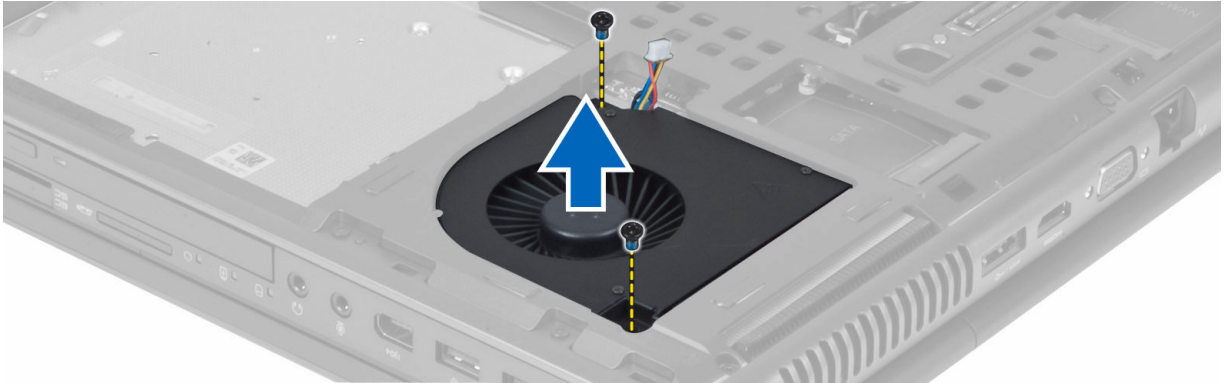

4. Disconnect the processor-fan cable.



Installing the Processor Fan

1. Connect the processor-fan cable.
 -  **NOTE:** Ensure that the processor-fan cable does not protrude outside its compartment.
2. Insert the processor fan into its slot in the computer.
3. Tighten the screws that secure the processor fan to the computer.
4. Install the:
 - a. base cover
 - b. battery
5. Follow the procedures in *After Working Inside Your Computer*.

Removing the Video-Card Fan

1. Follow the procedures in *Before Working Inside Your Computer*.
2. Remove the:
 - a. battery
 - b. base cover
3. Remove the screws that secure the video-card fan to the computer. Remove the video-card fan from the computer. Disconnect the video-card fan cable.

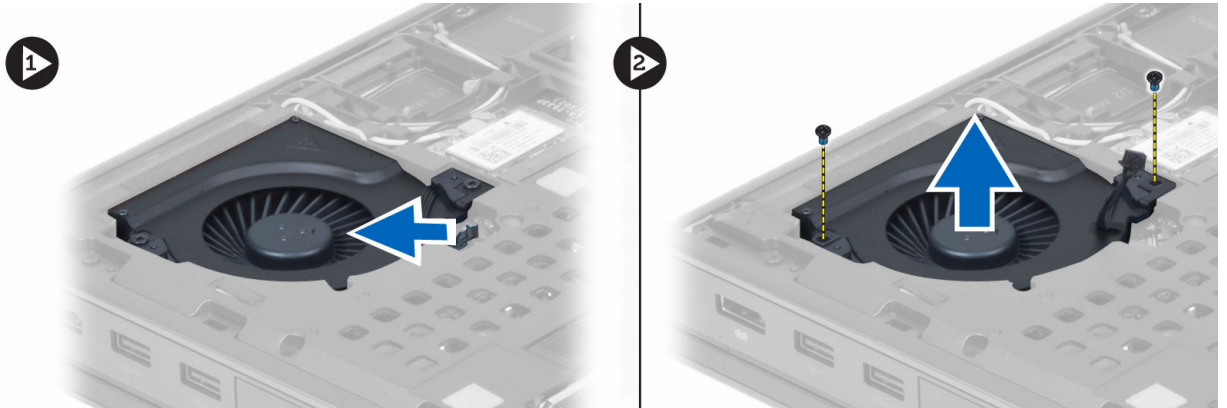

Installing the Video-Card Fan

1. Connect the video-card fan cable.
 -  **NOTE:** Ensure that the video-card fan cable does not protrude outside its compartment.
2. Insert the video-card fan into its slot and tighten the screws to secure it to the computer.
3. Install the:
 - a. base cover
 - b. battery
4. Follow the procedures in *After Working Inside Your Computer*.

Removing the Keyboard Trim

1. Follow the procedures in *Before Working Inside Your Computer*.
2. Remove the battery.
3. Pry up the keyboard trim starting from the bottom and work your way along the top edge. Remove the keyboard trim.

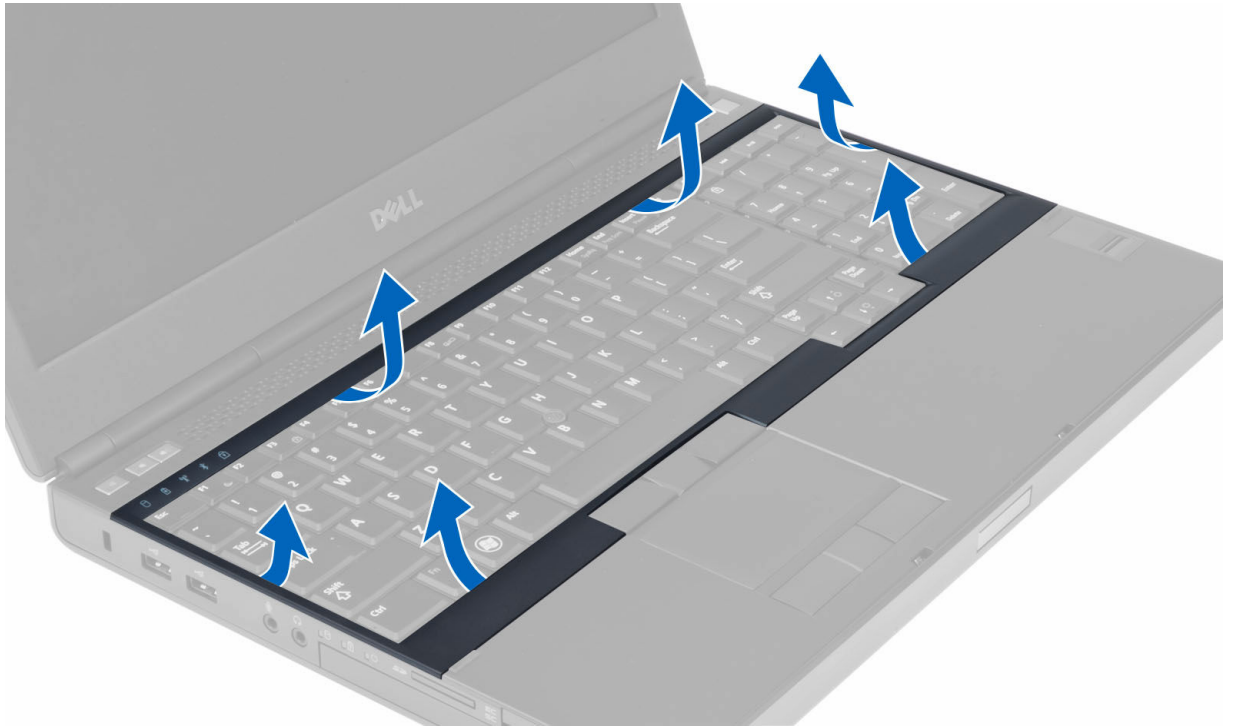

Installing the Keyboard Trim

1. Slide in the keyboard trim from the front and align it to its original position on the computer. Ensure that the hard-tab on the left corner snaps into place.

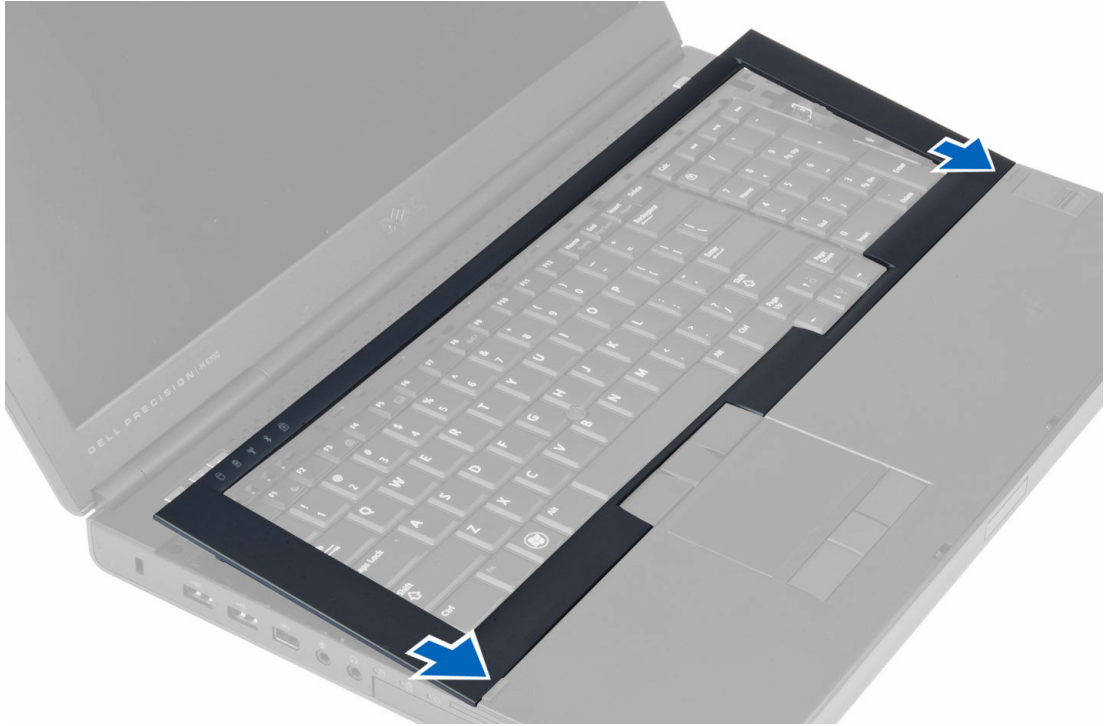

2. Press along the sides of the keyboard trim until it snaps in place.
3. Install the battery.
4. Follow the procedures in *After Working Inside Your Computer*.

Removing the Keyboard

1. Follow the procedures in *Before Working Inside Your Computer*.
2. Remove the:
 - a. battery
 - b. keyboard trim
3. Remove the screws that secure the keyboard to the computer.



4. Starting from the bottom of the keyboard, separate the keyboard from the computer and flip the keyboard over.



5. Disconnect the keyboard-data cable from the system board and remove the keyboard.

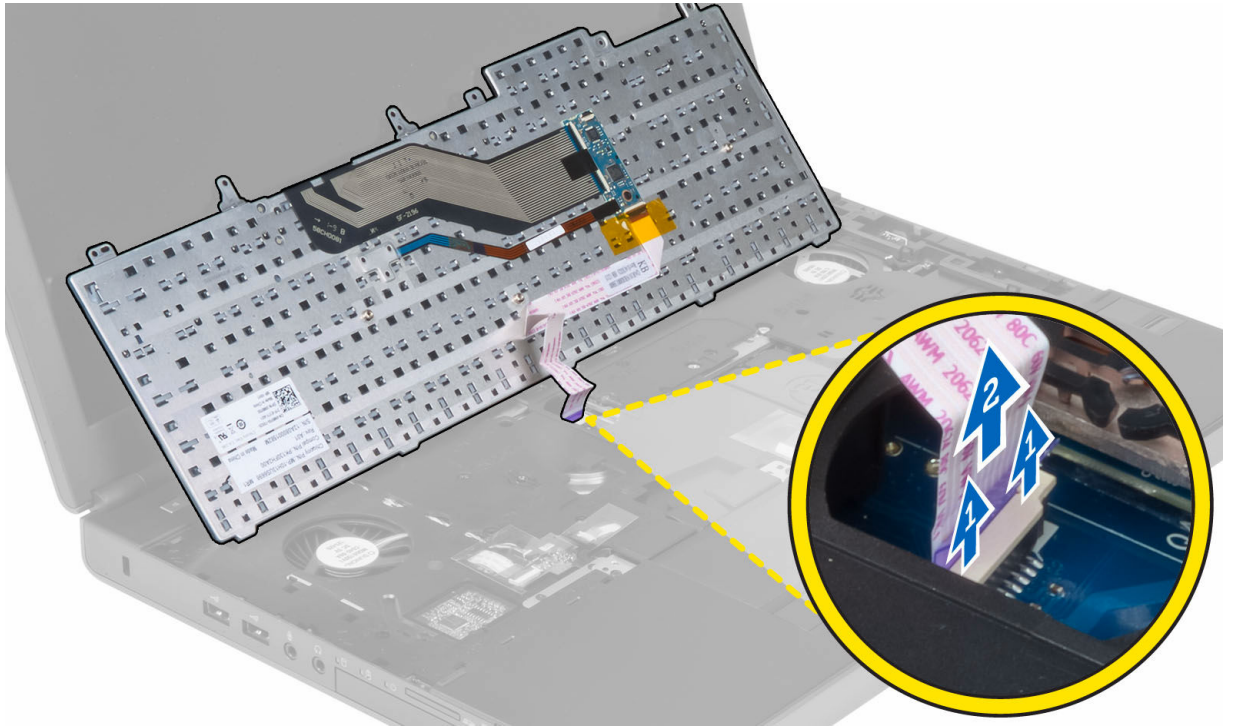

Installing the Keyboard

1. Connect the keyboard-data cable to the system board.
 -  **NOTE:** Ensure that you fold the keyboard-data cable in perfect alignment.
2. Press and align the keyboard to its compartment.
3. Tighten the screws to secure the keyboard to the computer.
4. Press over the cross section of the following keys to secure the keyboard to the computer:
 - a. <R> , <T> , <F> and <G> keys
 - b. over the <9> key
 - c. NUMLOCK <9> key



5. Install the:
 - a. keyboard trim
 - b. battery
6. Follow the procedures in *After Working Inside Your Computer*.

Removing the Primary Memory

1. Follow the procedures in *Before Working Inside Your Computer*.
2. Remove the:
 - a. battery
 - b. base cover
3. Pry the retention clips away from the primary memory until it pops up. Lift the primary memory and remove it from the computer.

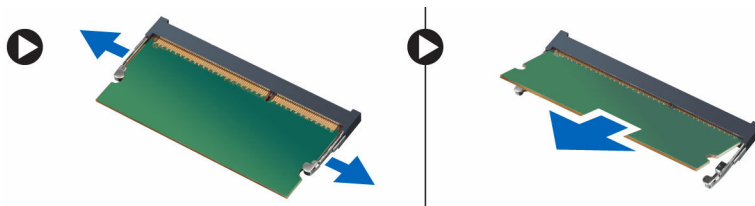

Installing the Primary Memory

1. Insert the primary memory into the memory socket.
2. Press the clips to secure the primary memory to the system board.
3. Install the:

- a. base cover
- b. battery
4. Follow the procedures in *After Working Inside Your Computer*.

Removing the Secondary Memory

1. Follow the procedures in *Before Working Inside Your Computer*.
2. Remove the:
 - a. battery
 - b. keyboard trim
 - c. keyboard
3. Remove the screw that secures the memory shield to the computer. Lift up and remove the memory shield from the computer.

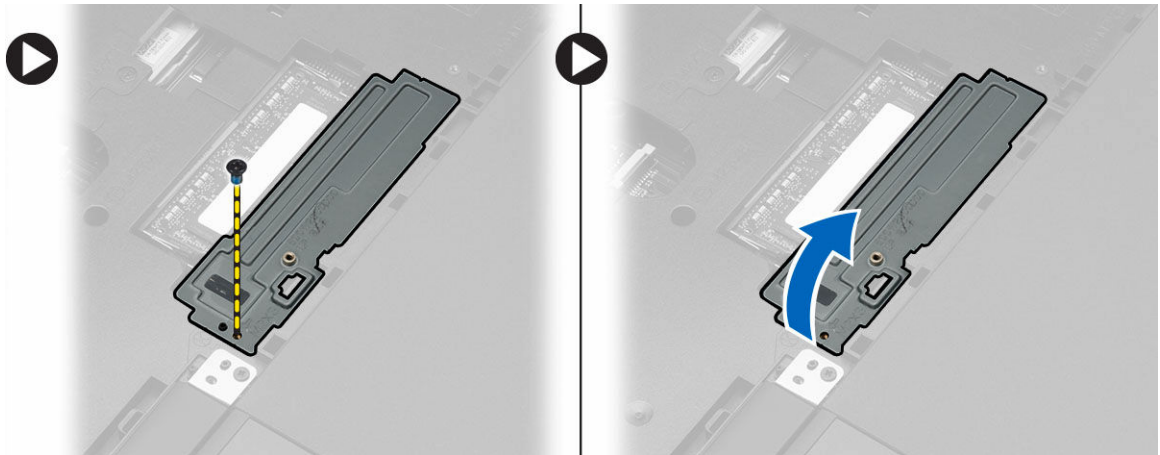

4. Pry the retention clips away from the memory module until it pops up. Lift up the memory module and remove it from the computer.

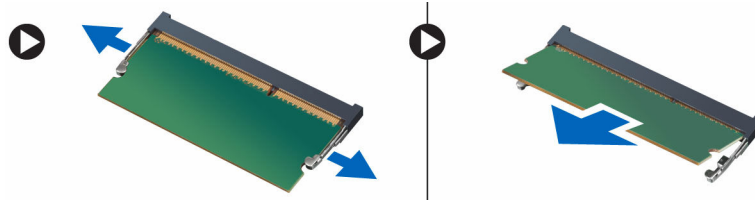

Installing the Secondary Memory

1. Insert the secondary memory into the memory socket.
2. Press the clips to secure the memory module to the system board.
3. Place the memory shield in its original position on the computer and tighten the screw to secure it to the computer.
4. Install the:
 - a. keyboard
 - b. keyboard trim
 - c. battery
5. Follow the procedures in *After Working Inside Your Computer*.

Removing the Display Bezel

1. Follow the procedures in *After Working Inside Your Computer*.
2. Remove the battery.
3. Pry up the bottom edge of the display bezel.

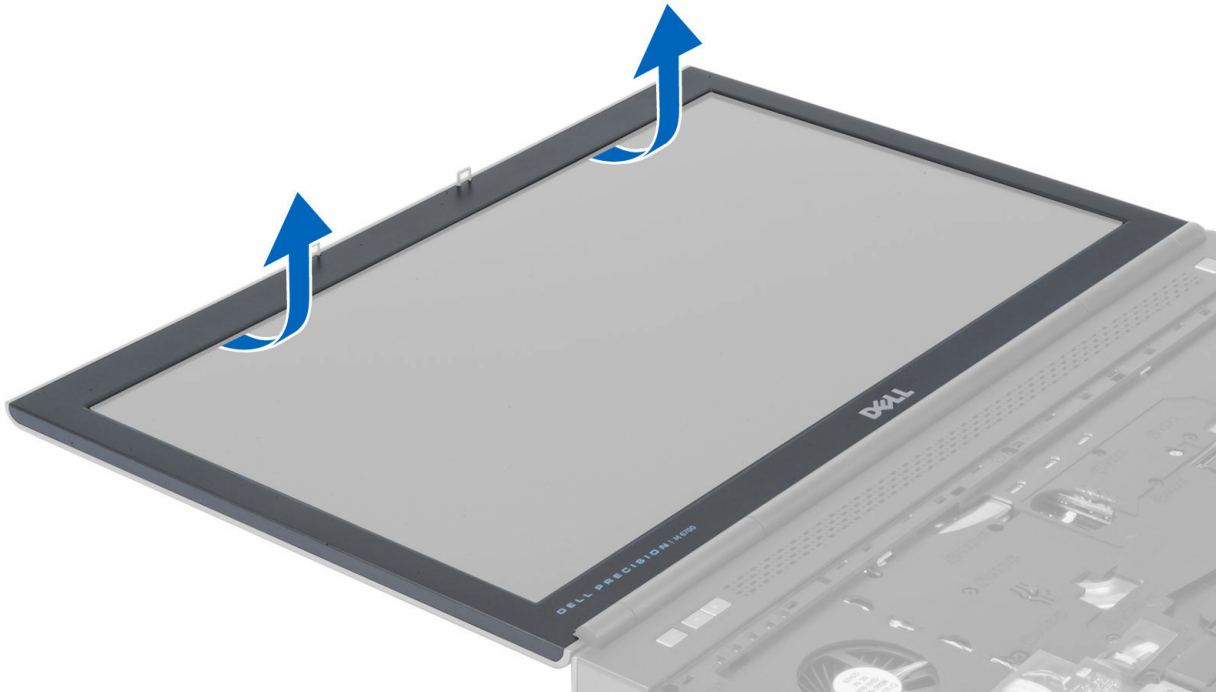

4. Work your way around the sides and top edge of the display bezel and remove the display bezel from the computer .

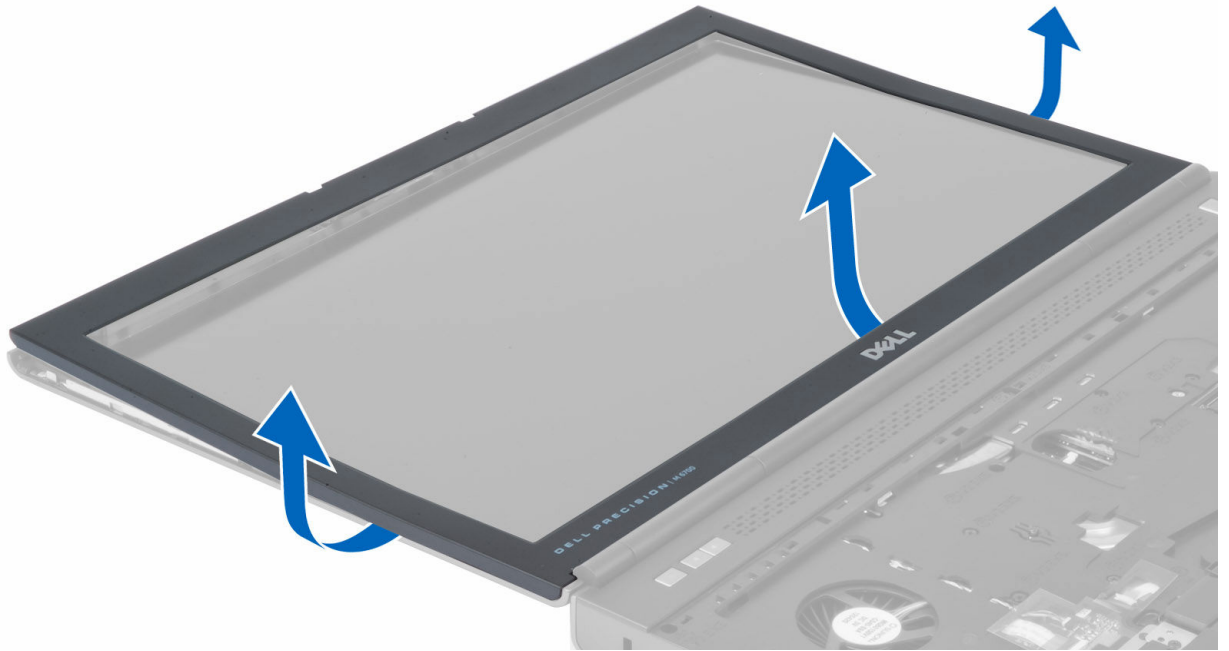

Installing the Display Bezel

1. Slide in the display bezel from the bottom and press on the display bezel.



2. Work around the entire bezel until it snaps onto the display assembly.
3. Install the battery.
4. Follow the procedures in *After Working Inside Your Computer*.

Removing the Camera

1. Follow the procedures in *Before Working Inside Your Computer*.
2. Remove the:
 - a. battery
 - b. display bezel
3. Perform the following steps to remove the camera:
 - a. Disconnect the camera cable.
 - b. Remove the screw that secures the camera module to the computer.
 - c. Remove the camera module from the computer.

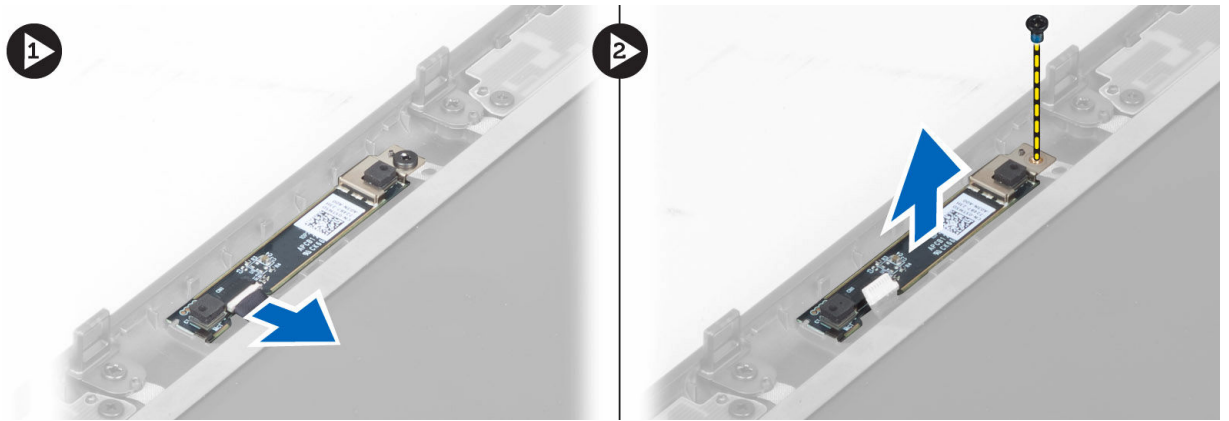

Installing the Camera

1. Connect the camera cable.
2. Place the camera module in its slot on the computer.
3. Tighten the screw to secure the camera module to the computer.
4. Install the:
 - a. display bezel
 - b. battery
5. Follow the procedures in *After Working Inside Your Computer*.

Removing the Display Panel

1. Follow the procedures in *Before Working Inside Your Computer*.
2. Remove the:
 - a. battery
 - b. display bezel
3. Remove the screws that secure the display panel to the display assembly. Flip the display panel over.

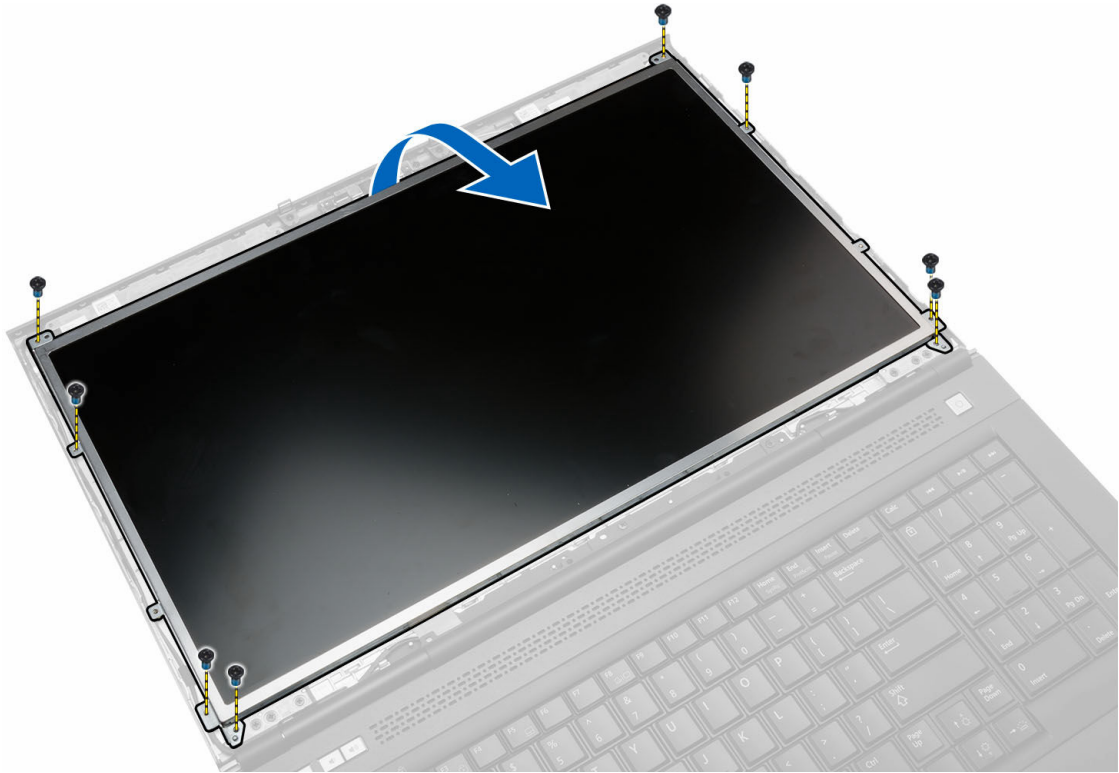

4. Peel back the adhesive tape that secures the LVDS cable to the display panel.

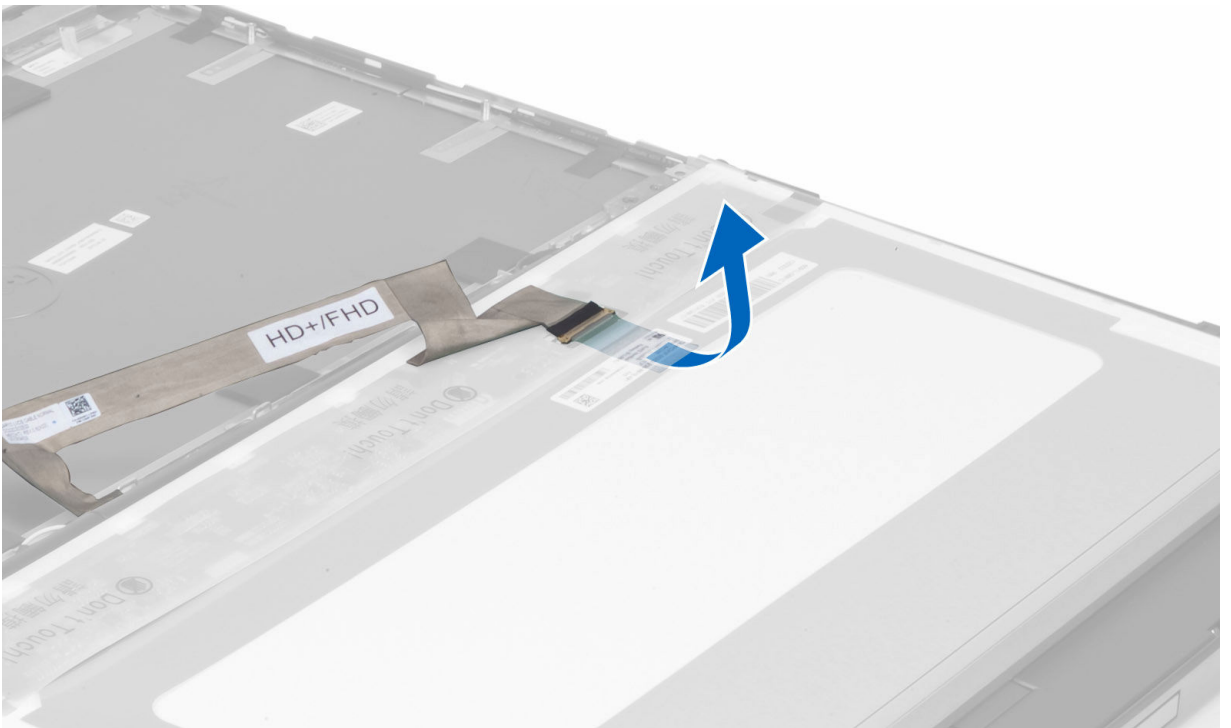

5. Disconnect the LVDS cable.

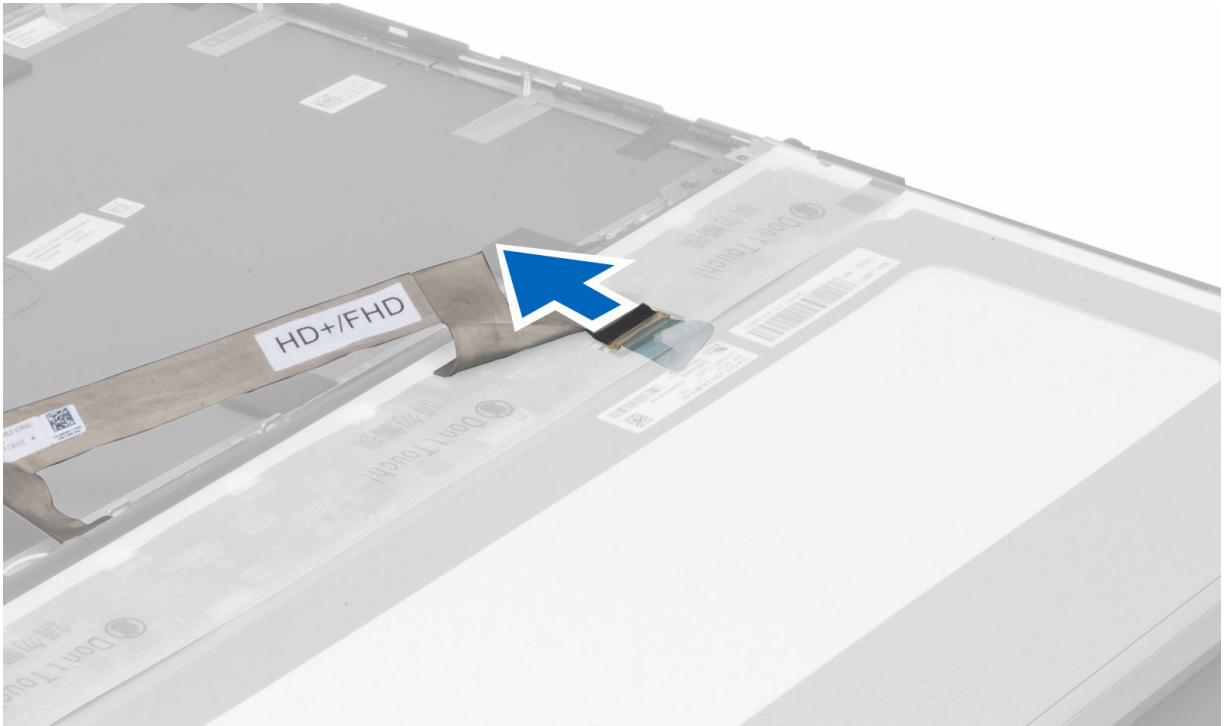

6. Remove the screws that secure the display brackets to the display panel. Pull away the display brackets to remove them from the display panel.

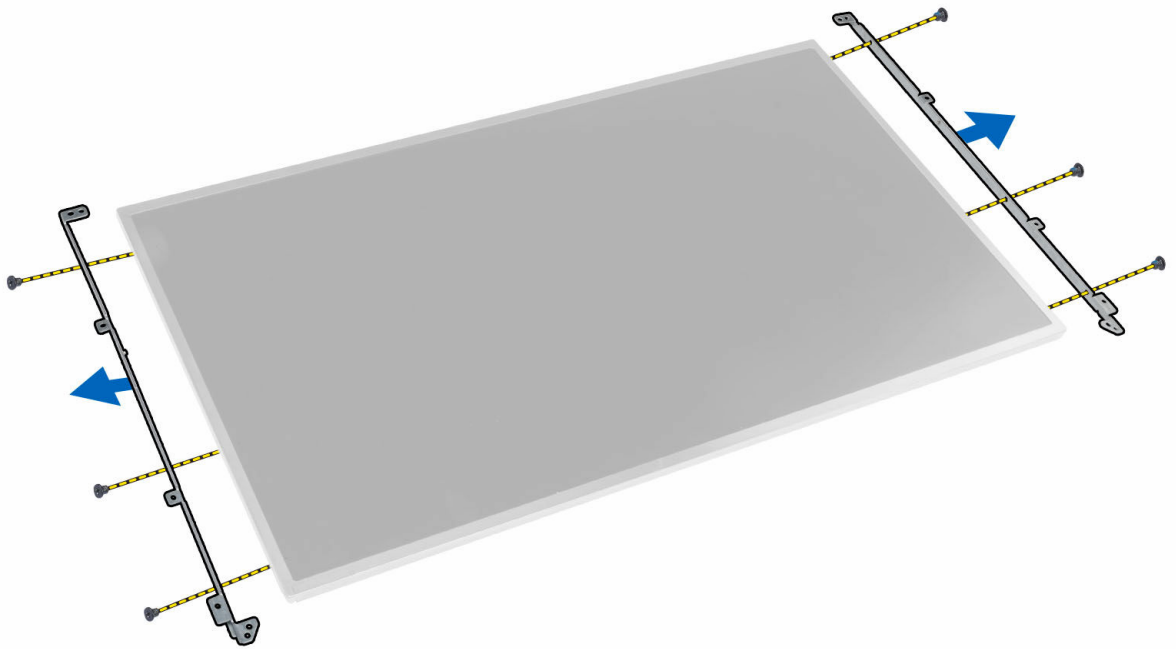

Installing the Display Panel

1. Align the display brackets to the display panel.
2. Tighten the screws to secure the display brackets to the display panel.
3. Connect the LVDS cable and affix the adhesive tape.
4. Align the display panel in its original position on the computer.
5. Tighten the screws to secure the display panel to the display assembly.
6. Install the:
 - a. display bezel
 - b. battery
7. Follow the procedures in *After Working Inside Your Computer*.

Removing the Palmrest

1. Follow the procedures in *Before Working Inside Your Computer*.
2. Remove the:
 - a. battery
 - b. base cover
 - c. keyboard trim
 - d. keyboard
 - e. optical drive
 - f. primary hard drive
 - g. secondary hard drive (if available)
3. Peel back the adhesive tape that secures the smart card cable to the computer.

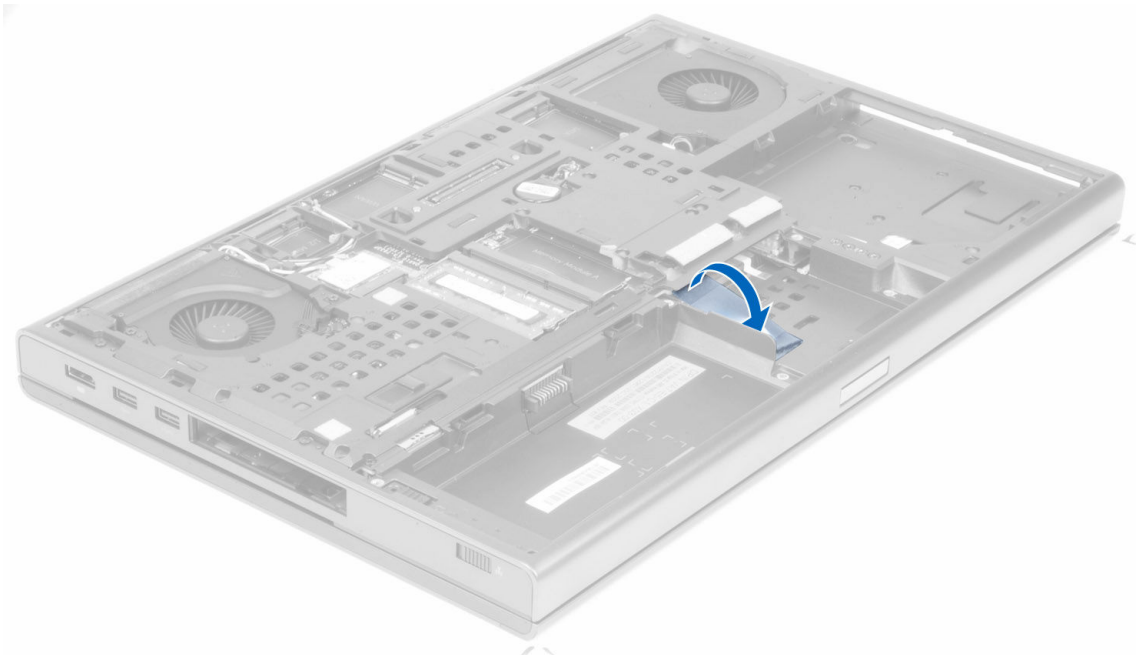

4. Disconnect the smart card cable from the computer.

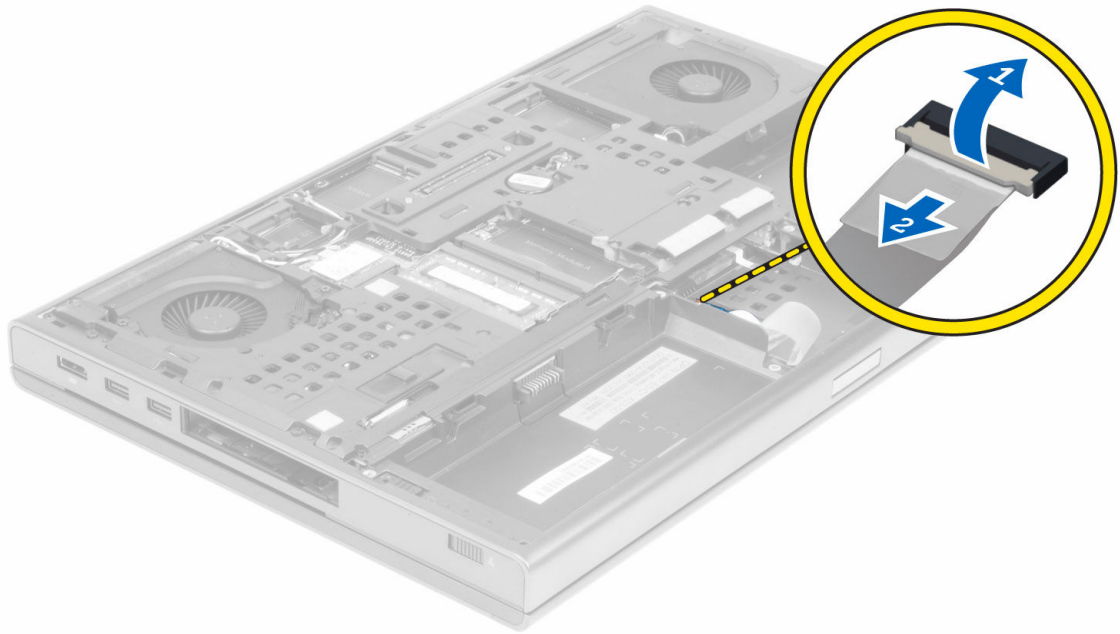

5. Remove the screws at the bottom of the computer.

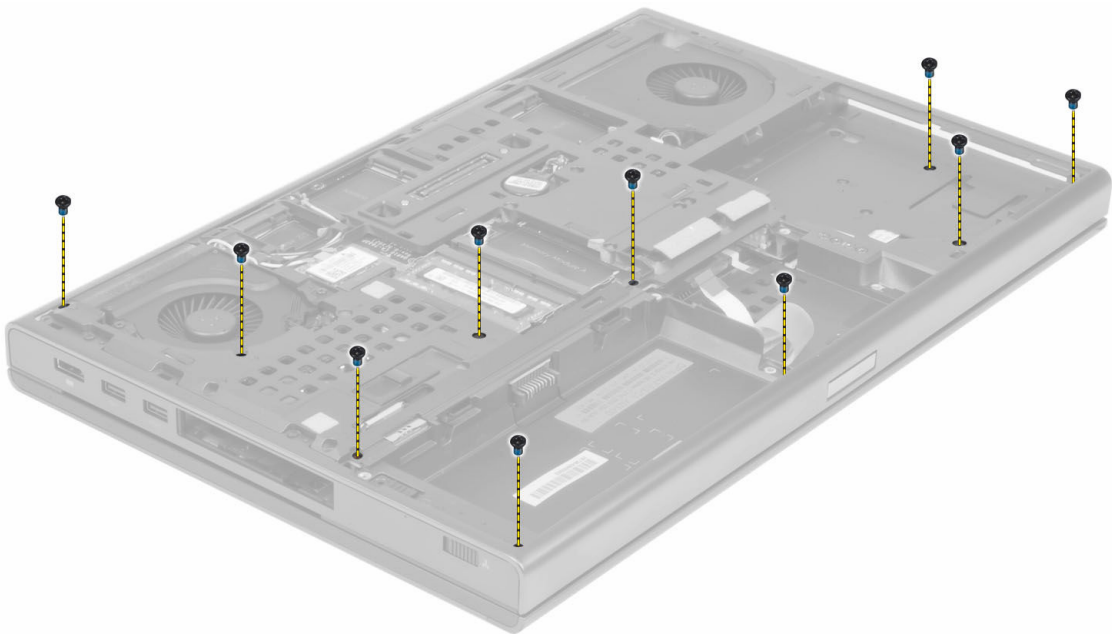

6. Peel the adhesive tape that secures the media board cable and speaker cable to the palmrest.

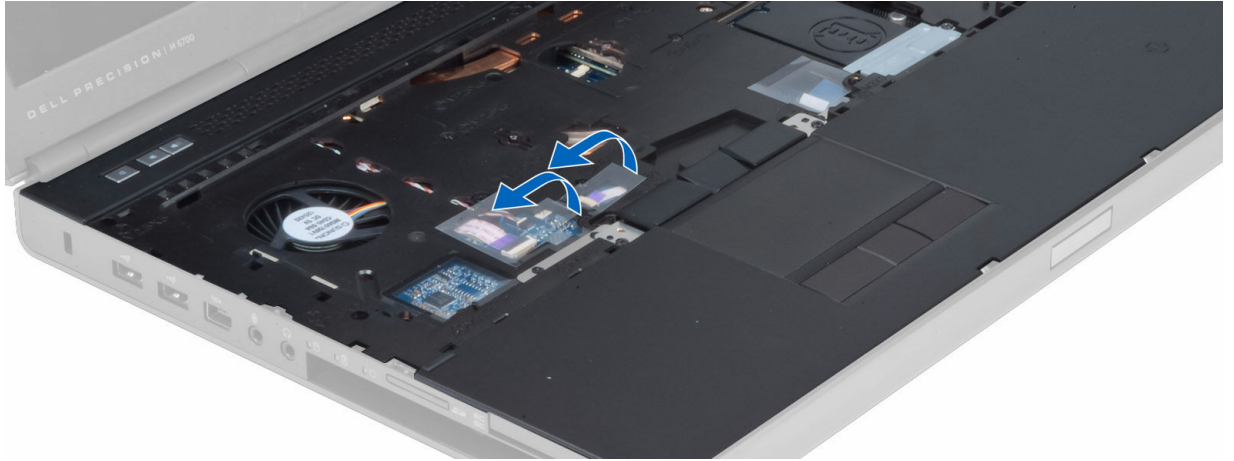

7. Disconnect the media board cable and the speaker cable from the system board.

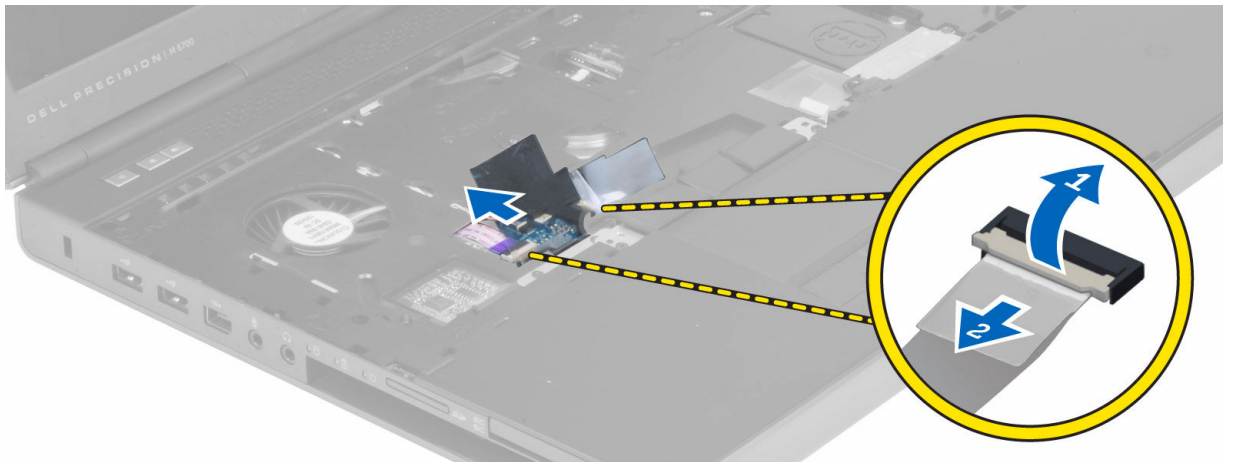

8. Peel the adhesive tape that secures the touchpad cable to the palmrest.

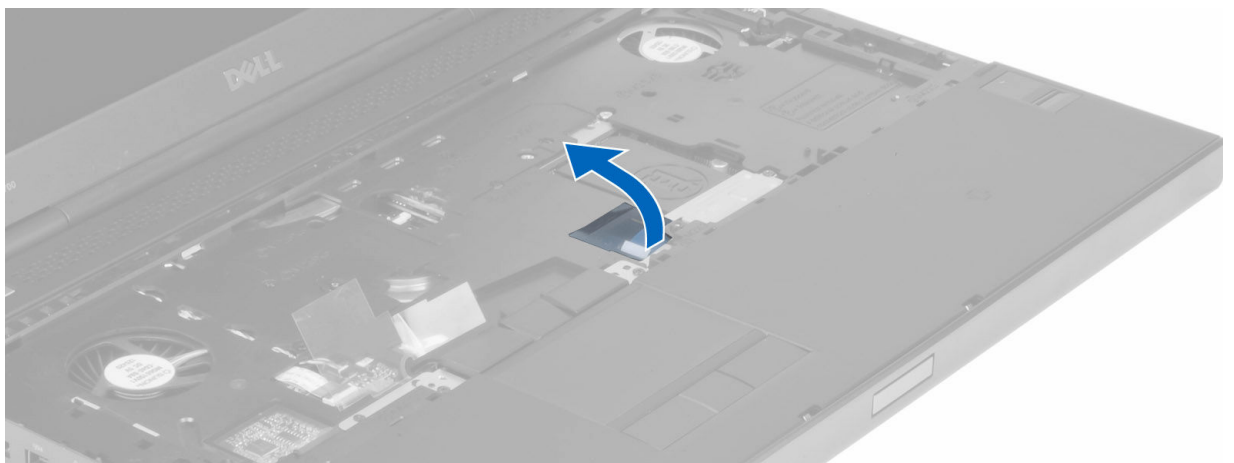

9. Disconnect the touchpad cable from the system board.

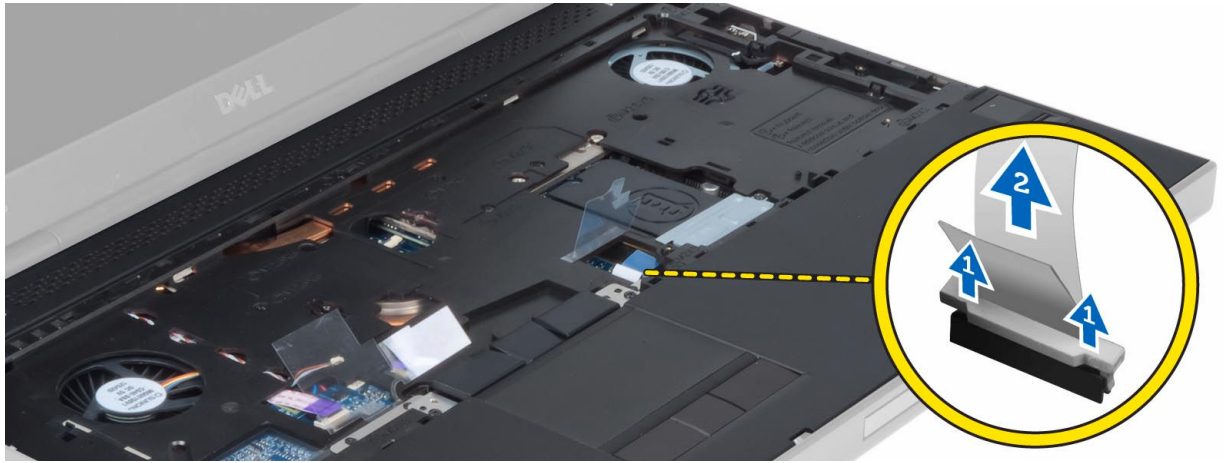

10. Disconnect the power button cable from the system board.

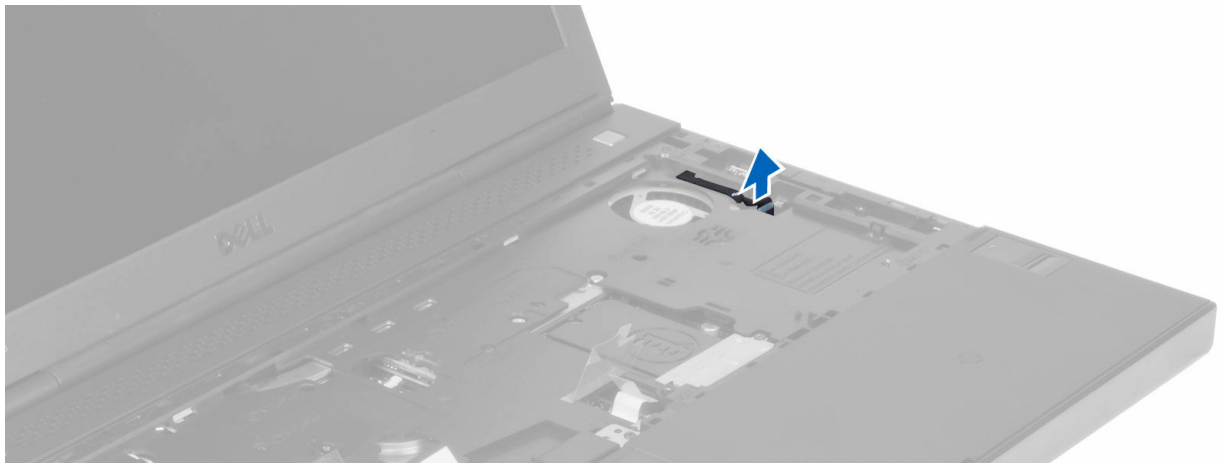

11. Remove the screws that secure the palmrest to the computer.

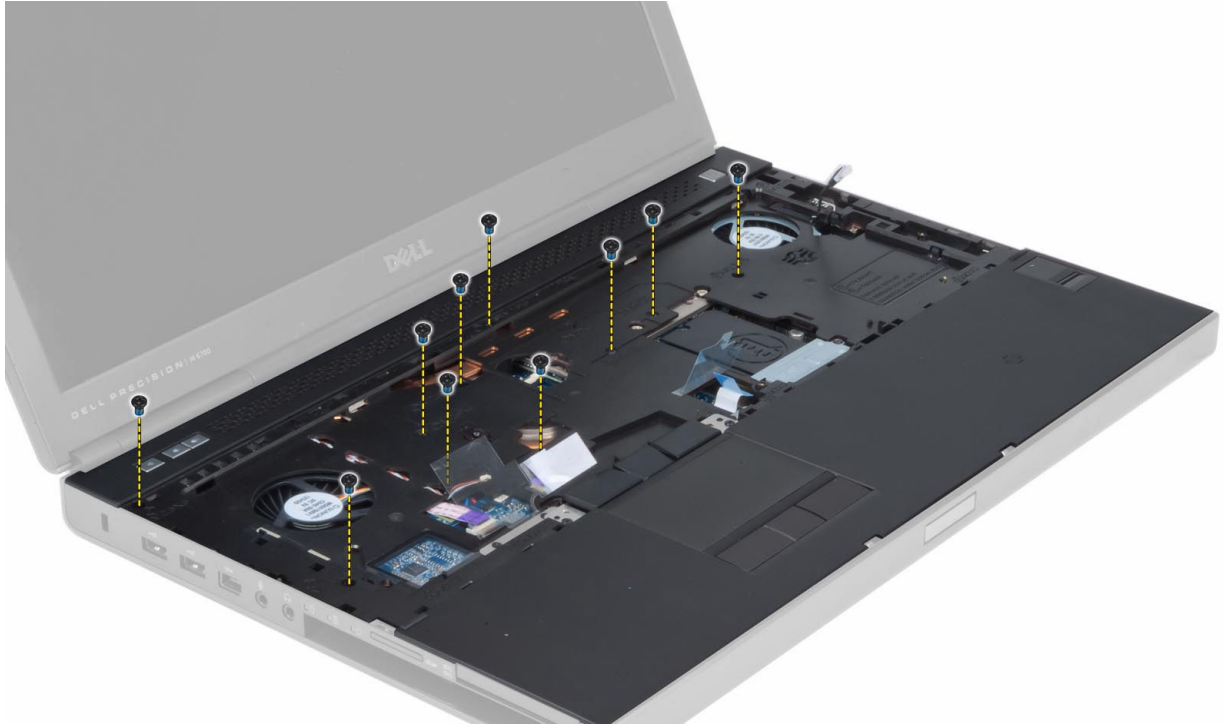

12. Lift the left edge of the palmrest. Release the tabs on the right edge of the palmrest and remove the palmrest from the computer.

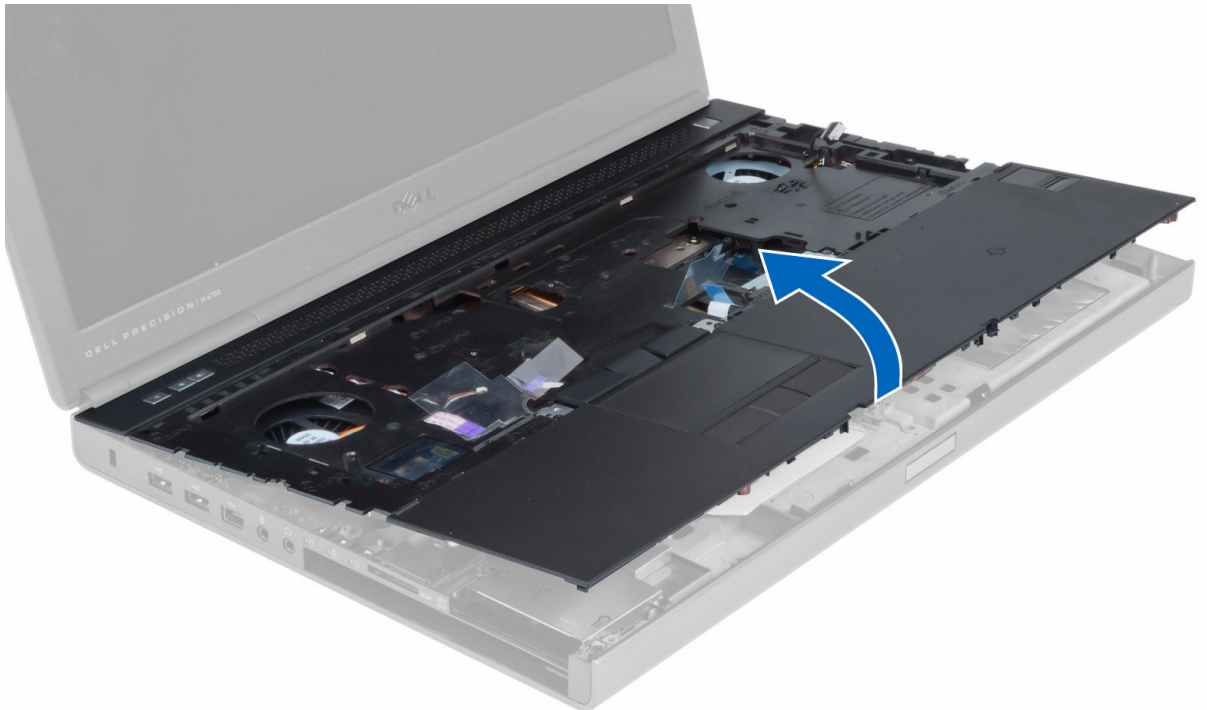

Installing the Palmrest

1. Align the palmrest to its original position on the computer and press on the positions indicated until it snaps in place.



2. Tighten the screws that secure the palmrest to the computer.
3. Connect the following cables:
 - a. power button
 - b. touchpad
 - c. media board
 - d. speaker
4. Affix the adhesive tape that secures the media card cable, speaker cable and touchpad cable to the palmrest.
5. Tighten the screws at the bottom of the computer.
6. Connect the smart card cable and affix the adhesive tape that secures it to the computer.
7. Install the:
 - a. secondary hard drive (if available)
 - b. primary hard drive
 - c. optical drive
 - d. keyboard
 - e. keyboard trim
 - f. base cover
 - g. battery
8. Follow the procedures in *After Working Inside Your Computer*.

Removing the ExpressCard Module

1. Follow the procedures in *Before Working Inside Your Computer*.
2. Remove the:
 - a. ExpressCard
 - b. battery
 - c. base cover
 - d. keyboard trim
 - e. keyboard
 - f. optical drive
 - g. primary and secondary hard drive
 - h. palm rest
3. Disconnect the :
 - a. ExpressCard cable from the system board
 - b. USH board cable from the USH board

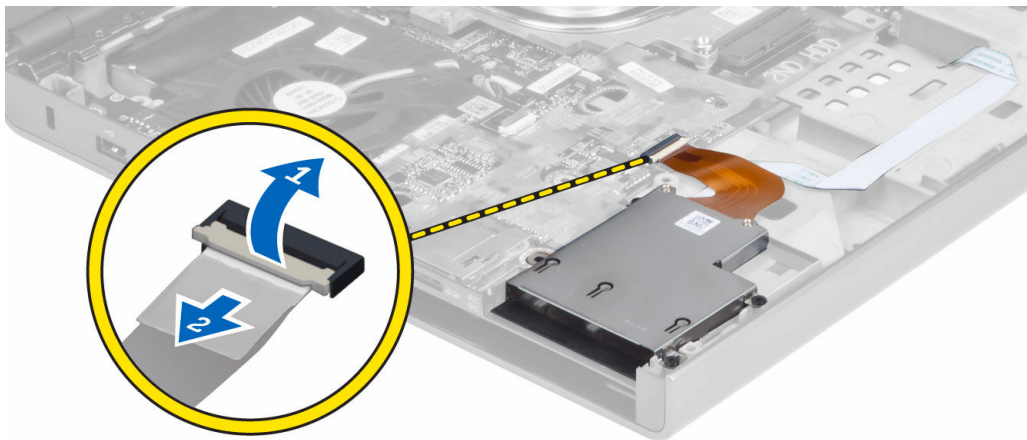

4. Remove the screws that secure the ExpressCard module to the computer and remove the ExpressCard module.

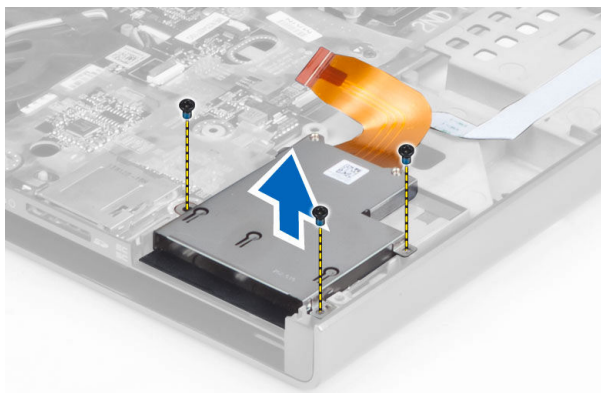

Installing the ExpressCard Module

1. Insert the ExpressCard module into its compartment.
2. Tighten the screws to secure the ExpressCard module to the computer.
3. Connect the:
 - a. ExpressCard cable to the system board
 - b. USH board cable to the USH board
4. Install the:
 - a. palm rest
 - b. primary and secondary hard drive
 - c. optical drive
 - d. keyboard
 - e. keyboard trim
 - f. base cover
 - g. battery
 - h. ExpressCard
5. Follow the procedures in *After Working Inside Your Computer*.

Removing The Heat Sink

1. Follow the procedures in *Before Working Inside Your Computer*.
2. Remove the:
 - a. battery
 - b. base cover
 - c. keyboard trim
 - d. keyboard
 - e. optical drive
 - f. primary and secondary hard drive
 - g. palm rest
 - h. processor fan
3. Loosen the captive screws that secure the heat sink to the computer. Lift up and remove the heat sink from the computer.

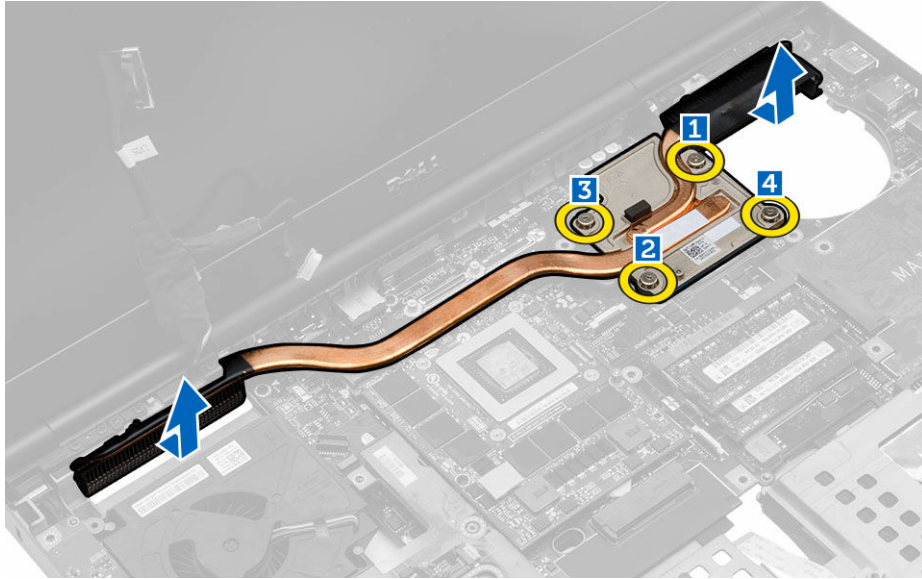

Installing the Heat Sink

1. Replace the heat sink in its slot.
2. Tighten the captive screws to secure the heat sink to the computer.
3. Connect the camera cable to the system board.
4. Install the:
 - a. processor fan
 - b. palm rest
 - c. primary and secondary hard drive
 - d. optical drive
 - e. keyboard
 - f. keyboard trim
 - g. base cover
 - h. battery
5. Follow the procedures in *After Working Inside Your Computer*.

Removing the Processor

1. Follow the procedures in *Before Working Inside Your Computer*.
2. Remove the:
 - a. battery
 - b. base cover
 - c. keyboard trim
 - d. keyboard
 - e. optical drive
 - f. primary and secondary hard drive
 - g. palm rest
 - h. processor fan
 - i. heat sink

3. Rotate the processor cam lock in a counter-clockwise direction. Remove the processor from the computer.

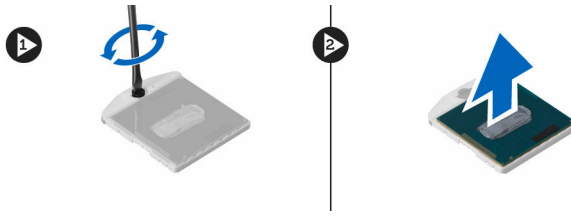

Installing the Processor

1. Align the notches on the processor and the socket, and insert the processor into the socket.
2. Rotate the processor cam lock in a clockwise direction.
3. Install the:
 - a. heat sink
 - b. processor fan
 - c. palm rest
 - d. primary and secondary hard drive
 - e. optical drive
 - f. keyboard
 - g. keyboard trim
 - h. base cover
 - i. battery
4. Follow the procedures in *After Working Inside Your Computer*.

Removing The Video-Card Heat Sink

1. Follow the procedures in *Before Working Inside Your Computer*.
2. Remove the:
 - a. battery
 - b. base cover
 - c. keyboard trim
 - d. keyboard
 - e. optical drive
 - f. primary and secondary hard drive
 - g. palm rest
 - h. heat-sink fan
 - i. heatsink
3. Perform the following steps to remove the video-card heat sink:
 - a. Disconnect the LVDS cable [1].
 - b. Remove the screws that secure the LVDS cable bracket to the computer. [2]
 - c. Remove the LVDS cable which was held in place by the bracket. [3]



4. Loosen the captive screws that secure the video-card heatsink to the computer [1, 2, 3, 4]. Remove the video-card heatsink from the computer.

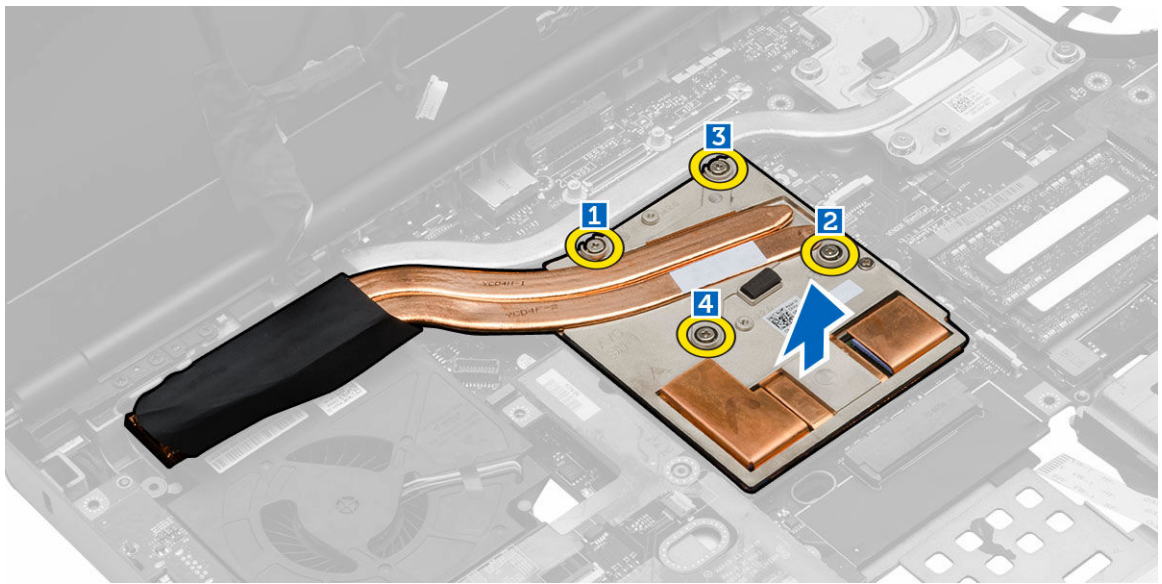

Installing the Video-Card Heat Sink

1. Replace the video-card heat sink in its slot.
2. Tighten the captive screws to secure the video-card heat sink to the computer.
3. Connect and route the LVDS cable.
4. Tighten the screws to secure the LVDS cable bracket to the computer.
5. Install the:
 - a. heat sink
 - b. heat-sink fan
 - c. palm rest
 - d. primary and secondary hard drive
 - e. optical drive
 - f. keyboard
 - g. keyboard trim
 - h. base cover

- i. battery
- 6. Follow the procedures in *After Working Inside Your Computer*.

Removing the Video Card

1. Follow the procedures in *Before Working Inside Your Computer*.
2. Remove the:
 - a. battery
 - b. base cover
 - c. keyboard trim
 - d. keyboard
 - e. optical drive
 - f. hard drive
 - g. palm rest
 - h. video fan
 - i. video heat sink
3. Perform the following steps as shown in the illustration:
 - a. Remove the screws that secure the video card to the computer.
 - b. Remove the video card from the computer.

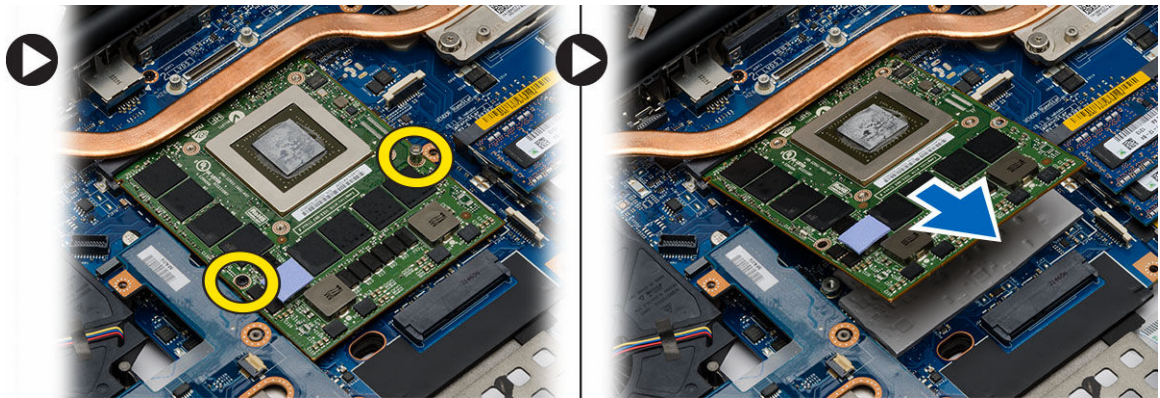

Installing the Video Card

1. Slide the video card into its original position in the computer.
2. Tighten the screws to secure the video card to the computer.
3. Install the:
 - a. video heat sink
 - b. video fan
 - c. palm rest
 - d. hard drive
 - e. optical drive
 - f. keyboard
 - g. keyboard trim
 - h. bottom door
 - i. battery
4. Follow the procedures in *After Working Inside Your Computer*.

Removing the Input/Output (I/O) Board

1. Follow the procedures in *Before Working Inside Your Computer*.
2. Remove the:
 - a. SD card
 - b. battery
 - c. base cover
 - d. keyboard trim
 - e. keyboard
 - f. optical drive
 - g. primary and secondary hard drive
 - h. palmrest
3. Perform the following steps to remove the I/O board:
 - a. Disconnect the ExpressCard module connector from the I/O board.
 - b. Remove the screw that secures the I/O board to the computer.
 - c. Lift the right edge of the I/O board upwards to disengage the connector and remove it from computer.

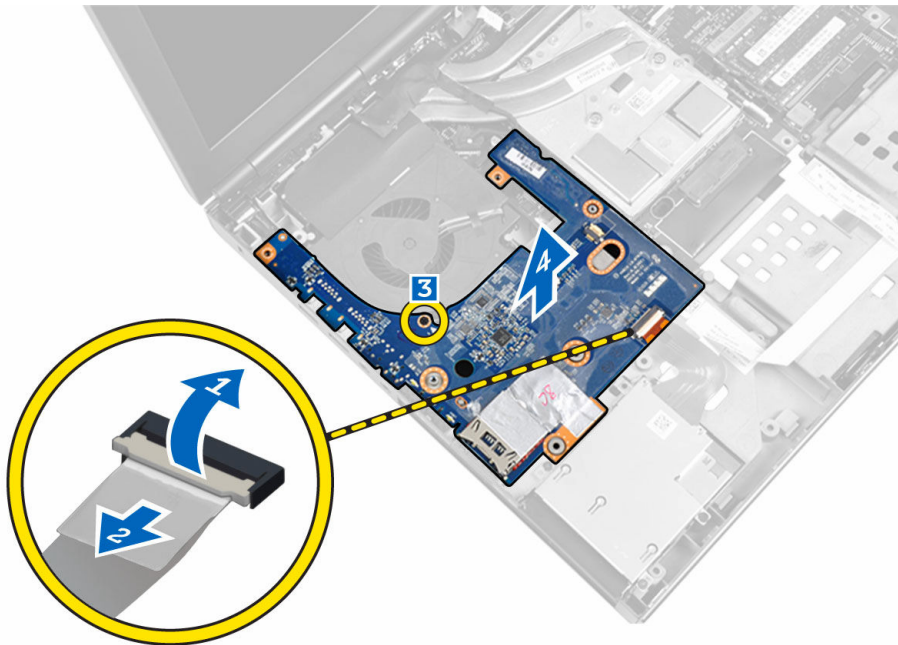

Installing the I/O Board

1. Connect the I/O board connector and slide the I/O board into its slot in the computer.
2. Tighten the screw to secure the I/O board to the computer.
3. Connect the ExpressCard module connector to the I/O board.
4. Install the:
 - a. palmrest
 - b. primary and secondary hard drive

- c. optical drive
 - d. keyboard
 - e. keyboard trim
 - f. base cover
 - g. battery
 - h. SD card
5. Follow the procedures in *After Working Inside Your Computer*.

Removing the Display Assembly

1. Follow the procedures in *Before Working Inside Your Computer*.
2. Remove the:
 - a. battery
 - b. base cover
 - c. keyboard trim
 - d. keyboard
 - e. optical drive
 - f. primary and secondary hard drive
 - g. palmrest
3. Disconnect the antenna cables from the wireless cards, and push them down the routing hole.

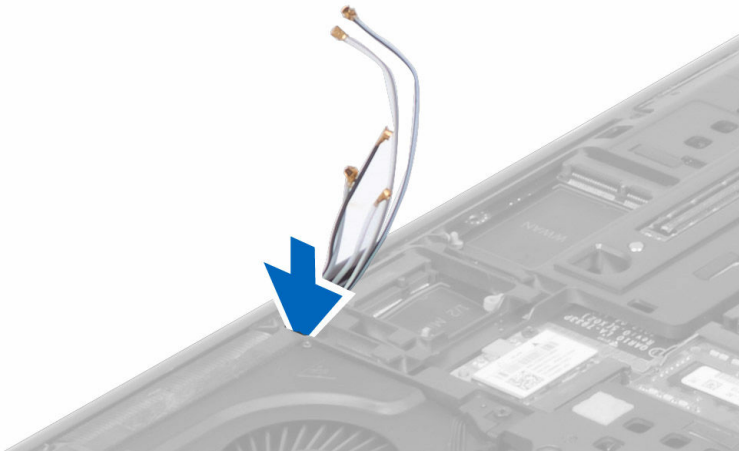

4. Flip the computer and pull up the antenna cables through the routing hole.

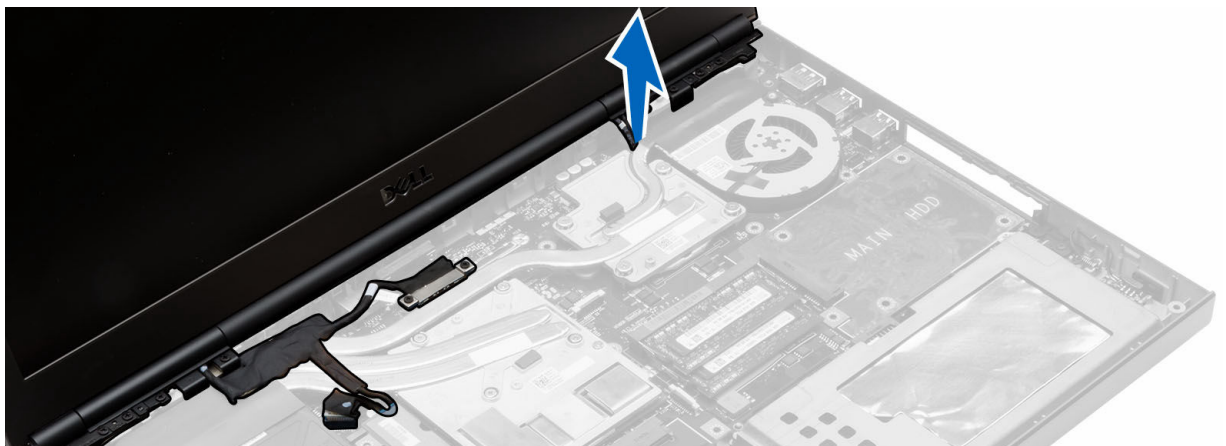

5. Flip the computer and remove the screws from the bottom and back of the computer.



6. Remove the screw that secures the low-voltage differential signalling (LVDS) cable bracket. Remove the LVDS cable bracket and disconnect the LVDS and camera cable from the system board.



7. Remove the screws that secure the display assembly to the computer. Remove the display assembly from the computer.

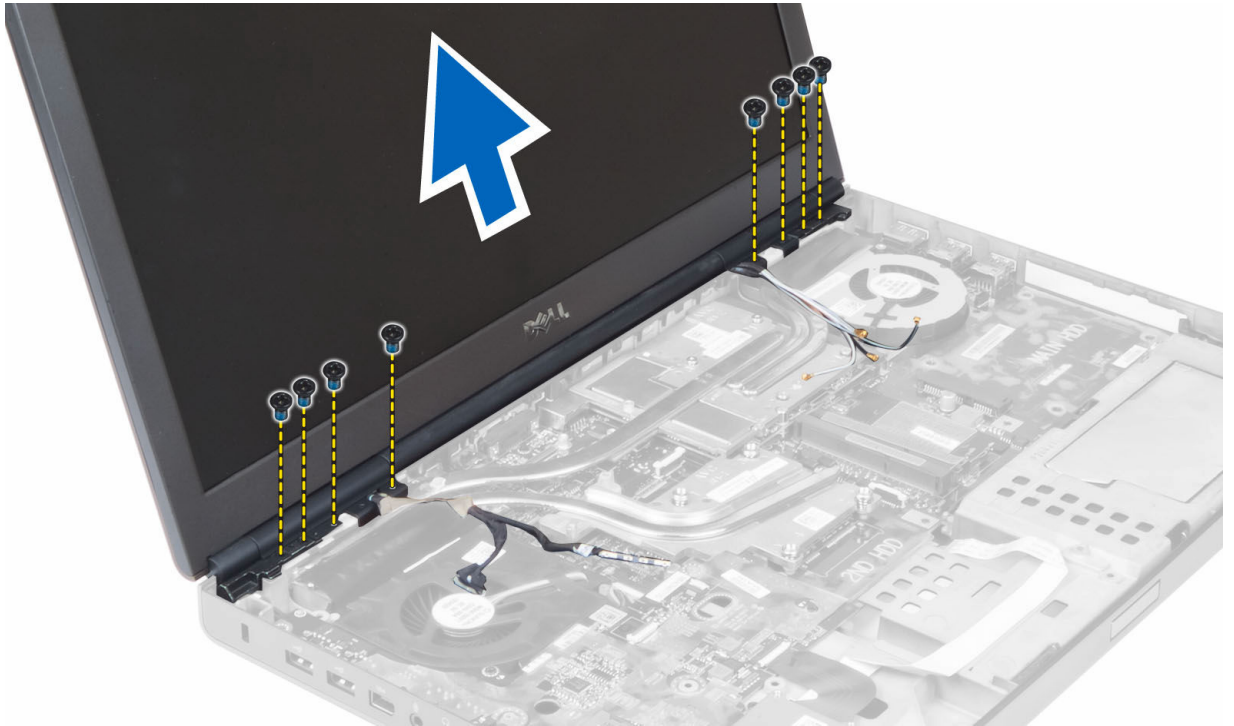

Installing the Display Assembly

1. Tighten the screws to secure the display assembly in place.
2. Connect the camera and LVDS cables to the correct connectors on the system board.
3. Place the LVDS cable bracket on the computer and tighten the screws to secure it to the computer.
4. Route the cables through the routing channels.
5. Insert the wireless antenna cables through the routing hole on the chassis.
6. Tighten the screws at the bottom and back of the computer.
7. Route and connect the antenna cables to their connectors.
8. Install the:
 - a. palmrest
 - b. primary and secondary hard drive
 - c. optical drive
 - d. keyboard
 - e. keyboard trim
 - f. base cover
 - g. battery
9. Follow the procedures in *After Working Inside Your Computer*.

Removing the Hinge Cover

1. Follow the procedures in *Before Working Inside Your Computer*.
2. Remove the:
 - a. battery

- b. base cover
 - c. keyboard trim
 - d. keyboard
 - e. optical drive
 - f. primary and secondary hard drive
 - g. palmrest
 - h. display assembly
3. Remove the screws that secure the hinge cover to the computer. Remove the hinge cover from the computer.

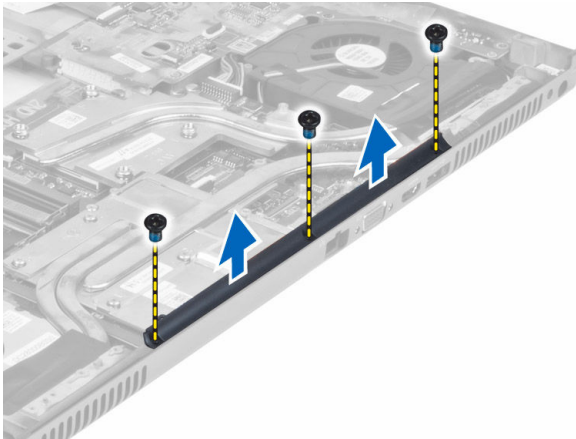

Installing the Hinge Cover

1. Place the hinge cover in its position on the computer.
2. Tighten the screws to secure the hinge cover to the computer.
3. Install the:
 - a. display assembly
 - b. palmrest
 - c. primary and secondary hard drive
 - d. optical drive
 - e. keyboard
 - f. keyboard trim
 - g. base cover
 - h. battery
4. Follow the procedures in *After Working Inside Your Computer*.

Removing the System Board

1. Follow the procedures in *Before Working Inside Your Computer*.
2. Remove the:
 - a. SD card
 - b. ExpressCard
 - c. battery
 - d. base cover
 - e. keyboard trim

- f. keyboard
 - g. optical drive
 - h. primary and secondary hard drive
 - i. primary memory
 - j. secondary memory
 - k. video-card fan
 - l. palmrest
 - m. heatsink
 - n. processor
 - o. video-card heatsink
 - p. video card
 - q. I/O board
 - r. display assembly
3. Disconnect the processor-fan cable, LVDS cable and the coin-cell battery cable from the system board.

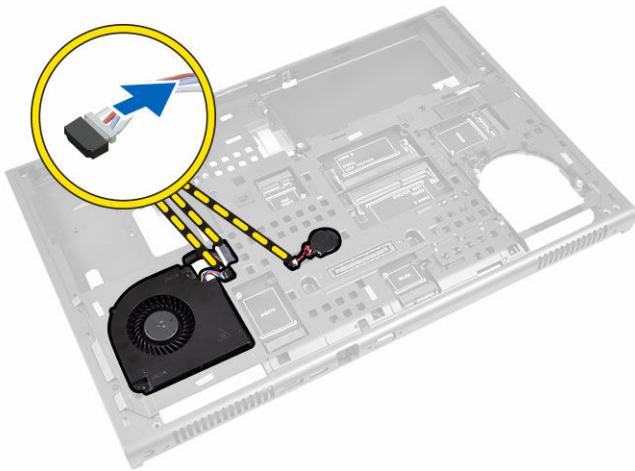

4. Disconnect the power connector cable. Remove the screws that secure the system board to the computer and lift the bottom edge of the system board at a 20-degree angle.

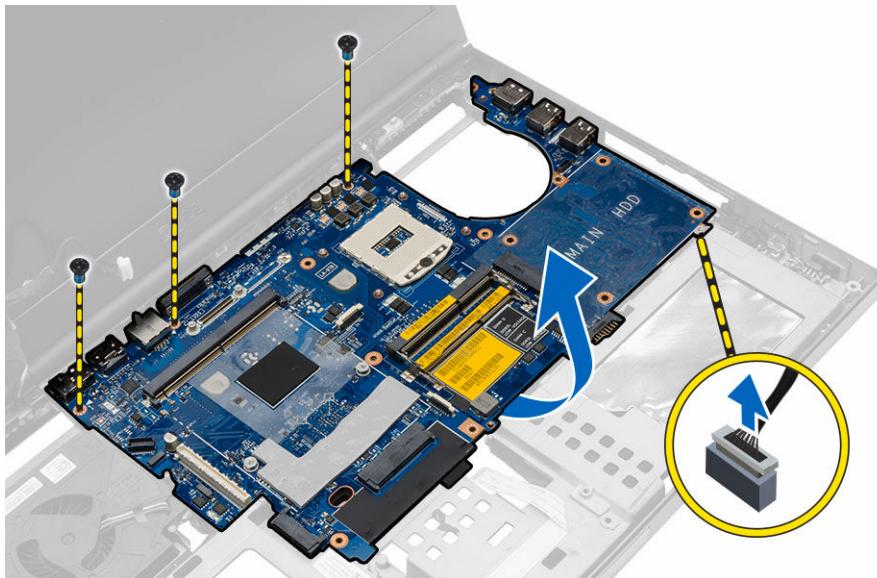

5. Remove the system board from the computer.

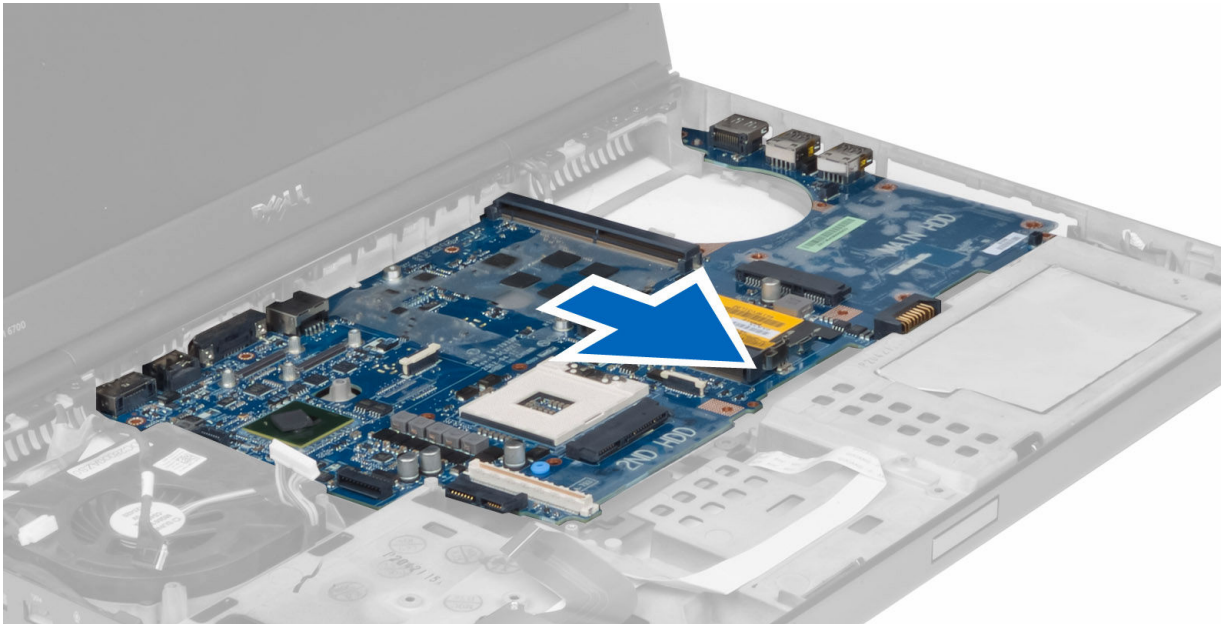

Installing the System Board

1. Align the system board into its original position on the computer.
2. Tighten the screws to secure the system board to the computer.
3. Connect the following cables:
 - a. power connector
 - b. LVDS
 - c. coin-cell battery
 - d. processor fan
4. Install the:
 - a. I/O board
 - b. video card
 - c. video-card heat sink.
 - d. processor
 - e. heatsink
 - f. palmrest
 - g. video-card fan
 - h. secondary memory
 - i. primary memory
 - j. primary and secondary hard drive
 - k. optical drive
 - l. keyboard
 - m. keyboard trim
 - n. base cover
 - o. battery
 - p. ExpressCard
 - q. SD card

5. Follow the procedures in *After Working Inside Your Computer*.

Removing the Power-Connector Port

1. Follow the procedures in *Before Working Inside Your Computer*.
2. Remove the:
 - a. battery
 - b. base cover
 - c. keyboard trim
 - d. keyboard
 - e. optical drive
 - f. primary and secondary hard drive
 - g. palmrest
 - h. I/O board
 - i. display assembly
3. Disconnect the power-connector cable from the system board and remove the power connector port from the computer.

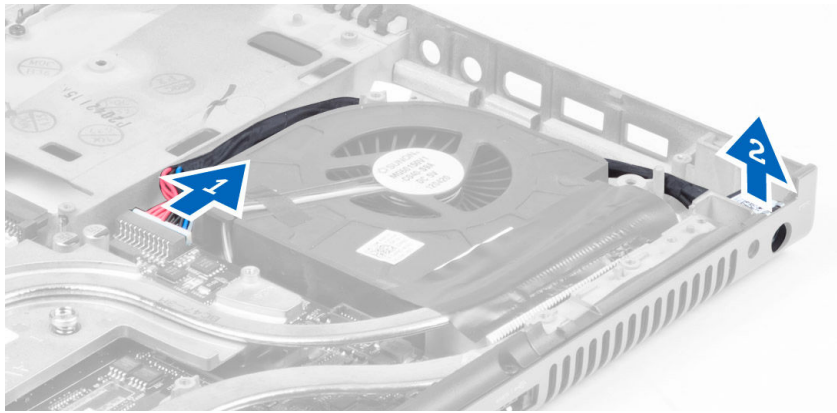

Installing the Power Connector Port

1. Insert the power-connector port in its slot and connect the power-connector cable to the system board.
2. Install the:
 - a. display assembly
 - b. I/O board
 - c. palmrest
 - d. primary and secondary hard drive
 - e. optical drive
 - f. keyboard
 - g. keyboard trim
 - h. base cover
 - i. battery
3. Follow the procedures in *After Working Inside Your Computer*.

Removing the Switch Board

1. Follow the procedures in *Before Working Inside Your Computer*.
2. Remove the:
 - a. battery
 - b. base cover
 - c. keyboard trim
 - d. keyboard
 - e. optical drive
 - f. primary and secondary hard drive
 - g. palmrest
3. Disconnect the switch-board cable from the system board and remove it from the latches. Remove the screws that secure the switch board to the computer and remove it from the computer.

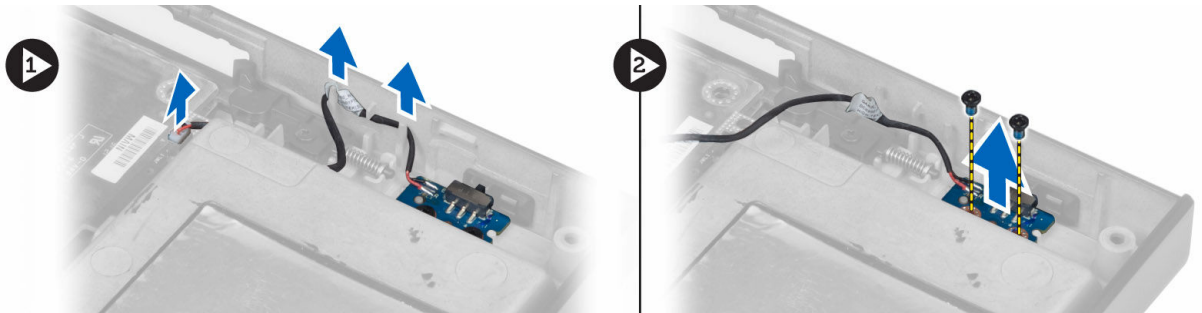

Installing the Switch Board

1. Align the switch board to its original position on the computer.
2. Tighten the screws to secure the switch board to the computer.
3. Connect the switch-board cable to the system board and secure it through the routing channel.
4. Install the:
 - a. palmrest
 - b. primary and secondary hard drive
 - c. optical drive
 - d. keyboard
 - e. keyboard trim
 - f. base cover
 - g. battery
5. Follow the procedures in *After Working Inside Your Computer*.

System Setup

System Setup enables you to manage your computer hardware and specify BIOS-level options. From the System Setup, you can:

- Change the NVRAM settings after you add or remove hardware
- View the system hardware configuration
- Enable or disable integrated devices
- Set performance and power management thresholds
- Manage your computer security

Boot Sequence

Boot Sequence allows you to bypass the System Setup-defined boot device order and boot directly to a specific device (for example: optical drive or hard drive). During the Power-on Self Test (POST), when the Dell logo appears, you can:

- Access System Setup by pressing <F2> key
- Bring up the one-time boot menu by pressing <F12> key

The one-time boot menu displays the devices that you can boot from including the diagnostic option. The boot-menu options are:

- Removable Drive (if available)
- STXXXX Drive

 **NOTE:** XXX denotes the SATA drive number.

- Optical Drive
- Diagnostics

 **NOTE:** Choosing Diagnostics, will display the **ePSA diagnostics** screen.

The boot sequence screen also displays the option to access the System Setup screen.

Navigation Keys

The following table displays the system setup navigation keys.



 **NOTE:** For most of the system setup options, changes that you make are recorded but do not take effect until you re-start the system.

Table 1. Navigation Keys

Keys	Navigation
Up arrow	Moves to the previous field.
Down arrow	Moves to the next field.
<Enter>	Allows you to select a value in the selected field (if applicable) or follow the link in the field.
Spacebar	Expands or collapses a drop-down list, if applicable.
<Tab>	Moves to the next focus area.
	 NOTE: For the standard graphics browser only.
<Esc>	Moves to the previous page till you view the main screen. Pressing <Esc> in the main screen displays a message that prompts you to save any unsaved changes and restarts the system.
<F1>	Displays the System Setup help file.

System Setup Options

 **NOTE:** Depending on your computer and its installed devices, the items listed in this section may or may not appear.

Table 2. General

Option	Description
System Information	This section lists the primary hardware features of your computer. <ul style="list-style-type: none"> • System Information • Memory Information • Processor Information • Device Information
Battery Information	Displays the charge status of the battery.
Boot Sequence	Allows you to change the order in which the computer attempts to find an operating system. All the below options are enabled by default. <ul style="list-style-type: none"> • Windows Boot Manager (Default Setting) • UEFI: WDC WD7500BPKT-75PK4TO (Default Setting) <p>You can also choose the Boot List option. The options are:</p> <ul style="list-style-type: none"> • Legacy • UEFI (Default Setting)
Advanced Boot Options	When in UEFI boot mode, the Enable Legacy Option ROMs option will allow



Option	Description
	<p>legacy option ROMs to load. This option is disabled by default.</p> <p> NOTE: Without this option, only UEFI option ROMs will load. This option is required for Legacy boot mode. This option is not allowed if Secure Boot is enabled.</p> <ul style="list-style-type: none"> Field Enable Legacy Option ROMs
Date/Time	Allows you to set the date and time.

Table 3. System Configuration

Option	Description
Integrated NIC	<p>Allows you to configure the integrated network controller. The options are:</p> <ul style="list-style-type: none"> Enable UEFI Network Stack Disabled Enabled Enabled w/PXE (Default Setting)
Parallel Port	<p>Allows you to define and set how the parallel port on the docking station operates. You can set the parallel port to:</p> <ul style="list-style-type: none"> Disabled AT (Default Setting) PS2 ECP
Serial Port	<p>Identifies and defines the serial port settings. You can set the serial port to:</p> <ul style="list-style-type: none"> Disabled COM1 (Default Setting) COM2 COM3 COM4 <p> NOTE: The operating system may allocate resources even if the setting is disabled.</p>
SATA Operation	<p>Allows you to configure the internal SATA hard-drive controller. The options are:</p> <ul style="list-style-type: none"> Disabled ATA AHCI RAID On (Default Setting)

Option	Description
Drives	<p data-bbox="943 249 1321 304"> NOTE: SATA is configured to support RAID mode.</p> <p data-bbox="943 331 1385 386">Allows you to configure the SATA drives on board. The options are:</p> <ul data-bbox="943 396 1171 627" style="list-style-type: none"> <li data-bbox="943 396 1066 422">• SATA-0 <li data-bbox="943 432 1066 457">• SATA-1 <li data-bbox="943 468 1066 493">• SATA-2 <li data-bbox="943 504 1066 529">• SATA-3 <li data-bbox="943 539 1066 564">• SATA-4 <li data-bbox="943 575 1066 600">• SATA-5 <li data-bbox="943 611 1171 636">• Zero Power ODD <p data-bbox="943 653 1385 701">Default Setting: The highlighted devices are enabled.</p>
SMART Reporting	<p data-bbox="943 743 1390 936">This field controls if the hard drive errors for the integrated drives are reported during system startup. This technology is part of the SMART (Self Monitoring Analysis and Reporting Technology) specification. This option is disabled by default.</p> <ul data-bbox="943 953 1257 978" style="list-style-type: none"> <li data-bbox="943 953 1257 978">• Enable SMART Reporting
USB Configuration	<p data-bbox="943 1010 1286 1064">Allows you to define the USB configuration. The options are:</p> <ul data-bbox="943 1075 1278 1167" style="list-style-type: none"> <li data-bbox="943 1075 1219 1100">• Enable Boot Support <li data-bbox="943 1110 1278 1136">• Enable USB 3.0 Controller <li data-bbox="943 1146 1267 1171">• Enable External USB Port <p data-bbox="943 1188 1321 1241">Default Setting: All the options are enabled.</p>
USB PowerShare	<p data-bbox="943 1283 1390 1362">Allows you to configure the behavior of the USB PowerShare feature. The option is disabled by default.</p> <ul data-bbox="943 1373 1246 1398" style="list-style-type: none"> <li data-bbox="943 1373 1246 1398">• Enable USB PowerShare
Audio	<p data-bbox="943 1440 1302 1486">This field enables or disables the integrated audio controller.</p> <ul data-bbox="943 1497 1315 1524" style="list-style-type: none"> <li data-bbox="943 1497 1315 1524">• Enable Audio (Default Setting)
Keyboard Illumination	<p data-bbox="943 1566 1378 1646">This field lets you choose the operating mode of the keyboard illumination feature.</p> <ul data-bbox="943 1656 1262 1778" style="list-style-type: none"> <li data-bbox="943 1656 1262 1682">• Disabled (Default Setting) <li data-bbox="943 1692 1114 1717">• Level is 25% <li data-bbox="943 1728 1114 1753">• Level is 50% <li data-bbox="943 1764 1114 1789">• Level is 75%

Option	Description
Unobtrusive Mode	<ul style="list-style-type: none"> Level is 100% <p>When enabled, pressing Fn+B will turn Off all light and sound emissions in the system. Press Fn+B to resume normal operation. The option is disabled by default.</p> <ul style="list-style-type: none"> Enable Unobtrusive Mode
Miscellaneous Devices	<p>Allows you enable or disable the various on board devices. The options are:</p> <ul style="list-style-type: none"> Enable Fixed Bay Enable Microphone Enable ExpressCard Enable eSATA Ports Enable Camera Enable Hard Drive Free Fall Protection Enable Media Card Disable Media Card <p>Default Setting: The highlighted devices are enabled.</p>

Table 4. Video









Option	Description
LCD Brightness	Allows you to set the panel brightness when the ambient sensor is Off.
Switchable Graphics	<p>This option enables or disables switchable graphics technologies such as NVIDIA Optimus and AMD Power Express .</p> <p> NOTE: It should only be enabled for Windows 7/8 32/64-bit or Ubuntu OS. This feature is not applicable to other OS.</p> <ul style="list-style-type: none"> Enable Switchable Graphics Enable dock Display Port through Integrated Graphics (Default Setting)

Table 5. Security

Option	Description
Admin Password	<p>Allows you to set, change, or delete the administrator (admin) password.</p> <p> NOTE: You must set the admin password before you set the system or hard drive password.</p> <p> NOTE: Successful password changes take effect immediately.</p> <p> NOTE: Deleting the admin password automatically deletes the system password and the hard drive password.</p>

Option	Description
System Password	 NOTE: Successful password changes take effect immediately. Default Setting: Not set
Internal HDD-0 Password	Allows you to set, change or delete the system password.  NOTE: Successful password changes take effect immediately. Default Setting: Not set
Strong Password	Allows you to set, change or delete the administrator password. Default Setting: Not set Allows you to enforce the option to always set strong passwords. Default Setting: Enable Strong Password is not selected.
Password Configuration	You can define the length of your password. Min = 4 , Max = 32
Password Bypass	Allows you to enable or disable the permission to bypass the System and the Internal HDD password, when they are set. The options are: <ul style="list-style-type: none"> • Disabled (Default Setting) • Reboot bypass
Password Change	Allows you to enable or disable permissions to set a System password and a Hard Drive password when the admin password is set. Default Setting: Allow Non-Admin Password Changes is not selected
Non-Admin Setup Changes	Allows you to determine whether changes to setup option are permitted when an administrator password is set. This option is disabled by default. <ul style="list-style-type: none"> • Allows Wireless Switch Changes
TPM Security	This option lets you control whether the Trusted Platform Module (TPM) in the system is enabled and visible to the operating system. When disabled the BIOS will not turn On the TPM During POST. The TPM will be non-functional and invisible to the operating system. When enabled, the BIOS will turn On the TPM during POST so that it can be used by the operating system. This option is disabled by default.  NOTE: Disabling this option does not change any settings you may have made to the TPM, nor does it delete or change any information or keys you may have stored there. It simply turns Off the TPM so that it cannot be used. When you re-enable this option, the TPM will function exactly as it did before it was disabled.  NOTE: Changes to this option take effect immediately. <ul style="list-style-type: none"> • TPM Security
Computrace	Allows you to activate or disable the optional Computrace software The options are: <ul style="list-style-type: none"> • Deactivate (Default Setting) • Disable

Option	Description
	<ul style="list-style-type: none"> • Activate <p> NOTE: The Activate and Disable options will permanently activate or disable the feature and no further changes will be allowed</p>
CPU XD Support	Allows you to enable the Execute Disable mode of the processor. Default Setting: Enable CPU XD Support
OROM Keyboard Access	Allows you to set access to enter the Option ROM Configuration screens using hotkeys during boot process. The options are: <ul style="list-style-type: none"> • Enable (Default Setting) • One Time Enable • Disable
Admin Setup Lockout	Allows you to prevent users from entering Setup when an Administrator password is set. Default Setting: Disabled

Table 6. Secure Boot

Option	Description
Secure Boot Enable	This option enables or disables the Secure Boot feature. <ul style="list-style-type: none"> • Disabled (Default Setting) • Enabled
Expert Key Management	Expert key Management allows the PK, KEK, db, and dbx security key databases to be manipulated. <ul style="list-style-type: none"> • Expert Key Management <ul style="list-style-type: none"> – Enable Custom Mode - Disabled by default • Custom Mode Key Management <ul style="list-style-type: none"> – PK (Default Setting) – KEK – Db – Dbx

Table 7. Performance

Option	Description
Multi Core Support	This field specifies whether the process will have one or all cores enabled. The performance of some applications will improve with the additional cores. This option is enabled by default. Allows you to enable or disable multi-core support for the processor. The options are:

Option	Description
	<ul style="list-style-type: none"> • All (Default Setting) • 1 • 2
Intel SpeedStep	<p>Allows you to enable or disable the Intel SpeedStep feature.</p> <p>Default Setting: Enable Intel SpeedStep</p>
C States Control	<p>Allows you to enable or disable the additional processor sleep states. Allows you to enable or disable the additional processor sleep states.</p> <p>Default Setting: C states.</p>
Limit CPUID	<p>This field limits the maximum value the processor Standard CPUID Function will support. Some operating systems will not complete installation when the maximum CPUID Function supported is greater than 3. This option is disabled by default.</p> <p>Enable CPUID Limit</p>
Intel TurboBoost	<p>Allows you to enable or disable the Intel TurboBoost mode of the processor.</p> <p>Default Setting: Enable Intel TurboBoost</p>
Hyper-Thread Control	<p>Allows you to enable or disable the HyperThreading in the processor.</p> <p>Default Setting: Enabled</p>
Rapid Start Technology	<p>Allows you to set the Rapid Start Technology feature. This feature is enabled by default. You can define the Rapid Start timer value.</p>

Table 8. Power Management

Option	Description
AC Behavior	<p>Allows the computer to power-up automatically, when AC adapter is plugged. The option is disabled.</p> <ul style="list-style-type: none"> • Wake on AC
Auto On Time	<p>Allows you to set the time at which the computer must turn on automatically. The options are:</p> <ul style="list-style-type: none"> • Disabled (Default Setting) • Every Day • Weekdays • Select Days

Option	Description
Deep Sleep Control	<p>Controls where Deep Sleep is enabled. The options are:</p> <ul style="list-style-type: none"> • Disabled (Default Setting) • Enabled in S5 only • Enabled in S4 and S5
USB Wake Support	<p>Allows you to enable the USB devices to wake the computer from standby mode. The option is disabled</p> <ul style="list-style-type: none"> • Enable USB Wake Support
Wireless Radio Control	<p>Allows you to control the WLAN and WWAN radio. The options are:</p> <ul style="list-style-type: none"> • Control WLAN radio • Control WWAN radio <p>Default Setting: both the options are disabled.</p>
Wake on LAN/WLAN	<p>This option allows the computer to power up from the off state when triggered by a special LAN signal. Wake-up from the Standby state is unaffected by this setting and must be enabled in the operating system. This feature only works when the computer is connected to AC power supply.</p> <ul style="list-style-type: none"> • Disabled - Does not allow the system to power on by special LAN signals when it receives a wake-up signal from the LAN or wireless LAN. (Default Setting) • LAN or WLAN - Allows the system to be powered on by special LAN signals or WLAN signals. • LAN Only - Allows the system to be powered on by special LAN signals. • LAN with PXE Boot - A wakeup packet sent to the system in either the S4 or S5 state will cause the system to wake-up and immediately boot to PXE. • WLAN Only - Allows the system to be powered on by special WLAN signals.
Block Sleep	<p>Allows you to block the computer from entering into the sleep state. This option is disabled by default.</p> <ul style="list-style-type: none"> • Block Sleep (S3)
Peak Shift	<p>Peak Shift can be used to minimize AC consumption during peak power times of day. For each weekday listed, set a start and end time to run in Peak Shift mode. During these times the system will run from the battery even if the AC is attached as long as the battery stays above the threshold specified in the Battery Threshold field. After the end time specified the system will run from AC if attached but will not charge the battery. The system will again function normally using AC and recharging the battery after the Charge Start time is specified. This option is disabled by default.</p> <ul style="list-style-type: none"> • Enable Peak Shift
Advanced Battery Charge Configuration	<p>This places all batteries in the system in Advanced Battery Charging Mode to maximize battery health. In Advanced Charging Mode the system will use standard charging algorithm and other techniques during non-work hours to maximize battery health. During work hours express</p>

Option	Description
	<p>charge is used so that the battery will be charged faster and therefore ready to use again sooner. For each weekday, specify the time of day in which the system will be most heavily used. Setting the Work Period to 0 means the system will only be lightly used that day. This option is disabled by default.</p> <ul style="list-style-type: none"> • Enable Advanced Battery Charge Mode
Primary Battery Configuration	<p>Allows you to define how to use the battery charge, when AC is plugged in. The options are:</p> <ul style="list-style-type: none"> • Adaptive • Standard Charge • Express Charge • Primarily AC use • Custom Charge - You can set the percentage to which the battery must charge .
Battery Slice Configuration	<p>Allows you to define the how to charge the battery. The options are:</p> <ul style="list-style-type: none"> • Standard Charge • Express Charge (Default Setting)
Module Bay Battery Charge Configuration	<ul style="list-style-type: none"> • Standard – Fully charges your battery at a standard rate • Express Charge - The battery may be charged over a shorter period of time using Dell's fast charging technology. <p> NOTE: Battery settings may not be available for all battery types. In order to enable this option Advanced Battery Charge Mode must be disabled.</p>

Table 9. POST Behavior

Option	Description
Adapter Warnings	<p>Allows you to activate the adapter warning messages when certain power adapters are used. The option is disabled by default.</p> <ul style="list-style-type: none"> • Enable Adapter Warnings
Mouse/Touchpad	<p>Allows you to define how the computer handles the mouse and touchpad input. The options are:</p> <ul style="list-style-type: none"> • Serial Mouse • PS2 Mouse • Touchpad/PS-2 Mouse (Default Setting)
Numlock Enable	<p>Specifies if the NumLock function can be enabled when the computer boots. This option is enabled by default.</p> <ul style="list-style-type: none"> • Enable Numlock
Fn Key Emulation	<p>Allows you to match the <Scroll Lock> key feature of PS-2 keyboard with the <Fn> key feature in an internal keyboard. The option is enabled by default.</p> <ul style="list-style-type: none"> • Enable Fn Key Emulation

Option	Description
MEBx Hotkey	This option specifies whether the MEBx Hotkey function should be enabled when the system boots. <ul style="list-style-type: none"> • Enable MEBx Hotkey (Default Setting)
Fastboot	This option can speed up the boot process by bypassing some compatibility steps. <ul style="list-style-type: none"> • Minimal – Reduces boot time by skipping certain hardware and configuration initialization during boot. • Thorough – Performs complete hardware and configuration initialization during boot. (Default Setting) • Auto – Allows the BIOS to decide configuration initialization performed during the boot.
Extend BIOS POST Time	This option creates an additional pre-boot delay. This allows the user to see POST status messages. <ul style="list-style-type: none"> • 0 seconds (Default Setting) • 5 seconds • 10 seconds

Table 10. Virtualization Support

Option	Description
Virtualization	This option specifies whether a Virtual Machine Monitor (VMM) can utilize the additional hardware capabilities provided by Intel Virtualization technology. <ul style="list-style-type: none"> • Enable Intel Virtualization Technology - Default Setting.
VT for Direct I/O	Enables or disables the Virtual Machine Monitor (VMM) from utilizing the additional hardware capabilities provided by Intel Virtualization technology for direct I/O. <ul style="list-style-type: none"> • Enable Intel Virtualization Technology for Direct I/O - Default Setting.
Trusted Execution	This option specifies whether a Measured Virtual Machine Monitor (MVMM) can utilize the additional hardware capabilities provided by Intel® Trusted Execution Technology. The TPM Virtualization Technology, and Virtualization Technology for Direct I/O must be enabled to use this feature. This option is disabled by default. <ul style="list-style-type: none"> • Trusted execution

Table 11. Wireless

Option	Description
Wireless Switch	Allows you to determine which wireless device can be controlled by the wireless switch. The options are: <ul style="list-style-type: none"> • WWAN • WLAN • WiGig • Bluetooth

Option	Description
	All options are enabled by default.
Wireless Device Enable	Allows you to enable or disable the wireless devices. The options are: <ul style="list-style-type: none"> • WWAN • WLAN/WiGig • Bluetooth All options are enabled by default.

Table 12. Maintenance



Option	Description
Service Tag	Displays the service tag of your computer.
Asset Tag	Allows you to create a system asset tag if an asset tag is not already set. This option is not set by default.

Table 13. System Logs

Option	Description
BIOS events	Displays the system event log and allows you to clear the log.
Thermal Events	Displays the thermal event logs and allows you clear the thermal event log.
Power Events	Displays the power event logs and allows you clear the power event log.

Updating the BIOS

It is recommended to update your BIOS (system setup), on replacing the system board or if an update is available. For laptops, ensure that your computer battery is fully charged and connected to a power outlet.

1. Restart the computer.
2. Go to dell.com/support.
3. If you have your computer's Service Tag or Express Service Code:
 -  **NOTE:** To locate the Service Tag, click **Where is my Service Tag?**
 -  **NOTE:** If you cannot find your Service Tag, click **Detect Service Tag**. Proceed with the instructions on screen.
4. Enter the **Service Tag** or **Express Service Code** and click **Submit**.
5. If you are unable to locate or find the Service Tag, click the Product Category of your computer.
6. Choose the **Product Type** from the list.
7. Select your computer model and the **Product Support** page of your computer appears.
8. Click **Drivers & Downloads**.
9. On the Drivers and Downloads screen, under the **Operating System** drop-down list, select **BIOS**.
10. Identify the latest BIOS file and click **Download File**.
11. Select your preferred download method in the **Please select your download method below window**; click **Download File**.

- The **File Download** window appears.
12. Click **Save** to save the file on your computer.
 13. Click **Run** to install the updated BIOS settings on your computer.
Follow the instructions on the screen.

System and Setup Password

You can create a system password and a setup password to secure your computer.

Password Type	Description
System password	Password that you must enter to log on to your system.
Setup password	Password that you must enter to access and make changes to the BIOS settings of your computer.

 **CAUTION:** The password features provide a basic level of security for the data on your computer.

 **CAUTION:** Anyone can access the data stored on your computer if it is not locked and left unattended.

 **NOTE:** Your computer is shipped with the system and setup password feature disabled.

Assigning a System Password and Setup Password

You can assign a new **System Password** and/or **Setup Password** or change an existing **System Password** and/or **Setup Password** only when **Password Status** is **Unlocked**. If the Password Status is **Locked**, you cannot change the System Password.

 **NOTE:** If the password jumper is disabled, the existing System Password and Setup Password are deleted and you need not provide the system password to log on to the computer.

To enter a system setup, press <F2> immediately after a power-on or re-boot.

1. In the **System BIOS** or **System Setup** screen, select **System Security** and press <Enter>. The **System Security** screen appears.
2. In the **System Security** screen, verify that **Password Status** is **Unlocked**.
3. Select **System Password**, enter your system password, and press <Enter> or <Tab>. Use the following guidelines to assign the system password:
 - A password can have up to 32 characters.
 - The password can contain the numbers 0 through 9.
 - Only lower case letters are valid, upper case letters are not allowed.
 - Only the following special characters are allowed: space, ("), (+), (.), (-), (:), (/), (;), (|), (\), (!), (').

Re-enter the system password when prompted.

4. Type the system password that you entered earlier and click **OK**.
5. Select **Setup Password**, type your system password and press <Enter> or <Tab>. A message prompts you to re-type the setup password.
6. Type the setup password that you entered earlier and click **OK**.
7. Press <Esc> and a message prompts you to save the changes.
8. Press <Y> to save the changes.

The computer reboots.

Deleting or Changing an Existing System and/or Setup Password

Ensure that the **Password Status** is Unlocked (in the System Setup) before attempting to delete or change the existing System and/or Setup password. You cannot delete or change an existing System or Setup password, if the **Password Status** is Locked.

To enter the System Setup, press <F2> immediately after a power-on or reboot.

1. In the **System BIOS** or **System Setup** screen, select **System Security** and press <Enter>. The **System Security** screen is displayed.
2. In the **System Security** screen, verify that **Password Status** is **Unlocked**.
3. Select **System Password**, alter or delete the existing system password and press <Enter> or <Tab>.
4. Select **Setup Password**, alter or delete the existing setup password and press <Enter> or <Tab>.



NOTE: If you change the System and/or Setup password, re-enter the new password when promoted. If you delete the System and/or Setup password, confirm the deletion when promoted.

5. Press <Esc> and a message prompts you to save the changes.
6. Press <Y> to save the changes and exit from the System Setup.

The computer reboots.

Diagnostics

If you experience a problem with your computer, run the ePSA diagnostics before contacting Dell for technical assistance. The purpose of running diagnostics is to test your computer's hardware without requiring additional equipment or risking data loss. If you are unable to fix the problem yourself, service and support personnel can use the diagnostics results to help you solve the problem.

Enhanced Pre-Boot System Assessment (ePSA) Diagnostics

The ePSA diagnostics (also known as system diagnostics) performs a complete check of your hardware. The ePSA is embedded with the BIOS and is launched by the BIOS internally. The embedded system diagnostics provides a set of options for particular devices or device groups allowing you to:

- Run tests automatically or in an interactive mode
- Repeat tests
- Display or save test results
- Run thorough tests to introduce additional test options to provide extra information about the failed device(s)
- View status messages that inform you if tests are completed successfully
- View error messages that inform you of problems encountered during testing



CAUTION: Use the system diagnostics to test only your computer. Using this program with other computers may cause invalid results or error messages.



NOTE: Some tests for specific devices require user interaction. Always ensure that you are present at the computer terminal when the diagnostic tests are performed.





1. Power-on the computer.
2. As the computer boots, press the <F12> key as the Dell logo appears.
3. On the boot menu screen, select the **Diagnostics** option.
The **Enhanced Pre-boot System Assessment** window is displayed, listing all devices detected in the computer. The diagnostics starts running the tests on all the detected devices.
4. If you wish to run a diagnostic test on a specific device, press <Esc> and click **Yes** to stop the diagnostic test.
5. Select the device from the left pane and click **Run Tests**.
6. If there are any issues, error codes are displayed.
Note the error code and contact Dell.

Troubleshooting Your Computer

You can troubleshoot your computer using indicators like Diagnostic Lights, Beep Codes, and Error Messages during the operation of the computer.

Device Status Lights

Table 14. Device Status Lights

	Turns on when you turn on the computer and blinks when the computer is in a power management mode.
	Turns on when the computer reads or writes data.
	Turns on steadily or blinks to indicate battery charge status.
	Turns on when wireless networking is enabled.

The device status LEDs are usually located either on the top or left side of the keyboard. They are used to display the storage, battery and wireless devices connectivity and activity. Apart from that they can be useful as a diagnostic tool when there's a possible failure to the system.

The following table lists how to read the LED codes when possible errors occur.

Table 15. LED Lights

Storage LED	Power LED	Wireless LED	Fault Description
Blinking	Solid	Solid	A possible processor failure has occurred.
Solid	Blinking	Solid	The memory modules are detected but has encountered an error.
Blinking	Blinking	Blinking	A system board failure has occurred.
Blinking	Blinking	Solid	A possible graphics card/video failure has occurred.
Blinking	Blinking	Off	System failed on hard drive initialization OR System failed in Option ROM initialization.
Blinking	Off	Blinking	The USB controller encountered a problem during initialization.
Solid	Blinking	Blinking	No memory modules are installed/detected.
Blinking	Solid	Blinking	The display encountered a problem during initialization.

Storage LED	Power LED	Wireless LED	Fault Description
Off	Blinking	Blinking	The modem is preventing the system from completing POST.
Off	Blinking	Off	Memory failed to initialize or memory is unsupported.

Battery Status Lights

If the computer is connected to an electrical outlet, the battery light operates as follows:

Alternately blinking amber light and white light An unauthenticated or unsupported non-Dell AC adapter is attached to your laptop.

Alternately blinking amber light with steady white light Temporary battery failure with AC adapter present.

Constantly blinking amber light Fatal battery failure with AC adapter present.

Light off Battery in full charge mode with AC adapter present.

White light on Battery in charge mode with AC adapter present.

Specifications

Technical Specification



 **NOTE:** Offerings may vary by region. For more information regarding the configuration of your computer, click Start  (**Start icon**) → **Help and Support**, and then select the option to view information about your computer.

Table 16. System Information

Feature	Specification
System Chipset	Mobile Intel 8 Series Chipset
DMA Channels	Enhanced DMA Controller <ul style="list-style-type: none"> • Two cascaded 8237 DMA controllers • Supports LPC DMA
Interrupt Levels	Interrupt Controller <ul style="list-style-type: none"> • Supports up to eight legacy interrupt pins • Supports PCI 2.3 Message Signaled Interrupts <ul style="list-style-type: none"> • Two cascaded 8259 with 15 interrupts • Integrated IO APIC capability with 24 interrupts • Supports Processor System Bus interrupt delivery
BIOS Chip (NVRAM)	96 Mb (12 MB)

Table 17. Processor

Feature	Specification
Processor type	<ul style="list-style-type: none"> • Intel Core i5 and i7 Dual Core • Intel Core i7 Quad Extreme • Intel Core i7 Quad Core
L1 cache	Up to 32 KB cache depending on processor type
L2 cache	Up to 256 KB cache depending on processor type
L3 cache	Up to 8 MB cache depending on processor type

Table 18. Memory

Feature	Specification
Type	DDR3L
Speed	1600 MHz and 1866 MHz
Connectors	4 SoDIMM Sockets <ul style="list-style-type: none"> • Intel Core i5 and i7 Dual processors – two DIMM slots • Intel Core i7 Quad Core and i7 Quad Extreme processors – four DIMM slots
Capacity	1 GB, 2 GB, 4 GB, and 8 GB
Minimum Memory	2 GB
Maximum memory	<ul style="list-style-type: none"> • Intel Core i5 and i7 Dual processors – 16 GB • Intel Core i7 Quad Core and i7 Quad Extreme processors – 32 GB

Table 19. Video

Feature	Specification
Type	
M4800	MXM type-A add-in card
M6800	MXM type-B add-in card
Data bus	PCIe x16, Gen3
Video controller and memory:	
M4800	<ul style="list-style-type: none"> • AMD FirePro M5100, 2GB GDDR5 VRAM • NVIDIA Quadro K1100M, 2GB GDDR5 VRAM • NVIDIA Quadro K2100M, 2GB GDDR5 VRAM
M6800	<ul style="list-style-type: none"> • AMD FirePro M6100, 2GB GDDR5 VRAM • Nvidia Quadro K3100M, 4GB GDDR5 VRAM • Nvidia Quadro K4100M, 4GB GDDR5 VRAM • Nvidia Quadro K5100M, 8GB GDDR5 VRAM

Table 20. Audio

Feature	Specification
Integrated	dual-channel High-Definition audio

Table 21. Communication

Feature	Specification
Network adapter	network interface card capable of 10/100/1000 Mb/s communication
Wireless	<ul style="list-style-type: none"> • internal wireless local area network (WLAN)

Feature	Specification
	<ul style="list-style-type: none"> internal wireless wide area network (WWAN) bluetooth wireless support WiGig support Bluetooth 4.0

Table 22. Expansion Bus

Feature	Specification
Bus Type	PCI 2.3, PCI Express 1.0 and 2.0, SATA 1.0A ,2.0 and 3.0, USB 2.0 and 3.0
Bus Width	PCIe X16
BIOS Chip (NVRAM)	96 Mb (12 MB)

Table 23. Ports and Connectors

Feature	Specification
Audio	two connectors for line-out and line-in/microphone
Network Adapter	one RJ45 connector
USB 2.0	four
USB 3.0	four
eSATA\USB 2.0	one
Video	15-pin VGA connector, 19-pin HDMI connector, 20-pin DisplayPort connector
Memory card reader	SD 4.0
Docking port	one
Micro Subscriber Identity Module (Micro SIM) port	one
ExpressCard	one
Smart card (optional)	one

Table 24. Display

Feature	M4800	M6800
Type	<ul style="list-style-type: none"> HD (1366 X 768) FHD (1920 X 1080) QHD+(3200 X1800) 	<ul style="list-style-type: none"> HD+ (1600 X 900) FHD (1920 X 1080)
Size	15.6 inches	17.3 inches
Dimensions:		
Height	210 mm (8.26 inches)	270.60 mm (10.65 inches)

Feature	M4800	M6800
Width	359.80 mm (14.16 inches)	416.70 mm (16.40 inches)
Diagonal	396.24 mm (15.60 inches)	439.42 mm (17.3 inches)
Active area (X/Y)	<ul style="list-style-type: none"> • HD (344.23 mm X 193.54 mm) • FHD (344.16 X 193.59 mm) • QHD+ (345.6 X 194.4 mm) 	<ul style="list-style-type: none"> • HD+ (382.08 mm X 214.92 mm) • FHD (381.89 mm X 214.81 mm)
Maximum resolution	1920 X 1080 pixels <ul style="list-style-type: none"> • HD (1366 X 768) • FHD (1920 X 1080) • QHD+(3200 X1800) 	1920 X 1080 pixels
Maximum Brightness	<ul style="list-style-type: none"> • HD (220 nits) • FHD (300 nits) • QHD+ (400nits) 	<ul style="list-style-type: none"> • HD+ (220 nits) • FHD (300 nits)
Operating angle	0° (closed) to 135°	
Refresh rate	60 Hz	
Minimum viewing angles:		
Horizontal/Vertical	<ul style="list-style-type: none"> • HD (40/40/10/30) • FHD (60/60/50/50) • QHD+ (80/80/80/80) 	

Table 25. Keyboard

Feature	Specification
Number of keys	<ul style="list-style-type: none"> • United States: 86 keys • United Kingdom: 87 keys • Brazil: 87 keys • Japan: 90 keys
Layout	QWERTY/AZERTY/Kanji

Table 26. Touchpad

Feature	Specification
Active Area:	
X-axis	80.00 mm
Y-axis	40.50 mm

Table 27. Camera

Feature	Specification
Type	CMOS Sensor
Still Resolution	1280 x 720 Pixels (Maximum)
Video Resolution	1280 x 720 Pixels @ 30 Frame Per Seconds (Maximum)
Diagonal	74 degrees

Table 28. Storage

Feature	Specification
Storage:	
Storage Interface	<ul style="list-style-type: none"> • SATA 1 (1.5 Gb/s) • SATA 2 (3.0 Gb/s) • SATA 3 (6 Gb/s)
Drives configurations:	
M4800	one internal 2.5 inch SATA HDD/SSD (SATA3) + one mSATA SSD (SATA2)
M6800	two internal 2.5 inch SATA HDD/SSD (SATA3) + one mSATA SSD (SATA2)
Size	1 TB 5400 rpm, 320/500/750 GB 7200 rpm, 320GB 7200 rpm SED FIPS; 128/256/512 GB SATA 3 SSD, 256 GB SATA 3 SSD
	 NOTE: The size of the hard drive is bound to change. For more information, see dell.com.
Optical Drive:	
Interface	<ul style="list-style-type: none"> • SATA 1 (1.5 Gb/s) • SATA 2 (3.0 Gb/s)
Configuration	supports ODD modules and Air Bay with SATA HDD option

Table 29. Battery

Feature	Specification
Type	lithium ion
Dimensions (6-cell / 9-cell / 9-cell long cycle life (LCL)):	
Depth	82.60 mm (3.25 inches)
Height	190.65 mm (7.50 inches)
Width	20 mm (0.78 inches)
Weight	<ul style="list-style-type: none"> • 6-cell - 345 g (0.76 lb) – (only M4800) • 9-cell /9-cell LCL - 535 g (1.18 lb)

Feature	Specification
Voltage	11.10 V
Life span	300 discharge/charge cycles
Temperature range:	
Operating	<ul style="list-style-type: none"> • Charge : 0 °C to 50 °C (32 °F to 158 °F) • Discharge: 0 °C to 70 °C (32 °F to 122 °F)
Non-operating	-20 °C to 65 °C (4 °F to 149 °F)
Coin-cell battery	3 V CR2032 lithium ion cell

Table 30. AC Adapter

Feature	M4800	M6800
Input voltage	90 VAC to 264 VAC	90 VAC to 264 VAC
Input current (maximum)	2.50 A	3.50 A
Input frequency	50 Hz to 60 Hz	50 Hz to 60 Hz
Output power	180 W	240 W
Output current	9.23 A	12.30 A
Rated output voltage	19.50 VDC	19.50 VDC
Dimensions:	180 W	240 W
Height	30 mm (1.18 inches)	25.40 mm (1 inch)
Width	155 mm (6.10 inches)	200 mm (7.87 inches)
Depth	76 mm (2.99 inches)	100 mm (3.93 inches)
Temperature range:		
Operating	0 °C to 40 °C (32 °F to 104 °F)	
Non Operating	-40 °C to 65 °C (-40 °F to 149 °F)	

Table 31. Contactless Smart Card

Feature	Specification
Supported Smart Cards and Technologies	<ul style="list-style-type: none"> • ISO14443A — 160 kbps, 212 kbps, 424 kbps, and 848 kbps • ISO14443B — 160 kbps, 212 kbps, 424 kbps, and 848 kbps • ISO15693 • HID iClass • FIPS201 • NXP Desfire

Table 32. Physical Dimension

Physical	M4800	M6800
Height:		
Touch		<ul style="list-style-type: none"> • Front: 36.1 mm (1.42 inches) • Back: 40.2 mm (1.58 inches)
Non-touch	<ul style="list-style-type: none"> • Front: 32.9 mm (1.29 inches) • Back: 36.7 mm (1.44 inches) 	<ul style="list-style-type: none"> • Front: 33.1 mm (1.30 inches) • Back: 37.2 mm (1.46 inches)
Width	376 mm (14.80 inches)	416.70 mm (16.40 inches)
Depth	256 mm (10.07 inches)	270.60 mm (10.65 inches)
Weight (Minimum)	2.89 kg (6.38 lb)	3.58 kg (7.89 lb)

Table 33. Environmental

Feature	Specification
Temperature range:	
Operating	0 °C to 40°C (32 °F to 104°F)
Storage	-40 °C to 65 °C (-40 °F to 149 °F)
Relative humidity (maximum):	
Operating	10 % to 90 % (non-condensing)
Storage	5 % to 95 % (non-condensing)
Maximum vibration:	
Operating	0.66 GRMS, 2 Hz - 600 Hz
Storage	1.3 GRMS, 2 Hz - 600 Hz
Maximum shock:	
Operating	140 G, 2 ms
Non-operating	163 G, 2 ms
Altitude:	
Storage	0 m to 10668 m (0 ft to 35,000 ft)
Airborne contaminant level	G1 or lower as defined by ANSI/ISA-S71.04-1985

Contacting Dell

Contacting Dell

 **NOTE:** If you do not have an active Internet connection, you can find contact information on your purchase invoice, packing slip, bill, or Dell product catalog.

Dell provides several online and telephone-based support and service options. Availability varies by country and product, and some services may not be available in your area. To contact Dell for sales, technical support, or customer service issues:

1. Go to **dell.com/support**.
2. Select your support category.
3. Verify your country or region in the **Choose a Country/Region** drop-down list at the bottom of the page.
4. Select the appropriate service or support link based on your need.