

Dell Precision 3540

Service Manual

Notes, cautions, and warnings

 **NOTE:** A NOTE indicates important information that helps you make better use of your product.

 **CAUTION:** A CAUTION indicates either potential damage to hardware or loss of data and tells you how to avoid the problem.

 **WARNING:** A WARNING indicates a potential for property damage, personal injury, or death.

Chapter 1: Working on your computer	7
Safety instructions.....	7
Before working inside your computer.....	7
Safety precautions.....	8
Electrostatic discharge—ESD protection.....	8
ESD field service kit	9
Transporting sensitive components.....	10
After working inside your computer.....	10
Chapter 2: Technology and components	11
USB features.....	11
USB Type-C.....	13
HDMI 1.4a.....	14
Power button LED behavior.....	15
Chapter 3: Major components of your system	17
Chapter 4: Disassembly and reassembly	19
microSD card.....	19
Removing microSD card.....	19
Installing microSD card.....	20
Base cover.....	21
Removing the base cover.....	21
Installing the base cover.....	23
Battery.....	26
Lithium-ion battery precautions.....	26
Removing the battery.....	27
Installing the battery.....	28
Memory modules.....	30
Removing the memory.....	30
Installing the memory.....	31
WLAN card.....	32
Removing the wireless card.....	32
Installing the wireless card.....	33
Hard disk drive (HDD).....	34
Removing hard disk drive.....	34
Installing hard disk drive.....	35
Solid state drive.....	36
Removing the Solid state drive.....	36
Installing the solid state drive.....	37
Solid state drive bracket.....	38
Removing the solid state drive bracket.....	38
Installing the solid state drive bracket.....	38
Palmrest bracket.....	39

Removing the palmrest bracket.....	39
Installing the palmrest bracket.....	41
Speaker.....	43
Removing the speakers.....	43
Installing the speakers.....	46
Heat sink.....	49
Removing the Heatsink.....	49
Installing the Heatsink.....	51
System fan.....	53
Removing the system fan.....	53
Installing the system fan.....	55
Power-adaptor port.....	57
Removing the DC-in port.....	57
Installing the DC-in port.....	59
LED board.....	61
Removing the LED board.....	61
Installing the LED board.....	64
Touchpad.....	67
Removing the touchpad buttons board.....	67
Installing the touchpad buttons board.....	69
System board.....	71
Removing the system board.....	71
Installing the system board.....	74
Coin-cell battery.....	77
Removing the coin cell battery.....	77
Installing the coin cell battery.....	78
Display assembly.....	79
Removing the LCD assembly.....	79
Installing the LCD assembly.....	82
Keyboard lattice and Keyboard.....	85
Removing the keyboard.....	85
Installing the keyboard.....	87
Keyboard bracket.....	89
Removing the keyboard bracket.....	89
Installing the keyboard bracket.....	90
Smart card reader board.....	92
Removing the smart card reader.....	92
Installing the smart card reader.....	93
Display bezel.....	95
Removing the display bezel.....	95
Installing the display bezel	97
Hinge caps.....	99
Removing hinge caps.....	99
Installing hinge caps.....	100
Display hinges.....	101
Removing display hinge.....	101
Installing display hinge	102
Display panel.....	103
Removing display panel.....	103
Installing display panel	106

Camera.....	108
Removing camera.....	108
Installing the camera.....	109
Display (eDP) cable.....	110
Removing display cable.....	110
Installing display cable.....	111
Display back cover assembly.....	112
Replacing the display back cover.....	112
Palmrest assembly.....	113
Replacing the palmrest and keyboard assembly.....	113
Chapter 5: Drivers and downloads.....	116
Chapter 6: BIOS setup.....	117
Boot menu.....	117
BIOS overview.....	117
Entering BIOS setup program.....	118
Navigation keys.....	118
One time boot menu.....	118
System setup options.....	118
General options.....	119
System information.....	119
Video.....	120
Security.....	120
Secure boot.....	121
Intel Software Guard Extensions.....	122
Performance.....	122
Power management.....	123
POST behavior.....	124
Virtualization support.....	124
Wireless.....	125
Maintenance screen.....	125
System logs.....	125
SupportAssist System Resolution.....	126
Updating the BIOS.....	126
Updating the BIOS in Windows.....	126
Updating the BIOS in Linux and Ubuntu.....	126
Updating the BIOS using the USB drive in Windows.....	127
Updating the BIOS from the F12 One-Time boot menu.....	127
System and setup password.....	128
Assigning a system setup password.....	128
Deleting or changing an existing system setup password.....	129
Clearing CMOS settings.....	129
Clearing BIOS (System Setup) and System passwords.....	129
Chapter 7: Troubleshooting.....	130
Handling swollen Lithium-ion batteries.....	130
Dell SupportAssist Pre-boot System Performance Check diagnostics.....	131
Running the SupportAssist Pre-Boot System Performance Check.....	131

Built-in self-test (BIST).....	131
M-BIST.....	131
LCD Power rail test (L-BIST).....	132
LCD Built-in Self Test (BIST).....	132
System-diagnostic lights.....	133
LED Indicators and Characteristics.....	133
Real-Time Clock (RTC Reset).....	133
Recovering the operating system.....	134
Backup media and recovery options.....	134
WiFi power cycle.....	134
Drain residual flea power (perform hard reset).....	134
Chapter 8: Getting help.....	136
Contacting Dell.....	136

Working on your computer

Topics:

- [Safety instructions](#)

Safety instructions

Prerequisites

Use the following safety guidelines to protect your computer from potential damage and to ensure your personal safety. Unless otherwise noted, each procedure included in this document assumes that the following conditions exist:

- You have read the safety information that shipped with your computer.
- A component can be replaced or, if purchased separately, installed by performing the removal procedure in reverse order.

About this task

⚠ WARNING: Before working inside your computer, read the safety information that shipped with your computer. For additional safety best practices information, see the [Regulatory Compliance Homepage](#)

⚠ CAUTION: Many repairs may only be done by a certified service technician. You should only perform troubleshooting and simple repairs as authorized in your product documentation, or as directed by the online or telephone service and support team. Damage due to servicing that is not authorized by Dell is not covered by your warranty. Read and follow the safety instructions that came with the product.

⚠ CAUTION: To avoid electrostatic discharge, ground yourself by using a wrist grounding strap or by periodically touching an unpainted metal surface at the same time as touching a connector on the back of the computer.

⚠ CAUTION: Handle components and cards with care. Do not touch the components or contacts on a card. Hold a card by its edges or by its metal mounting bracket. Hold a component such as a processor by its edges, not by its pins.

⚠ CAUTION: When you disconnect a cable, pull on its connector or on its pull-tab, not on the cable itself. Some cables have connectors with locking tabs; if you are disconnecting this type of cable, press in on the locking tabs before you disconnect the cable. As you pull connectors apart, keep them evenly aligned to avoid bending any connector pins. Also, before you connect a cable, ensure that both connectors are correctly oriented and aligned.

ⓘ NOTE: Disconnect all power sources before opening the computer cover or panels. After you finish working inside the computer, replace all covers, panels, and screws before connecting to the power source.

⚠ CAUTION: Exercise caution when handling Lithium-ion batteries in laptops. Swollen batteries should not be used and should be replaced and disposed properly.

ⓘ NOTE: The color of your computer and certain components may appear differently than shown in this document.

Before working inside your computer

Steps

1. Save and close all open files and exit all open applications.
2. Shut down your computer. Click **Start** > **Power** > **Shut down**.

 **NOTE:** If you are using a different operating system, see the documentation of your operating system for shut-down instructions.

3. Disconnect your computer and all attached devices from their electrical outlets.
4. Disconnect all attached network devices and peripherals, such as keyboard, mouse, and monitor from your computer.
5. Remove any media card and optical disc from your computer, if applicable.
6. After the computer is unplugged, press and hold the power button for 5 seconds to ground the system board.

 **CAUTION:** Place the computer on a flat, soft, and clean surface to avoid scratches on the display.

7. Place the computer face down.

Safety precautions

The safety precautions chapter details the primary steps to be taken before performing any disassembly instructions.

Observe the following safety precautions before you perform any installation or break/fix procedures involving disassembly or reassembly:

- Turn off the system and all attached peripherals.
- Disconnect the system and all attached peripherals from AC power.
- Disconnect all network cables, telephone, and telecommunications lines from the system.
- Use an ESD field service kit when working inside any to avoid electrostatic discharge (ESD) damage.
- After removing any system component, carefully place the removed component on an anti-static mat.
- Wear shoes with non-conductive rubber soles to reduce the chance of getting electrocuted.

Standby power

Dell products with standby power must be unplugged before you open the case. Systems that incorporate standby power are essentially powered while turned off. The internal power enables the system to be remotely turned on (wake on LAN) and suspended into a sleep mode and has other advanced power management features.

Unplugging, pressing and holding the power button for 20 seconds should discharge residual power in the system board.

Bonding

Bonding is a method for connecting two or more grounding conductors to the same electrical potential. This is done through the use of a field service electrostatic discharge (ESD) kit. When connecting a bonding wire, ensure that it is connected to bare metal and never to a painted or non-metal surface. The wrist strap should be secure and in full contact with your skin, and ensure that you remove all jewelry such as watches, bracelets, or rings prior to bonding yourself and the equipment.

Electrostatic discharge—ESD protection

ESD is a major concern when you handle electronic components, especially sensitive components such as expansion cards, processors, memory DIMMs, and system boards. Very slight charges can damage circuits in ways that may not be obvious, such as intermittent problems or a shortened product life span. As the industry pushes for lower power requirements and increased density, ESD protection is an increasing concern.

Due to the increased density of semiconductors used in recent Dell products, the sensitivity to static damage is now higher than in previous Dell products. For this reason, some previously approved methods of handling parts are no longer applicable.

Two recognized types of ESD damage are catastrophic and intermittent failures.

- **Catastrophic** – Catastrophic failures represent approximately 20 percent of ESD-related failures. The damage causes an immediate and complete loss of device functionality. An example of catastrophic failure is a memory DIMM that has received a static shock and immediately generates a "No POST/No Video" symptom with a beep code emitted for missing or nonfunctional memory.
- **Intermittent** – Intermittent failures represent approximately 80 percent of ESD-related failures. The high rate of intermittent failures means that most of the time when damage occurs, it is not immediately recognizable. The DIMM receives a static shock, but the tracing is merely weakened and does not immediately produce outward symptoms related to

the damage. The weakened trace may take weeks or months to melt, and in the meantime may cause degradation of memory integrity, intermittent memory errors, etc.

The more difficult type of damage to recognize and troubleshoot is the intermittent (also called latent or "walking wounded") failure.

Perform the following steps to prevent ESD damage:

- Use a wired ESD wrist strap that is properly grounded. The use of wireless anti-static straps is no longer allowed; they do not provide adequate protection. Touching the chassis before handling parts does not ensure adequate ESD protection on parts with increased sensitivity to ESD damage.
- Handle all static-sensitive components in a static-safe area. If possible, use anti-static floor pads and workbench pads.
- When unpacking a static-sensitive component from its shipping carton, do not remove the component from the anti-static packing material until you are ready to install the component. Before unwrapping the anti-static packaging, ensure that you discharge static electricity from your body.
- Before transporting a static-sensitive component, place it in an anti-static container or packaging.

ESD field service kit

The unmonitored Field Service kit is the most commonly used service kit. Each Field Service kit includes three main components: anti-static mat, wrist strap, and bonding wire.

Components of an ESD field service kit

The components of an ESD field service kit are:

- **Anti-Static Mat** – The anti-static mat is dissipative and parts can be placed on it during service procedures. When using an anti-static mat, your wrist strap should be snug and the bonding wire should be connected to the mat and to any bare metal on the system being worked on. Once deployed properly, service parts can be removed from the ESD bag and placed directly on the mat. ESD-sensitive items are safe in your hand, on the ESD mat, in the system, or inside a bag.
- **Wrist Strap and Bonding Wire** – The wrist strap and bonding wire can be either directly connected between your wrist and bare metal on the hardware if the ESD mat is not required, or connected to the anti-static mat to protect hardware that is temporarily placed on the mat. The physical connection of the wrist strap and bonding wire between your skin, the ESD mat, and the hardware is known as bonding. Use only Field Service kits with a wrist strap, mat, and bonding wire. Never use wireless wrist straps. Always be aware that the internal wires of a wrist strap are prone to damage from normal wear and tear, and must be checked regularly with a wrist strap tester in order to avoid accidental ESD hardware damage. It is recommended to test the wrist strap and bonding wire at least once per week.
- **ESD Wrist Strap Tester** – The wires inside of an ESD strap are prone to damage over time. When using an unmonitored kit, it is a best practice to regularly test the strap prior to each service call, and at a minimum, test once per week. A wrist strap tester is the best method for doing this test. If you do not have your own wrist strap tester, check with your regional office to find out if they have one. To perform the test, plug the wrist-strap's bonding-wire into the tester while it is strapped to your wrist and push the button to test. A green LED is lit if the test is successful; a red LED is lit and an alarm sounds if the test fails.
- **Insulator Elements** – It is critical to keep ESD sensitive devices, such as plastic heat sink casings, away from internal parts that are insulators and often highly charged.
- **Working Environment** – Before deploying the ESD Field Service kit, assess the situation at the customer location. For example, deploying the kit for a server environment is different than for a desktop or portable environment. Servers are typically installed in a rack within a data center; desktops or portables are typically placed on office desks or cubicles. Always look for a large open flat work area that is free of clutter and large enough to deploy the ESD kit with additional space to accommodate the type of system that is being repaired. The workspace should also be free of insulators that can cause an ESD event. On the work area, insulators such as Styrofoam and other plastics should always be moved at least 12 inches or 30 centimeters away from sensitive parts before physically handling any hardware components.
- **ESD Packaging** – All ESD-sensitive devices must be shipped and received in static-safe packaging. Metal, static-shielded bags are preferred. However, you should always return the damaged part using the same ESD bag and packaging that the new part arrived in. The ESD bag should be folded over and taped shut and all the same foam packing material should be used in the original box that the new part arrived in. ESD-sensitive devices should be removed from packaging only at an ESD-protected work surface, and parts should never be placed on top of the ESD bag because only the inside of the bag is shielded. Always place parts in your hand, on the ESD mat, in the system, or inside an anti-static bag.
- **Transporting Sensitive Components** – When transporting ESD sensitive components such as replacement parts or parts to be returned to Dell, it is critical to place these parts in anti-static bags for safe transport.

ESD protection summary

It is recommended that all field service technicians use the traditional wired ESD grounding wrist strap and protective anti-static mat at all times when servicing Dell products. In addition, it is critical that technicians keep sensitive parts separate from all insulator parts while performing service and that they use anti-static bags for transporting sensitive components.

Transporting sensitive components

When transporting ESD sensitive components such as replacement parts or parts to be returned to Dell, it is critical to place these parts in anti-static bags for safe transport.

Lifting equipment

Adhere to the following guidelines when lifting heavy weight equipment:

 **CAUTION: Do not lift greater than 50 pounds. Always obtain additional resources or use a mechanical lifting device.**

1. Get a firm balanced footing. Keep your feet apart for a stable base, and point your toes out.
2. Tighten stomach muscles. Abdominal muscles support your spine when you lift, offsetting the force of the load.
3. Lift with your legs, not your back.
4. Keep the load close. The closer it is to your spine, the less force it exerts on your back.
5. Keep your back upright, whether lifting or setting down the load. Do not add the weight of your body to the load. Avoid twisting your body and back.
6. Follow the same techniques in reverse to set the load down.

After working inside your computer

About this task

 **NOTE:** Leaving stray or loose screws inside your computer may severely damage your computer.

Steps

1. Replace all screws and ensure that no stray screws remain inside your computer.
2. Connect any external devices, peripherals, or cables you removed before working on your computer.
3. Replace any media cards, discs, or any other parts that you removed before working on your computer.
4. Connect your computer and all attached devices to their electrical outlets.
5. Turn on your computer.

Technology and components

This chapter details the technology and components available in the system.

Topics:

- [USB features](#)
- [USB Type-C](#)
- [HDMI 1.4a](#)
- [Power button LED behavior](#)

USB features

Universal Serial Bus, or USB, was introduced in 1996. It dramatically simplified the connection between host computers and peripheral devices like mice, keyboards, external drivers, and printers.

Table 1. USB evolution

Type	Data Transfer Rate	Category	Introduction Year
USB 2.0	480 Mbps	High Speed	2000
USB 3.0/USB 3.1 Gen 1	5 Gbps	SuperSpeed	2010
USB 3.1 Gen 2	10 Gbps	SuperSpeed	2013

USB 3.0/USB 3.1 Gen 1 (SuperSpeed USB)

For years, the USB 2.0 has been firmly entrenched as the de facto interface standard in the PC world with about 6 billion devices sold, and yet the need for more speed grows by ever faster computing hardware and ever greater bandwidth demands. The USB 3.0/USB 3.1 Gen 1 finally has the answer to the consumers' demands with a theoretically 10 times faster than its predecessor. In a nutshell, USB 3.1 Gen 1 features are as follows:

- Higher transfer rates (up to 5 Gbps)
- Increased maximum bus power and increased device current draw to better accommodate power-hungry devices
- New power management features
- Full-duplex data transfers and support for new transfer types
- Backward USB 2.0 compatibility
- New connectors and cable

The topics below cover some of the most commonly asked questions regarding USB 3.0/USB 3.1 Gen 1.



Speed

Currently, there are 3 speed modes defined by the latest USB 3.0/USB 3.1 Gen 1 specification. They are Super-Speed, Hi-Speed and Full-Speed. The new SuperSpeed mode has a transfer rate of 4.8 Gbps. While the specification retains Hi-Speed, and Full-Speed USB mode, commonly known as USB 2.0 and 1.1 respectively, the slower modes still operate at 480 Mbps and 12 Mbps respectively and are kept to maintain backward compatibility.

USB 3.0/USB 3.1 Gen 1 achieves the much higher performance by the technical changes below:

- An additional physical bus that is added in parallel with the existing USB 2.0 bus (refer to the picture below).
- USB 2.0 previously had four wires (power, ground, and a pair for differential data); USB 3.0/USB 3.1 Gen 1 adds four more for two pairs of differential signals (receive and transmit) for a combined total of eight connections in the connectors and cabling.
- USB 3.0/USB 3.1 Gen 1 utilizes the bidirectional data interface, rather than USB 2.0's half-duplex arrangement. This gives a 10-fold increase in theoretical bandwidth.

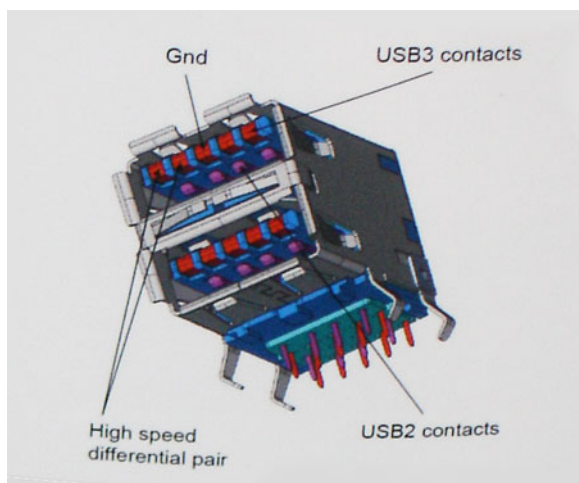

With today's ever increasing demands placed on data transfers with high-definition video content, terabyte storage devices, high megapixel count digital cameras etc., USB 2.0 may not be fast enough. Furthermore, no USB 2.0 connection could ever come close to the 480Mbps theoretical maximum throughput, making data transfer at around 320 Mbps (40 MB/s) — the actual real-world maximum. Similarly, USB 3.0/USB 3.1 Gen 1 connections will never achieve 4.8Gbps. We will likely see a real-world maximum rate of 400MB/s with overheads. At this speed, USB 3.0/USB 3.1 Gen 1 is a 10x improvement over USB 2.0.

Applications

USB 3.0/USB 3.1 Gen 1 opens up the laneways and provides more headroom for devices to deliver a better overall experience. Where USB video was barely tolerable previously (both from a maximum resolution, latency, and video compression perspective), it's easy to imagine that with 5-10 times the bandwidth available, USB video solutions should work that much better. Single-link DVI requires almost 2Gbps throughput. Where 480Mbps was limiting, 5Gbps is more than promising. With its promised 4.8Gbps speed, the standard will find its way into some products that previously weren't USB territory, like external RAID storage systems.

Listed below are some of the available SuperSpeed USB 3.0/USB 3.1 Gen 1 products:

- External Desktop USB 3.0/USB 3.1 Gen 1 Hard Drives
- Portable USB 3.0/USB 3.1 Gen 1 Hard Drives
- USB 3.0/USB 3.1 Gen 1 Drive Docks & Adapters
- USB 3.0/USB 3.1 Gen 1 Flash Drives & Readers
- USB 3.0/USB 3.1 Gen 1 Solid-state Drives
- USB 3.0/USB 3.1 Gen 1 RAIDs
- Optical Media Drives
- Multimedia Devices
- Networking
- USB 3.0/USB 3.1 Gen 1 Adapter Cards & Hubs

Compatibility

The good news is that USB 3.0/USB 3.1 Gen 1 has been carefully planned from the start to peacefully co-exist with USB 2.0. First of all, while USB 3.0/USB 3.1 Gen 1 specifies new physical connections and thus new cables to take advantage of the higher speed capability of the new protocol, the connector itself remains the same rectangular shape with the four USB 2.0 contacts in the exact same location as before. Five new connections to carry receive and transmitted data independently are present on USB 3.0/USB 3.1 Gen 1 cables and only come into contact when connected to a proper SuperSpeed USB connection.

USB Type-C

USB Type-C is a new, tiny physical connector. The connector itself can support various exciting new USB standards like USB 3.1 and USB power delivery (USB PD).

Alternate Mode

USB Type-C is a new connector standard that is very small. It is about a third the size of an old USB Type-A plug. This is a single connector standard that every device should be able to use. USB Type-C ports can support a variety of different protocols using "alternate modes," which allows you to have adapters that can output HDMI, VGA, DisplayPort, or other types of connections from that single USB port

USB Power Delivery

The USB PD specification is also closely intertwined with USB Type-C. Currently, smartphones, tablets, and other mobile devices often use a USB connection to charge. A USB 2.0 connection provides up to 2.5 watts of power — that'll charge your phone, but that's about it. A laptop might require up to 60 watts, for example. The USB Power Delivery specification ups this power delivery to 100 watts. It's bi-directional, so a device can either send or receive power. And this power can be transferred at the same time the device is transmitting data across the connection.

This could spell the end of all those proprietary laptop charging cables, with everything charging via a standard USB connection. You could charge your laptop from one of those portable battery packs you charge your smartphones and other portable devices from today. You could plug your laptop into an external display connected to a power cable, and that external display would charge your laptop as you used it as an external display — all via the one little USB Type-C connection. To use this, the device and the cable have to support USB Power Delivery. Just having a USB Type-C connection doesn't necessarily mean they do.

USB Type-C and USB 3.1

USB 3.1 is a new USB standard. USB 3's theoretical bandwidth is 5 Gbps, while USB 3.1's is 10 Gbps. That's double the bandwidth, as fast as a first-generation Thunderbolt connector. USB Type-C isn't the same thing as USB 3.1. USB Type-C is just a connector shape, and the underlying technology could just be USB 2 or USB 3.0. In fact, Nokia's N1 Android tablet uses a USB Type-C connector, but underneath it's all USB 2.0 — not even USB 3.0. However, these technologies are closely related.

Thunderbolt over USB Type-C

Thunderbolt is a hardware interface that combines data, video, audio, and power in a single connection. Thunderbolt combines PCI Express (PCIe) and DisplayPort (DP) into one serial signal, and additionally provides DC power, all in one cable. Thunderbolt 1 and Thunderbolt 2 use the same connector as miniDP (DisplayPort) to connect to peripherals, while Thunderbolt 3 uses a USB Type-C connector.

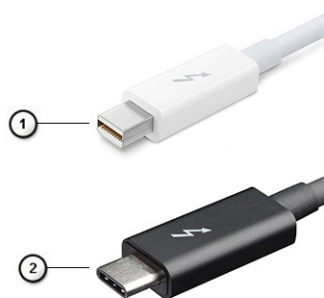

Figure 1. Thunderbolt 1 and Thunderbolt 3

1. Thunderbolt 1 and Thunderbolt 2 (using a miniDP connector)
2. Thunderbolt 3 (using a USB Type-C connector)

Thunderbolt 3 over USB Type-C

Thunderbolt 3 brings Thunderbolt to USB Type-C at speeds up to 40 Gbps, creating one compact port that does it all - delivering the fastest, most versatile connection to any dock, display or data device like an external hard drive. Thunderbolt 3 uses a USB Type-C connector/port to connect to supported peripherals.

1. Thunderbolt 3 uses USB Type-C connector and cables - It is compact and reversible
2. Thunderbolt 3 supports speed up to 40 Gbps
3. DisplayPort 1.4 – compatible with existing DisplayPort monitors, devices and cables
4. USB Power Delivery - Up to 130W on supported computers

Key Features of Thunderbolt 3 over USB Type-C

1. Thunderbolt, USB, DisplayPort and power on USB Type-C on a single cable (features vary between different products)
2. USB Type-C connector and cables which are compact and reversible
3. Supports Thunderbolt Networking (*varies between different products)
4. Supports up to 4K displays
5. Up to 40 Gbps

 **NOTE:** Data transfer speed may vary between different devices.

Thunderbolt Icons

Protocol	USB Type-A	USB Type-C	Notes
Thunderbolt	Not Applicable		Will use industry standard icon regardless of port style (i.e., mDP or USB Type-C)
Thunderbolt w/ Power Delivery	Not Applicable		Up to 130 Watts via USB Type-C

Figure 2. Thunderbolt Iconography Variations

HDMI 1.4a

This topic explains the HDMI 1.4a and its features along with the advantages.

HDMI (High-Definition Multimedia Interface) is an industry-supported, uncompressed, all-digital audio/video interface. HDMI provides an interface between any compatible digital audio/video source, such as a DVD player, or A/V receiver and a compatible digital audio and/or video monitor, such as a digital TV (DTV). The primary advantage is cable reduction and content protection provisions. HDMI supports standard, enhanced, or high-definition video, plus multichannel digital audio on a single cable.

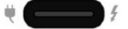
HDMI 1.4a Features

- **HDMI Ethernet Channel** - Adds high-speed networking to an HDMI link, allowing users to take full advantage of their IP-enabled devices without a separate Ethernet cable.
- **Audio Return Channel** - Allows an HDMI-connected TV with a built-in tuner to send audio data "upstream" to a surround audio system, eliminating the need for a separate audio cable.
- **3D** - Defines input/output protocols for major 3D video formats, paving the way for true 3D gaming and 3D home theater applications.
- **Content Type** - Real-time signaling of content types between display and source devices, enabling a TV to optimize picture settings based on content type.
- **Additional Color Spaces** - Adds support for additional color models used in digital photography and computer graphics.
- **4K Support** - Enables video resolutions far beyond 1080p, supporting next-generation displays that will rival the Digital Cinema systems used in many commercial movie theaters.
- **HDMI Micro Connector** - A new, smaller connector for phones and other portable devices, supporting video resolutions up to 1080p.

- **Automotive Connection System** - New cables and connectors for automotive video systems, designed to meet the unique demands of the motoring environment while delivering true HD quality.

Advantages of HDMI

- Quality HDMI transfers uncompressed digital audio and video for the highest, crispest image quality.
- Low-cost HDMI provides the quality and functionality of a digital interface while also supporting uncompressed video formats in a simple, cost-effective manner.
- Audio HDMI supports multiple audio formats from standard stereo to multichannel surround sound.
- HDMI combines video and multichannel audio into a single cable, eliminating the cost, complexity, and confusion of multiple cables currently used in A/V systems.
- HDMI supports communication between the video source (such as a DVD player) and the DTV, enabling new functionality.

Power button LED behavior

On certain Dell Latitude systems, the power button LED is used to provide an indication of the system status, and as a result the power button illuminates when pressed. The systems with the optional power button/fingerprint reader will have no LED under the power button and hence will apply the available LED's in the system to provide an indication of the system status.

Power button LED behavior without Fingerprint reader

- System is ON (S0) = LED illuminates solid white.
- System in Sleep/Standby (S3, SOix) = LED is off
- System is Off/Hibernating (S4/S5) = LED is off

Power On and LED behavior with Fingerprint reader

- Pressing the power button for a duration between 50 msec to 2 sec turns on the device.
- Power button does not register additional presses until the SOL (Sign-Of-Life) has been provided to the user.
- System LED's illuminates upon pressing the power button.
- All the available LED's (Keyboard backlit/ Keyboard caps lock LED/ Battery Charge LED) illuminates and displays specified behavior.
- The auditory tone is Off by default. It can be enabled in the BIOS setup.
- Safeguards do not time out if the device gets hung during the logon process.
- Dell logo: Turns on within 2 secs after pressing the power button.
- Full boot: Within 22 secs after pressing the power button.
- Below is the example timelines:



Power button with fingerprint reader will have no LED and will leverage the available LED's in the system to provide indication of the system status

- **Power Adapter LED:**
 - The LED on Power adapter connector illuminates white when power is supplied from electrical outlet.
- **Battery Indicator LED:**
 - If the computer is connected to an electrical outlet, the battery light operates as follows:
 1. Solid white -the battery is charging. When the charge is complete the LED turns off.
 - If the computer is running on a battery, the battery light operates as follows:
 1. Off -the battery is adequately charged (or the computer is turned off).
 2. Solid amber -the battery charge is critically low. A low battery state is approximately 30 minutes or less of battery life remaining.
- **Camera LED**
 - White LED activates when camera is on.
- **Mic Mute LED:**
 - When activated (muted), the mic mute LED on the F4 Key should illuminate WHITE.
- **RJ45 LEDs:**
 - [Table 2. LED on either side of RJ45 port](#)

Link speed indicator (LHS)	Activity indicator (RHS)
Green	Amber

Major components of your system

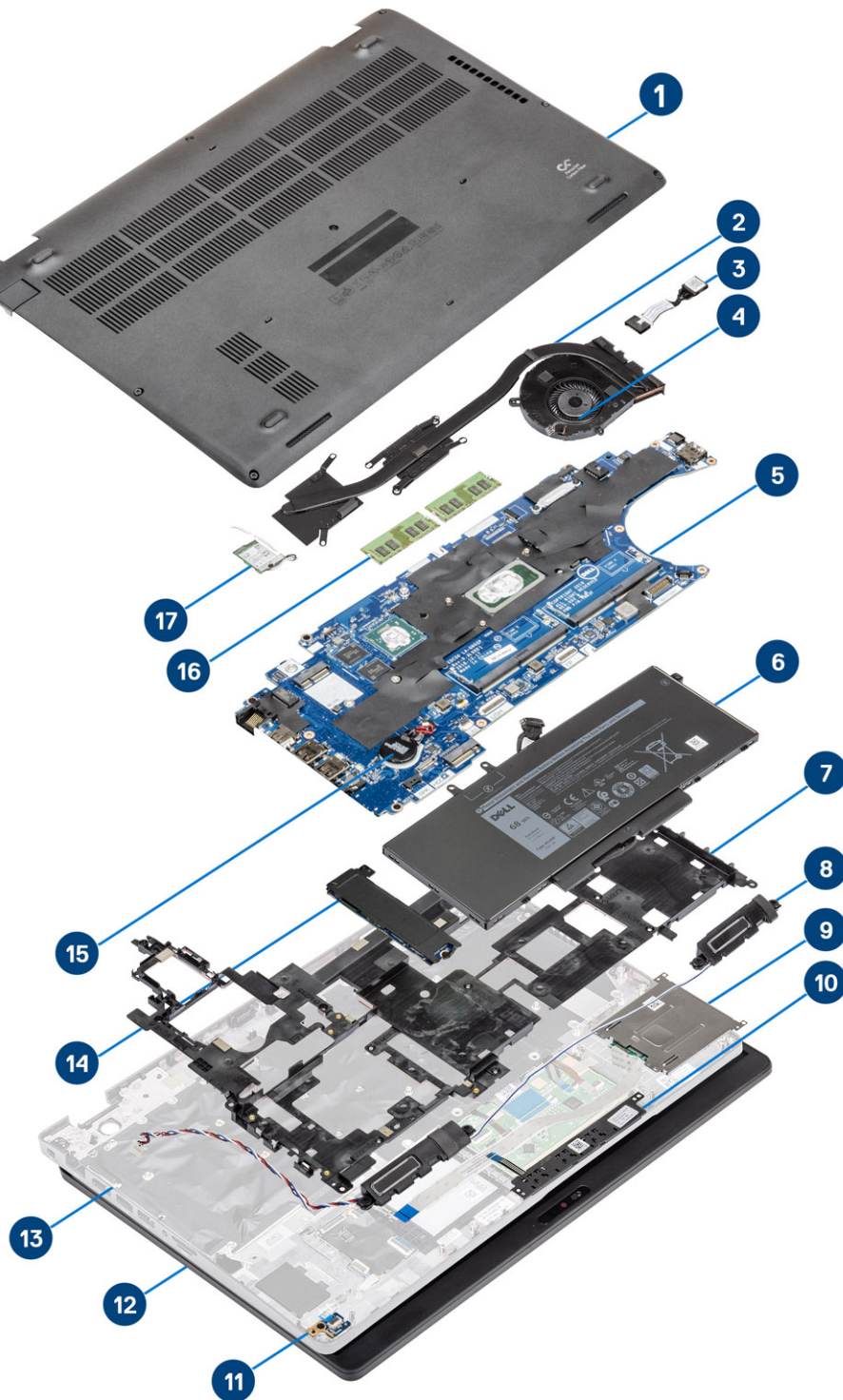

1. Base cover
2. Heatsink

3. Power-adapter port
4. System fan
5. System board
6. Battery
7. Palmrest bracket
8. Speakers
9. Smart card reader
10. Touchpad button board
11. LED board
12. Display assembly
13. Palmrest assembly
14. Solid state drive
15. Coin cell
16. Memory modules
17. WLAN card

 **NOTE:** Dell provides a list of components and their part numbers for the original system configuration purchased. These parts are available according to warranty coverages purchased by the customer. Contact your Dell sales representative for purchase options.

Disassembly and reassembly

 **NOTE:** The images in this document may differ from your computer depending on the configuration you ordered.

Topics:

- microSD card
- Base cover
- Battery
- Memory modules
- WLAN card
- Hard disk drive (HDD)
- Solid state drive
- Solid state drive bracket
- Palmrest bracket
- Speaker
- Heat sink
- System fan
- Power-adaptor port
- LED board
- Touchpad
- System board
- Coin-cell battery
- Display assembly
- Keyboard lattice and Keyboard
- Keyboard bracket
- Smart card reader board
- Display bezel
- Hinge caps
- Display hinges
- Display panel
- Camera
- Display (eDP) cable
- Display back cover assembly
- Palmrest assembly

microSD card

Removing microSD card

Steps

1. Follow the procedure in [Before working inside your computer](#).
2. Press in on the microSD card [1] and remove it from the computer [2].

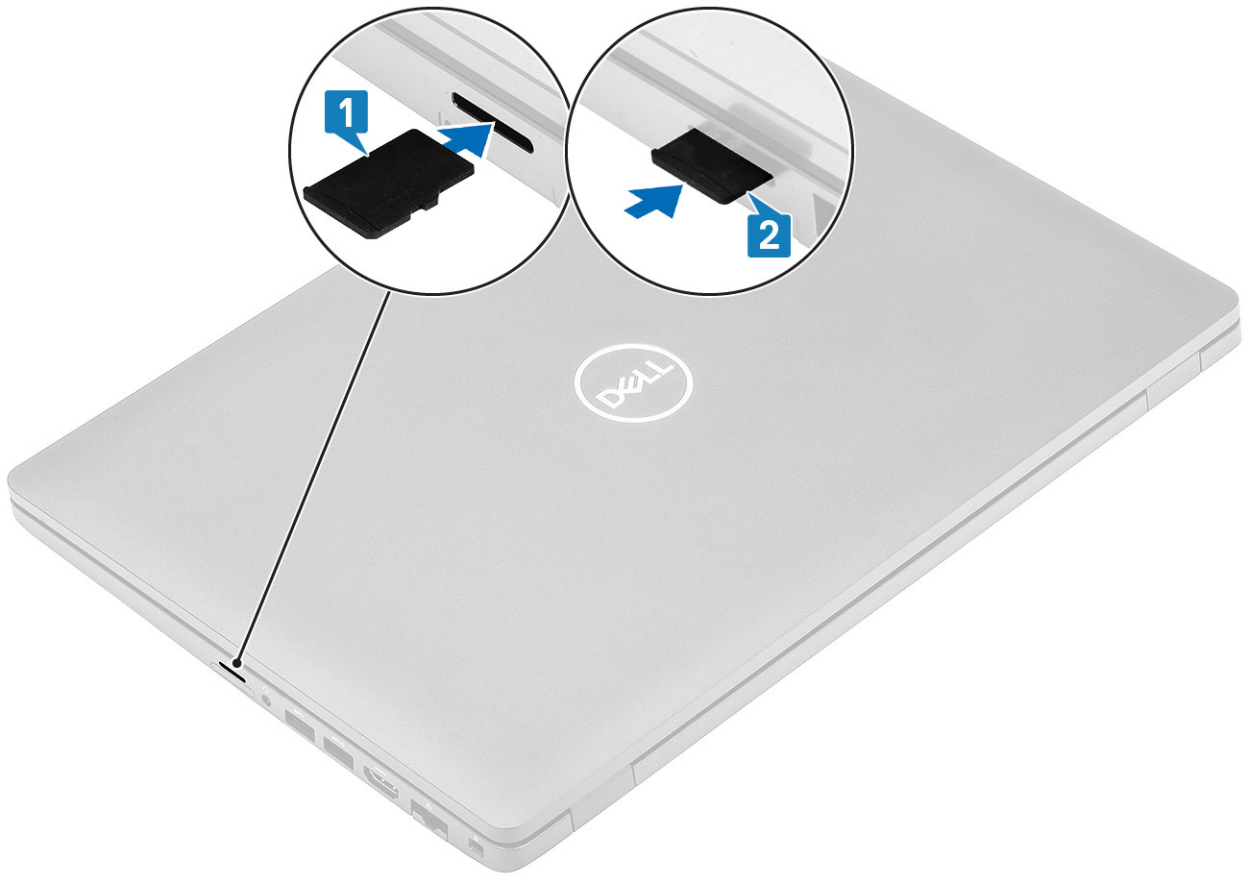

Installing microSD card

Steps

Slide the SD card into its slot until it clicks into place [1, 2].

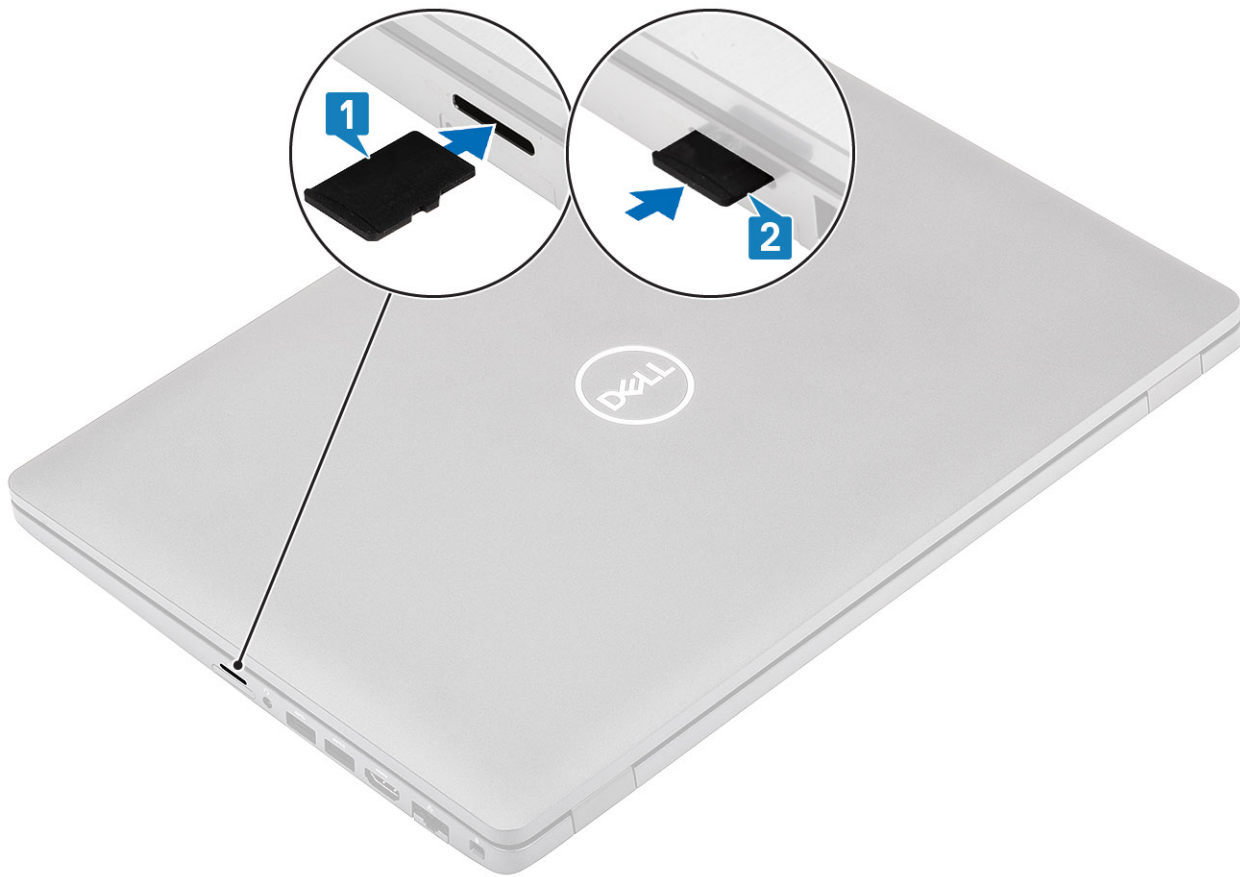

Next steps

Follow the procedure in [after working inside your computer](#).

Base cover

Removing the base cover

Prerequisites

1. Follow the procedure in [before working inside your computer](#).
2. Remove the [microSD card](#).

Steps

1. Loosen the eight captive screws that secure the base cover to the computer.

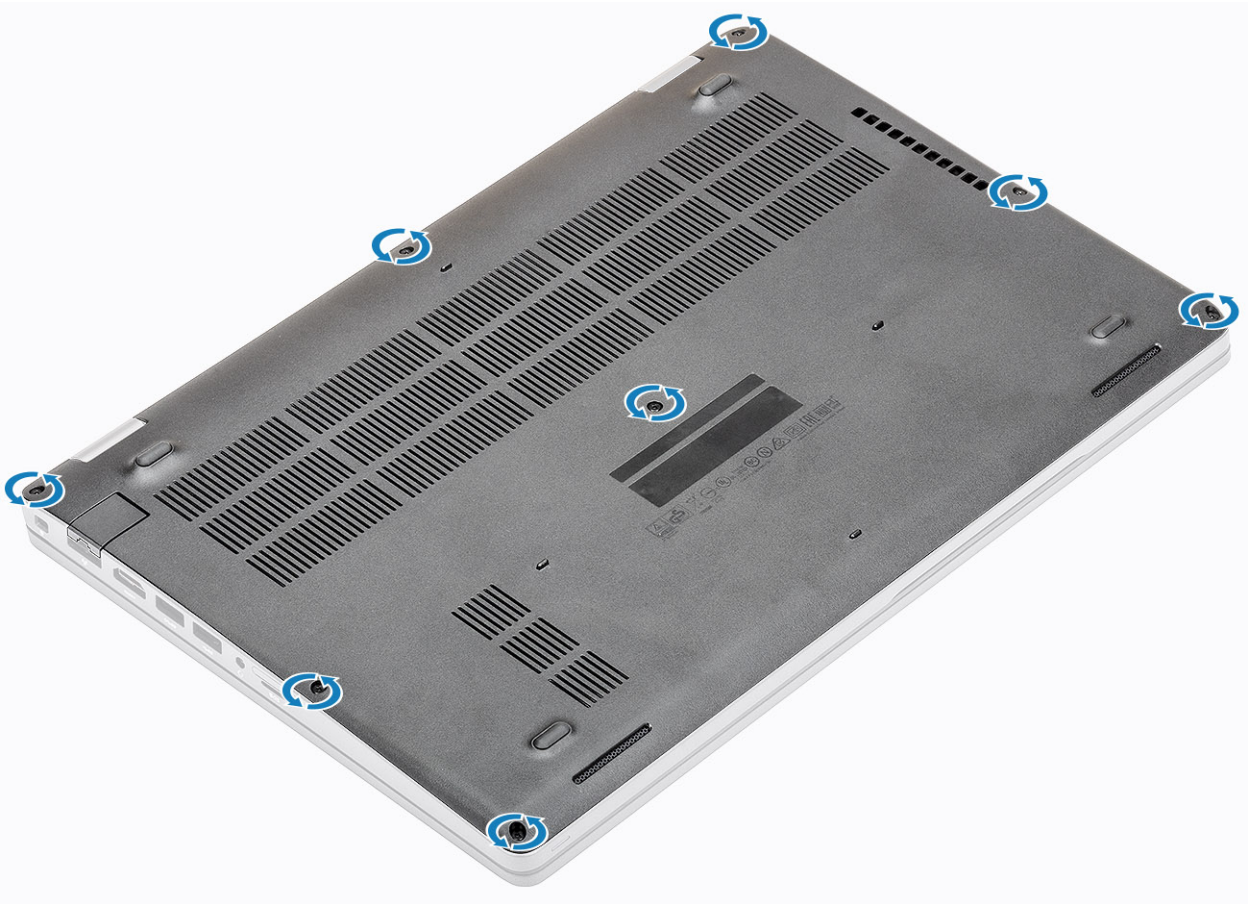

2. Pry the base cover from the edge using a plastic scribe [1, 2].

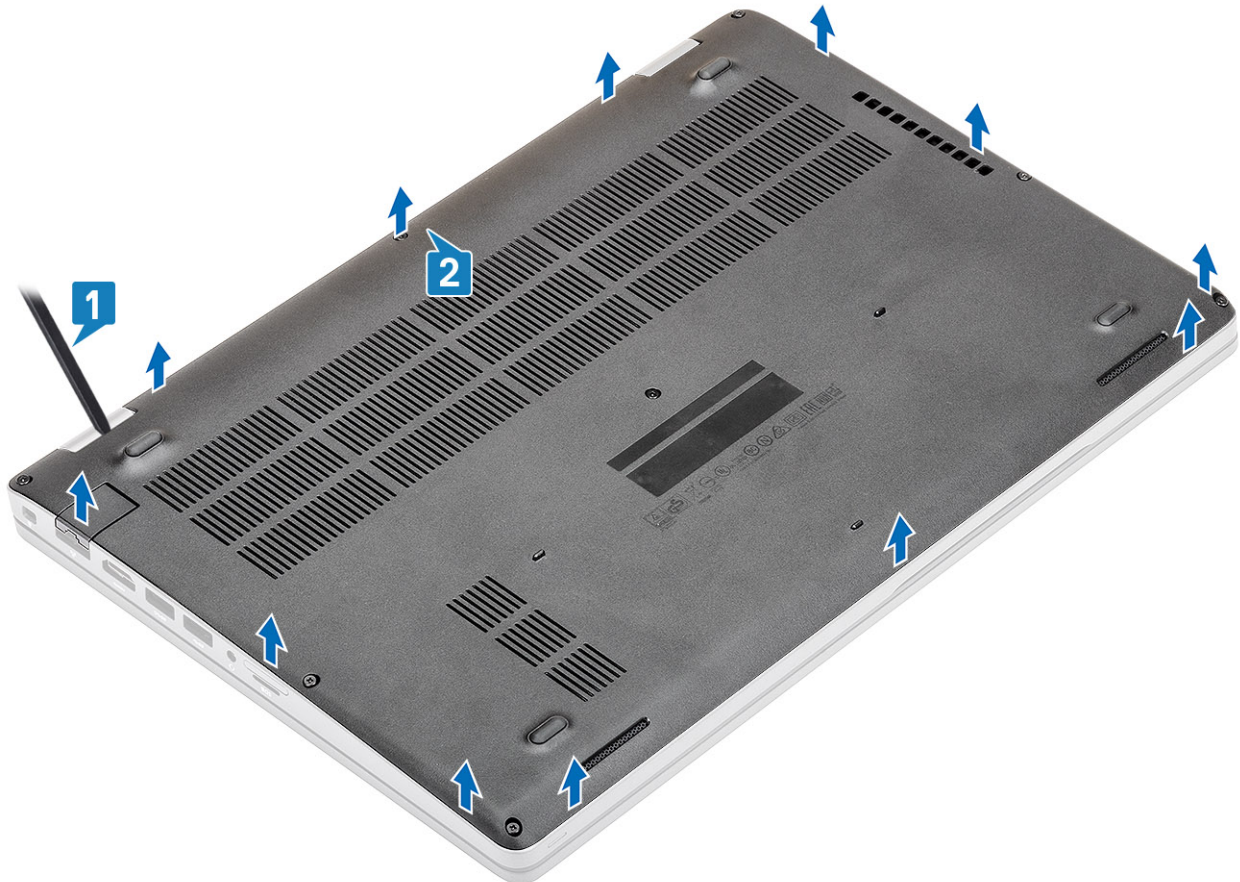

NOTE: While removing the base cover, on-site technicians must take care to remove the base cover carefully. There are prying recess points next to the left and right hinges which ease the disassembly procedure. With the help of a plastic scribe, pry open from the top left side of the base cover, continue working your way around the left and right side of the base cover, then remove the base cover from the system.

3. Lift the base cover from the computer.



Installing the base cover

Steps

1. Align the base cover on the computer and press the edges of the cover until it clicks into place.



2. Press down on the edges of the base cover till clicks in place.

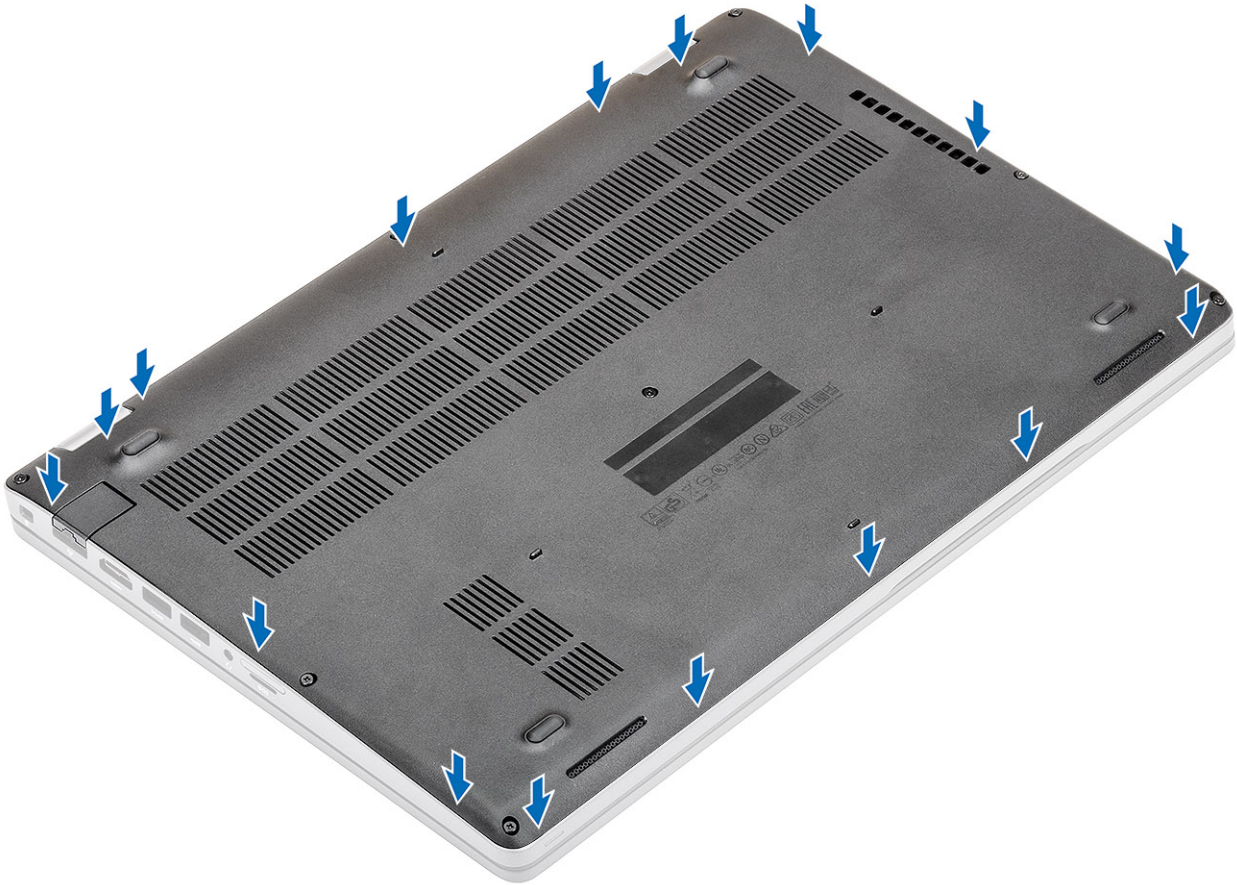

3. Tighten the eight captive screws to secure the base cover to the computer.

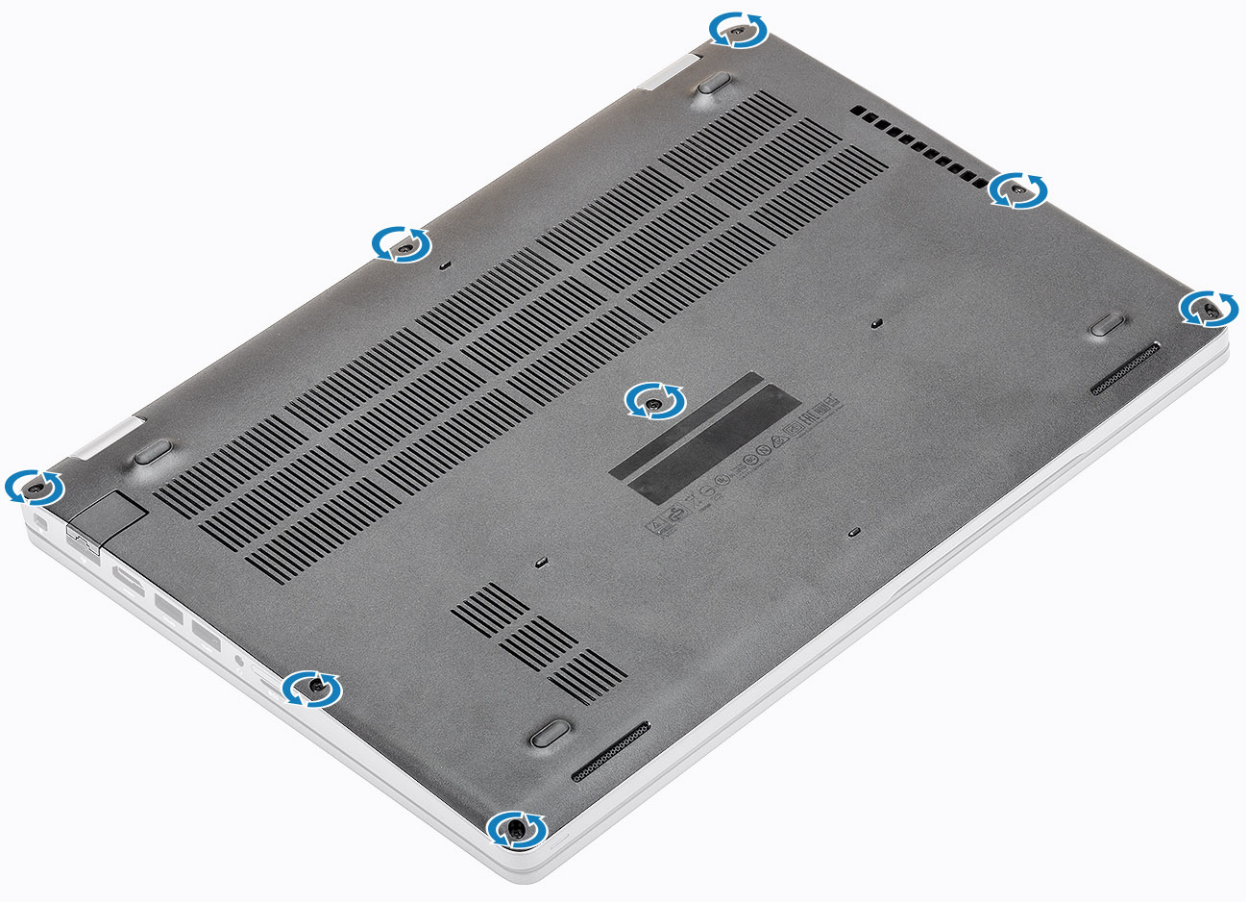

Next steps

1. Install the [microSD card](#).
2. Follow the procedure in [after working inside your computer](#).

Battery

Lithium-ion battery precautions

⚠ CAUTION:

- Exercise caution when handling Lithium-ion batteries.
- Discharge the battery completely before removing it. Disconnect the AC power adapter from the system and operate the computer solely on battery power—the battery is fully discharged when the computer no longer turns on when the power button is pressed.
- Do not crush, drop, mutilate, or penetrate the battery with foreign objects.
- Do not expose the battery to high temperatures, or disassemble battery packs and cells.
- Do not apply pressure to the surface of the battery.
- Do not bend the battery.
- Do not use tools of any kind to pry on or against the battery.
- Ensure any screws during the servicing of this product are not lost or misplaced, to prevent accidental puncture or damage to the battery and other system components.
- If the battery gets stuck inside your computer as a result of swelling, do not try to release it as puncturing, bending, or crushing a lithium-ion battery can be dangerous. In such an instance, contact Dell technical support for assistance. See www.dell.com/contactdell.

- Always purchase genuine batteries from www.dell.com or authorized Dell partners and resellers.
- Swollen batteries should not be used and should be replaced and disposed properly. For guidelines on how to handle and replace swollen Lithium-ion batteries, see [Handling swollen Lithium-ion batteries](#).

Removing the battery

Prerequisites

1. Follow the procedure in [before working inside your computer](#)
2. Remove the [microSD card](#).
3. Remove the [base cover](#).

Steps

1. Disconnect the battery cable from the connector in the system board.

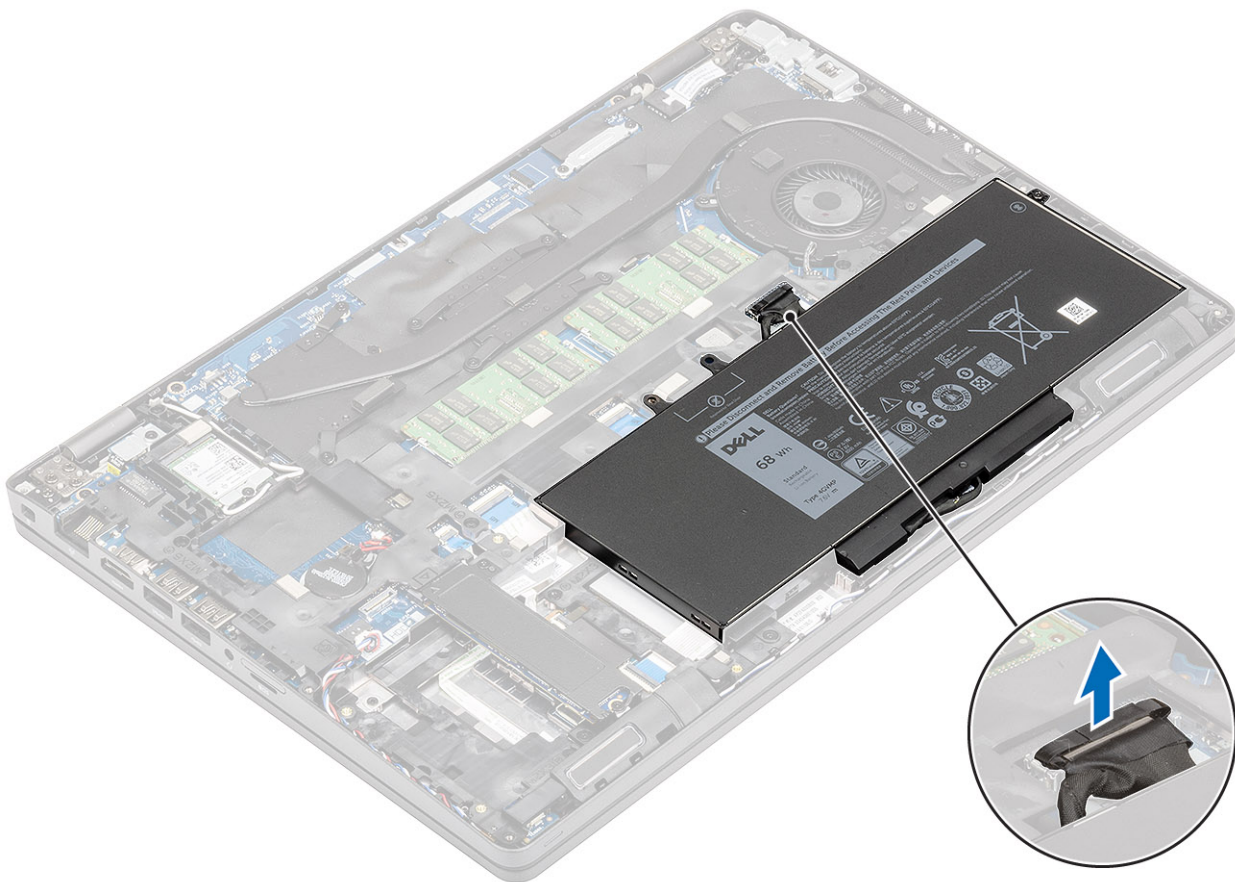

2. Remove the one (M2.0x4.0) screw that secures the battery to the palmrest [1].
3. Remove the battery from the computer [2].

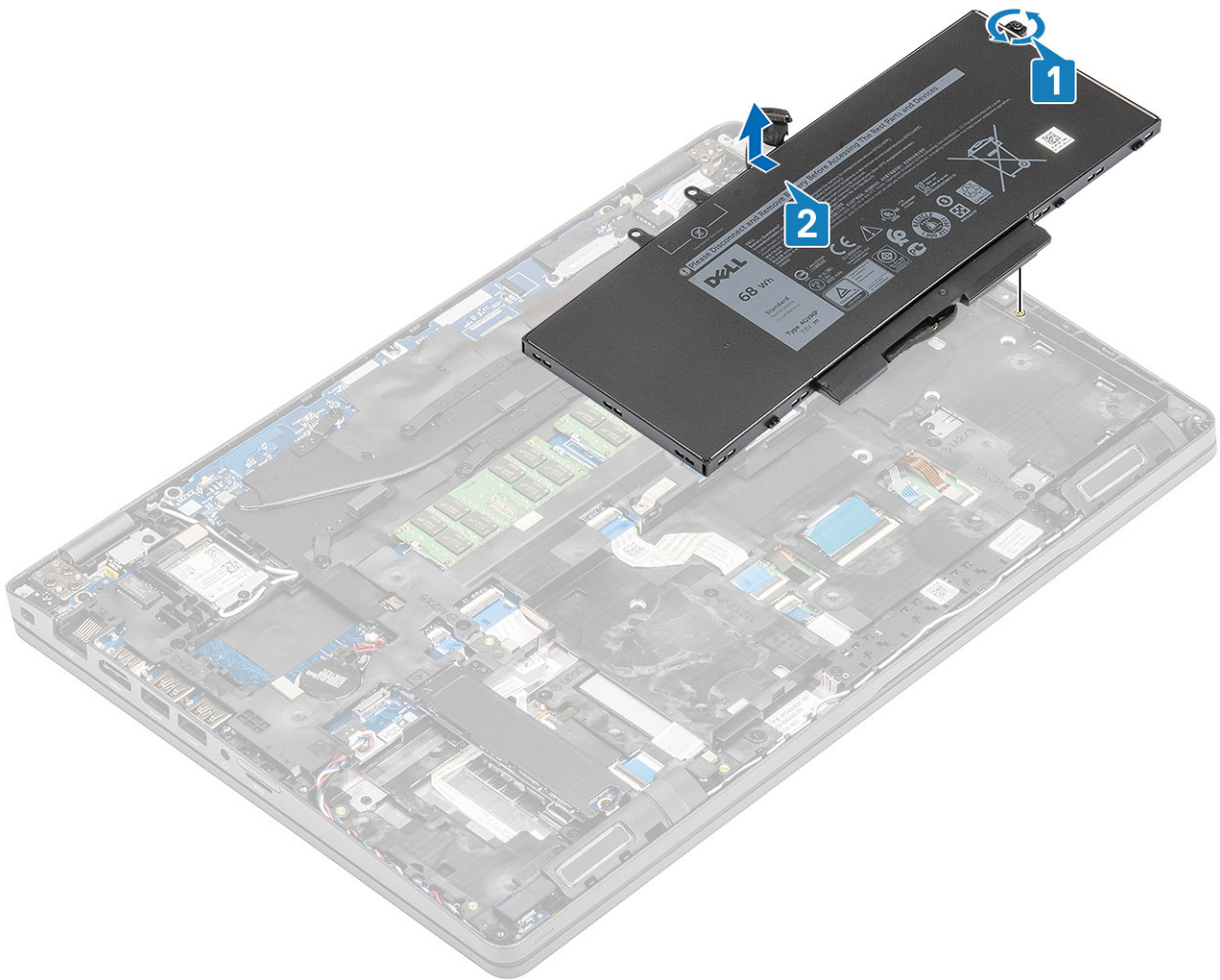

Installing the battery

Steps

1. Align the battery into the slot on the computer [1] and replace the single (M2.0x4.0) screw to secure the battery to the palmrest [2].

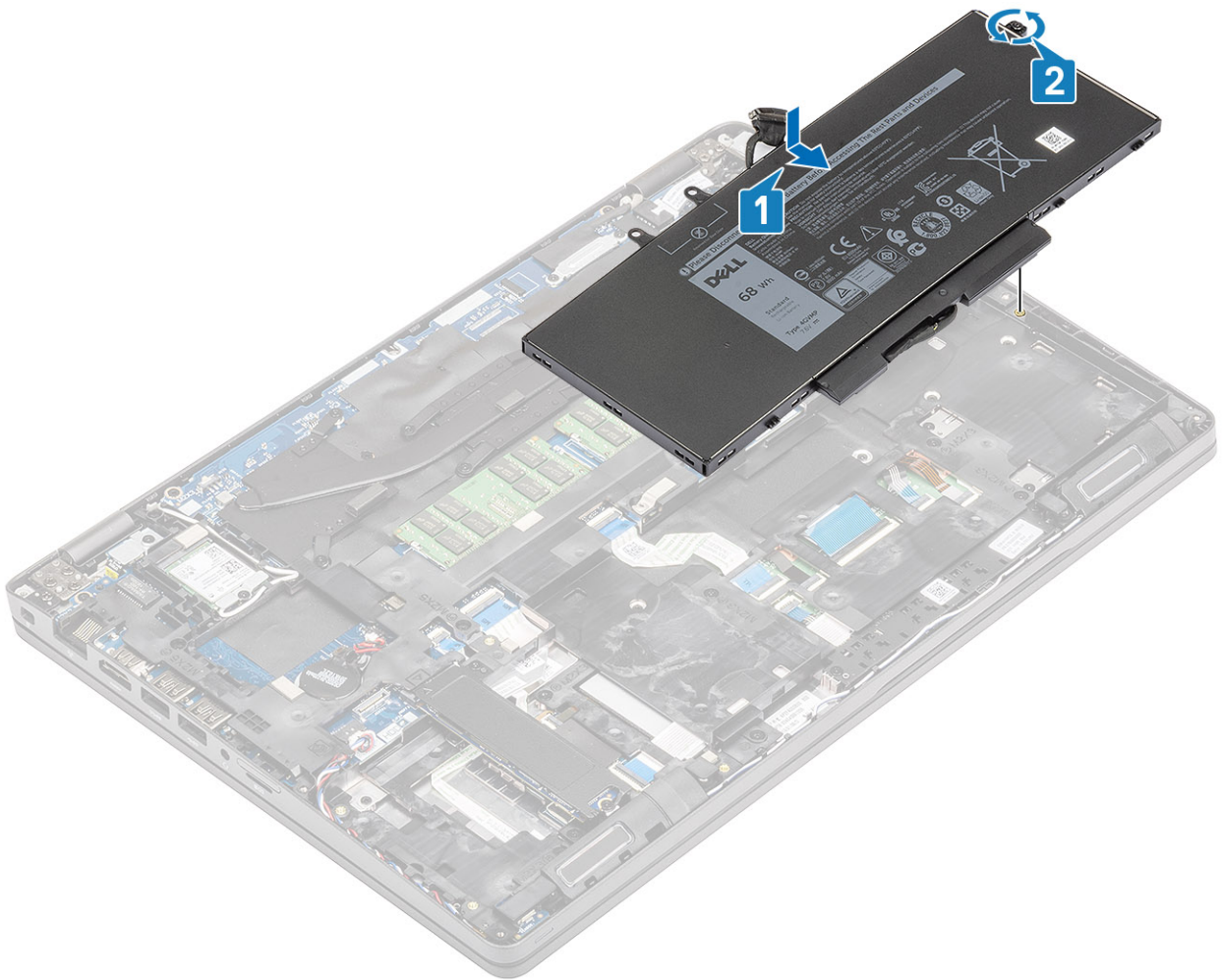

2. Reconnect the battery cable to the connector on the system board.

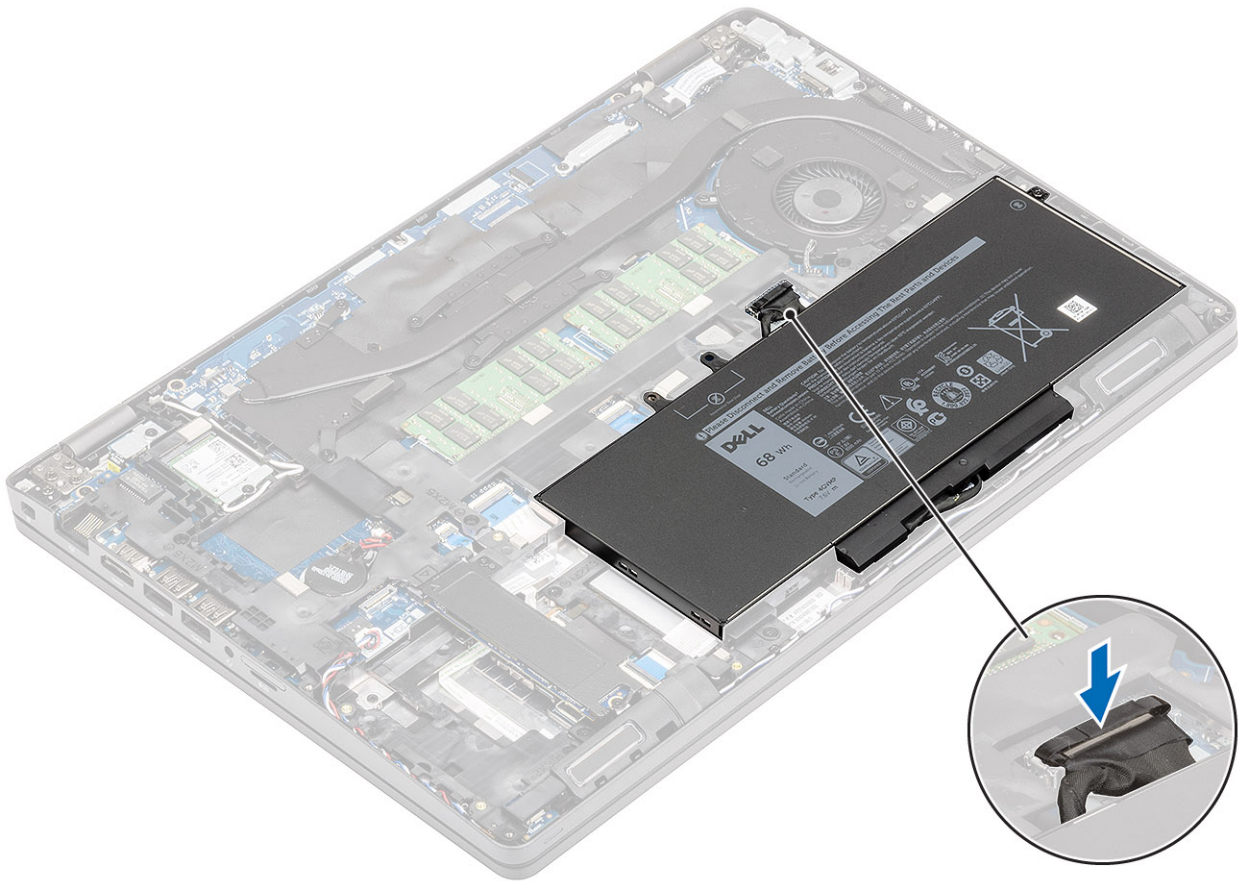

Next steps

1. Install the [base cover](#).
2. Install the [microSD card](#).
3. Follow the procedure in [after working inside your computer](#).

Memory modules

Removing the memory

Prerequisites

1. Follow the procedure in [before working inside your computer](#)
2. Remove the [microSD card](#).
3. Remove the [base cover](#).
4. Remove the [battery](#).

Steps

Gently pry on the memory module latch [1] and slide it out of the slot [2].

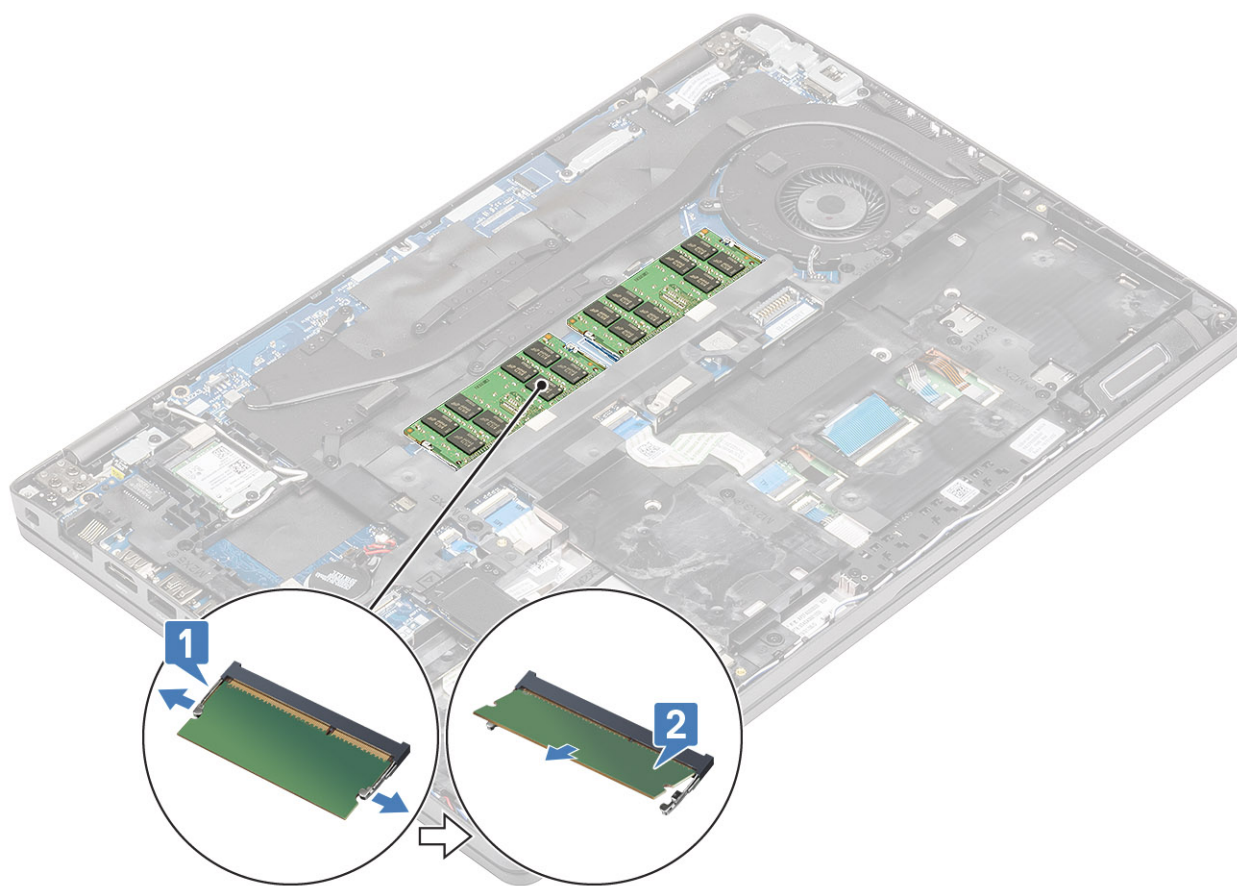

Installing the memory

Steps

Align the memory and slide it into the slot on the computer [1] and gently press down on the memory module till it locks into the latches [2].

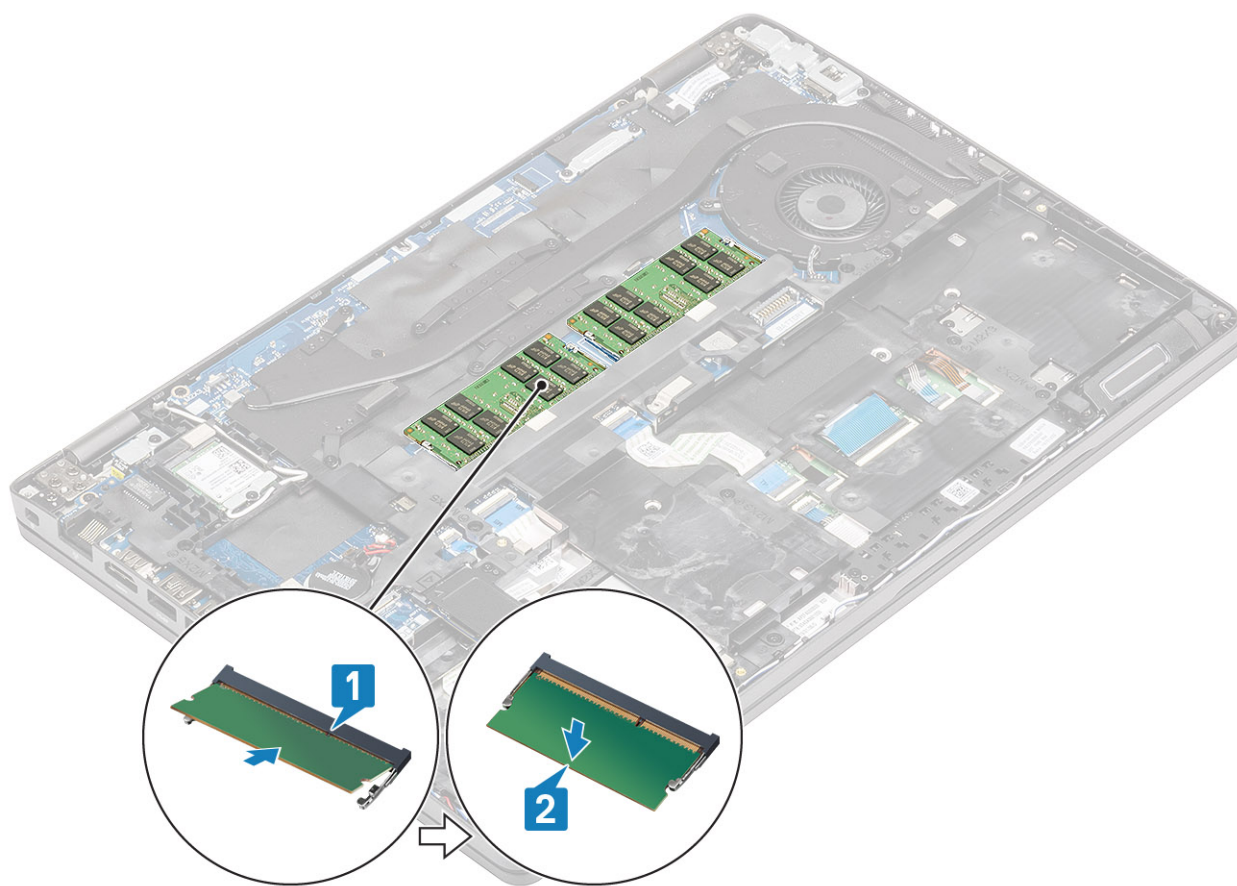

Next steps

1. Install the [battery](#).
2. Install the [base cover](#).
3. Install the [microSD card](#).
4. Follow the procedure in [after working inside your computer](#).

WLAN card

Removing the wireless card

Prerequisites

1. Follow the procedure in [before working inside your computer](#)
2. Remove the [microSD card](#).
3. Remove the [base cover](#).
4. Remove the [battery](#).

Steps

1. Remove the single screw that secures the wlan bracket to the computer [1] and lift the bracket away from the computer [2].
2. Disconnect the two wireless antennas from the wireless card [3] and slide the card out of the connector [4].

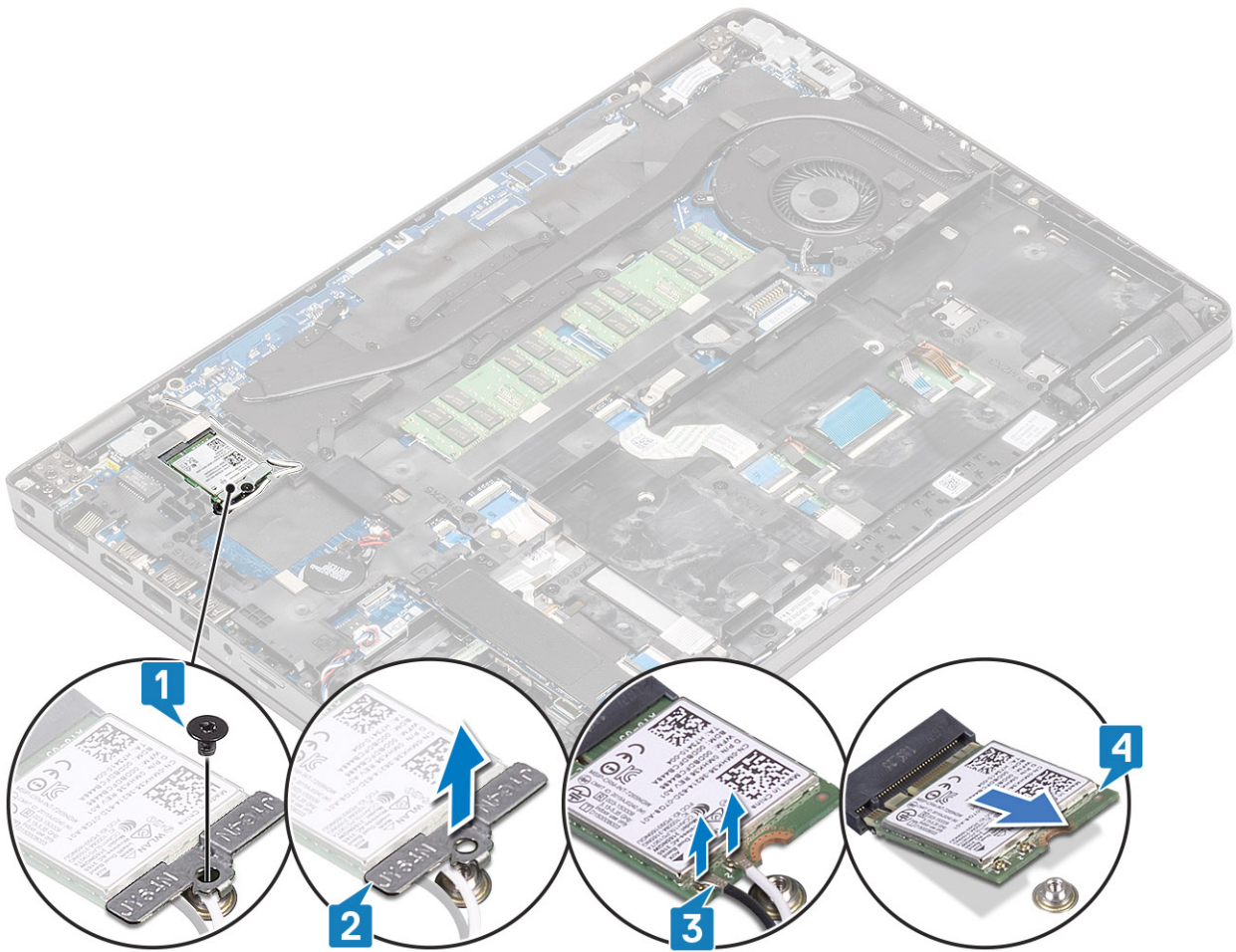

Installing the wireless card

Steps

1. Slide the wireless card into the slot on the computer [1] and reconnect the wireless antennas to the card [2].
2. Replace the wireless bracket on the card [3] and secure it with the single screw to the computer [4].

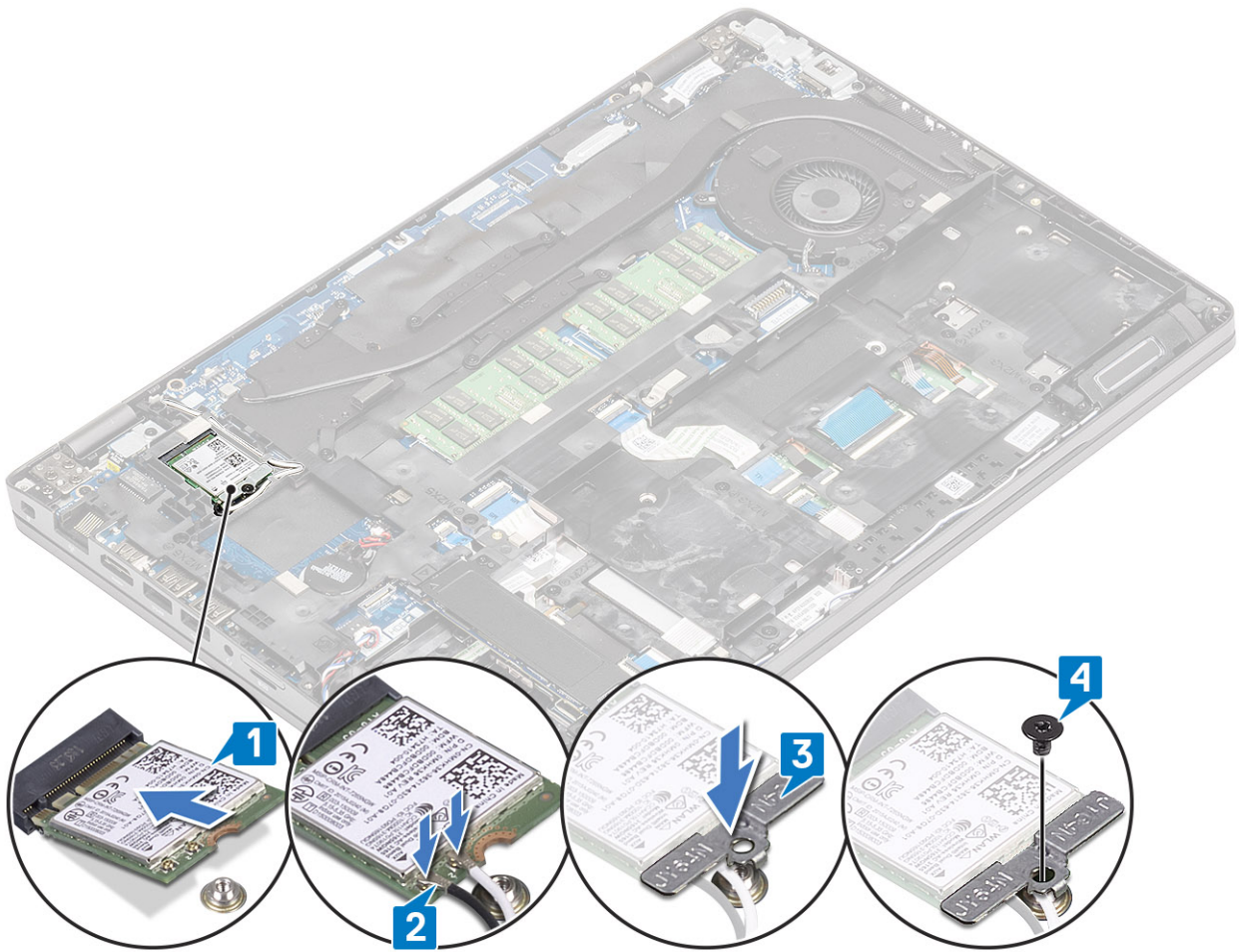

Next steps

1. Install the [battery](#).
2. Install the [base cover](#).
3. Install the [microSD card](#).
4. Follow the procedure in [after working inside your computer](#).

Hard disk drive (HDD)

Removing hard disk drive

Prerequisites

1. Follow the procedure in [before working inside your computer](#)
2. Remove the [microSD card](#).
3. Remove the [base cover](#).
4. Remove the [battery](#).

Steps

1. Disconnect the hard disk drive cable from the system board. [1]
2. Remove the four M2x2.7 screws securing the hard drive assembly in place [2].
3. Remove the hard drive assembly from the system [3].
4. Disconnect and remove the hard drive cable from the hard drive.



5. Remove the four M3x3 screws securing the hard drive bracket in place.
6. Remove the hard drive bracket.

Installing hard disk drive

Steps

1. Place the hard drive bracket.

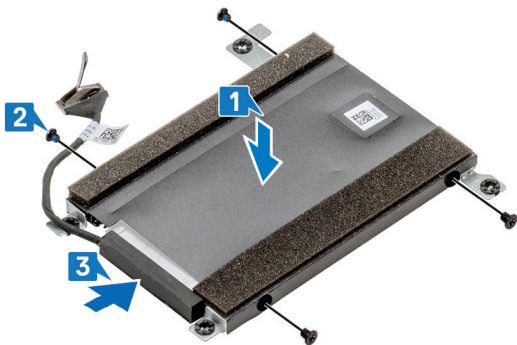

2. Tighten the four M3x3 screws to attach the metal bracket to the hard disk drive.
3. Connect the hard drive cable.
4. Insert the hard disk drive into the slot on the computer [1].
5. Tighten the four M2x2.7 screws to secure the hard disk drive to the computer [2].
6. Connect the hard disk drive cable to the system board [3].

Next steps

1. Install the [battery](#).
2. Install the [base cover](#).
3. Install the [microSD card](#).
4. Follow the procedure in [after working inside your computer](#).

Solid state drive

Removing the Solid state drive

Prerequisites

1. Follow the procedure in [before working inside your computer](#)
2. Remove the [microSD card](#).
3. Remove the [base cover](#).
4. Remove the [battery](#).

Steps

1. Remove the two screws that secure the ssd to computer [1] and slide the ssd module along with the metal bracket from the connector [2].

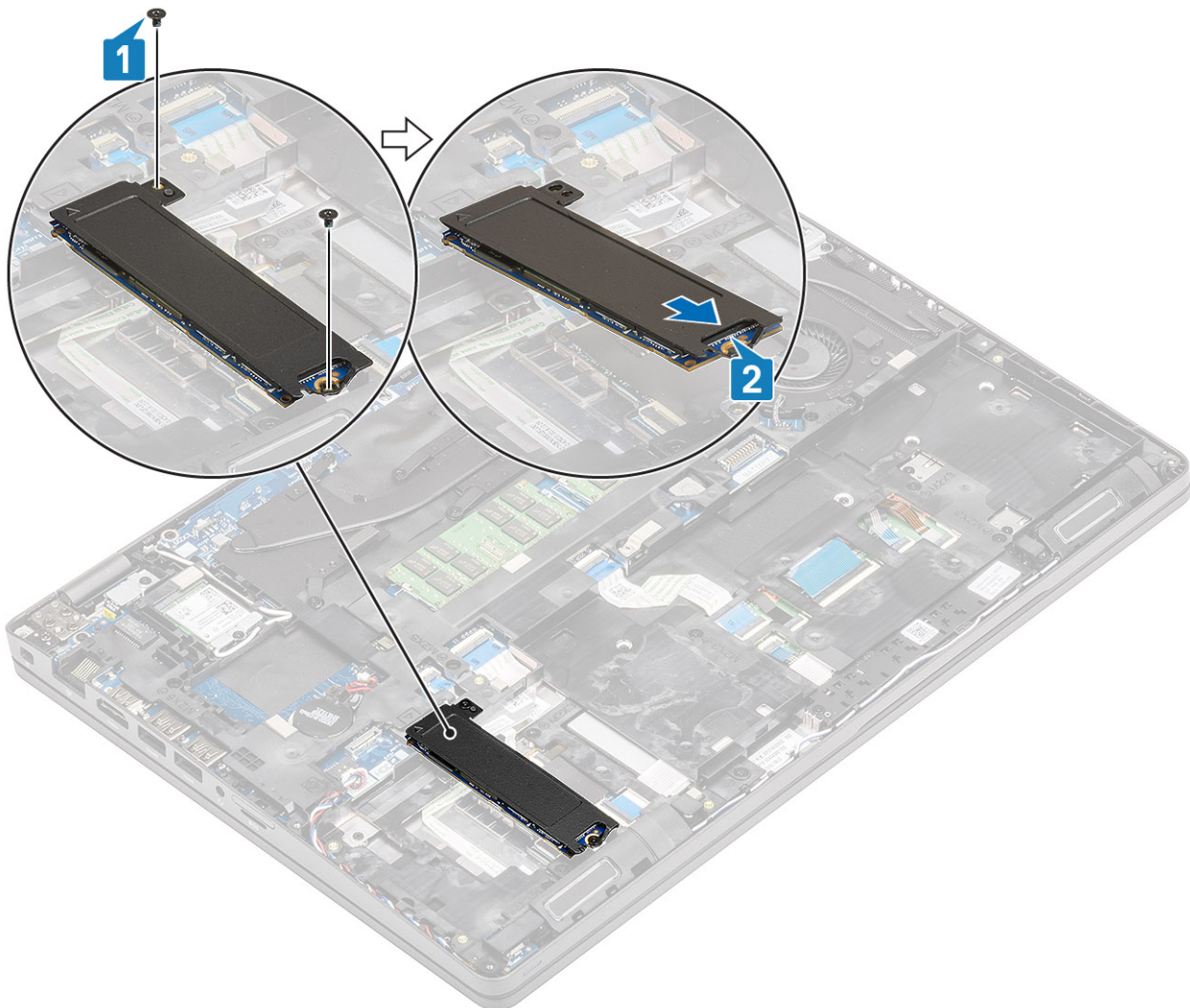

2. Turn the metal bracket over and detach the ssd module from the thermal pad on the metal bracket.

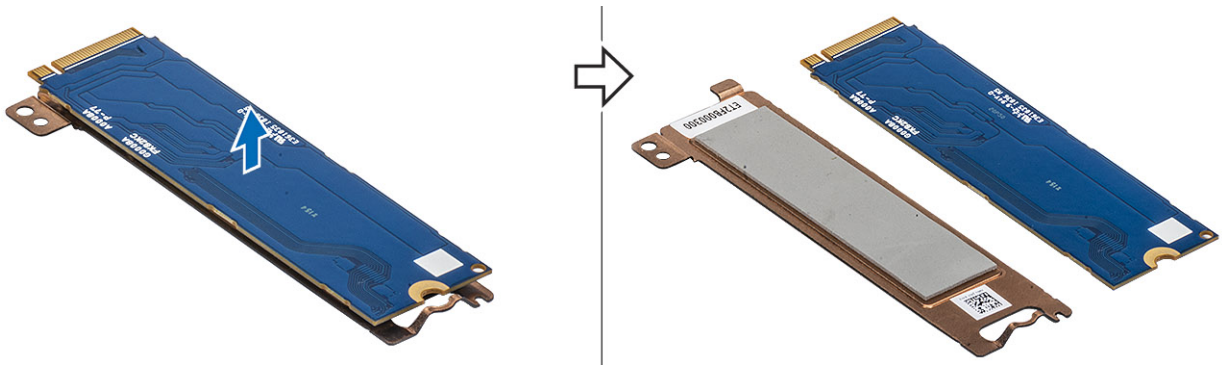

Installing the solid state drive

Steps

1. Affix the ssd module on the metal bracket [1] and slide the module into the connector on the computer [2].
2. Replace the two screws to secure the module on the computer [3].

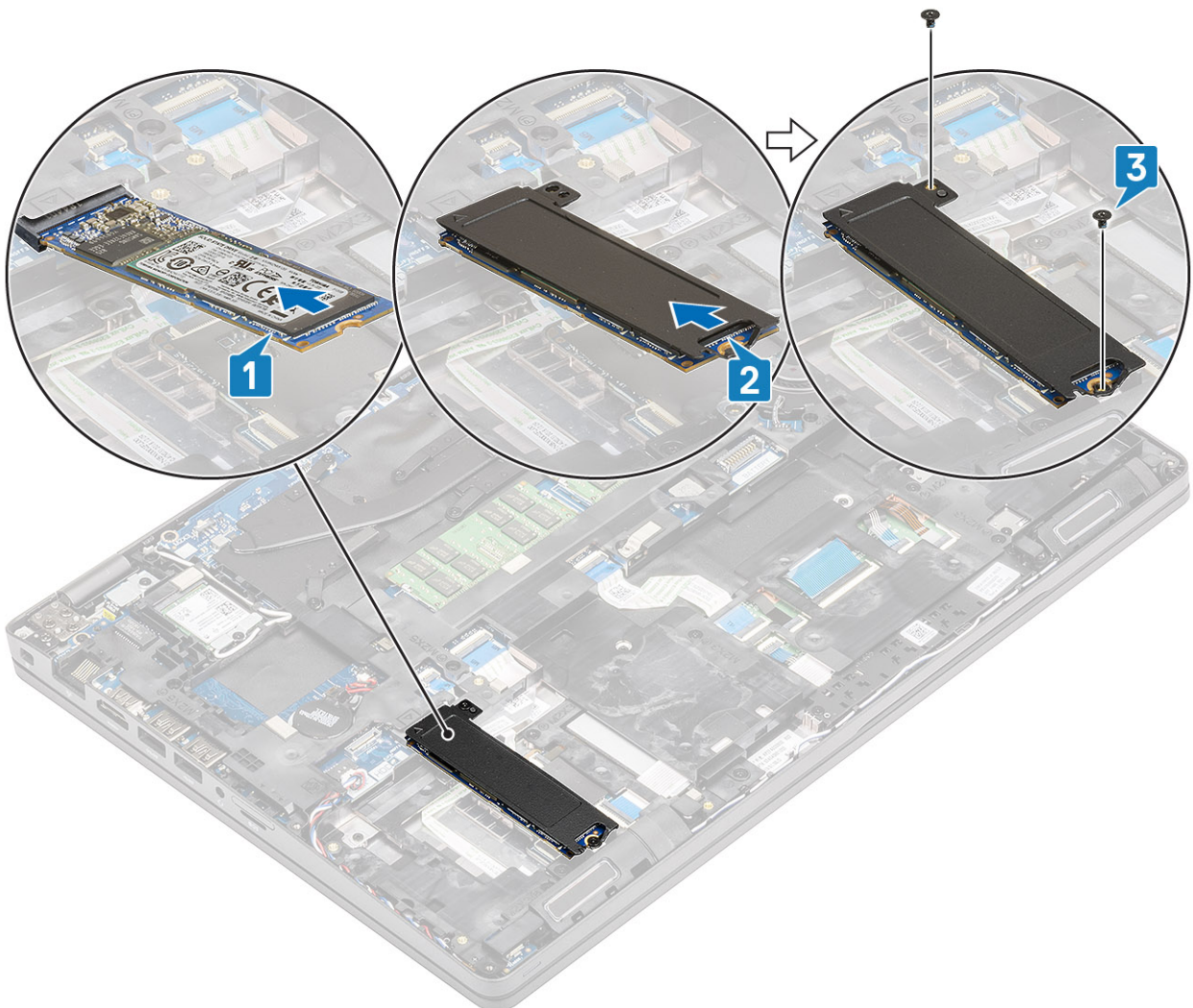

Next steps

1. Install the [battery](#).
2. Install the [base cover](#).
3. Install the [microSD card](#).

4. Follow the procedure in [after working inside your computer](#).

Solid state drive bracket

Removing the solid state drive bracket

Prerequisites

1. Follow the procedure in [before working inside your computer](#)
2. Remove the [microSD card](#).
3. Remove the [base cover](#).
4. Remove the [battery](#).
5. Remove the [ssd](#).

Steps

Remove the single screw that secures the bracket to the computer [1] and lift it out of the computer [2].

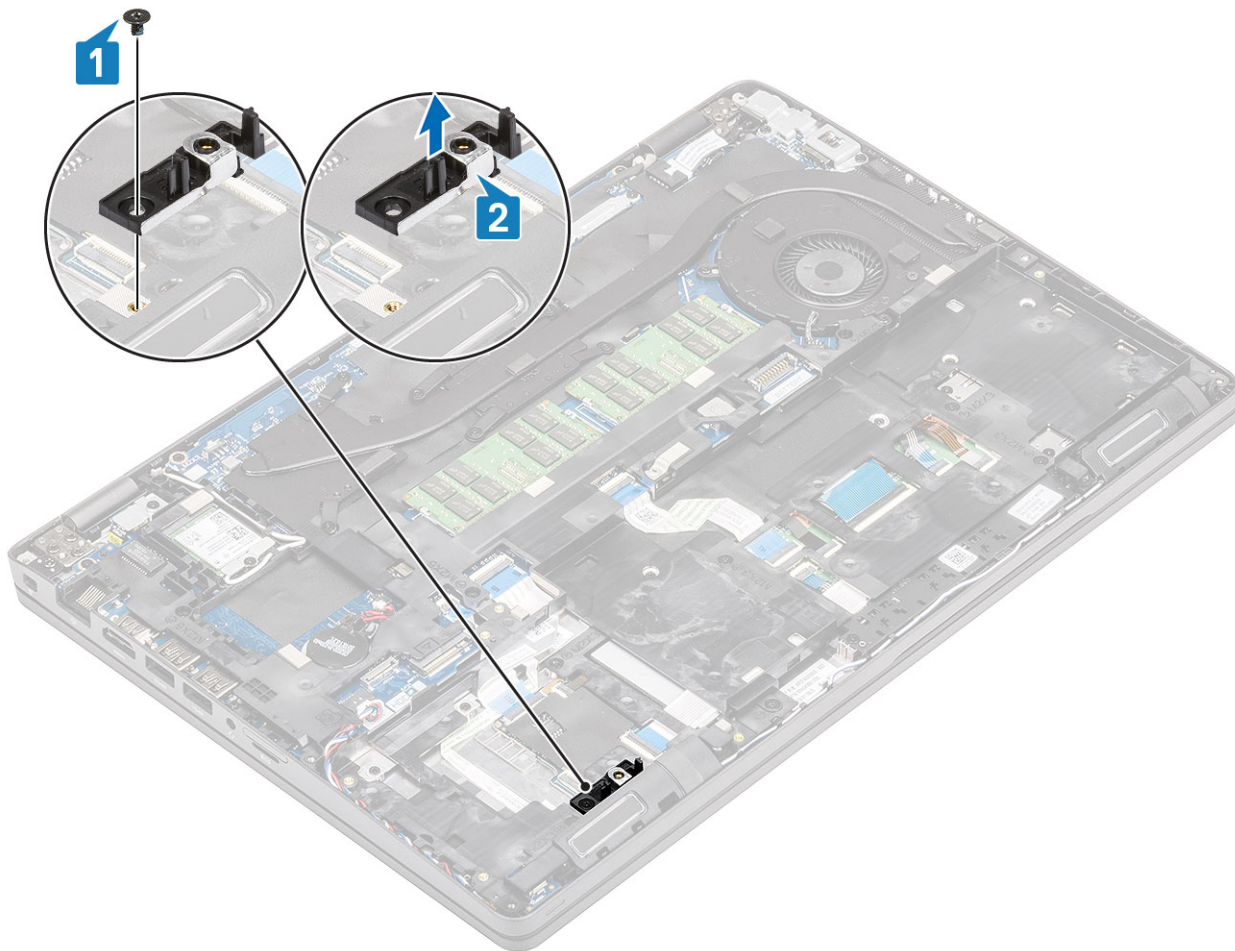

Installing the solid state drive bracket

Steps

Align the bracket and insert it into the slot on the computer [1] and replace the single screw that secures the bracket to the computer [2].

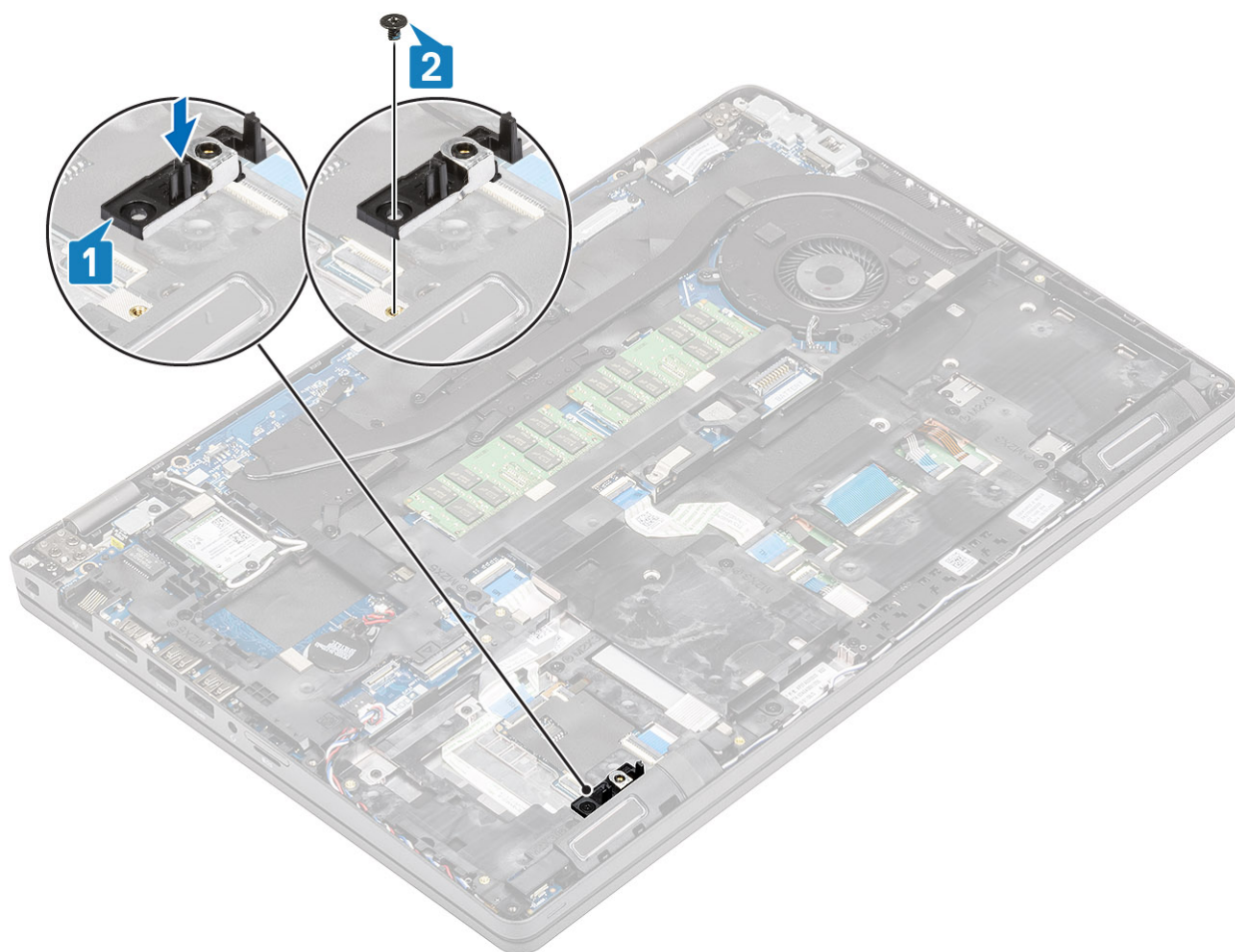

Next steps

1. Install the [ssd](#).
2. Install the [battery](#).
3. Install the [base cover](#).
4. Install the [microSD card](#).
5. Follow the procedure in [after working inside your computer](#).

Palmrest bracket

Removing the palmrest bracket

Prerequisites

1. Follow the procedure in [before working inside your computer](#)
2. Remove the [microSD card](#).
3. Remove the [base cover](#).
4. Remove the [battery](#).
5. Remove the [ssd](#).
6. Remove the [ssd bracket](#).

Steps

1. Un-route the wireless antenna [1] and then disconnect and un-route the speaker cable from the system board [2].

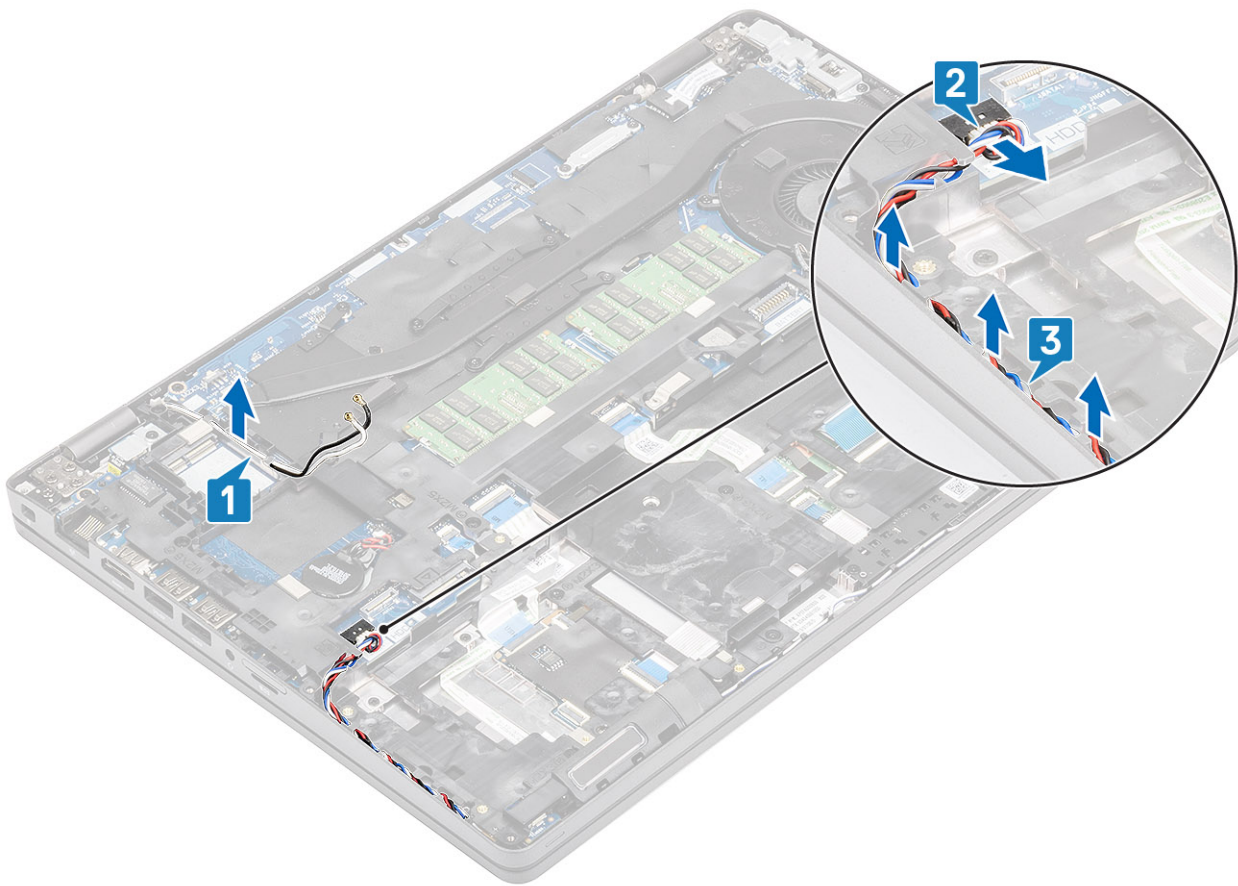

2. Remove the four (M2x5) and six (M2x3) screws that secure the palmrest bracket to the computer [1,2] and lift the bracket away from the computer [3].

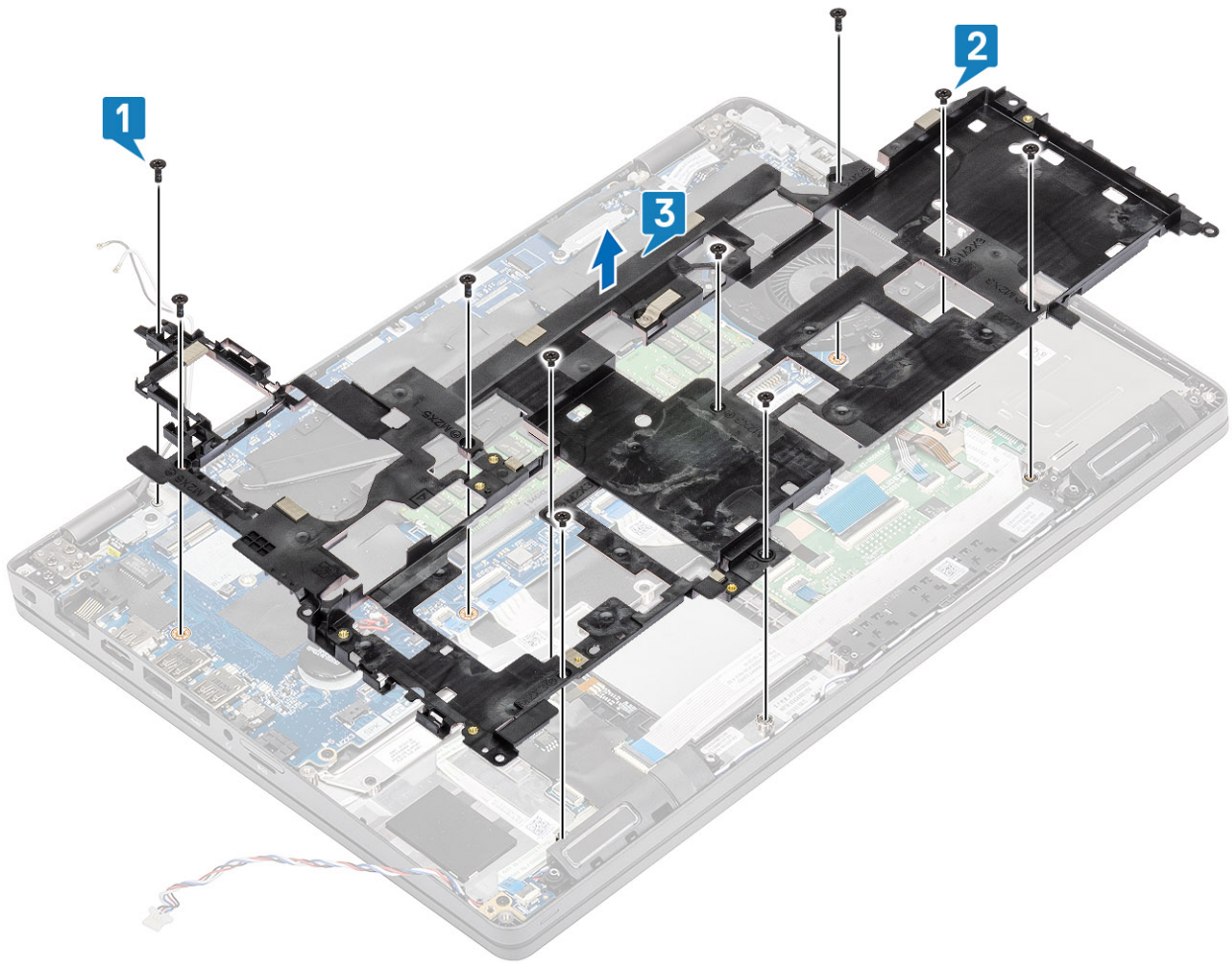

Installing the palmrest bracket

Steps

1. Align and insert the palmrest bracket into the computer [1].
2. Replace the four (M2x5) screws and six (M2x3) to secure the palmrest bracket to the computer [2,3].

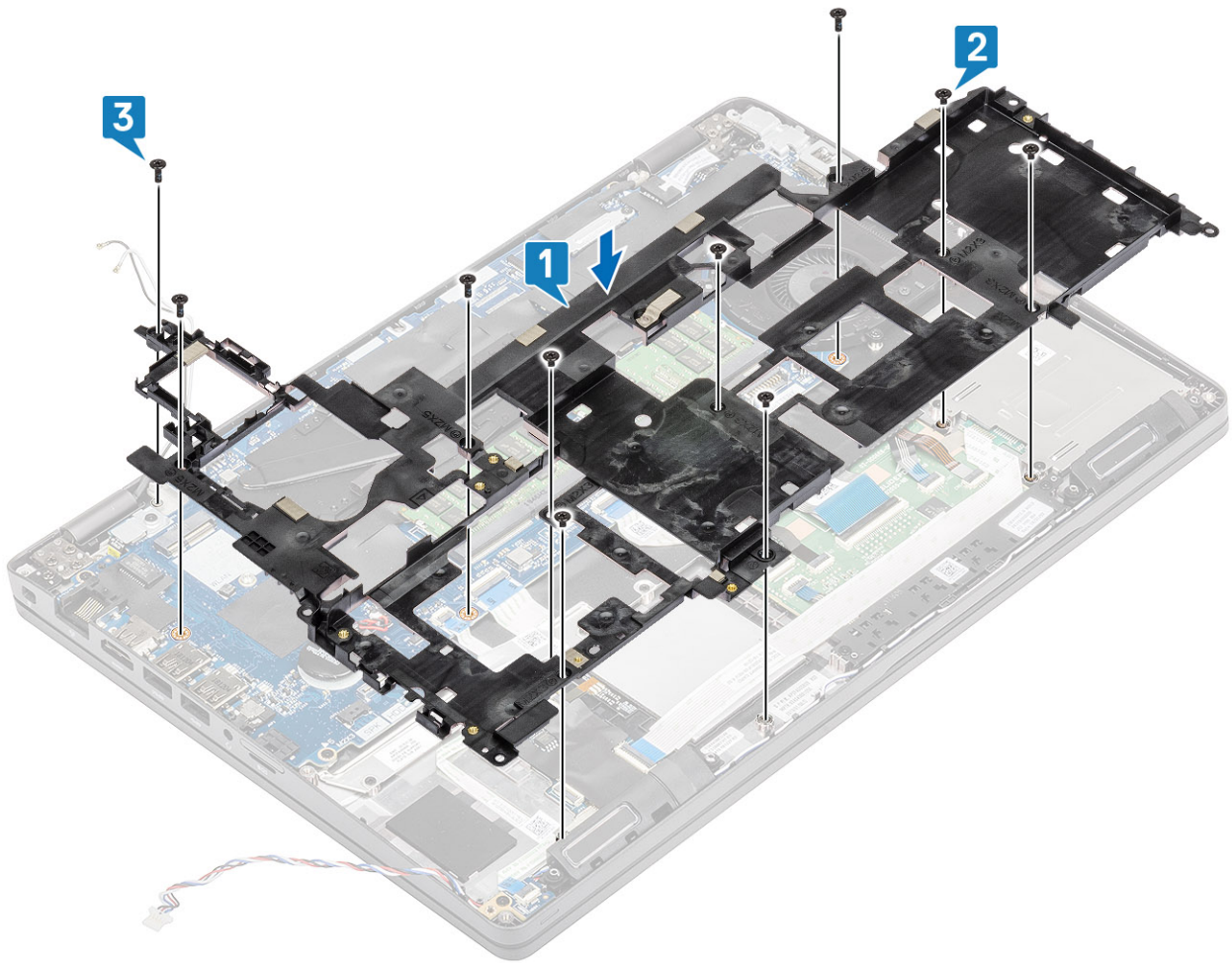

3. Re-route the wireless antennas and the speaker cable through the routing clips [1,2].
4. Reconnect the speaker cable to the system board [3].

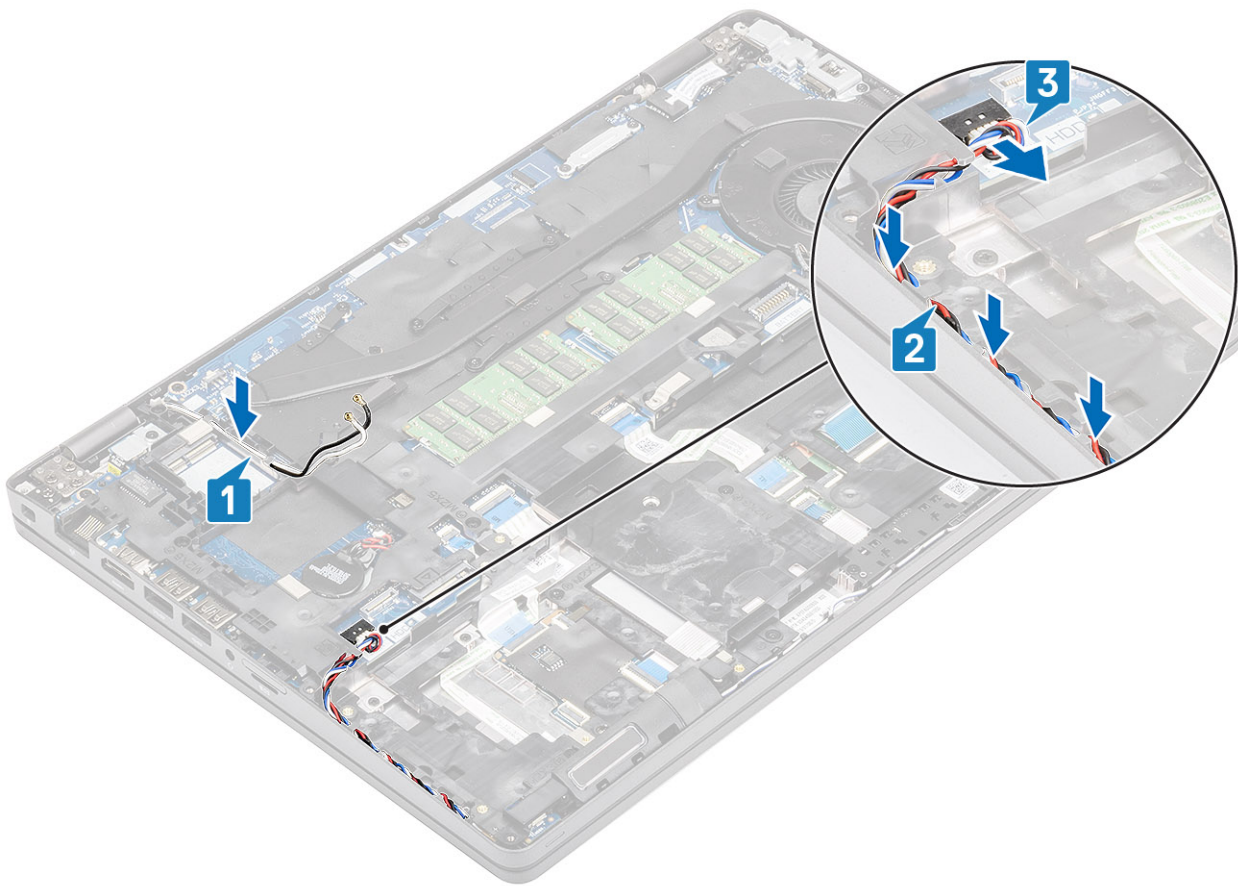

Next steps

1. Install the [ssd bracket](#).
2. Install the [ssd](#).
3. Install the [battery](#).
4. Install the [base cover](#).
5. Install the [microSD card](#).
6. Follow the procedure in [after working inside your computer](#).

Speaker

Removing the speakers

Prerequisites

1. Follow the procedure in [before working inside your computer](#)
2. Remove the [microSD card](#).
3. Remove the [base cover](#).
4. Remove the [battery](#).
5. Remove the [ssd](#).
6. Remove the [ssd bracket](#).
7. Remove the [palmrest bracket](#).

Steps

1. Remove the one (M2x2.5) screw that secures the LED board to the computer [1].
2. Lift and flip the LED board over to access the speaker cables [2].

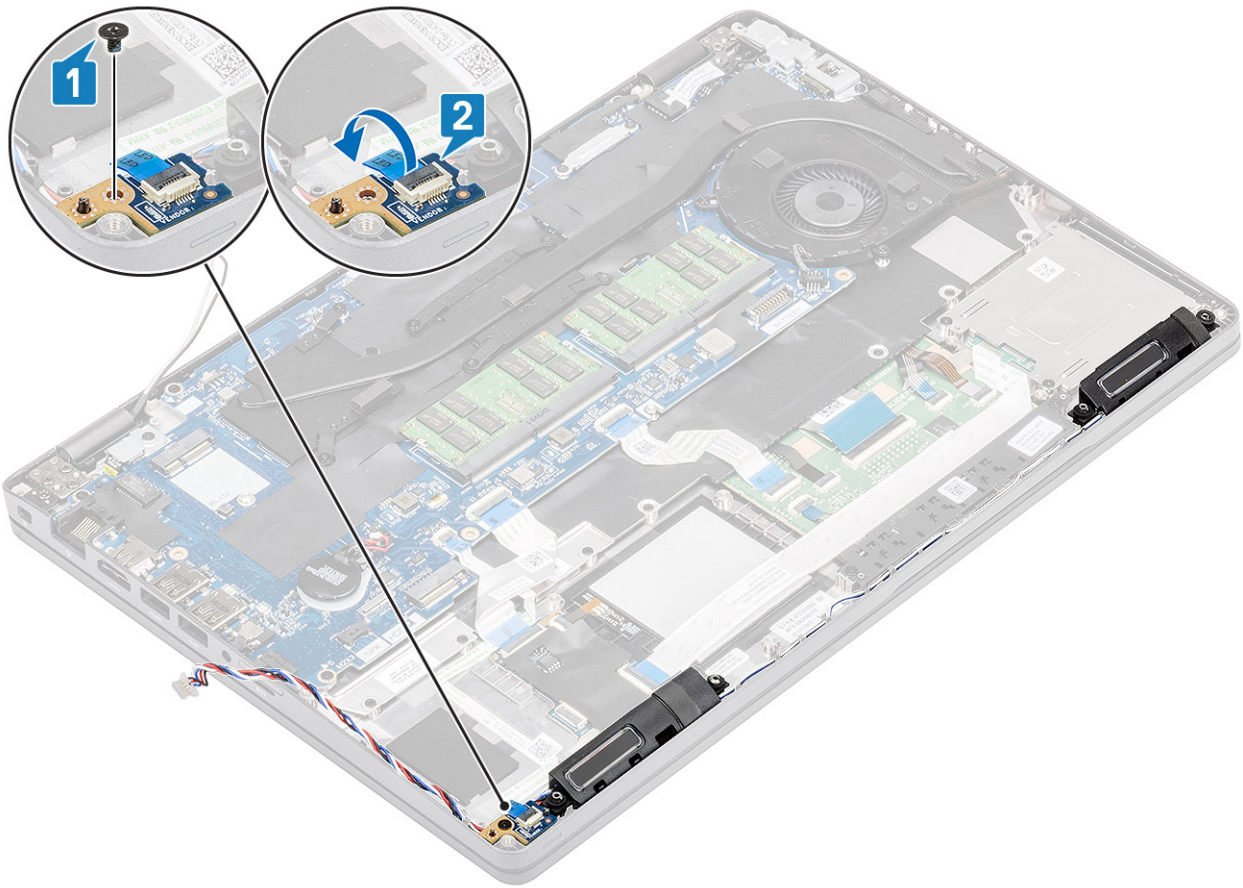

3. Un-route the speaker cables from the routing clips on the computer chassis.

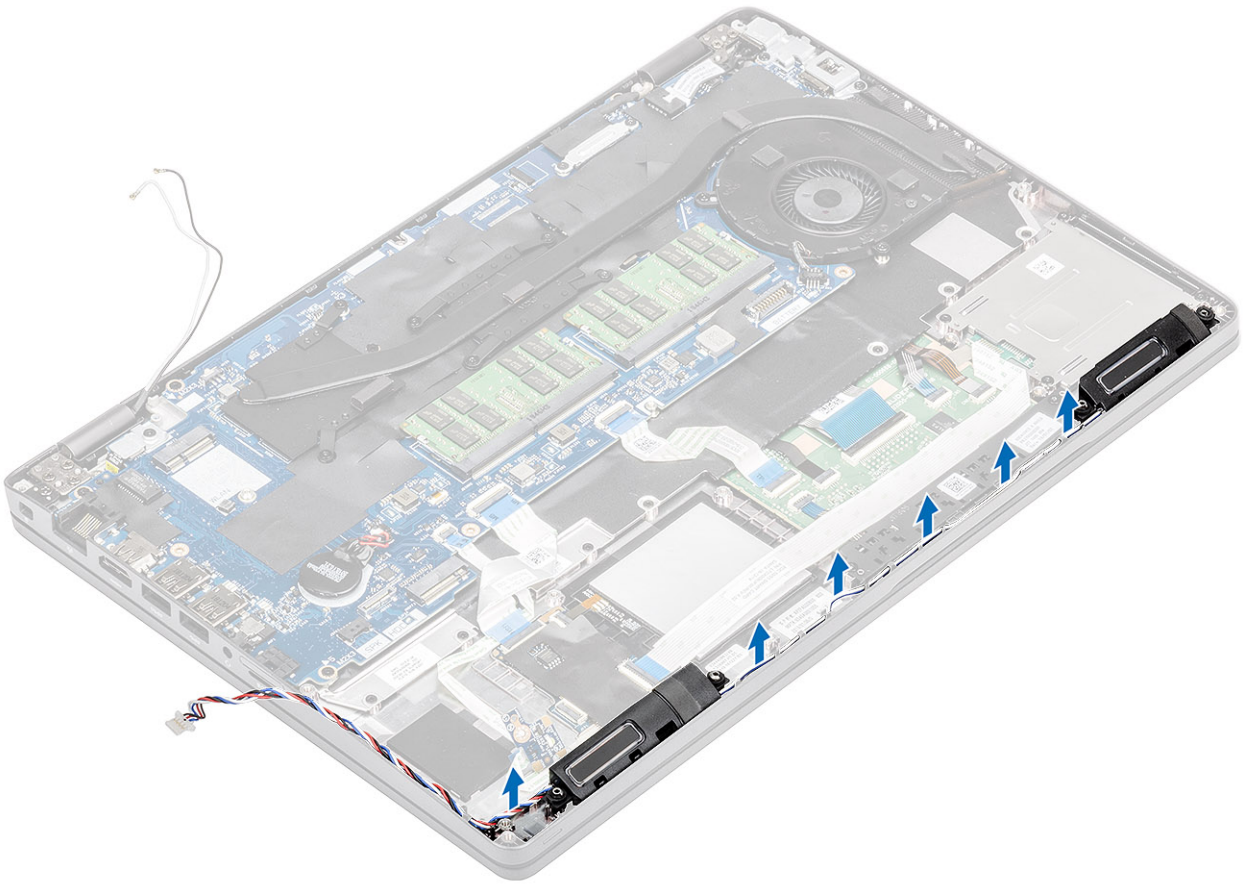

4. Lift the speaker up out of the computer.

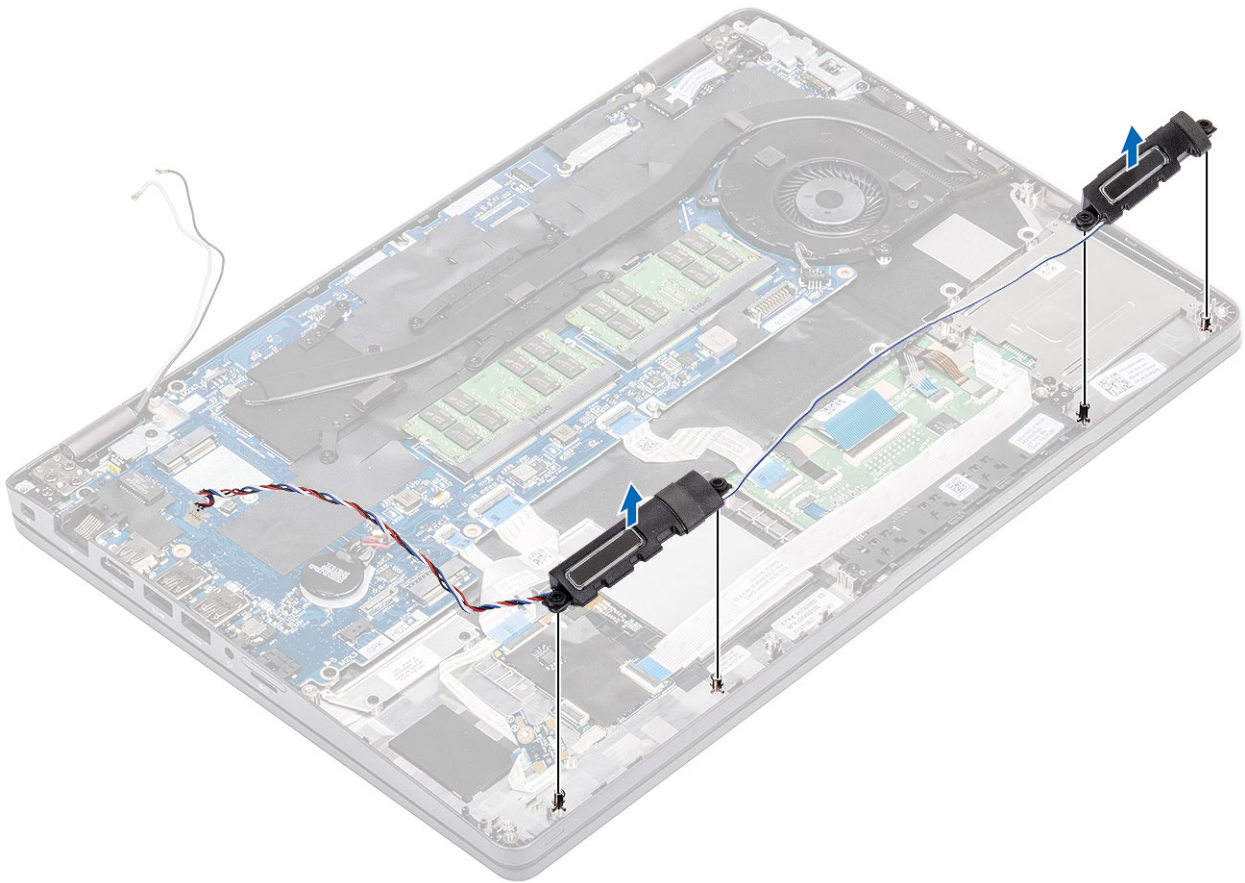

Installing the speakers

Steps

1. Align and place the holes on the speaker module with the pins located on the computer chassis.

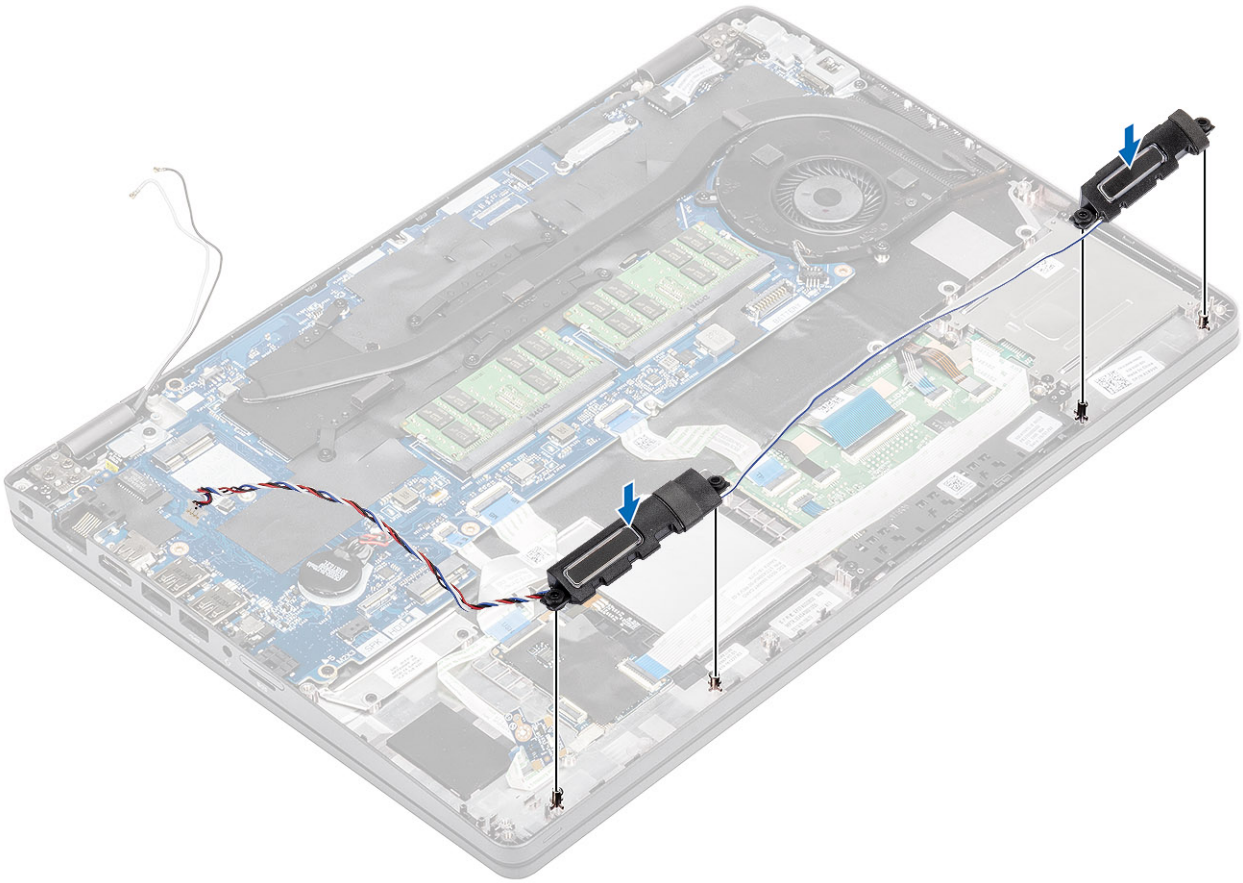

2. Re-route the speaker cables through the routing clips on the computer chassis

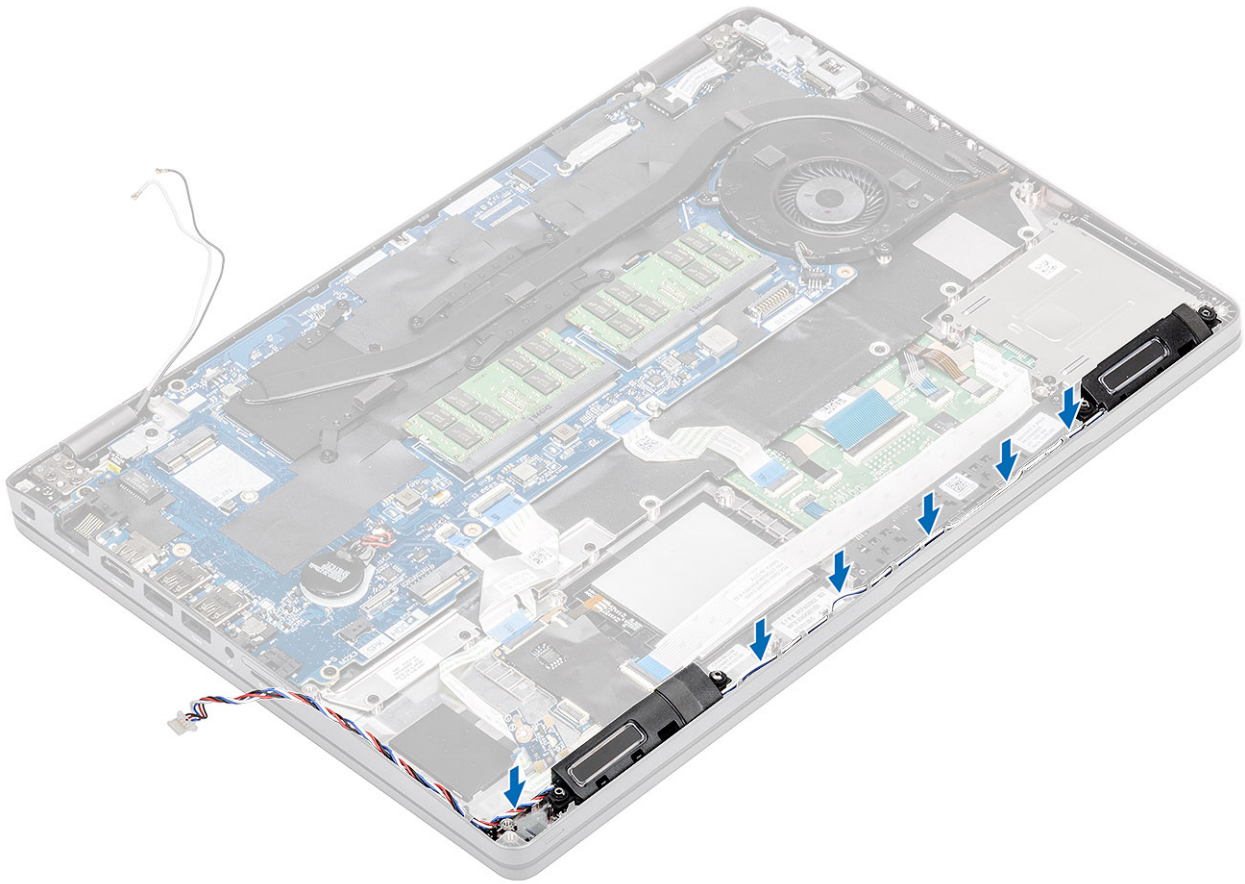

3. Reseat the LED board [1].
4. Replace the one (M2x2.5) to secure the LED board to the computer [2].

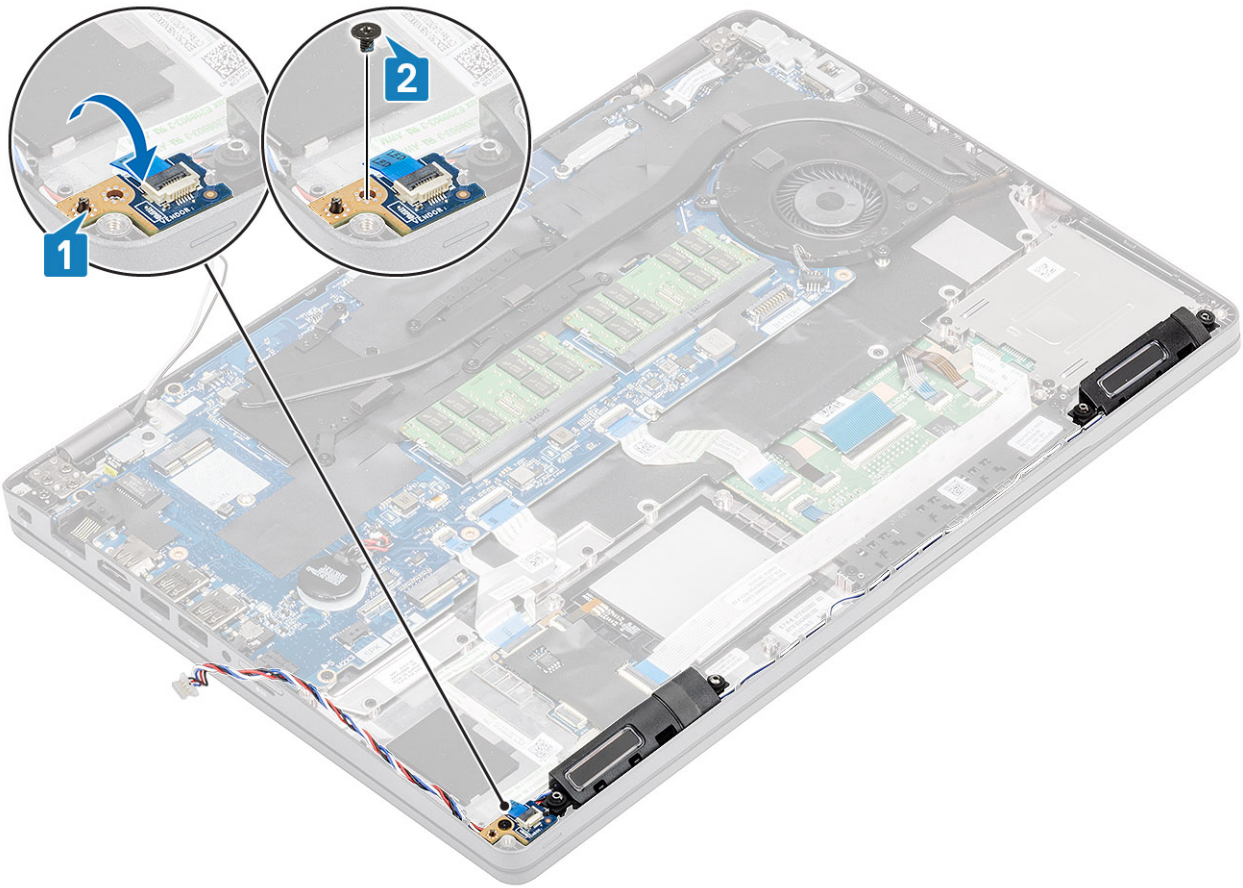

Next steps

1. Install the [palmrest bracket](#).
2. Install the [ssd bracket](#).
3. Install the [ssd](#).
4. Install the [battery](#).
5. Install the [base cover](#).
6. Install the [microSD card](#).
7. Follow the procedure in [after working inside your computer](#).

Heat sink

Removing the Heatsink

Prerequisites

1. Follow the procedure in [before working inside your computer](#)
2. Remove the [microSD card](#).
3. Remove the [base cover](#).
4. Remove the [battery](#).

Steps

1. Disconnect the Heatsink fan cable from the connector on the system board [1].

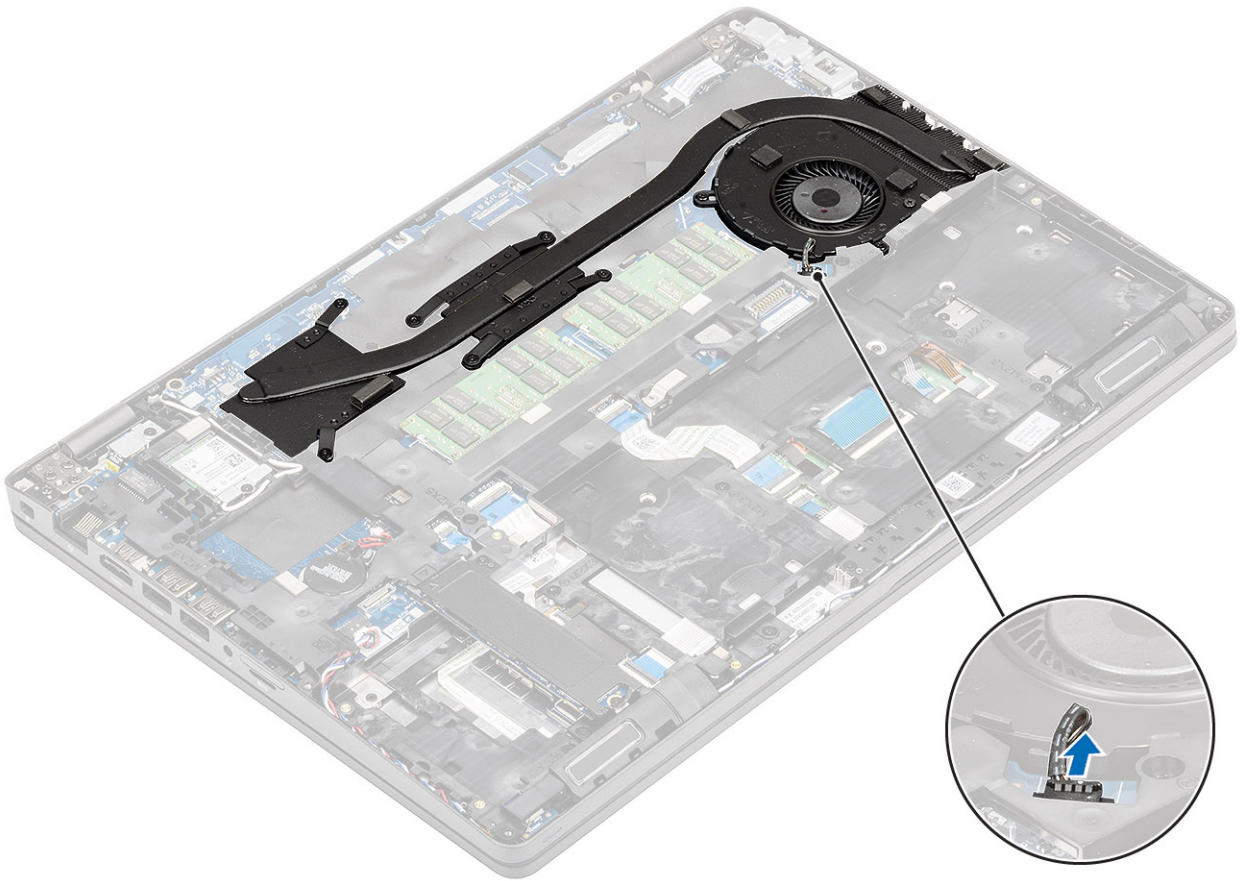

2. Remove the seven (M2x3) screws and the two (M2x5) screws as per the numerical callout on the Heatsink [1].
3. Lift the Heatsink out of the computer [2].

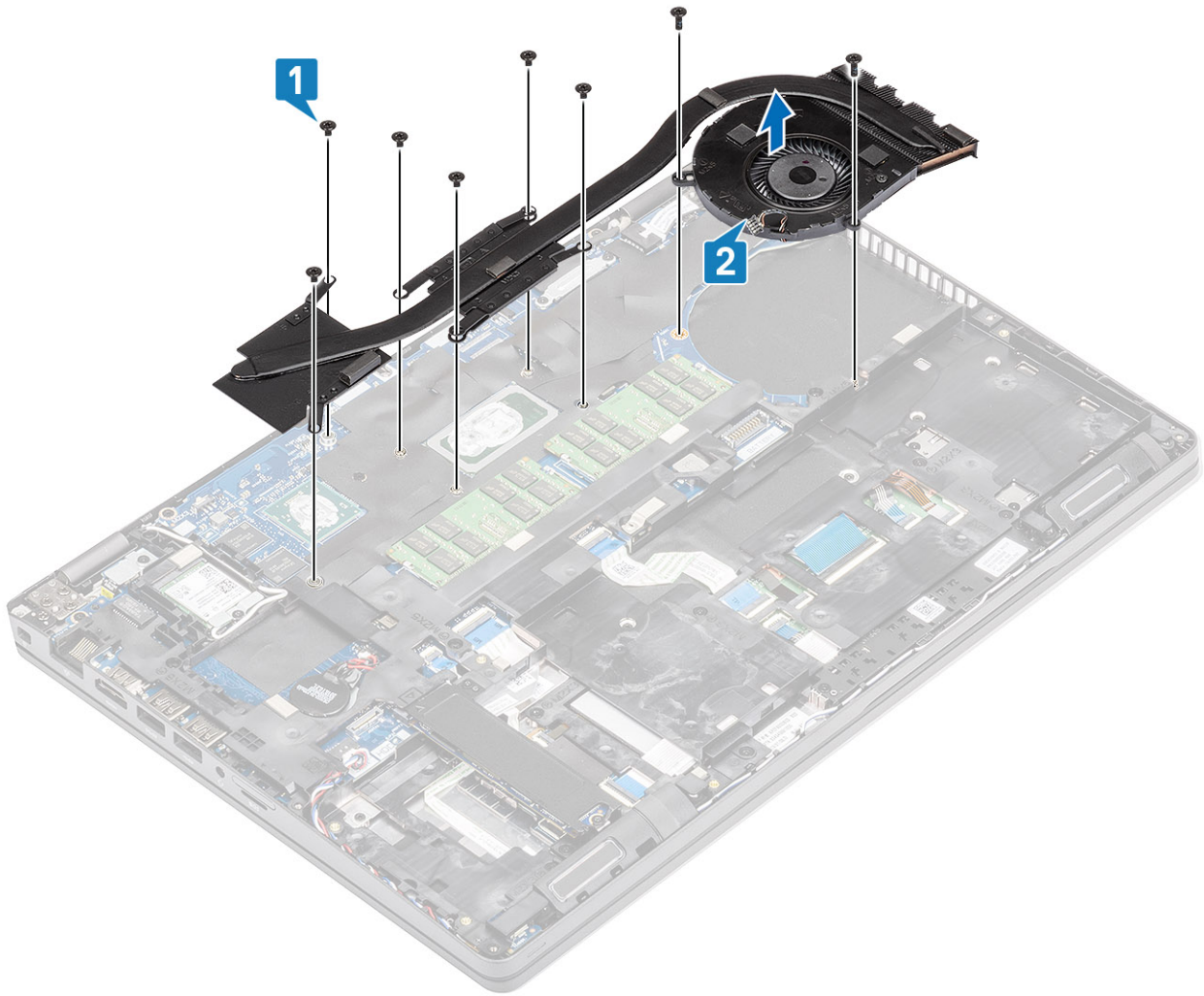

Installing the Heatsink

Steps

1. Align and place the Heatsink over the screw holes on the computer [1].
2. Replace the seven (M2x3) and (M2x5) screws as per the callouts on the Heatsink [2].

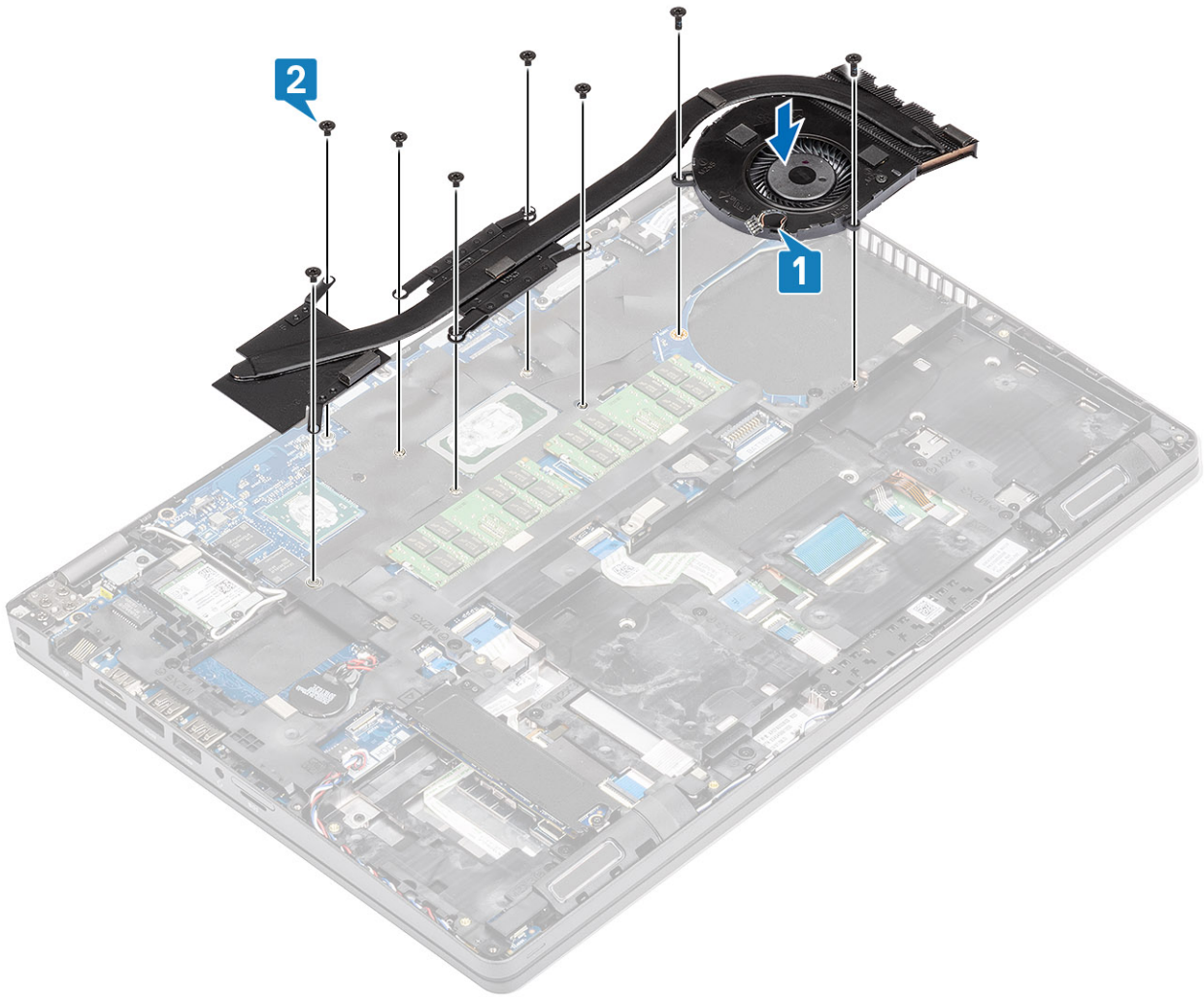

3. Re-connect the Heatsink fan cable to the connector on the system board.

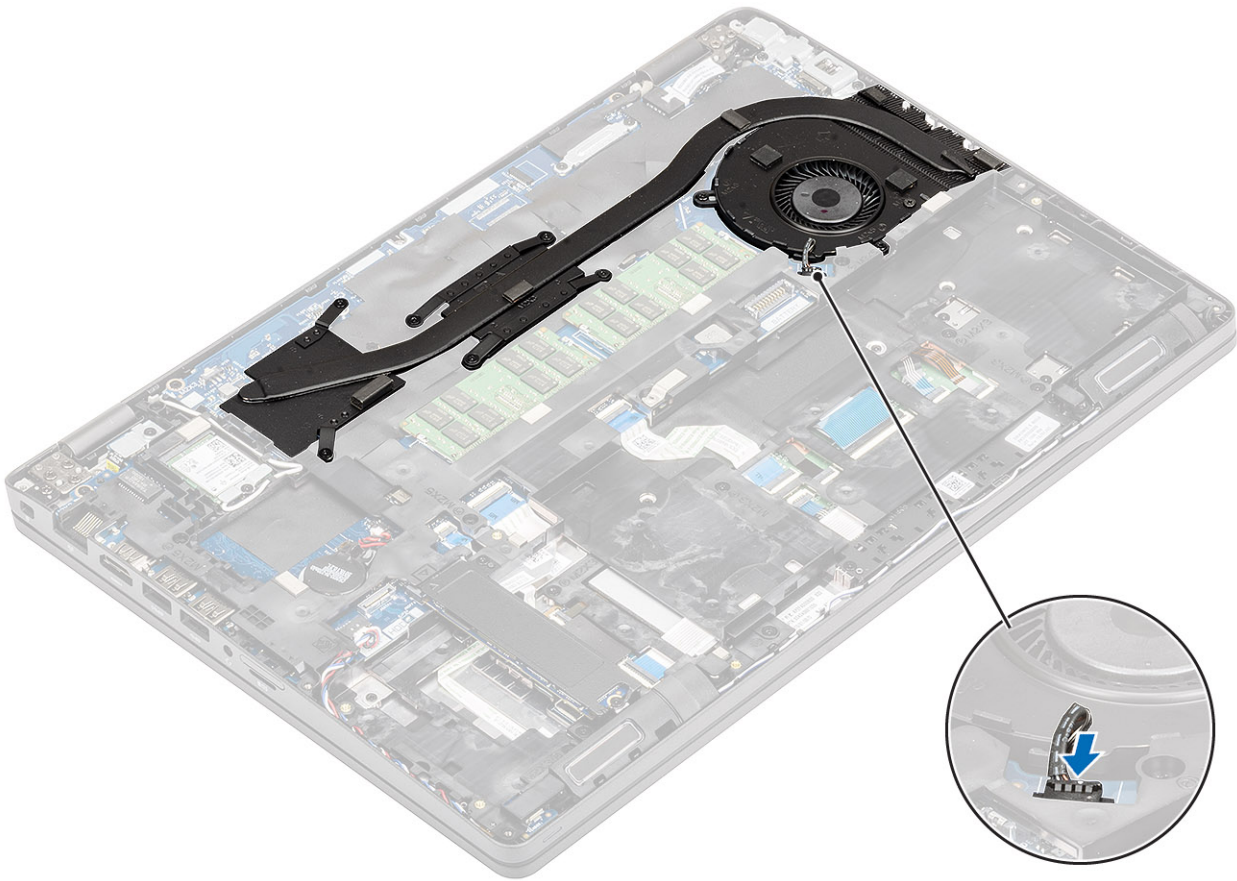

Next steps

1. Install the [battery](#).
2. Install the [base cover](#).
3. Install the [microSD card](#).
4. Follow the procedure in [after working inside your computer](#).

System fan

Removing the system fan

Prerequisites

1. Follow the procedure in [before working inside your computer](#).
2. Remove the [microSD card](#).
3. Remove the [base cover](#).
4. Remove the [battery](#).

Steps

1. Disconnect the system fan cable from the connector on the system board.

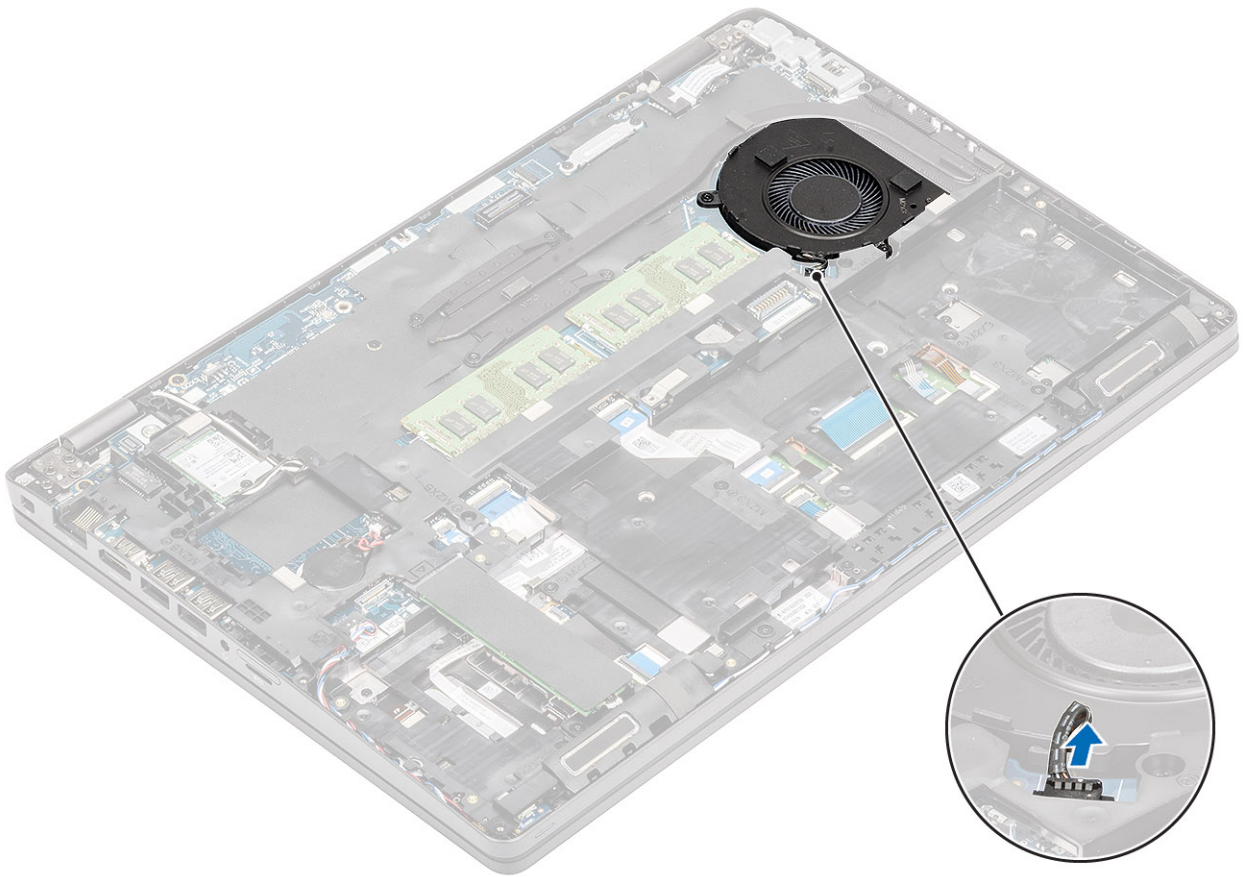

2. Remove the two (M2x5) screws that secure the system fan to the palmrest [1].
3. Lift the system fan away from the computer [2].

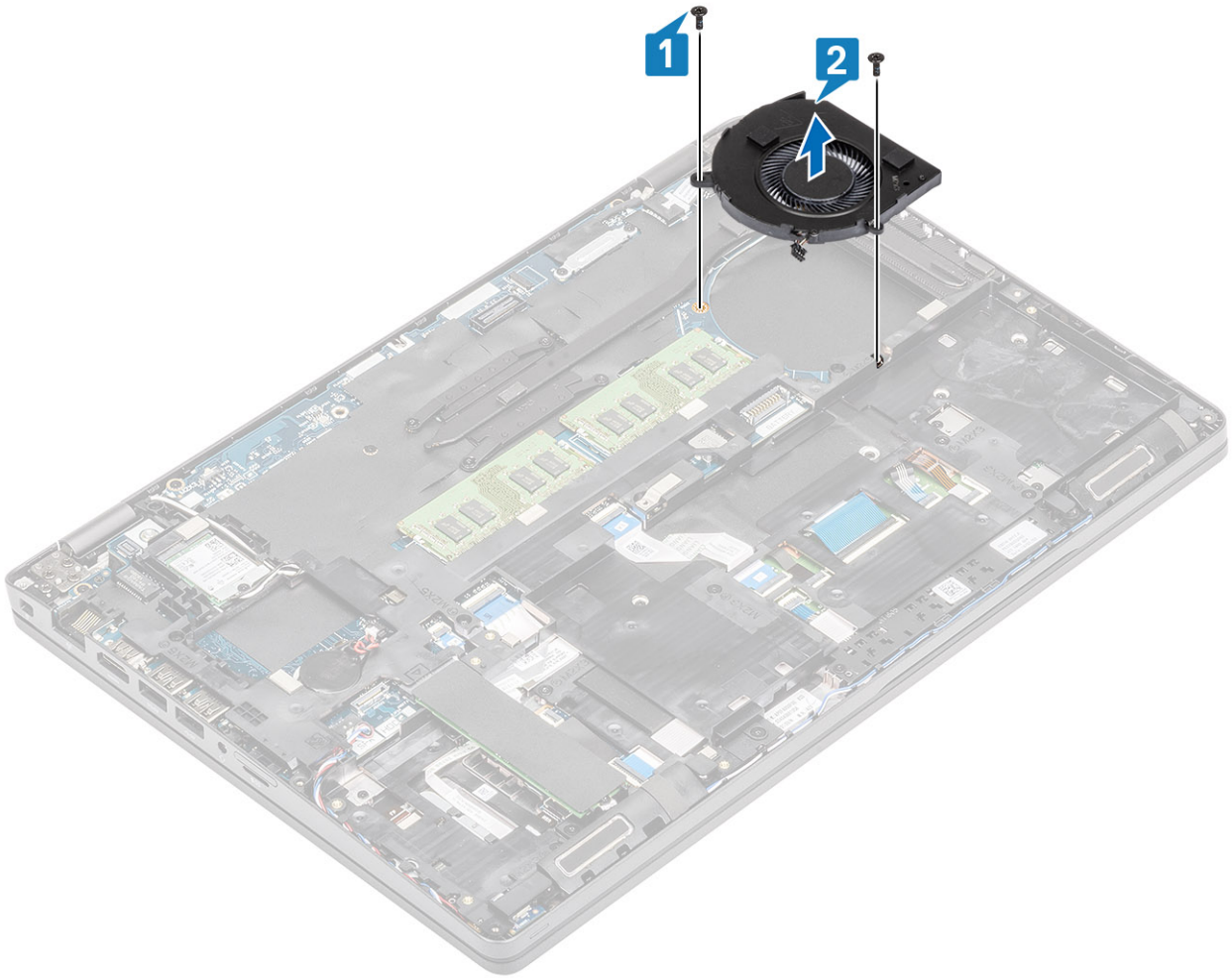

Installing the system fan

Steps

1. Place and align the screw holes on the system fan with the screw holes on to the palmrest [1].
2. Replace the two (M2x5) screws to secure the system fan to the palmrest [2].

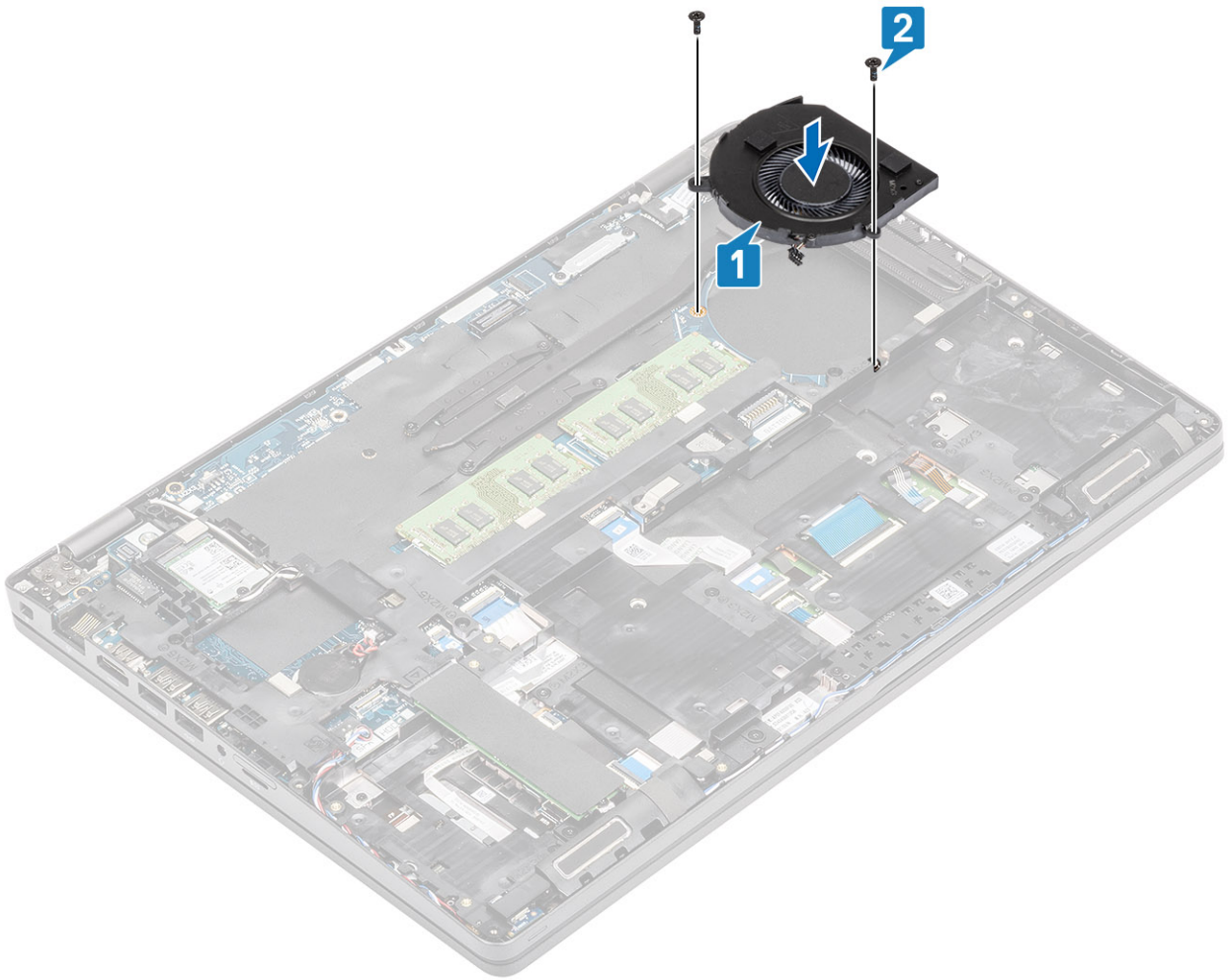

3. Connect the system fan cable to the connector on the system board.

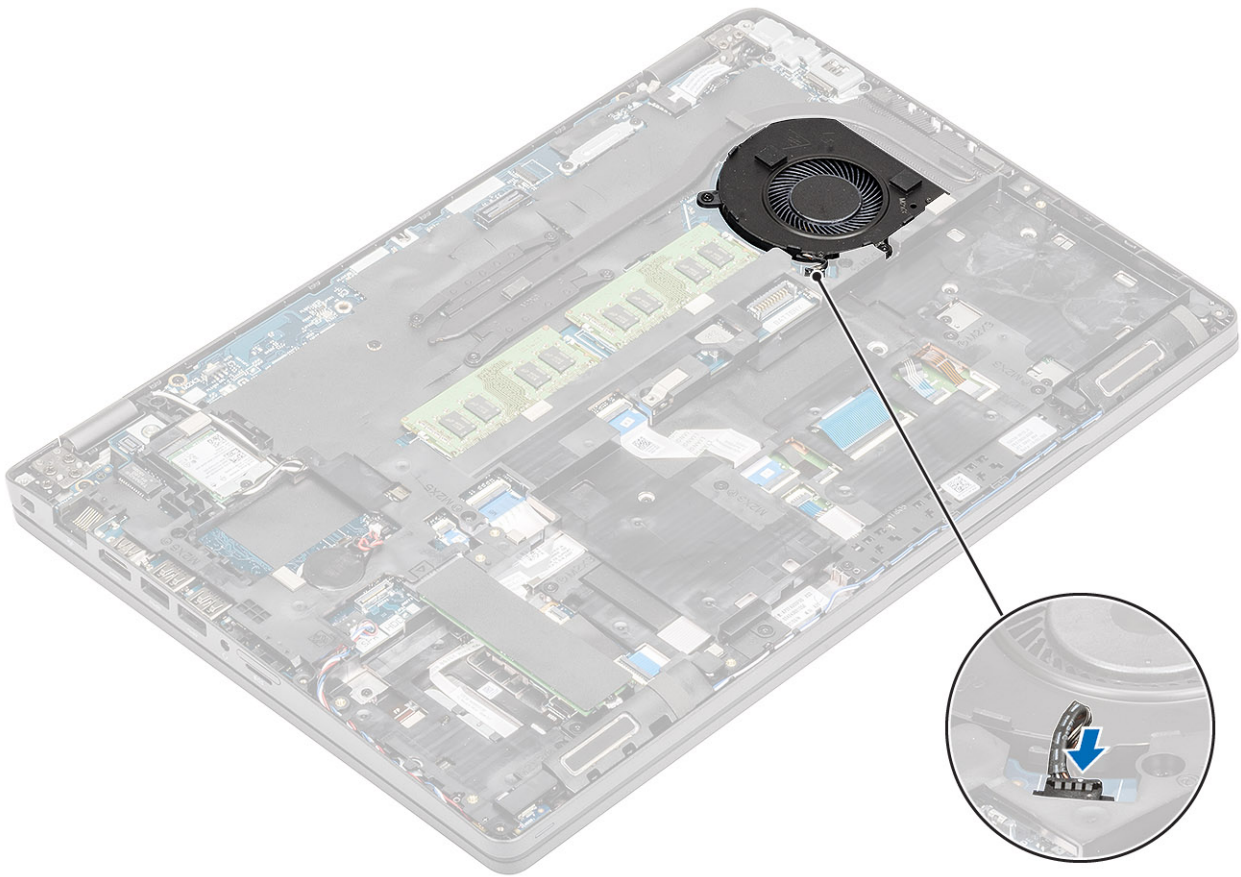

Next steps

1. Replace the [battery](#).
2. Replace the [base cover](#).
3. Replace the [microSD card](#).
4. Follow the procedure in [after working inside your computer](#).

Power-adapter port

Removing the DC-in port

Prerequisites

1. Follow the procedure in [before working inside your computer](#)
2. Remove the [microSD card](#).
3. Remove the [base cover](#).
4. Remove the [battery](#).

Steps

1. Remove the two (M2x5) screws that secure the Type-C bracket [1]
2. Lift the Type-C bracket away from the computer [2].

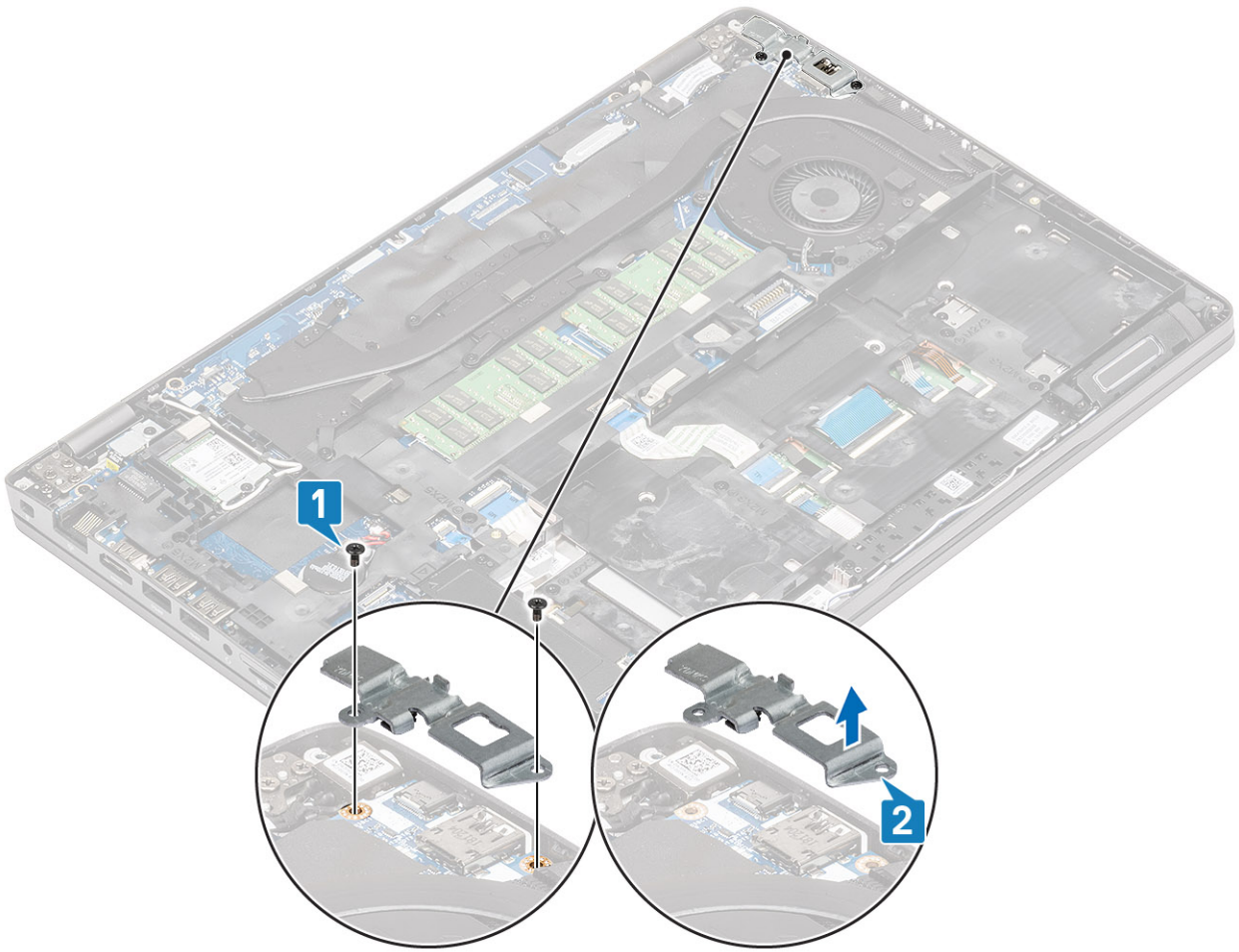

3. Disconnect the DC-in port cable from the connector on the system board and remove it from the computer [1,2].

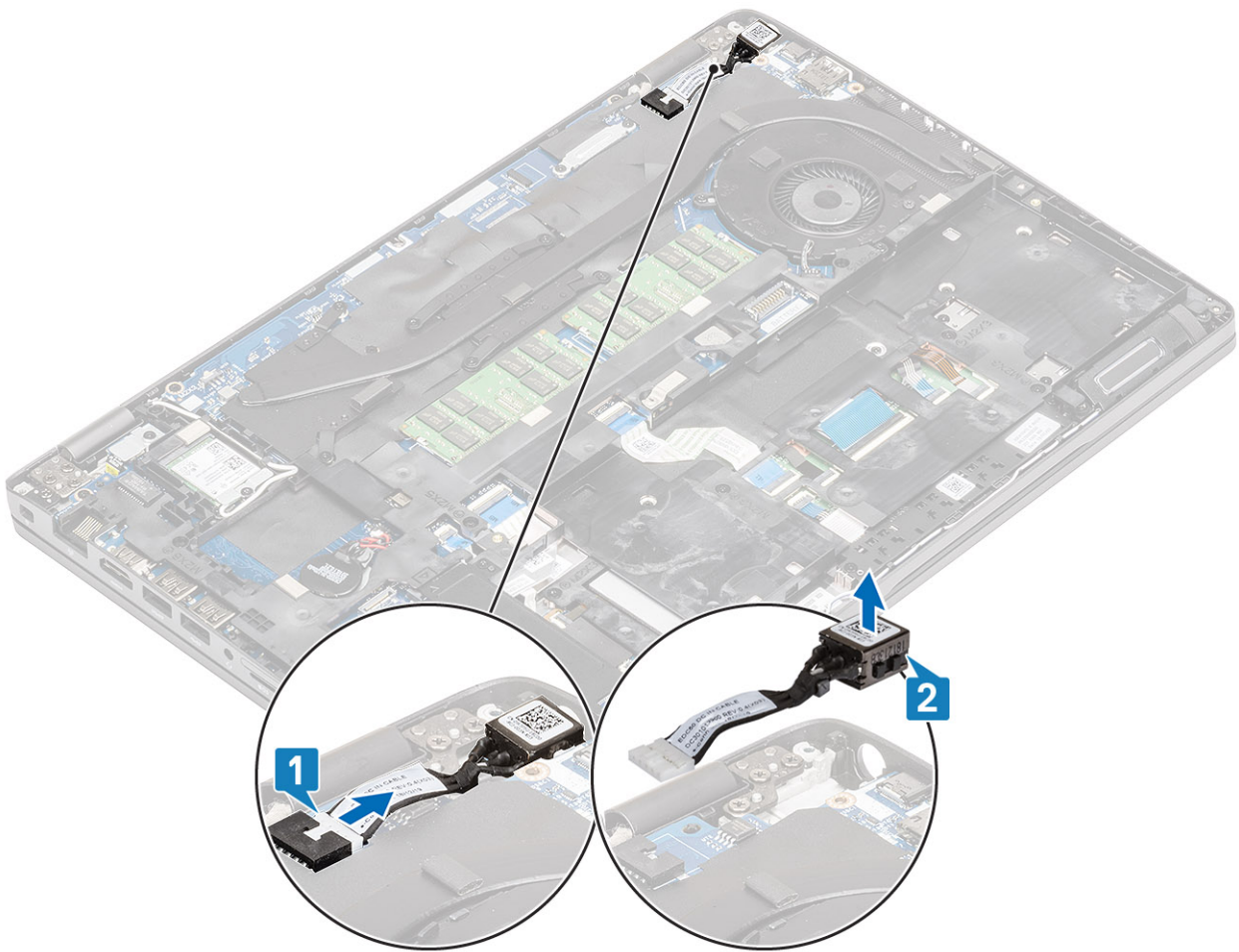

Installing the DC-in port

Steps

1. Insert the DC-in port into the computer [1].
2. Reconnect the DC-in port cable to the connector on the system board [2].

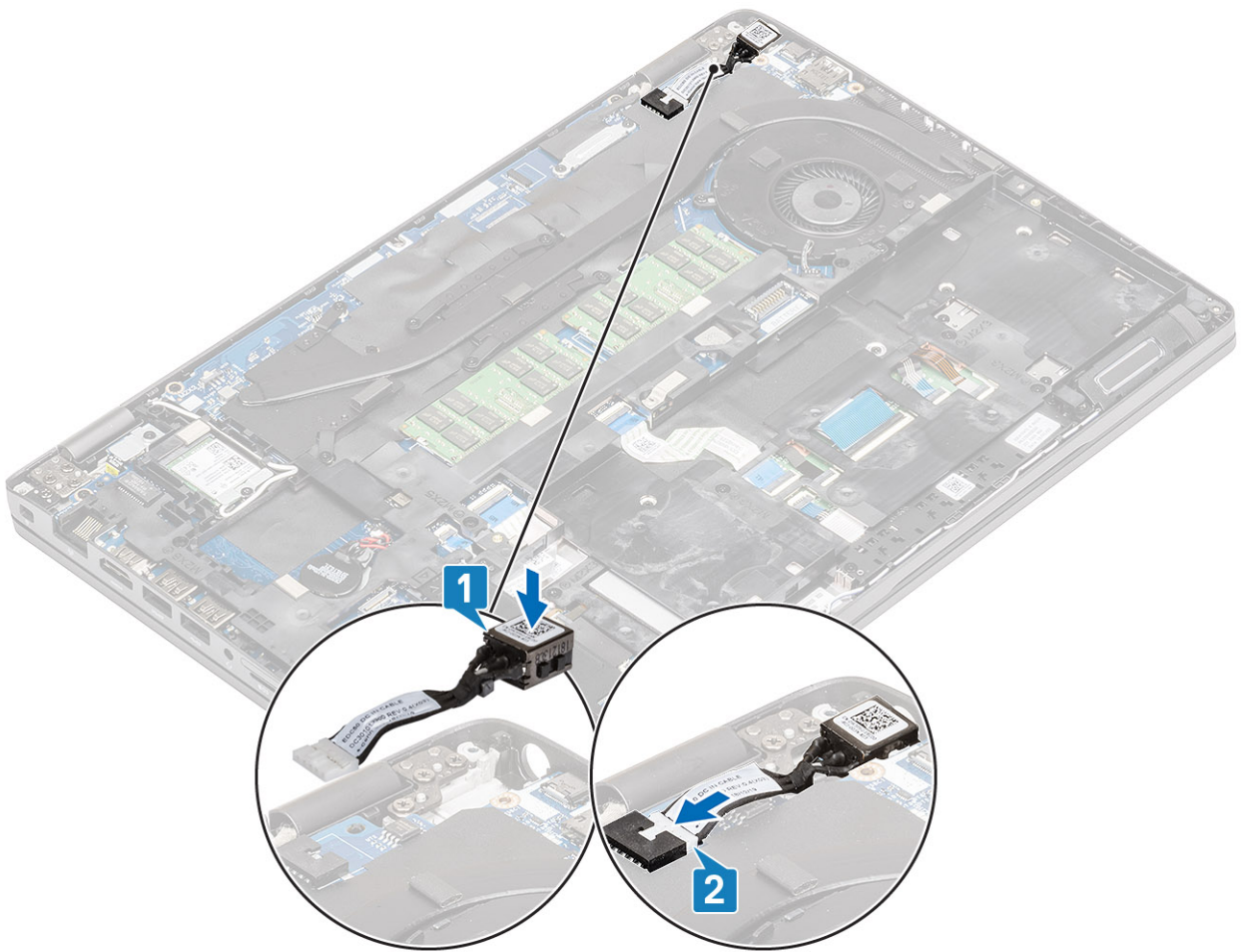

3. Place the Type-C bracket on top of the DC-in port [1].
4. Replace the two (M2x5) screws to secure the Type-C on the computer [2].

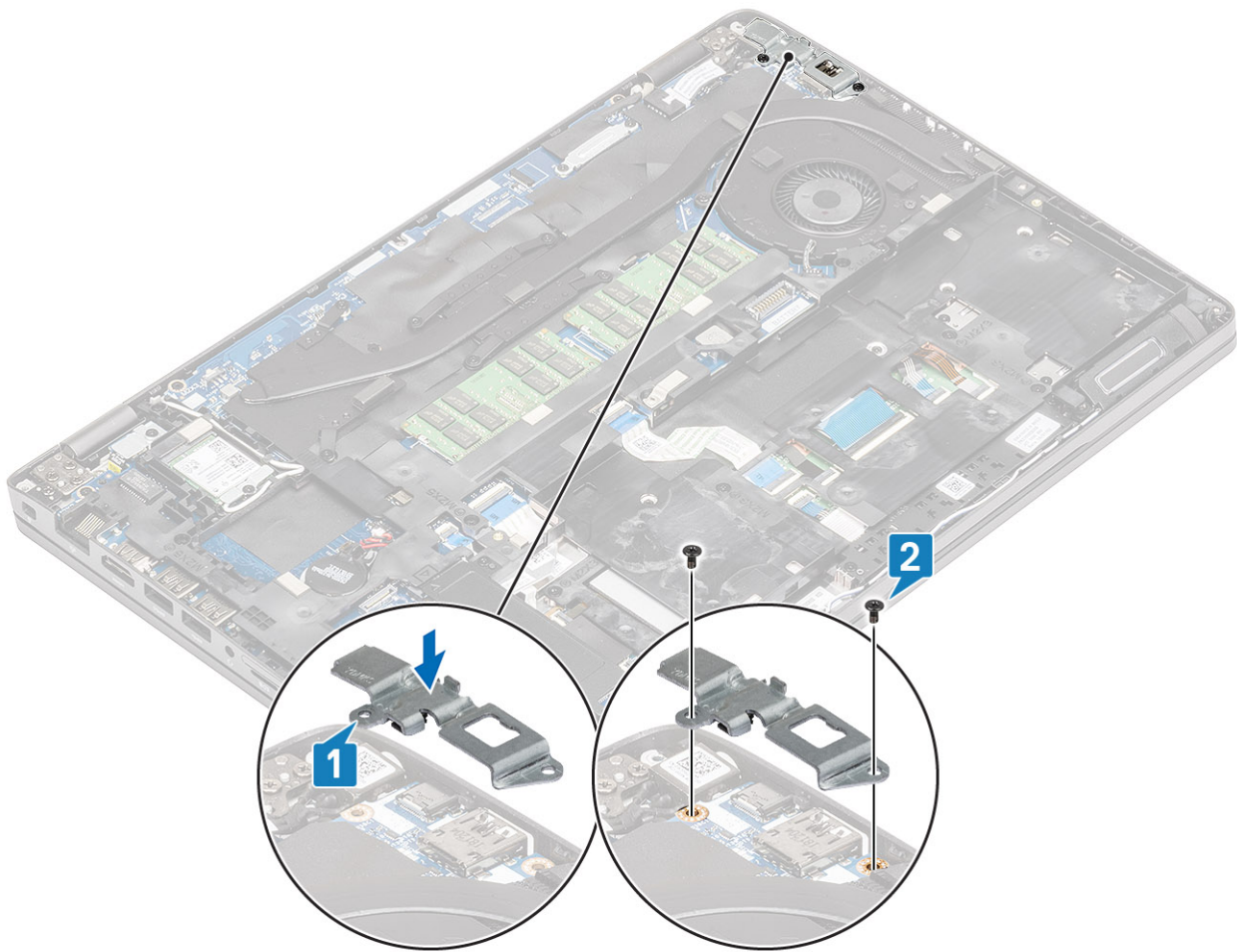

Next steps

1. Install the [battery](#).
2. Install the [base cover](#).
3. Install the [microSD card](#).
4. Follow the procedure in [after working inside your computer](#).

LED board

Removing the LED board

Prerequisites

1. Follow the procedure in [before working inside your computer](#)
2. Remove the [microSD card](#).
3. Remove the [base cover](#).
4. Remove the [battery](#).
5. Remove the [ssd](#).
6. Remove the [ssd bracket](#).
7. Remove the [palmrest bracket](#).

Steps

1. Unlock and disconnect the USH cable from the palmrest [1,2].

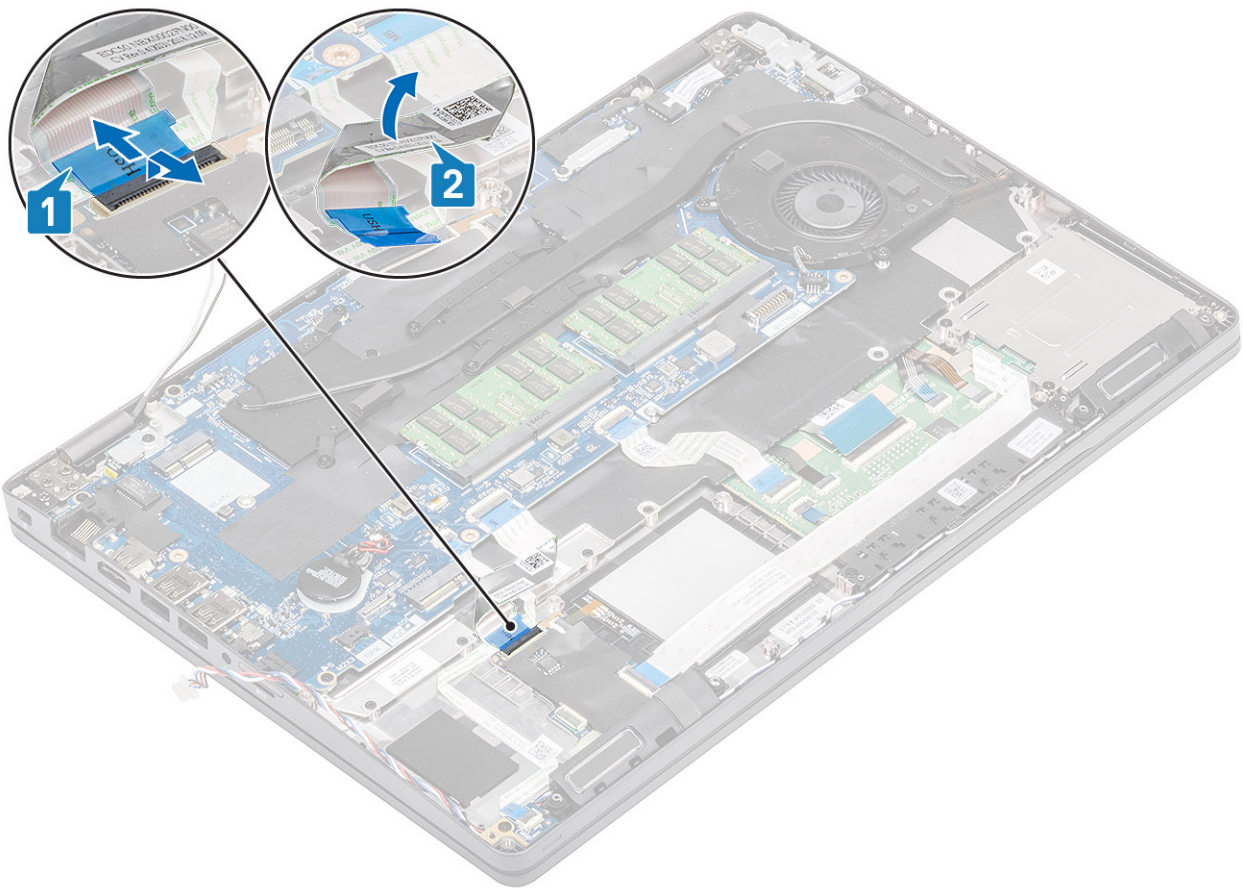

2. Unlock and disconnect the LED board cable from the system board [1].
3. Un-route the LED board cable from the computer chassis [2].

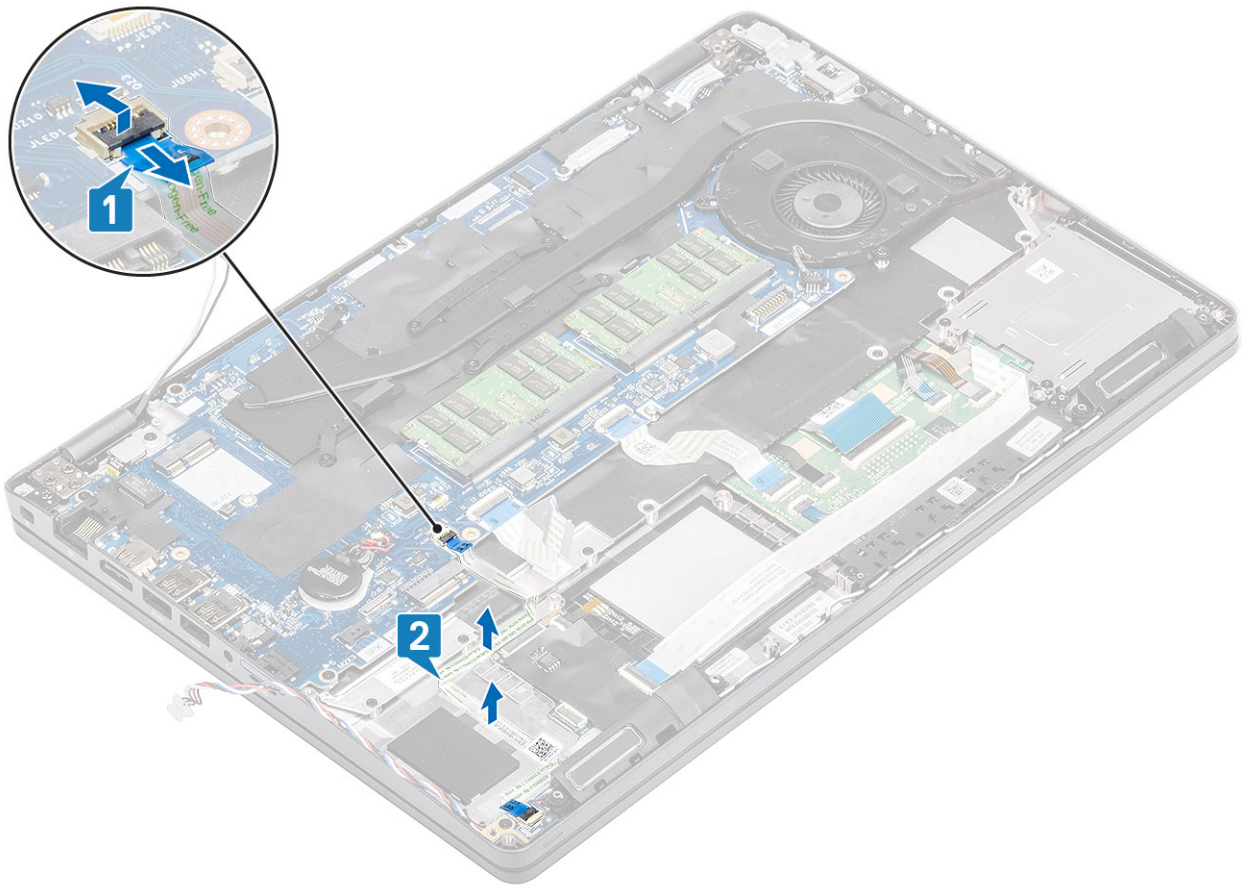

4. Remove the single (M2x2.5) screw and lift the LED board out of the computer [1,2].

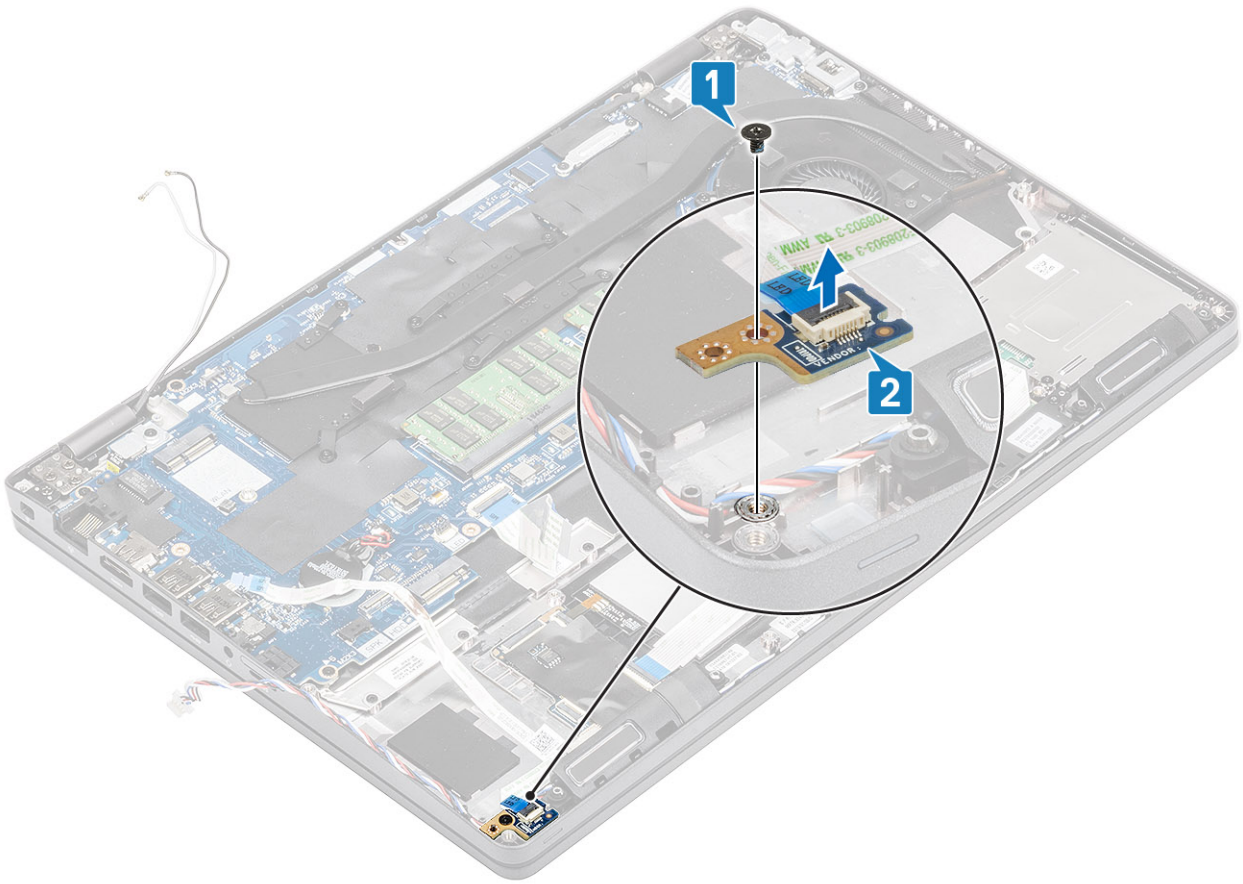

Installing the LED board

Steps

1. Reseat the LED board in its place and secure it with the single (M2x2.5) screw to the computer [1,2].

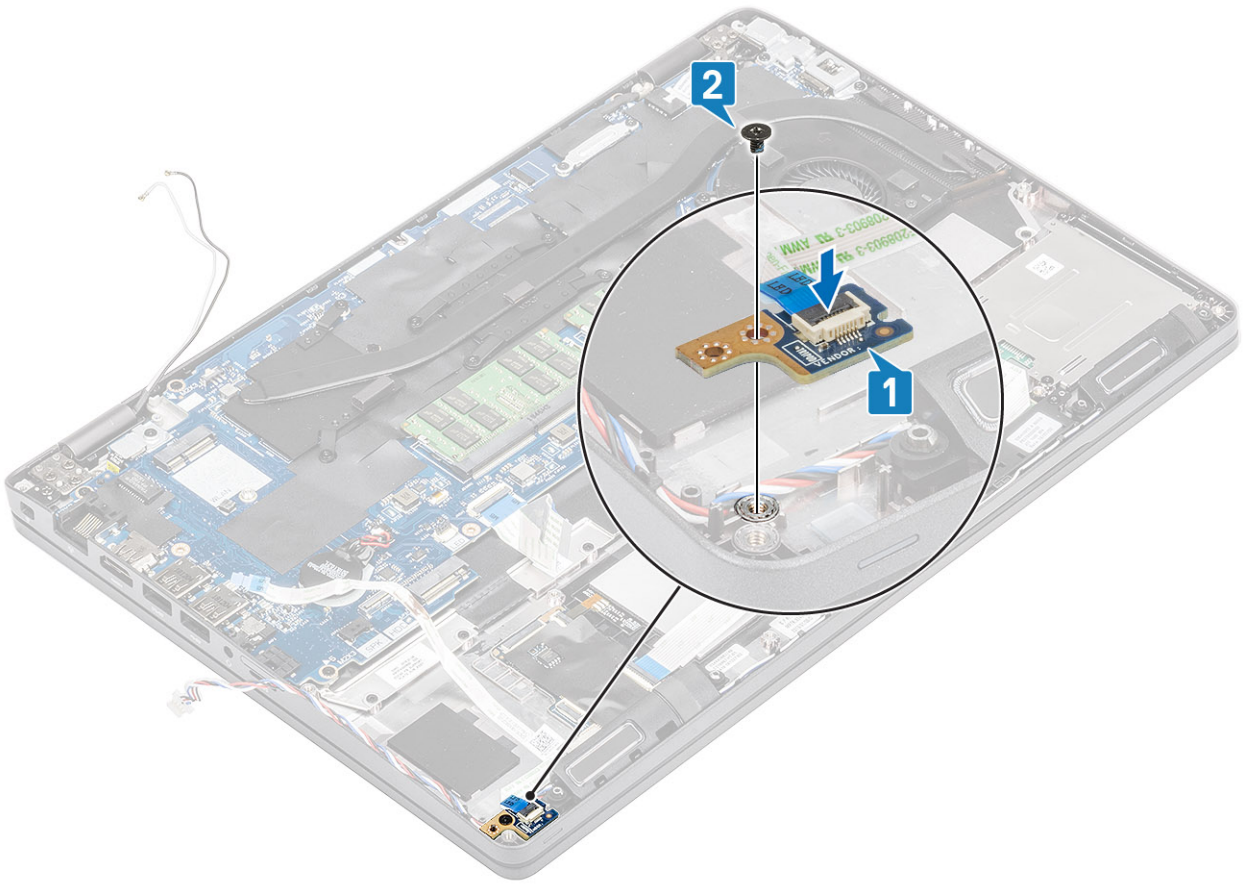

2. Connect the LED board cable to the system board and re-route it on the computer chassis [1,2]

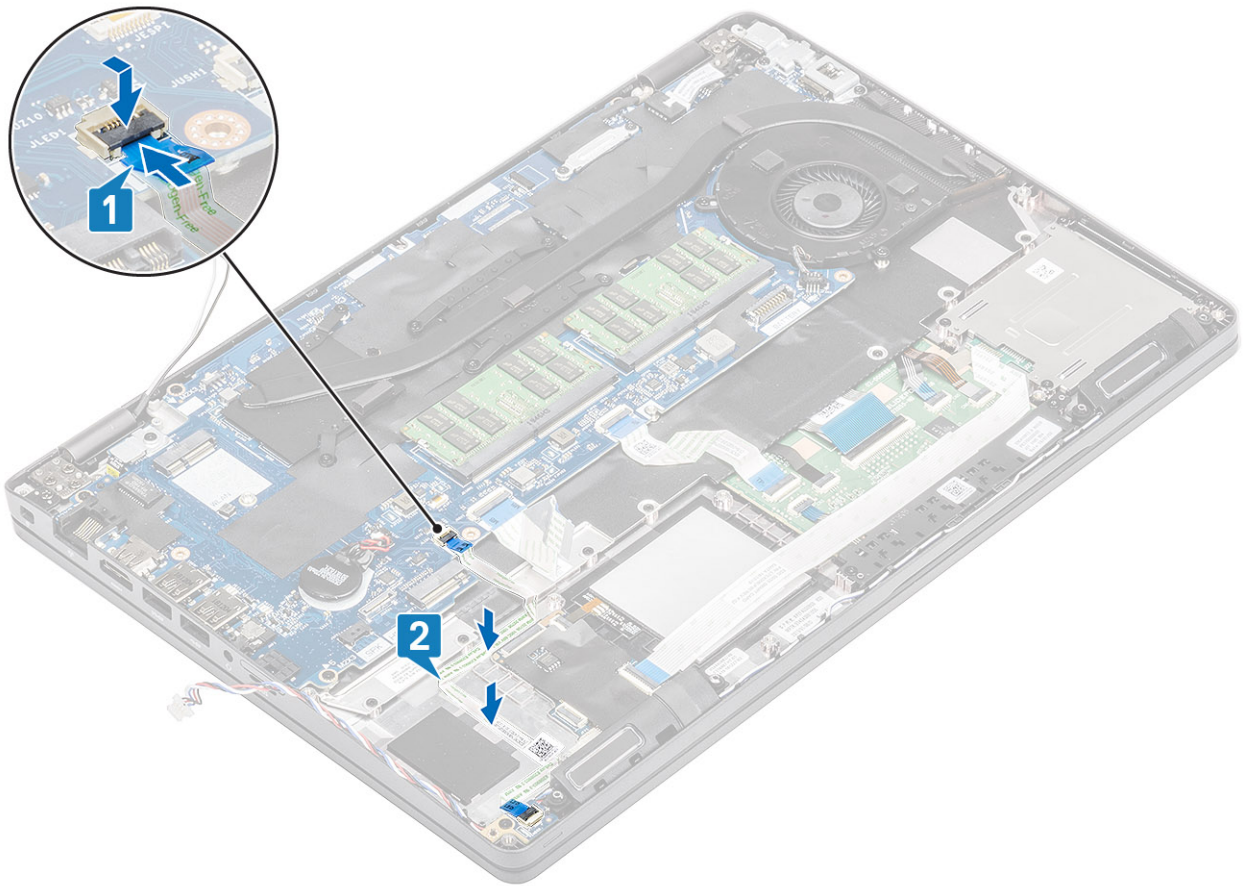

3. Gently fold the fold the USH cable as shown [1].
4. Re-connect the USH cable to the palmrest and secure the lock [2].

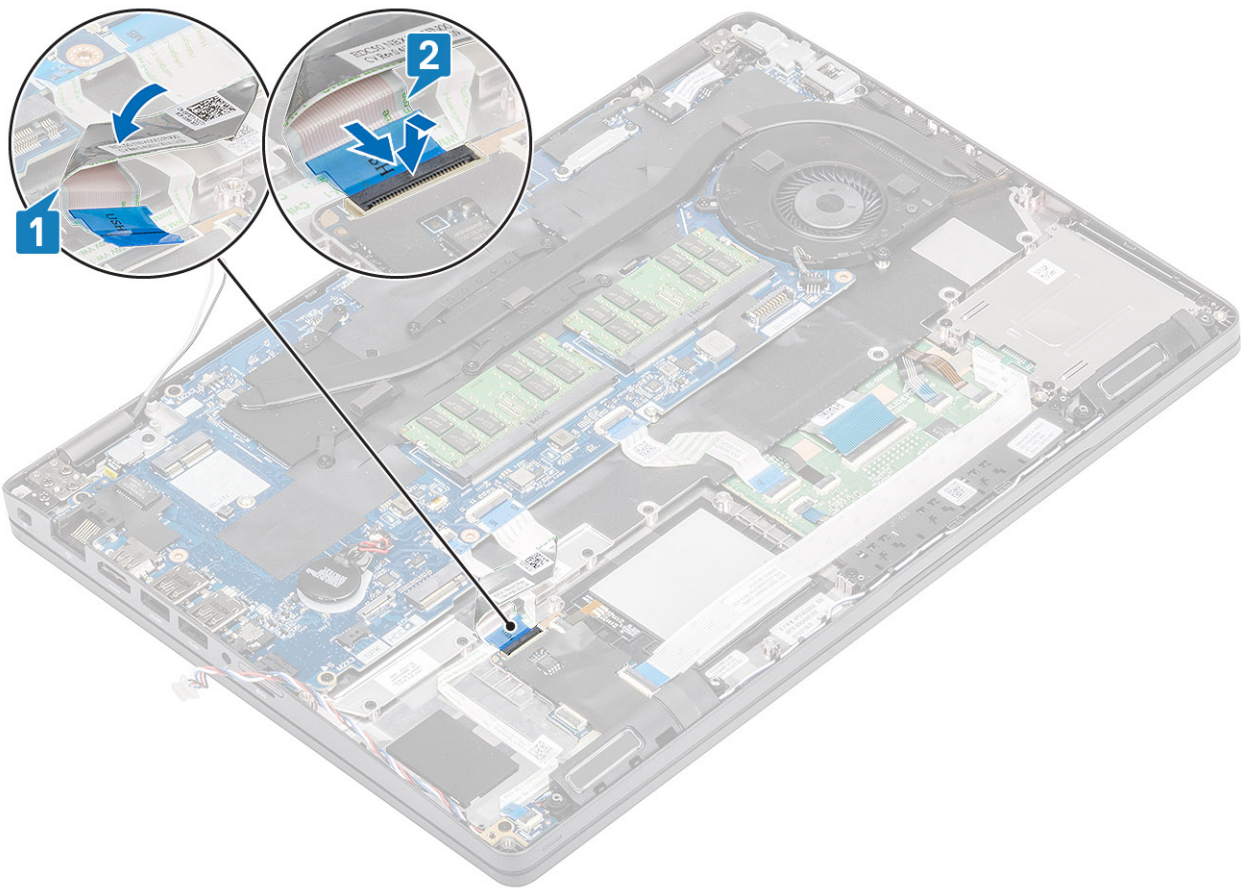

Next steps

1. Install the [palmrest bracket](#).
2. Install the [ssd bracket](#).
3. Install the [ssd](#).
4. Install the [battery](#).
5. Install the [base cover](#).
6. Install the [microSD card](#).
7. Follow the procedure in [after working inside your computer](#).

Touchpad

Removing the touchpad buttons board

Prerequisites

1. Follow the procedure in [before working inside your computer](#)
2. Remove the [microSD card](#).
3. Remove the [base cover](#).
4. Remove the [battery](#).
5. Remove the [ssd](#).
6. Remove the [ssd bracket](#).
7. Remove the [palmrest bracket](#).

Steps

1. Disconnect the smart card reader cable and unroute the cable [1,2].

2. Disconnect the touchpad cable from the connector [3].

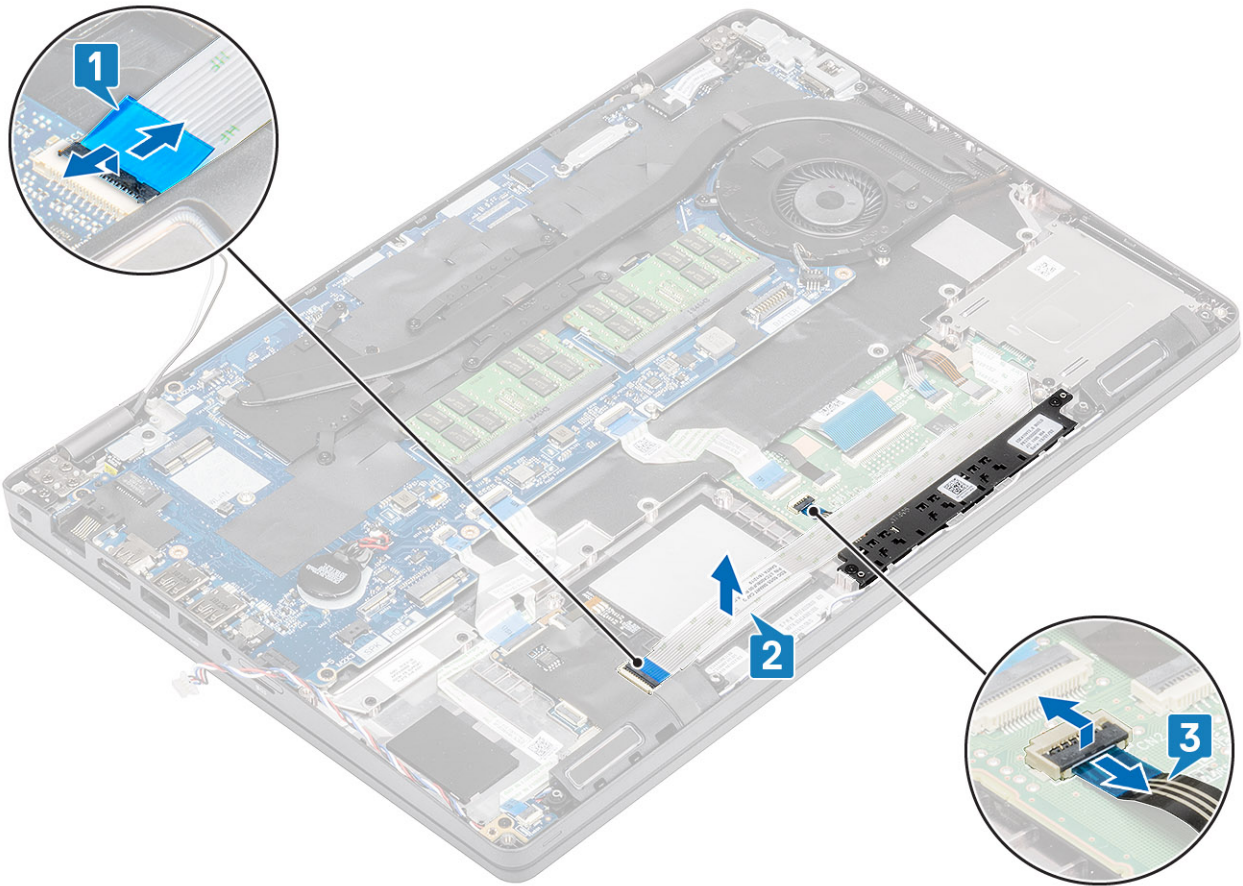

3. Remove the two (M2x3) screws and lift the touchpad away from the computer [1,2].

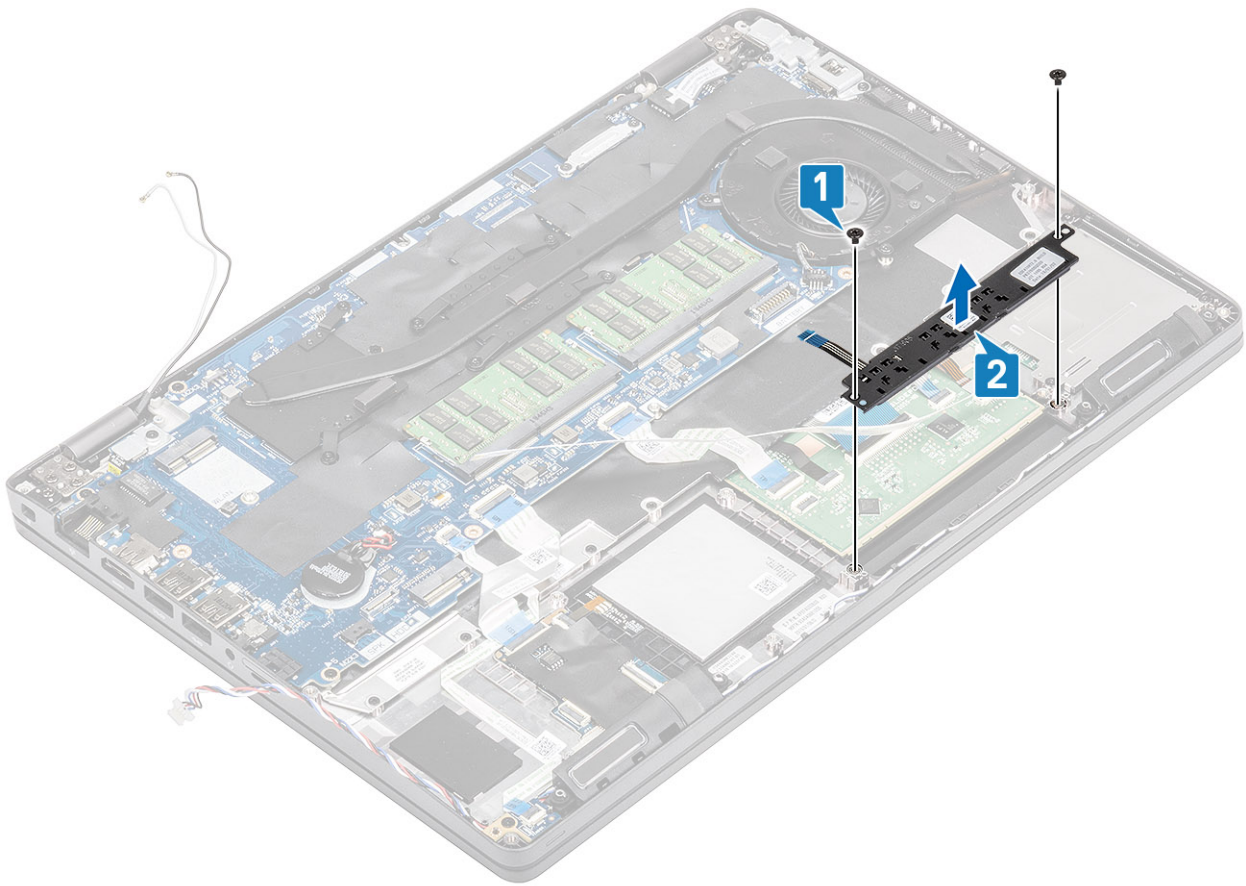

Installing the touchpad buttons board

Steps

1. Align and place touchpad with the computer chassis [1].
2. Replace the two (M2x3) screws that secure the touchpad to the computer [2].

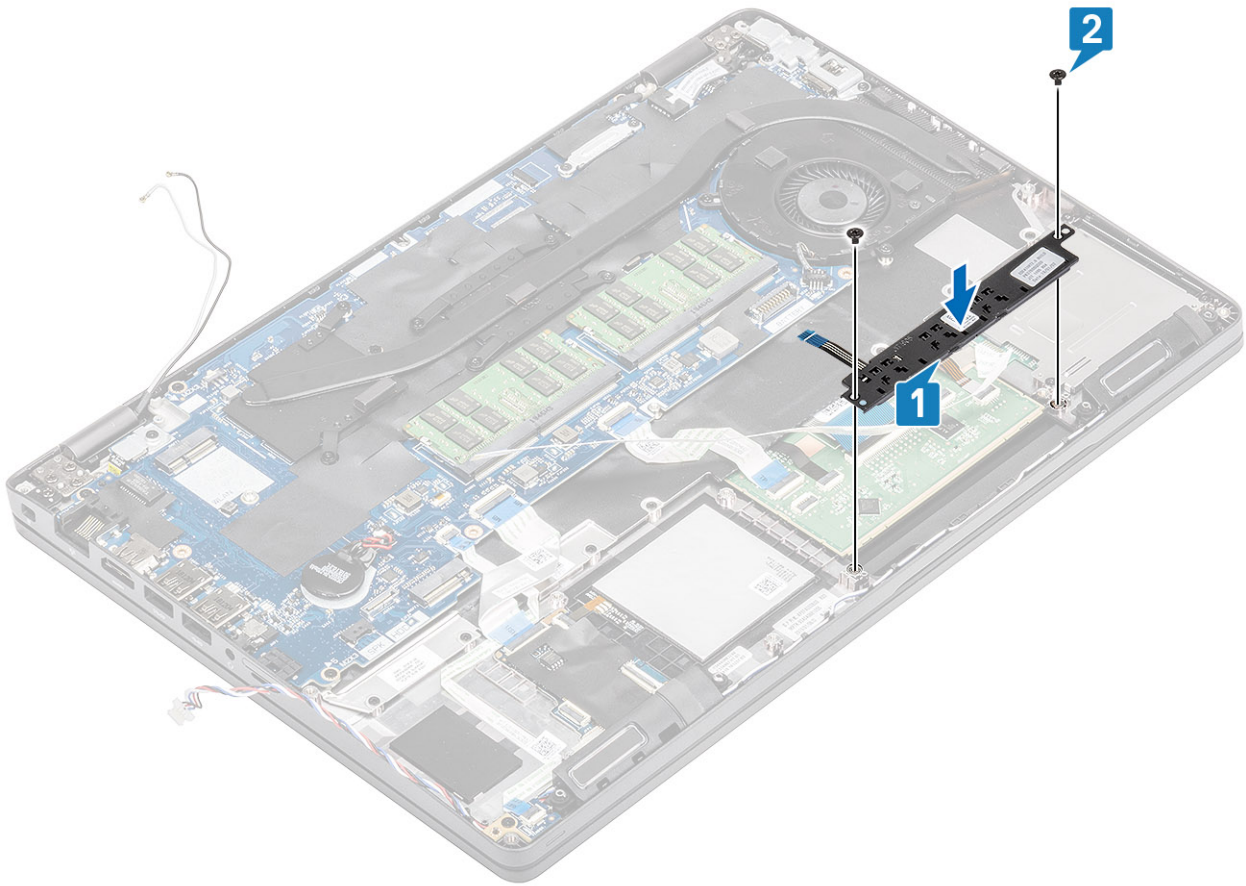

3. Re-connect the smart card reader cables and press it down to the computer chassis [1,2].
4. Re-connect the touchpad cable to the palmrest [3].

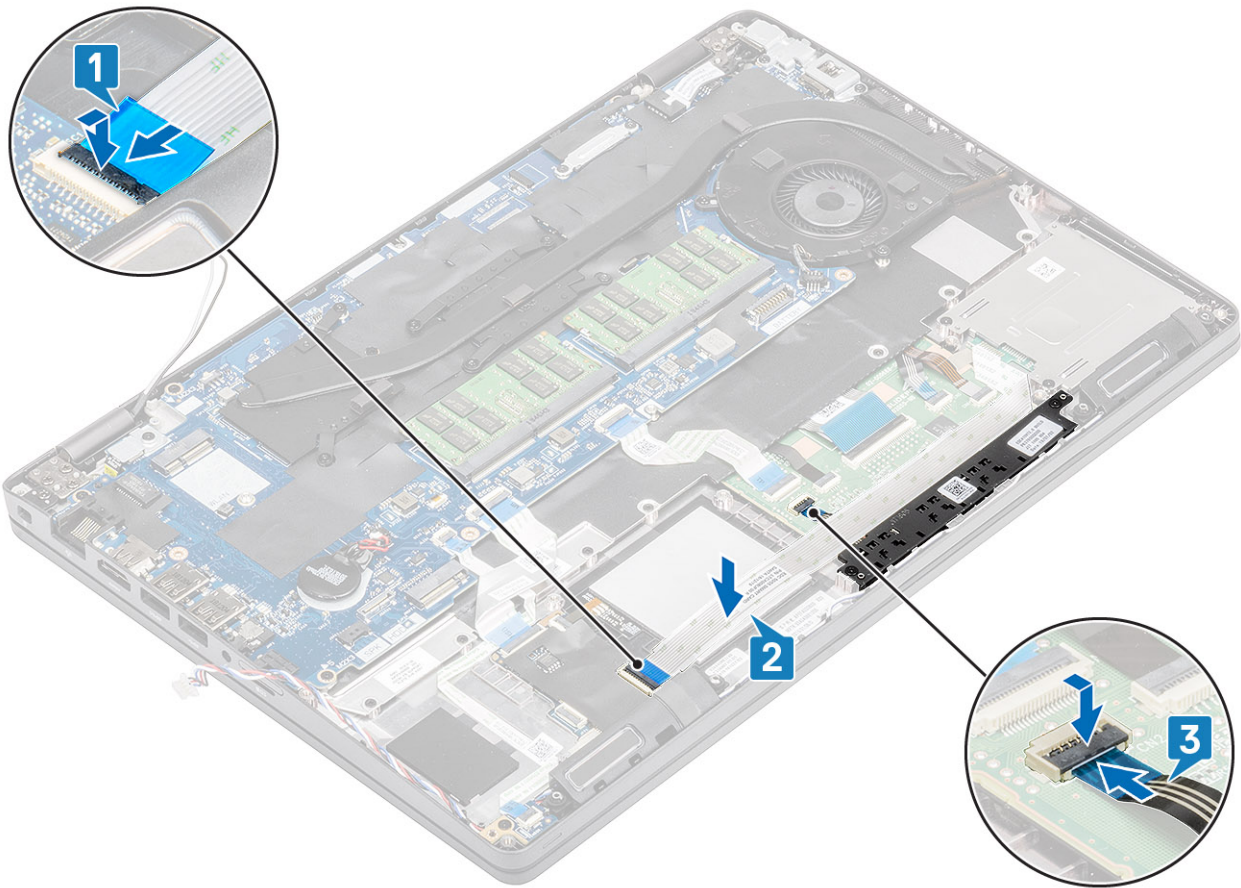

Next steps

1. Install the [palmrest bracket](#).
2. Install the [ssd bracket](#).
3. Install the [ssd](#).
4. Install the [battery](#).
5. Install the [base cover](#).
6. Install the [microSD card](#).
7. Follow the procedure in [after working inside your computer](#).

System board

Removing the system board

Prerequisites

1. Follow the procedure in [before working inside your computer](#)
2. Remove the [microSD card](#).
3. Remove the [base cover](#).
4. Remove the [battery](#).
5. Remove the [ssd](#).
6. Remove the [ssd bracket](#).
7. Remove the [palmrest bracket](#).
8. Remove the [LED board](#).
9. Remove the [heatsink](#).

Steps

1. Press the lock and release the card slot tray [1,2].
2. Unlock and disconnect the LED board, USH and the touchpad cables from the connectors on the system board [3,4,5].

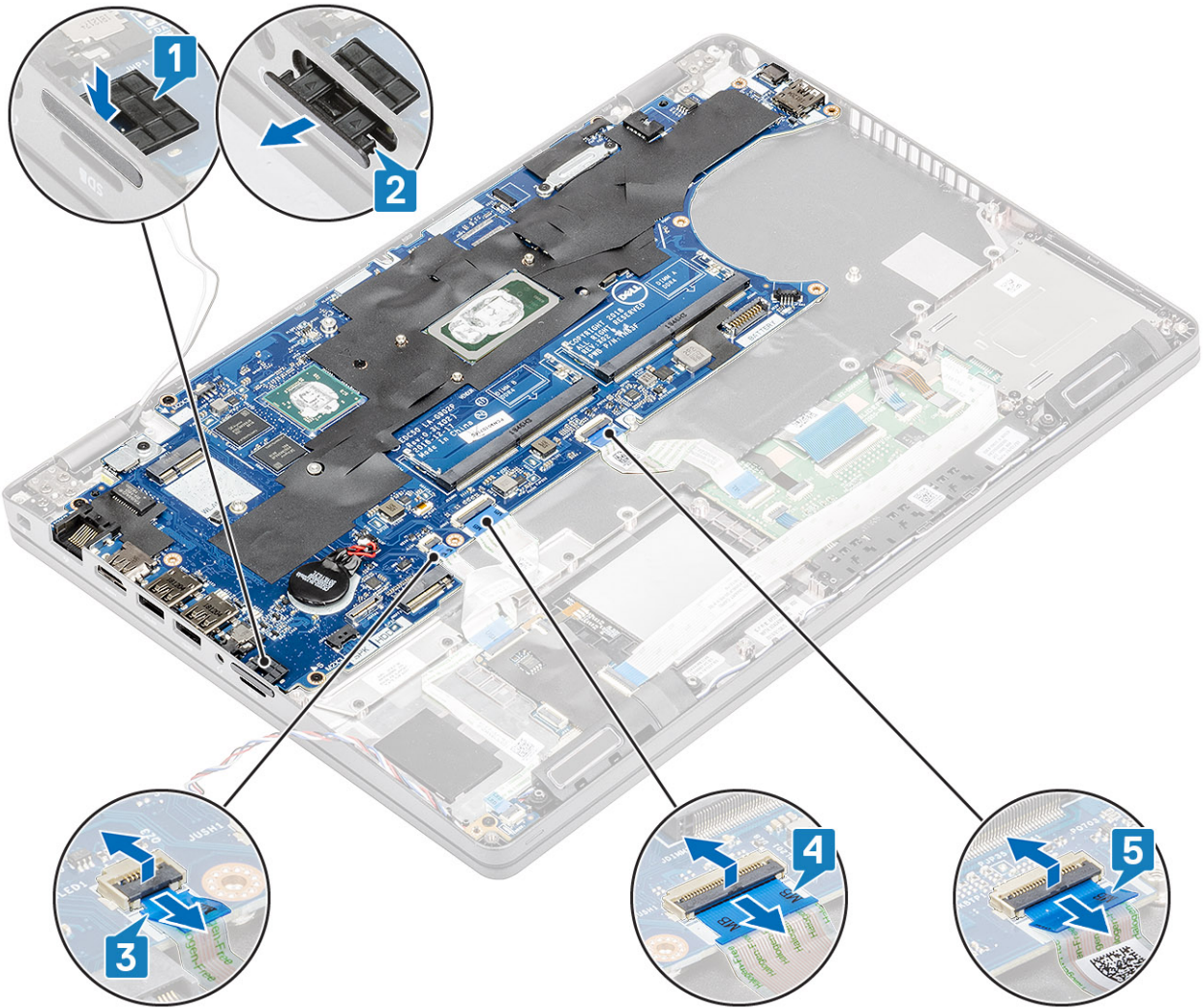

3. Remove the single screw securing the metal bracket to the computer [1] and lift it away from the computer [2].
4. Disconnect the fingerprint reader cable from the system board connector [3].

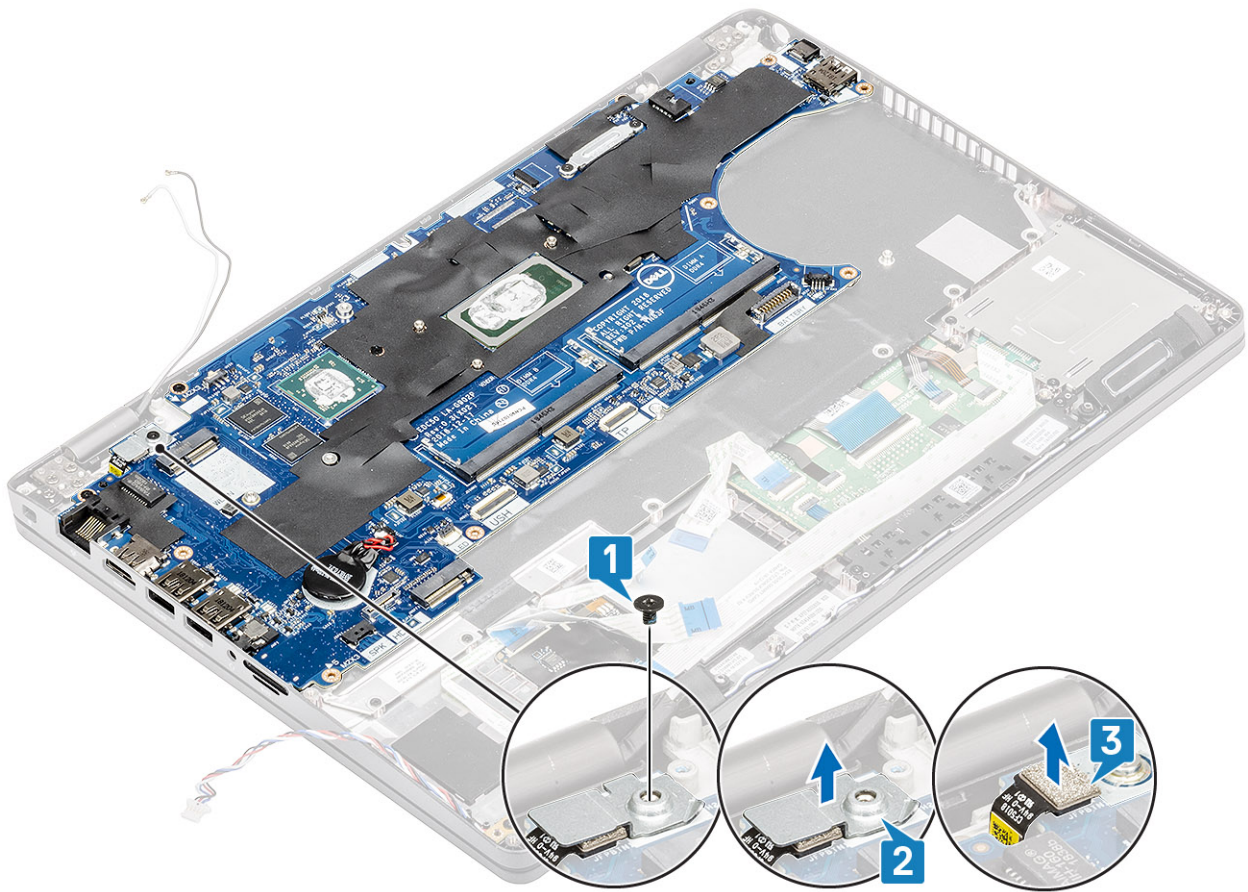

5. Remove the five (M2x3) screws that secure the system board to the computer [1].
6. Lift the system board out of the computer [2].

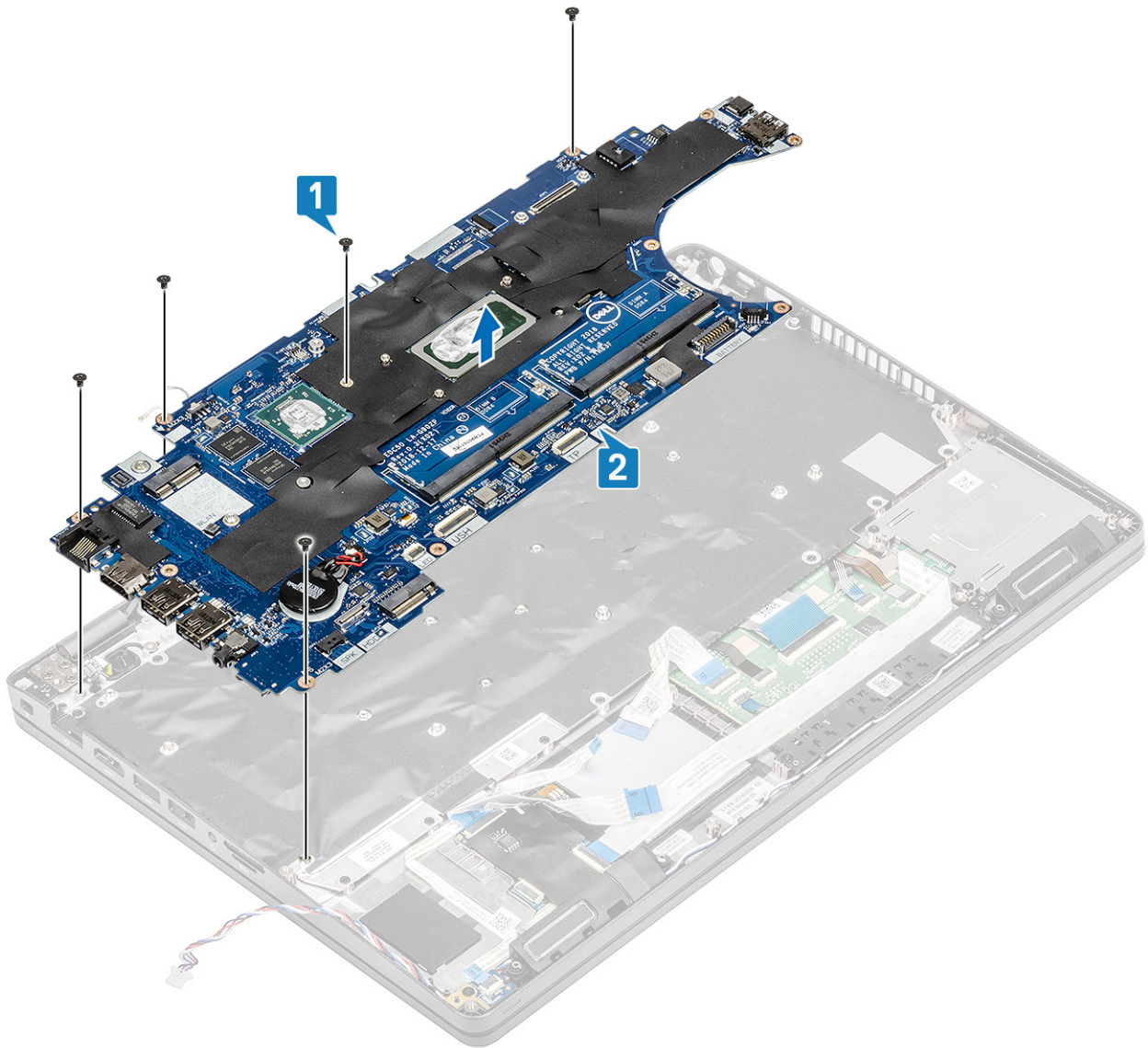

Installing the system board

Steps

1. Align and place the system board on the computer chassis [1].
2. Replace the five (M2x3) screws to secure the system board to the computer [2].

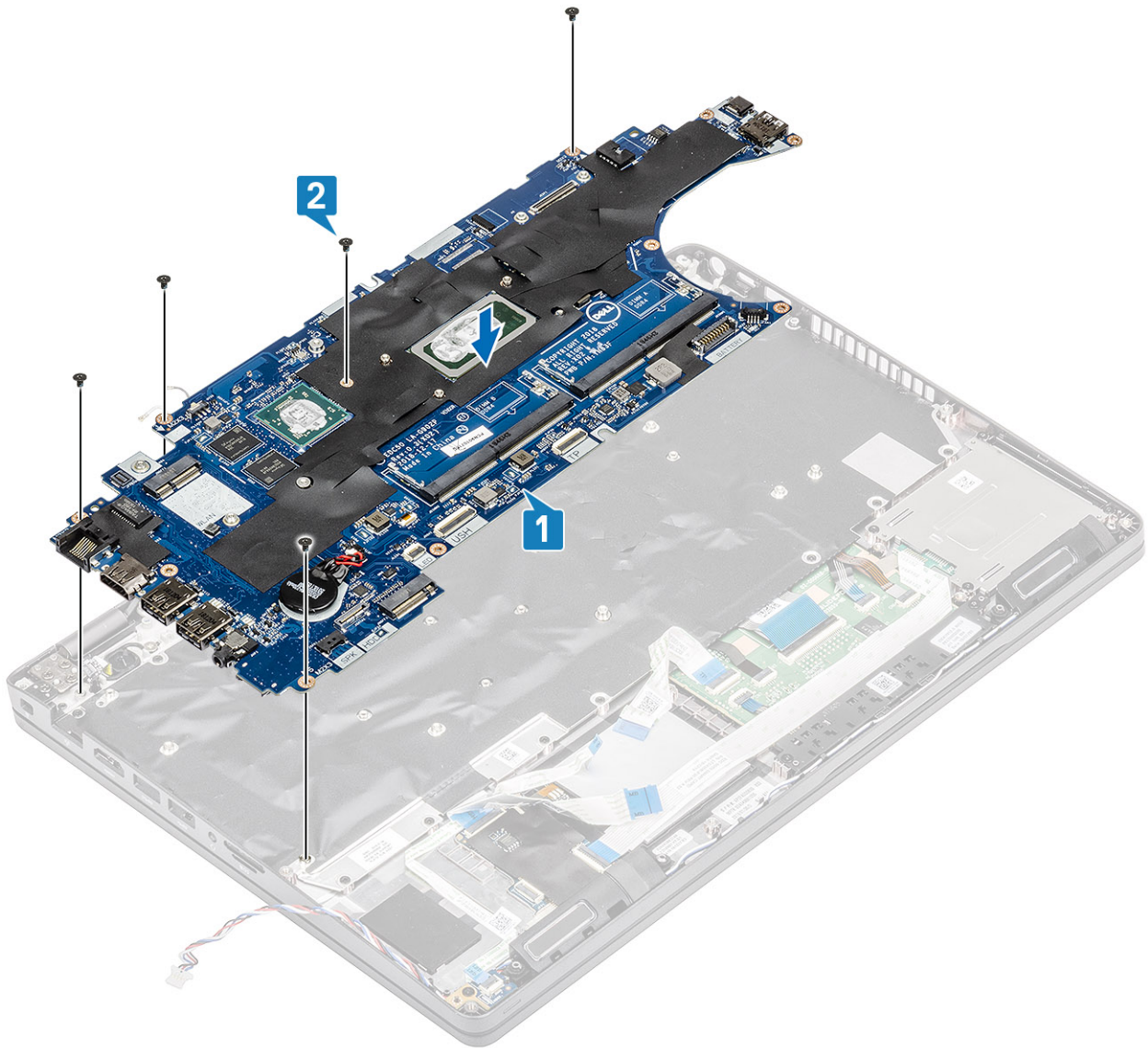

3. Re-connect the display cable [1].
4. Place the display cable bracket and secure it with the two (M2x2.5) screws [2,3].

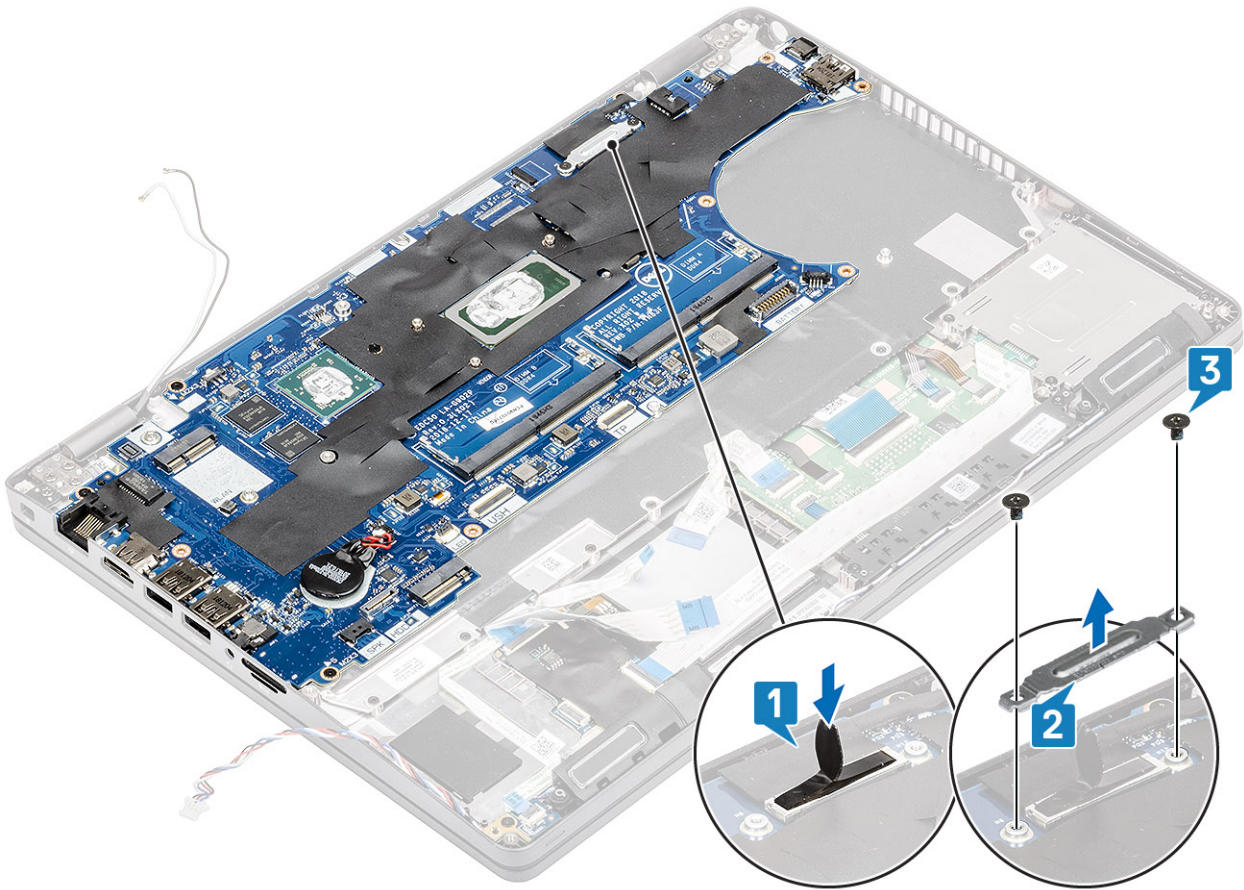

5. Replace the card slot tray [1].
6. Re-connect the LED board, USH and touchpad cables to the connector on the system board [2,3,4].

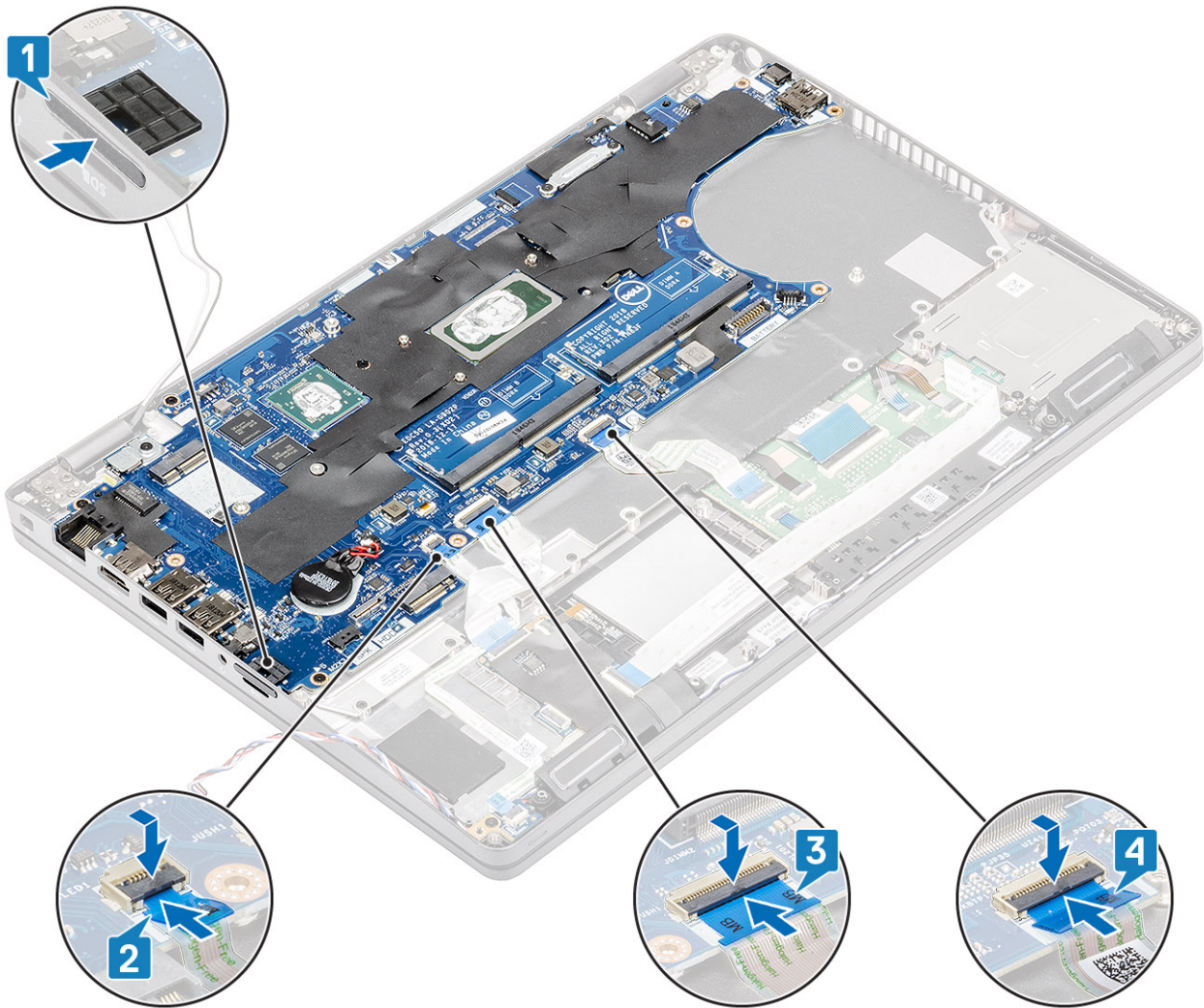

Next steps

1. Install the [heatsink](#).
2. Install the [LED board](#).
3. Install the [palmrest bracket](#).
4. Install the [ssd bracket](#).
5. Install the [ssd](#).
6. Install the [battery](#).
7. Install the [base cover](#).
8. Install the [microSD card](#).
9. Follow the procedure in [after working inside your computer](#).

Coin-cell battery

Removing the coin cell battery

Prerequisites

1. Follow the procedure in [before working inside your computer](#)
2. Remove the [microSD card](#).
3. Remove the [base cover](#).
4. Remove the [battery](#).

Steps

Disconnect the coin cell cable from the connector on the system board [1] and lift it out of the computer [2].

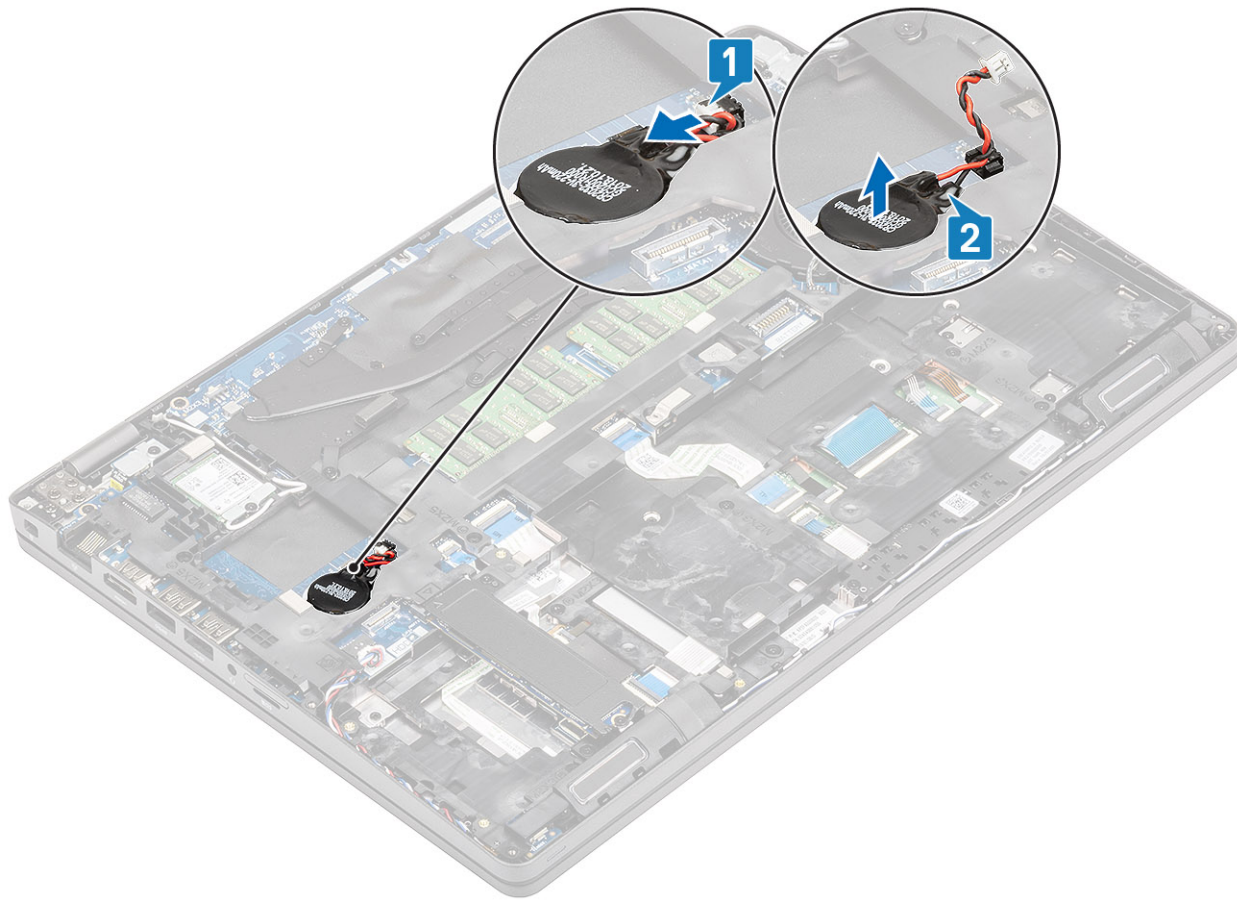

Installing the coin cell battery

Steps

Affix the coin cell battery back on the computer [1] and reconnect the coin cell battery cable to the connector on the system board [2].

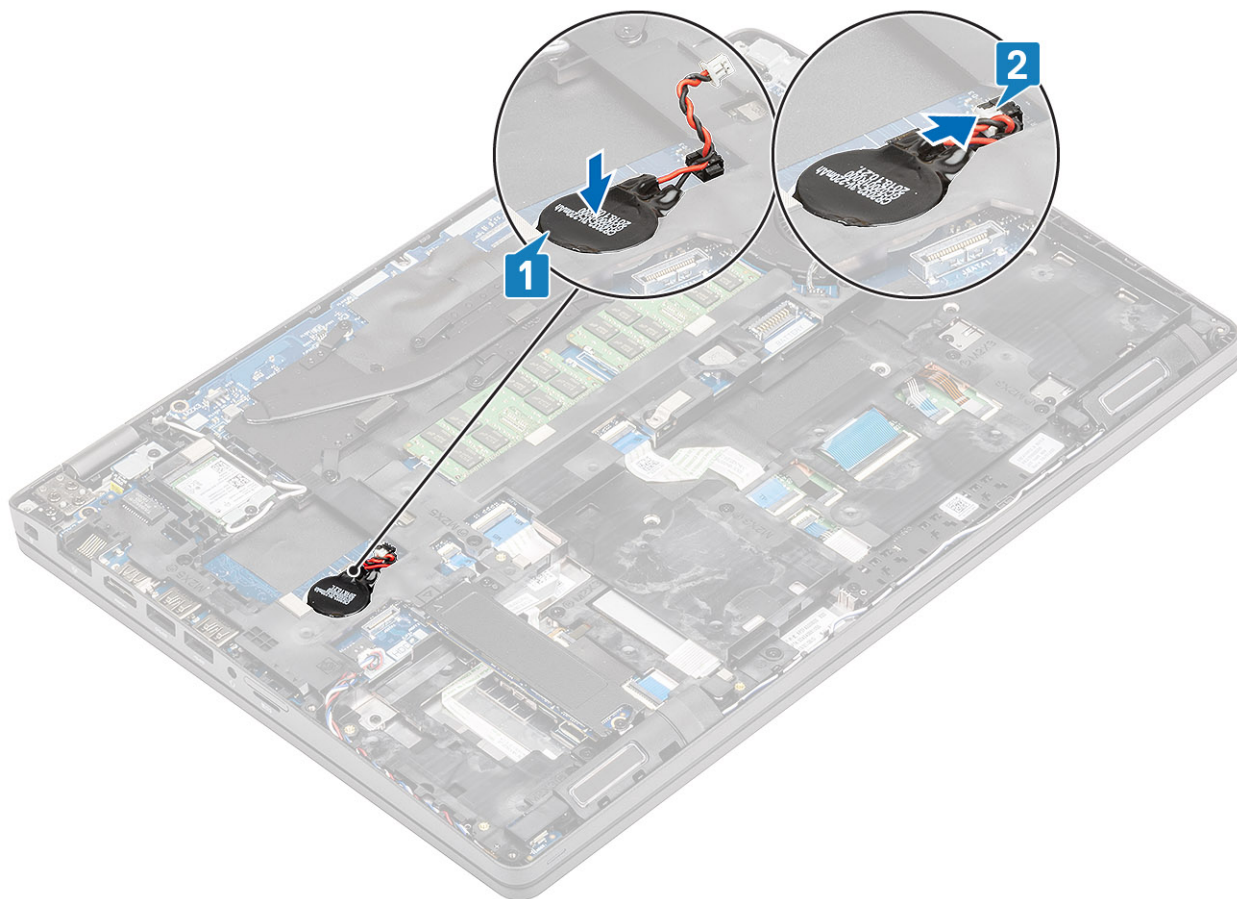

Next steps

1. Install the [battery](#).
2. Install the [base cover](#).
3. Install the [microSD card](#).
4. Follow the procedure in [after working inside your computer](#).

Display assembly

Removing the LCD assembly

Prerequisites

1. Follow the procedure in [before working inside your computer](#)
2. Remove the [microSD card](#).
3. Remove the [base cover](#).
4. Remove the [battery](#).
5. Remove the [WLAN card](#).

Steps

1. Un-route the wireless antenna [1].
2. Remove the two (M2x3) screws that secure the display cable bracket to the computer [2].

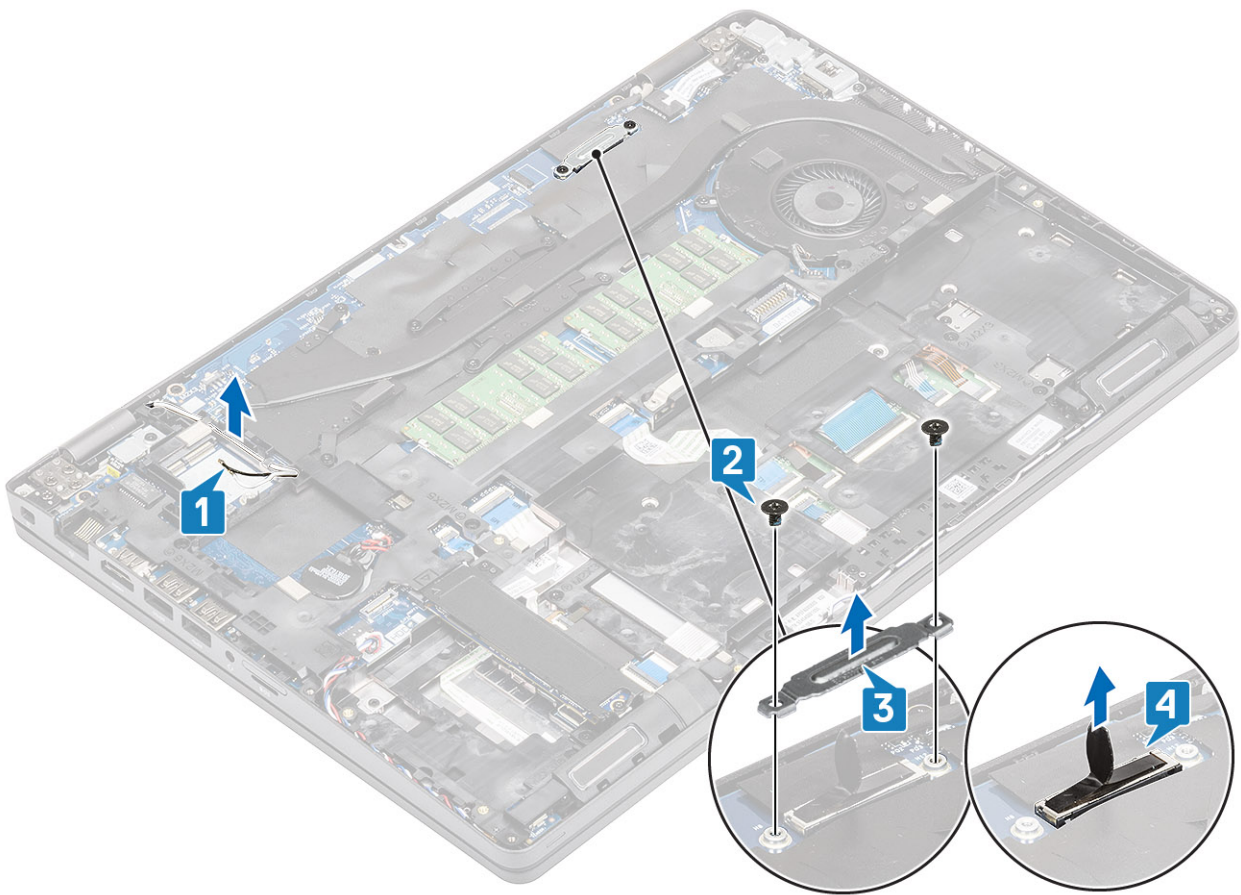

3. Open the system to 180 degrees and place the computer on a flat surface, with the display hinges facing up.

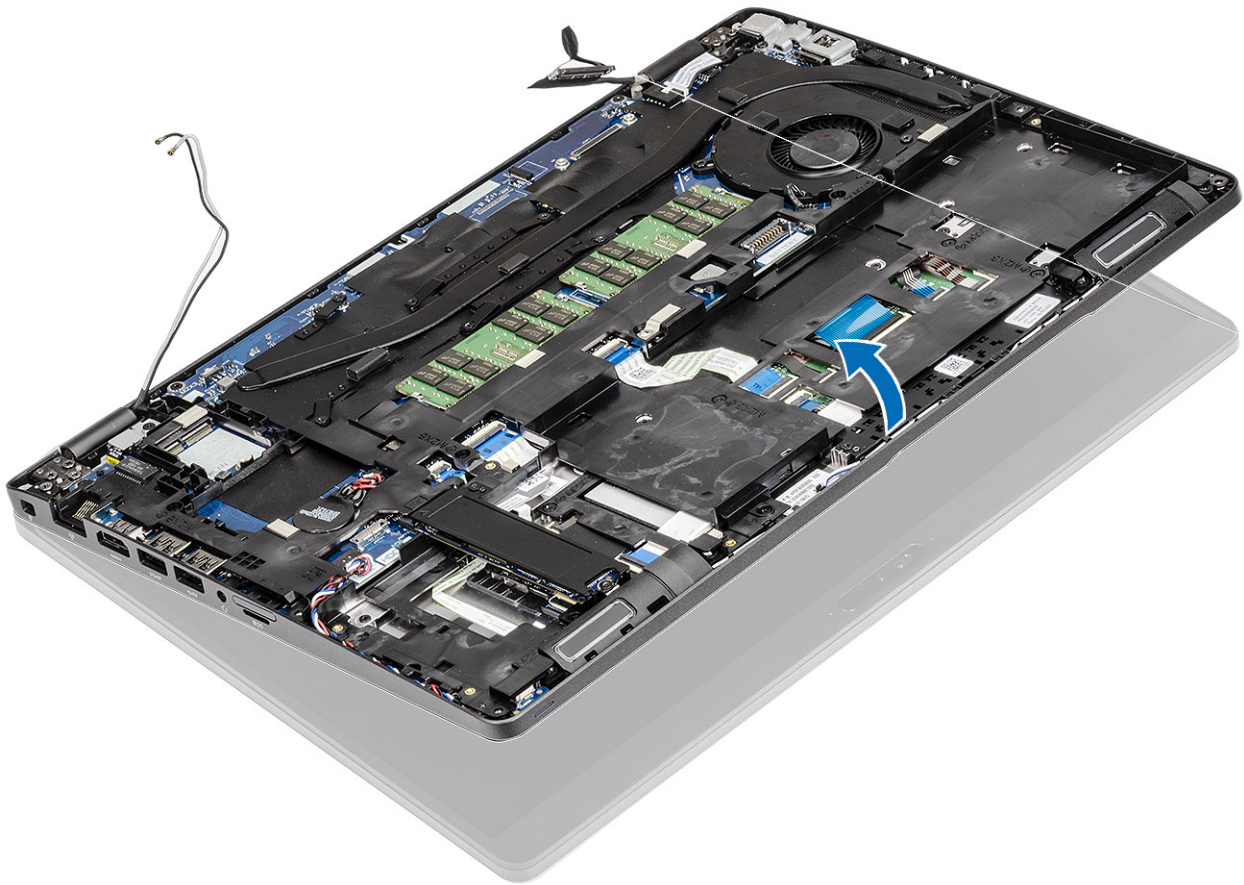

4. Remove the six (M2.5x5.0) display hinge bracket screws that secure the display assembly to the system [1].
5. Lift the display assembly away from the system [2].

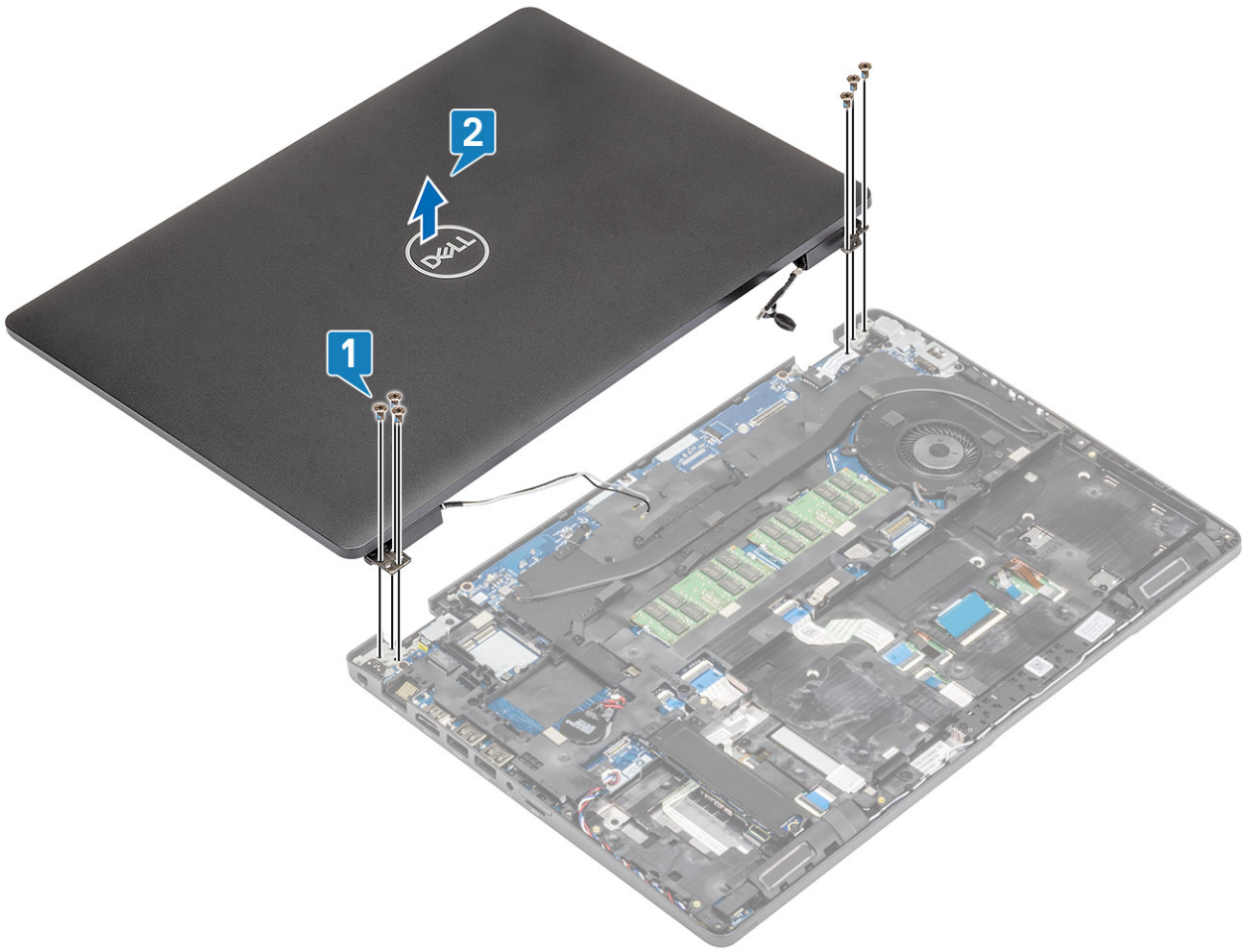

Installing the LCD assembly

Steps

1. Place the chassis on a plane surface.
2. Align the display assembly with the screw holders on the system [1].
3. Replace the six (M2.5x5.0) display hinge screws that secure the display assembly to the system [2].

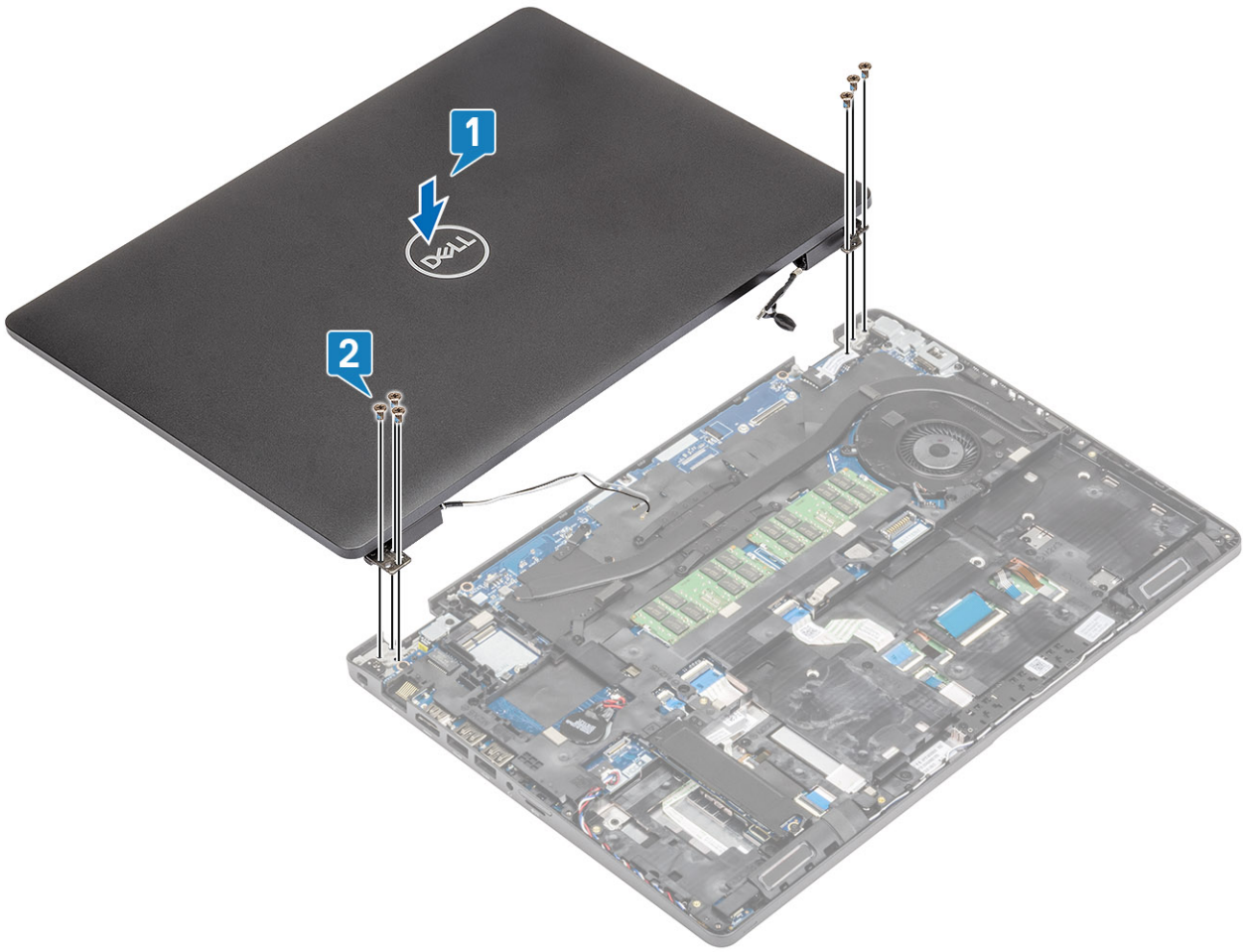

4. Carefully close the LCD screen.



5. Re-route the wireless antennas [1].
6. Re-connect the display cable to the connector on the system board [2].
7. Place the display cable bracket and secure it with the two (M2x3) screws [3,4].

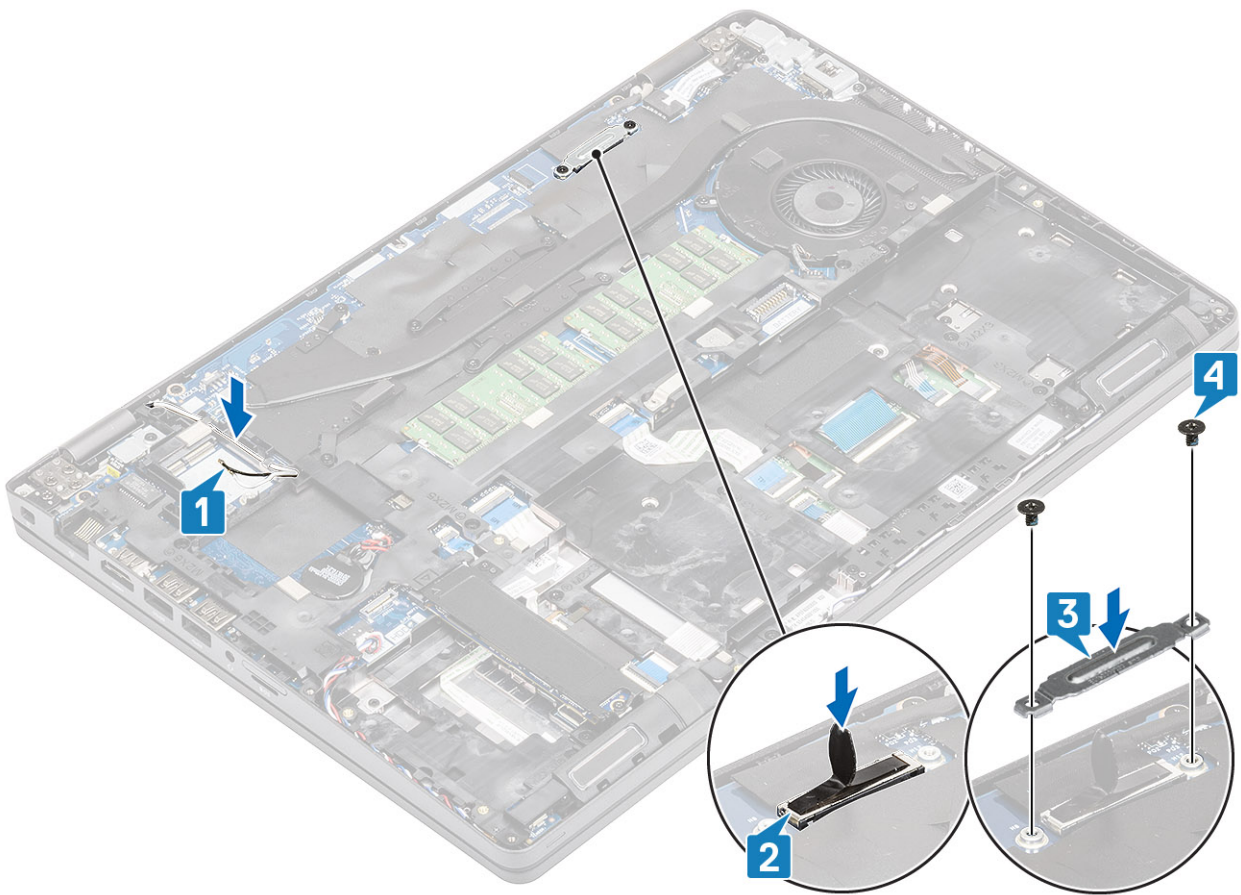

Next steps

1. Install the [WLAN card](#).
2. Install the [battery](#).
3. Install the [base cover](#).
4. Install the [microSD card](#).
5. Follow the procedure in [after working inside your computer](#).

Keyboard lattice and Keyboard

Removing the keyboard

Prerequisites

1. Follow the procedure in [before working inside your computer](#)
2. Remove the [microSD card](#).
3. Remove the [base cover](#).
4. Remove the [battery](#).
5. Remove the [ssd](#).
6. Remove the [ssd bracket](#).
7. Remove the [palmrest bracket](#).
8. Remove the [heatsink](#).
9. Remove the [memory module](#).
10. Remove the [DC-in](#).
11. Remove the [WLAN card](#).
12. Remove the [system board](#).

Steps

1. Disconnect the backlit cable and the keyboard cable from the touchpad.

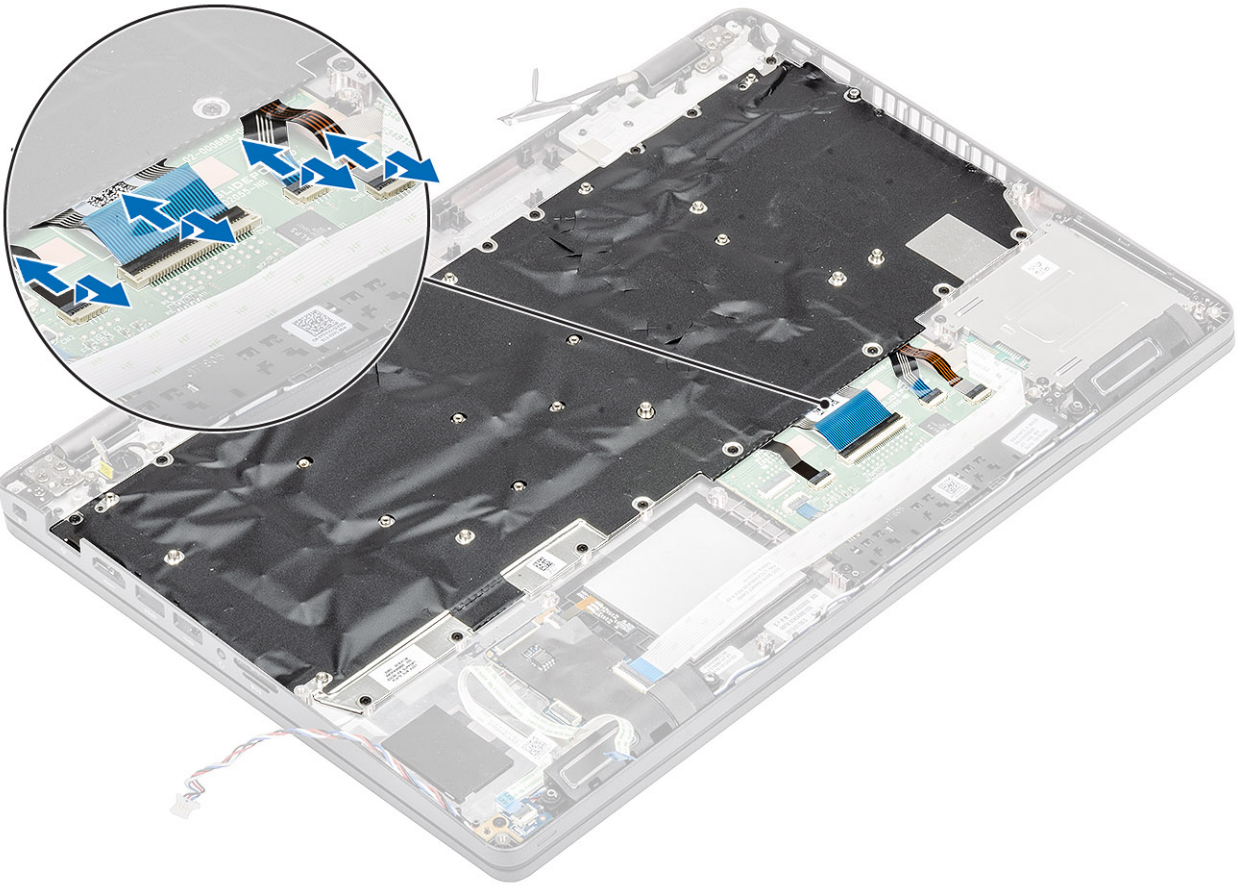

2. Remove the nineteen (M2x2) screws that secure the keyboard [1].
3. Lift the keyboard away from the computer [2].

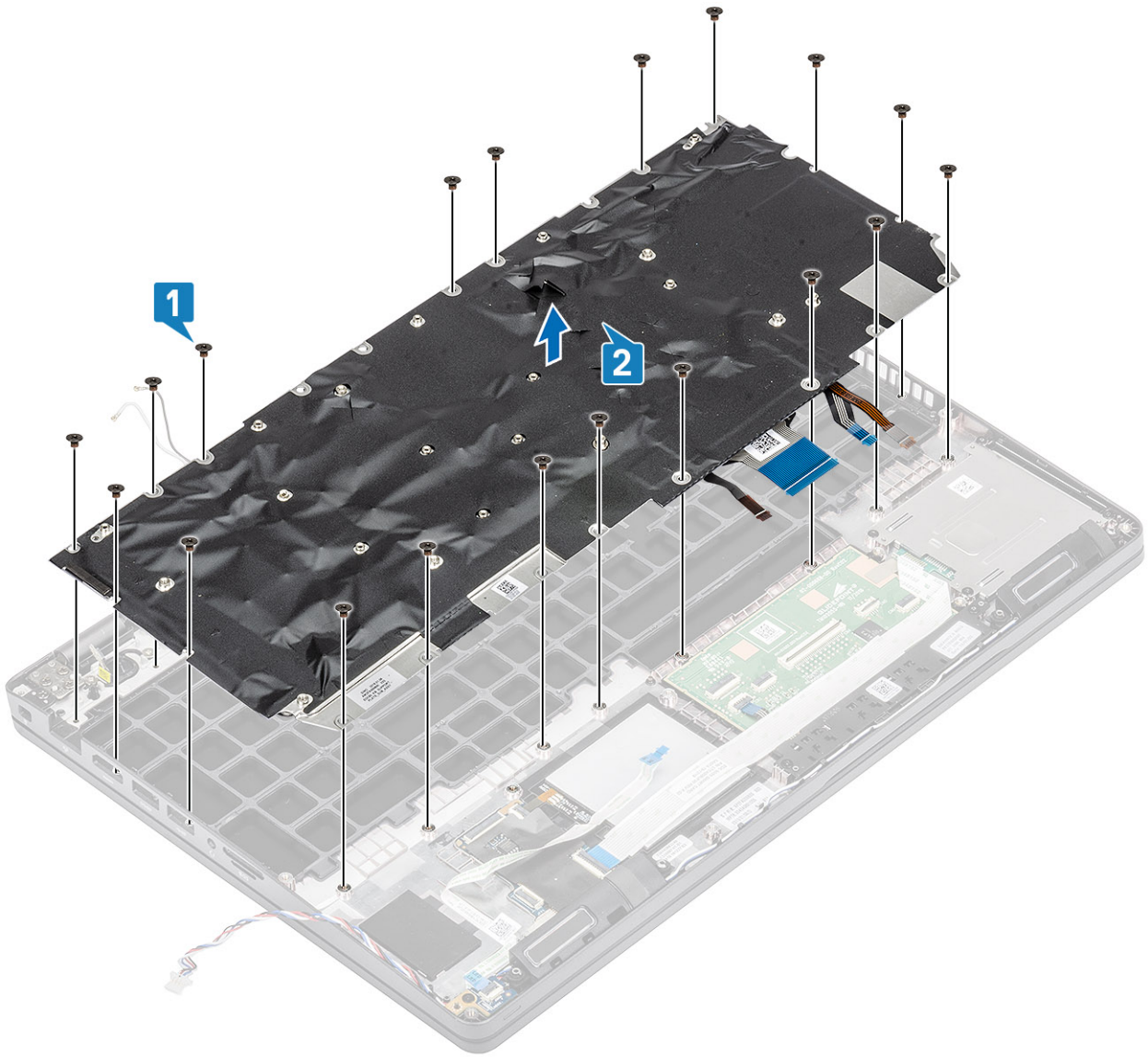

Installing the keyboard

Steps

1. Align and place the keyboard on the computer chassis [1].
2. Replace the nineteen (M2x2) screws to secure the keyboard to the computer [2].

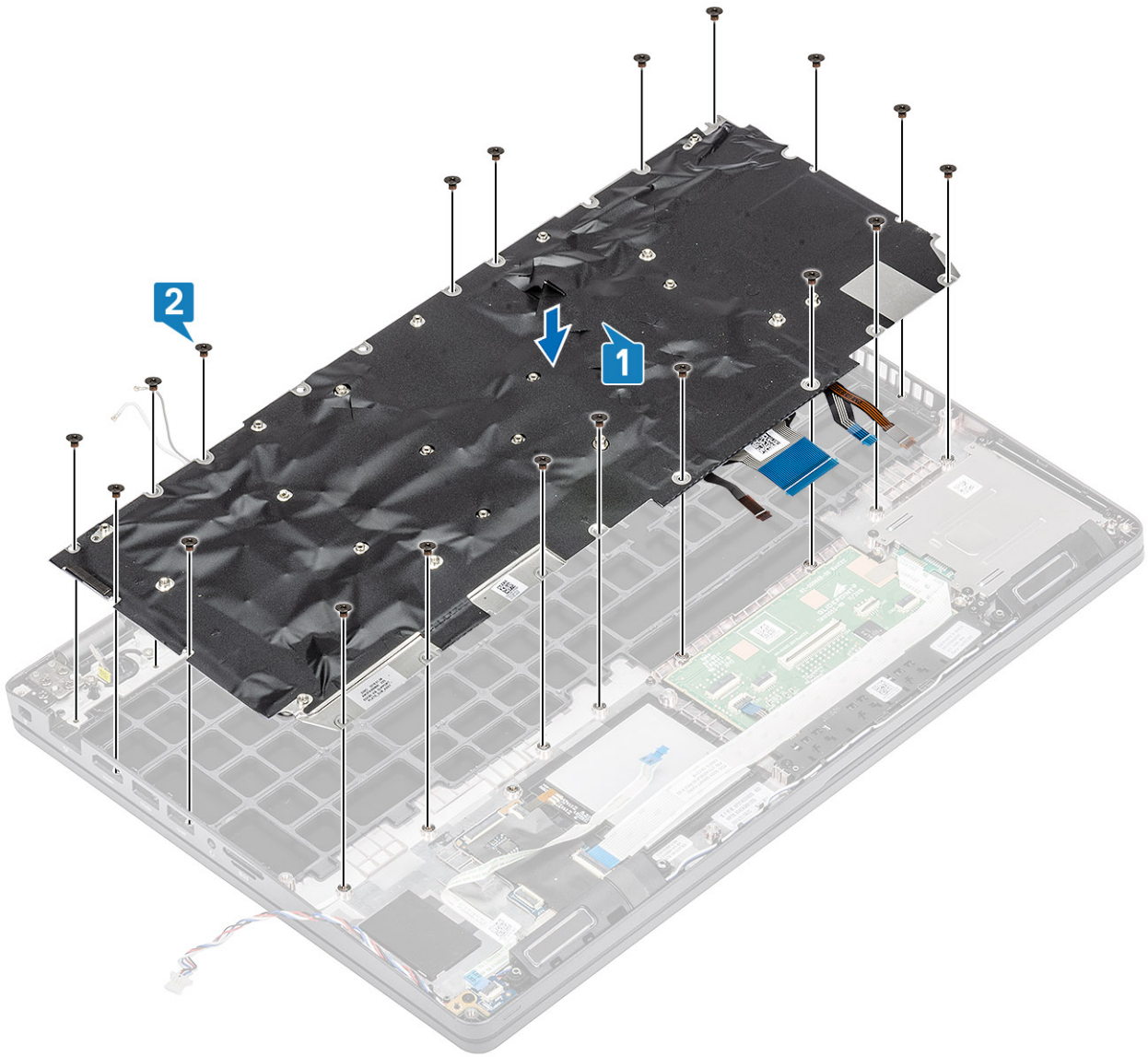

3. Reconnect the backlit cable and the keyboard cable to the touchpad.

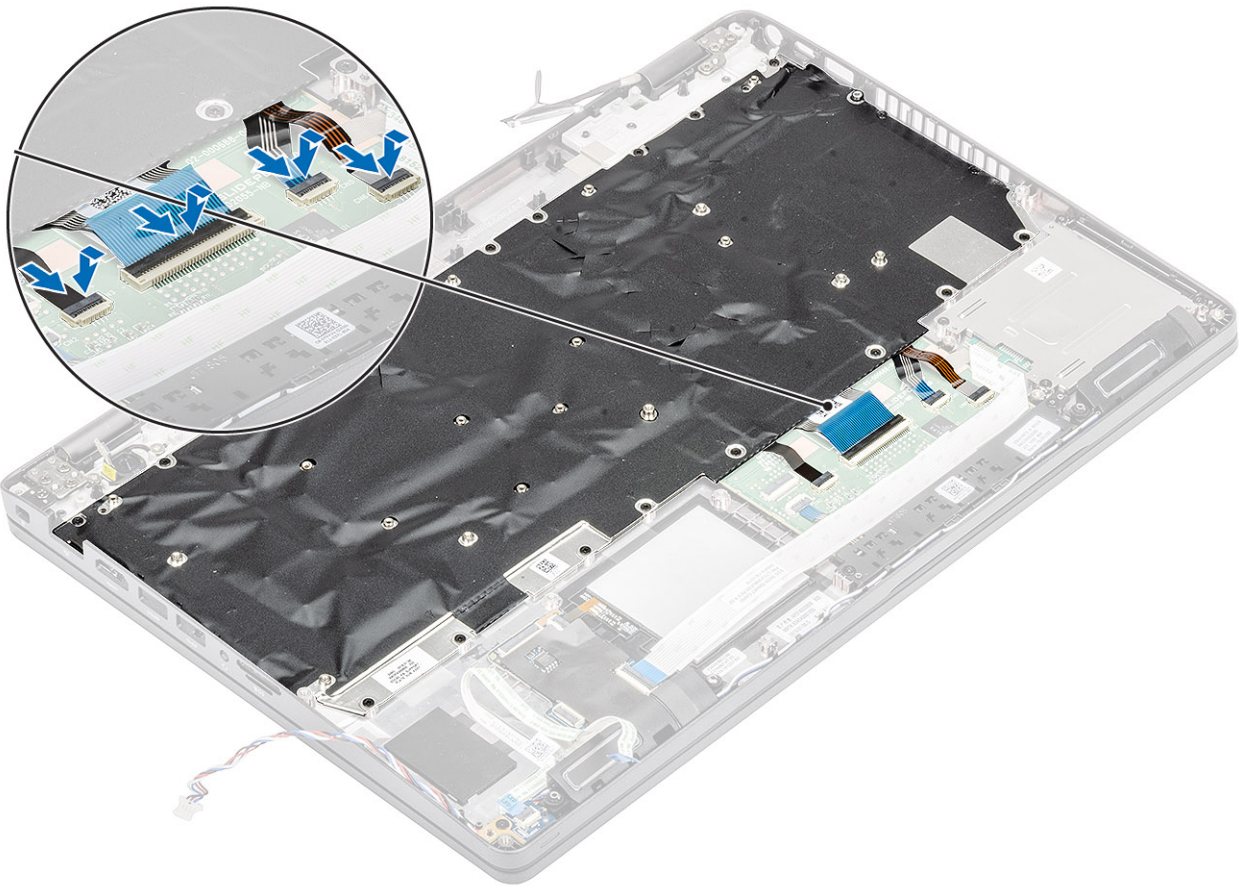

Next steps

1. Install the [system board](#).
2. Install the [WLAN card](#).
3. Install the [Dc-in](#).
4. Install the [memory module](#).
5. Install the [heatsink](#).
6. Install the [palmrest bracket](#).
7. Install the [ssd bracket](#).
8. Install the [ssd](#).
9. Install the [battery](#).
10. Install the [base cover](#).
11. Install the [microSD card](#).
12. Follow the procedure in [after working inside your computer](#).

Keyboard bracket

Removing the keyboard bracket

Prerequisites

1. Follow the procedure in [before working inside your computer](#).
2. Remove the [microSD card](#).
3. Remove the [base cover](#).
4. Remove the [battery](#).
5. Remove the [ssd](#).
6. Remove the [ssd bracket](#).

7. Remove the [palmrest bracket](#).
8. Remove the [LED board](#).
9. Remove the [speaker](#).
10. Remove the [heatsink](#).
11. Remove the [memory module](#).
12. Remove the [DC-in](#).
13. Remove the [WLAN card](#).
14. Remove the [system board](#).
15. Remove the [coin cell battery](#).
16. Remove the [keyboard](#).
17. Remove the [SmartCard reader board](#).

Steps

1. Remove the eleven (M2x2) screws that secure the keyboard to the keyboard bracket [1].
2. Remove the keyboard from the keyboard bracket [2].

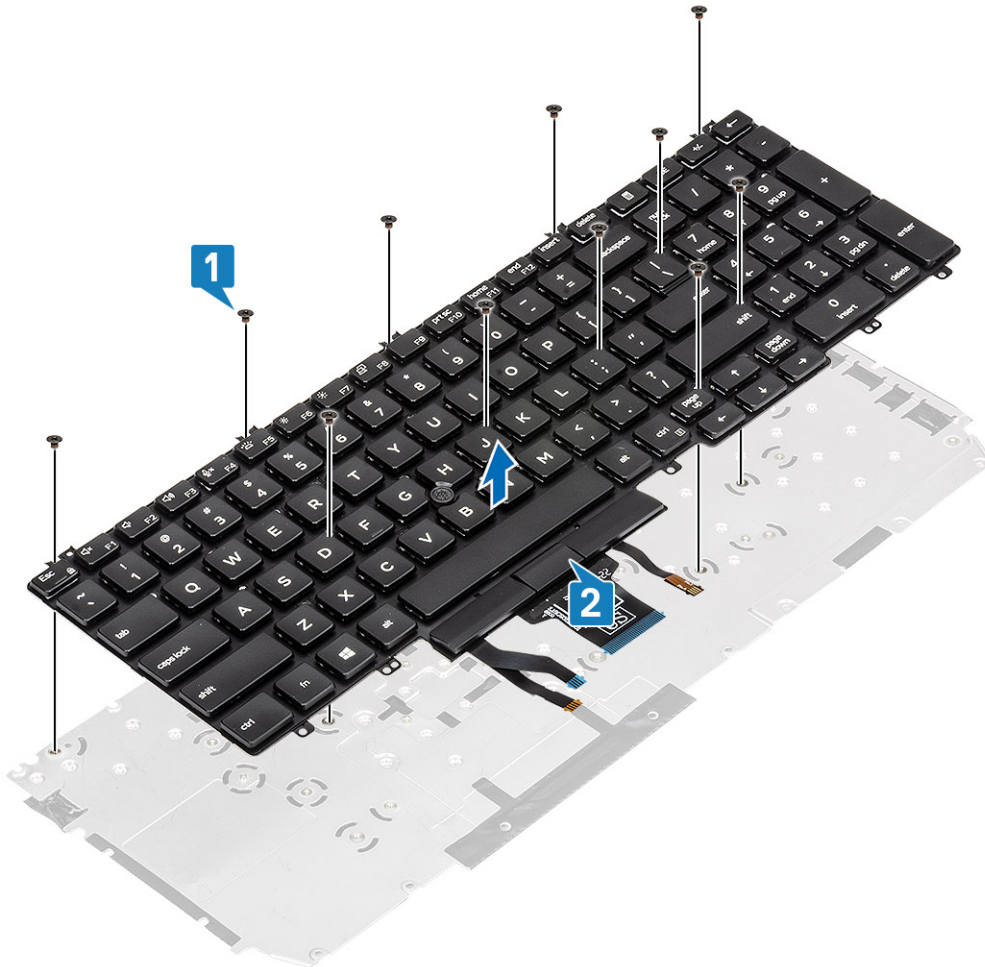

Installing the keyboard bracket

Steps

1. Align and place the keyboard on the keyboard bracket [1].
2. Replace the 12 (M2x2) screws to secure the keyboard on the keyboard bracket [2].

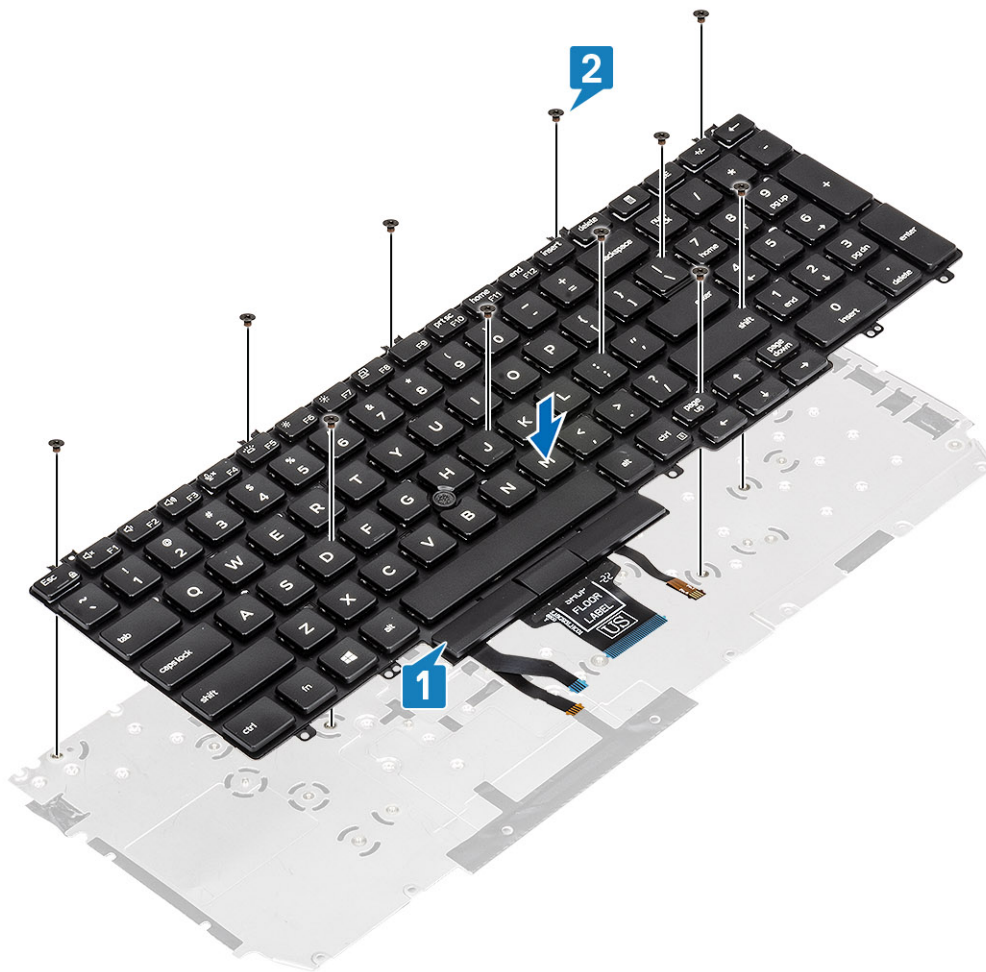

Next steps

1. Install the [SmartCard reader board](#).
2. Install the [keyboard](#).
3. Install the [coin cell battery](#).
4. Install the [system board](#).
5. Install the [WLAN card](#).
6. Install the [Dc-in](#).
7. Install the [memory module](#).
8. Install the [heatsink](#).
9. Install the [speaker](#).
10. Install the [LED board](#).
11. Install the [palmrest bracket](#).
12. Install the [ssd bracket](#).
13. Install the [ssd](#).
14. Install the [battery](#).
15. Install the [base cover](#).
16. Install the [microSD card](#).
17. Follow the procedure in [after working inside your computer](#).

Smart card reader board

Removing the smart card reader

Prerequisites

1. Follow the procedure in [before working inside your computer](#)
2. Remove the [microSD card](#).
3. Remove the [base cover](#).
4. Remove the [battery](#).
5. Remove the [ssd](#).
6. Remove the [ssd bracket](#).
7. Remove the [palmrest bracket](#).

Steps

1. Disconnect and un-route the smart card reader cable [1].

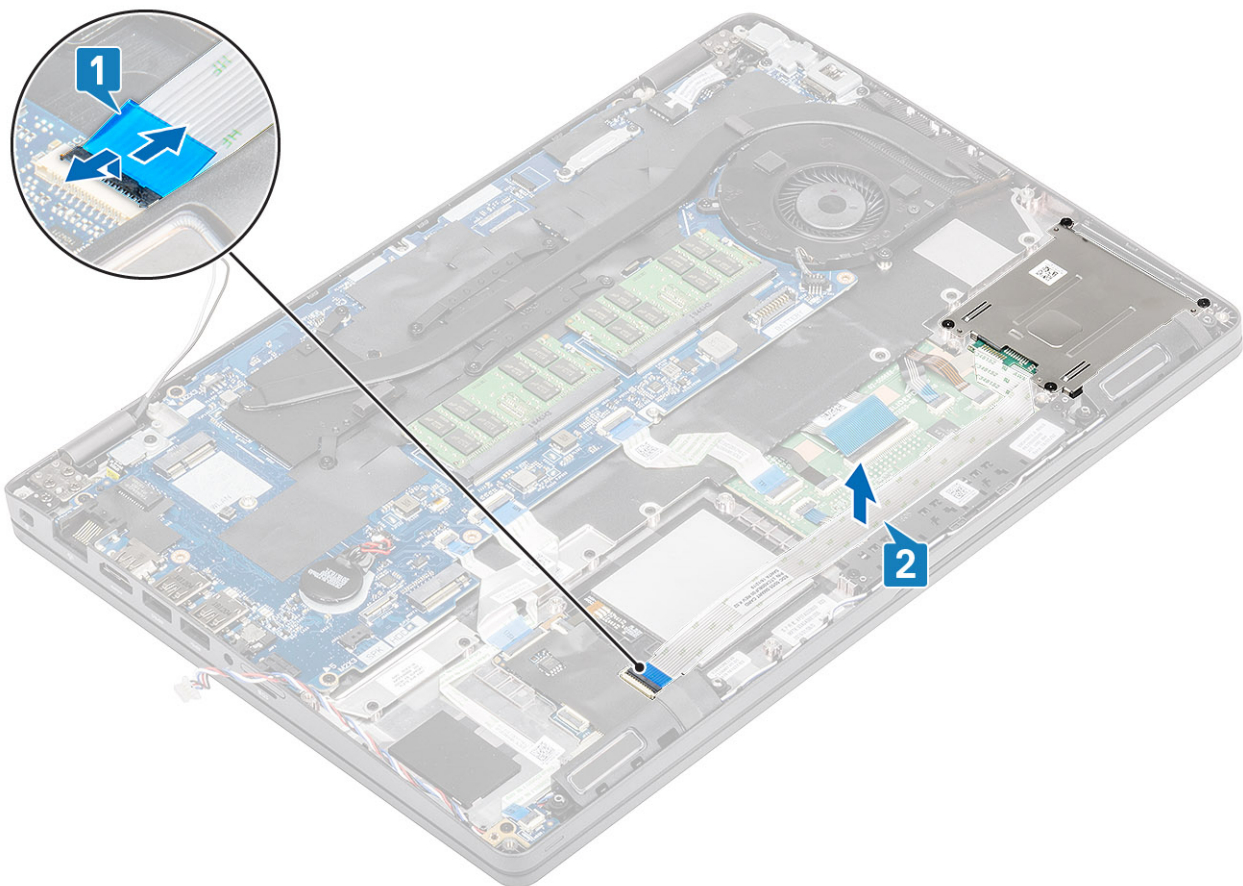

2. Remove the four (M2x2.5) screws that secure the smart card reader module to the computer [1].
3. Lift the smart card reader module out of the computer [2].

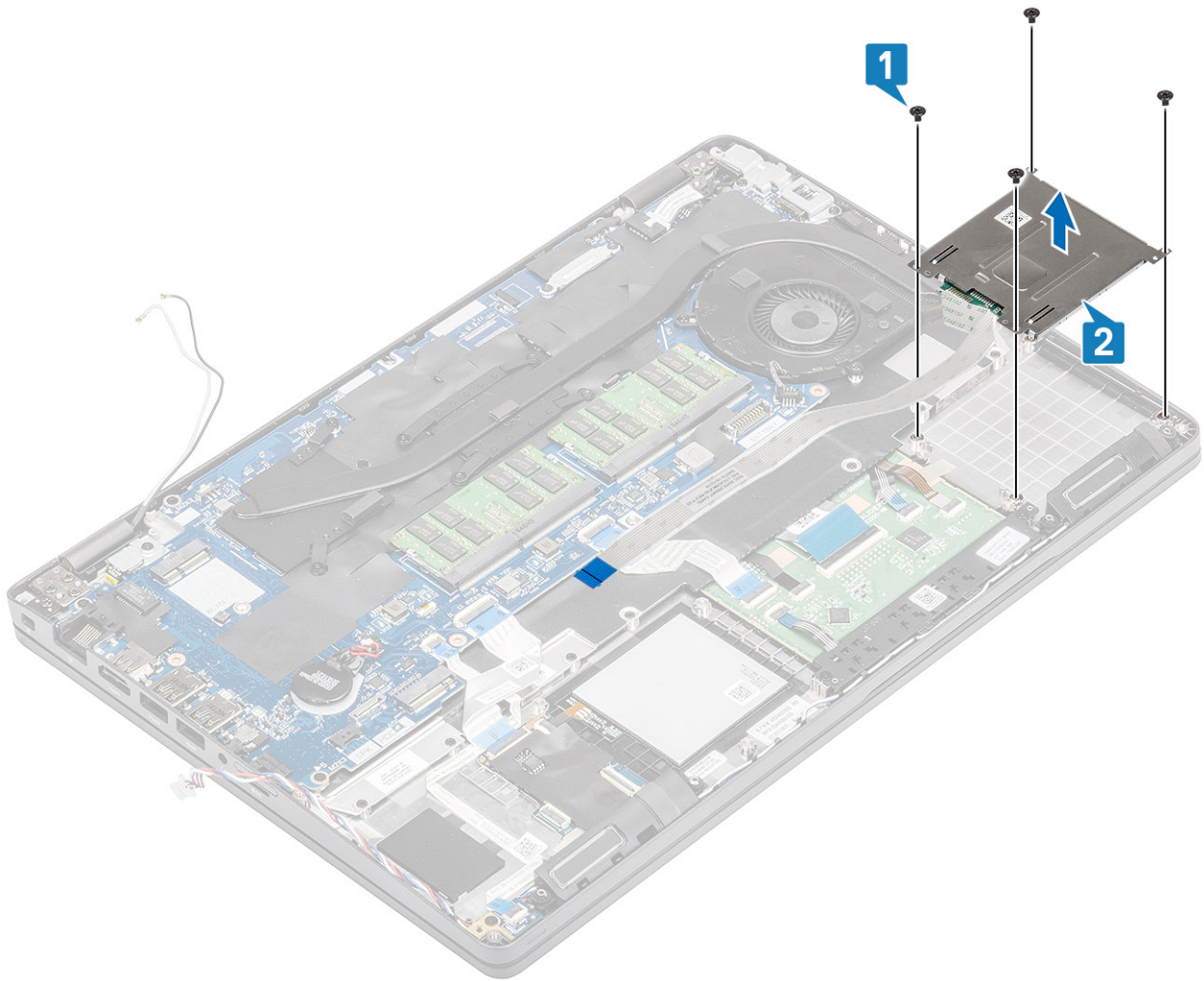

Installing the smart card reader

Steps

1. Align and place the smart card reader module into the computer chassis [1].
2. Replace the four (M2x2.5) screws to secure the smart card reader module to the computer [2].

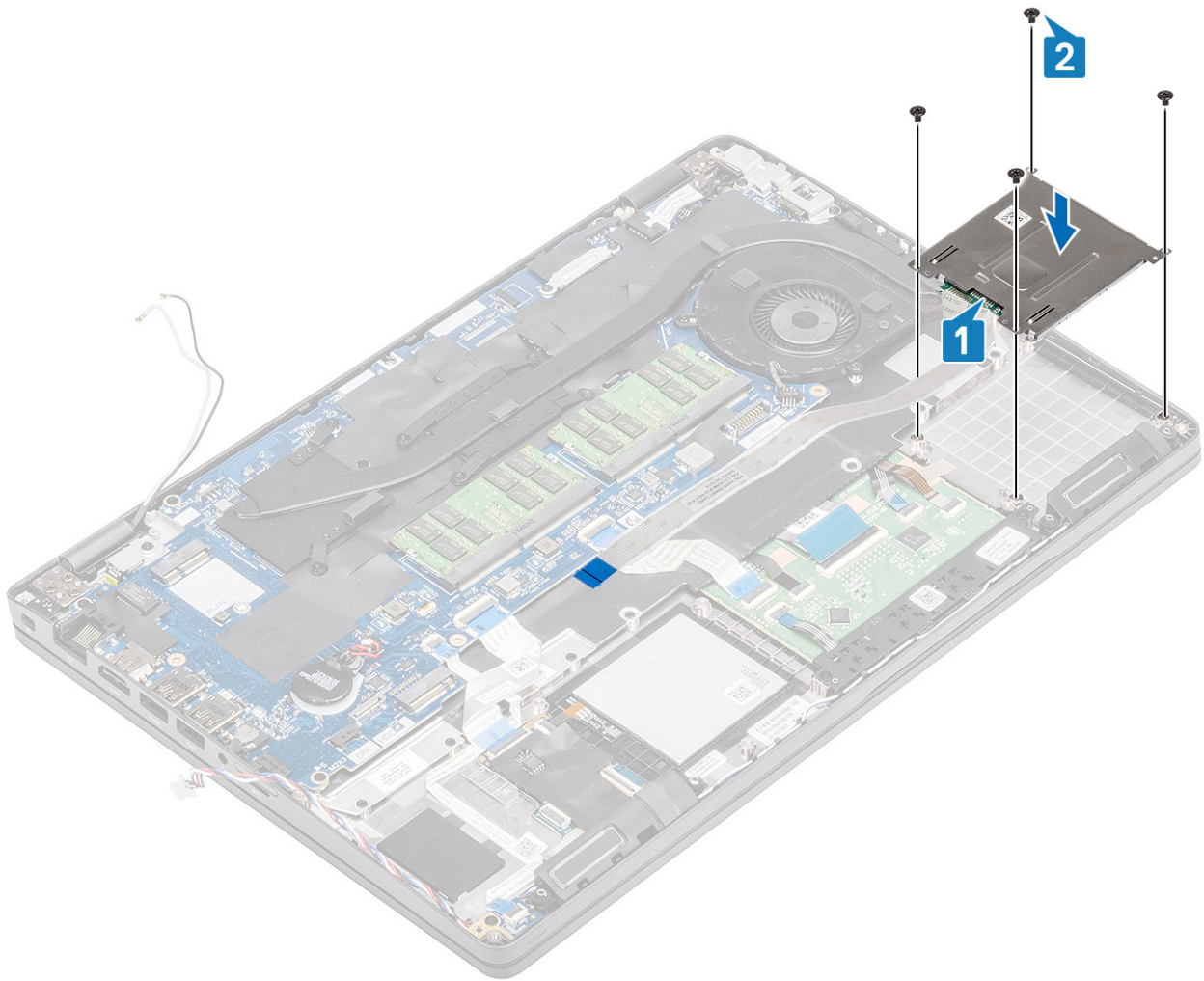

3. Re-connect the smart card reader cable to the system board and secure the cable to the computer [1,2].

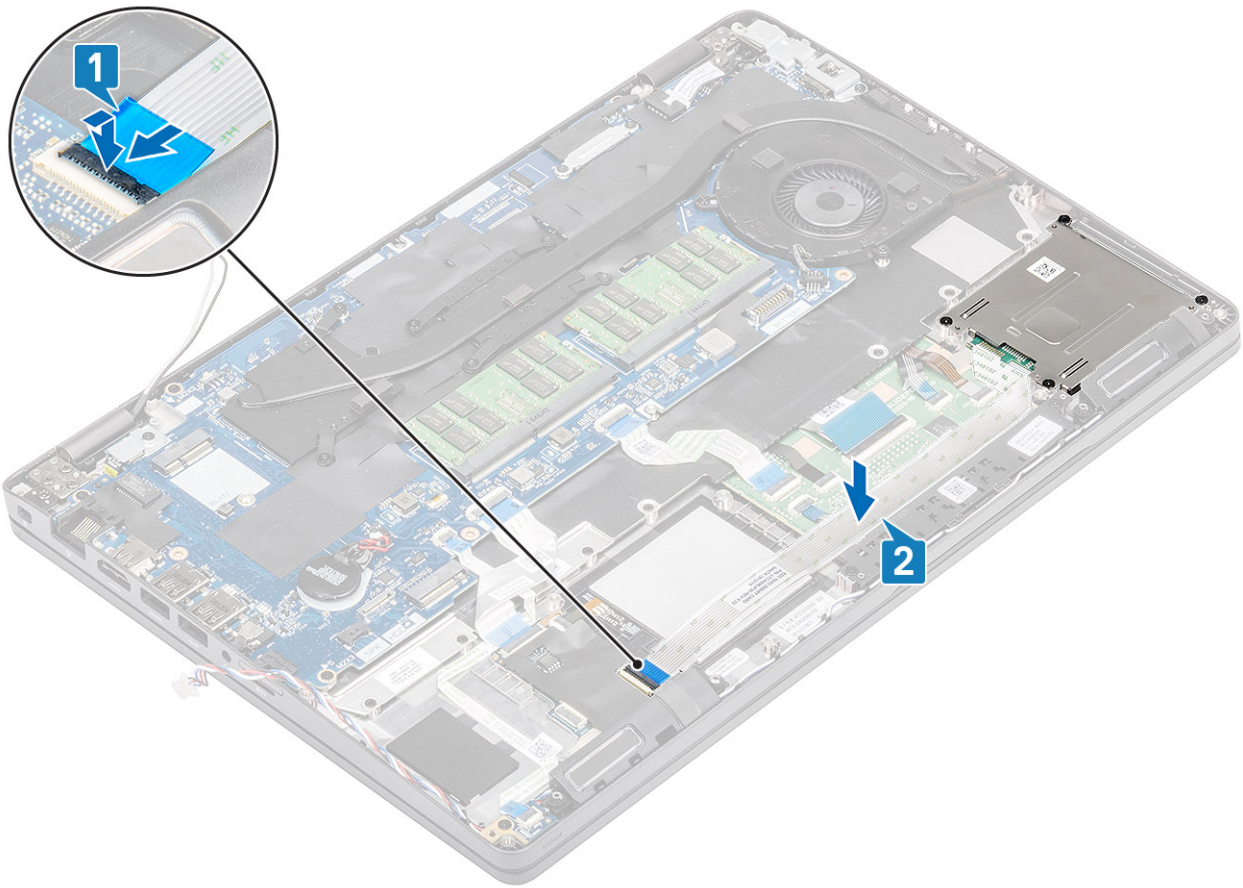

Next steps

1. Install the [palmrest bracket](#).
2. Install the [ssd bracket](#).
3. Install the [ssd](#).
4. Install the [battery](#).
5. Install the [base cover](#).
6. Install the [microSD card](#).
7. Follow the procedure in [after working inside your computer](#).

Display bezel

Removing the display bezel

Prerequisites

1. Follow the procedure in [before working inside your computer](#)
2. Remove the [microSD card](#).
3. Remove the [base cover](#).
4. Remove the [battery](#).
5. Remove the [display assembly](#)

Steps

1.  **NOTE:** Display bezel cannot be reused after being removed.

Use a plastic scribe to carefully pry open the recesses near the left and right hinges on the bottom edge of the display bezel [1].

- Carefully pry open the inside edge of the display bezel and then pry open the inside edge of the left and right sides of the display bezel [2].

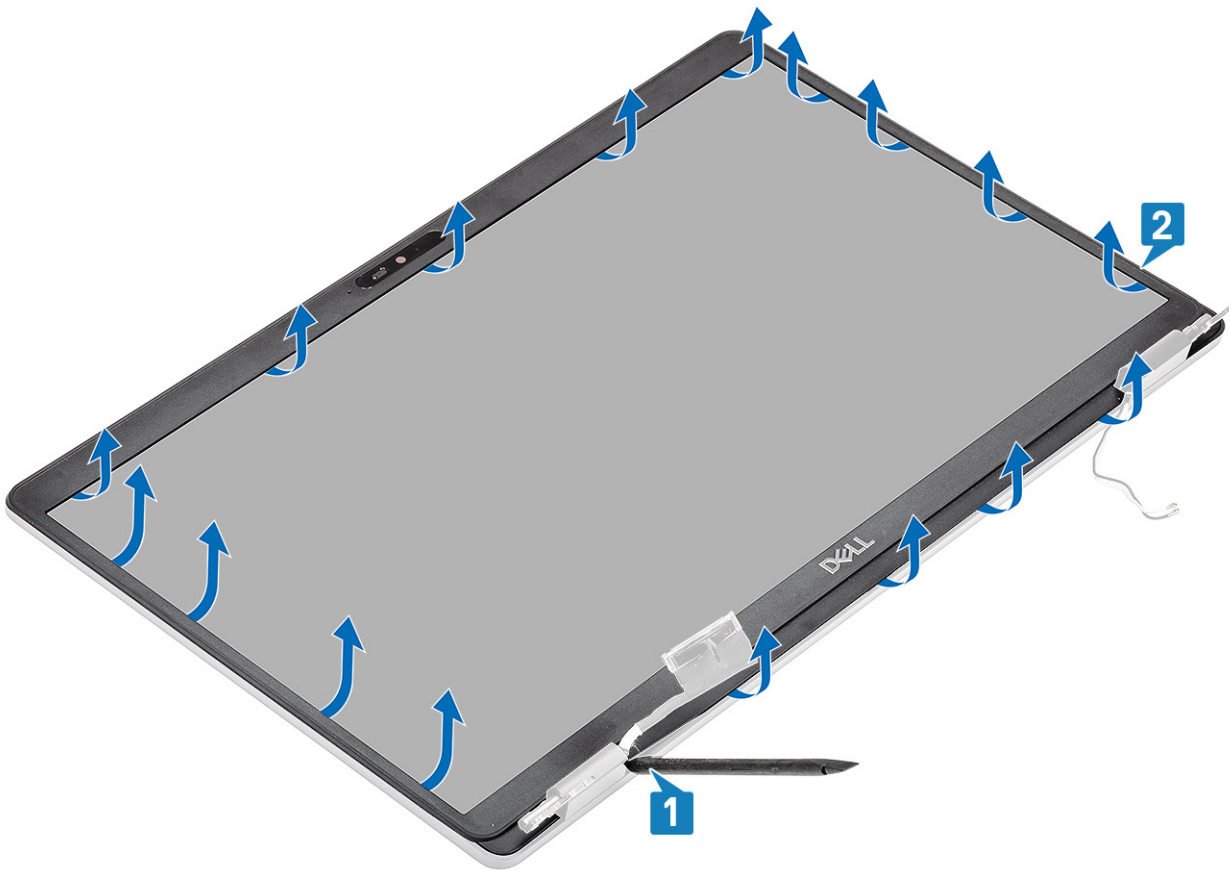

- Lift the display bezel from the display assembly.

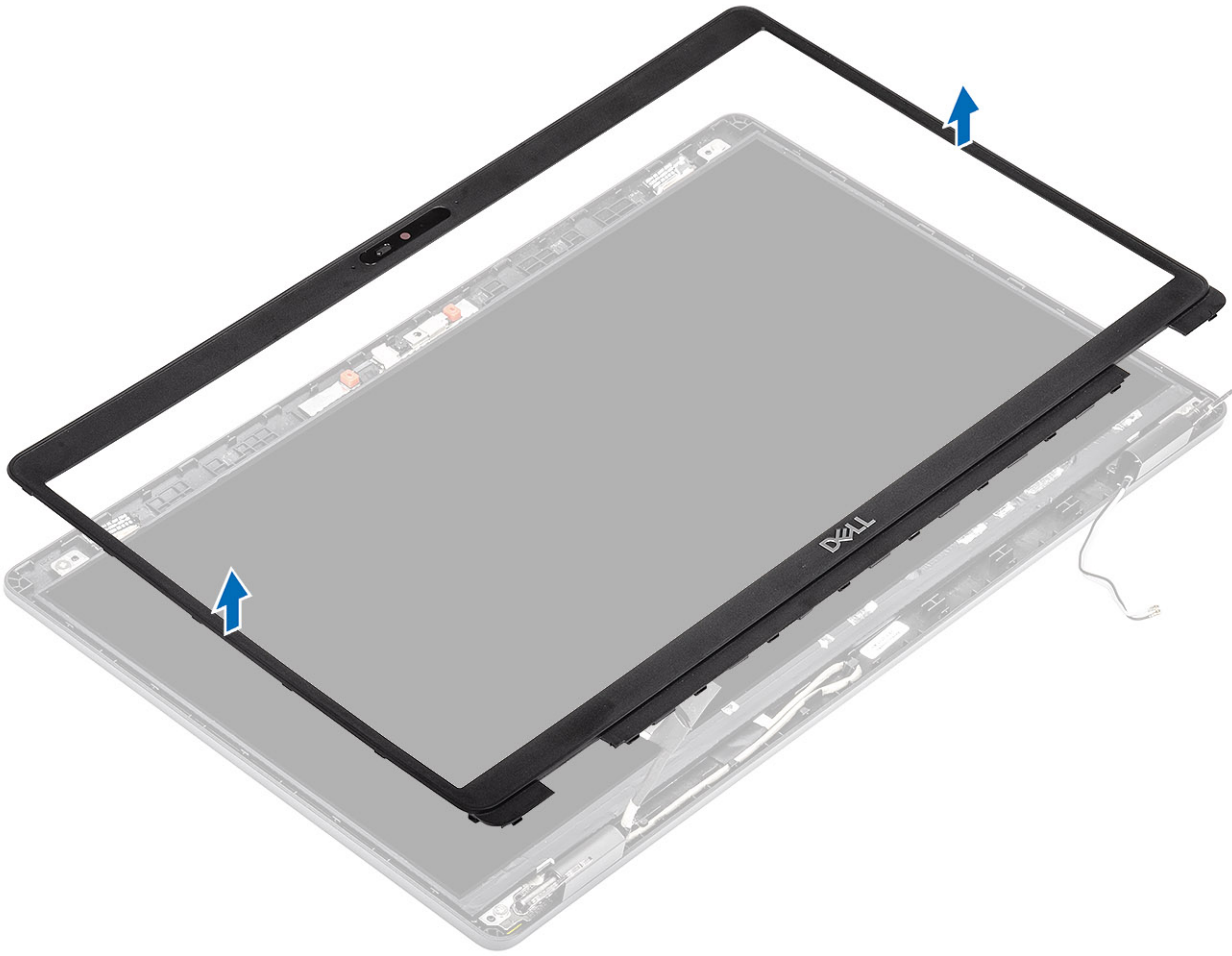

Installing the display bezel

Steps

1. Align and place the display bezel on the display assembly.

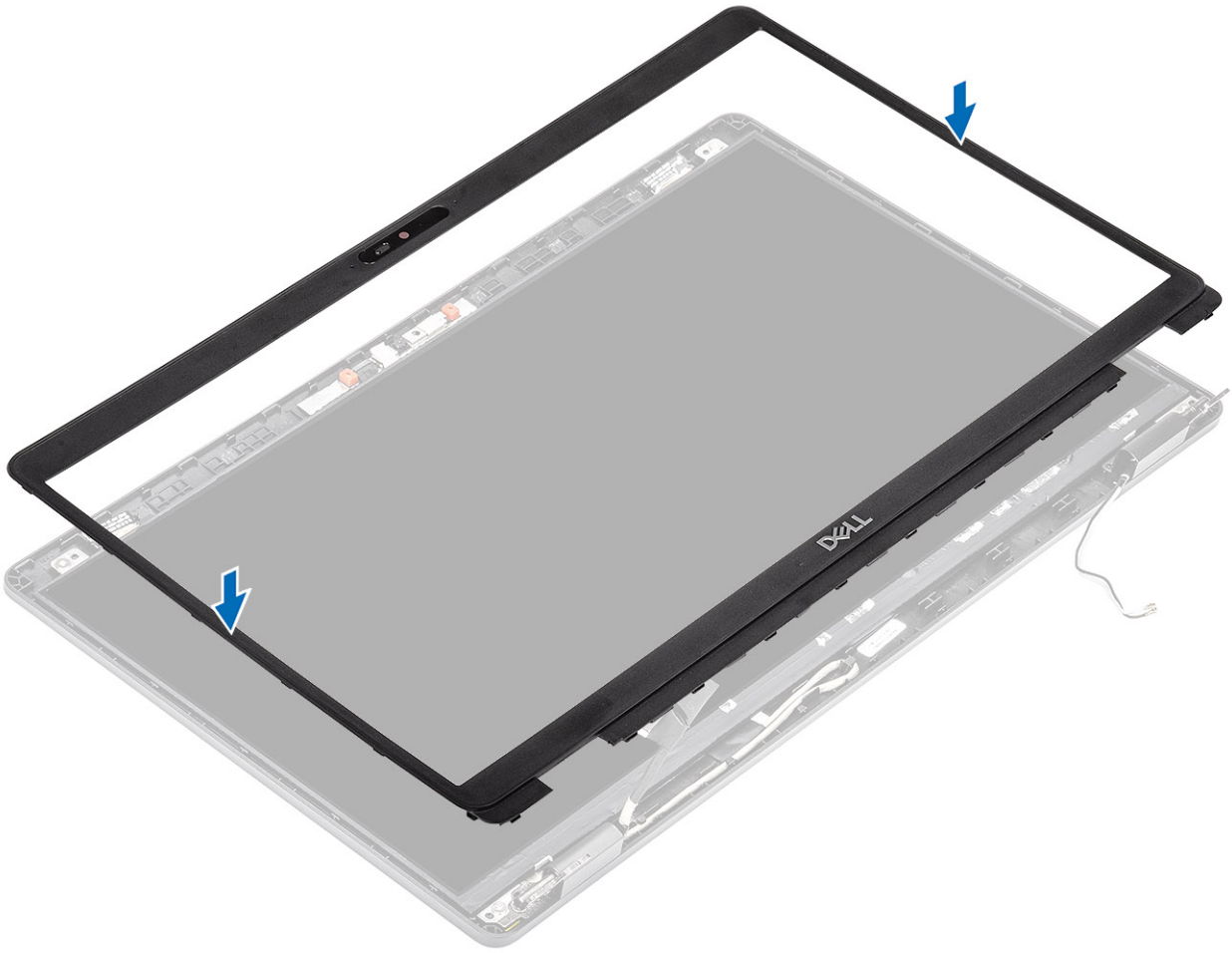

2. Gently snap the display bezel into place.

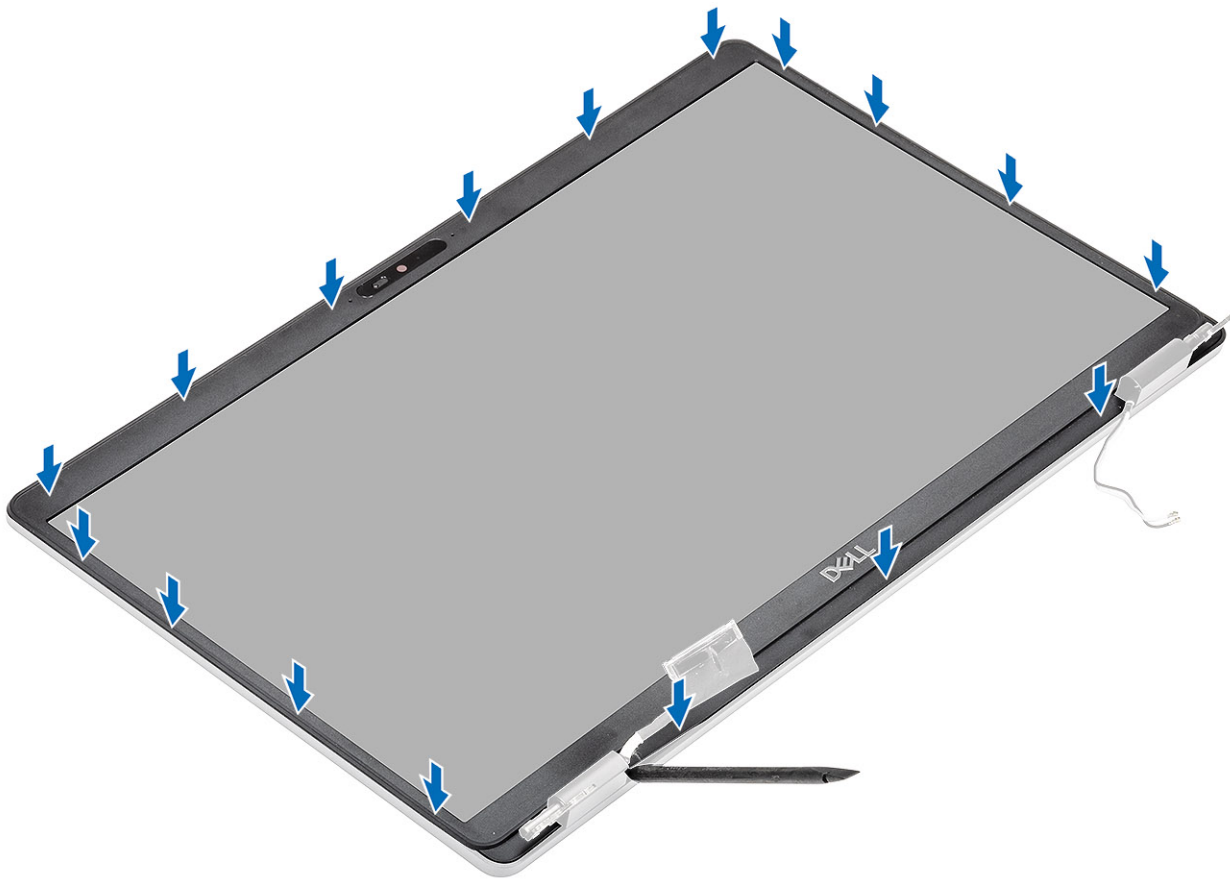

Next steps

1. Install the [display assembly](#).
2. Install the [battery](#).
3. Install the [base cover](#).
4. Install the [microSD card](#).
5. Follow the procedure in [after working inside your computer](#).

Hinge caps

Removing hinge caps

Prerequisites

1. Follow the procedure in [before working inside your computer](#).
2. Remove the [microSD card](#).
3. Remove the [base cover](#).
4. Remove the [battery](#).
5. Remove the [display assembly](#)
6. Remove the [display bezel](#).

Steps

1. Remove the two (M2x2.5) screws that secure the hinge caps to the chassis [1].
2. Pinch the hinge caps to release the hinge caps from the ribs on the display back cover and then slide inwards to remove the hinge caps from the display hinge [2].

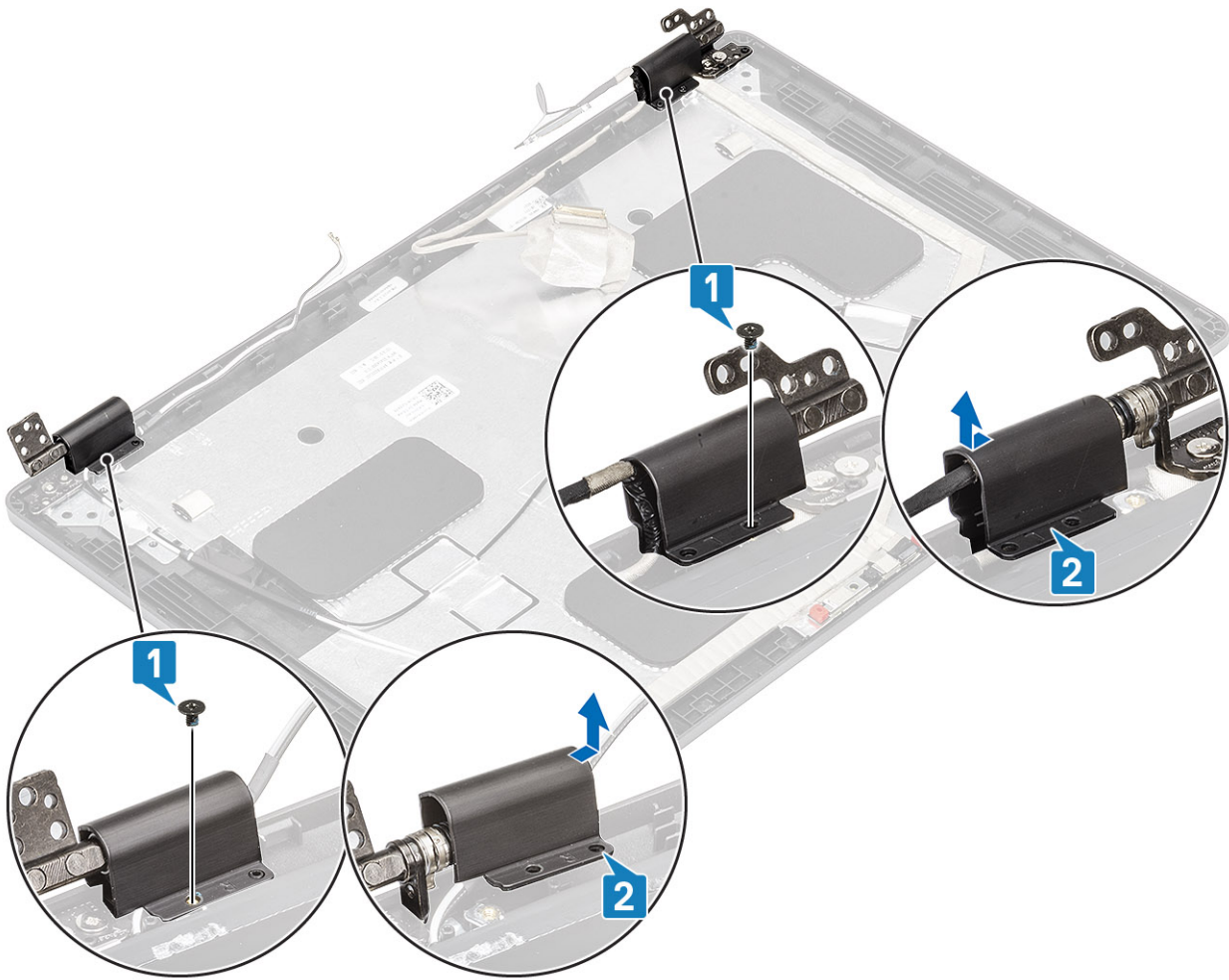

Installing hinge caps

Steps

1. Place the hinge caps and slide outward on the display hinges [1].
2. Replace the two (M2x2.5) screws to secure the hinge caps to the display hinge [2].

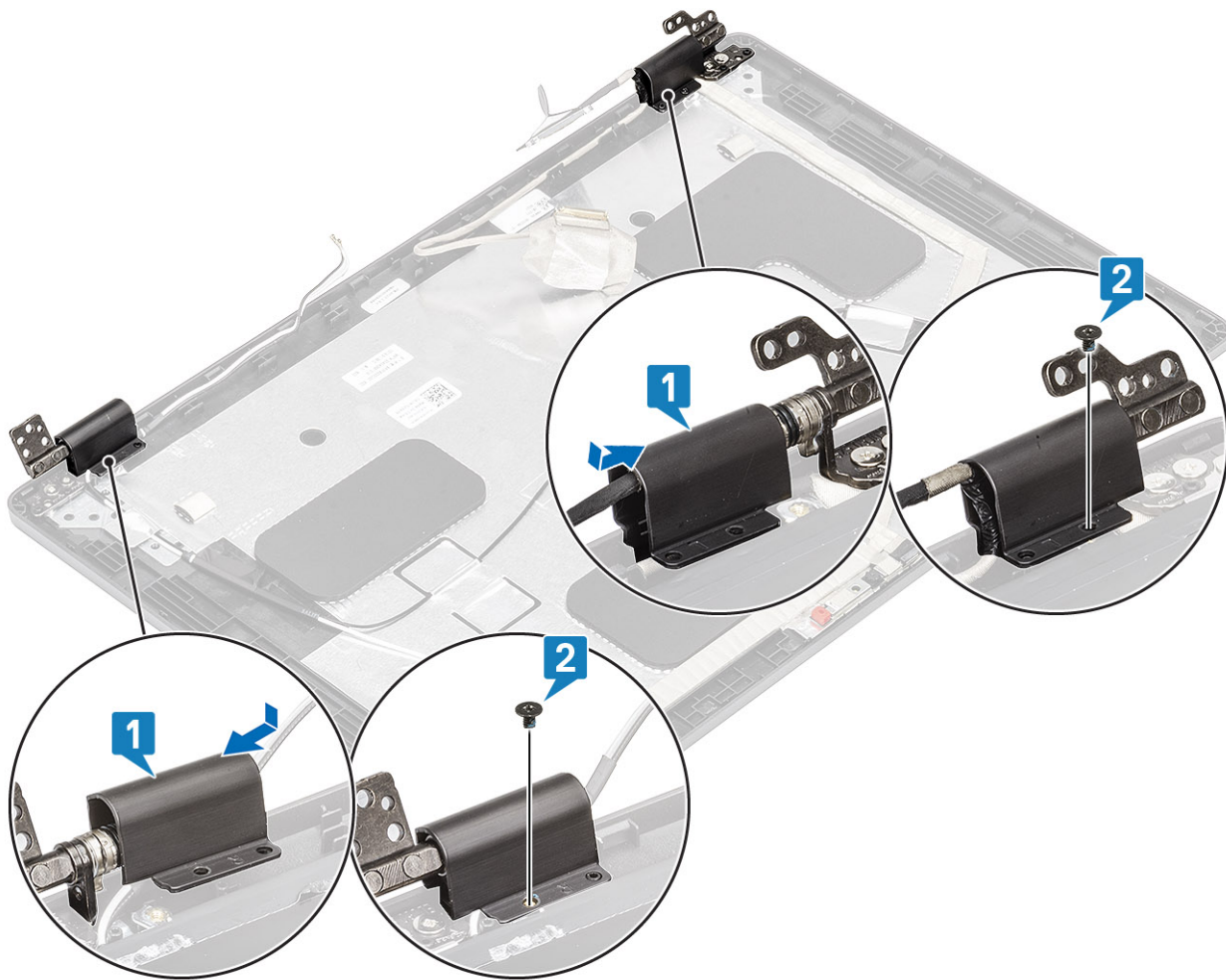

Next steps

1. Install the [display bezel](#).
2. Install the [display assembly](#).
3. Install the [battery](#).
4. Install the [base cover](#).
5. Install the [microSD card](#).
6. Follow the procedure in [after working inside your computer](#).

Display hinges

Removing display hinge

Prerequisites

1. Follow the procedure in [before working inside your computer](#).
2. Remove the [microSD card](#).
3. Remove the [base cover](#).
4. Remove the [battery](#).
5. Remove the [display assembly](#).
6. Remove the [display bezel](#).
7. Remove the [hinge caps](#).

Steps

1. Remove the four (M2.5x3.5) screws that secure the display hinge to the display assembly [1].
2. Remove the display hinges from the display back cover [2].

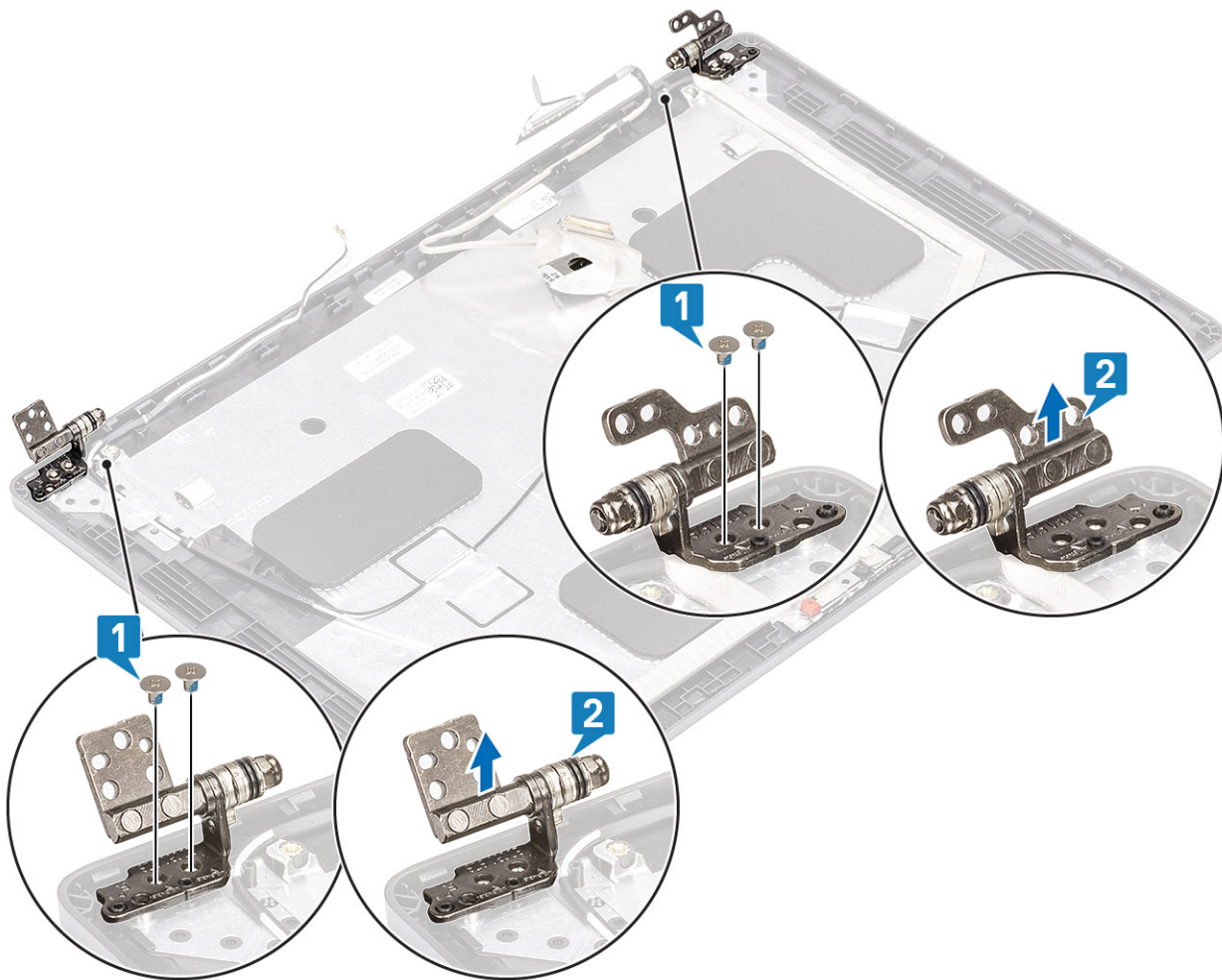

Installing display hinge

Steps

1. Align and place the display hinge on the display assembly.
2. Replace the four (M2.5x3.5) screws to secure the display hinge to the display assembly.

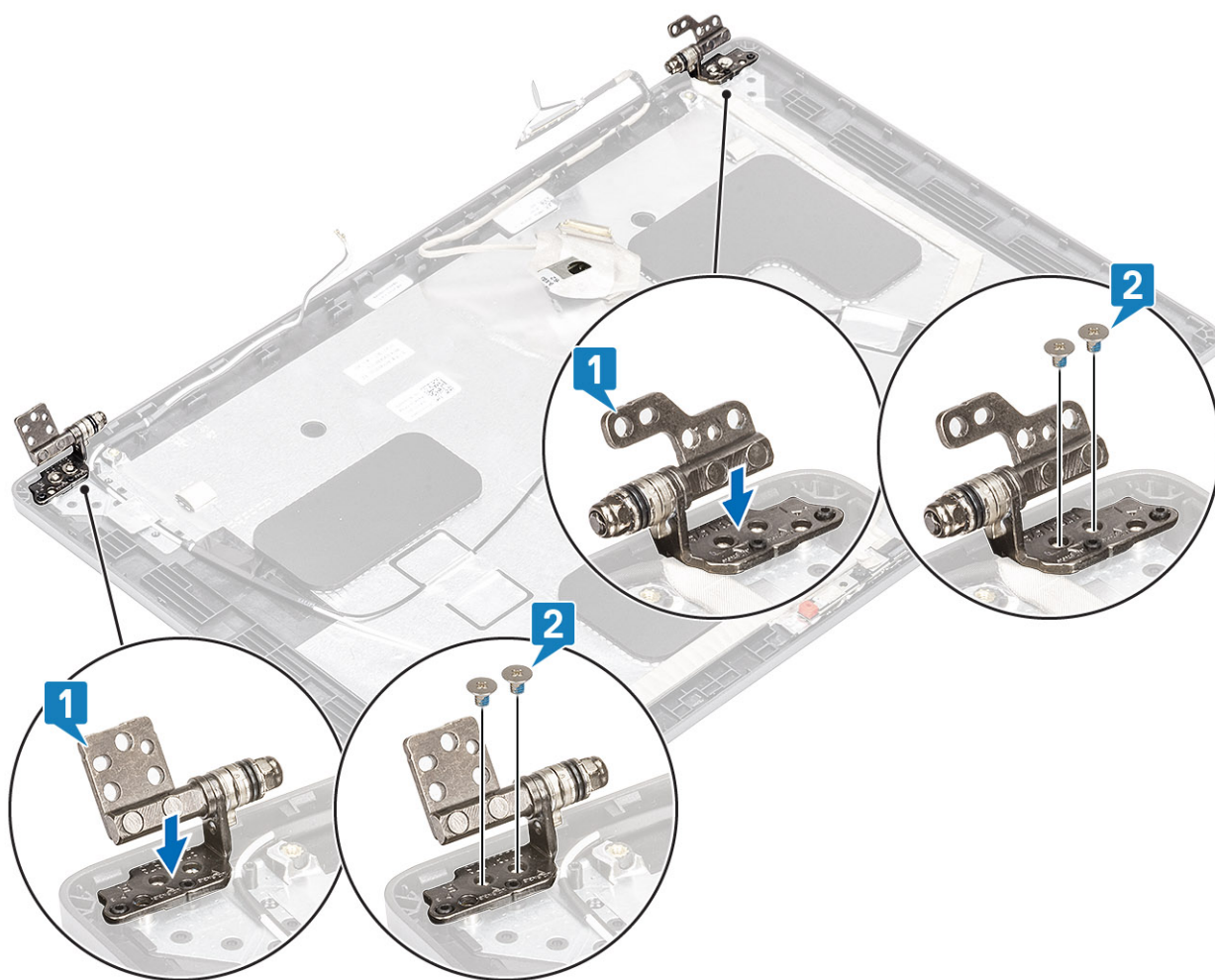

Next steps

1. Install the [hinge caps](#).
2. Install the [display bezel](#).
3. Install the [display assembly](#).
4. Install the [battery](#).
5. Install the [base cover](#).
6. Install the [microSD card](#).
7. Follow the procedure in [after working inside your computer](#).

Display panel

Removing display panel

Prerequisites

1. Follow the procedure in [before working inside your computer](#).
2. Remove the [microSD card](#).
3. Remove the [base cover](#).
4. Remove the [battery](#).
5. Remove the [display assembly](#)
6. Remove the [display bezel](#).
7. Remove the [hinge caps](#).
8. Remove the [display hinges](#).

Steps

1. Remove the four (M2x2) screws that secure the display panel to the display assembly [1] and lift to turn over the display panel to access the display cable [2].

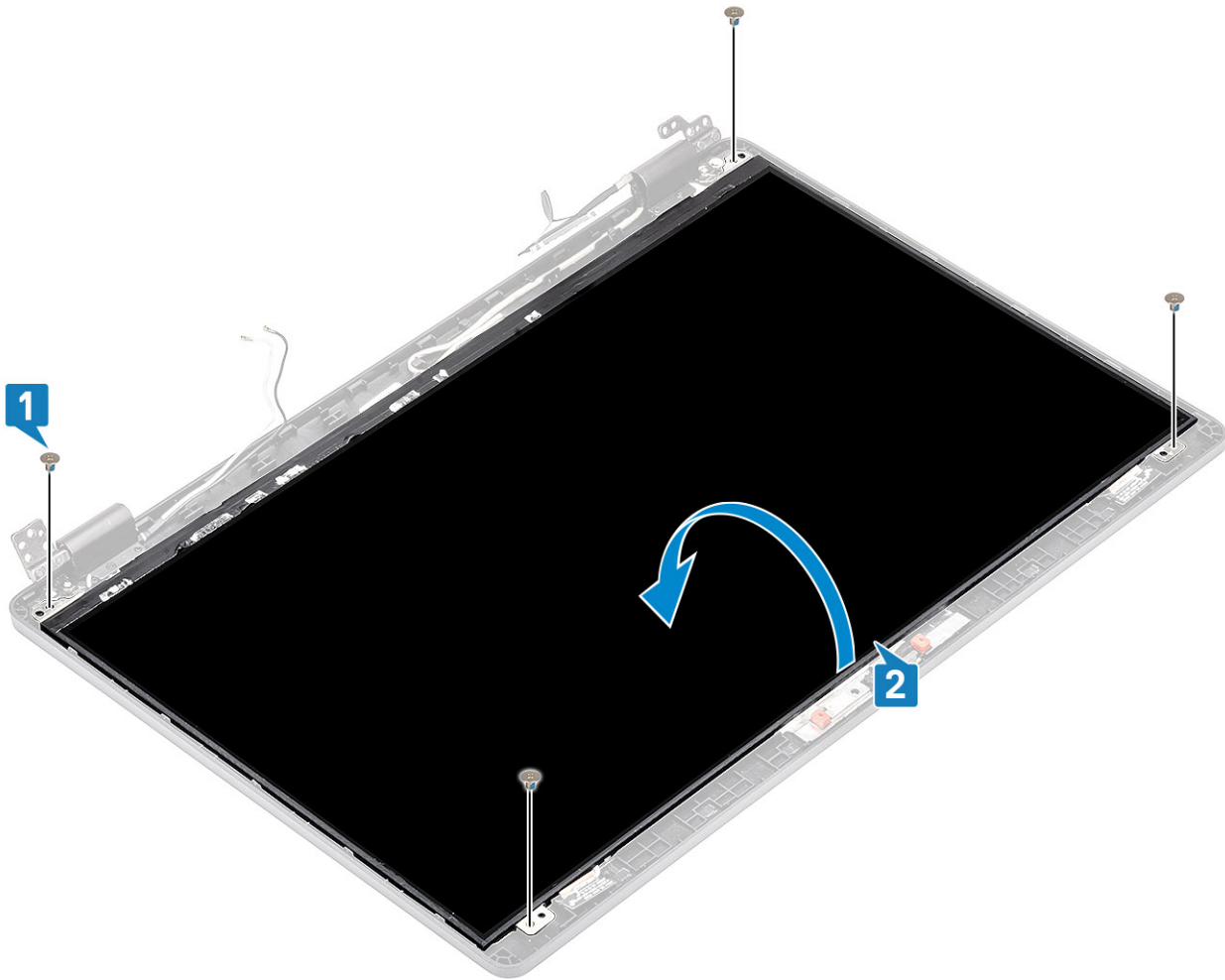

2. Peel the conductive tape [1] on the display cable connector.
3. Remove the adhesive strip that secures the display cable connector [2].
4. Lift the latch and disconnect the display cable from the connector on the display panel [3, 4] .



Installing display panel

Steps

1. Connect the display cable to the connector and close the latch [1, 2].
2. Adhere the adhesive strip to secure the display cable connector [3].
3. Adhere the conductive tape to secure the display cable connector [4].



4. Replace the four (M2x2) screws that secure the display panel to the display assembly.

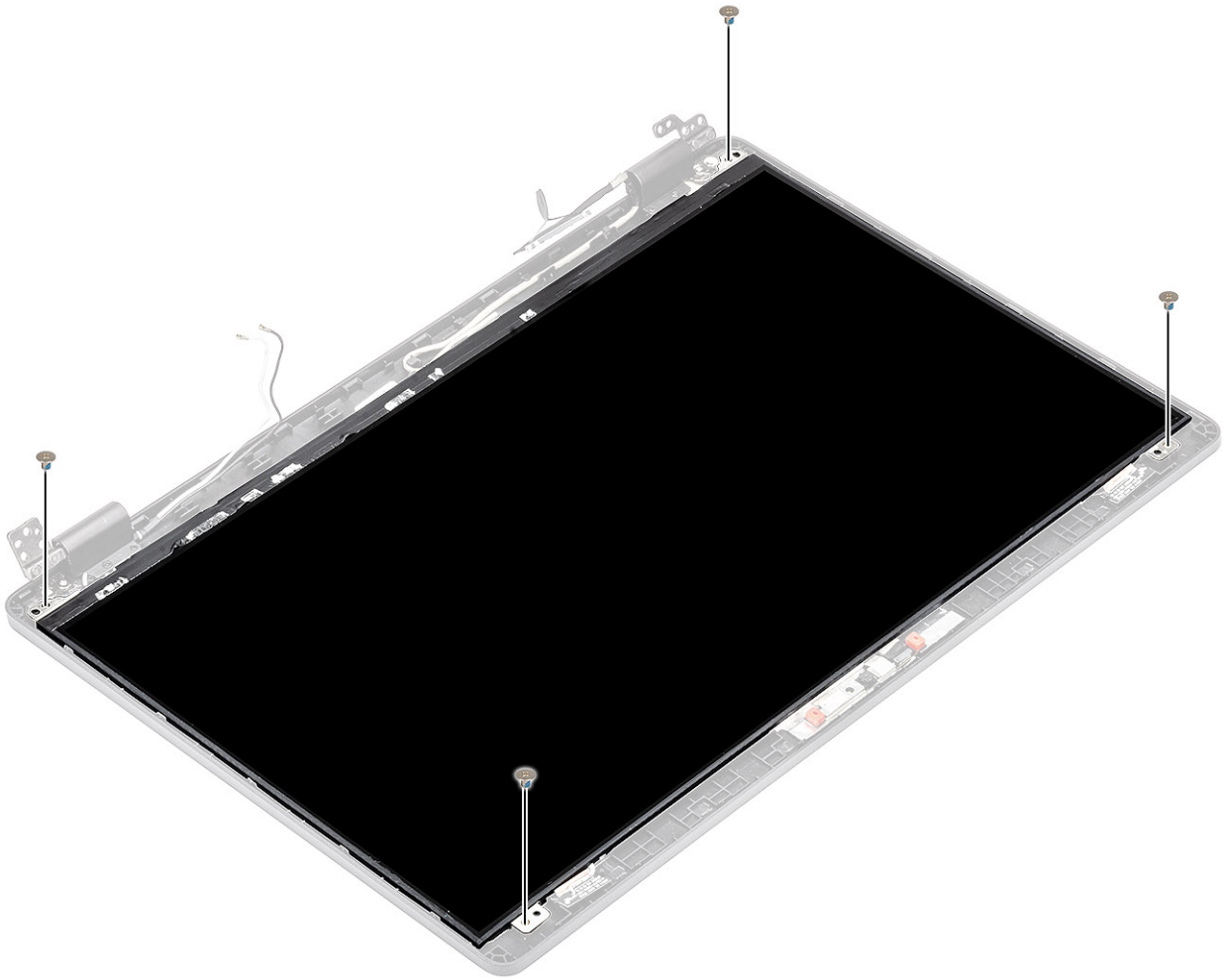

Next steps

1. Install the [display hinges](#).
2. Install the [hinge caps](#).
3. Install the [display bezel](#).
4. Install the [display assembly](#).
5. Install the [battery](#).
6. Install the [base cover](#).
7. Install the [microSD card](#).
8. Follow the procedure in [after working inside your computer](#).

Camera

Removing camera

Prerequisites

1. Follow the procedure in [before working inside your computer](#).
2. Remove the [microSD card](#).
3. Remove the [base cover](#).
4. Remove the [battery](#).
5. Remove the [display assembly](#)
6. Remove the [display bezel](#).
7. Remove the [hinge caps](#).

8. Remove the [display hinges](#).
9. Remove the [display panel](#).

Steps

1. Peel the two conductive tape that secures the camera in place [1].
2. Using a plastic scribe carefully pry and lift the camera module from the display back cover [2].
3. Disconnect the camera cable from the connector on the camera module [3].

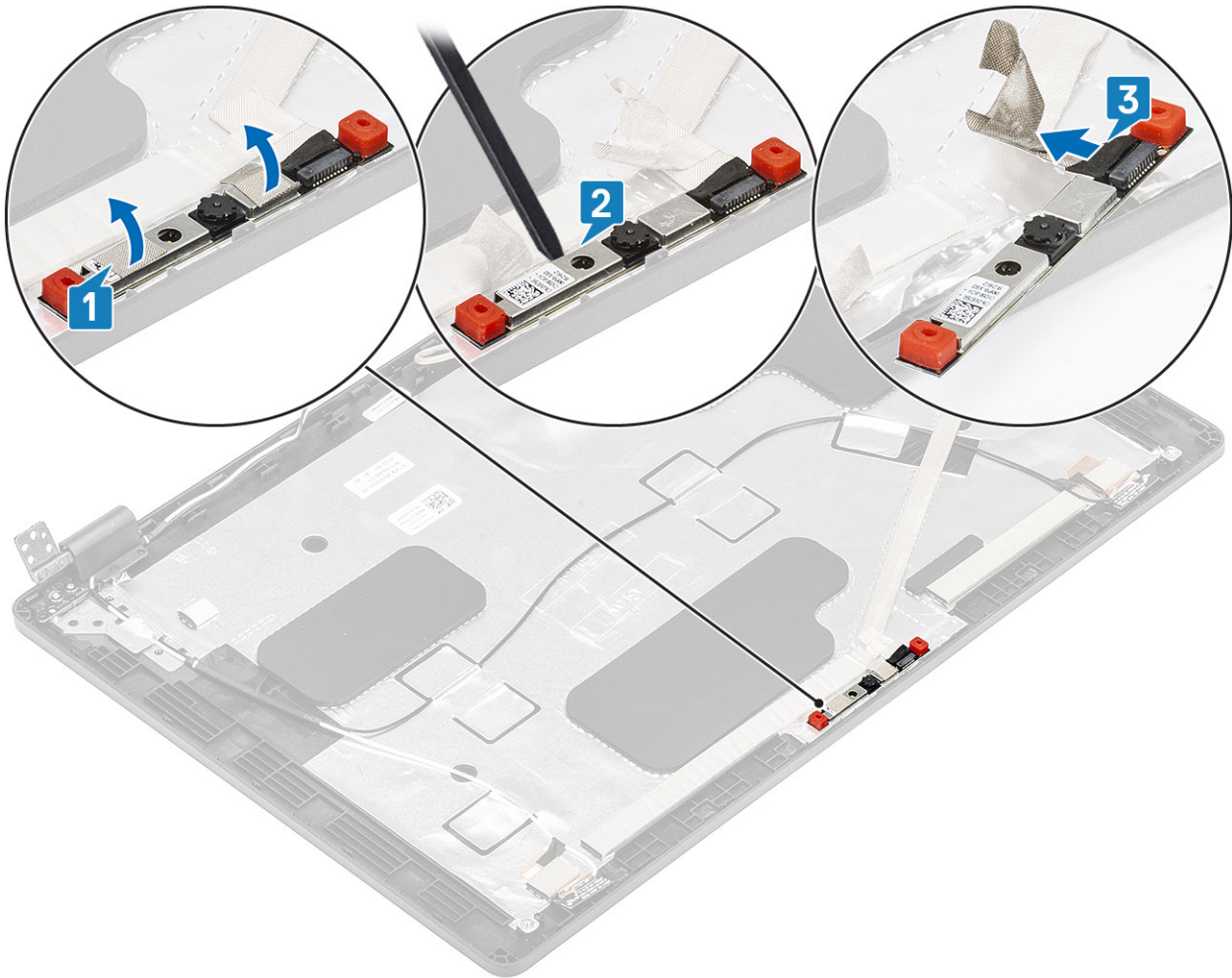

Installing the camera

Steps

1. Connect the camera cable to the connector on the camera module [1].
2. Insert the camera into the slot on the display back cover [2].
3. Affix the two conductive tape above the camera [3].

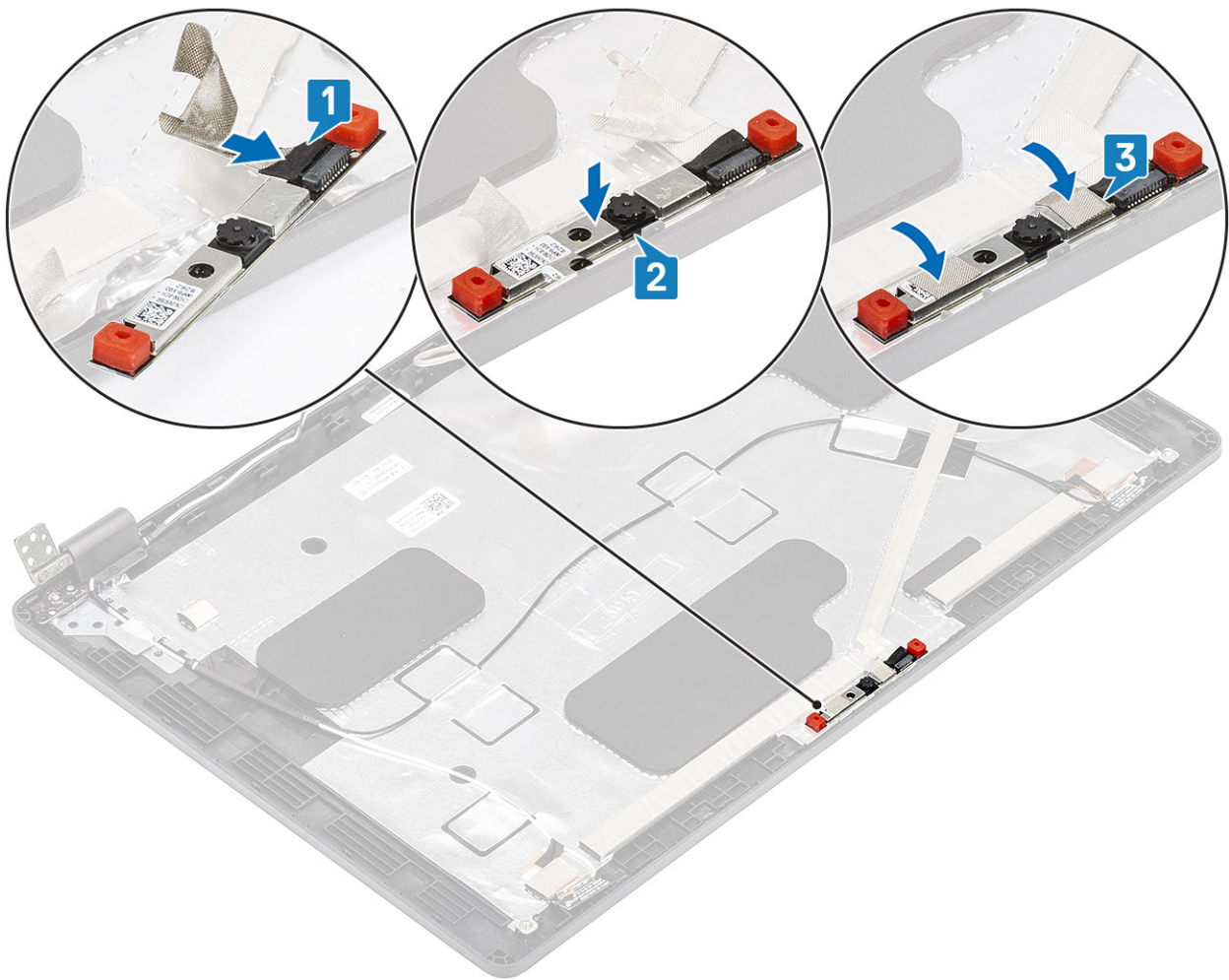

Next steps

1. Install the [display panel](#).
2. Install the [display hinges](#).
3. Install the [hinge caps](#).
4. Install the [display bezel](#).
5. Install the [display assembly](#).
6. Install the [battery](#).
7. Install the [base cover](#).
8. Install the [microSD card](#).
9. Follow the procedure in [after working inside your computer](#).

Display (eDP) cable

Removing display cable

Prerequisites

1. Follow the procedure in [before working inside your computer](#).
2. Remove the [microSD card](#).
3. Remove the [base cover](#).
4. Remove the [battery](#).
5. Remove the [display assembly](#)
6. Remove the [display bezel](#).

7. Remove the [hinge caps](#).
8. Remove the [display hinges](#).
9. Remove the [display panel](#).
10. Remove the [camera](#).

Steps

Peel the conductive tape and unroute the display cable to release it from the adhesive and lift the display cable from the display back cover.

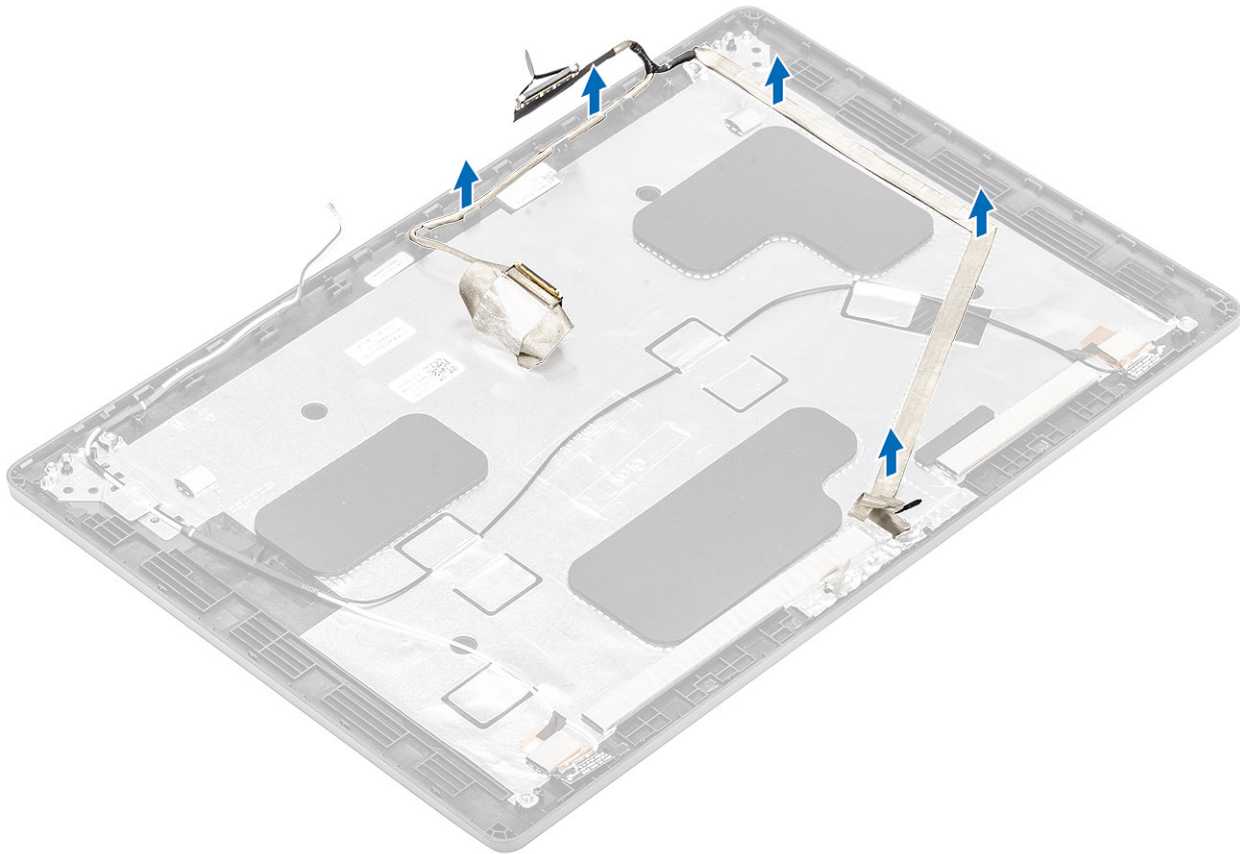

Installing display cable

Steps

1. Adhere the display cable to the display back cover.
2. Adhere the conductive tape and route the display cable to the display back cover.

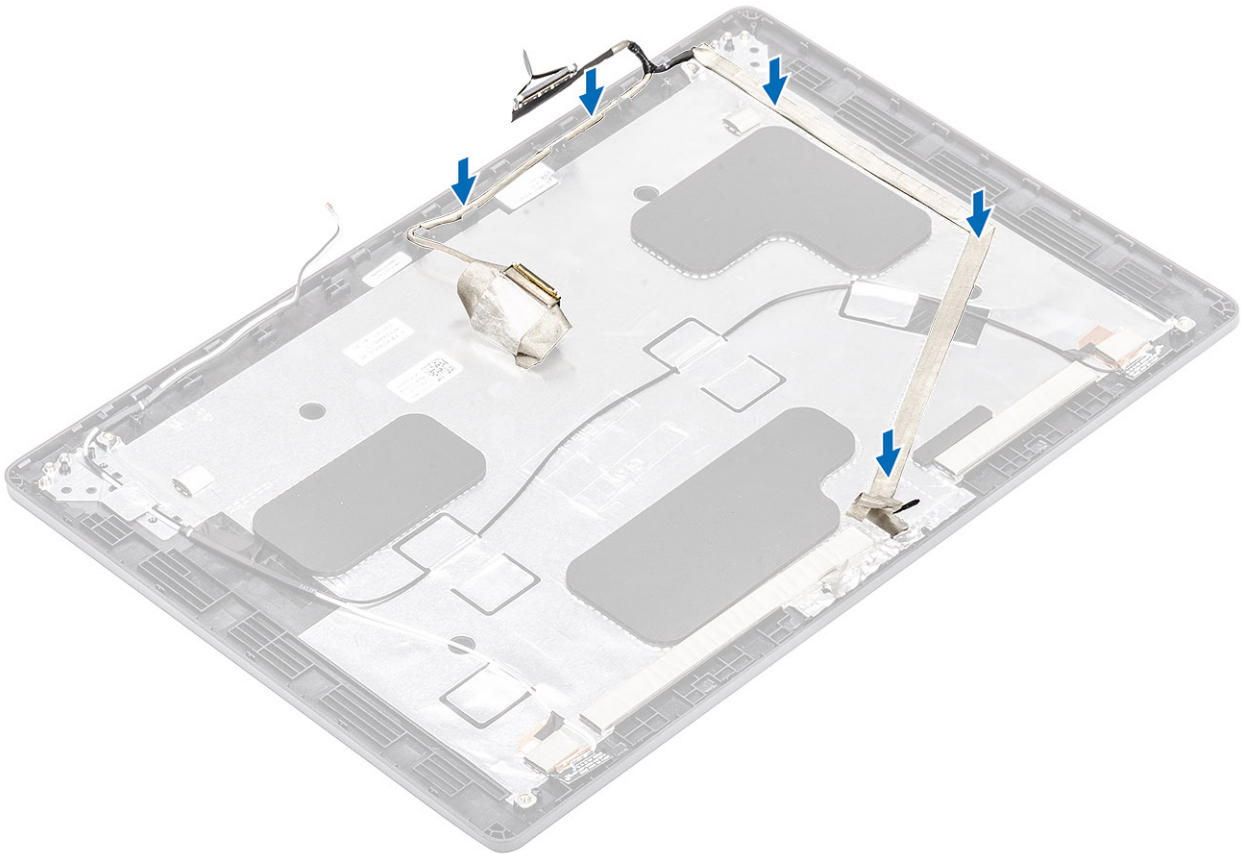

Next steps

1. Install the [camera](#).
2. Install the [display panel](#).
3. Install the [display hinges](#).
4. Install the [hinge caps](#).
5. Install the [display bezel](#).
6. Install the [display assembly](#).
7. Install the [battery](#).
8. Install the [base cover](#).
9. Install the [microSD card](#).
10. Follow the procedure in [after working inside your computer](#).

Display back cover assembly

Replacing the display back cover

Prerequisites

1. Follow the procedure in [before working inside your computer](#).
2. Remove the [microSD card](#).
3. Remove the [base cover](#).
4. Remove the [battery](#).
5. Remove the [display assembly](#).
6. Remove the [display bezel](#).
7. Remove the [hinge caps](#).
8. Remove the [display hinges](#).
9. Remove the [display panel](#).

10. Remove the [camera](#).
11. Remove the [display cable](#).

About this task

After performing the preceding steps, you are left with the display back cover.



Next steps

1. Install the [display cable](#).
2. Install the [camera](#).
3. Install the [display panel](#).
4. Install the [display hinges](#).
5. Install the [hinge caps](#).
6. Install the [display bezel](#).
7. Install the [display assembly](#).
8. Install the [battery](#).
9. Install the [base cover](#).
10. Install the [microSD card](#).
11. Follow the procedure in [after working inside your computer](#).

Palmrest assembly

Replacing the palmrest and keyboard assembly

Prerequisites

1. Follow the procedure in [before working inside your computer](#).
2. Remove the [microSD card](#).

3. Remove the [base cover](#).
4. Remove the [battery](#).
5. Remove the [ssd](#).
6. Remove the [ssd bracket](#).
7. Remove the [palmrest bracket](#).
8. Remove the [LED board](#).
9. Remove the [speaker](#).
10. Remove the [heatsink](#).
11. Remove the [memory module](#).
12. Remove the [DC-in](#).
13. Remove the [WLAN card](#).
14. Remove the [system board](#).
15. Remove the [coin cell battery](#).
16. Remove the [keyboard](#).
17. Remove the [SmartCard reader board](#).

About this task

After performing the preceding steps, you are left with the palmrest and keyboard assembly.

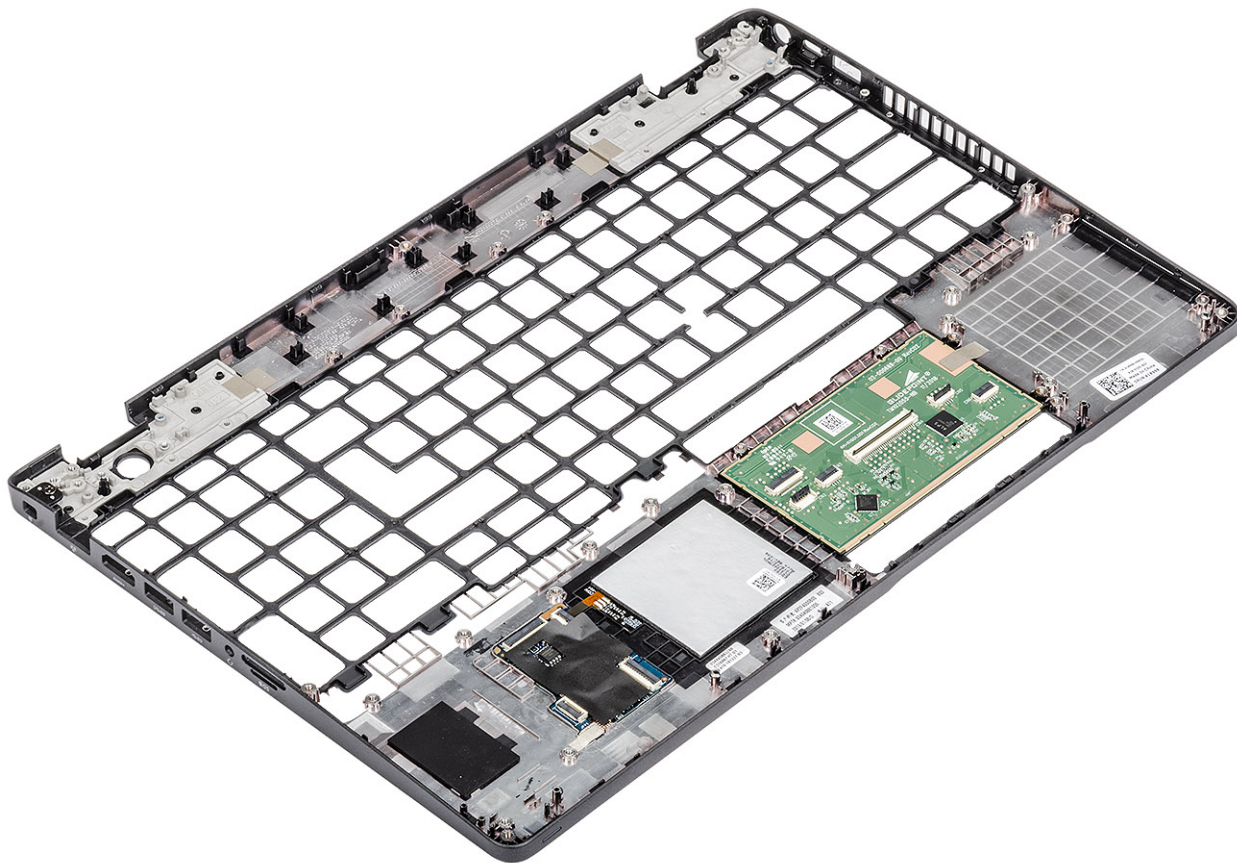

Next steps

1. Install the [SmartCard reader board](#).
2. Install the [keyboard](#).
3. Install the [coin cell battery](#).
4. Install the [system board](#).
5. Install the [WLAN card](#).
6. Install the [Dc-in](#).
7. Install the [memory module](#).
8. Install the [heatsink](#).

9. Install the [speaker](#).
10. Install the [LED board](#).
11. Install the [palmrest bracket](#).
12. Install the [ssd bracket](#).
13. Install the [ssd](#).
14. Install the [battery](#).
15. Install the [base cover](#).
16. Install the [microSD card](#).
17. Follow the procedure in [after working inside your computer](#).

Drivers and downloads

When troubleshooting, downloading or installing drivers it is recommended that you read the Dell Knowledge Based article, Drivers and Downloads FAQ [000123347](#).

BIOS setup

CAUTION: Unless you are an expert computer user, do not change the settings in the BIOS Setup program. Certain changes can make your computer work incorrectly.

NOTE: Depending on the computer and its installed devices, the items listed in this section may or may not be displayed.

NOTE: Before you change BIOS Setup program, it is recommended that you write down the BIOS Setup program screen information for future reference.

Use the BIOS Setup program for the following purposes:

- Get information about the hardware installed in your computer, such as the amount of RAM and the size of the hard drive.
- Change the system configuration information.
- Set or change a user-selectable option, such as the user password, type of hard drive installed, and enabling or disabling base devices.

Topics:

- [Boot menu](#)
- [BIOS overview](#)
- [Entering BIOS setup program](#)
- [Navigation keys](#)
- [One time boot menu](#)
- [System setup options](#)
- [Updating the BIOS](#)
- [System and setup password](#)
- [Clearing CMOS settings](#)
- [Clearing BIOS \(System Setup\) and System passwords](#)

Boot menu

Press <F12> when the Dell logo appears to initiate a one-time boot menu with a list of the valid boot devices for the system. Diagnostics and BIOS Setup options are also included in this menu. The devices listed on the boot menu depend on the bootable devices in the system. This menu is useful when you are attempting to boot to a particular device or to bring up the diagnostics for the system. Using the boot menu does not make any changes to the boot order stored in the BIOS.

The options are:

- UEFI Boot:
 - Windows Boot Manager
- Other Options:
 - BIOS Setup
 - BIOS Flash Update
 - Diagnostics
 - Change Boot Mode Settings

BIOS overview

The BIOS manages data flow between the computer's operating system and attached devices such as hard disk, video adapter, keyboard, mouse, and printer.

Entering BIOS setup program

Steps

1. Turn on your computer.
2. Press F2 immediately to enter the BIOS setup program.

i **NOTE:** If you wait too long and the operating system logo appears, continue to wait until you see the desktop. Then, turn off your computer and try again.

Navigation keys

i **NOTE:** For most of the System Setup options, changes that you make are recorded but do not take effect until you restart the system.

Table 3. Navigation keys

Keys	Navigation
Up arrow	Moves to the previous field.
Down arrow	Moves to the next field.
Enter	Selects a value in the selected field (if applicable) or follow the link in the field.
Spacebar	Expands or collapses a drop-down list, if applicable.
Tab	Moves to the next focus area. i NOTE: For the standard graphics browser only.
Esc	Moves to the previous page until you view the main screen. Pressing Esc in the main screen displays a message that prompts you to save any unsaved changes and restarts the system.

One time boot menu

To enter **one time boot menu**, turn on your computer, and then press F12 immediately.

i **NOTE:** It is recommended to shutdown the computer if it is on.

The one-time boot menu displays the devices that you can boot from including the diagnostic option. The boot menu options are:

- Removable Drive (if available)
- STXXXX Drive (if available)

i **NOTE:** XXX denotes the SATA drive number.

- Optical Drive (if available)
- SATA Hard Drive (if available)
- Diagnostics

The boot sequence screen also displays the option to access the System Setup screen.

System setup options

i **NOTE:** Depending on the and its installed devices, the items listed in this section may or may not appear.

General options

Table 4. General

Option	Description
System Information	<p>Displays the following information:</p> <ul style="list-style-type: none"> • System Information: Displays BIOS Version, Service Tag, Asset Tag, Ownership Tag, Ownership Date, Manufacture Date, and the Express Service Code. • Memory Information: Displays Memory Installed, Memory Available, Memory Speed, Memory Channel Mode, Memory Technology, DIMM A size, and DIMM B size • Processor Information: Displays Processor Type, Core Count, Processor ID, Current Clock Speed, Minimum Clock Speed, Maximum Clock Speed, Processor L2 Cache, Processor L3 Cache, HT Capable, and 64-Bit Technology. • Device Information: Displays Primary HDD, ODD Device, M.2 SATA SSD, M.2 PCIe SSD-0, LOM MAC Address, Video Controller, Video BIOS Version, Video Memory, Panel type, Native Resolution, Audio Controller, Wi-Fi Device, and Bluetooth Device.
Battery Information	Displays the battery status health and whether the AC adapter is installed.
Boot Sequence	Allows you to specify the order in which the computer attempts to find an operating system from the devices specified in this list.
Advanced Boot Options	<p>Allows you to select the Legacy Option ROMs option, when in UEFI boot mode. By default, no option is selected.</p> <ul style="list-style-type: none"> • Enable Legacy Option ROMs • Enable Attempt Legacy Boot
UEFI Boot Path Security	<p>This option controls whether or not the system will prompt the user to enter the Admin password when booting a UEFI boot path from the F12 Boot Menu.</p> <ul style="list-style-type: none"> • Always, Except Internal HDD—Default • Always • Never
Date/Time	Allows you to set the date and time settings. Changes to the system date and time take effect immediately.

System information

Table 5. System Configuration

Option	Description
Integrated NIC	<p>Allows you to configure the on-board LAN controller.</p> <ul style="list-style-type: none"> • Disabled = The internal LAN is off and not visible to the operating system. • Enabled = The internal LAN is enabled. • Enabled w/PXE = The internal LAN is enabled (with PXE boot) (selected by default)
SATA Operation	<p>Allows you to configure the operating mode of the integrated hard drive controller.</p> <ul style="list-style-type: none"> • Disabled = The SATA controllers are hidden • AHCI = SATA is configured for AHCI mode • RAID ON = SATA is configured to support RAID mode (selected by default)
Drives	<p>Allows you to enable or disable the various drives on-board:</p> <ul style="list-style-type: none"> • SATA-0 (enabled by default) • SATA-1 (enabled by default) • SATA-2 (enabled by default) • M.2 PCIe SSD-0 (enabled by default)

Table 5. System Configuration (continued)

Option	Description
Smart Reporting	This field controls whether hard drive errors for integrated drives are reported during system startup. The Enable Smart Reporting option is disabled by default.
USB Configuration	Allows you to enable or disable the integrated USB controller for: <ul style="list-style-type: none"> • Enable USB Boot Support • Enable External USB Port All the options are enabled by default.
Audio	Allows you to enable or disable the integrated audio controller. The option Enable Audio is selected by default. <ul style="list-style-type: none"> • Enable Microphone • Enable Internal Speaker Both the options are selected by default.
Miscellaneous Devices	Allows you to enable or disable the following devices: <ul style="list-style-type: none"> • Enable Camera (enabled by default)

Video

Option	Description
---------------	--------------------

LCD Brightness	Allows you to set the display brightness depending up on the power source—On Battery and On AC. The LCD brightness is independent for battery and AC adapter. It can be set using the slider.
-----------------------	---

 **NOTE:** The video setting is visible only when a video card is installed into the system.

Security

Table 6. Security

Option	Description
Admin Password	Allows you to set, change, and delete the admin password.
System Password	Allows you to set, change, and delete the system password.
Strong Password	This option lets you enable or disable strong passwords for the system.
Password Configuration	Allows you to control the minimum and maximum number of characters allowed for a administrative password and the system password. The range of characters is between 4 and 32.
Password Bypass	This option lets you bypass the System (Boot) Password and the internal HDD password prompts during a system restart. <ul style="list-style-type: none"> • Disabled — Always prompt for the system and internal HDD password when they are set. This option is enabled by default. • Reboot Bypass — Bypass the password prompts on Restarts (warm boots). <p> NOTE: The system will always prompt for the system and internal HDD passwords when powered on from the off state (a cold boot). Also, the system will always prompt for passwords on any module bay HDDs that may be present.</p>
Password Change	This option lets you determine whether changes to the System and Hard Disk passwords are permitted when an administrator password is set. <p>Allow Non-Admin Password Changes - This option is enabled by default.</p>
Non-Admin Setup Changes	Determines whether changes to the setup option are permitted when an administrator password is set.

Table 6. Security (continued)

Option	Description
UEFI Capsule Firmware Updates	This option controls whether this system allows BIOS updates via UEFI capsule update packages. This option is selected by default. Disabling this option will block BIOS updates from services such as Microsoft Windows Update and Linux Vendor Firmware Service (LVFS)
TPM 2.0 Security	Allows you to control whether the Trusted Platform Module (TPM) is visible to the operating system. <ul style="list-style-type: none"> ● TPM On (default) ● Clear ● PPI Bypass for Enable Commands ● PPI Bypass for Disable Commands ● PPI Bypass for Clear Commands ● Attestation Enable (default) ● Key Storage Enable (default) ● SHA-256 (default) Choose any one option: <ul style="list-style-type: none"> ● Disabled ● Enabled (default)
Computrace(R)	This field lets you Activate or Disable the BIOS module interface of the optional Computrace Service from Absolute Software. Enables or disables the optional Computrace service designed for asset management. <ul style="list-style-type: none"> ● Deactivate ● Disable ● Activate - This option is selected by default.
OROM Keyboard Access	This option determines whether users are able to enter Option ROM configuration screen via hotkeys during boot. <ul style="list-style-type: none"> ● Enabled (default) ● Disabled ● One Time Enable
Admin Setup Lockout	Allows you to prevent users from entering Setup when Admin password is set. This option is not set by default.
Master Password Lockout	Allows you to disable master password support Hard Disk passwords need to be cleared before the settings can be changed. This option is not set by default.
SMM Security Mitigation	Allows you to enable or disable additional UEFI SMM Security Mitigation protections. This option is not set by default.

Secure boot

Table 7. Secure Boot

Option	Description
Secure Boot Enable	Allows you to enable or disable Secure Boot feature <ul style="list-style-type: none"> ● Secure Boot Enable This option is selected by default.
Secure Boot Mode	Allows you to modify the behavior of Secure Boot to allow evaluation or enforcement of UEFI driver signatures. <ul style="list-style-type: none"> ● Deployed Mode (default) ● Audit Mode
Expert key Management	Allows you to manipulate the security key databases only if the system is in Custom Mode. The Enable Custom Mode option is disabled by default. The options are:

Table 7. Secure Boot (continued)

Option	Description
	<ul style="list-style-type: none"> ● PK (default) ● KEK ● db ● dbx <p>If you enable the Custom Mode, the relevant options for PK, KEK, db, and dbx appear. The options are:</p> <ul style="list-style-type: none"> ● Save to File- Saves the key to a user-selected file ● Replace from File- Replaces the current key with a key from a user-selected file ● Append from File- Adds a key to the current database from a user-selected file ● Delete- Deletes the selected key ● Reset All Keys- Resets to default setting ● Delete All Keys- Deletes all the keys <p>NOTE: If you disable the Custom Mode, all the changes made will be erased and the keys will restore to default settings.</p>

Intel Software Guard Extensions

Table 8. Intel Software Guard Extensions

Option	Description
Intel SGX Enable	<p>This field specifies you to provide a secured environment for running code/storing sensitive information in the context of the main OS.</p> <p>Click one of the following options:</p> <ul style="list-style-type: none"> ● Disabled ● Enabled ● Software controlled—Default
Enclave Memory Size	<p>This option sets SGX Enclave Reserve Memory Size</p> <p>Click one of the following options:</p> <ul style="list-style-type: none"> ● 32 MB ● 64 MB ● 128 MB—Default

Performance

Table 9. Performance

Option	Description
Multi Core Support	<p>This field specifies whether the process has one or all cores enabled. The performance of some applications improves with the additional cores.</p> <ul style="list-style-type: none"> ● All—Default ● 1
Intel SpeedStep	<p>Allows you to enable or disable the Intel SpeedStep mode of processor.</p> <ul style="list-style-type: none"> ● Enable Intel SpeedStep <p>This option is set by default.</p>

Table 9. Performance (continued)

Option	Description
C-States Control	<p>Allows you to enable or disable the additional processor sleep states.</p> <ul style="list-style-type: none"> ● C states <p>This option is set by default.</p>
Intel TurboBoost	<p>Allows you to enable or disable the Intel TurboBoost mode of the processor.</p> <ul style="list-style-type: none"> ● Enable Intel TurboBoost <p>This option is set by default.</p>
Hyper-Thread Control	<p>Allows you to enable or disable the HyperThreading in the processor.</p> <ul style="list-style-type: none"> ● Disabled ● Enabled—Default

Power management

Option	Description
AC Behavior	<p>Allows you to enable or disable the computer from turning on automatically when an AC adapter is connected.</p> <p>Default setting: Wake on AC is not selected.</p>
Enable Intel Speed Shift Technology	<ul style="list-style-type: none"> ● Enable Intel Speed Shift Technology <p>Default setting: Enabled</p>
Auto On Time	<p>Allows you to set the time at which the computer must turn on automatically. The options are:</p> <ul style="list-style-type: none"> ● Disabled ● Every Day ● Weekdays ● Select Days <p>Default setting: Disabled</p>
USB Wake Support	<p>Allows you to enable USB devices to wake the system from Standby.</p> <p> NOTE: This feature is only functional when the AC power adapter is connected. If the AC power adapter is removed during Standby, the system setup removes power from all the USB ports to conserve battery power.</p> <ul style="list-style-type: none"> ● Enable USB Wake Support
Wake on WLAN	<p>Allows you to enable or disable the feature that powers on the computer from the Off state when triggered by a LAN signal.</p> <ul style="list-style-type: none"> ● Disabled ● WLAN <p>Default setting: Disabled</p>
Peak Shift	<p>This option enables you to minimize the AC power consumption during the peak power times of day. After you enable this option, your system runs only in battery even if the AC is attached.</p> <ul style="list-style-type: none"> ● Enable peak shift—is disabled ● Set battery threshold (15% to 100%) - 15 % (enabled by default)
Advanced Battery Charge Configuration	<p>This option enables you to maximize the battery health. By enabling this option, your system uses the standard charging algorithm and other techniques, during the non work hours to improve the battery health.</p>

Option	Description
	Enable Advanced Battery Charge Mode- is disabled
Primary Battery Charge Configuration	<p>Allows you to select the charging mode for the battery. The options are:</p> <ul style="list-style-type: none"> • Adaptive—enabled by default • Standard—Fully charges your battery at a standard rate. • ExpressCharge—The battery charges over a shorter time using Dell's fast charging technology. • Primarily AC use • Custom <p>If Custom Charge is selected, you can also configure Custom Charge Start and Custom Charge Stop.</p> <p> NOTE: All charging mode may not be available for all the batteries. To enable this option, disable the Advanced Battery Charge Configuration option.</p>

POST behavior

Option	Description
Adapter Warnings	<p>Allows you to enable or disable the system setup (BIOS) warning messages when you use certain power adapters.</p> <p>Default setting: Enable Adapter Warnings</p>
Numlock Enable	<p>Allows you to enable the Numlock option when the computer boots.</p> <p>Enable Network. This option is enabled by default.</p>
Fn Lock Options	<p>Allows you to let hot key combinations Fn + Esc toggle the primary behavior of F1–F12, between their standard and secondary functions. If you disable this option, you cannot toggle dynamically the primary behavior of these keys. The available options are:</p> <ul style="list-style-type: none"> • Fn Lock—enabled by default • Lock Mode Disable/Standard—enabled by default • Lock Mode Enable/Secondary
Fastboot	<p>Allows you to speed up the boot process by bypassing some of the compatibility steps. The options are:</p> <ul style="list-style-type: none"> • Minimal—enabled by default • Thorough • Auto
Extended BIOS POST Time	<p>Allows you to create an extra preboot delay. The options are:</p> <ul style="list-style-type: none"> • 0 seconds—enabled by default. • 5 seconds • 10 seconds
Full Screen Log Warnings and errors	<ul style="list-style-type: none"> • Enable Full Screen Logo—not enabled • Prompt on warnings and errors—enabled by default • Continue on warnings • Continue on warnings and errors
Sign of Life Indication	<ul style="list-style-type: none"> • Enable Sign of Life Keyboard Backlight Indication—enabled by default

Virtualization support

Option	Description
Virtualization	<p>This field specifies whether a virtual Machine Monitor (VMM) can utilize the conditional hardware capabilities provided by Intel Virtualization Technology.</p> <p>Enable Intel Virtualization Technology—enabled by default.</p>

Option	Description
VT for Direct I/O	Enables or disables the Virtual Machine Monitor (VMM) from utilizing the additional hardware capabilities provided by Intel® Virtualization technology for direct I/O. Enable VT for Direct I/O - enabled by default.
Trusted Execution	This option specifies whether a Measured Virtual Machine Monitor (MVMM) can utilize the additional hardware capabilities provided by Intel Trusted Execution Technology. The TPM Virtualization Technology, and the Virtualization technology for direct I/O must be enabled to use this feature. Trusted Execution - disabled by default.

Wireless

Option	Description
Wireless Switch	Allows to set the wireless devices that can be controlled by the wireless switch. The options are: <ul style="list-style-type: none"> • WLAN • Bluetooth All the options are enabled by default. <p> NOTE: For WLAN enable or disable controls are tied together and they cannot be enabled or disabled independently.</p>
Wireless Device Enable	Allows you to enable or disable the internal wireless devices. <ul style="list-style-type: none"> • WLAN • Bluetooth All the options are enabled by default.

Maintenance screen

Option	Description
Service Tag	Displays the Service Tag of your computer.
Asset Tag	Allows you to create a system asset tag if an asset tag is not already set. This option is not set by default.
BIOS Downgrade	This controls flashing of the system firmware to previous revisions. Option 'Allow BIOS downgrade' is enabled by default.
Data Wipe	This field allows users to erase the data securely from all internal storage devices. Option 'Wipe on Next boot' is not enabled by default. The following is list of devices affected: <ul style="list-style-type: none"> • Internal SATA HDD/SSD • Internal M.2 SATA SDD • Internal M.2 PCIe SSD • Internal eMMC
BIOS Recovery	This field allows you to recover from certain corrupted BIOS conditions from a recover file on the user primary hard drive or an external USB key. <ul style="list-style-type: none"> • BIOS Recovery from Hard Drive—enabled by default • Always perform integrity check—disabled by default

System logs

Option	Description
BIOS Events	Allows you to view and clear the System Setup (BIOS) POST events.

Option	Description
Thermal Events	Allows you to view and clear the System Setup (Thermal) events.
Power Events	Allows you to view and clear the System Setup (Power) events.

SupportAssist System Resolution

Option	Description
Auto OS Recovery Threshold	Allows you to control the automatic boot flow for SupportAssist System. Options are: <ul style="list-style-type: none"> • Off • 1 • 2 (Enabled by default) • 3
SupportAssist OS Recovery	Allows you to recover the SupportAssist OS Recovery (Disabled by default)

Updating the BIOS

Updating the BIOS in Windows

About this task

CAUTION: If BitLocker is not suspended before updating the BIOS, the next time you reboot the system it will not recognize the BitLocker key. You will then be prompted to enter the recovery key to progress and the system will ask for this on each reboot. If the recovery key is not known this can result in data loss or an unnecessary operating system re-install. For more information on this subject, see Knowledge Article: <https://www.dell.com/support/article/sln153694>

Steps

1. Go to www.dell.com/support.
2. Click **Product support**. In the **Search support** box, enter the Service Tag of your computer, and then click **Search**.
 - NOTE:** If you do not have the Service Tag, use the SupportAssist feature to automatically identify your computer. You can also use the product ID or manually browse for your computer model.
3. Click **Drivers & Downloads**. Expand **Find drivers**.
4. Select the operating system installed on your computer.
5. In the **Category** drop-down list, select **BIOS**.
6. Select the latest version of BIOS, and click **Download** to download the BIOS file for your computer.
7. After the download is complete, browse the folder where you saved the BIOS update file.
8. Double-click the BIOS update file icon and follow the on-screen instructions.

For more information, see knowledge base article [000124211](https://www.dell.com/support/article/000124211) at www.dell.com/support.

Updating the BIOS in Linux and Ubuntu

To update the system BIOS on a computer that is installed with Linux or Ubuntu, see the knowledge base article [000131486](https://www.dell.com/support/article/000131486) at www.dell.com/support.

Updating the BIOS using the USB drive in Windows

About this task

 **CAUTION:** If BitLocker is not suspended before updating the BIOS, the next time you reboot the system it will not recognize the BitLocker key. You will then be prompted to enter the recovery key to progress and the system will ask for this on each reboot. If the recovery key is not known this can result in data loss or an unnecessary operating system re-install. For more information on this subject, see Knowledge Article: <https://www.dell.com/support/article/sln153694>

Steps

1. Follow the procedure from step 1 to step 6 in [Updating the BIOS in Windows](#) to download the latest BIOS setup program file.
2. Create a bootable USB drive. For more information, see the knowledge base article [000145519](#) at www.dell.com/support.
3. Copy the BIOS setup program file to the bootable USB drive.
4. Connect the bootable USB drive to the computer that needs the BIOS update.
5. Restart the computer and press **F12**.
6. Select the USB drive from the **One Time Boot Menu**.
7. Type the BIOS setup program filename and press **Enter**.
The **BIOS Update Utility** appears.
8. Follow the on-screen instructions to complete the BIOS update.

Updating the BIOS from the F12 One-Time boot menu

Update your computer BIOS using the BIOS update.exe file that is copied to a FAT32 USB drive and booting from the F12 One-Time boot menu.

About this task

 **CAUTION:** If BitLocker is not suspended before updating the BIOS, the next time you reboot the system it will not recognize the BitLocker key. You will then be prompted to enter the recovery key to progress and the system will ask for this on each reboot. If the recovery key is not known this can result in data loss or an unnecessary operating system re-install. For more information on this subject, see Knowledge Article: <https://www.dell.com/support/article/sln153694>

BIOS Update

You can run the BIOS update file from Windows using a bootable USB drive or you can also update the BIOS from the F12 One-Time boot menu on the computer.

Most of the Dell computers built after 2012 have this capability, and you can confirm by booting your computer to the F12 One-Time Boot Menu to see if BIOS FLASH UPDATE is listed as a boot option for your computer. If the option is listed, then the BIOS supports this BIOS update option.

 **NOTE:** Only computers with BIOS Flash Update option in the F12 One-Time boot menu can use this function.

Updating from the One-Time boot menu

To update your BIOS from the F12 One-Time boot menu, you need the following:

- USB drive formatted to the FAT32 file system (key does not have to be bootable)
- BIOS executable file that you downloaded from the Dell Support website and copied to the root of the USB drive
- AC power adapter that is connected to the computer
- Functional computer battery to flash the BIOS

Perform the following steps to perform the BIOS update flash process from the F12 menu:

 **CAUTION:** Do not turn off the computer during the BIOS update process. The computer may not boot if you turn off your computer.

Steps

1. From a turn off state, insert the USB drive where you copied the flash into a USB port of the computer.
2. Turn on the computer and press F12 to access the One-Time Boot Menu, select BIOS Update using the mouse or arrow keys then press Enter.
The flash BIOS menu is displayed.
3. Click **Flash from file**.
4. Select external USB device.
5. Select the file and double-click the flash target file, and then click **Submit**.
6. Click **Update BIOS**. The computer restarts to flash the BIOS.
7. The computer will restart after the BIOS update is completed.

System and setup password

Table 10. System and setup password

Password type	Description
System password	Password that you must enter to log in to your system.
Setup password	Password that you must enter to access and make changes to the BIOS settings of your computer.

You can create a system password and a setup password to secure your computer.

 **CAUTION:** The password features provide a basic level of security for the data on your computer.

 **CAUTION:** Anyone can access the data that is stored on your computer if it is not locked and left unattended.

 **NOTE:** System and setup password feature is disabled.

Assigning a system setup password

Prerequisites

You can assign a new **System or Admin Password** only when the status is in **Not Set**.

About this task

To enter the system setup, press F12 immediately after a power-on or reboot.

Steps

1. In the **System BIOS** or **System Setup** screen, select **Security** and press Enter.
The **Security** screen is displayed.
2. Select **System/Admin Password** and create a password in the **Enter the new password** field.
Use the following guidelines to assign the system password:
 - A password can have up to 32 characters.
 - At least one special character: ! " # \$ % & ' () * + , - . / : ; < = > ? @ [\] ^ _ ` { | }
 - Numbers 0 through 9.
 - Upper case letters from A to Z.
 - Lower case letters from a to z.
3. Type the system password that you entered earlier in the **Confirm new password** field and click **OK**.
4. Press Esc and save the changes as prompted by the pop-up message.
5. Press Y to save the changes.
The computer restarts.

Deleting or changing an existing system setup password

Prerequisites

Ensure that the **Password Status** is Unlocked (in the System Setup) before attempting to delete or change the existing System and/or Setup password. You cannot delete or change an existing System or Setup password, if the **Password Status** is Locked.

About this task

To enter the System Setup, press F12 immediately after a power-on or reboot.

Steps

1. In the **System BIOS** or **System Setup** screen, select **System Security** and press Enter.
The **System Security** screen is displayed.
2. In the **System Security** screen, verify that **Password Status** is **Unlocked**.
3. Select **System Password**, update, or delete the existing system password, and press Enter or Tab.
4. Select **Setup Password**, update, or delete the existing setup password, and press Enter or Tab.
 **NOTE:** If you change the System and/or Setup password, reenter the new password when prompted. If you delete the System and/or Setup password, confirm the deletion when prompted.
5. Press Esc and a message prompts you to save the changes.
6. Press Y to save the changes and exit from System Setup.
The computer restarts.

Clearing CMOS settings

About this task

 **CAUTION:** Clearing CMOS settings will reset the BIOS settings on your computer.

Steps

1. Remove the [base cover](#).
2. Disconnect the battery cable from the system board.
3. Remove the [coin-cell battery](#).
4. Wait for one minute.
5. Replace the [coin-cell battery](#).
6. Connect the battery cable to the system board.
7. Replace the [base cover](#).

Clearing BIOS (System Setup) and System passwords

About this task

To clear the system or BIOS passwords, contact Dell technical support as described at www.dell.com/contactdell.

 **NOTE:** For information on how to reset Windows or application passwords, refer to the documentation accompanying Windows or your application.

Troubleshooting

Topics:

- [Handling swollen Lithium-ion batteries](#)
- [Dell SupportAssist Pre-boot System Performance Check diagnostics](#)
- [Built-in self-test \(BIST\)](#)
- [System-diagnostic lights](#)
- [LED Indicators and Characteristics](#)
- [Real-Time Clock \(RTC Reset\)](#)
- [Recovering the operating system](#)
- [Backup media and recovery options](#)
- [WiFi power cycle](#)
- [Drain residual flea power \(perform hard reset\)](#)

Handling swollen Lithium-ion batteries

Like most laptops, Dell laptops use lithium-ion batteries. One type of lithium-ion battery is the lithium-ion polymer battery. Lithium-ion polymer batteries have increased in popularity in recent years and have become standard in the electronics industry due to customer preferences for a slim form factor (especially with newer ultra-thin laptops) and long battery life. Inherent to lithium-ion polymer battery technology is the potential for swelling of the battery cells.

Swollen battery may impact the performance of the laptop. To prevent possible further damage to the device enclosure or internal components leading to malfunction, discontinue the use of the laptop and discharge it by disconnecting the AC adapter and letting the battery drain.

Swollen batteries should not be used and should be replaced and disposed of properly. We recommend contacting Dell product support for options to replace a swollen battery under the terms of the applicable warranty or service contract, including options for replacement by a Dell authorized service technician.

The guidelines for handling and replacing Lithium-ion batteries are as follows:

- Exercise caution when handling Lithium-ion batteries.
- Discharge the battery before removing it from the system. To discharge the battery, unplug the AC adapter from the system and operate the system only on battery power. When the system will no longer power on when the power button is pressed, the battery is fully discharged.
- Do not crush, drop, mutilate, or penetrate the battery with foreign objects.
- Do not expose the battery to high temperatures, or disassemble battery packs and cells.
- Do not apply pressure to the surface of the battery.
- Do not bend the battery.
- Do not use tools of any type to pry on or against the battery.
- If a battery gets stuck in a device as a result of swelling, do not try to free it as puncturing, bending, or crushing a battery can be dangerous.
- Do not attempt to reassemble a damaged or swollen battery into a laptop.
- Swollen batteries that are covered under warranty should be returned to Dell in an approved shipping container (provided by Dell)—this is to comply with transportation regulations. Swollen batteries that are not covered under warranty should be disposed of at an approved recycling center. Contact Dell product support at <https://www.dell.com/support> for assistance and further instructions.
- Using a non-Dell or incompatible battery may increase the risk of fire or explosion. Replace the battery only with a compatible battery purchased from Dell that is designed to work with your Dell computer. Do not use a battery from other computers with your computer. Always purchase genuine batteries from <https://www.dell.com> or otherwise directly from Dell.

Lithium-ion batteries can swell for various reasons such as age, number of charge cycles, or exposure to high heat. For more information on how to improve the performance and lifespan of the laptop battery and to minimize the possibility of occurrence of the issue, see [Dell Laptop Battery - Frequently Asked Questions](#).

Dell SupportAssist Pre-boot System Performance Check diagnostics

About this task

SupportAssist diagnostics (also known as system diagnostics) performs a complete check of your hardware. The Dell SupportAssist Pre-boot System Performance Check diagnostics is embedded with the BIOS and is launched by the BIOS internally. The embedded system diagnostics provides a set of options for particular devices or device groups allowing you to:

- Run tests automatically or in an interactive mode
- Repeat tests
- Display or save test results
- Run thorough tests to introduce additional test options to provide extra information about the failed device(s)
- View status messages that inform you if tests are completed successfully
- View error messages that inform you of problems encountered during testing

 **NOTE:** Some tests for specific devices require user interaction. Always ensure that you are present at the computer terminal when the diagnostic tests are performed.

For more information, see <https://www.dell.com/support/kbdoc/000180971>.

Running the SupportAssist Pre-Boot System Performance Check

Steps

1. Turn on your computer.
2. As the computer boots, press the F12 key as the Dell logo appears.
3. On the boot menu screen, select the **Diagnostics** option.
4. Click the arrow at the bottom left corner.
Diagnostics front page is displayed.
5. Click the arrow in the lower-right corner to go to the page listing.
The items detected are listed.
6. To run a diagnostic test on a specific device, press Esc and click **Yes** to stop the diagnostic test.
7. Select the device from the left pane and click **Run Tests**.
8. If there are any issues, error codes are displayed.
Note the error code and validation number and contact Dell.

Built-in self-test (BIST)

M-BIST

M-BIST (Built In Self-Test) is the system board's built-in self-test diagnostics tool that improves the diagnostics accuracy of system board embedded controller (EC) failures.

 **NOTE:** M-BIST can be manually initiated before POST (Power On Self Test).

How to run M-BIST

 **NOTE:** M-BIST must be initiated on the system from a power-off state either connected to AC power or with battery only.

1. Press and hold both the **M** key on the keyboard and the **power button** to initiate M-BIST.
2. With both the **M** key and the **power button** held down, the battery indicator LED may exhibit two states:
 - a. OFF: No fault detected with the system board
 - b. AMBER: Indicates a problem with the system board
3. If there is a failure with the system board, the battery status LED will flash one of the following error codes for 30 seconds:

Table 11. LED error codes

Blinking Pattern		Possible Problem
Amber	White	
2	1	CPU Failure
2	8	LCD Power Rail Failure
1	1	TPM Detection Failure
2	4	Unrecoverable SPI Failure

4. If there is no failure with the system board, the LCD will cycle through the solid color screens described in the LCD-BIST section for 30 seconds and then power off.

LCD Power rail test (L-BIST)

L-BIST is an enhancement to the single LED error code diagnostics and is automatically initiated during POST. L-BIST will check the LCD power rail. If there is no power being supplied to the LCD (i.e., the L-BIST circuit fails), the battery status LED will flash either an error code [2,8] or an error code [2,7].

 **NOTE:** If L-BIST fails, LCD-BIST cannot function as no power will be supplied to the LCD.

How to invoke L-BIST Test:

1. Press the power button to start the system.
2. If the system does not start up normally, look at the battery status LED:
 - If the battery status LED flashes an error code [2,7], the display cable may not be connected properly.
 - If the battery status LED flashes an error code [2,8], there is a failure on the LCD power rail of the system board, hence there is no power supplied to the LCD.
3. For cases, when a [2,7] error code is shown, check to see if the display cable is properly connected.
4. For cases when a [2,8] error code is shown, replace the system board.

LCD Built-in Self Test (BIST)

Dell laptops have a built-in diagnostic tool that helps you determine if the screen abnormality you are experiencing is an inherent problem with the LCD (screen) of the Dell laptop or with the video card (GPU) and PC settings.

When you notice screen abnormalities like flickering, distortion, clarity issues, fuzzy or blurry image, horizontal or vertical lines, color fade etc., it is always a good practice to isolate the LCD (screen) by running the Built-In Self Test (BIST).

How to invoke LCD BIST Test

1. Power off the Dell laptop.
2. Disconnect any peripherals that are connected to the laptop. Connect only the AC adapter (charger) to the laptop.
3. Ensure that the LCD (screen) is clean (no dust particles on the surface of the screen).
4. Press and hold **D** key and **Power on** the laptop to enter LCD built-in self test (BIST) mode. Continue to hold the D key, until the system boots up.
5. The screen will display solid colors and change colors on the entire screen to white, black, red, green, and blue twice.
6. Then it will display the colors white, black and red.
7. Carefully inspect the screen for abnormalities (any lines, fuzzy color or distortion on the screen).
8. At the end of the last solid color (red), the system will shut down.

 **NOTE:** Dell SupportAssist Pre-boot diagnostics upon launch, initiates an LCD BIST first, expecting a user intervention confirm functionality of the LCD.

System-diagnostic lights

Power and battery-status light

The power and battery status light indicates the power and battery status of the computer. These are the power states:

Solid white:Power adapter is connected and the battery has more than 5% charge.

Amber:Computer is running on battery and the battery has less than 5% charge.

Off:

- Power adapter is connected, and the battery is fully charged.
- Computer is running on battery, and the battery has more than 5% charge.
- Computer is in sleep state, hibernation, or turned off.

The power and battery-status light may blink amber or white according to pre-defined "beep codes" indicating various failures.

For example, the power and battery-status light blinks amber two times followed by a pause, and then blinks white three times followed by a pause. This 2,3 pattern continues until the computer is turned off, indicating no memory or RAM is detected.

The following table shows different power and battery-status light patterns and associated problems.

i NOTE: The following diagnostic light codes and recommended solutions are intended for Dell service technicians to troubleshoot problems. You should only perform troubleshooting and repairs as authorized or directed by the Dell technical assistance team. Damage due to servicing that is not authorized by Dell is not covered by your warranty.

Table 12. Diagnostic-light LED codes

Diagnostic light codes (Amber,White)	Problem description
2,1	Processor failure
2,2	System board: BIOS or ROM (Read-Only Memory) failure
2,3	No memory or RAM (Random-Access Memory) detected
2,4	Memory or RAM (Random-Access Memory) failure
2,5	Invalid memory installed
2,6	System-board or chipset error
2,7	Display failure - SBIOS message
3,1	Coin-cell battery failure
3,2	PCI, video card/chip failure
3,3	Recovery image not found
3,4	Recovery image found but invalid
3,5	Power-rail failure
3,6	System BIOS Flash incomplete
3,7	Management Engine (ME) error

LED Indicators and Characteristics

Real-Time Clock (RTC Reset)

The Real Time Clock (RTC) reset function allows you or the service technician to recover Dell Latitude systems from No POST/No Power/No Boot situations. The legacy jumper enabled RTC reset has been retired on these models.

Start the RTC reset with the system powered off and connected to AC power. Press and hold the power button for thirty (30) seconds. The system RTC Reset occurs after you release the power button.

Recovering the operating system

When your computer is unable to boot to the operating system even after repeated attempts, it automatically starts Dell SupportAssist OS Recovery.

Dell SupportAssist OS Recovery is a standalone tool that is preinstalled in all Dell computers installed with Windows operating system. It consists of tools to diagnose and troubleshoot issues that may occur before your computer boots to the operating system. It enables you to diagnose hardware issues, repair your computer, back up your files, or restore your computer to its factory state.

You can also download it from the Dell Support website to troubleshoot and fix your computer when it fails to boot into their primary operating system due to software or hardware failures.

For more information about the Dell SupportAssist OS Recovery, see *Dell SupportAssist OS Recovery User's Guide* at www.dell.com/serviceabilitytools. Click **SupportAssist** and then, click **SupportAssist OS Recovery**.

Backup media and recovery options

It is recommended to create a recovery drive to troubleshoot and fix problems that may occur with Windows. Dell proposes multiple options for recovering Windows operating system on your Dell PC. For more information, see [Dell Windows Backup Media and Recovery Options](#).

WiFi power cycle

About this task

If your computer is unable to access the internet due to WiFi connectivity issues a WiFi power cycle procedure may be performed. The following procedure provides the instructions on how to conduct a WiFi power cycle:

 **NOTE:** Some ISPs (Internet Service Providers) provide a modem/router combo device.

Steps

1. Turn off your computer.
2. Turn off the modem.
3. Turn off the wireless router.
4. Wait for 30 seconds.
5. Turn on the wireless router.
6. Turn on the modem.
7. Turn on your computer.

Drain residual flea power (perform hard reset)

About this task

Flea power is the residual static electricity that remains in the computer even after it has been powered off and the battery is removed.

For your safety, and to protect the sensitive electronic components in your computer, you are requested to drain residual flea power before removing or replacing any components in your computer.

Draining residual flea power, also known as a performing a "hard reset", is also a common troubleshooting step if your computer does not power on or boot into the operating system.

To drain residual flea power (perform a hard reset)

Steps

1. Turn off your computer.
2. Disconnect the power adapter from your computer.
3. Remove the base cover.
4. Remove the battery.
5. Press and hold the power button for 20 seconds to drain the flea power.
6. Install the battery.
7. Install the base cover.
8. Connect the power adapter to your computer.
9. Turn on your computer.

 **NOTE:** For more information about performing a hard reset, see the knowledge base article [000130881](https://www.dell.com/support) at www.dell.com/support.

Getting help

Topics:

- [Contacting Dell](#)

Contacting Dell

Prerequisites

 **NOTE:** If you do not have an active Internet connection, you can find contact information on your purchase invoice, packing slip, bill, or Dell product catalog.

About this task

Dell provides several online and telephone-based support and service options. Availability varies by country and product, and some services may not be available in your area. To contact Dell for sales, technical support, or customer service issues:

Steps

1. Go to **Dell.com/support**.
2. Select your support category.
3. Verify your country or region in the **Choose a Country/Region** drop-down list at the bottom of the page.
4. Select the appropriate service or support link based on your need.