

Dell EMC PowerEdge XE7420

Installation and Service Manual

Notes, cautions, and warnings

 **NOTE:** A NOTE indicates important information that helps you make better use of your product.

 **CAUTION:** A CAUTION indicates either potential damage to hardware or loss of data and tells you how to avoid the problem.

 **WARNING:** A WARNING indicates a potential for property damage, personal injury, or death.

Contents

Chapter 1: About this document.....	7
Chapter 2: PowerEdge XE7420 overview.....	8
Rear view of the sled.....	8
Inside the system	10
Locating the Express Service Code and Service Tag.....	10
System information label.....	11
Rail sizing and rack compatibility matrix.....	15
Chapter 3: Initial system setup and configuration.....	16
Setting up the system.....	16
iDRAC configuration.....	16
Options to set up iDRAC IP address.....	16
Options to log in to iDRAC.....	17
Resources to install operating system.....	18
Options to download firmware	18
Options to download and install OS drivers	18
Downloading drivers and firmware.....	19
Channel Firmware Commodities.....	19
Chapter 4: Pre-operating system management applications.....	23
Options to manage the pre-operating system applications.....	23
System Setup.....	23
Viewing System Setup.....	23
System Setup details.....	24
System BIOS.....	24
iDRAC Settings utility.....	42
Device Settings.....	42
Dell Lifecycle Controller.....	42
Embedded system management.....	42
Boot Manager.....	42
Viewing Boot Manager.....	42
Boot Manager main menu.....	43
One-shot UEFI boot menu.....	43
System Utilities.....	43
PXE boot.....	43
Chapter 5: Installing and removing system components.....	44
Safety instructions.....	44
Before working inside your system.....	45
After working inside your system.....	45
Recommended tools.....	45
Sled.....	45
Removing the sled.....	45

Installing the sled.....	46
Air shroud.....	48
Removing the air shroud.....	48
Installing the air shroud.....	49
Cooling fan.....	49
Removing a cooling fan.....	49
Installing a cooling fan.....	50
PCIe card module.....	51
Removing the PCIe card module.....	51
Installing the PCIe card module.....	52
Cable M.2 riser card.....	53
Removing the cable M.2 riser board	53
Installing the cable M.2 riser board.....	55
Motherboard bridge module.....	57
Removing the motherboard bridge module.....	57
Installing the motherboard bridge module.....	58
Motherboard interposer board.....	59
Removing the motherboard interposer board.....	59
Installing the motherboard interposer board.....	61
Sled cables kit.....	62
Removing the sled cables kit.....	62
Installing the sled cables kit.....	63
Motherboard bridge board.....	65
Removing the motherboard bridge board	65
Installing the motherboard bridge board	65
Mini PERC card module.....	66
Removing mini PERC module.....	66
Installing the mini PERC card module.....	67
Mini PERC card battery.....	68
Removing the mini PERC card battery.....	68
Installing the mini PERC card battery.....	69
Mini PERC card.....	71
Removing the mini PERC card.....	71
Installing the mini PERC card.....	72
Mini PERC adaptor board.....	73
Removing the mini PERC adapter board.....	73
Installing the mini PERC adapter board.....	74
Mini PERC riser board.....	75
Removing the mini PERC riser board.....	75
Installing the mini PERC riser board.....	76
System memory.....	77
System memory guidelines.....	77
Removing a memory module.....	80
Installing a memory module.....	81
Expansion cards and expansion card risers.....	82
Removing the riser board.....	82
Installing the x16 riser board.....	83
Expansion cards.....	84
Processor and heat sink.....	86
Removing a processor and heat sink module.....	86

Installing a processor and heat sink module.....	88
Removing the fabric processor from the processor heat sink module.....	90
Installing the fabric processor into the processor heat sink module.....	92
Network daughter card.....	94
Removing the OCP card.....	94
Installing the OCP card.....	95
System battery	96
Replacing the system battery.....	96
System board.....	97
Removing the system board.....	97
Installing the system board.....	98
Restoring Service Tag using Easy Restore.....	100
Trusted Platform Module.....	100
Upgrading the Trusted Platform Module.....	100
Initializing TPM for users.....	101
Initializing the TPM 1.2 for users.....	101
Initializing the TPM 2.0 for users.....	102
Chapter 6: Jumpers and connectors	103
System board connectors.....	103
System board jumper settings.....	104
Disabling forgotten password.....	104
Chapter 7: Technical specifications.....	106
Dimensions of the PowerEdge XE7420 sled.....	106
Chassis weight.....	107
Processor specifications.....	107
Cooling specifications.....	107
Supported operating systems.....	108
System battery.....	108
Expansion bus specifications.....	108
Memory specifications.....	109
Drives and storage specifications.....	109
Video specifications.....	110
Environmental specifications.....	110
Standard operating temperature specifications.....	110
Expanded operating temperature specifications	110
Particulate and gaseous contamination specifications.....	111
Maximum vibration specifications.....	112
Maximum shock specifications.....	112
Maximum altitude specifications.....	112
Chapter 8: System diagnostics and indicator codes.....	113
NIC indicator codes.....	113
Using system diagnostics.....	113
Dell Embedded System Diagnostics.....	114
Chapter 9: Getting help.....	115
Contacting Dell EMC.....	115

Documentation feedback.....115
Accessing system information by using QRL.....115
 Quick Resource Locator for XE7100, XE7420 and XE7440 systems.....116
Receiving automated support with SupportAssist116
Recycling or End-of-Life service information.....116

Chapter 10: Documentation resources..... 117

About this document

This document provides an overview about the system, information about installing and replacing components, technical specifications, diagnostic tools, and guidelines to be followed while installing certain components.

PowerEdge XE7420 overview

The PowerEdge XE7420 server is a 1U server that supports:

- Two Intel Xeon Cascade Lake scalable processors (up to 150 W) with 26 cores per processor
- 16 DDR4 RDIMM and Load Reduced DIMM
- Full-width full-height (FWFH) and full-width low-profile (FWLP) system configurations are now available
- In FWFH, FE1 card is for increased flash tiering and GPGPU card is for intelligent video analytics
- In FWLP, flexible PCIe options are available to support GPGPU card (for media streaming) and NIC
- PCIe and Open Compute Project (OCP) adapters for expansion and connectivity

NOTE: The Intel Xeon Processor Scalable processor with fabric connector is also known as Native Omnipath.

NOTE: The PowerEdge XE7440 system is used for intelligent video analytics and media streaming.

Topics:

- [Rear view of the sled](#)
- [Inside the system](#)
- [Locating the Express Service Code and Service Tag](#)
- [System information label](#)
- [Rail sizing and rack compatibility matrix](#)

Rear view of the sled

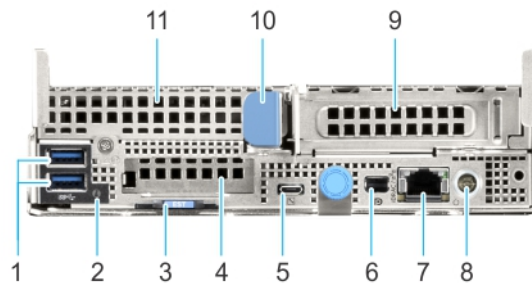

Figure 1. Rear view of the system

Table 1. Rear view of the system



Item	Ports, panels, and slots	Icon	Description
1	USB 3.0 port (2)		The USB ports are 9-pin and 3.0 compliant. These ports enable you to connect USB devices to the system.
2	System ID indicator		The System Identification(ID) LED is available on the back of the system. Press the system ID button on the front of the enclosure to identify a system in a rack.
3	EST tab	N/A	This tab has the unique Express Service Code,

Table 1. Rear view of the system (continued)

Item	Ports, panels, and slots	Icon	Description
			Service Tag, and MAC address labels.
4	OCP or OPA card slot	N/A	Enables you to connect Open Compute Project (OCP) or Omni-Path Architecture (OPA) expansion cards. For more information, see the Expansion cards section.
5	iDRAC Direct micro USB port		Enables you to connect a portable device to the sled.
6	Mini display port		Enables you to connect display devices to the system. For more information, see Technical Specifications section.
7	iDRAC or NIC port		Enables you to remotely access iDRAC. For more information, see the <i>Integrated Dell Remote Access Controller User's Guide</i> at www.dell.com/idracmanuals .
8	Rear power button	N/A	Enables you to power on the sled while accessing it from the rear.
9	Low Profile PCIe card slot	N/A	Enables you to connect low profile riser card. For more information, see the Expansion cards section.
10	Sled release handle	N/A	Enables you to remove the sled from the enclosure.
11	Mezzanine card slot	N/A	Enables you to connect mezzanine expansion cards. For more information, see the Expansion cards section.

For more information about the ports and connectors, see the [Technical Specifications](#) section.

Inside the system

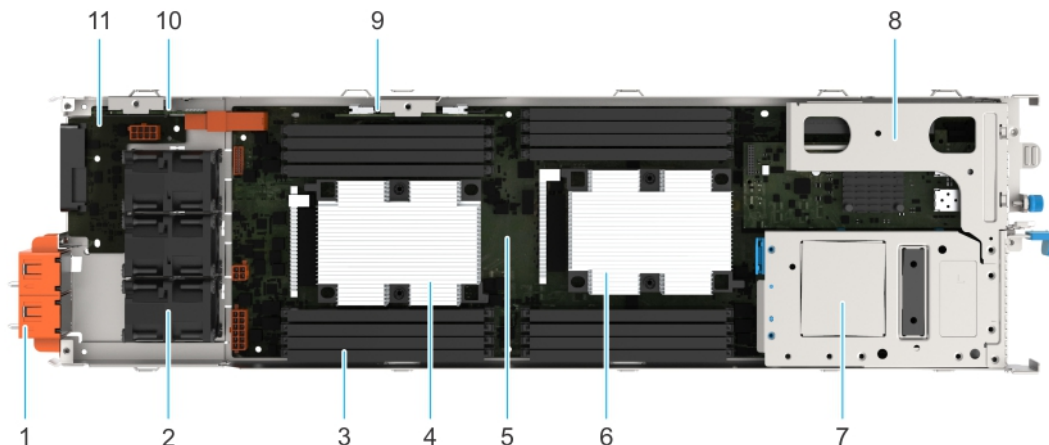

Figure 2. Half width sled Inside the system

- | | |
|------------------------------|----------------------------------|
| 1. Sled cable kit | 2. Cooling fans |
| 3. Memory sockets | 4. CPU heat sink 1 |
| 5. System board | 6. CPU heat sink 2 |
| 7. Mini PERC card module | 8. PCIe card module |
| 9. M.2 riser card | 10. Motherboard interposer board |
| 11. Motherboard bridge board | |

Locating the Express Service Code and Service Tag

The unique Express Service Code and Service Tag are used to identify the system.

The information tag is located on the front of the system that includes system information such as Service Tag, Express Service Code, Manufacture date, NIC, MAC address, QRL label, and so on. If you have opted for the secure default access to iDRAC, the Information tag also contains the iDRAC secure default password. If you have opted for iDRAC Quick Sync 2, the Information tag also contains the OpenManage Mobile (OMM) label, where administrators can configure, monitor, and troubleshoot the PowerEdge servers.

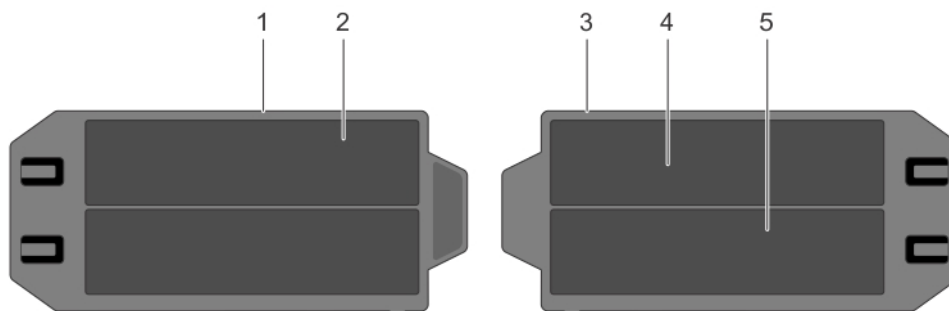

Figure 3. Locating the Service Tag of your system

1. Information tag (top view)
2. Express Service Tag label
3. Information tag (bottom view)
4. Network MAC address information label
5. iDRAC MAC address information label

The Mini Enterprise Service Tag (MEST) label is located on the rear of the system that includes Service Tag (ST), Express Service Code (Exp Svc Code), and Manufacture Date (Mfg. Date). The Exp Svc Code is used by Dell EMC to route support calls to the appropriate personnel.

Alternatively, the Service Tag information is located on a label on left wall of the chassis.

System information label

Express service tag

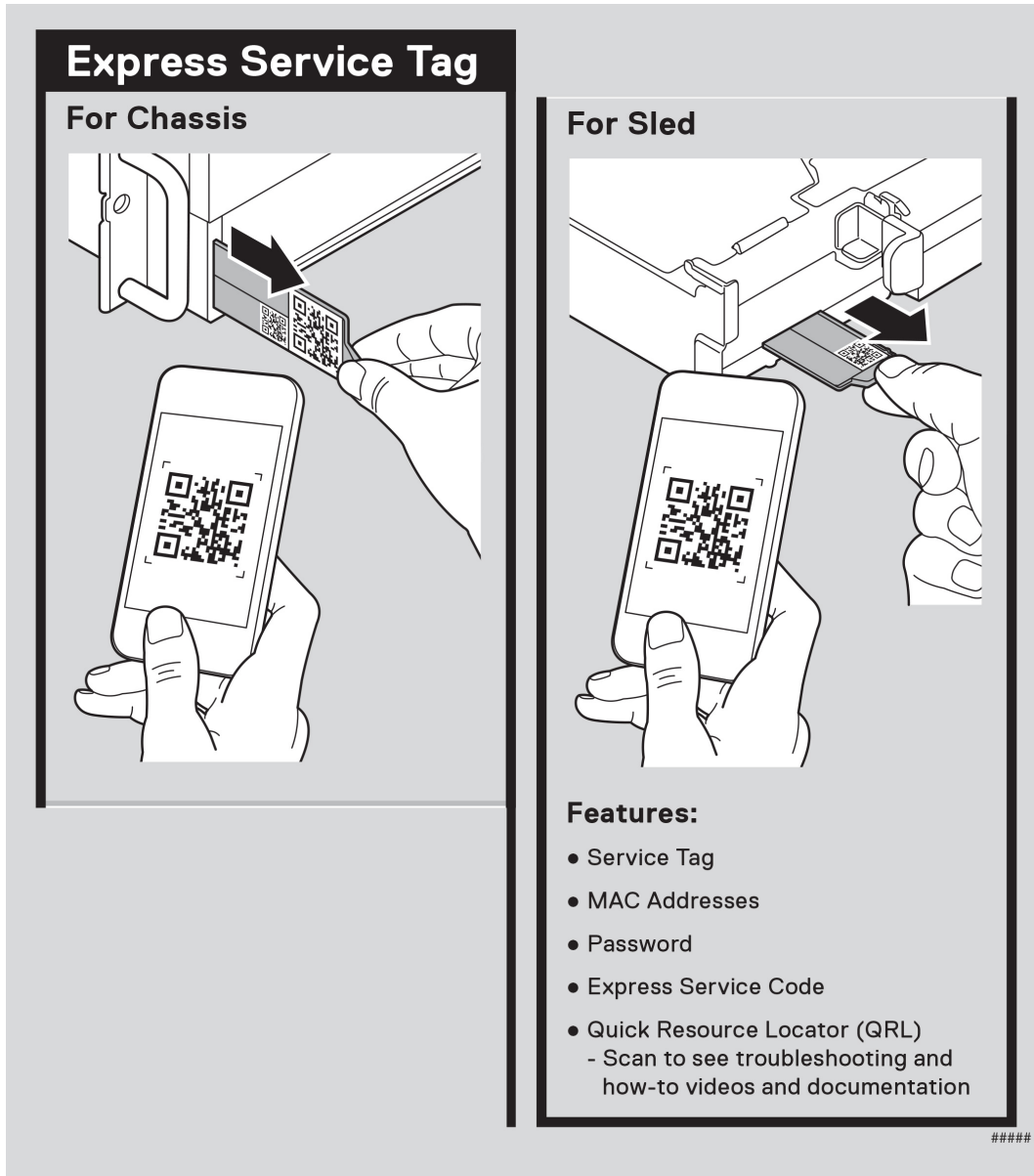

Figure 4. Express service tag

System Board Connections

- 1** Rear USB 3.0
- 2** OCP Mezzanine card
- 3** PCIe Gen3 x8 Mezzanine
- 4** SATA
- 5** DIMMs for CPU 1
- 6** CPU 1
- 7** CPU 2
- 8** DIMMs for CPU 2
- 9** NVMe
- 10** Power Connector
- 11** DIMMs for CPU 2
- 12** PCIe Gen3x16/M.2 Slot
- 13** DIMMs for CPU 1
- 14** HFI Sideband
- 15** PM BUS
- 16** PCIe Gen3 x16 Riser
- 17** Coin Cell Battery
- 18** Jumper
- 19** Power Button
- 20** Shared LAN
- 21** Mini DP
- 22** TPM
- 23** iDRAC Direct (Micro-AB USB)
- 24** UID LED

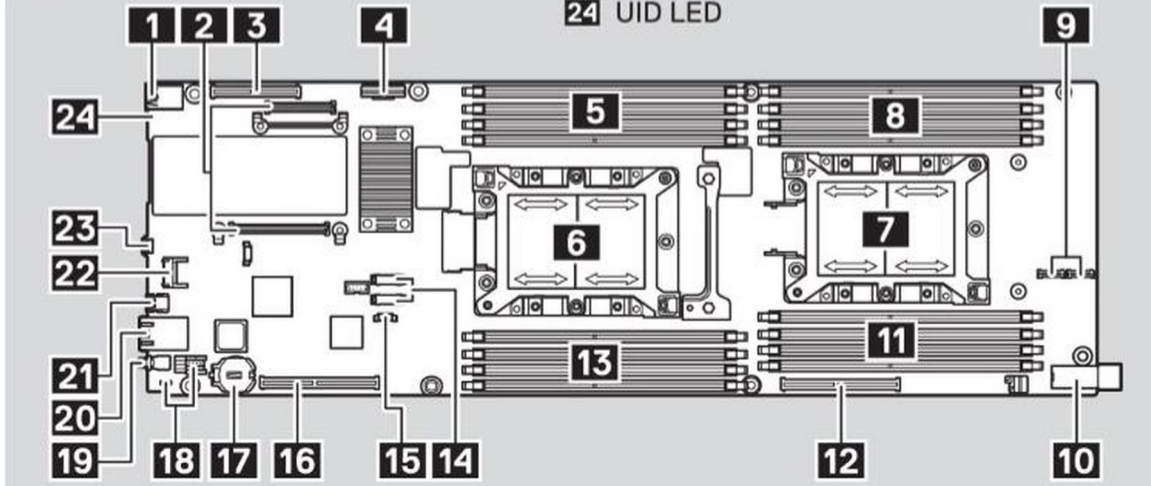



Figure 5. System board jumpers and connectors

Memory information

Memory Information

⚠ Caution: Memory (DIMMs) and CPUs may be hot during servicing.



A6 A5 A4
A8



1



A7
A1 A2 A3

⚠ WARNING:
 Battery cable attached below, handle carefully



Die-cut



B6 B5 B4
B8



2



B7
B1 B2 B3

Memory Population

Configuration	Sequence
Memory-Optimized	1, 2, 3, 4, 5, 6, 7, 8
Mirroring	(1, 2, 3, 4, 5, 6)

Memory Sparing details are documented in the *Installation and Service Manual*.

⚠ Caution: Many repairs may only be done by a certified service technician. You should only perform troubleshooting and simple repairs as authorized in your product documentation, or as directed by the online or telephone service and support team. Damage due to servicing that is not authorized by Dell is not covered by your warranty. Read and follow the safety instructions that came with the product.

To learn more about this Dell product or to order additional or replacement parts, go to Dell.com/support

Copyright © 2020 Dell Inc. or its subsidiaries. All Rights Reserved.

Figure 6. Memory information

System tasks

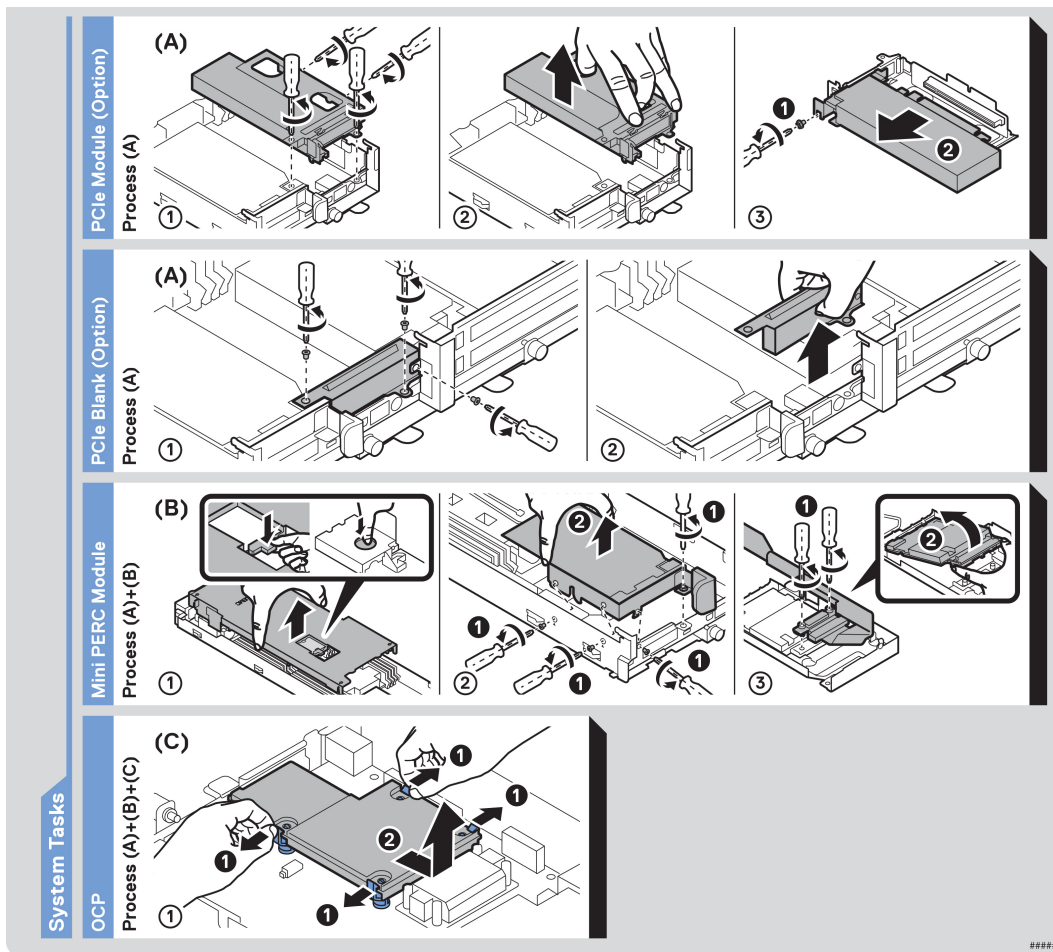

Figure 7. System task

Jumper settings

Jumper Settings		
Jumper	Setting	Description
PWRD_EN	(default)	BIOS password is enabled.
		BIOS password is disabled. iDRAC local access unlocked at next AC power cycle. iDRAC password reset is enabled in F2 iDRAC settings menu.
NVRAM_CLR	(default)	BIOS configuration settings retained at system boot.
		BIOS configuration settings cleared at system boot.

Icon Legend		
EST Express Service Tag	System Info	Fan
Memory Bank	Hard Drive Activity	CPU
Power Supply	Mgmt Port	
System Status	Push	

Caution: Many repairs may only be done by a certified service technician. You should only perform troubleshooting and simple repairs as authorized in your product documentation, or as directed by the online or telephone service and support team. Damage due to servicing that is not authorized by Dell is not covered by your warranty. Read and follow the safety instructions that came with the product.

To learn more about this Dell product or to order additional or replacement parts, go to Dell.com/support

Copyright © 2020 Dell Inc. or its subsidiaries. All Rights Reserved.

Figure 8. Jumper settings

Rail sizing and rack compatibility matrix

For specific information about the rail solutions compatible with your system, see the *Dell EMC Enterprise Systems Rail Sizing and Rack Compatibility Matrix* available at https://i.dell.com/sites/csdocuments/Business_solutions_engineering-Docs_Documents/en/rail-rack-matrix.pdf.

The document provides the information that is listed below:

- Specific details about rail types and their functionalities
- Rail adjustability ranges for various rack mounting flange types
- Rail depth with and without cable management accessories
- Rack types that are supported for various rack mounting flange types

Initial system setup and configuration

This section describes the tasks for initial setup and configuration of the Dell EMC system. The sections provide general steps that you must complete to set up the system and the reference guides for detailed information.

Topics:

- [Setting up the system](#)
- [iDRAC configuration](#)
- [Resources to install operating system](#)
- [Channel Firmware Commodities](#)

Setting up the system

Perform the following steps to set up the system:

Steps

1. Unpack the system.
2. Install the system into the rack. For more information see the rail installation and cable management accessory guides relevant to your rail and cable management solution at www.dell.com/xemanuals.
3. Connect the peripherals to the system and the system to the electrical outlet.
4. Power on the system by pressing the power button.

For more information about setting up the system, see the *Getting Started Guide* that is shipped with your system.

iDRAC configuration

The Integrated Dell Remote Access Controller (iDRAC) is designed to make you more productive as a system administrator and improve the overall availability of Dell EMC servers. iDRAC alerts you to system issues, helps you to perform remote management, and reduces the need for physical access to the system.

Options to set up iDRAC IP address

To enable communication between your system and iDRAC, you must first configure the network settings based on your network infrastructure. The network settings option is set to **DHCP**, by default.

 **NOTE:** For static IP configuration, you must request for the setting at the time of purchase.

You can set up the iDRAC IP address using one of the following interfaces. For information about how to set up iDRAC IP address, see the documentation links provided in the table.

Table 2. Interfaces to set up iDRAC IP address





Interface	Documentation links
iDRAC Settings utility	<p><i>Integrated Dell Remote Access Controller User's Guide</i> at https://www.dell.com/idracmanuals or for system specific <i>Integrated Dell Remote Access Controller User's Guide</i>, go to https://www.dell.com/poweredgemanuals > Product Support page of your system > Manuals & documents.</p> <p> NOTE: To determine the most recent iDRAC release for your platform and for latest documentation version,</p>

Table 2. Interfaces to set up iDRAC IP address (continued)

Interface	Documentation links
	see KB article https://www.dell.com/support/article/sln308699 .
OpenManage Deployment Toolkit	<i>OpenManage Deployment Toolkit User's Guide</i> at www.dell.com/openmanagemanuals > OpenManage Deployment Toolkit.
Lifecycle Controller	<i>Lifecycle Controller User's Guide</i> at https://www.dell.com/idracmanuals or for system-specific <i>Lifecycle Controller User's Guide</i> , go to https://www.dell.com/poweredgemanuals > Product Support page of your system > Manuals & documents .  NOTE: To determine the most recent iDRAC release for your platform and for latest documentation version, see KB article https://www.dell.com/support/article/sln308699 .
iDRAC Direct and Quick Sync 2 (optional)	<i>Integrated Dell Remote Access Controller User's Guide</i> at https://www.dell.com/idracmanuals or for system specific <i>Integrated Dell Remote Access Controller User's Guide</i> , go to https://www.dell.com/poweredgemanuals > Product Support page of your system > Manuals & documents .  NOTE: To determine the most recent iDRAC release for your platform and for latest documentation version, see KB article https://www.dell.com/support/article/sln308699 .

 **NOTE:** To access iDRAC, ensure that you connect the ethernet cable to the iDRAC9 dedicated network port or use iDRAC Direct port by using the USB cable. You can also access iDRAC through the shared LOM mode, if you have opted for a system that has the shared LOM mode enabled.

Options to log in to iDRAC

To log in to the iDRAC Web User Interface, open a browser and enter the IP address.

You can log in to iDRAC as:

- iDRAC user
- Microsoft Active Directory user
- Lightweight Directory Access Protocol (LDAP) user

In the log in screen displayed, if you have opted for secure default access to iDRAC, enter the iDRAC secure default password available on back side of the Information Tag. If you have not opted for secure default access to iDRAC, enter the default user name and password – `root` and `calvin`. You can also log in by using your Single Sign-On or Smart Card.

 **NOTE:** Ensure that you change the default username and password after setting up the iDRAC IP address.

For more information about logging in to the iDRAC and iDRAC licenses, see the latest *Integrated Dell Remote Access Controller User's Guide* at www.dell.com/idracmanuals.

 **NOTE:** To determine the most recent iDRAC release for your platform and for latest documentation version, see KB article <https://www.dell.com/support/article/sln308699>.

You can also access iDRAC using command-line protocol - RACADM. For more information, see the *iDRAC with Lifecycle Controller RACADM CLI Guide* available at www.dell.com/idracmanuals.

You can also access iDRAC using automation tool - Redfish API. For more information, see the *iDRAC9 with Lifecycle Controller Redfish API Guide* available at <https://www.dell.com/idracmanuals>.

Resources to install operating system

If the system is shipped without an operating system, you can install a supported operating system by using one of the resources that are provided in the table. For information about how to install the operating system, see the documentation links provided in the table.

Table 3. Resources to install the operating system

Resource	Documentation links
iDRAC	<i>Integrated Dell Remote Access Controller User's Guide</i> at https://www.dell.com/idracmanuals
Lifecycle Controller	<i>Lifecycle Controller User's Guide</i> at https://www.dell.com/idracmanuals  NOTE: To determine the most recent iDRAC release for your platform and for latest documentation version, see KB article at https://www.dell.com/support/article/sln308699 .
OpenManage Deployment Toolkit	www.dell.com/openmanagemanuals > OpenManage Deployment Toolkit
Dell certified VMware ESXi	www.dell.com/virtualizationsolutions

 **NOTE:** For more information about Installation and How-to videos for supported operating systems on PowerEdge system see, [Supported Operating Systems for Dell EMC PowerEdge systems](#).

Options to download firmware

You can download firmware from the Dell support site. For information, see the [Downloading drivers and firmware](#) section.

You can also choose any one of the following options to download the firmware. For information about how to download the firmware, see the documentation links provided in the table.

Table 4. Options to download firmware

Option	Documentation link
Using Dell Remote Access Controller Lifecycle Controller (iDRAC with LC)	www.dell.com/idracmanuals
Using Dell Repository Manager (DRM)	www.dell.com/openmanagemanuals > Repository Manager
Using Dell Server Update Utility (SUU)	www.dell.com/openmanagemanuals > Server Update Utility
Using Dell OpenManage Deployment Toolkit (DTK)	www.dell.com/openmanagemanuals > OpenManage Deployment Toolkit
Using iDRAC virtual media	www.dell.com/idracmanuals

Options to download and install OS drivers

You can choose any one of the following options to download and install OS drivers. For information about how to download or install OS drivers, see the documentation links provided in the table.

Table 5. Options to download and install OS drivers

Option	Documentation
Dell EMC support site	Downloading drivers and firmware section.
iDRAC virtual media	<i>Integrated Dell Remote Access Controller User's Guide</i> at https://www.dell.com/idracmanuals or for system specific <i>Integrated Dell Remote Access Controller User's Guide</i> , go to https://www.dell.com/poweredgemanuals > Product Support page of your system > Manuals & documents .

Table 5. Options to download and install OS drivers (continued)

Option	Documentation
	 NOTE: To determine the most recent iDRAC release for your platform and for latest documentation version, see https://www.dell.com/support/article/sln308699 .

Downloading drivers and firmware

It is recommended that you download and install the latest BIOS, drivers, and systems management firmware on the system.

Prerequisites

Ensure that you clear the web browser cache before downloading the drivers and firmware.

Steps

1. Go to www.dell.com/support/drivers.
2. Enter the Service Tag of the system in the **Enter a Dell Service Tag, Dell EMC Product ID or Model** field, and then press Enter.
 -  **NOTE:** If you do not have the Service Tag, select **Detect PC** to automatically detect the Service Tag, or click **Browse all products**, and navigate to your product.
3. On the displayed product page, click **Drivers & Downloads**.
On the **Drivers & Downloads** page, all drivers that are applicable to the system are displayed.
4. Download the drivers to a USB drive, CD, DVD or local machine.

Channel Firmware Commodities

Customers deploying cold storage workloads have unique requirements for caching/ journaling/ logging use cases and for flash tiering in the box without accessing the data bay. In order to meet these requirements, the following commodities were enabled in the XE7100 or XE7420 or XE7440:

- NVMe, Micron 7300PRO, 960 G with 2.5" 7 MM carrier (for caching/ journaling/ logging)
- NVMe, Micron 7300PRO, 1920 G with 2.5" 7 MM carrier (for caching/ journaling/ logging)
- M.2 NVMe, Micron 960 G, PCIE Storage Option, with 12, 16, or, 20 slots per card (for flash memory)
- M.2 NVMe, Micron 1.92 TB, PCIE Storage Option, with 12, 16, or, 20 slots per card (for flash memory)

These commodities contain channel firmware and therefore do not have standard Dell systems management support including iDRAC, DUPs, and Catalogs. Vendor tools are required to configure, deploy, manage, and update these commodities.

In addition, the firmware that is shipped at the time of order is the only Dell validated version. If an issue is reported to support on a later version flashed by the customer, the customer must flash back to the shipped version to begin the root cause process. Best effort support will still be provided for non-Dell validated firmware versions.

Systems Management Support

Table 6. System management support

Product	NVMe, Micron 7300PRO (960G/ 1920G) with 2.5" 7 MM carrier	M.2 NVMe, Micron (960G/ 1.92 TB), PCIE Storage Option, with 12, 16, or, 20 slots per card
Enterprise License	Supported*	Supported*
Data Center License	Supported*	Supported
iDRAC Service Module	Supported*	Supported*
DUPs and Catalogs	Not supported	Not supported

Table 6. System management support (continued)

Product	NVMe, Micron 7300PRO (960G/ 1920G) with 2.5" 7 MM carrier	M.2 NVMe, Micron (960G/ 1.92 TB), PCIE Storage Option, with 12, 16, or, 20 slots per card
Dell System Update (DSU)	Not supported	Not supported
Dell Repository Manager (DRM)	Not supported	Not supported
Server Update Utility (SUU)	Not supported	Not supported
Bootable ISO	Not supported	Not supported
Lifecycle Controller Driver Pack	Not supported	Not supported
OpenManage Server Administrator	Supported*	Supported*
OpenManage Enterprise	Supported*	Supported*
OpenManage Essentials	Supported	Supported
Power Manager Plug-In	Supported*	Supported*
Integrations		
VMware (OMIVV)	Not supported	Not supported
Microsoft	Not supported	Not supported
Secure Enterprise Key Manager (SED support)	Not supported	Not supported
CloudLink	Not supported	Not supported
SupportAssist for Enterprise	Not supported	Not supported
ServiceNow	Not supported	Not supported
Ansible Enablement	Not supported	Not supported
Quicksync2	Not supported	Not supported
Third-party Connectors (Nagios, Tivoli, CA, etc).	Not supported	Not supported

NOTE: *iDRAC supports these drives as channel cards only that is, standard support of firmware management is not supported.

Vendor tools

The vendor tools required to support these commodities are on the vendor websites. The html file to guide users to the correct website is found in the SWB for each commodity instead of the DUPS normally found in the SWB for PowerEdge commodities.

For html file to guide customer and the latest driver and firmware that is supported, see www.dell.com/support/drivers.

iDRAC Reporting and Limitations

NVMe, Micron 7300PRO (960 G/ 1920 G) with 2.5" 7 MM carrier

- See the screenshot below as to how this drive is reported in iDRAC Inventory.

— PCIe SSD in Slot 2 in Bay 0

```
Bus: D8
BusProtocol: PCIE
Device: 0
DeviceProtocol: NVMe-MI1.0
DriveFormFactor: 2.5 inch
FailurePredicted: NO
FQDD: Disk.Bay.2:Enclosure.Internal.0-0
FreeSizeInBytes: Information Not Available
Function: 0
HotSpareStatus: Information Not Available
InstanceID: Disk.Bay.2:Enclosure.Internal.0-0
Manufacturer: MICRON
MaximumCapableSpeed: 8 GT/s
MediaType: Solid State Drive
Model: Micron_7300_MTFDHBE1T9TDF
NegotiatedSpeed: 8 GT/s
PCieCapableLinkWidth: x4
PCieNegotiatedLinkWidth: x4
PrimaryStatus: Ok
ProductID: 51a2
RaidStatus: Information Not Available
RAIDType: Unknown
RemainingRatedWriteEndurance: 100 %
Revision: 95420100
SerialNumber: 194126DD35F3
SizeInBytes: 1920383410176
Slot: 2
State: Ready
SystemEraseCapability: Not Supported
```

Figure 9. NVMe Micron 7300PRO in iDRAC inventory

M.2 NVMe, Micron (960 G/ 1.92 TB), PCIE Storage Option, with 12, 16, or, 20 slots per card

- See the screenshot below as to how this drive is reported in iDRAC Inventory.

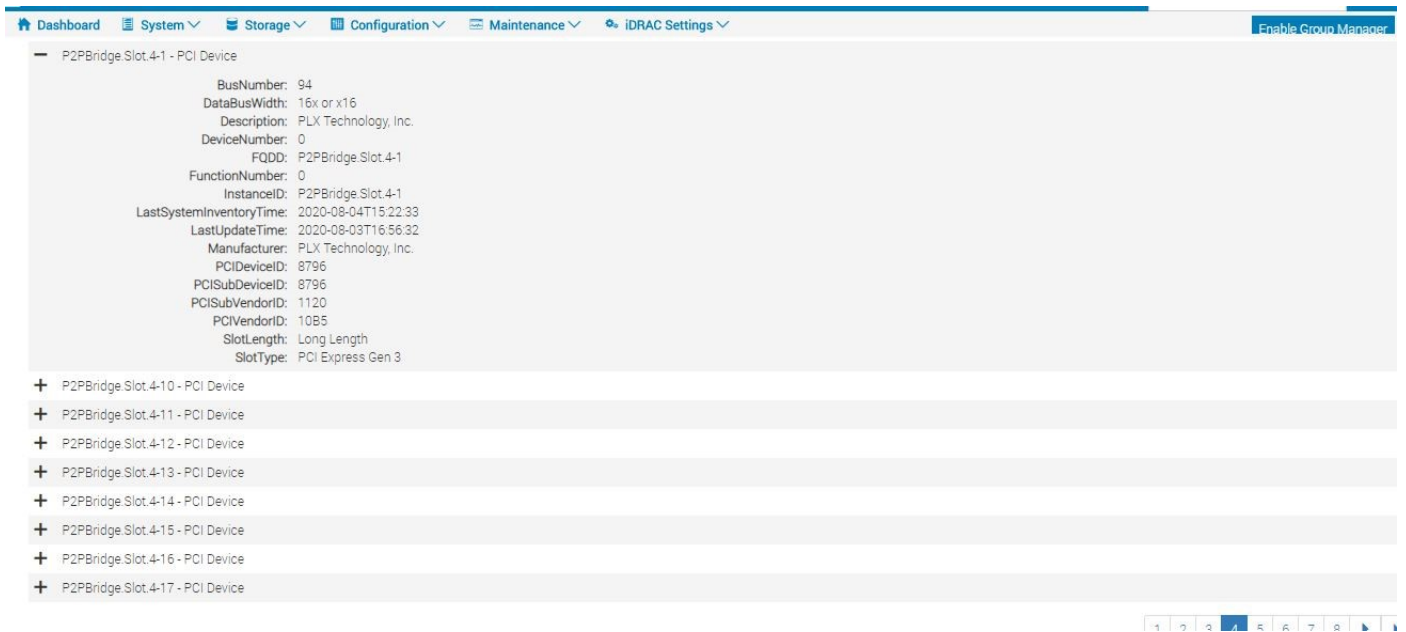

Figure 10. M.2 NVMe Micron PCIe storage in iDRAC inventory

Adapter for NVMe M.2, PCIe storage option (Single and Dual) in iDRAC Inventory



Figure 11. Adapter for NVMe M.2, PCIe storage options in iDRAC inventory

Pre-operating system management applications

You can manage basic settings and features of a system without booting to the operating system by using the system firmware.

Topics:

- [Options to manage the pre-operating system applications](#)
- [System Setup](#)
- [Dell Lifecycle Controller](#)
- [Boot Manager](#)
- [PXE boot](#)

Options to manage the pre-operating system applications

Your system has the following options to manage the pre-operating system applications:

- System Setup
- Dell Lifecycle Controller
- Boot Manager
- Preboot Execution Environment (PXE)

System Setup

By using the **System Setup** screen, you can configure the BIOS settings, iDRAC settings, and device settings of your system.

 **NOTE:** Help text for the selected field is displayed in the graphical browser by default. To view the help text in the text browser, press F1.

You can access system setup by one of the following:

- Standard graphical browser—The browser is enabled by default.
- Text browser—The browser is enabled by using Console Redirection.

Viewing System Setup

To view the **System Setup** screen, perform the following steps:

Steps

1. Power on, or restart your system.
2. Press F2 immediately after you see the following message:

```
F2 = System Setup
```

 **NOTE:** If your operating system begins to load before you press F2, wait for the system to finish booting, and then restart your system and try again.

System Setup details

The **System Setup Main Menu** screen details are explained as follows:

Option	Description
System BIOS	Enables you to configure BIOS settings.
iDRAC Settings	Enables you to configure the iDRAC settings. The iDRAC settings utility is an interface to set up and configure the iDRAC parameters by using UEFI (Unified Extensible Firmware Interface). You can enable or disable various iDRAC parameters by using the iDRAC settings utility. For more information about this utility, see <i>Integrated Dell Remote Access Controller User's Guide</i> at www.dell.com/poweredge/manuals .
Device Settings	Enables you to configure device settings.

System BIOS

You can use the **System BIOS** screen to edit specific functions such as boot order, system password, and setup password, set the SATA and PCIe NVMe RAID mode, and enable or disable USB ports.

Viewing System BIOS

To view the **System BIOS** screen, perform the following steps:

Steps

1. Power on, or restart your system.
2. Press F2 immediately after you see the following message:

```
F2 = System Setup
```

NOTE: If the operating system begins to load before you press F2, wait for the system to finish booting, and then restart the system and try again.

3. On the **System Setup Main Menu** screen, click **System BIOS**.

System BIOS Settings details

About this task

The **System BIOS Settings** screen details are explained as follows:

Option	Description
System Information	Provides information about the system such as the system model name, BIOS version, and Service Tag.
Memory Settings	Provides information and options related to the installed memory.
Processor Settings	Provides information and options related to the processor such as speed and cache size.
SATA Settings	Provides options to enable or disable the integrated SATA controller and ports.
NVMe Settings	Provides options to change the NVMe settings. If the system contains the NVMe drives that you want to configure in a RAID array, you must set both this field and the Embedded SATA field on the SATA Settings menu to RAID mode. You might also need to change the Boot Mode setting to UEFI . Otherwise, you should set this field to Non-RAID mode.
Boot Settings	Provides options to specify the Boot mode (BIOS or UEFI). Enables you to modify UEFI and BIOS boot settings.

Option	Description
Network Settings	Provides options to manage the UEFI network settings and boot protocols. Legacy network settings are managed from the Device Settings menu.
Integrated Devices	Provides options to manage integrated device controllers and ports, specifies related features and options.
Serial Communication	Provides options to manage the serial ports, their related features and options.
System Profile Settings	Provides options to change the processor power management settings, and memory frequency.
System Security	Provides options to configure the system security settings, such as system password, setup password, Trusted Platform Module (TPM) security, and UEFI secure boot. It also manages the power button on the system.
Redundant OS Control	Sets the redundant OS information for redundant OS control.
Miscellaneous Settings	Provides options to change the system date and time.

System Information

You can use the **System Information** screen to view system properties such as Service Tag, system model name, and BIOS version.

Viewing System Information

To view the **System Information** screen, perform the following steps:

Steps

1. Power on, or restart your system.
2. Press F2 immediately after you see the following message:

```
F2 = System Setup
```

NOTE: If your operating system begins to load before you press F2, wait for the system to finish booting, and then restart your system and try again.

3. On the **System Setup Main Menu** screen, click **System BIOS**.
4. On the **System BIOS** screen, click **System Information**.

System Information details

About this task

The **System Information** screen details are explained as follows:

Option	Description
System Model Name	Specifies the system model name.
System BIOS Version	Specifies the BIOS version installed on the system.
System Management Engine Version	Specifies the current version of the Management Engine firmware.

Option	Description
System Service Tag	Specifies the system Service Tag.
System Manufacturer	Specifies the name of the system manufacturer.
System Manufacturer Contact Information	Specifies the contact information of the system manufacturer.
System CPLD Version	Specifies the current version of the system complex programmable logic device (CPLD) firmware.
UEFI Compliance Version	Specifies the UEFI compliance level of the system firmware.

Memory Settings

You can use the **Memory Settings** screen to view all the memory settings and enable or disable specific memory functions, such as system memory testing and node interleaving.

Viewing Memory Settings

To view the **Memory Settings** screen, perform the following steps:

Steps

1. Power on, or restart your system.
2. Press F2 immediately after you see the following message:

```
F2 = System Setup
```

NOTE: If the operating system begins to load before you press F2, wait for the system to finish booting, and then restart the system and try again.

3. On the **System Setup Main Menu** screen, click **System BIOS**.
4. On the **System BIOS** screen, click **Memory Settings**.

Memory Settings details

About this task

The **Memory Settings** screen details are explained as follows:

Option	Description
System Memory Size	Specifies the memory size in the system.
System Memory Type	Specifies the type of memory that is installed in the system.
System Memory Speed	Specifies the system memory speed.
System Memory Voltage	Specifies the system memory voltage.
Video Memory	Specifies the amount of video memory.

Option	Description
System Memory Testing	Specifies whether the system memory tests are run during system boot. Options are Enabled and Disabled . This option is set to Disabled by default.
Dram Refresh Delay	By enabling the CPU memory controller to delay running the REFRESH commands, you can improve the performance for some workloads. By minimizing the delay time, it is ensured that the memory controller runs the REFRESH command at regular intervals. For Intel-based servers, this setting only affects systems configured with DIMMs which use 8 Gb density DRAMS.
Current State of Memory Operating Mode	Specifies the current state of the memory operating mode.
Node Interleaving	Specifies if Non-Uniform Memory Architecture (NUMA) is supported. If this field is set to Enabled , memory interleaving is supported if a symmetric memory configuration is installed. If this field is set to Disabled , the system supports NUMA (asymmetric) memory configurations. This option is set to Disabled by default.
ADDDC Setting	Enables or disables ADDDC Setting feature. When Adaptive Double DRAM Device Correction (ADDDC) is enabled, failing DRAMs are dynamically mapped out. When set to Enabled it can have some impact to system performance under certain workloads. This feature is applicable for x4 DIMMs only. This option is set to Enabled by default.
Opportunistic Self-Refresh	Enables or disables opportunistic self-refresh feature. This option is set to Disabled by default and is not supported when DCPMMs are in the system.
Correctable Error logging	Enables or disables logging of correctable memory threshold error. This option is set to Disabled by default.
DIMM Self Healing (Post Package Repair) on Uncorrectable Memory Error	Enable/Disable Post Package Repair (PPR) on Uncorrectable Memory Error. This option is set to Enabled by default.

Processor Settings

You can use the **Processor Settings** screen to view the processor settings and perform specific functions such as enabling virtualization technology, hardware prefetcher, logical processor idling.

Viewing Processor Settings

To view the **Processor Settings** screen, perform the following steps:

Steps

1. Power on, or restart your system.
2. Press F2 immediately after you see the following message:

```
F2 = System Setup
```



NOTE: If your operating system begins to load before you press F2, wait for the system to finish booting, and then restart your system and try again.

3. On the **System Setup Main Menu** screen, click **System BIOS**.
4. On the **System BIOS** screen, click **Processor Settings**.

Processor Settings details

About this task

The **Processor Settings** screen details are explained as follows:

Option	Description
Logical Processor	Enables or disables the logical processors and displays the number of logical processors. If this option is set to Enabled , the BIOS displays all the logical processors. If this option is set to Disabled , the BIOS displays only one logical processor per core. This option is set to Enabled by default.
Virtualization Technology	Enables or disables the virtualization technology for the processor. This option is set to Enabled by default.
Adjacent Cache Line Prefetch	Optimizes the system for applications that need high utilization of sequential memory access. This option is set to Enabled by default. You can disable this option for applications that need high utilization of random memory access.
Hardware Prefetcher	Enables or disables the hardware prefetcher. This option is set to Enabled by default.
DCU Streamer Prefetcher	Enables or disables the Data Cache Unit (DCU) streamer prefetcher. This option is set to Enabled by default.
DCU IP Prefetcher	Enables or disables the Data Cache Unit (DCU) IP prefetcher. This option is set to Enabled by default.
Sub NUMA Cluster	Sub NUMA Clustering (SNC) is a feature for breaking up the LLC into disjoint clusters based on address range, with each cluster bound to a subset of the memory controllers in the system. It improves average latency to the LLC. Enables or disables the Sub NUMA Cluster. This option is set to Disabled by default.
UPI Prefetch	Enables you to get the memory that is read started early on DDR bus. The Ultra Path Interconnect (UPI) Rx path will spawn the speculative memory that is read to Integrated Memory Controller (iMC) directly. This option is set to Enabled by default.
LLC Prefetch	Enables or disables the LLC Prefetch on all threads. This option is set to Disabled by default.
Dead Line LLC Alloc	Enables or disables the Dead Line LLC Alloc. This option is set to Enabled by default. You can enable this option to enter the dead lines in LLC or disable the option to not enter the dead lines in LLC.
Directory AtoS	Enables or disables the Directory AtoS. AtoS optimization reduces remote read latencies for repeat read accesses without intervening writes. This option is set to Disabled by default.
Logical Processor Idling	Enables you to improve the energy efficiency of a system. It uses the operating system core parking algorithm and parks some of the logical processors in the system which in turn allows the corresponding processor cores to transition into a lower power idle state. This option can only be enabled if the operating system supports it. It is set to Disabled by default.
Configurable TDP	Enables you to configure the TDP level. The available options are Nominal , Level 1 , and Level 2 . This option is set to Nominal by default.  NOTE: This option is only available on certain stock keeping units (SKUs) of the processors.
Number of Cores per Processor	Controls the number of enabled cores in each processor. This option is set to All by default.
Processor Core Speed	Specifies the maximum core frequency of the processor.
Processor n	 NOTE: Depending on the number of processors, there might be up to processors listed.

The following settings are displayed for each processor that is installed in the system:

Option	Description
Family-Model-Stepping	Specifies the family, model, and stepping of the processor as defined by Intel.
Brand	Specifies the brand name.
Level 2 Cache	Specifies the total L2 cache.
Level 3 Cache	Specifies the total L3 cache.
Number of Cores	Specifies the number of cores per processor.
Maximum Memory Capacity	Specifies the maximum memory capacity per processor.

Option	Description
Option	Description
Microcode	Specifies the microcode.

SATA Settings

You can use the **SATA Settings** screen to view the settings of SATA devices and enable SATA and PCIe NVMe RAID mode on your system.

Viewing SATA Settings

To view the **SATA Settings** screen, perform the following steps:

Steps

1. Power on, or restart your system.
2. Press F2 immediately after you see the following message:

```
F2 = System Setup
```

NOTE: If your operating system begins to load before you press F2, wait for the system to finish booting, and then restart your system and try again.

3. On the **System Setup Main Menu** screen, click **System BIOS**.
4. On the **System BIOS** screen, click **SATA Settings**.

SATA Settings details

About this task

The **SATA Settings** screen details are explained as follows:

Option	Description
Embedded SATA	Enables the embedded SATA option to be set to AHCI Mode , or RAID Mode . This option is set to AHCI Mode by default.
Security Freeze Lock	Enables you to send Security Freeze Lock command to the embedded SATA drives during POST. This option is applicable only for AHCI mode. This option is set to Enabled by default.
Write Cache	Enables or disables the command for the embedded SATA drives during POST. This option is set to Disabled by default.
Port n	Enables you to set the drive type of the selected device. For AHCI Mode or RAID Mode , BIOS support is always enabled.
Option	Description
Model	Specifies the drive model of the selected device.
Drive Type	Specifies the type of drive attached to the SATA port.
Capacity	Specifies the total capacity of the drive. This field is undefined for removable media devices such as optical drives.

NVMe Settings

The NVMe settings enable you to set the NVMe drives to either **RAID** mode or **Non-RAID** mode.

NOTE: To configure these drives as RAID drives, you must set the NVMe drives and the Embedded SATA option in the **SATA Settings** menu to **RAID** mode. If not, you must set this field to **Non-RAID** mode.

Viewing NVMe Settings

To view the **NVMe Settings** screen, perform the following steps:

Steps

1. Power on, or restart your system.
2. Press F2 immediately after you see the following message:

```
F2 = System Setup
```

NOTE: If your operating system begins to load before you press F2, wait for the system to finish booting, and then restart your system and try again.

3. On the **System Setup Main Menu** screen, click **System BIOS**.
4. On the **System BIOS** screen, click **NVMe Settings**.

NVMe Settings details

About this task

The NVMe Settings screen details are explained as follows:

Option	Description
NVMe Mode	Enables you to set the NVMe mode. This option is set to Non RAID by default.

Boot Settings

You can use the **Boot Settings** screen to set the boot mode to either **BIOS** or **UEFI**. It also enables you to specify the boot order.

- **UEFI:** The Unified Extensible Firmware Interface (UEFI) is a new interface between operating systems and platform firmware. The interface consists of data tables with platform related information, boot and runtime service calls that are available to the operating system and its loader. The following benefits are available when the **Boot Mode** is set to **UEFI**:
 - Support for drive partitions larger than 2 TB.
 - Enhanced security (e.g., UEFI Secure Boot).
 - Faster boot time.

NOTE: You must use only the UEFI boot mode in order to boot from NVMe drives.

- **BIOS:** The **BIOS Boot Mode** is the legacy boot mode. It is maintained for backward compatibility.

Viewing Boot Settings

To view the **Boot Settings** screen, perform the following steps:

Steps

1. Power on, or restart your system.

2. Press F2 immediately after you see the following message:

F2 = System Setup

NOTE: If your operating system begins to load before you press F2, wait for the system to finish booting, and then restart your system and try again.

3. On the **System Setup Main Menu** screen, click **System BIOS**.

4. On the **System BIOS** screen, click **Boot Settings**.

Boot Settings details

About this task

The **Boot Settings** screen details are explained as follows:



Option	Description
Boot Mode	<p>Enables you to set the boot mode of the system.</p> <p>CAUTION: Switching the boot mode may prevent the system from booting if the operating system is not installed in the same boot mode.</p> <p>If the operating system supports UEFI, you can set this option to UEFI. Setting this field to BIOS enables compatibility with non-UEFI operating systems. This option is set to UEFI by default.</p> <p>NOTE: Setting this field to UEFI disables the BIOS Boot Settings menu.</p>
Boot Sequence Retry	<p>Enables or disables the Boot Sequence Retry feature. If this option is set to Enabled and the system fails to boot, the system re-attempts the boot sequence after 30 seconds. This option is set to Enabled by default.</p>
Hard-Disk Failover	<p>Specifies the drive that is booted in the event of a drive failure. The devices are selected in the Hard-Disk Drive Sequence on the Boot Option Setting menu. When this option is set to Disabled, only the first drive in the list is attempted to boot. When this option is set to Enabled, all drives are attempted to boot in the order selected in the Hard-Disk Drive Sequence. This option is not enabled for UEFI Boot Mode. This option is set to Disabled by default.</p>
Generic USB Boot	<p>Enables or disables the USB boot option. This option is set to Disabled by default.</p>
Hard-disk Drive Placeholder	<p>Enables or disables the Hard-disk drive placeholder option. This option is set to Disabled by default.</p>
BIOS Boot Settings	<p>Enables or disables BIOS boot options.</p> <p>NOTE: This option is enabled only if the boot mode is BIOS.</p>
UEFI Boot Settings	<p>Enables or disables UEFI Boot options.</p> <p>The Boot options include IPv4 PXE and IPv6 PXE. This option is set to IPv4 by default.</p> <p>NOTE: This option is enabled only if the boot mode is UEFI.</p>
UEFI Boot Sequence	<p>Enables you to change the boot device order.</p>
Boot Options Enable/Disable	<p>Enables you to select the enabled or disabled boot devices.</p>

Choosing system boot mode

System Setup enables you to specify one of the following boot modes for installing your operating system:

- BIOS boot mode (the default) is the standard BIOS-level boot interface.
- UEFI boot mode (the default), is an enhanced 64-bit boot interface.

If you have configured your system to boot to UEFI mode, it replaces the system BIOS.

1. From the **System Setup Main Menu**, click **Boot Settings**, and select **Boot Mode**.
2. Select the UEFI boot mode you want the system to boot into.
 **CAUTION: Switching the boot mode may prevent the system from booting if the operating system is not installed in the same boot mode.**
3. After the system boots in the specified boot mode, proceed to install your operating system from that mode.
 **NOTE:** Operating systems must be UEFI-compatible to be installed from the UEFI boot mode. DOS and 32-bit operating systems do not support UEFI and can only be installed from the BIOS boot mode.
 **NOTE:** For the latest information about supported operating systems, go to www.dell.com/ossupport.

Changing boot order

About this task

You may have to change the boot order if you want to boot from a USB key. You may have to change the boot order if you want to boot from a USB key or an optical drive. The following instructions may vary if you have selected **BIOS** for **Boot Mode**.

Steps

1. On the **System Setup Main Menu** screen, click **System BIOS > Boot Settings > UEFI/BIOS Boot Settings > UEFI/BIOS Boot Sequence**.
2. Click **Boot Option Settings > BIOS/UEFI Boot Settings > Boot Sequence**.
 **NOTE:** Use the arrow keys to select a boot device, and use the plus (+) and minus (-) sign keys to move the device down or up in the order.
3. Click **Exit**, and then click **Yes** to save the settings on exit.

Network Settings

You can use the **Network Settings** screen to modify UEFI PXE, iSCSI, and HTTP boot settings. The network settings option is available only in the UEFI mode.

-  **NOTE:** BIOS does not control network settings in the BIOS mode. For the BIOS boot mode, the optional Boot ROM of the network controllers handles the network settings.

Viewing Network Settings

To view the **Network Settings** screen, perform the following steps:

Steps

1. Power on, or restart your system.
2. Press F2 immediately after you see the following message:

```
F2 = System Setup
```

-  **NOTE:** If your operating system begins to load before you press F2, wait for the system to finish booting, and then restart your system and try again.
3. On the **System Setup Main Menu** screen, click **System BIOS**.
4. On the **System BIOS** screen, click **Network Settings**.

Network Settings screen details

The **Network Settings** screen details are explained as follows:

About this task

Option	Description				
UEFI PXE Settings	<table><thead><tr><th>Options</th><th>Description</th></tr></thead><tbody><tr><td>PXE Device n (n = 1 to 4)</td><td>Enables or disables the device. When enabled, a UEFI PXE boot option is created for the device.</td></tr></tbody></table>	Options	Description	PXE Device n (n = 1 to 4)	Enables or disables the device. When enabled, a UEFI PXE boot option is created for the device.
Options	Description				
PXE Device n (n = 1 to 4)	Enables or disables the device. When enabled, a UEFI PXE boot option is created for the device.				
PXE Device n Settings (n = 1 to 4)	Enables you to control the configuration of the PXE device.				
UEFI HTTP Settings	<table><thead><tr><th>Options</th><th>Description</th></tr></thead><tbody><tr><td>HTTP Device (n = 1 to 4)</td><td>Enables or disables the device. When enabled, a UEFI HTTP boot option is created for the device.</td></tr></tbody></table>	Options	Description	HTTP Device (n = 1 to 4)	Enables or disables the device. When enabled, a UEFI HTTP boot option is created for the device.
Options	Description				
HTTP Device (n = 1 to 4)	Enables or disables the device. When enabled, a UEFI HTTP boot option is created for the device.				
HTTP Device n Settings (n = 1 to 4)	Enables you to control the configuration of the HTTP device.				
TLS Authentication Configuration	View and/or modify this device's boot TLS authentication mode. None means the HTTP server and the client will not authenticate each other for this boot. One way means the HTTP server will be authenticated by the client, while the client will not be authenticated by the server. This option is set to None by default.				

Integrated Devices

You can use the **Integrated Devices** screen to view and configure the settings of all integrated devices including the video controller, integrated RAID controller, and the USB ports.

Viewing Integrated Devices

To view the **Integrated Devices** screen, perform the following steps:

Steps

1. Power on, or restart your system.
2. Press F2 immediately after you see the following message:

```
F2 = System Setup
```

 **NOTE:** If your operating system begins to load before you press F2, wait for the system to finish booting, and then restart your system and try again.

3. On the **System Setup Main Menu** screen, click **System BIOS**.
4. On the **System BIOS** screen, click **Integrated Devices**.

Integrated Devices details

About this task

The **Integrated Devices** screen details are explained as follows:

Option	Description
iDRAC Direct USB Port	The iDRAC Direct USB port is managed by iDRAC exclusively with no host visibility. This option is set to ON or OFF . When set to OFF , iDRAC does not detect any USB devices installed in this managed port. This option is set to On by default.
I/OAT DMA Engine	Enables or disables the I/O Acceleration Technology (I/OAT) option. I/OAT is a set of DMA features designed to accelerate network traffic and lower CPU utilization. Enable only if the hardware and software support the feature. This option is set to Disabled by default.
I/O Snoop HoldOff Response	Selects the number of cycles PCI I/O can withhold snoop requests, from the CPU, to allow time to complete its own write to LLC. This setting can help improve performance on workloads where throughput and latency are critical.
Embedded Video Controller	Enables or disables the use of Embedded Video Controller as the primary display. When set to Enabled , the Embedded Video Controller is used as the primary display even if add-in graphic cards are installed. When set to Disabled , an add-in graphics card is used as the primary display. BIOS will output displays to both the primary add-in video and the embedded video during POST and pre-boot environment. The embedded video is disabled before the operating system boots. This option is set to Enabled by default.  NOTE: When there are multiple add-in graphic cards that are installed in the system, the first card discovered during PCI enumeration is selected as the primary video. You might have to re-arrange the cards in the slots in order to control which card is the primary video.
Current State of Embedded Video Controller	Displays the current state of the embedded video controller. The Current State of Embedded Video Controller option is a read-only field. If the Embedded Video Controller is the only display capability in the system (that is, no add-in graphics card is installed), then the Embedded Video Controller is automatically used as the primary display even if the Embedded Video Controller setting is set to .
SR-IOV Global Enable	Enables or disables the BIOS configuration of Single Root I/O Virtualization (SR-IOV) devices. This option is set to Disabled by default.
OS Watchdog Timer	If your system stops responding, this watchdog timer aids in the recovery of your operating system. When this option is set to Enabled , the operating system initializes the timer. When this option is set to Disabled (the default), the timer does not have any effect on the system.
Empty Slot Unhide	Enables or disables the root ports of all the empty slots that are accessible to the BIOS and OS. This option is set to Disabled by default.
Memory Mapped I/O above 4 GB	Enables or disables the support for the PCIe devices that need large amounts of memory. Enable this option only for 64-bit operating systems. This option is set to Enabled by default.

Serial Communication

You can use the **Serial Communication** screen to view the properties of the serial communication port.

Viewing Serial Communication

To view the **Serial Communication** screen, perform the following steps:

Steps

1. Power on, or restart your system.
2. Press F2 immediately after you see the following message:

```
F2 = System Setup
```

 **NOTE:** If your operating system begins to load before you press F2, wait for the system to finish booting, and then restart your system and try again.

3. On the **System Setup Main Menu** screen, click **System BIOS**.
4. On the **System BIOS** screen, click **Serial Communication**.

Serial Communication details

About this task

The **Serial Communication** screen details are explained as follows:

Option	Description
Serial Port Address	<p>Enables you to set the port address for serial device. This field sets the serial port address to either COM1 or COM2 (COM1=0x3F8, COM2=0x2F8).</p> <p>NOTE: You can use only Serial Device 2 for the Serial Over LAN (SOL) feature. To use console redirection by SOL, configure the same port address for console redirection and the serial device.</p> <p>NOTE: Every time the system boots, the BIOS syncs the serial MUX setting saved in iDRAC. The serial MUX setting can independently be changed in iDRAC. Loading the BIOS default settings from within the BIOS setup utility may not always revert the serial MUX setting to the default setting of Serial Device 1.</p>
Failsafe Baud Rate	<p>Specifies the failsafe baud rate for console redirection. The BIOS attempts to determine the baud rate automatically. This failsafe baud rate is used only if the attempt fails, and the value must not be changed. This option is set to 115200 by default.</p>
Remote Terminal Type	<p>Enables you to set the remote console terminal type. This option is set to VT100/VT220 by default.</p>
Redirection After Boot	<p>Enables or disables the BIOS console redirection when the operating system is loaded. This option is set to Enabled by default.</p>

System Profile Settings

You can use the **System Profile Settings** screen to enable specific system performance settings such as power management.

Viewing System Profile Settings

To view the **System Profile Settings** screen, perform the following steps:

Steps

1. Power on, or restart your system.
2. Press F2 immediately after you see the following message:

```
F2 = System Setup
```

NOTE: If your operating system begins to load before you press F2, wait for the system to finish booting, and then restart your system and try again.





3. On the **System Setup Main Menu** screen, click **System BIOS**.
4. On the **System BIOS** screen, click **System Profile Settings**.

System Profile Settings details

About this task

The **System Profile Settings** screen details are explained as follows:

Option	Description
System Profile	<p>Sets the system profile. If you set the System Profile option to a mode other than Custom, the BIOS automatically sets the rest of the options. You can only change the rest of the options if the mode is set to Custom. This option is set to Performance Per Watt Optimized (DAPC) by default. DAPC is Dell Active Power Controller.</p>

Option	Description
	<p> NOTE: All the parameters on the system profile setting screen are available only when the System Profile option is set to Custom.</p>
CPU Power Management	Sets the CPU power management. This option is set to System DBPM (DAPC) by default. DBPM is Demand-Based Power Management.
Memory Frequency	Sets the speed of the system memory. You can select Maximum Performance , Maximum Reliability , or a specific speed. This option is set to Maximum Performance by default.
Turbo Boost	Enables or disables the processor to operate in the turbo boost mode. This option is set to Enabled by default.
C1E	Enables or disables the processor to switch to a minimum performance state when it is idle. This option is set to Enabled by default.
Write Data CRC	Enables or disables the Write Data CRC. This option is set to Disabled by default.
Memory Patrol Scrub	Sets the memory patrol scrub frequency. This option is set to Standard by default.
Memory Refresh Rate	Sets the memory refresh rate to either 1x or 2x. This option is set to 1x by default.
Uncore Frequency	Enables you to select the Processor Uncore Frequency option. Dynamic mode enables the processor to optimize power resources across cores and uncores during runtime. The optimization of the uncore frequency to either save power or optimize performance is influenced by the setting of the Energy Efficiency Policy option.
Energy Efficient Policy	Enables you to select the Energy Efficient Policy option. The CPU uses the setting to manipulate the internal behavior of the processor and determines whether to target higher performance or better power savings. This option is set to Balanced Performance by default.
Number of Turbo Boost Enabled Cores for Processor 1	<p> NOTE: If there are two processors installed in the system, you will see an entry for Number of Turbo Boost Enabled Cores for Processor 2.</p> <p> NOTE: If there are four processors installed in the system, you will see an entry for Number of Turbo Boost Enabled Cores for Processor 4.</p> <p>Controls the number of turbo boost enabled cores for Processor 1. The maximum number of cores is enabled by default.</p>
Monitor/Mwait	Enables the Monitor/Mwait instructions in the processor. This option is set to Enabled for all system profiles, except Custom by default.  NOTE: This option can be disabled only if the C States option in the Custom mode is set to disabled .  NOTE: When C States is set to Enabled in the Custom mode, changing the Monitor/Mwait setting does not impact the system power or performance.
CPU Interconnect Bus Link Power Management	Enables or disables the CPU Interconnect Bus Link Power Management. This option is set to Enabled by default.
PCI ASPM L1 Link Power Management	Enables or disables the PCI ASPM L1 Link Power Management. This option is set to Enabled by default.
Intel Persistent Memory CR QoS	Enables you to select the tuning Method 1 for QoS knobs and is recommended for 2-2-2 memory configuration in active directory, Method 2 for QoS knobs and is recommended for other memory configuration in active directory or Method 3 for QoS knobs and is recommended for 1 DIMM per channel configuration. This option is set to Disabled by default.
Intel Persistent Memory	Enables you to select the NVMe performance settings depending on the workload behavior. If this option is set to BW Optimized , the performance is optimized for DDR and DDRT bandwidth. If this option is set

Option	Description
Performance Setting	to Latency Optimized , the performance is better DDR latency. This option is set to BW Optimized by default.

System Security

You can use the **System Security** screen to perform specific functions such as setting the system password, setup password and disabling the power button.

Viewing System Security

To view the **System Security** screen, perform the following steps:

Steps

1. Power on, or restart your system.
2. Press F2 immediately after you see the following message:

```
F2 = System Setup
```

NOTE: If your operating system begins to load before you press F2, wait for the system to finish booting, and then restart your system and try again.

3. On the **System Setup Main Menu** screen, click **System BIOS**.
4. On the **System BIOS** screen, click **System Security**.

System Security Settings details

About this task

The **System Security Settings** screen details are explained as follows:

Option	Description
CPU AES-NI	Improves the speed of applications by performing encryption and decryption by using the Advanced Encryption Standard Instruction Set (AES-NI). This option is set to Enabled by default.
System Password	Enables you to set the system password. This option is read-only if the password jumper is not installed in the system.
Setup Password	Enables you to set the system setup password. This option is read-only if the password jumper is not installed in the system.
Password Status	Enables you to lock the system password. This option is set to Unlocked by default.
TPM Security	NOTE: The TPM menu is available only when the TPM module is installed. Enables you to control the reporting mode of the TPM. The TPM Security option is set to Off by default. You can only modify the TPM Status TPM Activation, and the Intel TXT fields if the TPM Status field is set to either On with Pre-boot Measurements or On without Pre-boot Measurements .
TPM Information	Enables you to change the operational state of the TPM. This option is set to Type: 1.2-NTC by default.
Intel(R) TXT	Enables you to set the Intel Trusted Execution Technology (TXT) option. To enable the Intel TXT option, virtualization technology and TPM Security must be enabled with Pre-boot measurements. This option is set to Off by default.
Power Button	Enables you to set the power button on the front of the system. This option is set to Enabled by default.
AC Power Recovery	Sets how the system behaves after AC power is restored to the system. This option is set to Last by default.

Option	Description								
UEFI Variable Access	Provides varying degrees of securing UEFI variables. When set to Standard (the default), UEFI variables are accessible in the operating system per the UEFI specification. When set to Controlled , selected UEFI variables are protected in the environment, and new UEFI boot entries are forced to be at the end of the current boot order.								
Secure Boot	Enables Secure Boot, where the BIOS authenticates each pre-boot image by using the certificates in the Secure Boot Policy. Secure Boot is set to Disabled by default.								
Secure Boot Policy	When Secure Boot policy is set to Standard , the BIOS uses the system manufacturer key and certificates to authenticate pre-boot images. When Secure Boot policy is set to Custom , the BIOS uses the user-defined key and certificates. Secure Boot policy is set to Standard by default.								
Secure Boot Mode	Enables you to configure how the BIOS uses the Secure Boot Policy Objects (PK, KEK, db, dbx). If the current mode is set to Deployed Mode , the available options are User Mode and Deployed Mode . If the current mode is set to User Mode , the available options are User Mode , Audit Mode , and Deployed Mode .								
	<table border="1"> <thead> <tr> <th>Options</th> <th>Description</th> </tr> </thead> <tbody> <tr> <td>User Mode</td> <td>In User Mode, PK must be installed, and BIOS performs signature verification on programmatic attempts to update policy objects. BIOS allows unauthenticated programmatic transitions between modes.</td> </tr> <tr> <td>Audit Mode</td> <td>In Audit mode, PK is not present. BIOS does not authenticate programmatic updates to the policy objects, and transitions between modes. Audit Mode is useful for programmatically determining a working set of policy objects. BIOS performs signature verification on pre-boot images. BIOS also logs the results in the image Execution Information Table, but approves the images whether they pass or fail verification.</td> </tr> <tr> <td>Deployed Mode</td> <td>Deployed Mode is the most secure mode. In Deployed Mode, PK must be installed and the BIOS performs signature verification on programmatic attempts to update policy objects. Deployed Mode restricts the programmatic mode transitions.</td> </tr> </tbody> </table>	Options	Description	User Mode	In User Mode , PK must be installed, and BIOS performs signature verification on programmatic attempts to update policy objects. BIOS allows unauthenticated programmatic transitions between modes.	Audit Mode	In Audit mode , PK is not present. BIOS does not authenticate programmatic updates to the policy objects, and transitions between modes. Audit Mode is useful for programmatically determining a working set of policy objects. BIOS performs signature verification on pre-boot images. BIOS also logs the results in the image Execution Information Table, but approves the images whether they pass or fail verification.	Deployed Mode	Deployed Mode is the most secure mode. In Deployed Mode , PK must be installed and the BIOS performs signature verification on programmatic attempts to update policy objects. Deployed Mode restricts the programmatic mode transitions.
Options	Description								
User Mode	In User Mode , PK must be installed, and BIOS performs signature verification on programmatic attempts to update policy objects. BIOS allows unauthenticated programmatic transitions between modes.								
Audit Mode	In Audit mode , PK is not present. BIOS does not authenticate programmatic updates to the policy objects, and transitions between modes. Audit Mode is useful for programmatically determining a working set of policy objects. BIOS performs signature verification on pre-boot images. BIOS also logs the results in the image Execution Information Table, but approves the images whether they pass or fail verification.								
Deployed Mode	Deployed Mode is the most secure mode. In Deployed Mode , PK must be installed and the BIOS performs signature verification on programmatic attempts to update policy objects. Deployed Mode restricts the programmatic mode transitions.								
Secure Boot Policy Summary	Specifies the list of certificates and hashes that secure boot uses to authenticate images.								
Secure Boot Custom Policy Settings	Configures the Secure Boot Custom Policy. To enable this option, set the Secure Boot Policy to Custom .								

Creating a system and setup password

Prerequisites

Ensure that the password jumper is enabled. The password jumper enables or disables the system password and setup password features. For more information, see the System board jumper settings section.

 **NOTE:** If the password jumper setting is disabled, the existing system password and setup password are deleted and you need not provide the system password to boot the system.

Steps

1. To enter System Setup, press F2 immediately after turning on or rebooting your system.
2. On the **System Setup Main Menu** screen, click **System BIOS > System Security**.
3. On the **System Security** screen, verify that **Password Status** is set to **Unlocked**.
4. In the **System Password** field, type your system password, and press Enter or Tab.
Use the following guidelines to assign the system password:

- A password can have up to 32 characters.
- The password can contain the numbers 0 through 9.
- Only the following special characters are allowed: space, ("), (+), (.), (-), (.), (/), (;), ([), (\), (]), (`).

A message prompts you to reenter the system password.

5. Reenter the system password, and click **OK**.
6. In the **Setup Password** field, type your setup password and press Enter or Tab. A message prompts you to reenter the setup password.
7. Reenter the setup password, and click **OK**.
8. Press Esc to return to the System BIOS screen. Press Esc again. A message prompts you to save the changes.

 **NOTE:** Password protection does not take effect until the system reboots.

Using your system password to secure the system

About this task

If you have assigned a setup password, the system accepts your setup password as an alternate system password.

Steps

1. Power on or reboot your system.
2. Type the system password and press Enter.

Next steps

When **Password Status** is set to **Locked**, type the system password and press Enter when prompted at reboot.

 **NOTE:** If an incorrect system password is typed, the system displays a message and prompts you to reenter your password. You have three attempts to type the correct password. After the third unsuccessful attempt, the system displays an error message that the system has stopped functioning and must be turned off. Even after you turn off and restart the system, the error message is displayed until the correct password is entered.

Deleting or changing system and setup password

Prerequisites

 **NOTE:** You cannot delete or change an existing system or setup password if the **Password Status** is set to **Locked**.

Steps

1. To enter System Setup, press F2 immediately after turning on or restarting your system.
2. On the **System Setup Main Menu** screen, click **System BIOS > System Security**.
3. On the **System Security** screen, ensure that **Password Status** is set to **Unlocked**.
4. In the **System Password** field, change or delete the existing system password, and then press Enter or Tab.
5. In the **Setup Password** field, alter or delete the existing setup password, and then press Enter or Tab.

 **NOTE:** If you change the system password or setup password, a message prompts you to reenter the new password. If you delete the system password or setup password, a message prompts you to confirm the deletion.
6. Press Esc to return to the **System BIOS** screen. Press Esc again, and a message prompts you to save the changes.
7. Select **Setup Password**, change, or delete the existing setup password and press Enter or Tab.

 **NOTE:** If you change the system password or setup password, a message prompts you to reenter the new password. If you delete the system password or setup password, a message prompts you to confirm the deletion.

Operating with setup password enabled

If **Setup Password** is set to **Enabled**, type the correct setup password before modifying the system setup options.

If you do not type the correct password in three attempts, the system displays the following message:

```
Invalid Password! Number of unsuccessful password attempts: <x> System Halted! Must power down.
```

```
Password Invalid. Number of unsuccessful password attempts: <x> Maximum number of password attempts exceeded. System halted.
```

Even after you restart the system, the error message is displayed until the correct password is typed. The following options are exceptions:

- If **System Password** is not set to **Enabled** and is not locked through the **Password Status** option, you can assign a system password. For more information, see the [System Security Settings details](#) section.
- You cannot disable or change an existing system password.

 **NOTE:** You can use the password status option with the setup password option to protect the system password from unauthorized changes.

Redundant OS Control

In the **Redundant OS Control** screen you can set the redundant OS information. This enables you to set up a physical recovery disk on the system.

Viewing Redundant OS Control

To view the **Redundant OS Control** screen, perform the following steps:

Steps

1. Power on, or restart your system.
2. Press F2 immediately after you see the following message:

```
F2 = System Setup
```

 **NOTE:** If your operating system begins to load before you press F2, wait for the system to finish booting, and then restart your system and try again.

3. On the **System Setup Main Menu** screen, click **System BIOS**.
4. On the **System BIOS** screen, click **Redundant OS Control**.

Redundant OS Control screen details

The **Redundant OS Control** screen details are explained as follows:

About this task

Option	Description
Redundant OS Location	Enables you to select a backup disk from the following devices: <ul style="list-style-type: none">• None• IDSDM• SATA Ports in AHCI mode• BOSS PCIe Cards (Internal M.2 Drives)• Internal USB

Option	Description
	<p>NOTE: RAID configurations and NVMe cards not are included as BIOS does not have the ability to distinguish between individual drives in those configurations.</p>
Redundant OS State	<p>NOTE: This option is disabled if Redundant OS Location is set to None.</p> <p>When set to Visible, the backup disk is visible to the boot list and OS. When set to Hidden, the backup disk is disabled and is not visible to the boot list and OS. This option is set to Visible by default.</p> <p>NOTE: BIOS will disable the device in hardware, so it cannot be accessed by the OS.</p>
Redundant OS Boot	<p>NOTE: This option is disabled if Redundant OS Location is set to None or if Redundant OS State is set to Hidden.</p> <p>When set to Enabled, BIOS boots to the device specified in Redundant OS Location. When set to Disabled, BIOS preserves the current boot list settings. This option is set to Disabled by default.</p>

Miscellaneous Settings

You can use the **Miscellaneous Settings** screen to perform specific functions such as updating the asset tag and changing the system date and time.

Viewing Miscellaneous Settings

To view the **Miscellaneous Settings** screen, perform the following steps:

Steps

1. Power on, or restart your system.
2. Press F2 immediately after you see the following message:

```
F2 = System Setup
```

NOTE: If your operating system begins to load before you press F2, wait for the system to finish booting, and then restart your system and try again.

3. On the **System Setup Main Menu** screen, click **System BIOS**.
4. On the **System BIOS** screen, click **Miscellaneous Settings**.

Miscellaneous Settings details

About this task

The **Miscellaneous Settings** screen details are explained as follows:

Option	Description
System Time	Enables you to set the time on the system.
System Date	Enables you to set the date on the system.
Asset Tag	Specifies the asset tag and enables you to modify it for security and tracking purposes.
Keyboard NumLock	<p>Enables you to set whether the system should boot with the NumLock enabled or disabled. This option is set to On by default.</p> <p>NOTE: This option does not apply to 84-key keyboards.</p>
F1/F2 Prompt on Error	Enables or disables the F1/F2 prompt on error. This option is set to Enabled by default. The F1/F2 prompt also includes keyboard errors.

Option	Description
Load Legacy Video Option ROM	Enables you to determine whether the system BIOS loads the legacy video (INT 10H) option ROM from the video controller. Selecting Enabled in the operating system does not support UEFI video output standards. This field is available only for UEFI boot mode. You cannot set the option to Enabled if UEFI Secure Boot mode is enabled. This option is set to Disabled by default.
Dell Wyse P25/P45 BIOS Access	Enables or disables the Dell Wyse P25/P45 BIOS Access. This option is set to Enabled by default.

iDRAC Settings utility

The iDRAC settings utility is an interface to set up and configure the iDRAC parameters by using UEFI. You can enable or disable various iDRAC parameters by using the iDRAC settings utility.

 **NOTE:** Accessing some of the features on the iDRAC settings utility needs the iDRAC Enterprise License upgrade.

For more information about using iDRAC, see *Dell Integrated Dell Remote Access Controller User's Guide* at www.dell.com/poweredgemanuals.

Device Settings

Device Settings enables you to configure the below device parameters:

- Controller Configuration Utility
- Embedded NIC Port1-X Configuration
- NICs in slotX, Port1-X Configuration
- BOSS Card configuration

Dell Lifecycle Controller

Dell Lifecycle Controller (LC) provides advanced embedded systems management capabilities including system deployment, configuration, update, maintenance, and diagnosis. LC is delivered as part of the iDRAC out-of-band solution and Dell system embedded Unified Extensible Firmware Interface (UEFI) applications.

Embedded system management

The Dell Lifecycle Controller provides advanced embedded system management throughout the lifecycle of the system. The Dell Lifecycle Controller can be started during the boot sequence and can function independently of the operating system.

 **NOTE:** Certain platform configurations may not support the full set of features provided by the Dell Lifecycle Controller.

For more information about setting up the Dell Lifecycle Controller, configuring hardware and firmware, and deploying the operating system, see the Dell Lifecycle Controller documentation at www.dell.com/poweredgemanuals.

Boot Manager

The **Boot Manager** screen enables you to select boot options and diagnostic utilities.

Viewing Boot Manager

About this task

To enter Boot Manager:

Steps

1. Power on, or restart your system.
2. Press F11 when you see the following message:

F11 = Boot Manager

If your operating system begins to load before you press F11, allow the system to complete the booting, and then restart your system and try again.

Boot Manager main menu

Menu item	Description
Continue Normal Boot	The system attempts to boot to devices starting with the first item in the boot order. If the boot attempt fails, the system continues with the next item in the boot order until the boot is successful or no more boot options are found.
One-shot Boot Menu	Enables you to access boot menu, where you can select a one-time boot device to boot from.
Launch System Setup	Enables you to access System Setup.
Launch Lifecycle Controller	Exits the Boot Manager and invokes the Dell Lifecycle Controller program.
System Utilities	Enables you to launch System Utilities menu such as System Diagnostics and UEFI shell.

One-shot UEFI boot menu

One-shot UEFI boot menu enables you to select a boot device to boot from.

System Utilities

System Utilities contains the following utilities that can be launched:

- Launch Diagnostics
- BIOS Update File Explorer
- Reboot System

PXE boot

You can use the Preboot Execution Environment (PXE) option to boot and configure the networked systems, remotely.

To access the **PXE boot** option, boot the system and then press F12 during POST instead of using standard Boot Sequence from BIOS Setup. It does not pull any menu or allows managing of network devices.

Installing and removing system components

Topics:

- Safety instructions
- Before working inside your system
- After working inside your system
- Recommended tools
- Sled
- Air shroud
- Cooling fan
- PCIe card module
- Cable M.2 riser card
- Motherboard bridge module
- Motherboard interposer board
- Sled cables kit
- Motherboard bridge board
- Mini PERC card module
- Mini PERC card battery
- Mini PERC card
- Mini PERC adaptor board
- Mini PERC riser board
- System memory
- Expansion cards and expansion card risers
- Processor and heat sink
- Network daughter card
- System battery
- System board
- Trusted Platform Module

Safety instructions

 **NOTE:** To avoid injury, do not lift the system on your own, get others to assist you.

 **WARNING:** Opening or removing the system cover while the system is turned on may expose you to a risk of electric shock.

 **CAUTION:** Do not operate the system without the cover for a duration exceeding five minutes. Operating the system without the system cover can result in component damage.

 **CAUTION:** Many repairs may only be done by a certified service technician. You should only perform troubleshooting and simple repairs as authorized in your product documentation, or as directed by the online or telephone service and support team. Damage due to servicing that is not authorized by Dell is not covered by your warranty. Read and follow the safety instructions that are shipped with your product.

 **CAUTION:** To ensure proper operation and cooling, all bays in the system and system fans must be always populated with a component or a blank.

 **NOTE:** It is recommended that you always use an antistatic mat and antistatic strap while working on components inside the system.

- NOTE:** While replacing the hot swappable PSU, after next server boot; the new PSU automatically updates to the same firmware and configuration of the replaced one. For more information about the Part replacement configuration, see the *Lifecycle Controller User's Guide* at <https://www.dell.com/idracmanuals>
- NOTE:** While replacing faulty storage controller/FC/NIC card with the same type of card, after you power on the system; the new card automatically updates to the same firmware and configuration of the faulty one. For more information about the Part replacement configuration, see the *Lifecycle Controller User's Guide* at <https://www.dell.com/idracmanuals>

Before working inside your system

Prerequisites

Follow the safety guidelines listed in [Safety instruction](#).

Steps

1. Power off the system and all attached peripherals.
2. Disconnect the system from the electrical outlet, and disconnect the peripherals.
3. If applicable, remove the system from the rack.

For more information, see the *Rail Installation Guide* relevant to your rail solutions at www.dell.com/xemanuals.

After working inside your system

Prerequisites

Follow the safety guidelines listed in [Safety instruction](#).

Steps

1. If applicable, install the system into the rack.
For more information, see the *Rail Installation Guide* relevant to your rail solutions at www.dell.com/xemanuals.
2. Reconnect the peripherals, and connect the system to the electrical outlet, and then power on the system.

Recommended tools

You need the following tools to perform the removal and installation procedures:

- Phillips #1 screwdriver
- Phillips #2 screwdriver
- Torx #T30 screwdriver
- 5mm hex nut screwdriver
- Plastic scribe
- 1/4 inch flat blade screwdriver
- Wrist grounding strap connected to the ground
- ESD mat

Sled

Removing the sled

Prerequisites

1. Follow the safety guidelines listed in [Safety instructions](#).
2. Follow the procedure listed in the [Before working inside your system](#).

Steps

1. Loosen the captive screws and rotate the levers.
2. Using sled pull handle, slide the sled out of the enclosure.

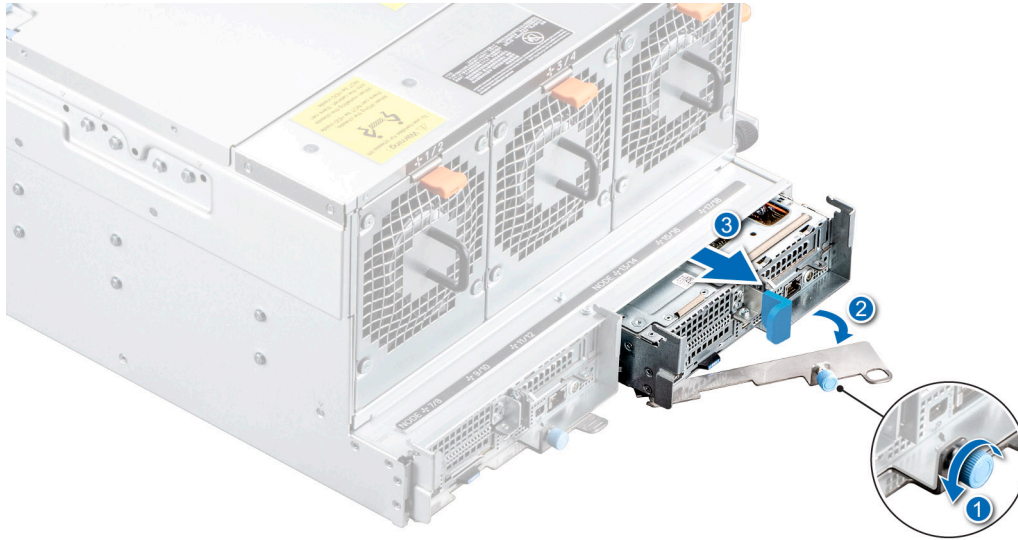

Figure 12. Removing the sled

Next steps

1. [Install the sled.](#)

Installing the sled

Prerequisites

Follow the safety guidelines listed in [Safety instructions](#).

Steps

1. Hold the sled on both sides and slide the sled into the enclosure until the sled is locked to enclosure.
2. Rotate the captive screw clockwise to tighten it.

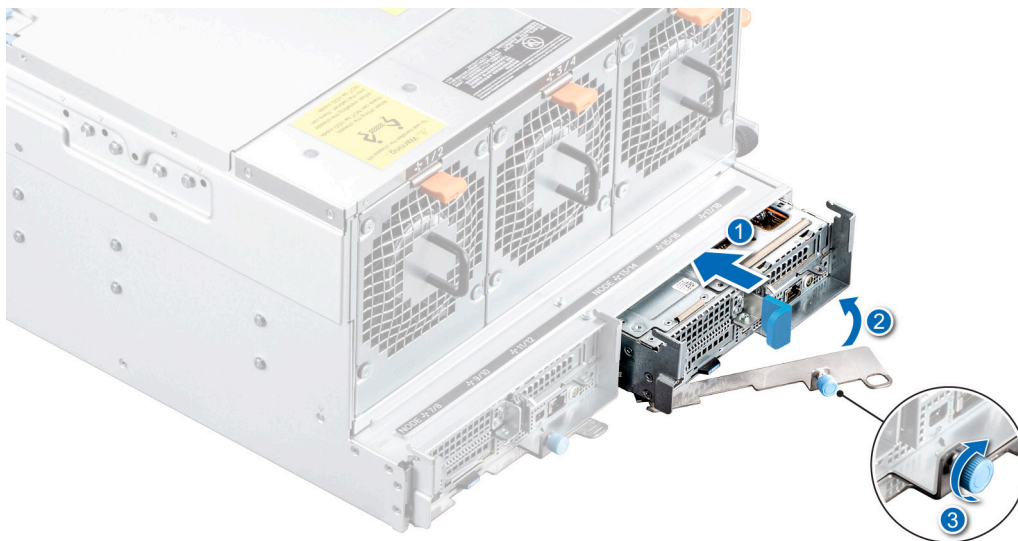

Figure 13. Installing the sled

Next steps

Follow the procedure listed in [After working inside your system.](#)

Air shroud

Removing the air shroud

Prerequisites

CAUTION: Never operate your system with the air shroud removed. The system may get overheated quickly, resulting in shutdown of the system and loss of data.

1. Follow the safety guidelines listed in the [Safety instructions](#).
2. Follow the procedure listed in the [Before working inside your system](#).
3. [Remove the sled](#).

Steps

1. Hold the air shroud touch points at both ends and lift the air shroud out of the system.
2. Push the retention clip down and lift the mini PERC battery out of the air shroud.

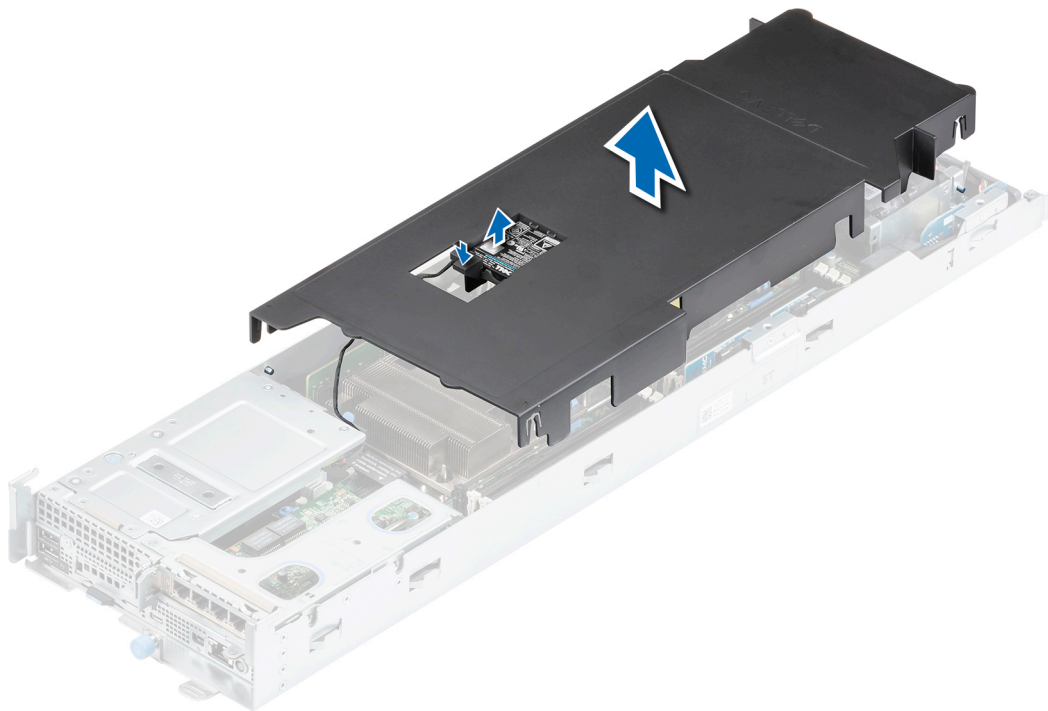

Figure 14. Removing the air shroud

Next steps

[Install the air shroud](#).

Installing the air shroud

Prerequisites

1. Follow the safety guidelines listed in the [Safety instructions](#).
2. Follow the procedure listed in the [Before working inside your system](#).

Steps

1. Push down the retention clip and insert the battery into the air shroud.
2. Hold the touch points and install the air shroud to system.

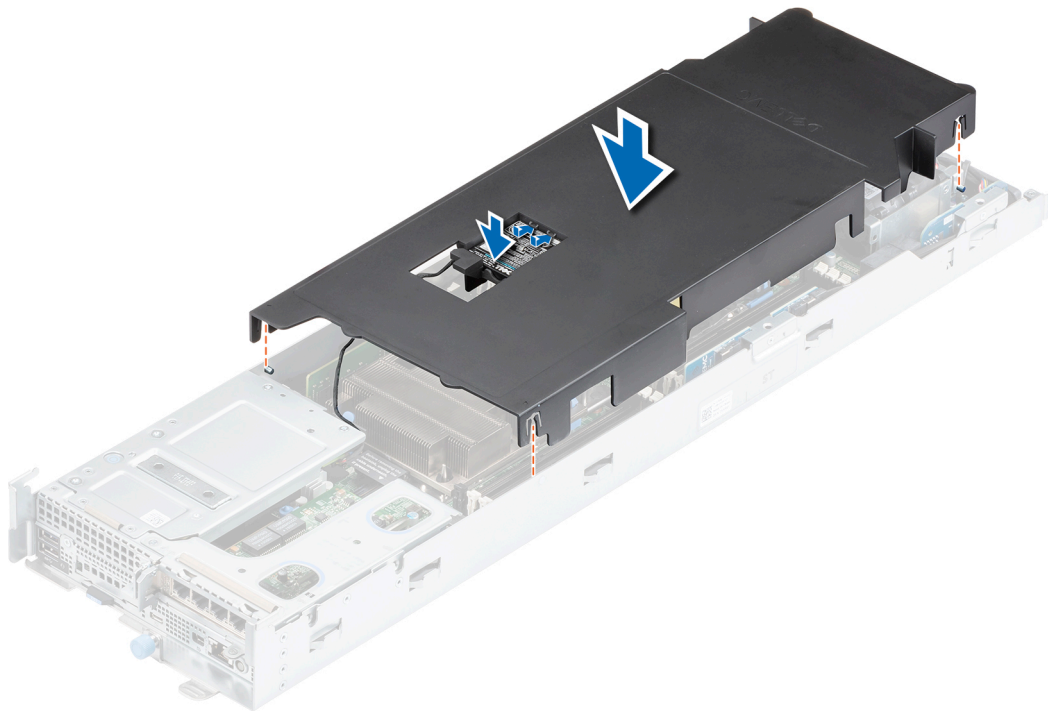

Figure 15. Installing the air shroud

Next steps

Follow the procedure listed in [After working inside your system](#).

Cooling fan

Removing a cooling fan

Prerequisites

1. Follow the safety guidelines listed in the [Safety instructions](#).
2. Follow the procedure listed in the [Before working inside your system](#).

3. Remove the sled from the enclosure.
4. Remove the air shroud.

Steps

1. Disconnect the fan cable that is connected to the motherboard bridge connector.
2. Lift the cooling fan out of cooling fan cage assembly.

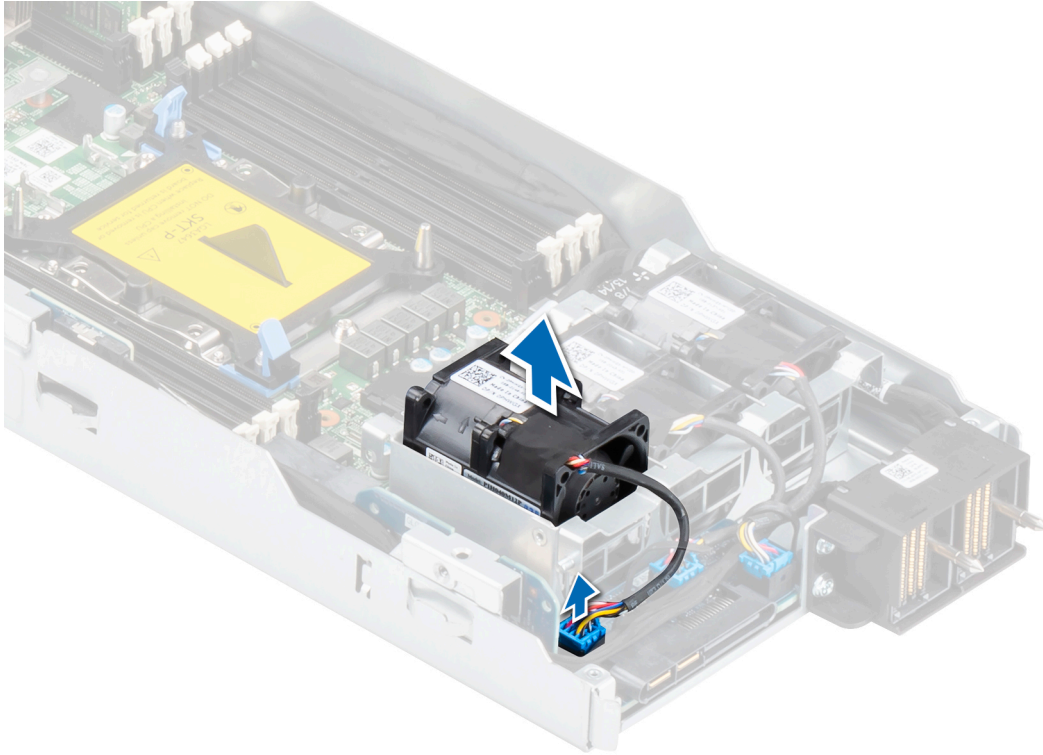

Figure 16. Removing a cooling fan

Next steps

Install a cooling fan.

Installing a cooling fan

Prerequisites

1. Follow the safety guidelines listed in the [Safety instructions](#).

Steps

1. Insert a cooling fan into the cooling fan cage assembly.
2. Connect the cooling fan cable to the motherboard bridge connector.

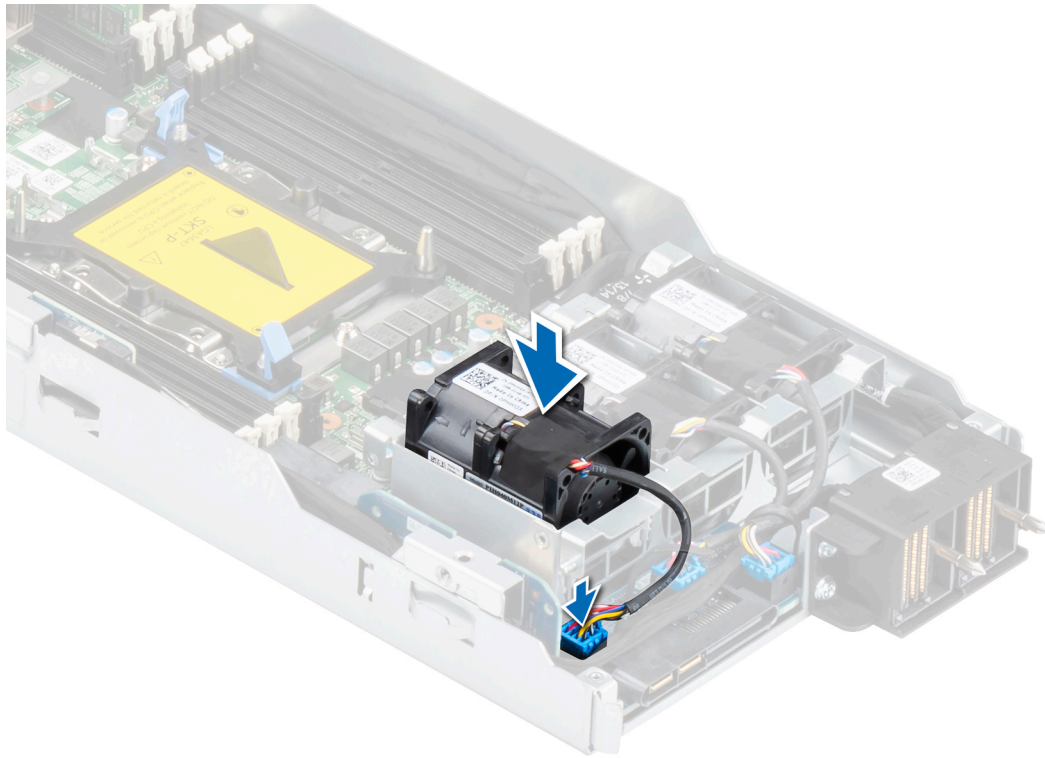

Figure 17. Installing a cooling fan

Next steps

1. [Install the air shroud.](#)
2. [Install the sled.](#)
3. Follow the procedure listed in [After working inside your system.](#)

PCIe card module

Removing the PCIe card module

Prerequisites

1. Follow the safety guidelines listed in [Safety instructions.](#)
2. Follow the procedure listed in the [Before working inside your system.](#)

Steps

1. Pull the sled out of the enclosure.
2. Remove the four screws securing the PCIe card module.
3. Lift the PCIe card module from the system board.

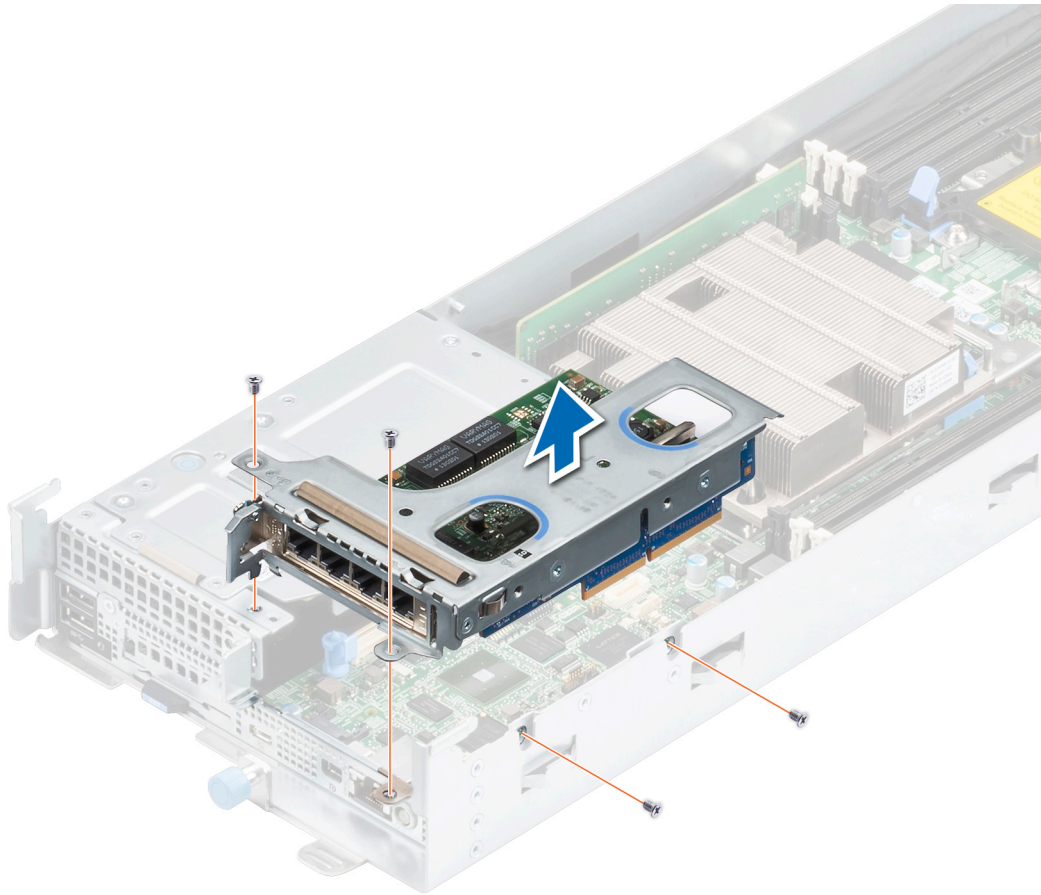

Figure 18. Removing the PCIe card module

4. Remove the screw securing the PCIe card to the bracket.
5. Pull the PCIe card out of the connector on the riser board.

Next steps

Install the PCIe card module.

Installing the PCIe card module

Prerequisites

1. Follow the safety guidelines listed in [Safety instructions](#).
2. Follow the procedure listed in the [Before working inside your system](#).

Steps

1. Insert and push the PCIe card into the internal riser board.
2. Tighten the screw to secure the PCIe card on the bracket.
3. Install the PCIe card module into the system board and press until the riser board fits into place.
4. Secure the PCIe card module with the four screws.

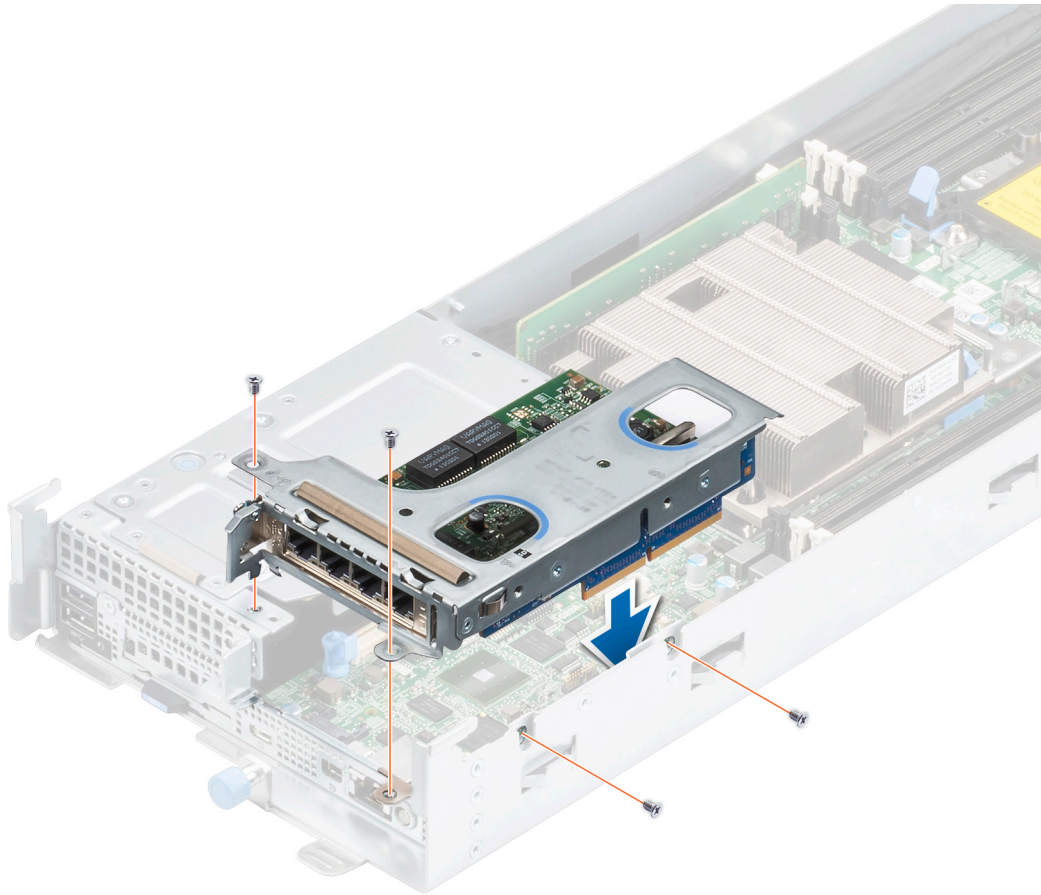

Figure 19. Installing the PCIe card module

Next steps

1. [Install the air shroud.](#)
2. [Install the sled.](#)
3. Follow the procedure listed in [After working inside your system.](#)

Cable M.2 riser card

Removing the cable M.2 riser board

Prerequisites

1. Follow the safety guidelines listed in the [Safety instructions.](#)
2. Follow the procedure listed in the [Before working inside your system.](#)
3. [Remove the sled.](#)
4. [Remove the air shroud.](#)

Steps

1. Using the Phillips #1 screwdriver, remove the screw that secures the M.2 riser board into system board.
2. Disconnect the SlimSAS cables from the M.2 riser board slots.

i **NOTE:** Observe the routing of the cable as you remove the M.2 riser board.

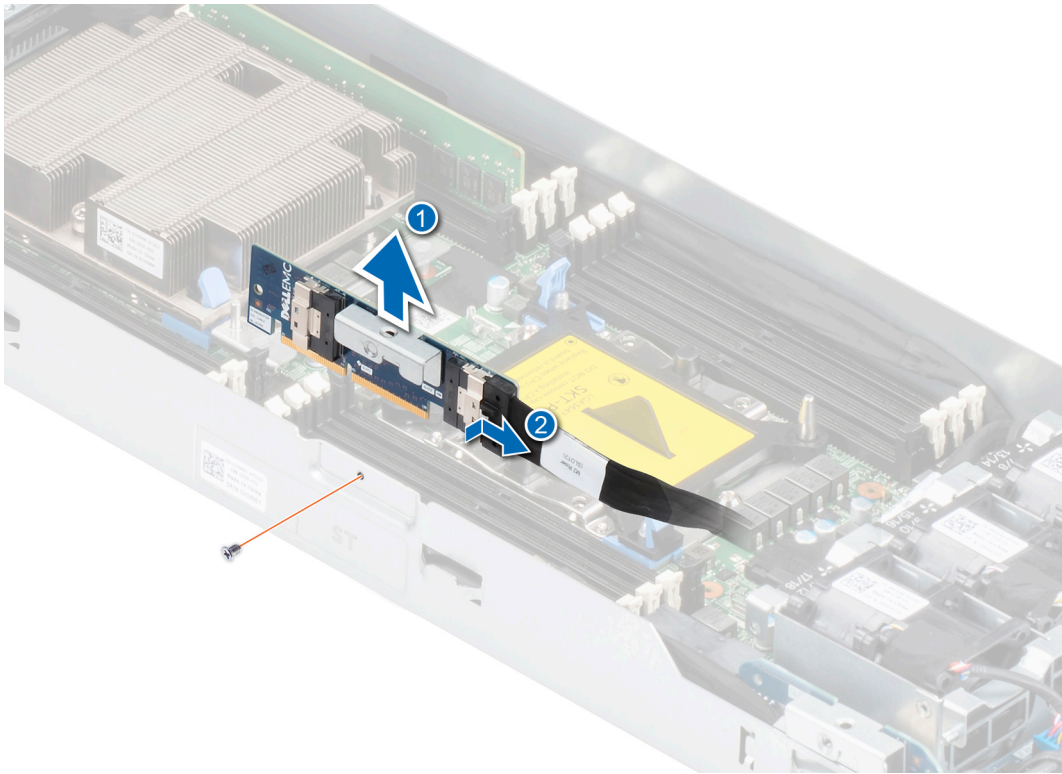

Figure 20. Removing the M.2 riser board

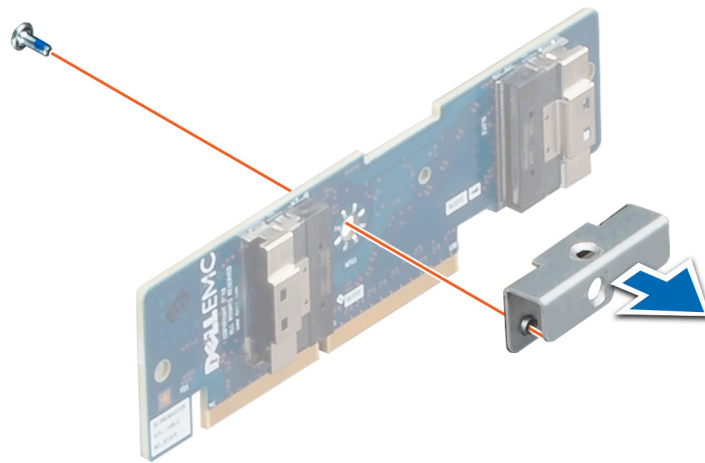

Figure 21. Removing the bracket

3. Remove the screw and separate the M.2 riser board from the bracket.

Next steps

Install the M.2 riser board.

Installing the cable M.2 riser board

Prerequisites

1. Follow the safety guidelines listed in the [Safety instructions](#).
2. Follow the procedure listed in the [Before working inside your system](#).

Steps

1. Place the bracket on the M.2 riser board and secure it by tightening the screw.
2. Connect the SlimSAS cable to the M.2 riser board.

NOTE: Route the cable properly to prevent the cable from being pinched or crimped.

3. Insert and push the M.2 riser board into the system board.
4. Using the Phillips #1 screwdriver, secure the M.2 riser board into the system board with the screw.

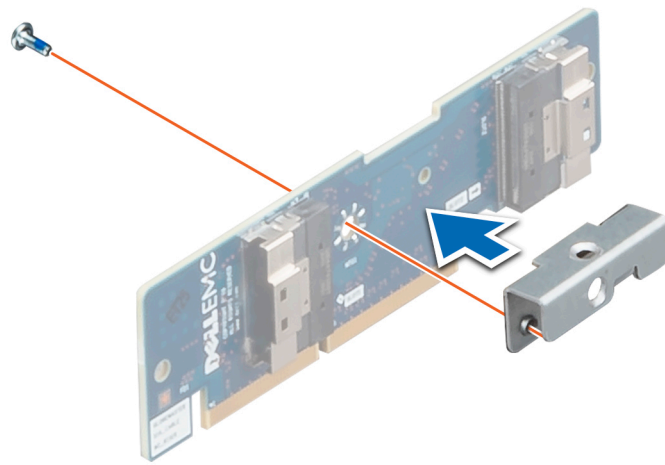

Figure 22. Installing the bracket

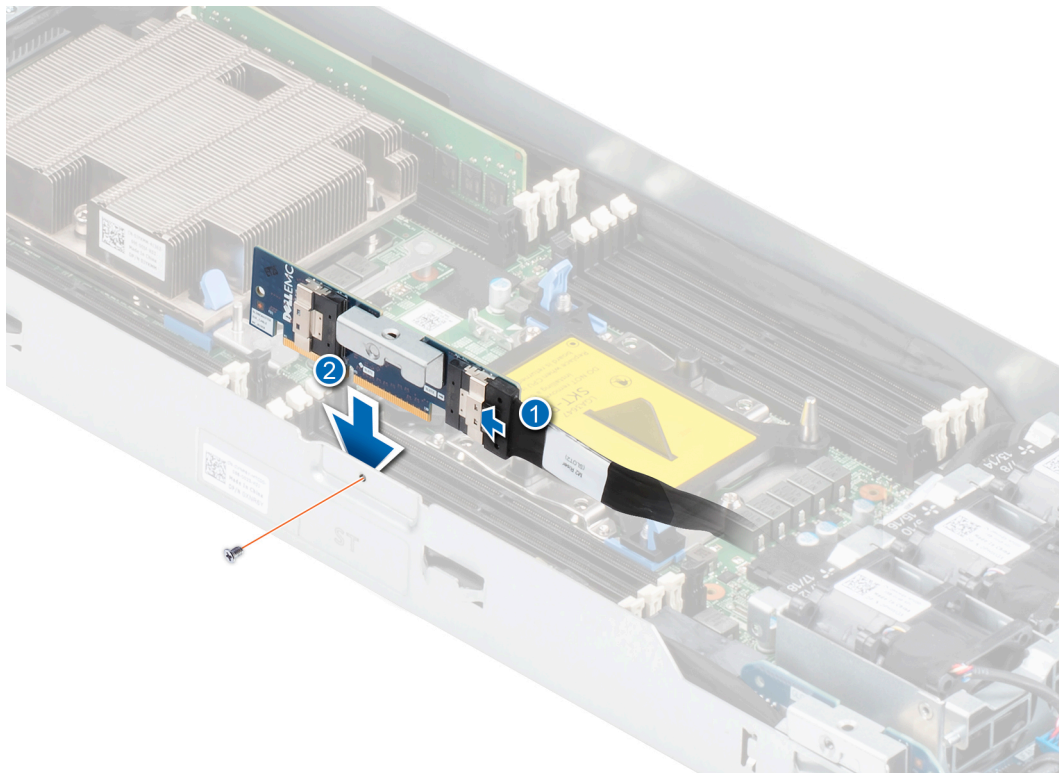

Figure 23. Installing the M.2 riser board

Next steps

1. [Install the air shroud.](#)
2. [Install the sled.](#)
3. Follow the procedure listed in [After working inside your system.](#)

Motherboard bridge module

Removing the motherboard bridge module

Prerequisites

1. Follow the safety guidelines listed in the [Safety instructions.](#)
2. Follow the procedure listed in the [Before working inside your system.](#)
3. [Remove the sled from the enclosure.](#)
4. [Remove the air shroud.](#)
5. [Remove the PCIe card module.](#)
6. [Remove the mini PERC module.](#)
7. [Remove the cable M.2 riser board.](#)
8. [Remove all the cooling fans.](#)

Steps

1. Using the Phillips #1 screwdriver, remove the two screws securing the motherboard bridge module to the sled.
2. Disconnect the cables.
3. Slide the motherboard bridge module out of the sled.

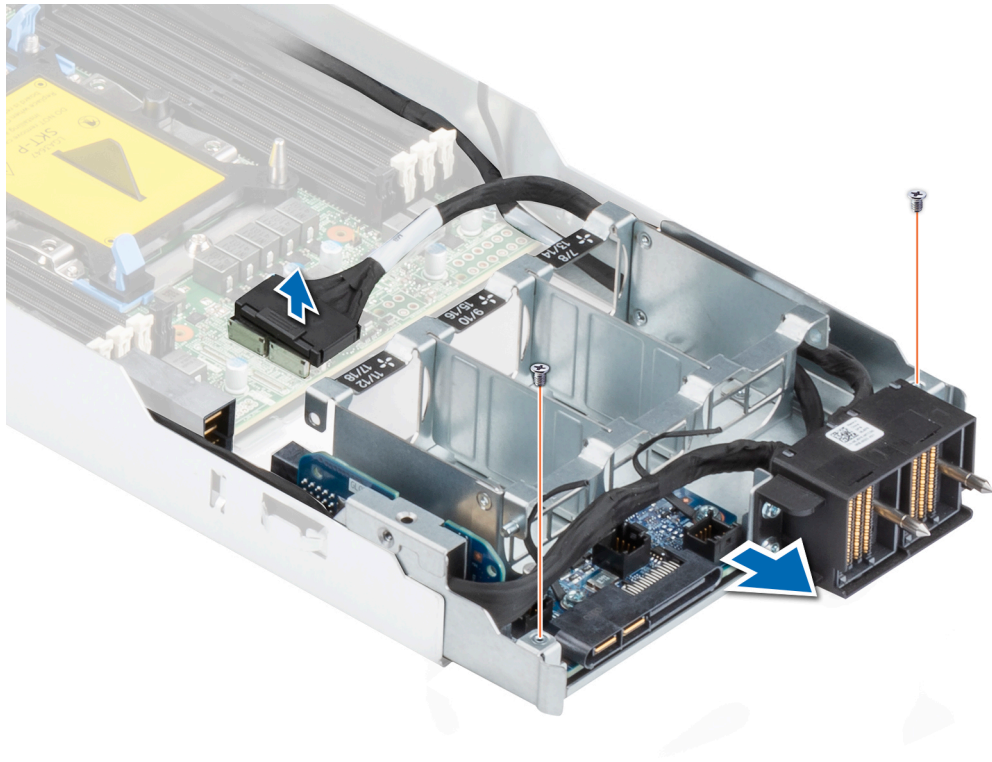

Figure 24. Removing the motherboard bridge module

Next steps

Install the motherboard bridge module.

Installing the motherboard bridge module

Prerequisites

1. Follow the safety guidelines listed in the [Safety instructions](#).
2. Follow the procedure listed in the [Before working inside your system](#).

Steps

1. Align and insert the motherboard bridge module into the sled.
2. Connect the cables.
3. Using the Phillips #1 screwdriver, secure the motherboard bridge module to the sled with two screws.

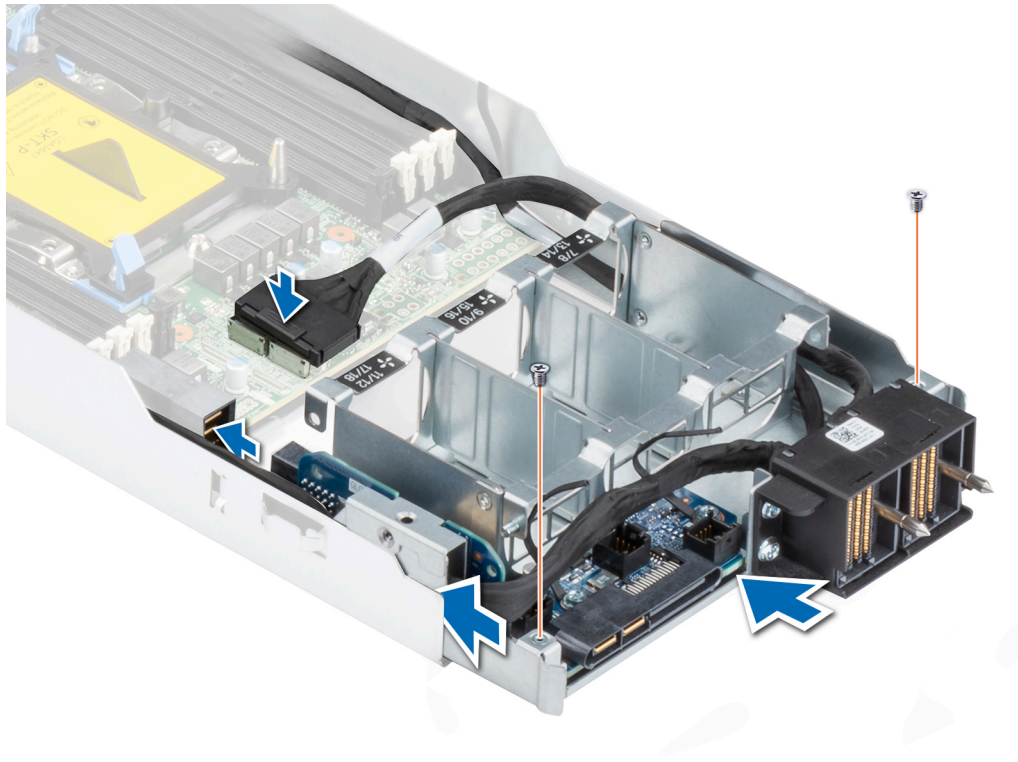

Figure 25. Installing the motherboard bridge module

Next steps

1. Install all the cooling fans.
2. Install the cable M.2 riser board.
3. Install the mini PERC card module.
4. Install the PCIe card module.
5. Install the air shroud.
6. Install the sled.
7. Follow the procedure listed in [After working inside your system](#).

Motherboard interposer board

Removing the motherboard interposer board

Prerequisites

1. Follow the safety guidelines listed in the [Safety instructions](#).
2. Follow the procedure listed in the [Before working inside your system](#).
3. [Remove the sled](#).
4. [Remove the air shroud](#).
5. [Remove the PCIe card module](#)
6. [Remove the mini PERC module](#).
7. [Remove the cable M.2 riser board](#).
8. [Remove all the cooling fans](#).
9. [Remove the motherboard bridge module](#).

Steps

1. Using the Phillips #1 screwdriver, remove the screw that secures the motherboard interposer board to the motherboard bridge module.
2. Pull out the motherboard interposer board from the motherboard bridge board.

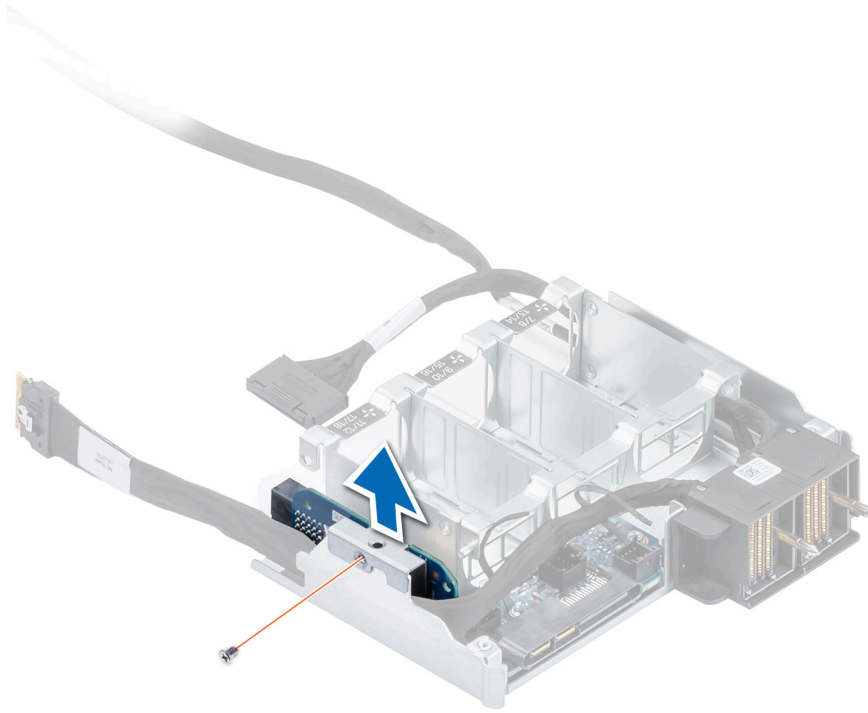

Figure 26. Removing the motherboard interposer board

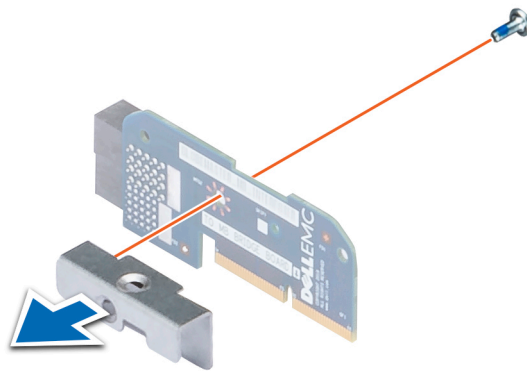

Figure 27. Removing the bracket

3. Remove the screw and separate the motherboard interposer board from the bracket.

Next steps

[Replace the motherboard interposer board](#)

Installing the motherboard interposer board

Prerequisites

1. Follow the safety guidelines listed in the [Safety instructions](#).
2. Follow the procedure listed in the [Before working inside your system](#).

Steps

1. Place the bracket on the motherboard interposer board and secure it by tightening the screw.

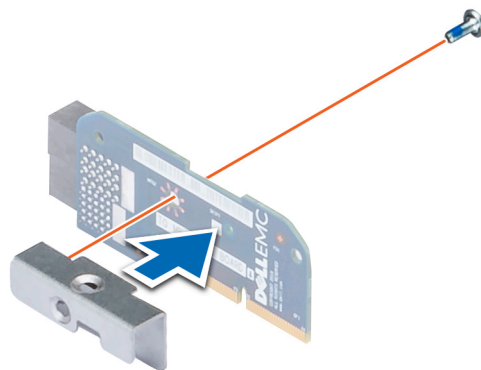

Figure 28. Installing the bracket

2. Insert the motherboard interposer board into the motherboard bridge board slot.
3. Using the Phillips #1 screwdriver, secure the motherboard interposer board to the motherboard bridge module with a screw.

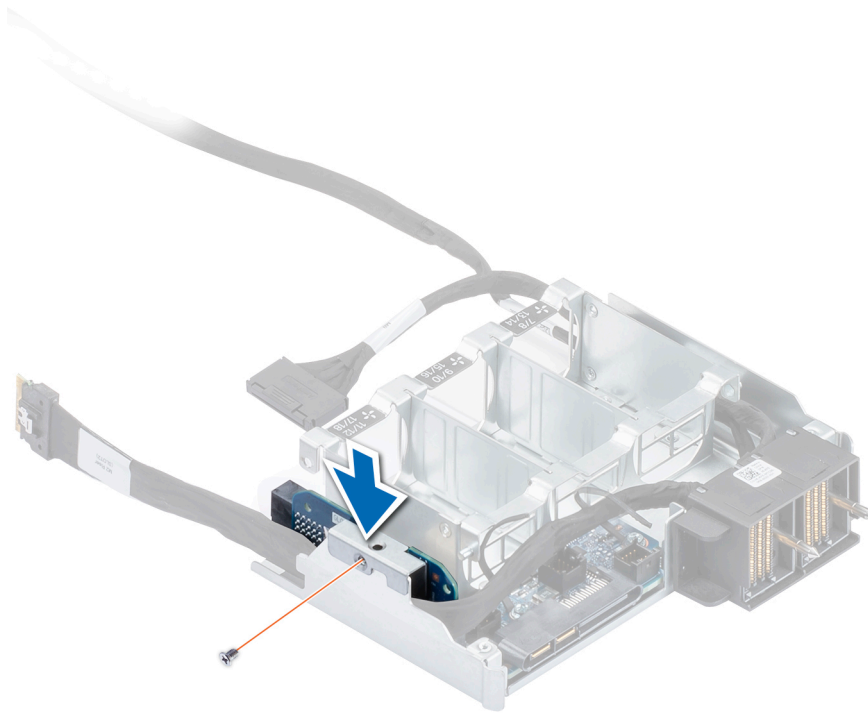

Figure 29. Installing the motherboard interposer board

Next steps

1. Install the motherboard bridge module.
2. Install all the cooling fans.
3. Install the cable M.2 riser board.
4. Install the mini PERC module.
5. Install the PCIe card module.
6. Install the air shroud.
7. Install the sled.
8. Follow the procedure listed in [After working inside your system](#).

Sled cables kit

Removing the sled cables kit

Prerequisites

1. Follow the safety guidelines listed in the [Safety instructions](#).
2. Follow the procedure listed in the [Before working inside your system](#).
3. [Remove the sled](#).

4. Remove the air shroud.
5. Remove the PCIe card module.
6. Remove the mini PERC module.
7. Disconnect the cables from the mini PERC module.
8. Disconnect the cables from the cable M.2 riser board.
9. Remove the motherboard bridge module.

Steps

1. Using the Phillips #2 screwdriver, remove the four screws that secure the sled cable kit to the MB bridge module.
2. Lift the sled cables kit from the sled.

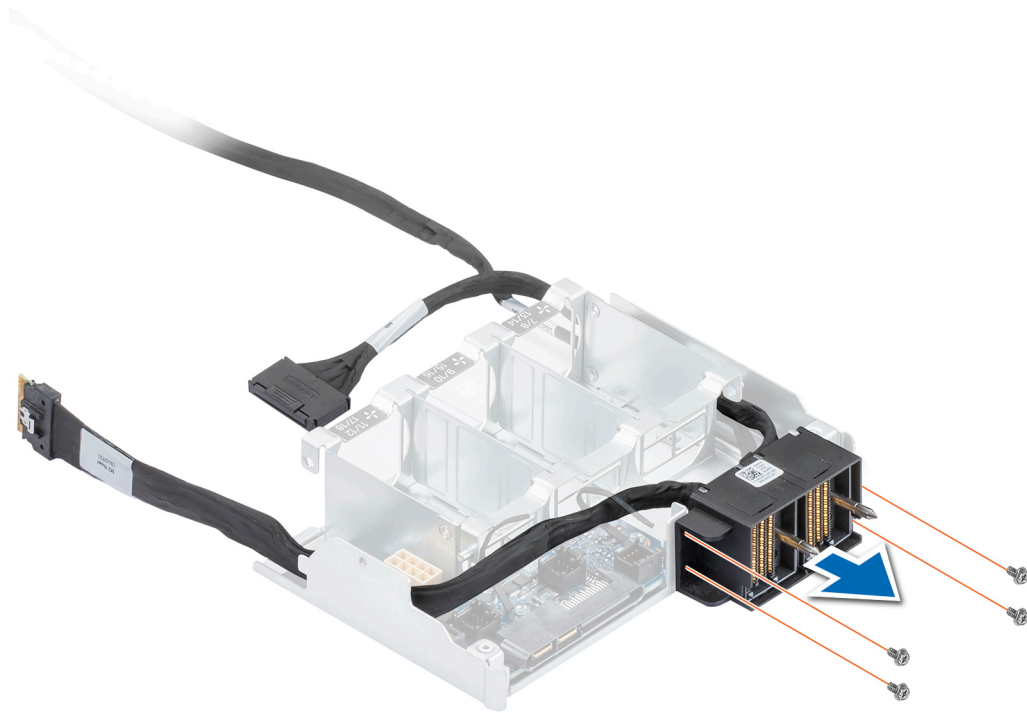

Figure 30. Removing the sled cables kit

NOTE: Follow the same steps to remove the other sled cables kit.

Next steps

Install the sled cables kit.

Installing the sled cables kit

Prerequisites

1. Follow the safety guidelines listed in [Safety instructions](#).
2. Follow the procedure listed in the [Before working inside your system](#).

Steps

1. Align and insert the sled cables kit into the motherboard bridge module.
2. Using the Phillips #2 screwdriver, secure the sled cable kit on the MB bridge module with four screws.

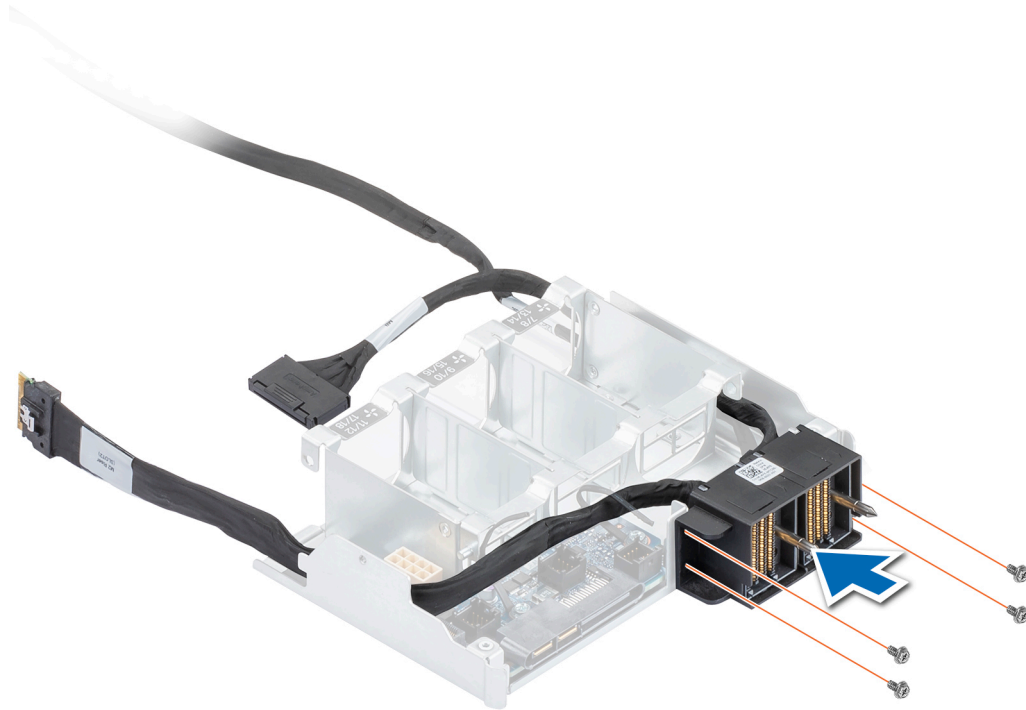

Figure 31. Removing the sled cables kit

NOTE: Follow the same steps to install the other sled cables kit.

Next steps

1. Connect the cables to the mini PERC module.
2. Connect the cables to the cable M.2 riser board..
3. [Install the motherboard bridge module.](#)
4. [Install the mini PERC module.](#)
5. [Install the PCIe card module.](#)
6. [Install the air shroud.](#)
7. [Install the sled.](#)
8. Follow the procedure listed in [After working inside your system.](#)

Motherboard bridge board

Removing the motherboard bridge board

Prerequisites

1. Follow the safety guidelines listed in the [Safety instructions](#).
2. Follow the procedure listed in the [Before working inside your system](#).
3. [Remove the sled](#).
4. [Remove the air shroud](#).
5. [Remove the PCIe card module](#)
6. [Remove the mini PERC module](#).
7. [Remove all the cooling fans](#).
8. [Remove the motherboard bridge module](#).
9. [Remove the the motherboard interposer board](#).
10. [Remove the sled cables kit](#).

Steps

1. Using the Phillips #1 screwdriver, remove the three screws that secure the motherboard bridge board to the motherboard bridge module.
2. Lift the motherboard bridge board out of the motherboard bridge module bracket.

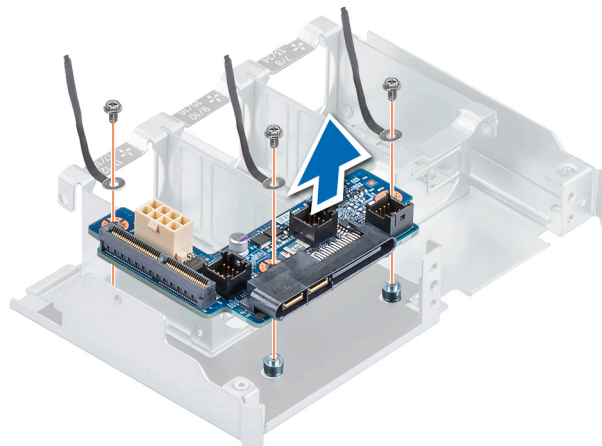

Figure 32. Removing the motherboard bridge board

Next steps

[Install the motherboard bridge board](#).

Installing the motherboard bridge board

Prerequisites

1. Follow the safety guidelines listed in [Safety instructions](#).

2. Follow the procedure listed in the [Before working inside your system.](#)

Steps

1. Align and insert motherboard bridge board into the motherboard bridge module bracket.
2. Using the Phillips #2 screwdriver, secure the motherboard bridge board to the module bracket with a screw.

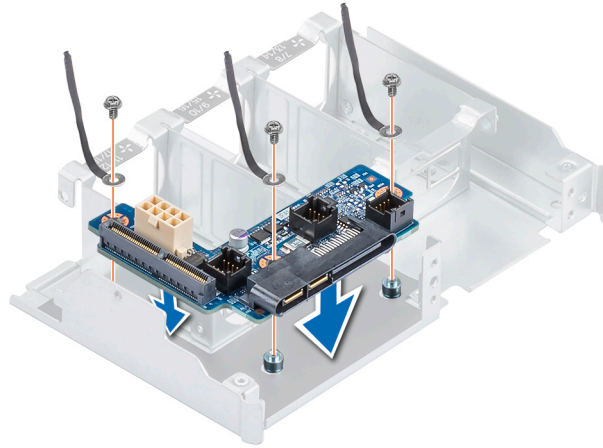

Figure 33. Installing the motherboard bridge board

Next steps

1. Install the sled cables kit.
2. Install the motherboard interposer module.
3. Install the motherboard bridge module.
4. Install all the cooling fans.
5. Install the mini PERC module.
6. Install the PCIe card module.
7. Install the air shroud.
8. Install the sled.
9. Follow the procedure listed in [After working inside your system.](#)

Mini PERC card module

Removing mini PERC module

Prerequisites

1. Follow the safety guidelines listed in the [Safety instructions.](#)
2. Follow the procedure listed in the [Before working inside your system.](#)
3. [Remove the sled.](#)
4. [Remove the air shroud.](#)
5. [Remove the PCIe card module.](#)

Steps

1. Loosen the captive screw and remove the three screws securing the mini card module.
2. Lift the mini PERC module from the system board.

NOTE: When mini PERC module is released out, mini PERC riser may be attached to system board, if the mini PERC riser is attached to system board then remove it and attach to the mini PERC adapter board.

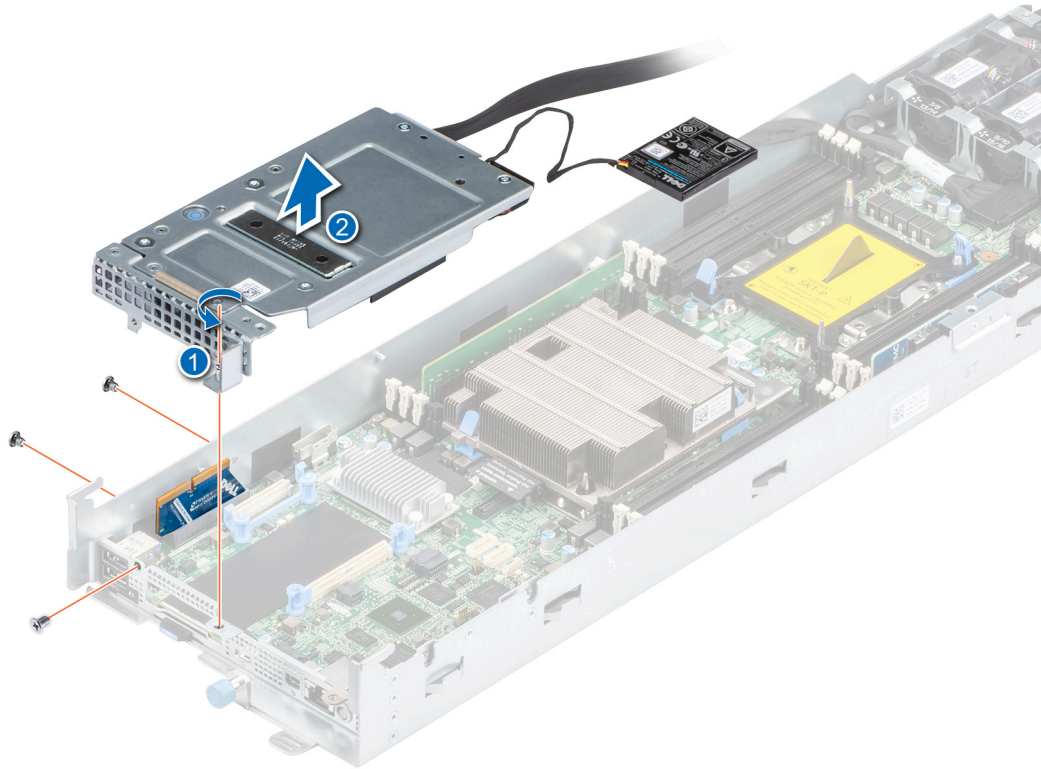

Figure 34. Removing the mini PERC module

3. Loosen the two captive screws and remove the mini PERC cable.
4. Disconnect the mini PERC battery cable.

Next steps

[Replace the mini PERC module .](#)

Installing the mini PERC card module

Prerequisites

1. Follow the safety guidelines listed in the [Safety instructions](#).
2. Follow the procedure listed in the [Before working inside your system](#).

Steps

1. Insert the mini PERC card module into the system board. Press until the internal PERC riser fits into place.
2. Fix the mini PERC module by three screws and one captive screw.

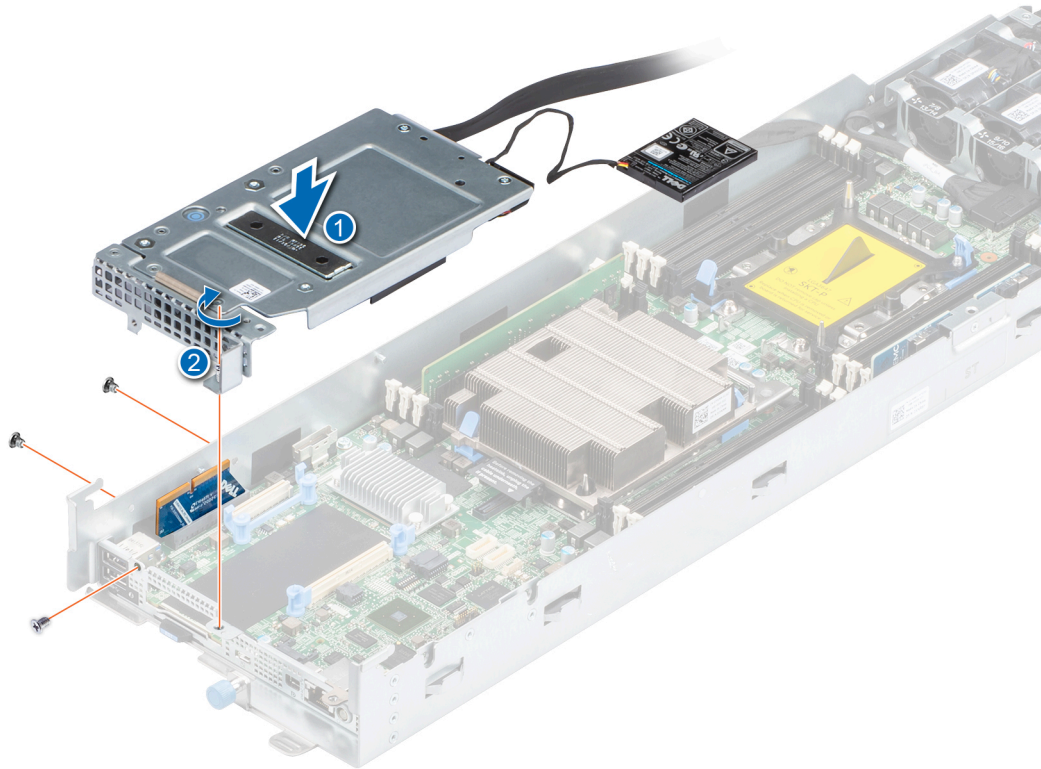

Figure 35. Installing the mini PERC module

Next steps

1. [Install the air shroud.](#)
2. [Install the sled.](#)
3. Follow the procedure listed in [After working inside your system.](#)

Mini PERC card battery

Removing the mini PERC card battery

Prerequisites

1. Follow the safety guidelines listed in the [Safety instructions.](#)
2. Follow the procedure listed in the [Before working inside your system.](#)
3. [Remove the sled.](#)
4. [remove the air shroud.](#)
5. [Remove the PCIe card module.](#)
6. [Remove the mini PERC card module](#) and disconnect the cable from the mini PERC card module.

Steps

1. Loosen the hook on the air shroud.
2. Push the retention clip down and lift the mini PERC battery out of the air shroud.

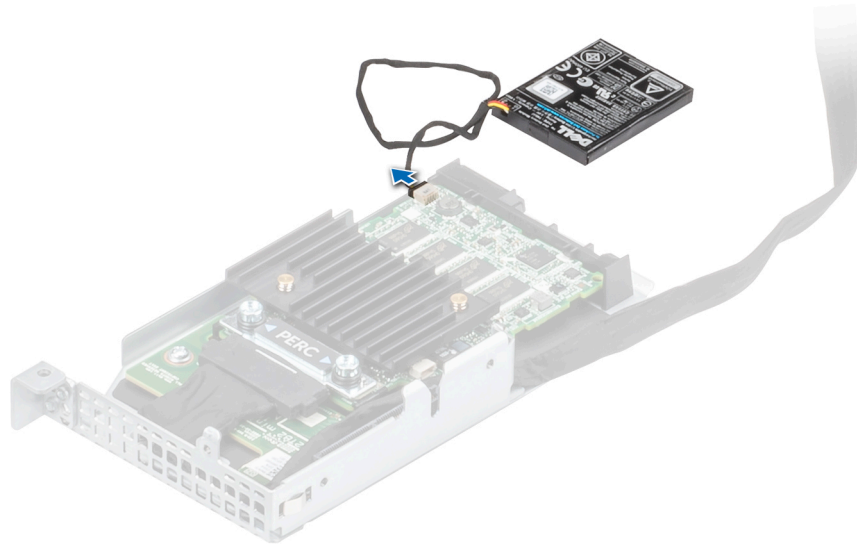

Figure 36. Removing the mini PERC battery

3. Disconnect the mini PERC card battery cable from mini PERC card.

Next steps

[Install the mini PERC battery.](#)

Installing the mini PERC card battery

Prerequisites

1. Follow the safety guidelines listed in the [Safety instructions](#).
2. Follow the procedure listed in the [Before working inside your system](#).

Steps

1. Connect the mini PERC battery cable into mini PERC card.
2. Push the retention clip and insert the mini PERC battery into the air shroud.

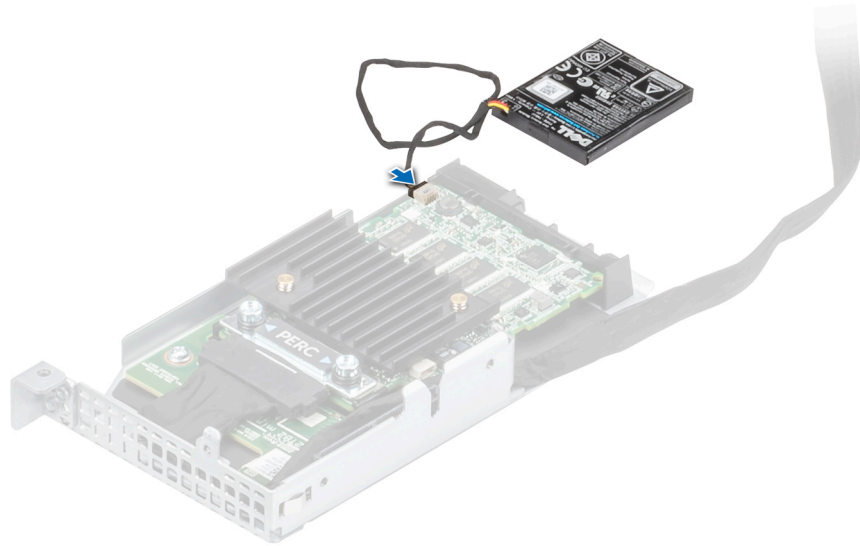

Figure 37. Installing the mini PERC battery cable to mini PERC

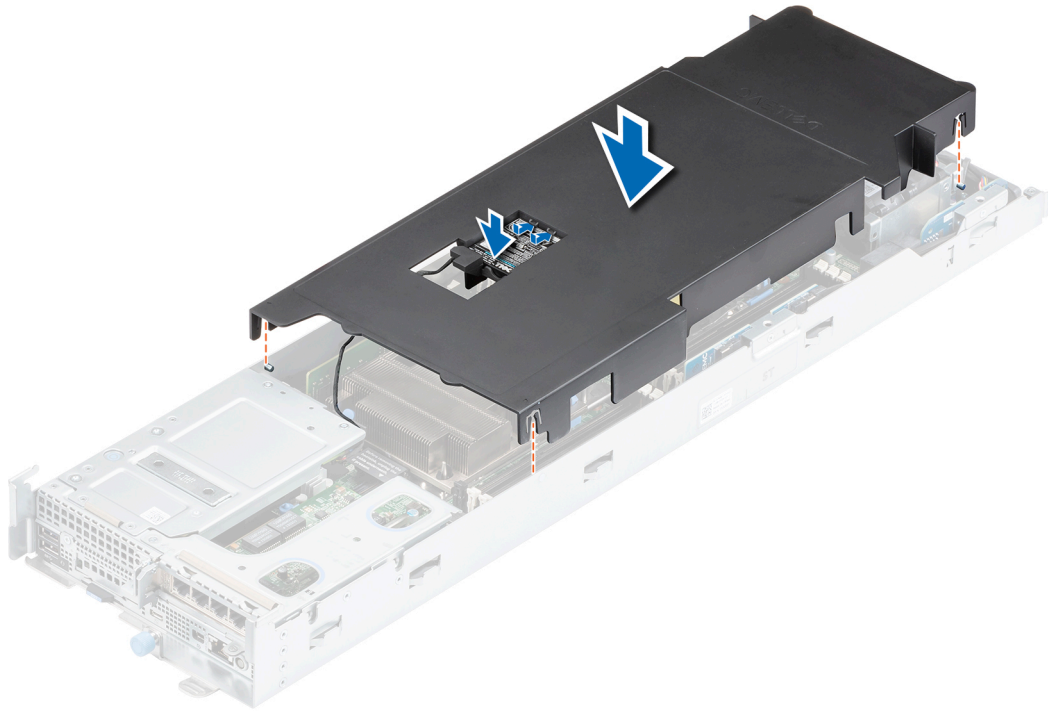

Figure 38. Installing the mini PERC battery

Next steps

1. Install the PCIe card module.
2. Install the air shroud.
3. Install the sled.
4. Follow the procedure listed in [After working inside your system](#).

Mini PERC card

Removing the mini PERC card

Prerequisites

1. Follow the safety guidelines listed in the [Safety instructions](#).
2. Follow the procedure listed in the [Before working inside your system](#).
3. [Remove the sled from chassis](#)
4. [Remove the air shroud](#).
5. [Remove the PCIe card module](#).
6. [Remove the mini PERC card module](#).

Steps

1. Loosen the two captive screws.

2. Remove the mini PERC cable.
3. Disconnect the mini PERC battery cable.
4. Pull the mini PERC card out of the hook located on the bracket.

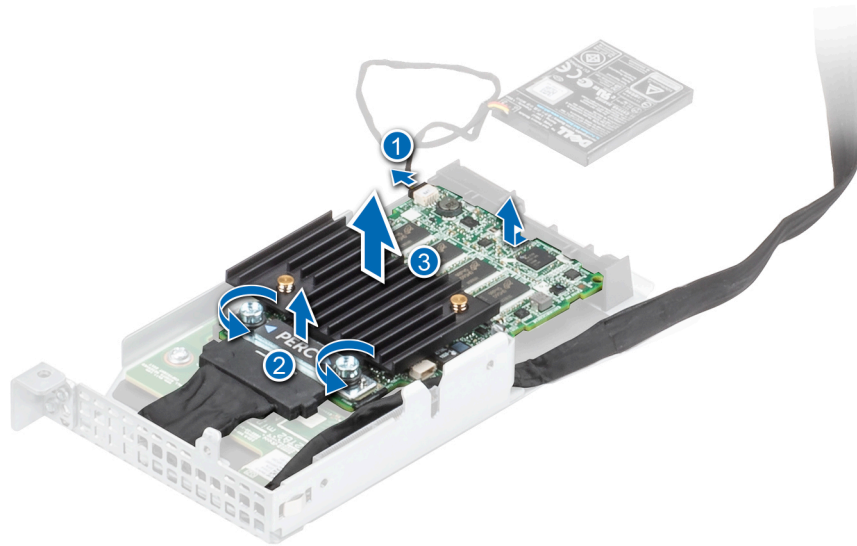

Figure 39. Removing the mini PERC card

Next steps

Install the mini PERC card.

Installing the mini PERC card

Prerequisites

1. Follow the safety guidelines listed in the [Safety instructions](#).
2. Follow the procedure listed in the [Before working inside your system](#).
3. If installing a new PERC card, unpack it and prepare the card for installation.

NOTE: For instructions, see the documentation accompanying the card.

Steps

1. Insert the mini PERC card into the mini PERC bracket.
2. Connect the mini PERC cable into the mini PERC card and then tighten the two captive screws to secure mini PERC cable.
3. Connect the mini PERC battery cable to mini PERC card.

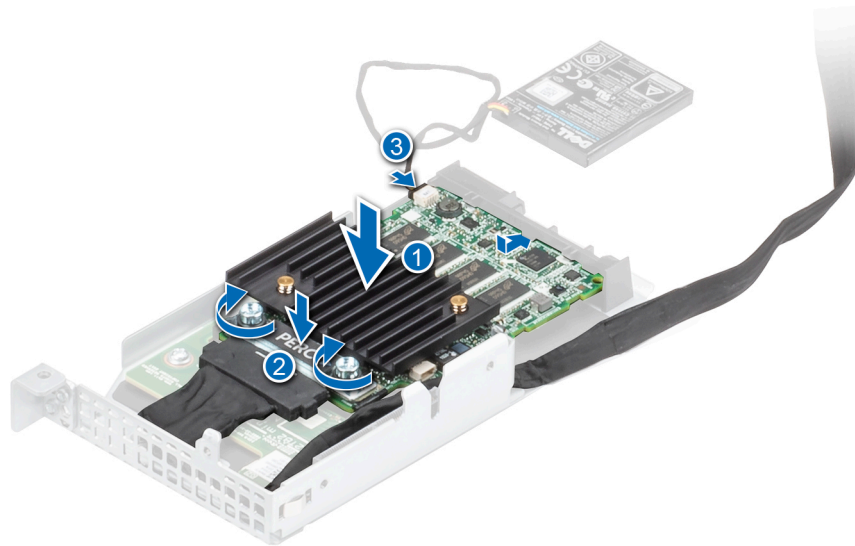

Figure 40. Installing the mini PERC

4. Insert the min PERC card module into the system board and press until internal PERC riser fits into place.
5. Fix the mini PERC module by three screws and one captive screw.

Next steps

1. [Install the PCIe card module.](#)
2. [Install the air shroud.](#)
3. [Install the sled.](#)
4. Follow the procedure listed in [After working inside the system.](#)

Mini PERC adaptor board

Removing the mini PERC adapter board

Prerequisites

1. Follow the safety guidelines listed in the [Safety instructions.](#)
2. Follow the procedure listed in the [Before working inside your system.](#)
3. [Remove the sled.](#)
4. [Remove the air shroud.](#)
5. [Remove the mini PERC card.](#)
6. [Remove the mini PERC riser board.](#)

Steps

1. Remove the three screws securing the mini PERC adapter board.
2. Pull the mini PERC adapter board from the bracket.

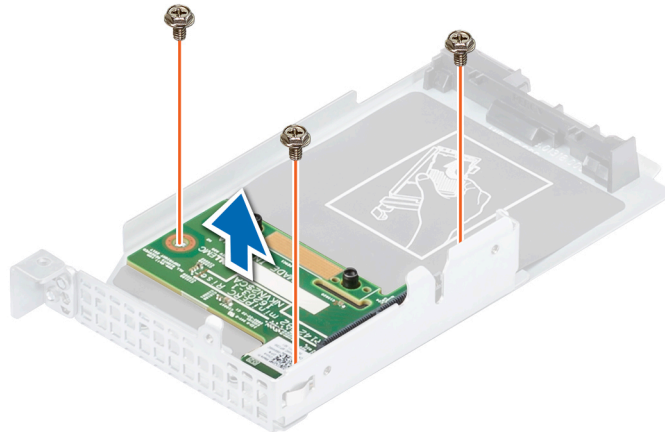

Figure 41. Removing the PERC adapter board

Next steps

Install the mini PERC adapter board.

Installing the mini PERC adapter board

Prerequisites

1. Follow the safety guidelines listed in the [Safety instructions](#).
2. Follow the procedure listed in the [Before working inside your system](#).

Steps

1. Insert the mini PERC adapter board into riser bracket.
2. Secure the mini PERC adapter board using the three screws to the mini PERC module.

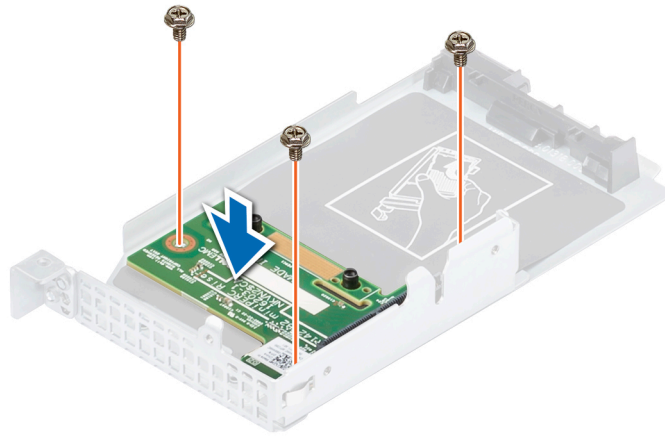

Figure 42. Installing the mini PERC adapter board

Next steps

1. [Install the mini PERC card.](#)
2. [Install the mini PERC riser board.](#)
3. [Install the PCIe card module.](#)
4. [Install the air shroud.](#)
5. [Install the sled.](#)
6. Follow the procedure listed in [After working inside your system.](#)

Mini PERC riser board

Removing the mini PERC riser board

Prerequisites

1. Follow the safety guidelines listed in the [Safety instruction.](#)
2. Follow the procedure listed in the [Before working inside your system.](#)
3. [Remove sled.](#)
4. [Remove the air shroud.](#)
5. [Remove the PCIe card module.](#)
6. [Remove the mini PERC module.](#)

Steps

Pull the mini PERC riser board out of the system board slot.

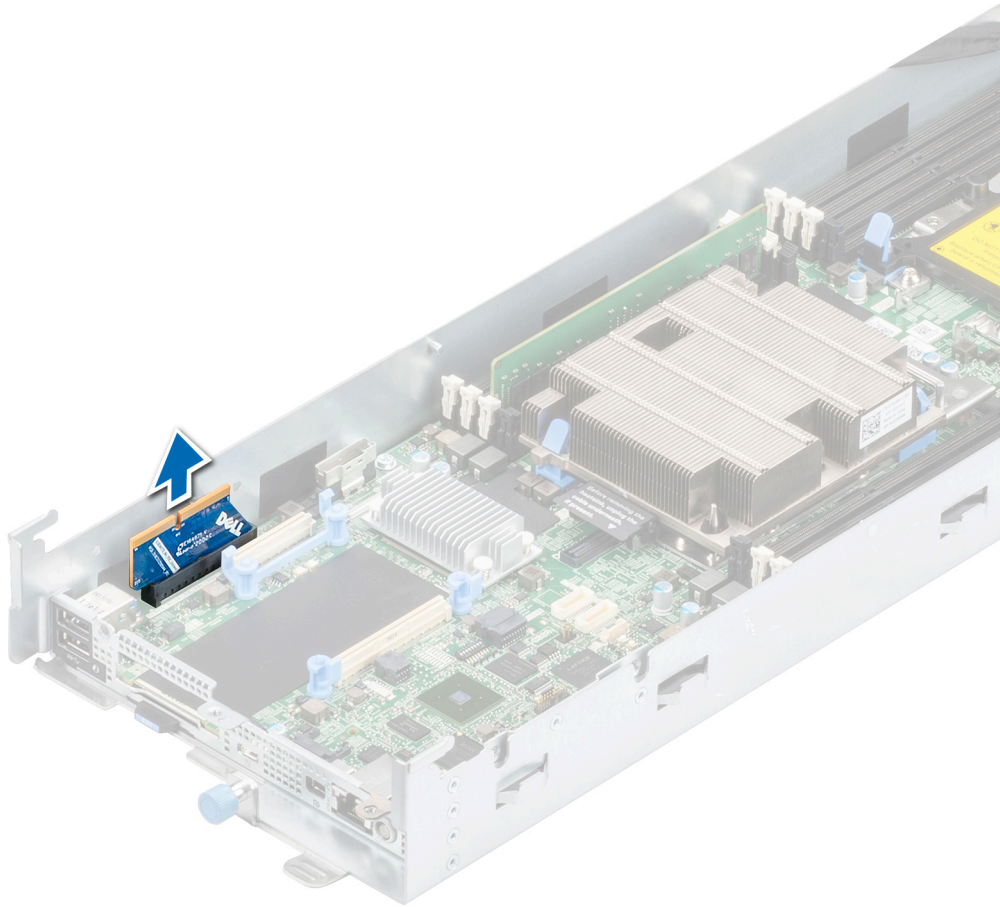

Figure 43. Removing the mini PERC riser board

Next steps

Install the mini PERC riser board.

Installing the mini PERC riser board

Prerequisites

1. Follow the safety guidelines listed in the [Safety instructions](#).
2. Follow the procedure listed in the [Before working inside your system](#).

Steps

Insert the mini PERC riser board into slot on system board.

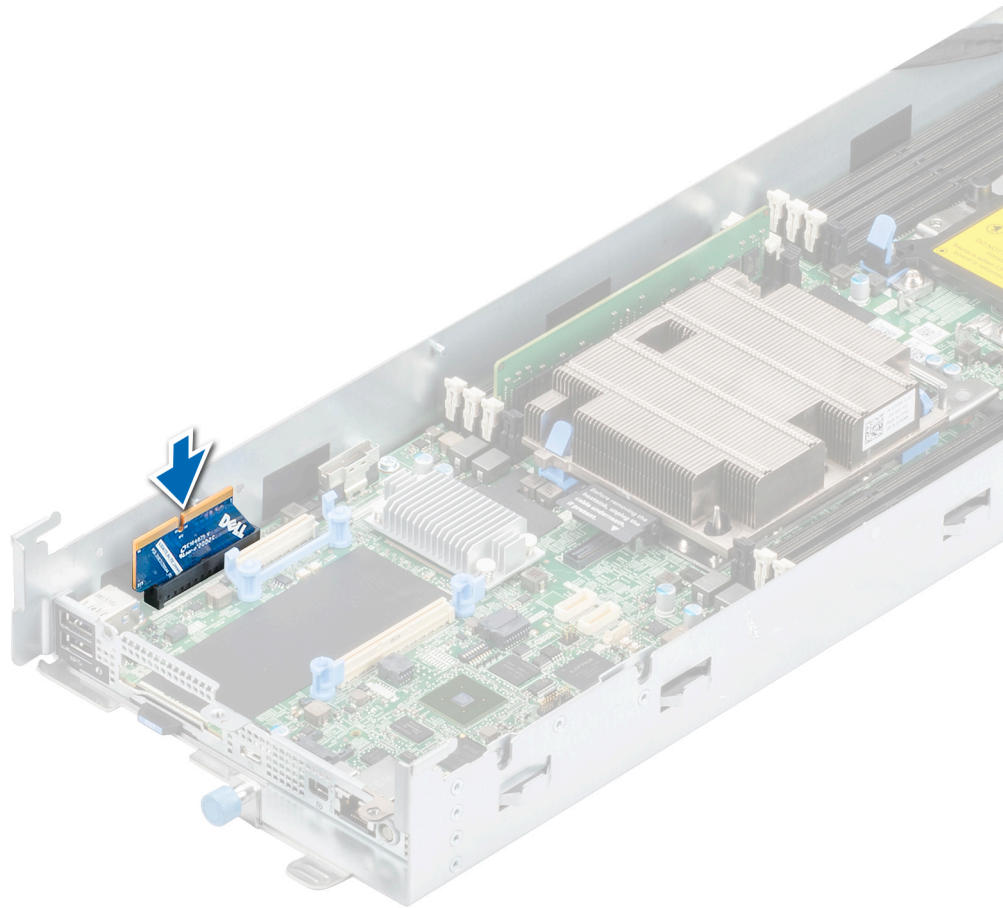

Figure 44. Installing the mini PERC riser board

Next steps

1. Install the mini PERC module.
2. Install the PCIe card module.
3. Install the air shroud.
4. Install the sled.
5. Follow the procedure listed in [After working inside the system](#).

System memory

System memory guidelines

The PowerEdge system supports DDR4 registered DIMMs (RDIMMs) and Load Reduced DIMMs (LRDIMMs). System memory holds the instructions that are executed by the processor.

Your system contains 16 memory sockets that are split into two sets of 8 sockets, one set per processor. Each 8-socket set is organized into channels. In each channel, the release tabs of the first socket are marked white, the second socket black.

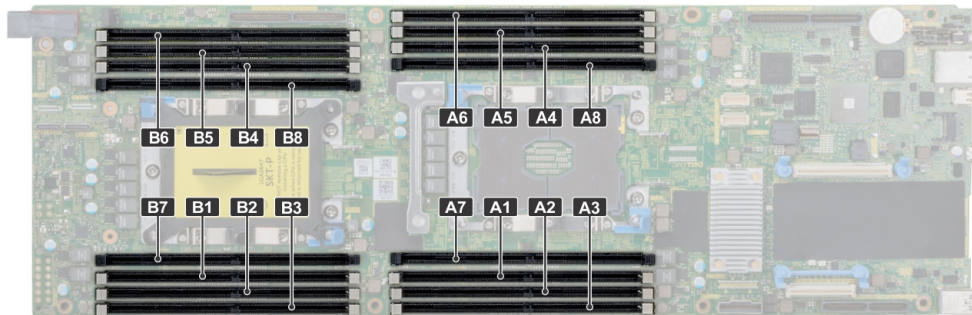

Figure 45. Memory socket locations

Memory channels are organized as follows:

Table 7. Memory channels

Processor	Channel 0	Channel 1	Channel 2	Channel 3	Channel 4	Channel 5
Processor 1	Slots A1 and A7	Slots A2	Slots A3	Slots A8 and A4	Slots A5	Slots A6
Processor 2	Slots B1 and B7	Slots B2	Slots B3	Slots B8 and B4	Slots B5	Slots B6

General memory module installation guidelines

To ensure optimal performance of your system, observe the following general guidelines when configuring your system memory. If your system's memory configurations fail to observe these guidelines, your system might not boot, stop responding during memory configuration, or operate with reduced memory.

- System profile selected (for example, Performance Optimized, or Custom [can be run at high speed or lower])
- Maximum supported DIMM speed of the processors.
- Maximum supported DIMM speed of the processors.
- Maximum supported speed of the DIMMs

i **NOTE:** MT/s indicates DIMM speed in MegaTransfers per second.

The system supports Flexible Memory Configuration, enabling the system to be configured and run in any valid chipset architectural configuration. The following are the recommended guidelines for installing memory modules:

- All DIMMs must be DDR4.
- RDIMMs and LRDIMMs must not be mixed.
- 64 GB LRDIMMs that are DDP (Dual Die Package) LRDIMMs must not be mixed with 128 GB LRDIMMs that are TSV (Through Silicon Via/3DS) LRDIMMs.
- x4 and x8 DRAM based memory modules can be mixed.
- Up to two RDIMMs can be populated per channel regardless of rank count.
- Up to two LRDIMMs can be populated per channel regardless of rank count.
- A maximum of two different ranked DIMMs can be populated in a channel regardless of rank count.
- If memory modules with different speeds are installed, they will operate at the speed of the slowest installed memory module(s).
- Populate memory module sockets only if a processor is installed.
- Populate all the sockets with white release tabs first, followed by the black release tabs.
- When mixing memory modules with different capacities, populate the sockets with memory modules with the highest capacity first.
- **i** **NOTE:** For example, if you want to mix 8 GB and 16 GB memory modules, populate 16 GB memory modules in the sockets with white release tabs and 8 GB memory modules in the sockets with black release tabs.
- Memory modules of different capacities can be mixed provided other memory population rules are followed.

i **NOTE:** For example, 8 GB and 16 GB memory modules can be mixed.

- In a dual-processor configuration, the memory configuration for each processor must be identical.

NOTE: For example, if you populate socket A1 for processor 1, then populate socket B1 for processor 2, and so on.

- Mixing of more than two memory module capacities in one system is not supported.
- Unbalanced memory configurations will result in a performance loss so always populate memory channels identically with identical DIMMs for best performance.
- Populate six identical memory modules per processor (one DIMM per channel) at a time to maximize performance.

Mode-specific guidelines

The configurations allowed depend on the memory mode selected in the System BIOS.

Table 8. Memory operating modes

Memory Operating Mode	Description
Optimizer Mode	The Optimizer Mode if enabled, the DRAM controllers operate independently in the 64-bit mode and provide optimized memory performance.
Mirror Mode	The Mirror Mode if enabled, the system maintains two identical copies of data in memory, and the total available system memory is one half of the total installed physical memory. Half of the installed memory is used to mirror the active memory modules. This feature provides maximum reliability and enables the system to continue running even during a catastrophic memory failure by switching over to the mirrored copy. The installation guidelines to enable Mirror Mode require that the memory modules be identical in size, speed, and technology, and they must be populated in sets of 6 per processor.
Single Rank Spare Mode	Single Rank Spare Mode allocates one rank per channel as a spare. If excessive correctable errors occur in a rank or channel, while the operating system is running, they are moved to the spare area to prevent errors from causing an uncorrectable failure. Requires two or more ranks to be populated in each channel.
Multi Rank Spare Mode	<p>Multi Rank Spare Mode allocates two ranks per channel as a spare. If excessive correctable errors occur in a rank or channel, while the operating system is running, they are moved to the spare area to prevent errors from causing an uncorrectable failure. Requires three or more ranks to be populated in each channel.</p> <p>With single rank memory sparing enabled, the system memory available to the operating system is reduced by one rank per channel.</p> <p>NOTE: To use memory sparing, this feature must be enabled in the BIOS menu of System Setup.</p> <p>NOTE: Memory sparing does not offer protection against a multi-bit uncorrectable error.</p>
Dell Fault Resilient Mode	<p>The Dell Fault Resilient Mode if enabled, the BIOS creates an area of memory that is fault resilient. This mode can be used by an OS that supports the feature to load critical applications or enables the OS kernel to maximize system availability.</p> <p>NOTE: This feature is only supported in Gold and Platinum Intel processors.</p> <p>NOTE: Memory configuration has to be of same size DIMM, speed, and rank.</p>

Optimizer Mode

This mode supports Single Device Data Correction (SDDC) only for memory modules that use x4 device width. It does not impose any specific slot population requirements.

- Dual processor: Populate the slots in round robin sequence starting with processor 1.

NOTE: Processor 1 and processor 2 population should match.

Table 9. Memory population rules

Processor	Configuration	Memory population	Memory population information
Single processor	Optimizer (Independent channel) population order	1, 2, 4, 5	Odd amount of DIMMs per processor allowed.
	Mirror population order	{1, 2, 3, 4, 5, 6}	Mirroring is supported with 6 DIMMs per processor
	Single rank sparing population order	1, 2, 3, 4, 5, 6, 7, 8	Populate in this order, odd amount per processor allowed. Requires two ranks or more per channel.
	Multi rank sparing population order	1, 2, 3, 4, 5, 6, 7, 8	Populate in this order, odd amount per processor allowed. Requires three ranks or more per channel.
	Fault resilient population order	{1, 2, 3, 4, 5, 6}	Supported with 6 DIMMs per processor.
Dual processor (Start with processor1. processor1 and processor 2 population should match)	Optimized (Independent channel) population order	A{1}, B{1}, A{2}, B{2}, A{4}, B{4}, A{5}, B{5}	Odd amount of DIMMs per processor allowed.
	Mirroring population order	A{1,2,3,4,5,6}, B{1,2,3,4,5,6}	Mirroring is supported with 6 DIMMs per processor.
	Single rank sparing population order	A{1}, B{1}, A{2}, B{2}, A{3}, B{3}...	Populate in this order, odd amount per processor allowed. Requires two ranks or more per channel.
	Multi rank spare population order	A{1}, B{1}, A{2}, B{2}, A{3}, B{3}...	Populate in this order, odd amount per processor allowed. Requires three ranks or more per channel.
	Fault resilient population order	A{1,2,3,4,5,6}, B{1,2,3,4,5,6}	Supported with 6 DIMMs per processor.

Removing a memory module

Prerequisites

1. Follow the safety guidelines listed in the [Safety instructions](#).
2. Follow the procedure listed in the [Before working inside your system](#).
3. [Remove the sled](#).
4. [Remove the air shroud](#).

 **WARNING:** The memory modules are hot to touch for some time after the system has been powered off. Allow the memory modules to cool before handling them.

Steps

1. Locate the appropriate memory module socket.
2. To release the memory module from the socket, simultaneously press the ejectors on both ends of the memory module socket to fully open.

 **CAUTION:** Handle each memory module only by the card edges, ensuring not to touch the middle of the memory module or metallic contacts.

3. Lift the memory module away from the system.

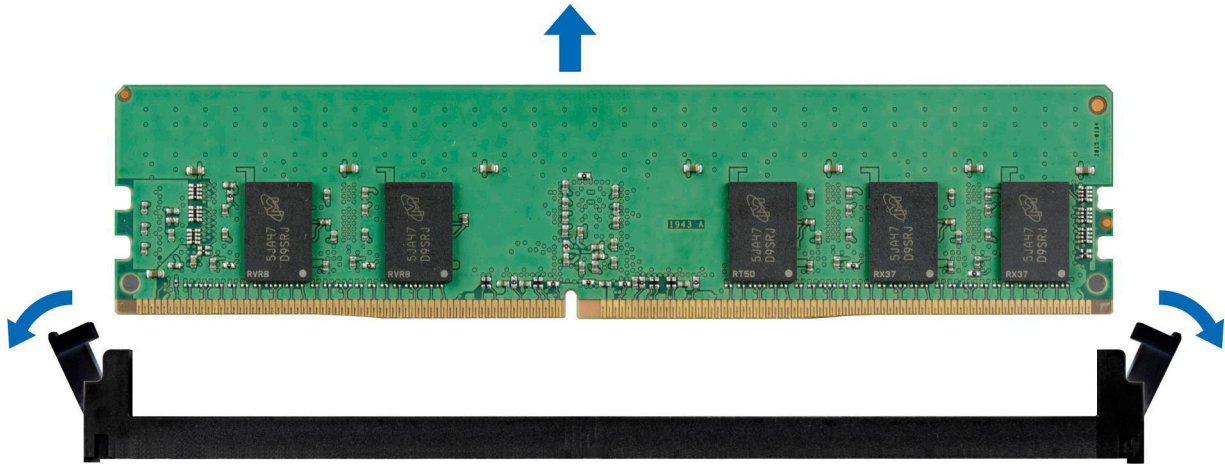

Figure 46. Removing a memory module

Next steps

Install the memory module .

Installing a memory module

Prerequisites

1. Follow the safety guidelines listed in the [Safety instructions](#).
2. Follow the procedure listed in the [Before working inside your system](#).

Steps

1. Locate the appropriate memory module socket.

CAUTION: Handle each memory module only by the card edges, ensuring not to touch the middle of the memory module or metallic contacts.

2. If a memory module is installed in the socket, remove it.

NOTE: Ensure that the socket ejector latches are fully open, before installing the memory module.

3. Align the edge connector of the memory module with the alignment key of the memory module socket, and insert the memory module in the socket.

CAUTION: To prevent damage to the memory module or the memory module socket during installation, do not bend or flex the memory module; insert both ends of the memory module simultaneously.

NOTE: The memory module socket has an alignment key that enables you to install the memory module in the socket in only one orientation.

CAUTION: Do not apply pressure at the center of the memory module; apply pressure at both ends of the memory module evenly.

4. Press the memory module with your thumbs until the ejectors firmly click into place. When the memory module is properly seated in the socket, the levers on the memory module socket align with the levers on the other sockets that have memory modules installed.

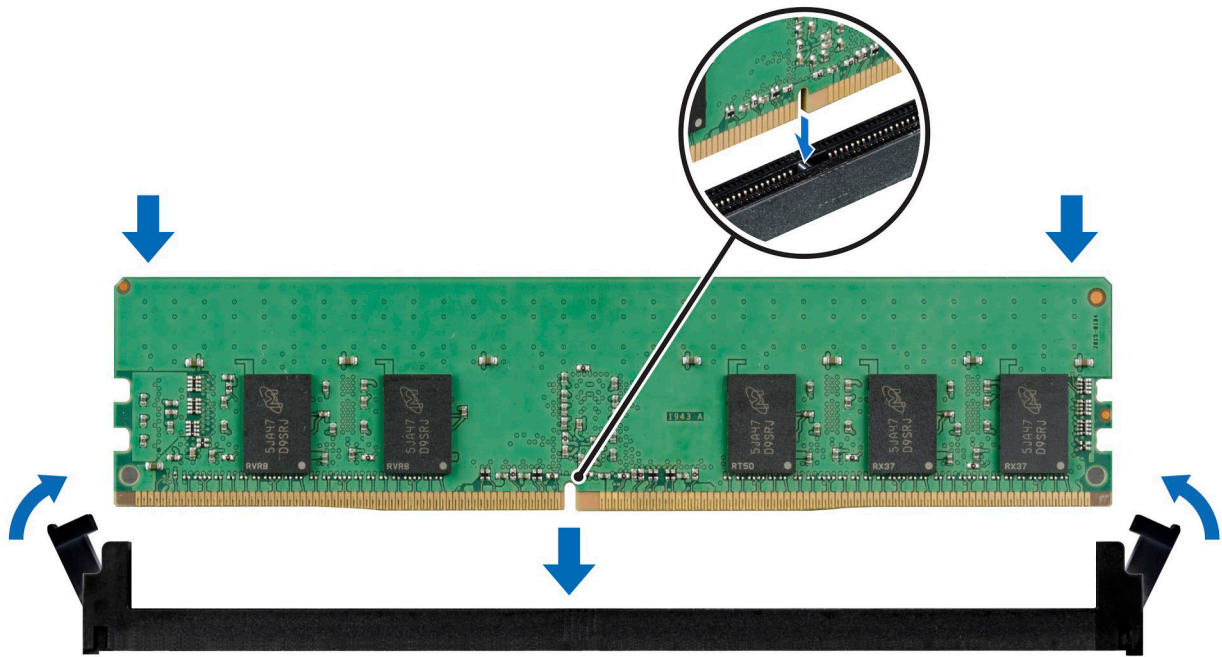

Figure 47. Installing a memory module

Next steps

1. [Install the air shroud.](#)
2. [Install the sled.](#)
3. Follow the procedure listed in [After working inside the system.](#)
4. To verify if the memory module has been installed properly, press F2 and navigate to **System Setup Main Menu > System BIOS > Memory Settings**. In the **Memory Settings** screen, the System Memory Size must reflect the updated capacity of the installed memory.
5. If the System Memory Size is incorrect, one or more of the memory modules may not be installed properly. Ensure that the memory modules are firmly seated in their sockets.
6. Run the system memory test in system diagnostics.

Expansion cards and expansion card risers

NOTE: A system event entry is logged in the iDRAC Lifecycle Controller if an expansion card riser is not supported or missing. It does not prevent your system from turning on.

Removing the riser board

Prerequisites

1. Follow the safety guidelines listed in the [Safety instruction](#).
2. Follow the procedure listed in the [Before working inside your system](#).
3. [Remove the sled from the enclosure.](#)
4. [Remove the PCIe card.](#)

Steps

1. Remove the two screws securing the x16 riser board.
2. Pull the x16 riser board from the bracket.

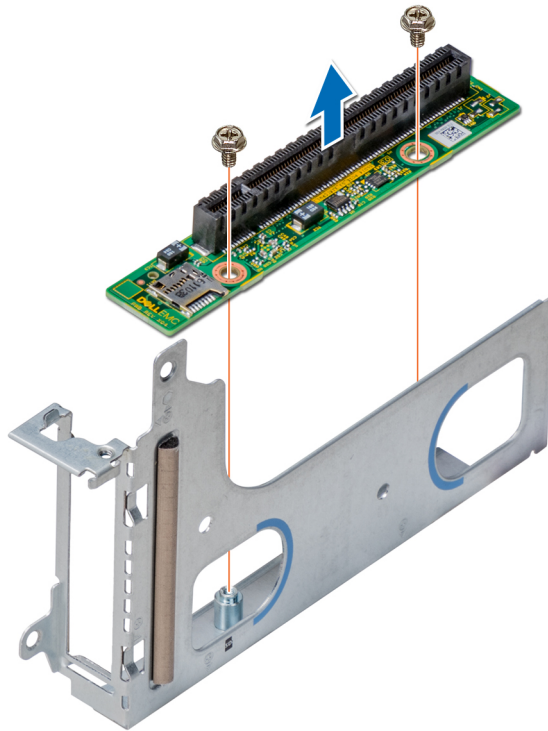

Figure 48. Removing the x16 riser board

Next steps

Install the X16 riser board .

Installing the x16 riser board

Prerequisites

1. Follow the safety guidelines listed in the [Safety instructions](#).
2. Follow the procedure listed in the [Before working inside your system](#).

Steps

1. Insert the x16 riser board into the riser bracket.
2. Secure fix the x16 riser board by two screws.

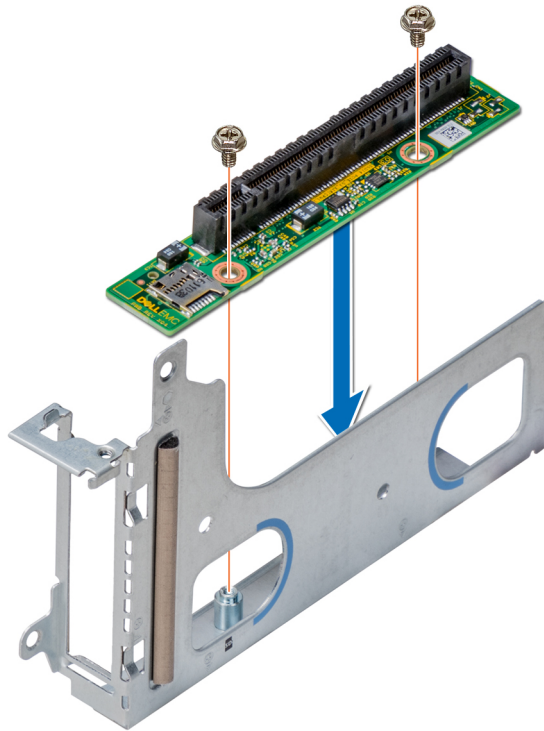

Figure 49. Installing the x16 riser board

Next steps

1. Install the PCIe card module.
2. Install the air shroud.
3. Install the sled.
4. Follow the procedure listed in [After working inside your system](#).

Expansion cards

NOTE: A missing or an unsupported expansion card riser logs a System Event Log (SEL) event. This does not prevent your system from powering on and no BIOS, POST messages, or F1 or F2 pause is displayed.

Expansion cards and risers

Table 10. Expansion slots mapping

Location	Width	Card length	Bracket height	Controlling CPU	PCIe width	Usage
PCIe Slot-1	None	None	None	CPU1	x8	miniPERC
PCIe Slot-3	None	None	None	CPU1	x8	OCP
PCIe Slot-4	SW	Half Length	Low Profile	CPU1	x16	CX4/T4
PCIe Slot-6	None	None	None	CPU2	x8	PERC

PCIe slot priority

Table 11. Supported card options

Card type	Category	Slot priority	Maximum number of cards	Max PCIe Width	Card length, Card height
ASSY,CRD,CTL,H730PV2,MNI,C6420	PERC	1	1	X16	None
CRD,NTWK,OCP2,BRCM,25GSFP	NIC	3	1	X16	None
CRD,NTWK,MEZZ,OCP,INTEL	NIC	3	1	X16	None
CRD,NTWK,PCIE,DP,25G,57414,LP	NIC	4	1	X16	Half length, Low profile
CRD,NTWK,10GBT,INTEL,LP,V2	NIC	4	1	X16	Half length, Low profile
CRD,NTWK,DP,INTEL,25G,SFP,LP	NIC	4	1	X16	Half length, Low profile
CRD,NTWK,10G,SFP+,DP FVL,IN,LP	NIC	4	1	X16	Half length, Low profile
CRD,NTWK,100G,CX5,DP,QSF,MLX,L	NIC	4	1	X16	Half length, Low profile
CRD,NTWK,PCIE,100G,CX6,DP,L,ML	NIC	4	1	X16	Half length, Low profile
PWA,CTL,HBA345,ADPT,V2	PERC	6	1	X8	Half length, Low profile
PWA,CTL,HBA345,ADPT	PERC	6	1	X8	Half length, Low profile
ASSY,CRD,CTL,H745,4GB,ADPT,V2	PERC	6	1	X8	Half length, Low profile
(ASSY,CRD,CTL,H730PV2,MNI,C6420)	PERC	1	1	X8	Half length, Low profile
(CRD,NTWK,OCP2,BRCM,25GSFP)	NIC	3	1	X8	Half length, Low profile
CRD,NTWK,MEZZ,OCP,INTEL	NIC	3	1	X8	Half length, Low profile
ASSY,PWA,LOM,SFP+,R540/440,V2	NIC	3	1	X8	Half length, Low profile
CRD,NTWK,PCIE,DP,25G,57414,LP	NIC	4	1	X8	Half length, Low profile
CRD,NTWK,10GBT,INTEL,LP,V2	NIC	4	1	X8	Half length, Low profile
CRD,NTWK,DP,INTEL,25G,SFP,LP	NIC	4	1	X8	Half length, Low profile
CRD,NTWK,10G,SFP+,DP FVL,LP,V2	NIC	4	1	X8	Half length, Low profile
CRD,NTWK,10G,SFP+,DP FVL,IN,LP	NIC	4	1	X8	Half length, Low profile
CRD,NTWK,100G,CX5,DP,QSF,MLX,L	NIC	4	1	X8	Half length, Low profile

Table 11. Supported card options (continued)

Card type	Category	Slot priority	Maximum number of cards	Max PCIe Width	Card length, Card height
CRD,NTWK,MLNX,LP,100G,2P,Q56	NIC	4	1	X8	Half length, Low profile
CRD,NTWK,25G,CX4LX,DP,SFP,ML,L	NIC	4	1	X8	Half length, Low profile
CRD,NTWK,PCIE,DP,10G,57416,LP	NIC	4	1	X8	Half length, Low profile
CRD,NTWK,INTL,LP,10G,2P,BT	NIC	4	1	X8	Half length, Low profile
CRD,NTWK,INTL,LP,25G,2P,S28	NIC	4	1	X8	Half length, Low profile
CRD,NTWK,MLNX,LP,25G,2P,S28	NIC	4	1	X8	Half length, Low profile
ASSY,CRD,CTL,H745,4GB,ADPT,V2	PERC	6	1	X8	Half length, Low profile
PWA,CTL,HBA355I,ADPT, V2	HBA	6	1	X8	Half length, Low profile

Processor and heat sink

Removing a processor and heat sink module

Prerequisites

 **WARNING:** The heat sink may be hot to touch for some time after the system is powered off. Allow the heat sink to cool before removing it.

1. Follow the safety guidelines listed in the [Safety instructions](#).
2. [Remove the sled](#).
3. [Remove the air shroud](#).

Steps

1. Using a Torx #T30 screwdriver, loosen the screws on the heat sink in the order that is mentioned below:
 - a. Loosen the first screw three turns.
 - b. Loosen the second screw completely.
 - c. Return to the first screw and loosen it completely.
2. Pushing both blue retention clips simultaneously, lift the processor and heat sink module.
3. Set the processor and heat sink module aside with the processor side facing up.

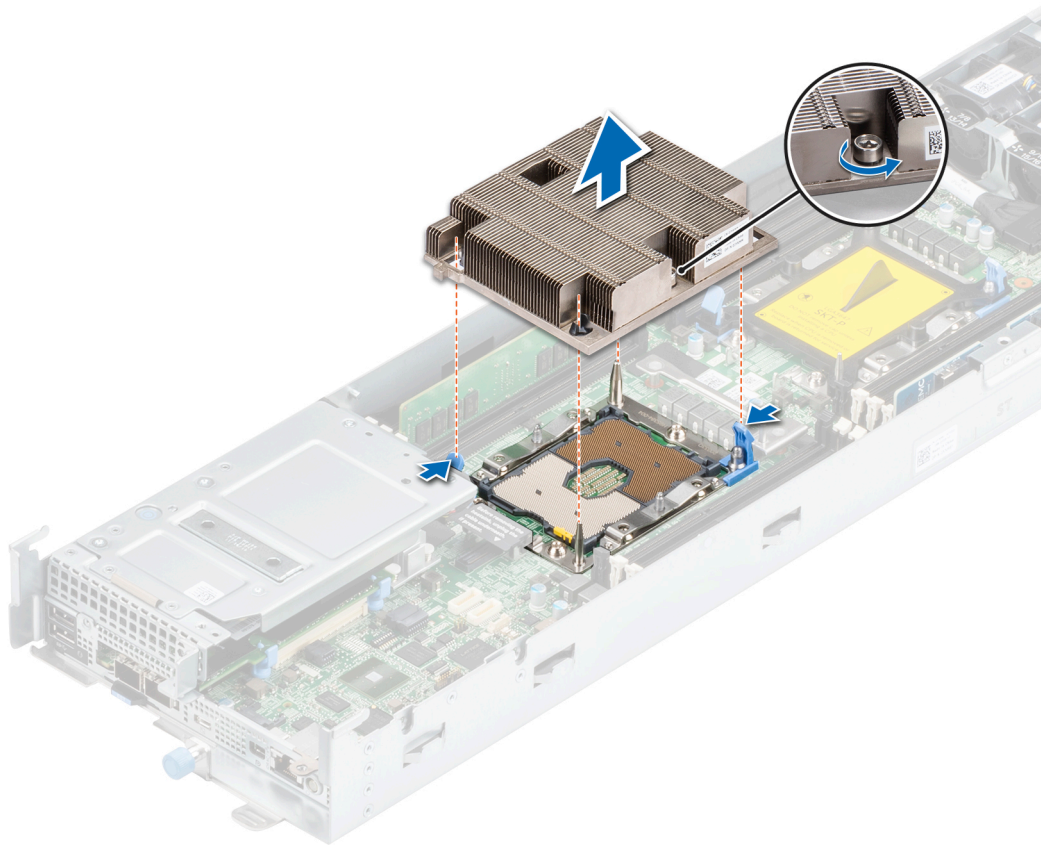

Figure 50. Removing the processor and heat sink module

4. Insert a CPU dust cover for protection.

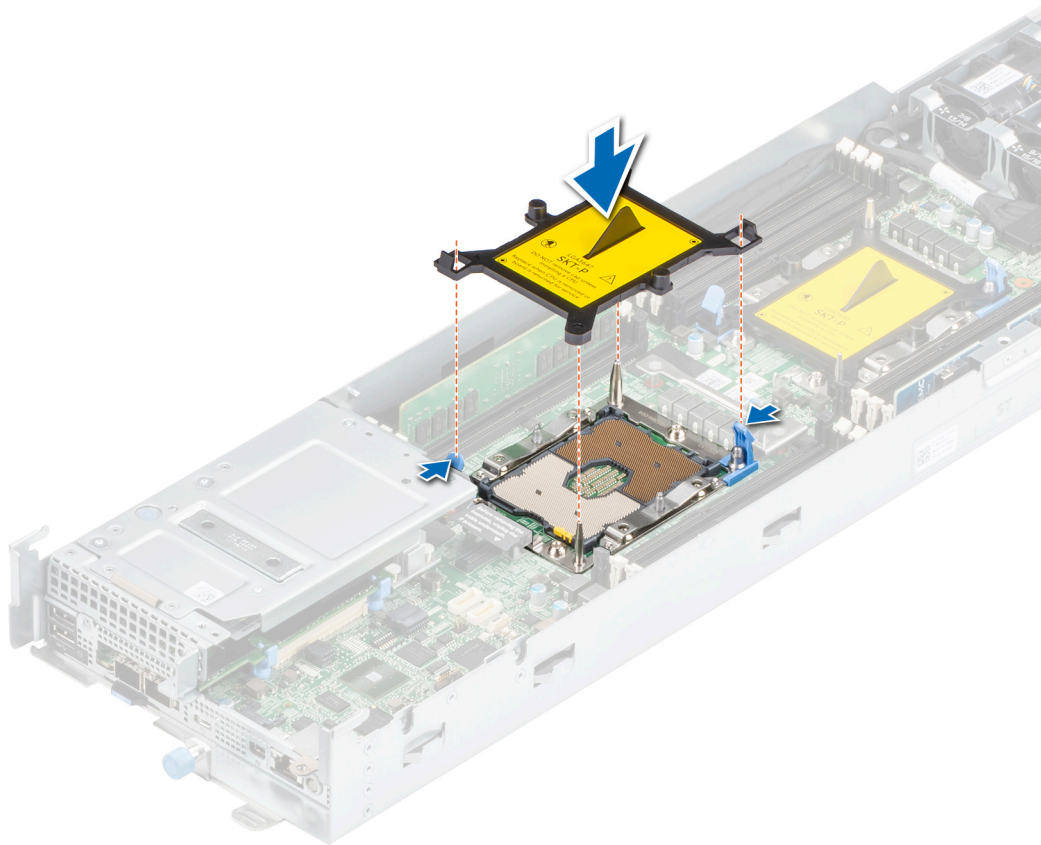

Figure 51. Inserting CPU dust cover

Next steps

Install the processor and heat sink module.

Installing a processor and heat sink module

Prerequisites

CAUTION: Never remove the heat sink from a processor unless you intend to replace the processor. The heat sink is necessary to maintain proper thermal conditions.

1. Follow the safety guidelines listed in the [Safety instructions](#).
2. If installed, remove the CPU dust cover.

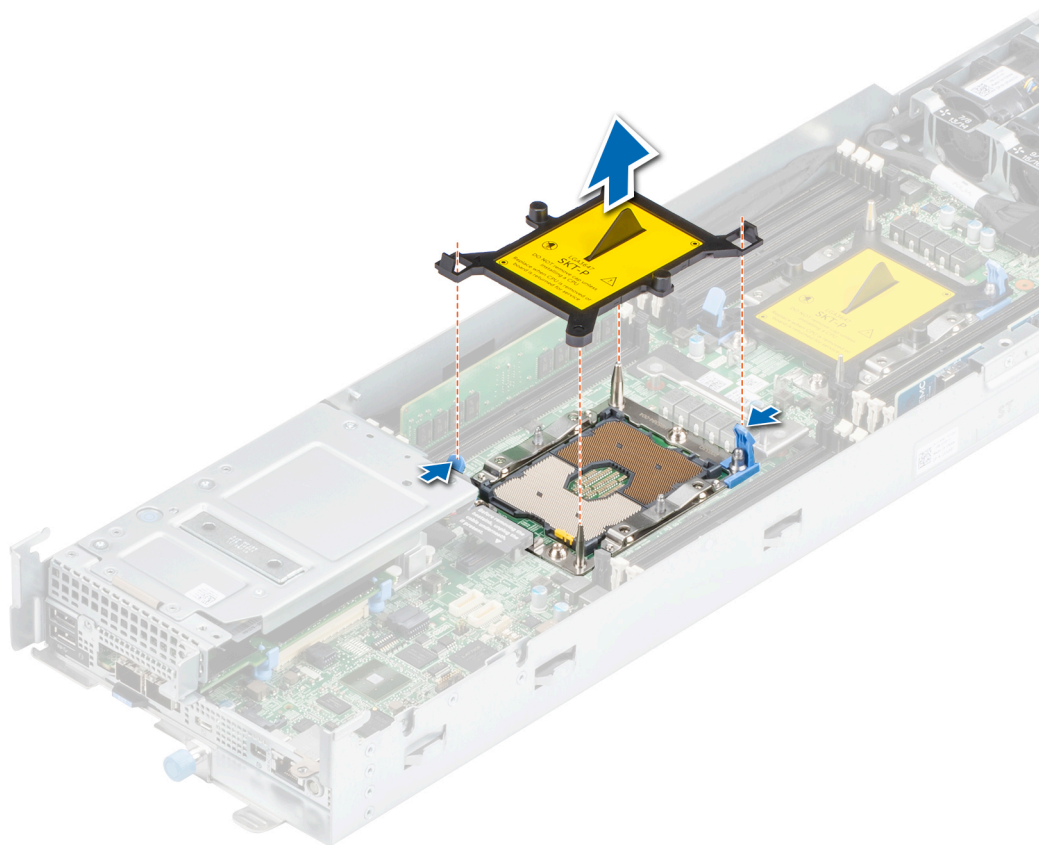

Figure 52. Removing CPU dust cover

Steps

1. Align the pin indicator of the heat sink to the system board and then place the processor and heat sink module (PHM) on the processor socket.

CAUTION: To avoid damaging the fins on the heat sink, do not press down on the heat sink fins.

NOTE: Ensure that the PHM is held parallel to the system board to prevent damaging the components.

2. Push the blue retention clips inward to allow the heat sink to drop into place.
3. Using the Torx #T30 screwdriver, tighten the screws on the heat sink in the order below:
 - a. Partially tighten the first screw (approximately three turns).
 - b. Tighten the second screw completely.
 - c. Return to the first screw and tighten it completely.

If the PHM slips off the blue retention clips when the screws are partially tightened, follow these steps to secure the PHM:

- a. Loosen both the heat sink screws completely.
- b. Lower the PHM on to the blue retention clips, following the procedure described in step 2.
- c. Secure the PHM to the system board, following the replacement instructions listed in this step above.

NOTE: The processor and heat sink module retention screws should not be tightened to more than 0.13 kgf-m (1.35 N.m or 12 in-lbf).

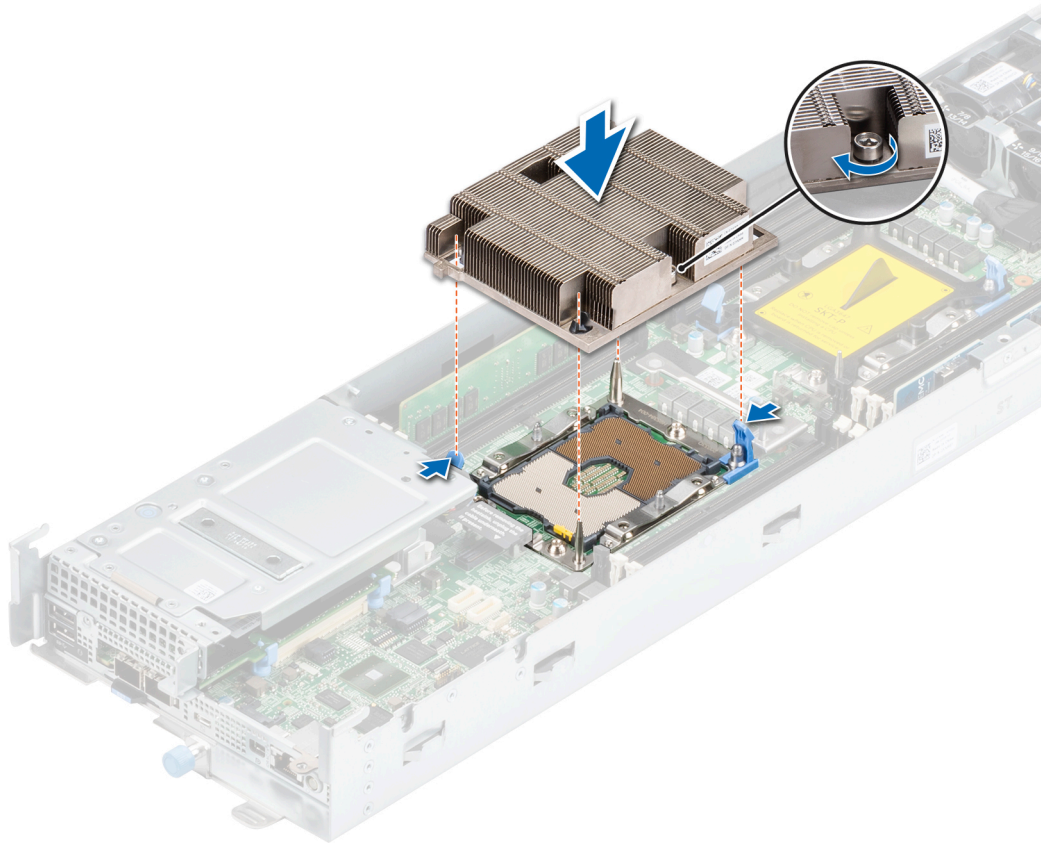

Figure 53. Installing a processor and heat sink module

Next steps

1. Install the air shroud.
2. Install the sled.
3. Follow the procedure listed in [After working inside the system](#).

Removing the fabric processor from the processor heat sink module

Prerequisites

⚠ WARNING: The heat sink may be hot to touch for some time after the system has been powered off. Allow the heat sink to cool before removing it.

i NOTE: This procedure is only for replacing a heat sink or a processor. This procedure should not be followed while replacing a system board.

1. Follow the safety guidelines listed in the [Safety instructions](#).
2. Follow the procedure listed in the [Before working inside your system](#).
3. [Remove the air shroud](#).
4. [Remove the processor and heat sink module](#).

Steps

1. Place the heat sink with the processor contact side facing up.

2. Insert the flat blade screwdriver into the release slot and twist (do not pry) the screwdriver to break the seal created by the thermal paste.
3. Push the retaining clips on the processor bracket to unlock the bracket from the heat sink.
4. Lift the bracket and the processor away from the heat sink, and place the processor side down on the processor tray.
5. Flex the outer edges of the bracket close to the fabric connector to release the bracket from the processor.

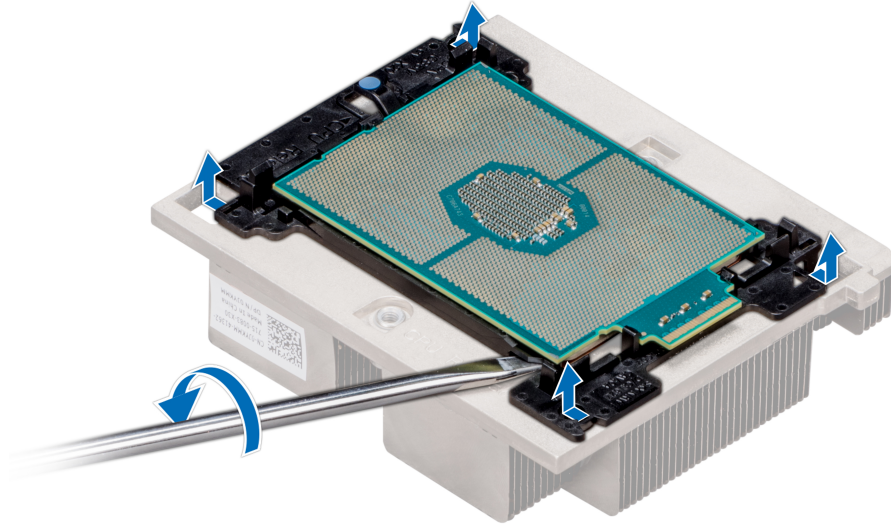

Figure 54. Loosening the processor bracket

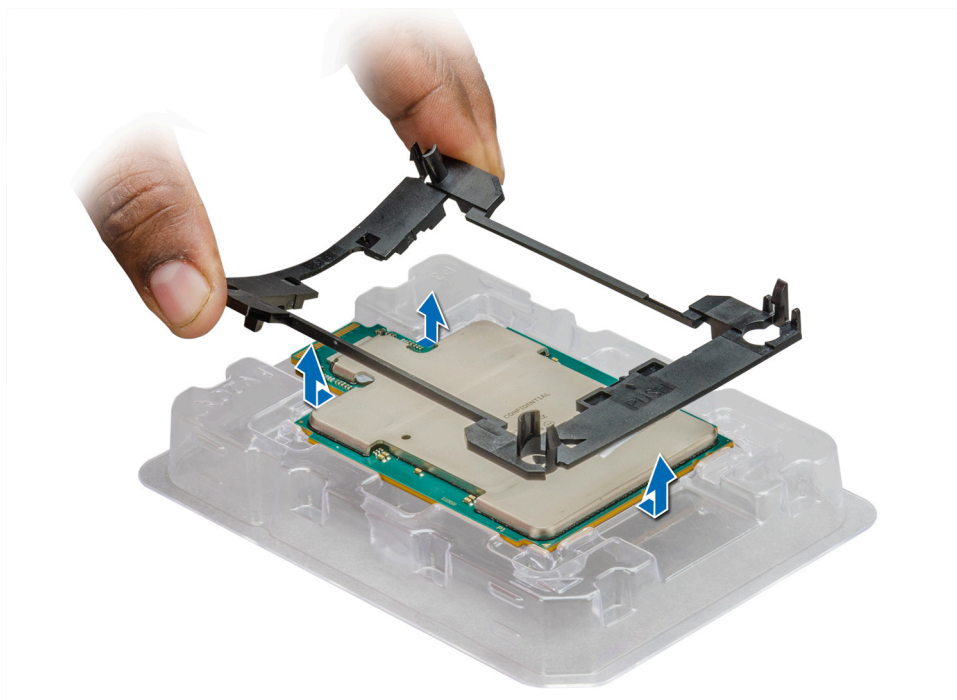

Figure 55. Removing the processor bracket

Next steps

Install the fabric processor into the processor heat sink module .

Installing the fabric processor into the processor heat sink module

Prerequisites

Follow the safety guidelines listed in [Safety instructions](#).

Steps

1. Ensure that the processor is in the CPU tray.

NOTE: Ensure that pin 1 indicator on the CPU tray is aligned with the pin 1 indicator on the processor.

2. Flex the outer edges of the bracket around the processor, close to the fabric connector, ensuring that the processor is locked into the clips on the bracket.

3. Press the other end of the bracket to ensure that the clip is locked on to the processor.

NOTE: Ensure that the pin 1 indicator on the bracket is aligned with the pin 1 indicator on the processor before placing the bracket on the processor.



Figure 56. Installing the processor bracket

4. If you are using an existing heat sink, remove the thermal grease from the heat sink by using a clean lint-free cloth.

CAUTION: Applying too much thermal grease can result in excess grease coming in contact with and contaminating the processor socket.

5. Use the thermal grease syringe included with your processor kit to apply the grease in a quadrilateral design on the top of the processor.

NOTE: The thermal grease syringe is intended for single use only. Dispose the syringe after you use it.



Figure 57. Applying thermal grease on top of the processor

6. Place the heat sink on the processor and push down until the bracket locks onto the heat sink.

i NOTE:

- Ensure that the two guide pin holes on the bracket match the guide holes on the heat sink.
- Ensure that the pin 1 indicator on the heat sink is aligned with the pin 1 indicator on the bracket before placing the heat sink on the processor and bracket.

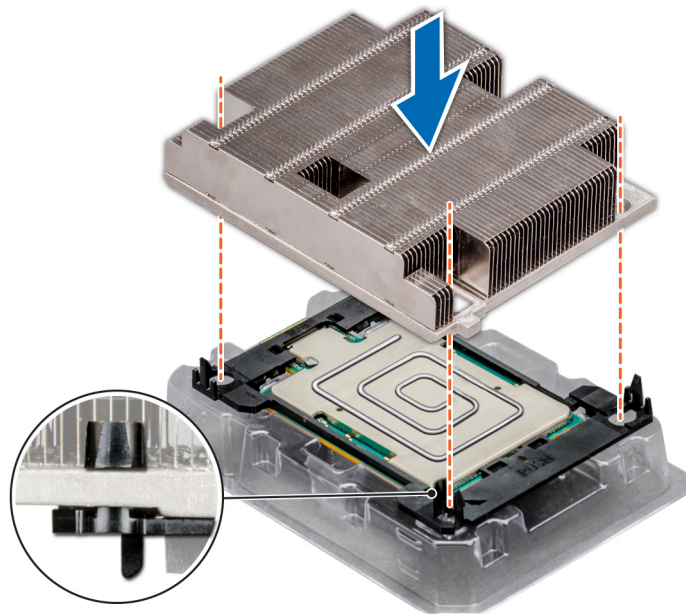

Figure 58. Installing the heat sink onto the processor

Next steps

1. Install the processor and heat sink module
2. Install the air shroud.

3. Install the sled.
4. Follow the procedure listed in [After working inside your system](#).

Network daughter card

Removing the OCP card

Prerequisites

1. Follow the safety guidelines listed in the [Safety instructions](#).
2. Follow the procedure listed in the [Before working inside your system](#).
3. [Remove the sled](#).
4. [Remove the air shroud](#).
5. [Remove the PCIe card module](#).
6. [Remove the mini PERC module](#).

Steps

1. Push the blue retention clips away on one side and release the OCP card. Repeat step 1 to release the card from the clips on the other side.
2. Slide the card toward the front of the sled to disengage the connectors from the chassis and lift the card up.

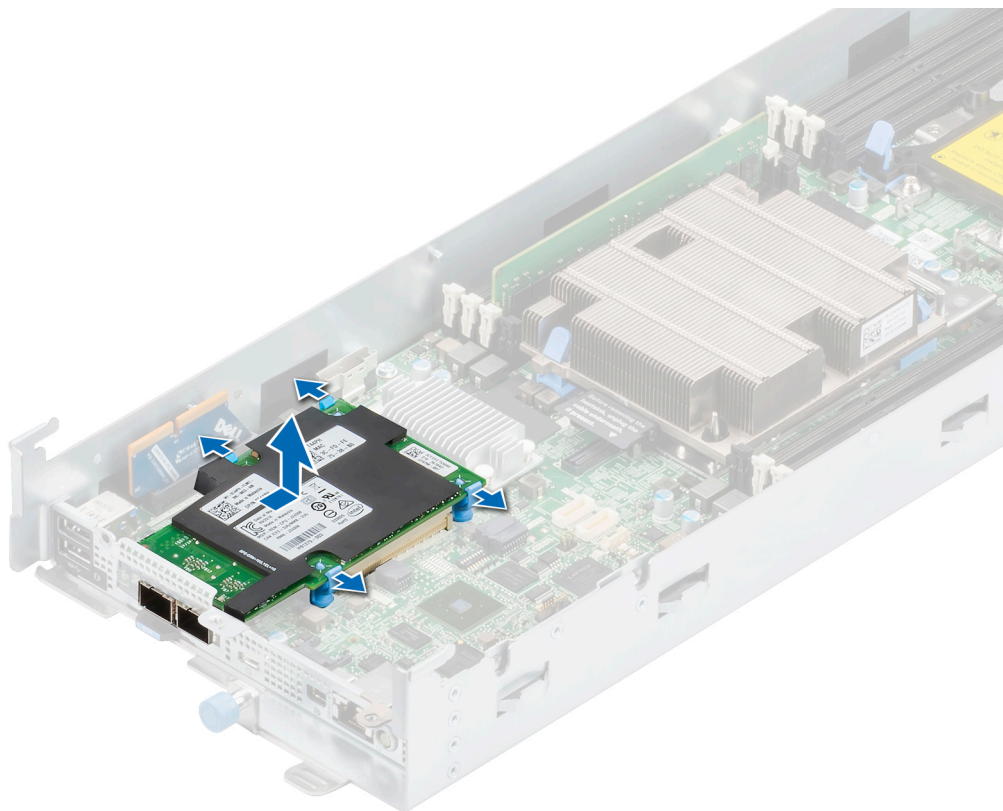

Figure 59. Removing the OCP card

Next steps

[Install the OCP Card](#).

Installing the OCP card

Prerequisites

1. Follow the safety guidelines listed in the [Safety instructions](#).
2. Follow the procedure listed in the [Before working inside your system](#).

Steps

1. Insert the OCP card into the sled, aligning the connector on the card with the connector in the system board.
2. Align the holes on the card with the guide pins on the blue retention clips.
3. Push down to lock the card in place.

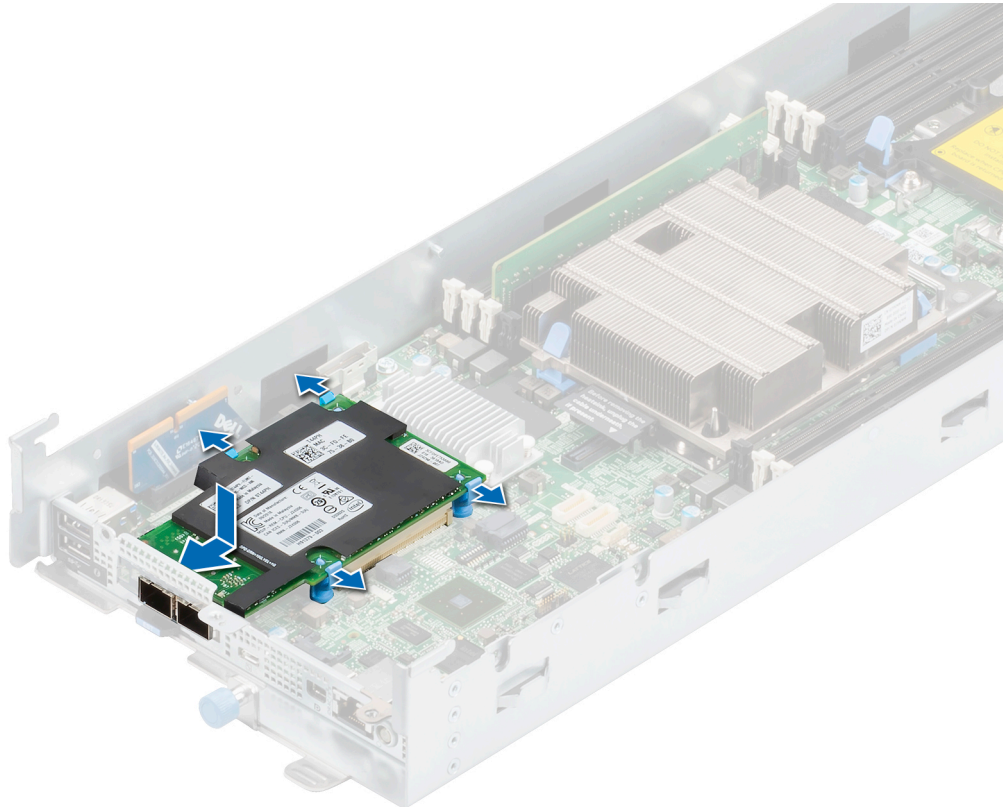

Figure 60. Installing the OCP card

Next steps

1. Install the mini PERC module.
2. Install the PCIe card module
3. Install the air shroud.
4. Install the sled.
5. Follow the procedure listed in [After working inside your system](#).

System battery

Replacing the system battery

Prerequisites

⚠ WARNING: There is a danger of a new battery exploding if it is incorrectly installed. Replace the battery only with the same or equivalent type that is recommended by the manufacturer. Discard used batteries according to the manufacturer's instructions. See the Safety instructions that came with your system for more information.

1. Follow the safety guidelines listed in the [Safety instructions](#).
2. Follow the procedure listed in the [Before working inside your system](#).

Steps

1. [Remove the sled](#).
2. [Remove the PCIe card module](#).
3. Locate the system battery on the system board.

⚠ CAUTION: To avoid damage to the battery connector, you must firmly support the connector while installing or removing a battery.

4. To remove the battery:
 - a. Use a plastic scribe to pry out the system battery.
 - b. Gently press the metal clip as shown to release the battery.
 - c. Remove the battery from the plastic socket.

⚠ CAUTION: To avoid damage to the battery connector, you must firmly support the connector while installing or removing a battery.

5. To install a new system battery:
 - a. Hold the battery with the positive side facing up and slide it under the securing tabs.
 - b. Press the battery into the connector until it snaps into place.



Figure 61. System battery installation

Next steps

1. [Install PCIe card module](#).
2. [Install the air shroud](#).
3. [Install the sled](#).
4. Follow the procedure listed in [After working inside your system](#).
5. Confirm that the battery is operating properly, by performing the following steps:
 - a. Enter the System Setup, while booting, by pressing F2.
 - b. Enter the correct time and date in the System Setup **Time** and **Date** fields.
 - c. **Exit** the System Setup.
 - d. To test the newly installed battery, remove the system from the enclosure for at least an hour.
 - e. Reinstall the system into the enclosure after an hour.
 - f. Enter the System Setup and if the time and date are still incorrect, see [Getting help](#) section.

System board

Removing the system board

Prerequisites

 **CAUTION:** If you are using the Trusted Platform Module (TPM) with an encryption key, you may be prompted to create a recovery key during program or System Setup. Be sure to create and safely store this recovery key. If you replace this system board, you must supply the recovery key when you restart your system or program before you can access the encrypted data on your drives.

1. Follow the safety guidelines listed in the [Safety instructions](#).
2. Follow the procedure listed in the [Before working inside your system](#).
3. Remove the following components:
 - a. [Sled](#)
 - b. [Air shroud](#)
 - c. [PCIe card module](#)
 - d. [Mini PERC module](#)
 - e. [OCP card](#)
 - f. [Sled cables kit](#)
 - g. [Motherboard bridge board module](#)
 - h. [Cable M.2 card](#)
 - i. [Memory](#)
 - j. [Processor and heat sink](#)

Steps

1. Remove the eight screws securing the system board to the chassis.
2. Slightly lift the system board and slide it towards the front of the chassis.
3. Lift the system board out of the chassis.

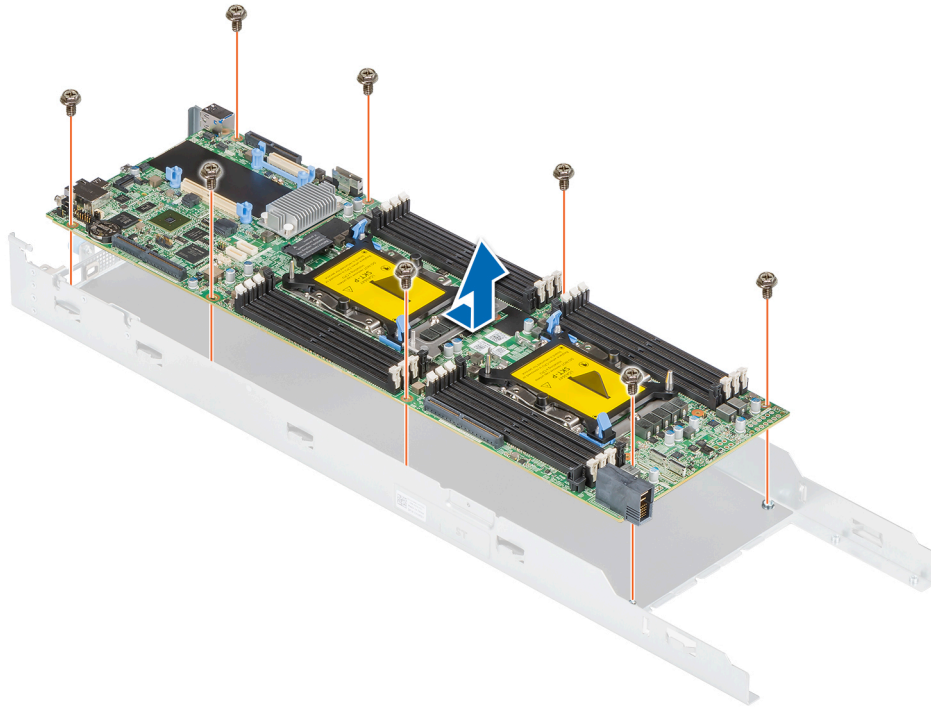

Figure 62. Removing the system board

Next steps

Install the system board.

Installing the system board

Prerequisites

NOTE: Before replacing the system board, replace the old iDRAC MAC address label in the Information tag with the iDRAC MAC address label of the replacement system board.

1. Follow the safety guidelines listed in the [Safety instructions](#).
2. Follow the procedure listed in [Before working inside your system](#).
3. If you are replacing the system board, remove all the components that are listed in the [removing the system board](#) section.

Steps

1. Unpack the new system board assembly.

CAUTION: Do not lift the system board by holding a memory module, processor, or other components.

CAUTION: Take care not to damage the system identification button while placing the system board into the chassis.

2. Holding the system board holder, lower and push the system board towards the back of the system till it is seated.
3. Tighten the eight screws to secure the system board to the chassis.

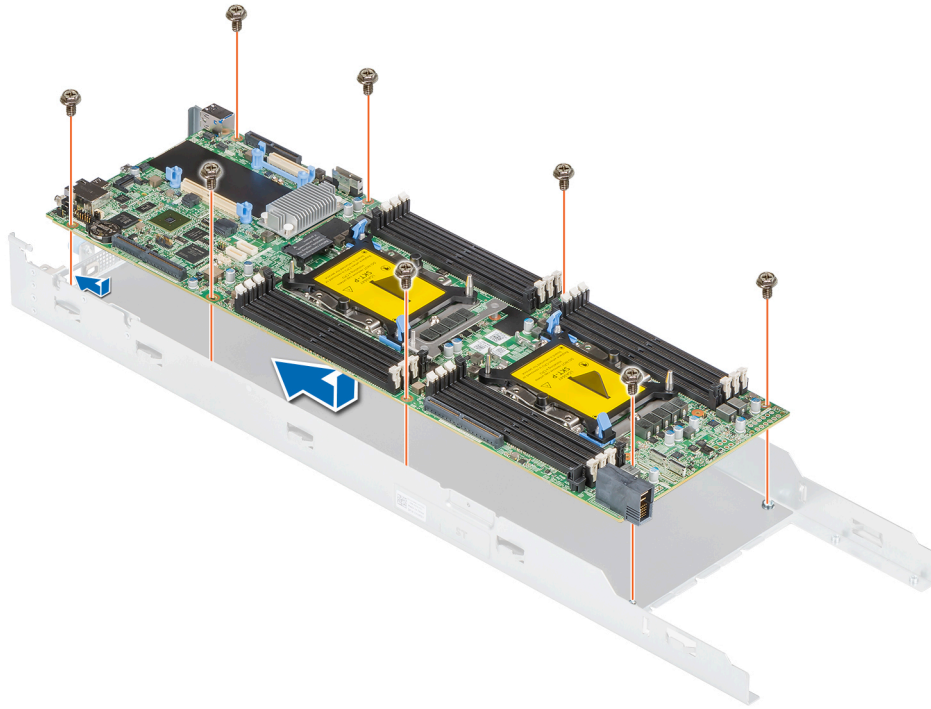

Figure 63. Installing the systemboard

Next steps



1. Install the following components:
 - a. [Trusted Platform Module](#)
 - i** **NOTE:** The TPM Module must be replaced only while installing new system board.
 - b. [Processor and heat sink](#)
 - c. [Memory](#)
 - d. [Cable M.2 riser card](#)
 - e. [Motherboard bridge module](#)
 - f. [OCP card](#)
 - g. [Mini PERC module](#)
 - h. [PCIe card module](#)
 - i. [Air shroud](#)
 - j. [Sled](#)
2. Reconnect all cables to the system board.
 - i** **NOTE:** Ensure that the cables inside the system are routed along the chassis wall and secured using the cable securing bracket.
3. Ensure that you perform the following steps:
 - a. Use the Easy Restore feature to restore the Service Tag. See the [Restoring the system by using the Easy Restore feature](#) section.
 - b. If the service tag is not backed up in the backup flash device, enter the system service tag manually. See the [Manually update the Service Tag by using System Setup](#) section.
 - c. Update the BIOS and iDRAC versions.
 - d. Re-enable the Trusted Platform Module (TPM). See the [Upgrading the Trusted Platform Module](#) section.
4. If you are not using Easy restore, import your new or existing iDRAC Enterprise license. For more information, see the *iDRAC User's Guide* available at <https://www.dell.com/iDRAC> manuals.
5. Follow the procedure listed in [After working inside the system](#).

Restoring Service Tag using Easy Restore

The Easy Restore feature allows you to restore your Service Tag, iDRAC license, UEFI configuration, and the system configuration data after replacing the system board. All data is backed up in a backup Flash drive device automatically. If BIOS detects a new system board, and the Service Tag in the backup Flash drive device is different, BIOS prompts the user to restore the backup information.

About this task

Below is a list of options available:

1. Restore the Service Tag, license, and diagnostics information, press **Y**.
 2. Go to the Lifecycle Controller based restore options, press **N**.
 3. Restore data from a previously created **Hardware Server Profile**, press **F10**.
 **NOTE:** When the restore process is complete, BIOS prompts to restore the system configuration data.
 4. To restore the system configuration data, press **Y**
 5. To use the default configuration settings, press **N**
 **NOTE:** After the restore process is complete, system reboots.
-  **NOTE:** If restoring the Service Tag is successful, you can check the Service Tag information in the **System Information** screen and compare it with the Service Tag on the system.

Manually updating Service Tag

After replacing a system board, if Easy Restore fails, follow this process to manually enter the Service Tag, using **System Setup**.

About this task

If you know the system Service Tag, use the **System Setup** menu to enter the Service Tag.

Steps

1. Turn on the system.
2. To enter the **System Setup**, press **F2**.
3. Click **Service Tag Settings**.
4. Enter the Service Tag.
 **NOTE:** You can enter the Service Tag only when the **Service Tag** field is empty. Ensure that you enter the correct Service Tag. After the Service Tag is entered, it cannot be updated or changed.
5. Click **OK**.

Trusted Platform Module

Upgrading the Trusted Platform Module

Prerequisites

-  **NOTE:**
- Ensure that your operating system supports the version of the TPM module being installed.
 - Ensure that you download and install the latest BIOS firmware on your system.
 - Ensure that the BIOS is configured to enable UEFI boot mode.

About this task

CAUTION: Once the TPM plug-in module is installed, it is cryptographically bound to that specific system board. Any attempt to remove an installed TPM plug-in module breaks the cryptographic binding, the removed TPM cannot be reinstalled or installed on another system board.

Removing the TPM

Steps

1. Locate the TPM connector on the system board.
2. Press to hold the module down and remove the screw using the security Torx 8-bit shipped with the TPM module.
3. Slide the TPM module out from its connector.
4. Push the plastic rivet away from the TPM connector and rotate it 90° counterclockwise to release it from the system board.
5. Pull the plastic rivet out of its slot on the system board.

Installing the TPM

Steps

1. To install the TPM, align the edge connectors on the TPM with the slot on the TPM connector.
2. Insert the TPM into the TPM connector such that the plastic rivet aligns with the slot on the system board.
3. Press the plastic rivet until the rivet snaps into place.
4. Replace the screw that secures the TPM to the system board.

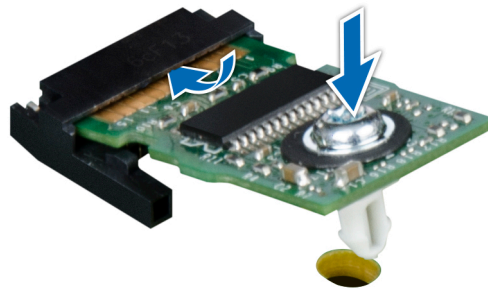

Figure 64. Installing the TPM

Initializing TPM for users

Steps

1. Initialize the TPM.
For more information, see [Initializing the TPM for users](#).
2. The **TPM Status** changes to **Enabled, Activated**.

Initializing the TPM 1.2 for users

Steps

1. While booting your system, press F2 to enter System Setup.
2. On the **System Setup Main Menu** screen, click **System BIOS > System Security Settings**.
3. From the **TPM Security** option, select **On with Preboot Measurements**.

4. From the **TPM Command** option, select **Activate**.
5. Save the settings.
6. Restart your system.

Initializing the TPM 2.0 for users

Steps

1. While booting your system, press F2 to enter System Setup.
2. On the **System Setup Main Menu** screen, click **System BIOS > System Security Settings**.
3. From the **TPM Security** option, select **On**.
4. Save the settings.
5. Restart your system.

Jumpers and connectors

This topic provides specific information about the jumpers. It also provides some basic information about jumpers and switches and describes the connectors on the various boards in the system. Jumpers on the system board help to disable the system and setup passwords. You must know the connectors on the system board to install components and cables correctly.

Topics:

- [System board connectors](#)
- [System board jumper settings](#)
- [Disabling forgotten password](#)

System board connectors

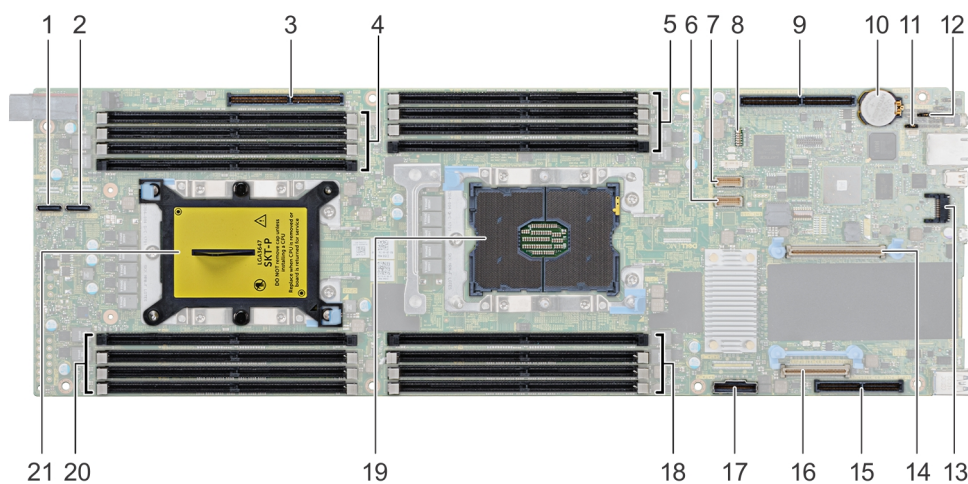

Figure 65. PowerEdge XE7420 system board connectors

Table 12. System Board Connectors and Description

Item	Connector	Description
1	PCIe B	NVMe B connector
2	PCIe A	NVMe A connector
3	PCIe Slot 5	Slot 5: x16 PCIe Gen3 from CPU 2
4	DIMM sockets (4)	DIMM B8, DIMM B4, DIMM B5, DIMM B6
5	DIMM sockets (4)	DIMM A8, DIMM A4, DIMM A5, DIMM A6
6	HFI_SB_1	Side band cable 1 for OCP
7	HFI_SB_2	Side band cable 2 for OCP
8	LEDs (7)	System board diagnostic LED indicators
9	PCIe Slot 4	Slot 4: x16 PCIe Gen3 CPU 1
10	Batt	System battery





Table 12. System Board Connectors and Description (continued)

Item	Connector	Description
11	PWDCLR	Password clear jumper
12	NVRAMCLR	NVRAM clear jumper
13	TPM	TPM connector
14	PCIe Slot 1	Slot 1: x8 PCIe Gen3 from CPU 1
15	PCIe Slot 3	Slot 3: x8 PCIe Gen3 from CPU 1
16	PCIe Slot 2	Slot 2: x8 PCIe Gen3 from CPU 1
17	SATA_A	SATA cable connector
18	DIMM sockets (4)	DIMM A7, DIMM A1, DIMM A2, DIMM A3
19	CPU 1	CPU socket 1
20	DIMM sockets (4)	DIMM B7, DIMM B1, DIMM B2, DIMM B3
21	CPU 2	CPU socket 2 (with a dust cover)

System board jumper settings

For information about resetting the password jumper to disable a password, see the [Disabling a forgotten password](#) section.

Table 13. System board jumper settings

Jumper	Setting	Pin number	Description
NVRAM_CLR		2, 3	The BIOS configuration settings are retained at system boot.
		1, 2	The BIOS configuration settings are cleared at system boot.
PWRD_EN		1, 2	The BIOS password feature is enabled.
		2, 3	The BIOS password feature is disabled. iDRAC local access is unlocked at next AC power cycle. iDRAC password reset is enabled in F2 iDRAC settings menu.

CAUTION: Be careful when changing the BIOS settings. The BIOS interface is designed for advanced users. Any change in the setting could prevent your system from starting correctly and you might have potential loss of data.

Disabling forgotten password

The software security features of the system include a system password and a setup password. The password jumper enables or disables password features and clears any password(s) currently in use.

Prerequisites

CAUTION: Many repairs may only be done by a certified service technician. You should only perform troubleshooting and simple repairs as authorized in your product documentation, or as directed by the online or

telephone service and support team. Damage due to servicing that is not authorized by Dell is not covered by your warranty. Read and follow the safety instructions that are shipped with your product.

Steps

1. Power off the system, including any attached peripherals, and disconnect the system from the electrical outlet.
2. Remove the system cover.
3. Move the jumper on the system board jumper from pins 2 and 4 to pins 4 and 6.
4. Install the system cover.

The existing passwords are not disabled (erased) until the system boots with the jumper on pins 4 and 6. However, before you assign a new system and/or setup password, you must move the jumper back to pins 2 and 4.

 **NOTE:** If you assign a new system and/or setup password with the jumper on pins 4 and 6, the system disables the new password(s) the next time it boots.

5. Reconnect the system to its electrical outlet and power on the system, including any attached peripherals.
6. Power off the system, including any attached peripherals, and disconnect the system from the electrical outlet.
7. Remove the system cover.
8. Move the jumper on the system board jumper from pins 4 and 6 to pins 2 and 4.
9. Install the system cover.
10. Reconnect the system to its electrical outlet and power on the system, including any attached peripherals.
11. Assign a new system and/or setup password.

Technical specifications

The technical and environmental specifications of your system are outlined in this section.

Topics:

- Dimensions of the PowerEdge XE7420 sled
- Chassis weight
- Processor specifications
- Cooling specifications
- Supported operating systems
- System battery
- Expansion bus specifications
- Memory specifications
- Drives and storage specifications
- Video specifications
- Environmental specifications

Dimensions of the PowerEdge XE7420 sled

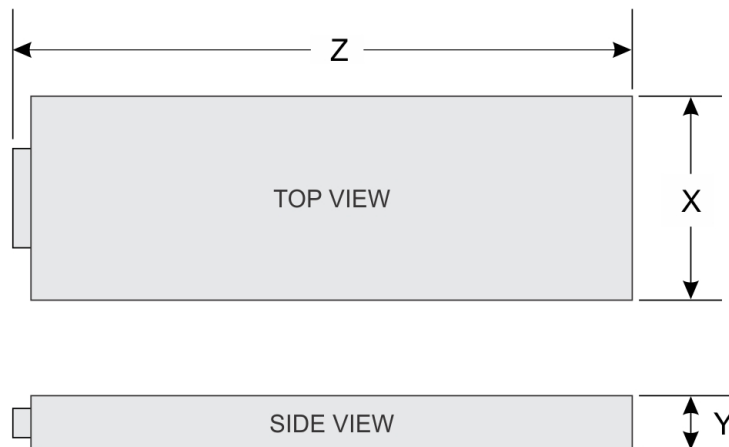

Figure 66. Dimensions of the PowerEdge XE7420 sled

Table 14. Dimensions of the PowerEdge XE7420 sled

X	Y	Z
187 mm (7.36 inches)	56.65 mm (2.23 inches)	691 mm (27.20 inches)

Chassis weight

Table 15. Chassis weight of the PowerEdge XE7100 enclosure with PowerEdge XE7440 and XE7420 sleds

System	Maximum weight (with all sleds and drives)
Chassis weight without sled	132.26 Kg (291.58 lb)
Chassis weight with half-width sled (XE7420)	137.12 Kg (302.29 lb)
Chassis weight with full- width full-height sled (XE7440).	140.93 Kg (310.69 lb)
Chassis weight with full- width low-profile sled (XE7440)	142.81 Kg (341.84 lb)

Processor specifications

The PowerEdge XE7420 sled supports up to two Intel Xeon Scalable processor in each independent sled. Each processor supports up to 26 cores.

Cooling specifications

The PowerEdge XE7100 chassis with two PowerEdge XE7420 nodes/sleds or one PowerEdge XE7440 node/sled has 18 fans. These are divided into three fan zones (Chassis, Node_A, and Node_B), and each zone has six fans.

The chassis fans are single rotor fans, and sled fans are dual rotor fans.

For Half-Width (HW) sled, sled 1 is Node 1 and sled 2 is Node 2.

Table 16. Fan numbering

PowerEdge systems	Fan numbering
XE7100 - Chassis	1-6
XE7440 (Single sled)	7-12 , 13-18
XE7420 (Dual sleds)	Node_A: 7-12 , Node_B: 13-18

NOTE: The reading and reporting of fan sensors are in the order of chassis fans, Node_A and Node_B fans, and sensors numbering is 1-6, 7-12 and 13-18 respectively.

- For XE7420, the sled 1/ node 1 reports six chassis fan sensors (1-6) and sled 1 fan sensors (7-12).
- For XE7420, the sled 2/ node 2 reports six chassis fan sensors (1-6) and sled 2 fan sensors (13-18).

Cooling fan-mapping

Table 17. Cooling fan-mapping

Fan name and configuration	iDRAC sensor number
(Chassis) FAN 1	38
FAN 2	39
FAN 3	3A
FAN 4	3B
FAN 5	3C
FAN 6	3D

Table 17. Cooling fan-mapping (continued)

Fan name and configuration	iDRAC sensor number
(Node_A) FAN 7	3E
FAN 8	3F
FAN 9	40
FAN 10	41
FAN 11	42
FAN 12	43
(Node_B) FAN 13	44
FAN 14	45
FAN 15	46
FAN 16	47
FAN 17	E2
FAN 18	E3

 **NOTE:** All the numbering are embossed on each fan.

Thermal recommendations

- After one fan rotor failure, you must estimate the fan service time while the system is under steady state.
- It is recommended to limit the minimum service time under 500 seconds.

 **NOTE:** For PSU and hard drive no limit is required for the service time.

Supported operating systems

The PowerEdge XE7420 supports the following operating systems:

- Canonical® Ubuntu®
- VMware® ESXi®
- Microsoft® Windows Server®
- Red Hat® Enterprise Linux
- SUSE® Linux Enterprise Server

 **NOTE:** For more information about the specific versions and additions, see <https://www.dell.com/ossupport>.

System battery

The PowerEdge XE7420 sled uses a CR 2032 3V replaceable lithium coin cell battery.

 **NOTE:** There is a system battery in each of the sleds.

Expansion bus specifications

The PowerEdge XE7420 sled supports four Generation 3 capable PCIe slots.

Table 18. Expansion bus specifications

PCIe Slots	Description	Form factor
x8 DCS Mezz PCIe riser	Slot 1: x8 PCIe Gen3 from processor 1	Mini PERC form factor
x8+x8 OCP Mezz riser	Slot 2: x8 PCIe Gen3 from processor 1	Standard Open Compute Project (OCP) form factor
	Slot 3: x8 PCIe Gen3 from processor 1	
x16 PCIe main riser	Slot 4: x16 PCIe Gen3 processor 1 (for FWFH configuration)	Standard PCIe form factor
	Slot 7: x16 PCIe Gen3 processor 1 (for FWLP configuration)	
	Slot 8: x16 PCIe Gen3 processor 1 (for FWLP configuration)	
	Slot 9: x16 PCIe Gen3 processor 1 (for FWLP configuration)	
	Slot 10: x16 PCIe Gen3 processor 1 (for FWLP configuration)	
x16 M.2 riser	Slot 5 and 6: x16 PCIe Gen3 from processor 2	Custom form factor (PERC card)

Memory specifications

Table 19. Memory specifications

Memory module sockets	DIMM type	DIMM rank	DIMM capacity	Single processor		Dual processors	
				Minimum RAM	Maximum RAM	Minimum RAM	Maximum RAM
Sixteen 288-pins	LRDIMM	Octal rank	128 GB	128 GB	1024 GB	256 GB	2048 GB
		Single rank	8 GB	8 GB	64 GB	16 GB	128 GB
	RDIMM	Dual rank	16 GB	16 GB	128 GB	32 GB	256 GB
			32 GB	32 GB	256 GB	64 GB	512 GB
			64 GB	64 GB	512 GB	128 GB	1024 GB

Drives and storage specifications

The PowerEdge XE7420 enclosure supports SAS and SATA hard drives and Solid State Drives (SSDs).

Table 20. Supported drive options for the PowerEdge XE7420 sled with enclosure

Maximum number of drives in the enclosure	Maximum number of drives assigned per sled
100 x 3.5-inch drive systems	50 SAS or SATA hard drives and SSDs per sled
4 x 2.5-inch drive systems	Four SAS or SATA hard drives or SSDs per sled
4 x 2.5-inch drive systems with NVMe	The NVMe backplane supports either of these configurations: <ul style="list-style-type: none"> Two NVMe drives and two SAS or SATA hard drives or SSDs per sled
M.2 SATA drive (optional)	The supported capacity of the M.2 SATA card is up to 240 GB <i>i</i> NOTE: The M.2 SATA card can be installed on the x8 (slot 1) mezzanine riser or the x16 riser slot (slot 5).
Micro-SD card (optional) for boot (up to 64 GB)	One on each PCIe riser of each sled

Video specifications

The PowerEdge XE7420 sled supports a Matrox G200 integrated graphics card with 16 MB RAM.

Table 21. Supported video resolution options

Resolution	Refresh rate (Hz)	Color depth (bits)
1024 x 768	60	up to 24
1280 x 800	60	up to 24
1280 x 1024	60	up to 24
1360 x 768	60	up to 24
1440 x 900	60	up to 24

Environmental specifications

The sections below contains information about the environmental specifications of the system.

i **NOTE:** For additional information about environmental certifications, please refer to the Product Environmental Datasheet located with the Manuals & Documents on www.dell.com/poweredgemanuals.

Standard operating temperature specifications

i **NOTE:** All components including the DIMMs, communication cards, M.2 SATA, and PERC cards can be supported with sufficient thermal margin if the ambient temperature is equal to or below the maximum continuous operating temperature listed in these tables except for the Mellanox DP LP card and Intel Rush Creek card.

Table 22. Standard operating temperature specifications

Standard operating temperature	Specifications
Temperature ranges (for altitude less than 900 m or 2953 ft)	10°C–35°C (50°F–95°F) with no direct sunlight on the equipment.

Expanded operating temperature specifications

i **NOTE:** When operating in the expanded temperature range, system performance may be impacted.

i **NOTE:** When operating in the expanded temperature range, ambient temperature warnings may be reported in the System Event Log.

Operating temperature derating specifications

Table 23. Operating temperature

Operating temperature derating	Specifications
≤ 35°C (95°F)	Maximum temperature is reduced by 1°C/300 m (1.8°F/984 ft) above 900 meters (2953 ft).
35°C–40°C (95°F–104°F)	Maximum temperature is reduced by 1°C/175 m (1.8°F/574 ft) above 900 meters (2953 ft).
40°C–45°C (104°F–113°F)	Maximum temperature is reduced by 1°C/125 m (1.8°F/410 ft) above 900 meters (2953 ft).

Relative humidity specifications

Table 24. Relative humidity specifications

Relative humidity	Specifications
Storage	5% to 95% RH with 27°C (80.6°F) maximum dew point. Atmosphere must be noncondensing always.
Operating	<ul style="list-style-type: none"> < 35°C (95°F): 8% RH with -12°C minimum dew point to 80% RH with 21°C (69.8°F) maximum dew point. 35°C–40°C (95°F–104°F): 8% RH with -12°C minimum dew point to 85% RH with 24°C (75.2°F) maximum dew point. 40°C– 45°C(104°F–113°F): 8% RH with -12°C minimum dew point to 90% RH with 24°C (75.2°F) maximum dew point

Temperature specifications

Table 25. Temperature specifications

Temperature	Specifications
Storage	–40°C–65°C (–40°F to 149°F)
Continuous operation (for altitude less than 950 m or 3117 ft)	10°C–35°C (50°F to 95°F) with no direct sunlight on the equipment.
Expanded operating temperature	For information about expanded operating temperature, see Expanded Operating Temperature section.
Maximum temperature gradient (operating and storage)	20°C/h (68°F/h)

NOTE: Some configurations require a lower ambient temperature for more information, see the [Standard operating temperature specifications](#).

Particulate and gaseous contamination specifications

Table 26. Particulate contamination specifications

Particulate contamination	Specifications
Air filtration	Data center air filtration as defined by ISO Class 8 per ISO 14644-1 with a 95% upper confidence limit.
NOTE: This condition applies only to data center environments. Air filtration requirements do not apply to IT equipment designed to be used outside a data center, in environments such as an office or factory floor.	
NOTE: Air entering the data center must have MERV11 or MERV13 filtration.	
Conductive dust	Air must be free of conductive dust, zinc whiskers, or other conductive particles.
NOTE: This condition applies to data center and non-data center environments.	
Corrosive dust	Air must be free of corrosive dust.
Residual dust present in the air must have a deliquescent point less than 60% relative humidity.	
NOTE: This condition applies to data center and non-data center environments.	

Table 27. Gaseous contamination specifications

Gaseous contamination	Specifications
Copper coupon corrosion rate	<300 Å/month per Class G1 as defined by ANSI/ISA71.04-2013
Silver coupon corrosion rate	<200 Å/month per Class G1 as defined by ANSI/ISA71.04-2013
 NOTE: Maximum corrosive contaminant levels measured at ≤50% relative humidity.	

Maximum vibration specifications

Table 28. Maximum vibration specifications

Maximum vibration	Specifications
Operating	0.26 Grms at 5 Hz to 350 Hz (all operation orientations).
Storage	1.88 Grms at 10 Hz to 500 Hz for 15 min (all six sides tested).

Maximum shock specifications

Table 29. Maximum shock specifications

Maximum shock	Specifications
Operating	24 executed shock pulses 6 G in the positive and negative x, y, z axis for up to 11 ms (four pulses on each side of the system).
Storage	6 consecutively executed shock pulses of 71 G in the positive and negative x, y, z axes for up to 2 ms (one pulse on each side of the system).

Maximum altitude specifications

Table 30. Maximum altitude specifications

Maximum altitude	Specifications
Operating	3048 m (10,000 ft)
Storage	12,000 m (39,370 ft)

System diagnostics and indicator codes

This section describes the diagnostic indicators on the system front panel that displays the system status during system startup.

Topics:

- [NIC indicator codes](#)
- [Using system diagnostics](#)

NIC indicator codes

Each NIC on the back of the system has indicators that provide information about the activity and link status. The activity LED indicator indicates if data is flowing through the NIC, and the link LED indicator indicates the speed of the connected network.

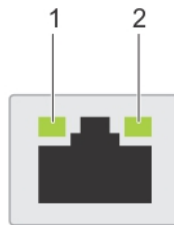

Figure 67. NIC indicator codes

1. Link LED indicator
2. Activity LED indicator

Table 31. NIC indicator codes

NIC indicator codes	Condition
Link and activity indicators are off.	Indicates that the NIC is not connected to the network.
Link indicator is green, and activity indicator is blinking green.	Indicates that the NIC is connected to a valid network at its maximum port speed, and data is being sent or received.
Link indicator is amber, and activity indicator is blinking green.	Indicates that the NIC is connected to a valid network at less than its maximum port speed, and data is being sent or received.
Link indicator is green, and activity indicator is off.	Indicates that the NIC is connected to a valid network at its maximum port speed, and data is not being sent or received.
Link indicator is amber, and activity indicator is off.	Indicates that the NIC is connected to a valid network at less than its maximum port speed, and data is not being sent or received.
Link indicator is blinking green, and activity is off.	Indicates that the NIC identify is enabled through the NIC configuration utility.

Using system diagnostics

If you experience an issue with the system, run the system diagnostics before contacting Dell for technical assistance. The purpose of running system diagnostics is to test the system hardware without using additional equipment or risking data loss. If you are unable to fix the issue yourself, service and support personnel can use the diagnostics results to help you solve the issue.

Dell Embedded System Diagnostics

NOTE: The Dell Embedded System Diagnostics is also known as Enhanced Pre-boot System Assessment (ePSA) diagnostics.

The Embedded System Diagnostics provide a set of options for particular device groups or devices allowing you to:

- Run tests automatically or in an interactive mode
- Repeat tests
- Display or save test results
- Run thorough tests to introduce additional test options to provide extra information about the failed device(s)
- View status messages that inform you if tests are completed successfully
- View error messages that inform you of issues encountered during testing

Running the Embedded System Diagnostics from the Dell Lifecycle Controller

Steps

1. As the system boots, press F10.
2. Select **Hardware Diagnostics** → **Run Hardware Diagnostics**.
The **ePSA Pre-boot System Assessment** window is displayed, listing all devices detected in the system. The diagnostics starts executing the tests on all the detected devices.

Running the Embedded System Diagnostics from Boot Manager

Run the Embedded System Diagnostics (ePSA) if your system does not boot.

Steps

1. When the system is booting, press F11.
2. Use the up arrow and down arrow keys to select **System Utilities** > **Launch Diagnostics**.
3. Alternatively, when the system is booting, press F10, select **Hardware Diagnostics** > **Run Hardware Diagnostics**.
The **ePSA Pre-boot System Assessment** window is displayed, listing all devices detected in the system. The diagnostics starts executing the tests on all the detected devices.

Results

System diagnostic controls

Table 32. System diagnostic controls

Menu	Description
Configuration	Displays the configuration and status information of all detected devices.
Results	Displays the results of all tests that are run.
System health	Provides the current overview of the system performance.
Event log	Displays a time-stamped log of the results of all tests run on the system. This is displayed if at least one event description is recorded.

Getting help

Topics:

- [Contacting Dell EMC](#)
- [Documentation feedback](#)
- [Accessing system information by using QRL](#)
- [Receiving automated support with SupportAssist](#)
- [Recycling or End-of-Life service information](#)

Contacting Dell EMC

Dell EMC provides several online and telephone based support and service options. If you do not have an active internet connection, you can find contact information about your purchase invoice, packing slip, bill, or Dell EMC product catalog. Availability varies by country and product, and some services may not be available in your area. To contact Dell EMC for sales, technical assistance, or customer service issues:

Steps

1. Go to www.dell.com/support/home.
2. Select your country from the drop-down menu on the lower right corner of the page.
3. For customized support:
 - a. Enter your system Service Tag in the **Enter your Service Tag** field.
 - b. Click **Submit**.
The support page that lists the various support categories is displayed.
4. For general support:
 - a. Select your product category.
 - b. Select your product segment.
 - c. Select your product.
The support page that lists the various support categories is displayed.
5. For contact details of Dell EMC Global Technical Support:
 - a. Click [Contact Technical Support](#).
 - b. Enter your system Service Tag in the **Enter your Service Tag** field on the Contact Us webpage.

Documentation feedback

You can rate the documentation or write your feedback on any of our Dell EMC documentation pages and click **Send Feedback** to send your feedback.

Accessing system information by using QRL

You can use the Quick Resource Locator (QRL) located on the information tag in the front of the system, to access the information about the PowerEdge system.

Prerequisites

Ensure that your smartphone or tablet has the QR code scanner installed.

The QRL includes the following information about your system:

- How-to videos

- Reference materials, including the Installation and Service Manual, LCD diagnostics, and mechanical overview
- Your system service tag to quickly access your specific hardware configuration and warranty information
- A direct link to Dell to contact technical assistance and sales teams

Steps

1. Go to www.dell.com/qrl and navigate to your specific product or
2. Use your smartphone or tablet to scan the model-specific Quick Resource (QR) code on your system or in the Quick Resource Locator section.

Quick Resource Locator for XE7100, XE7420 and XE7440 systems



Figure 68. Quick Resource Locator for PowerEdge XE7100, XE7420 and XE7440 systems

Receiving automated support with SupportAssist

Dell EMC SupportAssist is an optional Dell EMC Services offering that automates technical support for your Dell EMC server, storage, and networking devices. By installing and setting up a SupportAssist application in your IT environment, you can receive the following benefits:

- **Automated issue detection** — SupportAssist monitors your Dell EMC devices and automatically detects hardware issues, both proactively and predictively.
- **Automated case creation** — When an issue is detected, SupportAssist automatically opens a support case with Dell EMC Technical Support.
- **Automated diagnostic collection** — SupportAssist automatically collects system state information from your devices and uploads it securely to Dell EMC. This information is used by Dell EMC Technical Support to troubleshoot the issue.
- **Proactive contact** — A Dell EMC Technical Support agent contacts you about the support case and helps you resolve the issue.

The available benefits vary depending on the Dell EMC Service entitlement purchased for your device. For more information about SupportAssist, go to www.dell.com/supportassist.

Recycling or End-of-Life service information

Take back and recycling services are offered for this product in certain countries. If you want to dispose of system components, visit www.dell.com/recyclingworldwide and select the relevant country.

Documentation resources

This section provides information about the documentation resources for your system.

To view the document that is listed in the documentation resources table:

- From the Dell EMC support site:
 1. Click the documentation link that is provided in the Location column in the table.
 2. Click the required product or product version.
-  **NOTE:** To locate the product name and model, see the front of your system.
- 3. On the Product Support page, click **Manuals & documents**.
- Using search engines:
 - Type the name and version of the document in the search box.

Table 33. Additional documentation resources for your system

Task	Document	Location
Setting up your system	<p>For more information about installing and securing the system into a rack, see the Rail Installation Guide included with your rail solution.</p> <p>For information about setting up your system, see the <i>Getting Started Guide</i> document that is shipped with your system.</p>	www.dell.com/xemanuals
Configuring your system	<p>For information about the iDRAC features, configuring and logging in to iDRAC, and managing your system remotely, see the Integrated Dell Remote Access Controller User's Guide.</p> <p>For information about understanding Remote Access Controller Admin (RACADM) subcommands and supported RACADM interfaces, see the RACADM CLI Guide for iDRAC.</p> <p>For information about Redfish and its protocol, supported schema, and Redfish Eventing implemented in iDRAC, see the Redfish API Guide.</p> <p>For information about iDRAC property database group and object descriptions, see the Attribute Registry Guide.</p> <p>For information about Intel QuickAssist Technology, see the Integrated Dell Remote Access Controller User's Guide.</p>	www.dell.com/poweredgemanuals
	<p>For information about earlier versions of the iDRAC documents.</p> <p>To identify the version of iDRAC available on your system, on the iDRAC web interface, click ? > About.</p>	www.dell.com/idracmanuals

Table 33. Additional documentation resources for your system (continued)

Task	Document	Location
	For information about installing the operating system, see the operating system documentation.	www.dell.com/operatingsystemmanuals
	For information about updating drivers and firmware, see the Methods to download firmware and drivers section in this document.	www.dell.com/support/drivers
Managing your system	For information about systems management software offered by Dell, see the Dell OpenManage Systems Management Overview Guide.	www.dell.com/poweredgemanuals
	For information about setting up, using, and troubleshooting OpenManage, see the Dell OpenManage Server Administrator User's Guide.	www.dell.com/openmanagemanuals > OpenManage Server Administrator
	For information about installing, using, and troubleshooting Dell OpenManage Enterprise, see the Dell OpenManage Enterprise User's Guide.	https://www.dell.com/openmanagemanuals
	For information about installing and using Dell SupportAssist, see the Dell EMC SupportAssist Enterprise User's Guide.	https://www.dell.com/serviceabilitytools
	For information about partner programs enterprise systems management, see the OpenManage Connections Enterprise Systems Management documents.	www.dell.com/openmanagemanuals
Working with the Dell PowerEdge RAID controllers	For information about understanding the features of the Dell PowerEdge RAID controllers (PERC), Software RAID controllers, or BOSS card and deploying the cards, see the Storage controller documentation.	www.dell.com/storagecontrollermanuals
Understanding event and error messages	For information about the event and error messages generated by the system firmware and agents that monitor system components, go to qrl.dell.com > Look Up > Error Code , type the error code, and then click Look it up .	www.dell.com/qrl
Troubleshooting your system	For information about identifying and troubleshooting the PowerEdge server issues, see the Server Troubleshooting Guide.	www.dell.com/poweredgemanuals