

# Dell EMC PowerEdge T440

## Installation and Service Manual

## Notes, cautions, and warnings

 **NOTE:** A NOTE indicates important information that helps you make better use of your product.

 **CAUTION:** A CAUTION indicates either potential damage to hardware or loss of data and tells you how to avoid the problem.

 **WARNING:** A WARNING indicates a potential for property damage, personal injury, or death.

© 2018 - 2019 Dell Inc. or its subsidiaries. All rights reserved. Dell, EMC, and other trademarks are trademarks of Dell Inc. or its subsidiaries. Other trademarks may be trademarks of their respective owners.

<b>1 Dell EMC PowerEdge T440 system overview.....</b>	<b>8</b>
Supported configurations for the Dell EMC PowerEdge T440 system.....	8
Front view of the system.....	10
Status LED indicators.....	16
System health and system ID indicator codes.....	17
Drive indicator codes.....	18
Back view of the system.....	18
NIC indicator codes.....	20
Power supply unit indicator codes.....	20
Locating the Service Tag of your system.....	21
System information label.....	23
<b>2 Documentation resources.....</b>	<b>25</b>
<b>3 Technical specifications.....</b>	<b>27</b>
System dimensions.....	27
Chassis weight.....	28
Processor specifications.....	28
Supported operating systems.....	28
Cooling fan specifications.....	28
PSU specifications.....	28
System battery specifications.....	29
Expansion bus specifications.....	29
Memory specifications.....	29
Storage controller specifications.....	29
Drive specifications.....	29
Drives.....	29
Optical drive and tape drive.....	30
Ports and connectors specifications.....	30
USB ports.....	30
NIC ports.....	30
VGA ports.....	30
Serial connector.....	30
Internal Dual microSD Module or vFlash card.....	30
Video specifications.....	31
Environmental specifications.....	31
Standard operating temperature.....	32
Expanded operating temperature.....	32
Particulate and gaseous contamination specifications.....	33
<b>4 Initial system setup and configuration.....</b>	<b>35</b>
Setting up your system.....	35
iDRAC configuration.....	35
Options to set up iDRAC IP address.....	35

Log in to iDRAC.....	35
Options to install the operating system.....	36
Methods to download firmware and drivers.....	36
Downloading drivers and firmware.....	36
<b>5 Pre-operating system management applications.....</b>	<b>38</b>
Options to manage the pre-operating system applications.....	38
System Setup.....	38
Viewing System Setup.....	38
System Setup details.....	38
System BIOS.....	39
iDRAC Settings utility.....	58
Device Settings.....	58
Dell Lifecycle Controller.....	58
Embedded system management.....	58
Boot Manager.....	59
Viewing Boot Manager.....	59
Boot Manager main menu.....	59
One-shot UEFI boot menu.....	59
System Utilities.....	59
PXE boot.....	59
<b>6 Installing and removing system components.....</b>	<b>60</b>
Safety instructions.....	60
Before working inside your system.....	60
After working inside your system.....	60
Recommended tools.....	61
Optional front bezel.....	61
Removing the front bezel.....	61
Installing the front bezel.....	61
System feet.....	62
Removing the system feet.....	62
Installing the system feet.....	63
Inside the system.....	64
Caster wheels – optional.....	65
Removing caster wheels.....	65
Installing caster wheels.....	66
System cover.....	67
Removing the system cover.....	67
Installing the system cover.....	68
Air shroud.....	69
Removing the air shroud.....	69
Installing the air shroud.....	70
Drives.....	71
Removing a drive blank.....	71
Installing a drive blank.....	72
Removing a drive carrier.....	73
Installing a drive carrier.....	73
Removing the drive from the drive carrier.....	74

Installing a drive into the drive carrier.....	75
Removing a 2.5-inch drive from a 3.5-inch drive adapter.....	76
Installing a 2.5-inch drive into a 3.5-inch drive adapter.....	77
Removing a 3.5-inch drive adapter from a 3.5-inch drive carrier.....	77
Installing a 3.5-inch drive adapter into the 3.5-inch drive carrier.....	78
Optical drives and tape drives.....	79
Removing the optical or tape drive blank.....	79
Installing the optical or tape drive blank.....	80
Removing the optical drive cage or tape drive.....	81
Installing the optical drive cage or tape drive.....	82
Cabled drives.....	83
Removing the internal hard drive bay.....	83
Installing the internal hard drive bay.....	84
Removing a cabled drive.....	85
Installing a cabled drive.....	86
Drive backplane.....	87
Drive backplane guidelines.....	87
Backplane cable routing.....	90
Removing a hard drive backplane.....	92
Installing a hard drive backplane.....	93
System memory.....	94
System memory guidelines .....	94
General memory module installation guidelines.....	96
Mode-specific guidelines.....	96
Removing a memory module.....	99
Installing a memory module.....	100
Cooling fans.....	101
Removing the internal cooling fan.....	101
Installing the internal cooling fan.....	101
Removing the external cooling fan .....	102
Installing the external cooling fan.....	103
Optional internal USB memory key.....	103
Replacing the optional internal USB memory key.....	103
Expansion card holder.....	104
Removing the expansion card holder.....	104
Installing the expansion card holder.....	104
Expansion cards.....	105
Expansion card installation guidelines.....	105
GPU card installation guidelines.....	105
Removing a expansion card.....	106
Installing an expansion card.....	107
M.2 SSD module.....	108
Removing the M.2 SSD module.....	108
Installing the M.2 SSD module.....	108
Optional microSD or vFlash card.....	109
Removing the microSD card.....	109
Installing the microSD card.....	110
Optional IDSDM or vFlash module.....	110
Removing the optional IDSDM or vFlash card.....	110
Installing optional IDSDM or vFlash card.....	111

Processors and heat sinks.....	112
Removing a processor and heat sink module.....	112
Removing the processor from the processor and heat sink module.....	113
Installing the processor into a processor and heat sink module.....	115
Installing a processor and heat sink module.....	117
Power supply units.....	119
Removing a power supply unit blank.....	119
Installing a power supply unit blank.....	119
Removing a power supply unit.....	120
Installing a power supply unit.....	121
Removing a cabled power supply unit.....	121
Installing a cabled power supply unit.....	122
Power interposer board.....	123
Removing the power interposer board.....	123
Installing the power interposer board.....	123
System battery.....	124
Replacing the system battery.....	124
Control panel assembly.....	125
Removing the control panel assembly.....	125
Installing the control panel assembly.....	126
System board.....	127
Removing the system board.....	127
Installing the system board.....	130
Restoring the system using Easy Restore.....	131
Trusted Platform Module.....	132
Upgrading the Trusted Platform Module.....	132
Initializing TPM for BitLocker users.....	133
Initializing the TPM 1.2 for TXT users.....	133
Converting the system from tower mode to rack mode.....	133
Converting the system from tower mode to rack mode .....	134
Updating BIOS.....	134
<b>7 Using system diagnostics.....</b>	<b>136</b>
Dell Embedded System Diagnostics.....	136
Running the Embedded System Diagnostics from Boot Manager.....	136
Running the Embedded System Diagnostics from the Dell Lifecycle Controller.....	136
System diagnostic controls.....	137
<b>8 Jumpers and connectors .....</b>	<b>138</b>
System board jumpers and connectors.....	138
System board jumper settings.....	139
Disabling forgotten password.....	140
<b>9 Getting help.....</b>	<b>141</b>
Contacting Dell EMC.....	141
Documentation feedback.....	141
Accessing system information by using QRL.....	141
Quick Resource Locator for Dell EMC PowerEdge T440 system.....	142
Receiving automated support with SupportAssist .....	142

Recycling or End-of-Life service information.....142

# Dell EMC PowerEdge T440 system overview

The Dell EMC PowerEdge T440 system is a dual-socket, 5U rackable tower server that supports up to:

- Two Intel Xeon Scalable Processors
- 16 DIMM slots
- 4 or 8 x 3.5-inch SAS/SATA drive or SSDs, or 16 x 2.5-inch SAS/SATA drive bays (up to 12 Gbps SAS and 6 Gbps SATA)
- Redundant power supply units (PSUs)
- Cabled power supply units (PSUs)

## Topics:

- [Supported configurations for the Dell EMC PowerEdge T440 system](#)
- [Front view of the system](#)
- [Back view of the system](#)
- [Locating the Service Tag of your system](#)
- [System information label](#)

## Supported configurations for the Dell EMC PowerEdge T440 system

The Dell EMC PowerEdge T440 system supports the following configurations:

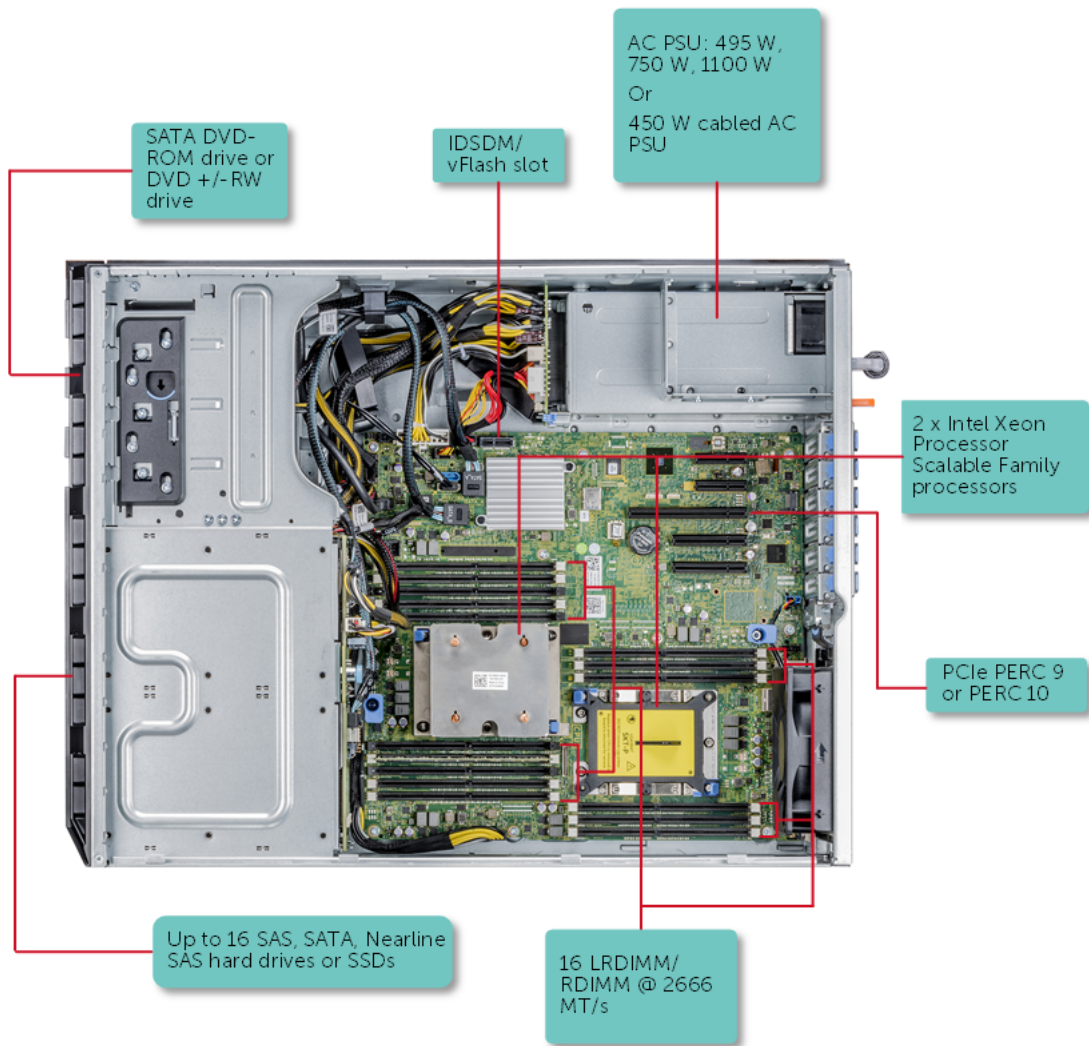

Figure 1. Supported configurations for a Dell EMC PowerEdge T440 system

# Front view of the system

The front view displays the features available on the front of the system.

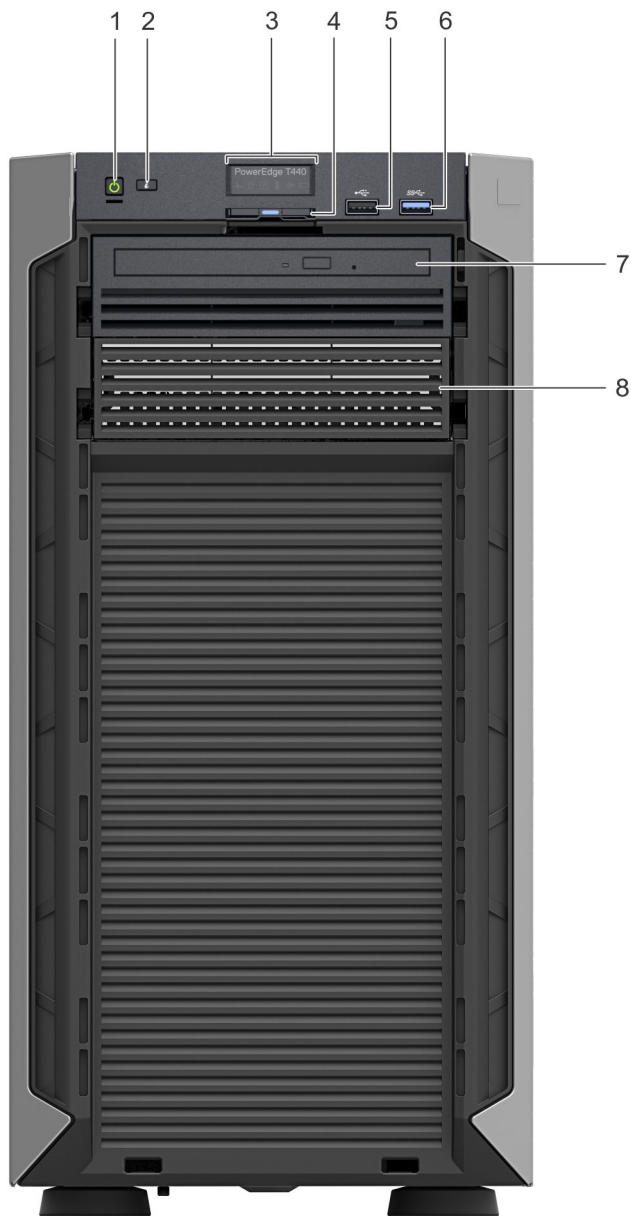





Figure 2. Front panel view of 4 x 3.5-inch cabled drive system

Table 1. Front panel features

Item	Components	Icon	Description
1	Power button		Indicates if the system is turned on or off. Press the power button to manually turn on or off the system. <b>NOTE: Press the power button to gracefully shut down an ACPI-compliant operating system.</b>
2	System identification button		The System Identification (ID) button is available on the front and back of the systems. Press the button to identify a system in a rack by turning on the system ID button. You can also use the system ID button to reset iDRAC and to access BIOS using the step through mode.

Item	Components	Icon	Description
3	Status LED indicator panel	N/A	Indicate the status of the system. For more information, see <a href="#">Status LED indicators</a> .
4	Information tag	N/A	The Information tag is a slide-out label panel that contains system information such as Service Tag, NIC, MAC address, and so on. If you have opted for the secure default access to iDRAC, the Information tag also contains the iDRAC secure default password.
5	USB port 2.0		The USB ports are 4-pin, 2.0-compliant. These ports enable you to connect USB devices to the system.
6	USB port 3.0		The USB port is USB 3.0 compliant.
7	Optical drive bay	N/A	Enable you to install drives that are supported on your system. For more information about drives, see <a href="#">Technical specifications</a> .
8	Drive slot	N/A	Enables you to install TBUs for 8x and 16x backplane configurations, or drive blank in the empty drive slot to maintain proper system cooling.

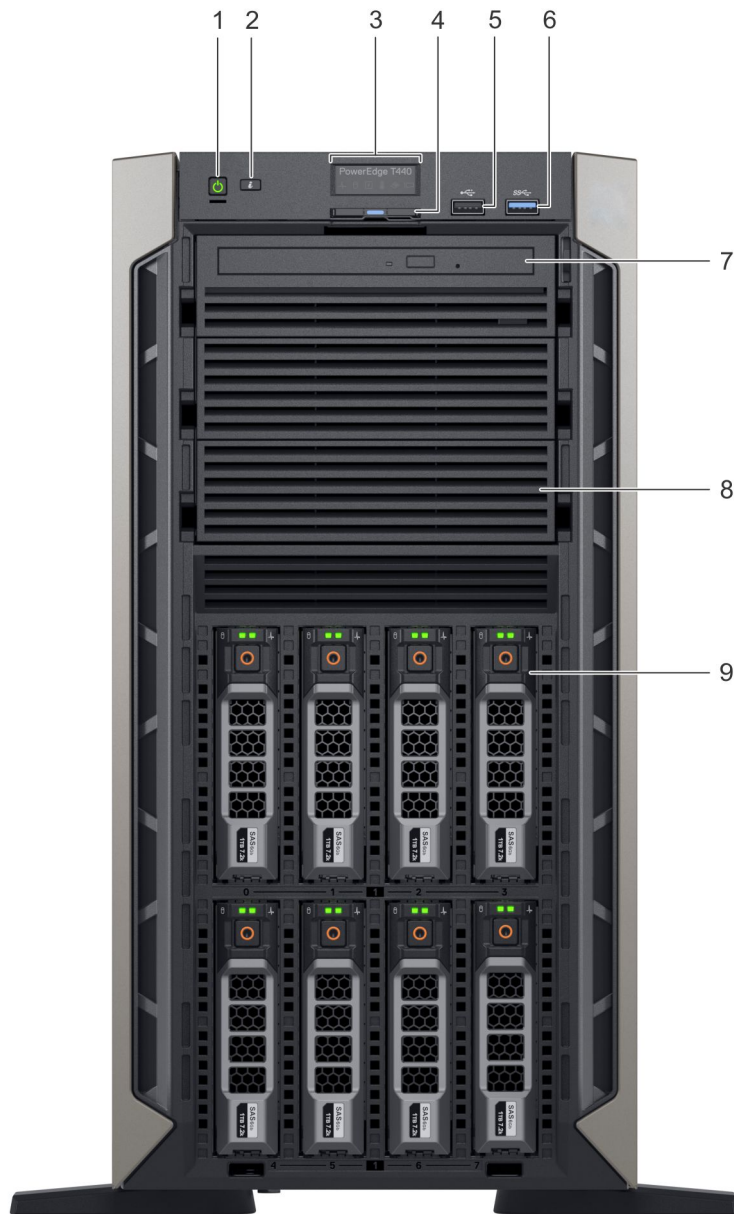



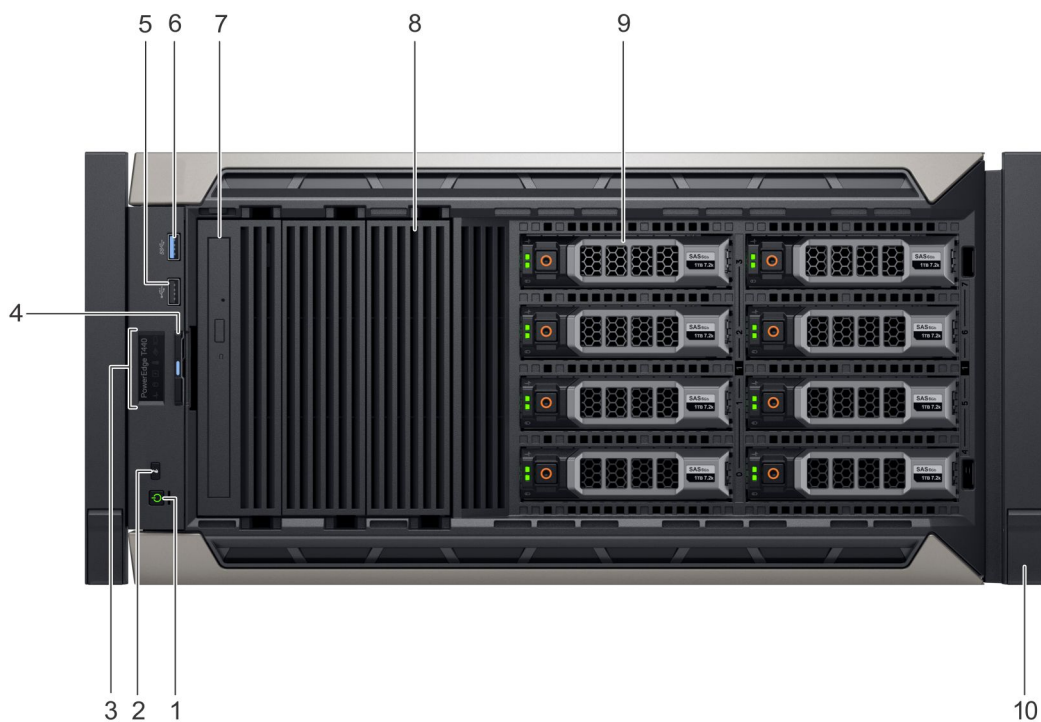

Figure 3. Front panel view of 8 x 3.5-inch hot swappable drive system

Table 2. Front panel features



Item	Components	Icon	Description
1	Power button		Indicates if the system is turned on or off. Press the power button to manually turn on or off the system.  <b>NOTE: Press the power button to gracefully shut down an ACPI-compliant operating system.</b>
2	System identification button		The System Identification (ID) button is available on the front and back of the systems. Press the button to identify a system in a rack by turning on the system ID button. You can also use the system ID button to reset iDRAC and to access BIOS using the step through mode.
3	Status LED indicator panel	N/A	Indicate the status of the system. For more information, see <a href="#">Status LED indicators</a> .



Item	Components	Icon	Description
4	Information tag	N/A	The Information tag is a slide-out label panel that contains system information such as Service Tag, NIC, MAC address, and so on. If you have opted for the secure default access to iDRAC, the Information tag also contains the iDRAC secure default password.
5	USB port 2.0		The USB ports are 4-pin, 2.0-compliant. These ports enable you to connect USB devices to the system.
6	USB port 3.0		The USB port is USB 3.0 compliant.
7	Optical drive bay	N/A	Enable you to install drives that are supported on your system. For more information about drives, see <a href="#">Technical specifications</a> .
8	Drive slot	N/A	Enables you to install TBUs for 8x and 16x backplane configurations, or drive blank in the empty drive slot to maintain proper system cooling.
9	Physical drives	N/A	3.5-inch drives and 2.5-inch drives/SSDs.



**Figure 4. Front panel view of 8 x 3.5-inch hot swappable drive system in rack mode**

**Table 3. Front panel features**

Item	Components	Icon	Description
1	Power button		Indicates if the system is turned on or off. Press the power button to manually turn on or off the system.  <b>NOTE:</b> Press the power button to gracefully shut down an ACPI-compliant operating system.
2	System identification button		The System Identification (ID) button is available on the front and back of the systems. Press the button to identify a system in a rack by turning on the system ID button. You can also use the system ID button to reset iDRAC and to access BIOS using the step through mode.
3	Status LED indicator panel	N/A	Indicate the status of the system. For more information, see <a href="#">Status LED indicators</a> .

Item	Components	Icon	Description
4	Information tag	N/A	The Information tag is a slide-out label panel that contains system information such as Service Tag, NIC, MAC address, and so on. If you have opted for the secure default access to iDRAC, the Information tag also contains the iDRAC secure default password.
5	USB port 2.0		The USB ports are 4-pin, 2.0-compliant. These ports enable you to connect USB devices to the system.
6	USB port 3.0		The USB port is USB 3.0 compliant.
7	Optical drive bay	N/A	Enable you to install drives that are supported on your system. For more information about drives, see <a href="#">Technical specifications</a> .
8	Drive slot	N/A	Enables you to install TBUs for 8x and 16x backplane configurations, or drive blank in the empty drive slot to maintain proper system cooling.
9	Physical drives	N/A	3.5-inch drives and 2.5-inch drives/SSDs.
10	Rack ear	N/A	Enables you to convert the tower system to a rack system.

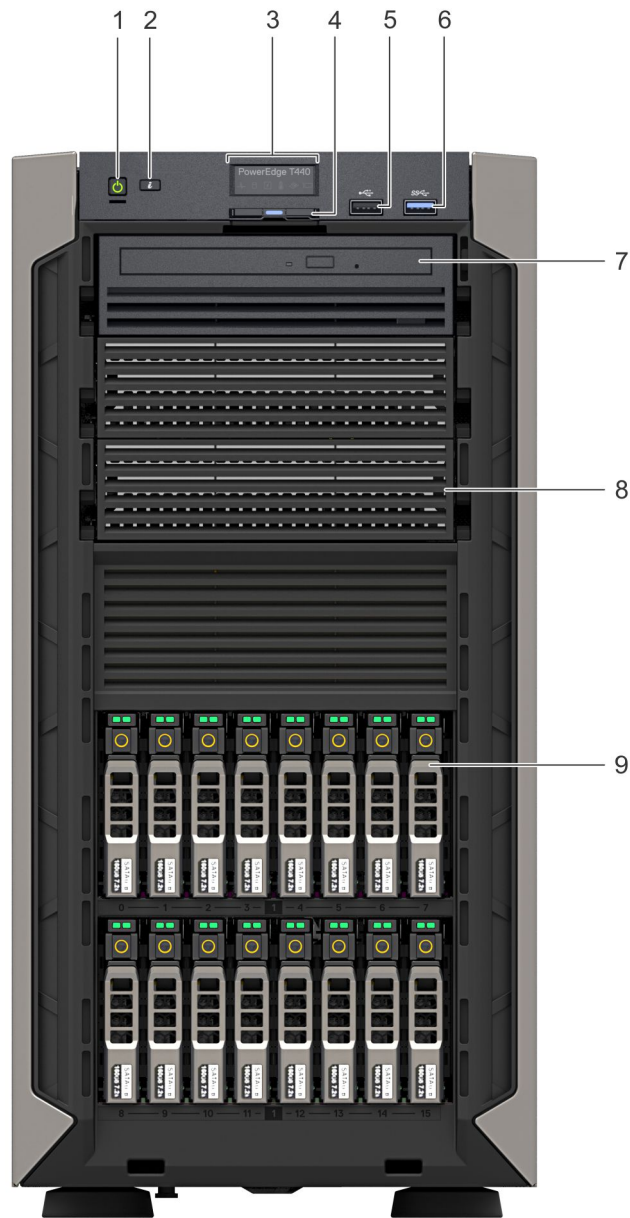





Figure 5. Front panel view of 16 x 2.5-inch hot swappable drive system

Table 4. Front panel features

Item	Components	Icon	Description
1	Power button		Indicates if the system is turned on or off. Press the power button to manually turn on or off the system.  <b>NOTE: Press the power button to gracefully shut down an ACPI-compliant operating system.</b>
2	System identification button		The System Identification (ID) button is available on the front and back of the systems. Press the button to identify a system in a rack by turning on the system ID button. You can also use the system ID button to reset iDRAC and to access BIOS using the step through mode.
3	Status LED indicator panel	N/A	Indicate the status of the system. For more information, see <a href="#">Status LED indicators</a> .

Item	Components	Icon	Description
4	Information tag	N/A	The Information tag is a slide-out label panel that contains system information such as Service Tag, NIC, MAC address, and so on. If you have opted for the secure default access to iDRAC, the Information tag also contains the iDRAC secure default password.
5	USB port 2.0		The USB ports are 4-pin, 2.0-compliant. These ports enable you to connect USB devices to the system.
6	USB port 3.0		The USB port is USB 3.0 compliant.
7	Optical drive bay	N/A	Enable you to install drives that are supported on your system. For more information about drives, see <a href="#">Technical specifications</a> .
8	Drive slot	N/A	Enables you to install TBUs for 8x and 16x backplane configurations, or drive blank in the empty drive slot to maintain proper system cooling.
9	Physical drives	N/A	3.5-inch drives and 2.5-inch drives/SSDs.

## Status LED indicators







 **NOTE:** The indicators display solid amber if any error occurs.



Figure 6. Status LED indicators

Table 5. Status LED indicators and descriptions

Icon	Description	Condition	Corrective action
	Health indicator	The indicator turns solid blue if the system is in good health.	None required.
		<p>The indicator blinks amber, when the system is:</p> <ul style="list-style-type: none"> <li>Powered on</li> <li>In standby</li> <li>In any error condition For example, a failed fan, PSU, or a drive</li> </ul>	<p>Check the System event log or system messages for the specific issue.</p> <p>For more information about error messages, see the <i>Event and Error Message Reference Guide for 14th Generation Dell EMC PowerEdge Servers</i> at <a href="http://www.dell.com/qr1">www.dell.com/qr1</a>.</p> <p>The POST process is interrupted without any video output due to invalid memory configurations. See <a href="#">Getting help</a>.</p>
	Drive indicator	The indicator turns solid amber if there is a drive error.	<ul style="list-style-type: none"> <li>Check the System event log to determine if the drive has an error.</li> <li>Run the appropriate Online Diagnostics test. Restart the system, and run embedded diagnostics (ePSA).</li> <li>If the drives are configured in a RAID array, restart the system, and enter the host adapter configuration utility.</li> </ul>

Icon	Description	Condition	Corrective action
	Electrical indicator	The indicator turns solid amber if the system experiences an electrical error. For example, voltage out of range, or a failed power supply unit (PSU) or voltage regulator.	Check the System event log or system messages for the specific issue. If it is due to a problem with the PSU, check the LED on the PSU. Reseat the PSU. If the problem persists, see <a href="#">Getting help</a> .
	Temperature indicator	The indicator turns solid amber if the system experiences a thermal error. For example, the ambient temperature is out of range or there is a fan failure.	Ensure that none of the following conditions exist: <ul style="list-style-type: none"> <li>• A cooling fan has been uninstalled or has failed.</li> <li>• System cover, air shroud, or back filler bracket is uninstalled.</li> <li>• Ambient temperature is too high.</li> <li>• External airflow is obstructed.</li> </ul> If the problem persists, see <a href="#">Getting help</a> .
	Memory indicator	The indicator turns solid amber if a memory error occurs.	Check the System event log or system messages for the location of the failed memory. Reseat the memory module. If the problem persists, see <a href="#">Getting help</a> .
	PCIe indicator	The indicator turns solid amber if a PCIe card experiences an error.	Restart the system. Update any required drivers for the PCIe card. Reinstall the card. If the problem persists, see <a href="#">Getting help</a> . <b>NOTE:</b> For more information about the supported PCIe cards, see <a href="#">Expansion card installation guidelines</a> .

## System health and system ID indicator codes

The system health and system ID button  is on the front panel of your system.



Figure 7. System health and system ID buttons

Table 6. System health and system ID indicator codes

System health and system ID indicator code	Condition
Solid blue	Indicates that the system is turned on, system is healthy, and system ID mode is not active. Press the system health and <b>system ID</b> button to switch to system ID mode.
Blinking blue	Indicates that the system ID mode is active. Press the system health and <b>system ID</b> button to switch to system health mode.
Solid amber	Indicates that the system is in fail-safe mode. If the problem persists, see <a href="#">Getting help</a> .
Blinking amber	Indicates that the system is experiencing a fault. Check the System Event Log for specific error messages. For information about the event and error messages generated by the system firmware and agents that monitor system components, see the Error Code Lookup page at <a href="http://qrl.dell.com">qrl.dell.com</a>

## Drive indicator codes

Each drive carrier has an activity LED indicator and a status LED indicator. The indicators provide information about the status of the drive. The activity LED indicator indicates whether the drive is in use or not. The status LED indicator indicates the power condition of the drive.

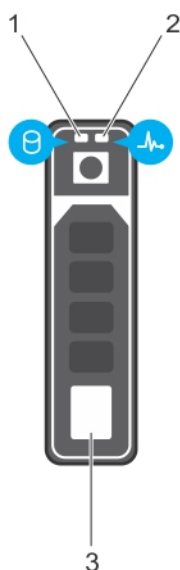

**Figure 8. Drive indicators**

1. Drive activity LED indicator
2. Drive status LED indicator
3. Drive capacity label

**NOTE:** If the drive is in the Advanced Host Controller Interface (AHCI) mode, the status LED indicator does not turn on.

**Table 7. Drive indicator codes**

Drive status indicator code	Condition
Flashes green twice per second	Identifying drive or preparing for removal.
Off	Drive ready for removal. <b>NOTE:</b> The drive status indicator remains off until all drives are initialized after the system is turned on. Drives are not ready for removal during this time.
Flashes green, amber, and then powers off	Predicted drive failure.
Flashes amber 4 times per second	Drive failed.
Flashes green slowly	Drive rebuilding.
Solid green	Drive online.
Flashes green for three seconds, amber for three seconds, and then turns off after six seconds.	Rebuild stopped.

## Back view of the system

The back panel view of the system shows the features available on the back of the server, such as the system identification button, power supply sockets, iDRAC storage media, NIC ports, and USB and VGA ports. Most of the expansion card ports can be accessed from the back panel. The hot swappable and cabled power supply units are accessible from the back panel.

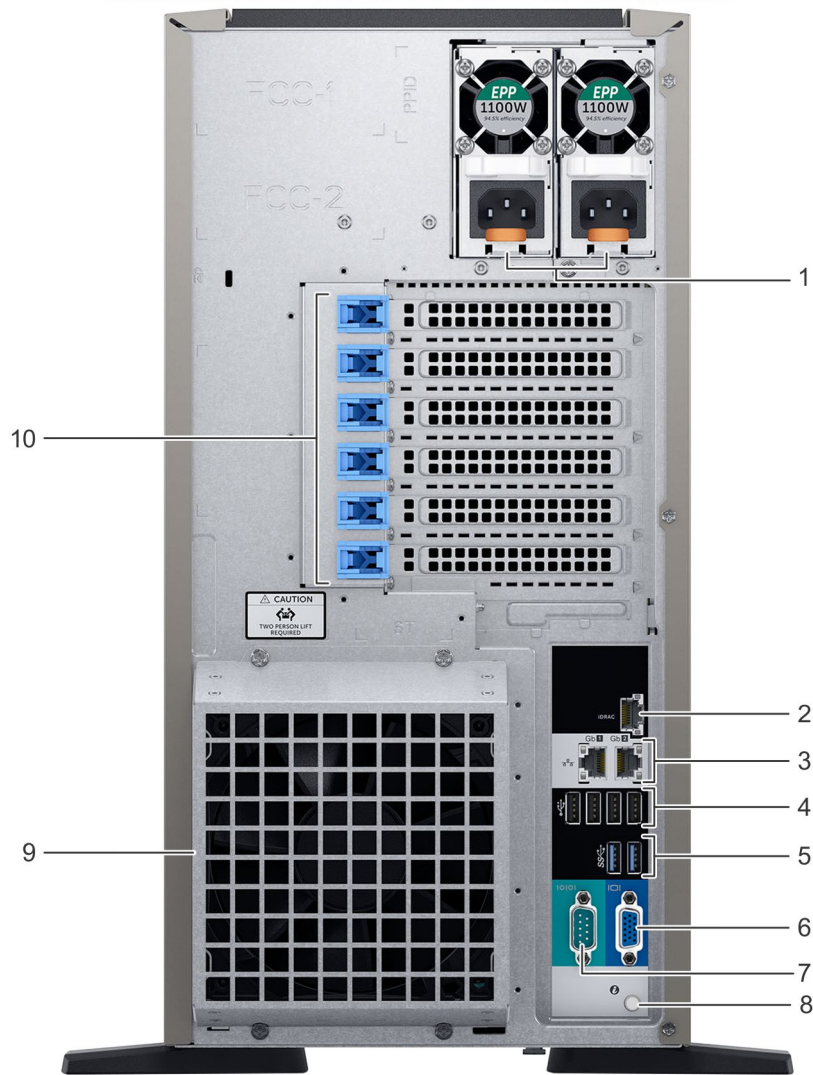







Figure 9. Back view of the system with optional redundant cooling fan

Table 8. Features available on the back view

Item	Ports, panels, or slots	Icon	Description
1	Power supply unit (2)	N/A	For more information about the PSU configurations, see <a href="#">Technical specifications</a> .
2	iDRAC9 dedicated network port		Enables you to remotely access iDRAC. For more information, see the iDRAC User's Guide at <a href="http://www.dell.com/poweredgemanuals">www.dell.com/poweredgemanuals</a> .
3	NIC port (2)		The NIC ports are integrated on the system board provide network connectivity. For more information about the supported configurations, see <a href="#">Technical specifications</a> .
4	USB 2.0 port (4)		The USB ports are 4-pin, 2.0-compliant. These ports enable you to connect USB devices to the system.
5	USB 3.0 port (2)		The USB ports are 9-pin and 3.0-compliant. These ports enable you to connect USB devices to the system.
6	VGA port		Enables you to connect a display device to the system. For more information, see <a href="#">Technical specifications</a> .

Item	Ports, panels, or slots	Icon	Description
7	Serial port	⏏	Enables you to connect a serial device to the system. For more information, see <a href="#">Technical specifications</a> .
8	System identification button	ⓘ	The System Identification (ID) button is available on the front and back of the systems. Press the button to identify a system in a rack by turning on the system ID button. You can also use the system ID button to reset iDRAC and to access BIOS using the step through mode.
9	External cooling fan (optional)	N/A	Enables you to connect an optional redundant cooling fan.
10	PCIe expansion card slot(6)	N/A	The expansion slots enable you to connect PCI Express expansion cards. For more information on the expansion cards that are supported on your system, see <a href="#">Expansion card installation guidelines</a> .

## NIC indicator codes

Each NIC on the back of the system has indicators that provide information about the activity and link status. The activity LED indicator indicates if data is flowing through the NIC, and the link LED indicator indicates the speed of the connected network.

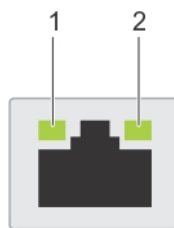

**Figure 10. NIC indicator codes**

1. Link LED indicator
2. Activity LED indicator

**Table 9. NIC indicator codes**

Status	Condition
Link and activity indicators are off.	The NIC is not connected to the network.
Link indicator is green, and activity indicator is blinking green.	The NIC is connected to a valid network at its maximum port speed, and data is being sent or received.
Link indicator is amber, and activity indicator is blinking green.	The NIC is connected to a valid network at less than its maximum port speed, and data is being sent or received.
Link indicator is green, and activity indicator is off.	The NIC is connected to a valid network at its maximum port speed, and data is not being sent or received.
Link indicator is amber, and activity indicator is off.	The NIC is connected to a valid network at less than its maximum port speed, and data is not being sent or received.
Link indicator is blinking green, and activity is off.	NIC identify is enabled through the NIC configuration utility.

## Power supply unit indicator codes

AC power supply units (PSUs) have an illuminated translucent handle that serves as an indicator. The indicator shows whether power is present or if a power fault has occurred.

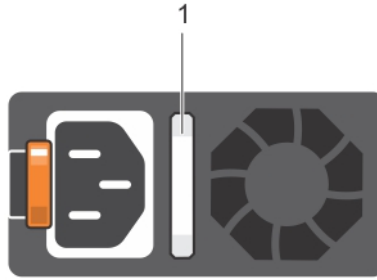

**Figure 11. AC PSU status indicator**

1. AC PSU status indicator/handle

**Table 10. AC PSU status indicator codes**

Power indicator codes	Condition
Green	A valid power source is connected to the PSU, and the PSU is operational.
Blinking amber	Indicates a problem with the PSU.
Not illuminated	Power is not connected to the PSU.
Blinking green	When the firmware of the PSU is being updated, the PSU handle blinks green. <b>⚠ CAUTION: Do not disconnect the power cord, or unplug the PSU when updating firmware. If firmware update is interrupted, the PSUs do not function.</b>
Blinking green and turns off	When hot-plugging a PSU, the PSU handle blinks green five times at a rate of 4 Hz and powers off. It indicates a PSU mismatch regarding efficiency, feature set, health status, or supported voltage. <b>⚠ CAUTION: If two PSUs are installed, both the PSUs must have the same type of label; for example, Extended Power Performance (EPP) label. Mixing PSUs from previous generations of PowerEdge servers is not supported, even if the PSUs have the same power rating. It results in a PSU mismatch condition or failure to power on the system.</b> <b>⚠ CAUTION: When correcting a PSU mismatch, replace only the PSU with the blinking indicator. Swapping the PSU to make a matched pair can result in an error condition and unexpected system shutdown. To change from a high output configuration to a low output configuration or conversely, you must turn off the system.</b> <b>⚠ CAUTION: AC PSUs support both 240 V and 120 V input voltages except for Titanium PSUs, which support only 240 V. When two identical PSUs receive different input voltages, they can output different wattages, and trigger a mismatch.</b> <b>⚠ CAUTION: If two PSUs are used, they must be of the same type and have the same maximum output power.</b>

## Locating the Service Tag of your system

You can identify your system using the unique Express Service Code and Service Tag. Pull out the information tag in front of the system to view the Express Service Code and Service Tag. Alternatively, the information may be on a sticker on the chassis of the system. The mini Enterprise Service Tag (EST) is found on the back of the system. This information is used by Dell to route support calls to the appropriate personnel.

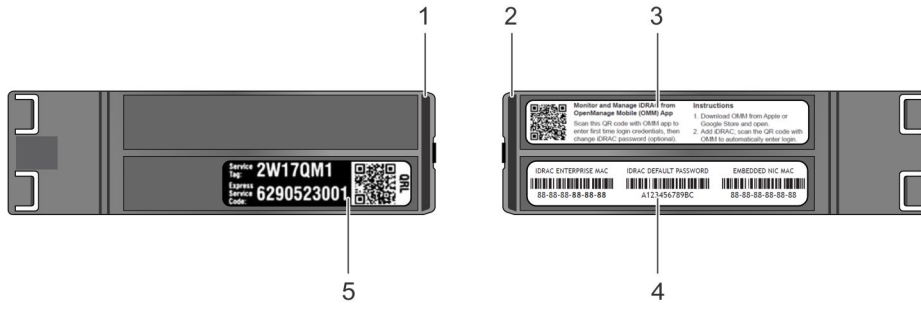

**Figure 12. Locating Service Tag of your system**

1. Information tag (top view)
2. OpenManage Mobile (OMM) label
3. Service Tag
4. iDRAC MAC address and iDRAC secure password label
5. Information tag (back view)

# System information label

## Service Information

### System Touchpoints

- Hot swap touchpoints: Components with terracotta touchpoints can be serviced while the system is running.
- Cold swap touchpoints: Components with blue touchpoints require a full system shutdown before servicing.

### Front View/Rack Mode

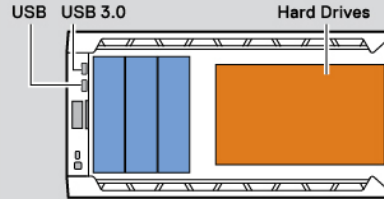

### Mechanical Overview

#### Rear View

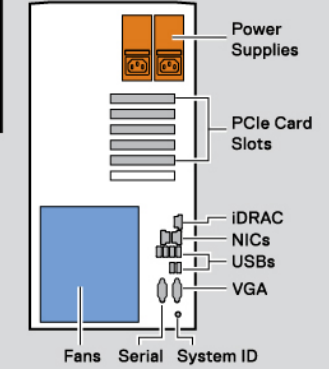

### Front View

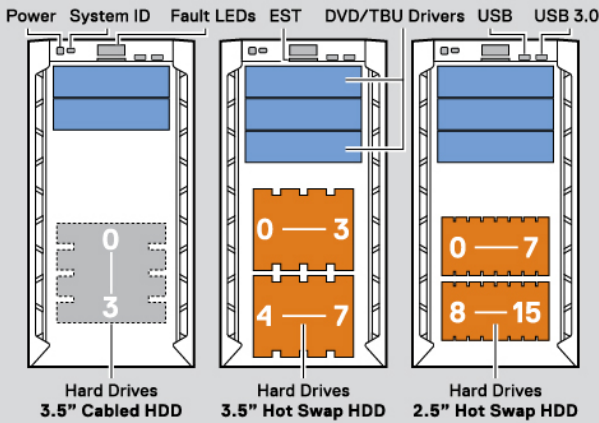

### Side View

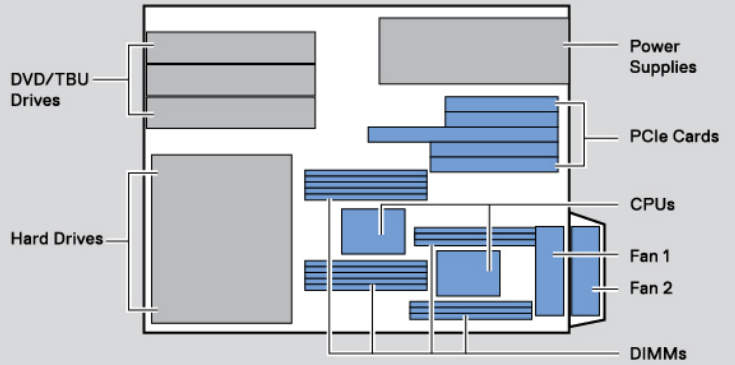

## Electrical Overview

### System Board Connections

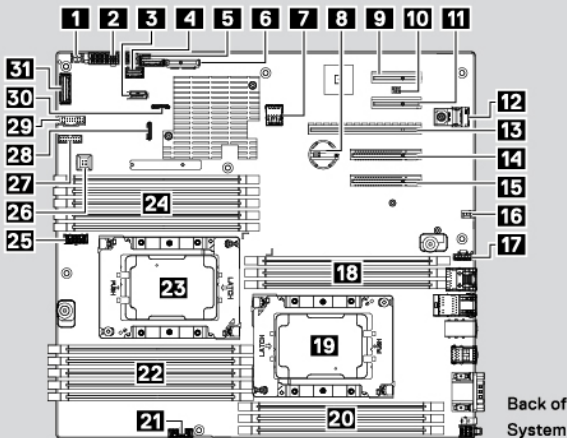

### Jumper Settings

Jumper	Setting	Description
PWRD_EN	(default)	BIOS password is enabled.
	(default)	BIOS password is disabled. iDRAC local access is unlocked at next AC power cycle. iDRAC password reset is enabled in F2 iDRAC settings menu.
NVRAM_CLR	(default)	BIOS configuration settings retained at system boot.
	(default)	BIOS configuration settings cleared at system boot.

## Memory Information

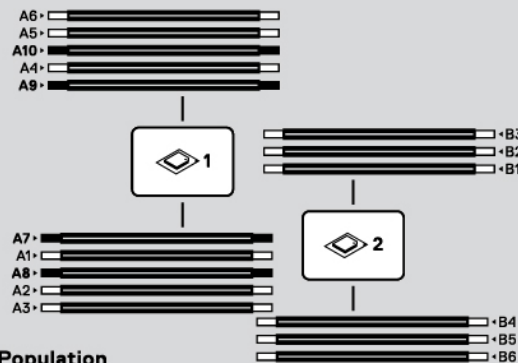

### Memory Population

Configuration	Sequence
Memory-Optimized	C1{1}, C2{1}, C1{2}, C2{2}, C1{3}, C2{3}
Mirroring	C1{1,2,3,4,5,6}, C2{1,2,3,4,5,6}

Memory sparing details are documented in the Installation and Service Manual.

Figure 13. PowerEdge T440 – Service information

### Icon Legend

	Status		System ID
	Hard Drive Activity		CPU
	Power Supply		Fan
	Temperature		EST Express Service Tag
	Memory Bank		vFlash Media
	PCI		

Scan to see hardware servicing and software setup videos, how-to's, and documentation.



**Quick Resource Locator**  
Dell.com/QRL/Server/PET440

**Caution:** Memory (DIMMs) and CPUs may be hot during servicing.

**Caution:** Many repairs may only be done by a certified service technician. You should only perform troubleshooting and simple repairs as authorized in your product documentation, or as directed by the online or telephone service and support team. Damage due to servicing that is not authorized by Dell is not covered by your warranty. Read and follow the safety instructions that came with the product.

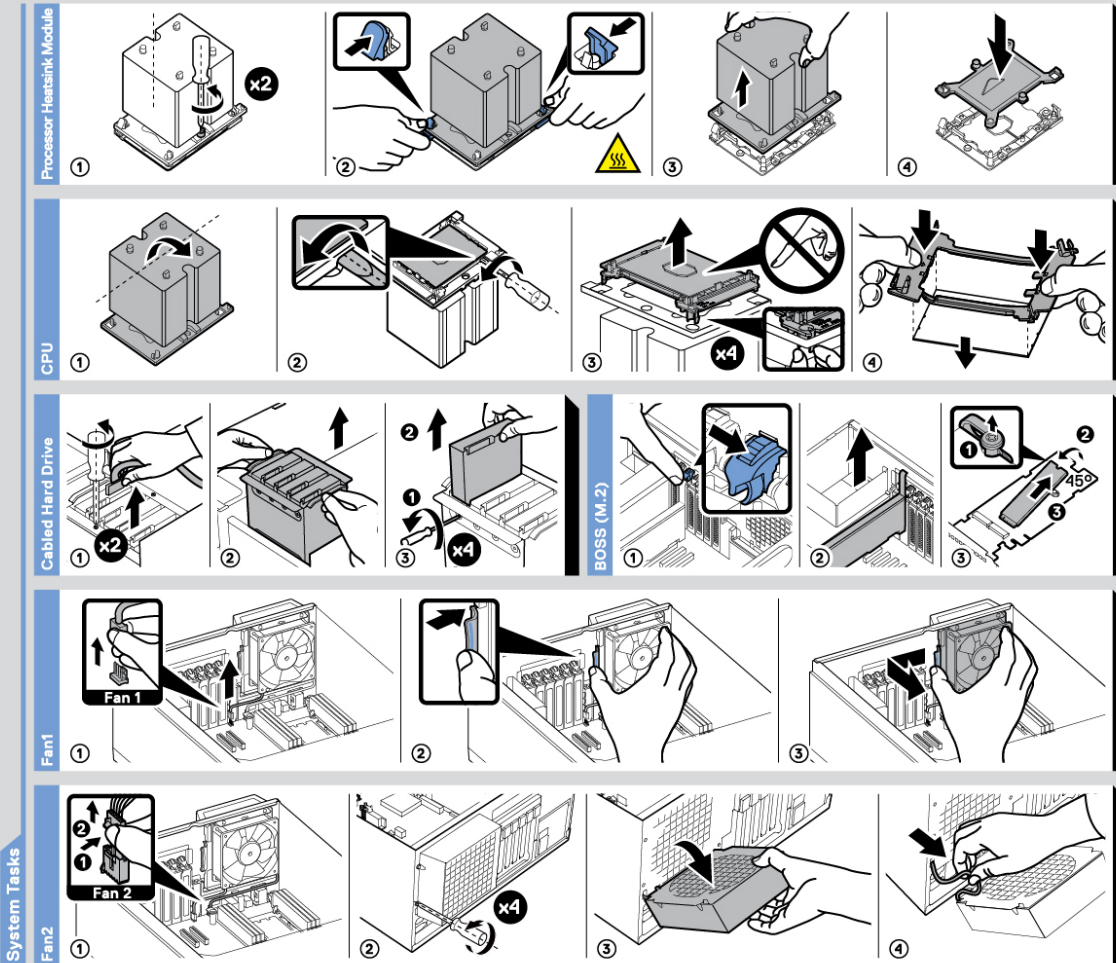

To learn more about this Dell product or to order additional or replacement parts, go to [Dell.com/support](http://Dell.com/support)  
Copyright © 2017 Dell Inc. or its subsidiaries. All Rights Reserved. Rev A00. Label Part No. RGC8F

Figure 14. PowerEdge T440 – Service information

## Documentation resources

This section provides information about the documentation resources for your system.

To view the document that is listed in the documentation resources table:

- From the Dell EMC support site:
  1. Click the documentation link that is provided in the Location column in the table.
  2. Click the required product or product version.
  3. On the Product Support page, click **Manuals & documents**.
- Using search engines:
  - Type the name and version of the document in the search box.

**NOTE:** To locate the product name and model, see the front of your system.

**Table 11. Additional documentation resources for your system**

Task	Document	Location
Setting up your system	For more information about installing and securing the system into a rack, see the Rail Installation Guide included with your rack solution.  For information about setting up your system, see the <i>Getting Started Guide</i> document that is shipped with your system.	<a href="http://www.dell.com/poweredgemanuals">www.dell.com/poweredgemanuals</a>
Configuring your system	For information about the iDRAC features, configuring and logging in to iDRAC, and managing your system remotely, see the Integrated Dell Remote Access Controller User's Guide.  For information about understanding Remote Access Controller Admin (RACADM) subcommands and supported RACADM interfaces, see the RACADM CLI Guide for iDRAC.  For information about Redfish and its protocol, supported schema, and Redfish Eventing are implemented in iDRAC, see the Redfish API Guide.  For information about iDRAC property database group and object descriptions, see the Attribute Registry Guide.	<a href="http://www.dell.com/poweredgemanuals">www.dell.com/poweredgemanuals</a>
	For information about earlier versions of the iDRAC documents, see the iDRAC documentation.  To identify the version of iDRAC available on your system, on the iDRAC web interface, click <b>? &gt; About</b> .	<a href="http://www.dell.com/idracmanuals">www.dell.com/idracmanuals</a>
	For information about installing the operating system, see the operating system documentation.	<a href="http://www.dell.com/operatingsystemmanuals">www.dell.com/operatingsystemmanuals</a>
	For information about updating drivers and firmware, see the Methods to download firmware and drivers section in this document.	<a href="http://www.dell.com/support/drivers">www.dell.com/support/drivers</a>
Managing your system	For information about systems management software offered by Dell, see the Dell	<a href="http://www.dell.com/poweredgemanuals">www.dell.com/poweredgemanuals</a>

Task	Document	Location
	OpenManage Systems Management Overview Guide.	
	For information about setting up, using, and troubleshooting OpenManage, see the Dell OpenManage Server Administrator User's Guide.	<a href="http://www.dell.com/openmanagemanuals">www.dell.com/openmanagemanuals</a> > OpenManage Server Administrator
	For information about installing, using, and troubleshooting Dell OpenManage Essentials, see the Dell OpenManage Essentials User's Guide.	<a href="http://www.dell.com/openmanagemanuals">www.dell.com/openmanagemanuals</a> > OpenManage Essentials
	For information about installing, using, and troubleshooting Dell OpenManage Enterprise, see the Dell OpenManage Enterprise User's Guide.	<a href="http://www.dell.com/openmanagemanuals">www.dell.com/openmanagemanuals</a> > OpenManage Enterprise
	For information about installing and using Dell SupportAssist, see the Dell EMC SupportAssist Enterprise User's Guide.	<a href="http://www.dell.com/serviceabilitytools">www.dell.com/serviceabilitytools</a>
	For information about partner programs enterprise systems management, see the OpenManage Connections Enterprise Systems Management documents.	<a href="http://www.dell.com/openmanagemanuals">www.dell.com/openmanagemanuals</a>
Working with the Dell PowerEdge RAID controllers	For information about understanding the features of the Dell PowerEdge RAID controllers (PERC), Software RAID controllers, or BOSS card and deploying the cards, see the Storage controller documentation.	<a href="http://www.dell.com/storagecontrollermanuals">www.dell.com/storagecontrollermanuals</a>
Understanding event and error messages	For information about the event and error messages that are generated by the system firmware and agents that monitor system components, see the Error Code Lookup.	<a href="http://www.dell.com/qrl">www.dell.com/qrl</a>
Troubleshooting your system	For information about identifying and troubleshooting the PowerEdge server issues, see the Server Troubleshooting Guide.	<a href="http://www.dell.com/poweredgemanuals">www.dell.com/poweredgemanuals</a>

## Technical specifications

The technical and environmental specifications of your system are outlined in this section.

### Topics:

- System dimensions
- Chassis weight
- Processor specifications
- Supported operating systems
- Cooling fan specifications
- PSU specifications
- System battery specifications
- Expansion bus specifications
- Memory specifications
- Storage controller specifications
- Drive specifications
- Ports and connectors specifications
- Video specifications
- Environmental specifications

## System dimensions

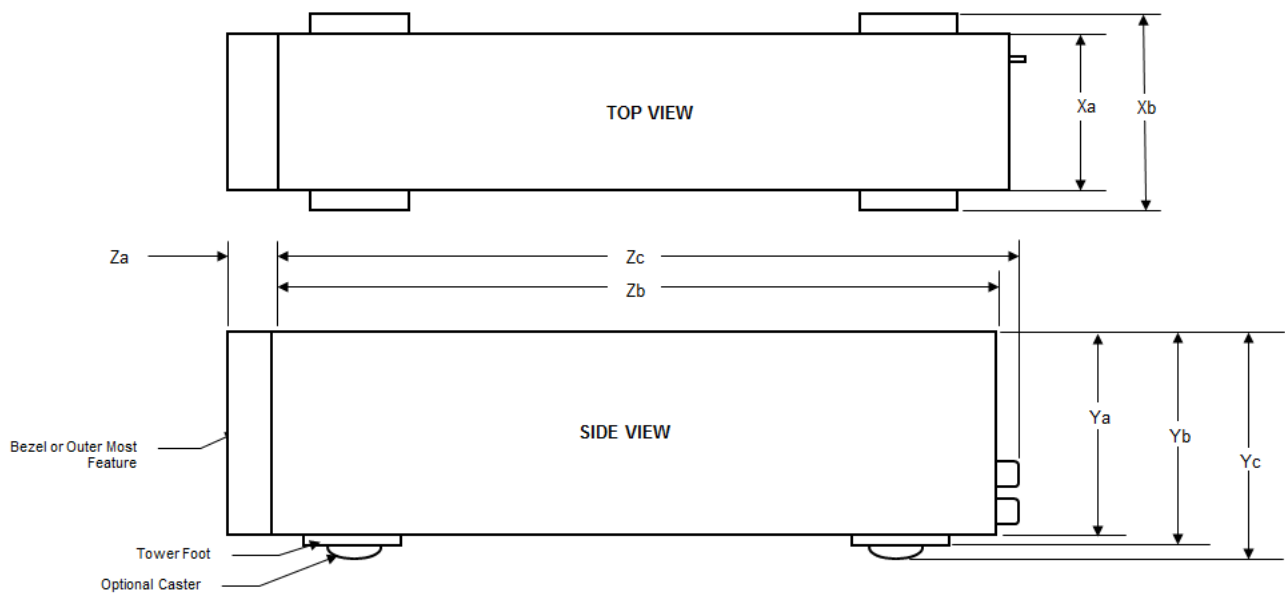

Figure 15. Dell EMC PowerEdge T440 system dimensions

**Table 12. Dimensions of Dell EMC PowerEdge T440 system**

Xa	Xb	Ya	Yb	Yc	Za	Zb	Zc
304.5 mm (11.98 in)	218 mm (8.58 in)	430.3 mm (16.94 in)	443.3 mm (17.45 in)	471.333 mm (17.37 in)	(with bezel) 37.065 mm (1.45 in)  (without bezel) 21.165 mm (0.83 in)	538.4 mm (21.19 in)	573.636 mm (22.58 in)

## Chassis weight

**Table 13. Dell EMC PowerEdge T440 Chassis weight**

System configuration	Maximum weight
4 x 3.5-inch drive system	23 Kg (50.71 lb)
8 x 3.5-inch drive system	29.3 Kg (64.60 lb)
16 x 2.5-inch drive system	27.7 Kg (61.06 lb)

## Processor specifications

The Dell EMC PowerEdge T440 system supports up to two Intel Xeon Scalable Processor, up to 14 cores per processor.

## Supported operating systems

The Dell EMC PowerEdge T440 system supports the following operating systems:

- Canonical Ubuntu LTS
- Citrix XenServer
- Microsoft Windows Server with Hyper-V
- Red Hat Enterprise Linux
- SUSE Linux Enterprise Server
- VMware ESXi

**i** **NOTE:** For more information about the specific versions and additions, go to <https://www.dell.com/support/home/Drivers/SupportedOS/poweredge-t440>.

## Cooling fan specifications

The Dell EMC PowerEdge T440 system supports the following:

- An internal cooling fan
- An optional external cooling fan at the back of the chassis

**i** **NOTE:** When selecting or upgrading your system configuration, verify the system power consumption with the Dell Energy Smart Solution Advisor at [Dell.com/ESSA](https://www.dell.com/ESSA) to ensure optimum power utilization.

## PSU specifications

The Dell EMC PowerEdge T440 system supports the following AC redundant power supply units (PSU):

**Table 14. Dell EMC PowerEdge T440 system PSU specifications**

PSU	Class	Heat dissipation (maximum)	Frequency	Voltage
1100 W AC	Platinum	4100 BTU/hr	50/60 Hz	100–240 V AC, autoranging
750 W AC	Platinum	2891 BTU/hr	50/60 Hz	100–240 V AC, autoranging
750 W AC (Mixed Mode)	Platinum	2891 BTU/hr	50/60 Hz	100–240 V AC, autoranging
495 W AC	Platinum	1908 BTU/hr	50/60 Hz	100–240 V AC, autoranging
450 W	Bronze	1871 BTU/hr	50/60 Hz	100–240 V AC, cabled PSU

This system is also designed to connect to the IT power systems with a phase to phase voltage not exceeding 230 V.

## System battery specifications

The Dell EMC PowerEdge T440 system supports CR 2032 3.0-V lithium coin cell system battery.

## Expansion bus specifications

The Dell EMC PowerEdge T440 system supports five PCI express (PCIe) generation 3 expansion cards.

## Memory specifications

**Table 15. Memory specifications**

DIMM type	DIMM rank	DIMM capacity	Single processor		Dual processors	
			Minimum RAM	Maximum RAM	Minimum RAM	Maximum RAM
RDIMM	Single rank	8 GB	8 GB	80 GB	16 GB	128 GB
RDIMM	Dual rank	16 GB	16 GB	160 GB	32 GB	256 GB
RDIMM	Dual rank	32 GB	32 GB	320 GB	64 GB	512 GB
LRDIMM	Quad rank	64 GB	64 GB	640 GB	128 GB	1024 GB

## Storage controller specifications

The Dell EMC PowerEdge T440 system supports:

- **Internal controllers:** PowerEdge Expandable RAID Controller (PERC) H730P, HBA330, H740P, H330, Software RAID (SWRAID)S140
- **External PERC (RAID):** H840
- **External HBAs (non-RAID):** 12Gbps SAS HBA
- **Boot Optimized Storage Subsystem (BOSS):** HWRAID 2 x M.2 SSDs 120GB or 240GB with 6Gbps
  - x8 connector using PCIe gen 2.0 x2 lanes, available only in the low-profile and half-height form factor

## Drive specifications

### Drives

The Dell EMC PowerEdge T440 system supports:

- Up to 4 x 3.5-inch cabled drives with drive adapter, internal, SATA, or Nearline SAS drives
- or

- Up to 8 x 3.5-inch hot swappable drives with drive adapter, internal, hot swappable SAS/SATA drives  
or
- Up to 16 x 2.5-inch hot swappable drives with drive adapter, internal, hot swappable SAS/SATA drives

## Optical drive and tape drive

The Dell EMC PowerEdge T440 system supports:

- one optional slim SATA DVD-ROM drive or DVD +/-RW drive
- internal tape drives LTO5, LTO6, LTO7 and external SAS drives.

Your system supports one of the following configurations:

- Systems with cabled drives support one optical drive and one tape drive.
- Systems with hot-swappable drives support up to one optical drive and two tape drives.

## Ports and connectors specifications

### USB ports

Dell EMC PowerEdge T440 system

**Table 16. USB specifications**

Front panel	Back panel
<ul style="list-style-type: none"> <li>• One USB 2.0-compliant port</li> <li>• One USB 3.0-compliant port</li> </ul>	<ul style="list-style-type: none"> <li>• 4 USB 2.0-compliant rear ports</li> <li>• 2 USB 3.0-compliant rear ports</li> </ul>

### NIC ports

The Dell EMC PowerEdge T440 system supports two Network Interface Controller (NIC) ports on the back panel each with 1 Gbps configuration.

 **NOTE: You can install up to five PCIe add-on cards.**

### VGA ports

The Video Graphic Array (VGA) port enables you to connect the system to a VGA display. The Dell EMC PowerEdge T440 system supports one 15-pin VGA ports on the back of the system.

### Serial connector

The Dell EMC PowerEdge T440 system supports one serial connector on the back panel, which is a 9-pin connector, Data Terminal Equipment (DTE), 16550-compliant.

### Internal Dual microSD Module or vFlash card

The Dell EMC PowerEdge T440 system supports Internal Dual microSD module (IDSDM) and vFlash card. In 14th generation of PowerEdge servers, IDSDM and vFlash card are combined into a single card module, and are available in these configurations:

- vFlash or
- IDSDM or
- vFlash and IDSDM

The IDSDM/vFlash card sits in the back of the system, in a Dell-proprietary slot. IDSDM/vFlash card supports three micro SD cards (two cards for IDSDM and one card for vFlash). microSD cards capacity for IDSDM are 16/32/64 GB while for vFlash the microSD card capacity is 16 GB.

Micro SD cards are supported only on IDSDM SD card slots.

The IDSDM or vFlash module combines the IDSDM or vFlash features into a single module.

**NOTE:** The write-protect switch is on the IDSDM or vFlash module.

## Video specifications

The Dell EMC PowerEdge T440 system supports Matrox G200eR2 graphics card with 16 MB capacity.

**Table 17. Supported video resolution options**

Resolution	Refresh rate	Color depth (bits)
640x480	60, 70	8, 16, 32
800x600	60, 75, 85	8, 16, 32
1024x768	60, 75, 85	8, 16, 32
1152x864	60, 75, 85	8, 16, 32
1280x1024	60, 75	8, 16, 32
1440x900	60	8, 16, 32

## Environmental specifications

**NOTE:** For additional information about environmental certifications, please refer to the Product Environmental Datasheet located with the Manuals & Documents on [www.dell.com/poweredgemanuals](http://www.dell.com/poweredgemanuals)

**Table 18. Temperature specifications**

Temperature	Specifications
Storage	-40°C–65°C (-40°F–149°F)
Continuous operation (for altitude less than 950 m or 3117 ft)	10°C–35°C (50°F–95°F) with no direct sunlight on the equipment.
Maximum temperature gradient (operating and storage)	20°C/h (68°F/h)

**Table 19. Relative humidity specifications**

Relative humidity	Specifications
Storage	5% to 95% RH with 33°C (91°F) maximum dew point. Atmosphere must be noncondensing always.
Operating	10% to 80% relative humidity with 29°C (84.2°F) maximum dew point.

**Table 20. Maximum vibration specifications**

Maximum vibration	Specifications
Operating	0.26 G <sub>rms</sub> at 5 Hz to 350 Hz (all 3 axes).
Storage	1.88 G <sub>rms</sub> at 10 Hz to 500 Hz for 15 min (all six sides tested).

**Table 21. Maximum shock specifications**

Maximum shock	Specifications
Operating	Six consecutively executed shock pulses in the positive and negative x, y, and z axes of 6 G for up to 11 ms.
Storage	6 consecutively executed shock pulses in the positive and negative x, y, and z axes (one pulse on each side of the system) of 71 G for up to 2 ms.

**Table 22. Maximum altitude specifications**

Maximum altitude	Specifications
Operating	3048 m (10,000 ft)
Storage	12,000 m (39,370 ft)

**Table 23. Operating temperature derating specifications**

Operating temperature derating	Specifications
Up to 35°C (95°F)	Maximum temperature reduces by 1°C/300 m (1°F/547 ft) above 950 m (3,117 ft).
35 °C–40°C (95 °F–104°F)	Maximum temperature reduces by 1°C/175 m (1°F/319 ft) above 950 m (3,117 ft).
40 °C–45°C (104 °F–113°F)	Maximum temperature reduces by 1°C/125 m (1°F/228 ft) above 950 m (3,117 ft).

## Standard operating temperature

**Table 24. Standard operating temperature specifications**

Standard operating temperature	Specifications
Continuous operation (for altitude less than 950 m or 3117 ft)	10°C–35°C (50°F–95°F) with no direct sunlight on the equipment.

## Expanded operating temperature

**Table 25. Expanded operating temperature specifications**

Expanded operating temperature	Specifications
Continuous operation	<p>5°C–40°C at 5% to 85% RH with 29°C dew point.</p> <p><b>NOTE:</b> Outside the standard operating temperature (10°C–35°C), the system can operate continuously in temperatures as low as 5°C and as high as 40°C.</p> <p>For temperatures between 35°C–40°C, derate maximum allowable temperature by 1°C per 175 m above 950 m (1°F per 319 ft).</p>
≤ 1% of annual operating hours	<p>–5°C–45°C at 5% to 90% RH with 29°C dew point.</p> <p><b>NOTE:</b> Outside the standard operating temperature (10–35°C), the system can operate down to –5°C or up to 45°C for a maximum of 1% of its annual operating hours.</p> <p>For temperatures 40°C–45°C, derate maximum allowable temperature by 1°C per 125 m above 950 m (1°F per 228 ft).</p>

**NOTE:** When operating in the expanded temperature range, system performance may be impacted.

**NOTE:** When operating in the expanded temperature range, ambient temperature warnings may be reported in the System Event Log.

## Expanded operating temperature restrictions

- Do not perform a cold startup below 5°C.
- The operating temperature specified is for a maximum altitude of 3048 m (10,000 ft).
- Two nonredundant power supply units are required.
- Two nonredundant system fans are required.

- Non-Dell qualified peripheral cards and/or peripheral cards greater than 25 W are not supported.
- GPU is not supported.
- Tape backup unit is not supported.

## Thermal restriction matrix

**Table 26. Thermal restriction matrix for Dell EMC PowerEdge T440 system**

Storage configuration			4x 3.5-inch cable drive	8x 3.5-inch drive	16x 2.5-inch drive
Processor number	TDP (W)	Core count	Ambient support = 35°C		
Intel Xeon Gold 5122	105	4	Yes	Yes	Yes
Intel Xeon Platinum 8156	105	4	Yes	Yes	Yes
Intel Xeon Gold 5120	105	14	Yes	Yes	Yes
Intel Xeon Gold 5118	105	12	Yes	Yes	Yes
Intel Xeon Gold 5115	85	10	Yes	Yes	Yes
Intel Xeon Silver 4116	85	12	Yes	Yes	Yes
Intel Xeon Silver 4114	85	10	Yes	Yes	Yes
Intel Xeon Silver 4110	85	8	Yes	Yes	Yes
Intel Xeon Silver 4108	85	8	Yes	Yes	Yes
Intel Xeon Bronze 3106	85	8	Yes	Yes	Yes
Intel Xeon Bronze 3104	85	6	Yes	Yes	Yes
Intel Xeon Silver 4112	85	4	Yes	Yes	Yes

## Particulate and gaseous contamination specifications

The following table defines the limitations that help avoid any equipment damage or failure from particulate and gaseous contamination. If the levels of particulate or gaseous pollution exceed the specified limitations and result in equipment damage or failure, you may need to rectify the environmental conditions. Remediation of environmental conditions is the responsibility of the customer.

**Table 27. Particulate contamination specifications**

Particulate contamination	Specifications
Air filtration	<p>Data center air filtration defines, ISO Class 8 per ISO 14644-1 with a 95% upper confidence limit.</p> <p><b>NOTE:</b> The ISO Class 8 condition applies to data center environments only. This air filtration requirement does not apply to IT equipment designed to be used outside a data center, in environments such as an office or factory floor.</p> <p><b>NOTE:</b> Air entering the data center must have MERV11 or MERV13 filtration.</p>
Conductive dust	<p>Air must be free of conductive dust, zinc whiskers, or other conductive particles.</p> <p><b>NOTE:</b> This condition applies to data center and nondata center environments.</p>
Corrosive dust	<ul style="list-style-type: none"> <li>• Air must be free of corrosive dust.</li> <li>• Residual dust present in the air must have a deliquescent point less than 60% relative humidity.</li> </ul> <p><b>NOTE:</b> This condition applies to data center and nondata center environments.</p>

**Table 28. Gaseous contamination specifications**

<b>Gaseous contamination</b>	<b>Specifications</b>
Copper coupon corrosion rate	<300 Å/month per Class G1 defines, ANSI/ISA71.04-2013.
Silver coupon corrosion rate	<200 Å/month defines, ANSI/ISA71.04-2013.

 **NOTE: Maximum corrosive contaminant levels measured at ≤50% relative humidity.**

# Initial system setup and configuration

## Setting up your system

Perform the following steps to set up your system:

### Steps

1. Unpack the system.
2. Install the system into the rack. For more information about installing the system into the rack, see the *Rail Installation Guide* at [www.dell.com/poweredgemanuals](http://www.dell.com/poweredgemanuals).
3. Connect the peripherals to the system.
4. Connect the system to its electrical outlet.
5. Power on the system by pressing the power button or by using iDRAC.
6. Power on the attached peripherals.

For more information about setting up your system, see the *Getting Started Guide* that shipped with your system.

## iDRAC configuration

The Integrated Dell Remote Access Controller (iDRAC) is designed to make system administrators more productive and improve the overall availability of Dell systems. iDRAC alerts administrators about system issues and enables them to perform remote system management. This reduces the need for physical access to the system.

## Options to set up iDRAC IP address

To enable communication between your system and iDRAC, you must first configure the network settings based on your network infrastructure.

**NOTE:** For static IP configuration, you must request for it at the time of purchase.

This option is set to **DHCP** by Default. You can set up the IP address by using one of the following interfaces:

Interfaces	Document/Section
<b>iDRAC Settings utility</b>	<i>Dell Integrated Dell Remote Access Controller User's Guide</i> at <a href="http://www.dell.com/poweredgemanuals">www.dell.com/poweredgemanuals</a>
<b>Dell Deployment Toolkit</b>	<i>Dell Deployment Toolkit User's Guide</i> at <a href="http://www.dell.com/openmanagemanuals">www.dell.com/openmanagemanuals</a> > OpenManage Deployment Toolkit
<b>Dell Lifecycle Controller</b>	<i>Dell Lifecycle Controller User's Guide</i> at <a href="http://www.dell.com/poweredgemanuals">www.dell.com/poweredgemanuals</a>

**NOTE:** To access iDRAC, ensure that you connect the ethernet cable to the iDRAC9 dedicated network port. You can also access iDRAC through the shared LOM mode, if you have opted for a system that has the shared LOM mode enabled.

## Log in to iDRAC

You can log in to iDRAC as:

- iDRAC user
- Microsoft Active Directory user
- Lightweight Directory Access Protocol (LDAP) user

If you have opted for secure default access to iDRAC, you must use the iDRAC secure default password available on the system Information tag. If you have not opted for secure default access to iDRAC, then use the default user name and password `-root` and `calvin`. You can also log in by using your Single Sign-On or Smart Card.

**NOTE:** You must have the iDRAC credentials to log in to iDRAC.

**NOTE:** Ensure that you change the default username and password after setting up the iDRAC IP address.

For more information about logging in to the iDRAC and iDRAC licenses, see the latest *Integrated Dell Remote Access Controller User's Guide* at [www.dell.com/poweredgemanuals](http://www.dell.com/poweredgemanuals).

You can also access iDRAC by using RACADM. For more information, see the *RACADM Command Line Interface Reference Guide* at [www.dell.com/poweredgemanuals](http://www.dell.com/poweredgemanuals).

## Options to install the operating system

If the system is shipped without an operating system, install a supported operating system by using one of the following resources:

**Table 29. Resources to install the operating system**

Resources	Location
iDRAC	<a href="http://www.dell.com/idracmanuals">www.dell.com/idracmanuals</a>
Lifecycle Controller	<a href="http://www.dell.com/idracmanuals">www.dell.com/idracmanuals</a> > Lifecycle Controller
OpenManage Deployment Toolkit	<a href="http://www.dell.com/openmanagemanuals">www.dell.com/openmanagemanuals</a> > OpenManage Deployment Toolkit
Dell certified VMware ESXi	<a href="http://www.dell.com/virtualizationsolutions">www.dell.com/virtualizationsolutions</a>
Installation and How-to videos for supported operating systems on PowerEdge systems	<a href="#">Supported Operating Systems for Dell EMC PowerEdge systems</a>

## Methods to download firmware and drivers

You can download the firmware and drivers by using any of the following methods:

**Table 30. Firmware and drivers**

Methods	Location
From the Dell EMC support site	<a href="http://www.dell.com/support/home">www.dell.com/support/home</a>
Using Dell Remote Access Controller Lifecycle Controller (iDRAC with LC)	<a href="http://www.dell.com/idracmanuals">www.dell.com/idracmanuals</a>
Using Dell Repository Manager (DRM)	<a href="http://www.dell.com/openmanagemanuals">www.dell.com/openmanagemanuals</a> > Repository Manager
Using Dell OpenManage Essentials	<a href="http://www.dell.com/openmanagemanuals">www.dell.com/openmanagemanuals</a> > OpenManage Essentials
Using Dell OpenManage Enterprise	<a href="http://www.dell.com/openmanagemanuals">www.dell.com/openmanagemanuals</a> > OpenManage Enterprise
Using Dell Server Update Utility (SUU)	<a href="http://www.dell.com/openmanagemanuals">www.dell.com/openmanagemanuals</a> > Server Update Utility
Using Dell OpenManage Deployment Toolkit (DTK)	<a href="http://www.dell.com/openmanagemanuals">www.dell.com/openmanagemanuals</a> > OpenManage Deployment Toolkit
Using iDRAC virtual media	<a href="http://www.dell.com/idracmanuals">www.dell.com/idracmanuals</a>

## Downloading drivers and firmware

Dell EMC recommends that you download and install the latest BIOS, drivers, and systems management firmware on your system.

### Prerequisites

Ensure that you clear the web browser cache before downloading the drivers and firmware.

## Steps

1. Go to [www.dell.com/support/home](http://www.dell.com/support/home).
2. In the **Drivers & Downloads** section, type the Service Tag of your system in the **Enter a Service Tag or product ID** box, and then click **Submit**.



**NOTE: If you do not have the Service Tag, select Detect Product to allow the system to automatically detect the Service Tag, or click View products, and navigate to your product.**

3. Click **Drivers & Downloads**.  
The drivers that are applicable to your system are displayed.
4. Download the drivers to a USB drive, CD, or DVD.

# Pre-operating system management applications

You can manage basic settings and features of a system without booting to the operating system by using the system firmware.

## Topics:

- [Options to manage the pre-operating system applications](#)
- [System Setup](#)
- [Dell Lifecycle Controller](#)
- [Boot Manager](#)
- [PXE boot](#)

## Options to manage the pre-operating system applications

Your system has the following options to manage the pre-operating system applications:

- System Setup
- Dell Lifecycle Controller
- Boot Manager
- Preboot Execution Environment (PXE)

## System Setup

By using the **System Setup** screen, you can configure the BIOS settings, iDRAC settings, and device settings of your system.

**i** **NOTE: Help text for the selected field is displayed in the graphical browser by default. To view the help text in the text browser, press F1.**

You can access system setup by one of the following:

- Standard graphical browser—The browser is enabled by default.
- Text browser—The browser is enabled by using Console Redirection.

## Viewing System Setup

To view the **System Setup** screen, perform the following steps:

### Steps

1. Power on, or restart your system.
2. Press F2 immediately after you see the following message:

```
F2 = System Setup
```

**i** **NOTE: If your operating system begins to load before you press F2, wait for the system to finish booting, and then restart your system and try again.**

## System Setup details

The **System Setup Main Menu** screen details are explained as follows:

Option	Description
<b>System BIOS</b>	Enables you to configure BIOS settings.
<b>iDRAC Settings</b>	Enables you to configure the iDRAC settings.  The iDRAC settings utility is an interface to set up and configure the iDRAC parameters by using UEFI (Unified Extensible Firmware Interface). You can enable or disable various iDRAC parameters by using the iDRAC settings utility. For more information about this utility, see <i>Integrated Dell Remote Access Controller User's Guide</i> at <a href="http://www.dell.com/poweredge/manuals">www.dell.com/poweredge/manuals</a> .
<b>Device Settings</b>	Enables you to configure device settings.
<b>Service Tag Settings</b>	Enables you to configure service tag settings.

## System BIOS

You can use the **System BIOS** screen to edit specific functions such as boot order, system password, and setup password, set the SATA and PCIe NVMe RAID mode, and enable or disable USB ports.

### Viewing System BIOS

To view the **System BIOS** screen, perform the following steps:

#### Steps

1. Power on, or restart your system.
2. Press F2 immediately after you see the following message:

```
F2 = System Setup
```

**NOTE:** If the operating system begins to load before you press F2, wait for the system to finish booting, and then restart the system and try again.

3. On the **System Setup Main Menu** screen, click **System BIOS**.

### System BIOS Settings details

#### About this task

The **System BIOS Settings** screen details are explained as follows:

Option	Description
<b>System Information</b>	Provides information about the system such as the system model name, BIOS version, and Service Tag.
<b>Memory Settings</b>	Provides information and options related to the installed memory.
<b>Processor Settings</b>	Provides information and options related to the processor such as speed and cache size.
<b>SATA Settings</b>	Provides options to enable or disable the integrated SATA controller and ports.
<b>NVMe Settings</b>	Provides options to change the NVMe settings. If the system contains the NVMe drives that you want to configure in a RAID array, you must set both this field and the <b>Embedded SATA</b> field on the <b>SATA Settings</b> menu to <b>RAID</b> mode. You might also need to change the <b>Boot Mode</b> setting to <b>UEFI</b> . Otherwise, you should set this field to <b>Non-RAID</b> mode.
<b>Boot Settings</b>	Provides options to specify the Boot mode (BIOS or UEFI). Enables you to modify UEFI and BIOS boot settings.
<b>Network Settings</b>	Provides options to manage the UEFI network settings and boot protocols.  Legacy network settings are managed from the <b>Device Settings</b> menu.
<b>Integrated Devices</b>	Provides options to manage integrated device controllers and ports, specifies related features and options.

Option	Description
<b>Serial Communication</b>	Provides options to manage the serial ports, their related features and options.
<b>System Profile Settings</b>	Provides options to change the processor power management settings, and memory frequency.
<b>System Security</b>	Provides options to configure the system security settings, such as system password, setup password, Trusted Platform Module (TPM) security, and UEFI secure boot. It also manages the power button on the system.
<b>Redundant OS Control</b>	Sets the redundant OS information for redundant OS control.
<b>Miscellaneous Settings</b>	Provides options to change the system date and time.

## System Information

You can use the **System Information** screen to view system properties such as Service Tag, system model name, and BIOS version.

### Viewing System Information

To view the **System Information** screen, perform the following steps:

#### Steps

1. Power on, or restart your system.
2. Press F2 immediately after you see the following message:

```
F2 = System Setup
```

**NOTE:** If your operating system begins to load before you press F2, wait for the system to finish booting, and then restart your system and try again.

3. On the **System Setup Main Menu** screen, click **System BIOS**.
4. On the **System BIOS** screen, click **System Information**.

### System Information details

#### About this task

The **System Information** screen details are explained as follows:

Option	Description
<b>System Model Name</b>	Specifies the system model name.
<b>System BIOS Version</b>	Specifies the BIOS version installed on the system.
<b>System Management Engine Version</b>	Specifies the current version of the Management Engine firmware.
<b>System Service Tag</b>	Specifies the system Service Tag.
<b>System Manufacturer</b>	Specifies the name of the system manufacturer.
<b>System Manufacturer Contact Information</b>	Specifies the contact information of the system manufacturer.

Option	Description
<b>System CPLD Version</b>	Specifies the current version of the system complex programmable logic device (CPLD) firmware.
<b>UEFI Compliance Version</b>	Specifies the UEFI compliance level of the system firmware.

## Memory Settings

You can use the **Memory Settings** screen to view all the memory settings and enable or disable specific memory functions, such as system memory testing and node interleaving.

### Viewing Memory Settings

To view the **Memory Settings** screen, perform the following steps:

#### Steps

1. Power on, or restart your system.
2. Press F2 immediately after you see the following message:

```
F2 = System Setup
```

**NOTE:** If the operating system begins to load before you press F2, wait for the system to finish booting, and then restart the system and try again.

3. On the **System Setup Main Menu** screen, click **System BIOS**.
4. On the **System BIOS** screen, click **Memory Settings**.

### Memory Settings details

#### About this task

The **Memory Settings** screen details are explained as follows:

Option	Description
<b>System Memory Size</b>	Specifies the memory size in the system.
<b>System Memory Type</b>	Specifies the type of memory installed in the system.
<b>System Memory Speed</b>	Specifies the system memory speed.
<b>System Memory Voltage</b>	Specifies the system memory voltage.
<b>Video Memory</b>	Specifies the amount of video memory.
<b>System Memory Testing</b>	Specifies whether the system memory tests are run during system boot. Options are <b>Enabled</b> and <b>Disabled</b> . This option is set to <b>Disabled</b> by default.
<b>Memory Operating Mode</b>	Specifies the memory operating mode. The options available are <b>Optimizer Mode</b> , <b>Single Rank Spare Mode</b> , <b>Multi Rank Spare Mode</b> , and <b>Mirror Mode</b> . This option is set to <b>Optimizer Mode</b> by default. <b>NOTE:</b> The Memory Operating Mode option can have different default and available options depending on the memory configuration of your system.
<b>Current State of Memory Operating Mode</b>	Specifies the current state of the memory operating mode.
<b>Node Interleaving</b>	Specifies if Non-Uniform Memory Architecture (NUMA) is supported. If this field is set to <b>Enabled</b> , memory interleaving is supported if a symmetric memory configuration is installed. If this field is set to <b>Disabled</b> , the system supports NUMA (asymmetric) memory configurations. This option is set to <b>Disabled</b> by default.

Option	Description
<b>ADDDC Setting</b>	Enables or disables <b>ADDDC Setting</b> feature. When Adaptive Double DRAM Device Correction (ADDDC) is enabled, failing DRAM's are dynamically mapped out. When set to <b>Enabled</b> it can have some impact to system performance under certain workloads. This feature is applicable for x4 DIMMs only. This option is set to <b>Enabled</b> by default.
<b>Opportunistic Self-Refresh</b>	Enables or disables opportunistic self-refresh feature. This option is set to <b>Disabled</b> by default.

## Processor Settings

You can use the **Processor Settings** screen to view the processor settings and perform specific functions such as enabling virtualization technology, hardware prefetcher, logical processor idling.

### Viewing Processor Settings

To view the **Processor Settings** screen, perform the following steps:

#### Steps

1. Power on, or restart your system.
2. Press F2 immediately after you see the following message:

```
F2 = System Setup
```

**NOTE:** If your operating system begins to load before you press F2, wait for the system to finish booting, and then restart your system and try again.



3. On the **System Setup Main Menu** screen, click **System BIOS**.
4. On the **System BIOS** screen, click **Processor Settings**.

### Processor Settings details

#### About this task

The **Processor Settings** screen details are explained as follows:

Option	Description
<b>Logical Processor</b>	Enables or disables the logical processors and displays the number of logical processors. If this option is set to <b>Enabled</b> , the BIOS displays all the logical processors. If this option is set to <b>Disabled</b> , the BIOS displays only one logical processor per core. This option is set to <b>Enabled</b> by default.
<b>CPU Interconnect Speed</b>	<p>Enables you to govern the frequency of the communication links among the processors in the system.</p> <p><b>NOTE:</b> The standard and basic bin processors support lower link frequencies.</p> <p>The options available are <b>Maximum data rate, 10.4 GT/s</b>, and <b>9.6 GT/s</b>. This option is set to <b>Maximum data rate</b> by default.</p> <p>Maximum data rate indicates that the BIOS runs the communication links at the maximum frequency that is supported by the processors. You can also select specific frequencies that the processors support, which can vary.</p> <p>For best performance, you should select <b>Maximum data rate</b>. Any reduction in the communication link frequency affects the performance of non-local memory accesses and cache coherency traffic. In addition, it can slow access to non-local I/O devices from a particular processor.</p> <p>However, if power saving considerations outweigh performance, you might want to reduce the frequency of the processor communication links. If you do this, you should localize memory and I/O accesses to the nearest NUMA node to minimize the impact to system performance.</p>
<b>Virtualization Technology</b>	Enables or disables the virtualization technology for the processor. This option is set to <b>Enabled</b> by default.

Option	Description
<b>Adjacent Cache Line Prefetch</b>	Optimizes the system for applications that need high utilization of sequential memory access. This option is set to <b>Enabled</b> by default. You can disable this option for applications that need high utilization of random memory access.
<b>Hardware Prefetcher</b>	Enables or disables the hardware prefetcher. This option is set to <b>Enabled</b> by default.
<b>Software Prefetcher</b>	Enables or disables the software prefetcher. This option is set to <b>Enabled</b> by default.
<b>DCU Streamer Prefetcher</b>	Enables or disables the Data Cache Unit (DCU) streamer prefetcher. This option is set to <b>Enabled</b> by default.
<b>DCU IP Prefetcher</b>	Enables or disables the Data Cache Unit (DCU) IP prefetcher. This option is set to <b>Enabled</b> by default.
<b>Sub NUMA Cluster</b>	Enables or disables the Sub NUMA Cluster. This option is set to <b>Disabled</b> by default.
<b>UPI Prefetch</b>	Enables you to get the memory that is read started early on DDR bus. The Ultra Path Interconnect (UPI) Rx path will spawn the speculative memory that is read to Integrated Memory Controller (iMC) directly. This option is set to <b>Enabled</b> by default.
<b>Logical Processor Idling</b>	Enables you to improve the energy efficiency of a system. It uses the operating system core parking algorithm and parks some of the logical processors in the system which in turn allows the corresponding processor cores to transition into a lower power idle state. This option can only be enabled if the operating system supports it. It is set to <b>Disabled</b> by default.
<b>Configurable TDP</b>	Enables you to configure the TDP level. The available options are <b>Nominal</b> , <b>Level 1</b> , and <b>Level 2</b> . This option is set to <b>Nominal</b> by default.  <b>NOTE: This option is only available on certain stock keeping units (SKUs) of the processors.</b>
<b>x2APIC Mode</b>	Enables or disables the x2APIC mode. This option is set to <b>Enabled</b> by default.
<b>Number of Cores per Processor</b>	Controls the number of enabled cores in each processor. This option is set to <b>All</b> by default.
<b>Processor Core Speed</b>	Specifies the maximum core frequency of the processor.
<b>Processor Bus Speed</b>	Displays the bus speed of the processor.
<b>Processor n</b>	 <b>NOTE: Depending on the number of processors, there might be up to two processors listed.</b>

The following settings are displayed for each processor that is installed in the system:

Option	Description
<b>Family-Model-Stepping</b>	Specifies the family, model, and stepping of the processor as defined by Intel.
<b>Brand</b>	Specifies the brand name.
<b>Level 2 Cache</b>	Specifies the total L2 cache.
<b>Level 3 Cache</b>	Specifies the total L3 cache.
<b>Number of Cores</b>	Specifies the number of cores per processor.
<b>Maximum Memory Capacity</b>	Specifies the maximum memory capacity per processor.
<b>Microcode</b>	Specifies the microcode.

## SATA Settings

You can use the **SATA Settings** screen to view the settings of SATA devices and enable SATA and PCIe NVMe RAID mode on your system.

# Viewing SATA Settings

To view the **SATA Settings** screen, perform the following steps:

## Steps

1. Power on, or restart your system.
2. Press F2 immediately after you see the following message:

```
F2 = System Setup
```

**NOTE:** If your operating system begins to load before you press F2, wait for the system to finish booting, and then restart your system and try again.

3. On the **System Setup Main Menu** screen, click **System BIOS**.
4. On the **System BIOS** screen, click **SATA Settings**.

# SATA Settings details

## About this task

The **SATA Settings** screen details are explained as follows:

Option	Description
<b>Embedded SATA</b>	Enables the embedded SATA option to be set to <b>AHCI Mode</b> , or <b>RAID Mode</b> . This option is set to <b>AHCI Mode</b> by default.
<b>Security Freeze Lock</b>	Enables you to send <b>Security Freeze Lock</b> command to the embedded SATA drives during POST. This option is applicable only for AHCI mode. This option is set to <b>Enabled</b> by default.
<b>Write Cache</b>	Enables or disables the command for the embedded SATA drives during POST. This option is set to <b>Disabled</b> by default.
<b>Port n</b>	Enables you to set the drive type of the selected device. For <b>AHCI Mode</b> or <b>RAID Mode</b> , BIOS support is always enabled.

Option	Description
<b>Model</b>	Specifies the drive model of the selected device.
<b>Drive Type</b>	Specifies the type of drive attached to the SATA port.
<b>Capacity</b>	Specifies the total capacity of the drive. This field is undefined for removable media devices such as optical drives.

# NVMe Settings

The NVMe settings enable you to set the NVMe drives to either **RAID** mode or **Non-RAID** mode.

**NOTE:** To configure these drives as RAID drives, you must set the NVMe drives and the Embedded SATA option in the SATA Settings menu to RAID mode. If not, you must set this field to Non-RAID mode.

# Viewing NVMe Settings

To view the **NVMe Settings** screen, perform the following steps:

## Steps

1. Power on, or restart your system.
2. Press F2 immediately after you see the following message:

```
F2 = System Setup
```

**NOTE:** If your operating system begins to load before you press F2, wait for the system to finish booting, and then restart your system and try again.

- On the **System Setup Main Menu** screen, click **System BIOS**.
- On the **System BIOS** screen, click **NVMe Settings**.

## NVMe Settings details

### About this task

The NVMe Settings screen details are explained as follows:

Option	Description
<b>NVMe Mode</b>	Enables you to set the NVMe mode. This option is set to <b>Non RAID</b> by default.

## Boot Settings

You can use the **Boot Settings** screen to set the boot mode to either **BIOS** or **UEFI**. It also enables you to specify the boot order.

- UEFI:** The Unified Extensible Firmware Interface (UEFI) is a new interface between operating systems and platform firmware. The interface consists of data tables with platform related information, boot and runtime service calls that are available to the operating system and its loader. The following benefits are available when the **Boot Mode** is set to **UEFI**:
  - Support for drive partitions larger than 2 TB.
  - Enhanced security (e.g., UEFI Secure Boot).
  - Faster boot time.

**NOTE:** You must use only the UEFI boot mode in order to boot from NVMe drives.

- BIOS:** The **BIOS Boot Mode** is the legacy boot mode. It is maintained for backward compatibility.

## Viewing Boot Settings

To view the **Boot Settings** screen, perform the following steps:

### Steps

- Power on, or restart your system.
- Press F2 immediately after you see the following message:

```
F2 = System Setup
```

**NOTE:** If your operating system begins to load before you press F2, wait for the system to finish booting, and then restart your system and try again.

- On the **System Setup Main Menu** screen, click **System BIOS**.
- On the **System BIOS** screen, click **Boot Settings**.

## Boot Settings details



### About this task

The **Boot Settings** screen details are explained as follows:

Option	Description
<b>Boot Mode</b>	Enables you to set the boot mode of the system.  <b>CAUTION:</b> Switching the boot mode may prevent the system from booting if the operating system is not installed in the same boot mode.

If the operating system supports **UEFI**, you can set this option to **UEFI**. Setting this field to **BIOS** enables compatibility with non-UEFI operating systems. This option is set to **UEFI** by default.

**NOTE:** Setting this field to UEFI disables the BIOS Boot Settings menu.

Option	Description
<b>Boot Sequence Retry</b>	Enables or disables the <b>Boot Sequence Retry</b> feature. If this option is set to <b>Enabled</b> and the system fails to boot, the system re-attempts the boot sequence after 30 seconds. This option is set to <b>Enabled</b> by default.
<b>Hard-Disk Failover</b>	Specifies the drive that is booted in the event of a drive failure. The devices are selected in the <b>Hard-Disk Drive Sequence</b> on the <b>Boot Option Setting</b> menu. When this option is set to <b>Disabled</b> , only the first drive in the list is attempted to boot. When this option is set to <b>Enabled</b> , all drives are attempted to boot in the order selected in the <b>Hard-Disk Drive Sequence</b> . This option is not enabled for <b>UEFI Boot Mode</b> . This option is set to <b>Disabled</b> by default.
<b>Generic USB Boot</b>	Enables or disables the USB boot option. This option is set to <b>Disabled</b> by default.
<b>Hard-disk Drive Placeholder</b>	Enables or disables the Hard-disk drive placeholder option. This option is set to <b>Disabled</b> by default.
<b>BIOS Boot Settings</b>	Enables or disables BIOS boot options.  <b>NOTE: This option is enabled only if the boot mode is BIOS.</b>
<b>UEFI Boot Settings</b>	Enables or disables UEFI Boot options. The Boot options include <b>IPv4 PXE</b> and <b>IPv6 PXE</b> . This option is set to <b>IPv4</b> by default.  <b>NOTE: This option is enabled only if the boot mode is UEFI.</b>
<b>UEFI Boot Sequence</b>	Enables you to change the boot device order.
<b>Boot Options Enable/Disable</b>	Enables you to select the enabled or disabled boot devices.

## Choosing system boot mode

System Setup enables you to specify one of the following boot modes for installing your operating system:

- BIOS boot mode is the standard BIOS-level boot interface.
- UEFI boot mode (the default), is an enhanced 64-bit boot interface.

If you have configured your system to boot to UEFI mode, it replaces the system BIOS.

1. From the **System Setup Main Menu**, click **Boot Settings**, and select **Boot Mode**.
2. Select the UEFI boot mode you want the system to boot into.

 **CAUTION: Switching the boot mode may prevent the system from booting if the operating system is not installed in the same boot mode.**

3. After the system boots in the specified boot mode, proceed to install your operating system from that mode.

 **NOTE: Operating systems must be UEFI-compatible to be installed from the UEFI boot mode. DOS and 32-bit operating systems do not support UEFI and can only be installed from the BIOS boot mode.**

 **NOTE: For the latest information about supported operating systems, go to [www.dell.com/ossupport](http://www.dell.com/ossupport).**

## Changing boot order

### About this task

You may have to change the boot order if you want to boot from a USB key or an optical drive. The following instructions may vary if you have selected **BIOS** for **Boot Mode**.

### Steps

1. On the **System Setup Main Menu** screen, click **System BIOS > Boot Settings > UEFI/BIOS Boot Settings > UEFI/BIOS Boot Sequence**.
2. Click **Exit**, and then click **Yes** to save the settings on exit.

# Network Settings

You can use the **Network Settings** screen to modify UEFI PXE, iSCSI, and HTTP boot settings. The network settings option is available only in the UEFI mode.

**NOTE:** BIOS does not control network settings in the BIOS mode. For the BIOS boot mode, the optional Boot ROM of the network controllers handles the network settings.

## Viewing Network Settings

To view the **Network Settings** screen, perform the following steps:

### Steps

1. Power on, or restart your system.
2. Press F2 immediately after you see the following message:

```
F2 = System Setup
```

**NOTE:** If your operating system begins to load before you press F2, wait for the system to finish booting, and then restart your system and try again.

3. On the **System Setup Main Menu** screen, click **System BIOS**.
4. On the **System BIOS** screen, click **Network Settings**.

## Network Settings screen details

The **Network Settings** screen details are explained as follows:

### About this task

Option	Description				
<b>UEFI PXE Settings</b>	<table border="1"> <thead> <tr> <th>Options</th> <th>Description</th> </tr> </thead> <tbody> <tr> <td><b>PXE Device n (n = 1 to 4)</b></td> <td>Enables or disables the device. When enabled, a UEFI PXE boot option is created for the device.</td> </tr> </tbody> </table>	Options	Description	<b>PXE Device n (n = 1 to 4)</b>	Enables or disables the device. When enabled, a UEFI PXE boot option is created for the device.
Options	Description				
<b>PXE Device n (n = 1 to 4)</b>	Enables or disables the device. When enabled, a UEFI PXE boot option is created for the device.				
<b>UEFI HTTP Settings</b>	<table border="1"> <thead> <tr> <th>Options</th> <th>Description</th> </tr> </thead> <tbody> <tr> <td><b>HTTP Device (n = 1 to 4)</b></td> <td>Enables or disables the device. When enabled, a UEFI HTTP boot option is created for the device.</td> </tr> </tbody> </table>	Options	Description	<b>HTTP Device (n = 1 to 4)</b>	Enables or disables the device. When enabled, a UEFI HTTP boot option is created for the device.
Options	Description				
<b>HTTP Device (n = 1 to 4)</b>	Enables or disables the device. When enabled, a UEFI HTTP boot option is created for the device.				
<b>UEFI iSCSI Settings</b>	Enables you to control the configuration of the iSCSI device.				

**Table 31. UEFI iSCSI Settings screen details**

Option	Description
<b>iSCSI Initiator Name</b>	Specifies the name of the iSCSI initiator in IQN format.
<b>iSCSI Device1</b>	Enables or disables the iSCSI device. When disabled, a UEFI boot option is created for the iSCSI device automatically. This is set to <b>Disabled</b> by default.
<b>iSCSI Device1 Settings</b>	Enables you to control the configuration of the iSCSI device.

# Integrated Devices

You can use the **Integrated Devices** screen to view and configure the settings of all integrated devices including the video controller, integrated RAID controller, and the USB ports.

## Viewing Integrated Devices

To view the **Integrated Devices** screen, perform the following steps:

### Steps

1. Power on, or restart your system.
2. Press F2 immediately after you see the following message:

```
F2 = System Setup
```

**NOTE:** If your operating system begins to load before you press F2, wait for the system to finish booting, and then restart your system and try again.

3. On the **System Setup Main Menu** screen, click **System BIOS**.
4. On the **System BIOS** screen, click **Integrated Devices**.

## Integrated Devices details

### About this task

The **Integrated Devices** screen details are explained as follows:

Option	Description
<b>User Accessible USB Ports</b>	<p>Configures the user accessible USB ports. Selecting <b>Only Back Ports On</b> disables the front USB ports; selecting <b>All Ports Off</b> disables all front and back USB ports.</p> <p>The USB keyboard and mouse still function in certain USB ports during the boot process, depending on the selection. After the boot process is complete, the USB ports will be enabled or disabled as per the setting.</p>
<b>Internal USB Port</b>	<p>Enables or disables the internal USB port. This option is set to <b>On</b> or <b>Off</b>. This option is set to <b>On</b> by default.</p> <p><b>NOTE:</b> The Internal SD Card Port on the PCIe riser is controlled by Internal USB Port.</p>
<b>Embedded NIC1 and NIC2</b>	<p><b>NOTE:</b> The Embedded NIC1 and NIC2 options are only available on systems that do not have Integrated Network Card 1.</p> <p>Enables or disables the Embedded NIC1 and NIC2 options. If set to <b>Disabled</b>, the NIC may still be available for shared network access by the embedded management controller. The embedded NIC1 and NIC2 options are only available on systems that do not have Network Daughter Cards (NDCs). The Embedded NIC1 and NIC2 option is mutually exclusive with the Integrated Network Card 1 option. Configure the Embedded NIC1 and NIC2 option by using the NIC management utilities of the system.</p>
<b>I/OAT DMA Engine</b>	<p>Enables or disables the I/O Acceleration Technology (I/OAT) option. I/OAT is a set of DMA features designed to accelerate network traffic and lower CPU utilization. Enable only if the hardware and software support the feature. This option is set to <b>Disabled</b> by default.</p>
<b>Embedded Video Controller</b>	<p>Enables or disables the use of Embedded Video Controller as the primary display. When set to <b>Enabled</b>, the Embedded Video Controller is used as the primary display even if add-in graphic cards are installed. When set to <b>Disabled</b>, an add-in graphics card is used as the primary display. BIOS will output displays to both the primary add-in video and the embedded video during POST and pre-boot environment. The embedded video is disabled before the operating system boots. This option is set to <b>Enabled</b> by default.</p> <p><b>NOTE:</b> When there are multiple add-in graphic cards installed in the system, the first card discovered during PCI enumeration is selected as the primary video. You might have to re-arrange the cards in the slots in order to control which card is the primary video.</p>
<b>Current State of Embedded Video Controller</b>	<p>Displays the current state of the embedded video controller. The <b>Current State of Embedded Video Controller</b> option is a read-only field. If the Embedded Video Controller is the only display capability in the system (that is, no add-in graphics card is installed), then the Embedded Video Controller is automatically used as the primary display even if the <b>Embedded Video Controller</b> setting is set to <b>Disabled</b>.</p>

Option	Description
<b>SR-IOV Global Enable</b>	Enables or disables the BIOS configuration of Single Root I/O Virtualization (SR-IOV) devices. This option is set to <b>Disabled</b> by default.
<b>Internal SD Card Port</b>	Enables or disables the internal SD card port of the Internal Dual SD Module (IDSMD). This option is set to <b>On</b> by default.
<b>Internal SD Card Redundancy</b>	Configures the redundancy mode of the Internal Dual SD Module (IDSMD). When set to <b>Mirror</b> Mode, data is written on both SD cards. After failure of either card and replacement of the failed card, the data of the active card is copied to the offline card during the system boot.  When Internal SD Card Redundancy is set to <b>Disabled</b> , only the primary SD card is visible to the OS. This option is set to <b>Disabled</b> by default.
<b>Internal SD Primary Card</b>	By default, the primary SD card is selected to be SD Card 1. If SD Card 1 is not present, then the controller selects SD Card 2 to be the primary SD card.
<b>OS Watchdog Timer</b>	If your system stops responding, this watchdog timer aids in the recovery of your operating system. When this option is set to <b>Enabled</b> , the operating system initializes the timer. When this option is set to <b>Disabled</b> (the default), the timer does not have any effect on the system.
<b>Empty Slot Unhide</b>	Enables or disables the root ports of all the empty slots that are accessible to the BIOS and OS. This option is set to <b>Disabled</b> by default.
<b>Memory Mapped I/O above 4 GB</b>	Enables or disables the support for the PCIe devices that need large amounts of memory. Enable this option only for 64-bit operating systems. This option is set to <b>Enabled</b> by default.
<b>Memory Mapped I/O Base</b>	When set to <b>12 TB</b> , the system maps the MMIO base to 12 TB. Enable this option for an OS that requires 44 bit PCIe addressing. When set to <b>512 GB</b> , the system maps the MMIO base to 512 GB, and reduces the maximum support for memory to less than 512 GB. Enable this option only for the 4 GPU DGMA issue. This option is set to <b>56 TB</b> by default.
<b>Slot Disablement</b>	Enables or disables the available PCIe slots on your system. The slot disablement feature controls the configuration of the PCIe cards installed in the specified slot. Slots must be disabled only when the installed peripheral card prevents booting into the operating system or causes delays in system startup. If the slot is disabled, both the Option ROM and UEFI drivers are disabled. Only slots that are present on the system are available for control.

**Table 32. Slot Disablement**

Option	Description
<b>Slot 1</b>	Enables or disables or only the boot driver is disabled for the PCIe slot 1. This option is set to <b>Enabled</b> by default.
<b>Slot 2</b>	Enables or disables or only the boot driver is disabled for the PCIe slot 2. This option is set to <b>Enabled</b> by default.
<b>Slot 3</b>	Enables or disables or only the boot driver is disabled for the PCIe slot 3. This option is set to <b>Enabled</b> by default.
<b>Slot 4</b>	Enables or disables or only the boot driver is disabled for the PCIe slot 4. This option is set to <b>Enabled</b> by default.
<b>Slot 5</b>	Enables or disables or only the boot driver is disabled for the PCIe slot 5. This option is set to <b>Enabled</b> by default.

<b>Slot Bifurcation</b>	Allows <b>Platform Default Bifurcation</b> , <b>Auto Discovery of Bifurcation</b> and <b>Manual Bifurcation Control</b> . The default is set to <b>Platform Default Bifurcation</b> . The slot bifurcation field is accessible when set to <b>Manual Bifurcation Control</b> and is disabled when set to <b>Platform Default Bifurcation</b> or <b>Auto Discovery of Bifurcation</b> .
-------------------------	--

## Option Description

Table 33. Slot Bifurcation

Option	Description
<b>Auto Discovery Bifurcation Settings</b>	Platform Default Bifurcation , Auto Bifurcation, and Manual bifurcation
<b>Slot 1 Bifurcation</b>	x4 Bifurcation
<b>Slot 2 Bifurcation</b>	x4 Bifurcation
<b>Slot 4 Bifurcation</b>	x4 Bifurcation
<b>Slot 5 Bifurcation</b>	x4 Bifurcation

## Serial Communication

You can use the **Serial Communication** screen to view the properties of the serial communication port.

### Viewing Serial Communication

To view the **Serial Communication** screen, perform the following steps:

#### Steps

1. Power on, or restart your system.
2. Press F2 immediately after you see the following message:

```
F2 = System Setup
```

**NOTE:** If your operating system begins to load before you press F2, wait for the system to finish booting, and then restart your system and try again.

3. On the **System Setup Main Menu** screen, click **System BIOS**.
4. On the **System BIOS** screen, click **Serial Communication**.

### Serial Communication details

#### About this task

The **Serial Communication** screen details are explained as follows:

Option	Description
<b>Serial Communication</b>	Enables you to select serial communication devices (Serial Device 1 and Serial Device 2) in BIOS. BIOS console redirection can also be enabled, and the port address can be specified. This option is set to <b>Auto</b> by default.
<b>Serial Port Address</b>	Enables you to set the port address for serial device. This field sets the serial port address to either <b>COM1</b> or <b>COM2</b> (COM1=0x3F8, COM2=0x2F8). This option is set to <b>Serial Device1=COM2 or Serial Device 2=COM1</b> by default. <b>NOTE:</b> You can use only Serial Device 2 for the Serial Over LAN (SOL) feature. To use console redirection by SOL, configure the same port address for console redirection and the serial device. <b>NOTE:</b> Every time the system boots, the BIOS syncs the serial MUX setting saved in iDRAC. The serial MUX setting can independently be changed in iDRAC. Loading the BIOS default settings from within the BIOS setup utility may not always revert the serial MUX setting to the default setting of Serial Device 1.
<b>External Serial Connector</b>	Enables you to associate the External Serial Connector to <b>Serial Device 1</b> , <b>Serial Device 2</b> , or the <b>Remote Access Device</b> by using this option. This option is set to <b>Serial Device 1</b> by default.

Option	Description
	<p><b>NOTE:</b> Only Serial Device 2 can be used for Serial Over LAN (SOL). To use console redirection by SOL, configure the same port address for console redirection and the serial device.</p> <p><b>NOTE:</b> Every time the system boots, the BIOS syncs the serial MUX setting saved in iDRAC. The serial MUX setting can independently be changed in iDRAC. Loading the BIOS default settings from within the BIOS setup utility may not always revert this setting to the default setting of Serial Device 1.</p>
<b>Failsafe Baud Rate</b>	Specifies the failsafe baud rate for console redirection. The BIOS attempts to determine the baud rate automatically. This failsafe baud rate is used only if the attempt fails, and the value must not be changed. This option is set to <b>115200</b> by default.
<b>Remote Terminal Type</b>	Enables you to set the remote console terminal type. This option is set to <b>VT100/VT220</b> by default.
<b>Redirection After Boot</b>	Enables or disables the BIOS console redirection when the operating system is loaded. This option is set to <b>Enabled</b> by default.

## System Profile Settings

You can use the **System Profile Settings** screen to enable specific system performance settings such as power management.

### Viewing System Profile Settings

To view the **System Profile Settings** screen, perform the following steps:

#### Steps

1. Power on, or restart your system.
2. Press F2 immediately after you see the following message:

```
F2 = System Setup
```

**NOTE:** If your operating system begins to load before you press F2, wait for the system to finish booting, and then restart your system and try again.

3. On the **System Setup Main Menu** screen, click **System BIOS**.
4. On the **System BIOS** screen, click **System Profile Settings**.

### System Profile Settings details

#### About this task

The **System Profile Settings** screen details are explained as follows:

Option	Description
<b>System Profile</b>	<p>Sets the system profile. If you set the System Profile option to a mode other than <b>Custom</b>, the BIOS automatically sets the rest of the options. You can only change the rest of the options if the mode is set to <b>Custom</b>. This option is set to <b>Performance Per Watt Optimized (DAPC)</b> by default. DAPC is Dell Active Power Controller. Other options include <b>Performance Per Watt (OS)</b>, <b>Performance</b>, and <b>Workstation Performance</b>.</p> <p><b>NOTE:</b> All the parameters on the system profile setting screen are available only when the System Profile option is set to Custom.</p>
<b>CPU Power Management</b>	Sets the CPU power management. This option is set to <b>System DBPM (DAPC)</b> by default. DBPM is Demand-Based Power Management. Other options include <b>OS DBPM</b> , and <b>Maximum Performance</b> .
<b>Memory Frequency</b>	Sets the speed of the system memory. You can select <b>Maximum Performance</b> , <b>Maximum Reliability</b> , or a specific speed. This option is set to <b>Maximum Performance</b> by default.
<b>Turbo Boost</b>	Enables or disables the processor to operate in the turbo boost mode. This option is set to <b>Enabled</b> by default.

Option	Description
<b>C1E</b>	Enables or disables the processor to switch to a minimum performance state when it is idle. This option is set to <b>Enabled</b> by default.
<b>C States</b>	Enables or disables the processor to operate in all available power states. This option is set to <b>Enabled</b> by default.
<b>Write Data CRC</b>	Enables or disables the Write Data CRC. This option is set to <b>Disabled</b> by default.
<b>Memory Patrol Scrub</b>	Sets the memory patrol scrub frequency. This option is set to <b>Standard</b> by default.
<b>Memory Refresh Rate</b>	Sets the memory refresh rate to either 1x or 2x. This option is set to <b>1x</b> by default.
<b>Uncore Frequency</b>	Enables you to select the <b>Processor Uncore Frequency</b> option. <b>Dynamic mode</b> enables the processor to optimize power resources across cores and uncores during runtime. The optimization of the uncore frequency to either save power or optimize performance is influenced by the setting of the <b>Energy Efficiency Policy</b> option.
<b>Energy Efficient Policy</b>	Enables you to select the <b>Energy Efficient Policy</b> option. The CPU uses the setting to manipulate the internal behavior of the processor and determines whether to target higher performance or better power savings. This option is set to <b>Balanced Performance</b> by default.
<b>Number of Turbo Boost Enabled Cores for Processor 1</b>	<p><b>NOTE: If there are two processors installed in the system, you will see an entry for Number of Turbo Boost Enabled Cores for Processor 2.</b></p> <p>Controls the number of turbo boost enabled cores for Processor 1. The maximum number of cores is enabled by default.</p>
<b>Monitor/Mwait</b>	<p>Enables the Monitor/Mwait instructions in the processor. This option is set to <b>Enabled</b> for all system profiles, except <b>Custom</b> by default.</p> <p><b>NOTE: This option can be disabled only if the C States option in the Custom mode is set to disabled.</b></p> <p><b>NOTE: When C States is set to Enabled in the Custom mode, changing the Monitor/Mwait setting does not impact the system power or performance.</b></p>
<b>CPU Interconnect Bus Link Power Management</b>	Enables or disables the CPU Interconnect Bus Link Power Management. This option is set to <b>Enabled</b> by default.
<b>PCI ASPM L1 Link Power Management</b>	Enables or disables the PCI ASPM L1 Link Power Management. This option is set to <b>Enabled</b> by default.

## System Security

You can use the **System Security** screen to perform specific functions such as setting the system password, setup password and disabling the power button.

### Viewing System Security

To view the **System Security** screen, perform the following steps:

#### Steps

1. Power on, or restart your system.
2. Press F2 immediately after you see the following message:

```
F2 = System Setup
```

**NOTE: If your operating system begins to load before you press F2, wait for the system to finish booting, and then restart your system and try again.**

3. On the **System Setup Main Menu** screen, click **System BIOS**.
4. On the **System BIOS** screen, click **System Security**.

# System Security Settings details

## About this task

The **System Security Settings** screen details are explained as follows:

Option	Description
<b>CPU AES-NI</b>	Improves the speed of applications by performing encryption and decryption by using the Advanced Encryption Standard Instruction Set (AES-NI). This option is set to <b>Enabled</b> by default.
<b>System Password</b>	Enables you to set the system password. This option is set to <b>Enabled</b> by default and is read-only if the password jumper is not installed in the system.
<b>Setup Password</b>	Enables you to set the system setup password. This option is read-only if the password jumper is not installed in the system.
<b>Password Status</b>	Enables you to lock the system password. This option is set to <b>Unlocked</b> by default.
<b>TPM Security</b>	 <b>NOTE: The TPM menu is available only when the TPM module is installed.</b>

Enables you to control the reporting mode of the TPM. The **TPM Security** option is set to **Off** by default. You can only modify the TPM Status TPM Activation, and the Intel TXT fields if the **TPM Status** field is set to either **On with Pre-boot Measurements** or **On without Pre-boot Measurements**.



**Table 34. TPM 1.2 security information**

Option	Description
<b>TPM Information</b>	Changes the operational state of the TPM. This option is set to <b>No Change</b> by default.
<b>TPM Firmware</b>	Indicates the firmware version of the TPM.
<b>TPM Status</b>	Specifies the TPM status.
<b>TPM Command</b>	Controls the Trusted Platform Module (TPM). When set to <b>None</b> , no command is sent to the TPM. When set to <b>Activate</b> , the TPM is enabled and activated. When set to <b>Deactivate</b> , the TPM is disabled and deactivated. When set to <b>Clear</b> , all the contents of the TPM are cleared. This option is set to <b>None</b> by default.

**Table 35. TPM 2.0 security information**

Option	Description
<b>TPM Information</b>	Changes the operational state of the TPM. This option is set to <b>No Change</b> by default.
<b>TPM Firmware</b>	Indicates the firmware version of the TPM.
<b>TPM Hierarchy</b>	<p>Enable, disable, or clear the storage and endorsement hierarchies. When set to <b>Enabled</b>, the storage and endorsement hierarchies can be used.</p> <p>When set to <b>Disabled</b>, the storage and endorsement hierarchies cannot be used.</p> <p>When set to <b>Clear</b>, the storage and endorsement hierarchies are cleared of any values, and then reset to <b>Enabled</b>.</p>

<b>TPM Information</b>	Enables you to change the operational state of the TPM. This option is set to <b>No Change</b> by default.
<b>TPM Status</b>	Specifies the TPM status.
<b>TPM Command</b>	Controls the Trusted Platform Module (TPM). When set to <b>None</b> , no command is sent to the TPM. When set to <b>Activate</b> , the TPM is enabled and activated. When set to <b>Deactivate</b> , the TPM is disabled and deactivated. When set to <b>Clear</b> , all the contents of the TPM are cleared. This option is set to <b>None</b> by default.

Option	Description								
	<p> <b>CAUTION:</b> Clearing the TPM results in the loss of all keys in the TPM. The loss of TPM keys may affect booting to the operating system.</p> <p>This field is read-only when <b>TPM Security</b> is set to <b>Off</b>. The action requires an additional reboot before it can take effect.</p>								
<b>TPM Advanced Settings</b>	This setting is enabled only when TPM Security is set to ON.								
<b>Intel(R) TXT</b>	Enables you to set the Intel Trusted Execution Technology (TXT) option. To enable the <b>Intel TXT</b> option, virtualization technology and TPM Security must be enabled with Pre-boot measurements. This option is set to <b>Off</b> by default.								
<b>Power Button</b>	Enables you to set the power button on the front of the system. This option is set to <b>Enabled</b> by default.								
<b>AC Power Recovery</b>	Sets how the system behaves after AC power is restored to the system. This option is set to <b>Last</b> by default.								
<b>AC Power Recovery Delay</b>	Enables you to set the time that the system should take to power up after AC power is restored to the system. This option is set to <b>Immediate</b> by default.								
<b>User Defined Delay (60 s to 600 s)</b>	Enables you to set the <b>User Defined Delay</b> option when the <b>User Defined</b> option for <b>AC Power Recovery Delay</b> is selected.								
<b>UEFI Variable Access</b>	Provides varying degrees of securing UEFI variables. When set to <b>Standard</b> (the default), UEFI variables are accessible in the operating system per the UEFI specification. When set to <b>Controlled</b> , selected UEFI variables are protected in the environment, and new UEFI boot entries are forced to be at the end of the current boot order.								
<b>In-Band Manageability Interface</b>	<p>When set to <b>Disabled</b>, this setting will hide the Management Engine's (ME), HECI devices, and the system's IPMI devices from the operating system. This prevents the operating system from changing the ME power capping settings, and blocks access to all in-band management tools. All management should be managed through out-of-band. This option is set to <b>Enabled</b> by default.</p> <p> <b>NOTE:</b> BIOS update requires HECI devices to be operational and DUP updates require IPMI interface to be operational. This setting needs to be set to Enabled to avoid updating errors.</p>								
<b>Secure Boot</b>	Enables Secure Boot, where the BIOS authenticates each pre-boot image by using the certificates in the Secure Boot Policy. Secure Boot is set to <b>Disabled</b> by default.								
<b>Secure Boot Policy</b>	When Secure Boot policy is set to <b>Standard</b> , the BIOS uses the system manufacturer key and certificates to authenticate pre-boot images. When Secure Boot policy is set to <b>Custom</b> , the BIOS uses the user-defined key and certificates. Secure Boot policy is set to <b>Standard</b> by default.								
<b>Secure Boot Mode</b>	<p>Enables you to configure how the BIOS uses the Secure Boot Policy Objects (PK, KEK, db, dbx).</p> <p>If the current mode is set to <b>Deployed Mode</b>, the available options are <b>User Mode</b> and <b>Deployed Mode</b>. If the current mode is set to <b>User Mode</b>, the available options are <b>User Mode</b>, <b>Audit Mode</b>, and <b>Deployed Mode</b>.</p> <table border="1"> <thead> <tr> <th>Options</th> <th>Description</th> </tr> </thead> <tbody> <tr> <td><b>User Mode</b></td> <td> <p>In <b>User Mode</b>, PK must be installed, and BIOS performs signature verification on programmatic attempts to update policy objects.</p> <p>BIOS allows unauthenticated programmatic transitions between modes.</p> </td> </tr> <tr> <td><b>Audit Mode</b></td> <td> <p>In <b>Audit mode</b>, PK is not present. BIOS does not authenticate programmatic updates to the policy objects, and transitions between modes.</p> <p><b>Audit Mode</b> is useful for programmatically determining a working set of policy objects.</p> <p>BIOS performs signature verification on pre-boot images and logs the results in the image Execution Information Table, but approves the images whether they pass or fail verification.</p> </td> </tr> <tr> <td><b>Deployed Mode</b></td> <td><b>Deployed Mode</b> is the most secure mode. In <b>Deployed Mode</b>, PK must be installed and the BIOS performs signature verification on programmatic attempts to update policy objects.</td> </tr> </tbody> </table>	Options	Description	<b>User Mode</b>	<p>In <b>User Mode</b>, PK must be installed, and BIOS performs signature verification on programmatic attempts to update policy objects.</p> <p>BIOS allows unauthenticated programmatic transitions between modes.</p>	<b>Audit Mode</b>	<p>In <b>Audit mode</b>, PK is not present. BIOS does not authenticate programmatic updates to the policy objects, and transitions between modes.</p> <p><b>Audit Mode</b> is useful for programmatically determining a working set of policy objects.</p> <p>BIOS performs signature verification on pre-boot images and logs the results in the image Execution Information Table, but approves the images whether they pass or fail verification.</p>	<b>Deployed Mode</b>	<b>Deployed Mode</b> is the most secure mode. In <b>Deployed Mode</b> , PK must be installed and the BIOS performs signature verification on programmatic attempts to update policy objects.
Options	Description								
<b>User Mode</b>	<p>In <b>User Mode</b>, PK must be installed, and BIOS performs signature verification on programmatic attempts to update policy objects.</p> <p>BIOS allows unauthenticated programmatic transitions between modes.</p>								
<b>Audit Mode</b>	<p>In <b>Audit mode</b>, PK is not present. BIOS does not authenticate programmatic updates to the policy objects, and transitions between modes.</p> <p><b>Audit Mode</b> is useful for programmatically determining a working set of policy objects.</p> <p>BIOS performs signature verification on pre-boot images and logs the results in the image Execution Information Table, but approves the images whether they pass or fail verification.</p>								
<b>Deployed Mode</b>	<b>Deployed Mode</b> is the most secure mode. In <b>Deployed Mode</b> , PK must be installed and the BIOS performs signature verification on programmatic attempts to update policy objects.								

Option	Description				
	<table border="1"> <thead> <tr> <th>Options</th> <th>Description</th> </tr> </thead> <tbody> <tr> <td><b>Deployed Mode</b></td> <td>restricts the programmatic mode transitions.</td> </tr> </tbody> </table>	Options	Description	<b>Deployed Mode</b>	restricts the programmatic mode transitions.
Options	Description				
<b>Deployed Mode</b>	restricts the programmatic mode transitions.				
<b>Secure Boot Policy Summary</b>	Specifies the list of certificates and hashes that secure boot uses to authenticate images.				
<b>Secure Boot Custom Policy Settings</b>	Configures the Secure Boot Custom Policy. To enable this option, set the <b>Secure Boot Policy</b> to <b>Custom</b> .				

## Creating a system and setup password

### Prerequisites

Ensure that the password jumper is enabled. The password jumper enables or disables the system password and setup password features. For more information, see the System board jumper settings section.

**NOTE:** If the password jumper setting is disabled, the existing system password and setup password are deleted and you need not provide the system password to boot the system.

### Steps

- To enter System Setup, press F2 immediately after turning on or rebooting your system.
- On the **System Setup Main Menu** screen, click **System BIOS > System Security**.
- On the **System Security** screen, verify that **Password Status** is set to **Unlocked**.
- In the **System Password** field, type your system password, and press Enter or Tab.

Use the following guidelines to assign the system password:

- A password can have up to 32 characters.
- The password can contain the numbers 0 through 9.

A message prompts you to reenter the system password.

- Reenter the system password, and click **OK**.
- In the **Setup Password** field, type your setup password and press Enter or Tab. A message prompts you to reenter the setup password.
- Reenter the setup password, and click **OK**.
- Press Esc to return to the System BIOS screen. Press Esc again. A message prompts you to save the changes.

**NOTE:** Password protection does not take effect until the system reboots.

## Using your system password to secure the system

### About this task

If you have assigned a setup password, the system accepts your setup password as an alternate system password.

### Steps

- Power on or reboot your system.
- Type the system password and press Enter.

### Next steps

When **Password Status** is set to **Locked**, type the system password and press Enter when prompted at reboot.

**NOTE:** If an incorrect system password is typed, the system displays a message and prompts you to reenter your password. You have three attempts to type the correct password. After the third unsuccessful attempt, the system

displays an error message that the system has stopped functioning and must be turned off. Even after you turn off and restart the system, the error message is displayed until the correct password is entered.

## Deleting or changing system and setup password

### Prerequisites

**NOTE:** You cannot delete or change an existing system or setup password if the Password Status is set to Locked.

### Steps

1. To enter System Setup, press F2 immediately after turning on or restarting your system.
2. On the **System Setup Main Menu** screen, click **System BIOS > System Security**.
3. On the **System Security** screen, ensure that **Password Status** is set to **Unlocked**.
4. In the **System Password** field, change or delete the existing system password, and then press Enter or Tab.
5. In the **Setup Password** field, alter or delete the existing setup password, and then press Enter or Tab.

**NOTE:** If you change the system password or setup password, a message prompts you to reenter the new password. If you delete the system password or setup password, a message prompts you to confirm the deletion.

6. Press Esc to return to the **System BIOS** screen. Press Esc again, and a message prompts you to save the changes.
7. Select **Setup Password**, change, or delete the existing setup password and press Enter or Tab.

**NOTE:** If you change the system password or setup password, a message prompts you to reenter the new password. If you delete the system password or setup password, a message prompts you to confirm the deletion.

## Operating with setup password enabled

If **Setup Password** is set to **Enabled**, type the correct setup password before modifying the system setup options.

If you do not type the correct password in three attempts, the system displays the following message:

```
Number of unsuccessful password attempts: <3> Maximum number of password attempts exceeded.  
System Halted!
```

Even after you restart the system, the error message is displayed until the correct password is typed. The following options are exceptions:

- If **System Password** is not set to **Enabled** and is not locked through the **Password Status** option, you can assign a system password. For more information, see the [System Security Settings details](#) section.
- You cannot disable or change an existing system password.

**NOTE:** You can use the password status option with the setup password option to protect the system password from unauthorized changes.

## Redundant OS Control

In the **Redundant OS Control** screen you can set the redundant OS information. This enables you to set up a physical recovery disk on the system.

## Viewing Redundant OS Control

To view the **Redundant OS Control** screen, perform the following steps:

### Steps

1. Power on, or restart your system.
2. Press F2 immediately after you see the following message:

```
F2 = System Setup
```

**NOTE:** If your operating system begins to load before you press F2, wait for the system to finish booting, and then restart your system and try again.

3. On the **System Setup Main Menu** screen, click **System BIOS**.
4. On the **System BIOS** screen, click **Redundant OS Control**.

## Redundant OS Control screen details

The **Redundant OS Control** screen details are explained as follows:

### About this task

Option	Description
<b>Redundant OS Location</b>	<p>Enables you to select a backup disk from the following devices:</p> <ul style="list-style-type: none"> <li>· <b>None</b></li> <li>· <b>IDSDM</b></li> <li>· <b>SATA Ports in AHCI mode</b></li> <li>· <b>BOSS PCIe Cards (Internal M.2 Drives)</b></li> <li>· <b>Internal USB</b></li> </ul> <p><b>NOTE:</b> RAID configurations and NVMe cards not are included as BIOS does not have the ability to distinguish between individual drives in those configurations.</p>
<b>Redundant OS State</b>	<p><b>NOTE:</b> This option is disabled if Redundant OS Location is set to None.</p> <p>When set to <b>Visible</b>, the backup disk is visible to the boot list and OS. When set to <b>Hidden</b>, the backup disk is disabled and is not visible to the boot list and OS. This option is set to <b>Visible</b> by default.</p> <p><b>NOTE:</b> BIOS will disable the device in hardware, so it cannot be accessed by the OS.</p>
<b>Redundant OS Boot</b>	<p><b>NOTE:</b> This option is disabled if Redundant OS Location is set to None or if Redundant OS State is set to Hidden.</p> <p>When set to <b>Enabled</b>, BIOS boots to the device specified in <b>Redundant OS Location</b>. When set to <b>Disabled</b>, BIOS preserves the current boot list settings. This option is set to <b>Disabled</b> by default.</p>

## Miscellaneous Settings

You can use the **Miscellaneous Settings** screen to perform specific functions such as updating the asset tag and changing the system date and time.

## Viewing Miscellaneous Settings

To view the **Miscellaneous Settings** screen, perform the following steps:

### Steps

1. Power on, or restart your system.
2. Press F2 immediately after you see the following message:

```
F2 = System Setup
```

**NOTE:** If your operating system begins to load before you press F2, wait for the system to finish booting, and then restart your system and try again.

3. On the **System Setup Main Menu** screen, click **System BIOS**.
4. On the **System BIOS** screen, click **Miscellaneous Settings**.

## Miscellaneous Settings details

### About this task

The **Miscellaneous Settings** screen details are explained as follows:

Option	Description
<b>System Time</b>	Enables you to set the time on the system.
<b>System Date</b>	Enables you to set the date on the system.
<b>Asset Tag</b>	Specifies the asset tag and enables you to modify it for security and tracking purposes.
<b>Keyboard NumLock</b>	Enables you to set whether the system should boot with the NumLock enabled or disabled. This option is set to <b>On</b> by default.  <b>NOTE: This option does not apply to 84-key keyboards.</b>
<b>F1/F2 Prompt on Error</b>	Enables or disables the F1/F2 prompt on error. This option is set to <b>Enabled</b> by default. The F1/F2 prompt also includes keyboard errors.
<b>Load Legacy Video Option ROM</b>	Enables you to determine whether the system BIOS loads the legacy video (INT 10H) option ROM from the video controller. Selecting <b>Enabled</b> in the operating system does not support UEFI video output standards. This field is available only for UEFI boot mode. You cannot set the option to <b>Enabled</b> if <b>UEFI Secure Boot</b> mode is enabled. This option is set to <b>Disabled</b> by default.
<b>Dell Wyse P25/P45 BIOS Access</b>	Enables or disables the Dell Wyse P25/P45 BIOS Access. This option is set to <b>Enabled</b> by default.
<b>Power Cycle Request</b>	Enables or disables the Power Cycle Request. This option is set to <b>None</b> by default.

## iDRAC Settings utility

The iDRAC settings utility is an interface to set up and configure the iDRAC parameters by using UEFI. You can enable or disable various iDRAC parameters by using the iDRAC settings utility.

 **NOTE: Accessing some of the features on the iDRAC settings utility needs the iDRAC Enterprise License upgrade.**

For more information about using iDRAC, see *Dell Integrated Dell Remote Access Controller User's Guide* at [www.dell.com/poweredge/manuals](http://www.dell.com/poweredge/manuals).

## Device Settings

**Device Settings** enables you to configure the below device parameters:

- Controller Configuration Utility
- Embedded NIC Port1-X Configuration
- NICs in slotX, Port1-X Configuration
- BOSS Card configuration

## Dell Lifecycle Controller

Dell Lifecycle Controller (LC) provides advanced embedded systems management capabilities including system deployment, configuration, update, maintenance, and diagnosis. LC is delivered as part of the iDRAC out-of-band solution and Dell system embedded Unified Extensible Firmware Interface (UEFI) applications.

## Embedded system management

The Dell Lifecycle Controller provides advanced embedded system management throughout the lifecycle of the system. The Dell Lifecycle Controller can be started during the boot sequence and can function independently of the operating system.

 **NOTE: Certain platform configurations may not support the full set of features provided by the Dell Lifecycle Controller.**

For more information about setting up the Dell Lifecycle Controller, configuring hardware and firmware, and deploying the operating system, see the Dell Lifecycle Controller documentation at [www.dell.com/poweredge/manuals](http://www.dell.com/poweredge/manuals).

# Boot Manager

The **Boot Manager** screen enables you to select boot options and diagnostic utilities.

## Viewing Boot Manager

### About this task

To enter Boot Manager:

### Steps

1. Power on, or restart your system.
2. Press F11 when you see the following message:  
`F11 = Boot Manager`  
If your operating system begins to load before you press F11, allow the system to complete the booting, and then restart your system and try again.

## Boot Manager main menu

Menu item	Description
<b>Continue Normal Boot</b>	The system attempts to boot to devices starting with the first item in the boot order. If the boot attempt fails, the system continues with the next item in the boot order until the boot is successful or no more boot options are found.
<b>One-shot Boot Menu</b>	Enables you to access boot menu, where you can select a one-time boot device to boot from.
<b>Launch System Setup</b>	Enables you to access System Setup.
<b>Launch Lifecycle Controller</b>	Exits the Boot Manager and invokes the Dell Lifecycle Controller program.
<b>System Utilities</b>	Enables you to launch System Utilities menu such as System Diagnostics.

## One-shot UEFI boot menu

**One-shot UEFI boot menu** enables you to select a boot device to boot from.

## System Utilities

**System Utilities** contains the following utilities that can be launched:

- Launch Diagnostics
- BIOS Update File Explorer
- Reboot System







## PXE boot

You can use the Preboot Execution Environment (PXE) option to boot and configure the networked systems, remotely.

To access the **PXE boot** option, boot the system and then press F12 during POST instead of using standard Boot Sequence from BIOS Setup. It does not pull any menu or allows managing of network devices.

# Installing and removing system components

## Safety instructions

-  **NOTE:** Whenever you need to lift the system, get others to assist you. To avoid injury, do not attempt to lift the system by yourself.
-  **WARNING:** Opening or removing the system cover while the system is powered on may expose you to a risk of electric shock.
-  **CAUTION:** Do not operate the system without the cover for a duration exceeding five minutes. Operating the system without the system cover can result in component damage.
-  **CAUTION:** Many repairs may only be done by a certified service technician. You should only perform troubleshooting and simple repairs as authorized in your product documentation, or as directed by the online or telephone service and support team. Damage due to servicing that is not authorized by Dell is not covered by your warranty. Read and follow the safety instructions that are shipped with your product.
-  **NOTE:** It is recommended that you always use an antistatic mat and antistatic strap while working on components inside the system.
-  **CAUTION:** To ensure proper operation and cooling, all bays in the system and system fans must be always populated with a component or a blank.

## Before working inside your system

### Prerequisites

Follow the safety guidelines listed in [Safety instructions](#).

### Steps

1. Turn off the system, including all attached peripherals.
2. Disconnect the system from the electrical outlet and disconnect the peripherals.
3. Lay the system on its side.
4. Remove the system cover.

## After working inside your system

### Prerequisites

Follow the safety guidelines listed in [Safety instructions](#).

### Steps

1. Install the system cover.
2. Place the system upright on a flat, stable surface.
3. Reconnect the peripherals and connect the system to the electrical outlet.
4. Turn on the attached peripherals and then turn on the system.

# Recommended tools

You need the following tools to perform the removal and installation procedures:

- Key to the bezel lock  
The key is required only if your system includes a bezel.
- Phillips #1 screwdriver
- Phillips #2 screwdriver
- Torx #T30 screwdriver
- Wrist grounding strap

# Optional front bezel

## Removing the front bezel

### Prerequisites

Follow the safety guidelines listed in [Safety instructions](#).

### Steps

1. Unlock the bezel by using the bezel key.  
**NOTE:** There are two bezel keys attached to the back of the bezel.
2. Press the release latch at the top of the bezel.
3. Pull the top end of the bezel away from the system.
4. Unhook the bezel tabs from the slots at the bottom of the system, and pull the bezel away from the system.

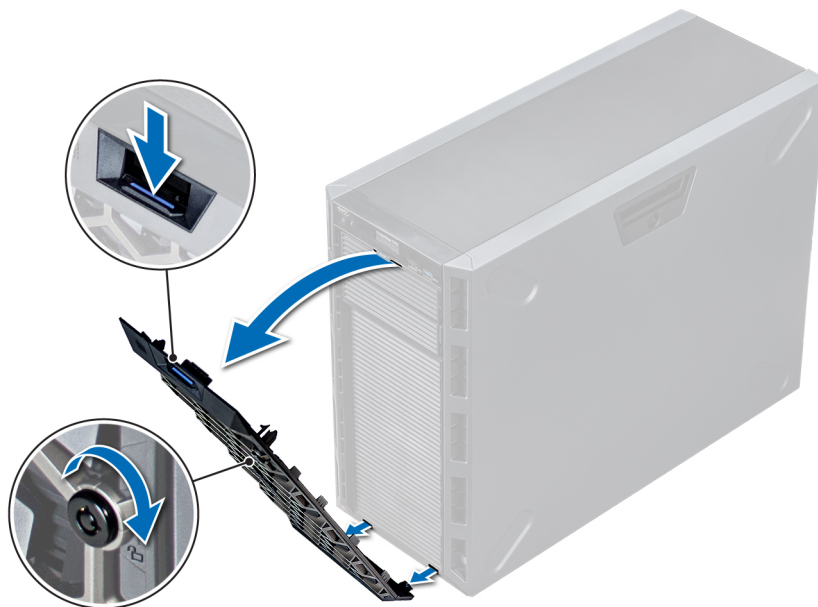

Figure 16. Removing the front bezel

## Installing the front bezel

### Prerequisites

Follow the safety guidelines listed in [Safety instructions](#).

## Steps

1. Locate and remove the bezel key.
  - NOTE:** There are two bezel keys attached to the back of the bezel.
2. Insert the bezel tabs into the slots in the chassis.
3. Press the release latch, and push the bezel toward the system until the bezel locks into place.
4. Using the key lock the bezel.

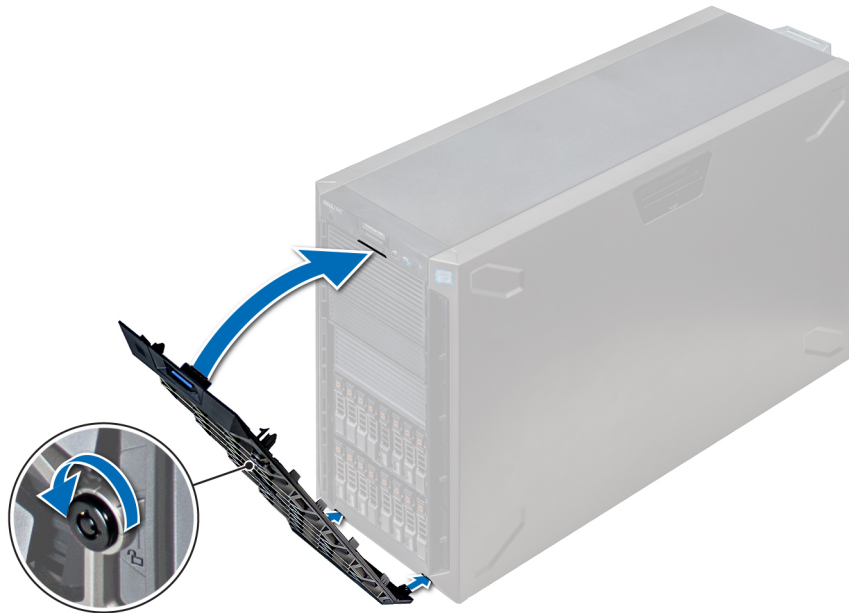

Figure 17. Installing the front bezel

# System feet

## Removing the system feet

### Prerequisites

**NOTE:** It is recommended that you remove the system feet only when you are converting the system from the tower mode to the rack mode, or when you are replacing the system feet with the wheel assembly.

1. Follow the safety guidelines listed in [Safety instructions](#).
2. Place the system on its side on a flat, stable surface.
3. Rotate the system feet inward.

### Steps

Using the Phillips #2 screwdriver, remove the screw that secures the foot to the base of the system.

- a) Repeat the above step for the 3 remaining feet.



**Figure 18. Removing the system feet**

**Next steps**

If applicable, [install the system feet or the caster wheel assembly](#).

## Installing the system feet

**Prerequisites**

**⚠ CAUTION:** Install the feet on a stand-alone tower system to provide stability to the system. An unstable system might tip over and cause injury to the user or damage to the system.

1. Follow the safety guidelines listed in [Safety instructions](#).
2. Place the system on its side, on a flat, stable surface.

**Steps**

1. Align the three tabs on the system foot with the three slots on the base of the system.
2. Using the Phillips #2 screwdriver, secure the screw that secures the foot to the base of the system.
  - a) Repeat the above steps to install the remaining system feet.



**Figure 19. Installing the system feet**

**Next steps**

1. Place the system upright on a flat, stable surface, and rotate the system feet outward.
2. Follow the procedure listed in [After working inside your system](#).

## Inside the system

**NOTE:** Components that are hot swappable are marked orange and touch points on the components are marked blue.

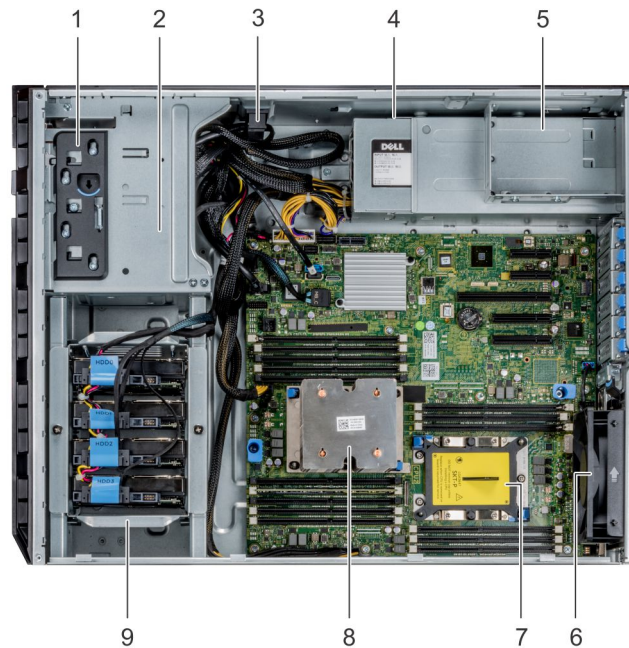

**Figure 20. Inside the system - Cabled drive system**

- |                         |                             |
|-------------------------|-----------------------------|
| 1. release latch        | 2. drive cage               |
| 3. cable retention lock | 4. cabled power supply unit |

- 5. power supply unit cage
- 6. fan
- 7. processor 2 socket
- 8. processor 1
- 9. cabled drive cage

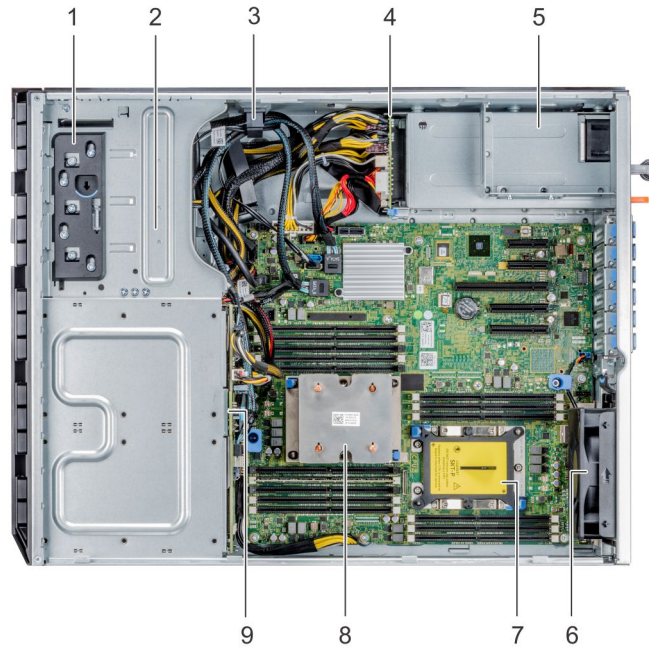

**Figure 21. Inside the system - hot swappable drive system**

- 1. release latch
- 2. drive cage
- 3. cable retention lock
- 4. power interposer board
- 5. power supply unit cage
- 6. fan
- 7. processor 2 socket
- 8. processor 1
- 9. backplane

## Caster wheels – optional

### Removing caster wheels

#### Prerequisites

- 1. Follow the safety guidelines listed in [Safety instructions](#).
- 2. Place the system on a flat, stable surface.
- 3. Extend the wheels beyond the edge of the surface.

#### Steps

- 1. Using the Phillips #2 screwdriver, loosen the captive screw that secures the front wheel unit to the base of the system.
- 2. Push the front wheel unit toward the rear of the system to release the retention hooks, and pull out the front wheel unit.
- 3. Loosen the screw that secures the back wheel unit to the base of the chassis.
- 4. Push the rear wheel unit toward the front of the system to release the retention hooks, and pull out the rear wheel unit.



**Figure 22. Removing caster wheels**

#### **Next steps**

Install the [caster wheels](#) or the [system feet](#), as applicable.

## **Installing caster wheels**

#### **Prerequisites**

1. Follow the safety guidelines listed in [Safety instructions](#).
2. Place the system on its side on a flat, stable surface.
3. If installed, [remove the system feet](#).

#### **Steps**

1. Align the two retention hooks on the rear wheel unit with the two slots on the base of the system, and insert the hooks into the slots.
2. Push the rear wheel unit toward the back of the system and using a Phillips #2 screwdriver secure the unit in place using a single screw.
3. Align the two retention hooks on the front wheel unit with the two slots on the base of the system, and insert the hooks into the slots.
4. Push the front wheel unit toward the front of the system and using a Phillips #2 screwdriver secure the unit in place using a single screw.



**Figure 23. Installing caster wheels**

#### **Next steps**

Follow the procedure listed in [After working inside your system](#).

## **System cover**

### **Removing the system cover**

#### **Prerequisites**

1. Follow the safety guidelines listed in [Safety instructions](#).
2. Turn off the system and all attached peripherals.
3. Disconnect the system from the electrical outlet and peripherals.
4. If installed, [remove the front bezel](#).
5. Place the system on a flat, stable surface.

#### **Steps**

1. Turn the latch release lock to the unlocked position.
2. Press the cover release latch and remove the system cover.

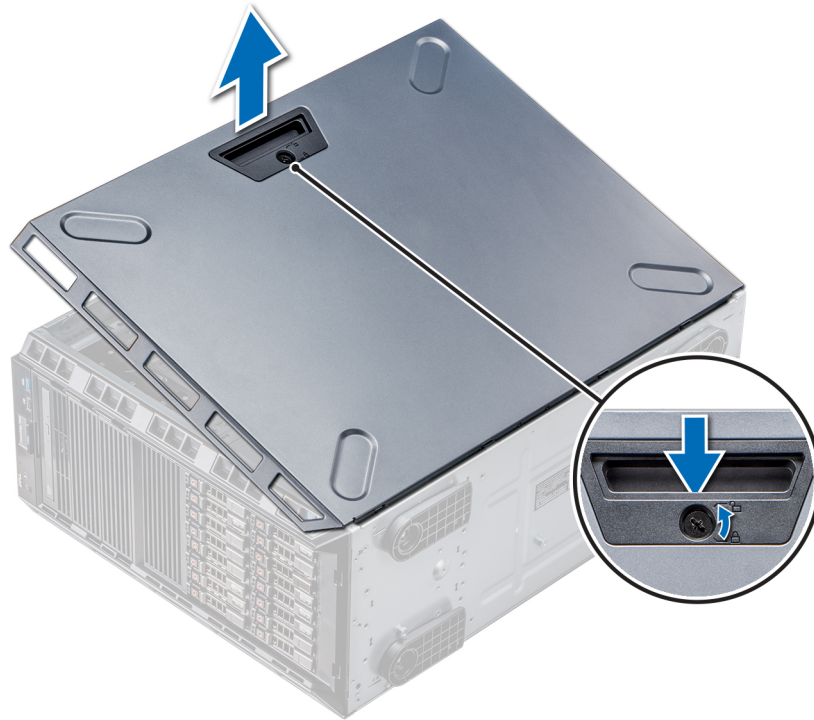

**Figure 24. Removing the system cover**

#### **Next steps**

Install the system cover.

## **Installing the system cover**

#### **Prerequisites**

**NOTE:** Ensure that all internal cables are connected and placed out of the way and no tools or extra parts are left inside the system.

Follow the safety guidelines listed in [Safety instructions](#).

#### **Steps**

1. Align the tabs on the system cover with the slots on the chassis.
2. Press the cover release latch, and push the cover toward the chassis until the latch locks into place.
3. Rotate the latch release lock clockwise to the locked position.

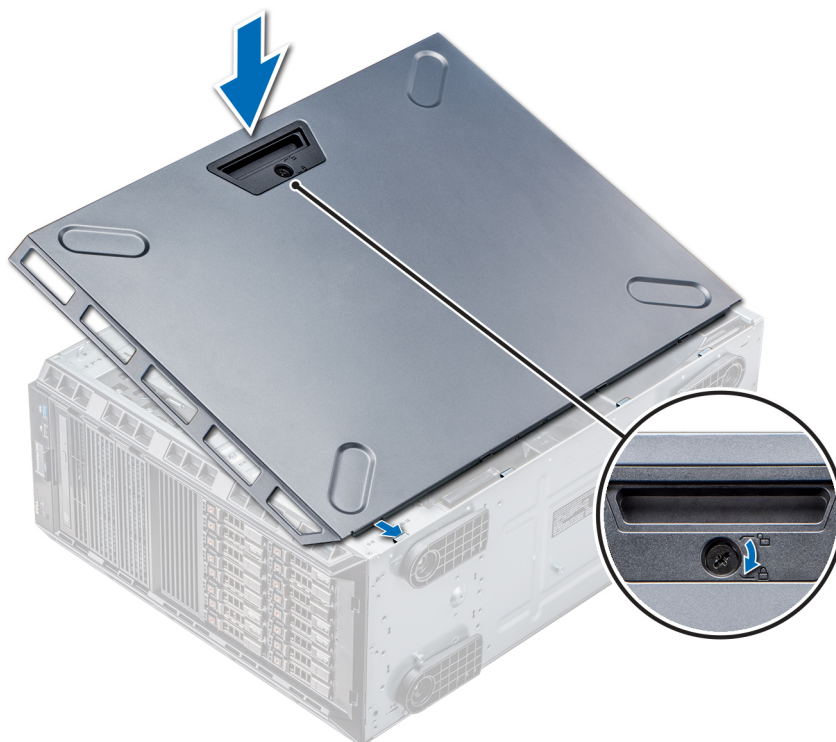

Figure 25. Installing the system cover

#### Next steps

1. Place the system upright on its feet on a flat and stable surface.
2. If removed, [install the bezel](#).
3. Reconnect the peripherals and connect the system to the electrical outlet.
4. Turn on the system, including all attached peripherals.

## Air shroud

### Removing the air shroud

#### Prerequisites

**CAUTION:** Never operate your system with the air shroud removed. The system may get overheated quickly, resulting in shutdown of the system and loss of data.

1. Follow the safety guidelines listed in [Safety instructions](#).
2. Follow the procedure listed in [Before working inside your system](#).

#### Steps

Holding the touch points at the center of the air shroud, lift the shroud from the system.

**NOTE:** Systems with x16 hard-drive backplanes use a different air shroud. To ensure proper cooling, always install the air shroud provided with your system.

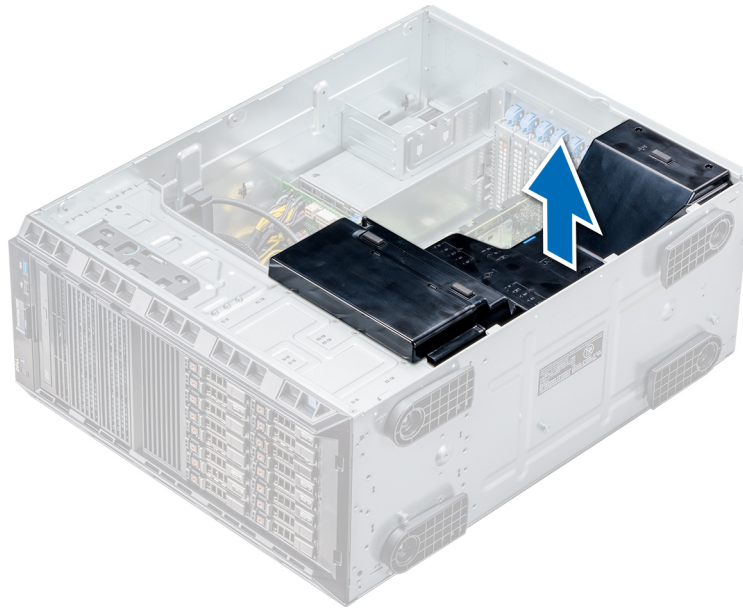

**Figure 26. Removing the air shroud**

#### **Next steps**

Install the air shroud.

## **Installing the air shroud**

#### **Prerequisites**

1. Follow the safety guidelines listed in [Safety instructions](#).
2. If applicable, route the cables inside the system along the chassis wall and secure the cables by using the cable-securing bracket.

#### **Steps**

1. Align the tabs on the air shroud with the securing slots on the chassis.
2. Lower the air shroud into the chassis until it is firmly seated.

**i** **NOTE:** When the cooling shroud is properly seated, the chassis intrusion-switch on the cooling shroud connects to the chassis intrusion-switch connector on the system board.

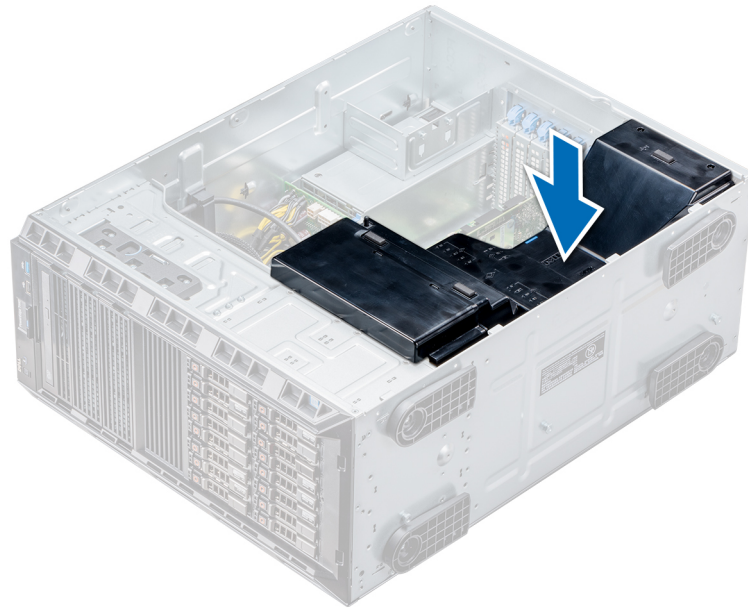

**Figure 27. Installing the air shroud**

#### Next steps

Follow the procedure listed in [After working inside your system](#).

## Drives

Drives are supplied in hot swappable drive carriers that fit in the drive slots.

**CAUTION:** Before attempting to remove or install a drive while the system is running, see the documentation for the storage controller card to ensure that the host adapter is configured correctly.

**CAUTION:** Do not turn off or restart your system while a drive is being formatted. Doing so can cause a drive failure.

When you format a drive, allow enough time for the formatting to complete. Be aware that high-capacity drives can take a long time to format.

## Removing a drive blank

The procedure for removing 2.5-inch and 3.5-inch drive blanks is identical.

#### Prerequisites

1. Follow the safety guidelines listed in [Safety instructions](#).
2. If installed, [remove the front bezel](#).

**CAUTION:** To maintain proper system cooling, drive blanks must be installed in all empty drive slots.

**CAUTION:** Mixing drive blanks from previous generations of PowerEdge servers is not supported.

#### Steps

Press the release button, and slide the drive blank out of the drive slot.

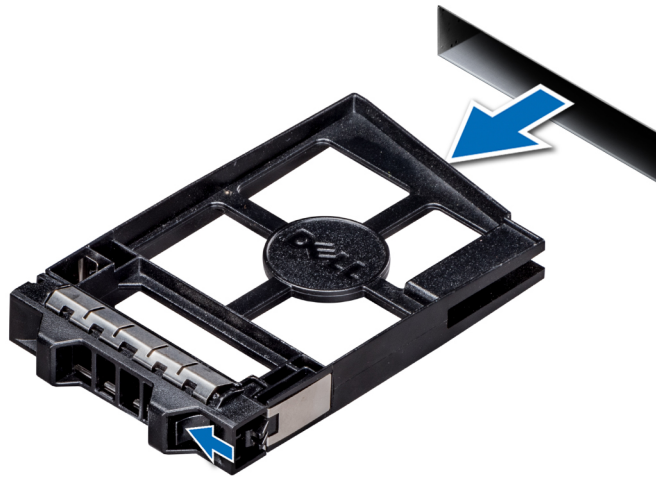

**Figure 28. Removing a drive blank**

**Next steps**

1. Install a drive or a drive blank.

## Installing a drive blank

The procedure for installing 2.5-inch and 3.5-inch drive blanks is identical.

**Prerequisites**

1. Follow the safety guidelines listed in [Safety instructions](#).
2. If installed, [remove the front bezel](#).

**CAUTION:** Mixing drive blanks from previous generations of PowerEdge servers is not supported.

**Steps**

Insert the drive blank into the drive slot, and push the blank until the release button clicks into place.

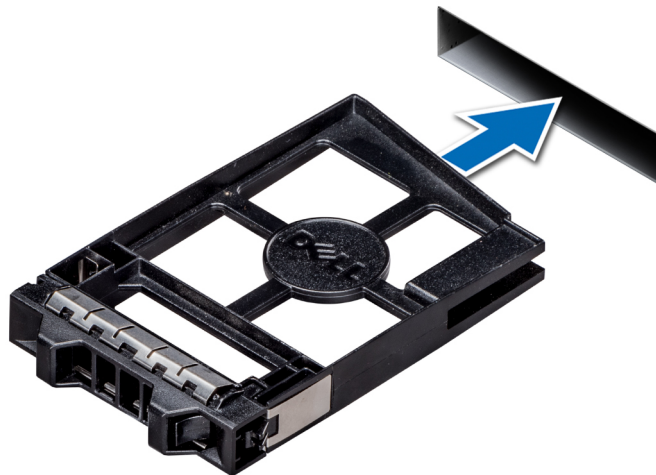

**Figure 29. Installing a drive blank**

**Next steps**

If removed, [install the bezel](#).

# Removing a drive carrier

## Prerequisites

1. Follow the safety guidelines listed in [Safety instructions](#).
2. If applicable, [remove the front bezel](#).
3. Using the management software, prepare the drive for removal.

If the drive is online, the green activity or fault indicator flashes while the drive is turning off. When the drive indicators are off, the drive is ready for removal. For more information, see the documentation for the storage controller.

**CAUTION:** Before attempting to remove or install a drive while the system is running, see the documentation for the storage controller card to ensure that the host adapter is configured correctly to support drive removal and insertion.

**CAUTION:** Mixing drives from previous generations of PowerEdge servers is not supported.

**CAUTION:** To prevent data loss, ensure that your operating system supports drive installation. See the documentation supplied with your operating system.

## Steps

1. Press the release button to open the drive carrier release handle.
2. Holding the handle, slide the drive carrier out of the drive slot.

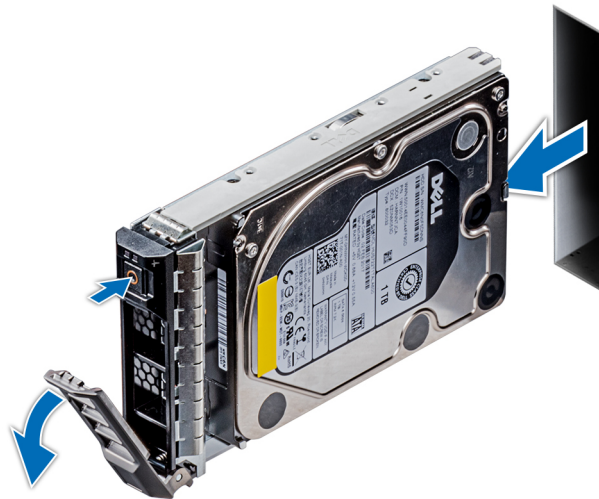

Figure 30. Removing a drive carrier

## Next steps

1. Follow the procedure listed in [After working inside your system](#).
2. Install a drive carrier.
3. If you are not replacing the drive immediately, insert a drive blank in the empty drive slot to maintain proper system cooling.

# Installing a drive carrier

## Prerequisites

**CAUTION:** Before attempting to remove or install a drive while the system is running, see the documentation for the storage controller card to ensure that the host adapter is configured correctly to support drive removal and insertion.

**CAUTION:** Mixing drives from previous generations of PowerEdge servers is not supported.

**CAUTION:** Combining SAS and SATA drives in the same RAID volume is not supported.

**CAUTION:** When installing a drive, ensure that the adjacent drives are fully installed. Inserting a drive carrier and attempting to lock its handle next to a partially installed carrier can damage the partially installed carrier's shield spring and make it unusable.

**CAUTION:** To prevent data loss, ensure that your operating system supports hot-swap drive installation. See the documentation supplied with your operating system.

**CAUTION:** When a replacement hot swappable drive is installed and the system is powered on, the drive automatically begins to rebuild. Ensure that the replacement drive is blank or contains data that you wish to overwrite. Any data on the replacement drive is immediately lost after the drive is installed.

1. Follow the safety guidelines listed in [Safety instructions](#).
2. If applicable, [remove the drive blank](#).

### Steps

1. Press the release button on the front of the drive carrier to open the release handle.
2. Insert the drive carrier into the drive slot and slide until the drive connects with the backplane.
3. Close the drive carrier release handle to lock the drive in place.

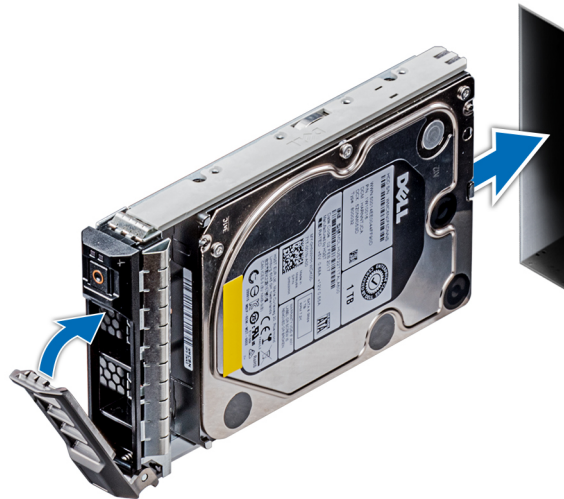

**Figure 31. Installing a drive carrier**

### Next steps

If applicable, [install the bezel](#).

## Removing the drive from the drive carrier

### Prerequisites

Follow the safety guidelines listed in [Safety instructions](#).

**CAUTION:** Mixing drives from previous generations of PowerEdge servers is not supported.

### Steps

1. Using a Phillips #1 screwdriver, remove the screws from the slide rails on the drive carrier.
2. Lift the drive out of the drive carrier.

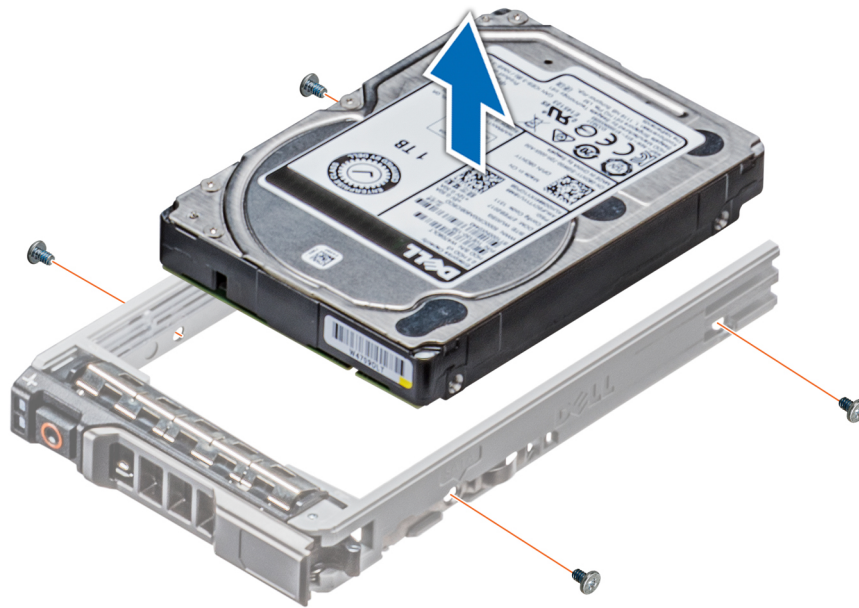

**Figure 32. Removing the drive from the drive carrier**

#### Next steps

If applicable, [Install the drives into their original slots.](#)

## Installing a drive into the drive carrier

#### Prerequisites

Follow the safety guidelines listed in [Safety instructions.](#)

**⚠ CAUTION: Mixing drive carriers from other generations of PowerEdge servers is not supported.**

**ℹ NOTE: When installing a drive into the drive carrier, ensure that the screws are torqued to 4 in-lbs.**

#### Steps

1. Insert the drive into the drive carrier with the connector end of the drive towards the back of the carrier.
2. Align the screw holes on the drive with the screw holes on the drive carrier.  
When aligned correctly, the back of the drive is flush with the back of the drive carrier.
3. Using a Phillips #1 screwdriver, secure the drive to the drive carrier with screws.

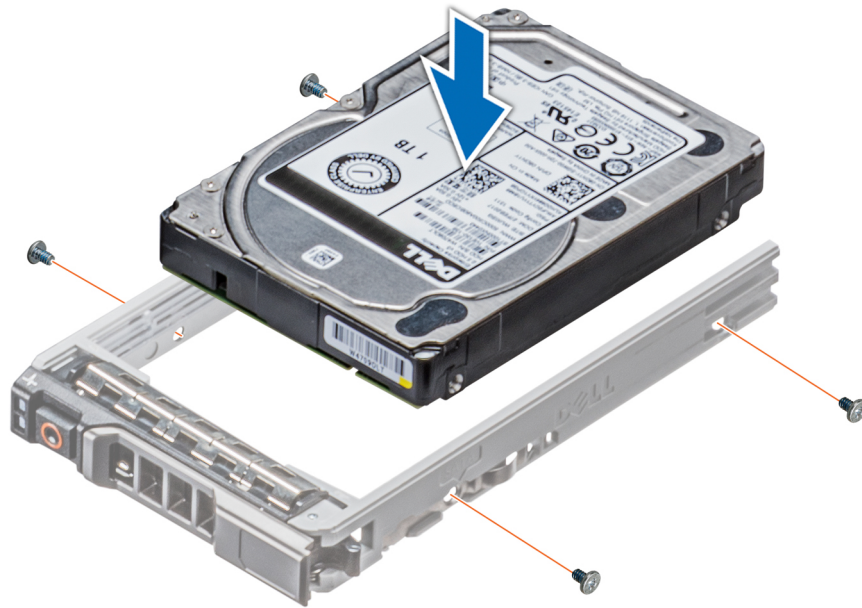

Figure 33. Installing a drive into the drive carrier

## Removing a 2.5-inch drive from a 3.5-inch drive adapter

### Prerequisites

1. Follow the safety guidelines listed in [Safety instructions](#).
2. Remove the 3.5-inch drive adapter from the 3.5-inch hot swappable drive carrier.

**NOTE:** A 2.5-inch drive is installed in a 3.5-inch drive adapter, which is then installed in the 3.5-inch drive carrier.

### Steps

1. Using a Phillips #2 screwdriver, remove the screws from the side of the 3.5-inch drive adapter.
2. Remove the 2.5-inch drive from the 3.5-inch drive adapter.

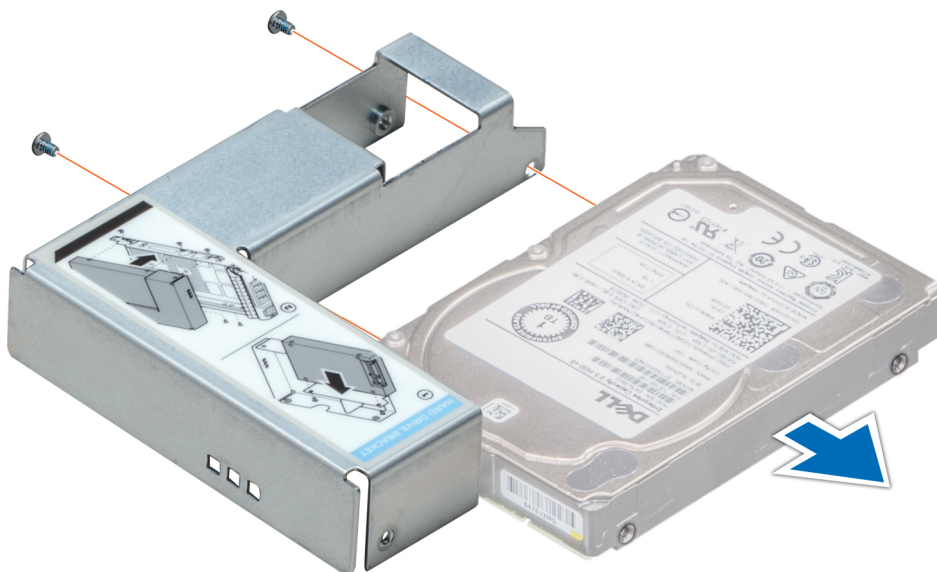

Figure 34. Removing a 2.5-inch drive from a 3.5-inch drive adapter

### Next steps

Install a 2.5-inch drive into a 3.5-inch drive adapter.

## Installing a 2.5-inch drive into a 3.5-inch drive adapter

### Prerequisites

1. Follow the safety guidelines listed in [Safety instructions](#).
2. [Remove the 3.5-inch drive adapter from the 3.5-inch hot swappable drive carrier.](#)

### Steps

1. Align the screw holes on the 2.5-inch drive with the screw holes on the 3.5-inch drive adapter.
2. Using a Phillips #2 screwdriver, secure the 2.5-inch drive to the 3.5-inch drive adapter.

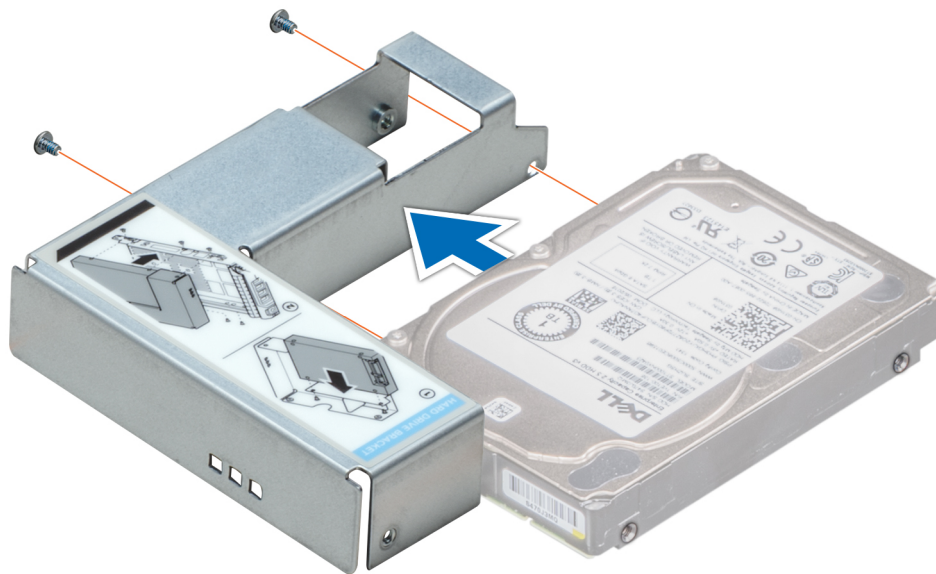

Figure 35. Installing a 2.5-inch drive into a 3.5-inch drive adapter

## Removing a 3.5-inch drive adapter from a 3.5-inch drive carrier

### Prerequisites

1. Follow the safety guidelines listed in [Safety instructions](#).
2. If installed, [remove the front bezel](#).
3. [Remove the 3.5-inch drive carrier from the system.](#)

### Steps

1. Using a Phillips #1 screwdriver, remove the screws from the rails on the drive carrier.
2. Lift the 3.5-inch drive adapter out of the 3.5-inch drive carrier.

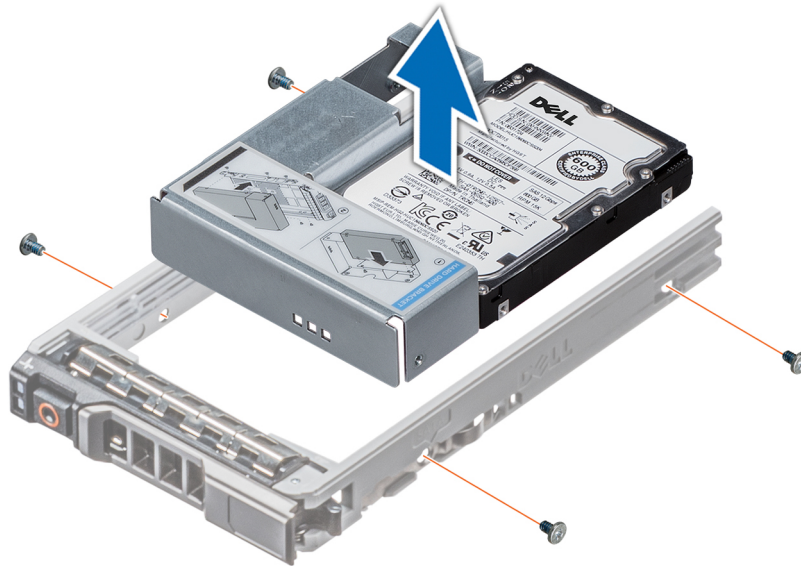

**Figure 36. Removing a 3.5-inch drive adapter from a 3.5-inch drive carrier**

#### **Next steps**

Install the 3.5-inch drive carrier or install the 3.5-inch drive adapter into the 3.5-inch drive carrier.

## **Installing a 3.5-inch drive adapter into the 3.5-inch drive carrier**

#### **Prerequisites**

1. Follow the safety guidelines listed in [Safety instructions](#).
2. [Remove the 2.5-inch drive into the 3.5-inch drive adapter](#).

#### **Steps**

1. Insert the 3.5-inch drive adapter into the 3.5-inch drive carrier with the connector end of the drive toward the back of the 3.5-inch drive carrier.
2. Align the screw holes on the 3.5-inch drive adapter with the holes on the 3.5-inch drive carrier.
3. Using a Phillips #1 screwdriver, secure the 3.5-inch drive adapter to the 3.5-inch carrier.

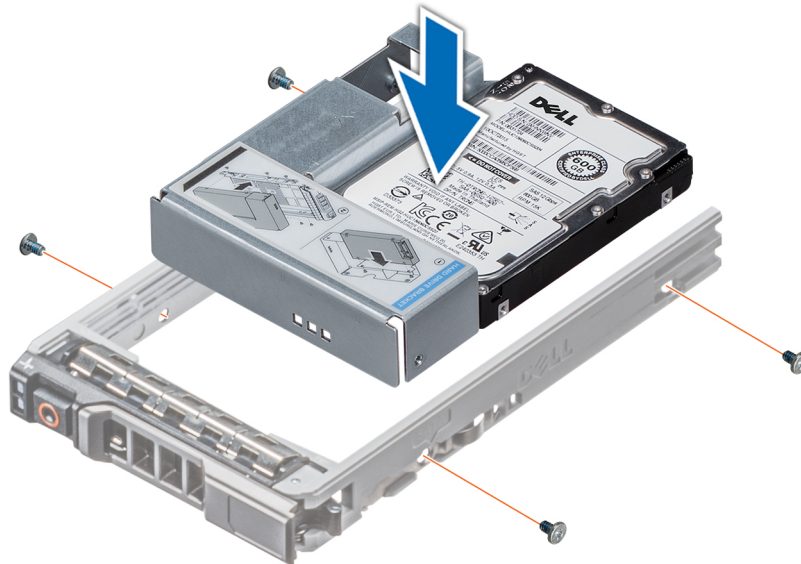

**Figure 37. Installing a 3.5-inch drive adapter into the 3.5-inch drive carrier**

#### Next steps

1. Installing a 2.5-inch drive into a 3.5-inch drive adapter.
2. If removed, install the front bezel.

## Optical drives and tape drives

### Removing the optical or tape drive blank

#### Prerequisites

1. Follow the safety guidelines listed in [Safety instructions](#).
2. Follow the procedure listed in [Before working inside your system](#).
3. If applicable, [remove the front bezel](#).

#### Steps

1. To remove the drive blank, slide the release latch down to release the drive blank.
2. Push the drive blank to slide it out of the drive bay.



**NOTE:** Blanks must be installed on empty optical drive or tape drive slots to maintain FCC certification of the system. The brackets also keep dust and dirt out of the system and aid in proper cooling and airflow inside the system. Perform the same steps to install blanks.



**Figure 38. Removing the optical drive or tape drive blank**

#### **Next steps**

1. [Install the optical drive cage or tape drive.](#)
2. If applicable, [install the bezel.](#)

## **Installing the optical or tape drive blank**

#### **Prerequisites**

1. Follow the safety guidelines listed in [Safety instructions.](#)
2. If applicable, [remove the front bezel.](#)

#### **Steps**

1. Align the guide on the drive blank with the slot on drive bay.
2. Slide the drive into the slot until the latch snaps into place.



**Figure 39. Installing the optical or tape drive blank**

#### Next steps

1. Follow the procedure listed in [After working inside your system](#).
2. If applicable, [install the bezel](#).

## Removing the optical drive cage or tape drive

#### Prerequisites

**NOTE:** The procedure to remove the optical drive cage is identical to removing a tape drive.

1. Follow the safety guidelines listed in [Safety instructions](#).
2. Follow the procedure listed in [Before working inside your system](#).
3. If installed, [remove the front bezel](#).

#### Steps

1. Disconnect the power and data cable from the back of the drive.  
**NOTE:** Observe the routing of the power and data cable inside the chassis as you remove them from the system board and the drive. You must route these cables properly when you replace them to prevent them from being pinched or crimped.
2. To remove the drive, push the release latch to release the drive.
3. Slide the drive out of the drive bay.
4. If you are not immediately replacing the tape drive, install the blank.  
**NOTE:** Blanks must be installed on empty optical drive or tape drive slots to maintain FCC certification of the system. The brackets also keep dust and dirt out of the system and aid in proper cooling and airflow inside the system. Perform the same steps to install blanks.



**Figure 40. Removing the optical drive cage or tape drive**

#### Next steps

Install the optical drive cage or tape drive.

## Installing the optical drive cage or tape drive

#### Prerequisites

**NOTE:** The procedure to install the optical drive cage is the same as installing the tape drive.

Follow the safety guidelines listed in [Safety instructions](#).

#### Steps

1. Unpack and prepare the drive for installation.  
For instructions, see the documentation that shipped with the drive.  
If you are installing a SAS tape drive, you must have an internal tape adapter installed. For more information on installing a SAS tape drive, see the [Installing an expansion card](#) section.
2. If applicable, remove the existing drive or the drive blank.
3. Align the guide on the drive with the slot on drive bay.
4. Slide the drive into the slot until the latch clicks into place.
5. Connect the power and data cable to the drive.
6. Connect the power and data cables to the backplane and the system board.



**Figure 41. Installing the optical drive cage or tape drive**

#### Next steps

1. Follow the procedure listed in [After working inside your system](#).
2. If applicable, [install the bezel](#).

## Cabled drives

**CAUTION:** Do not turn off or restart your system while the drive is being formatted. Doing so can cause a drive failure.

## Removing the internal hard drive bay

#### Prerequisites

1. Follow the safety guidelines listed in [Safety instructions](#).
2. Follow the procedure listed in [Before working inside your system](#).
3. Disconnect the data and power cable(s) from the hard drive(s).

#### Steps

1. Loosen the two captive screws securing the internal hard drive bay to the chassis.
2. Lift the internal hard drive bay up and out of the chassis.

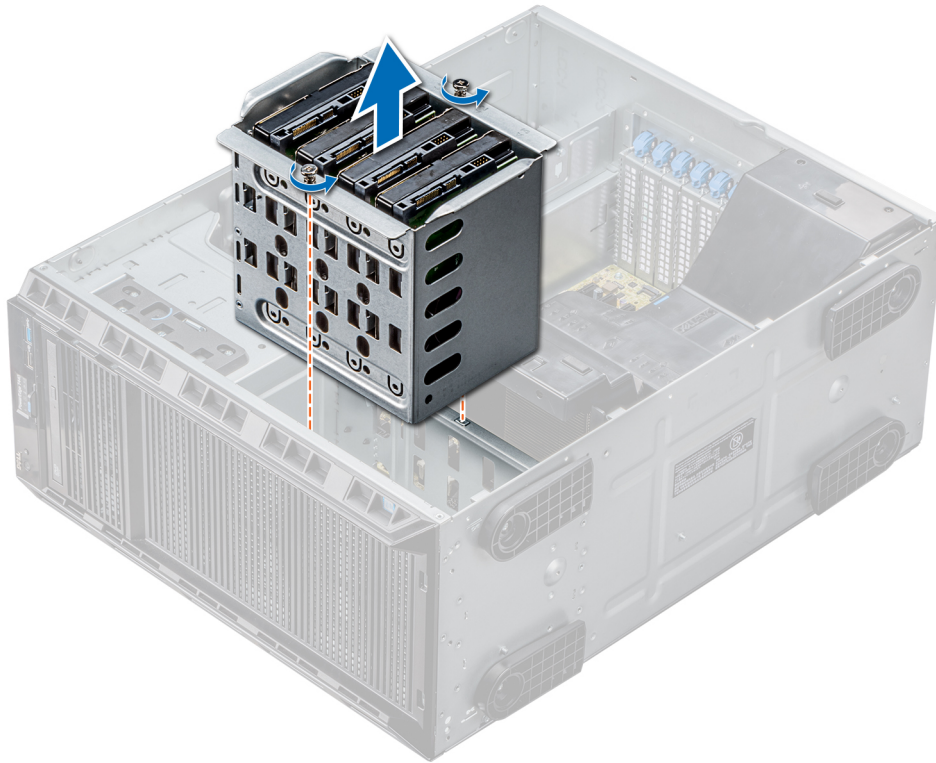

**Figure 42. Removing the internal hard drive bay**

#### **Next steps**

Follow the procedure listed in [After working inside your system](#).

## **Installing the internal hard drive bay**

#### **Prerequisites**

1. Follow the safety guidelines listed in [Safety instructions](#).
2. Follow the procedure listed in [Before working inside your system](#).
3. Keep the Phillips #2 screwdriver ready.

#### **Steps**

1. Align the internal hard-drive bay with the tabs on the chassis and slide the internal hard drive bay into the chassis.
2. Secure the internal hard drive bay to the chassis using the two captive screws.

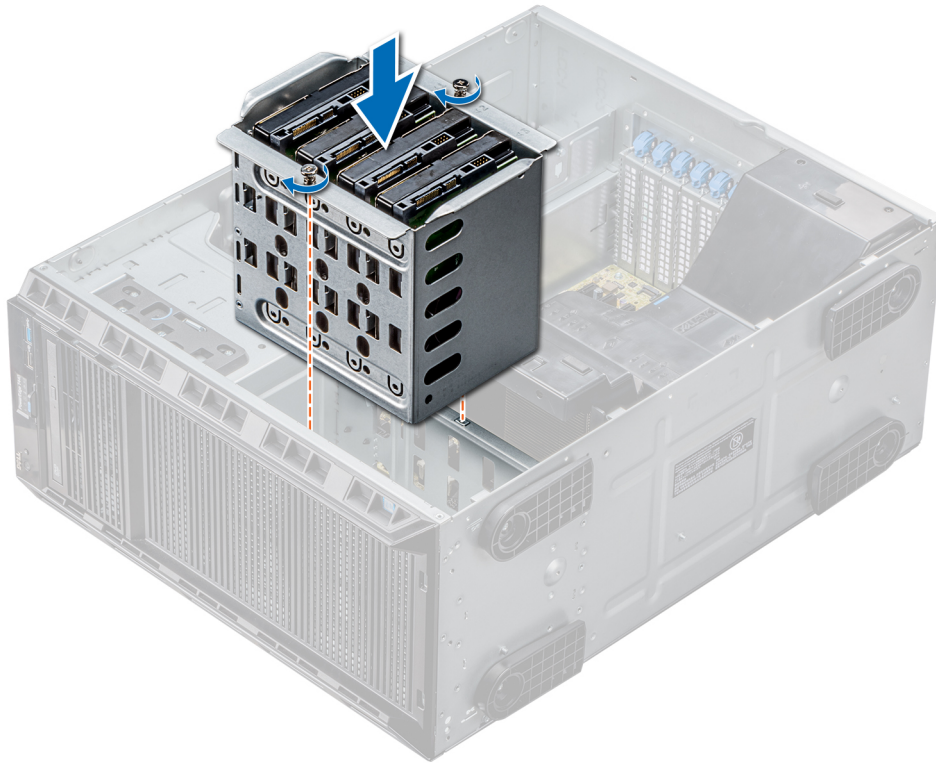

**Figure 43. Installing the internal hard drive bay**

**Next steps**

1. Follow the procedure listed in [After working inside your system](#).
2. Connect the data and power cables to the hard drive(s).

## Removing a cabled drive

**Prerequisites**

1. Follow the safety guidelines listed in [Safety instructions](#).
2. Follow the procedure listed in [Before working inside your system](#).
3. Remove the internal drive bay.

**Steps**

1. Remove the four screws securing the drive to the internal drive bay.
2. Remove the hard drive from the internal drive bay.

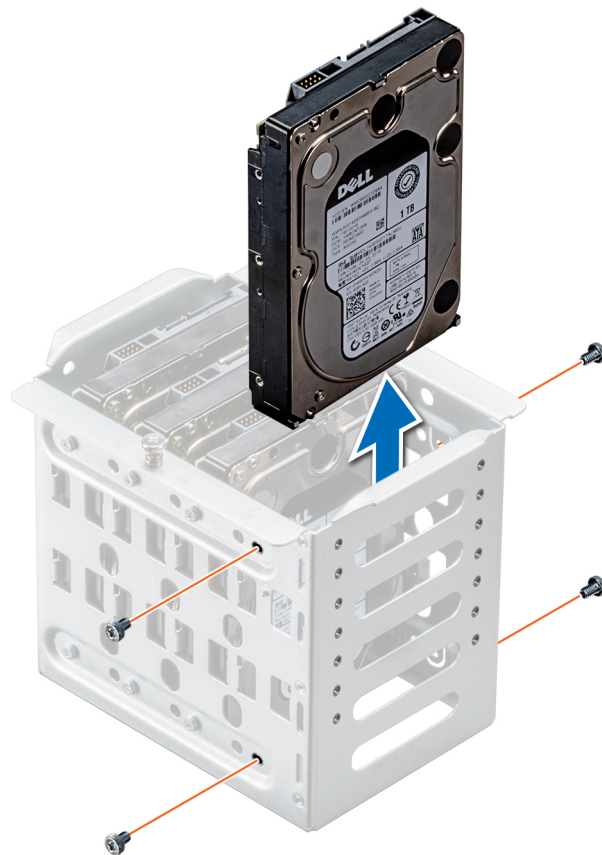

**Figure 44. Removing a cabled drive**

#### Next steps

1. Follow the procedure listed in [After working inside your system](#).
2. Install the internal drive bay into the chassis.
3. If disconnected, reconnect the power and data cable(s) to the remaining drive(s) in the internal drive bay.

## Installing a cabled drive

#### Prerequisites

1. Follow the safety guidelines listed in [Safety instructions](#).
2. Follow the procedure listed in [Before working inside your system](#).
3. Remove the internal drive bay.

#### Steps

1. Insert the drive into the internal drive bay with the drive connector facing outward.
2. Secure the drive to the internal drive bay using the four screws.

**NOTE:** When installing new drives into the internal drive bay, use the spare drive screws attached to the drive bay.

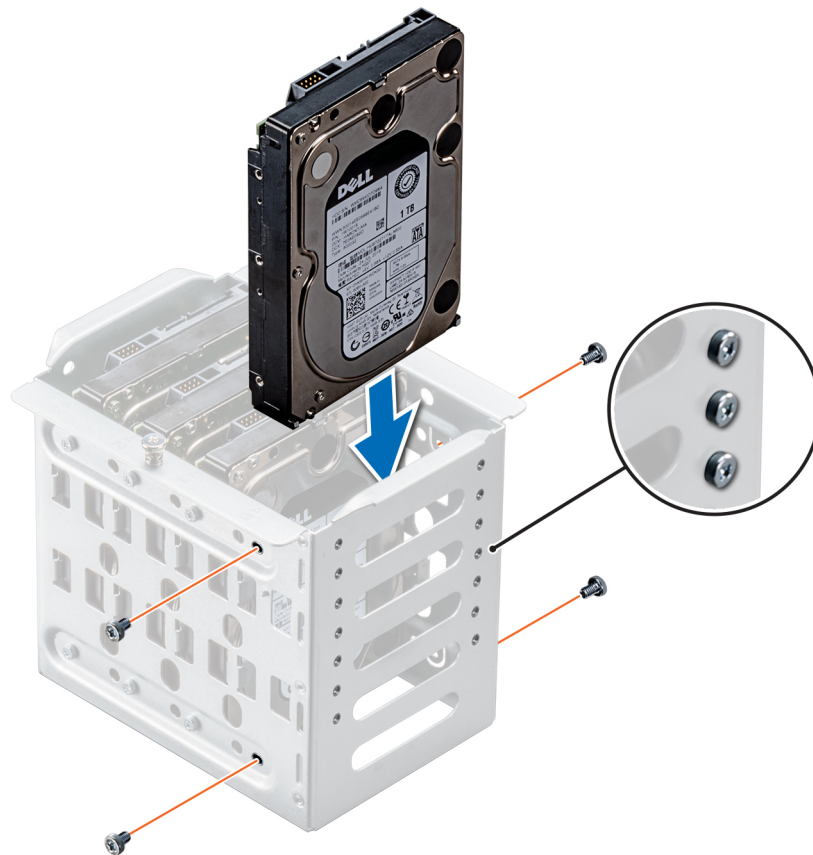

Figure 45. Installing a cabled drive

#### Next steps

1. Install the internal drive bay into the chassis.
2. Follow the procedure listed in [After working inside your system](#).
3. Enter **System Setup** and ensure that the drive controller is enabled.
4. Exit **System Setup** and restart the system.
5. Install any software required for operating the drive as described in the documentation for the drive.

## Drive backplane

### Drive backplane guidelines

Depending on the configuration, your system supports one of the following backplane configurations:

- x8 SAS/SATA backplane for 3.5 inch drives
  - ⓘ **NOTE:** The x8 backplane also supports up to eight 2.5 inch (SAS, SATA, or SSD) hot swappable drives that can be installed in 3.5 inch drive adapters, which can be installed in the 3.5 inch drive carriers.
- x16 SAS/SATA backplane for 2.5 inch drives

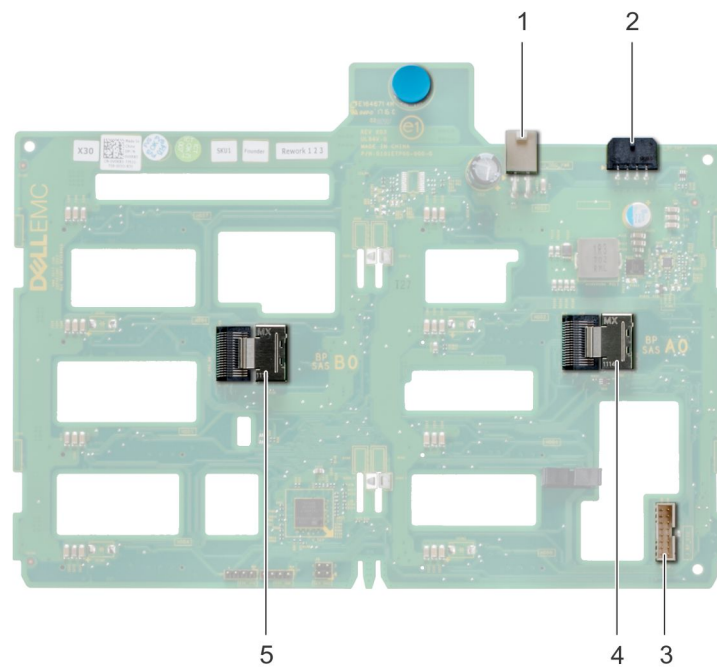

**Figure 46. x8 drive backplane**

- |  |                                 |
|--|---------------------------------|
| 1. ODD power connector                 | 2. backplane P4 power connector |
| 3. backplane sideband signal connector | 4. Mini SAS SAS_A0              |
| 5. Mini SAS SAS_B0                     |                                 |

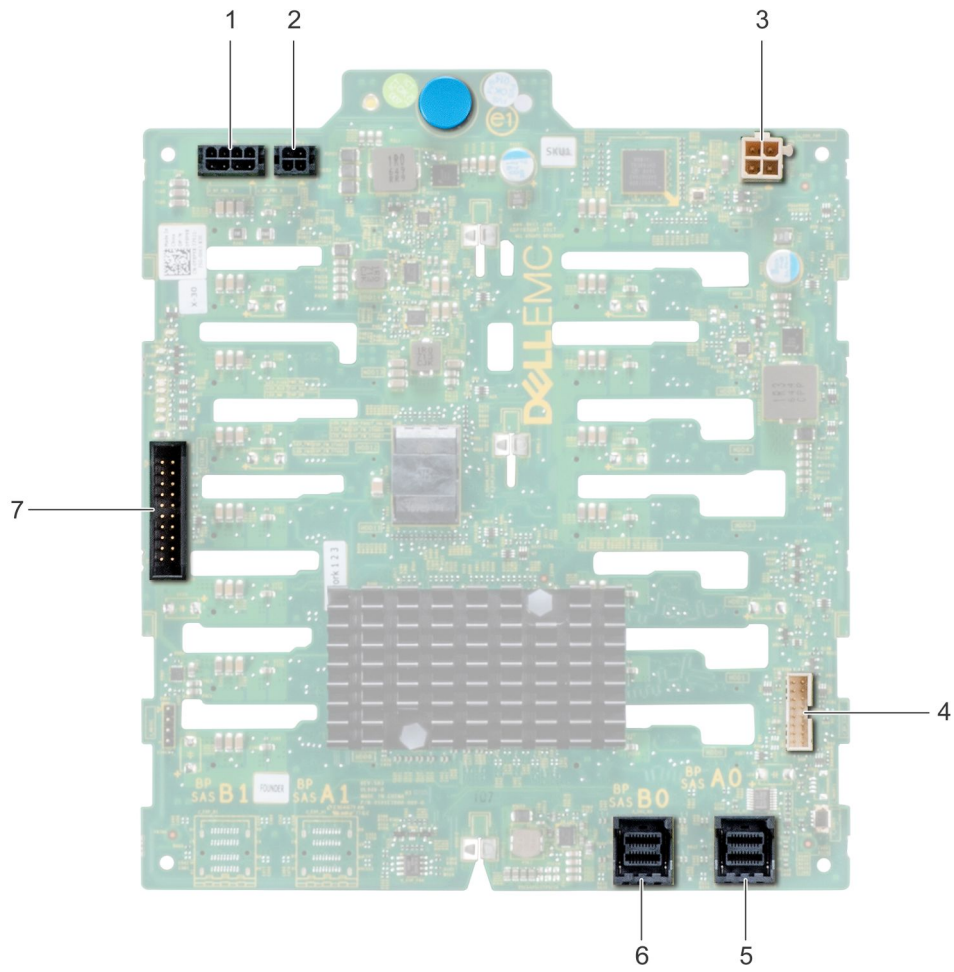
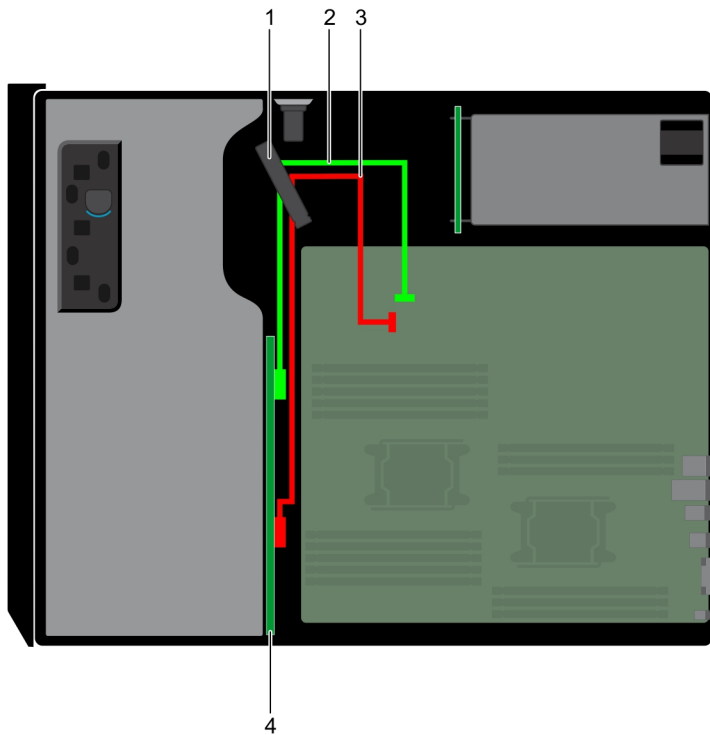

**Figure 47. x16 drive backplane**

- |  |                              |
|--|------------------------------|
| 1. backplane P4 power connector                          | 2. backplane power connector |
| 3. backplane power connector for optical and tape drives | 4. signal connector          |
| 5. Mini SAS HD SAS_A0                                    | 6. Mini SAS HD SAS_B0        |
| 7. I2C Connector   |                              |

# Backplane cable routing

## Cable routing - 8 x 3.5 inch drive backplane



- 1. cable retention latch
- 2. SATA cable (BP: BP\_A0 to MB: SATA\_A)
- 3. SATA cable (BP: BP\_B0 to MB: SATA\_B)
- 4. drive backplane

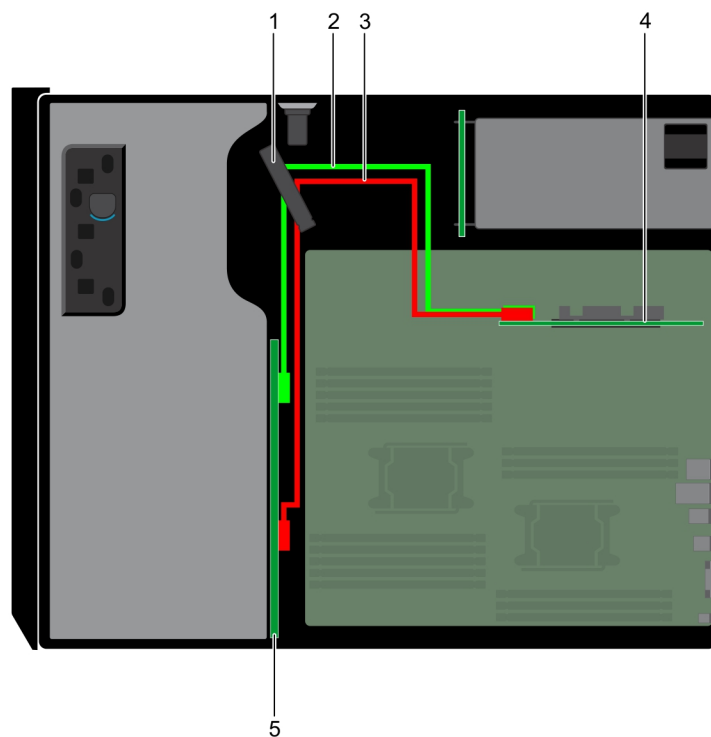
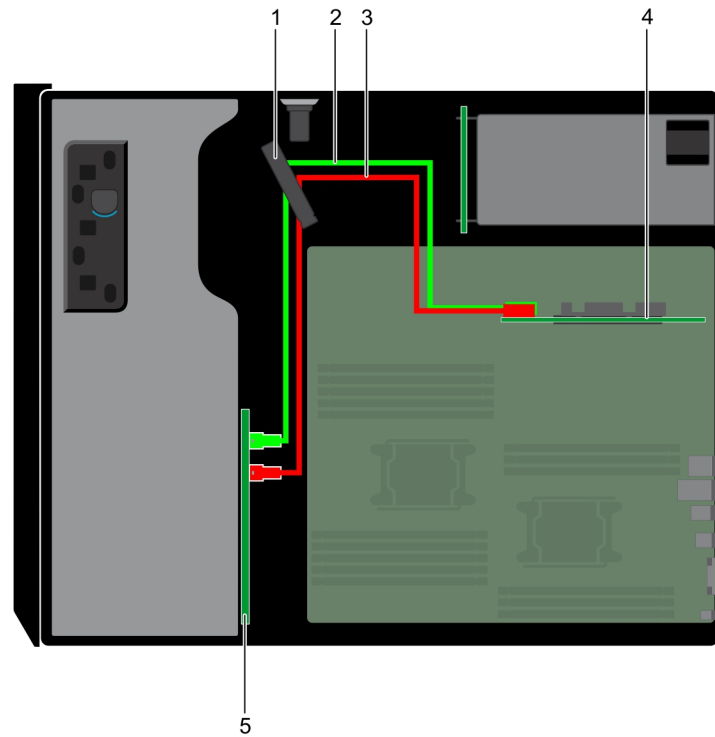

Figure 48. Cable routing - 8 x 3.5 inch drive backplane with internal PERC

- 1. cable retention latch
- 2. SAS cable (BP: BP\_A0 to internal PERC)

- 3. SAS cable (BP: BP\_B0 to internal PERC)
- 5. drive backplane

- 4. internal PERC



**Figure 49. Cable routing -16 x 2.5 inch drive backplane with internal PERC**

- 1. cable retention latch
- 3. SAS cable (BP: BP\_B0 to internal PERC)
- 5. drive backplane

- 2. SAS cable (BP: BP\_A0 to internal PERC)
- 4. internal PERC

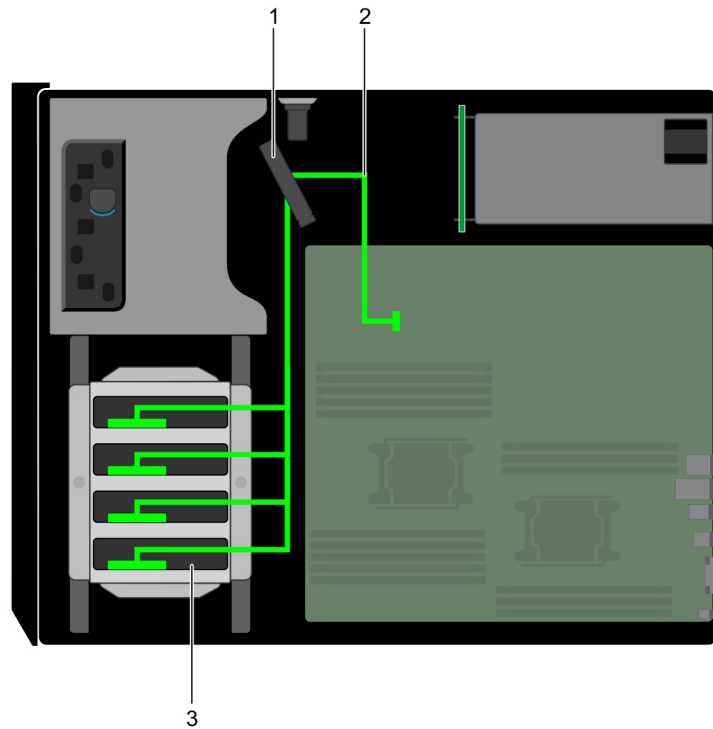

**Figure 50. Cable routing - 4 x 3.5 inch cabled HDD**

1. cable retention latch
2. signal cable
3. cabled HDD

## Removing a hard drive backplane

### Prerequisites

**CAUTION:** To prevent damage to the drives and backplane, you must remove the hard drives from the system before removing the backplane.

**CAUTION:** You must note the number of each hard drive and temporarily label them before removal so that you can replace them in the same locations.

1. Follow the safety guidelines listed in [Safety instructions](#).
2. Follow the procedure listed in [Before working inside your system](#).
3. If installed, [remove the front bezel](#).
4. [Remove all the drives](#).
5. [Remove the air shroud](#).

### Steps

1. Disconnect the data, signal, and power cables from the backplane.

**NOTE:** For the x8 backplane, press the SAS connector and push the connector toward the top of the system to release the SAS cable from the backplane.

2. Pull the release pin and holding the pin, lift the backplane out of the system.



**Figure 51. Removing a backplane**

### Next steps

Install a hard drive backplane.

## Installing a hard drive backplane

### Prerequisites

1. Follow the safety guidelines listed in [Safety instructions](#).
2. Follow the procedure listed in [Before working inside your system](#).
3. If installed, [remove the front bezel](#).
4. [Remove the air shroud](#).

### Steps

1. Use the hooks at the base of the system as guides to align the hard drive backplane.
2. Lower the hard-drive backplane into the system till the release pin locks in place, securing the hard drive backplane to the system.
3. Connect the data, signal, and power cables to the backplane.

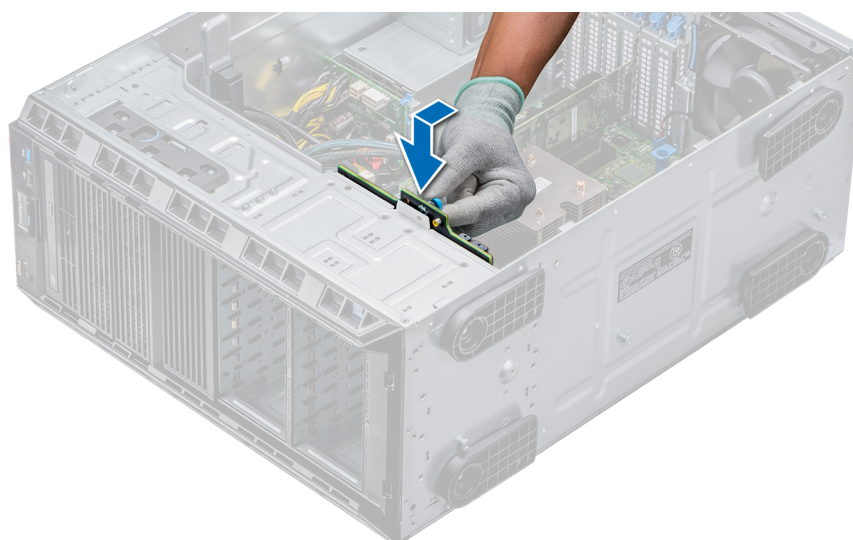

**Figure 52. Installing a hard drive backplane**

### Next steps

1. [Install the air shroud.](#)
2. [Install the drives into their original slots.](#)
3. If applicable, [install the bezel.](#)
4. Follow the procedure listed in [After working inside your system.](#)

## System memory

### System memory guidelines

The PowerEdge systems support DDR4 Registered DIMMs (RDIMMs), and Load Reduced DIMMs (LRDIMMs). System memory holds the instructions that are executed by the processor.

Your system contains 16 memory sockets. Processor 1 supports up to 10 DIMMs, and Processor 2 supports up to 6 DIMMS. Six memory channels are allocated to each processor. Processor 1 has four 2 DIMM slots per channel and two 1 DIMM slot per channel, Processor 2 has six 1 DIMM per channel.

Memory channels are organized as follows:

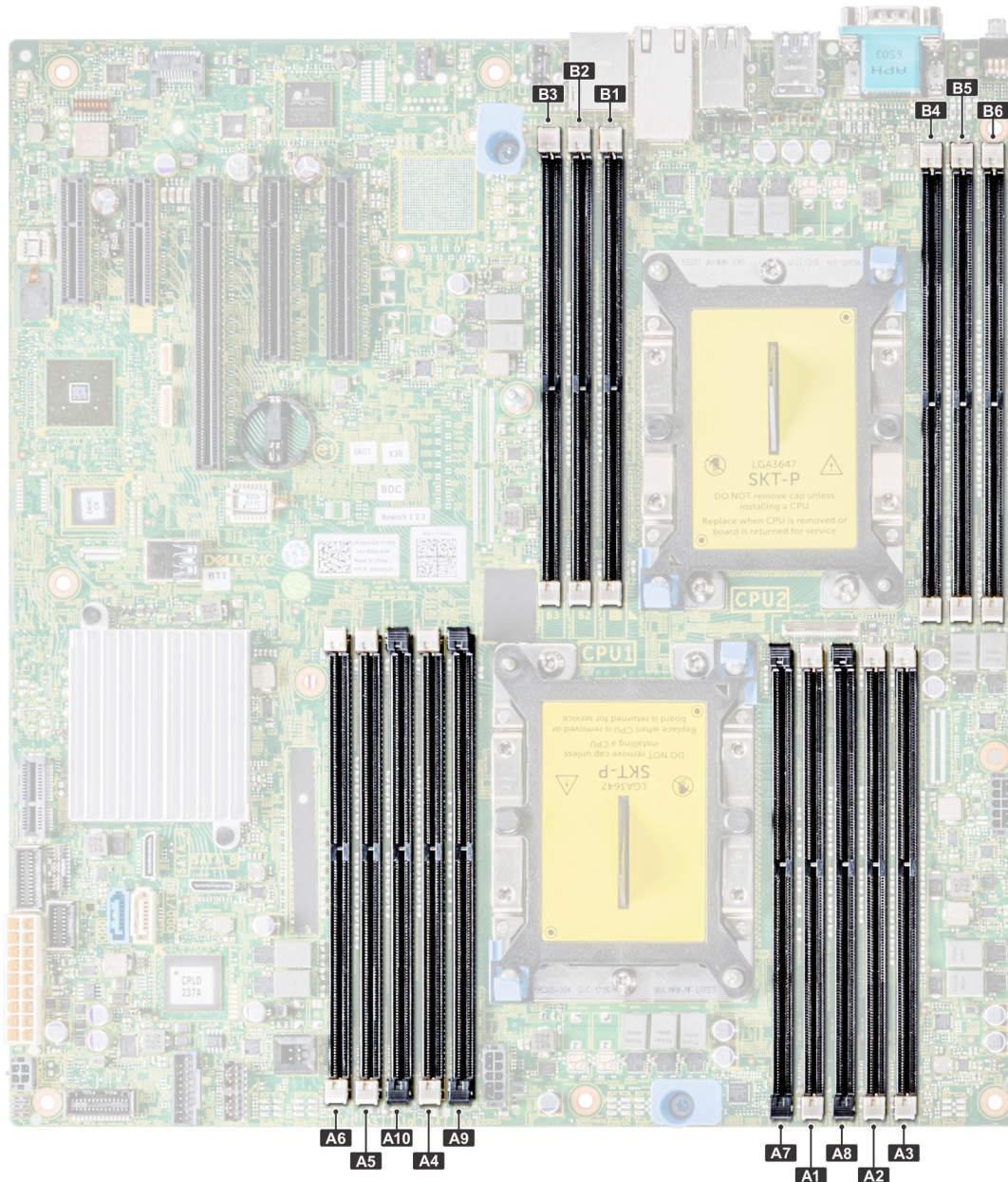

Figure 53. System memory view

Table 36. Memory channels

Processor	Channel 0	Channel 1	Channel 2	Channel 3	Channel 4	Channel 5
Processor 1	Slots A1 and A7	Slots A2 and A8	Slots A3	Slots A4 and A9	Slots A5 and A10	Slots A6
Processor 2	Slots B1	Slots B2	Slots B3	Slots B4	Slots B5	Slots B6

The following table shows the memory populations and operating frequencies for the supported configurations:

Table 37. Memory population

DIMM Type	DIMMs Populated/ Channel	Voltage	Operating Frequency (in MT/s)	Maximum DIMM Rank/ Channel
RDIMM	1	1.2 V	2666, 2400, 2133, 1866	Dual rank or single rank
	2		2666, 2400, 2133, 1866	Dual rank or single rank
LRDIMM	1	1.2 V	2666, 2400, 2133, 1866	Quad rank

DIMM Type	DIMMs Populated/ Channel	Voltage	Operating Frequency (in MT/s)	Maximum DIMM Rank/ Channel
	2		2666, 2400, 2133, 1866	Quad rank

## General memory module installation guidelines

To ensure optimal performance of your system, observe the following general guidelines when configuring your system memory. If your system's memory configurations fail to observe these guidelines, your system might not boot, stop responding during memory configuration, or operate with reduced memory.

- System profile selected (for example, Performance Optimized, or Custom [can be run at high speed or lower])
- Maximum supported DIMM speed of the processors.
- Maximum supported speed of the DIMMs

**i** **NOTE: MT/s indicates DIMM speed in MegaTransfers per second.**

The system supports Flexible Memory Configuration, enabling the system to be configured and run in any valid chipset architectural configuration. The following are the recommended guidelines for installing memory modules:

- All DIMMs must be DDR4.
- RDIMMs and LRDIMMs must not be mixed.
- 64 GB LRDIMMs that are DDP (Dual Die Package) LRDIMMs must not be mixed with 128 GB LRDIMMs that are TSV (Through Silicon Via/3DS) LRDIMMs.
- x4 and x8 DRAM based memory modules can be mixed.
- Up to two RDIMMs can be populated per channel regardless of rank count.
- Up to two LRDIMMs can be populated per channel regardless of rank count.
- A maximum of two different ranked DIMMs can be populated in a channel regardless of rank count.
- If memory modules with different speeds are installed, they will operate at the speed of the slowest installed memory module(s).
- Populate memory module sockets only if a processor is installed.

- For single-processor systems, sockets A1 to A10 are available.
- For dual-processor systems, sockets A1 to A10 and sockets B1 to B6 are available.

- Populate all the sockets with white release tabs first, followed by the black release tabs.
- When mixing memory modules with different capacities, populate the sockets with memory modules with the highest capacity first.

For example, if you want to mix 8 GB and 16 GB memory modules, populate 16 GB memory modules in the sockets with white release tabs and 8 GB memory modules in the sockets with black release tabs.

- Memory modules of different capacities can be mixed provided other memory population rules are followed.

For example, 8 GB and 16 GB memory modules can be mixed.

- In a dual-processor configuration, the memory configuration for each processor must be identical.

For example, if you populate socket A1 for processor 1, then populate socket B1 for processor 2, and so on.

- Mixing of more than two memory module capacities in a system is not supported.
- Unbalanced memory configurations will result in a performance loss so always populate memory channels identically with identical DIMMs for best performance.
- Populate six identical memory modules per processor (one DIMM per channel) at a time to maximize performance.

DIMM population update for Performance Optimized mode with quantity of 4 and 8 DIMMs per processor.

- When the DIMM quantity is 4 per processor, the population is slot 1, 2, 4, 5.
- When the DIMM quantity is 8 per processor, the population is slot 1, 2, 4, 5, 7, 8, 9, 10.

## Mode-specific guidelines

The configurations allowed depend on the memory mode selected in the System BIOS.

**Table 38. Memory operating modes**

Memory Operating Mode	Description
<b>Optimizer Mode</b>	<p>The <b>Optimizer Mode</b> if enabled, the DRAM controllers operate independently in the 64-bit mode and provide optimized memory performance.</p>
<b>Mirror Mode</b>	<p>The <b>Mirror Mode</b> if enabled, the system maintains two identical copies of data in memory, and the total available system memory is one half of the total installed physical memory. Half of the installed memory is used to mirror the active memory modules. This feature provides maximum reliability and enables the system to continue running even during a catastrophic memory failure by switching over to the mirrored copy. The installation guidelines to enable Mirror Mode require that the memory modules be identical in size, speed, and technology, and they must be populated in sets of 6 per processor.</p>
<b>Single Rank Spare Mode</b>	<p><b>Single Rank Spare Mode</b> allocates one rank per channel as a spare. If excessive correctable errors occur in a rank or channel, while the operating system is running, they are moved to the spare area to prevent errors from causing an uncorrectable failure. Requires two or more ranks to be populated in each channel.</p>
<b>Multi Rank Spare Mode</b>	<p><b>Multi Rank Spare Mode</b> allocates two ranks per channel as a spare. If excessive correctable errors occur in a rank or channel, while the operating system is running, they are moved to the spare area to prevent errors from causing an uncorrectable failure. Requires three or more ranks to be populated in each channel.</p> <p>With single rank memory sparing enabled, the system memory available to the operating system is reduced by one rank per channel.</p> <p>For example, in a dual-processor configuration with sixteen 16 GB dual-rank memory modules, the available system memory: <math>16\text{ GB} \times 16(\text{memory modules}) - 8\text{GB}(1\text{ rank sparing/channel}) \times 12(\text{channel}) = 256\text{ GB} - 96\text{ GB} = 160\text{ GB}</math></p> <p>For multi rank sparing, in a dual-processor configuration with sixteen 64 GB quad-rank memory modules, the available system memory: <math>64\text{ GB} \times 16(\text{memory modules}) - 32\text{ GB}(2\text{ rank sparing/channel}) \times 12(\text{channel}) = 1024\text{ GB} - 384\text{ GB} = 640\text{ GB}</math></p> <p><b>NOTE:</b> To use memory sparing, this feature must be enabled in the BIOS menu of System Setup.</p> <p><b>NOTE:</b> Memory sparing does not offer protection against a multi-bit uncorrectable error.</p>
<b>Dell Fault Resilient Mode</b>	<p>The <b>Dell Fault Resilient Mode</b> if enabled, the BIOS creates an area of memory that is fault resilient. This mode can be used by an OS that supports the feature to load critical applications or enables the OS kernel to maximize system availability.</p> <p><b>NOTE:</b> This feature is only supported in Gold and Platinum Intel processors.</p> <p><b>NOTE:</b> Memory configuration has to be of same size DIMM, speed, and rank.</p>

## Optimizer Mode

This mode supports Single Device Data Correction (SDDC) only for memory modules that use x4 device width. It does not impose any specific slot population requirements.

- Dual processor: Populate the slots in round robin sequence starting with processor 1.

**NOTE:** Processor 1 and processor 2 population should match.

**Table 39. Memory population rules**

Processor	Configuration	Memory population	Memory population information
Single processor	Optimizer (Independent channel) population order	1, 2, 3, 4, 5, 6, 7, 8, 9, 10	<ul style="list-style-type: none"> <li>Populate in this order, odd amount allowed.</li> <li>Odd number of DIMM population is allowed.</li> </ul> <p><b>NOTE:</b> Odd number of DIMMs will result in unbalanced memory configurations, which in turn will result in performance loss. It is recommended to populate all memory channels identically with identical DIMMs for best performance.</p> <ul style="list-style-type: none"> <li>Optimizer population order is not traditional for 4 and 8 DIMM installations of single processor. <ul style="list-style-type: none"> <li>For 4 DIMMs: A1, A2, A4, A5</li> <li>For 8 DIMMs: A1, A2, A4, A5, A7, A8, A9, A10</li> </ul> </li> </ul>
	Mirror population order	{1, 2, 3, 4, 5, 6}	Mirroring is supported with 6 DIMM slots per processor.
	Single rank sparing population order	1, 2, 3, 4, 5, 6, 7, 8, 9, 10	Populate in this order, odd amount allowed. Requires two ranks or more per channel.
	Multi rank sparing population order	1, 2, 3, 4, 5, 6, 7, 8, 9, 10	Populate in this order, odd amount allowed. Requires three ranks or more per channel.
Dual processor (Populate round robin starting with processor1)	Optimized (Independent channel) population order	A{1}, B{1}, A{2}, B{2}, A{3}, B{3}...	<ul style="list-style-type: none"> <li>Odd amount of DIMM slots per processor allowed.</li> <li>Odd number of DIMM population is allowed.</li> </ul> <p><b>NOTE:</b> Odd number of DIMMs will result in unbalanced memory configurations, which in turn will result in performance loss. It is recommended to populate all memory channels identically with identical DIMMs for best performance.</p> <ul style="list-style-type: none"> <li>Optimizer population order is not traditional for 8 and 14 DIMM installations of dual processor. <ul style="list-style-type: none"> <li>For 8 DIMMs: A1, A2, A4, A5, B1, B2, B4, B5</li> </ul> </li> </ul>

Processor	Configuration	Memory population	Memory population information
			<ul style="list-style-type: none"> <li>For 14 DIMMs: A1, A2, A4, A5, A7, A8, A9, A10, B1, B2, B3, B4, B5, B6</li> </ul>
	Mirroring population order	A{1, 2, 3, 4, 5, 6}, B{1, 2, 3, 4, 5, 6}	Mirroring is supported with 6 DIMM slots per processor.
	Single rank sparing population order	A{1}, B{1}, A{2}, B{2}, A{3}, B{3}...	Populate in this order, odd amount per processor allowed. Requires two ranks or more per channel.
	Multi rank sparing population order	A{1}, B{1}, A{2}, B{2}, A{3}, B{3}...	Populate in this order, odd amount per processor allowed. Requires three ranks or more per channel.

## Removing a memory module

### Prerequisites

- Follow the safety guidelines listed in [Safety instructions](#).
  - Follow the procedure listed in [Before working inside your system](#).
- [Remove the air shroud](#).

**WARNING:** Allow the memory modules to cool after you power off the system. Handle the memory modules by the card edges and avoid touching the components or metallic contacts on the memory module.

**CAUTION:** To ensure proper system cooling, memory module blanks must be installed in any memory socket that is not occupied. Remove memory module blanks only if you intend to install memory modules in those sockets.

### Steps

- Locate the appropriate memory module socket.

**CAUTION:** Handle each memory module only by the card edges, ensuring not to touch the middle of the memory module or metallic contacts.

- Push the ejectors outward on both ends of the memory module socket to release the memory module from the socket.
- Lift and uninstall the memory module from the system.

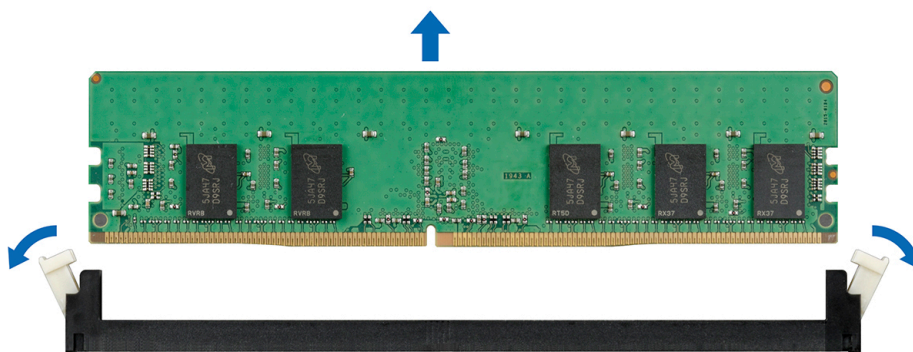

Figure 54. Removing a memory module

### Next steps

- [Install the memory module](#).

# Installing a memory module

## Prerequisites

Follow the safety guidelines listed in [Safety instructions](#).

**CAUTION:** To ensure proper system cooling, memory module blanks must be installed in any memory socket that is not occupied. Remove memory module blanks only if you intend to install memory modules in those sockets.

## Steps

1. Locate the appropriate memory module socket.

**CAUTION:** Handle each memory module only by the card edges, ensuring not to touch the middle of the memory module or metallic contacts.

**CAUTION:** To prevent damage to the memory module or the memory module socket during installation, do not bend or flex the memory module. You must insert both ends of the memory module simultaneously.

2. Open the ejectors on the memory module socket outward to allow the memory module to be inserted into the socket.

3. Align the edge connector of the memory module with the alignment key of the memory module socket, and insert the memory module in the socket.

**CAUTION:** Do not apply pressure at the center of the memory module; apply pressure at both ends of the memory module evenly.

**NOTE:** The memory module socket has an alignment key that enables you to install the memory module in the socket in only one orientation.

4. Press the memory module with your thumbs until the socket levers firmly click into place.

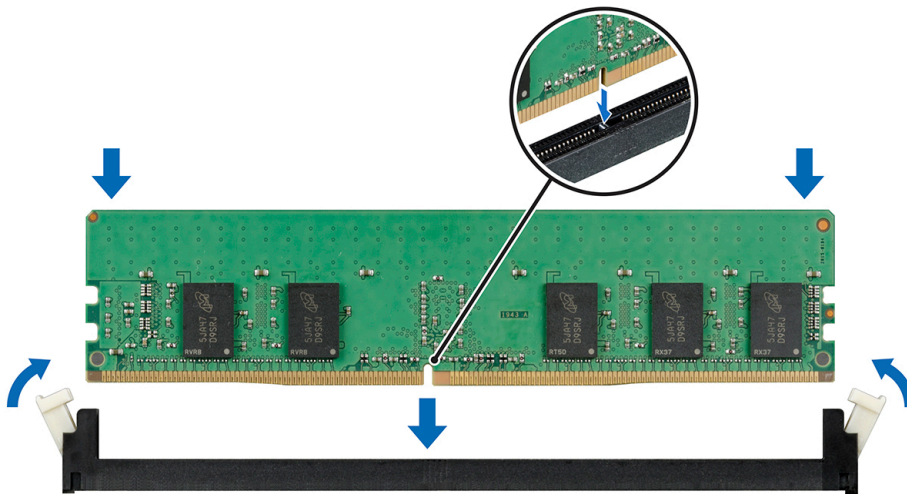

Figure 55. Installing a memory module

## Next steps

1. [Install the air shroud](#)
2. Follow the procedure listed in [After working inside your system](#).
3. To verify if the memory module has been installed properly, press F2 and navigate to **System Setup Main Menu > System BIOS > Memory Settings**. In the **Memory Settings** screen, the System Memory Size must reflect the updated capacity of the installed memory.
4. If the value is incorrect, one or more of the memory modules may not be installed properly. Ensure that the memory module is firmly seated in the memory module socket.
5. Run the system memory test in system diagnostics.

# Cooling fans

## Removing the internal cooling fan

### Prerequisites

**CAUTION:** Never operate your system with the internal cooling fan removed. The system can overheat and result in shutdown of the system and loss of data.

**CAUTION:** Do not operate the system with the cover removed for a duration exceeding 5 minutes.

1. Follow the safety guidelines listed in [Safety instructions](#).
2. Follow the procedure listed in [Before working inside your system](#).
3. [Remove the air shroud](#).

### Steps

1. Disconnect the internal cooling fan power cable from the system board.
2. Holding the internal cooling fan, press the release tab, and slide the cooling fan out in the direction of the arrow marked on the fan.

**CAUTION:** Do not remove or install the internal cooling fan by holding the fan blades.

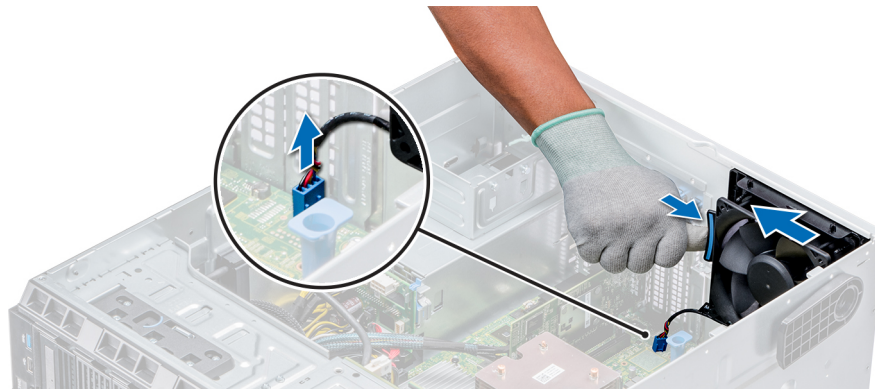

Figure 56. Removing the internal cooling fan

### Next steps

1. Follow the procedure listed in [After working inside your system](#).
2. [Install the internal cooling fan](#).

## Installing the internal cooling fan

### Prerequisites

1. Follow the safety guidelines listed in [Safety instructions](#).
2. Follow the procedure listed in [Before working inside your system](#).
3. [Remove the air shroud](#).
4. If installed, [remove the front bezel](#).

### Steps

1. Hold the cooling fan by the sides with the cable end facing the bottom of the system.
2. Align the four tabs on the internal cooling fan with the four slots on the system wall.
3. Press and slide the internal cooling fan into the slots until the release tab locks into place.
4. Connect the internal cooling fan power cable to the connector on the system board.

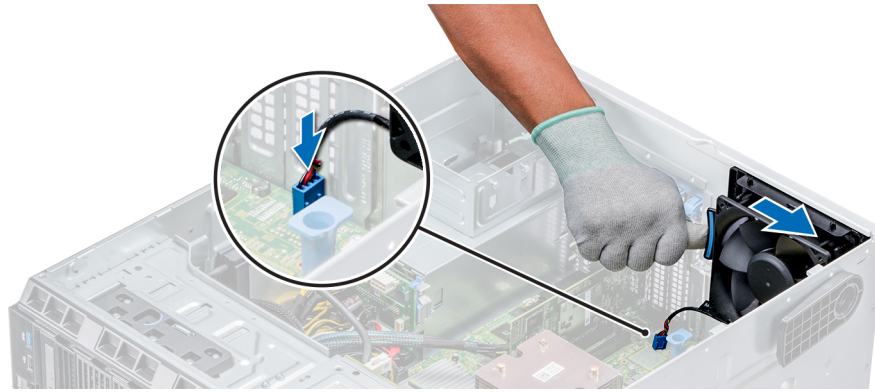

**Figure 57. Installing the internal cooling fan**

#### Next steps

1. [Install the air shroud.](#)
2. Follow the procedure listed in [After working inside your system.](#)

## Removing the external cooling fan

#### Prerequisites

1. Follow the safety guidelines listed in [Safety instructions.](#)
2. Follow the procedure listed in [Before working inside your system.](#)
3. [Remove the air shroud.](#)

#### Steps

1. Disconnect the external cooling fan power cable from the system board.
2. Remove the four screws that secure the external cooling fan to the chassis.
3. Lift the external cooling fan to disengage the upper and the lower hooks from the slots on the chassis wall and remove the cooling fan.
4. Remove the external cooling fan power cable from the slot on the system.

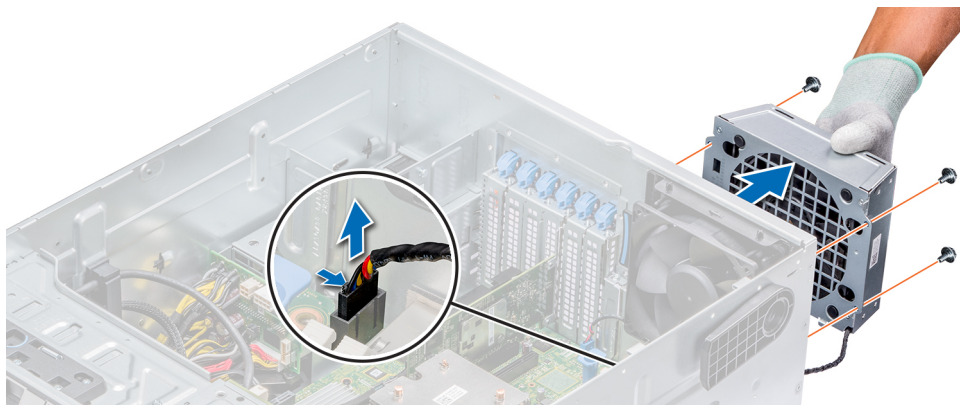

**Figure 58. Removing the external cooling fan**

#### Next steps

1. Follow the procedure listed in [After working inside your system.](#)
2. [Install the air shroud.](#)

# Installing the external cooling fan

## Prerequisites

1. Follow the safety guidelines listed in [Safety instructions](#).
2. Follow the procedure listed in [Before working inside your system](#).

## Steps

1. Route the external cooling fan power cable into the system through the slot at the back of the chassis.
2. Align and insert the lower and upper hooks on the external cooling fan into the corresponding slots at the back of the chassis.
3. Use the four screws to secure the external cooling fan to the chassis.
4. Connect the external cooling fan power cable to the FAN2 connector on the system board.

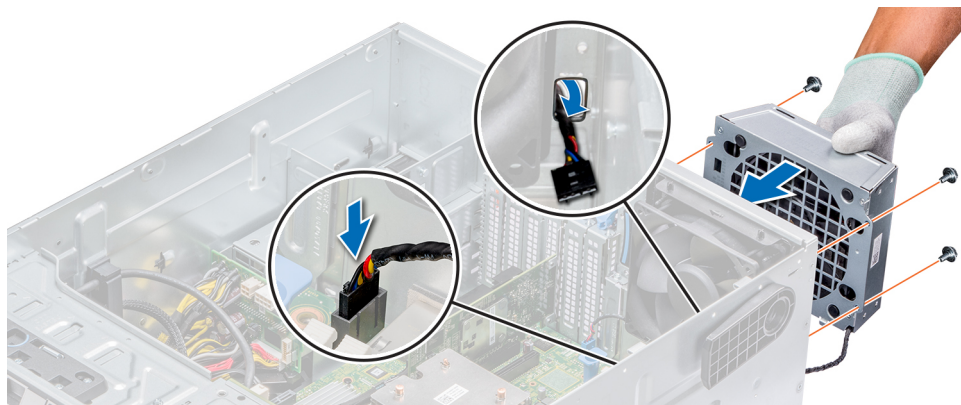

Figure 59. Installing the external cooling fan

## Next steps

1. [Install the air shroud](#).
2. Follow the safety guidelines listed in [After working inside your system](#).

# Optional internal USB memory key

## Replacing the optional internal USB memory key

### Prerequisites

**CAUTION:** To avoid interference with other components in the server, the maximum permissible dimensions of the USB memory key are 15.9 mm wide x 57.15 mm long x 7.9 mm high.

1. Follow the safety guidelines listed in [Safety instructions](#).
2. Follow the procedure listed in [Before working inside your system](#).

### Steps

1. Locate the USB port or USB memory key on the system board.  
To locate the USB port, see [Jumpers and connectors](#).
2. If installed, remove the USB memory key from the USB port.
3. Insert the replacement USB memory key into the USB port.

### Next steps

1. Follow the procedure listed in [After working inside your system](#).
2. While booting, press F2 to enter **System Setup** and verify that the system detects the USB memory key.

# Expansion card holder

## Removing the expansion card holder

### Prerequisites

1. Follow the safety guidelines listed in [Safety instructions](#).
2. Follow the procedure listed in [Before working inside your system](#).
3. [Remove the air shroud](#).

### Steps

Press the tab and remove the expansion-card holder from the chassis.

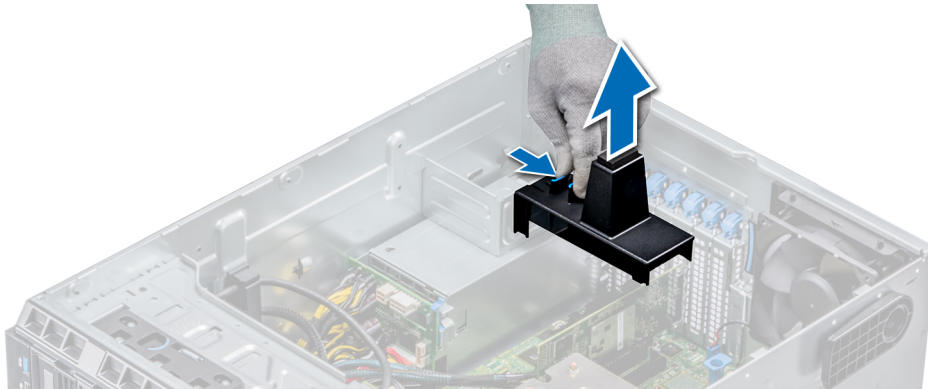

**Figure 60. Removing the expansion card holder**

### Next steps

1. [Install the air shroud](#).
2. Follow the procedure listed in [After working inside your system](#).

## Installing the expansion card holder

### Prerequisites

1. Follow the safety guidelines listed in [Safety instructions](#).
2. Follow the procedure listed in [Before working inside your system](#).

### Steps

Align the expansion card holder with the projections on the chassis and push it down until firmly seated.

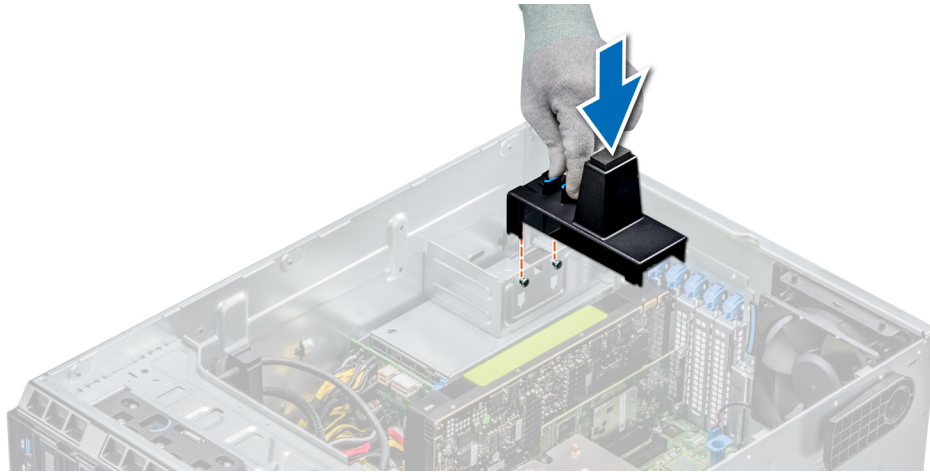

**Figure 61. Installing the expansion card holder**

**Next steps**

1. Follow the procedure listed in [After working inside your system](#).
2. [Install the air shroud](#).

## Expansion cards

### Expansion card installation guidelines

The following table describes the supported expansion cards:

**Table 40. Supported PCI express generation 3 expansion cards**

PCIe Slot	Processor Connection	Height	Length	Link Width	Slot Width
1 (Gen3)	Platform Controller Hub	Full Height	Half Length	x4	x4
2 (Gen3)	Processor 1	Full Height	Half Length	x4	x4
3 (Gen3)	Processor 2	Full Height	Full Length	x16	x16
4 (Gen3)	Processor 1	Full Height	Half Length	x8	x8
5 (Gen3)	Processor 1	Full Height	Half Length	x8	x8

**NOTE:** The expansion-card slots are not hot-swappable.

### GPU card installation guidelines

Observe the following guidelines while installing a GPU card:

- GPU is supported in the rack and tower mode configuration.
- GPU can be installed only on systems that have 1100 W or higher power supply units.
- Each GPU card supports up to 32 GB of dedicated GDDR5 memory.
- Two double-width GPU cards on a single processor configuration and four double width GPU cards on a dual processor configuration do not support any other add-on cards.
- Specific GPU cards need the use of the dongle power cable.

### GPU card installation restrictions

- Supports only single slot GPU card
- Supports only active (embedded fan) GPU card
- High power (>75 W) GPU cards that use GPU AUX cable should have dual system fans without redundancy.

# Removing a expansion card

## Prerequisites

1. Follow the safety guidelines listed in [Safety instructions](#).
2. Follow the procedure listed in [Before working inside your system](#).
3. [Remove the air shroud](#).
4. [Remove the expansion card holder](#).

## Steps

1. If installed, disconnect the data cables from the PERC card and/or the power cables from the GPU card.
2. Press the expansion card latch and push down the latch to open it.
3. Hold the expansion card by its edge, and pull the card up to remove it from the expansion card connector and the system.
4. Install the filler brackets by performing the following steps:
  - a) Align the slot on the filler bracket with the tab on the expansion card slot.
  - b) Press the expansion card latch till the filler bracket locks into place.

**NOTE:** Filler brackets must be installed in empty expansion-card slots to maintain FCC certification of the system. The brackets also keep dust and dirt out of the system and aid in proper cooling and airflow inside the system.

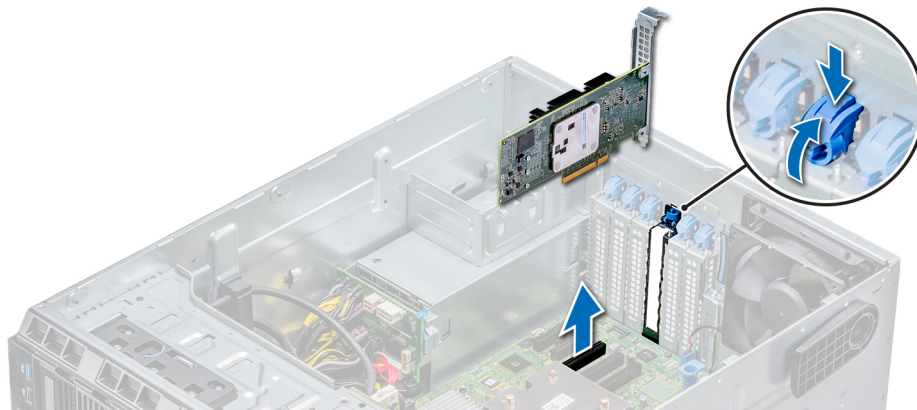

Figure 62. Removing an expansion card

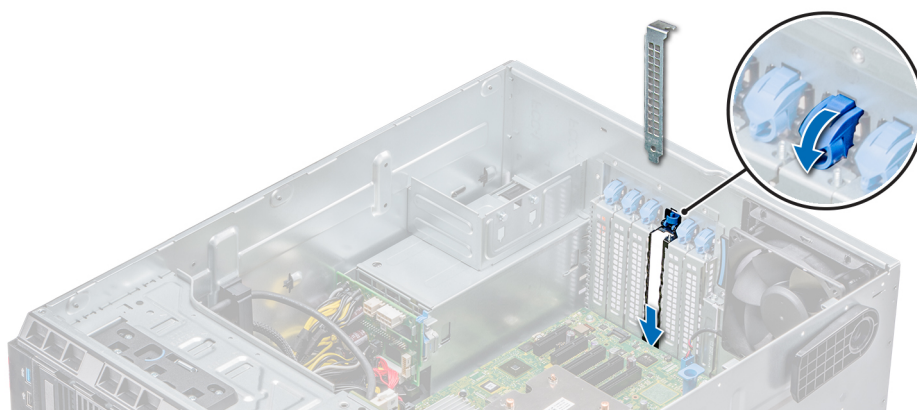

Figure 63. Installing the filler bracket

## Next steps

1. Follow the procedure listed in [After working inside your system](#).
2. [Install an expansion card](#).
3. [Install the expansion card holder](#).

4. Install the air shroud.

## Installing an expansion card

### Prerequisites

1. Follow the safety guidelines listed in [Safety instructions](#).
2. [Remove the air shroud](#).
3. [Remove the expansion card holder](#).

### Steps

1. Unpack the expansion card and prepare it for installation.  
For instructions, see the documentation accompanying the card.
2. Open the expansion card latch adjacent to the slot you want to install the expansion card.
3. Remove the existing expansion card or filler bracket from the expansion card holder.

**NOTE:** Store this bracket for future use. Filler brackets must be installed in empty expansion-card slots to maintain FCC certification of the system. The brackets also keep dust and dirt out of the system and aid in proper cooling and airflow inside the system.

4. Holding the card by its edges, position the card so that the card aligns with the expansion card connector.
5. Insert the card firmly into the expansion card connector until the card is fully seated.
6. Close the expansion card latch by pushing the latch up until the latch snaps into place.
7. Connect the data cables to the expansion card and/or the power cables to the GPU card.

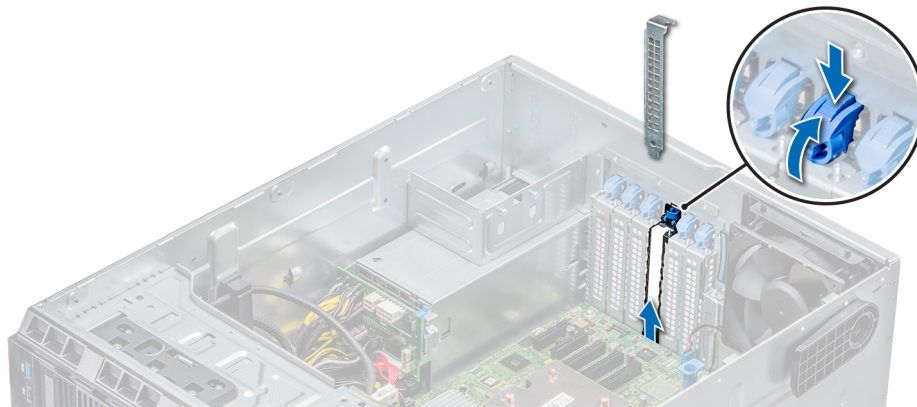

Figure 64. Removing the filler bracket

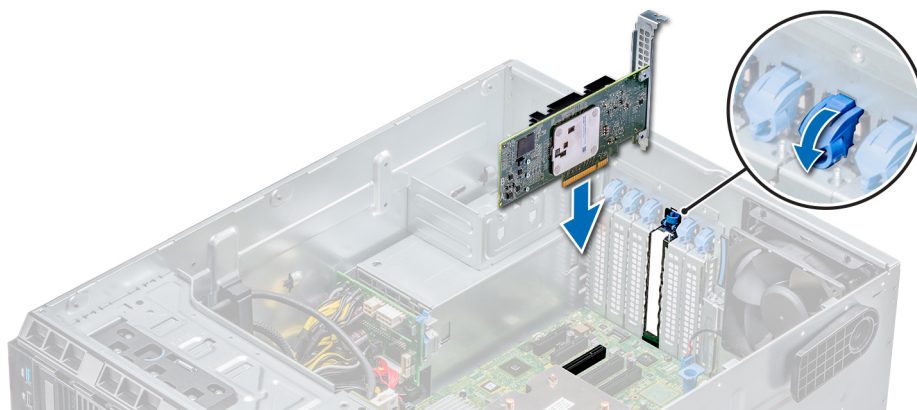

Figure 65. Installing an expansion card

### Next steps

1. Follow the procedure listed in [After working inside your system](#).
2. [Install the expansion card holder](#).
3. [Install the air shroud](#).

## M.2 SSD module

### Removing the M.2 SSD module

#### Prerequisites

1. Follow the safety guidelines listed in [Safety instructions](#).
2. Follow the procedure listed in [Before working inside your system](#).
3. [Remove the air shroud](#).
4. Remove the BOSS card.

**i** **NOTE:** The procedure to remove the BOSS card is similar to the removing an expansion card.

#### Steps

1. Loosen the screw and lift the retention strap that secures the M.2 SSD module on the BOSS card.
2. Lift the M.2 SSD module and slide it out of the connector on the BOSS card.

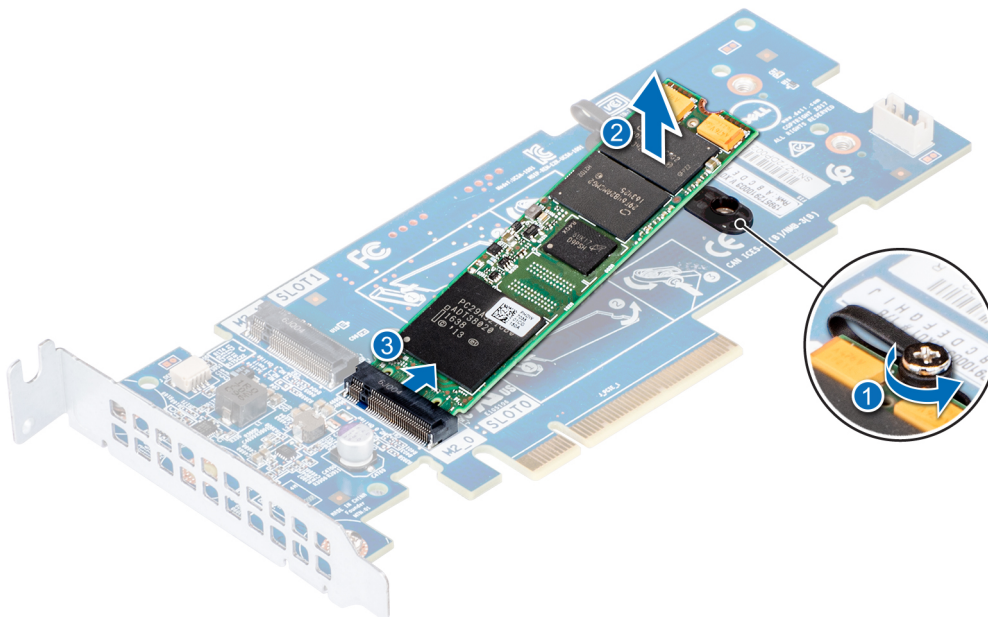

**Figure 66. Removing the M.2 SSD module**

### Next steps

[Replace the M.2 SSD module](#).

## Installing the M.2 SSD module

#### Prerequisites

1. Follow the safety guidelines listed in [Safety instructions](#).
2. Follow the procedure listed in [Before working inside your system](#).

3. Remove the air shroud.
4. Remove the BOSS card.

**NOTE:** The procedure to remove the BOSS card is similar to the removing an expansion card.

### Steps

1. Connect the M.2 SSD module to the connector on the BOSS card.
2. Place the retention strap on the M.2 SSD module, and tighten the screw to secure the module.

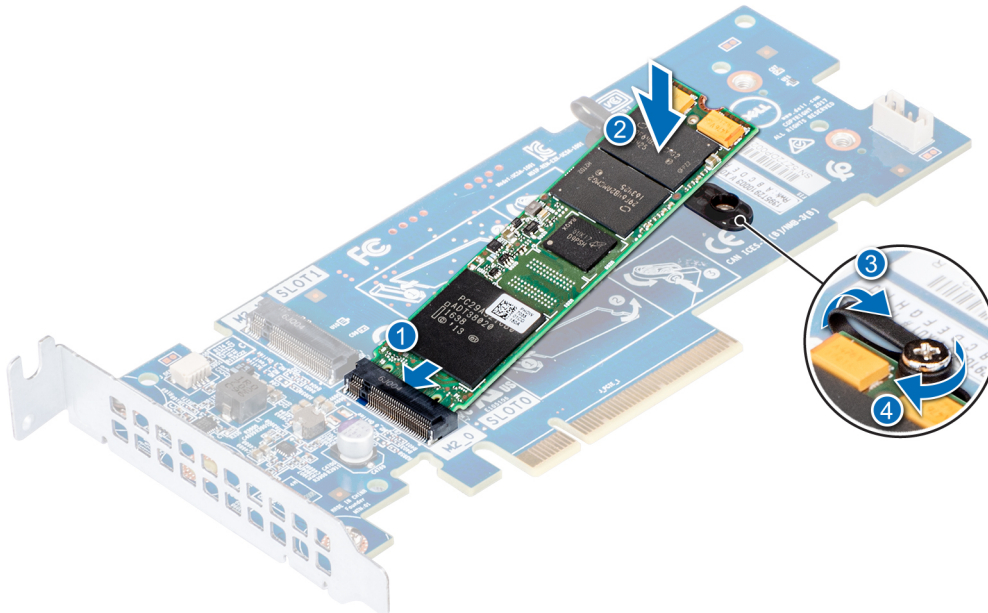

Figure 67. Installing the M.2 SSD module

### Next steps

1. Install the BOSS card.
- NOTE:** The procedure to install the BOSS card is similar to the removing an expansion card.
2. Install the applicable air shroud.
  3. Follow the procedure listed in [After working inside your system](#).

## Optional MicroSD or vFlash card

### Removing the MicroSD card

#### Prerequisites

1. Follow the safety guidelines listed in [Safety instructions](#).
2. Follow the procedure listed in [Before working inside your system](#).

#### Steps

1. Locate the MicroSD card slot on the vFlash/IDSDM module, and press the card to partially release it from the slot. To locate IDSDM/vFlash module, see the System board jumpers and connectors section.
2. Hold the MicroSD card and remove it from the slot.

**NOTE:** Temporarily label each MicroSD card with its corresponding slot number after removal.

### Next steps

1. Follow the procedure listed in [After working inside your system](#).
2. [Install a MicroSD card](#).

## Installing the MicroSD card

### Prerequisites

Follow the safety guidelines listed in [Safety instructions](#).

**NOTE:** To use an MicroSD card with your system, ensure that the Internal SD Card Port is enabled in System Setup.

**NOTE:** If reinstalling, ensure that you install the MicroSD cards into the same slots based on the labels you had marked on the cards during removal.

### Steps

1. Locate the MicroSD card connector on the IDSDM/vFlash module. Orient the MicroSD card appropriately and insert the contact-pin end of the card into the slot. To locate IDSDM/vFlash, see [Jumpers and connectors](#).

**NOTE:** The slot is keyed to ensure correct insertion of the card.

2. Press the card into the card slot to lock it into place.

### Next steps

Follow the procedure listed in [After working inside your system](#).

## Optional IDSDM or vFlash module

## Removing the optional IDSDM or vFlash card

### Prerequisites

1. Follow the safety guidelines listed in [Safety instructions](#).
2. Follow the procedure listed in [Before working inside your system](#).
3. [Install the air shroud](#).

### Steps

1. Locate the IDSDM/vFlash connector on the system board.  
To locate IDSDM/vFlash connector, see the System board jumpers and connectors section.
2. Holding the pull tab, lift the IDSDM/vFlash card out of the system.

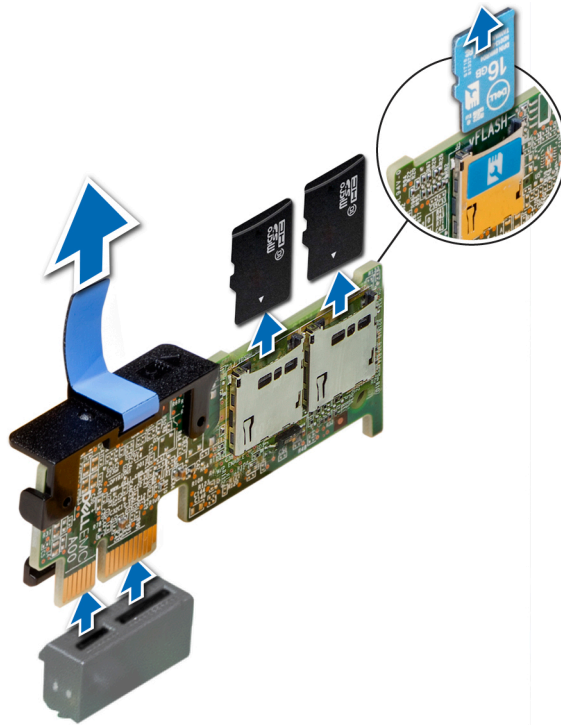

**Figure 68. Removing the optional IDSDM/vFlash card**

**NOTE:** There are two dip switches on the IDSDM/vFlash card for write-protection.

#### Next steps

Install the optional IDSDM/vFlash card.

## Installing optional IDSDM or vFlash card

#### Prerequisites

Follow the safety guidelines listed in [Safety instructions](#).

#### Steps

1. Locate the IDSDM/vFlash connector on the system board.  
To locate IDSDM/vFlash connector, see [Jumpers and connectors](#).
2. Align the IDSDM/vFlash card with the connector on the system board.
3. Push the IDSDM/vFlash card until it is firmly seated on the system board.

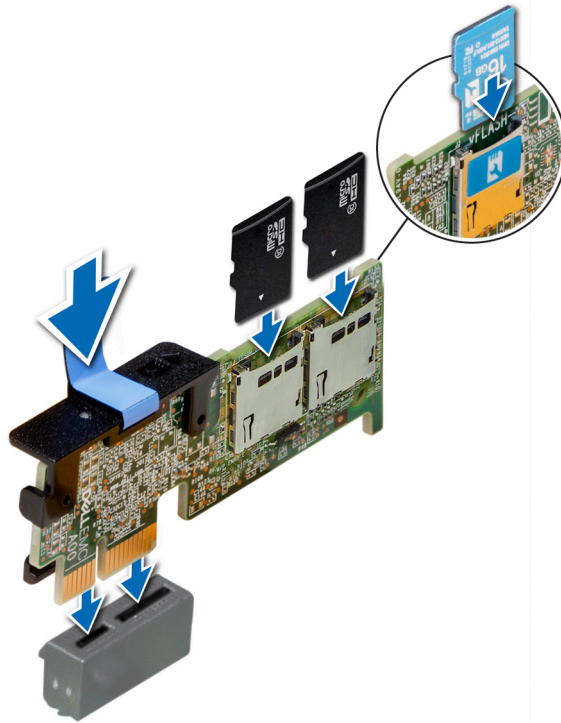

Figure 69. Installing optional IDSDM/vFlash card

#### Next steps

1. Install the MicroSD cards.



**NOTE:** Reinstall the MicroSD cards into the same slots based on the labels you had marked on the cards during removal.

2. Follow the procedure listed in [After working inside your system](#).

## Processors and heat sinks

### Removing a processor and heat sink module

#### Prerequisites

**WARNING:** The heat sink may be hot to touch for some time after the system is powered down. Allow the heat sink to cool before removing it.

1. Follow the safety guidelines listed in [Safety instructions](#).
2. Follow the procedure listed in [Before working inside your system](#).
3. [Remove the air shroud](#).

#### Steps

1. Using a Torx #T30 screwdriver, loosen the screws on the heat sink in the order below:
  - a) Loosen the first screw three turns.
  - b) Loosen the second screw completely.
  - c) Return to the first screw and loosen it completely.
2. Pushing both blue retention clips simultaneously, lift the processor and heat sink module (PHM) processor and heat sink module
3. Set the PHM aside with the processor side facing up.

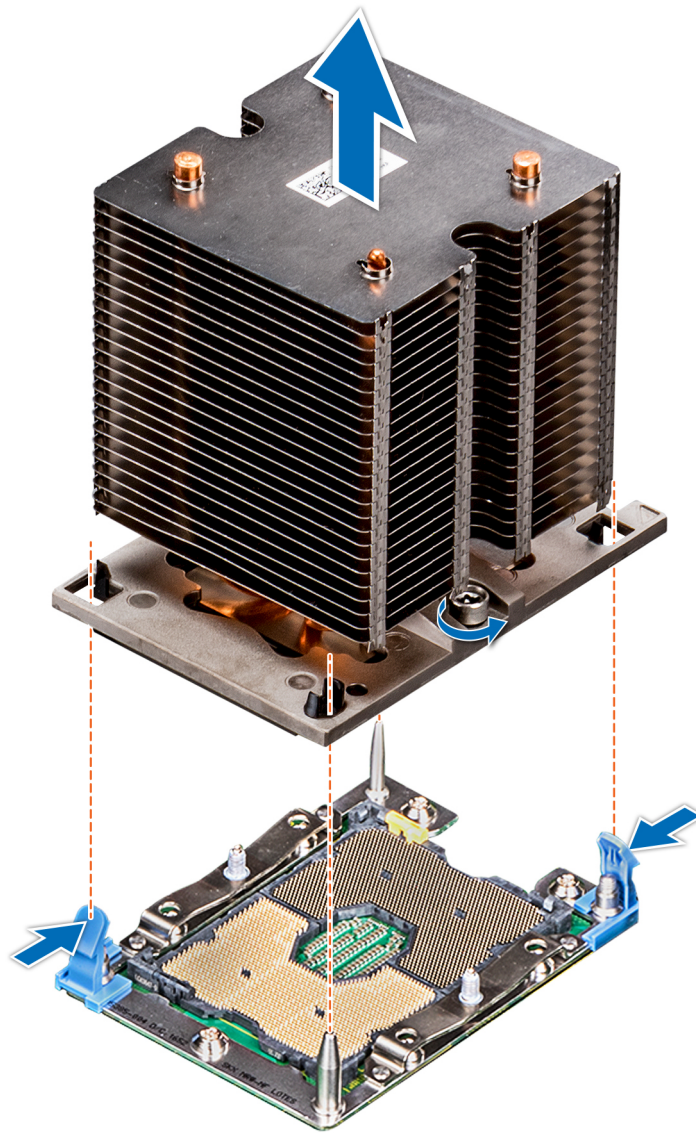

Figure 70. Removing the processor and heat sink module

#### Next steps

Install the processor and heat sink module.

## Removing the processor from the processor and heat sink module

#### Prerequisites

**NOTE:** Only remove the processor from the processor and heat sink module if you are replacing the processor or heat sink. This procedure is not required when replacing a system board.

1. Follow the safety guidelines listed in [Safety instructions](#).
2. Follow the procedure listed in [Before working inside your system](#).
3. [Remove the air shroud](#).
4. [Remove the processor and heat sink module](#).

#### Steps

1. Place the heat sink with the processor side facing up.

2. Insert a flat blade screwdriver into the release slot marked with a yellow label. Twist (do not pry) the screwdriver to break the thermal paste seal.
3. Push the retaining clips on the processor bracket to unlock the bracket from the heat sink.

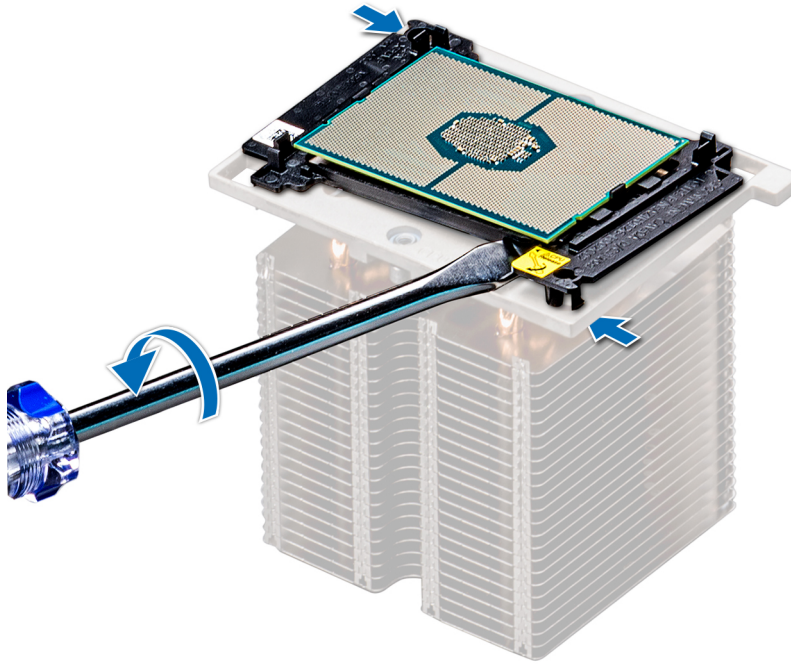

**Figure 71. Loosening the processor bracket**

4. Lift the bracket and the processor away from the heat sink, and place the processor connector side down on the processor tray.
5. Flex the outer edges of the bracket to release the bracket from the processor.

**NOTE:** Ensure that the processor and the bracket are placed in the tray after you remove the heat sink.



**Figure 72. Removing the processor bracket**

#### Next steps

Install the processor into the processor and heat sink module.

# Installing the processor into a processor and heat sink module

## Prerequisites

Follow the safety guidelines listed in [Safety instructions](#).

## Steps

1. Place the processor in the processor tray.

**i** **NOTE:** Ensure that the pin 1 indicator on the processor tray is aligned with the pin 1 indicator on the processor.

2. Flex the outer edges of the bracket around the processor ensuring that the processor is locked into the clips on the bracket.

**i** **NOTE:** Ensure that the pin 1 indicator on the bracket is aligned with the pin 1 indicator on the processor before placing the bracket on the processor.

**i** **NOTE:** Ensure that the processor and the bracket are placed in the tray before you install the heat sink.

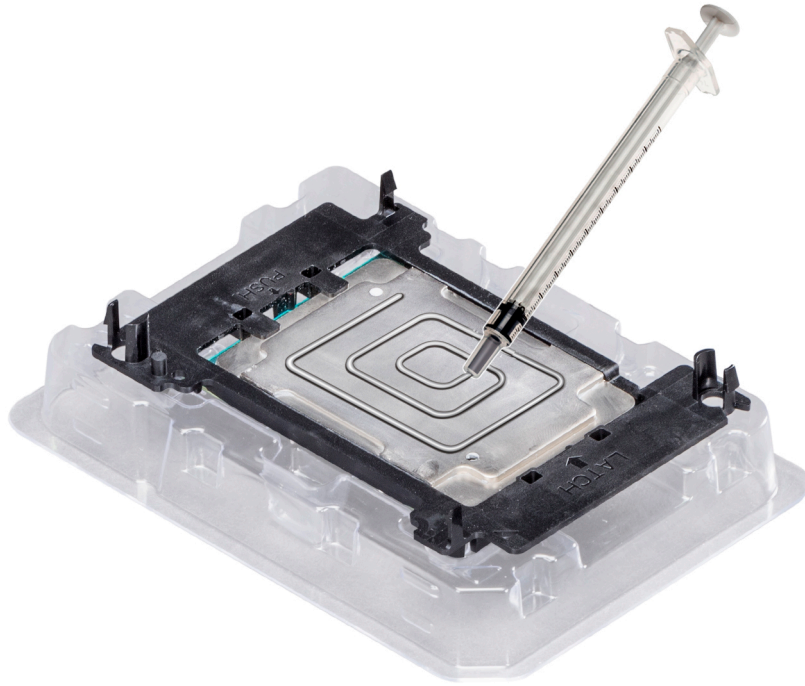

**Figure 73. Installing the processor bracket**

3. If you are using an existing heat sink, remove the thermal grease from the heat sink by using a clean lint-free cloth.
4. Use the thermal grease syringe included with your processor kit to apply the grease in a quadrilateral design on the top of the processor.

**⚠ CAUTION:** Applying too much thermal grease can result in excess grease coming in contact with and contaminating the processor socket.

**i** **NOTE:** The thermal grease syringe is intended for single use only. Dispose the syringe after you use it.



**Figure 74. Applying thermal grease on top of the processor**

5. Place the heat sink on the processor and push down on the base of the heat sink until the bracket locks onto the heat sink.

**NOTE:**

- Ensure that the two guide pin holes on the bracket match the guide holes on the heat sink.
- Do not press on the heat sink fins.
- Ensure that the pin 1 indicator on the heat sink is aligned with the pin 1 indicator on the bracket before placing the heat sink onto the processor and bracket.

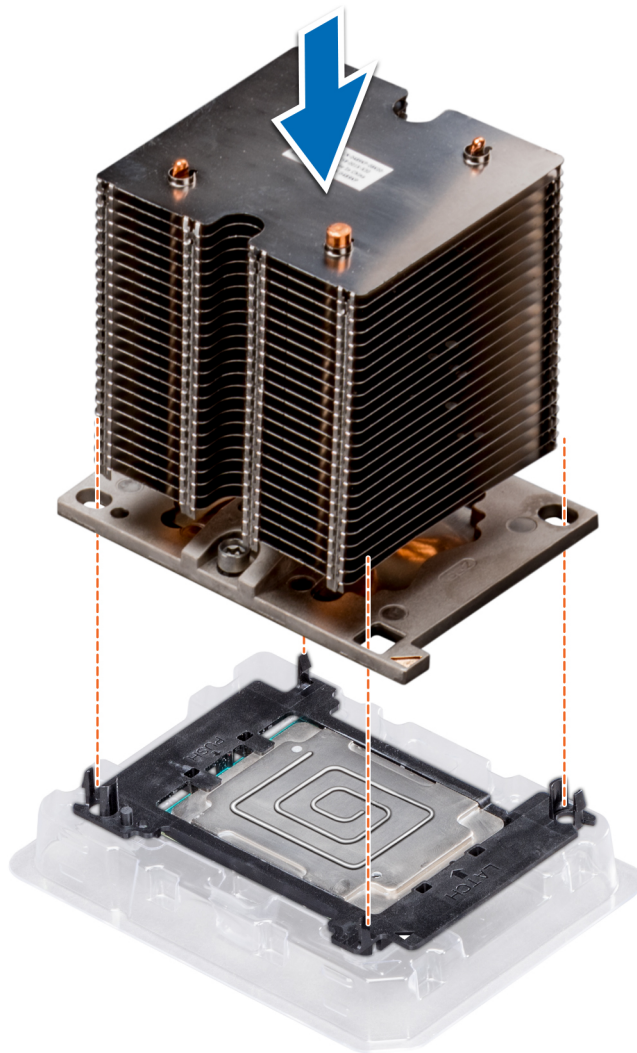

Figure 75. Installing the heat sink onto the processor

#### Next steps

1. [Install the processor and heat sink module.](#)
2. [Install the air shroud.](#)
3. Follow the procedure listed in [After working inside your system.](#)

## Installing a processor and heat sink module

#### Prerequisites

**CAUTION:** Never remove the heat sink from a processor unless you intend to replace the processor. The heat sink is necessary to maintain proper thermal conditions.

1. Follow the safety guidelines listed in [Safety instructions.](#)
2. If installed, remove the processor blank and CPU dust cover.

#### Steps

1. Align the pin 1 indicator of the heat sink to the system board and then place the processor and heat sink module (PHM) on the processor socket.

**CAUTION:** To avoid damaging the fins on the heat sink, do not press down on the heat sink fins.

**NOTE:** Ensure that the PHM is held parallel to the system board to prevent damaging the components.

2. Push the blue retention clips inward to allow the heat sink to drop into place.
3. Using the Torx #T30 screwdriver, tighten the screws on the heat sink in the order below:
  - a) Partially tighten the first screw (approximately 3 turns).
  - b) Tighten the second screw completely.
  - c) Return to the first screw and tighten it completely.

If the PHM slips off the blue retention clips when the screws are partially tightened, follow these steps to secure the PHM:

- a. Loosen both the heat sink screws completely.
- b. Lower the PHM on to the blue retention clips, following the procedure described in step 2.
- c. Secure the PHM to the system board, following the replacement instructions listed in this step above. 4.

**NOTE:** The processor and heat sink module retention screws should not be tightened to more than 0.13 kgf-m (1.35 N.m or 12 in-lbf).

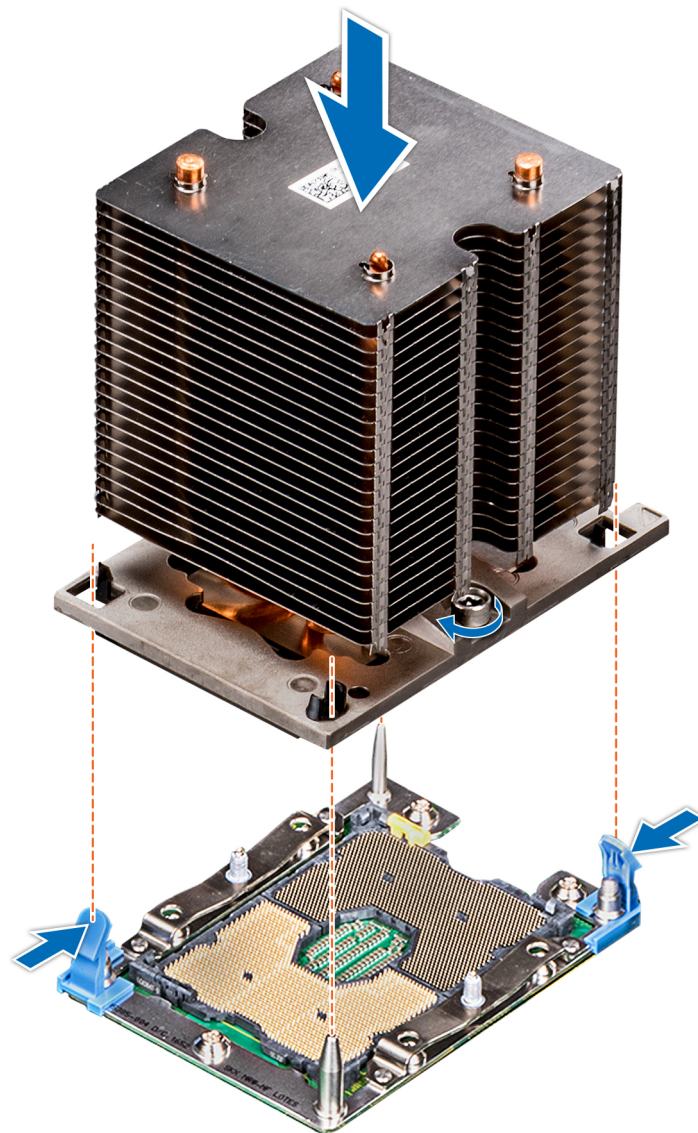

**Figure 76. Installing a processor and heat sink module**

#### Next steps

1. [Install the air shroud.](#)
2. Follow the procedure listed in [After working inside your system.](#)

# Power supply units

**i** **NOTE:** For more information, see the [Technical specifications](#) section.

**△** **CAUTION:** If two PSUs are installed, both the PSUs must have the same type of label. For example, Extended Power Performance (EPP) label. Mixing PSUs from previous generations of PowerEdge servers is not supported, even if the PSUs have the same power rating. Mixing PSUs will result in mismatch condition or failure to turn the system on.

**i** **NOTE:** When two identical PSUs are installed, power supply redundancy (1+1 – with redundancy or 2+0 – without redundancy) is configured in system BIOS. In redundant mode, power is supplied to the system equally from both PSUs when Hot Spare is disabled. When Hot Spare is enabled, one of the PSUs is put into the sleep mode when system utilization is low in order to maximize efficiency.

**i** **NOTE:** If two PSUs are used, they must be of the same maximum output power.

## Removing a power supply unit blank

### Prerequisites

Follow the safety guidelines listed in [Safety instructions](#).

### Steps

If you are installing a second power supply unit, remove the power supply unit blank in the bay by pulling the blank outward.

**△** **CAUTION:** To ensure proper system cooling, the power supply unit blank must be installed in the second power supply unit bay in a non-redundant configuration. Remove the power supply unit blank only if you are installing a second power supply unit.

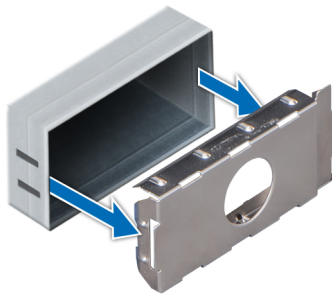

Figure 77. Removing a power supply unit blank

### Next steps

Install the second power supply unit blank.

## Installing a power supply unit blank

### Prerequisites

1. Follow the safety guidelines listed in [Safety instructions](#).

**i** **NOTE:** Install the power supply unit (PSU) blank only in the second PSU bay.

### Steps

Align the PSU blank with the PSU slot and push it into the PSU slot until it clicks into place.

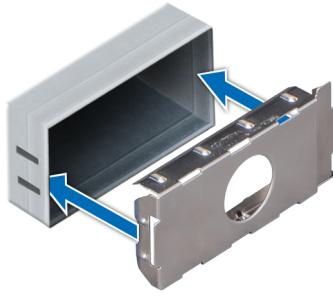

Figure 78. Installing a power supply unit blank

#### Next steps

Follow the procedure listed in [After working inside your system](#).

## Removing a power supply unit

#### Prerequisites

**CAUTION:** The system needs one power supply unit (PSU) for normal operation. On power-redundant systems, remove and replace only one PSU at a time in a system that is powered on.

1. Follow the safety guidelines listed in [Safety instructions](#).
2. Disconnect the power cable from the power source and from the PSU you intend to remove, and then remove the cable from the strap on the PSU handle.

#### Steps

Press the orange release latch and slide the PSU out of the system by using the PSU handle.

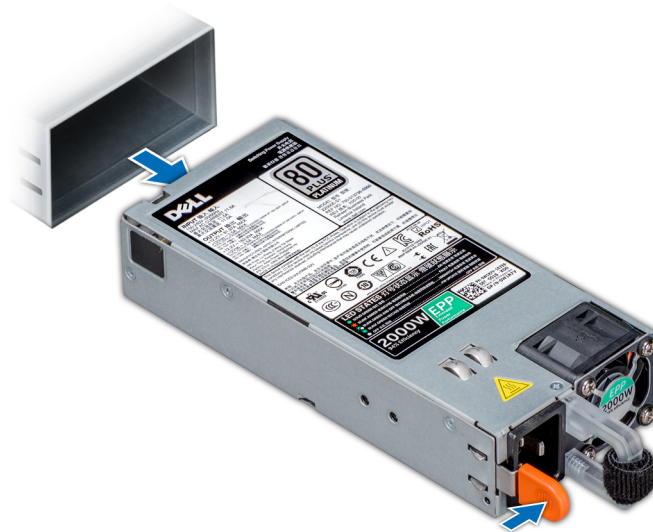

Figure 79. Removing a power supply unit

#### Next steps

Install the power supply unit.

# Installing a power supply unit

## Prerequisites

1. Follow the safety guidelines listed in [Safety instructions](#).
2. For systems that support redundant PSU, ensure that both the PSUs are of the same type and have the same maximum output power.

**NOTE:** The maximum output power (shown in watts) is listed on the PSU label.

## Steps

Slide the PSU into the system until the PSU is fully seated and the release latch snaps into place.

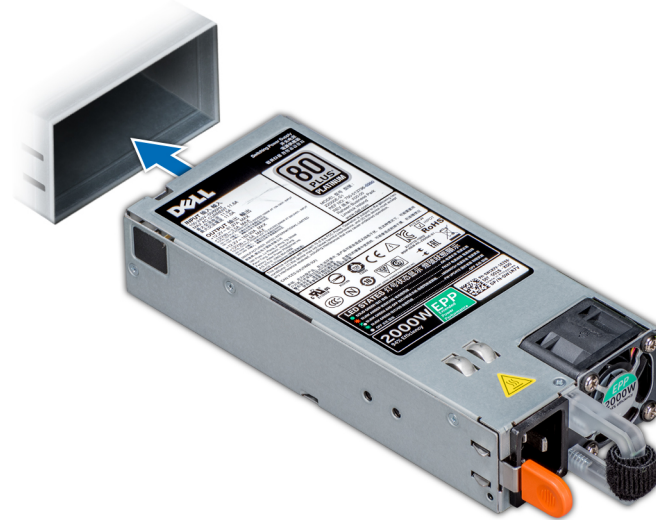

Figure 80. Installing a power supply unit

## Next steps

1. Connect the power cable to the PSU, and plug the cable into a power outlet.

**CAUTION:** When connecting the power cable to the PSU, secure the cable to the PSU with the strap.

**NOTE:** When installing, hot swapping, or hot adding a new PSU, wait for 15 seconds for the system to recognize the PSU and determine its status. The PSU redundancy may not occur until discovery is complete. Wait until the new PSU is discovered and enabled before you remove the other PSU. The PSU status indicator turns green to signify that the PSU is functioning properly.

# Removing a cabled power supply unit

## Prerequisites

1. Follow the safety guidelines listed in [Safety instructions](#).
2. Follow the procedure listed in [Before working inside your system](#).

## Steps

1. Disconnect all the power cables from the power supply unit (PSU).
2. Remove the screw securing the PSU to the chassis and slide the PSU out of the PSU cage.

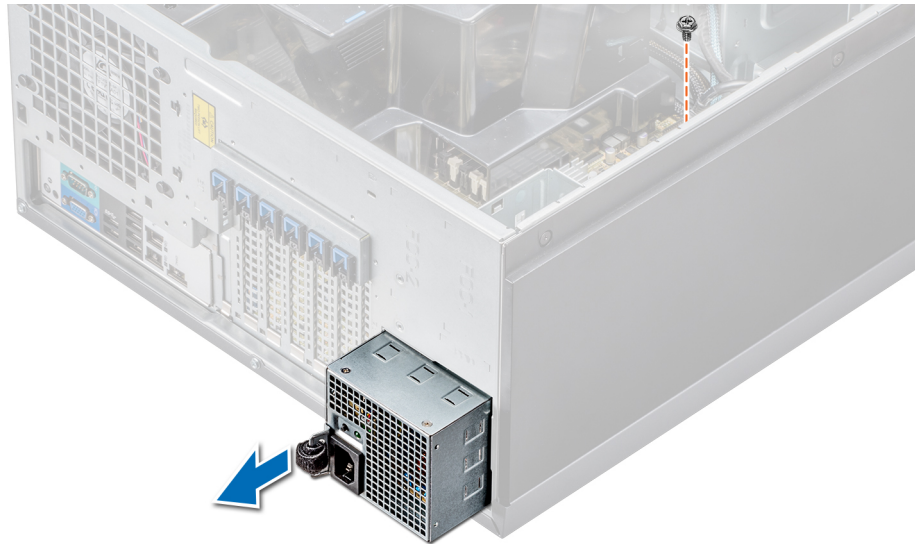

**Figure 81. Removing a cabled PSU**

#### Next steps

1. [Install a cabled power supply unit.](#)
2. Follow the procedure listed in [After working inside your system.](#)

## Installing a cabled power supply unit

#### Prerequisites

1. Follow the safety guidelines listed in [Safety instructions.](#)
2. Unpack the replacement power supply unit (PSU).

#### Steps

1. Slide the new PSU into the PSU cage until the PSU is fully seated.
2. Tighten the screw to secure the PSU to the chassis.
3. Connect all the power cables from the PSU to the system board, drive backplane, and drives.



**Figure 82. Installing a cabled PSU**

### Next steps

Follow the procedure listed in [After working inside your system](#).

## Power interposer board

### Removing the power interposer board

#### Prerequisites

1. Follow the safety guidelines listed in [Safety instructions](#).
2. Follow the procedure listed in [Before working inside your system](#).  
**CAUTION:** To prevent damage to the power interposer board, you must remove the power supply units (PSUs) or PSU blank from the system before removing the power interposer board (PIB).
3. Remove the PSUs or PSU blanks from the back of the chassis.
4. Remove the air shroud.

#### Steps

1. Disconnect the power cables from the drive backplane and the system board.  
**NOTE:** If installed, remove the expansion card to enable removing the P3 power cable from the system board.
2. Using the Phillips #2 screwdriver, remove the screw that secures PIB to the chassis.
3. Pressing the release latch on the PIB, lift the PIB to release it from the hooks on the PSU cage.
4. Lift the PIB out of the chassis.

**Figure 83. Removing the power interposer board**

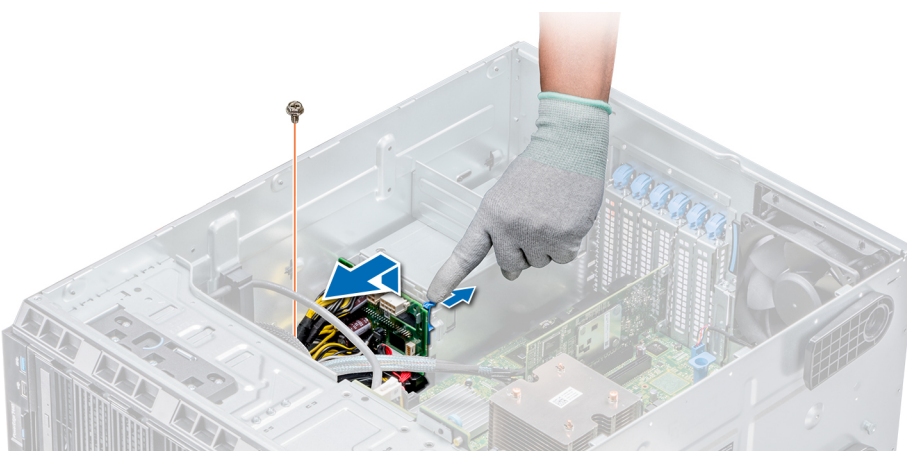

### Next steps

Follow the procedure listed in [After working inside your system](#).

## Installing the power interposer board

#### Prerequisites

- CAUTION:** Many repairs may only be done by a certified service technician. You should only perform troubleshooting and simple repairs as authorized in your product documentation, or as directed by the online or telephone service and support team. Damage due to servicing that is not authorized by Dell is not covered by your warranty. Read and follow the safety instructions that are shipped with your product.

Follow the safety guidelines listed in [Safety instructions](#).

## Steps

1. Align the slots on the power interposer board (PIB) with the hooks on the power supply unit (PSU) cage and slide the PIB until it snaps into place.
2. Secure the PIB to the chassis by using the screw.
3. Route the P3 power cable through the securing clip on the system board and connect power cable to the drive backplane.

**Figure 84. Installing the power interposer board**

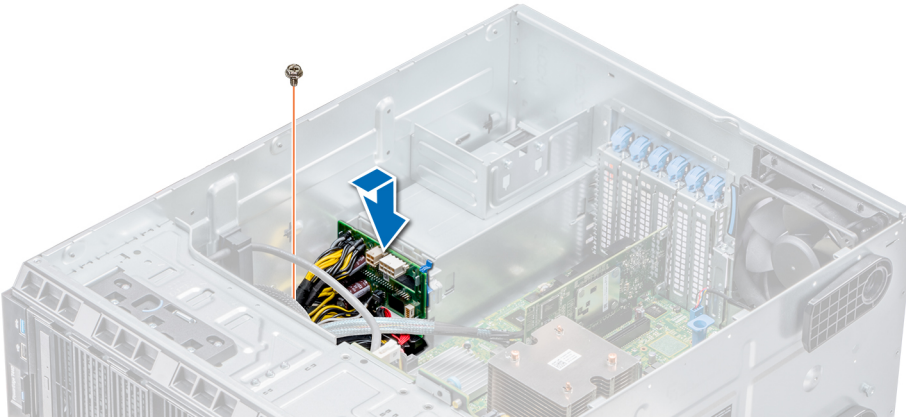

## Next steps

1. Install the cooling shroud.
2. Install the PSUs or PSU blank.
3. Follow the procedure listed in [After working inside your system](#).

# System battery

## Replacing the system battery

### Prerequisites

**⚠ WARNING:** There is a danger of a new battery exploding if it is incorrectly installed. Replace the battery only with the same or equivalent type recommended by the manufacturer. For more information, see the safety information that shipped with your system.

1. Follow the safety guidelines listed in [Safety instructions](#).
2. Follow the procedure listed in [Before working inside your system](#).
3. If applicable, disconnect the power or data cables from expansion card(s).

### Steps

1. Locate the battery socket. For more information, see the [System board jumpers and connectors](#) section.

**⚠ CAUTION:** To avoid damage to the battery connector, you must firmly support the connector while installing or removing a battery.

2. Use a plastic scribe to pry out the system battery.

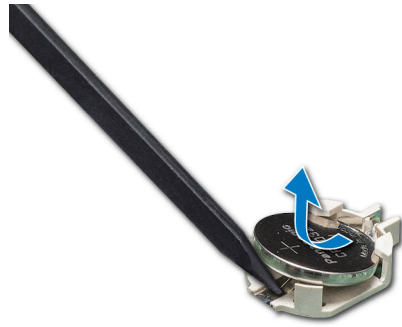

**Figure 85. Removing the system battery**

3. To install a new system battery, hold the battery with the positive side facing up and slide it under the securing tabs.
4. Press the battery into the connector until it snaps into place.

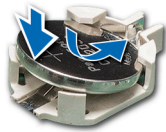

**Figure 86. Installing the system battery**

#### Next steps

1. If applicable, connect the cables to the expansion card(s).
2. Follow the procedure listed in [After working inside your system](#).
3. While booting, press F2 to enter the System Setup and ensure that the battery is operating properly.
4. Enter the correct time and date in the System Setup **Time** and **Date** fields.
5. Exit the System Setup.

## Control panel assembly

### Removing the control panel assembly

#### Prerequisites

1. Follow the safety guidelines listed in [Safety instructions](#).
2. Follow the procedure listed in [Before working inside your system](#).

#### Steps

1. Using the Phillips #2 screwdriver, remove the screw that secures control panel to the chassis.
2. Disconnect the control panel cable and the control panel USB cable from the system board.

**CAUTION:** Do not use excessive force when removing the control panel cables as it can damage the connectors.

3. Slide the control panel out of the chassis.

**NOTE:** Follow the same steps to remove the control panel in the rack-mode configuration.

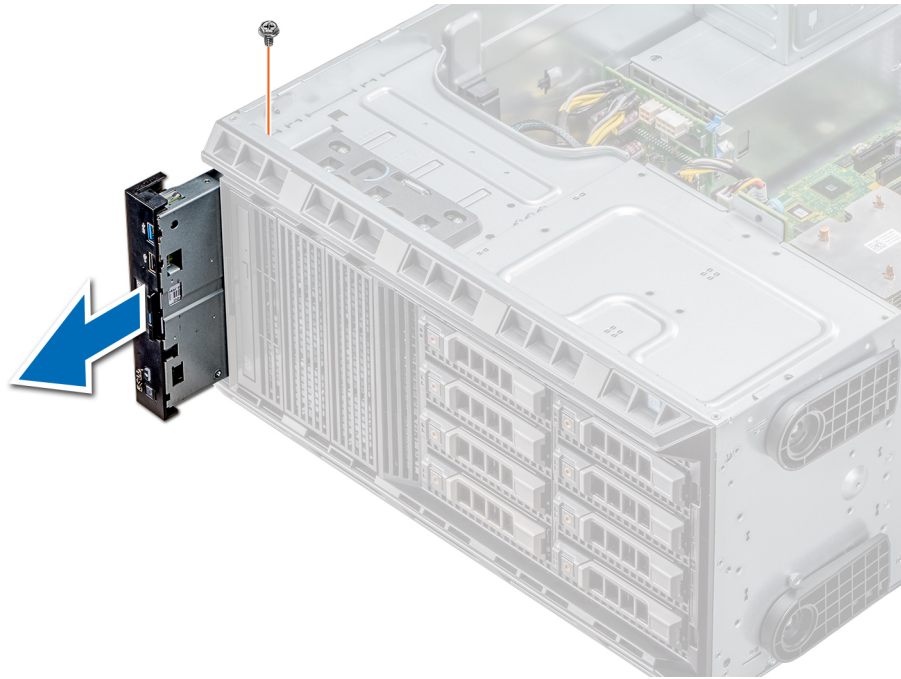

**Figure 87. Removing the control panel assembly**

4. To remove the information tag, perform the following steps:
  - a) Locate and press the tabs on the information tag.
  - b) Push the information tag out of the slot to remove it from the control panel.

**NOTE:** Retain the information tag to replace it in the new control panel.

## Installing the control panel assembly

### Prerequisites

Follow the safety guidelines listed in [Safety instructions](#).

### Steps

1. Replace the blank information tag in the new control panel with the information tag retained from the old control panel.

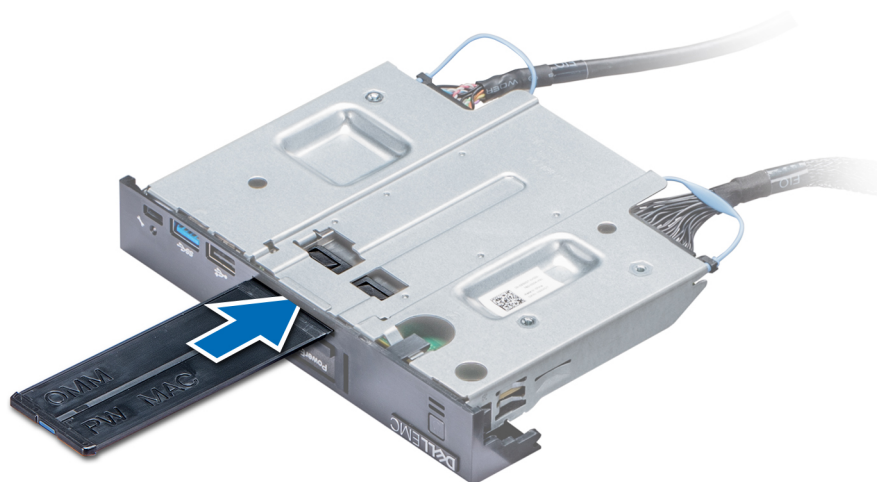

**Figure 88. Installing the information tag**

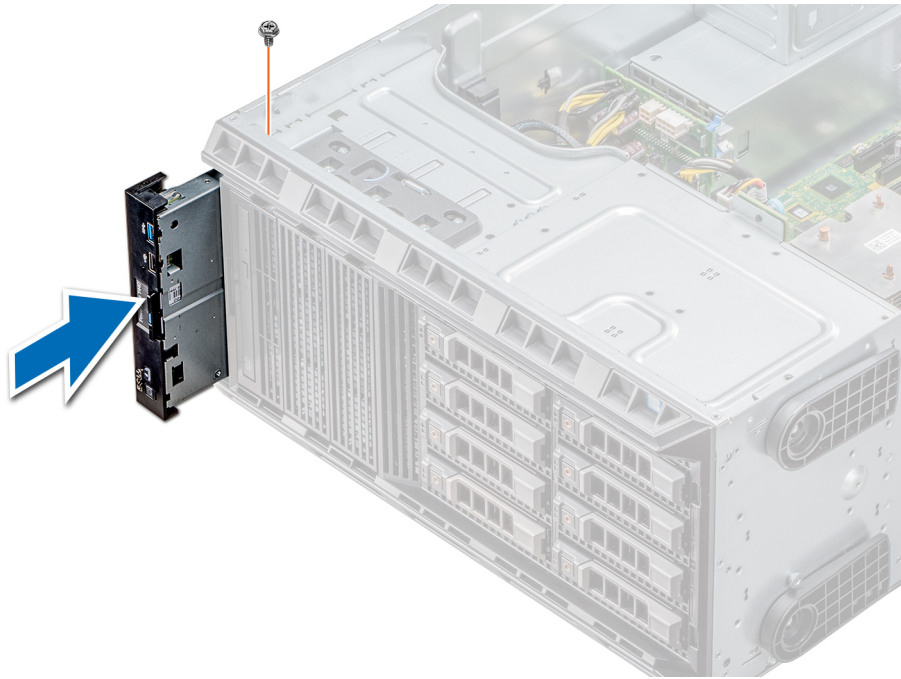

**Figure 89. Installing the control panel assembly**

2. To install the information tag, push the information tag into the control-panel slot.
3. Connect the control panel cable and the control panel USB cable to the control panel assembly.
4. Align and insert the control panel into the control panel slot in the chassis.
5. Secure the control panel to the chassis by using the screw.
6. Connect the control panel cable and the control panel USB cable to the system board.

#### Next steps

1. Follow the procedure listed in [After working inside your system](#).

## System board

### Removing the system board

#### Prerequisites

**CAUTION:** If you are using the Trusted Platform Module (TPM) with an encryption key, you may be prompted to create a recovery key during program or System Setup. Be sure to create and safely store this recovery key. If you replace this system board, you must supply the recovery key when you restart your system or program before you can access the encrypted data on your hard drives.

**CAUTION:** Do not attempt to remove the TPM plug-in module from the system board. Once the TPM plug-in module is installed, it is cryptographically bound to that specific system board. Any attempt to remove an installed TPM plug-in module breaks the cryptographic binding, and it cannot be reinstalled or installed on another system board.

1. Follow the safety guidelines listed in [Safety instructions](#).
2. Follow the procedure listed in [Before working inside your system](#).
3. Remove the following:
  - a. Air shroud
  - b. Internal cooling fan
  - c. Expansion card holder
  - d. Expansion cards, if installed
  - e. vFlash/IDSDM module

- f. Internal USB key, if installed
- g. Processors and heat sink modules
  -  **CAUTION:** To prevent damage to the processor pins when replacing a faulty system board, ensure that you cover the processor socket with the processor protective cap.
- h. Memory modules

### Steps

1. Disconnect all cables from the system board.

 **CAUTION:** Take care not to damage the system identification button while removing the system board from the chassis.

 **CAUTION:** Do not lift the system board by holding a memory module, processor, or other components.

2. Remove the screws that secure the system board to the chassis.

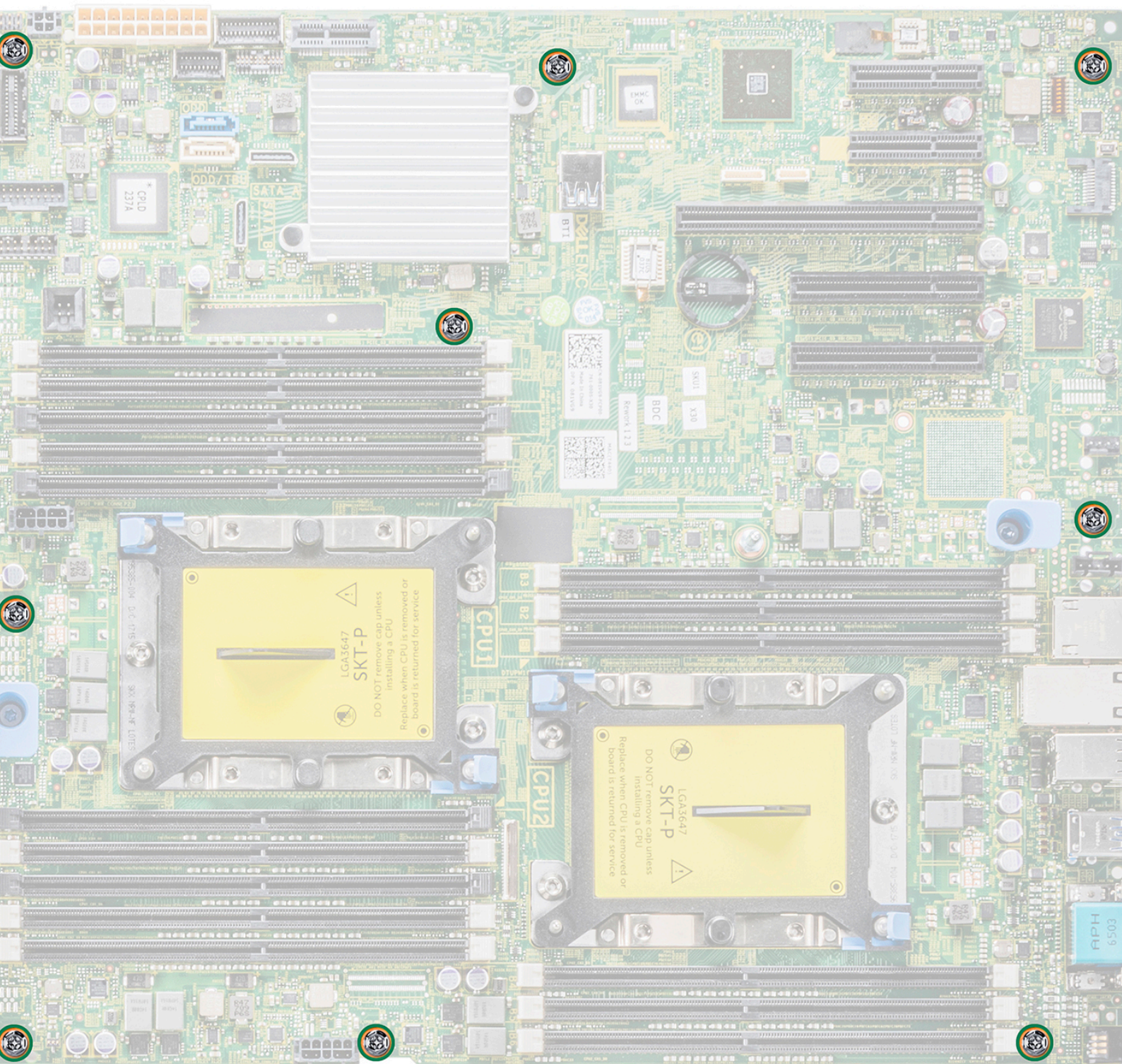

**Figure 90. System board screws**

3. Holding the post, incline the system board at an angle, and lift the system board out of the chassis.

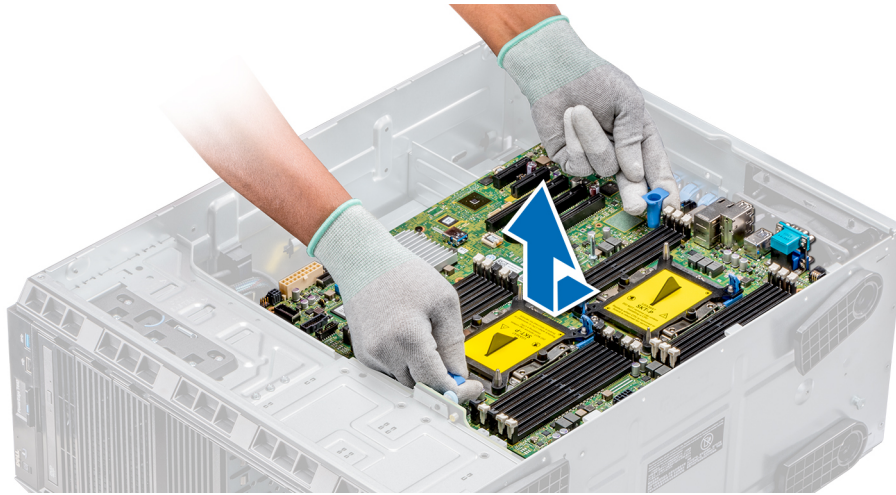

**Figure 91. Removing the system board**

### Next steps

Replace or Install the system board.

## Installing the system board

### Prerequisites

Follow the safety guidelines listed in [Safety instructions](#).

### Steps

1. Unpack the new system board assembly.

**CAUTION:** Do not lift the system board by holding a memory module, processor, or other components.

**CAUTION:** Take care not to damage the system identification button while placing the system board into the system.

2. Holding the post, incline the system board, and lower the system board into the chassis.
3. Holding the system board holder, push the system board toward the back of the system such that the ports on the system board align with the corresponding slots on the chassis.

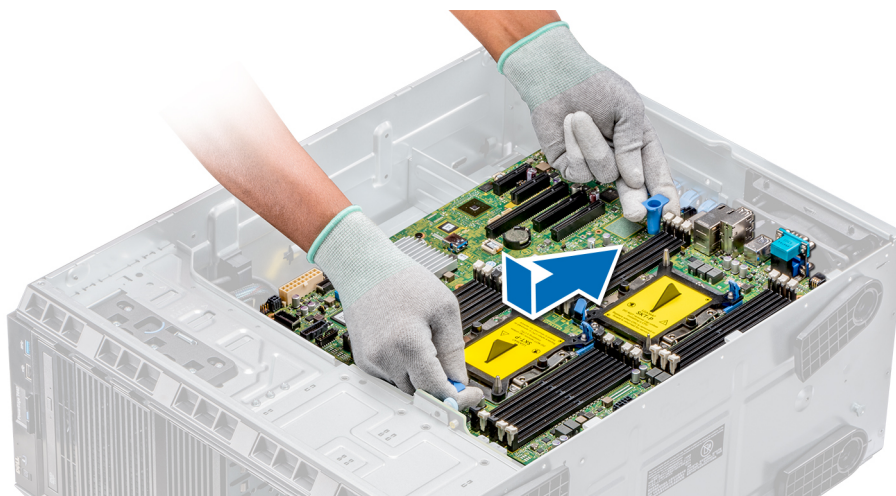

**Figure 92. Installing the system board**

4. Using the Phillips #2 screwdriver secure the system board to the chassis with screws.

## Next steps

1. Replace the following:
  - a. Trusted Platform Module (TPM)
  - b. Memory modules
  - c. Processors and heat sink modules
  - d. Internal USB key
  - e. vFlash/iDSDM module
  - f. Integrated storage controller card
  - g. Expansion cards, if installed
  - h. Expansion card holder
  - i. GPU card holder
  - j. Air shroud
2. Reconnect all cables to the system board.  
 **NOTE: Ensure that the cables inside the system are routed along the chassis wall and secured by using the cable securing bracket.**
3. Follow the procedure listed in [After working inside your system](#).
4. Ensure that you:
  - a. Use the Easy Restore feature to restore the Service Tag. For more information, see the [Restoring the Service Tag using Easy Restore](#) section.
  - b. If the Service Tag is not backed up in the backup flash device, enter the Service Tag manually. For more information, see the [Restoring the Service Tag using Easy Restore](#) section.
  - c. Update the BIOS and iDRAC versions.
  - d. Re-enable the Trusted Platform Module (TPM). For more information, see the [Upgrading the Trusted Platform Module](#) section.
5. Import your new or existing iDRAC Enterprise license.

For more information, see iDRAC User's Guide, at [www.dell.com/poweredgemanuals](http://www.dell.com/poweredgemanuals)

## Restoring the system using Easy Restore

The easy restore feature enables you to restore your service tag, license, UEFI configuration, and the system configuration data after replacing the system board. All data is backed up in a backup flash device automatically. If BIOS detects a new system board, and the service tag in the backup flash device, BIOS prompts the user to restore the backup information.

### About this task

Below is a list of options available:

- Restore the service tag, license, and diagnostics information, press **Y**
- Navigate to the Lifecycle Controller based restore options, press **N**.
- Restore data from a previously created **Hardware Server Profile**, press **F10**

 **NOTE: When the restore process is complete, BIOS prompts to restore the system configuration data.**

- To restore the system configuration data, press **Y**
- To use the default configuration settings, press **N**

 **NOTE: After the restore process is complete, system reboots.**

## Manually update the Service Tag

After replacing a system board, if Easy Restore fails, follow this process to manually enter the Service Tag, using **System Setup**.

### About this task

If you know the system service tag, use the **System Setup** menu to enter the service tag.

### Steps

1. Power on the system.
2. To enter the **System Setup**, press **F2**.
3. Click **Service Tag Settings**.

4. Enter the service tag.



**NOTE:** You can enter the service tag only when the Service Tag field is empty. Ensure that you enter the correct service tag. Once the service tag is entered, it cannot be updated or changed.

5. Click **OK**.

## Trusted Platform Module

### Upgrading the Trusted Platform Module

#### Prerequisites

1. Follow the safety guidelines listed in [Safety instructions](#).
2. Follow the procedure listed in [Before working inside your system](#).



#### NOTE:

- Ensure that your operating system supports the version of the TPM module being installed.
- Ensure that you download and install the latest BIOS firmware on your system.
- Ensure that the BIOS is configured to enable UEFI boot mode.

#### About this task



**CAUTION:** If you are using the Trusted Platform Module (TPM) with an encryption key, you may be prompted to create a recovery key during program or System Setup. Work with the customer to create and safely store this recovery key. When replacing this system board, you must supply the recovery key when you restart your system or program before you can access the encrypted data on your hard drives.



**CAUTION:** Once the TPM plug-in module is installed, it is cryptographically bound to that specific system board. Any attempt to remove an installed TPM plug-in module breaks the cryptographic binding, the removed TPM cannot be reinstalled or installed on another system board.

## Removing the TPM

#### Steps

1. Locate the TPM connector on the system board.
2. Press to hold the module down and remove the screw using the security Torx 8-bit shipped with the TPM module.
3. Slide the TPM module out from its connector.
4. Push the plastic rivet away from the TPM connector and rotate it 90° counterclockwise to release it from the system board.
5. Pull the plastic rivet out of its slot on the system board.

## Installing the TPM

#### Steps

1. To install the TPM, align the edge connectors on the TPM with the slot on the TPM connector.
2. Insert the TPM into the TPM connector such that the plastic rivet aligns with the slot on the system board.
3. Press the plastic rivet until the rivet snaps into place.

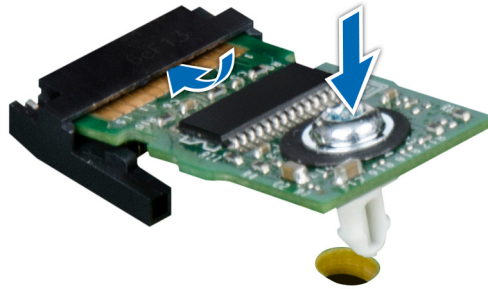

**Figure 93. Installing the TPM**

#### Next steps

1. Install the system board.
2. Follow the procedure listed in [After working inside your system](#).

## Initializing TPM for BitLocker users

#### Steps

Initialize the TPM.

For more information, see .

The **TPM Status** changes to **Enabled, Activated**.

## Initializing the TPM 1.2 for TXT users

#### Steps

1. While booting your system, press F2 to enter System Setup.
2. On the **System Setup Main Menu** screen, click **System BIOS > System Security Settings**.
3. From the **TPM Security** option, select **On with Pre-boot Measurements**.
4. From the **TPM Command** option, select **Activate**.
5. Save the settings.
6. Restart your system.
7. Enter **System Setup** again.
8. On the **System Setup Main Menu** screen, click **System BIOS > System Security Settings**.
9. From the **Intel TXT** option, select **On**.

## Converting the system from tower mode to rack mode

Your system can be converted from the tower mode to the rack mode.

To convert your system from the tower mode to the rack mode, you require the tower to rack conversion kit, which contains the following:

- Rack ears (left and right) with three screws each

# Converting the system from tower mode to rack mode

## Prerequisites

1. Follow the safety guidelines listed in [Safety instructions](#).
2. Follow the procedure listed in [Before working inside your system](#).
3. If installed, remove the system feet or caster wheels.

## Steps

1. Remove the control-panel assembly.
2. Install the rack slide cover by performing the following steps:
  - a) Slide the rack slide cover between the system's side cover and the chassis.
  - b) Slide the rack slide cover toward the back of the system until the tabs on rack slide cover locks with the tabs extending from the chassis.
3. Install the control panel assembly.
4. Install the rack ears by performing the following steps:
  - a) Align the three screw holes on the rack ears with the screw holes on the top and the bottom of system.
  - b) Using a Phillips #2 screwdriver, secure the rack ears to the system.



**Figure 94. Installing the system ears**

## Next steps

1. Install the system cover.
2. Install the system in the rack. For more information, see the Rack Installation Guide that is shipped with your system.
3. Follow the procedure listed in [After working inside your system](#).

# Updating BIOS

## About this task

To update the BIOS, perform the following steps:

## Steps

1. Copy the BIOS update file on a USB device.

2. Plug in the USB device into any of the USB ports on your system.
3. Power on your system.
4. While booting, press **F11** to enter the **Boot Manager**.
5. Go to **System Utilities** → **BIOS Update File Explorer**, and select the plugged in USB device.
6. From the **BIOS Update File Explorer**, select the **BIOS update file**.  
The **BIOS Update Utility** with the current and new version of BIOS is displayed.
7. Select **Continue BIOS Update** to install the BIOS update.

# Using system diagnostics

If you experience a problem with your system, run the system diagnostics before contacting Dell for technical assistance. The purpose of running system diagnostics is to test your system hardware without using additional equipment or risking data loss. If you are unable to fix the problem yourself, service and support personnel can use the diagnostics results to help you solve the problem.

## Topics:

- [Dell Embedded System Diagnostics](#)

## Dell Embedded System Diagnostics

 **NOTE:** The Dell Embedded System Diagnostics is also known as Enhanced Pre-boot System Assessment (ePSA) diagnostics.

The Embedded System Diagnostics provides a set of options for particular device groups or devices allowing you to:

- Run tests automatically or in an interactive mode
- Repeat tests
- Display or save test results
- Run thorough tests to introduce additional test options to provide extra information about the failed device(s)
- View status messages that inform you if tests are completed successfully
- View error messages that inform you of problems encountered during testing

## Running the Embedded System Diagnostics from Boot Manager

Run the Embedded System Diagnostics (ePSA) if your system does not boot.

### Steps

1. When the system is booting, press F11.
2. Use the up arrow and down arrow keys to select **System Utilities > Launch Diagnostics**.
3. Alternatively, when the system is booting, press F10, select **Hardware Diagnostics > Run Hardware Diagnostics**.  
The **ePSA Pre-boot System Assessment** window is displayed, listing all devices detected in the system. The diagnostics starts executing the tests on all the detected devices.

### Results

## Running the Embedded System Diagnostics from the Dell Lifecycle Controller

### Steps

1. As the system boots, press F10.
2. Select **Hardware Diagnostics → Run Hardware Diagnostics**.  
The **ePSA Pre-boot System Assessment** window is displayed, listing all devices detected in the system. The diagnostics starts executing the tests on all the detected devices.

# System diagnostic controls

<b>Menu</b>	<b>Description</b>
<b>Configuration</b>	Displays the configuration and status information of all detected devices.
<b>Results</b>	Displays the results of all tests that are run.
<b>System health</b>	Provides the current overview of the system performance.
<b>Event log</b>	Displays a time-stamped log of the results of all tests run on the system. This is displayed if at least one event description is recorded.

# Jumpers and connectors

This topic provides specific information about the jumpers. It also provides some basic information about jumpers and switches and describes the connectors on the various boards in the system. Jumpers on the system board help to disable the system and setup passwords. You must know the connectors on the system board to install components and cables correctly.

## Topics:

- System board jumpers and connectors
- System board jumper settings
- Disabling forgotten password

## System board jumpers and connectors

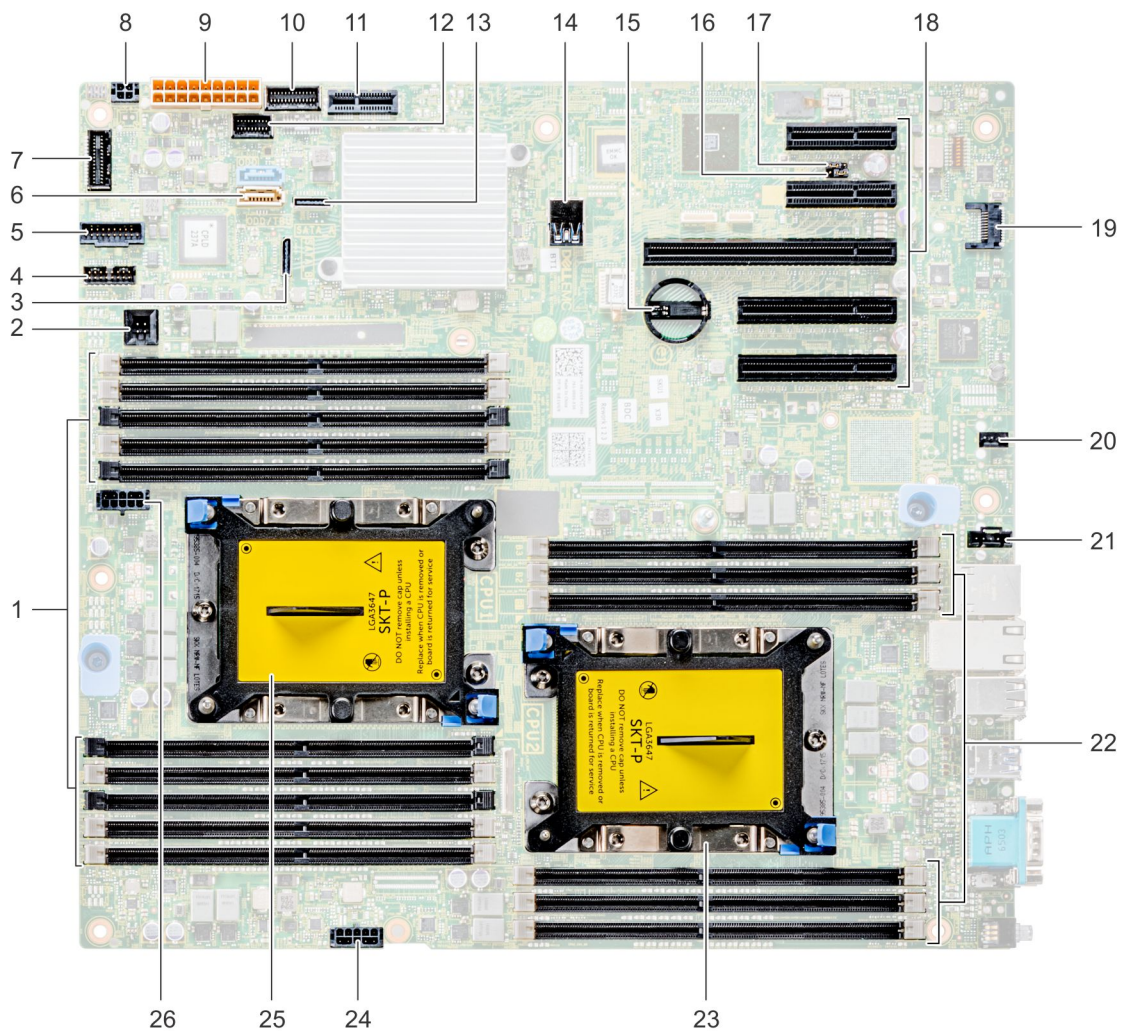

Figure 95. T440 system board jumpers and connectors





**Table 41. System board connectors**

Item	Connector	Description
1	DIMMs for Processor 1 channels 0,1,2,3,4,5	Memory slots A1-A10 for Processor 1
2	Intrusion switch	Intrusion switch connector
3	SATA B	Onboard SATA B connector
4	Backplane signal	Backplane signal connector
5	Front_USB	Front USB connector
6	SATA connector	SATA connector
7	Control panel	Control panel connector
8	ODD power	ODD power connector
9	System power	System power connector
10	PIB signal 2	PIB signal 2 connector
11	IDSDM+VFlash	IDSDM+VFlash connector
12	PIB signal 1	PIB signal 1 connector
13	SATA A	SATA A connector
14	Internal USB 3.0	Internal USB 3.0 connector
15	COIN Cell BATTERY	Coin cell battery
16	NVRAM_CLR	Clear NVRAM
17	PWRD_EN	Reset BIOS password
18	PCIe slots	PCIe slots 1 - 5
19	TPM	TPM connector
20	Fan 1	Internal fan connector
21	Fan 2	External fan connector
22	DIMMs for Processor 2 channels 0,1,2,4,5	Memory slots B1-B6 for Processor 2
23	Processor 2	Processor 2
24	Processor 2 PWR	Processor 2 Power connector
25	Processor 1	Processor 1
26	Processor 1 PWR	Processor 1 Power connector

## System board jumper settings

For information on resetting the password jumper to disable a password, see the [Disabling a forgotten password](#) section.

**Table 42. System board jumper settings**

Jumper	Setting	Description
PWRD_EN	 2 4 6 (default)	The BIOS password feature is enabled.
	 2 4 6	The BIOS password feature is disabled. iDRAC local access is unlocked at next AC power cycle. iDRAC password reset is enabled in F2 iDRAC settings menu.
NVRAM_CLR	 1 3 5 (default)	The BIOS configuration settings are retained at system boot.
	 1 3 5	The BIOS configuration settings are cleared at system boot.

## Disabling forgotten password

The software security features of the system include a system password and a setup password. The password jumper enables or disables password features and clears any password(s) currently in use.

### Prerequisites

**CAUTION:** Many repairs may only be done by a certified service technician. You should only perform troubleshooting and simple repairs as authorized in your product documentation, or as directed by the online or telephone service and support team. Damage due to servicing that is not authorized by Dell is not covered by your warranty. Read and follow the safety instructions that are shipped with your product.

### Steps

1. Power off the system, including any attached peripherals, and disconnect the system from the electrical outlet.
2. Remove the system cover.
3. Move the jumper on the system board jumper from pins 2 and 4 to pins 4 and 6.
4. Install the system cover.

The existing passwords are not disabled (erased) until the system boots with the jumper on pins 4 and 6. However, before you assign a new system and/or setup password, you must move the jumper back to pins 2 and 4.

**NOTE:** If you assign a new system and/or setup password with the jumper on pins 4 and 6, the system disables the new password(s) the next time it boots.

5. Reconnect the system to its electrical outlet and power on the system, including any attached peripherals.
6. Power off the system, including any attached peripherals, and disconnect the system from the electrical outlet.
7. Remove the system cover.
8. Move the jumper on the system board jumper from pins 4 and 6 to pins 2 and 4.
9. Install the system cover.
10. Reconnect the system to its electrical outlet and power on the system, including any attached peripherals.
11. Assign a new system and/or setup password.

# Getting help

## Topics:

- [Contacting Dell EMC](#)
- [Documentation feedback](#)
- [Accessing system information by using QRL](#)
- [Receiving automated support with SupportAssist](#)
- [Recycling or End-of-Life service information](#)

## Contacting Dell EMC

Dell EMC provides several online and telephone based support and service options. If you do not have an active internet connection, you can find contact information about your purchase invoice, packing slip, bill, or Dell EMC product catalog. Availability varies by country and product, and some services may not be available in your area. To contact Dell EMC for sales, technical assistance, or customer service issues:

### Steps

1. Go to [www.dell.com/support/home](http://www.dell.com/support/home).
2. Select your country from the drop-down menu on the lower right corner of the page.
3. For customized support:
  - a) Enter your system Service Tag in the **Enter your Service Tag** field.
  - b) Click **Submit**.  
The support page that lists the various support categories is displayed.
4. For general support:
  - a) Select your product category.
  - b) Select your product segment.
  - c) Select your product.  
The support page that lists the various support categories is displayed.
5. For contact details of Dell EMC Global Technical Support:
  - a) Click [Global Technical Support](#).
  - b) The **Contact Technical Support** page is displayed with details to call, chat, or e-mail the Dell EMC Global Technical Support team.

## Documentation feedback

You can rate the documentation or write your feedback on any of our Dell EMC documentation pages and click **Send Feedback** to send your feedback.

## Accessing system information by using QRL

You can use the Quick Resource Locator (QRL) located on the information tag in the front of the T440, to access the information about the Dell EMC PowerEdge T440.

### Prerequisites

Ensure that your smartphone or tablet has the QR code scanner installed.

The QRL includes the following information about your system:

- How-to videos
- Reference materials, including the Installation and Service Manual, and mechanical overview
- Your system service tag to quickly access your specific hardware configuration and warranty information

- A direct link to Dell to contact technical assistance and sales teams

### Steps

1. Go to [www.dell.com/qrl](http://www.dell.com/qrl) and navigate to your specific product or
2. Use your smartphone or tablet to scan the model-specific Quick Resource (QR) code on your system or in the Quick Resource Locator section.

## Quick Resource Locator for Dell EMC PowerEdge T440 system

### Quick Resource Locator for Dell EMC PowerEdge T440 system



## Receiving automated support with SupportAssist

Dell EMC SupportAssist is an optional Dell EMC Services offering that automates technical support for your Dell EMC server, storage, and networking devices. By installing and setting up a SupportAssist application in your IT environment, you can receive the following benefits:

- **Automated issue detection** — SupportAssist monitors your Dell EMC devices and automatically detects hardware issues, both proactively and predictively.
- **Automated case creation** — When an issue is detected, SupportAssist automatically opens a support case with Dell EMC Technical Support.
- **Automated diagnostic collection** — SupportAssist automatically collects system state information from your devices and uploads it securely to Dell EMC. This information is used by Dell EMC Technical Support to troubleshoot the issue.
- **Proactive contact** — A Dell EMC Technical Support agent contacts you about the support case and helps you resolve the issue.

The available benefits vary depending on the Dell EMC Service entitlement purchased for your device. For more information about SupportAssist, go to [www.dell.com/supportassist](http://www.dell.com/supportassist).

## Recycling or End-of-Life service information

Take back and recycling services are offered for this product in certain countries. If you want to dispose of system components, visit [www.dell.com/recyclingworldwide](http://www.dell.com/recyclingworldwide) and select the relevant country.