

# Dell PowerEdge T320 Getting Started Guide

Regulatory Model: E20S Series  
Regulatory Type: E20S001



# Notes, Cautions, and Warnings



**NOTE:** A NOTE indicates important information that helps you make better use of your computer.



**CAUTION:** A CAUTION indicates either potential damage to hardware or loss of data and tells you how to avoid the problem.



**WARNING:** A WARNING indicates a potential for property damage, personal injury, or death.

© 2012 Dell Inc.

Trademarks used in this text: Dell™, the Dell logo, Dell Boomi™, Dell Precision™, OptiPlex™, Latitude™, PowerEdge™, PowerVault™, PowerConnect™, OpenManage™, EqualLogic™, Compellent™, KACE™, FlexAddress™, Force10™ and Vostro™ are trademarks of Dell Inc. Intel®, Pentium®, Xeon®, Core® and Celeron® are registered trademarks of Intel Corporation in the U.S. and other countries. AMD® is a registered trademark and AMD Opteron™, AMD Phenom™ and AMD Sempron™ are trademarks of Advanced Micro Devices, Inc. Microsoft®, Windows®, Windows Server®, Internet Explorer®, MS-DOS®, Windows Vista® and Active Directory® are either trademarks or registered trademarks of Microsoft Corporation in the United States and/or other countries. Red Hat® and Red Hat® Enterprise Linux® are registered trademarks of Red Hat, Inc. in the United States and/or other countries. Novell® and SUSE® are registered trademarks of Novell Inc. in the United States and other countries. Oracle® is a registered trademark of Oracle Corporation and/or its affiliates. Citrix®, Xen®, XenServer® and XenMotion® are either registered trademarks or trademarks of Citrix Systems, Inc. in the United States and/or other countries. VMware®, Virtual SMP®, vMotion®, vCenter® and vSphere® are registered trademarks or trademarks of VMware, Inc. in the United States or other countries. IBM® is a registered trademark of International Business Machines Corporation.

2012 - 10

Rev. A02

# Installation And Configuration

**⚠ WARNING:** Before performing the following procedure, review the safety instructions that came with the system.

## Unpacking The System

Unpack your system and identify each item.

## Optional—Rack Configuration

If you are using the optional rack configuration, assemble the rails and install the system in the rack following the safety instructions and the rack installation instructions provided with your system.

## Stabilizing The Tower System

**⚠ WARNING:** The tower system has four feet on its bottom panel that can be extended outward to help properly stabilize the system. Failure to extend the feet poses the risk of having the system tip over, possibly causing bodily injury or damage to the system.

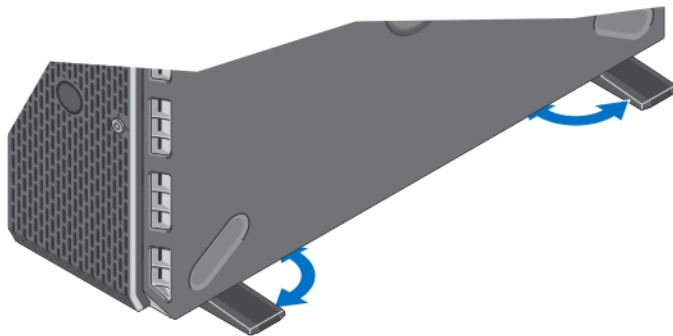
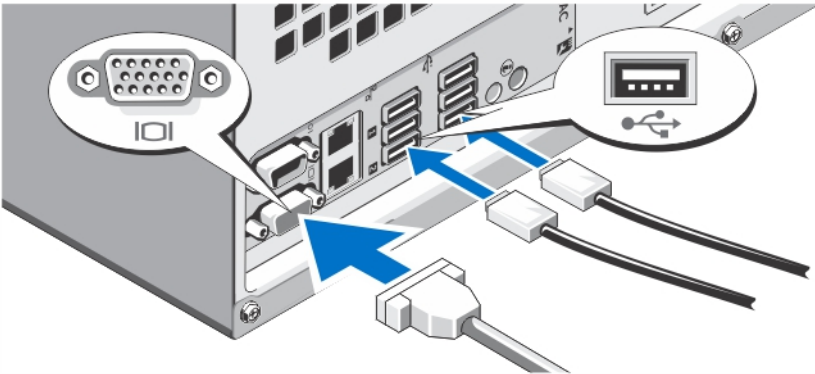

Figure 1. Extending the Feet of the Tower System

## Optional—Connecting The Keyboard, Mouse, And Monitor

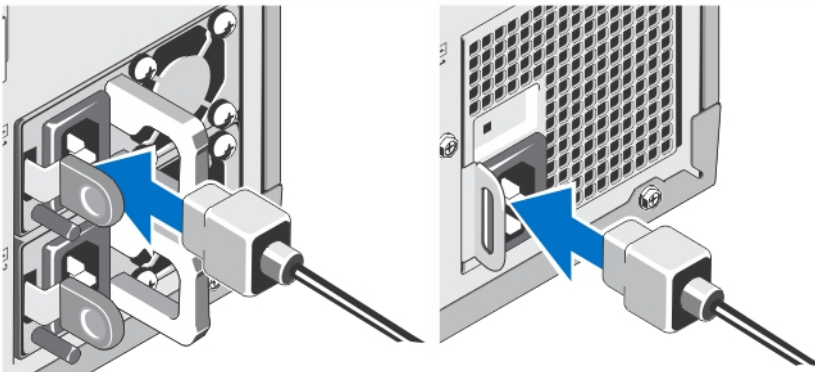

**Figure 2. Connecting the Keyboard, Mouse, and Monitor**

Connect the keyboard, mouse, and monitor (optional).

The connectors on the back of your system have icons indicating which cable to plug into each connector. Be sure to tighten the screws (if any) on the monitor's cable connector.

## Connecting The Power Cable(s)



**Figure 3. Connecting the Power Cable(s)**

Connect the system's power cable(s) to the system and, if a monitor is used, connect the monitor's power cable to the monitor.

## Securing The Power Cable(s)

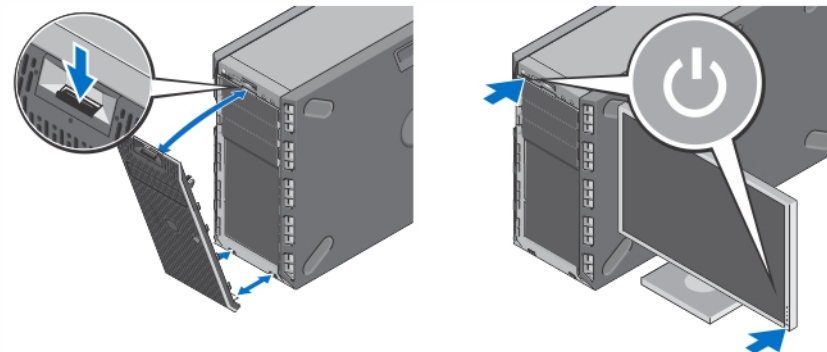

**Figure 4. Securing the Power Cable(s)**

Bend the system power cable into a loop as shown in the illustration and secure the cable to the bracket using the provided strap.

Plug the other end of the power cable(s) into a grounded electrical outlet or a separate power source such as an uninterruptible power supply (UPS) or a power distribution unit (PDU).

## Turning On The System



**Figure 5. Turning on the System**

If installed, remove the optional bezel. Press the power button. The power indicator should light.

## Installing The Optional Bezel

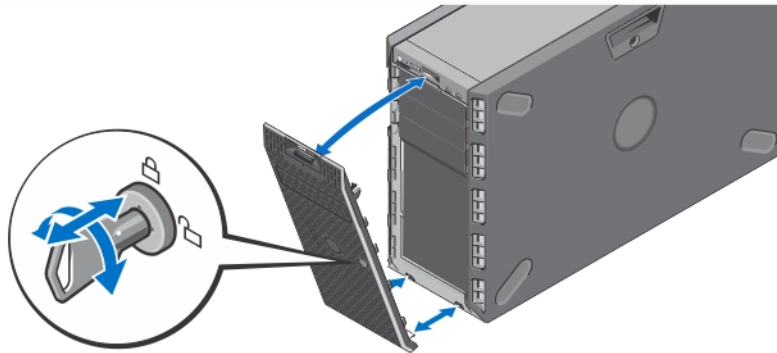

**Figure 6. Installing the Bezel**

Install the bezel (optional).

## Complete The Operating System Setup

If you purchased a preinstalled operating system, see the documentation associated with the operating system. To install an operating system for the first time, see the installation and configuration documentation for your operating system. Be sure the operating system is installed before installing hardware or software not purchased with the system.

 **NOTE:** See [dell.com/ossupport](http://dell.com/ossupport) for the latest information on supported operating systems.

## Dell Software License Agreement

Before using your system, read the Dell Software License Agreement that came with your system. You must consider any media of Dell-installed software as BACKUP copies of the software installed on your system's hard drive. If you do not accept the terms of the agreement, call the customer assistance telephone number. For customers in the United States, call 800-WWW-DELL (800-999-3355). For customers outside the United States, visit [support.dell.com](http://support.dell.com) and select your country or region from the bottom of the page.

## Other Information You May Need

 **WARNING:** See the safety and regulatory information that shipped with your system. Warranty information may be included within this document or as a separate document.

- The *Owner's Manual* provides information about system features and describes how to troubleshoot the system and install or replace system components. This document is available online at [support.dell.com/manuals](http://support.dell.com/manuals).
- The rack documentation included with your rack solution describes how to install your system into a rack, if required.
- Any media that ships with your system that provides documentation and tools for configuring and managing your system, including those pertaining to the operating system, system management software, system updates, and system components that you purchased with your system.

 **NOTE:** Always check for updates on [support.dell.com/manuals](http://support.dell.com/manuals) and read the updates first because they often supersede information in other documents.

 **NOTE:** When upgrading your system, it is recommended that you download and install the latest BIOS, driver, and systems management firmware on your system from [support.dell.com](http://support.dell.com).

## Obtaining Technical Assistance

If you do not understand a procedure in this guide or if the system does not perform as expected, see your *Owner's Manual*. Dell offers comprehensive hardware training and certification. See [dell.com/training](http://dell.com/training) for more information. This service may not be offered in all locations.

## NOM Information



The following information is provided on the device described in this document in compliance with the requirements of the official Mexican standards (NOM):

Importer:	Dell Inc. de México, S.A. de C.V. Paseo de la Reforma 2620 -11º Piso Col. Lomas Altas 11950 México, D.F.
Model number:	E20S
Supply voltage:	100–240 V CA (with 350 W, 495 W, and 750 W AC power supply units)
Frequency:	50 Hz/60 Hz (AC power supply unit)
Current consumption:	10 A – 5 A (X 2) (with 750 W AC power supply unit) 6.5 A – 3 A (X 2) (with 495 W AC power supply unit) 4.8 A – 2.4 A (with 350 W non-redundant AC power supply unit)

## Technical Specifications

 **NOTE:** The following specifications are only those required by law to ship with your system. For a complete and current listing of the specifications for your system, go to [support.dell.com](http://support.dell.com).

---

Power	
AC Power Supply (per power supply)	
Wattage	350 W, 495 W, or 750 W
Heat dissipation	1908 BTU/hr maximum (495 W power supply) 2891 BTU/hr maximum (750 W power supply) 1456 BTU/hr maximum (350 W non-redundant power supply)
 <b>NOTE:</b> Heat dissipation is calculated using the power supply wattage rating.	
Voltage	100 V AC to 240 V AC, autoranging, 50 Hz/60 Hz
 <b>NOTE:</b> This system is also designed to be connected to IT power systems with a phase to phase voltage not exceeding 230 V.	
Battery	
Coin-cell battery	3 V CR2032 Lithium coin cell

---

**Physical**

---

**Tower**

Height	443.3 mm (17.45 inch) with feet 430.3 mm (16.94 inch) without feet
Width	304.5 mm (11.99 inch) with feet opened 218 mm (8.58 inch) with feet closed
Depth	542.2 mm (21.35 inch) without bezel 558.6 mm (21.99 inch) with bezel

**Rack**

Height	218 mm (8.58 inch)
Width	430.3 mm (16.94 inch) without ears 482.4 mm (18.99 inch) with ears
Depth (minimum)	538.4 mm (21.2 inch) from back of rack ears and with cabled power supply module
Depth (maximum)	584.05 mm (22.99 inch) from back of rack ears and with external system fan
Maximum configuration weight	29.55 kg (65.14 lb)
Empty weight	15.6 kg (34.39 lb)

---

**Environmental**

---

 **NOTE:** Your system is capable of 40 °C and 45 °C excursion operation for fresh air cooled data centers. For more information, see the Owner's Manual.

 **NOTE:** For additional information about environmental measurements for specific system configurations, see [dell.com/environmental\\_datasheets](http://dell.com/environmental_datasheets).

**Temperature**

Operating	Continuous operation: 10 °C to 35 °C. De-rate maximum allowable dry bulb temperature at 1 °C/300 m above 900 m (1 °F /550 ft).
-----------	--

 **NOTE:** For information on supported expanded operating temperature range and configurations, see [support.dell.com/manuals](http://support.dell.com/manuals).

Storage	–40 °C to 65 °C (–40 °F to 149 °F) with a maximum temperature gradation of 20 °C per hour.
---------	--

**Relative humidity**

Operating	10% to 80% relative humidity (RH), with 26 °C maximum dew point.
Storage	5% to 95% relative humidity ambient with 33 °C (91 °F) maximum dew point.

**Maximum vibration**



<b>Environmental</b>	
Operating	0.26 Grms at 5 Hz to 350 Hz (all operation orientations).
Storage	1.87 Grms at 10 Hz to 500 Hz for 15 min (all six sides tested).
<b>Maximum shock</b>	
Operating	One shock pulse in the positive z axis (one pulse on each side of the system) of 31 G for 2.6 ms in the operational orientation.
Storage	<p>Six consecutively executed shock pulses in the positive and negative x, y, and z axes (one pulse on each side of the system) of 71 G for up to 2 ms.</p> <p>Six consecutively executed shock pulses in the positive and negative x, y, and z axes (one pulse on each side of the system) of 22 G faired square wave pulse with velocity change at 200 inches/second (508 centimeters/second).</p>
<b>Altitude</b>	
Operating	<p>–15.2 m to 3048 m (–50 to 10,000 ft).</p> <p> <b>NOTE:</b> For altitudes above 2950 ft, the maximum operating temperature is derated 1 °F/550 ft.</p>
Storage	–15.2 m to 10,668 m (–50 ft to 35,000 ft).
<b>Airborne contaminant level</b>	
Class	G1 as defined by ISA-S71.04-1985.