

# Dell EMC PowerEdge R840

## Installation and Service Manual

## Notes, cautions, and warnings

 **NOTE:** A NOTE indicates important information that helps you make better use of your product.

 **CAUTION:** A CAUTION indicates either potential damage to hardware or loss of data and tells you how to avoid the problem.

 **WARNING:** A WARNING indicates a potential for property damage, personal injury, or death.

© 2018 - 2019 Dell Inc. or its subsidiaries. All rights reserved. Dell, EMC, and other trademarks are trademarks of Dell Inc. or its subsidiaries. Other trademarks may be trademarks of their respective owners.

|  |           |
|--|-----------|
| <b>1 About this document.....</b>                            | <b>8</b>  |
| <b>2 Dell EMC PowerEdge R840 system overview.....</b>        | <b>9</b>  |
| Front view of the system.....                                | 9         |
| Control panels.....  | 10        |
| LCD panel.....   | 11        |
| Rear view of the system.....                                 | 13        |
| Inside the system.....                                       | 14        |
| Locating the Service Tag of your system.....                 | 15        |
| System Information Label.....                                | 16        |
| <b>3 Initial system setup and configuration.....</b>         | <b>19</b> |
| Setting up your system.....                                  | 19        |
| iDRAC configuration.....                                     | 19        |
| Options to set up iDRAC IP address.....                      | 19        |
| Log in to iDRAC.....   | 20        |
| Options to install the operating system.....                 | 20        |
| Methods to download firmware and drivers.....                | 20        |
| Downloading drivers and firmware.....                        | 21        |
| <b>4 Pre-operating system management applications.....</b>   | <b>22</b> |
| Options to manage the pre-operating system applications..... | 22        |
| System Setup.....  | 22        |
| View System Setup.....                                       | 22        |
| System Setup details.....                                    | 22        |
| System BIOS.....   | 23        |
| iDRAC Settings utility.....                                  | 41        |
| Device Settings.....   | 41        |
| Dell Lifecycle Controller.....                               | 41        |
| Embedded System Management.....                              | 41        |
| Boot Manager.....  | 41        |
| View the boot manager.....                                   | 41        |
| Boot Manager main menu.....                                  | 42        |
| One-shot UEFI Boot menu.....                                 | 42        |
| System Utilities.....  | 42        |
| PXE boot.....  | 42        |
| <b>5 Installing and removing system components.....</b>      | <b>43</b> |
| Safety instructions.....                                     | 43        |
| Before working inside your system.....                       | 43        |
| After working inside your system.....                        | 43        |
| Recommended tools.....                                       | 44        |
| Optional front bezel.....                                    | 44        |
| Removing front bezel.....                                    | 44        |

|  |    |
|--|----|
| Installing the front bezel.....                              | 45 |
| System cover.....  | 46 |
| Removing the system cover.....                               | 46 |
| Installing system cover.....                                 | 47 |
| Air shroud.....  | 48 |
| Removing the non-GPU air shroud.....                         | 48 |
| Installing the non-GPU air shroud.....                       | 49 |
| Removing the GPU air shroud.....                             | 50 |
| Installing the GPU air shroud.....                           | 52 |
| Cooling fan assembly.....                                    | 53 |
| Removing the cooling fan assembly.....                       | 53 |
| Installing the cooling fan assembly.....                     | 54 |
| Cooling fans.....  | 55 |
| Removing a cooling fan.....                                  | 55 |
| Installing a cooling fan.....                                | 56 |
| NVDIMM-N battery.....  | 57 |
| Removing the NVDIMM-N battery.....                           | 57 |
| Installing NVDIMM-N battery.....                             | 58 |
| Drives.....  | 60 |
| Removing a drive blank.....                                  | 60 |
| Installing a drive blank.....                                | 61 |
| Removing a drive carrier.....                                | 61 |
| Installing a drive carrier.....                              | 62 |
| Removing the drive from the drive carrier.....               | 63 |
| Installing a drive into the drive carrier.....               | 64 |
| Rear drive cage.....   | 65 |
| Removing the rear drive cage.....                            | 65 |
| Installing the rear drive cage.....                          | 66 |
| System memory.....   | 67 |
| General memory module installation guidelines.....           | 69 |
| NVDIMM-N memory module installation guidelines .....         | 69 |
| DCPMM installation guidelines .....                          | 72 |
| Mode-specific guidelines.....                                | 75 |
| Removing a memory module.....                                | 78 |
| Installing a memory module.....                              | 79 |
| Expansion cards and expansion card risers.....               | 80 |
| Expansion card installation guidelines.....                  | 81 |
| Removing expansion card from the expansion card riser.....   | 84 |
| Installing expansion card into the expansion card riser..... | 86 |
| Removing the expansion card risers.....                      | 87 |
| Installing the expansion card risers.....                    | 90 |
| Removing a PCIe expansion card.....                          | 92 |
| Installing a PCIe expansion card.....                        | 94 |
| GPU card installation guidelines.....                        | 95 |
| Removing a GPU.....  | 95 |
| Installing a GPU.....  | 96 |
| Optional M.2 SSD module.....                                 | 97 |
| Removing the M.2 SSD module.....                             | 97 |
| Installing the M.2 SSD module.....                           | 98 |
| Processors and heat sinks.....                               | 99 |

|   |     |
|---|-----|
| Removing a processor and heat sink module.....                      | 100 |
| Removing the processor from the processor and heat sink module..... | 101 |
| Installing the processor into a processor and heat sink module..... | 102 |
| Installing a processor and heat sink module.....                    | 105 |
| Optional IDSDM or vFlash module.....                                | 107 |
| Removing IDSDM or vFlash module.....                                | 107 |
| Installing IDSDM or vFlash module.....                              | 108 |
| Removing the MicroSD card.....                                      | 108 |
| Installing the MicroSD card.....                                    | 109 |
| Network daughter card.....  | 110 |
| Removing network daughter card.....                                 | 110 |
| Installing network daughter card.....                               | 111 |
| Drive backplane.....  | 112 |
| Drive mapping.....  | 113 |
| Removing drive backplane .....                                      | 114 |
| Installing drive backplane.....                                     | 115 |
| Cable routing.....  | 117 |
| System battery.....   | 122 |
| Replacing system battery.....                                       | 122 |
| Optional USB 3.0 module.....  | 123 |
| Removing USB 3.0 module.....  | 123 |
| Installing USB 3.0 module.....                                      | 124 |
| Optional internal USB memory key.....                               | 125 |
| Replacing optional internal USB memory key.....                     | 125 |
| Optional optical drive.....   | 126 |
| Removing optical drive.....   | 126 |
| Installing optical drive.....                                       | 127 |
| Power supply units.....   | 127 |
| Hot spare feature.....  | 128 |
| Removing a power supply unit blank.....                             | 128 |
| Installing a power supply unit blank.....                           | 129 |
| Removing power supply unit.....                                     | 129 |
| Installing power supply unit.....                                   | 130 |
| Wiring instructions for a DC power supply unit.....                 | 131 |
| Power Interposer Board.....   | 132 |
| Removing Power Interposer Board.....                                | 132 |
| Installing Power Interposer Board.....                              | 133 |
| System board.....   | 134 |
| Removing system board.....  | 134 |
| Installing system board.....  | 136 |
| Restore the service tag using Easy Restore.....                     | 137 |
| Manually updating Service Tag.....                                  | 137 |
| Trusted Platform Module.....  | 138 |
| Upgrading Trusted Platform Module.....                              | 138 |
| Initializing TPM for BitLocker users.....                           | 139 |
| Initializing the TPM 1.2 for TXT users.....                         | 139 |
| Control panel.....  | 139 |
| Removing left control panel.....                                    | 139 |
| Installing left control panel.....                                  | 140 |
| Removing right control panel.....                                   | 141 |

|  |            |
|--|------------|
| Installing right control panel.....                        | 142        |
| <b>6 Jumpers and connectors .....</b>                      | <b>144</b> |
| System board connectors.....                               | 145        |
| System board jumper settings.....                          | 147        |
| Disable a forgotten password.....                          | 147        |
| <b>7 Technical specifications.....</b>                     | <b>149</b> |
| Chassis dimensions.....                                    | 149        |
| Chassis weight.....  | 150        |
| Processor specifications.....                              | 150        |
| Supported operating systems.....                           | 150        |
| PSU specifications.....                                    | 150        |
| System battery specifications.....                         | 151        |
| Expansion card riser specifications.....                   | 151        |
| Memory specifications.....                                 | 152        |
| RAID controller specifications.....                        | 153        |
| Drive specifications.....                                  | 153        |
| Drives.....  | 153        |
| Optical drives.....  | 154        |
| Tape drives.....   | 154        |
| Ports and connectors specifications.....                   | 154        |
| USB ports.....   | 154        |
| NIC ports.....   | 155        |
| VGA ports.....   | 155        |
| Serial connector.....                                      | 155        |
| iDSDM or vFlash module.....                                | 155        |
| Video specifications.....                                  | 155        |
| Environmental specifications.....                          | 156        |
| Standard operating temperature.....                        | 157        |
| Expanded operating temperature.....                        | 157        |
| Particulate and gaseous contamination specifications ..... | 159        |
| <b>8 System diagnostics and indicator codes .....</b>      | <b>161</b> |
| Status LED indicators.....                                 | 161        |
| System health and system ID indicator codes.....           | 162        |
| iDRAC Quick Sync 2 indicator codes.....                    | 162        |
| iDRAC Direct LED indicator codes.....                      | 163        |
| NIC indicator codes.....                                   | 163        |
| Power supply unit indicator codes.....                     | 164        |
| Drive indicator codes.....                                 | 166        |
| System diagnostics.....                                    | 167        |
| Dell Embedded System Diagnostics.....                      | 167        |
| <b>9 Getting help.....</b>                                 | <b>168</b> |
| Contacting Dell.....                                       | 168        |
| Documentation feedback.....                                | 168        |
| Accessing system information by using QRL.....             | 168        |
| Receiving automated support with SupportAssist .....       | 169        |

|   |            |
|---|------------|
| Quick Resource Locator for PowerEdge R840 system..... | 169        |
| Recycling or End-of-Life service information.....     | 169        |
| <b>10 Documentation resources.....</b>                | <b>170</b> |

# About this document

This document provides an overview about the system, information about installing and replacing components, technical specifications, diagnostic tools, and guidelines to be followed while installing certain components.

# Dell EMC PowerEdge R840 system overview

The Dell EMC PowerEdge R840 system is a 2U server that supports up to:

- Four Intel Xeon scalable processors
- 48 DIMM slots
- Two AC or DC power supply units
- 26 SAS, SATA, Nearline SAS hard drives or SSDs including two rear accessible drives.

For more information about supported drives, see the [Technical specifications](#) section.

**NOTE:** All instances of SAS, SATA hard drives, NVMe and SSDs are referred to as drives in this document, unless specified otherwise.

## Topics:

- [Front view of the system](#)
- [Rear view of the system](#)
- [Inside the system](#)
- [Locating the Service Tag of your system](#)
- [System Information Label](#)

## Front view of the system

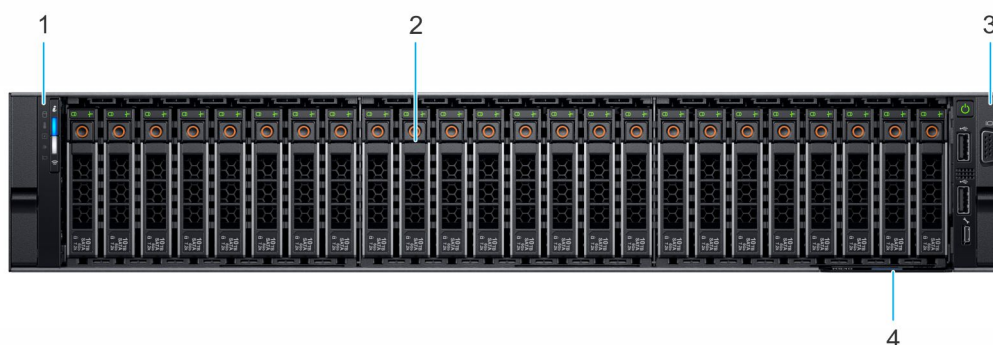

**Figure 1. Front view 24 x 2.5-inch drive system**

- |                        |                |
|------------------------|----------------|
| 1. Left control panel  | 2. Drives      |
| 3. Right control panel | 4. Service Tag |

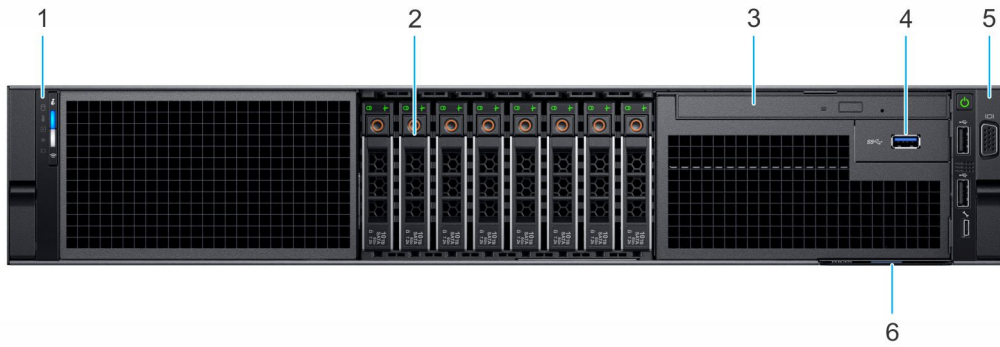

**Figure 2. Front view 8 x 2.5-inch drive system**

- |                             |                            |
|-----------------------------|----------------------------|
| 1. Left control panel       | 2. Drive slots             |
| 3. Optical drive (Optional) | 4. USB 3.0 port (Optional) |
| 5. Right control panel      | 6. Service Tag             |

**NOTE:** For more information about the ports and connectors, see the [Technical Specifications](#) section.

## Control panels

### Left control panel

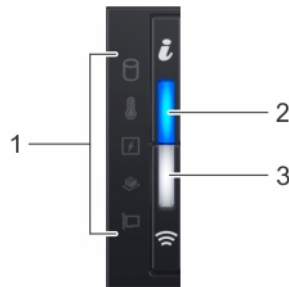
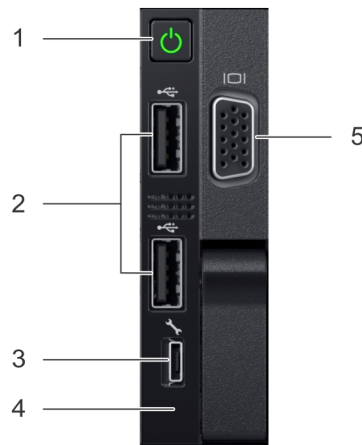

**Figure 3. Left control panel view (with optional iDRAC Quick Sync 2.0 indicator)**

1. Status LED indicators
2. System health and system ID indicator
3. iDRAC Quick Sync 2 wireless indicator (optional)

**NOTE:** iDRAC Quick Sync 2 feature allows you to manage your system using mobile devices. This feature is only available on certain configurations. For more information about the feature, see the [Integrated Dell Remote Access Controller User's Guide](#) at [www.dell.com/idracmanuals](http://www.dell.com/idracmanuals).

## Right control panel view



**Figure 4. Right control panel view**

- |                      |                     |
|----------------------|---------------------|
| 1. Power button      | 2. USB 2.0 port (2) |
| 3. iDRAC Direct port | 4. iDRAC Direct LED |
| 5. VGA port          |                     |

**NOTE:** For more information on the ports, see the [Technical Specifications](#) section.

## LCD panel

The LCD panel provides system information, status, and error messages to indicate if the system is functioning correctly or requires attention. The LCD panel can also be used to configure or view the system's iDRAC IP address. For information about the event and error messages generated by the system firmware and agents that monitor system components, go to [qrl.dell.com](http://qrl.dell.com) > **Look Up** > **Error Code**, type the error code, and then click **Look it up**.

The LCD panel is available only on the optional front bezel. The optional front bezel is hot pluggable.

The statuses and conditions of the LCD panel are outlined here:

- The LCD backlight is white during normal operating conditions.
  - When the system needs attention, the LCD backlight turns amber, and displays an error code followed by descriptive text.
  - NOTE:** If the system is connected to a power source and an error is detected, the LCD turns amber regardless of whether the system is turned on or off.
  - When the system turns off and there are no errors, LCD enters the standby mode after five minutes of inactivity. Press any button on the LCD to turn it on.
  - If the LCD panel stops responding, remove the bezel and reinstall it.
- If the problem persists, see [Getting help](#).
- The LCD backlight remains off if LCD messaging is turned off using the iDRAC utility, the LCD panel, or other tools.

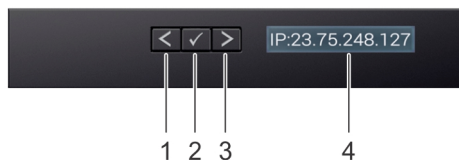

**Figure 5. LCD panel features**

**Table 1. LCD panel features**



| Item | Button or display | Description                                      |
|------|-------------------|--|
| 1    | Left              | Moves the cursor back in one-step increments.    |
| 2    | Select            | Selects the menu item highlighted by the cursor. |

| Item | Button or display | Description   |
|------|-------------------|---|
| 3    | Right             | <p>Moves the cursor forward in one-step increments.</p> <p>During message scrolling:</p> <ul style="list-style-type: none"> <li>Press and hold the right button to increase scrolling speed.</li> <li>Release the button to stop.</li> </ul> <p><b>NOTE:</b> The display stops scrolling when the button is released. After 45 seconds of inactivity, the display starts scrolling.</p> |
| 4    | LCD display       | Displays system information, status, and error messages or iDRAC IP address.  |

## Viewing Home screen

The **Home** screen displays user-configurable information about the system. This screen is displayed during normal system operation when there are no status messages or errors. When the system turns off and there are no errors, LCD enters the standby mode after five minutes of inactivity. Press any button on the LCD to turn it on.

### Steps

- To view the **Home** screen, press one of the three navigation buttons (Select, Left, or Right).
- To navigate to the **Home** screen from another menu, complete the following steps:
  - Press and hold the navigation button until the up arrow  is displayed.
  - Navigate to the **Home** icon  using the up arrow .
  - Select the **Home** icon.
  - On the **Home** screen, press the **Select** button to enter the main menu.

## Setup menu

**NOTE:** When you select an option in the Setup menu, you must confirm the option before proceeding to the next action.

| Option           | Description  |
|------------------|--|
| <b>iDRAC</b>     | Select <b>DHCP</b> or <b>Static IP</b> to configure the network mode. If <b>Static IP</b> is selected, the available fields are <b>IP</b> , <b>Subnet (Sub)</b> , and <b>Gateway (Gtw)</b> . Select <b>Setup DNS</b> to enable DNS and to view domain addresses. Two separate DNS entries are available.   |
| <b>Set error</b> | <p>Select <b>SEL</b> to view LCD error messages in a format that matches the IPMI description in the SEL. This enables you to match an LCD message with an SEL entry.</p> <p>Select <b>Simple</b> to view LCD error messages in a simplified user-friendly description. For information about the event and error messages generated by the system firmware and agents that monitor system components, go to <a href="http://qrl.dell.com">qrl.dell.com</a> &gt; <b>Look Up</b> &gt; <b>Error Code</b>, type the error code, and then click <b>Look it up</b>.</p> |
| <b>Set home</b>  | Select the default information to be displayed on the <b>Home</b> screen. See View menu section for the options and option items that can be set as the default on the <b>Home</b> screen.   |

## View menu

**NOTE:** When you select an option in the View menu, you must confirm the option before proceeding to the next action.

| Option          | Description  |
|-----------------|--|
| <b>iDRAC IP</b> | Displays the <b>IPv4</b> or <b>IPv6</b> addresses for iDRAC9. Addresses include <b>DNS (Primary and Secondary)</b> , <b>Gateway</b> , <b>IP</b> , and <b>Subnet</b> (IPv6 does not have Subnet). |
| <b>MAC</b>      | Displays the MAC addresses for <b>iDRAC</b> , <b>iSCSI</b> , or <b>Network</b> devices.  |
| <b>Name</b>     | Displays the name of the <b>Host</b> , <b>Model</b> , or <b>User String</b> for the system.  |
| <b>Number</b>   | Displays the <b>Asset tag</b> or the <b>Service tag</b> for the system.  |

| Option             | Description  |
|--------------------|--|
| <b>Power</b>       | Displays the power output of the system in BTU/hr or Watts. The display format can be configured in the <b>Set home</b> submenu of the <b>Setup</b> menu.      |
| <b>Temperature</b> | Displays the temperature of the system in Celsius or Fahrenheit. The display format can be configured in the <b>Set home</b> submenu of the <b>Setup</b> menu. |

## Rear view of the system

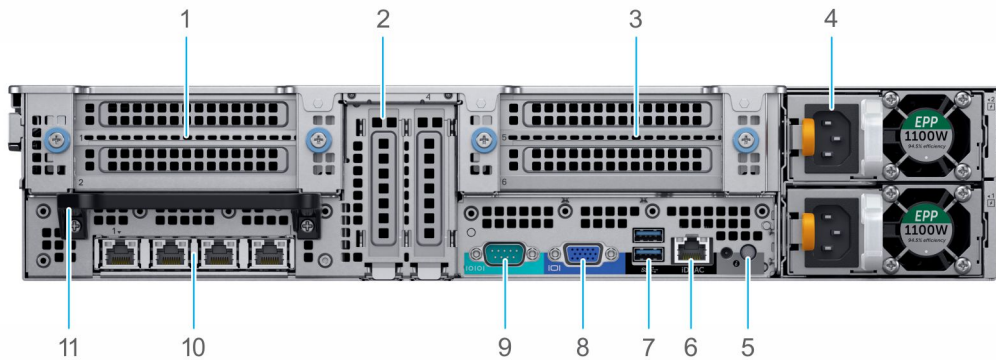

**Figure 6. Rear view of the 24 x 2.5-inch drive system**

- |   |   |
|---|---|
| 1. Riser 1 - Full-height PCIe expansion card (Slot 1 and 2)       | 2. Half-height PCIe expansion card slots located on the system board (Slot 3 and 4) |
| 3. Riser 2 - Full-height PCIe expansion card slots (Slot 5 and 6) | 4. Power supply units (2)   |
| 5. System identification button                                   | 6. iDRAC9 dedicated port  |
| 7. USB 3.0 ports (2)  | 8. VGA port   |
| 9. Serial port  | 10. NIC ports (4)   |
| 11. Rear handle   |   |

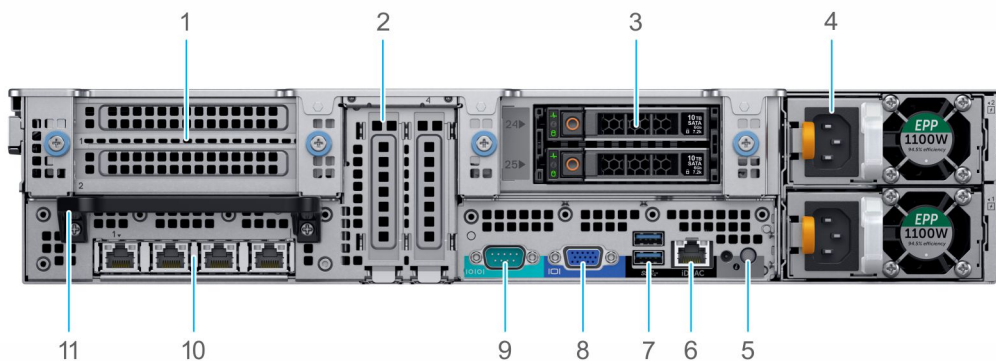

**Figure 7. Rear view of the 24 x 2.5-inch + 2 x 2.5-inch (rear) drive system**

- |   |   |
|---|---|
| 1. Riser 1 - Full-height PCIe expansion card slots (Slot 1 and 2) | 2. Half-height PCIe expansion card slots located on the system board (Slot 3 and 4) |
| 3. Rear drives (2)  | 4. Power supply units (2)   |
| 5. System identification button                                   | 6. iDRAC9 dedicated port  |
| 7. USB 3.0 ports (2)  | 8. VGA port   |
| 9. Serial port  | 10. NIC ports (4)   |
| 11. Rear handle   |   |

**NOTE:** For more information about the ports and connectors, see the [Technical Specifications](#) section.

# Inside the system

**NOTE:** Components that are hot swappable have orange touch points and the components that are not hot swappable have blue touch points.

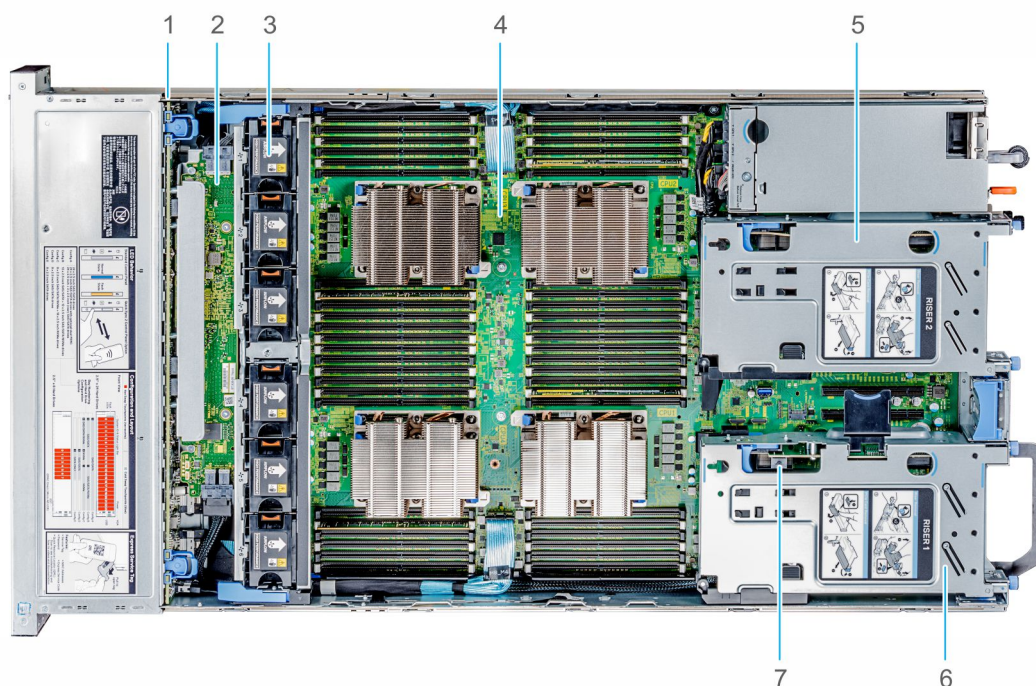

**Figure 8. Inside the system without rear drive cage**

- |                                       |                                       |
|---------------------------------------|---------------------------------------|
| 1. Drive backplane                    | 2. SAS Expander board                 |
| 3. Cooling fans (6)                   | 4. System board                       |
| 5. Full-height expansion card Riser 2 | 6. Full-height expansion card Riser 1 |
| 7. Intrusion switch                   |                                       |

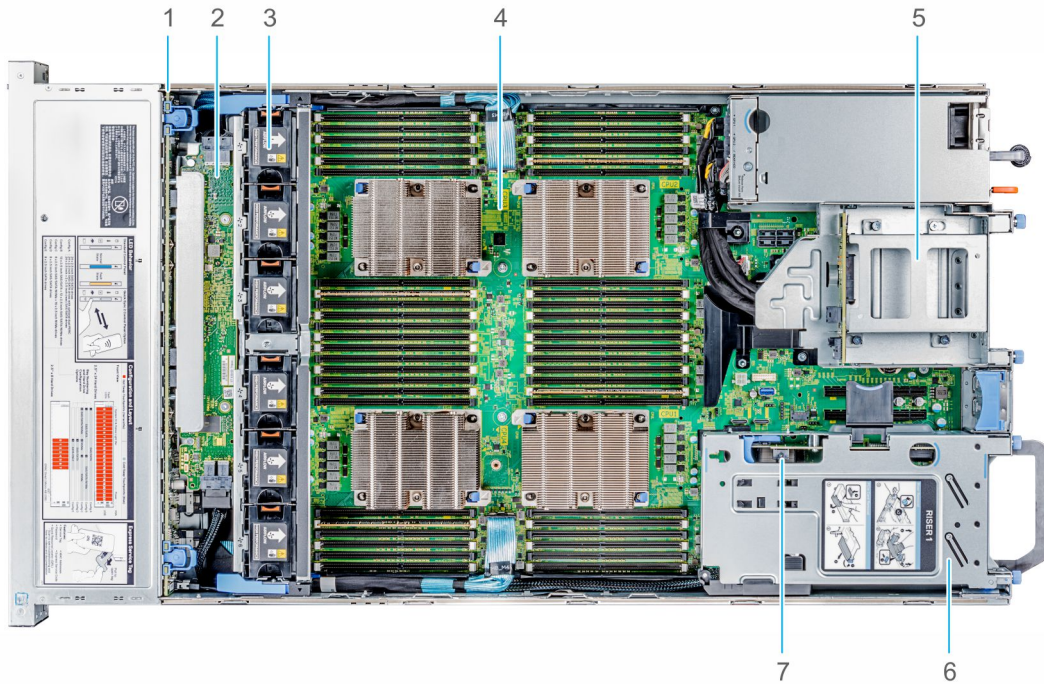

**Figure 9. Inside the system with rear drive cage**

- 1. Drive backplane
- 2. SAS Expander board
- 3. Cooling fans (6)
- 4. System board
- 5. Drive cage (rear)
- 6. Full-height expansion card Riser 1
- 7. Intrusion switch

## Locating the Service Tag of your system

You can identify your system using the unique Express Service Code and Service Tag. Pull out the information tag in the front of the system to view the Express Service Code and Service Tag. Alternatively, the information may be on a sticker on the chassis of the system.

The mini Enterprise Service Tag (EST) is found on the back of the system. This information is used by Dell to route support calls to the appropriate personnel.

**Figure 10. Locating Service Tag of your system**

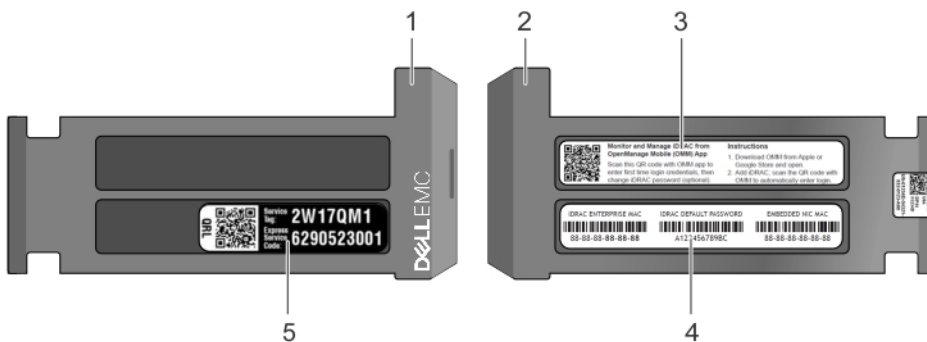

- 1. Information tag (top view)
- 2. Information tag (bottom view)
- 3. OpenManage Mobile (OMM) label (optional)
- 4. iDRAC MAC address and iDRAC secure password label

**NOTE:** If you have opted for secure default access to iDRAC, the iDRAC secure default password is available on the back of the system Information tag. This section of label will be blank, if you have not opted for secure default access to iDRAC, then the default user name and password are root and calvin.

# System Information Label

## PowerEdge R840 – Front system information label

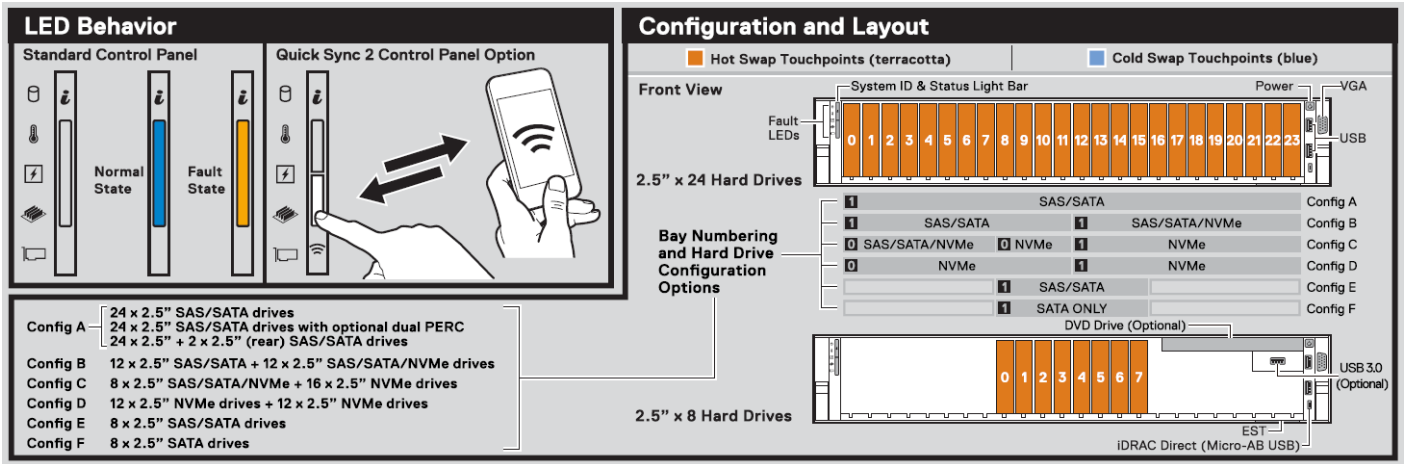

Figure 11. LED behavior, and Configuration and Layout

## PowerEdge R840 – Service information

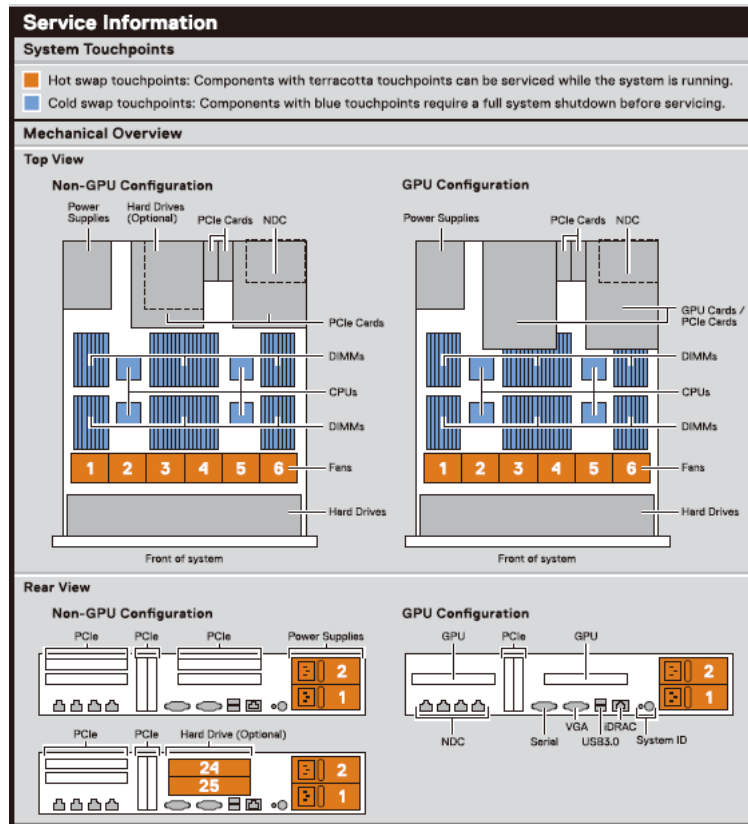

Figure 12. Mechanical overview

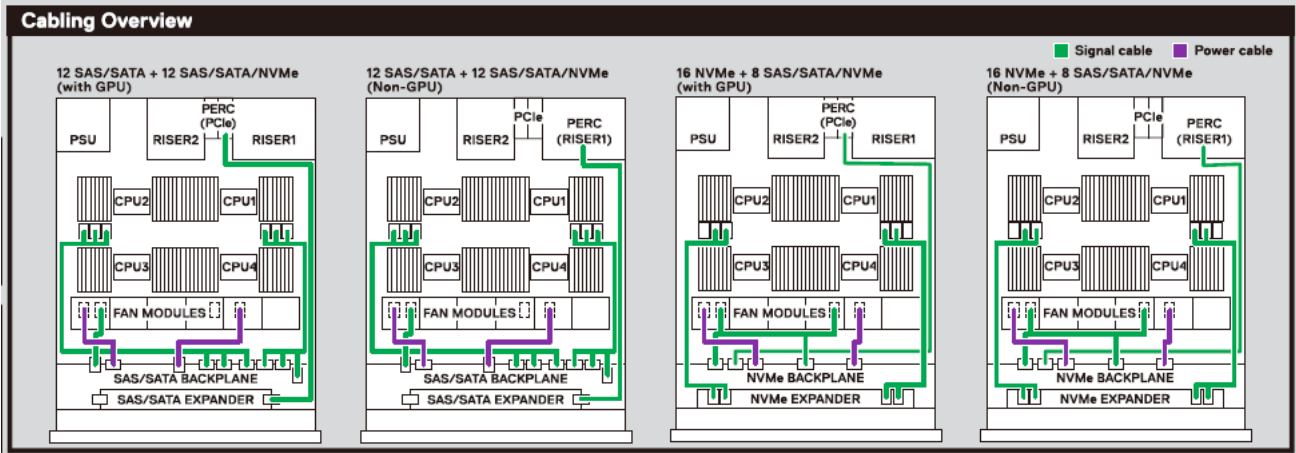

Figure 13. Signal and power cable routing

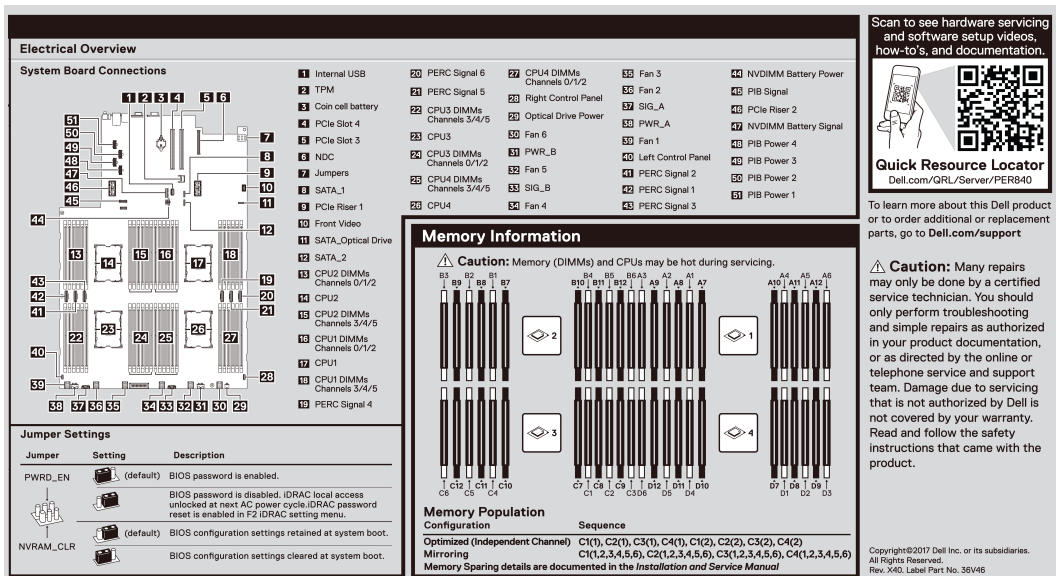

Figure 14. Electrical overview

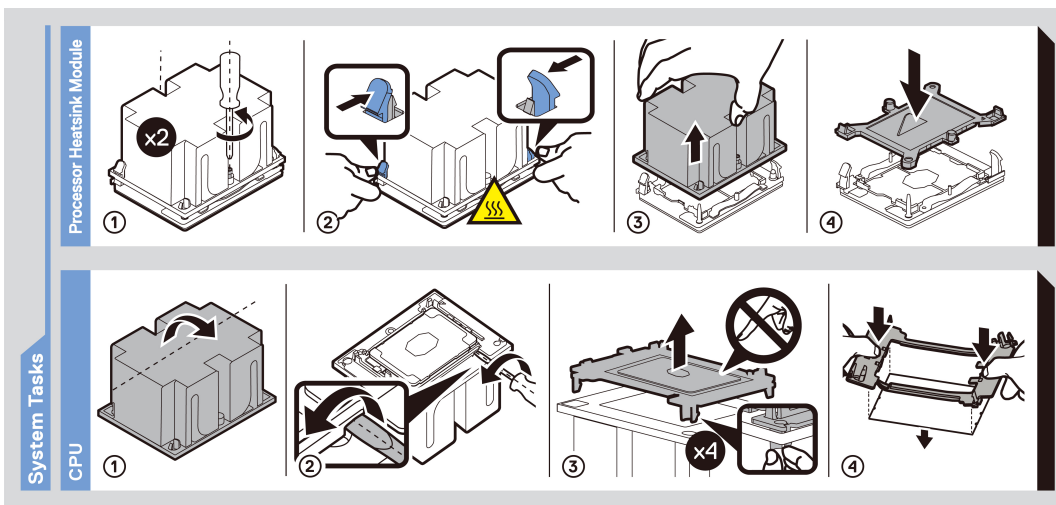

Figure 15. CPU installation

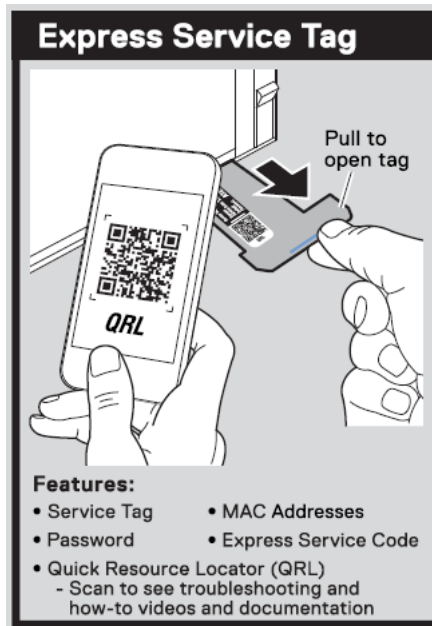

Figure 16. Express service tag

# Initial system setup and configuration

## Setting up your system

Perform the following steps to set up your system:

### Steps

1. Unpack the system.
2. Install the system into the rack. For more information about installing the system into the rack, see the *Rail Installation Guide* at [www.dell.com/poweredgemanuals](http://www.dell.com/poweredgemanuals).
3. Connect the peripherals to the system.
4. Connect the system to its electrical outlet.
5. Power on the system by pressing the power button or by using iDRAC.
6. Power on the attached peripherals.

For more information about setting up your system, see the *Getting Started Guide* that shipped with your system.

## iDRAC configuration

The Integrated Dell Remote Access Controller (iDRAC) is designed to make system administrators more productive and improve the overall availability of Dell systems. iDRAC alerts administrators about system issues and enables them to perform remote system management. This reduces the need for physical access to the system.

## Options to set up iDRAC IP address

To enable communication between your system and iDRAC, you must first configure the network settings based on your network infrastructure.

**NOTE:** For static IP configuration, you must request for it at the time of purchase.

This option is set to **DHCP** by Default. You can set up the IP address by using one of the following interfaces:

| Interfaces                                      | Document/Section  |
|---|---|
| <b>iDRAC Settings utility</b>                   | <i>Dell Integrated Dell Remote Access Controller User's Guide</i> at <a href="http://www.dell.com/poweredgemanuals">www.dell.com/poweredgemanuals</a>             |
| <b>Dell Deployment Toolkit</b>                  | <i>Dell Deployment Toolkit User's Guide</i> at <a href="http://www.dell.com/openmanagemanuals">www.dell.com/openmanagemanuals</a> > OpenManage Deployment Toolkit |
| <b>Dell Lifecycle Controller</b>                | <i>Dell Lifecycle Controller User's Guide</i> at <a href="http://www.dell.com/poweredgemanuals">www.dell.com/poweredgemanuals</a>                                 |
| <b>Server LCD panel</b>                         | <a href="#">LCD panel</a> section   |
| <b>iDRAC Direct and Quick Sync 2 (optional)</b> | See <i>Dell Integrated Dell Remote Access Controller User's Guide</i> at <a href="http://www.dell.com/poweredgemanuals">www.dell.com/poweredgemanuals</a>         |

**NOTE:** To access iDRAC, ensure that you connect the ethernet cable to the iDRAC9 dedicated network port. You can also access iDRAC through the shared LOM mode, if you have opted for a system that has the shared LOM mode enabled.

# Log in to iDRAC

You can log in to iDRAC as:

- iDRAC user
- Microsoft Active Directory user
- Lightweight Directory Access Protocol (LDAP) user

If you have opted for secure default access to iDRAC, you must use the iDRAC secure default password available on the system Information tag. If you have not opted for secure default access to iDRAC, then use the default user name and password `-root` and `ca1v1n`. You can also log in by using your Single Sign-On or Smart Card.

**NOTE:** You must have the iDRAC credentials to log in to iDRAC.

**NOTE:** Ensure that you change the default username and password after setting up the iDRAC IP address.

For more information about logging in to the iDRAC and iDRAC licenses, see the latest *Integrated Dell Remote Access Controller User's Guide* at [www.dell.com/poweredgemanuals](http://www.dell.com/poweredgemanuals).

You can also access iDRAC by using RACADM. For more information, see the *RACADM Command Line Interface Reference Guide* at [www.dell.com/poweredgemanuals](http://www.dell.com/poweredgemanuals).

## Options to install the operating system

If the system is shipped without an operating system, install a supported operating system by using one of the following resources:

**Table 2. Resources to install the operating system**

| Resources   | Location   |
|---|--|
| iDRAC   | <a href="http://www.dell.com/idracmanuals">www.dell.com/idracmanuals</a>   |
| Lifecycle Controller  | <a href="http://www.dell.com/idracmanuals">www.dell.com/idracmanuals</a> > Lifecycle Controller                    |
| OpenManage Deployment Toolkit   | <a href="http://www.dell.com/openmanagemanuals">www.dell.com/openmanagemanuals</a> > OpenManage Deployment Toolkit |
| Dell certified VMware ESXi  | <a href="http://www.dell.com/virtualizationsolutions">www.dell.com/virtualizationsolutions</a>                     |
| Installation and How-to videos for supported operating systems on PowerEdge systems | <a href="#">Supported Operating Systems for Dell EMC PowerEdge systems</a>   |

## Methods to download firmware and drivers

You can download the firmware and drivers by using any of the following methods:

**Table 3. Firmware and drivers**

| Methods  | Location   |
|--|--|
| From the Dell EMC support site   | <a href="http://www.dell.com/support/home">www.dell.com/support/home</a>   |
| Using Dell Remote Access Controller Lifecycle Controller (iDRAC with LC) | <a href="http://www.dell.com/idracmanuals">www.dell.com/idracmanuals</a>   |
| Using Dell Repository Manager (DRM)                                      | <a href="http://www.dell.com/openmanagemanuals">www.dell.com/openmanagemanuals</a> > Repository Manager            |
| Using Dell OpenManage Essentials   | <a href="http://www.dell.com/openmanagemanuals">www.dell.com/openmanagemanuals</a> > OpenManage Essentials         |
| Using Dell OpenManage Enterprise   | <a href="http://www.dell.com/openmanagemanuals">www.dell.com/openmanagemanuals</a> > OpenManage Enterprise         |
| Using Dell Server Update Utility (SUU)                                   | <a href="http://www.dell.com/openmanagemanuals">www.dell.com/openmanagemanuals</a> > Server Update Utility         |
| Using Dell OpenManage Deployment Toolkit (DTK)                           | <a href="http://www.dell.com/openmanagemanuals">www.dell.com/openmanagemanuals</a> > OpenManage Deployment Toolkit |
| Using iDRAC virtual media  | <a href="http://www.dell.com/idracmanuals">www.dell.com/idracmanuals</a>   |

# Downloading drivers and firmware

Dell EMC recommends that you download and install the latest BIOS, drivers, and systems management firmware on your system.

## Prerequisites

Ensure that you clear the web browser cache before downloading the drivers and firmware.

## Steps

1. Go to [www.dell.com/support/home](http://www.dell.com/support/home).
2. In the **Drivers & Downloads** section, type the Service Tag of your system in the **Enter a Service Tag or product ID** box, and then click **Submit**.  
 **NOTE: If you do not have the Service Tag, select Detect Product to allow the system to automatically detect the Service Tag, or click View products, and navigate to your product.**
3. Click **Drivers & Downloads**.  
The drivers that are applicable to your system are displayed.
4. Download the drivers to a USB drive, CD, or DVD.

# Pre-operating system management applications

You can manage basic settings and features of a system without booting to the operating system by using the system firmware.

## Topics:

- [Options to manage the pre-operating system applications](#)
- [System Setup](#)
- [Dell Lifecycle Controller](#)
- [Boot Manager](#)
- [PXE boot](#)

## Options to manage the pre-operating system applications

Your system has the following options to manage the pre-operating system applications:

- System Setup
- Dell Lifecycle Controller
- Boot Manager
- Preboot Execution Environment (PXE)

## System Setup

By using the **System Setup** screen, you can configure the BIOS settings, iDRAC settings, and Device settings of your system.

 **NOTE: Help text for the selected field is displayed in the graphical browser by default. To view the help text in the text browser, press F1.**

You can access system setup by using two methods:

- Standard graphical browser—The browser is enabled by default.
- Text browser—The browser is enabled by using Console Redirection.

## View System Setup

To view the **System Setup** screen, perform the following steps:

### Steps

1. Turn on, or restart your system.
2. Press F2 immediately after you see the following message:

```
F2 = System Setup
```

 **NOTE: If your operating system begins to load before you press F2, wait for the system to finish booting, and then restart your system and try again.**

## System Setup details

The **System Setup Main Menu** screen details are explained as follows:

| Option                 | Description  |
|------------------------|--|
| <b>System BIOS</b>     | Enables you to configure BIOS settings.  |
| <b>iDRAC Settings</b>  | Enables you to configure the iDRAC settings.<br><br>The iDRAC settings utility is an interface to set up and configure the iDRAC parameters by using UEFI (Unified Extensible Firmware Interface). You can enable or disable various iDRAC parameters by using the iDRAC settings utility. For more information about this utility, see <i>Integrated Dell Remote Access Controller User's Guide</i> at <a href="http://www.dell.com/idracmanuals">www.dell.com/idracmanuals</a> . |
| <b>Device Settings</b> | Enables you to configure device settings such as network cards or storage controllers.   |

## System BIOS

You can use the **System BIOS** screen to edit specific functions such as boot order, system password, setup password, set the SATA and PCIe NVMe RAID mode, and enable or disable USB ports.

### Viewing System BIOS

To view the **System Setup** screen, perform the following steps:

#### Steps

1. Turn on, or restart your system.
2. Press F2 immediately after you see the following message:

```
F2 = System Setup
```

**NOTE:** If your operating system begins to load before you press F2, wait for the system to finish booting, and then restart your system and try again.

3. On the **System Setup Main Menu** screen, click **System BIOS**.

### System BIOS Settings details

#### About this task

The **System BIOS Settings** screen details are explained as follows:

| Option                      | Description   |
|-----------------------------|---|
| <b>System Information</b>   | Specifies information about the system such as the system model name, BIOS version, and Service Tag.  |
| <b>Memory Settings</b>      | Specifies information and options related to the installed memory.  |
| <b>Processor Settings</b>   | Specifies information and options related to the processor such as speed and cache size.  |
| <b>SATA Settings</b>        | Specifies options to enable or disable the integrated SATA controller and ports.  |
| <b>NVMe Settings</b>        | Specifies options to change the NVMe settings. If the system contains the NVMe drives that you want to configure in a RAID array, you must set both this field and the <b>Embedded SATA</b> field on the <b>SATA Settings</b> menu to <b>RAID</b> mode. You might also need to change the <b>Boot Mode</b> setting to <b>UEFI</b> . Otherwise, you should set this field to <b>Non-RAID</b> mode. |
| <b>Boot Settings</b>        | Specifies options to specify the Boot mode (BIOS or UEFI). Enables you to modify UEFI and BIOS boot settings.   |
| <b>Network Settings</b>     | Specifies options to manage the UEFI network settings and boot protocols.<br><br>Legacy network settings are managed from the <b>Device Settings</b> menu.  |
| <b>Integrated Devices</b>   | Specifies options to manage integrated device controllers and ports, specifies related features and options.  |
| <b>Serial Communication</b> | Specifies options to manage the serial ports, its related features and options.   |

| Option                         | Description   |
|--------------------------------|---|
| <b>System Profile Settings</b> | Specifies options to change the processor power management settings, memory frequency.  |
| <b>System Security</b>         | Specifies options to configure the system security settings, such as system password, setup password, Trusted Platform Module (TPM) security, and UEFI secure boot. It also manages the power button on the system. |
| <b>Redundant OS Control</b>    | Sets the redundant OS info for redundant OS control.  |
| <b>Miscellaneous Settings</b>  | Specifies options to change the system date and time.   |

## System Information

You can use the **System Information** screen to view system properties such as Service Tag, system model name, and the BIOS version.

### View System Information

To view the **System Information** screen, perform the following steps:

#### Steps

1. Turn on, or restart your system.
2. Press F2 immediately after you see the following message:

```
F2 = System Setup
```



**NOTE:** If your operating system begins to load before you press F2, wait for the system to finish booting, and then restart your system and try again.

3. On the **System Setup Main Menu** screen, click **System BIOS**.
4. On the **System BIOS** screen, click **System Information**.

### System Information details

#### About this task

The **System Information** screen details are explained as follows:

| Option   | Description   |
|--|---|
| <b>System Model Name</b>                       | Specifies the system model name.  |
| <b>System BIOS Version</b>                     | Specifies the BIOS version installed on the system.   |
| <b>System Management Engine Version</b>        | Specifies the current version of the Management Engine firmware.                                |
| <b>System Service Tag</b>                      | Specifies the system Service Tag.   |
| <b>System Manufacturer</b>                     | Indicates the name of the Original Equipment Manufacturer (OEM).                                |
| <b>System Manufacturer Contact Information</b> | Indicates the contact information of the Original Equipment Manufacturer (OEM).                 |
| <b>System CPLD Version</b>                     | Specifies the current version of the system, complex programmable logic device (CPLD) firmware. |
| <b>UEFI Compliance Version</b>                 | Specifies the UEFI compliance level of the system firmware.                                     |

# Memory Settings

You can use the **Memory Settings** screen to view all the memory settings and enable or disable specific memory functions, such as system memory testing and node interleaving.

## View Memory Settings

To view the **Memory Settings** screen, perform the following steps:

### Steps

1. Turn on, or restart your system.
2. Press F2 immediately after you see the following message:

```
F2 = System Setup
```

**NOTE:** If your operating system begins to load before you press F2, wait for the system to finish booting, and then restart your system and try again.

3. On the **System Setup Main Menu** screen, click **System BIOS**.
4. On the **System BIOS** screen, click **Memory Settings**.

## Memory Settings details

### About this task

The **Memory Settings** screen details are explained as follows:

| Option                                   | Description   |
|--|---|
| <b>System Memory Size</b>                | Specifies the memory size in the system.  |
| <b>System Memory Type</b>                | Specifies the type of memory that is installed in the system.   |
| <b>System Memory Speed</b>               | Specifies the system memory speed.  |
| <b>System Memory Voltage</b>             | Specifies the system memory voltage.  |
| <b>Video Memory</b>                      | Specifies the amount of video memory.   |
| <b>System Memory Testing</b>             | Specifies whether the system memory tests are run during system boot. Options are <b>Enabled</b> and <b>Disabled</b> . This option is set to <b>Disabled</b> by default.<br><b>NOTE:</b> When Enabled the system takes more to boot. The booting time depends on the size of the system memory.   |
| <b>Native tRFC Timing for 16Gb DIMMs</b> | Enables 16 Gb density DIMMs to operate at their programmed Row Refresh Cycle Time (tRFC). Enabling this feature may improve system performance for some configurations. However, enabling this feature will have no effect on configurations with 16 Gb 3DS/TSV DIMMs. This option is set to <b>Enabled</b> by default.   |
| <b>Memory Operating Mode</b>             | Specifies the memory operating mode. The options available are <b>Optimizer Mode</b> , <b>Single Rank Spare Mode</b> , <b>Multi Rank Spare Mode</b> , <b>Mirror Mode</b> , and <b>Dell Fault Resilient Mode</b> . This option is set to <b>Optimizer Mode</b> by default.<br><b>NOTE:</b> The Memory Operating Mode option can have different default and available options based on the memory configuration of your system.<br><b>NOTE:</b> The Fault Resilient Mode option establishes an area of memory that is fault resilient. This mode can be used by an operating system that supports the feature to load critical applications or enables the operating system kernel to maximize system availability.<br><b>NOTE:</b> Only Optimizer Mode should be selected when Intel DC Optane Persistent Memory is installed. |

| Option  | Description  |
|---|--|
| <b>Current State of Memory Operating Mode</b> | Specifies the current state of the memory operating mode.  |
| <b>Node Interleaving</b>                      | Specifies if Non-Uniform Memory Architecture (NUMA) is supported. If this field is set to <b>Enabled</b> , memory interleaving is supported if a symmetric memory configuration is installed. If the field is set to <b>Disabled</b> , the system supports NUMA (asymmetric) memory configurations. This option is set to <b>Disabled</b> by default.        |
| <b>ADDDC Setting</b>                          | Enables or disables <b>ADDDC Setting</b> feature. When Adaptive Double DRAM Device Correction (ADDDC) is enabled, failing DRAMs are dynamically mapped out. When set to <b>Enabled</b> it can have some impact to system performance under certain workloads. This feature is applicable for x4 DIMMs only. This option is set to <b>Enabled</b> by default. |
| <b>Correctable Error Logging</b>              | Enables or disables logging of correctable memory threshold error. This option is set to <b>Enabled</b> by default.  |
| <b>Opportunistic Self-Refresh</b>             | Enables or disables opportunistic self-refresh feature. This option is set to <b>Disabled</b> by default.  |
| <b>Persistent Memory</b>                      | This field controls Persistent Memory on the system. This option is available if the persistent memory module is installed in the system.  |

*Persistent Memory details*

#### About this task

The **Persistent Memory** screen details can be found in the *NVDIMM-N User Guide* and *DCPMM User Guide* at [www.dell.com/poweredge manuals](http://www.dell.com/poweredge manuals).

## Processor Settings

You can use the **Processor Settings** screen to view the processor settings, and perform specific functions such as enabling virtualization technology, hardware prefetcher, logical processor idling, and opportunistic self-refresh.

### View Processor Settings

To view the **Processor Settings** screen, perform the following steps:

#### Steps

1. Turn on, or restart your system.
2. Press F2 immediately after you see the following message:

```
F2 = System Setup
```

**NOTE:** If your operating system begins to load before you press F2, wait for the system to finish booting, and then restart your system and try again.



3. On the **System Setup Main Menu** screen, click **System BIOS**.
4. On the **System BIOS** screen, click **Processor Settings**.

### Processor Settings details

#### About this task

The **Processor Settings** screen details are explained as follows:

| Option                        | Description  |
|-------------------------------|--|
| <b>Logical Processor</b>      | Enables or disables the logical processors and displays the number of logical processors. If this option is set to <b>Enabled</b> , the BIOS displays all the logical processors. If this option is set to <b>Disabled</b> , the BIOS displays only one logical processor per core. This option is set to <b>Enabled</b> by default. |
| <b>CPU Interconnect Speed</b> | Enables you to govern the frequency of the communication links among the CPUs in the system.   |

| Option  | Description   |
|---|---|
|   | <p> <b>NOTE: The standard and basic bin processors support lower link frequencies.</b></p> <p>The options available are <b>Maximum data rate, 10.4 GT/s</b>, and <b>9.6 GT/s</b>. This option is set to <b>Maximum data rate</b> by default.</p> <p>Maximum data rate indicates that the BIOS runs the communication links at the maximum frequency that is supported by the processors. You can also select specific frequencies that the processors support, which can vary.</p> <p>For best performance, you should select <b>Maximum data rate</b>. Any reduction in the communication link frequency affects the performance of nonlocal memory accesses and cache coherency traffic. In addition, it can slow access to nonlocal I/O devices from a particular CPU.</p> <p>However, if power-saving considerations outweigh performance, you might want to reduce the frequency of the CPU communication links. If you do this, you should localize memory and I/O accesses to the nearest NUMA node to minimize the impact to system performance.</p> |
| <b>Virtualization Technology</b>  | Enables or disables the virtualization technology for the processor. This option is set to <b>Enabled</b> by default.   |
| <b>Adjacent Cache Line Prefetch</b>   | Optimizes the system for applications that need high utilization of sequential memory access. This option is set to <b>Enabled</b> by default. You can disable this option for applications that need high utilization of random memory access.   |
| <b>Hardware Prefetcher</b>  | Enables or disables the hardware prefetcher. This option is set to <b>Enabled</b> by default.   |
| <b>Software Prefetcher</b>  | Enables or disables the software prefetcher. This option is set to <b>Enabled</b> by default.   |
| <b>DCU Streamer Prefetcher</b>  | Enables or disables the Data Cache Unit (DCU) streamer prefetcher. This option is set to <b>Enabled</b> by default.   |
| <b>DCU IP Prefetcher</b>  | Enables or disables the Data Cache Unit (DCU) IP prefetcher. This option is set to <b>Enabled</b> by default.   |
| <b>Sub NUMA Cluster</b>   | Sub NUMA Clustering (SNC) is a feature for breaking up the LLC into disjoint clusters based on address range, with each cluster bound to a subset of the memory controllers in the system. It improves average latency to the LLC. Enables or disables the Sub NUMA Cluster. This option is set to <b>Disabled</b> by default.  |
| <b>UPI Prefetch</b>   | Enables you to get the memory read started early on DDR bus. The Ultra Path Interconnect (UPI) Rx path spawns the speculative memory read to Integrated Memory Controller (iMC) directly. This option is set to <b>Enabled</b> by default.  |
| <b>LLC Prefetch</b>   | Enables or disables the LLC Prefetch on all threads. This option is set to <b>Disabled</b> by default.  |
| <b>Dead Line LLC Alloc</b>  | When enabled, it opportunistically fill dead lines in LLC. When disabled, it never fill dead lines in LLC. This option is set to <b>Enabled</b> by default.   |
| <b>Directory AtoS</b>   | AtoS optimization reduces remote read latencies for repeat read accesses without intervening writes. This option is set to <b>Disabled</b> by default.  |
| <b>Logical Processor Idling</b>   | Enables you to improve the energy efficiency of a system. It uses the operating system core parking algorithm and parks some of the logical processors in the system which in turn allows the corresponding processor cores to transition into a lower power idle state. This option can only be enabled if the operating system supports it. It is set to <b>Disabled</b> by default. <p> <b>NOTE: This feature is not supported if CPU Power Management is set to Maximum Performance.</b></p>   |
| <b>Configurable TDP</b>   | Enables you to configure the TDP level. The available options are <b>Nominal, Level 1</b> and <b>Level 2</b> . This option is set to <b>Nominal</b> by default. <p> <b>NOTE: This option is only available on certain stock keeping units (SKUs) of the processors.</b></p>  |
| <b>Enable Intel Speed Select Technology - Base Frequency (SST-BF) feature</b> | This option is only exposed if Performance Per Watt (OS) or Custom (when OSPM is enabled) system profiles are selected. This option is set to <b>Disabled</b> by default.   |
| <b>Enable Intel Speed Select Technology</b>                                   | This option is only exposed if Performance Per Watt (OS) or Custom (when OSPM is enabled) system profiles are selected. This option is set to <b>Disabled</b> by default.   |

| Option                        | Description   |        |             |                       |   |       |                           |               |                               |               |                               |                 |  |                         |  |           |                          |
|-------------------------------|---|--------|-------------|-----------------------|---|-------|---------------------------|---------------|-------------------------------|---------------|-------------------------------|-----------------|--|-------------------------|--|-----------|--------------------------|
| - CP Power (SST-CP) feature   |   |        |             |                       |   |       |                           |               |                               |               |                               |                 |  |                         |  |           |                          |
| x2APIC Mode                   | Enables or disables the x2APIC mode. This option is set to <b>Enabled</b> by default.   |        |             |                       |   |       |                           |               |                               |               |                               |                 |  |                         |  |           |                          |
| L2 RFO Prefetch               | Enables or disables the L2 RFO (Read For Ownership) prefetch. This option is set to <b>Enabled</b> by default. The RFO is the process of reading a cache line from the memory into the cache before it can be written to.<br><b>i</b> <b>NOTE: This feature is supported only when four processors are installed.</b>   |        |             |                       |   |       |                           |               |                               |               |                               |                 |  |                         |  |           |                          |
| Dell Controlled Turbo         | Controls the turbo engagement. Enable this option only when <b>System Profile</b> is set to <b>Performance</b> .<br><b>i</b> <b>NOTE: Depending on the number of installed CPUs, there might be up to four processor listings.</b>  |        |             |                       |   |       |                           |               |                               |               |                               |                 |  |                         |  |           |                          |
| Dell AVX Scaling Technology   | Enables you to configure the Dell AVX scaling technology. This option is set to <b>0</b> by default.  |        |             |                       |   |       |                           |               |                               |               |                               |                 |  |                         |  |           |                          |
| Number of Cores per Processor | Controls the number of enabled cores in the processor. Under certain circumstances, you may see limited performance improvements to Intel Turbo Boost Technology and benefits from potentially larger shared caches, when you reduce the number of enabled cores. Most computing environments tend to benefit more from larger number of processing cores, so you must carefully weigh the disabling of cores to gain nominal performance enhancements.   |        |             |                       |   |       |                           |               |                               |               |                               |                 |  |                         |  |           |                          |
| Process Core Speed            | Displays the core speed of the processor(s).  |        |             |                       |   |       |                           |               |                               |               |                               |                 |  |                         |  |           |                          |
| Process Bus Speed             | Displays the bus speed of the processor(s).   |        |             |                       |   |       |                           |               |                               |               |                               |                 |  |                         |  |           |                          |
| Processor n                   | The following settings are displayed for each processor installed in the system: <table border="1" data-bbox="335 1008 1356 1417"> <thead> <tr> <th>Option</th> <th>Description</th> </tr> </thead> <tbody> <tr> <td>Family-Model-Stepping</td> <td>Specifies the family, model, and stepping of the processor as defined by Intel.</td> </tr> <tr> <td>Brand</td> <td>Specifies the brand name.</td> </tr> <tr> <td>Level 2 Cache</td> <td>Specifies the total L2 cache.</td> </tr> <tr> <td>Level 3 Cache</td> <td>Specifies the total L3 cache.</td> </tr> <tr> <td>Number of Cores</td> <td>Specifies the number of cores per processor.</td> </tr> <tr> <td>Maximum Memory Capacity</td> <td>Specifies the maximum memory capacity per processor.</td> </tr> <tr> <td>Microcode</td> <td>Specifies the microcode.</td> </tr> </tbody> </table> | Option | Description | Family-Model-Stepping | Specifies the family, model, and stepping of the processor as defined by Intel. | Brand | Specifies the brand name. | Level 2 Cache | Specifies the total L2 cache. | Level 3 Cache | Specifies the total L3 cache. | Number of Cores | Specifies the number of cores per processor. | Maximum Memory Capacity | Specifies the maximum memory capacity per processor. | Microcode | Specifies the microcode. |
| Option                        | Description   |        |             |                       |   |       |                           |               |                               |               |                               |                 |  |                         |  |           |                          |
| Family-Model-Stepping         | Specifies the family, model, and stepping of the processor as defined by Intel.   |        |             |                       |   |       |                           |               |                               |               |                               |                 |  |                         |  |           |                          |
| Brand                         | Specifies the brand name.   |        |             |                       |   |       |                           |               |                               |               |                               |                 |  |                         |  |           |                          |
| Level 2 Cache                 | Specifies the total L2 cache.   |        |             |                       |   |       |                           |               |                               |               |                               |                 |  |                         |  |           |                          |
| Level 3 Cache                 | Specifies the total L3 cache.   |        |             |                       |   |       |                           |               |                               |               |                               |                 |  |                         |  |           |                          |
| Number of Cores               | Specifies the number of cores per processor.  |        |             |                       |   |       |                           |               |                               |               |                               |                 |  |                         |  |           |                          |
| Maximum Memory Capacity       | Specifies the maximum memory capacity per processor.  |        |             |                       |   |       |                           |               |                               |               |                               |                 |  |                         |  |           |                          |
| Microcode                     | Specifies the microcode.  |        |             |                       |   |       |                           |               |                               |               |                               |                 |  |                         |  |           |                          |

## SATA Settings

You can use the **SATA Settings** screen to view the SATA settings of SATA devices and enable SATA and PCIe NVMe RAID mode on your system.

### View SATA Settings

To view the **SATA Settings** screen, perform the following steps:

#### Steps

1. Turn on, or restart your system.
2. Press F2 immediately after you see the following message:

```
F2 = System Setup
```

**i** **NOTE: If your operating system begins to load before you press F2, wait for the system to finish booting, and then restart your system and try again.**



3. On the **System Setup Main Menu** screen, click **System BIOS**.
4. On the **System BIOS** screen, click **SATA Settings**.

## SATA Settings details

### About this task

The **SATA Settings** screen details are explained as follows:

| Option                      | Description   |
|-----------------------------|---|
| <b>Embedded SATA</b>        | Enables the embedded SATA option to be set to <b>Off</b> , <b>AHCI</b> , or <b>RAID</b> modes. This option is set to <b>AHCI Mode</b> by default. |
| <b>Security Freeze Lock</b> | Sends <b>Security Freeze Lock</b> command to the embedded SATA drives during POST. This option is set to <b>Enabled</b> by default.               |
| <b>Write Cache</b>          | Enables or disables the command for the embedded SATA drives during POST. This option is set to <b>Disabled</b> by default.                       |
| <b>Port n</b>               | Sets the drive type of the selected device.<br>For <b>AHCI Mode</b> or <b>RAID Mode</b> , BIOS support is always enabled.                         |

| Option            | Description  |
|-------------------|--|
| <b>Model</b>      | Specifies the drive model of the selected device.<br> <b>NOTE: If no device is installed, it displays Unkown.</b>   |
| <b>Drive Type</b> | Specifies the type of drive attached to the SATA port.<br> <b>NOTE: If no device is installed, it displays Unkown Device.</b>  |
| <b>Capacity</b>   | Specifies the total capacity of the drive. This field is undefined for removable media devices such as optical drives.<br> <b>NOTE: If no device is installed, it displays N/A.</b> |

## NVMe Settings

The NVMe settings enable you to set the NVMe drives to either **RAID** mode or **Non-RAID** mode.

 **NOTE: To configure these drives as RAID drives, click System BIOS Settings > SATA Settings > Embedded SATA Option and enable RAID mode. If not, you must set this field to Non-RAID mode.**

### View NVMe settings

To view the **NVMe Settings** screen, perform the following steps:

#### Steps

1. Turn on, or restart your system.
2. Press F2 immediately after you see the following message:

```
F2 = System Setup
```

 **NOTE: If your operating system begins to load before you press F2, wait for the system to finish booting, and then restart your system and try again.**

3. On the **System Setup Main Menu** screen, click **System BIOS**.
4. On the **System BIOS** screen, click **NVMe Settings**.

## NVMe Settings details

### About this task

The **NVMe Settings** screen details are explained as follows:

| Option           | Description   |
|------------------|---|
| <b>NVMe Mode</b> | Enables you to set the NVMe mode. This option is set to <b>Non RAID</b> by default. |

## Boot Settings

You can use the **Boot Settings** screen to set the boot mode to either **BIOS** or **UEFI**. It also enables you to specify the boot order.

- **BIOS:** The **BIOS Boot Mode** is the legacy boot mode. It is maintained for backward compatibility.
- **UEFI:** The Unified Extensible Firmware Interface (UEFI) is a new interface between operating systems and platform firmware. The interface consists of data tables with platform related information, also boot and runtime service calls that are available to the operating system and its loader. The following benefits are available when the **Boot Mode** is set to **UEFI**:
  - Support for drive partitions larger than 2 TB.
  - Enhanced security (e.g., UEFI Secure Boot).
  - Faster boot time.

 **NOTE:** You must use only the UEFI boot mode in order to boot from NVMe drives.

## View Boot Settings

To view the **Boot Settings** screen, perform the following steps:

### Steps

1. Turn on, or restart your system.
2. Press F2 immediately after you see the following message:

```
F2 = System Setup
```

 **NOTE:** If your operating system begins to load before you press F2, wait for the system to finish booting, and then restart your system and try again.

3. On the **System Setup Main Menu** screen, click **System BIOS**.
4. On the **System BIOS** screen, click **Boot Settings**.

## Boot Settings details

### About this task

The **Boot Settings** screen details are explained as follows:

| Option                             | Description  |
|------------------------------------|--|
| <b>Boot Mode</b>                   | Allows you to configure the Boot Sequence and Enable or Disable the individual boot options. The available options are <b>BIOS</b> and <b>UEFI</b> . The option is set to <b>UEFI</b> by default.  |
| <b>Boot Sequence Retry</b>         | Enables or disables the <b>Boot Sequence Retry</b> feature. If the last attempt to boot has failed, the system immediately performs a cold reset or retries to boot after 30 seconds time-out period base on the setting of <b>Reset</b> or <b>Enabled</b> . This option is set to <b>Enabled</b> by default.  |
| <b>Hard-Disk Failover</b>          | Specifies the drive that is booted in the event of a drive failure. The devices are selected in the <b>Hard-Disk Drive Sequence</b> on the <b>Boot Option Setting</b> menu. When this option is set to <b>Disabled</b> , only the first drive in the list is attempted to boot. When this option is set to <b>Enabled</b> , all drives are attempted to boot in the order selected in the <b>Hard-Disk Drive Sequence</b> . This option is not enabled for <b>UEFI Boot Mode</b> . This option is set to <b>Disabled</b> by default. |
| <b>Generic USB Boot</b>            | Enables or disables the USB boot option. This option is set to <b>Disabled</b> by default.   |
| <b>Hard-disk Drive Placeholder</b> | Enables or disables the Hard-disk Drive Placeholder option. This option is set to <b>disabled</b> by default.  |

## UEFI Boot Settings

The **UEFI Boot Settings** screen enables you to specify the UEFI boot order.

### About this task

| Option                             | Description  |
|------------------------------------|--|
| <b>UEFI Boot Sequence</b>          | Enables you to change the <b>UEFI</b> boot device order.       |
| <b>Boot Options Enable/Disable</b> | Enables you to enable or disable the <b>UEFI</b> boot devices. |

## Network Settings

You can use the **Network Settings** screen to modify UEFI PXE, iSCSI, and HTTP boot settings. The network settings option is available only in the UEFI mode.

**NOTE:** The BIOS does not control network settings in the BIOS mode. For the BIOS boot mode, the optional Boot ROM of the network controllers handles the network settings.

### Viewing Network Settings

To view the **Network Settings** screen, perform the following steps:

#### Steps

1. Turn on, or restart your system.
2. Press F2 immediately after you see the following message:

```
F2 = System Setup
```

**NOTE:** If your operating system begins to load before you press F2, wait for the system to finish booting, and then restart your system and try again.

3. On the **System Setup Main Menu** screen, click **System BIOS**.
4. On the **System BIOS** screen, click **Network Settings**.

### Network Settings screen details

The **Network Settings** screen details are explained as follows:

#### About this task

| Option                                     | Description  |
|--|--|
| <b>UEFI PXE Settings</b>                   | Enables you to control the configuration of the UEFI PXE device.                                 |
| <b>PXE Device n (n = 1 to 4)</b>           | Enables or disables the device. When enabled, a UEFI PXE boot option is created for the device.  |
| <b>PXE Device n Settings (n = 1 to 4)</b>  | Enables you to control the configuration of the PXE device.                                      |
| <b>UEFI HTTP Settings</b>                  | Enables or disables the device. When enabled, a UEFI HTTP boot option is created for the device. |
| <b>HTTP Device n Settings (n = 1 to 4)</b> | Enables you to control the configuration of the HTTP device.                                     |
| <b>UEFI iSCSI Settings</b>                 | Enables you to control the configuration of the iSCSI device.                                    |

**Table 4. UEFI iSCSI Settings screen details**

| Option                      | Description  |
|-----------------------------|--|
| <b>iSCSI Initiator Name</b> | Specifies the name of the iSCSI initiator in IQN format. |

| Option                                  | Description   |
|---|---|
| <b>TLS Authentication Configuration</b> | View and/or modify this device's boot TLS authentication mode. None means the HTTP server and the client will not authenticate each other for this boot. One way means the HTTP server will be authenticated by the client, while the client will not be authenticated by the server. This option is set to <b>None</b> by default. |
| <b>iSCSI Device1</b>                    | Enables or disables the iSCSI device. When disabled, a UEFI boot option is created for the iSCSI device automatically. This is set to <b>Disabled</b> by default.   |
| <b>iSCSI Device1 Settings</b>           | Enables you to control the configuration of the iSCSI device.   |

## Integrated Devices

You can use the **Integrated Devices** screen to view and configure the settings of all integrated devices including the video controller, integrated RAID controller, and the USB ports.

### Viewing Integrated Devices

To view the **Integrated Devices** screen, perform the following steps:

#### Steps

1. Power on or restart the system.
2. Press F2 immediately after you see the following message:

```
F2 = System Setup
```

**NOTE:** If your operating system begins to load before you press F2, wait for the system to finish booting, and then restart your system and try again.

3. On the **System Setup Main Menu** screen, click **System BIOS**.
4. On the **System BIOS** screen, click **Integrated Devices**.

### Integrated Devices details

#### About this task

The **Integrated Devices** screen details are explained as follows:

| Option                           | Description   |
|----------------------------------|---|
| <b>User Accessible USB Ports</b> | Configures the user accessible USB ports. Selecting <b>Only Back Ports On</b> disables the front USB ports; selecting <b>All Ports Off</b> disables all front and back USB ports; selecting <b>All Ports Off (Dynamic)</b> disables all front and back USB ports during POST and front ports can be enabled or disabled dynamically by authorized user without resetting the system.<br><br>The USB keyboard and mouse still function in certain USB ports during the boot process, depending on the selection. After the boot process is complete, the USB ports will be enabled or disabled as per the setting. |
| <b>Internal USB Port</b>         | Enables or disables the internal USB port. This option is set to <b>On</b> by default.  |
| <b>iDRAC Direct USB Port</b>     | The iDRAC Direct USB port is managed by iDRAC exclusively with no host visibility. This option is set to <b>ON</b> or <b>OFF</b> . When set to <b>OFF</b> , iDRAC does not detect any USB devices installed in this managed port. This option is set to <b>On</b> by default.   |
| <b>Integrated Network Card 1</b> | Enables or disables the integrated network card (NDC). When set to <b>Disabled</b> , the NDC is not available to the operating system (OS). This option is set to <b>Enabled</b> by default.<br><br><b>NOTE:</b> If set to <b>Disabled (OS)</b> , the Integrated NICs might still be available for shared network access by iDRAC.  |

| Option  | Description   |
|---|---|
| <b>I/OAT DMA Engine</b>                           | Enables or disables the I/O Acceleration Technology (I/OAT) option. I/OAT is a set of DMA features designed to accelerate network traffic and lower CPU utilization. Enable only if the hardware and software support the feature.  |
| <b>Embedded Video Controller</b>                  | Enables or disables the use of Embedded Video Controller as the primary display. When set to <b>Enabled</b> , the Embedded Video Controller will be the primary display even if add-in graphic cards are installed. When set to <b>Disabled</b> , an add-in graphics card will be used as the primary display. BIOS will output displays to both the primary add-in video and the embedded video during POST and pre-boot environment. The embedded video will then be disabled right before the operating system boots. This option is set to <b>Enabled</b> by default.<br> <b>NOTE: When there are multiple add-in graphic cards installed in the system, the first card discovered during PCI enumeration is selected as the primary video. You might have to re-arrange the cards in the slots in order to control which card is the primary video.</b> |
| <b>Current State of Embedded Video Controller</b> | Displays the current state of the embedded video controller. The <b>Current State of Embedded Video Controller</b> option is a read-only field. If the Embedded Video Controller is the only display capability in the system (that is, no add-in graphics card is installed), then the Embedded Video Controller is automatically used as the primary display even if the <b>Embedded Video Controller</b> setting is set to <b>Disabled</b> .   |
| <b>SR-IOV Global Enable</b>                       | Enables or disables the BIOS configuration of Single Root I/O Virtualization (SR-IOV) devices. This option is set to <b>Disabled</b> by default.  |
| <b>OS Watchdog Timer</b>                          | If your system stops responding, this watchdog timer aids in the recovery of your operating system. When this option is set to <b>Enabled</b> , the operating system initializes the timer. When this option is set to <b>Disabled</b> (the default), the timer does not have any effect on the system.   |
| <b>Empty Slot Unhide</b>                          | Enables or disables the root ports of all the empty slots that are accessible to the BIOS and OS. This option is set to <b>Disabled</b> by default.   |
| <b>Memory Mapped I/O above 4 GB</b>               | Enables or disables the support for the PCIe devices that need large amounts of memory. Enable this option only for 64-bit operating systems. This option is set to <b>Enabled</b> by default.  |
| <b>Memory Mapped I/O Base</b>                     | When set to <b>12 TB</b> , the system will map MMIO base to 12 TB. Enable this option for an OS that requires 44 bit PCIe addressing.   |

*Slot Disablement*

#### About this task

The **Slot Disablement** screen details are explained as follows:

|                         |  |
|-------------------------|--|
| <b>Slot Disablement</b> | Enables or disables the available PCIe slots on your system. The slot disablement feature controls the configuration of the PCIe cards installed in the specified slot. Slots must be disabled only when the installed peripheral card prevents booting into the operating system or causes delays in system startup. If the slot is disabled, both the Option ROM and UEFI drivers are disabled. Only slots that are present on the system will be available for control. |
|-------------------------|--|

**Table 5. Slot Disablement**

| Slot number   | Description   |
|---------------|---|
| <b>Slot 1</b> | Enables or disables or only the boot driver is disabled for the PCIe slot 1. This option is set to <b>Enabled</b> by default. |
| <b>Slot 2</b> | Enables or disables or only the boot driver is disabled for the PCIe slot 2. This option is set to <b>Enabled</b> by default. |
| <b>Slot 3</b> | Enables or disables or only the boot driver is disabled for the PCIe slot 3. This option is set to <b>Enabled</b> by default. |
| <b>Slot 4</b> | Enables or disables or only the boot driver is disabled for the PCIe slot 4. This option is set to <b>Enabled</b> by default. |
| <b>Slot 5</b> | Enables or disables or only the boot driver is disabled for the PCIe slot 5. This option is set to <b>Enabled</b> by default. |
| <b>Slot 6</b> | Enables or disables or only the boot driver is disabled for the PCIe slot 6. This option is set to <b>Enabled</b> by default. |

**About this task**

The **Slot Bifurcation** screen details are explained as follows:

**Slot Bifurcation** Allows **Platform Default Bifurcation**, **Auto discovery of Bifurcation** and **Manual bifurcation Control**. The default is set to **Platform Default Bifurcation**. The slot bifurcation field is accessible when set to **Manual bifurcation Control** and is grayed out when set to **Platform Default Bifurcation** or **Auto discovery of Bifurcation**.

**Table 6. Slot Bifurcation**

| Option                                     | Description   |
|--|---|
| <b>Auto Discovery Bifurcation Settings</b> | Platform Default Bifurcation, Auto Bifurcation, Manual bifurcation  |
| <b>Slot 1 Bifurcation</b>                  | x4 Bifurcation or x8 Bifurcation  |
| <b>Slot 2 Bifurcation</b>                  | x16 Bifurcation, or x8 Bifurcation, or x4 Bifurcation, or x4, x4, x8 Bifurcation, or x8, x4, x4 Bifurcation |
| <b>Slot 3 Bifurcation</b>                  | x16 Bifurcation, or x8 Bifurcation, or x4 Bifurcation, or x4, x4, x8 Bifurcation, or x8, x4, x4 Bifurcation |
| <b>Slot 4 Bifurcation</b>                  | x16 Bifurcation, or x8 Bifurcation, or x4 Bifurcation, or x4, x4, x8 Bifurcation, or x8, x4, x4 Bifurcation |
| <b>Slot 5 Bifurcation</b>                  | x4 Bifurcation or x8 Bifurcation  |
| <b>Slot 6 Bifurcation</b>                  | x16 Bifurcation, or x8 Bifurcation, or x4 Bifurcation, or x4, x4, x8 Bifurcation, or x8, x4, x4 Bifurcation |

## Serial Communication

Use the **Serial Communication** screen to view the properties of the serial communication port.

### Viewing Serial Communication

To view the **Serial Communication** screen, perform the following steps:

**Steps**

1. Power on or restart the system.

- Press F2 immediately after you see the following message:

F2 = System Setup

**NOTE:** If your operating system begins to load before you press F2, wait for the system to finish booting, and then restart your system and try again.

- On the **System Setup Main Menu** screen, click **System BIOS**.
- On the **System BIOS** screen, click **Serial Communication**.

## Serial Communication details

### About this task

The **Serial Communication** screen details are explained as follows:

| Option                           | Description  |
|----------------------------------|--|
| <b>Serial Communication</b>      | <p>Selects serial communication devices (Serial Device 1 and Serial Device 2) in BIOS. BIOS console redirection can also be enabled, and the port address can be specified. This option is set to <b>Auto</b> by default.</p> <p>Enables the <b>COM</b> port or <b>Console Redirection</b> options. This option is set to <b>Off</b> by default.</p>   |
| <b>Serial Port Address</b>       | <p>Enables you to set the port address for serial devices. This field sets the serial port address to either COM1 or COM2 (COM1=0x3F8, COM2=0x2F8). This option is set to <b>Serial Device 2=COM1</b> by default.</p> <p><b>NOTE:</b> You can use only Serial Device 2 for the Serial Over LAN (SOL) feature. To use console redirection by SOL, configure the same port address for console redirection and the serial device.</p>  |
| <b>External Serial Connector</b> | <p>Enables you to associate the External Serial Connector to <b>Serial Device 1</b>, <b>Serial Device 2</b>, or the <b>Remote Access Device</b> by using this option. This option is set to <b>Serial Device 1</b> by default.</p> <p><b>NOTE:</b> Only Serial Device 2 can be used for Serial Over LAN (SOL). To use console redirection by SOL, configure the same port address for console redirection and the serial device.</p> <p><b>NOTE:</b> Every time the system boots, the BIOS syncs the serial MUX setting saved in iDRAC. The serial MUX setting can independently be changed in iDRAC. Loading the BIOS default settings from within the BIOS setup utility may not always revert this setting to the default setting of Serial Device 1.</p> <p>Enables you to associate the External Serial Connector to Serial Device 1.</p> |
| <b>Failsafe Baud Rate</b>        | <p>Specifies the failsafe baud rate for console redirection. The BIOS attempts to determine the baud rate automatically. This failsafe baud rate is used only if the attempt fails, and the value must not be changed. This option is set to <b>115200</b> by default.</p>   |
| <b>Remote Terminal Type</b>      | <p>Sets the remote console terminal type. This option is set to <b>VT100/VT220</b> by default.</p>   |
| <b>Redirection After Boot</b>    | <p>Enables or disables the BIOS console redirection when the operating system is loaded. This option is set to <b>Enabled</b> by default.</p>  |

## System Profile Settings

You can use the **System Profile Settings** screen to enable specific system performance settings such as power management.

### Viewing System Profile Settings

To view the **System Profile Settings** screen, perform the following steps:

#### Steps

- Power on, or restart your system.
- Press F2 immediately after you see the following message:

F2 = System Setup

**NOTE:** If your operating system begins to load before you press F2, wait for the system to finish booting, and then restart your system and try again.

3. On the **System Setup Main Menu** screen, click **System BIOS**.
4. On the **System BIOS** screen, click **System Profile Settings**.

## System Profile Settings details

### About this task

The **System Profile Settings** screen details are explained as follows:

| Option   | Description   |
|--|---|
| <b>System Profile</b>                                      | Sets the system profile. If you set the System Profile option to a mode other than <b>Custom</b> , the BIOS automatically sets the rest of the options. You can only change the rest of the options if the mode is set to <b>Custom</b> . This option is set to <b>Performance Per Watt Optimized (DAPC)</b> by default. DAPC is Dell Active Power Controller. Other options include <b>Performance Per Watt (OS)</b> , <b>Performance</b> , and <b>Workstation Performance</b> .<br><b>NOTE:</b> All the parameters on the system profile setting screen are available only when the System Profile option is set to Custom. |
| <b>CPU Power Management</b>                                | Sets the CPU power management. This option is set to <b>System DBPM (DAPC)</b> by default. DBPM is Demand-Based Power Management.   |
| <b>Memory Frequency</b>                                    | Sets the speed of the system memory. You can select <b>Maximum Performance</b> or a specific speed. This option is set to <b>Maximum Performance</b> by default.  |
| <b>Turbo Boost</b>   | Enables or disables the processor to operate in the turbo boost mode. This option is set to <b>Enabled</b> by default.  |
| <b>C1E</b>   | Enables or disables the processor to switch to a minimum performance state when it is idle. This option is set to <b>Enabled</b> by default.  |
| <b>C States</b>  | Enables or disables the processor to operate in all available power states. This option is set to <b>Enabled</b> by default.  |
| <b>Write Data CRC</b>                                      | Enables or disables the Write Data CRC. This option is set to <b>Disabled</b> by default.   |
| <b>Memory Patrol Scrub</b>                                 | Sets the memory patrol scrub frequency. This option is set to <b>Standard</b> by default.   |
| <b>Memory Refresh Rate</b>                                 | Sets the memory refresh rate to either 1x or 2x. This option is set to <b>1x</b> by default.  |
| <b>Uncore Frequency</b>                                    | Enables you to select the <b>Processor Uncore Frequency</b> option.<br><b>Dynamic mode</b> enables the processor to optimize power resources across the cores and uncore during runtime. The optimization of the uncore frequency to either save power or optimize performance is influenced by the setting of the <b>Energy Efficiency Policy</b> option.  |
| <b>Energy Efficient Policy</b>                             | Enables you to select the <b>Energy Efficient Policy</b> option.<br>The CPU uses the setting to manipulate the internal behavior of the processor and determines whether to target higher performance or better power savings. This option is set to <b>Balanced Performance</b> by default.  |
| <b>Number of Turbo Boost Enabled Cores for Processor 1</b> | <b>NOTE:</b> If there are two processors installed in the system, you will see an entry for <b>Number of Turbo Boost Enabled Cores for Processor 2</b> .<br>Controls the number of turbo boost enabled cores for Processor 1. The maximum number of cores is enabled by default.  |
| <b>Monitor/Mwait</b>                                       | Enables the Monitor/Mwait instructions in the processor. This option is set to <b>Enabled</b> for all system profiles, except <b>Custom</b> by default.<br><b>NOTE:</b> This option can be disabled only if the <b>C States</b> option in the <b>Custom</b> mode is set to <b>disabled</b> .<br><b>NOTE:</b> When <b>C States</b> is set to <b>Enabled</b> in the <b>Custom</b> mode, changing the <b>Monitor/Mwait</b> setting does not impact the system power or performance.  |

| Option  | Description  |
|---|--|
| <b>CPU Interconnect Bus Link Power Management</b> | Enables or disables the CPU Interconnect Bus Link Power Management. This option is set to <b>Enabled</b> by default. |
| <b>PCI ASPM L1 Link Power Management</b>          | Enables or disables the PCI ASPM L1 Link Power Management. This option is set to <b>Enabled</b> by default.          |

## System Security

You can use the **System Security** screen to perform specific functions such as setting the system password, setup password and disabling the power button.

### Viewing System Security

To view the **System Security** screen, perform the following steps:

#### Steps

1. Turn on, or restart your system.
2. Press F2 immediately after you see the following message:

```
F2 = System Setup
```

**NOTE:** If your operating system begins to load before you press F2, wait for the system to finish booting, and then restart your system and try again.

3. On the **System Setup Main Menu** screen, click **System BIOS**.
4. On the **System BIOS** screen, click **System Security**.

### System Security Settings details

#### About this task

The **System Security Settings** screen details are explained as follows:

| Option                 | Description   |
|------------------------|---|
| <b>CPU AES-NI</b>      | Improves the speed of applications by performing encryption and decryption by using the Advanced Encryption Standard Instruction Set (AES-NI). This option is set to <b>Enabled</b> by default. |
| <b>System Password</b> | Sets the system password. This option is set to <b>Enabled</b> by default and is read-only if the password jumper is not installed in the system.   |
| <b>Setup Password</b>  | Sets the setup password. This option is read-only if the password jumper is not installed in the system.  |
| <b>Password Status</b> | Locks the system password. This option is set to <b>Unlocked</b> by default.  |
| <b>TPM Information</b> | <b>NOTE:</b> The TPM menu is available only when the TPM module is installed.   |

Enables you to control the reporting mode of the TPM. The **TPM Security** option is set to **Off** by default. You can only modify the TPM Status, and TPM Activation, and the Intel TXT fields if the **TPM Status** field is set to either **On with Pre-boot Measurements** or **On without Pre-boot Measurements**.

When TPM 1.2 is installed, the **TPM Security** option is set to **Off**, **On with Pre-boot Measurements**, or **On without Pre-boot Measurements**.

**Table 7. TPM 1.2 security information**

| TPM information        | Description  |
|------------------------|--|
| <b>TPM Information</b> | Changes the operational state of the TPM. This option is set to <b>No Change</b> by default. |
| <b>TPM Firmware</b>    | Indicates the firmware version of the TPM.   |
| <b>TPM Status</b>      | Specifies the TPM status.  |

| Option   | Description   |
|--|---|
| <b>TPM information</b>   | <b>Description</b>  |
| <b>TPM Command</b>   | Controls the Trusted Platform Module (TPM). When set to <b>None</b> , no command is sent to the TPM. When set to <b>Activate</b> , the TPM is enabled and activated. When set to <b>Deactivate</b> , the TPM is disabled and deactivated. When set to <b>Clear</b> , all the contents of the TPM are cleared. This option is set to <b>None</b> by default.   |
| When TPM 2.0 is installed, the <b>TPM Security</b> option is set to <b>On</b> or <b>Off</b> . This option is set to <b>Off</b> by default. |   |
| <b>Table 8. TPM 2.0 security information</b>   |   |
| <b>TPM information</b>   | <b>Description</b>  |
| <b>TPM Information</b>   | Changes the operational state of the TPM. This option is set to <b>No Change</b> by default.  |
| <b>TPM Firmware</b>  | Indicates the firmware version of the TPM.  |
| <b>TPM Hierarchy</b>   | Enable, disable, or clear the storage and endorsement hierarchies. When set to <b>Enabled</b> , the storage and endorsement hierarchies can be used.<br><br>When set to <b>Disabled</b> , the storage and endorsement hierarchies cannot be used.<br><br>When set to <b>Clear</b> , the storage and endorsement hierarchies are cleared of any values, and then reset to <b>Enabled</b> .   |
| <b>Intel(R) TXT</b>  | Enables or disables the Intel Trusted Execution Technology (TXT) option. To enable the <b>Intel TXT</b> option, virtualization technology and TPM Security must be enabled with Pre-boot measurements. This option is set to <b>Off</b> by default.<br><br>When TPM 2.0 is installed, <b>TPM 2 Algorithm</b> option is available. It enables you to select a hash algorithm from those supported by the TPM (SHA1, SHA256). <b>TPM 2 Algorithm</b> option must be set to <b>SHA256</b> , to enable TXT.   |
| <b>Power Button</b>  | Enables or disables the power button on the front of the system. This option is set to <b>Enabled</b> by default.   |
| <b>AC Power Recovery</b>   | Sets how the system behaves after AC power is restored to the system. This option is set to <b>Last</b> by default.   |
| <b>AC Power Recovery Delay</b>   | Sets the time delay for the system to power up after AC power is restored to the system. This option is set to <b>Immediate</b> by default.   |
| <b>User Defined Delay (60 s to 600 s)</b>  | Sets the <b>User Defined Delay</b> option when the <b>User Defined</b> option for <b>AC Power Recovery Delay</b> is selected.   |
| <b>UEFI Variable Access</b>  | Provides varying degrees of securing UEFI variables. When set to <b>Standard</b> (the default), UEFI variables are accessible in the operating system per the UEFI specification. When set to <b>Controlled</b> , selected UEFI variables are protected in the environment and new UEFI boot entries are forced to be at the end of the current boot order.   |
| <b>In-Band Manageability Interface</b>   | When set to <b>Disabled</b> , this setting will hide the Management Engine's (ME), HECI devices, and the system's IPMI devices from the operating system. This prevents the operating system from changing the ME power capping settings, and blocks access to all in-band management tools. All management should be managed through out-of-band. This option is set to <b>Enabled</b> by default.<br><br> <b>NOTE: BIOS update requires HECI devices to be operational and DUP updates require IPMI interface to be operational. This setting needs to be set to Enabled to avoid updating errors.</b> |
| <b>Secure Boot</b>   | Enables Secure Boot, where the BIOS authenticates each pre-boot image by using the certificates in the Secure Boot Policy. Secure Boot is set to <b>Disabled</b> by default.  |
| <b>Secure Boot Policy</b>  | When Secure Boot policy is set to <b>Standard</b> , the BIOS uses the system manufacturer's key and certificates to authenticate pre-boot images. When Secure Boot policy is set to <b>Custom</b> , the BIOS uses the user-defined key and certificates. Secure Boot policy is set to <b>Standard</b> by default.   |
| <b>Secure Boot Mode</b>  | Configures how the BIOS uses the Secure Boot Policy Objects (PK, KEK, db, dbx).<br><br>If the current mode is set to <b>Deployed Mode</b> , the available options are <b>User Mode</b> and <b>Deployed Mode</b> . If the current mode is set to <b>User Mode</b> , the available options are <b>User Mode</b> , <b>Audit Mode</b> , and <b>Deployed Mode</b> .  |

| Option               | Description   |
|----------------------|---|
| <b>Options</b>       | <b>Description</b>  |
| <b>User Mode</b>     | In <b>User Mode</b> , PK must be installed, and BIOS performs signature verification on programmatic attempts to update policy objects.<br>The BIOS allows unauthenticated programmatic transitions between modes.  |
| <b>Deployed Mode</b> | <b>Deployed Mode</b> is the most secure mode. In <b>Deployed Mode</b> , PK must be installed and the BIOS performs signature verification on programmatic attempts to update policy objects.<br><b>Deployed Mode</b> restricts the programmatic mode transitions. |

### Secure Boot Policy Summary

#### About this task

The **Secure Boot Policy Summary** screen details are explained as follows:

**Secure Boot Policy Summary** Specifies the list of certificates and hashes that secure boot uses to authenticate images.

### Secure Boot Custom Policy Settings

#### About this task

The **Secure Boot Custom Policy Settings** screen details are explained as follows:

**Secure Boot Custom Policy Settings** Configures the Secure Boot Custom Policy. To enable this option, set the Secure Boot Policy to **Custom** option.

## Redundant OS Control

You can use the **Redundant OS Control** screen to set the redundant OS info for redundant OS control. It enables you to set up a physical recovery disk on your system.

### Viewing Redundant OS Control

To view the **Redundant OS Control** screen, perform the following steps:

#### Steps

1. Turn on, or restart your system.
2. Press F2 immediately after you see the following message:

```
F2 = System Setup
```

**NOTE:** If your operating system begins to load before you press F2, wait for the system to finish booting, and then restart your system and try again.

3. On the **System Setup Main Menu** screen, click **System BIOS**.
4. On the **System BIOS** screen, click **Redundant OS Control**.

### Redundant OS Control screen details

The **Redundant OS Control** screen details are explained as follows:

#### About this task

| Option                       | Description   |
|------------------------------|---|
| <b>Redundant OS Location</b> | Enables you to select a backup disk from the following devices: |

| Option                    | Description   |
|---------------------------|---|
|                           | <ul style="list-style-type: none"> <li>· <b>None</b></li> <li>· <b>Internal SD card</b></li> <li>· <b>SATA Ports in AHCI mode</b></li> <li>· <b>BOSS PCIe cards (Internal M.2 Drives)</b></li> <li>· <b>Internal USB</b></li> </ul> <p><b>NOTE:</b> RAID configurations and NVMe cards not are included as BIOS does not have the ability to distinguish between individual drives in those configurations.</p>                   |
| <b>Redundant OS State</b> | <p><b>NOTE:</b> This option is disabled if Redundant OS Location is set to None.</p> <p>When set to <b>Visible</b>, the backup disk is visible to the boot list and OS. When set to <b>Hidden</b>, the backup disk is disabled and is not visible to the boot list and OS. This option is set to <b>Visible</b> by default.</p> <p><b>NOTE:</b> BIOS will disable the device in hardware, so it cannot be accessed by the OS.</p> |
| <b>Redundant OS Boot</b>  | <p><b>NOTE:</b> This option is disabled if Redundant OS Location is set to None or if Redundant OS State is set to Hidden.</p> <p>When set to <b>Enabled</b>, BIOS boots to the device specified in <b>Redundant OS Location</b>. When set to <b>Disabled</b>, BIOS preserves the current boot list settings. This option is set to <b>Disabled</b> by default.</p>   |

## Miscellaneous Settings

You can use the **Miscellaneous Settings** screen to perform specific functions such as updating the asset tag and changing the system date and time.

### View Miscellaneous Settings

To view the **Miscellaneous Settings** screen, perform the following steps:

#### Steps

1. Turn on, or restart your system.
2. Press F2 immediately after you see the following message:

```
F2 = System Setup
```

**NOTE:** If your operating system begins to load before you press F2, wait for the system to finish booting, and then restart your system and try again.

3. On the **System Setup Main Menu** screen, click **System BIOS**.
4. On the **System BIOS** screen, click **Miscellaneous Settings**.

### Miscellaneous Settings details

#### About this task

The **Miscellaneous Settings** screen details are explained as follows:

| Option                  | Description   |
|-------------------------|---|
| <b>System Time</b>      | Enables you to set the time on the system.  |
| <b>System Date</b>      | Enables you to set the date on the system.  |
| <b>Asset Tag</b>        | Specifies the asset tag and enables you to modify it for security and tracking purposes.                                      |
| <b>Keyboard NumLock</b> | Enables you to set whether the system boots with the NumLock enabled or disabled. This option is set to <b>On</b> by default. |
|                         | <b>NOTE:</b> This option does not apply to 84-key keyboards.  |

| Option                               | Description   |
|--------------------------------------|---|
| <b>F1/F2 Prompt on Error</b>         | Enables or disables the F1/F2 prompt on error. This option is set to <b>Enabled</b> by default. The F1/F2 prompt also includes keyboard errors.   |
| <b>Load Legacy Video Option ROM</b>  | Enables you to determine whether the system BIOS loads the legacy video (INT 10H) option ROM from the video controller. Selecting <b>Enabled</b> if the operating system does not support UEFI video output standards. This field is available only for UEFI boot mode. You cannot set the option to <b>Enabled</b> if <b>UEFI Secure Boot</b> mode is enabled. This option is set to <b>Disabled</b> by default. |
| <b>Dell Wyse P25/P45 BIOS Access</b> | Enables or disables the Dell Wyse P25/P45 BIOS Access. This option is set to <b>Enabled</b> by default.   |
| <b>Power Cycle Request</b>           | Enables or disables the Power Cycle Request. This option is set to <b>None</b> by default.  |

## iDRAC Settings utility

The iDRAC settings utility is an interface to set up and configure the iDRAC parameters by using UEFI. You can enable or disable various iDRAC parameters by using the iDRAC settings utility.

 **NOTE: Accessing some of the features on the iDRAC settings utility needs the iDRAC Enterprise License upgrade.**

For more information about using iDRAC, see *Dell Integrated Dell Remote Access Controller User's Guide* at [www.dell.com/idracmanuals](http://www.dell.com/idracmanuals).

## Device Settings

**Device Settings** enables you to configure the device parameters.

## Dell Lifecycle Controller

The Dell Lifecycle Controller (LC) provides advanced embedded systems management capabilities, including system deployment, configuration, update, maintenance, and diagnosis. LC is delivered as part of the iDRAC out-of-band solution and Dell system embedded Unified Extensible Firmware Interface (UEFI) applications.

## Embedded System Management

The Dell Lifecycle Controller provides advanced embedded system management throughout the system's lifecycle. The Dell Lifecycle Controller can be started during the boot sequence and can function independently of the operating system.

 **NOTE: Certain platform configurations may not support the full set of features provided by the Dell Lifecycle Controller.**

For more information about setting up the Dell Lifecycle Controller, configuring hardware and firmware, and deploying the operating system, see the Dell Lifecycle Controller documentation at [www.dell.com/idracmanuals](http://www.dell.com/idracmanuals).

## Boot Manager

The **Boot Manager** screen enables you to select boot options and diagnostic utilities.

## View the boot manager

Perform the following steps to enter the boot manager.

### Steps

1. Turn on, or restart your system.  
Enter the result of your step here (optional).
2. Press F11 when you see the following message:  
F11 = Boot Manager

If your operating system begins to load before you press F11, allow the system to complete the booting, and then restart your system and try again.

## Boot Manager main menu

| Menu item                          | Description   |
|------------------------------------|---|
| <b>Continue Normal Boot</b>        | The system attempts to boot to devices starting with the first item in the boot order. If the boot attempt fails, the system continues with the next item in the boot order until the boot is successful or no more boot options are found. |
| <b>One-shot UEFI Boot menu</b>     | Enables you to access the UEFI Boot menu and select an one-shot boot option to boot from.   |
| <b>Launch System Setup</b>         | Enables you to access System Setup.   |
| <b>Launch Lifecycle Controller</b> | Exits the Boot Manager and invokes the Dell Lifecycle Controller program.   |
| <b>System Utilities</b>            | Enables you to launch System Utilities menu such as System Diagnostics and UEFI shell.  |

## One-shot UEFI Boot menu

**One-shot UEFI Boot menu** enables you to access the UEFI Boot menu and select an one-shot boot option to boot from.

## System Utilities

**System Utilities** contains the following utilities that can be launched:

- Launch Diagnostics
- BIOS Update File Explorer
- Reboot System







## PXE boot

You can use the Preboot Execution Environment (PXE) option to boot and configure the networked systems remotely.

To access the **PXE boot** option, boot the system and then press F12 during POST instead of using standard Boot Sequence from BIOS Setup. It does not pull any menu or allow managing network devices.

# Installing and removing system components

## Safety instructions

-  **NOTE:** Whenever you need to lift the system, get others to assist you. To avoid injury, do not attempt to lift the system by yourself.
-  **WARNING:** Opening or removing the system cover while the system is powered on may expose you to a risk of electric shock.
-  **CAUTION:** Do not operate the system without the cover for a duration exceeding five minutes. Operating the system without the system cover can result in component damage.
-  **CAUTION:** Many repairs may only be done by a certified service technician. You should only perform troubleshooting and simple repairs as authorized in your product documentation, or as directed by the online or telephone service and support team. Damage due to servicing that is not authorized by Dell is not covered by your warranty. Read and follow the safety instructions that are shipped with your product.
-  **NOTE:** It is recommended that you always use an antistatic mat and antistatic strap while working on components inside the system.
-  **CAUTION:** To ensure proper operation and cooling, all bays in the system and system fans must be always populated with a component or a blank.
-  **CAUTION:** Ensure to have two or more people to lift the system horizontally from the box and place it on a flat surface, rack lift, or into the rails.

## Before working inside your system

### Prerequisites

Follow the safety guidelines listed in [Safety instructions](#).

### Steps

1. Turn off the system, including all attached peripherals.
2. Disconnect the system from the electrical outlet and disconnect the peripherals.
3. If applicable, remove the system from the rack.  
For more information, see the *Rail Installation Guide* at [www.dell.com/poweredgemanuals](http://www.dell.com/poweredgemanuals).
4. [Remove the system cover](#).

## After working inside your system

### Prerequisites

Follow the safety guidelines listed in [Safety instructions](#).

### Steps

1. [Install the system cover](#).
2. If applicable, install the system into the rack.  
For more information, see the *Rail Installation Guide* at [www.dell.com/poweredgemanuals](http://www.dell.com/poweredgemanuals).

3. Reconnect the peripherals and connect the system to the electrical outlet.
4. Turn on the attached peripherals and then turn on the system.

## Recommended tools

You need the following tools to perform the removal and installation procedures:

- Key to the bezel lock  
The key is required only if your system includes a bezel.
- Phillips #1 screwdriver
- Phillips #2 screwdriver
- Torx #T30 screwdriver
- 1/4 inch flat head screwdriver
- Wrist grounding strap

You need the following tools to assemble the cables for a DC power supply unit:

- AMP 90871-1 hand-crimping tool or equivalent
- Tyco Electronics 58433-3 or equivalent
- Wire-stripper pliers to remove insulation from size 10 AWG solid or stranded, insulated copper wire

 **NOTE: Use alpha wire part number 3080 or equivalent (65/30 stranding).**

## Optional front bezel

A lock on the bezel is used to protect unauthorized access to the drives. The system status can be viewed on the bezel with the LCD panel. For more information, see the [LCD panel](#) section.

## Removing front bezel

### Prerequisites

1. Follow the safety guidelines listed in [Safety instructions](#).

### Steps

1. Unlock the bezel by using the bezel key.
2. Press the release button, and pull the left end of the bezel.
3. Unhook the right end, and remove the bezel.



Figure 17. Removing optional front bezel

#### Next steps

1. [Replace the bezel.](#)

## Installing the front bezel

#### Prerequisites

1. Follow the safety guidelines listed in [Safety instructions](#).
2. Locate and remove the bezel key.

**NOTE:** The bezel key is part of the LCD bezel package.

#### Steps

1. Align and insert the right end of the bezel onto the system.
2. Press the release button and fit the left end of the bezel onto the system.
3. Lock the bezel by using the key.

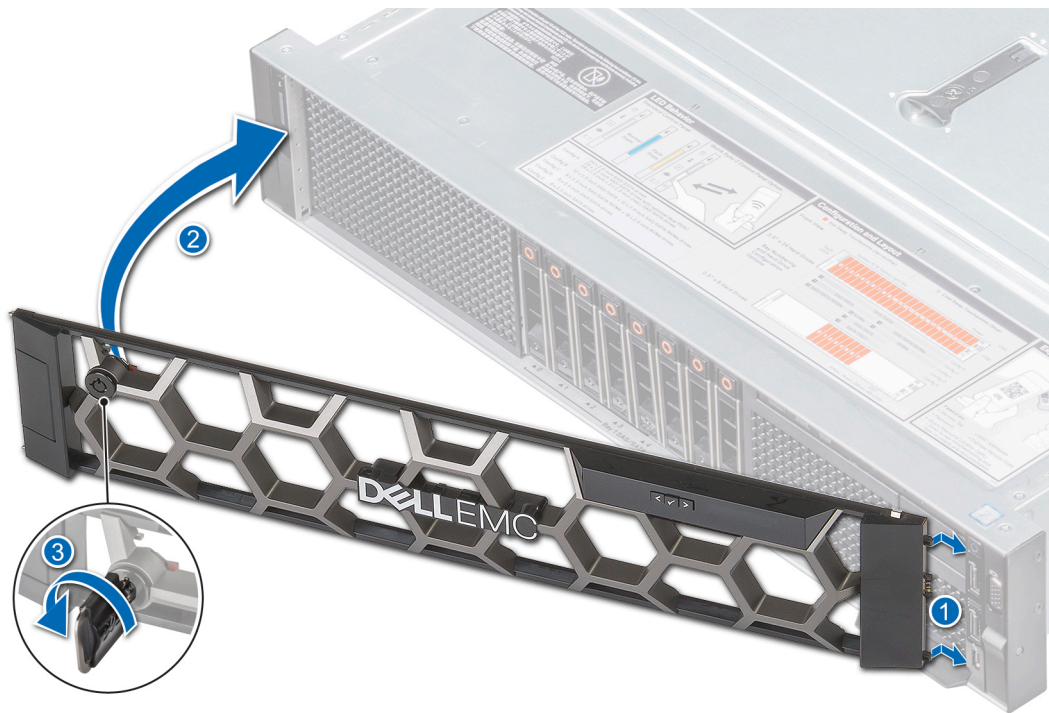

Figure 18. Installing the optional front bezel

## System cover

### Removing the system cover

#### Prerequisites

1. Follow the safety guidelines listed in [Safety instructions](#).
2. Turn off the system, including all attached peripherals.
3. Disconnect the system from the electrical outlet and disconnect the peripherals.
4. If applicable, remove the system from the rack.

**i** **NOTE:** For more information, see the *Rail Installation Guide* at [www.dell.com/poweredgemanuals](http://www.dell.com/poweredgemanuals).

#### Steps

1. Use a 1/4 inch flat head or a Phillips #2 screwdriver to turn the latch release lock counterclockwise to the unlock position.
2. Open the latch till the system cover slides back.
3. Lift the cover away from the system.

Figure 19. Removing the system cover



### Next steps

1. [Replace the system cover.](#)

## Installing system cover

### Prerequisites

1. Follow the safety guidelines listed in [Safety instructions](#).
2. Ensure that all internal cables are routed correctly and connected, and no tools or extra parts are left inside the system.

### Steps

1. Align the tabs on the system cover with the guide slots on the system.
2. Close the system cover latch.
3. Using a 1/4 inch flat head or Phillips #2 screwdriver, rotate the latch release lock clockwise to the lock position.



**Figure 20. Installing system cover**

#### Next steps

1. Follow the procedure listed in [After working inside your system](#).

## Air shroud

The air shroud directs the airflow across the entire system and maintain uniform airflow in the system. Air shroud prevents the system from overheating and is used to maintain uniform airflow inside the system. The system supports two types of air shrouds:

- Non-GPU air shroud
- GPU air shroud

## Removing the non-GPU air shroud

#### Prerequisites

**CAUTION:** Never operate your system with the air shroud removed. The system may get overheated quickly, resulting in shutdown of the system and loss of data.

1. Follow the safety guidelines listed in [Safety instructions](#).
2. Follow the procedure listed in [Before working inside your system](#).
3. If installed, [remove the NVDIMM battery](#).

#### Steps

Hold the air shroud and lift it away from the system.

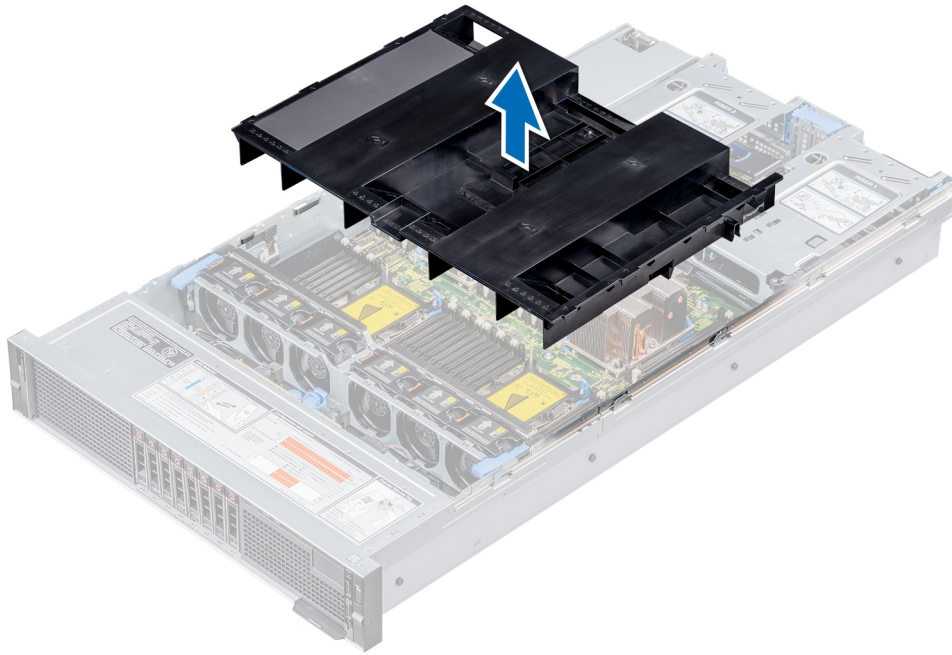

**Figure 21. Removing the non-GPU air shroud**

**Next steps**

1. [Replace the non-GPU air shroud.](#)

## Installing the non-GPU air shroud

**Prerequisites**

1. Follow the safety guidelines listed in [Safety instructions](#).
2. Follow the procedure listed in [Before working inside your system](#).

**Steps**

1. Align the tabs on the air shroud with the slots on the system.
2. Lower the air shroud into the system until it is firmly seated.

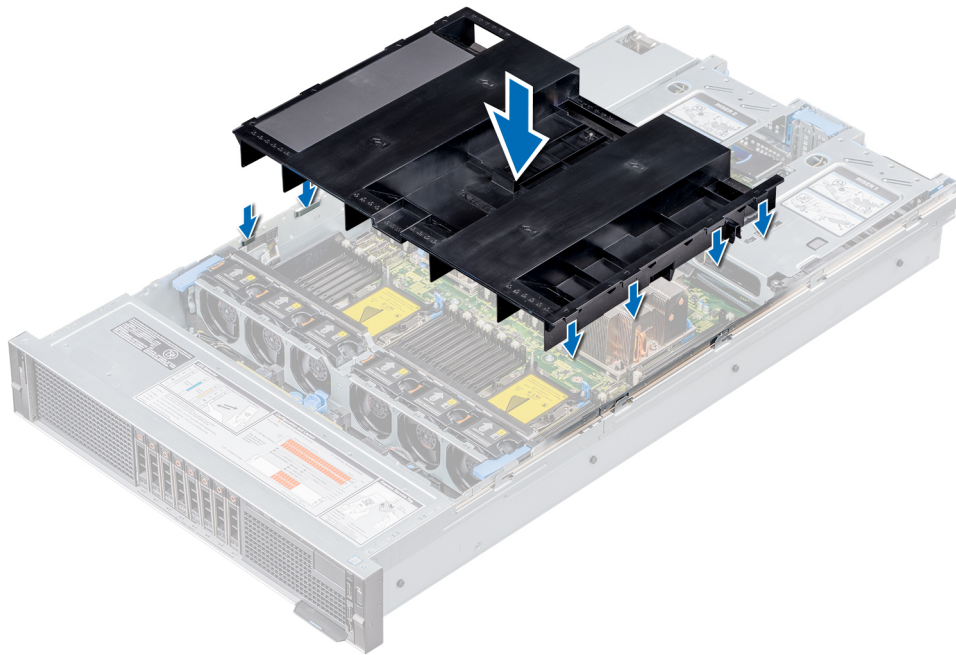

**Figure 22. Installing the non-GPU air shroud**

#### Next steps

1. If applicable, [install the NVDIMM battery](#).
2. Follow the procedure listed in [After working inside your system](#).

## Removing the GPU air shroud

#### Prerequisites

**CAUTION:** Never operate your system with the air shroud removed. The system may get overheated quickly, resulting in shutdown of the system and loss of data.

1. Follow the safety guidelines listed in [Safety instructions](#).
2. Follow the procedure listed in [Before working inside your system](#).

#### Steps

1. Holding the air shroud cover at the blue touch point, lift the cover at an angle to disengage it from the air shroud, and then lift it away from the system.

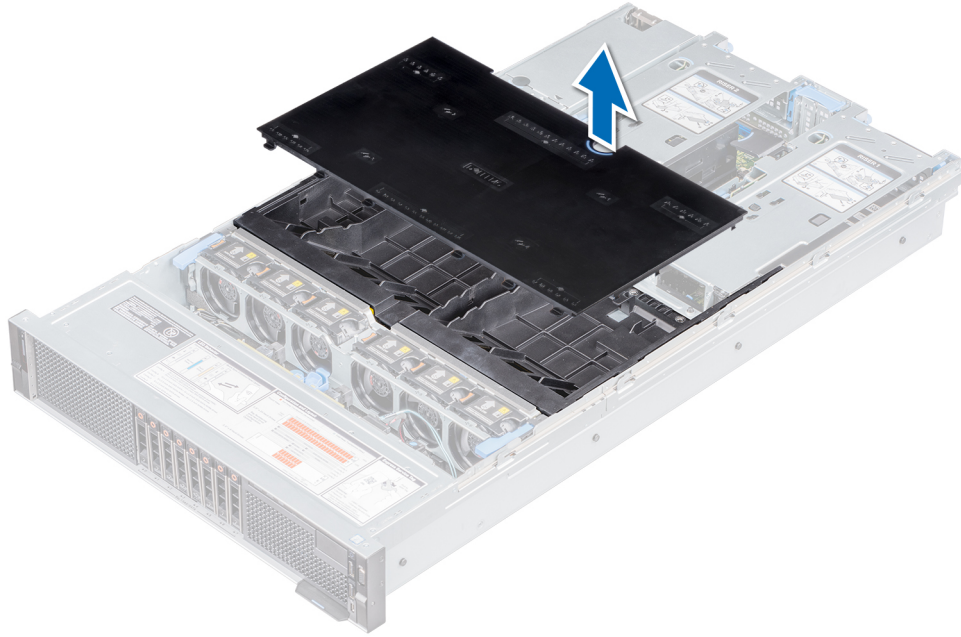

**Figure 23. Removing the GPU air shroud cover**

2. If installed, remove the NVDIMM-N battery.
3. Remove the expansion card riser 1 and 2.
4. Hold the air shroud and lift it away from the system.

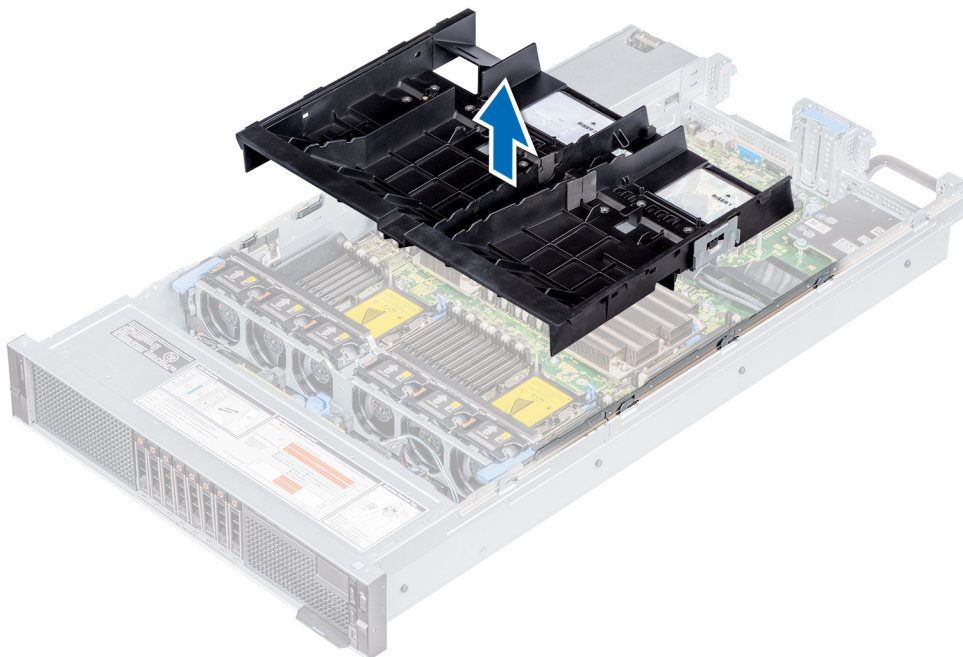

**Figure 24. Removing the GPU air shroud**

**Next steps**

1. Replace the air shroud.

# Installing the GPU air shroud

## Prerequisites

1. Follow the safety guidelines listed in [Safety instructions](#).
2. Follow the procedure listed in [Before working inside your system](#).

## Steps

1. Align the tabs on the air shroud with the slots on the system.

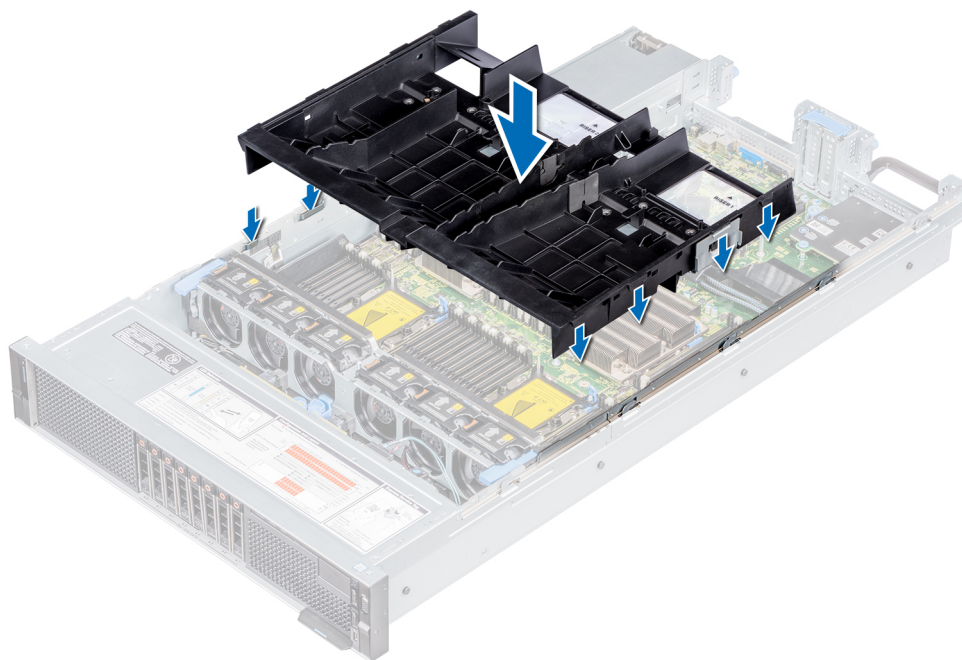

**Figure 25. Installing the GPU air shroud**

2. Lower the air shroud into the system until it is firmly seated.
3. [Install the expansion card riser 1 and 2.](#)
4. If applicable, [install the NVDIMM-N battery.](#)
5. Holding the blue touch point on the air shroud cover, incline the cover at an angle, and then push it down until it is firmly seated.

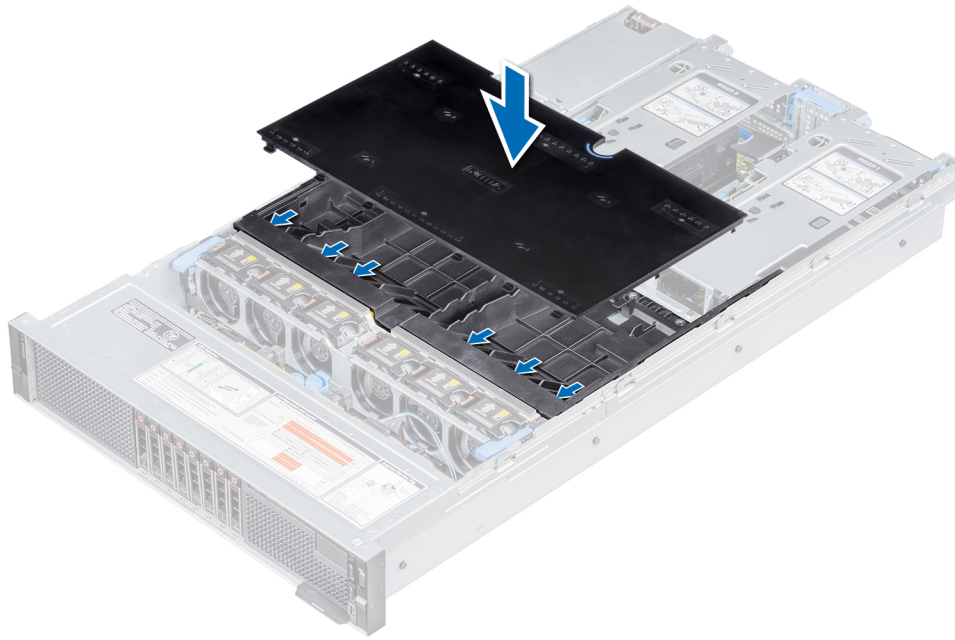

**Figure 26. Installing the GPU air shroud cover**

#### **Next steps**

1. Follow the procedure listed in [After working inside your system](#).

## **Cooling fan assembly**

The cooling fan assembly ensures that the key components of the server such as the processors, drives, and memory get adequate air circulation to keep them cool. A failure in the server's cooling system can result in the server overheating and may lead to damage.

## **Removing the cooling fan assembly**

#### **Prerequisites**

1. Follow the safety guidelines listed in [Safety instructions](#).
2. Follow the procedure listed in [Before working inside your system](#).

#### **Steps**

1. Lift the release levers to unlock the cooling fan assembly.
2. Holding the release levers, lift the cooling fan assembly out of the system.

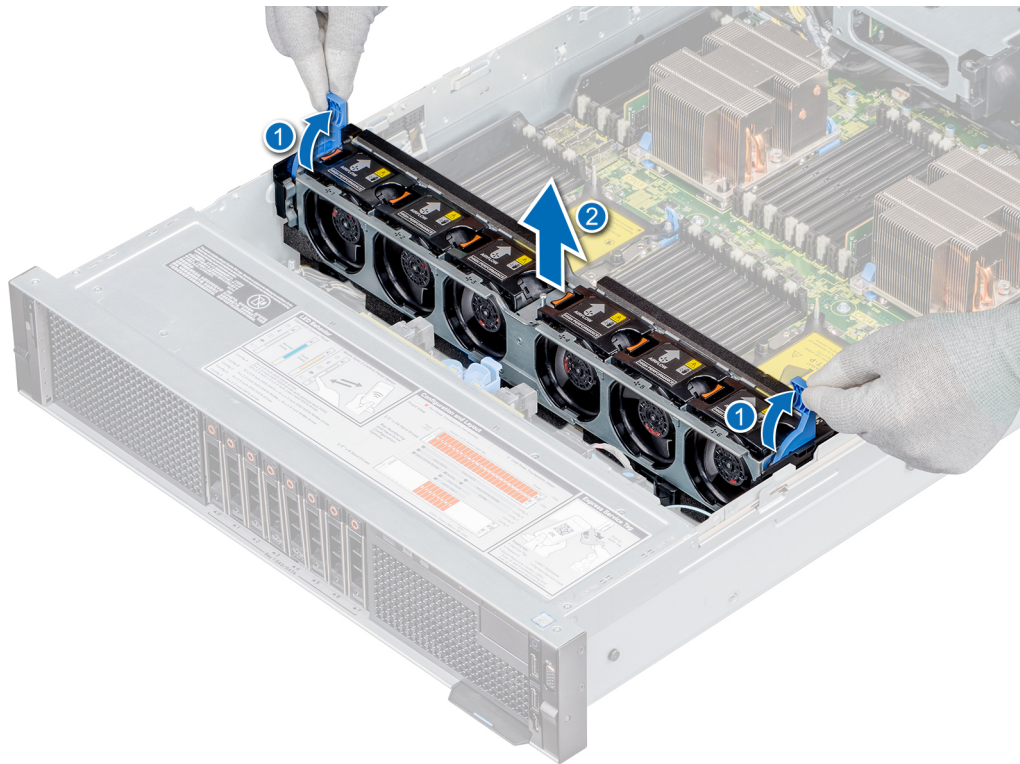

**Figure 27. Removing the cooling fan assembly**

#### **Next steps**

1. [Replace the cooling fan assembly.](#)

## **Installing the cooling fan assembly**

#### **Prerequisites**

1. Follow the safety guidelines listed in [Safety instructions](#).
2. Follow the procedure listed in [Before working inside your system](#).

#### **Steps**

1. Align the guide slots on the cooling fan assembly with the standoffs on the system.
2. Lower the cooling fan assembly into the system until the cooling fan connectors engage with the connectors on the system board.
3. Press the release levers to lock the cooling fan assembly in place.

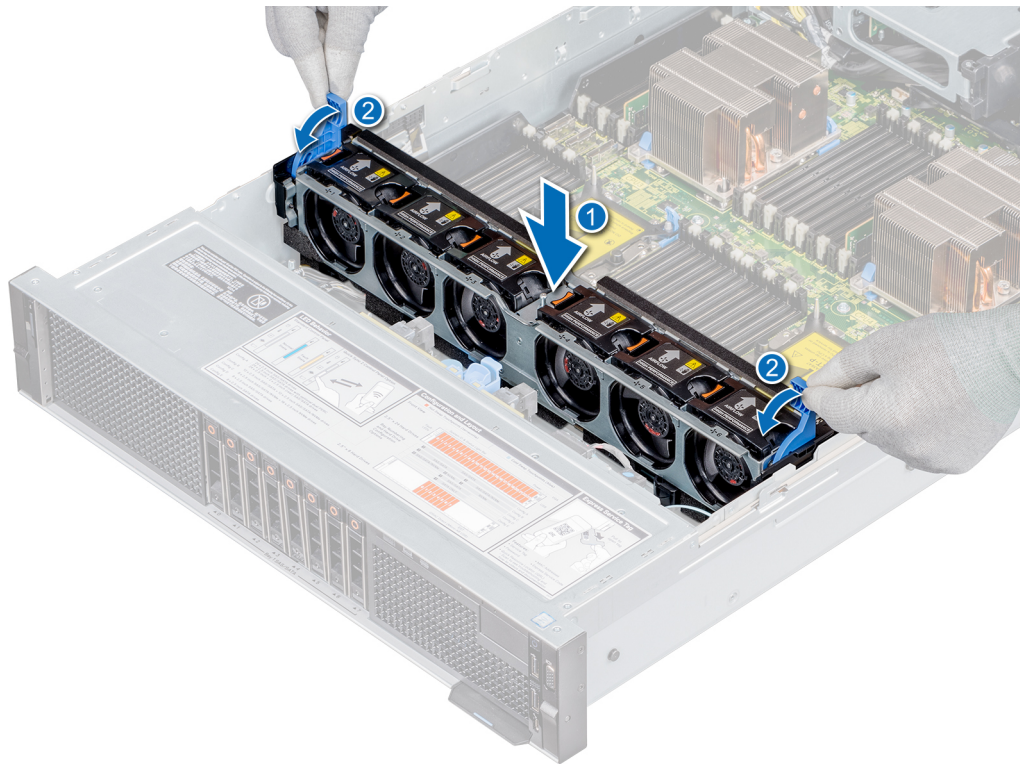

Figure 28. Installing the cooling fan assembly

#### Next steps

1. Follow the procedure listed in [After working inside your system](#).

## Cooling fans

The cooling fans are integrated into the system to dissipate the heat generated by the functioning of the system. These fans provide cooling for the processors, expansion cards, and memory modules.

- NOTE:** Each fan is listed in the systems management software, referenced by the respective fan number. If there is a problem with a particular fan, you can easily identify and replace the proper fan by noting the fan numbers on the cooling fan assembly.

## Removing a cooling fan

#### Prerequisites

- NOTE:** Opening or removing the system cover when the system is on may expose you to a risk of electric shock. Exercise utmost care while removing or installing cooling fans.

- CAUTION:** The cooling fans are hot swappable. To maintain proper cooling while the system is on, replace only one fan at a time.

1. Follow the safety guidelines listed in [Safety instructions](#).
2. Follow the procedure listed in [Before working inside your system](#).
3. [Remove the non-GPU air shroud](#) or [GPU air shroud](#).

#### Steps

Press the release tab and lift the cooling fan out of the cooling fan assembly.

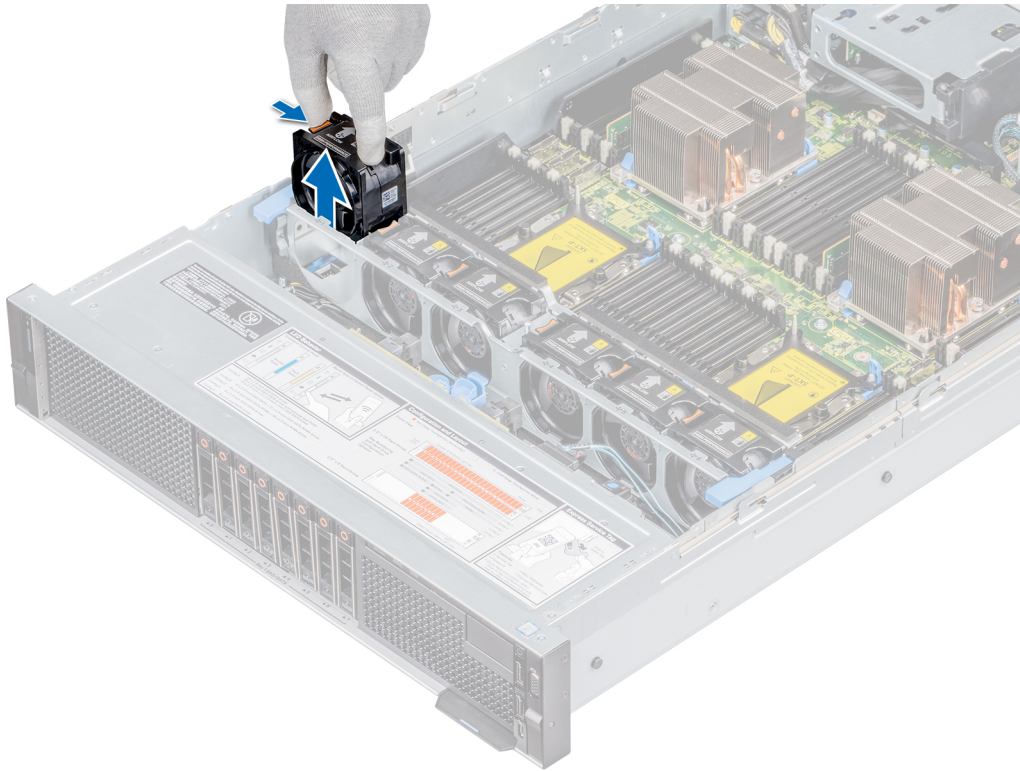

Figure 29. Removing cooling fan

#### Next steps

1. [Replace the cooling fan.](#)

## Installing a cooling fan

#### Prerequisites

**NOTE:** Opening or removing the system cover when the system is on may expose you to a risk of electric shock. Exercise utmost care while removing or installing cooling fans.

**CAUTION:** The cooling fans are hot swappable. To maintain proper cooling while the system is on, replace only one fan at a time.

1. Follow the safety guidelines listed in [Safety instructions](#).
2. Follow the procedure listed in [Before working inside your system](#).
3. [Remove the non-GPU air shroud](#) or [GPU air shroud](#).

#### Steps

1. Holding the touch points on the cooling fan, align the connector on the cooling fan with the connector on the system board.
2. Slide the cooling fan into the cooling fan assembly until the release tab locks into place.

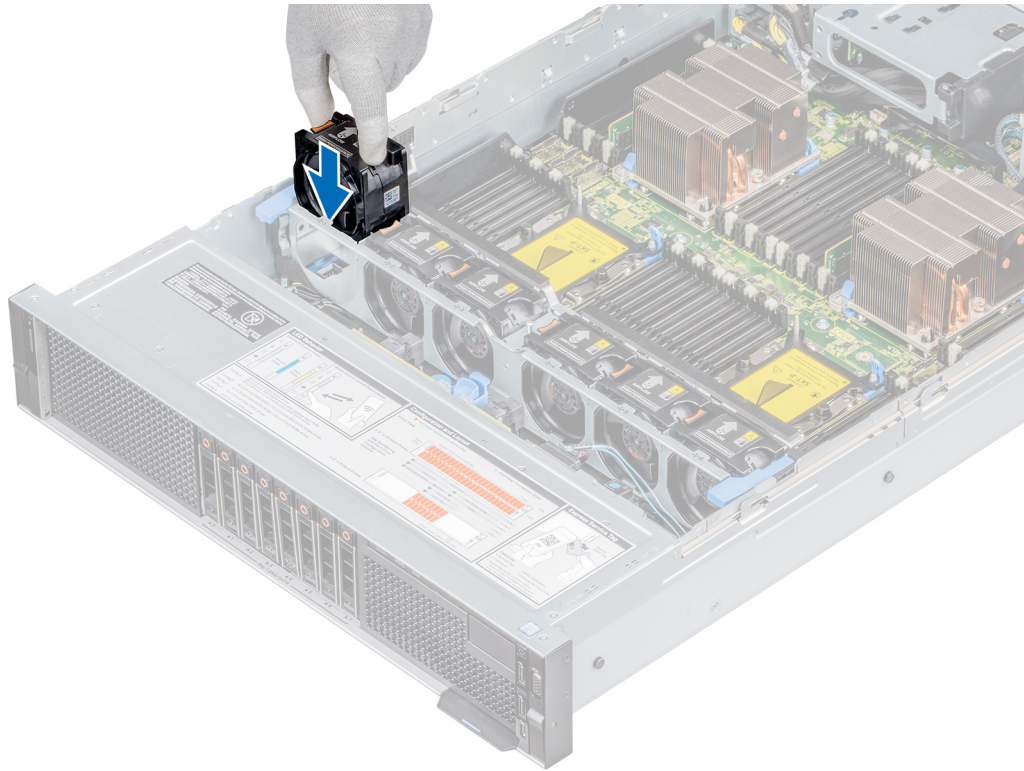

**Figure 30. Installing cooling fan**

#### Next steps

1. Install the [non-GPU air shroud](#) or [GPU air shroud](#).
2. Follow the procedure listed in [After working inside your system](#).

## NVDIMM-N battery

The NVDIMM-N battery is installed on the air shroud.

## Removing the NVDIMM-N battery

#### Prerequisites

1. Follow the safety guidelines listed in [Safety instructions](#).
2. Follow the procedure listed in [Before working inside your system](#).
3. For GPU air shroud, [remove the GPU air shroud cover](#).

**CAUTION:** NVDIMM-N battery is not hot swappable. To prevent data loss and potential damage to your system, ensure that your system, LEDs on system, LEDs on NVDIMM-N and LEDs on NVDIMM-N battery are turned off, by disconnecting the cables, before removing the NVDIMM-N battery.

**NOTE:** To avoid damage to the battery connector, hold the connector while installing or removing a battery.

#### Steps

1. Disconnect the cables from the NVDIMM-N battery.
2. Using Phillips #2 screwdriver, loosen the screw securing the NVDIMM-N battery to the air shroud.
3. Holding the blue touch point, lift the NVDIMM-N battery at an angle to disengage it from the slot on the air shroud.
4. Lift the NVDIMM-N battery away from the system.

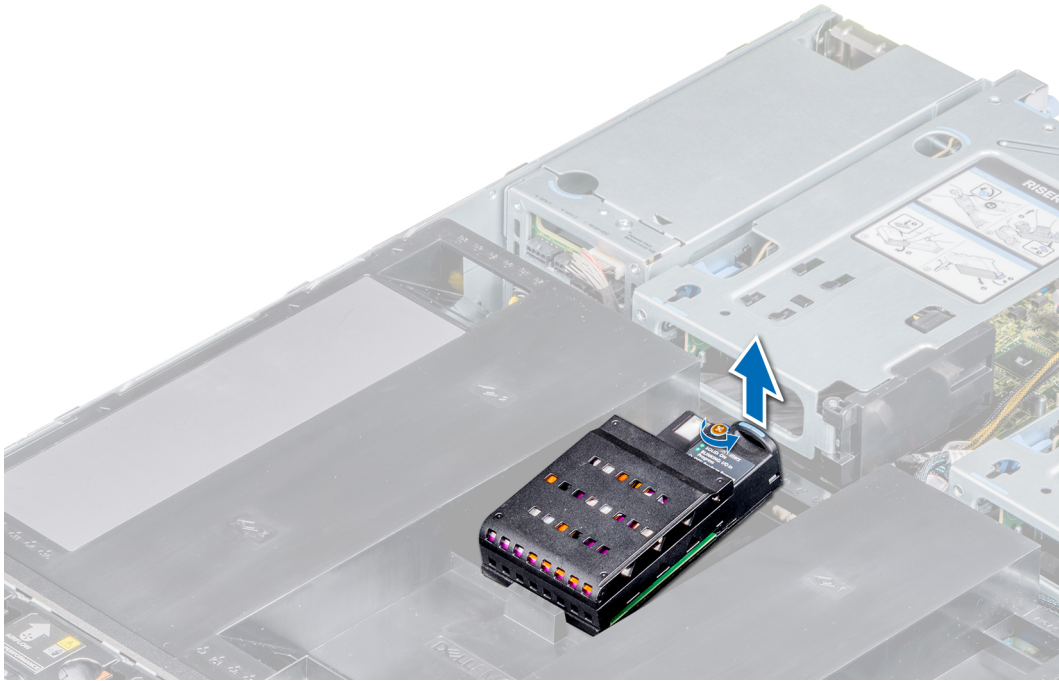

Figure 31. Removing the NVDIMM-N battery from the non-GPU air shroud

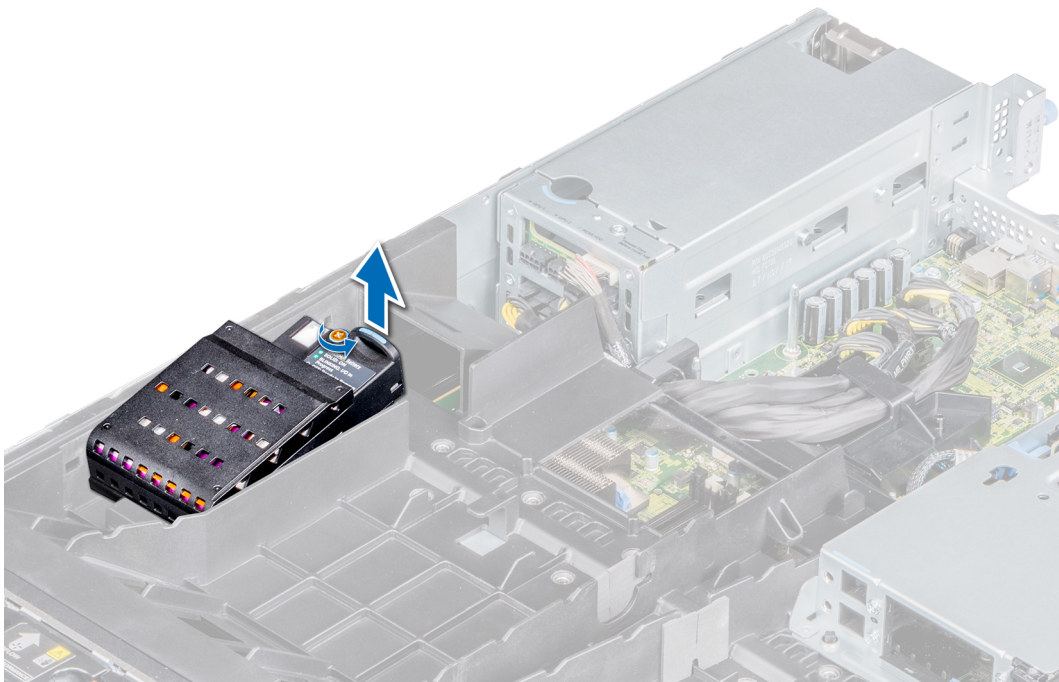

Figure 32. Removing the NVDIMM-N battery from the GPU air shroud

#### Next steps

1. Replace the NVDIMM-N battery.

## Installing NVDIMM-N battery

#### Prerequisites

1. Follow the safety guidelines listed in [Safety instructions](#).

2. Follow the procedure listed in [Before working inside your system](#)
3. For GPU air shroud, [remove the GPU air shroud cover](#).

**CAUTION:** NVDIMM-N battery is not hot swappable. To prevent data loss and potential damage to your system, ensure that your system, LEDs on system, LEDs on NVDIMM-N and LEDs on NVDIMM-N battery are turned off, by disconnecting the cables, before installing the NVDIMM-N battery.

**CAUTION:** To avoid damage to the battery connector, you must firmly support the connector while installing or removing a battery.

### Steps

1. Incline the NVDIMM-N battery at an angle, and place the battery on the slot on the air shroud.
2. Using a Phillips #2 screwdriver, replace the screw to secure the NVDIMM-N battery to the air shroud.
3. Connect the cables to the NVDIMM-N battery.

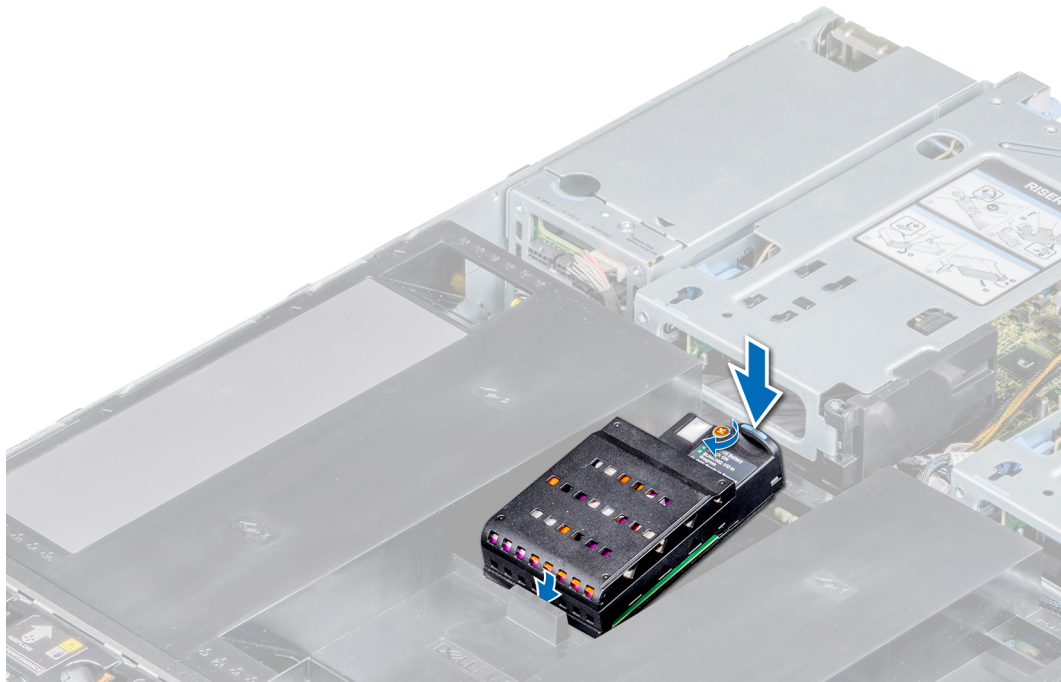

**Figure 33. Installing NVDIMM-N battery into non-GPU air shroud**

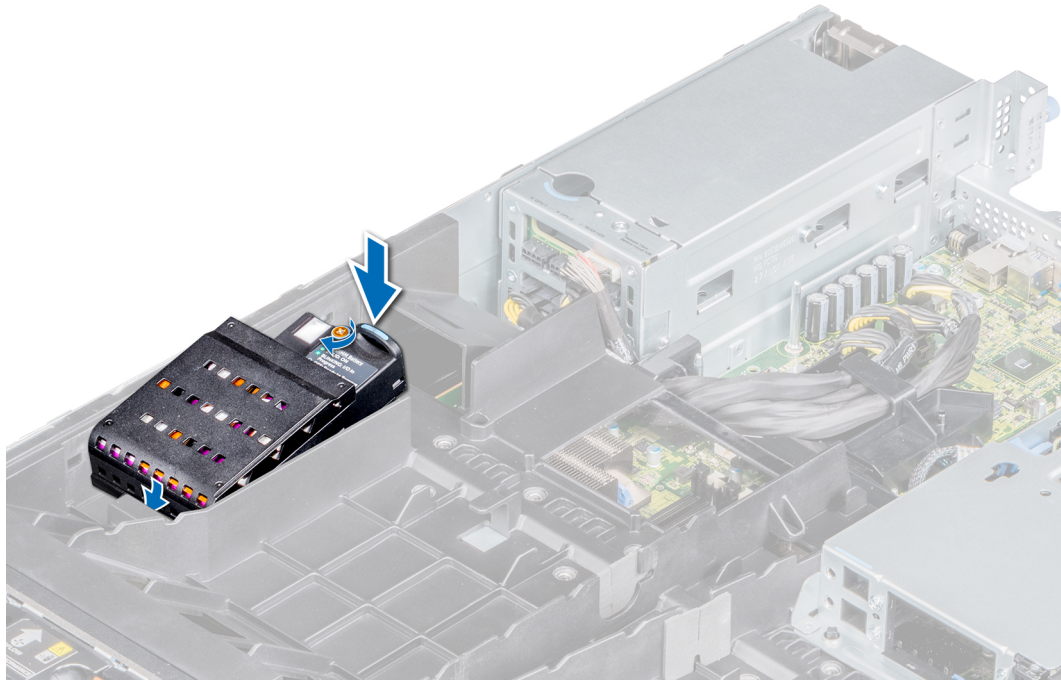

Figure 34. Installing NVDIMM-N battery into GPU air shroud

#### Next steps

1. For GPU air shroud, [install the GPU air shroud cover](#).
2. Follow the procedure listed in [After working inside your system](#).

## Drives

### Removing a drive blank

#### Prerequisites

1. Follow the safety guidelines listed in [Safety instructions](#).
2. Follow the procedure listed in [Before working inside your system](#).
3. If installed, [remove the front bezel](#).

**CAUTION:** To maintain proper system cooling, drive blanks must be installed in all empty drive slots.

**CAUTION:** Mixing drive blanks from previous generations of PowerEdge servers is not supported.

#### Steps

Press the release button, and slide the drive blank out of the drive slot.

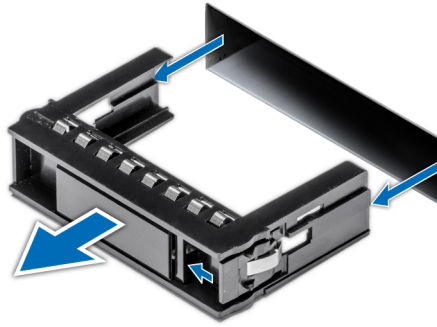

Figure 35. Removing a drive blank

#### Next steps

1. [Install a drive or drive blank.](#)

## Installing a drive blank

#### Prerequisites

1. Follow the safety guidelines listed in [Safety instructions](#).
2. Follow the procedure listed in [Before working inside your system](#).
3. If installed, [remove the front bezel](#).

**CAUTION:** To maintain proper system cooling, drive blanks must be installed in all empty drive slots.

**CAUTION:** Mixing drive blanks from previous generations of PowerEdge servers is not supported.

#### Steps

Slide the drive blank into the drive slot until the release button clicks into place.

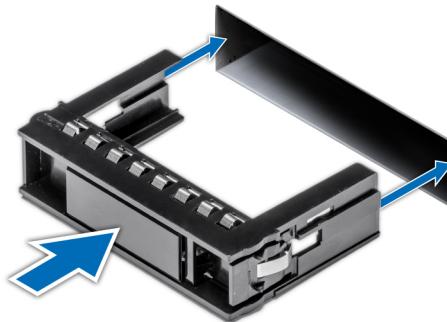

Figure 36. Installing a drive blank

#### Next steps

1. [Install the front bezel](#), if applicable.
2. Follow the procedure listed in [After working inside your system](#).

## Removing a drive carrier

#### Prerequisites

1. Follow the safety guidelines listed in [Safety instructions](#).
2. Follow the procedure listed in [Before working inside your system](#).
3. If installed, [remove the front bezel](#).

- Using the management software, prepare the drive for removal.

If the drive is online, the green activity or fault indicator flashes while the drive is turning off. When the drive indicators are off, the drive is ready for removal. For more information, see the storage controller documentation.

**CAUTION:** Before attempting to remove or install a drive while the system is running, see the documentation for the storage controller card to ensure that the host adapter is configured correctly to support drive removal and insertion.

**CAUTION:** Mixing drive carriers from previous generations of PowerEdge servers is not supported.

**CAUTION:** To prevent data loss, ensure that your operating system supports drive installation. See the documentation supplied with your operating system.

### Steps

- Press the release button to open the drive carrier release handle.
- Holding the handle, slide the drive carrier out of the drive slot.

**NOTE:** If you are not replacing the drive immediately, install a drive blank in the empty drive slot to maintain proper system cooling.



Figure 37. Removing a drive carrier

### Next steps

- Install a drive carrier or drive blank.

## Installing a drive carrier

### Prerequisites

**CAUTION:** Before attempting to remove or install a drive while the system is running, see the documentation for the storage controller card to ensure that the host adapter is configured correctly to support drive removal and insertion.

**CAUTION:** Combining SAS and SATA drives in the same RAID volume is not supported.

**CAUTION:** When installing a drive, ensure that the adjacent drives are fully installed. Inserting a drive carrier and attempting to lock its handle next to a partially installed carrier can damage the partially installed carrier's shield spring and make it unusable.

**CAUTION:** To prevent data loss, ensure that your operating system supports hot-swap drive installation. See the documentation supplied with your operating system.

**CAUTION:** When a replacement hot swappable drive is installed and the system is powered on, the drive automatically begins to rebuild. Ensure that the replacement drive is blank or contains data that you wish to overwrite. Any data on the replacement drive is immediately lost after the drive is installed.

1. Follow the safety guidelines listed in [Safety instructions](#).
2. Follow the procedure listed in [Before working inside your system](#).
3. If installed, [remove the front bezel](#).
4. If installed, [remove the drive blank](#).

### Steps

1. Press the release button on the front of the drive carrier to open the release handle.
2. Insert the drive carrier into the drive slot and push the drive until it connects with the backplane.
3. Close the drive carrier release handle to lock the drive in place.



**Figure 38. Installing a drive carrier**

### Next steps

1. If applicable, [install the front bezel](#).
2. Follow the procedure listed in [After working inside your system](#).

## Removing the drive from the drive carrier

### Prerequisites

1. Follow the safety guidelines listed in [Safety instructions](#).  
**CAUTION:** Mixing drive carriers from previous generations of PowerEdge servers is not supported.
2. Follow the procedure listed in [Before working inside your system](#).
3. If installed, [remove the front bezel](#).
4. [Remove the drive carrier](#).

### Steps

1. Using a Phillips #1 screwdriver, remove the screws from the slide rails on the drive carrier.
2. Lift the drive out of the drive carrier.



**Figure 39. Removing the drive from the drive carrier**

#### Next steps

1. [Install the drive into the drive carrier.](#)

## Installing a drive into the drive carrier

#### Prerequisites

1. Follow the safety guidelines listed in [Safety instructions](#).
2. Follow the procedure listed in [Before working inside your system](#).
3. If installed, [remove the front bezel](#).
4. [Remove the drive carrier](#).

**CAUTION:** Mixing drive carriers from other generations of PowerEdge servers is not supported.

#### Steps

1. Insert the drive into the drive carrier with the connector end of the drive towards the back of the carrier.
2. Align the screw holes on the drive with the screws holes on the drive carrier.  
When aligned correctly, the back of the drive is flush with the back of the drive carrier.
3. Using a Phillips #1 screwdriver, secure the drive to the drive carrier with screws.

**NOTE:** When installing a drive into the drive carrier, ensure that the screws are torqued to 4 in-lbs.



**Figure 40. Installing a drive into the drive carrier**

#### Next steps

1. [Install the drive carrier.](#)
2. If applicable, [install the front bezel.](#)
3. Follow the procedure listed in [After working inside your system.](#)

## Rear drive cage

The rear drive cage supports up to two 2.5 inch drives.

## Removing the rear drive cage

#### Prerequisites

1. Follow the safety guidelines listed in [Safety instructions.](#)
2. Follow the procedure listed in [Before working inside your system.](#)
3. [Remove the air shroud.](#)
4. [Remove all the drives.](#)
5. Disconnect all the cables from the rear drive backplane.

#### Steps

1. Using a Phillips #2 screwdriver, loosen the screws that secure the drive cage to the system.
2. Hold the drive cage and lift it away from the system.

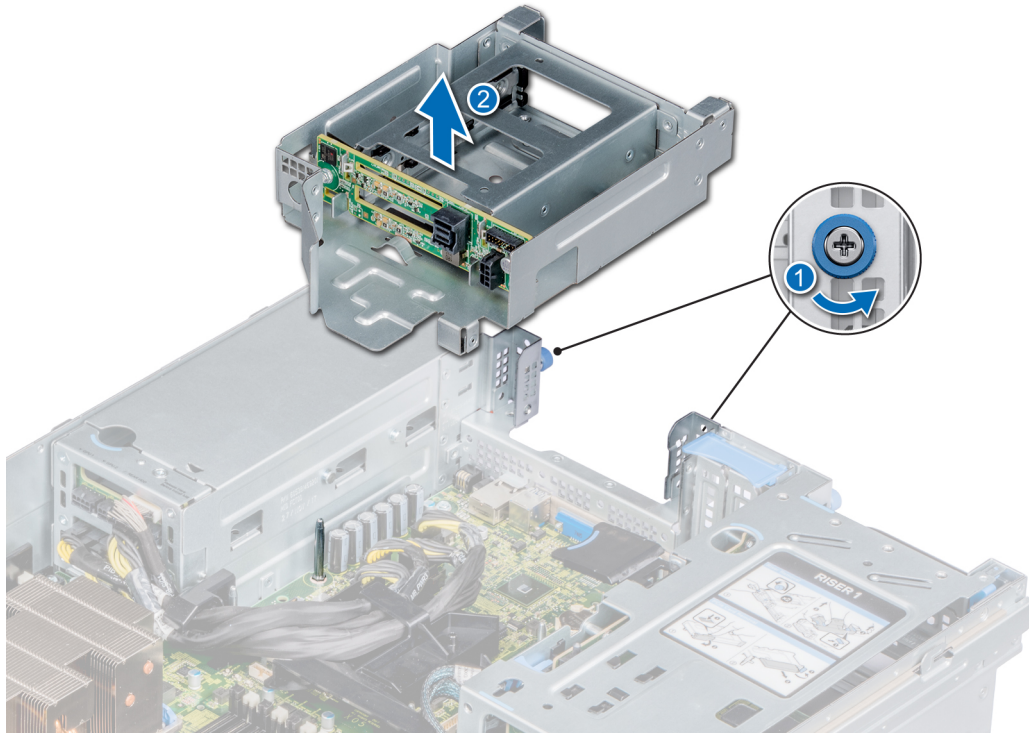

**Figure 41. Removing the rear drive cage**

#### **Next steps**

1. [Replace the rear drive cage.](#)

## **Installing the rear drive cage**

#### **Prerequisites**

1. Follow the safety guidelines listed in [Safety instructions](#).
2. Follow the procedure listed in [Before working inside your system](#).
3. [Remove the air shroud](#).

#### **Steps**

1. Align the slots on drive cage with the guides on the system chassis.
2. Lower the drive cage into the system until it is firmly seated.
3. Using a Phillips #2 screwdriver, tighten the screws.

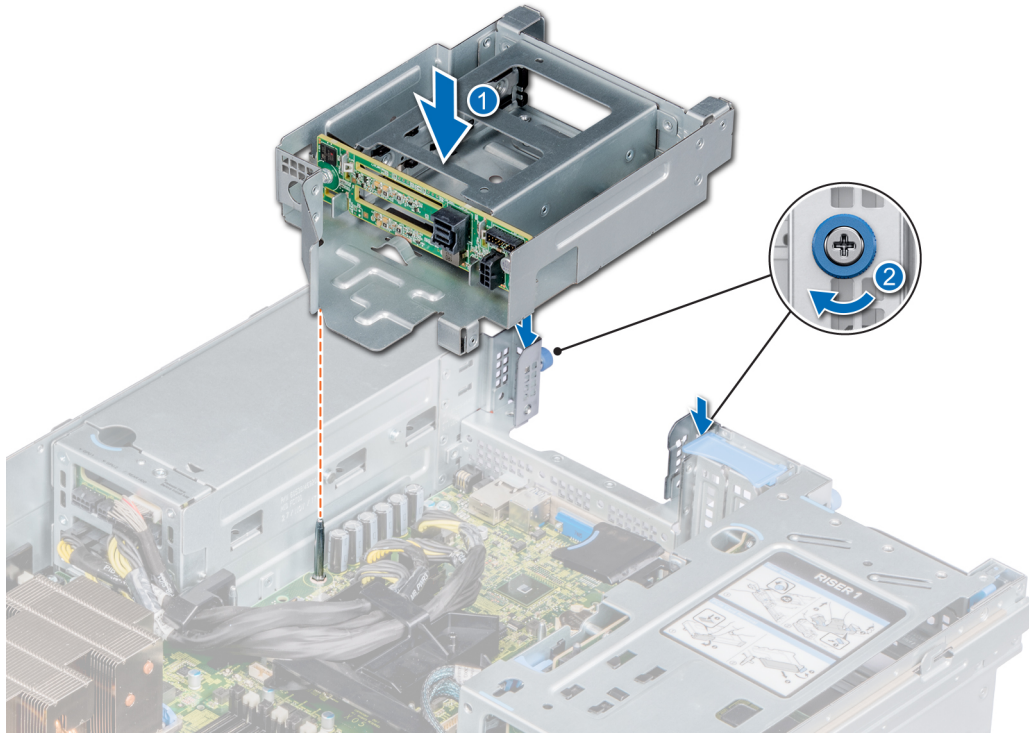

**Figure 42. Installing the rear drive cage**

#### **Next steps**

1. Connect all the cables to the rear drive backplane.
2. [Install the drives.](#)
3. [Install the air shroud.](#)
4. Follow the procedure listed in [After working inside your system.](#)

## **System memory**

Your system contains 48 memory sockets split into four sets of 12 sockets, one set per processor. Each 12-socket set is organized into six channels. Six memory channels are allocated to each processor. In each channel, the release tabs of the first socket are marked white, and the second socket black.

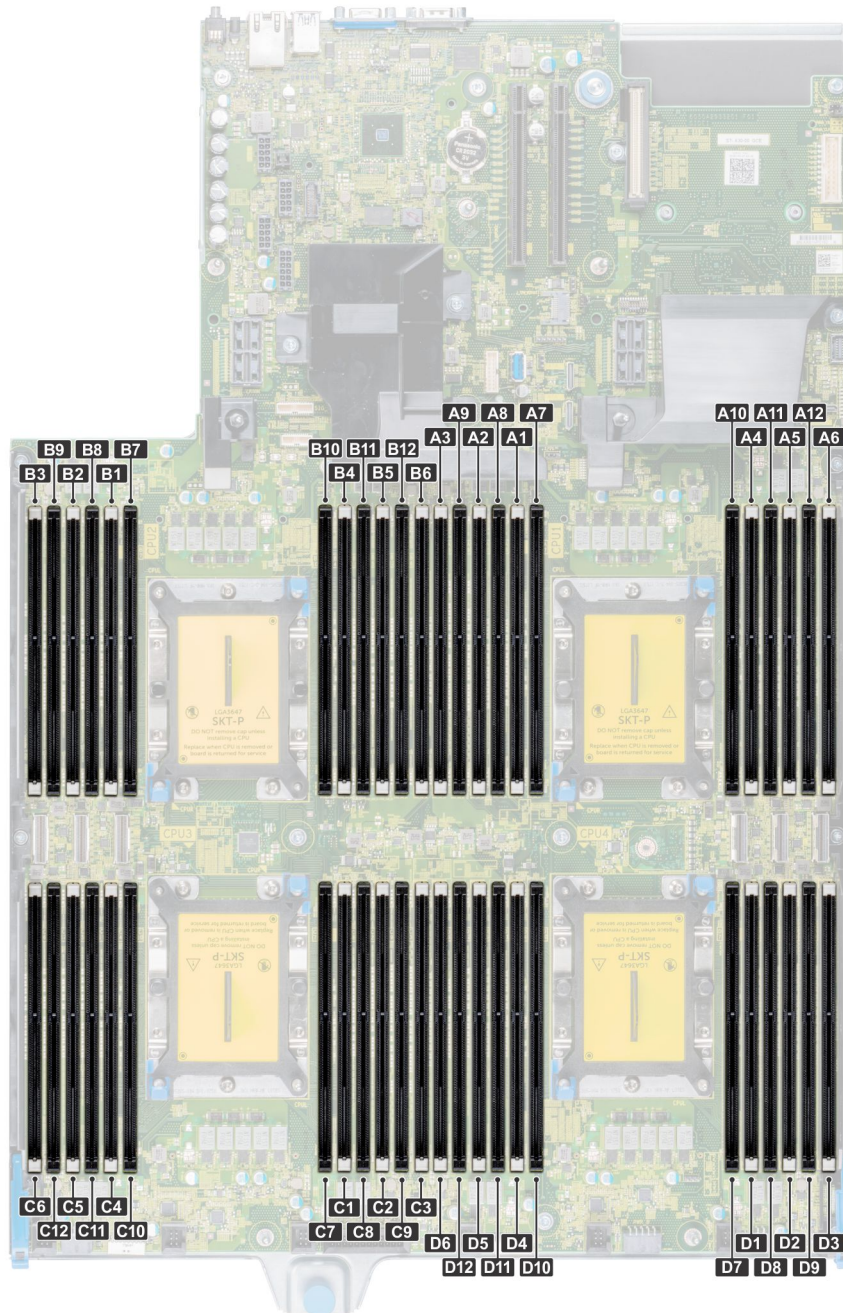

**Figure 43. Memory socket locations**

Memory channels are organized as follows:

**Table 9. Memory channels**

| Processor   | Channel 0       | Channel 1       | Channel 2       | Channel 3        | Channel 4        | Channel 5        |
|-------------|-----------------|-----------------|-----------------|------------------|------------------|------------------|
| Processor 1 | Slots A1 and A7 | Slots A2 and A8 | Slots A3 and A9 | Slots A4 and A10 | Slots A5 and A11 | Slots A6 and A12 |
| Processor 2 | Slots B1 and B7 | Slots B2 and B8 | Slots B3 and B9 | Slots B4 and B10 | Slots B5 and B11 | Slots B6 and B12 |
| Processor 3 | Slots C1 and C7 | Slots C2 and C8 | Slots C3 and C9 | Slots C4 and C10 | Slots C5 and C11 | Slots C6 and C12 |
| Processor 4 | Slots D1 and D7 | Slots D2 and D8 | Slots D3 and D9 | Slots D4 and D10 | Slots D5 and D11 | Slots D6 and D12 |

# General memory module installation guidelines

To ensure optimal performance of your system, observe the following general guidelines when configuring your system memory. If your system's memory configurations fail to observe these guidelines, your system might not boot, stop responding during memory configuration, or operate with reduced memory.

The memory bus may operate at frequency can be 2933 MT/s, 2666 MT/s, 2400 MT/s, or 2133 MT/s depending on the following factors:

- System profile selected (for example, Performance Optimized, or Custom [can be run at high speed or lower])
- Maximum supported DIMM speed of the processors. For memory frequency of 2933 MT/s, one DIMM per channel is supported.
- Maximum supported speed of the DIMMs

 **NOTE: MT/s indicates DIMM speed in MegaTransfers per second.**

The system supports Flexible Memory Configuration, enabling the system to be configured and run in any valid chipset architectural configuration. The following are the recommended guidelines for installing memory modules:

- All DIMMs must be DDR4.
- RDIMMs and LRDIMMs must not be mixed.
- NVDIMMs and LRDIMMs must not be mixed.
- NVDIMMs and RDIMMs can be mixed.
- 64 GB LRDIMMs that are DDP (Dual Die Package) LRDIMMs must not be mixed with 128 GB LRDIMMs that are TSV (Through Silicon Via/3DS) LRDIMMs.
- x4 and x8 DRAM based memory modules can be mixed.
- Up to two RDIMMs can be populated per channel regardless of rank count.
- Up to two LRDIMMs can be populated per channel regardless of rank count.
- A maximum of two different ranked DIMMs can be populated in a channel regardless of rank count.
- If memory modules with different speeds are installed, they will operate at the speed of the slowest installed memory module(s).
- Populate memory module sockets only if a processor is installed.
  - For single-processor systems, sockets A1 to A12 are available.
  - For dual-processor systems, sockets A1 to A12 and sockets B1 to B12 are available.
  - For quad-processor systems, sockets A1 to A12, sockets B1 to B12, sockets C1 to C12, and sockets D1 to D12 are available.
- Populate all the sockets with white release tabs first, followed by the black release tabs.
- When mixing memory modules with different capacities, populate the sockets with memory modules with the highest capacity first.

For example, if you want to mix 8 GB and 16 GB memory modules, populate 16 GB memory modules in the sockets with white release tabs and 8 GB memory modules in the sockets with black release tabs.

- Memory modules of different capacities can be mixed provided other memory population rules are followed.

For example, 8 GB and 16 GB memory modules can be mixed.

- In a dual-processor configuration, the memory configuration for each processor must be identical.

For example, if you populate socket A1 for processor 1, then populate socket B1 for processor 2, and so on.

- Mixing of more than two memory module capacities in a system is not supported.
- Unbalanced memory configurations will result in a performance loss so always populate memory channels identically with identical DIMMs for best performance.
- Populate six identical memory modules per processor (one DIMM per channel) at a time to maximize performance.

DIMM population update for Performance Optimized mode with quantity of 4 and 8 DIMMs per processor.

- When the DIMM quantity is 4 per processor, the population is slot 1, 2, 4, 5.
- When the DIMM quantity is 8 per processor, the population is slot 1, 2, 4, 5, 7, 8, 10, 11.

# NVDIMM-N memory module installation guidelines

The following are the recommended guidelines for installing NVDIMM-N memory modules:

- Each system supports memory configurations with 1, 2, 4, 6, or 12 NVDIMM-Ns.
- Supported configurations have dual processors and a minimum of 12x RDIMMs.
- Maximum of 12 NVDIMM-Ns can be installed in a system.
- NVDIMM-Ns or RDIMMs must not be mixed with LRDIMMs.
- DDR4 NVDIMM-Ns must be populated only on the black release tabs on processor 1 and 2.

- For systems with four processors, RDIMMs populated on processor 3 and 4 must be identical to the number of RDIMMs populated on processor 1 and 2.
- All slots on configurations 3, 6, 9, and 12 can be used, but a maximum of 12 NVDIMM-Ns can be installed in a system.

**NOTE: NVDIMM-N memory slots are not hot-pluggable.**

For more information about the supported NVDIMM-N configurations, see the *NVDIMM-N User Guide* at [www.dell.com/poweredge/manuals](http://www.dell.com/poweredge/manuals).

**Table 10. Supported NVDIMM-N for dual processor configurations**

| Configuration    | Description                    | Memory population rules  |  |
|------------------|--------------------------------|--|--|
|                  |                                | RDIMMs   | NVDIMM-N                                       |
| Configuration 1  | 12x 16 GB RDIMMs, 1x NVDIMM-N  | Processor1 {A1, 2, 3, 4, 5, 6}<br>Processor2 {B1, 2, 3, 4, 5, 6}                                       | Processor1 {A7}                                |
| Configuration 2  | 12x 32 GB RDIMMs, 1x NVDIMM-N  | Same for all 12x RDIMM configurations. See Configuration 1.  | Processor1 {A7}                                |
| Configuration 3  | 23x 32 GB RDIMMs, 1x NVDIMM-N  | Processor1 {A1, 2, 3, 4, 5, 6, 7, 8, 9, 10, 11, 12}<br>Processor2 {B1, 2, 3, 4, 5, 6, 7, 8, 9, 10, 11} | Processor2 {B12}                               |
| Configuration 4  | 12x 16 GB RDIMMs, 2x NVDIMM-Ns | Same for all 12x RDIMM configurations. See Configuration 1.  | Processor1 {A7}<br>Processor2 {B7}             |
| Configuration 5  | 12x 32 GB RDIMMs, 2x NVDIMM-Ns | Same for all 12x RDIMM configurations. See Configuration 1.  | Processor1 {A7}<br>Processor2 {B7}             |
| Configuration 6  | 22x 32 GB RDIMMs, 2x NVDIMM-Ns | Processor1 {A1, 2, 3, 4, 5, 6, 7, 8, 9, 10, 11}<br>Processor2 {B1, 2, 3, 4, 5, 6, 7, 8, 9, 10, 11}     | Processor1 {A12}<br>Processor2 {B12}           |
| Configuration 7  | 12x 16 GB RDIMMs, 4x NVDIMM-Ns | Same for all 12x RDIMM configurations. See Configuration 1.  | Processor1 {A7, A8}<br>Processor2 {B7, B8}     |
| Configuration 8  | 22x 32 GB RDIMMs, 4x NVDIMM-Ns | Same for all 12x RDIMM configurations. See Configuration 1.  | Processor1 {A7, A8}<br>Processor2 {B7, B8}     |
| Configuration 9  | 20x 32 GB RDIMMs, 4x NVDIMM-Ns | Processor1 {A1, 2, 3, 4, 5, 6, 7, 8, 9, 10}<br>Processor2 {B1, 2, 3, 4, 5, 6, 7, 8, 9, 10}             | Processor1 {A11, 12}<br>Processor2 {B11, 12}   |
| Configuration 10 | 12x 16 GB RDIMMs, 6x NVDIMM-Ns | Same for all 12x RDIMM configurations. See Configuration 1.  | Processor1 {A7, 8, 9}<br>Processor2 {B7, 8, 9} |
| Configuration 11 | 12x 32 GB RDIMMs, 6x NVDIMM-Ns | Same for all 12x RDIMM configurations. See Configuration 1.  | Processor1 {A7, 8, 9}<br>Processor2 {B7, 8, 9} |

| Configuration    | Description                     | Memory population rules  |  |
|------------------|---------------------------------|--|--|
|                  |                                 | RDIMMs   | NVDIMM-N   |
| Configuration 12 | 18x 32 GB RDIMMs, 6x NVDIMM-Ns  | Processor1 {1, 2, 3, 4, 5, 6, 7, 8, 9}<br>Processor2 {1, 2, 3, 4, 5, 6, 7, 8, 9} | Processor1 {A10, 11, 12}<br>Processor2 {B10, 11, 12}                   |
| Configuration 13 | 12x 16 GB RDIMMs, 12x NVDIMM-Ns | Same for all 12x RDIMM configurations. See Configuration 1.                      | Processor1 {A7, 8, 9, 10, 11, 12}<br>Processor2 {B7, 8, 9, 10, 11, 12} |
| Configuration 14 | 12x 32 GB RDIMMs, 12x NVDIMM-Ns | Same for all 12x RDIMM configurations. See Configuration 1.                      | Processor1 {A7, 8, 9, 10, 11, 12}<br>Processor2 {B7, 8, 9, 10, 11, 12} |

**Table 11. Supported NVDIMM-N for quad processor configurations**

| Configuration   | Description                    | Memory population rules   |   |
|-----------------|--------------------------------|---|---|
|                 |                                | RDIMMs  | NVDIMM-N                                |
| Configuration 1 | 24x 16 GB RDIMMs, 1x NVDIMM-N  | Processor1 {A1, 2, 3, 4, 5, 6},<br>Processor2 {B1, 2, 3, 4, 5, 6},<br>Processor3 {C1, 2, 3, 4, 5, 6}<br>Processor4 {D1, 2, 3, 4, 5, 6}  | Processor1 {A7}                         |
| Configuration 2 | 24x 32 GB RDIMMs, 1x NVDIMM-N  | Same for all 24x RDIMM configurations. See Configuration 1.   | Processor1 {A7}                         |
| Configuration 3 | 47x 32 GB RDIMMs, 1x NVDIMM-N  | Processor1 {A1, 2, 3, 4, 5, 6, 7, 8, 9, 10, 11, 12} ,<br>Processor2 {B1, 2, 3, 4, 5, 6, 7, 8, 9, 10, 11} ,<br>Processor3 {C1, 2, 3, 4, 5, 6, 7, 8, 9, 10, 11, 12}<br>Processor 4 {D1, 2, 3, 4, 5, 6, 7, 8, 9, 10, 11, 12} | Processor2 {B12}                        |
| Configuration 4 | 24x 16 GB RDIMMs, 2x NVDIMM-Ns | Processor1 {A1, 2, 3, 4, 5, 6},<br>Processor2 {B1, 2, 3, 4, 5, 6}<br>Processor3 {C1, 2, 3, 4, 5, 6}<br>Processor4 {D1, 2, 3, 4, 5, 6}   | Processor1 {A7},<br>Processor2 {B7}     |
| Configuration 5 | 24x 32 GB RDIMMs, 2x NVDIMM-Ns | Processor1 {A1, 2, 3, 4, 5, 6},<br>Processor2 {B1, 2, 3, 4, 5, 6},<br>Processor3 {C1, 2, 3, 4, 5, 6}<br>Processor4 {D1, 2, 3, 4, 5, 6}  | Processor1 {A7},<br>Processor2 {B7}     |
| Configuration 6 | 46x 32 GB RDIMMs, 2x NVDIMM-Ns | Processor1 {A1, 2, 3, 4, 5, 6, 7, 8, 9, 10, 11},<br>Processor2 {B1, 2, 3, 4, 5, 6, 7, 8, 9, 10, 11} ,<br>Processor3 {C1, 2, 3, 4, 5, 6, 7, 8, 9, 10, 11, 12}<br>Processor 4 {D1, 2, 3, 4, 5, 6, 7, 8, 9, 10, 11, 12}      | Processor1 {A12},<br>Processor2 {B12}   |
| Configuration 7 | 24x 16 GB RDIMMs, 4x NVDIMM-Ns | Processor1 {A1, 2, 3, 4, 5, 6},<br>Processor2 {B1, 2, 3, 4, 5, 6},  | Processor1 {A7,8},<br>Processor2 {B7,8} |

| Configuration    | Description                     | Memory population rules  |   |
|------------------|---------------------------------|--|---|
|                  |                                 | RDIMMs   | NVDIMM-N  |
|                  |                                 | Processor3 {C1, 2, 3, 4, 5, 6}<br>Processor4 {D1, 2, 3, 4, 5, 6}   |   |
| Configuration 8  | 24x 32 GB RDIMMs, 4x NVDIMMs    | Processor1 {A1, 2, 3, 4, 5, 6},<br>Processor2 {B1, 2, 3, 4, 5, 6},<br>Processor3 {C1, 2, 3, 4, 5, 6}<br>Processor4 {D1, 2, 3, 4, 5, 6}   | Processor1 {A7,8},<br>Processor2 {B7,8}                                 |
| Configuration 9  | 44x 32 GB RDIMMs, 4x NVDIMM-Ns  | Processor1 {A1, 2, 3, 4, 5, 6, 7, 8, 9, 10},<br>Processor2 {B1, 2, 3, 4, 5, 6, 7, 8, 9, 10},<br>Processor3 {C1, 2, 3, 4, 5, 6, 7, 8, 9, 10, 11, 12}<br>Processor4 {D1, 2, 3, 4, 5, 6, 7, 8, 9, 10, 11, 12} | Processor1 {A11, 12},<br>Processor2 {B11, 12}                           |
| Configuration 10 | 24x 16 GB RDIMMs, 6x NVDIMM-Ns  | Processor1 {A1, 2, 3, 4, 5, 6},<br>Processor2 {B1, 2, 3, 4, 5, 6}<br>Processor3 {C1, 2, 3, 4, 5, 6}<br>Processor4 {D1, 2, 3, 4, 5, 6}  | Processor1 {A7, 8, 9}<br>Processor2 {B7, 8, 9}                          |
| Configuration 11 | 24x 32 GB RDIMMs, 6x NVDIMM-Ns  | Processor1 {A1, 2, 3, 4, 5, 6},<br>Processor2 {B1, 2, 3, 4, 5, 6},<br>Processor3 {C1, 2, 3, 4, 5, 6}<br>Processor4 {D1, 2, 3, 4, 5, 6}   | Processor1 {A7, 8, 9}<br>Processor2 {B7, 8, 9}                          |
| Configuration 12 | 42x 32 GB RDIMMs, 6x NVDIMM-Ns  | Processor1 {A1, 2, 3, 4, 5, 6, 7, 8, 9},<br>Processor2 {B1, 2, 3, 4, 5, 6, 7, 8, 9}<br>Processor3 {C1, 2, 3, 4, 5, 6, 7, 8, 9, 10, 11, 12}<br>Processor4 {D1, 2, 3, 4, 5, 6, 7, 8, 9, 10, 11, 12}          | Processor1 {A10,11,12}<br>Processor2 {B10, 11, 12}                      |
| Configuration 13 | 24x 16 GB RDIMMs, 12x NVDIMM-Ns | Processor1 {A1, 2, 3, 4, 5, 6},<br>Processor2 {B1, 2, 3, 4, 5, 6},<br>Processor3 {C1, 2, 3, 4, 5, 6}<br>Processor4 {D1, 2, 3, 4, 5, 6}   | Processor1 {A7, 8, 9, 10, 11, 12},<br>Processor2 {B7, 8, 9, 10, 11, 12} |
| Configuration 14 | 24x 32 GB RDIMMs, 12x NVDIMM-Ns | Processor1 {A1, 2, 3, 4, 5, 6},<br>Processor2 {B1, 2, 3, 4, 5, 6},<br>Processor3 {C1, 2, 3, 4, 5, 6}<br>Processor4 {D1, 2, 3, 4, 5, 6}   | Processor1 {A7, 8, 9, 10, 11, 12},<br>Processor2 {B7, 8, 9, 10, 11, 12} |
| Configuration 15 | 36x 32 GB RDIMMs, 12x NVDIMM-Ns | Processor1 {A1, 2, 3, 4, 5, 6},<br>Processor2 {B1, 2, 3, 4, 5, 6},<br>Processor3 {C1, 2, 3, 4, 5, 6, 7, 8, 9, 10, 11, 12}<br>Processor 4 {D1, 2, 3, 4, 5, 6, 7, 8, 9, 10, 11, 12}                          | Processor1 {A7, 8, 9, 10, 11, 12},<br>Processor2 {B7, 8, 9, 10, 11, 12} |

## DCPMM installation guidelines

The following are the recommended guidelines for installing data center persistent memory module (DCPMM) memory modules:

- Each system supports maximum of one DCPMM memory module per channel.

**NOTE: If two different DCPMM capacities are mixed, an F1/F2 warning is displayed as the configuration is not supported.**

- DCPMM can be mixed with RDIMM, LRDIMM, and 3DS LRDIMM.
- Mixing of DDR4 DIMM types (RDIMM, LRDIMM, and 3DS LRDIMM), within channels, for Integrated Memory Controller (iMC), or across sockets are not supported.
- Mixing of DCPMM operating modes (App Direct, Memory Mode) is not supported.
- If only one DIMM is populated on a channel, it should always go to the first slot in that channel (white slot).
- If a DCPMM and a DDR4 DIMM are populated on the same channel, always plug DCPMM on second slot (black slot).
- If the DCPMM is configured in Memory Mode, the recommended DDR4 to DCPMM capacity ratio is 1:4 to 1:16 per iMC.
- DCPMMs cannot be mixed with other DCPMMs capacities or NVDIMMs.
- Mixing different capacities of RDIMMs and LRDIMMs are not allowed when DCPMM is installed.
- DCPMMs of different capacities are not allowed.

For more information about the supported DCPMM configurations, see the *Dell EMC DCPMM User's Guide* at [https://www.dell.com/support/home/products/server\\_int/server\\_int\\_poweredge](https://www.dell.com/support/home/products/server_int/server_int_poweredge).

**Table 12. 2 socket DCPMM configurations**

| No. of CPUs in the Server | DCPMM Population | DRAM Population | DRAM Capacity (GB) | DCPMM Capacity (GB) | Operating system Memory in Memory Mode (GB) | Total Memory (GB) | Total Memory per CPU (GB) | Ratio DRAM to Optane Memory | Requires an M or L CPU | Supported in App Direct Mode | Supported in Memory Mode |
|---------------------------|------------------|-----------------|--------------------|---------------------|---|-------------------|---------------------------|-----------------------------|------------------------|------------------------------|--------------------------|
| 2                         | 128 GB x 1       | 16 GB x 12      | 192                | 128                 | N/A   | 320               | 160                       | 1:0.7                       | No                     | Yes                          | No                       |
| 2                         | 128 GB x 2       | 16 GB x 12      | 192                | 256                 | N/A   | 448               | 224                       | 1:1.3                       | No                     | Yes                          | No                       |
| 2                         | 128 GB x 4       | 16 GB x 8       | 128                | 512                 | 512   | 640               | 320                       | 1:4                         | No                     | Yes                          | Yes                      |
| 2                         | 128 GB x 4       | 16 GB x 12      | 192                | 512                 | N/A   | 704               | 352                       | 1:2.7                       | No                     | Yes                          | No                       |
| 2                         | 128 GB x 8       | 16 GB x 12      | 192                | 1,024               | 1,024                                       | 1,216             | 608                       | 1:5.3                       | No                     | Yes                          | Yes                      |
| 2                         | 128 GB x 12      | 16 GB x 12      | 192                | 1,536               | 1,536                                       | 1,728             | 864                       | 1:8                         | No                     | Yes                          | Yes                      |
| 2                         | 128 GB x 1       | 32 GB x 12      | 384                | 128                 | N/A   | 512               | 256                       | 1:0.3                       | No                     | Yes                          | No                       |
| 2                         | 128 GB x 2       | 32 GB x 12      | 384                | 256                 | N/A   | 640               | 320                       | 1:0.7                       | No                     | Yes                          | No                       |
| 2                         | 128 GB x 4       | 32 GB x 12      | 384                | 512                 | N/A   | 896               | 448                       | 1:1.3                       | No                     | Yes                          | No                       |
| 2                         | 128 GB x 8       | 32 GB x 12      | 384                | 1,024               | N/A   | 1,408             | 704                       | 1:2.7                       | No                     | Yes                          | No                       |
| 2                         | 128 GB x 12      | 32 GB x 12      | 384                | 1,536               | 1,536                                       | 1,920             | 960                       | 1:4                         | No                     | Yes                          | Yes                      |
| 2                         | 128 GB x 4       | 64 GB x 12      | 768                | 512                 | N/A   | 1,280             | 640                       | 1:0.7                       | No                     | Yes                          | No                       |
| 2                         | 128 GB x 8       | 64 GB x 12      | 768                | 1,024               | N/A   | 1,792             | 896                       | 1:1.3                       | No                     | Yes                          | No                       |
| 2                         | 128 GB x 12      | 64 GB x 12      | 768                | 1,536               | N/A   | 2,304             | 1,152                     | 1:2                         | L SKU                  | Yes                          | No                       |
| 2                         | 128 GB x 12      | 128 GB x 12     | 1,536              | 1,536               | N/A   | 3,072             | 1,536                     | 1:1                         | L SKU                  | Yes                          | No                       |

| No. of CPUs in the Server | DCPMM Population | DRAM Population | DRAM Capacity (GB) | DCPMM Capacity (GB) | Operating system Memory in Memory Mode (GB) | Total Memory (GB) | Total Memory per CPU (GB) | Ratio DRAM to Optane Memory | Requires an M or L CPU | Supported in App Direct Mode | Supported in Memory Mode |
|---------------------------|------------------|-----------------|--------------------|---------------------|---|-------------------|---------------------------|-----------------------------|------------------------|------------------------------|--------------------------|
| 2                         | 512 GB x 8       | 32 GB x 12      | 384                | 4,096               | 4,096                                       | 4,480             | 2,240                     | 1: 10.7                     | L SKU                  | Yes                          | Yes                      |
| 2                         | 512 GB x 12      | 32 GB x 12      | 384                | 6,144               | 6,144                                       | 6,528             | 3,264                     | 1: 16                       | L SKU                  | Yes                          | Yes                      |
| 2                         | 512 GB x 8       | 64 GB x 12      | 768                | 4,096               | 4,096                                       | 4,864             | 2,432                     | 1: 5.3                      | L SKU                  | Yes                          | Yes                      |
| 2                         | 512 GB x 12      | 64 GB x 12      | 768                | 6,144               | 6,144                                       | 6,912             | 3,456                     | 1: 8                        | L SKU                  | Yes                          | Yes                      |
| 2                         | 512 GB x 12      | 128 GB x 12     | 1,536              | 6,144               | 6,144                                       | 7,680             | 3,840                     | 1: 4                        | L SKU                  | Yes                          | Yes                      |
| 2                         | 256 GB x 8       | 16 GB x 12      | 192                | 2,048               | 2,048                                       | 2,240             | 1,120                     | 1: 10.7                     | L SKU                  | Yes                          | Yes                      |
| 2                         | 256 GB x 8       | 32 GB x 12      | 384                | 2,048               | 2,048                                       | 2,432             | 1,216                     | 1: 5.3                      | L SKU                  | Yes                          | Yes                      |
| 2                         | 256 GB x 12      | 32 GB x 12      | 384                | 3,072               | 3,072                                       | 3,456             | 1,728                     | 1: 8                        | L SKU                  | Yes                          | Yes                      |
| 2                         | 256 GB x 8       | 64 GB x 12      | 768                | 2,048               | N/A   | 2,816             | 1,408                     | 1: 2.7                      | L SKU                  | Yes                          | No                       |
| 2                         | 256 GB x 12      | 64 GB x 12      | 768                | 3,072               | 3,072                                       | 3,840             | 1,920                     | 1: 4                        | L SKU                  | Yes                          | Yes                      |
| 2                         | 256 GB x 12      | 128 GB x 12     | 1,536              | 3,072               | N/A   | 4,608             | 2,304                     | 1: 2                        | L SKU                  | Yes                          | No                       |

**Table 13. 4 socket DCPMM configurations**

| No. of CPUs in the Server | DCPMM Population | DRAM Population | DRAM Capacity (GB) | DCPMM Capacity (GB) | Operating system Memory in Memory Mode (GB) | Total Memory (GB) | Total Memory per CPU (GB) | Ratio DRAM to Optane Memory | Requires an M or L CPU | Supported in App Direct Mode | Supported in Memory Mode |
|---------------------------|------------------|-----------------|--------------------|---------------------|---|-------------------|---------------------------|-----------------------------|------------------------|------------------------------|--------------------------|
| 4                         | 128 GB x 16      | 16 GB x 24      | 384                | 2,048               | 2,048                                       | 2,432             | 608                       | 1: 5.3                      | No                     | Yes                          | Yes                      |
| 4                         | 128 GB x 24      | 16 GB x 24      | 384                | 3,072               | 3,072                                       | 3,456             | 864                       | 1: 8                        | No                     | Yes                          | Yes                      |
| 4                         | 128 GB x 16      | 32 GB x 24      | 768                | 2,048               | N/A   | 2,816             | 704                       | 1: 2.7                      | No                     | Yes                          | No                       |
| 4                         | 128 GB x 24      | 32 GB x 24      | 768                | 3,072               | 3,072                                       | 3,840             | 960                       | 1: 4                        | No                     | Yes                          | Yes                      |
| 4                         | 128 GB x 24      | 64 GB x 24      | 1,536              | 3,072               | N/A   | 4,608             | 1,152                     | 1: 2                        | L SKU                  | Yes                          | No                       |
| 4                         | 128 GB x 24      | 128 GB x 24     | 3,072              | 3,072               | N/A   | 6,144             | 1,536                     | 1: 1                        | L SKU                  | Yes                          | No                       |
| 4                         | 512 GB x 16      | 32 GB x 24      | 768                | 8,192               | 8,192                                       | 8,960             | 2,240                     | 1: 10.7                     | L SKU                  | Yes                          | Yes                      |
| 4                         | 512 GB x 24      | 32 GB x 24      | 768                | 12,288              | 12,288                                      | 13,056            | 3,264                     | 1: 16                       | L SKU                  | Yes                          | Yes                      |

| No. of CPUs in the Server | DCPMM Population | DRAM Population | DRAM Capacity (GB) | DCPMM Capacity (GB) | Operating system Memory in Memory Mode (GB) | Total Memory (GB) | Total Memory per CPU (GB) | Ratio DRAM to Optane Memory | Requires an M or L CPU | Supported in App Direct Mode | Supported in Memory Mode |
|---------------------------|------------------|-----------------|--------------------|---------------------|---|-------------------|---------------------------|-----------------------------|------------------------|------------------------------|--------------------------|
| 4                         | 512 GB x 16      | 64 GB x 24      | 1,536              | 8,192               | 8,192                                       | 9,728             | 2,432                     | 1: 5.3                      | L SKU                  | Yes                          | Yes                      |
| 4                         | 512 GB x 24      | 64 GB x 24      | 1,536              | 12,288              | 12,288                                      | 13,824            | 3,456                     | 1: 8                        | L SKU                  | Yes                          | Yes                      |
| 4                         | 512 GB x 24      | 128 GB x 24     | 3,072              | 12,288              | 12,288                                      | 15,360            | 3,840                     | 1: 4                        | L SKU                  | Yes                          | Yes                      |
| 4                         | 256 GB x 16      | 16 GB x 24      | 384                | 4,096               | 4,096                                       | 4,480             | 1,120                     | 1: 10.7                     | L SKU                  | Yes                          | Yes                      |
| 4                         | 256 GB x 24      | 16 GB x 24      | 384                | 6,144               | 6,144                                       | 6,528             | 1,632                     | 1: 16                       | L SKU                  | Yes                          | Yes                      |
| 4                         | 256 GB x 16      | 32 GB x 24      | 768                | 4,096               | 4,096                                       | 4,864             | 1,216                     | 1: 5.3                      | L SKU                  | Yes                          | Yes                      |
| 4                         | 256 GB x 24      | 32 GB x 24      | 768                | 6,144               | 6,144                                       | 6,912             | 1,728                     | 1: 8                        | L SKU                  | Yes                          | Yes                      |
| 4                         | 256 GB x 16      | 64 GB x 24      | 1,536              | 4,096               | N/A   | 5,632             | 1,408                     | 1: 2.7                      | L SKU                  | Yes                          | No                       |
| 4                         | 256 GB x 24      | 64 GB x 24      | 1,536              | 6,144               | 6,144                                       | 7,680             | 1,920                     | 1: 4                        | L SKU                  | Yes                          | Yes                      |
| 4                         | 256 GB x 24      | 128 GB x 24     | 3,072              | 6,144               | N/A   | 9,216             | 2,304                     | 1: 2                        | L SKU                  | Yes                          | No                       |

**NOTE:**

DCPMM is supported on systems with 2400 W PSU configuration.

Max ambient Temperature is 30C.

Max hard drive is 2.5-inches x 8.

DCPMM does not support GPU configuration.

DCPMM does not support NVMe hard drive.

## Mode-specific guidelines

The configurations allowed depend on the memory mode selected in the System BIOS.

**Table 14. Memory operating modes**

| Memory Operating Mode | Description  |
|-----------------------|--|
| <b>Optimizer Mode</b> | The <b>Optimizer Mode</b> if enabled, the DRAM controllers operate independently in the 64-bit mode and provide optimized memory performance.<br><br><b>NOTE:</b> DCPMM supports only Optimizer mode.  |
| <b>Mirror Mode</b>    | The <b>Mirror Mode</b> if enabled, the system maintains two identical copies of data in memory, and the total available system memory is one half of the total installed physical memory. Half of the installed memory is used to mirror the active memory modules. This feature provides maximum reliability and enables the system to continue |

## Memory Operating Mode

## Description

### Single Rank Spare Mode

### Multi Rank Spare Mode

running even during a catastrophic memory failure by switching over to the mirrored copy. The installation guidelines to enable Mirror Mode require that the memory modules be identical in size, speed, and technology, and they must be populated in sets of 6 per processor.

**Single Rank Spare Mode** allocates one rank per channel as a spare. If excessive correctable errors occur in a rank or channel, while the operating system is running, they are moved to the spare area to prevent errors from causing an uncorrectable failure. Requires two or more ranks to be populated in each channel.

**Multi Rank Spare Mode** allocates two ranks per channel as a spare. If excessive correctable errors occur in a rank or channel, while the operating system is running, they are moved to the spare area to prevent errors from causing an uncorrectable failure. Requires three or more ranks to be populated in each channel.

With single rank memory sparing enabled, the system memory available to the operating system is reduced by one rank per channel.

For example, in a dual-processor configuration with 24x 16 GB dual-rank memory modules, the available system memory is:  $3/4$  (ranks/channel)  $\times$  24 (memory modules)  $\times$  16 GB = 288 GB, and not  $24$  (memory modules)  $\times$  16 GB = 384 GB. For multi rank sparing, the multiplier changes to  $1/2$  (ranks/channel).

**NOTE:** To use memory sparing, this feature must be enabled in the BIOS menu of System Setup.

**NOTE:** Memory sparing does not offer protection against a multi-bit uncorrectable error.

### Dell Fault Resilient Mode

The **Dell Fault Resilient Mode** if enabled, the BIOS creates an area of memory that is fault resilient. This mode can be used by an OS that supports the feature to load critical applications or enables the OS kernel to maximize system availability.

**NOTE:** This feature is only supported in Gold and Platinum Intel processors.

**NOTE:** Memory configuration has to be of same size DIMM, speed, and rank.

## Optimizer Mode

This mode supports Single Device Data Correction (SDDC) only for memory modules that use x4 device width. It does not impose any specific slot population requirements.

- Dual processor: Populate the slots in round robin sequence starting with processor 1.

**NOTE:** Processor 1 and processor 2 population should match.

- Quad processor: Populate the slots in round robin sequence starting with processor 1.

**NOTE:** Processor 1, processor 2, processor 3, and processor 4 population should match.

Table 15. Memory population rules

| Processor  | Configuration                                    | Memory population  | Memory population information  |
|--|--|--|--|
| Dual processor (Start with processor 1. processor 1 and processor 2 population should match) | Optimized (Independent channel) population order | A{1}, B{1},<br>A{2}, B{2},<br>A{3}, B{3},<br>A{4}, B{4}, | Odd number of DIMM population per processor is allowed.<br><b>NOTE:</b> Odd number of DIMMs will result in unbalanced memory configurations, which in turn will result in performance loss. It is recommended to populate all memory |

| Processor  | Configuration                                    | Memory population   | Memory population information  |
|--|--|---|--|
|  |  | A{5}, B{5},<br>A{6}, B{6}   | <p><b>channels identically with identical DIMMs for best performance.</b></p> <p><b>i NOTE: For best performance, 6 DIMMs or 12 DIMMs per processor is recommended.</b></p> <p>Optimizer population order is not traditional for 8 and 16 DIMMs installations for dual processor.</p> <ul style="list-style-type: none"> <li>For 8 DIMMs: A1, A2, A4, A5, B1, B2, B4, B5</li> <li>For 16 DIMMs:<br/>A1, A2, A4, A5, A7, A8, A10, A11<br/>B1, B2, B4, B5, B7, B8, B10, B11</li> </ul>   |
|  | Mirroring population order                       | A{1, 2, 3, 4, 5, 6},<br>B{1, 2, 3, 4, 5, 6},<br>A{7, 8, 9, 10, 11, 12},<br>B{7, 8, 9, 10, 11, 12}       | Mirroring is supported with 6 or 12 DIMMs per processor.   |
|  | Single rank sparing population order             | A{1}, B{1},<br>A{2}, B{2},<br>A{3}, B{3},<br>A{4}, B{4},<br>A{5}, B{5},<br>A{6}, B{6}                   | <ul style="list-style-type: none"> <li>DIMMs must be populated in the order specified.</li> <li>Requires two ranks or more per channel.</li> </ul>   |
|  | Multi rank sparing population order              | A{1}, B{1},<br>A{2}, B{2},<br>A{3}, B{3},<br>A{4}, B{4},<br>A{5}, B{5},<br>A{6}, B{6}                   | <ul style="list-style-type: none"> <li>DIMMs must be populated in the order specified.</li> <li>Requires three ranks or more per channel.</li> </ul>   |
|  | Fault resilient population order                 | A{1, 2, 3, 4, 5, 6},<br>B{1, 2, 3, 4, 5, 6},<br>A{7, 8, 9, 10, 11, 12},<br>B{7, 8, 9, 10, 11, 12}       | Supported with 6 or 12 DIMMs per processor.  |
| Quad processor (Starting with processor 1, and processor 1, processor 2, processor 3, and processor 4 population should match) | Optimized population order (Independent channel) | A{1}, B{1}, C{1}, D{1},<br>A{2}, B{2}, C{2}, D{2},<br>A{3}, B{3}, C{3}, D{3},<br>A{4}, B{4}, C{4}, D{4} | <p>Odd number of DIMM population per processor is allowed.</p> <p><b>i NOTE: Odd number of DIMMs will result in unbalanced memory configurations, which in turn will result in performance loss. It is recommended to populate all memory channels identically with identical DIMMs for best performance.</b></p> <p><b>i NOTE: For best performance, 6 DIMMs or 12 DIMMs per processor is recommended.</b></p> <p>Optimizer population order is not traditional for 16 and 32 DIMMs installations for dual processor.</p> <ul style="list-style-type: none"> <li>For 16 DIMMs:<br/>A1, A2, A4, A5, B1, B2, B4, B5,<br/>C1, C2, C4, C5, D1, D2, D4, D5</li> <li>For 32 DIMMs:</li> </ul> |

| Processor | Configuration                        | Memory population  | Memory population information  |
|-----------|--------------------------------------|--|--|
|           |                                      |  | A1, A2, A4, A5, A7, A8, A10, A11,<br>B1, B2, B4, B5, B7, B8, B10, B11<br>C1, C2, C4, C5, C7, C8, C10, C11<br>D1, D2, D4, D5, D7, D8, D10, D11        |
|           | Mirroring population order           | A{1, 2, 3, 4, 5, 6},<br>B{1, 2, 3, 4, 5, 6},<br>C{1, 2, 3, 4, 5, 6},<br>D{1, 2, 3, 4, 5, 6}<br>A{7, 8, 9, 10, 11, 12},<br>B{7, 8, 9, 10, 11, 12},<br>C{7, 8, 9, 10, 11, 12},<br>D{7, 8, 9, 10, 11, 12} | Mirroring is supported with 6 or 12 DIMM slots per processor.  |
|           | Single rank sparing population order | A{1}, B{1}, C{1}, D{1},<br>A{2}, B{2}, C{2}, D{2},<br>A{3}, B{3}, C{3}, D{3},<br>A{4}, B{4}, C{4}, D{4}  | <ul style="list-style-type: none"> <li>DIMMs must be populated in the order specified.</li> <li>Requires two ranks or more per channel.</li> </ul>   |
|           | Multi rank spare population order    | A{1}, B{1}, C{1}, D{1},<br>A{2}, B{2}, C{2}, D{2},<br>A{3}, B{3}, C{3}, D{3},<br>A{4}, B{4}, C{4}, D{4}  | <ul style="list-style-type: none"> <li>DIMMs must be populated in the order specified.</li> <li>Requires three ranks or more per channel.</li> </ul> |
|           | Fault resilient population order     | A{1, 2, 3, 4, 5, 6},<br>B{1, 2, 3, 4, 5, 6},<br>C{1, 2, 3, 4, 5, 6},<br>D{1, 2, 3, 4, 5, 6}<br>A{7, 8, 9, 10, 11, 12},<br>B{7, 8, 9, 10, 11, 12},<br>C{7, 8, 9, 10, 11, 12},<br>D{7, 8, 9, 10, 11, 12} | Supported with 6 or 12 DIMM slots per processor.   |

## Removing a memory module

### Prerequisites

 **WARNING:** Allow the memory modules to cool after you power off the system. Handle the memory modules by the card edges and avoid touching the components or metallic contacts on the memory module.

 **CAUTION:** To ensure proper system cooling, when processor 1 and processor 2 are installed, memory module blanks must be installed in memory sockets that are not occupied. Remove memory module blanks only if you intend to install memory modules in those sockets.

- Follow the safety guidelines listed in [Safety instructions](#).
- Follow the procedure listed in [Before working inside your system](#).
- Remove the applicable air shroud:
  - [Non-GPU air shroud](#)
OR
  - [GPU air shroud](#)

### Steps

- Locate the appropriate memory module socket.

 **CAUTION:** Handle each memory module only by the card edges, ensuring not to touch the middle of the memory module or metallic contacts.

2. Push the ejectors outward on both ends of the memory module socket to release the memory module from the socket.
3. Lift and remove the memory module from the system.

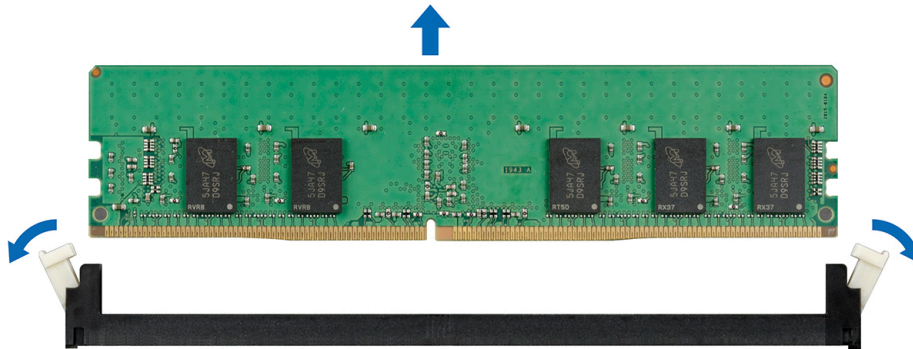

Figure 44. Removing a memory module

**NOTE:** If you are removing the memory module permanently, install a memory module blank. The procedure to install a memory module blank is similar to that of the memory module.

#### Next steps

1. [Replace the memory module.](#)

## Installing a memory module

#### Prerequisites

1. Follow the safety guidelines listed in [Safety instructions](#).
2. Follow the procedure listed in [Before working inside your system](#).
3. Remove the applicable air shroud:
  - [Non-GPU air shroud](#)OR
  - [GPU air shroud](#)

#### Steps

1. Locate the appropriate memory module socket.

**CAUTION:** Handle each memory module only by the card edges, ensuring not to touch the middle of the memory module or metallic contacts.

**CAUTION:** To prevent damage to the memory module or the memory module socket during installation, do not bend or flex the memory module. You must insert both ends of the memory module simultaneously.

2. Open the ejectors on the memory module socket outward to allow the memory module to be inserted into the socket.
3. Align the edge connector of the memory module with the alignment key of the memory module socket, and insert the memory module in the socket.

**CAUTION:** Do not apply pressure at the center of the memory module; apply pressure at both ends of the memory module evenly.

**NOTE:** The memory module socket has an alignment key that enables you to install the memory module in the socket in only one orientation.

4. Press the memory module with your thumbs until the socket levers firmly click into place.

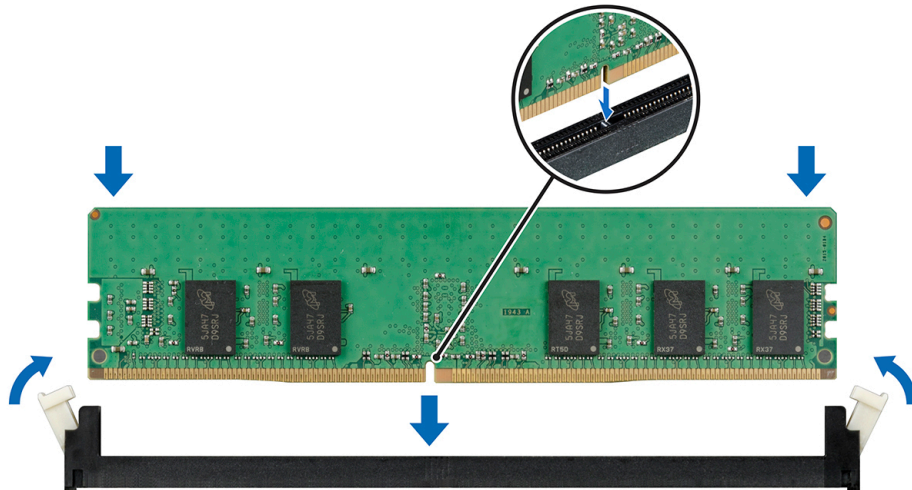

**Figure 45. Installing a memory module**

**Next steps**

1. Install the applicable air shroud:
  - [GPU air shroud](#)
 OR
  - [Non-GPU air shroud](#)
2. Follow the procedure listed in [After working inside your system](#).
3. Verify if the memory module has been installed properly, by pressing F2 and navigating to **System Setup Main Menu > System BIOS > Memory Settings**. In the **Memory Settings** screen, the System Memory Size must reflect the updated capacity of the installed memory. If the value is incorrect, one or more of the memory modules may not be installed properly. Ensure that the memory module is firmly seated in the memory module socket. Run the system memory test in system diagnostics.

## Expansion cards and expansion card risers

An expansion card in the system is an add-on card that can be installed into an expansion slot on the system board or a slot on a riser to add enhanced functionality to the system through the expansion bus.

**NOTE:** A System Event Log (SEL) event is logged if an expansion card riser is not supported or missing. It does not prevent your system from turning on. However, if a F1/F2 pause occurs, an error message is displayed.

**Table 16. Expansion card riser specifications**

| PCIe slot | Riser                       | Processor connection | Height      | Length      | Slot width |
|-----------|-----------------------------|----------------------|-------------|-------------|------------|
| 1         | X8 PCIe Riser 1             | Processor 1          | Full height | Half length | x8         |
| 2         | X16 PCIe Riser 1            | Processor 1          | Full height | Full length | x16        |
|           | X8 PCIe Riser 1             | Processor 1          | Full height | Half length | x8         |
| 3         | Located on the system board | Processor 1          | Low profile | Half length | x16        |
| 4         | Located on the system board | Processor 2          | Low profile | Half length | x16        |
| 5         | X8 PCIe Riser 2             | Processor 2          | Full height | Half length | x8         |
| 6         | X16 PCIe Riser 2            | Processor 2          | Full height | Full length | x16        |
|           | X8 PCIe Riser 2             | Processor 2          | Full height | Half length | x8         |

## Expansion card installation guidelines

To ensure proper cooling and mechanical fit, the following table provides guidelines for installing expansion cards. The expansion cards with the highest priority must be installed first using the slot priority indicated. All the other expansion cards should be installed in the card priority and slot priority order.

**NOTE:** The expansion-card slots are not hot-swappable.

**Table 17. x16 PCIe riser 1+ x16 PCIe riser 2 configuration**

| Card type          |             | Slot priority | Riser height | Maximum number of cards supported | Card height | Card length | Maximum PCIe width supported |
|--------------------|-------------|---------------|--------------|-----------------------------------|-------------|-------------|------------------------------|
| GPU                | Nvidia      | 2,6           | Full height  | 2                                 | Full length | Full height | x16                          |
| FPGA               | Intel       | 2,6           | Full height  | 2                                 | Half length | Full height | x16                          |
| PERC10             | Dell design | 3             | Low profile  | 1                                 | Half length | Low profile | x8                           |
| Infiniband HCA EDR | Mellanox    | 3,4           | Low profile  | 2                                 | Half length | Low profile | X16                          |
|                    |             | 2,6           | Full height  | 2                                 | Half length | Full height | X16                          |
| 100G NICs          | Mellanox    | 3,4           | Low profile  | 2                                 | Half length | Low profile | X16                          |
|                    |             | 2,6           | Full height  | 2                                 | Half length | Full height | X16                          |
| Omni-Path HFI      | INTEL       | 3,4           | Low profile  | 2                                 | Half length | Low profile | x16                          |
|                    |             | 2,6           | Full height  | 2                                 | Half length | Full height | x16                          |
| BOSS               | Dell design | 2,6           | Full height  | 1                                 | Half length | Full height | x4                           |
|                    |             | 2,6           | Full height  | 1                                 | Half length | Full height | x8                           |
|                    |             | 3,4           | Low profile  | 1                                 | Half length | Low profile | x4                           |
|                    |             | 3,4           | Low profile  | 1                                 | Half length | Low profile | x8                           |
| External RAID      | Dell design | 3,4           | Low profile  | 2                                 | Half length | Low profile | x8                           |
|                    |             | 2,6           | Full height  | 2                                 | Half length | Full height | x8                           |
| Infiniband HCA FDR | Mellanox    | 3,4           | Low profile  | 2                                 | Half length | Low profile | x8                           |
| 40Gb NICs          | INTEL       | 2,6           | Full height  | 2                                 | Half length | Full height | x8                           |
|                    |             | 3,4           | Low profile  | 2                                 | Half length | Low profile | x8                           |
| FC32 HBA           | Emulex      | 2,6           | Full height  | 2                                 | Half length | Full height | x8                           |
|                    |             | 3,4           | Low profile  | 2                                 | Half length | Low profile | x8                           |
| 25G NICs           | Broadcom    | 3,4           | Low profile  | 2                                 | Half length | Low profile | x8                           |
|                    |             | 2,6           | Full height  | 2                                 | Half length | Full height | x8                           |
| FC16 HBA           | Emulex      | 2,6           | Full height  | 2                                 | Half length | Full height | x8                           |
|                    |             | 3,4           | Low profile  | 2                                 | Half length | Low profile | x8                           |
| 10Gb NICs          |             | 3,4           | Low profile  | 2                                 | Half length | Low profile | x8                           |
|                    |             | 2,6           | Full height  | 2                                 | Half length | Full height | x8                           |
|                    |             | 3,4           | Low profile  | 2                                 | Half length | Low profile | x4                           |
|                    |             | 2,6           | Full height  | 2                                 | Half length | Full height | x4                           |
| FC8 HBA            |             | 3,4           | Low profile  | 2                                 | Half length | Low profile | x8                           |
|                    |             | 2,6           | Full height  | 2                                 | Half length | Full height | x8                           |

| Card type     |  | Slot priority   | Riser height               | Maximum number of cards supported | Card height | Card length                | Maximum PCIe width supported |
|---------------|--|-----------------|----------------------------|-----------------------------------|-------------|----------------------------|------------------------------|
| 1Gb NICs      |  | 2,6             | Full height                | 2                                 | Half length | Full height                | x1                           |
|               |  | 3,4             | Low profile                | 2                                 | Half length | Low profile                | x1                           |
|               |  | 2,6             | Full height                | 2                                 | Half length | Full height                | x4                           |
|               |  | 3,4             | Low profile                | 2                                 | Half length | Low profile                | x4                           |
| Non-RAID      |  | 3,4             | Low profile                | 2                                 | Half length | Low profile                | x8                           |
|               |  | 2,6             | Full height                | 2                                 | Half length | Full height                | x8                           |
| NVMe PCIe SSD |  | 3,4,2,6         | Full height or Low profile | 2                                 | Half length | Full height or Low profile | x8                           |
| rNDC          |  | Integrated Slot | None                       | 1                                 | None        | rNDC                       | x8                           |
|               |  | Integrated Slot | None                       | 1                                 | None        | rNDC                       | x1                           |
|               |  | Integrated Slot | None                       | 1                                 | None        | rNDC                       | x4                           |

**Table 18. x8 PCIe riser 1 + Null riser configuration**

| Card type          | Slot priority | Riser height | Maximum number of cards supported | Card height | Card length |
|--------------------|---------------|--------------|-----------------------------------|-------------|-------------|
| PERC10             | 1,2           | Full height  | 2                                 | Low profile | x8          |
|                    | 1             | Full height  | 1                                 | Low profile | x8          |
| Infiniband HCA EDR | 3,4           | Low profile  | 2                                 | Low profile | X16         |
| 100G NICs          | 3,4           | Low profile  | 2                                 | Low profile | X16         |
| Omni-Path HFI      | 3,4           | Low profile  | 2                                 | Low profile | x16         |
| BOSS               | 1,2           | Full height  | 1                                 | Full height | x4          |
|                    | 1,2           | Full height  | 1                                 | Full height | x8          |
|                    | 3,4           | Low profile  | 1                                 | Low profile | x4          |
|                    | 3,4           | Low profile  | 1                                 | Low profile | x8          |
| External RAID      | 3,4           | Low profile  | 2                                 | Low profile | x8          |
|                    | 1,2           | Full height  | 2                                 | Full height | x8          |
| Infiniband HCA FDR | 3,4           | Low profile  | 2                                 | Low profile | x8          |
| 40Gb NICs          | 1,2           | Full height  | 2                                 | Full height | x8          |
|                    | 3,4           | Low profile  | 2                                 | Low profile | x8          |
| FC32 HBA           | 1,2           | Full height  | 2                                 | Full height | x8          |
|                    | 3,4           | Low profile  | 2                                 | Low profile | x8          |
| 25G NICs           | 3,4           | Low profile  | 2                                 | Low profile | x8          |
|                    | 1,2           | Full height  | 2                                 | Full height | x8          |
| FC16 HBA           | 1,2           | Full height  | 2                                 | Full height | x8          |
|                    | 3,4           | Low profile  | 2                                 | Low profile | x8          |
| 10Gb NICs          | 3,4           | Low profile  | 2                                 | Low profile | x8          |

| Card type     | Slot priority   | Riser height               | Maximum number of cards supported | Card height                | Card length |
|---------------|-----------------|----------------------------|-----------------------------------|----------------------------|-------------|
|               | 1,2             | Full height                | 2                                 | Full height                | x8          |
|               | 3,4             | Low profile                | 2                                 | Low profile                | x4          |
|               | 1,2             | Full height                | 2                                 | Full height                | x4          |
| FC8 HBA       | 3,4             | Low profile                | 2                                 | Low profile                | x8          |
|               | 1,2             | Full height                | 2                                 | Full height                | x8          |
| 1Gb NICs      | 1,2             | Full height                | 2                                 | Full height                | x1          |
|               | 3,4             | Low profile                | 2                                 | Low profile                | x1          |
|               | 1,2             | Full height                | 2                                 | Full height                | x4          |
|               | 3,4             | Low profile                | 2                                 | Low profile                | x4          |
| Non-RAID      | 3,4             | Low profile                | 2                                 | Low profile                | x8          |
|               | 1,2             | Full height                | 2                                 | Full height                | x8          |
| NVMe PCIe SSD | 1,2,3,4         | Full height or Low profile | 2                                 | Full height or Low profile | x8          |
| rNDC          | Integrated Slot | None                       | 1                                 | rNDC                       | x8          |
|               | Integrated Slot | None                       | 1                                 | rNDC                       | x1          |
|               | Integrated Slot | None                       | 1                                 | rNDC                       | x4          |

**Table 19. x8 PCIe riser 1 + x8 PCIe riser 2 configuration**

| Card type          | Slot priority | Riser height | Maximum number of cards supported | Card height | Card length | Maximum PCIe width supported |
|--------------------|---------------|--------------|-----------------------------------|-------------|-------------|------------------------------|
| PERC10             | 1,2           | Full height  | 2                                 | Half length | Low profile | x8                           |
|                    | 1             | Full height  | 1                                 | Half length | Low profile | x8                           |
| Infiniband HCA EDR | 3,4           | Low profile  | 2                                 | Half length | Low profile | X16                          |
| 100G NICs          | 3,4           | Low profile  | 2                                 | Half length | Low profile | X16                          |
| Omni-Path HFI      | 3,4           | Low profile  | 2                                 | Half length | Low profile | x16                          |
| BOSS               | 1,2,5,6       | Full height  | 1                                 | Half length | Full height | x4                           |
|                    | 1,2,5,6       | Full height  | 1                                 | Half length | Full height | x8                           |
|                    | 3,4           | Low profile  | 1                                 | Half length | Low profile | x4                           |
|                    | 3,4           | Low profile  | 1                                 | Half length | Low profile | x8                           |
| External RAID      | 3,4           | Low profile  | 2                                 | Half length | Low profile | x8                           |
|                    | 1,2,5,6       | Full height  | 2                                 | Half length | Full height | x8                           |
| Infiniband HCA FDR | 3,4           | Low profile  | 2                                 | Half length | Low profile | x8                           |
| 40Gb NICs          | 1,2,5,6       | Full height  | 4                                 | Half length | Full height | x8                           |
|                    | 3,4           | Low profile  | 2                                 | Half length | Low profile | x8                           |
| FC32 HBA           | 1,2,5,6       | Full height  | 4                                 | Half length | Full height | x8                           |
|                    | 3,4           | Low profile  | 2                                 | Half length | Low profile | x8                           |
| 25G NICs           | 3,4           | Low profile  | 2                                 | Half length | Low profile | x8                           |

| Card type     | Slot priority   | Riser height               | Maximum number of cards supported | Card height | Card length                | Maximum PCIe width supported |
|---------------|-----------------|----------------------------|-----------------------------------|-------------|----------------------------|------------------------------|
|               | 1,2,5,6         | Full height                | 4                                 | Half length | Full height                | x8                           |
| FC16 HBA      | 1,2,5,6         | Full height                | 4                                 | Half length | Full height                | x8                           |
|               | 3,4             | Low profile                | 2                                 | Half length | Low profile                | x8                           |
| 10Gb NICs     | 3,4             | Low profile                | 2                                 | Half length | Low profile                | x8                           |
|               | 1,2,5,6         | Full height                | 4                                 | Half length | Full height                | x8                           |
|               | 3,4             | Low profile                | 2                                 | Half length | Low profile                | x4                           |
|               | 1,2,5,6         | Full height                | 4                                 | Half length | Full height                | x4                           |
| FC8 HBA       | 3,4             | Low profile                | 2                                 | Half length | Low profile                | x8                           |
|               | 1,2,5,6         | Full height                | 4                                 | Half length | Full height                | x8                           |
| 1Gb NICs      | 1,2,5,6         | Full height                | 4                                 | Half length | Full height                | x1                           |
|               | 3,4             | Low profile                | 2                                 | Half length | Low profile                | x1                           |
|               | 1,2,5,6         | Full height                | 4                                 | Half length | Full height                | x4                           |
|               | 3,4             | Low profile                | 2                                 | Half length | Low profile                | x4                           |
| Non-RAID      | 3,4             | Low profile                | 2                                 | Half length | Low profile                | x8                           |
|               | 1,2,5,6         | Full height                | 4                                 | Half length | Full height                | x8                           |
| NVMe PCIe SSD | 1,2,5,6,3,4     | Full height or Low profile | 2                                 | Half length | Full height or Low profile | x8                           |
| rNDC          | Integrated Slot | None                       | 1                                 | None        | rNDC                       | x8                           |
|               | Integrated Slot | None                       | 1                                 | None        | rNDC                       | x1                           |
|               | Integrated Slot | None                       | 1                                 | None        | rNDC                       | x4                           |

## Removing expansion card from the expansion card riser

### Prerequisites

1. Follow the safety guidelines listed in [Safety instructions](#).
2. Follow the procedure listed in [Before working inside your system](#).
3. [Remove the air shroud](#).
4. [Remove the expansion card risers](#).

 **NOTE:** The procedure to remove expansion card from riser for all risers is identical.

### Steps

1. Open the black expansion card latch on the riser.
2. Open the blue card holder latch on the riser.
3. Hold the expansion card by its edges, and pull the card until the card edge connector disengages from the connector on the riser.

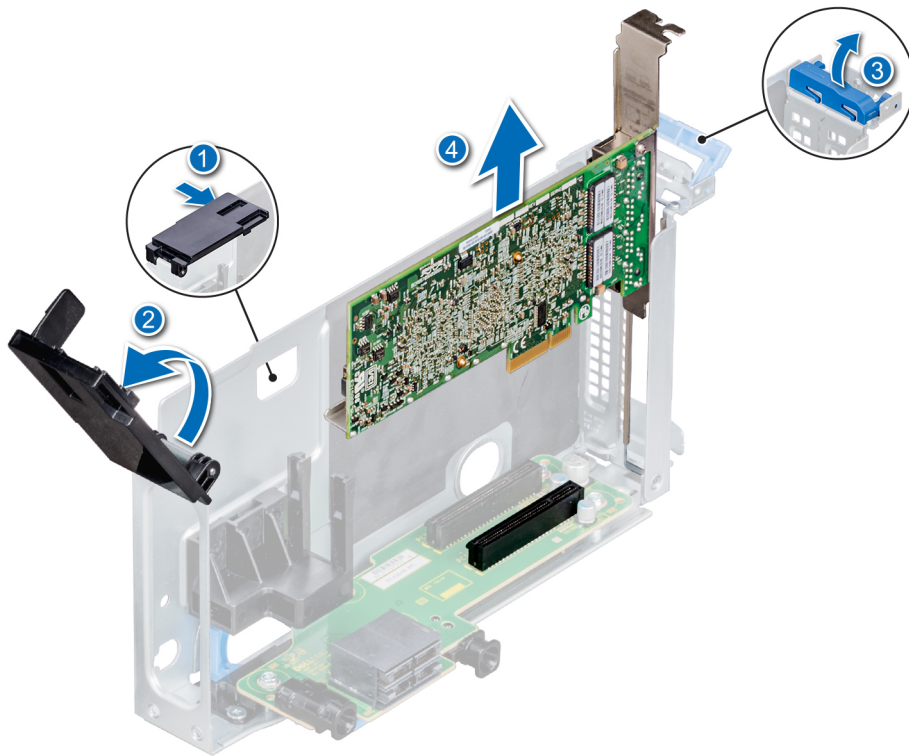
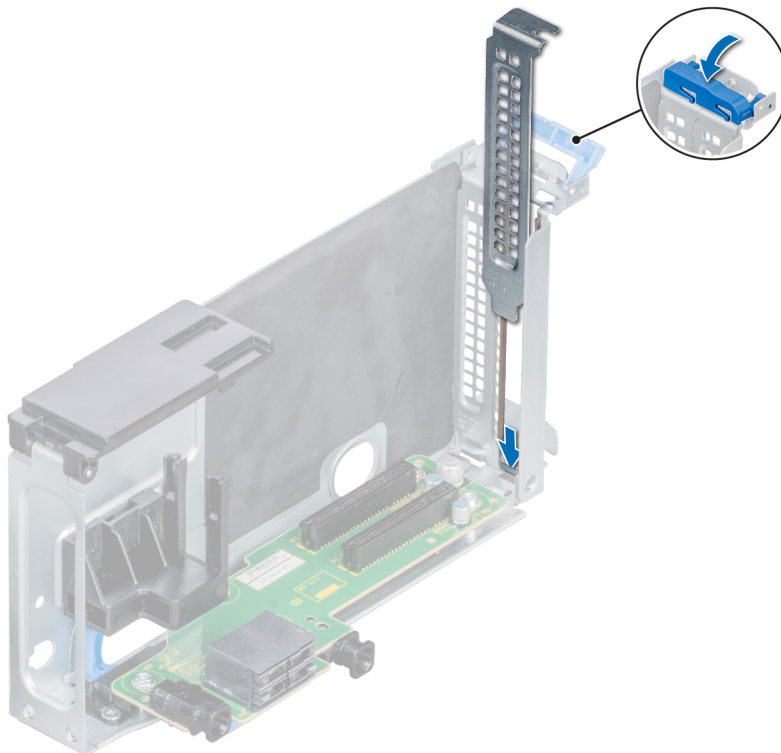

**Figure 46. Removing the expansion card from the riser**

4. Install a filler bracket if you are not going to replace the expansion card.

**NOTE:** You must install a filler bracket over an empty expansion card slot to maintain Federal Communications Commission (FCC) certification of the system. The brackets also keep dust and dirt out of the system and aid in proper cooling and airflow inside the system.

**Figure 47. Installing a filler bracket for a riser**



## Next steps

1. Install expansion card into the expansion card riser.

# Installing expansion card into the expansion card riser

## Prerequisites

1. Follow the safety guidelines listed in [Safety instructions](#).
2. Follow the procedure listed in [Before working inside your system](#).
3. If installing a new expansion card, unpack it and prepare the card for installation.

**i** **NOTE:** For instructions, see the documentation accompanying the card.

4. Remove the applicable air shroud.
5. Remove the expansion card risers.

**i** **NOTE:** The procedure to remove expansion card from riser for all risers is identical.

## Steps

1. Open the black expansion card latch on the riser.
2. Open the blue card holder latch on the riser.
3. If installed, remove the filler bracket.

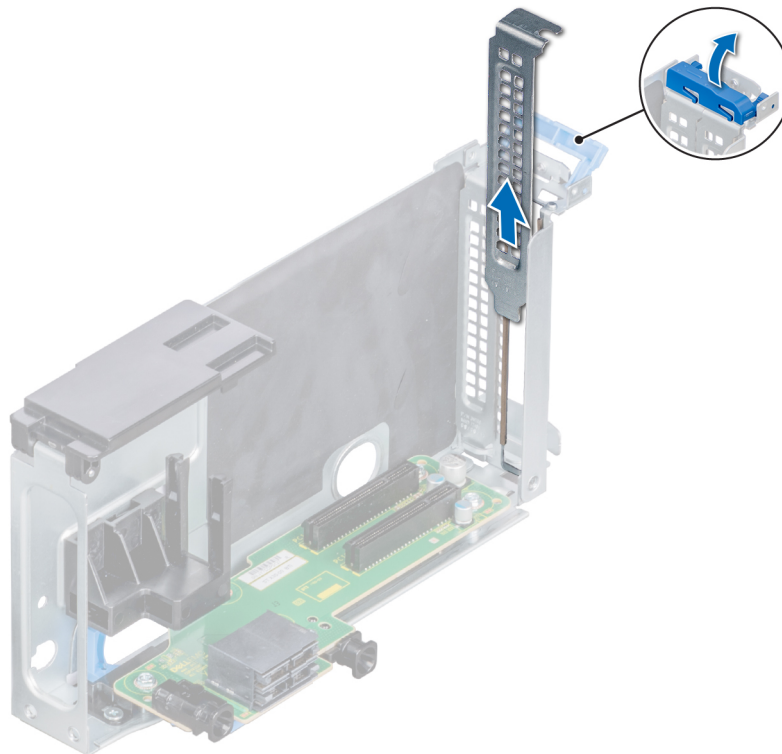

**Figure 48. Removing a filler bracket from a riser**

**i** **NOTE:** If applicable, connect the cables to the expansion card.

4. Hold the card by its edges, and align the card edge connector with the connector on the riser.
5. Insert the card edge connector firmly into the expansion card connector until the card is fully seated.
6. Close the expansion card retention latch.

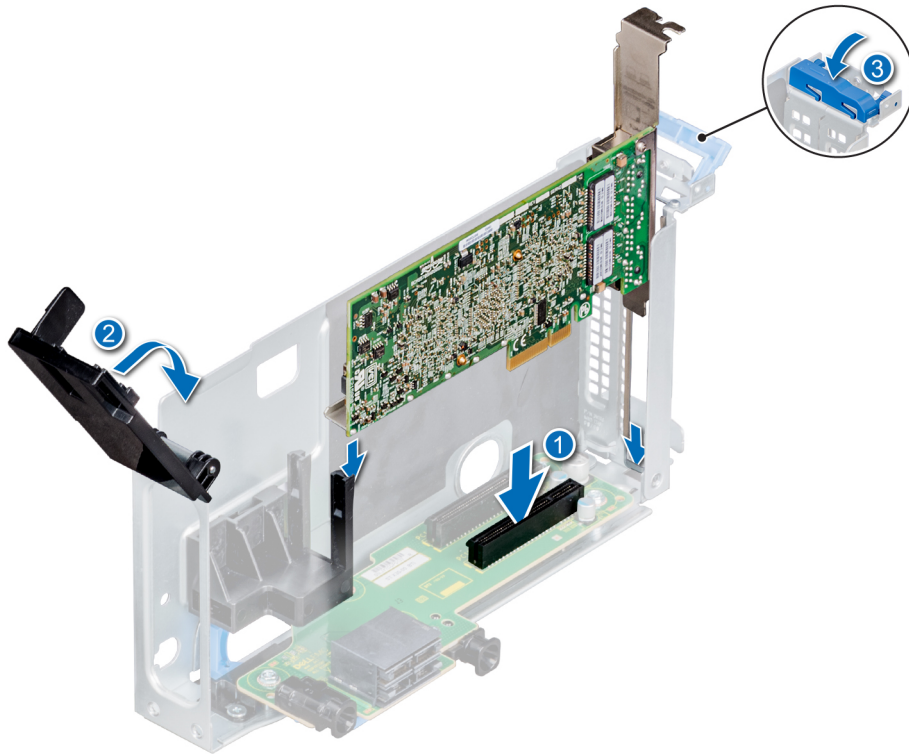

**Figure 49. Installing the expansion card into a riser**

#### Next steps

1. [Install the expansion card risers.](#)
2. If applicable, connect the cables to the expansion card.
3. [Install the applicable air shroud.](#)
4. Follow the procedure listed in [After working inside your system.](#)
5. Install any device drivers required for the card as described in the documentation for the card.

## Removing the expansion card risers

#### Prerequisites

1. Follow the safety guidelines listed in [Safety instructions.](#)
2. Follow the procedure listed in [Before working inside your system.](#)
3. [Remove the air shroud.](#)
4. Disconnect any cables connected to the expansion card.

#### Steps

1. Using the Phillips #2 screwdriver, loosen the screws that secure the riser to the system.
2. Press the blue release tab, and holding the riser by its edges, lift the riser from the riser connector on the system board.

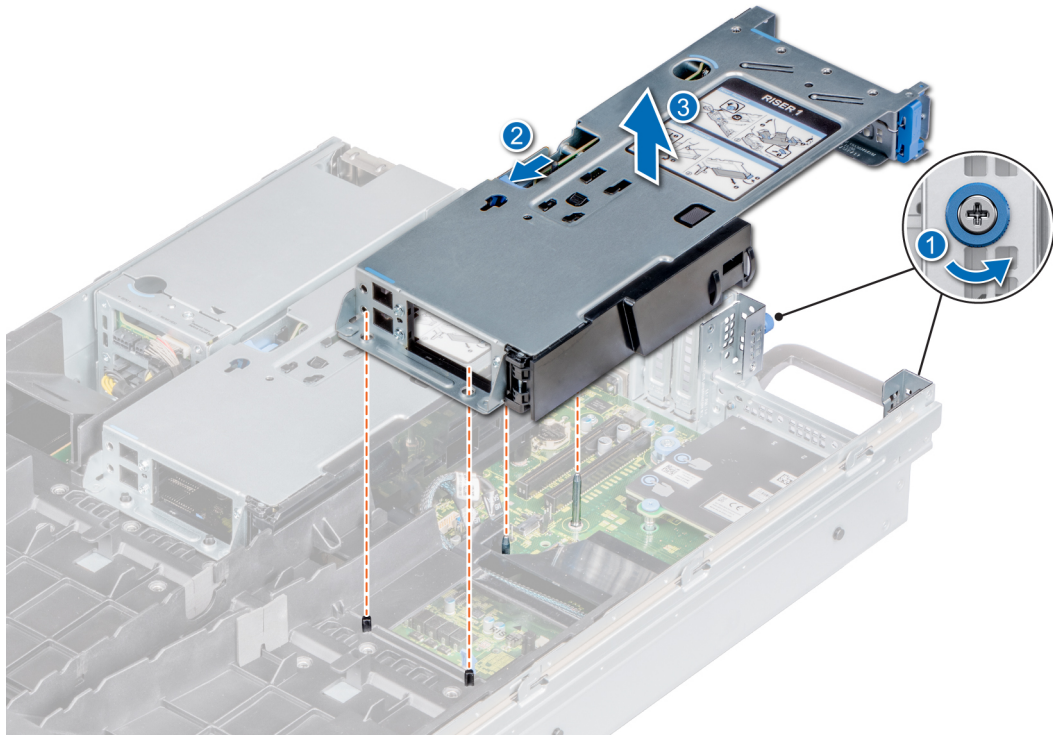

Figure 50. Removing the expansion card x16 PCIe riser 1

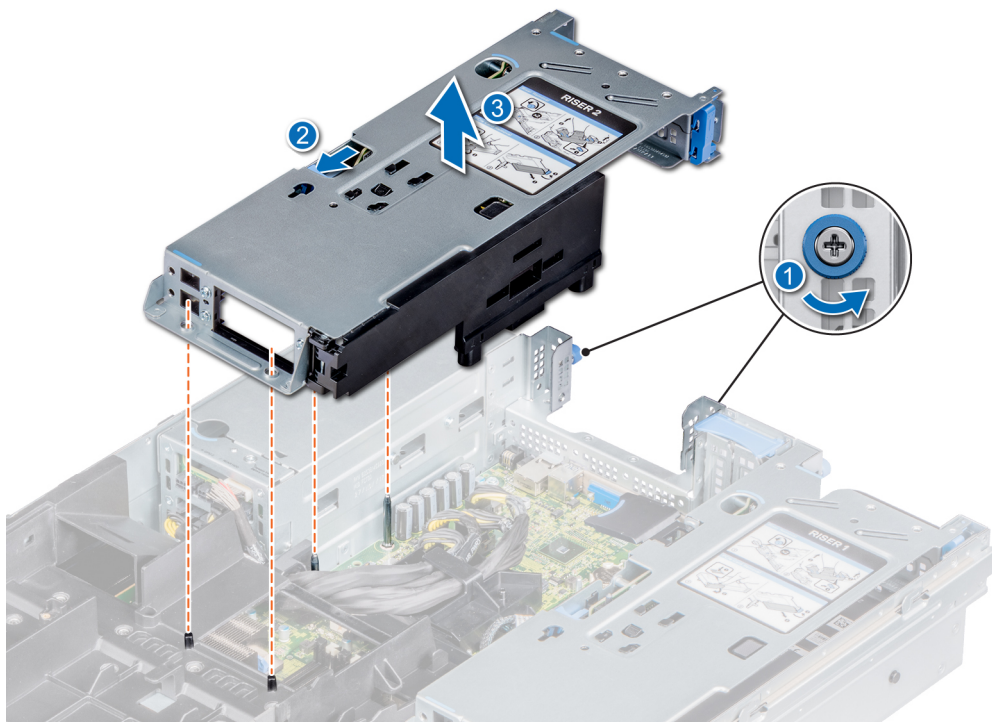

Figure 51. Removing the expansion card x16 PCIe riser 2

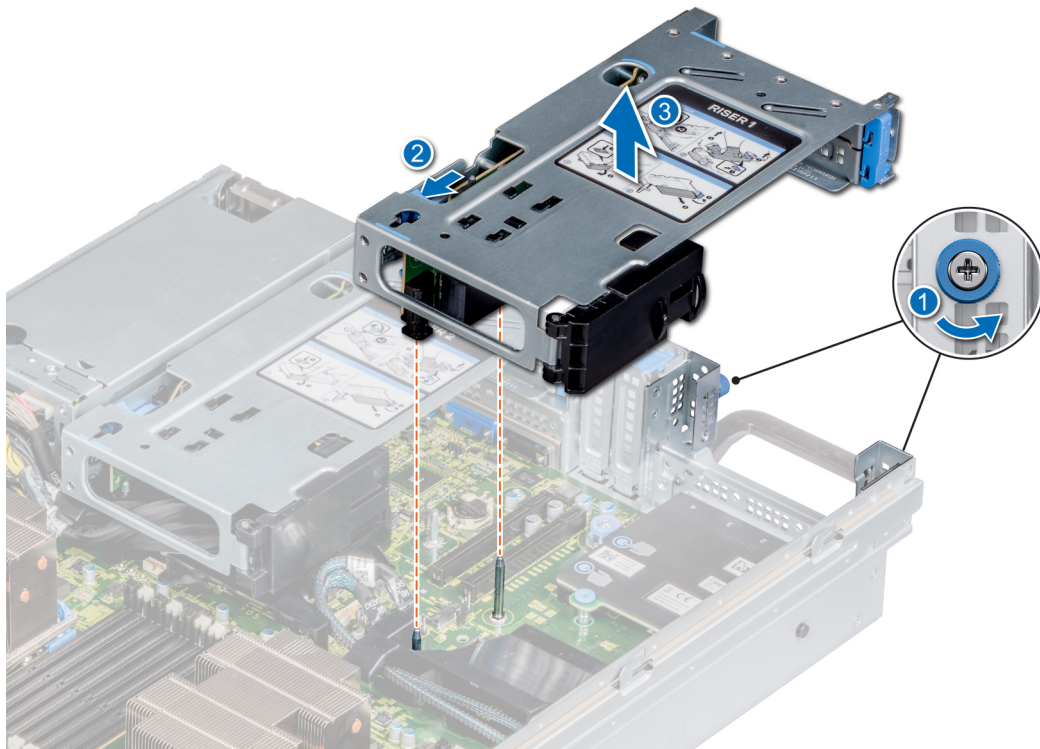

Figure 52. Removing the expansion card x8 PCIe riser 1

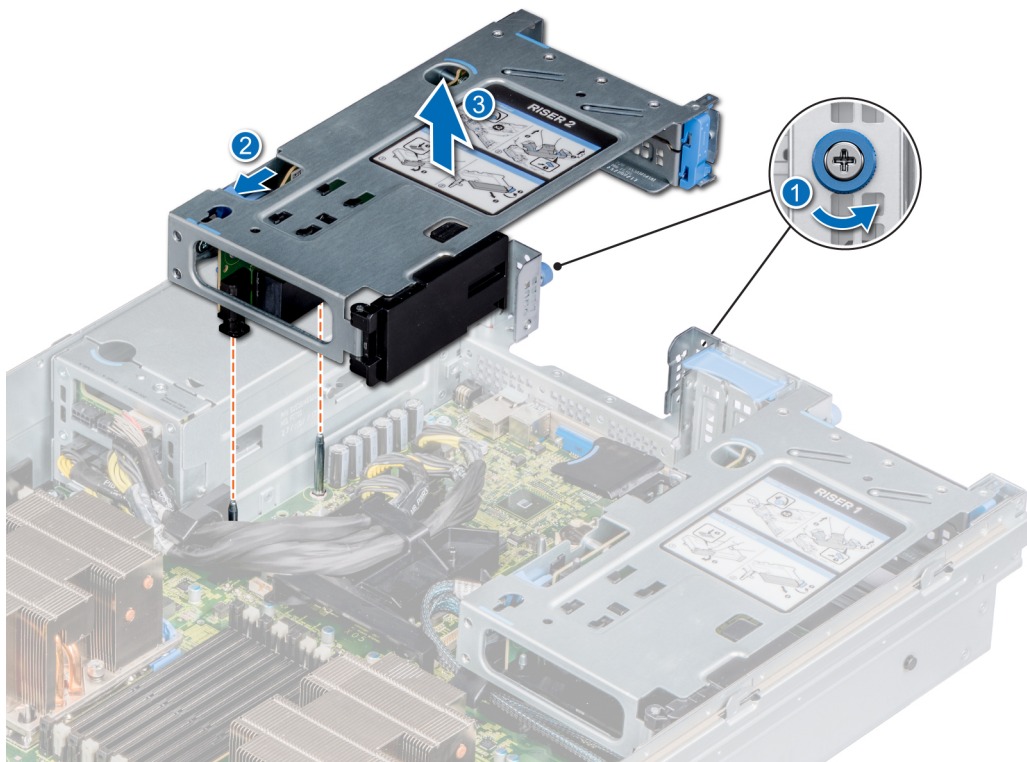

Figure 53. Removing the expansion card x8 PCIe riser 2

#### Next steps

1. Install the expansion card risers.

# Installing the expansion card risers

## Prerequisites

1. Follow the safety guidelines listed in [Safety instructions](#).
2. Follow the procedure listed in [Before working inside your system](#).
3. [Remove the air shroud](#).

## Steps

1. If removed, install the expansion cards into the expansion card risers.
2. Holding the touch points, align the slots on the riser with the guides on the system board and air shroud.
3. Lower the expansion card riser into place until the expansion card riser connector is fully seated in the connector.
4. Tighten the captive screws to secure the riser to the system.

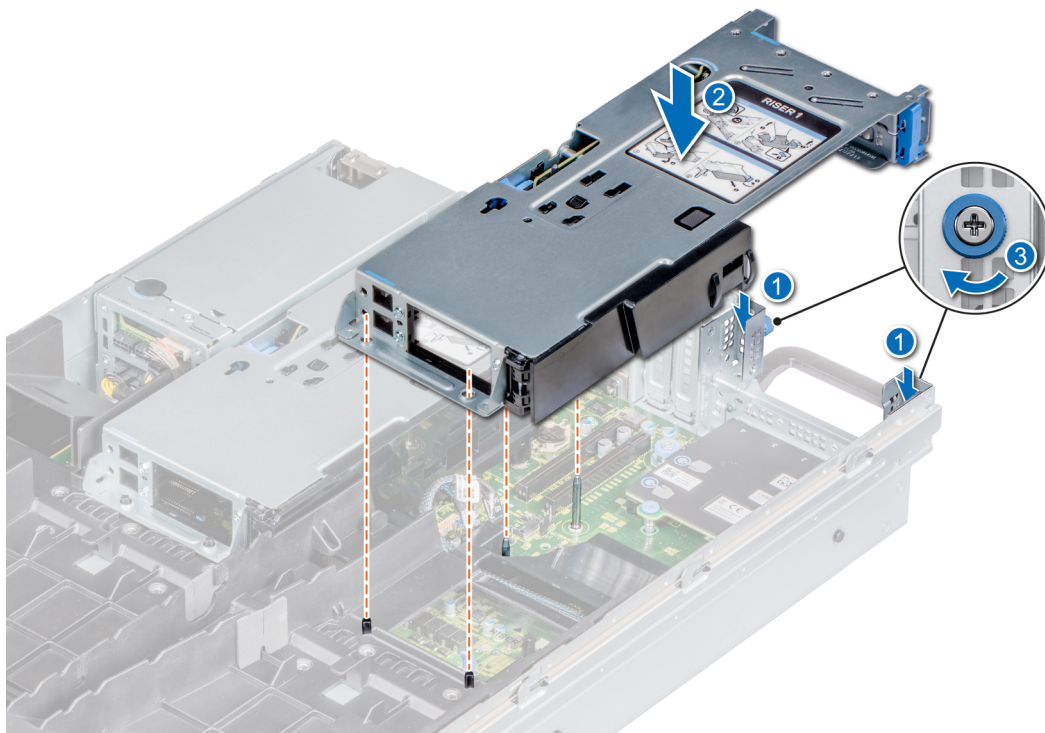

Figure 54. Installing the expansion card x16 PCIe riser 1

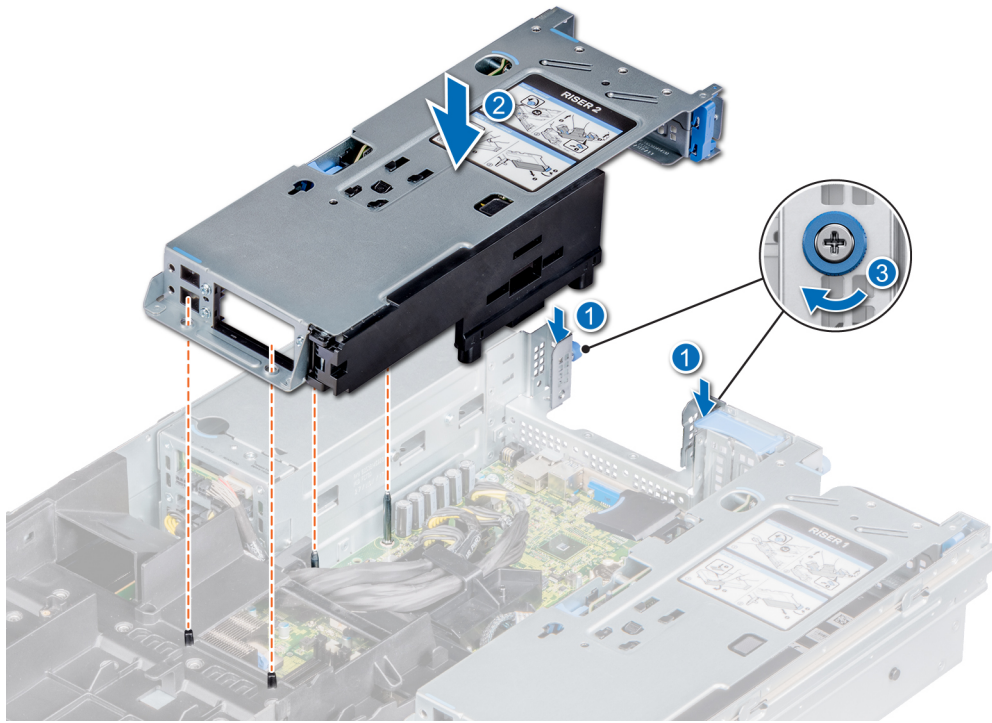

Figure 55. Installing the expansion card x16 PCIe riser 2

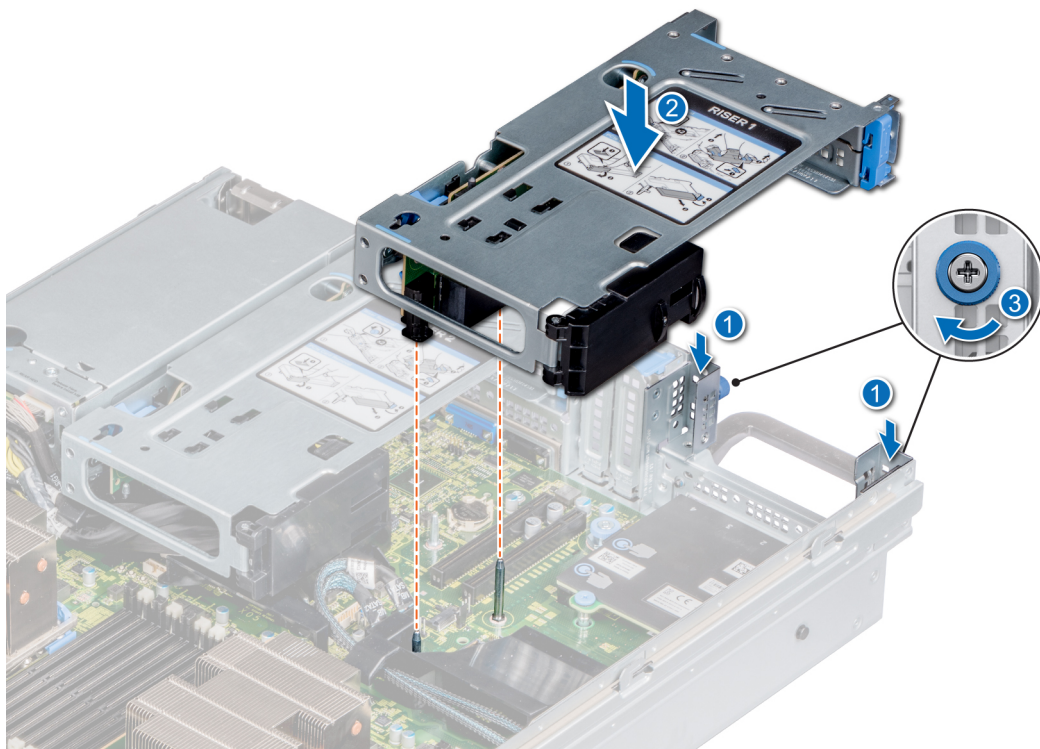
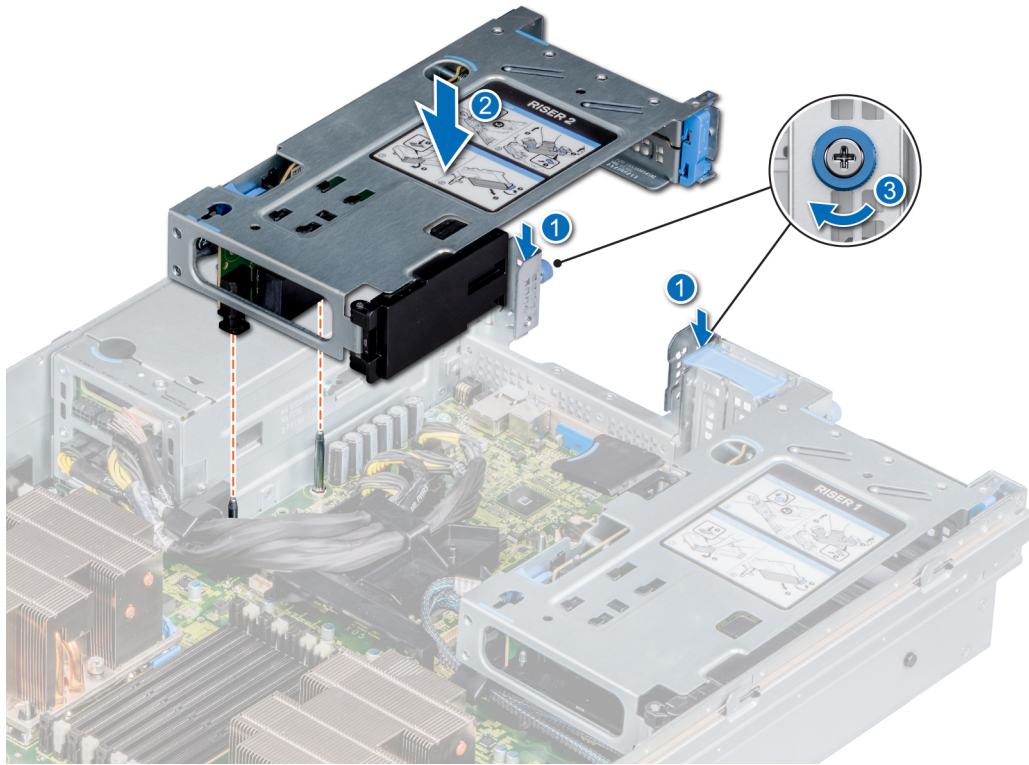

Figure 56. Installing the expansion card x8 PCIe riser 1



**Figure 57. Installing the expansion card x8 PCIe riser 2**

#### Next steps

1. Install any device drivers required for the card as described in the documentation for the card.
2. [Install the air shroud.](#)
3. Follow the procedure listed in [After working inside your system.](#)

## Removing a PCIe expansion card

#### Prerequisites

1. Follow the safety guidelines listed in [Safety instructions.](#)
2. Follow the procedure listed in [Before working inside your system.](#)
3. [Remove the air shroud.](#)
4. Disconnect any cables connected to the expansion card.

#### Steps

1. Open the blue expansion card retention latch lock.
2. Hold the expansion card by the edge, and pull the card to disconnect from the system board connector.

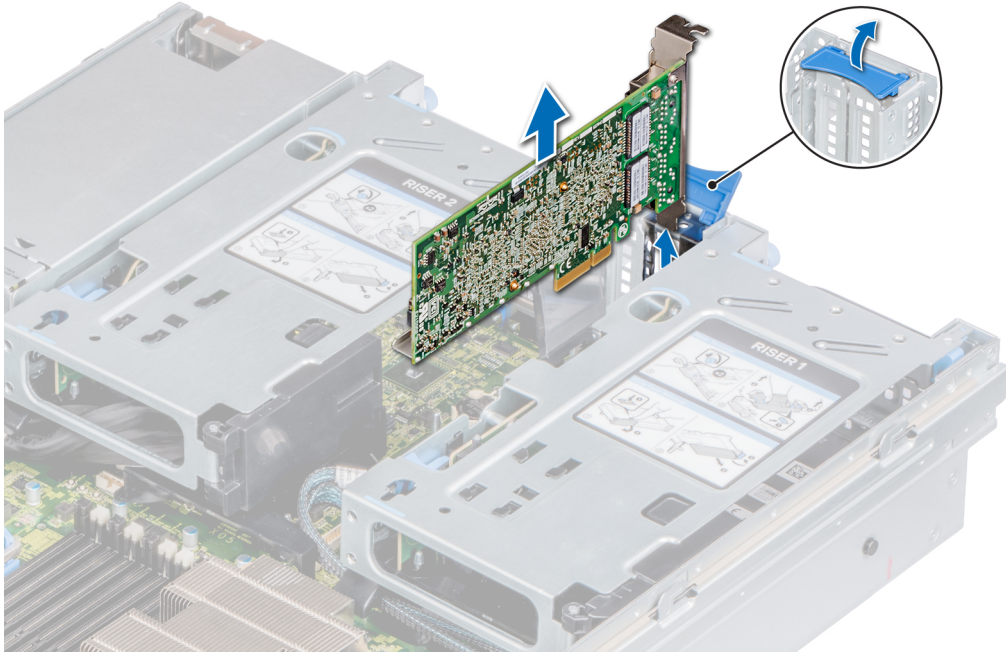

**Figure 58. Removing an expansion card from the system board**

3. If you are not replacing the expansion card, install a filler bracket by performing the following steps:
  - a) Align the slot on the filler bracket with the tab on the expansion card slot.
  - b) Align the filler bracket with the slot on the system.
  - c) Push the filler bracket downward until firmly seated.
  - d) Close the blue expansion card retention latch.

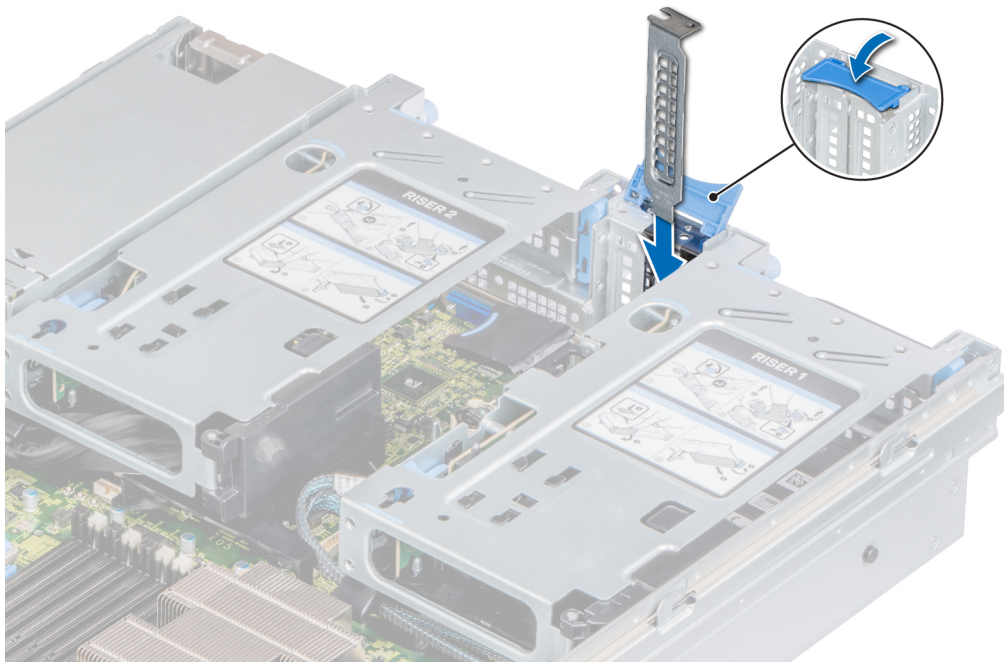

**Figure 59. Installing the filler bracket**

**Next steps**

1. [Install an expansion card.](#)

# Installing a PCIe expansion card

## Prerequisites

1. Follow the safety guidelines listed in [Safety instructions](#).
2. Follow the procedure listed in [Before working inside your system](#).
3. [Remove the air shroud](#).

## Steps

1. Unpack the expansion card and prepare it for installation.  
For instructions, see the documentation accompanying the card.
2. If you are installing a new card, remove the filler bracket.
  - a) Open the blue expansion card retention latch lock.
  - b) Slide the filler bracket out of the system.

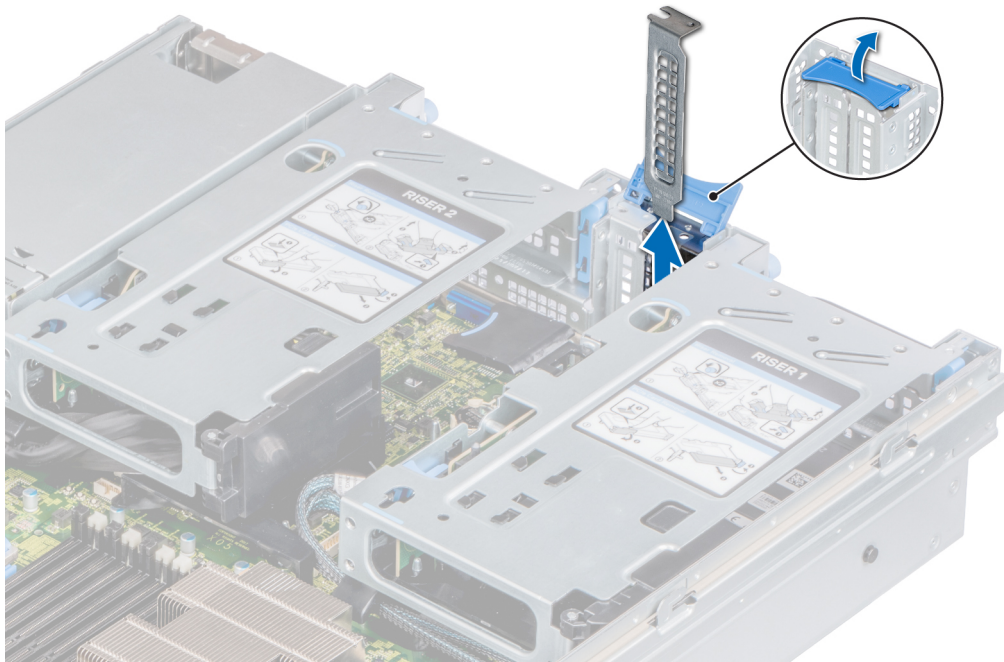

**Figure 60. Removing the filler bracket**

**i** **NOTE:** Store the filler bracket for future use. Filler brackets must be installed in empty expansion card slots to maintain FCC certification of the system. The brackets also keep dust and dirt out of the system and aid in proper cooling and airflow inside the system.

3. Holding the card on the edges, align the card with the expansion card connector on the system board.
4. Press the expansion card firmly into the expansion card connector on the system board until the card is fully seated.
5. Close the blue expansion card retention latch.

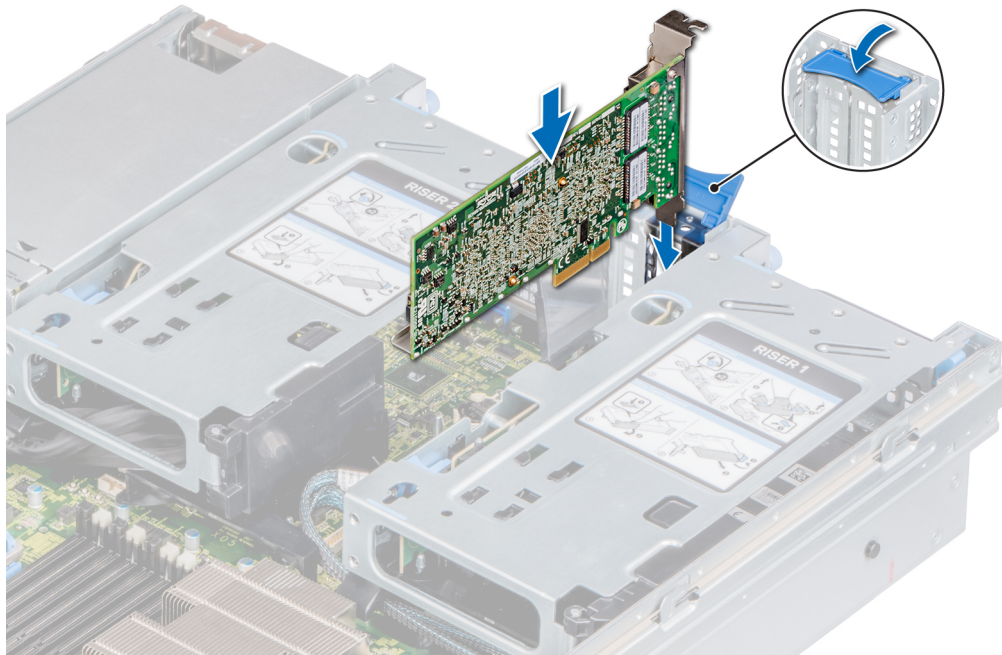

**Figure 61. Installing an expansion card on the system board**

#### Next steps

1. Connect the required cables to the expansion card.
2. [Install the air shroud.](#)
3. Follow the procedure listed in [After working inside your system.](#)

## GPU card installation guidelines

- Ensure that both the processors are installed.
- The processor must use the GPU kit low-profile heat sink.
- To ensure adequate cooling when one or more GPUs are installed, the ambient inlet temperature is restricted to 30°C for CPU 150 W/8 C, 165 W/12 C, 200 W, 205 W. For more information, see the [Ambient temperature limitations](#) section.
- All GPUs must be of the same type and model.
- The cover on the GPU air shroud must be removed before installing the GPU.
- Ensure that high performance fans and GPU air shroud are installed.

**NOTE:** When using systems with GPU, ensure that you install PSUs with 1100 W or higher, and set the PSU configuration to non-redundant mode.

## Removing a GPU

#### Prerequisites

1. Follow the safety guidelines listed in [Safety Instructions.](#)
2. Follow the procedure listed in [Before working inside your system.](#)
3. [Remove the GPU air shroud cover.](#)
4. [Remove the expansion card riser.](#)

#### Steps

1. Disconnect the GPU power cable from the PIB.
2. Open the expansion card latch and the card holder latch on the riser.

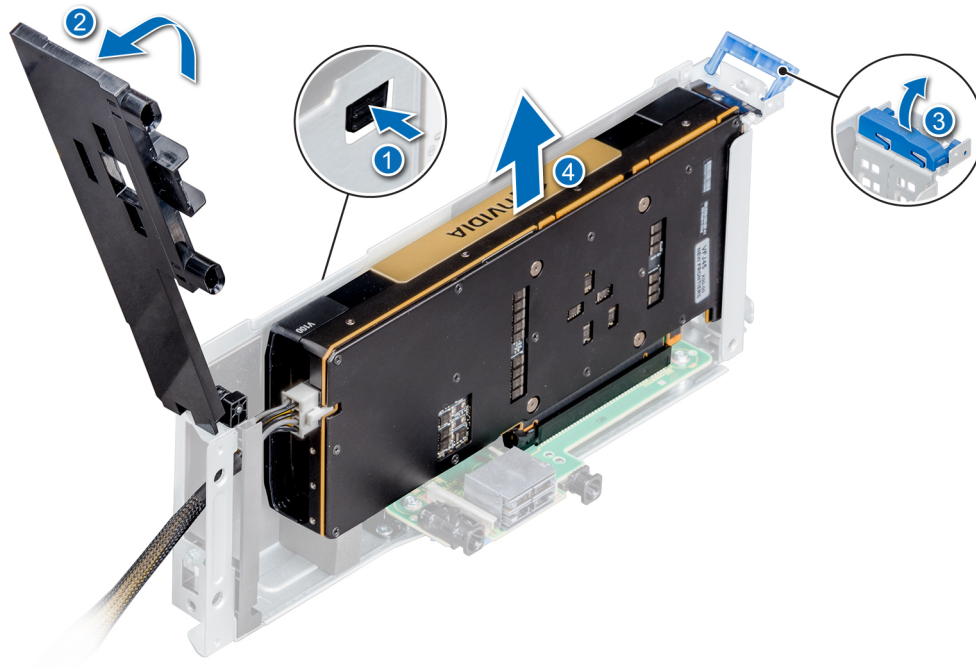

**Figure 62. Removing the GPU card from the riser**

3. Holding the card by its edges, lift to release it from the connector on the riser.
4. Disconnect the GPU power cable from the GPU.
5. If you are removing the GPU permanently, install a filler bracket.

**i** **NOTE:** You must install a filler bracket over an empty expansion card slot to maintain Federal Communications Commission (FCC) certification of the system. The brackets also keep dust and dirt out of the system and aid in proper cooling and airflow inside the system. The filler bracket is necessary to maintain proper thermal conditions.

#### Next steps

Replace the GPU.

## Installing a GPU

#### Prerequisites

1. Follow the safety guidelines listed in [Safety Instructions](#).
2. Follow the procedure listed in [Before working inside your system](#).
3. [Remove the GPU air shroud cover](#).
4. Remove the expansion card riser.

#### Steps

1. Connect the GPU power cable to the connector on the GPU.
2. Open the expansion card latch and the card holder latch on the riser.
3. Remove the existing expansion card or filler bracket from the riser.

**i** **NOTE:** You must install a filler bracket over an empty expansion card slot to maintain Federal Communications Commission (FCC) certification of the system. The brackets also keep dust and dirt out of the system and aid in proper cooling and airflow inside the system.

**i** **NOTE:** The filler bracket is necessary to maintain proper thermal conditions.

4. Route the GPU power cable through the slot on the riser bracket.
5. Holding the card by its edges, position the card so that the card aligns with the expansion card connector.
6. Insert the card firmly into the expansion card connector until the card is fully seated.

7. Close the expansion card latch and the card holder latch.

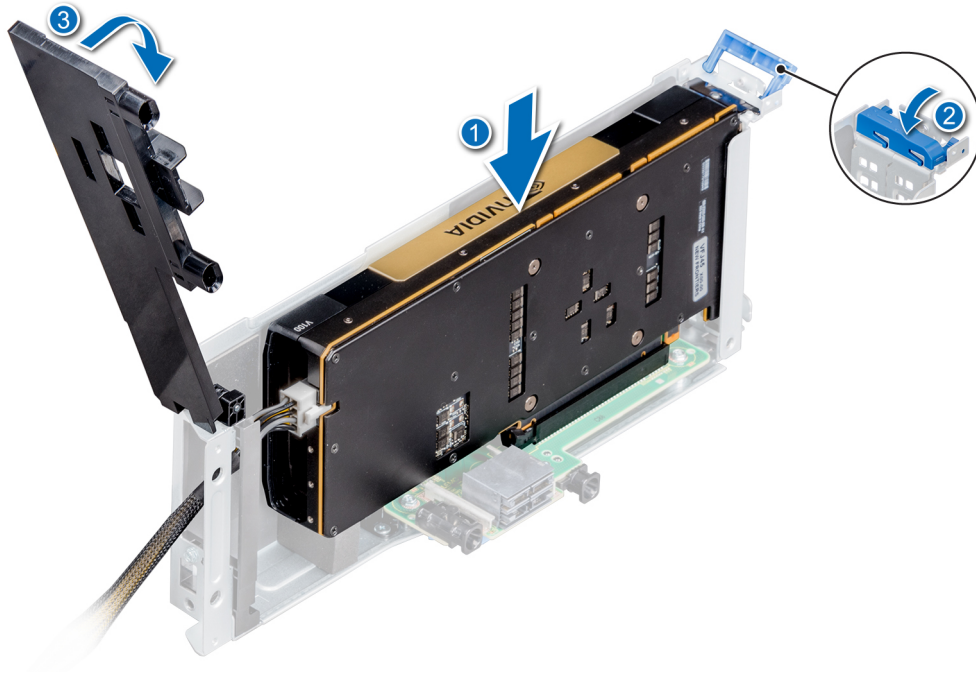

**Figure 63. Installing the GPU card on the riser**

8. Connect the other end of the GPU power cable to the PIB.

#### Next steps

1. [Install the top cover of the GPU air shroud.](#)
2. Follow the procedure listed in [After working inside your system.](#)

## Optional M.2 SSD module

The BOSS card is a simple RAID solution card designed specifically for booting a server's operating system. The card supports up to two 6 Gbps M.2 SATA drives. The BOSS adapter card has a x8 connector using PCIe gen 2.0 x2 lanes, available in both the low-profile and full-height form factor.

## Removing the M.2 SSD module

#### Prerequisites

1. Follow the safety guidelines listed in [Safety instructions.](#)
2. Follow the procedure listed in [Before working inside your system.](#)
3. [Remove the air shroud.](#)
4. If installed, [remove the rear drive cage.](#)
5. Remove the BOSS card.

**NOTE:** The procedure to remove the BOSS card is similar to the [removing an expansion card.](#)

#### Steps

1. Loosen the screw and lift the retention strap that secures the M.2 SSD module on the BOSS card.
2. Lift the M.2 SSD module and slide it out of the connector on the BOSS card.

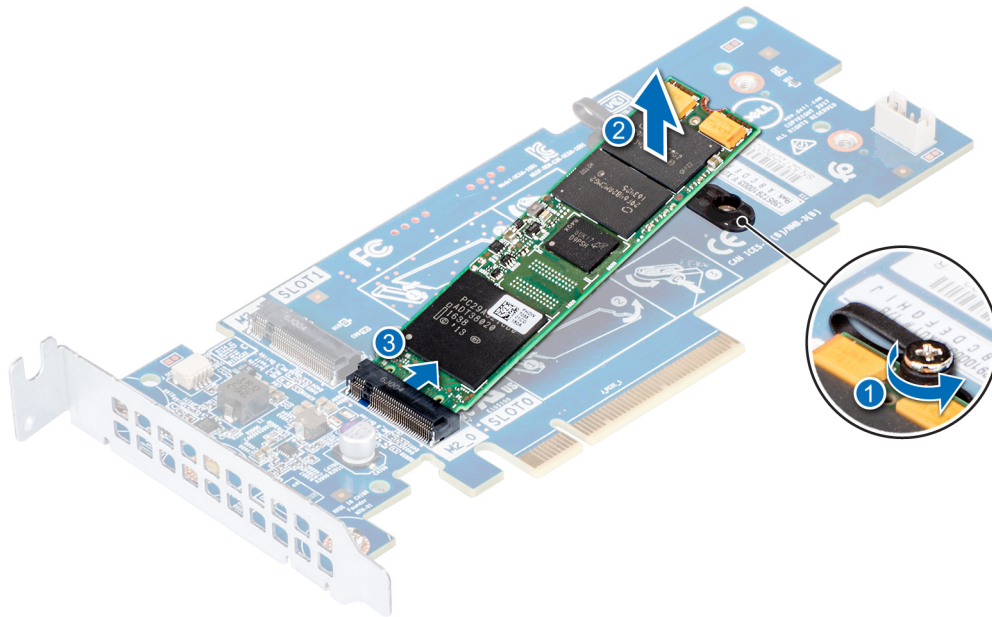

Figure 64. Removing the M.2 SSD module

#### Next steps

Replace the M.2 SSD card module.

## Installing the M.2 SSD module

#### Prerequisites

1. Follow the safety guidelines listed in [Safety instructions](#).
2. Follow the procedure listed in [Before working inside your system](#).
3. [Remove the air shroud](#).
4. Remove the BOSS card.

**NOTE:** The procedure to remove the BOSS card is similar to the [removing an expansion card](#).

#### Steps

1. Align and slide the M.2 BOSS card module at a 45-degree angle, into the SATA connector on the M.2 BOSS card.
2. Push the module down until firmly seated on the card.
3. Secure the module to the card with the retention strap, and using the Phillips #1 screwdriver tighten the screw.

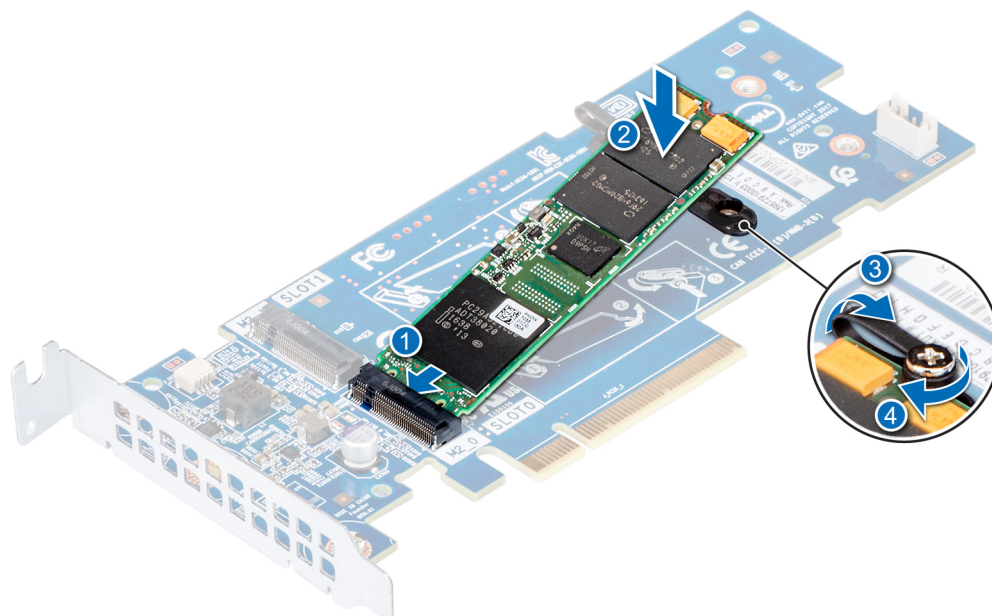

**Figure 65. Installing the M.2 SSD module**

#### Next steps

1. Install the BOSS card.

**NOTE:** The procedure to install the BOSS card is similar to the [removing an expansion card](#).

2. Install the applicable air shroud.
3. Follow the procedure listed in [After working inside your system](#).

## Processors and heat sinks

The processor controls memory, peripheral interfaces, and other components of the system. The system can have more than one processor configurations.

The heat sink absorbs the heat generated by the processor, and helps the processor to maintain its optimal temperature level.

**Table 20. Processor wattage and heat sink dimensions**

| Heat sink                                 |                                     |
|---|-------------------------------------|
| Heat sink type                            | Heat sink dimensions                |
| 1U heat sink<br>For GPU configuration     | L x W x H: 128 mm x 82 mm x 25.5 mm |
| 2U heat sink<br>For non-GPU configuration | L x W x H: 110 mm x 82 mm x 61 mm   |

#### Dual processor configuration

The system will function normally if there are two processors installed in the CPU 1 and 2 sockets. Processor and memory blanks associated with CPU 3 and 4 are not required to be installed. For information on the expansion card slots supported on dual processor, see [Expansion card riser specifications](#) section.

#### Quad processor configuration

For quad processor configurations, all installed risers will be functional.

# Removing a processor and heat sink module

## Prerequisites

**⚠ WARNING:** The heat sink may be hot to touch for some time after the system is powered down. Allow the heat sink to cool before removing it.

1. Follow the safety guidelines listed in [Safety instructions](#).
2. Follow the procedure listed in [Before working inside your system](#).
3. [Remove the air shroud](#).

## Steps

1. Using a Torx #T30 screwdriver, loosen the screws on the heat sink in the order below:
  - a) Loosen the first screw three turns.
  - b) Loosen the second screw completely.
  - c) Return to the first screw and loosen it completely.
2. Pushing both blue retention clips simultaneously, lift the processor and heat sink module (PHM).
3. Set the PHM aside with the processor side facing up.

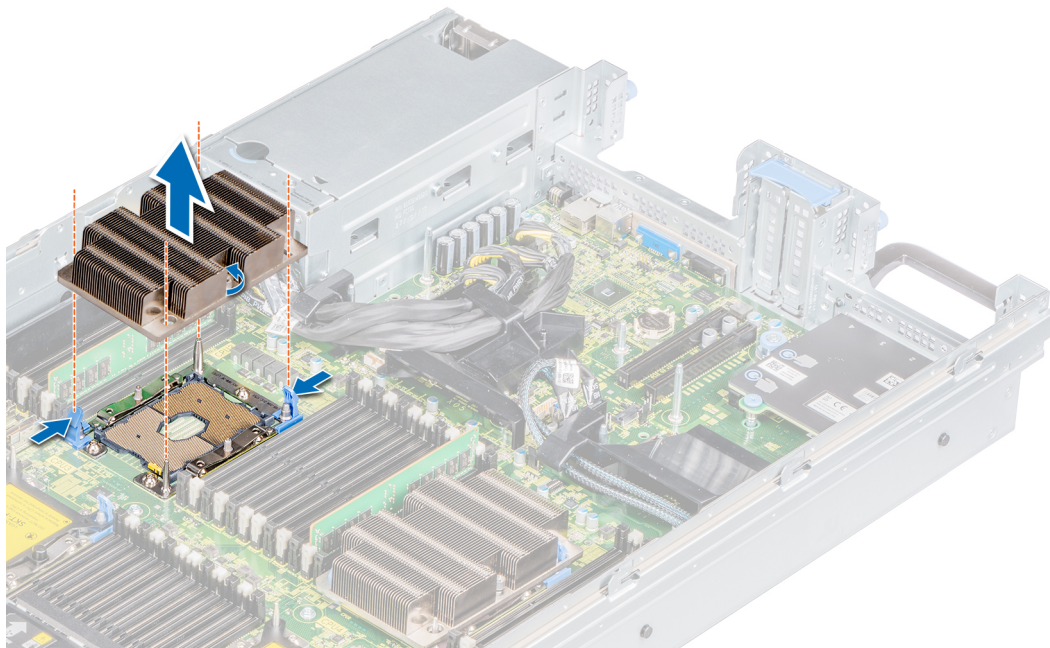

Figure 66. Removing the processor and heat sink module 1U

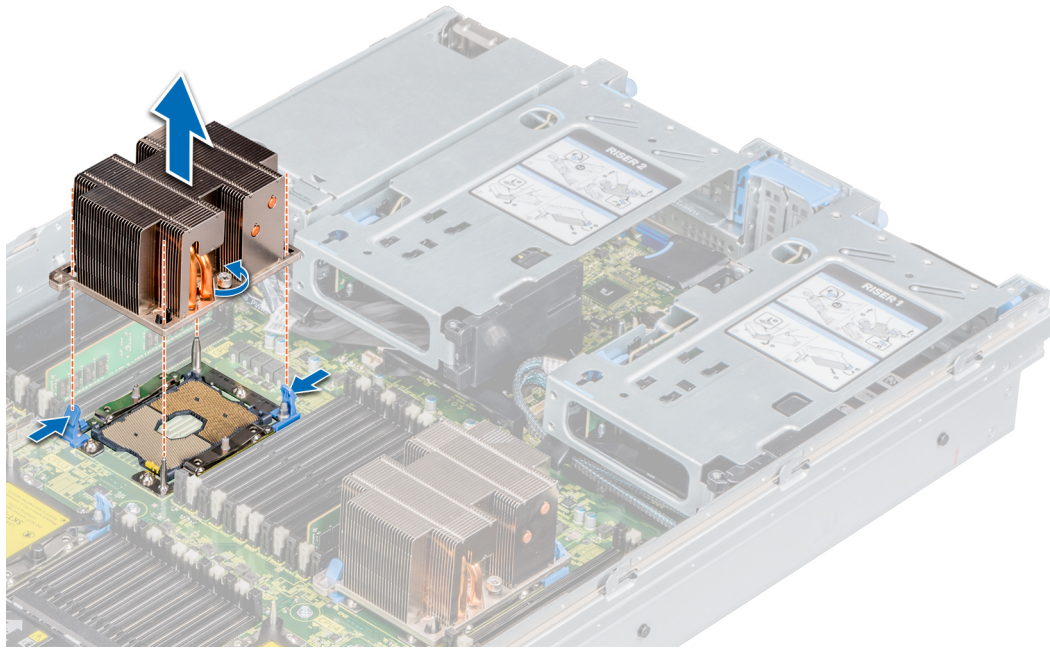

Figure 67. Removing the processor and heat sink module 2U

#### Next steps

1. [Replace the processor and heat sink module.](#)

## Removing the processor from the processor and heat sink module

#### Prerequisites

**⚠ WARNING:** The heat sink may be hot to touch for some time after the system has been powered down. Allow the heat sink to cool before removing it.

**ℹ NOTE:** Only remove the processor from the processor and heat sink module if you are replacing the processor or heat sink. This procedure is not required when replacing a system board.

1. Follow the safety guidelines listed in [Safety instructions](#).
2. Follow the procedure listed in [Before working inside your system](#).
3. [Remove the processor and heat sink module.](#)

#### Steps

1. Place the heat sink with the processor side facing up.
2. Insert a flat blade screwdriver into the release slot marked with a yellow label. Twist (do not pry) the screwdriver to break the thermal paste seal.
3. Push the retaining clips on the processor bracket to unlock the bracket from the heat sink.

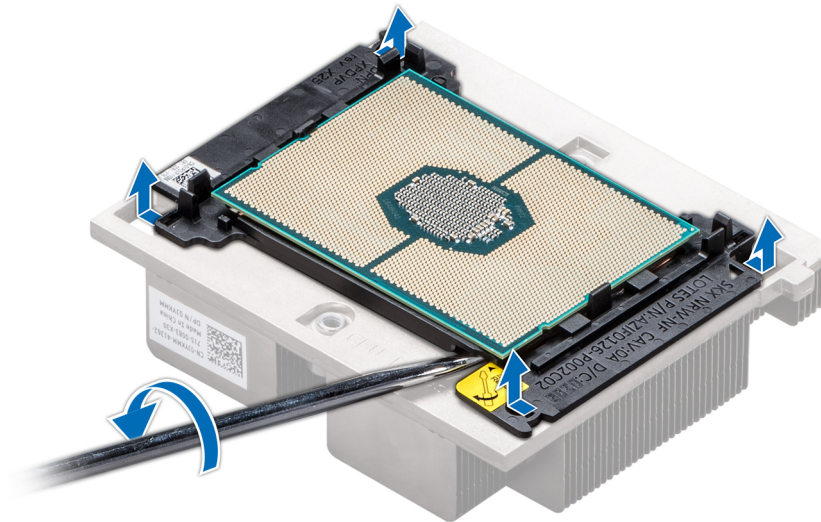

**Figure 68. Loosening the processor bracket**

4. Lift the bracket and the processor from the heat sink, and place the processor connector side down on the processor tray.
5. Flex the outer edges of the bracket to release the bracket from the processor.

**NOTE:** Ensure that the processor and the bracket are placed in the tray after you remove the heat sink.



**Figure 69. Removing the processor bracket**

#### Next steps

1. Install the processor into the processor and heat sink module.

## Installing the processor into a processor and heat sink module

#### Prerequisites

1. Follow the safety guidelines listed in [Safety instructions](#).
2. Follow the procedure listed in [Before working inside your system](#).
3. [Remove the processor and heat sink module](#).

## Steps

1. Place the processor in the processor tray.

**i** **NOTE:** Ensure that the pin 1 indicator on the processor tray is aligned with the pin 1 indicator on the processor.

2. Flex the outer edges of the bracket around the processor ensuring that the processor is locked into the clips on the bracket.

**i** **NOTE:** Ensure that the pin 1 indicator on the bracket is aligned with the pin 1 indicator on the processor before placing the bracket on the processor.

**i** **NOTE:** Ensure that the processor and the bracket are placed in the tray before you install the heat sink.

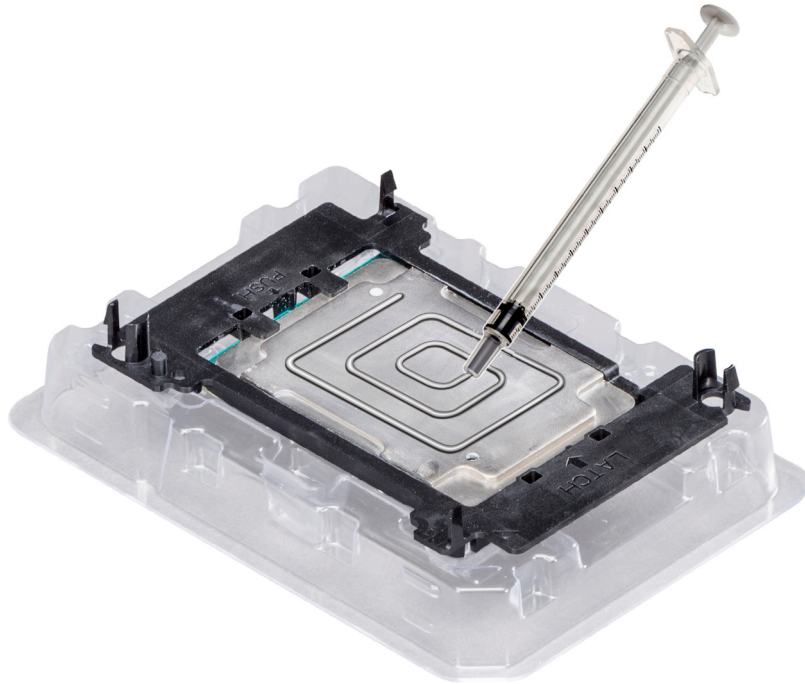

**Figure 70. Installing the processor bracket**

3. If you are using an existing heat sink, remove the thermal grease from the heat sink by using a clean lint-free cloth.
4. Use the thermal grease syringe included with your processor kit to apply the grease in a quadrilateral design on the top of the processor.

**⚠ CAUTION:** Applying too much thermal grease can result in excess grease coming in contact with and contaminating the processor socket.

**i** **NOTE:** The thermal grease syringe is intended for single use only. Dispose the syringe after you use it.

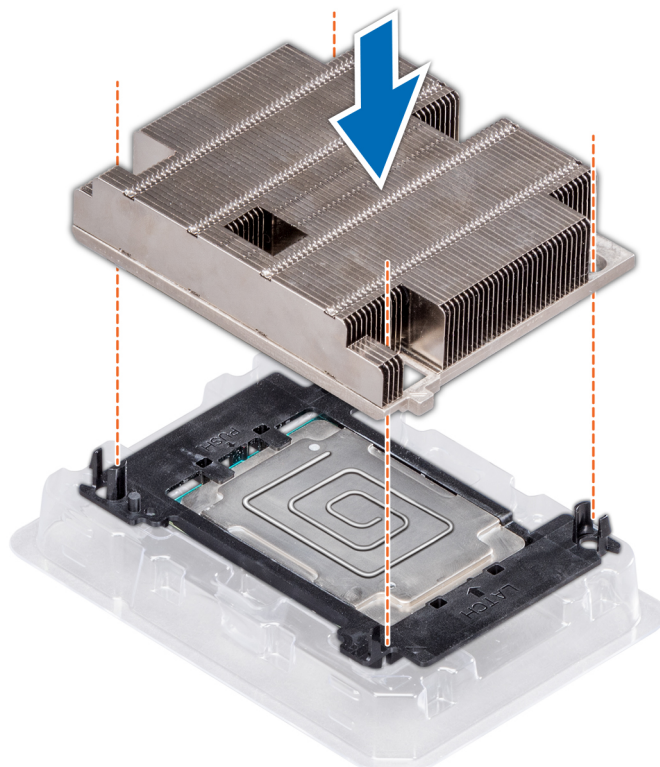

**Figure 71. Applying thermal grease on top of the processor**

5. Place the heat sink on the processor and push down on the base of the heat sink until the bracket locks onto the heat sink.

**NOTE:**

- Ensure that the two guide pin holes on the bracket match the guide holes on the heat sink.
- Do not press on the heat sink fins.
- Ensure that the pin 1 indicator on the heat sink is aligned with the pin 1 indicator on the bracket before placing the heat sink onto the processor and bracket.



**Figure 72. Installing the heat sink onto the processor 1U**

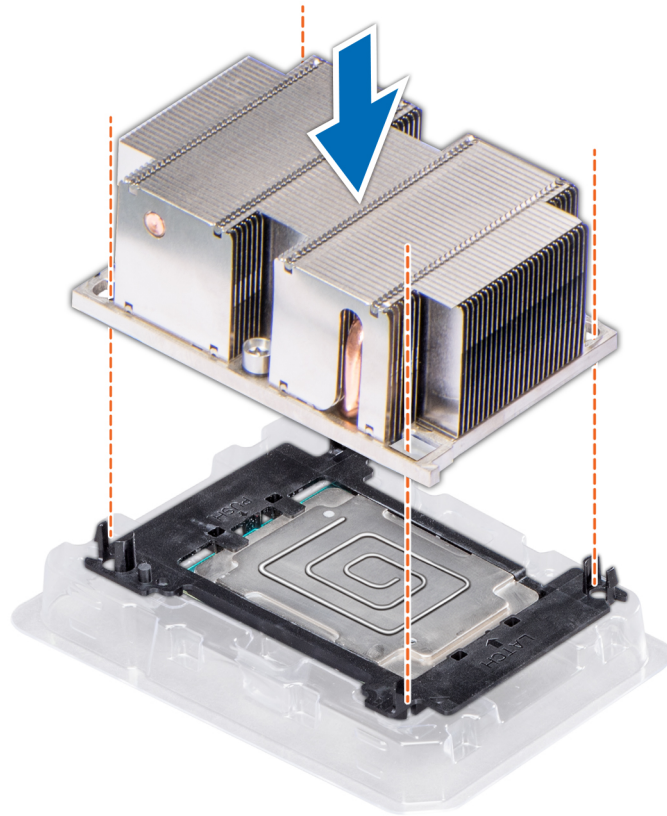

Figure 73. Installing the heat sink onto the processor 2U

#### Next steps

1. [Install the processor and heat sink module.](#)

## Installing a processor and heat sink module

#### Prerequisites

**CAUTION:** Never remove the heat sink from a processor unless you intend to replace the processor. The heat sink is necessary to maintain proper thermal conditions.

1. Follow the safety guidelines listed in [Safety instructions](#).
2. Follow the procedure listed in [Before working inside your system](#).
3. Remove the processor blank and CPU dust cover, if installed.

#### Steps

1. Align the Pin1 indicator on the heat sink with the indicator on the system board and place the processor and heat sink module (PHM) on the processor socket.

**CAUTION:** To avoid damaging the fins on the heat sink, do not press down on the heat sink fins.

**NOTE:** Ensure that the PHM is held parallel to the system board to prevent damaging the components.

2. Push the blue retention clips inward to allow the heat sink to drop in place.
3. Using the Torx #T30 screwdriver, tighten the screws on the heat sink in the order below:
  - a) Partially tighten the first screw (approximately 3 turns).
  - b) Tighten the second screw completely.
  - c) Return to the first screw and tighten it completely.

If the PHM slips off the blue retention clips when the screws are partially tightened, follow these steps to secure the PHM:

- a. Loosen both the heat sink screws completely.
- b. Lower the PHM on to the blue retention clips.
- c. Secure the PHM to the system board, following the replacement instructions listed in this step mentioned above.

**NOTE:** The processor and heat sink module retention screws should not be tightened to more than 0.13 kgf-m (1.35 N.m or 12 in-lbf).

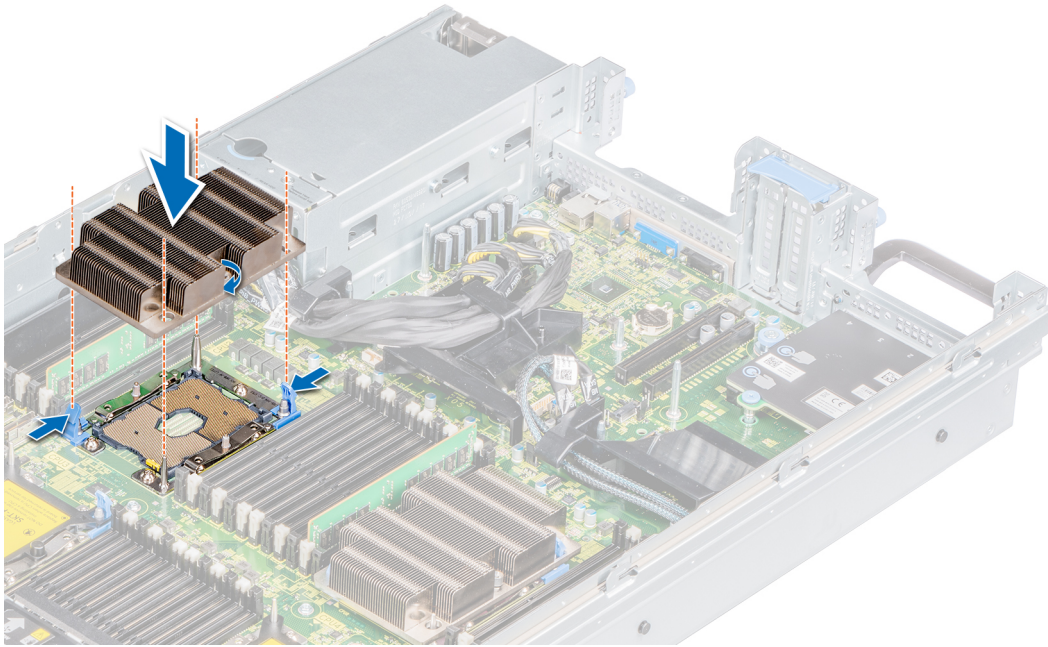

**Figure 74. Installing a processor and 1U heat sink module**

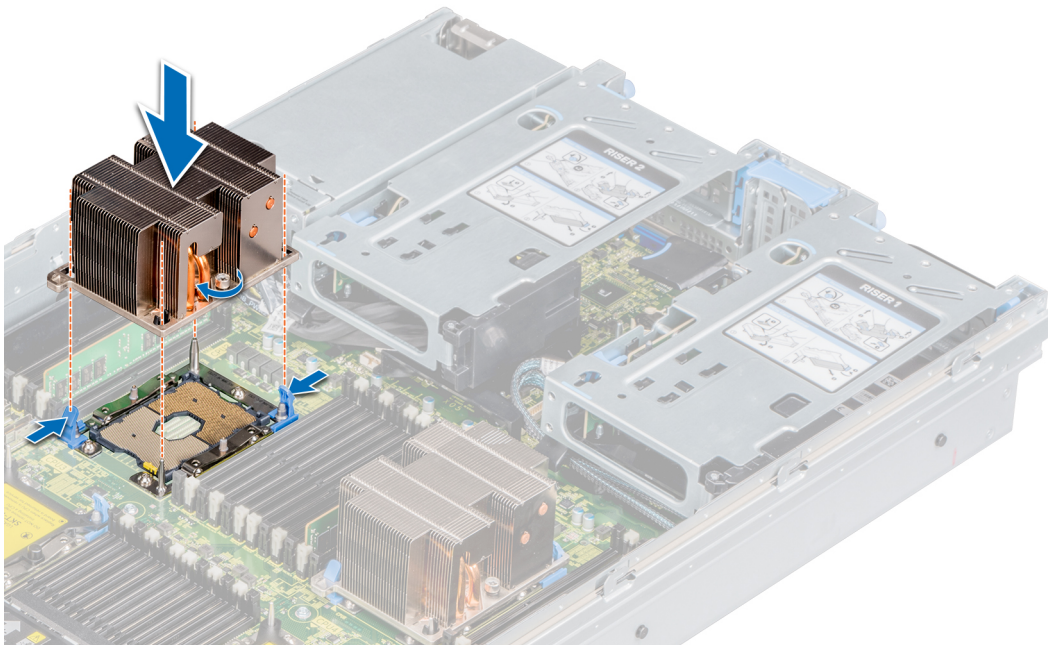

**Figure 75. Installing a processor and 2U heat sink module**

#### Next steps

1. [Install the air shroud.](#)
2. Follow the procedure listed in [After working inside your system](#)

# Optional IDSDM or vFlash module

**i** **NOTE:** The write-protect switch is on the IDSDM or vFlash module.

## Removing IDSDM or vFlash module

### Prerequisites

1. Follow the safety guidelines listed in [Safety instructions](#).
2. Follow the procedure listed in [Before working inside your system](#).
3. [Remove the air shroud](#).
4. [Remove the expansion card riser 1](#).

### Steps

1. Locate the IDSDM or vFlash connector on riser 1.
2. Holding the pull tab, lift the IDSDM or vFlash module out of the system.

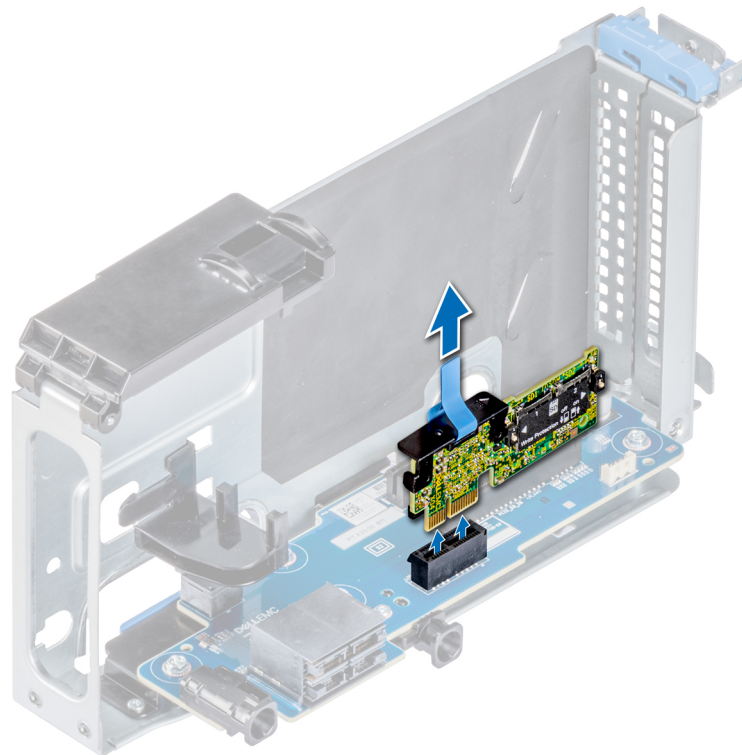

**Figure 76. Removing IDSDM or vFlash module**

**i** **NOTE:** There are two dip switches on the IDSDM or vFlash module for write-protection.

**i** **NOTE:** If you are replacing the IDSDM or vFlash module, [remove the microSD cards](#).

### Next steps

[Install the IDSDM or vFlash module](#).

# Installing IDSDM or vFlash module

## Prerequisites

1. Follow the safety guidelines listed in [Safety instructions](#).
2. Follow the procedure listed in [Before working inside your system](#).
3. [Remove the air shroud](#).
4. [Remove the expansion card riser 1](#).

## Steps

1. Locate the IDSDM or vFlash connector on riser 1.
2. Align IDSDM or vFlash module with the connector on the riser.
3. Push IDSDM or vFlash module until it is firmly seated in the connector on the riser.

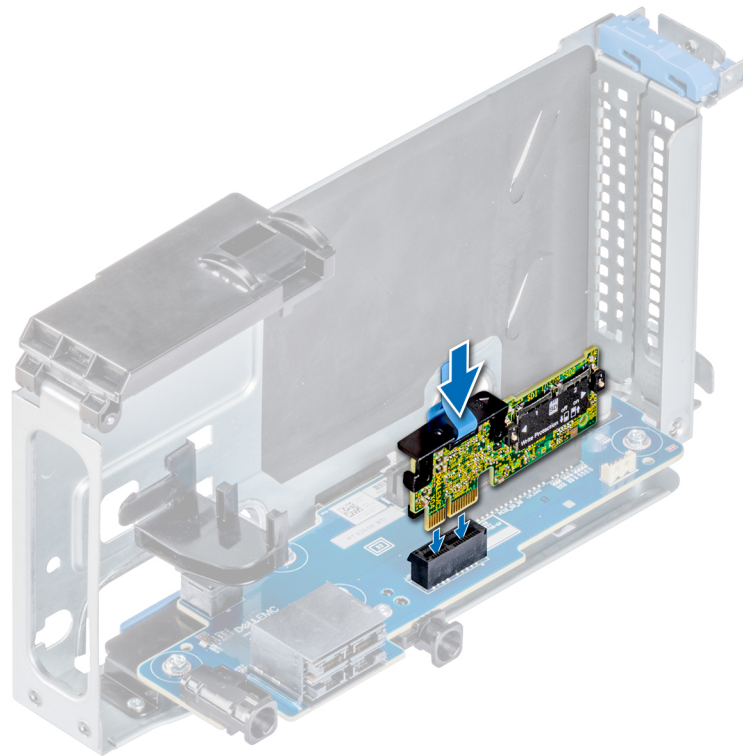

**Figure 77. Installing IDSDM or vFlash module**

## Next steps

1. [Install the microSD cards](#).  
**NOTE:** Reinstall the microSD cards into the same slots based on the labels you had marked on the cards during removal.
2. [Install the expansion card riser 1](#).
3. [Install the air shroud](#).
4. Follow the procedure listed in [After working inside your system](#).

# Removing the microSD card

## Prerequisites

1. Follow the safety guidelines listed in [Safety instructions](#).
2. Follow the procedure listed in [Before working inside your system](#).
3. [Remove the air shroud](#).

4. Remove the expansion card riser 1.
5. Remove the IDSDM or vFlash module.

### Steps

1. Locate the MicroSD card slot on the IDSDM or vFlash module, and press the card to partially release it from the slot.

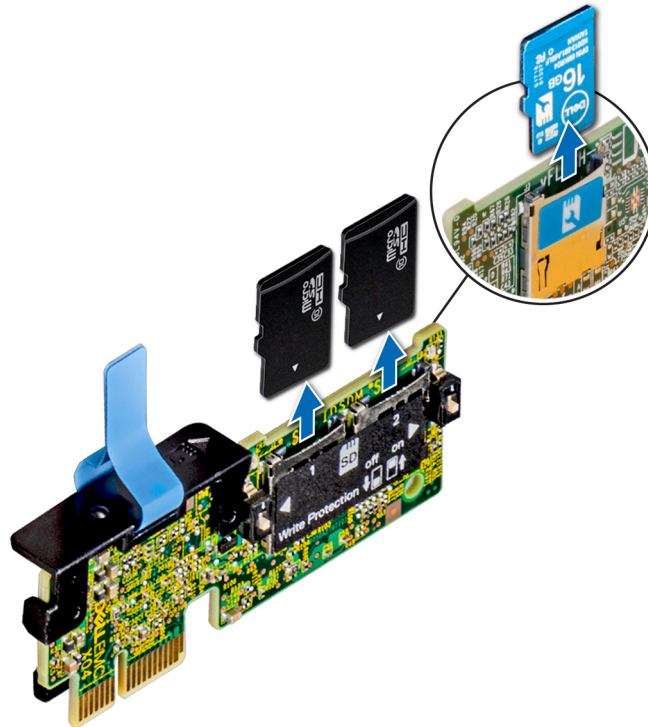

**Figure 78. Removing the MicroSD card**

2. Hold the MicroSD card and remove it from the slot.

**NOTE:** Temporarily label each MicroSD card with its corresponding slot number after removal.

### Next steps

Install the MicroSD card.

## Installing the MicroSD card

### Prerequisites

1. Follow the safety guidelines listed in [Safety instructions](#).
2. Follow the procedure listed in [Before working inside your system](#).
3. Remove the air shroud.
4. Remove the expansion card riser 1.
5. Remove the IDSDM or vFlash module.

**NOTE:** To use an MicroSD card with your system, ensure that the Internal SD Card Port is enabled in System Setup.

**NOTE:** If reinstalling, ensure that you install the MicroSD cards into the same slots based on the labels you had marked on the cards during removal.

### Steps

1. Locate the MicroSD card connector on the IDSDM or vFlash module. Orient the MicroSD card appropriately and insert the contact-pin end of the card into the slot.

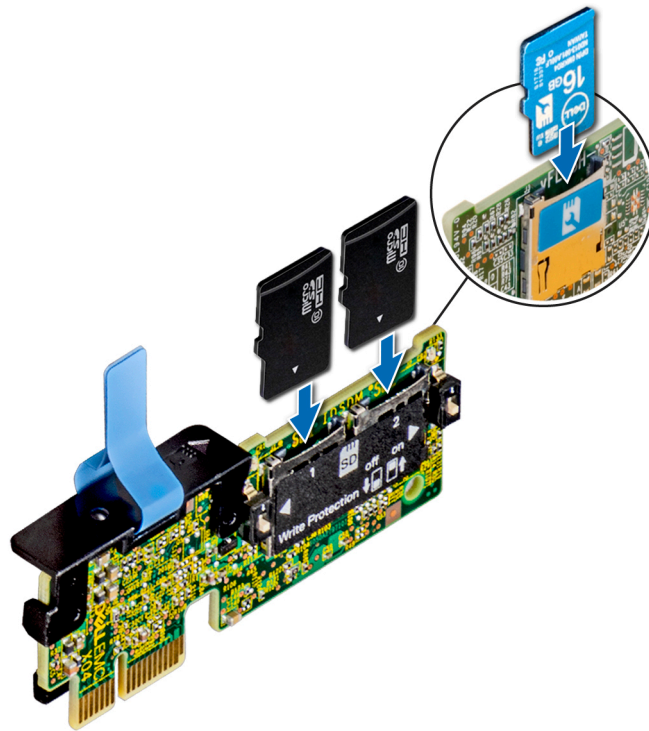

Figure 79. Installing the MicroSD card

**NOTE:** The slot is keyed to ensure correct insertion of the card.

2. Press the card into the card slot to lock it into place.

#### Next steps

1. Install the IDSDM or vFlash module.
2. Install the expansion card riser 1.
3. Install the air shroud.
4. Follow the procedure listed in [After working inside your system](#).

## Network daughter card

### Removing network daughter card

#### Prerequisites

1. Follow the safety guidelines listed in [Safety instructions](#).
2. Follow the procedure listed in [Before working inside your system](#).
3. [Remove the air shroud](#).
4. [Remove the expansion card riser 1](#).

#### Steps

1. Using a Phillips #2 screwdriver, loosen the captive screws that secure the network daughter card (NDC) to the system board.
2. Hold the NDC by the edges, and lift to disengage it from the connector on the system board.
3. Slide the NDC towards the front of the system until the Ethernet connectors are clear of the slot in the back of the system.

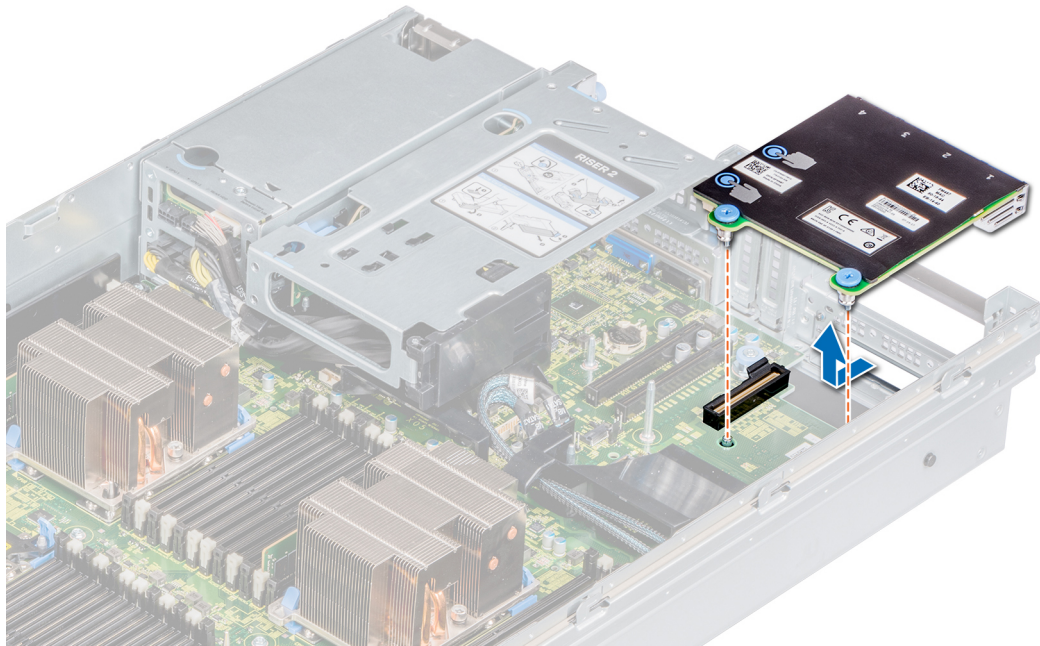

**Figure 80. Removing network daughter card**

#### **Next steps**

1. [Replace the Network daughter card.](#)

## **Installing network daughter card**

#### **Prerequisites**

1. Follow the safety guidelines listed in [Safety instructions](#).
2. Follow the procedure listed in [Before working inside your system](#).
3. [Remove the air shroud](#).
4. [Remove the expansion card riser 1](#).

#### **Steps**

1. Orient the NDC so that the Ethernet connectors fit through the slot in the chassis.
2. Align the captive screws on the card with the screw holes on the system board.
3. Press the touch points on the card until the card connector is firmly seated on the system board connector.
4. Using a Phillips #2 screwdriver, tighten the captive screws to secure the NDC to the system board.

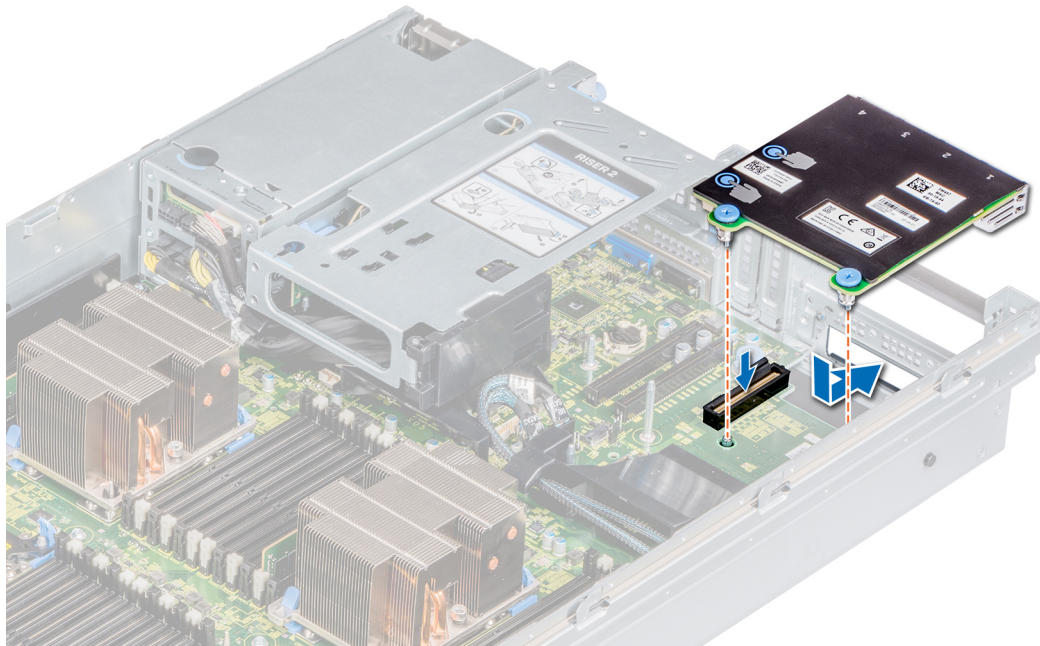

**Figure 81. Installing the network daughter card**

**Next steps**

1. [Install the expansion card riser 1](#) or the [rear drive cage](#), depending on the configuration of your system.
2. [Install the air shroud](#).
3. Follow the procedure listed in [After working inside your system](#).

## Drive backplane

The drive backplanes supported in PowerEdge R840 are shown here:

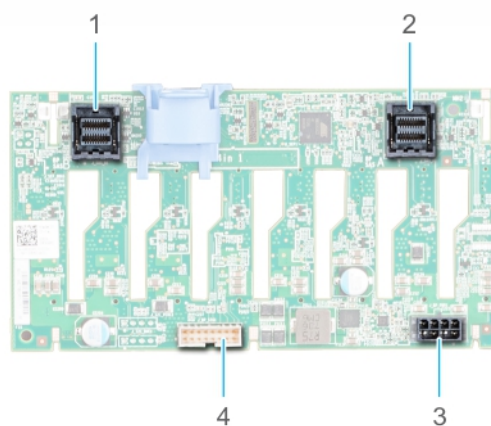

**Figure 82. 8 x 2.5-inch backplane**

- |   |  |
|---|--|
| <ol style="list-style-type: none"> <li>1. miniSAS hard drive B 1</li> <li>3. Power cable connector</li> </ol> | <ol style="list-style-type: none"> <li>2. miniSAS hard drive A 1</li> <li>4. Backplane signal connector</li> </ol> |
|---|--|

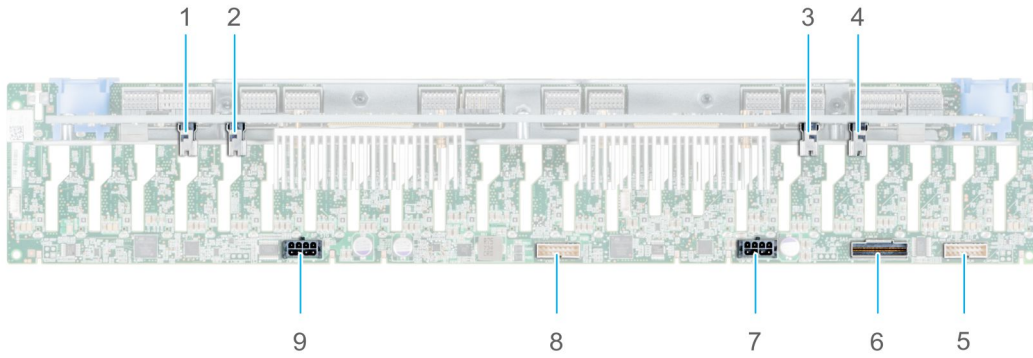

**Figure 83. 24 x 2.5-inch (24 NVMe) backplane**

- |                               |                               |
|-------------------------------|-------------------------------|
| 1. PCIe cable connector       | 2. PCIe cable connector       |
| 3. PCIe cable connector       | 4. PCIe cable connector       |
| 5. Backplane signal connector | 6. SAS/SATA cable connector   |
| 7. Power cable connector      | 8. Backplane signal connector |
| 9. Power cable connector      |                               |

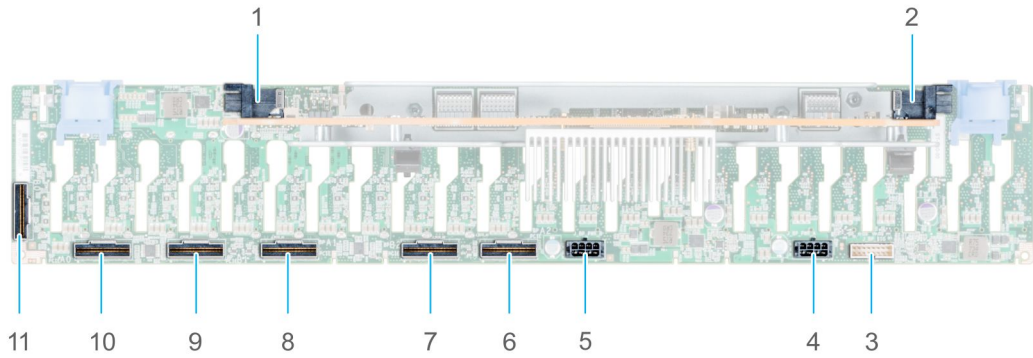





**Figure 84. 2.5 inch (x24) SAS/SATA (expander) with universal slot for NVMe backplane**

- |   |                                    |
|---|------------------------------------|
| 1. SAS cable connector A                | 2. SAS cable connector B           |
| 3. Backplane signal connector(J_BP_SIG) | 4. Power cable connector (J_PWR_A) |
| 5. Power cable connector (J_PWR_B)      | 6. PCIe cable connector            |
| 7. PCIe cable connector                 | 8. PCIe cable connector            |
| 9. PCIe cable connector                 | 10. PCIe cable connector           |
| 11. PCIe cable connector                |                                    |

## Drive mapping

**Table 21. Supported drive options**

| Chassis options           |  | Configurations   |
|---------------------------|--|--|
| Twenty-four drive chassis |  | <p>Up to twenty four 2.5 inch SAS/SATA front accessible drives in slots 0 through 23</p> <p>Up to twenty four 2.5 inch SAS/SATA front accessible drives in slots 0 through 23 + two 2.5 inch rear accessible SAS/SATA drives</p> |

| Chassis options          |  | Configurations   |
|--------------------------|--|--|
|                          |  | Up to twelve 2.5 inch SAS/SATA front accessible drives in slots 0 through 11 + twelve SAS/SATA/NVMe front accessible drives in slots 12 through 23                             |
|                          |  | Up to twenty four 2.5 inch NVMe front accessible drives in slots 0 through 23  |
|                          |  | Up to eight 2.5 inch SAS/SATA/NVMe front accessible drives in slots 0 through 7 + sixteen NVMe front accessible drives in Bay-0 slots 8 through 11 + Bay-1 slots 0 through 11. |
| Eight hard drive chassis |  | <p>Up to eight 2.5 inch SAS/SATA front accessible drives in slots 0 through 7</p> <p>Up to eight 2.5 inch SATA front accessible drives in slots 0 through 7</p>                |

## Removing drive backplane

### Prerequisites

**CAUTION:** To prevent damage to the drives and backplane, remove the drives from the system before removing the backplane.

**CAUTION:** Note the number of each drive and temporarily label them before you remove the drive so that you can replace them in the same location.

**NOTE:** The procedure to remove the backplane is similar for all backplane configurations.

1. Follow the safety guidelines listed in [Safety instructions](#).
2. Follow the procedure listed in [Before working inside your system](#).
3. If applicable, [remove the front bezel](#).
4. [Remove all drives from the front bay](#).
5. [Remove the air shroud](#).
6. [Remove the cooling fan assembly](#).

### Steps

1. Disconnect all the PERC cables from the adapter PERC cards.
2. Press and hold the blue release tabs, and lift the backplane up to disengage the slots on the backplane from the hooks on the system.

**NOTE:** If your backplane has an expander board, the procedure to remove remains the same.

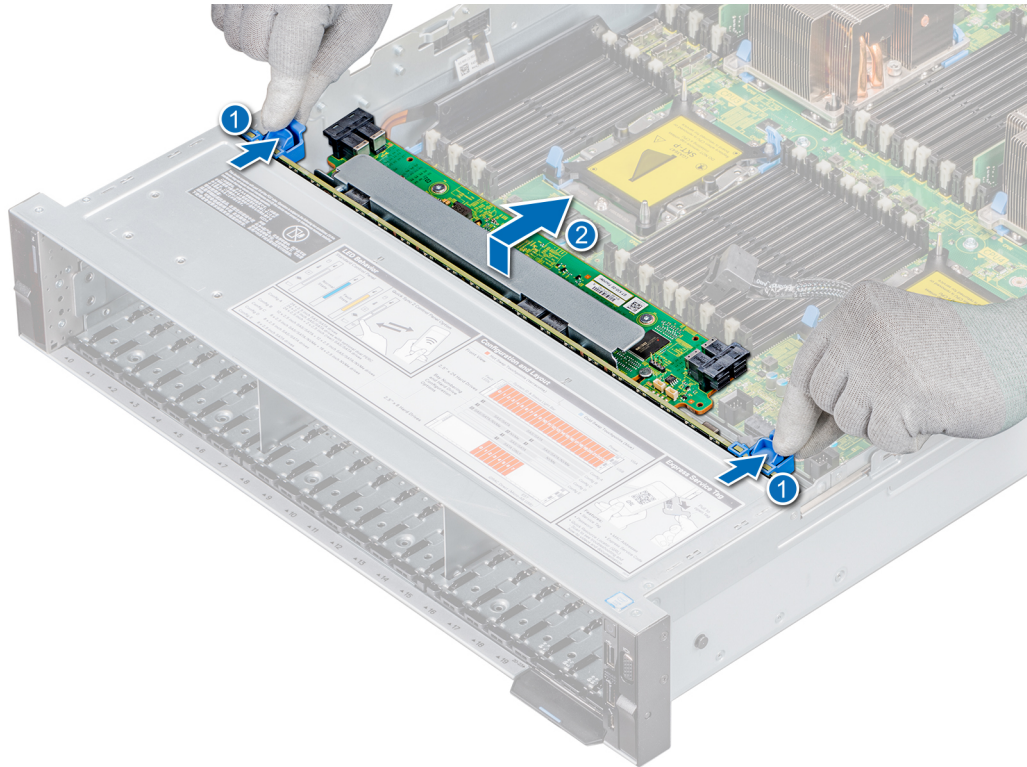

**Figure 85. Removing drive backplane**

3. Lift the backplane and place it on the top of the hard drive bay, and then disconnect the power and I2C cables.
4. If applicable, disconnect all the slimline SAS cables from the system board.

#### Next steps

1. [Replace the drive backplane.](#)

## Installing drive backplane

#### Prerequisites

**NOTE:** The procedure to install the backplane is similar for all backplane configurations.

1. Follow the safety guidelines listed in [Safety instructions](#).
2. Follow the procedure listed in [Before working inside your system](#).
3. [Remove the front bezel](#), if applicable.
4. [Remove all drives from the front bay](#).
5. [Remove the air shroud](#).
6. [Remove the cooling fan assembly](#).

#### Steps

1. Connect the cables.
  - a. If applicable, connect the slimline SAS, I2C, and power cables to the backplane.
  - b. Connect the I2C and power cables to the system board.
2. Holding the blue release tabs, align the slots on the backplane with the hooks on the system.
3. Lower the drive backplane until the blue release tabs snap into place.

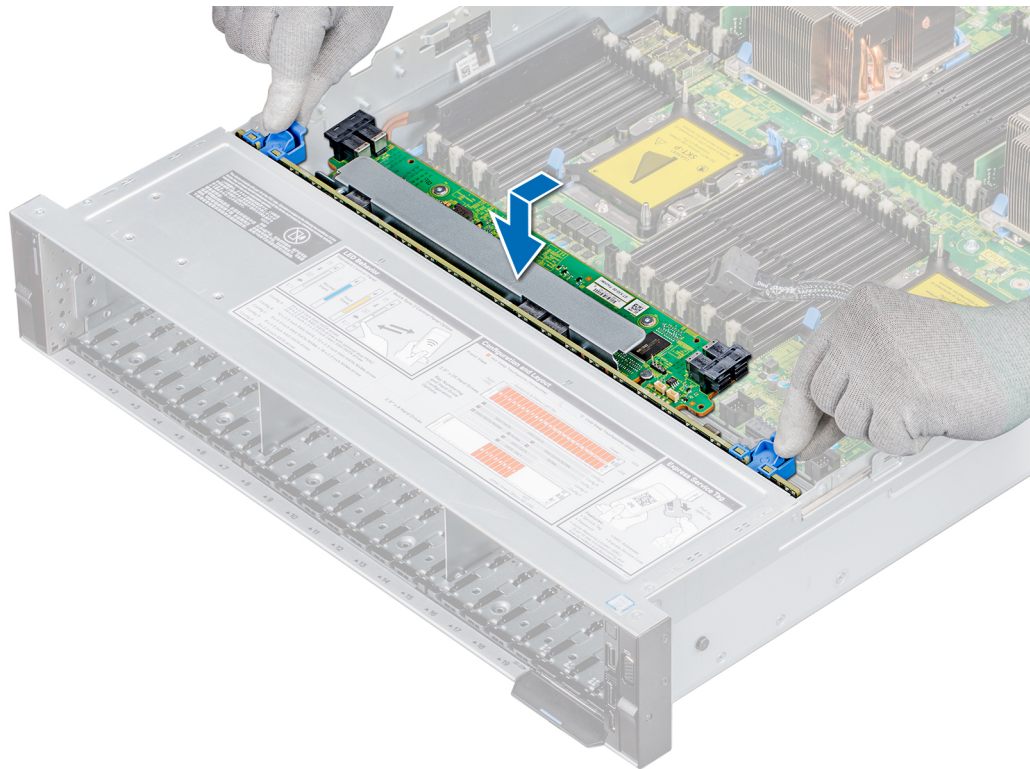

**Figure 86. Installing drive backplane**

4. If applicable, connect the slimline SAS cable to the system board.
5. If applicable, connect the PERC cables to the adapter PERC cards.

**Next steps**

1. [Install the cooling fan assembly.](#)
2. [Install the air shroud.](#)
3. [Install the drives.](#)
4. [Install the front bezel, if applicable.](#)
5. Follow the procedure listed in [After working inside your system.](#)

# Cable routing

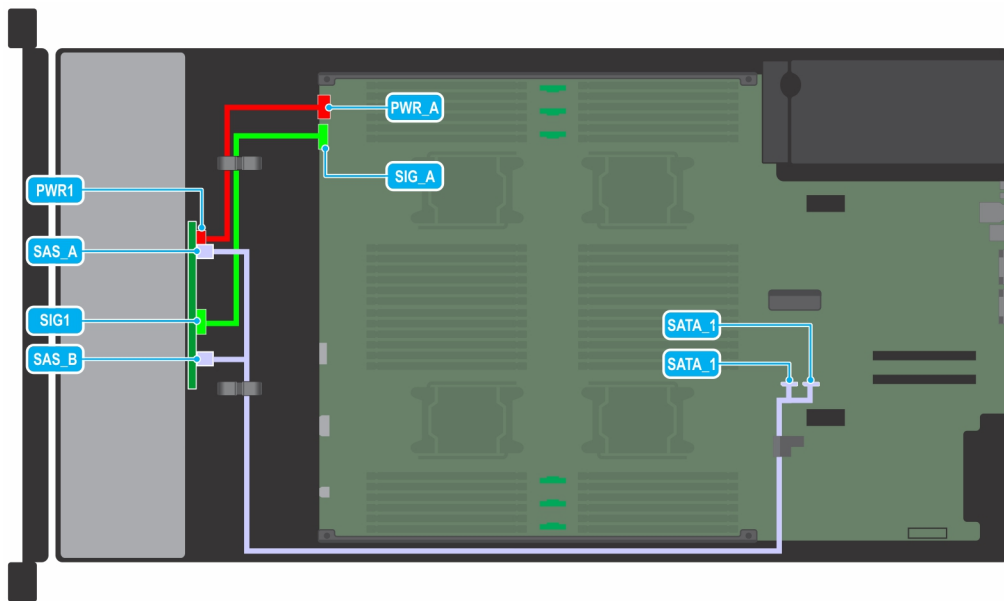

Figure 87. Cable routing - 8 x 2.5 inch, SATA drive backplane

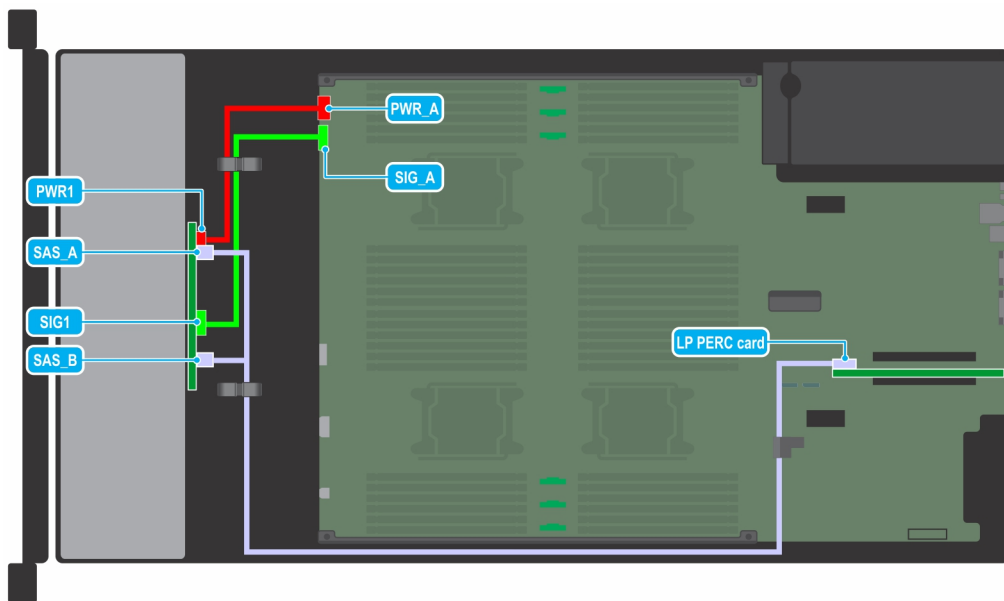

Figure 88. Cable routing - 8 x 2.5 inch, SAS/SATA drive backplane with GPU and single PERC card (Low profile riser)

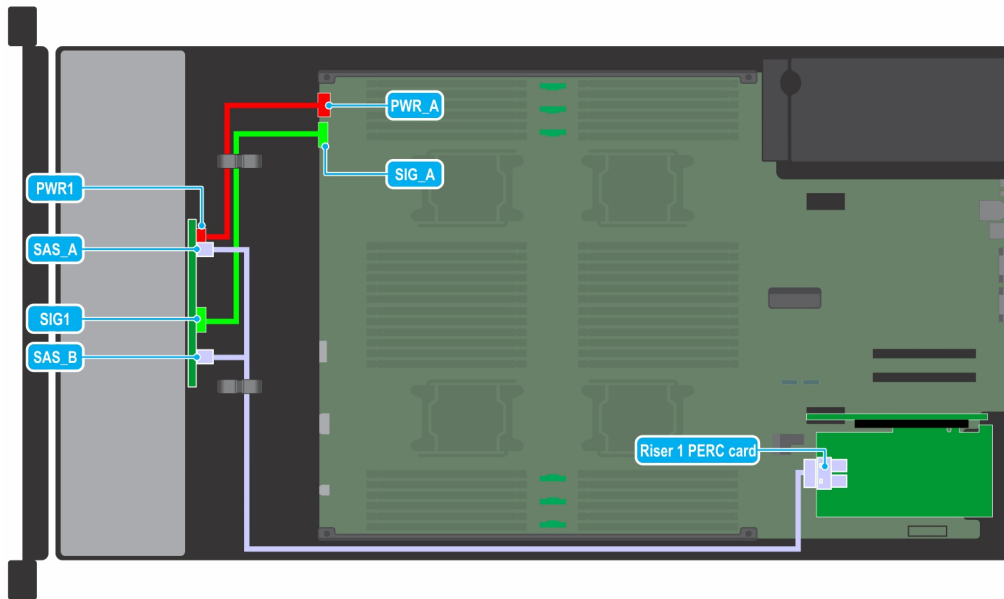

Figure 89. Cable routing - 8 x 2.5 inch, (SAS/SATA) drive backplane with single PERC card

**NOTE:** If a GPU card is installed, the PERC card must be installed in the low profile expansion card slot on the system board.

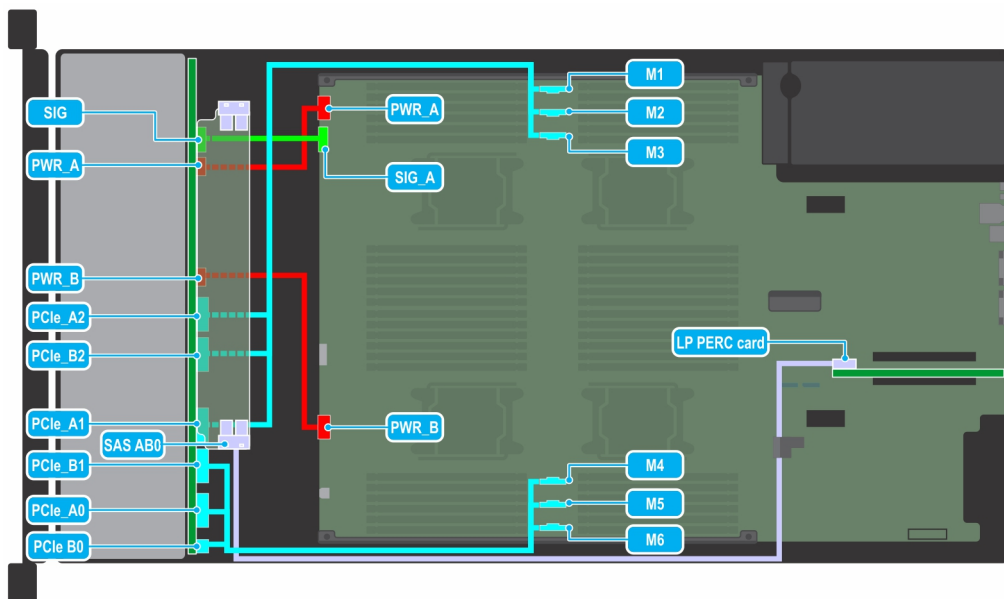

Figure 90. Cable routing - 24 x 2.5 inch, (SAS/SATA) drive backplane supporting x12 universal (SAS/SATA/NVMe) slots with GPU and single PERC card

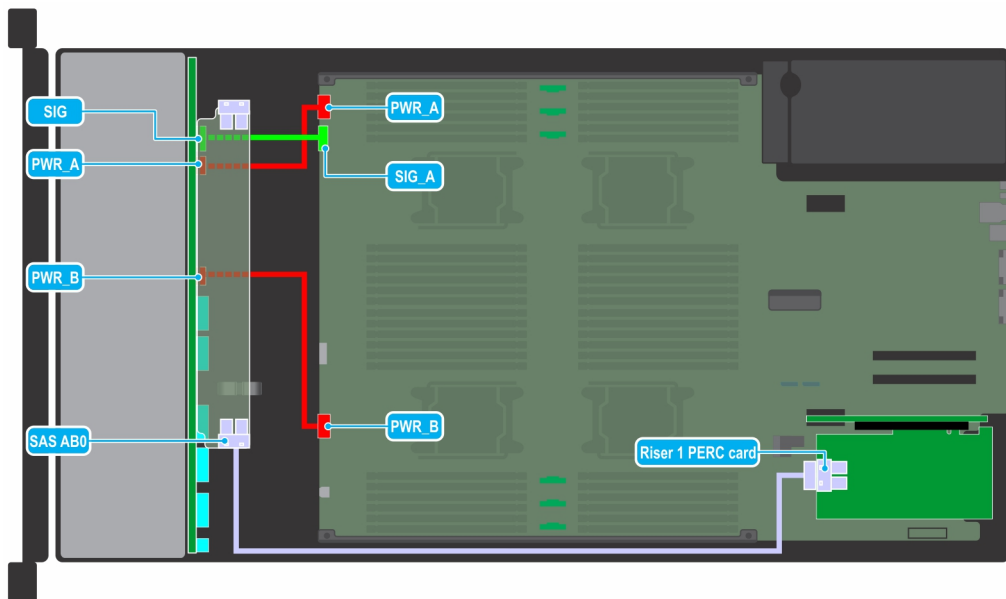

Figure 91. Cable routing - 24 x 2.5 inch, (SAS/SATA) drive backplane supporting with single PERC card

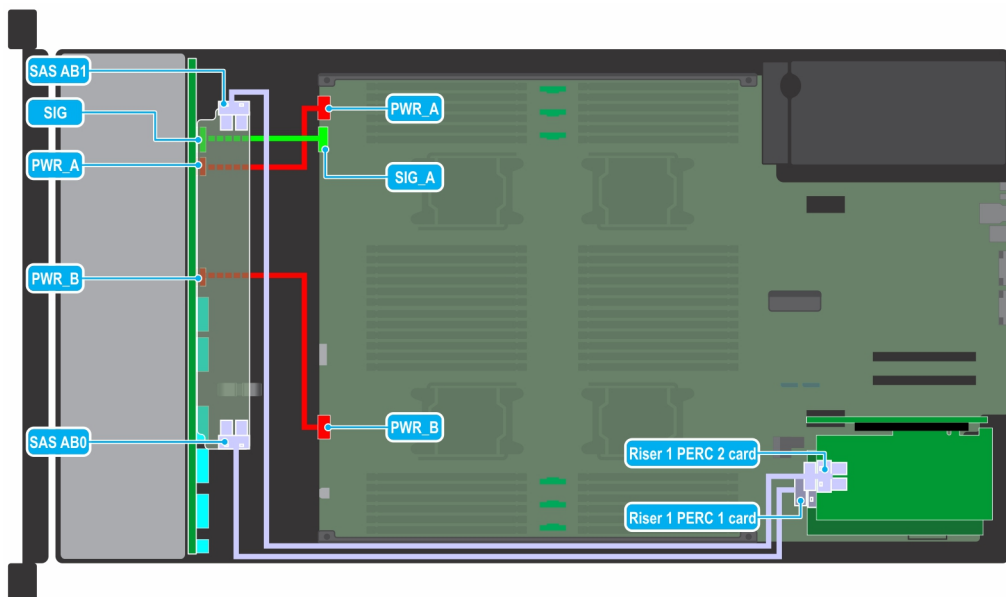

Figure 92. Cable routing - 24 x 2.5 inch, (SAS/SATA) drive backplane with dual PERC card

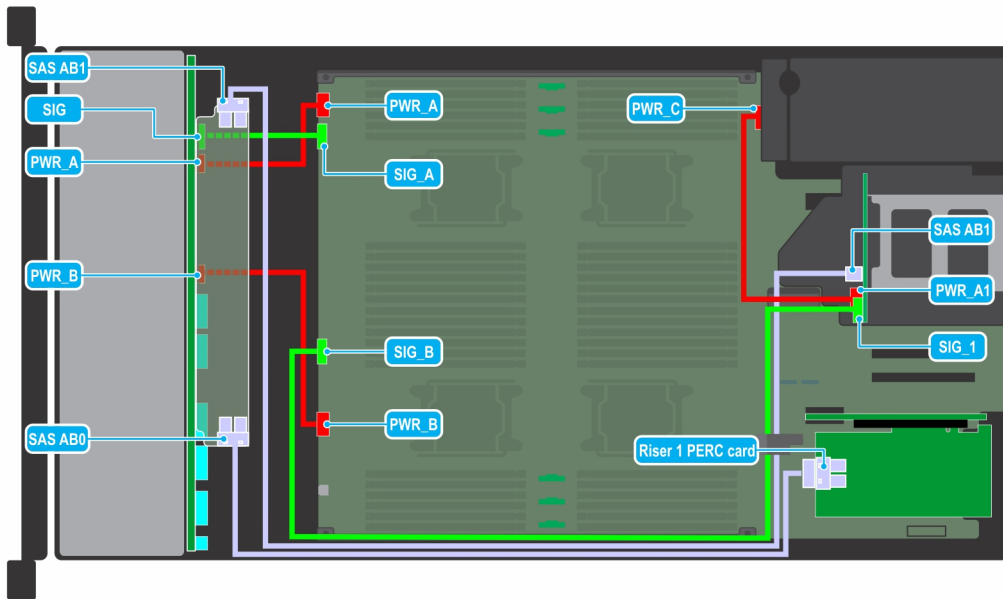

Figure 93. Cable routing - 26 x 2.5 inch, (SAS, 24 front + 2 rear) drive backplane with single PERC card

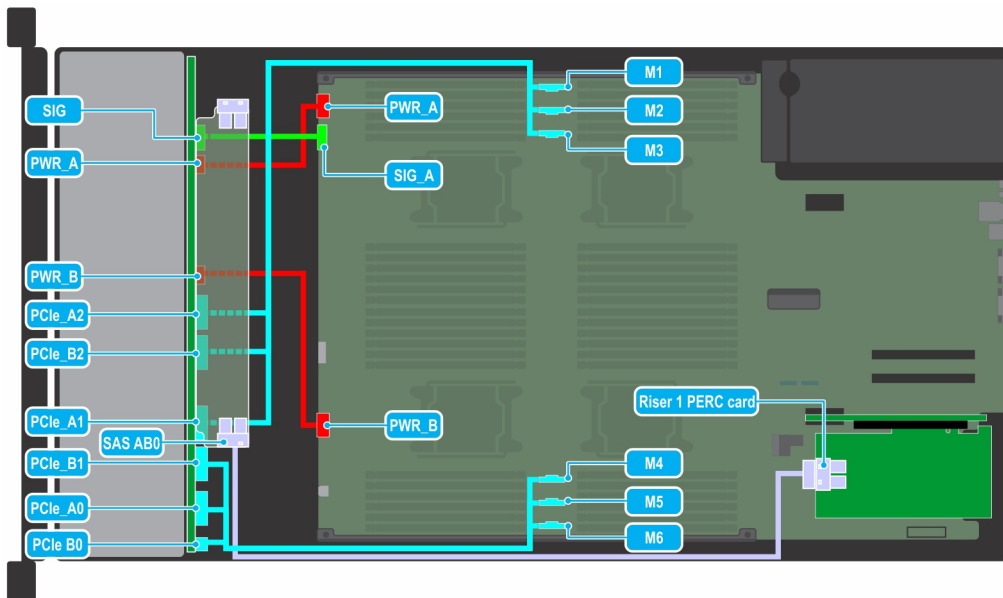

Figure 94. Cable routing - 24 x 2.5 inch, (12 SAS + 12 universal) drive backplane

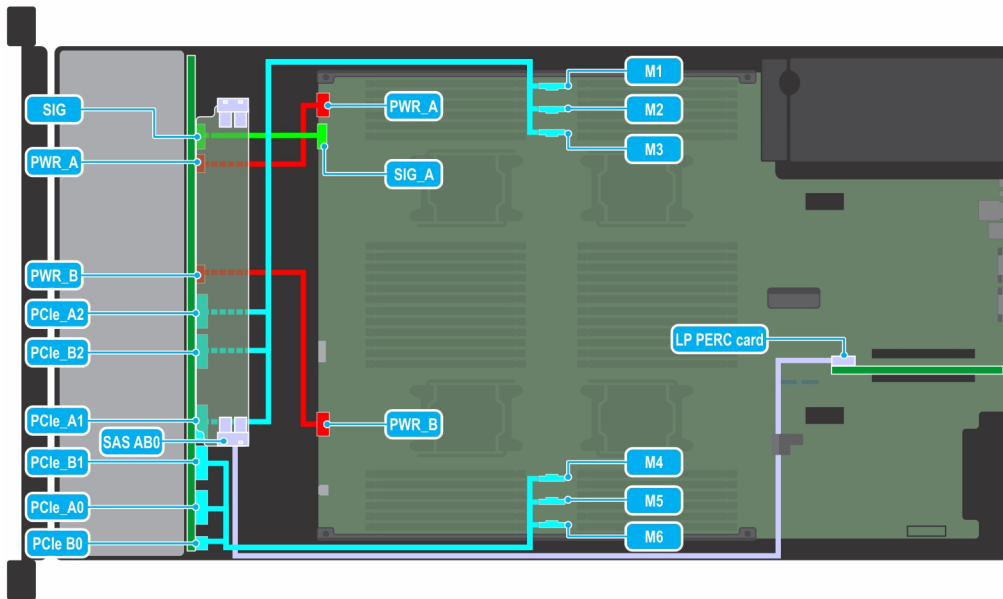

Figure 95. Cable routing - 24 x 2.5 inch, (12 SAS + 12 universal) drive backplane with single PERC card

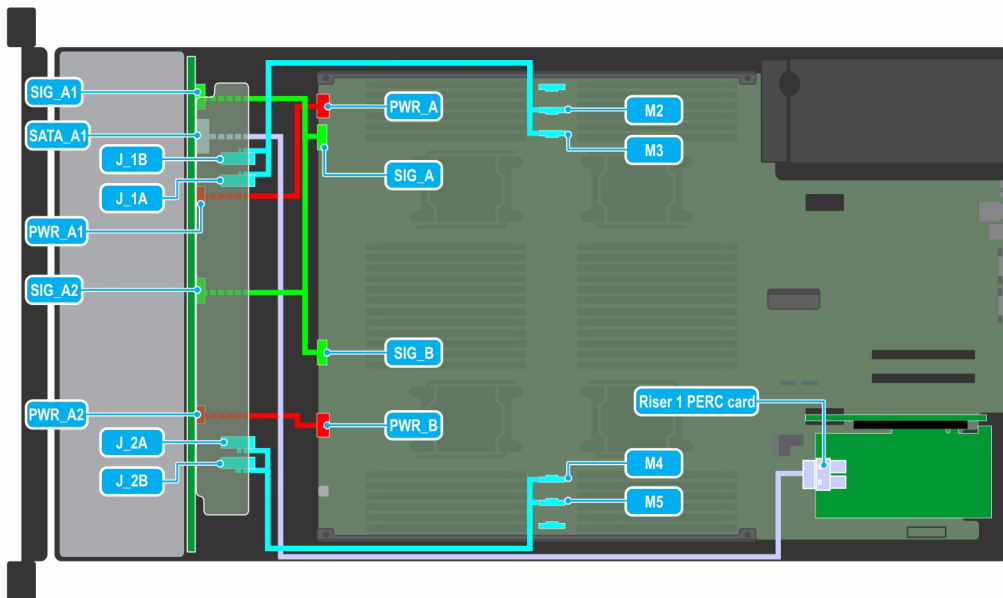

Figure 96. Cable routing - 24 x 2.5-inch, (16 NVMe + 8 universal) drive backplane with single PERC card

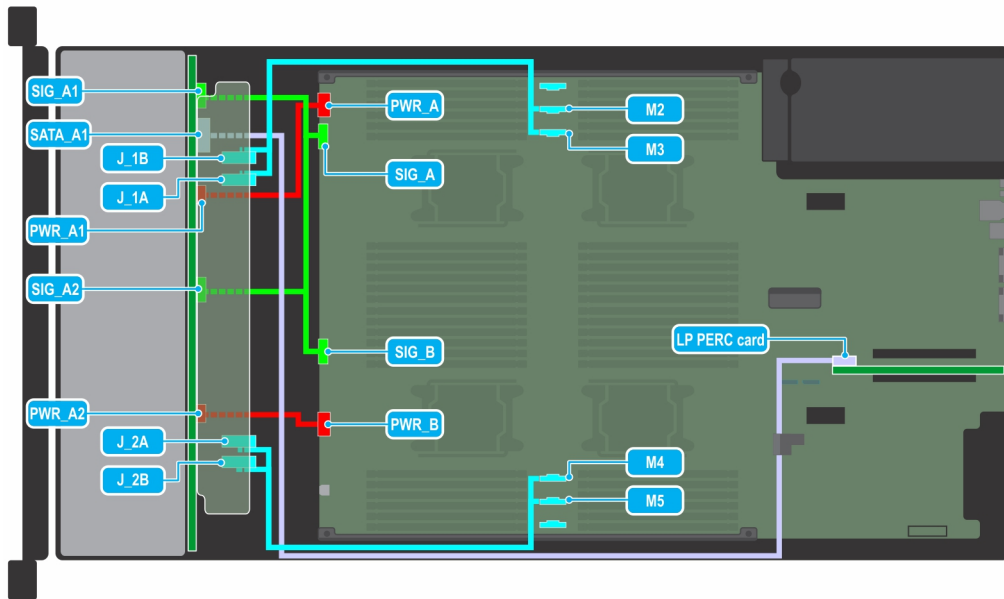

Figure 97. Cable routing - 24 x 2.5 inch, (16 NVMe + 8 universal) drive backplane

## System battery

### Replacing system battery

#### Prerequisites

**WARNING:** There is a danger of a new battery exploding if it is incorrectly installed. Replace the battery only with the same or equivalent type recommended by the manufacturer. For more information, see the safety information that shipped with your system.

1. Follow the safety guidelines listed in [Safety instructions](#).
2. Follow the procedure listed in [Before working inside your system](#).
3. [Remove the air shroud](#).
4. If applicable, disconnect the power or data cables from the expansion card riser x16 PCIe riser 2 or x8 PCIe riser 2.
5. If installed, [remove the expansion card risers](#).
6. If installed, [remove the PCIe expansion cards](#).

#### Steps

1. Locate the battery socket. For more information, see the [System board jumpers and connectors](#) section.

**CAUTION:** To avoid damage to the battery connector, you must firmly support the connector while installing or removing a battery.

2. Use a plastic scribe to pry out the system battery.



**Figure 98. Removing system battery**

3. To install a new system battery, hold the battery with the positive side facing up and slide it under the securing tabs.
4. Press the battery into the connector until it snaps into place.

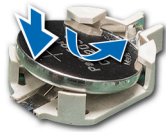

**Figure 99. Installing system battery**

#### Next steps

1. If applicable, [install the low profile PCIe cards](#).
2. If applicable, [install the expansion card riser x16 PCIe riser 2 or x8 PCIe riser 2](#).
3. Connect the power or data cables to the expansion card risers.
4. [Install air shroud](#).
5. Follow the procedure listed in [After working inside your system](#).
6. While booting, press F2 to enter the System Setup and ensure that the battery is operating properly.
7. Enter the correct time and date in the System Setup **Time** and **Date** fields.
8. Exit the System Setup.

## Optional USB 3.0 module

The USB 3.0 module cable connects to the internal USB port on the system board.

**i** **NOTE:** The optional USB 3.0 module is supported only on the 8 x 2.5-inch system configuration.

## Removing USB 3.0 module

#### Prerequisites

1. Follow the safety guidelines listed in [Safety instructions](#).
2. Follow the procedure listed in [Before working inside your system](#).
3. [Remove the air shroud](#).
4. [Remove the cooling fan assembly](#).
5. [Remove the internal USB memory key](#).

**i** **NOTE:** Ensure that you note the routing of the cables as you remove them from the system board. Route these cables properly when you replace them to prevent them from being pinched or crimped.

#### Steps

1. Disconnect the cables from the system board.
2. Using the Phillips #2 screwdriver, loosen the screw on the USB 3.0 module.
3. Slide the USB 3.0 module out of the system.

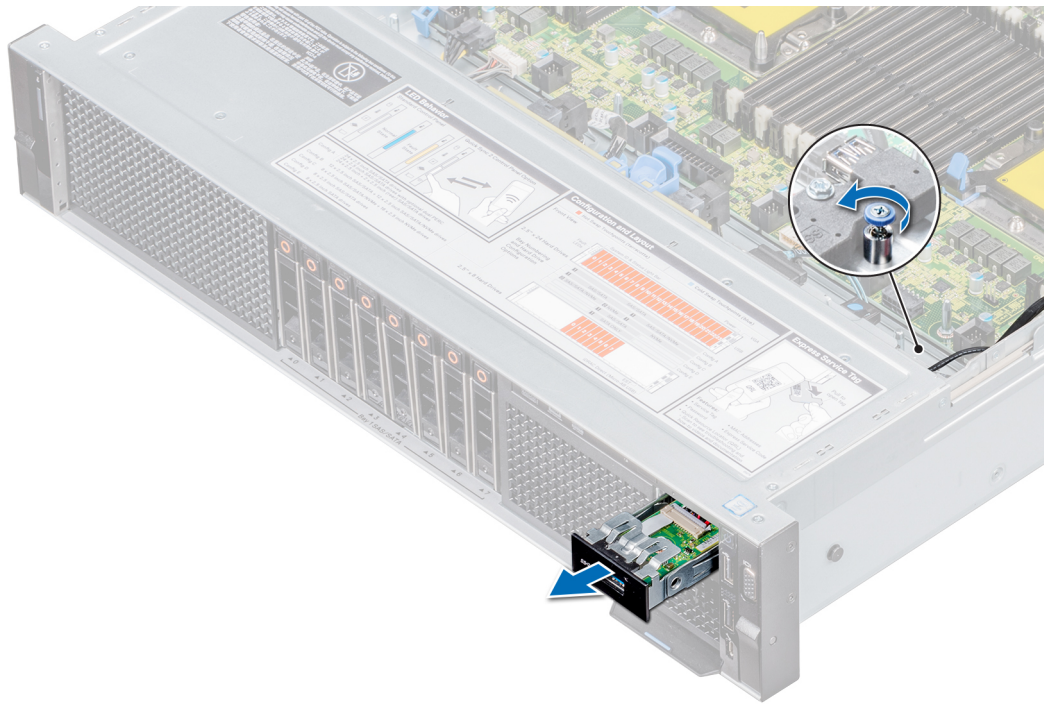

**Figure 100. Removing USB 3.0 module**

#### Next steps

1. [Replace the USB 3.0 module.](#)

## Installing USB 3.0 module

#### Prerequisites

1. Follow the safety guidelines listed in [Safety instructions](#).
2. Follow the procedure listed in [Before working inside your system](#).
3. [Remove the air shroud](#).
4. [Remove the cooling fan assembly](#).

#### Steps

1. Route the power and the USB cables on the USB 3.0 module through the USB 3.0 module slot on the front of the system.
2. Insert the USB 3.0 module into the slot on the front panel.
3. Align the screw on the module with the screw hole on the system.
4. Using a Phillips #2 screwdriver, tighten the screw to secure the module to the system.
5. Route and connect the USB cable to internal USB port and power cable to the backplane power connector on the system board. To locate the connector, see the [System board jumpers and connectors](#) section.

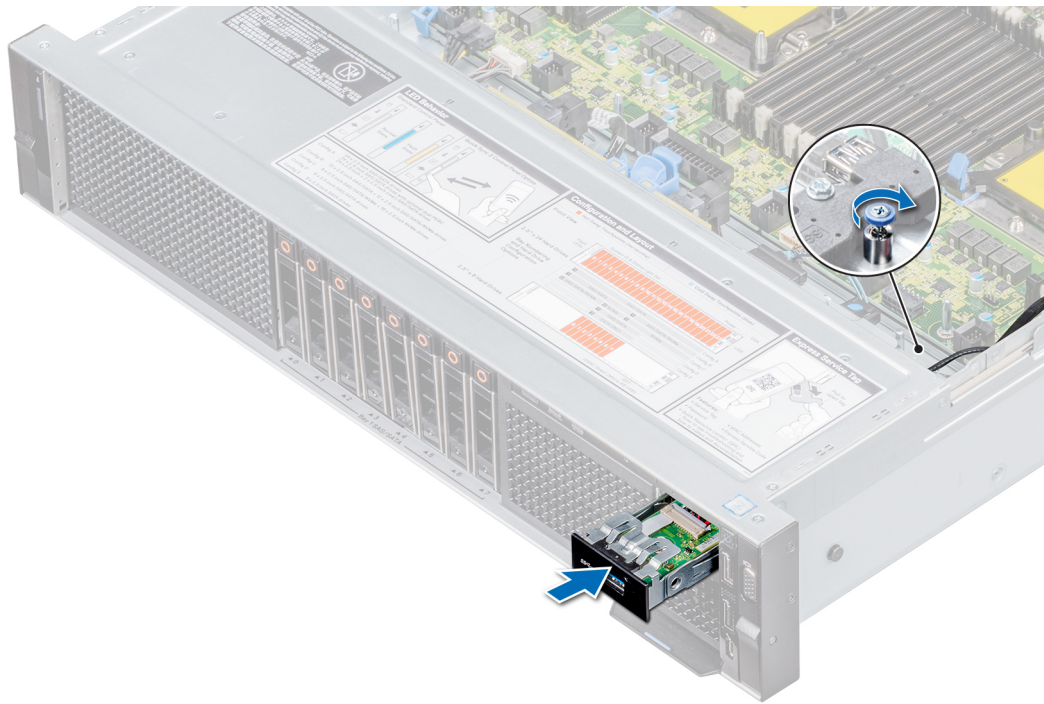

**Figure 101. Installing USB 3.0 module**

#### Next steps

1. Install the internal USB memory key.
2. Install the cooling fan assembly.
3. Install the air shroud.
4. Follow the procedure listed in [After working inside your system](#).

## Optional internal USB memory key

An optional USB memory key installed inside your system can be used as a boot device, security key, or mass storage device. To boot from the USB memory key, configure the USB memory key with a boot image and then specify the USB memory key in the boot sequence in System Setup.

An optional USB memory key can be installed in the internal USB 3.0 port.

**NOTE:** To locate the internal USB port on the system board, see the [System board jumpers and connectors](#) section.

## Replacing optional internal USB memory key

#### Prerequisites

**CAUTION:** To avoid interference with other components in the server, the maximum permissible dimensions of the USB memory key are 15.9 mm wide x 57.15 mm long x 7.9 mm high.

1. Follow the safety guidelines listed in [Safety instructions](#).
2. Follow the procedure listed in [Before working inside your system](#).
3. Remove the air shroud.

#### Steps

1. Locate the USB port or USB memory key on the system board.  
To locate the internal USB port on the system board, see the [System board jumpers and connectors](#) section.
2. If installed, remove the USB memory key from the USB port.
3. Insert the replacement USB memory key into the USB port.

### Next steps

1. [Install the air shroud.](#)
2. Follow the procedure listed in [After working inside your system.](#)
3. While booting, press F2 to enter **System Setup** and verify that the system detects the USB memory key.

## Optional optical drive

Optical drives retrieve and store data on optical discs such as CD and DVD. Optical drives can be categorized into two basic types: optical disc readers and optical disc writers.

**NOTE:** Optical drives are supported only on the 8 x 2.5-inch system configuration.

## Removing optical drive

### Prerequisites

1. Follow the safety guidelines listed in [Safety instructions.](#)
2. Follow the procedure listed in [Before working inside your system.](#)
3. If applicable, [remove the front bezel.](#)

### Steps

1. Press the release tab to release the optical drive.
2. Disconnect the power and data cables from the connectors on the optical drive.

**NOTE:** Ensure that you note the routing of the power and data cable on the side of the system as you remove them from the system board and drive.

3. Slide the optical drive out of the system until it is free of the optical drive slot.

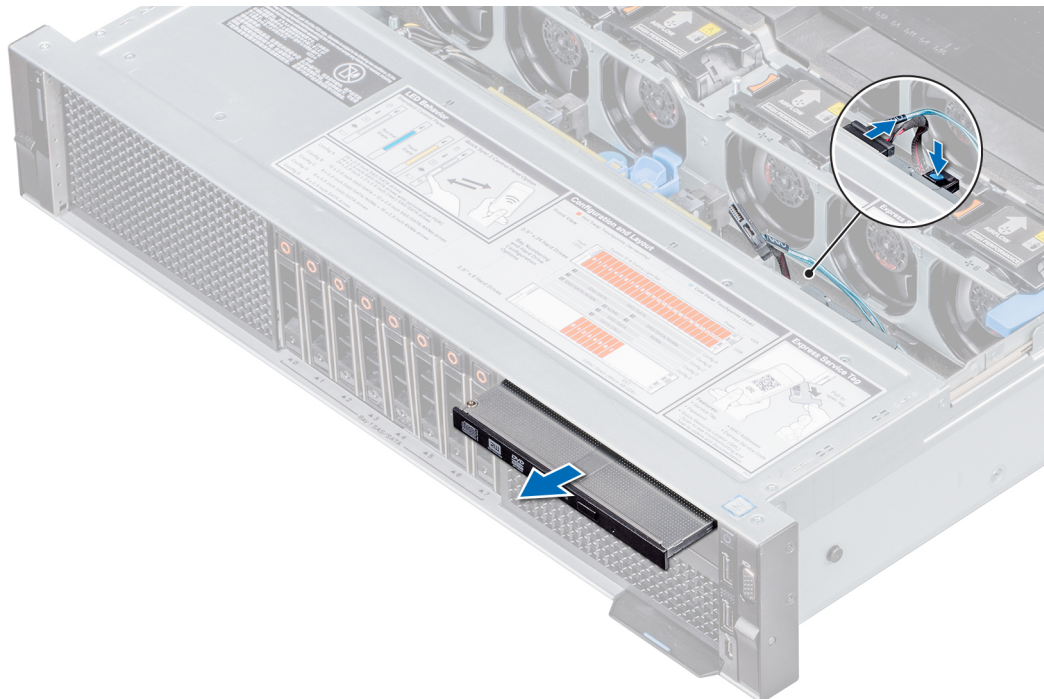

**Figure 102. Removing optical drive**

4. If you are not installing a new optical drive, install the optical drive blank.

**NOTE:** The procedure to install an optical blank is similar to the optical drive.

### Next steps

1. [Replace the optical drive.](#)

## Installing optical drive

### Prerequisites

1. Follow the safety guidelines listed in [Safety instructions](#).
2. Follow the procedure listed in [Before working inside your system](#).
3. If applicable, [remove the front bezel](#).

### Steps

1. If installed, remove the optical drive blank.

**i** **NOTE:** The procedure to remove an optical blank is similar to the optical drive.

2. Align the optical drive with the optical drive slot on the front of the system.
3. Slide in the optical drive until the release tab snaps into place.
4. Connect the power and data cables to the connectors on the optical drive.

**i** **NOTE:** Route the cables properly to prevent them from being pinched or crimped.

### Next steps

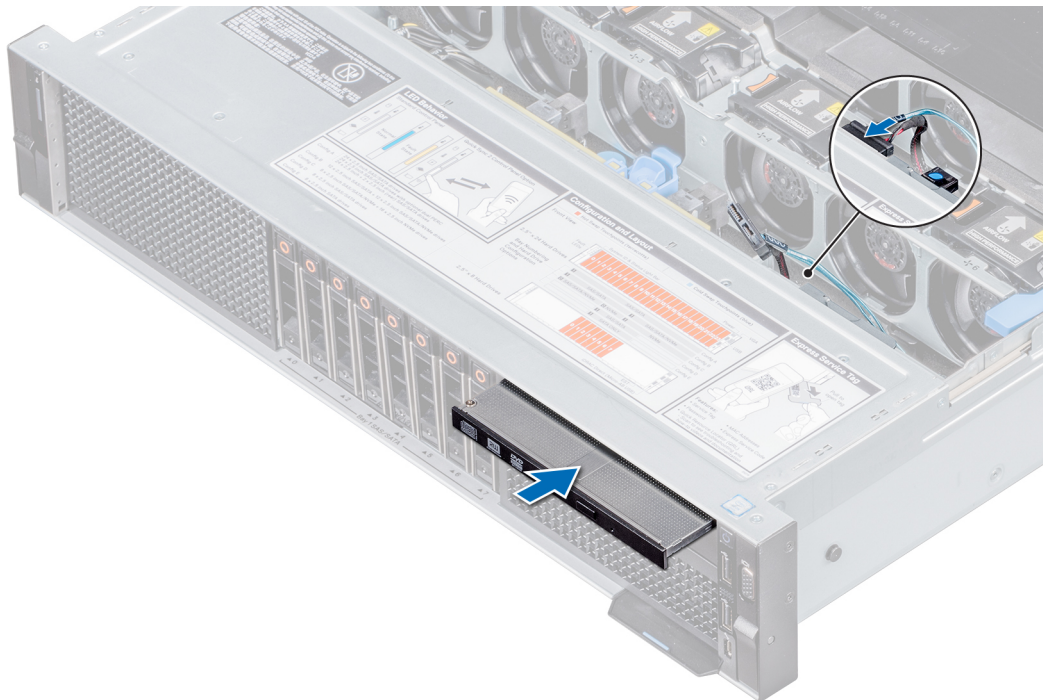

**Figure 103. Installing optical drive**

1. If applicable, [install the front bezel](#).
2. Follow the procedure listed in [After working inside your system](#).

## Power supply units

The power supply unit (PSU) is an internal hardware component which supplies power to the components in the system.

Your system supports one of the following:

- Two 2400 W, 2000 W, 1600 W, 1100 W, or 750 W AC PSUs

- Two 750 W DC PSUs (for China only)
- Two 1100 W DC PSUs
- Two 1100 W or 750 W (for China only) Mixed Mode HVDC PSUs

**NOTE:** For more information about power supply units, see the [Technical specifications](#) section.

**CAUTION:** If two PSUs are installed, both the PSUs must have the same type of label. For example, Extended Power Performance (EPP) label. Mixing PSUs from previous generations of PowerEdge servers is not supported, even if the PSUs have the same power rating. Mixing PSUs result in mismatch condition or failure to turn on the system.

**NOTE:** When two identical PSUs are installed, power supply redundancy (1+1 – with redundancy or 2+0 – without redundancy) is configured in system BIOS. In redundant mode, power is supplied to the system equally from both PSUs when Hot Spare is disabled. When Hot Spare is enabled, one of the PSUs is put into the sleep mode when system utilization is low to maximize efficiency.

**NOTE:** If two PSUs are used, they must be of the same maximum output power.

**NOTE:** In a single PSU configuration, install the PSU in bay 1 (bottom PSU slot).

## Hot spare feature

Your system supports the hot spare feature that significantly reduces the power overhead associated with power supply unit (PSU) redundancy.

When the hot spare feature is enabled, one of the redundant PSUs is switched to the sleep state. The active PSU supports 100 percent of the load, thus operating at higher efficiency. The PSU in the sleep state monitors output voltage of the active PSU. If the output voltage of the active PSU drops, the PSU in the sleep state returns to an active output state.

If having both PSUs active is more efficient than having one PSU in the sleep state, the active PSU can also activate the sleeping PSU.

The default PSU settings are as follows:

- If the load on the active PSU is more than 50 percent, then the redundant PSU is switched to the active state.
- If the load on the active PSU falls below 20 percent, then the redundant PSU is switched to the sleep state.

You can configure the hot spare feature by using the iDRAC settings. For more information about iDRAC settings, see the *Integrated Dell Remote Access Controller User's Guide* available at [www.dell.com/idracmanuals](http://www.dell.com/idracmanuals).

## Removing a power supply unit blank

### Prerequisites

Follow the safety guidelines listed in [Safety instructions](#).

### Steps

If you are installing a second PSU, remove the PSU blank in the bay by pulling the blank outward.

**CAUTION:** To ensure proper system cooling, the PSU blank must be installed in the second PSU bay in a non-redundant configuration. Remove the PSU blank only if you are installing a second PSU.

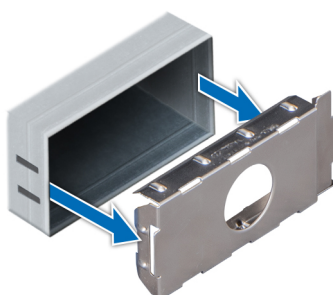

**Figure 104.** Removing a power supply unit blank

### Next steps

Install the PSU or PSU blank.

## Installing a power supply unit blank

### Prerequisites

1. Follow the safety guidelines listed in [Safety instructions](#).
2. Install the power supply unit (PSU) blank only in the second PSU bay.

### Steps

Align the PSU blank with the PSU slot and push it into the PSU slot until it clicks into place.

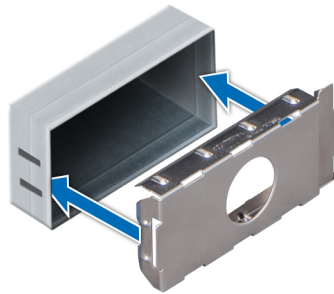

Figure 105. Installing a power supply unit blank

## Removing power supply unit

The procedure for removing AC and DC PSUs is identical.

### Prerequisites

**CAUTION:** The system needs one power supply unit (PSU) for normal operation. On power-redundant systems, remove and replace only one PSU at a time in a system that is powered on.

1. Follow the safety guidelines listed in [Safety instructions](#).
1. Disconnect the power cable from the power source and from the PSU you intend to remove, and then remove the cable from the strap on the PSU handle.
2. To remove the PSU, remove optional strain relief bar and strain relief bar attachment bracket, if they interfere with the PSU removal.

For information about the strain relief bar attachment bracket and strain relief bar, see the system's Rail Installation Guide at [www.dell.com/poweredgemanuals](http://www.dell.com/poweredgemanuals).

### Steps

Press the release latch, and holding the PSU handle slide the PSU out of the system.

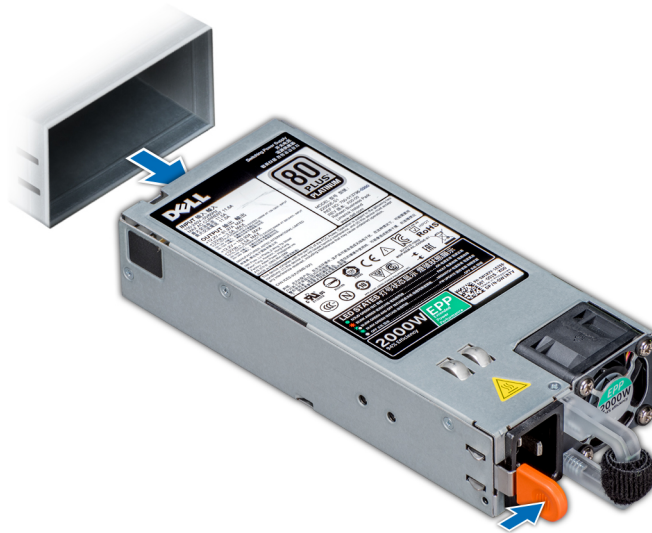

Figure 106. Removing power supply unit

#### Next steps

1. Install the PSU or the PSU blank.

## Installing power supply unit

The procedure for installing AC and DC PSUs is identical.

#### Prerequisites

1. Follow the safety guidelines listed in [Safety instructions](#).
2. For systems that support redundant PSU, ensure that both the PSUs are of the same type and have the same maximum output power.

**NOTE:** The maximum output power (shown in watts) is listed on the PSU label.

#### Steps

Slide the PSU into the system until the PSU is fully seated and the release latch snaps into place.

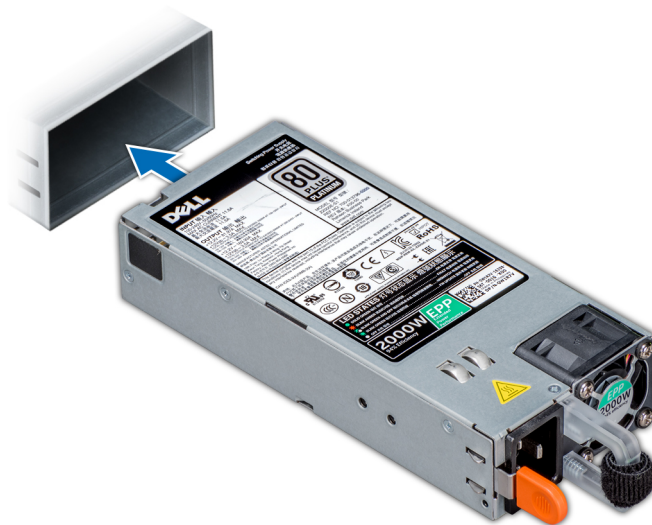

Figure 107. Installing power supply unit

## Next steps

1. If you have removed the strain relief bar attachment bracket and strain relief bar, reinstall them. For information about the strain relief bar attachment bracket and strain relief bar, see the system's Rail Installation Guide at [www.dell.com/poweredge manuals](http://www.dell.com/poweredge manuals).
2. Connect the power cable to the PSU, and plug the cable into a power outlet.

**CAUTION:** When connecting the power cable to the PSU, secure the cable to the PSU with the strap.

**NOTE:** When installing, hot swapping, or hot adding a new PSU, wait for 15 seconds for the system to recognize the PSU and determine its status. The PSU redundancy may not occur until discovery is complete. Wait until the new PSU is discovered and enabled before you remove the other PSU. The PSU status indicator turns green to signify that the PSU is functioning properly.

## Wiring instructions for a DC power supply unit

Your system supports up to two  $-(48-60)$  V DC power supply units (PSUs).

**NOTE:** For equipment using  $-(48-60)$  V DC power supply units (PSUs), a qualified electrician must perform all connections to DC power and to safety grounds. Do not attempt connecting to DC power or installing grounds yourself. All electrical wiring must comply with applicable local or national codes and practices. Damage due to servicing that is not authorized by Dell is not covered by your warranty. Read and follow all safety instructions that came with the product.

**CAUTION:** Wire the unit with copper only, unless otherwise specified, use only 10 American Wire Gauge (AWG) wire rated minimum  $90^{\circ}\text{C}$  for source and return. Protect the  $-(48-60)$  V DC (1 wire) with a branch circuit over-current protection rated 50 A for DC with a high interrupt current rating.

**CAUTION:** Connect the equipment to a  $-(48-60)$  V DC supply source that is electrically isolated from the AC source (reliably grounded  $-(48-60)$  V DC SELV source). Ensure that the  $-(48-60)$  V DC source is efficiently secured to earth (ground).

**NOTE:** A readily accessible disconnect device that is suitably approved and rated shall be incorporated in the field wiring.

## Input requirements

- Supply voltage:  $-(48-60)$  V DC
- Current consumption: 32 A (maximum)

## Kit contents

- Dell part number 6RYJ9 terminal block or equivalent (1)
- #6-32 nut equipped with lock washer (1)

## Required tools

Wire-stripper pliers capable of removing insulation from size 10 AWG solid or stranded, insulated copper wire.

**NOTE:** Use alpha wire part number 3080 or equivalent (65/30 stranding).

## Required wires

- One UL 10 AWG, 2 m maximum (stranded) black wire [ $-(48-60)$  V DC].
- One UL 10 AWG, 2 m maximum (stranded) red wire (V DC return).
- One UL 10 AWG, 2 m maximum, green with a yellow stripe, stranded wire (safety ground).

## Assembling and connecting safety ground wire

### Prerequisites

- i** **NOTE:** For equipment using –(48–60) V DC power supply units (PSUs), a qualified electrician must perform all connections to DC power and to safety grounds. Do not attempt connecting to DC power or installing grounds yourself. All electrical wiring must comply with applicable local or national codes and practices. Damage due to servicing that is not authorized by Dell is not covered by your warranty. Read and follow all safety instructions that came with the product.

### Steps

1. Strip the insulation from the end of the green or yellow wire, exposing approximately 4.5 mm (0.175 inch) of copper wire.
2. Using a hand-crimping tool (Tyco Electronics, 58433-3 or equivalent), crimp the ring-tongue terminal (Jeason Terminals Inc., R5-4SA or equivalent) to the green and yellow wire (safety ground wire).
3. Connect the safety ground wire to the grounding post on the back of the system by using a #6-32 nut equipped with a locking washer.

## Assembling DC input power wires

### Prerequisites

- i** **NOTE:** For equipment using –(48–60) V DC power supply units (PSUs), a qualified electrician must perform all connections to DC power and to safety grounds. Do not attempt connecting to DC power or installing grounds yourself. All electrical wiring must comply with applicable local or national codes and practices. Damage due to servicing that is not authorized by Dell is not covered by your warranty. Read and follow all safety instructions that came with the product.

### Steps

1. Strip the insulation from the ends of the DC power wires, exposing approximately 13 mm (0.5 inch) of copper wire.

**i** **NOTE:** Reversing polarity when connecting DC power wires can permanently damage the power supply or the system.
2. Insert the copper ends into the mating connectors and tighten the captive screws at the top of the mating connector using a Phillips #2 screwdriver.

**i** **NOTE:** To protect the power supply from electrostatic discharge, the captive screws must be covered with the rubber cap before inserting the mating connector into the power supply.
3. Rotate the rubber cap clockwise to fix it over the captive screws.
4. Insert the mating connector into the power supply.

## Power Interposer Board

The Power Interposer Board (PIB) is a board that connects the hot swappable power supply units (PSUs) to the system board.

## Removing Power Interposer Board

### Prerequisites

1. Follow the safety guidelines listed in [Safety instructions](#).
2. Follow the procedure listed in [Before working inside your system](#).
3. Remove the applicable air shroud:
  - a. [Non-GPU air shroud](#)
  - b. [Expansion card riser 2](#)OR

- a. GPU air shroud
  - b. Expansion card riser 2
4. Remove the power supply units

**CAUTION:** To prevent damage to the power interposer board, you must remove the power supply module (s) or power supply blank from the system before removing the power interposer board or power distribution board.

### Steps

1. Disconnect the cables connected from the power interposer board (PIB) to the system board, and remove the cables from the cable retention brackets.
  - NOTE:** Observe the routing of the cable as you remove it from the system. Route the cable properly when you replace it to prevent the cable from being pinched or crimped.
2. Using a Phillips #2 screwdriver, remove the screw securing the PIB to the system.
3. Holding the blue touch point on the PIB, gently lift, to release it from the PSU cage, and slide it out.
4. Lift the PIB away from the system.

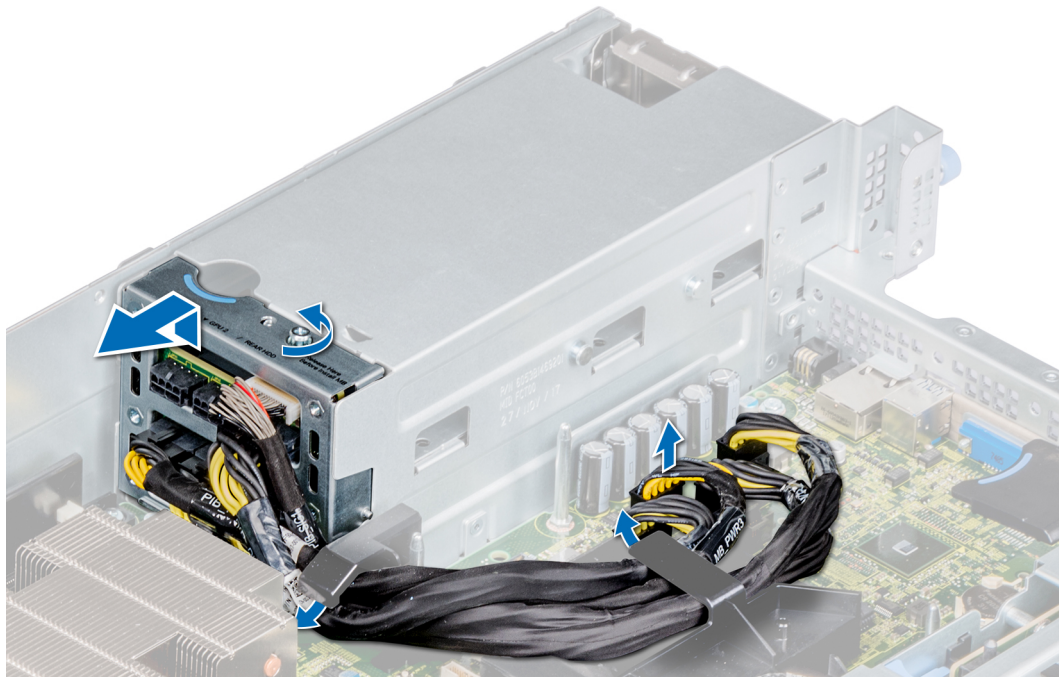

Figure 108. Removing power interposer board

### Next steps

1. Replace the power interposer board (PIB).

## Installing Power Interposer Board

### Prerequisites

1. Follow the safety guidelines listed in [Safety instructions](#).
2. Follow the procedure listed in [Before working inside your system](#).
3. Remove the applicable air shroud:
  - a. Non-GPU air shroud
  - b. Expansion card riser 2OR
  - a. GPU air shroud
  - b. Expansion card riser 2
4. Remove the power supply units

**CAUTION:** To prevent damage to the power interposer board, you must remove the power supply module (s) or power supply blank from the system before removing the power interposer board or power distribution board.

**NOTE:** Ensure that the cables inside the system are correctly routed and secured using the cable securing latches.

### Steps

1. Align and push the PIB to the PSU cage and slide it into place.
2. Using Phillips #2 screwdriver, tighten the screw to secure the PIB to the system.
3. Route the cables, and connect it to the system board.

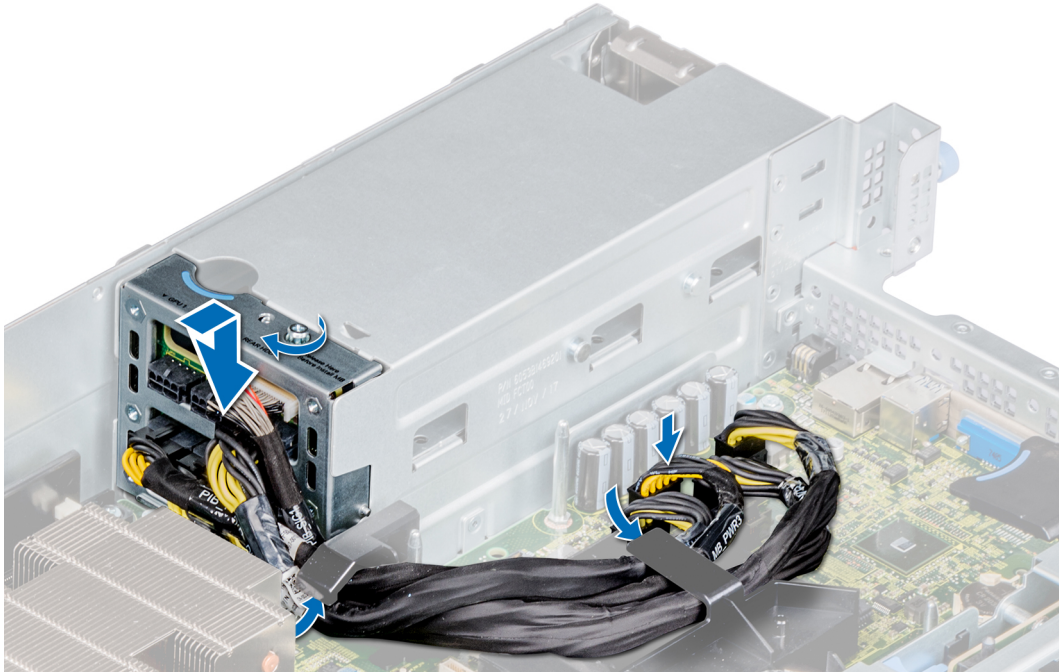

**Figure 109. Installing power interposer board**

### Next steps

1. [Install the power supply unit \(PSU\).](#)
2. Install the applicable air shroud:
  - a. [GPU air shroud](#)
  - b. [Expansion card riser 2](#)OR
  - a. [Expansion card riser 2](#)
  - b. [Non-GPU air shroud](#)
3. Follow the procedure listed in [After working inside your system.](#)

## System board

### Removing system board

#### Prerequisites

**CAUTION:** If you are using the Trusted Platform Module (TPM) with an encryption key, you may be prompted to create a recovery key during program or system setup. Be sure to create and safely store this recovery key. If you replace this system board, you must supply the recovery key when you restart your system or program before you can access the encrypted data on your drives.

**CAUTION:** Do not attempt to remove the TPM plug-in module from the system board. After the TPM plug-in module is installed, it is cryptographically bound to that specific system board. Any attempt to remove an installed TPM plug-in module breaks the cryptographic binding, and it cannot be reinstalled or installed on another system board.

1. Follow the safety guidelines listed in [Safety instructions](#).
2. Follow the procedure listed in [Before working inside your system](#).
3. Remove the following:

- a. [Non-GPU air shroud](#) or [GPU air shroud](#)
- b. [Cooling fan assembly](#).
- c. [Processor and heat sink module](#)
- d. [Backplane cables](#) connected to the system board
- e. [Power interposer board \(PIB\)](#).

**CAUTION:** When replacing the system board, disconnect the cables from the system board, but do not disconnect the cables attached to the PIB.

- f. [Expansion card risers](#)
- g. [iDSDM/vFlash card](#)
- h. [Internal USB key](#), if installed
- i. [USB 3.0 module cable](#) connected to the system board
- j. [Processor blanks](#), if installed

**CAUTION:** To prevent damage to the processor socket when replacing a faulty system board, ensure that you cover the processor socket with the processor dust cover.

- k. [Network daughter card](#).
- l. [Drive cage \(rear\)](#), if installed.

### Steps

1. Disconnect all cables from the system board.

**CAUTION:** Take care not to damage the system identification button while removing the system board from the system.

**CAUTION:** Do not lift the system board by holding a memory module, processor, or other components.

2. Holding the blue plungers, slide the system board to the front of the system.
3. Incline the system board at an angle, and lift the system board out of the system.

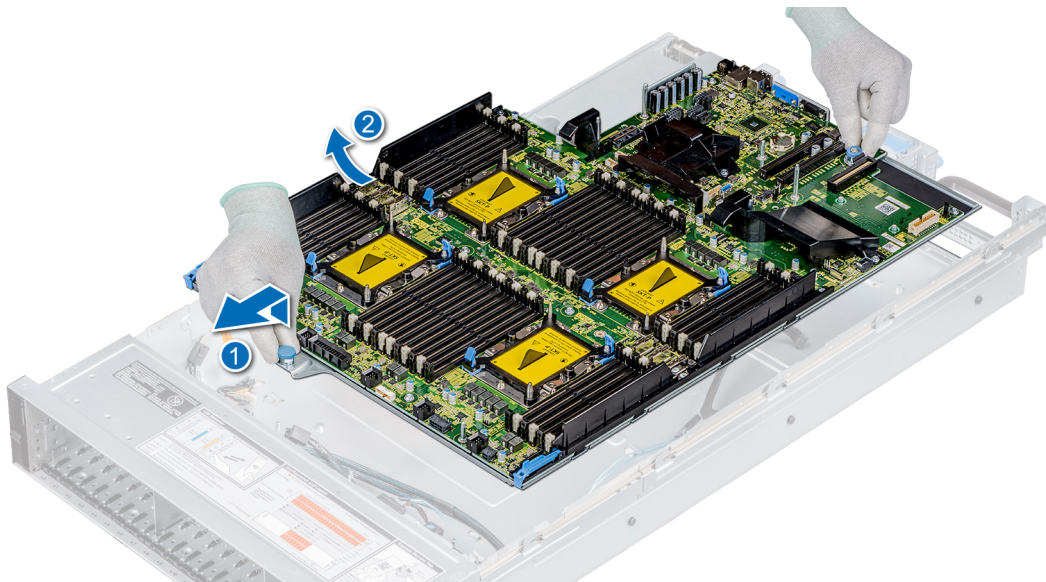

**Figure 110. Removing system board**

### Next steps

1. [Replace or install the system board](#).

# Installing system board

## Prerequisites

1. Follow the safety guidelines listed in [Safety instructions](#).
2. If you are replacing the system board, remove all the components listed in the [Removing the system board](#) section.

## Steps

1. Unpack the replacement system board assembly.

**CAUTION:** Do not lift the system board by holding a memory module, processor, or other components.

**CAUTION:** Take care not to damage the system identification button while placing the system board into the system.

2. Holding the system board plungers, incline the system board at an angle and align the connectors on the system board with the slots on the system, and lower the system board into the system.
3. Slide the system board toward the back of the system until the plungers click into place.

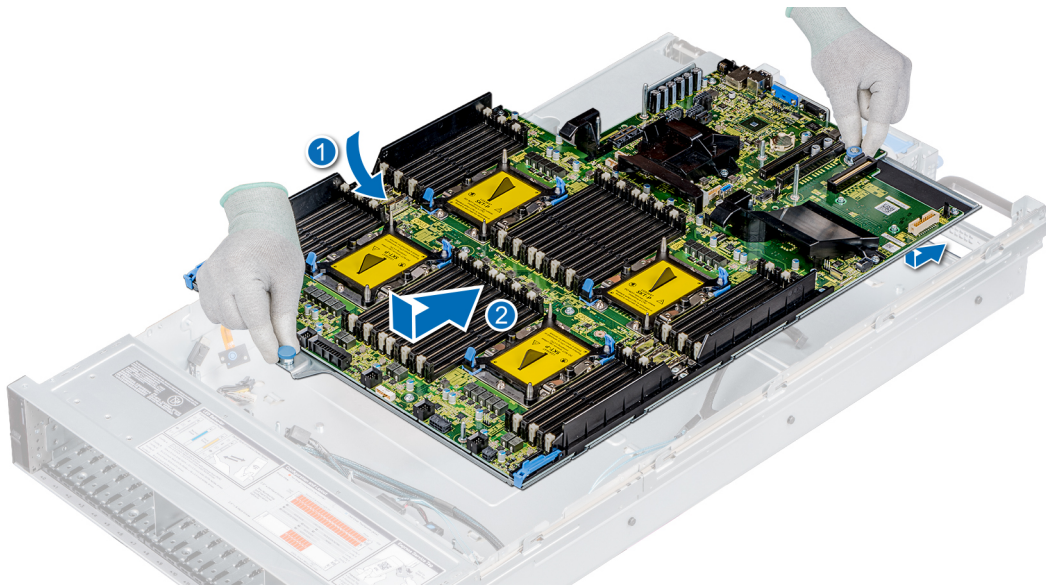

Figure 111. Installing system board

## Next steps

1. Replace the following:

- a. [Trusted Platform Module \(TPM\)](#)

**NOTE:** The TPM must be replaced only while installing a new system board.

**NOTE:** The TPM plug-in module is attached to the system board and cannot be removed. A replacement TPM plug-in module is provided for all system board replacements, where a TPM plug-in module was installed.

- b. [Network daughter card](#).
- c. [Power Interposer Board \(PIB\)](#).
- d. [USB 3.0 module cables](#), if applicable
- e. [Backplane cables](#), if applicable
- f. [Processor and heat sink module](#)
- g. [Internal USB key](#), if applicable
- h. [iDSDM/vFlash module](#)
- i. [Expansion card risers](#)
- j. [Cooling fan assembly](#).
- k. [Air shroud](#).
- l. [Drive cage \(rear\)](#), if applicable.

2. Replace the iDRAC MAC address label from the luggage tag on the front of the system with the new iDRAC MAC address label that came with the replacement system board.
3. Reconnect all cables to the system board.
  - NOTE:** Ensure that the cables inside the system are routed along the chassis wall and secured using the cable securing bracket.
4. Boot the system.
5. Follow the procedure listed in [After working inside your system](#).
6. Ensure that you:
  - a. Use the Easy Restore feature to restore the Service Tag. For more information, see the [Restoring the Service Tag using Easy Restore](#) section.
  - b. If the Service Tag is not backed up in the backup flash device, enter the Service Tag manually. For more information, see the [Manually update the Service Tag](#) section.
  - c. Update the BIOS and iDRAC versions.
  - d. Re-enable the Trusted Platform Module (TPM). For more information, see the [Upgrading the Trusted Platform Module \(TPM\)](#) section.
7. Import your new or existing iDRAC Enterprise license.

For more information, see iDRAC User's Guide, at [Dell.com/iDRACmanuals](http://Dell.com/iDRACmanuals).

## Restore the service tag using Easy Restore

The Easy Restore feature allows you to restore your Service Tag, iDRAC license, UEFI configuration, and the system configuration data after replacing the system board. All data is backed up automatically in a backup flash drive device. If BIOS detects a new system board, and the Service Tag in the backup Flash device is different, BIOS prompts the user to restore the backup information.

### About this task

Following is a list of options available:

1. Restore the Service Tag, iDRAC license, and diagnostics information, press **Y**.
  2. Navigate to the Lifecycle Controller based restore options, press **N**.
  3. Restore data from a previously created **Hardware Server Profile**, press **F10**.
    - NOTE:** When the restore process is complete, BIOS prompts to restore the system configuration data.
  4. To restore the system configuration data, press **Y**
  5. To use the default configuration settings, press **N**
    - NOTE:** After the restore process is complete, system reboots.
- NOTE:** If restoring the Service Tag is successful, you can check the Service Tag information in the System Information screen and compare it with the Service Tag on the system.

## Manually updating Service Tag

After replacing a system board, if Easy Restore fails, follow this process to manually enter the Service Tag, using **System Setup**.

### About this task

If you know the system Service Tag, use the **System Setup** menu to enter the Service Tag.

### Steps

1. Turn on the system.
2. To enter the **System Setup**, press **F2**.
3. Click **Service Tag Settings**.
4. Enter the Service Tag.
  - NOTE:** You can enter the Service Tag only when the Service Tag field is empty. Ensure that you enter the correct Service Tag. After the Service Tag is entered, it cannot be updated or changed.
5. Click **OK**.

# Trusted Platform Module

## Upgrading Trusted Platform Module

### Prerequisites

1. Follow the safety guidelines listed in [Safety instructions](#).
2. Follow the procedure listed in [Before working inside your system](#).

### **i** NOTE:

- Ensure that your operating system supports the version of the TPM being installed.
- Ensure that you download and install the latest BIOS firmware on your system.
- Ensure that the BIOS is configured to enable UEFI boot mode.

### About this task

**⚠ CAUTION:** After the TPM plug-in module is installed, it is cryptographically bound to that specific system board. Any attempt to remove an installed TPM plug-in module breaks the cryptographic binding, the removed TPM cannot be reinstalled or installed on another system board.

## Removing the TPM

### Steps

1. Locate the TPM connector on the system board.

***i*** NOTE: To locate the TPM connector on the system board, see the [System board jumpers and connectors](#) section.

2. Press to hold down the module and remove the screw using the security Torx 8-bit shipped with the TPM module.
3. Slide the TPM module out from its connector.
4. Push the plastic rivet away from the TPM connector and rotate it 90° counterclockwise to release it from the system board.
5. Pull the plastic rivet out of its slot on the system board.

## Installing the TPM

### Steps

1. To install the TPM, align the edge connectors on the TPM with the slot on the TPM connector.
2. Insert the TPM into the TPM connector such that the plastic rivet aligns with the slot on the system board.
3. Press the plastic rivet until the rivet snaps into place.

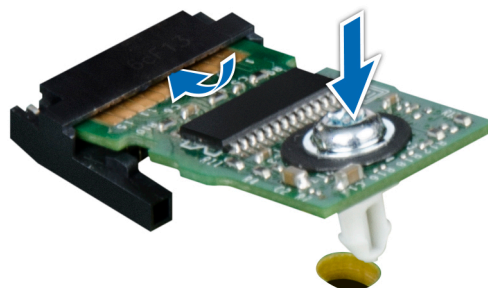

Figure 112. Installing the TPM

### Next steps

1. [Install the system board.](#)
2. Follow the procedure listed in [After working inside your system.](#)

## Initializing TPM for BitLocker users

### Steps

Initialize the TPM.

For more information, see <https://technet.microsoft.com/library/cc753140.aspx>.

The **TPM Status** changes to **Enabled, Activated**.

## Initializing the TPM 1.2 for TXT users

### Steps

1. While booting your system, press F2 to enter System Setup.
2. On the **System Setup Main Menu** screen, click **System BIOS > System Security Settings**.
3. From the **TPM Security** option, select **On with Pre-boot Measurements**.
4. From the **TPM Command** option, select **Activate**.
5. Save the settings.
6. Restart your system.
7. Enter **System Setup** again.
8. On the **System Setup Main Menu** screen, click **System BIOS > System Security Settings**.
9. From the **Intel TXT** option, select **On**.

## Control panel

A control panel allows you to manually control the inputs to the server.

## Removing left control panel

### Prerequisites

1. Follow the safety guidelines listed in [Safety instructions](#).
2. Follow the procedure listed in [Before working inside your system](#).
3. [Remove the non-GPU air shroud](#) or [GPU air shroud](#).
4. [Remove the cooling fan assembly](#).



**NOTE:** Ensure that you note the routing of the cables as you remove them from the system board. To prevent the cables from being pinched or crimped, route the cables properly when you replace them.

### Steps

1. Open the cable latch, and disconnect the control panel cable from the system board connector.
2. Using a Phillips #1 screwdriver, remove the screws that secure the control panel and ribbon cable to the system.
3. Holding the control panel and ribbon cable, remove the control panel along with the ribbon cable away from the system.

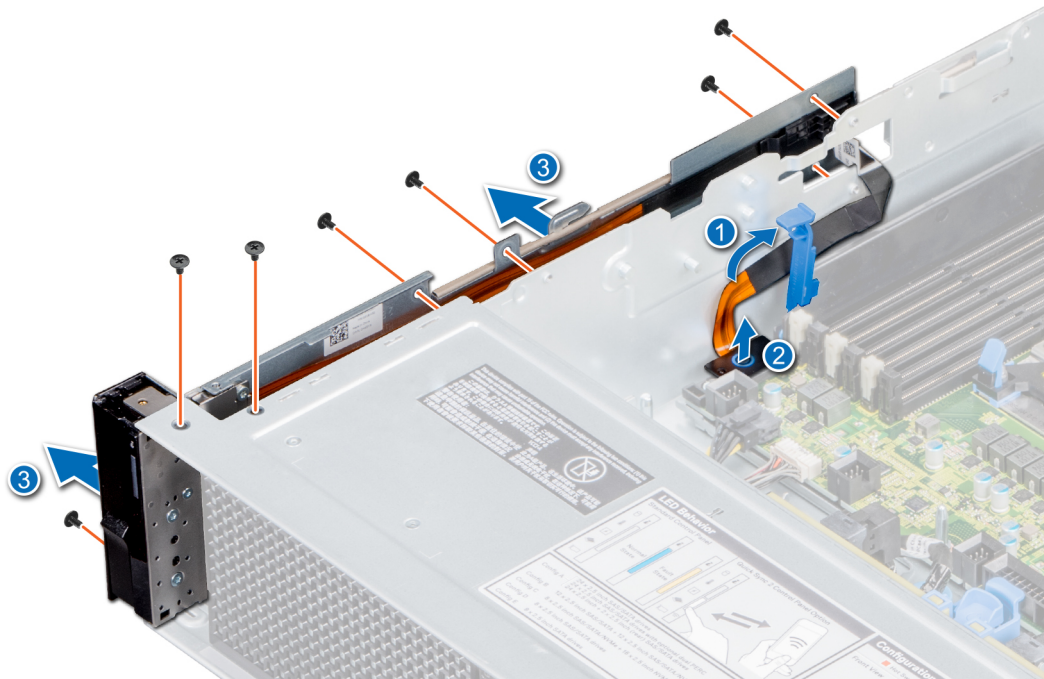

Figure 113. Removing left control panel

#### Next steps

1. [Install the left control panel.](#)

## Installing left control panel

#### Prerequisites

1. Follow the safety guidelines listed in [Safety instructions](#).
2. Follow the procedure listed in [Before working inside your system](#).
3. [Remove the non-GPU air shroud](#) or [GPU air shroud](#).
4. [Remove the cooling fan assembly](#).

**NOTE:** Ensure that you note the routing of the cables as you remove them from the system board. To prevent the cables from being pinched or crimped, you must route the cables properly when you replace them.

#### Steps

1. Route the control panel cable through the side wall of the system.
2. Align the control panel assembly with the control panel slot on the system and attach the control panel assembly to the system.
3. Connect the control panel cable to the system board connector.
4. Close the cable latch to secure the control panel cable.
5. Using a Phillips #1 screwdriver, install the screws that secure the control panel and ribbon cable to the system.

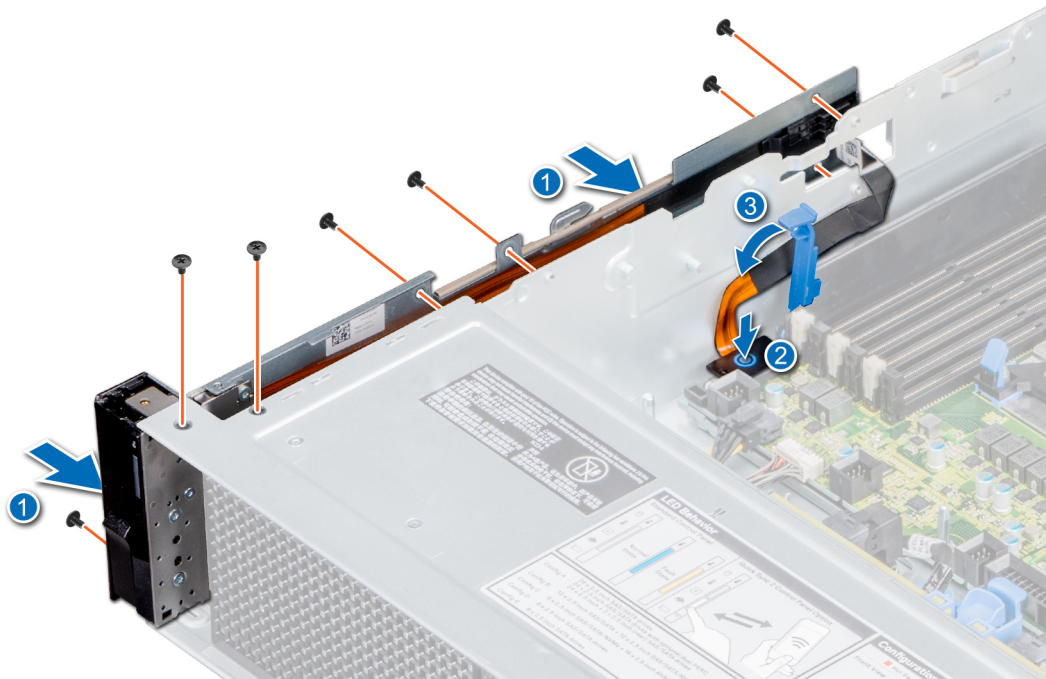

**Figure 114. Installing left control panel**

#### Next steps

1. [Install the cooling fan assembly.](#)
2. [Install the non-GPU air shroud or GPU air shroud.](#)
3. Follow the procedure listed in [After working inside your system.](#)

## Removing right control panel

#### Prerequisites

1. Follow the safety guidelines listed in [Safety instructions.](#)
2. Follow the procedure listed in [Before working inside your system.](#)
3. [Remove front bezel](#), if installed.
4. [Remove drives, optical drive, or drive blanks](#), if installed.
5. [Remove the non-GPU air shroud or GPU air shroud.](#)
6. [Remove the cooling fan assembly.](#)

#### Steps

1. Disconnect the VGA cable from the system board.
2. Open the cable latch, and disconnect the control panel cable from the system board connector.
3. Using a Phillips #1 screwdriver, remove the screws that secure the control panel and ribbon cable to the system.
4. Holding the control panel and ribbon cable, remove the control panel along with the ribbon cable away from the system.

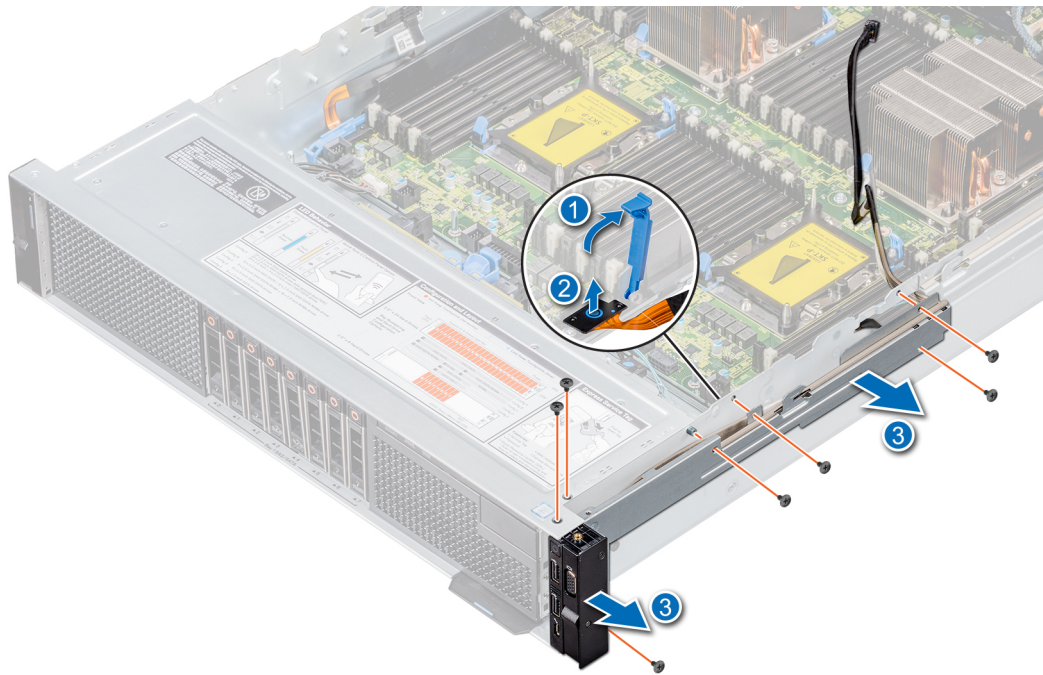

**Figure 115. Removing right control panel**

#### Next steps

1. [Replace the right control panel.](#)

## Installing right control panel

#### Prerequisites

1. Follow the safety guidelines listed in [Safety instructions](#).
2. Follow the procedure listed in [Before working inside your system](#).
3. [Remove front bezel](#), if installed.
4. [Remove drives, optical drive, or drive blanks](#), if installed.
5. [Remove the air shroud](#).
6. [Remove the cooling fan assembly](#).

**NOTE:** Ensure that you note the routing of the cables as you remove them from the system board. To prevent the cables from being pinched or crimped, you must route the cables properly when you replace them.

#### Steps

1. Route the control panel cable and VGA cable through the side wall of the system.
2. Align the control panel with the control panel slot on the system and attach the control panel to the system.
3. Connect the VGA cable to the system board.
4. Connect the control panel cable to the system board and secure it using cable latch.
5. Using a Phillips #1 screwdriver, install the screws that secure the control panel and ribbon cable to the system.

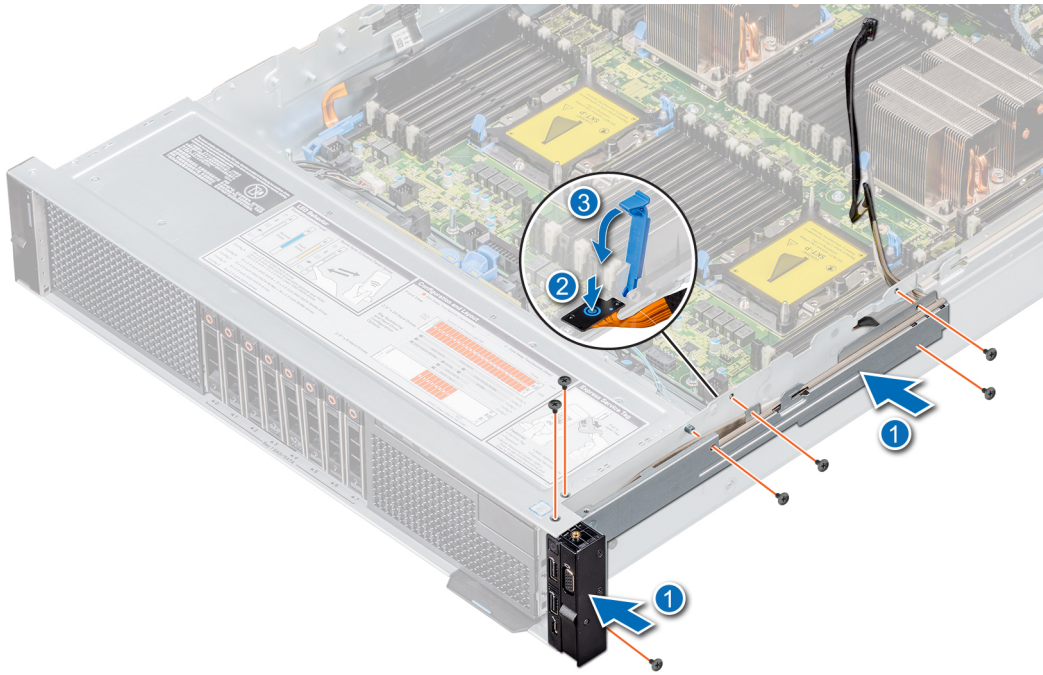

**Figure 116. Installing right control panel**

**Next steps**

1. Install the cooling fan assembly.
2. Install the non-GPU air shroud or GPU air shroud.
3. Install the drives, optical drives, or drive blanks, if applicable.
4. Install the front bezel, if applicable.
5. Follow the procedure listed in [After working inside your system](#).

# Jumpers and connectors

This topic provides specific information about the jumpers. It also provides some basic information about jumpers and switches and describes the connectors on the various boards in the system. Jumpers on the system board help to disable the system and setup passwords. You must know the connectors on the system board to install components and cables correctly.

**Topics:**

- [System board connectors](#)
- [System board jumper settings](#)
- [Disable a forgotten password](#)

# System board connectors

The following diagram and table describe the system board connectors and jumpers.

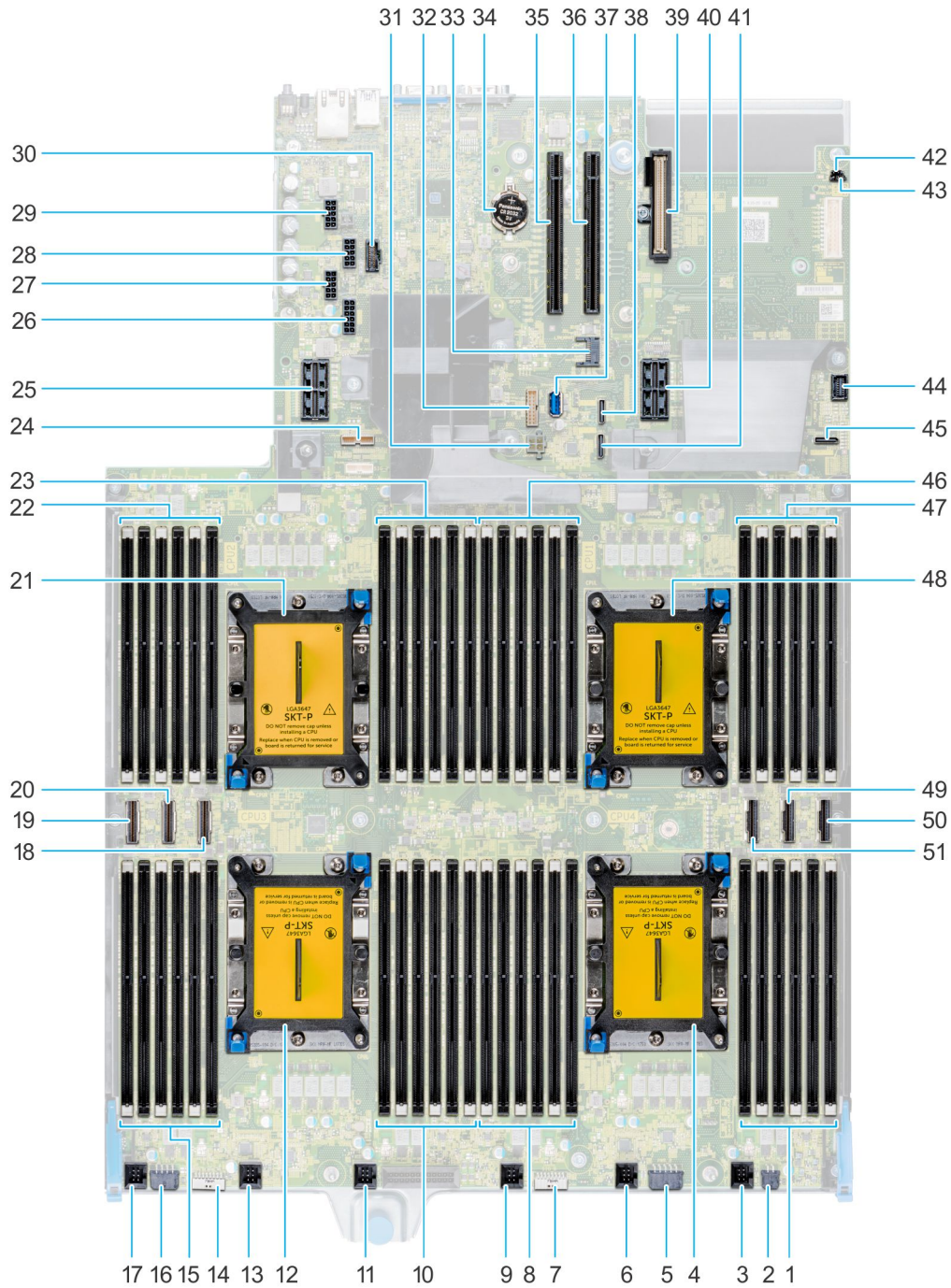

Figure 117. System board connectors

Table 22. System board jumpers and connectors

| Item | Connector              | Description                   |
|------|------------------------|-------------------------------|
| 1    | D7, D1, D8, D2, D9, D3 | Memory module sockets         |
| 2    | J_ODD                  | Optical drive power connector |
| 3    | J_FAN_6                | Cooling fan 6 connector       |

| Item | Connector                 | Description  |
|------|---------------------------|--|
| 4    | CPU4                      | CPU4 processor and heat sink module socket—with dust cover |
| 5    | J_BP_PWR0                 | Backplane power connector                                  |
| 6    | J_FAN_5                   | Cooling fan 5 connector                                    |
| 7    | J_BP_SIG_B                | Backplane B signal connector (rear)                        |
| 8    | D6, D12, D5, D11, D4, D10 | Memory module sockets                                      |
| 9    | J_FAN_4                   | Cooling fan 4 connector                                    |
| 10   | C7, C1, C8, C2, C9, C3    | Memory module sockets                                      |
| 11   | J_FAN_3                   | Cooling fan 3 connector                                    |
| 12   | CPU3                      | CPU3 processor and heat sink module socket—with dust cover |
| 13   | J_FAN_2                   | Cooling fan 2 connector                                    |
| 14   | J_BP_SIG_A                | Backplane A signal connector (front)                       |
| 15   | C6, C12, C5, C11, C4, C10 | Memory module sockets                                      |
| 16   | J_BP_PWR1                 | Backplane power connector                                  |
| 17   | J_FAN_1                   | Cooling fan 1 connector                                    |
| 18   | PCIe_M3                   | PCIe Signal M3 connector                                   |
| 19   | PCIe_M1                   | PCIe Signal M1 connector                                   |
| 20   | PCIe_M2                   | PCIe Signal M2 connector                                   |
| 21   | CPU2                      | CPU2 processor and heat sink module socket—with dust cover |
| 22   | B3, B9, B2, B8, B1, B7    | Memory module sockets                                      |
| 23   | B10, B4, B11, B5, B12, B6 | Memory module sockets                                      |
| 24   | J_PIB_SIG1                | Power Interposer Board signal connector                    |
| 25   | J_RISER2                  | PCIe riser 2 connector                                     |
| 26   | J_PIB_PWR 4               | PIB power connector 4                                      |
| 27   | J_PIB_PWR 3               | PIB power connector 3                                      |
| 28   | J_PIB_PWR 2               | PIB power connector 2                                      |
| 29   | J_PIB_PWR 1               | PIB power connector 1                                      |
| 30   | U_USB_RECONN              | USB Client power management                                |
| 31   | J_BATT_PWR                | NVDIMM-N battery power connector                           |
| 32   | J_BATT_SIG                | NVDIMM-N battery signal connector                          |
| 33   | J_TPM_MODULE              | TPM connector  |
| 34   | CMOS Battery              | CMOS Battery connector                                     |
| 35   | J_SLOT4                   | PCIe x16 connector   |
| 36   | J_SLOT3                   | PCIe x16 connector   |
| 37   | J_USB_INT                 | Internal USB connector                                     |
| 38   | J_SATA_1                  | NPIO connector1 for x8 backplane                           |
| 39   | J_NDC                     | NDC connector  |
| 40   | J_RISER1                  | PCIe riser 1 connector                                     |
| 41   | J_SATA_2                  | NPIO connector 2 for x8 backplane                          |





| Item | Connector                 | Description  |
|------|---------------------------|--|
| 42   | J_PSWD                    | Reset BIOS password  |
| 43   | NVRAM_CLR                 | Clear NVRAM  |
| 44   | J_FRONT_VIDEO             | Video connector  |
| 45   | J_SATA_3                  | SATA C connector—Optical drive SATA connector              |
| 46   | A3, A9, A2, A8, A1, A7    | Memory module sockets                                      |
| 47   | A10, A4, A11, A5, A12, A6 | Memory module sockets                                      |
| 48   | CPU1                      | CPU1 processor and heat sink module socket—with dust cover |
| 49   | PCIe_M5                   | PCIe Signal M5 connector                                   |
| 50   | PCIe_M6                   | PCIe Signal M6 connector                                   |
| 51   | PCIe_M4                   | PCIe Signal M4 connector                                   |

**CAUTION:** When replacing the system board, disconnect the cables from the system board, but do not disconnect the cables attached to the PIB.

## System board jumper settings

For information on resetting the password jumper to disable a password, see the Disabling a forgotten password section.

**Table 23. System board jumper settings**

| Jumper    | Setting   | Description  |
|-----------|---|--|
| PWRD_EN   |  (default) | The BIOS password feature is enabled.  |
|           |            | The BIOS password feature is disabled. iDRAC local access is unlocked at next AC power cycle. iDRAC password reset is enabled in F2 iDRAC settings menu. |
| NVRAM_CLR |  (default) | The BIOS configuration settings are retained at system boot.   |
|           |            | The BIOS configuration settings are cleared at system boot.  |

**CAUTION:** Be careful when altering BIOS settings. The BIOS interface is designed for advanced users, you can change a setting that could prevent your computer from starting correctly and you could suffer a potential loss of data.

1. Turn off the system, including any attached peripherals, and disconnect the system from the electrical outlet.
2. Remove the system cover.
3. Move the jumper on the system board jumper from pins 3 and 5 to pins 1 and 3 and wait approximately 10 seconds.
4. Replace the jumper plug on pins 3 and 5.
5. Install the system cover. Reconnect the system to its electrical outlet and turn on the system, including any attached peripherals.

## Disable a forgotten password

The software security features of the system include a system password and a setup password. The password jumper enables or disables password features and clears any password(s) currently in use.

### Prerequisites

**CAUTION:** Many repairs may only be done by a certified service technician. You should only perform troubleshooting and simple repairs as authorized in your product documentation, or as directed by the online or telephone service and support team. Damage due to servicing that is not authorized by Dell is not covered by your warranty. Read and follow the safety instructions that are shipped with your product.

## Steps

1. Turn off the system, including any attached peripherals, and disconnect the system from the electrical outlet.
2. Remove the system cover.
3. Move the jumper on the system board jumper from pins 2 and 4 to pins 4 and 6.
4. Install the system cover.

The existing passwords are not disabled (erased) until the system boots with the jumper on pins 4 and 6. However, before you assign a new system and/or setup password, you must move the jumper back to pins 2 and 4.

**i** **NOTE: If you assign a new system and/or setup password with the jumper on pins 4 and 6, the system disables the new password(s) the next time it boots.**

5. Reconnect the system to its electrical outlet and turn on the system, including any attached peripherals.
6. Turn off the system, including any attached peripherals, and disconnect the system from the electrical outlet.
7. Remove the system cover.
8. Move the jumper on the system board jumper from pins 4 and 6 to pins 2 and 4.
9. Install the system cover.
10. Reconnect the system to its electrical outlet and turn on the system, including any attached peripherals.
11. Assign a new system and/or setup password.

# Technical specifications

The technical and environmental specifications of your system are outlined in this section.

## Topics:

- Chassis dimensions
- Chassis weight
- Processor specifications
- Supported operating systems
- PSU specifications
- System battery specifications
- Expansion card riser specifications
- Memory specifications
- RAID controller specifications
- Drive specifications
- Ports and connectors specifications
- Video specifications
- Environmental specifications

## Chassis dimensions

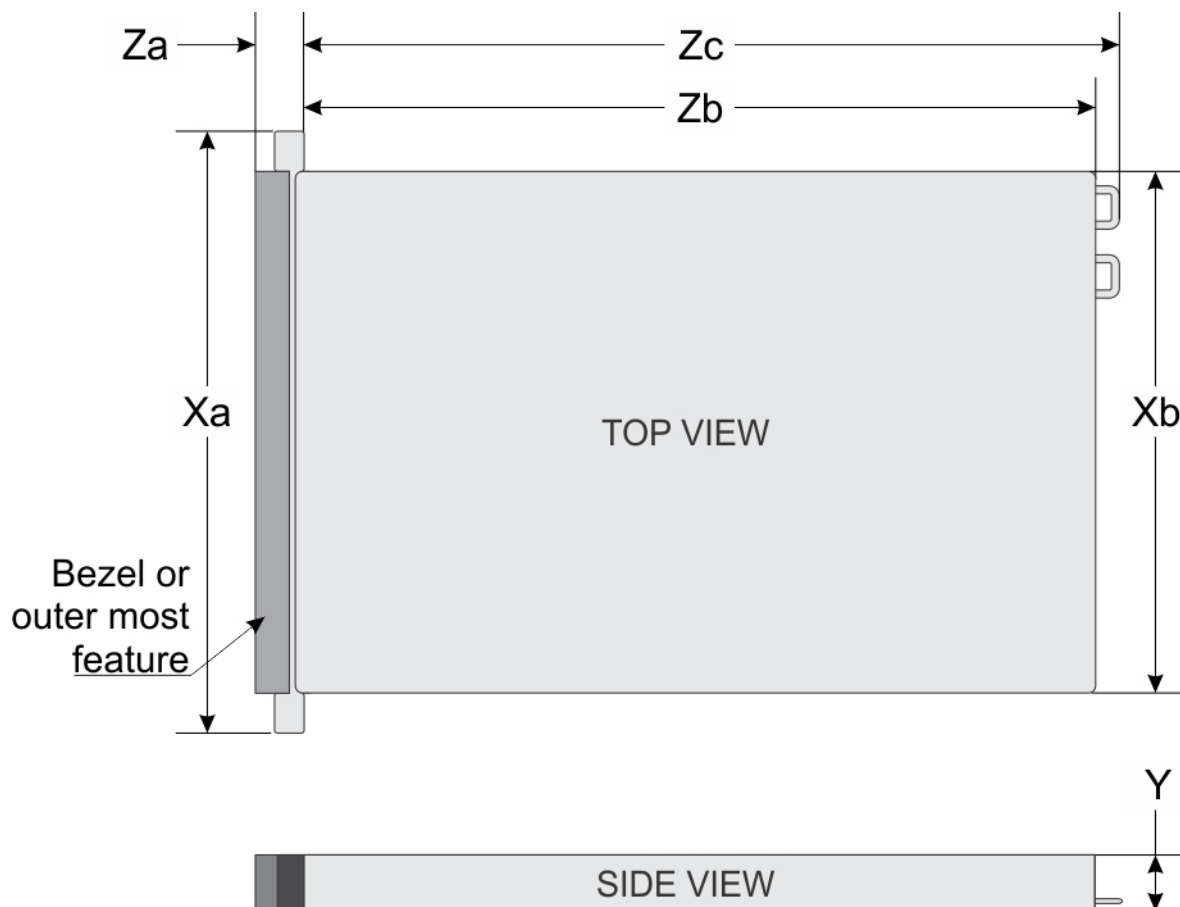

Figure 118. Dimensions of PowerEdge R840 system

**Table 24. Dimensions of PowerEdge R840 system**

| Xa                       | Xb (without brackets)    | Xb (w brackets)      | Y                        | Za (with bezel)           | Za (without bezel)       | Zb*                      | Zc (with PSU handle)     | Zc (with chassis rear wall handle) |
|--------------------------|--------------------------|----------------------|--------------------------|---------------------------|--------------------------|--------------------------|--------------------------|------------------------------------|
| 482 mm<br>(18.97 inches) | 434 mm<br>(17.08 inches) | 444.0 (17.48 inches) | 86.8 mm<br>(3.41 inches) | 37.84 mm<br>(1.41 inches) | 23.9 mm<br>(0.94 inches) | 812 mm<br>(31.96 inches) | 842 mm<br>(33.14 inches) | 902 mm<br>(35.51 inches)           |

\* - Zb refers to the nominal rear wall external surface, where the system board I/O connectors are located.

## Chassis weight

**Table 25. Chassis weight**

| System   | Maximum weight (with all drives/SSDs) |
|----------|---------------------------------------|
| 2.5 inch | 36.6 kg (80.68 lb)                    |

## Processor specifications

The PowerEdge R840 system supports four processors - Intel Xeon Scalable Processor family.

## Supported operating systems

The PowerEdge R840 supports the following operating systems:

- Canonical Ubuntu LTS
- Citrix XenServer
- Microsoft Windows Server with Hyper-V
- Red Hat Enterprise Linux
- SUSE Linux Enterprise Server
- VMware ESXi

For more information on the specific versions and additions, see <https://www.dell.com/support/home/Drivers/SupportedOS/poweredge-r840>.

## PSU specifications

The PowerEdge R840 system supports up to two AC or DC power supply units (PSUs).

**Table 26. PSU specifications**

| PSU                                    | Class    | Heat dissipation (maximum) | Frequency | Voltage                   | High line 200V–240 V | Low line 100 V– 140 V | DC    | Current  |
|--|----------|----------------------------|-----------|---------------------------|----------------------|-----------------------|-------|----------|
| 750 W AC                               | Platinum | 2891 BTU/hr                | 50/60 Hz  | 100–240 V AC, autoranging | 750 W                | 750 W                 | NA    | 10 A-5 A |
| 750 W AC                               | Titanium | 2843 BTU/hr                | 50/60 Hz  | 200–240 V AC, autoranging | 750 W                | NA                    | NA    | 5 A      |
| 750 W Mixed Mode HVDC (for China only) | Platinum | 2891 BTU/hr                | 50/60 Hz  | 100–240 V AC, autoranging | 750 W                | 750 W                 | NA    | NA       |
|  | N/A      | 2891 BTU/hr                | N/A       | 240 V DC, autoranging     | NA                   | NA                    | 750 W | 4.5 A    |

| PSU  | Class    | Heat dissipation (maximum) | Frequency | Voltage                    | High line 200V–240 V | Low line 100 V– 140 V | DC     | Current     |
|--|----------|----------------------------|-----------|----------------------------|----------------------|-----------------------|--------|-------------|
| 750 W Mixed Mode AC  | Platinum | 2891 BTU/hr                | 50/60 Hz  | 100–240 V AC               | 750 W                | 750 W                 | N/A    | 10 A-5 A    |
| 750 W Mixed Mode DC (for China only)                             | Platinum | 2891 BTU/hr                | 50/60 Hz  | 240 V DC                   | 750 W                | N/A                   | 750 W  | 5 A         |
| 1100 W AC  | Platinum | 4100 BTU/hr                | 50/60 Hz  | 100–240 V AC, autoranging  | 1100 W               | 1050 W                | NA     | 12 A-6.5 A  |
| 1100 W DC  | N/A      | 4416 BTU/hr                | N/A       | –(48–60) V DC, autoranging | NA                   | NA                    | 1100 W | 32 A        |
| 1100 W<br>10 A-5 A<br>Mixed Mode HVDC (for China and Japan only) | Platinum | 4100 BTU/hr                | 50/60 Hz  | 100–240 V AC, autoranging  | 1100 W               | 1050 W                | NA     | 12 A-6.5 A  |
|  | N/A      | 4100 BTU/hr                | N/A       | 200–380 V DC, autoranging  | NA                   | NA                    | 1100 W | 6.4 A-3.2 A |
| 1600 W AC  | Platinum | 6000 BTU/hr                | 50/60 Hz  | 100–240 V AC, autoranging  | 1600 W               | 800 W                 | NA     | 10 A        |
| 2000 W AC  | Platinum | 7500 BTU/hr                | 50/60 Hz  | 100–240 V AC, autoranging  | 2000 W               | 1000 W                | NA     | 11.5 A      |
| 2400 W AC  | Platinum | 9000 BTU/hr                | 50/60 Hz  | 100–240 V AC, autoranging  | 2400 W               | 1400 W                | NA     | 16 A        |

**NOTE:** Heat dissipation is calculated using the PSU wattage rating.

**NOTE:** This system is also designed to connect to the IT power systems with a phase-to-phase voltage not exceeding 240 V.

**NOTE:** PSUs rated for 1100 W AC or 1100 W Mixed Mode HVDC and higher require high-line voltage (200–240 V AC) to supply their rated capacity.

## System battery specifications

The PowerEdge R840 system supports CR 2032 3.0-V lithium coin cell system battery.

## Expansion card riser specifications

The PowerEdge R840 system supports up to six PCI express (PCIe) generation 3 expansion cards that can be installed on the system board and expansion card risers.

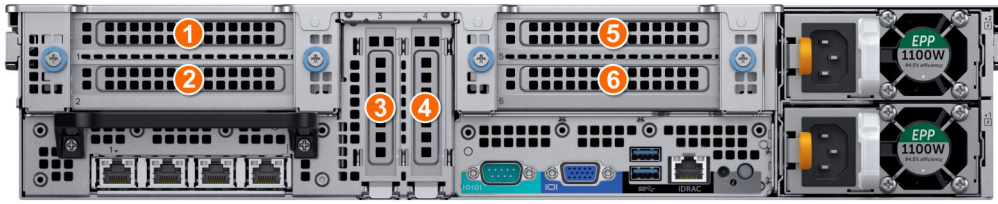

Figure 119. 24 x 2.5-inch drive system



Figure 120. 24 x 2.5-inch + 2 x 2.5-inch (rear) drive system

The following table provides detailed information about the expansion card riser specifications:

Table 27. Expansion card riser specifications

| PCIe slot | Riser               | Processor connection | Height      | Length      | Slot width |
|-----------|---------------------|----------------------|-------------|-------------|------------|
| 1         | X8 PCIe Riser 1     | Processor 1          | Full height | Half length | x8         |
| 2         | X16 PCIe Riser 1    | Processor 1          | Full height | Full length | x16        |
|           | X8 PCIe Riser 1     | Processor 1          | Full height | Half length | x8         |
| 3         | On the system board | Processor 1          | Low profile | Half length | x16        |
| 4         | On the system board | Processor 2          | Low profile | Half length | x16        |
| 5         | X8 PCIe Riser 2     | Processor 2          | Full height | Half length | x8         |
| 6         | X16 PCIe Riser 2    | Processor 2          | Full height | Full length | x16        |
|           | X8 PCIe Riser 2     | Processor 2          | Full height | Half length | x8         |

## Memory specifications

Table 28. Memory specifications

| Memory module sockets | DIMM type | DIMM rank  | DIMM capacity | Dual processors |             | Quad processors |             |
|-----------------------|-----------|------------|---------------|-----------------|-------------|-----------------|-------------|
|                       |           |            |               | Minimum RAM     | Maximum RAM | Minimum RAM     | Maximum RAM |
| 48 288-pins           | LRDIMM    | Octal rank | 128 GB        | 256 GB          | 3072 GB     | 512 GB          | 6144 GB     |

| Memory module sockets | DIMM type | DIMM rank   | DIMM capacity | Dual processors |                  | Quad processors  |                  |
|-----------------------|-----------|-------------|---------------|-----------------|------------------|------------------|------------------|
|                       |           |             |               | Minimum RAM     | Maximum RAM      | Minimum RAM      | Maximum RAM      |
|                       | LRDIMM    | Quad rank   | 64 GB         | 128 GB          | 1536 GB          | 256 GB           | 3072 GB          |
|                       | RDIMM     | Dual rank   | 64 GB         | 128 GB          | 1536 GB          | 256 GB           | 3072 GB          |
|                       | RDIMM     | Dual rank   | 32 GB         | 64 GB           | 768 GB           | 128 GB           | 1536 GB          |
|                       | RDIMM     | Dual rank   | 16 GB         | 32 GB           | 384 GB           | 64 GB            | 768 GB           |
|                       | RDIMM     | Single rank | 8 GB          | 16 GB           | 192 GB           | 32 GB            | 384 GB           |
|                       | NVDIMM-N  | Single rank | 16 GB         | RDIMM: 192 GB   | RDIMM: 384 GB    | RDIMM: 384 GB    | RDIMM: 1152 GB   |
|                       |           |             |               | NVDIMM-N: 16 GB | NVDIMM-N: 192 GB | NVDIMM-N: 16 GB  | NVDIMM-N: 192 GB |
|                       | DCPMM     | N/A         | 128 GB        | RDIMM: 192 GB   | LRDIMM: 1536 GB  | RDIMM: 384 GB    | LRDIMM: 3072 GB  |
|                       |           |             |               | DCPMM: 1536 GB  | DCPMM: 1536 GB   | DCPMM: 248 GB    | DCPMM: 3072 GB   |
|                       |           | N/A         | 256 GB        | RDIMM: 384 GB   | LRDIMM: 1536 GB  | RDIMM: 384 GB    | LRDIMM: 3072 GB  |
|                       |           |             |               | DCPMM: 2048 GB  | DCPMM: 3072 GB   | DCPMM: 4096 GB   | DCPMM: 6144 GB   |
|                       |           | N/A         | 512 GB        | RDIMM: 384 GB   | LRDIMM: 1536 GB  | RDIMM: 768 GB    | LRDIMM: 3072 GB  |
| DCPMM: 4096 GB        |           |             |               | DCPMM: 6144 GB  | DCPMM: 8192 GB   | DCPMM: 12,288 GB |                  |

**NOTE:** Do not mix 8 GB RDIMMs and 16 GB NVDIMM-Ns.

**NOTE:** Do not mix 64 GB LRDIMMs and 128 GB LRDIMMs.

Table 29. DIMM blank population rules

| Processor configuration | Processor 1 | Processor 2 | Processor 3  | Processor 4  |
|-------------------------|-------------|-------------|--------------|--------------|
| Dual processor          | Required    | Required    | Not required | Not required |
| Quad processor          | Required    | Required    | Required     | Required     |

## RAID controller specifications

The PowerEdge R840 system supports:

- Internal storage controller cards: PowerEdge RAID Controller (PERC) H330, PERC H730P, H740P, HBA330, and Boot Optimized Server Storage (BOSS-S1)
- External storage controller cards: S140 and 12 Gbps SAS HBA

## Drive specifications

### Drives

The PowerEdge R840 system supports SAS, SATA, Nearline SAS hard drives/SSDs, or NVMe drives.

**Table 30. Supported drive options for PowerEdge R840 system**

| Chassis options                            | Configurations   |
|--|--|
| Eight hard drive chassis                   | Up to eight 2.5-inch SAS/SATA front accessible drives in slots 0–7<br>Up to eight 2.5-inch SATA front accessible drives in slots 0–7   |
| Twenty-four drive chassis                  | Up to twenty-four 2.5-inch SAS/SATA front accessible drives in slots 0–23<br>Up to twelve 2.5-inch SAS/SATA front accessible drives in slots 0–11 + twelve SAS/SATA/NVMe front accessible drives in slots 12–23<br>Up to twenty-four 2.5-inch NVMe front accessible drives in slots 0–23 |
| Twenty four front + two rear drive chassis | Up to twenty-four 2.5 inch SAS/SATA front accessible drives in slots 0–23 + up to two 2.5-inch SAS/SATA rear accessible drives   |

## Optical drives

The PowerEdge R840 system supports one optional slim SATA DVD-ROM drive or DVD +/-RW drive.

**NOTE: DVD devices support only data.**

## Tape drives

The PowerEdge R840 system supports external tape backup devices.

**NOTE: The PowerEdge R840 system does not support internal tape drives.**

Supported external tape drives:

- External RD1000 USB
- External LTO-5, LTO-6, LTO-7, and 6 Gb SAS tape drives
- 114X rack mount chassis with LTO-5, LTO-6, and LTO-7, 6 Gb SAS tape drives
- TL1000 with LTO-5, LTO-6, and LTO-7 6 Gb SAS tape drives
- TL2000 with LTO-5, LTO-6, and LTO-7 6 Gb SAS tape drives
- TL2000 with LTO-5, LTO-6, and LTO-7 8 Gb FC tape drives
- TL4000 with LTO-5, LTO-6, and LTO-7 6 Gb SAS tape drives
- TL4000 with LTO-5, LTO-6, and LTO-7 8 Gb FC tape drives
- ML6000 with LTO-5, LTO-6, 6 Gb SAS tape drives
- ML6000 with LTO-5, LTO-6, LTO-7 8 Gb FC tape drives

## Ports and connectors specifications

### USB ports

The PowerEdge R840 system supports both USB 2.0-compliant ports and USB 3.0-compliant ports:

The following table provides more information about the USB specifications:

**Table 31. USB specifications**

| Front panel   | Back panel  | Internal USB  |
|---|---|---|
| <ul style="list-style-type: none"> <li>• Two USB 2.0-compliant ports</li> <li>• One micro USB 2.0-compliant port for iDRAC Direct</li> </ul> <p><b>NOTE: The micro USB 2.0 compliant port can only be</b></p> | <ul style="list-style-type: none"> <li>• Two USB 3.0-compliant ports</li> </ul> | <ul style="list-style-type: none"> <li>• One internal USB 3.0-compliant port</li> </ul> |

| Front panel   | Back panel | Internal USB |
|---|------------|--------------|
| <p><b>used as an iDRAC Direct or a management port.</b></p> <ul style="list-style-type: none"> <li>One optional USB 3.0-compliant port</li> </ul> |            |              |

## NIC ports

The PowerEdge R840 system supports up to four Network Interface Controller (NIC) ports that are integrated on the network daughter card (NDC), and are available in the following configurations:

- Four RJ-45 ports that support 10 Mbps, 100 Mbps, and 1000 Mbps
- Four RJ-45 ports that support 100 M, 1 G, and 10 Gbps
- Four RJ-45 ports, where two ports support maximum of 10 G and the other two ports maximum of 1 G
- Two RJ-45 ports that support up to 1 Gbps and 2 SFP+ ports that support up to 10 Gbps
- Four SFP+ ports that support up to 10 Gbps
- Two SFP28 ports that support up to 25 Gbps

## VGA ports

The Video Graphic Array (VGA) port enables you to connect the system to a VGA display.

The PowerEdge R840 system supports two 15-pin VGA ports, one each, on the front and back of the system.

## Serial connector

The serial connector on the rear of system for serial device connection and console redirection.

The PowerEdge R840 system supports one serial connector on the back panel, which is a 9-pin connector, Data Terminal Equipment (DTE), 16550-compliant.

## IDSDM or vFlash module

The PowerEdge R840 system supports optional Internal Dual SD module (IDSDM) or vFlash module. In 14<sup>th</sup> generation of PowerEdge servers, IDSDM or vFlash module is combined into a single card module, and are available in these configurations:

- vFlash or
- vFlash and IDSDM

The IDSDM or vFlash module is located in a slot on the back of the system. The module supports three microSD cards; two cards for IDSDM and one card for vFlash. The following capacities are supported:

- IDSDM: 16 GB, 32 GB, 64 GB
- vFlash: 16 GB

**NOTE:** There are two dip switches on the IDSDM or vFlash module for write-protection.

**NOTE:** One IDSDM card slot is dedicated for redundancy.

**NOTE:** Use Dell branded microSD cards associated with the IDSDM or vFlash configured systems.

## Video specifications

R840 servers support the integrated Matrox G200eW3 graphics controller with 16 MB of video frame buffer.

The following table describes the supported video resolution options.

**Table 32. Supported video resolution options**

| Resolution  | Refresh rate (Hz) | Color depth (bits) |
|-------------|-------------------|--------------------|
| 1024 x 768  | 60                | 8, 16, 32          |
| 1280 x 800  | 60                | 8, 16, 32          |
| 1280 x 1024 | 60                | 8, 16, 32          |
| 1360 x 768  | 60                | 8, 16, 32          |
| 1440 x 900  | 60                | 8, 16, 32          |
| 1600 x 900  | 60                | 8, 16, 32          |
| 1600 x 1200 | 60                | 8, 16, 32          |
| 1680 x 1050 | 60                | 8, 16, 32          |
| 1920 x 1080 | 60                | 8, 16, 32          |
| 1920 x 1200 | 60                | 8, 16, 32          |

**NOTE:** 1920 x 1080 and 1920 x 1200 resolutions are supported only in reduced blanking mode.

## Environmental specifications

**NOTE:** For additional information about environmental certifications, see the *Product Environmental Datasheet* located with the Manuals & Documents at [Dell.com/poweredge/manuals](http://Dell.com/poweredge/manuals).

**Table 33. Temperature specifications**

| Temperature  | Specifications  |
|--|---|
| Storage  | -40–65°C (-40 °F–149°F)                                       |
| Continuous operation (for altitude less than 950 m or 3117 ft) | 10–35°C (50 °F–95°F) with no direct sunlight on the equipment |
| Maximum temperature gradient (operating and storage)           | 20°C/h (36°F/h)   |

**Table 34. Relative humidity specifications**

| Relative humidity | Specifications  |
|-------------------|---|
| Storage           | 5% to 95% RH with 33°C (91°F) maximum dew point. Atmosphere must be noncondensing at all times. |
| Operating         | 10% to 80% RH with 29°C (84.2°F) maximum dew point.   |

**Table 35. Maximum vibration specifications**

| Maximum vibration | Specifications   |
|-------------------|--|
| Operating         | 0.26 G <sub>rms</sub> at 5 Hz to 350 Hz (all operation orientations)           |
| Storage           | 1.88 G <sub>rms</sub> at 10 Hz to 500 Hz for 15 minutes (all six sides tested) |

**Table 36. Maximum shock pulse specifications**

| Maximum shock pulse | Specifications   |
|---------------------|--|
| Operating           | Six consecutively executed shock pulses in the positive and negative x, y, and z axes of 6 G for up to 11 ms.  |
| Storage             | Six consecutively executed shock pulses in the positive and negative x, y, and z axes (one pulse on each side of the system) of 71 G for up to 2 ms. |

**Table 37. Maximum altitude specifications**

| Maximum altitude | Specifications       |
|------------------|----------------------|
| Operating        | 3048 m (10,000 ft)   |
| Storage          | 12,000 m (39,370 ft) |

**Table 38. Operating temperature derating specification**

| Operating temperature derating | Specifications  |
|--------------------------------|---|
| Up to 35°C (95°F)              | Maximum temperature is reduced by 1°C/300 m (1°F/547 ft), above 950 m (3,117 ft). |
| 35–40 °C (95–104 °F)           | Maximum temperature is reduced by 1°C/175 m (1°F/319 ft), above 950 m (3,117 ft). |
| 40–45 °C (104 °F–113 °F)       | Maximum temperature is reduced by 1°C/125 m (1°F/228 ft), above 950 m (3,117 ft). |

## Standard operating temperature

**Table 39. Standard operating temperature specifications**

| Standard operating temperature                                 | Specifications  |
|--|---|
| Continuous operation (for altitude less than 950 m or 3117 ft) | 10 °C–35°C (50 °F–95°F) with no direct sunlight on the equipment. |

## Expanded operating temperature

**Table 40. Expanded operating temperature specifications**

| Expanded operating temperature | Specifications  |
|--------------------------------|---|
| Continuous operation           | <p>5 °C–40°C at 5% to 85% RH with 29°C dew point.</p> <p><b>NOTE: Outside the standard operating temperature (10 °C–35°C), the system can operate continuously in temperatures as low as 5°C and as high as 40°C.</b></p> <p>For temperatures 35 °C – 40°C, derate maximum allowable temperature by 1°C per 175 m (1°F per 319 ft.) above 950 m (3,117 ft.).</p>                |
| ≤ 1% of annual operating hours | <p>–5 °C–45°C at 5% to 90% RH with 29°C dew point.</p> <p><b>NOTE: Outside the standard operating temperature (10 °C–35°C), the system can operate down to –5°C or up to 45°C for a maximum of 1% of its annual operating hours.</b></p> <p>For temperatures 40 °C – 45°C, derate maximum allowable temperature by 1°C per 125 m (1°F per 228 ft.) above 950 m (3,117 ft.).</p> |

**NOTE:** When operating in the expanded temperature range, the performance of the system may be impacted.

**NOTE:** When operating in the expanded temperature range, ambient temperature warnings may be reported on the LCD panel and in the System Event Log.

## Expanded operating temperature restrictions

- The operating temperature is specified for a maximum altitude of 950 m for Fresh Air Cooling.
- Do not perform cold start below 5°C due to hard drive constraints.

- Apache Pass DIMM, NVDIMM, PCIe SSD, and NVMe are not supported.
- Tape Backup Unit (TBU) is not supported in Fresh Air.
- LRDIMM >32 GB is not supported in x4 sockets configuration.
- DCPMMs are not supported.
- Rear installed drives and GPU configuration are not supported.
- Redundant power supplies are required.
- Non Dell qualified peripheral cards and /or peripheral cards greater than 25 W are not supported.
- Intel FPGA is not supported.
- 205 W SKUs, 200W/18C, 165W/12C, and 150W\_8C processor are not supported on all x4 socket processor configurations.
- 165 W SKUs, 130W/8C, 115W/6C, and 105W\_4C are not supported on the x4 socket processor configurations except front x8 inch SAS/SATA drives configurations.

## Ambient temperature limitations

**NOTE:** The ambient temperature limit must be adhered to ensure proper cooling and to avoid excess processor throttling, which may impact system performance.

**Table 41. Configuration-based ambient temperature restrictions with GPGPU**

| TDP(W)                   | R840<br>• 8 x 2.5 inch SAS/SATA<br>• 2 x CPU<br>• 2 x GPGPU |    |    | R840<br>• 8 x 2.5 inch SAS/SATA<br>• 4 x CPU<br>• 2 x GPGPU |    |    | R840<br>• 24 x 2.5 inch SAS/SATA<br>• 2 x CPU<br>• 2 x GPGPU |    |    | R840<br>• 24 x 2.5 inch SAS/SATA<br>• 4 x CPU<br>• 2 x GPGPU |    |    | R840<br>• 24 x 2.5 inch NVme<br>• 4 x CPU<br>• 2 x GPGPU |    |    |
|--------------------------|---|----|----|---|----|----|--|----|----|--|----|----|--|----|----|
|                          | C40E 45   | 35 | 30 | C40E 45   | 35 | 30 | C40E 45  | 35 | 30 | C40E 45  | 35 | 30 | C40E 45  | 35 | 30 |
| 205                      | N   | N  | N  | N   | N  | N  | N  | N  | N  | N  | N  | N  | N  | N  | N  |
| 200                      | N   | N  | N  | N   | N  | N  | N  | N  | N  | N  | N  | N  | N  | N  | N  |
| 165 (Gold 6146)          | N   | N  | N  | N   | N  | N  | N  | N  | N  | N  | N  | N  | N  | N  | N  |
| 150 (Gold 6144 and 6244) | N   | N  | N  | N   | N  | N  | N  | N  | N  | N  | N  | N  | N  | N  | N  |
| 150 (Gold 6240Y)         | N   | N  | N  | N   | N  | N  | N  | N  | N  | N  | N  | Y  | N  | N  | Y  |
| 165                      | N   | Y  | Y  | N   | Y  | Y  | N  | Y  | Y  | N  | N  | Y  | N  | N  | Y  |
| 150                      | N   | Y  | Y  | N   | Y  | Y  | N  | Y  | Y  | N  | N  | Y  | N  | N  | Y  |
| 140                      | N   | Y  | Y  | N   | Y  | Y  | N  | Y  | Y  | N  | N  | Y  | N  | N  | Y  |
| 130 ( Gold 6134)         | N   | Y  | Y  | N   | Y  | Y  | N  | Y  | Y  | N  | N  | Y  | N  | N  | Y  |
| 125                      | N   | Y  | Y  | N   | Y  | Y  | N  | Y  | Y  | N  | N  | Y  | N  | N  | Y  |
| 115 ( Gold 6128)         | N   | Y  | Y  | N   | Y  | Y  | N  | Y  | Y  | N  | N  | Y  | N  | N  | Y  |
| 115                      | N   | Y  | Y  | N   | Y  | Y  | N  | Y  | Y  | N  | N  | Y  | N  | N  | Y  |
| 105(Gold 5122 and 8156)  | N   | Y  | Y  | N   | Y  | Y  | N  | Y  | Y  | N  | N  | Y  | N  | N  | Y  |
| 105(Gold 5222 and 8256)  | N   | Y  | Y  | N   | Y  | Y  | N  | Y  | Y  | N  | N  | Y  | N  | N  | Y  |
| 105                      | N   | Y  | Y  | N   | Y  | Y  | N  | Y  | Y  | N  | N  | Y  | N  | N  | Y  |
| 100                      | N   | Y  | Y  | N   | Y  | Y  | N  | Y  | Y  | N  | N  | Y  | N  | N  | Y  |
| 85                       | N   | Y  | Y  | N   | Y  | Y  | N  | Y  | Y  | N  | N  | Y  | N  | N  | Y  |
| 70                       | N   | Y  | Y  | N   | Y  | Y  | N  | Y  | Y  | N  | N  | N  | N  | N  | N  |

N= Not Supported

Y= Supported

**Table 42. Configuration-based ambient temperature restrictions with PCIe**

| TDP(W)                   | R840<br>• 8 x 2.5 inch SAS/SATA<br>• 2 x CPU<br>• 6 x PCIe |    |    | R840<br>• 8 x 2.5 inch SAS/SATA<br>• 4 x CPU<br>• 6 x PCIe |    |    | R840<br>• 24 x 2.5 inch SAS/SATA<br>• 2 x CPU<br>• 6 x PCIe |    |    | R840<br>• 24 x 2.5 inch SAS/SATA<br>• 4 x CPU<br>• 6 x PCIe |    |    | R840<br>• 24 x 2.5 inch NVMe<br>• 4 x CPU<br>• 6 x PCIe |    |    |
|--------------------------|--|----|----|--|----|----|---|----|----|---|----|----|---|----|----|
|                          | C40E 45  | 35 | 30 | C40E 45  | 35 | 30 | C40E 45   | 35 | 30 | C40E 45   | 35 | 30 | C40E 45   | 35 | 30 |
| 205                      | Y  | Y  | Y  | N  | Y  | Y  | Y   | Y  | Y  | N   | N  | Y  | N   | N  | Y  |
| 200                      | Y  | Y  | Y  | N  | Y  | Y  | Y   | Y  | Y  | N   | N  | Y  | N   | N  | Y  |
| 165 (Gold 6146)          | Y  | Y  | Y  | N  | Y  | Y  | Y   | Y  | Y  | N   | N  | Y  | N   | N  | Y  |
| 150 (Gold 6144 and 6244) | Y  | Y  | Y  | N  | Y  | Y  | Y   | Y  | Y  | N   | N  | Y  | N   | N  | Y  |
| 150 (Gold 6240Y)         | Y  | Y  | Y  | N  | Y  | Y  | Y   | Y  | Y  | N   | Y  | Y  | N   | N  | Y  |
| 165                      | Y  | Y  | Y  | Y  | Y  | Y  | Y   | Y  | Y  | N   | Y  | Y  | N   | N  | Y  |
| 150                      | Y  | Y  | Y  | Y  | Y  | Y  | Y   | Y  | Y  | Y   | Y  | Y  | N   | Y  | Y  |
| 140                      | Y  | Y  | Y  | Y  | Y  | Y  | Y   | Y  | Y  | Y   | Y  | Y  | N   | Y  | Y  |
| 130 ( Gold 6134)         | Y  | Y  | Y  | Y  | Y  | Y  | Y   | Y  | Y  | N   | Y  | Y  | N   | N  | Y  |
| 125                      | Y  | Y  | Y  | Y  | Y  | Y  | Y   | Y  | Y  | Y   | Y  | Y  | N   | Y  | Y  |
| 115 ( Gold 6128)         | Y  | Y  | Y  | Y  | Y  | Y  | Y   | Y  | Y  | N   | Y  | Y  | N   | N  | Y  |
| 115                      | Y  | Y  | Y  | Y  | Y  | Y  | Y   | Y  | Y  | Y   | Y  | Y  | N   | Y  | Y  |
| 105(Gold 5122 and 8156)  | Y  | Y  | Y  | Y  | Y  | Y  | Y   | Y  | Y  | N   | Y  | Y  | N   | N  | Y  |
| 105(Gold 5222 and 8256)  | Y  | Y  | Y  | Y  | Y  | Y  | Y   | Y  | Y  | N   | Y  | Y  | N   | N  | Y  |
| 105                      | Y  | Y  | Y  | Y  | Y  | Y  | Y   | Y  | Y  | Y   | Y  | Y  | N   | Y  | Y  |
| 100                      | Y  | Y  | Y  | Y  | Y  | Y  | Y   | Y  | Y  | Y   | Y  | Y  | N   | Y  | Y  |
| 85                       | Y  | Y  | Y  | Y  | Y  | Y  | Y   | Y  | Y  | Y   | Y  | Y  | N   | Y  | Y  |
| 70                       | Y  | Y  | Y  | Y  | Y  | Y  | Y   | Y  | Y  | Y   | Y  | Y  | N   | Y  | Y  |

N=Not Supported

Y=Supported

**NOTE: C40E45 = Continuous operating temperature at 40°C, and Excursion temperature at 45°C.**

## Particulate and gaseous contamination specifications

The following table defines the limitations that help avoid any damages to the IT equipment and/or, or both failure from particulates and gaseous contamination. If the levels of particulates or gaseous pollution exceed the specified limitations and result in equipment damage or failure, you must rectify the environmental conditions. Remediation of environmental conditions is the responsibility of the customer.

**Table 43. Particulate contamination specifications**

| Particulate contamination | Specifications  |
|---------------------------|---|
| Air Filtration            | <p>Data center air filtration as defined by ISO Class 8 per ISO 14644-1 with a 95% upper confidence limit.</p> <p><b>NOTE:</b> This condition applies to data center environments only. Air filtration requirements do not apply to IT equipment designed to be used outside a data center, in environments such as an office or factory floor.</p> <p><b>NOTE:</b> Air entering the data center must have MERV11 or MERV13 filtration.</p> |
| Conductive dust           | <p>Air must be free of conductive dust, zinc whiskers, or other conductive particles.</p> <p><b>NOTE:</b> This condition applies to data center and non-data center environments.</p>   |
| Corrosive dust            | <ul style="list-style-type: none"> <li>Air must be free of corrosive dust.</li> <li>Residual dust present in the air must have a deliquescent point less than 60% relative humidity.</li> </ul> <p><b>NOTE:</b> This condition applies to data center and non-data center environments.</p>   |

**Table 44. Gaseous contamination specifications**

| Gaseous contamination   | Specifications  |
|-------------------------|---|
| Copper Coupon Corrosion | <300 Å/month per Class G1 as defined by ANSI/ISA71.04-1985. |
| Silver Coupon Corrosion | <200 Å/month as defined by AHSRAE TC9.9.                    |

**NOTE:** Maximum corrosive contaminant levels measured at ≤50% relative humidity.

# System diagnostics and indicator codes

The diagnostic indicators on the system front panel display system status during system startup.







## Topics:

- [Status LED indicators](#)
- [System health and system ID indicator codes](#)
- [iDRAC Quick Sync 2 indicator codes](#)
- [iDRAC Direct LED indicator codes](#)
- [NIC indicator codes](#)
- [Power supply unit indicator codes](#)
- [Drive indicator codes](#)
- [System diagnostics](#)

## Status LED indicators

 **NOTE:** The indicators display solid amber if any error occurs.

**Table 45. Status LED indicators and descriptions**

| Icon  | Description           | Condition  | Corrective action  |
|---|-----------------------|--|--|
|  | Drive indicator       | The indicator turns solid amber if there is a drive error.   | <ul style="list-style-type: none"> <li>• Check the System Event Log to determine if the drive has an error.</li> <li>• Run the appropriate Online Diagnostics test. Restart the system and run embedded diagnostics (ePSA).</li> <li>• If the drives are configured in a RAID array, restart the system, and enter the host adapter configuration utility program.</li> </ul>                                      |
|  | Temperature indicator | The indicator turns solid amber if the system experiences a thermal error (for example, the ambient temperature is out of range or there is a fan failure).                  | <p>Ensure that none of the following conditions exist:</p> <ul style="list-style-type: none"> <li>• A cooling fan has been removed or has failed.</li> <li>• System cover, air shroud, memory module blank, or back filler bracket is removed.</li> <li>• Ambient temperature is too high.</li> <li>• External airflow is obstructed.</li> </ul> <p>If the problem persists, see <a href="#">Getting help</a>.</p> |
|  | Electrical indicator  | The indicator turns solid amber if the system experiences an electrical error (for example, voltage out of range, or a failed power supply unit (PSU) or voltage regulator). | <p>Check the System Event Log or system messages for the specific issue. If it is due to a problem with the PSU, check the LED on the PSU. Reseat the PSU.</p> <p>If the problem persists, see <a href="#">Getting help</a>.</p>   |
|  | Memory indicator      | The indicator turns solid amber if a memory error occurs.  | <p>Check the System Event Log or system messages for the location of the failed memory. Reseat the memory module.</p> <p>If the problem persists, see <a href="#">Getting help</a>.</p>  |
|  | PCIe indicator        | The indicator turns solid amber if a PCIe card experiences an error.   | <p>Restart the system. Update any required drivers for the PCIe card. Reinstall the card.</p> <p>If the problem persists, see <a href="#">Getting help</a>.</p> <p> <b>NOTE:</b> For more information about the supported PCIe cards, see <a href="#">Expansion card installation guidelines</a>.</p>                           |

# System health and system ID indicator codes

The system health and system ID indicator is located on the left control panel of your system.



Figure 121. System health and system ID indicators

Table 46. System health and system ID indicator codes

| System health and system ID indicator code | Condition   |
|--|---|
| Solid blue                                 | Indicates that the system is turned on, system is healthy, and system ID mode is not active. Press the system health and system ID button to switch to system ID mode.  |
| Blinking blue                              | Indicates that the system ID mode is active. Press the system health and system ID button to switch to system health mode.  |
| Solid amber                                | Indicates that the system is in fail-safe mode. If the problem persists, see the Getting help section.  |
| Blinking amber                             | Indicates that the system is experiencing a fault. Check the System Event Log or the LCD panel, if available on the bezel, for specific error messages. For more information about error messages, see the <i>Dell Event and Error Messages Reference Guide</i> at <a href="http://www.dell.com/openmanagemanuals">www.dell.com/openmanagemanuals</a> . |

# iDRAC Quick Sync 2 indicator codes

iDRAC Quick Sync 2 module (optional) is located on the left control panel of your system.



Figure 122. iDRAC Quick Sync 2 indicators

Table 47. iDRAC Quick Sync 2 indicators and descriptions

| iDRAC Quick Sync 2 indicator code                  | Condition   | Corrective action  |
|--|---|--|
| Off (default state)                                | Indicates that the iDRAC Quick Sync 2 feature is turned off. Press the iDRAC Quick Sync 2 button to turn on the iDRAC Quick Sync 2 feature. | If the LED fails to turn on, reseal the left control panel flex cable and check. If the problem persists, see the <a href="#">Getting help</a> section.  |
| Solid white  | Indicates that iDRAC Quick Sync 2 is ready to communicate. Press the iDRAC Quick Sync 2 button to turn off.                                 | If the LED fails to turn off, restart the system. If the problem persists, see the <a href="#">Getting help</a> section.   |
| Blinks white rapidly                               | Indicates data transfer activity.   | If the indicator continues to blink indefinitely, see the <a href="#">Getting help</a> section.  |
| Blinks white slowly                                | Indicates that firmware update is in progress.  | If the indicator continues to blink indefinitely, see the <a href="#">Getting help</a> section.  |
| Blinks white five times rapidly and then turns off | Indicates that the iDRAC Quick Sync 2 feature is disabled.  | Check if iDRAC Quick Sync 2 feature is configured to be disabled by iDRAC. If the problem persists, see the <a href="#">Getting help</a> section. For more information, see <i>Integrated Dell Remote Access Controller User's</i> |

| iDRAC Quick Sync 2 indicator code | Condition  | Corrective action  |
|-----------------------------------|--|--|
| Solid amber                       | Indicates that the system is in fail-safe mode.                            | Restart the system. If the problem persists, see the <a href="#">Getting help</a> section. |
| Blinking amber                    | Indicates that the iDRAC Quick Sync 2 hardware is not responding properly. | Restart the system. If the problem persists, see the <a href="#">Getting help</a> section. |

Guide at [www.dell.com/idracmanuals](http://www.dell.com/idracmanuals) or *Dell OpenManage Server Administrator User's Guide* at [www.dell.com/openmanagemanuals](http://www.dell.com/openmanagemanuals).

## iDRAC Direct LED indicator codes

The iDRAC Direct LED indicator lights up to indicate that the port is connected and is being used as a part of the iDRAC subsystem.

You can configure iDRAC Direct by using a USB to micro USB (type AB) cable, which you can connect to your laptop or tablet. The following table describes iDRAC Direct activity when the iDRAC Direct port is active:

**Table 48. iDRAC Direct LED indicator codes**

| iDRAC Direct LED indicator code                             | Condition  |
|---|--|
| Solid green for two seconds                                 | Indicates that the laptop or tablet is connected.            |
| Flashing green (on for two seconds and off for two seconds) | Indicates that the laptop or tablet connected is recognized. |
| Turns off   | Indicates that the laptop or tablet is unplugged.            |

## NIC indicator codes

Each NIC on the back of the system has indicators that provide information about the activity and link status. The activity LED indicator indicates if data is flowing through the NIC, and the link LED indicator indicates the speed of the connected network.

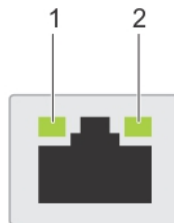

**Figure 123. NIC indicator codes**

1. Link LED indicator
2. Activity LED indicator

**Table 49. NIC indicator codes**

| Status   | Condition  |
|--|--|
| Link and activity indicators are off.                              | The NIC is not connected to the network.   |
| Link indicator is green, and activity indicator is blinking green. | The NIC is connected to a valid network at its maximum port speed, and data is being sent or received.               |
| Link indicator is amber, and activity indicator is blinking green. | The NIC is connected to a valid network at less than its maximum port speed, and data is being sent or received.     |
| Link indicator is green, and activity indicator is off.            | The NIC is connected to a valid network at its maximum port speed, and data is not being sent or received.           |
| Link indicator is amber, and activity indicator is off.            | The NIC is connected to a valid network at less than its maximum port speed, and data is not being sent or received. |

| Status   | Condition  |
|--|--|
| Link indicator is blinking green, and activity is off. | NIC identify is enabled through the NIC configuration utility. |

## Power supply unit indicator codes

AC power supply units (PSUs) have an illuminated translucent handle that serves as an indicator. The DC PSUs have an LED that serves as an indicator.

For more information about the PSU specifications, see [Technical Specifications](#).

For information about the event and error messages generated during POST, when a 2400W PSU is connected to a 110 V power source, see the Dell Event and Error Messages Reference Guide at [www.dell.com/openmanagemanuals](http://www.dell.com/openmanagemanuals).

The indicator shows whether power is present or if a power fault has occurred.

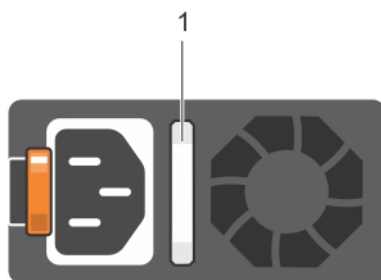

**Figure 124. AC PSU status indicator**

1. AC PSU status indicator/handle

**Table 50. AC PSU status indicator codes**

| Power indicator codes        | Condition   |
|------------------------------|---|
| Green                        | A valid power source is connected to the PSU, and the PSU is operational.   |
| Blinking amber               | Indicates a problem with the PSU.   |
| Not illuminated              | Power is not connected to the PSU.  |
| Blinking green               | When the firmware of the PSU is being updated, the PSU handle blinks green.<br><b>⚠ CAUTION: Do not disconnect the power cable, or unplug the PSU when updating firmware. If firmware update is interrupted, the PSUs do not function.</b>  |
| Blinking green and turns off | When hot-plugging a PSU, the PSU handle blinks green five times at a rate of 4 Hz and turns off. This indicates a PSU mismatch concerning efficiency, feature set, health status, or supported voltage.<br><b>⚠ CAUTION: If two PSUs are installed, both the PSUs must have the same type of label; for example, Extended Power Performance (EPP) label. Mixing PSUs from previous generations of PowerEdge servers is not supported, even if the PSUs have the same power rating. This results in a PSU mismatch condition, or failure to turn on the system.</b><br><b>⚠ CAUTION: When correcting a PSU mismatch, replace only the PSU with the blinking indicator. Swapping the PSU to make a matched pair can result in an error condition and unexpected system shutdown. To change from a high output configuration to a low output</b> |

| Power indicator codes | Condition   |
|-----------------------|---|
|                       | <p>configuration or conversely, you must turn off the system.</p> <p>⚠ <b>CAUTION:</b> AC PSUs support both 240 V and 120 V input voltages except for Titanium PSUs, which support only 240 V. When two identical PSUs receive different input voltages, they can output different wattages, and trigger a mismatch.</p> <p>⚠ <b>CAUTION:</b> If two PSUs are used, they must be of the same type and have the same maximum output power.</p> <p>⚠ <b>CAUTION:</b> Combining AC and DC PSUs is not supported and triggers a mismatch.</p> |

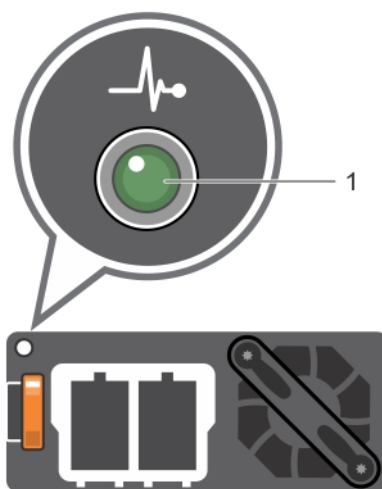

Figure 125. DC PSU status indicator

1. DC PSU status indicator

Table 51. DC PSU status indicator codes

| Power indicator codes | Condition  |
|-----------------------|--|
| Green                 | A valid power source is connected to the PSU, and the PSU is operational.  |
| Blinking amber        | Indicates a problem with the PSU.  |
| Not illuminated       | Power is not connected to the PSU.   |
| Blinking green        | <p>When hot-plugging a PSU, the PSU indicator blinks green. This indicates that there is a PSU mismatch about efficiency, feature set, health status, or supported voltage.</p> <p>⚠ <b>CAUTION:</b> If two PSUs are installed, both the PSUs must have the same type of label; for example, Extended Power Performance (EPP) label. Mixing PSUs from previous generations of PowerEdge servers is not supported, even if the PSUs have the same power rating. This results in a PSU mismatch condition, or failure to turn on the system.</p> <p>⚠ <b>CAUTION:</b> When correcting a PSU mismatch, replace only the PSU with the blinking indicator. Swapping the PSU to make a matched pair can result in an error condition and unexpected system shutdown. To change</p> |

| Power indicator codes | Condition   |
|-----------------------|---|
|                       | <p>from a High Output configuration to a Low Output configuration or conversely, you must turn off the system.</p> <p>⚠ <b>CAUTION:</b> If two PSUs are used, they must be of the same type and have the same maximum output power.</p> <p>⚠ <b>CAUTION:</b> Combining AC and DC PSUs is not supported and triggers a mismatch.</p> |

## Drive indicator codes

The LEDs on the drive carrier indicates the state of each drive. Each drive carrier in your system has two LEDs: an activity LED (green) and a status LED (bicolor, green/amber). The activity LED flashes whenever the drive is accessed.



**Figure 126. Drive indicators on the drive and the mid drive tray backplane**

1. Drive activity LED indicator
2. Drive status LED indicator
3. Drive capacity label

**NOTE:** If the drive is in the Advanced Host Controller Interface (AHCI) mode, the status LED indicator does not turn on.

**Table 52. Drive indicator codes**

| Drive status indicator code  | Condition  |
|--|--|
| Flashes green twice per second   | Identifying drive or preparing for removal.  |
| Off  | Drive ready for removal.<br><b>NOTE:</b> The drive status indicator remains off until all drives are initialized after the system is turned on. Drives are not ready for removal during this time. |
| Flashes green, amber, and then turns off   | Predicted drive failure.   |
| Flashes amber four times per second  | Drive failed.  |
| Flashes green slowly   | Drive rebuilding.  |
| Solid green  | Drive online.  |
| Flashes green for three seconds, amber for three seconds, and then turns off after six seconds | Rebuild stopped.   |

# System diagnostics

If you experience a problem with your system, run the system diagnostics before contacting Dell for technical assistance. The purpose of running system diagnostics is to test your system hardware without using additional equipment or risking data loss. If you are unable to fix the problem yourself, service and support personnel can use the diagnostics results to help you solve the problem.

## Dell Embedded System Diagnostics

 **NOTE:** The Dell Embedded System Diagnostics is also known as Enhanced Pre-boot System Assessment (ePSA) diagnostics.

The Embedded System Diagnostics provides a set of options for particular device groups or devices allowing you to:

- Run tests automatically or in an interactive mode
- Repeat tests
- Display or save test results
- Run thorough tests to introduce additional test options to provide extra information about the failed device(s)
- View status messages that inform you if tests are completed successfully
- View error messages that inform you of problems encountered during testing

## Running the Embedded System Diagnostics from Boot Manager

Run the Embedded System Diagnostics (ePSA) if your system does not boot.

### Steps

1. When the system is booting, press F11.
2. Use the up arrow and down arrow keys to select **System Utilities > Launch Diagnostics**.
3. Alternatively, when the system is booting, press F10, select **Hardware Diagnostics > Run Hardware Diagnostics**.  
The **ePSA Pre-boot System Assessment** window is displayed, listing all devices detected in the system. The diagnostics starts executing the tests on all the detected devices.

### Results

## Running the Embedded System Diagnostics from the Dell Lifecycle Controller

### Steps

1. As the system boots, press F10.
2. Select **Hardware Diagnostics → Run Hardware Diagnostics**.  
The **ePSA Pre-boot System Assessment** window is displayed, listing all devices detected in the system. The diagnostics starts executing the tests on all the detected devices.

## System diagnostic controls

| Menu                 | Description   |
|----------------------|---|
| <b>Configuration</b> | Displays the configuration and status information of all detected devices.  |
| <b>Results</b>       | Displays the results of all tests that are run.   |
| <b>System health</b> | Provides the current overview of the system performance.  |
| <b>Event log</b>     | Displays a time-stamped log of the results of all tests run on the system. This is displayed if at least one event description is recorded. |

# Getting help

## Topics:

- [Contacting Dell](#)
- [Documentation feedback](#)
- [Accessing system information by using QRL](#)
- [Receiving automated support with SupportAssist](#)
- [Quick Resource Locator for PowerEdge R840 system](#)
- [Recycling or End-of-Life service information](#)

## Contacting Dell

Dell provides several online and telephone based support and service options. If you do not have an active internet connection, you can find contact information about your purchase invoice, packing slip, bill, or Dell product catalog. Availability varies by country and product, and some services may not be available in your area. To contact Dell for sales, technical assistance, or customer service issues:

### Steps

1. Go to [www.dell.com/support/home](http://www.dell.com/support/home)
2. Select your country from the drop-down menu on the lower right corner of the page.
3. For customized support:
  - a) Enter your system Service Tag in the **Enter your Service Tag** field.
  - b) Click **Submit**.  
The support page that lists the various support categories is displayed.
4. For general support:
  - a) Select your product category.
  - b) Select your product segment.
  - c) Select your product.  
The support page that lists the various support categories is displayed.
5. For contact details of Dell Global Technical Support:
  - a) Click [Global Technical Support](#)
  - b) The **Contact Technical Support** page is displayed with details to call, chat, or e-mail the Dell Global Technical Support team.

## Documentation feedback

You can rate the documentation or write your feedback on any of our Dell EMC documentation pages and click **Send Feedback** to send your feedback.

## Accessing system information by using QRL

You can use the Quick Resource Locator (QRL) to get immediate access to the information about your system.

### Prerequisites

Ensure that your smart phone or tablet has the QR code scanner installed.

The QRL includes the following information about your system:

- How-to videos
- Reference materials, including the Owner's Manual, LCD diagnostics, and mechanical overview
- Service Tag to quickly access the specific hardware configuration and warranty information
- A direct link to Dell to contact technical support and sales teams

## Steps

1. Go to [www.dell.com/qrl](http://www.dell.com/qrl), and navigate to your specific product or
2. Use your smart phone or tablet to scan the model-specific Quick Resource (QR) code on your Dell system or in the [Quick Resource Locator](#) section.

# Receiving automated support with SupportAssist

Dell EMC SupportAssist is an optional Dell EMC Services offering that automates technical support for your Dell EMC server, storage, and networking devices. By installing and setting up a SupportAssist application in your IT environment, you can receive the following benefits:

- **Automated issue detection** — SupportAssist monitors your Dell EMC devices and automatically detects hardware issues, both proactively and predictively.
- **Automated case creation** — When an issue is detected, SupportAssist automatically opens a support case with Dell EMC Technical Support.
- **Automated diagnostic collection** — SupportAssist automatically collects system state information from your devices and uploads it securely to Dell EMC. This information is used by Dell EMC Technical Support to troubleshoot the issue.
- **Proactive contact** — A Dell EMC Technical Support agent contacts you about the support case and helps you resolve the issue.

The available benefits vary depending on the Dell EMC Service entitlement purchased for your device. For more information about SupportAssist, go to [www.dell.com/supportassist](http://www.dell.com/supportassist).

## Quick Resource Locator for PowerEdge R840 system



Figure 127. Quick Resource Locator for PowerEdge R840 system

## Recycling or End-of-Life service information

Take back and recycling services are offered for this product in certain countries. If you want to dispose of system components, visit [www.dell.com/recyclingworldwide](http://www.dell.com/recyclingworldwide) and select the relevant country.

## Documentation resources

This section provides information about the documentation resources for your system.

To view the document that is listed in the documentation resources table:

- From the Dell EMC support site:
  1. Click the documentation link that is provided in the Location column in the table.
  2. Click the required product or product version.
  3. On the Product Support page, click **Manuals & documents**.
- Using search engines:
  - Type the name and version of the document in the search box.

 **NOTE: To locate the product name and model, see the front of your system.**

**Table 53. Additional documentation resources for your system**

| Task                    | Document  | Location   |
|-------------------------|---|--|
| Setting up your system  | For more information about installing and securing the system into a rack, see the Rail Installation Guide included with your rack solution.<br><br>For information about setting up your system, see the <i>Getting Started Guide</i> document that is shipped with your system.   | <a href="http://www.dell.com/poweredgemanuals">www.dell.com/poweredgemanuals</a>             |
| Configuring your system | For information about the iDRAC features, configuring and logging in to iDRAC, and managing your system remotely, see the Integrated Dell Remote Access Controller User's Guide.<br><br>For information about understanding Remote Access Controller Admin (RACADM) subcommands and supported RACADM interfaces, see the RACADM CLI Guide for iDRAC.<br><br>For information about Redfish and its protocol, supported schema, and Redfish Eventing are implemented in iDRAC, see the Redfish API Guide.<br><br>For information about iDRAC property database group and object descriptions, see the Attribute Registry Guide. | <a href="http://www.dell.com/poweredgemanuals">www.dell.com/poweredgemanuals</a>             |
|                         | For information about earlier versions of the iDRAC documents, see the iDRAC documentation.<br><br>To identify the version of iDRAC available on your system, on the iDRAC web interface, click <b>? &gt; About</b> .   | <a href="http://www.dell.com/idracmanuals">www.dell.com/idracmanuals</a>                     |
|                         | For information about installing the operating system, see the operating system documentation.  | <a href="http://www.dell.com/operatingsystemmanuals">www.dell.com/operatingsystemmanuals</a> |
|                         | For information about updating drivers and firmware, see the Methods to download firmware and drivers section in this document.   | <a href="http://www.dell.com/support/drivers">www.dell.com/support/drivers</a>               |
| Managing your system    | For information about systems management software offered by Dell, see the Dell   | <a href="http://www.dell.com/poweredgemanuals">www.dell.com/poweredgemanuals</a>             |

| Task   | Document   | Location   |
|--|--|--|
|  | OpenManage Systems Management Overview Guide.  |  |
|  | For information about setting up, using, and troubleshooting OpenManage, see the Dell OpenManage Server Administrator User's Guide.  | <a href="http://www.dell.com/openmanagemanuals">www.dell.com/openmanagemanuals</a> > OpenManage Server Administrator |
|  | For information about installing, using, and troubleshooting Dell OpenManage Essentials, see the Dell OpenManage Essentials User's Guide.  | <a href="http://www.dell.com/openmanagemanuals">www.dell.com/openmanagemanuals</a> > OpenManage Essentials           |
|  | For information about installing, using, and troubleshooting Dell OpenManage Enterprise, see the Dell OpenManage Enterprise User's Guide.  | <a href="http://www.dell.com/openmanagemanuals">www.dell.com/openmanagemanuals</a> > OpenManage Enterprise           |
|  | For information about installing and using Dell SupportAssist, see the Dell EMC SupportAssist Enterprise User's Guide.   | <a href="http://www.dell.com/serviceabilitytools">www.dell.com/serviceabilitytools</a>                               |
|  | For information about partner programs enterprise systems management, see the OpenManage Connections Enterprise Systems Management documents.  | <a href="http://www.dell.com/openmanagemanuals">www.dell.com/openmanagemanuals</a>                                   |
| Working with the Dell PowerEdge RAID controllers | For information about understanding the features of the Dell PowerEdge RAID controllers (PERC), Software RAID controllers, or BOSS card and deploying the cards, see the Storage controller documentation. | <a href="http://www.dell.com/storagecontrollermanuals">www.dell.com/storagecontrollermanuals</a>                     |
| Understanding event and error messages           | For information about the event and error messages that are generated by the system firmware and agents that monitor system components, see the Error Code Lookup.   | <a href="http://www.dell.com/qrl">www.dell.com/qrl</a>   |
| Troubleshooting your system                      | For information about identifying and troubleshooting the PowerEdge server issues, see the Server Troubleshooting Guide.   | <a href="http://www.dell.com/poweredgemanuals">www.dell.com/poweredgemanuals</a>                                     |