

Dell EMC PowerEdge R940

Installation and Service Manual

Notes, cautions, and warnings

 **NOTE:** A NOTE indicates important information that helps you make better use of your product.

 **CAUTION:** A CAUTION indicates either potential damage to hardware or loss of data and tells you how to avoid the problem.

 **WARNING:** A WARNING indicates a potential for property damage, personal injury, or death.

Chapter 1: PowerEdge R940 overview.....	8
Supported configurations for the PowerEdge R940.....	8
Front view of the system.....	9
Left control panel view.....	11
Right control panel.....	14
Back view of the system.....	15
NIC indicator codes.....	16
Power supply unit indicator codes.....	16
Drive indicator codes.....	19
LCD panel.....	19
Viewing Home screen.....	20
Setup menu.....	20
View menu.....	21
Locating the Service Tag of your system.....	21
System information label.....	22
Chapter 2: Documentation resources.....	25
Chapter 3: PowerEdge R940 technical specifications.....	27
System dimensions.....	27
System weight.....	28
Cooling fan specifications.....	28
Processor specifications.....	28
Supported operating systems.....	29
PSU specifications.....	29
System battery specifications.....	30
Expansion bus specifications.....	30
Memory specifications.....	31
Storage controller specifications.....	31
Remote management port specifications.....	31
Drive specifications.....	32
Hard drives.....	32
Ports and connectors specifications.....	32
USB ports.....	32
NIC ports.....	32
Serial port.....	32
Internal Dual SD Module or vFlash card.....	33
VGA ports.....	33
Video specifications.....	33
Environmental specifications.....	33
Standard operating temperature.....	34
Expanded operating temperature.....	34
Particulate and gaseous contamination specifications.....	36

Chapter 4: Initial system setup and configuration.....	38
Setting up your system.....	38
iDRAC configuration.....	38
Options to set up iDRAC IP address.....	38
Log in to iDRAC.....	39
Options to install the operating system.....	39
Methods to download firmware and drivers.....	39
Downloading drivers and firmware.....	40
Chapter 5: Pre-operating system management applications.....	41
Options to manage the pre-operating system applications.....	41
System Setup.....	41
Viewing System Setup.....	41
System Setup details.....	42
System BIOS.....	42
iDRAC Settings utility.....	62
Device Settings.....	62
Dell Lifecycle Controller.....	62
Embedded system management.....	62
Boot Manager.....	63
Viewing Boot Manager.....	63
Boot Manager main menu.....	63
One-shot UEFI boot menu.....	63
System Utilities.....	63
PXE boot.....	63
Chapter 6: Installing and removing system components.....	65
Safety instructions.....	65
Before working inside your system.....	66
After working inside your system.....	66
Recommended tools.....	66
Optional front bezel.....	66
Removing the optional front bezel.....	66
Installing the optional front bezel.....	67
System cover.....	68
Removing the system cover.....	68
Installing the system cover.....	69
Inside the system.....	70
Air shroud.....	73
Removing the air shroud.....	73
Installing the air shroud.....	74
Cooling fans.....	76
Removing the cooling fan.....	76
Installing the cooling fan.....	77
Fan cage.....	78
Removing the fan cage.....	78
Installing the fan cage.....	79
Removing the fan tray.....	80

Installing the fan tray.....	81
Intrusion switch.....	82
Removing an intrusion switch.....	82
Installing an intrusion switch.....	83
Drives.....	84
Removing a drive blank.....	84
Installing a drive blank.....	85
Removing a drive carrier.....	85
Installing a drive carrier.....	86
Removing the drive from the drive carrier.....	87
Installing a drive into the drive carrier.....	88
Drive backplane.....	89
Drive backplane connectors.....	89
Removing drive backplane.....	91
Installing drive backplane	93
Cable routing.....	96
System memory.....	99
System memory guidelines.....	99
General memory module installation guidelines.....	101
NVDIMM-N memory module installation guidelines	102
DCPMM installation guidelines	105
Mode-specific guidelines.....	108
Removing a memory module.....	109
Installing a memory module.....	110
Processors and heat sinks.....	111
Removing a processor and heat sink module.....	111
Removing the processor from the processor and heat sink module.....	112
Installing the processor into a processor and heat sink module.....	114
Installing a processor and heat sink module.....	116
Processor expansion module.....	117
Removing the PEM.....	117
Installing the PEM.....	118
UPI cable routing.....	120
PEM power board.....	121
Removing the PEM power board.....	121
Installing the PEM power board.....	122
Expansion cards and expansion card risers.....	123
Expansion card installation guidelines.....	123
Removing expansion card riser blank	125
Installing expansion card riser blank.....	126
Removing the expansion card riser	127
Installing the expansion card riser.....	129
Removing the expansion card from expansion card riser.....	130
Installing expansion card into expansion card riser.....	131
M.2 SSD module.....	132
Removing the M.2 SSD module.....	132
Installing the M.2 SSD module.....	133
Network daughter card riser.....	134
Removing the NDC riser.....	134
Installing the NDC riser.....	135

Network daughter card.....	136
Removing the NDC.....	136
Installing the NDC.....	137
Storage controller card.....	138
Removing the storage controller card.....	138
Installing the storage controller card.....	139
Optional IDSDM or vFlash module.....	140
Removing the MicroSD card.....	140
Installing the MicroSD card.....	141
Optional IDSDM or vFlash module.....	142
Removing the optional IDSDM module.....	142
Installing optional IDSDM module.....	143
Power supply unit.....	144
Hot spare feature.....	144
Removing a power supply unit blank.....	144
Installing a power supply unit blank.....	145
Removing a power supply unit.....	145
Installing a power supply unit.....	146
Wiring instructions for a DC power supply unit.....	147
NVDIMM-N battery.....	148
Removing the NVDIMM-N battery.....	148
Installing NVDIMM-N battery.....	149
NVDIMM battery cable routing.....	151
System battery.....	151
Replacing system battery.....	151
Optional internal USB memory key.....	152
Replacing the optional internal USB memory key.....	152
System board.....	153
Removing the system board.....	153
Installing the system board.....	154
Trusted Platform Module.....	156
Upgrading the Trusted Platform Module.....	156
Initializing TPM for BitLocker users.....	158
Initializing the TPM 1.2 for TXT users.....	158
Initializing the TPM 2.0 for TXT users.....	158
Control panel.....	158
Removing the right control panel.....	158
Installing the right control panel.....	159
Removing the left control panel.....	160
Installing the left control panel.....	161
Chapter 7: System diagnostics.....	163
Dell Embedded System Diagnostics.....	163
Running the Embedded System Diagnostics from Boot Manager.....	163
Running the Embedded System Diagnostics from the Dell Lifecycle Controller.....	163
System diagnostic controls.....	164
Chapter 8: PowerEdge R940 Jumpers and connectors	165
System board jumpers and connectors.....	165

System board jumper settings.....	168
Disabling forgotten password.....	168
Chapter 9: Getting help.....	170
Recycling or End-of-Life service information.....	170
Contacting Dell EMC.....	170
Documentation feedback.....	171
Accessing system information by using QRL.....	171
Quick Resource Locator for PowerEdge R940 system.....	171
Receiving automated support with SupportAssist	171

PowerEdge R940 overview

The PowerEdge R940 is a 3U rack system, which is available in the following configurations:

Table 1. PowerEdge R940 configurations

Configurations	Specifications
8-drive bay system (without Processor Expansion Module)	<ul style="list-style-type: none"> Two Intel Xeon Scalable processors 24 DIMM slots supporting up to 3 TB of memory Up to two AC or DC power supply units (PSUs) 8 drives or SSDs
24-drive bay system (with PEM)	<ul style="list-style-type: none"> Four Intel Xeon Scalable processors 48 DIMM slots supporting up to 6 TB of memory Up to two AC or DC power supply units (PSUs) 24 drives or SSDs

NOTE: The PowerEdge R940 system supports hot swappable hard drives.

NOTE: The PowerEdge R940 system is also available in a diskless (no backplane) configuration.

Topics:

- Supported configurations for the PowerEdge R940
- Front view of the system
- Back view of the system
- Drive indicator codes
- LCD panel
- Locating the Service Tag of your system
- System information label

Supported configurations for the PowerEdge R940

The PowerEdge R940 system supports the following configurations:

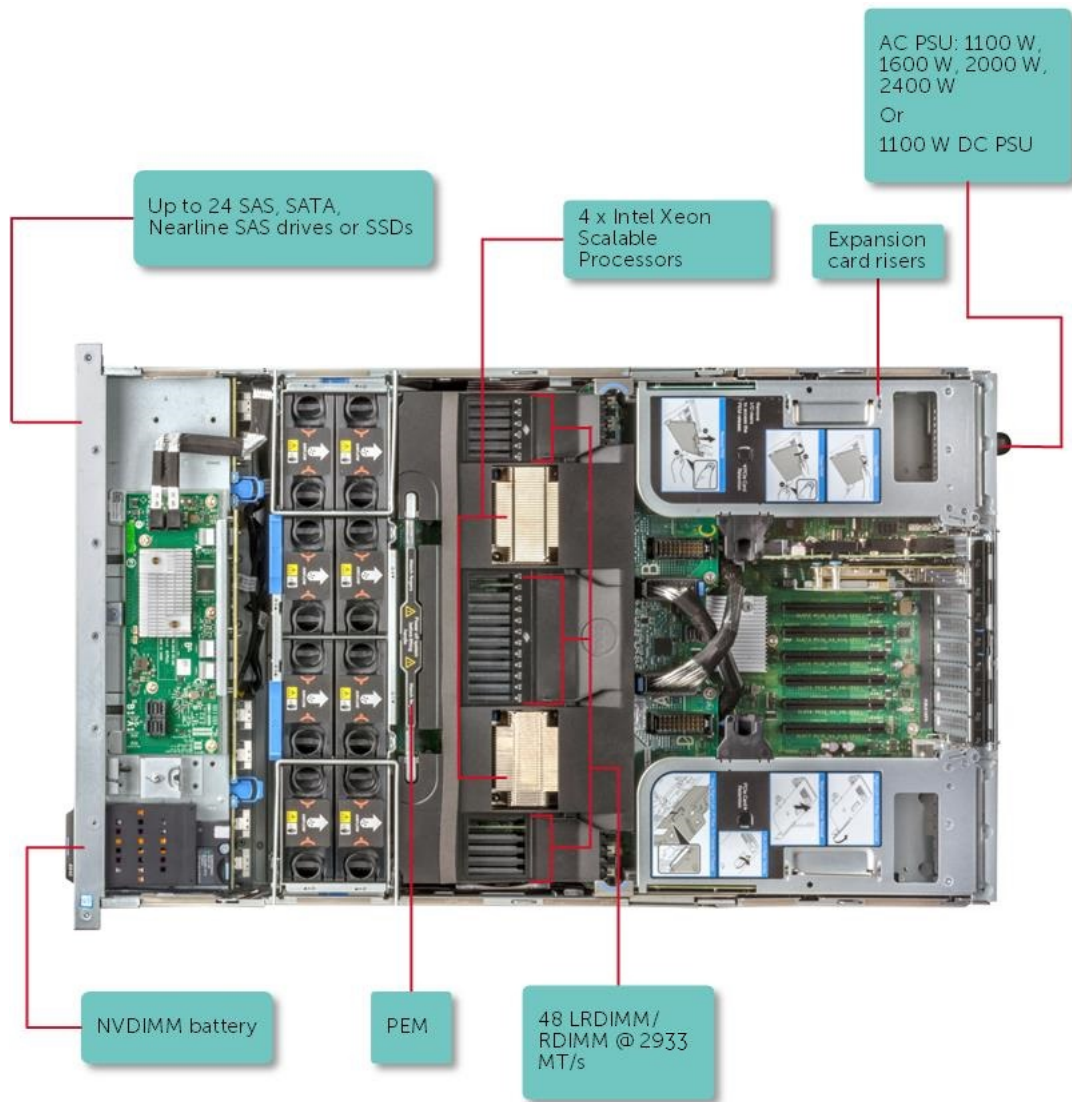

Figure 1. Supported configurations for the PowerEdge R940

Front view of the system

You can access the following components from the front of the system:

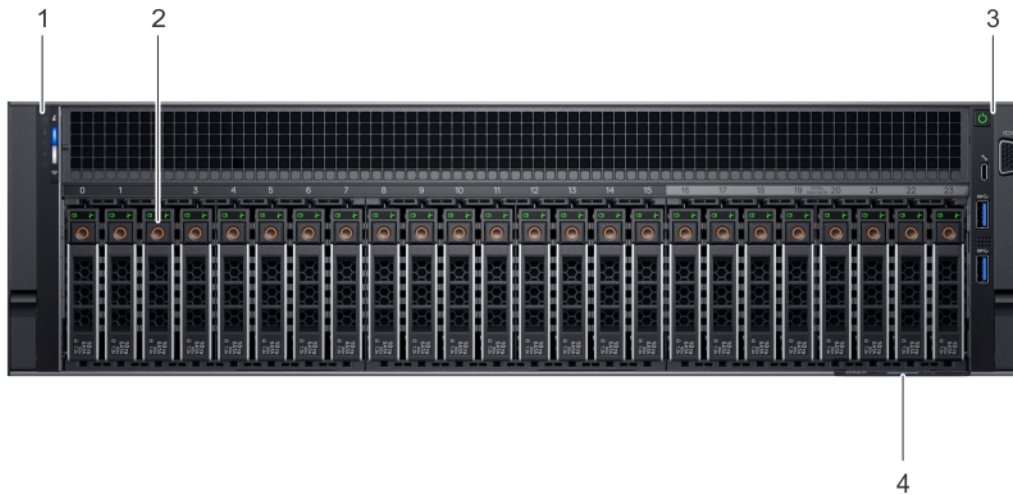

Figure 2. Front view of 24 x 2.5-inch drive system

Table 2. Features available on the front view of 24 x 2.5-inch drive system

Item	Component	Icon	Description
1	Left control panel	N/A	Contains the system health and system ID, status LED, and the iDRAC Quick Sync 2 (wireless) indicator. NOTE: The iDRAC Quick Sync 2 indicator is available only on certain configurations.
2	Drive slots	N/A	Enable you to install drives that are supported on your system. For more information about drives, see the Technical specifications section.
3	Right control panel	N/A	Contains the power button, VGA port, iDRAC Direct port and USB ports.
4	Information tag	N/A	The Information tag is a slide-out label panel that contains system information such as Service Tag, NIC, MAC address, and so on. If you have opted for the secure default access to iDRAC, the Information tag also contains the iDRAC secure default password.

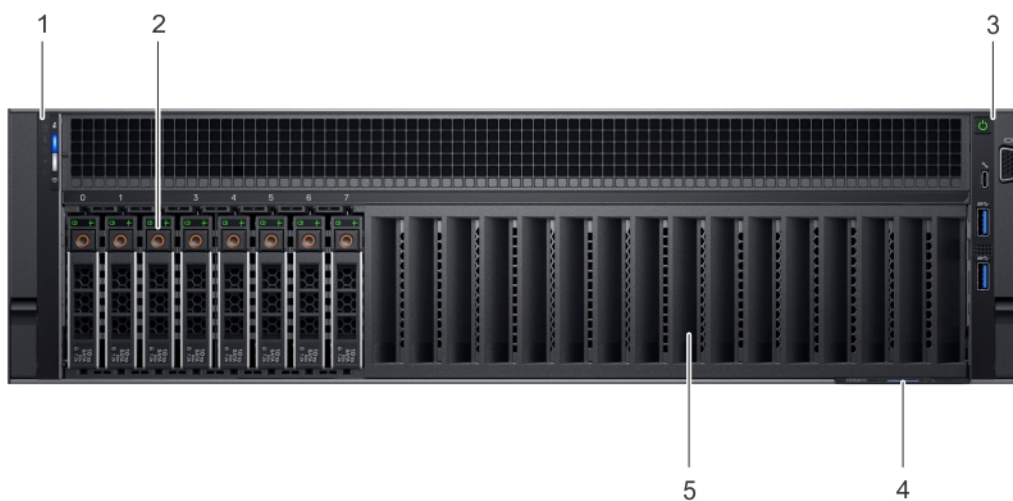

Figure 3. Front view of 8 x 2.5-inch drive system

Table 3. Features available on the front view of 8 x 2.5-inch drive system

Item	Component	Icon	Description
1	Left control panel	N/A	Contains the system health and system ID, status LED, and the iDRAC Quick Sync 2 (wireless) indicator. NOTE: The iDRAC Quick Sync 2 indicator is available only on certain configurations.
2	Drive slots	N/A	Enable you to install drives that are supported on your system. For more information about drives, see the Technical specifications section.
3	Right control panel	N/A	Contains the power button, VGA port, iDRAC Direct port and USB ports.
4	Information tag	N/A	The Information tag is a slide-out label panel that contains system information such as Service Tag, NIC, MAC address, and so on. If you have opted for the secure default access to iDRAC, the Information tag also contains the iDRAC secure default password.
5	Drive bay blank	N/A	For the 8 x 2.5-inch drive system, a drive bay blank is installed in the hard drive slots 8 - 23.

Left control panel view

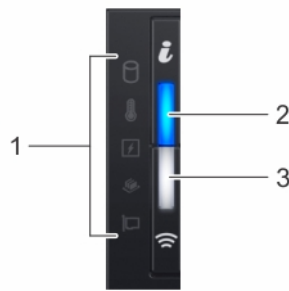

Figure 4. Left control panel with optional iDRAC Quick Sync 2.0 indicator

Table 4. Left control panel

Item	Indicator, button, or connector	Icon	Description
1	Status LED indicators	N/A	Indicate the status of the system. For more information, see the Status LED indicators section.
2	System health and system ID indicator		Indicates the system health. For more information, see the System health and system ID indicator codes section.
3	iDRAC Quick Sync 2 wireless indicator (optional)		Indicates if the iDRAC Quick Sync 2 wireless option is activated. The Quick Sync 2 feature allows management of the system using mobile devices. This feature aggregates hardware/firmware inventory and various system level diagnostic/error information that can be used in troubleshooting the system. You can access system inventory, Dell Lifecycle Controller logs or system logs, system health status, and also configure iDRAC, BIOS, and networking parameters. You can also launch the virtual Keyboard, Video, and Mouse (KVM) viewer and virtual Kernel-based Virtual Machine (KVM), on a supported mobile device. For more information, see the Integrated Dell Remote Access Controller User's Guide at www.dell.com/poweredgemanuals

Status LED indicators







 **NOTE:** The indicators display solid amber if any error occurs.

Table 5. Status LED indicators and descriptions

Icon	Description	Condition	Corrective action
	Drive indicator	The indicator turns solid amber if there is a drive error.	<ul style="list-style-type: none"> Check the System Event Log to determine if the drive has an error. Run the appropriate Online Diagnostics test. Restart the system and run embedded diagnostics (ePSA). If the drives are configured in a RAID array, restart the system, and enter the host adapter configuration utility program.
	Temperature indicator	The indicator turns solid amber if the system experiences a thermal error (for example, the ambient temperature is out of range or there is a fan failure).	<p>Ensure that none of the following conditions exist:</p> <ul style="list-style-type: none"> A cooling fan has been removed or has failed. System cover, air shroud, memory module blank, or back filler bracket is removed. Ambient temperature is too high. External airflow is obstructed. <p>If the problem persists, see Getting help.</p>
	Electrical indicator	The indicator turns solid amber if the system experiences an electrical error (for example, voltage out of range, or a failed power supply unit (PSU) or voltage regulator).	<p>Check the System Event Log or system messages for the specific issue. If it is due to a problem with the PSU, check the LED on the PSU. Reseat the PSU.</p> <p>If the problem persists, see Getting help.</p>
	Memory indicator	The indicator turns solid amber if a memory error occurs.	<p>Check the System Event Log or system messages for the location of the failed memory. Reseat the memory module.</p> <p>If the problem persists, see Getting help.</p>
	PCIe indicator	The indicator turns solid amber if a PCIe card experiences an error.	<p>Restart the system. Update any required drivers for the PCIe card. Reinstall the card.</p> <p>If the problem persists, see Getting help.</p>

System health and system ID indicator codes

The system health and system ID indicator is located on the left control panel of your system.



Figure 5. System health and system ID indicators

Table 6. System health and system ID indicator codes

System health and system ID indicator code	Condition
Solid blue	Indicates that the system is turned on, system is healthy, and system ID mode is not active. Press the system health and system ID button to switch to system ID mode.
Blinking blue	Indicates that the system ID mode is active. Press the system health and system ID button to switch to system health mode.
Solid amber	Indicates that the system is in fail-safe mode. If the problem persists, see the Getting help section.
Blinking amber	Indicates that the system is experiencing a fault. Check the System Event Log or the LCD panel, if available on the bezel, for specific error messages. For information about the event and error messages generated by the system firmware and agents that monitor system components, go to qrl.dell.com > Look Up > Error Code , type the error code, and then click Look it up .

iDRAC Quick Sync 2 indicator codes

iDRAC Quick Sync 2 module (optional) is located on the left control panel of your system.



Figure 6. iDRAC Quick Sync 2 indicators

Table 7. iDRAC Quick Sync 2 indicators and descriptions

iDRAC Quick Sync 2 indicator code	Condition	Corrective action
Off (default state)	Indicates that the iDRAC Quick Sync 2 feature is turned off. Press the iDRAC Quick Sync 2 button to turn on the iDRAC Quick Sync 2 feature.	If the LED fails to turn on, reseal the left control panel flex cable and check. If the problem persists, see the Getting help section.
Solid white	Indicates that iDRAC Quick Sync 2 is ready to communicate. Press the iDRAC Quick Sync 2 button to turn off.	If the LED fails to turn off, restart the system. If the problem persists, see the Getting help section.
Blinks white rapidly	Indicates data transfer activity.	If the indicator continues to blink indefinitely, see the Getting help section.
Blinks white slowly	Indicates that firmware update is in progress.	If the indicator continues to blink indefinitely, see the Getting help section.
Blinks white five times rapidly and then turns off	Indicates that the iDRAC Quick Sync 2 feature is disabled.	Check if iDRAC Quick Sync 2 feature is configured to be disabled by iDRAC. If the problem persists, see the Getting help section. For more information, see <i>Integrated Dell Remote Access Controller</i>

Table 7. iDRAC Quick Sync 2 indicators and descriptions (continued)

iDRAC Quick Sync 2 indicator code	Condition	Corrective action
		User's Guide at www.dell.com/poweredgemanuals or <i>Dell OpenManage Server Administrator User's Guide</i> at https://www.dell.com/openmanagemanuals .
Solid amber	Indicates that the system is in fail-safe mode.	Restart the system. If the problem persists, see the Getting help section.
Blinking amber	Indicates that the iDRAC Quick Sync 2 hardware is not responding properly.	Restart the system. If the problem persists, see the Getting help section.

Right control panel

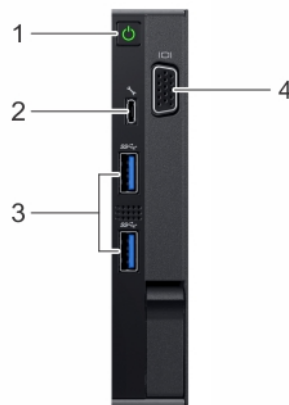

Figure 7. Right control panel

Table 8. Right control panel

Item	Button or port	Icon	Description
1	Power button		Indicates if the system is powered on or off. Press the power button to manually power on or off the system. NOTE: Press the power button to gracefully shut down an ACPI-compliant operating system.
2	iDRAC Direct port		The iDRAC Direct port is micro USB 2.0-compliant. This port enables you to access the iDRAC Direct features. For more information, see the <i>Integrated Dell Remote Access Controller User's Guide</i> at www.dell.com/poweredgemanuals .
3	USB ports		The USB ports are 9-pin, USB 3.0-compliant. These ports enable you to connect USB devices to the system.
4	VGA port		Enables you to connect a display device to the system. For more information, see the Technical specifications section.

iDRAC Direct LED indicator codes

The iDRAC Direct LED indicator lights up to indicate that the port is connected and is being used as a part of the iDRAC subsystem.

You can configure iDRAC Direct by using a USB to micro USB (type AB) cable, which you can connect to your laptop or tablet. The following table describes iDRAC Direct activity when the iDRAC Direct port is active:

Table 9. iDRAC Direct LED indicator codes

iDRAC Direct LED indicator code	Condition
Solid green for two seconds	Indicates that the laptop or tablet is connected.
Flashing green (on for two seconds and off for two seconds)	Indicates that the laptop or tablet connected is recognized.
Turns off	Indicates that the laptop or tablet is unplugged.

Back view of the system

You can access the following components from the back of the system:

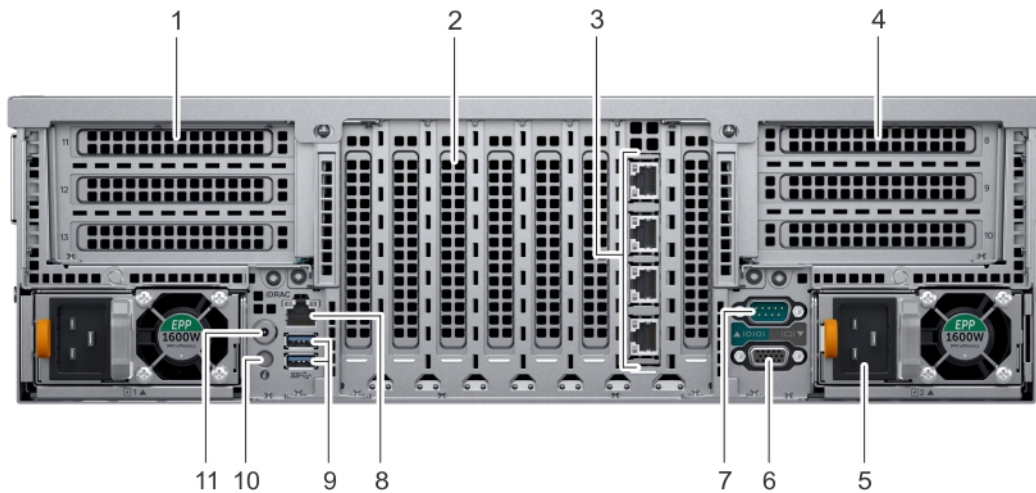

Figure 8. Back view features

Table 10. Features available on the back of the system







Item	Slot, button, or connector	Icon	Description
1	expansion card riser (right)	N/A	The expansion card riser (right) supports up to three full-height PCI Express expansion cards. For more information, see the Expansion card installation guidelines section.
2	expansion card slot	N/A	The expansion slots on the system board supports full-height half-length PCI Express expansion cards.
3	NIC port (4)		The NIC ports that are integrated on the network daughter card (NDC) provide network connectivity. For more information about the supported configurations, see the Technical specifications section.
4	expansion card riser (left)	N/A	The expansion card riser (left) supports up to three full-height PCI Express expansion cards. For more information, see the Expansion card installation guidelines section.
5	Power supply unit (2)		For more information, see the Technical specifications section.
6	Video port		Enables you to connect a display device to the system. For more information, see the Technical specifications section.
7	Serial port		Enables you to connect a serial device to the system. For more information, see the Technical specifications section.

Table 10. Features available on the back of the system (continued)

Item	Slot, button, or connector	Icon	Description
8	iDRAC9 Enterprise port		Enables you to remotely access iDRAC. For more information, see the iDRAC User's Guide at www.dell.com/poweredgemanuals .
9	USB port (2)		The USB ports are 9-pin, USB 3.0-compliant. These ports enable you to connect USB devices to the system.
10	System identification button		The System Identification (ID) button is available on the front and back of the systems. Press the button to identify a system in a rack by turning on the system ID button. You can also use the system ID button to reset iDRAC and to access BIOS using the step through mode.
11	System status indicator cable port		Enables you to connect the status indicator cable and view system status when the CMA is installed.

NIC indicator codes

Each NIC on the back of the system has indicators that provide information about the activity and link status. The activity LED indicator indicates if data is flowing through the NIC, and the link LED indicator indicates the speed of the connected network.

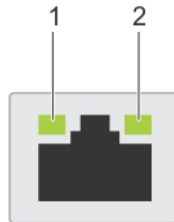

Figure 9. NIC indicator codes

1. Link LED indicator
2. Activity LED indicator

Table 11. NIC indicator codes

Status	Condition
Link and activity indicators are off.	The NIC is not connected to the network.
Link indicator is green, and activity indicator is blinking green.	The NIC is connected to a valid network at its maximum port speed, and data is being sent or received.
Link indicator is amber, and activity indicator is blinking green.	The NIC is connected to a valid network at less than its maximum port speed, and data is being sent or received.
Link indicator is green, and activity indicator is off.	The NIC is connected to a valid network at its maximum port speed, and data is not being sent or received.
Link indicator is amber, and activity indicator is off.	The NIC is connected to a valid network at less than its maximum port speed, and data is not being sent or received.
Link indicator is blinking green, and activity is off.	NIC identify is enabled through the NIC configuration utility.

Power supply unit indicator codes

AC power supply units (PSUs) have an illuminated translucent handle that serves as an indicator.

The DC PSUs have an LED that serves as an indicator.

The indicator shows whether power is present or if a power fault has occurred.

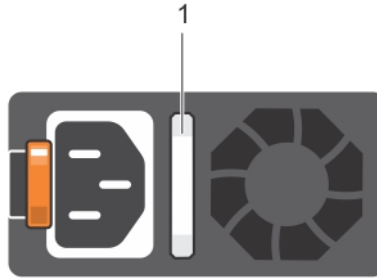

Figure 10. AC PSU status indicator

1. AC PSU status indicator/handle

Table 12. AC PSU status indicator codes

Power indicator codes	Condition
Green	A valid power source is connected to the PSU and the PSU is operational.
Blinking amber	Indicates a problem with the PSU.
Not illuminated	Power is not connected to the PSU.
Blinking green	When the firmware of the PSU is being updated, the PSU handle blinks green. ⚠ CAUTION: Do not disconnect the power cord or unplug the PSU when updating firmware. If firmware update is interrupted, the PSUs do not function.
Blinking green and turns off	When hot-plugging a PSU, the PSU handle blinks green five times at a rate of 4 Hz and turns off. This indicates a PSU mismatch with respect to efficiency, feature set, health status, or supported voltage. ⚠ CAUTION: If two PSUs are installed, both the PSUs must have the same type of label; for example, Extended Power Performance (EPP) label. Mixing PSUs from previous generations of PowerEdge servers is not supported, even if the PSUs have the same power rating. This results in a PSU mismatch condition or failure to turn the system on. ⚠ CAUTION: When correcting a PSU mismatch, replace only the PSU with the blinking indicator. Swapping the PSU to make a matched pair can result in an error condition and unexpected system shutdown. To change from a high output configuration to a low output configuration or vice versa, you must turn off the system. ⚠ CAUTION: AC PSUs support both 240 V and 120 V input voltages with the exception of Titanium PSUs, which support only 240 V. When two identical PSUs receive different input voltages, they can output different wattages, and trigger a mismatch. ⚠ CAUTION: If two PSUs are used, they must be of the same type and have the same maximum output power. ⚠ CAUTION: Combining AC and DC PSUs is not supported and triggers a mismatch.

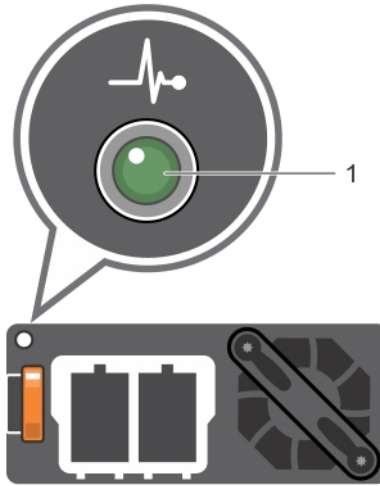

Figure 11. DC PSU status indicator

1. DC PSU status indicator

Table 13. DC PSU status indicator codes

Power indicator codes	Condition
Green	A valid power source is connected to the PSU and the PSU is operational.
Blinking amber	Indicates a problem with the PSU.
Not illuminated	Power is not connected to the PSU.
Blinking green	<p>When hot-plugging a PSU, the PSU indicator blinks green. This indicates that there is a PSU mismatch with respect to efficiency, feature set, health status, or supported voltage.</p> <p>⚠ CAUTION: If two PSUs are installed, both the PSUs must have the same type of label; for example, Extended Power Performance (EPP) label. Mixing PSUs from previous generations of PowerEdge servers is not supported, even if the PSUs have the same power rating. This results in a PSU mismatch condition or failure to turn the system on.</p> <p>⚠ CAUTION: When correcting a PSU mismatch, replace only the PSU with the blinking indicator. Swapping the PSU to make a matched pair can result in an error condition and unexpected system shutdown. To change from a High Output configuration to a Low Output configuration or vice versa, you must turn off the system.</p> <p>⚠ CAUTION: If two PSUs are used, they must be of the same type and have the same maximum output power.</p> <p>⚠ CAUTION: Combining AC and DC PSUs is not supported and triggers a mismatch.</p>

Drive indicator codes

Each drive carrier has an activity LED indicator and a status LED indicator. The indicators provide information about the current status of the drive. The activity LED indicator indicates whether the drive is currently in use or not. The status LED indicator indicates the power condition of the drive.



Figure 12. Drive indicators on the drive and the mid drive tray backplane

1. Drive activity LED indicator
2. Drive status LED indicator
3. Drive capacity label

NOTE: If the drive is in the Advanced Host Controller Interface (AHCI) mode, the status LED indicator does not turn on.

Table 14. Drive indicator codes

Drive status indicator code	Condition
Flashes green twice per second	Identifying drive or preparing for removal.
Off	Drive ready for removal. NOTE: The drive status indicator remains off until all drives are initialized after the system is turned on. Drives are not ready for removal during this time.
Flashes green, amber, and then turns off	Predicted drive failure.
Flashes amber four times per second	Drive failed.
Flashes green slowly	Drive rebuilding.
Solid green	Drive online.
Flashes green for three seconds, amber for three seconds, and then turns off after six seconds	Rebuild stopped.

LCD panel

The LCD panel provides system information, status, and error messages to indicate if the system is functioning correctly or requires attention. The LCD panel can also be used to configure or view the system's iDRAC IP address. For information about the event and error messages generated by the system firmware and agents that monitor system components, go to qrl.dell.com > **Look Up** > **Error Code**, type the error code, and then click **Look it up..**

The LCD panel is available only on the optional front bezel. The optional front bezel is hot pluggable.

The statuses and conditions of the LCD panel are outlined here:

- The LCD backlight is white during normal operating conditions.
- When the system needs attention, the LCD backlight turns amber, and displays an error code followed by descriptive text.

NOTE: If the system is connected to a power source and an error is detected, the LCD turns amber regardless of whether the system is turned on or off.

- When the system turns off and there are no errors, LCD enters the standby mode after five minutes of inactivity. Press any button on the LCD to turn it on.
- If the LCD panel stops responding, remove the bezel and reinstall it. If the problem persists, see [Getting help](#).
- The LCD backlight remains off if LCD messaging is turned off using the iDRAC utility, the LCD panel, or other tools.



Figure 13. LCD panel features



Table 15. LCD panel features

Item	Button or display	Description
1	Left	Moves the cursor back in one-step increments.
2	Select	Selects the menu item highlighted by the cursor.
3	Right	Moves the cursor forward in one-step increments. During message scrolling: <ul style="list-style-type: none"> Press and hold the right button to increase scrolling speed. Release the button to stop. <p>NOTE: The display stops scrolling when the button is released. After 45 seconds of inactivity, the display starts scrolling.</p>
4	LCD display	Displays system information, status, and error messages or iDRAC IP address.

Viewing Home screen

The **Home** screen displays user-configurable information about the system. This screen is displayed during normal system operation when there are no status messages or errors. When the system turns off and there are no errors, LCD enters the standby mode after five minutes of inactivity. Press any button on the LCD to turn it on.

Steps

- To view the **Home** screen, press one of the three navigation buttons (Select, Left, or Right).
- To navigate to the **Home** screen from another menu, complete the following steps:
 - Press and hold the navigation button till the up arrow  is displayed.
 - Navigate to the **Home** icon  using the up arrow .
 - Select the **Home** icon.
 - On the **Home** screen, press the **Select** button to enter the main menu.

Setup menu

NOTE: When you select an option in the Setup menu, you must confirm the option before proceeding to the next action.

Option	Description
iDRAC	Select DHCP or Static IP to configure the network mode. If Static IP is selected, the available fields are IP , Subnet (Sub) , and Gateway (Gtw) . Select Setup DNS to enable DNS and to view domain addresses. Two separate DNS entries are available.

Option	Description
Set error	Select SEL to view LCD error messages in a format that matches the IPMI description in the SEL. This enables you to match an LCD message with an SEL entry. Select Simple to view LCD error messages in a simplified user-friendly description. For more information about error messages, see the <i>Dell Event and Error Messages Reference Guide</i> at https://www.dell.com/openmanagemanuals .
Set home	Select the default information to be displayed on the Home screen. See View menu section for the options and option items that can be set as the default on the Home screen.

View menu

NOTE: When you select an option in the View menu, you must confirm the option before proceeding to the next action.

Option	Description
iDRAC IP	Displays the IPv4 or IPv6 addresses for iDRAC9. Addresses include DNS (Primary and Secondary) , Gateway , IP , and Subnet (IPv6 does not have Subnet).
MAC	Displays the MAC addresses for iDRAC , iSCSI , or Network devices.
Name	Displays the name of the Host , Model , or User String for the system.
Number	Displays the Asset tag or the Service tag for the system.
Power	Displays the power output of the system in BTU/hr or Watts. The display format can be configured in the Set home submenu of the Setup menu.
Temperature	Displays the temperature of the system in Celsius or Fahrenheit. The display format can be configured in the Set home submenu of the Setup menu.

Locating the Service Tag of your system

The Information Tag is a slide-out label panel that contains system information such as Service Tag, NIC, MAC address, and so on. If you have opted for the secure default access to iDRAC, the Information Tag also contains the iDRAC secure default password.

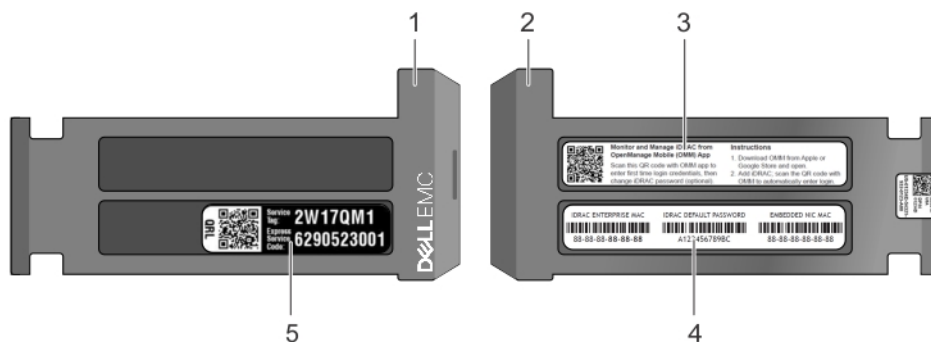

Figure 14. Locating Service Tag of your system

1. Information tag (front view)
2. Information tag (back view)
3. OpenManage Mobile (OMM) label
4. iDRAC MAC address and iDRAC secure password label
5. Service Tag

System information label

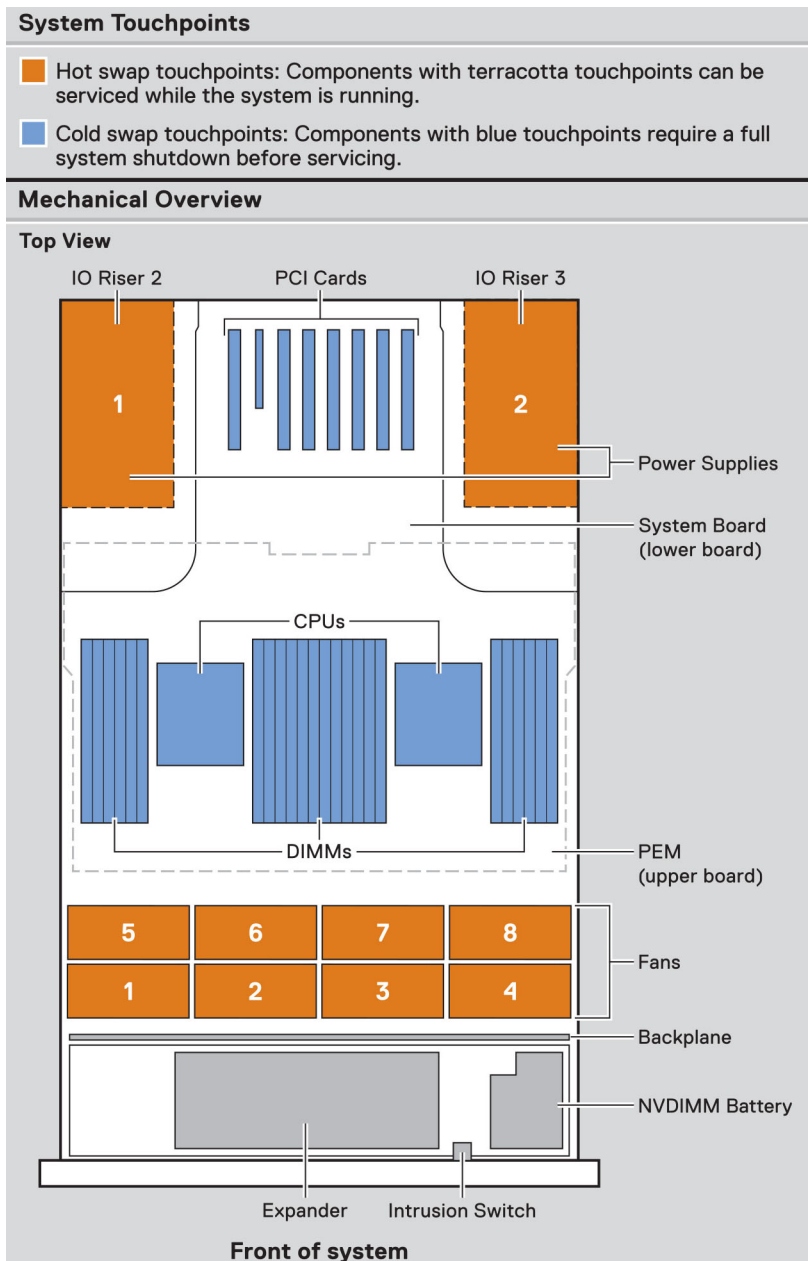

Figure 15. PowerEdge R940 system touch points

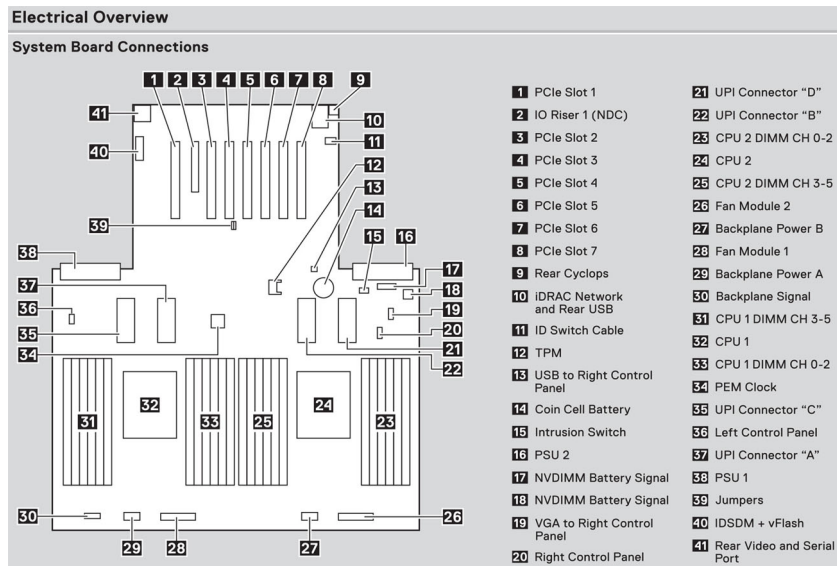

Figure 16. PowerEdge R940 system board information

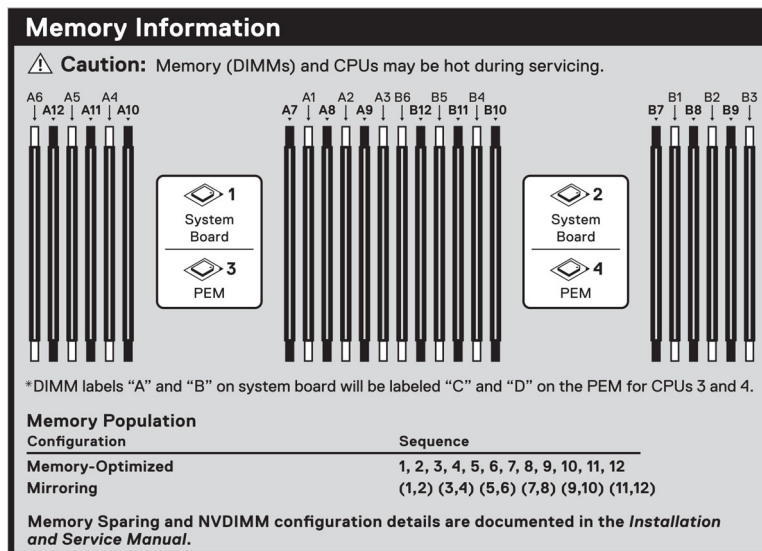

Figure 17. PowerEdge R940 memory information

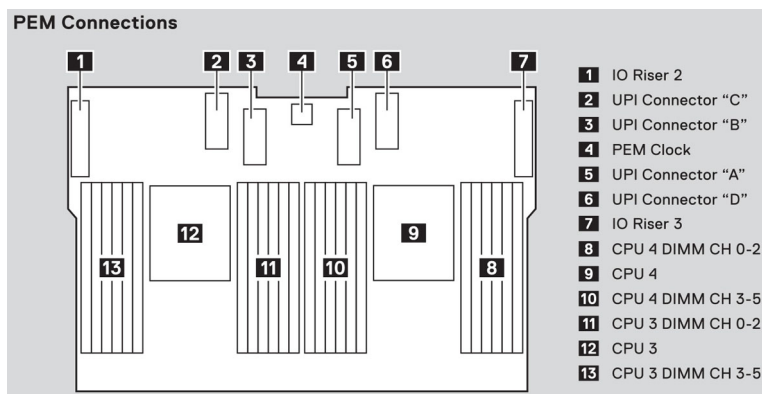

Figure 18. PowerEdge R940 Processor Expansion Module (PEM) information







Jumper Settings		
Jumper	Setting	Description
 PSWD_EN	 (default)	BIOS password can be enabled.
	 (default)	BIOS password is disabled. iDRAC local access unlocked at next AC power cycle. iDRAC password reset is enabled in F2 iDRAC settings menu.
 NVRAM_CLR	 (default)	BIOS configuration settings retained at system boot.
	 (default)	BIOS configuration settings cleared at system boot.

Figure 19. PowerEdge R940 jumper settings

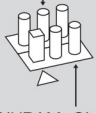
Documentation resources

This section provides information about the documentation resources for your system.

To view the document that is listed in the documentation resources table:

- From the Dell EMC support site:
 1. Click the documentation link that is provided in the Location column in the table.
 2. Click the required product or product version.
 3. On the Product Support page, click **Manuals & documents**.
- Using search engines:
 - Type the name and version of the document in the search box.

 **NOTE: To locate the product name and model, see the front of your system.**

Table 16. Additional documentation resources for your system

Task	Document	Location
Setting up your system	For more information about installing and securing the system into a rack, see the Rail Installation Guide included with your rack solution. For information about setting up your system, see the <i>Getting Started Guide</i> document that is shipped with your system.	www.dell.com/poweredgemanuals
Configuring your system	For information about the iDRAC features, configuring and logging in to iDRAC, and managing your system remotely, see the Integrated Dell Remote Access Controller User's Guide. For information about understanding Remote Access Controller Admin (RACADM) subcommands and supported RACADM interfaces, see the RACADM CLI Guide for iDRAC. For information about Redfish and its protocol, supported schema, and Redfish Eventing are implemented in iDRAC, see the Redfish API Guide. For information about iDRAC property database group and object descriptions, see the Attribute Registry Guide.	www.dell.com/poweredgemanuals
	For information about earlier versions of the iDRAC documents, see the iDRAC documentation. To identify the version of iDRAC available on your system, on the iDRAC web interface, click ? > About .	www.dell.com/idracmanuals
	For information about installing the operating system, see the operating system documentation.	www.dell.com/operatingsystemmanuals
	For information about updating drivers and firmware, see the Methods to download firmware and drivers section in this document.	www.dell.com/support/drivers
Managing your system	For information about systems management software offered by Dell, see the Dell	www.dell.com/poweredgemanuals

Table 16. Additional documentation resources for your system (continued)

Task	Document	Location
	OpenManage Systems Management Overview Guide.	
	For information about setting up, using, and troubleshooting OpenManage, see the Dell OpenManage Server Administrator User's Guide.	www.dell.com/openmanagemanuals > OpenManage Server Administrator
	For information about installing, using, and troubleshooting Dell OpenManage Essentials, see the Dell OpenManage Essentials User's Guide.	www.dell.com/openmanagemanuals > OpenManage Essentials
	For information about installing, using, and troubleshooting Dell OpenManage Enterprise, see the Dell OpenManage Enterprise User's Guide.	www.dell.com/openmanagemanuals > OpenManage Enterprise
	For information about installing and using Dell SupportAssist, see the Dell EMC SupportAssist Enterprise User's Guide.	https://www.dell.com/serviceabilitytools
	For information about partner programs enterprise systems management, see the OpenManage Connections Enterprise Systems Management documents.	www.dell.com/openmanagemanuals
Working with the Dell PowerEdge RAID controllers	For information about understanding the features of the Dell PowerEdge RAID controllers (PERC), Software RAID controllers, or BOSS card and deploying the cards, see the Storage controller documentation.	www.dell.com/storagecontrollermanuals
Understanding event and error messages	For information about the event and error messages that are generated by the system firmware and agents that monitor system components, see the Error Code Lookup.	www.dell.com/qrl
Troubleshooting your system	For information about identifying and troubleshooting the PowerEdge server issues, see the Server Troubleshooting Guide.	www.dell.com/poweredgemanuals

PowerEdge R940 technical specifications

The technical and environmental specifications of your system are outlined in this section.

Topics:

- [System dimensions](#)
- [System weight](#)
- [Cooling fan specifications](#)
- [Processor specifications](#)
- [Supported operating systems](#)
- [PSU specifications](#)
- [System battery specifications](#)
- [Expansion bus specifications](#)
- [Memory specifications](#)
- [Storage controller specifications](#)
- [Remote management port specifications](#)
- [Drive specifications](#)
- [Ports and connectors specifications](#)
- [Video specifications](#)
- [Environmental specifications](#)

System dimensions

This section describes the physical dimensions of the system.

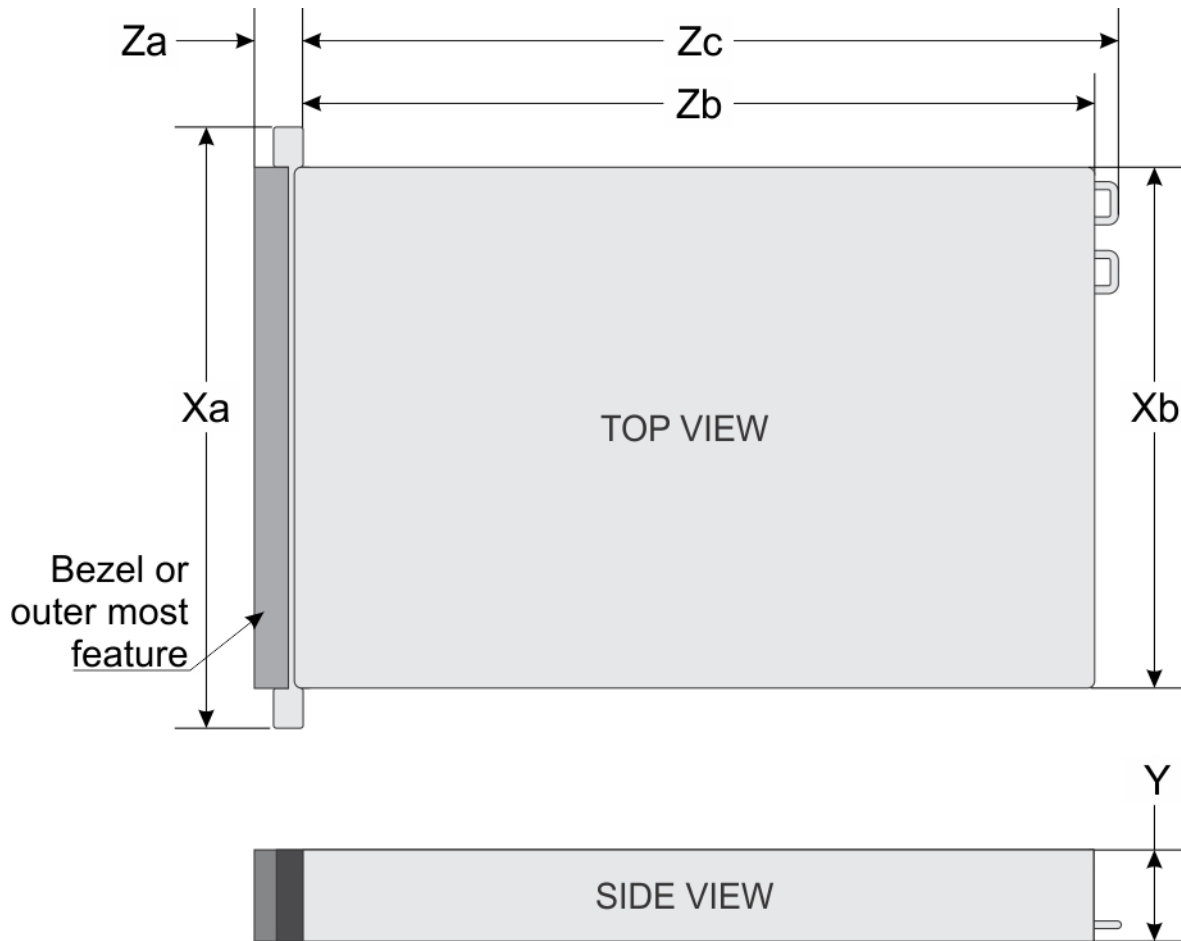

Figure 20. System dimensions of PowerEdge R940 system

Table 17. System dimensions of PowerEdge R940 system

System	Xa	Xb	Y	Za (with bezel)	Za (without bezel)	Zb	Zc
PowerEdge R940	482.0 mm (18.9 inches)	434.0 mm (17.08 inches)	130.3 mm (5.13 inches)	35.0 mm (1.37 inches)	22.0 mm (0.86 inches)	726.2 mm (28.59 inches)	777.046 mm (30.59 inches)

System weight

Table 18. System weight of PowerEdge R940 system

System	Maximum weight (with all hard drive/SSDs)
PowerEdge R940	49.9 kg (110.01 lb)

Cooling fan specifications

The PowerEdge R940 system supports up to eight standard or high performance hot swappable cooling fans.

Processor specifications

The PowerEdge R940 system supports two or four Intel Xeon Scalable Processors, up to 28 cores per socket.

Supported operating systems

The table below lists the primary operating systems supported on the PowerEdge R940:

- Red Hat® Enterprise Linux
- SUSE® Linux Enterprise Server
- Microsoft Windows Server® with Hyper-V
- VMware ESXi
- Canonical® Ubuntu® LTS

NOTE: For more information about the specific versions and additions, see <https://www.dell.com/ossupport>.

PSU specifications

The PowerEdge R940 system supports up to two AC or DC power supply units (PSUs):

- Two 2400 W, 2000 W, 1600 W, or 1100 W AC power supply units (PSUs)
- Two 1100 W DC PSUs
- Two 1100 W Mixed Mode HVDC PSUs

NOTE: The PowerEdge R940 system supports hot swappable PSUs.

CAUTION: If two PSUs are installed, both the PSUs must have the same type of label. For example, Extended Power Performance (EPP) label. Mixing PSUs from previous generations of PowerEdge servers is not supported, even if the PSUs have the same power rating. This results in a PSU mismatch condition or failure to turn the system on.

NOTE: Titanium PSU is nominally rated for 200 V AC to 240 V AC input only.

NOTE: When two identical PSUs are installed, power supply redundancy (1+1 – with redundancy or 2+0 – without redundancy) is configured in system BIOS. In redundant mode, power is supplied to the system equally from both PSUs when Hot Spare is disabled. When Hot Spare is enabled, one of the PSUs is put into the sleep mode when system utilization is low in order to maximize efficiency.

NOTE: If two PSUs are used, they must be of the same maximum output power.

Table 19. PSU specifications

PSU	Class	Heat dissipation (maximum)	Frequency	Voltage	Power rating	Current
1100 W AC	Platinum	4100 BTU/hr	50/60 Hz	100–120 V AC, autoranging	derated to 1050 W	12 A–6.5 A
				200–240 V AC, autoranging	1100 W	
1100 W DC	N/A	4416 BTU/hr	N/A	–(48–60) V DC, autoranging	1100 W	32 A
1100 W Mixed Mode HVDC (for China and Japan only)	Platinum	4100 BTU/hr	50/60 Hz	100–120 V AC, autoranging	derated to 1050 W	12 A–6.5 A
	N/A	4100 BTU/hr	N/A	200–380 V DC, autoranging	1100 W	6.4 A–3.2 A
1600 W AC	Platinum	6000 BTU/hr	50/60 Hz	100–120 V AC, autoranging	derated to 800 W	10 A
				200–240 V AC, autoranging	1600 W	
2000 W AC	Platinum	7500 BTU/hr	50/60 Hz	100–120 V AC, autoranging	derated to 1000 W	11.5 A

Table 19. PSU specifications (continued)

PSU	Class	Heat dissipation (maximum)	Frequency	Voltage	Power rating	Current
				200–240 V AC, autoranging	2000 W	
2400 W AC	Platinum	9000 BTU/hr	50/60 Hz	100–120 V AC, autoranging	derated to 1400 W	16 A
				200–240 V AC, autoranging	2400 W	

- NOTE:** Heat dissipation is calculated using the PSU wattage rating.
- NOTE:** This system is also designed to connect to the IT power systems with a phase to phase voltage not exceeding 240 V.
- NOTE:** PSUs rated for 1600 W and higher require high-line voltage (200-240 V) to supply their rated capacity.

System battery specifications

The PowerEdge R940 system supports CR 2032 3.0-V lithium coin cell system battery.

Expansion bus specifications

The PowerEdge R940 system supports PCI express (PCIe) generation 3 expansion cards, which you can install on the expansion slots available on the system board. If you are using PowerEdge R940 system with four processor configuration, then you can also install the cards by using the expansion card riser. This system supports up to two expansion card risers. The following table provides the expansion card riser specifications:

Table 20. Expansion card slots supported on the system board

PCIe slot on the system board	Processor connection	PCIe slots on system board (Height)	PCIe slots on system board (length)	Link width	Slot width
Slot 1	Processor 1	full height	half length	x8	x16
Slot 2	Processor 1	full height	half length	x16	x16
Slot 3	Processor 1	full height	half length	x16	x16
Slot 4	Processor 2	full height	half length	x16	x16
Slot 5	Processor 2	full height	half length	x8	x16
Slot 6	Processor 2	full height	half length	x8	x16
Slot 7	Processor 2	full height	half length	x16	x16

Table 21. Expansion card riser configurations

Riser	PCIe slot on the expansion card riser	Processor connection	PCIe slots on riser (Height)	PCIe slots on riser (length)	Link width	Slot width
Riser 2 (IO_RISER2)	Slot 8	Processor 3	full height	3/4 length	x16	x16
	Slot 9	Processor 3	full height	half length	x16	x16
	Slot 10	Processor 3	full height	half length	x16	x16
Riser 3 (IO_RISER3)	Slot 11	Processor 4	full height	3/4 length	x16	x16
	Slot 12	Processor 4	full height	half length	x16	x16
	Slot 13	Processor 4	full height	half length	x16	x16

Memory specifications

Table 22. Memory specifications

Memory module sockets	DIMM type	DIMM rank	DIMM capacity	Dual processors		Quad processors	
				Minimum RAM	Maximum RAM	Minimum RAM	Maximum RAM
Twenty four 288-pins	LRDIMM	Octa rank	128 GB	256 GB	3 TB	512 GB	6 TB
		Quad rank	64 GB	128 GB	1.5 TB	256 GB	3 TB
	RDIMM	Single rank	8 GB	16 GB	192 GB	32 GB	384 GB
		Dual rank	16 GB	32 GB	384 GB	64 GB	768 GB
		Dual rank	32 GB	64 GB	768 GB	128 GB	1.5 TB
		Dual rank	64 GB	64 GB	768 GB	128 GB	1.5 TB
	NVDIMM-N	Single rank	16 GB	16 GB	192 GB	Supported on the system board only (No NVDIMM-N on PEM)	
	DCPMM	NA	128 GB	RDIMM: 384 GB	LRDIMM: 1536 GB	RDIMM: 384 GB	LRDIMM: 3072 GB
				DCPMM: 1536 GB	DCPMM: 1536 GB	DCPMM: 248 GB	DCPMM: 3072 GB
		NA	256 GB	RDIMM: 192 GB	LRDIMM: 1536 GB	RDIMM: 384 GB	LRDIMM: 3072 GB
				DCPMM: 2048 GB	DCPMM: 3072 GB	DCPMM: 4096 GB	DCPMM: 6144 GB
		NA	512 GB	RDIMM: 384 GB	LRDIMM: 1536 GB	RDIMM: 768 GB	LRDIMM: 3072 GB
				DCPMM: 4096 GB	DCPMM: 6144 GB	DCPMM: 8192 GB	DCPMM: 12,288 GB

- NOTE:** 8 GB RDIMM and NVDIMM-N must not be mixed.
- NOTE:** NVDIMM-N memory modules must be installed only on the memory sockets available on the system board.
- NOTE:** The DIMM slots are not hot-pluggable.
- NOTE:** NVDIMM-N memory slots and NVDIMM-N battery are not hot-pluggable.

Storage controller specifications

The PowerEdge R940 system supports:

- **Internal controllers:** S140 (NVMe drives only), and NVMe PCIe SSD adapter.
- **Internal controllers:** PowerEdge RAID Controller (PERC) H330, HBA330, H730P, H740P and Boot optimized storage subsystem.
- **External HBAs (RAID):** H840
- **External HBAs (non-RAID):** 12Gbps SAS HBA

Remote management port specifications

The PowerEdge R940 system supports one dedicated 1Gbe Ethernet port with optional card and up to two optional shared NIC ports.

Drive specifications

Hard drives

The PowerEdge R940 system supports SAS, SATA, Nearline SAS, NVMe hard drives or SSDs.

Table 23. Supported drive options for the PowerEdge R940 system

System	Description
Eight drives system	Up to eight 2.5-inch (SAS, SATA or Nearline SAS) front accessible drives in slots 0 through 7
Twenty four drives system	Up to twenty four 2.5-inch (SAS, SATA or Nearline SAS) front accessible drives in slots 0 through 23
Twenty four drives system	Up to twenty SAS + 4 NVMe SAS/SATA drives in slots 0 to 19 + slots 20 to 23
Twenty four drives system	Up to sixteen SAS + 8 NVMe SAS/SATA drives in slots 0 to 15 + slots 16 to 23

Ports and connectors specifications

USB ports

The PowerEdge R940 system supports:

- Two USB 3.0-compliant ports on the front panel
- Two USB 3.0-compliant ports on the back panel
- One USB 3.0-compliant internal port

An optional USB memory key installed inside your system can be used as a boot device, security key, or mass storage device. To boot from the USB memory key, configure the USB memory key with a boot image and then specify the USB memory key in the boot sequence in System Setup.

NIC ports

The PowerEdge R940 system supports up to four NDC ports on the back panel, which are available in the following configurations:

- Four RJ-45 ports that support 10 Mbps, 100 Mbps, and 1000 Mbps
- Four RJ-45 ports that support 100 M, 1 G and 10 Gbps
- Four RJ-45 ports, where two ports support maximum of 10 G and the other two ports maximum of 1 G
- Two RJ-45 ports that support up to 1 Gbps and 2 SFP+ ports that support up to 10 Gbps
- Four SFP+ ports that support up to 10 Gbps
- Two SFP28 ports that support up to 25 Gbps

 **NOTE: The NDC slot is not hot-pluggable.**

Serial port

The PowerEdge R940 system supports one serial port on the back panel, which is a 9-pin connector, Data Terminal Equipment (DTE), 16550-compliant.

Internal Dual SD Module or vFlash card

The PowerEdge R940 system supports Internal Dual SD module (IDSDM) and vFlash card. In 14th generation of PowerEdge servers, IDSDM and vFlash card are combined into a single card module, and are available in these configurations:

- vFlash or
- IDSDM or
- vFlash and IDSDM

The IDSDM/vFlash card sits in the back of the system, in a Dell-proprietary slot. IDSDM/vFlash card supports three micro SD cards (two cards for IDSDM and one card for vFlash). Micro SD cards capacity for IDSDM are 16/32/64 GB while for vFlash the microSD card capacity is 16 GB.

NOTE: The write-protect switch is on the IDSDM or vFlash module.

VGA ports

The PowerEdge R940 system supports two 15-pin VGA ports. One of the VGA ports is located on the front of the system and the other port is located on the back of the system.

Video specifications

The PowerEdge R940 system supports integrated Matrox G200eW3 graphics controller with 16 MB of video frame buffer.

Table 24. Resolution information for video modes

Resolution	Refresh rate (Hz)
1024 x 768	60
1280 x 800	60
1280 x 1024	60
1360 x 768	60
1440 x 900	60
1600 x 900	60 (RB)
1600 x 1200	60
1680 x 1050	60 (RB)
1920 x 1080	60
1920 x 1200	60

Environmental specifications

NOTE: For additional information about environmental certifications, please refer to the Product Environmental Datasheet located with the Manuals & Documents on www.dell.com/poweredgemanuals.

Table 25. Temperature specifications

Temperature	Specifications
Storage	-40°C to 65°C (-40°F to 149°F)
Continuous operation (for altitude less than 950 m or 3117 ft)	10°C to 35°C (50°F to 95°F) with no direct sunlight on the equipment.
Maximum temperature gradient (operating and storage)	20°C/h (68°F/h)

Table 26. Relative humidity specifications

Relative humidity	Specifications
Storage	5% to 95% RH with 33°C (91°F) maximum dew point. Atmosphere must be non-condensing at all times.
Operating	10% to 80% relative humidity with 29°C (84.2°F) maximum dew point.

Table 27. Maximum vibration specifications

Maximum vibration	Specifications
Operating	0.26 G _{rms} at 5 Hz to 350 Hz (all three axes).
Storage	1.88 G _{rms} at 10 Hz to 500 Hz for 15 min (all six sides tested).

Table 28. Maximum shock specifications

Maximum shock	Specifications
Operating	Six consecutively executed shock pulses in the positive and negative x, y, and z axes of 6 G for up to 11 ms.
Storage	Six consecutively executed shock pulses in the positive and negative x, y, and z axes (one pulse on each side of the system) of 71 G for up to 2 ms.

Table 29. Maximum altitude specifications

Maximum altitude	Specifications
Operating	3048 m (10,000 ft)
Storage	12,000 m (39,370 ft)

Table 30. Operating temperature de-rating specifications

Operating temperature de-rating	Specifications
Up to 35°C (95°F)	Maximum temperature is reduced by 1°C/300 m (1°F/547 ft) above 950 m (3,117 ft).
35°C to 40°C (95°F to 104°F)	Maximum temperature is reduced by 1°C/175 m (1°F/319 ft) above 950 m (3,117 ft).
40°C to 45°C (104°F to 113°F)	Maximum temperature is reduced by 1°C/125 m (1°F/228 ft) above 950 m (3,117 ft).

Standard operating temperature

Table 31. Standard operating temperature specifications

Standard operating temperature	Specifications
Continuous operation (for altitude less than 950 m or 3117 ft)	10°C to 35°C (50°F to 95°F) with no direct sunlight on the equipment.
Humidity percentage range	10% to 80% Relative Humidity with 29°C (84.2°F) maximum dew point.

Expanded operating temperature

Table 32. Expanded operating temperature specifications

Expanded operating temperature	Specifications
Continuous operation	5°C to 40°C at 5% to 85% RH with 29°C dew point.

Table 32. Expanded operating temperature specifications (continued)

Expanded operating temperature	Specifications
	<p>i NOTE: Outside the standard operating temperature (10°C to 35°C), the system can operate continuously in temperatures as low as 5°C and as high as 40°C.</p> <p>For temperatures between 35°C to 40°C, de-rate maximum allowable temperature by 1°C per 175 m above 950 m (1°F per 319 ft).</p>
≤ 1% of annual operating hours	<p>–5°C to 45°C at 5% to 90% RH with 29°C dew point.</p> <p>i NOTE: Outside the standard operating temperature (10°C to 35°C), the system can operate down to –5°C or up to 45°C for a maximum of 1% of its annual operating hours.</p> <p>For temperatures between 40°C and 45°C, de-rate maximum allowable temperature by 1°C per 125 m above 950 m (1°F per 228 ft).</p>

i **NOTE: When operating in the expanded temperature range, system performance may be impacted.**

i **NOTE: When operating in the expanded temperature range, ambient temperature warnings may be reported in the System Event Log.**

Expanded operating temperature restrictions

- Do not perform a cold startup below 5°C.
- The operating temperature specified is for a maximum altitude of 3050 m (10,000 ft).
- 150 W/8 core, 165 W/12 core and higher wattage processor [Thermal Design Power (TDP)>165 W] are not supported.
- Redundant power supply unit is required.
- Non-Dell qualified peripheral cards and/or peripheral cards greater than 25 W are not supported.
- NVMe drives are not supported.
- NVDIMMs are not supported.
- DCPMMs are not supported.
- Tape backup unit is not supported.

Thermal restrictions

Following table lists the configuration required for efficient cooling.

Table 33. Thermal restriction for efficient cooling

Configuration	Number of processors	Heatsink	Processor blank	DIMM blanks	Fresh air	Fan
Eight 2.5 inch hard drive system	2	Two heat sinks for CPU < 165W	Not required	12	Yes	eight standard fans
		Two heat sinks for CPU ≥ 165 W			No	
	4	Four standard heat sinks for CPU < 165 W	Not required	24	Yes	eight standard fans
		Four heat sinks CPU ≥ 165 W			No	
Twenty four 2.5 inch hard drive system	2	Two standard heat sinks for CPU < 165W	Not required	12	Yes	eight standard fans
		Two heat sinks for CPU ≥ 165 W			No	
	4	Four standard heat sinks for CPU < 165 W	Not required	24	Yes	eight standard fans

Table 33. Thermal restriction for efficient cooling (continued)

Configuration	Number of processors	Heatsink	Processor blank	DIMM blanks	Fresh air	Fan
		Four heat sinks for CPU ≥ 165 W			No	

Table 34. NIC card slot restrictions

System	Configuration	Slot restriction	Ambient restriction
PowerEdge R940	Eight 2.5-inch hard drive system	Slots 1, 5, and 6 do not support NIC cards	35°C
	Twenty four 2.5-inch hard drive system	Slots 1, 5, and 6 do not support NIC cards	35°C

Ambient temperature limitations

The following table lists configurations that require ambient temperature less than 35°C.

i **NOTE: The ambient temperature limit must be adhered to ensure proper cooling and to avoid excess CPU throttling, which may impact system performance.**

Table 35. Configuration based ambient temperature restrictions

System	Front drive configuration	Processor Thermal Design Power (TDP)	Processor count and Memory	Ambient Restriction
PowerEdge R940	Any	150 W/8 core, 165 W/12 core, 200 W, 205 W	Any	35°C
	NVMe	Any	Any	35°C
	Any	Any	4 CPUs with DCPMMs	35°C
	Any	Any	Any number of CPUs with NVDIMMs	35°C

Particulate and gaseous contamination specifications

The following table defines the limitations that help avoid any equipment damage or failure from particulate and gaseous contamination. If the levels of particulate or gaseous pollution exceed the specified limitations and result in equipment damage or failure, you may need to rectify the environmental conditions. Remediation of environmental conditions is the responsibility of the customer.

Table 36. Particulate contamination specifications

Particulate contamination	Specifications
Air filtration	<p>Data center air filtration as defined by ISO Class 8 per ISO 14644-1 with a 95% upper confidence limit.</p> <p>i NOTE: The ISO Class 8 condition applies to data center environments only. This air filtration requirement does not apply to IT equipment designed to be used outside a data center, in environments such as an office or factory floor.</p> <p>i NOTE: Air entering the data center must have MERV11 or MERV13 filtration.</p>
Conductive dust	<p>Air must be free of conductive dust, zinc whiskers, or other conductive particles.</p> <p>i NOTE: This condition applies to data center and non-data center environments.</p>

Table 36. Particulate contamination specifications (continued)

Particulate contamination	Specifications
Corrosive dust	<ul style="list-style-type: none"> · Air must be free of corrosive dust. · Residual dust present in the air must have a deliquescent point less than 60% relative humidity. <p>NOTE: This condition applies to data center and non-data center environments.</p>

Table 37. Gaseous contamination specifications

Gaseous contamination	Specifications
Copper coupon corrosion rate	<300 Å/month per Class G1 as defined by ANSI/ISA71.04-2013.
Silver coupon corrosion rate	<200 Å/month as defined by ANSI/ISA71.04-2013.

NOTE: Maximum corrosive contaminant levels measured at ≤50% relative humidity.

Initial system setup and configuration

Topics:

- [Setting up your system](#)
- [iDRAC configuration](#)
- [Options to install the operating system](#)

Setting up your system

Perform the following steps to set up your system:

Steps

1. Unpack the system.
2. Install the system into the rack. For more information about installing the system into the rack, see the *Rail Installation Guide* at www.dell.com/poweredgemanuals.
3. Connect the peripherals to the system.
4. Connect the system to its electrical outlet.
5. Power on the system by pressing the power button or by using iDRAC.
6. Power on the attached peripherals.

For more information about setting up your system, see the *Getting Started Guide* that shipped with your system.

iDRAC configuration

The Integrated Dell Remote Access Controller (iDRAC) is designed to make system administrators more productive and improve the overall availability of Dell systems. iDRAC alerts administrators about system issues and enables them to perform remote system management. This reduces the need for physical access to the system.

Options to set up iDRAC IP address

To enable communication between your system and iDRAC, you must first configure the network settings based on your network infrastructure.

 **NOTE:** For static IP configuration, you must request for it at the time of purchase.

This option is set to **DHCP** by Default. You can set up the IP address by using one of the following interfaces:

Interfaces	Document/Section
iDRAC Settings utility	<i>Dell Integrated Dell Remote Access Controller User's Guide</i> at www.dell.com/poweredgemanuals
Dell Deployment Toolkit	<i>Dell Deployment Toolkit User's Guide</i> at www.dell.com/openmanagemanuals > OpenManage Deployment Toolkit
Dell Lifecycle Controller	<i>Dell Lifecycle Controller User's Guide</i> at www.dell.com/poweredgemanuals
Server LCD panel	LCD panel section
iDRAC Direct and Quick Sync 2 (optional)	See <i>Dell Integrated Dell Remote Access Controller User's Guide</i> at www.dell.com/poweredgemanuals

NOTE: To access iDRAC, ensure that you connect the ethernet cable to the iDRAC9 dedicated network port. You can also access iDRAC through the shared LOM mode, if you have opted for a system that has the shared LOM mode enabled.

Log in to iDRAC

You can log in to iDRAC as:

- iDRAC user
- Microsoft Active Directory user
- Lightweight Directory Access Protocol (LDAP) user

If you have opted for secure default access to iDRAC, you must use the iDRAC secure default password available on the system Information tag. If you have not opted for secure default access to iDRAC, then use the default user name and password `-root` and `calvin`. You can also log in by using your Single Sign-On or Smart Card.

NOTE: You must have the iDRAC credentials to log in to iDRAC.

NOTE: Ensure that you change the default username and password after setting up the iDRAC IP address.

For more information about logging in to the iDRAC and iDRAC licenses, see the latest *Integrated Dell Remote Access Controller User's Guide* at www.dell.com/poweredgemanuals.

You can also access iDRAC by using RACADM. For more information, see the *RACADM Command Line Interface Reference Guide* at www.dell.com/poweredgemanuals.

Options to install the operating system

If the system is shipped without an operating system, install a supported operating system by using one of the following resources:

Table 38. Resources to install the operating system

Resources	Location
iDRAC	www.dell.com/idracmanuals
Lifecycle Controller	www.dell.com/idracmanuals > Lifecycle Controller
OpenManage Deployment Toolkit	www.dell.com/openmanagemanuals > OpenManage Deployment Toolkit
Dell certified VMware ESXi	www.dell.com/virtualizationsolutions
Installation and How-to videos for supported operating systems on PowerEdge systems	Supported Operating Systems for Dell EMC PowerEdge systems

Methods to download firmware and drivers

You can download the firmware and drivers by using any of the following methods:

Table 39. Firmware and drivers

Methods	Location
From the Dell EMC support site	www.dell.com/support/home
Using Dell Remote Access Controller Lifecycle Controller (iDRAC with LC)	www.dell.com/idracmanuals
Using Dell Repository Manager (DRM)	www.dell.com/openmanagemanuals > Repository Manager
Using Dell OpenManage Essentials	www.dell.com/openmanagemanuals > OpenManage Essentials
Using Dell OpenManage Enterprise	www.dell.com/openmanagemanuals > OpenManage Enterprise
Using Dell Server Update Utility (SUU)	www.dell.com/openmanagemanuals > Server Update Utility

Table 39. Firmware and drivers (continued)

Methods	Location
Using Dell OpenManage Deployment Toolkit (DTK)	www.dell.com/openmanagemanuals > OpenManage Deployment Toolkit
Using iDRAC virtual media	www.dell.com/idracmanuals

Downloading drivers and firmware

Dell EMC recommends that you download and install the latest BIOS, drivers, and systems management firmware on your system.

Prerequisites

Ensure that you clear the web browser cache before downloading the drivers and firmware.

Steps

1. Go to www.dell.com/support/home.
2. In the **Drivers & Downloads** section, type the Service Tag of your system in the **Enter a Service Tag or product ID** box, and then click **Submit**.
 **NOTE:** If you do not have the Service Tag, select **Detect Product** to allow the system to automatically detect the Service Tag, or click **View products**, and navigate to your product.
3. Click **Drivers & Downloads**.
The drivers that are applicable to your system are displayed.
4. Download the drivers to a USB drive, CD, or DVD.

Pre-operating system management applications

You can manage basic settings and features of a system without booting to the operating system by using the system firmware.

Topics:

- [Options to manage the pre-operating system applications](#)
- [System Setup](#)
- [Dell Lifecycle Controller](#)
- [Boot Manager](#)
- [PXE boot](#)

Options to manage the pre-operating system applications

Your system has the following options to manage the pre-operating system applications:

- System Setup
- Dell Lifecycle Controller
- Boot Manager
- Preboot Execution Environment (PXE)

System Setup

By using the **System Setup** screen, you can configure the BIOS settings, iDRAC settings, and device settings of your system.

These settings have already been pre-configured per solution requirements. Contact Dell EMC before you change these settings.

 **NOTE: Help text for the selected field is displayed in the graphical browser by default. To view the help text in the text browser, press F1.**

You can access system setup by one of the following:

- Standard graphical browser—The browser is enabled by default.
- Text browser—The browser is enabled by using Console Redirection.

Viewing System Setup

To view the **System Setup** screen, perform the following steps:

Steps

1. Power on, or restart your system.
2. Press F2 immediately after you see the following message:

```
F2 = System Setup
```

 **NOTE: If your operating system begins to load before you press F2, wait for the system to finish booting, and then restart your system and try again.**

System Setup details

The **System Setup Main Menu** screen details are explained as follows:

Option	Description
System BIOS	Enables you to configure BIOS settings.
iDRAC Settings	Enables you to configure the iDRAC settings. The iDRAC settings utility is an interface to set up and configure the iDRAC parameters by using UEFI (Unified Extensible Firmware Interface). You can enable or disable various iDRAC parameters by using the iDRAC settings utility. For more information about this utility, see <i>Integrated Dell Remote Access Controller User's Guide</i> at www.dell.com/poweredgemanuals .
Device Settings	Enables you to configure device settings.

System BIOS

You can use the **System BIOS** screen to edit specific functions such as boot order, system password, and setup password, set the SATA and PCIe NVMe RAID mode, and enable or disable USB ports.

Viewing System BIOS

To view the **System BIOS** screen, perform the following steps:

Steps

1. Power on, or restart your system.
2. Press F2 immediately after you see the following message:

```
F2 = System Setup
```

NOTE: If the operating system begins to load before you press F2, wait for the system to finish booting, and then restart the system and try again.

3. On the **System Setup Main Menu** screen, click **System BIOS**.

System BIOS Settings details

About this task

The **System BIOS Settings** screen details are explained as follows:

Option	Description
System Information	Provides information about the system such as the system model name, BIOS version, and Service Tag.
Memory Settings	Provides information and options related to the installed memory.
Processor Settings	Provides information and options related to the processor such as speed and cache size.
SATA Settings	Provides options to enable or disable the integrated SATA controller and ports.
NVMe Settings	Provides options to change the NVMe settings. If the system contains the NVMe drives that you want to configure in a RAID array, you must set both this field and the Embedded SATA field on the SATA Settings menu to RAID mode. You might also need to change the Boot Mode setting to UEFI . Otherwise, you should set this field to Non-RAID mode.
Boot Settings	Provides options to specify the Boot mode (BIOS or UEFI). Enables you to modify UEFI and BIOS boot settings.
Network Settings	Provides options to manage the UEFI network settings and boot protocols. Legacy network settings are managed from the Device Settings menu.

Option	Description
Integrated Devices	Provides options to manage integrated device controllers and ports, specifies related features and options.
Serial Communication	Provides options to manage the serial ports, their related features and options.
System Profile Settings	Provides options to change the processor power management settings, and memory frequency.
System Security	Provides options to configure the system security settings, such as system password, setup password, Trusted Platform Module (TPM) security, and UEFI secure boot. It also manages the power button on the system.
Redundant OS Control	Sets the redundant OS information for redundant OS control.
Miscellaneous Settings	Provides options to change the system date and time.

System Information

You can use the **System Information** screen to view system properties such as Service Tag, system model name, and BIOS version.

Viewing System Information

To view the **System Information** screen, perform the following steps:

Steps

1. Power on, or restart your system.
2. Press F2 immediately after you see the following message:

```
F2 = System Setup
```

NOTE: If your operating system begins to load before you press F2, wait for the system to finish booting, and then restart your system and try again.

3. On the **System Setup Main Menu** screen, click **System BIOS**.
4. On the **System BIOS** screen, click **System Information**.

System Information details

About this task

The **System Information** screen details are explained as follows:

Option	Description
System Model Name	Specifies the system model name.
System BIOS Version	Specifies the BIOS version installed on the system.
System Management Engine Version	Specifies the current version of the Management Engine firmware.
System Service Tag	Specifies the system Service Tag.
System Manufacturer	Specifies the name of the system manufacturer.
System Manufacturer	Specifies the contact information of the system manufacturer.

Option	Description
Contact Information	
System CPLD Version	Specifies the current version of the system complex programmable logic device (CPLD) firmware.
Secondary System CPLD Version	Specifies the current version of the system complex programmable logic device (CPLD) firmware.
UEFI Compliance Version	Specifies the UEFI compliance level of the system firmware.

Memory Settings

You can use the **Memory Settings** screen to view all the memory settings and enable or disable specific memory functions, such as system memory testing and node interleaving.

Viewing Memory Settings

To view the **Memory Settings** screen, perform the following steps:

Steps

1. Power on, or restart your system.
2. Press F2 immediately after you see the following message:

```
F2 = System Setup
```

NOTE: If the operating system begins to load before you press F2, wait for the system to finish booting, and then restart the system and try again.

3. On the **System Setup Main Menu** screen, click **System BIOS**.
4. On the **System BIOS** screen, click **Memory Settings**.

Memory Settings details

About this task

The **Memory Settings** screen details are explained as follows:

Option	Description
System Memory Size	Specifies the memory size in the system.
System Memory Type	Specifies the type of memory that is installed in the system.
System Memory Speed	Specifies the system memory speed.
System Memory Voltage	Specifies the system memory voltage.
Video Memory	Specifies the amount of video memory.
System Memory Testing	Specifies whether the system memory tests are run during system boot. Options are Enabled and Disabled . This option is set to Disabled by default.
Memory Operating Mode	Specifies the memory operating mode. The options available are Optimizer Mode , Single Rank Spare Mode , Multi Rank Spare Mode , Mirror Mode , and Dell Fault Resilient Mode . This option is set to Optimizer Mode by default.
	NOTE: The Memory Operating Mode option can have different default and available options based on the memory configuration of your system.

Option	Description
	<p>NOTE: The Dell Fault Resilient Mode option establishes an area of memory that is fault resilient. This mode can be used by an operating system that supports the feature to load critical applications or enables the operating system kernel to maximize system availability.</p> <p>NOTE: Only Optimizer Mode should be selected when Intel DC Optane Persistent Memory is installed.</p>
Current State of Memory Operating Mode	Specifies the current state of the memory operating mode.
Node Interleaving	Specifies if Non-Uniform Memory Architecture (NUMA) is supported. If this field is set to Enabled , memory interleaving is supported if a symmetric memory configuration is installed. If this field is set to Disabled , the system supports NUMA (asymmetric) memory configurations. This option is set to Disabled by default.
ADDDC Setting	Enables or disables ADDDC Setting feature. When Adaptive Double DRAM Device Correction (ADDDC) is enabled, failing DRAMs are dynamically mapped out. When set to Enabled it can have some impact to system performance under certain workloads. This feature is applicable for x4 DIMMs only. This option is set to Enabled by default.
Opportunistic Self-Refresh	Enables or disables opportunistic self-refresh feature. This option is set to Disabled by default and is not supported when DCPMMs are in the system.
Correctable Error logging	Enables or disables logging of correctable memory threshold error. This option is set to Enabled by default.
Persistent Memory	This field controls Persistent Memory on the system. This option is only available if the persistent memory module is installed in the system.

Persistent Memory details

About this task

The **Persistent Memory** screen details can be found in the *NVDIMM-N User Guide* and *DCPMM User Guide* at <https://www.dell.com/poweredge/manuals>.

Processor Settings

You can use the **Processor Settings** screen to view the processor settings and perform specific functions such as enabling virtualization technology, hardware prefetcher, logical processor idling.

Viewing Processor Settings

To view the **Processor Settings** screen, perform the following steps:

Steps

1. Power on, or restart your system.
2. Press F2 immediately after you see the following message:

```
F2 = System Setup
```

NOTE: If your operating system begins to load before you press F2, wait for the system to finish booting, and then restart your system and try again.



3. On the **System Setup Main Menu** screen, click **System BIOS**.
4. On the **System BIOS** screen, click **Processor Settings**.

Processor Settings details

About this task

The **Processor Settings** screen details are explained as follows:

Option	Description
Logical Processor	Enables or disables the logical processors and displays the number of logical processors. If this option is set to Enabled , the BIOS displays all the logical processors. If this option is set to Disabled , the BIOS displays only one logical processor per core. This option is set to Enabled by default.
CPU Interconnect Speed	<p>Enables you to govern the frequency of the communication links among the processors in the system.</p> <p> NOTE: The standard and basic bin processors support lower link frequencies.</p> <p>The options available are Maximum data rate, 10.4 GT/s, and 9.6 GT/s. This option is set to Maximum data rate by default.</p> <p>Maximum data rate indicates that the BIOS runs the communication links at the maximum frequency that is supported by the processors. You can also select specific frequencies that the processors support, which can vary.</p> <p>For best performance, you should select Maximum data rate. Any reduction in the communication link frequency affects the performance of non-local memory accesses and cache coherency traffic. Besides, it can slow access to non-local I/O devices from a particular processor.</p> <p>However, if power-saving considerations outweigh performance, you might want to reduce the frequency of the processor communication links. If you do this, you should localize memory and I/O accesses to the nearest NUMA node to minimize the impact to system performance.</p>
Virtualization Technology	Enables or disables the virtualization technology for the processor. This option is set to Enabled by default.
Adjacent Cache Line Prefetch	Optimizes the system for applications that need high utilization of sequential memory access. This option is set to Enabled by default. You can disable this option for applications that need high utilization of random memory access.
Hardware Prefetcher	Enables or disables the hardware prefetcher. This option is set to Enabled by default.
Software Prefetcher	Enables or disables the software prefetcher. This option is set to Enabled by default.
DCU Streamer Prefetcher	Enables or disables the Data Cache Unit (DCU) streamer prefetcher. This option is set to Enabled by default.
DCU IP Prefetcher	Enables or disables the Data Cache Unit (DCU) IP prefetcher. This option is set to Enabled by default.
Sub NUMA Cluster	Sub NUMA Clustering (SNC) is a feature for breaking up the LLC into disjoint clusters based on address range, with each cluster bound to a subset of the memory controllers in the system. It improves average latency to the LLC. Enables or disables the Sub NUMA Cluster. This option is set to Disabled by default.
UPI Prefetch	Enables you to get the memory that is read started early on DDR bus. The Ultra Path Interconnect (UPI) Rx path will spawn the speculative memory that is read to Integrated Memory Controller (iMC) directly. This option is set to Enabled by default.
LLC Prefetch	Enables or disables the LLC Prefetch on all threads. This option is set to Disabled by default.
Dead Line LLC Alloc	Enables or disables the Dead Line LLC Alloc. This option is set to Enabled by default. You can enable this option to enter the dead lines in LLC or disable the option to not enter the dead lines in LLC.
Directory AtoS	Enables or disables the Directory AtoS. AtoS optimization reduces remote read latencies for repeat read accesses without intervening writes. This option is set to Disabled by default.
Logical Processor Idling	Enables you to improve the energy efficiency of a system. It uses the operating system core parking algorithm and parks some of the logical processors in the system which in turn allows the corresponding processor cores to transition into a lower power idle state. This option can only be enabled if the operating system supports it. It is set to Disabled by default.
Configurable TDP	Enables you to configure the TDP level. The available options are Nominal , Level 1 , and Level 2 . This option is set to Nominal by default.

Option	Description
	 NOTE: This option is only available on certain stock keeping units (SKUs) of the processors.
SST-Performance Profile	Enables you to reconfigure the processor using Speed Select Technology.
x2APIC Mode	Enables or disables the x2APIC mode. This option is set to Enabled by default.
Dell Controlled Turbo	Controls the turbo engagement. Enable this option only when System Profile is set to Disabled .  NOTE: Depending on the number of installed processors, there might be up to four processor listings.
Dell AVX Scaling Technology	Enables you to configure the Dell AVX scaling technology. This option is set to 0 by default.
Number of Cores per Processor	Controls the number of enabled cores in each processor. This option is set to All by default.
Processor Core Speed	Specifies the maximum core frequency of the processor.
Processor Bus Speed	Displays the bus speed of the processor.
Processor n	 NOTE: Depending on the number of processors, there might be up to four processors listed.

The following settings are displayed for each processor that is installed in the system:

Option	Description
Family-Model-Stepping	Specifies the family, model, and stepping of the processor as defined by Intel.
Brand	Specifies the brand name.
Level 2 Cache	Specifies the total L2 cache.
Level 3 Cache	Specifies the total L3 cache.
Number of Cores	Specifies the number of cores per processor.
Maximum Memory Capacity	Specifies the maximum memory capacity per processor.
Microcode	Specifies the microcode.

SATA Settings

You can use the **SATA Settings** screen to view the settings of SATA devices and enable SATA and PCIe NVMe RAID mode on your system.

Viewing SATA Settings

To view the **SATA Settings** screen, perform the following steps:

Steps

1. Power on, or restart your system.
2. Press F2 immediately after you see the following message:

F2 = System Setup

 **NOTE:** If your operating system begins to load before you press F2, wait for the system to finish booting, and then restart your system and try again.

3. On the **System Setup Main Menu** screen, click **System BIOS**.

4. On the **System BIOS** screen, click **SATA Settings**.

SATA Settings details

About this task

The **SATA Settings** screen details are explained as follows:

Option	Description
Embedded SATA	Enables the embedded SATA option to be set to AHCI Mode , or RAID Mode . This option is set to AHCI Mode by default.
Security Freeze Lock	Enables you to send Security Freeze Lock command to the embedded SATA drives during POST. This option is applicable only for AHCI mode. This option is set to Enabled by default.
Write Cache	Enables or disables the command for the embedded SATA drives during POST. This option is set to Disabled by default.
Port n	Enables you to set the drive type of the selected device. For AHCI Mode or RAID Mode , BIOS support is always enabled.
Option	Description
Model	Specifies the drive model of the selected device.
Drive Type	Specifies the type of drive attached to the SATA port.
Capacity	Specifies the total capacity of the drive. This field is undefined for removable media devices such as optical drives.

NVMe Settings

The NVMe settings enable you to set the NVMe drives to either **RAID** mode or **Non-RAID** mode.

NOTE: To configure these drives as RAID drives, you must set the NVMe drives and the Embedded SATA option in the SATA Settings menu to RAID mode. If not, you must set this field to Non-RAID mode.

Viewing NVMe Settings

To view the **NVMe Settings** screen, perform the following steps:

Steps

1. Power on, or restart your system.
2. Press F2 immediately after you see the following message:

```
F2 = System Setup
```

NOTE: If your operating system begins to load before you press F2, wait for the system to finish booting, and then restart your system and try again.

3. On the **System Setup Main Menu** screen, click **System BIOS**.
4. On the **System BIOS** screen, click **NVMe Settings**.

NVMe Settings details

About this task

The NVMe Settings screen details are explained as follows:

Option	Description
NVMe Mode	Enables you to set the NVMe mode. This option is set to Non RAID by default.

Boot Settings

You can use the **Boot Settings** screen to set the boot mode to either **BIOS** or **UEFI**. It also enables you to specify the boot order.

- **UEFI:** The Unified Extensible Firmware Interface (UEFI) is a new interface between operating systems and platform firmware. The interface consists of data tables with platform related information, boot and runtime service calls that are available to the operating system and its loader. The following benefits are available when the **Boot Mode** is set to **UEFI**:
 - Support for drive partitions larger than 2 TB.
 - Enhanced security (e.g., UEFI Secure Boot).
 - Faster boot time.
- **BIOS:** The **BIOS Boot Mode** is the legacy boot mode. It is maintained for backward compatibility.

NOTE: You must use only the UEFI boot mode in order to boot from NVMe drives.

Viewing Boot Settings

To view the **Boot Settings** screen, perform the following steps:

Steps

1. Power on, or restart your system.
2. Press F2 immediately after you see the following message:

```
F2 = System Setup
```

NOTE: If your operating system begins to load before you press F2, wait for the system to finish booting, and then restart your system and try again.



3. On the **System Setup Main Menu** screen, click **System BIOS**.
4. On the **System BIOS** screen, click **Boot Settings**.

Boot Settings details

About this task

The **Boot Settings** screen details are explained as follows:

Option	Description
Boot Mode	<p>Enables you to set the boot mode of the system.</p> <p>CAUTION: Switching the boot mode may prevent the system from booting if the operating system is not installed in the same boot mode.</p> <p>If the operating system supports UEFI, you can set this option to UEFI. Setting this field to BIOS enables compatibility with non-UEFI operating systems. This option is set to UEFI by default.</p> <p>NOTE: Setting this field to UEFI disables the BIOS Boot Settings menu.</p>
Boot Sequence Retry	<p>Enables or disables the Boot Sequence Retry feature or resets the system. If the last attempt to boot has failed, the system immediately performs a cold reset or retries to boot after a 30 seconds, depending on if this field is set to Reset or Enabled. This option is set to Enabled by default.</p>
Hard-Disk Failover	<p>Specifies the drive that is booted in the event of a drive failure. The devices are selected in the Hard-Disk Drive Sequence on the Boot Option Setting menu. When this option is set to Disabled, only the first drive in the list is attempted to boot. When this option is set to Enabled, all drives are attempted to boot in the order selected in the Hard-Disk Drive Sequence. This option is not enabled for UEFI Boot Mode. This option is set to Disabled by default.</p>
Generic USB Boot	<p>Enables or disables the USB boot option. This option is set to Disabled by default.</p>
Hard-disk Drive Placeholder	<p>Enables or disables the Hard-disk drive placeholder option. This option is set to Disabled by default.</p>

BIOS Boot Settings	Enables or disables BIOS boot options.  NOTE: This option is enabled only if the boot mode is BIOS.
UEFI Boot Settings	Enables or disables UEFI Boot options. The Boot options include IPv4 PXE and IPv6 PXE . This option is set to IPv4 by default.  NOTE: This option is enabled only if the boot mode is UEFI.
UEFI Boot Sequence	Enables you to change the boot device order.
Boot Options Enable/Disable	Enables you to select the enabled or disabled boot devices.

Choosing system boot mode

System Setup enables you to specify one of the following boot modes for installing your operating system:

- BIOS boot mode (the default) is the standard BIOS-level boot interface.
- UEFI boot mode (the default), is an enhanced 64-bit boot interface.

If you have configured your system to boot to UEFI mode, it replaces the system BIOS.

1. From the **System Setup Main Menu**, click **Boot Settings**, and select **Boot Mode**.
2. Select the UEFI boot mode you want the system to boot into.

 **CAUTION: Switching the boot mode may prevent the system from booting if the operating system is not installed in the same boot mode.**

3. After the system boots in the specified boot mode, proceed to install your operating system from that mode.

 **NOTE: Operating systems must be UEFI-compatible to be installed from the UEFI boot mode. DOS and 32-bit operating systems do not support UEFI and can only be installed from the BIOS boot mode.**

 **NOTE: For the latest information about supported operating systems, go to www.dell.com/ossupport.**

Changing boot order

About this task

You may have to change the boot order if you want to boot from a USB key. You may have to change the boot order if you want to boot from a USB key or an optical drive. The following instructions may vary if you have selected **BIOS** for **Boot Mode**.

Steps

1. On the **System Setup Main Menu** screen, click **System BIOS > Boot Settings > UEFI/BIOS Boot Settings > UEFI/BIOS Boot Sequence**.
2. Click **Boot Option Settings > BIOS/UEFI Boot Settings > Boot Sequence**.

 **NOTE: Use the arrow keys to select a boot device, and use the plus (+) and minus (-) sign keys to move the device down or up in the order.**

3. Click **Exit**, and then click **Yes** to save the settings on exit.

Network Settings

You can use the **Network Settings** screen to modify UEFI PXE, iSCSI, and HTTP boot settings. The network settings option is available only in the UEFI mode.

 **NOTE: BIOS does not control network settings in the BIOS mode. For the BIOS boot mode, the optional Boot ROM of the network controllers handles the network settings.**

Viewing Network Settings

To view the **Network Settings** screen, perform the following steps:

Steps

1. Power on, or restart your system.
2. Press F2 immediately after you see the following message:

```
F2 = System Setup
```

NOTE: If your operating system begins to load before you press F2, wait for the system to finish booting, and then restart your system and try again.

3. On the **System Setup Main Menu** screen, click **System BIOS**.
4. On the **System BIOS** screen, click **Network Settings**.

Network Settings screen details

The **Network Settings** screen details are explained as follows:

About this task

Option	Description				
UEFI PXE Settings	<table border="1"> <thead> <tr> <th>Options</th> <th>Description</th> </tr> </thead> <tbody> <tr> <td>PXE Device n (n = 1 to 4)</td> <td>Enables or disables the device. When enabled, a UEFI PXE boot option is created for the device.</td> </tr> </tbody> </table>	Options	Description	PXE Device n (n = 1 to 4)	Enables or disables the device. When enabled, a UEFI PXE boot option is created for the device.
Options	Description				
PXE Device n (n = 1 to 4)	Enables or disables the device. When enabled, a UEFI PXE boot option is created for the device.				
PXE Device n Settings (n = 1 to 4)	Enables you to control the configuration of the PXE device.				
UEFI HTTP Settings	<table border="1"> <thead> <tr> <th>Options</th> <th>Description</th> </tr> </thead> <tbody> <tr> <td>HTTP Device (n = 1 to 4)</td> <td>Enables or disables the device. When enabled, a UEFI HTTP boot option is created for the device.</td> </tr> </tbody> </table>	Options	Description	HTTP Device (n = 1 to 4)	Enables or disables the device. When enabled, a UEFI HTTP boot option is created for the device.
Options	Description				
HTTP Device (n = 1 to 4)	Enables or disables the device. When enabled, a UEFI HTTP boot option is created for the device.				
HTTP Device n Settings (n = 1 to 4)	Enables you to control the configuration of the HTTP device.				
UEFI iSCSI Settings	Enables you to control the configuration of the iSCSI device.				

Table 40. UEFI iSCSI Settings screen details

Option	Description
iSCSI Initiator Name	Specifies the name of the iSCSI initiator in IQN format.
iSCSI Device1	Enables or disables the iSCSI device. When disabled, a UEFI boot option is created for the iSCSI device automatically. This is set to by default.
iSCSI Device1 Settings	Enables you to control the configuration of the iSCSI device.

TLS Authentication Configuration View and/or modify this device's boot TLS authentication mode. **None** means the HTTP server and the client will not authenticate each other for this boot. **One way** means the HTTP server will be authenticated by the client, while the client will not be authenticated by the server. This option is set to **None** by default.

Integrated Devices

You can use the **Integrated Devices** screen to view and configure the settings of all integrated devices including the video controller, integrated RAID controller, and the USB ports.

Viewing Integrated Devices

To view the **Integrated Devices** screen, perform the following steps:

Steps

1. Power on, or restart your system.
2. Press F2 immediately after you see the following message:

```
F2 = System Setup
```

NOTE: If your operating system begins to load before you press F2, wait for the system to finish booting, and then restart your system and try again.

3. On the **System Setup Main Menu** screen, click **System BIOS**.
4. On the **System BIOS** screen, click **Integrated Devices**.

Integrated Devices details

About this task

The **Integrated Devices** screen details are explained as follows:

Option	Description
User Accessible USB Ports	<p>Configures the user accessible USB ports. Selecting Only Back Ports On disables the front USB ports; selecting All Ports Off disables all front and back USB ports; selecting All Ports Off (Dynamic) disables all front and back USB ports during POST and front ports can be enabled or disabled dynamically by an authorized user or authorized users without resetting the system.</p> <p>The USB keyboard and mouse function in certain USB ports during the boot process, depending on the selection. After the boot process is complete, the USB ports will be enabled or disabled as per the setting.</p>
Internal USB Port	<p>Enables or disables the internal USB port. This option is set to On or Off. This option is set to On by default.</p> <p>NOTE: The Internal SD Card Port on the PCIe riser is controlled by Internal USB Port.</p>
iDRAC Direct USB Port	<p>The iDRAC Direct USB port is managed by iDRAC exclusively with no host visibility. This option is set to ON or OFF. When set to OFF, iDRAC does not detect any USB devices installed in this managed port. This option is set to On by default.</p>
Integrated RAID Controller	<p>Enables or disables the integrated RAID controller. This option is set to Enabled by default.</p>
Integrated Network Card 1	<p>Enables or disables the integrated network card (NDC). When set to Disabled, the NDC is not available to the operating system (OS). This option is set to Enabled by default.</p> <p>NOTE: If set to Disabled (OS), the Integrated NICs might still be available for shared network access by iDRAC.</p>
I/OAT DMA Engine	<p>Enables or disables the I/O Acceleration Technology (I/OAT) option. I/OAT is a set of DMA features designed to accelerate network traffic and lower CPU utilization. Enable only if the hardware and software support the feature. This option is set to Disabled by default.</p>
Embedded Video Controller	<p>Enables or disables the use of Embedded Video Controller as the primary display. When set to Enabled, the Embedded Video Controller is used as the primary display even if add-in graphic cards are installed. When set to Disabled, an add-in graphics card is used as the primary display. BIOS will output displays to both the primary add-in video and the embedded video during POST and pre-boot environment. The embedded video is disabled before the operating system boots. This option is set to Enabled by default.</p>

Option	Description
	<p>NOTE: When there are multiple add-in graphic cards installed in the system, the first card discovered during PCI enumeration is selected as the primary video. You might have to re-arrange the cards in the slots in order to control which card is the primary video.</p>
Current State of Embedded Video Controller	Displays the current state of the embedded video controller. The Current State of Embedded Video Controller option is a read-only field. If the Embedded Video Controller is the only display capability in the system (that is, no add-in graphics card is installed), then the Embedded Video Controller is automatically used as the primary display even if the Embedded Video Controller setting is set to Enabled .
SR-IOV Global Enable	Enables or disables the BIOS configuration of Single Root I/O Virtualization (SR-IOV) devices. This option is set to Disabled by default.
Internal SD Card Port	Enables or disables the internal SD card port of the Internal Dual SD Module (IDSMD). This option is set to On by default.
Internal SD Card Redundancy	Configures the redundancy mode of the Internal Dual SD Module (IDSMD). When set to Mirror Mode , data is written on both SD cards. After failure of either card and replacement of the failed card, the data of the active card is copied to the offline card during the system boot. When Internal SD Card Redundancy is set to Disabled , only the primary SD card is visible to the OS. This option is set to Disabled by default.
Internal SD Primary Card	By default, the primary SD card is selected to be SD Card 1. If SD Card 1 is not present, then the controller selects SD Card 2 to be the primary SD card.
OS Watchdog Timer	If your system stops responding, this watchdog timer aids in the recovery of your operating system. When this option is set to Enabled , the operating system initializes the timer. When this option is set to Disabled (the default), the timer does not have any effect on the system.
Empty Slot Unhide	Enables or disables the root ports of all the empty slots that are accessible to the BIOS and OS. This option is set to Disabled by default.
Memory Mapped I/O above 4 GB	Enables or disables the support for the PCIe devices that need large amounts of memory. Enable this option only for 64-bit operating systems. This option is set to Enabled by default.
Memory Mapped I/O Base	When set to 12 TB , the system maps the MMIO base to 12 TB. Enable this option for an OS that requires 44 bit PCIe addressing. When set to 512 GB , the system maps the MMIO base to 512 GB, and reduces the maximum support for memory to less than 512 GB. Enable this option only for the 4 GPU DGMA issue. This option is set to 56 TB by default.
Slot Disablement	Enables or disables the available PCIe slots on your system. The slot disablement feature controls the configuration of the PCIe cards installed in the specified slot. Slots must be disabled only when the installed peripheral card prevents booting into the operating system or causes delays in system startup. If the slot is disabled, both the Option ROM and UEFI drivers are disabled. Only slots that are present on the system are available for control.

Table 41. Slot Disablement

Option	Description
Slot 1	Enables or disables the PCIe slot 1. This option is set to Enabled by default.
Slot 2	Enables or disables or only the boot driver is disabled for the PCIe slot 2. This option is set to Enabled by default.
Slot 3	Enables or disables or only the boot driver is disabled for the PCIe slot 3. This option is set to Enabled by default.
Slot 4	Enables or disables or only the boot driver is disabled for the PCIe slot 4. This option is set to Enabled by default.

Option **Description**

Table 41. Slot Disablement (continued)

Option	Description
Slot 5	Enables or disables or only the boot driver is disabled for the PCIe slot 5. This option is set to Enabled by default.
Slot 6	Enables or disables or only the boot driver is disabled for the PCIe slot 6. This option is set to Enabled by default.
Slot 7	Enables or disables or only the boot driver is disabled for the PCIe slot 7. This option is set to Enabled by default.

NOTE: If your system supports four processors, you may have 13 PCIe slots.

Slot Bifurcation Allows **Platform Default Bifurcation**, **Auto Discovery of Bifurcation** and **Manual Bifurcation Control**. The default is set to **Platform Default Bifurcation**. The slot bifurcation field is accessible when set to **Manual Bifurcation Control** and is disabled when set to **Platform Default Bifurcation** or **Auto Discovery of Bifurcation**.

Table 42. Slot Bifurcation

Option	Description
Slot 1 Bifurcation	x4 or x8 or x4x4x4x8 or x8x4x4 Bifurcation
Slot 2 Bifurcation	x4 or x8 Bifurcation
Slot 3 Bifurcation	x4 or x8 or x4x4x4x8 or x8x4x4 Bifurcation
Slot 4 Bifurcation	x16 or x4 or x8 or x4x4x4x8 or x8x4x4 Bifurcation
Slot 5 Bifurcation	x4 Bifurcation or x8 Bifurcation
Slot 6 Bifurcation	x4 or x8 Bifurcation
Slot 7 Bifurcation	x16 or x4 or x8 or x4x4x4x8 or x8x4x4 Bifurcation

Serial Communication

You can use the **Serial Communication** screen to view the properties of the serial communication port.

Viewing Serial Communication

To view the **Serial Communication** screen, perform the following steps:

Steps

1. Power on, or restart your system.
2. Press F2 immediately after you see the following message:

```
F2 = System Setup
```

NOTE: If your operating system begins to load before you press F2, wait for the system to finish booting, and then restart your system and try again.

3. On the **System Setup Main Menu** screen, click **System BIOS**.
4. On the **System BIOS** screen, click **Serial Communication**.

Serial Communication details

About this task

The **Serial Communication** screen details are explained as follows:

Option	Description
Serial Communication	Enables you to select serial communication devices (Serial Device 1 and Serial Device 2) in BIOS. BIOS console redirection can also be enabled, and the port address can be specified. This option is set to Auto by default.
Serial Port Address	Enables you to set the port address for serial device. This field sets the serial port address to either COM1 or COM2 (COM1=0x3F8, COM2=0x2F8). This option is set to Serial Device1=COM2 or Serial Device 2=COM1 by default. <i>i</i> NOTE: You can use only Serial Device 2 for the Serial Over LAN (SOL) feature. To use console redirection by SOL, configure the same port address for console redirection and the serial device. <i>i</i> NOTE: Every time the system boots, the BIOS syncs the serial MUX setting saved in iDRAC. The serial MUX setting can independently be changed in iDRAC. Loading the BIOS default settings from within the BIOS setup utility may not always revert the serial MUX setting to the default setting of Serial Device 1.
External Serial Connector	Enables you to associate the External Serial Connector to Serial Device 1 , Serial Device 2 , or the Remote Access Device by using this option. This option is set to Serial Device 1 by default. <i>i</i> NOTE: Only Serial Device 2 can be used for Serial Over LAN (SOL). To use console redirection by SOL, configure the same port address for console redirection and the serial device. <i>i</i> NOTE: Every time the system boots, the BIOS syncs the serial MUX setting saved in iDRAC. The serial MUX setting can independently be changed in iDRAC. Loading the BIOS default settings from within the BIOS setup utility may not always revert this setting to the default setting of Serial Device 1.
Failsafe Baud Rate	Specifies the failsafe baud rate for console redirection. The BIOS attempts to determine the baud rate automatically. This failsafe baud rate is used only if the attempt fails, and the value must not be changed. This option is set to 115200 by default.
Remote Terminal Type	Enables you to set the remote console terminal type. This option is set to VT100/VT220 by default.
Redirection After Boot	Enables or disables the BIOS console redirection when the operating system is loaded. This option is set to Enabled by default.

System Profile Settings

You can use the **System Profile Settings** screen to enable specific system performance settings such as power management.

Viewing System Profile Settings

To view the **System Profile Settings** screen, perform the following steps:

Steps

1. Power on, or restart your system.
2. Press F2 immediately after you see the following message:

```
F2 = System Setup
```

- i* **NOTE: If your operating system begins to load before you press F2, wait for the system to finish booting, and then restart your system and try again.**

3. On the **System Setup Main Menu** screen, click **System BIOS**.
4. On the **System BIOS** screen, click **System Profile Settings**.

System Profile Settings details

About this task

The **System Profile Settings** screen details are explained as follows:

Option	Description
System Profile	<p>Sets the system profile. If you set the System Profile option to a mode other than Custom, the BIOS automatically sets the rest of the options. You can only change the rest of the options if the mode is set to Custom. This option is set to Performance Per Watt Optimized (DAPC) by default. DAPC is Dell Active Power Controller.</p> <p>NOTE: All the parameters on the system profile setting screen are available only when the System Profile option is set to Custom.</p>
CPU Power Management	Sets the CPU power management. This option is set to System DBPM (DAPC) by default. DBPM is Demand-Based Power Management.
Memory Frequency	Sets the speed of the system memory. You can select Maximum Performance , Maximum Reliability , or a specific speed. This option is set to Maximum Performance by default.
Turbo Boost	Enables or disables the processor to operate in the turbo boost mode. This option is set to Enabled by default.
C1E	Enables or disables the processor to switch to a minimum performance state when it is idle. This option is set to Enabled by default.
C States	Enables or disables the processor to operate in all available power states. This option is set to Enabled by default.
Write Data CRC	Enables or disables the Write Data CRC. This option is set to Disabled by default.
Memory Patrol Scrub	Sets the memory patrol scrub frequency. This option is set to Standard by default.
Memory Refresh Rate	Sets the memory refresh rate to either 1x or 2x. This option is set to 1x by default.
Uncore Frequency	Enables you to select the Processor Uncore Frequency option. Dynamic mode enables the processor to optimize power resources across cores and uncores during runtime. The optimization of the uncore frequency to either save power or optimize performance is influenced by the setting of the Energy Efficiency Policy option.
Energy Efficient Policy	<p>Enables you to select the Energy Efficient Policy option.</p> <p>The CPU uses the setting to manipulate the internal behavior of the processor and determines whether to target higher performance or better power savings. This option is set to Balanced Performance by default.</p>
Number of Turbo Boost Enabled Cores for Processor 1	<p>NOTE: If there are four processors installed in the system, you will see an entry for Number of Turbo Boost Enabled Cores for Processor 4.</p> <p>Controls the number of turbo boost enabled cores for Processor 1. The maximum number of cores is enabled by default.</p>
Monitor/Mwait	<p>Enables the Monitor/Mwait instructions in the processor. This option is set to Enabled for all system profiles, except Custom by default.</p> <p>NOTE: This option can be disabled only if the C States option in the Custom mode is set to disabled.</p> <p>NOTE: When C States is set to Enabled in the Custom mode, changing the Monitor/Mwait setting does not impact the system power or performance.</p>
CPU Interconnect Bus Link Power Management	Enables or disables the CPU Interconnect Bus Link Power Management. This option is set to Enabled by default.
PCI ASPM L1 Link Power Management	Enables or disables the PCI ASPM L1 Link Power Management. This option is set to Enabled by default.

Option	Description
Intel Persistent Memory CR QoS	Controls the tuning recipe for Quality of Service (QoS) knobs. Disabled by default. Method 1 is recommended for 2-2-2 memory configurations in App-Direct. Method 2 is recommended for other memory configurations in App-Direct. Method 3 is recommended for 1 DIMM per channel configurations.
Intel Persistent Memory Performance Setting	Controls the thresholds that trigger switching between near (RDIMM/LRDIMM) and far (DCPMM) memory. BW Optimized , selected by default, optimizes for RDIMM/LRDIMM and DCPMM bandwidth. Latency Optimized offers better RDIMM/LRDIMM latency in the presence of DCPMM. Balanced Profile optimizes performance with Memory Mode configured DCPMM.

System Security

You can use the **System Security** screen to perform specific functions such as setting the system password, setup password and disabling the power button.

Viewing System Security

To view the **System Security** screen, perform the following steps:

Steps

1. Power on, or restart your system.
2. Press F2 immediately after you see the following message:

```
F2 = System Setup
```

NOTE: If your operating system begins to load before you press F2, wait for the system to finish booting, and then restart your system and try again.



3. On the **System Setup Main Menu** screen, click **System BIOS**.
4. On the **System BIOS** screen, click **System Security**.

System Security Settings details

About this task

The **System Security Settings** screen details are explained as follows:

Option	Description
CPU AES-NI	Improves the speed of applications by performing encryption and decryption by using the Advanced Encryption Standard Instruction Set (AES-NI). This option is set to Enabled by default.
System Password	Enables you to set the system password. This option is set to Enabled by default and is read-only if the password jumper is not installed in the system.
Setup Password	Enables you to set the system setup password. This option is read-only if the password jumper is not installed in the system.
Password Status	Enables you to lock the system password. This option is set to Unlocked by default.
TPM Security	NOTE: The TPM menu is available only when the TPM module is installed. Enables you to control the reporting mode of the TPM. The TPM Security option is set to Off by default. You can only modify the TPM Status TPM Activation, and the Intel TXT fields if the TPM Status field is set to either On with Pre-boot Measurements or On without Pre-boot Measurements .
TPM Information	Enables you to change the operational state of the TPM. This option is set to No Change by default.
TPM Status	Specifies the TPM status.
TPM Command	Controls the Trusted Platform Module (TPM). When set to None , no command is sent to the TPM. When set to Activate , the TPM is enabled and activated. When set to Deactivate , the TPM is disabled and deactivated. When set to Clear , all the contents of the TPM are cleared. This option is set to None by default.

Option	Description
	<p> CAUTION: Clearing the TPM results in the loss of all keys in the TPM. The loss of TPM keys may affect booting to the operating system.</p> <p>This field is read-only when TPM Security is set to Off. The action requires an additional reboot before it can take effect.</p>
TPM Advanced Settings	This setting is enabled only when TPM Security is set to ON.
Intel(R) TXT	Enables you to set the Intel Trusted Execution Technology (TXT) option. To enable the Intel TXT option, virtualization technology and TPM Security must be enabled with Pre-boot measurements. This option is set to Off by default.
Power Button	Enables you to set the power button on the front of the system. This option is set to Enabled by default.
AC Power Recovery	Sets how the system behaves after AC power is restored to the system. This option is set to Last by default.
AC Power Recovery Delay	Enables you to set the time that the system should take to turn on after AC power is restored to the system. This option is set to Immediate by default.
User Defined Delay (60 s to 600 s)	Enables you to set the User Defined Delay option when the User Defined option for AC Power Recovery Delay is selected.
UEFI Variable Access	Provides varying degrees of securing UEFI variables. When set to Standard (the default), UEFI variables are accessible in the operating system per the UEFI specification. When set to Controlled , selected UEFI variables are protected in the environment, and new UEFI boot entries are forced to be at the end of the current boot order.
In-Band Manageability Interface	<p>When set to Disabled, this setting hides the Management Engine's (ME), HECI devices, and the system's IPMI devices from the operating system. This prevents the operating system from changing the ME power capping settings, and blocks access to all in-band management tools. All management should be managed through out-of-band. This option is set to Enabled by default.</p> <p> NOTE: BIOS update requires HECI devices to be operational and DUP updates require IPMI interface to be operational. This setting needs to be set to Enabled to avoid updating errors.</p>
Secure Boot	Enables Secure Boot, where the BIOS authenticates each pre-boot image by using the certificates in the Secure Boot Policy. Secure Boot is set to Disabled by default.
Secure Boot Policy	When Secure Boot policy is set to Standard , the BIOS uses the system manufacturer key and certificates to authenticate pre-boot images. When Secure Boot policy is set to Custom , the BIOS uses the user-defined key and certificates. Secure Boot policy is set to Standard by default.
Secure Boot Mode	<p>Enables you to configure how the BIOS uses the Secure Boot Policy Objects (PK, KEK, db, dbx).</p> <p>If the current mode is set to Deployed Mode, the available options are User Mode and Deployed Mode. If the current mode is set to User Mode, the available options are User Mode, Audit Mode, and Deployed Mode.</p>

Options	Description
User Mode	<p>In User Mode, PK must be installed, and BIOS performs signature verification on programmatic attempts to update policy objects.</p> <p>BIOS allows unauthenticated programmatic transitions between modes.</p>
Audit Mode	<p>In Audit mode, PK is not present. BIOS does not authenticate programmatic updates to the policy objects, and transitions between modes.</p> <p>Audit Mode is useful for programmatically determining a working set of policy objects.</p> <p>BIOS performs signature verification on pre-boot images. BIOS also logs the results in the image Execution Information Table, but approves the images whether they pass or fail verification.</p>
Deployed Mode	Deployed Mode is the most secure mode. In Deployed Mode , PK must be installed and the BIOS performs signature verification on programmatic attempts to update policy objects.

Option	Description				
	<table border="1"> <thead> <tr> <th>Options</th> <th>Description</th> </tr> </thead> <tbody> <tr> <td>Deployed Mode</td> <td>restricts the programmatic mode transitions.</td> </tr> </tbody> </table>	Options	Description	Deployed Mode	restricts the programmatic mode transitions.
Options	Description				
Deployed Mode	restricts the programmatic mode transitions.				
Secure Boot Policy Summary	Specifies the list of certificates and hashes that secure boot uses to authenticate images.				
Secure Boot Custom Policy Settings	Configures the Secure Boot Custom Policy. To enable this option, set the Secure Boot Policy to Custom .				

Creating a system and setup password

Prerequisites

Ensure that the password jumper is enabled. The password jumper enables or disables the system password and setup password features. For more information, see the System board jumper settings section.

 **NOTE: If the password jumper setting is disabled, the existing system password and setup password are deleted and you need not provide the system password to boot the system.**

Steps

1. To enter System Setup, press F2 immediately after turning on or rebooting your system.
2. On the **System Setup Main Menu** screen, click **System BIOS > System Security**.
3. On the **System Security** screen, verify that **Password Status** is set to **Unlocked**.
4. In the **System Password** field, type your system password, and press Enter or Tab.

Use the following guidelines to assign the system password:

- A password can have up to 32 characters.
- The password can contain the numbers 0 through 9.
- Only the following special characters are allowed: space, ("), (+), (,), (-), (.), (/), (:), ([), (\), (]), (').

A message prompts you to reenter the system password.

5. Reenter the system password, and click **OK**.
6. In the **Setup Password** field, type your setup password and press Enter or Tab. A message prompts you to reenter the setup password.
7. Reenter the setup password, and click **OK**.
8. Press Esc to return to the System BIOS screen. Press Esc again.

A message prompts you to save the changes.

 **NOTE: Password protection does not take effect until the system reboots.**

Using your system password to secure the system

About this task

If you have assigned a setup password, the system accepts your setup password as an alternate system password.

Steps

1. Power on or reboot your system.
2. Type the system password and press Enter.

Next steps

When **Password Status** is set to **Locked**, type the system password and press Enter when prompted at reboot.

NOTE: If an incorrect system password is typed, the system displays a message and prompts you to reenter your password. You have three attempts to type the correct password. After the third unsuccessful attempt, the system displays an error message that the system has stopped functioning and must be turned off. Even after you turn off and restart the system, the error message is displayed until the correct password is entered.

Deleting or changing system and setup password

Prerequisites

NOTE: You cannot delete or change an existing system or setup password if the Password Status is set to Locked.

Steps

1. To enter System Setup, press F2 immediately after turning on or restarting your system.
2. On the **System Setup Main Menu** screen, click **System BIOS > System Security**.
3. On the **System Security** screen, ensure that **Password Status** is set to **Unlocked**.
4. In the **System Password** field, change or delete the existing system password, and then press Enter or Tab.
5. In the **Setup Password** field, alter or delete the existing setup password, and then press Enter or Tab.

NOTE: If you change the system password or setup password, a message prompts you to reenter the new password. If you delete the system password or setup password, a message prompts you to confirm the deletion.

6. Press Esc to return to the **System BIOS** screen. Press Esc again, and a message prompts you to save the changes.
7. Select **Setup Password**, change, or delete the existing setup password and press Enter or Tab.

NOTE: If you change the system password or setup password, a message prompts you to reenter the new password. If you delete the system password or setup password, a message prompts you to confirm the deletion.

Operating with setup password enabled

If **Setup Password** is set to **Enabled**, type the correct setup password before modifying the system setup options.

If you do not type the correct password in three attempts, the system displays the following message:

```
Invalid Password! Number of unsuccessful password attempts: <x> System Halted! Must power down.
```

```
Password Invalid. Number of unsuccessful password attempts: <x> Maximum number of password attempts exceeded. System halted.
```

Even after you restart the system, the error message is displayed until the correct password is typed. The following options are exceptions:

- If **System Password** is not set to **Enabled** and is not locked through the **Password Status** option, you can assign a system password. For more information, see the [System Security Settings details](#) section.
- You cannot disable or change an existing system password.

NOTE: You can use the password status option with the setup password option to protect the system password from unauthorized changes.

Redundant OS Control

In the **Redundant OS Control** screen you can set the redundant OS information. This enables you to set up a physical recovery disk on the system.

Viewing Redundant OS Control

To view the **Redundant OS Control** screen, perform the following steps:

Steps

1. Power on, or restart your system.

2. Press F2 immediately after you see the following message:

F2 = System Setup

NOTE: If your operating system begins to load before you press F2, wait for the system to finish booting, and then restart your system and try again.

3. On the **System Setup Main Menu** screen, click **System BIOS**.
4. On the **System BIOS** screen, click **Redundant OS Control**.

Redundant OS Control screen details

The **Redundant OS Control** screen details are explained as follows:

About this task

Option	Description
Redundant OS Location	<p>Enables you to select a backup disk from the following devices:</p> <ul style="list-style-type: none">• None• IDSDM• SATA Ports in AHCI mode• BOSS PCIe Cards (Internal M.2 Drives)• Internal USB <p>NOTE: RAID configurations and NVMe cards not are included as BIOS does not have the ability to distinguish between individual drives in those configurations.</p>
Redundant OS State	<p>NOTE: This option is disabled if Redundant OS Location is set to None.</p> <p>When set to Visible, the backup disk is visible to the boot list and OS. When set to Hidden, the backup disk is disabled and is not visible to the boot list and OS. This option is set to Visible by default.</p> <p>NOTE: BIOS will disable the device in hardware, so it cannot be accessed by the OS.</p>
Redundant OS Boot	<p>NOTE: This option is disabled if Redundant OS Location is set to None or if Redundant OS State is set to Hidden.</p> <p>When set to Enabled, BIOS boots to the device specified in Redundant OS Location. When set to Disabled, BIOS preserves the current boot list settings. This option is set to Disabled by default.</p>

Miscellaneous Settings

You can use the **Miscellaneous Settings** screen to perform specific functions such as updating the asset tag and changing the system date and time.

Viewing Miscellaneous Settings

To view the **Miscellaneous Settings** screen, perform the following steps:

Steps

1. Power on, or restart your system.
2. Press F2 immediately after you see the following message:

F2 = System Setup

NOTE: If your operating system begins to load before you press F2, wait for the system to finish booting, and then restart your system and try again.

3. On the **System Setup Main Menu** screen, click **System BIOS**.
4. On the **System BIOS** screen, click **Miscellaneous Settings**.

Miscellaneous Settings details

About this task

The **Miscellaneous Settings** screen details are explained as follows:

Option	Description
System Time	Enables you to set the time on the system.
System Date	Enables you to set the date on the system.
Asset Tag	Specifies the asset tag and enables you to modify it for security and tracking purposes.
Keyboard NumLock	Enables you to set whether the system should boot with the NumLock enabled or disabled. This option is set to On by default.  NOTE: This option does not apply to 84-key keyboards.
F1/F2 Prompt on Error	Enables or disables the F1/F2 prompt on error. This option is set to Enabled by default. The F1/F2 prompt also includes keyboard errors.
Load Legacy Video Option ROM	Enables you to determine whether the system BIOS loads the legacy video (INT 10H) option ROM from the video controller. Selecting Enabled in the operating system does not support UEFI video output standards. This field is available only for UEFI boot mode. You cannot set the option to Enabled if UEFI Secure Boot mode is enabled. This option is set to Disabled by default.
Dell Wyse P25/P45 BIOS Access	Enables or disables the Dell Wyse P25/P45 BIOS Access. This option is set to Enabled by default.
Power Cycle Request	Enables or disables the Power Cycle Request. This option is set to None by default.

iDRAC Settings utility

The iDRAC settings utility is an interface to set up and configure the iDRAC parameters by using UEFI. You can enable or disable various iDRAC parameters by using the iDRAC settings utility.

 **NOTE: Accessing some of the features on the iDRAC settings utility needs the iDRAC Enterprise License upgrade.**

For more information about using iDRAC, see *Dell Integrated Dell Remote Access Controller User's Guide* at www.dell.com/poweredge/manuals.

Device Settings

Device Settings enables you to configure the below device parameters:

- Controller Configuration Utility
- Embedded NIC Port1-X Configuration
- NICs in slotX, Port1-X Configuration
- BOSS Card configuration

Dell Lifecycle Controller

Dell Lifecycle Controller (LC) provides advanced embedded systems management capabilities including system deployment, configuration, update, maintenance, and diagnosis. LC is delivered as part of the iDRAC out-of-band solution and Dell system embedded Unified Extensible Firmware Interface (UEFI) applications.

Embedded system management

The Dell Lifecycle Controller provides advanced embedded system management throughout the lifecycle of the system. The Dell Lifecycle Controller can be started during the boot sequence and can function independently of the operating system.

 **NOTE:** Certain platform configurations may not support the full set of features provided by the Dell Lifecycle Controller.

For more information about setting up the Dell Lifecycle Controller, configuring hardware and firmware, and deploying the operating system, see the Dell Lifecycle Controller documentation at www.dell.com/poweredgemanuals.

Boot Manager

The **Boot Manager** screen enables you to select boot options and diagnostic utilities.

Viewing Boot Manager

About this task

To enter Boot Manager:

Steps

1. Power on, or restart your system.
2. Press F11 when you see the following message:

F11 = Boot Manager

If your operating system begins to load before you press F11, allow the system to complete the booting, and then restart your system and try again.

Boot Manager main menu

Menu item	Description
Continue Normal Boot	The system attempts to boot to devices starting with the first item in the boot order. If the boot attempt fails, the system continues with the next item in the boot order until the boot is successful or no more boot options are found.
One-shot Boot Menu	Enables you to access boot menu, where you can select a one-time boot device to boot from.
Launch System Setup	Enables you to access System Setup.
Launch Lifecycle Controller	Exits the Boot Manager and invokes the Dell Lifecycle Controller program.
System Utilities	Enables you to launch System Utilities menu such as System Diagnostics and UEFI shell.

One-shot UEFI boot menu

One-shot UEFI boot menu enables you to select a boot device to boot from.

System Utilities

System Utilities contains the following utilities that can be launched:

- Launch Diagnostics
- BIOS Update File Explorer
- Reboot System

PXE boot

You can use the Preboot Execution Environment (PXE) option to boot and configure the networked systems, remotely.

To access the **PXE boot** option, boot the system and then press F12 during POST instead of using standard Boot Sequence from BIOS Setup. It does not pull any menu or allows managing of network devices.

Installing and removing system components

Topics:

- Safety instructions
- Before working inside your system
- After working inside your system
- Recommended tools
- Optional front bezel
- System cover
- Inside the system
- Air shroud
- Cooling fans
- Fan cage
- Intrusion switch
- Drives
- Drive backplane
- Cable routing
- System memory
- Processors and heat sinks
- Processor expansion module
- PEM power board
- Expansion cards and expansion card risers
- M.2 SSD module
- Network daughter card riser
- Network daughter card
- Storage controller card
- Optional IDSDM or vFlash module
- Optional IDSDM or vFlash module
- Power supply unit
- NVDIMM-N battery
- System battery
- Optional internal USB memory key
- System board
- Trusted Platform Module
- Control panel

Safety instructions

 **NOTE:** Whenever you need to lift the system, get others to assist you. To avoid injury, do not attempt to lift the system by yourself.

 **WARNING:** Opening or removing the system cover while the system is powered on may expose you to a risk of electric shock.

 **CAUTION:** Do not operate the system without the cover for a duration exceeding five minutes. Operating the system without the system cover can result in component damage.

 **CAUTION:** Many repairs may only be done by a certified service technician. You should only perform troubleshooting and simple repairs as authorized in your product documentation, or as directed by the online or telephone service and support team. Damage due to servicing that is not authorized by Dell is not covered by your warranty. Read and follow the safety instructions that are shipped with your product.

 **NOTE:** It is recommended that you always use an antistatic mat and antistatic strap while working on components inside the system.

 **CAUTION:** To ensure proper operation and cooling, all bays in the system and system fans must be always populated with a component or a blank.

Before working inside your system

Prerequisites

Follow the safety guidelines listed in [Safety instructions](#) on page 65.

Steps

1. Turn off the system, including all attached peripherals.
2. Disconnect the system from the electrical outlet and disconnect the peripherals.
3. Remove the system cover.

After working inside your system

Prerequisites

Follow the safety guidelines listed in [Safety instructions](#) on page 65.

Steps

1. Install the system cover.
2. Reconnect the peripherals and connect the system to the electrical outlet.
3. Turn on the attached peripherals and then turn on the system.

Recommended tools

You need the following tools to perform the removal and installation procedures:

- Key to the bezel lock
The key is required only if your system includes a bezel.
- Phillips #1 screwdriver
- Phillips #2 screwdriver
- Torx #T30 screwdriver
- Torx #T8 screwdriver
- Wrist grounding strap

You need the following tools to assemble the cables for a DC power supply unit:

- AMP 90871-1 hand-crimping tool or equivalent
- Tyco Electronics 58433-3 or equivalent
- Wire-stripper pliers to remove insulation from size 10 AWG solid or stranded, insulated copper wire

 **NOTE:** Use alpha wire part number 3080 or equivalent (65/30 stranding).

Optional front bezel

Removing the optional front bezel

Prerequisites

Follow the safety guidelines listed in [Safety instructions](#) on page 65.

Steps

1. Unlock the bezel by using the bezel key.
2. Press the release button, and pull the left end of the bezel.
3. Unhook the right end, and remove the bezel.



Figure 21. Removing the optional front bezel with the LCD panel

Next steps

Install the optional front bezel.

Installing the optional front bezel

Prerequisites

Follow the safety guidelines listed in [Safety instructions](#) on page 65.

Steps

1. Locate and remove the bezel key.
 - NOTE:** The bezel key is part of the LCD bezel package.
2. Align and insert the right end of the bezel onto the system.
3. Press the release button and fit the left end of the bezel onto the system.
4. Lock the bezel by using the key.

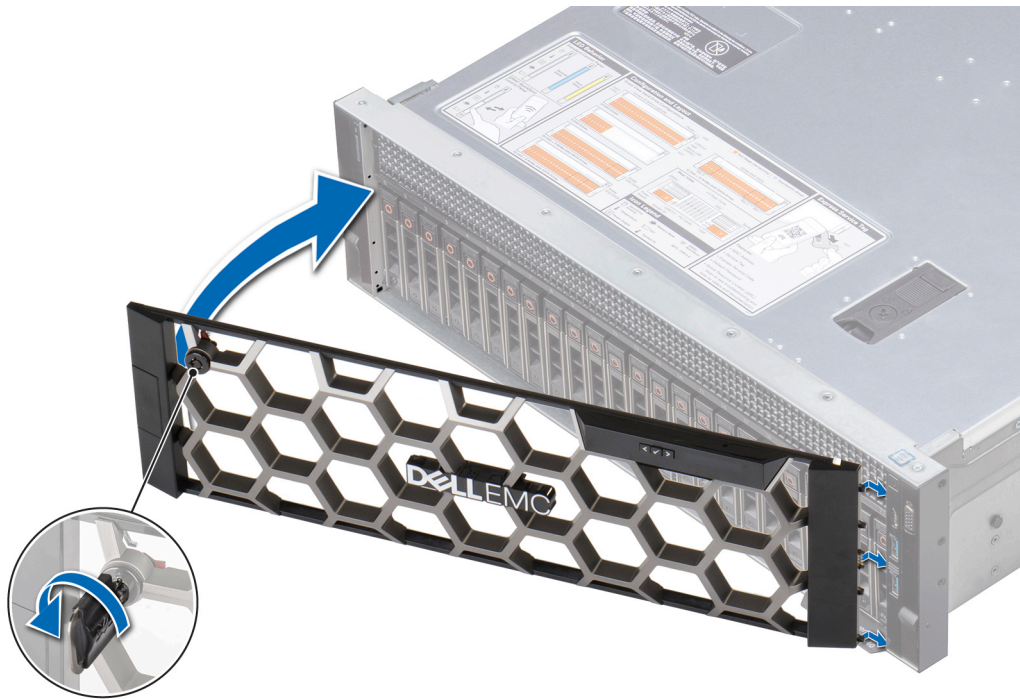

Figure 22. Installing the optional front bezel with the LCD panel

System cover

Removing the system cover

Prerequisites

1. Follow the safety guidelines listed in [Safety instructions](#) on page 65.
2. Power off the system, including any attached peripherals.
3. Disconnect the system from the electrical outlet and disconnect the peripherals.

Steps

1. Using a 1/4 inch flat head or a Phillips #2 screwdriver, rotate the latch release lock counter clockwise to the unlocked position.
2. Lift the latch till the system cover slides back and the tabs on the system cover disengage from the guide slots on the system.
3. Hold the cover on both sides, and lift the cover away from the system.



Figure 23. Removing the system cover

Next steps

[Installing the system cover.](#)

Installing the system cover

Prerequisites

1. Follow the safety guidelines listed in [Safety instructions](#) on page 65.
2. Ensure that all internal cables are routed correctly and connected, and no tools or extra parts are left inside the system.

Steps

1. Align the tabs on the system cover with the guide slots on the system.
2. Push the system cover latch down.
The system cover slides forward, the tabs on the system cover engage with the guide slots on the system and the system cover latch locks into place.
3. Using a 1/4 inch flat head or Phillips #2 screwdriver, rotate the latch release lock clockwise to the locked position.



Figure 24. Installing the system cover

Next steps

1. Reconnect the peripherals and connect the system to the electrical outlet.
2. Power on the system, including any attached peripherals.

Inside the system

CAUTION: Many repairs may only be done by a certified service technician. You should only perform troubleshooting and simple repairs as authorized in your product documentation, or as directed by the online or telephone service and support team. Damage due to servicing that is not authorized by Dell is not covered by your warranty. Read and follow the safety instructions that are shipped with your product.

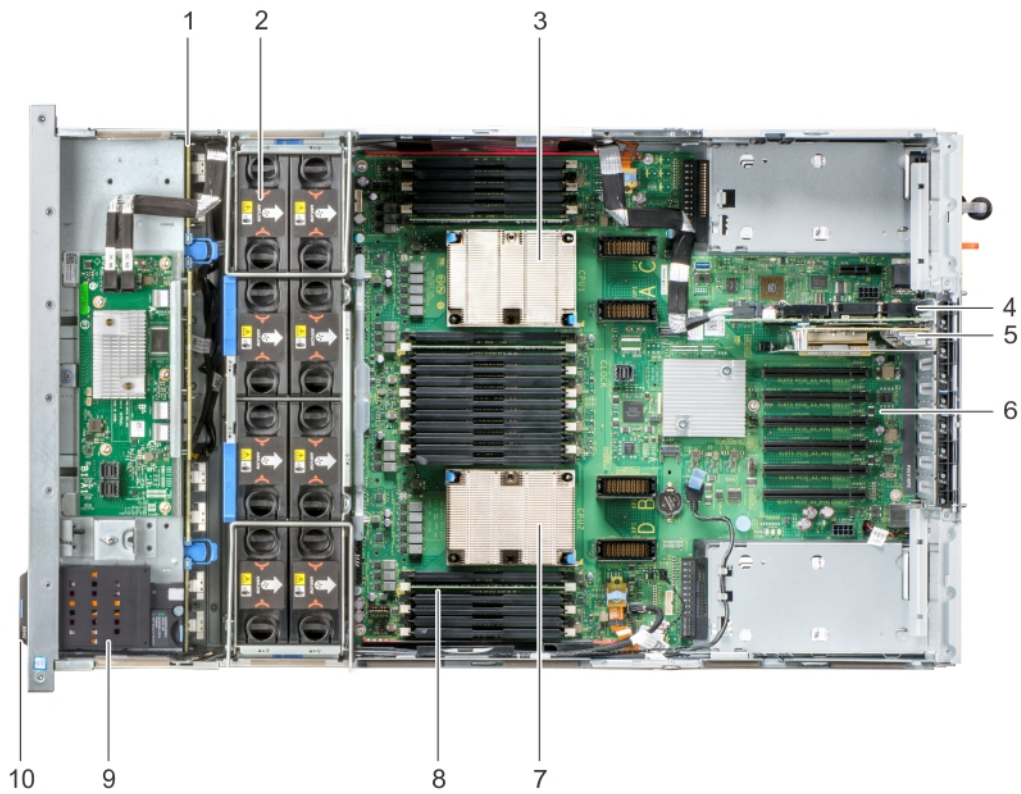

Figure 25. Inside the system — Two processor system

- | | |
|---|----------------------------|
| 1. hard drive/SSD backplane with expander board | 2. cooling fan (8) |
| 3. heat sink (CPU1) | 4. storage controller card |
| 5. network daughter card riser | 6. system board |
| 7. heat sink (CPU2) | 8. memory module (24) |
| 9. NVDIMM-N battery | 10. information tag |

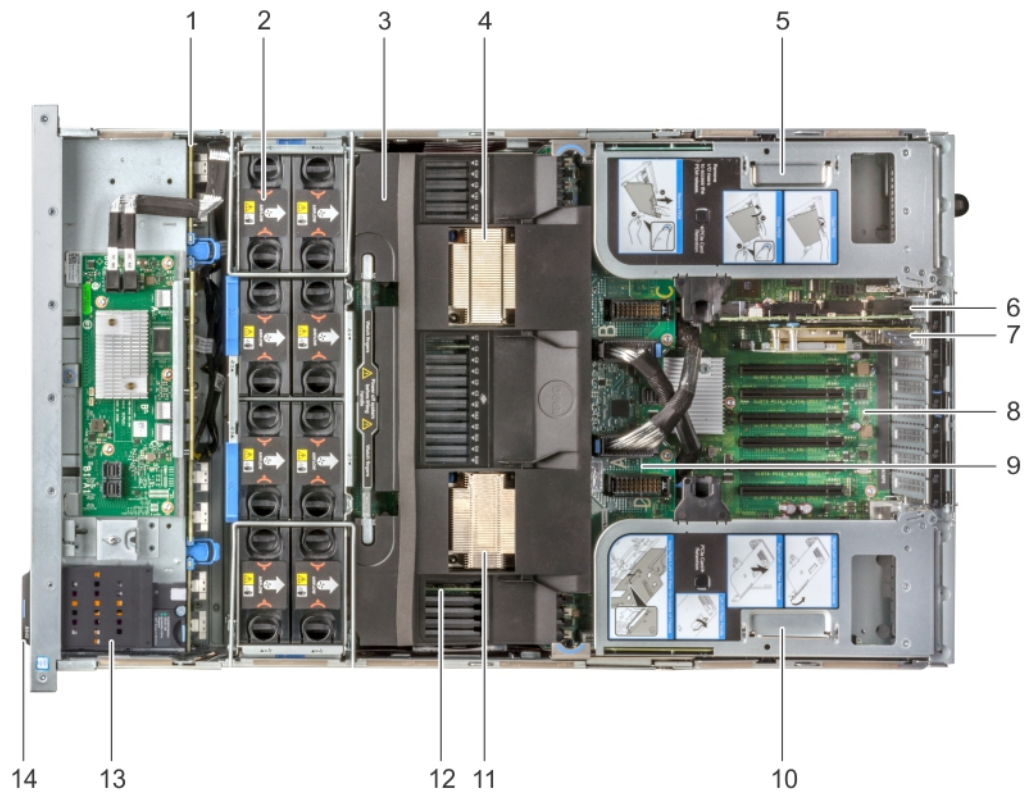

Figure 26. Inside the system — Four processor system with processor expansion module (PEM)

- | | |
|---|--------------------------------|
| 1. hard drive/SSD backplane with expander board | 2. cooling fan (8) |
| 3. air shroud | 4. heat sink (CPU3) |
| 5. left expansion card riser | 6. storage controller card |
| 7. network daughter card riser | 8. system board |
| 9. processor expansion module (PEM) | 10. right expansion card riser |
| 11. heat sink (CPU4) | 12. memory module (48) |
| 13. NVDIMM-N battery | 14. information tag |

Air shroud

Removing the air shroud

Prerequisites

CAUTION: Never operate your system with the air shroud removed. The system may get overheated quickly, resulting in shutdown of the system and loss of data.

1. Follow the safety guidelines listed in [Safety instructions](#) on page 65.
2. Follow the procedure listed in [Before working inside your system](#) on page 66.

Steps

1. To remove the air shroud from a two processor configuration system, hold the shroud at both ends and lift it out of the system.

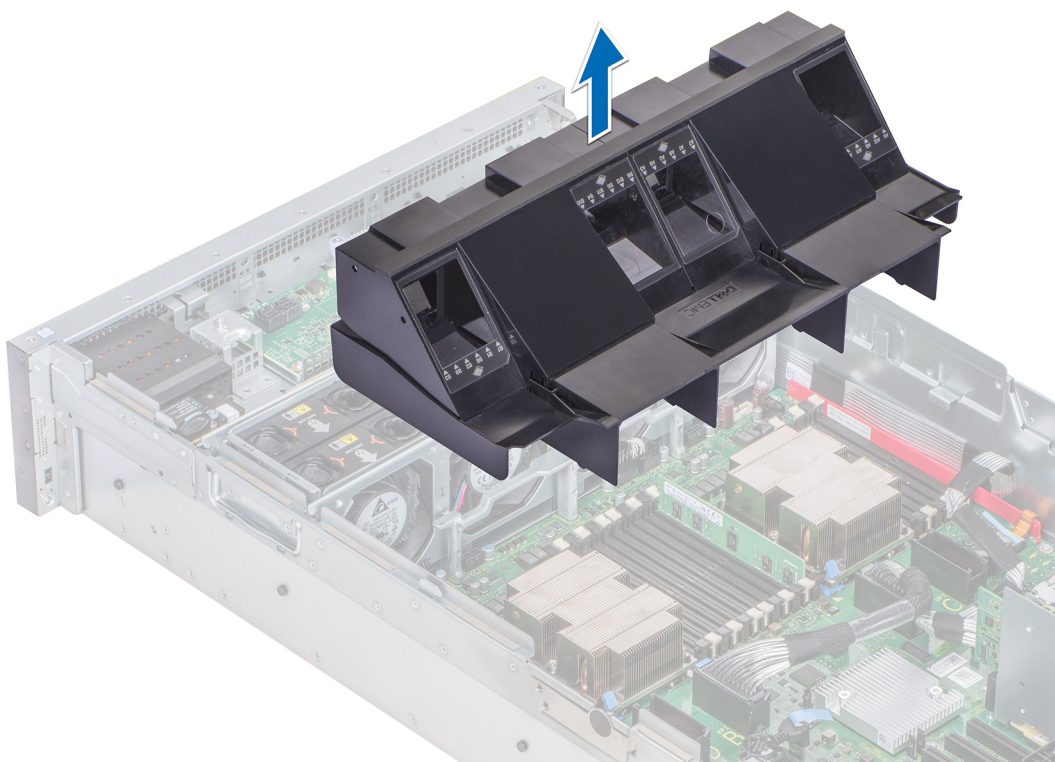

Figure 27. Removing the air shroud — Two processor system

2. To remove the air shroud from a four processor configuration system:
 - a. Remove the expansion card risers. See [Removing the expansion card riser](#) on page 127.
 - b. Hook the expansion card riser on the side of the system by using the I/O riser handle on the expansion card riser.

CAUTION: To avoid damage to the PCIe cables connected to the NVMe cards installed in the expansion card riser, ensure that you hook the riser to the system using the I/O riser handle.
 - c. Hold the shroud at both ends and lift it away from the system.

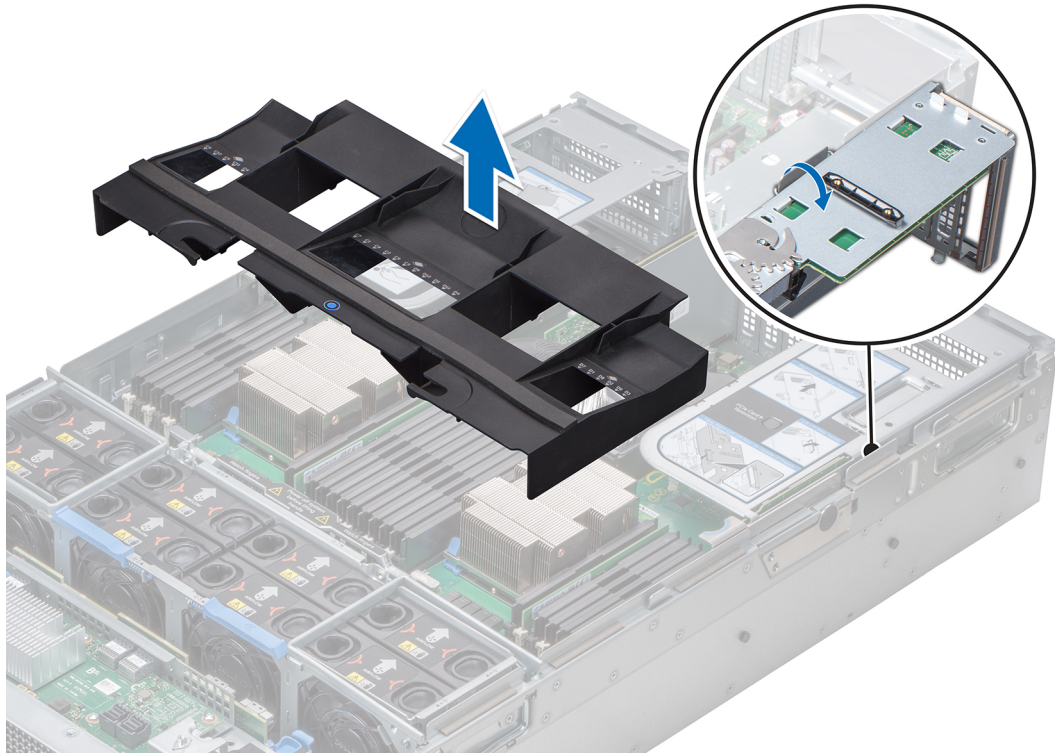

Figure 28. Removing the air shroud — Four processor system

Next steps

Install the air shroud.

Installing the air shroud

Prerequisites

1. Follow the safety guidelines listed in [Safety instructions](#) on page 65.
2. Follow the procedure listed in [Before working inside your system](#) on page 66.

Steps

1. To install the air shroud in a two processor configuration system:
 - a. Lower the air shroud into the system until it is firmly seated.
When firmly seated, the memory socket numbers marked on the air shroud align with the respective memory sockets on the system board.

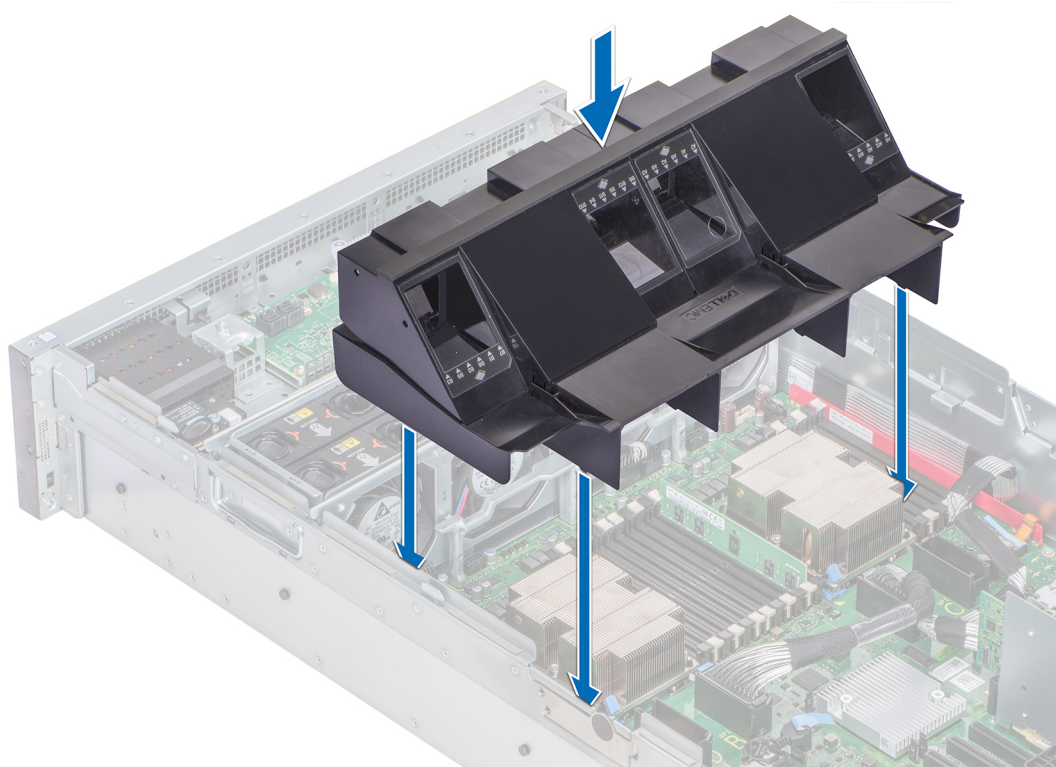

Figure 29. Installing the air shroud — Two processor system

2. To install the air shroud in a four processor configuration system:
 - a. Align the slots on the air shroud with the tabs on the processor expansion module (PEM) handle.
 - b. Lower the air shroud into the system until it is firmly seated.
When firmly seated, the memory socket numbers marked on the air shroud align with the memory sockets on the PEM.
 - c. Press the blue touch point to ensure that the air shroud is seated firmly.
 - d. Unhook the expansion card riser from the side of the system.
 - e. Install the expansion card risers. See [Installing the expansion card riser](#) on page 129.

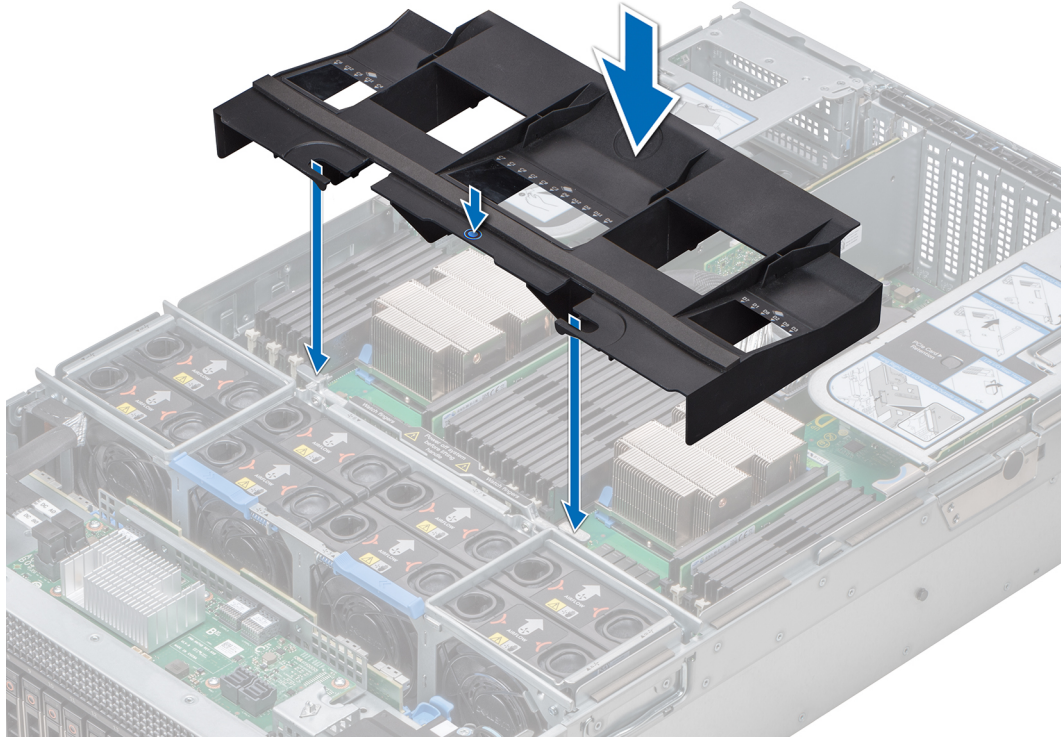

Figure 30. Installing the air shroud — Four processor system

Next steps

1. Follow the procedure listed in [After working inside your system](#) on page 66.

Cooling fans

Removing the cooling fan

Prerequisites

⚠ WARNING: Do not drop the fan into the fan cage while removing or installing the fan as this may cause damage to the connectors on the fan tray. Exercise utmost care while removing or installing cooling fans.

1. Follow the safety guidelines listed in [Safety instructions](#) on page 65.
2. Follow the procedure listed in [Before working inside your system](#) on page 66.

Steps

Press the release tabs and lift the cooling fan out of the fan cage.

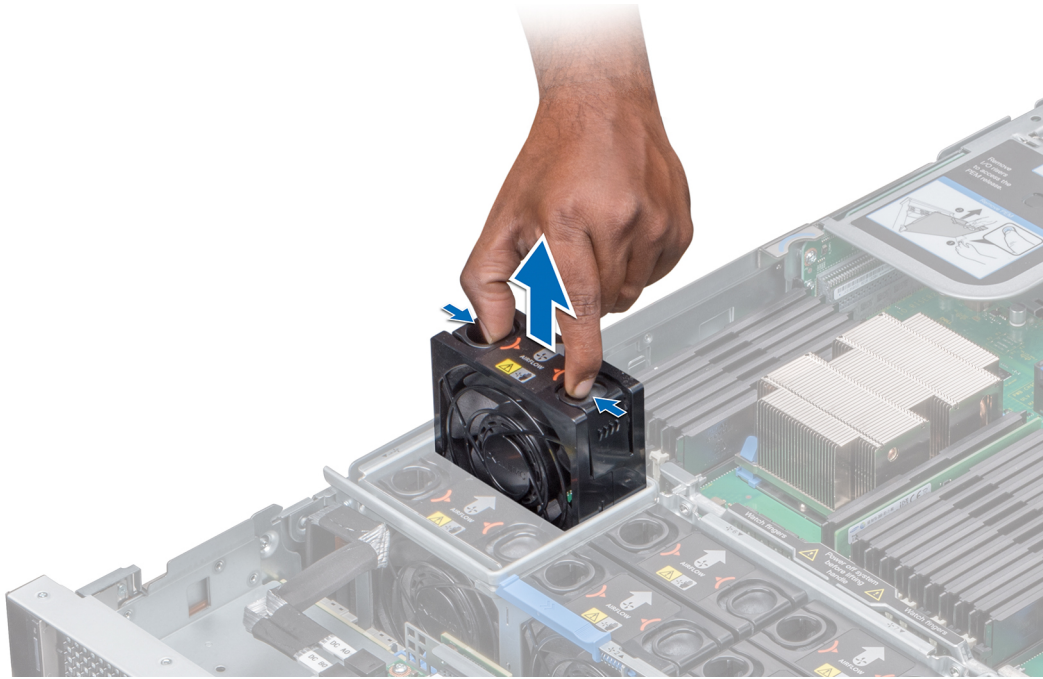

Figure 31. Removing the cooling fan

Next steps

Install the cooling fan.

Installing the cooling fan

Prerequisites

1. Follow the safety guidelines listed in [Safety instructions](#) on page 65.
2. Follow the procedure listed in [Before working inside your system](#) on page 66.

⚠ WARNING: Do not drop the fan into the fan cage while removing or installing the fan as this may cause damage to the connectors on the fan tray. Exercise utmost care while removing or installing cooling fans.

Steps

1. Holding the release tabs, insert the cooling fan into the fan cage with the arrow marked on the fan pointing towards the back of the system.
2. Lower the cooling fan to connect the connector on the fan to the connector on the fan tray.

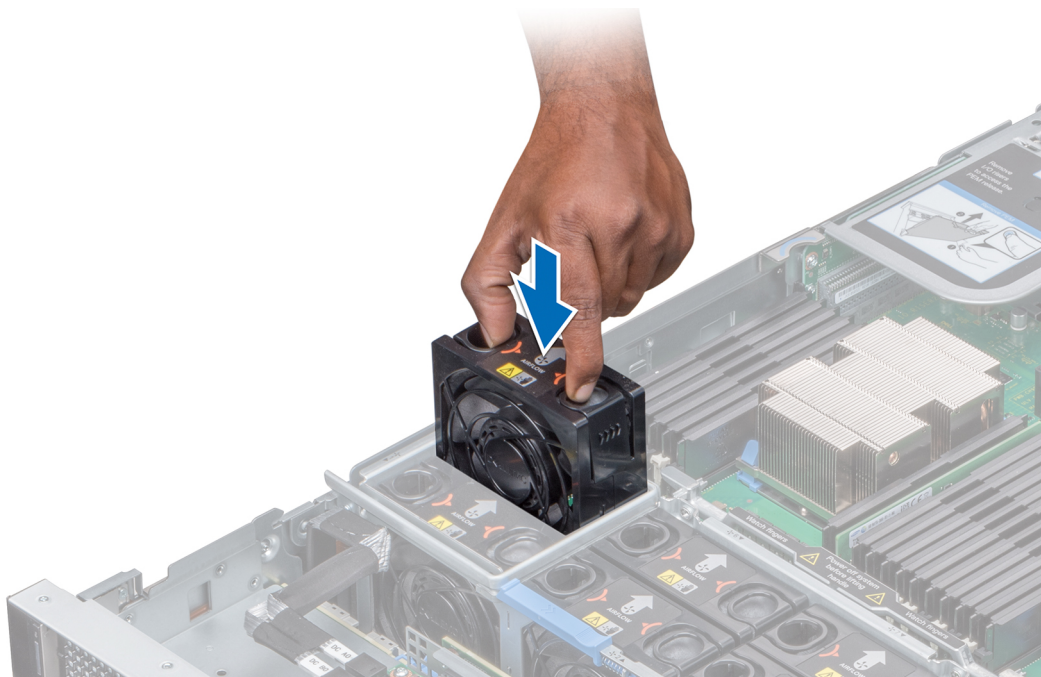

Figure 32. Installing the cooling fan

Next steps

1. Follow the procedure listed in [After working inside your system](#).

Fan cage

Removing the fan cage

Prerequisites

1. Follow the safety guidelines listed in [Safety instructions](#) on page 65.
2. Follow the procedure listed in [Before working inside your system](#) on page 66.

Steps

1. Slide the fan cage locks in the direction of the arrow indicated on the locks.
2. Hold the cage handle and lift the cage out of the fan tray.

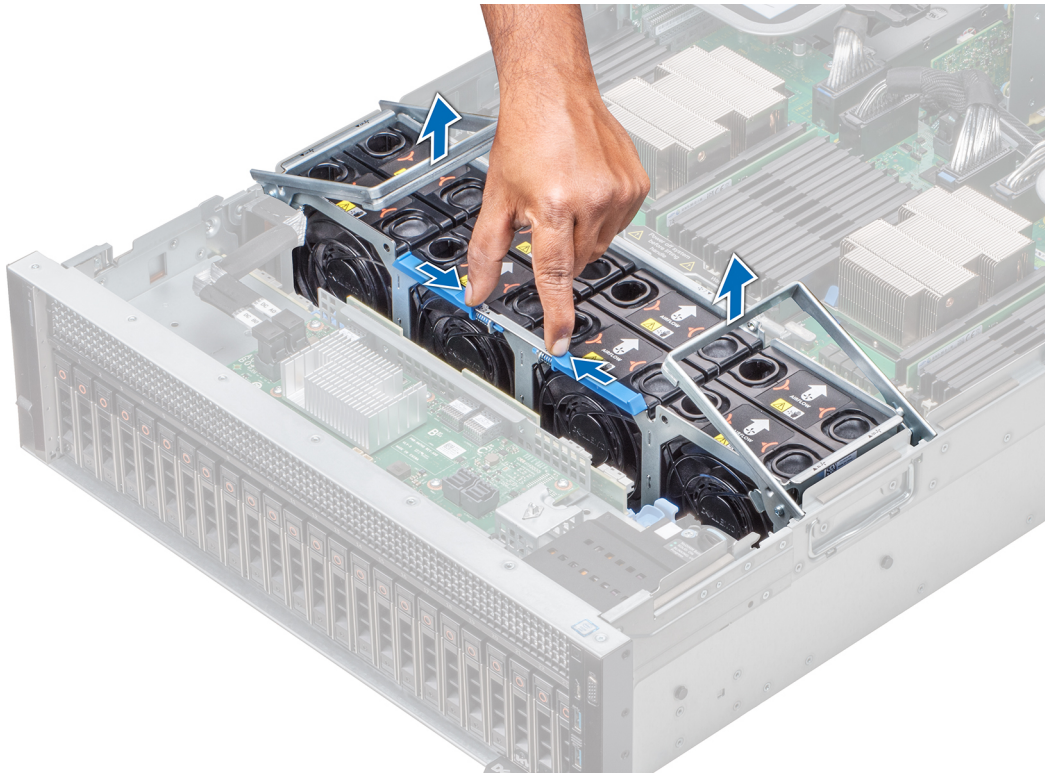

Figure 33. Removing the fan cage

Next steps

Install the fan cage.

Installing the fan cage

Prerequisites

1. Follow the safety guidelines listed in [Safety instructions](#) on page 65.
2. Follow the procedure listed in [Before working inside your system](#) on page 66.

Steps

1. Holding the cage handles, lower the cage into the fan tray.
2. Lower the cage handles until the handles lock into place.

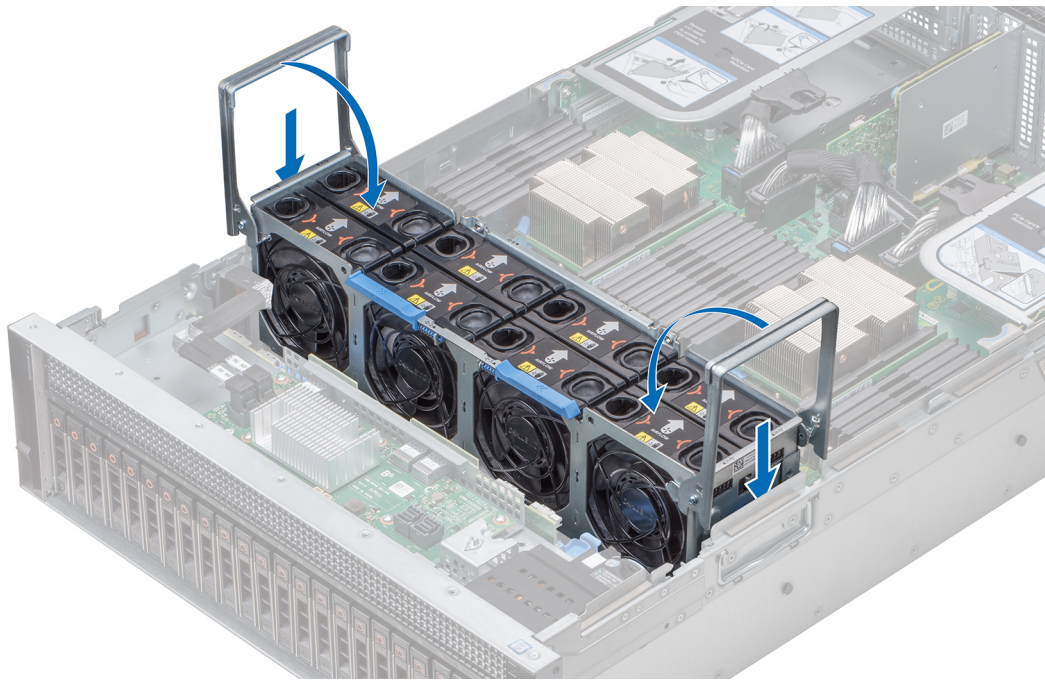

Figure 34. Installing the fan cage

Next steps

1. Follow the procedure listed in [After working inside your system](#) on page 66.

Removing the fan tray

Prerequisites

1. Follow the safety guidelines listed in [Safety instructions](#) on page 65.
2. Follow the procedure listed in [Before working inside your system](#) on page 66.
3. [Remove the air shroud](#).
4. [Remove the fan cage](#).
5. If installed, [remove the expansion card risers](#).
6. If applicable, lift the PEM by using the PEM handle until the PEM is in an upright position.
7. Release the backplane and fan power cables from the cable clips on the fan tray and disconnect the power cables from the connectors on the system board.

Steps

1. Press the blue release tabs on the side of the fan tray to unlock the tray.
2. Holding the fan tray lift the tray out of the system.

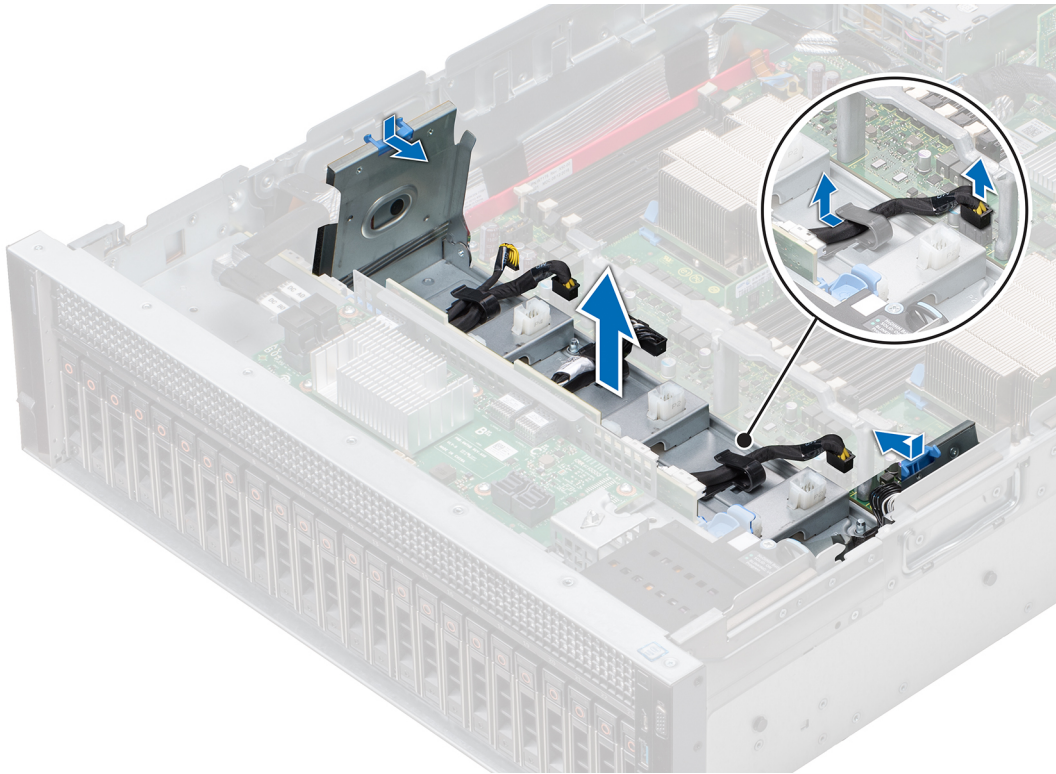

Figure 35. Removing the fan tray

Next steps

Install the fan tray.

Installing the fan tray

Prerequisites

1. Follow the safety guidelines listed in [Safety instructions](#) on page 65.
2. Follow the procedure listed in [Before working inside your system](#) on page 66.

Steps

1. Holding the fan tray, align the slots on the fan tray with the standoffs on the system.
2. Lower the fan tray into the system until the slots on the fan tray engage with the standoffs on the system.
3. Press the blue release tabs on the side of fan tray towards the side of the system until the tabs click in place.

(i) NOTE: Ensure that you route the cables correctly against the side of the system.

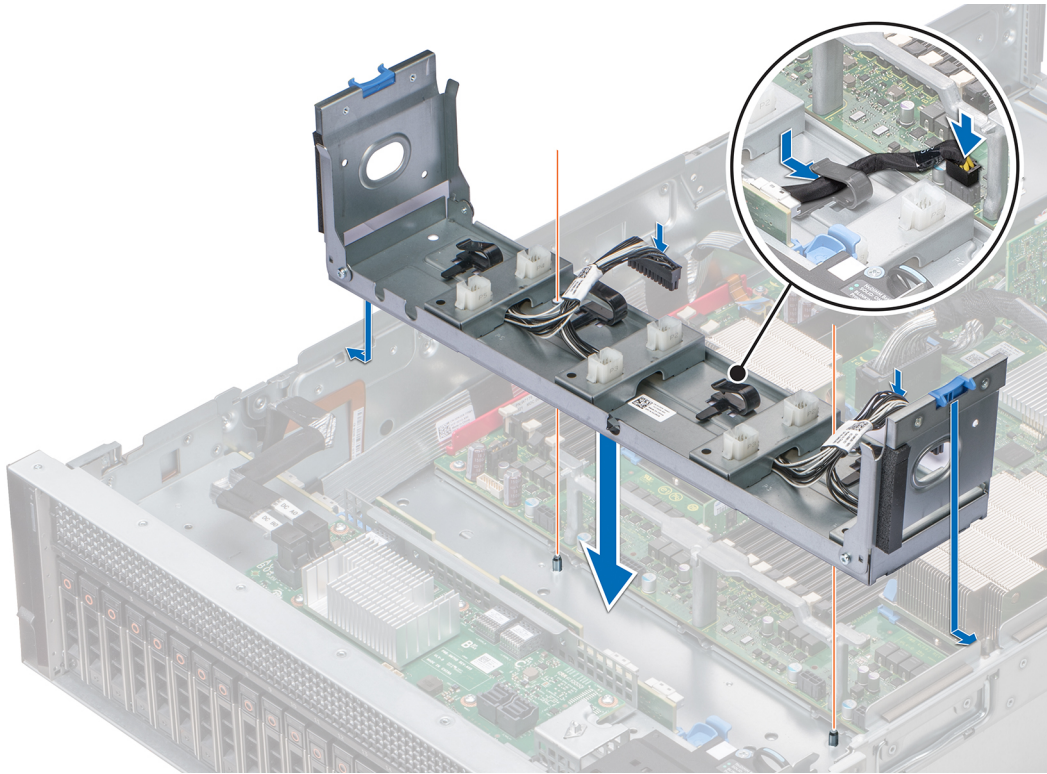

Figure 36. Installing the fan tray

Next steps

1. Route the fan power cables and the backplane cables through the cable clips on the fan tray and connect the cables to the connectors on the system board.
2. If applicable, lower the PEM by using PEM handle until the PEM clicks in place.
3. If removed, [install the expansion card risers](#).
4. [Install the fan cage](#).
5. [Install the air shroud](#).
6. Follow the procedure listed in [After working inside your system](#) on page 66.

Intrusion switch

Removing an intrusion switch

Prerequisites

1. Follow the safety guidelines listed in [Safety instructions](#) on page 65.
2. Follow the procedure listed in [Before working inside your system](#) on page 66.
3. [Remove the fan cage](#).
4. [Remove the air shroud](#).
5. If applicable, [remove the expansion card risers](#).
6. [Remove the PEM](#).
7. Press the blue release tabs on the fan tray and lower the sides of the tray.
8. Disconnect the cable connected to the intrusion switch connector (INTRUSION) on the system board.

Steps

1. Press the cable management bracket down until the tabs on the bracket disengage from the slots on the side of the system.
2. Lift the cable management bracket out of the system.

3. Press the tab on the intrusion switch cable connector and disconnect the cable connected to the intrusion switch connector (INTRUSION) on the system board.
4. Remove the cables routed through the cable routing hooks on the right side of the system.
5. Push the intrusion switch out of the intrusion switch slot.

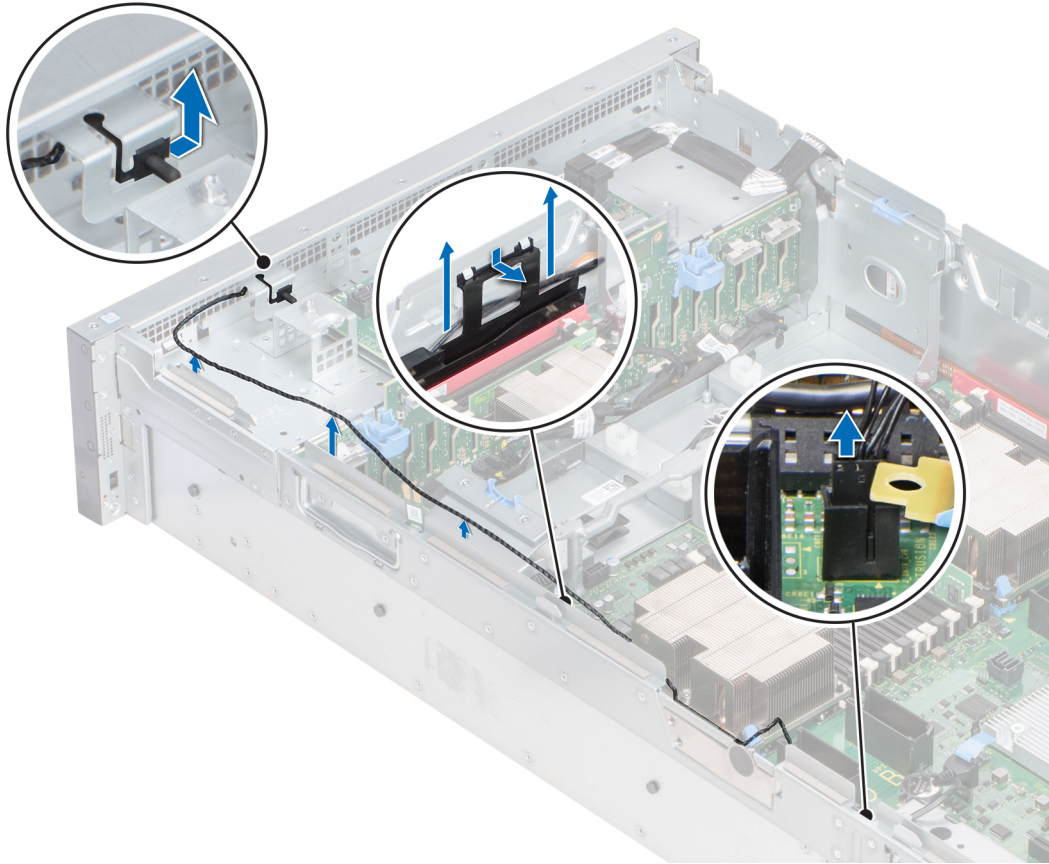

Figure 37. Removing an intrusion switch

Next steps

Install an intrusion switch.

Installing an intrusion switch

Prerequisites

1. Follow the safety guidelines listed in [Safety instructions](#) on page 65.
2. Follow the procedure listed in [Before working inside your system](#) on page 66.

Steps

1. Slide the intrusion switch into the intrusion switch slot.
2. Route the cables through the cable routing hooks on the side of the system.
3. Lower the cable management bracket into the system.
4. Press the bracket and insert the tabs on the bracket into the slots on the right side of the system.
5. Connect the cable to the connector (INTRUSION) on the system board.

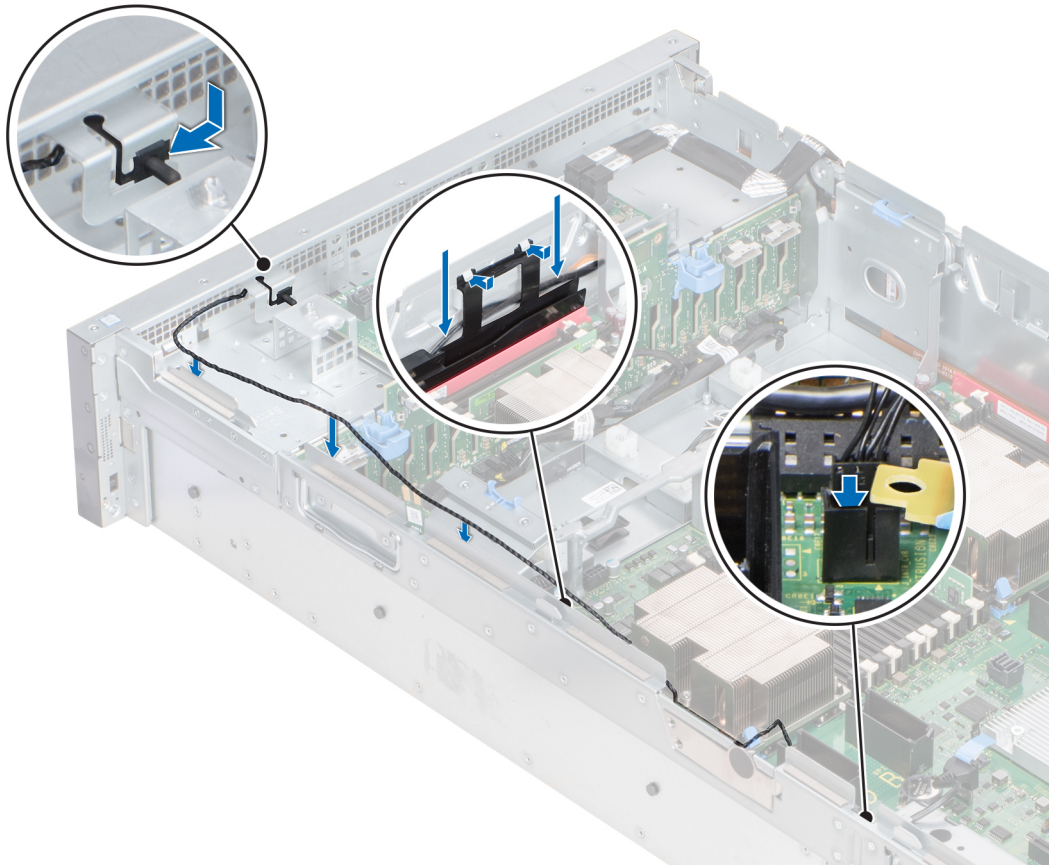

Figure 38. Installing an intrusion switch

Next steps

1. Lift the sides of the fan tray until the blue release tabs click in place.
2. [Install the PEM.](#)
3. If removed, [install the expansion card risers.](#)
4. [Install the air shroud.](#)
5. [Install the fan cage.](#)
6. Follow the procedure listed in [After working inside your system](#) on page 66.

Drives

Removing a drive blank

Prerequisites

1. Follow the safety guidelines listed in [Safety instructions](#) on page 65.
2. If installed, [remove the front bezel.](#)

⚠ CAUTION: To maintain proper system cooling, drive blanks must be installed in all empty drive slots.

⚠ CAUTION: Mixing drive blanks from previous generations of PowerEdge servers is not supported.

Steps

Press the release button, and slide the drive blank out of the drive slot.

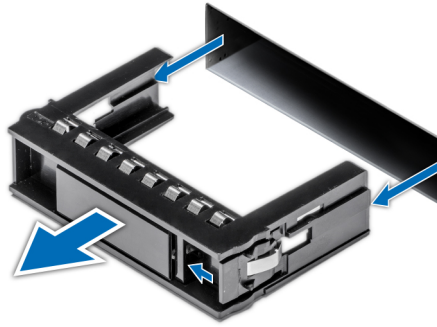

Figure 39. Removing a drive blank

Next steps

Install a drive or drive blank.

Installing a drive blank

Prerequisites

1. Follow the safety guidelines listed in [Safety instructions](#) on page 65.

CAUTION: Mixing drive blanks from previous generations of PowerEdge servers is not supported.

Steps

Insert the drive blank into the drive slot, and push the blank until the release button clicks into place.

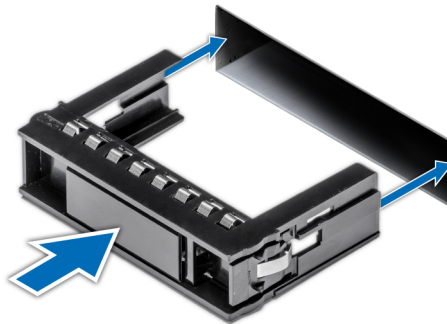

Figure 40. Installing a drive blank

Next steps

If removed, [install the front bezel](#).

Removing a drive carrier

Prerequisites

1. Follow the safety guidelines listed in [Safety instructions](#) on page 65.
2. If installed, [remove the front bezel](#).
3. Using the management software, prepare the drive for removal.

If the drive is online, the green activity or fault indicator flashes while the drive is turning off. When the drive indicators are off, the drive is ready for removal. For more information, see the documentation for the storage controller.

CAUTION: Before attempting to remove or install a drive while the system is running, see the documentation for the storage controller card to ensure that the host adapter is configured correctly to support drive removal and insertion.

CAUTION: Mixing drives from previous generations of PowerEdge servers is not supported.

CAUTION: To prevent data loss, ensure that your operating system supports drive installation. See the documentation supplied with your operating system.

Steps

1. Press the release button to open the drive carrier release handle.
2. Holding the handle, slide the drive carrier out of the drive slot.



Figure 41. Removing a drive carrier

Next steps

1. [Install a drive carrier.](#)
2. If you are not replacing the drive immediately, insert a drive blank in the empty drive slot to maintain proper system cooling.

Installing a drive carrier

Prerequisites

CAUTION: Before attempting to remove or install a drive while the system is running, see the documentation for the storage controller card to ensure that the host adapter is configured correctly to support drive removal and insertion.

CAUTION: Mixing drives from previous generations of PowerEdge servers is not supported.

CAUTION: Combining SAS and SATA drives in the same RAID volume is not supported.

CAUTION: When installing a drive, ensure that the adjacent drives are fully installed. Inserting a drive carrier and attempting to lock its handle next to a partially installed carrier can damage the partially installed carrier's shield spring and make it unusable.

CAUTION: To prevent data loss, ensure that your operating system supports hot-swap drive installation. See the documentation supplied with your operating system.

CAUTION: When a replacement hot swappable drive is installed and the system is powered on, the drive automatically begins to rebuild. Ensure that the replacement drive is blank or contains data that you wish to overwrite. Any data on the replacement drive is immediately lost after the drive is installed.

1. Follow the safety guidelines listed in [Safety instructions](#) on page 65.
2. If installed, [remove the drive blank](#).

Steps

1. Press the release button on the front of the drive carrier to open the release handle.
2. Insert the drive carrier into the drive slot and slide until the drive connects with the backplane.
3. Close the drive carrier release handle to lock the drive in place.



Figure 42. Installing a drive carrier

Next steps

If removed, [install the front bezel](#).

Removing the drive from the drive carrier

Prerequisites

Follow the safety guidelines listed in [Safety instructions](#) on page 65.

CAUTION: Mixing drives from previous generations of PowerEdge servers is not supported.

Steps

1. Using a Phillips #1 screwdriver, remove the screws from the slide rails on the drive carrier.
2. Lift the drive out of the drive carrier.

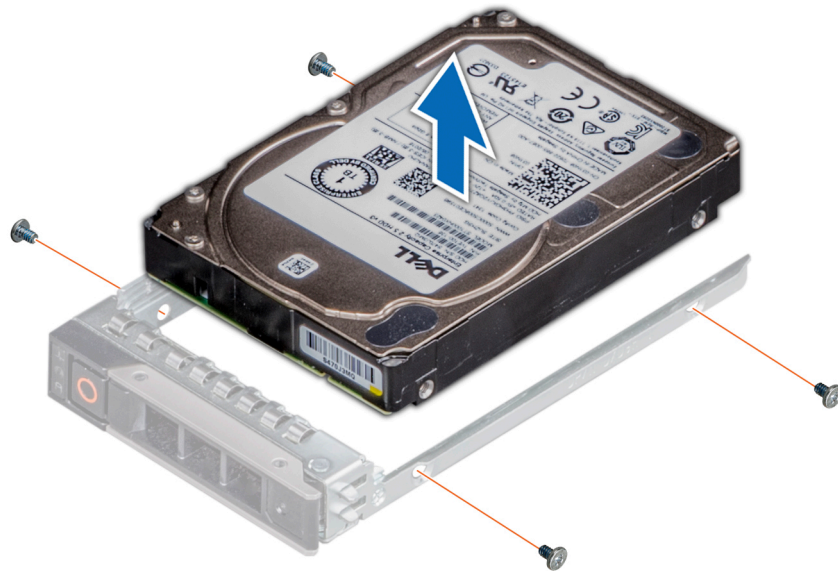

Figure 43. Removing the drive from the drive carrier

Next steps

Install the drive into the drive carrier.

Installing a drive into the drive carrier

Prerequisites

Follow the safety guidelines listed in [Safety instructions](#) on page 65.

CAUTION: Mixing drive carriers from other generations of PowerEdge servers is not supported.

NOTE: When installing a drive into the drive carrier, ensure that the screws are torqued to 4 in-lbs.

Steps

1. Insert the drive into the drive carrier with the connector end of the drive towards the back of the carrier.
2. Align the screw holes on the drive with the screws holes on the drive carrier.
When aligned correctly, the back of the drive is flush with the back of the drive carrier.
3. Using a Phillips #1 screwdriver, secure the drive to the drive carrier with screws.



Figure 44. Installing a drive into the drive carrier

Drive backplane

Drive backplane connectors

Depending on the configuration, your system supports the following backplanes:

Table 43. Supported drive backplane options for the PowerEdge R940 system

Backplane	Description
8 x 2.5 inch drive backplane	Up to eight 2.5 inch (SAS, SATA or Nearline SAS) front accessible drives in slots 0 through 7
24 x 2.5 inch drive backplane	Up to twenty four 2.5 inch (SAS, SATA or Nearline SAS) front accessible drives in slots 0 through 23
24 x 2.5 inch drive backplane	Up to twenty SAS + 4 NVMe SAS/SATA drives in slots 0 to 19 + slots 20 to 23
24 x 2.5 inch drive backplane	Up to sixteen SAS + 8 NVMe SAS/SATA drives in slots 0 to 15 + slots 16 to 23

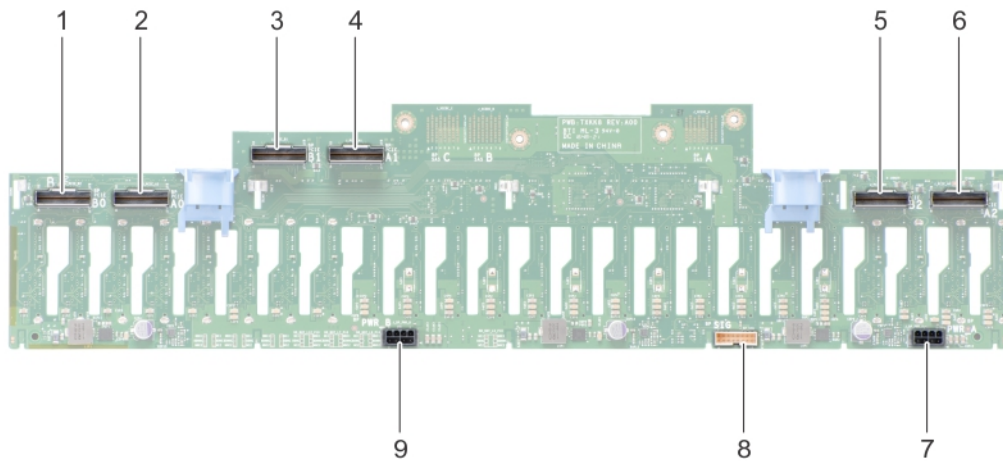

Figure 45. Connectors on the 24 x 2.5 inch drive backplane

- | | |
|--------------------------------|--------------------------------|
| 1. PCIe connector (BP PCIE B0) | 2. PCIe connector (BP PCIE A0) |
| 3. PCIe connector (BP PCIE B1) | 4. PCIe connector (BP PCIE A1) |
| 5. PCIe connector (BP PCIE B2) | 6. PCIe connector (BP PCIE A2) |
| 7. power connector (BP PWR_A) | 8. signal connector (BP SIG) |
| 9. power connector (BP PWR_B) | |

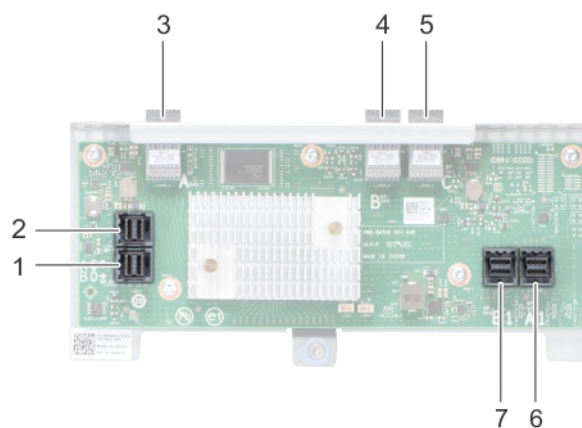

Figure 46. Connectors on the expander board

- | | |
|------------------------------|------------------------------|
| 1. SAS connector (BP SAS B0) | 2. SAS connector (BP SAS A0) |
| 3. SAS connector (BP SAS A) | 4. SAS connector (BP SAS B) |
| 5. SAS connector (BP SAS C) | 6. SAS connector (BP SAS A1) |
| 7. SAS connector (BP SAS B1) | |

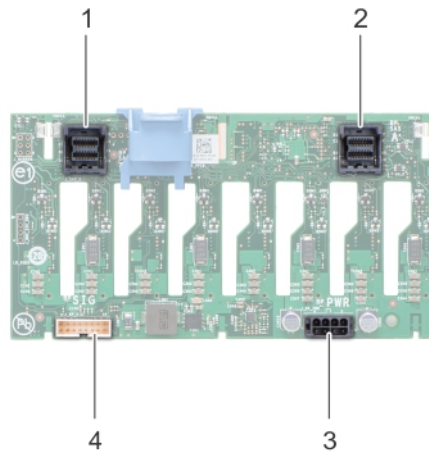

Figure 47. Connectors on the 8 x 2.5 inch drive backplane

1. SAS connector (BP SAS B)
2. SAS connector (BP SAS A)
3. power connector (BP PWR)
4. signal connector (BP SIG)

Removing drive backplane

Prerequisites

- CAUTION:** To prevent damage to the drives and backplane, remove the hard drives from the system before removing the backplane.
- CAUTION:** Note the number of each hard drive and temporarily label them before you remove the hard drive so that you can replace them in the same location.

1. Follow the safety guidelines listed in [Safety instructions](#) on page 65.
2. Follow the procedure listed in [Before working inside your system](#) on page 66.
3. If installed, [remove the front bezel](#).
4. [Remove the drives](#).
5. [Remove the fan cage](#).

Steps

1. To remove the 2.5-inch (x24) drive backplane:
 - a. Disconnect all the cables connected to the drive backplane and expander board.
 - NOTE:** To disconnect the NVMe cables, ensure that you remove the NVMe cables routed through the side of the system by lowering the fan tray side wall.
 - b. Loosen the retention screw that secures the expander board to the system.
 - c. Press the blue release tabs on the drive backplane.
 - d. Tilt the backplane to disengage the guides on the system from the slots on the backplane.
 - e. Lift the backplane out of the system.

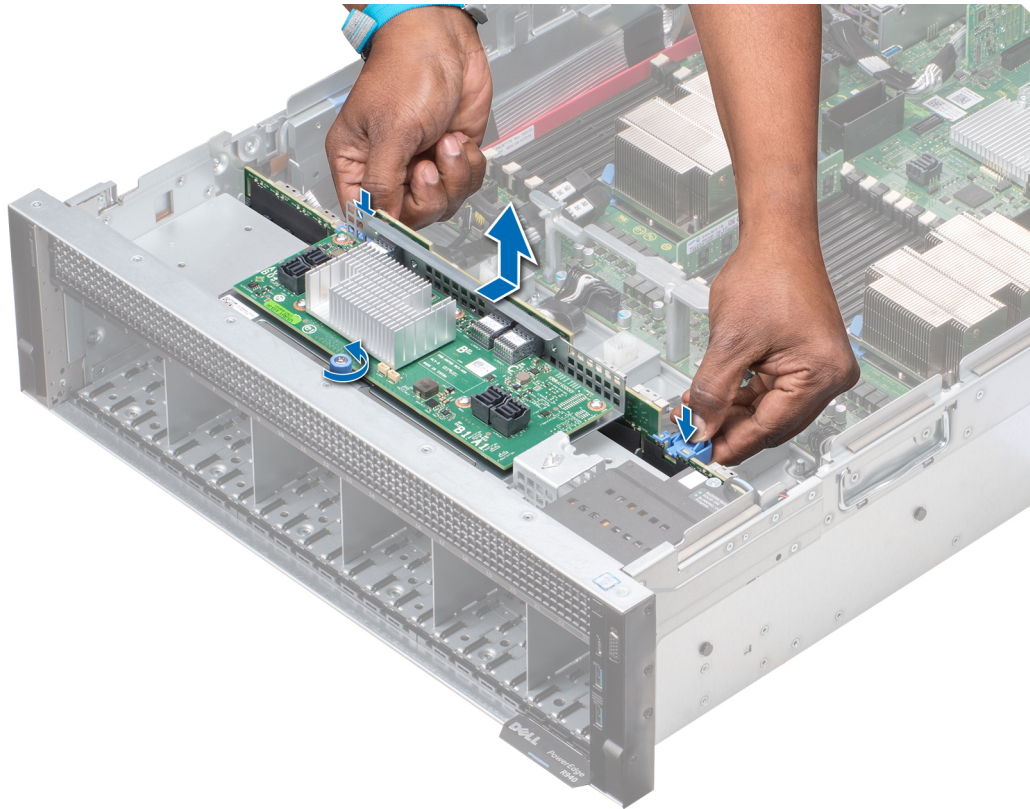

Figure 48. Removing the 2.5-inch (x24) drive backplane

2. To remove the 2.5-inch (x8) drive backplane:
 - a. Disconnect all the cables connected to the drive backplane.
 - b. Press the release tab on the drive backplane.
 - c. Lift the backplane away from the system until the hooks on the system disengage from the slots on the backplane.

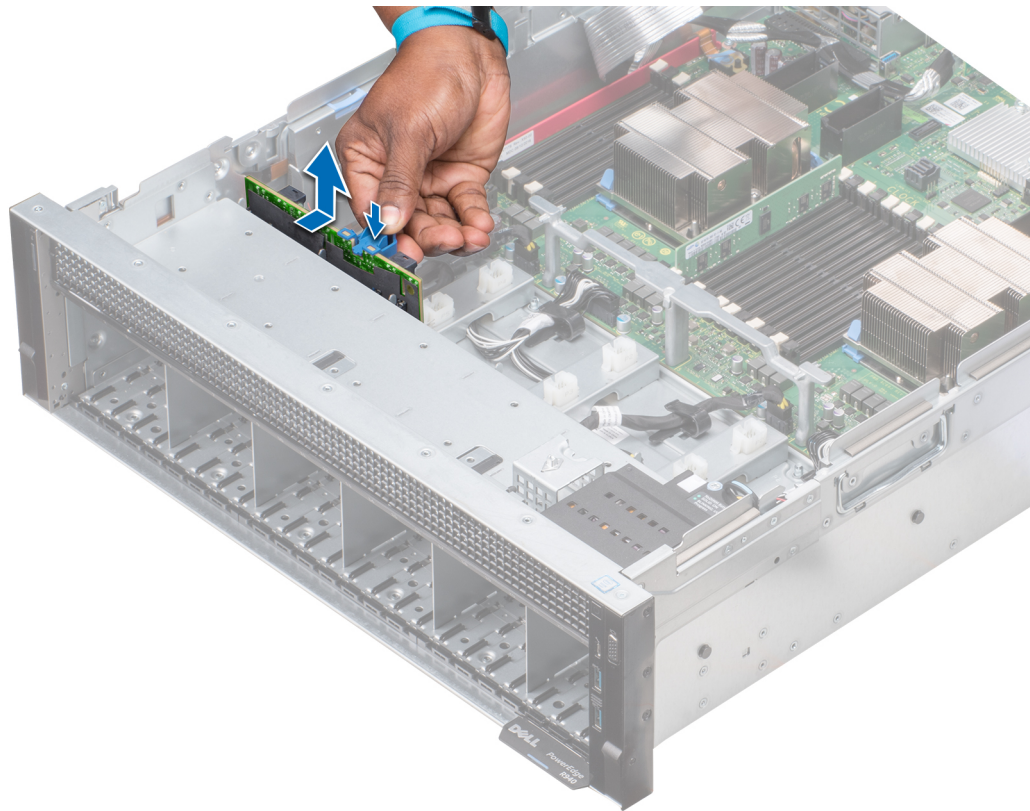

Figure 49. Removing the 2.5-inch (x8) drive backplane

Next steps

Install the drive backplane.

Installing drive backplane

Prerequisites

Follow the safety guidelines listed in [Safety instructions](#) on page 65.

Steps

1. To install the 2.5-inch (x24) drive backplane:
 - a. Holding the release latches, align the hooks on the system with the slots on the drive backplane.
 - b. Lower the backplane into the system until the hooks on the system engage with the slots on the backplane.
 - c. Push the expander board bracket until the release latches on the backplane click into place.
 - d. Tighten the retention screw to secure the expander board to the system.

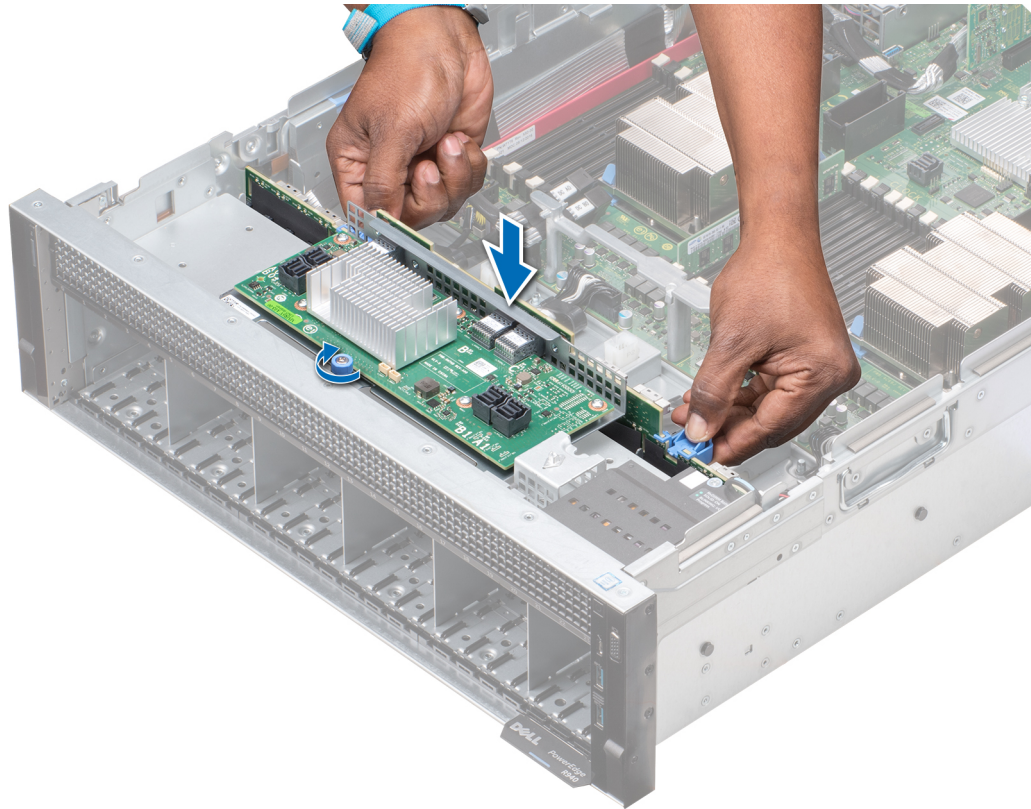

Figure 50. Installing the 2.5-inch (x24) drive backplane

2. To install the 2.5-inch (x8) drive backplane:
 - a. Align the hooks on the system with the slots on the drive backplane.
 - b. Lower the backplane into the system until the hooks on the system engage with the slots on the backplane.

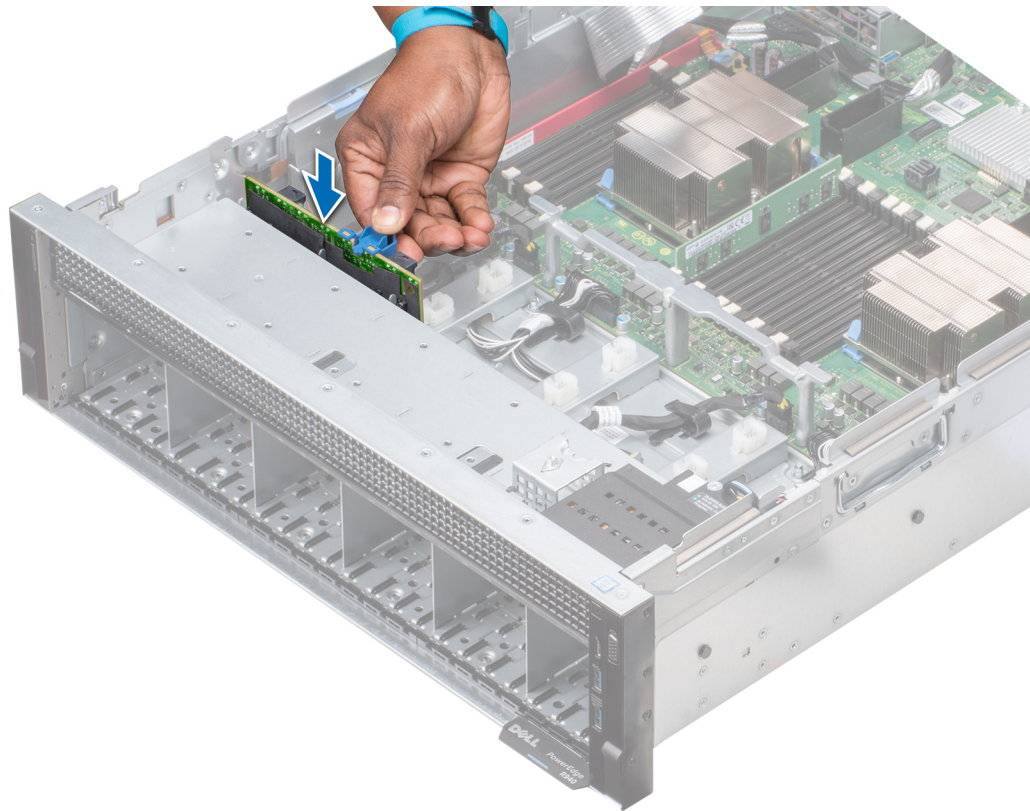

Figure 51. Installing the 2.5-inch (x8) drive backplane

Next steps

1. Connect all the cables to the drive backplane.
2. [Install the fan cage.](#)
3. [Install the drives.](#)
4. If removed, [install the front bezel.](#)
5. Follow the procedure listed in [After working inside your system](#) on page 66.

Cable routing

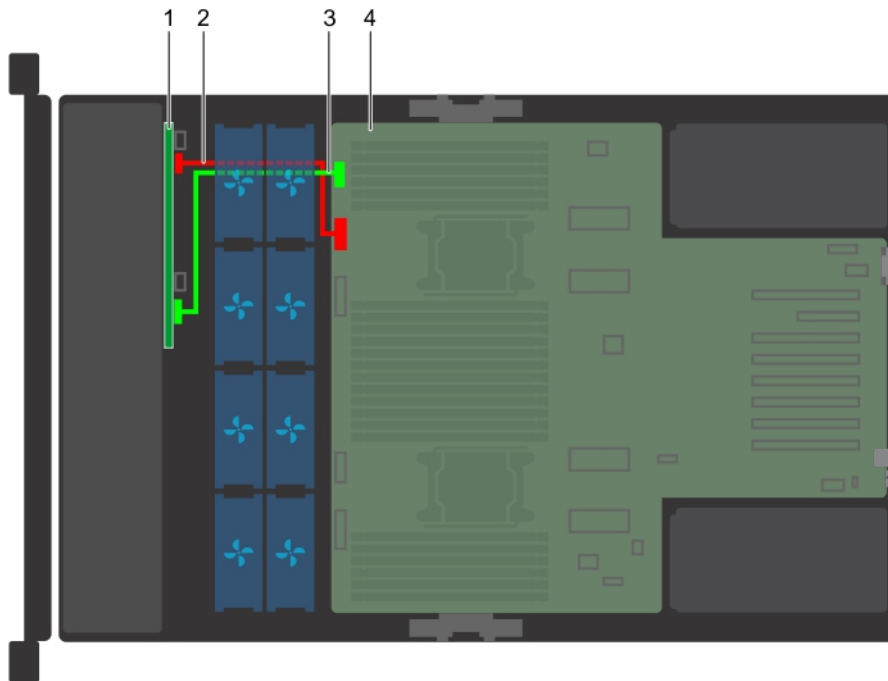

Figure 52. Cable routing – 8 x 2.5 inch hard drive backplane

- | | |
|--|---|
| 1. 8 x 2.5 inch hard drive backplane | 2. backplane power cable (BP: BP PWR to MB) |
| 3. backplane signal cable (BP: BP SIG to MB) | 4. system board |

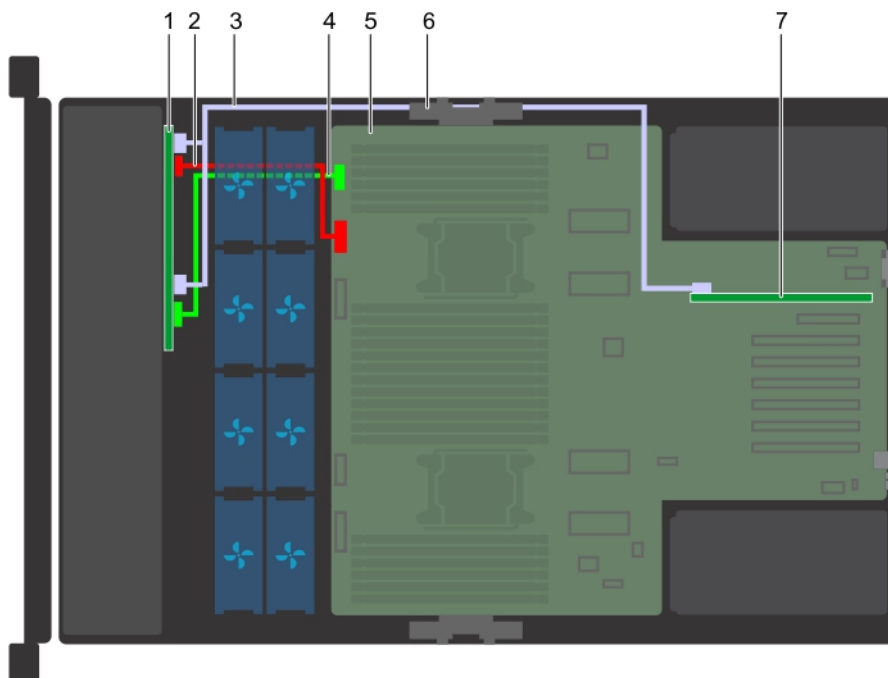

Figure 53. Cable routing – 8 x 2.5 inch hard drive backplane with PERC

- | | |
|--|--|
| 1. 8 x 2.5 inch hard drive backplane | 2. backplane power cable (BP: BP PWR to MB) |
| 3. SAS cable (BP: BP SAS B, BP SAS A to RAID controller) | 4. backplane signal cable (BP: BP SIG to MB) |
| 5. system board | 6. cable management bracket |

7. storage controller card (slot 1)

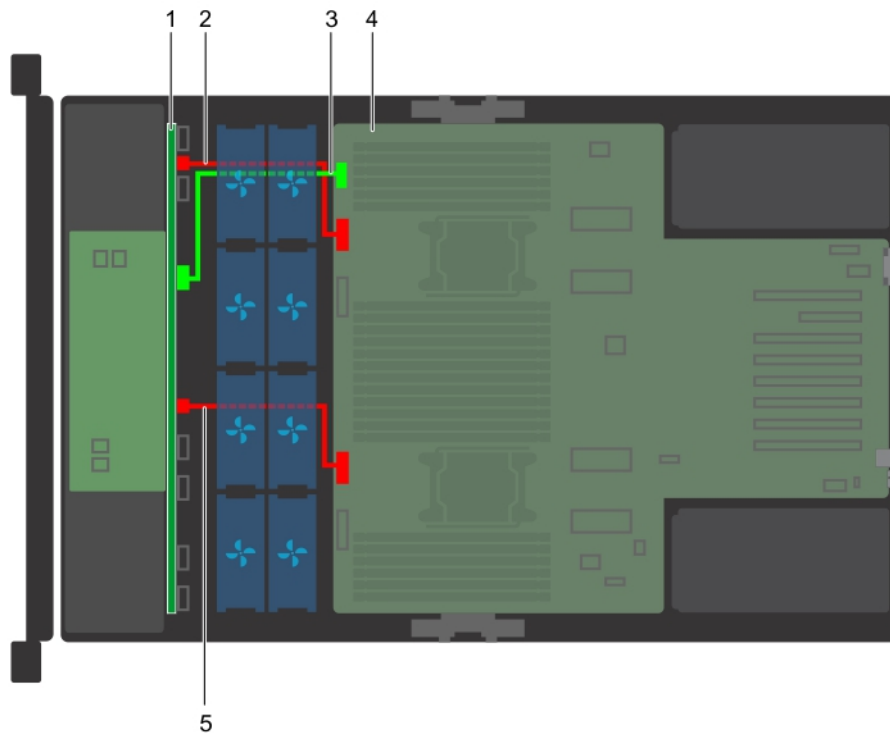

Figure 54. Cable routing – 24 x 2.5 inch hard drive backplane

1. 24 x 2.5 inch hard drive backplane with expander board
2. backplane power cable A (BP: BP PWR_A to MB)
3. backplane signal cable (BP: BP SIG to MB)
4. system board
5. backplane power cable B (BP: BP PWR_B to MB)

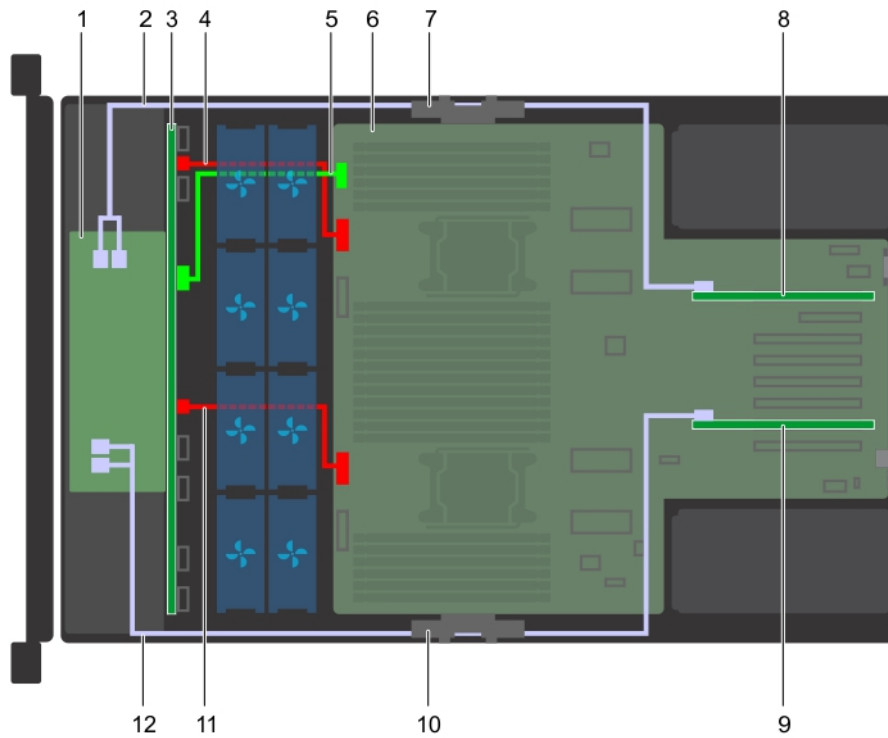

Figure 55. Cable routing – 24 x 2.5 inch hard drive backplane with PERC

- | | |
|--|---|
| 1. expander board | 2. SAS cable (BP: BP SAS A1, BP SAS B1 to RAID controller) |
| 3. 24 x 2.5 inch hard drive backplane | 4. backplane power cable A (BP: BP PWR_A to MB) |
| 5. backplane signal cable (BP: BP SIG to MB) | 6. system board |
| 7. cable management bracket (left) | 8. storage controller card (slot 1) |
| 9. storage controller card (slot 6) | 10. cable management bracket (right) |
| 11. backplane power cable B (BP: BP PWR_B to MB) | 12. SAS cable (BP: BP SAS A0, BP SAS B0 to RAID controller) |

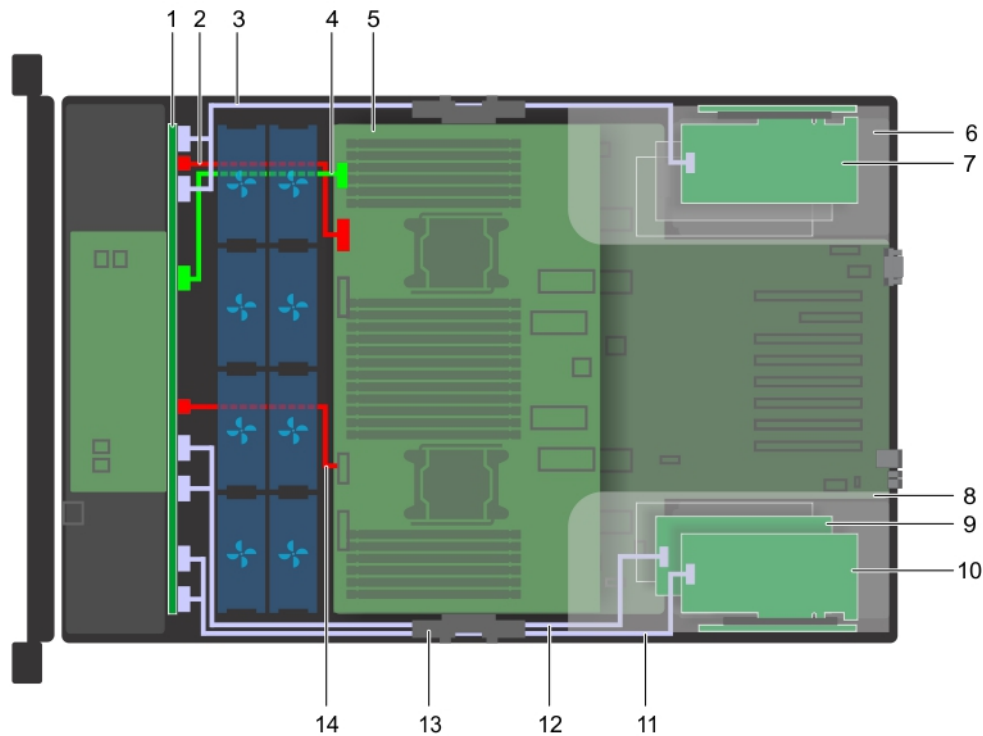

Figure 56. Cable routing – 24 x 2.5 inch hard drive backplane with NVMe cards

- | | |
|--|--|
| 1. 24 x 2.5 inch hard drive backplane with expander board | 2. backplane power cable A (BP: BP PWR_A to MB) |
| 3. PCIe cable (BP: BP PCIE B2, BP PCIE A2 to RAID controller) | 4. backplane signal cable (BP: BP SIG to MB) |
| 5. system board | 6. expansion card riser (left) |
| 7. NVMe card (slot 8) | 8. expansion card riser (right) |
| 9. NVMe card (slot 12) | 10. NVMe card (slot 11) |
| 11. PCIe cable (BP: BP PCIE B0, BP PCIE A0 to RAID controller) | 12. PCIe cable (BP: BP PCIE B1, BP PCIE A1 to RAID controller) |
| 13. cable management bracket (right) | 14. backplane power cable B (BP: BP PWR_B to MB) |

System memory

System memory guidelines

The system supports DDR4 registered DIMMs (RDIMMs), load reduced DIMMs (LRDIMMs), data center persistent memory module (DCPMM) and non-volatile dual in-line DIMM-Ns (NVDIMM-N). System memory holds the instructions that are executed by the processor.

The PowerEdge R940 system (without PEM) contains 24 memory sockets split into two sets of 12 sockets, one set per processor. Each 12-socket set is organized into six channels. Six memory channels are allocated to each processor. In each channel, the release tabs of the first socket are marked white, and the second socket black.

The PowerEdge R940 system (with PEM) contains 48 memory sockets split into four sets of 12 sockets, one set per processor. Each 12-socket set is organized into six channels. Six memory channels are allocated to each processor. In each channel, the release tabs of the first socket are marked white, and the second socket black.

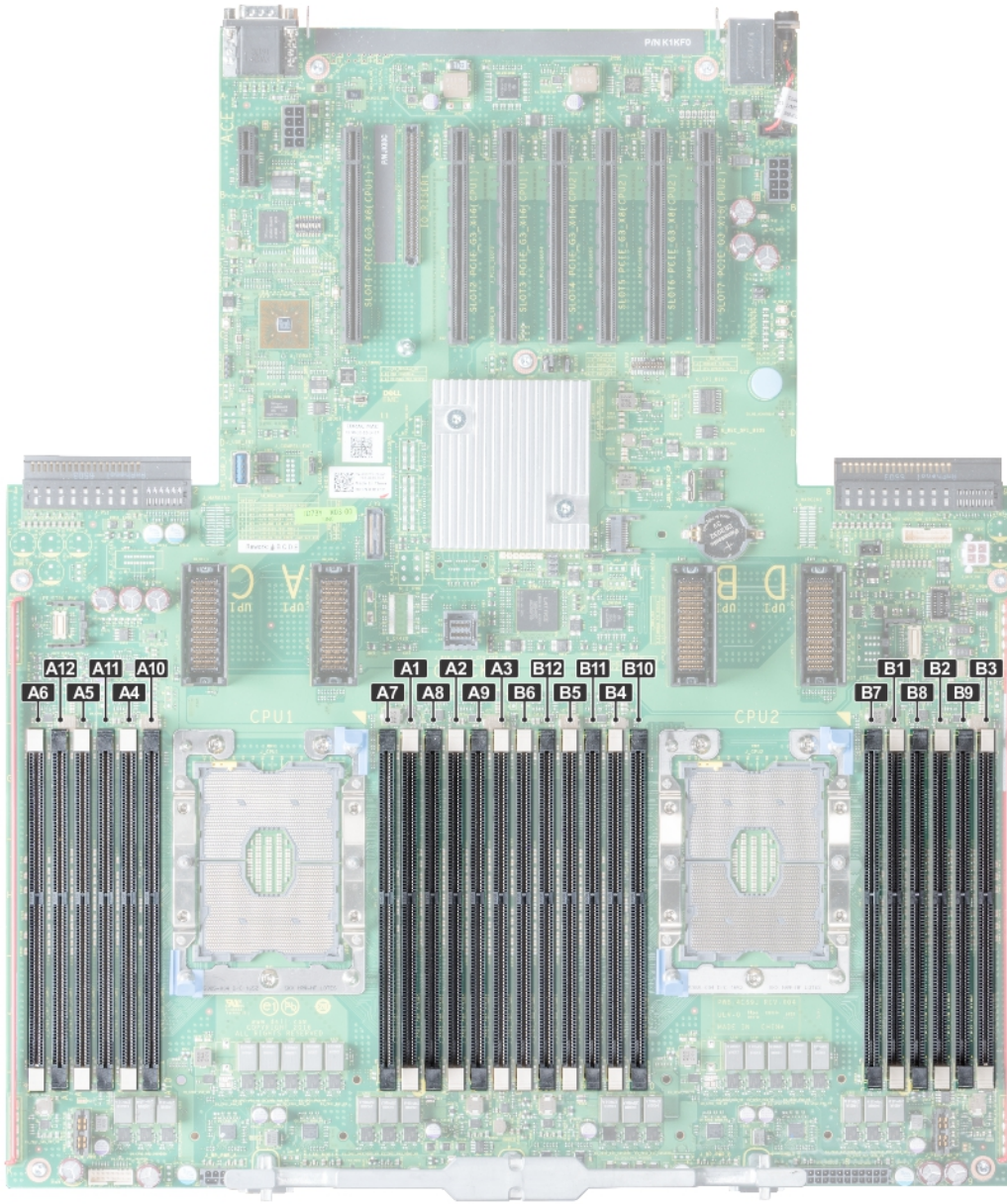

Figure 57. Memory socket location

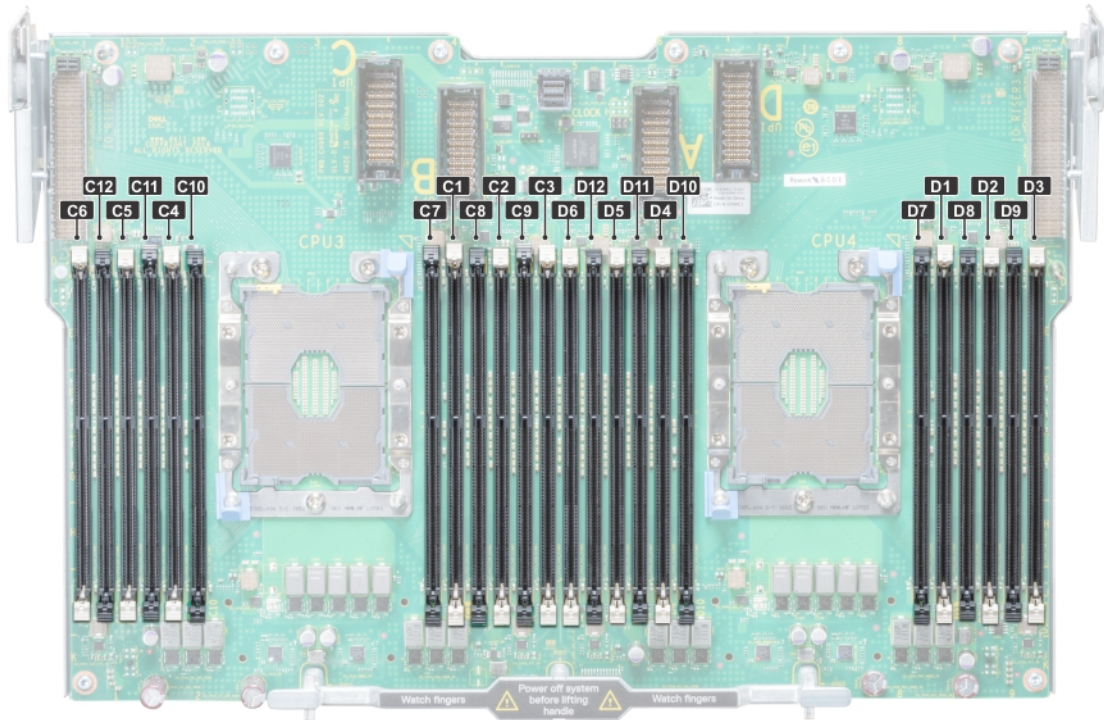

Figure 58. Memory socket location on the processor expansion module

Memory channels are organized as follows:

Table 44. Memory channels

Processor	Channel 0	Channel 1	Channel 2	Channel 3	Channel 4	Channel 5
Processor 1	Slots A1 and A7	Slots A2 and A8	Slots A3 and A9	Slots A4 and A10	Slots A5 and A11	Slots A6 and A12
Processor 2	Slots B1 and B7	Slots B2 and B8	Slots B3 and B9	Slots B4 and B10	Slots B5 and B11	Slots B6 and B12
Processor 3	Slots C1 and C7	Slots C2 and C8	Slots C3 and C9	Slots C4 and C10	Slots C5 and C11	Slots C6 and C12
Processor 4	Slots D1 and D7	Slots D2 and D8	Slots D3 and D9	Slots D4 and D10	Slots D5 and D11	Slots D6 and D12

General memory module installation guidelines

To ensure optimal performance of your system, observe the following general guidelines when configuring your system memory. If your system's memory configurations fail to observe these guidelines, your system might not boot, stop responding during memory configuration, or operate with reduced memory.

The memory bus may operate at frequency can be 2933 MT/s, 2666 MT/s, 2400 MT/s, or 2133 MT/s depending on the following factors:

- System profile selected (for example, Performance Optimized, or Custom [can be run at high speed or lower])
- Maximum supported DIMM speed of the processors. For memory frequency of 2933 MT/s, one DIMM per channel is supported.
- Maximum supported DIMM speed of the processors.
- Maximum supported speed of the DIMMs

NOTE: MT/s indicates DIMM speed in MegaTransfers per second.

The system supports Flexible Memory Configuration, enabling the system to be configured and run in any valid chipset architectural configuration. The following are the recommended guidelines for installing memory modules:

- All DIMMs must be DDR4.
- RDIMMs and LRDIMMs must not be mixed.
- NVDIMMs and LRDIMMs must not be mixed.
- NVDIMMs and RDIMMs can be mixed.
- 64 GB LRDIMMs that are DDP (Dual Die Package) LRDIMMs must not be mixed with 128 GB LRDIMMs that are TSV (Through Silicon Via/3DS) LRDIMMs.
- x4 and x8 DRAM based memory modules can be mixed.
- Up to two RDIMMs can be populated per channel regardless of rank count.
- Up to two LRDIMMs can be populated per channel regardless of rank count.
- A maximum of two different ranked DIMMs can be populated in a channel regardless of rank count.
- If memory modules with different speeds are installed, they will operate at the speed of the slowest installed memory module(s).
- Populate memory module sockets only if a processor is installed.
 - For single-processor systems, sockets A1 to A12 are available.
 - For dual-processor systems, sockets A1 to A12 and sockets B1 to B12 are available.
- Populate all the sockets with white release tabs first, followed by the black release tabs.
- When mixing memory modules with different capacities, populate the sockets with memory modules with the highest capacity first.

For example, if you want to mix 8 GB and 16 GB memory modules, populate 16 GB memory modules in the sockets with white release tabs and 8 GB memory modules in the sockets with black release tabs.
- Memory modules of different capacities can be mixed provided other memory population rules are followed.

For example, 8 GB and 16 GB memory modules can be mixed.
- In a dual-processor configuration, the memory configuration for each processor must be identical.

For example, if you populate socket A1 for processor 1, then populate socket B1 for processor 2, and so on.
- Mixing of more than two memory module capacities in a system is not supported.
- Unbalanced memory configurations will result in a performance loss so always populate memory channels identically with identical DIMMs for best performance.
- Populate six identical memory modules per processor (one DIMM per channel) at a time to maximize performance.

DIMM population update for Performance Optimized mode with quantity of 4 and 8 DIMMs per processor.

- When the DIMM quantity is 4 per processor, the population is slot 1, 2, 4, 5.
- When the DIMM quantity is 8 per processor, the population is slot 1, 2, 4, 5, 7, 8, 10, 11.

NVDIMM-N memory module installation guidelines

The following are the recommended guidelines for installing NVDIMM-N memory modules:

- Each system supports memory configurations with 1, 2, 4, 6, or 12 NVDIMM-Ns.
- Supported configurations have dual processors and a minimum of 12x RDIMMs.
- Maximum of 12 NVDIMM-Ns can be installed in a system.
- NVDIMM-Ns or RDIMMs must not be mixed with LRDIMMs.
- DDR4 NVDIMM-Ns must be populated only on the black release tabs on processor 1 and 2.
- For systems with four processors, RDIMMs populated on processor 3 and 4 must be identical to the number of RDIMMs populated on processor 1 and 2.
- All slots on configurations 3, 6, 9, and 12 can be used, but a maximum of 12 NVDIMM-Ns can be installed in a system.

 **NOTE: NVDIMM-N memory slots are not hot-pluggable.**

For more information about the supported NVDIMM-N configurations, see the *NVDIMM-N User Guide* at www.dell.com/poweredge/manuals.

Table 45. Supported NVDIMM-N for dual processor configurations

Configuration	Description	Memory population rules	
		RDIMMs	NVDIMM-N
Configuration 1	12x 16 GB RDIMMs, 1x NVDIMM-N	Processor1 {A1, 2, 3, 4, 5, 6} Processor2 {B1, 2, 3, 4, 5, 6}	Processor1 {A7}

Table 45. Supported NVDIMM-N for dual processor configurations (continued)

Configuration	Description	Memory population rules	
		RDIMMs	NVDIMM-N
Configuration 2	12x 32 GB RDIMMs, 1x NVDIMM-N	Same for all 12x RDIMM configurations. See Configuration 1.	Processor1 {A7}
Configuration 3	23x 32 GB RDIMMs, 1x NVDIMM-N	Processor1 {A1, 2, 3, 4, 5, 6, 7, 8, 9, 10, 11, 12} Processor2 {B1, 2, 3, 4, 5, 6, 7, 8, 9, 10, 11}	Processor2 {B12}
Configuration 4	12x 16 GB RDIMMs, 2x NVDIMM-Ns	Same for all 12x RDIMM configurations. See Configuration 1.	Processor1 {A7} Processor2 {B7}
Configuration 5	12x 32 GB RDIMMs, 2x NVDIMM-Ns	Same for all 12x RDIMM configurations. See Configuration 1.	Processor1 {A7} Processor2 {B7}
Configuration 6	22x 32 GB RDIMMs, 2x NVDIMM-Ns	Processor1 {A1, 2, 3, 4, 5, 6, 7, 8, 9, 10, 11} Processor2 {B1, 2, 3, 4, 5, 6, 7, 8, 9, 10, 11}	Processor1 {A12} Processor2 {B12}
Configuration 7	12x 16 GB RDIMMs, 4x NVDIMM-Ns	Same for all 12x RDIMM configurations. See Configuration 1.	Processor1 {A7, A8} Processor2 {B7, B8}
Configuration 8	22x 32 GB RDIMMs, 4x NVDIMM-Ns	Same for all 12x RDIMM configurations. See Configuration 1.	Processor1 {A7, A8} Processor2 {B7, B8}
Configuration 9	20x 32 GB RDIMMs, 4x NVDIMM-Ns	Processor1 {A1, 2, 3, 4, 5, 6, 7, 8, 9, 10} Processor2 {B1, 2, 3, 4, 5, 6, 7, 8, 9, 10}	Processor1 {A11, 12} Processor2 {B11, 12}
Configuration 10	12x 16 GB RDIMMs, 6x NVDIMM-Ns	Same for all 12x RDIMM configurations. See Configuration 1.	Processor1 {A7, 8, 9} Processor2 {B7, 8, 9}
Configuration 11	12x 32 GB RDIMMs, 6x NVDIMM-Ns	Same for all 12x RDIMM configurations. See Configuration 1.	Processor1 {A7, 8, 9} Processor2 {B7, 8, 9}
Configuration 12	18x 32 GB RDIMMs, 6x NVDIMM-Ns	Processor1 {1, 2, 3, 4, 5, 6, 7, 8, 9} Processor2 {1, 2, 3, 4, 5, 6, 7, 8, 9}	Processor1 {A10, 11, 12} Processor2 {B10, 11, 12}
Configuration 13	12x 16 GB RDIMMs, 12x NVDIMM-Ns	Same for all 12x RDIMM configurations. See Configuration 1.	Processor1 {A7, 8, 9, 10, 11, 12} Processor2 {B7, 8, 9, 10, 11, 12}
Configuration 14	12x 32 GB RDIMMs, 12x NVDIMM-Ns	Same for all 12x RDIMM configurations. See Configuration 1.	Processor1 {A7, 8, 9, 10, 11, 12} Processor2 {B7, 8, 9, 10, 11, 12}

Table 46. Supported NVDIMM-N for quad processor configurations

Configuration	Description	Memory population rules	
		RDIMMs	NVDIMM-N
Configuration 1	24x 16 GB RDIMMs, 1x NVDIMM-N	Processor1 {A1, 2, 3, 4, 5, 6}, Processor2 {B1, 2, 3, 4, 5, 6}, Processor3 {C1, 2, 3, 4, 5, 6} Processor4 {D1, 2, 3, 4, 5, 6}	Processor1 {A7}
Configuration 2	24x 32 GB RDIMMs, 1x NVDIMM-N	Same for all 24x RDIMM configurations. See Configuration 1.	Processor1 {A7}
Configuration 3	47x 32 GB RDIMMs, 1x NVDIMM-N	Processor1 {A1, 2, 3, 4, 5, 6, 7, 8, 9, 10, 11, 12} , Processor2 {B1, 2, 3, 4, 5, 6, 7, 8, 9, 10, 11} , Processor3 {C1, 2, 3, 4, 5, 6, 7, 8, 9, 10, 11, 12} Processor 4 {D1, 2, 3, 4, 5, 6, 7, 8, 9, 10, 11, 12}	Processor2 {B12}
Configuration 4	24x 16 GB RDIMMs, 2x NVDIMM-Ns	Processor1 {A1, 2, 3, 4, 5, 6}, Processor2 {B1, 2, 3, 4, 5, 6} Processor3 {C1, 2, 3, 4, 5, 6} Processor4 {D1, 2, 3, 4, 5, 6}	Processor1 {A7}, Processor2 {B7}
Configuration 5	24x 32 GB RDIMMs, 2x NVDIMM-Ns	Processor1 {A1, 2, 3, 4, 5, 6}, Processor2 {B1, 2, 3, 4, 5, 6}, Processor3 {C1, 2, 3, 4, 5, 6} Processor4 {D1, 2, 3, 4, 5, 6}	Processor1 {A7}, Processor2 {B7}
Configuration 6	46x 32 GB RDIMMs, 2x NVDIMM-Ns	Processor1 {A1, 2, 3, 4, 5, 6, 7, 8, 9, 10, 11}, Processor2 {B1, 2, 3, 4, 5, 6, 7, 8, 9, 10, 11} , Processor3 {C1, 2, 3, 4, 5, 6, 7, 8, 9, 10, 11, 12} Processor 4 {D1, 2, 3, 4, 5, 6, 7, 8, 9, 10, 11, 12}	Processor1 {A12}, Processor2 {B12}
Configuration 7	24x 16 GB RDIMMs, 4x NVDIMM-Ns	Processor1 {A1, 2, 3, 4, 5, 6}, Processor2 {B1, 2, 3, 4, 5, 6}, Processor3 {C1, 2, 3, 4, 5, 6} Processor4 {D1, 2, 3, 4, 5, 6}	Processor1 {A7,8}, Processor2 {B7,8}
Configuration 8	24x 32 GB RDIMMs, 4x NVDIMMs	Processor1 {A1, 2, 3, 4, 5, 6}, Processor2 {B1, 2, 3, 4, 5, 6}, Processor3 {C1, 2, 3, 4, 5, 6} Processor4 {D1, 2, 3, 4, 5, 6}	Processor1 {A7,8}, Processor2 {B7,8}
Configuration 9	44x 32 GB RDIMMs, 4x NVDIMM-Ns	Processor1 {A1, 2, 3, 4, 5, 6, 7, 8, 9, 10}, Processor2 {B1, 2, 3, 4, 5, 6, 7, 8, 9, 10}, Processor3 {C1, 2, 3, 4, 5, 6, 7, 8, 9, 10, 11, 12} Processor4 {D1, 2, 3, 4, 5, 6, 7, 8, 9, 10, 11, 12}	Processor1 {A11, 12}, Processor2 {B11, 12}

Table 46. Supported NVDIMM-N for quad processor configurations (continued)

Configuration	Description	Memory population rules	
		RDIMMs	NVDIMM-N
Configuration 10	24x 16 GB RDIMMs, 6x NVDIMM-Ns	Processor1 {A1, 2, 3, 4, 5, 6}, Processor2 {B1, 2, 3, 4, 5, 6} Processor3 {C1, 2, 3, 4, 5, 6} Processor4 {D1, 2, 3, 4, 5, 6}	Processor1 {A7, 8, 9} Processor2 {B7, 8, 9}
Configuration 11	24x 32 GB RDIMMs, 6x NVDIMM-Ns	Processor1 {A1, 2, 3, 4, 5, 6}, Processor2 {B1, 2, 3, 4, 5, 6}, Processor3 {C1, 2, 3, 4, 5, 6} Processor4 {D1, 2, 3, 4, 5, 6}	Processor1 {A7, 8, 9} Processor2 {B7, 8, 9}
Configuration 12	42x 32 GB RDIMMs, 6x NVDIMM-Ns	Processor1 {A1, 2, 3, 4, 5, 6, 7, 8, 9}, Processor2 {B1, 2, 3, 4, 5, 6, 7, 8, 9} Processor3 {C1, 2, 3, 4, 5, 6, 7, 8, 9, 10, 11, 12} Processor4 {D1, 2, 3, 4, 5, 6, 7, 8, 9, 10, 11, 12}	Processor1 {A10,11,12} Processor2 {B10, 11, 12}
Configuration 13	24x 16 GB RDIMMs, 12x NVDIMM-Ns	Processor1 {A1, 2, 3, 4, 5, 6}, Processor2 {B1, 2, 3, 4, 5, 6}, Processor3 {C1, 2, 3, 4, 5, 6} Processor4 {D1, 2, 3, 4, 5, 6}	Processor1 {A7, 8, 9, 10, 11, 12}, Processor2 {B7, 8, 9, 10, 11, 12}
Configuration 14	24x 32 GB RDIMMs, 12x NVDIMM-Ns	Processor1 {A1, 2, 3, 4, 5, 6}, Processor2 {B1, 2, 3, 4, 5, 6}, Processor3 {C1, 2, 3, 4, 5, 6} Processor4 {D1, 2, 3, 4, 5, 6}	Processor1 {A7, 8, 9, 10, 11, 12}, Processor2 {B7, 8, 9, 10, 11, 12}
Configuration 15	36x 32 GB RDIMMs, 12x NVDIMM-Ns	Processor1 {A1, 2, 3, 4, 5, 6}, Processor2 {B1, 2, 3, 4, 5, 6}, Processor3 {C1, 2, 3, 4, 5, 6, 7, 8, 9, 10, 11, 12} Processor 4 {D1, 2, 3, 4, 5, 6, 7, 8, 9, 10, 11, 12}	Processor1 {A7, 8, 9, 10, 11, 12}, Processor2 {B7, 8, 9, 10, 11, 12}

DCPMM installation guidelines

The following are the recommended guidelines for installing data center persistent memory module (DCPMM) memory modules:

- Each system supports maximum of one DCPMM memory module per channel.
- i** **NOTE: If two different DCPMM capacities are mixed, an F1/F2 warning is displayed as the configuration is not supported.**
- DCPMM can be mixed with RDIMM, LRDIMM, and 3DS LRDIMM.
- Mixing of DDR4 DIMM types (RDIMM, LRDIMM, and 3DS LRDIMM), within channels, for Integrated Memory Controller (iMC), or across sockets are not supported.
- Mixing of DCPMM operating modes (App Direct, Memory Mode) is not supported.
- If only one DIMM is populated on a channel, it should always go to the first slot in that channel (white slot).
- If a DCPMM and a DDR4 DIMM are populated on the same channel, always plug DCPMM on second slot (black slot).
- If the DCPMM is configured in Memory Mode, the recommended DDR4 to DCPMM capacity ratio is 1:4 to 1:16 per iMC.
- DCPMMs cannot be mixed with other DCPMMs capacities or NVDIMMs.
- Mixing different capacities of RDIMMs and LRDIMMs are not allowed when DCPMM is installed.
- DCPMMs of different capacities are not allowed.

For more information about the supported DCPMM configurations, see the *Dell EMC DCPMM User 's Guide* at https://www.dell.com/support/home/products/server_int/server_int_poweredge.

Table 47. 2 socket DCPMM configurations

No. of CPUs in the Server	DCPMM Population	DRAM Population	DRAM Capacity (GB)	DCPM M Capacity (GB)	Operating system Memory in Memory Mode (GB)	Total Memory (GB)	Total Memory per CPU (GB)	Ratio DRAM to Optane Memory	Requires an M or L CPU	Supported in App Direct Mode	Supported in Memory Mode
2	128 GB x 1	16 GB x 12	192	128	N/A	320	160	1: 0.7	No	Yes	No
2	128 GB x 2	16 GB x 12	192	256	N/A	448	224	1: 1.3	No	Yes	No
2	128 GB x 4	16 GB x 8	128	512	512	640	320	1: 4	No	Yes	Yes
2	128 GB x 4	16 GB x 12	192	512	N/A	704	352	1: 2.7	No	Yes	No
2	128 GB x 8	16 GB x 12	192	1,024	1,024	1,216	608	1: 5.3	No	Yes	Yes
2	128 GB x 12	16 GB x 12	192	1,536	1,536	1,728	864	1: 8	No	Yes	Yes
2	128 GB x 1	32 GB x 12	384	128	N/A	512	256	1: 0.3	No	Yes	No
2	128 GB x 2	32 GB x 12	384	256	N/A	640	320	1: 0.7	No	Yes	No
2	128 GB x 4	32 GB x 12	384	512	N/A	896	448	1: 1.3	No	Yes	No
2	128 GB x 8	32 GB x 12	384	1,024	N/A	1,408	704	1: 2.7	No	Yes	No
2	128 GB x 12	32 GB x 12	384	1,536	1,536	1,920	960	1: 4	No	Yes	Yes
2	128 GB x 4	64 GB x 12	768	512	N/A	1,280	640	1: 0.7	No	Yes	No
2	128 GB x 8	64 GB x 12	768	1,024	N/A	1,792	896	1: 1.3	No	Yes	No
2	128 GB x 12	64 GB x 12	768	1,536	N/A	2,304	1,152	1: 2	L SKU	Yes	No
2	128 GB x 12	128 GB x 12	1,536	1,536	N/A	3,072	1,536	1: 1	L SKU	Yes	No
2	512 GB x 8	32 GB x 12	384	4,096	4,096	4,480	2,240	1: 10.7	L SKU	Yes	Yes
2	512 GB x 12	32 GB x 12	384	6,144	6,144	6,528	3,264	1: 16	L SKU	Yes	Yes
2	512 GB x 8	64 GB x 12	768	4,096	4,096	4,864	2,432	1: 5.3	L SKU	Yes	Yes
2	512 GB x 12	64 GB x 12	768	6,144	6,144	6,912	3,456	1: 8	L SKU	Yes	Yes
2	512 GB x 12	128 GB x 12	1,536	6,144	6,144	7,680	3,840	1: 4	L SKU	Yes	Yes
2	256 GB x 8	16 GB x 12	192	2,048	2,048	2,240	1,120	1: 10.7	L SKU	Yes	Yes

Table 47. 2 socket DCPMM configurations (continued)

No. of CPUs in the Server	DCPMM Population	DRAM Population	DRAM Capacity (GB)	DCPMM Capacity (GB)	Operating system Memory in Memory Mode (GB)	Total Memory (GB)	Total Memory per CPU (GB)	Ratio DRAM to Optane Memory	Requires an M or L CPU	Supported in App Direct Mode	Supported in Memory Mode
2	256 GB x 8	32 GB x 12	384	2,048	2,048	2,432	1,216	1: 5.3	L SKU	Yes	Yes
2	256 GB x 12	32 GB x 12	384	3,072	3,072	3,456	1,728	1: 8	L SKU	Yes	Yes
2	256 GB x 8	64 GB x 12	768	2,048	N/A	2,816	1,408	1: 2.7	L SKU	Yes	No
2	256 GB x 12	64 GB x 12	768	3,072	3,072	3,840	1,920	1: 4	L SKU	Yes	Yes
2	256 GB x 12	128 GB x 12	1,536	3,072	N/A	4,608	2,304	1: 2	L SKU	Yes	No

Table 48. 4 socket DCPMM configurations

No. of CPUs in the Server	DCPMM Population	DRAM Population	DRAM Capacity (GB)	DCPMM Capacity (GB)	Operating system Memory in Memory Mode (GB)	Total Memory (GB)	Total Memory per CPU (GB)	Ratio DRAM to Optane Memory	Requires an M or L CPU	Supported in App Direct Mode	Supported in Memory Mode
4	128 GB x 16	16 GB x 24	384	2,048	2,048	2,432	608	1: 5.3	No	Yes	Yes
4	128 GB x 24	16 GB x 24	384	3,072	3,072	3,456	864	1: 8	No	Yes	Yes
4	128 GB x 16	32 GB x 24	768	2,048	N/A	2,816	704	1: 2.7	No	Yes	No
4	128 GB x 24	32 GB x 24	768	3,072	3,072	3,840	960	1: 4	No	Yes	Yes
4	128 GB x 24	64 GB x 24	1,536	3,072	N/A	4,608	1,152	1: 2	L SKU	Yes	No
4	128 GB x 24	128 GB x 24	3,072	3,072	N/A	6,144	1,536	1: 1	L SKU	Yes	No
4	512 GB x 16	32 GB x 24	768	8,192	8,192	8,960	2,240	1: 10.7	L SKU	Yes	Yes
4	512 GB x 24	32 GB x 24	768	12,288	12,288	13,056	3,264	1: 16	L SKU	Yes	Yes
4	512 GB x 16	64 GB x 24	1,536	8,192	8,192	9,728	2,432	1: 5.3	L SKU	Yes	Yes
4	512 GB x 24	64 GB x 24	1,536	12,288	12,288	13,824	3,456	1: 8	L SKU	Yes	Yes
4	512 GB x 24	128 GB x 24	3,072	12,288	12,288	15,360	3,840	1: 4	L SKU	Yes	Yes
4	256 GB x 16	16 GB x 24	384	4,096	4,096	4,480	1,120	1: 10.7	L SKU	Yes	Yes
4	256 GB x 24	16 GB x 24	384	6,144	6,144	6,528	1,632	1: 16	L SKU	Yes	Yes

Table 48. 4 socket DCPMM configurations (continued)

No. of CPUs in the Server	DCPMM Population	DRAM Population	DRAM Capacity (GB)	DCPMM Capacity (GB)	Operating system Memory in Memory Mode (GB)	Total Memory (GB)	Total Memory per CPU (GB)	Ratio DRAM to Optane Memory	Requires an M or L CPU	Supported in App Direct Mode	Supported in Memory Mode
4	256 GB x 16	32 GB x 24	768	4,096	4,096	4,864	1,216	1: 5.3	L SKU	Yes	Yes
4	256 GB x 24	32 GB x 24	768	6,144	6,144	6,912	1,728	1: 8	L SKU	Yes	Yes
4	256 GB x 16	64 GB x 24	1,536	4,096	N/A	5,632	1,408	1: 2.7	L SKU	Yes	No
4	256 GB x 24	64 GB x 24	1,536	6,144	6,144	7,680	1,920	1: 4	L SKU	Yes	Yes
4	256 GB x 24	128 GB x 24	3,072	6,144	N/A	9,216	2,304	1: 2	L SKU	Yes	No

NOTE: There are limited configurations available for Dual Socket Servers with only one CPU populated.

NOTE: DCPMM is supported on systems with 1600W and 2400W PSU configuration.

Mode-specific guidelines

The configurations allowed depend on the memory mode selected in the System BIOS.

Table 49. Memory operating modes

Memory Operating Mode	Description
Optimizer Mode	<p>The Optimizer Mode if enabled, the DRAM controllers operate independently in the 64-bit mode and provide optimized memory performance.</p> <p>NOTE: DCPMM supports only Optimizer mode.</p>
Mirror Mode	<p>The Mirror Mode if enabled, the system maintains two identical copies of data in memory, and the total available system memory is one half of the total installed physical memory. Half of the installed memory is used to mirror the active memory modules. This feature provides maximum reliability and enables the system to continue running even during a catastrophic memory failure by switching over to the mirrored copy. The installation guidelines to enable Mirror Mode require that the memory modules be identical in size, speed, and technology, and they must be populated in sets of 6 per processor.</p>
Single Rank Spare Mode	<p>Single Rank Spare Mode allocates one rank per channel as a spare. If excessive correctable errors occur in a rank or channel, while the operating system is running, they are moved to the spare area to prevent errors from causing an uncorrectable failure. Requires two or more ranks to be populated in each channel.</p>
Multi Rank Spare Mode	<p>Multi Rank Spare Mode allocates two ranks per channel as a spare. If excessive correctable errors occur in a rank or channel, while the operating system is running, they are moved to the spare area to prevent errors from causing an uncorrectable failure. Requires three or more ranks to be populated in each channel.</p>

Table 49. Memory operating modes (continued)

Memory Operating Mode	Description
	<p>With single rank memory sparing enabled, the system memory available to the operating system is reduced by one rank per channel.</p> <p>For example, in a dual-processor configuration with 24x 16 GB dual-rank memory modules, the available system memory is: 3/4 (ranks/channel) × 24 (memory modules) × 16 GB = 288 GB, and not 24 (memory modules) × 16 GB = 384 GB. For multi rank sparing, the multiplier changes to 1/2 (ranks/channel).</p> <p>NOTE: To use memory sparing, this feature must be enabled in the BIOS menu of System Setup.</p> <p>NOTE: Memory sparing does not offer protection against a multi-bit uncorrectable error.</p>
<p>Dell Fault Resilient Mode</p>	<p>The Dell Fault Resilient Mode if enabled, the BIOS creates an area of memory that is fault resilient. This mode can be used by an OS that supports the feature to load critical applications or enables the OS kernel to maximize system availability.</p> <p>NOTE: This feature is only supported in Gold and Platinum Intel processors.</p> <p>NOTE: Memory configuration has to be of same size DIMM, speed, and rank.</p>

Optimizer Mode

This mode supports Single Device Data Correction (SDDC) only for memory modules that use x4 device width. It does not impose any specific slot population requirements.

- Dual processor: Populate the slots in round robin sequence starting with processor 1.
 - NOTE:** Processor 1 and processor 2 population should match.
- Quad processor: Populate the slots in round robin sequence starting with processor 1.
 - NOTE:** Processor 1, processor 2, processor 3, and processor 4 population should match.

Removing a memory module

The procedure for removing a DIMM module and an NVDIMM-N module is identical.

Prerequisites

1. Follow the safety guidelines listed in [Safety instructions](#) on page 65.
 2. Follow the procedure listed in [Before working inside your system](#) on page 66.
 - CAUTION:** To prevent data loss and potential damage to your system, ensure that your system, LEDs on system, LEDs on NVDIMM-N and LEDs on NVDIMM-N battery are turned off before removing the NVDIMM-N battery.
 3. [Remove the air shroud.](#)
- WARNING:** Allow the memory modules to cool after you power off the system. Handle the memory modules by the card edges and avoid touching the components or metallic contacts on the memory module.
- CAUTION:** To ensure proper system cooling, memory module blanks must be installed in any memory socket that is not occupied. Remove memory module blanks only if you intend to install memory modules in those sockets.

Steps

1. Locate the appropriate memory module socket.

CAUTION: Handle each memory module only by the card edges, ensuring not to touch the middle of the memory module or metallic contacts.

2. Push the ejectors outward on both ends of the memory module socket to release the memory module from the socket.
3. Lift and remove the memory module from the system.

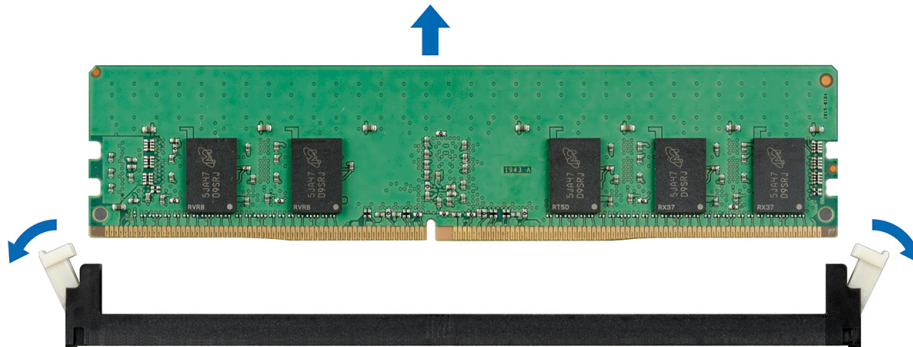

Figure 59. Removing a memory module

Next steps

1. [Install the memory module.](#)
2. If you are removing the memory module permanently, install a memory module blank. The procedure to install a memory module blank is similar to that of the memory module.

Installing a memory module

The procedure for installing a DIMM module and an NVDIMM-N module is identical.

Prerequisites

1. Follow the safety guidelines listed in [Safety instructions](#) on page 65.
2. Follow the procedure listed in [Before working inside your system](#) on page 66.

CAUTION: Ensure that you install the NVDIMM-N battery if you are using NVDIMM-N.

CAUTION: To prevent data loss and potential damage to your system, ensure that your system, LEDs on system, LEDs on NVDIMM-N and LEDs on NVDIMM-N battery are turned off before installing the NVDIMM-N battery.

CAUTION: To ensure proper system cooling, memory module blanks must be installed in any memory socket that is not occupied. Remove memory module blanks only if you intend to install memory modules in those sockets.

Steps

1. Locate the appropriate memory module socket.

CAUTION: Handle each memory module only by the card edges, ensuring not to touch the middle of the memory module or metallic contacts.

CAUTION: To prevent damage to the memory module or the memory module socket during installation, do not bend or flex the memory module. You must insert both ends of the memory module simultaneously.

2. Open the ejectors on the memory module socket outward to allow the memory module to be inserted into the socket.
3. Align the edge connector of the memory module with the alignment key of the memory module socket, and insert the memory module in the socket.

CAUTION: Do not apply pressure at the center of the memory module; apply pressure at both ends of the memory module evenly.

NOTE: The memory module socket has an alignment key that enables you to install the memory module in the socket in only one orientation.

4. Press the memory module with your thumbs until the socket levers firmly click into place.

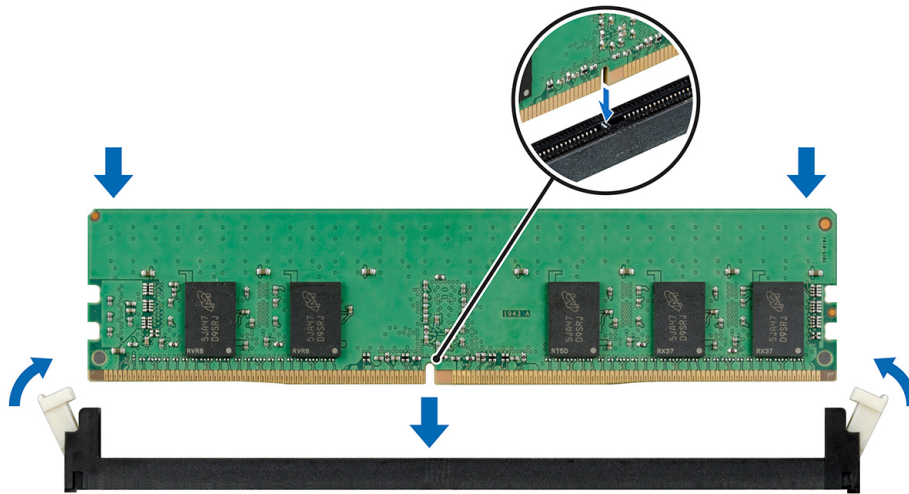

Figure 60. Installing a memory module

Next steps

1. [Install the air shroud.](#)
2. Follow the procedure listed in [After working inside your system](#) on page 66.
3. To verify if the memory module has been installed properly, press F2 and navigate to **System Setup Main Menu > System BIOS > Memory Settings**. In the **Memory Settings** screen, the System Memory Size must reflect the updated capacity of the installed memory.
4. If the value is incorrect, one or more of the memory modules may not be installed properly. Ensure that the memory module is firmly seated in the memory module socket.
5. Run the system memory test in system diagnostics.

Processors and heat sinks

Removing a processor and heat sink module

Prerequisites

WARNING: The heat sink may be hot to touch for some time after the system is powered down. Allow the heat sink to cool before removing it.

1. Follow the safety guidelines listed in [Safety instructions](#) on page 65.
2. Follow the procedure listed in [Before working inside your system](#) on page 66.
3. [Remove the air shroud.](#)
4. If installed, [remove the expansion card risers](#) and lift the PEM to the upright position.

NOTE: When using a four processor system, ensure to follow step 3 only if you have to remove the processors installed on the system board.

Steps

1. Using a Torx #T30 screwdriver, loosen the screws on the heat sink in the order below:
 - a. Loosen the first screw three turns.
 - b. Loosen the second screw completely.

- c. Return to the first screw and loosen it completely.
2. Pushing both blue retention clips simultaneously, lift the processor and heat sink module (PHM).
3. Set the PHM aside with the processor side facing up.

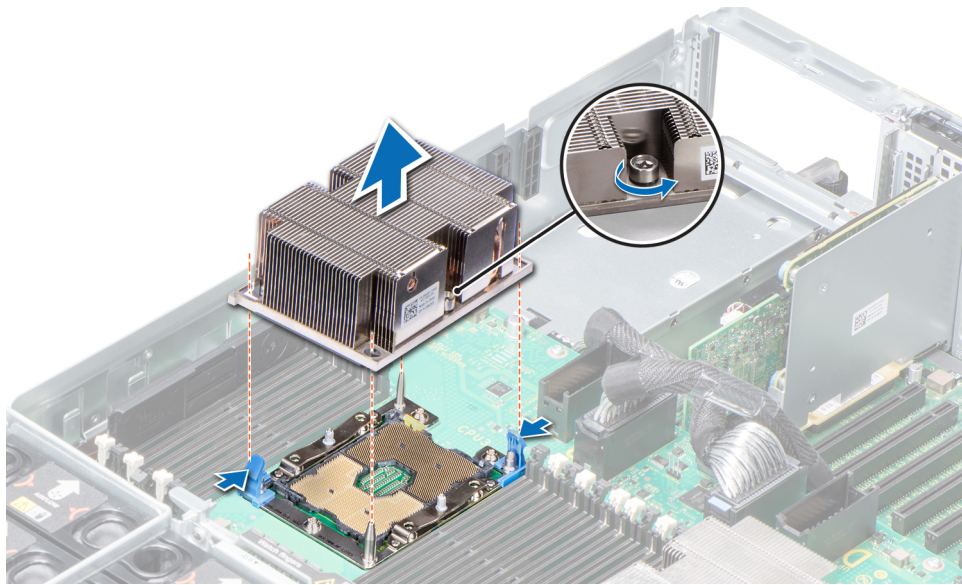

Figure 61. Removing the processor and heat sink module

Next steps

Install the PHM.

Removing the processor from the processor and heat sink module

Prerequisites

NOTE: Only remove the processor from the processor and heat sink module if you are replacing the processor or heat sink. This procedure is not required when replacing a system board.

1. Follow the safety guidelines listed in [Safety instructions](#) on page 65.
2. Follow the procedure listed in [Before working inside your system](#) on page 66.
3. [Remove the air shroud](#).
4. [Remove the processor and heat sink module](#).

Steps

1. Place the heat sink with the processor side facing up.
2. Insert a flat blade screwdriver into the release slot marked with a yellow label. Twist (do not pry) the screwdriver to break the thermal paste seal.
3. Push the retaining clips on the processor bracket to unlock the bracket from the heat sink.

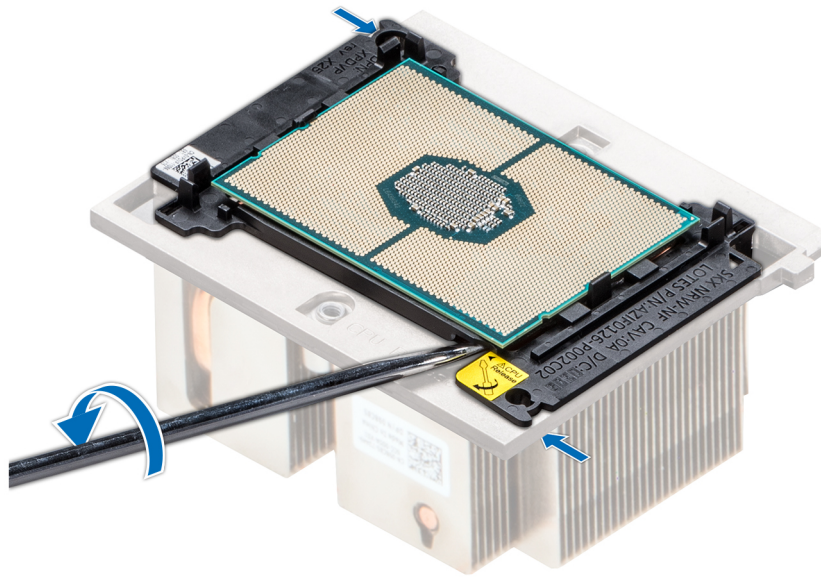

Figure 62. Loosening the processor bracket

4. Lift the bracket and the processor away from the heat sink, and place the processor connector side down on the processor tray.
5. Flex the outer edges of the bracket to release the bracket from the processor.

NOTE: Ensure that the processor and the bracket are placed in the tray after you remove the heat sink.



Figure 63. Removing the processor bracket

Next steps

Install the processor into the processor and heat sink module.

Installing the processor into a processor and heat sink module

Prerequisites

1. Follow the safety guidelines listed in [Safety instructions](#) on page 65.
2. Follow the procedure listed in [Before working inside your system](#) on page 66.

Steps

1. Place the processor in the processor tray.

i **NOTE:** Ensure that the pin 1 indicator on the processor tray is aligned with the pin 1 indicator on the processor.

2. Flex the outer edges of the bracket around the processor ensuring that the processor is locked into the clips on the bracket.

i **NOTE:** Ensure that the pin 1 indicator on the bracket is aligned with the pin 1 indicator on the processor before placing the bracket on the processor.

i **NOTE:** Ensure that the processor and the bracket are placed in the tray before you install the heat sink.



Figure 64. Installing the processor bracket

3. If you are using an existing heat sink, remove the thermal grease from the heat sink by using a clean lint-free cloth.
4. Use the thermal grease syringe included with your processor kit to apply the grease in a quadrilateral design on the top of the processor.

⚠ CAUTION: Applying too much thermal grease can result in excess grease coming in contact with and contaminating the processor socket.

i **NOTE:** The thermal grease syringe is intended for single use only. Dispose the syringe after you use it.

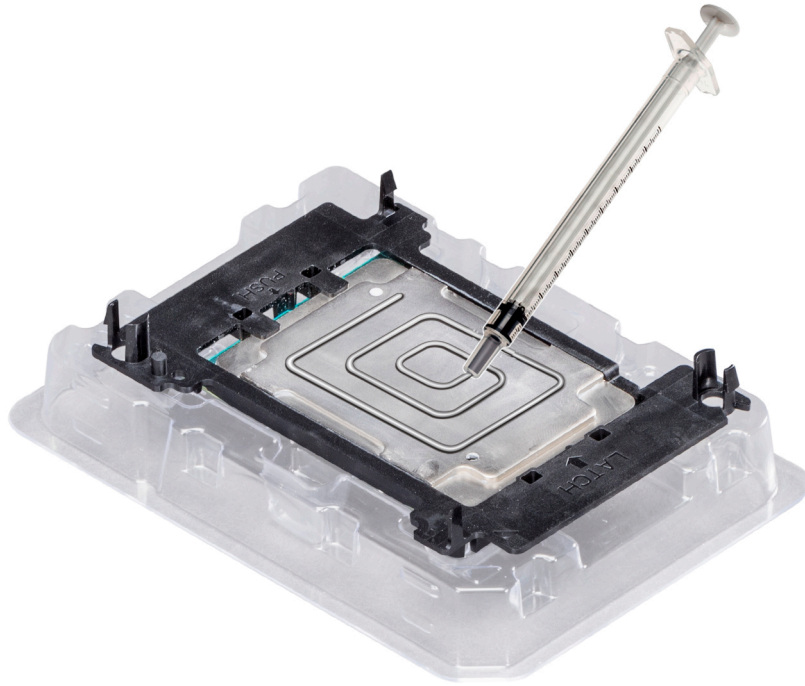

Figure 65. Applying thermal grease on top of the processor

5. Place the heat sink on the processor and push down on the base of the heat sink until the bracket locks onto the heat sink.

i NOTE:

- **Ensure that the two guide pin holes on the bracket match the guide holes on the heat sink.**
- **Do not press on the heat sink fins.**
- **Ensure that the pin 1 indicator on the heat sink is aligned with the pin 1 indicator on the bracket before placing the heat sink onto the processor and bracket.**

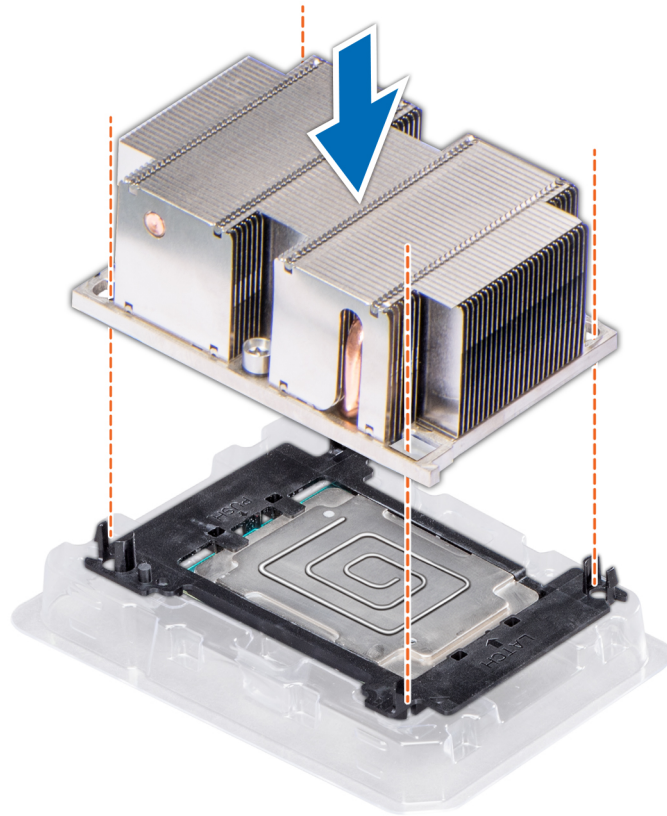

Figure 66. Installing the heat sink onto the processor

Next steps

1. [Install the processor and heat sink module.](#)
2. [Install the air shroud.](#)
3. Follow the procedure listed in [After working inside your system](#) on page 66.

Installing a processor and heat sink module

Prerequisites

CAUTION: Never remove the heat sink from a processor unless you intend to replace the processor. The heat sink is necessary to maintain proper thermal conditions.

1. Follow the safety guidelines listed in [Safety instructions](#) on page 65.
2. Follow the procedure listed in [Before working inside your system](#) on page 66.
3. If installed, remove the processor blank and CPU dust cover.

Steps

1. Align the pin 1 indicator of the heat sink to the system board and then place the processor and heat sink module (PHM) on the processor socket.

CAUTION: To avoid damaging the fins on the heat sink, do not press down on the heat sink fins.

NOTE: Ensure that the PHM is held parallel to the system board to prevent damaging the components.

2. Push the blue retention clips inward to allow the heat sink to drop into place.

3. Using the Torx #T30 screwdriver, tighten the screws on the heat sink in the order below:
 - a. Partially tighten the first screw (approximately 3 turns).
 - b. Tighten the second screw completely.
 - c. Return to the first screw and tighten it completely.

If the PHM slips off the blue retention clips when the screws are partially tightened, follow these steps to secure the PHM:

- a. Loosen both the heat sink screws completely.
- b. Lower the PHM on to the blue retention clips, following the procedure described in step 2.
- c. Secure the PHM to the system board, following the replacement instructions listed in this step above. 4.

NOTE: The processor and heat sink module retention screws should not be tightened to more than 0.13 kgf-m (1.35 N.m or 12 in-lbf).

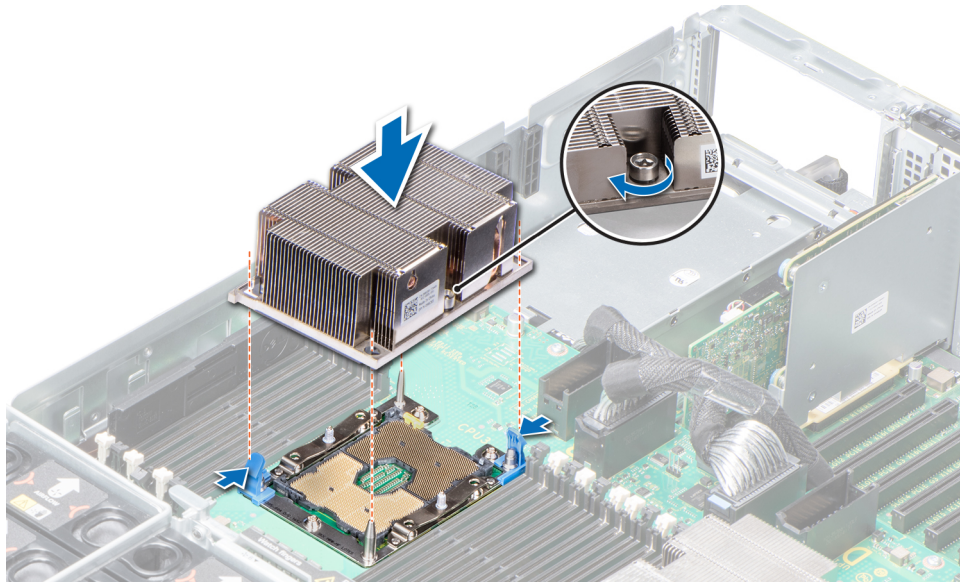

Figure 67. Installing the processor and heat sink module

Next steps

1. Lower the PEM until it firmly seats in place.
2. If removed, [install the expansion card risers](#).
3. Follow the procedure listed in [After working inside your system](#) on page 66.

Processor expansion module

Removing the PEM

Prerequisites

1. Follow the safety guidelines listed in [Safety instructions](#) on page 65.
2. Follow the procedure listed in [Before working inside your system](#) on page 66.
3. [Remove the expansion card risers](#).
4. [Remove the air shroud](#).

Steps

1. Lift the PEM using the handle until the PEM is in an upright position.
2. Press the release latch on the cable and disconnect the cables connected to the connectors on the PEM.
3. Press the release latch on the side of the chassis and lift the PEM out of the system.

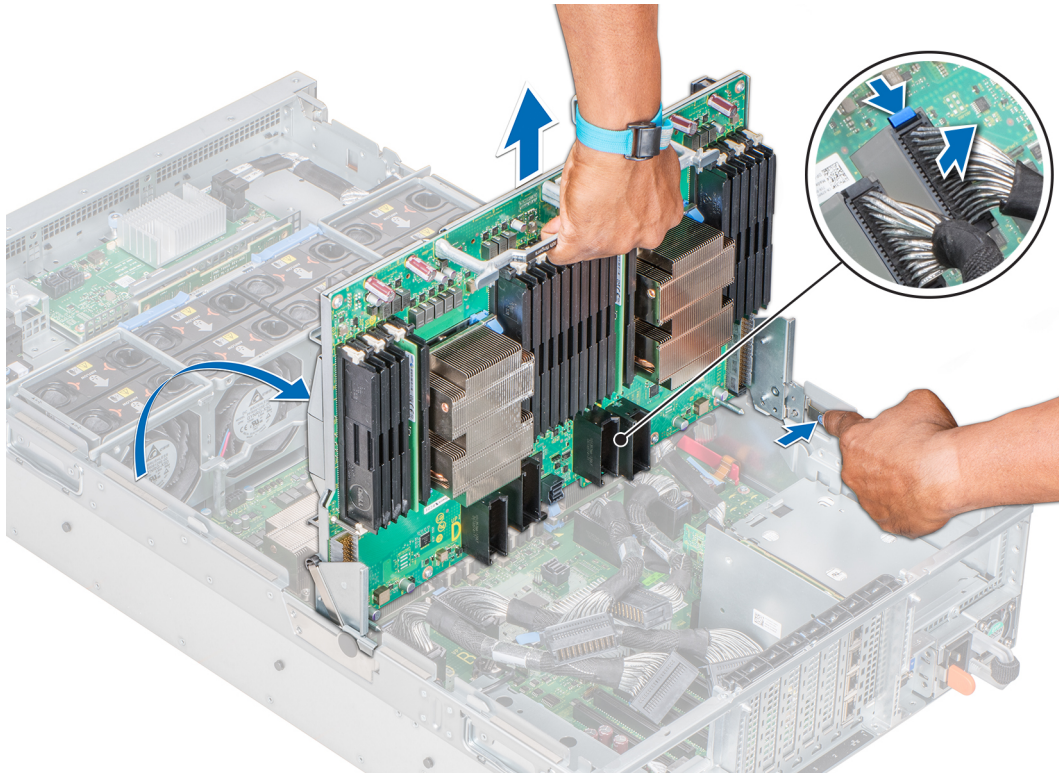

Figure 68. Removing the PEM

Next steps

Install the PEM.

Installing the PEM

Prerequisites

1. Follow the safety guidelines listed in [Safety instructions](#) on page 65.
2. Follow the procedure listed in [Before working inside your system](#) on page 66.

Steps

1. Hold the PEM using the handle and align the slots on the sides of the PEM with the standoffs on the sides of the system.
2. Lower the PEM until it clicks into place.
3. Re-connect the cables to the PEM. For information about cable routing, see the section [UPI cable routing](#) on page 120.
4. Hold the PEM handle and lower the PEM until it firmly seats in place.

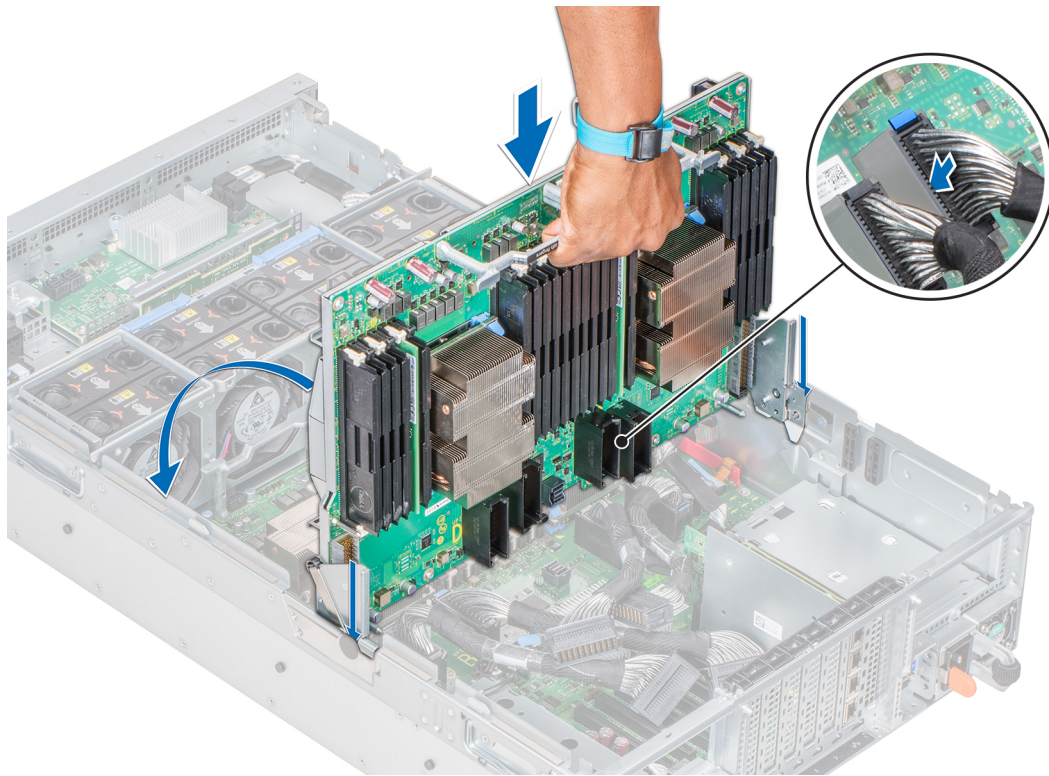

Figure 69. Installing the PEM

Next steps

1. [Install the expansion card risers.](#)
2. [Install the air shroud.](#)
3. Follow the procedure listed in [After working inside your system](#) on page 66.

UPI cable routing

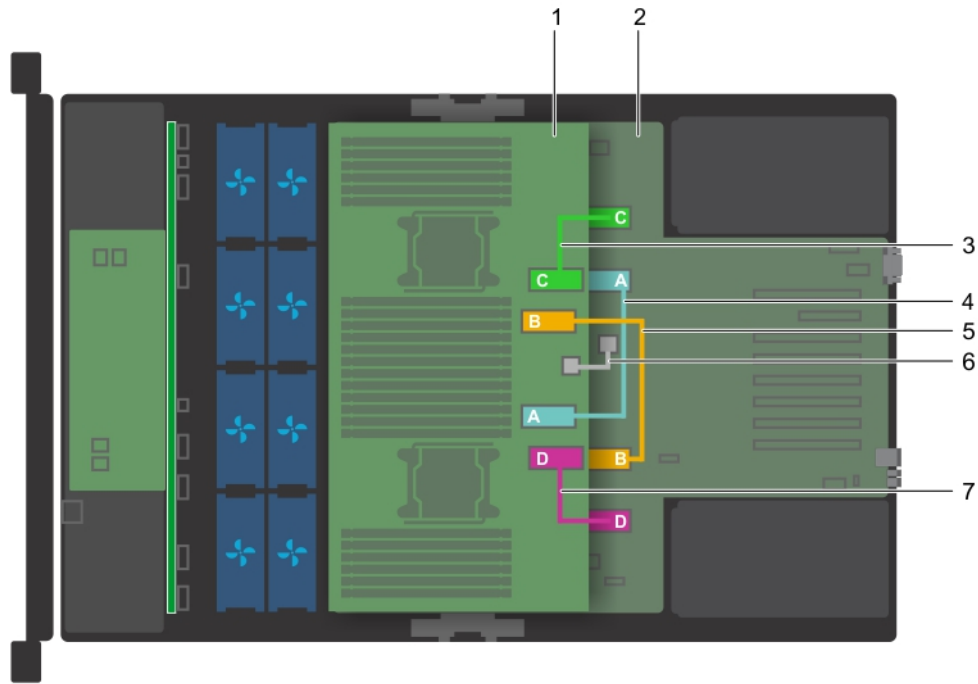

Figure 70. Cable routing - Four processor system

- 1. PEM
- 2. system board
- 3. UPI cable connecting RM_UPI_C connectors on system board and PEM
- 4. UPI cable connecting RM_UPI_A connectors on system board and PEM
- 5. UPI cable connecting RM_UPI_B connectors on system board and PEM
- 6. cable connecting the J_PEM_CLK connectors on system board and PEM
- 7. UPI cable connecting RM_UPI_D connectors on system board and PEM

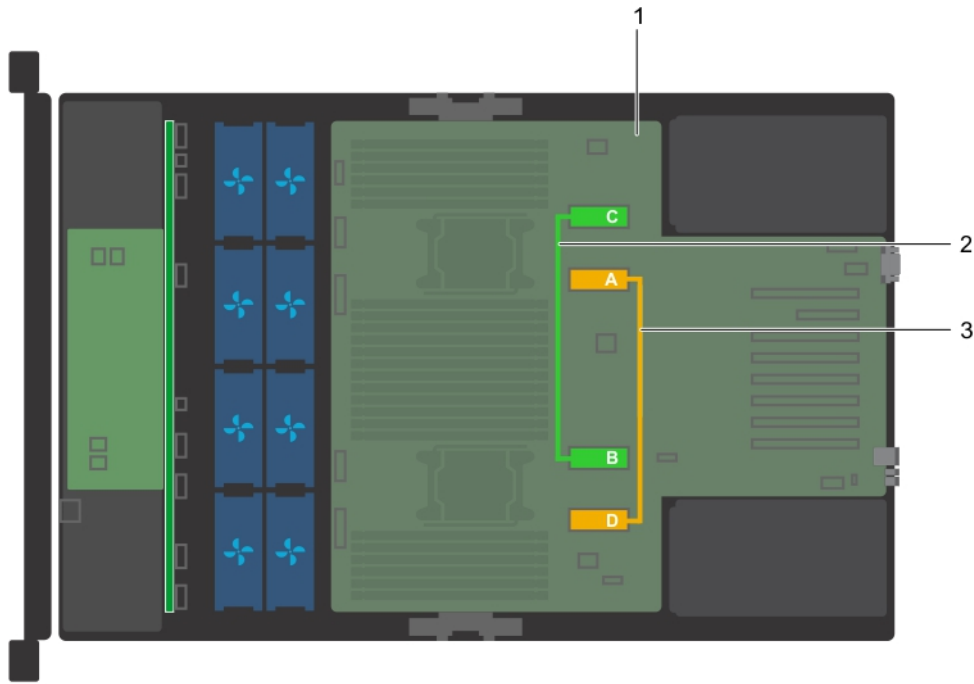

Figure 71. Cable routing - Two processor system

1. system board
2. UPI cable connecting RM_UPI_A and RM_UPI_D connectors on system board
3. UPI cable connecting RM_UPI_C and RM_UPI_B connectors on system board

NOTE: This is only applicable for using Intel Processor 61xx, 62xx, 81xx and 82xx series.

PEM power board

Removing the PEM power board

Prerequisites

1. Follow the safety guidelines listed in [Safety instructions](#) on page 65.
2. Follow the procedure listed in [Before working inside your system](#) on page 66.
3. [Remove the air shroud](#).
4. Lift the PEM by using the PEM handle until the PEM is in an upright position.

Steps

Hold the PEM power board by its edges and remove the power board from the connector on the system board.

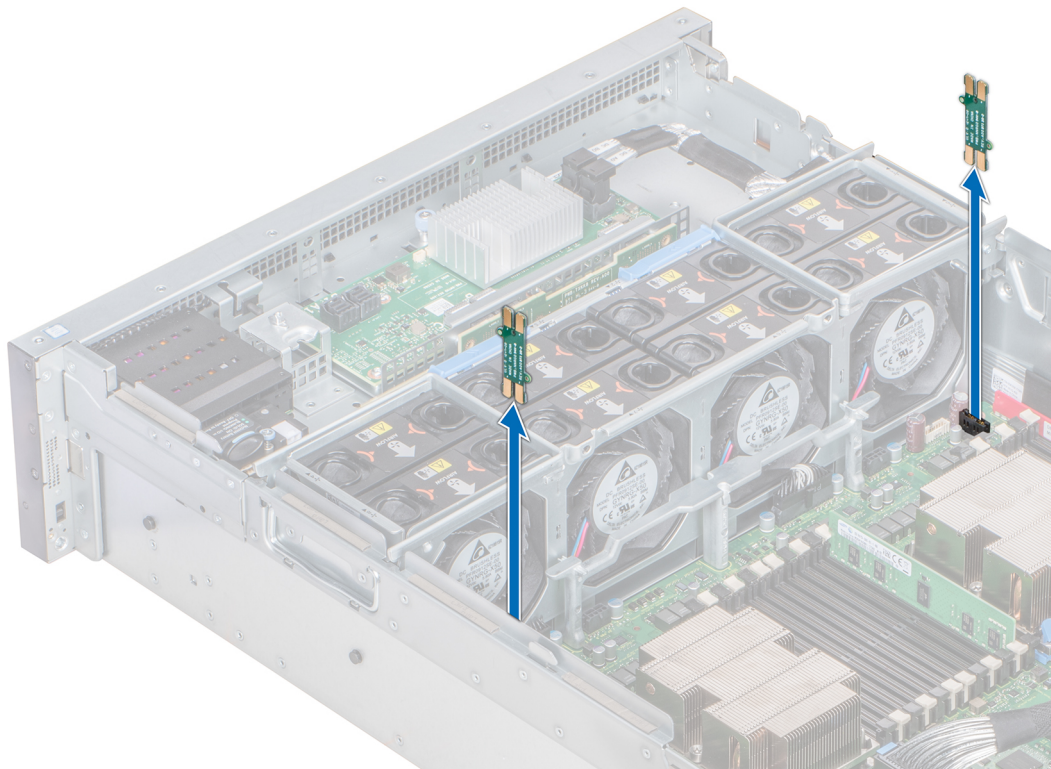

Figure 72. Removing the PEM power board

Next steps

Install the PEM power board.

Installing the PEM power board

Prerequisites

1. Follow the safety guidelines listed in [Safety instructions](#) on page 65.
2. Follow the procedure listed in [Before working inside your system](#) on page 66.

Steps

1. Hold the PEM power board by its edges, position the power board so that the power board connector aligns with the connector on the system board.
2. Insert the power board into the connector on the system board until the power board is fully seated.

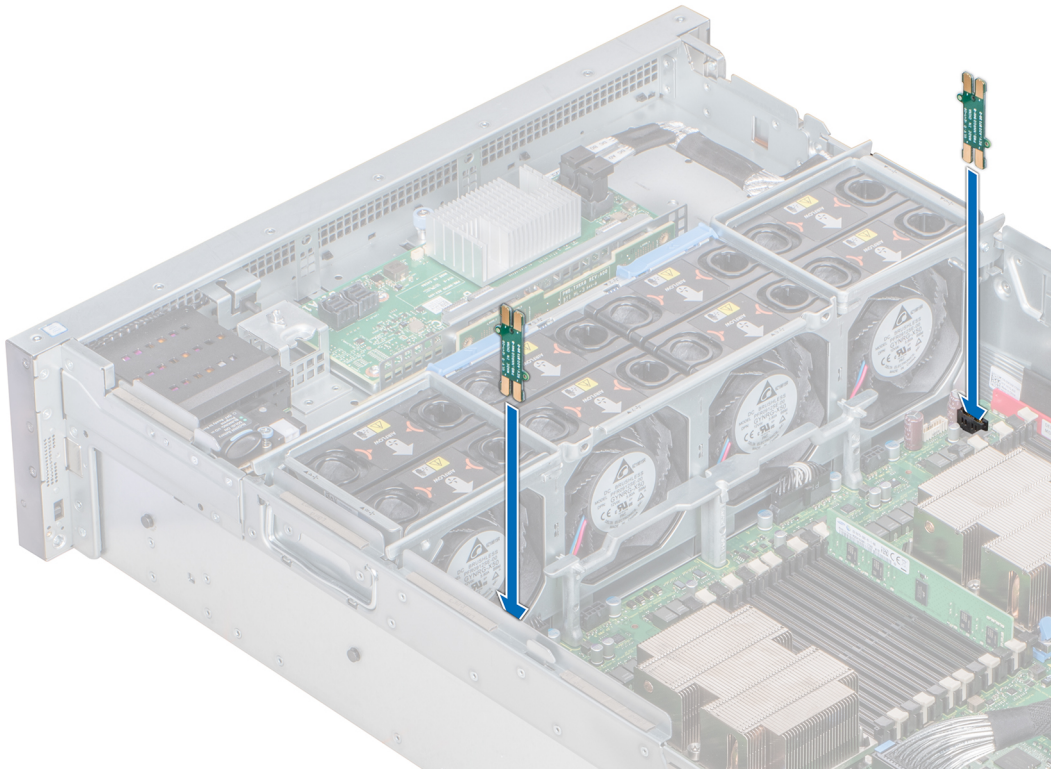

Figure 73. Installing the PEM power board

Next steps

1. Holding the PEM handle, lower the PEM until it firmly seats in place.
2. [Install the air shroud.](#)
3. Follow the procedure listed in [After working inside your system](#) on page 66.

Expansion cards and expansion card risers

Expansion card installation guidelines

Depending on your system configuration, the following PCI Express (PCIe) generation 3 expansion cards are supported:

Table 50. Expansion card riser configurations

Riser	PCIe slot on the expansion card riser	Processor connection	PCIe slots on riser (Height)	PCIe slots on riser (length)	Link width	Slot width
Riser 2 (IO_RISER2)	Slot 8	Processor 3	full height	3/4 length	x16	x16
	Slot 9	Processor 3	full height	half length	x16	x16
	Slot 10	Processor 3	full height	half length	x16	x16
Riser 3 (IO_RISER3)	Slot 11	Processor 4	full height	3/4 length	x16	x16
	Slot 12	Processor 4	full height	half length	x16	x16
	Slot 13	Processor 4	full height	half length	x16	x16

NOTE: The expansion card slots are not hot-swappable.

The following table provides guidelines for installing expansion cards to ensure proper cooling and mechanical fit. The expansion cards with the highest priority should be installed first using the slot priority indicated.

Table 51. Expansion card installation order — Two processor configuration

Card Type	Slot priority	Maximum number of cards
Internal storage adapter	1, 6	2
PERC H330	1	1
PCIe extender card	7, 4, 2	3
PCIe card (Mellanox)	4, 3, 2, 7	3
100 GB NIC (Mellanox)	4, 3, 2, 7	3
100 G OPA (Intel)	2, 3, 4, 7	4
External adapter (12 Gbps HBA, H840, H830)	5, 1, 6, 2, 4, 3, 7	2
NVMe PCIe storage (Samsung)	5, 1, 6, 2, 4, 3, 7	7
40 GB (x8) NIC (Intel)	5, 1, 6, 2, 4, 3, 7	7
40 GB (x8) NIC (Mellanox)	4, 3, 2, 7, 5, 1, 6	7
FC32 HBA (Emulex and QLogic FC16)	5, 1, 6, 2, 4, 3, 7	7
FC32 HBA x8 (Emulex and QLogic FC16)	5, 1, 6, 2, 4, 3, 7	7
25 GB NIC (Broadcom)	5, 1, 6, 2, 4, 3, 7	7
25 GB NIC (Mellanox)	4, 3, 2, 7, 5, 1, 6	7
25 GB NIC x8 (QLogic FC16)	5, 1, 6, 2, 4, 3, 7	7
FC16 HBA (Emulex and QLogic FC16)	5, 1, 6, 2, 4, 3, 7	7
10 GB NIC (SolarFlare)	5, 1, 6, 2, 4, 3, 7	7
FC 8 HBA (Emulex and QLogic FC16)	5, 1, 6, 2, 4, 3, 7	7
1 GB NIC (Broadcom and Intel)	5, 1, 6, 2, 4, 3	6
10 GB NIC SFP, SFP+ (QLogic FC16)	5, 1, 6, 2, 4, 3, 7	7
10 GB NIC SFP+ (Intel)	5, 1, 6, 2, 4, 3, 7	7
10 GB NIC (Broadcom)	5, 1, 6, 2, 4, 3, 7	7
10 GB NIC (QLogic FC16)	5, 1, 6, 2, 4, 3	6
10 GB NIC dual port (Intel)	5, 1, 6, 2, 4, 3	6
10 GB NIC quad port (Intel)	4, 3, 5, 2	4
10 GB NIC SFP+ (Mellanox)	4, 3, 2, 7, 5, 1, 6	7
PERC 9 : Internal Adapter	1,6	2
PCIe Extender	4,7,2	3
PERC 9 : External Adapter	5,1,6,2,4,3,7	2

Table 52. Expansion card installation order — Four processor configuration

Card type	Slot priority	Maximum number of cards
Internal storage adapter	1, 6	2
PERC H330	1	1
PCIe extender card	11, 12, 8	3
HBA PCIe dual and single ports (Mellanox)	11, 8, 3, 4, 12, 9, 2, 10	4

Table 52. Expansion card installation order — Four processor configuration (continued)

Card type	Slot priority	Maximum number of cards
100 GB NIC dual port (Mellanox)	11, 8, 3, 4, 12, 9, 2, 10, 13, 7	4
100 GB OPA x16 (Intel)	2, 4, 8, 11, 3, 7, 9, 12, 10, 13	10
External adapter (12 Gbps HBA, H840, H830)	5, 1, 6, 8, 11, 2, 4, 9, 12, 3, 7, 10, 13	2
NVMe PCIe storage (Samsung)	5, 1, 6, 8, 11, 2, 4, 9, 12, 3, 7, 10, 13	13
40Gb NIC x8 (Intel)	5, 1, 6, 8, 11, 2, 4, 9, 12, 3, 7, 10, 13	13
40Gb NIC x8 (Mellanox)	11, 8, 3, 4, 12, 9, 2, 10, 13, 7, 6, 1, 5	8
FC32 HBA (Emulex and QLogic FC16)	5, 1, 6, 8, 11, 2, 4, 9, 12, 3, 7, 10, 13	13
FC32 HBA x8 (Emulex and QLogic FC16)	5, 1, 6, 8, 11, 2, 4, 9, 12, 3, 7, 10, 13	13
25 GB NIC (Broadcom)	5, 1, 6, 8, 11, 2, 4, 9, 12, 3, 7, 10, 13	13
25 GB NIC (Mellanox)	11, 8, 3, 4, 12, 9, 2, 10, 13, 7, 6, 1, 5	8
25 GB NIC x8 (QLogic FC16)	5, 1, 6, 8, 11, 2, 4, 9, 12, 3, 7, 10, 13	13
FC16 HBA (Emulex and QLogic FC16)	5, 1, 6, 8, 11, 2, 4, 9, 12, 3, 7, 10, 13	13
FC8 HBA (Emulex and QLogic FC16)	5, 1, 6, 8, 11, 2, 4, 9, 12, 3, 7, 10, 13	13
1 GB NIC (Broadcom and Intel)	5, 1, 6, 11, 2, 4, 9, 12, 3, 10, 13	11
10 GB NIC dual port (SolarFlare)	5, 1, 6, 8, 11, 2, 4, 9, 12, 3, 7, 10, 13	13
10 GB NIC dual port (Intel, QLogic FC16, Broadcom)	5, 1, 6, 11, 2, 4, 9, 12, 3, 10, 13	11
10 GB NIC SFP SFP+ dual port (QLogic FC16)	5, 1, 6, 8, 11, 2, 4, 9, 12, 3, 7, 10, 13	13
10 GB NIC SFP+ dual port (Mellanox)	11, 8, 3, 4, 12, 9, 2, 10, 13, 7, 6, 1, 5	8
10 GB NIC dual port (Broadcom)	5, 1, 6, 8, 11, 2, 4, 9, 12, 3, 7, 10, 13	13
10 GB NIC SFP+ (Intel)	5, 1, 6, 8, 11, 2, 4, 9, 12, 3, 7, 10, 13	13
10 GB NIC Quad port (Intel)	11, 10, 2, 4	4
PERC 9 : Internal Adapter	1,6	2
PCIe Extender	11,12,8	3
PERC 9 : External Adapter	5,1,6,8,11,2,4,9,12,3,7,10,13	2

Removing expansion card riser blank

Prerequisites

1. Follow the safety guidelines listed in [Safety instructions](#) on page 65.
2. Follow the procedure listed in [Before working inside your system](#) on page 66.

Steps

Hold the expansion card riser blank and lift the blank out of the system.

NOTE: When you upgrade your system from two processor configuration to four processor, ensure that you remove the riser blanks from the system.

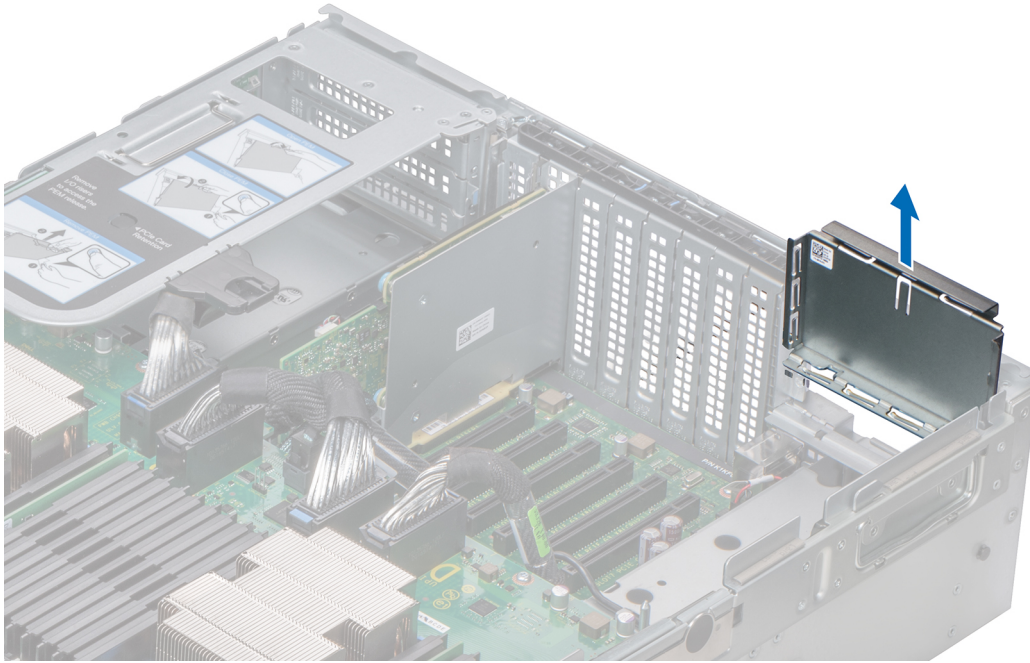

Figure 74. Removing expansion card riser blank

Next steps

Install the expansion card riser blank.

Installing expansion card riser blank

Prerequisites

1. Follow the safety guidelines listed in [Safety instructions](#) on page 65.
2. Follow the procedure listed in [Before working inside your system](#) on page 66.

Steps

Lower the expansion card riser blank into the system until the blank is seated on the corresponding slot at the back of the system.

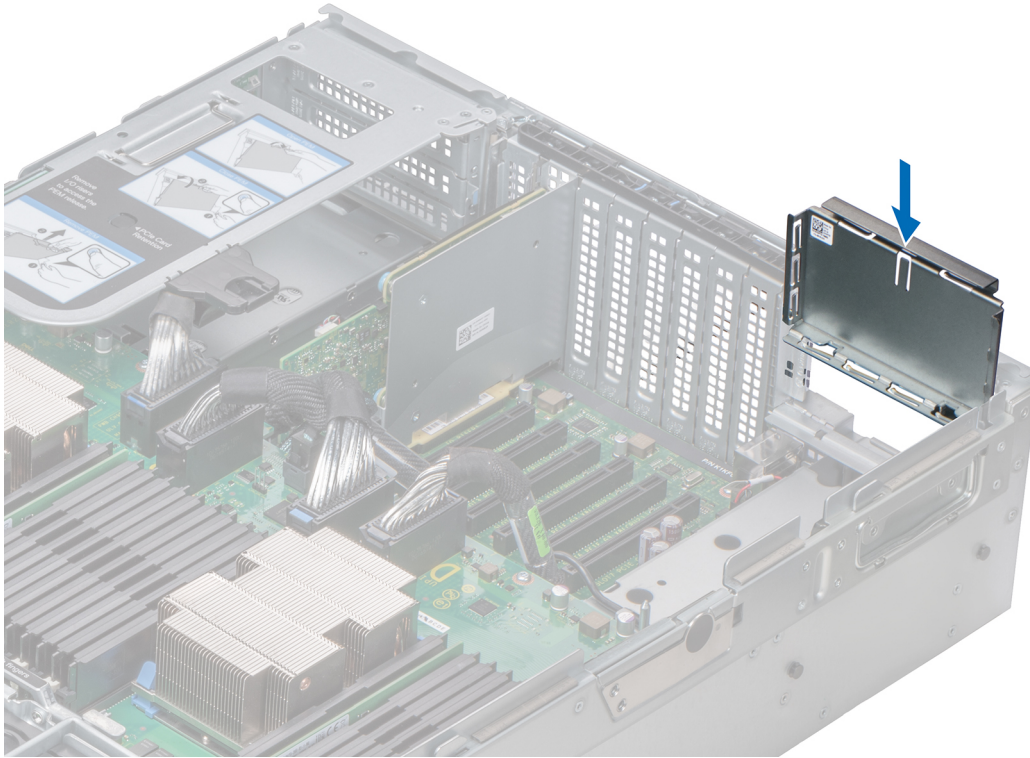

Figure 75. Installing expansion card riser blank (right)

Next steps

Follow the procedure listed in [After working inside your system](#) on page 66.

Removing the expansion card riser

Prerequisites

1. Follow the safety guidelines listed in [Safety instructions](#) on page 65.
2. Follow the procedure listed in [Before working inside your system](#) on page 66.
3. Disconnect any cables connected to the expansion card.

Steps

1. Lift the release lever until the connector on the riser disconnects from the connector on the processor expansion module (PEM).
2. Lift the riser away from the system.

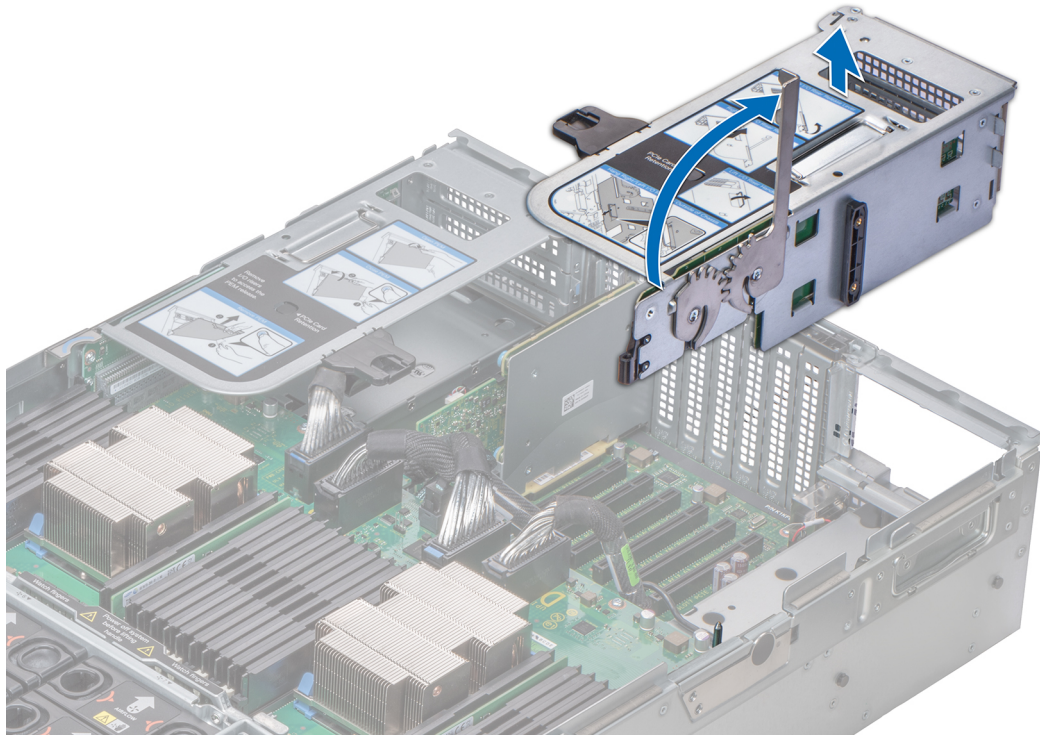

Figure 76. Removing expansion card riser (right)

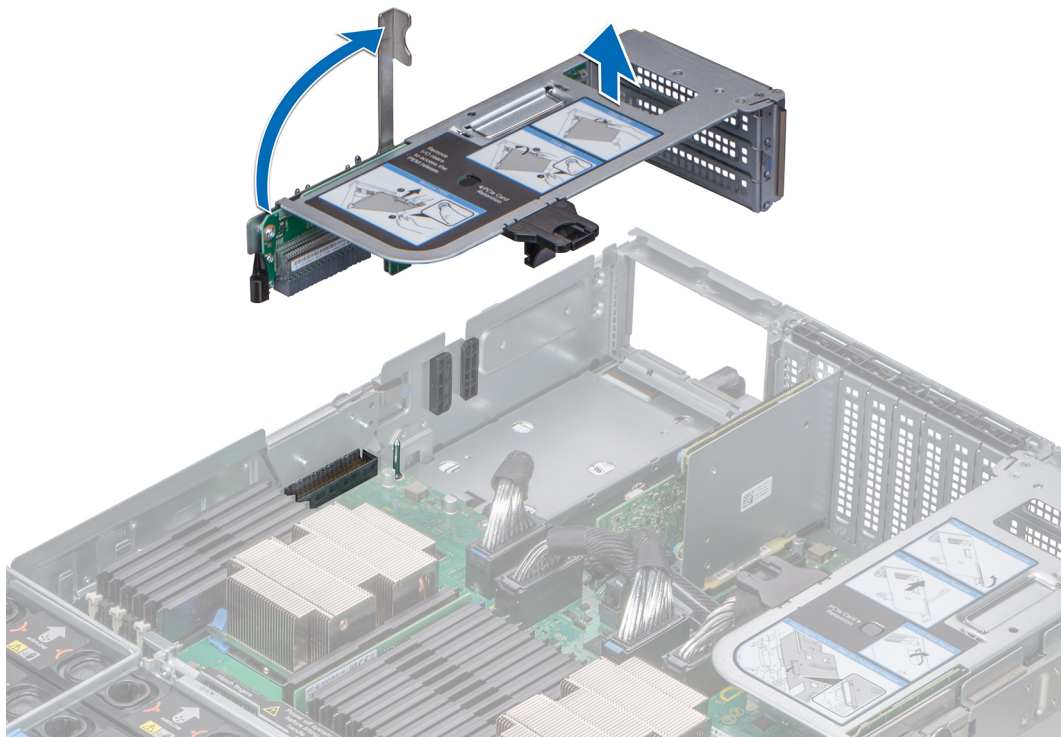

Figure 77. Removing expansion card riser (left)

Next steps

Install the expansion card riser.

Installing the expansion card riser

Prerequisites

1. Follow the safety guidelines listed in [Safety instructions](#) on page 65.
2. Follow the procedure listed in [Before working inside your system](#) on page 66.

Steps

1. Align the guide rail on the side of the riser with the slot on the side of the chassis and lower the riser into the system.
2. Lower the release lever until the connector on the riser connects with the connector on the processor expansion module (PEM).

 **CAUTION:** To avoid damage to the connectors on the PEM, you must only use the release levers to seat the expansion card risers firmly on the PEM.

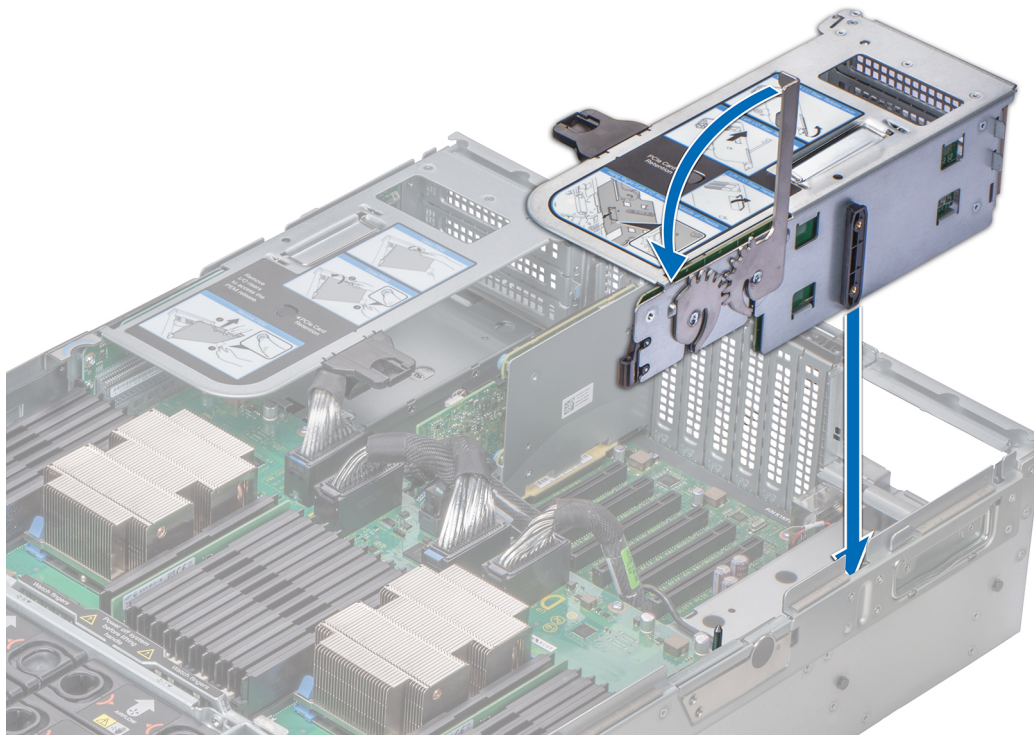

Figure 78. Installing expansion card riser (right)

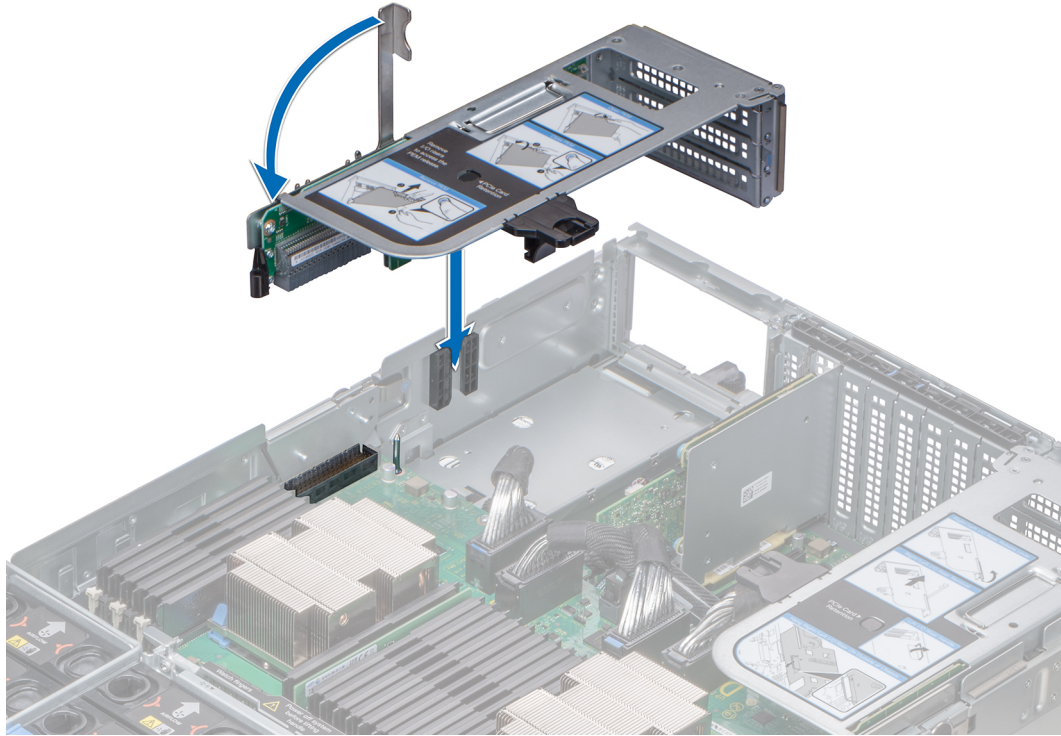

Figure 79. Installing expansion card riser (left)

Next steps

1. Connect the cables to the expansion card.
2. Follow the procedure listed in [After working inside your system](#) on page 66.

Removing the expansion card from expansion card riser

Prerequisites

1. Follow the safety guidelines listed in [Safety instructions](#) on page 65.
2. Follow the procedure listed in [Before working inside your system](#) on page 66.
3. Disconnect the cables from the expansion card.
4. [Remove the expansion card riser](#).

Steps

1. Press the black tab on the expansion card riser and slide the PCIe retention bracket up.

NOTE: This step is applicable only if you are removing the expansion cards from the slots 12 and 13 of Riser 3 (IO_RISER3) and slots 9 and 10 of Riser 2 (IO_RISER2).

2. Lift the PCIe card latch.
3. Hold the expansion card by its edges, and lift the card out until the connector on the card disconnects from the connector on the riser.

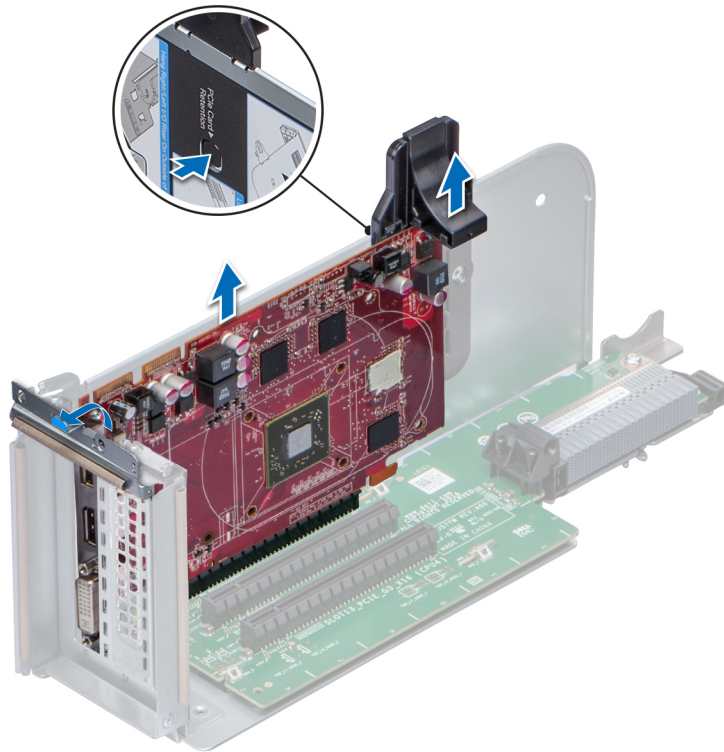

Figure 80. Removing the expansion card from expansion card riser

Next steps

1. [Install the expansion card into expansion card riser.](#)
2. If you are removing the card permanently, install a metal filler bracket over the empty expansion slot opening and lower the PCIe card latch to lock the bracket in place.

i **NOTE:** You must install a filler bracket over an empty expansion card slot to maintain Federal Communications Commission (FCC) certification of the system. The brackets also keep dust and dirt out of the system and aid in proper cooling and airflow inside the system.

Installing expansion card into expansion card riser

Prerequisites

1. Follow the safety guidelines listed in [Safety instructions](#) on page 65.
2. Follow the procedure listed in [Before working inside your system](#) on page 66.
3. If installing a new expansion card, unpack it and prepare the card for installation.

i **NOTE:** For instructions, see the documentation accompanying the card.

Steps

1. If installed, remove the filler bracket.

i **NOTE:** Store the filler bracket for future use. Filler brackets must be installed in empty expansion card slots to maintain Federal Communications Commission (FCC) certification of the system. The brackets also keep dust and dirt out of the system and aid in proper cooling and airflow inside the system.

2. Holding the expansion card by its edges, position the card so that the connector on the card aligns with the connector on the riser.
3. Insert the connector on the card into the connector on the riser until the card is fully seated.
4. Slide the PCIe retention bracket down to hold the card in place.

NOTE: This step is applicable only if you are installing the expansion cards in the slots 12 and 13 of Riser 3 (IO_RISER3) and slots 9 and 10 of Riser 2 (IO_RISER2).

5. Close the PCIe card latch.

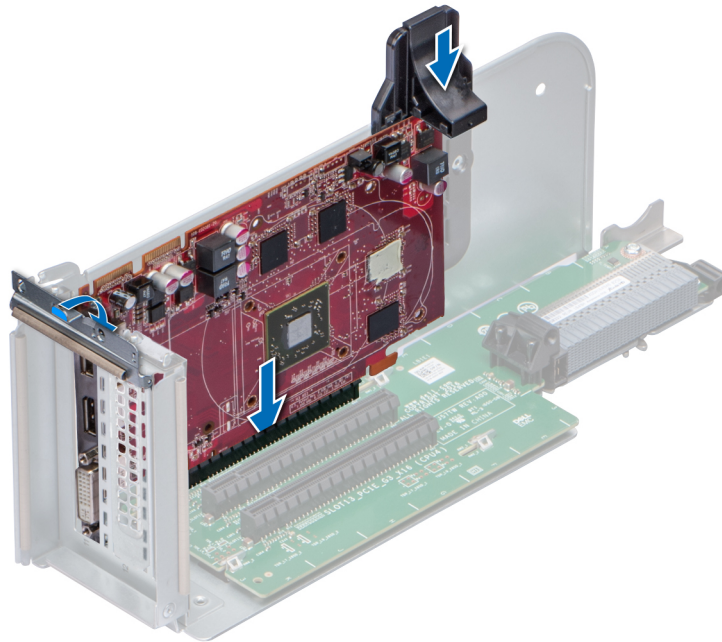

Figure 81. Installing expansion card into expansion card riser

Next steps

1. [Install the expansion card riser.](#)
2. Connect the cables to the expansion card.
3. Follow the procedure listed in [After working inside your system](#) on page 66.

M.2 SSD module

Removing the M.2 SSD module

Prerequisites

1. Follow the safety guidelines listed in [Safety instructions](#) on page 65.
2. Follow the procedure listed in [Before working inside your system](#) on page 66.
3. [Remove the air shroud.](#)
4. Remove the BOSS card.

NOTE: Removing the BOSS card is similar to the procedure for [removing an expansion card riser](#).

Steps

1. Loosen the screws and lift the retention straps that secure the M.2 SSD module on the BOSS card.
2. Pull the M.2 SSD module away from the BOSS card.

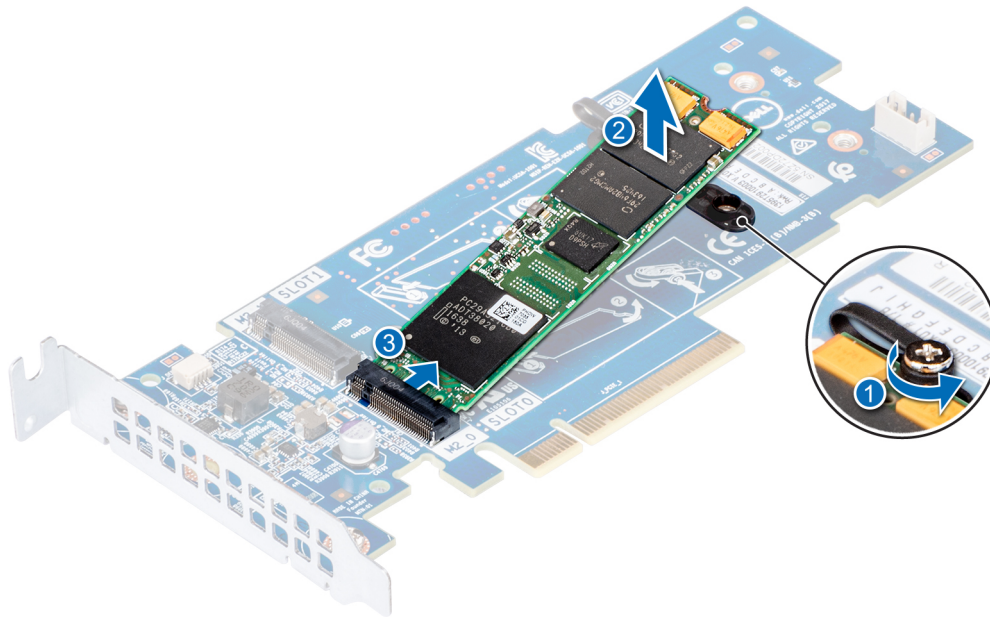

Figure 82. Removing the M.2 SSD module

Next steps

Install the M.2 SSD module.

Installing the M.2 SSD module

Prerequisites

1. Follow the safety guidelines listed in [Safety instructions](#) on page 65.
2. Follow the procedure listed in [Before working inside your system](#) on page 66.

Steps

1. Align the M.2 SSD module connectors with the connectors on the BOSS card.
2. Push the M.2 SSD module until the module is seated firmly on the BOSS card.
3. Secure the M.2 SSD module on the BOSS card with the retention straps and screws.

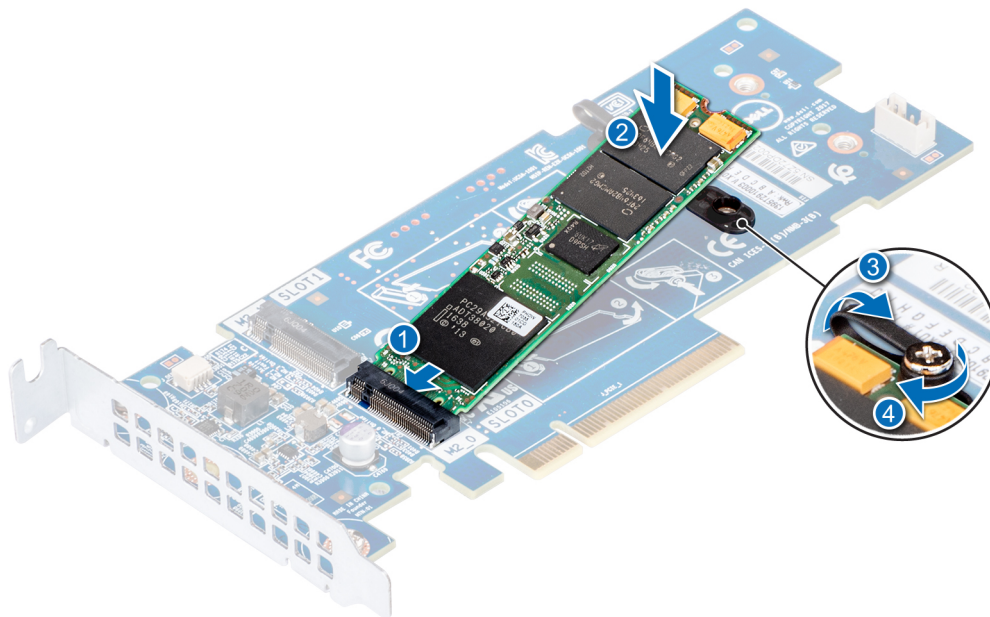

Figure 83. Installing the M.2 SSD module

Next steps

1. Install the BOSS card.
 - NOTE:** Installing the BOSS card is similar to installing the expansion card riser.
2. [Install the air shroud.](#)
3. Follow the procedure listed in [After working inside your system](#) on page 66.

Network daughter card riser

Removing the NDC riser

Prerequisites

1. Follow the safety guidelines listed in [Safety instructions](#) on page 65.
2. Follow the procedure listed in [Before working inside your system](#) on page 66.
3. Disconnect the cables connected to the Network Daughter Card (NDC) riser.

Steps

1. Slide the riser retention bracket to unlock the NDC riser.
2. Hold the NDC riser by its edges, and pull the NDC riser until the card edge connector disengages from the connector on the system board.
3. Lift the NDC riser from the system.

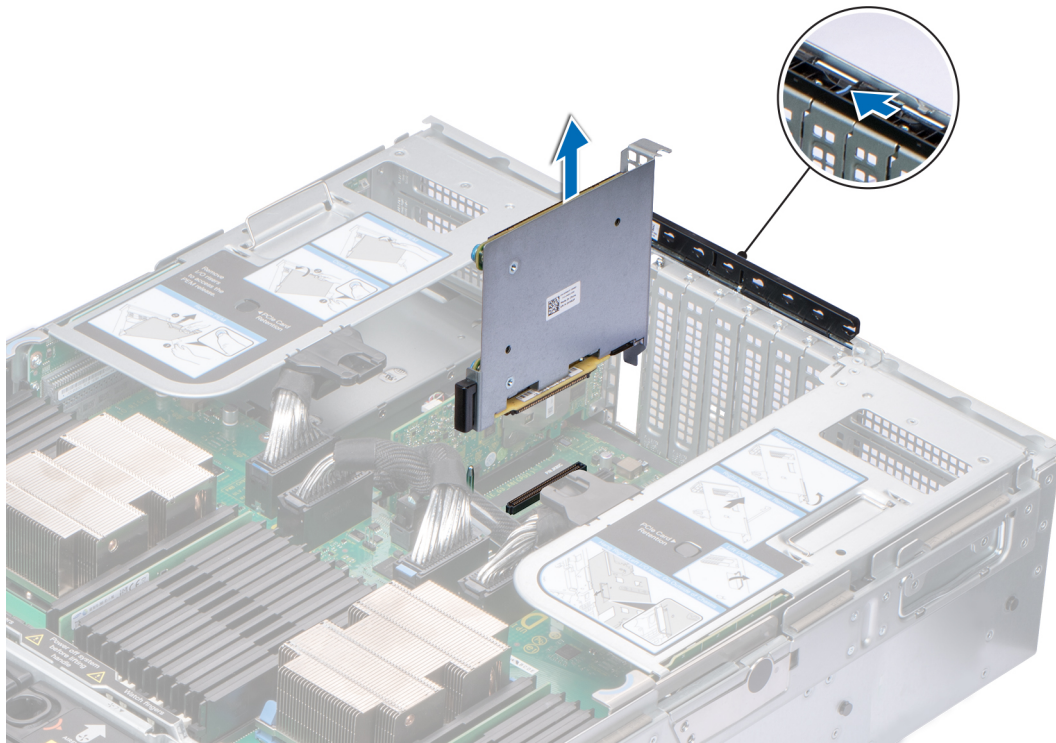

Figure 84. Removing the NDC riser

Next steps

1. [Install the NDC riser.](#)

Installing the NDC riser

Prerequisites

1. Follow the safety guidelines listed in [Safety instructions](#) on page 65.
2. Follow the procedure listed in [Before working inside your system](#) on page 66.

Steps

1. Hold the Network Daughter Card (NDC) riser by its edges and align the connector on the NDC riser and guide pin on the system board.
2. Insert the NDC riser until the card is fully seated.
3. Close the riser retention bracket and slide the bracket to lock the NDC riser.

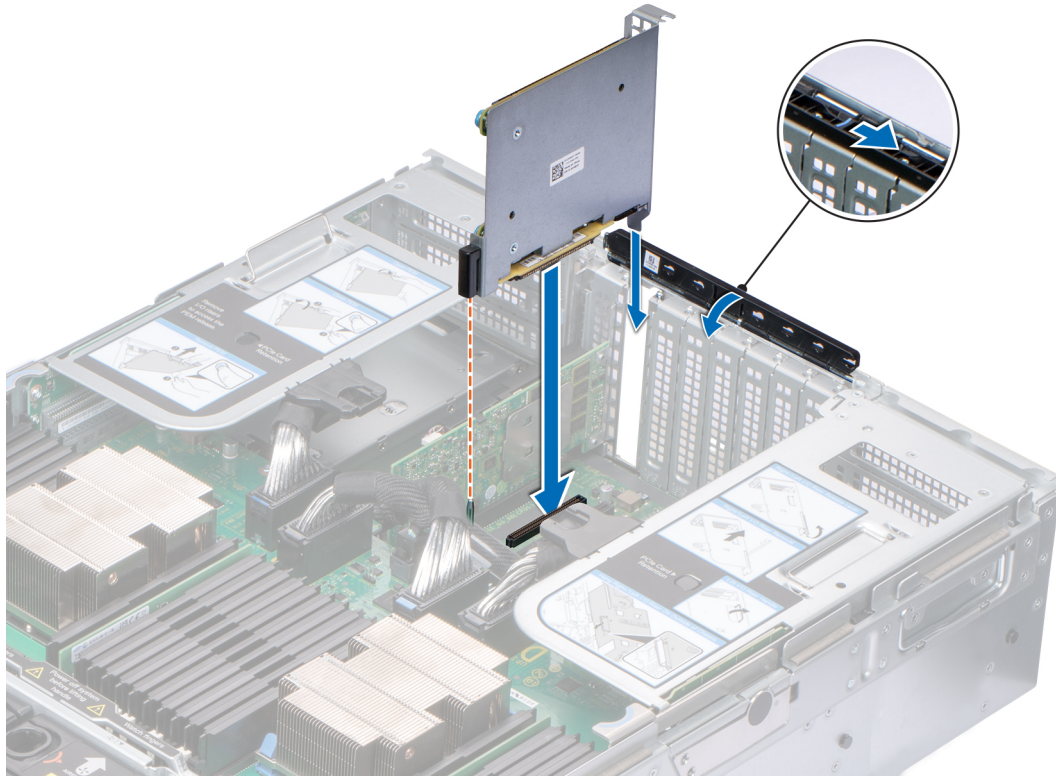

Figure 85. Install the NDC riser

Next steps

1. Connect the cables to the NDC riser.
2. Follow the procedure listed in [After working inside your system](#) on page 66.

Network daughter card

Removing the NDC

Prerequisites

1. Follow the safety guidelines listed in [Safety instructions](#) on page 65.
2. Follow the procedure listed in [Before working inside your system](#) on page 66.
3. [Remove the Network Daughter Card \(NDC\) riser.](#)

Steps

1. Using a Phillips #2 screwdriver, loosen the captive screws that secure the NDC to the NDC riser.
2. Hold the NDC by the edges on either side of the touch points, and lift to remove it from the connector on the NDC riser.
3. Slide the NDC away from the NDC riser bracket until the Ethernet connectors are clear of the slot in the NDC riser.

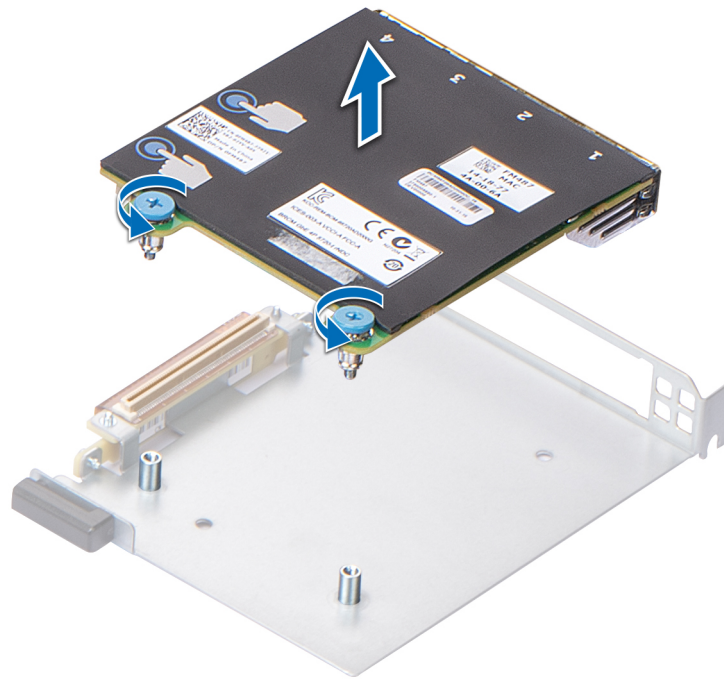

Figure 86. Removing the NDC

Next steps

1. [Install the NDC.](#)

Installing the NDC

Prerequisites

1. Follow the safety guidelines listed in [Safety instructions](#) on page 65.
2. Follow the procedure listed in [Before working inside your system](#) on page 66.

Steps

1. Orient and slide the NDC so that the Ethernet ports fit through the slot in the NDC riser.
2. Align the captive screws on the card with the screw holes on the NDC riser.
3. Press the touch points on the card until the connector connects with the connector on the NDC riser.
4. Using a Phillips #2 screwdriver, tighten the captive screws to secure the NDC to the NDC riser.

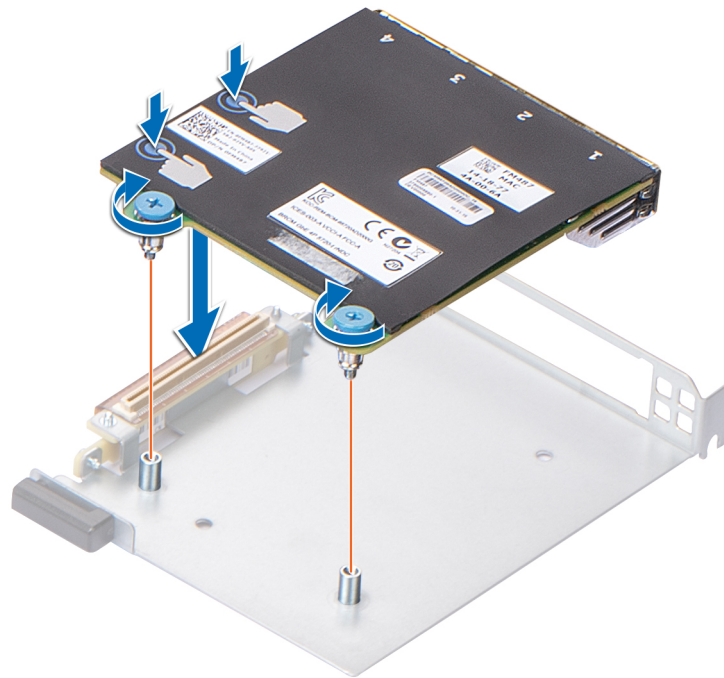

Figure 87. Installing the NDC

Next steps

1. [Install the NDC riser.](#)
2. Follow the procedure listed in [After working inside your system](#) on page 66.

Storage controller card

Removing the storage controller card

Prerequisites

1. Follow the safety guidelines listed in [Safety instructions](#) on page 65.
2. Follow the procedure listed in [Before working inside your system](#) on page 66.
3. [Remove the Network Daughter Card \(NDC\) riser.](#)

Steps

1. Slide the riser retention bracket to unlock the storage controller card.
2. Hold the storage controller card by its edges and lift to remove it from the connector on the system board.
3. Press the release tab on the SAS cable connector to disconnect the cable from the storage controller card.

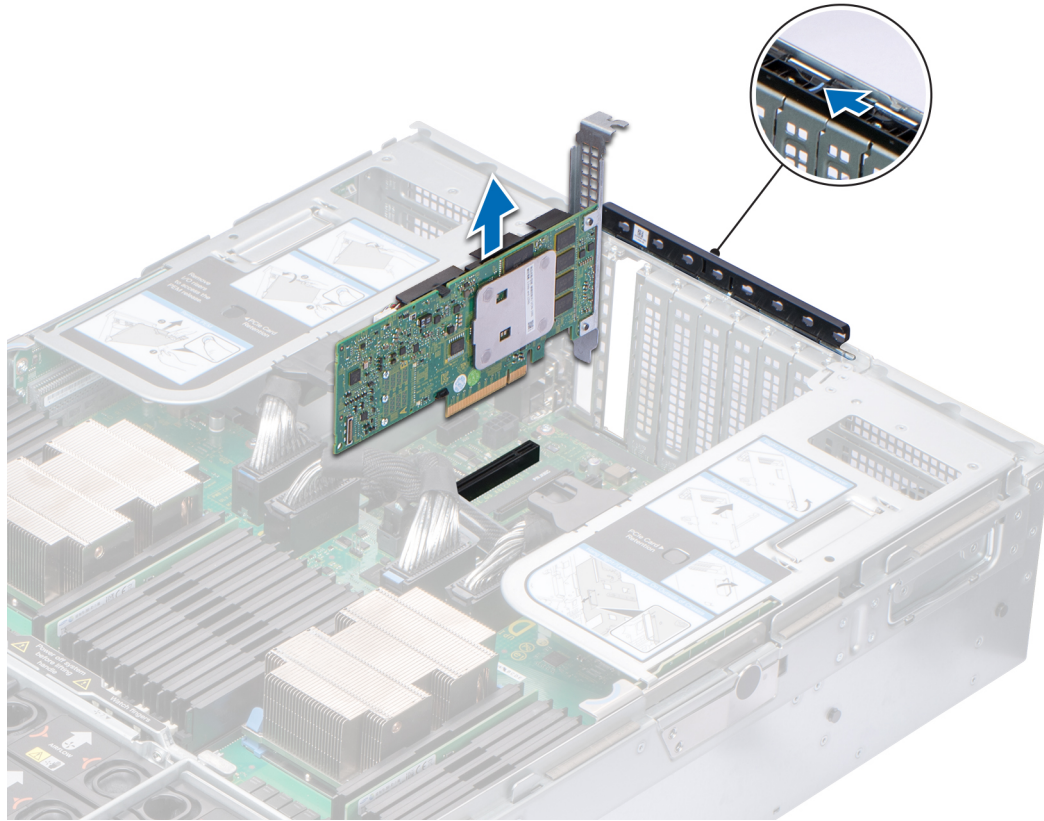

Figure 88. Removing the storage controller card

Next steps

1. [Install the storage controller card.](#)

Installing the storage controller card

Prerequisites

1. Follow the safety guidelines listed in [Safety instructions](#) on page 65.
2. Follow the procedure listed in [Before working inside your system](#) on page 66.

Steps

1. Connect the SAS cables to the card.

NOTE: Ensure that you use the labels on the cable to connect the cables to the correct connectors. The cable does not function properly if reversed.

2. Hold the storage controller card by its edges, and align the connector on the card with the connector on the system board.
3. Lower the card into the system until the card is firmly seated.
4. Route the SAS cable through the channel on the inner side of the chassis.
5. Connect the SAS cables from the storage controller card to the connectors on hard drive backplane. For more information about cabling images, see the [Cable routing](#) on page 96.
6. Close the riser retention bracket and slide the bracket to lock the storage controller card.

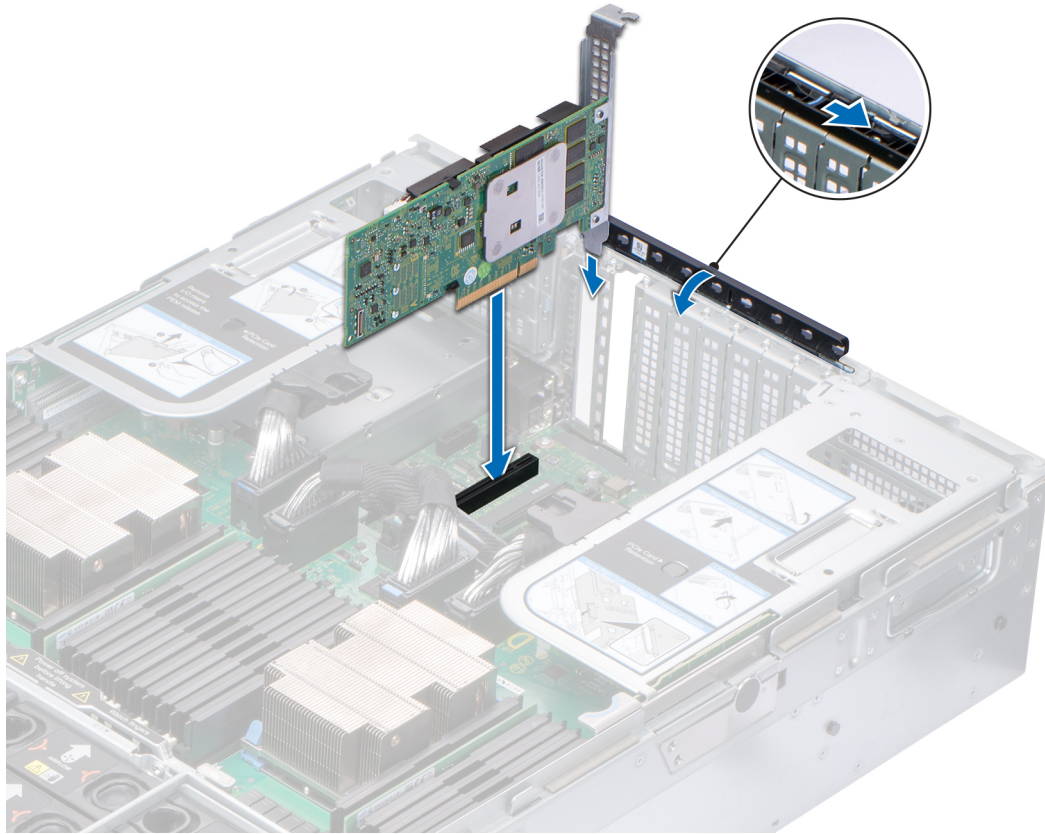

Figure 89. Installing the storage controller card

Next steps

1. [Install the NDC riser.](#)
2. Follow the procedure listed in [After working inside your system](#) on page 66.

Optional IDSDM or vFlash module

Removing the MicroSD card

Prerequisites

1. Follow the safety guidelines listed in [Safety instructions](#) on page 65.
2. Follow the procedure listed in [Before working inside your system](#) on page 66.

Steps

1. Locate the MicroSD card slot on the IDSDM module, and press the card to partially release it from the slot. To locate IDSDM module, see the [System board jumpers and connectors](#) section.
2. Hold the MicroSD card and remove it from the slot.

(i) NOTE: Temporarily label each MicroSD card with its corresponding slot number after removal.

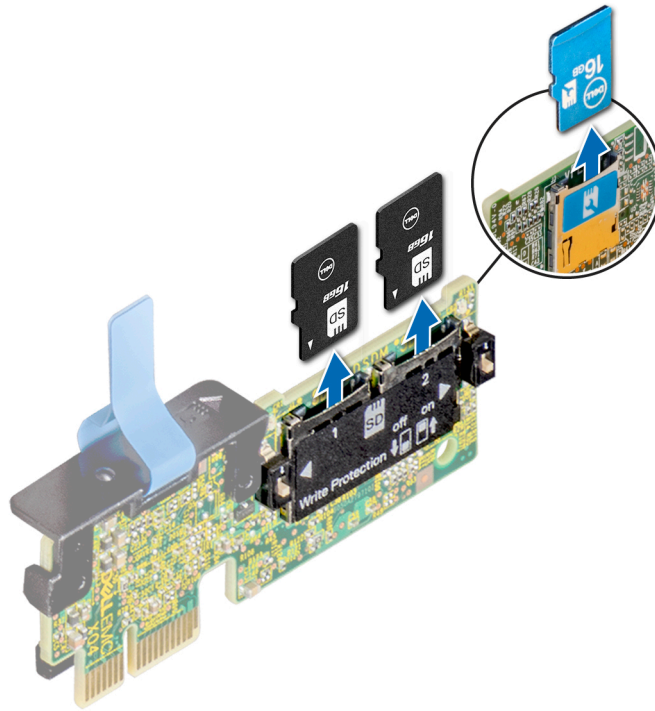

Figure 90. Removing the MicroSD card

Next steps

1. [Install a MicroSD card.](#)

Installing the MicroSD card

Prerequisites

1. Follow the safety guidelines listed in [Safety instructions](#) on page 65.
2. Follow the procedure listed in [Before working inside your system](#) on page 66.

NOTE: To use an MicroSD card with your system, ensure that the Internal SD Card Port is enabled in System Setup.

NOTE: If reinstalling, ensure that you install the MicroSD cards into the same slots based on the labels you had marked on the cards during removal.

Steps

1. Locate the MicroSD card connector on the IDSDM module. Orient the MicroSD card appropriately and insert the contact-pin end of the card into the slot. To locate IDSDM module, see the [System board jumpers and connectors](#) section.

NOTE: The slot is keyed to ensure correct insertion of the card.

2. Press the card into the card slot to lock it into place.

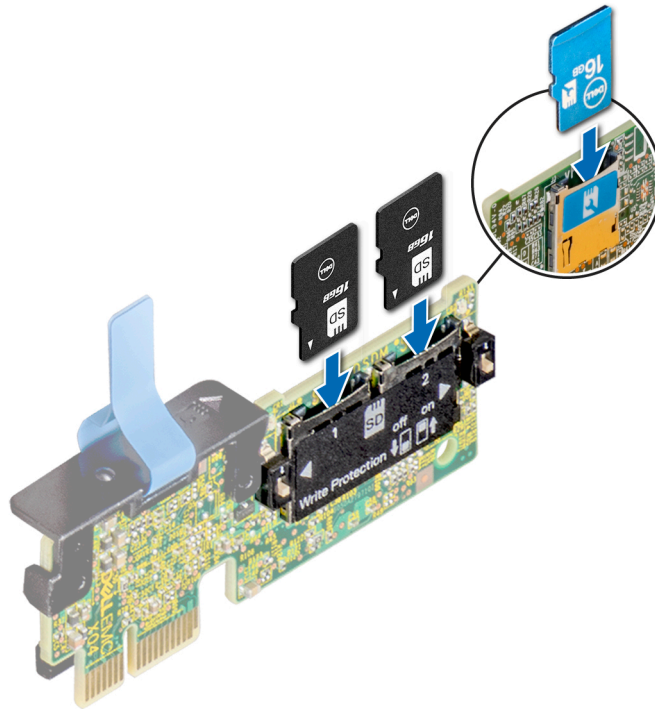

Figure 91. Installing the MicroSD card

Next steps

1. Follow the procedure listed in [After working inside your system](#) on page 66.

Optional IDSDM or vFlash module

Removing the optional IDSDM module

Prerequisites

1. Follow the safety guidelines listed in [Safety instructions](#) on page 65.
2. Follow the procedure listed in [Before working inside your system](#) on page 66.
3. If you are replacing the IDSDM module, [remove the MicroSD cards](#).

NOTE: Temporarily label each MicroSD card with its corresponding slot number after removal.

Steps

1. Locate the IDSDM module connector on the system board.
To locate IDSDM module connector, see the [System board jumpers and connectors](#) section.
2. Holding the pull tab, lift the IDSDM module out of the system.

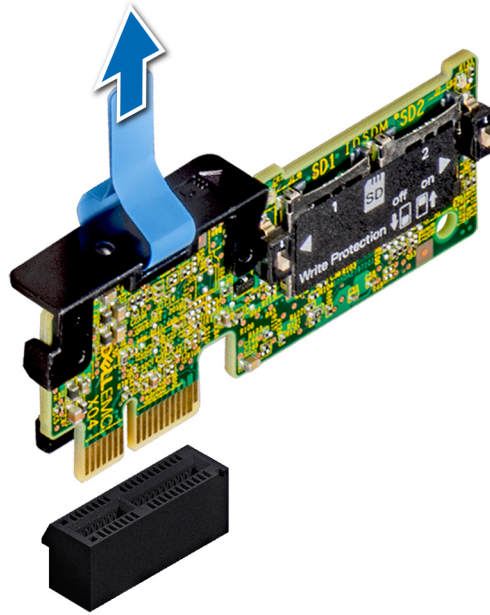

Figure 92. Removing the optional IDSDM module

NOTE: There are two dip switches on the IDSDM module for write-protection.

Next steps

Install the optional IDSDM module.

Installing optional IDSDM module

Prerequisites

1. Follow the safety guidelines listed in [Safety instructions](#) on page 65.
2. Follow the procedure listed in [Before working inside your system](#) on page 66.

Steps

1. Locate the IDSDM module on the system board.
To locate IDSDM module, see the [System board jumpers and connectors](#) section.
2. Align the IDSDM module with the connector on the system board.
3. Push the IDSDM module until it is firmly seated on the system board.

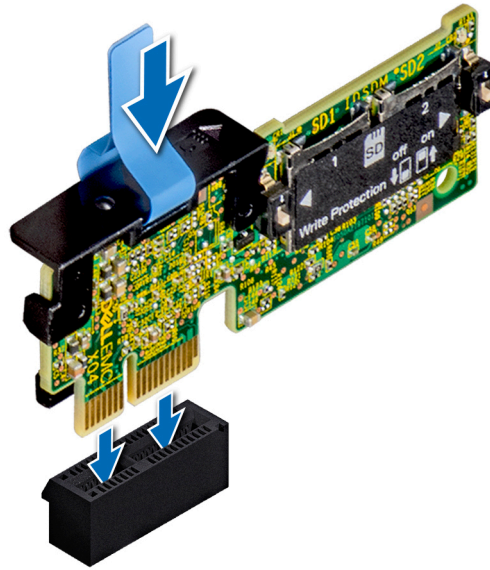

Figure 93. Installing optional IDSDM module

Next steps

1. [Install the MicroSD cards.](#)



NOTE: Reinstall the MicroSD cards into the same slots based on the labels you had marked on the cards during removal.

2. Follow the procedure listed in [After working inside your system](#) on page 66.

Power supply unit

Hot spare feature

Your system supports the hot spare feature that significantly reduces the power overhead associated with power supply unit (PSU) redundancy.

When the hot spare feature is enabled, one of the redundant PSUs is switched to the sleep state. The active PSU supports 100 percent of the system load, thus operating at higher efficiency. The PSU in the sleep state monitors output voltage of the active PSU. If the output voltage of the active PSU drops, the PSU in the sleep state returns to an active output state.

If having both PSUs active is more efficient than having one PSU in the sleep state, the active PSU can also activate the sleeping PSU.

The default PSU settings are as follows:

- If the load on the active PSU is more than 50 percent of PSU rated power wattage, then the redundant PSU is switched to the active state.
- If the load on the active PSU falls below 20 percent of PSU rated power wattage, then the redundant PSU is switched to the sleep state.

You can configure the hot spare feature by using the iDRAC settings. For more information, see the iDRAC User's Guide available at Dell.com/idracmanuals.

Removing a power supply unit blank

Prerequisites

Follow the safety guidelines listed in [Safety instructions](#) on page 65.

Steps

If you are installing a second power supply unit, remove the power supply unit blank in the bay by pulling the blank outward.

CAUTION: To ensure proper system cooling, the power supply unit blank must be installed in the second power supply unit bay in a non-redundant configuration. Remove the power supply unit blank only if you are installing a second power supply unit.

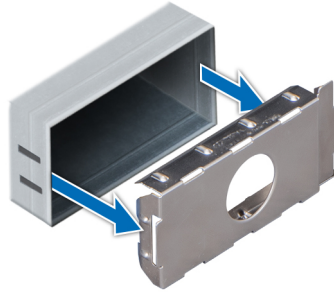

Figure 94. Removing a power supply unit blank

Next steps

Install the second power supply unit blank.

Installing a power supply unit blank

Prerequisites

1. Follow the safety guidelines listed in [Safety instructions](#) on page 65.

NOTE: Install the power supply unit (PSU) blank only in the second PSU bay.

Steps

Align the PSU blank with the PSU slot and push it into the PSU slot until it clicks into place.

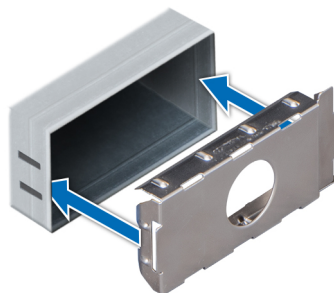

Figure 95. Installing a power supply unit blank

Removing a power supply unit

The procedure for removing AC and DC PSUs is identical.

Prerequisites

CAUTION: The system needs one power supply unit (PSU) for normal operation. On power-redundant systems, remove and replace only one PSU at a time in a system that is powered on.

1. Follow the safety guidelines listed in [Safety instructions](#) on page 65.

2. Disconnect the power cable from the power source and from the PSU you intend to remove, and then remove the cable from the strap on the PSU handle.
3. Unlatch and lift the optional cable management arm if it interferes with the PSU removal.

For information about the cable management arm, see the system's rack documentation at www.dell.com/poweredge manuals.

Steps

Press the orange release latch and slide the PSU out of the system by using the PSU handle.

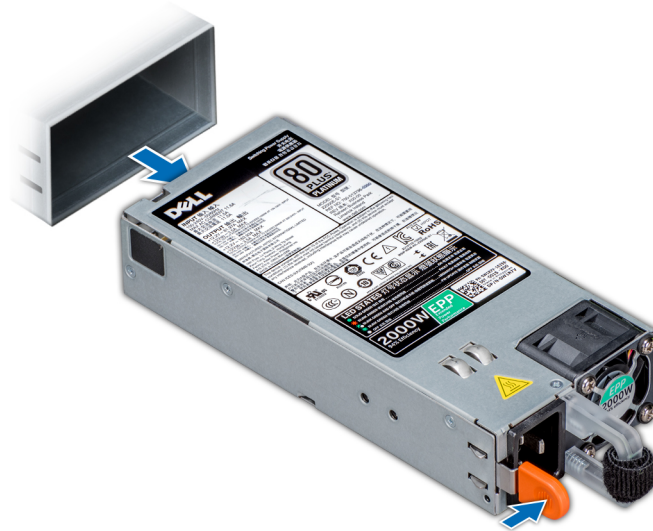

Figure 96. Removing a power supply unit

Next steps

Install the PSU or the PSU blank.

Installing a power supply unit

The procedure for installing AC and DC PSUs is identical.

Prerequisites

1. Follow the safety guidelines listed in [Safety instructions](#) on page 65.
2. For systems that support redundant PSU, ensure that both the PSUs are of the same type and have the same maximum output power.

NOTE: The maximum output power (shown in watts) is listed on the PSU label.

Steps

Slide the PSU into the system until the PSU is fully seated and the release latch snaps into place.

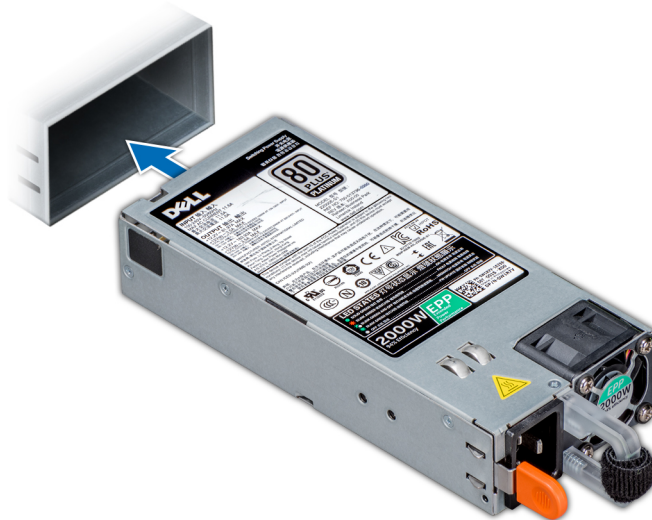

Figure 97. Installing a power supply unit

Next steps

1. If you have unlatched the cable management arm, relatch it. For information about the cable management arm, see the system's rack documentation at www.dell.com/poweredgemanuals.
2. Connect the power cable to the PSU, and plug the cable into a power outlet.

CAUTION: When connecting the power cable to the PSU, secure the cable to the PSU with the strap.

NOTE: When installing, hot swapping, or hot adding a new PSU, wait for 15 seconds for the system to recognize the PSU and determine its status. The PSU redundancy may not occur until discovery is complete. Wait until the new PSU is discovered and enabled before you remove the other PSU. The PSU status indicator turns green to signify that the PSU is functioning properly.

Wiring instructions for a DC power supply unit

Your system supports up to two $-(48-60)$ V DC power supply units (PSUs).

NOTE: For equipment using $-(48-60)$ V DC power supply units (PSUs), a qualified electrician must perform all connections to DC power and to safety grounds. Do not attempt connecting to DC power or installing grounds yourself. All electrical wiring must comply with applicable local or national codes and practices. Damage due to servicing that is not authorized by Dell is not covered by your warranty. Read and follow all safety instructions that came with the product.

CAUTION: Wire the unit with copper only, unless otherwise specified, use only 10 American Wire Gauge (AWG) wire rated minimum 90°C for source and return. Protect the $-(48-60)$ V DC (1 wire) with a branch circuit over-current protection rated 50 A for DC with a high interrupt current rating.

CAUTION: Connect the equipment to a $-(48-60)$ V DC supply source that is electrically isolated from the AC source (reliably grounded $-(48-60)$ V DC SELV source). Ensure that the $-(48-60)$ V DC source is efficiently secured to earth (ground).

NOTE: A readily accessible disconnect device that is suitably approved and rated shall be incorporated in the field wiring.

Input requirements

- Supply voltage: $-(48-60)$ V DC
- Current consumption: 32 A (maximum)

Kit contents

- Dell part number 6RYJ9 terminal block or equivalent (1)
- #6-32 nut equipped with lock washer (1)

Required tools

Wire-stripper pliers capable of removing insulation from size 10 AWG solid or stranded, insulated copper wire.

 **NOTE: Use alpha wire part number 3080 or equivalent (65/30 stranding).**

Required wires

- One UL 10 AWG, 2 m maximum (stranded) black wire [-(48–60) V DC].
- One UL 10 AWG, 2 m maximum (stranded) red wire (V DC return).
- One UL 10 AWG, 2 m maximum, green with a yellow stripe, stranded wire (safety ground).

NVDIMM-N battery

Removing the NVDIMM-N battery

Prerequisites

1. Follow the safety guidelines listed in [Safety instructions](#) on page 65.
2. Follow the procedure listed in [Before working inside your system](#) on page 66.

 **CAUTION: NVDIMM-N battery is not hot swappable. To prevent data loss and potential damage to your system, ensure that your system, LEDs on system, LEDs on NVDIMM-N and LEDs on NVDIMM-N battery are turned off before removing the NVDIMM-N battery.**

 **CAUTION: To avoid damage to the battery connector, you must firmly support the connector while installing or removing a battery.**

Steps

1. Disconnect the cables from the NVDIMM-N battery.
2. Using Phillips #2 screwdriver, loosen the retention screw that secures the battery to the system.
3. Holding the edges, slide the battery toward the back of the system until the battery disengages from the slot on the system.
4. Lift the battery away from the system.

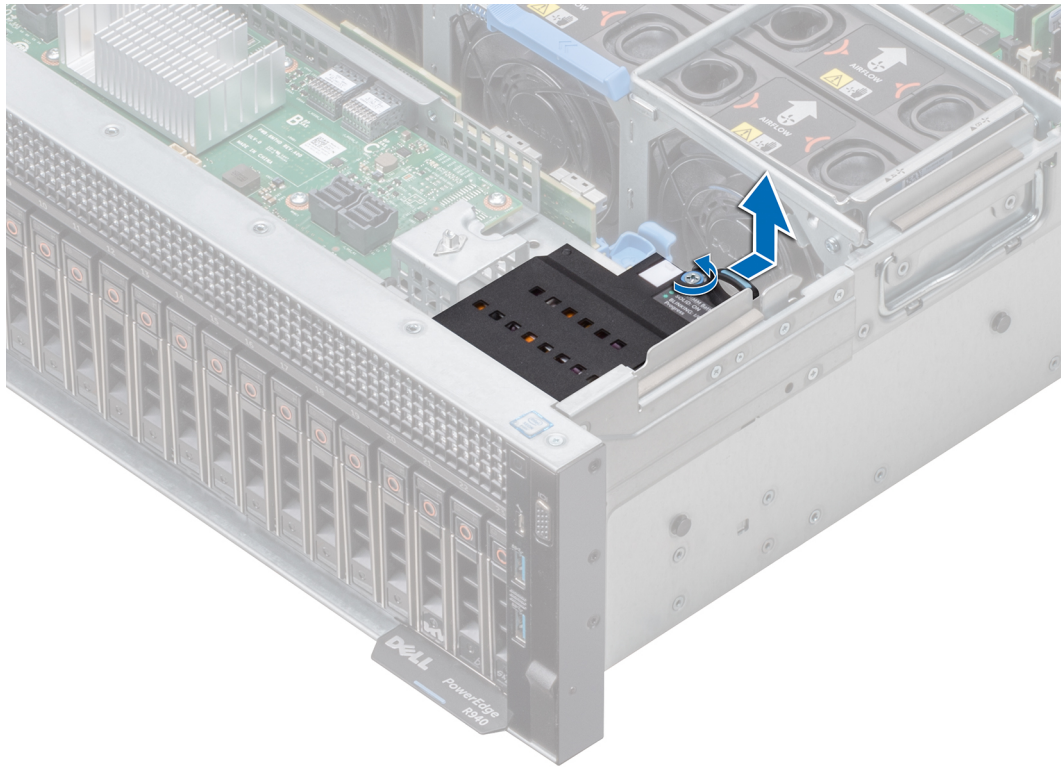

Figure 98. Removing the NVDIMM-N battery

Next steps

Install the NVDIMM-N battery.

Installing NVDIMM-N battery

Prerequisites

1. Follow the safety guidelines listed in [Safety instructions](#) on page 65.
2. Follow the procedure listed in [Before working inside your system](#) on page 66.

CAUTION: NVDIMM-N battery is not hot swappable. To prevent data loss and potential damage to your system, ensure that your system, LEDs on system, LEDs on NVDIMM-N and LEDs on NVDIMM-N battery are turned off before removing the NVDIMM-N battery.

CAUTION: To avoid damage to the battery connector, you must firmly support the connector while installing or removing a battery.

Steps

1. Place the NVDIMM-N battery on the NVDIMM slot on the system and slide the battery into place.
2. Using Phillips #2 screwdriver, tighten the retention screw to secure the battery to the system.
3. Reconnect the cables to the battery.

CAUTION: Exercise care when installing the NVDIMM-N battery so that you do not cause any damage to the intrusion switch cable.

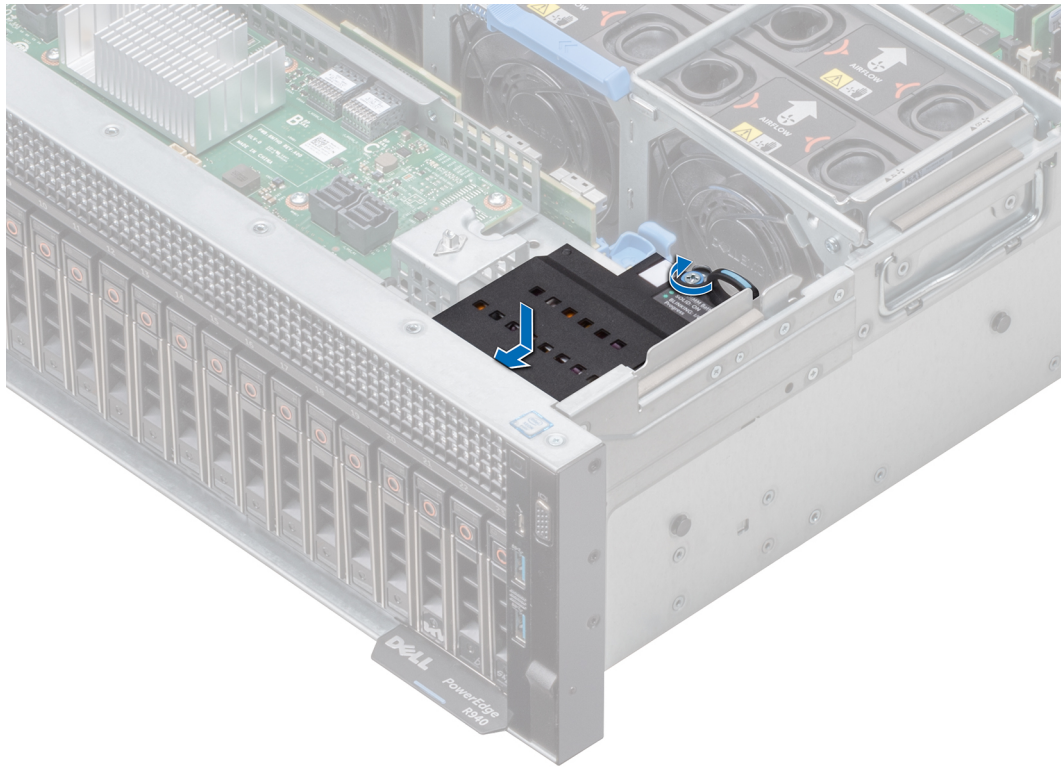

Figure 99. Installing NVDIMM-N battery

Next steps

Follow the procedure listed in [After working inside your system](#) on page 66.

NVDIMM battery cable routing

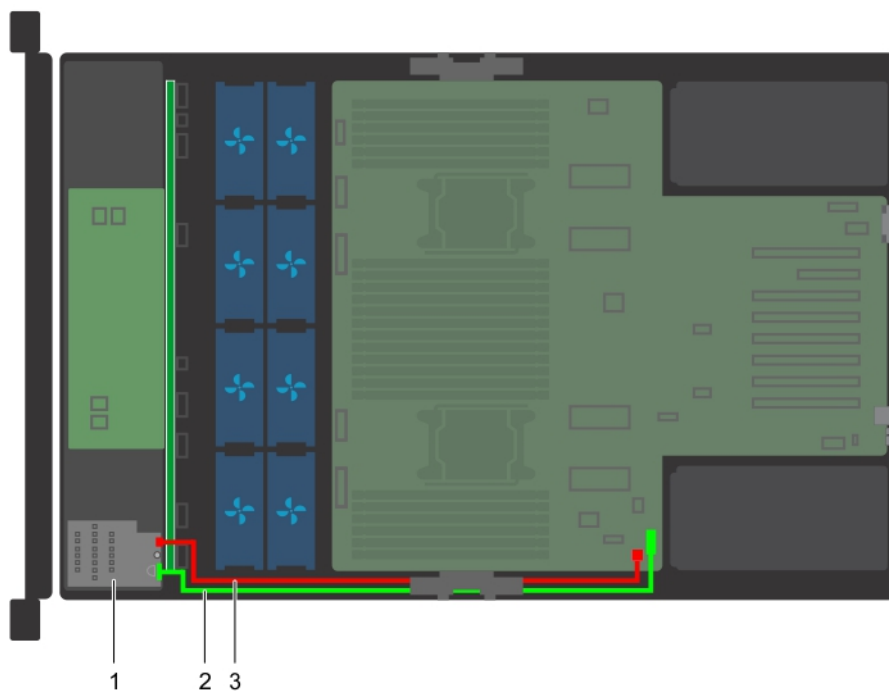

Figure 100. Cable routing – NVDIMM battery cables

1. NVDIMM battery
2. battery cable connecting J_NVDIMM_BATT connector on the system board
3. batter power cable connecting BATT_PWR connector on the system board

NOTE: For information about system board connectors, see [System board jumpers and connectors](#) on page 165.

System battery

Replacing system battery

Prerequisites

NOTE: There is a danger of a new battery exploding if it is incorrectly installed. Replace the battery only with the same or equivalent type recommended by the manufacturer. For more information, see the safety information that is shipped with you system.

1. Follow the safety guidelines listed in [Safety instructions](#) on page 65.
2. Follow the procedure listed in [Before working inside your system](#) on page 66.
3. [Remove the air shroud](#).
4. If applicable, disconnect the power or data cables from expansion card(s).
5. If installed, [remove the expansion card risers](#).
6. If installed, [remove the PEM](#).

Steps

1. Locate the battery socket. For more information on locating the system battery, see the [System board jumpers and connectors](#) section.

CAUTION: To avoid damage to the battery connector, you must firmly support the connector while installing or removing a battery.

2. Use a plastic scribe to pry out the system battery as shown in the illustration below.



Figure 101. Removing the system battery

3. To install a new system battery, hold the battery with the positive side facing up and slide it under the securing tabs.
4. Press the battery into the connector until it snaps into place.

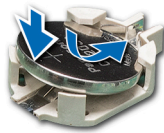

Figure 102. Installing the system battery

Next steps

1. If removed, [install the PEM](#).
2. If removed, [install the expansion card risers](#).
3. If applicable, connect the cables to the expansion card(s).
4. [Install the air shroud](#).
5. Follow the procedure listed in [After working inside your system](#) on page 66.
6. While booting, press F2 to enter the System Setup and ensure that the battery is operating properly.
7. Enter the correct time and date in the System Setup **Time** and **Date** fields.
8. Exit the System Setup.

Optional internal USB memory key

Replacing the optional internal USB memory key

Prerequisites

CAUTION: To avoid interference with other components in the server, the maximum permissible dimensions of the USB memory key are 15.9 mm wide x 57.15 mm long x 7.9 mm high.

1. Follow the safety guidelines listed in [Safety instructions](#) on page 65.
2. Follow the procedure listed in [Before working inside your system](#) on page 66.

Steps

1. Locate the USB port or USB memory key on the system board.
To locate the USB port, see the [System board jumpers and connectors](#).
2. If installed, remove the USB memory key from the USB port.
3. Insert the replacement USB memory key into the USB port.

Next steps

1. Follow the procedure listed in [After working inside your system](#) on page 66.
2. While booting, press F2 to enter **System Setup** and verify that the system detects the USB memory key.

System board

Removing the system board

Prerequisites

 **CAUTION:** If you are using the Trusted Platform Module (TPM) with an encryption key, you may be prompted to create a recovery key during program or System Setup. Be sure to create and safely store this recovery key. If you replace this system board, you must supply the recovery key when you restart your system or program before you can access the encrypted data on your hard drives.

 **CAUTION:** Do not attempt to remove the TPM plug-in module from the system board. Once the TPM plug-in module is installed, it is cryptographically bound to that specific system board. Any attempt to remove an installed TPM plug-in module breaks the cryptographic binding, and it cannot be re-installed or installed on another system board.

1. Follow the safety guidelines listed in [Safety instructions](#) on page 65.
2. Follow the procedure listed in [Before working inside your system](#) on page 66.
3. Remove the following:

- a. [Air shroud](#)
- b. [Fan cage with cooling fans](#)
- c. [Power supply unit\(s\)](#)
- d. All [expansion cards](#) and [risers](#)
- e. [Processor expansion module \(PEM\)](#)
- f. [Integrated storage controller card](#)
- g. [IDSDM module](#)
- h. [Internal USB key \(if applicable\)](#)
- i. [Processor and heat sink module](#)
- j. [Processors](#)

 **CAUTION:** To prevent damage to the processor pins when replacing a faulty system board, ensure that you cover the processor socket with the processor protective cap.

- k. [Memory modules and memory module blanks](#)
- l. [Network daughter card risers](#)
- m. Cable management bracket

Steps

1. Disconnect all cables from the system board.
2. Holding the system board handle, pull the blue release pin, slide the system board towards the front of the system. Sliding the system board toward the front of the system disengages the connectors from the back of the system slots.
3. Lift the system board out of the system.

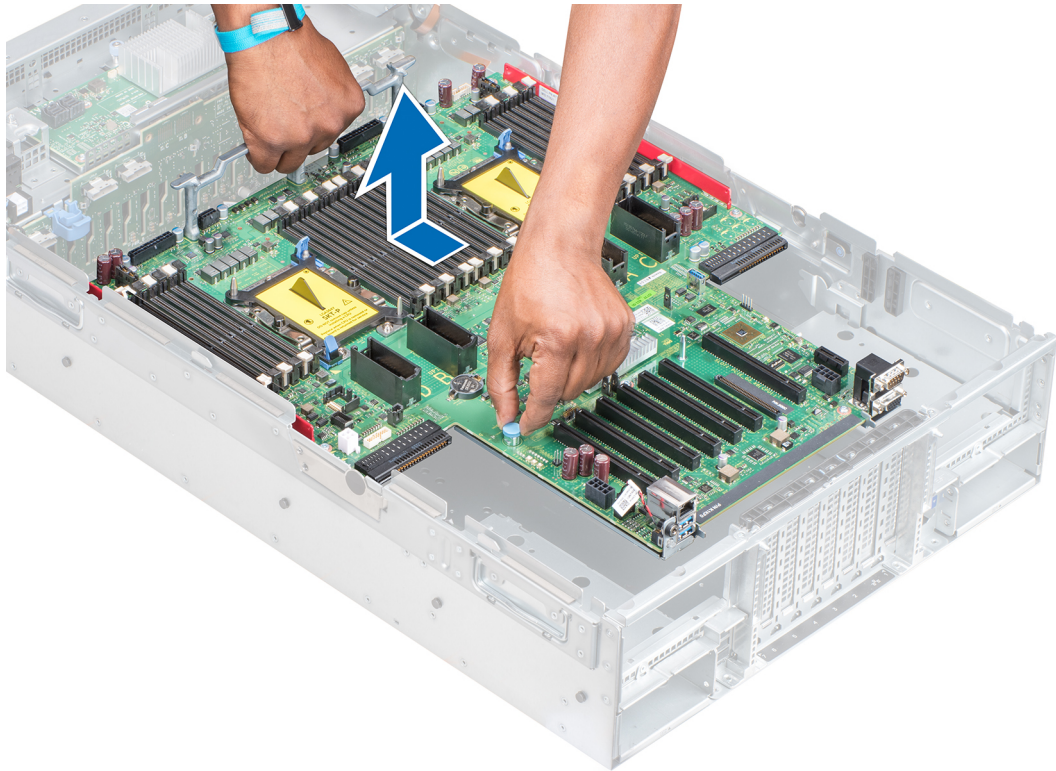

Figure 103. Removing system board

Next steps

Install the system board.

Installing the system board

Prerequisites

1. Follow the safety guidelines listed in [Safety instructions](#) on page 65.
2. Follow the procedure listed in [Before working inside your system](#) on page 66.

Steps

1. Unpack the replacement system board assembly.

 **CAUTION:** Do not lift the system board by holding a memory module, processor, or other components.

 **CAUTION:** Take care not to damage the system identification button while placing the system board into the system.

2. Holding the system board handle and blue release pin, incline the system board and lower the system board into the system.
3. Slide the system board toward the back of the system until the release pin clicks into place.

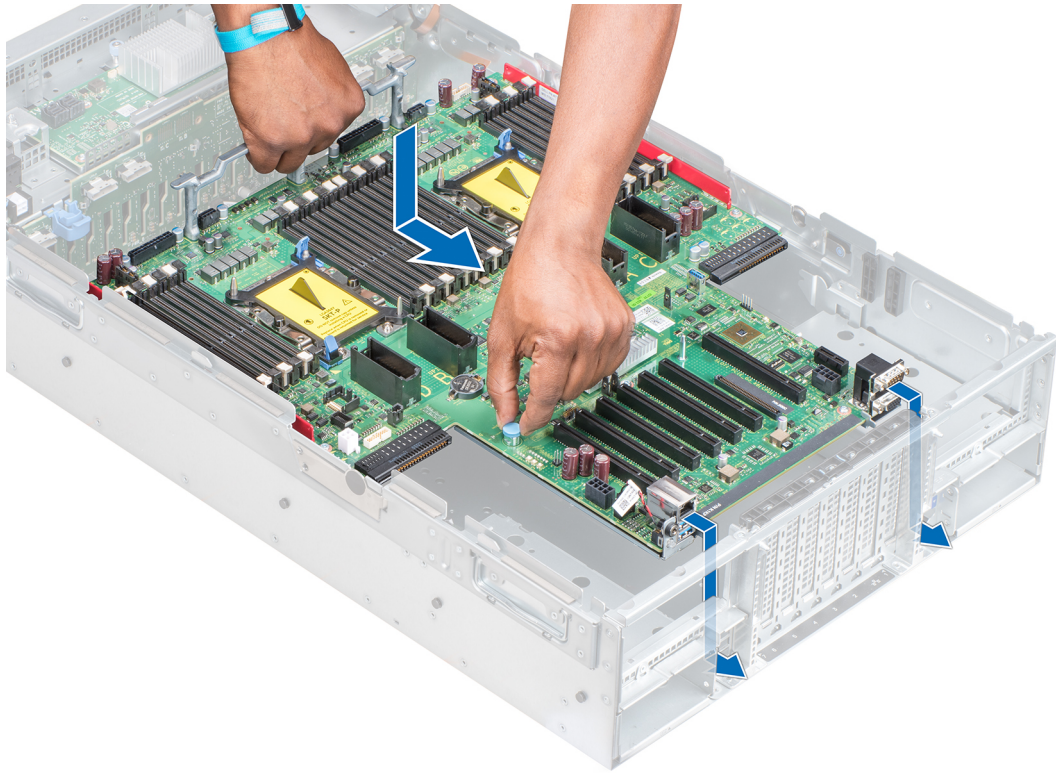

Figure 104. Installing system board

Next steps

1. Replace the following:
 - a. [Trusted Platform Module \(TPM\)](#)
 - NOTE:** The TPM plug-in module is attached to the system board and cannot be removed. A replacement TPM plug-in module will be provided for all system board replacements where a TPM plug-in module was installed.
 - b. [Cable management bracket](#)
 - c. [Integrated storage controller card](#)
 - d. [Internal USB key \(if applicable\)](#)
 - e. [IDSDM module](#)
 - f. [Processor expansion module \(PEM\)](#)
 - g. [Expansion cards and risers](#)
 - h. [Processor and heat sink module](#)
 - i. [Processors](#)
 - j. [Memory modules and memory module blanks](#)
 - k. [Network daughter card riser](#)
 - l. [Fan cage with cooling fans](#)
 - m. [Air shroud](#)
 - n. [Power supply unit\(s\)](#)
2. Reconnect all cables to the system board.
 - NOTE:** Ensure that the cables inside the system are routed along the chassis wall and secured using the cable securing bracket.
3. Follow the procedure listed in [After working inside your system](#) on page 66.
4. Ensure that you:
 - a. Use the Easy Restore feature to restore the Service Tag. For more information, see the [Restoring the Service Tag by using the Easy Restore feature](#) section.
 - b. If the Service Tag is not backed up in the backup flash device, enter the Service Tag manually. For more information, see the [Entering the system Service Tag by using System Setup](#) section.
 - c. Update the BIOS and iDRAC versions.

- d. Re-enable the Trusted Platform Module (TPM). For more information, see the [Upgrading the Trusted Platform Module](#) section.
5. Import your new or existing iDRAC Enterprise license. For more information, see *Integrated Dell Remote Access Controller User's Guide*, at www.dell.com/poweredge/manuals.

Entering the system Service Tag by using System Setup

If Easy Restore fails to restore the Service Tag, use System Setup to enter the Service Tag.

Steps

1. Turn on the system.
2. Press F2 to enter System Setup.
3. Click **Service Tag Settings**.
4. Enter the Service Tag.

 **NOTE:** You can enter the Service Tag only when the Service Tag field is empty. Ensure that you enter the correct Service Tag. After the Service Tag is entered, it cannot be updated or changed.

5. Click **OK**.
6. Import your new or existing iDRAC Enterprise license.
For more information, see the *Integrated Dell Remote Access Controller User's Guide* at Dell.com/idracmanuals.
You can configure the hot spare feature by using the iDRAC settings. For more information, see the iDRAC User's Guide available at Dell.com/idracmanuals.

Restoring the Service Tag by using the Easy Restore feature

By using the Easy Restore feature, you can restore your Service Tag, license, UEFI configuration, and the system configuration data after replacing the system board. All data is automatically backed up in a backup flash device. If BIOS detects a new system board and the Service Tag in the backup flash device, BIOS prompts the user to restore the backup information.

Steps

1. Turn on the system.
If BIOS detects a new system board, and if the Service Tag is present in the backup flash device, BIOS displays the Service Tag, the status of the license, and the **UEFI Diagnostics** version.
2. Perform one of the following steps:
 - Press **Y** to restore the Service Tag, license, and diagnostics information.
 - Press **N** to navigate to the Dell Lifecycle Controller based restore options.
 - Press F10 to restore data from a previously created **Hardware Server Profile**.

After the restore process is complete, BIOS prompts to restore the system configuration data.

3. Perform one of the following steps:
 - Press **Y** to restore the system configuration data.
 - Press **N** to use the default configuration settings.

After the restore process is complete, the system restarts.

Trusted Platform Module

Upgrading the Trusted Platform Module

Prerequisites

1. Follow the safety guidelines listed in [Safety instructions](#) on page 65.
2. Follow the procedure listed in [Before working inside your system](#) on page 66.

 **NOTE:**

- Ensure that your operating system supports the version of the TPM module being installed.
- Ensure that you download and install the latest BIOS firmware on your system.
- Ensure that the BIOS is configured to enable UEFI boot mode.

About this task

CAUTION: If you are using the Trusted Platform Module (TPM) with an encryption key, you may be prompted to create a recovery key during program or System Setup. Work with the customer to create and safely store this recovery key. When replacing this system board, you must supply the recovery key when you restart your system or program before you can access the encrypted data on your hard drives.

CAUTION: Once the TPM plug-in module is installed, it is cryptographically bound to that specific system board. Any attempt to remove an installed TPM plug-in module breaks the cryptographic binding, the removed TPM cannot be reinstalled or installed on another system board.

Removing the TPM

Steps

1. Locate the TPM connector on the system board.
2. Press to hold the module down and remove the screw using the security Torx 8-bit shipped with the TPM module.
3. Slide the TPM module out from its connector.
4. Push the plastic rivet away from the TPM connector and rotate it 90° counterclockwise to release it from the system board.
5. Pull the plastic rivet out of its slot on the system board.

Installing the TPM

Steps

1. To install the TPM, align the edge connectors on the TPM with the slot on the TPM connector.
2. Insert the TPM into the TPM connector such that the plastic rivet aligns with the slot on the system board.
3. Press the plastic rivet until the rivet snaps into place.

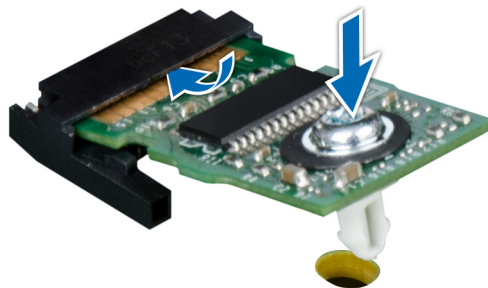

Figure 105. Installing the TPM

Next steps

1. [Install the system board.](#)
2. Follow the procedure listed in [After working inside your system](#) on page 66.

Initializing TPM for BitLocker users

Steps

Initialize the TPM.

For more information, see <https://technet.microsoft.com/en-us/library/cc753140.aspx>.

The **TPM Status** changes to **Enabled, Activated**.

Initializing the TPM 1.2 for TXT users

Steps

1. While booting your system, press F2 to enter System Setup.
2. On the **System Setup Main Menu** screen, click **System BIOS > System Security Settings**.
3. From the **TPM Security** option, select **On with Pre-boot Measurements**.
4. From the **TPM Command** option, select **Activate**.
5. Save the settings.
6. Restart your system.
7. Enter **System Setup** again.
8. On the **System Setup Main Menu** screen, click **System BIOS > System Security Settings**.
9. From the **Intel TXT** option, select **On**.

Initializing the TPM 2.0 for TXT users

Steps

1. While booting your system, press F2 to enter System Setup.
2. On the **System Setup Main Menu** screen, click **System BIOS > System Security Settings**.
3. From the **TPM Security** option, select **On**.
4. Save the settings.
5. Restart your system.
6. Enter **System Setup** again.
7. On the **System Setup Main Menu** screen, click **System BIOS > System Security Settings**.
8. Select the **TPM Advanced Settings** option.
9. From the **TPM2 Algorithm Selection** option, select **SHA256**, then go back to **System Security Settings** screen.
10. On the **System Security Settings** screen, from the **Intel TXT** option, select **On**.
11. Save the settings.
12. Restart your system.

Control panel

Removing the right control panel

Prerequisites

1. Follow the safety guidelines listed in [Safety instructions](#) on page 65.
2. Follow the procedure listed in [Before working inside your system](#) on page 66.
3. [Remove the fan cage](#).
4. [Remove the air shroud](#).
5. If installed, [remove the expansion card risers](#).
6. If installed, [remove the PEM](#).

NOTE: Ensure that you note the routing of the cables as you remove them from the system board. You must route the cables properly when you replace them to prevent the cables from being pinched or crimped.

7. Press the blue release tabs on the fan tray and lower the sides of the tray.

Steps

1. Press the cable management bracket until the tabs on the bracket disengage from the slots on the right side of the system and lift the cable management bracket from the system.
2. Holding the pull tab, disconnect the control panel cable from the system board.
3. Using a Torx #T30 screwdriver, remove the screws that connect the control panel to the system.
4. Holding the control panel by its sides, remove the control panel away from the system.

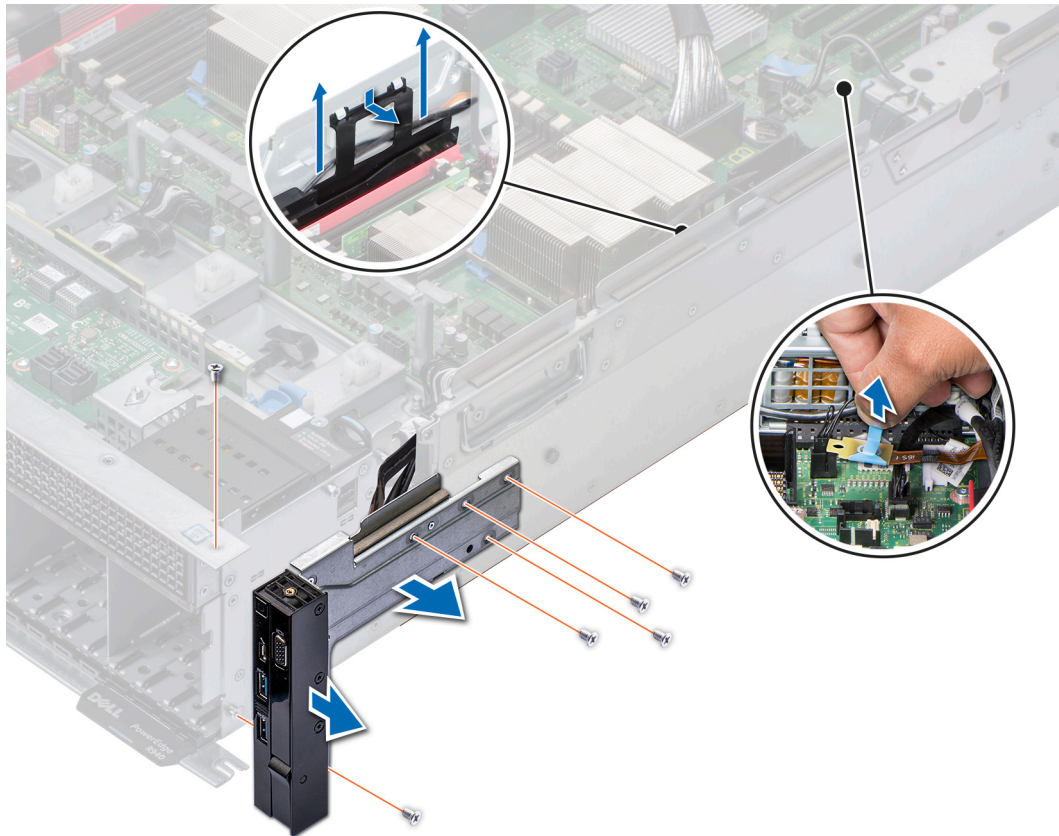

Figure 106. Removing the right control panel

Next steps

Install the right control panel.

Installing the right control panel

Prerequisites

1. Follow the safety guidelines listed in [Safety instructions](#) on page 65.
2. Follow the procedure listed in [Before working inside your system](#) on page 66.

Steps

1. Route the cables through the cable routing hooks on the side of the system.
2. Lower the cable management bracket into the system.
3. Press the bracket and insert the tabs on the bracket into the slots on the right side of the system.

4. Align the control panel with the control panel slot on the system and attach the control panel to the system.
5. Connect the control panel cable connector on the system board.
6. Using a Torx #T30 screwdriver, install the screws that secure the control panel to the system.

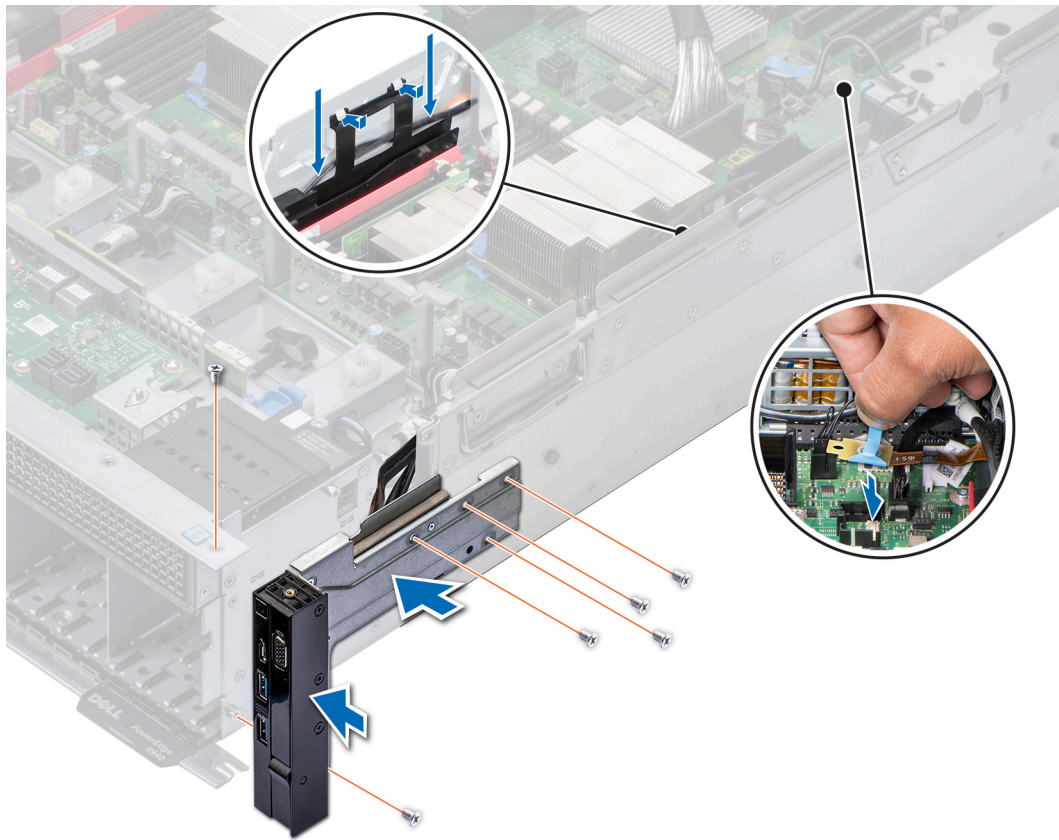

Figure 107. Installing the right control panel

Next steps

1. Lift the sides of the fan tray until the blue release tabs click in place.
2. If removed, [install the expansion card risers](#)
3. If removed, [install the PEM](#).
4. [Install the air shroud](#).
5. [Install the fan cage](#).
6. Follow the procedure listed in [After working inside your system](#) on page 66.

Removing the left control panel

Prerequisites

1. Follow the safety guidelines listed in [Safety instructions](#) on page 65.
2. Follow the procedure listed in [Before working inside your system](#) on page 66.
3. [Remove the fan cage](#).
4. [Remove the air shroud](#).
5. If installed, [remove the expansion card risers](#).
6. If installed, [remove the PEM](#).

NOTE: Ensure that you note the routing of the cables as you remove them from the system. You must route the cables properly when you replace them to prevent the cables from being pinched or crimped.

7. Press the blue release tabs on the fan tray and lower the sides of the tray.

Steps

1. Holding the pull tab, disconnect the control panel cable from the connector on the system board.
2. Using a Torx #T30 screwdriver, remove the screws that secure the left control panel to the system.
3. Holding the control panel by its sides, remove the control panel away from the system.

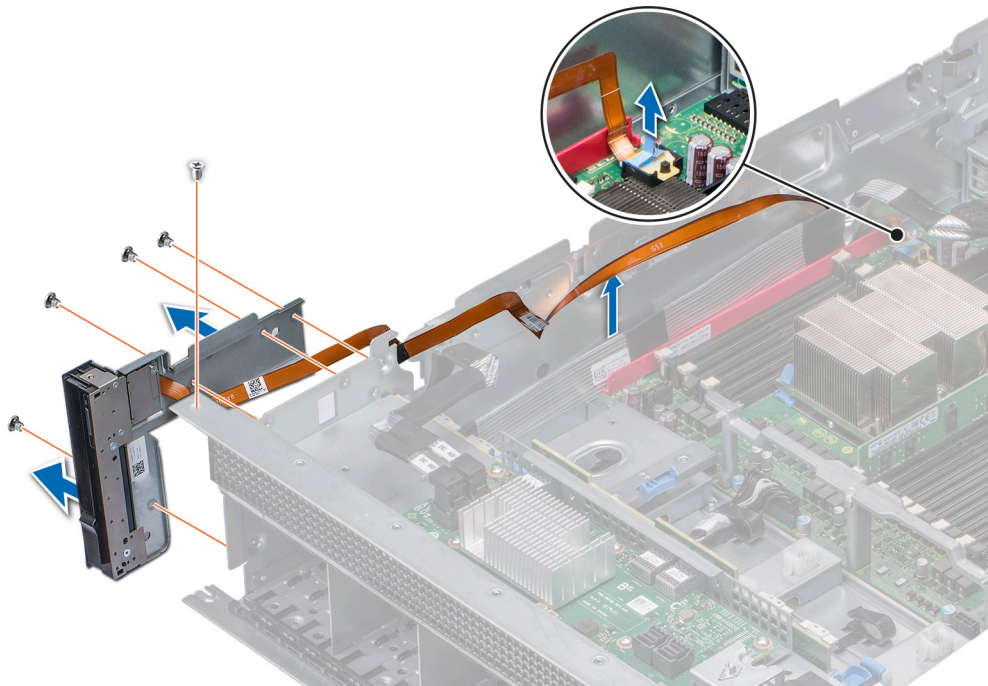

Figure 108. Removing left control panel

Next steps

Install the left control panel.

Installing the left control panel

Prerequisites

1. Follow the safety guidelines listed in [Safety instructions](#) on page 65.
2. Follow the procedure listed in [Before working inside your system](#) on page 66.

Steps

1. Route the control panel cable through the side wall of the system.
2. Align the control panel with the control panel slot on the system and attach the control panel to the system.
3. Connect the control panel cable connector on the system board.
4. Using a Torx #T30 screwdriver, install the screws that secure the control panel to the system.

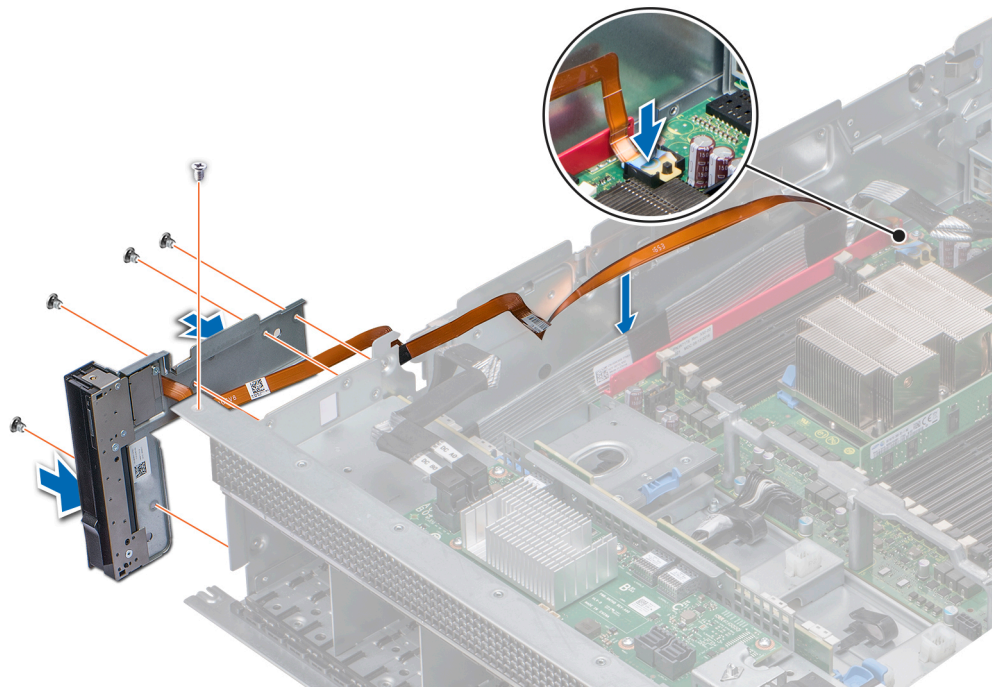

Figure 109. Installing left control panel

Next steps

1. Lift the sides of the fan tray until the blue release tabs click in place.
2. If removed, [install the expansion card risers](#).
3. If removed, [install the PEM](#).
4. [Install the air shroud](#).
5. [Install the fan cage](#).
6. Follow the procedure listed in [After working inside your system](#) on page 66.

System diagnostics

If you experience a problem with your system, run the system diagnostics before contacting Dell for technical assistance. The purpose of running system diagnostics is to test your system hardware without using additional equipment or risking data loss. If you are unable to fix the problem yourself, service and support personnel can use the diagnostics results to help you solve the problem.

Topics:

- [Dell Embedded System Diagnostics](#)

Dell Embedded System Diagnostics

 **NOTE:** The Dell Embedded System Diagnostics is also known as Enhanced Pre-boot System Assessment (ePSA) diagnostics.

The Embedded System Diagnostics provides a set of options for particular device groups or devices allowing you to:

- Run tests automatically or in an interactive mode
- Repeat tests
- Display or save test results
- Run thorough tests to introduce additional test options to provide extra information about the failed device(s)
- View status messages that inform you if tests are completed successfully
- View error messages that inform you of problems encountered during testing

Running the Embedded System Diagnostics from Boot Manager

Run the Embedded System Diagnostics (ePSA) if your system does not boot.

Steps

1. When the system is booting, press F11.
2. Use the up arrow and down arrow keys to select **System Utilities > Launch Diagnostics**.
3. Alternatively, when the system is booting, press F10, select **Hardware Diagnostics > Run Hardware Diagnostics**.
The **ePSA Pre-boot System Assessment** window is displayed, listing all devices detected in the system. The diagnostics starts executing the tests on all the detected devices.

Results

Running the Embedded System Diagnostics from the Dell Lifecycle Controller

Steps

1. As the system boots, press F10.
2. Select **Hardware Diagnostics → Run Hardware Diagnostics**.
The **ePSA Pre-boot System Assessment** window is displayed, listing all devices detected in the system. The diagnostics starts executing the tests on all the detected devices.

System diagnostic controls

Menu	Description
Configuration	Displays the configuration and status information of all detected devices.
Results	Displays the results of all tests that are run.
System health	Provides the current overview of the system performance.
Event log	Displays a time-stamped log of the results of all tests run on the system. This is displayed if at least one event description is recorded.

PowerEdge R940 Jumpers and connectors

This topic provides specific information about the jumpers. It also provides some basic information about jumpers and switches and describes the connectors on the system board or PEM board. Jumpers on the system board help to disable the system and setup passwords. You must know the connectors on the system board or PEM board to install components and cables correctly.

Topics:

- [System board jumpers and connectors](#)
- [System board jumper settings](#)
- [Disabling forgotten password](#)

System board jumpers and connectors

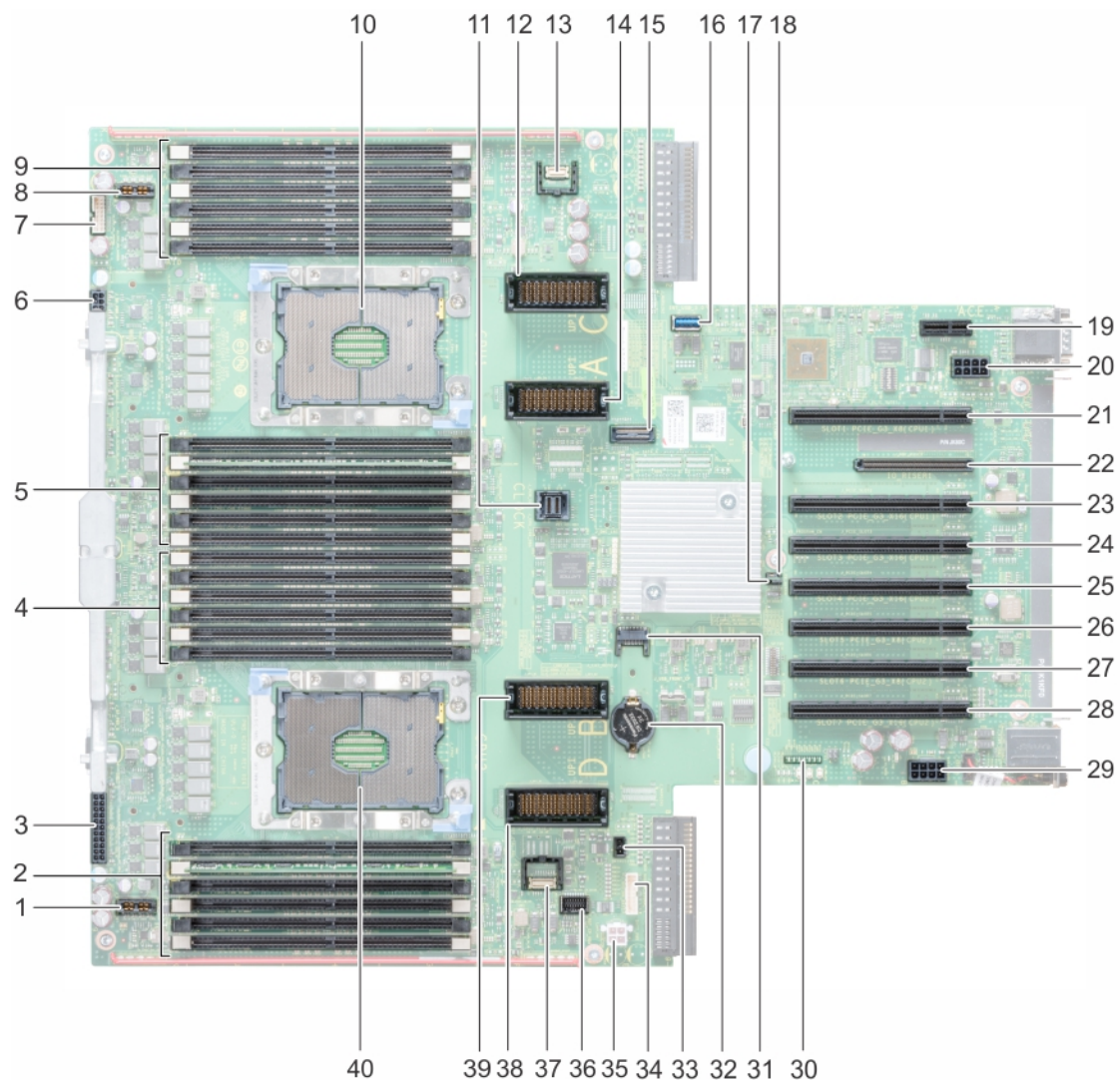

Figure 110. System board jumpers and connectors

Table 53. System board jumpers and connectors

Item	Connector	Description
1	J_PEM_PWR_R	Right PEM power board connector
2	B7, B1, B8, B2, B9, B3	Memory module sockets
3	FAN_MOD2	Fan module cable connector
4	B6, B12, B5, B11, B4, B10	Memory module sockets
5	A7, A1, A8, A2, A9, A3	Memory module sockets
6	J_BP_P1	Backplane 1 power connector
7	J_BP_SIG1	Backplane 1 signal connector
8	J_PEM_PWR_L	Left PEM power board connector
9	A6, A12, A5, A11, A4, A10	Memory module sockets
10	CPU1	CPU1 processor heat sink module socket
11	J_PEM_CLK	PEM clock connector
12	RM_UPI_C	UPI cable connector "C"
13	LFT_CTRL_PNL	Left control panel connector
14	RM_UPI_A	UPI cable connector "A"
15	J_M.2	SATA M.2 connector
16	INT_USB_3.0	Internal USB 3.0 connector
17	PWRD_EN	Reset BIOS password
18	NVRAM_CLR	Clear NVRAM
19	J_IDSDM	iDSDM and vFlash connector
20	PCIE_PWR1	PCIe power connector 1
21	SLOT1 PCIE_G3_X8(CPU1)	PCIe slot 1
22	IO_RISER1	Network daughter card riser connector
23	SLOT2 PCIE_G3_X16(CPU1)	PCIe slot 2
24	SLOT3 PCIE_G3_X16(CPU1)	PCIe slot 3
25	SLOT4 PCIE_G3_X16(CPU2)	PCIe slot 4
26	SLOT5 PCIE_G3_X8(CPU2)	PCIe slot 5
27	SLOT6 PCIE_G3_X8(CPU2)	PCIe slot 6
28	SLOT7 PCIE_G3_X16(CPU2)	PCIe slot 7
29	PCIE_PWR2	PCIe power connector 2
30	System board LED Diagnostic Indicators	System board LED Diagnostic Indicators
31	J_TPM	Trusted Platform Module (TPM) connector
32	BATTERY	System board battery connector
33	INTRUSION	Intrusion switch connector
34	J_NVDIMM_BATT	NVDIMM-N battery connector
35	BATT_PWR	NVDIMM-N battery power connector
36	RM_RGT_CP_GUIDE	VGA to right control panel connector
37	RGT_CTRL_PNL	Right control panel connector

Table 53. System board jumpers and connectors (continued)

Item	Connector	Description
38	RM_UPI_D	UPI cable connector "D"
39	RM_UPI_B	UPI cable connector "B"
40	CPU2	CPU2 processor heat sink module socket

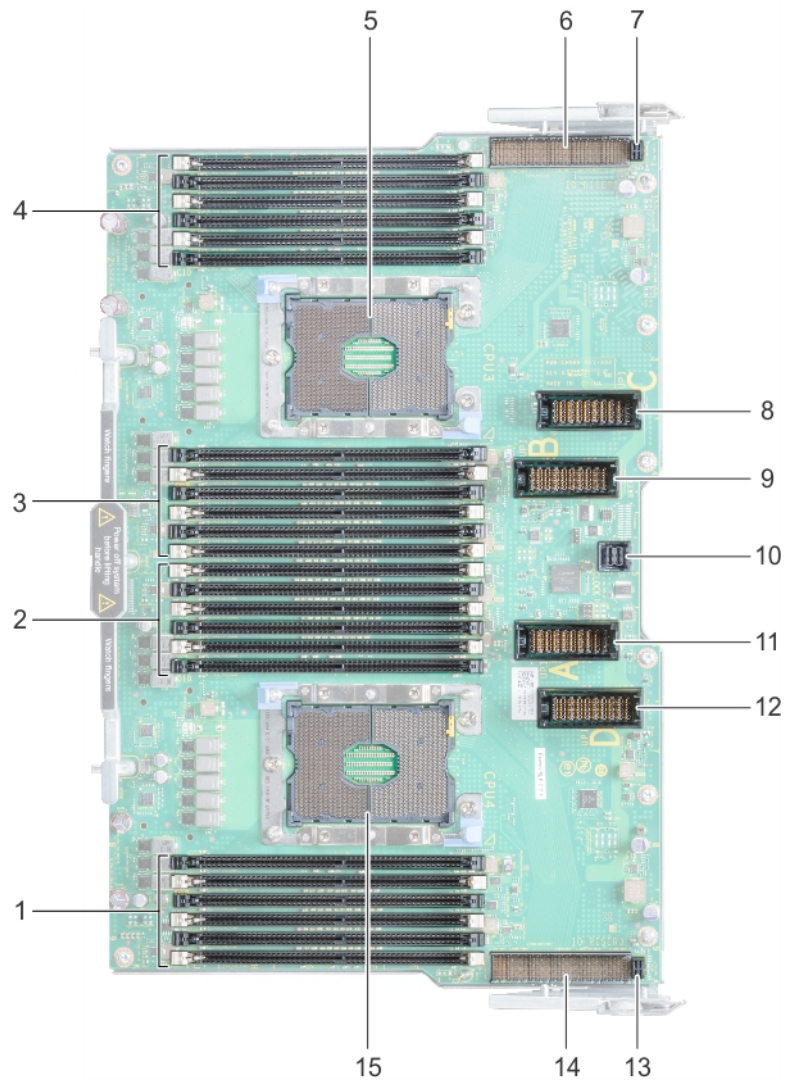

Figure 111. Processor expansion module (PEM) connectors

Table 54. Processor expansion module (PEM) connectors

Item	Connector	Description
1	D7, D1, D8, D2, D9, D3	Memory module sockets
2	D6, D12, D5, D11, D4, D10	Memory module sockets
3	C7, C1, C8, C2, C9, C3	Memory module sockets
4	C6, C12, C5, C11, C4, C10	Memory module sockets
5	CPU3	CPU3 processor heat sink module socket
6	IO_RISER2	Riser 2 connector
7	J_IORL_PWR	Left expansion card riser power connector





Table 54. Processor expansion module (PEM) connectors (continued)

Item	Connector	Description
8	RM_UPL_C	UPI cable connector "C"
9	RM_UPL_B	UPI cable connector "B"
10	J_PEM_CLK	PEM clock connector
11	RM_UPL_A	UPI cable connector "A"
12	RM_UPL_D	UPI cable connector "D"
13	J_IORR_PWR	Right expansion card riser power connector
14	IO_RISER3	Riser 3 connector
15	CPU4	CPU4 processor heat sink module socket

System board jumper settings

For information on resetting the password jumper to disable a password, see the [Disabling a forgotten password](#) section.

Table 55. System board jumper settings

Jumper	Setting	Description
PWRD_EN	 2 4 6 (default)	The BIOS password feature is enabled.
	 2 4 6	The BIOS password feature is disabled. iDRAC local access is unlocked at next AC power cycle. iDRAC password reset is enabled in F2 iDRAC settings menu.
NVRAM_CLR	 1 3 5 (default)	The BIOS configuration settings are retained at system boot.
	 1 3 5	The BIOS configuration settings are cleared at system boot.

Disabling forgotten password

The software security features of the system include a system password and a setup password. The password jumper enables or disables password features and clears any password(s) currently in use.

Prerequisites

CAUTION: Many repairs may only be done by a certified service technician. You should only perform troubleshooting and simple repairs as authorized in your product documentation, or as directed by the online or telephone service and support team. Damage due to servicing that is not authorized by Dell is not covered by your warranty. Read and follow the safety instructions that are shipped with your product.

Steps

1. Turn off the system, including any attached peripherals, and disconnect the system from the electrical outlet.
2. Remove the system cover.
3. Move the jumper on the system board jumper from pins 2 and 4 to pins 4 and 6.
4. Install the system cover.

The existing passwords are not disabled (erased) until the system boots with the jumper on pins 4 and 6. However, before you assign a new system and/or setup password, you must move the jumper back to pins 2 and 4.

NOTE: If you assign a new system and/or setup password with the jumper on pins 4 and 6, the system disables the new password(s) the next time it boots.

5. Reconnect the system to its electrical outlet and turn on the system, including any attached peripherals.
6. Turn off the system, including any attached peripherals, and disconnect the system from the electrical outlet.
7. Remove the system cover.
8. Move the jumper on the system board jumper from pins 4 and 6 to pins 2 and 4.
9. Install the system cover.
10. Reconnect the system to its electrical outlet and turn on the system, including any attached peripherals.
11. Assign a new system and/or setup password.

Getting help

Topics:

- [Recycling or End-of-Life service information](#)
- [Contacting Dell EMC](#)
- [Documentation feedback](#)
- [Accessing system information by using QRL](#)
- [Receiving automated support with SupportAssist](#)

Recycling or End-of-Life service information

Take back and recycling services are offered for this product in certain countries. If you want to dispose of system components, visit www.dell.com/recyclingworldwide and select the relevant country.

Contacting Dell EMC

Dell EMC provides several online and telephone based support and service options. If you do not have an active internet connection, you can find contact information about your purchase invoice, packing slip, bill, or Dell EMC product catalog. Availability varies by country and product, and some services may not be available in your area. To contact Dell EMC for sales, technical assistance, or customer service issues:

Steps

1. Go to www.dell.com/support/home.
2. Select your country from the drop-down menu on the lower right corner of the page.
3. For customized support:
 - a. Enter your system Service Tag in the **Enter your Service Tag** field.
 - b. Click **Submit**.
The support page that lists the various support categories is displayed.
4. For general support:
 - a. Select your product category.
 - b. Select your product segment.
 - c. Select your product.
The support page that lists the various support categories is displayed.
5. For contact details of Dell EMC Global Technical Support:
 - a. Click [Global Technical Support](#).
 - b. The **Contact Technical Support** page is displayed with details to call, chat, or e-mail the Dell EMC Global Technical Support team.

Documentation feedback

You can rate the documentation or write your feedback on any of our Dell EMC documentation pages and click **Send Feedback** to send your feedback.

Accessing system information by using QRL

You can use the Quick Resource Locator (QRL) located on the information tag in the front of the system, to access the information about the PowerEdge system.

Prerequisites

Ensure that your smartphone or tablet has the QR code scanner installed.

The QRL includes the following information about your system:

- How-to videos
- Reference materials, including the Installation and Service Manual, LCD diagnostics, and mechanical overview
- Your system service tag to quickly access your specific hardware configuration and warranty information
- A direct link to Dell to contact technical assistance and sales teams

Steps

1. Go to www.dell.com/qrl and navigate to your specific product or
2. Use your smartphone or tablet to scan the model-specific Quick Resource (QR) code on your system or in the Quick Resource Locator section.

Quick Resource Locator for PowerEdge R940 system



Figure 112. Quick Resource Locator for PowerEdge R940 system

Receiving automated support with SupportAssist

Dell EMC SupportAssist is an optional Dell EMC Services offering that automates technical support for your Dell EMC server, storage, and networking devices. By installing and setting up a SupportAssist application in your IT environment, you can receive the following benefits:

- **Automated issue detection** — SupportAssist monitors your Dell EMC devices and automatically detects hardware issues, both proactively and predictively.
- **Automated case creation** — When an issue is detected, SupportAssist automatically opens a support case with Dell EMC Technical Support.
- **Automated diagnostic collection** — SupportAssist automatically collects system state information from your devices and uploads it securely to Dell EMC. This information is used by Dell EMC Technical Support to troubleshoot the issue.
- **Proactive contact** — A Dell EMC Technical Support agent contacts you about the support case and helps you resolve the issue.

The available benefits vary depending on the Dell EMC Service entitlement purchased for your device. For more information about SupportAssist, go to www.dell.com/supportassist.