

Dell PowerEdge R420xr Owner's Manual

Regulatory Model: E27S Series
Regulatory Type: E27S001



Notes, Cautions, and Warnings

 **NOTE:** A NOTE indicates important information that helps you make better use of your computer.

 **CAUTION:** A CAUTION indicates either potential damage to hardware or loss of data and tells you how to avoid the problem.

 **WARNING:** A WARNING indicates a potential for property damage, personal injury, or death.

Copyright © 2014 Dell Inc. All rights reserved. This product is protected by U.S. and international copyright and intellectual property laws. Dell™ and the Dell logo are trademarks of Dell Inc. in the United States and/or other jurisdictions. All other marks and names mentioned herein may be trademarks of their respective companies.

2014 - 06

Rev. A01

Contents

1 About Your System.....	8
Front-Panel Features And Indicators.....	8
LCD Panel Features.....	9
Hard-Drive Indicator Patterns.....	10
Back-Panel Features And Indicators.....	11
NIC Indicator Codes.....	12
Power Indicator Codes.....	13
Other Information You May Need.....	14
2 Using The System Setup and Boot Manager.....	15
Choosing The System Boot Mode.....	16
Entering System Setup.....	16
Responding To Error Messages.....	16
Using The System Setup Navigation Keys.....	16
System Setup Options.....	17
System Setup Main Screen.....	17
System BIOS Screen.....	17
System Information Screen.....	18
Memory Settings Screen.....	18
Processor Settings Screen.....	19
SATA Settings Screen.....	20
Boot Settings Screen.....	21
Integrated Devices Screen.....	21
Serial Communications Screen.....	22
System Profile Settings Screen.....	23
System Security Screen.....	24
Miscellaneous Settings.....	25
System And Setup Password Features.....	25
Assigning A System And/Or Setup Password.....	26
Deleting Or Changing An Existing Setup Password.....	27
Using Your System Password To Secure Your System.....	27
Operating With A Setup Password Enabled.....	27
Entering The UEFI Boot Manager.....	28
Using The Boot Manager Navigation Keys.....	28
Boot Manager Screen.....	29
UEFI Boot Menu.....	29
Embedded System Management.....	29
iDRAC Settings Utility.....	30

Entering The iDRAC Settings Utility.....	30
Changing The Thermal Settings.....	30
3 Installing System Components.....	31
Recommended Tools.....	31
Front Bezel (Optional).....	31
Installing The Front Bezel.....	32
Removing The Front Bezel.....	32
Bezel Filter (Optional).....	32
Removing the Bezel Filter.....	32
Installing The Bezel Filter.....	33
Opening And Closing The System.....	33
Opening The System.....	34
Closing The System.....	35
Inside The System.....	36
Cooling Shroud.....	37
Removing The Cooling Shroud.....	37
Installing The Cooling Shroud.....	38
System Memory.....	39
General Memory Module Installation Guidelines.....	41
Mode-Specific Guidelines.....	41
Sample Memory Configurations.....	42
Removing Memory Modules.....	44
Installing Memory Modules.....	46
Hard Drives.....	48
Removing A Hot-Swap Hard Drive.....	48
Installing A Hot-Swap Hard Drive.....	49
Removing A Hard Drive From A Hard-Drive Carrier.....	50
Installing A Hard Drive Into A Hard-Drive Carrier.....	50
Cooling Fans.....	51
Removing A Cooling Fan.....	52
Installing A Cooling Fan.....	53
Internal USB Memory Key (Optional).....	53
Replacing The Internal USB Key.....	53
Expansion Cards And Expansion-Card Risers.....	54
Expansion Card Installation Guidelines.....	54
Removing An Expansion Card.....	55
Installing An Expansion Card.....	58
Removing Expansion-Card Risers 1 And 2.....	58
Installing Expansion-Card Risers 1 And 2.....	60
iDRAC Enterprise Card (Optional).....	60
Removing The iDRAC Enterprise Card.....	60

Installing The iDRAC Enterprise Card.....	61
SD vFlash Card.....	62
Replacing An SD vFlash Card.....	62
Internal Dual SD Module.....	62
Removing The Internal Dual SD Module.....	63
Installing The Internal Dual SD Module.....	64
Internal SD Card.....	65
Removing An Internal SD Card.....	65
Installing An Internal SD Card.....	65
Integrated Storage Controller Card.....	65
Removing The Integrated Storage Controller Card.....	66
Installing The Integrated Storage Controller Card.....	67
Processors.....	68
Removing A Processor.....	68
Installing A Processor.....	70
Power Supplies.....	72
Hot Spare Feature.....	72
Removing A Power Supply.....	72
Installing A Power Supply.....	73
System Battery.....	73
Replacing The System Battery.....	73
Hard-Drive Backplane.....	74
Removing The Hard-Drive Backplane.....	75
Installing The Hard-Drive Backplane.....	78
Control Panel Assembly.....	79
Removing The Control Panel.....	79
Installing The Control Panel.....	80
Removing The Control-Panel Module.....	80
Installing The Control-Panel Module.....	81
Power Distribution Board Shroud.....	82
Removing The Power Distribution Board Shroud.....	82
Installing The Power Distribution Board Shroud.....	83
Power Distribution Board.....	84
Removing The Power Distribution Board.....	84
Installing The Power Distribution Board.....	85
System Board.....	86
Removing The System Board.....	86
Installing The System Board.....	87
4 Troubleshooting Your System.....	89
Safety First—For You And Your System.....	89
Troubleshooting System Startup Failure.....	89

Troubleshooting External Connections.....	89
Troubleshooting The Video Subsystem.....	89
Troubleshooting A USB Device.....	89
Troubleshooting A Serial I/O Device.....	90
Troubleshooting A NIC.....	90
Troubleshooting A Wet System.....	91
Troubleshooting A Damaged System.....	91
Troubleshooting The System Battery.....	92
Troubleshooting Power Supplies.....	92
Troubleshooting Cooling Problems.....	93
Troubleshooting Cooling Fans.....	93
Troubleshooting System Memory.....	93
Troubleshooting An Internal USB Key.....	94
Troubleshooting An SD Card.....	95
Troubleshooting A Hard Drive.....	95
Troubleshooting A Storage Controller.....	96
Troubleshooting Expansion Cards.....	97
Troubleshooting Processors.....	98
5 Using System Diagnostics.....	99
Dell Embedded System Diagnostics.....	99
When To Use The Embedded System Diagnostics.....	99
Running The Embedded System Diagnostics.....	99
System Diagnostic Controls.....	99
6 Jumpers And Connectors.....	101
System Board Jumper Settings.....	101
System Board Connectors.....	102
Disabling A Forgotten Password.....	103
7 Technical Specifications.....	105
8 System Messages.....	110
LCD Messages.....	110
Viewing LCD Messages.....	110
Removing LCD Messages.....	110
System Error Messages.....	110
Warning Messages.....	127
Diagnostic Messages.....	127
Alert Messages.....	127
9 Getting Help.....	128

Contacting Dell.....	128
Locating Your System Service Tag.....	128
Documentation Feedback.....	128

About Your System

Front-Panel Features And Indicators

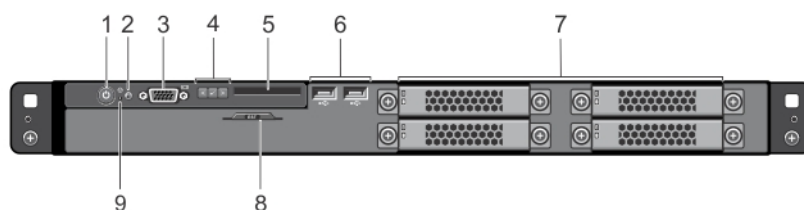









Figure 1. Front-Panel Features and Indicators

Item	Indicator, Button, or Connector	Icon	Description
1	Power-on indicator, power button		<p>The power-on indicator lights when the system power is on. The power button controls the power supply output to the system.</p> <p> NOTE: On ACPI-compliant operating systems, turning off the system using the power button causes the system to perform a graceful shutdown before power to the system is turned off.</p>
2	System identification button		<p>The identification buttons on the front and back panels can be used to locate a particular system within a rack. When one of these buttons is pressed, the LCD panel on the front and the system status indicator on the back flashes until one of the buttons is pressed again.</p> <p>Press to toggle the system ID on and off.</p> <p>If the system stops responding during POST, press and hold the system ID button for more than five seconds to enter BIOS progress mode.</p> <p>To reset iDRAC (if not disabled in F2 iDRAC setup) press and hold the button for more than 15 seconds.</p>
3	Video connector		Allows you to connect a VGA display to the system.
8			

Item	Indicator, Button, or Connector	Icon	Description
4	LCD menu buttons		Allow you to navigate the control panel LCD menu.
5	LCD panel		Displays system ID, status information, and system error messages. The LCD lights blue during normal system operation. The LCD lights amber when the system needs attention, and the LCD panel displays an error code followed by descriptive text.  NOTE: If the system is connected to a power source and an error is detected, the LCD lights amber regardless of whether the system is turned on or off.
6	USB connectors (2)		Allow you to connect USB devices to the system. The ports are USB 2.0-compliant.
7	Hard drives		Up to four 2.5 inch hot-swappable SAS or SATA SSDs.
8	Information tag		A slide-out label panel which allows you to record system information such as Service Tag, NIC, MAC address, and so on as per your need.
9	NMI button		Used to troubleshoot software and device driver errors when running certain operating systems. This button can be pressed using the end of a paper clip. Use this button only if directed to do so by qualified support personnel or by the operating system's documentation.

LCD Panel Features

The system's LCD panel provides system information and status and error messages to indicate when the system is operating correctly or when the system needs attention. See System Error Messages for information about specific error codes.

- The LCD backlight lights blue during normal operating conditions and lights amber to indicate an error condition.
- The LCD backlight is off when the system is in standby mode and can be turned on by pressing either the Select, Left, or Right button on the LCD panel.
- The LCD backlight remains off if LCD messaging is turned off through the iDRAC utility, the LCD panel, or other tools.

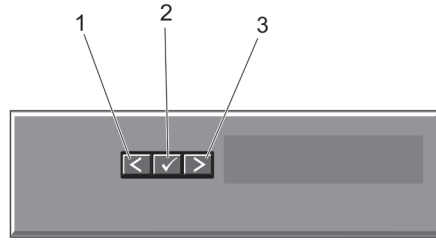

Figure 2. LCD Panel Features

Item	Button	Description
1	Left	Moves the cursor back in one-step increments.
2	Select	Selects the menu item highlighted by the cursor.
3	Right	Moves the cursor forward in one-step increments. During message scrolling: <ul style="list-style-type: none"> • Press once to increase scrolling speed • Press again to stop • Press again to return to default scrolling speed • Press again to repeat the cycle

Hard-Drive Indicator Patterns



Figure 3. Hard-Drive Indicators

1. hard-drive activity indicator (green)
2. hard-drive status indicator (green and amber)

NOTE: If the hard drive is in Advanced Host Controller Interface (AHCI) mode, the status indicator does not function and remains off.

Drive-Status Indicator Pattern (RAID Only)	Condition
Blinks green two times per second	Identifying drive or preparing for removal
Off	Drive ready for insertion or removal
	 NOTE: The drive status indicator remains off until all hard drives are initialized after the system is turned on. Drives are not ready for insertion or removal during this time.
Blinks green, amber, and off	Predicted drive failure
Blinks amber four times per second	Drive failed
Blinks green slowly	Drive rebuilding
Steady green	Drive online
Blinks green three seconds, amber three seconds, and off six seconds	Rebuild aborted

Back-Panel Features And Indicators

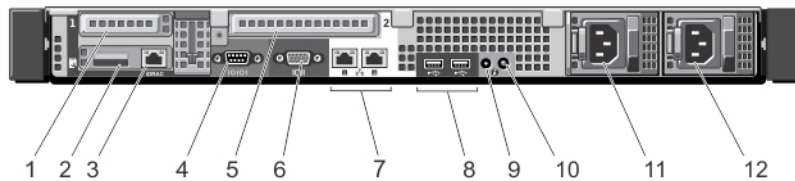







Figure 4. Back-Panel Features and Indicators

Item	Indicator, Button, or Connector	Icon	Description
1	PCIe expansion card slot 1		Allows you to connect one low-profile PCI Express expansion card.
2	vFlash card slot		Allows you to connect the vFlash card.
3	iDRAC port (optional)		Dedicated management port on the iDRAC Enterprise card.
4	Serial connector		Allows you to connect a serial device to the system.
5	PCIe expansion card slot 2		Allows you to connect a full-height PCI Express expansion card.

Item	Indicator, Button, or Connector	Icon	Description
6	Video connector		Allows you to connect a VGA display to the system.
7	Ethernet connectors (2)		Integrated 10/100/1000 Mbps NIC connector.
8	USB connectors (2)		Allow you to connect USB devices to the system. The ports are USB 2.0-compliant.
9	System identification connector		Connects the optional system status indicator assembly through the optional cable management arm.
10	System identification button		<p>The identification buttons on the front and back panels can be used to locate a particular system within a rack. When one of these buttons is pressed, the system status indicator on the back flashes until one of the buttons is pressed again. Press to toggle the system ID on and off. If the system stops responding during POST, press and hold the system ID button for more than five seconds to enter BIOS progress mode.</p> <p>To reset the iDRAC (if not disabled in F2 iDRAC setup) press and hold the button for more than 15 seconds.</p>
11	Power supply (PSU1)		550 W
12	Power supply (PSU2)		

NIC Indicator Codes

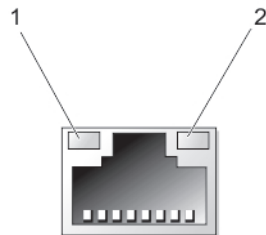

Figure 5. NIC Indicator

1. link indicator
2. activity indicator

Indicator	Indicator Code
Link and activity indicators are off	The NIC is not connected to the network.
Link indicator is green	The NIC is connected to a valid network at its maximum port speed (1 Gbps or 10 Gbps).

Indicator	Indicator Code
Link indicator is amber	The NIC is connected to a valid network at less than its maximum port speed.
Activity indicator is blinking green	Network data is being sent or received.

Power Indicator Codes

Each power supply has an illuminated translucent handle that serves as an indicator to show whether power is present or whether a power fault has occurred.

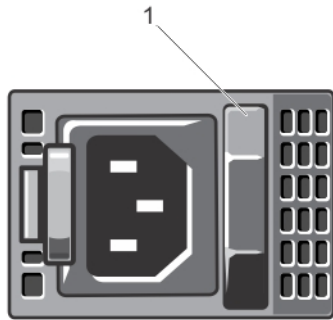

Figure 6. Power Supply Status Indicator

1. power supply status indicator/handle

Power Indicator Pattern	Condition
Not lit	Power is not connected.
Green	The handle indicator lights green indicating that a valid power source is connected to the power supply and that the power supply is operational.
Flashing amber	Indicates a problem with the power supply. <ul style="list-style-type: none"> ⚠ CAUTION: When correcting a power supply mismatch, replace only the power supply with the flashing indicator. Swapping the opposite power supply to make a matched pair can result in an error condition and unexpected system shutdown. To change from a High Output configuration to a Low Output configuration or vice versa, you must power down the system. ⚠ CAUTION: AC power supplies support both 220 V and 110 V input voltages. When two identical power supplies receive different input voltages, they can output different wattages, and trigger a mismatch. ⚠ CAUTION: If two power supplies are used, they must be of the same type and have the same maximum output power.
Flashing green	When hot-adding a power supply, this indicates that the power supply is mismatched with the other power supply (in terms of efficiency, feature set, health

Power Indicator Condition
Pattern

status, and supported voltage). Replace the power supply that has the flashing indicator with a power supply that matches the capacity of the other installed power supply.

Other Information You May Need

 **WARNING:** See the safety and regulatory information that shipped with your system. Warranty information may be included within this document or as a separate document.

- The *Getting Started Guide* provides an overview of setting up your system, and technical specifications. This document is available online at dell.com/support/manuals.
- The rack documentation included with your rack solution describes how to install your system into a rack, if required.
- Any media that ships with your system that provides documentation and tools for configuring and managing your system, including those pertaining to the operating system, system management software, system updates, and system components that you purchased with your system.
- The *Integrated Dell Remote Access Controller (iDRAC) User's Guide* provides information about installation, configuration and maintenance of the iDRAC on managed systems. This document is available online at dell.com/esmmanuals.
- For the full name of an abbreviation or acronym used in this document, see the Glossary at <http://dell.com/poweredgemanuals>.

 **NOTE:** Always check for updates on dell.com/support/manuals and read the updates first because they often supersede information in other documents.

Using The System Setup and Boot Manager

System Setup enables you to manage your system hardware and specify BIOS-level options.

The following keystrokes provide access to system features during startup:

Keystroke	Description
<F2>	Opens the System Setup page.
<F10>	Enters System Services and starts Lifecycle Controller 2 (LC2) which supports systems management features such as operating system deployment, hardware diagnostics, firmware updates, and platform configuration, using a graphical user interface. The feature set available in Lifecycle Controller is determined by the iDRAC license purchased.
<F11>	Enters the BIOS Boot Manager or the Unified Extensible Firmware Interface (UEFI) Boot Manager, depending on the system's boot configuration.
<F12>	Starts Preboot Execution Environment (PXE) boot.

From the System Setup, you can:

- Change the NVRAM settings after you add or remove hardware
- View the system hardware configuration
- Enable or disable integrated devices
- Set performance and power management thresholds
- Manage system security

You can access the System Setup using the:

- Standard graphical browser, which is enabled by default
- Text browser, which is enabled using **Console Redirection**

To enable **Console Redirection**, in **System Setup**, select **System BIOS** → **Serial Communication screen** → **Serial Communication**, select **On with Console Redirection**.

 **NOTE:** By default, help text for the selected field is displayed in the graphical browser. To view the help text in the text browser, press <F1>.

Choosing The System Boot Mode

System Setup enables you to specify the boot mode for installing your operating system:

- BIOS boot mode (the default) is the standard BIOS-level boot interface.
- UEFI boot mode is an enhanced 64-bit boot interface based on Unified Extensible Firmware Interface (UEFI) specifications that overlays the system BIOS.

You must select the boot mode in the **Boot Mode** field of the **Boot Settings** screen of System Setup. Once you specify the boot mode, the system boots in the specified boot mode and you then proceed to install your operating system from that mode. Thereafter, you must boot the system in the same boot mode (BIOS or UEFI) to access the installed operating system. Trying to boot the operating system from the other boot mode will cause the system to halt at startup.

 **NOTE:** Operating systems must be UEFI-compatible to be installed from the UEFI boot mode. DOS and 32-bit operating systems do not support UEFI and can only be installed from the BIOS boot mode.

 **NOTE:** For the latest information on supported operating systems, go to dell.com/ossupport.

Entering System Setup

1. Turn on or restart your system.
2. Press **<F2>** immediately after you see the following message:

`<F2> = System Setup`

If your operating system begins to load before you press **<F2>**, allow the system to finish booting, and then restart your system and try again.

Responding To Error Messages

If an error message is displayed while the system is booting, make a note of the message. For more information, see System Error Messages.

 **NOTE:** After installing a memory upgrade, it is normal for your system to display a message the first time you start your system.

Using The System Setup Navigation Keys

Keys	Action
Up arrow	Moves to the previous field.
Down arrow	Moves to the next field.
<Enter>	Allows you to type in a value in the selected field (if applicable) or follow the link in the field.
Spacebar	Expands or collapses a drop-down menu, if applicable.
<Tab>	Moves to the next focus area.

 **NOTE:** For the standard graphics browser only.

<Esc> Moves to the previous page till you view the main screen. Pressing **<Esc>** in the main screen displays a message that prompts you to save any unsaved changes and restarts the system.

<F1> Displays the System Setup help file.

 **NOTE:** For most of the options, any changes that you make are recorded but do not take effect until you restart the system.

System Setup Options

System Setup Main Screen

 **NOTE:** Press <Alt><F> to reset the BIOS or UEFI settings to their default settings.

Menu Item	Description
System BIOS	This option is used to view and configure BIOS settings.
iDRAC Settings	This option is used to view and configure iDRAC settings.
Device Settings	This option is used to view and configure device settings.

System BIOS Screen

 **NOTE:** The options for System Setup change based on the system configuration.

 **NOTE:** System Setup defaults are listed under their respective options in the following sections, where applicable.

Menu Item	Description
System Information	Displays information about the system such as the system model name, BIOS version, Service Tag, and so on.
Memory Settings	Displays information and options related to installed memory.
Processor Settings	Displays information and options related to the processor such as speed, cache size, and so on.
SATA Settings	Displays options to enable or disable the integrated SATA controller and ports.
Boot Settings	Displays options to specify the boot mode (BIOS or UEFI). Enables you to modify UEFI and BIOS boot settings.
Integrated Devices	Displays options to enable or disable integrated device controllers and ports, and to specify related features and options.
Serial Communication	Displays options to enable or disable the serial ports and specify related features and options.
System Profile Settings	Displays options to change the processor power management settings, memory frequency, and so on.



Menu Item	Description
System Security	Displays options to configure the system security settings like, system password, setup password, TPM security, and so on. It also enables or disables the power and NMI buttons on the system.
Miscellaneous Settings	Displays options to change the system date, time, and so on.

System Information Screen

Menu Item	Description
System Model Name	Displays the system model name.
System BIOS Version	Displays the BIOS version installed on the system.
System Service Tag	Displays the system Service Tag.
System Manufacturer	Displays the name of the system manufacturer.
System Manufacturer Contact Information	Displays the contact information of the system manufacturer.



Memory Settings Screen

Menu Item	Description
System Memory Size	Displays the amount of memory installed in the system.
System Memory Type	Displays the type of memory installed in the system.
System Memory Speed	Displays the system memory speed.
System Memory Voltage	Displays the system memory voltage.
Video Memory	Displays the amount of video memory.
System Memory Testing	Specifies whether system memory tests are run during system boot. Options are Enabled and Disabled . By default, the System Memory Testing option is set to Disabled .
Memory Operating Mode	Specifies the memory operating mode. The options available depending on the memory configuration of your system are Optimizer Mode , Advanced ECC Mode , Mirror Mode , Spare Mode , Spare with Advanced ECC Mode , and Dell Fault Resilient Mode . By default, the Memory Operating Mode option is set to Optimizer Mode .

Menu Item	Description
	<p> NOTE: The Memory Operating Mode can have different defaults and available options based on the memory configuration.</p> <p> NOTE: The Dell Fault Resilient Mode establishes an area of memory that is fault resilient. This mode can be used by an operating system that supports the feature to load critical applications or enables the operating system kernel to maximize system availability.</p>
Node Interleaving	If this field is Enabled , memory interleaving is supported if a symmetric memory configuration is installed. If Disabled , the system supports Non-Uniform Memory architecture (NUMA) (asymmetric) memory configurations. By default, Node Interleaving option is set to Disabled .

Processor Settings Screen

Menu Item	Description
Logical Processor	Allows you to enable or disable logical processors and display the number of logical processors. If the Logical Processor option is set to Enabled , the BIOS displays all the logical processors. If this option is set to Disabled , the BIOS only displays one logical processor per core. By default, the Logical Processor option is set to Enabled .
QPI Speed	Allows you to set the QuickPath Interconnect (QPI) data rate settings. By default, the QPI Speed option is set to Maximum data rate .  NOTE: QPI Speed displays only when both the processors are installed.
Alternate RTID (Requestor Transaction ID) Setting	Allows you to allocate more RTIDs to the remote socket, increasing cache performance between the sockets or work in normal mode for NUMA. By default, the Alternate RTID (Requestor Transaction ID) Setting is set to Disabled .
Virtualization Technology	Allows you to enable or disable the additional hardware capabilities provided for virtualization. By default, the Virtualization Technology option is set to Enabled .
Adjacent Cache Line Prefetch	Allows you to optimize the system for applications that require high utilization of sequential memory access. By default, the Adjacent Cache Line Prefetch option is set to Enabled . You can disable this option for applications that require high utilization of random memory access.
Hardware Prefetcher	Allows you to enable or disable the hardware prefetcher. By default, the Hardware Prefetcher option is set to Enabled .
DCU Streamer Prefetcher	Allows you to enable or disable the Data Cache Unit (DCU) streamer prefetcher. By default, the DCU Streamer Prefetcher option is set to Enabled .
DCU IP Prefetcher	Allows you to enable or disable the Data Cache Unit (DCU) IP prefetcher. By default, the DCU IP Prefetcher option is set to Enabled .
Execute Disable	Allows you enable or disable execute disable memory protection technology. By default, the Execute Disable option is set to Enabled .





Menu Item	Description
Logical Processor Idling	Allows you to enable or disable the OS capability to put logical processors in the idling state in order to reduce power consumption. By default, the option is set to Disabled .
Number of Cores per Processor	Allows you to control the number of enabled cores in each processor. By default, the Number of Cores per Processor option is set to All .
Processor 64-bit Support	Specifies if the processor(s) support 64-bit extensions.
Processor Core Speed	Displays the maximum core frequency of the processor.
Processor Bus Speed	Displays the bus speed of the processors.  NOTE: The processor bus speed option displays only when both the processors are installed.
Processor 1	 NOTE: The following settings are displayed for each processor installed in the system.
Family-Model-Stepping	Displays the family, model and stepping of the processor as defined by Intel.
Brand	Displays the brand name reported by the processor.
Level 2 Cache	Displays the total L2 cache.
Level 3 Cache	Displays the total L3 cache.
Number of Cores	Displays the number of cores per processor.

SATA Settings Screen

Menu Item	Description
Embedded SATA	Allows the embedded SATA to be set to Off, ATA, AHCI, or RAID mode. By default, Embedded SATA is set to AHCI Mode .
Port A	Auto enables BIOS support for the device attached to SATA port A. By default, Port A is set to Auto .
Port B	Auto enables BIOS support for the device attached to SATA port B. By default, Port B is set to Auto .
Port C	Auto enables BIOS support for the device attached to SATA port C. By default, Port C is set to Auto .
Port D	Auto enables BIOS support for the device attached to SATA port D. By default, Port D is set to Auto .
Port E	Auto enables BIOS support for the device attached to SATA port E. By default, Port E is set to Auto .



 **NOTE:** Ports A, B, C, and D are used for the backplane drives, and port E for the optical drive (CD/DVD).

Boot Settings Screen

Menu Item	Description
Boot Mode	<p>Allows you to set the boot mode of the system.</p> <p> CAUTION: Switching the boot mode may prevent the system from booting if the operating system is not installed in the same boot mode.</p> <p>If the operating system supports UEFI, you can set this option to UEFI. Setting this field to BIOS allows compatibility with non-UEFI operating systems. By default, the Boot Mode option is set to BIOS.</p> <p> NOTE: Setting this field to UEFI disables BIOS Boot Settings menu. Setting this field to BIOS disables the UEFI Boot Settings menu.</p>
Boot Sequence Retry	<p>Allows you to enable or disable the boot sequence retry feature. If this field is enabled and the system fails to boot, the system reattempts the boot sequence after 30 seconds. By default, the Boot Sequence Retry option is set to Disabled.</p>
BIOS Boot Settings	<p>Allows you to enable or disable BIOS Boot options.</p> <p> NOTE: This option is enabled only if the boot mode is BIOS.</p>
UEFI Boot Settings	<p>Allows you to enable or disable UEFI Boot options. The Boot options include IPv4 PXE and IPv6 PXE. By default, the UEFI PXE boot protocol is set to IPv4.</p> <p> NOTE: This option is enabled only if the boot mode is UEFI.</p>
One-Time Boot	<p>Allows you to enable or disable a one-time boot from a selected device.</p>

Integrated Devices Screen

Menu Item	Description
Integrated RAID Controller	<p>Allows you to enable or disable the integrated RAID controller. By default, the Integrated RAID Controller option is set to Enabled.</p>
User Accessible USB Ports	<p>Allows you enable or disable the user accessible USB ports. Selecting Only Back Ports On disables the front USB ports and selecting All Ports Off disables both front and back USB ports. By default, the User Accessible USB Ports option is set to All Ports On.</p>
Internal USB Port	<p>Allows you to enable or disable the internal USB port. By default, the Internal USB Port option is set to On.</p>
Internal SD Card Port	<p>Enables or disables the system's internal SD card port. By default, Internal SD Card Port option is set to On.</p> <p> NOTE: This option is displayed only if IDSDM is installed on the system board.</p>



Menu Item	Description
Internal SD Card Redundancy	<p>If set to Mirror mode, data is written on both SD cards. If any one of the SD card fails, data is written to the active SD card. Data from this card is copied to the replacement SD card at the next boot. By default, Internal SD Card Redundancy option is set to Mirror.</p> <p> NOTE: This option is displayed only if IDSDM is installed on the system board.</p>
Integrated Network Card 1	<p>Allows you to enable or disable the integrated network card 1. By default, the Integrated Network Card 1 option is set to Enabled.</p>
OS Watchdog Timer	<p>Allows you to enable or disable the OS watchdog timer. When this field is enabled, the operating system initializes the timer and the OS watchdog timer helps in recovering the operating system. By default, the OS Watchdog Timer option is set to Disabled.</p>
Embedded Video Controller	<p>Allows you to enable or disable the Embedded Video Controller. By default, the embedded video controller is Enabled.</p>
SR-IOV Global Enable	<p>Allows you to enable or disable the BIOS configuration of Single Root I/O Virtualization (SR-IOV) devices. By default, the SR-IOV Global Enable option is set to Disabled.</p>
Slot Disablement	<p>Allows you to enable or disable available PCIe slots on your system. The Slot Disablement feature controls the configuration of PCIe cards installed in the specified slot.</p> <p> CAUTION: Slot disablement must be used only when the installed peripheral card is preventing booting into the Operating System or causing delays in system startup. If the slot is disabled, both the Option ROM and UEFI driver are disabled.</p>
Memory Mapped I/O above 4 GB	<p>Allows you to enable support for PCIe devices that require large amounts of memory. By default, the option is set to Enabled.</p>

Serial Communications Screen

Menu Item	Description
Serial Communication	<p>Allows you to select serial communication devices (Serial Device 1 and Serial Device 2) in the BIOS. BIOS console redirection can also be enabled and the port address used can be specified. By default, Serial Communication option is set to On without Console Redirection.</p>
Serial Port Address	<p>Allows you to set the port address for serial devices. By default, the Serial Port Address option is set to Serial Device 1=COM2, Serial Device 2=COM1.</p> <p> NOTE: Only Serial Device 2 can be used for Serial Over LAN (SOL). To use console redirection by SOL, configure the same port address for console redirection and the serial device.</p>
External Serial Connector	<p>Allows you to associate the external serial connector to serial device 1, serial device 2, or remote access device. By default, the External Serial Connector option is set to Serial Device1.</p>

Menu Item	Description
	 NOTE: Only Serial Device 2 can be used for SOL. To use console redirection by SOL, configure the same port address for console redirection and the serial device.
Failsafe Baud Rate	Displays the failsafe baud rate for console redirection. The BIOS attempts to determine the baud rate automatically. This failsafe baud rate is used only if the attempt fails and the value must not be changed. By default, the Failsafe Baud Rate option is set to 115200 .
Remote Terminal Type	Allows you to set the remote console terminal type. By default, the Remote Terminal Type option is set to VT 100/VT 220 .
Redirection After Boot	Allows you to enable or disable to the BIOS console redirection when the operating system is loaded. By default, the Redirection After Boot option is set to Enabled .

System Profile Settings Screen

Menu Item	Description
System Profile	<p>Allows you to set the system profile. If you set the System Profile option to a mode other than Custom, the BIOS automatically sets the rest of the options. You can only change the rest of the options if the mode is set to Custom. By default, the System Profile option is set to Performance Per Watt Optimized (DAPC). DAPC is Dell Active Power Controller.</p> <p>  NOTE: The following parameters are available only when the System Profile is set to Custom. </p>
CPU Power Management	Allows you to set the CPU power management. By default, the CPU Power Management option is set to System DBPM (DAPC) . DBPM is Demand-Based Power Management.
Memory Frequency	Allows you to set the memory frequency. By default, the Memory Frequency option is set to Maximum Performance .
Turbo Boost	Allows you to enable or disable the processor to operate in turbo boost mode. By default, the Turbo Boost option is set to Enabled .
C1E	Allows you to enable or disable the processor to switch to a minimum performance state when it is idle. By default, the C1E option is set to Enabled .
C States	Allows you to enable or disable the processor to operate in all available power states. By default, the C States option is set to Enabled .
Monitor/Mwait	<p>Allows you to enable Monitor/Mwait instructions in the processor. By default, the Monitor/Mwait option is set to Enabled for all system profiles, except Custom.</p> <p>  NOTE: This option can be disabled only if the C States option in Custom mode is disabled. </p> <p>  NOTE: When C States is enabled in Custom mode, changing the Monitor/Mwait setting does not impact system power/performance. </p>

Menu Item	Description
Memory Patrol Scrub	Allows you to set the memory patrol scrub frequency. By default, the Memory Patrol Scrub option is set to Standard .
Memory Refresh Rate	Allows you to set the memory refresh rate. By default, the Memory Refresh Rate option is set to 1x .
Memory Operating Voltage	Allows you to set the DIMM voltage selection. When set to Auto , the system automatically sets the system voltage to the optimal setting based on the DIMM capacity and the number of DIMMs installed. By default, the Memory Operating Voltage option is set to Auto .
Collaborative CPU Performance Control	When set to Enabled , the CPU power management is controlled by the OS DBPM and the System DBPM (DAPC). By default, the option is set to Disabled .

System Security Screen

Menu Item	Description
Intel AES-NI	Improves the speed of applications by performing encryption and decryption using the Advanced Encryption Standard Instruction Set and is set to Enabled by default.
System Password	Allows you to set the system password. This option is set to Enabled by default and is read-only if the password jumper is not installed in the system.
Setup Password	Allows you to set the setup password. This option is read-only if the password jumper is not installed in the system.
Password Status	Allows you to lock the system password. By default, the Password Status option is set to Unlocked .
TPM Security	Allows you to control the reporting mode of the Trusted Platform Module (TPM). By default, the TPM Security option is set to Off . You can only modify the TPM Status, TPM Activation , and Intel TXT fields if the TPM Status field is set to either On with Pre-boot Measurements or On without Pre-boot Measurements .
TPM Activation	Allows you to change the operational state of the TPM. By default, the TPM Activation option is set to No Change .
TPM Status	Displays the TPM status.
TPM Clear	 CAUTION: Clearing the TPM results in the loss of all keys in the TPM. The loss of TPM keys may affect booting to the operating system. Allows you to clear all the contents of the TPM. By default, the TPM Clear option is set to No .
Intel TXT	Allows you to enable or disable Intel Trusted Execution Technology (TXT). To enable Intel TXT , Virtualization Technology must be enabled and TPM Security must be Enabled with Pre-boot measurements. By default, the Intel TXT option is set to Off .
BIOS Update Control	Allows you to update the BIOS using either DOS or UEFI shell-based flash utilities. For environments that do not require local BIOS updates, it is recommended to set

Menu Item	Description
	<p>this option to Disabled. By default, the BIOS Update Control option is set to Unlocked.</p> <p> NOTE: BIOS updates using the Dell Update Package are not affected by this option.</p>
Power Button	Allows you to enable or disable the power button on the front of the system. By default, the Power Button option is set to Enabled .
NMI Button	Allows you to enable or disable the NMI button on the front of the system. By default, the NMI Button option is set to Disabled .
AC Power Recovery	Allows you to set how the system reacts after AC power is restored to the system. By default, the AC Power Recovery option is set to Last .
AC Power Recovery Delay	Allows you to set how the system supports staggering of power up after AC power is restored to the system. By default, the AC Power Recovery Delay option is set to Immediate .
User Defined Delay (60s to 240s)	Allows you to set the User Defined Delay when the User Defined option for AC Power Recovery Delay is selected.

Miscellaneous Settings

Menu Item	Description
System Time	Allows you to set the time on the system.
System Date	Allows you to set the date on the system.
Asset Tag	Displays the asset tag and allows you to modify it for security and tracking purposes.
Keyboard NumLock	<p>Allows you to set whether the system boots with the NumLock enabled or disabled. By default the Keyboard NumLock is set to On.</p> <p> NOTE: This option does not apply to 84-key keyboards.</p>
Report Keyboard Errors	Allows you to set whether keyboard-related error messages are reported during system boot. By default, the Report Keyboard Errors option is set to Report .
F1/F2 Prompt on Error	Allows you to enable or disable the F1/F2 prompt on error. By default, F1/F2 Prompt on Error is set to Enabled .
In-System Characterization	This option enables or disables In-System Characterization . By default, In-System Characterization is set to Enabled .

System And Setup Password Features

You can create a system password and a setup password to secure your system. To enable creation of the system and setup password, the password jumper must be set to enabled. For more information on the password jumper settings, see System Board Jumper Settings.

System password	This is the password that you must enter before you can boot your system.
Setup password	This is the password that you must enter to access and make changes to the BIOS or UEFI settings of your system.

 **CAUTION:** The password features provide a basic level of security for the data on your system.

 **CAUTION:** Anyone can access the data stored on your system if the system is running and unattended.

 **NOTE:** Your system is shipped with the system and setup password feature disabled.

Assigning A System And/Or Setup Password

 **NOTE:** The password jumper enables or disables the System Password and Setup Password features. For more information on the password jumper settings, see System Board Jumper Settings.

You can assign a new **System Password** and/or **Setup Password** or change an existing **System Password** and/or **Setup Password** only when the password jumper setting is enabled and **Password Status** is **Unlocked**. If the Password Status is **Locked**, you cannot change the System Password.

If the password jumper setting is disabled, the existing System Password and Setup Password is deleted and you need not provide the system password to log on to the system.

To assign a system and/or setup password:

1. To enter System Setup, press <F2> immediately after a power-on or reboot.
2. In the **System Setup Main Menu**, select **System BIOS** and press <Enter>. The **System BIOS** screen is displayed.
3. In the **System BIOS** screen, select **System Security** and press <Enter>. The **System Security** screen is displayed.
4. In the **System Security** screen, verify that **Password Status** is **Unlocked**.
5. Select **System Password**, enter your system password, and press <Enter> or <Tab>. Use the following guidelines to assign the system password:
 - A password can have up to 32 characters.
 - The password can contain the numbers 0 through 9.
 - Only lower case letters are valid, upper case letters are not allowed.
 - Only the following special characters are allowed: space, ("), (+), (.), (-), (.), (/), (:), (I), (\), (l), (').

A message prompts you to re-enter the system password.

6. Re-enter the system password that you entered earlier and click **OK**.
7. Select **Setup Password**, enter your system password and press <Enter> or <Tab>. A message prompts you to re-enter the setup password.
8. Re-enter the setup password that you entered earlier and click **OK**.
9. Press <Esc> to return to the System BIOS screen. Press <Esc> again, and a message prompts you to save the changes.

 **NOTE:** Password protection does not take effect until the system reboots.

Deleting Or Changing An Existing Setup Password

Ensure that the Password jumper is set to enabled and the **Password Status** is **Unlocked** before attempting to delete or change the existing System and/or Setup password. You cannot delete or change an existing System password if the **Password Status** is **Locked**.

To delete or change the existing System and/or Setup password:

1. To enter System Setup, press <F2> immediately after a power-on or reboot.
2. In the **System Setup Main Menu**, select **System BIOS** and press <Enter>. The **System BIOS** screen is displayed.
3. In the **System BIOS Screen**, select **System Security** and press <Enter>. The **System Security** screen is displayed.
4. In the **System Security** screen, verify that **Password Status** is **Unlocked**.
5. Select **System Password**, alter or delete the existing system password and press <Enter> or <Tab>.
6. Select **Setup Password**, alter or delete the existing setup password and press <Enter> or <Tab>.
 -  **NOTE:** If you change the System and/or Setup password a message prompts you to re-enter the new password. If you delete the System and/or Setup password, a message prompts you to confirm the deletion.
7. Press <Esc> to return to the System BIOS screen. Press <Esc> again, and a message prompts you to save the changes.

-  **NOTE:** You can disable password security while logging on to the system. To disable the password security, turn on or reboot your system, type your password and press <Ctrl><Enter>.

Using Your System Password To Secure Your System

-  **NOTE:** If you have assigned a setup password, the system accepts your setup password as an alternate system password.

1. Turn on or reboot your system.
2. Type your password and press <Enter>.

When **Password Status** is **Locked**, type the password and press <Enter> when prompted at reboot.

If an incorrect system password is entered, the system displays a message and prompts you to re-enter your password. You have three attempts to enter the correct password. After the third unsuccessful attempt, the system displays an error message that the system has halted and must be powered down.

Even after you shut down and restart the system, the error message is displayed until the correct password is entered.

-  **NOTE:** You can use the **Password Status** option in conjunction with the **System Password** and **Setup Password** options to protect your system from unauthorized changes.

Operating With A Setup Password Enabled

If **Setup Password** is **Enabled**, enter the correct setup password before modifying most of the System Setup options.

If you do not enter the correct password in three attempts, the system displays the message
Invalid Password! Number of unsuccessful password attempts: <x> System Halted!
Must power down.

Even after you shut down and restart the system, the error message is displayed until the correct password is entered. The following options are exceptions:

- If **System Password** is not **Enabled** and is not locked through the **Password Status** option, you can assign a system password.
- You cannot disable or change an existing system password.

 **NOTE:** You can use the Password Status option in conjunction with the **Setup Password** option to protect the system password from unauthorized changes.

Entering The UEFI Boot Manager

 **NOTE:** Operating systems must be 64-bit UEFI-compatible (for example, Microsoft Windows Server 2008 x64 version) to be installed from the UEFI boot mode. DOS and 32-bit operating systems can only be installed from the BIOS boot mode.

The Boot Manager enables you to:

- Add, delete, and arrange boot options.
- Access System Setup and BIOS-level boot options without restarting.

To enter the Boot Manager:

1. Turn on or restart your system.
2. Press **<F11>** after you see the following message:

<F11> = UEFI Boot Manager

If your operating system begins to load before you press **<F11>**, allow the system to finish booting, and then restart your system and try again.

Using The Boot Manager Navigation Keys

Key	Description
Up arrow	Moves to the previous field.
Down arrow	Moves to the next field.
<Enter>	Allows you to type in a value in the selected field (if applicable) or follow the link in the field.
Spacebar	Expands or collapses a drop-down list, if applicable.
<Tab>	Moves to the next focus area.
	 NOTE: For the standard graphics browser only.
<Esc>	Moves to the previous page till you view the main screen. Pressing <Esc> in the main screen exits the Boot Manager and proceeds with system boot.
<F1>	Displays the System Setup help file.

 **NOTE:** For most of the options, any changes that you make are recorded but do not take effect until you restart the system.

Boot Manager Screen

Menu Item	Description
Continue Normal Boot	The system attempts to boot to devices starting with the first item in the boot order. If the boot attempt fails, the system continues with the next item in the boot order until the boot is successful or no more boot options are found.
BIOS Boot Menu	Displays the list of available BIOS boot options (marked with asterisks). Select the boot option you wish to use and press <Enter>.
UEFI Boot Menu	Displays the list of available UEFI boot options (marked with asterisks). Select the boot option you wish to use and press <Enter>. The UEFI Boot Menu enables you to Add Boot Option , Delete Boot Option , or Boot From File .
Driver Health Menu	Displays a list of the drivers installed on the system and their health status.
Launch System Setup	Enables you to access the System Setup.
System Utilities	Enables you to access the BIOS Update File Explorer, run the Dell Diagnostics program, and reboot the system.

UEFI Boot Menu

Menu Item	Description
Select UEFI Boot Option	Displays the list of available UEFI boot options (marked with asterisks), select the boot option you wish to use and press <Enter>.
Add Boot Option	Adds a new boot option.
Delete Boot Option	Deletes an existing boot option.
Boot From File	Sets a one-time boot option not included in the boot option list.

Embedded System Management

The Dell Lifecycle Controller provides advanced embedded systems management throughout the server's lifecycle. The Lifecycle Controller can be started during the boot sequence and can function independently of the operating system.

 **NOTE:** Certain platform configurations may not support the full set of features provided by the Lifecycle Controller.

For more information about setting up the Lifecycle Controller, configuring hardware and firmware, and deploying the operating system, see the Lifecycle Controller documentation at dell.com/esmanuals.

iDRAC Settings Utility

The iDRAC Settings utility is an interface to set up and configure the iDRAC parameters using UEFI. You can enable or disable various iDRAC parameters using the iDRAC Settings Utility.

 **NOTE:** Accessing some of the features on the iDRAC Settings Utility requires the iDRAC7 Enterprise License upgrade.

For more information on using iDRAC, see the *iDRAC7 User's Guide* at dell.com/esmmanuals.

Entering The iDRAC Settings Utility

1. Turn on or restart the managed system.
2. Press <F2> during Power-on Self-test (POST).
3. In the System Setup Main Menu page, click **iDRAC Settings**.
The iDRAC Settings screen is displayed.

Changing The Thermal Settings

The iDRAC Settings utility enables you to select and customize the thermal control settings for your system.

1. Enter the iDRAC Settings utility.
2. Under **iDRAC Settings** → **Thermal** → **User Option**, select between the following options:
 - Default
 - Maximum Exhaust Temperature
 - Fan Speed Offset

 **NOTE:** When the **User Option** is set to the default **Auto** setting, the user option cannot be modified.

3. Set the **Maximum Air Exhaust Temperature** or the **Fan Speed Offset** fields.
4. Click **Back** → **Finish** → **Yes**.

Installing System Components

Recommended Tools

You may need the following items to perform the procedures in this section:

- #2 Phillips screwdriver
- T10 and T15 Torx screwdrivers
- Wrist grounding strap connected to ground

Front Bezel (Optional)

Installing The Front Bezel

1. Align the thumb screws on the bezel with the rack ears on the front of the system.
2. Tighten the thumb screws to secure the bezel to the system chassis.

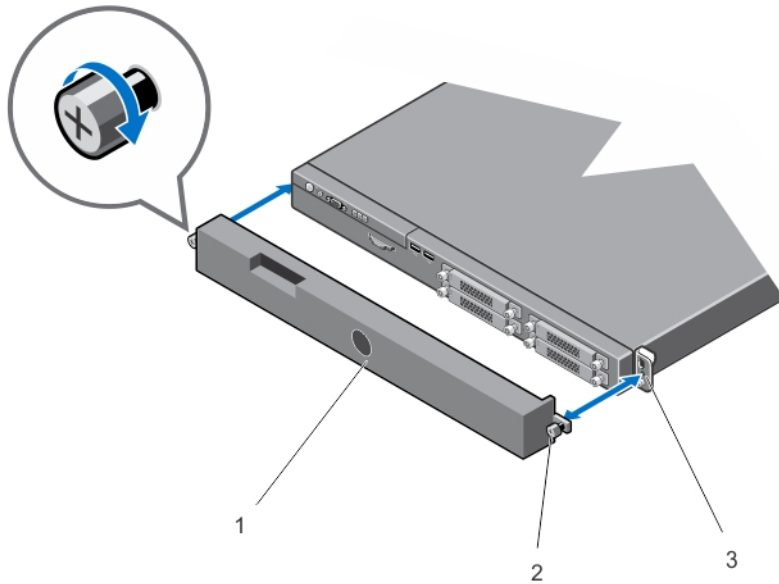

Figure 7. Installing and Removing the Front Bezel

- | | |
|------------------|---------------------|
| 1. front bezel | 2. thumb screws (2) |
| 3. rack ears (2) | |

Removing The Front Bezel

1. Loosen the thumb screws using a #2 Phillips screwdriver.
2. Unhook the bezel from the rack ears and pull the bezel away from the system.

Bezel Filter (Optional)

Removing the Bezel Filter

1. Remove the screw that secures the filter frame to the bezel.
2. Rotate one end of the filter frame away from the bezel and remove the filter frame.

3. Remove the filter.

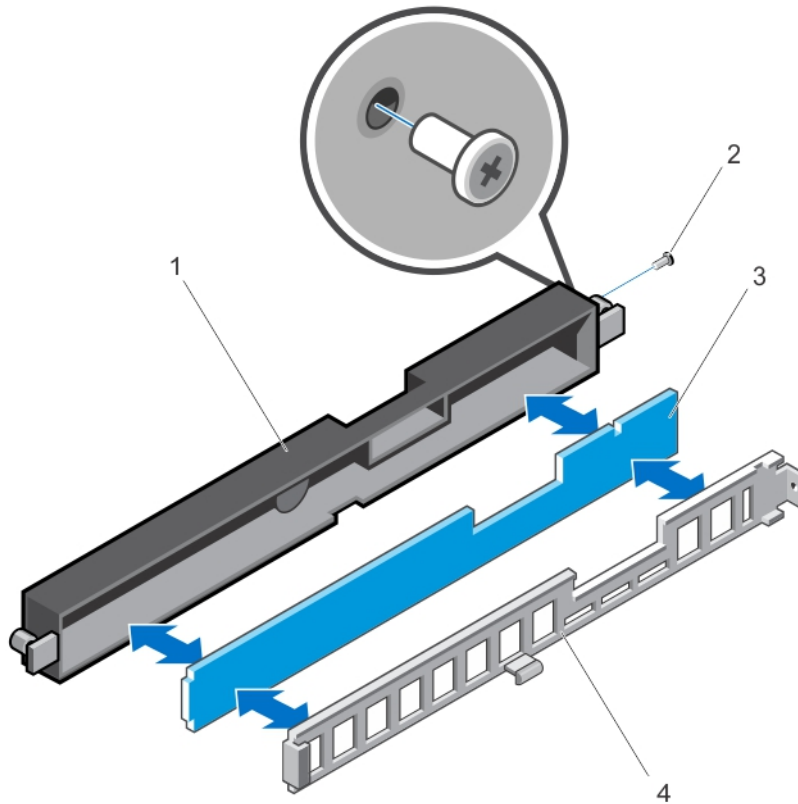



Figure 8. Removing and Installing the Bezel Filter

- | | |
|-----------|-----------------|
| 1. bezel | 2. screw |
| 3. filter | 4. filter frame |

 **NOTE:** It is recommended that you clean or replace the filter once every three months. To purchase additional replacement filters, contact Dell Technical Support.

Installing The Bezel Filter

1. Install the filter into the bezel.
2. Insert the filter frame into the bezel and align the screw hole on the filter frame with the corresponding hole on the bezel.
3. Secure the filter frame with the screw.

Opening And Closing The System

 **WARNING:** Whenever you need to lift the system, get others to assist you. To avoid injury, do not attempt to lift the system by yourself.

 **WARNING:** Opening or removing the system cover when the system is on may expose you to a risk of electric shock.

 **CAUTION:** Many repairs may only be done by a certified service technician. You should only perform troubleshooting and simple repairs as authorized in your product documentation, or as directed by the online or telephone service and support team. Damage due to servicing that is not authorized by Dell is not covered by your warranty. Read and follow the safety instructions that came with the product.

 **CAUTION:** Do not operate the system without the cover for a duration exceeding five minutes.

Opening The System

 **NOTE:** It is recommended that you always use a static mat and static strap while working on components in the interior of the system.

1. Turn off the system and attached peripherals, and disconnect the system from the electrical outlet.
2. Loosen the three captive screws on the top of the system cover.
3. Loosen the thumb screws that secure the back of the system cover to the chassis.
4. Hold the thumb screws and slide the system cover toward the back of the system.

5. Grasp the cover on both sides and lift the cover away from the system.

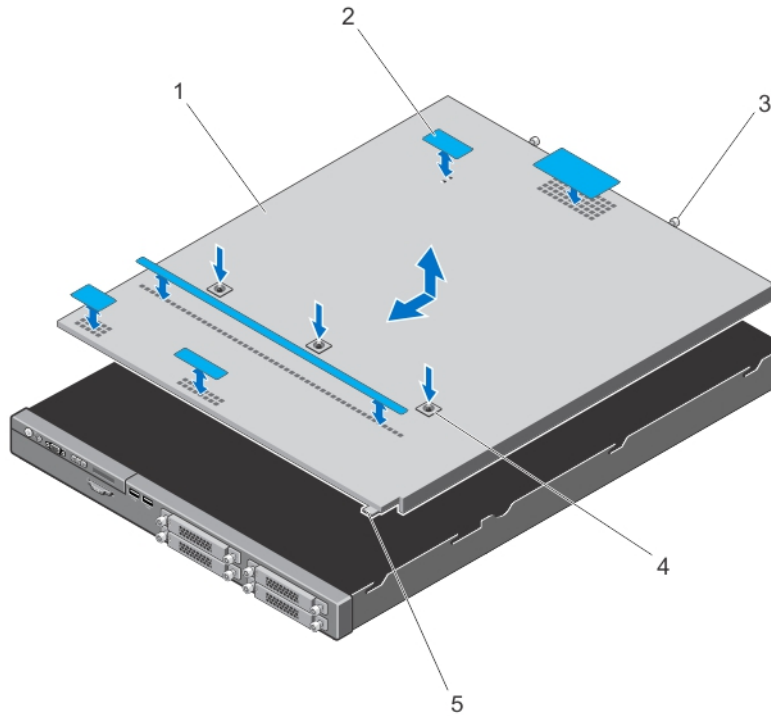



Figure 9. Opening and Closing the System

- | | |
|---------------------|-------------------------------|
| 1. system cover | 2. Mylar adhesive sheaths (5) |
| 3. thumb screws (2) | 4. captive screws (3) |
| 5. tab | |

Closing The System

1. Place the cover onto the chassis and offset the cover slightly back so that it clears the chassis hooks and lays flush on the chassis.
2. Tighten the thumb screws that secure the back of the system cover to the chassis.
3. Tighten the captive screws on the top of the system cover.
4. If applicable, affix the Mylar adhesive sheaths over the vents present on the top of the system cover.

 **NOTE:** The Mylar adhesive sheaths protect the system by preventing unfiltered air and other contaminants from entering the system. The Mylar adhesive sheaths are included with the bezel kit.

5. Reconnect the system to its electrical outlet and turn the system on, including any attached peripherals.

Inside The System

⚠ CAUTION: Many repairs may only be done by a certified service technician. You should only perform troubleshooting and simple repairs as authorized in your product documentation, or as directed by the online or telephone service and support team. Damage due to servicing that is not authorized by Dell is not covered by your warranty. Read and follow the safety instructions that came with the product.

🔧 NOTE: Components that are hot-swappable are marked orange and touch points on the components are marked blue.

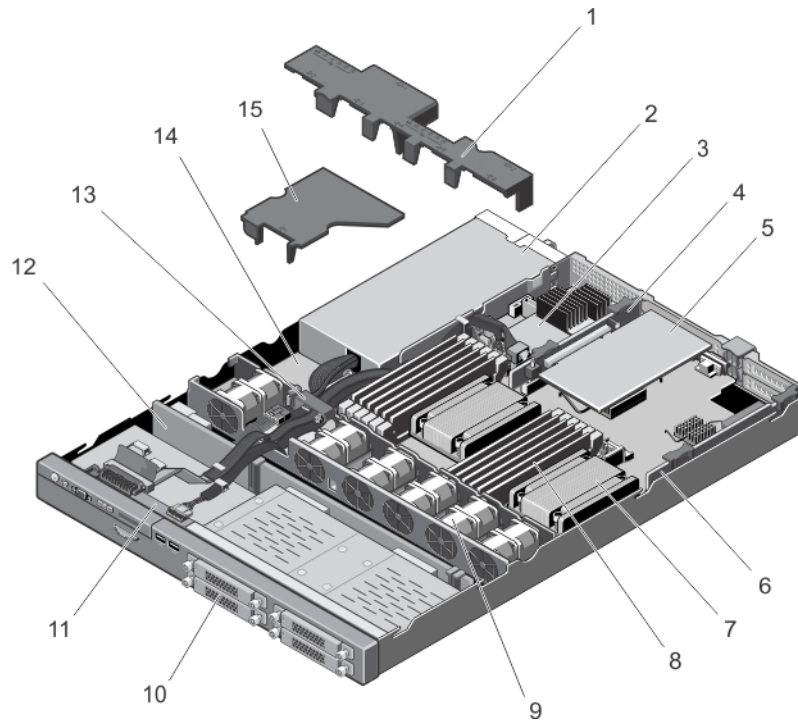



Figure 10. Inside the System

1. cooling shroud
2. power supply units (2)
3. storage controller card
4. expansion-card riser 2
5. expansion card
6. expansion-card riser 1
7. heat sink for processor 2
8. DIMMs (12)
9. cooling fans (6)
10. hard drives (4)
11. control panel
12. hard-drive backplane

13. cable routing latch
14. power distribution board
15. power distribution board shroud

Cooling Shroud

Removing The Cooling Shroud

 **CAUTION:** Many repairs may only be done by a certified service technician. You should only perform troubleshooting and simple repairs as authorized in your product documentation, or as directed by the online or telephone service and support team. Damage due to servicing that is not authorized by Dell is not covered by your warranty. Read and follow the safety instructions that came with the product.

 **CAUTION:** Never operate your system with the cooling shroud removed. The system may get overheated quickly, resulting in shutdown of the system and loss of data.

1. Turn off the system, including any attached peripherals, and disconnect the system from the electrical outlet and peripherals.
2. Open the system.

3. Lift the shroud away from the fan bracket.

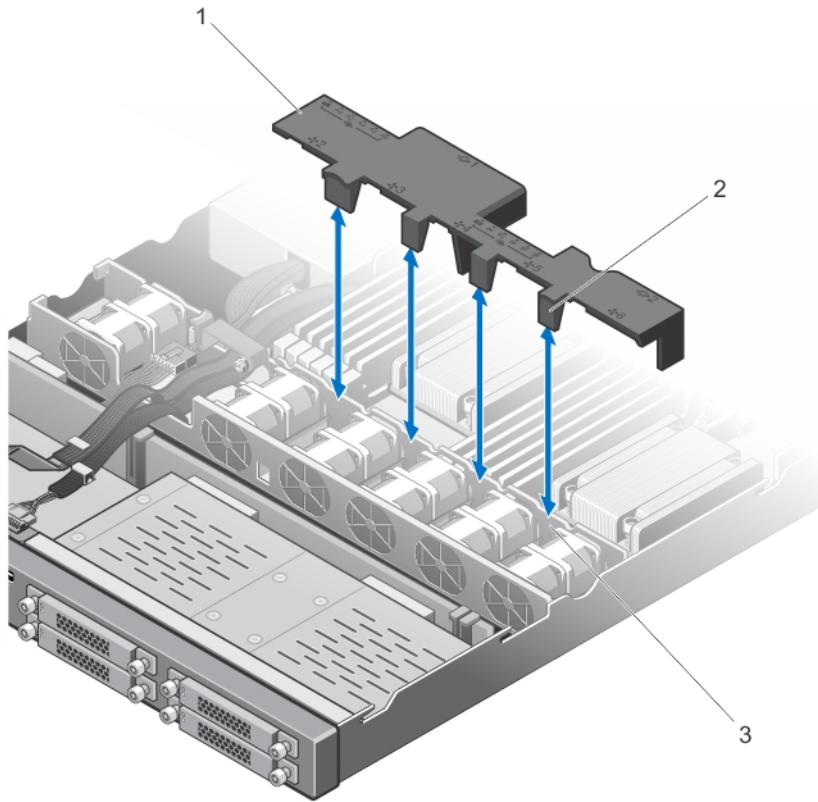

Figure 11. Removing and Installing the Cooling Shroud

- | | |
|------------------------|----------------------------|
| 1. cooling shroud | 2. cooling shroud tabs (4) |
| 3. cooling-fan bracket | |

Installing The Cooling Shroud

CAUTION: Many repairs may only be done by a certified service technician. You should only perform troubleshooting and simple repairs as authorized in your product documentation, or as directed by the online or telephone service and support team. Damage due to servicing that is not authorized by Dell is not covered by your warranty. Read and follow the safety instructions that came with the product.

NOTE: For proper seating of the cooling shroud in the chassis, ensure that the cables inside the system are routed through the cable routing latch.

1. Align the cooling shroud with the numbered fan bays as a guide.
2. Lower the cooling shroud into the chassis.
When firmly seated, the memory socket numbers marked on the cooling shroud align with the respective memory sockets. The four tabs on the cooling shroud rest on the cooling fan bracket.
3. Close the system.
4. Reconnect the system to its electrical outlet and turn the system on, including any attached peripherals.

System Memory

Your system supports DDR3 unbuffered ECC DIMMs (UDIMM ECC) and registered DIMMs (RDIMMs). It supports DDR3 and DDR3L voltage specifications.

 **NOTE:** MT/s indicates DIMM speed in MegaTransfers per second.

Memory bus operating frequency can be 1600 MT/s, 1333 MT/s, 1066 MT/s, or 800 MT/s depending on:

- DIMM type (UDIMM or RDIMM)
- DIMM configuration (number of ranks)
- maximum frequency of the DIMMs
- number of DIMMs populated per channel
- DIMM operating voltage
- system profile selected (for example, Performance Optimized, Custom, or Dense Configuration Optimized)
- maximum supported DIMM frequency of the processors

The following table shows the memory populations and operating frequencies for the supported configurations.

DIMM Type	DIMMs Populated/ Channel	Operating Frequency (in MT/s)		Maximum DIMM Rank/ Channel
		1.5 V	1.35 V	
UDIMM ECC	1	1333, 1066, and 800	1333, 1066 and 800	Dual rank
	2	1333, 1066, and 800	1066 and 800	Dual rank
RDIMM	1	1600, 1333, 1066, and 800	1333, 1066, and 800	Dual rank
		1333, 1066, and 800	1066 and 800	Quad rank
	2	1600, 1333, 1066, and 800	1333, 1066, and 800	Dual rank
		1066 and 800	1066 and 800	Quad rank

The system contains 12 memory sockets split into two sets of six sockets, one set per processor. Each six-socket set is organized into three channels. In each channel, the release levers of the first socket is marked white and the second black.

 **NOTE:** DIMMs in sockets A1 to A6 are assigned to processor 1 and DIMMs in sockets B1 to B6 are assigned to processor 2.

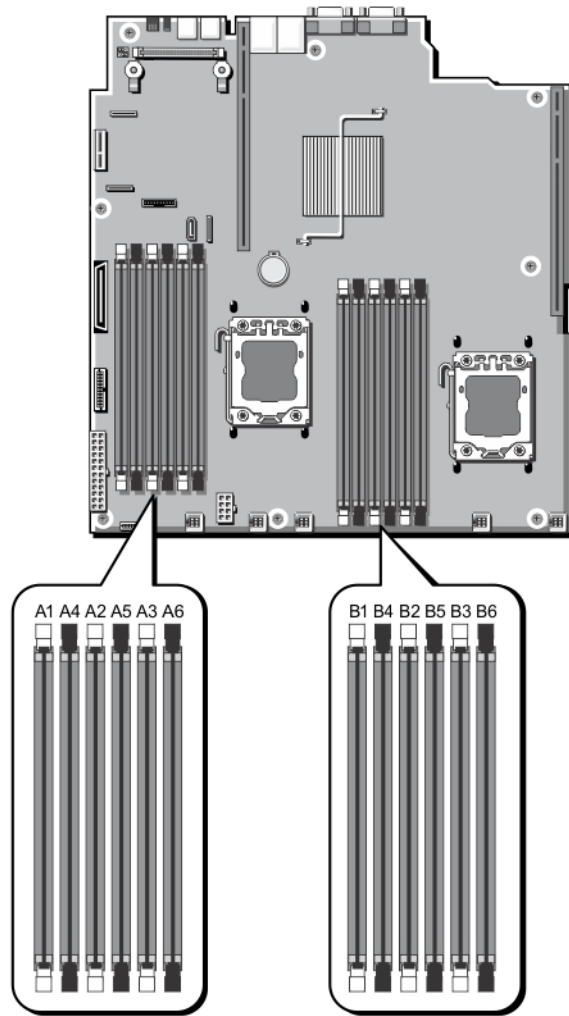

Figure 12. Memory Socket Locations

Memory channels are organized as follows:

- | | |
|--------------------|-------------------------------------|
| Processor 1 | channel 1: memory sockets A1 and A4 |
| | channel 2: memory sockets A2 and A5 |
| | channel 3: memory sockets A3 and A6 |
| Processor 2 | channel 1: memory sockets B1 and B4 |
| | channel 2: memory sockets B2 and B5 |
| | channel 3: memory sockets B3 and B6 |

General Memory Module Installation Guidelines

This system supports Flexible Memory Configuration, enabling the system to be configured and run in any valid chipset architectural configuration. The following are the recommended guidelines for best performance:

- UDIMMs and RDIMMs must not be mixed.
- x4 and x8 DRAM based DIMMs can be mixed. For more information, see Mode-Specific Guidelines.
- A maximum of two UDIMMs can be populated in a channel.
- A maximum of two single- or dual- or quad-rank RDIMMs can be populated in a channel.
- One quad-rank RDIMM and one single- or dual-rank RDIMM can be populated per channel.
- Populate DIMM sockets only if a processor is installed. For single-processor systems, sockets A1 to A6 are available. For dual-processor systems, sockets A1 to A6 and sockets B1 to B6 are available.
- Populate all sockets with white release tabs first and then black.
- Populate the sockets by highest rank count in the following order - first in sockets with white release levers and then black. For example, if you want to mix quad-rank and dual-rank DIMMs, populate quad-rank DIMMs in the sockets with white release tabs and dual-rank DIMMs in the sockets with black release tabs.
- In a dual-processor configuration, the memory configuration for each processor must be identical. For example, if you populate socket A1 for processor 1, then populate socket B1 for processor 2, and so on.
- Memory modules of different sizes can be mixed provided that other memory population rules are followed (for example, 2 GB and 4 GB memory modules can be mixed).
- Depending on mode-specific guidelines, populate two or three DIMMs per processor (one DIMM per channel) at a time to maximize performance. For more information, see Mode-Specific Guidelines.
- If memory modules with different speeds are installed, they will operate at the speed of the slowest installed memory module(s) or slower depending on system DIMM configuration.

Mode-Specific Guidelines

Three memory channels are allocated to each processor. The allowable configurations depend on the memory mode selected.

 **NOTE:** x4 and x8 DRAM based DIMMs can be mixed providing support for (Reliability, Availability, and Serviceability) RAS features. However, all guidelines for specific RAS features must be followed. x4 DRAM based DIMMs retain Single Device Data Correction (SDDC) in either memory optimized (independent channel) or Advanced ECC modes. x8 DRAM based DIMMs require Advanced ECC mode to gain SDDC.

The following sections provide additional slot population guidelines for each mode.

Advanced ECC (Lockstep)

Advanced ECC mode extends SDDC from x4 DRAM based DIMMs to both x4 and x8 DRAMs. This protects against single DRAM chip failures during normal operation.

Memory installation guidelines:

- Memory sockets A1, A4, B1, and B4 are disabled and do not supported Advanced ECC mode.
- DIMMs must be installed in matched pairs — DIMMs installed in memory sockets (A2, B2) must match DIMMs installed in memory sockets (A3, B3) and DIMMs installed in memory sockets (A5, B5) must match DIMMs installed in memory sockets (A6, B6).

 **NOTE:** Advanced ECC with mirroring is not supported.

Memory Optimized (Independent Channel) Mode

This mode supports SDDC only for memory modules that use x4 device width and does not impose any specific slot population requirements.

Memory Sparing

 **NOTE:** To use memory sparing, this feature must be enabled in the System Setup.

In this mode, one rank per channel is reserved as a spare. If persistent correctable errors are detected on a rank, the data from this rank is copied to the spare rank and the failed rank is disabled.

With memory sparing enabled, the system memory available to the operating system is reduced by one rank per channel. For example, in a system with three 8 GB dual-rank DIMMs, the available system memory is: $1/2$ (ranks/channel) \times 3 (DIMMs) \times 8 GB = 12 GB, and not 3 (DIMMs) \times 8 GB = 24 GB.

 **NOTE:** Memory sparing does not offer protection against a multi-bit uncorrectable error.

 **NOTE:** Both Advanced ECC/Lockstep and Optimizer modes support Memory Sparing.

Memory Mirroring

Memory Mirroring offers the strongest DIMM reliability mode compared to all other modes, providing improved uncorrectable multi-bit failure protection. In a mirrored configuration, the total available system memory is one half of the total installed physical memory. Half of the installed memory is used to mirror the active DIMMs. In the event of an uncorrectable error, the system will switch over to the mirrored copy. This ensures SDDC and multi-bit protection.

Memory installation guidelines:

 **NOTE:** The first memory channel for each processor (Channel 1) is disabled and not available for Memory Mirroring.

- Memory channels 2 and 3 must be populated.
- Memory modules must be identical in size, speed, and technology.
- DIMMs installed in memory sockets with white release tabs must be identical and similar rule applies for sockets with black release tabs. For example, DIMMs installed in sockets A2 and A3 must be identical.

Sample Memory Configurations

The following tables show sample memory configurations that follow the appropriate memory guidelines stated in this section.

 **NOTE:** 16 GB quad-rank RDIMMs are not supported.

 **NOTE:** 1R, 2R, and 4R in the following tables indicate single-, dual-, and quad-rank DIMMs respectively.

Table 1. Memory Configurations — Single Processor

System Capacity (in GB)	DIMM Size (in GB)	Number of DIMMs	Organization and Speed	DIMM Slot Population
2	2	1	1R x8, 1333 MT/s 1R x8, 1600 MT/s	A1
4	2	2	1R x8, 1333 MT/s 1R x8, 1600 MT/s	A1, A2
10	2	5	1R x8, 1333 MT/s 1R x8, 1600 MT/s	A1, A2, A3, A4, A5
12	4	3	1R x8, 1333 MT/s 1R x8, 1600 MT/s	A1, A2, A3
20	4	5	1R x8, 1333 MT/s 1R x8, 1600 MT/s	A1, A2, A3, A4, A5
24	8	3	2R x4, 1333 MT/s 2R x4, 1600 MT/s	A1, A2, A3
32	8	4	2R x4, 1333 MT/s 2R x4, 1600 MT/s	A1, A2, A3, A4
48	16	3	2R x4, 1333 MT/s 2R x4, 1600 MT/s	A1, A2, A3
96	16	6	2R x4, 1333 MT/s 2R x4, 1600 MT/s	A1, A2, A3, A4, A5, A6
128	32	4	4R x4, 1066 MT/s	A1, A2, A3, A4
192	32	6	4R x4, 1066 MT/s	A1, A2, A3, A4, A5, A6

Table 2. Memory Configurations — Two Processors

System Capacity (in GB)	DIMM Size (in GB)	Number of DIMMs	Organization and Speed	DIMM Slot Population
4	2	2	1R x8, 1333 MT/s 1R x8, 1600 MT/s	A1, B1
8	2	4	1R x8, 1333 MT/s	A1, A2, B1, B2

System Capacity (in GB)	DIMM Size (in GB)	Number of DIMMs	Organization and Speed	DIMM Slot Population
			1R x8, 1600 MT/s	
12	2	6	1R x8, 1333 MT/s	A1, A2, A3, B1, B2, B3
			1R x8, 1600 MT/s	
24	4	6	2R x8, 1333 MT/s	A1, A2, A3, B1, B2, B3
			2R x8, 1600 MT/s	
48	8	6	2R x4, 1333 MT/s	A1, A2, A3, B1, B2, B3
			2R x4, 1600 MT/s	
96	16	6	2R x4, 1333 MT/s	A1, A2, A3, B1, B2, B3
			2R x4, 1600 MT/s	
128	16	8	2R x4, 1333 MT/s	A1, A2, A3, A4, B1, B2, B3, B4
			2R x4, 1600 MT/s	
160	16	10	2R x4, 1333 MT/s	A1, A2, A3, A4, A5, B1, B2, B3, B4, B5
			2R x4, 1600 MT/s	
192	16	12	2R x4, 1333 MT/s	A1, A2, A3, A4, A5, A6, B1, B2, B3, B4, B5, B6
			2R x4, 1600 MT/s	
256	32	8	4R x4, 1066 MT/s	A1, A2, A3, A4, B1, B2, B3, B4
384	32	12	4R x4, 1066 MT/s	A1, A2, A3, A4, A5, A6, B1, B2, B3, B4, B5, B6

Removing Memory Modules

 **WARNING:** The memory modules are hot to the touch for some time after the system has been powered down. Allow time for the memory modules to cool before handling them. Handle the memory modules by the card edges and avoid touching the components or metallic contacts on the memory module.

 **CAUTION:** Many repairs may only be done by a certified service technician. You should only perform troubleshooting and simple repairs as authorized in your product documentation, or as directed by the online or telephone service and support team. Damage due to servicing that is not authorized by Dell is not covered by your warranty. Read and follow the safety instructions that came with the product.

△ CAUTION: To ensure proper system cooling, memory-module blanks must be installed in any memory socket that is not occupied. Remove memory-module blanks only if you intend to install memory modules in those sockets.

1. Turn off the system, including any attached peripherals, and disconnect the system from the electrical outlet and peripherals.
2. Open the system.
3. Remove the cooling shroud.
4. Locate the appropriate memory-module socket(s).
5. To release the memory-module blank from the socket, simultaneously press the ejectors on both ends of the memory module socket.

△ CAUTION: Handle each memory module only by the card edges, making sure not to touch the middle of the memory module or metallic contacts. To avoid damaging the memory module, handle only one memory module at a time.

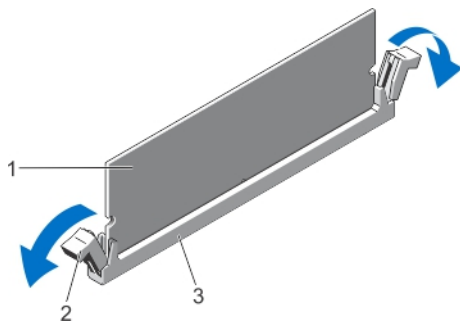



Figure 13. Ejecting The Memory Module

1. memory module
2. memory-module socket ejectors (2)
3. memory-module socket

6. If a memory module or a memory-module blank is installed in the socket, remove it.

 **NOTE:** Retain removed memory-module blank(s) for future use.

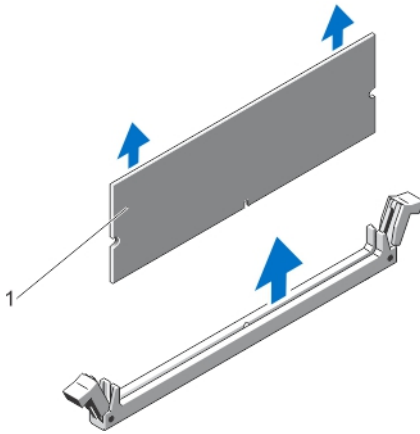





Figure 14. Removing The Memory Module

1. memory module/memory-module blank
7. Install the cooling shroud.
8. Close the system.
9. Reconnect the system to its electrical outlet and turn the system on, including any attached peripherals.

Installing Memory Modules



 **WARNING:** The memory modules are hot to the touch for some time after the system has been powered down. Allow time for the memory modules to cool before handling them. Handle the memory modules by the card edges and avoid touching the components or metallic contacts on the memory module.

 **CAUTION:** Many repairs may only be done by a certified service technician. You should only perform troubleshooting and simple repairs as authorized in your product documentation, or as directed by the online or telephone service and support team. Damage due to servicing that is not authorized by Dell is not covered by your warranty. Read and follow the safety instructions that came with the product.

 **CAUTION:** To ensure proper system cooling, memory-module blanks must be installed in any memory socket that is not occupied. Remove memory-module blanks only if you intend to install memory modules in those sockets.

1. Turn off the system, including any attached peripherals, and disconnect the system from the electrical outlet.
2. Open the system.
3. If applicable, remove the cooling shroud.
4. Locate the memory-module sockets.

 **CAUTION:** Handle each memory module only by the card edges, making sure not to touch the middle of the memory module or metallic contacts. To avoid damaging the memory module, handle only one memory module at a time.

5. If a memory module or a memory-module blank is installed in the socket, remove it.
 -  **NOTE:** Retain removed memory-module blank(s) for future use.
6. Align the memory-module's edge connector with the alignment key of the memory-module socket, and insert the memory module in the socket.
 -  **NOTE:** The memory-module socket has an alignment key that allows you to install the memory module in the socket in only one orientation.
 -  **CAUTION:** To prevent damage to the memory-module socket during installation, apply pressure at both ends of the memory module evenly. Do not apply pressure to the center of the memory module.
7. Press down on the memory module with your thumbs until the memory module snaps into place.

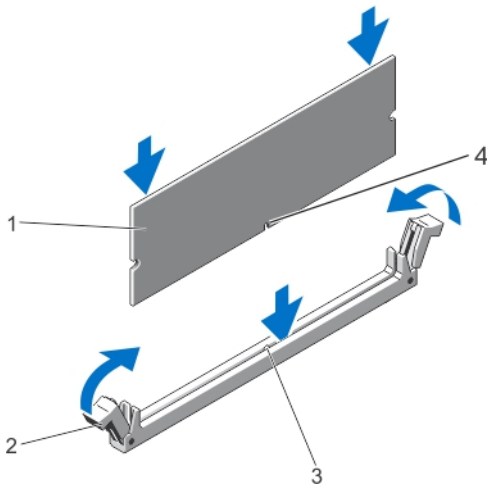



Figure 15. Installing The Memory Module

- | | |
|---------------------------------------|--------------------------------|
| 1. memory module | 2. memory-module ejectors |
| 3. memory-module socket alignment key | 4. memory-module alignment key |

 **NOTE:** When the memory module is properly seated in the socket, the levers on the memory-module socket align with the levers on the other identical sockets that have memory modules installed.

8. Repeat step 4 through step 7 of this procedure to install the remaining memory modules.
9. Replace the cooling shroud.
10. Close the system.
11. Reconnect the system to its electrical outlet and turn on the system, including any attached peripherals.
12. Press <F2> to enter the System Setup, and check the memory settings.
The system should have already changed the value to reflect the newly installed memory.
13. If the value is incorrect, one or more of the memory modules may not be installed properly. Repeat step 4 through step 7 of this procedure, checking to ensure that the memory modules are firmly seated in their sockets.
14. Run the appropriate diagnostic test. For more information, see Using System Diagnostics.

Hard Drives

Depending on the configuration, your system supports up to four 2.5 inch, hot-swappable SAS or SATA SSDs.

 **NOTE:** SSD/SAS/SATA hard drives cannot be mixed in a system.

The hot-swappable hard drives connect to the system board through the hard-drive backplane. Hot-swappable hard drives are supplied in hot-swappable hard-drive carriers that fit in the hard-drive slots.

 **CAUTION:** Before attempting to remove or install a hot-swappable hard drive while the system is running, see the documentation for the storage controller card to ensure that the host adapter is configured correctly to support hot-swap hard drive removal and insertion.

 **CAUTION:** Do not turn off or reboot your system while the hard drive is being formatted. Doing so can cause a hard drive failure.

 **NOTE:** Use only hard drives that have been tested and approved for use with the hard-drive backplane.

When you format a hard drive, allow enough time for the formatting to be completed. Be aware that high-capacity hard drives can take a number of hours to format.

Removing A Hot-Swap Hard Drive

 **CAUTION:** To prevent data loss, ensure that your operating system supports hot-swap drive installation. See the documentation supplied with your operating system.

1. From the management software, prepare the hard drive for removal. Wait until the indicators on the hard-drive carrier signal that the hard drive can be removed safely. For more information, see the documentation for the storage controller.
If the hard drive is online, the green activity/fault indicator flashes as the drive is turned off. When the hard-drive indicators are off, the hard drive is ready for removal.
2. Loosen the two thumb screws on the front of the hard-drive carrier.
3. Hold the thumb screws and slide the hard-drive carrier out until it is free of the hard-drive slot.

 **CAUTION:** To maintain proper system cooling, all unused hard-drive slots must have empty hard-drive carriers installed.

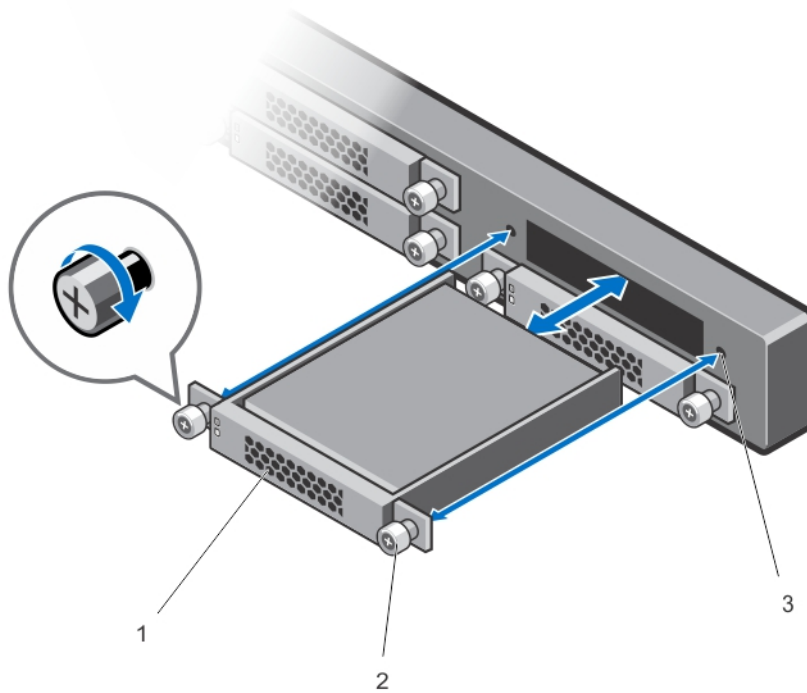

Figure 16. Removing and Installing a Hot-Swap Hard Drive

- | | |
|-----------------------|---------------------|
| 1. hard drive carrier | 2. thumb screws (2) |
| 3. screw holes (2) | |

Installing A Hot-Swap Hard Drive

- △ **CAUTION:** Many repairs may only be done by a certified service technician. You should only perform troubleshooting and simple repairs as authorized in your product documentation, or as directed by the online or telephone service and support team. Damage due to servicing that is not authorized by Dell is not covered by your warranty. Read and follow the safety instructions that came with the product.
- △ **CAUTION:** Use only hard drives that have been tested and approved for use with the hard-drive backplane.
- △ **CAUTION:** Combining SAS and SATA hard drives in the same RAID volume is not supported.
- △ **CAUTION:** To prevent data loss, ensure that your operating system supports hot-swap drive installation. See the documentation supplied with your operating system.
- △ **CAUTION:** When a replacement hot-swappable hard drive is installed and the system is powered on, the hard drive automatically begins to rebuild. Make absolutely sure that the replacement hard drive is blank or contains data that you wish to have over-written. Any data on the replacement hard drive is immediately lost after the hard drive is installed.

1. Install a hard drive in the hard-drive carrier.
2. Insert the hard-drive carrier into the hard-drive slot until the carrier connects with the backplane.

3. Tighten the thumb screws to lock the hard drive in place.

Removing A Hard Drive From A Hard-Drive Carrier

1. Remove the screws from the slide rails on the hard-drive carrier.
2. Slide the hard drive out of the hard-drive carrier.

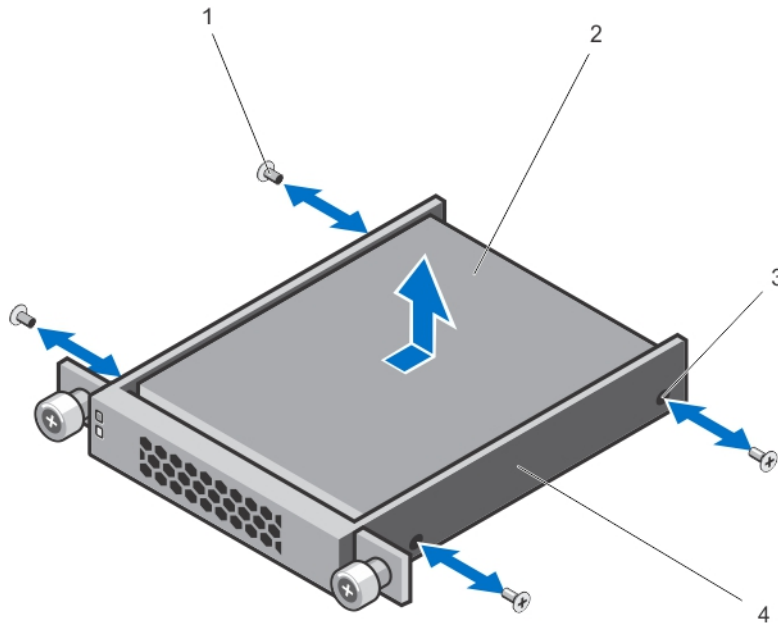



Figure 17. Removing and Installing a Hot-Swap Hard Drive Into a Hard-Drive Carrier

- | | |
|--------------------|-----------------------|
| 1. screws (4) | 2. hard drive |
| 3. screw holes (4) | 4. hard-drive carrier |

Installing A Hard Drive Into A Hard-Drive Carrier

CAUTION: Many repairs may only be done by a certified service technician. You should only perform troubleshooting and simple repairs as authorized in your product documentation, or as directed by the online or telephone service and support team. Damage due to servicing that is not authorized by Dell is not covered by your warranty. Read and follow the safety instructions that came with the product.

1. Insert the hard drive into the hard-drive carrier with the connector end of the hard drive toward the back.
2. Align the screw holes on the hard drive with the back set of holes on the hard-drive carrier.
When aligned correctly, the back of the hard drive will be flush with the back of the hard-drive carrier.
3. Install the screws to secure the hard drive to the hard-drive carrier.

 **NOTE:** When installing new hard drives into blank hard-drive carriers, use the spare hard-drive screws supplied with the system.

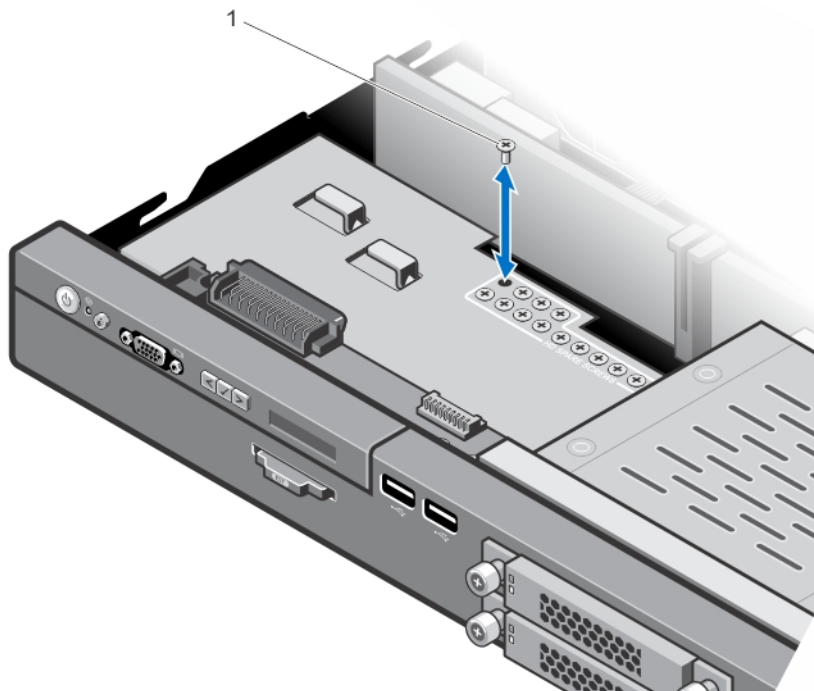



Figure 18. Location of the Spare Hard-Drive Screws

1. spare hard-drive screw (16)





Cooling Fans

Your system supports up to six cooling fans.

 **NOTE:** Hot-swap removal or installation of the fans is not supported.

 **NOTE:** In the event of a problem with a particular fan, the fan number is referenced by the system's management software, allowing you to easily identify and replace the proper fan by noting the fan numbers on the cooling fan assembly.

Removing A Cooling Fan

-  **WARNING:** Opening or removing the system cover when the system is on may expose you to a risk of electric shock. Exercise utmost care while removing or installing cooling fans.
 -  **CAUTION:** Many repairs may only be done by a certified service technician. You should only perform troubleshooting and simple repairs as authorized in your product documentation, or as directed by the online or telephone service and support team. Damage due to servicing that is not authorized by Dell is not covered by your warranty. Read and follow the safety instructions that came with the product.
 -  **CAUTION:** Do not operate the system with the cover removed for a duration exceeding five minutes.
 -  **NOTE:** The procedure for removing each fan is identical.
1. Turn off the system, including any attached peripherals, and disconnect the system from its electrical outlet.
 2. Open the system.
 3. Remove the cooling shroud or power distribution board shroud as applicable.
 4. Disconnect the fan's power cable from the power cable connector on the system board or power distribution board as applicable.
 5. Lift the fan out of the cooling-fan bracket.

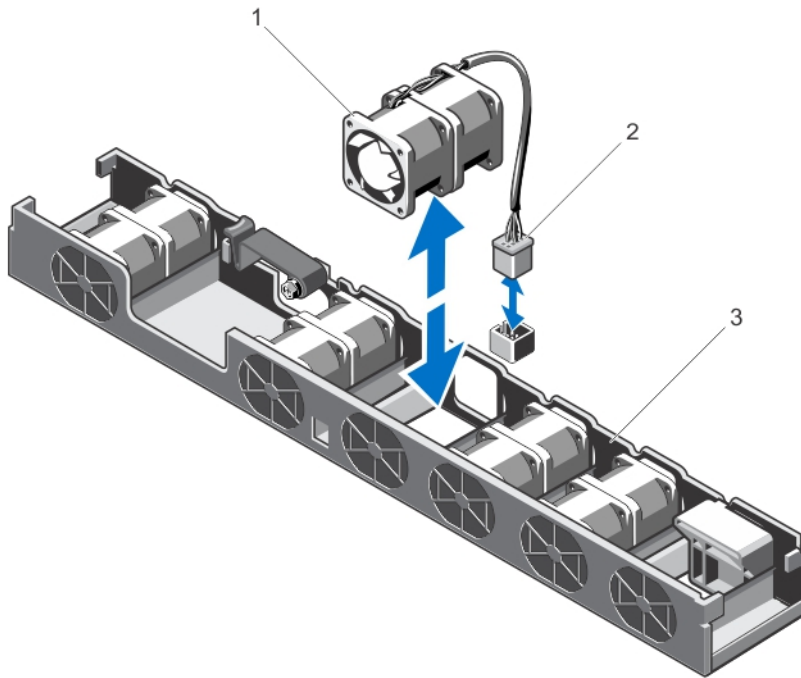



Figure 19. Removing and Installing a Cooling Fan

- | | |
|------------------------|--------------------------|
| 1. cooling fan | 2. power cable connector |
| 3. cooling-fan bracket | |

Installing A Cooling Fan

 **CAUTION:** Many repairs may only be done by a certified service technician. You should only perform troubleshooting and simple repairs as authorized in your product documentation, or as directed by the online or telephone service and support team. Damage due to servicing that is not authorized by Dell is not covered by your warranty. Read and follow the safety instructions that came with the product.

1. Turn off the system, including any attached peripherals, and disconnect the system from its electrical outlet.
2. Open the system.
3. Remove the cooling shroud or power distribution board shroud as applicable.
4. Facing the front of the system, lower the fan into the cooling-fan bracket.

 **NOTE:** When aligned correctly, the fan cable is on the left of the fan.

5. Connect the fan's power cable to the power cable connector on the system board or power distribution board as applicable.
6. Replace the cooling shroud or power distribution board shroud as applicable.
7. Close the system.
8. Reconnect the system to its electrical outlet and turn the system on, including any attached peripherals.

Internal USB Memory Key (Optional)

An optional USB memory key installed inside your system can be used as a boot device, security key, or mass storage device. The USB connector must be enabled by the **Internal USB Port** option in the **Integrated Devices** screen of the System Setup.

To boot from the USB memory key, configure the USB memory key with a boot image and then specify the USB memory key in the boot sequence in the System Setup.

 **NOTE:** The internal USB connector (INT_USB) is located on expansion-card riser 2.

Replacing The Internal USB Key

 **CAUTION:** Many repairs may only be done by a certified service technician. You should only perform troubleshooting and simple repairs as authorized in your product documentation, or as directed by the online or telephone service and support team. Damage due to servicing that is not authorized by Dell is not covered by your warranty. Read and follow the safety instructions that came with the product.

1. Turn off the system, including any attached peripherals, and disconnect the system from the electrical outlet and peripherals.
2. Open the system.
3. Locate the USB connector (INT_USB) on the expansion-card riser 2.
4. If installed, remove the USB key.
5. Insert the USB key into the USB connector.
6. Close the system.
7. Reconnect the system to its electrical outlet and turn the system on, including any attached peripherals.

8. Enter the System Setup and verify that the USB key is detected by the system.

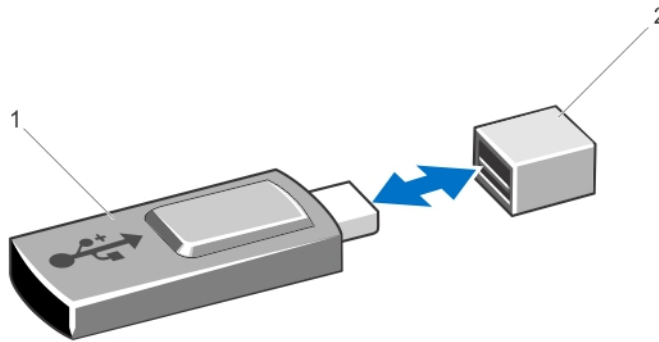

Figure 20. Replacing the Internal USB Key

1. USB memory key
2. USB memory key connector

Expansion Cards And Expansion-Card Risers

NOTE: A missing or an unsupported expansion-card riser logs an SEL event. It does not prevent your system from powering on and no BIOS POST message or F1/F2 pause is displayed.

Expansion Card Installation Guidelines

Your system supports PCI Express Generation 2 and Generation 3 expansion cards.

NOTE: If you install a second processor, you must upgrade expansion card riser 1 to optimize PCIe slot 1 speed.

The following table provides the riser configurations for single- and dual-processor systems:

Table 3. Riser Configuration for Single- and Dual-Processor Systems

Number of Processors	Expansion Card Connector	
	Riser 1	Riser 2
One	PCIE_G2_X4	PCIE_G3_X16
	iDRAC_Enterprise	
Two	PCIE_G3_X16	PCIE_G3_X16
	iDRAC_Enterprise	

NOTE: The expansion-card risers listed in the above table cannot be interchanged between single- and dual- processor systems.

The following table provides a guide for installing expansion cards to ensure proper cooling and mechanical fit. The expansion cards with the highest priority must be installed first using the slot priority indicated. All other expansion cards must be installed in card priority and slot priority order.

Table 4. Expansion-Card Installation Priority

Card Priority	Card Type	Height	Slot Priority	Max Allowed Per Slot
1	RAID	Full Height Low Profile	2	1
2	Converged Network Adapters (CNAs)	Full Height Low Profile	2 or 1	1
3	10 Gb NICs	Full Height Low Profile	2 or 1	1
4	FC8 HBA	Full Height Low Profile	2 or 1	1
5	FC4 HBA	Full Height Low Profile	2 or 1	1
6	1 Gb NICs	Full Height Low Profile	2 or 1	1
7	Non-RAID	Full Height Low Profile	2 or 1	1

Removing An Expansion Card

 **CAUTION:** Many repairs may only be done by a certified service technician. You should only perform troubleshooting and simple repairs as authorized in your product documentation, or as directed by the online or telephone service and support team. Damage due to servicing that is not authorized by Dell is not covered by your warranty. Read and follow the safety instructions that came with the product.

 **CAUTION:** To prevent damage to the card, you must hold the card by its edges only.

1. Turn off the system, including any attached peripherals, and disconnect the system from the electrical outlet and peripherals.
2. Open the system.
3. Disconnect any cables connected to the expansion card or expansion-card riser.
4. Lift the expansion-card latch.
5. To remove an expansion card from riser 2, pull the blue latch on the expansion-card holder.
6. Hold the expansion card by its edges and remove it from the expansion-card connector on the riser.

7. If you are removing the card permanently, install a metal filler bracket over the empty expansion slot opening and close the expansion-card latch.



NOTE: You must install a filler bracket over an empty expansion slot to maintain Federal Communications Commission (FCC) certification of the system. The brackets also keep dust and dirt out of the system and aid in proper cooling and airflow inside the system.

8. Close the system.

9. Reconnect the system to its electrical outlet and turn the system on, including any attached peripherals.

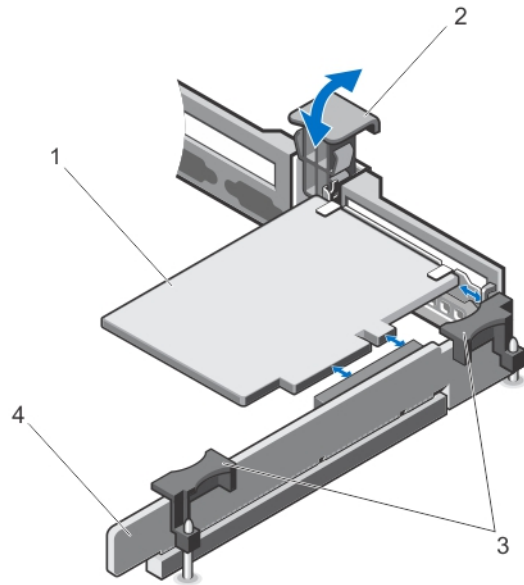

Figure 21. Removing and Installing the Expansion Card from Expansion-Card Riser 1

- | | |
|---------------------------|---------------------------|
| 1. expansion card | 2. expansion-card latch |
| 3. riser touch points (2) | 4. expansion-card riser 1 |

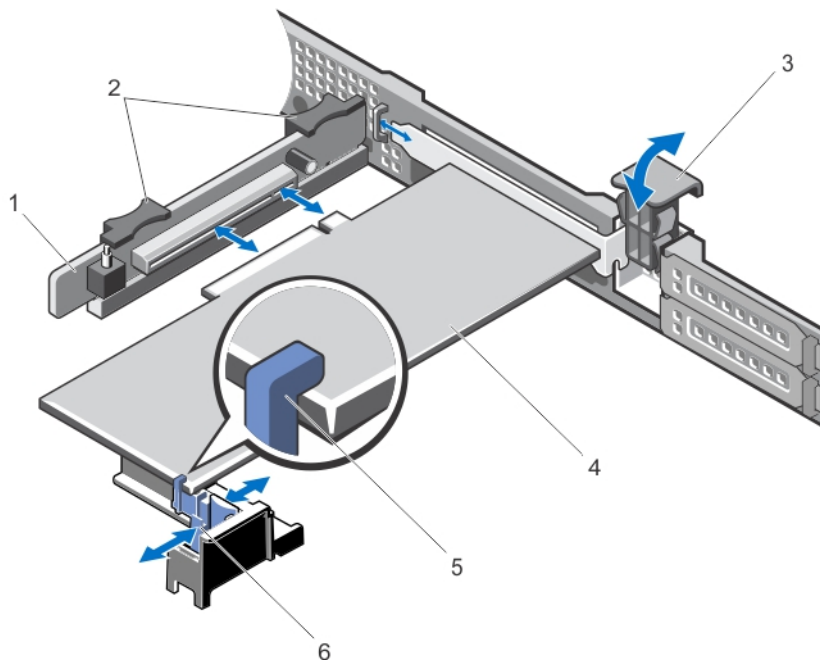



Figure 22. Removing and Installing the Expansion Card from Expansion-Card Riser 2



- | | |
|---------------------------|--|
| 1. expansion-card riser 2 | 2. expansion-card riser touch points (2) |
|---------------------------|--|

3. expansion-card latch
4. expansion card
5. expansion-card holder
6. tab

Installing An Expansion Card

 **CAUTION:** Many repairs may only be done by a certified service technician. You should only perform troubleshooting and simple repairs as authorized in your product documentation, or as directed by the online or telephone service and support team. Damage due to servicing that is not authorized by Dell is not covered by your warranty. Read and follow the safety instructions that came with the product.

 **CAUTION:** To prevent damage to the card, you must hold the card by its edges only.

1. Unpack the expansion card and prepare it for installation.
For instructions, see the documentation accompanying the card.
2. Turn off the system, including any attached peripherals, and disconnect the system from the electrical outlet and peripherals.
3. Open the system.
4. Locate the expansion-card connector on the riser.
5. Open the expansion-card latch and remove the filler bracket.
6. Holding the card by its edges, position the card so that the card-edge connector aligns with the expansion-card connector.
7. Insert the card-edge connector into the expansion-card connector until the card is fully seated.
 -  **NOTE:** Ensure that the expansion card is properly seated along the chassis, so that expansion-card latch can be closed.
8. Press the release latch on the expansion-card holder and move the expansion card holder so that it supports the expansion card on expansion-card riser 2.
 -  **NOTE:** Ensure that the expansion card bracket is attached properly to the chassis, so that expansion-card latch can be inserted back to chassis.
9. If applicable, connect cables to the expansion card.
10. Close the system.
11. Reconnect the system to its electrical outlet and turn the system on, including any attached peripherals.
12. Install any device drivers required for the card as described in the documentation for the card.

Removing Expansion-Card Risers 1 And 2

 **CAUTION:** Many repairs may only be done by a certified service technician. You should only perform troubleshooting and simple repairs as authorized in your product documentation, or as directed by the online or telephone service and support team. Damage due to servicing that is not authorized by Dell is not covered by your warranty. Read and follow the safety instructions that came with the product.

1. Turn off the system, including any attached peripherals, and disconnect the system from the electrical outlet and peripherals.
2. Open the system.
3. If installed, remove the expansion-card.

4. Holding the touch points, lift the expansion-card riser from the riser connector on the system board.

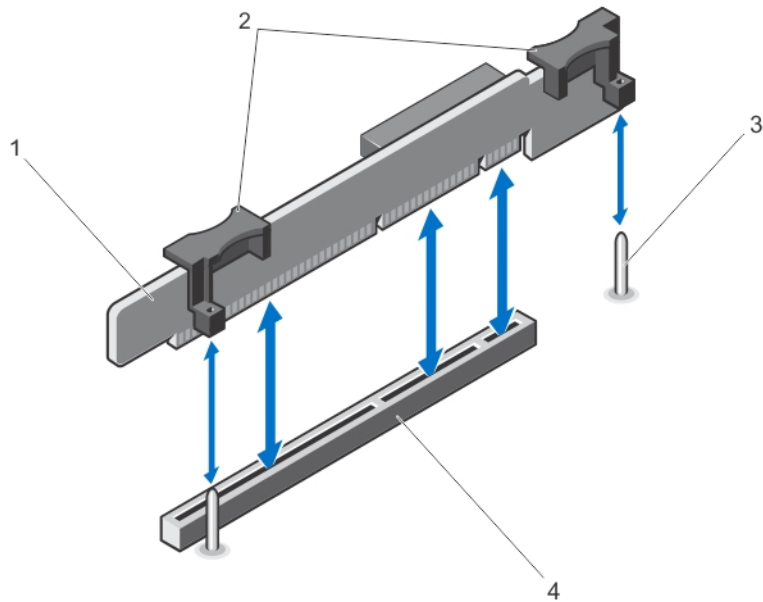

Figure 23. Removing and Installing the Expansion-Card Riser 1

- | | |
|---------------------------|--|
| 1. expansion-card riser 1 | 2. expansion-card riser touch points (2) |
| 3. riser guides (2) | 4. connector |

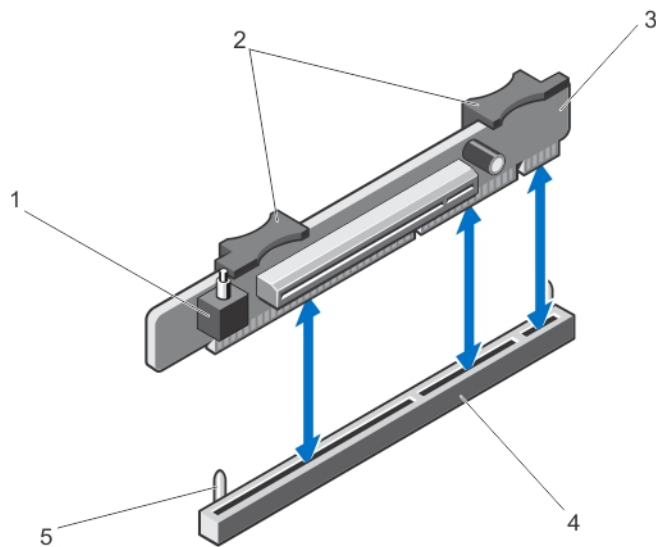



Figure 24. Removing and Installing the Expansion-Card Riser 2

- | | |
|-----------------------------|--------------------------------------|
| 1. chassis intrusion switch | 2. expansion-card riser touch points |
| 3. expansion-card riser 2 | 4. expansion-card riser 2 connector |

5. riser guides (2)

5. Replace the expansion-card riser.
6. Close the system.
7. Reconnect the system to its electrical outlet and turn the system on, including any attached peripherals.

Installing Expansion-Card Risers 1 And 2

 **CAUTION: Many repairs may only be done by a certified service technician. You should only perform troubleshooting and simple repairs as authorized in your product documentation, or as directed by the online or telephone service and support team. Damage due to servicing that is not authorized by Dell is not covered by your warranty. Read and follow the safety instructions that came with the product.**

1. If applicable, reinstall the expansion card(s) into the expansion-card riser.
2. Align the expansion-card riser with the connector and the riser guides on the system board.
3. Lower the expansion-card riser into place until the expansion-card riser connector is fully seated in the connector.
4. Close the system.
5. Reconnect the system to its electrical outlet and turn the system on, including any attached peripherals.
6. Install any device drivers required for the card as described in the documentation for the card.

iDRAC Enterprise Card (Optional)

The iDRAC Enterprise card supports:

- one 1GbE Ethernet port
- SD vFlash card

Removing The iDRAC Enterprise Card

 **CAUTION: Many repairs may only be done by a certified service technician. You should only perform troubleshooting and simple repairs as authorized in your product documentation, or as directed by the online or telephone service and support team. Damage due to servicing that is not authorized by Dell is not covered by your warranty. Read and follow the safety instructions that came with the product.**

1. Turn off the system, including any attached peripherals, and disconnect the system from the electrical outlet and peripherals.
2. Open the system.
3. Disconnect any cables connected to the iDRAC Enterprise card.
4. Lift the expansion-card latch.
5. If installed, remove the expansion card from expansion-card riser 1.
6. Supporting the expansion-card riser by the touch points, hold the iDRAC Enterprise card by its edges and remove it from the iDRAC Enterprise card connector on the riser.

7. If you are removing the card permanently, install a metal filler bracket over the empty expansion slot opening and close the expansion-card latch.

NOTE: You must install a filler bracket over an empty expansion slot to maintain Federal Communications Commission (FCC) certification of the system. The brackets also keep dust and dirt out of the system and aid in proper cooling and airflow inside the system.

8. Close the system.
9. Reconnect the system to its electrical outlet and turn the system on, including any attached peripherals.

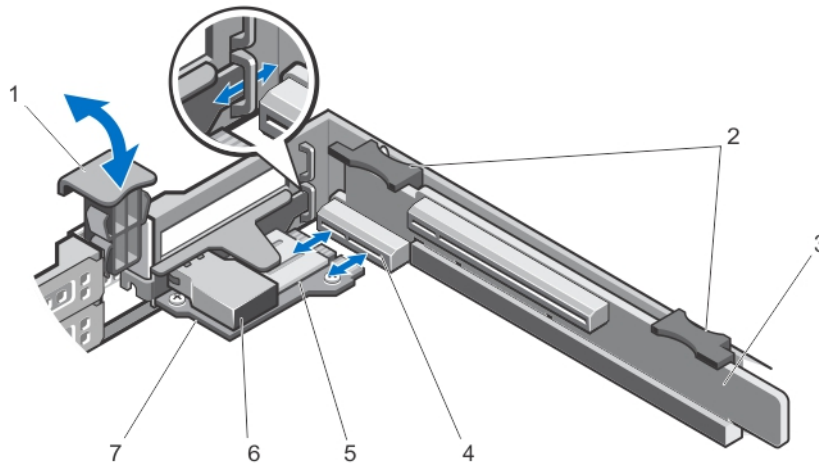

Figure 25. Removing and Installing the iDRAC Enterprise Card

- | | |
|---------------------------|--|
| 1. expansion-card latch | 2. expansion-card riser touch points (2) |
| 3. expansion-card riser 1 | 4. iDRAC Enterprise card connector |
| 5. SD card slot | 6. RJ-45 Ethernet port |
| 7. iDRAC Enterprise card | |

Installing The iDRAC Enterprise Card

CAUTION: Many repairs may only be done by a certified service technician. You should only perform troubleshooting and simple repairs as authorized in your product documentation, or as directed by the online or telephone service and support team. Damage due to servicing that is not authorized by Dell is not covered by your warranty. Read and follow the safety instructions that came with the product.

1. Unpack the iDRAC Enterprise card and prepare it for installation.
For instructions, see the documentation accompanying the card.
2. Turn off the system, including any attached peripherals, and disconnect the system from the electrical outlet and peripherals.
3. Open the system.
4. Locate the iDRAC Enterprise card connector on expansion-card riser 1.
5. Open the expansion-card latch and remove the filler bracket.
6. Holding the card by its edges, position the card so that the card-edge connector aligns with the iDRAC Enterprise card connector.

7. Align the iDRAC Enterprise card bracket with the hooks on the chassis.
8. Insert the card-edge connector firmly into the iDRAC Enterprise card connector until the card is fully seated.
9. Slide the expansion-card latch into position.
10. If applicable, connect cables to the iDRAC Enterprise card.
11. Close the system.
12. Reconnect the system to its electrical outlet and turn the system on, including any attached peripherals.
13. Install any device drivers required for the card as described in the documentation for the card.

SD vFlash Card

A vFlash SD card is a Secure Digital (SD) card that plugs into the vFlash SD card slot in the system. It provides persistent on-demand local storage and a custom deployment environment that allows automation of server configuration, scripts, and imaging. It emulates USB device(s). For more information, see the *iDRAC7 User's Guide* under **Remote Access Controller**, at dell.com/esmmanuals.

Replacing An SD vFlash Card

1. Locate the vFlash media slot on the system.
2. To remove the SD vFlash card, push inward on the card to release it, and pull the card from the card slot.

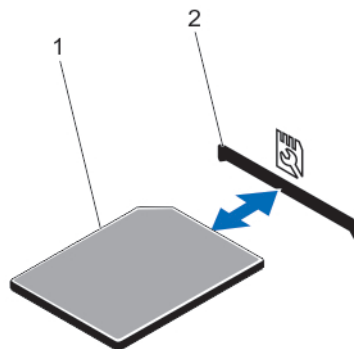





Figure 26. Removing and Installing the SD vFlash Card

1. SD vFlash card
2. SD vFlash card slot
3. To install the SD vFlash card, with the label side facing up, insert the contact-pin end of the SD card into the card slot on the module.
 -  **NOTE:** The slot is keyed to ensure correct insertion of the card.
4. Press inward on the card to lock it into the slot.

Internal Dual SD Module

-  **NOTE:** When the **Redundancy** option is set to **Mirror Mode** in the **Integrated Devices** screen of the System Setup, the information is replicated from one SD card to another.

Removing The Internal Dual SD Module

 **CAUTION:** Many repairs may only be done by a certified service technician. You should only perform troubleshooting and simple repairs as authorized in your product documentation, or as directed by the online or telephone service and support team. Damage due to servicing that is not authorized by Dell is not covered by your warranty. Read and follow the safety instructions that came with the product.

1. Turn off the system, including any attached peripherals, and disconnect the system from the electrical outlet and peripherals.
2. Open the system.
3. Locate the internal dual SD module installed on the IDSDM connector on the system board.
4. If applicable, remove the SD card(s).
5. Holding the tab, pull the dual SD module to remove it from the system board.
6. Close the system.

7. Reconnect the system to its electrical outlet and turn the system on, including any attached peripherals.

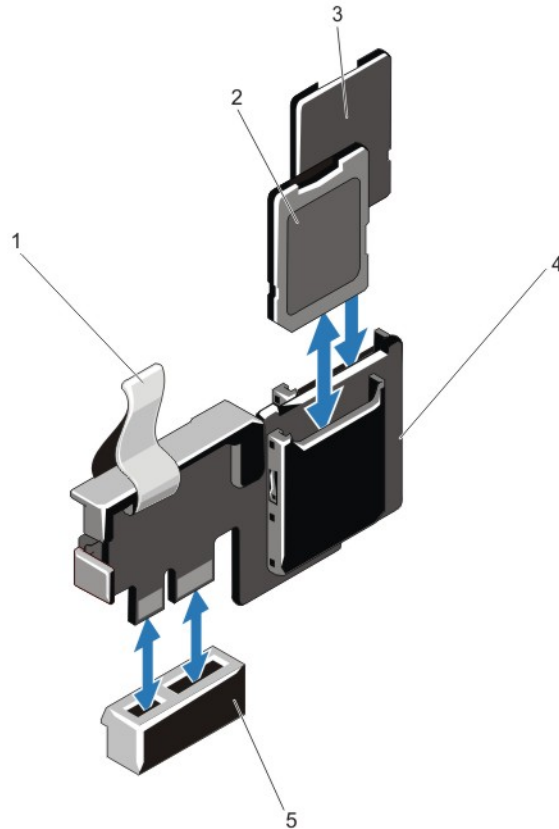

Figure 27. Removing and Installing the Internal Dual SD Module

- | | |
|----------------------------------|-------------------|
| 1. blue pull tab | 2. SD card 1 |
| 3. SD card 2 | 4. dual SD module |
| 5. connector on the system board | |

Installing The Internal Dual SD Module

⚠ CAUTION: Many repairs may only be done by a certified service technician. You should only perform troubleshooting and simple repairs as authorized in your product documentation, or as directed by the online or telephone service and support team. Damage due to servicing that is not authorized by Dell is not covered by your warranty. Read and follow the safety instructions that came with the product.

1. Turn off the system, including any attached peripherals, and disconnect the system from the electrical outlet and peripherals.
2. Open the system.
3. Locate the IDSDM connector on the system board.
4. Align the connectors on the system board and the dual SD module.
5. Push the dual SD module until it is firmly seated on the system board.
6. Close the system.

7. Reconnect the system to its electrical outlet and turn the system on, including any attached peripherals.

Internal SD Card

Removing An Internal SD Card

 **CAUTION:** Many repairs may only be done by a certified service technician. You should only perform troubleshooting and simple repairs as authorized in your product documentation, or as directed by the online or telephone service and support team. Damage due to servicing that is not authorized by Dell is not covered by your warranty. Read and follow the safety instructions that came with the product.

1. Turn off the system, including any attached peripherals, and disconnect the system from the electrical outlet and peripherals.
2. Open the system.
3. Locate the SD card slot on the internal dual SD module and press inward on the card to release it from the slot and remove the card.
4. Close the system.
5. Reconnect the system to its electrical outlet and turn the system on, including any attached peripherals.

Installing An Internal SD Card

 **CAUTION:** Many repairs may only be done by a certified service technician. You should only perform troubleshooting and simple repairs as authorized in your product documentation, or as directed by the online or telephone service and support team. Damage due to servicing that is not authorized by Dell is not covered by your warranty. Read and follow the safety instructions that came with the product.

 **NOTE:** To use an SD card with your system, ensure that the internal SD card port is enabled in the System Setup.

1. Turn off the system, including any attached peripherals, and disconnect the system from the electrical outlet and peripherals.
2. Open the system.
3. Locate the SD card connector on the internal dual SD module. With the label side facing up, insert the contact-pin end of the card into the slot.

 **NOTE:** The slot is keyed to ensure correct insertion of the card.

4. Press the card into the card slot to lock it into place.
5. Close the system.
6. Reconnect the system to its electrical outlet and turn the system on, including any attached peripherals.

Integrated Storage Controller Card

Your system includes a dedicated expansion-card slot on the system board for an integrated controller card that provides the integrated storage subsystem for your system's internal hard drives. The controller supports SAS and SATA hard drives and also enables you to set up the hard drives in RAID configurations as supported by the version of the storage controller included with your system.

Removing The Integrated Storage Controller Card

 **CAUTION:** Many repairs may only be done by a certified service technician. You should only perform troubleshooting and simple repairs as authorized in your product documentation, or as directed by the online or telephone service and support team. Damage due to servicing that is not authorized by Dell is not covered by your warranty. Read and follow the safety instructions that came with the product.

 **CAUTION:** To prevent damage to the card, you must hold the card by its edges only.

1. Turn off the system, including any attached peripherals, and disconnect the system from the electrical outlet and peripherals.
2. Open the system.

 **NOTE:** It is recommended that you remove the expansion-card riser 2, before removing the storage controller card.

3. Push down the two release levers at the edge of the card to disengage the card from the connector.
4. Disengage the card from the storage-controller card holder on the system board.
5. Remove the card.
6. Close the system.

7. Reconnect the system to its electrical outlet and turn the system on, including any attached peripherals.

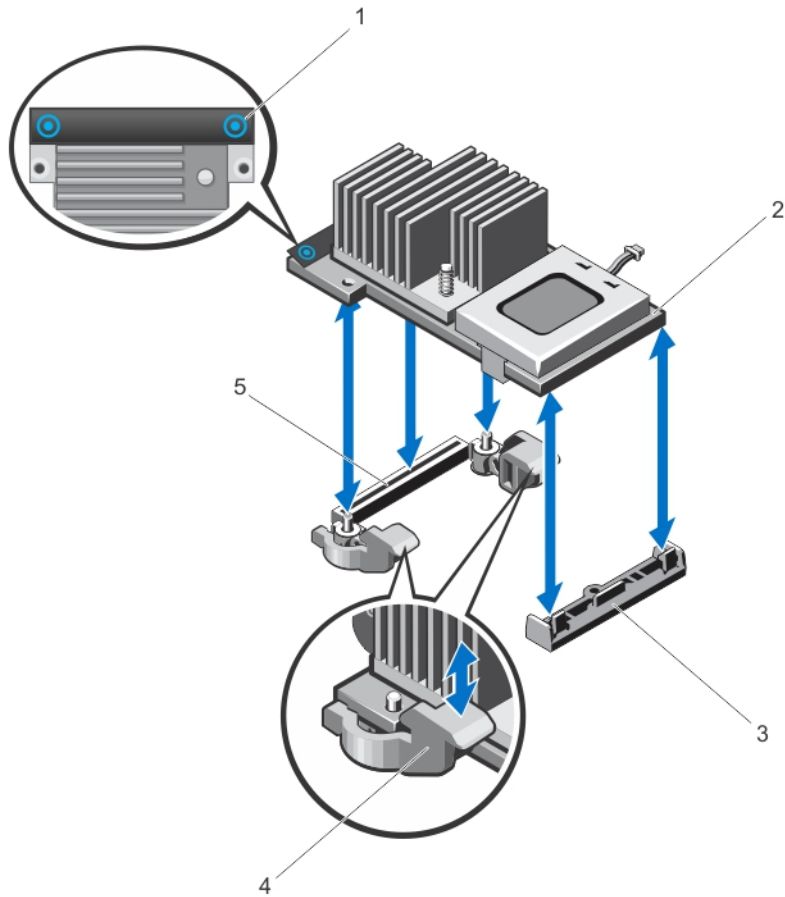

Figure 28. Removing and Installing the Integrated Storage Controller Card

- | | |
|--------------------------------------|----------------------------|
| 1. touch-points (2) | 2. storage controller card |
| 3. storage-controller card holder | 4. release levers (2) |
| 5. storage-controller card connector | |

Installing The Integrated Storage Controller Card

⚠ CAUTION: Many repairs may only be done by a certified service technician. You should only perform troubleshooting and simple repairs as authorized in your product documentation, or as directed by the online or telephone service and support team. Damage due to servicing that is not authorized by Dell is not covered by your warranty. Read and follow the safety instructions that came with the product.

⚠ CAUTION: To prevent damage to the card, you must hold the card by its edges only.

1. Turn off the system, including any attached peripherals, and disconnect the system from the electrical outlet.
2. Open the system.

3. Align one end of the card with the storage-controller card holder on the system board.
4. Lower the other end of the card into the storage-controller card connector on the system board.
5. Press the touch-points on the card and push the card down until it is fully seated.
When the card is fully seated, the release levers snap over the edge of the card.
6. Close the system.
7. Reconnect the system to its electrical outlet and turn the system on, including any attached peripherals.

Processors

Use the following procedure when:

- Installing an additional processor
- Replacing a processor

 **NOTE:** To ensure proper system cooling, you must install a processor blank and a heat-sink blank in any empty processor socket.

Removing A Processor

 **CAUTION:** Many repairs may only be done by a certified service technician. You should only perform troubleshooting and simple repairs as authorized in your product documentation, or as directed by the online or telephone service and support team. Damage due to servicing that is not authorized by Dell is not covered by your warranty. Read and follow the safety instructions that came with the product.

1. Before upgrading your system, download the latest system BIOS version from dell.com/support and follow the instructions included in the compressed download file to install the update on your system.

 **NOTE:** You can update the system BIOS using the Lifecycle Controller.

2. Turn off the system, including any attached peripherals, and disconnect the system from the electrical outlet. When disconnected from AC power, press and hold the power button for three seconds to fully drain the system of stored power prior to removing the cover.
3. Open the system.
4. Remove the cooling shroud.

 **WARNING:** The heat sink and processor are hot to the touch for some time after the system has been powered down. Allow the heat sink and processor to cool before handling them.

 **CAUTION:** Never remove the heat sink from a processor unless you intend to remove the processor. The heat sink is necessary to maintain proper thermal conditions.

5. Loosen the first screw that secures the heat sink to the system board.
6. Wait 30 seconds for the heat sink to loosen from the processor and remove the screw diagonally opposite the first screw.
7. Repeat steps 5 and 6 for the other pair of screws.

8. Lift the heat sink up from the processor and set the heat sink aside upside-down (thermal grease side facing up).

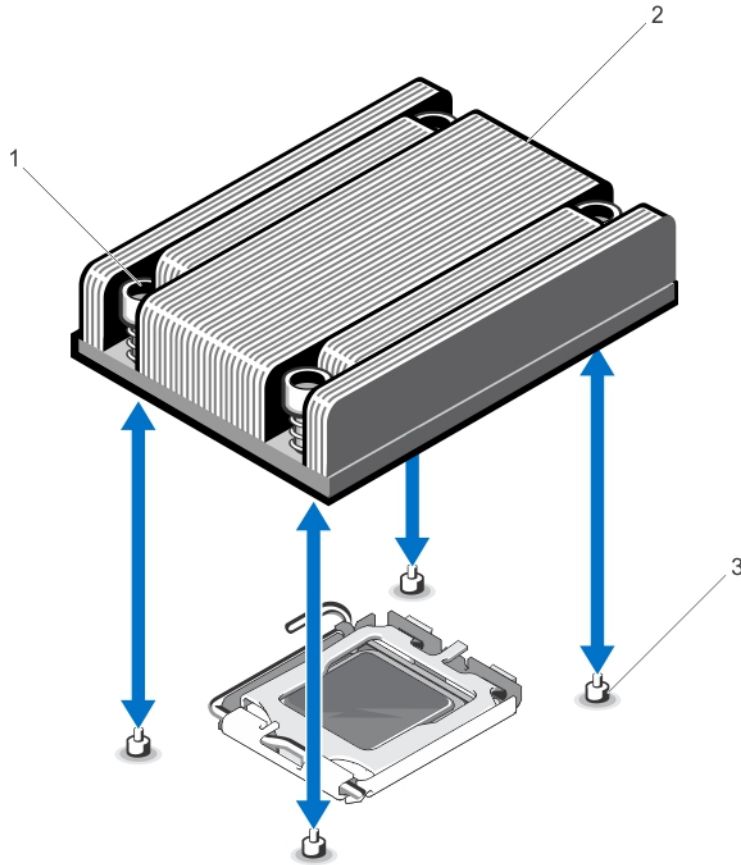

Figure 29. Removing and Installing the Processor Heat Sink

- | | |
|--------------------------|--------------|
| 1. retention sockets (4) | 2. heat sink |
| 3. retention screws (4) | |

△ CAUTION: The processor is held in its socket under strong pressure. Be aware that the release lever can spring up suddenly if not firmly grasped.

9. Position your thumb firmly over the processor socket-release lever and release the lever from the locked position by pushing down and out from under the tab. Rotate the lever upward.
10. Rotate the processor shield upward and out of the way.

△ CAUTION: The socket pins are fragile and can be permanently damaged. Be careful not to bend the pins in the socket when removing the processor out of the socket.

11. Lift the processor out of the socket and leave the release lever up so that the socket is ready for the new processor.

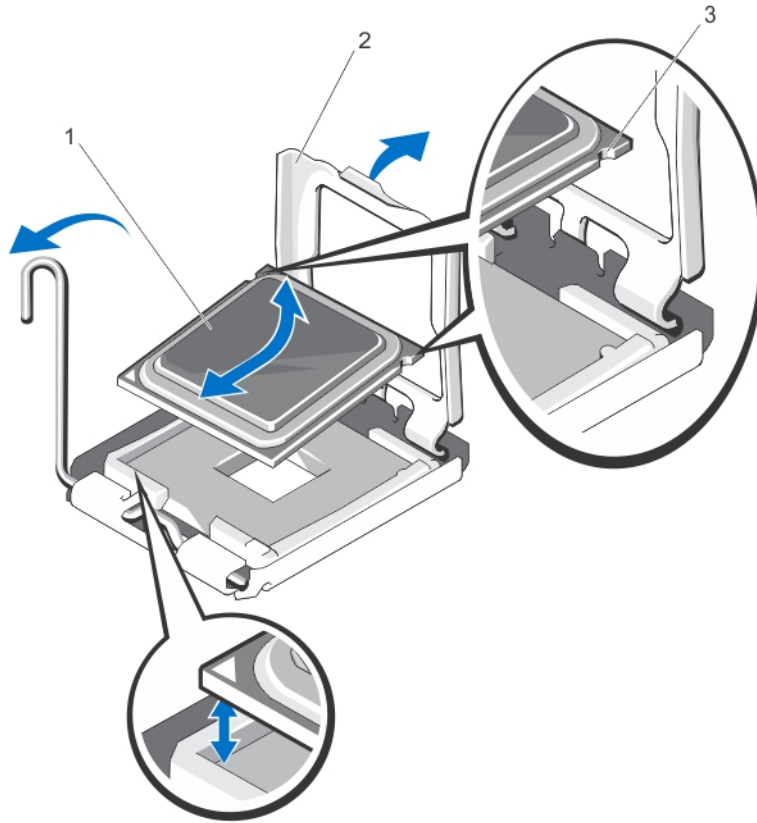

Figure 30. Removing and Installing a Processor

1. processor
2. processor shield
3. notches in processor (2)

NOTE: After removing the processor, place it in an antistatic container for reuse, return, or temporary storage. Do not touch the bottom of the processor. Touch only the side edges of the processor.

Installing A Processor

CAUTION: Many repairs may only be done by a certified service technician. You should only perform troubleshooting and simple repairs as authorized in your product documentation, or as directed by the online or telephone service and support team. Damage due to servicing that is not authorized by Dell is not covered by your warranty. Read and follow the safety instructions that came with the product.

NOTE: If you are installing a single processor, it must be installed in socket CPU1.

 **NOTE:** If you install a second processor, you must remove the dummy fan from the FAN 6 slot, install a cooling fan in the FAN 6 slot, and upgrade both the riser cards (riser1 and riser 2). For more information, see Expansion Card Installation Guidelines.

1. Before upgrading your system, download the latest system BIOS version from dell.com/support and follow the instructions included in the compressed download file to install the update on your system.

 **NOTE:** You can update the system BIOS using the Lifecycle Controller.

2. Turn off the system, including any attached peripherals, and disconnect the system from the electrical outlet. When disconnected from the power source, press and hold the power button for three seconds to fully drain the system of stored power prior to removing the cover.
3. Open the system.
4. Remove the cooling shroud.

 **WARNING:** The heat sink and processor are hot to the touch for some time after the system has been powered down. Allow the heat sink and processor to cool before handling them.

 **CAUTION:** Never remove the heat sink from a processor unless you intend to remove the processor. The heat sink is necessary to maintain proper thermal conditions.

5. Remove the heat sink/heat-sink blank and processor/processor blank, as applicable.

 **NOTE:** The procedure to remove the heat-sink blank or processor blank is similar to removing a heat-sink or processor.

6. Unpack the new processor.
7. Release the lever from the locked position by pushing down and out from under the tab.
8. Rotate the processor shield upward and out of the way.
9. Align the processor with the socket keys on the ZIF socket.

 **CAUTION:** Positioning the processor incorrectly can permanently damage the system board or the processor. Be careful not to bend the pins in the socket.

 **CAUTION:** Do not use force to seat the processor. When the processor is positioned correctly, it engages easily into the socket.

10. With the release lever on the processor socket in the open position, align the pin of the processor, using the pin position guide on the socket, as reference and set the processor lightly in the socket.
11. Close the processor shield.
12. Using a clean lint-free cloth, remove the thermal grease from the heat sink.

 **CAUTION:** Applying too much thermal grease can result in excess grease coming in contact with and contaminating the processor socket.

13. Open the grease applicator included with your processor kit and apply all of the thermal grease in the applicator to the center of the topside of the new processor.
14. Place the heat sink on the processor.
15. Using a #2 Phillips screwdriver, tighten the heat-sink retention sockets.
16. Install the cooling shroud.
17. Close the system.
18. Reconnect your system and peripherals to their electrical outlets, and turn on the system.
19. Press <F2> to enter the System Setup and check that the processor information matches the new system configuration.
20. Run the system diagnostics to verify that the new processor operates correctly.

Power Supplies

Your system supports 550 W power supply.

When two identical power supplies are installed, the power supply configuration is redundant (1 + 1). In redundant mode, power is supplied to the system equally from both power supplies to maximize efficiency.

 **CAUTION: If two power supplies are used, they must be of the same type and have the same maximum output power.**

Hot Spare Feature

Your system supports the Hot Spare feature that significantly reduces the power overhead associated with power supply redundancy.

When the Hot Spare feature is enabled, a redundant power supply is switched to a sleep state. The active power supply supports 100% of the load, thus operating at higher efficiency. The redundant power supply in the sleep state monitors output voltage of the active power supply. If the output voltage of the active power supply drops, the redundant power supply in the sleep state returns to an active output state.

The active power supply can also activate a sleeping power supply if having both power supplies active is more efficient than having the redundant power supply in a sleep state. The power supply defaults are to wake both power supplies if the load on the active power supply is greater than 50% and to sleep the redundant power supply if the load falls below 20%.

You can configure the Hot Spare feature using the iDRAC settings. For more information on iDRAC settings, see the *iDRAC7 User's Guide* under **Remote Access Controller**, at dell.com/esmanuals.

Removing A Power Supply

 **CAUTION: Many repairs may only be done by a certified service technician. You should only perform troubleshooting and simple repairs as authorized in your product documentation, or as directed by the online or telephone service and support team. Damage due to servicing that is not authorized by Dell is not covered by your warranty. Read and follow the safety instructions that came with the product.**

 **CAUTION: The system requires one power supply for normal operation. On power-redundant systems, remove and replace only one power supply at a time in a system that is powered on.**

1. Disconnect the power cable from the power source.
2. Disconnect the power cable from the power supply and remove the straps that bundle and secure the system cables.

 **NOTE:** You may have to unlatch and lift the optional cable management arm if it interferes with power-supply removal. For information about the cable management arm, see the system's rack documentation.

3. Press the release latch and pull the power supply straight out to release it from the power distribution board and clear the chassis.

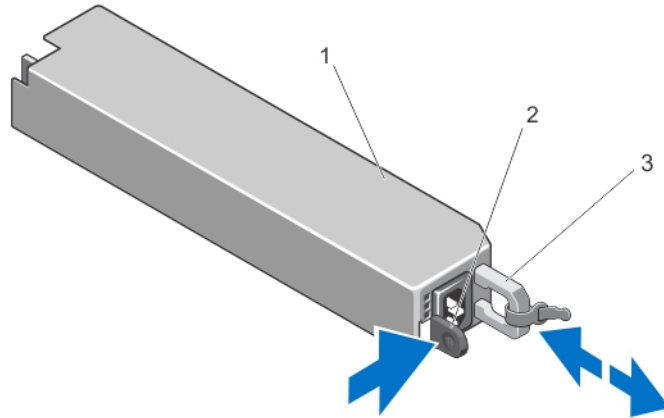

Figure 31. Removing and Installing a Power Supply

- | | |
|------------------------|------------------|
| 1. power supply unit | 2. release latch |
| 3. power supply handle | |

Installing A Power Supply

CAUTION: Ensure that both power supplies are of the same type and have the same maximum output power.

NOTE: The maximum output power (shown in Watts) is listed on the power supply label.

1. Slide the new power supply into the chassis until the power supply is fully seated and the release latch snaps into place.

NOTE: If you unlatched the cable management arm in step 2 of the previous procedure, relatch it. For information about the cable management arm, see the system's rack documentation.

2. Connect the power cable to the power supply and plug the cable into a power outlet.

CAUTION: When connecting the power cable, secure the cable with the strap.

NOTE: When installing, hot-swapping, or hot-adding a new power supply in a system with two power supplies, allow several seconds for the system to recognize the power supply and determine its status. The power-supply status indicator turns green to signify that the power supply is functioning properly.

System Battery

Replacing The System Battery

WARNING: There is a danger of a new battery exploding if it is incorrectly installed. Replace the battery only with the same or equivalent type recommended by the manufacturer. See your safety information for additional information.

△ CAUTION: Many repairs may only be done by a certified service technician. You should only perform troubleshooting and simple repairs as authorized in your product documentation, or as directed by the online or telephone service and support team. Damage due to servicing that is not authorized by Dell is not covered by your warranty. Read and follow the safety instructions that came with the product.

1. Turn off the system, including any attached peripherals, and disconnect the system from the electrical outlet and peripherals.
2. Open the system.
3. Locate the battery socket.

△ CAUTION: To avoid damage to the battery connector, you must firmly support the connector while installing or removing a battery.

4. To remove the battery, support the battery connector by pressing down firmly on the positive side of the connector.

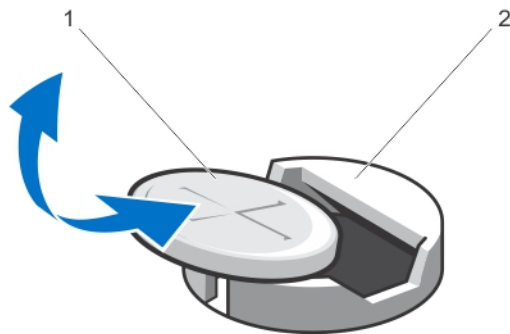



Figure 32. Replacing the System Battery

1. positive side of battery
2. securing tab
5. Lift the battery out of the securing tabs at the negative side of the connector.
6. To install a new system battery, support the battery connector by pressing down firmly on the positive side of the connector.
7. Hold the battery with the "+" facing up and slide it under the securing tabs at the positive side of the connector.
8. Press the battery straight down into the connector until it snaps into place.
9. Close the system.
10. Reconnect the system to the electrical outlet and turn the system on, including any attached peripherals
11. Enter the System Setup to confirm that the battery is operating properly.
12. Enter the correct time and date in the System Setup **Time** and **Date** fields.
13. Exit the System Setup.

Hard-Drive Backplane

Your system supports a four hard-drive backplane.

Removing The Hard-Drive Backplane

 **CAUTION:** Many repairs may only be done by a certified service technician. You should only perform troubleshooting and simple repairs as authorized in your product documentation, or as directed by the online or telephone service and support team. Damage due to servicing that is not authorized by Dell is not covered by your warranty. Read and follow the safety instructions that came with the product.

1. If installed, remove the front bezel
2. Turn off the system, including any attached peripherals, and disconnect the system from the electrical outlet.
3. Open the system.

 **CAUTION:** To prevent damage to the drives and backplane, you must remove the hard drives from the system before removing the backplane.

 **CAUTION:** You must note the number of each hard drive and temporarily label them before removal so that you can replace them in the same locations.

4. Remove all hard drives.
5. Disconnect the SAS/SATA/SSD data, signal, and power cable(s) from the backplane.

6. Press the release tabs and slide the backplane upward.

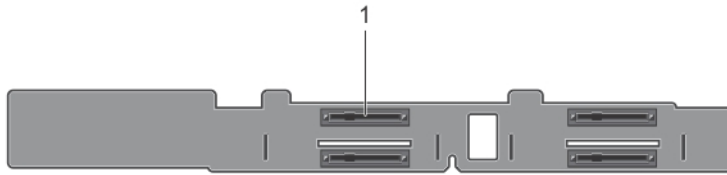

Figure 33. Front View of the Hard-Drive Backplane

1. hard-drive connectors (4)

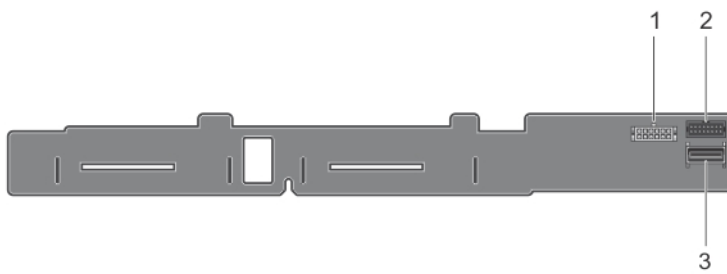

Figure 34. Rear View of the Hard-Drive Backplane

1. backplane power connector
2. backplane signal connector
3. SAS connector

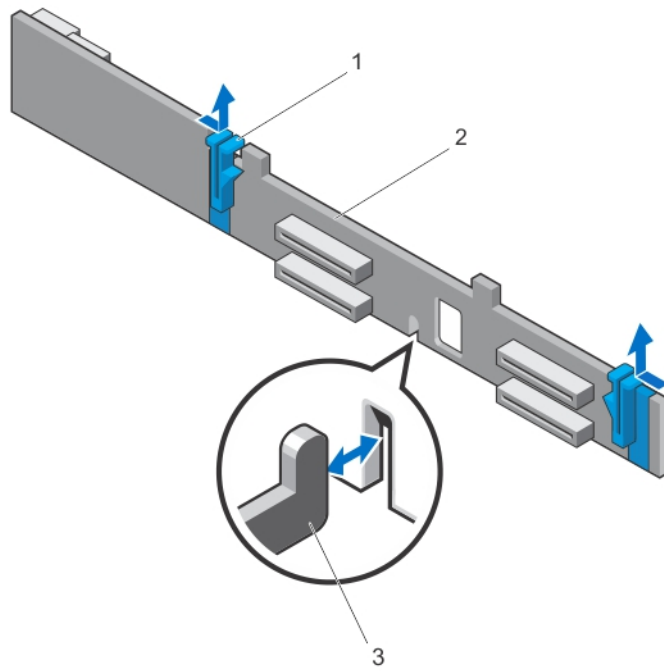

Figure 35. Removing and Installing the Hard-Drive Backplane

- | | |
|---------------------|-------------------------|
| 1. release tabs (2) | 2. hard-drive backplane |
| 3. guide pins (2) | 4. chassis hooks (4) |

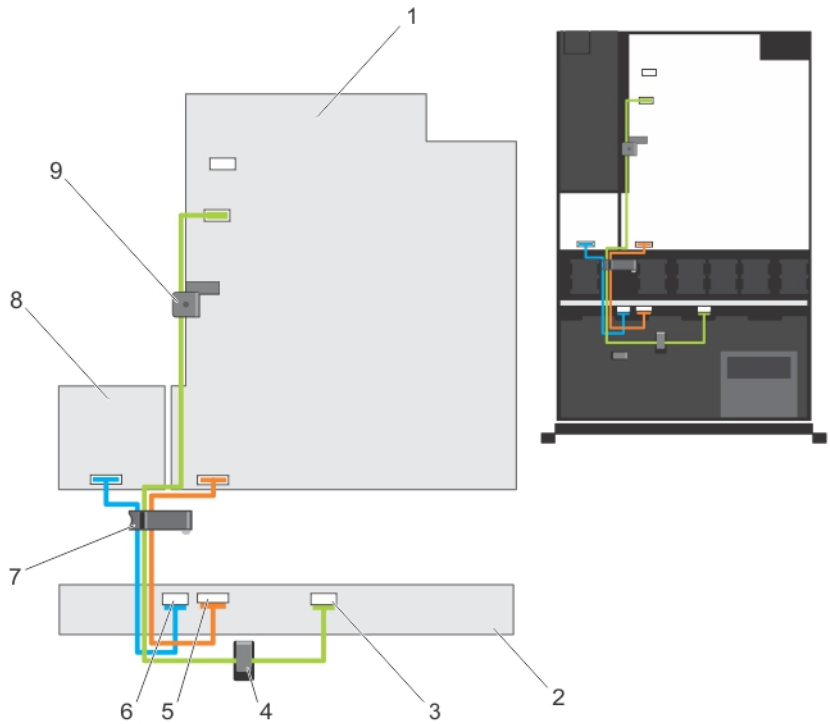

Figure 36. Cabling Diagram

- | | |
|---------------------------|-----------------------------|
| 1. system board | 2. hard-drive backplane |
| 3. SAS cable connector | 4. cable routing guide |
| 5. signal cable connector | 6. power cable connector |
| 7. cable routing latch | 8. power distribution board |
| 9. cable retention latch | |

Installing The Hard-Drive Backplane

⚠ CAUTION: Many repairs may only be done by a certified service technician. You should only perform troubleshooting and simple repairs as authorized in your product documentation, or as directed by the online or telephone service and support team. Damage due to servicing that is not authorized by Dell is not covered by your warranty. Read and follow the safety instructions that came with the product.

1. Use the hooks at the base of the chassis as guides to align the hard-drive backplane.
2. Slide down the hard-drive backplane until the release tabs snap into place.
3. Connect the SAS/SATA/SSD data, signal, and power cable(s) to the backplane.
4. Install the hard drives in their original locations.
5. Close the system.
6. Reconnect the system to its electrical outlet and turn the system on, including any attached peripherals.
7. If applicable, install the front bezel.

Control Panel Assembly

Removing The Control Panel

CAUTION: Many repairs may only be done by a certified service technician. You should only perform troubleshooting and simple repairs as authorized in your product documentation, or as directed by the online or telephone service and support team. Damage due to servicing that is not authorized by Dell is not covered by your warranty. Read and follow the safety instructions that came with the product.

1. If installed, remove the front bezel.
2. Turn off the system, including any attached peripherals, and disconnect the system from the electrical outlet and peripherals.
3. Open the system.

CAUTION: Do not use excessive force when removing the control panel as it can damage the connectors.

4. Release the locking tabs of the control panel by angling the control panel up and away from the system.

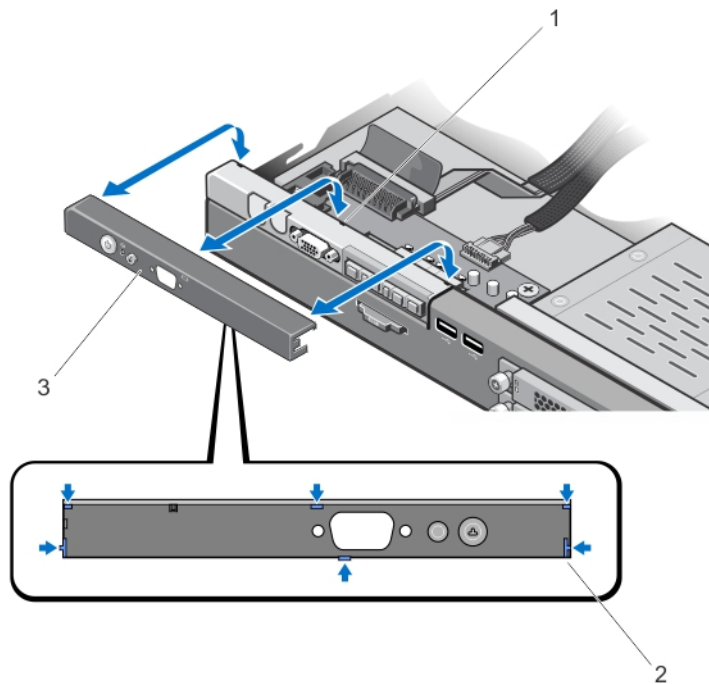



Figure 37. Removing and Installing the Control Panel

- | | |
|------------------|---------------------|
| 1. notches (6) | 2. locking tabs (6) |
| 3. control panel | |

Installing The Control Panel

 **CAUTION:** Many repairs may only be done by a certified service technician. You should only perform troubleshooting and simple repairs as authorized in your product documentation, or as directed by the online or telephone service and support team. Damage due to servicing that is not authorized by Dell is not covered by your warranty. Read and follow the safety instructions that came with the product.

1. If applicable, insert the control panel cable through the slot on the chassis.

 **CAUTION:** To avoid damaging the power LED, do not use excessive force.

2. Align the locking tabs on the control panel with the notches on the chassis and angle the control panel until it snaps into place.

When properly seated, the control panel will be flush with the front panel.

3. Close the system.
4. Reconnect the system and peripherals to their power sources, and turn them on.
5. If applicable, install the front bezel.

Removing The Control-Panel Module

 **CAUTION:** Many repairs may only be done by a certified service technician. You should only perform troubleshooting and simple repairs as authorized in your product documentation, or as directed by the online or telephone service and support team. Damage due to servicing that is not authorized by Dell is not covered by your warranty. Read and follow the safety instructions that came with the product.

1. If installed, remove the front bezel.
2. Turn off the system, including any attached peripherals, and disconnect the system from the electrical outlet and peripherals.
3. Open the system.
4. Remove the control panel from the chassis.
5. Remove the screw(s) securing the control-panel module to the chassis.

6. Remove all the cables connecting the control-panel module to the chassis.

CAUTION: Do not use excessive force when removing the control panel as it can damage the connectors.

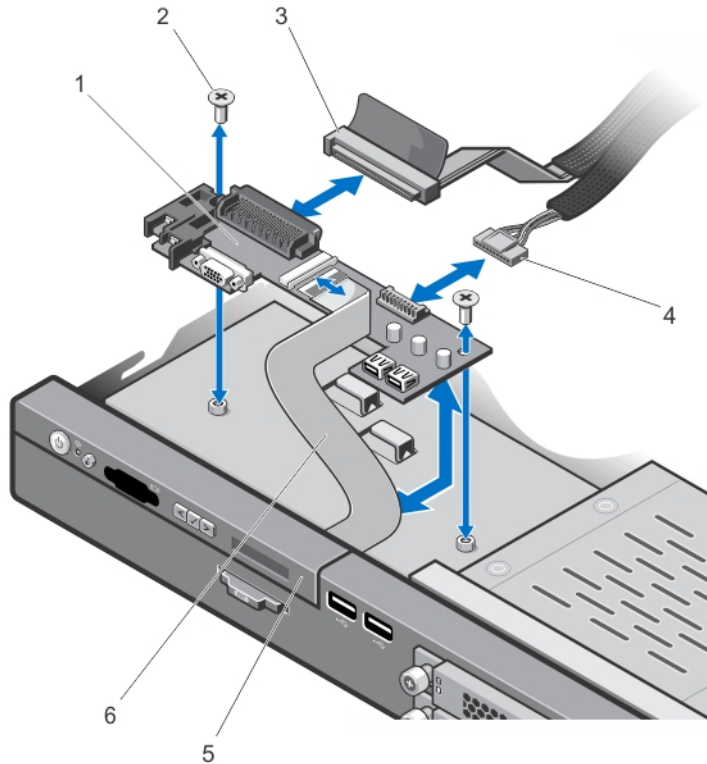

Figure 38. Removing and Installing the Control-Panel Module

- | | |
|---|------------------------------------|
| 1. control-panel module | 2. control-panel module screws (2) |
| 3. control-panel module connector cable | 4. USB connector cable |
| 5. control panel | 6. LCD cable |

Installing The Control-Panel Module

CAUTION: Many repairs may only be done by a certified service technician. You should only perform troubleshooting and simple repairs as authorized in your product documentation, or as directed by the online or telephone service and support team. Damage due to servicing that is not authorized by Dell is not covered by your warranty. Read and follow the safety instructions that came with the product.

1. Insert the control-panel module into the slot in the chassis and align the two screw holes on the control-panel module with the corresponding holes on the chassis.
2. Secure the control-panel module with the screws.
3. Connect all the applicable cables to the control-panel module.
4. Close the system.

5. Install the control panel.
6. Reconnect the system and peripherals to their power sources, and turn them on.
7. If applicable, install the front bezel.

Power Distribution Board Shroud

Removing The Power Distribution Board Shroud

 **CAUTION:** Many repairs may only be done by a certified service technician. You should only perform troubleshooting and simple repairs as authorized in your product documentation, or as directed by the online or telephone service and support team. Damage due to servicing that is not authorized by Dell is not covered by your warranty. Read and follow the safety instructions that came with the product.

 **CAUTION:** Never operate your system without the power distribution board shroud. The system may get overheated, which may result in loss of performance.

1. Turn off the system, including any attached peripherals, and disconnect the system from the electrical outlet and peripherals.
2. Open the system.

3. Lift the power distribution board (PDB) shroud away from the system.

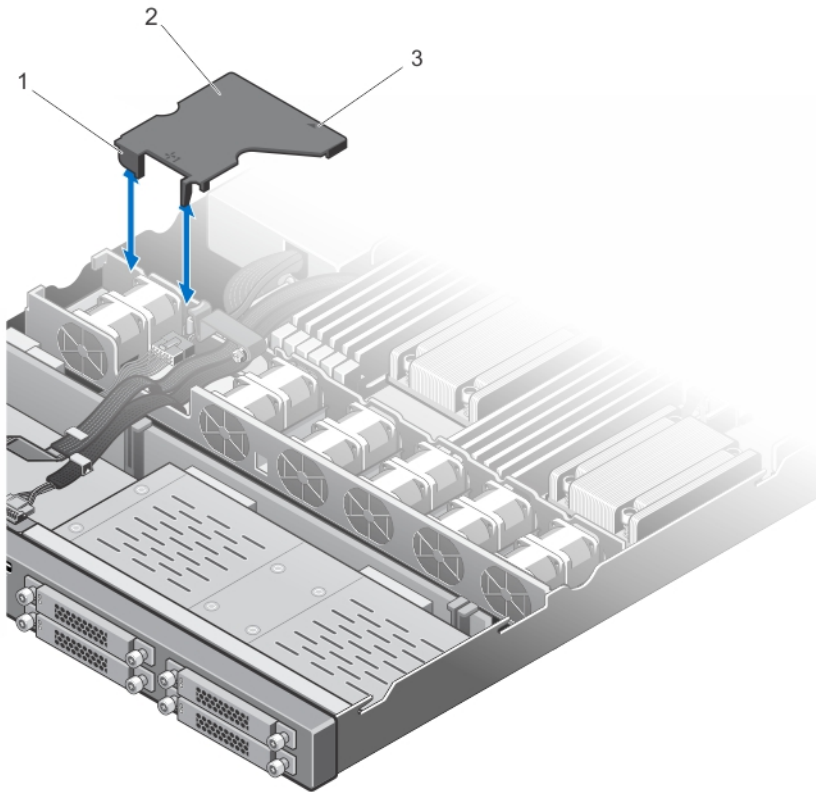

Figure 39. Removing and Installing the PDB Shroud

1. PDB shroud tabs (2)
2. PDB shroud
3. arrow marked on the PDB shroud

Installing The Power Distribution Board Shroud

⚠ CAUTION: Many repairs may only be done by a certified service technician. You should only perform troubleshooting and simple repairs as authorized in your product documentation, or as directed by the online or telephone service and support team. Damage due to servicing that is not authorized by Dell is not covered by your warranty. Read and follow the safety instructions that came with the product.

✍ NOTE: For proper seating of the power distribution shroud in the chassis, ensure that the cables inside the system are routed through the cable securing latch.

1. Align the PDB shroud with the numbered fan bay and the arrow as the guide.
2. Lower the PDB shroud into the chassis so that the two tabs on the PDB shroud rest on the cooling fan bracket.

When firmly seated, the PDB shroud aligns flush with the power supply unit bracket and the arrow marked on the shroud aligns with the arrow on the power supply bracket.

3. Close the system.
4. Reconnect the system to its electrical outlet and turn the system on, including any attached peripherals.

Power Distribution Board

Removing The Power Distribution Board

 **CAUTION:** Many repairs may only be done by a certified service technician. You should only perform troubleshooting and simple repairs as authorized in your product documentation, or as directed by the online or telephone service and support team. Damage due to servicing that is not authorized by Dell is not covered by your warranty. Read and follow the safety instructions that came with the product.

 **NOTE:** The power distribution board is present only in systems that support redundant power supplies.

1. If installed, remove the front bezel.
2. Turn off the system, including any attached peripherals, and disconnect the system from the electrical outlet and peripherals.
3. Open the system.
4. Remove the power supplies from the system.
5. Remove the PDB shroud.
6. Disconnect the power distribution cables from the system board.
7. Disconnect the fan cable.

8. Remove the two screws securing the power distribution board to the chassis and lift the board out of the chassis.

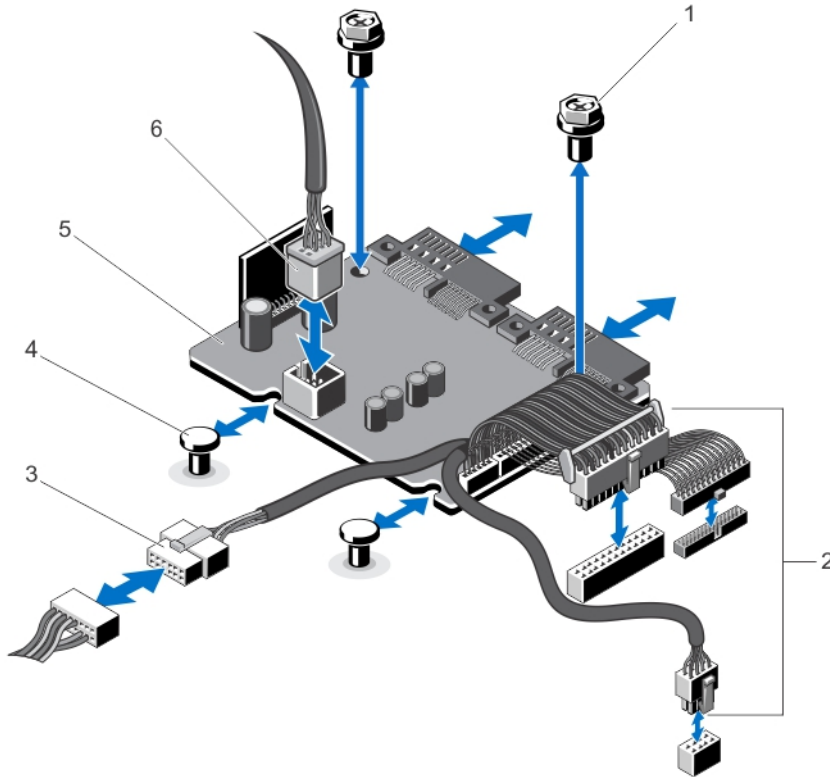

Figure 40. Removing and Installing the Power Distribution Board

- | | |
|---|--|
| 1. screws (2) | 2. power supply cables to the system board (3) |
| 3. power supply cable to the hard-drive backplane | 4. standoffs (2) |
| 5. power distribution board | 6. fan cable connector |

Installing The Power Distribution Board

CAUTION: Many repairs may only be done by a certified service technician. You should only perform troubleshooting and simple repairs as authorized in your product documentation, or as directed by the online or telephone service and support team. Damage due to servicing that is not authorized by Dell is not covered by your warranty. Read and follow the safety instructions that came with the product.

1. Align the power distribution board with the standoffs on the chassis.
2. Install the two screws that secure the power distribution board to the chassis.
3. Connect the power distribution cables to the system board and fan cable connector to the power distribution board.
4. Install the PDB shroud.
5. Close the system.

6. Reconnect the system to its electrical outlet and turn the system on, including any attached peripherals.

System Board

Removing The System Board

 **CAUTION:** Many repairs may only be done by a certified service technician. You should only perform troubleshooting and simple repairs as authorized in your product documentation, or as directed by the online or telephone service and support team. Damage due to servicing that is not authorized by Dell is not covered by your warranty. Read and follow the safety instructions that came with the product.

 **CAUTION:** If you are using the Trusted Program Module (TPM) with an encryption key, you may be prompted to create a recovery key during program or System Setup. Be sure to create and safely store this recovery key. If you replace this system board, you must supply the recovery key when you restart your system or program before you can access the encrypted data on your hard drives.

1. Turn off the system, including any attached peripherals, and disconnect the system from the electrical outlet.
2. If installed, remove the front bezel.
3. Open the system.
4. Remove the following:
 - a. cooling shroud
 - b. PDB shroud
 - c. memory modules
 - d. expansion cards and the expansion-card risers
 - e. integrated storage controller card

 **WARNING:** The heat sink and processor are hot to the touch for some time after the system has been powered down. Allow the heat sink and processor to cool before handling them.

- f. heat sink/heat-sink blank and processor/processor blank
- g. internal dual SD module
- h. expansion card holder

 **NOTE:** It is recommended that you remove the power distribution board before removing the system board from the chassis.

5. Disconnect all other cables from the system board.

 **CAUTION:** Do not lift the system board assembly by grasping a memory module, processor, or other components.

6. Remove the nine screws on the system board and slide the system board toward the front of the system.

7. Hold the system board by its edges and lift the system board out of the chassis.

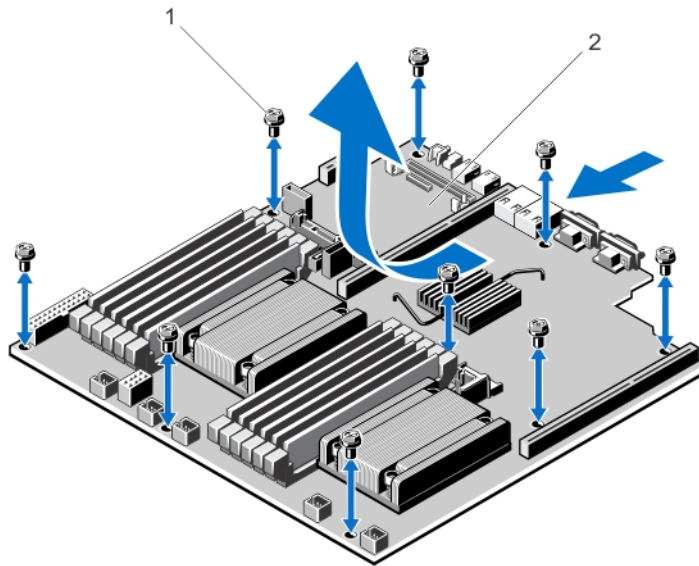

Figure 41. Removing and Installing the System Board

1. screws (9)

2. system board

Installing The System Board

△ CAUTION: Many repairs may only be done by a certified service technician. You should only perform troubleshooting and simple repairs as authorized in your product documentation, or as directed by the online or telephone service and support team. Damage due to servicing that is not authorized by Dell is not covered by your warranty. Read and follow the safety instructions that came with the product.

1. Unpack the new system board assembly.
2. Transfer the following components to the new system board:
 - a. heat sink(s)/heat-sink blank(s) and processors(s)/processor blank(s)
 - b. memory modules and memory module blanks

△ CAUTION: Do not lift the system board assembly by grasping a memory module, processor, or other components.

△ CAUTION: Take care not to damage the system identification button while placing the system board into the chassis.

3. Hold and align the system board by its edges and align it to the back of the chassis.
4. Lower the system board and align the screw holes to the standoffs on the chassis till firmly seated.
5. Tighten the screws of the system board to secure the system board to the chassis.

6. Replace the following:
 - a. expansion card holder
 - b. expansion-card risers
 - c. expansion cards
 - d. integrated storage controller card
 - e. internal dual SD module
 - f. PDB shroud
 - g. cooling shroud
7. Reconnect all cables to the system board.
 **NOTE:** Ensure that the cables inside the system are routed secured using the cable securing latches.
8. Close the system.
9. Reconnect the system to its electrical outlet and turn the system on, including any attached peripherals.
10. Import your new or existing iDRAC Enterprise license. For more information, see *iDRAC7 User's Guide*, under **Remote Access Controller**, at dell.com/esmmanuals.

Troubleshooting Your System

Safety First—For You And Your System

 **CAUTION:** Many repairs may only be done by a certified service technician. You should only perform troubleshooting and simple repairs as authorized in your product documentation, or as directed by the online or telephone service and support team. Damage due to servicing that is not authorized by Dell is not covered by your warranty. Read and follow the safety instructions that came with the product.

Troubleshooting System Startup Failure

- If you boot the system to the BIOS boot mode after installing an operating system from the UEFI Boot Manager, the system hangs. The reverse is also true. You must boot to the same boot mode in which you installed the operating system.
- For all other startup issues, note the system messages that appear on the screen.

Troubleshooting External Connections

Ensure that all external cables are securely attached to the external connectors on your system before troubleshooting any external devices.

Troubleshooting The Video Subsystem

1. Check the system and power connections to the monitor.
2. Check the video interface cabling from the system to the monitor.
3. Run the appropriate diagnostic test.

If the tests run successfully, the problem is not related to video hardware.

If the tests fail, see [Getting Help](#).

Troubleshooting A USB Device

Use the following steps to troubleshoot a USB keyboard/mouse. For other USB devices, go to step 7.

1. Disconnect the keyboard and mouse cables from the system briefly and reconnect them.
2. Connect the keyboard/mouse to the USB port(s) on the opposite side of the system.
3. If the problem is resolved, restart the system, enter the System Setup, and check if the non-functioning USB ports are enabled.
4. Replace the keyboard/mouse with another working keyboard/mouse.
5. If the problem is resolved, replace the faulty keyboard/mouse.

6. If the problem is not resolved, proceed to the next step to begin troubleshooting the other USB devices attached to the system.
7. Power down all attached USB devices and disconnect them from the system.
8. Reboot the system and, if your keyboard is functioning, enter the System Setup. Verify that all USB ports are enabled on the **Integrated Devices** screen, in the System Setup options.
If your keyboard is not functioning, you can also use remote access. If the system is not accessible, reset the NVRAM_CLR jumper inside your system and restore the BIOS to the default settings.
9. Reconnect and power on each USB device one at a time.
10. If a device causes the same problem, power down the device, replace the USB cable with a known good cable, and power up the device.

If all troubleshooting fails, see [Getting Help](#).

Troubleshooting A Serial I/O Device

1. Turn off the system and any peripheral devices connected to the serial port.
2. Swap the serial interface cable with a working cable, and turn on the system and the serial device.
If the problem is resolved, replace the interface cable with a known good cable.
3. Turn off the system and the serial device, and swap the device with a comparable device.
4. Turn on the system and the serial device.

If the problem persists, see [Getting Help](#).

Troubleshooting A NIC

1. Run the appropriate diagnostic test.
2. Restart the system and check for any system messages pertaining to the NIC controller.
3. Check the appropriate indicator on the NIC connector:
 - If the link indicator does not light, check all cable connections.
 - If the activity indicator does not light, the network driver files might be damaged or missing. Remove and reinstall the drivers if applicable. See the NIC's documentation.
 - If applicable, change the autonegotiation setting.
 - Use another connector on the switch or hub.
4. Ensure that the appropriate drivers are installed and the protocols are bound. See the NIC's documentation.
5. Enter the System Setup and confirm that the NIC ports are enabled on the Integrated Devices Screen.
6. Ensure that the NICs, hubs, and switches on the network are all set to the same data transmission speed and duplex. See the documentation for each network device.
7. Ensure that all network cables are of the proper type and do not exceed the maximum length.

If all troubleshooting fails, see [Getting Help](#).

Troubleshooting A Wet System

 **CAUTION:** Many repairs may only be done by a certified service technician. You should only perform troubleshooting and simple repairs as authorized in your product documentation, or as directed by the online or telephone service and support team. Damage due to servicing that is not authorized by Dell is not covered by your warranty. Read and follow the safety instructions that came with the product.

1. Turn off the system and attached peripherals, and disconnect the system from the electrical outlet.
2. Open the system.
3. Disassemble components from the system:
 - Hard drives
 - Hard-drive backplane
 - USB memory key
 - Cooling shroud
 - Expansion cards
 - Power supply(s)
 - Cooling fans
 - Processor(s) and heat sink(s)
 - Memory modules
4. Let the system dry thoroughly for at least 24 hours.
5. Reinstall the components you removed in step 3.
6. Close the system.
7. Turn on the system and attached peripherals.
If the system does not start properly, see [Getting Help](#).
8. If the system starts properly, shut down the system and reinstall all of the expansion cards that you removed.
9. Run the appropriate diagnostic test.

If the tests fail, see [Getting Help](#).

Troubleshooting A Damaged System

 **CAUTION:** Many repairs may only be done by a certified service technician. You should only perform troubleshooting and simple repairs as authorized in your product documentation, or as directed by the online or telephone service and support team. Damage due to servicing that is not authorized by Dell is not covered by your warranty. Read and follow the safety instructions that came with the product.

1. Turn off the system and attached peripherals, and disconnect the system from the electrical outlet.
2. Open the system.

3. Ensure that the following components are properly installed:
 - Cooling shroud
 - Expansion cards
 - Power supply(s)
 - Cooling fans
 - Processor(s) and heat sink(s)
 - Memory modules
 - Hard-drive carriers
 - Hard-drive backplane
4. Ensure that all cables are properly connected.
5. Close the system.
6. Run the system board tests in the system diagnostics.

If the tests fail, see [Getting Help](#).

Troubleshooting The System Battery

 **CAUTION:** Many repairs may only be done by a certified service technician. You should only perform troubleshooting and simple repairs as authorized in your product documentation, or as directed by the online or telephone service and support team. Damage due to servicing that is not authorized by Dell is not covered by your warranty. Read and follow the safety instructions that came with the product.

 **NOTE:** If the system is turned off for long periods of time (for weeks or months), the NVRAM may lose its system configuration information. This situation is caused by a defective battery.

1. Re-enter the time and date in the System Setup.
2. Turn off the system and disconnect it from the electrical outlet for at least one hour.
3. Reconnect the system to the electrical outlet and turn on the system.
4. Enter the System Setup.
If the date and time are not correct in the System Setup, check the SEL for system battery messages.

If the problem persists, see [Getting Help](#).

 **NOTE:** Some software may cause the system time to speed up or slow down. If the system seems to operate normally except for the time kept in the System Setup, the problem may be caused by software rather than by a defective battery.

Troubleshooting Power Supplies

 **CAUTION:** Many repairs may only be done by a certified service technician. You should only perform troubleshooting and simple repairs as authorized in your product documentation, or as directed by the online or telephone service and support team. Damage due to servicing that is not authorized by Dell is not covered by your warranty. Read and follow the safety instructions that came with the product.

Reseat the power supply by removing and reinstalling it.

 **NOTE:** After installing a power supply, allow several seconds for the system to recognize the power supply and to determine if it is working properly.

If the problem persists, see [Getting Help](#).

Troubleshooting Cooling Problems

△ CAUTION: Many repairs may only be done by a certified service technician. You should only perform troubleshooting and simple repairs as authorized in your product documentation, or as directed by the online or telephone service and support team. Damage due to servicing that is not authorized by Dell is not covered by your warranty. Read and follow the safety instructions that came with the product.

Ensure that none of the following conditions exist:

- System cover, cooling shroud, EMI filler panel, memory-module blank, or back-filler bracket is removed.
- Ambient temperature is too high.
- Front bezel filter (if installed) is clogged with dust or debris.
- External airflow is obstructed.
- A cooling fan is removed or has failed.
- The expansion card installation guidelines have not been followed.

Troubleshooting Cooling Fans

△ CAUTION: Many repairs may only be done by a certified service technician. You should only perform troubleshooting and simple repairs as authorized in your product documentation, or as directed by the online or telephone service and support team. Damage due to servicing that is not authorized by Dell is not covered by your warranty. Read and follow the safety instructions that came with the product.

1. Open the system.
2. Reseat the fan or the fan's power cable.
3. If the fan functions properly, close the system.

If the problem persists, see [Getting Help](#).

Troubleshooting System Memory

△ CAUTION: Many repairs may only be done by a certified service technician. You should only perform troubleshooting and simple repairs as authorized in your product documentation, or as directed by the online or telephone service and support team. Damage due to servicing that is not authorized by Dell is not covered by your warranty. Read and follow the safety instructions that came with the product.

1. If the system is operational, run the appropriate diagnostic test. See Using System Diagnostics for available diagnostic tests.
If diagnostics indicates a fault, follow the corrective actions provided by the diagnostic program.
2. If the system is not operational, turn off the system and attached peripherals, and unplug the system from the power source. Wait at least 10 seconds and then reconnect the system to power.
3. Turn on the system and attached peripherals and note the messages on the screen.
If an error message is displayed indicating a fault with a specific memory module, go to step 12.

4. Enter the System Setup and check the system memory setting. Make any changes to the memory settings, if needed.
If the memory settings match the installed memory but a problem is still indicated, go to step 12.
5. Turn off the system and attached peripherals, and disconnect the system from the electrical outlet.
6. Open the system.
7. Check the memory channels and ensure that they are populated correctly.
8. Reseat the memory modules in their sockets.
9. Close the system.
10. Enter the System Setup and check the system memory setting.
If the problem is not resolved, proceed with the next step.
11. Open the system.
12. If a diagnostic test or error message indicates a specific memory module as faulty, swap or replace the module with a known good memory module.
13. To troubleshoot an unspecified faulty memory module, replace the memory module in the first DIMM socket with a module of the same type and capacity.
If an error message is displayed on the screen, this may indicate a problem with the installed DIMM type(s), incorrect DIMM installation, or defective DIMM(s). Follow the on-screen instructions to resolve the problem. For more information, see [General Memory Module Installation Guidelines](#).
14. Close the system.
15. As the system boots, observe any error message that is displayed and the diagnostic indicators on the front of the system.
16. If the memory problem is still indicated, repeat step 12 through step 15 for each memory module installed.

If the problem persists after all memory modules have been checked, see [Getting Help](#).

Troubleshooting An Internal USB Key





CAUTION: Many repairs may only be done by a certified service technician. You should only perform troubleshooting and simple repairs as authorized in your product documentation, or as directed by the online or telephone service and support team. Damage due to servicing that is not authorized by Dell is not covered by your warranty. Read and follow the safety instructions that came with the product.

1. Enter the System Setup and ensure that the **USB key port** is enabled from the **Integrated Devices** screen.
2. Turn off the system and attached peripherals, and disconnect the system from the electrical outlet.
3. Open the system.
4. Locate the USB key and reseat it.
5. Close the system.
6. Turn on the system and attached peripherals and check if the USB key is functioning.
7. If the problem is not resolved, repeat step 2 and step 3.
8. Insert a different USB key that you know works properly.
9. Close the system.

If the problem is not resolved, see [Getting Help](#).

Troubleshooting An SD Card

 **CAUTION:** Many repairs may only be done by a certified service technician. You should only perform troubleshooting and simple repairs as authorized in your product documentation, or as directed by the online or telephone service and support team. Damage due to servicing that is not authorized by Dell is not covered by your warranty. Read and follow the safety instructions that came with the product.

 **NOTE:** Certain SD cards have a physical write-protect switch on the card. If the write-protect switch is turned on then the SD card is not writeable.

1. Enter the System Setup and ensure that the **Internal SD Card Port** is enabled.
2. Turn off the system, including any attached peripherals, and disconnect the system from the electrical outlet.
3. Open the system.

 **CAUTION:** If the **Internal SD Card Redundancy** option is set to **Mirror Mode** in the **Integrated Devices** screen of the **System Setup**, you must follow the instructions in step 4 through step 7 to avoid loss of data.

 **NOTE:** When an SD card failure occurs, the internal dual SD module controller notifies the system. On the next reboot, the system displays a message indicating the failure.

4. If the **Internal SD Card Redundancy** option is set to **Disabled**, replace the failed SD card with a new SD card.
5. If SD card 1 has failed, remove the card from SD card slot 1. If SD card 2 has failed, install a new SD card in SD card slot 2 and proceed to step 7.
6. Remove the card present in SD card slot 2 and insert it into SD card slot 1.
7. Insert the new SD card into SD card slot 2.
8. Close the system.
9. Reconnect the system to its electrical outlet and turn the system on, including any attached peripherals.
10. Enter the System Setup and ensure that the **Internal SD Card Port** and **Internal SD Card Redundancy** mode is enabled.
11. Check if the SD card is functioning properly.
If the problem persists, see [Getting Help](#).

Troubleshooting A Hard Drive

 **CAUTION:** Many repairs may only be done by a certified service technician. You should only perform troubleshooting and simple repairs as authorized in your product documentation, or as directed by the online or telephone service and support team. Damage due to servicing that is not authorized by Dell is not covered by your warranty. Read and follow the safety instructions that came with the product.

 **CAUTION:** This troubleshooting procedure can erase data stored on the hard drive. Before you proceed, back up all files on the hard drive.

1. Run the appropriate diagnostic test. For more information, see [Using System Diagnostics](#). Depending on the results of the diagnostics test, proceed as needed through the following steps.
2. If your system has a RAID controller and your hard drives are configured in a RAID array, perform the following steps:
 - a. Reboot the system and press <F10> during system startup to run the Lifecycle Controller, and then run the Hardware Configuration wizard to check the RAID configuration.
See the Lifecycle Controller documentation or online help for information on RAID configuration.
 - b. Ensure that the hard drive(s) are configured correctly for the RAID array.
 - c. Take the hard drive offline and reseal the drive.
 - d. Exit the configuration utility and allow the system to boot to the operating system.
3. Ensure that the required device drivers for your controller card are installed and are configured correctly. See the operating system documentation for more information.
4. Reboot the system and enter the System Setup.
5. Verify that the controller is enabled and the drives are displayed in the System Setup.

If the problem persists, try troubleshooting the expansion cards or see [Getting Help](#).

Troubleshooting A Storage Controller

 **CAUTION:** Many repairs may only be done by a certified service technician. You should only perform troubleshooting and simple repairs as authorized in your product documentation, or as directed by the online or telephone service and support team. Damage due to servicing that is not authorized by Dell is not covered by your warranty. Read and follow the safety instructions that came with the product.

 **NOTE:** When troubleshooting a SAS or PERC controller, see the documentation for your operating system and the controller.

1. Run the appropriate diagnostic test. For more information, see [Using System Diagnostics](#).
2. Turn off the system and attached peripherals, and disconnect the system from the electrical outlet.
3. Open the system.
4. Verify that the installed expansion cards are compliant with the expansion card installation guidelines.
5. Ensure that each expansion card is firmly seated in its connector.
6. Close the system
7. Reconnect the system to the electrical outlet, and turn on the system and attached peripherals.
8. If the problem is not resolved, turn off the system and attached peripherals, and disconnect the system from the electrical outlet.
9. Open the system.
10. Remove all expansion cards installed in the system.
11. Close the system.
12. Reconnect the system to the electrical outlet, and turn on the system and attached peripherals.
13. Run the appropriate diagnostic test. For more information, see [Using System Diagnostics](#). If the tests fail, see [Getting Help](#).
14. For each expansion card you removed in step 10, perform the following steps:

- a. Turn off the system and attached peripherals, and disconnect the system from the electrical outlet.
- b. Open the system.
- c. Reinstall one of the expansion cards.
- d. Close the system.
- e. Run the appropriate diagnostic test. For more information, see [Using System Diagnostics](#).

If the tests fail, see [Getting Help](#).

Troubleshooting Expansion Cards

 **CAUTION:** Many repairs may only be done by a certified service technician. You should only perform troubleshooting and simple repairs as authorized in your product documentation, or as directed by the online or telephone service and support team. Damage due to servicing that is not authorized by Dell is not covered by your warranty. Read and follow the safety instructions that came with the product.

 **NOTE:** When troubleshooting an expansion card, see the documentation for your operating system and the expansion card.

1. Run the appropriate diagnostic test.
2. Turn off the system and attached peripherals, and disconnect the system from the electrical outlet.
3. Open the system.
4. Ensure that each expansion card is firmly seated in its connector.
5. Close the system.
6. If the problem is not resolved, turn off the system and attached peripherals, and disconnect the system from the electrical outlet.
7. Open the system.
8. Remove all expansion cards installed in the system.
9. Close the system.
10. Run the appropriate diagnostic test.
If the tests fail, see [Getting Help](#).
11. For each expansion card you removed in step 8, perform the following steps:
 - a. Turn off the system and attached peripherals, and disconnect the system from the electrical outlet.
 - b. Open the system.
 - c. Reinstall one of the expansion cards.
 - d. Close the system.
 - e. Run the appropriate diagnostic test.

If a problem is still indicated, see [Getting Help](#).

Troubleshooting Processors



CAUTION: Many repairs may only be done by a certified service technician. You should only perform troubleshooting and simple repairs as authorized in your product documentation, or as directed by the online or telephone service and support team. Damage due to servicing that is not authorized by Dell is not covered by your warranty. Read and follow the safety instructions that came with the product.

1. Run the appropriate diagnostics test.
2. Turn off the system and attached peripherals, and disconnect the system from the electrical outlet.
3. Open the system.
4. Ensure that the processor and heat sink are properly installed.
5. Close the system.
6. Run the appropriate diagnostic test.

If a problem is still indicated, see [Getting Help](#).

Using System Diagnostics

If you experience a problem with your system, run the system diagnostics before contacting Dell for technical assistance. The purpose of running system diagnostics is to test your system hardware without requiring additional equipment or risking data loss. If you are unable to fix the problem yourself, service and support personnel can use the diagnostics results to help you solve the problem.

Dell Embedded System Diagnostics

 **NOTE:** Also known as Enhanced Pre-boot System Assessment (ePSA) diagnostics.

The embedded system diagnostics provides a set of options for particular device groups or devices allowing you to:

- Run tests automatically or in an interactive mode
- Repeat tests
- Display or save test results
- Run thorough tests to introduce additional test options to provide extra information about the failed device(s)
- View status messages that inform you if tests are completed successfully
- View error messages that inform you of problems encountered during testing

When To Use The Embedded System Diagnostics

If a major component or device in the system does not operate properly, running the embedded system diagnostics may indicate component failure.

Running The Embedded System Diagnostics

The embedded system diagnostics program is run from the Dell Lifecycle Controller.

 **CAUTION:** Use the embedded system diagnostics to test only your system. Using this program with other systems may cause invalid results or error messages.

1. As the system boots, press <F11>.
2. Use the up and down arrow keys to select **System Utilities** → **Launch Dell Diagnostics**.
The **ePSA Pre-boot System Assessment** window is displayed, listing all devices detected in the system. The diagnostics starts executing the tests on all the detected devices.

System Diagnostic Controls

Menu	Description
Configuration	Displays the configuration and status information of all detected devices.
Results	Displays the results of all tests that are executed.

Menu	Description
System Health	Provides the current overview of the system performance.
Event Log	Displays a time-stamped log of the results of all tests run on the system. This is displayed if at least one event description is recorded.





For information about embedded system diagnostics, see the *ePSA Diagnostics Guide (Notebooks, Desktops and Servers)* at dell.com/support/manuals.

Jumpers And Connectors

System Board Jumper Settings

For information on resetting the password jumper to disable a password, see [Disabling A Forgotten Password](#).

Table 5. System Board Jumper Settings

Jumper	Setting	Description
PWRD_EN	 2 4 6 (default)	The password feature is enabled (pins 2–4).
	 2 4 6	The password feature is disabled (pins 4–6). iDRAC local access is unlocked at the next AC power cycle.
NVRAM_CLR	 1 3 5 (default)	The configuration settings are retained at system boot (pins 3–5).
	 1 3 5	The configuration settings are cleared at the next system boot (pins 1–3).

System Board Connectors

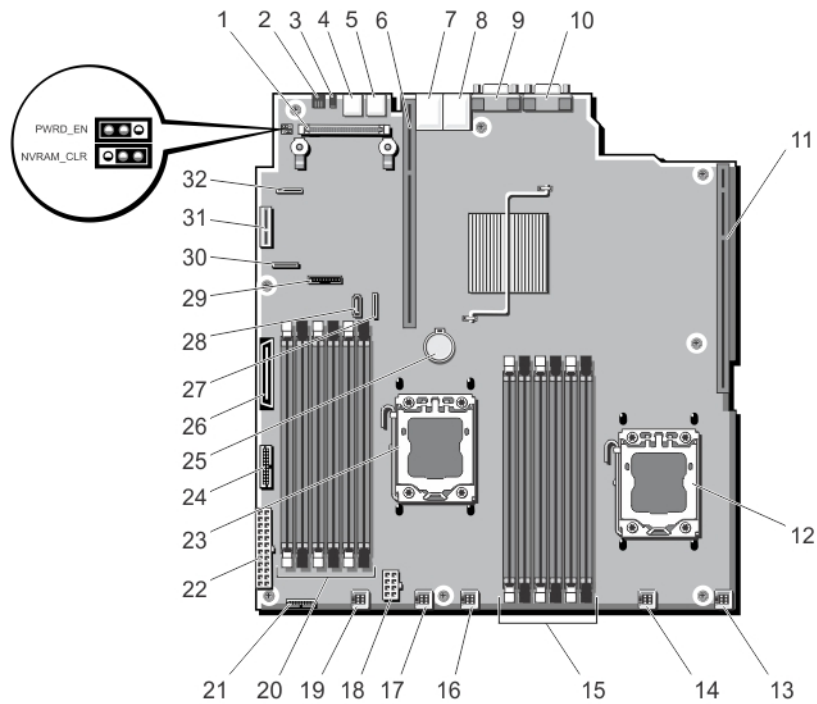

Figure 42. System Board Jumpers and Connectors

Item	Connector	Description
1	INT_STORAGE	Storage controller card connector
2	ID_BTN	System identification button
3	CMA_JACK	System identification connector
4	USB 2	USB connector
5	USB 1	USB connector
6	IO_RISER2	Riser 2 connector
7	NIC2	Network connector
8	NIC1	Network connector
9	VGA	Video connector
10	COM	Serial connector
11	IO_RISER1	Riser 1 connector
12	CPU2	Processor socket 2
13	FAN6	Cooling fan connector
14	FAN5	Cooling fan connector

Item	Connector	Description
15	B1, B4, B2, B5, B3, B6	Memory module sockets
16	FAN4	Cooling fan connector
17	FAN3	Cooling fan connector
18	PWR_CONN_1	8-pin power connector
19	FAN2	Cooling fan connector
20	A1, A4, A2, A5, A3, A6	Memory module sockets
21	BP_SIG	Backplane signal connector
22	PWR_CONN_2	24-pin power connector
23	CPU1	Processor socket 1
24	PDB_CONN	Power distribution board connector
25	BATTERY	Battery connector
26	CTRL_PNL_MB	Control panel interface connector
27	SATA_A-D	SATA connector A-D
28	SATA_E	SATA connector E
29	FP_USB	Front panel USB connector
30	SAS_A	SAS connector A
31	IDSDM	Internal Dual SD Module connector
32	SAS_B	SAS connector B

Disabling A Forgotten Password

The system's software security features include a system password and a setup password. The password jumper enables these password features or disables them and clears any password(s) currently in use.



CAUTION: See "Protecting Against Electrostatic Discharge" in the safety instructions that came with the system.

1. Turn off the system, including any attached peripherals, and disconnect the system from the electrical outlet.
2. Open the system.
3. Remove the jumper plug from the password jumper.
4. Close the system.

The existing passwords are not disabled (erased) until the system boots with the password jumper plug removed. However, before you assign a new system and/or setup password, you must install the jumper plug.



NOTE: If you assign a new system and/or setup password with the jumper plug still removed, the system disables the new password(s) the next time it boots.

5. Turn off the system, including any attached peripherals, and disconnect the system from the electrical outlet.

6. Open the system.
7. Install the jumper plug on the password jumper.
8. Close the system.
9. Assign a new system and/or setup password.

Technical Specifications

Processor	
Processor type	One or two Intel Xeon processors E5-2400 v2 product family
Expansion Bus	
Bus type	PCI Express Generation 2 and 3
Expansion slots using riser card:	
Riser 1	(Slot 1) One half-height, half length x4 link (for single processor) or One half-height, half length x16 link (for two processors)
Riser 2	(Slot 2) One full-height, half-length x16 link
Memory	
Architecture	800 MT/s, 1066 MT/s, 1333 MT/s, or 1600 MT/s DDR3 registered, unbuffered or load-reduced Error Correcting Code (ECC) DIMMs Support for advanced ECC or memory optimized operation
Memory module sockets	Twelve 240-pin
Memory module capacities	
RDIMMs	4 GB (single-rank), 8 GB (single- and dual-rank), 16 GB (dual-rank), and 32 GB (quad-rank)
UDIMMs	4 GB (single- rank) and 8 GB (single- and dual- rank)
Minimum RAM	4 GB with one processor 8 GB with two processors
Maximum RAM	192 GB with one processor 384 GB with two processors
Drives	
Hard drives	Up to four 2.5 inch hot-swappable SAS or SATA SSDs.

Drives

 **NOTE:** Four-hard-drive systems support software RAID. For more information on software RAID, see the Dell PowerEdge RAID Controller (PERC) documentation at dell.com/storagecontrollermanuals.

Connectors

Back

NIC	Two 10/100/1000 Mbps
Serial	9-pin, DTE, 16550-compatible
USB	Two 4-pin, USB 2.0-compliant
Video	15-pin VGA
iDRAC7	One optional 1 GbE Ethernet
External vFlash card	One flash memory card slot with iDRAC Enterprise card

 **NOTE:** The card slot is available for use only if the iDRAC7 Enterprise license is installed on your system.

Front

USB	Two 4-pin, USB 2.0-compliant
Video	15-pin VGA

Internal

USB	One 4-pin, USB 2.0-compliant
Internal Dual SD Module	Two optional flash memory card slots with the internal SD module

 **NOTE:** One card slot is dedicated for redundancy.

Video

Video type	Integrated Matrox G200 with iDRAC7
Video memory	16 MB shared with iDRAC application memory

Power

AC Power Supply (per power supply)	
Wattage	550 W

Power

Heat dissipation 2132 BTU/hr maximum (redundant, 550 W power supply)

 **NOTE:** Heat dissipation is calculated using the power supply wattage rating.

Voltage 100–240 V AC, autoranging, 50/60 Hz

 **NOTE:** This system is also designed to be connected to IT power systems with a phase to phase voltage not exceeding 230 V.

Battery

Coin-cell battery 3 V CR2032 Lithium coin cell

Expanded Operating Temperature

 **NOTE:** When operating in the expanded temperature range, system performance may be impacted.

 **NOTE:** When operating in the expanded temperature range, ambient temperature warnings may be reported on the LCD and in the System Event Log.

≤ 10% of annual operating hours

5 °C to 40 °C at 5% to 85% RH with 26 °C dew point.

 **NOTE:** Outside the standard operating temperature (10 °C to 35 °C), the system can operate down to 5 °C or up to 40 °C for a maximum of 10% of its annual operating hours.

For temperatures between 35 °C and 40 °C, de-rate maximum allowable dry bulb temperature by 1 °C per 175 m above 950 m (1 °F per 319 ft).

≤ 1% of annual operating hours

–5 °C to 45 °C at 5% to 90% RH with 26 °C dew point.

 **NOTE:** Outside the standard operating temperature (10 °C to 35 °C), the system can operate down to –5 °C or up to 45 °C for a maximum of 1% of its annual operating hours.

For temperatures between 40 °C and 45 °C, de-rate maximum allowable dry bulb temperature by 1 °C per 125 m above 950 m (1 °F per 228 ft).

Expanded Operating Temperature Restrictions

- Do not perform a cold startup below 5 °C.
- Allow processor performance degrade.
- Non-redundant power supplies are not supported.
- Non Dell qualified peripheral cards and/or peripheral cards are not supported.

Expanded Operating Temperature

- Maximum altitude for the operating temperature must be 3050 m (10,000 ft).

Environmental

 **NOTE:** For additional information about environmental measurements for specific system configurations, see dell.com/environmental_datasheets.

Temperature

Maximum Temperature Gradient (Operating and Storage)	20 °C/h (36 °F/h)
Storage Temperature Limits	-40 °C to 65 °C (-40 °F to 149 °F)

Temperature (Continuous Operation)

Temperature Ranges (for altitude less than 950 m or 3117 ft)	10 °C to 45 °C (50 °F to 113 °F) with no direct sunlight on the equipment.
Humidity Percentage Range	10% to 80% Relative Humidity with 26 °C (78.8 °F) maximum dew point.

Relative Humidity

Storage	5% to 95% RH with 33 °C (91 °F) maximum dew point. Atmosphere must be non-condensing at all times.
---------	--

Vibration

Operating	MIL-STD-810G, Method 514.6, Figure 514.6D-9, 0.00220783 g ² /Hz at 10-500 Hz (overall 1.04 G _{rms}), 1 hour per axis
Non-operating	MIL-STD-810G, Method 514.6, Figure 514.6, Procedure I, Category 4, Figure 514.6C-1 (US highway truck vibration), Vertical: 5-500 Hz at 1.04 _{G_{rms}} , Transverse: 5-500 Hz at 0.204 _{G_{rms}} , Longitudinal: 5-500 Hz at 0.740 _{G_{rms}} , 1 hour per axis

Shock

Operating	MIL-STD-810G, Method 516.6, Procedure I, 20G for rotational hard drives and 40G for solid state drives, 11 ms, saw tooth, 3 shocks, +/- per axis
Non-operating	MIL-STD-810G, Method 516.6, Procedure V, 40G, 11 ms, saw tooth, 3 shocks, +/- per axis

Maximum Altitude

Operating	3048 m (10,000 ft) per IEC 60950-1.
-----------	-------------------------------------

Environmental

4572 m (15,000 ft) per MIL-STD-810G, Method 500.5, Procedure II

Storage

12,192 m (40,000 ft).

Operating Altitude De-rating

Up to 35 °C (95 °F)

Maximum temperature is reduced by 1 °C/300 m (1 °F/547 ft) above 950 m (3,117 ft).

35 °C to 40 °C (95 °F to 104 °F)

Maximum temperature is reduced by 1 °C/175 m (1 °F/319 ft) above 950 m (3,117 ft).

40 °C to 45 °C (104 °F to 113 °F)

Maximum temperature is reduced by 1 °C/125 m (1 °F/228 ft) above 950 m (3,117 ft).

Particulate Contamination

 **NOTE:** This section defines the limits to help avoid IT equipment damage and/or failure from particulates and gaseous contamination. If it is determined that levels of particulates or gaseous pollution are beyond the limits specified below and are the reason for the damage and/or failures to your equipment, it may be necessary for you to re-mediate the environmental conditions that are causing the damage and/or failures. Re-mediation of environmental conditions will be the responsibility of the customer.

Air Filtration

Data center air filtration as defined by ISO Class 8 per ISO 14644-1 with a 95% upper confidence limit.

 **NOTE:** Applies to data center environments only. Air filtration requirements do not apply to IT equipment designed to be used outside a data center, in environments such as an office or factory floor.

 **NOTE:** Air entering the data center must have MERV11 or MERV13 filtration.

Conductive Dust

Air must be free of conductive dust, zinc whiskers, or other conductive particles.

 **NOTE:** Applies to data center and non-data center environments.

Corrosive Dust

- Air must be free of corrosive dust.
- Residual dust present in the air must have a deliquescent point less than 60% relative humidity.

 **NOTE:** Applies to data center and non-data center environments.

Gaseous Contamination

 **NOTE:** Maximum corrosive contaminant levels measured at $\leq 50\%$ relative humidity.

Copper Coupon Corrosion Rate

<300 Å/month per Class G1 as defined by ANSI/ISA71.04-1985.

Silver Coupon Corrosion Rate

<200 Å/month as defined by AHSRAE TC9.9.

System Messages

LCD Messages

 **NOTE:** Applicable only if your system has an LCD display.

The LCD messages consist of brief text messages that refer to events recorded in the System Event Log (SEL). For information on the SEL and configuring system management settings, see the systems management software documentation.

 **NOTE:** If your system fails to boot, press the System ID button for at least 5 seconds until an error code is displayed on the LCD. Record the code, then see System Error Messages.

Viewing LCD Messages

If a system error occurs, the LCD screen will turn amber. Press the Select button to view the list of errors or status messages. Use the Left and Right buttons to highlight an error number, and press the Select button to view the error.

Removing LCD Messages

For faults associated with sensors, such as temperature, voltage, fans, and so on, the LCD message is automatically removed when that sensor returns to a normal state. For other faults, you must take action to remove the message from the display:

- Clear the SEL — You can perform this task remotely, but you will lose the event history for the system.
- Power cycle — Turn off the system and disconnect it from the electrical outlet; wait approximately 10 seconds, reconnect the power cable, and restart the system.

System Error Messages

System messages appear on the monitor to notify you of a possible problem with the system. These messages refer to events recorded in the System Event Log (SEL). For information on the SEL and configuring system management settings, see the systems management software documentation.

Some messages are also displayed in an abbreviated form on the system's LCD, if the system includes that feature.

 **NOTE:** The LCD error messages listed here are displayed in the simple format. See Setup Menu to select the format in which the messages are displayed.

 **NOTE:** If you receive a system message not listed here, check the documentation of the application that was running when the message was displayed or the operating system's documentation for an explanation of the message and recommended action.

 **NOTE:** In some messages, a particular system component is identified by name (“<name>”) component number (“<number>”), or location (“bay”).

Error Code	Message Information	
AMP0302	Message	The system board <name> current is greater than the upper warning threshold.
	Details	System board <name> current is outside of the optimum range.
	Action	<ol style="list-style-type: none">1. Review system power policy.2. Check system logs for power related failures.3. Review system configuration changes.4. If the issue persists, see Getting Help.
AMP0303	Message	The system board <name> current is greater than the upper critical threshold.
	LCD Message	System board <name> current is outside of range.
	Details	System board <name> current is outside of the optimum range.
	Action	<ol style="list-style-type: none">1. Review system power policy.2. Check system logs for power related failures.3. Review system configuration changes.4. If the issue persists, see Getting Help.
ASR0000	Message	The watchdog timer expired.
	Details	The operating system or an application failed to communicate within the time-out period.
	Action	Check the operating system, application, hardware, and system event log for exception events.
ASR0001	Message	The watchdog timer reset the system.
	Details	The operating system or an application failed to communicate within the time-out period. The system was reset.
	Action	Check the operating system, application, hardware, and system event log for exception events.
ASR0002	Message	The watchdog timer powered off the system.

Error Code	Message Information	
	Details	The operating system or an application failed to communicate within the time-out period. The system was shut down.
	Action	Check the operating system, application, hardware, and system event log for exception events.
ASR0003	Message	The watchdog timer power cycled the system.
	Details	The operating system or an application failed to communicate within the time-out period. The system was power-cycled.
	Action	Check the operating system, application, hardware, and system event log for exception events.
BAT0002	Message	The system board battery has failed.
	LCD Message	The system board battery has failed. Check battery.
	Details	The system board battery is either missing or bad.
	Action	See Getting Help .
BAT0017	Message	The <name> battery has failed.
	LCD Message	The <name> battery has failed. Check battery.
	Details	The <name> battery is either missing, bad, or unable to charge due to thermal issues.
	Action	Check system fans. If the problem persists, see Getting Help .
CPU0000	Message	CPU <number> has an internal error (IERR).
	LCD Message	CPU <number> has an internal error (IERR).
	Details	System Event Log and Operating System Logs may indicate that the exception is external to the processor.
	Action	Review System Event Log and Operating System Logs. If the issue persists, see Getting Help .
CPU0001	Message	CPU <number> has a thermal trip (over-temperature) event.
	LCD Message	CPU <number> has a thermal trip. Check CPU heat sink.
	Details	The processor temperature increased beyond the operational range.

Error Code	Message Information	
	Action	Review the logs for fan failures. If no fan failures are detected, check inlet temperature (if available) and reinstall processor heat sink. If the problem persists, see Getting Help .
CPU0005	Message	CPU <number> configuration is unsupported.
	LCD Message	CPU <number> configuration is unsupported. Check CPU or BIOS revision.
	Details	System is unable to boot or may run in a degraded state.
	Action	Review the technical specifications for supported processor types.
CPU0010	Message	CPU <number> is throttled.
	Details	The CPU is throttled due to thermal or power conditions.
	Action	Review system logs for power or thermal exceptions.
CPU0023	Message	CPU <number> is absent.
	LCD Message	CPU <number> is absent. Check CPU.
	Action	Verify processor installation. If present, re-seat the processor.
CPU0204	Message	CPU <number> <name> voltage is outside of range.
	LCD Message	CPU <number> <name> voltage is outside of range. Re-seat CPU.
	Details	Voltages outside the allowable range may damage electrical components or may cause the system to shutdown.
	Action	<ol style="list-style-type: none"> 1. Turn off the system and remove input power for one minute. 2. Ensure the processor is seated correctly. 3. Reapply input power and turn on the system. 4. If the issue persists, see Getting Help.
CPU0700	Message	CPU <number> initialization error detected.
	LCD Message	CPU <number> initialization error detected. Power cycle system.
	Details	System BIOS was unable to initialize the processor.

Error Code	Message Information	
	Action	<ol style="list-style-type: none"> 1. Turn off the system and remove input power for one minute. 2. Ensure the processor is seated correctly. 3. Reapply input power and turn on the system. 4. If the issue persists, see Getting Help.
CPU0701	Message	CPU <number> protocol error detected.
	LCD Message	CPU <number> protocol error detected. Power cycle system.
	Details	System event log and operating system logs may indicate that the exception is external to the processor.
	Action	<ol style="list-style-type: none"> 1. Check system and operating system logs for exceptions. If no exceptions are found, continue. 2. Turn off the system and remove input power for one minute. 3. Ensure the processor is seated correctly. 4. Reapply input power and turn on the system. 5. If the issue persists, see Getting Help.
CPU0702	Message	CPU bus parity error detected.
	LCD Message	CPU bus parity error detected. Power cycle system.
	Details	System event log and operating system logs may indicate that the exception is external to the processor.
	Action	<ol style="list-style-type: none"> 1. Check system and operating system logs for exceptions. If no exceptions are found, continue. 2. Turn off the system and remove input power for one minute. 3. Ensure the processor is seated correctly. 4. Reapply input power and turn on the system. 5. If the issue persists, see Getting Help.
CPU0703	Message	CPU bus initialization error detected.
	LCD Message	CPU bus initialization error detected. Power cycle system.
	Details	System event log and operating system logs may indicate that the exception is external to the processor.

Error Code	Message Information	
	Action	<ol style="list-style-type: none"> 1. Check system and operating system logs for exceptions. If no exceptions are found, continue. 2. Turn off the system and remove input power for one minute. 3. Ensure the processor is seated correctly. 4. Reapply input power and turn on the system. 5. If the issue persists, see Getting Help.
CPU0704	Message	CPU <number> machine check error detected.
	LCD Message	CPU <number> machine check error detected. Power cycle system.
	Details	System event log and operating system logs may indicate that the exception is external to the processor.
	Action	<ol style="list-style-type: none"> 1. Check system and operating system logs for exceptions. If no exceptions are found, continue. 2. Turn off the system and remove input power for one minute. 3. Ensure the processor is seated correctly. 4. Reapply input power and turn on the system. 5. If the issue persists, see Getting Help.
FAN0000	Message	Fan <number> RPM is less than the lower warning threshold.
	Details	Fan operating speed is out of range.
	Action	Remove and reinstall the fan. If the issue persists, see Getting Help .
FAN0001	Message	Fan <number> RPM is less than the lower critical threshold.
	LCD Message	Fan <number> RPM is outside of range. Check fan.
	Details	Fan operating speed is out of range.
	Action	Remove and reinstall the fan. If the issue persists, see Getting Help .
FAN1201	Message	Fan redundancy is lost.
	LCD Message	Fan redundancy is lost. Check fans.
	Details	Fan has failed.
	Action	Remove and reinstall failed fans or install additional fans.

Error Code	Message Information	
HWC1001	Message	The <name> is absent.
	LCD Message	The <name> is absent. Check hardware.
	Details	The absent device may be necessary for proper operation. System functionality may be degraded.
	Action	Reinstall or reconnect the hardware.
HWC2003	Message	The storage <name> cable is not connected, or is improperly connected.
	LCD Message	Storage <name> cable or interconnect failure. Check connection.
	Details	The cable may be necessary for proper operation. System functionality may be degraded.
	Action	Check if the cable is present, then reinstall or reconnect.
HWC2005	Message	The system board <name> cable is not connected, or is improperly connected.
	LCD Message	System board <name> cable connection failure. Check connection.
	Details	The cable may be necessary for proper operation. System functionality may be degraded.
	Action	Check if the cable is present, then reinstall or reconnect.
MEM0000	Message	Persistent correctable memory errors detected on a memory device at location(s) <location>.
	Details	This is an early indicator of a possible future uncorrectable error.
	Action	Re-seat the memory modules. If the issue persists, see Getting Help .
MEM0001	Message	Multi-bit memory errors detected on a memory device at location(s) <location>.
	LCD Message	Multi-bit memory error on <location>. Re-seat memory.
	Details	The memory module has encountered an uncorrectable error. System performance may be degraded. The operating system and/or applications may fail as a result.
	Action	Re-seat the memory modules. If the issue persists, see Getting Help .

Error Code	Message Information	
MEM0007	Message	Unsupported memory configuration; check memory device at location <location>.
	LCD Message	Unsupported memory configuration. Check memory <location>.
	Details	The memory may not be seated correctly, misconfigured, or has failed. Memory size is reduced.
	Action	Check the memory configuration. Re-seat the memory modules. If the issue persists, see Getting Help .
MEM0701	Message	Correctable memory error rate exceeded for <location>.
	Details	The memory may not be operational. This an early indicator of a possible future uncorrectable error.
	Action	Re-seat the memory modules. If the issue persists, see Getting Help .
MEM0702	Message	Correctable memory error rate exceeded for <location>.
	LCD Message	Correctable memory error rate exceeded for <location>. Re-seat memory.
	Details	The memory may not be operational. This an early indicator of a possible future uncorrectable error.
	Action	Re-seat the memory modules. If the issue persists, see Getting Help .
MEM1205	Message	Memory mirror redundancy is lost. Check memory device at location(s) <location>.
	LCD Message	Memory mirror lost on <location>. Power cycle system.
	Details	The memory may not be seated correctly, misconfigured, or has failed.
	Action	Check the memory configuration. Re-seat the memory modules. If the issue persists, see Getting Help .
MEM1208	Message	Memory spare redundancy is lost. Check memory device at location <location>.
	LCD Message	Memory spare lost on <location>. Power cycle system.
	Details	Memory sparing is no longer available.
	Action	Re-seat the memory modules. If the issue persists, see Getting Help .

Error Code	Message Information	
MEM8000	Message	Correctable memory error logging disabled for a memory device at location <location>.
	LCD Message	SBE log disabled on <location>. Re-seat memory.
	Details	Errors are being corrected but no longer logged.
	Action	Review system logs for memory exceptions. Reinstall memory at location <location>.
PCI1302	Message	A bus time-out was detected on a component at bus <bus> device<device> function <func>.
	Details	System performance may be degraded. The device has failed to respond to a transaction.
	Action	Cycle input power, update component drivers, if device is removable, reinstall the device.
PCI1304	Message	An I/O channel check error was detected.
	LCD Message	I/O channel check error detected. Power cycle system.
	Action	Cycle input power, update component drivers, if device is removable, reinstall the device.
PCI1308	Message	A PCI parity error was detected on a component at bus <bus>device<device>function <func>.
	LCD Message	PCI parity error on bus <bus> device <device> function <func>. Power cycle system.
	Details	System performance may be degraded, PCI device may fail to operate, or system may fail to operate.
	Action	Cycle input power, update component drivers, if device is removable, reinstall the device.
PCI1320	Message	A bus fatal error was detected on a component at bus <bus>device<device>function <func>.
	LCD Message	Bus fatal error on bus <bus> device <device> function <func>. Power cycle system.
	Details	System performance may be degraded, or system may fail to operate.
	Action	Cycle input power, update component drivers, if device is removable, reinstall the device.

Error Code	Message Information	
PCI1342	Message	A bus time-out was detected on a component at slot <number>.
	Details	System performance may be degraded, or system may fail to operate.
	Action	Cycle input power, update component drivers, if device is removable, reinstall the device.
PCI1348	Message	A PCI parity error was detected on a component at slot <number>.
	LCD Message	PCI parity error on slot <number>. Re-seat PCI card.
	Details	System performance may be degraded, or system may fail to operate.
	Action	Cycle input power, update component drivers, if device is removable, reinstall the device.
PCI1360	Message	A bus fatal error was detected on a component at slot <number>.
	LCD Message	Bus fatal error on slot <number>. Re-seat PCI card.
	Details	System performance may be degraded, or system may fail to operate.
	Action	Cycle input power, update component drivers, if device is removable, reinstall the device.
PDR0001	Message	Fault detected on drive <number>.
	LCD Message	Fault detected on drive <number>. Check drive.
	Details	The controller detected a failure on the disk and has taken the disk offline.
	Action	Remove and re-seat the failed disk. If the issue persists, see Getting Help .
PDR1016	Message	Drive <number> is removed from disk drive bay <bay>.
	LCD Message	Drive <number> removed from disk drive bay <bay>. Check drive.
	Details	The controller detected that the drive was removed.
	Action	Verify drive installation. Re-seat the failed drive. If the issue persists, see Getting Help .

Error Code	Message Information	
PST0128	Message	No memory is detected.
	LCD Message	No memory is detected. Inspect memory devices.
	Details	System BIOS was unable to detect memory in the system.
	Action	Re-seat the memory modules. If the issue persists, see Getting Help .
PST0129	Message	Memory is detected, but is not configurable.
	LCD Message	Memory is detected, but is not configurable. Check memory devices.
	Details	System BIOS detected memory, but was unable to configure the memory for system operation.
	Action	Compare system memory installation to supported system memory configurations.
PSU0001	Message	Power supply <number> failed.
	LCD Message	PSU <number> failed. Check PSU.
	Action	Remove and reinstall the power supply. If the issue persists, see Getting Help .
PSU0002	Message	A predictive failure detected on power supply <number>.
	LCD Message	Predictive failure on PSU <number>. Check PSU.
	Details	System performance and power redundancy may be degraded or lost.
	Action	Remove and reinstall the power supply at the next service window. If the issue persists, see Getting Help .
PSU0003	Message	The power input for power supply <number> is lost.
	LCD Message	Power input for PSU <number> is lost. Check PSU cables.
	Details	The power supply is installed correctly but an input source is not connected or is not functional.
	Action	Verify the input source is attached to the power supply. Verify the input power is within the operating requirements for the power supply.
PSU0006	Message	Power supply <number> type mismatch.

Error Code	Message Information	
	LCD Message	Power supply <number> is incorrectly configured. Check PSU.
	Details	Power supplies should be of the same input type and power rating.
	Action	Install matched power supplies and review proper configuration in this manual.
PSU0016	Message	Power supply <number> is absent.
	LCD Message	PSU <number> is absent. Check PSU.
	Details	The power supply has been removed or has failed.
	Action	<ol style="list-style-type: none"> 1. Remove and reinstall the power supply. 2. Check cables and subsystem components in the system for damage. 3. If the issue persists, see Getting Help.
PSU0031	Message	Cannot communicate with power supply <number>.
	LCD Message	Cannot communicate with PSU <number>. Re-seat PSU.
	Details	The power supply may operate, however power supply monitoring is degraded. System performance may be degraded.
	Action	Remove and reinstall the power supply. If the issue persists, see Getting Help .
PSU0032	Message	The temperature for power supply <number> is in a warning range.
	Details	System performance may be degraded.
	Action	Check the system operating environment, including airflow and inlet temperature. Check system logs for temperature and thermal component failures.
PSU0033	Message	The temperature for power supply <number> is outside of the allowable range.
	LCD Message	PSU <number> temperature outside of range. Check PSU.
	Details	System performance may be degraded.

Error Code	Message Information	
PSU0034	Action	Check the system operating environment, including airflow and inlet temperature. Check system logs for temperature and thermal component failures.
	Message	An under voltage fault detected on power supply <number>.
	LCD Message	An under voltage fault detected on PSU <number>. Check power source.
	Details	This failure may be the result of an electrical issue with cables or subsystem components in the system.
Action	1. Remove and reinstall the power supply.	
	2. Check cables and subsystem components in the system for damage.	
	3. If the issue persists, see Getting Help .	
PSU0035	Message	An over voltage fault detected on power supply <number>.
	LCD Message	Over voltage fault on PSU <number>. Check PSU.
	Action	Check input power or reinstall the power supply. If the issue persists, see Getting Help .
PSU0036	Message	An over current fault detected on power supply <number>.
	LCD Message	An over current fault detected on PSU <number>. Check PSU.
	Details	This failure may be the result of an electrical issue with cables or subsystem components in the system.
	Action	1. Remove and reinstall the power supply.
2. Check cables and subsystem components in the system for damage.		
3. If the issue persists, see Getting Help .		
PSU0037	Message	Fan failure detected on power supply <number>.
	LCD Message	Fan failure detected on PSU <number>. Check PSU.
	Action	Check for fan blockage. If the problem persists, see Getting Help .
PSU0076	Message	A power supply wattage mismatch is detected; power supply <number> is rated for <value> watts.

Error Code	Message Information	
	LCD Message	PSU wattage mismatch; PSU <number> = <value >watts
	Details	Power supplies should be of the same input type and power rating.
	Action	Install matched power supplies and review this manual for proper configuration.
PSU1201	Message	Power supply redundancy is lost.
	Details	The power supply tries to operate in a degraded state. System Performance and power redundancy may be degraded or lost.
	Action	Check input power. Reinstall the power supply. If the issue persists, see Getting Help .
PSU1204	Message	The power supplies are not redundant. Insufficient resources to maintain normal operations.
	LCD Message	PSU redundancy degraded. Check PSU cables.
	Details	The current power operational mode is non-redundant because of a power supply exception, a power supply inventory change, or a system power inventory change.
	Action	Check the event log for power supply failures. Review system configuration and power consumption.
PWR1004	Message	The system performance degraded because power capacity has changed.
	Details	The system may power down or operate in a performance degraded state.
	Action	Check the event log for power supply failures. Review system configuration and power consumption and upgrade or install power supplies accordingly.
PWR1005	Message	The system performance degraded because the user-defined power capacity has changed.
	Details	The user-defined power settings have affected system operation.
	Action	If unintended, review system configuration changes and power policy.
PWR1006	Message	The system halted because system power exceeds capacity.

Error Code	Message Information	
	LCD Message	System power demand exceeds capacity. System halted.
	Details	The system halted because system power exceeds capacity.
	Action	Review system configuration, upgrade power supplies or reduce system power consumption.
RFM1008	Message	Failure detected on Removable Flash Media <name>.
	LCD Message	Removable Flash Media <name> failed. Check SD Card.
	Details	An error was reported during a SD card read or write.
	Action	Reseat the flash media. If the problem persists, see Getting Help .
RFM1014	Message	Removable Flash Media <name> is write protected.
	LCD Message	Removable Flash Media <name> is write protected. Check SD Card.
	Details	The card is write-protected by the physical latch on the SD card. A write-protected card cannot be used.
	Action	If unintended, remove the media and disable write protection.
RFM1201	Message	Internal Dual SD Module redundancy is lost.
	LCD Message	Internal Dual SD Module redundancy is lost. Check SD Card.
	Details	Either one or both the SD cards are not functioning properly.
	Action	See Getting Help .
RFM2001	Message	Internal Dual SD Module <name> is absent.
	LCD Message	Internal Dual SD Module <name> is absent. Check SD Card.
	Details	The SD card module is not detected or not installed.
	Action	If unintended, reinstall the SD module.
RFM2002	Message	Internal Dual SD Module <name> is offline.
	Details	The SD card module is installed but may be improperly installed or configured incorrectly.
	Action	Reinstall the SD module.
RFM2004	Message	Failure detected on Internal Dual SD Module <name>.

Error Code	Message Information	
	LCD Message	Internal Dual SD Module <name> failed. Check SD Card.
	Details	The SD card module is installed but improperly configured or failed to initialize.
	Action	Reinstall the SD module and remove and reinstall SD cards.
RFM2006	Message	Internal Dual SD Module <name> is write protected.
	Details	The module is write-protected. Changes may not be written to the media.
	Action	If unintended, remove the media and disable write protection.
SEC0031	Message	The chassis is open while the power is on.
	LCD Message	Intrusion detected. Check chassis cover.
	Details	The chassis is open. System performance may be degraded, and security may be compromised.
	Action	Close the chassis. Check system logs.
SEC0033	Message	The chassis is open while the power is off.
	LCD Message	Intrusion detected. Check chassis cover.
	Details	The chassis was opened while the power was off. System security may have been compromised.
	Action	Close the chassis and verify hardware inventory. Check system logs.
SEL0006	Message	All event logging is disabled.
	Details	This message is displayed when all event logging has been disabled by the user.
	Action	If unintended, re-enable logging.
SEL0008	Message	Log is full.
	Details	When the event log is full, additional events are not written to the log. Older events may be overwritten and lost. This message may also appear if the user disabled event logging.
	Action	Backup and clear log.
SEL0012	Message	Could not create or initialize the system event log.

Error Code	Message Information	
	Details	If the system event log fails to initialize, platform status and failure events are not captured. Some management software do not report platform exceptions.
	Action	Reboot the management controller or iDRAC. Cycle system input power. If problem persists call support.
SEL1204	Message	An unknown system hardware failure detected.
	LCD Message	Unknown system hardware failure.
	Details	If the system event log failed to initialize, platform status and failure events are not captured. Some management software do not report platform exceptions.
	Action	Re-configure system to the minimum supported configuration. If issues persists, contact support.
TMP0118	Message	The system inlet temperature is less than the lower warning threshold.
	LCD Message	System inlet temperature is outside of range.
	Details	Ambient air temperature is too cool.
	Action	Check the system operating environment.
TMP0119	Message	The system inlet temperature is less than the lower critical threshold.
	LCD Message	System inlet temperature is outside of range.
	Details	Ambient air temperature is too cool.
	Action	Check the system operating environment.
TMP0120	Message	The system inlet temperature is greater than the upper warning threshold.
	LCD Message	System inlet temperature is outside of range.
	Details	Ambient air temperature is too warm or one or more fans may have failed.
	Action	Check the system operating environment and review event log for fan failures.
TMP0121	Message	The system inlet temperature is greater than the upper critical threshold.

Error Code	Message Information	
	LCD Message	System inlet <name> temperature is outside of range. Check Fans.
	Details	Ambient air temperature is too warm or one or more fans may have failed.
	Action	Check the system operating environment and review event log for fan failures.
VLT0204	Message	The system board <name> voltage is outside of the allowable range.
	LCD Message	System board voltage is outside of range.
	Details	System hardware detected an over voltage or under voltage condition. If multiple voltage exceptions occur consecutively the system may power down in fail-safe mode.
	Action	<ol style="list-style-type: none"> 1. Review system logs for power supply exceptions. 2. Re-configure the system to minimum configuration, inspect and reinstall system cables. 3. If the issue persists, see Getting Help.

Warning Messages

A warning message alerts you to a possible problem and prompts you to respond before the system continues a task. For example, before you format a hard drive, a message warns you that you may lose all data on the hard drive. Warning messages usually interrupt the task and require you to respond by typing y (yes) or n (no).

 **NOTE:** Warning messages are generated by either the application or the operating system. For more information, see the documentation that accompanied the operating system or application.

Diagnostic Messages

The system diagnostic utilities may issue messages if you run diagnostic tests on your system. See the "Using System Diagnostics" chapter for more information about system diagnostics.

Alert Messages

Systems management software generates alert messages for your system. Alert messages include information, status, warning, and failure messages for drive, temperature, fan, and power conditions. For more information, see the systems management software documentation.

Getting Help

Contacting Dell

 **NOTE:** If you do not have an active Internet connection, you can find contact information on your purchase invoice, packing slip, bill, or Dell product catalog.

Dell provides several online and telephone-based support and service options. Availability varies by country and product, and some services may not be available in your area. To contact Dell for sales, technical support, or customer service issues:

1. Visit dell.com/support
2. Select your support category.
3. Verify your country or region in the Choose a Country/Region drop-down menu at the top of page.
4. Select the appropriate service or support link based on your need.

Locating Your System Service Tag

Your system is identified by a unique Express Service Code and Service Tag number. The Express Service Code and Service Tag are found on the front of the system by pulling out the information tag.

Alternatively, the information may be on a sticker on the chassis of the system. This information is used by Dell to route support calls to the appropriate personnel.

Documentation Feedback

If you have feedback for this document, write to documentation_feedback@dell.com. Alternatively, you can click on the **Feedback** link in any of the Dell documentation pages, fill out the form, and click **Submit** to send your feedback.