

Dell EMC PowerEdge M640 for VRTX enclosure

Installation and Service Manual

Notes, cautions, and warnings

 **NOTE:** A NOTE indicates important information that helps you make better use of your product.

 **CAUTION:** A CAUTION indicates either potential damage to hardware or loss of data and tells you how to avoid the problem.

 **WARNING:** A WARNING indicates a potential for property damage, personal injury, or death.

| | |
|--|-----------|
| Chapter 1: Dell EMC PowerEdge M640 overview | 7 |
| Front view of the system | 7 |
| Health status indicator | 8 |
| Hard drive indicator codes | 8 |
| iDRAC Direct LED indicator codes | 9 |
| Locating the Service Tag of your system | 9 |
| System information label | 10 |
| Chapter 2: Documentation resources | 11 |
| Chapter 3: Technical specifications | 13 |
| System dimensions | 13 |
| System weight | 13 |
| Processor specifications | 14 |
| Supported operating systems | 14 |
| System battery specifications | 14 |
| Memory specifications | 14 |
| Mezzanine card specifications | 14 |
| Storage controller specifications | 14 |
| Drive specifications | 14 |
| Hard drives | 15 |
| Ports and connectors specifications | 15 |
| USB ports | 15 |
| Internal Dual SD Module | 15 |
| Micro SD vFlash connector | 15 |
| Video specifications | 15 |
| Environmental specifications | 15 |
| Particulate and gaseous contamination specifications | 16 |
| Standard operating temperature | 17 |
| Expanded operating temperature | 17 |
| Expanded operating temperature restrictions | 18 |
| Thermal Restriction matrix | 18 |
| Chapter 4: Initial system setup and configuration | 20 |
| Setting up your system | 20 |
| iDRAC configuration | 20 |
| Options to set up iDRAC IP address | 20 |
| Log in to iDRAC | 21 |
| Options to install the operating system | 21 |
| Methods to download firmware and drivers | 21 |
| Downloading drivers and firmware | 22 |
| Chapter 5: Pre-operating system management applications | 23 |
| Options to manage the pre-operating system applications | 23 |

| | |
|---------------------------------|----|
| System Setup..... | 23 |
| Viewing System Setup..... | 23 |
| System Setup details..... | 24 |
| System BIOS..... | 24 |
| iDRAC Settings utility..... | 43 |
| Device Settings..... | 43 |
| Dell Lifecycle Controller..... | 43 |
| Embedded system management..... | 43 |
| Boot Manager..... | 43 |
| Viewing Boot Manager..... | 43 |
| Boot Manager main menu..... | 44 |
| One-shot UEFI boot menu..... | 44 |
| System Utilities..... | 44 |
| PXE boot..... | 44 |

Chapter 6: Installing and removing system components..... 45

| | |
|---|----|
| Safety instructions..... | 45 |
| Before working inside your system..... | 45 |
| After working inside your system..... | 46 |
| Recommended tools..... | 46 |
| Removing the system from the enclosure..... | 46 |
| Installing the system into the enclosure..... | 48 |
| Inside the system..... | 49 |
| System cover..... | 50 |
| Removing the system cover..... | 50 |
| Installing the system cover..... | 51 |
| Air shroud..... | 53 |
| Removing the air shroud..... | 53 |
| Installing the air shroud..... | 53 |
| Drives..... | 54 |
| Removing a drive blank..... | 54 |
| Installing a drive blank..... | 55 |
| Removing a drive carrier..... | 55 |
| Installing a drive carrier..... | 56 |
| Removing a drive from a drive carrier..... | 57 |
| Installing a drive into drive carrier..... | 58 |
| Removing the drive cage..... | 59 |
| Installing the drive cage..... | 60 |
| Drive backplane..... | 61 |
| Removing the drive backplane..... | 61 |
| Installing the drive backplane..... | 63 |
| System memory | 65 |
| System memory guidelines..... | 65 |
| General memory module installation guidelines..... | 66 |
| Mode-specific guidelines..... | 66 |
| Removing a memory module..... | 68 |
| Installing a memory module..... | 69 |
| Processors and heat sinks..... | 70 |
| Removing a processor and heat sink module..... | 70 |
| Removing the processor from the processor and heat sink module..... | 71 |

| | |
|---|------------|
| Installing the processor into a processor and heat sink module..... | 73 |
| Installing a processor and heat sink module..... | 75 |
| M.2 SSD module..... | 76 |
| Removing the M.2 SSD module..... | 76 |
| Installing the M.2 SSD module..... | 77 |
| Network Daughter Card..... | 78 |
| Removing the Network Daughter Card..... | 78 |
| Installing the Network Daughter Card..... | 79 |
| PCIe mezzanine card..... | 80 |
| PCIe mezzanine card installation guidelines..... | 80 |
| Removing the PCIe mezzanine card..... | 80 |
| Installing the PCIe mezzanine card..... | 81 |
| Storage controller card | 82 |
| Removing the storage controller card..... | 82 |
| Installing the storage controller card..... | 83 |
| System battery..... | 84 |
| Replacing the NVRAM backup battery - Option A..... | 84 |
| Replacing the NVRAM backup battery - Option B..... | 86 |
| Optional internal USB memory key..... | 87 |
| Replacing optional internal USB memory key..... | 87 |
| Optional MicroSD or vFlash card..... | 88 |
| Removing the internal micro SD card..... | 88 |
| Installing an internal micro SD card..... | 88 |
| IDSDM..... | 89 |
| Removing the optional internal dual SD module | 89 |
| Installing the optional internal dual SD module..... | 90 |
| System board..... | 91 |
| Removing the system board..... | 91 |
| Installing the system board..... | 93 |
| Trusted Platform Module..... | 96 |
| Upgrading the Trusted Platform Module..... | 96 |
| Initializing TPM for BitLocker users..... | 97 |
| Initializing the TPM 1.2 for TXT users..... | 97 |
| Initializing the TPM 2.0 for TXT users..... | 97 |
| rSPI card..... | 98 |
| Removing the rSPI card..... | 98 |
| Installing the rSPI card..... | 99 |
| Chapter 7: System diagnostics..... | 100 |
| Dell Embedded System Diagnostics..... | 100 |
| Running the Embedded System Diagnostics from Boot Manager..... | 100 |
| Running the Embedded System Diagnostics from the Dell Lifecycle Controller..... | 100 |
| System diagnostic controls..... | 101 |
| Chapter 8: Jumpers and connectors..... | 102 |
| System board jumpers and connectors..... | 102 |
| System board jumper settings..... | 103 |
| Disabling a forgotten password..... | 103 |

| | |
|---|------------|
| Chapter 9: Getting help | 105 |
| Contacting Dell EMC..... | 105 |
| Documentation feedback..... | 105 |
| Accessing system information by using QRL..... | 105 |
| Quick Resource Locator for PowerEdge M640 system..... | 106 |
| Receiving automated support with SupportAssist | 106 |
| Recycling or End-of-Life service information..... | 106 |

Dell EMC PowerEdge M640 overview

The Dell EMC PowerEdge M640 is a half-height server module supported on the PowerEdge VRTX enclosure and supports up to:

- Two Intel Xeon scalable processors
- Two 2.5-inch hard drives/SSDs
- 16 DIMMs

NOTE: All instances of SAS, SATA hard drives and SSDs are referred to as drives in this document, unless specified otherwise.

Topics:

- [Front view of the system](#)
- [System information label](#)

Front view of the system

The front view displays the features available on the front of the system.

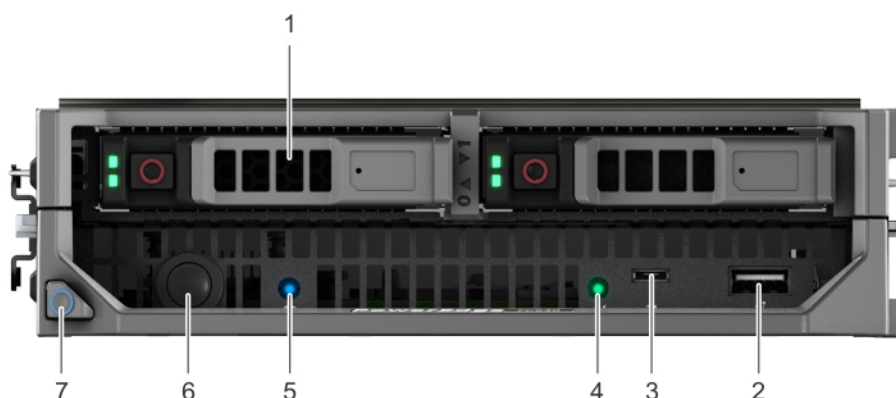

Figure 1. Front view of the system

Table 1. Features available on the front of the system





| Item | Ports, panels, and components | Icon | Description |
|------|-------------------------------|---|---|
| 1 | Hard drives/SSDs | N/A | 2.5-inch hard drive/SSDs are supported. For more information, see the Technical specifications section. |
| 2 | USB 3.0 port |  | Enables you to connect USB devices to the system. |
| 3 | iDRAC Direct port |  | The iDRAC Direct port is micro USB 2.0-compliant. This port enables you to access the iDRAC Direct features. For more information, see the <i>Integrated Dell Remote Access Controller User's Guide</i> at www.dell.com/poweredgemanuals . |
| 4 | iDRAC Direct LED indicator | N/A | The iDRAC Direct LED indicator lights up to indicate that the iDRAC Direct port is actively connected to a device. For more information, see the iDRAC Direct LED indicator codes section. |
| 5 | Status indicator |  | Provides information about the status of the system. For more information, see the Health status indicator section. |

Table 1. Features available on the front of the system (continued)

| Item | Ports, panels, and components | Icon | Description |
|------|-------------------------------|---|---|
| 6 | Power button |  | Indicates if the system is turned on or off. Press the power button to manually turn on or off the system. NOTE: Press the power button to gracefully shut down an ACPI-compliant operating system. |
| 7 | System handle release button | N/A | Enables you to unlock the system from the enclosure. |

Health status indicator

The Health status indicator indicates the health condition of the system.

Table 2. Health status indicator codes

| Icon | Health-status indicator pattern | Condition |
|---|---------------------------------|--|
|  | Solid blue | No errors are present in the system. System is in good health. |
| | Blinking blue | Identify mode is enabled (regardless of system errors)—system is in the process of identifying the system. |
| | Solid amber | System is in failsafe mode—system is not ready or available and cannot be turned on. |
| | Flashes amber | Errors present in the system. |

Hard drive indicator codes

Each drive carrier has an activity LED indicator and a status LED indicator. The indicators provide information about the current status of the drive. The activity LED indicator indicates whether the drive is currently in use or not. The status LED indicator indicates the power condition of the drive.



Figure 2. Drive indicators on the drive and the mid drive tray backplane

1. Drive activity LED indicator
2. Drive status LED indicator
3. Drive capacity label

If the drive is in the Advanced Host Controller Interface (AHCI) mode, the status LED indicator does not turn on.

Table 3. Drive indicator codes

| Drive status indicator code | Condition |
|--|--|
| Flashes green twice per second | Identifying drive or preparing for removal. |
| Off | Drive ready for removal. NOTE: The drive status indicator remains off until all drives are initialized after the system is turned on. Drives are not ready for removal during this time. |
| Flashes green, amber, and then turns off | Predicted drive failure. |
| Flashes amber four times per second | Drive failed. |
| Flashes green slowly | Drive rebuilding. |
| Solid green | Drive online. |
| Flashes green for three seconds, amber for three seconds, and then turns off after six seconds | Rebuild stopped. |

iDRAC Direct LED indicator codes

The iDRAC Direct LED indicator lights up to indicate that the port is connected and is being used as a part of the iDRAC subsystem. You can configure iDRAC Direct by using a USB to micro USB (type AB) cable, which you can connect to your laptop or tablet. The following table describes iDRAC Direct activity when the iDRAC Direct port is active:

Table 4. iDRAC Direct LED indicator codes

| iDRAC Direct LED indicator code | Condition |
|---|--|
| Solid green for two seconds | Indicates that the laptop or tablet is connected. |
| Flashing green (on for two seconds and off for two seconds) | Indicates that the laptop or tablet connected is recognized. |
| Turns off | Indicates that the laptop or tablet is unplugged. |

Locating the Service Tag of your system

You can identify your system using the unique Express Service Code and Service Tag. The service tag information is available on a sticker on the chassis of the system. This information is used by Dell EMC personnel to route support calls to the appropriate personnel.

The following image displays a sample service tag, which is available as a sticker on the hard drive cage.



Figure 3. Sample Service Tag

The following image displays a sample iDRAC MAC address label, which is available as a sticker at the bottom of the system.



Figure 4. Sample iDRAC MAC address

System information label

Service Information

System Touchpoints

- Hot swap touchpoints: Components with terracotta touchpoints can be serviced while the system is running.
- Cold swap touchpoints: Components with blue touchpoints require a full system shutdown before servicing.

Mechanical Overview

Front View

2 x 2.5" Drives

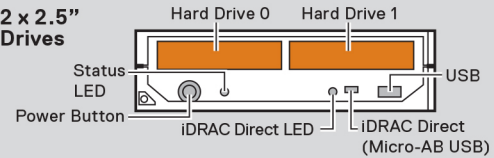

Memory Information

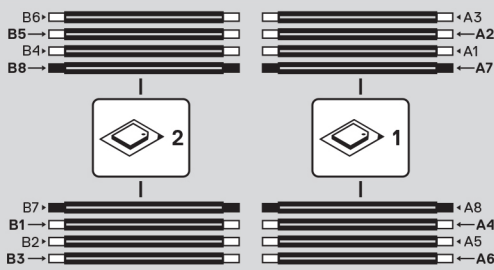

| Configuration | Sequence |
|----------------------------|------------------------|
| Memory-Optimized | 1, 2, 3, 4, 5, 6, 7, 8 |
| Mirroring Population Order | (1, 2, 3, 4, 5, 6) |

Memory sparing details are documented in the *Installation and Service Manual*.

Icon Legend

System Status CPU vFlash Media

Electrical Overview

System Board Connections

| | |
|--|--|
| <ul style="list-style-type: none"> 1 Power Button 2 PERC Backplane 3 SATA/PCIe Backplane 4 BOSS(M.2)/iDSDM 5 DIMMs for CPU2 6 CPU2 7 CPU1 8 DIMMs for CPU1 9 Internal USB 10 Mezz1_FAB_C 11 Mezz2_FAB_B 12 iDRAC vFlash 13 bNDC 14 DIMMs for CPU1 15 DIMMs for CPU2 16 NVRAM_CLR | <ul style="list-style-type: none"> 17 Battery 18 PWRD_EN 19 USB 20 iDRAC Direct (Micro-AB USB) 21 iDRAC Direct LED 22 TPM 23 Status LED |
|--|--|

Front Side

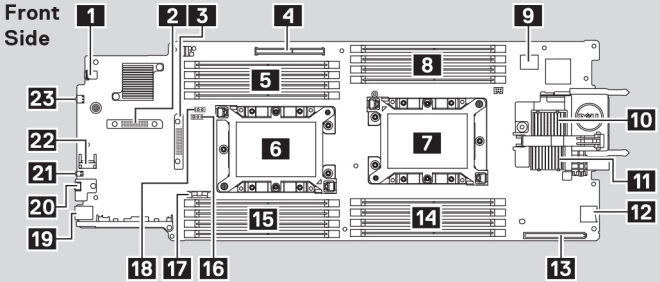

Jumper Settings

| Jumper | Setting | Description |
|-----------|-----------|--|
| PWRD_EN | (default) | BIOS password is enabled. |
| | (default) | BIOS password is disabled. Local access unlocked at next AC power cycle. |
| NVRAM_CLR | (default) | BIOS configuration settings retained at system boot. |
| | (default) | BIOS configuration settings cleared at system boot. |

Scan to see hardware servicing and software setup videos, how-to's, and documentation.



Quick Resource Locator
Dell.com/QR/Server/PEM640

Mezzanine Removal

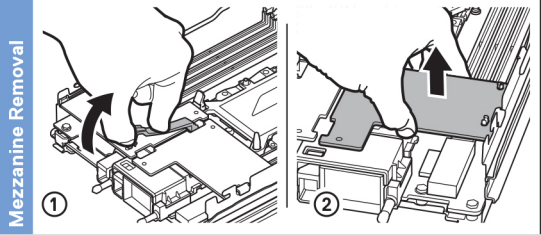

vFlash Media

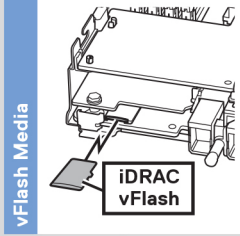

Internal USB Key

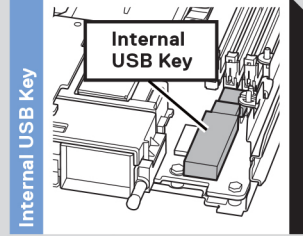

System Tasks

BOSS(M.2)/iDSDM

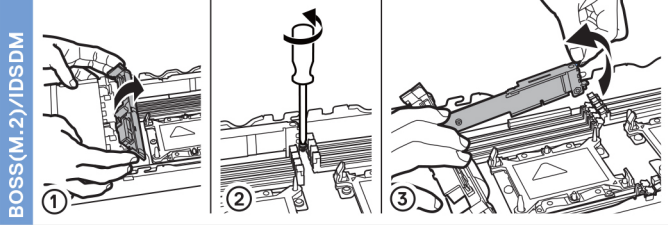

Caution: Memory (DIMMs) and CPUs may be hot during servicing.

Caution: Many repairs may only be done by a certified service technician. You should only perform troubleshooting and simple repairs as authorized in your product documentation, or as directed by the online or telephone service and support team. Damage due to servicing that is not authorized by Dell is not covered by your warranty. Read and follow the safety instructions that came with the product.

To learn more about this Dell product or order additional or replacement parts, go to Dell.com/support

Copyright © 2017 Dell Inc. or its subsidiaries. All Rights Reserved.
Rev A00. Label Part No. FXDP0

Figure 5. System information label

Documentation resources

This section provides information about the documentation resources for your system.

To view the document that is listed in the documentation resources table:

- From the Dell EMC support site:
 1. Click the documentation link that is provided in the Location column in the table.
 2. Click the required product or product version.
 3. On the Product Support page, click **Manuals & documents**.
- Using search engines:
 - Type the name and version of the document in the search box.

 **NOTE: To locate the product name and model, see the front of your system.**

Table 5. Additional documentation resources for your system

| Task | Document | Location |
|-------------------------|---|--|
| Setting up your system | For information about installing the system into the enclosure, see the <i>Getting Started Guide</i> document that is shipped with your system. | www.dell.com/poweredgemanuals |
| Configuring your system | For information about the iDRAC features, configuring and logging in to iDRAC, and managing your system remotely, see the Integrated Dell Remote Access Controller User's Guide. For information about understanding Remote Access Controller Admin (RACADM) subcommands and supported RACADM interfaces, see the RACADM CLI Guide for iDRAC. For information about Redfish and its protocol, supported schema, and Redfish Eventing are implemented in iDRAC, see the Redfish API Guide. For information about iDRAC property database group and object descriptions, see the Attribute Registry Guide. | www.dell.com/poweredgemanuals |
| | For information about earlier versions of the iDRAC documents, see the iDRAC documentation. To identify the version of iDRAC available on your system, on the iDRAC web interface, click ? > About . | www.dell.com/idracmanuals |
| | For information about installing the operating system, see the operating system documentation. | www.dell.com/operatingsystemmanuals |
| | For information about updating drivers and firmware, see the Methods to download firmware and drivers section in this document. | www.dell.com/support/drivers |
| Managing your system | For information about systems management software offered by Dell, see the Dell OpenManage Systems Management Overview Guide. | www.dell.com/poweredgemanuals |

Table 5. Additional documentation resources for your system (continued)

| Task | Document | Location |
|--|---|--|
| | For information about setting up, using, and troubleshooting OpenManage, see the Dell OpenManage Server Administrator User's Guide. | www.dell.com/openmanagemanuals > OpenManage Server Administrator |
| | For information about installing, using, and troubleshooting Dell OpenManage Essentials, see the Dell OpenManage Essentials User's Guide. | www.dell.com/openmanagemanuals > OpenManage Essentials |
| | For information about installing, using, and troubleshooting Dell OpenManage Enterprise, see the Dell OpenManage Enterprise User's Guide. | www.dell.com/openmanagemanuals > OpenManage Enterprise |
| | For information about installing and using Dell SupportAssist, see the Dell EMC SupportAssist Enterprise User's Guide. | www.dell.com/serviceabilitytools |
| | For information about partner programs enterprise systems management, see the OpenManage Connections Enterprise Systems Management documents. | www.dell.com/openmanagemanuals |
| | For information about viewing inventory, performing configuration, and monitoring tasks, remotely turning on or off servers, and enabling alerts for events on servers and components using the Dell Chassis Management Controller (CMC), see the CMC User's Guide. | www.dell.com/openmanagemanuals > Chassis Management Controllers |
| Working with the Dell PowerEdge RAID controllers | For information about understanding the features of the Dell PowerEdge RAID controllers (PERC), Software RAID controllers, or BOSS card and deploying the cards, see the Storage controller documentation. | www.dell.com/storagecontrollermanuals |
| Understanding event and error messages | For information about the event and error messages that are generated by the system firmware and agents that monitor system components, see the Error Code Lookup. | www.dell.com/qrl |
| Troubleshooting your system | For information about identifying and troubleshooting the PowerEdge server issues, see the Server Troubleshooting Guide. | www.dell.com/poweredgemanuals |

Technical specifications

Topics:

- System dimensions
- System weight
- Processor specifications
- Supported operating systems
- System battery specifications
- Memory specifications
- Mezzanine card specifications
- Storage controller specifications
- Drive specifications
- Ports and connectors specifications
- Video specifications
- Environmental specifications

System dimensions

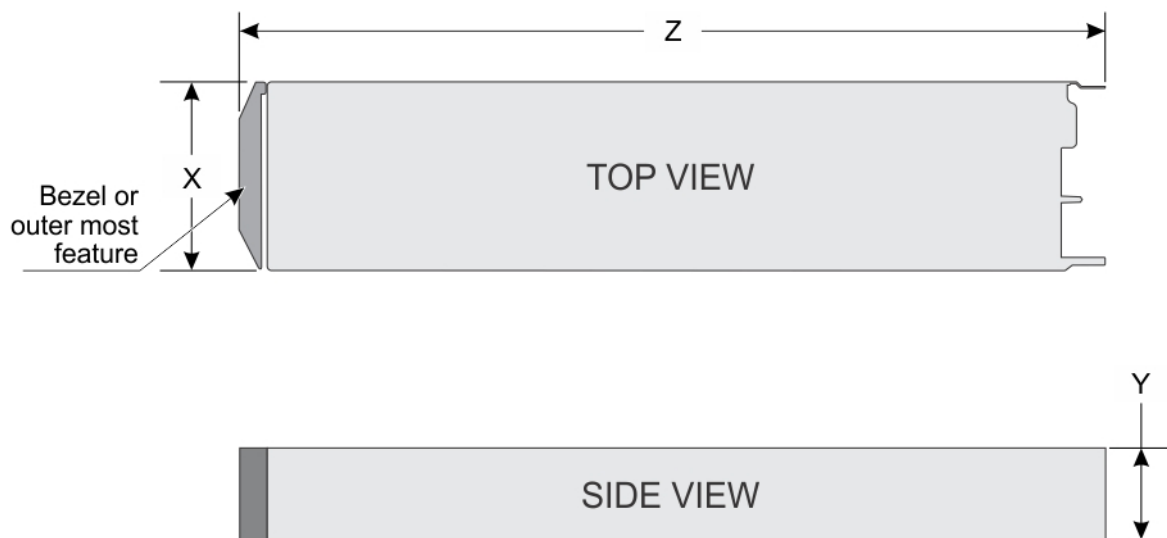

Figure 6. System dimensions

Table 6. System dimensions of the Dell EMC PowerEdge M640 system

| System | X | Y | Z (handle closed) |
|-------------------------|-------------------------|------------------------|--------------------------|
| Dell EMC PowerEdge M640 | 197.92 mm (7.79 inches) | 50.35 mm (1.98 inches) | 544.32 mm (21.43 inches) |

System weight

Table 7. System weight

| System | Maximum weight |
|-------------------------|-------------------|
| Dell EMC PowerEdge M640 | 6.4 kg (14.11 lb) |

Processor specifications

The PowerEdge M640 system supports up to two Intel Xeon Processor Scalable processors up to 28 cores per processor.

Supported operating systems

The PowerEdge FC640 supports the follow operating systems:

- RedHat Enterprise Linux Server
- SUSE Linux Enterprise Server
- Microsoft Windows Server
- VMware
- Citrix Xen Server
- Canonical Ubuntu LTS

For more information, go to www.dell.com/ossupport

System battery specifications

The PowerEdge M640 system supports CR 2032 3.0-V lithium coin cell system battery.

Memory specifications

Table 8. Memory specifications

| Memory module sockets | DIMM type | DIMM rank | DIMM capacity | Single processor | | Dual processors | |
|-----------------------|-----------|-------------|---------------|------------------|-------------|-----------------|-------------|
| | | | | Minimum RAM | Maximum RAM | Minimum RAM | Maximum RAM |
| Sixteen 288-pins | LRDIMM | Octa rank | 128 GB | 128 GB | 1024 GB | 256 GB | 2048 GB |
| | | Quad rank | 64 GB | 64 GB | 512 GB | 128 GB | 1024 GB |
| | RDIMM | Single rank | 8 GB | 8 GB | 64 GB | 16 GB | 128 GB |
| | | Dual rank | 16 GB | 16 GB | 128 GB | 32 GB | 256 GB |
| | | Dual rank | 32 GB | 32 GB | 256 GB | 64 GB | 512 GB |
| | | Dual rank | 64 GB | 64 GB | 512 GB | 128 GB | 1024 GB |

Mezzanine card specifications

The PowerEdge M640 system supports two PCIe x8 Gen 3 slots mezzanine card supporting dual port 10 Gb Ethernet, quad port 1 Gb, FC8 Fibre Channel, FC16 Fibre Channel, or Infiniband mezzanine cards.

Storage controller specifications

The PowerEdge M640p system supports :

- **Internal controllers:**Software RAID S140, PowerEdge RAID controller(PERC)9 H330, H730P
- **Boot Optimized Storage Subsystem(BOSS):** HWRAID 2 x M.2 SSDs 120GB, 240 GB
- Internal Dual SD Module optional

Drive specifications

Hard drives

The PowerEdge M640 system supports up to two 2.5-inch, hot-swappable SAS/SATA hard drives, SSDs, or PCIe NVMe drives.

Ports and connectors specifications

USB ports

The PowerEdge M640 system supports:

- One USB 3.0-compliant port on the front of the system
- One micro USB/iDRAC direct USB 2.0-compliant port on the front of the system
- One USB 3.0-compliant internal port

NOTE: The micro USB 2.0-compliant port on the front of the system can only be used as an iDRAC Direct or a management port.

Internal Dual SD Module

The PowerEdge M640 system supports two internal micro SD cards dedicated for the hypervisor. This card offers the following features:

- Dual card operation — maintains a mirrored configuration by using micro SD cards in both slots and provides redundancy.
- Single card operation — single card operation is supported, but without redundancy.

NOTE: One IDSDM card slot is dedicated for redundancy. It is recommended to use Dell branded micro SD cards associated with the IDSDM/micro SD vFlash configured systems.

Micro SD vFlash connector

The Dell EMC PowerEdge M640 system supports one dedicated micro SD card for vFlash support.

Video specifications

Table 9. Video specifications

| Features | Specifications |
|--------------|---|
| Video type | Matrox G200 graphics controller integrated with iDRAC |
| Video memory | 4 GB DDR4 shared with iDRAC application memory |

Environmental specifications

NOTE: For additional information about environmental certifications, please refer to the Product Environmental Datasheet located with the Manuals & Documents on www.dell.com/poweredgemanuals

Table 10. Temperature specifications

| Temperature | Specifications |
|--|---|
| Storage | -40°C to 65°C (-40°F to 149°F) |
| Continuous operation (for altitude less than 950 m or 3117 ft) | 10°C to 35°C (50°F to 95°F) with no direct sunlight on the equipment. |
| Maximum temperature gradient (operating and storage) | 20°C/h (68°F/h) |

Table 11. Relative humidity specifications

| Relative humidity | Specifications |
|-------------------|--|
| Storage | 5% to 95% RH with 33°C (91°F) maximum dew point. Atmosphere must be non-condensing at all times. |
| Operating | 10% to 80% relative humidity with 26°C (78.8°F) maximum dew point. |

Table 12. Maximum vibration specifications

| Maximum vibration | Specifications |
|-------------------|---|
| Operating | 0.26 G _{rms} at 5 Hz to 350 Hz (all operation orientations). |
| Storage | 1.87 G _{rms} at 10 Hz to 500 Hz for 15 min (all six sides tested). |

Table 13. Maximum shock specifications

| Maximum shock | Specifications |
|---------------|--|
| Operating | Six consecutively executed shock pulses in the positive and negative x, y, and z axes of 6 G for up to 11 ms. |
| Storage | Six consecutively executed shock pulses in the positive and negative x, y, and z axes (one pulse on each side of the system) of 71 G for up to 2 ms. |

Table 14. Maximum altitude specifications

| Maximum altitude | Specifications |
|------------------|----------------------|
| Operating | 3048 m (10,000 ft) |
| Storage | 12,000 m (39,370 ft) |

Table 15. Operating temperature de-rating specifications

| Operating temperature de-rating | Specifications |
|---------------------------------|--|
| Up to 35°C (95°F) | Maximum temperature is reduced by 1°C/300 m (1°F/547 ft) above 950 m (3,117 ft). |
| 35°C to 40°C (95°F to 104°F) | Maximum temperature is reduced by 1°C/175 m (1°F/319 ft) above 950 m (3,117 ft). |
| 40°C to 45°C (104°F to 113°F) | Maximum temperature is reduced by 1°C/125 m (1°F/228 ft) above 950 m (3,117 ft). |

Particulate and gaseous contamination specifications

The following table defines the limitations that help avoid any equipment damage or failure from particulates and gaseous contamination. If the levels of particulates or gaseous pollution exceed the specified limitations and result in equipment damage or failure, you may need to rectify the environmental conditions. Re-mediation of environmental conditions is the responsibility of the customer.

Table 16. Particulate contamination specifications

| Particulate contamination | Specifications |
|---------------------------|---|
| Air filtration | <p>Data center air filtration as defined by ISO Class 8 per ISO 14644-1 with a 95% upper confidence limit.</p> <p>NOTE: This condition applies to data center environments only. Air filtration requirements do not apply to IT equipment designed to be used outside a data center, in environments such as an office or factory floor.</p> <p>NOTE: Air entering the data center must have MERV11 or MERV13 filtration.</p> |

Table 16. Particulate contamination specifications (continued)

| Particulate contamination | Specifications |
|---------------------------|---|
| Conductive dust | Air must be free of conductive dust, zinc whiskers, or other conductive particles. i NOTE: This condition applies to data center and non-data center environments. |
| Corrosive dust | <ul style="list-style-type: none"> Air must be free of corrosive dust. Residual dust present in the air must have a deliquescent point less than 60% relative humidity. i NOTE: This condition applies to data center and non-data center environments. |

Table 17. Gaseous contamination specifications

| Gaseous contamination | Specifications |
|------------------------------|---|
| Copper coupon corrosion rate | <300 Å/month per Class G1 as defined by ANSI/ISA71.04-1985. |
| Silver coupon corrosion rate | <200 Å/month as defined by AHSRAE TC9.9. |

i **NOTE: Maximum corrosive contaminant levels measured at ≤50% relative humidity.**

Standard operating temperature

Table 18. Standard operating temperature specifications

| Standard operating temperature | Specifications |
|--|---|
| Continuous operation (for altitude less than 950 m or 3117 ft) | 10°C to 35°C (50°F to 95°F) with no direct sunlight on the equipment. |
| Humidity percentage range | 10% to 80% Relative Humidity with 26°C (78.8°F) maximum dew point. |

Expanded operating temperature

Table 19. Expanded operating temperature specifications

| Expanded operating temperature | Specifications |
|--|--|
| Continuous operation | 5°C to 40°C at 5% to 85% RH with 29°C dew point. i NOTE: Outside the standard operating temperature (10°C to 35°C), the system can operate continuously in temperatures as low as 5°C and as high as 40°C. For temperatures between 35°C and 40°C, de-rate maximum allowable dry bulb temperature by 1°C per 175 m above 950 m (1°F per 319 ft). |
| Less than or equal to 1% of annual operating hours | –5°C to 45°C at 5% to 90% RH with 29°C dew point. i NOTE: Outside the standard operating temperature (10°C to 35°C), the system can operate down to –5°C or up to 45°C for a maximum of 1% of its annual operating hours. For temperatures between 40°C and 45°C, de-rate maximum allowable temperature by 1°C per 125 m above 950 m (1°F per 228 ft). |

i **NOTE: When operating in the expanded temperature range, system performance may be impacted.**

i **NOTE: When operating in the expanded temperature range, ambient temperature warnings maybe reported in the System Event Log.**

Expanded operating temperature restrictions

The expanded operating temperature restrictions for the PowerEdge M640 system are listed here:

- Do not perform a cold startup below 5°C.
- The operating temperature specified is for a maximum altitude of 3048 metres (10,000 feet).
- NVME drives are not supported.
- AEP DIMMs are not supported.
- 105 W/4 C, 115 W/6 C, 130 W/8 C, 140 W/14 C or higher wattage processor (TDP > 140 W) are not supported.
- NEBS SKU processors higher than 85 W are not supported.
- Peripheral cards and /or peripheral cards greater than 25 W, that are not verified by Dell, are not supported.

Thermal Restriction matrix

Table 20. Thermal restrictions matrix

| Thermal Design Power (TDP) for the processor | Core count | Processors | Ambient restriction | | |
|--|-------------|--|---------------------|--------------------|---------------------|
| | | | M1000e | VRTX | FX2 |
| 205W | 28/24 | 8180; 8168 | Not supported | C25, DIMM limit 2* | C25, Special limit* |
| 205W | 28/26/24 | 8280; 8270;8268;8280M;8280L | Not supported | C25, DIMM limit 2* | C25, Special limit* |
| 205W | 24/16/20 | 6248R;6246R;6242R | Not supported* | Not supported* | Not supported* |
| 200W | 18 | 6154;6254 | Not supported | C25, DIMM limit 2* | C25, Special limit* |
| 165W | 28/26/18 | 8176; 8170; 6150 | C30, DIMM limit 1* | C35, DIMM limit 1* | C30, DIMM limit 1* |
| 165W | 12 | 6246 | C25, Special limit* | C30, DIMM limit 1* | C25, Special limit* |
| 165W | 28/24 | 6240R;6238R;6212U;8276; 8260;8260M;8260L;8276M;8276L | C30 | C35 | C30 |
| 150W | 26/24/20 | 8164; 8160; 6148 | C30 | C35 | C30 |
| 150W | 16/12 | 6142; 6136; 8158 | C30 | C35 | C30 |
| 150W | 24 | 8160T | C25, DIMM limit 2* | C25, DIMM limit 2* | C25, DIMM limit 2* |
| 150W | 8 | 6244 | C25, Special limit* | C30, DIMM limit 1* | C25, Special limit* |
| 150W | 24/20/18/16 | 6248;6240;6242;6252;6210U;6240M | C30 | C35 | C30 |
| 150W | 24/16/8 | 6252N | C25, Special limit* | C30, DIMM limit 1* | C25, Special limit* |
| 150W | 16/26/16/24 | 6226R/6230R/6208U/5220R | C30 | C35 | C30 |
| 140W | 22/8 | 6152; 6140 | C40E45 | C40E45 | C35 |
| 140W | 14 | 6132 | C30 | C35 | C30 |
| 140W | 22 | 6238;6238M | C40E45 | C40E45 | C35 |
| 135W | 24 | 6262V | C40E45 | C40E45 | C35 |
| 130W | 8 | 6234 | C40E45 | C40E45 | C35 |
| 130W | 8 | 6134 | C30 | C35 | C30 |
| 130W | 8 | 4215R | C30 | C35 | C30 |

Table 20. Thermal restrictions matrix (continued)

| Thermal Design Power (TDP) for the processor | Core count | Processors | Ambient restriction | | |
|--|-------------|--|---------------------|--------|--------|
| | | | M1000e | VRTX | FX2 |
| 125W | 20/16 | 6138; 6130; 8153 | C40E45 | C40E45 | C35 |
| 125W | 12 | 6126 | C40E45 | C40E45 | C35 |
| 125W | 20 | 6138T | C30 | C35 | C30 |
| 125W | 16 | 6130T | C30 | C35 | C30 |
| 125W | 12 | 6126T | C30 | C35 | C30 |
| 125W | 20/18/16/12 | 6209U;6230;5220S;5218;8253;6226;5220 | C40E45 | C40E45 | C35 |
| 125W | 20/16/4 | 6230N | C35 | C35 | C35 |
| 125W | 20 | 5218R | C40E45 | C40E45 | C35 |
| 115W | 6 | 6128 | C30 | C35 | C30 |
| 115W | 8 | 5217 | C35 | C35 | C35 |
| 115W | 20 | 6222V | C35 | C35 | C35 |
| 105W | 4 | 5122; 8156 | C30 | C35 | C30 |
| 105W | 14/12 | 5120; 5118 | C40E45 | C40E45 | C40E45 |
| 105W | 14 | 5120T | C30 | C35 | C30 |
| 105W | 4 | 5222/8256 | C30 | C35 | C30 |
| 105W | 16 | 5218T | C30 | C30 | C30 |
| 100W | 16 | 4216 | C40E45 | C40E45 | C40E45 |
| 95W | 10 | 4210T | C40E45 | C40E45 | C40E45 |
| 85W | 12/10/8/6/4 | 4116; 5115; 4114; 4110; 4108; 3106; 3104; 4112 | C40E45 | C40E45 | C40E45 |
| 85W | 14 | 5119T | C40E45 | C40E45 | C40E45 |
| 85W | 12 | 4116T | C40E45 | C40E45 | C40E45 |
| 85W | 10 | 4114T | C40E45 | C40E45 | C40E45 |
| 85W | 12/10/8/6 | 5215;4215;4214;4216; 4210;4208;3204;5215M;5215L | C40E45 | C40E45 | C40E45 |
| 70W | 8 | 4109T | C40E45 | C40E45 | C40E45 |

* DIMM limit 1 – Max 64 GB LRDIMMs. No 128 GB, No AEP(Apache Pass). This is applicable only for systems with dual processors.

* DIMM limit 2– Max 32 GB LRDIMMs. No 128 GB/ 64 GB, No AEP(Apache Pass). This is applicable only for systems with dual processors.

* Special limit – No drives, No Backplane, No PCIe, and Max 64GB LRDIMM

**C indicates that the processor is continuously operating at the specified temperature or lower.

***E indicates the expanded operating temperature specified for the processor.

* Not Supported - Only supported in a 1 socket config at ambient 30C

Initial system setup and configuration

Topics:

- [Setting up your system](#)
- [iDRAC configuration](#)
- [Options to install the operating system](#)

Setting up your system

Complete the following steps to set up your system:

Steps

1. Unpack the system.
2. Remove the I/O connector cover from the system connectors.

 **CAUTION: While installing the system, ensure that it is properly aligned with the slot on the enclosure to prevent damage to the system connectors.**

3. Install the system in the enclosure.
4. Turn on the enclosure.

 **NOTE: Wait for the chassis to initialize before you press the power button.**

5. Press the power button on the system.

Alternatively, you can also turn on the system by using:

- The system iDRAC. For more information, see the [Log in to iDRAC](#) section.
- The enclosure Chassis Management Controller (CMC), after the system iDRAC is configured on the CMC. For more information, see the *CMC User's Guide* at www.dell.com/openmanagemanuals > Chassis Management Controllers

iDRAC configuration

The Integrated Dell Remote Access Controller (iDRAC) is designed to make system administrators more productive and improve the overall availability of Dell systems. iDRAC alerts administrators about system issues and enables them to perform remote system management. This reduces the need for physical access to the system.

Options to set up iDRAC IP address

To enable communication between your system and iDRAC, you must first configure the network settings based on your network infrastructure.

 **NOTE: For static IP configuration, you must request for it at the time of purchase.**

This option is set to **DHCP** by Default. You can set up the IP address by using one of the following interfaces:

| Interfaces | Document/Section |
|--------------------------------|---|
| iDRAC Settings utility | <i>Dell Integrated Dell Remote Access Controller User's Guide</i> at www.dell.com/poweredge manuals |
| Dell Deployment Toolkit | <i>Dell Deployment Toolkit User's Guide</i> at www.dell.com/openmanagemanuals > OpenManage Deployment Toolkit |

| Interfaces | Document/Section |
|----------------------------------|--|
| Dell Lifecycle Controller | <i>Dell Lifecycle Controller User's Guide</i> at www.dell.com/poweredgemanuals |
| CMC Web interface | <i>Dell Chassis Management Controller Firmware User's Guide</i> at www.dell.com/openmanagemanuals > Chassis Management Controllers |
| iDRAC Direct | See <i>Dell Integrated Dell Remote Access Controller User's Guide</i> at www.dell.com/poweredgemanuals |

Log in to iDRAC

You can log in to iDRAC as:

- iDRAC user
- Microsoft Active Directory user
- Lightweight Directory Access Protocol (LDAP) user

If you have opted for secure default access to iDRAC, you must use the iDRAC secure default password available on the system Information tag. If you have not opted for secure default access to iDRAC, then use the default user name and password `-root` and `calvin`. You can also log in by using your Single Sign-On or Smart Card.

NOTE: You must have the iDRAC credentials to log in to iDRAC.

NOTE: Ensure that you change the default username and password after setting up the iDRAC IP address.

For more information about logging in to the iDRAC and iDRAC licenses, see the latest *Integrated Dell Remote Access Controller User's Guide* at www.dell.com/poweredgemanuals.

You can also access iDRAC by using RACADM. For more information, see the *RACADM Command Line Interface Reference Guide* at www.dell.com/poweredgemanuals.

Options to install the operating system

If the system is shipped without an operating system, install a supported operating system by using one of the following resources:

Table 21. Resources to install the operating system

| Resources | Location |
|---|--|
| iDRAC | www.dell.com/idracmanuals |
| Lifecycle Controller | www.dell.com/idracmanuals > Lifecycle Controller |
| OpenManage Deployment Toolkit | www.dell.com/openmanagemanuals > OpenManage Deployment Toolkit |
| Dell certified VMware ESXi | www.dell.com/virtualizationsolutions |
| Installation and How-to videos for supported operating systems on PowerEdge systems | Supported Operating Systems for Dell EMC PowerEdge systems |

Methods to download firmware and drivers

You can download the firmware and drivers by using any of the following methods:

Table 22. Firmware and drivers

| Methods | Location |
|--|---|
| From the Dell EMC support site | www.dell.com/support/home |
| Using Dell Remote Access Controller Lifecycle Controller (iDRAC with LC) | www.dell.com/idracmanuals |
| Using Dell Repository Manager (DRM) | www.dell.com/openmanagemanuals > Repository Manager |

Table 22. Firmware and drivers (continued)

| Methods | Location |
|--|--|
| Using Dell OpenManage Essentials | www.dell.com/openmanagemanuals > OpenManage Essentials |
| Using Dell OpenManage Enterprise | www.dell.com/openmanagemanuals > OpenManage Enterprise |
| Using Dell Server Update Utility (SUU) | www.dell.com/openmanagemanuals > Server Update Utility |
| Using Dell OpenManage Deployment Toolkit (DTK) | www.dell.com/openmanagemanuals > OpenManage Deployment Toolkit |
| Using iDRAC virtual media | www.dell.com/idracmanuals |

Downloading drivers and firmware

Dell EMC recommends that you download and install the latest BIOS, drivers, and systems management firmware on your system.

Prerequisites

Ensure that you clear the web browser cache before downloading the drivers and firmware.

Steps

1. Go to www.dell.com/support/home.
2. In the **Drivers & Downloads** section, type the Service Tag of your system in the **Enter a Service Tag or product ID** box, and then click **Submit**.

 **NOTE:** If you do not have the Service Tag, select **Detect Product** to allow the system to automatically detect the Service Tag, or click **View products**, and navigate to your product.

3. Click **Drivers & Downloads**.
The drivers that are applicable to your system are displayed.
4. Download the drivers to a USB drive, CD, or DVD.

Pre-operating system management applications

You can manage basic settings and features of a system without booting to the operating system by using the system firmware.

Topics:

- [Options to manage the pre-operating system applications](#)
- [System Setup](#)
- [Dell Lifecycle Controller](#)
- [Boot Manager](#)
- [PXE boot](#)

Options to manage the pre-operating system applications

Your system has the following options to manage the pre-operating system applications:

- System Setup
- Dell Lifecycle Controller
- Boot Manager
- Preboot Execution Environment (PXE)

System Setup

By using the **System Setup** screen, you can configure the BIOS settings, iDRAC settings, and device settings of your system.

 **NOTE: Help text for the selected field is displayed in the graphical browser by default. To view the help text in the text browser, press F1.**

You can access system setup by one of the following:

- Standard graphical browser—The browser is enabled by default.
- Text browser—The browser is enabled by using Console Redirection.

Viewing System Setup

To view the **System Setup** screen, perform the following steps:

Steps

1. Power on, or restart your system.
2. Press F2 immediately after you see the following message:

```
F2 = System Setup
```

 **NOTE: If your operating system begins to load before you press F2, wait for the system to finish booting, and then restart your system and try again.**

System Setup details

The **System Setup Main Menu** screen details are explained as follows:

| Option | Description |
|------------------------|--|
| System BIOS | Enables you to configure BIOS settings. |
| iDRAC Settings | Enables you to configure the iDRAC settings. The iDRAC settings utility is an interface to set up and configure the iDRAC parameters by using UEFI (Unified Extensible Firmware Interface). You can enable or disable various iDRAC parameters by using the iDRAC settings utility. For more information about this utility, see <i>Integrated Dell Remote Access Controller User's Guide</i> at www.dell.com/poweredgemanuals . |
| Device Settings | Enables you to configure device settings. |

System BIOS

You can use the **System BIOS** screen to edit specific functions such as boot order, system password, and setup password, set the SATA and PCIe NVMe RAID mode, and enable or disable USB ports.

Viewing System BIOS

To view the **System BIOS** screen, perform the following steps:

Steps

1. Power on, or restart your system.
2. Press F2 immediately after you see the following message:

```
F2 = System Setup
```

NOTE: If the operating system begins to load before you press F2, wait for the system to finish booting, and then restart the system and try again.

3. On the **System Setup Main Menu** screen, click **System BIOS**.

System BIOS Settings details

About this task

The **System BIOS Settings** screen details are explained as follows:

| Option | Description |
|---------------------------|--|
| System Information | Provides information about the system such as the system model name, BIOS version, and Service Tag. |
| Memory Settings | Provides information and options related to the installed memory. |
| Processor Settings | Provides information and options related to the processor such as speed and cache size. |
| SATA Settings | Provides options to enable or disable the integrated SATA controller and ports. |
| NVMe Settings | Provides options to change the NVMe settings. If the system contains the NVMe drives that you want to configure in a RAID array, you must set both this field and the Embedded SATA field on the SATA Settings menu to RAID mode. You might also need to change the Boot Mode setting to UEFI . Otherwise, you should set this field to Non-RAID mode. |
| Boot Settings | Provides options to specify the Boot mode (BIOS or UEFI). Enables you to modify UEFI and BIOS boot settings. |
| Network Settings | Provides options to manage the UEFI network settings and boot protocols. Legacy network settings are managed from the Device Settings menu. |

| Option | Description |
|--------------------------------|--|
| Integrated Devices | Provides options to manage integrated device controllers and ports, specifies related features and options. |
| Serial Communication | Provides options to manage the serial ports, their related features and options. |
| System Profile Settings | Provides options to change the processor power management settings, and memory frequency. |
| System Security | Provides options to configure the system security settings, such as system password, setup password, Trusted Platform Module (TPM) security, and UEFI secure boot. It also manages the power button on the system. |
| Redundant OS Control | Sets the redundant OS information for redundant OS control. |
| Miscellaneous Settings | Provides options to change the system date and time. |

System Information

You can use the **System Information** screen to view system properties such as Service Tag, system model name, and BIOS version.

Viewing System Information

To view the **System Information** screen, perform the following steps:

Steps

1. Power on, or restart your system.
2. Press F2 immediately after you see the following message:

```
F2 = System Setup
```

NOTE: If your operating system begins to load before you press F2, wait for the system to finish booting, and then restart your system and try again.

3. On the **System Setup Main Menu** screen, click **System BIOS**.
4. On the **System BIOS** screen, click **System Information**.

System Information details

About this task

The **System Information** screen details are explained as follows:

| Option | Description |
|---|--|
| System Model Name | Specifies the system model name. |
| System BIOS Version | Specifies the BIOS version installed on the system. |
| System Management Engine Version | Specifies the current version of the Management Engine firmware. |
| System Service Tag | Specifies the system Service Tag. |
| System Manufacturer | Specifies the name of the system manufacturer. |
| System Manufacturer | Specifies the contact information of the system manufacturer. |

| Option | Description |
|--------------------------------|--|
| Contact Information | |
| System CPLD Version | Specifies the current version of the system complex programmable logic device (CPLD) firmware. |
| UEFI Compliance Version | Specifies the UEFI compliance level of the system firmware. |

Memory Settings

You can use the **Memory Settings** screen to view all the memory settings and enable or disable specific memory functions, such as system memory testing and node interleaving.

Viewing Memory Settings

To view the **Memory Settings** screen, perform the following steps:

Steps

1. Power on, or restart your system.
2. Press F2 immediately after you see the following message:

```
F2 = System Setup
```

NOTE: If the operating system begins to load before you press F2, wait for the system to finish booting, and then restart the system and try again.

3. On the **System Setup Main Menu** screen, click **System BIOS**.
4. On the **System BIOS** screen, click **Memory Settings**.

Memory Settings details

About this task

The **Memory Settings** screen details are explained as follows:

| Option | Description |
|------------------------------|---|
| System Memory Size | Specifies the memory size in the system. |
| System Memory Type | Specifies the type of memory that is installed in the system. |
| System Memory Speed | Specifies the system memory speed. |
| System Memory Voltage | Specifies the system memory voltage. |
| Video Memory | Specifies the amount of video memory. |
| System Memory Testing | Specifies whether the system memory tests are run during system boot. Options are Enabled and Disabled . This option is set to Disabled by default. |
| Memory Operating Mode | Specifies the memory operating mode. The options available are Optimizer Mode , Single Rank Spare Mode , Multi Rank Spare Mode , Mirror Mode , and Dell Fault Resilient Mode . This option is set to Optimizer Mode by default. |

NOTE: The **Memory Operating Mode** option can have different default and available options based on the memory configuration of your system.

| Option | Description |
|---|--|
| | <p>NOTE: The Dell Fault Resilient Mode option establishes an area of memory that is fault resilient. This mode can be used by an operating system that supports the feature to load critical applications or enables the operating system kernel to maximize system availability.</p> <p>NOTE: Only Optimizer Mode should be selected when Intel DC Optane Persistent Memory is installed.</p> |
| Current State of Memory Operating Mode | Specifies the current state of the memory operating mode. |
| Node Interleaving | Specifies if Non-Uniform Memory Architecture (NUMA) is supported. If this field is set to Enabled , memory interleaving is supported if a symmetric memory configuration is installed. If this field is set to Disabled , the system supports NUMA (asymmetric) memory configurations. This option is set to Disabled by default. |
| ADDDC Setting | Enables or disables ADDDC Setting feature. When Adaptive Double DRAM Device Correction (ADDDC) is enabled, failing DRAM's are dynamically mapped out. When set to Enabled it can have some impact to system performance under certain workloads. This feature is applicable for x4 DIMMs only. This option is set to Enabled by default. |
| Native tRFC Timing for 16Gb DIMMs | Enables 16 Gb density DIMMs to operate at their programmed Row Refresh Cycle Time (tRFC). Enabling this feature may improve system performance for some configurations. However, enabling this feature has no effect on configurations with 16 Gb 3DS/TSV DIMMs. This option is set to Enabled by default. |
| Opportunistic Self-Refresh | Enables or disables opportunistic self-refresh feature. This option is set to Disabled by default and is not supported when DCPMM(s) are in the system. |
| Correctable Error logging | Enables or disables logging of correctable memory threshold error. This option is set to Enabled by default. |

Processor Settings

You can use the **Processor Settings** screen to view the processor settings and perform specific functions such as enabling virtualization technology, hardware prefetcher, logical processor idling.

Viewing Processor Settings

To view the **Processor Settings** screen, perform the following steps:

Steps

1. Power on, or restart your system.
2. Press F2 immediately after you see the following message:

```
F2 = System Setup
```

NOTE: If your operating system begins to load before you press F2, wait for the system to finish booting, and then restart your system and try again.

3. On the **System Setup Main Menu** screen, click **System BIOS**.
4. On the **System BIOS** screen, click **Processor Settings**.

Processor Settings details

About this task

The **Processor Settings** screen details are explained as follows:

| Option | Description |
|-------------------------------------|---|
| Logical Processor | Enables or disables the logical processors and displays the number of logical processors. If this option is set to Enabled , the BIOS displays all the logical processors. If this option is set to Disabled , the BIOS displays only one logical processor per core. This option is set to Enabled by default. |
| CPU Interconnect Speed | <p>Enables you to govern the frequency of the communication links among the processors in the system.</p> <p> NOTE: The standard and basic bin processors support lower link frequencies.</p> <p>The options available are Maximum data rate, 10.4 GT/s, and 9.6 GT/s. This option is set to Maximum data rate by default.</p> <p>Maximum data rate indicates that the BIOS runs the communication links at the maximum frequency that is supported by the processors. You can also select specific frequencies that the processors support, which can vary.</p> <p>For best performance, you should select Maximum data rate. Any reduction in the communication link frequency affects the performance of non-local memory accesses and cache coherency traffic. Besides, it can slow access to non-local I/O devices from a particular processor.</p> <p>However, if power-saving considerations outweigh performance, you might want to reduce the frequency of the processor communication links. If you do this, you should localize memory and I/O accesses to the nearest NUMA node to minimize the impact to system performance.</p> |
| Virtualization Technology | Enables or disables the virtualization technology for the processor. This option is set to Enabled by default. |
| Adjacent Cache Line Prefetch | Optimizes the system for applications that need high utilization of sequential memory access. This option is set to Enabled by default. You can disable this option for applications that need high utilization of random memory access. |
| Hardware Prefetcher | Enables or disables the hardware prefetcher. This option is set to Enabled by default. |
| Software Prefetcher | Enables or disables the software prefetcher. This option is set to Enabled by default. |
| DCU Streamer Prefetcher | Enables or disables the Data Cache Unit (DCU) streamer prefetcher. This option is set to Enabled by default. |
| DCU IP Prefetcher | Enables or disables the Data Cache Unit (DCU) IP prefetcher. This option is set to Enabled by default. |
| Sub NUMA Cluster | Sub NUMA Clustering (SNC) is a feature for breaking up the LLC into disjoint clusters based on address range, with each cluster bound to a subset of the memory controllers in the system. It improves average latency to the LLC. Enables or disables the Sub NUMA Cluster. This option is set to Disabled by default. |
| UPI Prefetch | Enables you to get the memory that is read started early on DDR bus. The Ultra Path Interconnect (UPI) Rx path will spawn the speculative memory that is read to Integrated Memory Controller (iMC) directly. This option is set to Enabled by default. |
| LLC Prefetch | Enables or disables the LLC Prefetch on all threads. This option is set to Disabled by default. |
| Dead Line LLC Alloc | Enables or disables the Dead Line LLC Alloc. This option is set to Enabled by default. You can enable this option to enter the dead lines in LLC or disable the option to not enter the dead lines in LLC. |
| Directory AtoS | Enables or disables the Directory AtoS. AtoS optimization reduces remote read latencies for repeat read accesses without intervening writes. This option is set to Disabled by default. |
| Logical Processor Idling | Enables you to improve the energy efficiency of a system. It uses the operating system core parking algorithm and parks some of the logical processors in the system which in turn allows the corresponding processor cores to transition into a lower power idle state. This option can only be enabled if the operating system supports it. It is set to Disabled by default. |
| Intel SST-BF | Enable Intel SST-BF. This option is displayed if Performance Per Watt (operating system) or Custom (when OSPM is enabled) system profiles are selected. It is set to Disabled by default. |
| Intel SST-CP | Enable Intel SST-CP. This option is displayed if Performance Per Watt (operating system) or Custom (when OSPM is enabled) system profiles are selected. It is set to Disabled by default. |
| Configurable TDP | Enables you to configure the TDP level. The available options are Nominal, Level 1 , and Level 2 . This option is set to Nominal by default. |

| Option | Description |
|--------------------------------------|--|
| | NOTE: This option is only available on certain stock keeping units (SKUs) of the processors. |
| SST-Performance Profile | Enables you to reconfigure the processor using Speed Select Technology. |
| x2APIC Mode | Enables or disables the x2APIC mode. This option is set to Enabled by default. |
| Dell Controlled Turbo | Controls the turbo engagement. Enable this option only when System Profile is set to Performance . NOTE: Depending on the number of installed processors, there might be up to two processor listings. |
| Number of Cores per Processor | Controls the number of enabled cores in each processor. This option is set to All by default. |
| Processor Core Speed | Specifies the maximum core frequency of the processor. |
| Processor Bus Speed | Displays the bus speed of the processor. |
| Processor n | NOTE: Depending on the number of processors, there might be up to two processors listed. |

The following settings are displayed for each processor that is installed in the system:

| Option | Description |
|--------------------------------|---|
| Family-Model-Stepping | Specifies the family, model, and stepping of the processor as defined by Intel. |
| Brand | Specifies the brand name. |
| Level 2 Cache | Specifies the total L2 cache. |
| Level 3 Cache | Specifies the total L3 cache. |
| Number of Cores | Specifies the number of cores per processor. |
| Maximum Memory Capacity | Specifies the maximum memory capacity per processor. |
| Microcode | Specifies the microcode. |

SATA Settings

You can use the **SATA Settings** screen to view the settings of SATA devices and enable SATA and PCIe NVMe RAID mode on your system.

Viewing SATA Settings

To view the **SATA Settings** screen, perform the following steps:

Steps

1. Power on, or restart your system.
2. Press F2 immediately after you see the following message:

```
F2 = System Setup
```

NOTE: If your operating system begins to load before you press F2, wait for the system to finish booting, and then restart your system and try again.

3. On the **System Setup Main Menu** screen, click **System BIOS**.
4. On the **System BIOS** screen, click **SATA Settings**.

SATA Settings details

About this task

The **SATA Settings** screen details are explained as follows:

| Option | Description |
|-----------------------------|---|
| Embedded SATA | Enables the embedded SATA option to be set to Off , or AHCI Mode , or RAID Mode . This option is set to AHCI Mode by default. |
| Security Freeze Lock | Enables you to send Security Freeze Lock command to the embedded SATA drives during POST. This option is applicable only for AHCI mode. This option is set to Enabled by default. |
| Write Cache | Enables or disables the command for the embedded SATA drives during POST. This option is set to Disabled by default. |
| Port n | Enables you to set the drive type of the selected device. For AHCI Mode or RAID Mode , BIOS support is always enabled. |

| Option | Description |
|-------------------|--|
| Model | Specifies the drive model of the selected device. |
| Drive Type | Specifies the type of drive attached to the SATA port. |
| Capacity | Specifies the total capacity of the drive. This field is undefined for removable media devices such as optical drives. |

NVMe Settings

The NVMe settings enable you to set the NVMe drives to either **RAID** mode or **Non-RAID** mode.

NOTE: To configure these drives as RAID drives, you must set the NVMe drives and the Embedded SATA option in the SATA Settings menu to RAID mode. If not, you must set this field to Non-RAID mode.

Viewing NVMe Settings

To view the **NVMe Settings** screen, perform the following steps:

Steps

1. Power on, or restart your system.
2. Press F2 immediately after you see the following message:

```
F2 = System Setup
```

NOTE: If your operating system begins to load before you press F2, wait for the system to finish booting, and then restart your system and try again.

3. On the **System Setup Main Menu** screen, click **System BIOS**.
4. On the **System BIOS** screen, click **NVMe Settings**.

NVMe Settings details

About this task

The NVMe Settings screen details are explained as follows:

| Option | Description |
|------------------|---|
| NVMe Mode | Enables you to set the NVMe mode. This option is set to Non RAID by default. |

Boot Settings

You can use the **Boot Settings** screen to set the boot mode to either **BIOS** or **UEFI**. It also enables you to specify the boot order.

- **UEFI:** The Unified Extensible Firmware Interface (UEFI) is a new interface between operating systems and platform firmware. The interface consists of data tables with platform related information, boot and runtime service calls that are available to the operating system and its loader. The following benefits are available when the **Boot Mode** is set to **UEFI**:
 - Support for drive partitions larger than 2 TB.
 - Enhanced security (e.g., UEFI Secure Boot).
 - Faster boot time.
- **BIOS:** The **BIOS Boot Mode** is the legacy boot mode. It is maintained for backward compatibility.

NOTE: You must use only the UEFI boot mode in order to boot from NVMe drives.

Viewing Boot Settings

To view the **Boot Settings** screen, perform the following steps:

Steps

1. Power on, or restart your system.
2. Press F2 immediately after you see the following message:

```
F2 = System Setup
```

NOTE: If your operating system begins to load before you press F2, wait for the system to finish booting, and then restart your system and try again.

3. On the **System Setup Main Menu** screen, click **System BIOS**.
4. On the **System BIOS** screen, click **Boot Settings**.

Boot Settings details

About this task

The **Boot Settings** screen details are explained as follows:

| Option | Description |
|------------------------------------|--|
| Boot Mode | Enables you to set the boot mode of the system. CAUTION: Switching the boot mode may prevent the system from booting if the operating system is not installed in the same boot mode. If the operating system supports UEFI , you can set this option to UEFI . Setting this field to BIOS enables compatibility with non-UEFI operating systems. This option is set to UEFI by default. NOTE: Setting this field to UEFI disables the BIOS Boot Settings menu. |
| Boot Sequence Retry | Enables or disables the Boot Sequence Retry feature. If this option is set to Enabled and the system fails to boot, the system re-attempts the boot sequence after 30 seconds. This option is set to Enabled by default. |
| Hard-Disk Failover | Specifies the drive that is booted in the event of a drive failure. The devices are selected in the Hard-Disk Drive Sequence on the Boot Option Setting menu. When this option is set to Disabled , only the first drive in the list is attempted to boot. When this option is set to Enabled , all drives are attempted to boot in the order selected in the Hard-Disk Drive Sequence . This option is not enabled for UEFI Boot Mode . This option is set to Disabled by default. |
| Generic USB Boot | Enables or disables the USB boot option. This option is set to Disabled by default. |
| Hard-disk Drive Placeholder | Enables or disables the Hard-disk drive placeholder option. This option is set to Disabled by default. |
| BIOS Boot Settings | Enables or disables BIOS boot options. |

 **NOTE:** This option is enabled only if the boot mode is BIOS.

UEFI Boot Settings

Enables or disables UEFI Boot options.

The Boot options include **IPv4 PXE** and **IPv6 PXE**. This option is set to **IPv4** by default.

 **NOTE:** This option is enabled only if the boot mode is UEFI.

UEFI Boot Sequence

Enables you to change the boot device order.

Boot Options Enable/Disable

Enables you to select the enabled or disabled boot devices.

Choosing system boot mode

System Setup enables you to specify one of the following boot modes for installing your operating system:

- BIOS boot mode (the default) is the standard BIOS-level boot interface.
- UEFI boot mode (the default), is an enhanced 64-bit boot interface.

If you have configured your system to boot to UEFI mode, it replaces the system BIOS.

1. From the **System Setup Main Menu**, click **Boot Settings**, and select **Boot Mode**.
2. Select the UEFI boot mode you want the system to boot into.

 **CAUTION:** Switching the boot mode may prevent the system from booting if the operating system is not installed in the same boot mode.

3. After the system boots in the specified boot mode, proceed to install your operating system from that mode.

 **NOTE:** Operating systems must be UEFI-compatible to be installed from the UEFI boot mode. DOS and 32-bit operating systems do not support UEFI and can only be installed from the BIOS boot mode.

 **NOTE:** For the latest information about supported operating systems, go to www.dell.com/ossupport.

Changing boot order

About this task

You may have to change the boot order if you want to boot from a USB key. You may have to change the boot order if you want to boot from a USB key or an optical drive. The following instructions may vary if you have selected **BIOS** for **Boot Mode**.

Steps

1. On the **System Setup Main Menu** screen, click **System BIOS > Boot Settings > UEFI/BIOS Boot Settings > UEFI/BIOS Boot Sequence**.
2. Click **Boot Option Settings > BIOS/UEFI Boot Settings > Boot Sequence**.

 **NOTE:** Use the arrow keys to select a boot device, and use the plus (+) and minus (-) sign keys to move the device down or up in the order.

3. Click **Exit**, and then click **Yes** to save the settings on exit.

Network Settings

You can use the **Network Settings** screen to modify UEFI PXE, iSCSI, and HTTP boot settings. The network settings option is available only in the UEFI mode.

 **NOTE:** BIOS does not control network settings in the BIOS mode. For the BIOS boot mode, the optional Boot ROM of the network controllers handles the network settings.

Viewing Network Settings

To view the **Network Settings** screen, perform the following steps:

Steps

1. Power on, or restart your system.
2. Press F2 immediately after you see the following message:

F2 = System Setup

NOTE: If your operating system begins to load before you press F2, wait for the system to finish booting, and then restart your system and try again.

3. On the **System Setup Main Menu** screen, click **System BIOS**.
4. On the **System BIOS** screen, click **Network Settings**.

Network Settings screen details

The **Network Settings** screen details are explained as follows:

About this task

| Option | Description | |
|----------------------------|---|--|
| UEFI PXE Settings | Options | Description |
| | PXE Device n (n = 1 to 4) | Enables or disables the device. When enabled, a UEFI PXE boot option is created for the device. |
| UEFI HTTP Settings | Options | Description |
| | HTTP Device (n = 1 to 4) | Enables or disables the device. When enabled, a UEFI HTTP boot option is created for the device. |
| UEFI iSCSI Settings | Enables you to control the configuration of the iSCSI device. | |

Table 23. UEFI iSCSI Settings screen details

| Option | Description |
|-------------------------------|---|
| iSCSI Initiator Name | Specifies the name of the iSCSI initiator in IQN format. |
| iSCSI Device1 | Enables or disables the iSCSI device. When disabled, a UEFI boot option is created for the iSCSI device automatically. This is set to Disabled by default. |
| iSCSI Device1 Settings | Enables you to control the configuration of the iSCSI device. |

Integrated Devices

You can use the **Integrated Devices** screen to view and configure the settings of all integrated devices including the video controller, integrated RAID controller, and the USB ports.

Viewing Integrated Devices

To view the **Integrated Devices** screen, perform the following steps:

Steps

1. Power on, or restart your system.

2. Press F2 immediately after you see the following message:

F2 = System Setup

NOTE: If your operating system begins to load before you press F2, wait for the system to finish booting, and then restart your system and try again.

3. On the **System Setup Main Menu** screen, click **System BIOS**.
4. On the **System BIOS** screen, click **Integrated Devices**.

Integrated Devices details

About this task

The **Integrated Devices** screen details are explained as follows:

| Option | Description |
|---|---|
| User Accessible USB Ports | Configures the user accessible USB ports. Selecting Only Back Ports On disables the front USB ports; selecting All Ports Off disables all front and back USB ports. The USB keyboard and mouse still function in certain USB ports during the boot process, depending on the selection. After the boot process is complete, the USB ports will be enabled or disabled as per the setting. |
| Internal USB Port | Enables or disables the internal USB port. This option is set to On or Off . This option is set to On by default. NOTE: The Internal SD Card Port on the PCIe riser is controlled by Internal USB Port. |
| iDRAC Direct USB Port | The iDRAC Direct USB port is managed by iDRAC exclusively with no host visibility. This option is set to ON or OFF . When set to OFF , iDRAC does not detect any USB devices installed in this managed port. This option is set to On by default. |
| Integrated RAID Controller | Enables or disables the integrated RAID controller. This option is set to Enabled by default. |
| Integrated Network Card 1 | Enables or disables the integrated network card (NDC). When set to Disabled , the NDC is not available to the operating system (OS). This option is set to Enabled by default. NOTE: If set to Disabled (OS) , the Integrated NICs might still be available for shared network access by iDRAC. |
| I/OAT DMA Engine | Enables or disables the I/O Acceleration Technology (I/OAT) option. I/OAT is a set of DMA features designed to accelerate network traffic and lower CPU utilization. Enable only if the hardware and software support the feature. This option is set to Disabled by default. |
| Embedded Video Controller | Enables or disables the use of Embedded Video Controller as the primary display. When set to Enabled , the Embedded Video Controller is used as the primary display even if add-in graphic cards are installed. When set to Disabled , an add-in graphics card is used as the primary display. BIOS will output displays to both the primary add-in video and the embedded video during POST and pre-boot environment. The embedded video is disabled before the operating system boots. This option is set to Enabled by default. NOTE: When there are multiple add-in graphic cards installed in the system, the first card discovered during PCI enumeration is selected as the primary video. You might have to re-arrange the cards in the slots in order to control which card is the primary video. |
| Current State of Embedded Video Controller | Displays the current state of the embedded video controller. The Current State of Embedded Video Controller option is a read-only field. If the Embedded Video Controller is the only display capability in the system (that is, no add-in graphics card is installed), then the Embedded Video Controller is automatically used as the primary display even if the Embedded Video Controller setting is set to Disabled . |
| SR-IOV Global Enable | Enables or disables the BIOS configuration of Single Root I/O Virtualization (SR-IOV) devices. This option is set to Disabled by default. |
| Internal SD Card Port | Enables or disables the internal SD card port of the Internal Dual SD Module (IDSMD). This option is set to On by default. |
| Internal SD Card Redundancy | Configures the redundancy mode of the Internal Dual SD Module (IDSMD). When set to Mirror Mode , data is written on both SD cards. After failure of either card and replacement of the failed card, the data of the active card is copied to the offline card during the system boot. |

| Option | Description |
|-------------------------------------|---|
| | When Internal SD Card Redundancy is set to Disabled , only the primary SD card is visible to the OS. This option is set to Disabled by default. |
| Internal SD Primary Card | By default, the primary SD card is selected to be SD Card 1. If SD Card 1 is not present, then the controller selects SD Card 2 to be the primary SD card. |
| OS Watchdog Timer | If your system stops responding, this watchdog timer aids in the recovery of your operating system. When this option is set to Enabled , the operating system initializes the timer. When this option is set to Disabled (the default), the timer does not have any effect on the system. |
| Empty Slot Unhide | Enables or disables the root ports of all the empty slots that are accessible to the BIOS and OS. This option is set to Disabled by default. |
| Memory Mapped I/O above 4 GB | Enables or disables the support for the PCIe devices that need large amounts of memory. Enable this option only for 64-bit operating systems. This option is set to Enabled by default. |
| Memory Mapped I/O Base | When set to 12 TB , the system maps the MMIO base to 12 TB. Enable this option for an OS that requires 44 bit PCIe addressing. When set to 512 GB , the system maps the MMIO base to 512 GB, and reduces the maximum support for memory to less than 512 GB. Enable this option only for the 4 GPU DGMA issue. This option is set to 56 TB by default. |
| Mezzanine Slot Disablement | The Slot Disablement feature controls the configuration of mezzanine cards installed in the specified slots. Only mezzanine card slots that are present on your system are available for control. |

Serial Communication

You can use the **Serial Communication** screen to view the properties of the serial communication port.

Viewing Serial Communication

To view the **Serial Communication** screen, perform the following steps:

Steps

1. Power on, or restart your system.
2. Press F2 immediately after you see the following message:

```
F2 = System Setup
```

NOTE: If your operating system begins to load before you press F2, wait for the system to finish booting, and then restart your system and try again.

3. On the **System Setup Main Menu** screen, click **System BIOS**.
4. On the **System BIOS** screen, click **Serial Communication**.

Serial Communication details

About this task

The **Serial Communication** screen details are explained as follows:

| Option | Description |
|-----------------------------|--|
| Serial Communication | Enables you to select serial communication devices (Serial Device 1 and Serial Device 2) in BIOS. BIOS console redirection can also be enabled, and the port address can be specified. This option is set to Auto by default. |
| Serial Port Address | Enables you to set the port address for serial device. This field sets the serial port address to either COM1 or COM2 (COM1=0x3F8, COM2=0x2F8). This option is set to Serial Device1=COM2 or Serial Device 2=COM1 by default. NOTE: You can use only Serial Device 2 for the Serial Over LAN (SOL) feature. To use console redirection by SOL, configure the same port address for console redirection and the serial device. |

| Option | Description |
|----------------------------------|--|
| | <p>NOTE: Every time the system boots, the BIOS syncs the serial MUX setting saved in iDRAC. The serial MUX setting can independently be changed in iDRAC. Loading the BIOS default settings from within the BIOS setup utility may not always revert the serial MUX setting to the default setting of Serial Device 1.</p> |
| External Serial Connector | <p>Enables you to associate the External Serial Connector to Serial Device 1, Serial Device 2, or the Remote Access Device by using this option. This option is set to Serial Device 1 by default.</p> <p>NOTE: Only Serial Device 2 can be used for Serial Over LAN (SOL). To use console redirection by SOL, configure the same port address for console redirection and the serial device.</p> <p>NOTE: Every time the system boots, the BIOS syncs the serial MUX setting saved in iDRAC. The serial MUX setting can independently be changed in iDRAC. Loading the BIOS default settings from within the BIOS setup utility may not always revert this setting to the default setting of Serial Device 1.</p> |
| Failsafe Baud Rate | <p>Specifies the failsafe baud rate for console redirection. The BIOS attempts to determine the baud rate automatically. This failsafe baud rate is used only if the attempt fails, and the value must not be changed. This option is set to 115200 by default.</p> |
| Remote Terminal Type | <p>Enables you to set the remote console terminal type. This option is set to VT100/VT220 by default.</p> |
| Redirection After Boot | <p>Enables or disables the BIOS console redirection when the operating system is loaded. This option is set to Enabled by default.</p> |

System Profile Settings

You can use the **System Profile Settings** screen to enable specific system performance settings such as power management.

Viewing System Profile Settings

To view the **System Profile Settings** screen, perform the following steps:

Steps

1. Power on, or restart your system.
2. Press F2 immediately after you see the following message:

```
F2 = System Setup
```

NOTE: If your operating system begins to load before you press F2, wait for the system to finish booting, and then restart your system and try again.





3. On the **System Setup Main Menu** screen, click **System BIOS**.
4. On the **System BIOS** screen, click **System Profile Settings**.

System Profile Settings details

About this task

The **System Profile Settings** screen details are explained as follows:

| Option | Description |
|-----------------------|---|
| System Profile | <p>Sets the system profile. If you set the System Profile option to a mode other than Custom, the BIOS automatically sets the rest of the options. You can only change the rest of the options if the mode is set to Custom. This option is set to Performance Per Watt Optimized (DAPC) by default. DAPC is Dell Active Power Controller. Other options include Performance Per Watt (OS), Performance, and Workstation Performance.</p> |

| Option | Description |
|--|---|
| | <p> NOTE: All the parameters on the system profile setting screen are available only when the System Profile option is set to Custom.</p> |
| CPU Power Management | Sets the CPU power management. This option is set to System DBPM (DAPC) by default. DBPM is Demand-Based Power Management. Other options include OS DBPM , and Maximum Performance . |
| Memory Frequency | Sets the speed of the system memory. You can select Maximum Performance , Maximum Reliability , or a specific speed. This option is set to Maximum Performance by default. |
| Turbo Boost | Enables or disables the processor to operate in the turbo boost mode. This option is set to Enabled by default. |
| C1E | Enables or disables the processor to switch to a minimum performance state when it is idle. This option is set to Enabled by default. |
| C States | Enables or disables the processor to operate in all available power states. This option is set to Enabled by default. |
| Write Data CRC | Enables or disables the Write Data CRC. This option is set to Disabled by default. |
| Memory Patrol Scrub | Sets the memory patrol scrub frequency. This option is set to Standard by default. |
| Memory Refresh Rate | Sets the memory refresh rate to either 1x or 2x. This option is set to 1x by default. |
| Uncore Frequency | Enables you to select the Processor Uncore Frequency option. Dynamic mode enables the processor to optimize power resources across cores and uncores during runtime. The optimization of the uncore frequency to either save power or optimize performance is influenced by the setting of the Energy Efficiency Policy option. |
| Energy Efficient Policy | Enables you to select the Energy Efficient Policy option. The CPU uses the setting to manipulate the internal behavior of the processor and determines whether to target higher performance or better power savings. This option is set to Balanced Performance by default. |
| Number of Turbo Boost Enabled Cores for Processor 1 | <p> NOTE: If there are two processors installed in the system, you will see an entry for Number of Turbo Boost Enabled Cores for Processor 2.</p> <p>Controls the number of turbo boost enabled cores for Processor 1. The maximum number of cores is enabled by default.</p> |
| Monitor/Mwait | Enables the Monitor/Mwait instructions in the processor. This option is set to Enabled for all system profiles, except Custom by default. <p> NOTE: This option can be disabled only if the C States option in the Custom mode is set to disabled.</p> <p> NOTE: When C States is set to Enabled in the Custom mode, changing the Monitor/Mwait setting does not impact the system power or performance.</p> |
| CPU Interconnect Bus Link Power Management | Enables or disables the CPU Interconnect Bus Link Power Management. This option is set to Enabled by default. |
| PCI ASPM L1 Link Power Management | Enables or disables the PCI ASPM L1 Link Power Management. This option is set to Enabled by default. |

System Security

You can use the **System Security** screen to perform specific functions such as setting the system password, setup password and disabling the power button.

Viewing System Security

To view the **System Security** screen, perform the following steps:

Steps

1. Power on, or restart your system.

2. Press F2 immediately after you see the following message:

F2 = System Setup

NOTE: If your operating system begins to load before you press F2, wait for the system to finish booting, and then restart your system and try again.

3. On the **System Setup Main Menu** screen, click **System BIOS**.
4. On the **System BIOS** screen, click **System Security**.

System Security Settings details

About this task

The **System Security Settings** screen details are explained as follows:

| Option | Description |
|--|---|
| CPU AES-NI | Improves the speed of applications by performing encryption and decryption by using the Advanced Encryption Standard Instruction Set (AES-NI). This option is set to Enabled by default. |
| System Password | Enables you to set the system password. This option is set to Enabled by default and is read-only if the password jumper is not installed in the system. |
| Setup Password | Enables you to set the system setup password. This option is read-only if the password jumper is not installed in the system. |
| Password Status | Enables you to lock the system password. This option is set to Unlocked by default. |
| TPM Security | <p>NOTE: The TPM menu is available only when the TPM module is installed.</p> <p>Enables you to control the reporting mode of the TPM. The TPM Security option is set to Off by default. You can only modify the TPM Status TPM Activation, and the Intel TXT fields if the TPM Status field is set to either On with Pre-boot Measurements or On without Pre-boot Measurements.</p> |
| TPM Information | Enables you to change the operational state of the TPM. This option is set to No Change by default. |
| TPM Status | Specifies the TPM status. |
| TPM Command | <p>Controls the Trusted Platform Module (TPM). When set to None, no command is sent to the TPM. When set to Activate, the TPM is enabled and activated. When set to Deactivate, the TPM is disabled and deactivated. When set to Clear, all the contents of the TPM are cleared. This option is set to None by default.</p> <p>CAUTION: Clearing the TPM results in the loss of all keys in the TPM. The loss of TPM keys may affect booting to the operating system.</p> <p>This field is read-only when TPM Security is set to Off. The action requires an additional reboot before it can take effect.</p> |
| TPM Advanced Settings | This setting is enabled only when TPM Security is set to ON. |
| Intel(R) TXT | Enables you to set the Intel Trusted Execution Technology (TXT) option. To enable the Intel TXT option, virtualization technology and TPM Security must be enabled with Pre-boot measurements. This option is set to Off by default. |
| Power Button | Enables you to set the power button on the front of the system. This option is set to Enabled by default. |
| AC Power Recovery | Sets how the system behaves after AC power is restored to the system. This option is set to Last by default. |
| UEFI Variable Access | Provides varying degrees of securing UEFI variables. When set to Standard (the default), UEFI variables are accessible in the operating system per the UEFI specification. When set to Controlled , selected UEFI variables are protected in the environment, and new UEFI boot entries are forced to be at the end of the current boot order. |
| In-Band Manageability Interface | When set to Disabled , this setting will hide the Management Engine's (ME), HECI devices, and the system's IPMI devices from the operating system. This prevents the operating system from changing the ME power capping settings, and blocks access to all in-band management tools. All management should be managed through out-of-band. This option is set to Enabled by default. |

| Option | Description | | | | | | | | |
|---|--|---------|-------------|------------------|--|-------------------|--|----------------------|---|
| | <p>NOTE: BIOS update requires HECI devices to be operational and DUP updates require IPMI interface to be operational. This setting needs to be set to Enabled to avoid updating errors.</p> | | | | | | | | |
| Secure Boot | Enables Secure Boot, where the BIOS authenticates each pre-boot image by using the certificates in the Secure Boot Policy. Secure Boot is set to Disabled by default. | | | | | | | | |
| Secure Boot Policy | When Secure Boot policy is set to Standard , the BIOS uses the system manufacturer key and certificates to authenticate pre-boot images. When Secure Boot policy is set to Custom , the BIOS uses the user-defined key and certificates. Secure Boot policy is set to Standard by default. | | | | | | | | |
| Secure Boot Mode | Enables you to configure how the BIOS uses the Secure Boot Policy Objects (PK, KEK, db, dbx). If the current mode is set to Deployed Mode , the available options are User Mode and Deployed Mode . If the current mode is set to User Mode , the available options are User Mode , Audit Mode , and Deployed Mode . | | | | | | | | |
| | <table border="1"> <thead> <tr> <th>Options</th> <th>Description</th> </tr> </thead> <tbody> <tr> <td>User Mode</td> <td>In User Mode, PK must be installed, and BIOS performs signature verification on programmatic attempts to update policy objects. BIOS allows unauthenticated programmatic transitions between modes.</td> </tr> <tr> <td>Audit Mode</td> <td>In Audit mode, PK is not present. BIOS does not authenticate programmatic updates to the policy objects, and transitions between modes. Audit Mode is useful for programmatically determining a working set of policy objects. BIOS performs signature verification on pre-boot images and logs the results in the image Execution Information Table, but approves the images whether they pass or fail verification.</td> </tr> <tr> <td>Deployed Mode</td> <td>Deployed Mode is the most secure mode. In Deployed Mode, PK must be installed and the BIOS performs signature verification on programmatic attempts to update policy objects. Deployed Mode restricts the programmatic mode transitions.</td> </tr> </tbody> </table> | Options | Description | User Mode | In User Mode , PK must be installed, and BIOS performs signature verification on programmatic attempts to update policy objects. BIOS allows unauthenticated programmatic transitions between modes. | Audit Mode | In Audit mode , PK is not present. BIOS does not authenticate programmatic updates to the policy objects, and transitions between modes. Audit Mode is useful for programmatically determining a working set of policy objects. BIOS performs signature verification on pre-boot images and logs the results in the image Execution Information Table, but approves the images whether they pass or fail verification. | Deployed Mode | Deployed Mode is the most secure mode. In Deployed Mode , PK must be installed and the BIOS performs signature verification on programmatic attempts to update policy objects. Deployed Mode restricts the programmatic mode transitions. |
| Options | Description | | | | | | | | |
| User Mode | In User Mode , PK must be installed, and BIOS performs signature verification on programmatic attempts to update policy objects. BIOS allows unauthenticated programmatic transitions between modes. | | | | | | | | |
| Audit Mode | In Audit mode , PK is not present. BIOS does not authenticate programmatic updates to the policy objects, and transitions between modes. Audit Mode is useful for programmatically determining a working set of policy objects. BIOS performs signature verification on pre-boot images and logs the results in the image Execution Information Table, but approves the images whether they pass or fail verification. | | | | | | | | |
| Deployed Mode | Deployed Mode is the most secure mode. In Deployed Mode , PK must be installed and the BIOS performs signature verification on programmatic attempts to update policy objects. Deployed Mode restricts the programmatic mode transitions. | | | | | | | | |
| Secure Boot Policy Summary | Specifies the list of certificates and hashes that secure boot uses to authenticate images. | | | | | | | | |
| Secure Boot Custom Policy Settings | Configures the Secure Boot Custom Policy. To enable this option, set the Secure Boot Policy to Custom . | | | | | | | | |

Creating a system and setup password

Prerequisites

Ensure that the password jumper is enabled. The password jumper enables or disables the system password and setup password features. For more information, see the System board jumper settings section.

NOTE: If the password jumper setting is disabled, the existing system password and setup password are deleted and you need not provide the system password to boot the system.

Steps

- To enter System Setup, press F2 immediately after turning on or rebooting your system.
- On the **System Setup Main Menu** screen, click **System BIOS > System Security**.
- On the **System Security** screen, verify that **Password Status** is set to **Unlocked**.
- In the **System Password** field, type your system password, and press Enter or Tab.
Use the following guidelines to assign the system password:
 - A password can have up to 32 characters.
 - The password can contain the numbers 0 through 9.

- Only the following special characters are allowed: space, ("), (+), (,), (-), (.), (\/), (:), ([), (\), (]), (´).

A message prompts you to reenter the system password.

5. Reenter the system password, and click **OK**.
6. In the **Setup Password** field, type your setup password and press Enter or Tab.
A message prompts you to reenter the setup password.
7. Reenter the setup password, and click **OK**.
8. Press Esc to return to the System BIOS screen. Press Esc again.
A message prompts you to save the changes.

 **NOTE: Password protection does not take effect until the system reboots.**

Using your system password to secure the system

About this task

If you have assigned a setup password, the system accepts your setup password as an alternate system password.

Steps

1. Power on or reboot your system.
2. Type the system password and press Enter.

Next steps

When **Password Status** is set to **Locked**, type the system password and press Enter when prompted at reboot.

 **NOTE: If an incorrect system password is typed, the system displays a message and prompts you to reenter your password. You have three attempts to type the correct password. After the third unsuccessful attempt, the system displays an error message that the system has stopped functioning and must be turned off. Even after you turn off and restart the system, the error message is displayed until the correct password is entered.**

Deleting or changing system and setup password

Prerequisites

 **NOTE: You cannot delete or change an existing system or setup password if the Password Status is set to Locked.**

Steps

1. To enter System Setup, press F2 immediately after turning on or restarting your system.
2. On the **System Setup Main Menu** screen, click **System BIOS > System Security**.
3. On the **System Security** screen, ensure that **Password Status** is set to **Unlocked**.
4. In the **System Password** field, change or delete the existing system password, and then press Enter or Tab.
5. In the **Setup Password** field, alter or delete the existing setup password, and then press Enter or Tab.

 **NOTE: If you change the system password or setup password, a message prompts you to reenter the new password. If you delete the system password or setup password, a message prompts you to confirm the deletion.**

6. Press Esc to return to the **System BIOS** screen. Press Esc again, and a message prompts you to save the changes.
7. Select **Setup Password**, change, or delete the existing setup password and press Enter or Tab.

 **NOTE: If you change the system password or setup password, a message prompts you to reenter the new password. If you delete the system password or setup password, a message prompts you to confirm the deletion.**

Operating with setup password enabled

If **Setup Password** is set to **Enabled**, type the correct setup password before modifying the system setup options.

If you do not type the correct password in three attempts, the system displays the following message:

```
Invalid Password! Number of unsuccessful password attempts: <x> System Halted! Must power down.
```

```
Password Invalid. Number of unsuccessful password attempts: <x> Maximum number of password attempts exceeded. System halted.
```

Even after you restart the system, the error message is displayed until the correct password is typed. The following options are exceptions:

- If **System Password** is not set to **Enabled** and is not locked through the **Password Status** option, you can assign a system password. For more information, see the [System Security Settings details](#) section.
- You cannot disable or change an existing system password.

i **NOTE:** You can use the password status option with the setup password option to protect the system password from unauthorized changes.

Redundant OS Control

In the **Redundant OS Control** screen you can set the redundant OS information. This enables you to set up a physical recovery disk on the system.

Viewing Redundant OS Control

To view the **Redundant OS Control** screen, perform the following steps:

Steps

1. Power on, or restart your system.
2. Press F2 immediately after you see the following message:

```
F2 = System Setup
```

i **NOTE:** If your operating system begins to load before you press F2, wait for the system to finish booting, and then restart your system and try again.



3. On the **System Setup Main Menu** screen, click **System BIOS**.
4. On the **System BIOS** screen, click **Redundant OS Control**.

Redundant OS Control screen details

The **Redundant OS Control** screen details are explained as follows:

About this task

| Option | Description |
|------------------------------|--|
| Redundant OS Location | <p>Enables you to select a backup disk from the following devices:</p> <ul style="list-style-type: none">• None• IDSDM• SATA Ports in AHCI mode• BOSS PCIe Cards (Internal M.2 Drives)• Internal USB <p>i NOTE: RAID configurations and NVMe cards not are included as BIOS does not have the ability to distinguish between individual drives in those configurations.</p> |
| Redundant OS State | <p>i NOTE: This option is disabled if Redundant OS Location is set to None.</p> <p>When set to Visible, the backup disk is visible to the boot list and OS. When set to Hidden, the backup disk is disabled and is not visible to the boot list and OS. This option is set to Visible by default.</p> |

| Option | Description |
|-------------------|---|
| |  NOTE: BIOS will disable the device in hardware, so it cannot be accessed by the OS. |
| Redundant OS Boot |  NOTE: This option is disabled if Redundant OS Location is set to None or if Redundant OS State is set to Hidden. When set to Enabled , BIOS boots to the device specified in Redundant OS Location . When set to Disabled , BIOS preserves the current boot list settings. This option is set to Disabled by default. |

Miscellaneous Settings

You can use the **Miscellaneous Settings** screen to perform specific functions such as updating the asset tag and changing the system date and time.

Viewing Miscellaneous Settings

To view the **Miscellaneous Settings** screen, perform the following steps:

Steps

1. Power on, or restart your system.
2. Press F2 immediately after you see the following message:

```
F2 = System Setup
```

 **NOTE:** If your operating system begins to load before you press F2, wait for the system to finish booting, and then restart your system and try again.

3. On the **System Setup Main Menu** screen, click **System BIOS**.
4. On the **System BIOS** screen, click **Miscellaneous Settings**.

Miscellaneous Settings details

About this task

The **Miscellaneous Settings** screen details are explained as follows:

| Option | Description |
|--------------------------------------|---|
| System Time | Enables you to set the time on the system. |
| System Date | Enables you to set the date on the system. |
| Asset Tag | Specifies the asset tag and enables you to modify it for security and tracking purposes. |
| Keyboard NumLock | Enables you to set whether the system should boot with the NumLock enabled or disabled. This option is set to On by default.  NOTE: This option does not apply to 84-key keyboards. |
| F1/F2 Prompt on Error | Enables or disables the F1/F2 prompt on error. This option is set to Enabled by default. The F1/F2 prompt also includes keyboard errors. |
| Load Legacy Video Option ROM | Enables you to determine whether the system BIOS loads the legacy video (INT 10H) option ROM from the video controller. Selecting Enabled in the operating system does not support UEFI video output standards. This field is available only for UEFI boot mode. You cannot set the option to Enabled if UEFI Secure Boot mode is enabled. This option is set to Disabled by default. |
| Dell Wyse P25/P45 BIOS Access | Enables or disables the Dell Wyse P25/P45 BIOS Access. This option is set to Enabled by default. |

iDRAC Settings utility

The iDRAC settings utility is an interface to set up and configure the iDRAC parameters by using UEFI. You can enable or disable various iDRAC parameters by using the iDRAC settings utility.

NOTE: Accessing some of the features on the iDRAC settings utility needs the iDRAC Enterprise License upgrade.

For more information about using iDRAC, see *Dell Integrated Dell Remote Access Controller User's Guide* at www.dell.com/poweredgemanuals.

Device Settings

Device Settings enables you to configure the below device parameters:

- Controller Configuration Utility
- Embedded NIC Port1-X Configuration
- NICs in slotX, Port1-X Configuration
- BOSS Card configuration

Dell Lifecycle Controller

Dell Lifecycle Controller (LC) provides advanced embedded systems management capabilities including system deployment, configuration, update, maintenance, and diagnosis. LC is delivered as part of the iDRAC out-of-band solution and Dell system embedded Unified Extensible Firmware Interface (UEFI) applications.

Embedded system management

The Dell Lifecycle Controller provides advanced embedded system management throughout the lifecycle of the system. The Dell Lifecycle Controller can be started during the boot sequence and can function independently of the operating system.

NOTE: Certain platform configurations may not support the full set of features provided by the Dell Lifecycle Controller.

For more information about setting up the Dell Lifecycle Controller, configuring hardware and firmware, and deploying the operating system, see the Dell Lifecycle Controller documentation at www.dell.com/poweredgemanuals.

Boot Manager

The **Boot Manager** screen enables you to select boot options and diagnostic utilities.

Viewing Boot Manager

About this task

To enter Boot Manager:

Steps

1. Power on, or restart your system.
2. Press F11 when you see the following message:

F11 = Boot Manager

If your operating system begins to load before you press F11, allow the system to complete the booting, and then restart your system and try again.

Boot Manager main menu

| Menu item | Description |
|------------------------------------|---|
| Continue Normal Boot | The system attempts to boot to devices starting with the first item in the boot order. If the boot attempt fails, the system continues with the next item in the boot order until the boot is successful or no more boot options are found. |
| One-shot Boot Menu | Enables you to access boot menu, where you can select a one-time boot device to boot from. |
| Launch System Setup | Enables you to access System Setup. |
| Launch Lifecycle Controller | Exits the Boot Manager and invokes the Dell Lifecycle Controller program. |
| System Utilities | Enables you to launch System Utilities menu such as System Diagnostics and UEFI shell. |

One-shot UEFI boot menu

One-shot UEFI boot menu enables you to select a boot device to boot from.

System Utilities

System Utilities contains the following utilities that can be launched:

- Launch Diagnostics
- BIOS Update File Explorer
- Reboot System

PXE boot

You can use the Preboot Execution Environment (PXE) option to boot and configure the networked systems, remotely.

To access the **PXE boot** option, boot the system and then press F12 during POST instead of using standard Boot Sequence from BIOS Setup. It does not pull any menu or allows managing of network devices.

Installing and removing system components

Topics:

- Safety instructions
- Before working inside your system
- After working inside your system
- Recommended tools
- Removing the system from the enclosure
- Installing the system into the enclosure
- Inside the system
- System cover
- Air shroud
- Drives
- Drive backplane
- System memory
- Processors and heat sinks
- M.2 SSD module
- Network Daughter Card
- PCIe mezzanine card
- Storage controller card
- System battery
- Optional internal USB memory key
- Optional MicroSD or vFlash card
- IDSDM
- System board
- Trusted Platform Module
- rSPI card

Safety instructions

CAUTION: Many repairs may only be done by a certified service technician. You should only perform troubleshooting and simple repairs as authorized in your product documentation, or as directed by the online or telephone service and support team. Damage due to servicing that is not authorized by Dell is not covered by your warranty. Read and follow the safety instructions that are shipped with your product.

NOTE: It is recommended that you always use an antistatic mat and antistatic strap while working on components inside the system.

CAUTION: To ensure proper operation and cooling, all bays in the system must be populated always with a component or a blank.

Before working inside your system

Prerequisites

Follow the safety guidelines listed in [Safety instructions](#) on page 45.

Steps

1. Turn off the system.
2. Remove the system from the enclosure.

3. Install the I/O connector cover.

 **CAUTION:** To prevent damage to the I/O connectors, ensure that you cover the connectors when you remove the system from the enclosure.

4. Remove the system cover.

After working inside your system

Prerequisites

Follow the safety guidelines listed in [Safety instructions](#) on page 45.

Steps

1. Install the system cover.
2. Remove the I/O connector cover.

 **CAUTION:** To prevent damage to the I/O connectors, do not touch the connectors or the connector pins.

3. Install the system into the enclosure.
4. Turn on the system.

Recommended tools

You may need the following items to perform the procedures in this section:

- Phillips #1 and #2 screwdrivers
- T8 and T30 Torx drivers
- Wrist grounding strap
- Hex nut driver-5 mm

Removing the system from the enclosure

Prerequisites

1. Follow the safety guidelines listed in [Safety instructions](#) on page 45.
2. If installed, remove the front bezel from the PowerEdge VRTX enclosure.
3. Turn off the system.

Steps

1. Press the release button on the system handle and simultaneously pull the system handle to unlock the system from the enclosure.

 **CAUTION:** To prevent damage to the I/O connectors, do not touch connectors or the connector pins.

 **CAUTION:** To protect the I/O connector pins, install the I/O connector covers every time a system is removed from the enclosure.

2. Holding the system handle, slide the system out of the enclosure.

 **NOTE:** Ensure that you do not lift the system by using only the system handle.

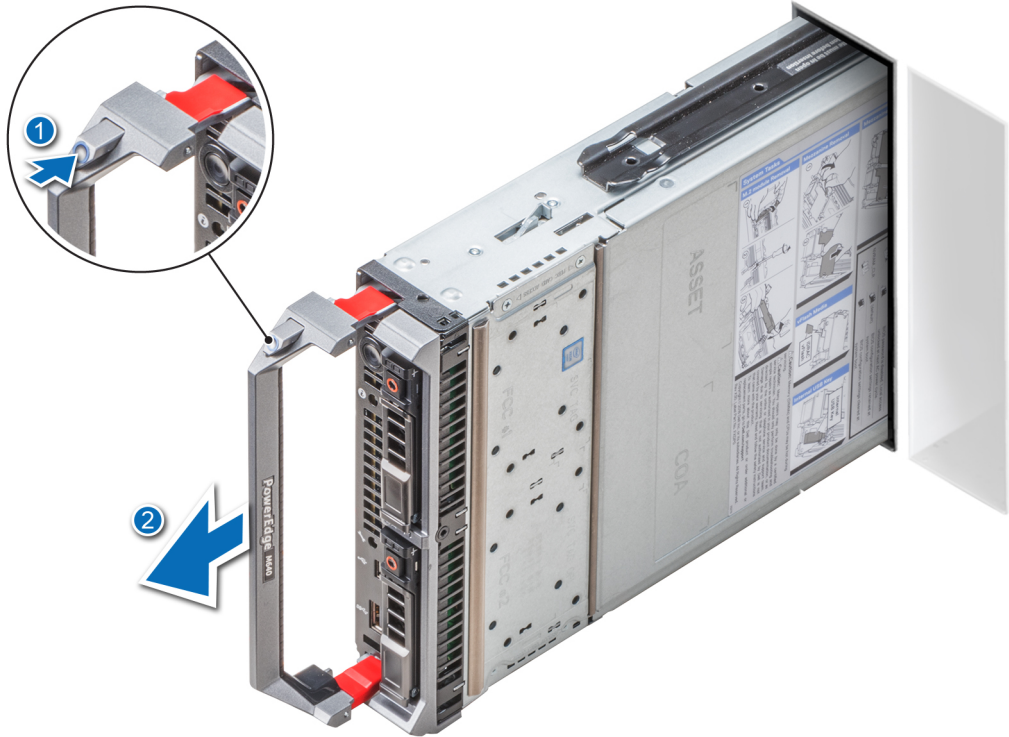

Figure 7. Removing the system from the enclosure

3. Install the I/O connector cover over the I/O connector.



Figure 8. Installing the I/O connector cover

Next steps

Install the system or system blank into the enclosure.

⚠ CAUTION: If you are permanently removing the system, install a system blank. Operating the enclosure for extended periods of time without a system blank installed can cause the enclosure to overheat.

Installing the system into the enclosure

Prerequisites

Follow the safety guidelines listed in [Safety instructions](#) on page 45.

CAUTION: To prevent damage to the I/O connectors, do not touch connectors or the connector pins.

NOTE: Install the system partitions to install half-height system(s). For more information, see the *PowerEdge VRTX Enclosure Owner's Manual* at Dell.com/poweredgemanuals.

Steps

1. If you are installing a new system, remove the I/O connector cover from the I/O connector(s) and save for future use.



Figure 9. Removing the I/O connector cover

2. Orient the system so that the system handle is on the left side of the system.

CAUTION: While installing the system into the enclosure, ensure that they are properly aligned with the slots, to prevent damage to the system connectors.

3. Align the system with the system slot and guide rails on the enclosure.
4. Holding the system handle, slide the system into the enclosure until the system locks into place.



Figure 10. Installing the system into the enclosure

Next steps

1. Turn on the system.
2. If applicable, install the front bezel of the PowerEdge VRTX enclosure.

Inside the system

CAUTION: Many repairs may only be done by a certified service technician. You should only perform troubleshooting and simple repairs as authorized in your product documentation, or as directed by the online or telephone service and support team. Damage due to servicing that is not authorized by Dell is not covered by your warranty. Read and follow the safety instructions that are shipped with your product.

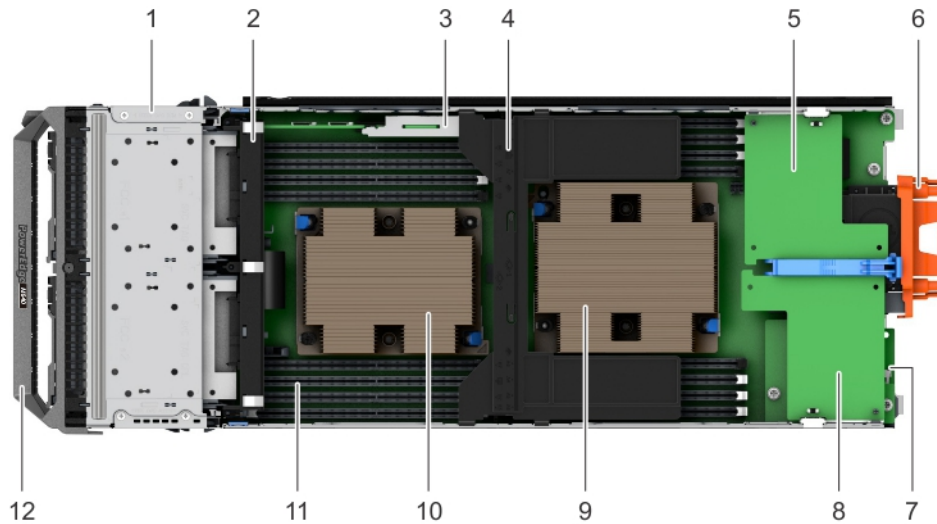

Figure 11. Inside the system

- | | |
|--------------------------------|------------------------------|
| 1. drive cage | 2. drive backplane |
| 3. IDSDM card | 4. air shroud |
| 5. mezzanine card (fabric C) | 6. I/O connector cover |
| 7. Network Daughter Card (NDC) | 8. mezzanine card (fabric B) |
| 9. heat sink (CPU1) | 10. heat sink (CPU2) |
| 11. memory module (16) | 12. system handle |

System cover

Removing the system cover

Prerequisites

1. Follow the safety guidelines listed in [Safety instructions](#) on page 45.
2. Turn off the system.
3. [Remove the system from the enclosure.](#)
4. Install the I/O connector cover.

Steps

1. Press the release button, and slide the cover toward the back of the system.
2. Lift the cover away from the system.



Figure 12. Removing the system cover

Installing the system cover

Prerequisites

1. Follow the safety guidelines listed in [Safety instructions](#) on page 45.
2. Ensure that all internal cables are routed correctly and connected, and no tools or extra parts are left inside the system.

Steps

1. Align the alignment guides on the system cover with the alignment slots on the system.
2. Slide the system cover forward until the system cover clicks into place.



Figure 13. Installing the system cover

Next steps

1. Remove the I/O connector cover and save for future use.
2. [Install the system into the enclosure](#)
3. Turn on the system.

Air shroud

Removing the air shroud

Prerequisites

CAUTION: Never operate your system with the air shroud removed. The system may get overheated quickly, resulting in shutdown of the system and loss of data.

1. Follow the safety guidelines listed in [Safety instructions](#) on page 45.
2. Follow the procedure listed in [Before working inside your system](#) on page 45.

Steps

Hold the air shroud at both ends, and lift it away from the system.

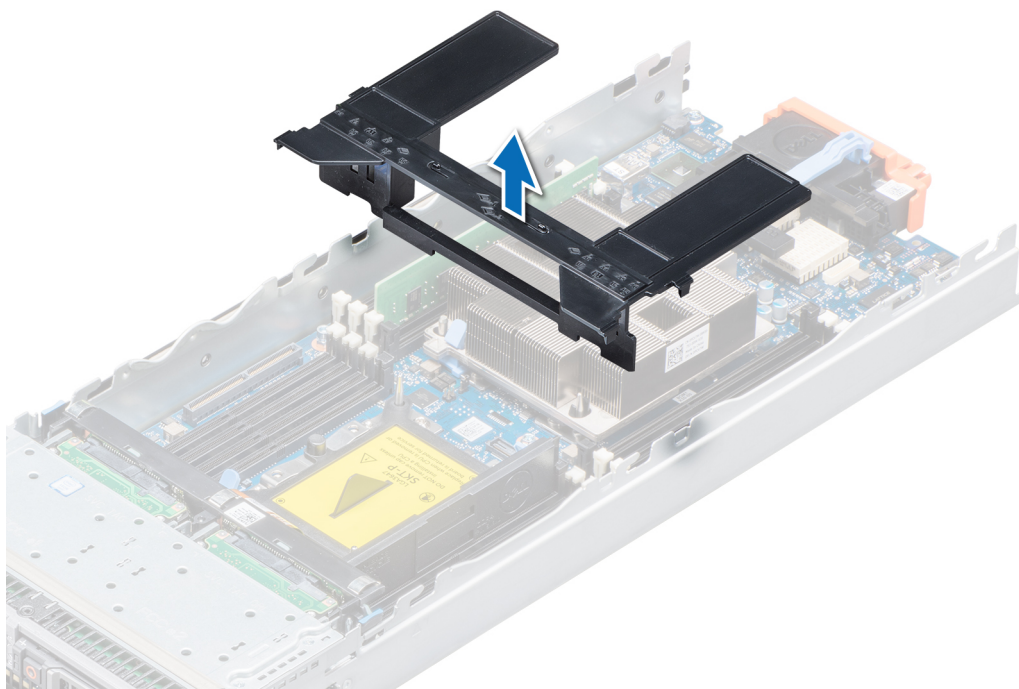

Figure 14. Removing the air shroud

Next steps

[Install the airshroud](#)

Installing the air shroud

Prerequisites

1. Follow the safety guidelines listed in [Safety instructions](#) on page 45.

Steps

1. Align the tabs on the air shroud with the slots on the system.
2. Lower the air shroud into the system until the air shroud is firmly seated.

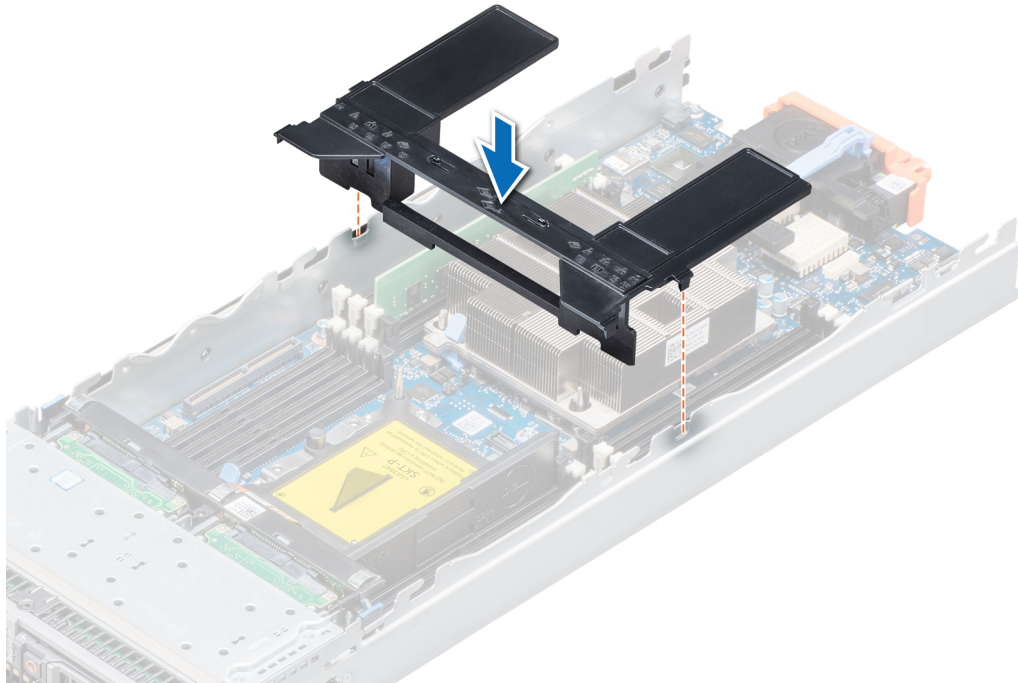

Figure 15. Installing the air shroud

Next steps

1. Follow the procedure listed in [After working inside your system](#) on page 46.

Drives

NOTE: Mixing of PCIe, SSD, SAS or SATA drives is not supported.

Removing a drive blank

Prerequisites

CAUTION: To maintain proper system cooling, all empty drive slots must have drive blanks installed.

Follow the safety guidelines listed in [Safety instructions](#) on page 45.

Steps

Press the release button and slide the drive blank out of the drive slot.

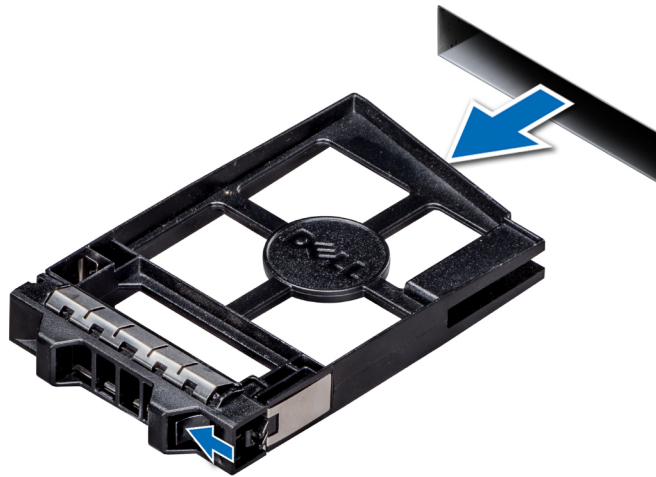

Figure 16. Removing a 1-inch drive blank

Next steps

Installing a drive blank or drive carrier.

Installing a drive blank

Prerequisites

Follow the safety guidelines listed in [Safety instructions](#) on page 45.

Steps

Insert the drive blank into the drive slot until the release button clicks into place.

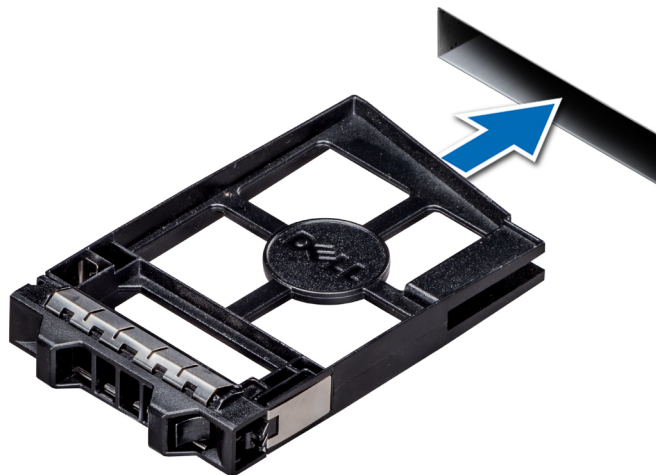

Figure 17. Installing a drive blank

Removing a drive carrier

Prerequisites

CAUTION: To maintain proper system cooling, all empty drive bays must have drive blanks installed.

WARNING: Ensure that you back up your data, before removing a drive. For more information about preparing your drive for removal and supported RAID redundancy, see the Troubleshooting guide of your system at [Dell.com/poweredgemanuals](https://www.dell.com/poweredge/manuals).

NOTE: Using the management software, prepare the drive for removal. If the drive is online, the green activity or fault indicator flashes while the drive is turning off. When the drive indicators are off, the drive is ready for removal. For more information, see the documentation for the storage controller.

Follow the safety guidelines listed in [Safety instructions](#) on page 45.

Steps

1. Press the button on the drive carrier to open the release handle.
2. Holding the release handle, slide the carrier out.

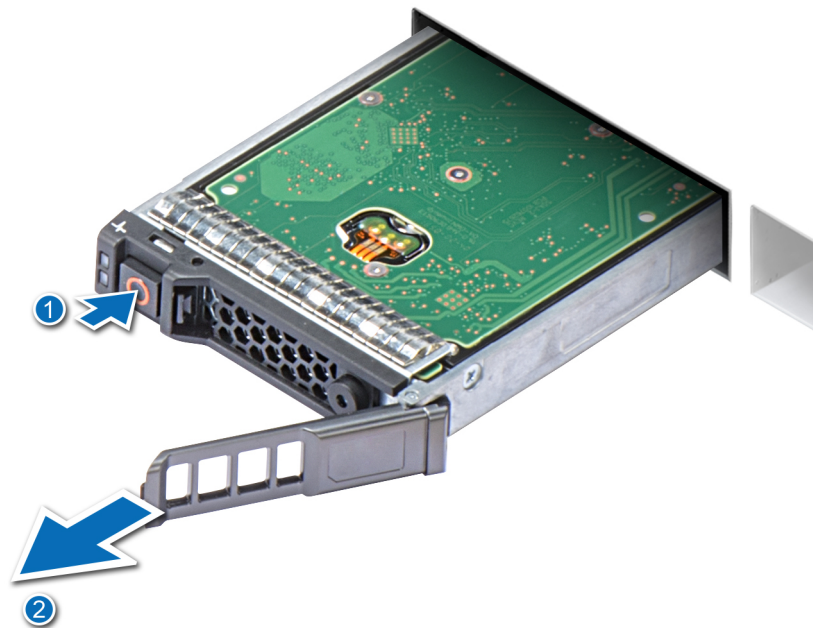

Figure 18. Removing a drive carrier

Next steps

Install the [drive carrier](#) or [drive blank](#).

Installing a drive carrier

Prerequisites

Follow the safety guidelines listed in [Safety instructions](#) on page 45.

Steps

1. Insert the drive carrier into the drive slot.
2. Push the release handle until the carrier locks in place.

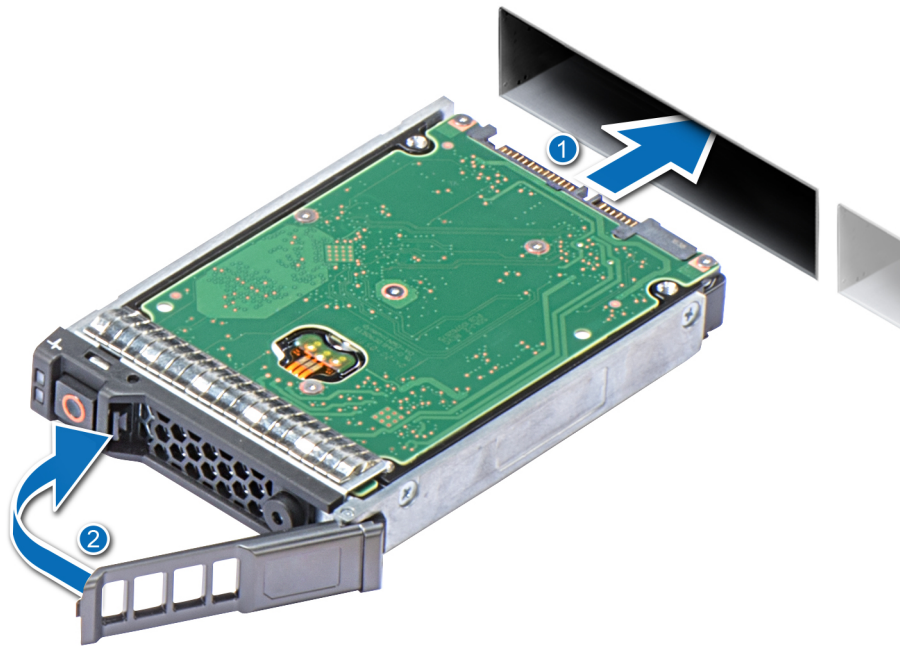

Figure 19. Installing a drive carrier

Removing a drive from a drive carrier

Prerequisites

1. Follow the safety guidelines listed in [Safety instructions](#) on page 45.
2. [Remove the drive carrier from the system.](#)

Steps

1. Using the Phillips #1 screwdriver, remove the screws from the slide rails on the drive carrier.
2. Lift the drive out of the drive carrier.

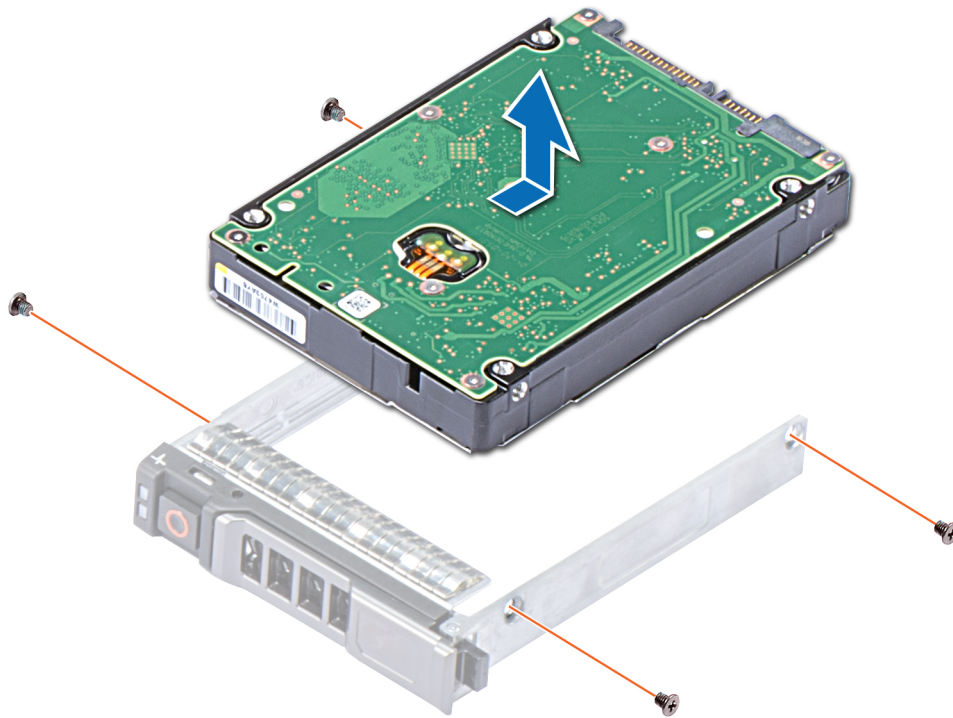

Figure 20. Removing the drive from the drive carrier

Next steps

If applicable, [Install a drive into the drive carrier](#)

Installing a drive into drive carrier

Prerequisites

Follow the safety guidelines listed in [Safety instructions](#) on page 45.

Steps

1. Insert the drive into the drive carrier, with the connector end of the drive towards the back of the carrier.
2. Align the screw holes on the drive with the screw holes on the drive carrier.
3. Using the Phillips #1 screwdriver, replace the screws to secure the drive to the drive carrier.

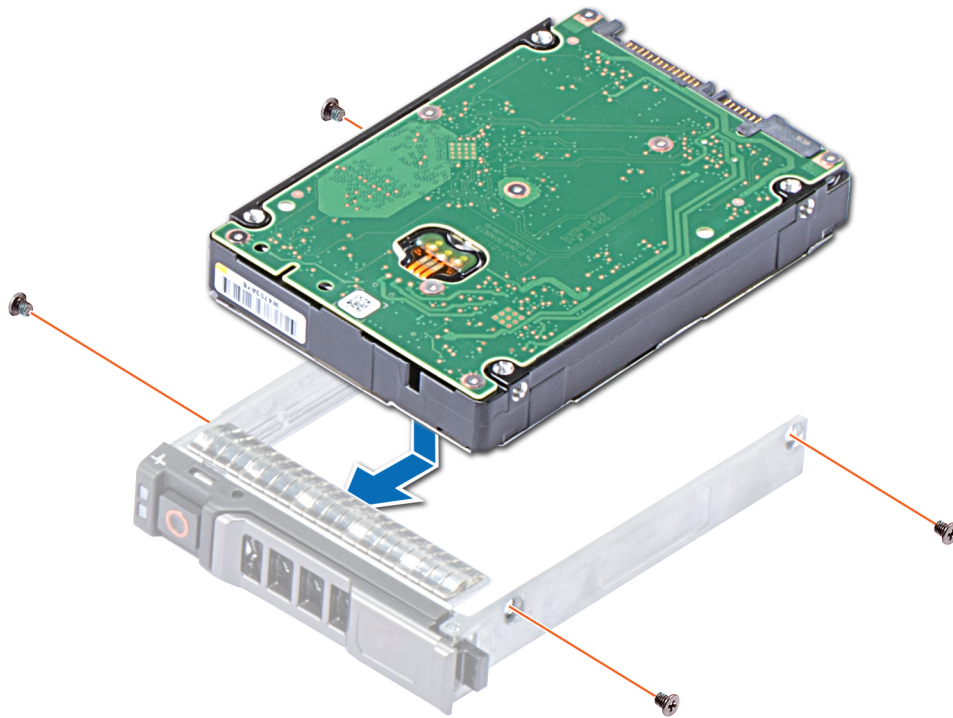

Figure 21. Installing a drive into the drive carrier

Removing the drive cage

Prerequisites

1. Follow the safety guidelines listed in [Safety instructions](#) on page 45.
2. Follow the procedure listed in [Before working inside your system](#) on page 45.
3. [Remove the drives](#)
4. [Remove the drive backplane](#)

Steps

1. Using the Phillips #1 screwdriver, remove the screws securing the drive cage to the chassis.
2. Holding the drive cage by its edges, lift the drive cage away from the system.

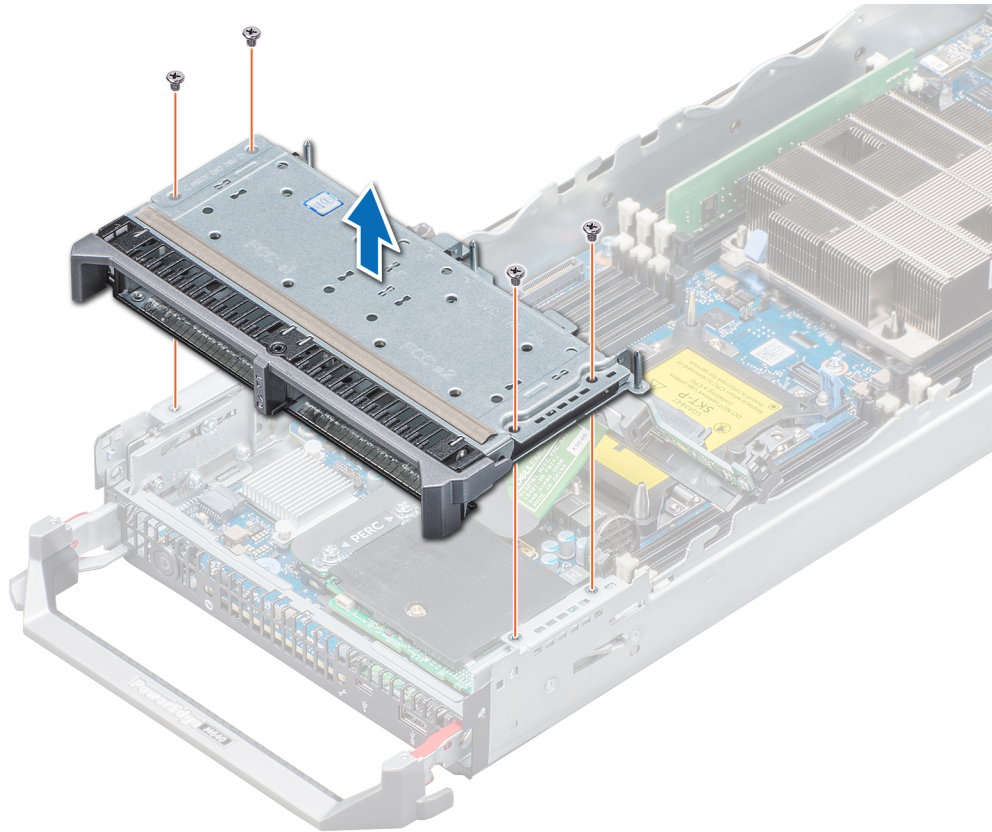

Figure 22. Removing the drive cage

Next steps

[Install the drive cage](#)

Installing the drive cage

Prerequisites

Follow the safety guidelines listed in [Safety instructions](#) on page 45.

Steps

1. Align the screw holes on the drive cage with the screw holes on the system.
2. Lower the drive cage into the system until the drive cage is seated in place.
3. Using the Phillips #1 screwdriver, replace the screws to secure the drive cage to the system.

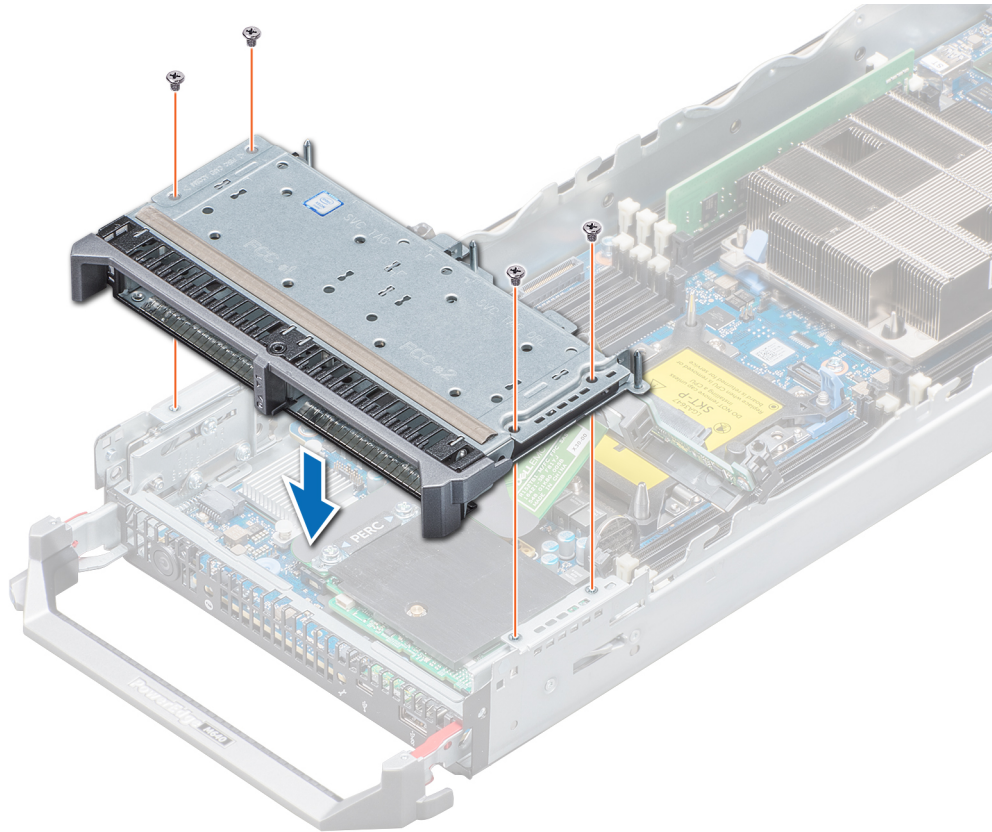

Figure 23. Installing the drive cage

Next steps

1. [Install the drive backplane.](#)
2. [Install the drives.](#)
3. Follow the procedure listed in [After working inside your system](#) on page 46.

Drive backplane

Removing the drive backplane

Prerequisites

CAUTION: To prevent damage to the drives and the drive backplane, you must remove the drives from the system before removing the drive backplane.

CAUTION: Note the number of each drive and temporarily label them before removal so that you can replace them at the same locations.

1. Follow the safety guidelines listed in [Safety instructions](#) on page 45.
2. Follow the procedure listed in [Before working inside your system](#) on page 45.
3. [Remove the drives](#)

Steps

1. Pressing the release latches, lift the drive backplane only until the guide pins on the drive cage disengage from the guides on the drive backplane.

NOTE: You cannot disconnect the drive backplane cable from the system board connector, until you remove the drive cage.

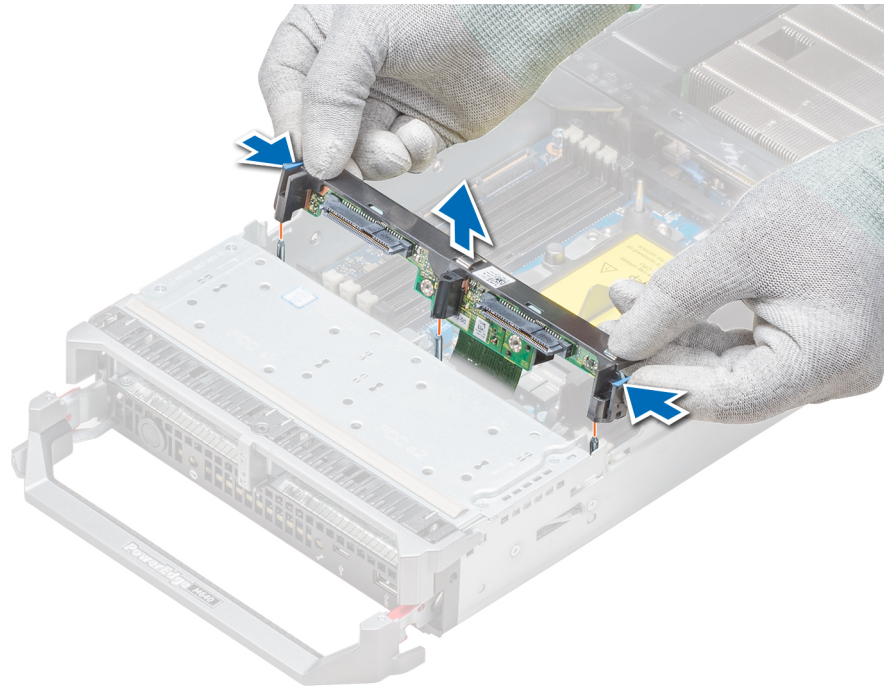

Figure 24. Removing the drive backplane

NOTE: If your system supports a SAS/PCIe backplane, then you must also loosen two additional retention screws that connect the storage controller cable connector to the system board connector.

2. Remove the drive cage.
3. Using the Phillips #2 screwdriver, loosen the retention screws securing the drive backplane cable connector to the system board connector.
4. Lift the drive backplane away from the system.

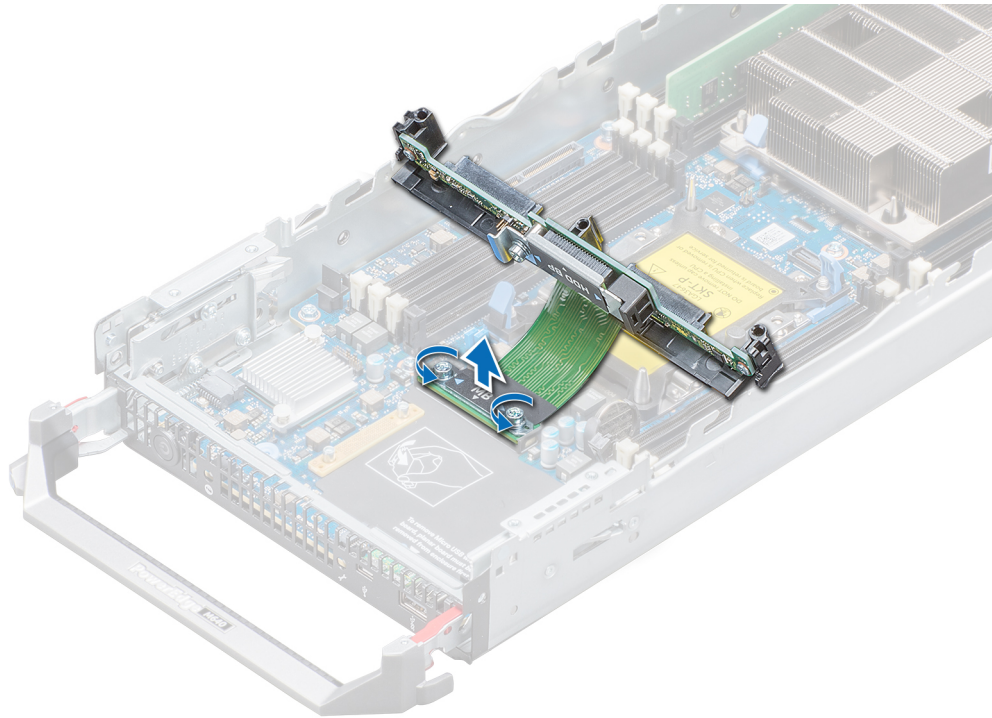

Figure 25. Removing the backplane cable

Next steps

[Install the drives](#) or [Install the drive backplane](#)

Installing the drive backplane

Prerequisites

Follow the safety guidelines listed in [Safety instructions](#) on page 45.

Steps

1. Align the retention screws on the drive backplane cable connector with the screw holes on the system board connector.
2. Using the Phillips #2 screwdriver, tighten the retention screws to secure the drive backplane cable connector to the system board.

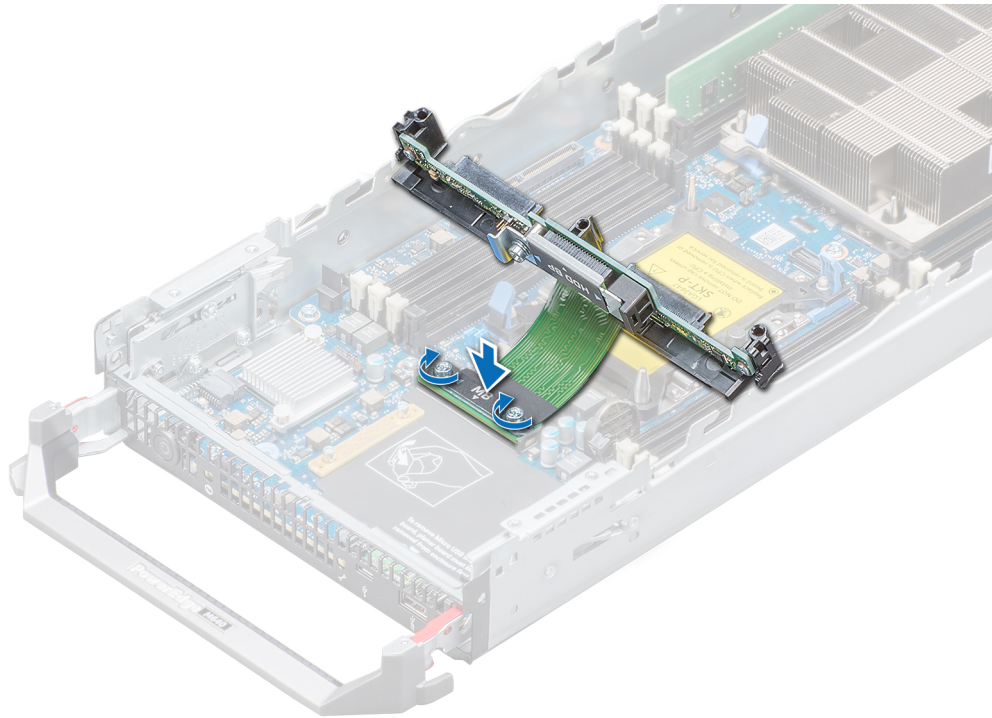

Figure 26. Installing the drive backplane cable

i **NOTE:** If your system supports a SAS/PCIe backplane, then you must also secure two additional retention screws that connect the storage controller cable connector to the system board connector.

3. Install the drive cage.
4. Align the guides on the drive backplane with the guide pins on the drive cage.
5. Pressing the release latches, lower the drive backplane into the system until it is firmly seated, and the latches engage with the system.

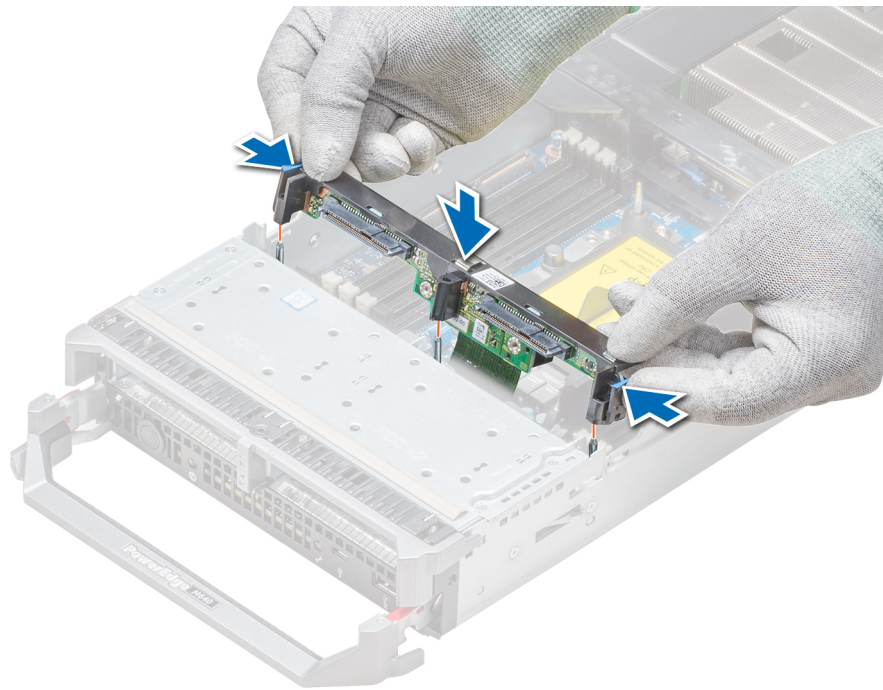

Figure 27. Installing the drive backplane

Next steps

1. Install the drives in their original locations.
2. Follow the procedure listed in [After working inside your system](#) on page 46.

System memory

System memory guidelines

Your system contains 16 memory sockets split into two sets of 8 sockets, one set per processor. Each 8-socket set is organized into six channels. Six memory channels are allocated to each processor. In each channel, the release tabs of the first three sockets are marked white, and the fourth socket black.

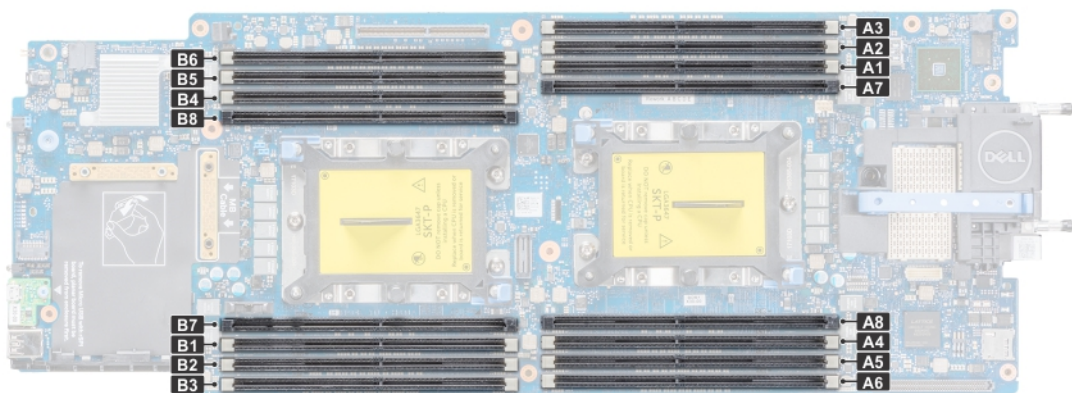

Figure 28. System memory view

Memory channels are organized as follows:

Table 24. Memory channels

| Processor | Channel 0 | Channel 1 | Channel 2 | Channel 3 | Channel 4 | Channel 5 |
|-------------|-----------------|-----------|-----------|-----------------|-----------|-----------|
| Processor 1 | Slots A1 and A7 | Slots A2 | Slots A3 | Slots A4 and A8 | Slots A5 | Slots A6 |
| Processor 2 | Slots B1 and B7 | Slots B2 | Slots B3 | Slots B4 and B8 | Slots B5 | Slots B6 |

General memory module installation guidelines

To ensure optimal performance of your system, observe the following general guidelines when configuring your system memory. If your system's memory configurations fail to observe these guidelines, your system might not boot, stop responding during memory configuration, or operate with reduced memory.

The memory bus may operate at frequency can be 2933 MT/s, 2666 MT/s, 2400 MT/s, or 2133 MT/s depending on the following factors:

- System profile selected (for example, Performance Optimized, or Custom [can be run at high speed or lower])
- Maximum supported DIMM speed of the processors.
- Maximum supported speed of the DIMMs

 NOTE: MT/s indicates DIMM speed in MegaTransfers per second.

The system supports Flexible Memory Configuration, enabling the system to be configured and run in any valid chipset architectural configuration. The following are the recommended guidelines for installing memory modules:

- All DIMMs must be DDR4.
- RDIMMs and LRDIMMs must not be mixed.
- 64 GB LRDIMMs that are DDP (Dual Die Package) LRDIMMs must not be mixed with 128 GB LRDIMMs that are TSV (Through Silicon Via/3DS) LRDIMMs.
- x4 and x8 DRAM based memory modules can be mixed.
- Up to two RDIMMs can be populated per channel regardless of rank count.
- Up to two LRDIMMs can be populated per channel regardless of rank count.
- A maximum of two different ranked DIMMs can be populated in a channel regardless of rank count.
- If memory modules with different speeds are installed, they will operate at the speed of the slowest installed memory module(s).
- Populate memory module sockets only if a processor is installed.
 - For single-processor systems, sockets A1 to A8 are available.
 - For dual-processor systems, sockets A1 to A8 and sockets B1 to B8 are available.
- Populate all the sockets with white release tabs first, followed by the black release tabs.
- When mixing memory modules with different capacities, populate the sockets with memory modules with the highest capacity first.

For example, if you want to mix 8 GB and 16 GB memory modules, populate 16 GB memory modules in the sockets with white release tabs and 8 GB memory modules in the sockets with black release tabs.
- Memory modules of different capacities can be mixed provided other memory population rules are followed.

For example, 8 GB and 16 GB memory modules can be mixed.
- In a dual-processor configuration, the memory configuration for each processor must be identical.

For example, if you populate socket A1 for processor 1, then populate socket B1 for processor 2, and so on.
- Mixing of more than two memory module capacities in a system is not supported.
- Unbalanced memory configurations will result in a performance loss so always populate memory channels identically with identical DIMMs for best performance.
- Populate six identical memory modules per processor (one DIMM per channel) at a time to maximize performance.

DIMM population update for Performance Optimized mode with quantity of 4 and 8 DIMMs per processor.

- When the DIMM quantity is 4 per processor, the population is slot 1, 2, 3, 4
- When the DIMM quantity is 8 per processor, the population is slot 1, 2, 3, 4, 5, 6, 7, 8 (2-1-1 platforms).

Mode-specific guidelines

The configurations allowed depend on the memory mode selected in the System BIOS.

Table 25. Memory operating modes

| Memory Operating Mode | Description |
|----------------------------------|---|
| Optimizer Mode | The Optimizer Mode if enabled, the DRAM controllers operate independently in the 64-bit mode and provide optimized memory performance. |
| Mirror Mode | The Mirror Mode if enabled, the system maintains two identical copies of data in memory, and the total available system memory is one half of the total installed physical memory. Half of the installed memory is used to mirror the active memory modules. This feature provides maximum reliability and enables the system to continue running even during a catastrophic memory failure by switching over to the mirrored copy. The installation guidelines to enable Mirror Mode require that the memory modules be identical in size, speed, and technology, and they must be populated in sets of 6 per processor. |
| Single Rank Spare Mode | Single Rank Spare Mode allocates one rank per channel as a spare. If excessive correctable errors occur in a rank or channel, while the operating system is running, they are moved to the spare area to prevent errors from causing an uncorrectable failure. Requires two or more ranks to be populated in each channel. |
| Multi Rank Spare Mode | Multi Rank Spare Mode allocates two ranks per channel as a spare. If excessive correctable errors occur in a rank or channel, while the operating system is running, they are moved to the spare area to prevent errors from causing an uncorrectable failure. Requires three or more ranks to be populated in each channel. |
| | <p>With single rank memory sparing enabled, the system memory available to the operating system is reduced by one rank per channel.</p> <p>For example, in a dual-processor configuration with sixteen 16 GB single-rank memory modules, the available system memory is: $\frac{3}{4}$ (ranks/channel) \times 16 (memory modules) \times 16 GB = 192 GB, and not 16 (memory modules) \times 16 GB = 256 GB. For multi rank sparing, the multiplier changes to $\frac{1}{2}$ (ranks/channel).</p> <p>NOTE: To use memory sparing, this feature must be enabled in the BIOS menu of System Setup.</p> <p>NOTE: Memory sparing does not offer protection against a multi-bit uncorrectable error.</p> |
| Dell Fault Resilient Mode | The Dell Fault Resilient Mode if enabled, the BIOS creates an area of memory that is fault resilient. This mode can be used by an OS that supports the feature to load critical applications or enables the OS kernel to maximize system availability. |

Optimizer Mode

This mode supports Single Device Data Correction (SDDC) only for memory modules that use x4 device width. It does not impose any specific slot population requirements.

- Dual processor: Populate the slots in round robin sequence starting with processor 1.

NOTE: Processor 1 and processor 2 population should match.

Table 26. Memory population rules

| Processor | Configuration | Memory population | Memory population information |
|------------------|--|------------------------|--|
| Single processor | Optimizer (Independent channel) population order | 1, 2, 3, 4, 5, 6, 7, 8 | Odd amount of DIMMs per processor allowed. |

Table 26. Memory population rules (continued)

| Processor | Configuration | Memory population | Memory population information |
|--|--|---|---|
| | Mirror population order | {1, 2, 3, 4, 5, 6} | Mirroring is supported with 6 DIMMs per processor |
| | Single rank sparing population order | 1, 2, 3, 4, 5, 6, 7, 8 | Populate in this order, odd amount per processor allowed. Requires two ranks or more per channel. |
| | Multi rank sparing population order | 1, 2, 3, 4, 5, 6, 7, 8 | Populate in this order, odd amount per processor allowed. Requires three ranks or more per channel. |
| | Fault resilient population order | {1, 2, 3, 4, 5, 6} | Supported with 6 DIMMs per processor. |
| Dual processor (Start with processor1. processor1 and processor 2 population should match) | Optimized (Independent channel) population order | A{1}, B{1}, A{2}, B{2}, A{3}, B{3} ... | Odd amount of DIMMs per processor allowed. |
| | Mirroring population order | A{1,2,3,4,5,6}, B{1,2,3,4,5,6} | Mirroring is supported with 6 DIMMs per processor. |
| | Single rank sparing population order | A{1}, B{1}, A{2}, B{2}, A{3}, B{3} ... | Populate in this order, odd amount per processor allowed. Requires two ranks or more per channel. |
| | Multi rank spare population order | A{1}, B{1}, A{2}, B{2}, A{3}, B{3} ... | Populate in this order, odd amount per processor allowed. Requires three ranks or more per channel. |
| | Fault resilient population order | A{1,2,3,4,5,6}, B{1,2,3,4,5,6} | Supported with 6 DIMMs per processor. |

Removing a memory module

Prerequisites

1. Follow the safety guidelines listed in [Safety instructions](#) on page 45.
2. Follow the procedure listed in [Before working inside your system](#) on page 45.
3. Remove the air shroud.
4. Remove the drive backplane.

 **WARNING:** Allow the memory modules to cool after you power off the system. Handle the memory modules by the card edges and avoid touching the components or metallic contacts on the memory module.

 **CAUTION:** To ensure proper system cooling, memory module blanks must be installed in any memory socket that is not occupied. Remove memory module blanks only if you intend to install memory modules in those sockets.

Steps

1. Locate the appropriate memory module socket.
2. Push the ejectors outward on both ends of the memory module socket to release the memory module from the socket.
3. Lift and remove the memory module from the system.

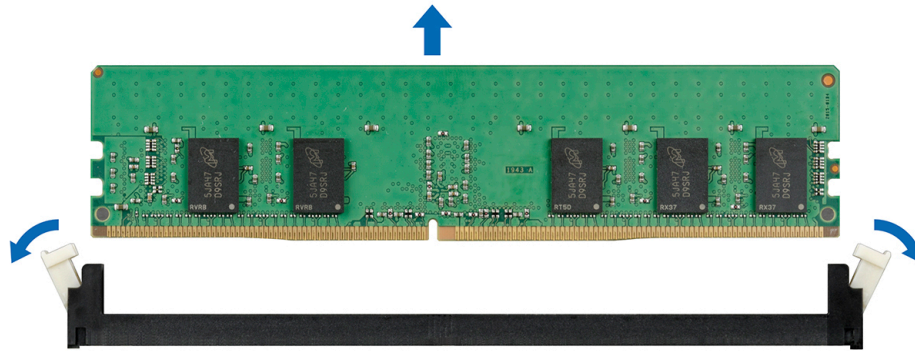

Figure 29. Removing a memory module

Next steps

1. [Install the memory module](#)
2. If you are removing the memory module permanently, install a memory module blank. The procedure to install a memory module blank is similar to that of the memory module.

Installing a memory module

Prerequisites

Follow the safety guidelines listed in [Safety instructions](#) on page 45.

CAUTION: To ensure proper system cooling, memory module blanks must be installed in any memory socket that is not occupied. Remove memory module blanks only if you intend to install memory modules in those sockets.

Steps

1. Locate the appropriate memory module socket.
 - CAUTION:** Handle each memory module only by the card edges, ensuring not to touch the middle of the memory module or metallic contacts.
 - CAUTION:** To prevent damage to the memory module or the memory module socket during installation, do not bend or flex the memory module. You must insert both ends of the memory module simultaneously.
2. Open the ejectors on the memory module socket outward to allow the memory module to be inserted into the socket.
3. Align the edge connector of the memory module with the alignment key of the memory module socket, and insert the memory module in the socket.
 - CAUTION:** Do not apply pressure at the center of the memory module; apply pressure at both ends of the memory module evenly.
 - NOTE:** The memory module socket has an alignment key that enables you to install the memory module in the socket in only one orientation.
4. Press the memory module with your thumbs until the socket levers firmly click into place.

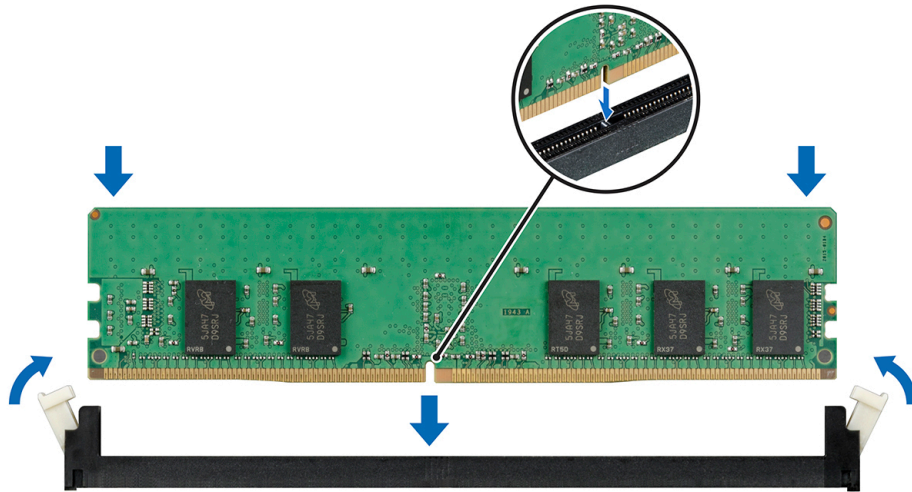

Figure 30. Installing a memory module

Next steps

1. [Install the drive backplane](#)
2. [Install the air shroud](#)
3. Follow the procedure listed in [After working inside your system](#) on page 46.
4. To verify if the memory module has been installed properly, press F2 and navigate to **System Setup Main Menu > System BIOS > Memory Settings**. In the **Memory Settings** screen, the System Memory Size must reflect the updated capacity of the installed memory.
5. If the value is incorrect, one or more of the memory modules may not be installed properly. Ensure that the memory module is firmly seated in the memory module socket.
6. Run the system memory test in system diagnostics.

Processors and heat sinks

Removing a processor and heat sink module

Prerequisites

⚠ WARNING: The heat sink may be hot to touch for some time after the system has been powered down. Allow the heat sink to cool before removing it.

1. Follow the safety guidelines listed in [Safety instructions](#) on page 45.
2. Follow the procedure listed in [Before working inside your system](#) on page 45.
3. [Remove the air shroud](#).

Steps

1. Using a Torx #T30 screwdriver, loosen the screws on the heat sink in the order below:
 - a. Loosen the first screw three turns.
 - b. Loosen the second screw completely.
 - c. Return to the first screw and loosen it completely.

i NOTE: It is normal for the heat sink to slip off the blue retention clips when the screws are partially loosened, continue to loosen the screw(s).

2. Pushing both retention clips simultaneously, lift the Processor and heat sink module (PHM) out of the system.
3. Set the PHM aside with the processor side facing up.

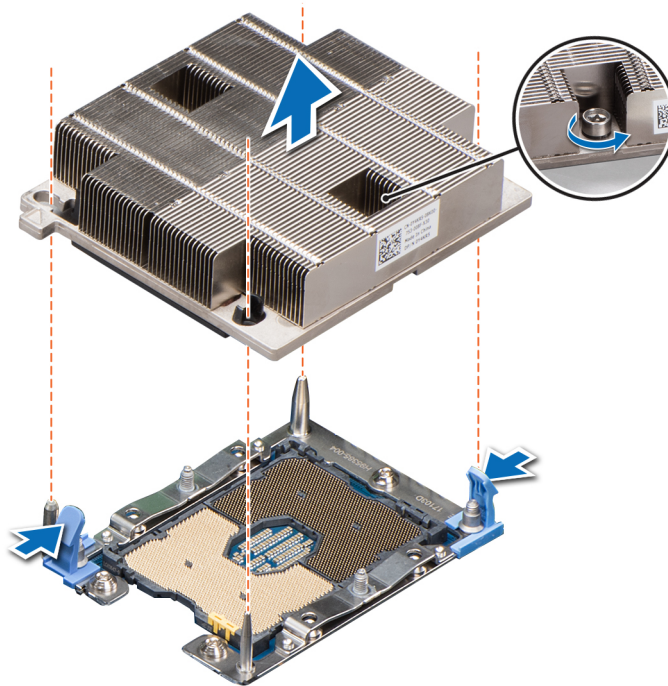

Figure 31. Removing the processor and heat sink module

Next steps

1. [Install the processor into the processor and heat sink module.](#)

Removing the processor from the processor and heat sink module

Prerequisites

⚠ WARNING: The heat sink may be hot to touch for some time after the system has been powered down. Allow the heat sink to cool before removing it.

1. Follow the safety guidelines listed in [Safety instructions](#) on page 45.
2. Follow the procedure listed in [Before working inside your system](#) on page 45.
3. [Remove the air shroud.](#)
4. [Remove the processor into the processor and heat sink module.](#)

Steps

1. Insert a flat blade screwdriver into the release slot marked with a yellow label. Rotate (do not pry) the screwdriver to break the thermal paste seal.
2. Push the retaining clips on the processor bracket to unlock the bracket from the heat sink.

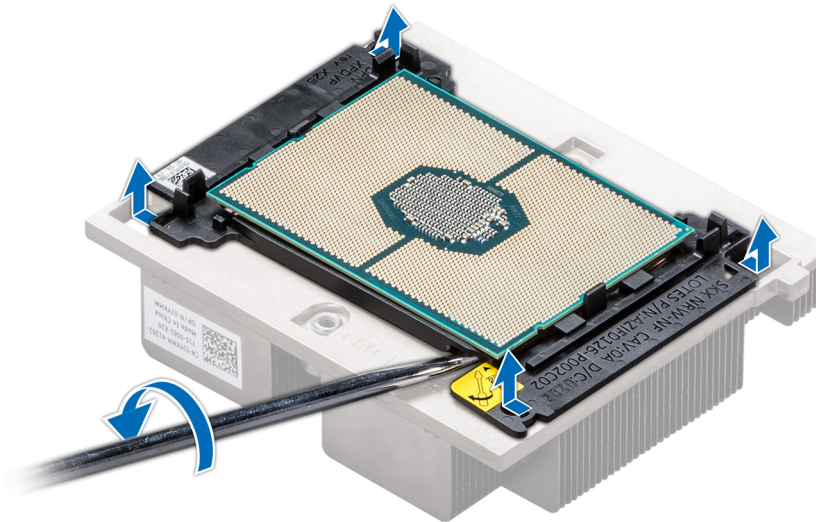

Figure 32. Loosening the processor bracket

3. Lift the bracket and the processor away from the heat sink, and place the processor connector side down on the processor tray.
4. Flex the outer edges of the bracket to release the processor from the bracket.

NOTE: Ensure that the processor and the bracket are placed in the tray after you remove the heat sink.

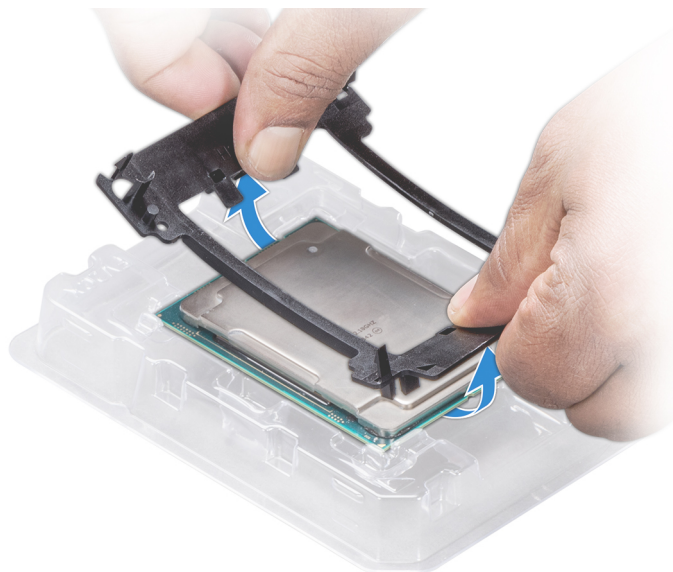

Figure 33. Removing the processor bracket

Next steps

[Install the processor and heat sink module](#)

Installing the processor into a processor and heat sink module

Prerequisites

Follow the safety guidelines listed in [Safety instructions](#) on page 45.

Steps

1. Place the processor in the processor tray.

i **NOTE:** Ensure that the pin 1 indicator on the processor tray is aligned with the pin 1 indicator on the processor.

2. Flex the outer edges of the bracket around the processor ensuring that the processor is locked into the clips on the bracket.

i **NOTE:** Ensure that the pin 1 indicator on the bracket is aligned with the pin 1 indicator on the processor before placing the bracket on the processor.

i **NOTE:** Ensure that the processor and the bracket are placed in the tray before you install the heat sink.



Figure 34. Installing the processor bracket

3. If you are using an existing heat sink, remove the thermal grease from the heat sink by using a clean lint-free cloth.
4. Use the thermal grease syringe included with your processor kit to apply the grease in a quadrilateral design on the top of the processor.

⚠ CAUTION: Applying too much thermal grease can result in excess grease coming in contact with and contaminating the processor socket.

i **NOTE:** The thermal grease syringe is intended for single use only. Dispose the syringe after you use it.

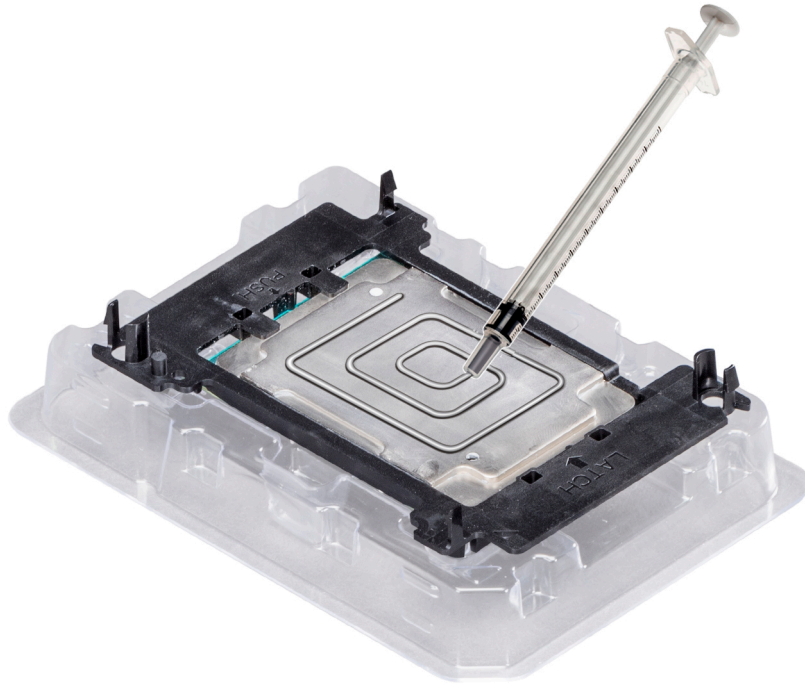

Figure 35. Applying thermal grease on top of the processor

5. Place the heat sink on the processor and push down until the bracket locks onto the heat sink.

i NOTE:

- Ensure that the two guide pin holes on the bracket match the guide holes on the heat sink.
- Ensure that the pin 1 indicator on the heat sink is aligned with the pin 1 indicator on the bracket before placing the heat sink onto the processor and bracket.

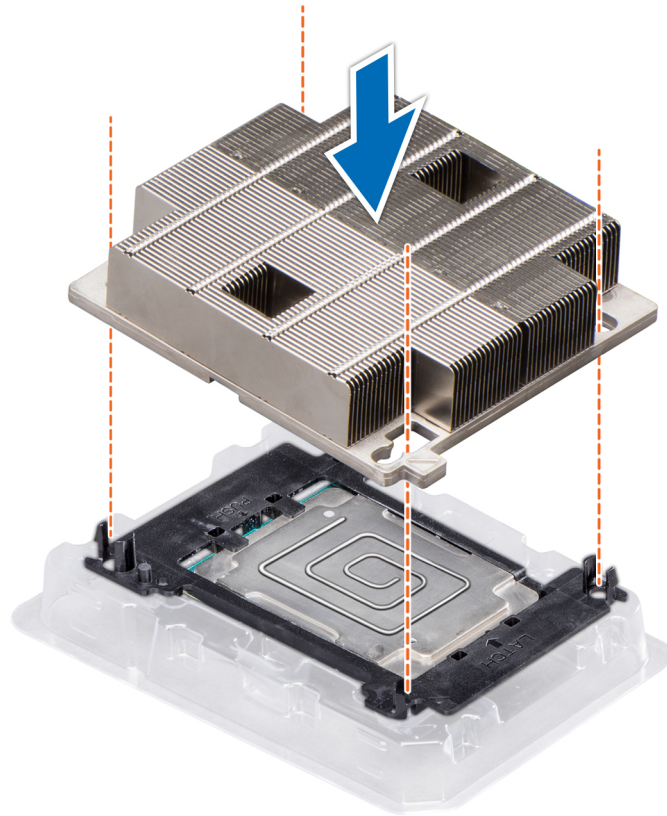

Figure 36. Installing the heat sink onto the processor

Next steps

1. [Install the processor and heat sink module](#)
2. [Install the airshroud](#)
3. Follow the procedure listed in [After working inside your system](#) on page 46.

Installing a processor and heat sink module

Prerequisites

CAUTION: Never remove the heat sink from a processor unless you intend to replace the processor. The heat sink is necessary to maintain proper thermal conditions.

WARNING: The heat sink may be hot to touch for some time after the system has been powered down. Allow the heat sink to cool before removing it.

Follow the safety guidelines listed in [Safety instructions](#) on page 45.

Steps

1. Align the pin 1 indicator of the heat sink to the system board and then place the processor and heat sink module (PHM) on the processor socket.

CAUTION: To avoid damaging the fins on the heat sink, do not press down on the heat sink fins.

NOTE: Ensure that the PHM is held parallel to the system board to prevent damaging the components.

2. Push the blue retention clips inward to allow the heat sink to drop into place.

3. Supporting the heat sink with one hand, use the Torx #T30 screwdriver and tighten the screws on the heat sink in the order below:
 - a. Partially tighten the first screw (approximately 3 turns).
 - b. Tighten the second screw completely.
 - c. Return to the first screw and tighten it completely.

If the PHM slips off the blue retention clips when the screws are partially tightened, follow these steps to secure the PHM:

- a. Loosen both the heat sink screws completely.
- b. Lower the PHM on to the blue retention clips, follow the procedure described above in step 2.
- c. Secure the PHM, follow the procedure described above in step 3.

NOTE: The processor and heat sink module retention screws should not be tightened to more than 0.13 kgf-m (1.35 N.m or 12 in-lbf).

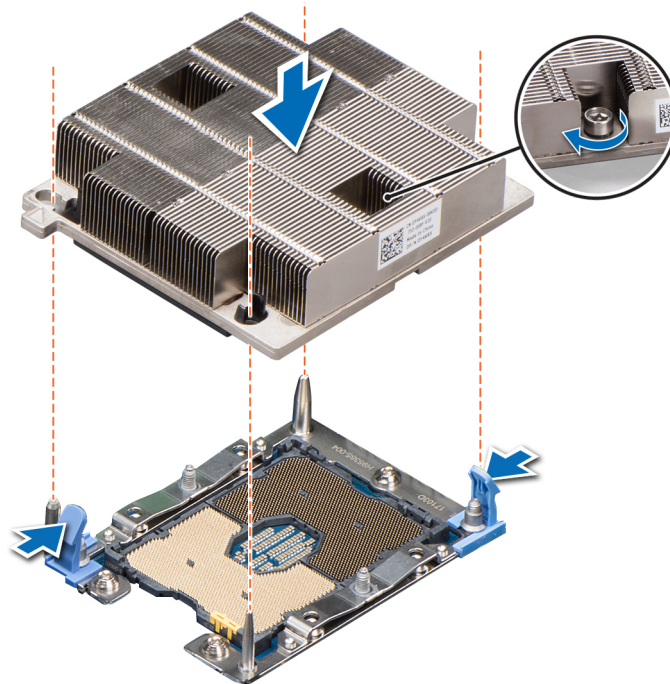

Figure 37. Installing a processor and heat sink module

Next steps

1. [Install the airshroud.](#)
2. Follow the procedure listed in [After working inside your system](#) on page 46.

M.2 SSD module

Removing the M.2 SSD module

Prerequisites

1. Follow the safety guidelines listed in [Safety instructions](#) on page 45.
2. Follow the procedure listed in [Before working inside your system](#) on page 45.
3. [Remove the airshroud.](#)
4. Remove the BOSS card.

NOTE: Removing the BOSS card is similar to the procedure for removing an expansion card riser.

Steps

1. Loosen the screws and lift the retention straps that secure the M.2 SSD module on the BOSS card.
2. Pull the M.2 SSD module away from the BOSS card.

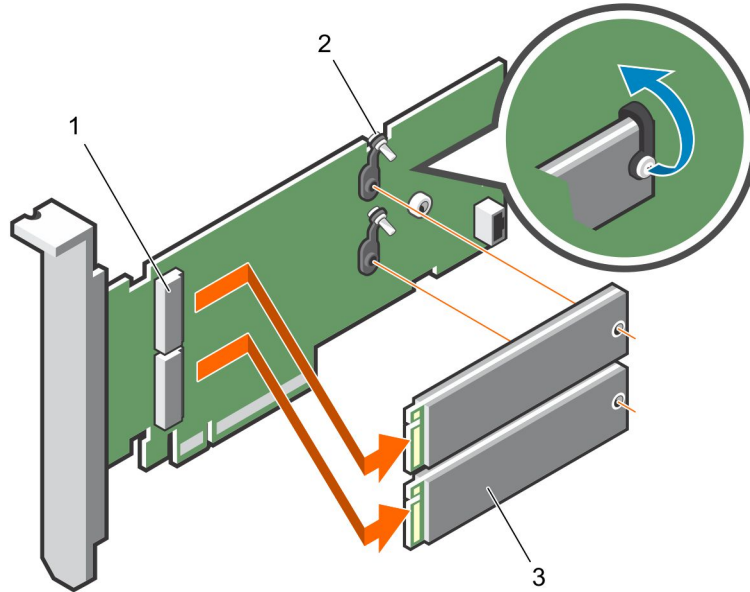

Figure 38. Removing the M.2 SSD module

- a. module connector (2)
- b. screws (2)
- c. module (2)

Next steps

[Install the SSD card.](#)

Installing the M.2 SSD module

Prerequisites

1. Follow the safety guidelines listed in [Safety instructions](#) on page 45.

Steps

1. Align the M.2 SSD module connectors with the connectors on the BOSS card.
2. Push the M.2 SSD module until the module is seated firmly on the BOSS card.
3. Secure the M.2 SSD module on the BOSS card with the retention straps and screws.

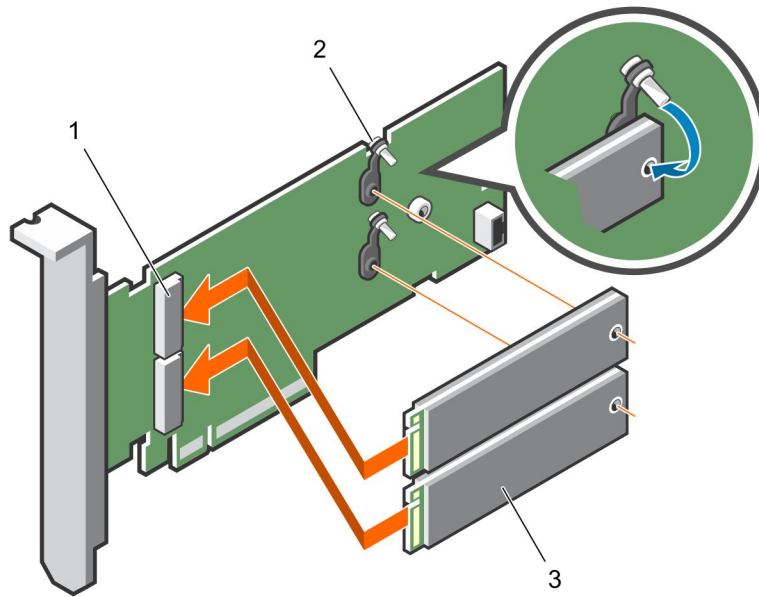

Figure 39. Installing the M.2 SSD module

- a. module connector (2)
- b. screws (2)
- c. modules (2)

Next steps

1. [Install the air shroud.](#)
2. Follow the procedure listed in [After working inside your system](#) on page 46.

Network Daughter Card

Removing the Network Daughter Card

Prerequisites

1. Follow the safety guidelines listed in [Safety instructions](#) on page 45.
2. Follow the procedure listed in [Before working inside your system](#) on page 45.
3. [Remove the mezzanine card.](#)

Steps

1. Using the Phillips #2 screwdriver, remove the two screws that secure the Network Daughter Card (NDC) to the system board.

⚠ CAUTION: To prevent damage to the NDC, you must hold the card only by its edges.

2. Lift the card from the system board.

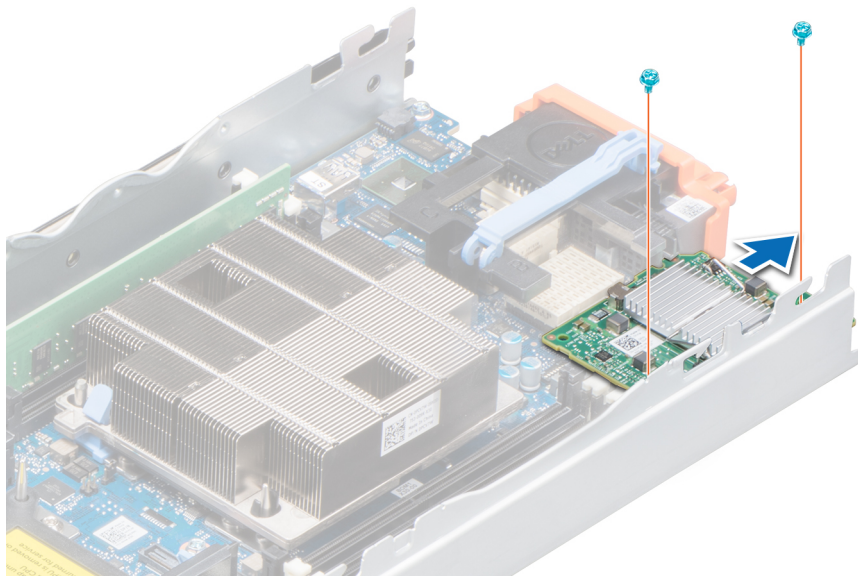

Figure 40. Removing the Network Daughter Card

Next steps

1. [Install the NDC.](#)

Installing the Network Daughter Card

Prerequisites

CAUTION: To prevent damage to the Network Daughter Card (NDC), you must hold the card only by its edges.

1. Follow the safety guidelines listed in [Safety instructions](#) on page 45.

Steps

1. Align the following:
 - a. The slots on the card edge with the projection tabs on the plastic bracket covering the PCIe mezzanine card slots.
 - b. Screw holes on the card with the standoffs on the system board.
2. Lower the card into place until the card connector fits into the corresponding connector on the system board.
3. Using the Phillips #2 screwdriver, replace the screws to secure the card.

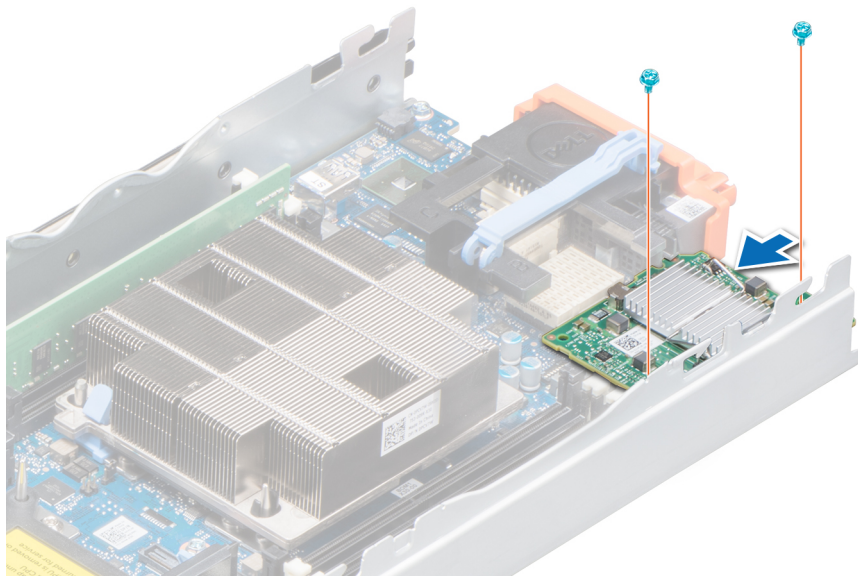

Figure 41. Installing the Network Daughter Card

Next steps

1. [Install the Mezzanine card.](#)
2. Follow the procedure listed in [After working inside your system](#) on page 46.

PCIe mezzanine card

PCIe mezzanine card installation guidelines

Your system supports two PCIe mezzanine cards:

- PCIe mezzanine card slot C supports Fabric C. This card must match the fabric type of I/O modules installed in I/O module bays C1 and C2.
- PCIe mezzanine card slot B supports Fabric B. This card must match the fabric type of I/O modules installed in I/O module bays B1 and B2.

Removing the PCIe mezzanine card

Prerequisites

1. Follow the safety guidelines listed in [Safety instructions](#) on page 45.
2. Follow the procedure listed in [Before working inside your system](#) on page 45.

Steps

1. Open the retention latch by pressing the ridged area on the retention latch, and lifting the latch up.

CAUTION: To prevent damage to the PCIe mezzanine card, you must hold the card only by its edges.

2. Lift the PCIe mezzanine card up and away from the system.
3. Close the retention latch.

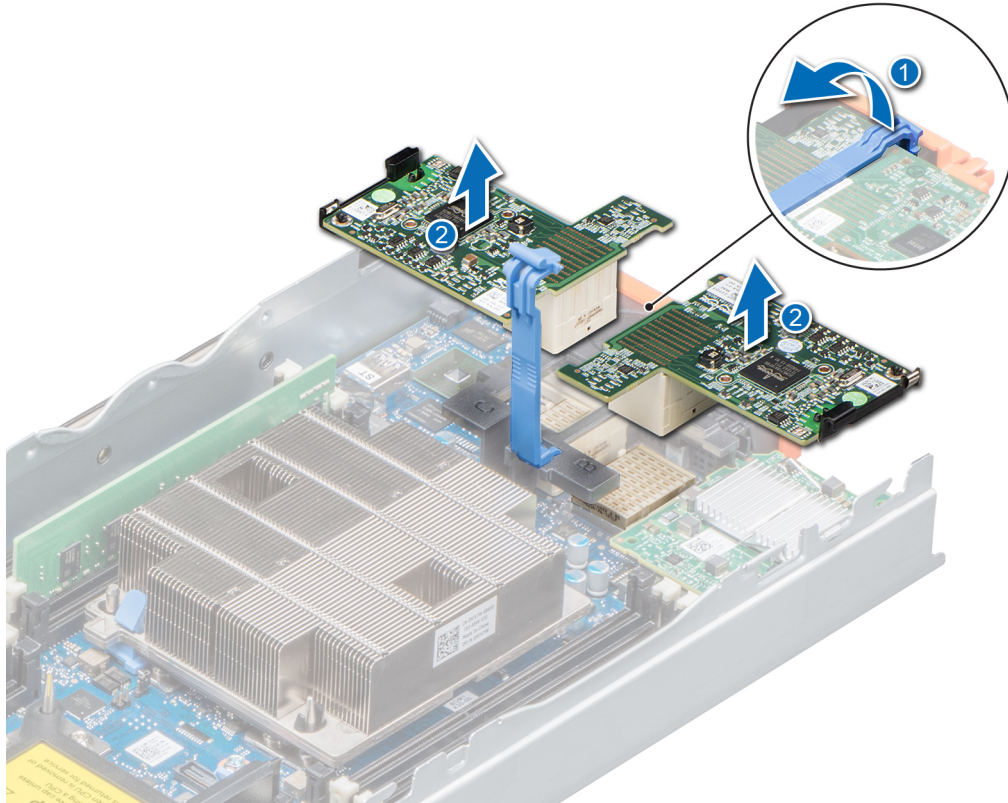

Figure 42. Removing the PCIe mezzanine card

Next steps

Install the PCIe mezzanine card.

Installing the PCIe mezzanine card

Prerequisites

NOTE: You must remove the PCIe mezzanine card to replace a faulty PCIe mezzanine card or service other components inside the system.

Follow the safety guidelines listed in [Safety instructions](#) on page 45.

Steps

1. Open the retention latch by pressing the ridged area on the retention latch with your thumb and lifting the end of the latch.
2. If present, remove the connector cover from the PCIe mezzanine card bay.

CAUTION: To prevent damage to the PCIe mezzanine card, you must hold the card only by its edges.

3. Rotate the card to align the connector on the bottom of the PCIe mezzanine card with the corresponding socket on the system board.
4. Lower the card into place until it is fully seated and the plastic clip on the outer edge of the card engages over the side of the system.
5. Close the retention latch to secure the PCIe mezzanine card.

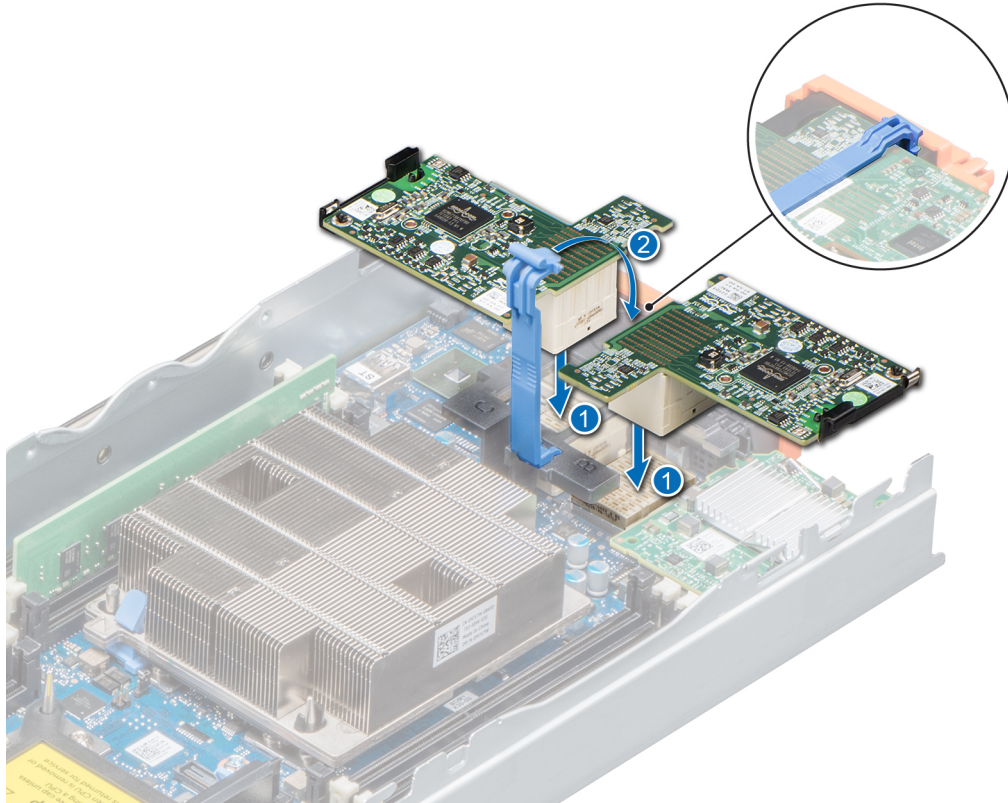

Figure 43. Installing the PCIe mezzanine card

Next steps

Follow the procedure listed in [After working inside your system](#) on page 46.

Storage controller card

Removing the storage controller card

Prerequisites

1. Follow the safety guidelines listed in [Safety instructions](#) on page 45.
2. Follow the procedure listed in [Before working inside your system](#) on page 45.
3. Remove the following:
 - a. [Drives](#)
 - b. [Drive backplane](#)
 - c. [Drive cage](#)

Steps

1. Using the Phillips #2 screwdriver, loosen the retention screws on the drive cable connector and lift it away from the storage controller card.

CAUTION: To prevent damage to the storage controller card, you must hold the card only by its edges.

2. Lift the storage controller card away from the system.

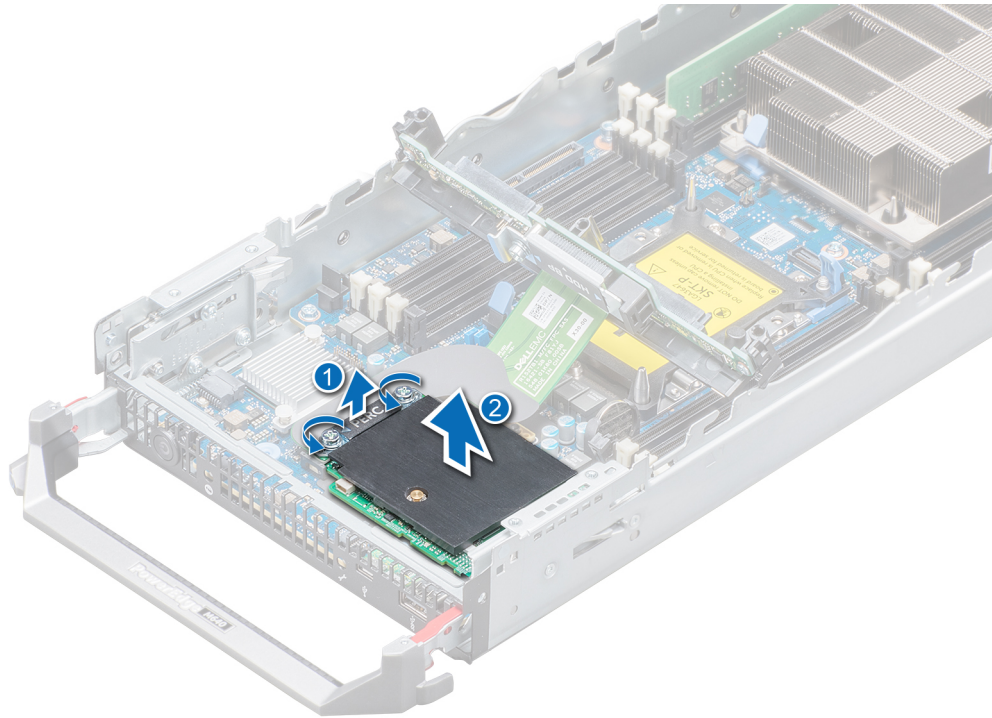

Figure 44. Removing the storage controller card

Next steps

Install the storage controller card.

Installing the storage controller card

Prerequisites

Follow the safety guidelines listed in [Safety instructions](#) on page 45.

Steps

1. Align the slots on the edge of the storage controller card with the tabs on the support bracket.

CAUTION: To prevent damage to the storage controller card, you must hold the card only by its edges.

2. Lower the storage controller card onto the connector on the system board.
3. Using the Phillips #2 screwdriver, tighten the retention screws on the drive backplane cable connector to secure the card to the system board.

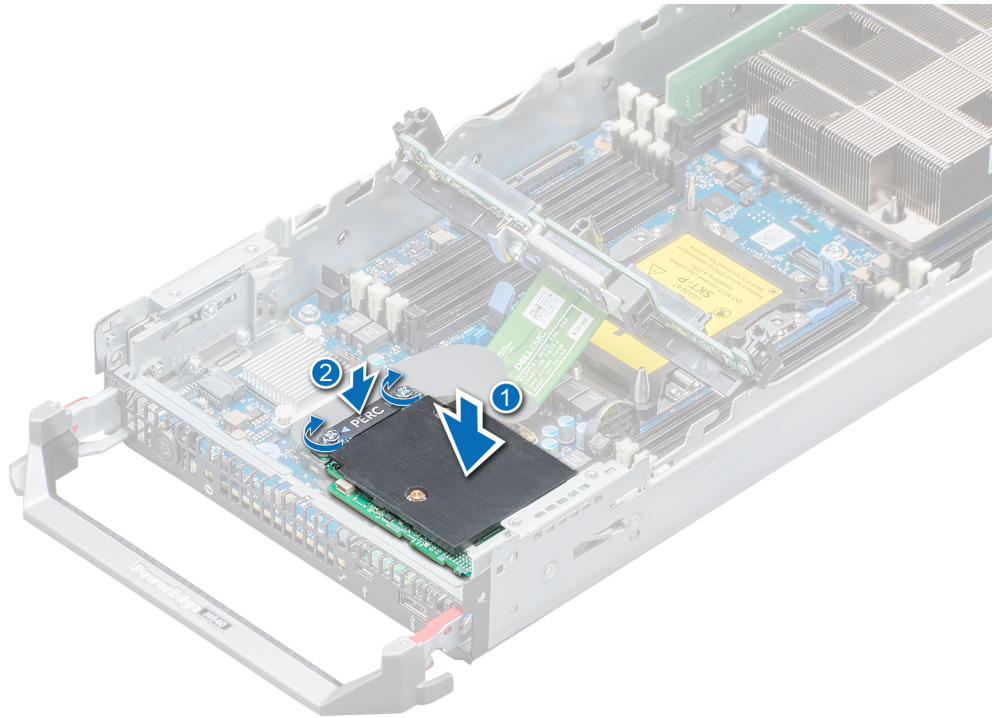

Figure 45. Installing the storage controller card

Next steps

1. Install the following:
 - a. [Drives](#)
 - b. [Drive backplane](#)
 - c. [Drive cage](#)
2. Follow the procedure listed in [After working inside your system](#) on page 46.

System battery

Replacing the NVRAM backup battery - Option A

Prerequisites

i **NOTE:** There is a danger of a new battery exploding if it is incorrectly installed. Replace the battery only with the same or equivalent type recommended by the manufacturer. Discard used batteries according to the manufacturer's instructions. See the safety instructions that came with your system for additional information.

1. Follow the safety guidelines listed in [Safety instructions](#) on page 45.
2. Follow the procedure listed in [Before working inside your system](#) on page 45.
3. Remove the following:
 - a. [drives](#)
 - b. [backplane](#)

Steps

1. Locate the system battery on the system.
2. To remove the battery:
 - a. Push the battery toward the positive side of the battery until the battery disengages from the connector.

- b. Lift the battery away from the system.



Figure 46. Removing the system battery

- 3. To install a new system battery:
 - a. Hold the battery with the "+" sign facing the positive side of the battery connector.
 - b. Insert the battery down into the connector and push the positive side of the battery until the battery snaps into place.



Figure 47. Installing the system battery

Next steps

1. Install the following:
 - a. [backplane](#)
 - b. [drives](#)
2. Follow the procedure listed in [After working inside your system](#) on page 46.
3. Enter the System Setup to confirm that the battery is operating properly.
4. Enter the correct time and date in the System Setup's **Time** and **Date** fields.
5. Exit the System Setup.
6. To test the newly installed battery, remove the system from the enclosure, for at least an hour.
7. Reinstall the system into the enclosure, after an hour.
8. Enter the System Setup and if the time and date are still incorrect, see the [Getting help](#) on page 105section.

Replacing the NVRAM backup battery - Option B

Prerequisites

i **NOTE:** There is a danger of a new battery exploding if it is incorrectly installed. Replace the battery only with the same or equivalent type recommended by the manufacturer. Discard used batteries according to the manufacturer's instructions. See the safety instructions that came with your system for additional information.

1. Follow the safety guidelines listed in [Safety instructions](#) on page 45.
2. Follow the procedure listed in [Before working inside your system](#) on page 45.
3. Remove the following:
 - a. [drives](#).
 - b. [backplane](#).

Steps

1. Locate the system battery on the system.
2. To remove the battery:

- a. Push the battery holder slightly away.

i **NOTE:** Ensure that you do not push the battery holder more that 3.2 millimeters or you might risk damaging the part.

- b. Push the battery toward the positive side of the battery till the battery disengages from the connector.
- c. Lift the battery away from the system.

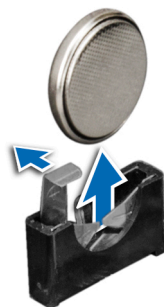

Figure 48. Removing the system battery

3. To install a new system battery:

- a. Push the battery holder slightly away.

i **NOTE:** Ensure that you do not push the battery holder more that 3.2 millimeters or you might risk damaging the part.

- b. Hold the battery with the "+" sign facing the positive side of the battery connector.
- c. Insert the battery down into the connector and push the positive side of the battery until the battery snaps into place.

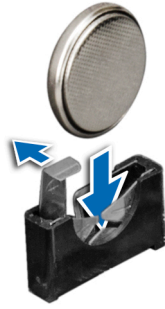

Figure 49. Installing the system battery

Next steps

1. Install the following:
 - a. drives
 - b. air shroud
 - c. drives
2. Follow the procedure listed in [After working inside your system](#) on page 46.
3. Enter the System Setup to confirm that the battery is operating properly.
4. Enter the correct time and date in the System Setup's **Time** and **Date** fields.
5. Exit the System Setup.
6. To test the newly installed battery, remove the system from the enclosure, for at least an hour.
7. Reinstall the system into the enclosure, after an hour.
8. Enter the System Setup and if the time and date are still incorrect, see the [Getting help](#) on page 105section.

Optional internal USB memory key

NOTE: To locate the internal USB port on the system board, see the [System board jumpers and connectors](#) section.

Replacing optional internal USB memory key

Prerequisites

CAUTION: To avoid interference with other components in the server, the maximum permissible dimensions of the USB memory key are 15.9 mm wide x 57.15 mm long x 7.9 mm high.

1. Follow the safety guidelines listed in [Safety instructions](#) on page 45.
2. Follow the procedure listed in [Before working inside your system](#) on page 45.

Steps

1. Locate the USB port or USB memory key on the system board.
2. If installed, remove the USB memory key from the USB port.
3. Insert the replacement USB memory key into the USB port.

Next steps

1. Follow the procedure listed in [After working inside your system](#) on page 46.
2. While booting, press F2 to enter **System Setup** and verify that the system detects the USB memory key.

Optional MicroSD or vFlash card

Removing the internal micro SD card

Prerequisites

1. Follow the safety guidelines listed in [Safety instructions](#) on page 45.
2. Follow the procedure listed in [Before working inside your system](#) on page 45.

Steps

Locate the micro SD card slot on the internal dual SD module (IDSDM), and press the card to release it from the slot.

i **NOTE:** Temporarily label each micro SD card with its corresponding slot number before removal. Reinstall the micro SD cards into the corresponding slots.

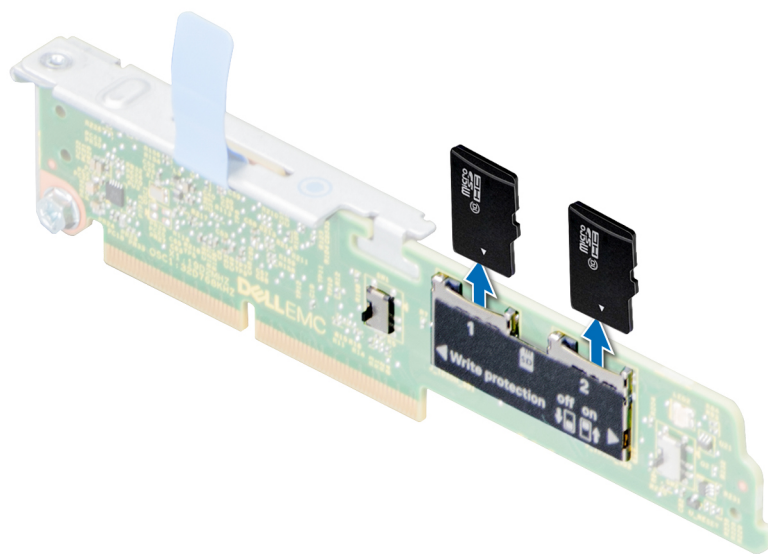

Figure 50. Removing the internal MicroSD card

Next steps

[Install internal micro SD card](#)

Installing an internal micro SD card

Prerequisites

Follow the safety guidelines listed in [Safety instructions](#) on page 45.

i **NOTE:** To use an micro SD card with your system, ensure that the Internal SD Card Port is enabled in System Setup.

Steps

1. Locate the micro SD card connector on the internal dual SD module. Orient the micro SD card appropriately and insert the contact-pin end of the card into the slot.

i **NOTE:** The slot is keyed to ensure correct insertion of the card.

2. Press the card into the card slot to lock it into place.

NOTE: Temporarily label each SD card with its corresponding slot before removal.

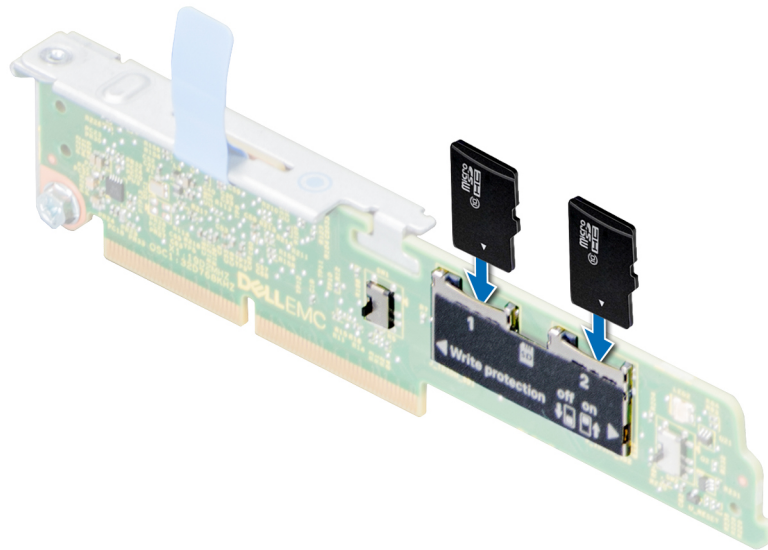

Figure 51. Installing the internal MicroSD card

Next steps

Follow the procedure listed in [After working inside your system](#) on page 46.

IDSDM

Removing the optional internal dual SD module

Prerequisites

1. Follow the safety guidelines listed in [Safety instructions](#) on page 45.
2. Follow the procedure listed in [Before working inside your system](#) on page 45.
3. [Install the air shroud](#).

NOTE: The procedure to remove IDSDM and the BOSS M.2 card is the same.

Steps

1. Pressing the release latches, lift the drive backplane only until the guide pins on the drive cage disengage from the guides on the drive backplane.
2. Using the Phillips #2 screwdriver, loosen the retention screw that connects the internal dual SD module (IDSDM) to the system board.
3. Lift the release tab that secures the IDSDM to the system board.
4. Holding both ends of the IDSDM, lift the IDSDM out of the IDSDM/BOSS M.2 connector on the system board.

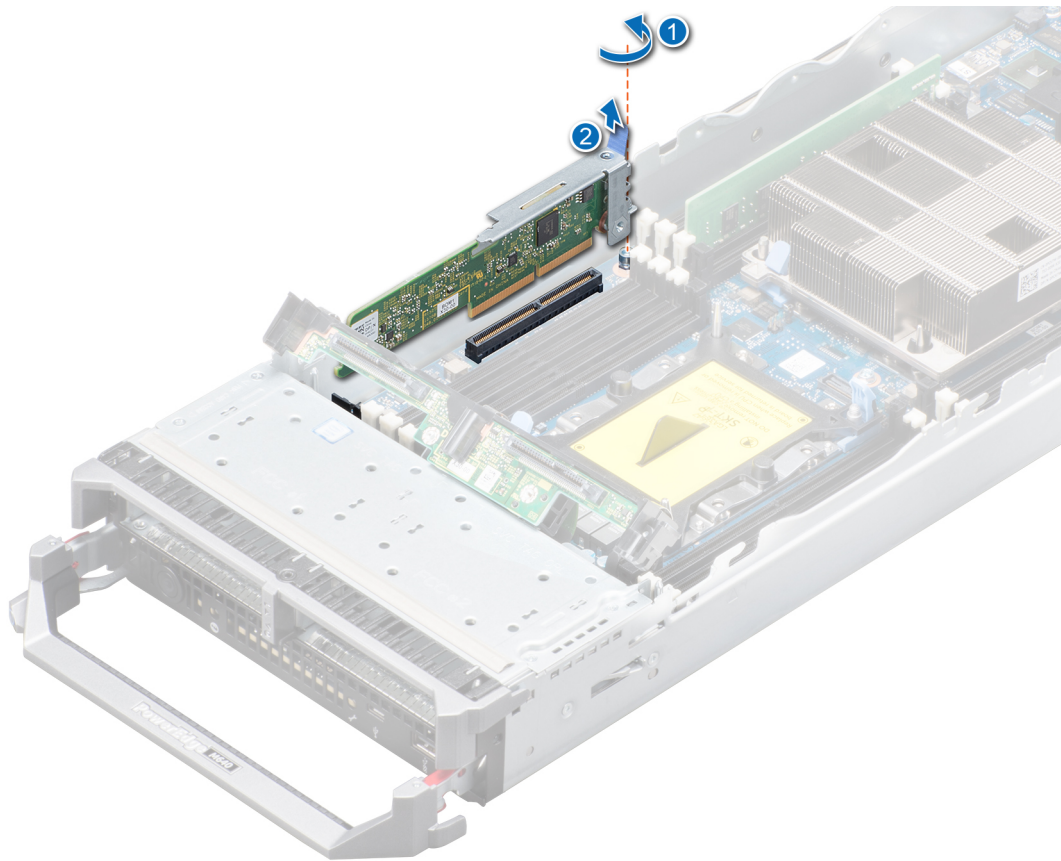

Figure 52. Removing the optional IDSDM module

Next steps

Install the IDSDM

Installing the optional internal dual SD module

Prerequisites

Follow the safety guidelines listed in [Safety instructions](#) on page 45.

NOTE: You must install either the Internal dual SD module (IDSDM) or the BOSS M.2 card in the same IDSDM/BOSS M.2 connector.

NOTE: The procedure to install IDSDM and the BOSS M.2 card is the same.

Steps

1. Holding both ends of the IDSDM, insert the IDSDM into the IDSDM/BOSS M.2 connector on the system board.

NOTE: For information on the location of the IDSDM/BOSS M.2 connector, see the [System board jumpers and connectors section](#).

2. Push the release tab that secures the IDSDM to the system board, in place.
3. Using the Phillips #2 screwdriver, tighten the retention screw that connects the internal dual SD module (IDSDM) to the system board.
4. Pressing the release latches, lower the drive backplane into the system until it is firmly seated, and the latches engage with the system.

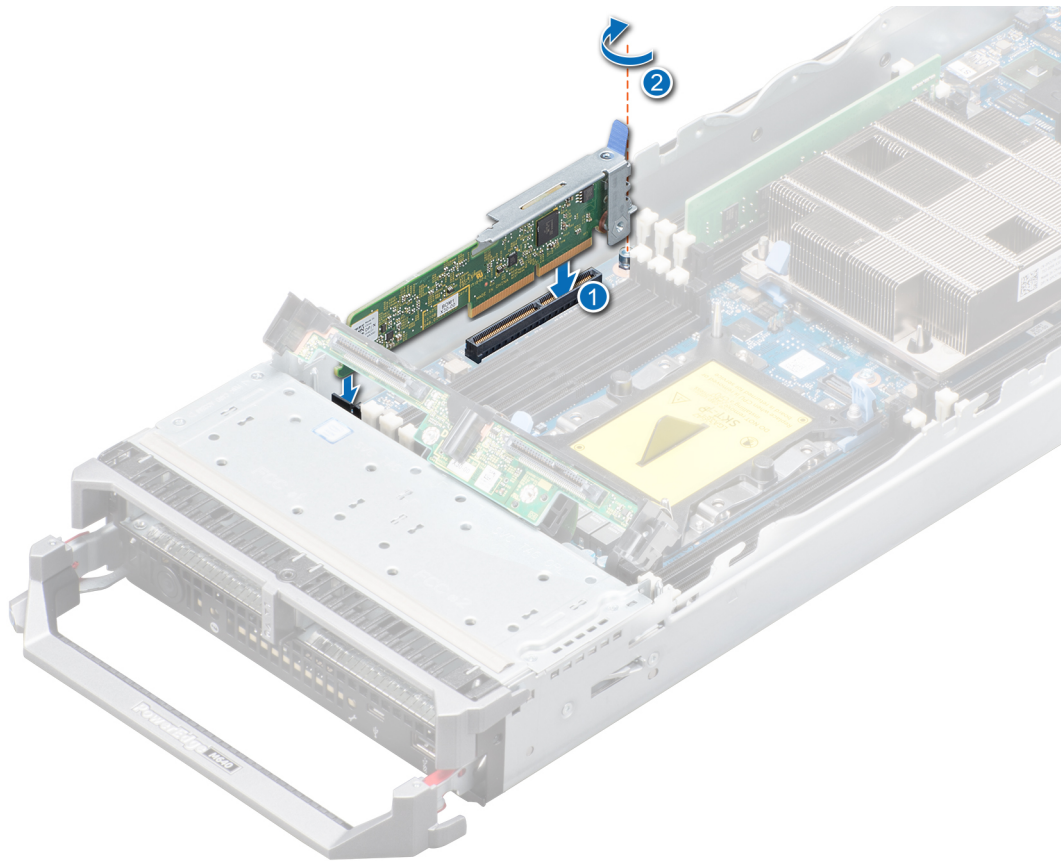

Figure 53. Installing the optional IDSDM module

Next steps

1. [Install the airshroud](#)
2. Follow the procedure listed in [After working inside your system](#) on page 46.

System board

Removing the system board

Prerequisites

CAUTION: If you are using the Trusted Platform Module (TPM) with an encryption key, you may be prompted to create a recovery key during program or System Setup. Be sure to create and safely store this recovery key. If you replace this system board, you must supply the recovery key when you restart your system or program before you can access the encrypted data on your drives.

CAUTION: Do not attempt to remove the TPM plug-in module from the system board. Once the TPM plug-in module is installed, it is cryptographically bound to that specific system board. Any attempt to remove an installed TPM plug-in module breaks the cryptographic binding, and it cannot be re-installed or installed on another system board.

1. Follow the safety guidelines listed in [Safety instructions](#) on page 45.
2. Follow the procedure listed in [Before working inside your system](#) on page 45.
3. Remove the following:

CAUTION: Do not lift the system board by holding a memory module, processor, or other components.

- a. [Processor\(s\) and heat sink\(s\)](#)

- b. Memory modules
- c. Air shroud
- d. Drives
- e. Drive backplane
- f. Drive cage
- g. Storage controller card
- h. Mezzanine card(s)
- i. IDSDM
- j. Network Daughter Card (NDC)
- k. Micro SD vFlash card
- l. Internal USB key

Steps

1. Disconnect all cables from the system board.

CAUTION: Take care not to damage the system identification button while removing the system board from the chassis.

2. Using the Hex nut driver-5 mm and Phillips #2 screwdrivers, remove the screws that secure the system board to the system.

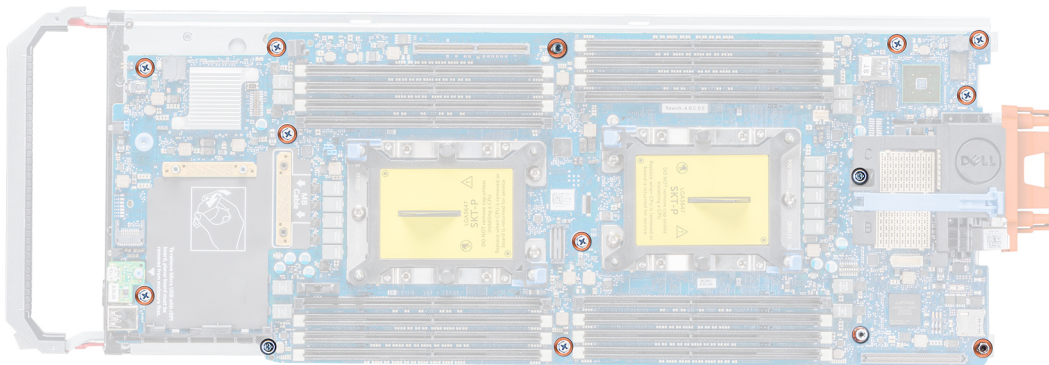

Figure 54. Locations of the screws on the system board

3. Holding the system board holder, slide the system board to the back of the system until the USB connectors disengage from the slots on the front wall of the system.
4. Lift the system board by holding the system board holder and the I/O connector cover.

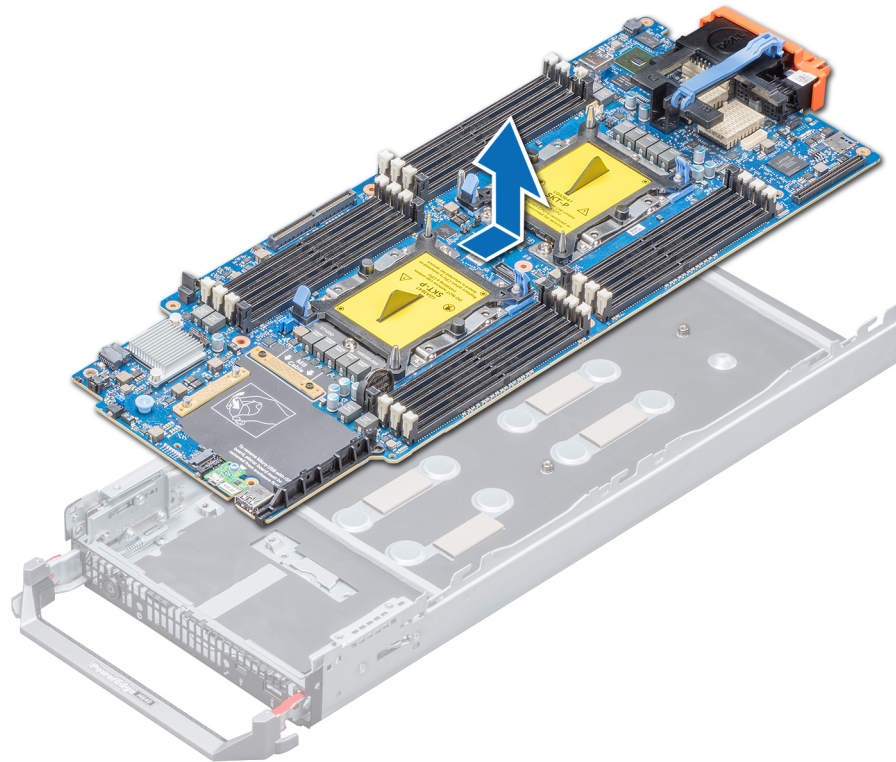

Figure 55. Removing the system board

Next steps

[Install the system board](#)

Installing the system board

Prerequisites

Follow the safety guidelines listed in [Safety instructions](#) on page 45.

⚠ CAUTION: Do not lift the system board by holding a memory module, processor, or other components.

⚠ CAUTION: Take care not to damage the system identification button while placing the system board into the system.

Steps

1. Unpack the new system board assembly.

⚠ CAUTION: Do not lift the system board by holding a memory module, processor, or other components.

2. Incline the system board toward the front of the system by holding the system board holder and I/O connector cover.

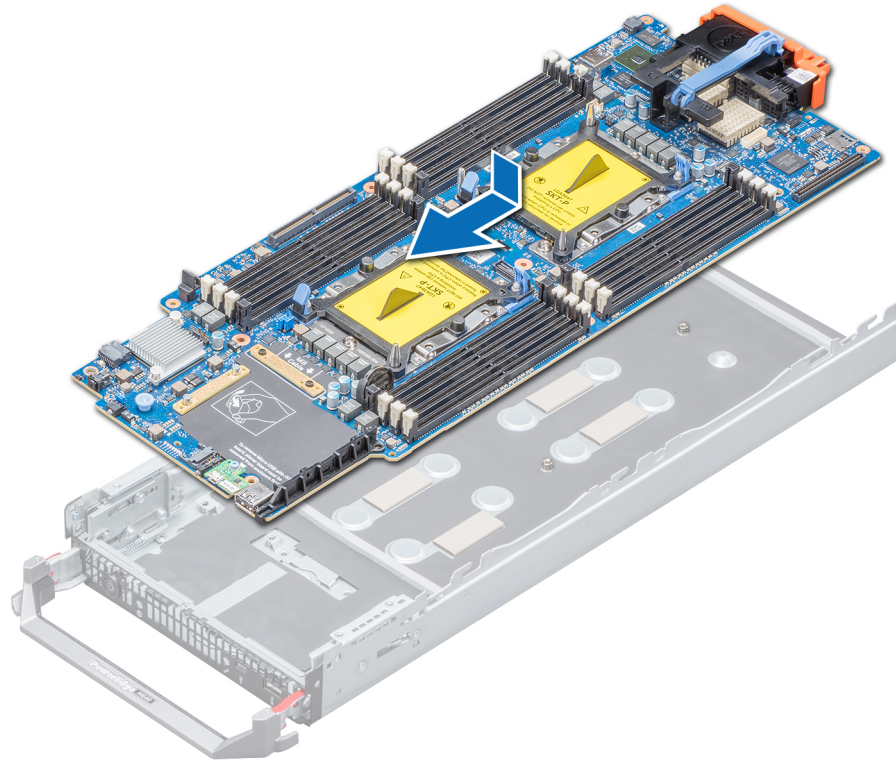

Figure 56. Installing the system board

3. Install the rSPI card to the system board before installing the system board into the chassis.
4. Align the USB connectors with the slots on the front of the system until the connectors engage with the slots.
5. Lower the system board and install the screws to secure the system board to the system, by using Hex nut driver-5 mm and Phillips #2 screwdrivers.

Next steps

1. Replace the following:
 - a. [Trusted Platform Module](#) on page 96
 - b. [Internal USB key](#)
 - c. [Micro SD vFlash card](#)
 - d. [IDSDM](#)
 - e. [Network Daughter Card \(NDC\)](#)
 - f. [Mezzanine card\(s\)](#)
 - g. [Storage controller card](#)
 - h. [Drive cage](#)
 - i. [Drive backplane](#)
 - j. [Drives](#)
 - i** **NOTE: Ensure that you reinstall the drives in their original locations.**
 - k. [Air shroud](#)
 - l. [Memory modules](#)
 - m. [Processor\(s\) and heat sink\(s\)](#)
2. Reconnect all cables to the system board.
 - i** **NOTE: Ensure that the cables inside the system are routed along the chassis wall and secured using the cable securing bracket.**
3. Remove the plastic I/O connector cover from the back of the system.
4. Follow the procedure listed in the [After working inside your system](#) on page 46.
5. Ensure that you:

- a. Use the Easy Restore feature to restore the Service Tag. For more information, see the [Restoring the Service Tag by using the Easy Restore feature](#) section.
 - b. If the Service Tag is not backed up in the backup flash device, enter the Service Tag manually. For more information, see the [Restoring the Service Tag by using the Easy Restore feature](#) section.
 - c. Update the BIOS and iDRAC versions.
 - d. Re-enable the Trusted Platform Module (TPM). For more information, see the [Upgrading the Trusted Platform Module](#) section.
6. Import your new or existing iDRAC Enterprise license.



For more information, see *Integrated Dell Remote access Controller User's Guide*, at www.dell.com/poweredgemanuals

Restoring the system using Easy Restore

The easy restore feature enables you to restore your service tag, license, UEFI configuration, and the system configuration data after replacing the system board. All data is backed up in a backup flash device automatically. If BIOS detects a new system board, and the service tag in the backup flash device, BIOS prompts the user to restore the backup information.

About this task

Below is a list of options available:

- Restore the service tag, license, and diagnostics information, press **Y**
 - Navigate to the Lifecycle Controller based restore options, press **N**.
 - Restore data from a previously created **Hardware Server Profile**, press **F10**
-  **NOTE: When the restore process is complete, BIOS prompts to restore the system configuration data.**
- To restore the system configuration data, press **Y**
 - To use the default configuration settings, press **N**
-  **NOTE: After the restore process is complete, system reboots.**

Manually update the Service Tag

After replacing a system board, if Easy Restore fails, follow this process to manually enter the Service Tag, using **System Setup**.

About this task

If you know the system service tag, use the **System Setup** menu to enter the service tag.

Steps

1. Power on the system.
 2. To enter the **System Setup**, press **F2**.
 3. Click **Service Tag Settings**.
 4. Enter the service tag.
-  **NOTE: You can enter the service tag only when the Service Tag field is empty. Ensure that you enter the correct service tag. Once the service tag is entered, it cannot be updated or changed.**
5. Click **OK**.

Entering the system Service Tag by using System Setup

If Easy Restore fails to restore the Service Tag, use System Setup to enter the Service Tag.

Steps

1. Turn on the system.
 2. Press F2 to enter System Setup.
 3. Click **Service Tag Settings**.
 4. Enter the Service Tag.
-  **NOTE: You can enter the Service Tag only when the Service Tag field is empty. Ensure that you enter the correct Service Tag. After the Service Tag is entered, it cannot be updated or changed.**
5. Click **OK**.

6. Import your new or existing iDRAC Enterprise license.

For more information, see the *Integrated Dell Remote Access Controller User's Guide* at www.dell.com/poweredge/manuals.

Trusted Platform Module

Upgrading the Trusted Platform Module

Prerequisites

1. Follow the safety guidelines listed in [Safety instructions](#) on page 45.
2. Follow the procedure listed in [Before working inside your system](#) on page 45.

NOTE:

- Ensure that your operating system supports the version of the TPM module being installed.
- Ensure that you download and install the latest BIOS firmware on your system.
- Ensure that the BIOS is configured to enable UEFI boot mode.

About this task

 **CAUTION:** If you are using the Trusted Platform Module (TPM) with an encryption key, you may be prompted to create a recovery key during program or System Setup. Work with the customer to create and safely store this recovery key. When replacing this system board, you must supply the recovery key when you restart your system or program before you can access the encrypted data on your hard drives.

 **CAUTION:** Once the TPM plug-in module is installed, it is cryptographically bound to that specific system board. Any attempt to remove an installed TPM plug-in module breaks the cryptographic binding, the removed TPM cannot be reinstalled or installed on another system board.

Removing the TPM

Steps

1. Locate the TPM connector on the system board.
2. Press to hold the module down and remove the screw using the security Torx 8-bit shipped with the TPM module.
3. Slide the TPM module out from its connector.
4. Push the plastic rivet away from the TPM connector and rotate it 90° counterclockwise to release it from the system board.
5. Pull the plastic rivet out of its slot on the system board.

Installing the TPM

Steps

1. To install the TPM, align the edge connectors on the TPM with the slot on the TPM connector.
2. Insert the TPM into the TPM connector such that the plastic rivet aligns with the slot on the system board.
3. Press the plastic rivet until the rivet snaps into place.

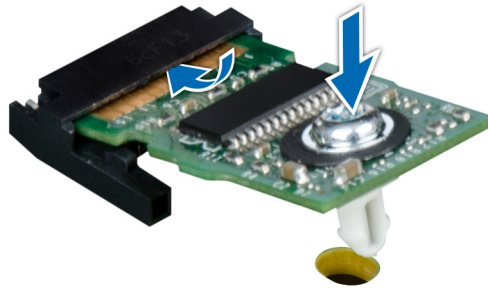

Figure 57. Installing the TPM

Next steps

1. Install the system board.
2. Follow the procedure listed in [After working inside your system](#) on page 46.

Initializing TPM for BitLocker users

Steps

Initialize the TPM.

For more information, see <https://www.technet.microsoft.com/en-us/library/cc753140.aspx>.

The **TPM Status** changes to **Enabled, Activated**.

Initializing the TPM 1.2 for TXT users

Steps

1. While booting your system, press F2 to enter System Setup.
2. On the **System Setup Main Menu** screen, click **System BIOS > System Security Settings**.
3. From the **TPM Security** option, select **On with Pre-boot Measurements**.
4. From the **TPM Command** option, select **Activate**.
5. Save the settings.
6. Restart your system.
7. Enter **System Setup** again.
8. On the **System Setup Main Menu** screen, click **System BIOS > System Security Settings**.
9. From the **Intel TXT** option, select **On**.

Initializing the TPM 2.0 for TXT users

Steps

1. While booting your system, press F2 to enter System Setup.
2. On the **System Setup Main Menu** screen, click **System BIOS > System Security Settings**.
3. From the **TPM Security** option, select **On**.
4. Save the settings.
5. Restart your system.
6. Enter **System Setup** again.
7. On the **System Setup Main Menu** screen, click **System BIOS > System Security Settings**.

8. Select the **TPM Advanced Settings** option.
9. From the **TPM2 Algorithm Selection** option, select **SHA256**, then go back to **System Security Settings** screen.
10. On the **System Security Settings** screen, from the **Intel TXT** option, select **On**.
11. Save the settings.
12. Restart your system.

rSPI card

NOTE: The inlet temperature sensor is located on the rSPI card.

Removing the rSPI card

Prerequisites

1. Follow the safety guidelines listed in [Safety instructions](#) on page 45.
2. Follow the procedure listed in [Before working inside your system](#) on page 45.
3. [Remove the system board](#)

Steps

1. Using the Torx #8 screwdriver, remove the screw securing the rSPI card to the system board.
2. Holding the rSPI card by its edges, lift the card away from the system.

CAUTION: To prevent damage to the rSPI card, you must not tilt the card while lifting it from the system board.

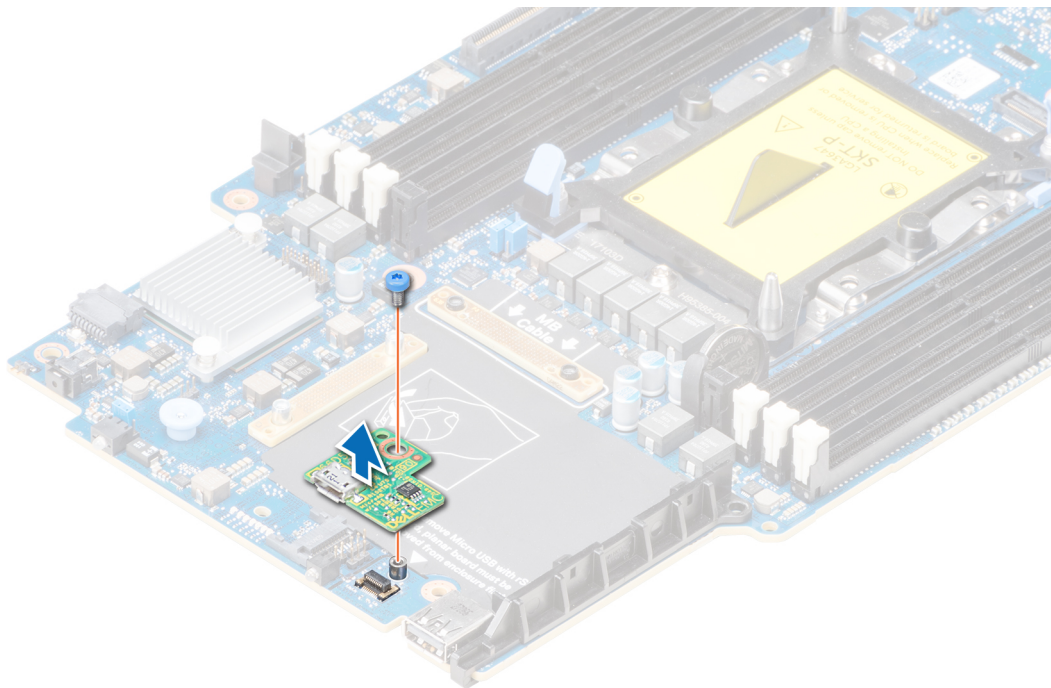

Figure 58. Removing the rSPI card

Next steps

[Install the rSPI card.](#)

Installing the rSPI card

Prerequisites

Follow the safety guidelines listed in [Safety instructions](#) on page 45.

 **CAUTION:** To prevent damage to the rSPI card, you must hold the card only by its edges.

Steps

1. Align the screw hole on the rSPI card with the standoff on the system board.
2. Using the Torx #8 screwdriver, replace the screw to secure the rSPI card to the system board.

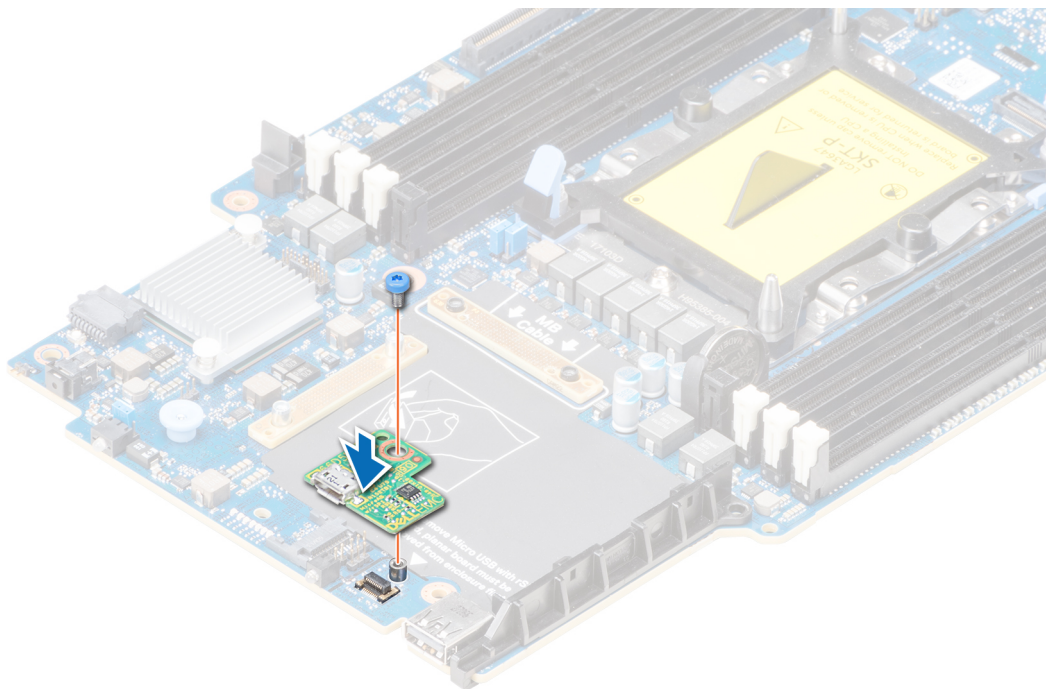

Figure 59. Installing the rSPI card

Next steps

1. [Install the system board](#)
2. Follow the procedure listed in [After working inside your system](#) on page 46.

System diagnostics

If you experience a problem with your system, run the system diagnostics before contacting Dell for technical assistance. The purpose of running system diagnostics is to test your system hardware without using additional equipment or risking data loss. If you are unable to fix the problem yourself, service and support personnel can use the diagnostics results to help you solve the problem.

Topics:

- [Dell Embedded System Diagnostics](#)

Dell Embedded System Diagnostics

 **NOTE:** The Dell Embedded System Diagnostics is also known as Enhanced Pre-boot System Assessment (ePSA) diagnostics.

The Embedded System Diagnostics provides a set of options for particular device groups or devices allowing you to:

- Run tests automatically or in an interactive mode
- Repeat tests
- Display or save test results
- Run thorough tests to introduce additional test options to provide extra information about the failed device(s)
- View status messages that inform you if tests are completed successfully
- View error messages that inform you of problems encountered during testing

Running the Embedded System Diagnostics from Boot Manager

Run the Embedded System Diagnostics (ePSA) if your system does not boot.

Steps

1. When the system is booting, press F11.
2. Use the up arrow and down arrow keys to select **System Utilities > Launch Diagnostics**.
3. Alternatively, when the system is booting, press F10, select **Hardware Diagnostics > Run Hardware Diagnostics**.
The **ePSA Pre-boot System Assessment** window is displayed, listing all devices detected in the system. The diagnostics starts executing the tests on all the detected devices.

Results

Running the Embedded System Diagnostics from the Dell Lifecycle Controller

Steps

1. As the system boots, press F10.
2. Select **Hardware Diagnostics → Run Hardware Diagnostics**.
The **ePSA Pre-boot System Assessment** window is displayed, listing all devices detected in the system. The diagnostics starts executing the tests on all the detected devices.

System diagnostic controls

| Menu | Description |
|----------------------|---|
| Configuration | Displays the configuration and status information of all detected devices. |
| Results | Displays the results of all tests that are run. |
| System health | Provides the current overview of the system performance. |
| Event log | Displays a time-stamped log of the results of all tests run on the system. This is displayed if at least one event description is recorded. |

Jumpers and connectors

Topics:

- System board jumpers and connectors
- System board jumper settings
- Disabling a forgotten password

System board jumpers and connectors

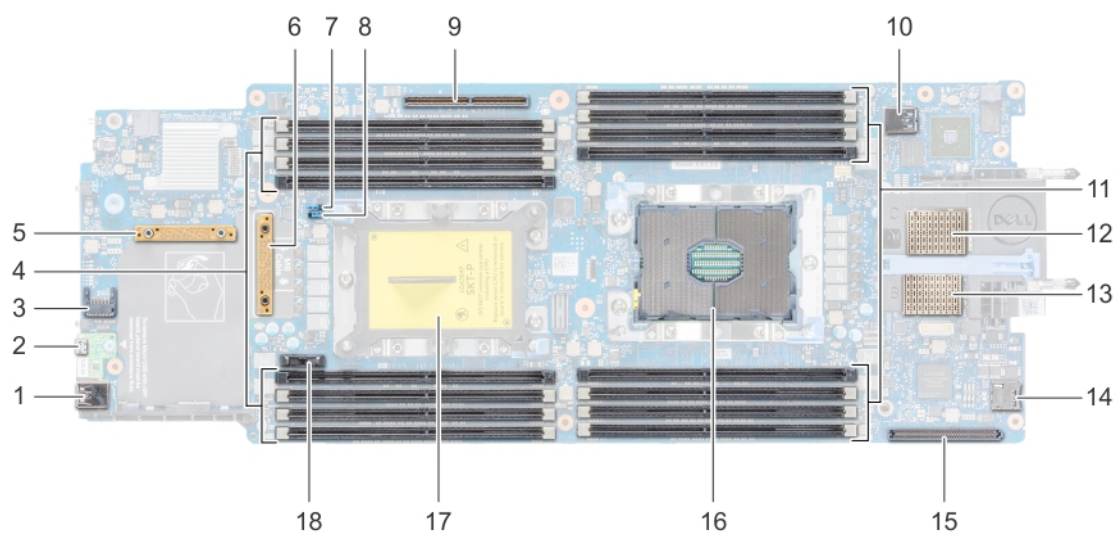

Figure 60. System board connectors

Table 27. System board jumpers and connectors

| Item | Connector | Description |
|------|--------------------------------|--|
| 1. | J_USB3 | USB connector |
| 2. | iDRAC Direct (Micro-AB USB) | iDRAC Direct port and rSPI connector |
| 3. | TPM | TPM connector |
| 4. | B8, B4, B5, B6, B7, B1, B2, B3 | Memory module sockets |
| 5. | PERC_Backplane | PERC card connector |
| 6. | PCIE_SATA_BP | Drive backplane connector |
| 7. | PWRD_EN | System configuration jumper (Enabling or disabling the password) |
| 8. | NVRAM_CLR | System configuration jumper (Retaining or clearing configuration settings) |
| 9. | BOSS/IDSDM | IDSDM or BOSS card connector |
| 10. | INT_USB1_3.0 | Internal USB connector |
| 11. | A8, A4, A5, A6, A7, A1, A2, A3 | Memory module sockets |





Table 27. System board jumpers and connectors (continued)

| Item | Connector | Description |
|------|-------------|---------------------------------------|
| 12. | MEZZ1_FAB_C | Mezzanine card connector |
| 13. | MEZZ2_FAB_B | Mezzanine card connector |
| 14. | VFLASH | Micro vFlash card connector |
| 15. | bNDC | Network Daughter Card (NDC) connector |
| 16. | CPU1 | Processor 1 |
| 17. | CPU2 | Processor 2 |
| 18. | BATTERY | System battery connector |

System board jumper settings

For information on resetting the password jumper to disable a password, see [Disabling a forgotten password](#) on page 103.

Table 28. System board jumper settings

| Jumper | Setting | Description |
|-----------|--|--|
| NVRAM_CLR |  1 2 3 (default) | The BIOS configuration settings are retained at system boot. |
| |  1 2 3 | The BIOS configuration settings are cleared at system boot. |
| PWRD_EN |  1 2 3 (default) | The BIOS password feature is enabled. |
| |  1 2 3 | The BIOS password feature is disabled. iDRAC local access is unlocked at next AC power cycle. iDRAC password reset is enabled in F2 iDRAC settings menu. |

Disabling a forgotten password

The software security features of the PowerEdge M640 system include a system password and a setup password. The password jumper enables these password features or disables them, and clears any password(s) currently in use.

Prerequisites

CAUTION: Many repairs may only be done by a certified service technician. You should only perform troubleshooting and simple repairs as authorized in your product documentation, or as directed by the online or telephone service and support team. Damage due to servicing that is not authorized by Dell is not covered by your warranty. Read and follow the safety instructions that came with the product.

Steps

1. Turn off the system by using the operating system commands or the CMC.
2. Remove the system from the enclosure to access the jumpers.
3. Move the jumper on the system-board jumper from pins 2 and 3 to pins 1 and 2.
4. Install the system in the enclosure.
5. Turn on the system.

When the system is turned on, power indicator turns on to solid green. Allow the system to finish booting.

The existing passwords are not disabled (erased) until the system boots with the password jumper on pins 2 and 3. However, before you assign a new system and/or setup password, you must reinstall the password jumper back to pins 1 and 2.

 **NOTE: If you assign a new system and/or setup password with the jumper on pins 2 and 3, the system disables the new password(s) the next time it boots.**

6. Turn off the system by using the operating system commands or the CMC.
7. Remove the system from the enclosure to access the jumpers.
8. Move the jumper on the system-board jumper from pins 1 and 2 to pins 2 and 3.
9. Install the system in the enclosure.
10. Turn on the system.
11. Assign a new system and/or setup password.

Getting help

Topics:

- [Contacting Dell EMC](#)
- [Documentation feedback](#)
- [Accessing system information by using QRL](#)
- [Receiving automated support with SupportAssist](#)
- [Recycling or End-of-Life service information](#)

Contacting Dell EMC

Dell EMC provides several online and telephone based support and service options. If you do not have an active internet connection, you can find contact information about your purchase invoice, packing slip, bill, or Dell EMC product catalog. Availability varies by country and product, and some services may not be available in your area. To contact Dell EMC for sales, technical assistance, or customer service issues:

Steps

1. Go to www.dell.com/support/home.
2. Select your country from the drop-down menu on the lower right corner of the page.
3. For customized support:
 - a. Enter your system Service Tag in the **Enter your Service Tag** field.
 - b. Click **Submit**.
The support page that lists the various support categories is displayed.
4. For general support:
 - a. Select your product category.
 - b. Select your product segment.
 - c. Select your product.
The support page that lists the various support categories is displayed.
5. For contact details of Dell EMC Global Technical Support:
 - a. Click [Global Technical Support](#).
 - b. The **Contact Technical Support** page is displayed with details to call, chat, or e-mail the Dell EMC Global Technical Support team.

Documentation feedback

You can rate the documentation or write your feedback on any of our Dell EMC documentation pages and click **Send Feedback** to send your feedback.

Accessing system information by using QRL

You can use the Quick Resource Locator (QRL) located on the information tag in the front of the M640, to access the information about the Dell EMC PowerEdge M640.

Prerequisites

Ensure that your smartphone or tablet has the QR code scanner installed.

The QRL includes the following information about your system:

- How-to videos
- Reference materials, including the Installation and Service Manual, and mechanical overview

- Your system service tag to quickly access your specific hardware configuration and warranty information
- A direct link to Dell to contact technical assistance and sales teams

Steps

1. Go to www.dell.com/qrl and navigate to your specific product or
2. Use your smartphone or tablet to scan the model-specific Quick Resource (QR) code on your system or in the Quick Resource Locator section.

Quick Resource Locator for PowerEdge M640 system



Figure 61. Quick Resource Locator for PowerEdge M640 system

Receiving automated support with SupportAssist

Dell EMC SupportAssist is an optional Dell EMC Services offering that automates technical support for your Dell EMC server, storage, and networking devices. By installing and setting up a SupportAssist application in your IT environment, you can receive the following benefits:

- **Automated issue detection** — SupportAssist monitors your Dell EMC devices and automatically detects hardware issues, both proactively and predictively.
- **Automated case creation** — When an issue is detected, SupportAssist automatically opens a support case with Dell EMC Technical Support.
- **Automated diagnostic collection** — SupportAssist automatically collects system state information from your devices and uploads it securely to Dell EMC. This information is used by Dell EMC Technical Support to troubleshoot the issue.
- **Proactive contact** — A Dell EMC Technical Support agent contacts you about the support case and helps you resolve the issue.

The available benefits vary depending on the Dell EMC Service entitlement purchased for your device. For more information about SupportAssist, go to www.dell.com/supportassist.

Recycling or End-of-Life service information

Take back and recycling services are offered for this product in certain countries. If you want to dispose of system components, visit www.dell.com/recyclingworldwide and select the relevant country.