

# Dell OptiPlex 9020 AIO Owner's Manual

Regulatory Model: W04C  
Regulatory Type: W04C002



# Notes, Cautions, and Warnings



**NOTE:** A NOTE indicates important information that helps you make better use of your computer.



**CAUTION:** A CAUTION indicates either potential damage to hardware or loss of data and tells you how to avoid the problem.



**WARNING:** A WARNING indicates a potential for property damage, personal injury, or death.

**Copyright © 2014 Dell Inc. All rights reserved.** This product is protected by U.S. and international copyright and intellectual property laws. Dell™ and the Dell logo are trademarks of Dell Inc. in the United States and/or other jurisdictions. All other marks and names mentioned herein may be trademarks of their respective companies.

2013 - 11

Rev. A01

# Contents

<b>1 Working on Your Computer.....</b>	<b>5</b>
Before Working Inside Your Computer.....	5
Recommended Tools.....	6
Turning Off Your Computer.....	6
After Working Inside Your Computer.....	7
Important Information.....	7
<b>2 Removing and Installing Components.....</b>	<b>8</b>
System Overview.....	8
Removing the VESA Stand.....	9
Installing the VESA Stand.....	10
Removing the Back Cover.....	10
Installing the Back Cover.....	11
Removing the Memory.....	11
Installing the Memory.....	12
Removing the VESA Mount Bracket.....	12
Installing the VESA Mount Bracket.....	13
Removing the Power and On-Screen Display (OSD) Buttons Board.....	13
Installing the Power and OSD Buttons Board.....	14
Removing the System-Board Shield.....	14
Installing the System-Board Shield.....	15
Removing the Converter Board.....	15
Installing the Converter Board.....	16
Removing the Coin-Cell Battery.....	16
Installing the Coin-Cell Battery.....	16
Removing the Optical Drive.....	16
Installing the Optical Drive.....	18
Removing the Hard Drive.....	18
Installing the Hard Drive.....	19
Removing the Intrusion Switch.....	20
Installing the Intrusion Switch.....	21
Removing the Wireless Local Area Network (WLAN) Card.....	21
Installing the WLAN Card.....	22
Removing the Heat-Sink Assembly.....	22
Installing the Heat-Sink Assembly.....	22
Removing the Processor Fan.....	23
Installing the Processor Fan.....	23
Removing the Power-Supply Fan.....	23

Installing the Power-Supply Fan.....	24
Removing the I/O Board Shield.....	25
Installing the I/O Board Shield.....	27
Removing the Power Supply Unit (PSU).....	27
Installing the Power Supply Unit.....	28
Removing the Processor.....	29
Installing the Processor.....	29
Removing the Speakers.....	29
Installing the Speakers.....	30
Removing the System Board.....	31
System Board Layout.....	31
Installing the System Board.....	33
Removing the Heat Sink (Graphics Card).....	33
Installing the Heat Sink (Graphics Card).....	34
Removing the Antenna Module.....	35
Installing the Antenna Module.....	36
Removing the Display Panel.....	36
Installing the Display Panel.....	38
Removing the Camera.....	39
Installing the Camera.....	40
<b>3 System Setup.....</b>	<b>41</b>
Boot Sequence.....	41
Navigation Keys.....	41
System Setup Options.....	42
Updating the BIOS .....	51
System and Setup Password.....	51
Assigning a System Password and Setup Password.....	52
Deleting or Changing an Existing System and/or Setup Password.....	52
<b>4 Technical Specifications.....</b>	<b>54</b>
<b>5 Contacting Dell.....</b>	<b>59</b>

# Working on Your Computer

## Before Working Inside Your Computer

Use the following safety guidelines to help protect your computer from potential damage and to help to ensure your personal safety. Unless otherwise noted, each procedure included in this document assumes that the following conditions exist:

- You have read the safety information that shipped with your computer.
- A component can be replaced or--if purchased separately--installed by performing the removal procedure in reverse order.

 **WARNING:** Disconnect all power sources before opening the computer cover or panels. After you finish working inside the computer, replace all covers, panels, and screws before connecting to the power source.

 **WARNING:** Before working inside your computer, read the safety information that shipped with your computer. For additional safety best practices information, see the Regulatory Compliance Homepage at [www.dell.com/regulatory\\_compliance](http://www.dell.com/regulatory_compliance)

 **CAUTION:** Many repairs may only be done by a certified service technician. You should only perform troubleshooting and simple repairs as authorized in your product documentation, or as directed by the online or telephone service and support team. Damage due to servicing that is not authorized by Dell is not covered by your warranty. Read and follow the safety instructions that came with the product.

 **CAUTION:** To avoid electrostatic discharge, ground yourself by using a wrist grounding strap or by periodically touching an unpainted metal surface, such as a connector on the back of the computer.

 **CAUTION:** Handle components and cards with care. Do not touch the components or contacts on a card. Hold a card by its edges or by its metal mounting bracket. Hold a component such as a processor by its edges, not by its pins.

 **CAUTION:** When you disconnect a cable, pull on its connector or on its pull-tab, not on the cable itself. Some cables have connectors with locking tabs; if you are disconnecting this type of cable, press in on the locking tabs before you disconnect the cable. As you pull connectors apart, keep them evenly aligned to avoid bending any connector pins. Also, before you connect a cable, ensure that both connectors are correctly oriented and aligned.

 **NOTE:** The color of your computer and certain components may appear differently than shown in this document.

To avoid damaging your computer, perform the following steps before you begin working inside the computer.

1. Ensure that your work surface is flat and clean to prevent the computer cover from being scratched.
2. Turn off your computer (see Turning Off Your Computer).

 **CAUTION:** To disconnect a network cable, first unplug the cable from your computer and then unplug the cable from the network device.

3. Disconnect all network cables from the computer.
4. Disconnect your computer and all attached devices from their electrical outlets.
5. Press and hold the power button while the computer is unplugged to ground the system board.
6. Remove the cover.

**⚠ CAUTION:** Before touching anything inside your computer, ground yourself by touching an unpainted metal surface, such as the metal at the back of the computer. While you work, periodically touch an unpainted metal surface to dissipate static electricity, which could harm internal components.

## Recommended Tools



The procedures in this document may require the following tools:

- Small flat-blade screwdriver
- Phillips screwdriver
- Small plastic scribe

## Turning Off Your Computer

**⚠ CAUTION:** To avoid losing data, save and close all open files and exit all open programs before you turn off your computer.

1. Shut down the operating system:

- In Windows 8:
  - Using a touch-enabled device:
    - a. Swipe in from the right edge of the screen, opening the Charms menu and select **Settings**.
    - b. Select the  and then select **Shut down**
  - Using a mouse:
    - a. Point to upper-right corner of the screen and click **Settings**.
    - b. Click the  and select **Shut down**.

- In Windows 7:

1. Click **Start** .
2. Click **Shut Down**.

or

1. Click **Start** .
2. Click the arrow in the lower-right corner of the **Start** menu as shown below, and then click **Shut Down**.



2. Ensure that the computer and all attached devices are turned off. If your computer and attached devices did not automatically turn off when you shut down your operating system, press and hold the power button for about 6 seconds to turn them off.

## After Working Inside Your Computer

After you complete any replacement procedure, ensure you connect any external devices, cards, and cables before turning on your computer.

1. Replace the cover.



**CAUTION:** To connect a network cable, first plug the cable into the network device and then plug it into the computer.

2. Connect any telephone or network cables to your computer.
3. Connect your computer and all attached devices to their electrical outlets.
4. Turn on your computer.
5. If required, verify that the computer works correctly by running the Dell Diagnostics.

## Important Information



**NOTE:** Avoid using the touchscreen in dusty, hot, or humid environments.



**NOTE:** Sudden change in temperature may cause condensation on the inner surface of the glass screen, which will disappear after a short time and does not affect normal usage.

# Removing and Installing Components

This section provides detailed information on how to remove or install the components from your computer.

## System Overview

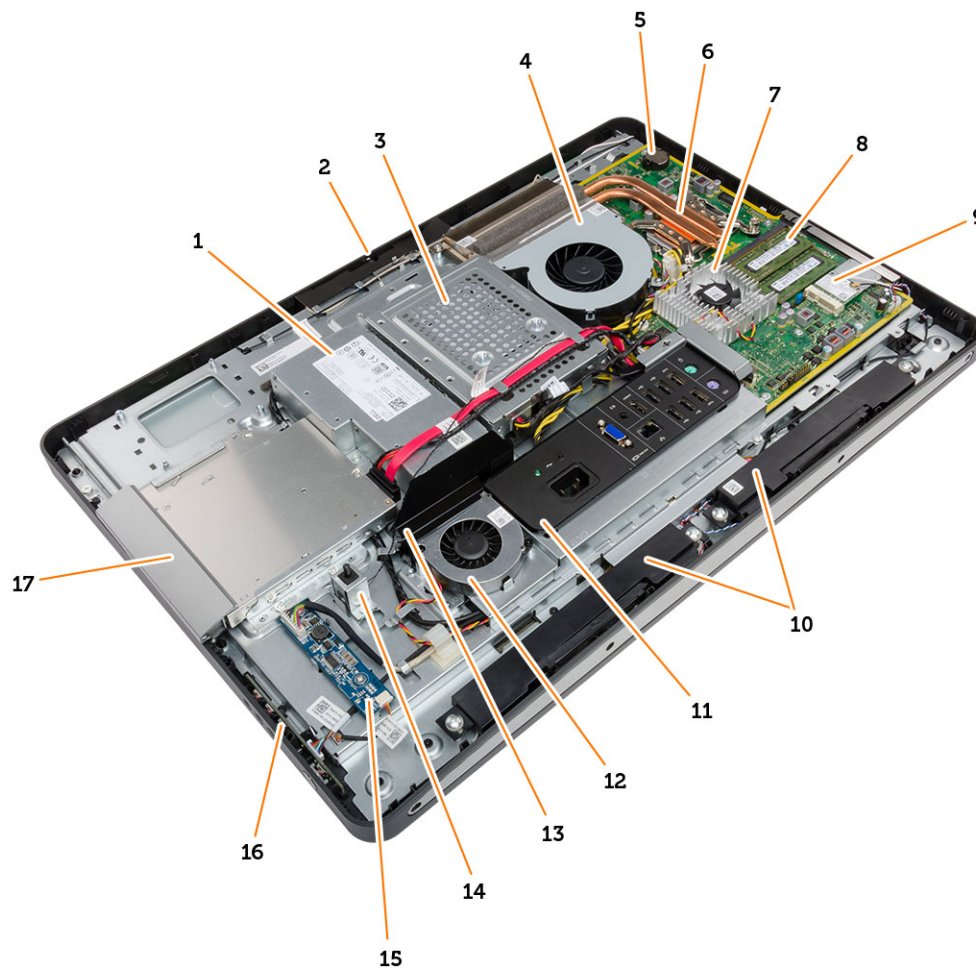

**Figure 1. Inside View**

- |                            |                       |
|----------------------------|-----------------------|
| 1. power supply unit (PSU) | 2. camera             |
| 3. hard drive              | 4. processor fan      |
| 5. coin-cell battery       | 6. heat sink assembly |
| 7. heat sink               | 8. memory module      |



- 9. WLAN card
- 10. speakers
- 11. input/output (I/O) board shield
- 12. power-supply fan
- 13. power-supply fan bracket
- 14. intrusion switch
- 15. converter board
- 16. power-button and on-screen display (OSD) buttons board
- 17. optical drive

## Removing the VESA Stand

1. Follow the procedures in *Before Working Inside Your Computer*.
2. Place the computer on a flat surface, display side facing downwards.
3. Using a plastic scribe, release the cover starting with the notches at the bottom.

 **NOTE:** To avoid damaging the VESA stand cover, handle the plastic scribe with care.



4. Slide and lift the VESA cover upwards and away from the computer.



5. Remove the screws that secure the VESA stand to the computer and lift the VESA stand away from the computer.

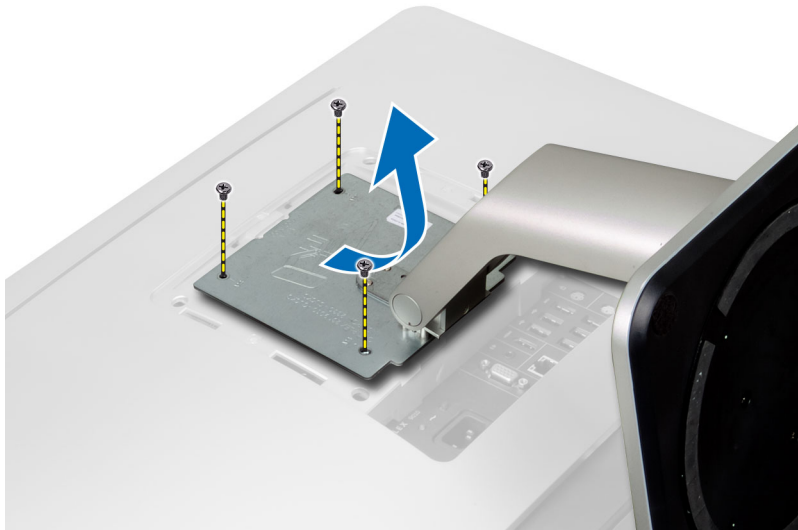

## Installing the VESA Stand

1. Align and place the VESA stand on the back of the computer.
2. Tighten the screws that secure the VESA stand to the computer.
3. Place and press the VESA cover on the computer, until it clicks into place.
4. Follow the procedures in *After Working Inside Your Computer*.

## Removing the Back Cover

1. Follow the procedures in *Before Working Inside Your Computer*.
2. Remove the VESA stand.
3. Remove the screws from the base of the computer.

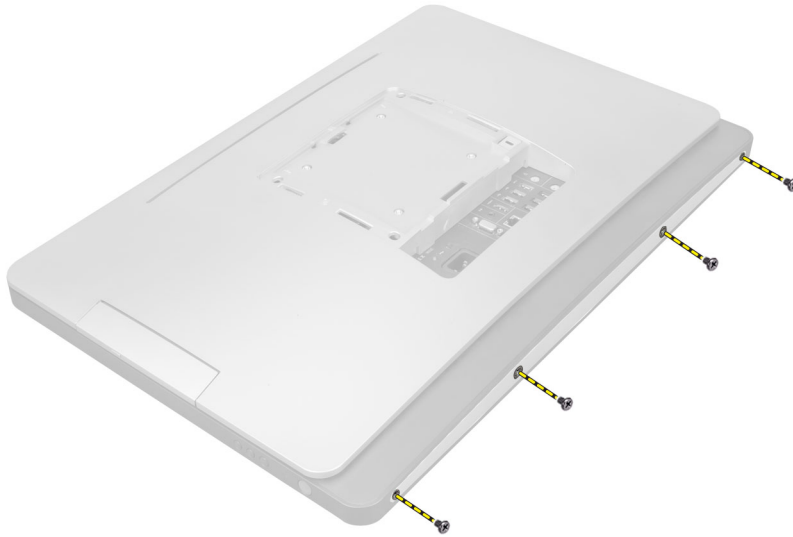

4. Lift the cover and remove it from the computer using the notches near the input/output (I/O) panel.



## Installing the Back Cover

1. Align the back cover to its original position on the computer and press until it clicks in place.
2. Tighten the screws to secure the back cover to the computer.
3. Install the VESA stand.
4. Follow the procedures in *After Working Inside Your Computer*.

## Removing the Memory

1. Follow the procedures in *Before Working Inside Your Computer*.
2. Remove the:
  - a. VESA stand
  - b. back cover

3. Lift the memory shield outwards.

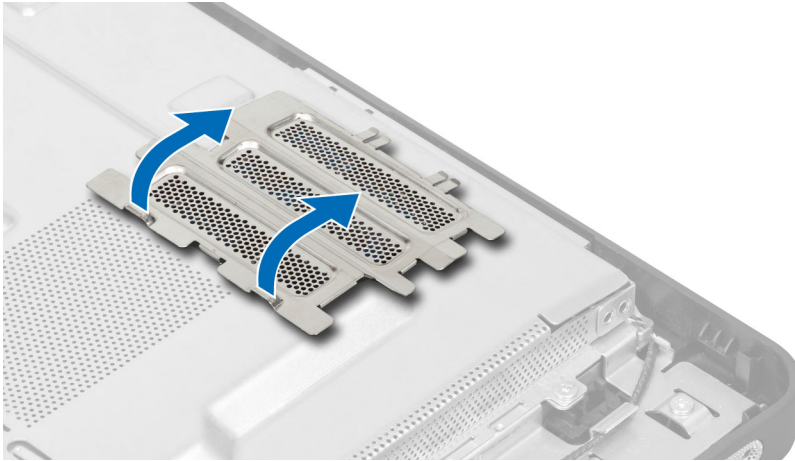

4. Pry the retention clips away from the memory module until it pops-up. Lift and remove the memory module from its connector.

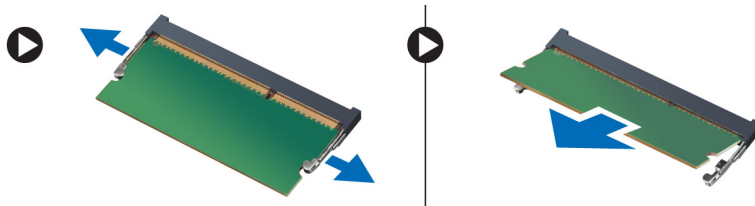

## Installing the Memory

1. Align the notch on the memory-card with the tab in the system-board connector.
2. Press down on the memory module until the release tabs spring back to secure them in place.
3. Place the memory shield back into its place.
4. Install the:
  - a. back cover
  - b. VESA stand
5. Follow the procedures in *After Working Inside Your Computer*.

## Removing the VESA Mount Bracket

1. Follow the procedures in *Before Working Inside Your Computer*.
2. Remove the:
  - a. VESA stand
  - b. back cover
3. Remove the screws that secure the VESA mount bracket to the computer. Lift the bracket away from the computer.

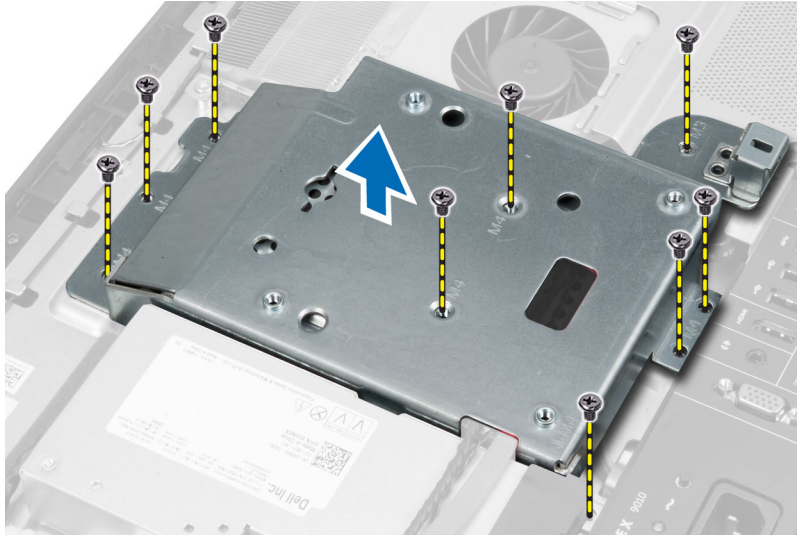

## Installing the VESA Mount Bracket

1. Align and place the bracket on the back of the computer.
2. Tighten the screws that secure the VESA mount bracket to the computer.
3. Install the:
  - a. back cover
  - b. VESA stand
4. Follow the procedures in *After Working Inside Your Computer*.

## Removing the Power and On-Screen Display (OSD) Buttons Board

1. Follow the procedures in *Before Working Inside Your Computer*.
2. Remove the:
  - a. VESA stand
  - b. back cover
3. Disconnect the cable from the and power and OSD buttons board. Lift the power and OSD buttons board from the chassis.

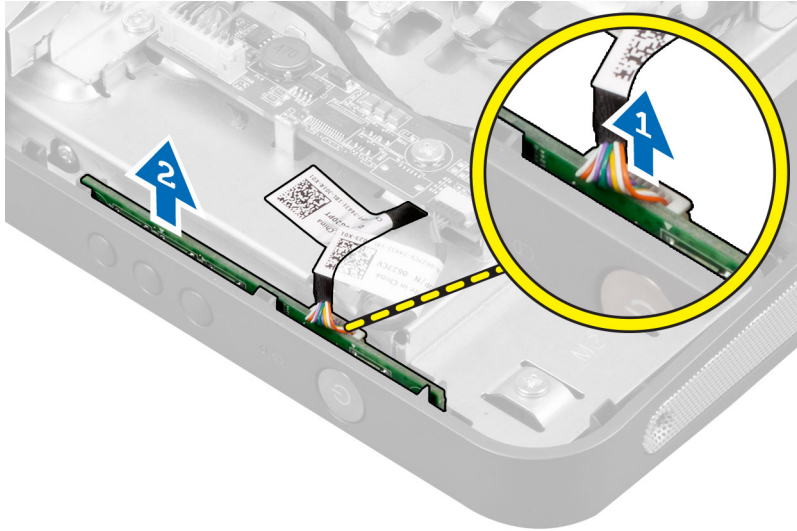

## Installing the Power and OSD Buttons Board

1. Align and place the power and OSD buttons board on the computer.
2. Connect the cable to the power and OSD buttons board.
3. Install:
  - a. back cover
  - b. VESA stand
4. Follow the procedures in *After Working Inside Your Computer*.

## Removing the System-Board Shield

1. Follow the procedures in *Before Working Inside Your Computer*.
2. Remove the:
  - a. VESA stand
  - b. back cover
  - c. VESA mount bracket
3. Remove the screws that secure the system-board shield to the computer. Lift the system-board shield away from the computer.

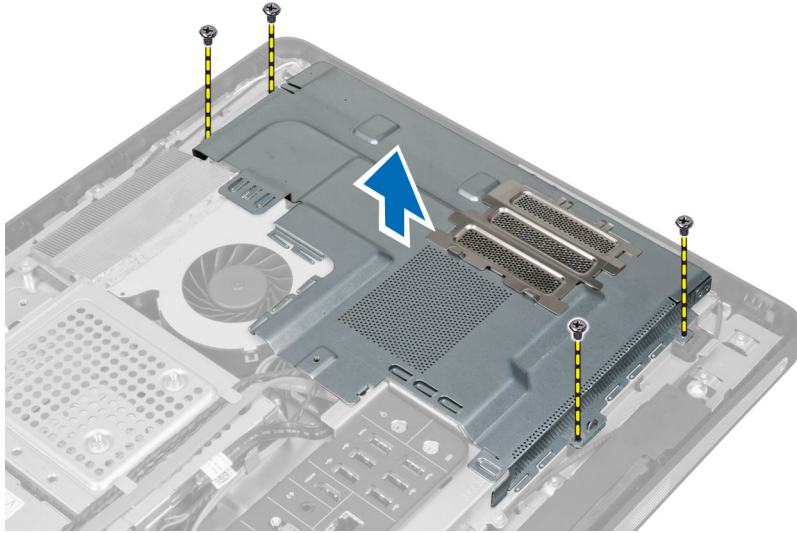

## Installing the System-Board Shield

1. Align and place the system-board shield on the back of the computer.
2. Tighten the screws that secure the system-board shield to the computer.
3. Install the:
  - a. VESA mount bracket
  - b. back cover
  - c. VESA stand
4. Follow the procedures in *After Working Inside Your Computer*.

## Removing the Converter Board

1. Follow the procedures in *Before Working Inside Your Computer*.
2. Remove the:
  - a. VESA stand
  - b. back cover
3. Disconnect the backlight and converter cables from the converter board.
4. Remove the screws that secure the converter board to the computer.
5. Lift the converter board away from the computer.

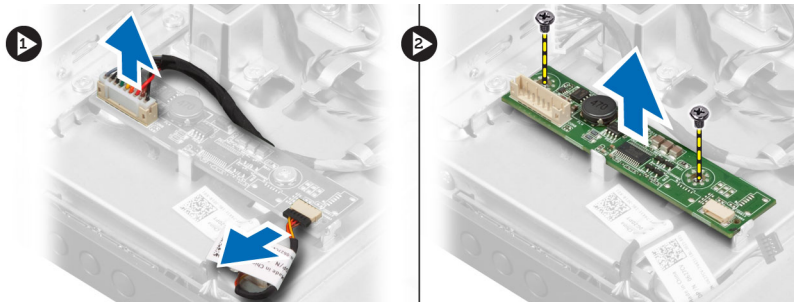

## Installing the Converter Board

1. Place the converter board into its place.
2. Tighten the screws to secure the converter board to the computer.
3. Connect the backlight and converter cables to the converter board.
4. Install the:
  - a. back cover
  - b. VESA stand
5. Follow the procedures in *After Working Inside Your Computer*.

## Removing the Coin-Cell Battery

1. Follow the procedures in *Before Working Inside Your Computer*.
2. Remove the:
  - a. VESA stand
  - b. back cover
  - c. system-board shield
3. Press the release latch away from the battery. The battery pops-out from the socket; lift the coin-cell battery out of the computer.

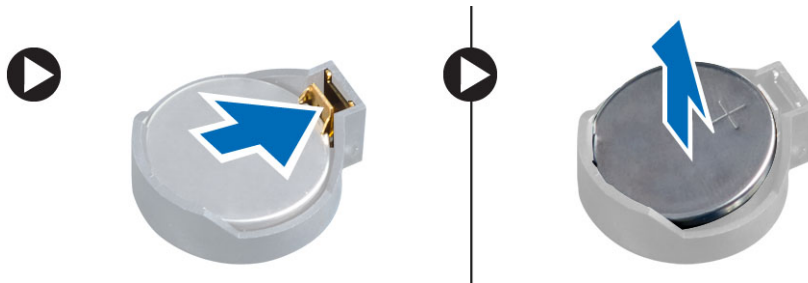

## Installing the Coin-Cell Battery

1. Place the coin-cell battery into its slot on the system board.
2. Press the coin-cell battery downward until the release latch springs back into place and secures it.
3. Install:
  - a. system-board shield
  - b. base cover
  - c. VESA stand
4. Follow the procedures in *After Working Inside Your Computer*.

## Removing the Optical Drive

1. Follow the procedures in *Before Working Inside Your Computer*.
2. Remove the:
  - a. VESA stand
  - b. back cover
3. Remove the screws that secure the optical-drive bracket to the computer.



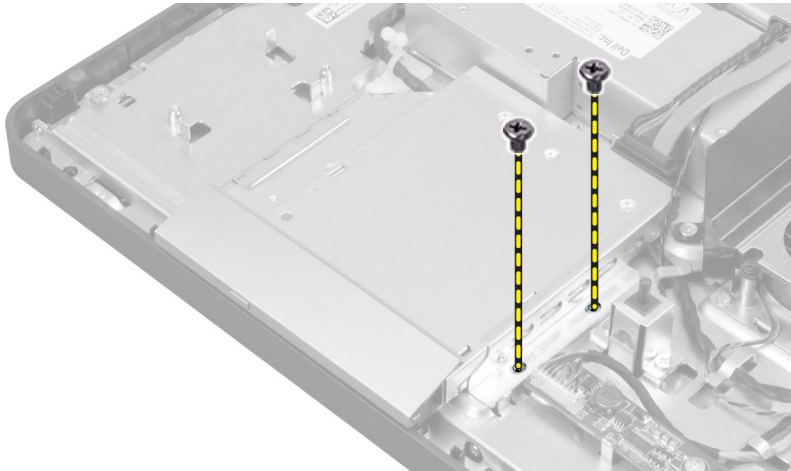

4. Slide the optical drive outward and disconnect the optical-drive cable.

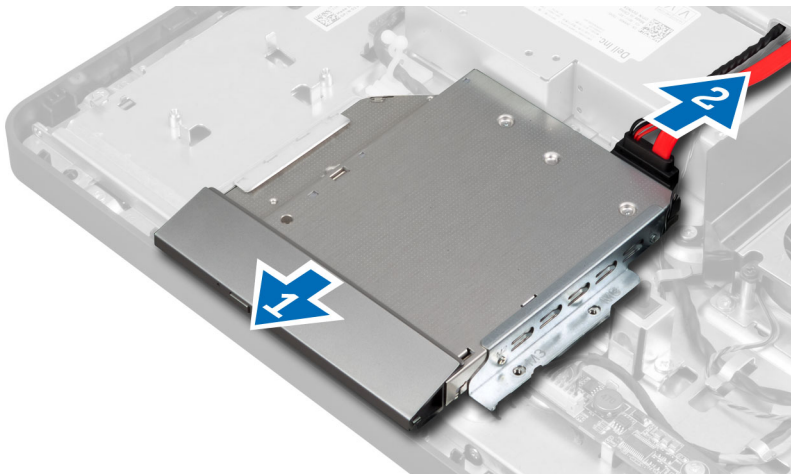

5. Slide and lift the optical drive from the computer.

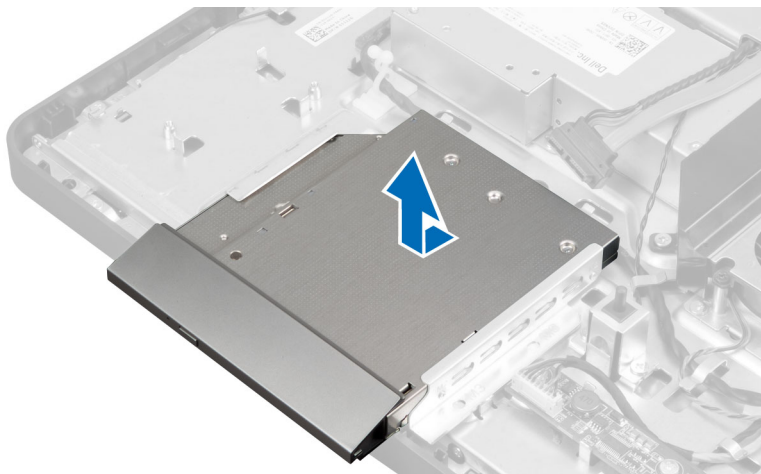

6. Remove the screws that secure the optical-drive bracket to the optical drive. Remove the optical-drive bracket from the optical drive.



## Installing the Optical Drive

1. Place the optical-drive bracket on the optical drive.
2. Tighten the screws that secure the optical-drive bracket to the optical drive.
3. Align and slide the optical drive into its slot.
4. Connect the optical-drive cable.
5. Tighten the screws that secure the optical drive to the computer.
6. Install the:
  - a. back cover
  - b. VESA stand
7. Follow the procedures in *After Working Inside Your Computer*.

## Removing the Hard Drive

1. Follow the procedures in *Before Working Inside Your Computer*.
2. Remove the:
  - a. VESA stand
  - b. back cover
  - c. VESA mount bracket
3. Unthread the cables from the notches on the hard-drive bracket. Disconnect the hard-drive cables from the hard drive.

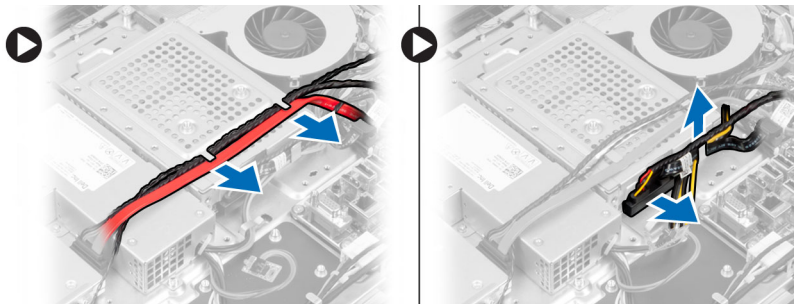

4. Remove the screw that secures the hard-drive bracket to the system board. Slide and lift the hard-drive bracket away from the computer.

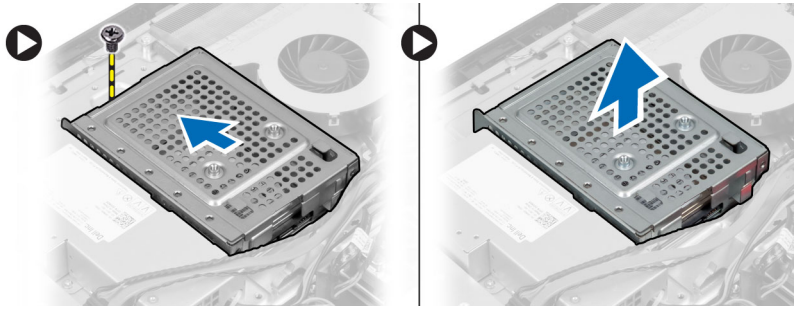

5. For a 2.5-inch hard drive, remove the screws that secure the hard drive to the hard-drive bracket. Slide the hard drive from the hard-drive bracket. Remove the screws that secure the hard-drive case to the hard drive.

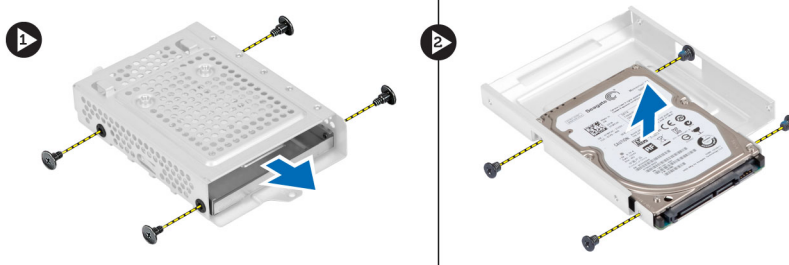

6. For a 3.5-inch hard drive, remove the screws that secure the hard drive to the hard-drive bracket. Slide the hard drive from the hard-drive bracket.



## Installing the Hard Drive

1. For a 3.5-inch hard drive, slide the hard drive into the hard-drive bracket.
2. For a 2.5-inch hard drive, tighten the screws that secure the hard-drive case to the hard drive. Slide the hard drive into the hard-drive bracket.
3. Align and place the hard-drive bracket on the computer.
4. Tighten the screws that secure the hard drive to the hard-drive bracket
5. Connect the hard-drive cables to the hard drive. Thread the cables into the notches on the hard-drive bracket.
6. Install:
  - a. VESA mount bracket
  - b. back cover

- c. VESA stand
7. Follow the procedures in *After Working Inside Your Computer*.

## Removing the Intrusion Switch

1. Follow the procedures in *Before Working Inside Your Computer*.
2. Remove the:
  - a. VESA stand
  - b. back cover
  - c. VESA mount bracket
  - d. system-board shield
3. Disconnect the intrusion-switch cable from the connector on the system board. Unthread the cable from the notches on the computer.

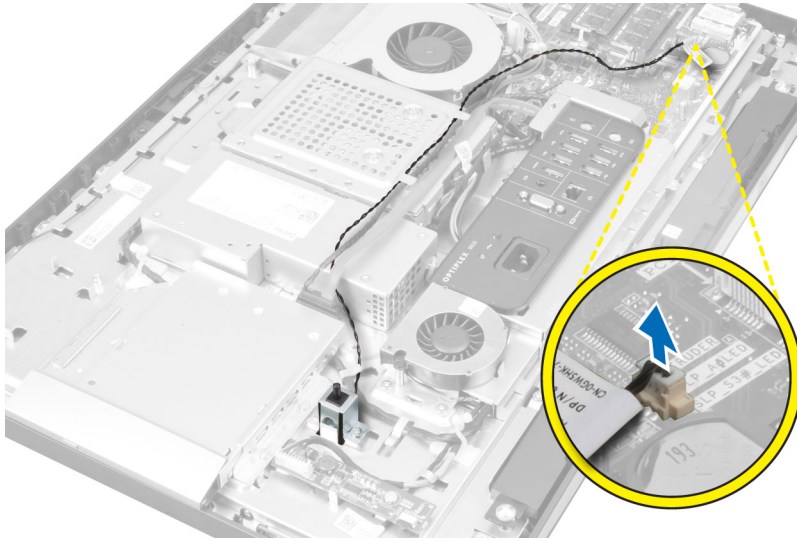

4. Remove the screws that secure the intrusion switch to the chassis. Lift the intrusion switch and remove it from the computer.

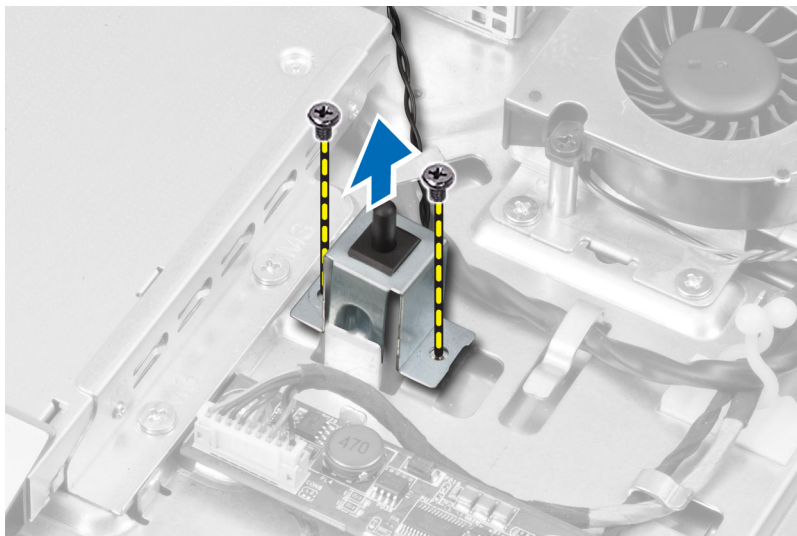

## Installing the Intrusion Switch

1. Place the intrusion switch on the computer and tighten the screw to secure it to the chassis.
2. Thread the cable along the notches on the chassis and connect the intrusion-switch cable to the connector on the system board.
3. Install:
  - a. system-board shield
  - b. VESA mount bracket
  - c. back cover
  - d. VESA stand
4. Follow the procedures in *After Working Inside Your Computer*.

## Removing the Wireless Local Area Network (WLAN) Card

1. Follow the procedures in *Before Working Inside Your Computer*.
2. Remove the:
  - a. VESA stand
  - b. back cover
  - c. VESA mount bracket
  - d. system-board shield
3. Disconnect the WLAN antenna cables and remove the screws that secure the WLAN card to the system board. Remove the WLAN card from the connector.

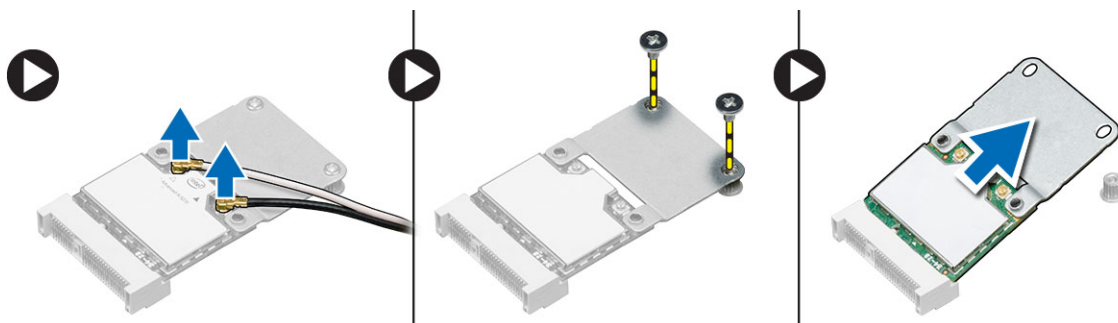

4. Flip the WLAN card and remove the screws that secure the WLAN card to the WLAN adapter. Remove the WLAN card from the adapter.



## Installing the WLAN Card

1. Align and place the WLAN card on the WLAN adapter. Tighten the screws to secure the WLAN card to the WLAN adapter
2. Place the WLAN card along with the WLAN adapter on its connector and tighten the screws to secure the WLAN card to the system board.
3. Connect the WLAN cables.
4. Install:
  - a. system-board shield
  - b. VESA mount bracket
  - c. back cover
  - d. VESA stand
5. Follow the procedures in *After Working Inside Your Computer*.

## Removing the Heat-Sink Assembly

1. Follow the procedures in *Before Working Inside Your Computer*.
2. Remove the:
  - a. VESA stand
  - b. back cover
  - c. VESA mount bracket
  - d. system-board shield
3. Remove the screws that secure the heat- sink module to the chassis. Lift the heat-sink assembly up and remove it from the computer.

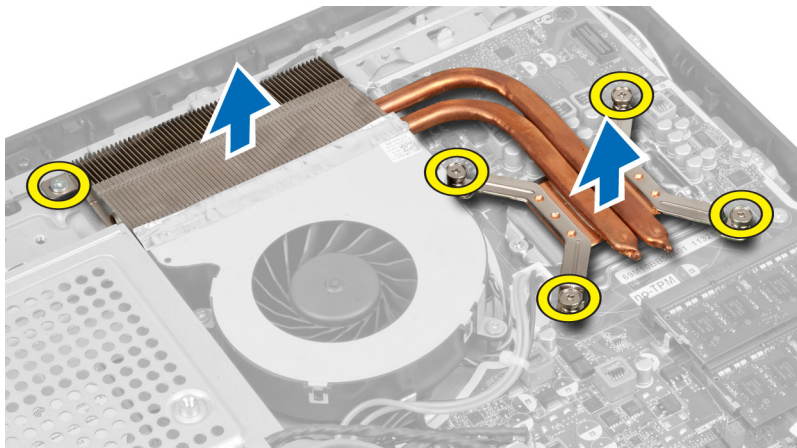

## Installing the Heat-Sink Assembly

1. Align and place the heat-sink assembly on the computer.
2. Tighten the screws that secure the heat-sink assembly to the chassis.
3. Install:
  - a. system-board shield
  - b. VESA mount bracket
  - c. back cover

- d. VESA stand
4. Follow the procedures in *After Working Inside Your Computer*.

## Removing the Processor Fan

1. Follow the procedures in *Before Working Inside Your Computer*.
2. Remove the:
  - a. VESA stand
  - b. back cover
  - c. VESA mount bracket
  - d. system-board shield
3. Disconnect the processor-fan cable from the connector on the system board. Remove the screws that secure the processor fan to the system board and lift it away from the computer.

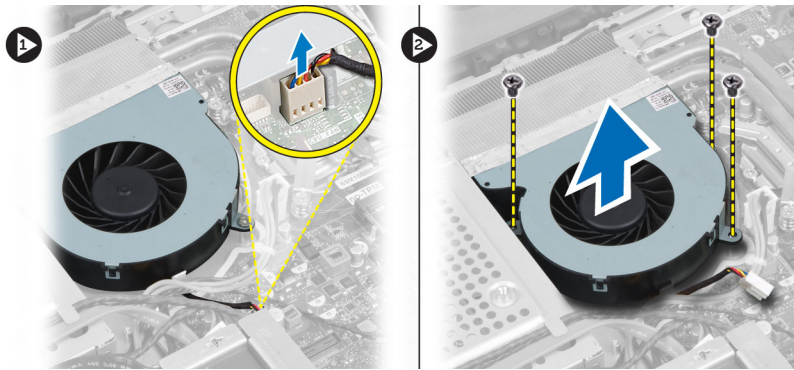

## Installing the Processor Fan

1. Place the processor fan on the computer and tighten the screws to secure the processor fan to the system board.
2. Connect the processor-fan cable to the connector on the system board.
3. Install:
  - a. system-board shield
  - b. VESA mount bracket
  - c. back cover
  - d. VESA stand
4. Follow the procedures in *After Working Inside Your Computer*.

## Removing the Power-Supply Fan

1. Follow the procedures in *Before Working Inside Your Computer*.
2. Remove the:
  - a. VESA stand
  - b. back cover
  - c. VESA mount bracket
  - d. system-board shield
3. Remove the screw that secures the fan duct to the chassis. Lift the fan bracket away from the computer.

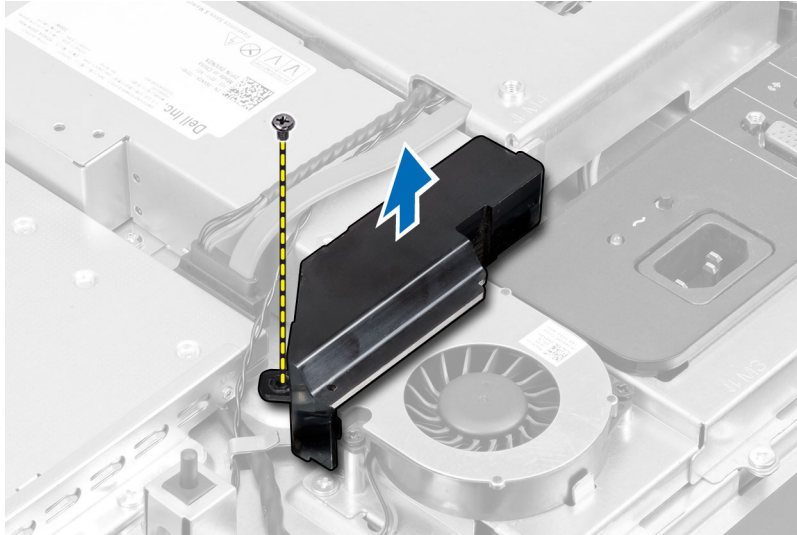

4. Remove the screws that secure the power-supply fan to the chassis and lift it away from the computer.

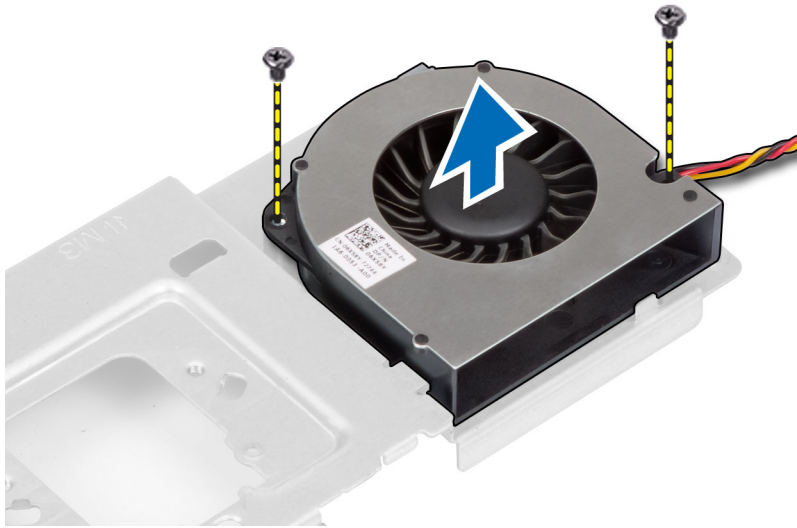

## Installing the Power-Supply Fan

1. Place the power-supply fan on the computer and tighten the screws to secure it to the chassis.
2. Align and place the fan duct from the computer.
3. Tighten the screw that secures the fan duct to the chassis.
4. Install:
  - a. system-board shield
  - b. VESA mount bracket
  - c. back cover
  - d. VESA stand
5. Follow the procedures in *After Working Inside Your Computer*.



## Removing the I/O Board Shield

1. Follow the procedures in *Before Working Inside Your Computer*.
2. Remove the:
  - a. VESA stand
  - b. back cover
  - c. VESA mount bracket
  - d. power supply fan
  - e. system-board shield
3. Lift the I/O panel away from the computer.



4. Remove the screws that secure the power connector to the I/O board shield.

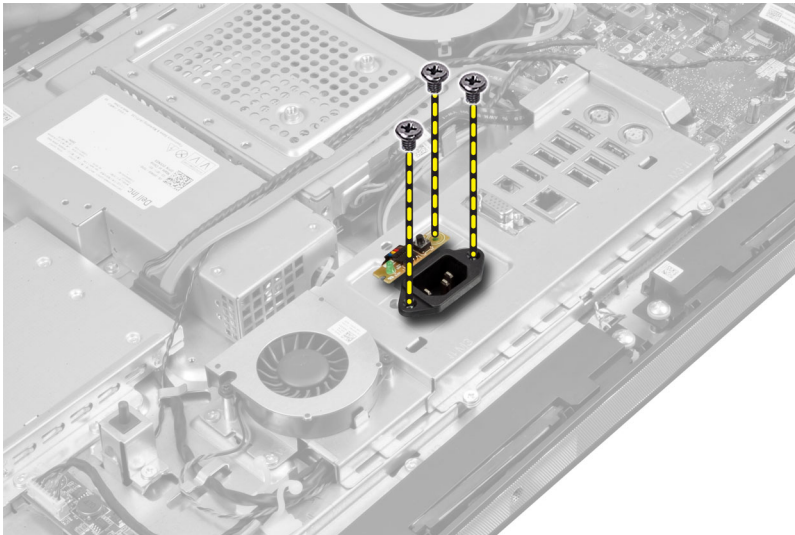

5. Remove the screws that secure the I/O board shield to the chassis. Loosen the power connector and press it down the socket.

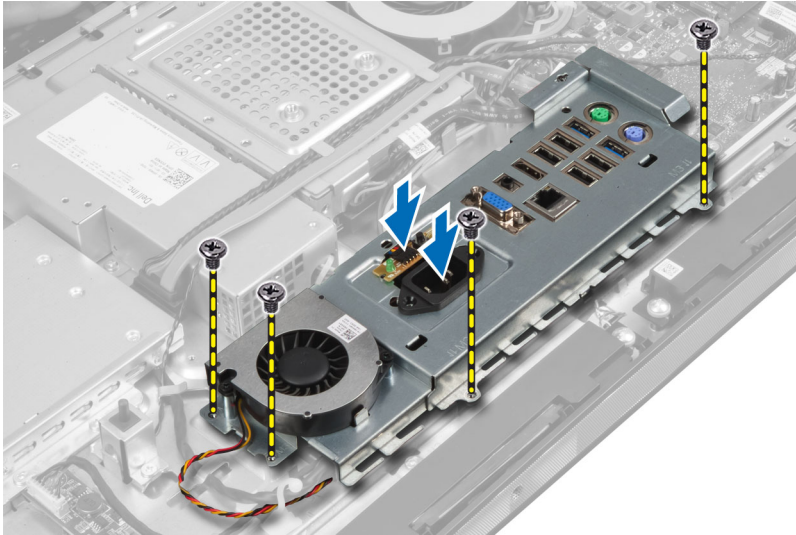

6. Flip the input/output (I/O) board shield and remove it from the computer.

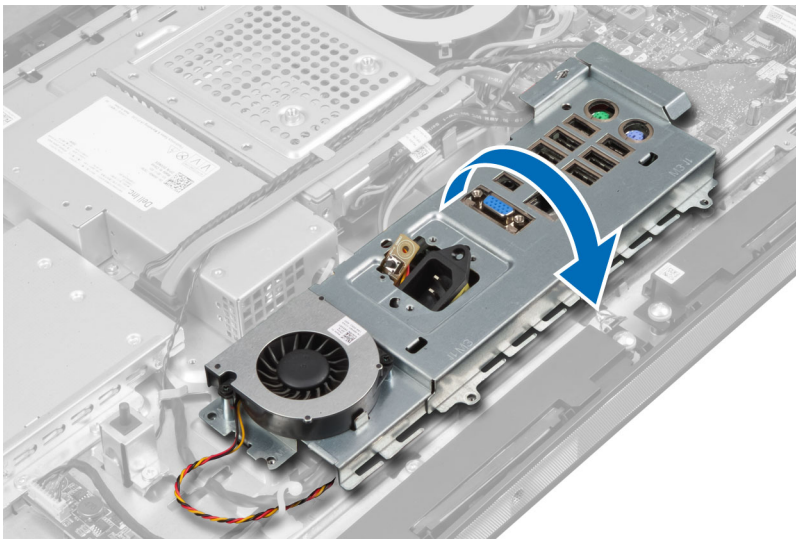

7. Disconnect the power-conector cable from the system board.

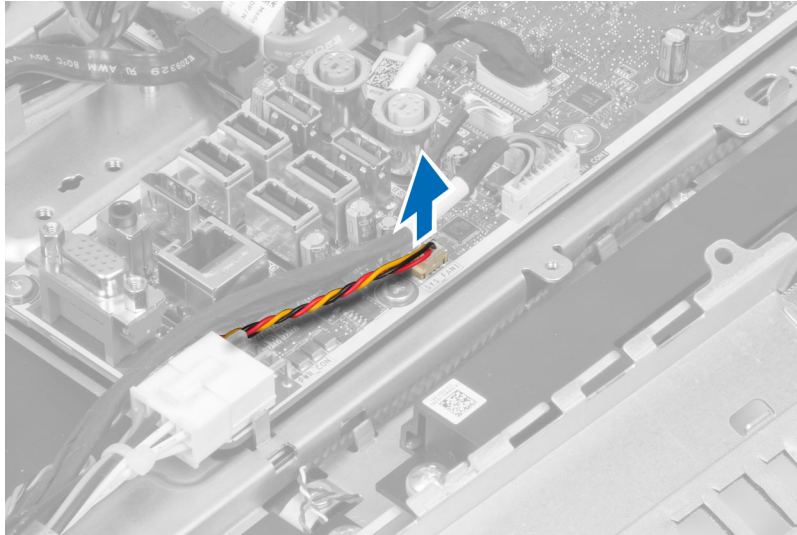

## Installing the I/O Board Shield

1. Connect the power-connector cable to the system board.
2. Place the I/O board shield on the computer.
3. Pass the power connector and fix it to the socket. Tighten the screws that secure the I/O board shield to the chassis.
4. Tighten the screws that secure the power connector to the I/O shield.
5. Place the I/O panel on the computer.
6. Install:
  - a. power-supply fan
  - b. system-board shield
  - c. VESA mount bracket
  - d. back cover
  - e. VESA stand
7. Follow the procedures in *After Working Inside Your Computer*.

## Removing the Power Supply Unit (PSU)

1. Follow the procedures in *Before Working Inside Your Computer*.
2. Remove the:
  - a. VESA stand
  - b. back cover
  - c. VESA mount bracket
  - d. system-board shield
  - e. input/output (I/O) board shield
  - f. power-supply fan
3. Disconnect the power-supply cables from the system board. Unthread the cable from the hooks in the computer.

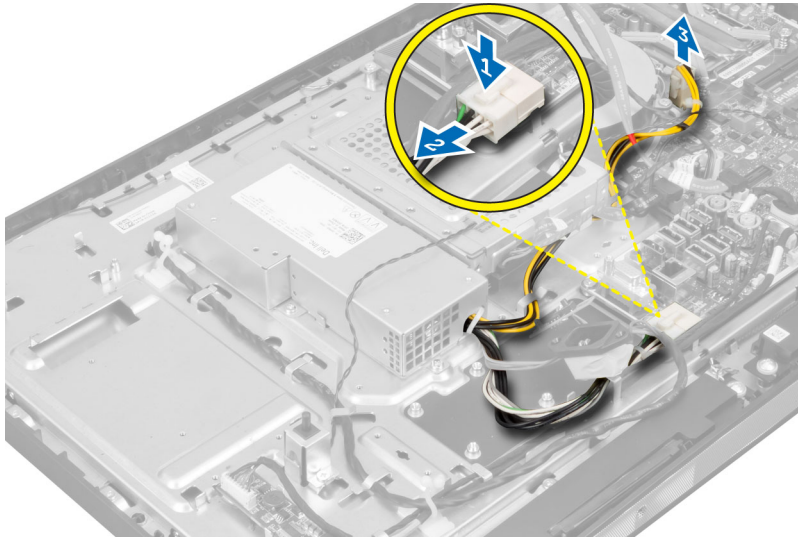

4. Remove the screws that secure the PSU to the chassis. Lift the PSU up and remove it from the computer.

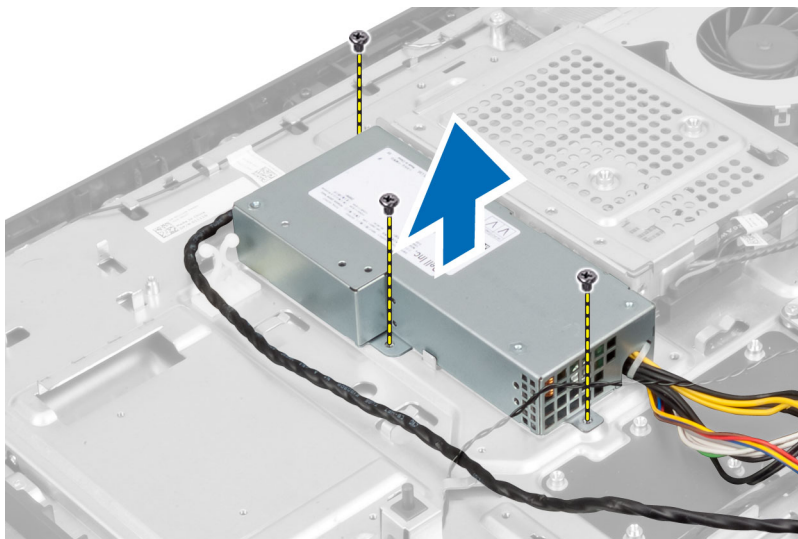

## Installing the Power Supply Unit

1. Place the power supply unit on the computer.
2. Tighten the screws to secure the power supply unit to the chassis.
3. Thread the cable on the hooks in the computer.
4. Connect the power-supply cables to the connector on the system board.
5. Install:
  - a. power-supply fan
  - b. input/output (I/O) board shield
  - c. system-board shield
  - d. VESA mount bracket
  - e. back cover
  - f. VESA stand

6. Follow the procedures in *After Working Inside Your Computer*.

## Removing the Processor

1. Follow the procedures in *Before Working Inside Your Computer*.
2. Remove the:
  - a. VESA stand
  - b. back cover
  - c. VESA mount bracket
  - d. system-board shield
  - e. heat-sink assembly
3. Press the release lever down and then move it outward to release it from the retention hook that secures it. Lift the processor cover and remove the processor from its socket.



## Installing the Processor

1. Insert the processor into the processor socket. Ensure the processor is properly seated.
2. Press the release lever down and then move it inward to secure it with the retention hook.
3. Install:
  - a. heat-sink assembly
  - b. system-board shield
  - c. VESA mount bracket
  - d. back cover
  - e. VESA stand
4. Follow the procedures in *After Working Inside Your Computer*.

## Removing the Speakers

1. Follow the procedures in *Before Working Inside Your Computer*.
2. Remove the:
  - a. VESA stand
  - b. back cover
  - c. VESA mount bracket
  - d. system-board shield
3. Disconnect the speaker cables from the connector on the system board. Unthread the cables from the notches.

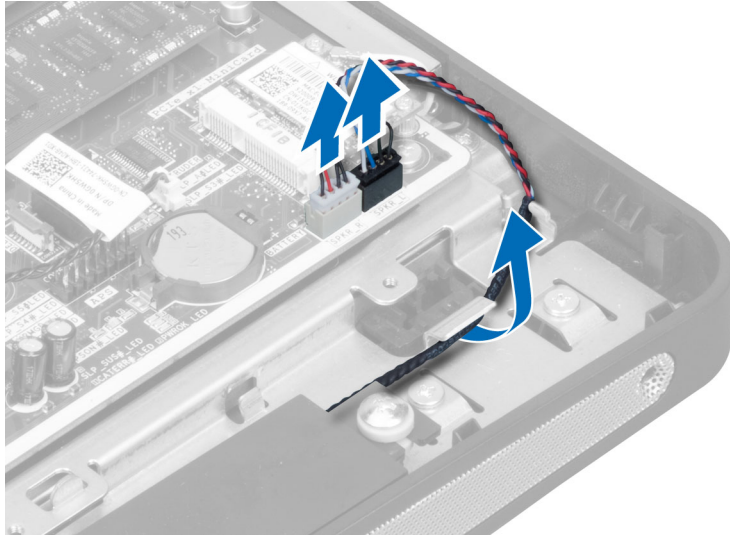

4. Remove the screws that secure the speakers to the chassis. Lift the speakers from the computer.

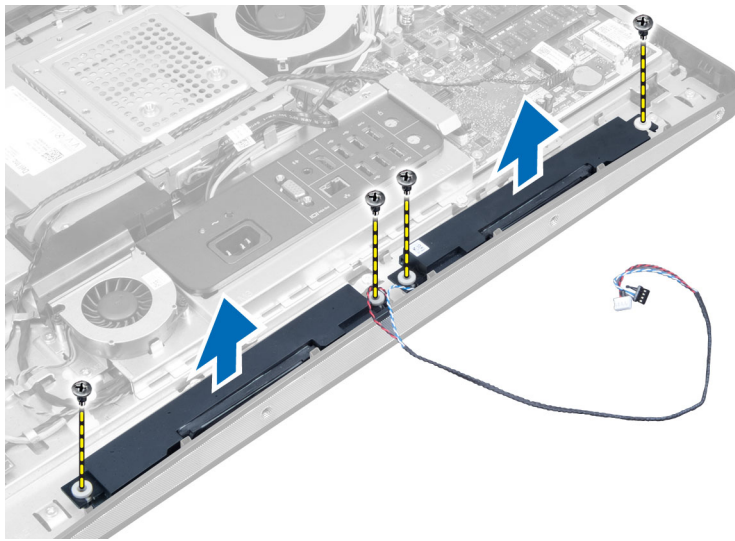

## Installing the Speakers

1. Place and align the speakers on the chassis. Tighten the screws that secure the speaker to the chassis.
2. Thread the cables on the notches. Connect the speaker cables to the system board.
3. Install:
  - a. system-board shield
  - b. VESA mount bracket
  - c. back cover
  - d. VESA stand
4. Follow the procedures in *After Working Inside Your Computer*.

## Removing the System Board

1. Follow the procedures in *Before Working Inside Your Computer*.
2. Remove the:
  - a. VESA stand
  - b. back cover
  - c. VESA mount bracket
  - d. system-board shield
  - e. memory
  - f. optical drive
  - g. hard drive
  - h. heat-sink assembly
  - i. power supply unit
  - j. input/output (I/O) board shield
  - k. converter board
  - l. power-supply fan
3. Disconnect all the cables that are connected to the system board.
4. Remove the screws that secure the system board to the computer.

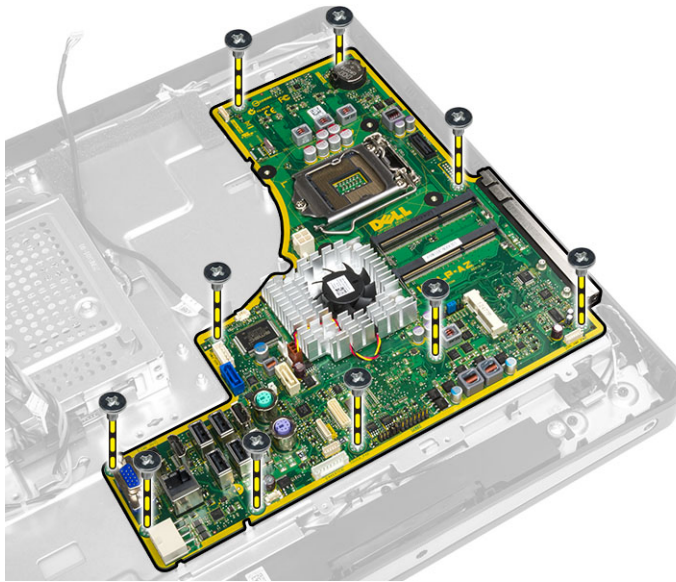

5. Lift and remove the system board from the chassis.

## System Board Layout

The following image displays the system board layout of the computer.

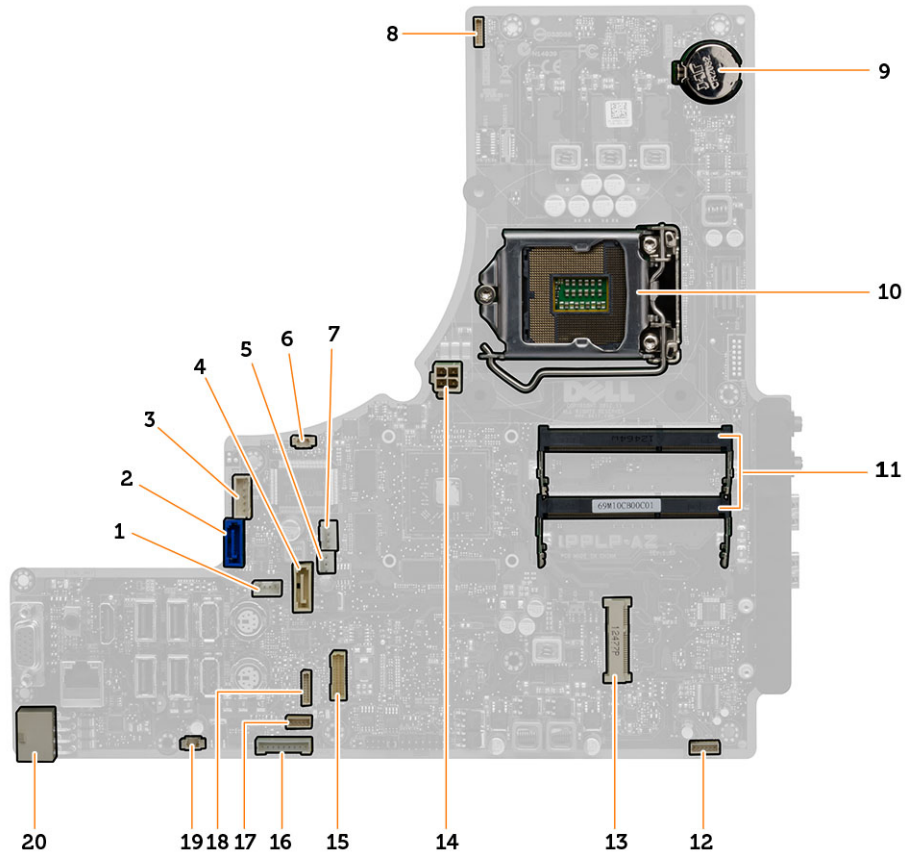

1. SATA ODD power connector
2. SATA HDD connector
3. SATA HDD power connector
4. SATA ODD connector
5. graphic heat sink fan connector
6. intrusion switch connector
7. processor heat sink fan connector
8. camera connector
9. coin-cell battery connector
10. processor socket
11. memory connectors (SODIMM sockets)
12. speaker connector
13. mini-PCI Express socket
14. 12V CPU power connector
15. LVDS Connector
16. convertor board connector
17. touch panel connector
18. front panel connector
19. PSU fan connector
20. 8-pin power connector



## Installing the System Board

1. Place the system board on the computer.
2. Connect all the cables to the system board.
3. Tighten the screws to secure the system board to the base panel.
4. Install:
  - a. power-supply fan
  - b. converter board
  - c. input/output (I/O) board shield
  - d. power supply unit
  - e. heat-sink assembly
  - f. hard drive
  - g. optical drive
  - h. memory
  - i. system-board shield
  - j. VESA mount bracket
  - k. back cover
  - l. VESA stand
5. Follow the procedures in *After Working Inside Your Computer*.

## Removing the Heat Sink (Graphics Card)

1. Follow the procedures in *Before Working Inside Your Computer*.
2. Remove the:
  - a. VESA stand
  - b. back cover
  - c. VESA mount bracket
  - d. system-board shield
  - e. memory
  - f. optical drive
  - g. hard drive
  - h. heat-sink assembly
  - i. power supply unit
  - j. input/output (I/O) board shield
  - k. converter board
  - l. power-supply fan
  - m. system board
3. Disconnect the fan cable connected to the system board and lift the system board to its back.

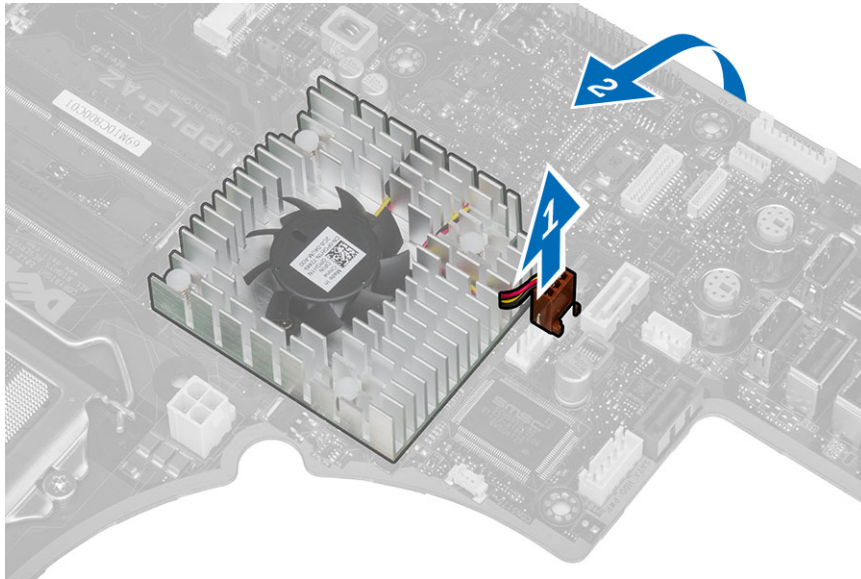

4. Press and push down the screws that are connected to the system board.

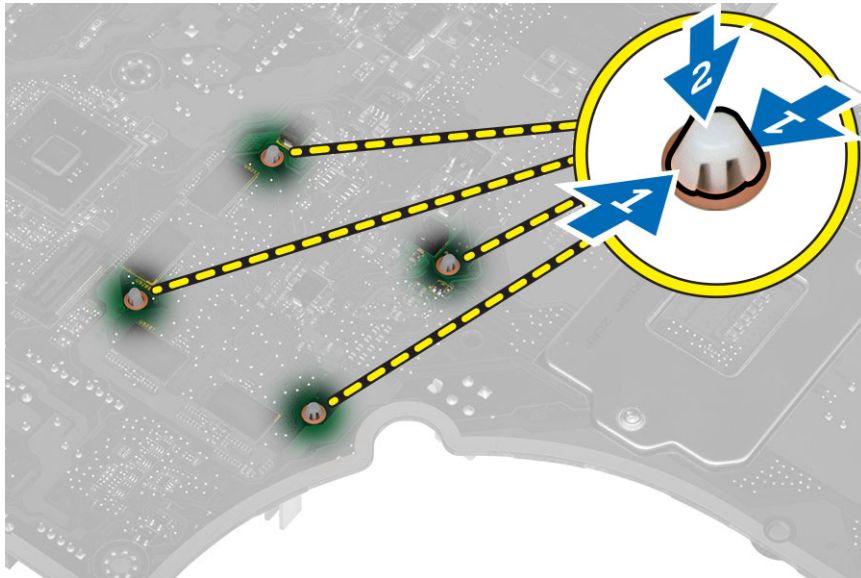

5. Remove the heat sink from the system board.

## Installing the Heat Sink (Graphics Card)

1. Place the heat sink on the system board.
2. Press the screws to lock the heat sink to its position.
3. Connect the fan cable.
4. Install:
  - a. system board
  - b. power-supply fan
  - c. converter board

- d. input/output (I/O) board shield
  - e. power supply unit
  - f. heat-sink assembly
  - g. hard drive
  - h. optical drive
  - i. memory
  - j. system-board shield
  - k. VESA mount bracket
  - l. back cover
  - m. VESA stand
5. Follow the procedures in *After Working Inside Your Computer*.

## Removing the Antenna Module

1. Follow the procedures in *Before Working Inside Your Computer*.
2. Remove the:
  - a. VESA stand
  - b. back cover
  - c. VESA mount bracket
  - d. system-board shield
  - e. input/output (I/O) board shield
  - f. WLAN card
  - g. optical drive
  - h. hard drive
  - i. intrusion switch
  - j. power and OSD buttons board
  - k. converter board
  - l. processor fan
  - m. power supply unit
  - n. heat-sink assembly
  - o. power-supply fan
  - p. system board
3. Remove the screws that secure the antenna module to the chassis. Unthread the antenna cable from around the edges of the computer. Lift and remove the antenna module.

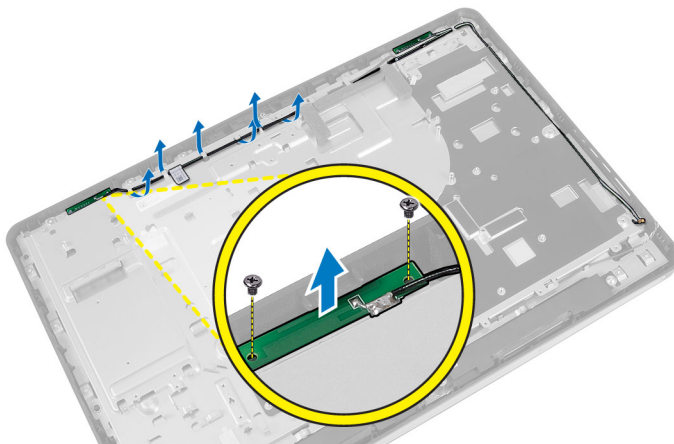

## Installing the Antenna Module

1. Place the antenna module on the chassis.
2. Thread the antenna cable around the edges of the computer. Tighten the screws to secure the antenna module to the chassis
3. Install:
  - a. system board
  - b. power-supply fan
  - c. heat-sink assembly
  - d. power supply unit
  - e. processor fan
  - f. converter board
  - g. power and OSD buttons board
  - h. intrusion switch
  - i. hard drive
  - j. optical drive
  - k. WLAN card
  - l. input/output (I/O) board shield
  - m. system-board shield
  - n. VESA mount bracket
  - o. back cover
  - p. VESA stand
4. Follow the procedures in *After Working Inside Your Computer*.

## Removing the Display Panel

1. Follow the procedures in *Before Working Inside Your Computer*.
2. Remove the:
  - a. VESA stand
  - b. back cover
  - c. VESA mount bracket
  - d. system-board shield
  - e. input/output (I/O) board shield
  - f. WLAN card
  - g. optical drive
  - h. hard drive
  - i. intrusion switch
  - j. power and OSD buttons board
  - k. converter board
  - l. power-supply fan
  - m. power supply unit
  - n. heat-sink assembly
  - o. processor fan
  - p. speakers
  - q. antenna module
  - r. system board

 **NOTE:** These instructions are valid only for non-touch computers. For touch computers, the display panel should be disassembled in a clean-room environment.

3. Disconnect the LVDS cable from the display panel. Remove any other cables or antennae around the edges of the base panel.

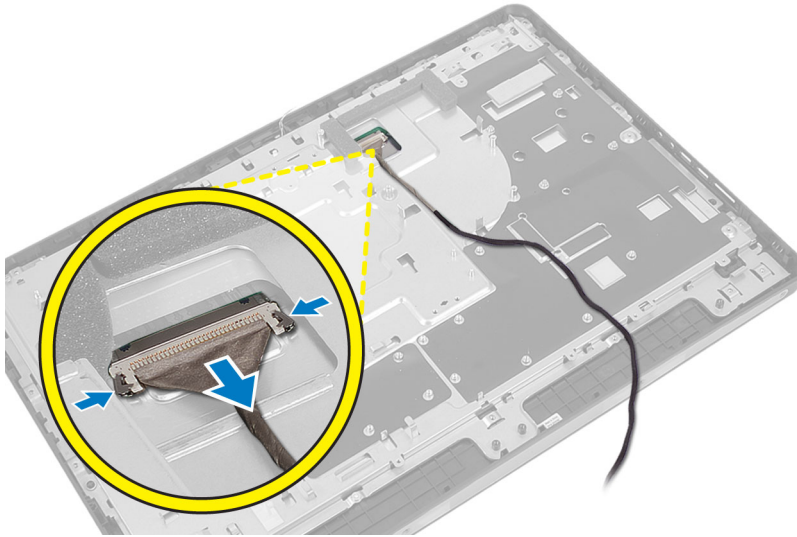

4. Remove the screws that secure the base panel to the chassis. Lift the base panel from the chassis.

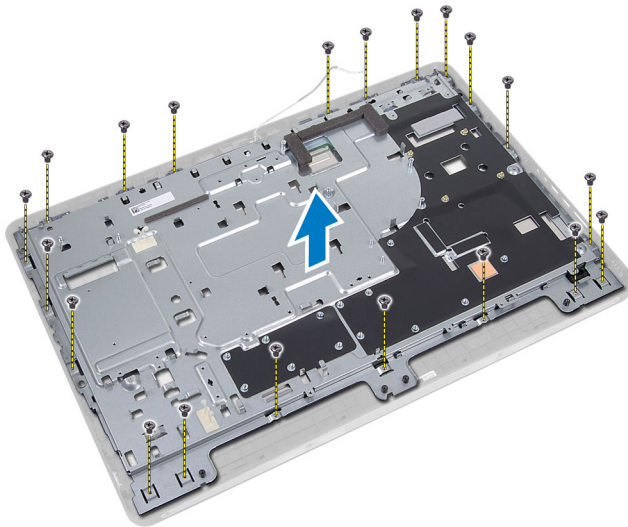

5. Lift the display panel from the chassis.



6. Remove the screws that secure the display bracket to the display panel. Remove the display bracket from the display panel.

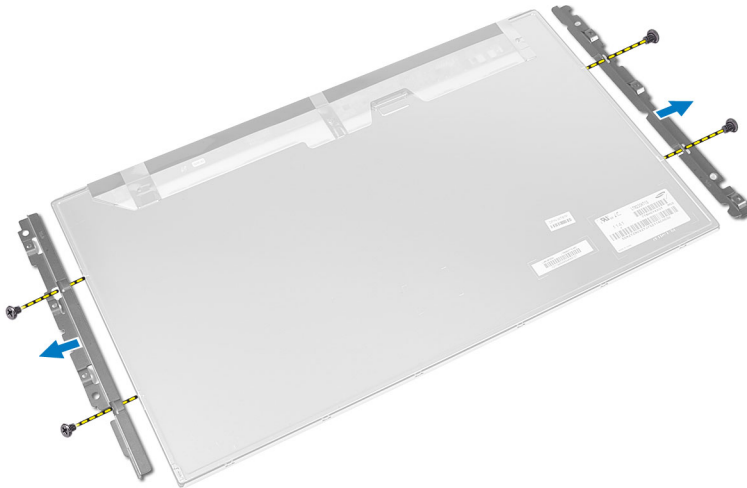

## Installing the Display Panel

1. Tighten the screws to secure the display bracket to the display panel.
2. Place the display panel on the chassis.
3. Place the base panel on the chassis.
4. Tighten the screws to secure the base panel to the chassis.
5. Connect the LVDS cable to the display panel.
6. Install:
  - a. system board
  - b. antenna module
  - c. speakers
  - d. processor fan
  - e. heat-sink assembly

- f. power supply unit
- g. power-supply fan
- h. converter board
- i. power and OSD buttons board
- j. intrusion switch
- k. hard drive
- l. optical drive
- m. WLAN card
- n. input/output (I/O) board shield
- o. system-board shield
- p. VESA mount bracket
- q. back cover
- r. VESA stand

7. Follow the procedures in *After Working Inside Your Computer*.

## Removing the Camera

1. Follow the procedures in *Before Working Inside Your Computer*.

2. Remove the:

- a. VESA stand
- b. back cover
- c. VESA mount bracket
- d. system-board shield
- e. input/output (I/O) board shield
- f. WLAN card
- g. optical drive
- h. hard drive
- i. intrusion switch
- j. power and OSD buttons board
- k. converter board
- l. processor fan
- m. power supply unit
- n. heat-sink assembly
- o. power-supply fan
- p. system board
- q. display panel

3. Lift the latch and disconnect the camera cable. Remove the screws that secure the camera to the chassis.

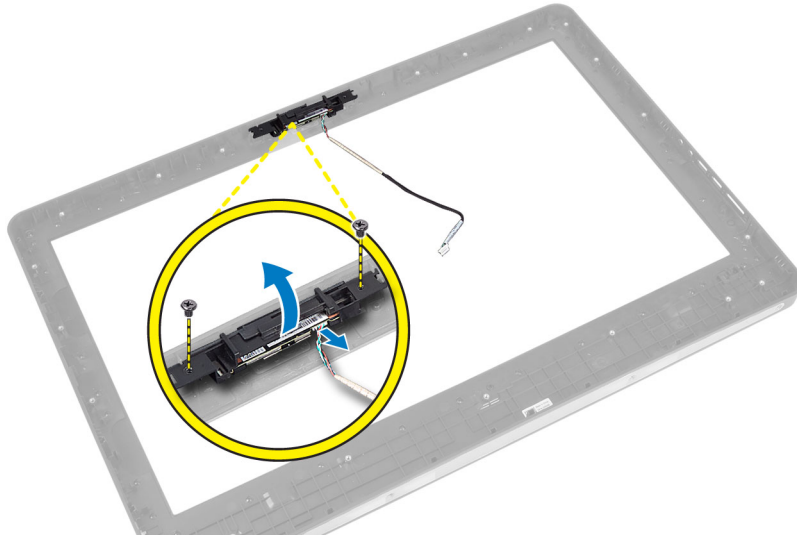

## Installing the Camera

1. Tighten the screws to secure the camera to the chassis.
2. Connect the camera cable and fix the latch.
3. Install:
  - a. display panel
  - b. system board
  - c. power-supply fan
  - d. heat-sink assembly
  - e. power supply unit
  - f. processor fan
  - g. converter board
  - h. power and OSD buttons board
  - i. intrusion switch
  - j. hard drive
  - k. optical drive
  - l. WLAN card
  - m. input/output (I/O) board shield
  - n. system-board shield
  - o. VESA mount bracket
  - p. back cover
  - q. VESA stand
4. Follow the procedures in *After Working Inside Your Computer*.



## System Setup

System Setup enables you to manage your computer hardware and specify BIOS-level options. From the System Setup, you can:

- Change the NVRAM settings after you add or remove hardware
- View the system hardware configuration
- Enable or disable integrated devices
- Set performance and power management thresholds
- Manage your computer security

## Boot Sequence

Boot Sequence allows you to bypass the System Setup-defined boot device order and boot directly to a specific device (for example: optical drive or hard drive). During the Power-on Self Test (POST), when the Dell logo appears, you can:

- Access System Setup by pressing <F2> key
- Bring up the one-time boot menu by pressing <F12> key

The one-time boot menu displays the devices that you can boot from including the diagnostic option. The boot-menu options are:

- Removable Drive (if available)
- STXXXX Drive

 **NOTE:** XXX denotes the SATA drive number.

- Optical Drive
- Diagnostics

 **NOTE:** Choosing Diagnostics, will display the **ePSA diagnostics** screen.

The boot sequence screen also displays the option to access the System Setup screen.

## Navigation Keys

The following table displays the system setup navigation keys.

 **NOTE:** For most of the system setup options, changes that you make are recorded but do not take effect until you re-start the system.

**Table 1. Navigation Keys**



Keys	Navigation
Up arrow	Moves to the previous field.
Down arrow	Moves to the next field.

Keys	Navigation
<Enter>	Allows you to select a value in the selected field (if applicable) or follow the link in the field.
Spacebar	Expands or collapses a drop-down list, if applicable.
<Tab>	Moves to the next focus area.
	 <b>NOTE:</b> For the standard graphics browser only.
<Esc>	Moves to the previous page till you view the main screen. Pressing <Esc> in the main screen displays a message that prompts you to save any unsaved changes and restarts the system.
<F1>	Displays the System Setup help file.

## System Setup Options

 **NOTE:** Depending on the computer and its installed devices, the items listed in this section may or may not appear

**Table 2. General**

Option	Description
System Information	<p>Displays the following information:</p> <ul style="list-style-type: none"> <li>• <b>System Information</b> - Displays <b>BIOS Version, Service Tag, Asset Tag, Ownership Tag, Ownership Date, Manufacture Date, and Express Service Code.</b></li> <li>• <b>Memory Information</b> - Displays <b>Memory Installed, Memory Available, Memory Speed, Memory Channels Mode, Memory Technology, DIMM A Size, DIMM B Size.</b></li> <li>• <b>PCI Information</b> - Displays <b>SLOT1</b></li> <li>• <b>Processor Information</b> - Displays <b>Processor Type, Core Count, Processor ID, Current Clock Speed, Minimum Clock Speed, Maximum Clock Speed, Processor L2 Cache, Processor L3 Cache, HT Capable, and 64-Bit Technology.</b></li> <li>• <b>Device Information</b> - Displays <b>SATA-0, SATA-1, SATA-4, LOM MAC Address, and Video Controller Audio Controller, Wi-Fi Device, Bluetooth Device.</b></li> </ul>
Boot Sequence	<p>Allows you to specify the order in which the computer attempts to find an operating system. To change the boot order, select the device that you want to change in the list, which is available on the right-hand side. After you select the device, click <b>up/down</b> arrows or use your keyboard <b>PgUp / PgDn</b> keys to change the boot options order. You can also select or de-select from the list using the check-boxes available on the left hand side. You should enable the Legacy Option ROMs to setup the Legacy boot mode. This Legacy boot mode is not allowed when you enable the Secure Boot. The options are:</p> <ul style="list-style-type: none"> <li>• Boot Sequence - By default, the <b>Windows Boot Manager</b> check box is selected. <ul style="list-style-type: none"> <li> <b>NOTE:</b> The default option might differ based on the operating system of your computer.</li> </ul> </li> <li>• Boot List Option - The list options are <b>Legacy</b> and <b>UEFI</b>. By default, the option <b>UEFI</b> is selected. <ul style="list-style-type: none"> <li> <b>NOTE:</b> The default option might differ based on the operating system of your computer.</li> </ul> </li> <li>• Add Boot Option - Enables you to add a boot option.</li> <li>• Delete Boot Option - Enables you to delete an existing boot option.</li> <li>• View - Enables you to view the current boot option in the computer.</li> <li>• Load Defaults - Restores the default settings of the computer.</li> </ul>

Option	Description
	<ul style="list-style-type: none"> <li>• Apply - Enables you to apply the settings.</li> <li>• Exit - Exits and starts the computer.</li> </ul>
Advanced Boot Options	<p>The Enable Legacy Option ROMs option will allow the legacy option ROMs to load, when in UEFI boot mode. Without this option, only UEFI option ROMs will load. This option is required for Legacy boot mode. This Legacy boot mode is not allowed when you enable the Secure Boot. By default, the <b>Enable Legacy Option ROMs</b> check-box is not selected. The other options are:</p> <ul style="list-style-type: none"> <li>• Load Defaults - Restores the default settings of the computer.</li> <li>• Apply - Enables you to apply the settings.</li> <li>• Exit - Exits and starts the computer.</li> </ul>
Date/Time	Allows you to set the date and time. The changes to the system date and time takes effect immediately.



**Table 3. System Configuration**

Option	Description
Integrated NIC	<p>Allows you to enable or disable the integrated network card. You can set the integrated NIC to:</p> <ul style="list-style-type: none"> <li>• Disabled</li> <li>• Enabled</li> <li>• Enabled w/PXE</li> <li>• Enabled w/Cloud Desktop</li> </ul> <p> <b>NOTE:</b> Depending on the computer and its installed devices, the items listed in this section may or may not appear.</p>
SATA Operation	<p>Allows you to configure the operating mode of the integrated SATA hard drive controller.</p> <ul style="list-style-type: none"> <li>• <b>Disabled</b> - The SATA controllers are hidden.</li> <li>• <b>ATA</b> - SATA is configured for ATA mode.</li> <li>• <b>AHCI</b> - SATA is configured for AHCI mode.</li> <li>• <b>RAID ON</b> - SATA is configured to support RAID mode.</li> </ul>
Drives	<p>Allows you to enable or disable the various on-board drives:</p> <ul style="list-style-type: none"> <li>• SATA-0</li> <li>• SATA-1</li> <li>• SATA-4</li> </ul>
SMART Reporting	<p>This field controls if the hard drive errors for the integrated drives are reported during system startup. This technology is part of the SMART (Self Monitoring Analysis and Reporting Technology) specification.</p> <ul style="list-style-type: none"> <li>• <b>Enable SMART Reporting</b> - This option is disabled by default.</li> </ul>

Option	Description
USB Configuration	<p>This field configures the integrated USB controller. If <i>Boot Support</i> is enabled, the system is allowed to boot any type of USB mass storage devices (HDD, memory key, floppy).</p> <p>If USB port is enabled, device attached to this port is enabled and available for operation system.</p> <p>If USB port is disabled, the operation system cannot see any device attached to this port.</p> <p> <b>NOTE:</b> USB keyboard and mouse always work in the BIOS setup irrespective of these settings.</p>
Audio	<p>Allows you to enable or disable the integrated audio controllers. By default, the <b>Enable Audio</b> option is selected.</p>
Miscellaneous Devices	<p>Allows you to enable or disable various on-board devices.</p> <ul style="list-style-type: none"> <li>• <b>Enable Microphone</b> - This option is selected by default.</li> <li>• <b>Enable Camera</b> - This option is selected by default.</li> <li>• <b>Enable Media Card</b> - This option is selected by default.</li> <li>• Disable Media Card</li> </ul>

**Table 4. Security**

Option	Description
Admin Password	<p>This field lets you set, change, or delete the administrator (admin) password (sometimes called the setup password). The admin password enables several security features.</p> <p>The drive does not have a password set by default.</p> <ul style="list-style-type: none"> <li>• Enter the old password</li> <li>• Enter the new password</li> <li>• Confirm the new password</li> </ul> <p>The successful changes in the password will take effect immediately.</p> <p> <b>NOTE:</b> If you delete the admin password, the system password also gets deleted. You can also use the admin password to delete the HDD password. You cannot set an admin password if a system password or an HDD password is already set. You must set the admin password first, if you want to use the admin password with a system password and/or HDD password.</p>
System Password	<p>Allows you to set, change, or delete the computer password (previously called the primary password).</p> <p>The drive does not have a password set by default.</p> <ul style="list-style-type: none"> <li>• Enter the old password</li> <li>• Enter the new password</li> <li>• Confirm the new password</li> </ul> <p>The successful changes in the password will take effect immediately.</p>
Internal HDD-0 Password	<p>Allows you to set, change, or delete the password on the computer's internal hard disk drive (HDD). Successful changes to this password take effect immediately.</p>

Option	Description
	<p>The drive does not have a password set by default.</p> <ul style="list-style-type: none"> <li>• Enter the old password</li> <li>• Enter the new password</li> <li>• Confirm the new password</li> </ul>
Internal HDD-4 Password	<p>Allows you to set, change, or delete the password on the computer's internal hard disk drive (HDD). Successful changes to this password take effect immediately. The drive does not have a password set by default.</p> <ul style="list-style-type: none"> <li>• Enter the old password</li> <li>• Enter the new password</li> <li>• Confirm the new password</li> </ul>
Strong Password	<p><b>Enable strong password</b> - This option is disabled by default.</p>
Password Configuration	<p>This field controls the minimum and maximum number of characters allowed for the admin and system passwords.</p> <ul style="list-style-type: none"> <li>• Admin Password Min</li> <li>• Admin Password Max</li> <li>• System Password Min</li> <li>• System Password Max</li> </ul>
Password Bypass	<p>Allows you to bypass the <i>System Password</i> and the internal HDD password prompts during a system restart.</p> <ul style="list-style-type: none"> <li>• Disabled - Always prompt for the system and internal HDD password when they are set. This option is disabled by default.</li> <li>• Reboot Bypass - Bypass the password prompts on restarts (warm boots).</li> </ul> <p> <b>NOTE:</b> The system will always prompt for the system and internal HDD passwords when powered on from the off state (a cold boot). Also, the system will always prompt for passwords on any module bay HDDs that may be present.</p>
Password Change	<p>Allows you to determine whether changes to the system and hard disk passwords are permitted when an administrator password is set.</p> <ul style="list-style-type: none"> <li>• <b>Allow Non-Admin Password Changes</b> - This option is enabled by default.</li> </ul>
TPM Security	<p>This option lets you control whether the Trusted Platform Module (TPM) in the system is enabled and visible to the operating system.</p> <p><b>TPM Security</b> - This option is disabled by default.</p> <p> <b>NOTE:</b> Activation, deactivation, and clear options are not affected if you load the setup program's default values. Changes to this option take effect immediately.</p>
Computrace	<p>This field lets you activate or disable the BIOS module interface of the optional <i>Computrace Service</i> from <i>Absolute Software</i>.</p> <ul style="list-style-type: none"> <li>• <b>Deactivate</b> - This option is enabled by default.</li> <li>• Disable</li> <li>• Activate</li> </ul>
Chassis Intrusion	<p>This field controls the chassis intrusion feature. The options are:</p>

Option	Description
	<ul style="list-style-type: none"> <li>• Disable</li> <li>• <b>Enable</b> - This option is enabled by default</li> <li>• On-Silent</li> </ul>
CPU XD Support	<p>Allows you to enable or disable the execute disable mode of the processor.</p> <ul style="list-style-type: none"> <li>• <b>Enable CPU XD Support</b> - This option is enabled by default.</li> </ul>
OROM Keyboard Access	<p>Allows you to determine if you access the Option Read Only Memory (OROM) configuration screens via hotkeys during boot. These settings prevent access to the Intel RAID (CTRL+I) or Intel Management Engine BIOS Extension (CTRL+P/F12).</p> <ul style="list-style-type: none"> <li>• <b>Enable</b> - User may enter OROM configuration screens via the hotkey. This option is enabled by default.</li> <li>• <b>One-Time Enable</b> - User can enter the OROM configuration screens via the hotkeys during the next boot. After the boot, the setting will revert to disabled.</li> <li>• <b>Disable</b> - User can not enter the OROM configuration screens via the hotkey.</li> </ul> <p>This option is set to <b>Enable</b> by default.</p>
Admin Setup Lockout	<p>Allows you to enable or disable the option to enter setup when an admin password is set.</p> <ul style="list-style-type: none"> <li>• <b>Enable Admin Setup Lockout</b> - This option is not set by default.</li> </ul>
HDD Protection Support	<p>Allows you to enable or disable the HDD Protection feature.</p> <ul style="list-style-type: none"> <li>• <b>HDD Protection Support</b> - This option is disabled by default.</li> </ul>

**Table 5. Secure Boot**

Option	Description
Secure Boot Enable	<p>This option enables or disables the Secure Boot feature. To enable the Secure Boot, the computer has to be in UEFI boot mode and the Enable Legacy Option ROMs option needs to be turned-off.</p> <ul style="list-style-type: none"> <li>• Disabled</li> <li>• <b>Enabled</b> - Enabled by default</li> </ul>
Expert Key Management	<p>Allows you to manipulate the security key databases only if the system is in Custom Mode. The <b>Enable Custom Mode</b> option is disabled by default. The options are:</p> <ul style="list-style-type: none"> <li>• PK</li> <li>• KEK</li> <li>• db</li> <li>• dbx</li> </ul> <p>If you enable the <b>Custom Mode</b>, the relevant options for <b>PK, KEK, db, and dbx</b> appear. The options are:</p> <ul style="list-style-type: none"> <li>• <b>Save to File</b>- Saves the key to a user-selected file</li> <li>• <b>Replace from File</b>- Replaces the current key with a key from a user-selected file</li> <li>• <b>Append from File</b>- Adds a key to the current database from a user-selected file</li> <li>• <b>Delete</b>- Deletes the selected key</li> </ul>



Option	Description
	<ul style="list-style-type: none"> <li>• <b>Reset All Keys</b>- Resets to default setting</li> <li>• <b>Delete All Keys</b>- Deletes all the keys</li> </ul> <p> <b>NOTE:</b> If you disable the Custom Mode, all the changes made will be erased and the keys will restore to default settings.</p>

**Table 6. Performance**

Option	Description
Multi Core Support	<p>Specifies whether the process will have one or all cores enabled. The performance of some applications will improve with the additional cores.</p> <ul style="list-style-type: none"> <li>• All - Enabled by default</li> <li>• 1</li> <li>• 2</li> </ul>
Intel SpeedStep	<p>Allows you to enable or disable the Intel SpeedStep mode of the processor. This option is enabled by default.</p>
C States Control	<p>Allows you to enable or disable the additional processor sleep states. This option is enabled by default.</p>
Limited CPUID Value	<p>Allows you to limit the maximum value of the Standard CPUID Function support. Some operation systems will not complete installation when maximum CPUID Function supported is greater than 3.</p> <ul style="list-style-type: none"> <li>• <b>Enable CPUID Limit</b> - This option is disabled by default</li> </ul>
Intel TurboBoost	<p>Allows you to enable or disable Intel TurboBoost mode of the processor. This option is enabled by default.</p> <ul style="list-style-type: none"> <li>• <b>Disabled</b> - Does not allow the TurboBoost driver to increase the performance state of the processor above the standard performance.</li> <li>• <b>Enabled</b> - Allows the Intel TurboBoost driver to increase the performance of the CPU or graphics processor.</li> </ul>
Hyper-Thread Control	<p>Allows you to enable or disable the Hyper-Threading technology. This option is enabled by default.</p>
Rapid Start Technology	<p>Improves the battery life automatically by putting system into a low power state during Sleep, after a user-specified amount of time. Some increase in resume time from Sleep state may be experience, but the average resume times should be faster than the resume from Hibernate. The timer can be set starting from the value "0". By default, this option is disabled.</p>

**Table 7. Power Management**

Option	Description
AC Recovery	<p>Specifies how the computer will respond when AC power is applied after an AC power loss. You can set the AC Recovery to:</p> <ul style="list-style-type: none"> <li>• Power Off (default)</li> <li>• Power On</li> </ul>

Option	Description
	<ul style="list-style-type: none"> <li>Last Power State</li> </ul>
Auto On Time	<p>This option sets the time of the day when you would like the system to turn on automatically. Time is kept in standard 12-hour format (hour:minutes:seconds). The startup time can be changed by typing the values in the time and A.M./P.M. fields.</p> <ul style="list-style-type: none"> <li><b>Disabled</b> - The system will not automatically power up.</li> <li><b>Every Day</b> - The system will power up every day at the time you specified above .</li> <li><b>Weekdays</b> - The system will power up Monday through Friday at the time you specified above.</li> <li><b>Select Days</b> - The system will power up on days selected above at the time you specified above.</li> </ul> <p> <b>NOTE:</b> This feature does not work if you turn off your computer using the switch on a power strip or surge protector or if <b>Auto Power is set to disabled</b>.</p>
Deep Sleep Control	<p>Allows you to define the controls when Deep Sleep is enabled.</p> <ul style="list-style-type: none"> <li>Disabled</li> <li>Enabled in S5 only</li> <li>Enabled in S4 and S5</li> </ul> <p>This option is disabled by default.</p>
Fan Control Override	<p>Controls the speed of the system fan. This option is disabled by default.</p> <p> <b>NOTE:</b> When enabled, the fan runs at full speed.</p>
USB Wake Support	<p>This option allows you to enable USB devices to wake the computer from standby.</p> <ul style="list-style-type: none"> <li><b>Enable USB Wake Support</b> - This option is enabled by default.</li> </ul>
Wake on LAN / WLAN	<p>This option allows the computer to power up from the off state when triggered by a special LAN signal. Wake-up from the Standby state is unaffected by this setting and must be enabled in the operating system. This feature only works when the computer is connected to AC power supply.</p>
Block Sleep	<p>This option lets you block entering to sleep (S3 state) in operating system environment.</p> <ul style="list-style-type: none"> <li><b>Block Sleep (S3 state)</b> - This option is disabled by default.</li> </ul>
Intel Smart Connect Technology	<p>This option is disabled by default. If this option is enabled, the feature will periodically sense the nearby wireless connection while the system is asleep. The Smart Connect will synchronize the email or social media applications that are open, when the computer enters the sleep state.</p>

**Table 8. POST Behavior**

Option	Description
Numlock LED	Specifies if the NumLock function can be enabled when the system boots. This option is enabled by default.
Keyboard Errors	Specifies whether keyboard related errors are reported when it boots. This option is enabled by default.



Option	Description
POST Hotkeys	Specifies whether the sign-on screen displays a message, that displays the keystroke sequence required to enter the BIOS Boot Option Menu. <ul style="list-style-type: none"> <li>• <b>Enable F12 Boot Option menu</b> - This option is enabled by default.</li> </ul>
Fastboot	Speeds up the boot process by bypassing some compatibility steps. The options are: <ul style="list-style-type: none"> <li>• Minimal</li> <li>• <b>Thorough</b> - This option is selected by default.</li> <li>• Auto</li> </ul>
MEBx Hotkey	Specifies whether the MEBx Hotkey function should be enabled when the computer boots. This option is enabled by default.

**Table 9. Virtualization Support**

Option	Description
Virtualization	This option specifies whether a Virtual Machine Monitor (VMM) can utilize the additional hardware capabilities provided by Intel Virtualization technology. <ul style="list-style-type: none"> <li>• <b>Enable Intel Virtualization Technology</b> - This option is enabled by default.</li> </ul>
VT for Direct I/O	Enables or disables the Virtual Machine Monitor (VMM) from utilizing the additional hardware capabilities provided by Intel® Virtualization technology for direct I/O. <ul style="list-style-type: none"> <li>• <b>Enable Intel Virtualization Technology for Direct I/O</b> - This option is enabled by default.</li> </ul>
Trusted Execution	This option specifies whether a Measured Virtual Machine Monitor (MVMM) can utilize the additional hardware capabilities provided by Intel Trusted Execution technology. The TPM virtualization technology, and Virtualization technology for direct I/O must be enabled to use this feature. <ul style="list-style-type: none"> <li>• <b>Trusted Execution</b> - This option is disabled by default.</li> </ul>

**Table 10. Wireless**







Option	Description
Wireless Device Enable	Allows enabling/disabling the internal wireless devices. The options are: <ul style="list-style-type: none"> <li>• <b>WLAN</b></li> <li>• <b>Bluetooth</b></li> </ul> Both the options are enabled by default.

**Table 11. Maintenance**

Option	Description
Service Tag	Displays the service tag of your computer.
Asset Tag	Allows you to create a system asset tag if an asset tag is not already set. This option is not set by default.

Option	Description
SERR Messages	Controls the SERR message mechanism. This option is not set by default. Some graphics cards require that the SERR message mechanism be disabled.

**Table 12. Cloud Desktop**

Option	Description
Server Lookup Method	<p>This option specifies how the Cloud Desktop software will lookup the server address. The options are:</p> <ul style="list-style-type: none"> <li>• Static IP - Uses the static IP address</li> <li>• <b>DNS</b> - Obtains several IP addresses using the Domain Name System (DNS) protocol. This option is selected by default</li> </ul> <p> <b>NOTE:</b> This option is relevant only when the Integrated NIC control in the System Configuration group is set to Enable with Cloud Desktop.</p>
Server IP Address	<p>This option specifies the primary static IP address of the Cloud Desktop Server with which the client software communicates. The default Server IP Address is <b>255.255.255.255</b></p> <p> <b>NOTE:</b> This option is relevant only when the Integrated NIC control in the System Configuration group is set to Enable with Cloud Desktop.</p>
Server Port	<p>This option specifies the primary IP port of the Cloud Desktop with which the client software communicates. The default Server Port value is <b>06910</b>.</p> <p> <b>NOTE:</b> This option is relevant only when the Integrated NIC control in the System Configuration group is set to Enable with Cloud Desktop.</p>
Client Address Method	<p>This option specifies how the client obtains its IP address. The options are:</p> <ul style="list-style-type: none"> <li>• Static IP - Uses the static IP address</li> <li>• <b>DNS</b> - Obtains several IP addresses using the Domain Name System (DNS) protocol. This option is selected by default</li> </ul> <p> <b>NOTE:</b> This option is relevant only when the Integrated NIC control in the System Configuration group is set to Enable with Cloud Desktop.</p>
Client IP Address	<p>This option specifies the static IP address of the client. The default IP Address is <b>255.255.255.255</b></p> <p> <b>NOTE:</b> This option is relevant only when the Integrated NIC control in the System Configuration group is set to Enable with Cloud Desktop.</p>
Client Subnet Mask	<p>This option specifies the subnet mask IP address of the client. The default IP Address is <b>255.255.255.255</b></p> <p> <b>NOTE:</b> This option is relevant only when the Integrated NIC control in the System Configuration group is set to Enable with Cloud Desktop.</p>
Client Gateway	<p>This option specifies the gateway IP address of the client. The default IP Address is <b>255.255.255.255</b></p> <p> <b>NOTE:</b> This option is relevant only when the Integrated NIC control in the System Configuration group is set to Enable with Cloud Desktop.</p>
Advanced	<p>This option turns on the Verbose Mode for advanced debugging. By default, this option is not enabled.</p>



Option	Description
	 <b>NOTE:</b> This option is relevant only when the Integrated NIC control in the System Configuration group is set to Enable with Cloud Desktop.

**Table 13. System Logs**

Option	Description
BIOS events	Displays the system event log and allows you to clear the log. <ul style="list-style-type: none"> <li>• Clear Log</li> </ul>

## Updating the BIOS

It is recommended to update your BIOS (system setup), on replacing the system board or if an update is available. For laptops, ensure that your computer battery is fully charged and connected to a power outlet

1. Re-start the computer.
2. Go to [dell.com/support](http://dell.com/support).
3. Enter the **Service Tag** or **Express Service Code** and click **Submit**.
  -  **NOTE:** To locate the Service Tag, click **Where is my Service Tag?**
  -  **NOTE:** If you cannot find your Service Tag, click **Detect My Product**. Proceed with the instructions on screen.
4. If you are unable to locate or find the Service Tag, click the Product Category of your computer.
5. Choose the **Product Type** from the list.
6. Select your computer model and the **Product Support** page of your computer appears.
7. Click **Get drivers** and click **View All Drivers**.  
The Drivers and Downloads page opens.
8. On the Drivers and Downloads screen, under the **Operating System** drop-down list, select **BIOS**.
9. Identify the latest BIOS file and click **Download File**.  
You can also analyze which drivers need an update. To do this for your product, click **Analyze System for Updates** and follow the instructions on the screen.
10. Select your preferred download method in the **Please select your download method below window**; click **Download File**.  
The **File Download** window appears.
11. Click **Save** to save the file on your computer.
12. Click **Run** to install the updated BIOS settings on your computer.  
Follow the instructions on the screen.

## System and Setup Password

You can create a system password and a setup password to secure your computer.

Password Type	Description
<b>System password</b>	Password that you must enter to log on to your system.
<b>Setup password</b>	Password that you must enter to access and make changes to the BIOS settings of your computer.

 **CAUTION:** The password features provide a basic level of security for the data on your computer.

 **CAUTION:** Anyone can access the data stored on your computer if it is not locked and left unattended.

 **NOTE:** Your computer is shipped with the system and setup password feature disabled.

## Assigning a System Password and Setup Password

You can assign a new **System Password** and/or **Setup Password** or change an existing **System Password** and/or **Setup Password** only when **Password Status** is **Unlocked**. If the Password Status is **Locked**, you cannot change the System Password.

 **NOTE:** If the password jumper is disabled, the existing System Password and Setup Password is deleted and you need not provide the system password to log on to the computer.

To enter a system setup, press <F2> immediately after a power-on or re-boot.

1. In the **System BIOS** or **System Setup** screen, select **System Security** and press <Enter>. The **System Security** screen appears.

2. In the **System Security** screen, verify that **Password Status** is **Unlocked**.

3. Select **System Password**, enter your system password, and press <Enter> or <Tab>.

Use the following guidelines to assign the system password:

- A password can have up to 32 characters.
- The password can contain the numbers 0 through 9.
- Only lower case letters are valid, upper case letters are not allowed.
- Only the following special characters are allowed: space, ("), (+), (,), (-), (.), (/), (;), ([), (\), (]), (^).

Re-enter the system password when prompted.

4. Type the system password that you entered earlier and click **OK**.

5. Select **Setup Password**, type your system password and press <Enter> or <Tab>.

A message prompts you to re-type the setup password.

6. Type the setup password that you entered earlier and click **OK**.

7. Press <Esc> and a message prompts you to save the changes.

8. Press <Y> to save the changes.

The computer reboots.

## Deleting or Changing an Existing System and/or Setup Password

Ensure that the **Password Status** is **Unlocked** (in the System Setup) before attempting to delete or change the existing System and/or Setup password. You cannot delete or change an existing System or Setup password, if the **Password Status** is **Locked**.

To enter the System Setup, press <F2> immediately after a power-on or reboot.

1. In the **System BIOS** or **System Setup** screen, select **System Security** and press <Enter>.

The **System Security** screen is displayed.

2. In the **System Security** screen, verify that **Password Status** is **Unlocked**.

3. Select **System Password**, alter or delete the existing system password and press <Enter> or <Tab>.

4. Select **Setup Password**, alter or delete the existing setup password and press <Enter> or <Tab>.

 **NOTE:** If you change the System and/or Setup password, re-enter the new password when prompted. If you delete the System and/or Setup password, confirm the deletion when prompted.

5. Press <Esc> and a message prompts you to save the changes.
6. Press <Y> to save the changes and exit from the System Setup.  
The computer reboots.

# Technical Specifications



**NOTE:** Offerings may vary by region. For more information regarding the configuration of your computer, click Start (Start icon) → **Help and Support**, and then select the option to view information about your computer.

**Table 14. System Information**

Feature	Specification
Processor type	<ul style="list-style-type: none"> <li>Intel Dual / Quad Core</li> <li>Intel Core i3 / i5 / i7 series</li> </ul>
Total cache	Up to 8 MB cache depending on processor type
Chipset	Intel Q87 Express chipset

**Table 15. Memory**

Feature	Specification
Type	up to 1600 MHz, unbuffered non-ECC, dual-channel DDR3L configuration
Connectors	two internally-accessible DDR3L SODIMM sockets
Capacity	2 GB, 4 GB, and 8 GB
Minimum Memory	2 GB
Maximum Memory	16 GB

**Table 16. Video**

Feature	Specification
Video Controller (Integrated)	Integrated Intel HD Graphics 4600 (4th generation Core i3/i5/i7 DC/QC CPUs), AMD Radeon HD8750A (optional discrete video solution)
Video Memory	shared memory
External Display Support	VGA, HDMI, and Wi-Fi display



**NOTE:** Wi-Fi display requires a wireless card which must be purchased separately.

**Table 17. Audio**

<b>Feature</b>	<b>Specification</b>
Controller	Intel High Definition Audio with Waves MaxxVoice Pro
Speaker	single 8-ohms speakers in both the left and right speaker assembly (5 W average per channel)
Internal speaker amplifier	up to 15 W per channel
Internal microphone support	dual digital microphone
Volume controls	Volume up/down buttons (Windows 7 only), program menus, and keyboard media-control keys

**Table 18. Communications**

<b>Feature</b>	<b>Specification</b>
Network adapter	Intel 10/100/1000 Mbps Ethernet LAN on system board
Wireless	<ul style="list-style-type: none"> <li>• half mini-card (Wi-Fi b/g/n supporting Wi-Fi display)</li> <li>• combo half mini-card (Bluetooth 4.0 and Wi-Fi b/g/n supporting Wi-Fi display)</li> </ul>

**Table 19. Cards**

<b>Feature</b>	<b>Specification</b>
Mini PCI Express	one

**Table 20. Displays**

<b>Feature</b>	<b>Specification</b>
Type	23-inch full-HD WLED
Maximum resolution	1920 x 1080
Refresh rate	60 Hz
Brightness	Brightness up/down buttons
Operating angle	178 horizontal / 178 vertical
Pixel pitch	0.2652 mm
Controls	on-screen controls

**Table 21. Drives**

<b>Feature</b>	<b>Specification</b>
Hard drive	one 3.5-inch SATA drive or one 2.5-inch SATA drive with an adapter bracket
Optical drive (optional)	one DVD-ROM, DVD+/- RW or combo Blu-ray writer

**Table 22. Ports and Connectors**

<b>Feature</b>	<b>Specification</b>
Audio:	<ul style="list-style-type: none"> <li>• one line-out connector</li> <li>• one audio input/microphone port</li> <li>• one headphone port</li> </ul>
Network adapter	one RJ45 connector
USB 2.0	four
USB 3.0	four
Video	15-pin VGA connector
HDMI	one 19-pin output port
Media card reader	one 8-in-1 slot

**Table 23. Power**

<b>Feature</b>	<b>Specification</b>
200 Watt PSU	
Frequency	50 Hz — 60 Hz
Voltage	100 VAC — 240 VAC
Input current	Maximum 2.90 A Maximum 1.45 A
Coin-cell battery	3 V CR2032 lithium coin cell

**Table 24. Camera (optional)**

<b>Feature</b>	<b>Specification</b>
Image resolution	2.0 megapixel
Video resolution	FHD (1080p)
Diagonal viewing angle	66.2 degrees

**Table 25. Stand**

<b>Feature</b>	<b>Specification</b>
Tilt	–5 degrees to 30 degrees

**Table 26. Physical Dimensions**

<b>Feature</b>	<b>Without Stand</b>	<b>With Stand</b>
Width	574.00 mm (22.60 inches)	574.00 mm (22.60 inches)
Height	385.80 mm (15.19 inches)	441.86 mm (17.40 inches)
Depth:		



Feature	Without Stand	With Stand
non-touch	70.50 mm (2.78 inches)	174.40 mm (6.87 inches)
touch	72.80 mm (2.87 inches)	174.40 mm (6.87 inches)
Weight:		
non-touch	8.10 kg to 8.76 kg (17.86 lb to 19.31 lb)	10.25 kg to 10.91 kg (22.60 lb to 24.05 lb)
touch	9.19 kg to 9.84 kg (20.26 lb to 21.70 lb)	11.34 kg to 11.99 kg (25.00 lb to 26.43 lb)



**NOTE:** The weight of your computer may vary depending on the configuration ordered and the manufacturing variability.

**Table 27. Controls and Lights**

Feature	Specification
Power button light	White light — Solid white light indicates power-on state; blinking white light indicates sleep state of the computer.
Hard Drive activity light	White light — Blinking white light indicates that the computer is reading data from or writing data to the hard drive.
Camera LED	White light — solid white light indicates that the camera is on.
Back panel:	
Link integrity light on integrated network adapter :	Green — a good 10 Mbps connection exists between the network and the computer. Green — a good 100 Mbps connection exists between the network and the computer. Orange — a good 1000 Mbps connection exists between the network and the computer. Off (no light) — the computer is not detecting a physical connection to the network.
Network activity light on integrated network adapter	Yellow light — A blinking yellow light indicates that network activity is present.
Power supply diagnostic light	Green light — The power supply is turned on and is functional. The power cable must be connected to the power connector (at the back of the computer) and the electrical outlet.

**Table 28. Environmental**

Feature	Specification
Temperature range:	
Operating	5°C to 35 °C (41 °F to 95 °F)
Storage	-40 °C to 65 °C (-40 °F to 149 °F)

<b>Feature</b>	<b>Specification</b>
Relative humidity (maximum):	
Operating	10% to 90% (non-condensing)
Storage	10% to 95% (non-condensing)
Maximum vibration:	
Operating	0.66 GRMS
Storage	1.30 GRMS
Maximum shock:	
Operating	110 G
Storage	160 G
Altitude:	
Operating	-15.2 m to 3048 m (-50 to 10,000 ft)
Storage	-15.20 m to 10,668 m (-50 ft to 35,000 ft)
Airborne contaminant level	G2 or lower as defined by ANSI/ISA-S71.04-1985

## Contacting Dell

 **NOTE:** If you do not have an active Internet connection, you can find contact information on your purchase invoice, packing slip, bill, or Dell product catalog.

Dell provides several online and telephone-based support and service options. Availability varies by country and product, and some services may not be available in your area. To contact Dell for sales, technical support, or customer service issues:

1. GO to **dell.com/support**.
2. Select your support category.
3. Verify your country or region in the **Choose a Country/Region** drop-down list at the top of page.
4. Select the appropriate service or support link based on your need.