

# Dell EMC PowerEdge MX740c

## Installation and Service Manual

## Notes, cautions, and warnings

 **NOTE:** A NOTE indicates important information that helps you make better use of your product.

 **CAUTION:** A CAUTION indicates either potential damage to hardware or loss of data and tells you how to avoid the problem.

 **WARNING:** A WARNING indicates a potential for property damage, personal injury, or death.

<b>Chapter 1: About this document.....</b>	<b>7</b>
<b>Chapter 2: PowerEdge MX740c sled overview.....</b>	<b>8</b>
Front view of the system.....	9
Inside the system.....	9
Locating the Service Tag of your system.....	10
System information label.....	11
<b>Chapter 3: Initial system setup and configuration.....</b>	<b>14</b>
Setting up your system.....	14
iDRAC configuration.....	14
Options to set up iDRAC IP address.....	14
Log in to iDRAC.....	15
Options to install the operating system.....	15
Methods to download firmware and drivers.....	16
Downloading drivers and firmware.....	16
<b>Chapter 4: Pre-operating system management applications.....</b>	<b>17</b>
Options to manage the pre-operating system applications.....	17
System Setup.....	17
View System Setup.....	17
System Setup details.....	18
System BIOS.....	18
iDRAC Settings utility.....	39
Device Settings.....	39
Dell Lifecycle Controller.....	39
Embedded System Management.....	39
Boot Manager.....	39
View the boot manager.....	39
Boot Manager main menu.....	40
One-shot UEFI Boot menu.....	40
System Utilities.....	40
PXE boot.....	40
<b>Chapter 5: Installing and removing system components.....</b>	<b>41</b>
Safety instructions.....	41
Before working inside your sled.....	42
After working inside your sled.....	42
Recommended tools.....	42
PowerEdge MX740c sled.....	42
Removing the sled from enclosure.....	42
Installing the sled into enclosure.....	44
System cover.....	45
Removing the system cover.....	45

Installing system cover.....	46
Air shroud.....	48
Removing air shroud.....	48
Installing air shroud.....	48
Drives.....	49
Removing drive blank.....	49
Installing drive blank.....	50
Removing drive carrier.....	50
Installing drive carrier.....	51
Removing a drive from drive carrier.....	52
Installing a drive into drive carrier.....	53
Drive backplane.....	54
Removing drive backplane.....	55
Installing drive backplane.....	56
Cable routing.....	58
Drive cage.....	62
Removing the drive cage.....	62
Installing the drive cage.....	63
Battery backup unit .....	64
Removing the battery backup unit.....	64
Installing the battery backup unit.....	65
Removing the BBU from the BBU cage.....	66
Installing the BBU into the BBU cage.....	67
Control panel.....	68
Removing the control panel.....	68
Installing the control panel .....	69
System memory.....	70
General memory module installation guidelines.....	72
NVDIMM-N memory module installation guidelines .....	72
DCPMM installation guidelines .....	74
Mode-specific guidelines.....	76
Removing a memory module.....	79
Installing a memory module.....	80
Processors and heat sinks.....	81
Removing the processor and heat sink module.....	81
Removing the processor from the processor and heat sink module.....	82
Installing the processor into a processor and heat sink module.....	83
Installing a processor and heat sink module.....	86
iDRAC card.....	87
Removing the iDRAC card.....	87
Installing the iDRAC card.....	88
PERC card.....	89
Removing the PERC card.....	90
Installing the PERC card.....	90
Removing the Jumbo PERC card.....	91
Installing the Jumbo PERC card.....	92
Optional Internal dual SD module.....	93
Removing the IDSDM card.....	93
Installing the IDSDM card.....	94
Removing a MicroSD card.....	95

Installing a MicroSD card.....	96
M.2 BOSS module.....	97
Removing the M.2 BOSS module.....	97
Installing the M.2 BOSS module.....	98
Removing the M.2 BOSS card.....	99
Installing the M.2 BOSS card.....	100
Mezzanine card.....	101
Removing the Mezzanine card.....	101
Installing the Mezzanine card.....	102
Removing the mini Mezzanine card.....	103
Installing the mini Mezzanine card.....	104
Removing the mini Mezzanine card blank.....	105
Installing the mini Mezzanine card blank.....	106
Optional internal USB memory key.....	107
Replacing the optional internal USB memory key.....	107
System battery.....	107
Replacing the system battery - Option A.....	107
Replacing the system battery - Option B.....	109
System board.....	110
Removing the system board.....	110
Installing the system board.....	112
Trusted Platform Module.....	114
Upgrading the TPM.....	115
Initializing TPM for BitLocker users.....	116
Initializing the TPM 1.2 for TXT users.....	116
Initializing the TPM 2.0 for TXT users.....	116
<b>Chapter 6: Jumpers and connectors.....</b>	<b>118</b>
System board jumpers and connectors.....	118
System board jumper settings.....	119
Disabling a forgotten password.....	120
<b>Chapter 7: Technical specifications.....</b>	<b>121</b>
System dimensions.....	121
System weight.....	122
Processor specifications.....	122
Intel Quick Assist Technology.....	122
Supported operating systems.....	122
System battery specifications.....	122
Memory specifications.....	123
Hard drives.....	123
Mezzanine and Mini Mezzanine slots specifications.....	123
Storage controller specifications.....	124
Ports and connectors specifications.....	124
USB ports.....	124
Internal Dual SD Module .....	124
Micro SD vFlash connector.....	124
Video specifications .....	124
Environmental specifications.....	124

Particulate and gaseous contamination specifications .....	125
Standard operating temperature.....	126
Expanded operating temperature.....	126
Thermal.....	127
<b>Chapter 8: System diagnostics and indicator codes .....</b>	<b>129</b>
Power button LED.....	129
Drive indicator codes.....	129
System health and system ID indicator codes.....	130
System diagnostics.....	130
Dell Embedded System Diagnostics.....	131
<b>Chapter 9: Getting help.....</b>	<b>132</b>
Contacting Dell EMC.....	132
Documentation feedback.....	132
Accessing system information by using QRL.....	132
Quick Resource Locator for PowerEdge MX740c system.....	133
Receiving automated support with SupportAssist .....	133
Recycling or End-of-Life service information.....	133
<b>Chapter 10: Documentation resources.....</b>	<b>134</b>

# About this document

This document provides an overview about the PowerEdge MX740c system, information about installing and replacing components, technical specifications, diagnostic tools, and guidelines to be followed while installing certain components.

The PowerEdge MX740c is compatible with the PowerEdge MX7000 enclosure. For more information about the enclosure, refer to the *Installation and Service Manual* for the PowerEdge MX7000 at [www.dell.com/poweredgemanuals](http://www.dell.com/poweredgemanuals).

# PowerEdge MX740c sled overview

The Dell EMC PowerEdge MX740c is a single width compute sled and supports:

- Up to two Intel Xeon Scalable processors.
- Up to 24 DIMM slots.
- Up to six 2.5-inch SAS, SATA (HDD/SSD), or NVMe drives.

**NOTE:** All instances of SAS, NVMe, SATA HDDs, and SSDs are referred to as drives in this document, unless specified otherwise.

## Topics:

- [Front view of the system](#)
- [Inside the system](#)
- [Locating the Service Tag of your system](#)
- [System information label](#)

# Front view of the system

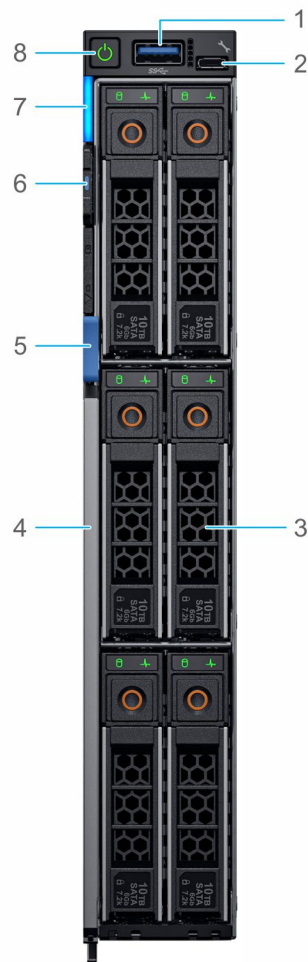

**Figure 1. Front view of the 6 drive configuration**

- 1. USB 3.0 port
- 2. iDRAC direct port
- 3. Drives
- 4. Release handle
- 5. Release handle button
- 6. Information tag
- 7. System health and System ID indicator
- 8. Power button

For more information about the ports, see [Technical Specifications](#).

## Inside the system

**NOTE:** Components that are hot swappable have orange touch points and the components that are not hot swappable have blue touch points.

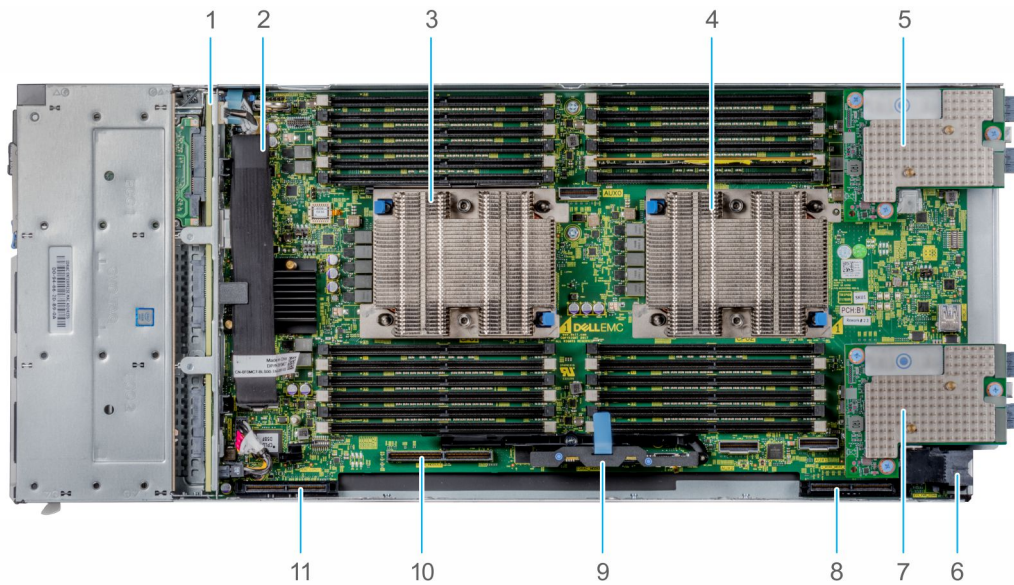
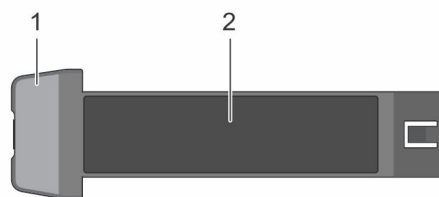

**Figure 2. Inside the system**

1. Backplane
2. Backplane cable
3. Processor 1 (heat sink)
4. Processor 2 (heat sink)
5. Mezzanine card A1
6. Power connector
7. Mezzanine card B1
8. Mini Mezzanine connector
9. iDRAC card
10. BOSS connector
11. PERC connector

## Locating the Service Tag of your system

The System Information Tab contains the system's unique Express Service Code and Service Tag. This information is used by Dell EMC to identify system configuration, warranty terms, and to route support calls to the appropriate personnel. A Quick Resource Locator (QRL) label on the System Information Tab links to a web page that shows the exact factory configuration and specific warranty purchased.



**Figure 3. Locating Service Tag of your system**

1. Information tag
2. Service tag

# System information label

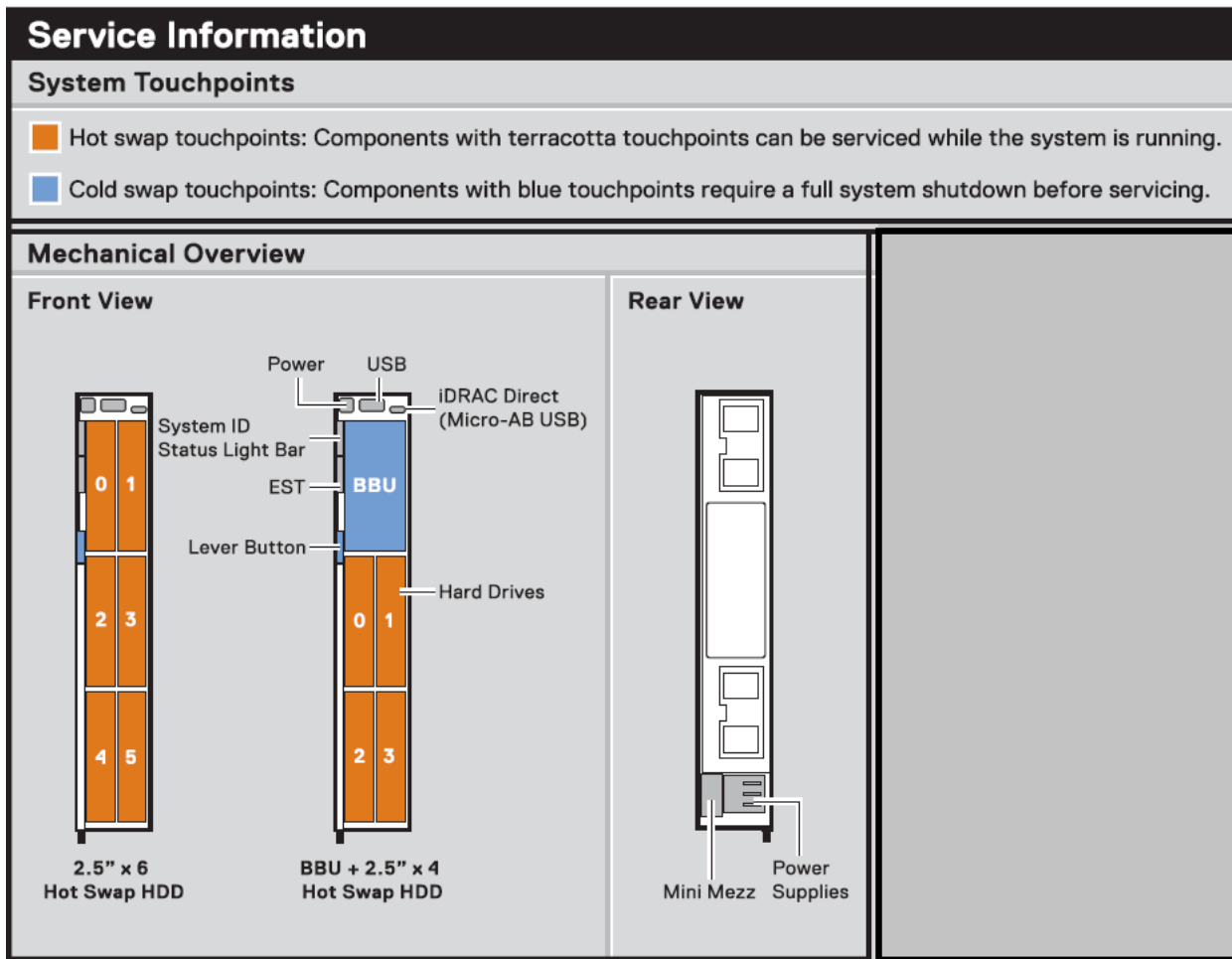

Figure 4. Mechanical overview

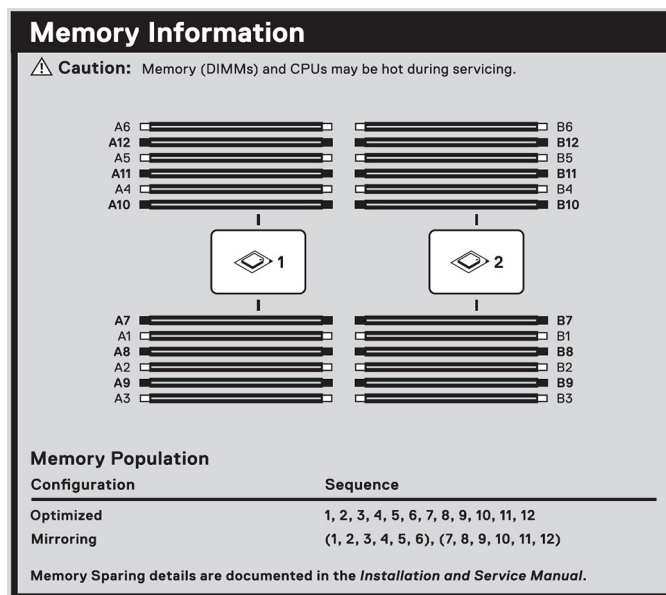

Figure 5. Memory information

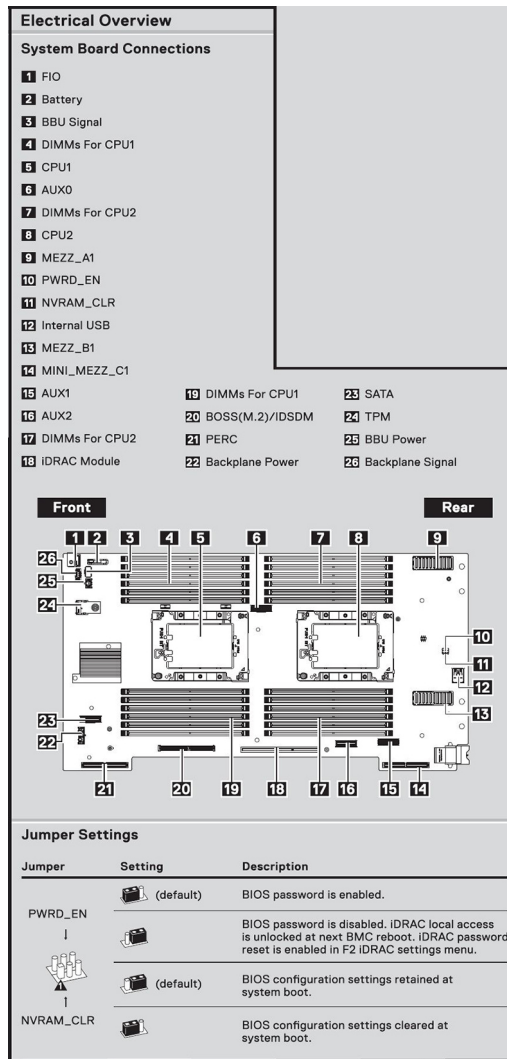

Figure 6. System board

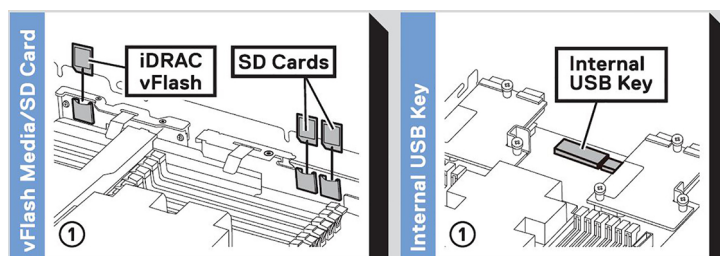

Figure 7. Removal of iDSMD and Internal USB memory key(optional)

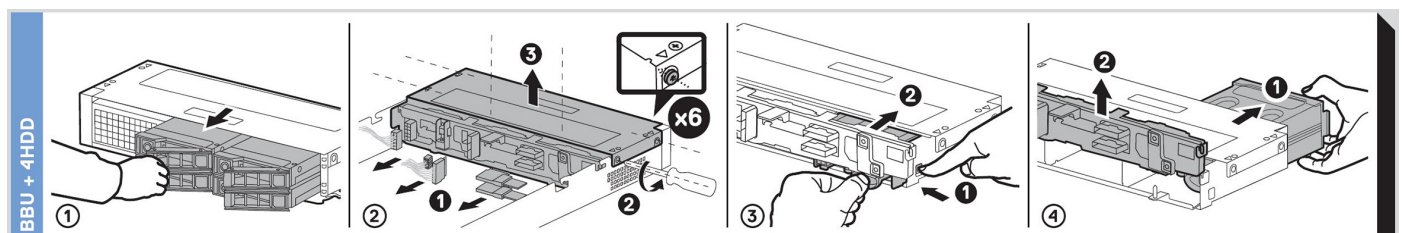

Figure 8. Removal of BBU module and drive cage

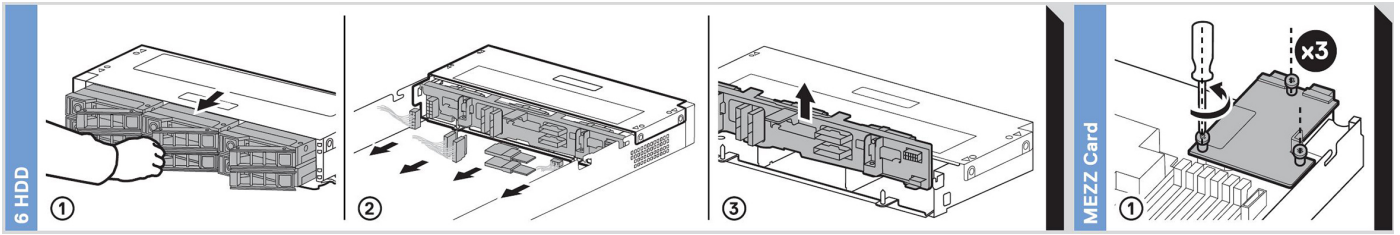

Figure 9. Removal of backplane and Mezzanine card

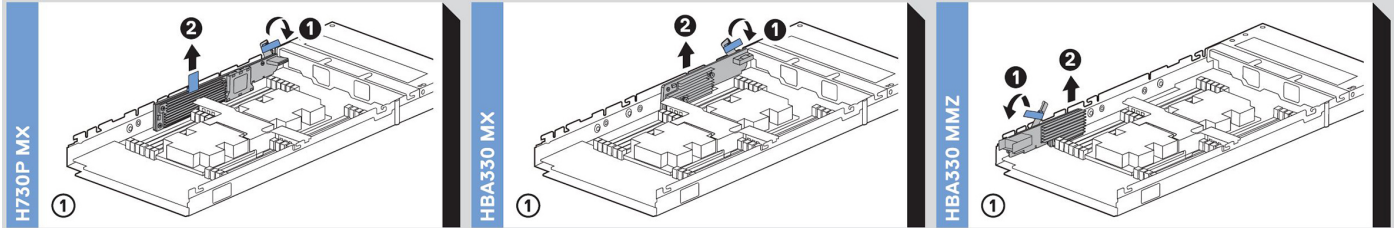

Figure 10. Removal of PERC cards and Mini Mezzanine card

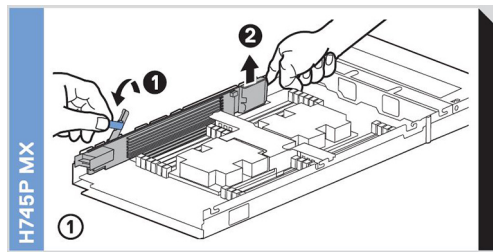

Figure 11. Removal of Jumbo PERC card

# Initial system setup and configuration

## Topics:

- [Setting up your system](#)
- [iDRAC configuration](#)
- [Options to install the operating system](#)

## Setting up your system

Complete the following steps to set up your system:

### Steps

1. Unpack the system.
2. Remove the I/O connector cover from the system connectors.

 **CAUTION:** While installing the system, ensure that it is properly aligned with the slot on the enclosure to prevent damage to the system connectors.

3. Install the system in the enclosure.
4. Turn on the enclosure.

 **NOTE:** Wait for the enclosure to initialize before you press the power button.

5. Press the power button on the system.

Alternatively, you can also turn on the system by using iDRAC:

- For more information, see the [Log in to iDRAC](#) on page 15
- Open OpenManage Enterprise modular(OME modular), after the iDRAC is configured on the OME. For more information, see the OME-modular User's Guide at [Dell.com/manuals](http://Dell.com/manuals).

## iDRAC configuration

The Integrated Dell Remote Access Controller (iDRAC) is designed to make system administrators more productive and improve the overall availability of Dell systems. iDRAC alerts administrators about system issues and enables them to perform remote system management. This reduces the need for physical access to the system.

## Options to set up iDRAC IP address

You must configure the initial network settings based on your network infrastructure to enable the communication to and from iDRAC.

You can set up the IP address by using one of the following interfaces:

Interfaces	Document/Section
<b>iDRAC Settings utility</b>	See <i>Dell Integrated Dell Remote Access Controller User's Guide</i> at <a href="http://www.dell.com/poweredgemanuals">www.dell.com/poweredgemanuals</a>
<b>Dell Deployment Toolkit</b>	See <i>Dell Deployment Toolkit User's Guide</i> at <a href="http://www.dell.com/openmanagemanuals">www.dell.com/openmanagemanuals</a> > OpenManage Deployment Toolkit

Interfaces	Document/Section
Dell Lifecycle Controller	See <i>Dell Lifecycle Controller User's Guide</i> at <a href="http://www.dell.com/poweredgemanuals">www.dell.com/poweredgemanuals</a>
OME Modular	See <i>Dell OpenManagement Enterprise Modular User's Guide</i> at <a href="http://www.dell.com/openmanagemanuals">www.dell.com/openmanagemanuals</a>
iDRAC Direct	See <i>Dell Integrated Dell Remote Access Controller User's Guide</i> at <a href="http://www.dell.com/poweredgemanuals">www.dell.com/poweredgemanuals</a>

## Log in to iDRAC

You can log in to iDRAC as:

- iDRAC user
- Microsoft Active Directory user
- Lightweight Directory Access Protocol (LDAP) user

If you have opted for secure default access to iDRAC, you must use the iDRAC secure default password available on the system Information tag. If you have not opted for secure default access to iDRAC, then use the default user name and password `-root` and `calvin`. You can also log in by using your Single Sign-On or Smart Card.

**NOTE:** You must have the iDRAC credentials to log in to iDRAC.

**NOTE:** Ensure that you change the default username and password after setting up the iDRAC IP address.

**NOTE:** The Intel Quick Assist Technology (QAT) on the Dell EMC PowerEdge MX740c is supported with chipset integration and is enabled through an optional license. The license files are enabled on the sleds through iDRAC.

For more information about drivers, documentation, and white papers on the Intel QAT, see <https://01.org/intel-quickassist-technology>.

For more information about logging in to the iDRAC and iDRAC licenses, see the latest *Integrated Dell Remote Access Controller User's Guide* at [www.dell.com/poweredgemanuals](http://www.dell.com/poweredgemanuals).

You can also access iDRAC by using RACADM. For more information, see the *RACADM Command Line Interface Reference Guide* at [www.dell.com/poweredgemanuals](http://www.dell.com/poweredgemanuals).

## Options to install the operating system

If the system is shipped without an operating system, install the supported operating system by using one of the following resources:

**Table 1. Resources to install the operating system**

Resources	Location
iDRAC	<a href="http://www.dell.com/idracmanuals">www.dell.com/idracmanuals</a>
Lifecycle Controller	<a href="http://www.dell.com/idracmanuals">www.dell.com/idracmanuals</a>
OpenManage Deployment Toolkit	<a href="http://www.dell.com/openmanagemanuals">www.dell.com/openmanagemanuals</a> > OpenManage Deployment Toolkit
Dell certified VMware ESXi	<a href="http://www.dell.com/virtualizationsolutions">www.dell.com/virtualizationsolutions</a>
Installation and How-to videos for supported operating systems on PowerEdge systems	<a href="#">Supported Operating Systems for Dell PowerEdge Systems</a>

**NOTE:** Virtual Media is optional for integrated Dell Remote Access Controllers (iDRAC) with an Enterprise license (iDRAC 7, 8 and 9) or module (iDRAC 6). It allows the usage of software image files (ISO-files), which can be used for installing operating systems or updating servers.

## Methods to download firmware and drivers

You can download the firmware and drivers by using any of the following methods:

**Table 2. Firmware and drivers**

Methods	Location
From the Dell EMC support site	<a href="http://www.dell.com/support/home">www.dell.com/support/home</a>
Using Dell Remote Access Controller Lifecycle Controller (iDRAC with LC)	<a href="http://www.dell.com/idracmanuals">www.dell.com/idracmanuals</a>
Using Dell Repository Manager (DRM)	<a href="http://www.dell.com/openmanagemanuals">www.dell.com/openmanagemanuals</a> > Repository Manager
Using Dell OpenManage Essentials	<a href="http://www.dell.com/openmanagemanuals">www.dell.com/openmanagemanuals</a> > OpenManage Essentials
Using Dell OpenManage Enterprise	<a href="http://www.dell.com/openmanagemanuals">www.dell.com/openmanagemanuals</a> > OpenManage Enterprise
Using Dell Server Update Utility (SUU)	<a href="http://www.dell.com/openmanagemanuals">www.dell.com/openmanagemanuals</a> > Server Update Utility
Using Dell OpenManage Deployment Toolkit (DTK)	<a href="http://www.dell.com/openmanagemanuals">www.dell.com/openmanagemanuals</a> > OpenManage Deployment Toolkit
Using iDRAC virtual media	<a href="http://www.dell.com/idracmanuals">www.dell.com/idracmanuals</a>

## Downloading drivers and firmware

Dell EMC recommends that you download and install the latest BIOS, drivers, and systems management firmware on your system.

### Prerequisites

Ensure that you clear the web browser cache before downloading the drivers and firmware.

### Steps

1. Go to [www.dell.com/support/home](http://www.dell.com/support/home).
2. In the **Drivers & Downloads** section, type the Service Tag of your system in the **Enter a Service Tag or product ID** box, and then click **Submit**.  
 **NOTE:** If you do not have the Service Tag, select **Detect Product** to allow the system to automatically detect the Service Tag, or click **View products**, and navigate to your product.
3. Click **Drivers & Downloads**.  
The drivers that are applicable to your system are displayed.
4. Download the drivers to a USB drive, CD, or DVD.

# Pre-operating system management applications

You can manage basic settings and features of a system without booting to the operating system by using the system firmware.

## Topics:

- [Options to manage the pre-operating system applications](#)
- [System Setup](#)
- [Dell Lifecycle Controller](#)
- [Boot Manager](#)
- [PXE boot](#)

## Options to manage the pre-operating system applications

Your system has the following options to manage the pre-operating system applications:

- System Setup
- Dell Lifecycle Controller
- Boot Manager
- Preboot Execution Environment (PXE)

## System Setup

By using the **System Setup** screen, you can configure the BIOS settings, iDRAC settings, and Device settings of your system.

 **NOTE:** Help text for the selected field is displayed in the graphical browser by default. To view the help text in the text browser, press F1.

You can access system setup by using two methods:

- Standard graphical browser—The browser is enabled by default.
- Text browser—The browser is enabled by using Console Redirection.

## View System Setup

To view the **System Setup** screen, perform the following steps:

### Steps

1. Turn on, or restart your system.
2. Press F2 immediately after you see the following message:

```
F2 = System Setup
```

 **NOTE:** If your operating system begins to load before you press F2, wait for the system to finish booting, and then restart your system and try again.

## System Setup details

The **System Setup Main Menu** screen details are explained as follows:

Option	Description
<b>System BIOS</b>	Enables you to configure BIOS settings.
<b>iDRAC Settings</b>	Enables you to configure the iDRAC settings.  The iDRAC settings utility is an interface to set up and configure the iDRAC parameters by using UEFI (Unified Extensible Firmware Interface). You can enable or disable various iDRAC parameters by using the iDRAC settings utility. For more information about this utility, see <i>Integrated Dell Remote Access Controller User's Guide</i> at <a href="http://www.dell.com/idracmanuals">www.dell.com/idracmanuals</a> .
<b>Device Settings</b>	Enables you to configure device settings such as network cards or storage controllers.

## System BIOS

You can use the **System BIOS** screen to edit specific functions such as boot order, system password, setup password, set the SATA and PCIe NVMe RAID mode, and enable or disable USB ports.

### Viewing System BIOS

To view the **System Setup** screen, perform the following steps:

#### Steps

1. Turn on, or restart your system.
2. Press F2 immediately after you see the following message:

```
F2 = System Setup
```

**NOTE:** If your operating system begins to load before you press F2, wait for the system to finish booting, and then restart your system and try again.

3. On the **System Setup Main Menu** screen, click **System BIOS**.

## System BIOS Settings details

#### About this task

The **System BIOS Settings** screen details are explained as follows:

Option	Description
<b>System Information</b>	Specifies information about the system such as the system model name, BIOS version, and Service Tag.
<b>Memory Settings</b>	Specifies information and options related to the installed memory.
<b>Processor Settings</b>	Specifies information and options related to the processor such as speed and cache size.
<b>SATA Settings</b>	Specifies options to enable or disable the integrated SATA controller and ports.
<b>NVMe Settings</b>	Specifies options to change the NVMe settings. If the system contains the NVMe drives that you want to configure in a RAID array, you must set both this field and the <b>Embedded SATA</b> field on the <b>SATA Settings</b> menu to <b>RAID</b> mode. You might also need to change the <b>Boot Mode</b> setting to <b>UEFI</b> . Otherwise, you should set this field to <b>Non-RAID</b> mode.
<b>Boot Settings</b>	Specifies options to specify the Boot mode (BIOS or UEFI). Enables you to modify UEFI and BIOS boot settings.

Option	Description
<b>Network Settings</b>	Specifies options to manage the UEFI network settings and boot protocols. Legacy network settings are managed from the <b>Device Settings</b> menu.
<b>Integrated Devices</b>	Specifies options to manage integrated device controllers and ports, specifies related features and options.
<b>Serial Communication</b>	Specifies options to manage the serial ports, its related features and options.
<b>System Profile Settings</b>	Specifies options to change the processor power management settings, memory frequency.
<b>System Security</b>	Specifies options to configure the system security settings, such as system password, setup password, Trusted Platform Module (TPM) security, and UEFI secure boot. It also manages the power button on the system.
<b>Redundant OS Control</b>	Sets the redundant OS info for redundant OS control.
<b>Miscellaneous Settings</b>	Specifies options to change the system date and time.

## System Information

You can use the **System Information** screen to view system properties such as Service Tag, system model name, and the BIOS version.

### View System Information

To view the **System Information** screen, perform the following steps:

#### Steps

1. Turn on, or restart your system.
2. Press F2 immediately after you see the following message:

```
F2 = System Setup
```

**NOTE:** If your operating system begins to load before you press F2, wait for the system to finish booting, and then restart your system and try again.

3. On the **System Setup Main Menu** screen, click **System BIOS**.
4. On the **System BIOS** screen, click **System Information**.

### System Information details

#### About this task

The **System Information** screen details are explained as follows:

Option	Description
<b>System Model Name</b>	Specifies the system model name.
<b>System BIOS Version</b>	Specifies the BIOS version installed on the system.
<b>System Management Engine Version</b>	Specifies the current version of the Management Engine firmware.

Option	Description
<b>System Service Tag</b>	Specifies the system Service Tag.
<b>System Manufacturer</b>	Indicates the name of the Original Equipment Manufacturer (OEM).
<b>System Manufacturer Contact Information</b>	Indicates the contact information of the Original Equipment Manufacturer (OEM).
<b>System CPLD Version</b>	Specifies the current version of the system, complex programmable logic device (CPLD) firmware.
<b>UEFI Compliance Version</b>	Specifies the UEFI compliance level of the system firmware.

## Memory Settings

You can use the **Memory Settings** screen to view all the memory settings and enable or disable specific memory functions, such as system memory testing and node interleaving.

### View Memory Settings

To view the **Memory Settings** screen, perform the following steps:

#### Steps

1. Turn on, or restart your system.
2. Press F2 immediately after you see the following message:

```
F2 = System Setup
```

**NOTE:** If your operating system begins to load before you press F2, wait for the system to finish booting, and then restart your system and try again.

3. On the **System Setup Main Menu** screen, click **System BIOS**.
4. On the **System BIOS** screen, click **Memory Settings**.

### Memory Settings details

#### About this task

The **Memory Settings** screen details are explained as follows:

Option	Description
<b>System Memory Size</b>	Specifies the memory size in the system.
<b>System Memory Type</b>	Specifies the type of memory that is installed in the system.
<b>System Memory Speed</b>	Specifies the system memory speed.
<b>System Memory Voltage</b>	Specifies the system memory voltage.
<b>Video Memory</b>	Specifies the amount of video memory.
<b>System Memory Testing</b>	Specifies whether the system memory tests are run during system boot. Options are <b>Enabled</b> and <b>Disabled</b> . This option is set to <b>Disabled</b> by default.

Option	Description
	<p><b>NOTE:</b> When <b>Enabled</b> the system takes more to boot. The booting time depends on the size of the system memory.</p>
<b>Memory Operating Mode</b>	<p>Specifies the memory operating mode. The options available are <b>Optimizer Mode</b>, <b>Single Rank Spare Mode</b>, <b>Multi Rank Spare Mode</b>, <b>Mirror Mode</b>, and <b>Dell Fault Resilient Mode</b>. This option is set to <b>Optimizer Mode</b> by default.</p> <p><b>NOTE:</b> The <b>Memory Operating Mode</b> option can have different default and available options based on the memory configuration of your system.</p> <p><b>NOTE:</b> The <b>Fault Resilient Mode</b> option establishes an area of memory that is fault resilient. This mode can be used by an operating system that supports the feature to load critical applications or enables the operating system kernel to maximize system availability.</p> <p><b>NOTE:</b> Only Optimizer Mode should be selected when Intel DC Optane Persistent Memory is installed.</p>
<b>Current State of Memory Operating Mode</b>	Specifies the current state of the memory operating mode.
<b>Node Interleaving</b>	Specifies if Non-Uniform Memory Architecture (NUMA) is supported. If this field is set to <b>Enabled</b> , memory interleaving is supported if a symmetric memory configuration is installed. If the field is set to <b>Disabled</b> , the system supports NUMA (asymmetric) memory configurations. This option is set to <b>Disabled</b> by default.
<b>ADDDC Setting</b>	Enables or disables <b>ADDDC Setting</b> feature. When Adaptive Double DRAM Device Correction (ADDDC) is enabled, failing DRAMs are dynamically mapped out. When set to <b>Enabled</b> it can have some impact to system performance under certain workloads. This feature is applicable for x4 DIMMs only. This option is set to <b>Enabled</b> by default.
<b>Native tRFC Timing for 16Gb DIMMs</b>	Enables 16 Gb density DIMMs to operate at their programmed Row Refresh Cycle Time (tRFC). Enabling this feature may improve system performance for some configurations. However, enabling this feature will have no effect on configurations with 16 Gb 3DS/TSV DIMMs. This option is set to <b>Enabled</b> by default.
<b>Opportunistic Self-Refresh</b>	Enables or disables opportunistic self-refresh feature. This option is set to <b>Disabled</b> by default.
<b>Correctable Error Logging</b>	Enables or disables logging of correctable memory threshold error. This option is set to <b>Enabled</b> by default.
<b>Persistent Memory</b>	This field controls Persistent Memory on the system. This option is available if the persistent memory module is installed in the system.

## Persistent Memory details

### About this task

The **Persistent Memory** screen details are explained as follows:

Option	Description
<b>Persistent Memory</b>	Enables or disables persistency for NVDIMM-N. If this option is set to <b>Off</b> , persistency for all NVDIMM-N is disabled and is not presented to operating system (data is not preserved). If this option is set to <b>Non-Volatile DIMM</b> , persistency for all NVDIMM-N is enabled and presented to operating system (data is preserved). This option is set to <b>Non-Volatile DIMM</b> by default.
<b>Persistent Memory Scrubbing</b>	Enables scrubbing of persistent memory during POST.
<b>Sanitize All NVDIMMs</b>	Enables or disables clearing data on the NVDIMM-N. If set to <b>Enable</b> , all data on the NVDIMM-N is lost. This option is used to remove data on the NVDIMM-N, repurpose your system. This option is set to <b>Disable</b> by default.

Option	Description
<b>NVDIMM-N Read-Only</b>	Enables or disables the read-only option for the NVDIMM-N. If set to <b>Enable</b> , all NVDIMM-N is forced to read-only. Read-only is intended to be for debug or maintenance when customers would like to access the NVDIMM-N data and also to lock it from being updated. This option is set to <b>Disable</b> by default.
<b>NVDIMM-N Interleave</b>	Enables or disables interleaving on NVDIMM-N. Volatile RDIMM interleaving policy is not affected by this option. This option is set to <b>Disable</b> by default.
<b>Battery Status</b>	Indicates if the NVDIMM-N battery is ready. <b>Battery Status</b> can display one of the following states: <ul style="list-style-type: none"> <li>• <b>Present-Ready</b></li> <li>• <b>Present-Offline</b></li> <li>• <b>Not-Ready</b></li> </ul> <p>The following settings are applicable for every NVDIMM-N present in the system.</p>
<b>NVDIMM-N Memory Location</b>	Specifies the location of the NVDIMM-N in each channel.
<b>NVDIMM-N Memory Size</b>	Specifies information about the capacity of the NVDIMM-N.
<b>NVDIMM-N Memory Speed</b>	Specifies information about the speed of the NVDIMM-N.
<b>NVDIMM-N Memory Firmware version</b>	Specifies information about the current firmware version on the NVDIMM-N.
<b>NVDIMM-N Memory Serial Number</b>	Specifies information about the serial number of the NVDIMM-N.
<b>Remaining Rated Write Endurance[%]</b>	Specifies information on the remaining NVDIMM-N flash life-time in terms of percentage.
<b>Sanitize All NVDIMMs</b>	Enables clearing data on specific NVDIMM-N and results in loss of data on that specific NVDIMM-N.

The **Persistent Memory** screen details can be found in the *NVDIMM-N User Guide* and *DCPMM User Guide* at [www.dell.com/poweredge/manuals](http://www.dell.com/poweredge/manuals).

## Processor Settings

You can use the **Processor Settings** screen to view the processor settings, and perform specific functions such as enabling virtualization technology, hardware prefetcher, logical processor idling, and opportunistic self-refresh.

### View Processor Settings

To view the **Processor Settings** screen, perform the following steps:

#### Steps

1. Turn on, or restart your system.
2. Press F2 immediately after you see the following message:

```
F2 = System Setup
```

**NOTE:** If your operating system begins to load before you press F2, wait for the system to finish booting, and then restart your system and try again.

3. On the **System Setup Main Menu** screen, click **System BIOS**.
4. On the **System BIOS** screen, click **Processor Settings**.

## Processor Settings details

### About this task

The **Processor Settings** screen details are explained as follows:

Option	Description
<b>Logical Processor</b>	Enables or disables the logical processors and displays the number of logical processors. If this option is set to <b>Enabled</b> , the BIOS displays all the logical processors. If this option is set to <b>Disabled</b> , the BIOS displays only one logical processor per core. This option is set to <b>Enabled</b> by default.
<b>CPU Interconnect Speed</b>	<p>Enables you to govern the frequency of the communication links among the CPUs in the system.</p> <p> <b>NOTE:</b> The standard and basic bin processors support lower link frequencies.</p> <p>The options available are <b>Maximum data rate, 10.4 GT/s</b>, and <b>9.6 GT/s</b>. This option is set to <b>Maximum data rate</b> by default.</p> <p>Maximum data rate indicates that the BIOS runs the communication links at the maximum frequency that is supported by the processors. You can also select specific frequencies that the processors support, which can vary.</p> <p>For best performance, you should select <b>Maximum data rate</b>. Any reduction in the communication link frequency affects the performance of nonlocal memory accesses and cache coherency traffic. In addition, it can slow access to nonlocal I/O devices from a particular CPU.</p> <p>However, if power-saving considerations outweigh performance, you might want to reduce the frequency of the CPU communication links. If you do this, you should localize memory and I/O accesses to the nearest NUMA node to minimize the impact to system performance.</p>
<b>Virtualization Technology</b>	Enables or disables the virtualization technology for the processor. This option is set to <b>Enabled</b> by default.
<b>Adjacent Cache Line Prefetch</b>	Optimizes the system for applications that need high utilization of sequential memory access. This option is set to <b>Enabled</b> by default. You can disable this option for applications that need high utilization of random memory access.
<b>Hardware Prefetcher</b>	Enables or disables the hardware prefetcher. This option is set to <b>Enabled</b> by default.
<b>Software Prefetcher</b>	Enables or disables the software prefetcher. This option is set to <b>Enabled</b> by default.
<b>DCU Streamer Prefetcher</b>	Enables or disables the Data Cache Unit (DCU) streamer prefetcher. This option is set to <b>Enabled</b> by default.
<b>DCU IP Prefetcher</b>	Enables or disables the Data Cache Unit (DCU) IP prefetcher. This option is set to <b>Enabled</b> by default.
<b>Sub NUMA Cluster</b>	Sub NUMA Clustering (SNC) is a feature for breaking up the LLC into disjoint clusters based on address range, with each cluster bound to a subset of the memory controllers in the system. It improves average latency to the LLC. Enables or disables the Sub NUMA Cluster. This option is set to <b>Disabled</b> by default.
<b>UPI Prefetch</b>	Enables you to get the memory read started early on DDR bus. The Ultra Path Interconnect (UPI) Rx path spawns the speculative memory read to Integrated Memory Controller (iMC) directly. This option is set to <b>Enabled</b> by default.
<b>LLC Prefetch</b>	Enables or disables the LLC Prefetch on all threads. This option is set to <b>Disabled</b> by default.
<b>Dead Line LLC Alloc</b>	When enabled, it opportunistically fill dead lines in LLC. When disabled, it never fill dead lines in LLC. This option is set to <b>Enabled</b> by default.
<b>Directory AtoS</b>	AtoS optimization reduces remote read latencies for repeat read accesses without intervening writes. This option is set to <b>Disabled</b> by default.
<b>FastGo</b>	Enables you to select CR OOS Configuration Profiles.
<b>IRQ Throttle</b>	Enables you to throttle local requests that are targeting a remote address.
<b>Logical Processor Idling</b>	Enables you to improve the energy efficiency of a system. It uses the operating system core parking algorithm and parks some of the logical processors in the system which in turn allows the corresponding

Option	Description																
	processor cores to transition into a lower power idle state. This option can only be enabled if the operating system supports it. It is set to <b>Disabled</b> by default. <i>i</i> <b>NOTE:</b> This feature is not supported if CPU Power Management is set to Maximum Performance.																
<b>Configurable TDP</b>	Enables you to configure the TDP level. The available options are <b>Nominal</b> , <b>Level 1</b> and <b>Level 2</b> . This option is set to <b>Nominal</b> by default. <i>i</i> <b>NOTE:</b> This option is only available on certain stock keeping units (SKUs) of the processors.																
<b>x2APIC Mode</b>	Enables or disables the x2APIC mode. This option is set to <b>Enabled</b> by default.																
<b>Dell Controlled Turbo</b>	Controls the turbo engagement. Enable this option only when <b>System Profile</b> is set to <b>Performance</b> . <i>i</i> <b>NOTE:</b> Depending on the number of installed CPUs, there might be up to two processor listings.																
<b>Dell AVX Scaling Technology</b>	Enables you to configure the Dell AVX scaling technology. This option is set to <b>0</b> by default.																
<b>Number of Cores per Processor</b>	Controls the number of enabled cores in the processor. Under certain circumstances, you may see limited performance improvements to Intel Turbo Boost Technology and benefits from potentially larger shared caches, when you reduce the number of enabled cores. Most computing environments tend to benefit more from larger number of processing cores, so you must carefully weigh the disabling of cores to gain nominal performance enhancements.																
<b>Process Core Speed</b>	Displays the core speed of the processor(s).																
<b>Process Bus Speed</b>	Displays the bus speed of the processor(s).																
<b>Processor n</b>	The following settings are displayed for each processor installed in the system:																
	<table border="1"> <thead> <tr> <th>Option</th> <th>Description</th> </tr> </thead> <tbody> <tr> <td><b>Family-Model-Stepping</b></td> <td>Specifies the family, model, and stepping of the processor as defined by Intel.</td> </tr> <tr> <td><b>Brand</b></td> <td>Specifies the brand name.</td> </tr> <tr> <td><b>Level 2 Cache</b></td> <td>Specifies the total L2 cache.</td> </tr> <tr> <td><b>Level 3 Cache</b></td> <td>Specifies the total L3 cache.</td> </tr> <tr> <td><b>Number of Cores</b></td> <td>Specifies the number of cores per processor.</td> </tr> <tr> <td><b>Maximum Memory Capacity</b></td> <td>Specifies the maximum memory capacity per processor.</td> </tr> <tr> <td><b>Microcode</b></td> <td>Specifies the microcode.</td> </tr> </tbody> </table>	Option	Description	<b>Family-Model-Stepping</b>	Specifies the family, model, and stepping of the processor as defined by Intel.	<b>Brand</b>	Specifies the brand name.	<b>Level 2 Cache</b>	Specifies the total L2 cache.	<b>Level 3 Cache</b>	Specifies the total L3 cache.	<b>Number of Cores</b>	Specifies the number of cores per processor.	<b>Maximum Memory Capacity</b>	Specifies the maximum memory capacity per processor.	<b>Microcode</b>	Specifies the microcode.
Option	Description																
<b>Family-Model-Stepping</b>	Specifies the family, model, and stepping of the processor as defined by Intel.																
<b>Brand</b>	Specifies the brand name.																
<b>Level 2 Cache</b>	Specifies the total L2 cache.																
<b>Level 3 Cache</b>	Specifies the total L3 cache.																
<b>Number of Cores</b>	Specifies the number of cores per processor.																
<b>Maximum Memory Capacity</b>	Specifies the maximum memory capacity per processor.																
<b>Microcode</b>	Specifies the microcode.																

## SATA Settings

You can use the **SATA Settings** screen to view the SATA settings of SATA devices and enable SATA and PCIe NVMe RAID mode on your system.

### View SATA Settings

To view the **SATA Settings** screen, perform the following steps:

#### Steps

1. Turn on, or restart your system.

2. Press F2 immediately after you see the following message:

F2 = System Setup

**NOTE:** If your operating system begins to load before you press F2, wait for the system to finish booting, and then restart your system and try again.

3. On the **System Setup Main Menu** screen, click **System BIOS**.

4. On the **System BIOS** screen, click **SATA Settings**.

## SATA Settings details

### About this task

The **SATA Settings** screen details are explained as follows:

Option	Description
<b>Embedded SATA</b>	Enables the embedded SATA option to be set to <b>Off</b> , <b>AHCI</b> , or <b>RAID</b> modes. This option is set to <b>AHCI Mode</b> by default.
<b>Security Freeze Lock</b>	Sends <b>Security Freeze Lock</b> command to the embedded SATA drives during POST. This option is applicable only for AHCI mode. This option is set to <b>Enabled</b> by default.
<b>Write Cache</b>	Enables or disables the command for the embedded SATA drives during POST. This option is set to <b>Disabled</b> by default.
<b>Port n</b>	Sets the drive type of the selected device. For <b>AHCI Mode</b> or <b>RAID Mode</b> , BIOS support is always enabled.
<b>Option</b>	<b>Description</b>
<b>Model</b>	Specifies the drive model of the selected device. <b>NOTE:</b> If no device is installed, it displays <b>Unknown</b> .
<b>Drive Type</b>	Specifies the type of drive attached to the SATA port. <b>NOTE:</b> If no device is installed, it displays <b>Unkown Device</b> .
<b>Capacity</b>	Specifies the total capacity of the drive. This field is undefined for removable media devices such as optical drives. <b>NOTE:</b> If no device is installed, it displays <b>N/A</b> .

## NVMe Settings

The NVMe settings enable you to set the NVMe drives to either **RAID** mode or **Non-RAID** mode.

**NOTE:** To configure these drives as RAID drives, click **System BIOS Settings > SATA Settings > Embedded SATA Option** and enable **RAID** mode. If not, you must set this field to **Non-RAID** mode.

### View NVMe settings

To view the **NVMe Settings** screen, perform the following steps:

#### Steps

1. Turn on, or restart your system.
2. Press F2 immediately after you see the following message:

F2 = System Setup

**NOTE:** If your operating system begins to load before you press F2, wait for the system to finish booting, and then restart your system and try again.

3. On the **System Setup Main Menu** screen, click **System BIOS**.
4. On the **System BIOS** screen, click **NVMe Settings**.

## NVMe Settings details

### About this task

The **NVMe Settings** screen details are explained as follows:

Option	Description
<b>NVMe Mode</b>	Enables you to set the NVMe mode. This option is set to <b>Non RAID</b> by default.

## Boot Settings

You can use the **Boot Settings** screen to set the boot mode to either **BIOS** or **UEFI**. It also enables you to specify the boot order.

- **BIOS:** The **BIOS Boot Mode** is the legacy boot mode. It is maintained for backward compatibility.
- **UEFI:** The Unified Extensible Firmware Interface (UEFI) is a new interface between operating systems and platform firmware. The interface consists of data tables with platform related information, also boot and runtime service calls that are available to the operating system and its loader. The following benefits are available when the **Boot Mode** is set to **UEFI**:
  - Support for drive partitions larger than 2 TB.
  - Enhanced security (e.g., UEFI Secure Boot).
  - Faster boot time.

**NOTE:** You must use only the UEFI boot mode in order to boot from NVMe drives.

## View Boot Settings

To view the **Boot Settings** screen, perform the following steps:

### Steps

1. Turn on, or restart your system.
2. Press F2 immediately after you see the following message:

```
F2 = System Setup
```

**NOTE:** If your operating system begins to load before you press F2, wait for the system to finish booting, and then restart your system and try again.

3. On the **System Setup Main Menu** screen, click **System BIOS**.
4. On the **System BIOS** screen, click **Boot Settings**.

## Boot Settings details

### About this task

The **Boot Settings** screen details are explained as follows:

Option	Description
<b>Boot Mode</b>	Allows you to configure the Boot Sequence and Enable or Disable the individual boot options. The available options are <b>BIOS</b> and <b>UEFI</b> . The option is set to <b>UEFI</b> by default.

Option	Description
<b>Boot Sequence Retry</b>	Enables or disables the <b>Boot Sequence Retry</b> feature. If the last attempt to boot has failed, the system immediately performs a cold reset or retries to boot after 30 seconds time-out period base on the setting of <b>Reset</b> or <b>Enabled</b> . This option is set to <b>Enabled</b> by default.
<b>Hard-Disk Failover</b>	Specifies the drive that is booted in the event of a drive failure. The devices are selected in the <b>Hard-Disk Drive Sequence</b> on the <b>Boot Option Setting</b> menu. When this option is set to <b>Disabled</b> , only the first drive in the list is attempted to boot. When this option is set to <b>Enabled</b> , all drives are attempted to boot in the order selected in the <b>Hard-Disk Drive Sequence</b> . This option is not enabled for <b>UEFI Boot Mode</b> . This option is set to <b>Disabled</b> by default.
<b>Generic USB Boot</b>	Enables or disables the USB boot option. This option is set to <b>Disabled</b> by default.
<b>Hard-disk Drive Placeholder</b>	Enables or disables the Hard-disk Drive Placeholder option. This option is set to <b>disabled</b> by default.

## UEFI Boot Settings

The **UEFI Boot Settings** screen enables you to specify the UEFI boot order.

### About this task

Option	Description
<b>UEFI Boot Sequence</b>	Enables you to change the <b>UEFI</b> boot device order.
<b>Boot Options Enable/Disable</b>	Enables you to enable or disable the <b>UEFI</b> boot devices.

## Choosing system boot mode

System Setup enables you to specify one of the following boot modes for installing your operating system:

- BIOS boot mode is the standard BIOS-level boot interface.
- UEFI boot mode (the default), is an enhanced 64-bit boot interface.

If you have configured your system to boot to UEFI mode, it replaces the system BIOS.

1. From the **System Setup Main Menu**, click **Boot Settings**, and select **Boot Mode**.
2. Select the UEFI boot mode you want the system to boot into.

 **CAUTION: Switching the boot mode may prevent the system from booting if the operating system is not installed in the same boot mode.**

3. After the system boots in the specified boot mode, proceed to install your operating system from that mode.

 **NOTE:** Operating systems must be UEFI-compatible to be installed from the UEFI boot mode. DOS and 32-bit operating systems do not support UEFI and can only be installed from the BIOS boot mode.

 **NOTE:** For the latest information about supported operating systems, go to **Dell.com/ossupport**.

## Changing boot order

### About this task

You may have to change the boot order if you want to boot from a USB key or an optical drive. The following instructions may vary if you have selected **BIOS** for **Boot Mode**.

### Steps

1. On the **System Setup Main Menu** screen, click **System BIOS > Boot Settings > UEFI/BIOS Boot Settings > UEFI/BIOS Boot Sequence**.

2. Use the arrow keys to select a boot device, and use the plus (+) and minus (-) sign keys to move the device down or up in the order.
3. Click **Exit**, and then click **Yes** to save the settings on exit.

## Network Settings

You can use the **Network Settings** screen to modify UEFI PXE, iSCSI, and HTTP boot settings. The network settings option is available only in the UEFI mode.

**NOTE:** The BIOS does not control network settings in the BIOS mode. For the BIOS boot mode, the optional Boot ROM of the network controllers handles the network settings.

## Viewing Network Settings

To view the **Network Settings** screen, perform the following steps:

### Steps

1. Turn on, or restart your system.
2. Press F2 immediately after you see the following message:

```
F2 = System Setup
```

**NOTE:** If your operating system begins to load before you press F2, wait for the system to finish booting, and then restart your system and try again.

3. On the **System Setup Main Menu** screen, click **System BIOS**.
4. On the **System BIOS** screen, click **Network Settings**.

## Network Settings screen details

The **Network Settings** screen details are explained as follows:

### About this task

Option	Description
<b>UEFI PXE Settings</b>	Enables you to control the configuration of the UEFI PXE device.
<b>PXE Device n (n = 1 to 4)</b>	Enables or disables the device. When enabled, a UEFI PXE boot option is created for the device.
<b>PXE Device n Settings(n = 1 to 4)</b>	Enables you to control the configuration of the PXE device.
<b>UEFI HTTP Settings</b>	Enables or disables the device. When enabled, a UEFI HTTP boot option is created for the device.
<b>HTTP Device n Settings (n = 1 to 4)</b>	Enables you to control the configuration of the HTTP device.
<b>UEFI iSCSI Settings</b>	Enables you to control the configuration of the iSCSI device.

**Table 3. UEFI iSCSI Settings screen details**

Option	Description
<b>iSCSI Initiator Name</b>	Specifies the name of the iSCSI initiator in IQN format.

Option	Description
--------	-------------

**Table 3. UEFI iSCSI Settings screen details (continued)**

Option	Description
<b>iSCSI Device1</b>	Enables or disables the iSCSI device. When disabled, a UEFI boot option is created for the iSCSI device automatically. This is set to <b>Disabled</b> by default.
<b>iSCSI Device1 Settings</b>	Enables you to control the configuration of the iSCSI device.

**TLS Authentication Configuration**

View and/or modify this device's boot TLS authentication mode. None means the HTTP server and the client will not authenticate each other for this boot. One way means the HTTP server will be authenticated by the client, while the client will not be authenticated by the server. This option is set to **None** by default.

## Integrated Devices

You can use the **Integrated Devices** screen to view and configure the settings of all integrated devices including the video controller, integrated RAID controller, and the USB ports.

### Viewing Integrated Devices

To view the **Integrated Devices** screen, perform the following steps:

**Steps**

1. Power on or restart the system.
2. Press F2 immediately after you see the following message:

```
F2 = System Setup
```

**NOTE:** If your operating system begins to load before you press F2, wait for the system to finish booting, and then restart your system and try again.

3. On the **System Setup Main Menu** screen, click **System BIOS**.
4. On the **System BIOS** screen, click **Integrated Devices**.

### Integrated Devices details

**About this task**

The **Integrated Devices** screen details are explained as follows:

Option	Description
--------	-------------



**User Accessible USB Ports**

Configures the user accessible USB ports. Selecting **All Ports Off** disables all USB ports; selecting **All Ports Off (Dynamic)** disables all USB ports during POST and front ports can be enabled or disabled dynamically by authorized user without resetting the system.

The USB keyboard and mouse still function in certain USB ports during the boot process, depending on the selection. After the boot process is complete, the USB ports will be enabled or disabled as per the setting.

**Internal USB Port**

Enables or disables the internal USB port. This option is set to **On** by default.

Option	Description
<b>iDRAC Direct USB Port</b>	The iDRAC Direct USB port is managed by iDRAC exclusively with no host visibility. This option is set to <b>ON</b> or <b>OFF</b> . When set to <b>OFF</b> , iDRAC does not detect any USB devices installed in this managed port. This option is set to <b>On</b> by default.
<b>Integrated RAID Controller</b>	Enables or disables the integrated RAID controllers. This option is set to <b>Enabled</b> by default.
<b>I/OAT DMA Engine</b>	Enables or disables the I/O Acceleration Technology (I/OAT) option. I/OAT is a set of DMA features designed to accelerate network traffic and lower CPU utilization. Enable only if the hardware and software support the feature.
<b>I/O Snoop HoldOff Response</b>	Enables you to select the number of cycles PCI I/O can withhold snoop requests from the CPU to allow time to complete its own write to LLC. This setting can help improve performance on workloads where throughput and latency are critical.
<b>Embedded Video Controller</b>	Enables or disables the use of Embedded Video Controller as the primary display. When set to <b>Enabled</b> , the Embedded Video Controller will be the primary display even if add-in graphic cards are installed. When set to <b>Disabled</b> , an add-in graphics card will be used as the primary display. BIOS will output displays to both the primary add-in video and the embedded video during POST and pre-boot environment. The embedded video will then be disabled right before the operating system boots. This option is set to <b>Enabled</b> by default.  <b>NOTE:</b> When there are multiple add-in graphic cards installed in the system, the first card discovered during PCI enumeration is selected as the primary video. You might have to re-arrange the cards in the slots in order to control which card is the primary video.
<b>Current State of Embedded Video Controller</b>	Displays the current state of the embedded video controller. The <b>Current State of Embedded Video Controller</b> option is a read-only field. If the Embedded Video Controller is the only display capability in the system (that is, no add-in graphics card is installed), then the Embedded Video Controller is automatically used as the primary display even if the <b>Embedded Video Controller</b> setting is set to <b>Disabled</b> .
<b>SR-IOV Global Enable</b>	Enables or disables the BIOS configuration of Single Root I/O Virtualization (SR-IOV) devices. This option is set to <b>Disabled</b> by default.
<b>Internal SD Card Port</b>	Enables or disables the Internal SD Card Port of the Internal Dual SD Module (IDSDM). This option is set to <b>On</b> by default.
<b>Internal SD Card Redundancy</b>	Configures the redundancy mode of the Internal Dual SD Module (IDSDM). When set to <b>Mirror Mode</b> , data is written on both SD cards. After failure of either card and replacement of the failed card, the data of the active card is copied to the offline card during the system boot.  When Internal SD Card Redundancy is set to <b>Disabled</b> , only the primary SD card is visible to the OS. This option is set to <b>Disabled</b> by default.
<b>Internal SD Primary Card</b>	When <b>Redundancy</b> is set to <b>Disabled</b> , either one of the SD card can be selected to present itself as mass storage device by setting it to be primary card. By default primary SD card is selected to be SD Card 1. If SD Card 1 is not present, then the controller will select SD Card 2 to be primary SD card.
<b>OS Watchdog Timer</b>	If your system stops responding, this watchdog timer aids in the recovery of your operating system. When this option is set to <b>Enabled</b> , the operating system initializes the timer. When this option is set to <b>Disabled</b> (default), the timer does not have any effect on the system. This option is set to <b>Disabled</b> by default.
<b>Empty Slot Unhide</b>	Enables or disables the root ports of all the empty slots that are accessible to the BIOS and OS. This option is set to <b>Disabled</b> by default.
<b>Memory Mapped I/O above 4 GB</b>	Enables or disables the support for the PCIe devices that need large amounts of memory. Enable this option only for 64-bit operating systems. This option is set to <b>Enabled</b> by default.
<b>Memory Mapped I/O Base</b>	When set to <b>12 TB</b> , the system will map MMIO base to 12 TB. Enable this option for an OS that requires 44 bit PCIe addressing.  <b>NOTE:</b> Setting <b>Memory Mapped I/O Base</b> to <b>512 GB</b> requires less than 512 GB of physical memory else the system might fail to POST.
<b>Mezzanine Slot Disablement</b>	The Slot Disablement feature controls the configuration of mezzanine cards installed in the specified slots. Only mezzanine card slots that are present on your system are available for control.

## Serial Communication

Use the **Serial Communication** screen to view the properties of the serial communication port.

### Viewing Serial Communication

To view the **Serial Communication** screen, perform the following steps:

#### Steps

1. Power on or restart the system.
2. Press F2 immediately after you see the following message:

```
F2 = System Setup
```

**NOTE:** If your operating system begins to load before you press F2, wait for the system to finish booting, and then restart your system and try again.

3. On the **System Setup Main Menu** screen, click **System BIOS**.
4. On the **System BIOS** screen, click **Serial Communication**.

### Serial Communication details

#### About this task

The **Serial Communication** screen details are explained as follows:

Option	Description
<b>Serial Communication</b>	Selects serial communication devices (Serial Device 1 and Serial Device 2) in BIOS. BIOS console redirection can also be enabled, and the port address can be specified. This option is set to <b>Off</b> by default.  Enables the <b>COM</b> port or <b>Console Redirection</b> options.
<b>Serial Port Address</b>	Enables you to set the port address for serial devices. This field sets the serial port address to either COM1 or COM2 (COM1=0x3F8, COM2=0x2F8). This option is set to <b>Serial Device 1=COM1</b> by default. <b>NOTE:</b> You can use only Serial Device 2 for the Serial Over LAN (SOL) feature. To use console redirection by SOL, configure the same port address for console redirection and the serial device.
<b>Failsafe Baud Rate</b>	Specifies the failsafe baud rate for console redirection. The BIOS attempts to determine the baud rate automatically. This failsafe baud rate is used only if the attempt fails, and the value must not be changed. This option is set to <b>115200</b> by default.
<b>Remote Terminal Type</b>	Sets the remote console terminal type. This option is set to <b>VT100/VT220</b> by default.
<b>Redirection After Boot</b>	Enables or disables the BIOS console redirection when the operating system is loaded. This option is set to <b>Enabled</b> by default.

## System Profile Settings

You can use the **System Profile Settings** screen to enable specific system performance settings such as power management.

### Viewing System Profile Settings

To view the **System Profile Settings** screen, perform the following steps:

#### Steps

1. Power on, or restart your system.

2. Press F2 immediately after you see the following message:

F2 = System Setup

**NOTE:** If your operating system begins to load before you press F2, wait for the system to finish booting, and then restart your system and try again.

3. On the **System Setup Main Menu** screen, click **System BIOS**.

4. On the **System BIOS** screen, click **System Profile Settings**.

## System Profile Settings details

### About this task

The **System Profile Settings** screen details are explained as follows:

Option	Description
<b>System Profile</b>	Sets the system profile. If you set the System Profile option to a mode other than <b>Custom</b> , the BIOS automatically sets the rest of the options. You can only change the rest of the options if the mode is set to <b>Custom</b> . This option is set to <b>Performance Per Watt Optimized (DAPC)</b> by default. DAPC is Dell Active Power Controller. Other options include <b>Performance Per Watt (OS)</b> , <b>Performance</b> , and <b>Workstation Performance</b> . <b>NOTE:</b> All the parameters on the system profile setting screen are available only when the <b>System Profile</b> option is set to <b>Custom</b> .
<b>CPU Power Management</b>	Sets the CPU power management. This option is set to <b>System DBPM (DAPC)</b> by default. DBPM is Demand-Based Power Management. Other options include <b>OS DBPM</b> , and <b>Maximum Performance</b> .
<b>Memory Frequency</b>	Sets the speed of the system memory. You can select <b>Maximum Performance</b> , <b>Maximum Reliability</b> or a specific speed. This option is set to <b>Maximum Performance</b> by default.
<b>Turbo Boost</b>	Enables or disables the processor to operate in the turbo boost mode. This option is set to <b>Enabled</b> by default.
<b>C1E</b>	Enables or disables the processor to switch to a minimum performance state when it is idle. This option is set to <b>Enabled</b> by default.
<b>C States</b>	Enables or disables the processor to operate in all available power states. This option is set to <b>Enabled</b> by default.
<b>Write Data CRC</b>	Enables or disables the Write Data CRC. This option is set to <b>Disabled</b> by default.
<b>Memory Patrol Scrub</b>	Sets the memory patrol scrub frequency. This option is set to <b>Standard</b> by default.
<b>Memory Refresh Rate</b>	Sets the memory refresh rate to either 1x or 2x. This option is set to <b>1x</b> by default.
<b>Uncore Frequency</b>	Enables you to select the <b>Processor Uncore Frequency</b> option. <b>Dynamic mode</b> enables the processor to optimize power resources across the cores and uncore during runtime. The optimization of the uncore frequency to either save power or optimize performance is influenced by the setting of the <b>Energy Efficiency Policy</b> option.
<b>Energy Efficient Policy</b>	Enables you to select the <b>Energy Efficient Policy</b> option. The CPU uses the setting to manipulate the internal behavior of the processor and determines whether to target higher performance or better power savings. This option is set to <b>Balanced Performance</b> by default.
<b>Number of Turbo Boost Enabled Cores for Processor 1</b>	<b>NOTE:</b> If there are two processors installed in the system, you will see an entry for <b>Number of Turbo Boost Enabled Cores for Processor 2</b> . Controls the number of turbo boost enabled cores for Processor 1. The maximum number of cores is enabled by default.
<b>Monitor/Mwait</b>	Enables the Monitor/Mwait instructions in the processor. This option is set to <b>Enabled</b> for all system profiles, except <b>Custom</b> by default.

Option	Description
	<p><b>NOTE:</b> This option can be disabled only if the <b>C States</b> option in the <b>Custom</b> mode is set to <b>disabled</b>.</p> <p><b>NOTE:</b> When <b>C States</b> is set to <b>Enabled</b> in the <b>Custom</b> mode, changing the Monitor/Mwait setting does not impact the system power or performance.</p>
<b>CPU Interconnect Bus Link Power Management</b>	Enables or disables the CPU Interconnect Bus Link Power Management. This option is set to <b>Enabled</b> by default.
<b>PCI ASPM L1 Link Power Management</b>	Enables or disables the PCI ASPM L1 Link Power Management. This option is set to <b>Enabled</b> by default.
<b>Intel Persistent Memory CR QoS</b>	Controls the tuning function for Quality of Service (QoS) knobs. <b>Disabled</b> by default. <b>Method 1</b> is recommended for 2-2-2 memory configurations in App-Direct. <b>Method 2</b> is recommended for other memory configurations in App-Direct. <b>Method 3</b> is recommended for 1 DIMM per channel configurations.
<b>Intel Persistent Memory Performance Setting</b>	Controls the thresholds that trigger switching between near (RDIMM/LRDIMM) and far (DCPMM) memory. <b>BW Optimized</b> , selected by default, optimizes for RDIMM/LRDIMM and DCPMM bandwidth. <b>Latency Optimized</b> offers better RDIMM/LRDIMM latency in the presence of DCPMM. <b>Balanced Profile</b> optimizes performance with Memory Mode-configured DCPMM.

## System Security

You can use the **System Security** screen to perform specific functions such as setting the system password, setup password and disabling the power button.

### Viewing System Security

To view the **System Security** screen, perform the following steps:

#### Steps

1. Turn on, or restart your system.
2. Press F2 immediately after you see the following message:

```
F2 = System Setup
```

**NOTE:** If your operating system begins to load before you press F2, wait for the system to finish booting, and then restart your system and try again.

3. On the **System Setup Main Menu** screen, click **System BIOS**.
4. On the **System BIOS** screen, click **System Security**.

### System Security Settings details

#### About this task

The **System Security Settings** screen details are explained as follows:

Option	Description
<b>CPU AES-NI</b>	Improves the speed of applications by performing encryption and decryption by using the Advanced Encryption Standard Instruction Set (AES-NI). This option is set to <b>Enabled</b> by default.
<b>System Password</b>	Sets the system password. This option is set to <b>Enabled</b> by default and is read-only if the password jumper is not installed in the system.

Option	Description
<b>Setup Password</b>	Sets the setup password. This option is read-only if the password jumper is not installed in the system.
<b>Password Status</b>	Locks the system password. This option is set to <b>Unlocked</b> by default.
<b>TPM Information</b>	 <b>NOTE:</b> The TPM menu is available only when the TPM module is installed.

Enables you to control the reporting mode of the TPM. The **TPM Security** option is set to **Off** by default. You can only modify the TPM Status, and TPM Activation, and the Intel TXT fields if the **TPM Status** field is set to either **On with Pre-boot Measurements** or **On without Pre-boot Measurements**.

When TPM 1.2 is installed, the **TPM Security** option is set to **Off**, **On with Pre-boot Measurements**, or **On without Pre-boot Measurements**.

**Table 4. TPM 1.2 security information**

TPM information	Description
<b>TPM Information</b>	Changes the operational state of the TPM. This option is set to <b>No Change</b> by default.
<b>TPM Firmware</b>	Indicates the firmware version of the TPM.
<b>TPM Status</b>	Specifies the TPM status.
<b>TPM Command</b>	Controls the Trusted Platform Module (TPM). When set to <b>None</b> , no command is sent to the TPM. When set to <b>Activate</b> , the TPM is enabled and activated. When set to <b>Deactivate</b> , the TPM is disabled and deactivated. When set to <b>Clear</b> , all the contents of the TPM are cleared. This option is set to <b>None</b> by default.

When TPM 2.0 is installed, the **TPM Security** option is set to **On** or **Off**. This option is set to **Off** by default.

**Table 5. TPM 2.0 security information**

TPM information	Description
<b>TPM Information</b>	Changes the operational state of the TPM. This option is set to <b>No Change</b> by default.
<b>TPM Firmware</b>	Indicates the firmware version of the TPM.
<b>TPM Hierarchy</b>	Enable, disable, or clear the storage and endorsement hierarchies. When set to <b>Enabled</b> , the storage and endorsement hierarchies can be used.  When set to <b>Disabled</b> , the storage and endorsement hierarchies cannot be used.  When set to <b>Clear</b> , the storage and endorsement hierarchies are cleared of any values, and then reset to <b>Enabled</b> .

**Intel(R) TXT** Enables or disables the Intel Trusted Execution Technology (TXT) option. To enable the **Intel TXT** option, virtualization technology and TPM Security must be enabled with Pre-boot measurements. This option is set to **Off** by default.

When TPM 2.0 is installed, **TPM 2 Algorithm** option is available. It enables you to select a hash algorithm from those supported by the TPM (SHA1, SHA256). **TPM 2 Algorithm** option must be set to **SHA256**, to enable TXT.

**Power Button** Enables or disables the power button on the front of the system. This option is set to **Enabled** by default.

**AC Power Recovery** Sets how the system behaves after AC power is restored to the system. This option is set to **Last** by default.

**UEFI Variable Access** Provides varying degrees of securing UEFI variables. When set to **Standard** (the default), UEFI variables are accessible in the operating system per the UEFI specification. When set to **Controlled**, selected UEFI

Option	Description								
	variables are protected in the environment and new UEFI boot entries are forced to be at the end of the current boot order.								
<b>In-Band Manageability Interface</b>	When set to <b>Disabled</b> , this setting will hide the Management Engine's (ME), HECI devices, and the system's IPMI devices from the operating system. This prevents the operating system from changing the ME power capping settings, and blocks access to all in-band management tools. All management should be managed through out-of-band. This option is set to <b>Enabled</b> by default.  <b>NOTE:</b> BIOS update requires HECI devices to be operational and DUP updates require IPMI interface to be operational. This setting needs to be set to <b>Enabled</b> to avoid updating errors.								
<b>Secure Boot</b>	Enables Secure Boot, where the BIOS authenticates each pre-boot image by using the certificates in the Secure Boot Policy. Secure Boot is set to <b>Disabled</b> by default.								
<b>Secure Boot Policy</b>	When Secure Boot policy is set to <b>Standard</b> , the BIOS uses the system manufacturer's key and certificates to authenticate pre-boot images. When Secure Boot policy is set to <b>Custom</b> , the BIOS uses the user-defined key and certificates. Secure Boot policy is set to <b>Standard</b> by default.								
<b>Secure Boot Mode</b>	Configures how the BIOS uses the Secure Boot Policy Objects (PK, KEK, db, dbx). If the current mode is set to <b>Deployed Mode</b> , the available options are <b>User Mode</b> and <b>Deployed Mode</b> . If the current mode is set to <b>User Mode</b> , the available options are <b>User Mode</b> , <b>Audit Mode</b> , and <b>Deployed Mode</b> .								
	<table border="1"> <thead> <tr> <th>Options</th> <th>Description</th> </tr> </thead> <tbody> <tr> <td><b>User Mode</b></td> <td>In <b>User Mode</b>, PK must be installed, and BIOS performs signature verification on programmatic attempts to update policy objects. The BIOS allows unauthenticated programmatic transitions between modes.</td> </tr> <tr> <td><b>Deployed Mode</b></td> <td><b>Deployed Mode</b> is the most secure mode. In <b>Deployed Mode</b>, PK must be installed and the BIOS performs signature verification on programmatic attempts to update policy objects. <b>Deployed Mode</b> restricts the programmatic mode transitions.</td> </tr> <tr> <td><b>Audit Mode</b></td> <td>In <b>Audit mode</b>, PK is not present. The BIOS does not authenticate programmatic updates to the policy objects, and transitions between modes. <b>Audit Mode</b> is useful for programmatically determining a working set of policy objects. BIOS performs signature verification on pre-boot images and logs results in the image Execution Information Table, but executes the images whether they pass or fail verification.</td> </tr> </tbody> </table>	Options	Description	<b>User Mode</b>	In <b>User Mode</b> , PK must be installed, and BIOS performs signature verification on programmatic attempts to update policy objects. The BIOS allows unauthenticated programmatic transitions between modes.	<b>Deployed Mode</b>	<b>Deployed Mode</b> is the most secure mode. In <b>Deployed Mode</b> , PK must be installed and the BIOS performs signature verification on programmatic attempts to update policy objects. <b>Deployed Mode</b> restricts the programmatic mode transitions.	<b>Audit Mode</b>	In <b>Audit mode</b> , PK is not present. The BIOS does not authenticate programmatic updates to the policy objects, and transitions between modes. <b>Audit Mode</b> is useful for programmatically determining a working set of policy objects. BIOS performs signature verification on pre-boot images and logs results in the image Execution Information Table, but executes the images whether they pass or fail verification.
Options	Description								
<b>User Mode</b>	In <b>User Mode</b> , PK must be installed, and BIOS performs signature verification on programmatic attempts to update policy objects. The BIOS allows unauthenticated programmatic transitions between modes.								
<b>Deployed Mode</b>	<b>Deployed Mode</b> is the most secure mode. In <b>Deployed Mode</b> , PK must be installed and the BIOS performs signature verification on programmatic attempts to update policy objects. <b>Deployed Mode</b> restricts the programmatic mode transitions.								
<b>Audit Mode</b>	In <b>Audit mode</b> , PK is not present. The BIOS does not authenticate programmatic updates to the policy objects, and transitions between modes. <b>Audit Mode</b> is useful for programmatically determining a working set of policy objects. BIOS performs signature verification on pre-boot images and logs results in the image Execution Information Table, but executes the images whether they pass or fail verification.								
<b>Secure Boot Policy Summary</b>	Specifies the list of certificates and hashes that secure boot uses to authenticate images.								
<b>Secure Boot Custom Policy Settings</b>	Configures the Secure Boot Custom Policy. To enable this option, set the Secure Boot Policy to <b>Custom</b> option.								

## Creating a system and setup password

### Prerequisites

Ensure that the password jumper is enabled. The password jumper enables or disables the system password and setup password features. For more information, see the System board jumper settings section.

 **NOTE:** If the password jumper setting is disabled, the existing system password and setup password are deleted and you need not provide the system password to boot the system.

### Steps

1. To enter System Setup, press F2 immediately after turning on or rebooting your system.

2. On the **System Setup Main Menu** screen, click **System BIOS > System Security**.
3. On the **System Security** screen, verify that **Password Status** is set to **Unlocked**.
4. In the **System Password** field, type your system password, and press Enter or Tab.

Use the following guidelines to assign the system password:

- A password can have up to 32 characters. The password can contain any of the characters in the ASCII character set.

A message prompts you to reenter the system password.

5. Reenter the system password, and click **OK**.
6. In the **Setup Password** field, type your setup password and press Enter or Tab.  
A message prompts you to reenter the setup password.
7. Reenter the setup password, and click **OK**.
8. Press Esc to return to the System BIOS screen. Press Esc again.  
A message prompts you to save the changes.

 **NOTE:** Password protection does not take effect until the system reboots.

## Using your system password to secure your system

### Prerequisites

If you have assigned a setup password, the system accepts your setup password as an alternate system password.

### Steps

1. Turn on or reboot your system.
2. Type the system password and press Enter.

### Next steps

When **Password Status** is set to **Locked**, type the system password and press Enter when prompted at reboot.

 **NOTE:** If an incorrect system password is typed, the system displays a message and prompts you to reenter your password. You have three attempts to type the correct password. After the third unsuccessful attempt, the system displays an error message that the system has stopped functioning and must be turned off. Even after you turn off and restart the system, the error message is displayed until the correct password is entered.

## Deleting or changing system and Setup password

### Prerequisites

 **NOTE:** You cannot delete or change an existing system or Setup password if the **Password Status** is set to **Locked**.

### Steps

1. To enter System Setup, press F2 immediately after turning on or restarting your system.
2. On the **System Setup Main Menu** screen, click **System BIOS > System Security**.
3. On the **System Security** screen, ensure that **Password Status** is set to **Unlocked**.
4. In the **System Password** field, alter or delete the existing system password, and then press Enter or Tab.
5. In the **Setup Password** field, alter or delete the existing setup password, and then press Enter or Tab.  
If you change the system and Setup password, a message prompts you to reenter the new password. If you delete the system and Setup password, a message prompts you to confirm the deletion.
6. Press Esc to return to the **System BIOS** screen. Press Esc again, and a message prompts you to save the changes.
7. Select **Setup Password**, change, or delete the existing setup password and press Enter or Tab.

 **NOTE:** If you change the system password or setup password, a message prompts you to reenter the new password. If you delete the system password or setup password, a message prompts you to confirm the deletion.

## Operating with setup password enabled

If **Setup Password** is set to **Enabled**, type the correct setup password before modifying the system setup options.

If you do not type the correct password in three attempts, the system displays the following message:

```
Password Invalid.
```

```
Number of unsuccessful password attempts: <3> Maximum number of password attempts exceeded. System Halted!
```

Even after you turn off and restart the system, the error message is displayed until the correct password is typed. The following options are exceptions:

- If **System Password** is not set to **Enabled** and is not locked through the **Password Status** option, you can assign a system password. For more information, see the System Security Settings screen section.
- You cannot disable or change an existing system password.

 **NOTE:** You can use the password status option with the setup password option to protect the system password from unauthorized changes.

## Redundant OS Control

You can use the **Redundant OS Control** screen to set the redundant OS info for redundant OS control. It enables you to set up a physical recovery disk on your system.

### Viewing Redundant OS Control

To view the **Redundant OS Control** screen, perform the following steps:

#### Steps

1. Turn on, or restart your system.
2. Press F2 immediately after you see the following message:

```
F2 = System Setup
```

 **NOTE:** If your operating system begins to load before you press F2, wait for the system to finish booting, and then restart your system and try again.

3. On the **System Setup Main Menu** screen, click **System BIOS**.
4. On the **System BIOS** screen, click **Redundant OS Control**.

### Redundant OS Control screen details

The **Redundant OS Control** screen details are explained as follows:

#### About this task

##### Option



##### Description

##### Redundant OS Location

Enables you to select a backup disk from the following devices:

- **None**
- **Internal SD card**
- **SATA Ports in AHCI mode**
- **BOSS PCIe cards (Internal M.2 Drives)**
- **Internal USB**

 **NOTE:** RAID configurations and NVMe cards not are included as BIOS does not have the ability to distinguish between individual drives in those configurations.

Option	Description
<b>Redundant OS State</b>	<p> <b>NOTE:</b> This option is disabled if Redundant OS Location is set to None.</p> <p>When set to <b>Visible</b>, the backup disk is visible to the boot list and OS. When set to <b>Hidden</b>, the backup disk is disabled and is not visible to the boot list and OS. This option is set to <b>Visible</b> by default.</p> <p> <b>NOTE:</b> BIOS will disable the device in hardware, so it cannot be accessed by the OS.</p>
<b>Redundant OS Boot</b>	<p> <b>NOTE:</b> This option is disabled if Redundant OS Location is set to None or if Redundant OS State is set to Hidden.</p> <p>When set to <b>Enabled</b>, BIOS boots to the device specified in <b>Redundant OS Location</b>. When set to <b>Disabled</b>, BIOS preserves the current boot list settings. This option is set to <b>Disabled</b> by default.</p>

## Miscellaneous Settings

You can use the **Miscellaneous Settings** screen to perform specific functions such as updating the asset tag and changing the system date and time.

### View Miscellaneous Settings

To view the **Miscellaneous Settings** screen, perform the following steps:

#### Steps

1. Turn on, or restart your system.
2. Press F2 immediately after you see the following message:

```
F2 = System Setup
```

 **NOTE:** If your operating system begins to load before you press F2, wait for the system to finish booting, and then restart your system and try again.

3. On the **System Setup Main Menu** screen, click **System BIOS**.
4. On the **System BIOS** screen, click **Miscellaneous Settings**.

### Miscellaneous Settings details

#### About this task

The **Miscellaneous Settings** screen details are explained as follows:

Option	Description
<b>System Time</b>	Enables you to set the time on the system.
<b>System Date</b>	Enables you to set the date on the system.
<b>Asset Tag</b>	Specifies the asset tag and enables you to modify it for security and tracking purposes.
<b>Keyboard NumLock</b>	Enables you to set whether the system boots with the NumLock enabled or disabled. This option is set to <b>On</b> by default.  <b>NOTE:</b> This option does not apply to 84-key keyboards.
<b>F1/F2 Prompt on Error</b>	Enables or disables the F1/F2 prompt on error. This option is set to <b>Enabled</b> by default. The F1/F2 prompt also includes keyboard errors.
<b>Load Legacy Video Option ROM</b>	Enables you to determine whether the system BIOS loads the legacy video (INT 10H) option ROM from the video controller. Selecting <b>Enabled</b> if the operating system does not support UEFI video output standards. This field is available only for UEFI boot mode. You cannot set the option to <b>Enabled</b> if <b>UEFI Secure Boot</b> mode is enabled. This option is set to <b>Disabled</b> by default.

Option	Description
<b>Dell Wyse P25/P45 BIOS Access</b>	Enables or disables the Dell Wyse P25/P45 BIOS Access. This option is set to <b>Enabled</b> by default.
<b>Power Cycle Request</b>	Enables or disables the Power Cycle Request. This option is set to <b>None</b> by default.

## iDRAC Settings utility

The iDRAC settings utility is an interface to set up and configure the iDRAC parameters by using UEFI. You can enable or disable various iDRAC parameters by using the iDRAC settings utility.

 **NOTE:** Accessing some of the features on the iDRAC settings utility needs the iDRAC Enterprise License upgrade.

For more information about using iDRAC, see *Dell Integrated Dell Remote Access Controller User's Guide* at [www.dell.com/idracmanuals](http://www.dell.com/idracmanuals).

## Device Settings

**Device Settings** enables you to configure the device parameters.

## Dell Lifecycle Controller

The Dell Lifecycle Controller (LC) provides advanced embedded systems management capabilities, including system deployment, configuration, update, maintenance, and diagnosis. LC is delivered as part of the iDRAC out-of-band solution and Dell system embedded Unified Extensible Firmware Interface (UEFI) applications.

## Embedded System Management

The Dell Lifecycle Controller provides advanced embedded system management throughout the system's lifecycle. The Dell Lifecycle Controller can be started during the boot sequence and can function independently of the operating system.

 **NOTE:** Certain platform configurations may not support the full set of features provided by the Dell Lifecycle Controller.

For more information about setting up the Dell Lifecycle Controller, configuring hardware and firmware, and deploying the operating system, see the Dell Lifecycle Controller documentation at [www.dell.com/idracmanuals](http://www.dell.com/idracmanuals).

## Boot Manager

The **Boot Manager** screen enables you to select boot options and diagnostic utilities.

## View the boot manager

Perform the following steps to enter the boot manager.

### Steps

1. Turn on, or restart your system.  
Enter the result of your step here (optional).
2. Press F11 when you see the following message:

F11 = Boot Manager

If your operating system begins to load before you press F11, allow the system to complete the booting, and then restart your system and try again.

## Boot Manager main menu

Menu item	Description
<b>Continue Normal Boot</b>	The system attempts to boot to devices starting with the first item in the boot order. If the boot attempt fails, the system continues with the next item in the boot order until the boot is successful or no more boot options are found.
<b>One-shot UEFI Boot menu</b>	Enables you to access the UEFI Boot menu and select an one-shot boot option to boot from.
<b>Launch System Setup</b>	Enables you to access System Setup.
<b>Launch Lifecycle Controller</b>	Exits the Boot Manager and invokes the Dell Lifecycle Controller program.
<b>System Utilities</b>	Enables you to launch System Utilities menu such as System Diagnostics and UEFI shell.

## One-shot UEFI Boot menu

**One-shot UEFI Boot menu** enables you to access the UEFI Boot menu and select an one-shot boot option to boot from.

## System Utilities

**System Utilities** contains the following utilities that can be launched:

- Launch Diagnostics
- BIOS Update File Explorer
- Reboot System

## PXE boot

You can use the Preboot Execution Environment (PXE) option to boot and configure the networked systems remotely.

To access the **PXE boot** option, boot the system and then press F12 during POST instead of using standard Boot Sequence from BIOS Setup. It does not pull any menu or allow managing network devices.

# Installing and removing system components

## Topics:

- Safety instructions
- Before working inside your sled
- After working inside your sled
- Recommended tools
- PowerEdge MX740c sled
- System cover
- Air shroud
- Drives
- Drive backplane
- Cable routing
- Drive cage
- Battery backup unit
- Control panel
- System memory
- Processors and heat sinks
- iDRAC card
- PERC card
- Optional Internal dual SD module
- M.2 BOSS module
- Mezzanine card
- Optional internal USB memory key
- System battery
- System board
- Trusted Platform Module

## Safety instructions

 **NOTE:** Whenever you need to lift the system, get others to assist you. To avoid injury, do not attempt to lift the system by yourself.

 **WARNING:** Opening or removing the system cover while the system is powered on may expose you to a risk of electric shock.

 **CAUTION:** Do not operate the system without the cover for a duration exceeding five minutes. Operating the system without the system cover can result in component damage.

 **CAUTION:** Many repairs may only be done by a certified service technician. You should only perform troubleshooting and simple repairs as authorized in your product documentation, or as directed by the online or telephone service and support team. Damage due to servicing that is not authorized by Dell is not covered by your warranty. Read and follow the safety instructions that are shipped with your product.

 **NOTE:** It is recommended that you always use an antistatic mat and antistatic strap while working on components inside the system.

 **CAUTION:** To ensure proper operation and cooling, all bays in the system and system fans must be always populated with a component or a blank.

# Before working inside your sled

## Prerequisites

Follow the safety guidelines listed in [Safety instructions](#) on page 41.

## Steps

1. Power off the sled.
2. Remove the sled from the enclosure.
3. If applicable install the I/O connector cover.

 **CAUTION: To prevent damage to the I/O connectors on the system, ensure that you cover the connectors when you remove the system from the enclosure.**

4. Remove the system cover.

# After working inside your sled

## Prerequisites

Follow the safety guidelines listed in [Safety instructions](#) on page 41.

## Steps

1. Install the system cover.
2. If installed, remove the I/O connector cover on the system.

 **CAUTION: To prevent damage to the I/O connectors, do not touch the connectors or the connector pins.**

3. Install the sled in the enclosure.
4. Power on the sled.

 **NOTE:** Ability to power on the sled requires iDRAC to fully initialize first.

# Recommended tools

You need the following tools to perform the removal and installation procedures:

- Phillips #1 and Phillips #2 screwdrivers
- Torx T15 and T30 screwdrivers
- Wrist grounding strap

# PowerEdge MX740c sled

The PowerEdge MX740c sled is a server unit that is installed into the PowerEdge MX7000 enclosure.

# Removing the sled from enclosure

## Prerequisites

1. Follow the safety guidelines listed in [Safety Instructions](#).
2. Power off the sled.

## Steps

1. Press the blue release button on the sled to release the sled handle.
2. Holding the sled handle, slide the sled out of the enclosure.

**i** **NOTE:** Support the system with both hands while sliding it out of the enclosure.

**i** **NOTE:** Removing the sled with the enclosure powered on is supported if you shut down the sled before removal.



**Figure 12. Removing the sled from enclosure**

3. Install the I/O connector cover on the sled.

**⚠ CAUTION:** To protect the I/O connector pins, install the I/O connector cover every time a sled is removed from the enclosure.



**Figure 13. Installing the I/O connector cover on sled**

**NOTE:** The color of the I/O connector cover may differ.

**CAUTION:** If you are permanently removing the sled, install a sled blank promptly. Operating the enclosure without a blank, for an extended time can result in overheating or performance loss.

### Next steps

1. Install the sled or the sled blank into the enclosure.

## Installing the sled into enclosure

### Prerequisites

1. Follow the safety guidelines listed in [Safety instructions](#) on page 41.

**CAUTION:** To prevent damage to the I/O connectors, do not touch the connectors or the connector pins.

### Steps

1. Remove the I/O connector cover from the I/O connector(s) and store for future use.

**CAUTION:** To protect the I/O connector pins, install the I/O connector cover every time a sled is removed from the enclosure.



**Figure 14. Removing the I/O connector cover from sled**

**NOTE:** The color of the I/O connector cover may differ.

2. Press the blue release button on the sled to release the sled handle.
3. Holding the sled with both hands, align the sled with the compute sled-bay in the enclosure.
4. Slide the sled into the enclosure, until the sled handle is in the lock position.
5. Push the sled handle inwards so that it locks into place to secure the sled in the enclosure.



**Figure 15. Installing the sled into enclosure**

#### **Next steps**

1. Power on the sled.

## **System cover**

The system cover protects the components inside the system and helps in maintaining air flow inside the system.

## **Removing the system cover**

#### **Prerequisites**

1. Follow the safety guidelines listed in [Safety instructions](#) on page 41.
2. Power off the sled.
3. [Remove the sled from the enclosure.](#)
4. Place the sled on the flat surface with the top cover facing upwards.

#### **Steps**

1. Press the blue release tab on the system cover and slide the cover towards the rear of the system.
2. Hold the cover on both sides, and lift the cover away from the system.

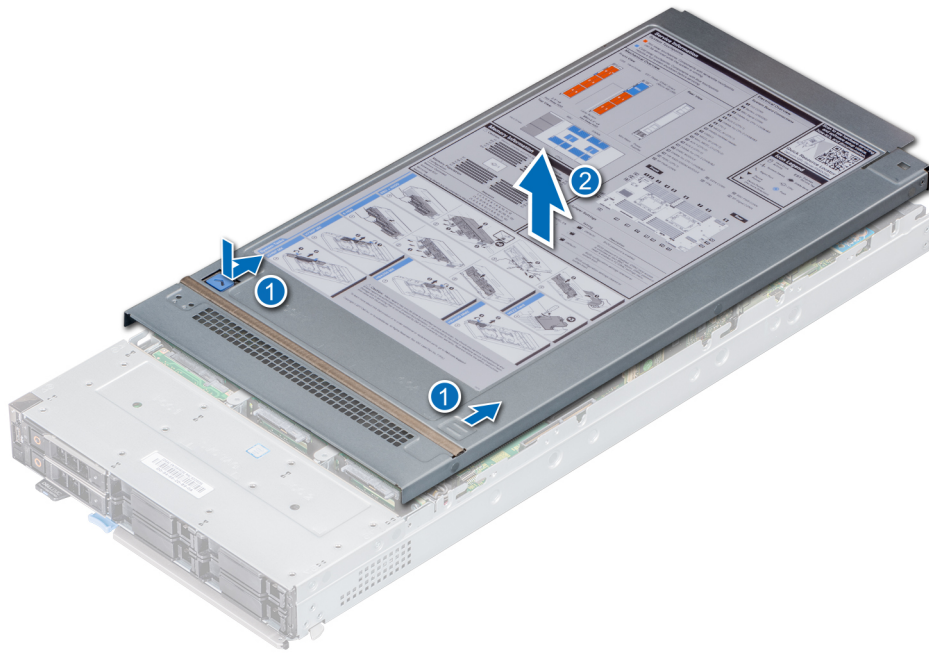

**Figure 16. Removing system cover**

#### **Next steps**

1. [Replace the system cover.](#)

## **Installing system cover**

#### **Prerequisites**

1. Follow the safety guidelines listed in [Safety instructions](#) on page 41.
2. Ensure that all internal cables are routed correctly and connected, and no tools or extra parts are left inside the system.

#### **Steps**

1. Align the tabs on the system cover with the guide slots on the system.
2. Slide the cover towards the front of the system.



**Figure 17. Installing system cover**

**Next steps**

1. [Install the sled into the enclosure.](#)
2. Turn on the sled.

# Air shroud

The air shroud aerodynamically directs the airflow across the entire system. The airflow passes air through all the critical parts of the system thus allowing increased cooling preventing overheating.

## Removing air shroud

### Prerequisites

**CAUTION:** Never operate your system with the air shroud removed. The system may get overheated quickly, resulting in shutdown of the system and loss of data.

1. Follow the safety guidelines listed in [Safety Instructions](#).
2. Follow the procedure listed in [Before working inside your sled](#) on page 42.

### Steps

Hold both the edges of the air shroud and lift it out of the system.

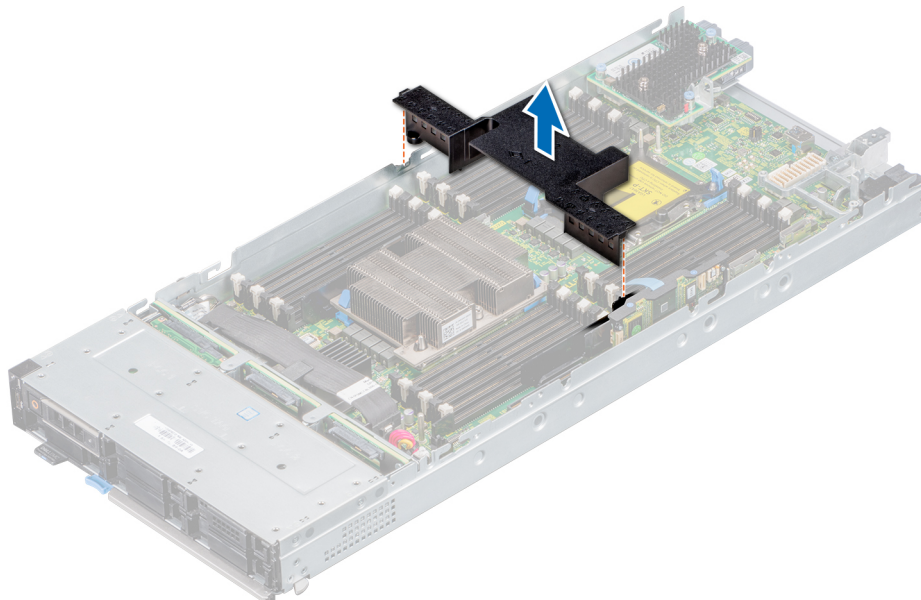

Figure 18. Removing air shroud

### Next steps

1. [Install the air shroud](#).

## Installing air shroud

### Prerequisites

1. Follow the safety guidelines listed in [Safety Instructions](#).
2. Follow the procedure listed in [Before working inside your sled](#) on page 42.

### Steps

1. Align the air shroud with the guide slots on the system.
2. Lower the air shroud into the system until it is firmly seated.

**NOTE:** When firmly seated, the memory socket and processor numbers marked on the air shroud aligns with the respective memory socket and processor numbers marked on the system.

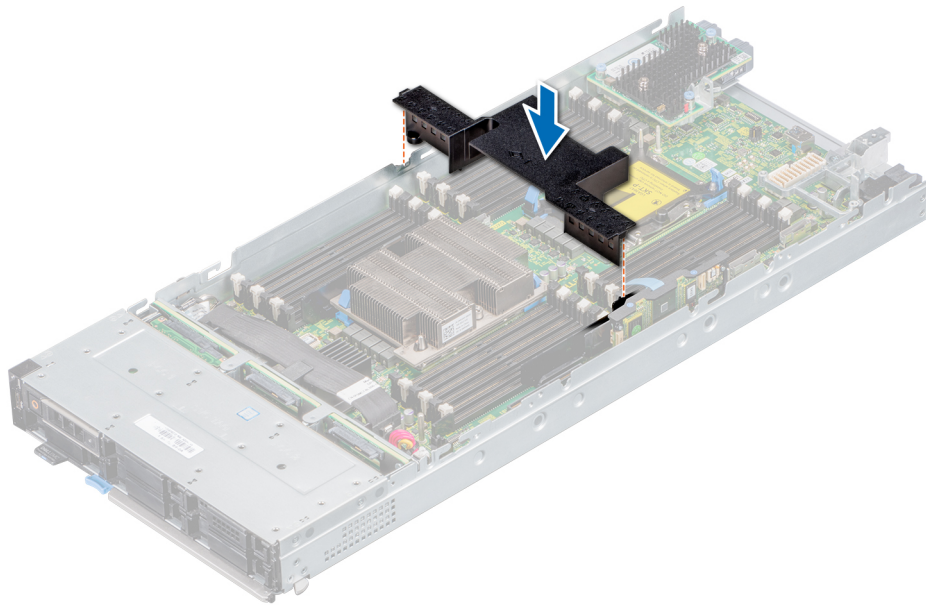

Figure 19. Installing air shroud

#### Next steps

1. Follow the procedure listed in [After working inside the sled](#).

## Drives

Your system supports 2.5-inch SAS/SATA SSD, NVMe drives and PCIe SSDs. The drives or SSDs are supplied in a hot-swappable drive carriers that fit in the drive bays and these drives connect to the system board through the drive backplane.

**CAUTION:** Before attempting to remove or install a drive while the system is running, see the documentation to ensure that the host adapter is configured correctly to support hot-swap drive removal and insertion.

**CAUTION:** Do not turn off or restart your system while the drive is being formatted. Doing so can cause a drive failure.

When you format a drive, allow enough time for the formatting to be complete. The high-capacity drives can take a long time to format.

## Removing drive blank

#### Prerequisites

1. Follow the safety guidelines listed in [Safety instructions](#) on page 41

**CAUTION:** Mixing drive blanks from previous generations of PowerEdge servers is not supported

**CAUTION:** To maintain proper system cooling, all empty drive slots must have drive blanks installed.

#### Steps

Press the release button and slide the drive blank out of the drive slot.

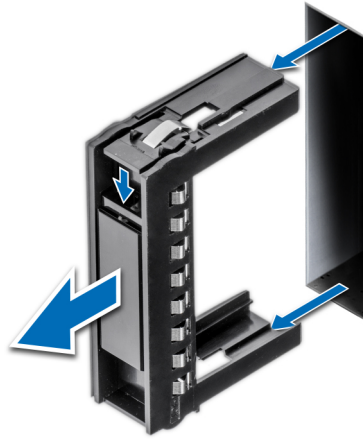

Figure 20. Removing drive blank

#### Next steps

1. [Install a drive](#) or a [drive blank](#).

## Installing drive blank

#### Prerequisites

1. Follow the safety guidelines listed in [Safety instructions](#) on page 41.

**CAUTION:** Mixing drive blanks from previous generations of PowerEdge servers is not supported.

#### Steps

Insert the drive blank into the drive slot and push the blank until the release button clicks into place.

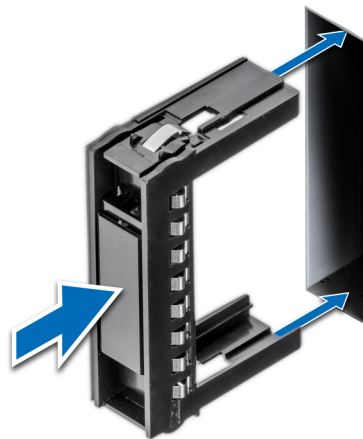

Figure 21. Installing drive blank

## Removing drive carrier

#### Prerequisites

1. Follow the safety guidelines listed in [Safety instructions](#) on page 41.
2. Using the management software, prepare the drive for removal.

If the drive is online, the green activity or fault indicator flashes while the drive is turning off. When the drive indicators are off, the drive is ready for removal. For more information, see the documentation for the storage controller.

**CAUTION:** Before attempting to remove or install a drive while the system is running, see the documentation for the storage controller card to ensure that the host adapter is configured correctly to support drive removal and insertion.

**CAUTION:** Mixing drive carriers from previous generations or other platforms of PowerEdge servers is not supported.

**CAUTION:** To prevent data loss, ensure that your operating system supports hot-swap drive installation. See the documentation supplied with your operating system.

**CAUTION:** To maintain proper system cooling, all empty drive bays must have drive blanks installed.

**WARNING:** Ensure that you back up your data, before removing a drive. For more information about preparing your drive for removal and supported RAID redundancy, see the Troubleshooting guide of your system at [www.dell.com/poweredgemanuals](http://www.dell.com/poweredgemanuals).

### Steps

1. Press the release button to open the release handle.
2. Holding the handle, slide the drive carrier out of the drive slot.

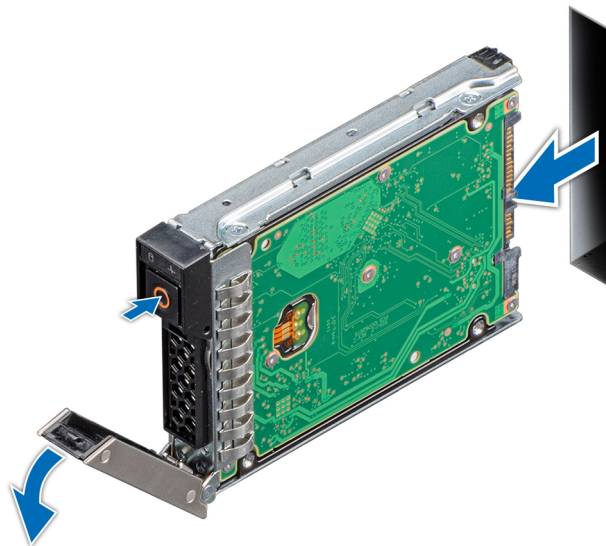

Figure 22. Removing drive carrier

### Next steps

1. Replace the drive carrier or a drive blank.

## Installing drive carrier

### Prerequisites

**CAUTION:** Before attempting to remove or install a drive while the system is running, see the documentation for the storage controller card to ensure that the host adapter is configured correctly to support drive removal and insertion.

**CAUTION:** Mixing drive carriers from previous generations of PowerEdge servers is not supported.

**CAUTION:** Combining SAS and SATA drives in the same RAID volume is not supported.

**CAUTION:** When installing a drive carrier, ensure that the adjacent drives are fully installed. Inserting a drive carrier and attempting to lock its handle next to a partially installed carrier can damage the partially installed carrier's shield spring and make it unusable.

**CAUTION:** To prevent data loss, ensure that your operating system supports hot-swap drive installation. See the documentation supplied with your operating system.

**CAUTION:** When a replacement hot swappable drive is installed and the system is powered on, the drive automatically begins to rebuild. Ensure that the replacement drive is blank or contains data that you wish to overwrite. Any data on the replacement drive is immediately lost after the drive is installed.

1. Follow the safety guidelines listed in the [Safety instructions](#).
2. If installed, [remove the drive blank](#).

### Steps

1. Press the release button on the front of the drive carrier to open the release handle.
2. Insert the drive carrier into the drive slot and slide until the drive carrier connects with the backplane.
3. Close the release handle of the drive carrier to lock the drive in place.

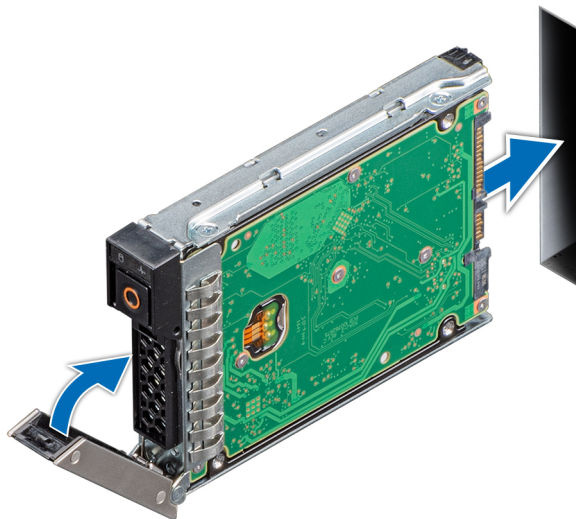

**Figure 23. Installing drive carrier**

## Removing a drive from drive carrier

### Prerequisites

1. Follow the safety guidelines listed in [Safety instructions](#) on page 41.
2. [Remove the drive carrier](#).

### Steps

1. Using the Phillips #1 screwdriver, remove the screws from the slide rails on the drive carrier.
2. Lift the drive out of the drive carrier.

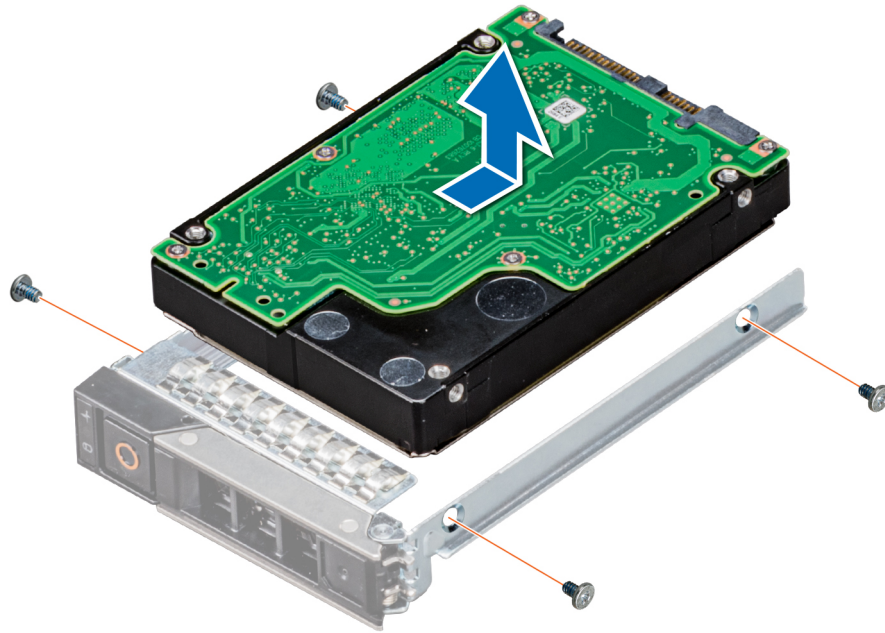

**Figure 24. Removing a drive from drive carrier**

#### **Next steps**

1. [Replace the drive into the drive carrier.](#)

## **Installing a drive into drive carrier**

#### **Prerequisites**

1. Follow the safety guidelines listed in [Safety instructions](#) on page 41

#### **Steps**

1. Insert the drive into the drive carrier, with the connector end of the drive towards the back of the carrier.
2. Align the screw holes on the drive with the screw holes on the drive carrier.
3. Using the Phillips #1 screwdriver, replace the screws to secure the drive to the drive carrier.

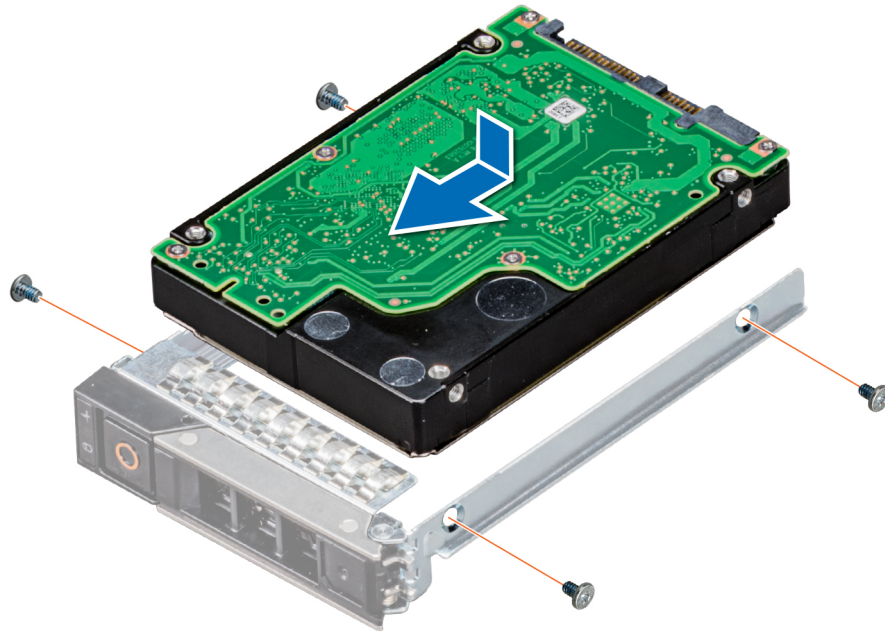
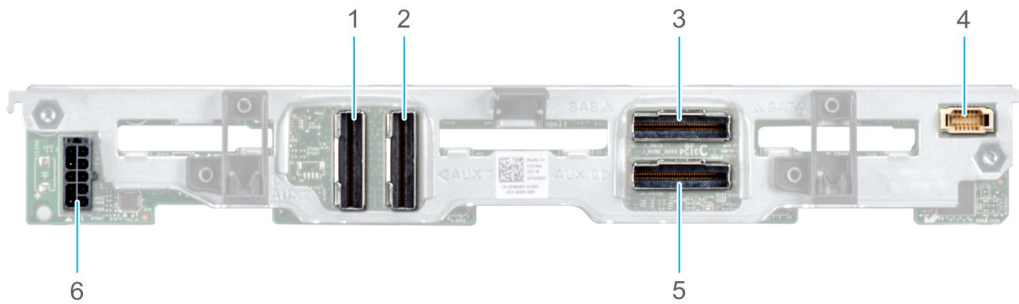

**Figure 25. Installing a drive into drive carrier**

## Drive backplane

Depending on the configuration, your system supports:

- 2.5 inch (x6) Universal backplane
- 2.5 inch (x6) SAS/SATA backplane
- 2.5 inch (x4) Universal backplane



**Figure 26. 6 x 2.5-inch universal backplane**

1. AUX 2 cable connector
2. AUX 1 cable connector
3. SAS/SATA connector
4. Signal cable connector
5. AUX 0 cable connector
6. Power cable connector

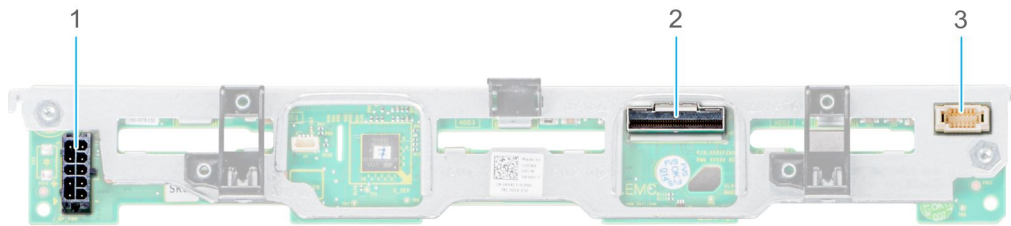

**Figure 27. 6 x 2.5-inch SAS/SATA backplane**

1. Power cable connector
2. SAS/SATA connector
3. Signal cable connector

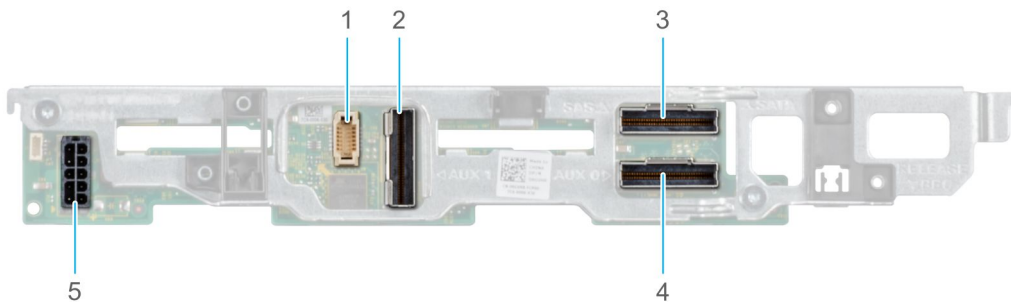

**Figure 28. 4 x 2.5-inch universal backplane**

1. Signal cable connector
2. AUX 1 cable connector
3. SAS/SATA connector
4. AUX 0 cable connector
5. Power cable connector

## Removing drive backplane

### Prerequisites

**CAUTION:** To prevent damage to the drives and the drive backplane, you must remove the drives from the system before removing the drive backplane. For more information, see [Removing a drive carrier](#).

**CAUTION:** Temporarily label drives before you remove the drive so that you can replace them in the same slots.

**NOTE:** Observe the routing of the cable as you remove it from the sled. Route the cable properly when you replace it, to prevent the cable from being pinched or crimped.

1. Follow the safety guidelines listed in [Safety Instructions](#).
2. Follow the procedure listed in [Before working inside your sled](#).
3. Disconnect the cables connected to the backplane.
4. [Remove the drives](#).

### Steps

1. Hold the drive backplane by the edges and lift it upwards to disengage the backplane from the guide pins.
2. Lift the backplane out of the sled.

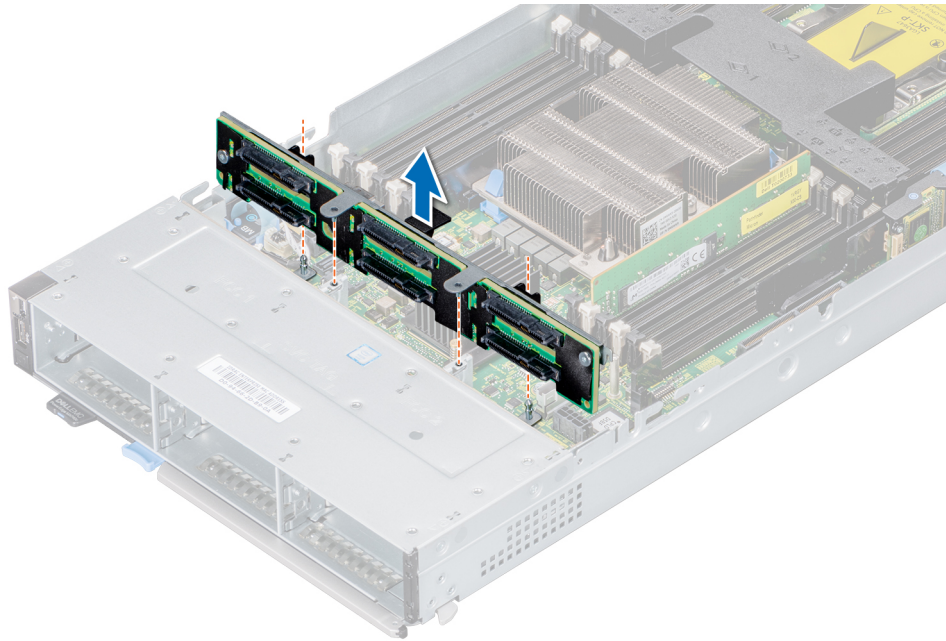

**Figure 29. Removing drive backplane**

#### **Next steps**

1. [Replace the drive backplane.](#)

## **Installing drive backplane**

#### **Prerequisites**

1. Follow the safety guidelines listed in [Safety instructions](#) on page 41
2. Follow the procedure listed in [Before working inside the sled.](#)

#### **Steps**

1. Align the guide pins on the drive backplane with the sled.
2. Lower the drive backplane, until it is fully seated.

**NOTE:** To install the backplane, ensure the two pins on the backplane tab seat into the two slots on the system chassis.

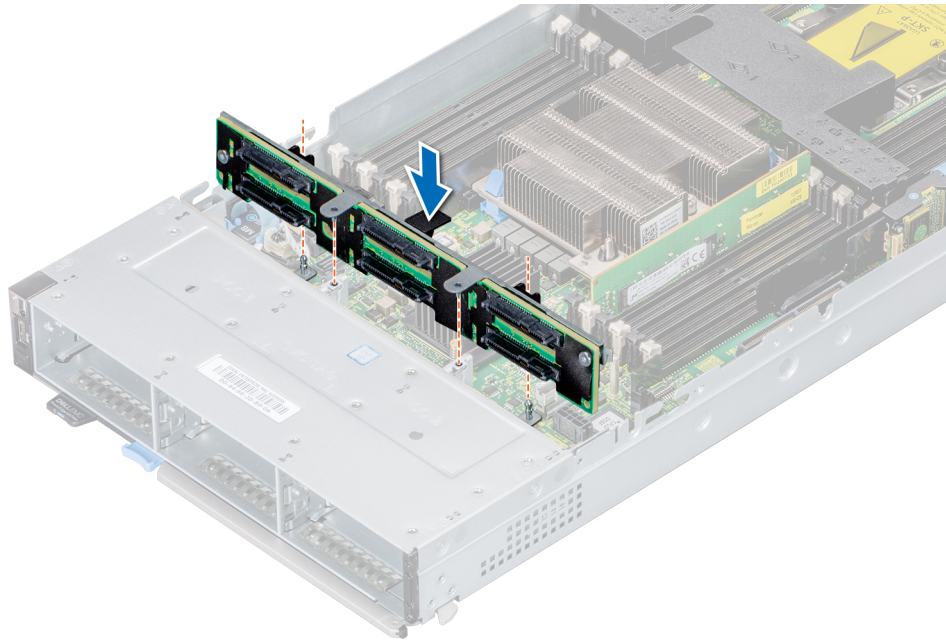

**Figure 30. Installing drive backplane**

#### **Next steps**

1. Connect the cables to the backplane connectors.

**i** **NOTE:** Verify backplane connector pins are not bent and then connect the signal cable to the backplane.

**i** **NOTE:** Verify both power and signal cable connections are fully seated to backplane and system board.

**i** **NOTE:** Connect the integrated cable to the backplane and system board if there is no PERC card installed in the system.

2. [Install the drives.](#)
3. Follow the procedure listed in [After working inside the sled.](#)

# Cable routing

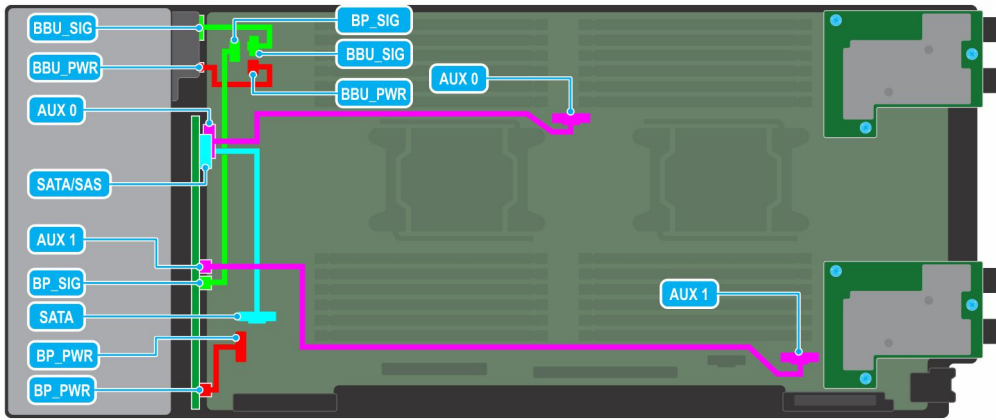

Figure 31. Cable routing - 4 x 2.5-inch backplane BBU cabling.

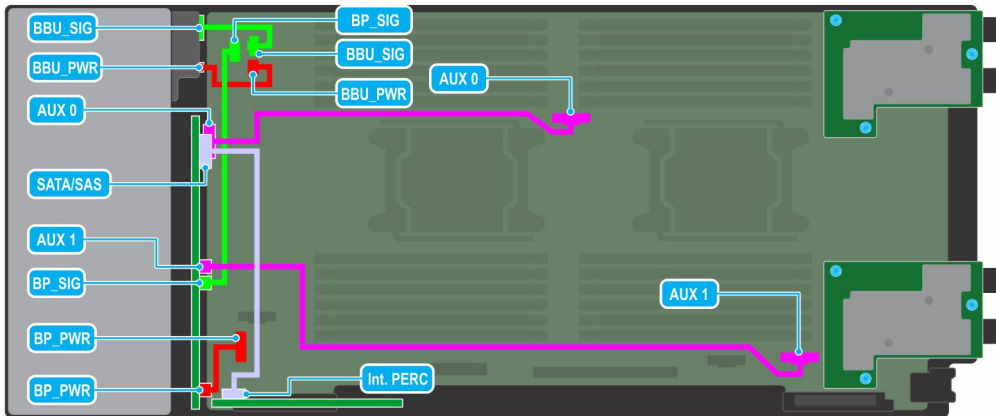

Figure 32. Cable routing - 4 x 2.5-inch backplane with internal PERC card

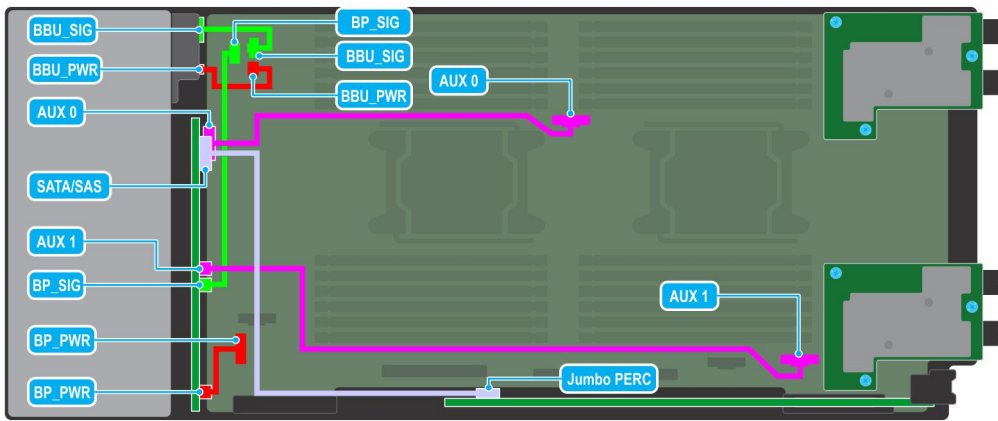

Figure 33. Cable routing - 4 x 2.5 PCIe backplane with Jumbo PERC card

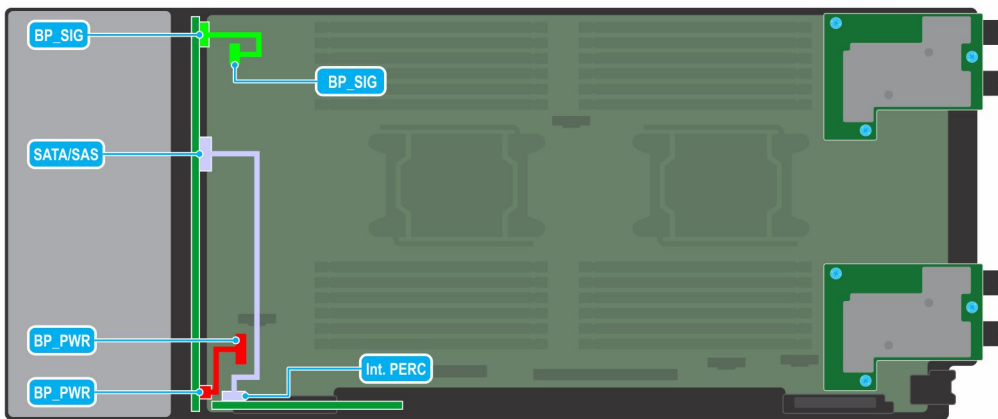

Figure 34. Cable routing - 6 x 2.5-inch SAS/SATA backplane with internal PERC card

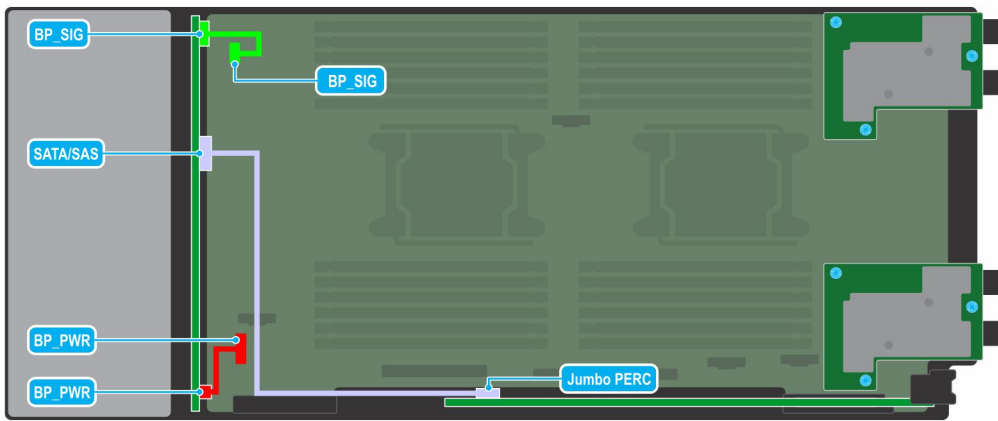

Figure 35. Cable routing - 6 x 2.5-inch SAS/SATA backplane with Jumbo PERC card

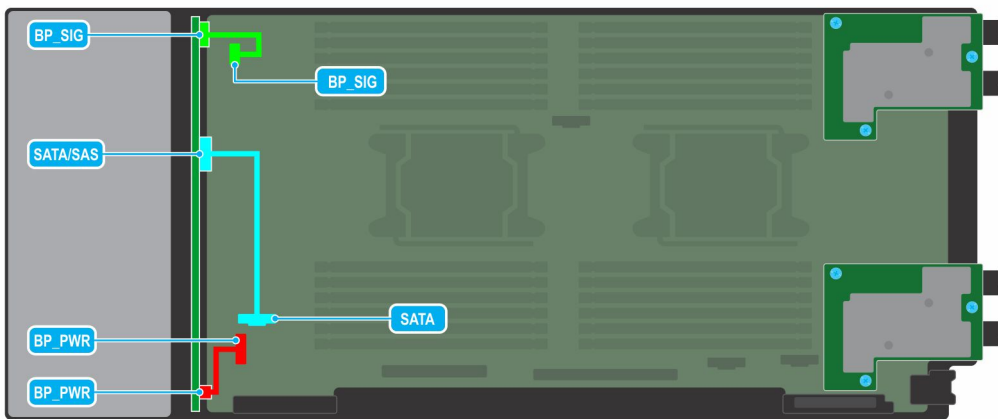

Figure 36. Cable routing - 6 x 2.5-inch SAS/SATA backplane SATA cabling

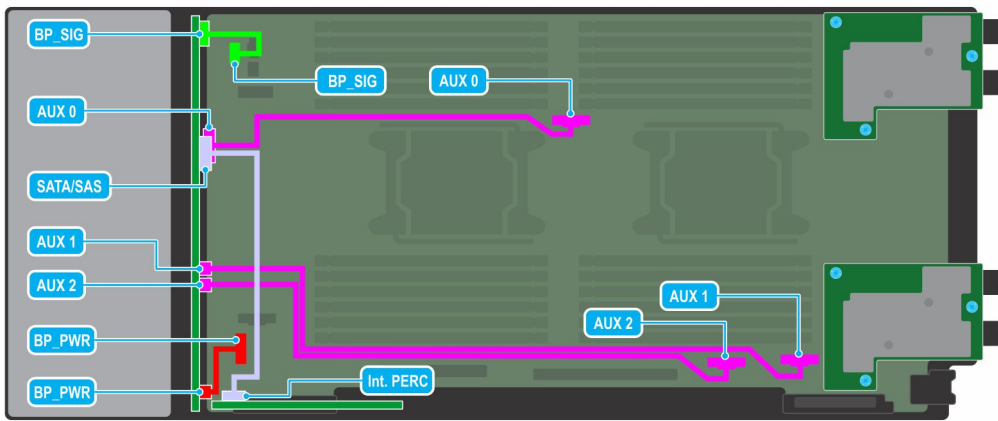

Figure 37. Cable routing - 6 x 2.5-inch backplane with internal PERC card

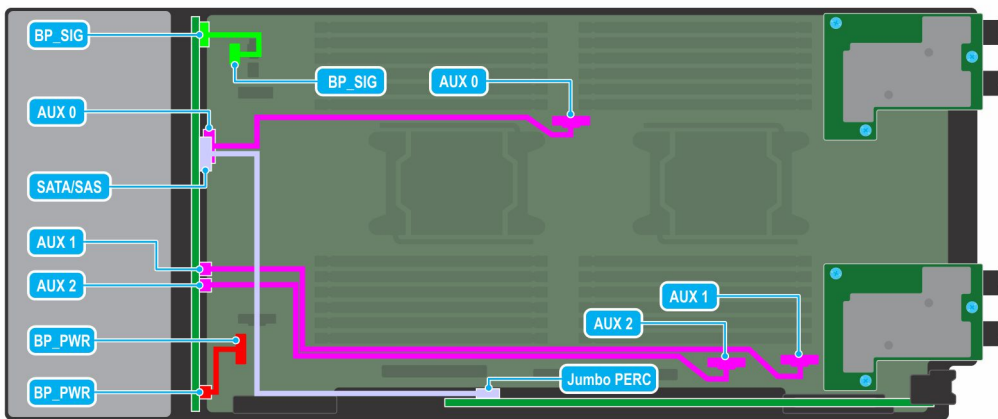

Figure 38. Cable routing - 6 x 2.5-inch backplane with Jumbo PERC card

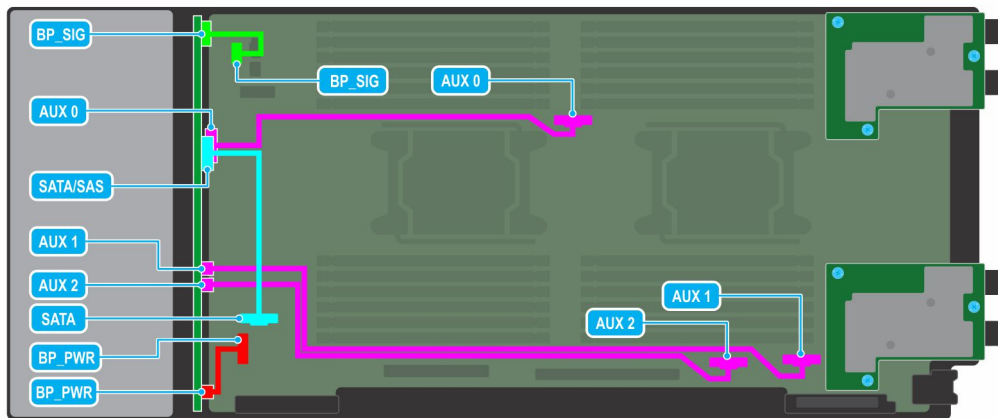

Figure 39. Cable routing - 6 x 2.5-inch backplane SATA cabling

## Drive cage

The drive cage contains the drives and the battery backup unit module.

## Removing the drive cage

### Prerequisites

**CAUTION:** To prevent damage to the drives and backplane, you must remove the drives from the system before removing the backplane.

**CAUTION:** Temporarily label drives before you remove the drives so that you can replace them in the same slots.

**NOTE:** Observe the routing of the cables on the chassis as you remove them from the system. You must route these cables properly when you replace them to prevent the cables from being pinched or crimped.

1. Follow the safety guidelines listed in [Safety instructions](#) on page 41.
2. Follow the procedure listed in [Before working inside your sled](#) on page 42.
3. Disconnect the cables connected to the backplane.
4. [Remove the drives](#)
5. [Remove the drive backplane.](#)

### Steps

1. Using the Phillips #1 screwdriver, remove the screws that secure the drive cage to the sled.
2. Lift the drive cage away from the sled.

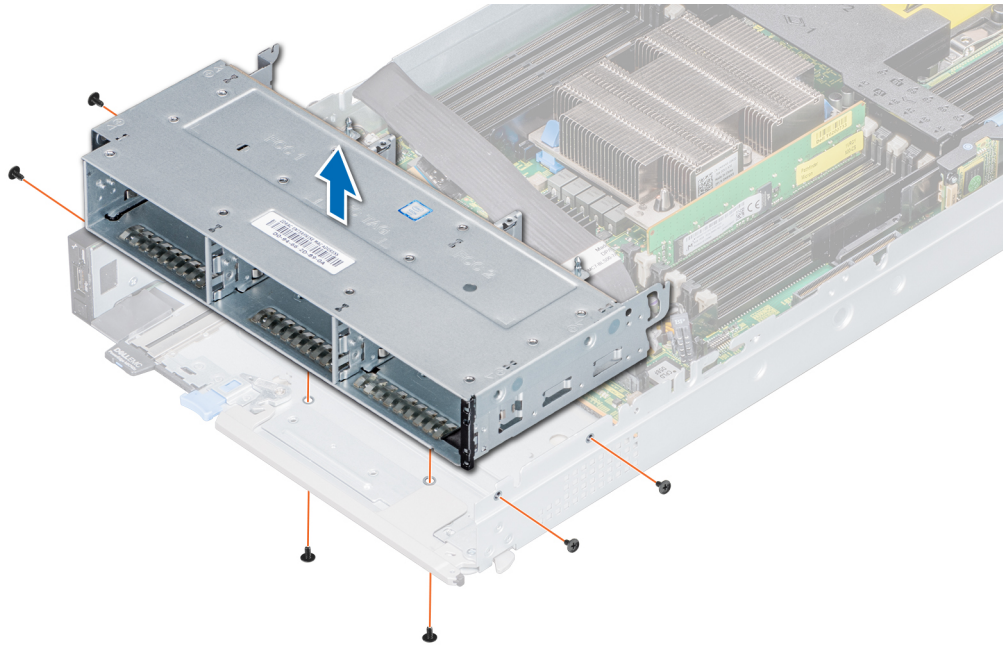

**Figure 40. Removing the drive cage**

#### **Next steps**

1. [Replace the drive cage.](#)

## **Installing the drive cage**

#### **Prerequisites**

1. Follow the safety guidelines listed in [Safety Instructions](#).
2. Follow the procedure listed in [Before working inside the sled](#).

#### **Steps**

1. Place the drive cage into the system, aligning with the screw holes on the system.
2. Using the Phillips #1 screwdriver, secure the drive cage in place with screws.

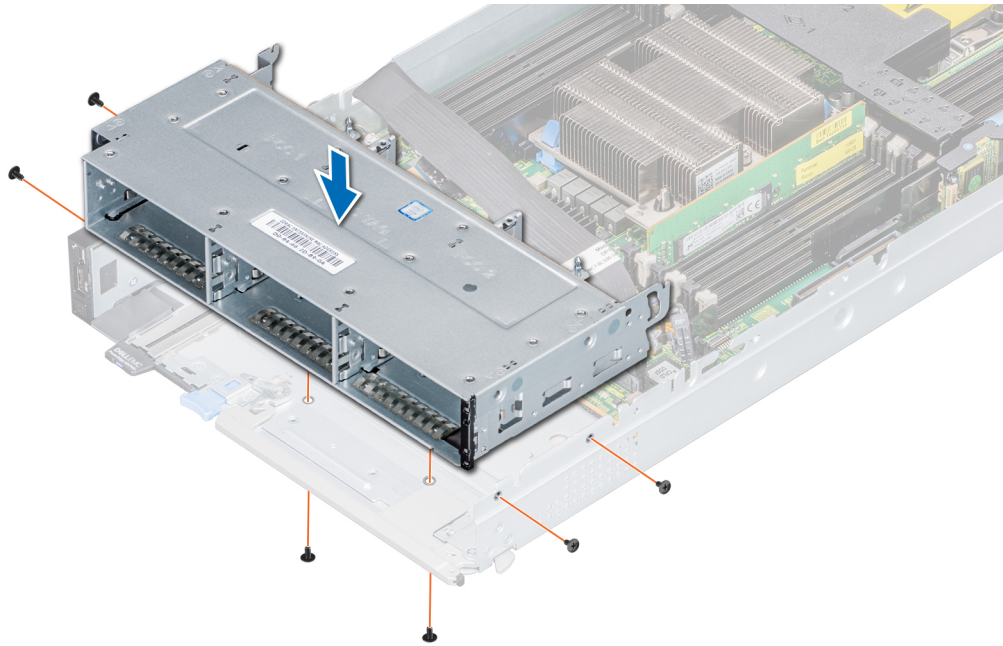

**Figure 41. Installing the drive cage**

#### **Next steps**

1. [Install the drive backplane.](#)
2. [Install the drives.](#)
3. Follow the procedure listed in [After working inside your sled](#) on page 42.

## **Battery backup unit**

### **Removing the battery backup unit**

#### **Prerequisites**

1. Follow the safety guidelines listed in [Safety Instructions](#).
2. Follow the procedure listed in [Before working inside your sled](#) on page 42.
3. [Remove the drives.](#)
4. Disconnect the battery backup unit (BBU) cable from the system board.
5. Disconnect the backplane cables.
6. [Remove the drive cage.](#)
7. [Remove the drive backplane.](#)

#### **Steps**

1. Press the latch on the side of the drive cage to release the BBU module.
2. Holding the BBU module by the edges, slide the BBU module out of the system.

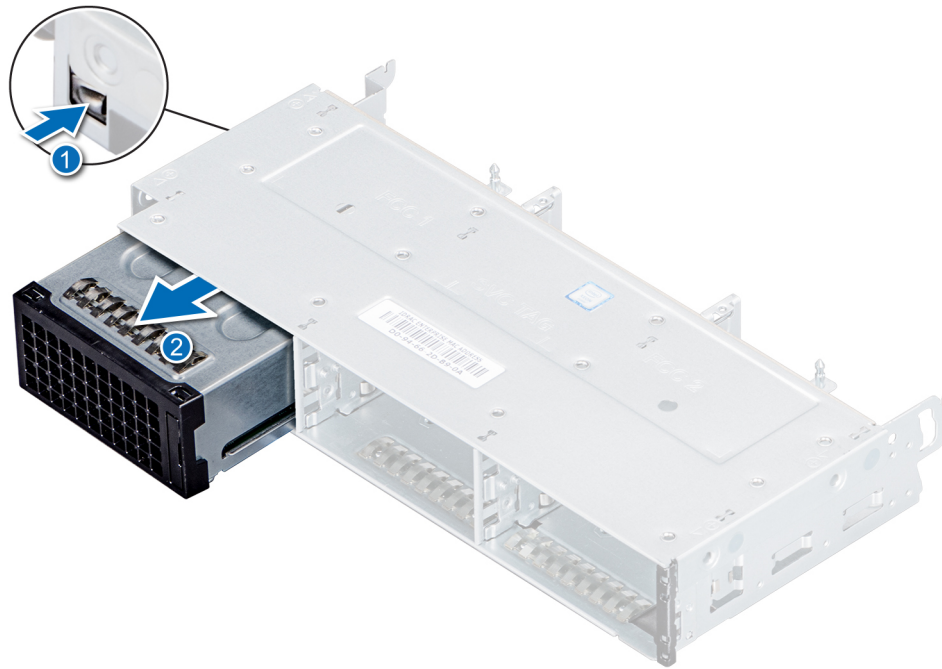

**Figure 42. Removing the BBU module**

#### **Next steps**

1. [Replace the BBU in the cage.](#)
2. [Replace the BBU module.](#)

## **Installing the battery backup unit**

#### **Prerequisites**

1. Follow the safety guidelines listed in [Safety Instructions](#).
2. Follow the procedure listed in [Before working inside your sled](#) on page 42.
3. [Install the BBU into the BBU cage.](#)
4. [Install the drive cage.](#)
5. [Install the backplane.](#)

#### **Steps**

1. Route the cable on the battery backup unit (BBU) through the front end of the drive cage.
2. Align and slide the BBU until it firmly locks in place with the drive cage.

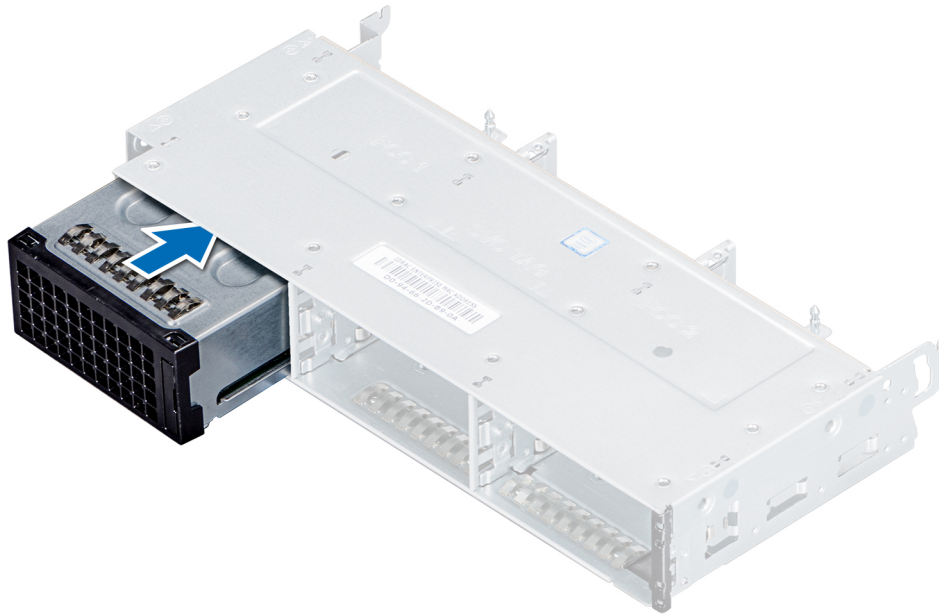

**Figure 43. Installing the BBU**

3. Connect the BBU cables to the connector on the system board.

#### **Next steps**

1. Follow the procedure listed in the [After working inside your sled](#).
2. [Replace the drive carrier](#) or a [drive blank](#).

## **Removing the BBU from the BBU cage**

#### **Prerequisites**

1. Follow the safety guidelines listed in [Safety Instructions](#).
2. Follow the procedure listed in the [Before working inside your sled](#).
3. [Remove the BBU module](#).

#### **Steps**

1. Using a Phillips #1 screwdriver, loosen the captive screw securing the BBU to the BBU cage.
2. Lift and slide the BBU out of the BBU cage.



**Figure 44. Removing the BBU from the BBU cage**

#### **Next steps**

1. [Install the BBU into the BBU cage.](#)

## **Installing the BBU into the BBU cage**

#### **Prerequisites**

1. Follow the safety guidelines listed in [Safety Instructions](#).

#### **Steps**

1. Align and slide the BBU into the BBU cage.
2. Using a Phillips #1 screwdriver, tighten the captive screw to secure the BBU to the BBU cage.

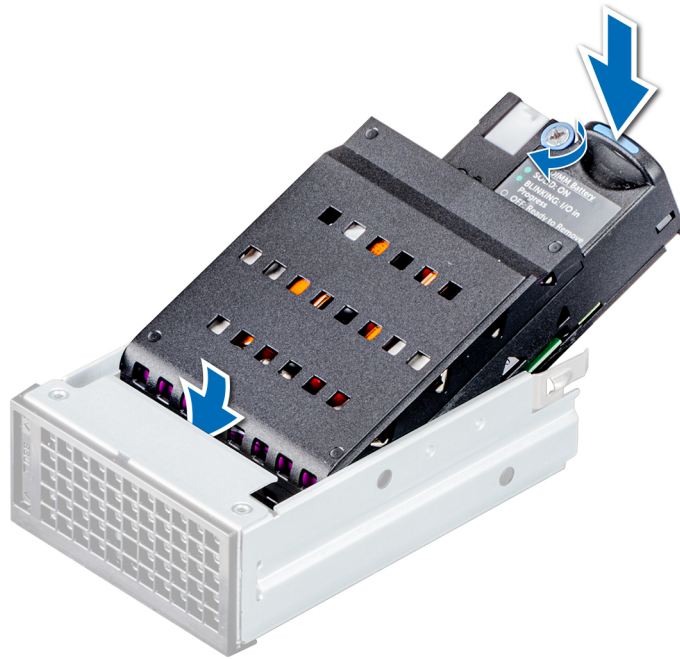

**Figure 45. Installing the BBU into the BBU cage**

#### **Next steps**

1. [Install the BBU module.](#)

## **Control panel**

The control panel allows you to manually control the inputs to the sled.

## **Removing the control panel**

#### **Prerequisites**

1. Follow the safety guidelines listed in [Safety Instructions](#).
2. Follow the procedure listed in [Before working inside the sled](#).
3. [Remove the drives.](#)
4. [Remove the drive cage.](#)

#### **Steps**

1. Pull the blue strap to disconnect the control panel cable connected to the system board.
2. Using a Phillips #1 screwdriver, remove the screws that secure the control panel to the system.
3. Slide the control panel out of the system.

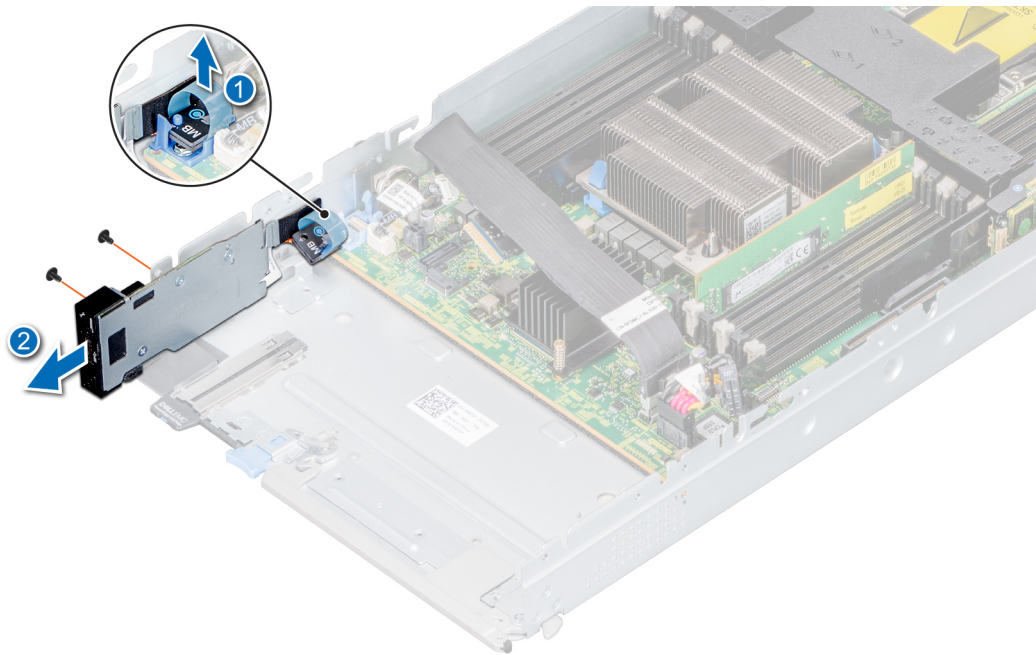

**Figure 46. Removing the control panel**

### Next steps

1. [Install the control panel.](#)

## Installing the control panel

### Prerequisites

1. Follow the safety guidelines listed in [Safety Instructions](#).
2. Follow the procedure listed in [Before working inside your sled](#).

### Steps

1. Align control panel with the slots on the system and slide it in.
2. Connect the control panel cable to the connector on the system board.
3. Using a Phillips #1 screwdriver, secure the control panel to the system with the screws.

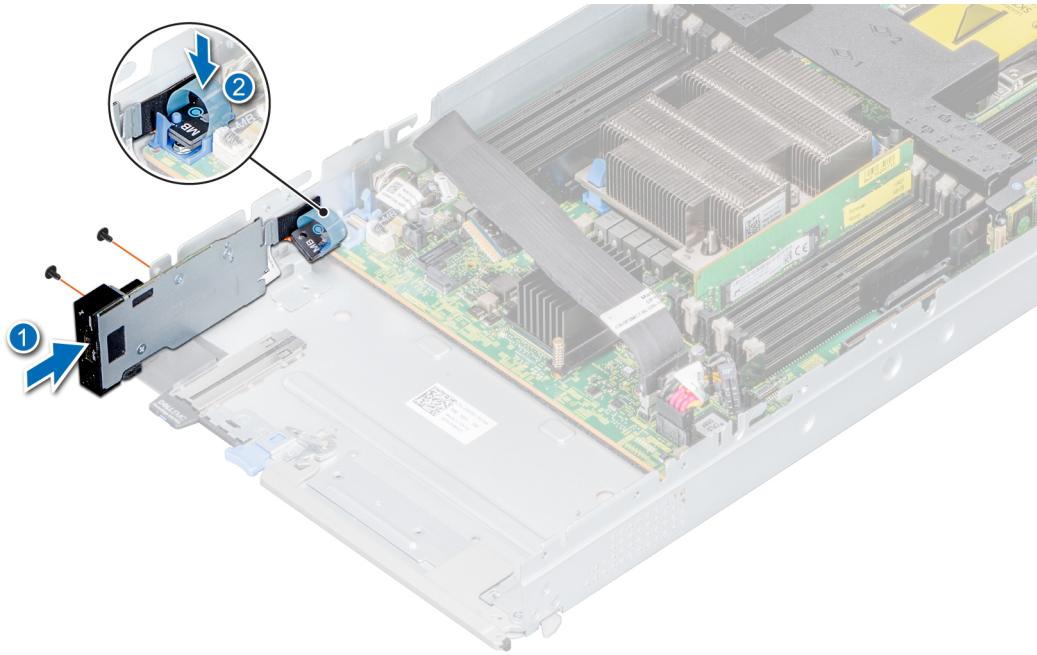

**Figure 47. Installing the control panel**

### **Next steps**

1. [Install the drive cage.](#)
2. [Install the drives.](#)
3. Follow the procedure listed in the [After working inside your sled.](#)

## **System memory**

The system supports DDR4 registered DIMMs (RDIMMs), load reduced DIMMs (LRDIMMs), Non-Volatile DIMMs (NVDIMM-Ns), and Intel Optane Data Center Persistent Memory Modules (DCPMMs). System memory holds the instructions that are executed by the processor.

Your system contains 24 memory sockets split into two sets of 12 sockets, one set per processor. Each 12-socket set is organized into six channels. Six memory channels are allocated to each processor. In each channel, the release tabs of the first socket are marked white, and the second socket black.

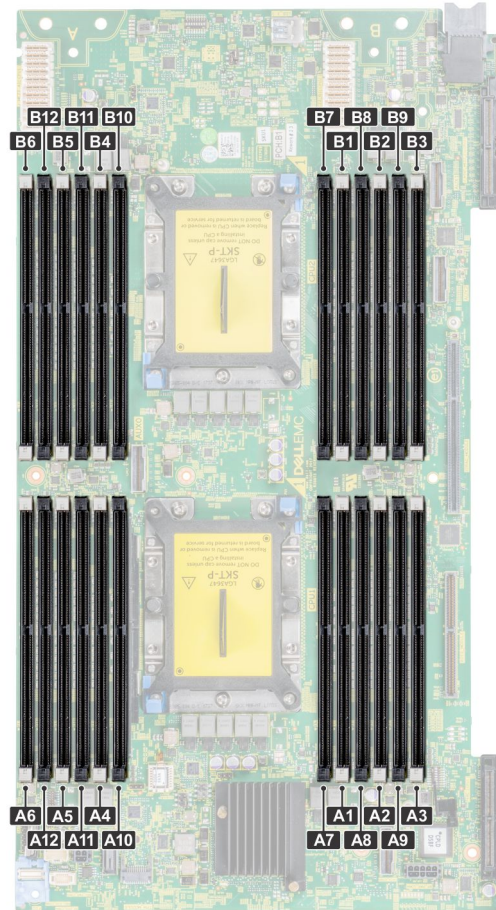

**Figure 48. System memory layout**

Memory channels are organized as follows:

**Table 6. Memory channels**

Channel	Processor 1	Processor 2
0	Slots A1 and A7	Slots B1 and B7
1	Slots A2 and A8	Slots B2 and B8
2	Slots A3 and A9	Slots B3 and B9
3	Slots A4 and A10	Slots B4 and B10
4	Slots A5 and A11	Slots B5 and B11
5	Slots A6 and A12	Slots B6 and B12

**Table 7. Memory population**

DIMM Type	DIMM Ranking	Voltage	Operating Frequency (in MT/s)
RDIMM	1R / 2R	1.2 V	2933, 2666
LRDIMM	4R / 8R	1.2 V	2666

## General memory module installation guidelines

To ensure optimal performance of your system, observe the following general guidelines when configuring your system memory. If your system's memory configurations fail to observe these guidelines, your system might not boot, stop responding during memory configuration, or operate with reduced memory.

The memory bus may operate at frequency can be 2933 MT/s, 2666 MT/s, 2400 MT/s, or 2133 MT/s depending on the following factors:

- System profile selected (for example, Performance Optimized, or Custom [can be run at high speed or lower])
- Maximum supported DIMM speed of the processors. For memory frequency of 2933 MT/s, one DIMM per channel is supported.
- Maximum supported DIMM speed of the processors.
- Maximum supported speed of the DIMMs

**i** **NOTE:** MT/s indicates DIMM speed in MegaTransfers per second.

The system supports Flexible Memory Configuration, enabling the system to be configured and run in any valid chipset architectural configuration. The following are the recommended guidelines for installing memory modules:

- All DIMMs must be DDR4.
- RDIMMs and LRDIMMs must not be mixed.
- 64 GB LRDIMMs that are DDP (Dual Die Package) LRDIMMs must not be mixed with 128 GB LRDIMMs that are TSV (Through Silicon Via/3DS) LRDIMMs.
- x4 and x8 DRAM based memory modules can be mixed.
- Up to two RDIMMs can be populated per channel regardless of rank count.
- Up to two LRDIMMs can be populated per channel regardless of rank count.
- A maximum of two different ranked DIMMs can be populated in a channel regardless of rank count.
- If memory modules with different speeds are installed, they will operate at the speed of the slowest installed memory module(s).
- Populate memory module sockets only if a processor is installed.
  - For single-processor systems, sockets A1 to A12 are available.
  - For dual-processor systems, sockets A1 to A12 and sockets B1 to B12 are available.
- Populate all the sockets with white release tabs first, followed by the black release tabs.
- When mixing memory modules with different capacities, populate the sockets with memory modules with the highest capacity first.

For example, if you want to mix 8 GB and 16 GB memory modules, populate 16 GB memory modules in the sockets with white release tabs and 8 GB memory modules in the sockets with black release tabs.

- Memory modules of different capacities can be mixed provided other memory population rules are followed.

For example, 8 GB and 16 GB memory modules can be mixed.
- In a dual-processor configuration, the memory configuration for each processor must be identical.

For example, if you populate socket A1 for processor 1, then populate socket B1 for processor 2, and so on.
- Mixing of more than two memory module capacities in a system is not supported.
- Unbalanced memory configurations will result in a performance loss so always populate memory channels identically with identical DIMMs for best performance.
- Populate six identical memory modules per processor (one DIMM per channel) at a time to maximize performance.

DIMM population update for Performance Optimized mode with quantity of 4 and 8 DIMMs per processor.

- When the DIMM quantity is 4 per processor, the population is slot 1, 2, 4, 5.
- When the DIMM quantity is 8 per processor, the population is slot 1, 2, 4, 5, 7, 8, 10, 11.

## NVDIMM-N memory module installation guidelines

The following are the recommended guidelines for installing NVDIMM-N memory modules:

- Each system supports memory configurations with 1, 2, 4, 6, or 12 NVDIMM-Ns.
- Supported configurations have dual processors and a minimum of 12x RDIMMs.
- Maximum of 12 NVDIMM-Ns can be installed in a system.

- NVDIMM-Ns or RDIMMs must not be mixed with LRDIMMs.
- DDR4 NVDIMM-Ns must be populated only on the black release tabs on processor 1 and 2.
- All slots on configurations 3, 6, 9, and 12 can be used, but a maximum of 12 NVDIMM-Ns can be installed in a system.

**NOTE:** NVDIMM-N memory slots are not hot-pluggable.

For more information about the supported NVDIMM-N configurations, see the *NVDIMM-N User Guide* at [www.dell.com/poweredgemanuals](http://www.dell.com/poweredgemanuals).

**Table 8. Supported NVDIMM-N for dual processor configurations**

Configuration	Description	Memory population rules	
		RDIMMs	NVDIMM-N
Configuration 1	12x 16 GB RDIMMs, 1x NVDIMM-N	Processor1 {A1, 2, 3, 4, 5, 6} Processor2 {B1, 2, 3, 4, 5, 6}	Processor1 {A7}
Configuration 2	12x 32 GB RDIMMs, 1x NVDIMM-N	Same for all 12x RDIMM configurations. See Configuration 1.	Processor1 {A7}
Configuration 3	23x 32 GB RDIMMs, 1x NVDIMM-N	Processor1 {A1, 2, 3, 4, 5, 6, 7, 8, 9, 10, 11, 12} Processor2 {B1, 2, 3, 4, 5, 6, 7, 8, 9, 10, 11}	Processor2 {B12}
Configuration 4	12x 16 GB RDIMMs, 2x NVDIMM-Ns	Same for all 12x RDIMM configurations. See Configuration 1.	Processor1 {A7} Processor2 {B7}
Configuration 5	12x 32 GB RDIMMs, 2x NVDIMM-Ns	Same for all 12x RDIMM configurations. See Configuration 1.	Processor1 {A7} Processor2 {B7}
Configuration 6	22x 32 GB RDIMMs, 2x NVDIMM-Ns	Processor1 {A1, 2, 3, 4, 5, 6, 7, 8, 9, 10, 11} Processor2 {B1, 2, 3, 4, 5, 6, 7, 8, 9, 10, 11}	Processor1 {A12} Processor2 {B12}
Configuration 7	12x 16 GB RDIMMs, 4x NVDIMM-Ns	Same for all 12x RDIMM configurations. See Configuration 1.	Processor1 {A7, A8} Processor2 {B7, B8}
Configuration 8	22x 32 GB RDIMMs, 4x NVDIMM-Ns	Same for all 12x RDIMM configurations. See Configuration 1.	Processor1 {A7, A8} Processor2 {B7, B8}
Configuration 9	20x 32 GB RDIMMs, 4x NVDIMM-Ns	Processor1 {A1, 2, 3, 4, 5, 6, 7, 8, 9, 10} Processor2 {B1, 2, 3, 4, 5, 6, 7, 8, 9, 10}	Processor1 {A11, 12} Processor2 {B11, 12}
Configuration 10	12x 16 GB RDIMMs, 6x NVDIMM-Ns	Same for all 12x RDIMM configurations. See Configuration 1.	Processor1 {A7, 8, 9} Processor2 {B7, 8, 9}
Configuration 11	12x 32 GB RDIMMs, 6x NVDIMM-Ns	Same for all 12x RDIMM configurations. See Configuration 1.	Processor1 {A7, 8, 9} Processor2 {B7, 8, 9}

**Table 8. Supported NVDIMM-N for dual processor configurations (continued)**

Configuration	Description	Memory population rules	
		RDIMMs	NVDIMM-N
Configuration 12	18x 32 GB RDIMMs, 6x NVDIMM-Ns	Processor1 {1, 2, 3, 4, 5, 6, 7, 8, 9} Processor2 {1, 2, 3, 4, 5, 6, 7, 8, 9}	Processor1 {A10, 11, 12} Processor2 {B10, 11, 12}
Configuration 13	12x 16 GB RDIMMs, 12x NVDIMM-Ns	Same for all 12x RDIMM configurations. See Configuration 1.	Processor1 {A7, 8, 9, 10, 11, 12} Processor2 {B7, 8, 9, 10, 11, 12}
Configuration 14	12x 32 GB RDIMMs, 12x NVDIMM-Ns	Same for all 12x RDIMM configurations. See Configuration 1.	Processor1 {A7, 8, 9, 10, 11, 12} Processor2 {B7, 8, 9, 10, 11, 12}

## DCPMM installation guidelines

The following are the recommended guidelines for installing data center persistent memory module (DCPMM) memory modules:

- Each system supports maximum of one DCPMM memory module per channel.
- **NOTE:** If two different DCPMM capacities are mixed, an F1/F2 warning is displayed as the configuration is not supported.
- DCPMM can be mixed with RDIMM, LRDIMM, and 3DS LRDIMM.
- Mixing of DDR4 DIMM types (RDIMM, LRDIMM, and 3DS LRDIMM), within channels, for Integrated Memory Controller (iMC), or across sockets are not supported.
- Mixing of DCPMM operating modes (App Direct, Memory Mode) is not supported.
- If only one DIMM is populated on a channel, it should always go to the first slot in that channel (white slot).
- If a DCPMM and a DDR4 DIMM are populated on the same channel, always plug DCPMM on second slot (black slot).
- If the DCPMM is configured in Memory Mode, the recommended DDR4 to DCPMM capacity ratio is 1:4 to 1:16 per iMC.
- DCPMMs cannot be mixed with other DCPMMs capacities or NVDIMMs.
- Mixing different capacities of RDIMMs and LRDIMMs are not allowed when DCPMM is installed.
- DCPMMs of different capacities are not allowed.

For more information about the supported DCPMM configurations, see the *Dell EMC DCPMM User 's Guide* at [https://www.dell.com/support/home/products/server\\_int/server\\_int\\_poweredge](https://www.dell.com/support/home/products/server_int/server_int_poweredge).

**Table 9. 1 socket DCPMM configurations**

No. of CPUs in the Server	DCPMM Population	DRAM Population	DRAM Capacity (GB)	DCPMM Capacity (GB)	Operating system Memory in Memory Mode (GB)	Total Memory (GB)	Total Memory per CPU (GB)	Ratio DRAM to Optane Memory	Requires an M or L CPU	Supported in App Direct Mode	Supported in Memory Mode
1	128 GB x 2	16 GB x 4	64	256	256	320	320	1 : 4	No	Yes	Yes
1	128 GB x 1	16 GB x 6	96	128	N/A	224	224	1 : 1.3	No	Yes	No
1	128 GB x 2	16 GB x 6	96	256	N/A	352	352	1 : 2.7	No	Yes	No
1	128 GB x 4	16 GB x 6	96	512	512	608	608	1 : 5.3	No	Yes	Yes
1	128 GB x 6	16 GB x 6	96	768	768	864	864	1 : 8	No	Yes	Yes

**Table 9. 1 socket DCPMM configurations (continued)**

No. of CPUs in the Server	DCPM M Population	DRAM Population	DRAM Capacity (GB)	DCPM M Capacity (GB)	Operating system Memory in Memory Mode (GB)	Total Memory (GB)	Total Memory per CPU (GB)	Ratio DRAM to Optane Memory	Requires an M or L CPU	Supported in App Direct Mode	Supported in Memory Mode
1	128 GB x 1	32 GB x 6	192	128	N/A	320	320	1 : 0.7	No	Yes	No
1	128 GB x 2	32 GB x 6	192	256	N/A	448	448	1 : 1.3	No	Yes	No
1	128 GB x 4	32 GB x 6	192	512	N/A	704	704	1 : 2.7	No	Yes	No
1	128 GB x 6	32 GB x 6	192	768	768	960	960	1 : 4	No	Yes	Yes
1	128 GB x 1	64 GB x 6	384	128	N/A	512	512	1 : 0.3	No	Yes	No

**Table 10. 2 socket DCPMM configurations**

No. of CPUs in the Server	DCPM M Population	DRAM Population	DRAM Capacity (GB)	DCPM M Capacity (GB)	Operating system Memory in Memory Mode (GB)	Total Memory (GB)	Total Memory per CPU (GB)	Ratio DRAM to Optane Memory	Requires an M or L CPU	Supported in App Direct Mode	Supported in Memory Mode
2	128 GB x 1	16 GB x 12	192	128	N/A	320	160	1 : 0.7	No	Yes	No
2	128 GB x 2	16 GB x 12	192	256	N/A	448	224	1 : 1.3	No	Yes	No
2	128 GB x 4	16 GB x 8	128	512	512	640	320	1 : 4	No	Yes	Yes
2	128 GB x 4	16 GB x 12	192	512	N/A	704	352	1 : 2.7	No	Yes	No
2	128 GB x 8	16 GB x 12	192	1,024	1,024	1,216	608	1 : 5.3	No	Yes	Yes
2	128 GB x 12	16 GB x 12	192	1,536	1,536	1,728	864	1 : 8	No	Yes	Yes
2	128 GB x 1	32 GB x 12	384	128	N/A	512	256	1 : 0.3	No	Yes	No
2	128 GB x 2	32 GB x 12	384	256	N/A	640	320	1 : 0.7	No	Yes	No
2	128 GB x 4	32 GB x 12	384	512	N/A	896	448	1 : 1.3	No	Yes	No
2	128 GB x 8	32 GB x 12	384	1,024	N/A	1,408	704	1 : 2.7	No	Yes	No
2	128 GB x 12	32 GB x 12	384	1,536	1,536	1,920	960	1 : 4	No	Yes	Yes
2	128 GB x 4	64 GB x 12	768	512	N/A	1,280	640	1 : 0.7	No	Yes	No
2	128 GB x 8	64 GB x 12	768	1,024	N/A	1,792	896	1 : 1.3	No	Yes	No
2	128 GB x 12	64 GB x 12	768	1,536	N/A	2,304	1,152	1 : 2	L SKU	Yes	No

**Table 10. 2 socket DCPMM configurations (continued)**

No. of CPUs in the Server	DCPM M Population	DRAM Population	DRAM Capacity (GB)	DCPM M Capacity (GB)	Operating system Memory in Memory Mode (GB)	Total Memory (GB)	Total Memory per CPU (GB)	Ratio DRAM to Optane Memory	Requires an M or L CPU	Supported in App Direct Mode	Supported in Memory Mode
2	128 GB x 12	128 GB x 12	1,536	1,536	N/A	3,072	1,536	1 : 1	L SKU	Yes	No
2	512 GB x 8	32 GB x 12	384	4,096	4,096	4,480	2,240	1 : 10.7	L SKU	Yes	Yes
2	512 GB x 12	32 GB x 12	384	6,144	6,144	6,528	3,264	1 : 16	L SKU	Yes	Yes
2	512 GB x 8	64 GB x 12	768	4,096	4,096	4,864	2,432	1 : 5.3	L SKU	Yes	Yes
2	512 GB x 12	64 GB x 12	768	6,144	6,144	6,912	3,456	1 : 8	L SKU	Yes	Yes
2	512 GB x 12	128 GB x 12	1,536	6,144	6,144	7,680	3,840	1 : 4	L SKU	Yes	Yes
2	256 GB x 8	16 GB x 12	192	2,048	2,048	2,240	1,120	1 : 10.7	L SKU	Yes	Yes
2	256 GB x 8	32 GB x 12	384	2,048	2,048	2,432	1,216	1 : 5.3	L SKU	Yes	Yes
2	256 GB x 12	32 GB x 12	384	3,072	3,072	3,456	1,728	1 : 8	L SKU	Yes	Yes
2	256 GB x 8	64 GB x 12	768	2,048	N/A	2,816	1,408	1 : 2.7	L SKU	Yes	No
2	256 GB x 12	64 GB x 12	768	3,072	3,072	3,840	1,920	1 : 4	L SKU	Yes	Yes
2	256 GB x 12	128 GB x 12	1,536	3,072	N/A	4,608	2,304	1 : 2	L SKU	Yes	No

**NOTE:** There are limited configurations available for Dual Socket Servers with only one CPU populated.





## Mode-specific guidelines

The configurations allowed depend on the memory mode selected in the System BIOS.

**Table 11. Memory operating modes**

Memory Operating Mode	Description
<b>Optimizer Mode</b>	The <b>Optimizer Mode</b> if enabled, the DRAM controllers operate independently in the 64-bit mode and provide optimized memory performance. <b>NOTE:</b> DCPMM supports only Optimizer mode.
<b>Mirror Mode</b>	The <b>Mirror Mode</b> if enabled, the system maintains two identical copies of data in memory, and the total available system memory is one half of the total installed physical memory. Half of the installed memory is used to mirror the active memory modules. This feature provides maximum reliability and enables the system to continue running even during a catastrophic memory failure by switching over to the mirrored copy. The installation guidelines to enable Mirror

**Table 11. Memory operating modes (continued)**

Memory Operating Mode	Description
	Mode require that the memory modules be identical in size, speed, and technology, and they must be populated in sets of 6 per processor.
<b>Single Rank Spare Mode</b>	<b>Single Rank Spare Mode</b> allocates one rank per channel as a spare. If excessive correctable errors occur in a rank or channel, while the operating system is running, they are moved to the spare area to prevent errors from causing an uncorrectable failure. Requires two or more ranks to be populated in each channel.
<b>Multi Rank Spare Mode</b>	<b>Multi Rank Spare Mode</b> allocates two ranks per channel as a spare. If excessive correctable errors occur in a rank or channel, while the operating system is running, they are moved to the spare area to prevent errors from causing an uncorrectable failure. Requires three or more ranks to be populated in each channel.
	<p>With single rank memory sparing enabled, the system memory available to the operating system is reduced by one rank per channel.</p> <p>For example, in a dual-processor configuration with 24x 16 GB dual-rank memory modules, the available system memory is: <math>3/4</math> (ranks/channel) <math>\times</math> 24 (memory modules) <math>\times</math> 16 GB = 288 GB, and not 24 (memory modules) <math>\times</math> 16 GB = 384 GB. For multi rank sparing, the multiplier changes to <math>1/2</math> (ranks/channel).</p> <p> <b>NOTE:</b> To use memory sparing, this feature must be enabled in the BIOS menu of System Setup.</p> <p> <b>NOTE:</b> Memory sparing does not offer protection against a multi-bit uncorrectable error.</p>
<b>Dell Fault Resilient Mode</b>	<p>The <b>Dell Fault Resilient Mode</b> if enabled, the BIOS creates an area of memory that is fault resilient. This mode can be used by an OS that supports the feature to load critical applications or enables the OS kernel to maximize system availability.</p> <p> <b>NOTE:</b> This feature is only supported in Gold and Platinum Intel processors.</p> <p> <b>NOTE:</b> Memory configuration has to be of same size DIMM, speed, and rank.</p>

## Optimizer Mode

This mode supports Single Device Data Correction (SDDC) only for memory modules that use x4 device width. It does not impose any specific slot population requirements.

- Dual processor: Populate the slots in round robin sequence starting with processor 1.

 **NOTE:** Processor 1 and processor 2 population should match.

**Table 12. Memory population rules**

Processor	Configuration	Memory population	Memory population information
Single processor	Optimizer (Independent channel) population order	1, 2, 3, 4, 5, 6, 7, 8, 9, 10, 11, 12	<ul style="list-style-type: none"> <li>• DIMMs must be populated in the order specified.</li> <li>• Odd number of DIMM population is allowed</li> </ul>

**Table 12. Memory population rules (continued)**

Processor	Configuration	Memory population	Memory population information
			<p><b>i</b> <b>NOTE:</b> Odd number of DIMMs will result in unbalanced memory configurations, which in turn will result in performance loss. It is recommended to populate all memory channels identically with identical DIMMs for best performance.</p> <ul style="list-style-type: none"> <li>Optimizer population order is not traditional for 4 and 8 DIMM installations of single processor.                             <ul style="list-style-type: none"> <li>For 4 DIMMs: A1, A2, A4, A5</li> <li>For 8 DIMMs: A1, A2, A4, A5, A7, A8, A10, A11</li> </ul> </li> </ul>
	Mirror population order	{1, 2, 3, 4, 5, 6} {7, 8, 9, 10, 11, 12}	Mirroring is supported with 6 or 12 DIMMs per processor.
	Single rank sparing population order	1, 2, 3, 4, 5, 6, 7, 8, 9, 10, 11, 12	<ul style="list-style-type: none"> <li>DIMMs must be populated in the order specified.</li> <li>Requires two ranks or more per channel.</li> </ul>
	Multi rank sparing population order	1, 2, 3, 4, 5, 6, 7, 8, 9, 10, 11, 12	<ul style="list-style-type: none"> <li>DIMMs must be populated in the order specified.</li> <li>Requires three ranks or more per channel.</li> </ul>
	Fault resilient population order	{1, 2, 3, 4, 5, 6} {7, 8, 9, 10, 11, 12}	Supported with 6 or 12 DIMMs per processor.
Dual processor (Start with processor1. processor1 and processor 2 population should match)	Optimized (Independent channel) population order	A{1}, B{1}, A{2}, B{2}, A{3}, B{3}, A{4}, B{4}, A{5}, B{5}, A{6}, B{6}	<p>Odd number of DIMM population per processor is allowed.</p> <p><b>i</b> <b>NOTE:</b> Odd number of DIMMs will result in unbalanced memory configurations, which in turn will result in performance loss. It is recommended to populate all memory channels identically with identical DIMMs for best performance.</p> <p>Optimizer population order is not traditional for 8 and 16 DIMMs installations for dual processor.</p> <ul style="list-style-type: none"> <li>For 8 DIMMs: A1, A2, A4, A5, B1, B2, B4, B5</li> <li>For 16 DIMMs: A1, A2, A4, A5, A7, A8, A10, A11 B1, B2, B4, B5, B7, B8, B10, B11</li> </ul>
	Mirroring population order	A{1, 2, 3, 4, 5, 6}, B{1, 2, 3, 4, 5, 6}, A{7, 8, 9, 10, 11, 12}, B{7, 8, 9, 10, 11, 12}	Mirroring is supported with 6 or 12 DIMMs per processor.
	Single rank sparing population order	A{1}, B{1}, A{2}, B{2}, A{3}, B{3}, A{4}, B{4}, A{5}, B{5}, A{6}, B{6}	<ul style="list-style-type: none"> <li>DIMMs must be populated in the order specified.</li> <li>Requires two ranks or more per channel.</li> </ul>

**Table 12. Memory population rules (continued)**

Processor	Configuration	Memory population	Memory population information
	Multi rank sparing population order	A{1}, B{1}, A{2}, B{2}, A{3}, B{3}, A{4}, B{4}, A{5}, B{5}, A{6}, B{6}	<ul style="list-style-type: none"> <li>DIMMs must be populated in the order specified.</li> <li>Requires three ranks or more per channel.</li> </ul>
	Fault resilient population order	A{1, 2, 3, 4, 5, 6}, B{1, 2, 3, 4, 5, 6}, A{7, 8, 9, 10, 11, 12}, B{7, 8, 9, 10, 11, 12}	Supported with 6 or 12 DIMMs per processor.

## Removing a memory module

### Prerequisites

1. Follow the safety guidelines listed in [Safety instructions](#) on page 41.
2. Follow the procedure listed in [Before working inside your sled](#) on page 42.
3. [Remove the air shroud](#).

**⚠ WARNING:** Allow the memory modules to cool after you power off the system. Handle the memory modules by the card edges and avoid touching the components or metallic contacts on the memory module.

**⚠ CAUTION:** To ensure proper system cooling, memory module blanks must be installed in any memory socket that is not occupied. Remove memory module blanks only if you intend to install memory modules in those sockets.

**ℹ NOTE:** You must follow the thermal restriction while using DIMM blank. For information about thermal restriction, see [Thermal restrictions](#).

### Steps

1. Locate the appropriate memory module socket.

**⚠ WARNING:** Handle each memory module only by the card edges, ensuring not to touch the middle of the memory module or metallic contacts.

2. Push the ejectors outward on both ends of the memory module socket to release the memory module from the socket.
3. Lift the memory module from the system.

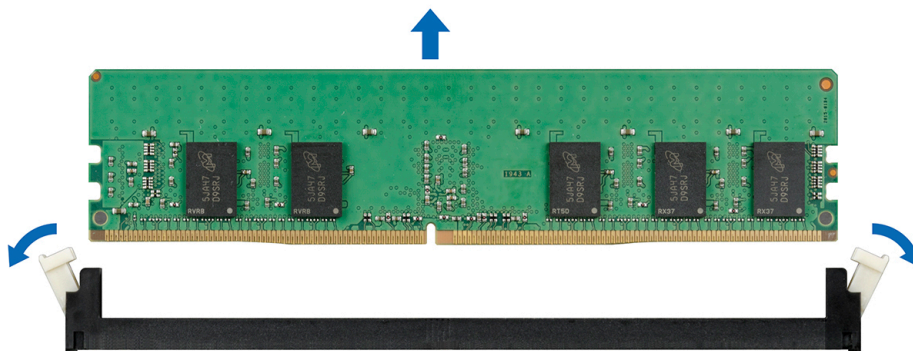

**Figure 49. Removing a memory module**

### Next steps

1. [Install the memory module](#).

2. If you are removing the memory module permanently, install a memory module blank. The procedure to install a memory module blank is similar to that of the memory module.

**i** **NOTE:** When operating your system with single processor, install DIMM blanks in CPU2 memory sockets.

## Installing a memory module

### Prerequisites

Follow the safety guidelines listed in [Safety instructions](#) on page 41.

**△ CAUTION:** To ensure proper system cooling, memory module blanks must be installed in any memory socket that is not occupied. Remove memory module blanks only if you intend to install memory modules in those sockets.

**i** **NOTE:** You must follow the thermal restriction while using DIMM blank. For information about thermal restriction, see [Thermal restrictions matrix](#).

### Steps

1. Locate the appropriate memory module socket.

**△ CAUTION:** Handle each memory module only by the card edges, ensuring not to touch the middle of the memory module or metallic contacts.

**△ CAUTION:** To prevent damage to the memory module or the memory module socket during installation, do not bend or flex the memory module. You must insert both ends of the memory module simultaneously.

2. Open the ejectors on the memory module socket to allow the memory module to be inserted into the socket.

3. Align the edge connector of the memory module with the alignment key of the memory module socket, and insert the memory module in the socket.

**△ CAUTION:** Do not apply pressure at the center of the memory module; apply pressure at both ends of the memory module evenly.

**i** **NOTE:** The memory module socket has an alignment key that enables you to install the memory module in the socket in only one orientation

4. Press the memory module with your thumbs until the socket levers firmly click into place.

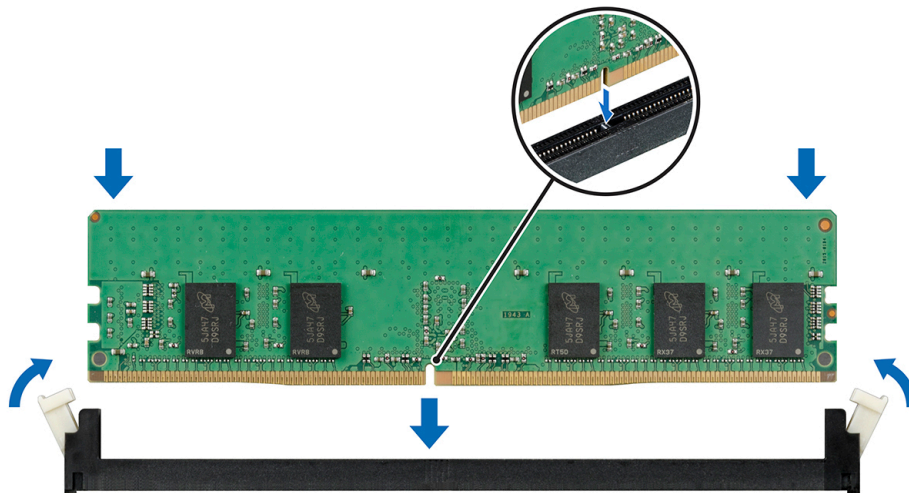

Figure 50. Installing a memory module

### Next steps

1. [Replace the air shroud.](#)

2. Follow the procedure listed in [After working inside your sled](#) on page 42.
3. To verify if the memory module has been installed properly, press F2 and navigate to **System Setup Main Menu > System BIOS > Memory Settings**. In the **Memory Settings** screen, the System Memory Size must reflect the updated capacity of the installed memory.  
**NOTE:** If memory size changes in anyway from the previous successful system boot, the system will prompt the end user during POST that the memory configuration has changed.
4. If the value is incorrect, one or more of the memory modules may not be installed properly. Ensure that the memory module is firmly seated in the memory module socket.
5. Run the system memory test in system diagnostics.

## Processors and heat sinks

The processor controls memory, peripheral interfaces, and other components of the system. The system can have more than one processor configurations.

The heat sink absorbs the heat generated by the processor, and helps the processor to maintain its optimal temperature level.

## Removing the processor and heat sink module

### Prerequisites

**WARNING:** The heat sink may be hot to touch for some time after the system has been powered down. Allow the heat sink to cool before removing it.

1. Follow the safety guidelines listed in [Safety instructions](#) on page 41.
2. Follow the procedure listed in [Before working inside your sled](#).
3. [Remove the air shroud](#).

### Steps

1. Using a Torx #T30 screwdriver, loosen the screws on the heat sink in the order below:
  - a. Loosen the first screw three turns.
  - b. Loosen the second screw completely.
  - c. Return to the first screw and loosen it completely.**NOTE:** It is normal for the heat sink to slip off the blue retention clips when the screws are partially loosened, continue to loosen the screw(s).
2. Pushing both the blue retention clips simultaneously, lift the processor and heat sink module (PHM) out of the system.
3. Set the PHM aside with the processor side facing up.

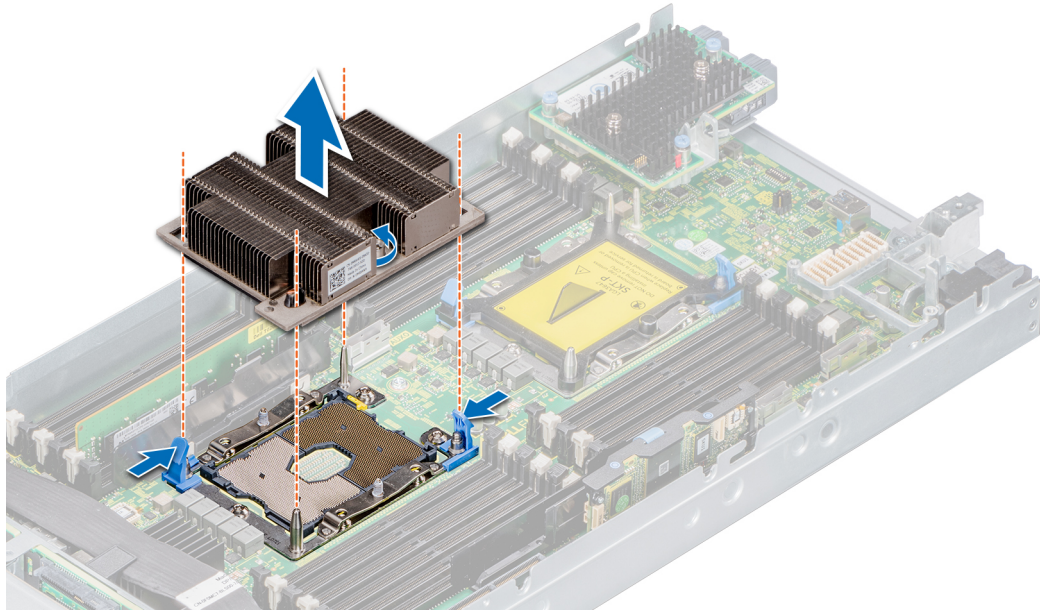

Figure 51. Removing the processor and heat sink module ( PHM )

#### Next steps

1. [Install the processor and heat sink module.](#)

## Removing the processor from the processor and heat sink module

#### Prerequisites

1. Follow the safety guidelines listed in [Safety Instructions](#).
2. Follow the procedure listed in [Before working inside your sled](#).
3. [Remove the air shroud](#).
4. [Remove the processor and heat sink module](#)

**⚠ WARNING:** The heat sink may be hot to touch for some time after the system has been powered down. Allow the heat sink to cool before removing it.

**i NOTE:** This procedure is only needed when replacing a processor or heat sink. This is not needed when replacing system board.

#### Steps

1. Place the heat sink with the processor side facing up.
2. Insert a flat blade screwdriver into the release slot marked with a yellow label. Twist (do not pry) the screwdriver to break the thermal paste seal.
3. Push the retaining clips on the processor bracket to unlock the bracket from the heat sink.

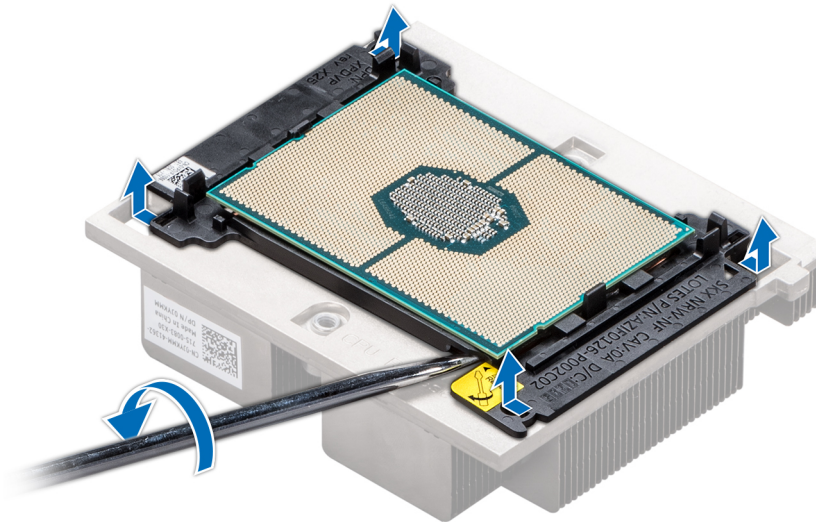

**Figure 52. Loosening the processor bracket**

4. Lift the bracket and the processor away from the heat sink, and place the processor connector side down on the processor tray.
5. Flex the outer edges of the bracket to release the bracket from the processor.

**NOTE:** Ensure that the processor and the bracket are placed in the tray after you remove the heat sink.



**Figure 53. Removing the processor bracket**

#### Next steps

1. [Install the processor into the processor and heat sink module.](#)

## Installing the processor into a processor and heat sink module

#### Prerequisites

1. Follow the safety guidelines listed in [Safety instructions](#) on page 41.

2. Follow the procedure listed in the [Before working inside the sled.](#)

### Steps

1. Place the processor in the processor tray.

**i** **NOTE:** Ensure that the pin 1 indicator on the processor tray is aligned with the pin 1 indicator on the processor.

2. Flex the outer edges of the bracket around the processor ensuring that the processor is locked into the clips on the bracket.

**i** **NOTE:** Ensure that the pin 1 indicator on the bracket is aligned with the pin 1 indicator on the processor before placing the bracket on the processor.

**i** **NOTE:** Ensure that the processor and the bracket are placed in the tray before you install the heat sink.

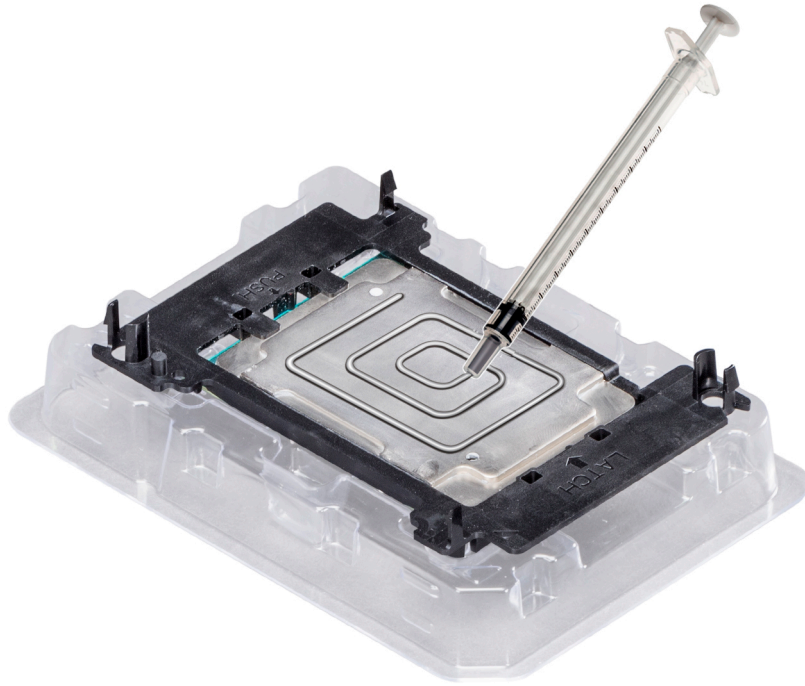

**Figure 54. Installing the processor bracket**

3. If you are using an existing heat sink, remove the thermal grease from the heat sink by using a clean lint-free cloth.
4. Use the thermal grease syringe included with your processor kit to apply the grease in a quadrilateral design on the top of the processor.

**△ CAUTION:** Applying too much thermal grease can result in excess grease coming in contact with and contaminating the processor socket.

**i** **NOTE:** The thermal grease syringe is intended for single use only. Dispose the syringe after you use it.

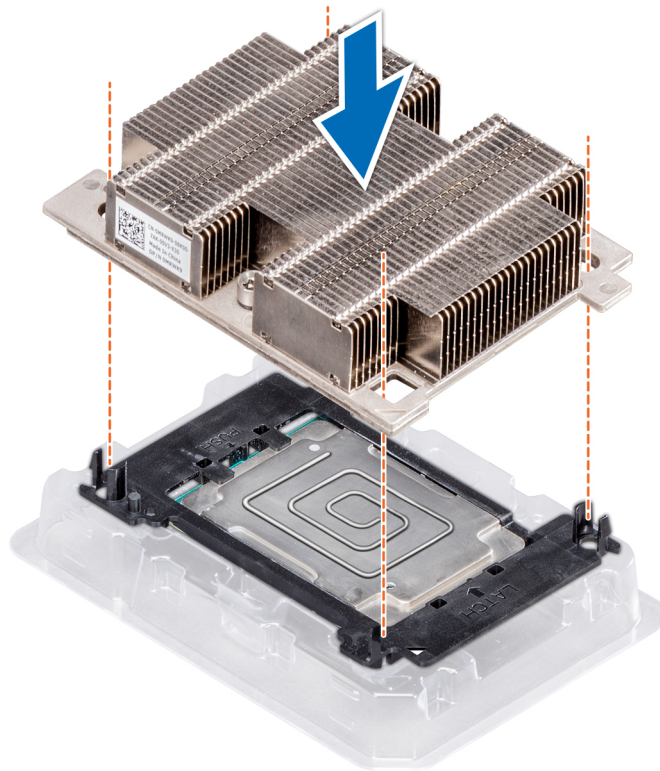

**Figure 55. Applying thermal grease on top of the processor**

5. Place the heat sink on the processor and push down on the base of the heat sink until the bracket locks onto the heat sink.

**i NOTE:**

- Ensure that the two guide pin holes on the bracket match the guide holes on the heat sink.
- Do not press on the heat sink fins.
- Ensure that the pin 1 indicator on the heat sink is aligned with the pin 1 indicator on the bracket before placing the heat sink onto the processor and bracket.



**Figure 56. Installing the heat sink onto the processor**

### Next steps

1. [Install the processor and heat sink module.](#)
2. [Install the air shroud.](#)
3. Follow the procedure listed in [After working inside your sled](#) on page 42.

## Installing a processor and heat sink module

### Prerequisites

**CAUTION:** Never remove the heat sink from a processor unless you intend to replace the processor. The heat sink is necessary to maintain proper thermal conditions.

1. Follow the safety guidelines listed in [Safety instructions](#) on page 41.
2. Follow the procedure listed in the [Before working inside your sled](#).
3. If installed, remove the processor dust cover.

### Steps

1. Align the pin 1 indicator of the heat sink to the system board and then place the processor and heat sink module (PHM) on the processor socket.

**CAUTION:** To avoid damaging the fins on the heat sink, do not press down on the heat sink fins.

**NOTE:** Ensure that the PHM is held parallel to the system board to prevent damaging the components.

2. Push the blue retention clips inward to allow the heat sink to drop into place.
3. Using the Torx #T30 screwdriver, tighten the screws on the heat sink in the order below:
  - a. Partially tighten the first screw (approximately three turns).
  - b. Tighten the second screw completely.
  - c. Return to the first screw and tighten it completely.

If the PHM slips off the blue retention clips when the screws are partially tightened, follow these steps to secure the PHM:

- a. Loosen both the heat sink screws completely.
- b. Lower the PHM on to the blue retention clips, following the procedure described in step 2.
- c. Secure the PHM to the system board, following the replacement instructions listed in step 3 above.

**NOTE:** The processor and heat sink module retention screws should not be tightened to more than 0.11 kgf-m (1.13 N.m or 10+/-0.2 in-lbf).

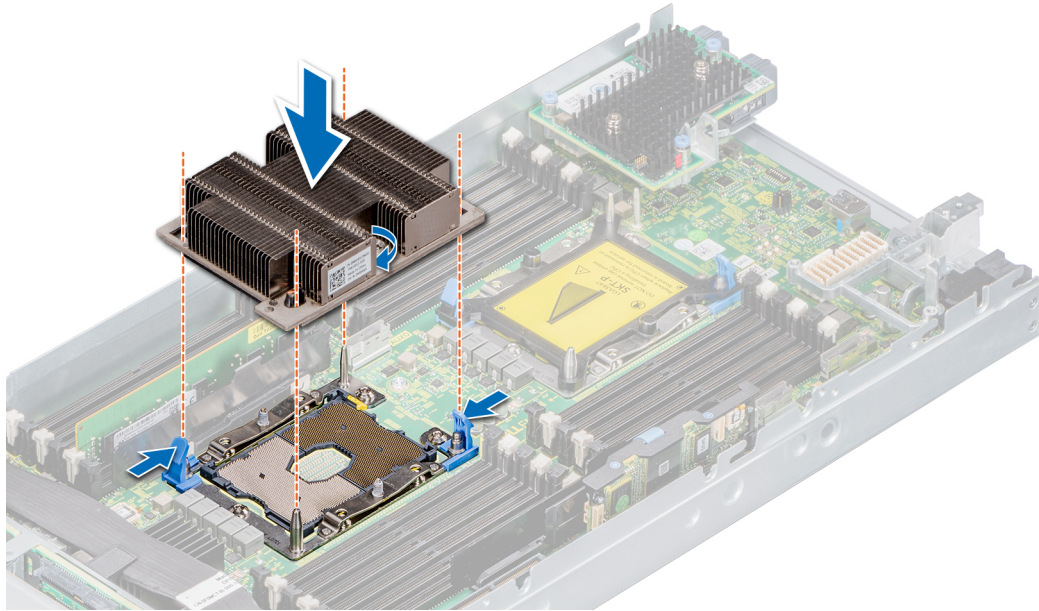

**Figure 57. Installing a processor and heat sink module**

#### Next steps

1. [Install the air shroud.](#)
2. Follow the procedure listed in [After working inside your sled.](#)

## iDRAC card

In the PowerEdge MX740c, iDRAC is not embedded on the system board. The iDRAC is a separate card unlike other 14G PowerEdge servers. The vFlash card for the PowerEdge MX740c is available on the iDRAC card.

## Removing the iDRAC card

#### Prerequisites

1. Follow the safety guidelines listed in [Safety Instructions.](#)
2. Follow the procedure listed in [Before working inside the sled.](#)
3. [Remove the air shroud.](#)

**CAUTION:** If either the system board or iDRAC card fails, it is required to replace both system board and iDRAC card at the same time.

#### Steps

Hold the blue pull tag and lift the iDRAC card away from the system.

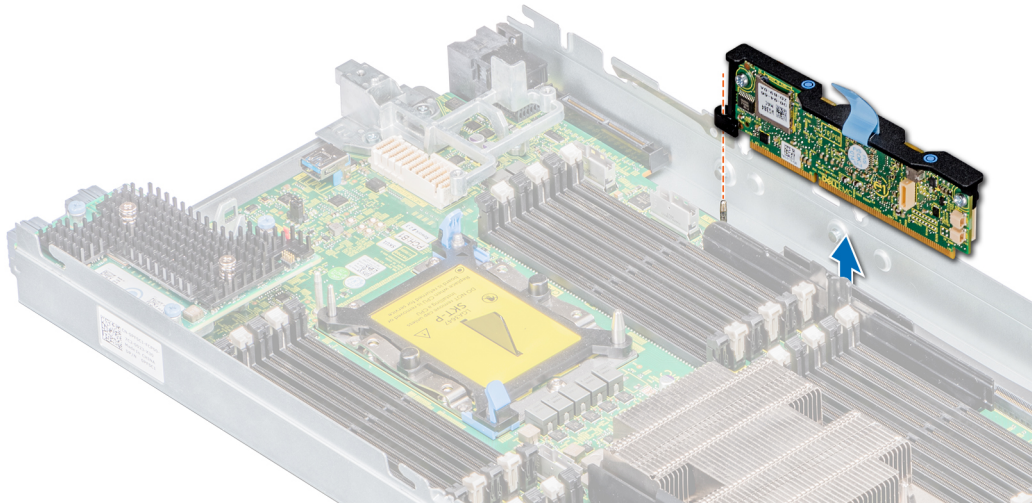

**Figure 58. Removing the iDRAC**

**NOTE:** The iDRAC module is not swappable with other MX series systems in the MX7000 enclosure.

**NOTE:** The procedure to remove vFlash card is similar to [Removing the MicroSD card](#).

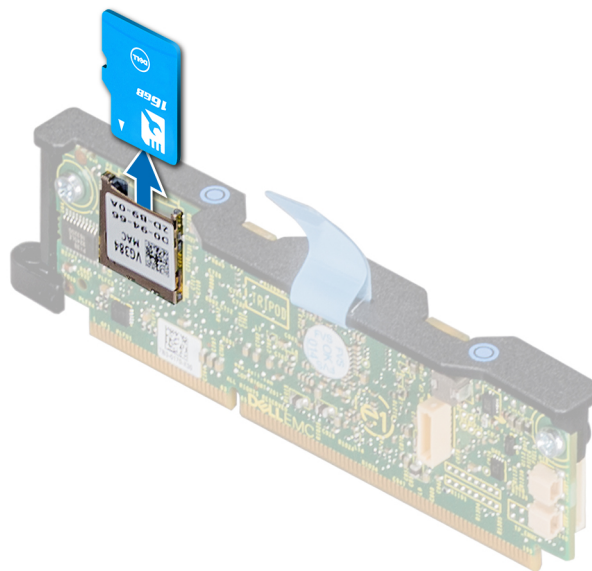

**Figure 59. Removing a vFlash card**

#### Next steps

1. [Install the iDRAC.](#)
2. Follow the procedure listed in [After working inside your sled](#) on page 42.

## Installing the iDRAC card

#### Prerequisites

**CAUTION:** To prevent damage to the iDRAC card, you must hold the card only by its edges.

1. Follow the safety guidelines listed in [Safety Instructions](#).
2. Follow the procedure listed in [Before working inside the sled](#).

**CAUTION:** If either the system board or iDRAC card fails, it is required to replace both system board and iDRAC card at the same time.

### Steps

1. Align the iDRAC card with the guide pin on the system board.
2. Lower the iDRAC card into place until the iDRAC connector is fully seated.
3. Press the blue touch points till the iDRAC card is firmly seated on the system board connector.

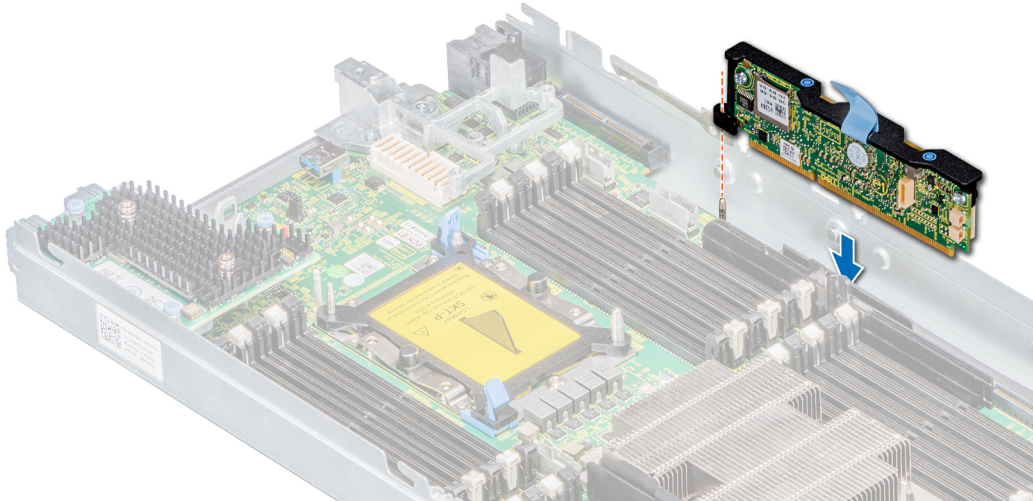

Figure 60. Installing the iDRAC card

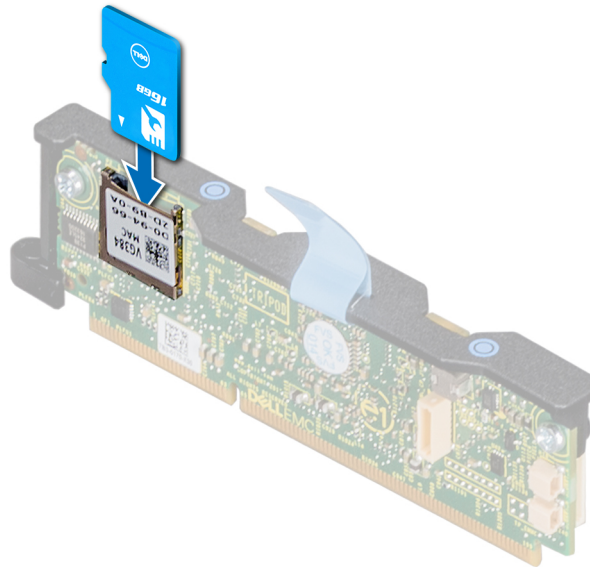

Figure 61. Installing a vFlash card

### Next steps

1. Follow the procedure listed in [After working inside your sled](#) on page 42.

## PERC card

Your system includes dedicated slots on the system board for PERC cards.

# Removing the PERC card

## Prerequisites

1. Follow the safety guidelines listed in [Safety Instructions](#).
2. Follow the procedure listed in [Before working inside the sled](#).
3. Disconnect the cable connected to the PERC card.

## Steps

1. Pull the blue pull tag to raise the lever up on the PERC card.
  - NOTE:** For the H730P MX(non-RAID) card, pull the two blue pull tags to raise the lever up. Rest of the procedure to remove the PERC card remains identical to HBA330 MX (non-RAID) card.
  - NOTE:** The MX740c supports both HBA330 MX or H730P MX PERC card.
2. Holding the blue pull tag, lift the PERC card away from the system.

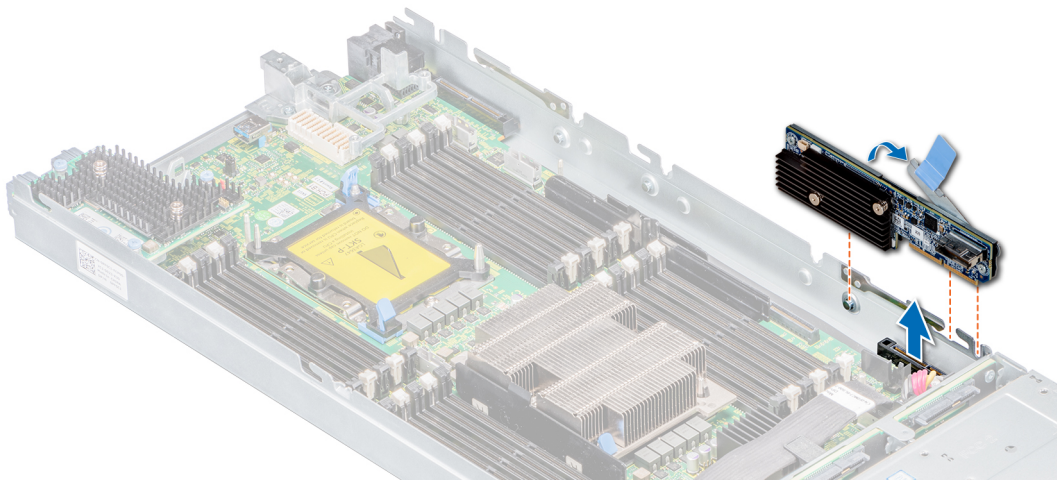

Figure 62. Removing the PERC card (HBA330)

## Next steps

1. Follow the procedure listed in [After working inside your sled](#) on page 42.

# Installing the PERC card

## Prerequisites

1. Follow the safety guidelines listed in [Safety Instructions](#).
2. Follow the procedure listed in [Before working inside the sled](#).

## Steps

1. Pull the blue pull tag to raise the lever up on the PERC card.
2. Align the connector on the PERC card with the connector on the system board.
  - NOTE:** The procedure to install the HBA330 MX or a H730P MX PERC card is the same.
  - NOTE:** The MX740c supports both HBA330 MX or H730P MX PERC card.
3. Align the guides on the PERC card with the slots on the system.

4. Press the PERC card to firmly seat in the system board connector.

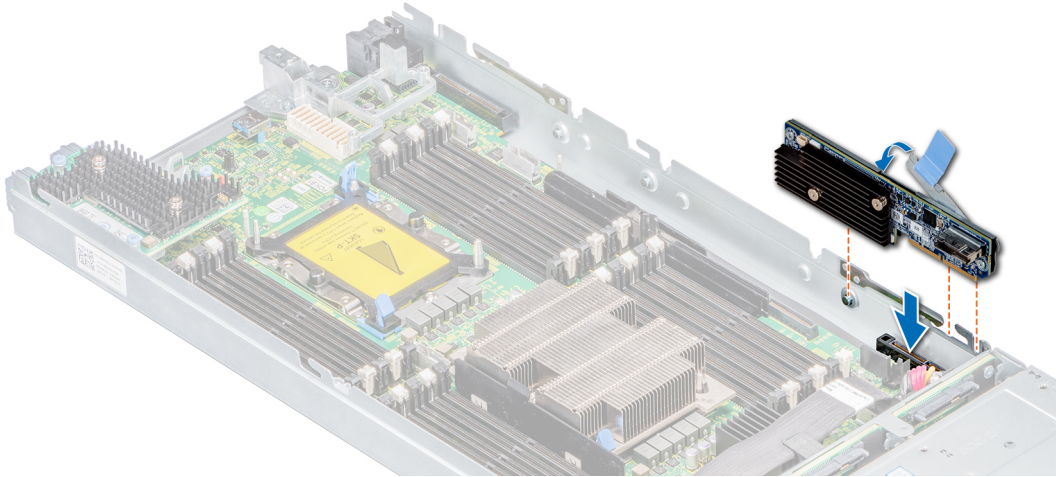

**Figure 63. Installing the PERC card**

5. Close the lever on the PERC card.

#### **Next steps**

1. Connect the cable to the PERC card.
2. Follow the procedure listed in [After working inside your sled](#) on page 42.

## **Removing the Jumbo PERC card**

#### **Prerequisites**

1. Follow the safety guidelines listed in the [Safety instructions](#).
2. Follow the procedure listed in the [Before working inside your sled](#).
3. Disconnect the cable connected to the Jumbo PERC card.

#### **Steps**

1. Pull the two blue pull tags to raise the lever up on the Jumbo PERC card.
2. Holding both the blue pull tags, lift the Jumbo PERC card away from the system.
3. Install the connector cap on the I/O connector of the Jumbo PERC card.

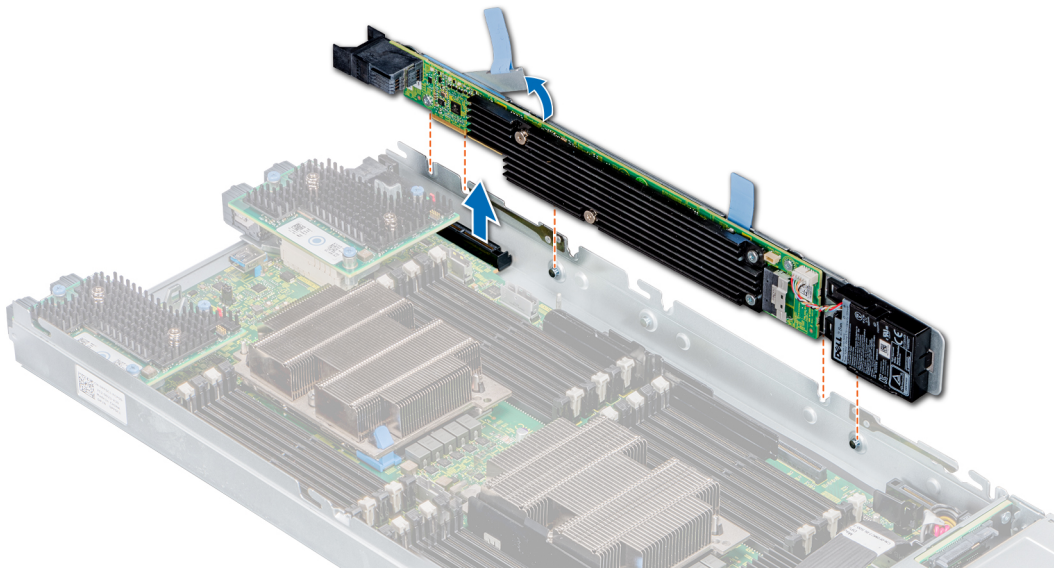

**Figure 64. Removing the Jumbo PERC card**

- NOTE:** When Jumbo PERC is installed in the mini Mezzanine slot, you cannot install any other controller cards in the mini Mezzanine slot.
- NOTE:** The Jumbo PERC card controls the internal drives, and the storage sled drives mapped to the storage controller.

#### Next steps

1. [Install the Jumbo PERC card.](#)

## Installing the Jumbo PERC card

#### Prerequisites

1. Follow the safety guidelines listed in the [Safety instructions](#).
2. Follow the procedure listed in the [Before working inside your sled](#).
3. [Remove the iDRAC card](#) before installing the Jumbo PERC card.

**NOTE:** A dual-processor configuration is required to support a Jumbo PERC card.

#### Steps

1. Remove the connector cap on the I/O connector from the Jumbo PERC card.
2. Pull the blue pull tag to raise the lever on the Jumbo PERC card.
3. Align the Jumbo PERC card with the slots on the system board.
4. Press the Jumbo PERC card until it is fully seated.
5. Close the lever on the Jumbo PERC card.

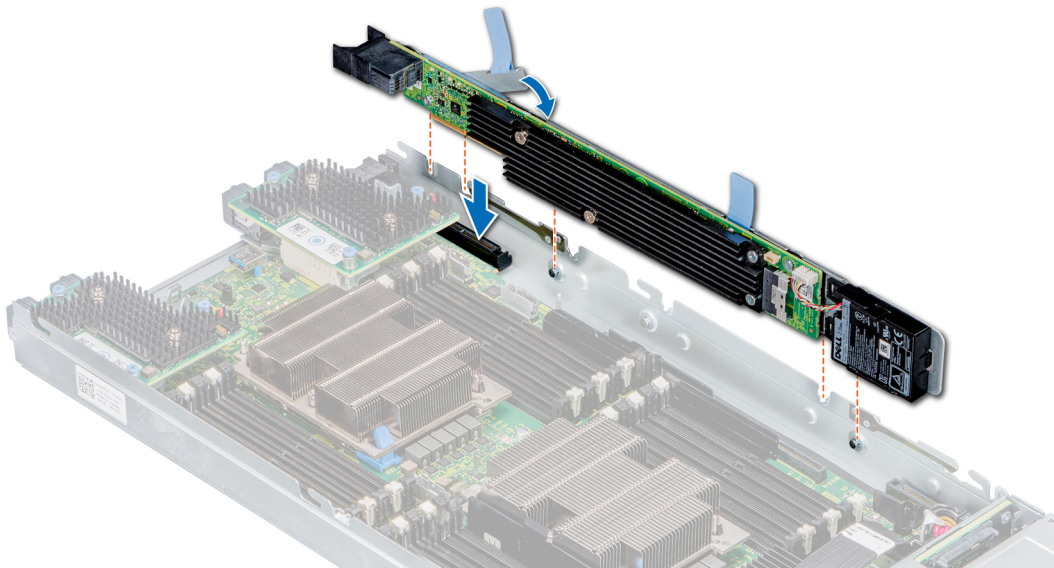

**Figure 65. Installing the Jumbo PERC card**

### Next steps

1. Connect the cable on the Jumbo PERC card.
2. Follow the procedure listed in the [After working inside your sled](#).

## Optional Internal dual SD module

The IDSDM module combines the IDSDM features into a single module.

**NOTE:** The write-protect switch is on the IDSDM module.

## Removing the IDSDM card

### Prerequisites

1. Follow the safety guidelines listed in [Safety Instructions](#).
2. Follow the procedure listed in [Before working inside the sled](#).
3. [Remove the air shroud](#).

### Steps

1. Locate the IDSDM card connector on the system board. To locate IDSDM connector, see the [system board jumpers and connectors](#) section.
2. Using the Phillips #2 screwdriver, loosen the retention screw that connects the internal dual SD card (IDSDM) to the system board.

**CAUTION:** To prevent damage to the IDSDM card, you must not tilt the card while lifting it from the system board.

3. Lift the release tab that secures the IDSDM to the system board.
4. Holding both ends of the IDSDM, lift the IDSDM out of the BOSS connector on the system board.

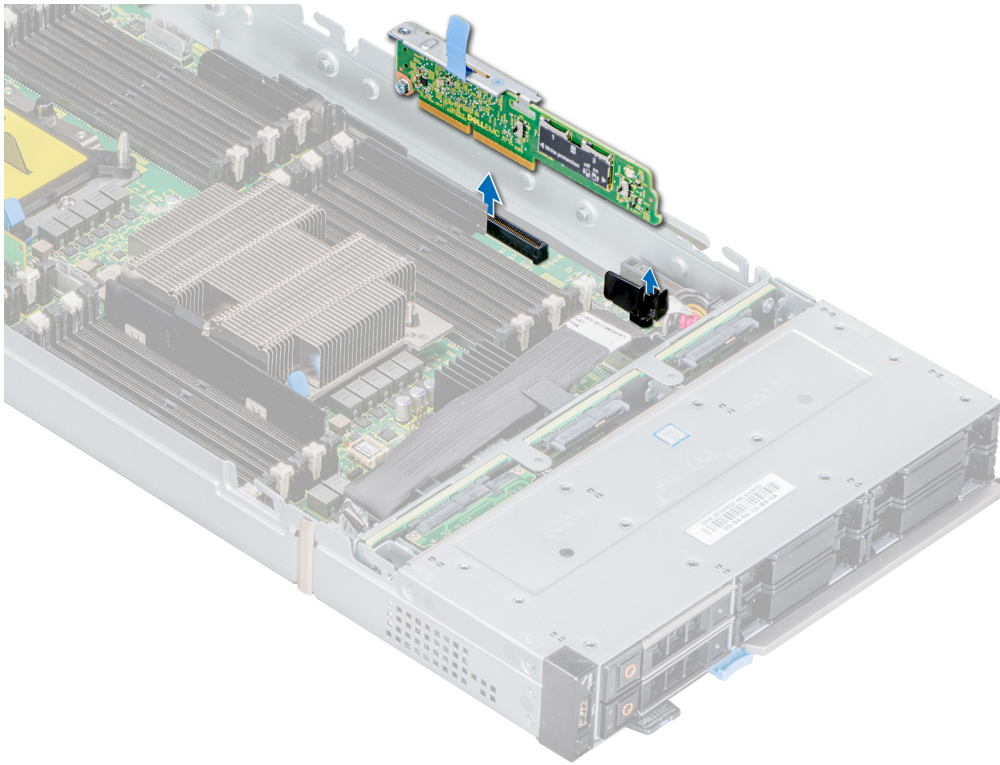

**Figure 66. Removing the IDSDM card**

### Next steps

Install the IDSDM card.

## Installing the IDSDM card

### Prerequisites

1. Follow the safety guidelines listed in [Safety Instructions](#).
2. Follow the procedure listed in [Before working inside your sled](#) on page 42.

**CAUTION:** To prevent damage to the IDSDM card, you must hold the card only by its edges.

### Steps

1. Locate the IDSDM card connector on the system board. To locate IDSDM connector, see the [system board jumpers and connectors](#) section.
2. Align the IDSDM card with the connector on the system board.
3. Press the IDSDM card until it is firmly seated on the system board.

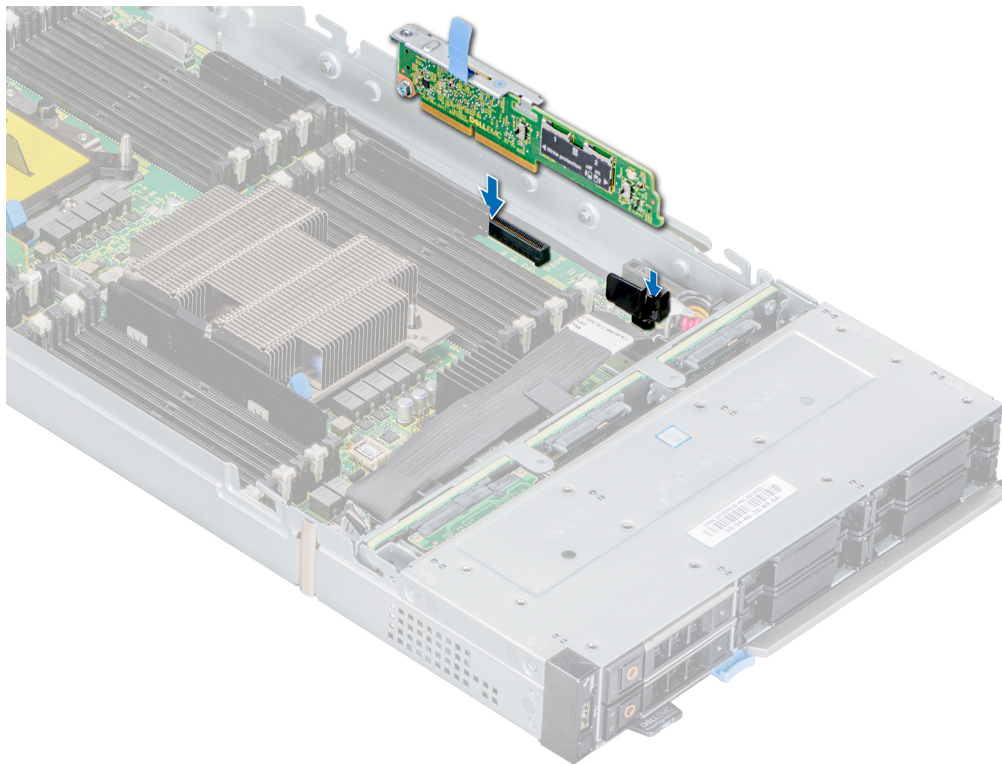

**Figure 67. Installing the IDSDM card**

### Next steps

Follow the procedure listed in [After working inside your sled](#).

## Removing a MicroSD card

### Prerequisites

1. Follow the safety guidelines listed in [Safety Instructions](#).
2. Follow the procedure listed in [Before working inside the sled](#).
3. [Remove the IDSDM card](#).

### Steps

1. Locate the MicroSD card slot on the IDSDM card.

**NOTE:** To locate IDSDM slot on the system board, see the [system board jumpers and connectors](#).

2. Press the card to partially release from the slot.
3. Hold the MicroSD card and remove it from the slot.

**NOTE:** Temporarily label each MicroSD card with the corresponding slot number after removal.

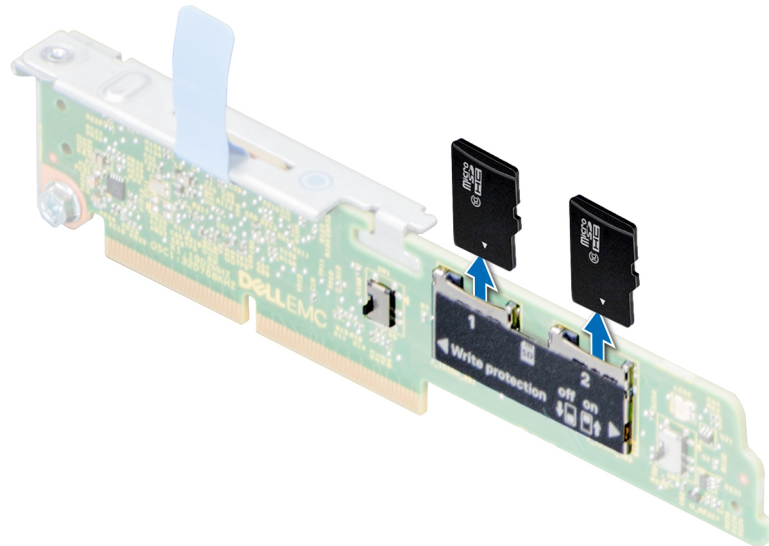

**Figure 68. Removing a MicroSD card**

#### Next steps

1. [Install a MicroSD card.](#)
2. Follow the procedure listed in [After working inside your sled](#)

## Installing a MicroSD card

#### Prerequisites

1. Follow the safety guidelines listed in [Safety Instructions](#).
2. Follow the procedure listed in [Before working inside the sled](#).
  - NOTE:** To use an MicroSD card with your system, ensure that the **Internal SD Card Port** is enabled in System Setup.
  - NOTE:** If reinstalling, ensure that you install the MicroSD cards into the same slots based on the labels you had marked on the cards during removal.

#### Steps

1. Locate the MicroSD card slot on the IDSDM card. Orient the MicroSD card appropriately and place the contact-pin end of the card into the slot.
  - NOTE:** The slot is keyed to ensure correct installation of the card.
2. Press the card into the card slot to lock it into their original location.

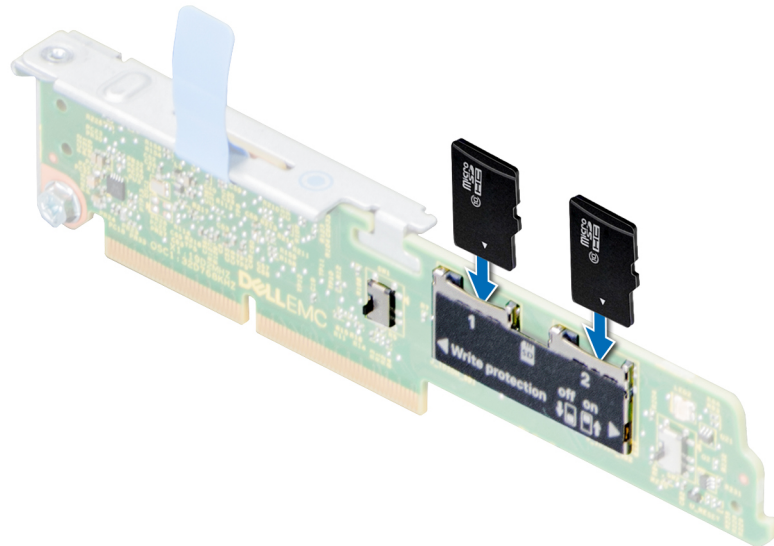

**Figure 69. Installing a MicroSD card**

#### **Next steps**

1. [Install the IDSDM card.](#)
2. Follow the procedure listed in [After working inside your sled](#)

## **M.2 BOSS module**

The BOSS card is a simple RAID solution card which supports upto 2 M.2 SATA drives. The BOSS adapter card has a x8 connector using PCIe gen 2.0 x2 lanes, available only in the low-profile and half-height form factor.

## **Removing the M.2 BOSS module**

#### **Prerequisites**

1. Follow the safety guidelines listed in [Safety instructions](#) on page 41.
2. Follow the procedure listed in [Before working inside your sled](#) on page 42.

#### **Steps**

Holding the blue tag, lift the M.2 BOSS module away from the system.

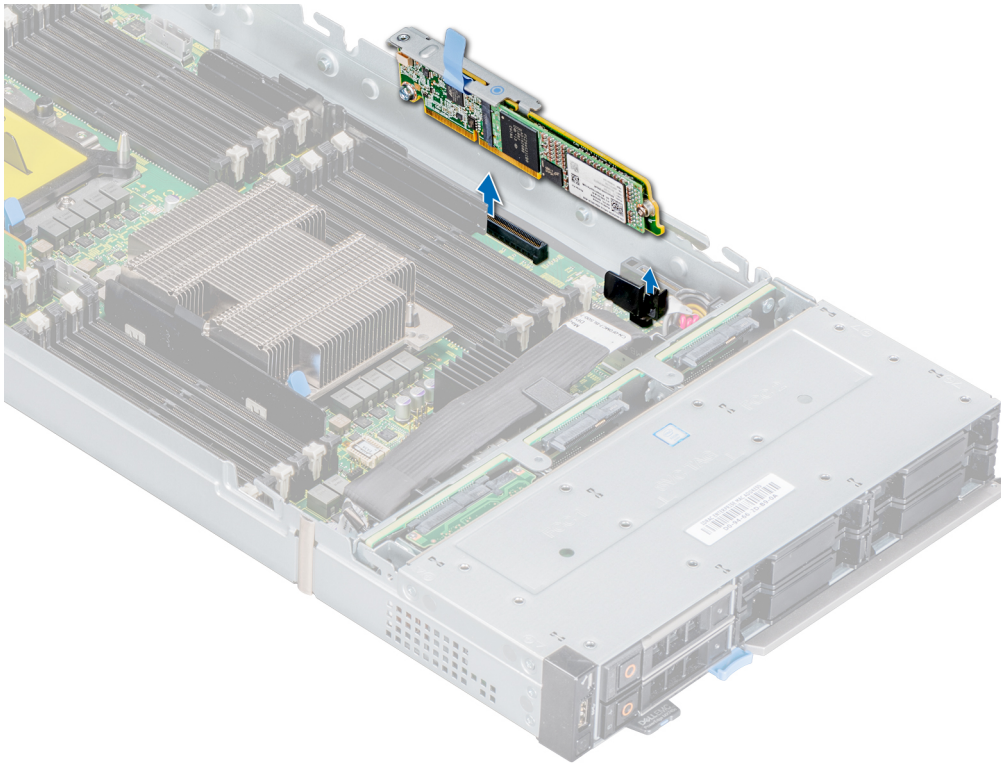

**Figure 70. Removing the M.2 BOSS module**

**Next steps**

1. [Install the M.2 BOSS module.](#)

## Installing the M.2 BOSS module

**Prerequisites**

1. Follow the safety guidelines listed in [Safety instructions](#) on page 41.
2. Follow the procedure listed in the [Before working inside your sled](#) on page 42.

**Steps**

1. Align the M.2 BOSS module connector with the connectors on the system board and the guide on the M.2 BOSS module with the guiding slot on the system board.
2. Press the touch point on the M.2 BOSS module until it is firmly seated.

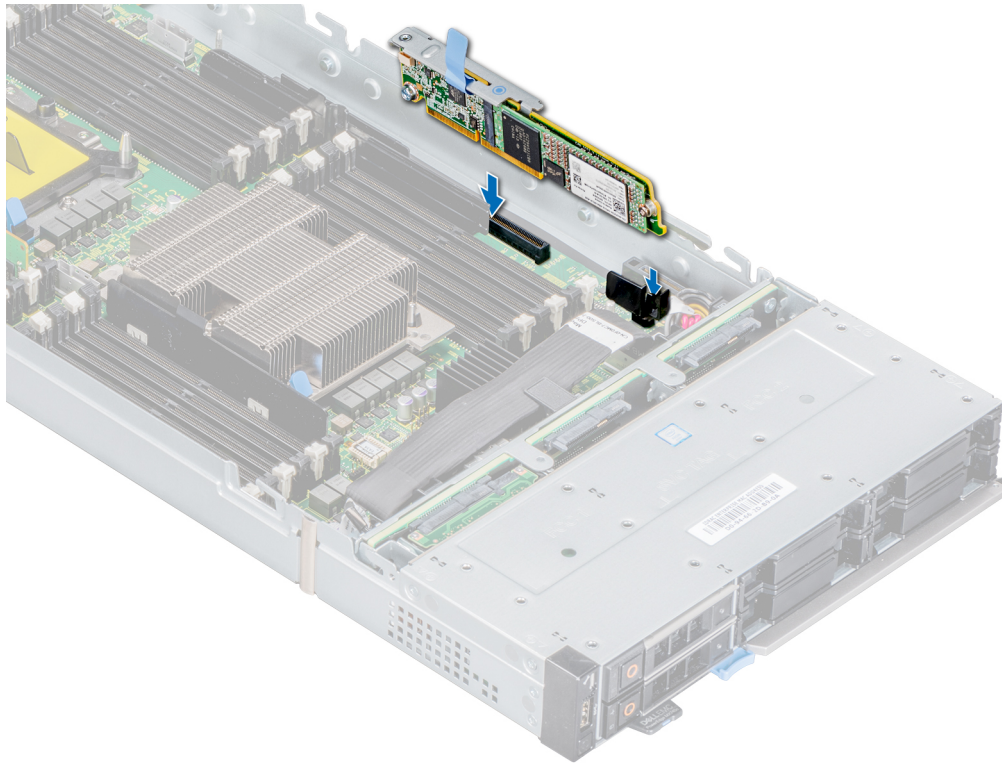

**Figure 71. Installing the M.2 boss module**

### **Next steps**

Follow the procedure listed in [After working inside your sled](#).

## **Removing the M.2 BOSS card**

### **Prerequisites**

1. Follow the safety guidelines listed in the [Safety instructions](#).
2. Follow the procedure listed in the [Before working inside your sled](#) on page 42.
3. [Remove the M.2 BOSS card](#).

### **Steps**

1. Using the Phillips #1 screwdriver, remove the screw on the M.2 BOSS module.
2. Pull the card out of the connector, and lift the card away from the module.

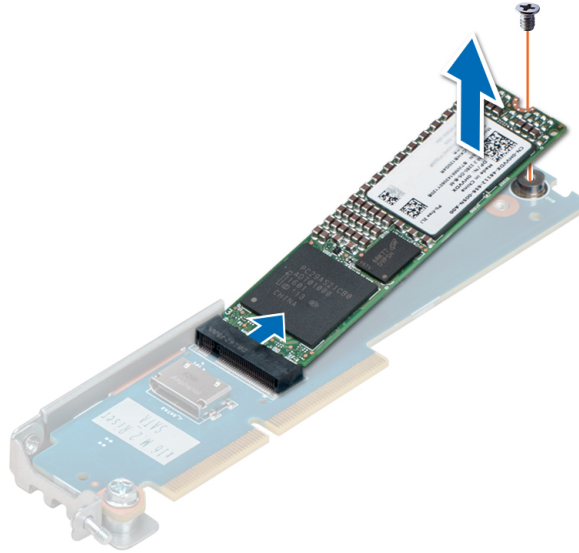

**Figure 72. Removing the M.2 BOSS card**

### Next steps

1. [Install the M.2 BOSS card.](#)

## Installing the M.2 BOSS card

### Prerequisites

1. Follow the safety guidelines listed in the [Safety instructions](#).
2. Follow the procedure listed in the [Before working inside your sled](#) on page 42.

### Steps

1. Align the M.2 BOSS card at angle of 45 degrees with the SATA connector on the M.2 BOSS module.
2. Press the M.2 BOSS card into the SATA connector until firmly seated in place.
3. Push down the M.2 BOSS card and using Phillips #1 screwdriver, secure the M.2 BOSS card to the module.

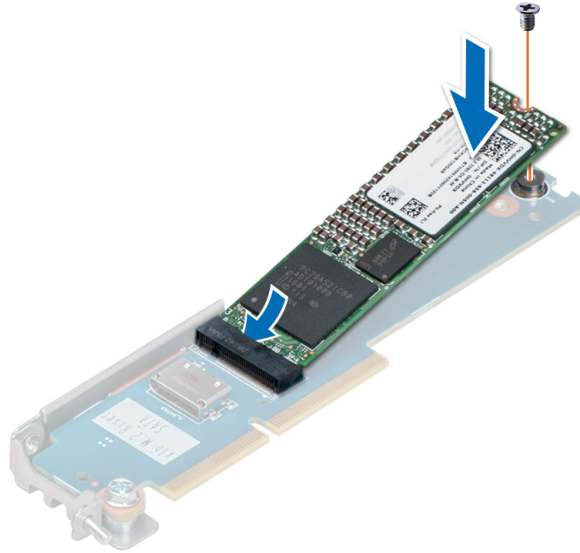

**Figure 73. Installing the M.2 BOSS card**

### Next steps

1. [Install the M.2 BOSS module.](#)
2. Follow the procedure listed in the [After working inside your sled.](#)

## Mezzanine card

Your system supports two mezzanine cards:

- PCIe mezzanine card slot A supports fabric A. This card must match the fabric type of I/O modules installed in I/O module bays A1.
- PCIe mezzanine card slot B supports fabric B. This card must match the fabric type of I/O modules installed in I/O module bays B1.

**NOTE:** The Mezzanine B1 card requires processor 2 to be installed.

## Removing the Mezzanine card

### Prerequisites

1. Follow the safety guidelines listed in [Safety Instructions.](#)
2. Follow the procedure listed in [Before working inside the sled.](#)

### Steps

1. Use the Phillips #2 screwdriver, loosen the captive screws that secure the Mezzanine card to the system.
2. Lift the Mezzanine card out of the sled.

**NOTE:** To prevent damage to Mezzanine card, you must hold the card only by its edges.

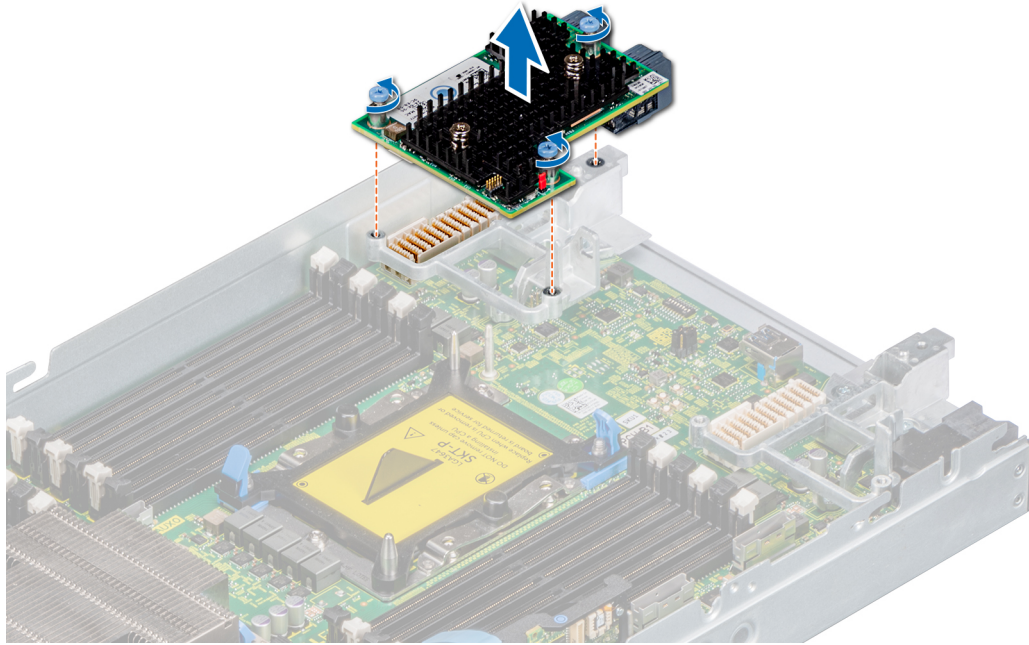

**Figure 74. Removing the Mezzanine card**

#### Next steps

1. [Install the Mezzanine card.](#)
2. Follow the procedure listed in [After working inside your sled](#) on page 42.

## Installing the Mezzanine card

#### Prerequisites

1. Follow the safety guidelines listed in [Safety Instructions](#).
2. Follow the procedure listed in [Before working inside the sled](#).

**NOTE:** A dual-processor configuration is required to support the Mezzanine B1 card.

#### Steps

1. Align the connector on the Mezzanine card with the connector on the system board.
2. Place the Mezzanine card on the connector and press the blue touch point until it is firmly seated.
3. Use the Phillips #2 screwdriver, tighten the captive screws on the Mezzanine card.

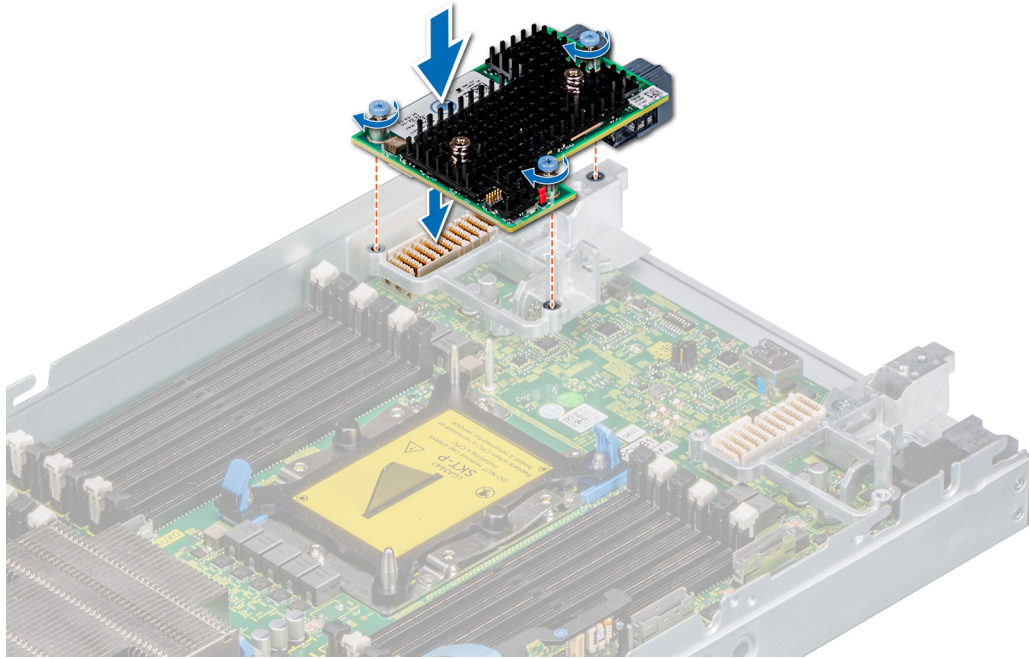

Figure 75. Installing the Mezzanine card

### Next steps

1. Follow the procedure listed in [After working inside your sled](#) on page 42.

## Removing the mini Mezzanine card

### Prerequisites

**CAUTION:** To ensure proper system cooling, mini Mezzanine blank must be installed in the mini Mezzanine socket.

**NOTE:** The removal of the blank is recommended only if you intend to install a mini Mezzanine card in this socket.

1. Follow the safety guidelines listed in [Safety Instructions](#).
2. Follow the procedure listed in [Before working inside the sled](#).

**NOTE:** MX740c supports HBA330 MMZ and Fiber channel MMZ which is installed in mini Mezzanine slot.

### Steps

1. Pull the blue pull tag to raise the lever up of the mini Mezzanine card.
2. Holding the lever and the edge of the mini Mezzanine card, lift the mini Mezzanine card from the system.

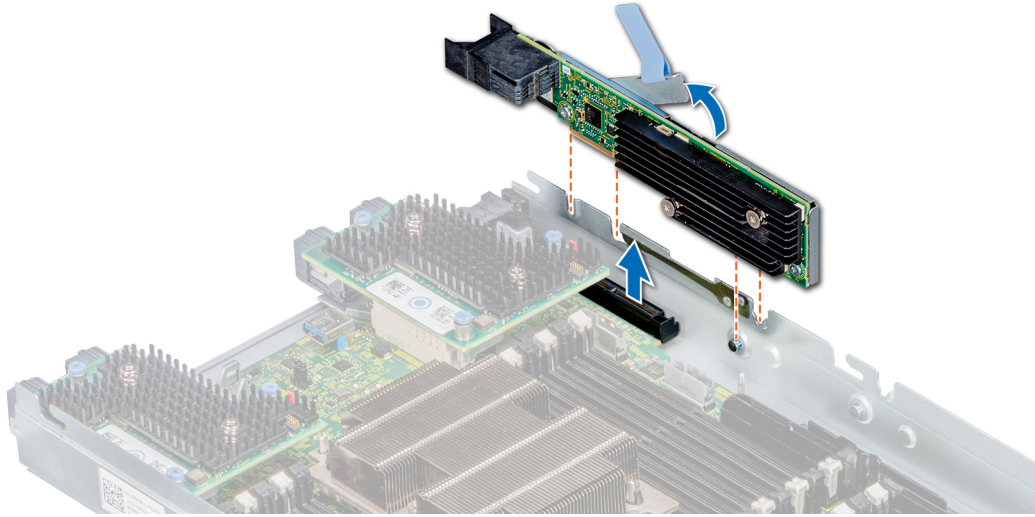

**Figure 76. Removing the mini Mezzanine card**

**NOTE:** Install the connector cap on the I/O connector of the mini Mezzanine card, when not installed on system board.

#### Next steps

1. Follow the procedure listed in [After working inside your sled](#) on page 42.

## Installing the mini Mezzanine card

#### Prerequisites

1. Follow the safety guidelines listed in [Safety Instructions](#).
2. Follow the procedure listed in [Before working inside the sled](#).

**NOTE:** The mini Mezzanine card is supported only on systems with two processors.

#### Steps

1. Remove the connector cap on the I/O connector of the mini Mezzanine card.
2. Pull the blue pull tag to raise the lever on the mini Mezzanine card.
3. Align the mini Mezzanine card connector with the connector on the system board.
4. Lower the mini Mezzanine card into place, and push the lever down to lock the card in place.

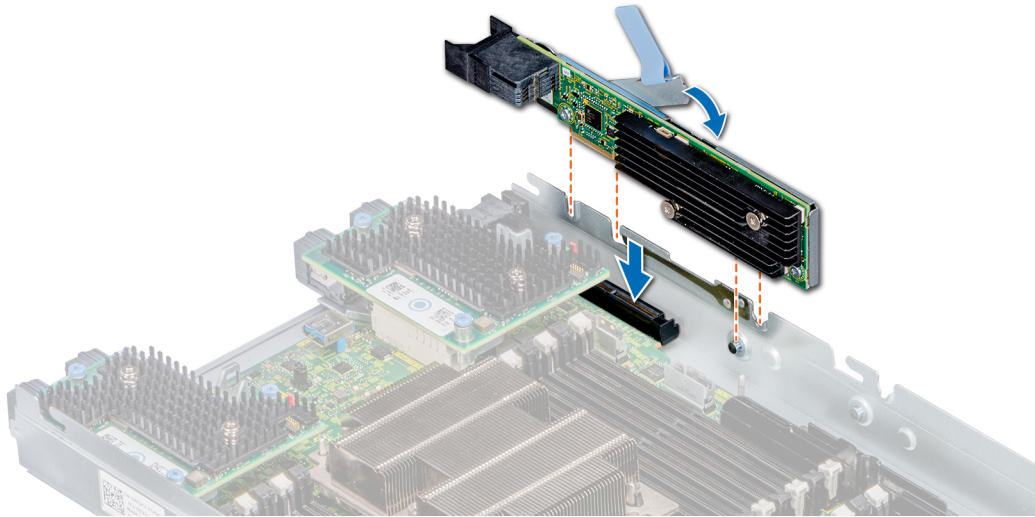

**Figure 77. Installing the mini Mezzanine card**

5. Close the lever on the mini Mezzanine card.

#### Next steps

1. Follow the procedure listed in [After working inside your sled](#) on page 42.

## Removing the mini Mezzanine card blank

#### Prerequisites

**CAUTION:** To ensure proper system cooling, the mini Mezzanine blank must be installed in the mini Mezzanine socket.

**NOTE:** The removal of the blank is recommended only if you intend to install a mini Mezzanine card in the socket.

1. Follow the safety guidelines listed in [Safety Instructions](#).
2. Follow the procedure listed in [Before working inside the sled](#).

#### Steps

Lift the mini Mezzanine card blank from the slot to remove it from the system.

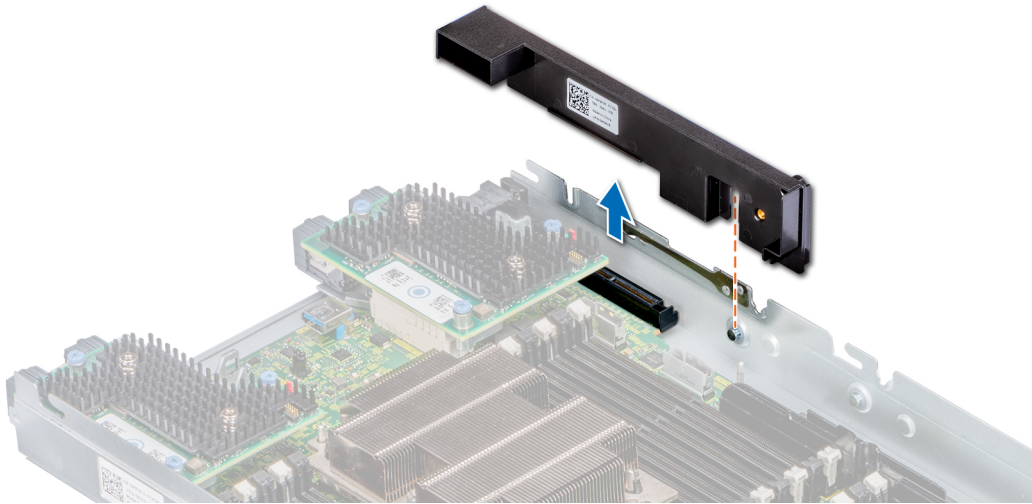

**Figure 78. Removing the mini Mezzanine card blank**

**Next steps**

1. Follow the procedure listed in [After working inside your sled](#) on page 42.

## Installing the mini Mezzanine card blank

**Prerequisites**

1. Follow the safety guidelines listed in [Safety Instructions](#).
2. Follow the procedure listed in [Before working inside the sled](#).

**Steps**

Align the guiding groove of the card on the slot and push down to insert the mini Mezzanine blank to the system board.

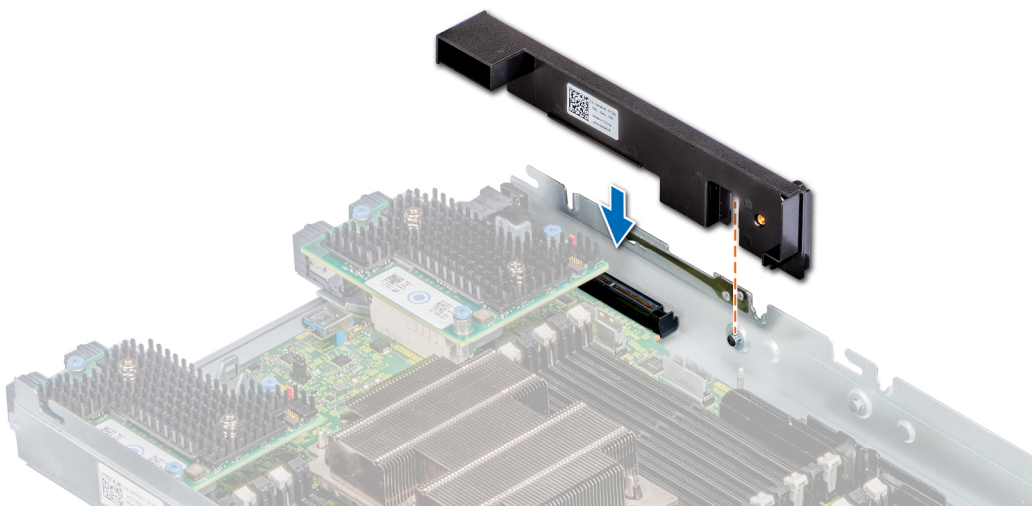

**Figure 79. Installing the mini Mezzanine card blank**

**Next steps**

Follow the procedure listed in [After working inside your sled](#) on page 42.

# Optional internal USB memory key

An optional USB memory key installed inside your system can be used as a boot device, security key, or mass storage device. To boot from the USB memory key, configure the USB memory key with a boot image and then specify the USB memory key in the boot sequence in System Setup.

An optional USB memory key can be installed in the internal USB 3.0 port and can be used as a boot device, security key or mass storage device.

The internal USB port is on the system board.

 **NOTE:** To locate the internal USB port on the system board, see the [System board jumpers and connectors](#).

## Replacing the optional internal USB memory key

### Prerequisites

 **CAUTION:** To avoid interference with other components in the server module, the maximum permissible dimensions of the USB memory key are 15.9 mm wide x 57.15 mm long x 7.9 mm high.

1. Follow the safety guidelines listed in [Safety instructions](#) on page 41.
2. Follow the procedure listed in [Before working inside your sled](#) on page 42.

### Steps

1. Locate the USB port or USB memory key on the system board.

 **NOTE:** To locate the USB port, see the [System board jumpers and connectors](#) section.

2. If installed, remove the USB memory key from the USB port.
3. Place the replacement USB memory key into the USB port.

### Next steps

1. While booting, press F2 to enter System Setup and verify that the system detects the USB memory key.
2. Follow the procedure listed in [After working inside your sled](#) on page 42.

# System battery

The system battery is used for low-level system functions such as powering the real-time and date settings of the system.

## Replacing the system battery - Option A

### Prerequisites

 **NOTE:** There is a danger of a new battery exploding if it is incorrectly installed. Replace the battery only with the same or equivalent type recommended by the manufacturer. Discard used batteries according to the manufacturer's instructions. See the safety instructions that came with your system for more information.

1. Follow the safety guidelines listed in [Safety instructions](#) on page 41.
2. Follow the procedure listed in [Before working inside the sled](#).

### Steps

1. Locate the system battery on the system.
2. To remove the battery:
  - a. Push the battery toward the positive side of the battery until the battery disengages from the connector.
  - b. Lift the battery away from the system.



**Figure 80. Removing the system battery**

3. To install a new system battery:
  - a. Hold the battery with the + sign facing the positive side of the battery connector.
  - b. Insert the battery down into the connector and push the positive side of the battery until the battery snaps into place.



**Figure 81. Installing the system battery**

#### **Next steps**

1. Follow the procedure listed in [After working inside your sled](#) on page 42.
2. Enter the System Setup to confirm that the battery is operating properly.
3. Enter the correct time and date in the System Setup's **Time** and **Date** fields.
4. Exit the System Setup.
5. To test the newly installed battery, remove the system from the enclosure, for at least an hour.
6. Reinstall the system into the enclosure, after an hour.
7. Enter the System Setup and if the time and date are still incorrect, see [Getting help](#).

## Replacing the system battery - Option B

### Prerequisites

**i** **NOTE:** There is a danger of a new battery exploding if it is incorrectly installed. Replace the battery only with the same or equivalent type recommended by the manufacturer. Discard used batteries according to the manufacturer's instructions. See the safety instructions that came with your system for more information.

1. Follow the safety guidelines listed in [Safety Instructions](#).
2. Follow the procedure listed in [Before working inside the sled](#).

### Steps

1. Locate the system battery on the system.
2. To remove the battery:

- a. Push the battery holder clip.

**i** **NOTE:** Ensure that you do not push the battery holder clip more than 3.2 millimeters, It may damage the battery holder.

- b. Push the battery toward the positive side of the battery until the battery disengages from the connector.
- c. Lift the battery away from the system.



**Figure 82. Removing the system battery**

3. To install a new system battery:

- a. Push the battery lock slightly away.

**i** **NOTE:** Ensure that you do not push the battery holder more that 3.2 millimeters or you might risk damaging the part.

- b. Hold the battery with the + sign facing the positive side of the battery connector.
- c. Insert the battery into the battery socket and push the positive side of the battery until the battery snaps into place.



**Figure 83. Installing the system battery**

#### Next steps

1. Follow the procedure listed in [After working inside your sled](#) on page 42.
2. Enter the System Setup to confirm that the battery is operating properly.
3. Enter the correct time and date in the System Setup's **Time** and **Date** fields.
4. Exit the System Setup.
5. To test the newly installed battery, remove the system from the enclosure, for at least an hour.
6. Reinstall the system into the enclosure, after an hour.
7. Enter the System Setup and if the time and date are still incorrect, see [Getting help](#).

## System board

A system board (also known as the motherboard) is the main printed circuit board in the system with different connectors used to connect different components or peripherals of the system. A system board provides the electrical connections to the components in the system to communicate.

## Removing the system board

#### Prerequisites

- ⚠ **CAUTION:** If you are using the Trusted Platform Module (TPM) with an encryption key, you may be prompted to create a recovery key during program or System Setup. Be sure to create and safely store this recovery key. If you replace this system board, you must supply the recovery key when you restart your system or program before you can access the encrypted data on your drives.
- ⚠ **CAUTION:** You may find the CMOS battery loss or CMOS checksum error displayed during the first instance of powering on the system after the processor or system board replacement which is expected. To fix this, go to setup option to configure the system settings.

 **NOTE:** It is required to reactivate the licenses after the system board replacement.

 **CAUTION:** If either the system board or iDRAC card fails, it is required to replace the system board and iDRAC card at the same time.

 **CAUTION:** Do not attempt to remove the TPM plug-in module from the system board. After the TPM plug-in module is installed, it is cryptographically bound to that specific system board. Any attempt to remove an installed TPM plug-in module breaks the cryptographic binding, and it cannot be reinstalled or installed on another system board.

1. Follow the safety guidelines listed in [Safety instructions](#) on page 41.
2. Follow the procedure listed in [Before working inside your sled](#) on page 42.
3. Remove the following:
  - a. [Air shroud](#)
  - b. [Memory modules](#)
  - c. [Processor\(s\) and heat sink\(s\)](#)
  - d. [Drives](#)
  - e. [Drive backplane](#)
  - f. [Drive cage](#)
  - g. [PERC card](#)
  - h. [IDSDM](#)
  - i. [Mezzanine card](#)
  - j. [Mini Mezzanine card](#)
  - k. [iDRAC card](#)
  - l. [Internal USB key](#)

 **WARNING:** The processor and heat sink can become hot. Be sure that the processor has had sufficient time to cool before handling.

 **WARNING:** The memory modules are hot to touch for some time after the system has been powered down. Allow time for the memory modules to cool before handling them. Handle the memory modules by the card edges and avoid touching the components.

 **CAUTION:** Do not lift the system board by holding a memory module, processor, or other components.

 **CAUTION:** Temporarily label the drives before removal so that you can replace them back in their respective slots.

### Steps

1. Disconnect all cables from the system board.
2. Using the Phillips #2 screwdriver, remove all the screws that secure the system board to the chassis.
3. Holding the edges, lift the system board out of the system.

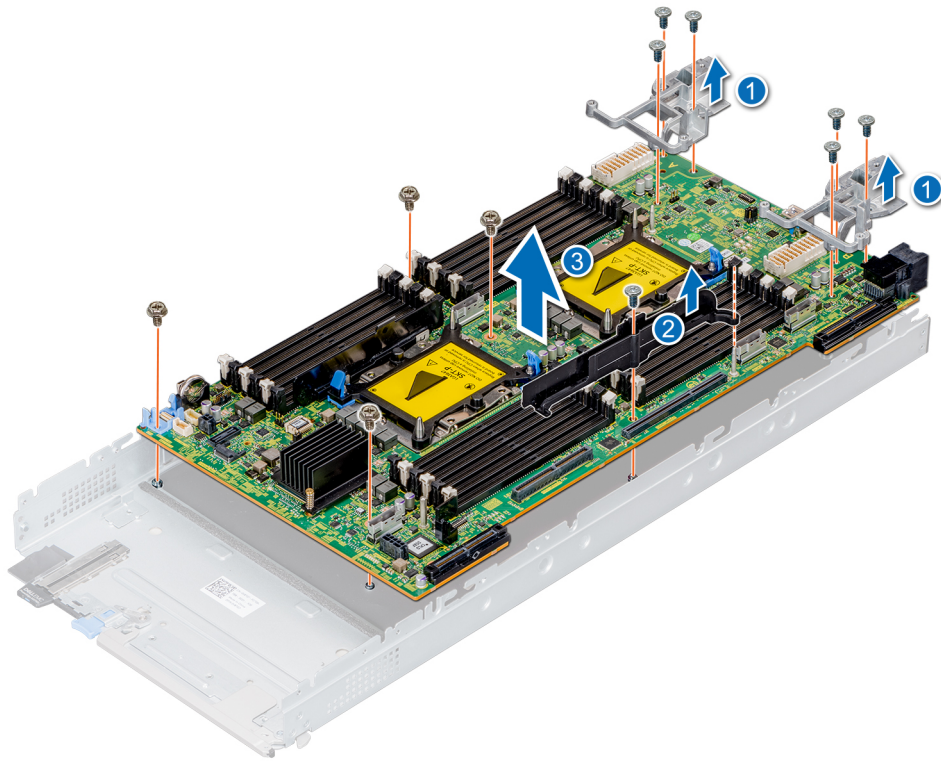

Figure 84. Removing the system board

#### Next steps

1. [Install the system board.](#)

## Installing the system board

#### Prerequisites

Follow the safety guidelines listed in [Safety instructions](#) on page 41.

**CAUTION:** Do not lift the system board by holding a memory module, processor, or other components.

**CAUTION:** Take care not to damage the system identification button while placing the system board into the system.

#### Steps

1. Unpack the replacement system board assembly.

**CAUTION:** Take care not to damage the system identification button while placing the system board into the chassis.

**NOTE:** It is required to reactivate the licenses after the system board replacement.

2. Holding the system board by the edges, place the system board into the system.
3. Using the Phillips #2 screwdriver, secure the system board to the chassis with the screws.

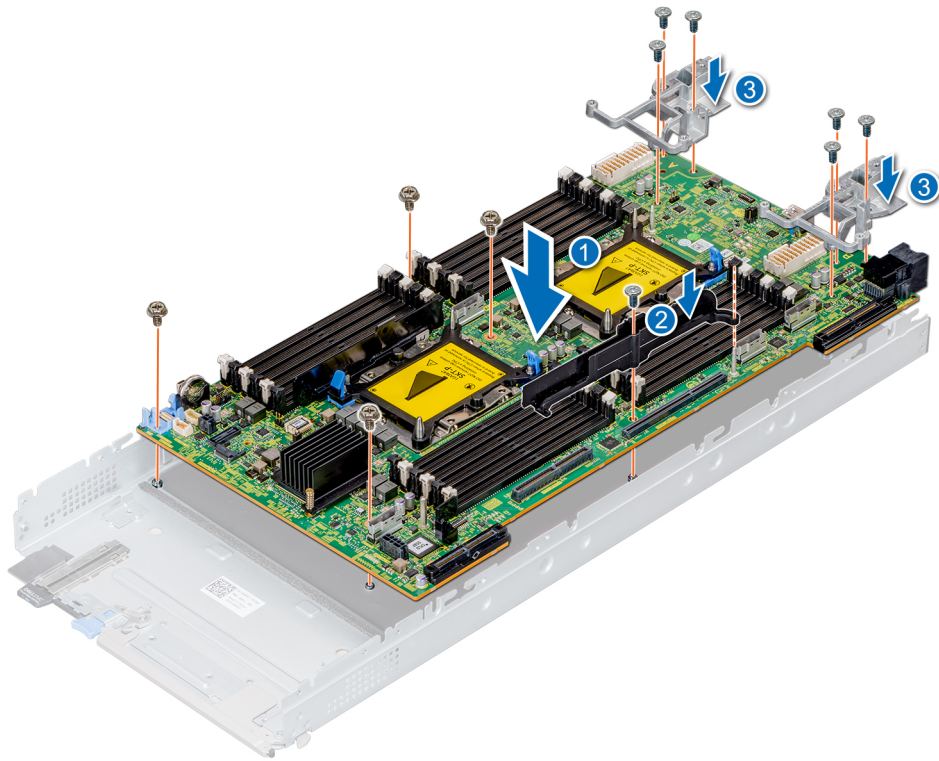

**Figure 85. Installing the system board**

4. Lower the system board and install the screws to secure the system board to the system.

**Next steps**

1. Install the following:
  - a. [Internal USB key](#)
  - b. [iDRAC card](#)
  - c. [IDSDM](#)
  - d. [Mini Mezzanine card](#)
  - e. [Mezzanine card\(s\)](#)
  - f. [PERC card](#)
  - g. [Drive cage](#)
  - h. [Drive backplane](#)
  - i. [Drives](#)
  - i** **NOTE:** Ensure that you reinstall the drives in their original locations.
  - j. [BBU module](#)
  - k. [Memory modules](#)
  - l. [Processor\(s\) and heat sink\(s\)](#)
  - m. [Air shroud](#)
2. Remove the plastic I/O connector cover from the back of the system.
3. Install the sled in the enclosure.
4. Follow the procedure listed in [After working inside your sled](#) on page 42.
5. Ensure that you:

- a. Use the Easy Restore feature to restore the Service Tag. For more information, see the [Restoring the Service Tag by using the Easy Restore feature](#) section.
  - b. If the Service Tag is not backed up in the backup flash device, enter the Service Tag manually. For more information, see the [Entering the system Service Tag by using System Setup](#) section.
  - c. Update the BIOS and iDRAC versions.
  - d. Re-enable the Trusted Platform Module (TPM). For more information, see the [Upgrading the Trusted Platform Module](#) section.
6. Import your new or existing iDRAC Enterprise license.

For more information, see Integrated Dell Remote Access Controller User's Guide, at [www.dell.com/idracmanuals](http://www.dell.com/idracmanuals).

## Restoring the Service Tag by using the Easy Restore feature

By using the Easy Restore feature, you can restore your Service Tag, license, UEFI configuration, and the system configuration data after replacing the system board. All data is automatically backed up in a backup flash device. If BIOS detects a new system board and the Service Tag in the backup flash device, BIOS prompts the user to restore the backup information.

### Steps

1. Turn on the system.  
If BIOS detects a new system board, and if the Service Tag is present in the backup flash device, BIOS displays the Service Tag, the status of the license, and the **UEFI Diagnostics** version.
2. Perform one of the following steps:
  - Press **Y** to restore the Service Tag, license, and diagnostics information.
  - Press **N** to navigate to the Dell Lifecycle Controller based restore options.
  - Press F10 to restore data from a previously created **Hardware Server Profile**.

After the restore process is complete, BIOS prompts to restore the system configuration data.

3. Perform one of the following steps:
  - Press **Y** to restore the system configuration data.
  - Press **N** to use the default configuration settings.

After the restore process is complete, the system restarts.

## Entering the system Service Tag by using System Setup

If Easy Restore fails to restore the Service Tag, use System Setup to enter the Service Tag.

### Steps

1. Turn on the system.
2. Press F2 to enter System Setup.
3. Click **Service Tag Settings**.
4. Enter the Service Tag.  
 **NOTE:** You can enter the Service Tag only when the **Service Tag** field is empty. Ensure that you enter the correct Service Tag. After the Service Tag is entered, it cannot be updated or changed.
5. Click **OK**.
6. Import your new or existing iDRAC Enterprise license.

For more information, see the *Integrated Dell Remote Access Controller User's Guide* at [www.dell.com/poweredgemanuals](http://www.dell.com/poweredgemanuals).

## Trusted Platform Module

Trusted Platform Module (TPM) is a dedicated microprocessor designed to secure hardware by integrating cryptographic keys into devices. Software can use a TPM to authenticate hardware devices. Because each TPM chip has a unique and secret RSA key which is embedded during the manufacture of the TPM, it is capable of performing platform authentication operation.

# Upgrading the TPM

## Prerequisites

1. Follow the safety guidelines listed in [Safety instructions](#) on page 41.
2. Follow the procedure listed in [Before working inside your sled](#) on page 42.
3. Disconnect the cables.
4. [Remove the drive backplane](#).

### NOTE:

- Ensure that your operating system supports the version of the TPM module being installed.
- Ensure that you download and install the latest BIOS firmware on your system.
- Ensure that the BIOS is configured to enable UEFI boot mode.

## About this task

 **CAUTION:** If you are using the Trusted Platform Module (TPM) with an encryption key, you may be prompted to create a recovery key during program or System Setup. Work with the customer to create and safely store this recovery key. When replacing this system board, you must supply the recovery key when you restart your system or program before you can access the encrypted data on your hard drives.

 **CAUTION:** After the TPM plug-in module is installed, it is cryptographically bound to that specific system board. Any attempt to remove an installed TPM plug-in module breaks the cryptographic binding, the removed TPM cannot be reinstalled or installed on another system board.

# Removing the TPM

## Steps

1. Locate the TPM connector on the system board.  
To locate the TPM connector, see [System board jumpers and connectors](#).
2. Press to hold down the module and remove the screw using the security Torx 8-bit shipped with the TPM module.
3. Slide the TPM module out from its connector.
4. Push the plastic rivet away from the TPM connector and rotate it 90° counterclockwise to release it from the system board.
5. Pull the plastic rivet out of its slot on the system board.

# Installing the TPM

## Steps

1. To install the TPM, align the edge connectors on the TPM with the slot on the TPM connector.
2. Insert the TPM into the TPM connector such that the plastic rivet aligns with the slot on the system board.
3. Press the plastic rivet until the rivet snaps into place.

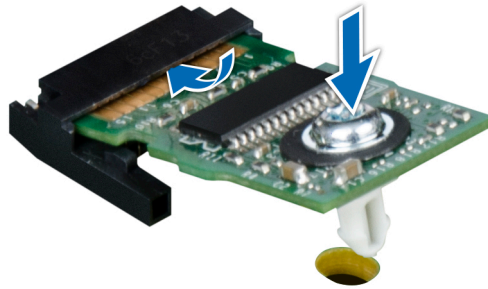

**Figure 86. Installing the TPM**

### Next steps

1. [Install the system board.](#)
2. [Install the drive backplane.](#)
3. Follow the procedure listed in [After working inside your sled](#) on page 42.

## Initializing TPM for BitLocker users

### Steps

Initialize the TPM.

For more information, see <https://technet.microsoft.com/library/cc753140.aspx>.

The **TPM Status** changes to **Enabled, Activated**.

## Initializing the TPM 1.2 for TXT users

### Steps

1. While booting your system, press F2 to enter System Setup.
2. On the **System Setup Main Menu** screen, click **System BIOS > System Security Settings**.
3. From the **TPM Security** option, select **On with Pre-boot Measurements**.
4. From the **TPM Command** option, select **Activate**.
5. Save the settings.
6. Restart your system.
7. Enter **System Setup** again.
8. On the **System Setup Main Menu** screen, click **System BIOS > System Security Settings**.
9. From the **Intel TXT** option, select **On**.

## Initializing the TPM 2.0 for TXT users

### Steps

1. While booting your system, press F2 to enter System Setup.
2. On the **System Setup Main Menu** screen, click **System BIOS > System Security Settings**.
3. From the **TPM Security** option, select **On**.
4. Save the settings.
5. Restart your system.
6. Enter **System Setup** again.

7. On the **System Setup Main Menu** screen, click **System BIOS > System Security Settings**.
8. Select the **TPM Advanced Settings** option.
9. From the **TPM2 Algorithm Selection** option, select **SHA256**, then go back to **System Security Settings** screen.
10. On the **System Security Settings** screen, from the **Intel TXT** option, select **On**.
11. Save the settings.
12. Restart your system.

# Jumpers and connectors

## Topics:

- System board jumpers and connectors
- System board jumper settings
- Disabling a forgotten password

## System board jumpers and connectors

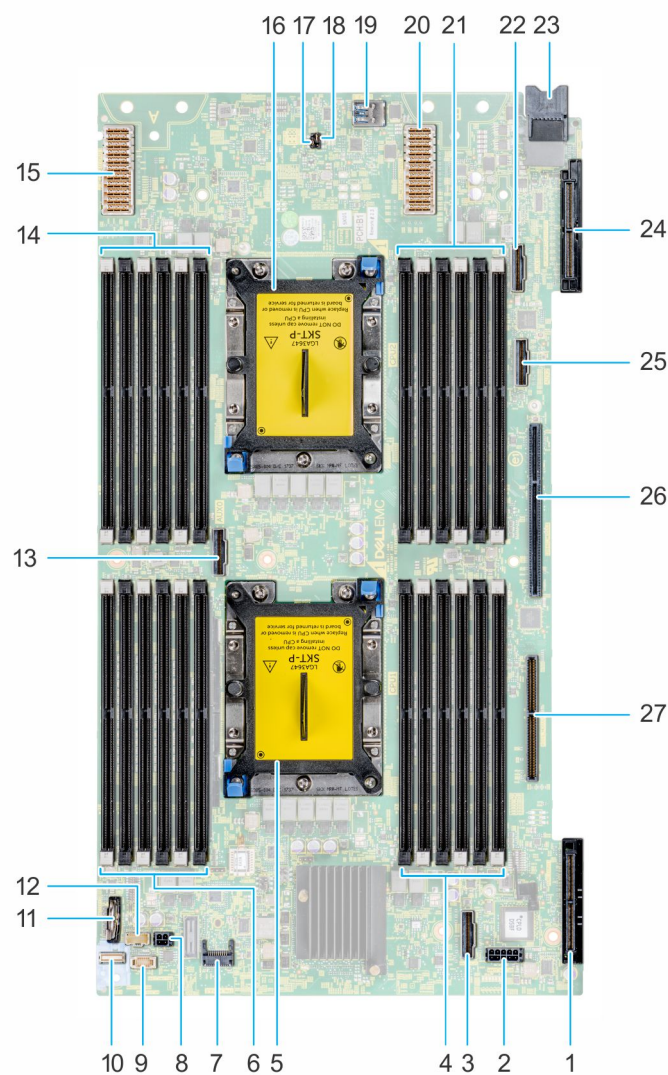

Figure 87. System board jumpers and connectors

Table 13. System board jumpers and connectors

Item	Connector	Description
1.	PERC	PERC card slot



**Table 13. System board jumpers and connectors (continued)**

Item	Connector	Description
2.	BP_PWR_CONN	Backplane power connector
3.	SATA_CONN	SATA connector
4.	A1, A2,, A3,, A7,, A8,, A9	DIMMS for CPU1
5.	CPU1	Processor 1 (blank)
6.	A4, A5,, A6,, A10,, A11,, A12	DIMMS For CPU1
7.	TPM_MODULE	Trusted Platform Module
8.	BBU_PWR_CONN	BBU power connector
9.	BACKPLANE SIGNAL	Backplane signal connector
10.	FIO	Control panel(FIO) connector
11.	BATTERY	System battery
12.	BBU SIGNAL	Battery backup unit signal slot
13.	AUX 0	AUX 0 cable connector
14.	B4, B5,, B6,, B10,, B11,, B12	DIMMS for CPU2
15.	MEZZ_A1	Mezzanine card A1
16.	CPU2	Processor 2 (blank)
17.	PWRD_EN	System configuration jumper (enabling or disabling the password settings)
18.	NVRAM_CLR	System configuration jumper (retaining-/ configuration settings)
19.	INTERNAL USB	Internal USB 3.0
20.	MEZZ_B1	Mezzanine card B1
21.	B1, B2,, B3,, B7,, B8,, B9	DIMMS for CPU2
22.	AUX1	AUX1 cable connector
23.	POWER CONNECTOR	Power connector
24.	MINI_MEZZ_C1	Mini Mezzanine card C1
25.	AUX2	AUX 2 cable connector
26.	iDRAC	iDRAC module connector
27.	BOSS (M.2)/IDSDM	BOSS (M.2)/IDSDM card connector



## System board jumper settings

For information on resetting the password jumper to disable a password, see [Disabling a forgotten password](#) on page 120.

**Table 14. System board jumper settings**

Jumper	Setting	Description
NVRAM_CLR	 1 2 3 (default)	The BIOS configuration settings are retained at system boot.
	 1 2 3	The BIOS configuration settings are cleared at system boot.

**Table 14. System board jumper settings (continued)**

Jumper	Setting	Description
PWRD_EN	 1 2 3 (default)	The BIOS password feature is enabled.
	 1 2 3	The BIOS password feature is disabled. iDRAC local access is unlocked at next AC power cycle. iDRAC password reset is enabled in F2 iDRAC settings menu.

## Disabling a forgotten password

The system's software security features include a system password and a setup password. The password jumper enables these password features or disables them and clears any password(s) currently in use.

### Prerequisites

**CAUTION:** Many repairs may only be done by a certified service technician. You should only perform troubleshooting and simple repairs as authorized in your product documentation, or as directed by the online or telephone service and support team. Damage due to servicing that is not authorized by Dell is not covered by your warranty. Read and follow the safety instructions that are shipped with your product.

### Steps

1. Power off the compute sled.
2. Remove the compute sled from chassis.
3. [Remove the system cover.](#)
4. Move the jumper on the system board jumper from pins 2 and 4 to pins 4 and 6.
5. [Install the system cover.](#)

The existing passwords are not disabled (erased) until the system boots with the jumper on pins 4 and 6. However, before you assign a new system and/or setup password, you must move the jumper back to pins 2 and 4.

**NOTE:** If you assign a new system and/or setup password with the jumper on pins 4 and 6, the system disables the new password(s) the next time it boots.

6. Insert compute sled into chassis and power on the compute sled.
7. Power off the compute sled, Remove the compute sled from chassis.
8. [Remove the system cover.](#)
9. Move the jumper on the system board jumper from pins 4 and 6 to pins 2 and 4.
10. [Install the system cover.](#)
11. Insert the compute sled into chassis and turn the compute sled on.
12. Assign a new system and/or setup password.

# Technical specifications

The technical and environmental specifications of your system are outlined in this section.

## Topics:

- System dimensions
- System weight
- Processor specifications
- Supported operating systems
- System battery specifications
- Memory specifications
- Hard drives
- Mezzanine and Mini Mezzanine slots specifications
- Storage controller specifications
- Ports and connectors specifications
- Video specifications
- Environmental specifications

## System dimensions

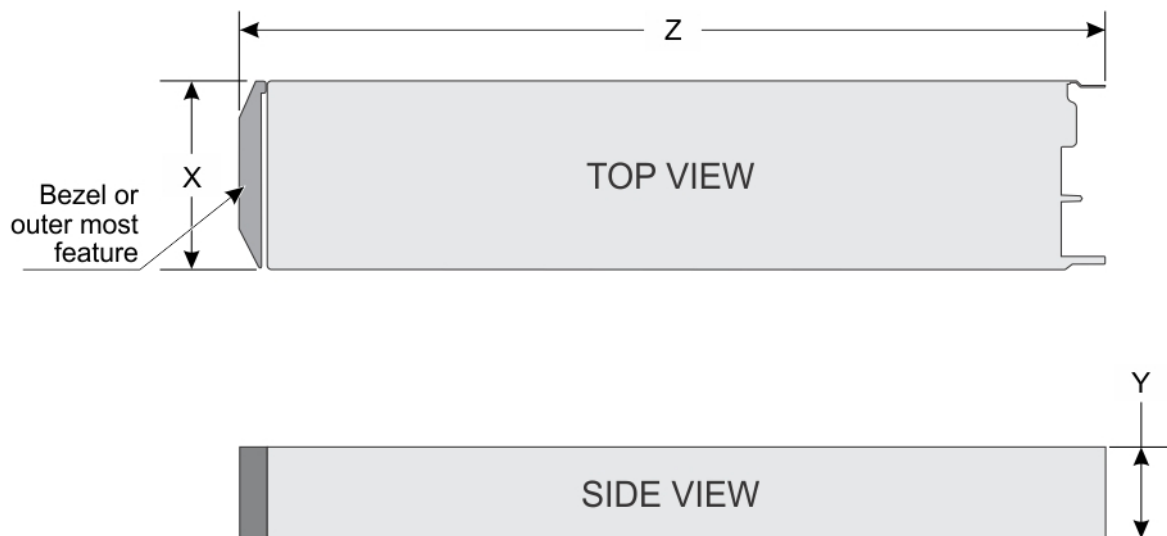

Figure 88. System dimensions

Table 15. System dimensions of thePowerEdge MX740c system

System	X	Y	Z (handle closed).
Dell EMC PowerEdge MX740c	250.2 mm (9.85 inches)	42.15 mm (1.65 inches)	620.35 mm (24.42 inches)

# System weight

Table 16. System weight

System	Maximum weight
Dell EMC PowerEdge MX740c	9.5 kg (20.94 lb)

# Processor specifications

The Dell EMC PowerEdge MX740c system supports up to two Intel Xeon Scalable processors, up to 28 cores per processor.

## Processor wattage and heat sink dimensions

Table 17. Processor wattage and heat sink dimensions

Processor configuration	Processor type	Heat sink width	Number of maximum DIMMS per processor	Number of DIMMS, (RAS)
All	Up to 205 W	90 mm	12	12

# Intel Quick Assist Technology

The Intel® Quick Assist Technology (QAT) on the Dell EMC PowerEdge MX740c is supported with chipset integration and is enabled through an optional license. The license files are enabled on the sleds through iDRAC.

For more information about iDRAC, see the *Dell Integrated Remote Access Controller User's Guide* at [www.dell.com/poweredgemanuals](http://www.dell.com/poweredgemanuals)

For more information about drivers, documentation, and white papers on the Intel® QAT, see <https://01.org/intel-quickassist-technology>.

# Supported operating systems

The Dell EMC PowerEdge MX740c sled supports the following operating systems:

- Citrix XenServer
- Microsoft Windows Server with Hyper-V
- Red Hat Enterprise Linux
- SuSE Linux Enterprise Server
- Ubuntu
- VMWare ESXi

For more information about the specific versions and editions, go to <https://www.dell.com/ossupport>.

# System battery specifications

The Dell EMC PowerEdge MX740c system supports CR 2032 3.0-V Nickel-Plated lithium coin cell system battery.

# Memory specifications

Table 18. Memory specifications

DIMM type	DIMM rank	DIMM capacity	Single processor		Dual processors	
			Minimum RAM	Maximum RAM	Minimum RAM	Maximum RAM
LRDIMM	Octal rank	128 GB	128 GB	1536 GB	256 GB	3072 GB
	Quad rank	64 GB	64 GB	768 GB	128 GB	1536 GB
RDIMM	Single rank	8 GB	8 GB	96 GB	16 GB	192 GB
	Dual rank	16 GB	16 GB	192 GB	32 GB	384 GB
		32 GB	32 GB	384 GB	64 GB	768 GB
		64 GB	64 GB	768 GB	128 GB	1536 GB
NVDIMM-N	Single rank	16 GB	Not supported with single processor	Not supported with single processor	RDIMM: 192 GB	RDIMM: 384 GB
					NVDIMM-N: 16 GB	NVDIMM-N: 192 GB
DCPMM	NA	128 GB	RDIMM: 64 GB	RDIMM: 384 GB	RDIMM: 128 GB	LRDIMM: 1536 GB
			DCPMM: 128 GB	DCPMM: 128 GB	DCPMM: 1536 GB	DCPMM: 1536 GB
	NA	256 GB	NA	NA	RDIMM: 192 GB	LRDIMM: 1536 GB
			NA	NA	DCPMM: 2048 GB	DCPMM: 3072 GB
	NA	512 GB	NA	NA	RDIMM: 384 GB	RDIMM: 1536 GB
			NA	NA	DCPMM: 4096 GB	DCPMM: 6144 GB

**NOTE:** 8 GB RDIMMs and NVDIMM-N must not be mixed.

**NOTE:** 64 GB LRDIMMs and 128 GB LRDIMMs must not be mixed.

**NOTE:** Minimum of two processors are required for any configurations that support NVDIMM-N.

**NOTE:** DCPMM can be mixed with RDIMMs and LRDIMMs.

**NOTE:** Mix of Intel DCPMM operating modes (App Direct, Memory Mode) is not supported within socket or across sockets.

## Hard drives

The Dell EMC PowerEdge MX740c system supports upto six 2.5-inch, hot-swappable SAS/SATA HDDs, SSDs, or PCIe NVMe drives.

The drives are supplied in a hot-swappable drive carriers and these drives connect to the system board or RAID controller through the backplane.

**NOTE:** A dual-processor configuration is required to support NVMe drives.

## Mezzanine and Mini Mezzanine slots specifications

The Dell EMC PowerEdge MX740c supports:

- One x16 PCIe Gen3 for Mini Mezzanine cards - connected to Processor 2.
- Two x16 PCIe Gen3 for Mezzanine cards - Mezzanine A1 is connected to Processor 1, Mezzanine B1 is connected to Processor 2.

# Storage controller specifications

The Dell EMC PowerEdge MX740c system supports PowerEdge RAID Controller (PERC) HBA330 MX, HBA330, H730P MX, H745P MX, H730P, H745P, S140 (SATA and NVMe drives), HBA330 MMZ (mini Mezzanine card), Fiber Fiber channel HBA (in Mini mezzanine Fab C slot), and Boot Optimized Server Storage (BOSS M.2).

# Ports and connectors specifications

## USB ports

The Dell EMC PowerEdge MX740c system supports:

- One USB 3.0-compliant port on the front of the system
- One micro USB/iDRAC Direct USB 2.0-compliant port on the front of the system
- One USB 3.0-compliant internal port

**NOTE:** The micro USB 2.0-compliant port on the front of the system can only be used as an iDRAC Direct management port.

## Internal Dual SD Module

The Dell EMC PowerEdge MX740c system supports optional Internal Dual SD module (IDSDM) module. In 14th generation of PowerEdge servers, IDSDM module supports two micro SD cards. Micro SD cards capacities for IDSDM are 16, 32, 64 GB.

**NOTE:** There are two dip switches on the IDSDM module for write-protection.

**NOTE:** One IDSDM card slot is dedicated for redundancy.

**NOTE:** It is recommended to use Dell branded MicroSD cards associated with the IDSDM configured systems.

## Micro SD vFlash connector

The Dell EMC PowerEdge MX740c system supports one dedicated micro SD card on iDRAC module for future vFlash support. It is recommended to use Dell branded MicroSD card associated with the iDRAC module.

# Video specifications

Table 19. Video specifications

Type	Description	
Video type	Matrox G200 graphics controller integrated with iDRAC	
Video memory	4 Gb DDR4 shared with iDRAC application memory	

# Environmental specifications

**NOTE:** For additional information about environmental certifications, please refer to the Product Environmental Datasheet located with the Manuals & Documents on [www.dell.com/poweredgemanuals](http://www.dell.com/poweredgemanuals)

**Table 20. Temperature specifications**

Temperature	Specifications
Storage	-40°C to 65°C (-40°F to 149°F)
Continuous operation (for altitude less than 950 m or 3117 ft)	10°C to 35°C (50°F to 95°F) with no direct sunlight on the equipment.
Maximum temperature gradient (operating and storage)	20°C/h (68°F/h)

**Table 21. Relative humidity specifications**

Relative humidity	Specifications
Storage	5% to 95% RH with 33°C (91°F) maximum dew point. Atmosphere must be noncondensing always.
Operating	10% to 80% relative humidity with 29°C (84.2°F) maximum dew point.

**Table 22. Maximum vibration specifications**

Maximum vibration	Specifications
Operating	0.26 G <sub>rms</sub> at 5 Hz to 350 Hz (all operation orientations).
Storage	1.87 G <sub>rms</sub> at 10 Hz to 500 Hz for 15 min (all six sides tested).

**Table 23. Maximum shock specifications**

Maximum shock	Specifications
Operating	Six consecutively executed shock pulses in the positive and negative x, y, and z axes of 6 G for up to 11 ms.
Storage	Six consecutively executed shock pulses in the positive and negative x, y, and z axes (one pulse on each side of the system) of 71 G for up to 2 ms.

**Table 24. Maximum altitude specifications**

Maximum altitude	Specifications
Operating	3048 m (10,000 ft)
Storage	12,000 m (39,370 ft)

**Table 25. Operating temperature derating specifications**

Operating temperature derating	Specifications
Up to 35°C (95°F)	Maximum temperature is reduced by 1°C/300 m (1°F/547 ft) above 950 m (3,117 ft).
35°C to 40°C (95°F to 104°F)	Maximum temperature is reduced by 1°C/175 m (1°F/319 ft) above 950 m (3,117 ft).
40°C to 45°C (104°F to 113°F)	Maximum temperature is reduced by 1°C/125 m (1°F/228 ft) above 950 m (3,117 ft).

## Particulate and gaseous contamination specifications

The following table defines the limitations that help avoid any equipment damage or failure from particulates and gaseous contamination. If the levels of particulates or gaseous pollution exceed the specified limitations and result in equipment damage or failure, you may must rectify the environmental conditions. Remediation of environmental conditions is the responsibility of the customer.

**Table 26. Particulate contamination specifications**

Particulate contamination	Specifications
Air filtration	Data center air filtration as defined by ISO Class 8 per ISO 14644-1 with a 95% upper confidence limit. <i>i</i> <b>NOTE:</b> This condition applies to data center environments only. Air filtration requirements do not apply to IT equipment designed to be used outside a data center, in environments such as an office or factory floor. <i>i</i> <b>NOTE:</b> Air entering the data center must have MERV11 or MERV13 filtration.
Conductive dust	Air must be free of conductive dust, zinc whiskers, or other conductive particles. <i>i</i> <b>NOTE:</b> This condition applies to data center and nondata center environments.
Corrosive dust	<ul style="list-style-type: none"> <li>• Air must be free of corrosive dust.</li> <li>• Residual dust present in the air must have a deliquescent point less than 60% relative humidity.</li> </ul> <i>i</i> <b>NOTE:</b> This condition applies to data center and nondata center environments.

**Table 27. Gaseous contamination specifications**

Gaseous contamination	Specifications
Copper coupon corrosion rate	<300 Å/month per Class G1 as defined by ANSI/ISA71.04-1985.
Silver coupon corrosion rate	<200 Å/month as defined by AHSRAE TC9.9.

*i* **NOTE:** Maximum corrosive contaminant levels measured at ≤50% relative humidity.

## Standard operating temperature

**Table 28. Standard operating temperature specifications**

Standard operating temperature	Specifications
Continuous operation (for altitude less than 950 m or 3117 ft)	10°C to 35°C (50°F to 95°F) with no direct sunlight on the equipment.
Humidity percentage range	10% to 80% Relative Humidity with 29°C (84.2°F) maximum dew point.

## Expanded operating temperature

**Table 29. Expanded operating temperature specifications**

Expanded operating temperature	Specifications
Continuous Operation	5°C–40°C at 5% to 85% RH with 29°C dew point <i>i</i> <b>NOTE:</b> Outside the standard operating temperature (10°C–35°C), the system can operate continuously in temperatures as low as 5°C and as high as 40°C. For temperatures 35°C–40°C, derate maximum allowable dry bulb temperature by 1°C per 175 m above 950 m (1°F per 319 ft).
Less than or equal to 1% of annual operating hours	–5°C–45°C at 5% to 90% RH with 29°C dew point

**Table 29. Expanded operating temperature specifications (continued)**

Expanded operating temperature	Specifications
	<p><b>i</b> <b>NOTE:</b> Outside the standard operating temperature (10°C–35°C), the system can operate down to –5°C or up to 45°C for a maximum of 1% of its annual operating hours.</p> <p>For temperatures 40°C–45°C, derate maximum allowable temperature by 1°C per 125 m above 950 m (1°F per 228 ft).</p>

**i** **NOTE:** When operating in the expanded temperature range, system performance may be impacted.

**i** **NOTE:** When operating in the expanded temperature range, ambient temperature warnings maybe reported on the LCD panel and in the System event log.

## Expanded operating temperature restrictions

1. Do not perform a cold startup below 5°C.
2. The operating temperature that is specified is for a maximum altitude of 3050 m(10,000 ft).
3. Low core count processors [Gold 6146,6144,6134,6128,5222,5217,5122] and higher wattage processors [Thermal Design Power (TDP)>140 W] are not supported.
4. Non-Dell qualified peripheral cards or peripheral cards greater than 30 W are not supported.
5. PCIe SSD is not supported.
6. NVDIMM are not supported.
7. DCPMMs are not supported.

## Thermal

PowerEdge servers have an extensive collection of sensors that automatically track thermal activity, which helps regulate temperature thereby reducing server noise and power consumption. The sensors in the MX740c interact with the chassis management services module which regulates fan speed. All fans which cool the MX740c are contained in the MX7000 chassis.

Thermal management of PowerEdge MX740c delivers high performance for the right amount of cooling to components at the lowest fan speeds across a wide range of ambient temperatures from 10°C to 35°C (50°F to 95°F) and to extended ambient temperature ranges (see Environmental Specifications section). The benefits to you are lower fan power consumption (lower server system power and data center power consumption) and greater acoustical versatility.

For detailed information about thermal please consult the MX7000 Technical Guide.

**Table 30. Thermal restriction matrix**

Ambient Support	25 ° C	30 ° C	35 ° C	40 ° C ~ 45 ° C Expanded Operating Temperature
<b>CPU</b>	No restriction	No restriction	No restriction (The recommended operating temperature for processors with Thermal Design Power (TDP) > 165W is under 32°C)	Does not support processor with TDP > 140W  Does not Support Gold 6146 Gold 6144 Gold 6134 Gold 6132 Gold 6128 Gold 5122  No support for 6234(130W8c), 5217(115W8c) and 5222(105W4c) processors.
<b>DIMM</b>	No restriction	No restriction	No restriction	Does not support NVDIMM

**Table 30. Thermal restriction matrix (continued)**

<b>Ambient Support</b>	<b>25 ° C</b>	<b>30 ° C</b>	<b>35 ° C</b>	<b>40 ° C ~ 45 ° C Expanded Operating Temperature</b>
<b>Drives</b>	No restriction	No restriction	No restriction	Does not support NVMe (PCIe SSDs)
<b>Mezzanine Cards</b>	No restriction	No restriction	No restriction	Does not support mezzanine cards with power above 30W

# System diagnostics and indicator codes

The diagnostic indicators on the system front panel display system status during system startup.

## Topics:

- [Power button LED](#)
- [Drive indicator codes](#)
- [System health and system ID indicator codes](#)
- [System diagnostics](#)

## Power button LED

The power button LED is located on the front panel of your system.



Figure 89. Power button LED

Table 31. Power button LED

Power button LED indicator code	Condition
Off	System is not operating, regardless of power supply available.
On	System is operating, one or more of the non-standby power supplies are active.
Slowly blinking	System is performing powering on sequence and iDRAC is still booting.

## Drive indicator codes

The LEDs on the drive carrier indicates the state of each drive. Each drive carrier in your system has two LEDs: an activity LED (green) and a status LED (bicolor, green/amber). The activity LED flashes whenever the drive is accessed.



Figure 90. Drive indicators on the drive and the mid drive tray backplane

1. Drive activity LED indicator

2. Drive status LED indicator
3. Drive capacity label

**NOTE:** If the drive is in the Advanced Host Controller Interface (AHCI) mode, the status LED indicator does not turn on.

**Table 32. Drive indicator codes**

Drive status indicator code	Condition
Flashes green twice per second	Identifying drive or preparing for removal.
Off	Drive ready for removal. <b>NOTE:</b> The drive status indicator remains off until all drives are initialized after the system is turned on. Drives are not ready for removal during this time.
Flashes green, amber, and then turns off	Predicted drive failure.
Flashes amber four times per second	Drive failed.
Flashes green slowly	Drive rebuilding.
Solid green	Drive online.
Flashes green for three seconds, amber for three seconds, and then turns off after six seconds	Rebuild stopped.

## System health and system ID indicator codes

The system health and system ID indicator is located on the left control panel of your system.



**Figure 91. System health and system ID indicators**

**Table 33. System health and system ID indicator codes**

System health and system ID indicator code	Condition
Solid blue	Indicates that the system is turned on, system is healthy, and system ID mode is not active. Press the system health and system ID button on left control panel of MX7000 to switch to system ID mode.
Blinking blue	Indicates that the system ID mode is active. Press the system health and system ID button on left control panel of MX7000 to switch to system health mode.
Solid amber	Indicates that the system is in fail-safe mode.
Blinking amber	Indicates that the system is experiencing a fault. Check the System Event Log for specific error messages. For more information about error messages, see the <i>Dell Event and Error Messages Reference Guide</i> at <a href="http://www.dell.com/openmanagemanuals">www.dell.com/openmanagemanuals</a> .

## System diagnostics

If you experience a problem with your system, run the system diagnostics before contacting Dell for technical assistance. The purpose of running system diagnostics is to test your system hardware without using additional equipment or risking data loss. If

you are unable to fix the problem yourself, service and support personnel can use the diagnostics results to help you solve the problem.

## Dell Embedded System Diagnostics

**NOTE:** The Dell Embedded System Diagnostics is also known as Enhanced Pre-boot System Assessment (ePSA) diagnostics.

The Embedded System Diagnostics provides a set of options for particular device groups or devices allowing you to:

- Run tests automatically or in an interactive mode
- Repeat tests
- Display or save test results
- Run thorough tests to introduce additional test options to provide extra information about the failed device(s)
- View status messages that inform you if tests are completed successfully
- View error messages that inform you of problems encountered during testing

## Running the Embedded System Diagnostics from Boot Manager

Run the Embedded System Diagnostics (ePSA) if your system does not boot.

### Steps

1. When the system is booting, press F11.
2. Use the up arrow and down arrow keys to select **System Utilities > Launch Diagnostics**.
3. Alternatively, when the system is booting, press F10, select **Hardware Diagnostics > Run Hardware Diagnostics**. The **ePSA Pre-boot System Assessment** window is displayed, listing all devices detected in the system. The diagnostics starts executing the tests on all the detected devices.

### Results

## Running the Embedded System Diagnostics from the Dell Lifecycle Controller

### Steps

1. As the system boots, press F10.
2. Select **Hardware Diagnostics → Run Hardware Diagnostics**. The **ePSA Pre-boot System Assessment** window is displayed, listing all devices detected in the system. The diagnostics starts executing the tests on all the detected devices.

## System diagnostic controls

Menu	Description
<b>Configuration</b>	Displays the configuration and status information of all detected devices.
<b>Results</b>	Displays the results of all tests that are run.
<b>System health</b>	Provides the current overview of the system performance.
<b>Event log</b>	Displays a time-stamped log of the results of all tests run on the system. This is displayed if at least one event description is recorded.

# Getting help

## Topics:

- [Contacting Dell EMC](#)
- [Documentation feedback](#)
- [Accessing system information by using QRL](#)
- [Receiving automated support with SupportAssist](#)
- [Recycling or End-of-Life service information](#)

## Contacting Dell EMC

Dell EMC provides several online and telephone based support and service options. If you do not have an active internet connection, you can find contact information about your purchase invoice, packing slip, bill, or Dell EMC product catalog. Availability varies by country and product, and some services may not be available in your area. To contact Dell EMC for sales, technical assistance, or customer service issues:

### Steps

1. Go to [www.dell.com/support/home](http://www.dell.com/support/home).
2. Select your country from the drop-down menu on the lower right corner of the page.
3. For customized support:
  - a. Enter your system Service Tag in the **Enter your Service Tag** field.
  - b. Click **Submit**.  
The support page that lists the various support categories is displayed.
4. For general support:
  - a. Select your product category.
  - b. Select your product segment.
  - c. Select your product.  
The support page that lists the various support categories is displayed.
5. For contact details of Dell EMC Global Technical Support:
  - a. Click [Global Technical Support](#).
  - b. The **Contact Technical Support** page is displayed with details to call, chat, or e-mail the Dell EMC Global Technical Support team.

## Documentation feedback

You can rate the documentation or write your feedback on any of our Dell EMC documentation pages and click **Send Feedback** to send your feedback.

## Accessing system information by using QRL

You can use the Quick Resource Locator (QRL) located on the information tag in the front of the system, to access the information about the PowerEdge system.

### Prerequisites

Ensure that your smartphone or tablet has the QR code scanner installed.

The QRL includes the following information about your system:

- How-to videos
- Reference materials, including the Installation and Service Manual, and mechanical overview
- Your system service tag to quickly access your specific hardware configuration and warranty information
- A direct link to Dell to contact technical assistance and sales teams

### Steps

1. Go to [www.dell.com/qrl](http://www.dell.com/qrl) and navigate to your specific product or
2. Use your smartphone or tablet to scan the model-specific Quick Resource (QR) code on your system or in the Quick Resource Locator section.

## Quick Resource Locator for PowerEdge MX740c system



Figure 92. Quick Resource Locator for PowerEdge MX740c system

## Receiving automated support with SupportAssist

Dell EMC SupportAssist is an optional Dell EMC Services offering that automates technical support for your Dell EMC server, storage, and networking devices. By installing and setting up a SupportAssist application in your IT environment, you can receive the following benefits:

- **Automated issue detection** — SupportAssist monitors your Dell EMC devices and automatically detects hardware issues, both proactively and predictively.
- **Automated case creation** — When an issue is detected, SupportAssist automatically opens a support case with Dell EMC Technical Support.
- **Automated diagnostic collection** — SupportAssist automatically collects system state information from your devices and uploads it securely to Dell EMC. This information is used by Dell EMC Technical Support to troubleshoot the issue.
- **Proactive contact** — A Dell EMC Technical Support agent contacts you about the support case and helps you resolve the issue.

The available benefits vary depending on the Dell EMC Service entitlement purchased for your device. For more information about SupportAssist, go to [www.dell.com/supportassist](http://www.dell.com/supportassist).

## Recycling or End-of-Life service information

Take back and recycling services are offered for this product in certain countries. If you want to dispose of system components, visit [www.dell.com/recyclingworldwide](http://www.dell.com/recyclingworldwide) and select the relevant country.

## Documentation resources

This section provides information about the documentation resources for your system.

To view the document that is listed in the documentation resources table:

- From the Dell EMC support site:
  1. Click the documentation link that is provided in the Location column in the table.
  2. Click the required product or product version.
  3. On the Product Support page, click **Manuals & documents**.
- Using search engines:
  - Type the name and version of the document in the search box.

**Table 34. Additional documentation resources for your system**

Task	Document	Location
Setting up your system	<p>For more information about installing and securing the system into a rack, see the Rail Installation Guide included with your rack solution.</p> <p>For information about setting up your system, see the <i>Getting Started Guide</i> document that is shipped with your system.</p>	<a href="http://www.dell.com/poweredgemanuals">www.dell.com/poweredgemanuals</a>
Configuring your system	<p>For information about the iDRAC features, configuring and logging in to iDRAC, and managing your system remotely, see the Integrated Dell Remote Access Controller User's Guide.</p> <p>For information about understanding Remote Access Controller Admin (RACADM) subcommands and supported RACADM interfaces, see the RACADM CLI Guide for iDRAC.</p> <p>For information about Redfish and its protocol, supported schema, and Redfish Eventing are implemented in iDRAC, see the Redfish API Guide.</p> <p>For information about iDRAC property database group and object descriptions, see the Attribute Registry Guide.</p> <p>For information about Intel QuickAssist Technology, see the Integrated Dell Remote Access Controller User's Guide.</p>	<a href="http://www.dell.com/poweredgemanuals">www.dell.com/poweredgemanuals</a>
	<p>For information about earlier versions of the iDRAC documents, see the iDRAC documentation.</p> <p>To identify the version of iDRAC available on your system, on the iDRAC web interface, click <b>? &gt; About</b>.</p>	<a href="http://www.dell.com/idracmanuals">www.dell.com/idracmanuals</a>

**Table 34. Additional documentation resources for your system (continued)**

<b>Task</b>	<b>Document</b>	<b>Location</b>
	For information about installing the operating system, see the operating system documentation.	<a href="http://www.dell.com/operatingsystemmanuals">www.dell.com/operatingsystemmanuals</a>
	For information about updating drivers and firmware, see the Methods to download firmware and drivers section in this document.	<a href="http://www.dell.com/support/drivers">www.dell.com/support/drivers</a>
Managing your system	For information about systems management software offered by Dell, see the Dell OpenManage Systems Management Overview Guide.	<a href="http://www.dell.com/poweredgemanuals">www.dell.com/poweredgemanuals</a>
	For information about setting up, using, and troubleshooting OpenManage, see the Dell OpenManage Server Administrator User's Guide.	<a href="http://www.dell.com/openmanagemanuals">www.dell.com/openmanagemanuals</a> > OpenManage Server Administrator
	For information about installing, using, and troubleshooting Dell OpenManage Essentials, see the Dell OpenManage Essentials User's Guide.	<a href="http://www.dell.com/openmanagemanuals">www.dell.com/openmanagemanuals</a> > OpenManage Essentials
	For information about installing, using, and troubleshooting Dell OpenManage Enterprise, see the Dell OpenManage Enterprise User's Guide.	<a href="http://www.dell.com/openmanagemanuals">www.dell.com/openmanagemanuals</a> > OpenManage Enterprise
	For information about installing and using Dell SupportAssist, see the Dell EMC SupportAssist Enterprise User's Guide.	<a href="https://www.dell.com/serviceabilitytools">https://www.dell.com/serviceabilitytools</a>
	For information about partner programs enterprise systems management, see the OpenManage Connections Enterprise Systems Management documents.	<a href="http://www.dell.com/openmanagemanuals">www.dell.com/openmanagemanuals</a>
Working with the Dell PowerEdge RAID controllers	For information about understanding the features of the Dell PowerEdge RAID controllers (PERC), Software RAID controllers, or BOSS card and deploying the cards, see the Storage controller documentation.	<a href="http://www.dell.com/storagecontrollermanuals">www.dell.com/storagecontrollermanuals</a>
Understanding event and error messages	For information about the event and error messages that are generated by the system firmware and agents that monitor system components, see the Error Code Lookup.	<a href="http://www.dell.com/qrl">www.dell.com/qrl</a>
Troubleshooting your system	For information about identifying and troubleshooting the PowerEdge server issues, see the Server Troubleshooting Guide.	<a href="http://www.dell.com/poweredgemanuals">www.dell.com/poweredgemanuals</a>