

Inspiron 3785

Service Manual



Notes, cautions, and warnings

 **NOTE:** A NOTE indicates important information that helps you make better use of your product.

 **CAUTION:** A CAUTION indicates either potential damage to hardware or loss of data and tells you how to avoid the problem.

 **WARNING:** A WARNING indicates a potential for property damage, personal injury, or death.

Contents

Chapter 1: Before working inside your computer	9
Before you begin	9
Chapter 2: After working inside your computer	10
Chapter 3: Safety instructions	11
Electrostatic discharge—ESD protection.....	11
ESD field service kit	12
Transporting sensitive components.....	13
Chapter 4: Recommended tools	14
Chapter 5: Screw list	15
Chapter 6: Removing the optical drive	17
Procedure.....	17
Chapter 7: Replacing the optical drive	19
Procedure	19
Chapter 8: Removing the base cover	21
Prerequisites.....	21
Procedure.....	21
Chapter 9: Replacing the base cover	23
Procedure	23
Post-requisites.....	24
Chapter 10: Removing the battery	25
Lithium-ion battery precautions.....	25
Prerequisites.....	25
Procedure.....	25
Chapter 11: Replacing the battery	27
Lithium-ion battery precautions.....	27
Procedure	27
Post-requisites.....	28
Chapter 12: Removing the memory modules	29
Prerequisites.....	29
Procedure.....	29
Chapter 13: Replacing the memory modules	30

Procedure	30
Post-requisites.....	30
Chapter 14: Removing the wireless card.....	31
Prerequisites.....	31
Procedure.....	31
Chapter 15: Replacing the wireless card.....	33
Procedure.....	33
Post-requisites.....	33
Chapter 16: Removing the optical-drive connector board.....	34
Prerequisites.....	34
Procedure.....	34
Chapter 17: Replacing the optical-drive connector board.....	35
Procedure	35
Post-requisites.....	35
Chapter 18: Removing the coin-cell battery.....	36
Prerequisites.....	36
Procedure.....	36
Chapter 19: Replacing the coin-cell battery.....	37
Procedure.....	37
Post-requisites.....	37
Chapter 20: Removing the fan.....	38
Prerequisites.....	38
Procedure.....	38
Chapter 21: Replacing the fan.....	40
Procedure	40
Post-requisites.....	41
Chapter 22: Removing the solid-state drive.....	42
Prerequisites.....	42
Procedure.....	42
Chapter 23: Replacing the solid-state drive.....	44
Procedure	44
Post-requisites.....	44
Chapter 24: Removing the hard drive.....	45
Prerequisites.....	45
Procedure.....	45
Chapter 25: Replacing the hard drive.....	47

Procedure	47
Post-requisites.....	48
Chapter 26: Removing the touchpad.....	49
Prerequisites.....	49
Procedure.....	49
Chapter 27: Replacing the touchpad.....	51
Procedure	51
Post-requisites.....	52
Chapter 28: Removing the speakers.....	53
Prerequisites.....	53
Procedure.....	53
Chapter 29: Replacing the speakers.....	54
Procedure	54
Post-requisites.....	54
Chapter 30: Removing the heat sink.....	55
Prerequisites.....	55
Procedure.....	55
Chapter 31: Replacing the heat sink.....	56
Procedure	56
Post-requisites.....	56
Chapter 32: Removing the power-adapter port.....	57
Removing the display assembly.....	57
Prerequisites.....	57
Procedure.....	57
Procedure.....	59
Chapter 33: Replacing the power-adapter port.....	61
Procedure	61
Replacing the display assembly.....	61
Procedure	61
Post-requisites.....	63
Chapter 34: Removing the display assembly.....	64
Prerequisites.....	64
Procedure.....	64
Chapter 35: Replacing the display assembly.....	67
Procedure	67
Post-requisites.....	68
Chapter 36: Removing the I/O board.....	69

Prerequisites.....	69
Procedure.....	69
Chapter 37: Replacing the I/O board.....	70
Procedure	70
Post-requisites.....	70
Chapter 38: Removing the power-button board.....	71
Prerequisites.....	71
Procedure.....	71
Chapter 39: Replacing the power-button board.....	73
Procedure	73
Post-requisites.....	74
Chapter 40: Removing the system board.....	75
Prerequisites.....	75
Procedure.....	75
Chapter 41: Replacing the system board.....	78
Procedure.....	78
Post-requisites.....	79
Entering the Service Tag in the BIOS setup program.....	80
Chapter 42: Removing the power button with fingerprint reader.....	81
Prerequisites.....	81
Procedure.....	81
Chapter 43: Replacing the power button with fingerprint reader.....	83
Procedure	83
Post-requisites.....	83
Chapter 44: Removing the palm-rest and keyboard assembly.....	85
Prerequisites.....	85
Procedure.....	85
Chapter 45: Replacing the palm-rest and keyboard assembly.....	87
Procedure	87
Post-requisites.....	87
Chapter 46: Removing the display bezel.....	89
Prerequisites.....	89
Procedure.....	89
Chapter 47: Replacing the display bezel.....	90
Procedure	90
Post-requisites.....	90



Chapter 48: Removing the camera.....	91
Prerequisites.....	91
Procedure.....	91
Chapter 49: Replacing the camera.....	92
Procedure	92
Post-requisites.....	92
Chapter 50: Removing the display panel.....	93
Prerequisites.....	93
Procedure.....	93
Chapter 51: Replacing the display panel.....	95
Procedure	95
Post-requisites.....	96
Chapter 52: Removing the display hinges.....	97
Prerequisites.....	97
Procedure.....	97
Chapter 53: Replacing the display hinges.....	98
Procedure	98
Post-requisites.....	98
Chapter 54: Removing the display cable.....	99
Prerequisites.....	99
Procedure.....	99
Chapter 55: Replacing the display cable.....	100
Procedure	100
Post-requisites.....	100
Chapter 56: Removing the display back-cover and antenna assembly.....	101
Prerequisites.....	101
Procedure.....	101
Chapter 57: Replacing the display back-cover and antenna assembly.....	102
Procedure	102
Post-requisites.....	102
Chapter 58: System setup.....	103
System setup.....	103
Entering BIOS setup program.....	103
Navigation keys.....	103
Boot Sequence.....	104
System setup options.....	104
Clearing CMOS settings.....	107

Clearing BIOS (System Setup) and System passwords.....	107
Chapter 59: Troubleshooting.....	108
Flashing the BIOS.....	108
Flashing BIOS (USB key).....	108
Enhanced Pre-Boot System Assessment (ePSA) diagnostics.....	108
Running the ePSA diagnostics.....	109
System diagnostic lights.....	109
WiFi power cycle.....	110
Flea power release.....	110
Chapter 60: Getting help and contacting Dell.....	111

Before working inside your computer

 **NOTE:** The images in this document may differ from your computer depending on the configuration you ordered.

Before you begin

1. Save and close all open files and exit all open applications.
2. Shut down your computer. Click **Start** >  **Power** > **Shut down**.
 **NOTE:** If you are using a different operating system, see the documentation of your operating system for shut-down instructions.
3. Disconnect your computer and all attached devices from their electrical outlets.
4. Disconnect all attached network devices and peripherals, such as keyboard, mouse, and monitor from your computer.
5. Remove any media card and optical disc from your computer, if applicable.









After working inside your computer

 **CAUTION:** Leaving stray or loose screws inside your computer may severely damage your computer.

1. Replace all screws and ensure that no stray screws remain inside your computer.
2. Connect any external devices, peripherals, or cables you removed before working on your computer.
3. Replace any media cards, discs, or any other parts that you removed before working on your computer.
4. Connect your computer and all attached devices to their electrical outlets.
5. Turn on your computer.

Safety instructions

Use the following safety guidelines to protect your computer from potential damage and ensure your personal safety.

-  **NOTE:** Before working inside your computer, read the safety information that shipped with your computer. For more safety best practices, see the Regulatory Compliance home page at www.dell.com/regulatory_compliance.
-  **NOTE:** Disconnect all power sources before opening the computer cover or panels. After you finish working inside the computer, replace all covers, panels, and screws before connecting to the electrical outlet.
-  **CAUTION:** To avoid damaging the computer, ensure that the work surface is flat and clean.
-  **CAUTION:** To avoid damaging the components and cards, handle them by their edges, and avoid touching pins and contacts.
-  **CAUTION:** You should only perform troubleshooting and repairs as authorized or directed by the Dell technical assistance team. Damage due to servicing that is not authorized by Dell is not covered by your warranty. See the safety instructions that shipped with the product or at www.dell.com/regulatory_compliance.
-  **CAUTION:** Before touching anything inside your computer, ground yourself by touching an unpainted metal surface, such as the metal at the back of the computer. While you work, periodically touch an unpainted metal surface to dissipate static electricity, which could harm internal components.
-  **CAUTION:** When you disconnect a cable, pull on its connector or on its pull tab, not on the cable itself. Some cables have connectors with locking tabs or thumb-screws that you must disengage before disconnecting the cable. When disconnecting cables, keep them evenly aligned to avoid bending any connector pins. When connecting cables, ensure that the ports and connectors are correctly oriented and aligned.
-  **CAUTION:** Press and eject any installed card from the media-card reader.

Electrostatic discharge—ESD protection

ESD is a major concern when you handle electronic components, especially sensitive components such as expansion cards, processors, memory DIMMs, and system boards. Very slight charges can damage circuits in ways that may not be obvious, such as intermittent problems or a shortened product life span. As the industry pushes for lower power requirements and increased density, ESD protection is an increasing concern.

Due to the increased density of semiconductors used in recent Dell products, the sensitivity to static damage is now higher than in previous Dell products. For this reason, some previously approved methods of handling parts are no longer applicable.

Two recognized types of ESD damage are catastrophic and intermittent failures.

- **Catastrophic** – Catastrophic failures represent approximately 20 percent of ESD-related failures. The damage causes an immediate and complete loss of device functionality. An example of catastrophic failure is a memory DIMM that has received a static shock and immediately generates a "No POST/No Video" symptom with a beep code emitted for missing or nonfunctional memory.
- **Intermittent** – Intermittent failures represent approximately 80 percent of ESD-related failures. The high rate of intermittent failures means that most of the time when damage occurs, it is not immediately recognizable. The DIMM receives a static shock, but the tracing is merely weakened and does not immediately produce outward symptoms related to the damage. The weakened trace may take weeks or months to melt, and in the meantime may cause degradation of memory integrity, intermittent memory errors, etc.

The more difficult type of damage to recognize and troubleshoot is the intermittent (also called latent or "walking wounded") failure.

Perform the following steps to prevent ESD damage:

- Use a wired ESD wrist strap that is properly grounded. The use of wireless anti-static straps is no longer allowed; they do not provide adequate protection. Touching the chassis before handling parts does not ensure adequate ESD protection on parts with increased sensitivity to ESD damage.
- Handle all static-sensitive components in a static-safe area. If possible, use anti-static floor pads and workbench pads.
- When unpacking a static-sensitive component from its shipping carton, do not remove the component from the anti-static packing material until you are ready to install the component. Before unwrapping the anti-static packaging, ensure that you discharge static electricity from your body.
- Before transporting a static-sensitive component, place it in an anti-static container or packaging.

ESD field service kit

The unmonitored Field Service kit is the most commonly used service kit. Each Field Service kit includes three main components: anti-static mat, wrist strap, and bonding wire.

Components of an ESD field service kit

The components of an ESD field service kit are:

- **Anti-Static Mat** – The anti-static mat is dissipative and parts can be placed on it during service procedures. When using an anti-static mat, your wrist strap should be snug and the bonding wire should be connected to the mat and to any bare metal on the system being worked on. Once deployed properly, service parts can be removed from the ESD bag and placed directly on the mat. ESD-sensitive items are safe in your hand, on the ESD mat, in the system, or inside a bag.
- **Wrist Strap and Bonding Wire** – The wrist strap and bonding wire can be either directly connected between your wrist and bare metal on the hardware if the ESD mat is not required, or connected to the anti-static mat to protect hardware that is temporarily placed on the mat. The physical connection of the wrist strap and bonding wire between your skin, the ESD mat, and the hardware is known as bonding. Use only Field Service kits with a wrist strap, mat, and bonding wire. Never use wireless wrist straps. Always be aware that the internal wires of a wrist strap are prone to damage from normal wear and tear, and must be checked regularly with a wrist strap tester in order to avoid accidental ESD hardware damage. It is recommended to test the wrist strap and bonding wire at least once per week.
- **ESD Wrist Strap Tester** – The wires inside of an ESD strap are prone to damage over time. When using an unmonitored kit, it is a best practice to regularly test the strap prior to each service call, and at a minimum, test once per week. A wrist strap tester is the best method for doing this test. If you do not have your own wrist strap tester, check with your regional office to find out if they have one. To perform the test, plug the wrist-strap's bonding-wire into the tester while it is strapped to your wrist and push the button to test. A green LED is lit if the test is successful; a red LED is lit and an alarm sounds if the test fails.
- **Insulator Elements** – It is critical to keep ESD sensitive devices, such as plastic heat sink casings, away from internal parts that are insulators and often highly charged.
- **Working Environment** – Before deploying the ESD Field Service kit, assess the situation at the customer location. For example, deploying the kit for a server environment is different than for a desktop or portable environment. Servers are typically installed in a rack within a data center; desktops or portables are typically placed on office desks or cubicles. Always look for a large open flat work area that is free of clutter and large enough to deploy the ESD kit with additional space to accommodate the type of system that is being repaired. The workspace should also be free of insulators that can cause an ESD event. On the work area, insulators such as Styrofoam and other plastics should always be moved at least 12 inches or 30 centimeters away from sensitive parts before physically handling any hardware components.
- **ESD Packaging** – All ESD-sensitive devices must be shipped and received in static-safe packaging. Metal, static-shielded bags are preferred. However, you should always return the damaged part using the same ESD bag and packaging that the new part arrived in. The ESD bag should be folded over and taped shut and all the same foam packing material should be used in the original box that the new part arrived in. ESD-sensitive devices should be removed from packaging only at an ESD-protected work surface, and parts should never be placed on top of the ESD bag because only the inside of the bag is shielded. Always place parts in your hand, on the ESD mat, in the system, or inside an anti-static bag.
- **Transporting Sensitive Components** – When transporting ESD sensitive components such as replacement parts or parts to be returned to Dell, it is critical to place these parts in anti-static bags for safe transport.

ESD protection summary

It is recommended that all field service technicians use the traditional wired ESD grounding wrist strap and protective anti-static mat at all times when servicing Dell products. In addition, it is critical that technicians keep sensitive parts separate from all insulator parts while performing service and that they use anti-static bags for transporting sensitive components.

Transporting sensitive components

When transporting ESD sensitive components such as replacement parts or parts to be returned to Dell, it is critical to place these parts in anti-static bags for safe transport.

Lifting equipment

Adhere to the following guidelines when lifting heavy weight equipment:

 **CAUTION: Do not lift greater than 50 pounds. Always obtain additional resources or use a mechanical lifting device.**

1. Get a firm balanced footing. Keep your feet apart for a stable base, and point your toes out.
2. Tighten stomach muscles. Abdominal muscles support your spine when you lift, offsetting the force of the load.
3. Lift with your legs, not your back.
4. Keep the load close. The closer it is to your spine, the less force it exerts on your back.
5. Keep your back upright, whether lifting or setting down the load. Do not add the weight of your body to the load. Avoid twisting your body and back.
6. Follow the same techniques in reverse to set the load down.

Recommended tools

The procedures in this document may require the following tools:

- Philips screwdriver #1
- Flat-head screwdriver
- Plastic scribe

Screw list

NOTE: When removing screws from a component, it is recommended to note the screw type, the quantity of screws, and then place them in a screw storage box. This is to ensure that the correct number of screws and correct screw type is restored when the component is replaced.

NOTE: Some computers have magnetic surfaces. Ensure that the screws are not left attached to such surface when replacing a component.

NOTE: Screw color may vary with the configuration ordered.

Table 1. Screw list























Component	Secured to	Screw type	Quantity	Screw image
Base cover	Palm rest and keyboard assembly	M2x2	2	
Base cover	Palm rest and keyboard assembly	M2x4	1	
Base cover	Palm rest and keyboard assembly	M2.5x7	7	 NOTE: Screw color may vary depending on the configuration ordered.
Battery	Palm rest and keyboard assembly	M2x3	4	
Display panel	Display back-cover and antenna assembly	M2x2	4	
Fan	Palm rest and keyboard assembly	M2.5x5	3	
Hard-drive assembly	Palm rest and keyboard assembly	M2x3	4	
Hard-drive bracket	Hard drive	M3x3	4	
Heat sink NOTE: For computers shipped with discrete graphics.	System board	M2x3	3	
Hinges	Palm rest and keyboard assembly	M2.5x5	5	
Hinge brackets	Display back-cover and antenna assembly	M2.5x4	8	

Table 1. Screw list (continued)

Component	Secured to	Screw type	Quantity	Screw image
Hinge brackets	Display back-cover and antenna assembly	M2x2	2	
I/O board	Palm rest and keyboard assembly	M2x4	1	
Optical-drive bracket	Optical drive	M2x3	2	
Optical-drive connector board	Palm rest and keyboard assembly	M2x2 Big Head	1	
Power-adaptor port	Palm rest and keyboard assembly	M2x2	1	
Power-button board	Palm rest and keyboard assembly	M2x3	1	
Power button with fingerprint reader (optional)	Palm rest and keyboard assembly	M2x2	1	
Solid-state drive	Palm rest and keyboard assembly	M2x2.2	1	
System board	Palm rest and keyboard assembly	M2x4	1	
Touchpad	Palm rest and keyboard assembly	M2x2	4	
Wireless-card bracket	System board	M2x3	1	

Removing the optical drive

NOTE: Before working inside your computer, read the safety information that shipped with your computer and follow the steps in [Before working inside your computer](#). After working inside your computer, follow the instructions in [After working inside your computer](#). For more safety best practices, see the Regulatory Compliance home page at www.dell.com/regulatory_compliance.

Procedure

1. Remove the screw (M2x2) that secures the optical-drive assembly to the base cover.
2. Using a screwdriver, push the optical drive through the slot to release the optical-drive assembly out of the optical-drive bay.
3. Slide the optical-drive assembly out of the optical-drive bay.

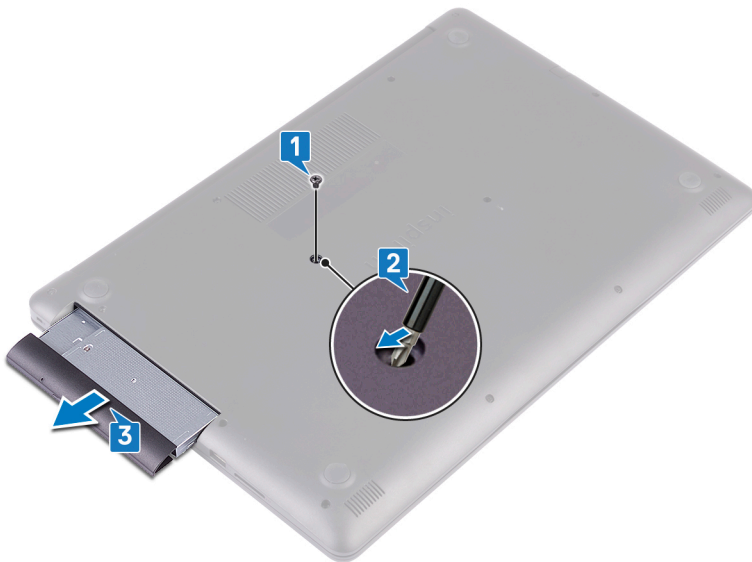

4. Remove the two screws (M2x3) that secure the optical-drive bracket to the optical drive.
5. Remove the optical-drive bracket from optical drive.



6. Pull the optical-drive bezel carefully to remove it from the optical drive.



Replacing the optical drive

NOTE: Before working inside your computer, read the safety information that shipped with your computer and follow the steps in [Before working inside your computer](#). After working inside your computer, follow the instructions in [After working inside your computer](#). For more safety best practices, see the Regulatory Compliance home page at www.dell.com/regulatory_compliance.

Procedure

1. Align the tabs on the optical-drive bezel with the slots on the optical drive and snap the optical-drive bezel into place.



2. Align the screw holes on the optical-drive bracket with the screw holes on the optical drive.
3. Replace the two screws (M2x3) that secure the optical-drive bracket to the optical drive.



4. Slide the optical-drive assembly into the optical-drive bay.
5. Align the screw hole on the optical-drive bracket with the screw hole on the base cover.
6. Replace the screw (M2x2) that secures the optical-drive assembly to the base cover.

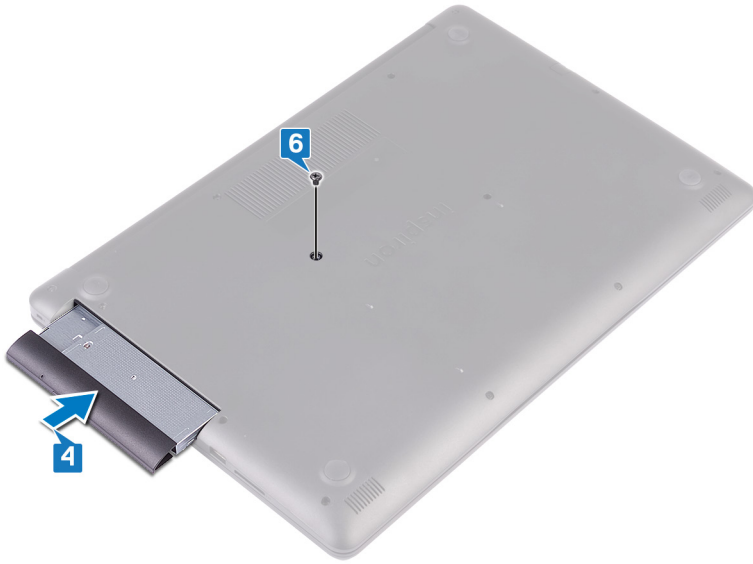

Removing the base cover

NOTE: Before working inside your computer, read the safety information that shipped with your computer and follow the steps in [Before working inside your computer](#). After working inside your computer, follow the instructions in [After working inside your computer](#). For more safety best practices, see the Regulatory Compliance home page at www.dell.com/regulatory_compliance.

Prerequisites

Remove the [optical drive](#).

Procedure

1. Loosen the four captive screws on the base cover.
2. Remove the screw (M2x4) that secures the base cover to the palm rest and keyboard assembly.
3. Remove the two screws (M2x2) that secure the base cover to the palm rest and keyboard assembly.
4. Remove the seven screws (M2.5x7) that secure the base cover to the palm rest and keyboard assembly.

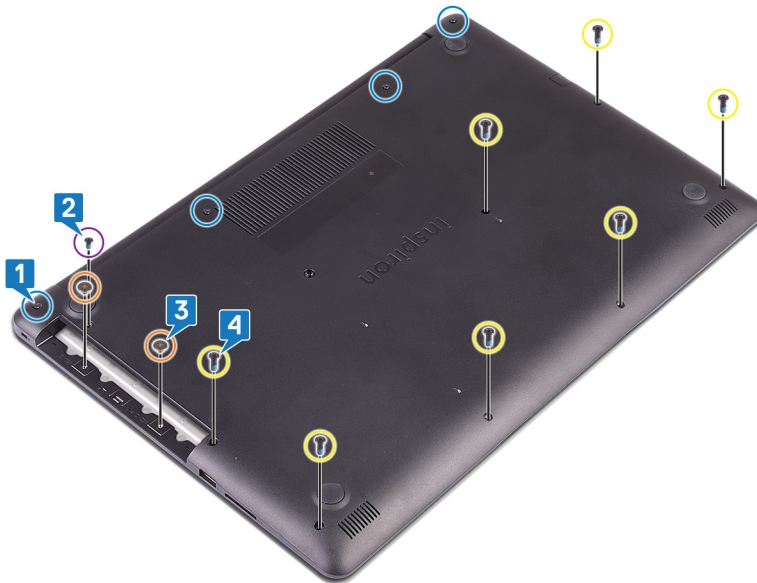

5. Pry the base cover starting from the top-left corner of the computer base.
6. Lift the base cover off the palm rest and keyboard assembly.



i | **NOTE:** The following steps are applicable only if you want to further remove any other component from your computer.

7. Disconnect the battery cable from the system board.

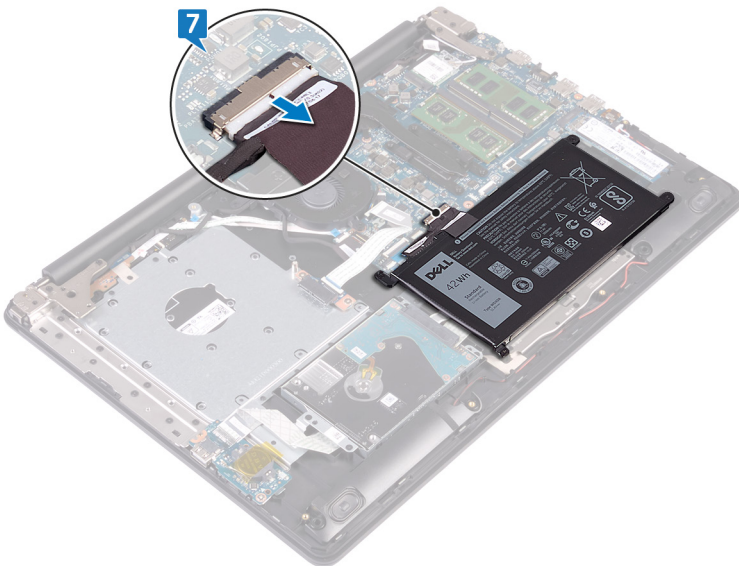

8. Press and hold the power button for 5 seconds to ground the computer and drain the flea power.

Replacing the base cover

NOTE: Before working inside your computer, read the safety information that shipped with your computer and follow the steps in [Before working inside your computer](#). After working inside your computer, follow the instructions in [After working inside your computer](#). For more safety best practices, see the Regulatory Compliance home page at www.dell.com/regulatory_compliance.

Procedure

1. Connect the battery cable to the system board, if applicable.

CAUTION: To avoid accidental damage to the power-adapter port, do not press the base cover against the power-adapter port when you snap the base cover to the computer base.

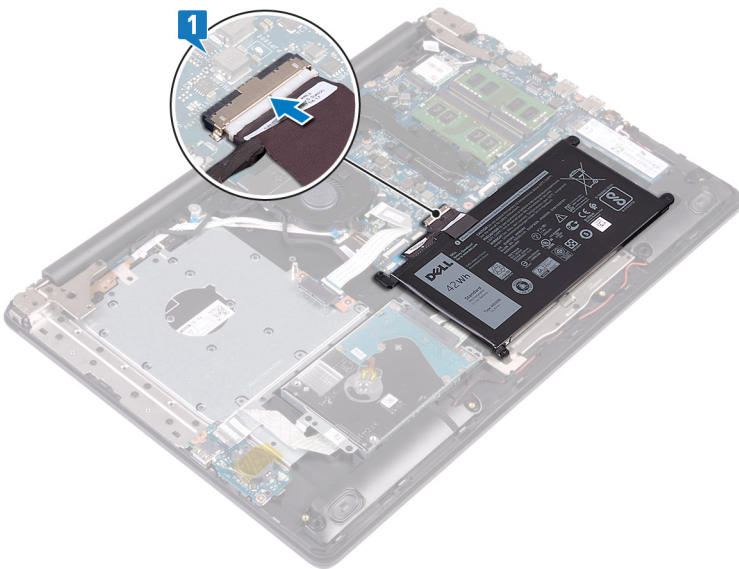

2. Place the base cover on the palm rest and keyboard assembly, and snap the base cover into place starting from the power-adapter port.

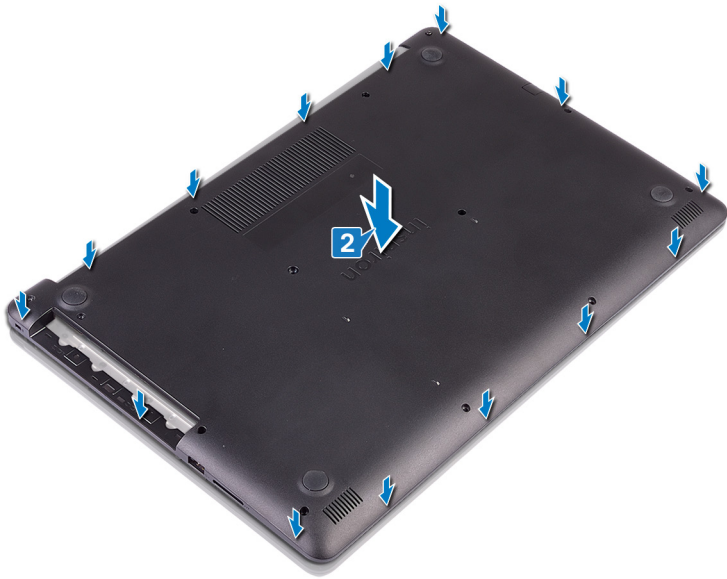

3. Replace the seven screws (M2.5x7) that secure the base cover to the palm rest and keyboard assembly.
4. Replace the two screws (M2x2) that secure the base cover to the palm rest and keyboard assembly.
5. Replace the screw (M2x4) that secures the base cover to the palm rest and keyboard assembly.
6. Tighten the four captive screws that secure the base cover to the palm rest and keyboard assembly.

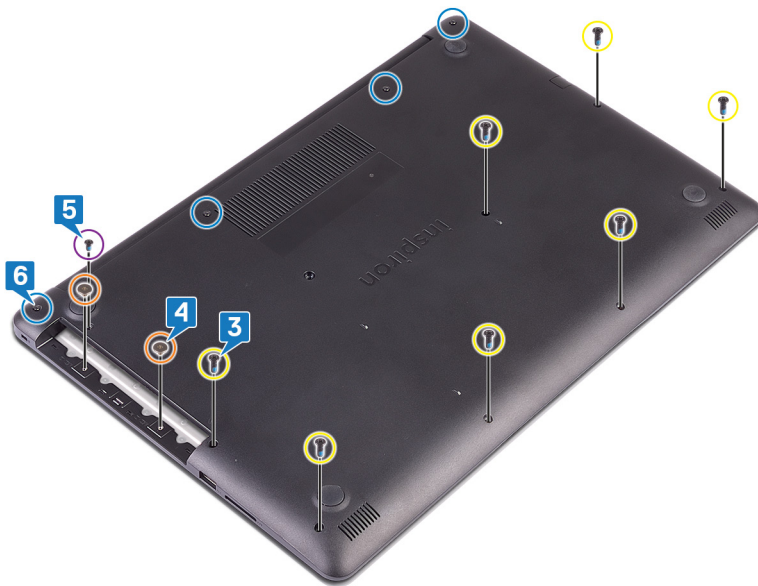

Post-requisites

Replace the [optical drive](#).

Removing the battery

NOTE: Before working inside your computer, read the safety information that shipped with your computer and follow the steps in [Before working inside your computer](#). After working inside your computer, follow the instructions in [After working inside your computer](#). For more safety best practices, see the Regulatory Compliance home page at www.dell.com/regulatory_compliance.

Lithium-ion battery precautions

CAUTION:

- Exercise caution when handling Lithium-ion batteries.
- Discharge the battery as much as possible before removing it from the system. This can be done by disconnecting the AC adapter from the system to allow the battery to drain.
- Do not crush, drop, mutilate, or penetrate the battery with foreign objects.
- Do not expose the battery to high temperatures, or disassemble battery packs and cells.
- Do not apply pressure to the surface of the battery.
- Do not bend the battery.
- Do not use tools of any kind to pry on or against the battery.
- Ensure any screws during the servicing of this product are not lost or misplaced, to prevent accidental puncture or damage to the battery and other system components.
- If a battery gets stuck in a device as a result of swelling, do not try to free it as puncturing, bending, or crushing a Lithium-ion battery can be dangerous. In such an instance, contact for assistance and further instructions.
- If the battery gets stuck inside your computer as a result of swelling, do not try to release it as puncturing, bending, or crushing a lithium-ion battery can be dangerous. In such an instance, contact Dell technical support for assistance. See www.dell.com/contactdell.
- Always purchase genuine batteries from www.dell.com or authorized Dell partners and resellers.

Prerequisites

1. Remove the [optical drive](#).
2. Remove the [base cover](#).

Procedure

NOTE: Ensure that the battery cable has been disconnected from the system board before performing the following procedure.

1. Remove the four screws (M2x3) that secure the battery to the palm rest and keyboard assembly.
2. Lift the battery off the palm rest and keyboard assembly.

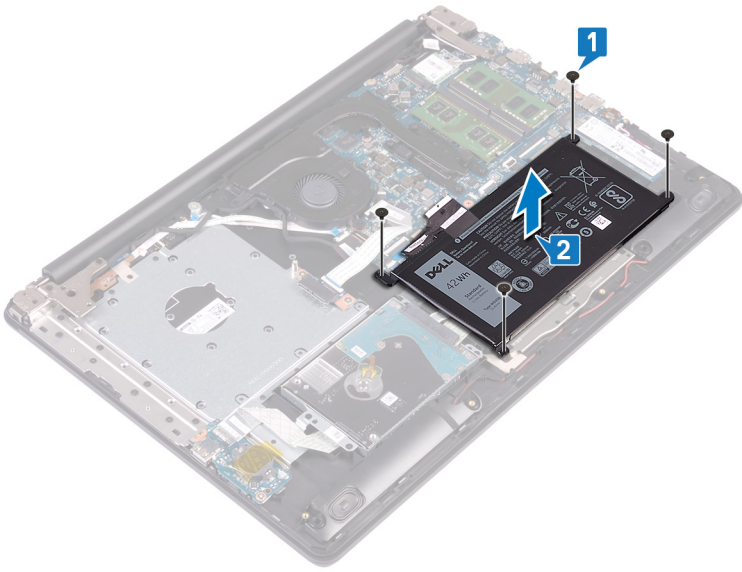

Replacing the battery

NOTE: Before working inside your computer, read the safety information that shipped with your computer and follow the steps in [Before working inside your computer](#). After working inside your computer, follow the instructions in [After working inside your computer](#). For more safety best practices, see the Regulatory Compliance home page at www.dell.com/regulatory_compliance.

Lithium-ion battery precautions

CAUTION:

- Exercise caution when handling Lithium-ion batteries.
- Discharge the battery as much as possible before removing it from the system. This can be done by disconnecting the AC adapter from the system to allow the battery to drain.
- Do not crush, drop, mutilate, or penetrate the battery with foreign objects.
- Do not expose the battery to high temperatures, or disassemble battery packs and cells.
- Do not apply pressure to the surface of the battery.
- Do not bend the battery.
- Do not use tools of any kind to pry on or against the battery.
- Ensure any screws during the servicing of this product are not lost or misplaced, to prevent accidental puncture or damage to the battery and other system components.
- If a battery gets stuck in a device as a result of swelling, do not try to free it as puncturing, bending, or crushing a Lithium-ion battery can be dangerous. In such an instance, contact for assistance and further instructions.
- If the battery gets stuck inside your computer as a result of swelling, do not try to release it as puncturing, bending, or crushing a lithium-ion battery can be dangerous. In such an instance, contact Dell technical support for assistance. See www.dell.com/contactdell.
- Always purchase genuine batteries from www.dell.com or authorized Dell partners and resellers.

Procedure

1. Align the screw holes on the battery with the screw holes on the palm rest and keyboard assembly.
2. Replace the four screws (M2x3) that secure the battery to the palm rest and keyboard assembly.

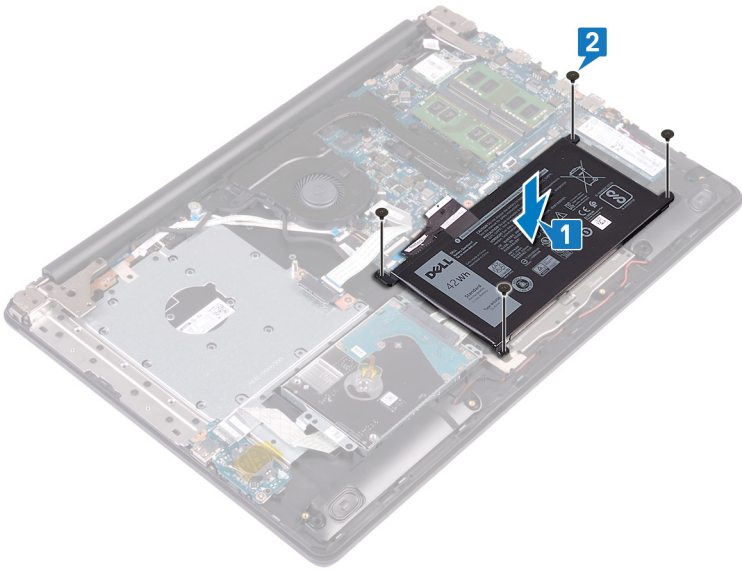

Post-requisites

1. Replace the [base cover](#).
2. Replace the [optical drive](#).

Removing the memory modules

NOTE: Before working inside your computer, read the safety information that shipped with your computer and follow the steps in [Before working inside your computer](#). After working inside your computer, follow the instructions in [After working inside your computer](#). For more safety best practices, see the Regulatory Compliance home page at www.dell.com/regulatory_compliance.

Prerequisites

1. Remove the [optical drive](#).
2. Remove the [base cover](#).

Procedure

1. Locate the memory module on your computer.

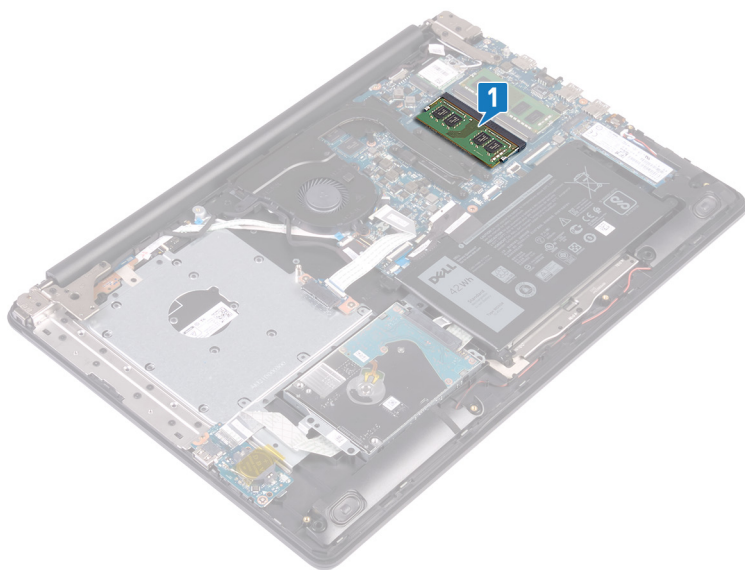

2. Use your fingertips to carefully spread apart the securing-clips on each end of the memory-module slot until the memory module pops up.
3. Remove the memory module from the memory-module slot.

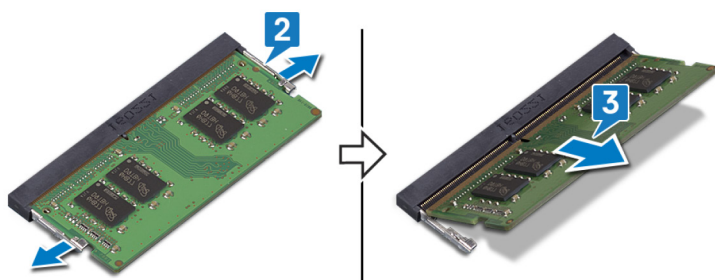

Replacing the memory modules

NOTE: Before working inside your computer, read the safety information that shipped with your computer and follow the steps in [Before working inside your computer](#). After working inside your computer, follow the instructions in [After working inside your computer](#). For more safety best practices, see the Regulatory Compliance home page at www.dell.com/regulatory_compliance.

Procedure

1. Align the notch on the memory module with the tab on the memory-module slot.
2. Slide the memory module firmly into the slot at an angle.
3. Press the memory module down until it clicks into place.

NOTE: If you do not hear the click, remove the memory module and reinstall it.

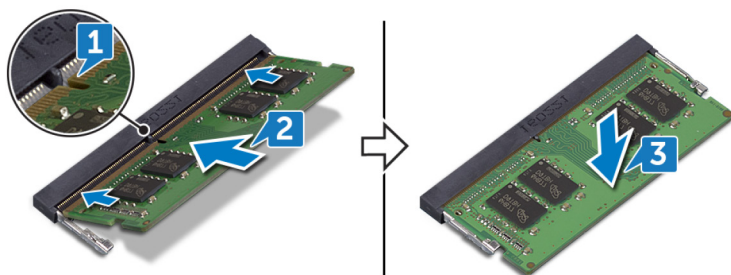

Post-requisites

1. Replace the [base cover](#).
2. Replace the [optical drive](#).

Removing the wireless card

NOTE: Before working inside your computer, read the safety information that shipped with your computer and follow the steps in [Before working inside your computer](#). After working inside your computer, follow the instructions in [After working inside your computer](#). For more safety best practices, see the Regulatory Compliance home page at www.dell.com/regulatory_compliance.

Prerequisites

1. Remove the [optical drive](#).
2. Remove the [base cover](#).

Procedure

1. Locate the wireless card on your computer.

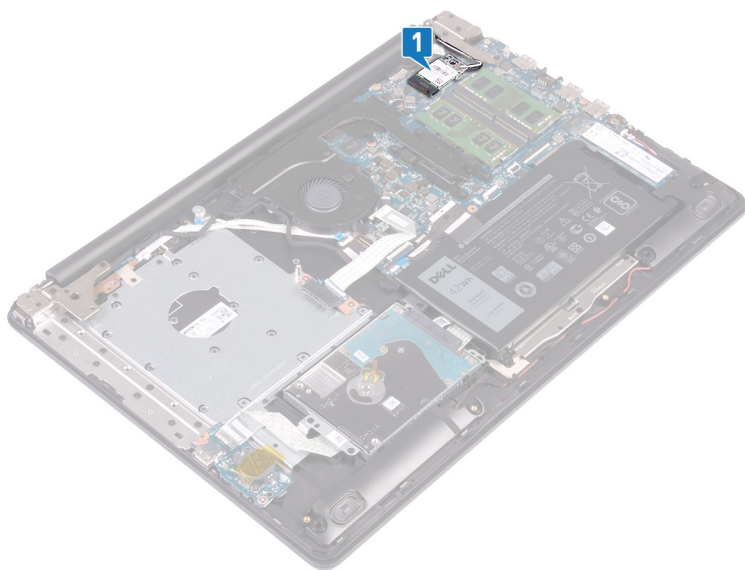

2. Remove the screw (M2x3) that secures the wireless-card bracket to the system board.
3. Slide and remove the wireless-card bracket from the wireless card.
4. Using a plastic scribe, disconnect the antenna cables from the wireless card.
5. Slide and remove the wireless card from the wireless-card slot.

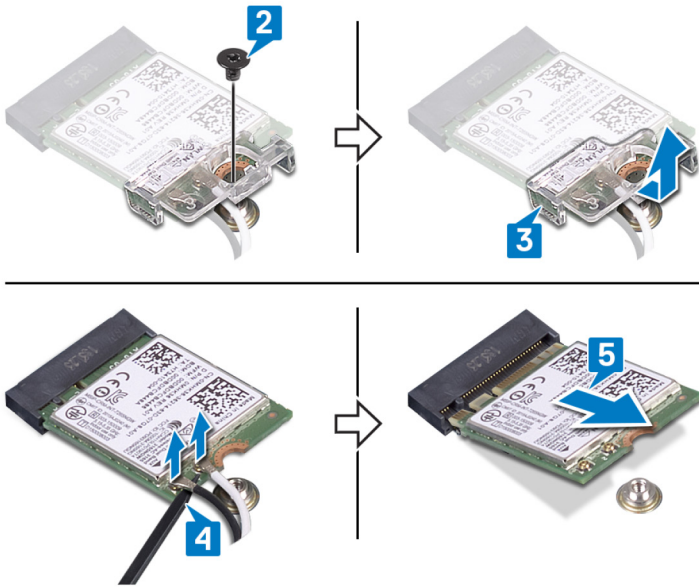

Replacing the wireless card

NOTE: Before working inside your computer, read the safety information that shipped with your computer and follow the steps in [Before working inside your computer](#). After working inside your computer, follow the instructions in [After working inside your computer](#). For more safety best practices, see the Regulatory Compliance home page at www.dell.com/regulatory_compliance.

Procedure

CAUTION: To avoid damage to the wireless card, do not place any cables under it.

1. Connect the antenna cables to the wireless card.

The following table provides the antenna-cable color scheme for the wireless card supported by your computer.

Table 2. Antenna-cable color scheme

Connectors on the wireless card	Antenna-cable color
Main (white triangle)	White
Auxiliary (black triangle)	Black

2. Slide and replace the wireless-card bracket on the wireless-card.
3. Align the notch on the wireless card with the tab on the wireless-card slot and insert the wireless card at an angle into the wireless-card slot.
4. Replace the screw (M2x3) that secures the wireless-card bracket to the wireless card and the palm rest and keyboard assembly.

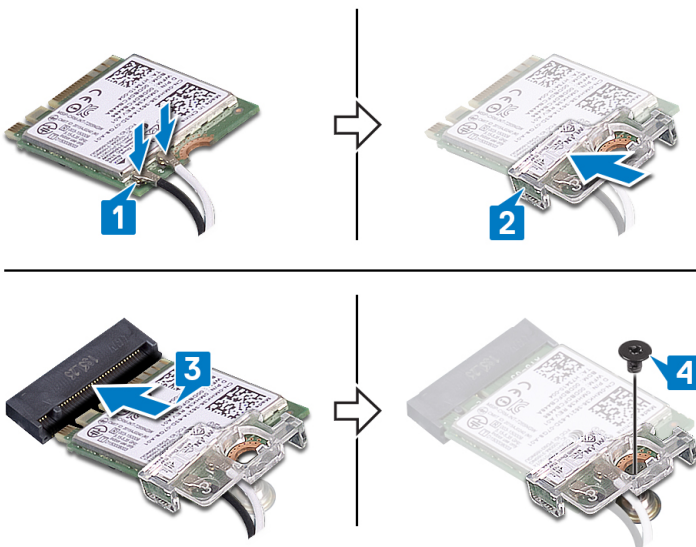

Post-requisites

1. Replace the [base cover](#).
2. Replace the [optical drive](#).

Removing the optical-drive connector board

NOTE: Before working inside your computer, read the safety information that shipped with your computer and follow the steps in [Before working inside your computer](#). After working inside your computer, follow the instructions in [After working inside your computer](#). For more safety best practices, see the Regulatory Compliance home page at www.dell.com/regulatory_compliance.

Prerequisites

1. Remove the [optical drive](#).
2. Remove the [base cover](#).

Procedure

NOTE: Applicable only for computers that are shipped with optical drive.

1. Lift the latch and disconnect the optical-drive connector-board cable from the system board.
2. Remove the two screws (M2x2) that secure the optical-drive connector board to the palm rest and keyboard assembly.
3. Lift the optical-drive connector board along with the cable off the palm rest and keyboard assembly.

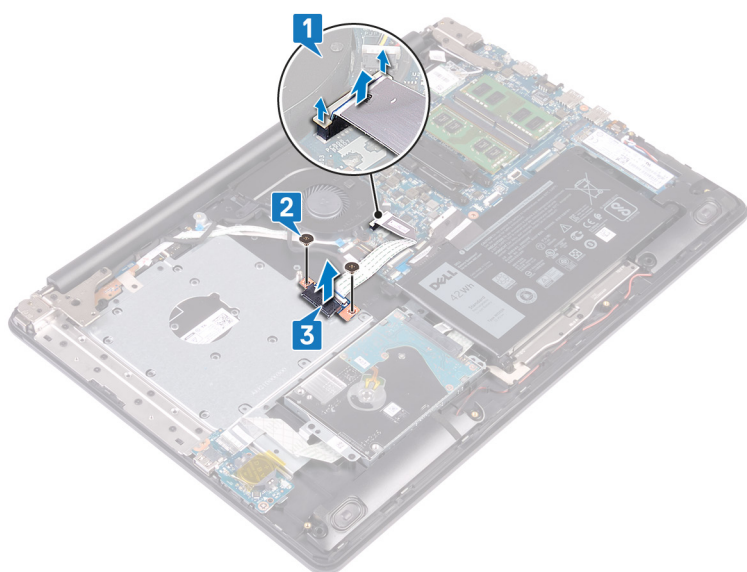

Replacing the optical-drive connector board

NOTE: Before working inside your computer, read the safety information that shipped with your computer and follow the steps in [Before working inside your computer](#). After working inside your computer, follow the instructions in [After working inside your computer](#). For more safety best practices, see the Regulatory Compliance home page at www.dell.com/regulatory_compliance.

Procedure

1. Align the screw hole on the optical-drive connector board with the screw hole on the palm rest and keyboard assembly.
2. Replace the two screws (M2x2) that secure the optical-drive connector board to the palm rest and keyboard assembly.
3. Connect the optical-drive connector-board cable to the system board.
4. Close the latch that secures the optical-drive connector-board cable to the system board.

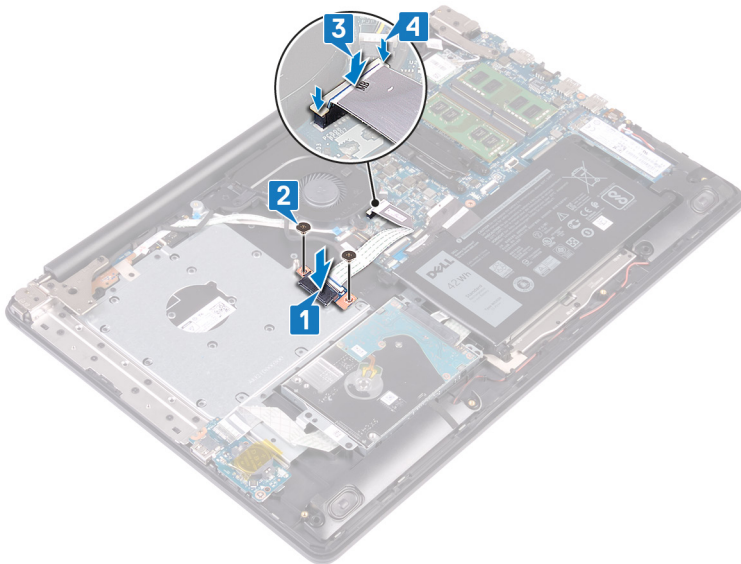

Post-requisites

1. Replace the [base cover](#).
2. Replace the [optical drive](#).

Removing the coin-cell battery

NOTE: Before working inside your computer, read the safety information that shipped with your computer and follow the steps in [Before working inside your computer](#). After working inside your computer, follow the instructions in [After working inside your computer](#). For more safety best practices, see the Regulatory Compliance home page at www.dell.com/regulatory_compliance.

CAUTION: Removing the coin-cell battery resets the BIOS setup program's settings to default. It is recommended that you note the BIOS setup program's settings before removing the coin-cell battery.

Prerequisites

1. Remove the [optical drive](#).
2. Remove the [base cover](#).

Procedure

CAUTION: Removing the coin-cell battery resets the BIOS setup program's settings to default. Before removing the coin-cell battery, it is recommended to note the BIOS setup program's settings.

1. If available, peel off the tape that secures the coin-cell battery to the I/O board.
2. Using a plastic scribe, gently pry the coin-cell battery out of the battery socket on the I/O board.

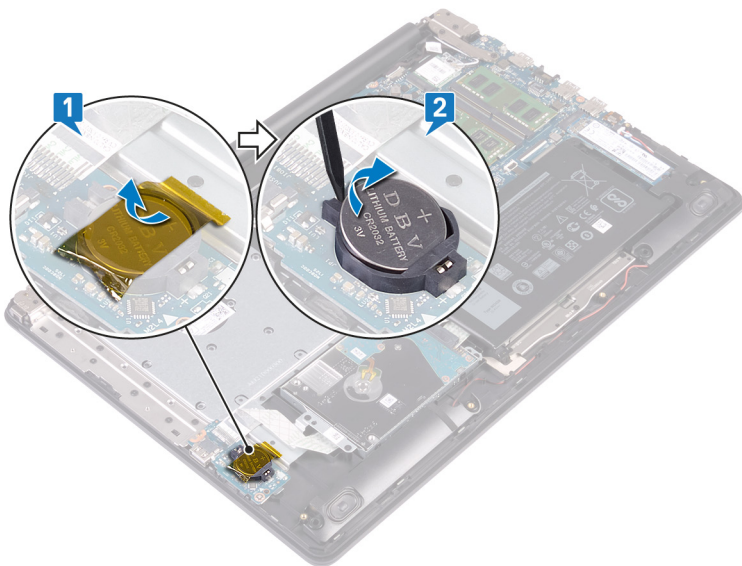

Replacing the coin-cell battery

NOTE: Before working inside your computer, read the safety information that shipped with your computer and follow the steps in [Before working inside your computer](#). After working inside your computer, follow the instructions in [After working inside your computer](#). For more safety best practices, see the Regulatory Compliance home page at www.dell.com/regulatory_compliance.

Procedure

1. With the positive-side facing up, snap the coin-cell battery into the battery socket on the I/O board.
2. If available, adhere the tape that secures the coin-cell battery to the I/O board.

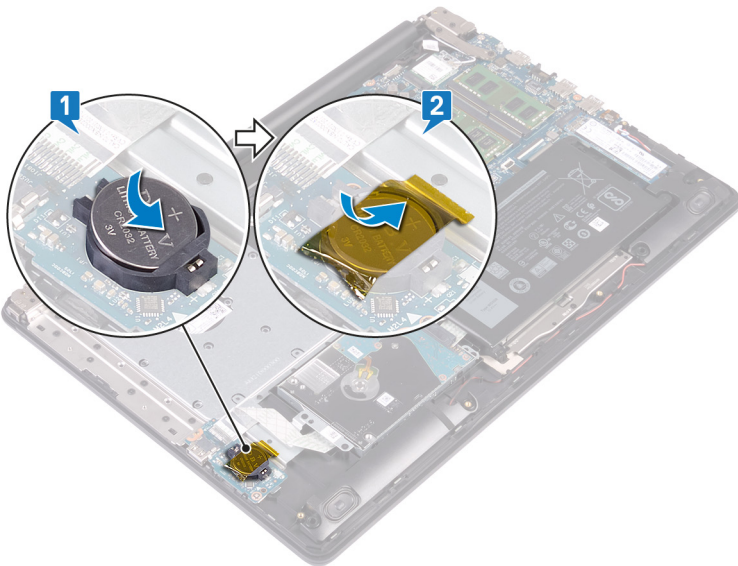

Post-requisites

1. Replace the [base cover](#).
2. Replace the [optical drive](#).

Removing the fan

NOTE: Before working inside your computer, read the safety information that shipped with your computer and follow the steps in [Before working inside your computer](#). After working inside your computer, follow the instructions in [After working inside your computer](#). For more safety best practices, see the Regulatory Compliance home page at www.dell.com/regulatory_compliance.

Prerequisites

1. Remove the [optical drive](#).
2. Remove the [base cover](#).

Procedure

1. Lift the latch and disconnect the optical-drive connector-board cable from the system board.
2. Lift the latch and disconnect the optical-drive connector-board cable from the optical-drive board connector.
3. Lift the optical-drive connector-board cable off the system board.
4. Open the latch and disconnect the display cable from the system board.
5. Remove the display cable from the routing guides on the fan.

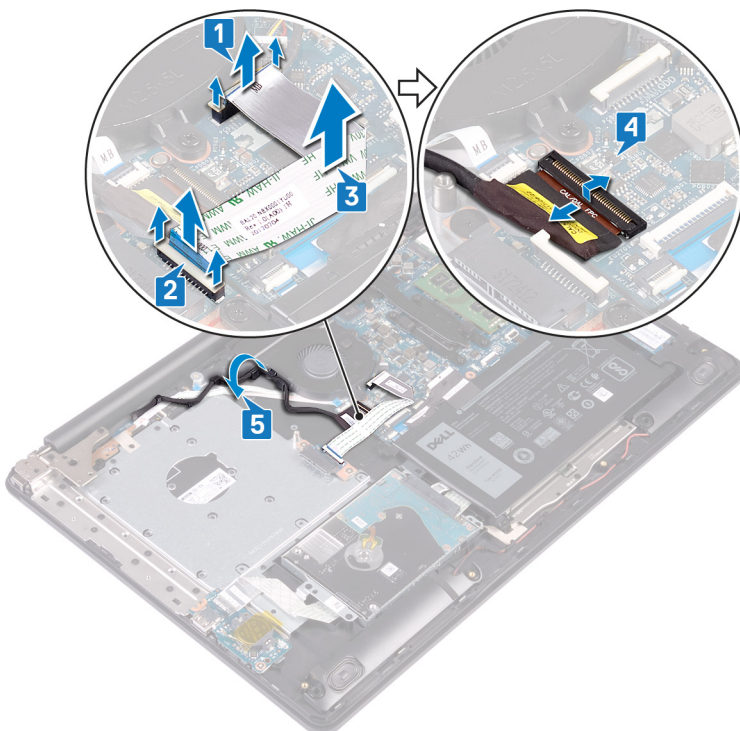

6. Disconnect the fan cable from the system board.
7. Remove the three screws (M2.5x5) that secure the fan to the palm rest and keyboard board assembly.
8. Lift the fan off the palm rest and keyboard board assembly.

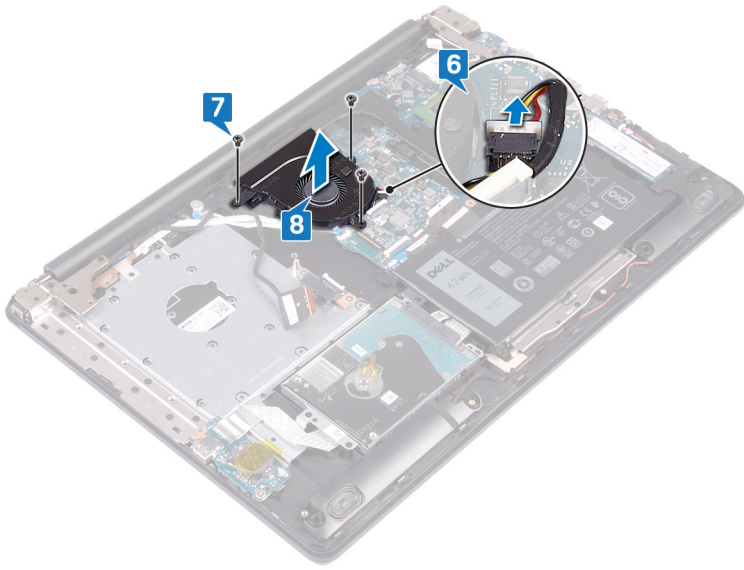

Replacing the fan

NOTE: Before working inside your computer, read the safety information that shipped with your computer and follow the steps in [Before working inside your computer](#). After working inside your computer, follow the instructions in [After working inside your computer](#). For more safety best practices, see the Regulatory Compliance home page at www.dell.com/regulatory_compliance.

Procedure

1. Align the screw holes on the fan with the screw holes on to the palm rest and keyboard board assembly.
2. Replace the three screws (M2.5x5) that secure the fan to the palm rest and keyboard board assembly.
3. Connect the fan cable to the system board.

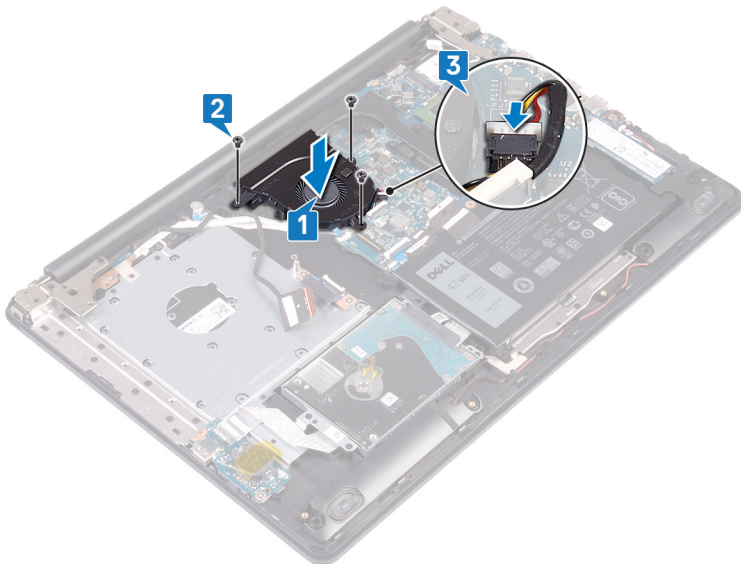

4. Route the display cable through the routing guides on the fan.
5. Connect the display cable to its connector on system board and close the latch to secure the cable.
6. Press down on the latch to connect the optical-drive connector-board cable to the optical-drive connector board.
7. Press down on the latch to connect the optical-drive connector-board cable to the system board.

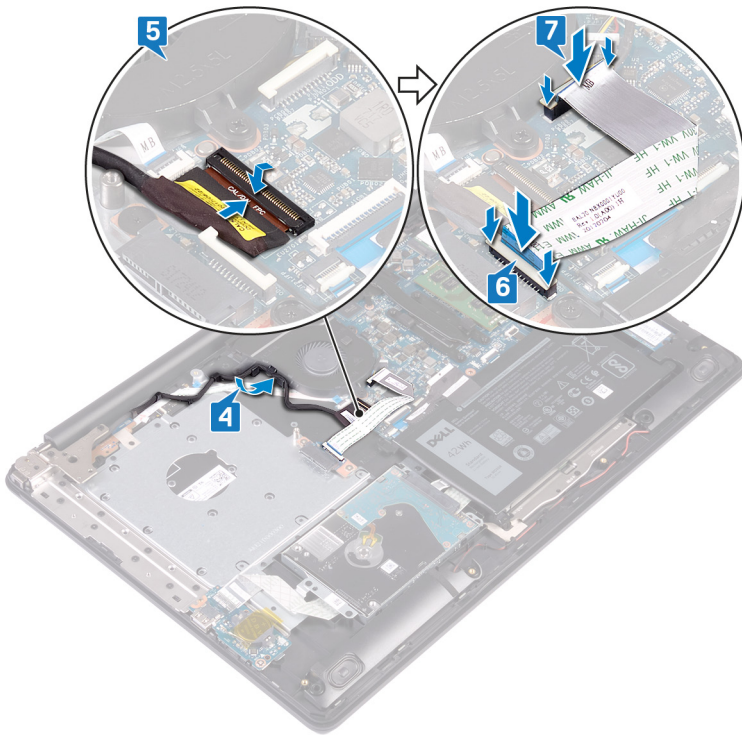

Post-requisites

1. Replace the [base cover](#).
2. Replace the [optical drive](#).

Removing the solid-state drive

NOTE: Before working inside your computer, read the safety information that shipped with your computer and follow the steps in [Before working inside your computer](#). After working inside your computer, follow the instructions in [After working inside your computer](#). For more safety best practices, see the Regulatory Compliance home page at www.dell.com/regulatory_compliance.

CAUTION: Solid-state drives are fragile. Exercise care when handling the solid-state drive.

CAUTION: To avoid data loss, do not remove the solid-state drive while the computer is in sleep or on state.

Prerequisites

1. Remove the [optical drive](#).
2. Remove the [base cover](#).

Procedure

1. Locate the solid-state drive on your computer.

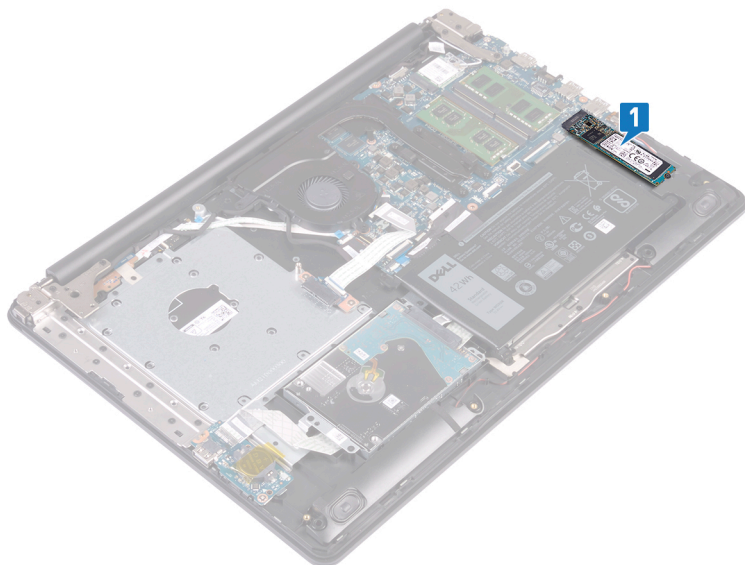

NOTE: If available, remove the thermal shield before removing the solid-state drive.

2. Remove the screw (M2x2.2) that secures the solid-state drive to the palm rest and keyboard assembly.
3. Lift the solid-state drive at an angle and remove it from the solid-state drive.

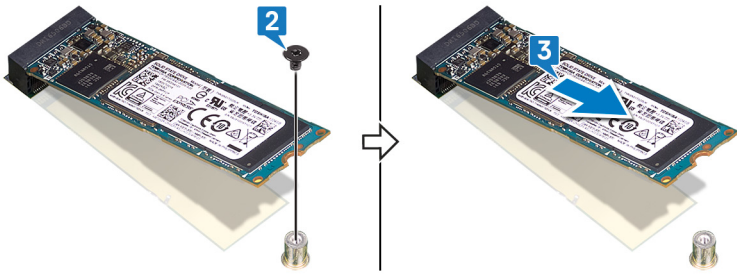

Replacing the solid-state drive

NOTE: Before working inside your computer, read the safety information that shipped with your computer and follow the steps in [Before working inside your computer](#). After working inside your computer, follow the instructions in [After working inside your computer](#). For more safety best practices, see the Regulatory Compliance home page at www.dell.com/regulatory_compliance.

CAUTION: Solid-state drives are fragile. Exercise care when handling the solid-state drive.

Procedure

1. Align the notch on the solid-state drive with the tab on the solid-state drive slot.
2. Slide the solid-state drive into the solid-state drive slot on the system board.
3. Replace the screw (M2x2.2) that secures the solid-state drive to the palm rest and keyboard assembly

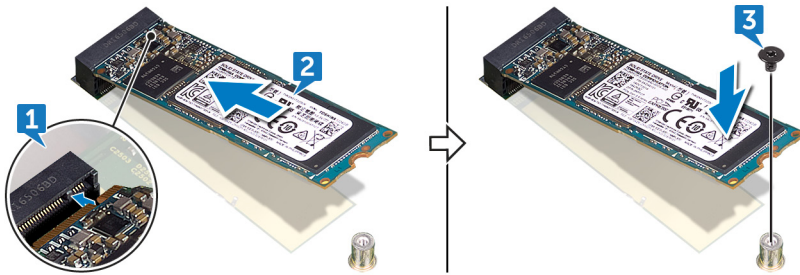

NOTE: If available, replace the solid-state drive shield after replacing the solid-state drive.

Post-requisites

1. Replace the [base cover](#).
2. Replace the [optical drive](#).

Removing the hard drive

NOTE: Before working inside your computer, read the safety information that shipped with your computer and follow the steps in [Before working inside your computer](#). After working inside your computer, follow the instructions in [After working inside your computer](#). For more safety best practices, see the Regulatory Compliance home page at www.dell.com/regulatory_compliance.

CAUTION: Hard drives are fragile. Exercise care when handling the hard drive.

CAUTION: To avoid data loss, do not remove the hard drive while the computer is in sleep or on state.

Prerequisites

1. Remove the [optical drive](#).
2. Remove the [base cover](#).
3. Remove the [battery](#).

Procedure

1. Open the latch and disconnect the hard-drive cable from the system board.
2. Remove the four screws (M2x3) that secure the hard-drive assembly to the palm rest and keyboard assembly.
3. Lift the hard-drive assembly along with its cable off the palm rest and keyboard assembly.

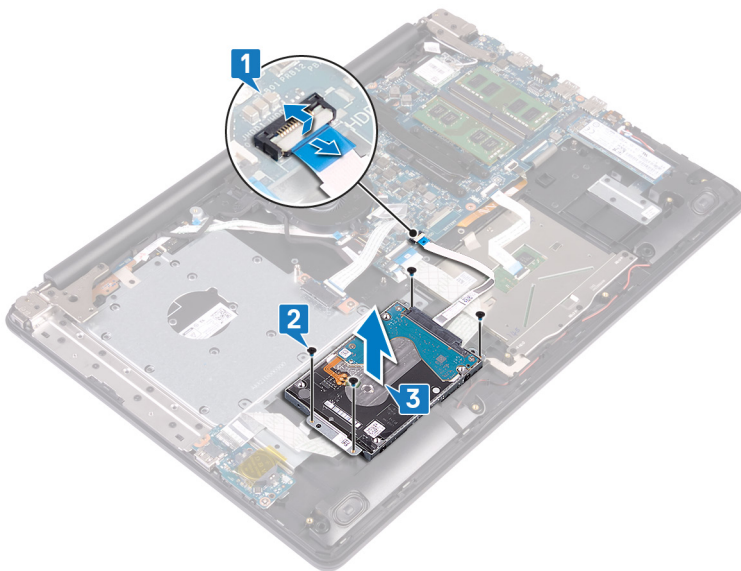

4. Disconnect the interposer from the hard-drive assembly.

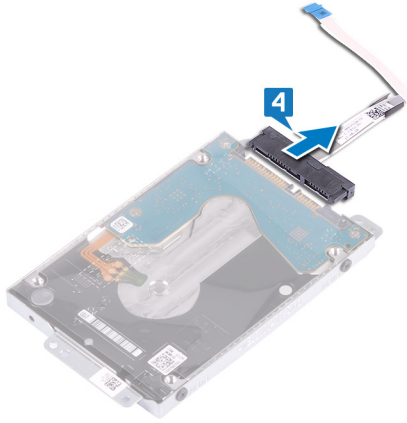

5. Remove the four screws (M3x3) that secure the hard-drive bracket to the hard drive.
6. Lift the hard-drive bracket off the hard drive.

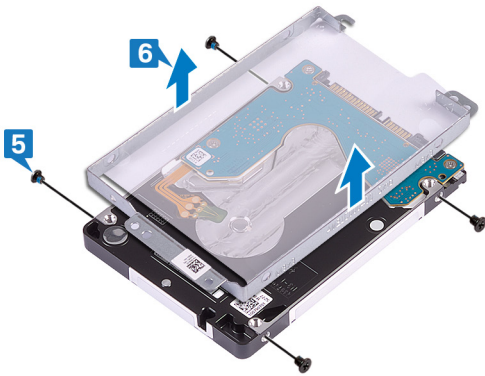

Replacing the hard drive

NOTE: Before working inside your computer, read the safety information that shipped with your computer and follow the steps in [Before working inside your computer](#). After working inside your computer, follow the instructions in [After working inside your computer](#). For more safety best practices, see the Regulatory Compliance home page at www.dell.com/regulatory_compliance.

CAUTION: Hard drives are fragile. Exercise care when handling the hard drive.

Procedure

1. Align the screw holes on the hard-drive bracket with the screw holes on the hard drive.
2. Replace the four screws (M3x3) that secure the hard-drive bracket to the hard drive.

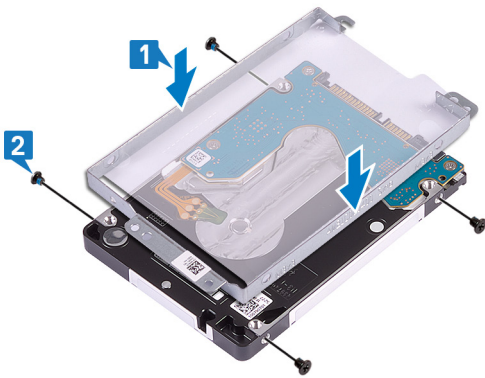

3. Connect the interposer to the hard-drive assembly.



4. Align the screw holes on the hard-drive assembly with the screw holes on the palm rest and keyboard assembly.
5. Replace the four screws (M2x3) that secure the hard-drive assembly to the palm rest and keyboard assembly.
6. Connect the hard-drive cable to the system board and close the latch to secure the cable.

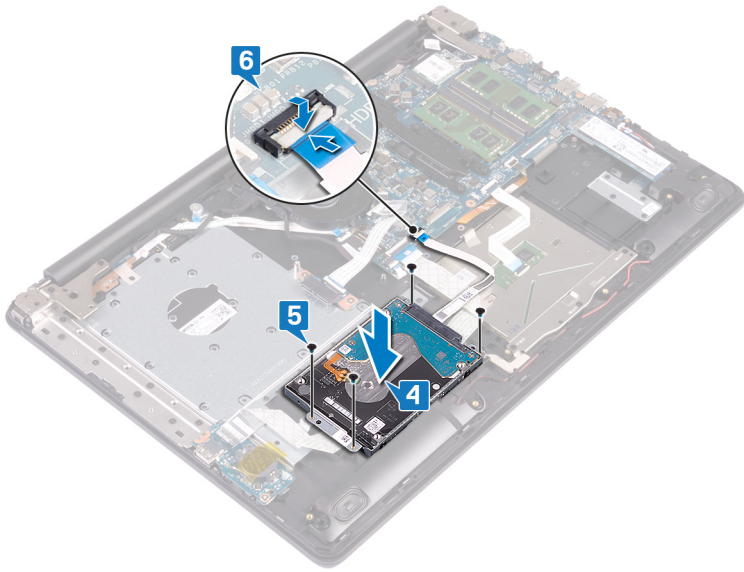

Post-requisites

1. Replace the [battery](#).
2. Replace the [base cover](#).
3. Replace the [optical drive](#).

Removing the touchpad

NOTE: Before working inside your computer, read the safety information that shipped with your computer and follow the steps in [Before working inside your computer](#). After working inside your computer, follow the instructions in [After working inside your computer](#). For more safety best practices, see the Regulatory Compliance home page at www.dell.com/regulatory_compliance.

Prerequisites

1. Remove the [optical drive](#).
2. Remove the [base cover](#).
3. Remove the [battery](#).

Procedure

1. Open the latch and disconnect the I/O-board cable from the system board.
2. Open the latch and disconnect the hard-drive cable from the system board.
3. Gently peel the tape that secures the touchpad to the palm rest and keyboard assembly.
4. Open the latch and disconnect the touchpad cable from the system board.

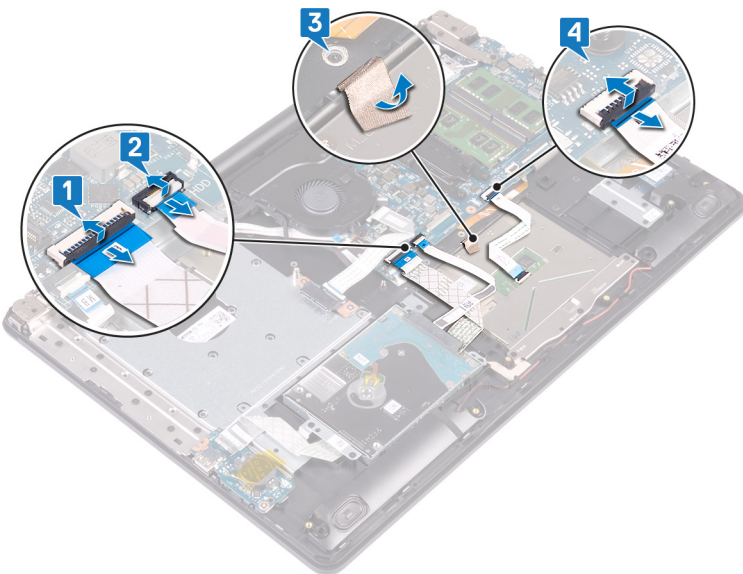

5. Remove the four screws (M2x2) that secure the touchpad to the palm rest and keyboard assembly.
6. Slide and lift the touchpad off the palm rest and keyboard assembly.

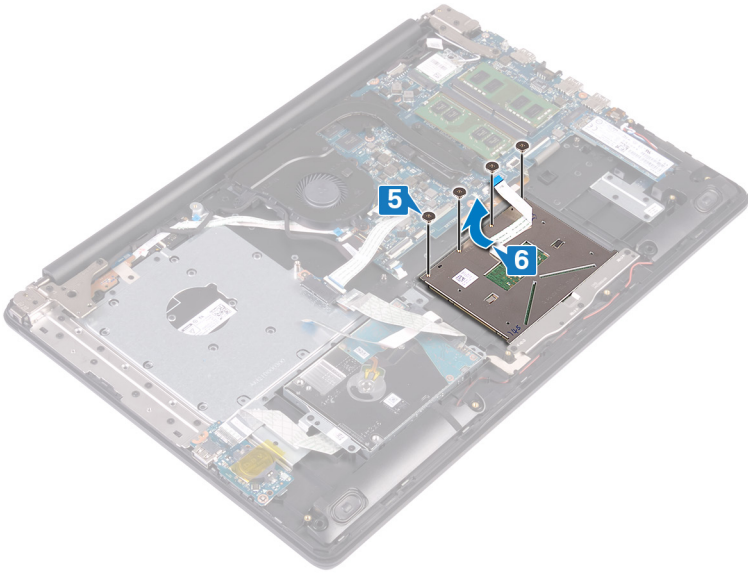

Replacing the touchpad

NOTE: Before working inside your computer, read the safety information that shipped with your computer and follow the steps in [Before working inside your computer](#). After working inside your computer, follow the instructions in [After working inside your computer](#). For more safety best practices, see the Regulatory Compliance home page at www.dell.com/regulatory_compliance.

Procedure

NOTE: Ensure that the touchpad is aligned with the guides available on the palm-rest and keyboard assembly, and the gap on either sides of the touchpad is equal.

1. Slide and place the touchpad into the slot on the palm rest and keyboard assembly.
2. Replace the four screws (M2x2) that secure the touchpad to the palm rest and keyboard assembly.

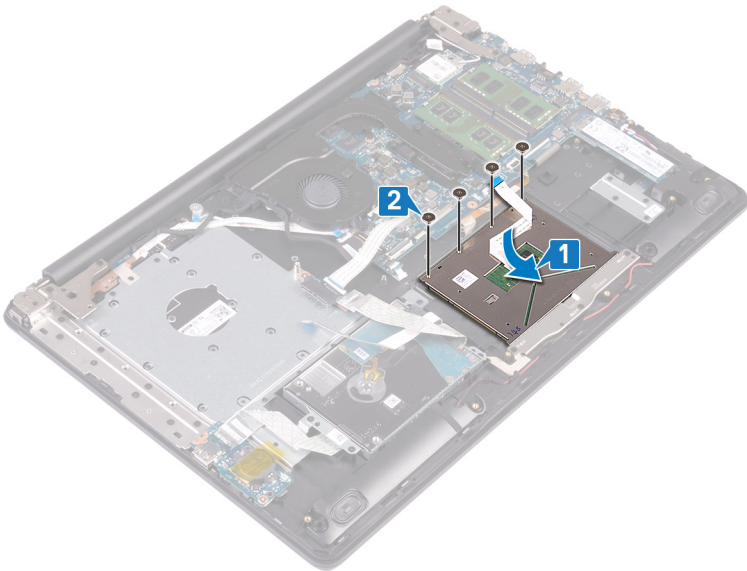

3. Adhere the tape that secures the touchpad to the palm rest and keyboard assembly.
4. Slide the touchpad cable into the touchpad connector on the system board and close the latch to secure the cable.
5. Slide the I/O-board cable into the connector on the system board and close the latch to secure the cable.
6. Slide the hard-drive cable into the hard-drive connector on the system board and close the latch to secure the cable.

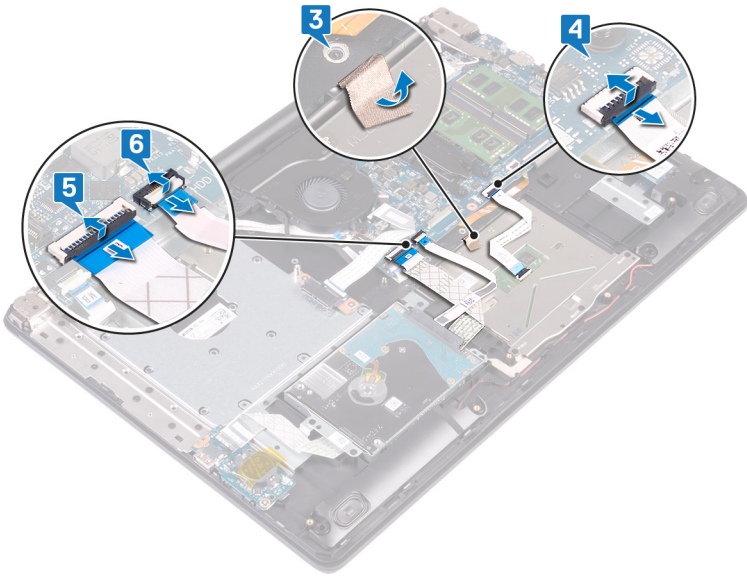

Post-requisites

1. Replace the [battery](#).
2. Replace the [base cover](#).
3. Replace the [optical drive](#).

Removing the speakers

NOTE: Before working inside your computer, read the safety information that shipped with your computer and follow the steps in [Before working inside your computer](#). After working inside your computer, follow the instructions in [After working inside your computer](#). For more safety best practices, see the Regulatory Compliance home page at www.dell.com/regulatory_compliance.

Prerequisites

1. Remove the [optical drive](#).
2. Remove the [base cover](#).
3. Remove the [solid-state drive](#).

Procedure

1. Disconnect the speaker cable from the system board and lift the right speaker off the palm rest and keyboard assembly.
2. Note the speaker cable routing and remove it from the routing guides on palm rest and key board assembly.
3. Lift the left speaker, along with the cable, off the palm rest and keyboard assembly.

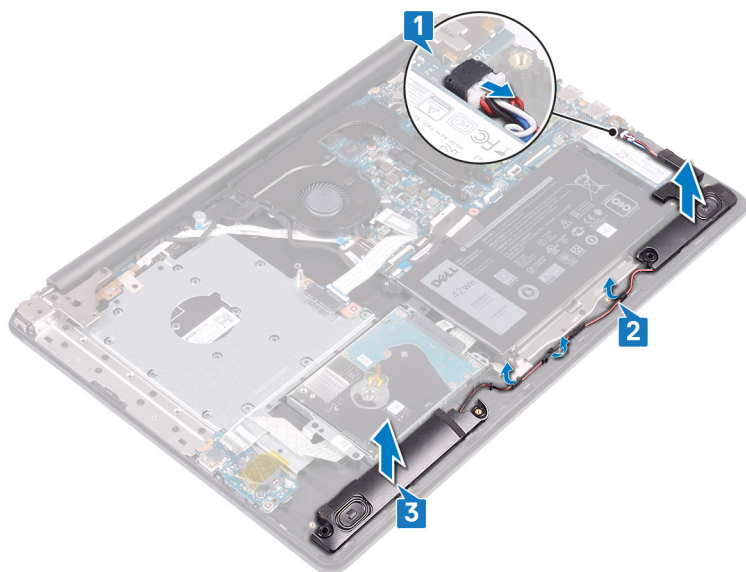

Replacing the speakers

NOTE: Before working inside your computer, read the safety information that shipped with your computer and follow the steps in [Before working inside your computer](#). After working inside your computer, follow the instructions in [After working inside your computer](#). For more safety best practices, see the Regulatory Compliance home page at www.dell.com/regulatory_compliance.

Procedure

NOTE: If the rubber grommets are pushed out when removing the speakers, push them back in before replacing the speakers.

1. Using the alignment posts and rubber grommets, place the left speakers in the slots on the palm rest and keyboard assembly.
2. Route the speaker cable through the routing guides on the palm rest and keyboard assembly.
3. Replace the right speaker.
4. Connect the speaker cable to the system board.

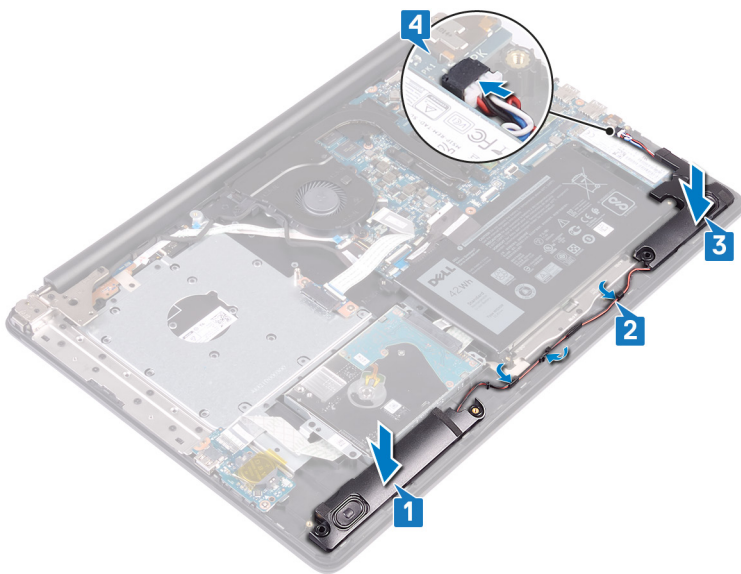

Post-requisites

1. Replace the [solid-state drive](#).
2. Replace the [base cover](#).
3. Replace the [optical drive](#).

Removing the heat sink

NOTE: Before working inside your computer, read the safety information that shipped with your computer and follow the steps in [Before working inside your computer](#). After working inside your computer, follow the instructions in [After working inside your computer](#). For more safety best practices, see the Regulatory Compliance home page at www.dell.com/regulatory_compliance.

NOTE: The heat sink may become hot during normal operation. Allow sufficient time for the heat sink to cool before you touch it.

CAUTION: For maximum cooling of the processor, do not touch the heat transfer areas on the heat sink. The oils in your skin can reduce the heat transfer capability of the thermal grease.

Prerequisites

1. Remove the [optical drive](#).
2. Remove the [base cover](#).

Procedure

1. In sequential order (as indicated on the heat sink), loosen the four captive screws that secure the heat sink to the system board.
2. Lift the heat sink off the system board.

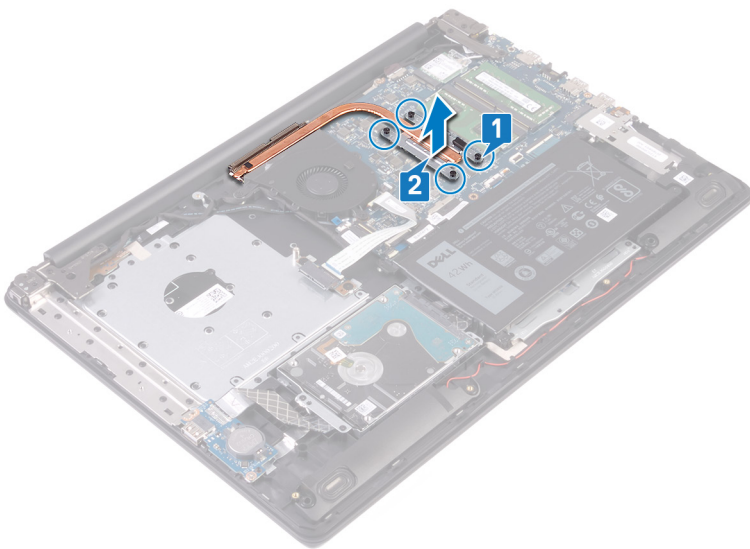

Replacing the heat sink

NOTE: Before working inside your computer, read the safety information that shipped with your computer and follow the steps in [Before working inside your computer](#). After working inside your computer, follow the instructions in [After working inside your computer](#). For more safety best practices, see the Regulatory Compliance home page at www.dell.com/regulatory_compliance.

CAUTION: Incorrect alignment of the heat sink can damage the system board and processor.

NOTE: If either the system board or the heat sink is replaced, use the thermal pad provided in the kit to ensure that thermal conductivity is achieved.

Procedure

1. Place the heat sink on the system board and align the screw holes on the heat sink with the screw holes on the system board.
2. Tighten the captive screws in the reverse order (4->3->2->1) to secure the heat sink to the system board.
3. In computers that are shipped with discrete graphics card, replace the three (M2x3) screws that secure the heat sink to the system board.

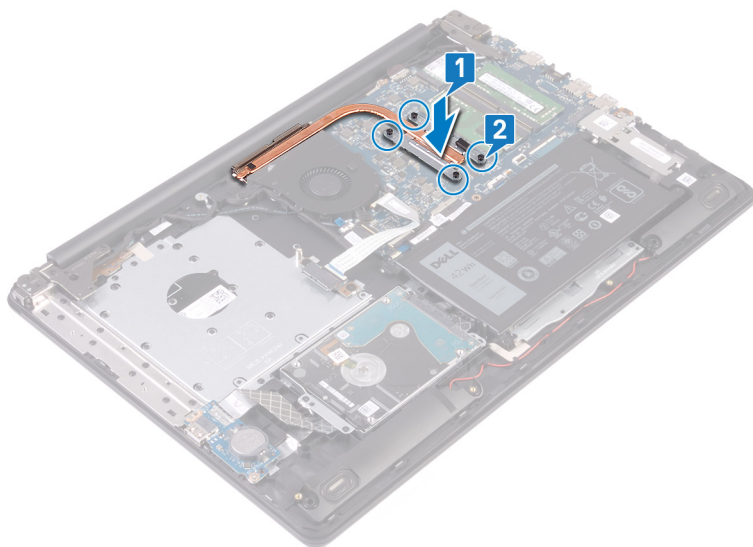

Post-requisites

1. Replace the [base cover](#).
2. Replace the [optical drive](#).

Removing the power-adapter port

NOTE: Before working inside your computer, read the safety information that shipped with your computer and follow the steps in [Before working inside your computer](#). After working inside your computer, follow the instructions in [After working inside your computer](#). For more safety best practices, see the Regulatory Compliance home page at www.dell.com/regulatory_compliance.

Removing the display assembly

NOTE: Before working inside your computer, read the safety information that shipped with your computer and follow the steps in [Before working inside your computer](#). After working inside your computer, follow the instructions in [After working inside your computer](#). For more safety best practices, see the Regulatory Compliance home page at www.dell.com/regulatory_compliance.

Prerequisites

1. Remove the [optical drive](#).
2. Remove the [base cover](#).
3. Remove the [wireless card](#).

Procedure

1. Lift the latch and disconnect the optical-drive connector-board cable from the system board.
2. Lift the latch and disconnect the optical-drive connector-board cable from the optical-drive board connector.
3. Lift the optical-drive connector-board cable off the system board.
4. Open the latch and disconnect the display cable from the system board.
5. Note the routing of the display cable and remove the cable from its routing guides on the fan and palm rest and keyboard assembly.

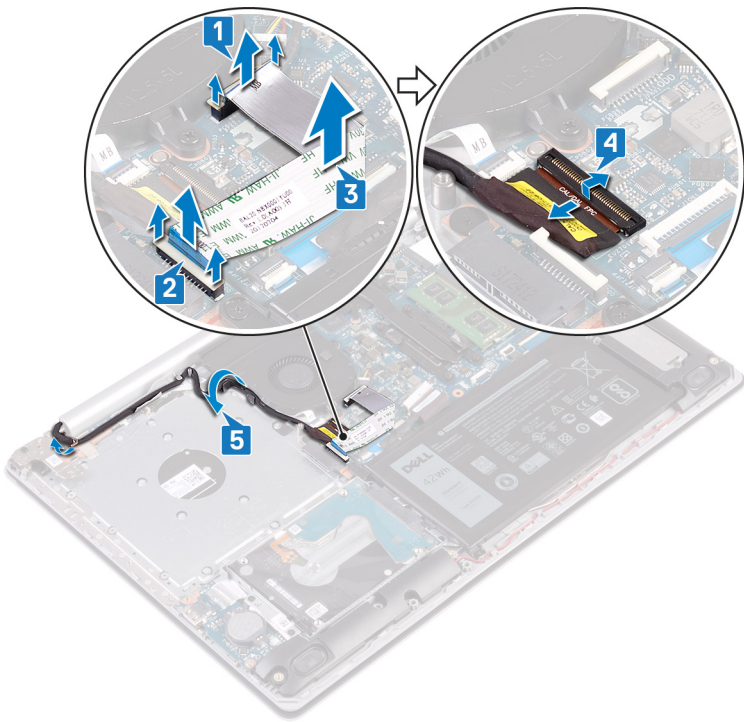

6. Remove the five screws (M2.5x5) that secure the left and right hinges to the system board and palm rest and keyboard assembly.
7. Open the hinges.

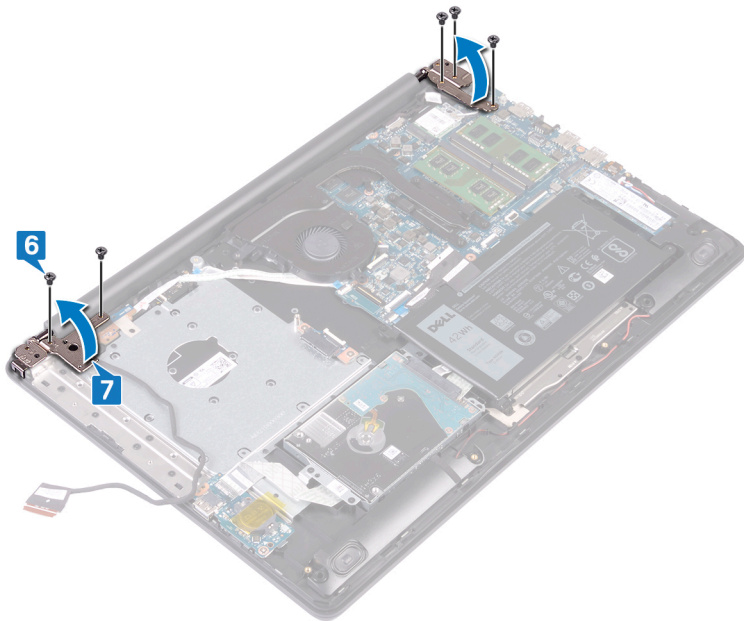

8. Lift the palm rest and keyboard assembly at an angle.
9. Slide and remove the palm rest and keyboard assembly off the display assembly.

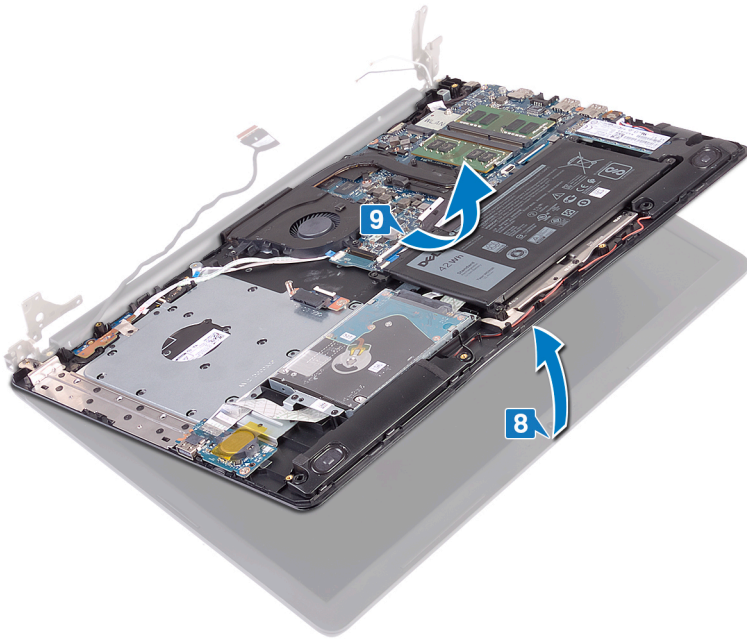

10. After performing all the above steps, you are left with display assembly.



Procedure

1. Remove the three screws (M2.5x5) that secure the right hinge to the system board and palm rest assembly.
2. Lift the right hinge.
3. Disconnect the power-adaptor port cable from the system board.
4. Note the power-adaptor port cable routing and remove it from the routing guides on the palm rest and keyboard assembly.
5. Remove the screw (M2x2) that secures the power-adaptor port to the palm rest and keyboard assembly.
6. Lift the power-adaptor port, along with its cable, off the palm rest and keyboard assembly.

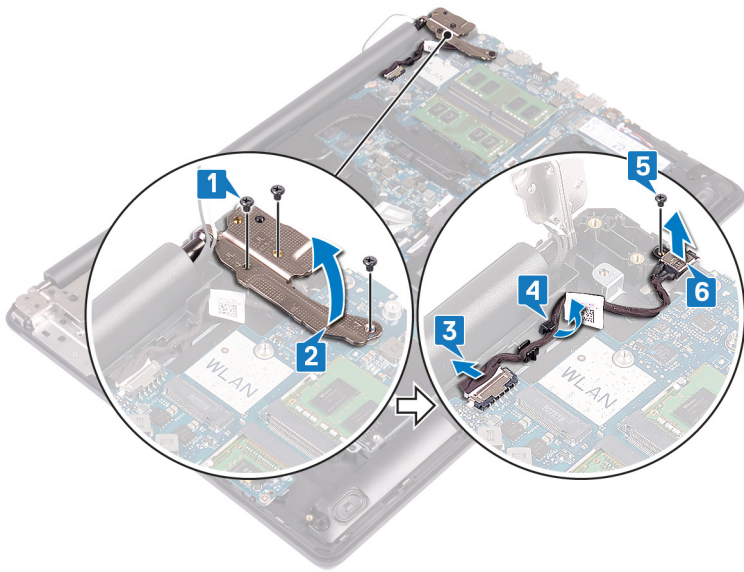

Replacing the power-adapter port

NOTE: Before working inside your computer, read the safety information that shipped with your computer and follow the steps in [Before working inside your computer](#). After working inside your computer, follow the instructions in [After working inside your computer](#). For more safety best practices, see the Regulatory Compliance home page at www.dell.com/regulatory_compliance.

Procedure

1. Align the screw hole on the power-adapter port with the screw hole on the palm rest and keyboard assembly.
2. Replace the screw (M2x2) that secures the power-adapter port to the palm rest and keyboard assembly.
3. Route the power-adapter port cable through the routing guides on the palm rest and keyboard assembly.
4. Connect the power-adapter port cable to the system board.
5. Close the right hinge.
6. Replace the three screws (M2.5x5) that secure the right hinge to the system board and palm rest assembly.

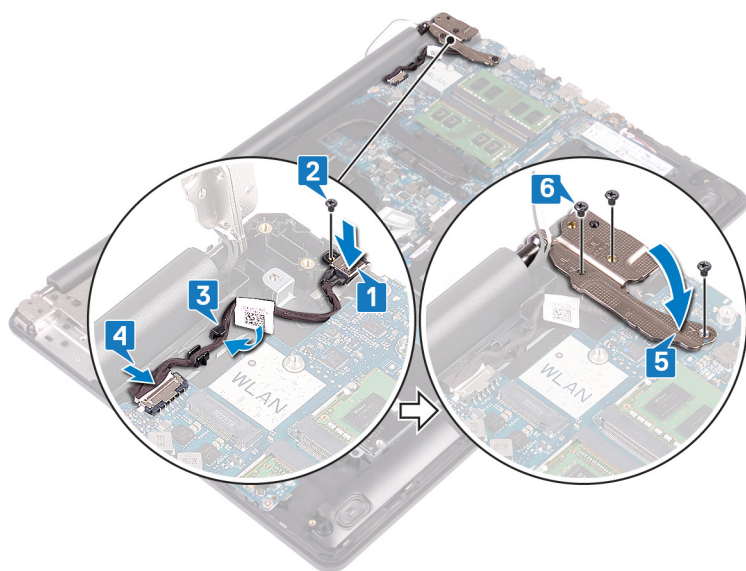

Replacing the display assembly

NOTE: Before working inside your computer, read the safety information that shipped with your computer and follow the steps in [Before working inside your computer](#). After working inside your computer, follow the instructions in [After working inside your computer](#). For more safety best practices, see the Regulatory Compliance home page at www.dell.com/regulatory_compliance.

Procedure

NOTE: Ensure that the hinges are opened to the maximum before replacing the display assembly on palm rest and keyboard assembly.

1. Slide the palm rest and keyboard assembly under the hinges on the display assembly and close it.

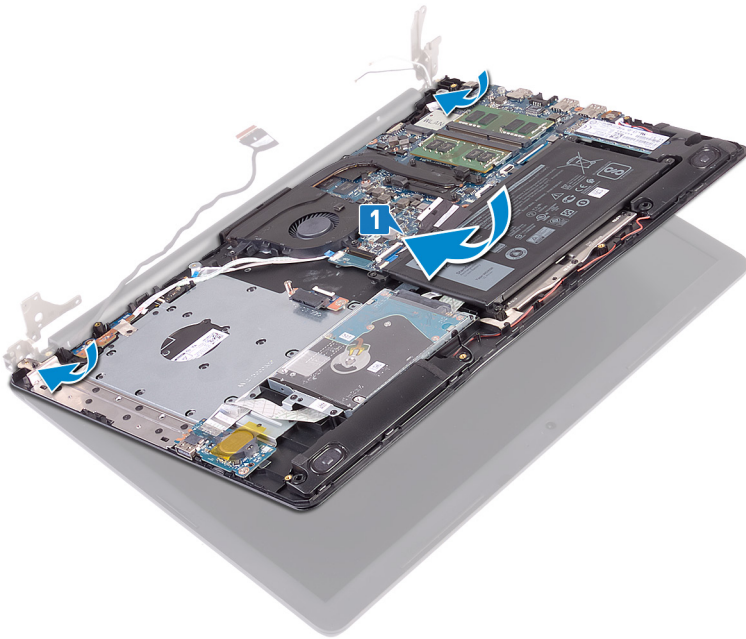

2. Using the alignment posts, press the hinges down on the system board and the palm rest and keyboard assembly.
3. Replace the five screws (M2.5x5) that secure the left and right hinges to the system board and palm rest and keyboard assembly.

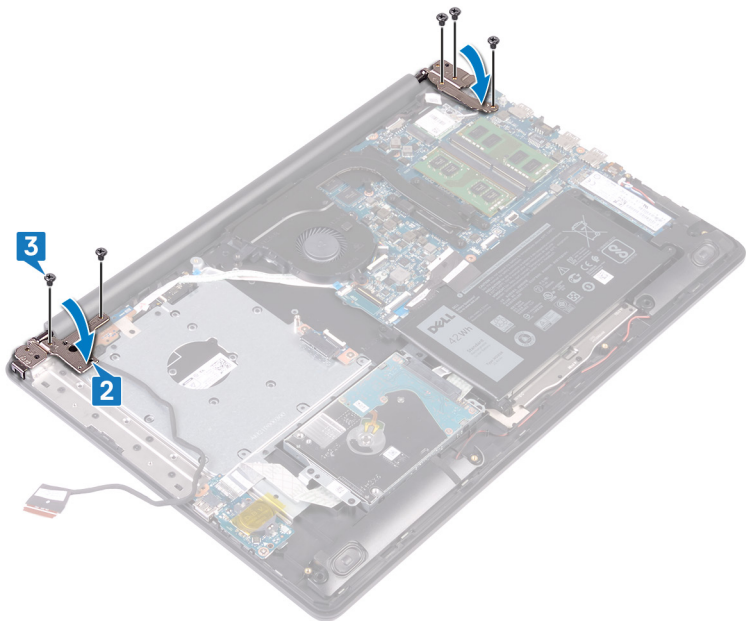

4. Route the display cable through the routing guides on the fan and the palm rest and keyboard assembly.
5. Slide the display cable to the connector on the system board and close the latch to secure the cable.
6. Press down on the latch to connect the optical-drive connector board cable to the optical-drive connector board.
7. Press down on the latch to connect the optical-drive connector board cable to the system board.

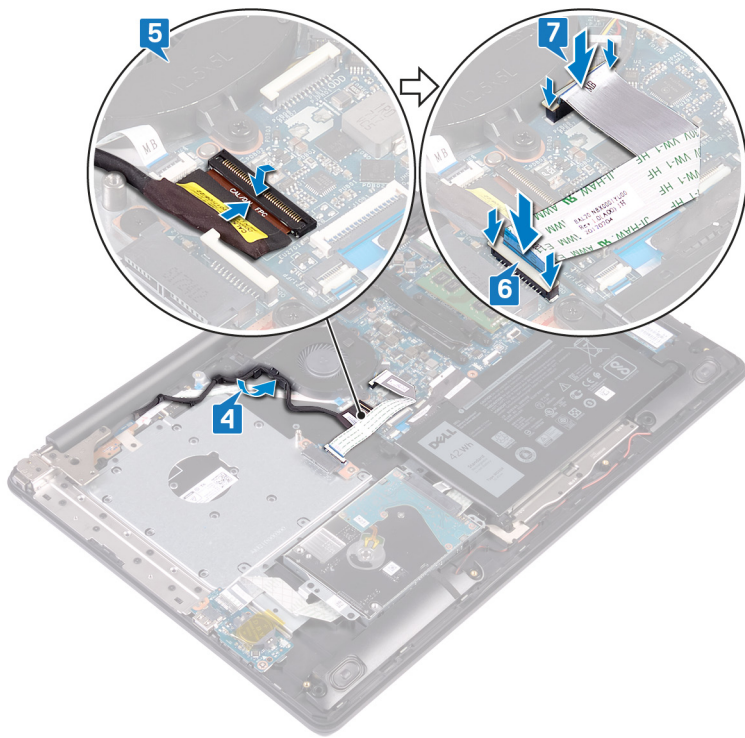

Post-requisites

1. Replace the [wireless card](#).
2. Replace the [base cover](#).
3. Replace the [optical drive](#).

Removing the display assembly

NOTE: Before working inside your computer, read the safety information that shipped with your computer and follow the steps in [Before working inside your computer](#). After working inside your computer, follow the instructions in [After working inside your computer](#). For more safety best practices, see the Regulatory Compliance home page at www.dell.com/regulatory_compliance.

Prerequisites

1. Remove the [optical drive](#).
2. Remove the [base cover](#).
3. Remove the [wireless card](#).

Procedure

1. Lift the latch and disconnect the optical-drive connector-board cable from the system board.
2. Lift the latch and disconnect the optical-drive connector-board cable from the optical-drive board connector.
3. Lift the optical-drive connector-board cable off the system board.
4. Open the latch and disconnect the display cable from the system board.
5. Note the routing of the display cable and remove the cable from its routing guides on the fan and palm rest and keyboard assembly.

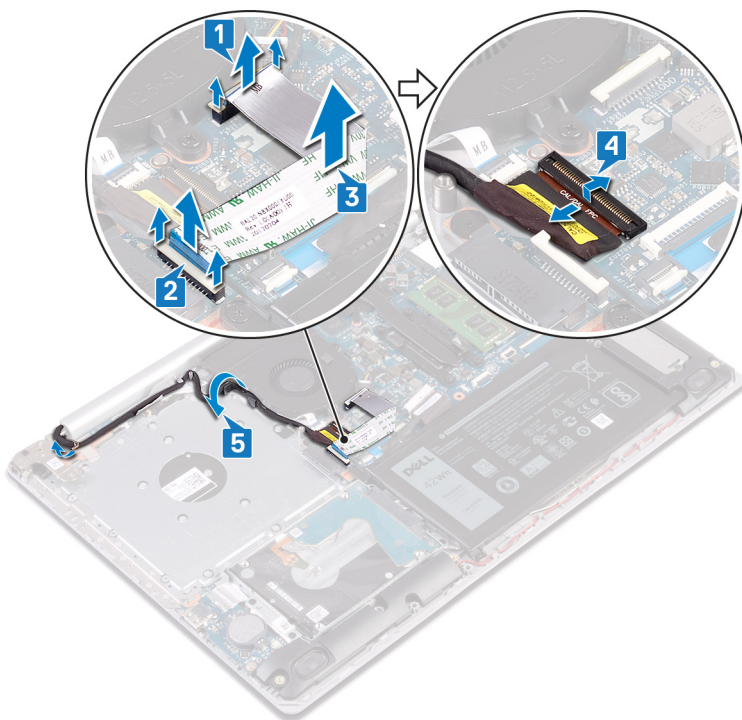

6. Remove the five screws (M2.5x5) that secure the left and right hinges to the system board and palm rest and keyboard assembly.
7. Open the hinges.

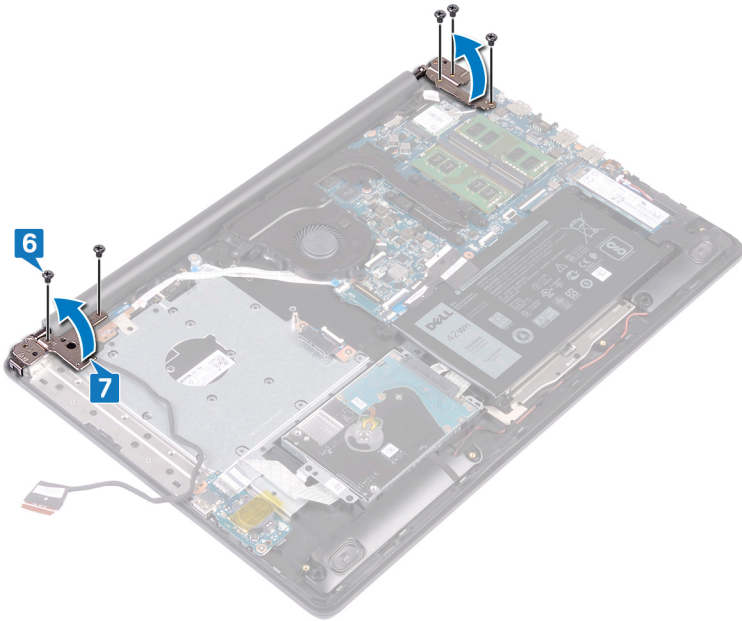

8. Lift the palm rest and keyboard assembly at an angle.
9. Slide and remove the palm rest and keyboard assembly off the display assembly.

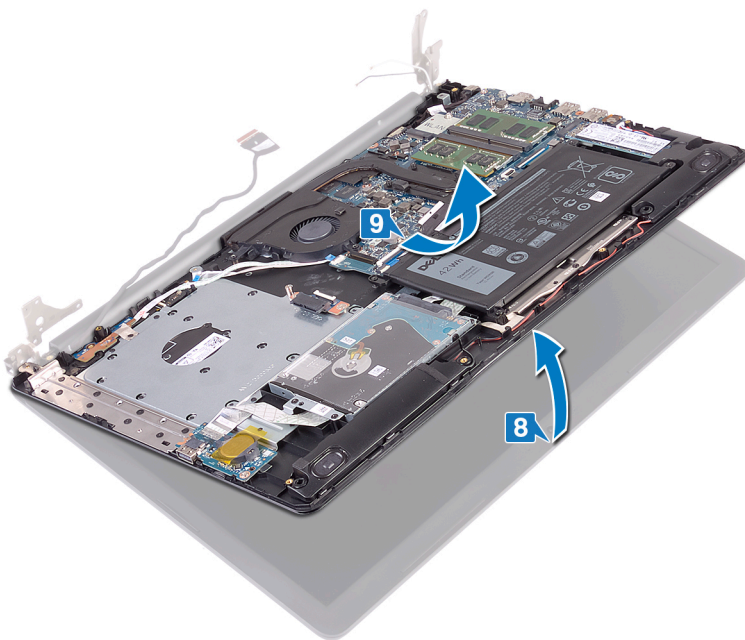

10. After performing all the above steps, you are left with display assembly.



Replacing the display assembly

NOTE: Before working inside your computer, read the safety information that shipped with your computer and follow the steps in [Before working inside your computer](#). After working inside your computer, follow the instructions in [After working inside your computer](#). For more safety best practices, see the Regulatory Compliance home page at www.dell.com/regulatory_compliance.

Procedure

NOTE: Ensure that the hinges are opened to the maximum before replacing the display assembly on palm rest and keyboard assembly.

1. Slide the palm rest and keyboard assembly under the hinges on the display assembly and close it.

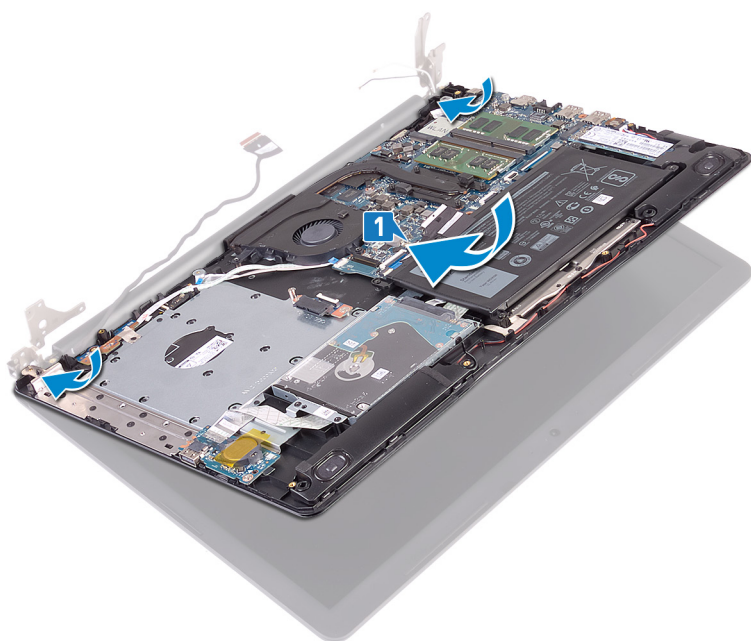

2. Using the alignment posts, press the hinges down on the system board and the palm rest and keyboard assembly.
3. Replace the five screws (M2.5x5) that secure the left and right hinges to the system board and palm rest and keyboard assembly.

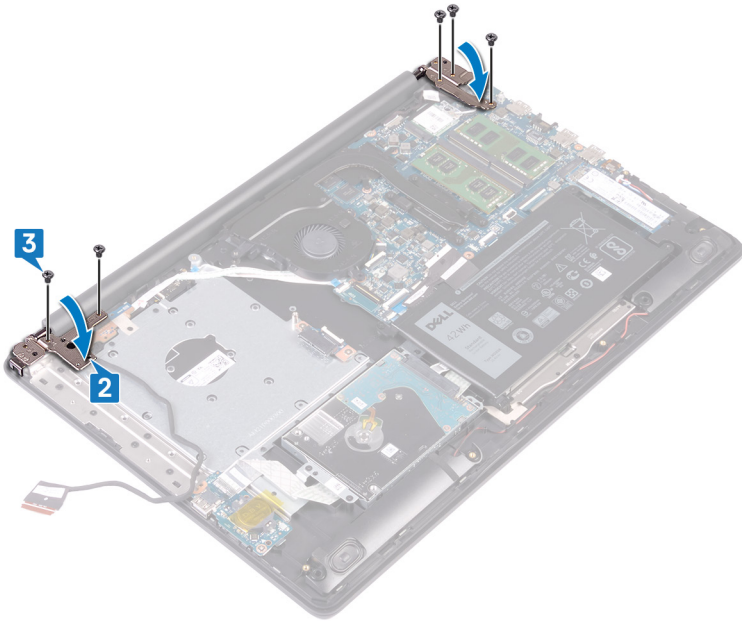

4. Route the display cable through the routing guides on the fan and the palm rest and keyboard assembly.
5. Slide the display cable to the connector on the system board and close the latch to secure the cable.
6. Press down on the latch to connect the optical-drive connector board cable to the optical-drive connector board.
7. Press down on the latch to connect the optical-drive connector board cable to the system board.

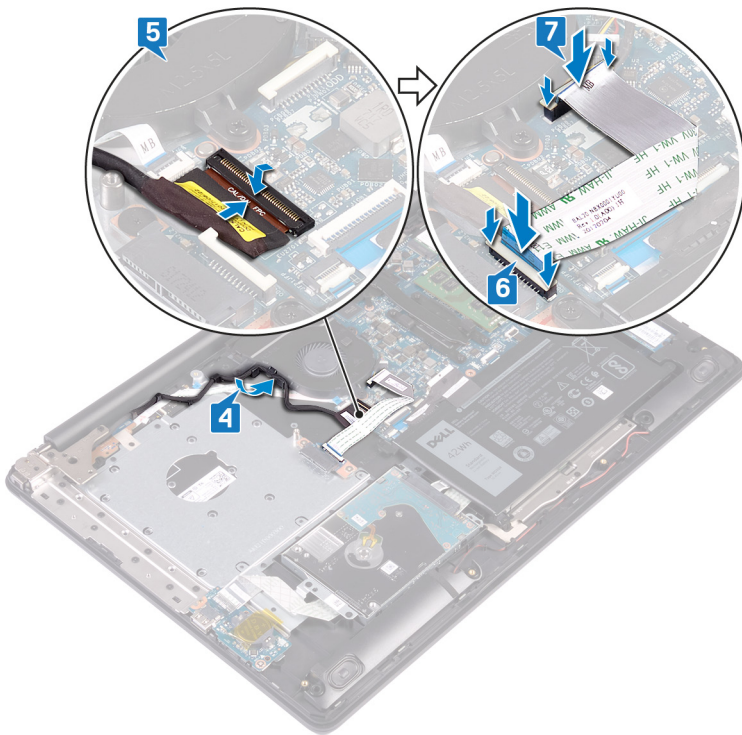

Post-requisites

1. Replace the [wireless card](#).
2. Replace the [base cover](#).
3. Replace the [optical drive](#).

Removing the I/O board

NOTE: Before working inside your computer, read the safety information that shipped with your computer and follow the steps in [Before working inside your computer](#). After working inside your computer, follow the instructions in [After working inside your computer](#). For more safety best practices, see the Regulatory Compliance home page at www.dell.com/regulatory_compliance.

Prerequisites

CAUTION: Removing the coin-cell battery resets the BIOS setup program's settings to default. Before removing the I/O board along with the coin-cell battery, it is recommended to note the BIOS setup program's settings.

1. Remove the [optical drive](#).
2. Remove the [base cover](#).
3. Remove the [battery](#).
4. Remove the [hard drive](#).

Procedure

1. Open the latch and disconnect the I/O-board cable from the system board.
2. Peel the I/O-board cable from the palm rest and keyboard assembly.
3. Remove the screw (M2x4) that secures the I/O board to the palm rest and keyboard assembly.
4. Lift the I/O board, along with the cable, off the palm rest and keyboard assembly.

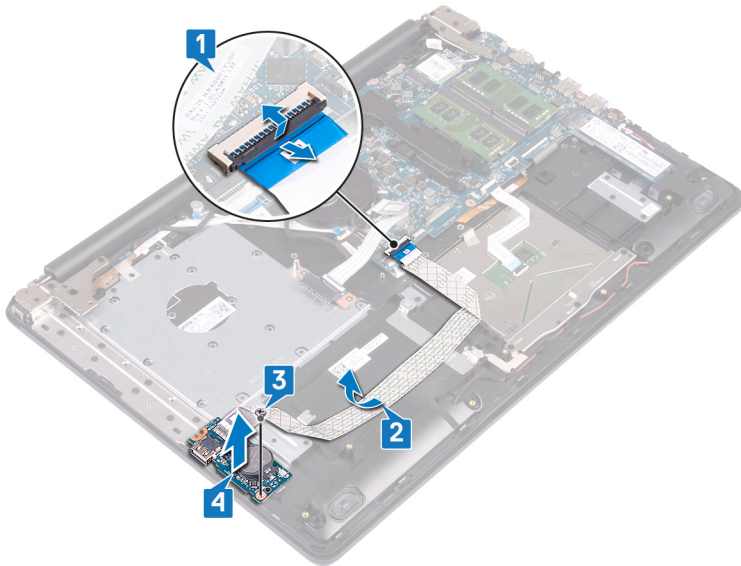

Replacing the I/O board

NOTE: Before working inside your computer, read the safety information that shipped with your computer and follow the steps in [Before working inside your computer](#). After working inside your computer, follow the instructions in [After working inside your computer](#). For more safety best practices, see the Regulatory Compliance home page at www.dell.com/regulatory_compliance.

Procedure

1. Using the alignment posts, place the I/O board on the palm rest and keyboard assembly.
2. Replace the screw (M2x4) that secures the I/O board to the palm rest and keyboard assembly.
3. Adhere the I/O-board cable to the palm rest and keyboard assembly.
4. Connect the I/O-board cable to the system board and close the latch to secure the cable.

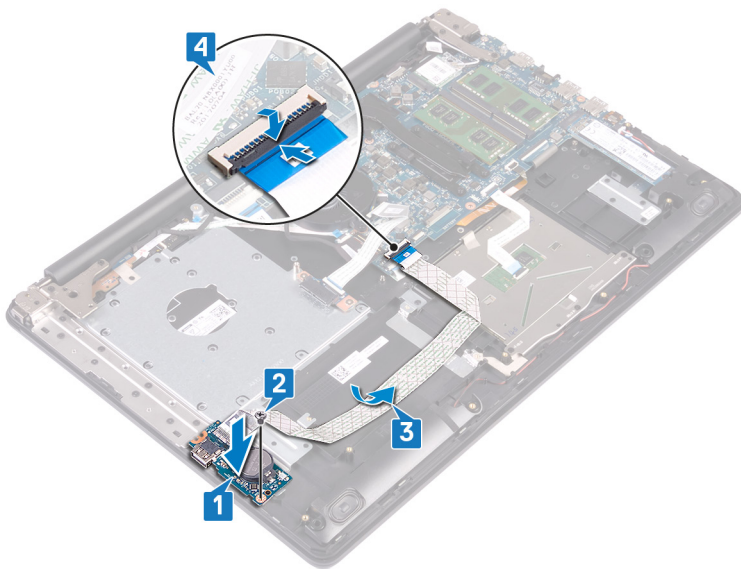

Post-requisites

1. Replace the [hard drive](#).
2. Replace the [battery](#).
3. Replace the [base cover](#).
4. Replace the [optical drive](#).

Removing the power-button board

NOTE: Before working inside your computer, read the safety information that shipped with your computer and follow the steps in [Before working inside your computer](#). After working inside your computer, follow the instructions in [After working inside your computer](#). For more safety best practices, see the Regulatory Compliance home page at www.dell.com/regulatory_compliance.

Prerequisites

1. Remove the [optical drive](#).
2. Remove the [base cover](#).
3. Remove the [fan](#).

Procedure

1. Remove the two screws (M2.5x5) that secure the left hinge to palm rest and keyboard assembly.
2. Open the left hinge.

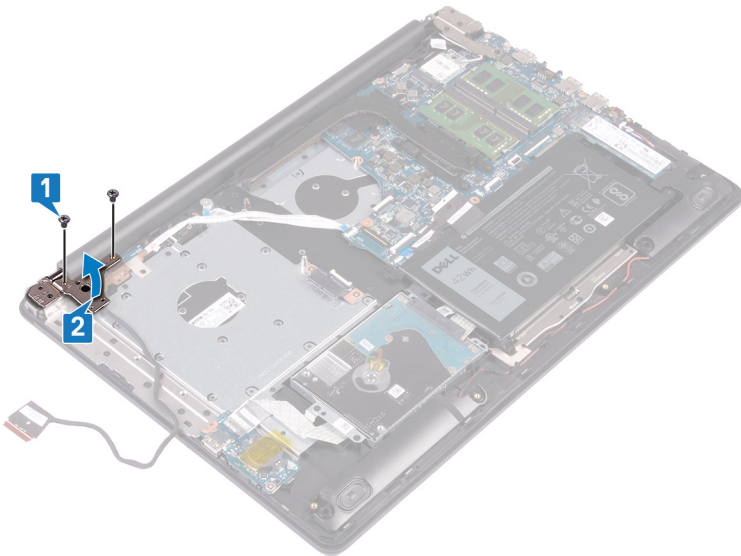

3. Open the latch and disconnect the power-button board cable from the system board.
4. Peel off the tape that secures the power-button board to the palm rest and keyboard assembly.
5. Remove the screw (M2x3) that secures the power-button board to the palm rest and keyboard assembly.
6. Lift the power-button board, along with the cable, off the palm rest and keyboard assembly.

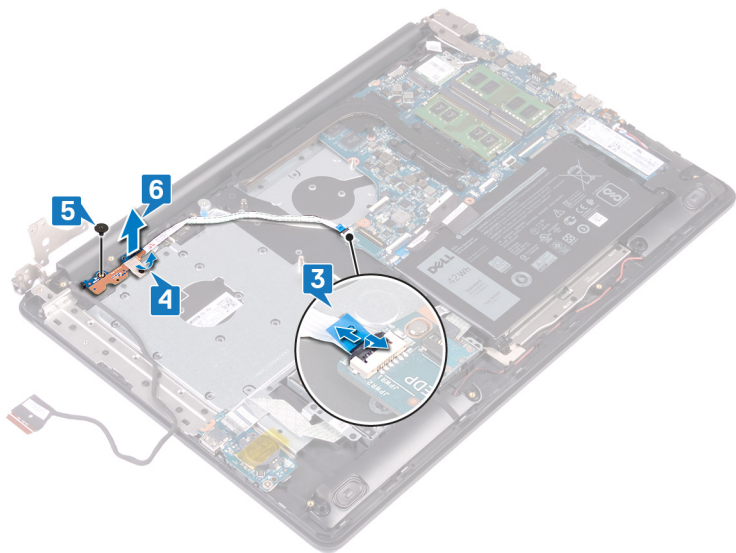

Replacing the power-button board

NOTE: Before working inside your computer, read the safety information that shipped with your computer and follow the steps in [Before working inside your computer](#). After working inside your computer, follow the instructions in [After working inside your computer](#). For more safety best practices, see the Regulatory Compliance home page at www.dell.com/regulatory_compliance.

Procedure

1. Place the power-button board on the palm rest and keyboard assembly and align the screw hole on the power-button board with the screw hole on the palm rest and keyboard assembly.
2. Replace the screw (M2x3) that secures the power-button board to the palm rest and keyboard assembly.
3. Adhere the tape that secures the power-button board to the palm rest and keyboard assembly.
4. Slide the power-button cable to the system board and close the latch to secure the cable.

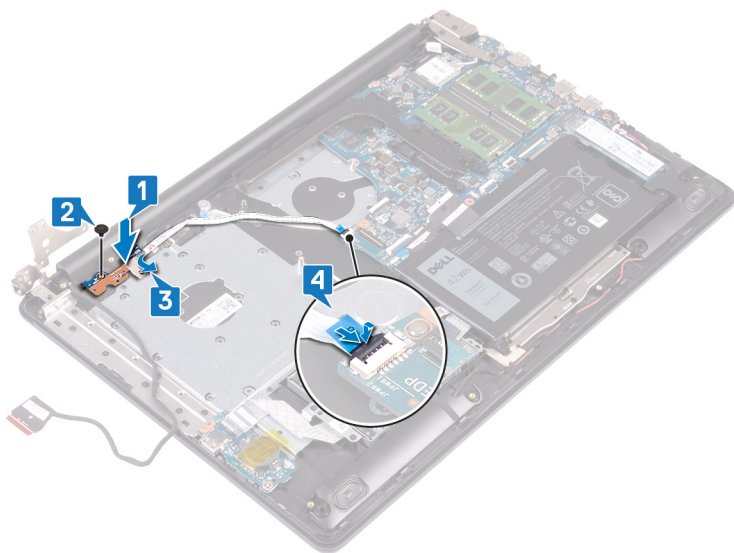

5. Close the left hinge.
6. Replace the two screws (M2.5x5) that secure the left hinge to palm rest and keyboard assembly.

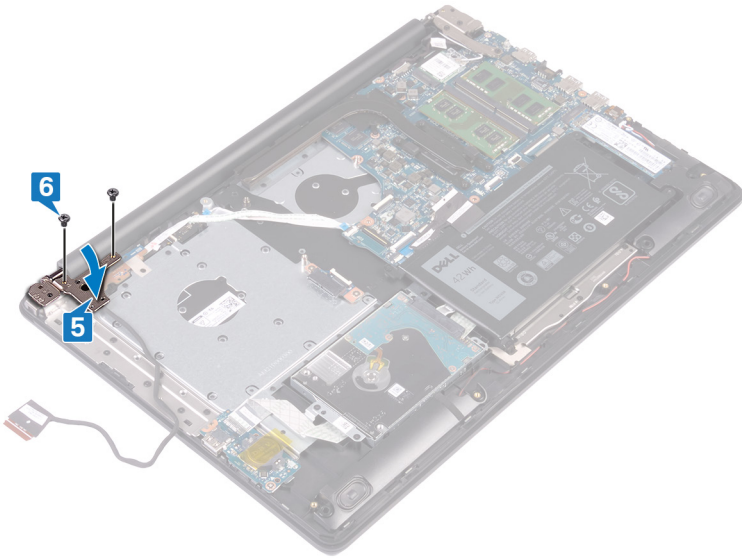

Post-requisites

1. Replace the [fan](#).
2. Replace the [base cover](#).
3. Replace the [optical drive](#).

Removing the system board

- NOTE:** Before working inside your computer, read the safety information that shipped with your computer and follow the steps in [Before working inside your computer](#). After working inside your computer, follow the instructions in [After working inside your computer](#). For more safety best practices, see the Regulatory Compliance home page at www.dell.com/regulatory_compliance.
- NOTE:** Your computer's Service Tag is stored in the system board. You must enter the Service Tag in the BIOS setup program after you replace the system board.
- NOTE:** Replacing the system board removes any changes you have made to the BIOS using the BIOS setup program. You must make the appropriate changes again after you replace the system board.
- NOTE:** Before disconnecting the cables from the system board, note the location of the connectors so that you can reconnect the cables correctly after you replace the system board.

Prerequisites

1. Remove the [optical drive](#).
2. Remove the [base cover](#).
3. Remove the [battery](#).
4. Remove the [memory modules](#).
5. Remove the [wireless card](#).
6. Remove the [solid-state drive](#).
7. Remove the [fan](#).
8. Remove the [heat sink](#).

Procedure

1. Disconnect the power-adaptor port cable from the system board.
2. Disconnect the speaker cable from the system board.
3. Open the latch and disconnect the keyboard from the system board.
4. Open the latch and disconnect the keyboard back-light cable from the system board.
5. Open the latch and disconnect the touchpad cable from the system board.
6. Open the latch and disconnect the hard-drive cable from the system board.
7. Open the latch and disconnect the I/O board cable from the system board.
8. Open the latch and disconnect the finger-print reader cable from the system board.
9. Open the latch and disconnect the power-button board cable from the system board.

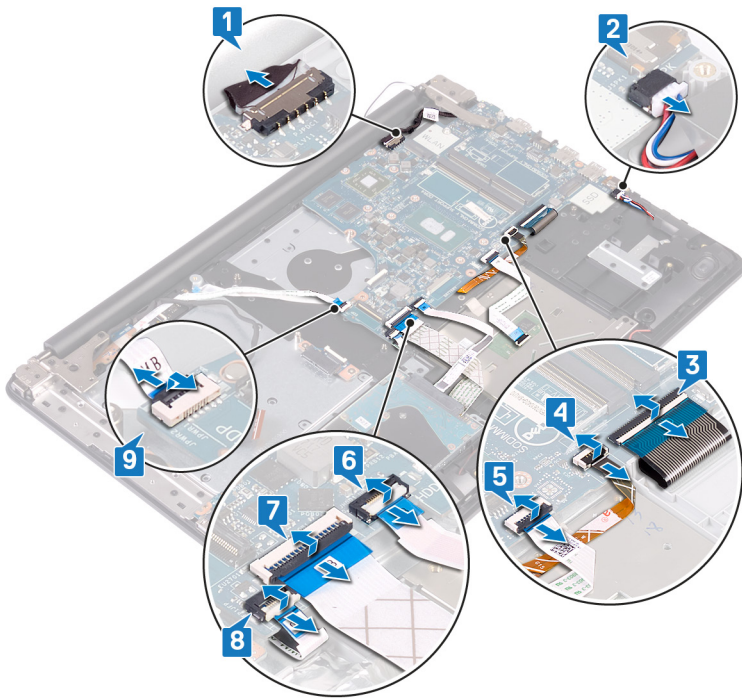

10. Remove the three screws (M2.5x5) that secure the right hinge to the system board.
11. Open the right hinge.

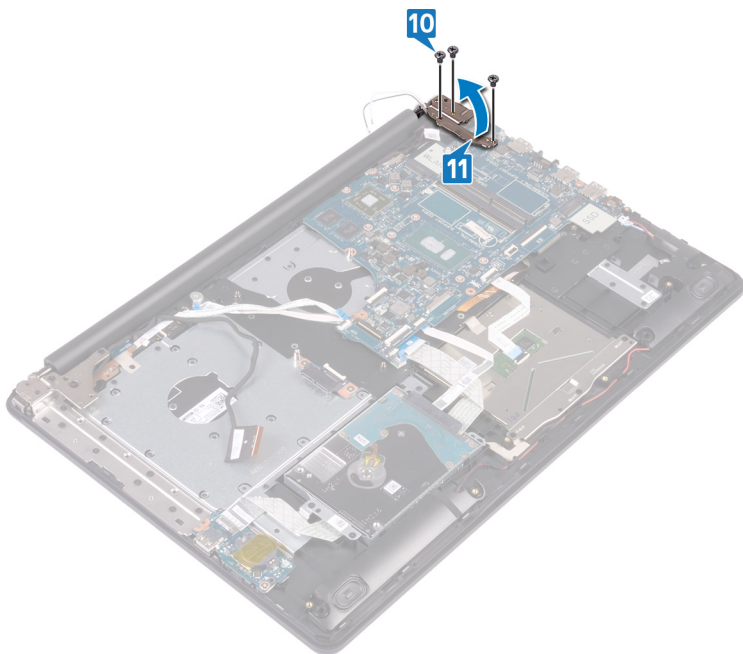

12. Remove the screw (M2x4) that secures the system board to palm rest and keyboard assembly.
13. Lift the system board off the palm rest and keyboard assembly.

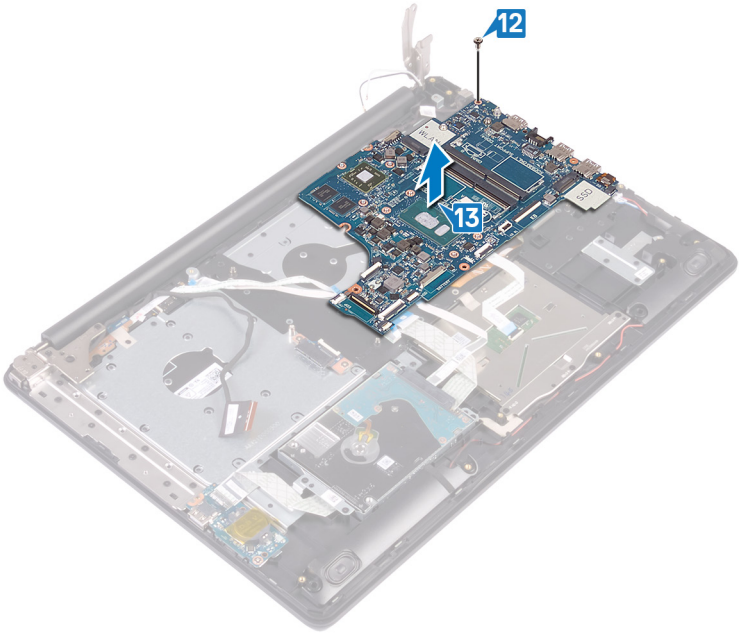

Replacing the system board

- NOTE:** Before working inside your computer, read the safety information that shipped with your computer and follow the steps in [Before working inside your computer](#). After working inside your computer, follow the instructions in [After working inside your computer](#). For more safety best practices, see the Regulatory Compliance home page at www.dell.com/regulatory_compliance.
- NOTE:** Your computer's Service Tag is stored in the system board. You must enter the Service Tag in the BIOS setup program after you replace the system board.
- NOTE:** Replacing the system board removes any changes you have made to the BIOS using the BIOS setup program. You must make the appropriate changes again after you replace the system board.

Procedure

1. Align the screw hole on the system board with the screw hole on the palm rest and keyboard assembly.
2. Replace the screw (M2x4) that secures the system board to the palm rest and keyboard assembly.

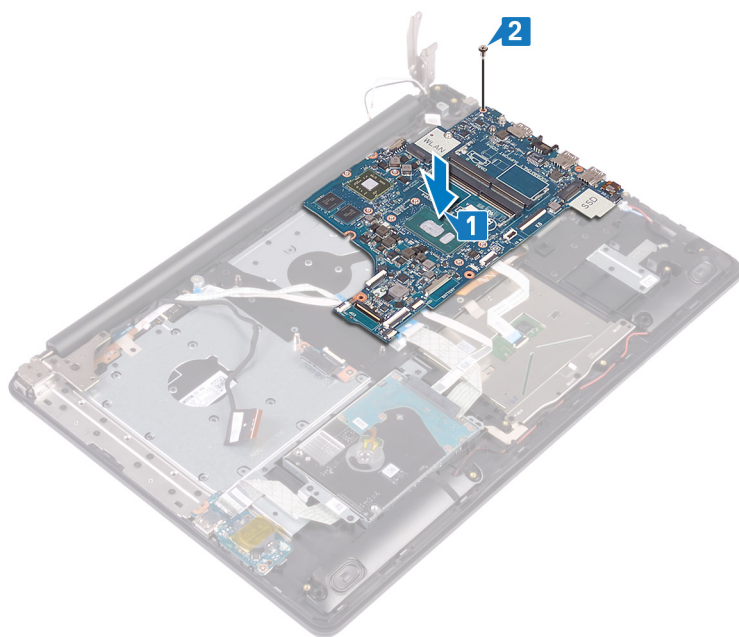

3. Close the right display hinge.
4. Replace the three screws (M2.5x5) that secure the right hinge to the system board.

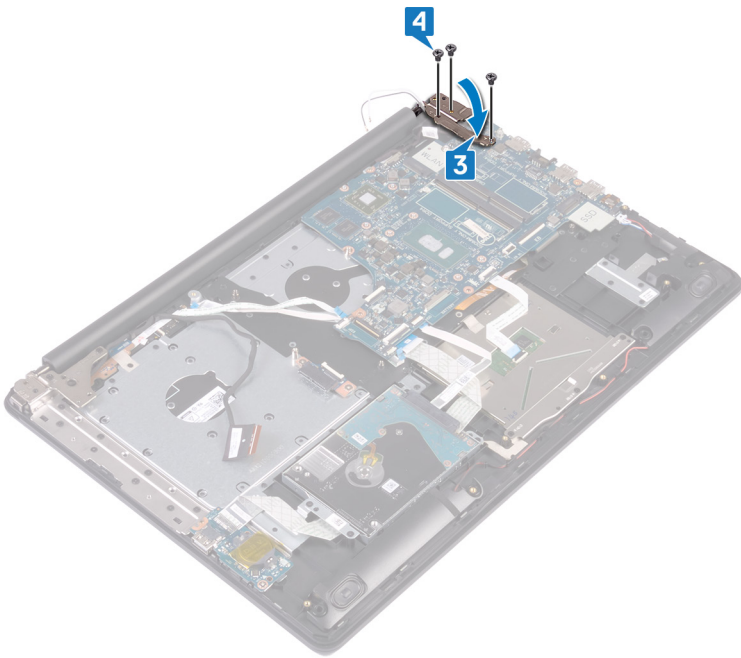

5. Connect the power-adaptor port cable and speaker cable to the system board.
6. Slide the keyboard back-light cable and keyboard cable into their respective connectors on the system board and close the latches.
7. Slide the touchpad cable and hard-drive cable into their respective connectors on the system board and close the latches.
8. Slide the I/O-board cable and finger-print reader cable into their respective connectors on the system board and close the latch.
9. Slide the power-button board cable into the connector on the system board and close the latch.

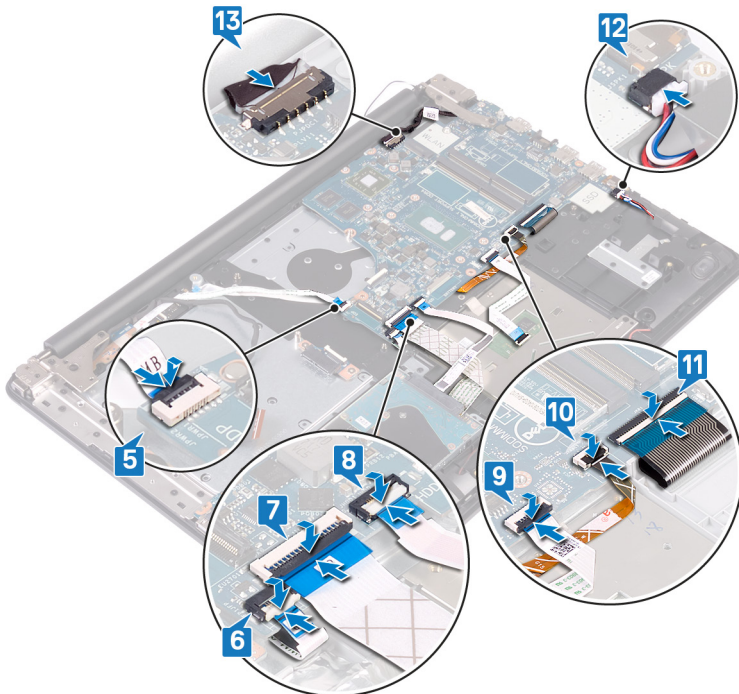

Post-requisites

1. Replace the [heat sink](#).
2. Replace the [fan](#).

3. Replace the [solid-state drive](#).
4. Replace the [wireless card](#).
5. Replace the [memory modules](#).
6. Replace the [battery](#).
7. Replace the [base cover](#).
8. Replace the [optical drive](#).

Entering the Service Tag in the BIOS setup program

1. Turn on or restart your computer.
2. Press F2 when the Dell logo is displayed to enter the BIOS setup program.
3. Navigate to the **Main** tab and enter the Service Tag in the **Service Tag Input** field.

 **NOTE:** Service tag is the alphanumeric identifier located at the back side of your computer.

Removing the power button with fingerprint reader

NOTE: Before working inside your computer, read the safety information that shipped with your computer and follow the steps in [Before working inside your computer](#). After working inside your computer, follow the instructions in [After working inside your computer](#). For more safety best practices, see the Regulatory Compliance home page at www.dell.com/regulatory_compliance.

NOTE: Applicable only for computers that are shipped with fingerprint reader.

Prerequisites

1. Remove the [optical drive](#).
2. Remove the [base cover](#).
3. Remove the [battery](#).
4. Remove the [solid-state drive](#).
5. Remove the [fan](#).
6. Remove the [heat sink](#).
7. Remove the [wireless card](#).
8. Remove the [power-button board](#).
9. Remove the [system board](#).

Procedure

1. Peel the fingerprint reader cable off the palm rest and keyboard assembly.
2. Remove the screw (M2x2) that secures the power button with fingerprint reader to the palm rest and keyboard assembly.
3. Using a plastic scribe, release the fingerprint-reader board from the palm rest and keyboard assembly.
4. Lift the power button with fingerprint reader, along with its cable, off the palm rest and keyboard assembly.

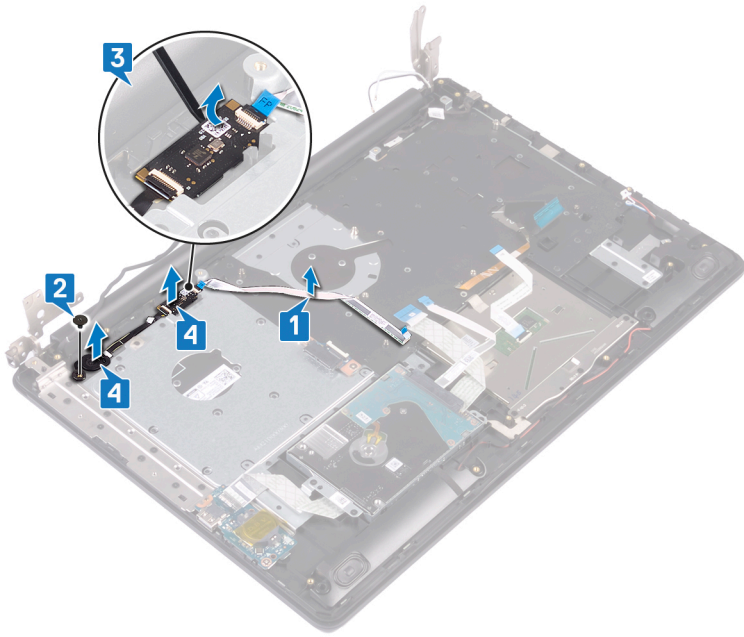

Replacing the power button with fingerprint reader

NOTE: Before working inside your computer, read the safety information that shipped with your computer and follow the steps in [Before working inside your computer](#). After working inside your computer, follow the instructions in [After working inside your computer](#). For more safety best practices, see the Regulatory Compliance home page at www.dell.com/regulatory_compliance.

NOTE: Applicable only for computers that are shipped with fingerprint reader.

Procedure

1. Using the alignment posts, align and place the power button with fingerprint reader on the palm rest and keyboard assembly.
2. Replace the screw (M2x2) that secures the power button with fingerprint reader to the palm rest and keyboard assembly.
3. Adhere the fingerprint reader cable on the palm rest and keyboard assembly.

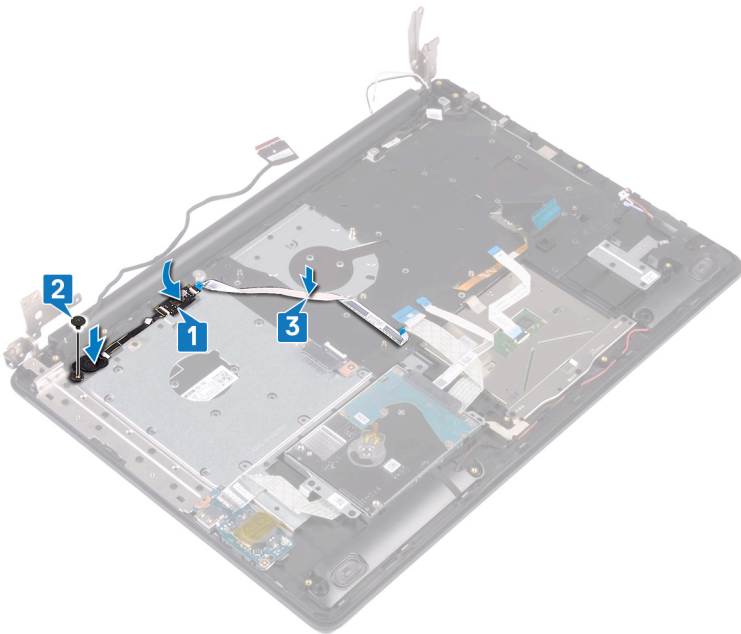

Post-requisites

1. Replace the [system board](#).
2. Replace the [power-button board](#).
3. Replace the [wireless card](#).
4. Replace the [heat sink](#).
5. Replace the [fan](#).
6. Replace the [solid-state drive](#).
7. Replace the [battery](#).
8. Replace the [base cover](#).

9. Replace the [optical drive](#).

Removing the palm-rest and keyboard assembly

NOTE: Before working inside your computer, read the safety information that shipped with your computer and follow the steps in [Before working inside your computer](#). After working inside your computer, follow the instructions in [After working inside your computer](#). For more safety best practices, see the Regulatory Compliance home page at www.dell.com/regulatory_compliance.

Prerequisites

1. Remove the [optical drive](#).
2. Remove the [base cover](#).
3. Remove the [battery](#).
4. Remove the [optical-drive connector board](#).
5. Remove the [fan](#).
6. Remove the [solid-state drive](#).
7. Remove the [wireless card](#).
8. Remove the [speakers](#).
9. Remove the [hard drive](#).
10. Remove the [touchpad](#).
11. Remove the [power-adaptor port](#).
12. Remove the [display assembly](#).
13. Remove the [I/O board](#).
14. Remove the [power-button board](#).
15. Remove the [system board](#).
16. Remove the [power button with fingerprint reader](#) (optional).

Procedure

After performing the above steps, we are left with the palm rest and keyboard assembly.



Replacing the palm-rest and keyboard assembly

NOTE: Before working inside your computer, read the safety information that shipped with your computer and follow the steps in [Before working inside your computer](#). After working inside your computer, follow the instructions in [After working inside your computer](#). For more safety best practices, see the Regulatory Compliance home page at www.dell.com/regulatory_compliance.

Procedure

Place the palm rest and keyboard assembly on a flat surface.



Post-requisites

1. Replace the [power button with fingerprint reader](#) (optional).
2. Replace the [system board](#).
3. Replace the [power-button board](#).
4. Replace the [I/O board](#).
5. Replace the [display assembly](#).
6. Replace the [power-adapter port](#).
7. Replace the [touchpad](#).
8. Replace the [hard drive](#).
9. Replace the [speakers](#).
10. Replace the [wireless card](#).
11. Replace the [solid-state drive](#).
12. Replace the [fan](#).
13. Replace the [optical-drive connector board](#).
14. Replace the [battery](#).

15. Replace the [base cover](#).
16. Replace the [optical drive](#).

Removing the display bezel

NOTE: Before working inside your computer, read the safety information that shipped with your computer and follow the steps in [Before working inside your computer](#). After working inside your computer, follow the instructions in [After working inside your computer](#). For more safety best practices, see the Regulatory Compliance home page at www.dell.com/regulatory_compliance.

Prerequisites

1. Remove the [optical drive](#).
2. Remove the [base cover](#).
3. Remove the [wireless card](#).
4. Remove the [display assembly](#).

Procedure

1. Using a plastic scribe, carefully pry up the display bezel from the top-left outer edge of the display back-cover and antenna assembly.
2. Remove the display bezel off the display back-cover and antenna assembly.

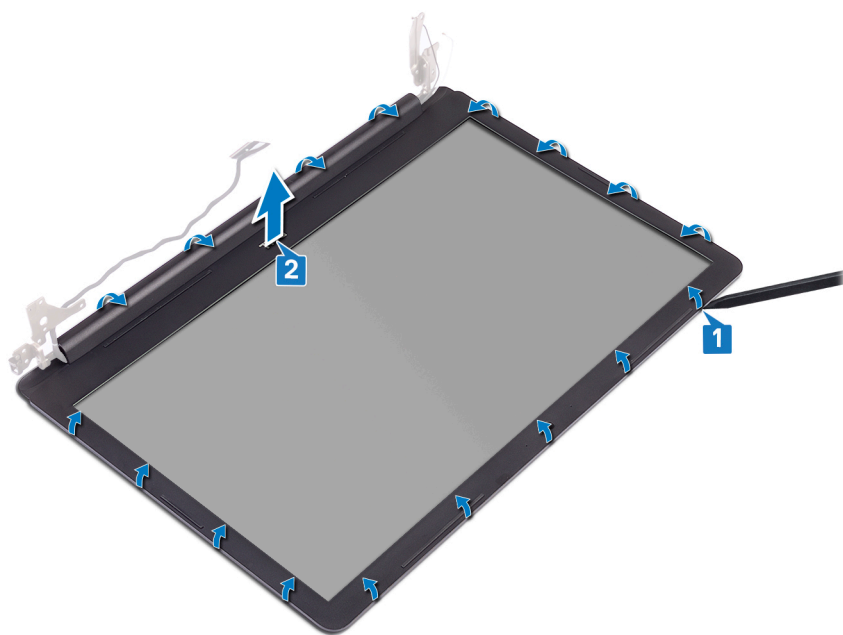

Replacing the display bezel

NOTE: Before working inside your computer, read the safety information that shipped with your computer and follow the steps in [Before working inside your computer](#). After working inside your computer, follow the instructions in [After working inside your computer](#). For more safety best practices, see the Regulatory Compliance home page at www.dell.com/regulatory_compliance.

Procedure

Align the display bezel with the display back-cover and antenna assembly, and then gently snap the display bezel into place.

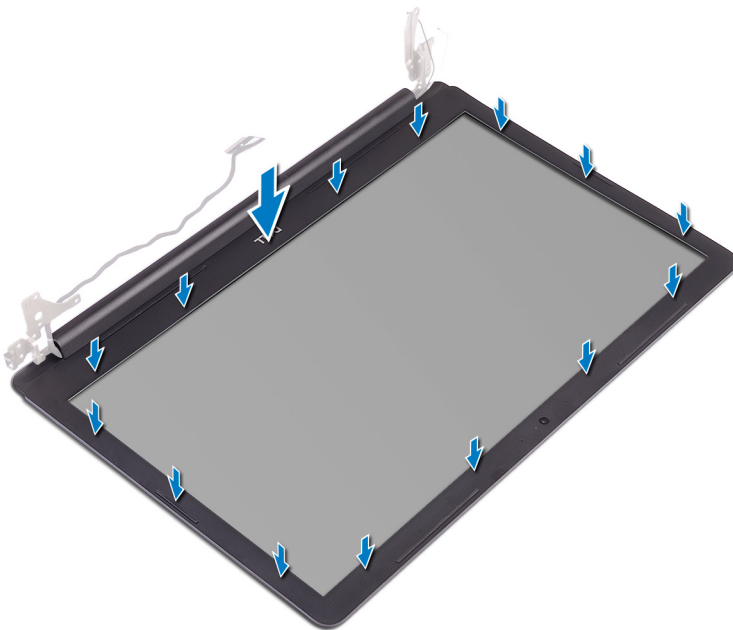

Post-requisites

1. Replace the [display assembly](#).
2. Replace the [wireless card](#).
3. Replace the [base cover](#).
4. Replace the [optical drive](#).

Removing the camera

NOTE: Before working inside your computer, read the safety information that shipped with your computer and follow the steps in [Before working inside your computer](#). After working inside your computer, follow the instructions in [After working inside your computer](#). For more safety best practices, see the Regulatory Compliance home page at www.dell.com/regulatory_compliance.

Prerequisites

1. Remove the [optical drive](#).
2. Remove the [base cover](#).
3. Remove the [wireless card](#).
4. Remove the [display assembly](#).
5. Remove the [display bezel](#).

Procedure

1. Using a plastic scribe, gently pry the camera off the display back-cover and antenna assembly.
2. Disconnect the camera cable from the camera module.
3. Lift the camera module from the display back-cover and antenna assembly.

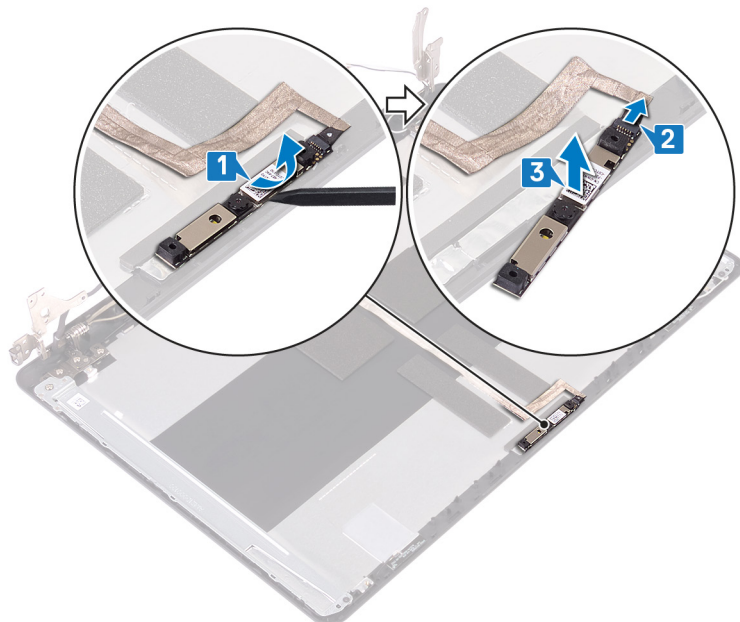

Replacing the camera

NOTE: Before working inside your computer, read the safety information that shipped with your computer and follow the steps in [Before working inside your computer](#). After working inside your computer, follow the instructions in [After working inside your computer](#). For more safety best practices, see the Regulatory Compliance home page at www.dell.com/regulatory_compliance.

Procedure

1. Connect the camera cable to the camera module.
2. Using the alignment post adhere the camera module on the display back-cover and antenna assembly.

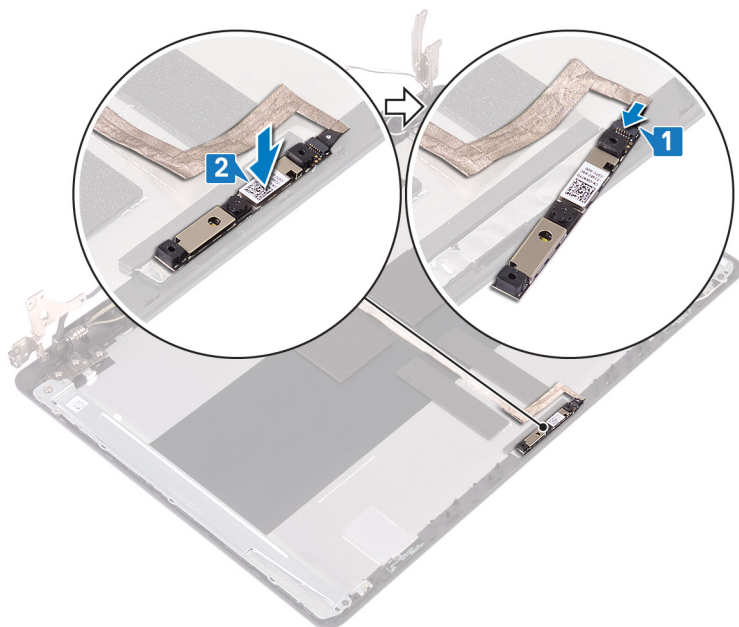

Post-requisites

1. Replace the [display bezel](#).
2. Replace the [display assembly](#).
3. Replace the [wireless card](#).
4. Replace the [base cover](#).
5. Replace the [optical drive](#).

Removing the display panel

NOTE: Before working inside your computer, read the safety information that shipped with your computer and follow the steps in [Before working inside your computer](#). After working inside your computer, follow the instructions in [After working inside your computer](#). For more safety best practices, see the Regulatory Compliance home page at www.dell.com/regulatory_compliance.

Prerequisites

1. Remove the [optical drive](#) (optional).
2. Remove the [base cover](#).
3. Remove the [wireless card](#).
4. Remove the [display assembly](#).
5. Remove the [display bezel](#).

Procedure

1. Remove the four screws (M2x2) that secure the display panel to the display back-cover and antenna assembly.
2. Lift the display panel and turn it over.

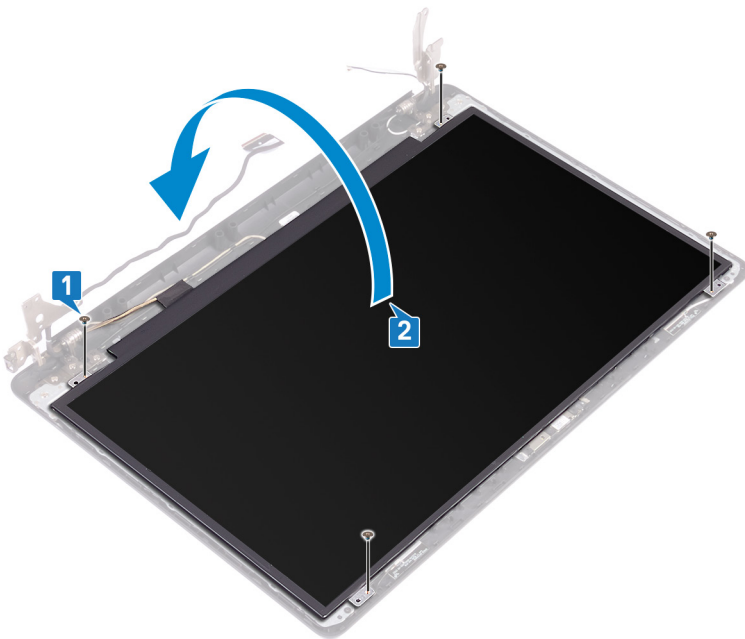

3. Peel the tape adhering the display cable to the back of the display panel.
4. Lift the latch and disconnect the display cable from the display-panel cable connector.
5. Lift the display panel away from the display back-cover and antenna assembly.

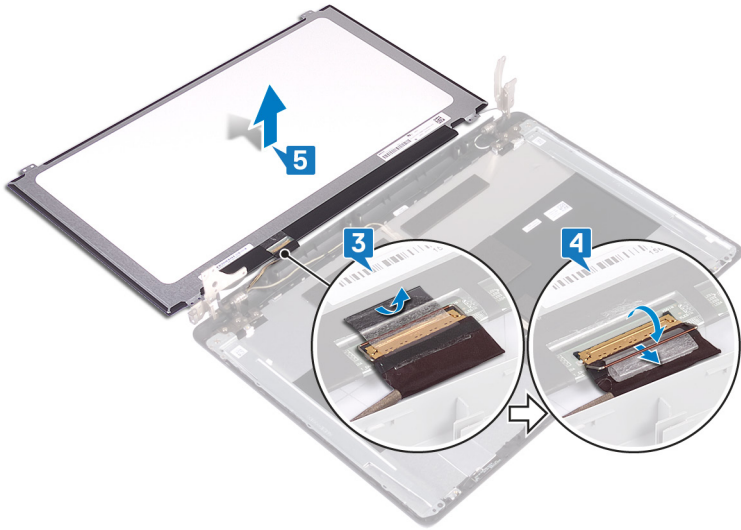

Replacing the display panel

NOTE: Before working inside your computer, read the safety information that shipped with your computer and follow the steps in [Before working inside your computer](#). After working inside your computer, follow the instructions in [After working inside your computer](#). For more safety best practices, see the Regulatory Compliance home page at www.dell.com/regulatory_compliance.

Procedure

1. Place the display panel on a flat and clean surface.
2. Connect the display cable to the connector at the back of the display panel and close the latch to secure the cable.
3. Adhere the tape that secures the display cable to the back of the display panel.

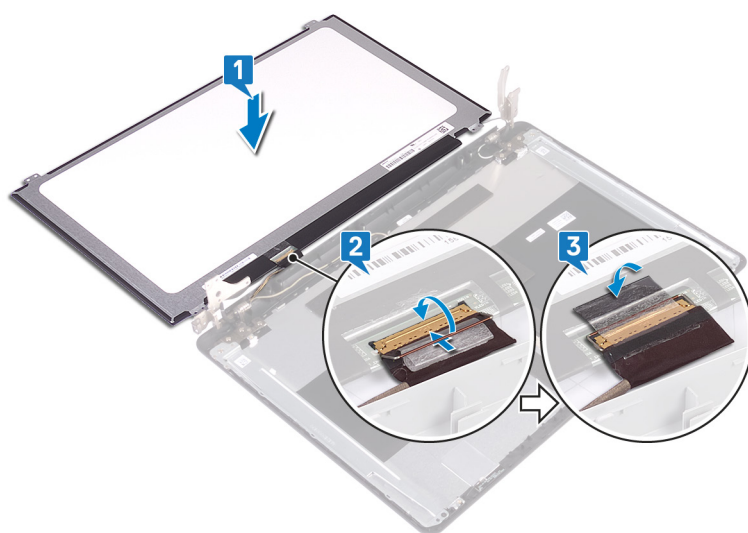

4. Place the display panel on the display back-cover and antenna assembly.
5. Align the screw holes on the display panel with the screw holes on the display back-cover and antenna assembly.
6. Replace the screws that secure the display panel to the display back-cover and antenna assembly.

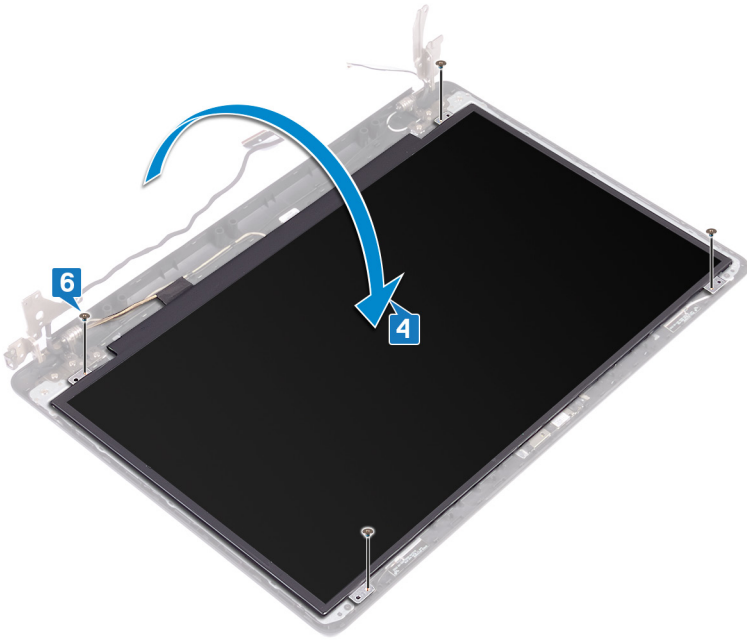

Post-requisites

1. Replace the [display bezel](#).
2. Replace the [display assembly](#).
3. Replace the [wireless card](#).
4. Replace the [base cover](#).
5. Replace the [optical drive](#) (optional).

Removing the display hinges

NOTE: Before working inside your computer, read the safety information that shipped with your computer and follow the steps in [Before working inside your computer](#). After working inside your computer, follow the instructions in [After working inside your computer](#). For more safety best practices, see the Regulatory Compliance home page at www.dell.com/regulatory_compliance.

Prerequisites

1. Remove the [optical drive](#).
2. Remove the [base cover](#).
3. Remove the [wireless card](#).
4. Remove the [display assembly](#).
5. Remove the [display bezel](#).
6. Remove the [display panel](#).

Procedure

1. Remove the eight screws (M2.5x4) that secure the display hinges to the display back-cover and antenna assembly.
2. Remove the two screws (M2x2) that secure the display-hinge brackets to the display back-cover and antenna assembly.
3. Lift the display hinges and brackets off the display back-cover and antenna assembly.

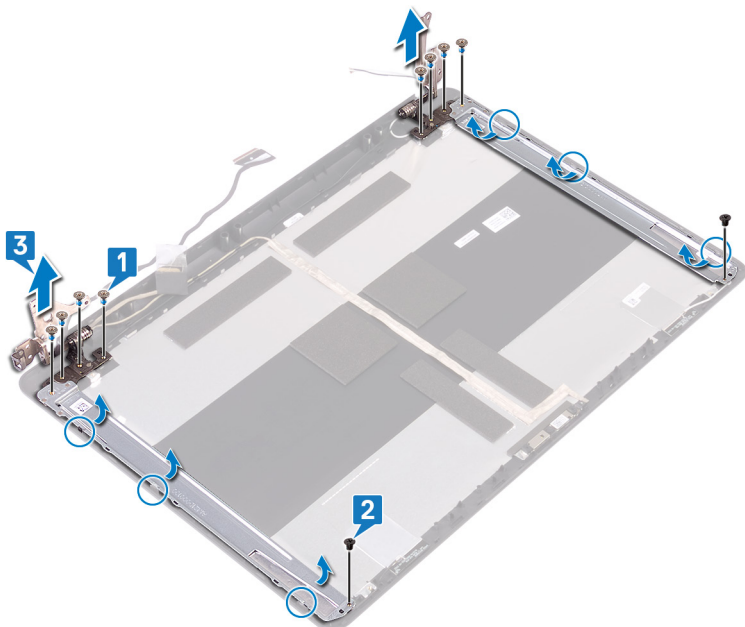

Replacing the display hinges

NOTE: Before working inside your computer, read the safety information that shipped with your computer and follow the steps in [Before working inside your computer](#). After working inside your computer, follow the instructions in [After working inside your computer](#). For more safety best practices, see the Regulatory Compliance home page at www.dell.com/regulatory_compliance.

Procedure

1. Align the screw holes on the display hinges and brackets with the screw holes on the display back-cover and antenna assembly.
2. Replace the two screws (M2x2) that secure the display-hinge brackets to the display back-cover and antenna assembly.
3. Replace the eight screws (M2.5x4) that secure the display hinges to the display back-cover and antenna assembly .

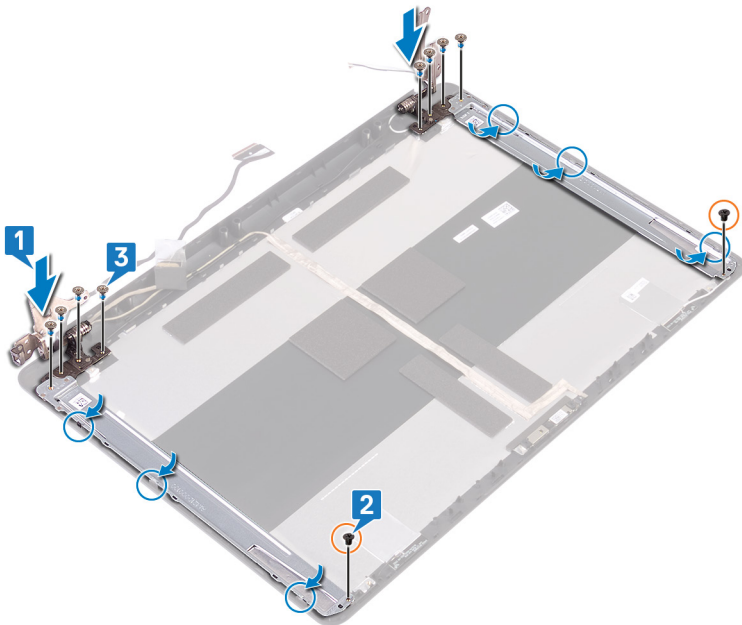

Post-requisites

1. Replace the [display panel](#).
2. Replace the [display bezel](#).
3. Replace the [display assembly](#).
4. Replace the [wireless card](#).
5. Replace the [base cover](#).
6. Replace the [optical drive](#).

Removing the display cable

NOTE: Before working inside your computer, read the safety information that shipped with your computer and follow the steps in [Before working inside your computer](#). After working inside your computer, follow the instructions in [After working inside your computer](#). For more safety best practices, see the Regulatory Compliance home page at www.dell.com/regulatory_compliance.

Prerequisites

1. Remove the [optical drive](#).
2. Remove the [base cover](#).
3. Remove the [wireless card](#).
4. Remove the [display assembly](#).
5. Remove the [display bezel](#).
6. Remove the [display panel](#).
7. Remove the [display hinges](#).

Procedure

1. Disconnect the camera cable from the camera module.
2. Note the display cable routing and remove the cable from the routing guides on the display back-cover and antenna assembly.
3. Remove the display cable from the display back-cover and antenna assembly.

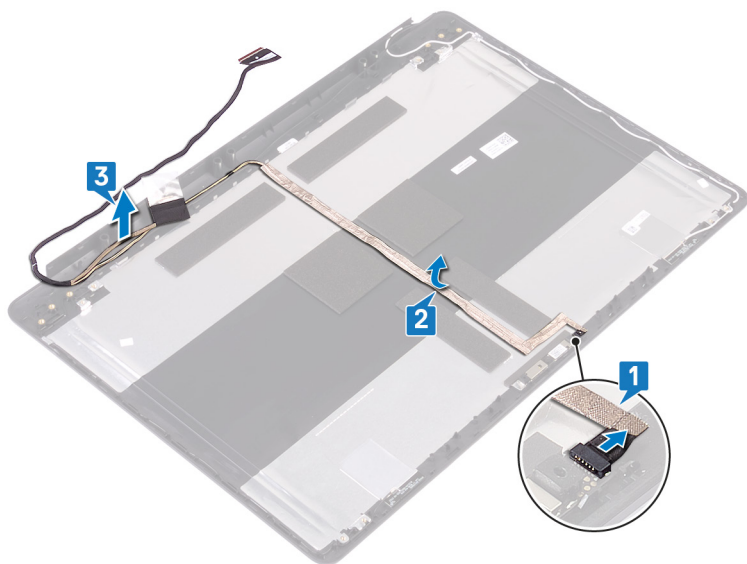

Replacing the display cable

NOTE: Before working inside your computer, read the safety information that shipped with your computer and follow the steps in [Before working inside your computer](#). After working inside your computer, follow the instructions in [After working inside your computer](#). For more safety best practices, see the Regulatory Compliance home page at www.dell.com/regulatory_compliance.

Procedure

1. Route the display cable through the routing guides on the display back-cover and antenna assembly.
2. Slide the camera cable into the connector on the camera module to secure the cable.

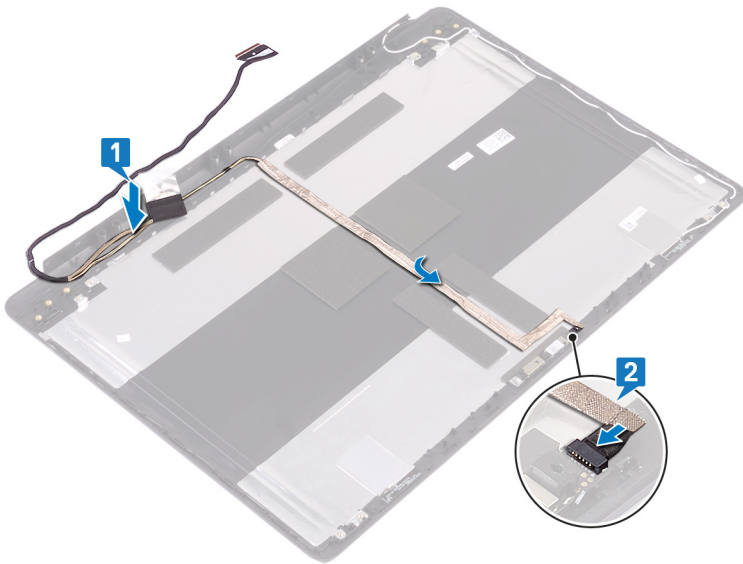

Post-requisites

1. Replace the [display hinges](#).
2. Replace the [display panel](#).
3. Replace the [display bezel](#).
4. Replace the [display assembly](#).
5. Replace the [wireless card](#).
6. Replace the [base cover](#).
7. Replace the [optical drive](#).

Removing the display back-cover and antenna assembly

NOTE: Before working inside your computer, read the safety information that shipped with your computer and follow the steps in [Before working inside your computer](#). After working inside your computer, follow the instructions in [After working inside your computer](#). For more safety best practices, see the Regulatory Compliance home page at www.dell.com/regulatory_compliance.

Prerequisites

1. Remove the [optical drive](#).
2. Remove the [base cover](#).
3. Remove the [wireless card](#).
4. Remove the [display assembly](#).
5. Remove the [display bezel](#).
6. Remove the [camera](#).
7. Remove the [display panel](#).
8. Remove the [display hinges](#).
9. Remove the [display cable](#).

Procedure

After performing all the above steps, we are left with the display back-cover and antenna assembly.

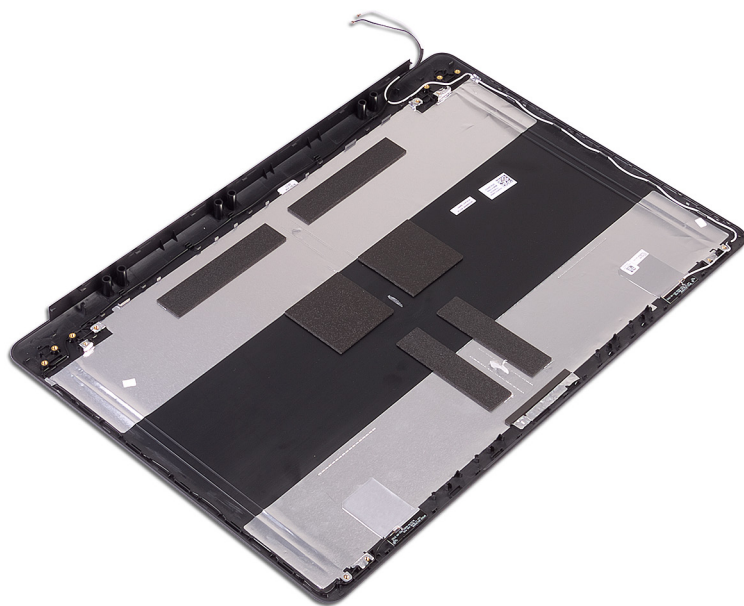

Replacing the display back-cover and antenna assembly

NOTE: Before working inside your computer, read the safety information that shipped with your computer and follow the steps in [Before working inside your computer](#). After working inside your computer, follow the instructions in [After working inside your computer](#). For more safety best practices, see the Regulatory Compliance home page at www.dell.com/regulatory_compliance.

Procedure

Place the display back-cover and antenna assembly on a clean and flat surface.

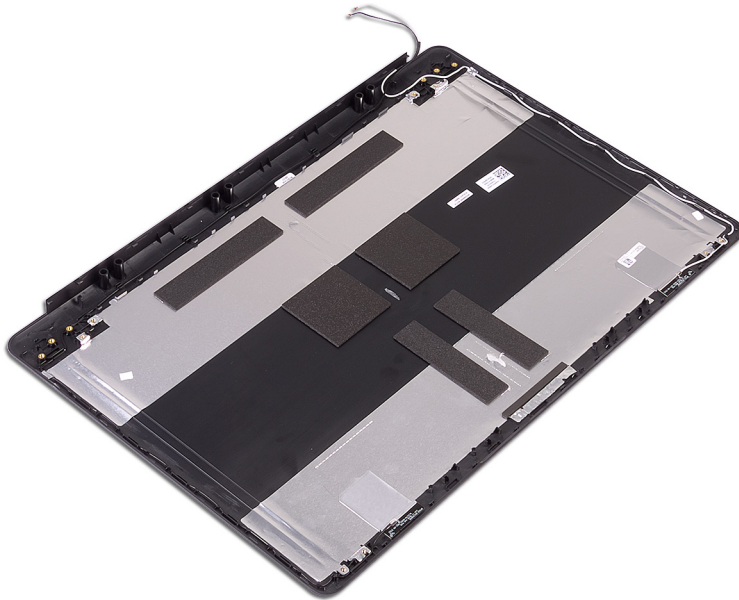

Post-requisites

1. Replace the [display cable](#).
2. Replace the [display hinges](#).
3. Replace the [display panel](#).
4. Replace the [camera](#).
5. Replace the [display bezel](#).
6. Replace the [display assembly](#).
7. Replace the [wireless card](#).
8. Replace the [base cover](#).
9. Replace the [optical drive](#).

System setup

NOTE: Depending on the computer and its installed devices, the items listed in this section may or may not be displayed.

System setup

CAUTION: Unless you are an expert computer user, do not change the settings in the BIOS Setup program. Certain changes can make your computer work incorrectly.

NOTE: Before you change BIOS Setup program, it is recommended that you write down the BIOS Setup program screen information for future reference.

Use the BIOS Setup program for the following purposes:

- Get information about the hardware installed in your computer, such as the amount of RAM and the size of the hard drive.
- Change the system configuration information.
- Set or change a user-selectable option, such as the user password, type of hard drive installed, and enabling or disabling base devices.

Entering BIOS setup program

1. Turn on (or restart) your computer.
2. During POST, when the DELL logo is displayed, watch for the F2 prompt to appear, and then press F2 immediately.

NOTE: The F2 prompt indicates that the keyboard is initialized. This prompt can appear very quickly, so you must watch for it, and then press F2. If you press F2 before the F2 prompt, this keystroke is lost. If you wait too long and the operating system logo appears, continue to wait until you see the desktop. Then, turn off your computer and try again.

Navigation keys

NOTE: For most of the System Setup options, changes that you make are recorded but do not take effect until you restart the system.

Keys	Navigation
Up arrow	Moves to the previous field.
Down arrow	Moves to the next field.
Enter	Selects a value in the selected field (if applicable) or follow the link in the field.
Spacebar	Expands or collapses a drop-down list, if applicable.
Tab	Moves to the next focus area. NOTE: For the standard graphics browser only.
Esc	Moves to the previous page until you view the main screen. Pressing Esc in the main screen displays a message that prompts you to save any unsaved changes and restarts the system.

Boot Sequence

Boot Sequence allows you to bypass the System Setup–defined boot device order and boot directly to a specific device (for example: optical drive or hard drive). During the Power-on Self Test (POST), when the Dell logo appears, you can:

- Access System Setup by pressing F2 key
- Bring up the one-time boot menu by pressing F12 key

The one-time boot menu displays the devices that you can boot from including the diagnostic option. The boot menu options are:

- Removable Drive (if available)
- STXXXX Drive
i **NOTE:** XXX denotes the SATA drive number.
- Optical Drive (if available)
- SATA Hard Drive (if available)
- Diagnostics
i **NOTE:** Choosing **Diagnostics**, will display the **ePSA diagnostics** screen.

The boot sequence screen also displays the option to access the System Setup screen.

System setup options

i **NOTE:** Depending on this computer and its installed devices, the items listed in this section may or may not appear.

Table 3. System setup options—Main menu

Main	
System Time	Displays the current time in hh:mm:ss format.
System Date	Displays the current date in mm/dd/yyyy format.
BIOS Version	Displays the BIOS version.
Product Name	Displays the model number of your computer.
Service Tag	Displays the service tag of your computer.
Asset Tag	Displays the asset tag of your computer.
CPU Type	Displays the processor type.
CPU Speed	Displays the processor speed.
CPU ID	Displays the processor identification code.
CPU Cache	
L1 Cache	Displays the processor L1 cache size.
L2 Cache	Displays the processor L2 cache size.
L3 Cache	Displays the processor L3 cache size. i NOTE: This option is displayed only when the processor supports L3 Cache.
First HDD	Displays the type of hard drive installed.
SATA ODD	Displays the type of optical drive installed.
M.2 PCIe SSD	Displays the type of solid-state drive installed.
AC Adapter Type	Displays the type of AC adapter.
System Memory	Displays the size of memory installed.
Memory Speed	Displays the speed of memory.

Table 3. System setup options—Main menu (continued)

Main

Keyboard Type	Displays the type of keyboard installed.
---------------	--

Table 4. System setup options—Advanced menu

Advanced

PowerNow! Enable	Enables or disables the Intel(R) SpeedStep(tm) mode of the processor. Default: Enabled
Virtualization	Allows you to enable or disable the Virtualization technology. Default: Enabled
VT for Direct I/O	Allows you to enable or disable the Virtualization technology for improving the performance of I/O devices. Default: Enabled
Integrated NIC	Allows you to enable or disable the on-board LAN controller. Default: Enabled
USB Emulation	Allows you to enable or disable the USB emulation feature. This feature defines how the BIOS, in the absence of a USB-aware operating system, handles USB devices. USB emulation is always enabled during POST. i NOTE: You cannot boot any type of USB device (floppy, hard drive, or memory key) when this option is off. Default: Enabled
USB Wake Support	Allows you to enable USB devices to wake the computer from standby or to disable the USB wake support feature. i NOTE: If USB PowerShare is enabled, a device connected to the USB PowerShare connector may not wake the computer. Default: Disabled
SATA Operation	Allows you to configure the operating mode of the integrated SATA hard drive controller. Default: AHCI
Adapter Warnings	Allows you to choose if the computer should display warning messages when you use AC adapters that are not supported by your computer. Default: Enabled
Function Key Behavior	Allows you to set function key or multimedia key as the default function key behavior. Default: Multimedia key
Battery Health	Displays the battery health.
Miscellaneous Devices	
USB Debug	Enable or disable USB debug. Default: Disabled
BIOS Recovery from Hard Drive	Enable or disable BIOS recovery from hard drive. Default: Enabled

Table 4. System setup options—Advanced menu (continued)

Advanced	
Battery Charge Configuration	Set the battery charge settings with a preselected custom charge start and stop. Default: Adaptive
Advanced Battery Charge Configuration	Enable Advance Battery Charge Configuration from the beginning of the day to a specified work period. Default: Disabled
SupportAssist System Resolution	
Auto OS Recovery Threshold	Controls the automatic boot flow for SupportAssist System Resolution Console and for the Dell OS Recovery tool. Default: 2
SupportAssist OS Recovery	Enable or disable the boot flow for the SupportAssist OS Recovery tool in the even of certain system errors. Default: Disabled

Table 5. System setup options—Security menu

Security	
Admin Password	Allows you to set the administrator password. The administrator password controls access to the system setup utility.
System Password	Allows you to set the system password. The system password controls access to the computer at boot.
HDD1 password	Allows you to set, change, or delete the hard drive password.
Password Change	Allows you to permit or deny system password or HDD password changes. Default: Permitted
Computrace	Enable or disable the BIOS module interface of the optional Computrace Service from Absolute Software. Default: Deactivate
Firmware TPM	Enable or disable the firmware TPM. Default: Disabled.
PPI Bypass for Clear Command	Enable or disable the PPI Bypass for Clear Command. Default: Disabled.
UEFI Firmware Capsule Updates	Enable or disable BIOS updates through UEFI capsule update packages. Default: Enabled.

Table 6. System setup options—Boot menu

Boot	
Secure Boot	Enable or disable the secure boot feature. Default: Disabled.
Load Legacy Option ROMs	Enable or disable the Load Legacy Option ROMs. Default: Disabled.

Table 6. System setup options—Boot menu (continued)

Boot	
Boot List Option	Displays the boot list options.
File Browser Add Boot Option	Add the file system for boot option.
File Browser Add Boot Option	Delete the file system for boot option.

Table 7. System setup options—Exit menu

Exit	
Exit Saving Changes	Allows you to exit system setup saving your changes.
Save Changes Without Exit	Allows you to save your changes without exiting system setup.
Exit Discarding Changes	Allows you to exit system setup without saving your changes.
Load Optimal Defaults	Allows you to restore default values for all system setup options.
Discard Changes	Allows you to load previous values for all system setup options.

Clearing CMOS settings

 **CAUTION:** Clearing CMOS settings will reset the BIOS settings on your computer.

1. Remove the [base cover](#).
2. Disconnect the battery cable from the system board.
3. Remove the [coin-cell battery](#).
4. Wait for one minute.
5. Replace the [coin-cell battery](#).
6. Connect the battery cable to the system board.
7. Replace the [base cover](#).

Clearing BIOS (System Setup) and System passwords

To clear the system or BIOS passwords, contact Dell technical support as described at www.dell.com/contactdell.

 **NOTE:** For information on how to reset Windows or application passwords, refer to the documentation accompanying Windows or your application.

Troubleshooting

Flashing the BIOS

You may need to flash (update) the BIOS when an update is available or when you replace the system board.

Follow these steps to flash the BIOS:

1. Turn on your computer.
2. Go to www.dell.com/support.
3. Click **Product support**, enter the Service Tag of your computer, and then click **Submit**.

 **NOTE:** If you do not have the Service Tag, use the auto-detect feature or manually browse for your computer model.

4. Click **Drivers & downloads > Find it myself**.
5. Select the operating system installed on your computer.
6. Scroll down the page and expand **BIOS**.
7. Click **Download** to download the latest version of the BIOS for your computer.
8. After the download is complete, navigate to the folder where you saved the BIOS update file.
9. Double-click the BIOS update file icon and follow the instructions on the screen.

Flashing BIOS (USB key)

1. Follow the procedure from step 1 to step 7 in "Flashing the BIOS" to download the latest BIOS setup program file.
2. Create a bootable USB drive. For more information see the knowledge base article [SLN143196](https://www.dell.com/support/solutions/articles/SLN143196) at www.dell.com/support.
3. Copy the BIOS setup program file to the bootable USB drive.
4. Connect the bootable USB drive to the computer that needs the BIOS update.
5. Restart the computer and press **F12** when the Dell logo is displayed on the screen.
6. Boot to the USB drive from the **One Time Boot Menu**.
7. Type the BIOS setup program filename and press **Enter**.
8. The **BIOS Update Utility** appears. Follow the instructions on the screen to complete the BIOS update.

Enhanced Pre-Boot System Assessment (ePSA) diagnostics

 **CAUTION:** Use the ePSA diagnostics to test only your computer. Using this program with other computers may cause invalid results or error messages.

The ePSA diagnostics (also known as system diagnostics) performs a complete check of your hardware. The ePSA is embedded with the BIOS and is launched by the BIOS internally. The embedded system diagnostics provides a set of options for particular devices or device groups allowing you to:

- Run tests automatically or in an interactive mode
- Repeat tests
- Display or save test results
- Run thorough tests to introduce additional test options to provide extra information about the failed device(s)
- View status messages that inform you if tests are completed successfully

- View error messages that inform you of problems encountered during testing

NOTE: Some tests for specific devices require user interaction. Always ensure that you are present at the computer terminal when the diagnostic tests are performed.

Running the ePSA diagnostics

1. Turn on your computer.
2. As the computer boots, press the F12 key as the Dell logo appears.
3. On the boot menu screen, select the **Diagnostics** option.
4. Click the arrow at the bottom left corner.
Diagnostics front page is displayed.
5. Click the arrow in the lower-right corner to go to the page listing.
The items detected are listed.
6. To run a diagnostic test on a specific device, press Esc and click **Yes** to stop the diagnostic test.
7. Select the device from the left pane and click **Run Tests**.
8. If there are any issues, error codes are displayed.
Note the error code and validation number and contact Dell.

System diagnostic lights

Battery-status light

Indicates the power and battery-charge status.

Solid white — Power adapter is connected and the battery has more than 5 percent charge.

Amber — Computer is running on battery and the battery has less than 5 percent charge.

Off

- Power adapter is connected and the battery is fully charged.
- Computer is running on battery and the battery has more than 5 percent charge.
- Computer is in sleep state, hibernation, or turned off.

The power and battery-status light blinks amber along with beep codes indicating failures.

For example, the power and battery-status light blinks amber two times followed by a pause, and then blinks white three times followed by a pause. This 2,3 pattern continues until the computer is turned off indicating no memory or RAM is detected.

The following table shows different power and battery-status light patterns and associated problems.

Table 8. LED codes

Diagnostic light codes	Problem description
2,1	Processor failure
2,2	System board: BIOS or ROM (Read-Only Memory) failure
2,3	No memory or RAM (Random-Access Memory) detected
2,4	Memory or RAM (Random-Access Memory) failure
2,5	Invalid memory installed
2,6	System-board or chipset error
2,7	Display failure
3,1	Coin-cell battery failure
3,2	PCI, video card/chip failure
3,3	Recovery image not found
3,4	Recovery image found but invalid

Table 8. LED codes (continued)

Diagnostic light codes	Problem description
3,5	Power-rail failure
3,6	System BIOS Flash incomplete
3,7	Management Engine (ME) error

Camera status light: Indicates whether the camera is in use.

- Solid white — Camera is in use.
- Off — Camera is not in use.

Caps Lock status light: Indicates whether Caps Lock is enabled or disabled.

- Solid white — Caps Lock enabled.
- Off — Caps Lock disabled.

WiFi power cycle

If your computer is unable to access the internet due to WiFi connectivity issues a WiFi power cycle procedure may be performed. The following procedure provides the instructions on how to conduct a WiFi power cycle:

 **NOTE:** Some ISPs (Internet Service Providers) provide a modem/router combo device.

1. Turn off your computer.
2. Turn off the modem.
3. Turn off the wireless router.
4. Wait for 30 seconds.
5. Turn on the wireless router.
6. Turn on the modem.
7. Turn on your computer.

Flea power release

Flea power is the residual static electricity that remains on the computer even after it has been powered off and the battery has been removed. The following procedure provides the instructions on how to conduct flea power release:



1. Turn off your computer.
2. Disconnect the power adapter from your computer.
3. Press and hold the power button for 15 seconds to drain the flea power.
4. Connect the power adapter to your computer.
5. Turn on your computer.

Getting help and contacting Dell

Self-help resources

You can get information and help on Dell products and services using these self-help resources:

Table 9. Self-help resources

Self-help resources	Resource location
Information about Dell products and services	www.dell.com
My Dell app	
Tips	
Contact Support	In Windows search, type Contact Support , and press Enter.
Online help for operating system	www.dell.com/support/windows
Troubleshooting information, user manuals, setup instructions, product specifications, technical help blogs, drivers, software updates, and so on.	www.dell.com/support
Dell knowledge base articles for a variety of computer concerns.	<ol style="list-style-type: none"> 1. Go to www.dell.com/support. 2. Type the subject or keyword in the Search box. 3. Click Search to retrieve the related articles.
Learn and know the following information about your product: <ul style="list-style-type: none"> • Product specifications • Operating system • Setting up and using your product • Data backup • Troubleshooting and diagnostics • Factory and system restore • BIOS information 	See <i>Me and My Dell</i> at www.dell.com/support/manuals . To locate the <i>Me and My Dell</i> relevant to your product, identify your product through one of the following: <ul style="list-style-type: none"> • Select Detect Product. • Locate your product through the drop-down menu under View Products. • Enter the Service Tag number or Product ID in the search bar.

Contacting Dell

To contact Dell for sales, technical support, or customer service issues, see www.dell.com/contactdell.

 **NOTE:** Availability varies by country and product, and some services may not be available in your country.

 **NOTE:** If you do not have an active internet connection, you can find contact information on your purchase invoice, packing slip, bill, or Dell product catalog.