

# Inspiron 16 7610

Service Manual for computers with three fans

## Notes, cautions, and warnings

 **NOTE:** A NOTE indicates important information that helps you make better use of your product.

 **CAUTION:** A CAUTION indicates either potential damage to hardware or loss of data and tells you how to avoid the problem.

 **WARNING:** A WARNING indicates a potential for property damage, personal injury, or death.

<b>Chapter 1: Identifying the correct manual for your Inspiron 16 7610.....</b>	<b>6</b>
<b>Chapter 2: Working inside your computer.....</b>	<b>7</b>
Before working inside your computer.....	7
Entering Service Mode.....	7
Safety instructions.....	7
Electrostatic discharge—ESD protection.....	8
ESD field service kit .....	9
Transporting sensitive components.....	10
Exiting Service Mode.....	10
After working inside your computer.....	10
<b>Chapter 3: Removing and installing components.....</b>	<b>11</b>
Recommended tools.....	11
Screw list.....	11
Major components of Inspiron 16 7610.....	12
Base cover.....	14
Removing the base cover.....	14
Installing the base cover.....	15
Memory module.....	17
Removing the memory.....	17
Installing the memory.....	18
Solid-state drive—M.2 slot one.....	20
Removing the M.2 2230 solid-state drive.....	20
Installing the M.2 2230 solid-state drive.....	20
Removing the M.2 2280 solid-state drive.....	21
Installing the M.2 2280 solid-state drive.....	22
Solid-state drive—M.2 slot two.....	23
Removing the M.2 2230 solid-state drive.....	23
Installing the M.2 2230 solid-state drive.....	24
Wireless card.....	25
Removing the wireless card.....	25
Installing the wireless card.....	26
Battery.....	28
Lithium-ion battery precautions.....	28
Removing the battery.....	28
Installing the battery.....	29
Battery cable.....	30
Removing the battery cable.....	30
Installing the battery cable.....	31
Display assembly.....	32
Removing the display assembly.....	32
Installing the display assembly.....	34
I/O board.....	35

Removing the I/O board.....	35
Installing the I/O board.....	36
Fans.....	37
Removing the left fan.....	37
Installing the left fan.....	38
Removing the right fan.....	38
Installing the right fan.....	39
Heat sink.....	40
Removing the heat sink.....	40
Installing the heat sink.....	41
Power-adaptor port.....	42
Removing the power-adaptor port.....	42
Installing the power-adaptor port.....	43
Power-button and fingerprint reader.....	44
Removing the power-button board.....	44
Installing the power-button board.....	45
Power button.....	47
Installing the power button.....	47
Removing the power-button.....	48
Power button with fingerprint reader.....	49
Removing the power-button with fingerprint reader.....	49
Installing the power-button with fingerprint reader.....	50
System board.....	51
Removing the system board.....	51
Installing the system board.....	52
Touchpad.....	55
Removing the touchpad.....	55
Installing the touchpad.....	56
Speakers.....	57
Removing the speakers.....	57
Installing the speakers.....	58
Palm-rest and keyboard assembly.....	59
Removing the palm-rest and keyboard assembly.....	59
Installing the palm-rest and keyboard assembly.....	60

**Chapter 4: Drivers and downloads..... 62**

**Chapter 5: System setup..... 63**

Entering BIOS setup program.....	63
Navigation keys.....	63
Boot Sequence.....	64
System setup options.....	64
System and setup password.....	68
Assigning a system setup password.....	69
Deleting or changing an existing system setup password.....	69
Clearing CMOS settings.....	70
Clearing BIOS (System Setup) and System passwords.....	70
Updating the BIOS.....	70
Updating the BIOS in Windows.....	70

Updating the BIOS using the USB drive in Windows.....	70
Updating the BIOS from the F12 One-Time boot menu.....	71
<b>Chapter 6: Troubleshooting.....</b>	<b>72</b>
Handling swollen Lithium-ion batteries.....	72
<b>Locate the Service Tag or Express Service Code of your Dell computer</b> .....	72
System-diagnostic lights.....	73
SupportAssist   On-board Diagnostics.....	74
Recovering the operating system.....	74
WiFi power cycle.....	74
<b>Chapter 7: Getting help and contacting Dell.....</b>	<b>76</b>

# Identifying the correct manual for your Inspiron 16 7610

The internal layout of the components and the design of the system board of your Inspiron 16 7610 will differ depending on the graphics card configuration you have ordered.

This topic is to help you determine if you are referring to the correct manual when attempting to remove or install components on your computer.

This manual is only applicable for Inspiron 16 7610 computers with three fans installed. This three fan configuration is only available in systems shipped with a NVIDIA GeForce RTX 3060.

To physically identify if your computer is a two fan or three fan configuration follow the procedure in [removing the base cover](#).



# Working inside your computer

## Before working inside your computer

### About this task

 **NOTE:** The images in this document may differ from your computer depending on the configuration you ordered.



### Steps

1. Save and close all open files and exit all open applications.
2. Shut down your computer. Click **Start** >  **Power** > **Shut down**.  
 **NOTE:** If you are using a different operating system, see the documentation of your operating system for shut-down instructions.
3. Disconnect your computer and all attached devices from their electrical outlets.
4. Disconnect all attached network devices and peripherals, such as keyboard, mouse, and monitor from your computer.  
 **CAUTION:** To disconnect a network cable, first unplug the cable from your computer and then unplug the cable from the network device.
5. Remove any media card and optical disc from your computer, if applicable.

## Entering Service Mode

**Service Mode** allows users to immediately cut off electricity from the computer and conduct repairs without disconnecting the battery cable from the system board.

To enter **Service Mode**:

1. Shut down your computer and disconnect the AC adapter.
2. Hold **<B>** key on the keyboard and press the power button for 3 seconds or until the Dell logo appears on the screen.
3. Press any key to continue.  
 **NOTE:** If the power adapter has not been disconnected, a message prompting you to remove the AC adapter appears on the screen. Remove the AC adapter and then press any key to continue the **Service Mode** procedure.  
 **NOTE:** The **Service Mode** procedure automatically skips the following step if the **Owner Tag** of the computer is not set up in advance by the manufacturer.
4. When the ready-to-proceed message appears on the screen, press any key to proceed. The computer emits three short beeps and shuts down immediately.  
Once the computer shuts down, you may perform the replacement procedures without disconnecting the battery cable from the system board.

## Safety instructions

Use the following safety guidelines to protect your computer from potential damage and to ensure your personal safety. Unless otherwise noted, each procedure included in this document assumes that you have read the safety information that shipped with your computer.

 **WARNING:** Before working inside your computer, read the safety information that is shipped with your computer. For more safety best practices, see the Regulatory Compliance home page at [www.dell.com/regulatory\\_compliance](http://www.dell.com/regulatory_compliance).

 **WARNING:** Disconnect your computer from all power sources before opening the computer cover or panels. After you finish working inside the computer, replace all covers, panels, and screws before connecting your computer to an electrical outlet.

 **CAUTION:** To avoid damaging the computer, ensure that the work surface is flat, dry, and clean.

 **CAUTION:** To avoid damaging the components and cards, handle them by their edges, and avoid touching the pins and the contacts.

 **CAUTION:** You should only perform troubleshooting and repairs as authorized or directed by the Dell technical assistance team. Damage due to servicing that is not authorized by Dell is not covered by your warranty. See the safety instructions that is shipped with the product or at [www.dell.com/regulatory\\_compliance](http://www.dell.com/regulatory_compliance).

 **CAUTION:** Before touching anything inside your computer, ground yourself by touching an unpainted metal surface, such as the metal at the back of the computer. While you work, periodically touch an unpainted metal surface to dissipate static electricity which could harm internal components.

 **CAUTION:** When you disconnect a cable, pull it by its connector or its pull tab, not the cable itself. Some cables have connectors with locking tabs or thumbscrews that you must disengage before disconnecting the cable. When disconnecting cables, keep them evenly aligned to avoid bending the connector pins. When connecting cables, ensure that the ports and the connectors are correctly oriented and aligned.

 **CAUTION:** Press and eject any installed card from the media-card reader.

 **CAUTION:** Exercise caution when handling Lithium-ion batteries in laptops. Swollen batteries should not be used and should be replaced and disposed properly.

 **NOTE:** The color of your computer and certain components may appear differently than shown in this document.

## Electrostatic discharge—ESD protection

ESD is a major concern when you handle electronic components, especially sensitive components such as expansion cards, processors, memory DIMMs, and system boards. Very slight charges can damage circuits in ways that may not be obvious, such as intermittent problems or a shortened product life span. As the industry pushes for lower power requirements and increased density, ESD protection is an increasing concern.

Due to the increased density of semiconductors used in recent Dell products, the sensitivity to static damage is now higher than in previous Dell products. For this reason, some previously approved methods of handling parts are no longer applicable.

Two recognized types of ESD damage are catastrophic and intermittent failures.

- **Catastrophic** – Catastrophic failures represent approximately 20 percent of ESD-related failures. The damage causes an immediate and complete loss of device functionality. An example of catastrophic failure is a memory DIMM that has received a static shock and immediately generates a "No POST/No Video" symptom with a beep code emitted for missing or nonfunctional memory.
- **Intermittent** – Intermittent failures represent approximately 80 percent of ESD-related failures. The high rate of intermittent failures means that most of the time when damage occurs, it is not immediately recognizable. The DIMM receives a static shock, but the tracing is merely weakened and does not immediately produce outward symptoms related to the damage. The weakened trace may take weeks or months to melt, and in the meantime may cause degradation of memory integrity, intermittent memory errors, etc.

The more difficult type of damage to recognize and troubleshoot is the intermittent (also called latent or "walking wounded") failure.

Perform the following steps to prevent ESD damage:

- Use a wired ESD wrist strap that is properly grounded. The use of wireless anti-static straps is no longer allowed; they do not provide adequate protection. Touching the chassis before handling parts does not ensure adequate ESD protection on parts with increased sensitivity to ESD damage.
- Handle all static-sensitive components in a static-safe area. If possible, use anti-static floor pads and workbench pads.

- When unpacking a static-sensitive component from its shipping carton, do not remove the component from the anti-static packing material until you are ready to install the component. Before unwrapping the anti-static packaging, ensure that you discharge static electricity from your body.
- Before transporting a static-sensitive component, place it in an anti-static container or packaging.

## ESD field service kit

The unmonitored Field Service kit is the most commonly used service kit. Each Field Service kit includes three main components: anti-static mat, wrist strap, and bonding wire.

### Components of an ESD field service kit

The components of an ESD field service kit are:

- **Anti-Static Mat** – The anti-static mat is dissipative and parts can be placed on it during service procedures. When using an anti-static mat, your wrist strap should be snug and the bonding wire should be connected to the mat and to any bare metal on the system being worked on. Once deployed properly, service parts can be removed from the ESD bag and placed directly on the mat. ESD-sensitive items are safe in your hand, on the ESD mat, in the system, or inside a bag.
- **Wrist Strap and Bonding Wire** – The wrist strap and bonding wire can be either directly connected between your wrist and bare metal on the hardware if the ESD mat is not required, or connected to the anti-static mat to protect hardware that is temporarily placed on the mat. The physical connection of the wrist strap and bonding wire between your skin, the ESD mat, and the hardware is known as bonding. Use only Field Service kits with a wrist strap, mat, and bonding wire. Never use wireless wrist straps. Always be aware that the internal wires of a wrist strap are prone to damage from normal wear and tear, and must be checked regularly with a wrist strap tester in order to avoid accidental ESD hardware damage. It is recommended to test the wrist strap and bonding wire at least once per week.
- **ESD Wrist Strap Tester** – The wires inside of an ESD strap are prone to damage over time. When using an unmonitored kit, it is a best practice to regularly test the strap prior to each service call, and at a minimum, test once per week. A wrist strap tester is the best method for doing this test. If you do not have your own wrist strap tester, check with your regional office to find out if they have one. To perform the test, plug the wrist-strap's bonding-wire into the tester while it is strapped to your wrist and push the button to test. A green LED is lit if the test is successful; a red LED is lit and an alarm sounds if the test fails.
- **Insulator Elements** – It is critical to keep ESD sensitive devices, such as plastic heat sink casings, away from internal parts that are insulators and often highly charged.
- **Working Environment** – Before deploying the ESD Field Service kit, assess the situation at the customer location. For example, deploying the kit for a server environment is different than for a desktop or portable environment. Servers are typically installed in a rack within a data center; desktops or portables are typically placed on office desks or cubicles. Always look for a large open flat work area that is free of clutter and large enough to deploy the ESD kit with additional space to accommodate the type of system that is being repaired. The workspace should also be free of insulators that can cause an ESD event. On the work area, insulators such as Styrofoam and other plastics should always be moved at least 12 inches or 30 centimeters away from sensitive parts before physically handling any hardware components
- **ESD Packaging** – All ESD-sensitive devices must be shipped and received in static-safe packaging. Metal, static-shielded bags are preferred. However, you should always return the damaged part using the same ESD bag and packaging that the new part arrived in. The ESD bag should be folded over and taped shut and all the same foam packing material should be used in the original box that the new part arrived in. ESD-sensitive devices should be removed from packaging only at an ESD-protected work surface, and parts should never be placed on top of the ESD bag because only the inside of the bag is shielded. Always place parts in your hand, on the ESD mat, in the system, or inside an anti-static bag.
- **Transporting Sensitive Components** – When transporting ESD sensitive components such as replacement parts or parts to be returned to Dell, it is critical to place these parts in anti-static bags for safe transport.

### ESD protection summary

It is recommended to use the traditional wired ESD grounding wrist strap and protective anti-static mat at all times when servicing Dell products. In addition, it is critical to keep sensitive parts separate from all insulator parts while performing service and that they use anti-static bags for transporting sensitive components.

# Transporting sensitive components

When transporting ESD sensitive components such as replacement parts or parts to be returned to Dell, it is critical to place these parts in anti-static bags for safe transport.

## Lifting equipment

Adhere to the following guidelines when lifting heavy weight equipment:

 **CAUTION: Do not lift greater than 50 pounds. Always obtain additional resources or use a mechanical lifting device.**

1. Get a firm balanced footing. Keep your feet apart for a stable base, and point your toes out.
2. Tighten stomach muscles. Abdominal muscles support your spine when you lift, offsetting the force of the load.
3. Lift with your legs, not your back.
4. Keep the load close. The closer it is to your spine, the less force it exerts on your back.
5. Keep your back upright, whether lifting or setting down the load. Do not add the weight of your body to the load. Avoid twisting your body and back.
6. Follow the same techniques in reverse to set the load down.

## Exiting Service Mode

**Service Mode** allows users to immediately cut off electricity from the computer and conduct repairs without disconnecting the battery cable from the system board.

To exit **Service Mode**:

1. Connect the AC adapter to the power-adapter port on your computer.
2. Press the power button to turn on the computer. Your computer will automatically return to normal functioning mode.

## After working inside your computer

### About this task

 **CAUTION: Leaving stray or loose screws inside your computer may severely damage your computer.**

### Steps

1. Replace all screws and ensure that no stray screws remain inside your computer.
2. Connect any external devices, peripherals, or cables you removed before working on your computer.
3. Replace any media cards, discs, or any other parts that you removed before working on your computer.
4. Connect your computer and all attached devices to their electrical outlets.
5. Turn on your computer.

# Removing and installing components

**NOTE:** The images in this document may differ from your computer depending on the configuration you ordered.

## Recommended tools

The procedures in this document may require the following tools:

- Phillips screwdriver #0/#1
- Plastic scribe









## Screw list

**NOTE:** When removing screws from a component, it is recommended to note the screw type, the quantity of screws, and then place them in a screw storage box. This is to ensure that the correct number of screws and correct screw type is restored when the component is replaced.







**NOTE:** Some computers have magnetic surfaces. Ensure that the screws are not left attached to such surfaces when replacing a component.

**NOTE:** Screw color may vary with the configuration ordered.

**Table 1. Screw list**

Component	Secured to	Screw type	Quantity	Screw image
Base cover	Palm-rest and keyboard assembly	M2x4	7	
Base cover	Palm-rest and keyboard assembly	M2x8.5 (captive)	2	
Battery	Palm-rest and keyboard assembly	M2x3	5	
Solid-state drive	Palm-rest and keyboard assembly	M2x3	1 per solid-state drive	
Left fan	Palm-rest and keyboard assembly	M2x5	2	
Right fan	Palm-rest and keyboard assembly	M2x5 M2x5	2	
Wireless card	System board	M2x3	1	
Touchpad	Palm-rest and keyboard assembly	M2x2	2	
Touchpad bracket	Palm-rest and keyboard assembly	M2x2	2	

**Table 1. Screw list (continued)**

<b>Component</b>	<b>Secured to</b>	<b>Screw type</b>	<b>Quantity</b>	<b>Screw image</b>
Power-button with optional fingerprint reader	Palm-rest and keyboard assembly	M2x3	1	
Type-C port bracket	System board	M2x5	2	
Display hinges	Palm-rest and keyboard assembly	M2.5x5	6	
Power-button board	Palm-rest and keyboard assembly	M2x3	1	
I/O board	Palm-rest and keyboard assembly	M2x3	2	
System board	Palm-rest and keyboard assembly	M2x2	1	
System board	Palm-rest and keyboard assembly	M2x3	2	

## Major components of Inspiron 16 7610

The following image shows the major components of Inspiron 16 7610.

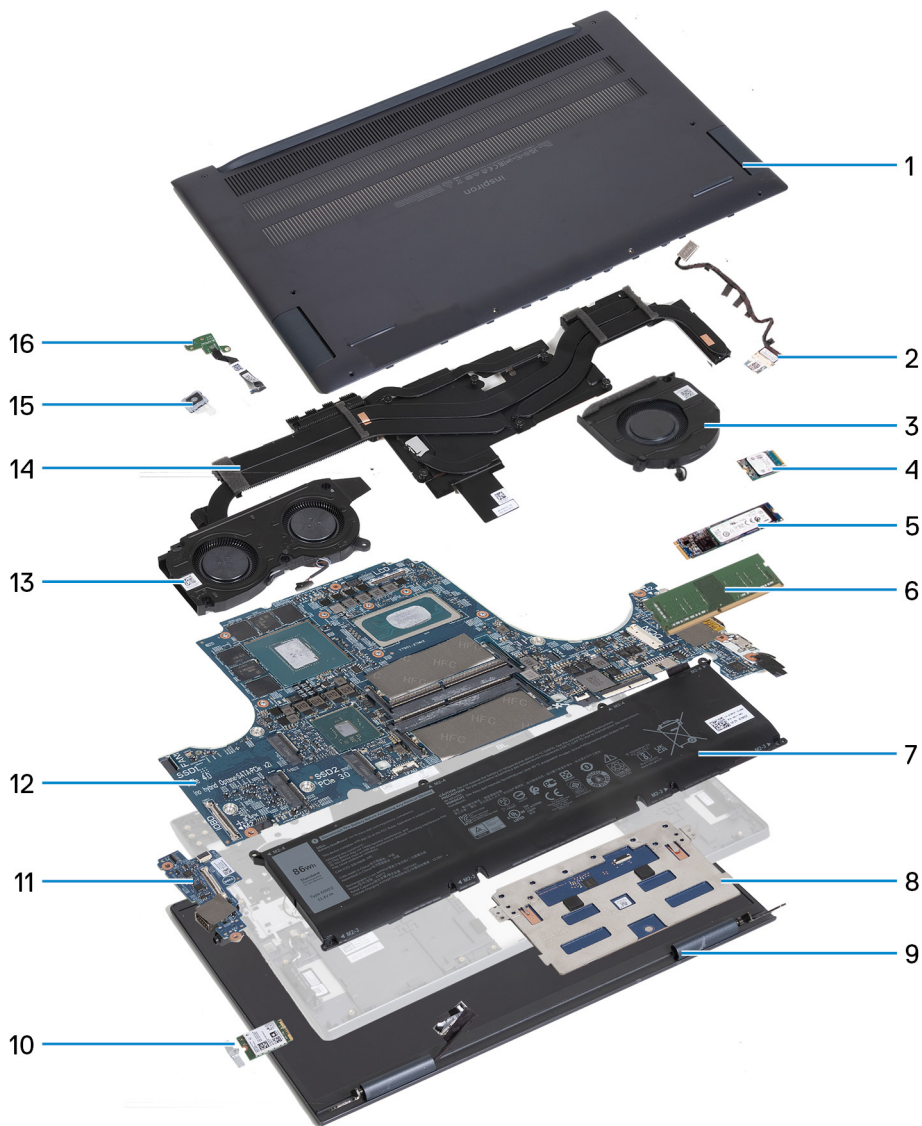

1. Base cover
2. Power-adaptor port
3. Right fan
4. M.2 2230 solid-state drive, if installed
5. M.2 2280 solid-state drive, if installed
6. System board
7. Battery
8. Touchpad
9. Display assembly
10. Wireless card and wireless-card bracket
11. I/O board
12. Memory
13. Left fan
14. Heat sink
15. Power-button with optional fingerprint-reader
16. Power-button board

**i NOTE:** Dell provides a list of components and their part numbers for the original system configuration purchased. These parts are available according to warranty coverages purchased by the customer. Contact your Dell sales representative for purchase options.

# Base cover

## Removing the base cover

### Prerequisites

1. Follow the procedure in [Before working inside your computer](#).
2. Enter [Service Mode](#).

### About this task

**NOTE:** Before removing the base cover, ensure that there is no micro-SD card installed in the micro-SD card slot on your computer.

The following image(s) indicate the location of the base cover and provides a visual representation of the removal procedure.

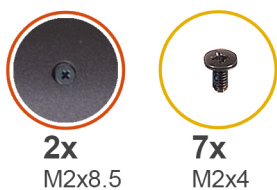

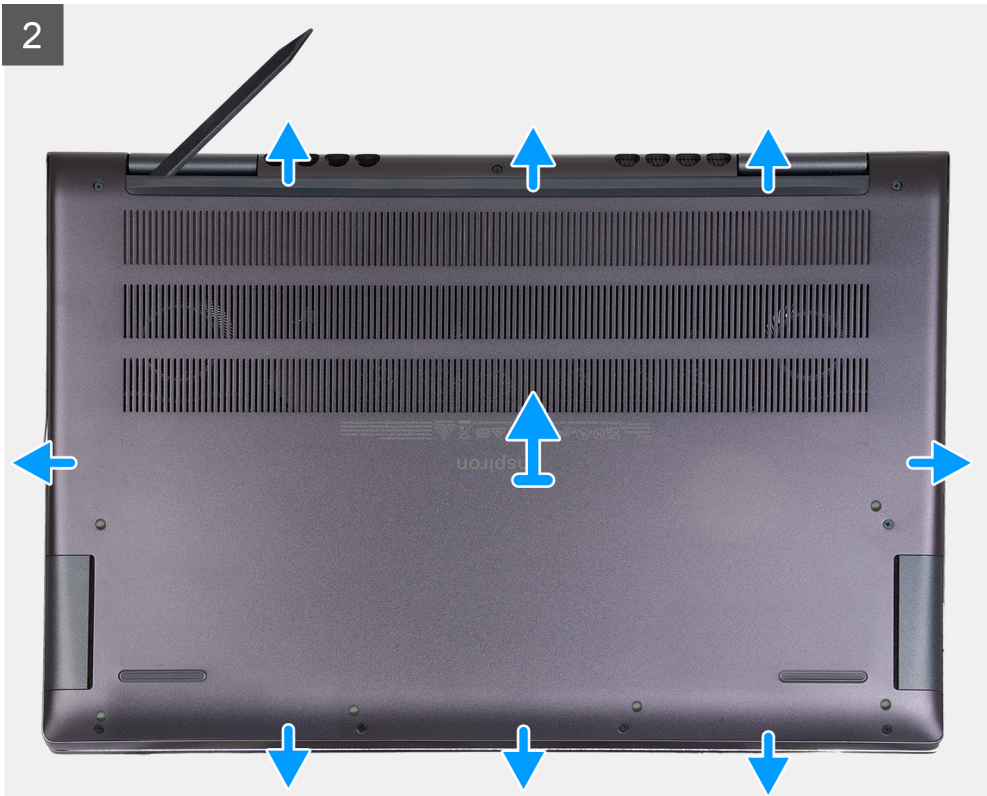

### Steps

1. Remove the seven screws (M2x4) that secure the base cover to the palm-rest and keyboard assembly.
2. Loosen the two captive screws (M2x8.5) that secure the base cover to the palm-rest and keyboard assembly.
3. Using a plastic scribe, pry the base cover from the top left at the hinge and continue to work on the sides to open the base cover.
4. Lift the base cover off the palm-rest and keyboard assembly.

## Installing the base cover

### Prerequisites

If you are replacing a component, remove the existing component before performing the installation process.

### About this task

The following image(s) indicate the location of the base cover and provides a visual representation of the installation procedure.



2x



6x  
M2x4

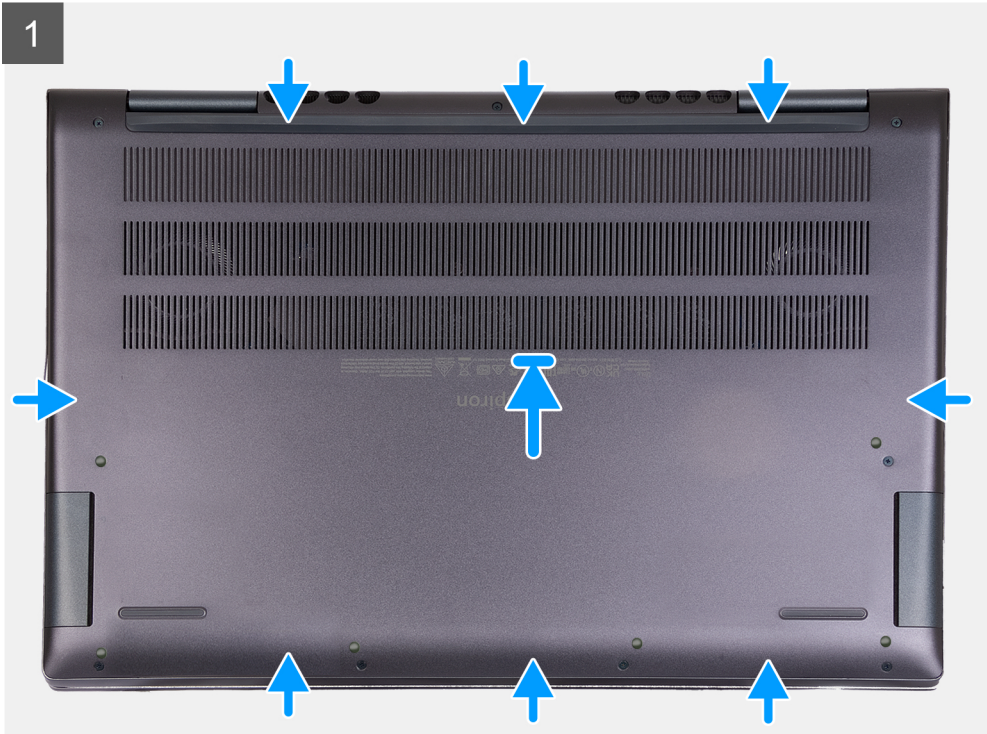

### Steps

1. Place and snap the base cover into place on the palm-rest and keyboard assembly.

2. Tighten the two captive screws (M2x8.5) that secure the base cover to the palm-rest and keyboard assembly.
3. Replace the seven screws (M2x4) that secure the base cover to the palm-rest and keyboard assembly.

#### **Next steps**

1. Exit [Service Mode](#).
2. Follow the procedure in [After working inside your computer](#).

## **Memory module**

### **Removing the memory**

#### **Prerequisites**

1. Follow the procedure in [Before working inside your computer](#).
2. Enter [Service Mode](#).
3. Remove the [base cover](#).

#### **About this task**

The following image(s) indicate the location of the memory and provides a visual representation of the removal procedure.

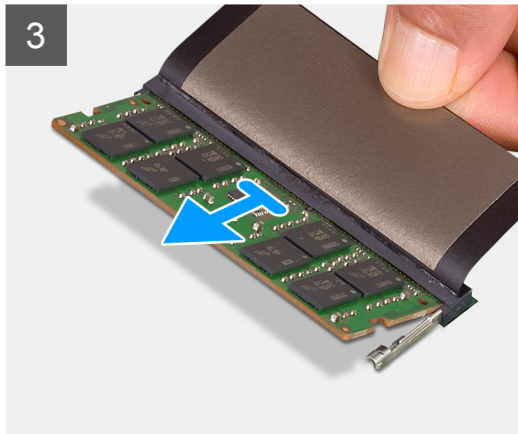
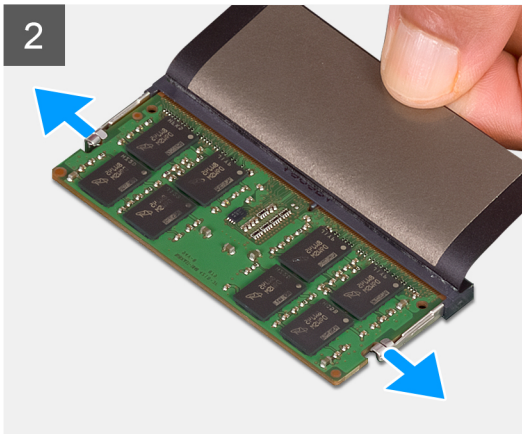
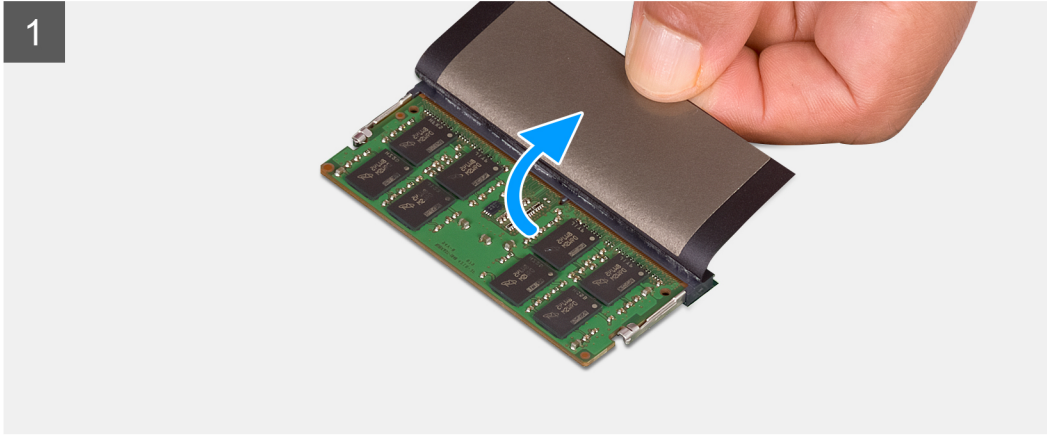
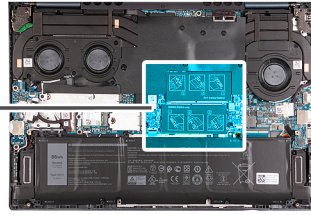
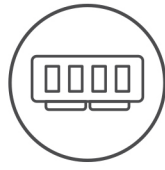

### Steps

1. Lift the Mylar to access the memory module.
2. Using your fingertips, carefully spread apart the securing-clips on each end of the memory-module slot until the memory module pops-up.
3. Remove the memory module from the memory-module slot on the system board.

**NOTE:** Your computer may have up to two memory modules installed. Repeat steps 1 to 3 if there is a second memory module installed.

## Installing the memory

### Prerequisites

If you are replacing a component, remove the existing component before performing the installation process.

### About this task

The following image(s) indicate the location of the memory and provides a visual representation of the installation procedure.

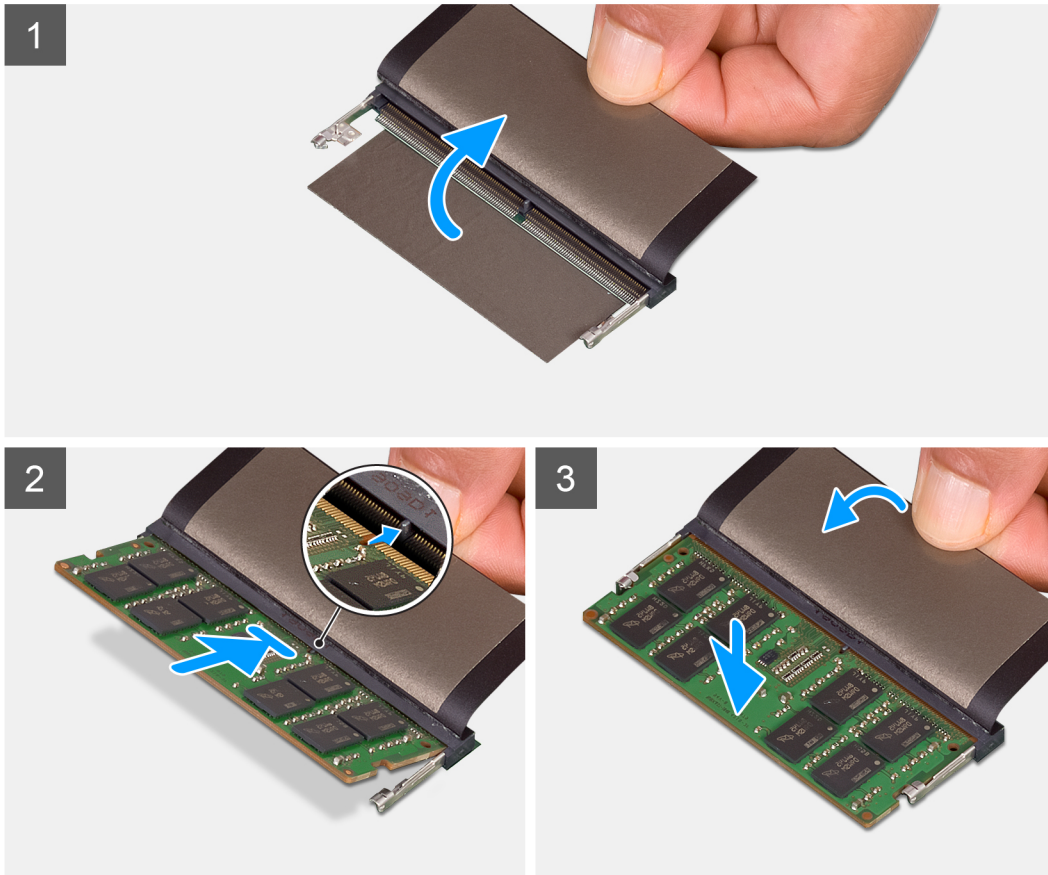
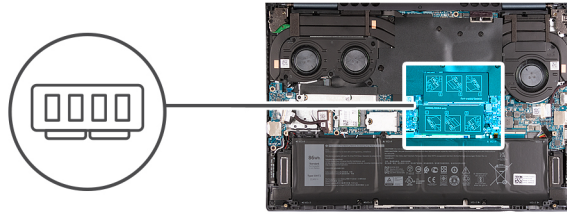

### Steps

1. Lift the Mylar to access the memory-module slot.
2. Align the notch on the memory module with the tab on the memory-module slot on the system board.
3. Slide the memory module into the memory-module slot on the system board.
4. Press down on the memory module till the securing clips click, locking the memory module in place.

**i** **NOTE:** Repeat steps 1 to 4 for each memory module being installed into your computer.

### Next steps

1. Install the [base cover](#).
2. Exit [Service Mode](#).
3. Follow the procedure in [After working inside your computer](#).

# Solid-state drive—M.2 slot one

## Removing the M.2 2230 solid-state drive

### Prerequisites

1. Follow the procedure in [Before working inside your computer](#).
2. Enter [Service Mode](#).
3. Remove the [base cover](#).

### About this task

**NOTE:** This procedure applies only to computers shipped with an M.2 2230 solid-state drive installed in M.2 slot one.

**NOTE:** The M.2 card installed on M.2 slot one will depend on the configuration ordered. Supported card configurations on the M.2 card slot:

- M.2 2230 solid-state drive + M.2 2230 mounting bracket
- M.2 2280 solid-state drive

The following image(s) indicate the location of the M.2 2230 solid-state drive and provides a visual representation of the removal procedure.



1x  
M2x3

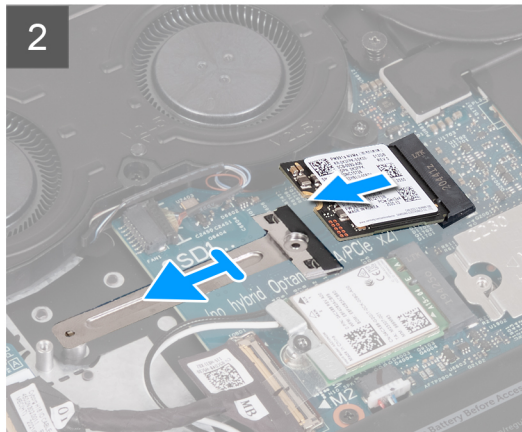
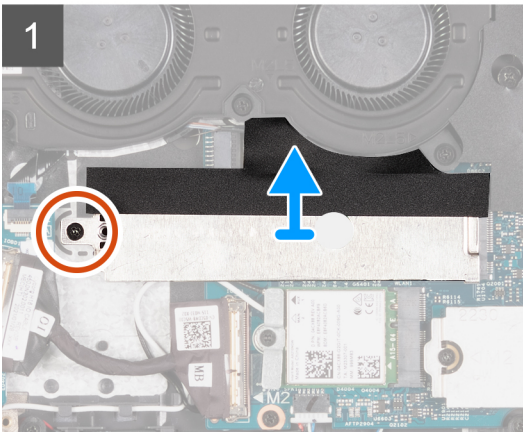
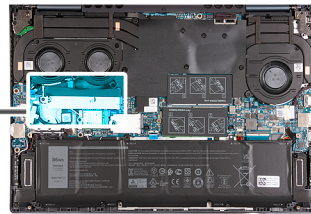

### Steps

1. Remove the screw (M2x3) that secures the M.2 thermal shield to the system board.
2. Slide and lift the M.2 thermal shield off the system board.
3. Lift the M.2 2230 bracket off the system board.
4. Slide and lift the M.2 2230 solid-state drive off the system board.

## Installing the M.2 2230 solid-state drive

### Prerequisites

If you are replacing a component, remove the existing component before performing the installation process.

## About this task

**NOTE:** This procedure applies if you are installing a M.2 2230 solid-state drive into M.2 slot one.

**NOTE:** Supported card configurations on M.2 slot one:

- M.2 2230 solid-state drive + M.2 2230 mounting bracket
- M.2 2280 solid-state drive

**NOTE:** If you are replacing a M.2 2280 solid-state drive with a M.2 2230 solid-state drive, contact Dell Support to purchase the M.2 2230 mounting bracket.

The following image(s) indicate the location of the M.2 2230 solid-state drive and provides a visual representation of the installation procedure.

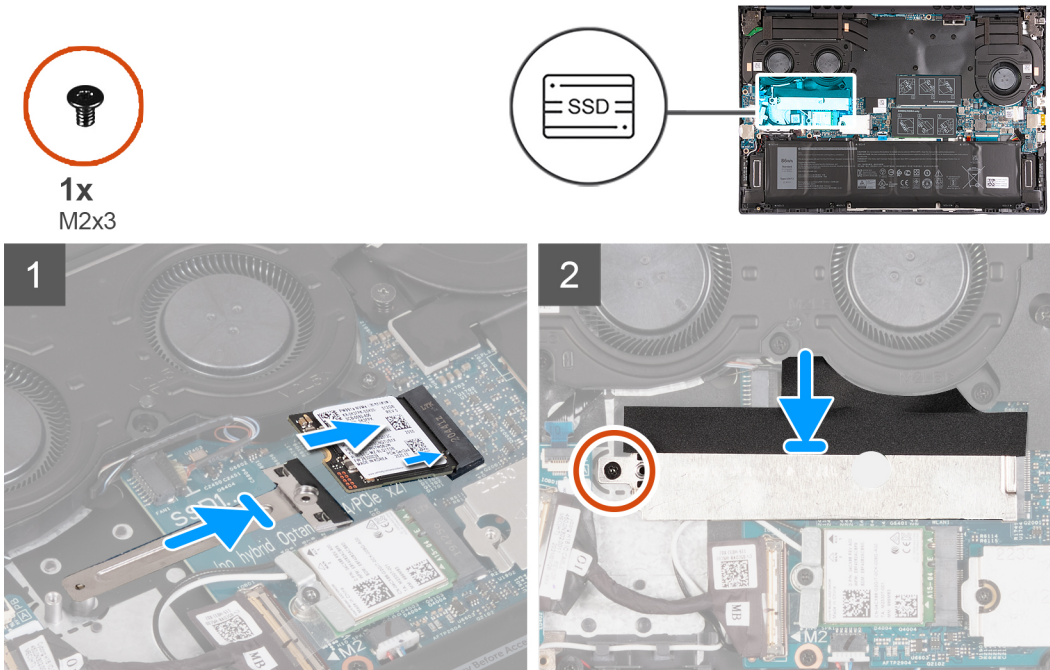

## Steps

1. Align the notch on the M.2 2230 solid-state drive with the tab on the M.2 card slot on the system board.
2. Slide the M.2 2230 solid-state drive into the M.2 card slot on the system board.
3. Align the notch on the M.2 2230 solid-state drive with the securing peg on the M.2 2230 bracket and clamp the M.2 2230 solid-state drive in place.
4. Slide the tab on the M.2 thermal shield into the M.2 card slot and align the screw hole on the thermal shield to the screw hole on the M.2 2230 bracket.
5. Replace the screw (M2x3) that secures the M.2 thermal shield to the palm-rest and keyboard assembly.

## Next steps

1. Install the [base cover](#).
2. Exit [Service Mode](#).
3. Follow the procedure in [After working inside your computer](#).

## Removing the M.2 2280 solid-state drive

### Prerequisites

1. Follow the procedure in [Before working inside your computer](#).
2. Enter [Service Mode](#).
3. Remove the [base cover](#).

### About this task

**NOTE:** This procedure applies only to computers shipped with an M.2 2280 solid-state drive installed in M.2 slot one.

**NOTE:** The M.2 card installed on M.2 slot one will depend on the configuration ordered. Supported card configurations on the M.2 card slot:

- M.2 2230 solid-state drive + M.2 2230 mounting bracket
- M.2 2280 solid-state drive

The following image(s) indicate the location of the M.2 2280 solid-state drive and provides a visual representation of the removal procedure.

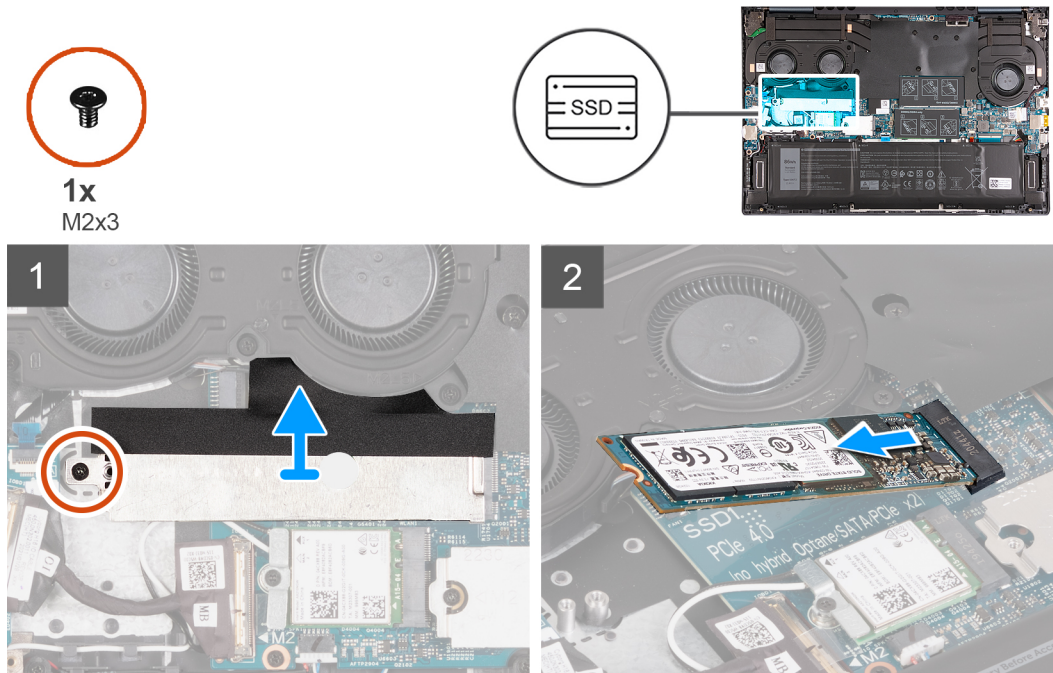

### Steps

1. Remove the screw (M2x3) that secures the M.2 thermal shield to the system board.
2. Slide and lift the M.2 thermal shield from the M.2 card slot on the system board.
3. Slide and lift the M.2 2280 solid-state drive from the M.2 card slot on the system board.

## Installing the M.2 2280 solid-state drive

### Prerequisites

If you are replacing a component, remove the existing component before performing the installation process.

### About this task

**NOTE:** This procedure applies if you are installing a M.2 2280 solid-state drive into M.2 slot one.

**NOTE:** Supported card configurations on M.2 slot one:

- M.2 2230 solid-state drive + M.2 2230 mounting bracket
- M.2 2280 solid-state drive

**NOTE:** When installing a M.2 2280 NVMe Gen4.0 x4 solid-state drive, you may order a copper thermal shield from Dell support for better thermal performance.

The following image(s) indicate the location of the M.2 2280 solid-state drive and provides a visual representation of the installation procedure.



1x  
M2x3

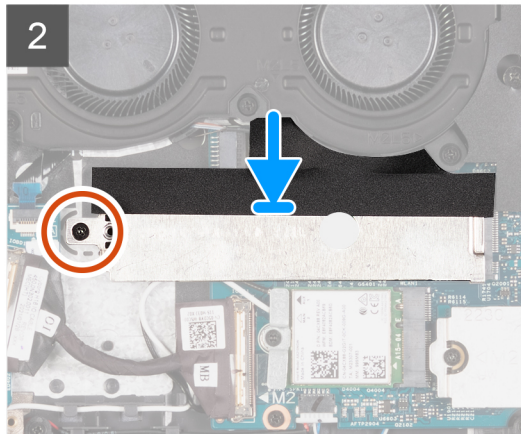
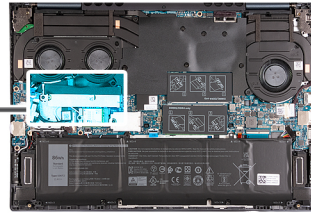

### Steps

1. Align the notch on the M.2 2280 solid-state drive with the tab on the M.2 card slot on the system board.
2. Slide the M.2 2280 solid-state drive into the M.2 card slot on the system board.
3. Slide the tab on the M.2 thermal shield into the M.2 card slot and align the screw hole on the thermal shield to the screw hole on the system board.
4. Replace the screw (M2x3) that secures the M.2 2280 solid-state drive to the system board.

### Next steps

1. Install the [base cover](#).
2. Exit [Service Mode](#).
3. Follow the procedure in [After working inside your computer](#).

## Solid-state drive—M.2 slot two

### Removing the M.2 2230 solid-state drive

#### Prerequisites

1. Follow the procedure in [Before working inside your computer](#).
2. Enter [Service Mode](#).
3. Remove the [base cover](#).

#### About this task

 **NOTE:** This procedure applies only to computers shipped with an M.2 2230 solid-state drive installed in M.2 slot two.

The following image(s) indicate the location of the M.2 2230 solid-state drive and provides a visual representation of the removal procedure.



1x  
M2x3

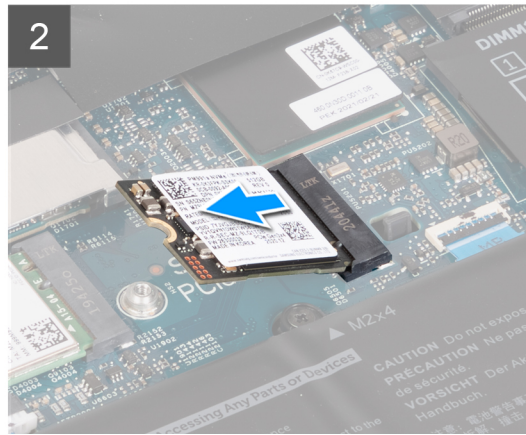
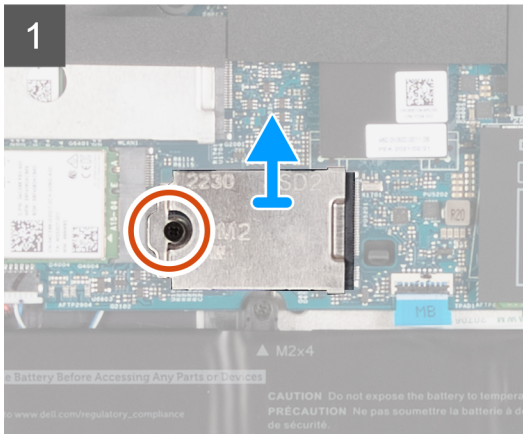
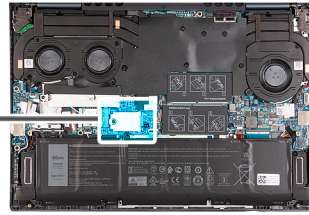

### Steps

1. Remove the screw (M2x3) that secures the M.2 2230 solid-state drive and M.2 2230 thermal shield to the system board.
2. Slide and lift the M.2 2230 thermal shield off the system board.
3. Slide and lift the M.2 2230 solid-state drive off the system board.

## Installing the M.2 2230 solid-state drive

### Prerequisites

If you are replacing a component, remove the existing component before performing the installation process.

### About this task

**NOTE:** M.2 card slot two can only support an M.2 2230 solid-state drive.

The following image(s) indicate the location of the M.2 2230 solid-state drive and provides a visual representation of the installation procedure.



1x  
M2x3

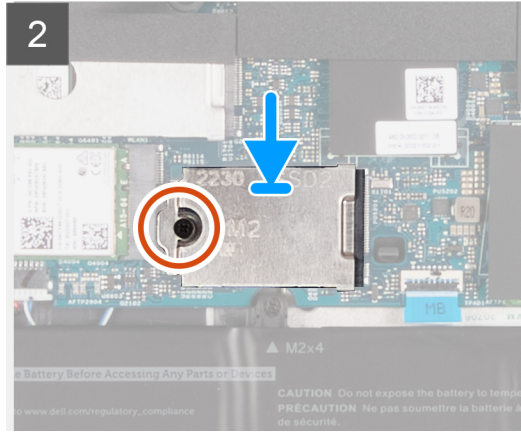
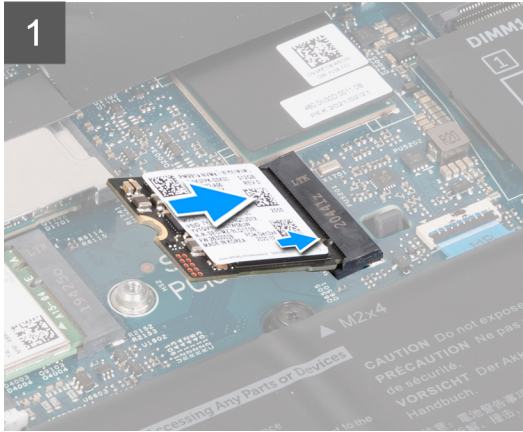
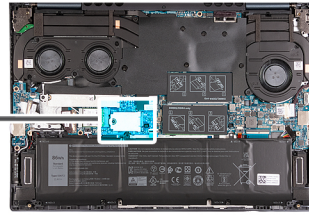

### Steps

1. Align the notch on the M.2 2230 solid-state drive with the tab on the M.2 card slot on the system board.
2. Slide the M.2 2230 solid-state drive into the M.2 card slot on the system board.
3. Slide the tab on the M.2 2230 thermal shield into the M.2 card slot and align the screw hole on the thermal shield to the screw hole on the system board.
4. Replace the screw (M2x3) that secures the M.2 2230 thermal shield to the system board.

### Next steps

1. Install the [base cover](#).
2. Exit [Service Mode](#).
3. Follow the procedure in [After working inside your computer](#).

## Wireless card

### Removing the wireless card

#### Prerequisites

1. Follow the procedure in [Before working inside your computer](#).
2. Enter [Service Mode](#).
3. Remove the [base cover](#).

#### About this task

The following image(s) indicate the location of the wireless card and provides a visual representation of the removal procedure.



1x  
M2x3

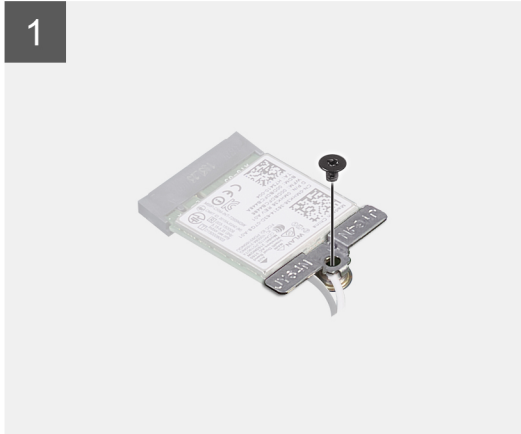
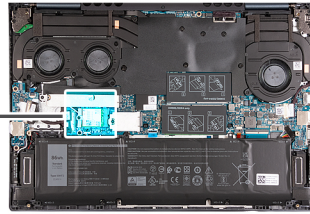

### Steps

1. Remove the screw (M2x3) that secures the wireless-card bracket to the wireless card and system board.
2. Lift the wireless-card bracket off the wireless card.
3. Disconnect the antenna cables from the wireless card.
4. Slide and remove the wireless card from the M.2 card slot on the system board.

## Installing the wireless card

### Prerequisites

If you are replacing a component, remove the existing component before performing the installation process.

### About this task

The following image(s) indicate the location of the wireless card and provides a visual representation of the installation procedure.



1x  
M2x3

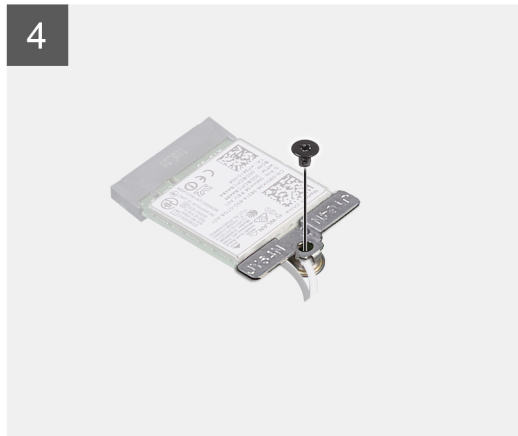
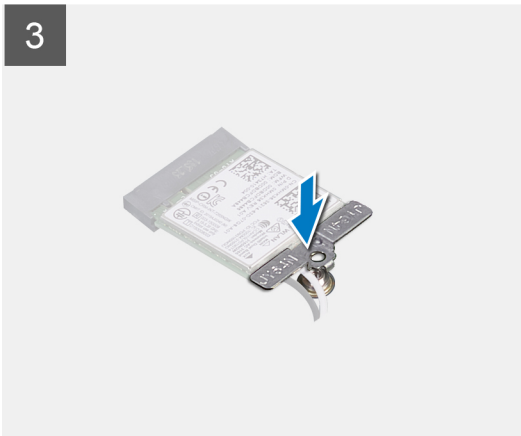
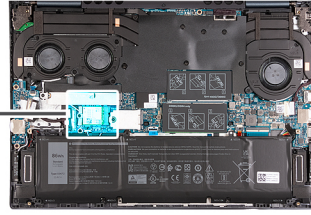

### Steps

1. Connect the antenna cables to the wireless card.

**Table 2. Antenna-cable color scheme**

Connectors on the wireless card	Antenna-cable color	Silkscreen marking	
Main	White	MAIN	△ (white triangle)
Auxiliary	Black	AUX	▲ (black triangle)

2. Place the wireless-card bracket on the wireless card.
3. Align the notch on the wireless card with the tab on the M.2 card slot on the system board.
4. Slide the wireless card into the M.2 card slot on the system board.
5. Replace the screw (M2x3) that secures the wireless card and wireless-card bracket to the system board.

### Next steps

1. Install the [base cover](#).
2. Exit [Service Mode](#).
3. Follow the procedure in [After working inside your computer](#).

# Battery

## Lithium-ion battery precautions

### ⚠ CAUTION:

- Exercise caution when handling Lithium-ion batteries.
- Discharge the battery completely before removing it. Disconnect the AC power adapter from the system and operate the computer solely on battery power—the battery is fully discharged when the computer no longer turns on when the power button is pressed.
- Do not crush, drop, mutilate, or penetrate the battery with foreign objects.
- Do not expose the battery to high temperatures, or disassemble battery packs and cells.
- Do not apply pressure to the surface of the battery.
- Do not bend the battery.
- Do not use tools of any kind to pry on or against the battery.
- Ensure any screws during the servicing of this product are not lost or misplaced, to prevent accidental puncture or damage to the battery and other system components.
- If the battery gets stuck inside your computer as a result of swelling, do not try to release it as puncturing, bending, or crushing a lithium-ion battery can be dangerous. In such an instance, contact Dell technical support for assistance. See [www.dell.com/contactdell](http://www.dell.com/contactdell).
- Always purchase genuine batteries from [www.dell.com](http://www.dell.com) or authorized Dell partners and resellers.
- Swollen batteries should not be used and should be replaced and disposed properly. For guidelines on how to handle and replace swollen Lithium-ion batteries, see [Handling swollen Lithium-ion batteries](#).

## Removing the battery

### Prerequisites

1. Follow the procedure in [Before working inside your computer](#).
2. Remove the [base cover](#).

### About this task

 **NOTE:** This procedure applies to both 3-cell and 6-cell battery configurations that may be installed in your computer.

The following image(s) indicate the location of the battery and provides a visual representation of the removal procedure.



5x  
M2x3

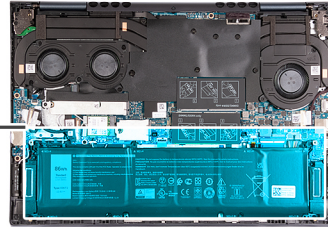
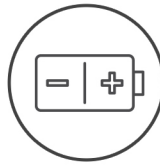

## Steps

1. Peel the tape that secures the battery cable to the battery.
2. Disconnect the battery cable from the system board.
3. Remove the five screws (M2x3) that secure the battery to the palm-rest and keyboard assembly.
4. Lift the battery off the palm-rest and keyboard assembly.

## Installing the battery

### Prerequisites

If you are replacing a component, remove the existing component before performing the installation process.

### About this task

**NOTE:** This procedure applies to both 3-cell and 6-cell battery configurations that can be installed in your computer.

The following image(s) indicate the location of the battery and provides a visual representation of the installation procedure.

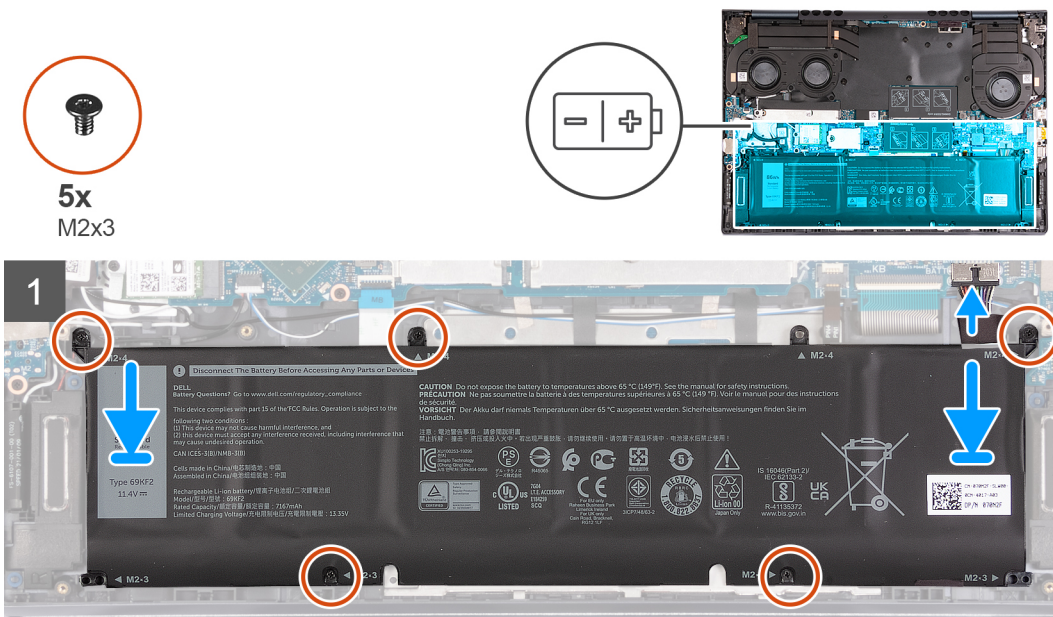

## Steps

1. Align the screw holes on the battery with the screw holes on the palm-rest and keyboard assembly.
2. Replace the five screws (M2x3) that secure the battery to the palm-rest and keyboard assembly.

**i NOTE:** As this battery is leveraged for use across multiple products, the printed screw information is not accurately reflecting the actual size of the screws used. This system only uses M2x3; it is correct to install the M2x3 screws into the screw holes marked with M2x4.

3. Connect the battery cable to the system board.
4. Adhere the tape that secures the battery cable to the battery.

## Next steps

1. Install the [base cover](#).
2. Follow the procedure in [After working inside your computer](#).

# Battery cable

## Removing the battery cable

### Prerequisites

1. Follow the procedure in [Before working inside your computer](#).
2. Remove the [base cover](#).
3. Remove the [battery](#).

### About this task

The following image(s) indicate the location of the battery cable and provides a visual representation of the removal procedure.

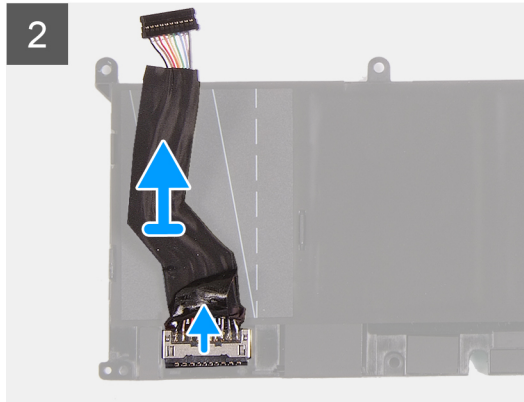
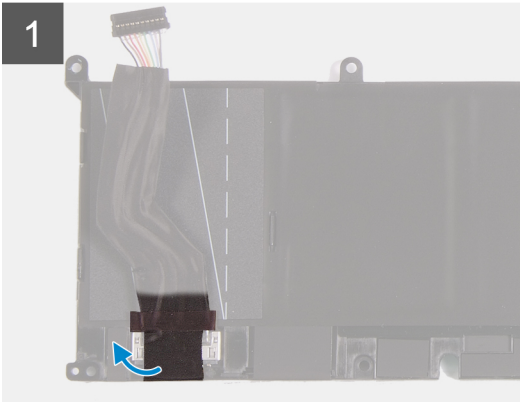

### Steps

1. Turn the battery over.
2. Peel the battery cable off the battery.
3. Disconnect the battery cable from the battery.
4. Lift the battery cable off the battery.

## Installing the battery cable

### Prerequisites

If you are replacing a component, remove the existing component before performing the installation process.

### About this task

The following image(s) indicate the location of the battery cable and provides a visual representation of the installation procedure.

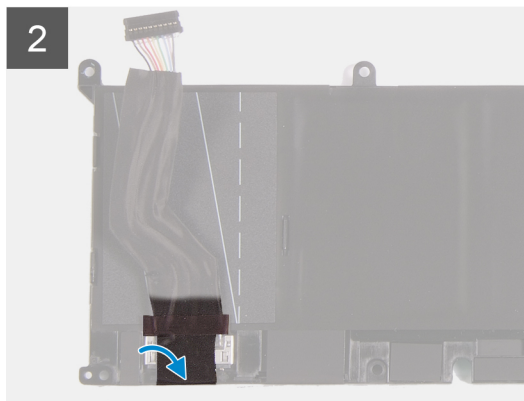
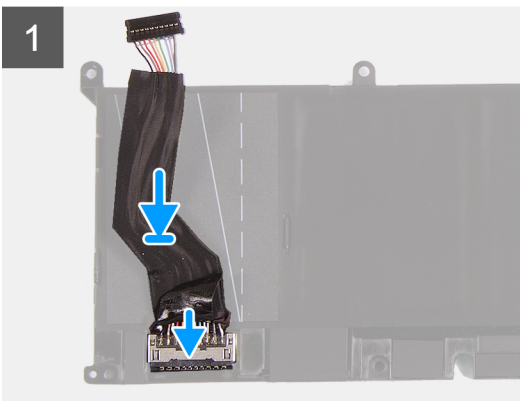

### Steps

1. Connect the battery cable to the battery.
2. Adhere the battery cable to the battery.
3. Turn the battery over.

### Next steps

1. Install the [base cover](#).
2. Follow the procedure in [After working inside your computer](#).

## Display assembly

### Removing the display assembly

#### Prerequisites

1. Follow the procedure in [Before working inside your computer](#).
2. Enter [Service Mode](#).
3. Remove the [base cover](#).

#### About this task

The following image(s) indicate the location of the display assembly and provides a visual representation of the removal procedure.



6x  
M2x5.5

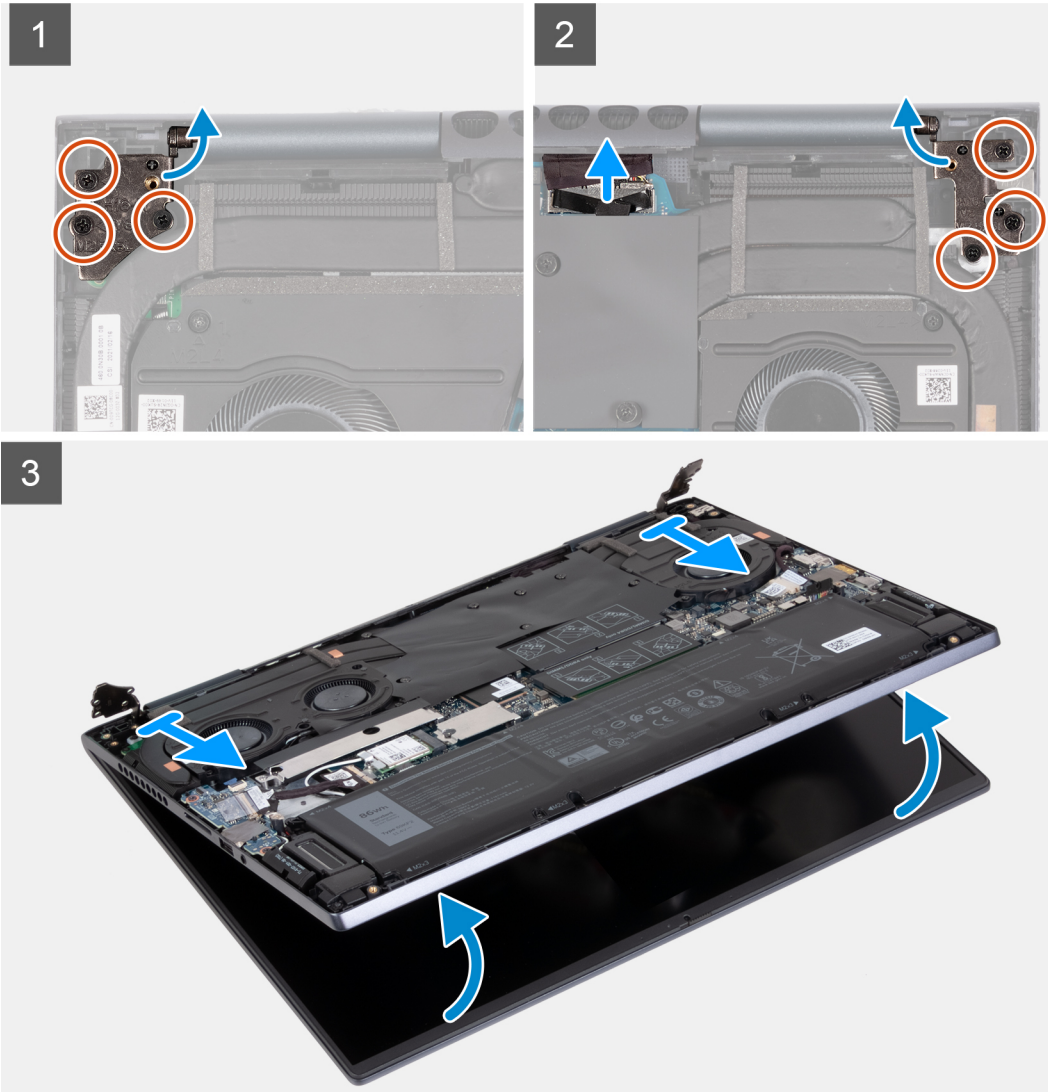
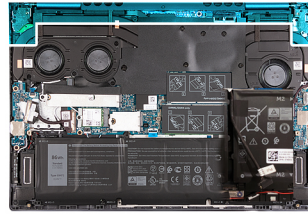

### Steps

1. Using the pull tab, disconnect the display-cable from the connector on the system board.
2. Remove the three screws (M2.5x5) that secure the right-display hinge to the system board.
3. Pry open the right-display hinge at an angle of 90 degrees.
4. Remove the three screws (M2.5x5) that secure the left-display hinge to the I/O board.
5. Pry open the left-display hinge at an angle of 90 degrees.
6. Gently lift the palm-rest and keyboard assembly off the display assembly

 **CAUTION:** To avoid damaging the display, do not slide the palm-rest and keyboard assembly over the display assembly.

# Installing the display assembly

## Prerequisites

If you are replacing a component, remove the existing component before performing the installation process.

## About this task

The following image(s) indicate the location of the display assembly and provides a visual representation of the installation procedure.



6x  
M2x5.5

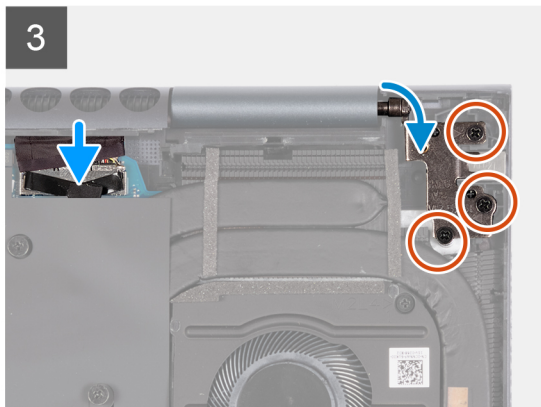
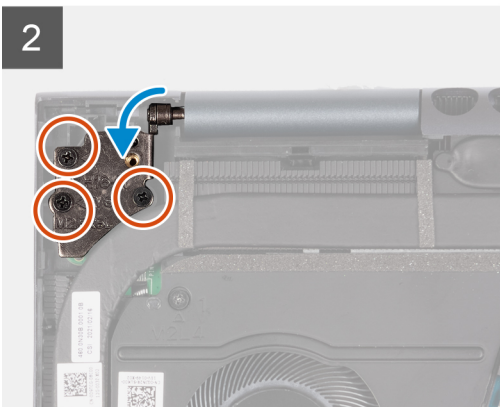
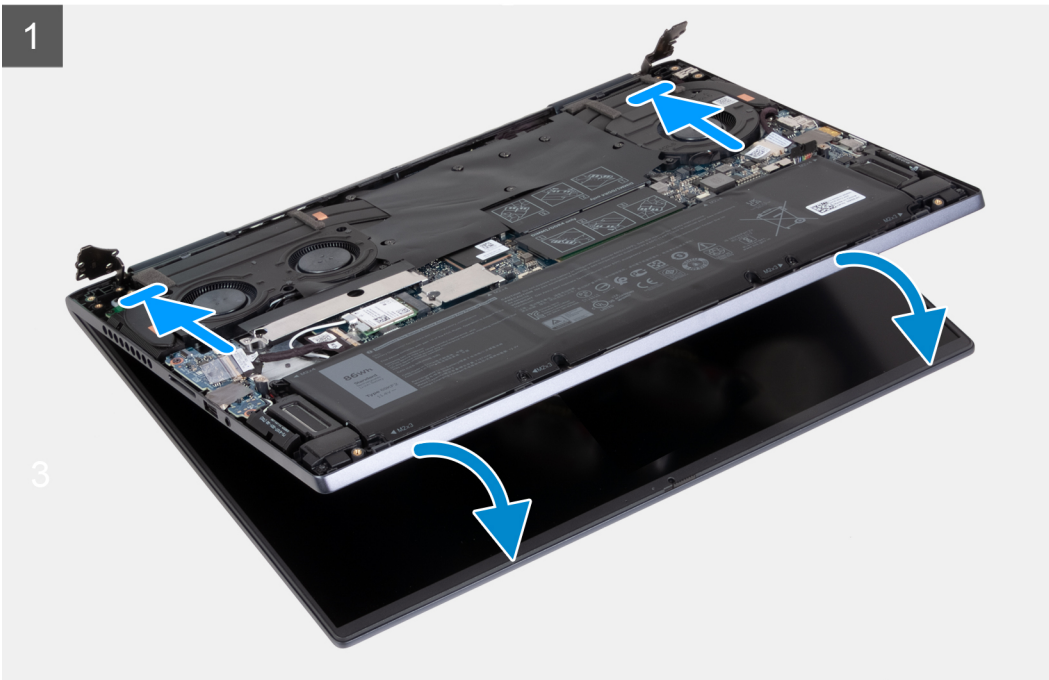
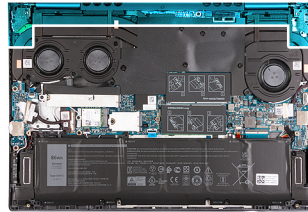

## Steps

1. Place the display assembly on a clean and flat surface with the display panel facing up.
2. Gently place the palm-rest and keyboard assembly under the display hinges.

**CAUTION:** To avoid damaging the display, do not slide the palm-rest and keyboard assembly over the display assembly.

3. Close the left-display hinge and align the screw holes on the left-display hinge with the screw holes on the I/O board.
4. Replace the three screws (M2.5x5) that secure the left-display hinge to the palm-rest and keyboard assembly.
5. Close the right-display hinge and align the screw holes on the right-display hinge with the screw holes on the system board.
6. Replace the three screws (M2.5x5) that secure the right-display hinge to the palm-rest and keyboard assembly.
7. Connect the display cable to the connector on the system board.

### Next steps

1. Install the [base cover](#).
2. Exit [Service Mode](#).
3. Follow the procedure in [After working inside your computer](#).

## I/O board

### Removing the I/O board

#### Prerequisites

1. Follow the procedure in [Before working inside your computer](#).
2. Enter [Service Mode](#).
3. Remove the [base cover](#).

#### About this task

The following image(s) indicate the location of the I/O board and provides a visual representation of the removal procedure.



2x  
M2x3

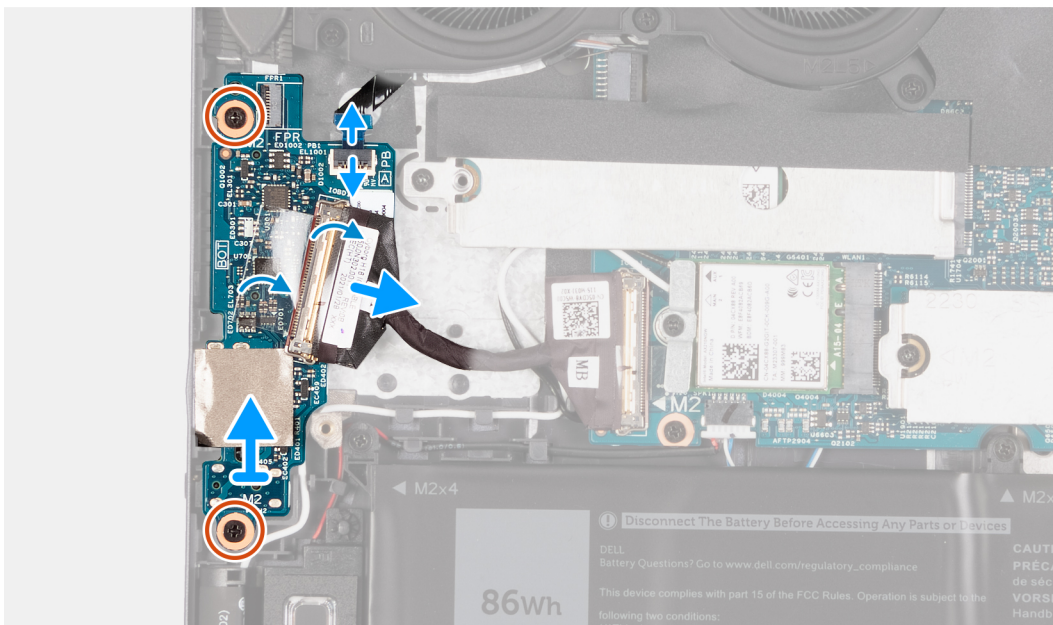
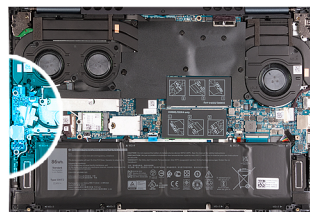

## Steps

1. Lift the I/O-board cable-connector latch and disconnect the I/O-board cable from the I/O board.
2. Lift the power-button with fingerprint-reader cable-connector latch and disconnect the power-button with fingerprint-reader cable from the I/O board.

**i** **NOTE:** This step is only applicable for computers shipped with the optional fingerprint reader.

3. Lift the power-button board cable-connector latch and disconnect the power-button board cable from the I/O board.
4. Remove the two screws (M2x3) that secure the I/O board to the palm-rest and keyboard assembly.
5. Disconnect the coin-cell battery cable from the I/O board.
6. Lift the I/O board off the palm-rest and keyboard assembly.

## Installing the I/O board

### Prerequisites

If you are replacing a component, remove the existing component before performing the installation process.

### About this task

The following image(s) indicate the location of the I/O board and provides a visual representation of the installation procedure.



**2x**  
M2x3

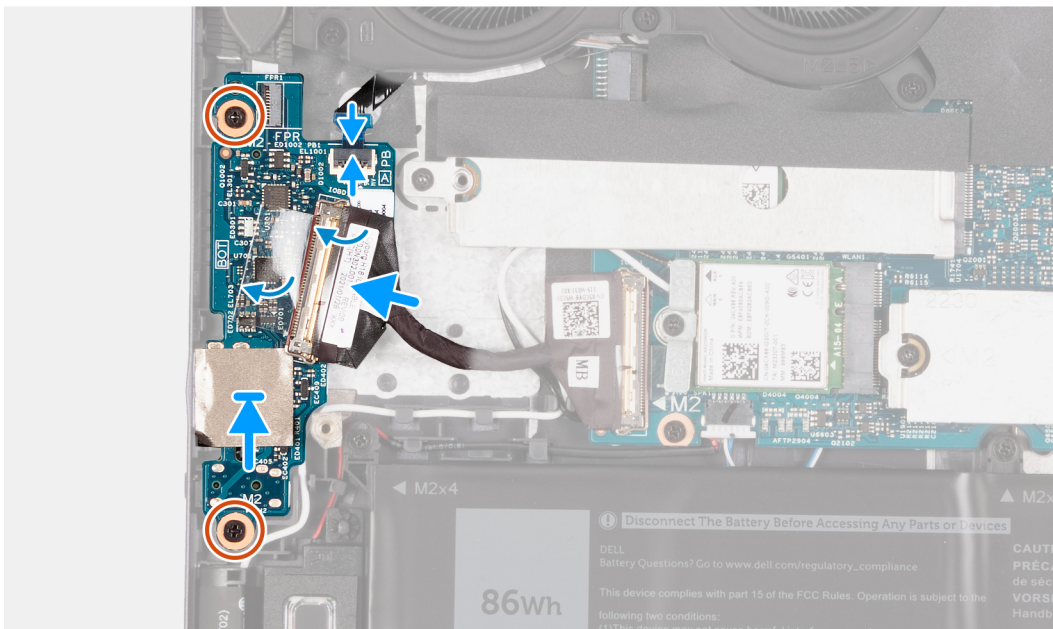
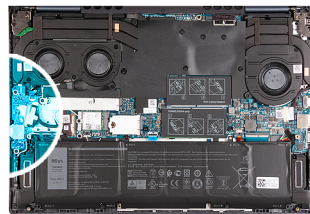

## Steps

1. Align the ports on the I/O board to the slots on the palm-rest and keyboard assembly.
2. Place the I/O board on the palm-rest and keyboard assembly.
3. Align the screw hole on the I/O board to the screw hole on the palm-rest and keyboard assembly.
4. Replace the two screws (M2x3) that secure the I/O board to the palm-rest and keyboard assembly.
5. Connect the I/O-board cable to the connector on the I/O board and close the latch.

6. Connect the power-button board cable to the connector on the I/O board and close the latch.
7. Connect the power-button with fingerprint-reader cable to the connector on the I/O board and close the latch.
  - i** **NOTE:** This step is only applicable for computers shipped with the optional fingerprint reader.
8. Connect the coin-cell battery cable to the I/O board.

**Next steps**

1. Install the [base cover](#).
2. Exit [Service Mode](#).
3. Follow the procedure in [After working inside your computer](#).

## Fans

### Removing the left fan

**Prerequisites**

1. Follow the procedure in [Before working inside your computer](#).
2. Enter [Service Mode](#).
3. Remove the [base cover](#).

**About this task**

The following image(s) indicate the location of the left fan and provides a visual representation of the removal procedure.

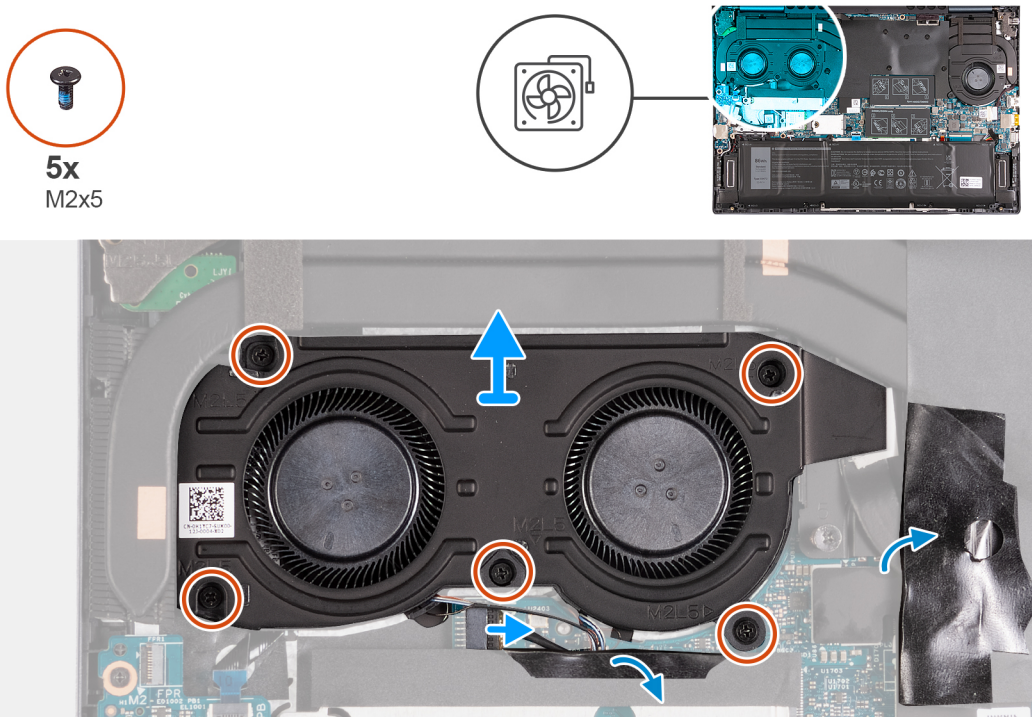

**Steps**

1. Lift the corner of the Mylar that covers the system board.
2. Disconnect the left-fan cable from the system board.
3. Remove the five screws (M2x5) that secure the right fan to the palm-rest and keyboard assembly.
4. Lift the left fan at an angle till the left fan disengages from the slot on the palm-rest and keyboard assembly.

- Slide and lift the left fan off the palm-rest and keyboard assembly.

## Installing the left fan

### Prerequisites

If you are replacing a component, remove the existing component before performing the installation process.

### About this task

The following image(s) indicate the location of the left fan and provides a visual representation of the installation procedure.



5x  
M2x5

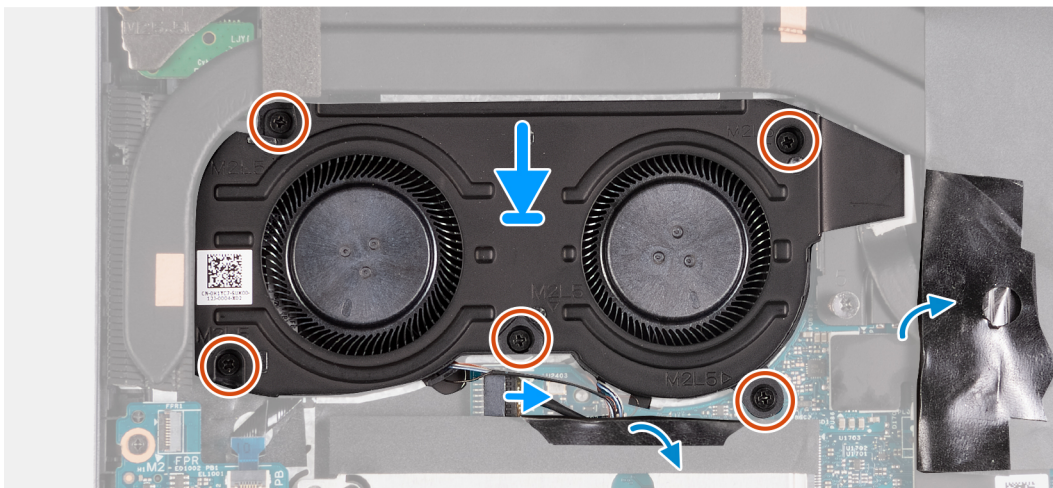
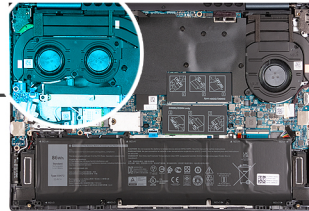
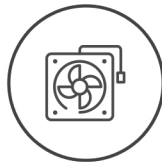

### Steps

- Slide the fan under the heat sink into the slot on the palm-rest and keyboard assembly.
- Align the screw holes on the fan with the screw holes on the palm-rest and keyboard assembly.
- Replace the five screws (M2x5) that secure the fan to the palm-rest and keyboard assembly.
- Lift the corner of the Mylar that covers the system board.
- Connect the fan cable to the system board.

### Next steps

- Install the [base cover](#).
- Exit [Service Mode](#).
- Follow the procedure in [After working inside your computer](#).

## Removing the right fan

### Prerequisites

- Follow the procedure in [Before working inside your computer](#).
- Enter [Service Mode](#).
- Remove the [base cover](#).

### About this task

The following image(s) indicate the location of the right fan and provides a visual representation of the removal procedure.



2x  
M2x5

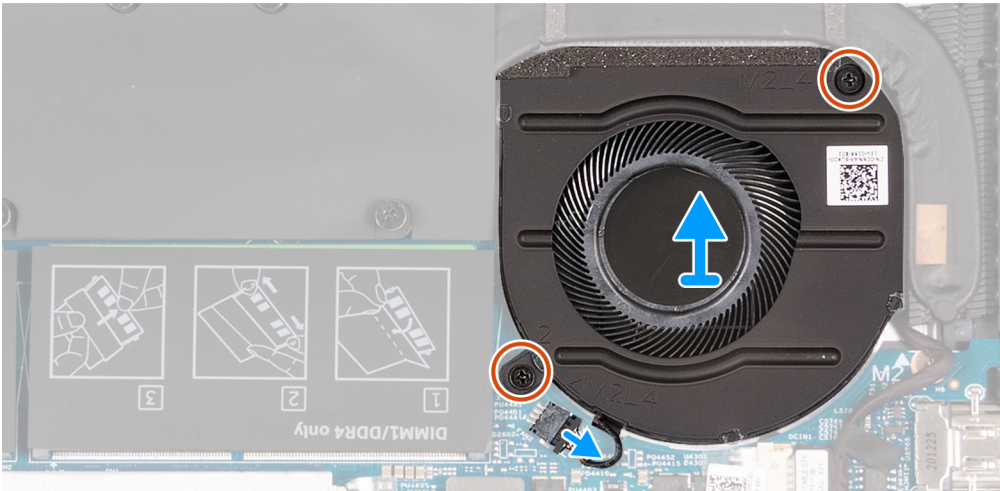
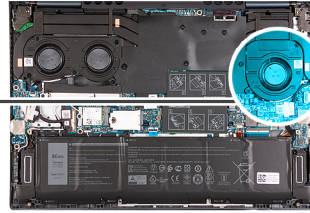
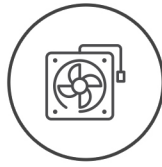

### Steps

1. Disconnect the right-fan cable from the system board.
2. Remove the two screws (M2x5) that secure the right fan to the palm-rest and keyboard assembly.
3. Lift the fan off the palm-rest and keyboard assembly.

## Installing the right fan

### Prerequisites

If you are replacing a component, remove the existing component before performing the installation process.

### About this task

The following image(s) indicate the location of the right fan and provides a visual representation of the installation procedure.



2x  
M2x5

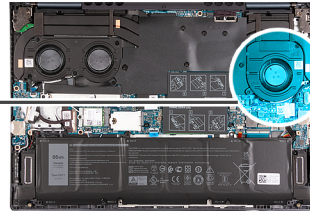
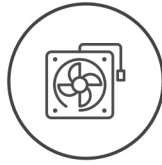

### Steps

1. Place the right fan on the palm-rest and keyboard assembly.
2. Align the screw holes on the right fan with the screw holes on the palm-rest and keyboard assembly.
3. Replace the two screws (M2x5) that secure the right fan to the palm-rest and keyboard assembly.
4. Connect the right-fan cable to the system board.

### Next steps

1. Install the [base cover](#).
2. Exit [Service Mode](#).
3. Follow the procedure in [After working inside your computer](#).

## Heat sink

### Removing the heat sink

#### Prerequisites

1. Follow the procedure in [Before working inside your computer](#).
2. Enter [Service Mode](#).
3. Remove the [base cover](#).
4. Remove the [left fan](#).

#### About this task

**CAUTION:** The heat sink may become hot during normal operation. Allow sufficient time for the heat sink to cool before you touch it.

**NOTE:** For maximum cooling of the processor, do not touch the heat transfer areas on the heat sink. The oils in your skin can reduce the heat transfer capability of the thermal grease.

The following image(s) indicate the location of the heat sink and provides a visual representation of the removal procedure.

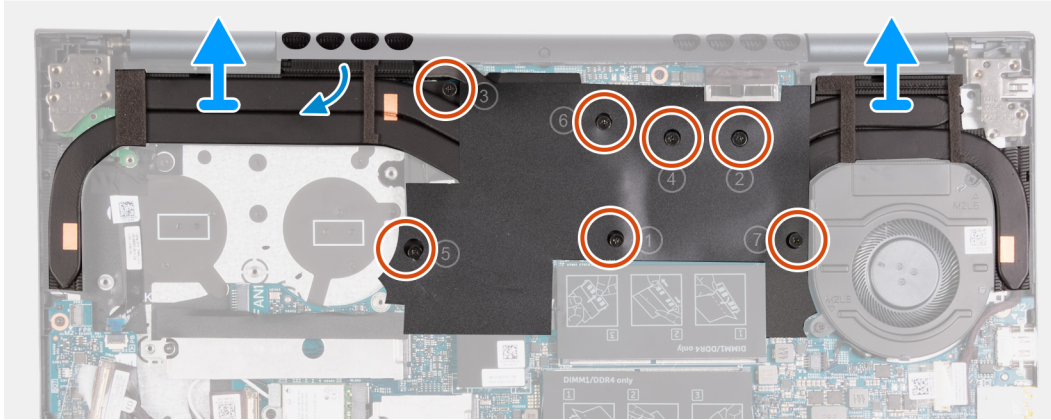
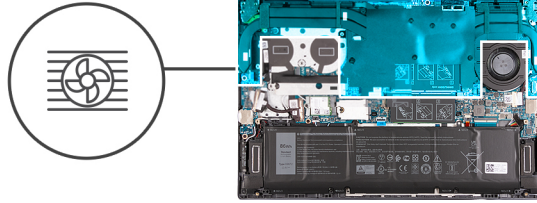

### Steps

1. In reverse sequential order (7>6>5>4>3>2>1) loosen the seven captive screws that secure the heat sink to the system board.
2. Lift the heat sink from the system board.

## Installing the heat sink

### Prerequisites

If you are replacing a component, remove the existing component before performing the installation process.

### About this task

**NOTE:** If either the system board or the heat sink is replaced, use the thermal grease provided in the kit to ensure that thermal conductivity is achieved.

The following image(s) indicate the location of the heat sink and provides a visual representation of the installation procedure.

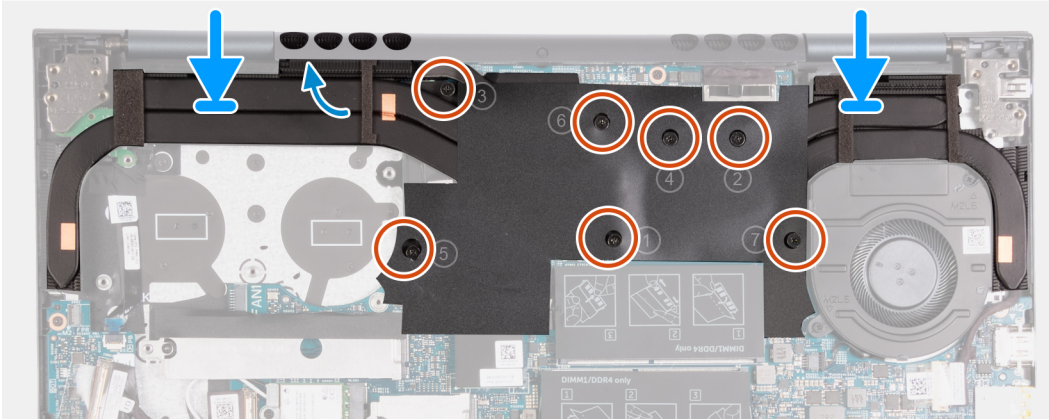
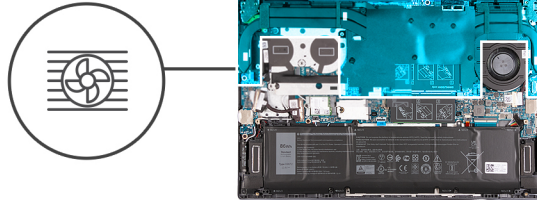

### Steps

1. Place the heat-sink on the system board.
2. Align the screw holes on the heat sink to the screw holes on the system board.
3. In sequential order (1>2>3>4>5>6>7) tighten the seven captive screws that secure the heat sink to the system board.

### Next steps

1. Install the [left fan](#).
2. Install the [base cover](#).
3. Exit [Service Mode](#).
4. Follow the procedure in [After working inside your computer](#).

## Power-adapter port

### Removing the power-adapter port

#### Prerequisites

1. Follow the procedure in [Before working inside your computer](#).
2. Enter [Service Mode](#).
3. Remove the [base cover](#).
4. Remove the [left fan](#).
5. Remove the [heat sink](#).

#### About this task

The following image(s) indicate the location of the power-adapter port and provides a visual representation of the removal procedure.



3x  
M2.5x5

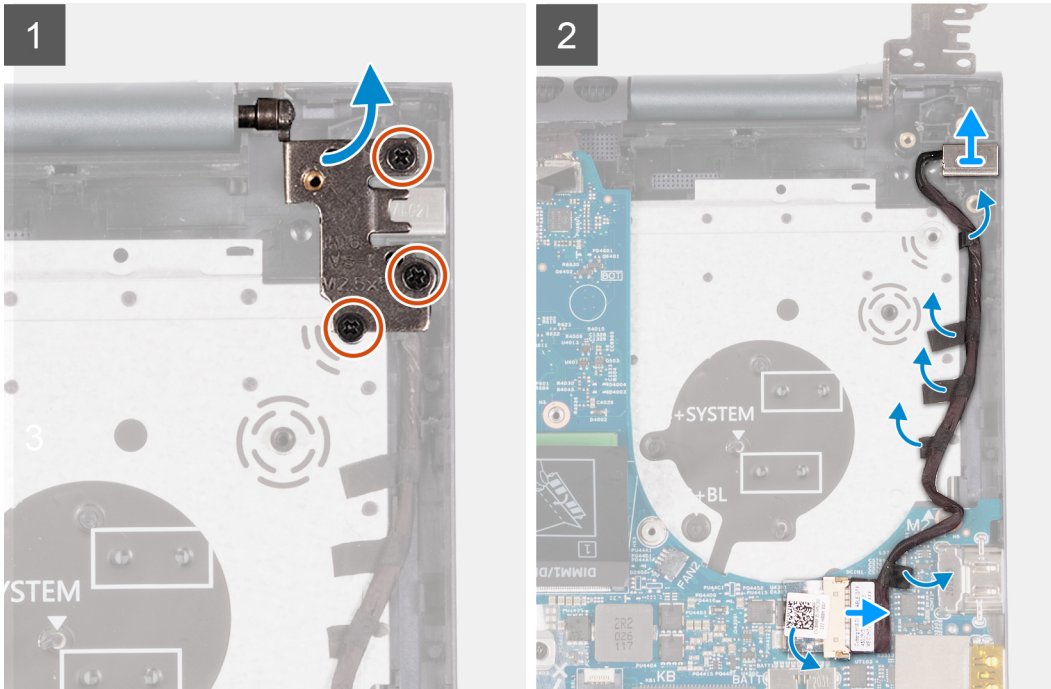
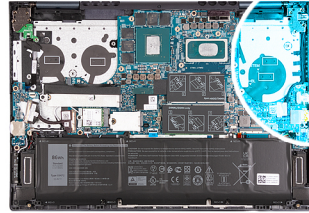

### Steps

1. Remove the three screws (M2.5x5) that secures the right-display hinge to the system board.
2. Pry open the right-display hinge at an angle of 90 degrees.
3. Peel the tape that covers the power-adapter port connector on the system board.
4. Disconnect the power-adapter port from the system board.
5. Peel the tapes that secure the power-adapter port cable to the palm-rest and keyboard assembly.
6. Remove the power-adapter port cable from the routing guides on the palm-rest and keyboard assembly.
7. Remove the power-adapter port from the palm-rest and keyboard assembly.

## Installing the power-adapter port

### Prerequisites

If you are replacing a component, remove the existing component before performing the installation process.

### About this task

The following image(s) indicate the location of the power-adapter port and provides a visual representation of the installation procedure.



3x  
M2.5x5

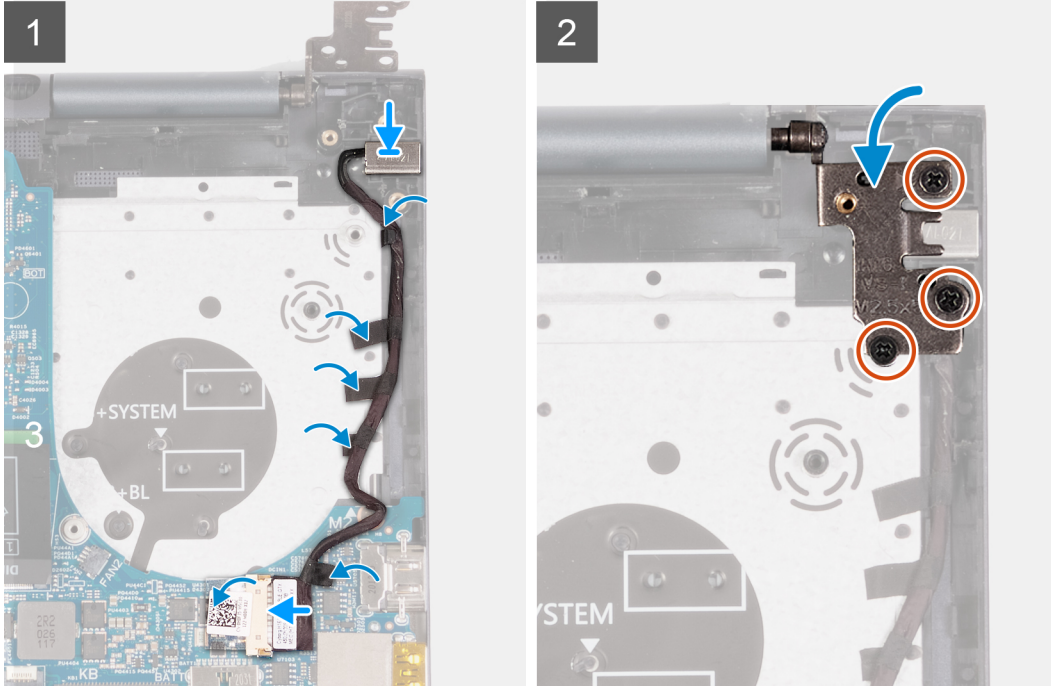
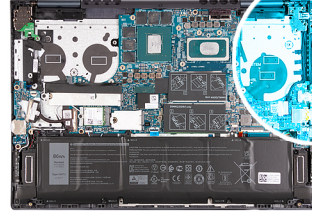

### Steps

1. Connect the power-adapter port cable to the system board.
2. Adhere the tape that covers the power-adapter port connector on the system board.
3. Route the power-adapter port cable through the routing guides on the palm-rest and keyboard assembly.
4. Place the power-adapter port into the slot on the palm-rest and keyboard assembly.
5. Close the right-display hinge and align the screw holes on the right-display hinge with the screw holes on the system board.
6. Replace the three screws (M2.5x5) that secures the right-display hinge to the system board.

### Next steps

1. Install the [heat sink](#).
2. Install the [left fan](#).
3. Install the [base cover](#).
4. Exit [Service Mode](#).
5. Follow the procedure in [After working inside your computer](#).

## Power-button and fingerprint reader

### Removing the power-button board

#### Prerequisites

1. Follow the procedure in [Before working inside your computer](#).
2. Enter [Service Mode](#).

3. Remove the [base cover](#).
4. Remove the [heat sink](#).
5. Remove the [left fan](#).

### About this task

The following image(s) indicate the location of the power-button board and provides a visual representation of the removal procedure.

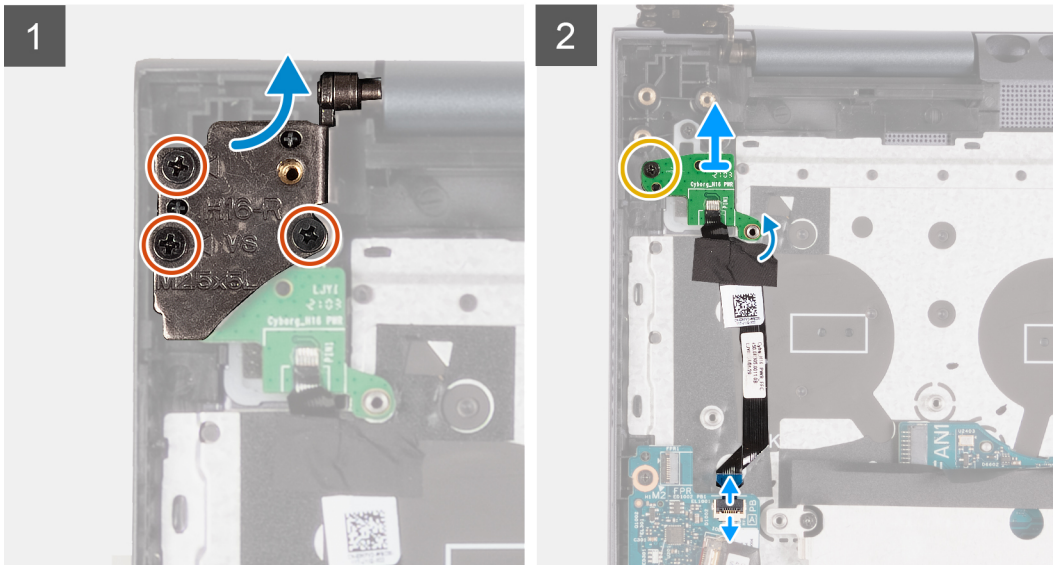
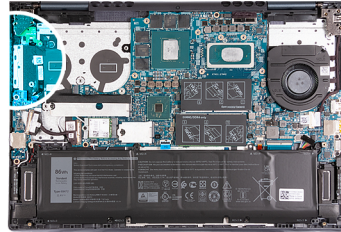
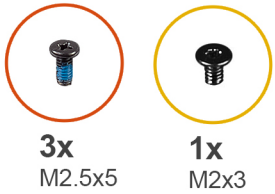

### Steps

1. Remove the three screws (M2.5x5) that secure the left-display hinge to the I/O board.
2. Pry open the left-display hinge at an angle of 90 degrees.
3. Lift the power-button with fingerprint-reader cable-connector latch and disconnect the power-button with fingerprint-reader cable from the I/O board.

**NOTE:** This step is only applicable for computers shipped with the optional fingerprint reader.

4. Lift the power-button board cable-connector latch and disconnect the power-button board cable from the I/O board.
5. Peel the tape that secures the power-button with optional fingerprint reader cable and power-button board cable to the palm-rest and keyboard assembly.
6. Remove the screw (M2x3) that secures the power-button board to the palm-rest and keyboard assembly.
7. Lift the power-button with optional fingerprint reader off the palm-rest and keyboard assembly.

## Installing the power-button board

### Prerequisites

If you are replacing a component, remove the existing component before performing the installation process.

## About this task

The following image(s) indicate the location of the power-button board and provides a visual representation of the installation procedure.

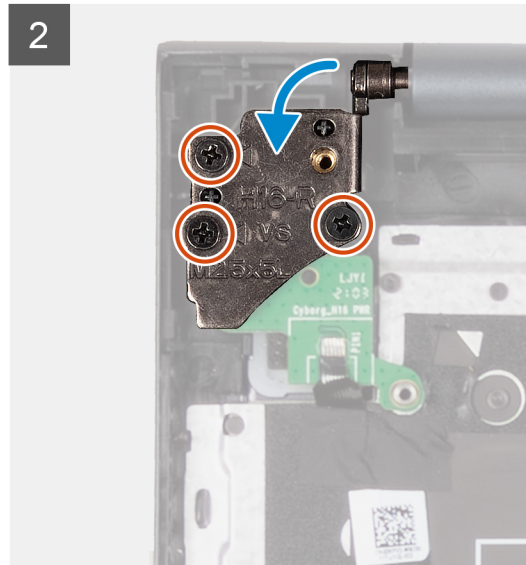
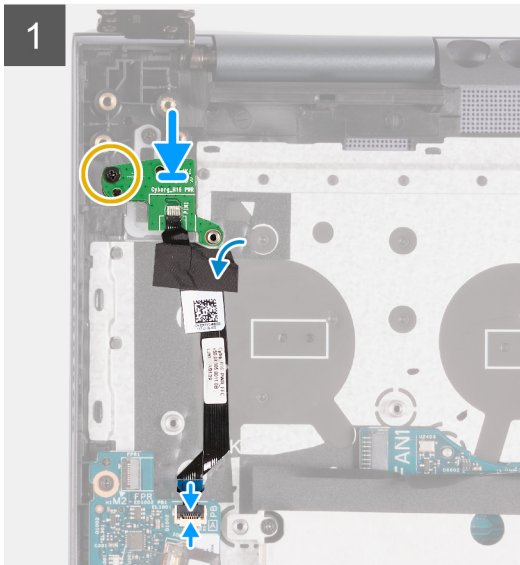
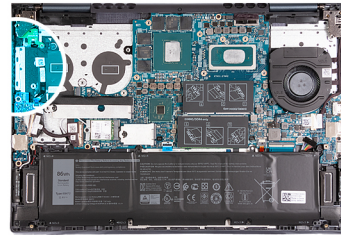
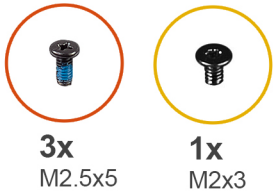

## Steps

1. Using the alignment posts, place the power-button board over the power-button with optional fingerprint reader.
2. Replace the screw (M2x3) that secures the power-button board to the palm-rest and keyboard assembly.
3. Connect the power-button board cable to the connector on the I/O board and close the latch.
4. Connect the power-button with fingerprint-reader cable to the connector on the I/O board and close the latch.

**NOTE:** This step is only applicable for computers shipped with the optional fingerprint reader.

5. Adhere the tape that secures the power-button with optional fingerprint reader cable and power-button board cable to the palm-rest and keyboard assembly.
6. Close the left-display hinge and align the screw holes on the left-display hinge with the screw holes on the I/O board.
7. Replace the three screws (M2.5x5) that secure the left-display hinge to the palm-rest and keyboard assembly.

## Next steps

1. Install the [heat sink](#).
2. Install the [left fan](#).
3. Install the [base cover](#).
4. Exit [Service Mode](#).
5. Follow the procedure in [After working inside your computer](#).

# Power button

## Installing the power button

### Prerequisites

If you are replacing a component, remove the existing component before performing the installation process.

### About this task

The following image(s) indicate the location of the power-button and provides a visual representation of the installation procedure.



1x  
M2x3

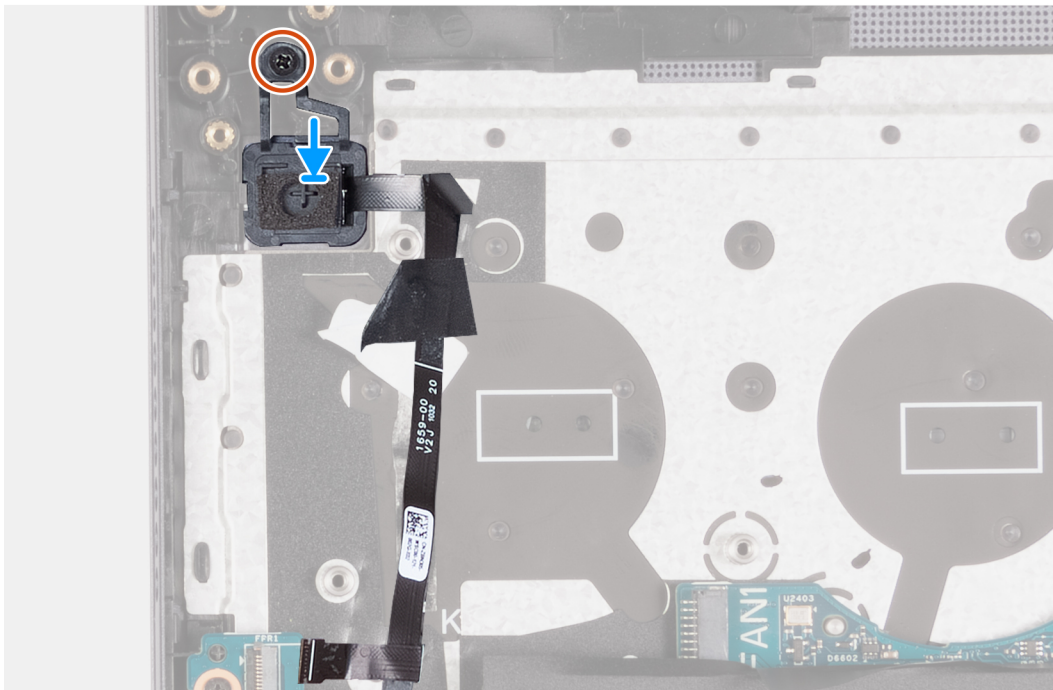
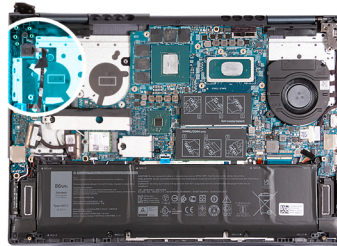

### Steps

1. Using the alignment posts, place the power-button with fingerprint reader into its slot on the palm-rest and keyboard assembly.
2. Replace the screw (M2x3) that secures the power-button with fingerprint reader to the palm-rest and keyboard assembly.

### Next steps

1. Install the [power-button board](#).
2. Install the [heat sink](#).
3. Install the [left fan](#).
4. Install the [base cover](#).
5. Exit [Service Mode](#).
6. Follow the procedure in [After working inside your computer](#).

# Removing the power-button

## Prerequisites

1. Follow the procedure in [Before working inside your computer](#).
2. Enter [Service Mode](#).
3. Remove the [base cover](#).
4. Remove the [heat sink](#).
5. Remove the [left fan](#).
6. Remove the [power-button board](#).

## About this task

The following image(s) indicate the location of the power-button and provides a visual representation of the removal procedure.



1x  
M2x3

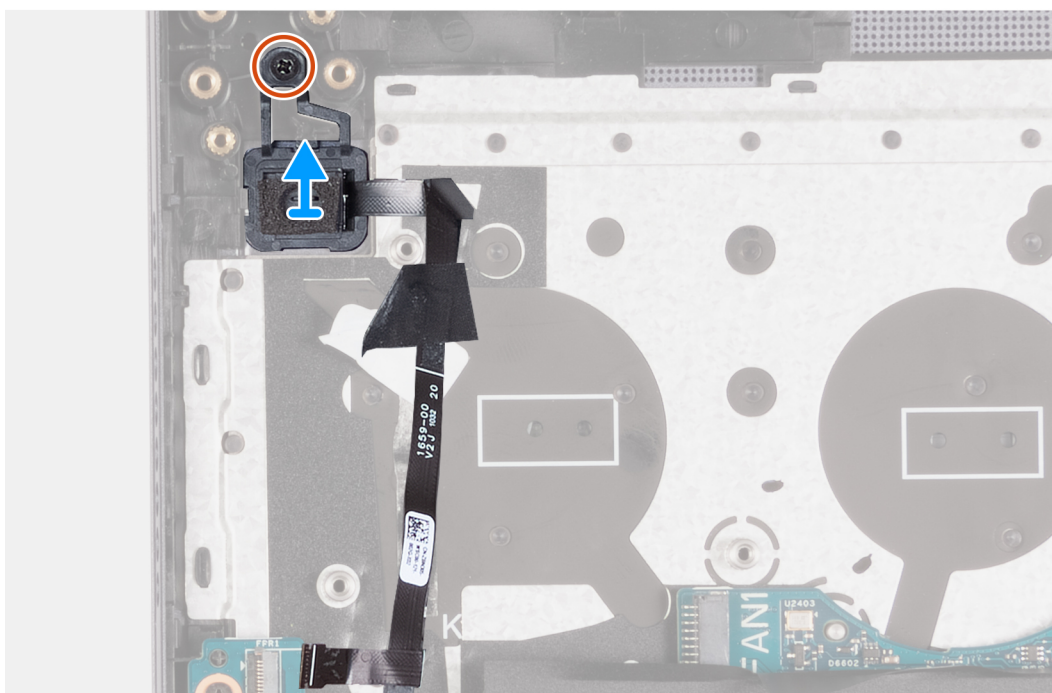
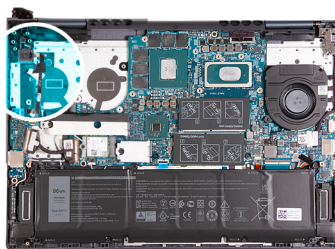

## Steps

1. Remove the screw (M2x3) that secures the power-button with fingerprint reader to the palm-rest and keyboard assembly.
2. Lift the power-button with fingerprint reader off the palm-rest and keyboard assembly.

# Power button with fingerprint reader

## Removing the power-button with fingerprint reader

### Prerequisites

1. Follow the procedure in [Before working inside your computer](#).
2. Enter [Service Mode](#).
3. Remove the [base cover](#).
4. Remove the [heat sink](#).
5. Remove the [left fan](#).
6. Remove the [power-button board](#).

### About this task

The following image(s) indicate the location of the power-button with fingerprint reader and provides a visual representation of the removal procedure.



1x  
M2x3

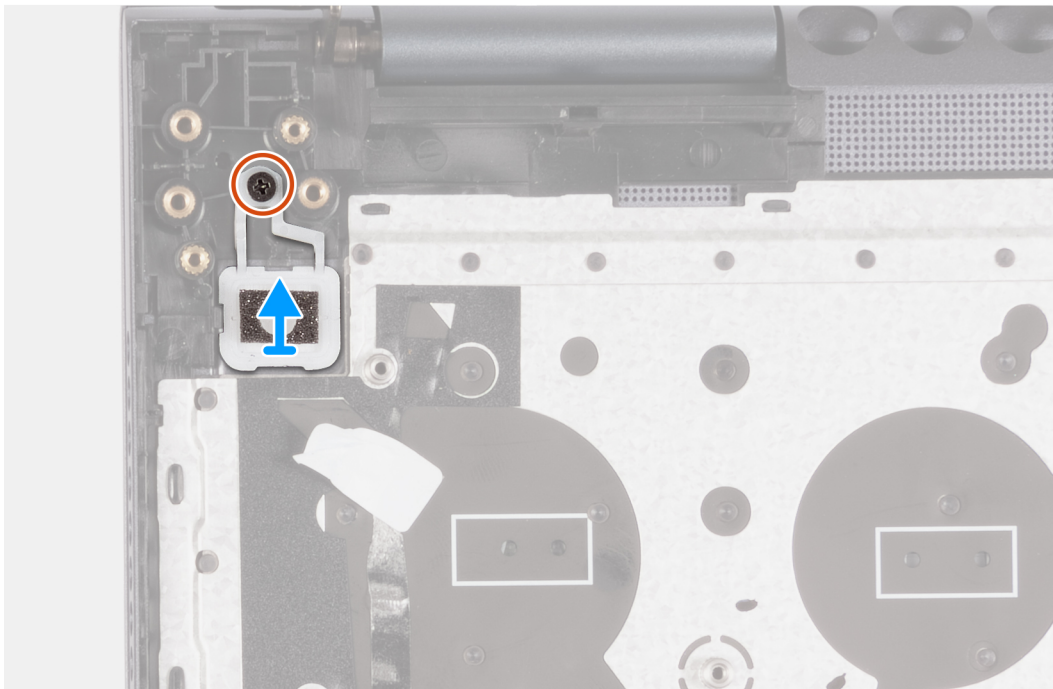
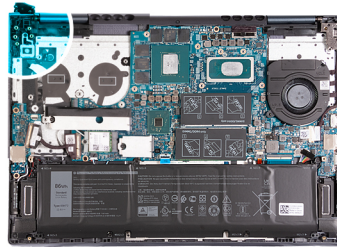

### Steps

1. Remove the screw (M2x3) that secures the power-button with fingerprint reader to the palm-rest and keyboard assembly.
2. Lift the power-button with fingerprint reader off the palm-rest and keyboard assembly.

# Installing the power-button with fingerprint reader

## Prerequisites

If you are replacing a component, remove the existing component before performing the installation process.

## About this task

The following image(s) indicate the location of the power-button with fingerprint reader and provides a visual representation of the installation procedure.



1x  
M2x3

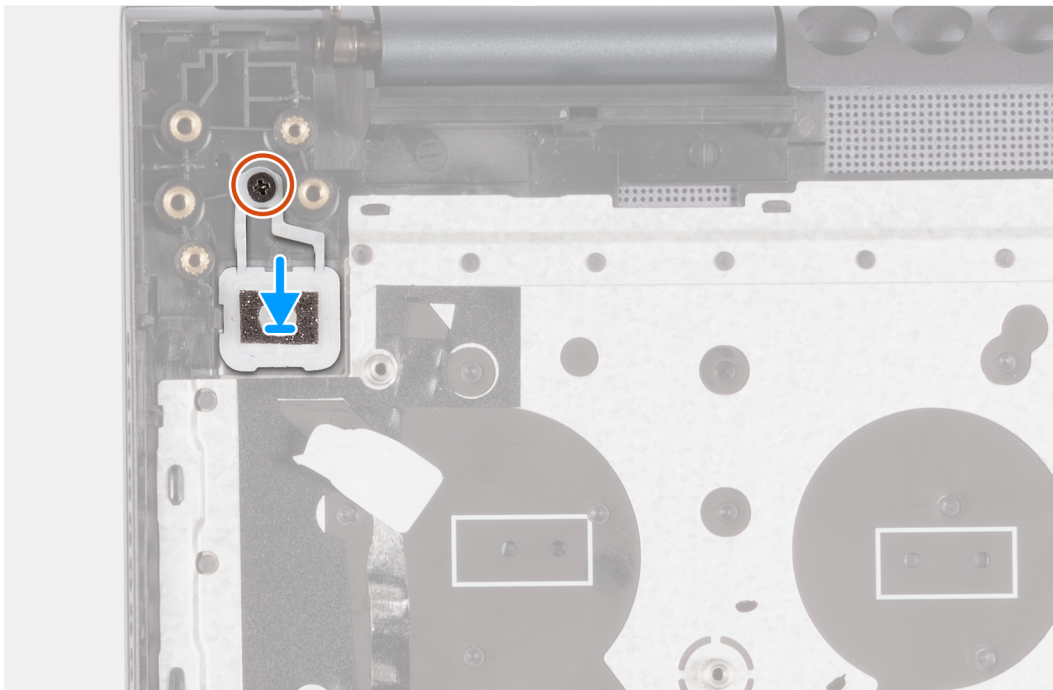
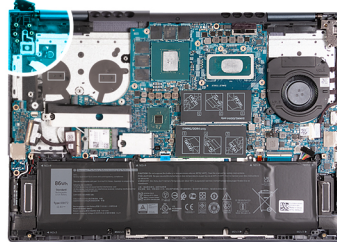

## Steps

1. Using the alignment posts, place the power-button with fingerprint reader into its slot on the palm-rest and keyboard assembly.
2. Replace the screw (M2x3) that secures the power-button with fingerprint reader to the palm-rest and keyboard assembly.

## Next steps

1. Install the [power-button board](#).
2. Install the [heat sink](#).
3. Install the [left fan](#).
4. Install the [base cover](#).
5. Exit [Service Mode](#).
6. Follow the procedure in [After working inside your computer](#).

# System board

## Removing the system board

### Prerequisites

1. Follow the procedure in [Before working inside your computer](#).
2. Remove the [base cover](#).
3. Remove the [memory](#).
4. Remove the [M.2 2230 solid-state drive](#) or [M.2 2280 solid-state drive](#) from M.2 slot one, whichever applicable.
5. Remove the [M.2 2230 solid-state drive](#) from M.2 slot two.
6. Remove the [wireless card](#).
7. Remove the [battery](#).
8. Remove the [left fan](#).
9. Remove the [right fan](#).
10. Remove the [heat sink](#).

### About this task

The following image indicates the connectors on your system board.

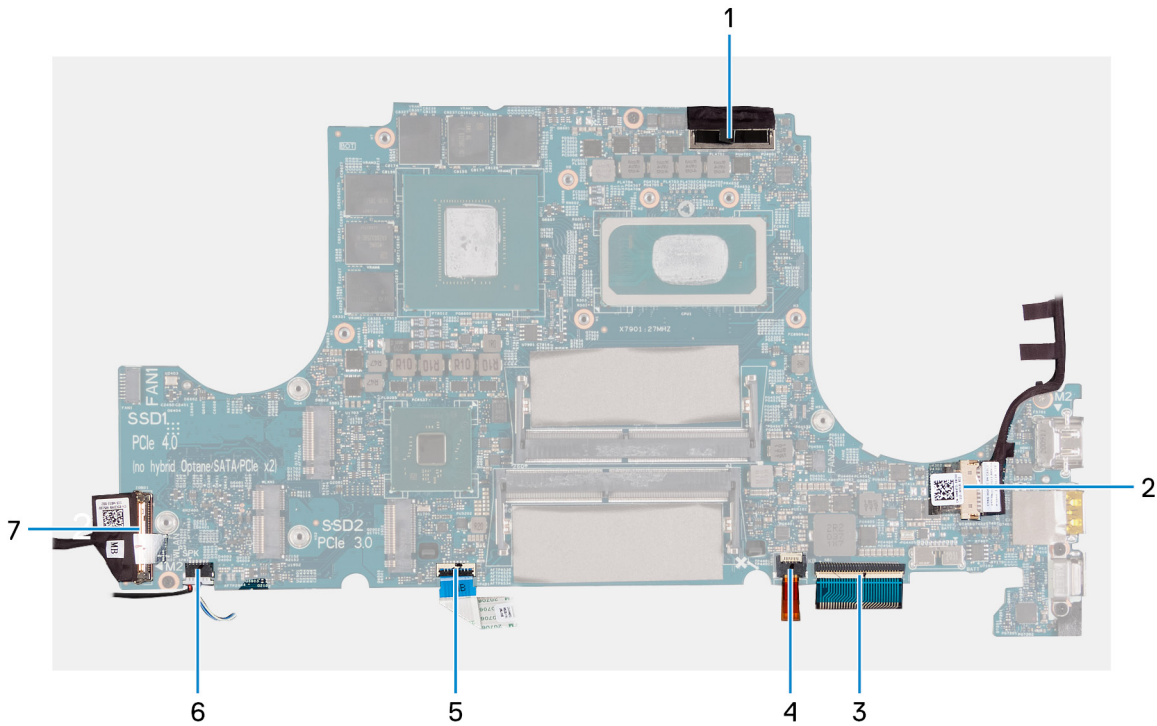

1. Display cable
2. Power-adapter port cable
3. Keyboard-backlight cable
4. Keyboard cable
5. Touchpad cable
6. Speaker cable
7. I/O-board cable

The following image(s) indicate the location of the system board and provides a visual representation of the removal procedure.



2x  
M2x3



1x  
M2x2



2x  
M2x5

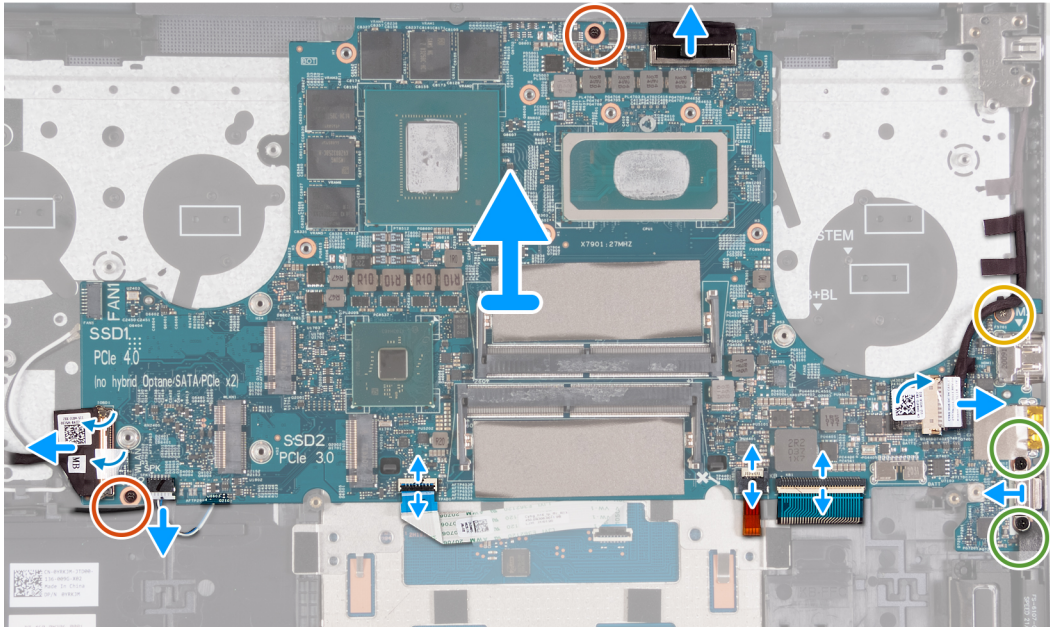
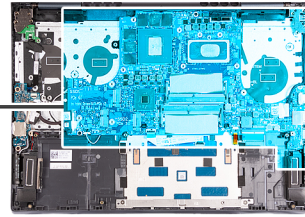

### Steps

1. Using the pull tab, disconnect the display-cable from the connector on the system board.
2. Peel the tape that covers the power-adapter port cable-connector on the system board.
3. Disconnect the power-adapter port cable from the system board.
4. Remove the two screws (M2x5) that secure the Type-C port-bracket to the system board.
5. Lift the latch and disconnect the keyboard-backlight cable from the system board.
6. Lift the latch and disconnect the keyboard cable from the system board.
7. Lift the latch and disconnect the touchpad cable from the system board.
8. Disconnect the speaker cable from the system board.
9. Lift the I/O-board cable-connector latch and disconnect the I/O-board cable from the system board.
10. Lift the Type-C port-bracket off the system board.
11. Remove the two screws (M2x3) that secure the system board to the palm-rest and keyboard assembly.
12. Remove the screw (M2x2) that secures the system board to the palm-rest and keyboard assembly.
13. Lift the system board from the palm-rest and keyboard assembly.

## Installing the system board

### Prerequisites

If you are replacing a component, remove the existing component before performing the installation process.

### About this task

The following image indicates the connectors on your system board.

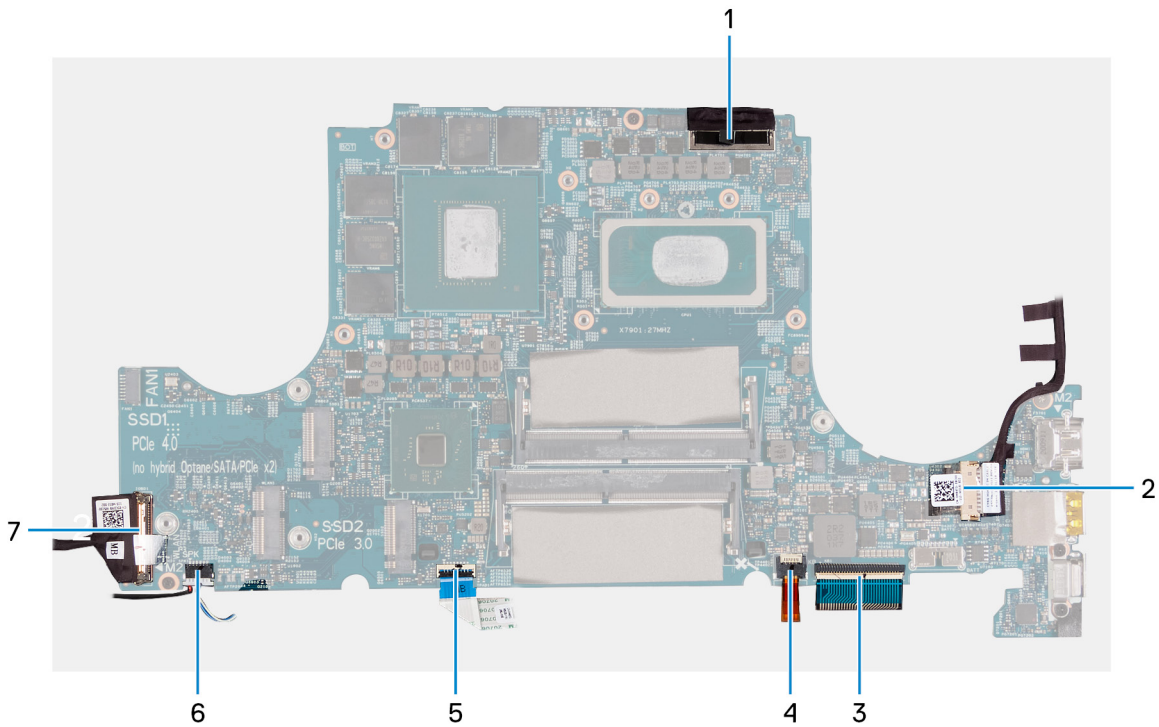

1. Display cable
2. Power-adaptor port cable
3. Keyboard-backlight cable
4. Keyboard cable
5. Touchpad cable
6. Speaker cable
7. I/O-board cable

The following image(s) indicate the location of the system board and provides a visual representation of the installation procedure.



2x  
M2x3



1x  
M2x2



2x  
M2x5

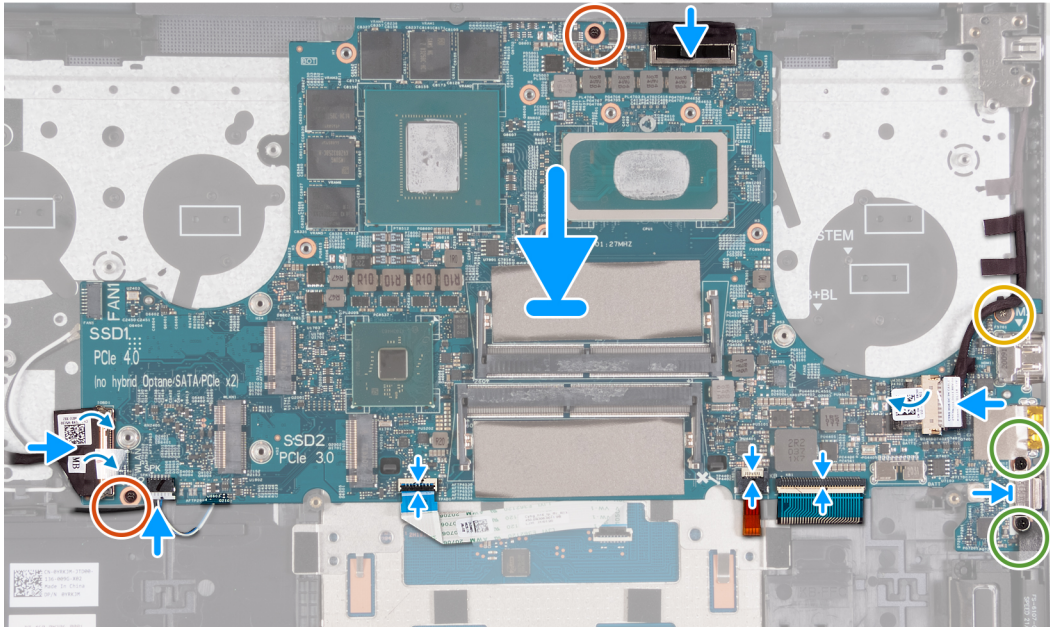
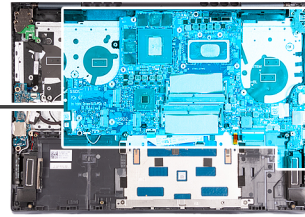

### Steps

1. Place the system board on the palm-rest and keyboard assembly.
2. Align the screw holes on the system board with the screw holes on the palm-rest and keyboard assembly.
3. Replace the two screws (M2x3) that secure the system board to the palm-rest and keyboard assembly.
4. Replace the screw (M2x2) that secures the system board to the palm-rest and keyboard assembly.
5. Place the Type-C port-bracket on the system board.
6. Replace the two screws (M2x5) that secure the Type-C port-bracket to the system board.
7. Connect the power-adapter port cable to the system board,
8. Adhere the tape that covers the power-adapter cable-connector on the system board.
9. Connect the keyboard-backlight cable to the connector on the system board and close the latch.
10. Connect the keyboard cable to the connector on the system board and close the latch.
11. Connect the touchpad cable to the connector on the system board and close the latch.
12. Connect the speaker cable to the system board.
13. Connect the I/O-board cable to the connector on the system board and close the latch.
14. Connect the display cable to the connector on the system board.

### Next steps

1. Install the [heat sink](#).
2. Install the [left fan](#).
3. Install the [right fan](#).
4. Install the [battery](#).
5. Install the [wireless card](#).
6. Install the [M.2 2230 solid-state drive](#) or [M.2 2280 solid-state drive](#) into M.2 slot one, whichever applicable.
7. Install the [M.2 2230 solid-state drive](#) into M.2 slot two.
8. Install the [memory](#).
9. Install the [base cover](#).

10. Follow the procedure in [After working inside your computer](#).

# Touchpad

## Removing the touchpad

### Prerequisites

1. Follow the procedure in [Before working inside your computer](#).
2. Remove the [base cover](#).
3. Remove the [M.2 2230 solid-state drive](#) or [M.2 2280 solid-state drive](#) from M.2 slot one, whichever applicable
4. Remove the [M.2 2230 solid-state drive](#) from M.2 slot two.
5. Remove the [wireless card](#).
6. Remove the [battery](#).
7. Remove the [left fan](#).
8. Remove the [right fan](#).
9. Remove the [heat sink](#).
10. Remove the [system board](#).

 **NOTE:** The system board can be removed with the heat sink, solid-state drives, and memory installed.

### About this task

The following image(s) indicate the location of the touchpad and provides a visual representation of the removal procedure.

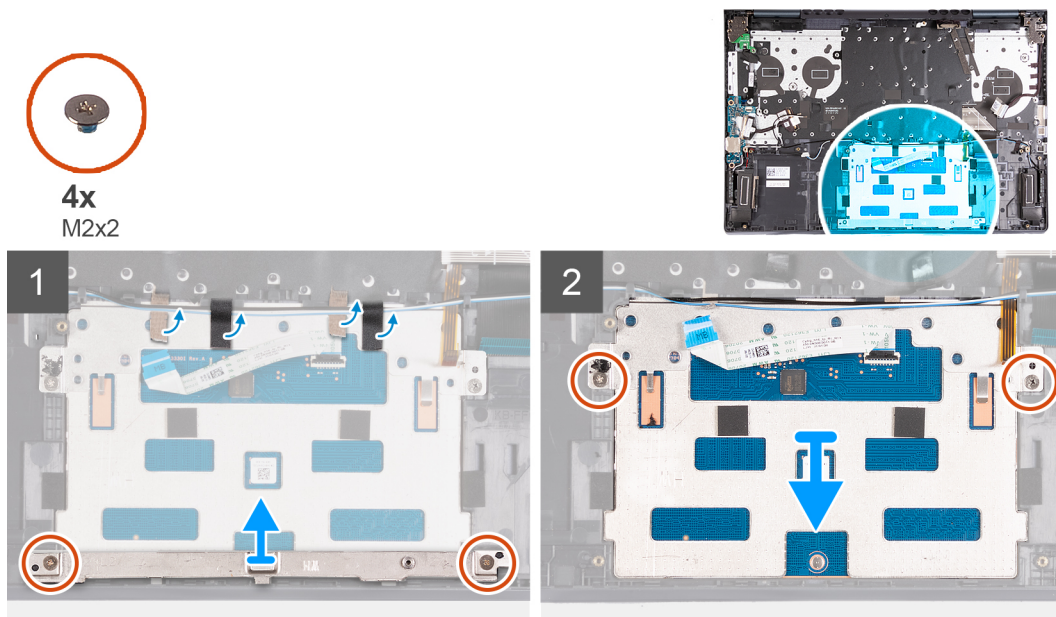

### Steps

1. Open the latch and disconnect the touchpad cable from the touchpad.
2. Remove the two screws (M2x2) that secure the touchpad bracket to the palm-rest and keyboard assembly.
3. Lift the touchpad bracket off the palm-rest and keyboard assembly.
4. Remove the two screws (M2x2) that secure the touchpad to the palm-rest and keyboard assembly.
5. Peel the tapes that secure the speaker cable to the palm-rest and keyboard assembly.
6. Move the speaker cables off the touchpad.
7. Peel the tapes that secure the touchpad to the palm-rest and keyboard assembly.
8. Lift the touchpad off the palm-rest and keyboard assembly.

# Installing the touchpad

## Prerequisites

If you are replacing a component, remove the existing component before performing the installation process.

## About this task

The following image(s) indicate the location of the touchpad and provides a visual representation of the installation procedure.

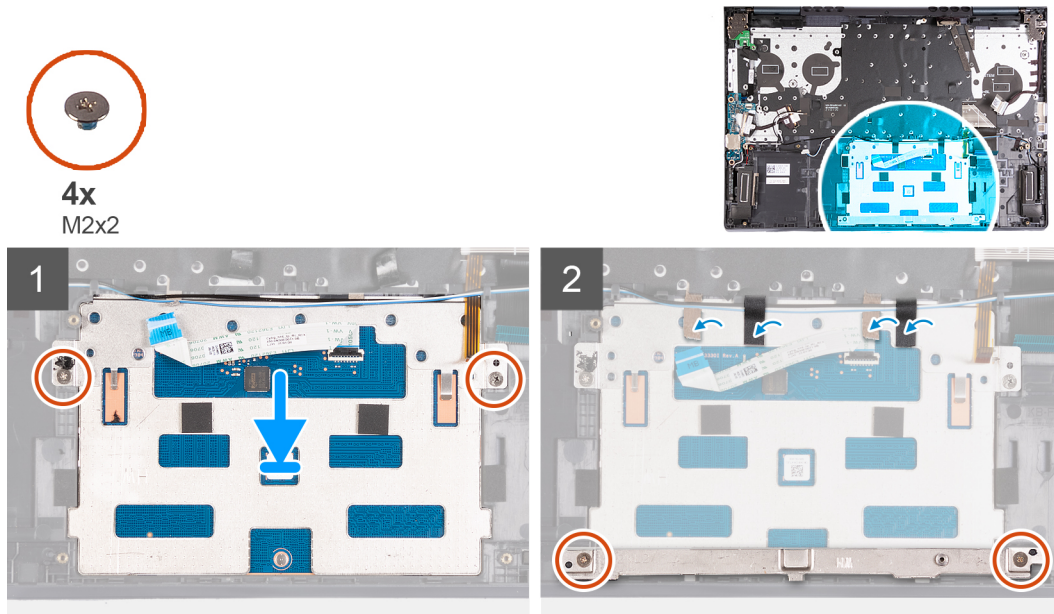

## Steps

1. Place the touchpad on the palm-rest and keyboard assembly.
2. Turn the computer over and open the display to ensure that the touchpad is equally aligned on all sides.

**NOTE:** The image below shows the proper touchpad alignment for your computer.

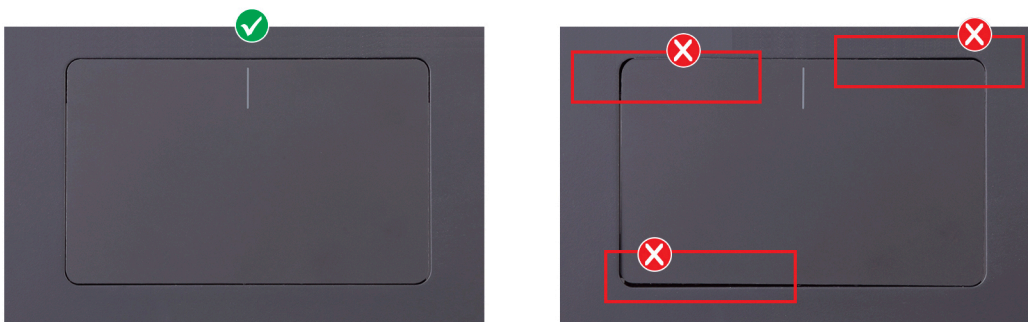

3. Close the display and place the computer in the position shown.
4. Replace the two screws (M2x2) that secure the touchpad to the palm-rest and keyboard assembly.
5. Place the touchpad bracket on the touchpad.
6. Align the screw holes on the touchpad bracket to the screw holes on the palm-rest and keyboard assembly.
7. Replace the two screws (M2x2) that secure the touchpad bracket to the palm-rest and keyboard assembly.
8. Adhere the tapes that secure the touchpad to the palm-rest and keyboard assembly.
9. Move the speaker cables over the touchpad.
10. Adhere the tapes that secure the speaker cables to the palm-rest and keyboard assembly.

**NOTE:** When adhering the tapes, ensure that it is adhered to its original position so that it runs across touchpad and palmrest and keyboard assembly.

11. Connect the touchpad cable to the touchpad and close the latch.

### Next steps

1. Install the [system board](#).
2. Install the [heat sink](#).
3. Install the [left fan](#).
4. Install the [right fan](#).
5. Install the [battery](#).
6. Install the [wireless card](#).
7. Install the [M.2 2230 solid-state drive](#) or [M.2 2280 solid-state drive](#) into M.2 slot one, whichever applicable.
8. Install the [M.2 2230 solid-state drive](#) into M.2 slot two.
9. Install the [base cover](#).
10. Follow the procedure in [After working inside your computer](#).

## Speakers

### Removing the speakers

#### Prerequisites

1. Follow the procedure in [Before working inside your computer](#).
2. Remove the [base cover](#).
3. Remove the [wireless card](#).
4. Remove the [battery](#).
5. Remove the [left fan](#).
6. Remove the [right fan](#).
7. Remove the [heat sink](#).
8. Remove the [system board](#).

**NOTE:** The system board can be removed with the heat sink and memory installed.

#### About this task

The following image(s) indicate the location of the speakers and provides a visual representation of the removal procedure.

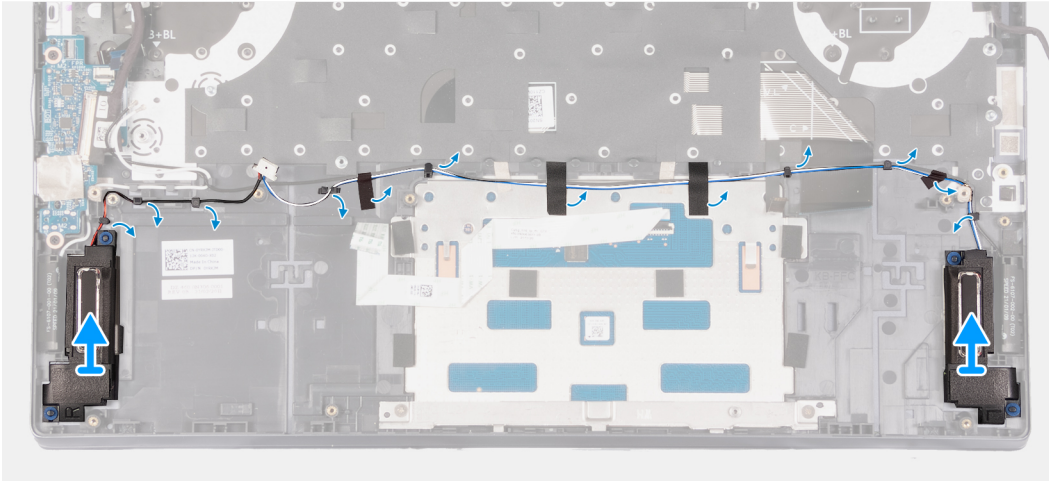
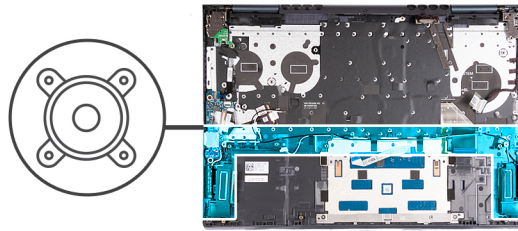

### Steps

1. Peel off the tapes that secure the speaker cable to the palm-rest and keyboard assembly.
2. Remove the speaker cables from the routing guides on the palm-rest and keyboard assembly.
3. Lift the speakers along with their cables off the palm-rest and keyboard assembly.

## Installing the speakers

### Prerequisites

If you are replacing a component, remove the existing component before performing the installation process.

### About this task

The following image(s) indicate the location of the speakers and provides a visual representation of the installation procedure.

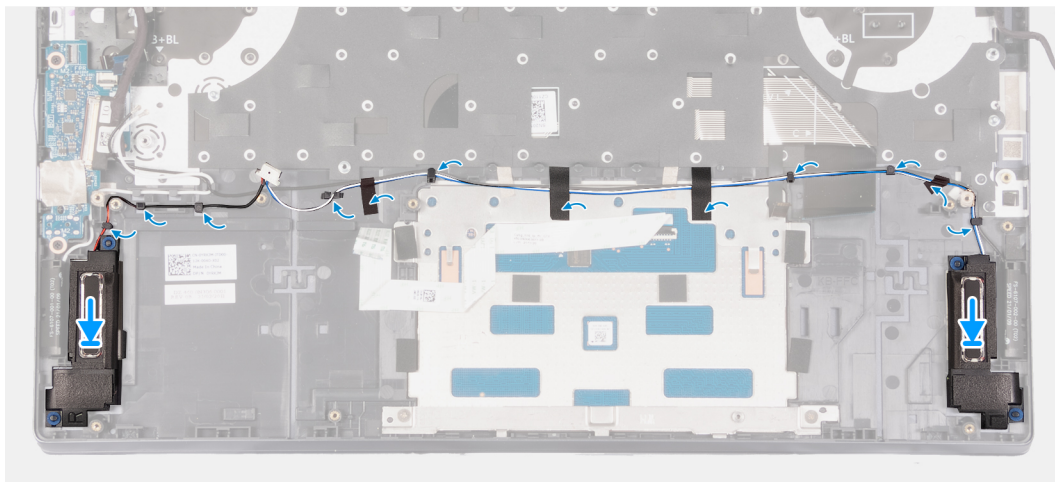
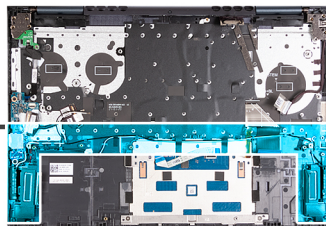
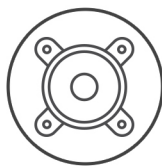

### Steps

1. Using the alignment posts, place the left and right speakers on the palm-rest and keyboard assembly.  
**NOTE:** Ensure that the alignment posts are threaded through the rubber grommets on the speaker.
2. Route the speaker cable through the routing guides on the palm-rest and keyboard assembly.
3. Adhere the tapes that secure the speaker cable to the palm-rest and keyboard assembly.

### Next steps

1. Install the [system board](#).
2. Install the [heat sink](#).
3. Install the [left fan](#).
4. Install the [right fan](#).
5. Install the [battery](#).
6. Install the [wireless card](#).
7. Install the [base cover](#).
8. Follow the procedure in [After working inside your computer](#).

## Palm-rest and keyboard assembly

### Removing the palm-rest and keyboard assembly

#### Prerequisites

1. Follow the procedure in [Before working inside your computer](#).
2. Remove the [base cover](#).
3. Remove the [wireless card](#).
4. Remove the [battery](#).
5. Remove the [power-adaptor port](#).
6. Remove the [I/O board](#).
7. Remove the [touchpad](#).

8. Remove the [display assembly](#).
9. Remove the [power-button board](#).
10. Remove the [power button](#) or [power button with fingerprint](#), whichever applicable.
11. Remove the [left fan](#).
12. Remove the [right fan](#).
13. Remove the [system board](#).

**i** **NOTE:** The system board can be removed with the heat sink and memory installed.

14. Remove the [speakers](#).

### About this task

The following image(s) indicate the location of the palm-rest and keyboard assembly and provides a visual representation of the removal procedure.

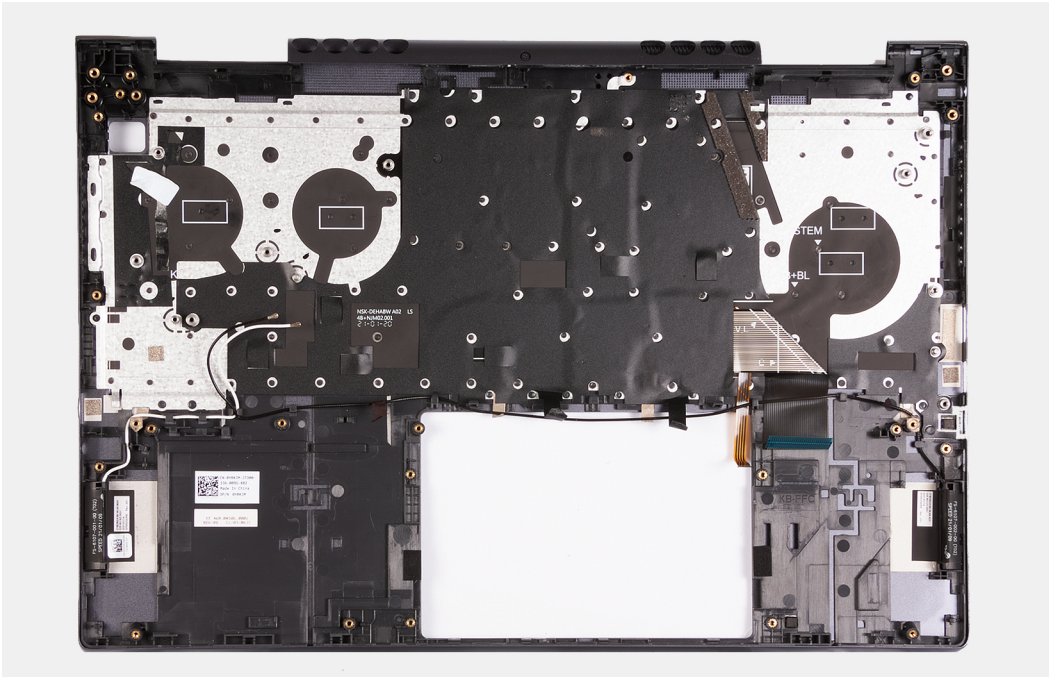

### Steps

After performing the pre-requisites you are left with the palm-rest and keyboard assembly.

## Installing the palm-rest and keyboard assembly

### Prerequisites

If you are replacing a component, remove the existing component before performing the installation process.

### About this task

The following image(s) indicate the location of the palm-rest and keyboard assembly and provides a visual representation of the installation procedure.

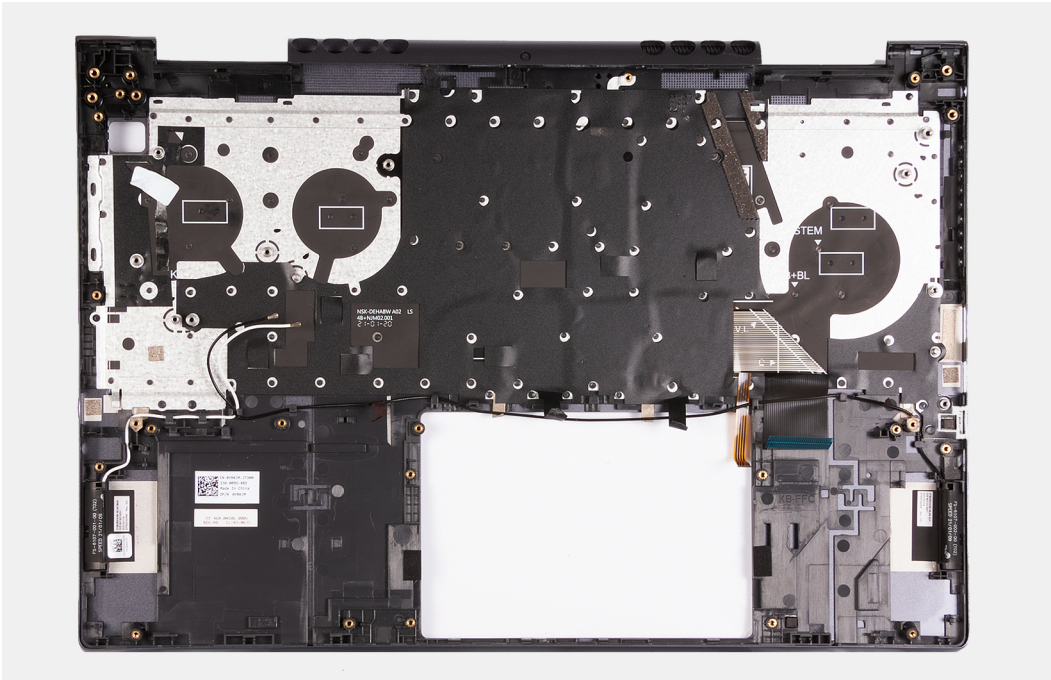

### Steps

Place the palm-rest and keyboard assembly on a flat and clean surface and perform the post-requisites to install the palm-rest and keyboard assembly.

### Next steps

1. Install the [speakers](#).
2. Install the [system board](#).
3. Install the [left fan](#).
4. Install the [right fan](#).
5. Install the [power button](#) or [power button with fingerprint](#), whichever applicable.
6. Install the [power-button board](#).
7. Install the [display assembly](#).
8. Install the [touchpad](#).
9. Install the [IO board](#).
10. Install the [power-adapter port](#).
11. Install the [battery](#).
12. Install the [wireless card](#).
13. Install the [base cover](#).
14. Follow the procedure in [After working inside your computer](#).

## Drivers and downloads

When troubleshooting, downloading or installing drivers it is recommended that you read the Dell Knowledge Based article, Drivers and Downloads FAQ [000123347](#).

# System setup

**CAUTION:** Unless you are an expert computer user, do not change the settings in the BIOS Setup program. Certain changes can make your computer work incorrectly.

**NOTE:** Depending on the computer and its installed devices, the items listed in this section may or may not be displayed.

**NOTE:** Before you change BIOS Setup program, it is recommended that you write down the BIOS Setup program screen information for future reference.

Use the BIOS Setup program for the following purposes:

- Get information about the hardware installed in your computer, such as the amount of RAM and the size of the hard drive.
- Change the system configuration information.
- Set or change a user-selectable option, such as the user password, type of hard drive installed, and enabling or disabling base devices.

## Entering BIOS setup program

### Steps

1. Turn on your computer.
2. Press F2 immediately to enter the BIOS setup program.

**NOTE:** If you wait too long and the operating system logo appears, continue to wait until you see the desktop. Then, turn off your computer and try again.

## Navigation keys

**NOTE:** For most of the System Setup options, changes that you make are recorded but do not take effect until you restart the system.

**Table 3. Navigation keys**

Keys	Navigation
Up arrow	Moves to the previous field.
Down arrow	Moves to the next field.
Enter	Selects a value in the selected field (if applicable) or follow the link in the field.
Spacebar	Expands or collapses a drop-down list, if applicable.
Tab	Moves to the next focus area. <b>NOTE:</b> For the standard graphics browser only.
Esc	Moves to the previous page until you view the main screen. Pressing Esc in the main screen displays a message that prompts you to save any unsaved changes and restarts the system.

# Boot Sequence

Boot Sequence allows you to bypass the System Setup–defined boot device order and boot directly to a specific device (for example: optical drive or hard drive). During the Power-on Self Test (POST), when the Dell logo appears, you can:

- Access System Setup by pressing F2 key
- Bring up the one-time boot menu by pressing F12 key

The one-time boot menu displays the devices that you can boot from including the diagnostic option. The boot menu options are:

- Removable Drive (if available)
- STXXXX Drive (if available)  
**i** **NOTE:** XXX denotes the SATA drive number.
- Optical Drive (if available)
- SATA Hard Drive (if available)
- Diagnostics

The boot sequence screen also displays the option to access the System Setup screen.

## System setup options

**i** **NOTE:** Depending on this computer and its installed devices, the items that are listed in this section may or may not be displayed.

**Table 4. System setup options—System information menu**

Overview	
BIOS Version	Displays the BIOS version number.
Service Tag	Displays the Service Tag of the computer.
Asset Tag	Displays the Asset Tag of the computer.
Manufacture Date	Displays the manufacture date of the computer.
Ownership Date	Displays the ownership date of the computer.
Express Service Code	Displays the express service code of the computer.
Ownership Tag	Displays the ownership tag of the computer.
Signed Firmware Update	Displays whether the signed firmware update is enabled. Default: Enabled
<b>Battery</b>	Displays the battery health information.
Primary	Displays the primary battery.
Battery Level	Displays the battery level.
Battery State	Displays the battery state.
Health	Displays the battery health.
AC Adapter	Displays whether an AC adapter is connected. If connected, the AC adapter type.
<b>PROCESSOR</b>	
Processor Type	Displays the processor type.
Maximum Clock Speed	Displays the maximum processor clock speed.
Minimum Clock Speed	Displays the minimum processor clock speed.
Current Clock Speed	Displays the current processor clock speed.
Core Count	Displays the number of cores on the processor.

**Table 4. System setup options—System information menu (continued)**

<b>Overview</b>	
Processor ID	Displays the processor identification code.
Processor L2 Cache	Displays the processor L2 Cache size.
Processor L3 Cache	Displays the processor L3 Cache size.
Microcode Version	Displays the microcode version.
Intel Hyper-Threading Capable	Displays whether the processor is Hyper-Threading (HT) capable.
64-Bit Technology	Displays whether 64-bit technology is used.
<b>MEMORY</b>	
Memory Installed	Displays the total computer memory installed.
Memory Available	Displays the total computer memory available.
Memory Speed	Displays the memory speed.
Memory Channel Mode	Displays single or dual channel mode.
Memory Technology	Displays the technology that is used for the memory.
DIMM A Size	Displays the memory configuration of DIMM A.
DIMM B Size	Displays the memory configuration of DIMM B.
<b>DEVICES</b>	
Panel Type	Displays the Panel Type of the computer.
Video Controller	Displays the integrate graphics information of the computer.
Video Memory	Displays the video memory information of the computer.
Wi-Fi Device	Displays the Wi-Fi device installed in the computer.
Native Resolution	Displays the native resolution of the computer.
Video BIOS Version	Displays the video BIOS version of the computer.
Audio Controller	Displays the audio controller information of the computer.
Bluetooth Device	Displays whether a Bluetooth device is installed in the computer.
LOM MAC Address	Displays the MAC address of the LAN on Motherboard (LOM)

**Table 5. System setup options—Boot Configuration menu**

<b>Boot Configuration</b>	
<b>Boot Sequence</b>	
Boot Mode: UEFI only	Displays the boot mode of this computer.
Boot Sequence	Specifies the order that the BIOS searches the list of devices to find an operating system to boot.  By default, ONBOARD NIC (IPV4) is selected By default, ONBOARD NIC (IPV6) is selected By default, UEFI Hard Drive is selected
<b>Secure Boot</b>	
Enable Secure Boot	Enables secure boot using only validated boot software.  Default: OFF
Secure Boot Mode	Modifies the behavior of Secure Boot to allow evaluation or enforcement of UEFI driver signatures. Deployed Mode should be selected for normal operation of Secure Boot.  By default, Deployed Mode is selected.

**Table 5. System setup options—Boot Configuration menu (continued)**

<b>Boot Configuration</b>	
<b>Expert Key Management</b>	
Enable Custom Mode	Allows the PK, KEK, db, and dbx security key databases to be modified. Default: OFF
	 <b>NOTE:</b> If Custom Mode is not enabled, any changes made with respect to the keys will not be saved.
Custom Mode Key Management	Allows for selection of key database. <ul style="list-style-type: none"> <li>● Save to File will save the key to a user-selected file.</li> <li>● Replace from File will replace the current key with a key from a user-selected file.</li> <li>● Append from File will add a key to the current database from a user-selected file.</li> <li>● Delete will delete the selected key.</li> <li>● Reset All Keys will reset all four keys to their default settings.</li> </ul> By default, PK security key database is selected. By default, Save to File is selected.

**Table 6. System setup options—Integrated Devices menu**

<b>Integrated Devices</b>	
<b>Date/Time</b>	
Date	Sets the computer date in MM/DD/YYYY format. Changes to the date take effect immediately.
Time	Sets the computer time in HH/MM/SS 24-hour format. You can switch between 12-hour and 24-hour clock. Changes to the time take effect immediately.
<b>Camera</b>	
Enable Camera	Enables or disables the camera. By default, Enable Camera is selected.
<b>Audio</b>	
	Enables or disables all integrated audio controller. Default: ON
Enable Microphone	Enables or disables microphone. By default, Enable Microphone is selected.
Enable Internal Speaker	Enables or disables internal speaker. By default, Enable Internal Speaker is selected.
<b>USB Configuration</b>	
	Enables or disables booting from USB mass storage devices such as external hard drive, optical drive, and USB drive. By default, Enable USB Boot Support is selected.

**Table 7. System setup options—Storage menu**

<b>Storage</b>	
<b>SATA/NVMe Operation</b>	
SATA/NVMe Operation	Configures operating mode of the integrated storage device controller. Default: RAID On. Storage device is configured to support RAID functions. When enabled, all NVMe and SATA devices will be mapped under VMD

**Table 7. System setup options—Storage menu (continued)**

Storage	
	controller. Windows RST (Intel Rapid Restore Technology) driver, or Linux kernel VMD driver must be loaded in order to boot the OS.
<b>Storage Interface</b>	
Port Enablement	Enables or disables the onboard drives. Default: ON
<b>Drive Information</b>	Displays the information of various onboard drives.

**Table 8. System setup options—Display menu**

Display	
<b>Display Brightness</b>	
Brightness on battery power	Sets the screen brightness when the computer is running on battery power. Default: 50
Brightness on AC power	Sets the screen brightness when the computer is running on AC power. Default: 100

**Table 9. System setup options—Passwords menu**

Passwords	
<b>Admin Password</b>	Enables the user to set, change, or delete the administrator (admin) password. The admin password enables several security features
<b>System Password</b>	Enables the user to set, change, or delete the system password.
<b>Internal HDD-1 Password</b>	Enables the user to set, change, or delete the Internal HDD-1 password.

**Table 10. System setup options—Update,Recovery menu**

Update,Recovery	
<b>SupportAssist OS Recovery</b>	Enables or disables the boot flow for SupportAssist OS Recovery tool, in the event of certain system error. Default: ON
<b>BIOSConnect</b>	Enables or disables cloud Service OS recovery if the main OS fails to boot within the number of failures equal or greater than the value specified by Dell Auto OS Recovery Threshold, and local Service does not boot, or is not installed. Default: ON
<b>Dell Auto OS Recovery Threshold</b>	Controls the automatic boot flow for SupportAssist System Resolution Console and for Dell operating system Recovery tool. Default: 2.

**Table 11. System setup options—System Management menu**

System Management	
<b>Service Tag</b>	Displays the Service Tag of the computer.
<b>Asset Tag</b>	Creates a system Asset Tag that can be used by an IT administrator to uniquely identify a particular system. Once set in BIOS, the Asset Tag cannot be changed.

**Table 12. System setup options—Keyboard menu**

Keyboard	
<b>Numlock Enable</b>	This option specifies whether the Numlock function should be enabled when the system boots.
<b>Fn Lock Options</b>	Enables Fn Lock mode. Once Fn lock mode is enabled, there are two Fn Lock options that can be selected. Lock mode standard allows the Fn keys to perform the standard function. Lock mode secondary allows the Fn keys to perform Fn key functions without holding down the Fn key and F1-F12 functions when the Fn key is held down.
<b>Keyboard Illumination</b>	The option specifies the brightness of the keyboard backlight.
<b>Keyboard Backlight Timeout on AC</b>	The option specifies when the keyboard backlight turns off when the computer is has a power adapter connected and is on idle.
<b>Keyboard Backlight Timeout on Battery</b>	The option specifies when the keyboard backlight turns off when the computer does not have a power adapter connected and is on idle.

**Table 13. System setup options—Pre-boot Behavior menu**

Pre-boot Behavior	
<b>Adapter warnings</b>	
Enable Adapter warnings	Enables or disables the computer to display adapter warning messages when adapters with too little power capacity are detected. Default: ON
<b>Warnings and Errors</b>	Selects an action on encountering a warning or error during boot. Default: Prompt on Warnings and Errors. Stop, prompt, and wait for user input when warnings or errors are detected.
	<b>NOTE:</b> Errors deemed critical to the operation of the computer hardware will always halt the computer.

**Table 14. System setup options—System Logs menu**

System Logs	
<b>BIOS Event Log</b>	
Clear Bios Event Log	Select keep or clear BIOS events. Default: Keep
<b>Thermal Event Log</b>	
Clear Thermal Event Log	Select keep or clear Thermal events. Default: Keep
<b>Power Event Log</b>	
Clear POWER Event Log	Select keep or clear Power events. Default: Keep

## System and setup password

**Table 15. System and setup password**

Password type	Description
System password	Password that you must enter to log on to your system.

**Table 15. System and setup password (continued)**

Password type	Description
Setup password	Password that you must enter to access and make changes to the BIOS settings of your computer.

You can create a system password and a setup password to secure your computer.

 **CAUTION:** The password features provide a basic level of security for the data on your computer.

 **CAUTION:** Anyone can access the data stored on your computer if it is not locked and left unattended.

 **NOTE:** System and setup password feature is disabled.

## Assigning a system setup password

### Prerequisites

You can assign a new **System or Admin Password** only when the status is in **Not Set**.

### About this task

To enter the system setup, press F12 immediately after a power-on or reboot.

### Steps

1. In the **System BIOS** or **System Setup** screen, select **Security** and press Enter.  
The **Security** screen is displayed.
2. Select **System/Admin Password** and create a password in the **Enter the new password** field.  
Use the following guidelines to assign the system password:
  - A password can have up to 32 characters.
  - At least one special character: ! " # \$ % & ' ( ) \* + , - . / : ; < = > ? @ [ \ ] ^ \_ ` { | }
  - Numbers 0 through 9.
  - Upper case letters from A to Z.
  - Lower case letters from a to z.
3. Type the system password that you entered earlier in the **Confirm new password** field and click **OK**.
4. Press Esc and save the changes as prompted by the pop-up message.
5. Press Y to save the changes.  
The computer restarts.

## Deleting or changing an existing system setup password

### Prerequisites

Ensure that the **Password Status** is Unlocked (in the System Setup) before attempting to delete or change the existing System and/or Setup password. You cannot delete or change an existing System or Setup password, if the **Password Status** is Locked.

### About this task

To enter the System Setup, press F12 immediately after a power-on or reboot.

### Steps

1. In the **System BIOS** or **System Setup** screen, select **System Security** and press Enter.  
The **System Security** screen is displayed.
2. In the **System Security** screen, verify that **Password Status** is **Unlocked**.
3. Select **System Password**, update, or delete the existing system password, and press Enter or Tab.

4. Select **Setup Password**, update, or delete the existing setup password, and press Enter or Tab.

 **NOTE:** If you change the System and/or Setup password, reenter the new password when prompted. If you delete the System and/or Setup password, confirm the deletion when prompted.

5. Press Esc and a message prompts you to save the changes.
6. Press Y to save the changes and exit from System Setup.  
The computer restarts.

## Clearing CMOS settings

### About this task

 **CAUTION:** Clearing CMOS settings will reset the BIOS settings on your computer.

### Steps

1. Enter [Service Mode](#).
2. Wait for one minute.
3. Exit [Service Mode](#).

## Clearing BIOS (System Setup) and System passwords

### About this task

To clear the system or BIOS passwords, contact Dell technical support as described at [www.dell.com/contactdell](http://www.dell.com/contactdell).

 **NOTE:** For information on how to reset Windows or application passwords, refer to the documentation accompanying Windows or your application.

## Updating the BIOS

### Updating the BIOS in Windows

#### Steps

1. Go to [www.dell.com/support](http://www.dell.com/support).
2. Click **Product support**. In the **Search support** box, enter the Service Tag of your computer, and then click **Search**.  
 **NOTE:** If you do not have the Service Tag, use the SupportAssist feature to automatically identify your computer. You can also use the product ID or manually browse for your computer model.
3. Click **Drivers & Downloads**. Expand **Find drivers**.
4. Select the operating system installed on your computer.
5. In the **Category** drop-down list, select **BIOS**.
6. Select the latest version of BIOS, and click **Download** to download the BIOS file for your computer.
7. After the download is complete, browse the folder where you saved the BIOS update file.
8. Double-click the BIOS update file icon and follow the on-screen instructions.  
For more information, see knowledge base article [000124211](http://www.dell.com/support) at [www.dell.com/support](http://www.dell.com/support).

### Updating the BIOS using the USB drive in Windows

#### Steps

1. Follow the procedure from step 1 to step 6 in [Updating the BIOS in Windows](#) to download the latest BIOS setup program file.
2. Create a bootable USB drive. For more information, see the knowledge base article [000145519](http://www.dell.com/support) at [www.dell.com/support](http://www.dell.com/support).

3. Copy the BIOS setup program file to the bootable USB drive.
4. Connect the bootable USB drive to the computer that needs the BIOS update.
5. Restart the computer and press **F12** .
6. Select the USB drive from the **One Time Boot Menu**.
7. Type the BIOS setup program filename and press **Enter**.  
The **BIOS Update Utility** appears.
8. Follow the on-screen instructions to complete the BIOS update.

## Updating the BIOS from the F12 One-Time boot menu

Update your computer BIOS using the BIOS update.exe file that is copied to a FAT32 USB drive and booting from the F12 One-Time boot menu.

### About this task

#### BIOS Update

You can run the BIOS update file from Windows using a bootable USB drive or you can also update the BIOS from the F12 One-Time boot menu on the computer.

Most of the Dell computers built after 2012 have this capability, and you can confirm by booting your computer to the F12 One-Time Boot Menu to see if BIOS FLASH UPDATE is listed as a boot option for your computer. If the option is listed, then the BIOS supports this BIOS update option.

 **NOTE:** Only computers with BIOS Flash Update option in the F12 One-Time boot menu can use this function.

#### Updating from the One-Time boot menu

To update your BIOS from the F12 One-Time boot menu, you need the following:

- USB drive formatted to the FAT32 file system (key does not have to be bootable)
- BIOS executable file that you downloaded from the Dell Support website and copied to the root of the USB drive
- AC power adapter that is connected to the computer
- Functional computer battery to flash the BIOS

Perform the following steps to perform the BIOS update flash process from the F12 menu:

 **CAUTION:** Do not turn off the computer during the BIOS update process. The computer may not boot if you turn off your computer.

#### Steps

1. From a turn off state, insert the USB drive where you copied the flash into a USB port of the computer.
2. Turn on the computer and press F12 to access the One-Time Boot Menu, select BIOS Update using the mouse or arrow keys then press Enter.  
The flash BIOS menu is displayed.
3. Click **Flash from file**.
4. Select external USB device.
5. Select the file and double-click the flash target file, and then click **Submit**.
6. Click **Update BIOS**. The computer restarts to flash the BIOS.
7. The computer will restart after the BIOS update is completed.

# Troubleshooting

## Handling swollen Lithium-ion batteries

Like most laptops, Dell laptops use lithium-ion batteries. One type of lithium-ion battery is the lithium-ion polymer battery. Lithium-ion polymer batteries have increased in popularity in recent years and have become standard in the electronics industry due to customer preferences for a slim form factor (especially with newer ultra-thin laptops) and long battery life. Inherent to lithium-ion polymer battery technology is the potential for swelling of the battery cells.

Swollen battery may impact the performance of the laptop. To prevent possible further damage to the device enclosure or internal components leading to malfunction, discontinue the use of the laptop and discharge it by disconnecting the AC adapter and letting the battery drain.

Swollen batteries should not be used and should be replaced and disposed of properly. We recommend contacting Dell product support for options to replace a swollen battery under the terms of the applicable warranty or service contract, including options for replacement by a Dell authorized service technician.

The guidelines for handling and replacing Lithium-ion batteries are as follows:

- Exercise caution when handling Lithium-ion batteries.
- Discharge the battery before removing it from the system. To discharge the battery, unplug the AC adapter from the system and operate the system only on battery power. When the system will no longer power on when the power button is pressed, the battery is fully discharged.
- Do not crush, drop, mutilate, or penetrate the battery with foreign objects.
- Do not expose the battery to high temperatures, or disassemble battery packs and cells.
- Do not apply pressure to the surface of the battery.
- Do not bend the battery.
- Do not use tools of any type to pry on or against the battery.
- If a battery gets stuck in a device as a result of swelling, do not try to free it as puncturing, bending, or crushing a battery can be dangerous.
- Do not attempt to reassemble a damaged or swollen battery into a laptop.
- Swollen batteries that are covered under warranty should be returned to Dell in an approved shipping container (provided by Dell)—this is to comply with transportation regulations. Swollen batteries that are not covered under warranty should be disposed of at an approved recycling center. Contact Dell product support at <https://www.dell.com/support> for assistance and further instructions.
- Using a non-Dell or incompatible battery may increase the risk of fire or explosion. Replace the battery only with a compatible battery purchased from Dell that is designed to work with your Dell computer. Do not use a battery from other computers with your computer. Always purchase genuine batteries from <https://www.dell.com> or otherwise directly from Dell.

Lithium-ion batteries can swell for various reasons such as age, number of charge cycles, or exposure to high heat. For more information on how to improve the performance and lifespan of the laptop battery and to minimize the possibility of occurrence of the issue, search Dell Laptop Battery in the Knowledge Base Resource at [www.dell.com/support](http://www.dell.com/support).

## Locate the Service Tag or Express Service Code of your Dell computer

Your Dell computer is uniquely identified by a Service Tag or Express Service Code. To view relevant support resources for your Dell computer, we recommend entering the Service Tag or Express Service Code at [www.dell.com/support](http://www.dell.com/support).

For more information on how to find the Service Tag for your computer, see [Locate the Service Tag for your Dell Laptop](#).

# System-diagnostic lights

The power and battery status light indicates the power and battery status of the computer. These are the power states:

**Solid white:** Power adapter is connected, and the battery has more than 5% charge.

**Amber:** Computer is running on battery, and the battery has less than 5% charge.

**Off:**

- Power adapter is connected, and the battery is fully charged.
- Computer is running on battery, and the battery has more than 5% charge.
- Computer is in sleep state, hibernation, or turned off.

The power and battery-status light may also blink amber or white according to predefined "beep codes" indicating various failures.

For example, the power and battery-status light blinks amber two times followed by a pause, and then blinks white three times followed by a pause. This 2,3 pattern continues until the computer is turned off, indicating no memory or RAM is detected.

The following table shows different power and battery-status light patterns and associated problems.

**NOTE:** The following diagnostic light codes and recommended solutions are intended for Dell service technicians to troubleshoot problems. You should only perform troubleshooting and repairs as authorized or directed by the Dell technical support team. Damage due to servicing that is not authorized by Dell is not covered by your warranty.

**Table 16. Diagnostic-light codes**

Diagnostic light codes (Amber, white)	Problem description
1,1	TPM detection failure
1,2	Unrecoverable SPI flash failure
1,3	Short in hinge cable tripped OCP1
1,4	Short in hinge cable tripped OCP2
1,5	EC unable to program i-Fuse
1,6	EC internal Failure
2,1	Processor failure
2,2	System board: BIOS or ROM (Read-Only Memory) failure
2,3	No memory or RAM (Random-Access Memory) detected
2,4	Memory or RAM (Random-Access Memory) failure
2,5	Invalid memory installed
2,6	System-board or chipset error
2,7	Display failure - SBIOS message
2,8	LCD failure (EC detection of power rail failure)
3,2	PCI, video card/chip failure
3,3	BIOS recovery image not found
3,4	Recovery image found but invalid
3,5	Power-rail failure
3,6	System BIOS Flash incomplete
3,7	Management Engine (ME) error

**Camera status light:** Indicates whether the camera is in use.

- Solid white—Camera is in use.

- Off—Camera is not in use.

**Caps Lock status light:** Indicates whether Caps Lock is enabled or disabled.

- Solid white—Caps Lock enabled.
- Off—Caps Lock disabled.

## SupportAssist | On-board Diagnostics

### About this task

The SupportAssist | On-board Diagnostics performs a complete check of your hardware.

This diagnostic is the new on-board diagnostic tool and replaces the ePSA 3.0 diagnostics. It has a clean and modern user interface, quicker tests, simplified messaging.

SupportAssist | On-board Diagnostics can be initiated by one of the following methods:

- Pressing F12 to enter one-time Boot Menu and selecting Diagnostics to initiate the diagnostics OR Fn + Power
- BIOS POST detecting a hardware failure or error and initiating the diagnostics

The SupportAssist | On-board Diagnostics is embedded with the BIOS and is launched by the BIOS internally. The embedded system diagnostics provides a set of options for particular devices or device groups allowing you to:

- Run tests in either Quick Test Mode or Advanced Test Mode
- Run thorough tests to introduce additional test options to provide extra information about the failed device(s)
- Run tests in either Automatic Mode or Interactive Test Mode
- Run interactive tests on LCD panel and keyboard
- Display or save test results
- View status messages that indicate if the tests are completed successfully
- View error messages that indicate if problems were encountered during the test

 **NOTE:** Some tests for specific devices require user interaction. Ensure that you are present at the computer terminal when the diagnostic tests are performed.

For more information, see [SupportAssist Pre-Boot System Performance Check](#).

## Recovering the operating system

When your computer is unable to boot to the operating system even after repeated attempts, it automatically starts Dell SupportAssist OS Recovery.

Dell SupportAssist OS Recovery is a standalone tool that is preinstalled in all Dell computers installed with Windows operating system. It consists of tools to diagnose and troubleshoot issues that may occur before your computer boots to the operating system. It enables you to diagnose hardware issues, repair your computer, back up your files, or restore your computer to its factory state.

You can also download it from the Dell Support website to troubleshoot and fix your computer when it fails to boot into their primary operating system due to software or hardware failures.

For more information about the Dell SupportAssist OS Recovery, see *Dell SupportAssist OS Recovery User's Guide* at [www.dell.com/serviceabilitytools](http://www.dell.com/serviceabilitytools). Click **SupportAssist** and then, click **SupportAssist OS Recovery**.

## WiFi power cycle

### About this task

If your computer is unable to access the internet due to WiFi connectivity issues a WiFi power cycle procedure may be performed. The following procedure provides the instructions on how to conduct a WiFi power cycle:

 **NOTE:** Some ISPs (Internet Service Providers) provide a modem/router combo device.

### Steps

1. Turn off your computer.



2. Turn off the modem.
3. Turn off the wireless router.
4. Wait for 30 seconds.
5. Turn on the wireless router.
6. Turn on the modem.
7. Turn on your computer.

# Getting help and contacting Dell

## Self-help resources

You can get information and help on Dell products and services using these self-help resources:

**Table 17. Self-help resources**

Self-help resources	Resource location
Information about Dell products and services	<a href="http://www.dell.com">www.dell.com</a>
My Dell app	
Tips	
Contact Support	In Windows search, type <code>Contact Support</code> , and press Enter.
Online help for operating system	<a href="http://www.dell.com/support/windows">www.dell.com/support/windows</a> <a href="http://www.dell.com/support/linux">www.dell.com/support/linux</a>
Access top solutions, diagnostics, drivers and downloads, and learn more about your computer through videos, manuals and documents.	Your Dell computer is uniquely identified by a Service Tag or Express Service Code. To view relevant support resources for your Dell computer, enter the Service Tag or Express Service Code at <a href="http://www.dell.com/support">www.dell.com/support</a> .  For more information on how to find the Service Tag for your computer, see <a href="#">Locate the Service Tag on your computer</a> .
Dell knowledge base articles for a variety of computer concerns	<ol style="list-style-type: none"> <li>1. Go to <a href="http://www.dell.com/support">www.dell.com/support</a>.</li> <li>2. On the menu bar at the top of the Support page, select <b>Support &gt; Knowledge Base</b>.</li> <li>3. In the Search field on the Knowledge Base page, type the keyword, topic, or model number, and then click or tap the search icon to view the related articles.</li> </ol>

## Contacting Dell

To contact Dell for sales, technical support, or customer service issues, see [www.dell.com/contactdell](http://www.dell.com/contactdell).

 **NOTE:** Availability varies by country/region and product, and some services may not be available in your country/region.

 **NOTE:** If you do not have an active Internet connection, you can find contact information about your purchase invoice, packing slip, bill, or Dell product catalog.