

Inspiron 5594

Service Manual



Notes, cautions, and warnings

 **NOTE:** A NOTE indicates important information that helps you make better use of your product.

 **CAUTION:** A CAUTION indicates either potential damage to hardware or loss of data and tells you how to avoid the problem.

 **WARNING:** A WARNING indicates a potential for property damage, personal injury, or death.

© 2019 Dell Inc. or its subsidiaries. All rights reserved. Dell, EMC, and other trademarks are trademarks of Dell Inc. or its subsidiaries. Other trademarks may be trademarks of their respective owners.

1 Working inside your computer	6
Safety instructions.....	6
Before working inside your computer.....	6
Before you begin	6
Electrostatic discharge—ESD protection.....	7
ESD field service kit	7
Transporting sensitive components.....	8
After working inside your computer.....	8
2 Removing and installing components	9
Recommended tools.....	9
Screw list.....	9
Base cover.....	10
Removing the base cover.....	10
Replacing the base cover.....	13
Battery.....	16
Removing the battery.....	16
Replacing the battery.....	17
Memory modules.....	19
Removing the memory modules.....	19
Replacing the memory modules.....	20
Wireless card.....	20
Removing the wireless card.....	20
Replacing the wireless card.....	21
Fan.....	22
Removing the fan.....	22
Replacing the fan.....	23
Solid-state drive/Intel Optane.....	24
Removing the solid-state drive/Intel Optane.....	24
Replacing the solid-state drive/Intel Optane.....	26
Hard drive.....	28
Removing the hard drive.....	28
Replacing the hard drive.....	30
Touchpad.....	32
Removing the touchpad.....	32
Replacing the touchpad.....	33
Speakers.....	35
Removing the speakers.....	35
Replacing the speakers.....	36
Heat sink.....	36
Removing the heat sink.....	36
Replacing the heat sink.....	37
Display assembly.....	38
Removing the display assembly.....	38









Replacing the display assembly.....	41
Power-adapter port.....	43
Removing the power-adapter port.....	43
Replacing the power-adapter port.....	44
I/O board.....	45
Removing the I/O board.....	45
Replacing the I/O board.....	46
Coin-cell battery.....	47
Removing the coin-cell battery.....	47
Replacing the coin-cell battery.....	48
Power button.....	49
Removing the power button.....	49
Replacing the power button.....	50
System board.....	50
Removing the system board.....	50
Replacing the system board.....	53
Power button with fingerprint reader.....	56
Removing the power button with fingerprint reader.....	56
Replacing the power button with fingerprint reader.....	57
Palm-rest and keyboard assembly.....	58
Removing the palm-rest and keyboard assembly.....	58
Replacing the palm-rest and keyboard assembly.....	59
Display bezel.....	60
Removing the display bezel.....	60
Replacing the display bezel.....	61
Camera.....	62
Removing the camera.....	62
Replacing the camera.....	63
Display panel.....	64
Removing the display panel.....	64
Replacing the display panel.....	66
Display cable.....	68
Removing the display cable.....	68
Replacing the display cable.....	69
Display back-cover and antenna assembly.....	70
Removing the display back-cover and antenna assembly.....	70
Replacing the display back-cover and antenna assembly.....	71
3 Device drivers.....	73
Downloading the audio driver.....	73
Downloading the network driver.....	73
Downloading the chipset driver.....	74
Downloading the media-card reader driver.....	74
Downloading the WiFi driver.....	75
Downloading the USB driver.....	75
Downloading the graphics driver.....	76
4 System setup.....	77
System setup.....	77

Entering BIOS setup program.....	77
Navigation keys.....	77
Boot Sequence.....	78
Clearing CMOS settings.....	78
Clearing BIOS (System Setup) and System passwords.....	78
5 Troubleshooting.....	79
Enhanced Pre-Boot System Assessment (ePSA) diagnostics.....	79
Running the ePSA diagnostics.....	79
System diagnostic lights.....	79
Recovering the operating system.....	80
Flashing the BIOS.....	80
Enabling Intel Optane memory.....	81
Disabling Intel Optane memory.....	81
Flashing BIOS (USB key).....	81
WiFi power cycle.....	81
Flea power release.....	82
6 Getting help and contacting Dell.....	83

Working inside your computer

Safety instructions



Use the following safety guidelines to protect your computer from potential damage and to ensure your personal safety. Unless otherwise noted, each procedure included in this document assumes that you have read the safety information that shipped with your computer.

-  **NOTE:** Before working inside your computer, read the safety information that shipped with your computer. For more safety best practices, see the Regulatory Compliance home page at www.dell.com/regulatory_compliance.
-  **NOTE:** Disconnect all power sources before opening the computer cover or panels. After you finish working inside the computer, replace all covers, panels, and screws before connecting to the electrical outlet.
-  **CAUTION:** To avoid damaging the computer, ensure that the work surface is flat and clean.
-  **CAUTION:** Handle components and cards with care. Do not touch the components or contacts on a card. Hold a card by its edges or by its metal mounting bracket. Hold a component such as a processor by its edges, not by its pins.
-  **CAUTION:** You should only perform troubleshooting and repairs as authorized or directed by the Dell technical assistance team. Damage due to servicing that is not authorized by Dell is not covered by your warranty. See the safety instructions that shipped with the product or at www.dell.com/regulatory_compliance.
-  **CAUTION:** Before touching anything inside your computer, ground yourself by using a wrist grounding strap or by periodically touching an unpainted metal surface, such as the metal at the back of the computer. While you work, periodically touch an unpainted metal surface to dissipate static electricity, which could harm internal components.
-  **CAUTION:** When you disconnect a cable, pull on its connector or on its pull tab, not on the cable itself. Some cables have connectors with locking tabs or thumb-screws that you must disengage before disconnecting the cable. When disconnecting cables, keep them evenly aligned to avoid bending any connector pins. When connecting cables, ensure that the ports and connectors are correctly oriented and aligned.
-  **CAUTION:** Press and eject any installed card from the media-card reader.
-  **NOTE:** The color of your computer and certain components may appear differently than shown in this document.

Before working inside your computer

-  **NOTE:** The images in this document may differ from your computer depending on the configuration you ordered.

Before you begin

1. Save and close all open files and exit all open applications.
2. Shut down your computer. Click **Start** >  **Power** > **Shut down**.
 -  **NOTE:** If you are using a different operating system, see the documentation of your operating system for shut-down instructions.
3. Disconnect your computer and all attached devices from their electrical outlets.
4. Disconnect all attached network devices and peripherals, such as keyboard, mouse, and monitor from your computer.
5. Remove any media card and optical disc from your computer, if applicable.

Electrostatic discharge—ESD protection

ESD is a major concern when you handle electronic components, especially sensitive components such as expansion cards, processors, memory DIMMs, and system boards. Very slight charges can damage circuits in ways that may not be obvious, such as intermittent problems or a shortened product life span. As the industry pushes for lower power requirements and increased density, ESD protection is an increasing concern.

Due to the increased density of semiconductors used in recent Dell products, the sensitivity to static damage is now higher than in previous Dell products. For this reason, some previously approved methods of handling parts are no longer applicable.

Two recognized types of ESD damage are catastrophic and intermittent failures.

- **Catastrophic** – Catastrophic failures represent approximately 20 percent of ESD-related failures. The damage causes an immediate and complete loss of device functionality. An example of catastrophic failure is a memory DIMM that has received a static shock and immediately generates a "No POST/No Video" symptom with a beep code emitted for missing or nonfunctional memory.
- **Intermittent** – Intermittent failures represent approximately 80 percent of ESD-related failures. The high rate of intermittent failures means that most of the time when damage occurs, it is not immediately recognizable. The DIMM receives a static shock, but the tracing is merely weakened and does not immediately produce outward symptoms related to the damage. The weakened trace may take weeks or months to melt, and in the meantime may cause degradation of memory integrity, intermittent memory errors, etc.

The more difficult type of damage to recognize and troubleshoot is the intermittent (also called latent or "walking wounded") failure.

Perform the following steps to prevent ESD damage:

- Use a wired ESD wrist strap that is properly grounded. The use of wireless anti-static straps is no longer allowed; they do not provide adequate protection. Touching the chassis before handling parts does not ensure adequate ESD protection on parts with increased sensitivity to ESD damage.
- Handle all static-sensitive components in a static-safe area. If possible, use anti-static floor pads and workbench pads.
- When unpacking a static-sensitive component from its shipping carton, do not remove the component from the anti-static packing material until you are ready to install the component. Before unwrapping the anti-static packaging, ensure that you discharge static electricity from your body.
- Before transporting a static-sensitive component, place it in an anti-static container or packaging.

ESD field service kit

The unmonitored Field Service kit is the most commonly used service kit. Each Field Service kit includes three main components: anti-static mat, wrist strap, and bonding wire.

Components of an ESD field service kit

The components of an ESD field service kit are:

- **Anti-Static Mat** – The anti-static mat is dissipative and parts can be placed on it during service procedures. When using an anti-static mat, your wrist strap should be snug and the bonding wire should be connected to the mat and to any bare metal on the system being worked on. Once deployed properly, service parts can be removed from the ESD bag and placed directly on the mat. ESD-sensitive items are safe in your hand, on the ESD mat, in the system, or inside a bag.
- **Wrist Strap and Bonding Wire** – The wrist strap and bonding wire can be either directly connected between your wrist and bare metal on the hardware if the ESD mat is not required, or connected to the anti-static mat to protect hardware that is temporarily placed on the mat. The physical connection of the wrist strap and bonding wire between your skin, the ESD mat, and the hardware is known as bonding. Use only Field Service kits with a wrist strap, mat, and bonding wire. Never use wireless wrist straps. Always be aware that the internal wires of a wrist strap are prone to damage from normal wear and tear, and must be checked regularly with a wrist strap tester in order to avoid accidental ESD hardware damage. It is recommended to test the wrist strap and bonding wire at least once per week.
- **ESD Wrist Strap Tester** – The wires inside of an ESD strap are prone to damage over time. When using an unmonitored kit, it is a best practice to regularly test the strap prior to each service call, and at a minimum, test once per week. A wrist strap tester is the best method for doing this test. If you do not have your own wrist strap tester, check with your regional office to find out if they have one. To perform the test, plug the wrist-strap's bonding-wire into the tester while it is strapped to your wrist and push the button to test. A green LED is lit if the test is successful; a red LED is lit and an alarm sounds if the test fails.
- **Insulator Elements** – It is critical to keep ESD sensitive devices, such as plastic heat sink casings, away from internal parts that are insulators and often highly charged.
- **Working Environment** – Before deploying the ESD Field Service kit, assess the situation at the customer location. For example, deploying the kit for a server environment is different than for a desktop or portable environment. Servers are typically installed in a rack within a data center; desktops or portables are typically placed on office desks or cubicles. Always look for a large open flat work area that is free of clutter and large enough to deploy the ESD kit with additional space to accommodate the type of system that is being repaired. The workspace should also be free of insulators that can cause an ESD event. On the work area, insulators such as

Styrofoam and other plastics should always be moved at least 12 inches or 30 centimeters away from sensitive parts before physically handling any hardware components

- **ESD Packaging** – All ESD-sensitive devices must be shipped and received in static-safe packaging. Metal, static-shielded bags are preferred. However, you should always return the damaged part using the same ESD bag and packaging that the new part arrived in. The ESD bag should be folded over and taped shut and all the same foam packing material should be used in the original box that the new part arrived in. ESD-sensitive devices should be removed from packaging only at an ESD-protected work surface, and parts should never be placed on top of the ESD bag because only the inside of the bag is shielded. Always place parts in your hand, on the ESD mat, in the system, or inside an anti-static bag.
- **Transporting Sensitive Components** – When transporting ESD sensitive components such as replacement parts or parts to be returned to Dell, it is critical to place these parts in anti-static bags for safe transport.

ESD protection summary

It is recommended that all field service technicians use the traditional wired ESD grounding wrist strap and protective anti-static mat at all times when servicing Dell products. In addition, it is critical that technicians keep sensitive parts separate from all insulator parts while performing service and that they use anti-static bags for transporting sensitive components.

Transporting sensitive components

When transporting ESD sensitive components such as replacement parts or parts to be returned to Dell, it is critical to place these parts in anti-static bags for safe transport.

Lifting equipment

Adhere to the following guidelines when lifting heavy weight equipment:

 **CAUTION: Do not lift greater than 50 pounds. Always obtain additional resources or use a mechanical lifting device.**

1. Get a firm balanced footing. Keep your feet apart for a stable base, and point your toes out.
2. Tighten stomach muscles. Abdominal muscles support your spine when you lift, offsetting the force of the load.
3. Lift with your legs, not your back.
4. Keep the load close. The closer it is to your spine, the less force it exerts on your back.
5. Keep your back upright, whether lifting or setting down the load. Do not add the weight of your body to the load. Avoid twisting your body and back.
6. Follow the same techniques in reverse to set the load down.

After working inside your computer

 **CAUTION: Leaving stray or loose screws inside your computer may severely damage your computer.**

1. Replace all screws and ensure that no stray screws remain inside your computer.
2. Connect any external devices, peripherals, or cables you removed before working on your computer.
3. Replace any media cards, discs, or any other parts that you removed before working on your computer.
4. Connect your computer and all attached devices to their electrical outlets.
5. Turn on your computer.

Removing and installing components

Recommended tools

The procedures in this document may require the following tools:

- Phillips screwdriver #1
- Flat-head screwdriver
- Plastic scribe









Screw list

NOTE: When removing screws from a component, it is recommended to note the screw type, the quantity of screws, and then place them in a screw storage box. This is to ensure that the correct number of screws and correct screw type is restored when the component is replaced.









NOTE: Some computers have magnetic surfaces. Ensure that the screws are not left attached to such surface when replacing a component.

NOTE: Screw color may vary with the configuration ordered.

Table 1. Screw list

Component	Secured to	Screw type	Quantity	Screw image
Base cover	Palm-rest and keyboard assembly	M2.5x6	7	
Battery	Palm-rest and keyboard assembly	M2x3	3	
Display panel	Display back-cover and antenna assembly	M2.5x2.5	6	
Display panel	Display back-cover and antenna assembly	M2x3	2	
Fan	Palm-rest and keyboard assembly	M2.5x5	2	
Hard-drive assembly	Palm-rest and keyboard assembly	M2x3	3	
Hard-drive bracket	Hard drive	M3x3	4	
Heat sink	System board	M2x3	3	

NOTE: Applicable only for computers shipped with discrete graphics configuration.

Component	Secured to	Screw type	Quantity	Screw image
Display assembly	Palm-rest and keyboard assembly	M2.5x5	6	
I/O board	Palm-rest and keyboard assembly	M2x4	3	
Power button with optional fingerprint reader	Palm-rest and keyboard assembly	M2x3	2	
M.2 2230/2280 Solid-state drive/Intel Optane	Palm-rest and keyboard assembly	M2x3	1	
M.2 2230 Solid-state drive/Intel Optane	Thermal shield	M2x2	1	
System board	Palm-rest and keyboard assembly	M2x4	1	
Touchpad bracket	Palm-rest and keyboard assembly	M1.6x2	3	
Touchpad	Palm-rest and keyboard assembly	M1.6x2	2	
Wireless-card bracket	System board	M2x3	1	

Base cover

Removing the base cover

NOTE: Before working inside your computer, read the safety information that shipped with your computer and follow the steps in [Before working inside your computer](#). After working inside your computer, follow the instructions in [After working inside your computer](#). For more safety best practices, see the Regulatory Compliance home page at www.dell.com/regulatory_compliance.

Procedure

1. Loosen the two captive screws on the base cover.
2. Remove the seven screws (M2.5x6) that secure the base cover to the palm-rest and keyboard assembly.

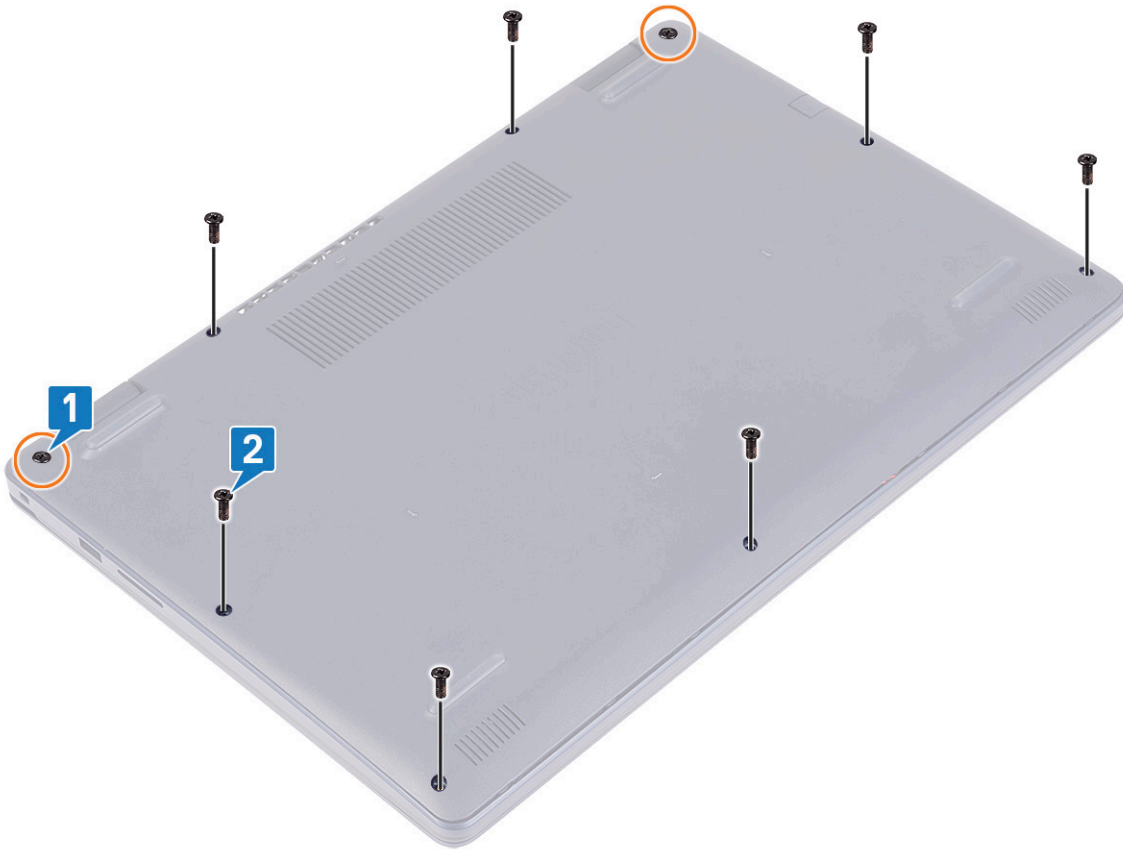

3. Pry the base cover starting from the indents at the display hinges located at the top-left and top-right corners of the computer base.
4. Lift the base cover off the palm-rest and keyboard assembly.

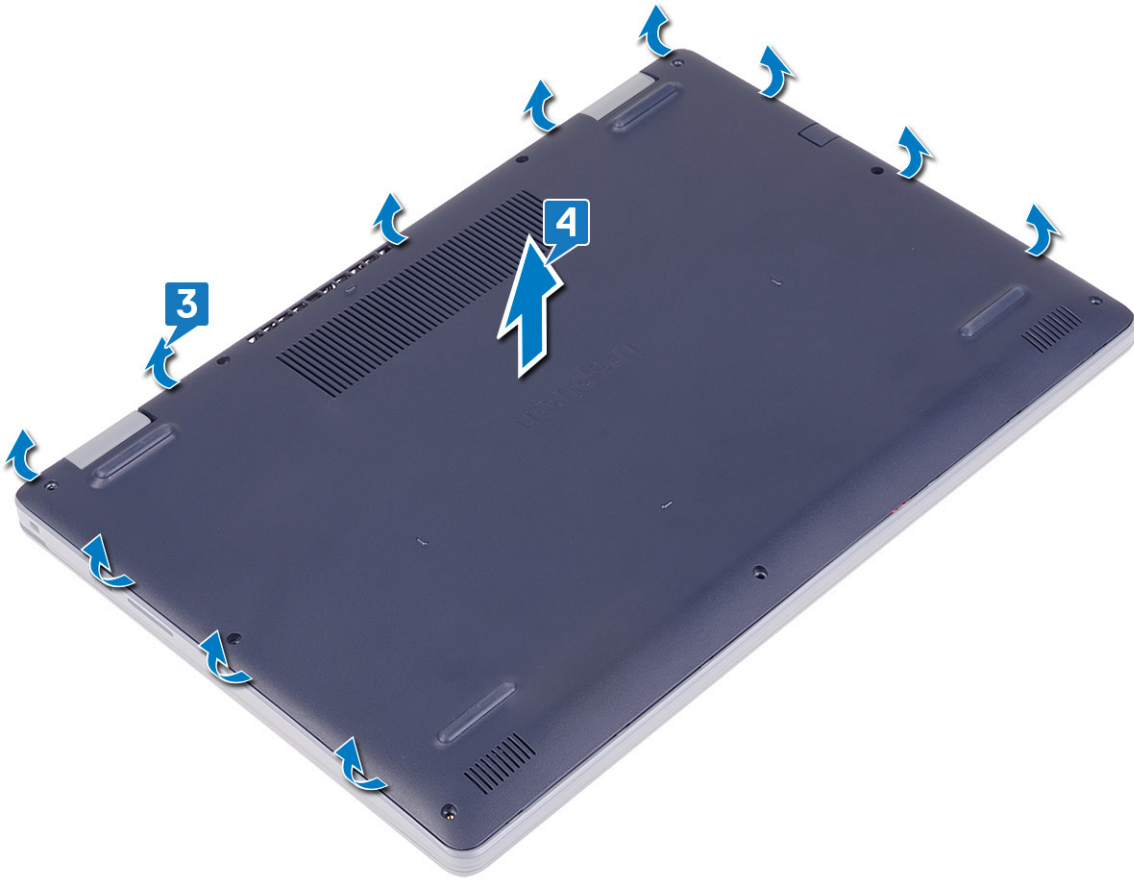

NOTE: The following steps are applicable only if you want to further remove any other component from your computer.

5. Peel the tape that adheres the battery cable to the connector and disconnect the battery cable from the system board.

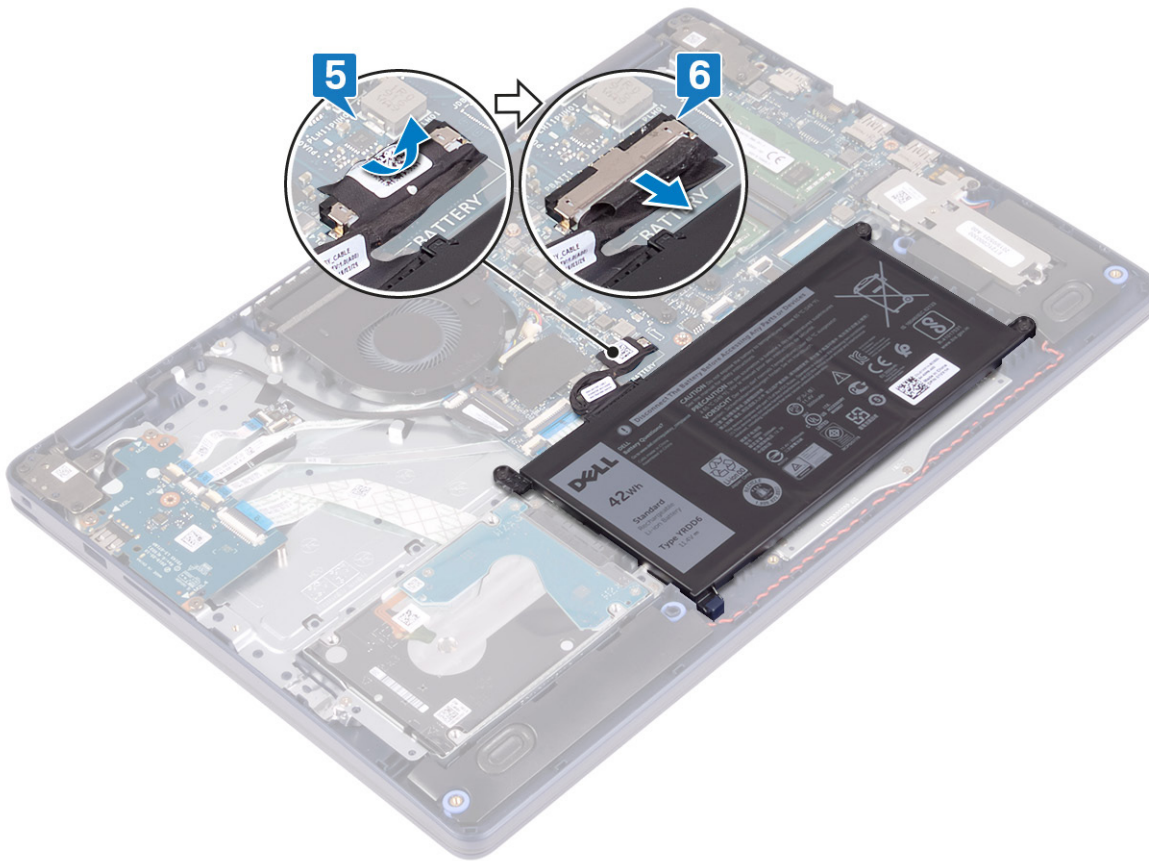

6. Press and hold the power button for five seconds to ground the computer and drain the flea power.

Replacing the base cover

NOTE: Before working inside your computer, read the safety information that shipped with your computer and follow the steps in [Before working inside your computer](#). After working inside your computer, follow the instructions in [After working inside your computer](#). For more safety best practices, see the Regulatory Compliance home page at www.dell.com/regulatory_compliance.

Procedure

1. Connect the battery cable to the system board.
2. Adhere the tape that secures the battery cable to the connector on the system board, if applicable.

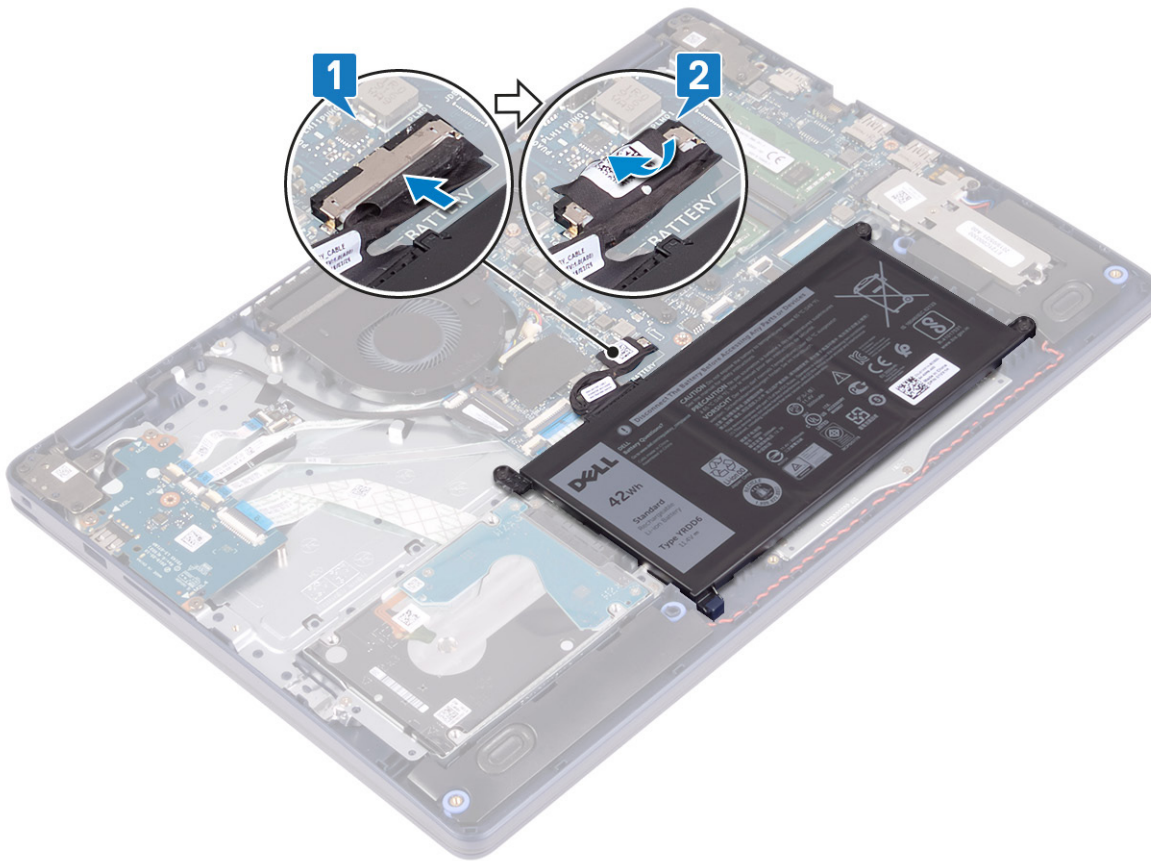

3. Place the base cover on the palm-rest and keyboard assembly, and snap the base cover into place starting from the power-adapter port.

CAUTION: To avoid accidental damage to the power-adapter port, do not press the base cover against the power-adapter port when you snap the base cover to the computer base.

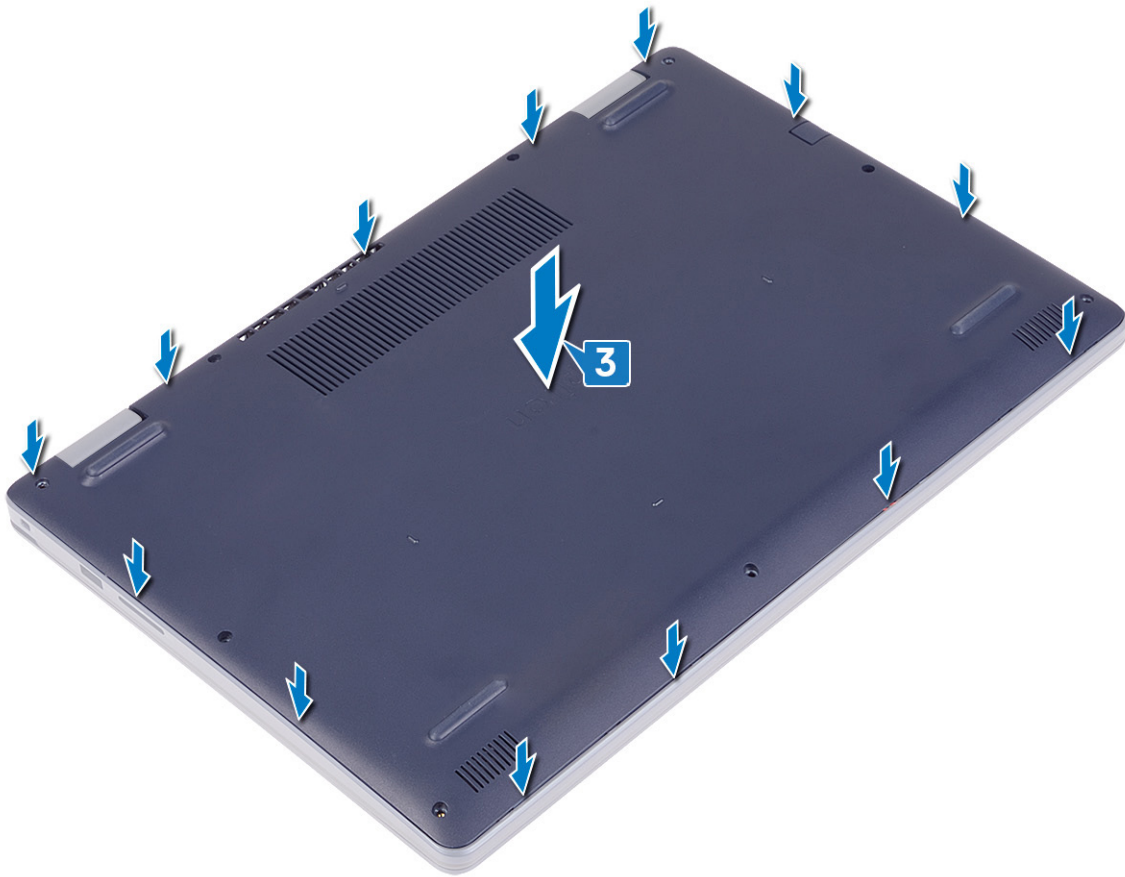

4. Replace the seven screws (M2.5x6) that secure the base cover to the palm-rest and keyboard assembly.
5. Tighten the two captive screws that secure the base cover to the palm-rest and keyboard assembly.

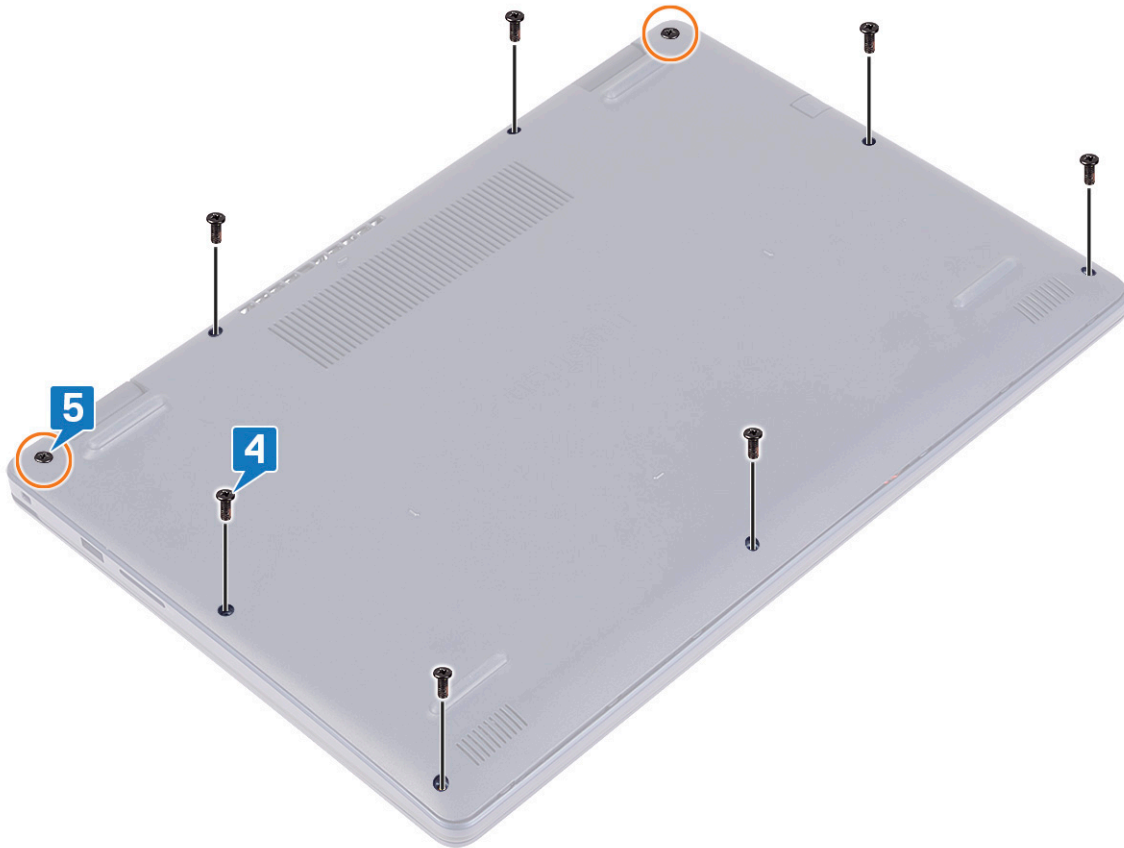

Battery

Removing the battery

NOTE: Before working inside your computer, read the safety information that shipped with your computer and follow the steps in [Before working inside your computer](#). After working inside your computer, follow the instructions in [After working inside your computer](#). For more safety best practices, see the Regulatory Compliance home page at www.dell.com/regulatory_compliance.

Lithium-ion battery precautions

CAUTION:

- Exercise caution when handling Lithium-ion batteries.
- Discharge the battery as much as possible before removing it from the system. This can be done by disconnecting the AC adapter from the system to allow the battery to drain.
- Do not crush, drop, mutilate, or penetrate the battery with foreign objects.
- Do not expose the battery to high temperatures, or disassemble battery packs and cells.
- Do not apply pressure to the surface of the battery.
- Do not bend the battery.
- Do not use tools of any kind to pry on or against the battery.
- Ensure any screws during the servicing of this product are not lost or misplaced, to prevent accidental puncture or damage to the battery and other system components.

- If a battery gets stuck in a device as a result of swelling, do not try to free it as puncturing, bending, or crushing a Lithium-ion battery can be dangerous. In such an instance, contact for assistance and further instructions.
- If the battery gets stuck inside your computer as a result of swelling, do not try to release it as puncturing, bending, or crushing a lithium-ion battery can be dangerous. In such an instance, contact Dell technical support for assistance. See www.dell.com/contactdell.
- Always purchase genuine batteries from www.dell.com or authorized Dell partners and resellers.

Prerequisites

Remove the [base cover](#).

Procedure

1. Peel off the tape that secures the battery cable to the battery connector.
2. Disconnect the battery cable from the system board.
3. Remove the three screws (M2x3) that secure the battery to the palm-rest and keyboard assembly.
4. Slide and lift the battery off the palm-rest and keyboard assembly.

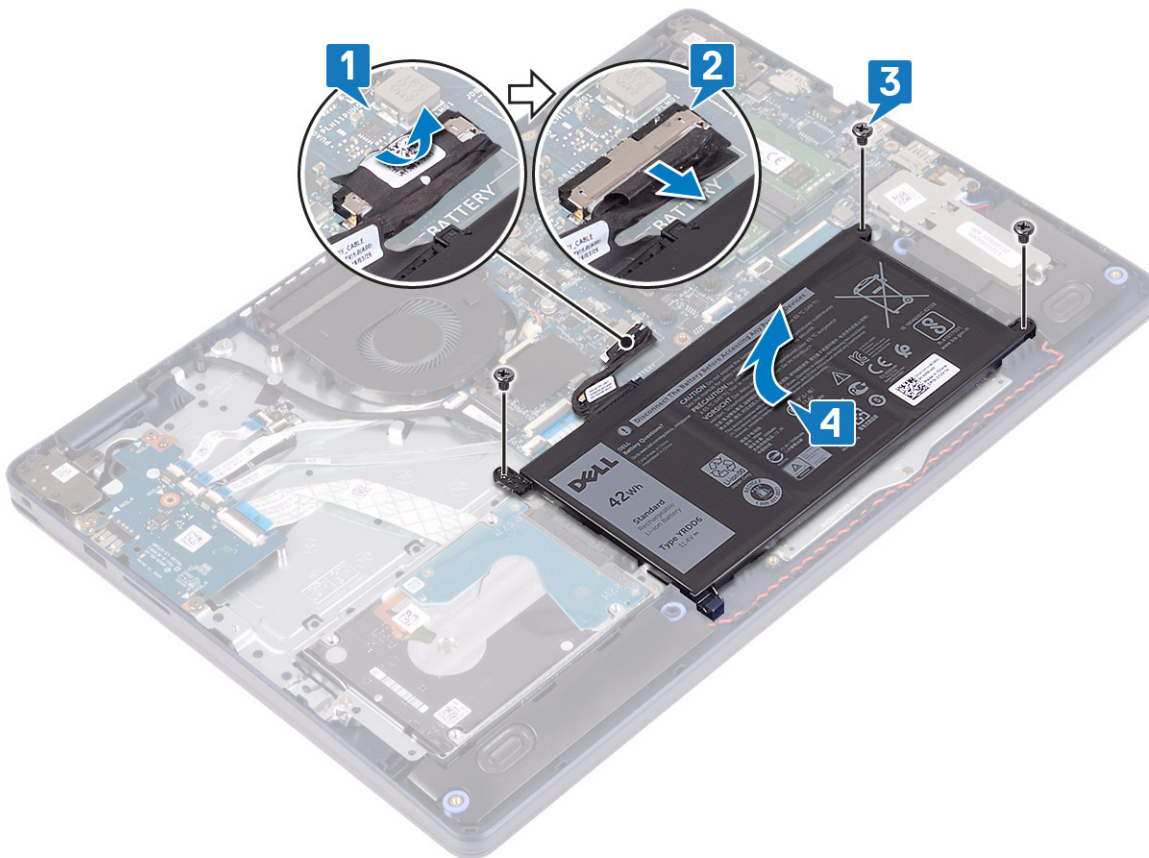

Replacing the battery

- NOTE:** Before working inside your computer, read the safety information that shipped with your computer and follow the steps in [Before working inside your computer](#). After working inside your computer, follow the instructions in [After working inside your computer](#). For more safety best practices, see the Regulatory Compliance home page at www.dell.com/regulatory_compliance.

Lithium-ion battery precautions

CAUTION:

- Exercise caution when handling Lithium-ion batteries.
- Discharge the battery as much as possible before removing it from the system. This can be done by disconnecting the AC adapter from the system to allow the battery to drain.
- Do not crush, drop, mutilate, or penetrate the battery with foreign objects.
- Do not expose the battery to high temperatures, or disassemble battery packs and cells.
- Do not apply pressure to the surface of the battery.
- Do not bend the battery.
- Do not use tools of any kind to pry on or against the battery.
- Ensure any screws during the servicing of this product are not lost or misplaced, to prevent accidental puncture or damage to the battery and other system components.
- If a battery gets stuck in a device as a result of swelling, do not try to free it as puncturing, bending, or crushing a Lithium-ion battery can be dangerous. In such an instance, contact for assistance and further instructions.
- If the battery gets stuck inside your computer as a result of swelling, do not try to release it as puncturing, bending, or crushing a lithium-ion battery can be dangerous. In such an instance, contact Dell technical support for assistance. See www.dell.com/contactdell.
- Always purchase genuine batteries from www.dell.com or authorized Dell partners and resellers.

Procedure

1. Align the screw holes on the battery with the screw holes on the palm-rest and keyboard assembly.
2. Ensure that the tab at the bottom-left corner of the battery is seated in the slot.
3. Replace the three screws (M2x3) that secure the battery to the palm-rest and keyboard assembly.
4. Connect the battery cable to the system board.
5. Adhere the tape that secures the battery cable to the battery connector.

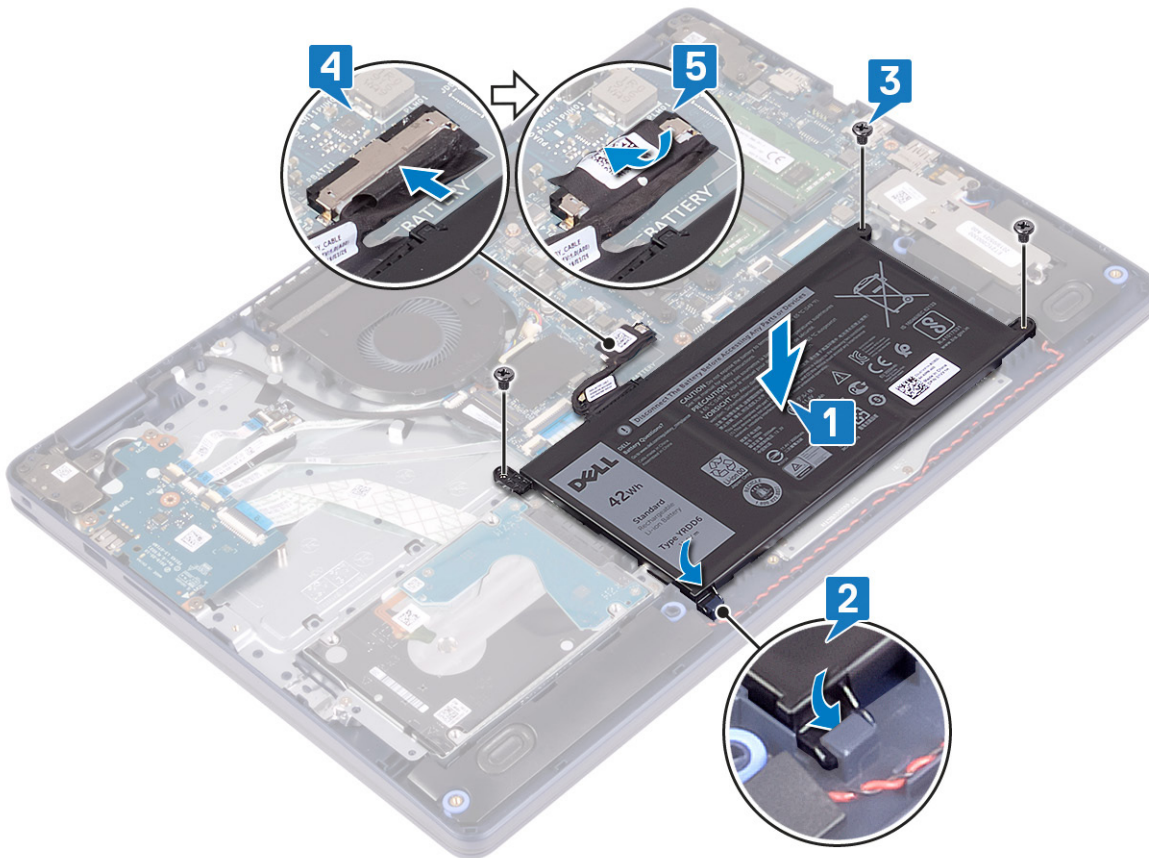

Post-requisites

Replace the [base cover](#).

Memory modules

Removing the memory modules

NOTE: Before working inside your computer, read the safety information that shipped with your computer and follow the steps in [Before working inside your computer](#). After working inside your computer, follow the instructions in [After working inside your computer](#). For more safety best practices, see the Regulatory Compliance home page at www.dell.com/regulatory_compliance.

Prerequisites

Remove the [base cover](#).

Procedure

1. Locate the memory module on your computer.

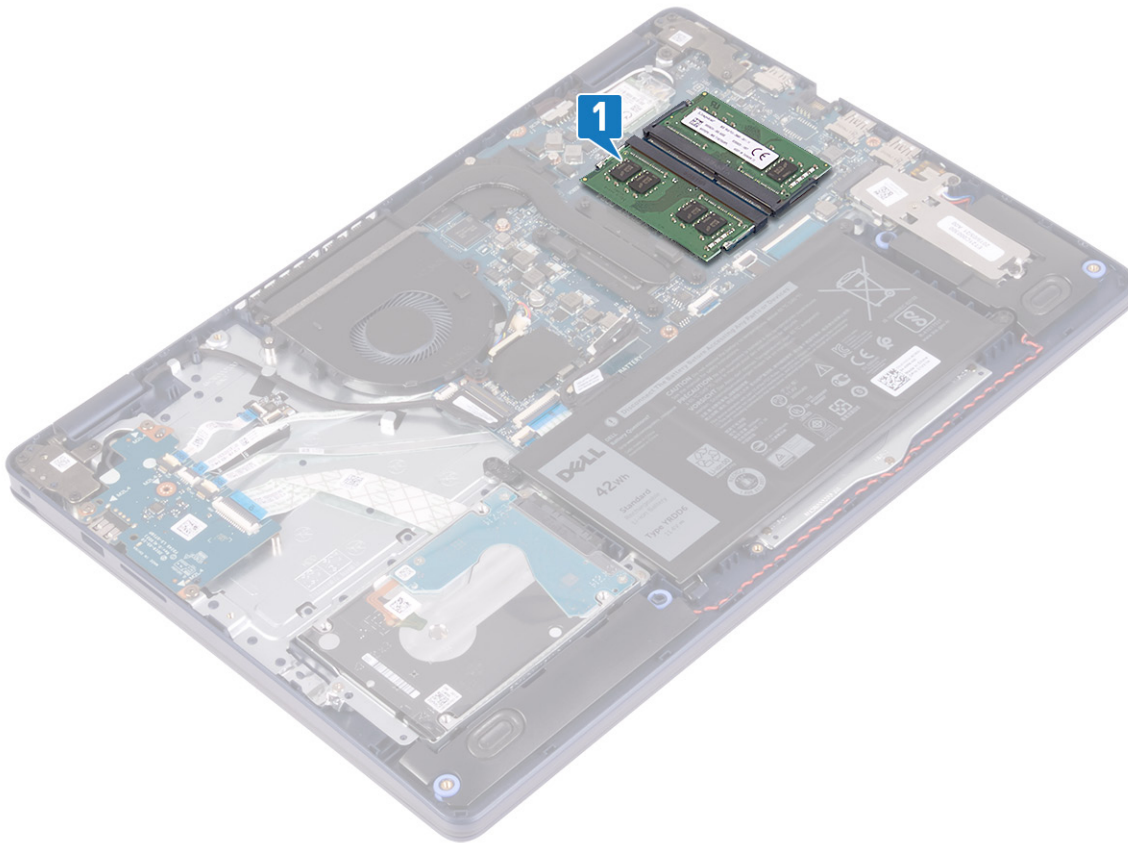

2. Use your fingertips to carefully spread apart the securing-clips on each end of the memory-module slot until the memory module pops up.
3. Remove the memory module from the memory-module slot.

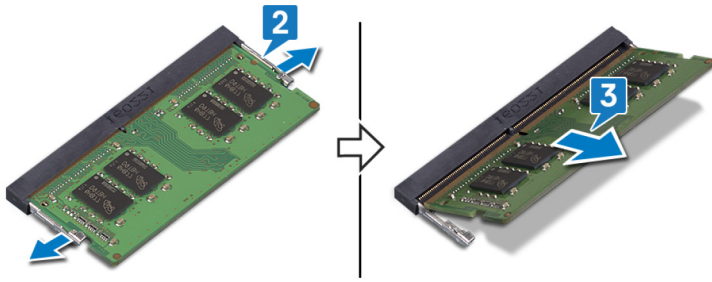

Replacing the memory modules

NOTE: Before working inside your computer, read the safety information that shipped with your computer and follow the steps in [Before working inside your computer](#). After working inside your computer, follow the instructions in [After working inside your computer](#). For more safety best practices, see the Regulatory Compliance home page at www.dell.com/regulatory_compliance.

Procedure

1. Align the notch on the memory module with the tab on the memory-module slot.
2. Slide the memory module firmly into the slot at an angle.
3. Press the memory module down until it clicks into place.

NOTE: If you do not hear the click, remove the memory module and reinstall it.

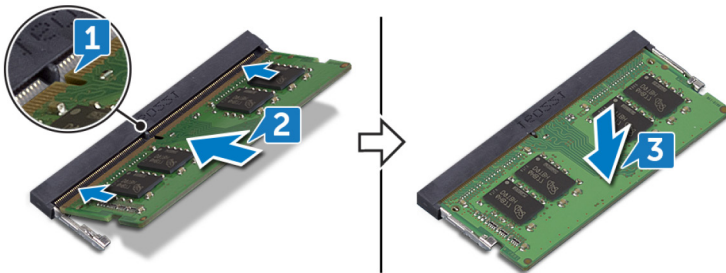

Post-requisites

Replace the [base cover](#).

Wireless card

Removing the wireless card

NOTE: Before working inside your computer, read the safety information that shipped with your computer and follow the steps in [Before working inside your computer](#). After working inside your computer, follow the instructions in [After working inside your computer](#). For more safety best practices, see the Regulatory Compliance home page at www.dell.com/regulatory_compliance.

Prerequisites

Remove the [base cover](#).

Procedure

1. Locate the wireless card on your computer.

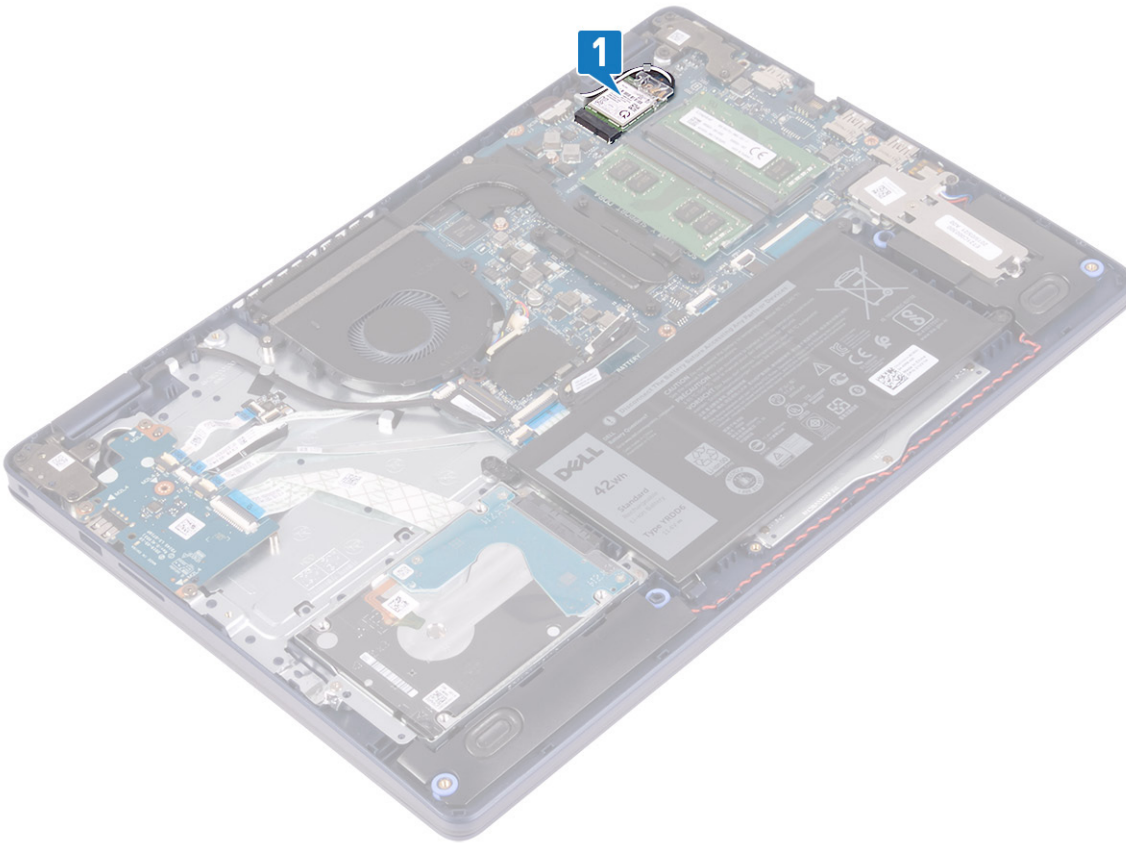

2. Remove the screw (M2x3) that secures the wireless-card bracket to the system board.
3. Slide and remove the wireless-card bracket from the wireless card.
4. Using a plastic scribe, disconnect the antenna cables from the wireless card.
5. Slide and remove the wireless card from the wireless-card slot.

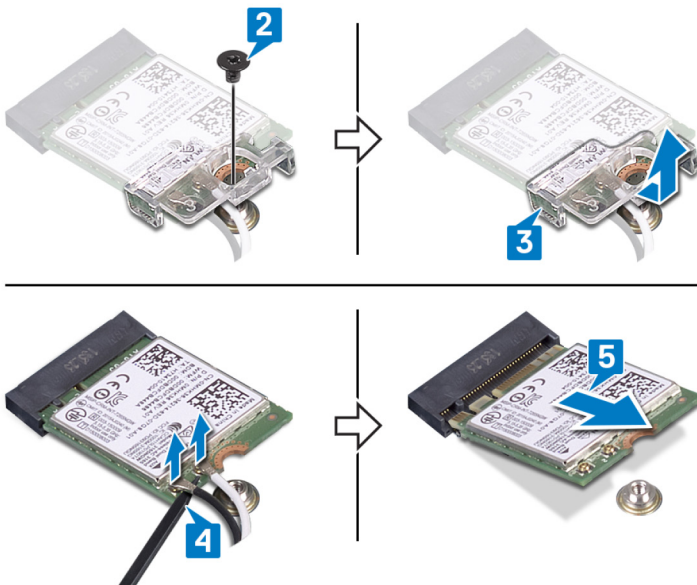

Replacing the wireless card

NOTE: Before working inside your computer, read the safety information that shipped with your computer and follow the steps in [Before working inside your computer](#). After working inside your computer, follow the instructions in [After](#)

working inside your computer. For more safety best practices, see the Regulatory Compliance home page at www.dell.com/regulatory_compliance.

Procedure

CAUTION: To avoid damage to the wireless card, do not place any cables under it.

1. Connect the antenna cables to the wireless card.

The following table provides the antenna-cable color scheme for the wireless card supported by your computer.

Table 2. Antenna-cable color scheme

Connectors on the wireless card	Antenna-cable color
Main (white triangle)	White
Auxiliary (black triangle)	Black

2. Slide and replace the wireless-card bracket on the wireless-card.
3. Align the notch on the wireless card with the tab on the wireless-card slot and insert the wireless card at an angle into the wireless-card slot.
4. Replace the screw (M2x3) that secures the wireless-card bracket to the system board.

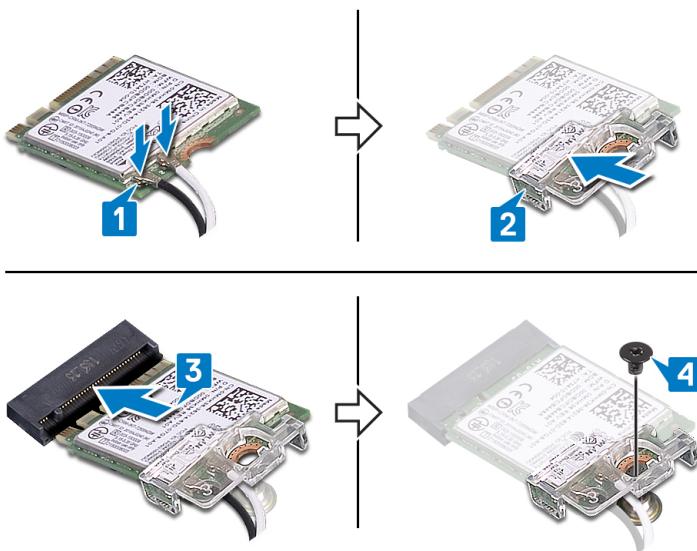

Post-requisites

Replace the [base cover](#).

Fan

Removing the fan

NOTE: Before working inside your computer, read the safety information that shipped with your computer and follow the steps in [Before working inside your computer](#). After working inside your computer, follow the instructions in [After working inside your computer](#). For more safety best practices, see the Regulatory Compliance home page at www.dell.com/regulatory_compliance.

Prerequisites

Remove the [base cover](#).

Procedure

1. Disconnect the fan cable from the system board.
2. Remove the two screws (M2.5x5) that secure the fan to the palm-rest and keyboard assembly.
3. Slide and lift the fan off the palm-rest and keyboard assembly.

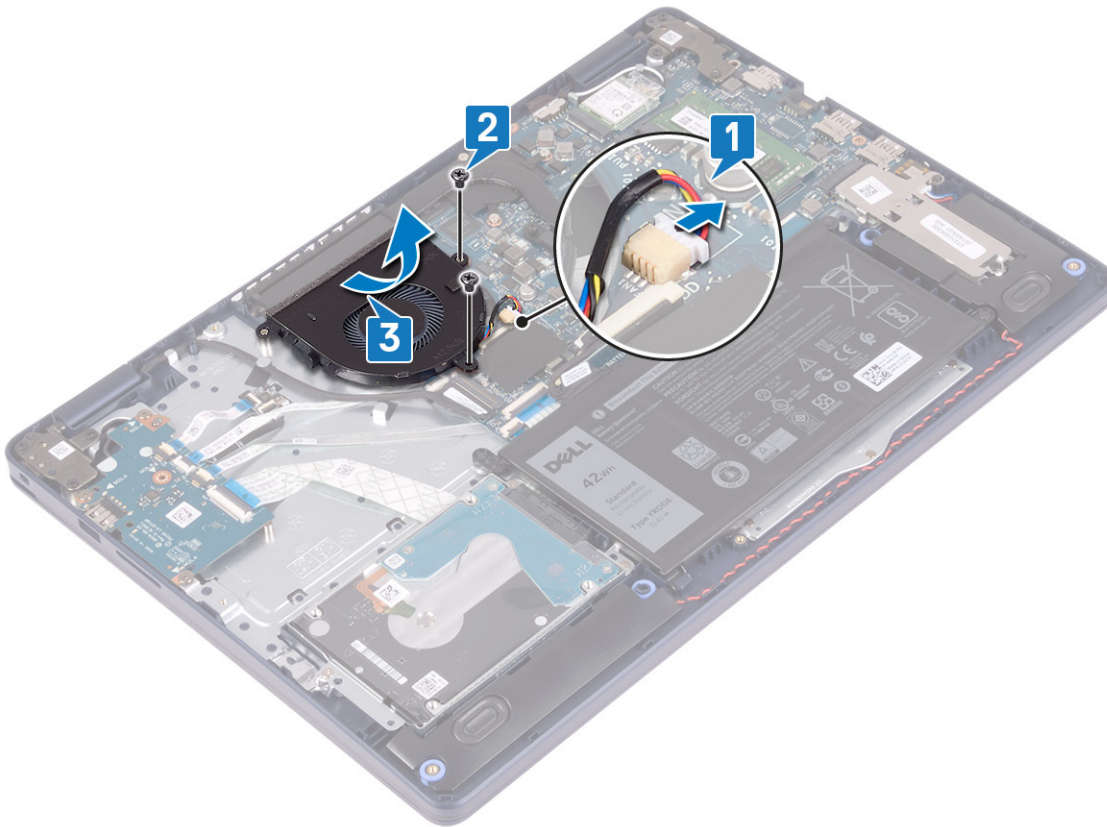

Replacing the fan

NOTE: Before working inside your computer, read the safety information that shipped with your computer and follow the steps in [Before working inside your computer](#). After working inside your computer, follow the instructions in [After working inside your computer](#). For more safety best practices, see the Regulatory Compliance home page at www.dell.com/regulatory_compliance.

Procedure

1. Using the alignment post, align the screw holes on the fan with the screw holes on the palm-rest and keyboard assembly.
2. Replace the two screws (M2.5x5) that secure the fan to the palm-rest and keyboard assembly.
3. Connect the fan cable to the system board.

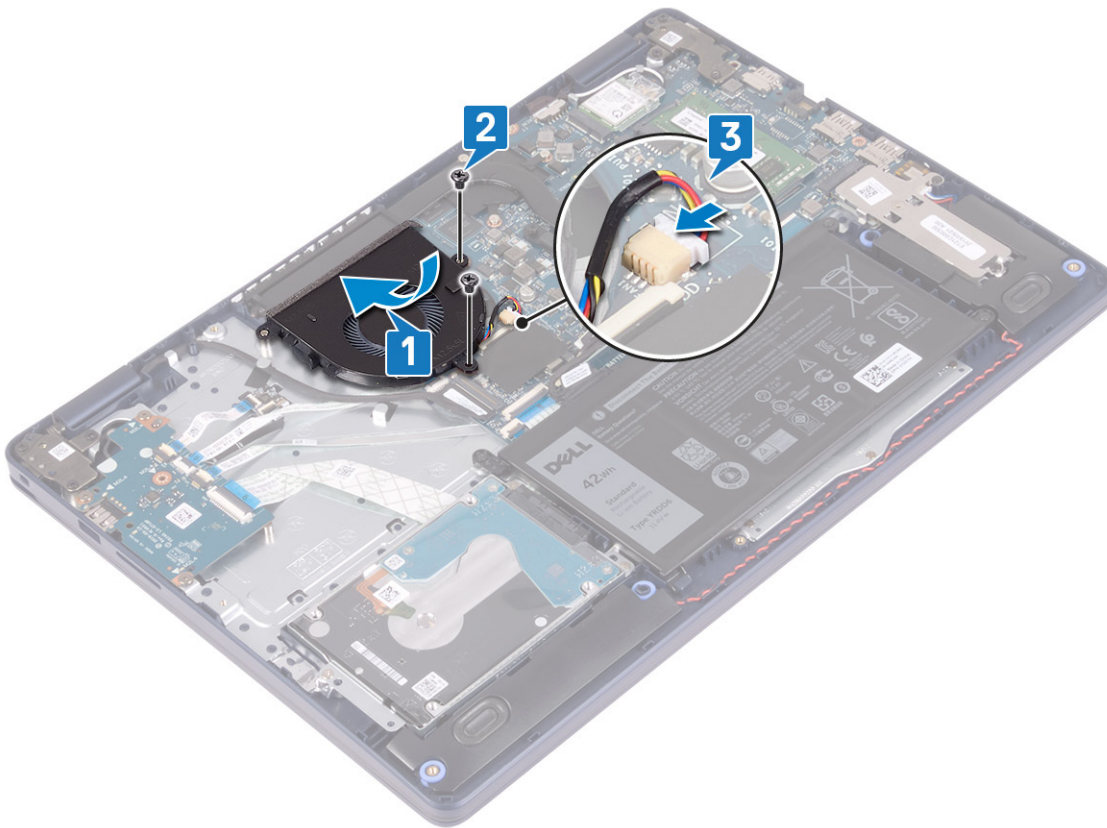

Post-requisites

Replace the [base cover](#).

Solid-state drive/Intel Optane

Removing the solid-state drive/Intel Optane

You need to disable the Intel Optane device before removing it from your computer. For more information about disabling the Intel Optane device, see [Disabling Intel Optane memory](#).

NOTE: Before working inside your computer, read the safety information that shipped with your computer and follow the steps in [Before working inside your computer](#). After working inside your computer, follow the instructions in [After working inside your computer](#). For more safety best practices, see the Regulatory Compliance home page at www.dell.com/regulatory_compliance.

Prerequisites

Remove the [base cover](#).

Procedure to remove the M.2 2230 solid-state drive

1. Loosen the captive screw that secures the M.2 2230 shield to the palm-rest and keyboard assembly.
2. Remove the screw (M2x3) that secures the M.2 2230 shield to the palm-rest and keyboard assembly.
3. Slide and remove the tab on the M.2 2230 thermal shield from the slot on the palm-rest and keyboard assembly.
4. Lift the solid-state drive and M.2 2230 thermal shield at an angle and remove it from the M.2 slot on the system board.

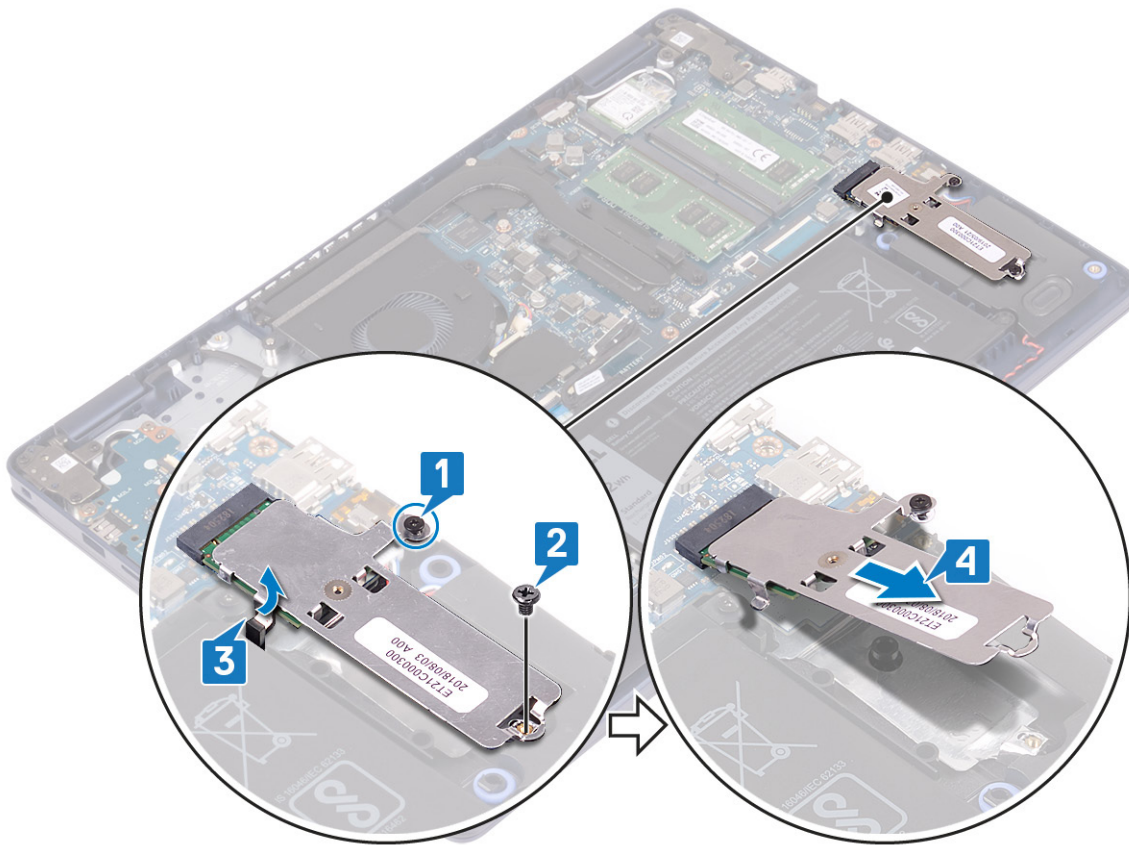

5. Turn the M.2 2230 thermal shield over.
6. Remove the screw (M2x2) that secures the solid-state drive to the M.2 2230 thermal shield.
7. Lift the solid-state drive off the M.2 2230 thermal shield.

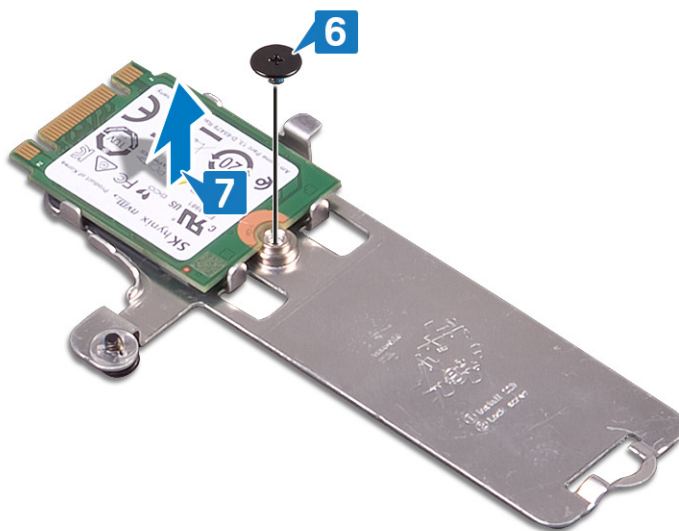

Procedure to remove the M.2 2280 solid-state drive

1. Loosen the captive screw that secures the M.2 2280 thermal shield to the palm-rest and keyboard assembly.
2. Remove the screw (M2x3) that secures the M.2 2280 thermal shield and the solid-state drive to the palm-rest and keyboard assembly.
3. Slide and remove the M.2 2280 thermal shield from the slot on the palm-rest and keyboard assembly.
4. Lift the solid-state drive at an angle and remove it from the M.2 slot on the system board.

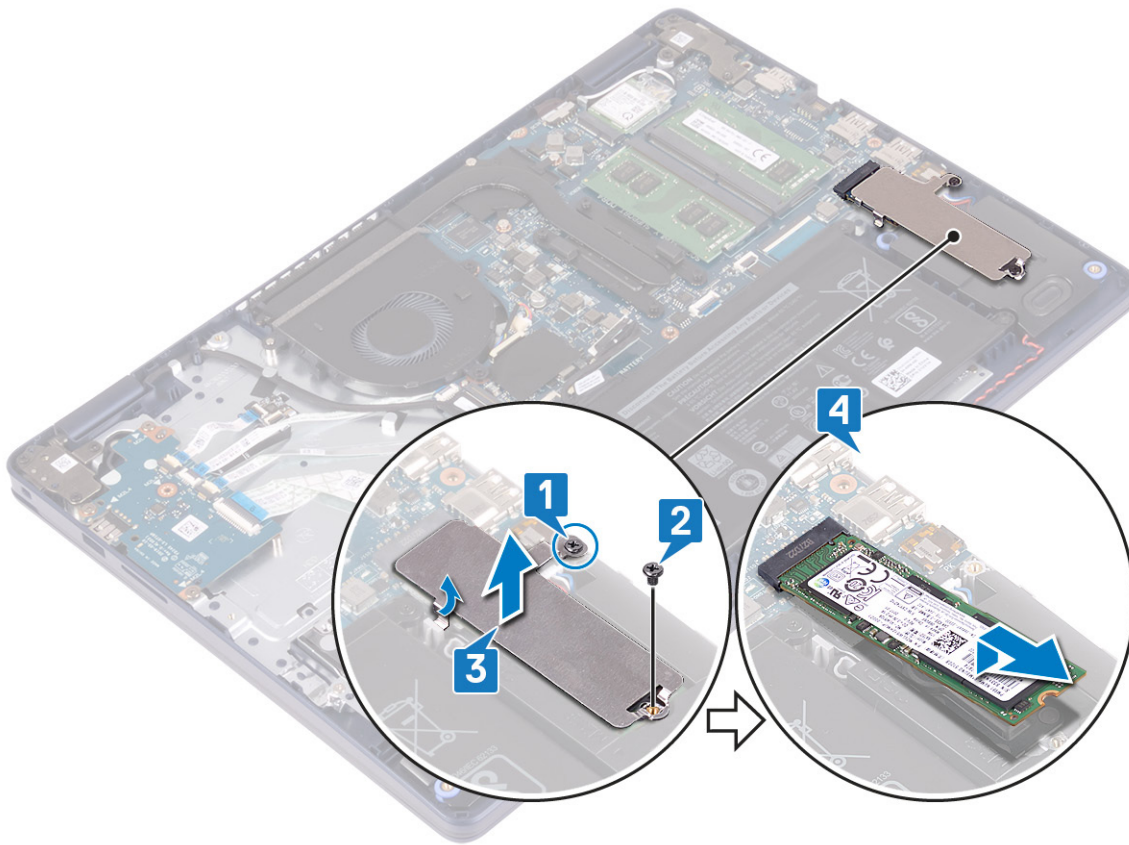

Replacing the solid-state drive/Intel Optane

Enable the Intel Optane device after you replace it. For more information about enabling the Intel Optane device, see [Enabling Intel Optane memory](#).

NOTE: Before working inside your computer, read the safety information that shipped with your computer and follow the steps in [Before working inside your computer](#). After working inside your computer, follow the instructions in [After working inside your computer](#). For more safety best practices, see the Regulatory Compliance home page at www.dell.com/regulatory_compliance.

CAUTION: Solid-state drives are fragile. Exercise care when handling the solid-state drive.

Procedure to replace M.2 2230 solid-state drive

1. Place the solid-state drive into the slot at the back of the M.2 2230 thermal shield.
2. Replace the screw (M2x2) that secures the solid-state drive to the M.2 2230 thermal shield.

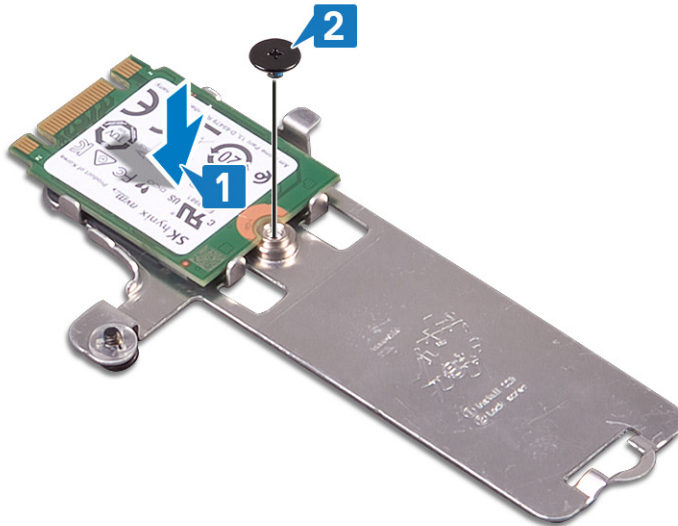

3. Turn over the solid-state drive and M.2 2230 thermal shield.
4. Align the notch on the solid-state drive with the tab on the M.2 slot and slide the solid-state drive into place.
5. Insert the tab on the M.2 2230 thermal shield into the slot on the palm-rest and keyboard assembly.
6. Tighten the captive screw that secures the M.2 2230 thermal shield to the palm-rest and keyboard assembly.
7. Replace the screw (M2x3) that secures the M.2 2230 thermal shield to the palm-rest and keyboard assembly.

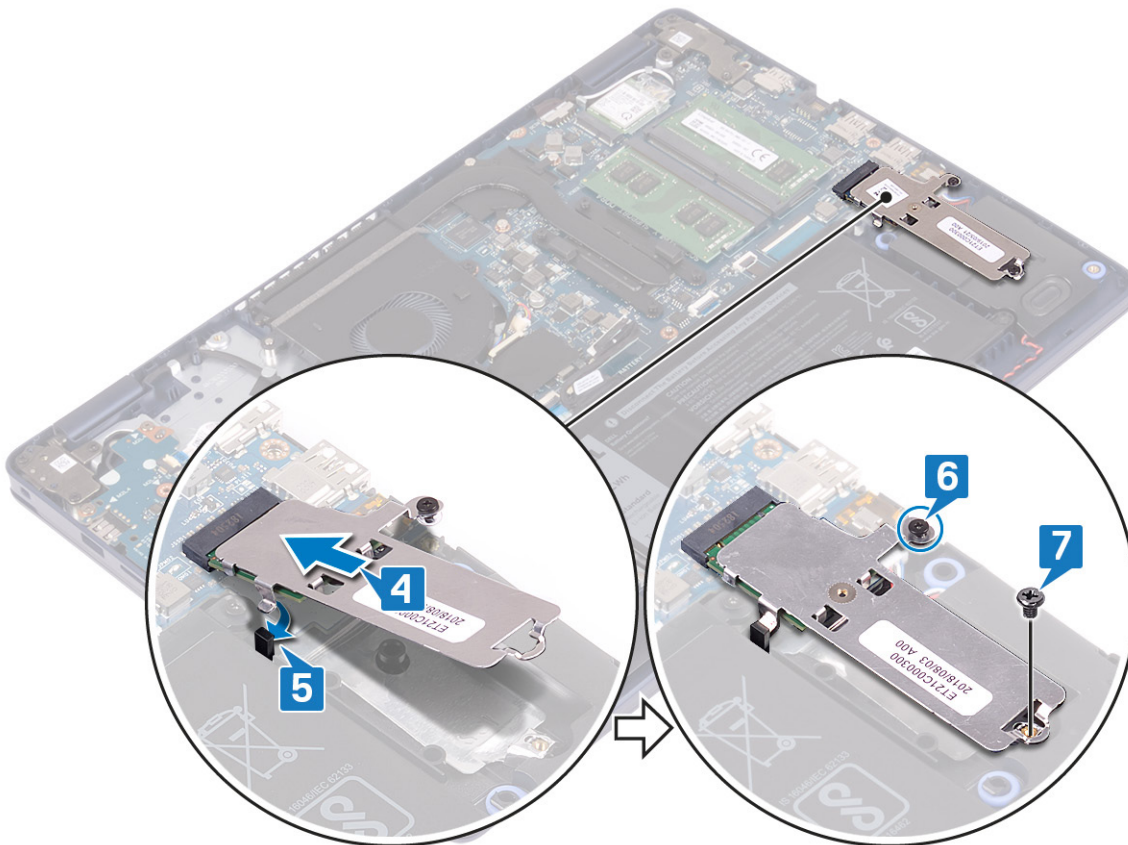

Procedure to replace the M.2 2280 solid-state drive

1. Align the notch on the solid-state drive with the tab on the M.2 slot and slide the solid-state drive into place.
2. Insert the tab of the M.2 2280 thermal shield into the slot on the palm-rest and keyboard assembly.
3. Replace the screw (M2x3) that secures the M.2 2280 thermal shield and solid-state drive to the palm-rest and keyboard assembly.
4. Tighten the captive screw that secures the M.2 2280 thermal shield to the palm rest and keyboard assembly.

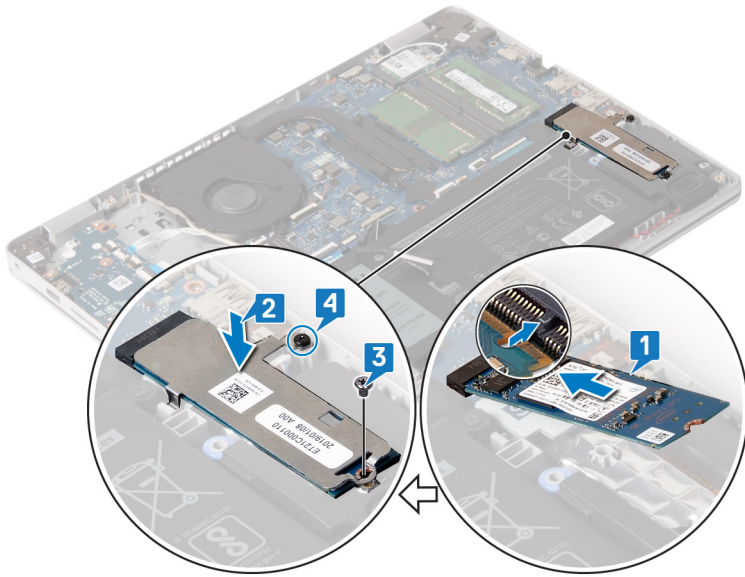

Post-requisites

Replace the [base cover](#).

Hard drive

Removing the hard drive

If your computer is using a SATA storage device accelerated by Intel Optane memory, disable Intel Optane before removing the SATA storage device. For more information about disabling the Intel Optane, see [Disabling Intel Optane](#).

NOTE: Before working inside your computer, read the safety information that shipped with your computer and follow the steps in [Before working inside your computer](#). After working inside your computer, follow the instructions in [After working inside your computer](#). For more safety best practices, see the Regulatory Compliance home page at www.dell.com/regulatory_compliance.

CAUTION: Hard drives are fragile. Exercise care when handling the hard drive.

CAUTION: To avoid data loss, do not remove the hard drive while the computer is in sleep or on state.

Prerequisites

1. Remove the [base cover](#).
2. Remove the [battery](#).

Procedure

1. Lift the latch and disconnect the hard-drive cable from the system board.
2. Remove the three screws (M2x3) that secure the hard-drive assembly to the palm-rest and keyboard assembly.
3. Lift the hard-drive assembly along with its cable off the palm-rest and keyboard assembly.

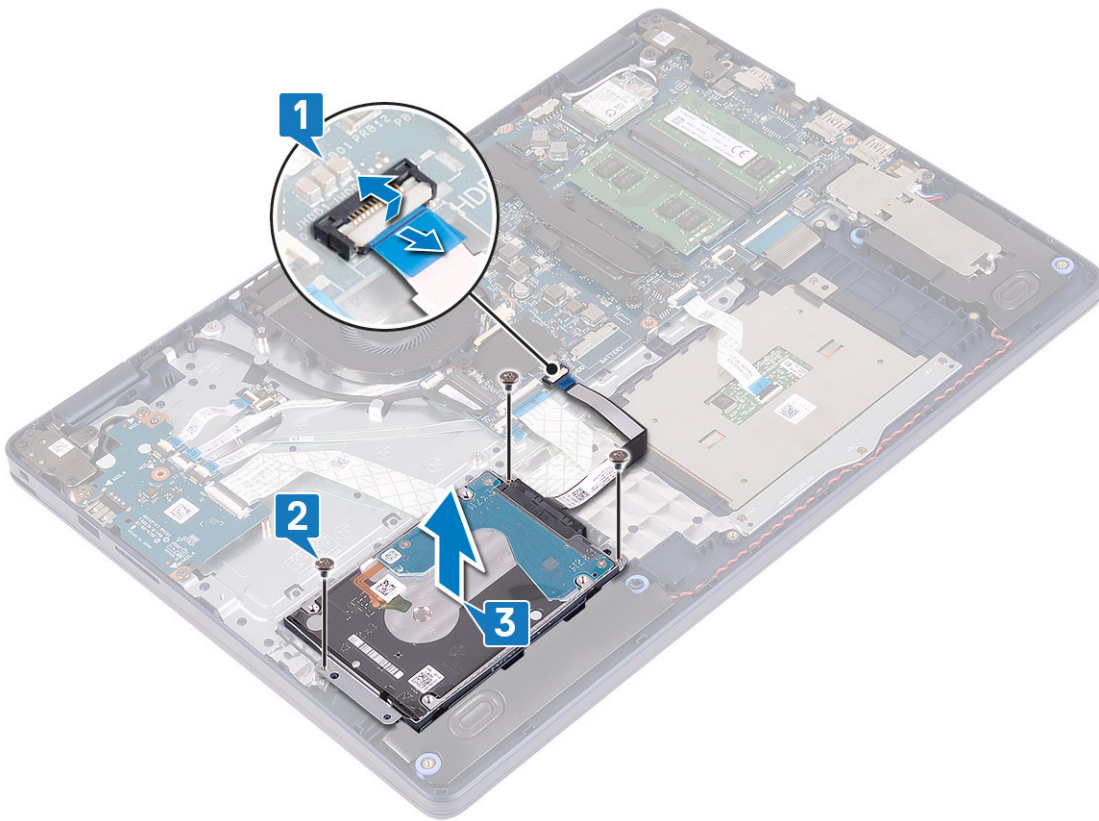

4. Disconnect the interposer from the hard-drive assembly.

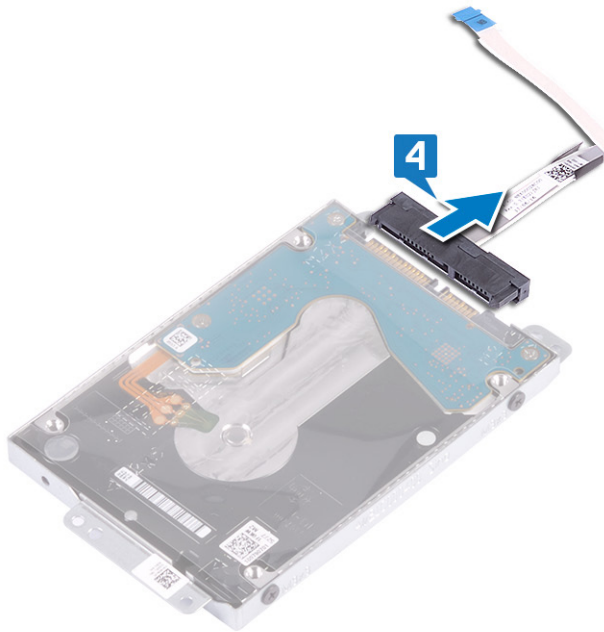

5. Remove the four screws (M3x3) that secure the hard-drive bracket to the hard drive.

6. Lift the hard drive off the hard-drive bracket.

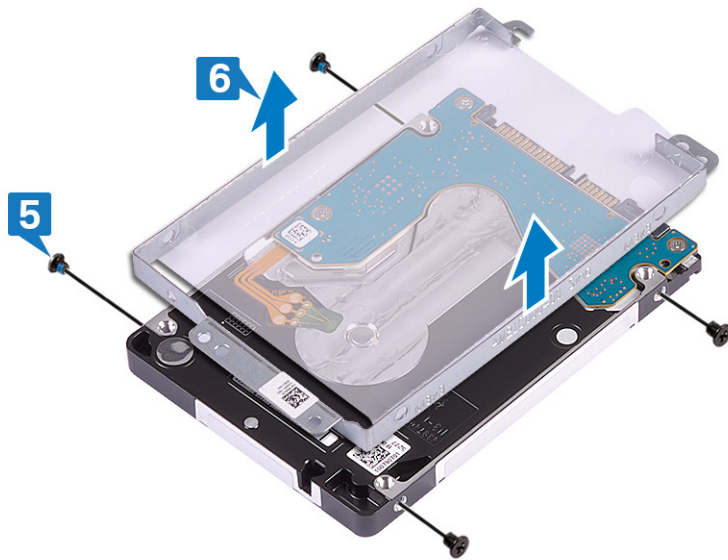

Replacing the hard drive

Enable Intel Optane after replacing the SATA storage. For more information about enabling the Intel Optane, see [Enabling Intel Optane](#).

NOTE: Before working inside your computer, read the safety information that shipped with your computer and follow the steps in [Before working inside your computer](#). After working inside your computer, follow the instructions in [After working inside your computer](#). For more safety best practices, see the Regulatory Compliance home page at www.dell.com/regulatory_compliance.

CAUTION: Hard drives are fragile. Exercise care when handling the hard drive.

Procedure

1. Align the screw holes on the hard-drive bracket with the screw holes on the hard drive.
2. Replace the four screws (M3x3) that secure the hard-drive bracket to the hard drive.

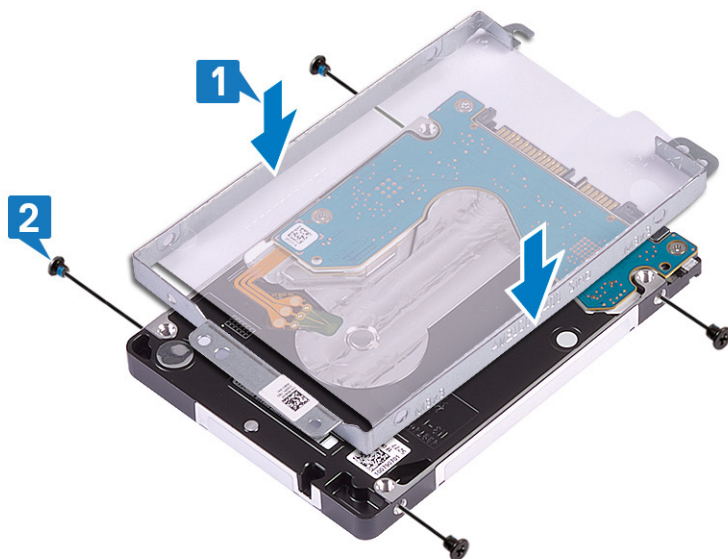

3. Connect the interposer to the hard-drive assembly.



4. Using the alignment posts, place the hard-drive assembly on the palm-rest and keyboard assembly.
5. Replace the three screws (M2x3) that secure the hard-drive assembly to the palm-rest and keyboard assembly.
6. Connect the hard-drive cable to the system board and close the latch to secure the cable.

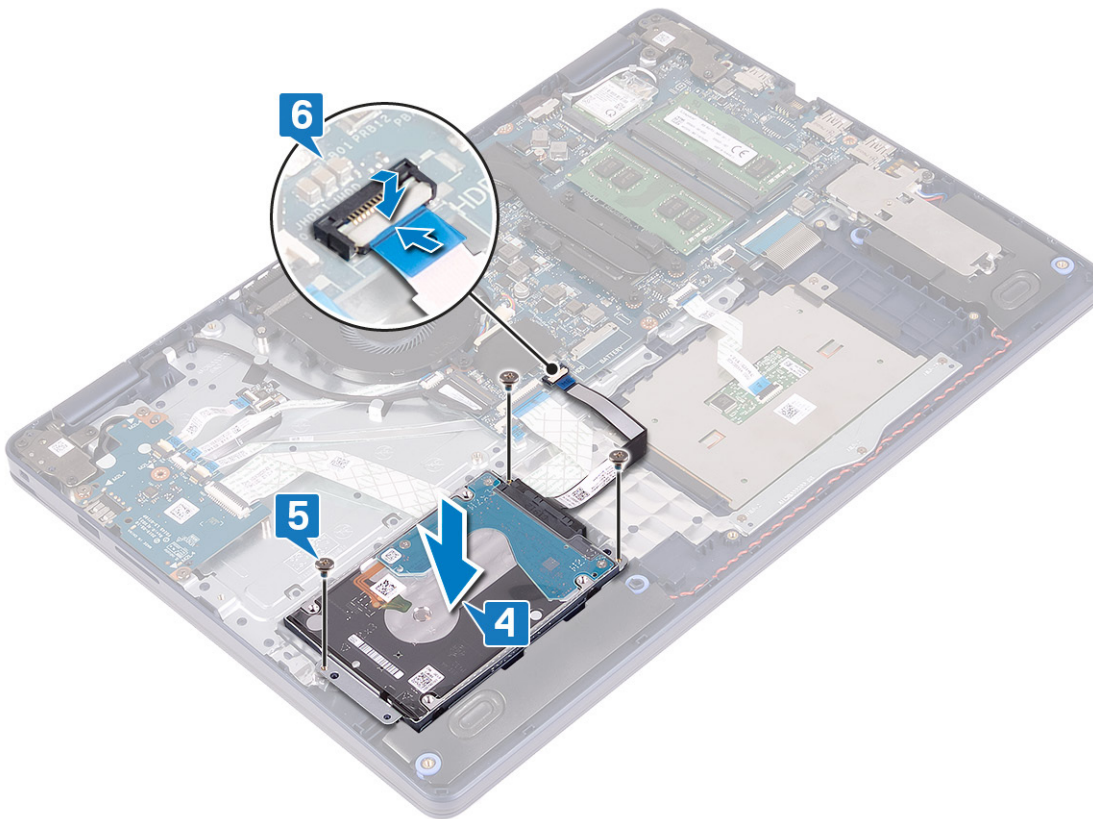

Post-requisites

1. Replace the [battery](#).
2. Replace the [base cover](#).

Touchpad

Removing the touchpad

NOTE: Before working inside your computer, read the safety information that shipped with your computer and follow the steps in [Before working inside your computer](#). After working inside your computer, follow the instructions in [After working inside your computer](#). For more safety best practices, see the Regulatory Compliance home page at www.dell.com/regulatory_compliance.

Prerequisites

1. Remove the [base cover](#).
2. Remove the [battery](#).

Procedure

1. Open the latch and disconnect the touchpad cable from the system board.
2. Remove the three screws (M1.6x2) that secure the touchpad bracket to the palm-rest and keyboard assembly.
3. Lift the touchpad bracket off the palm-rest and keyboard assembly.

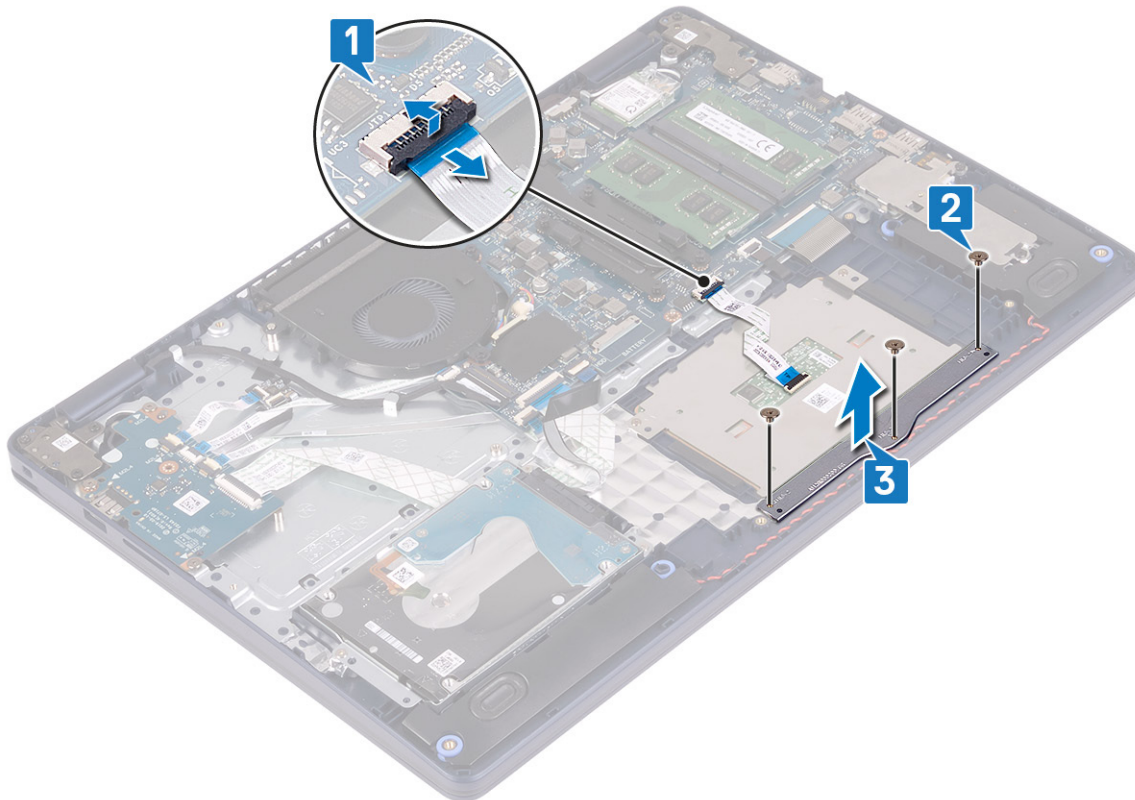

4. Remove the two screws (M1.6x2) that secure the touchpad to the palm-rest and keyboard assembly.
5. Slide and lift the touchpad off the palm-rest and keyboard assembly.

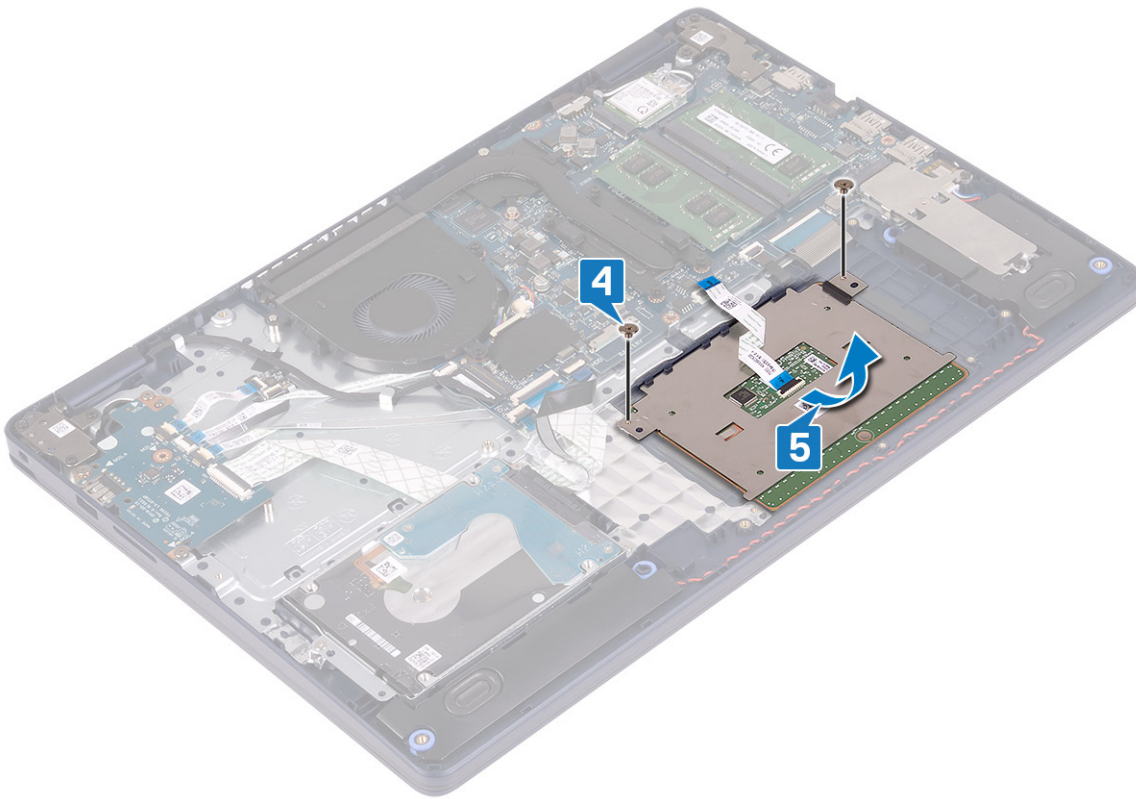

Replacing the touchpad

NOTE: Before working inside your computer, read the safety information that shipped with your computer and follow the steps in [Before working inside your computer](#). After working inside your computer, follow the instructions in [After working inside your computer](#). For more safety best practices, see the Regulatory Compliance home page at www.dell.com/regulatory_compliance.

Procedure

NOTE: Ensure that the touchpad is aligned with the guides available on the palm-rest and keyboard assembly, and the gap on either sides of the touchpad is equal.

1. Using the alignment post, slide and place the touchpad into the slot on the palm-rest and keyboard assembly.
2. Replace the two screws (M1.6x2) that secure the touchpad to the palm-rest and keyboard assembly.

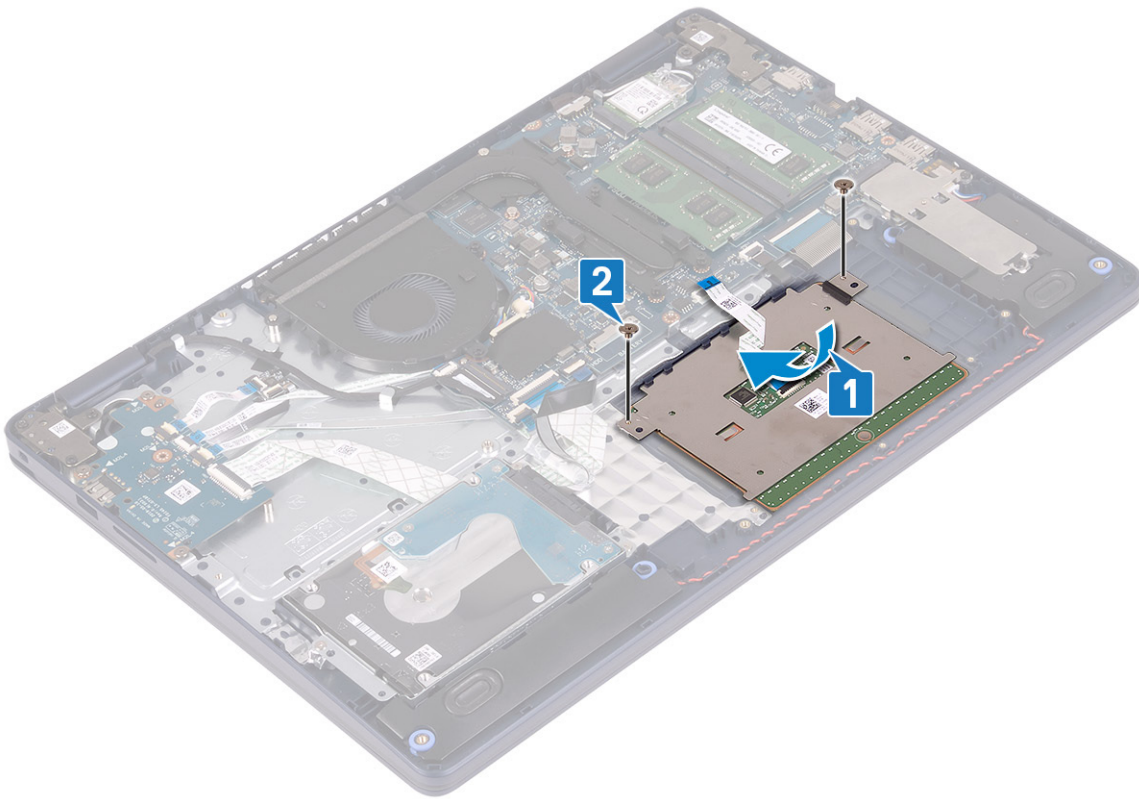

3. Place the touchpad bracket on the palm-rest and keyboard assembly.
4. Replace the three screws (M1.6x2) that secure the touchpad to the palm-rest and keyboard assembly.
5. Slide the touchpad cable into the connector on the system board and close the latch to secure the cable.

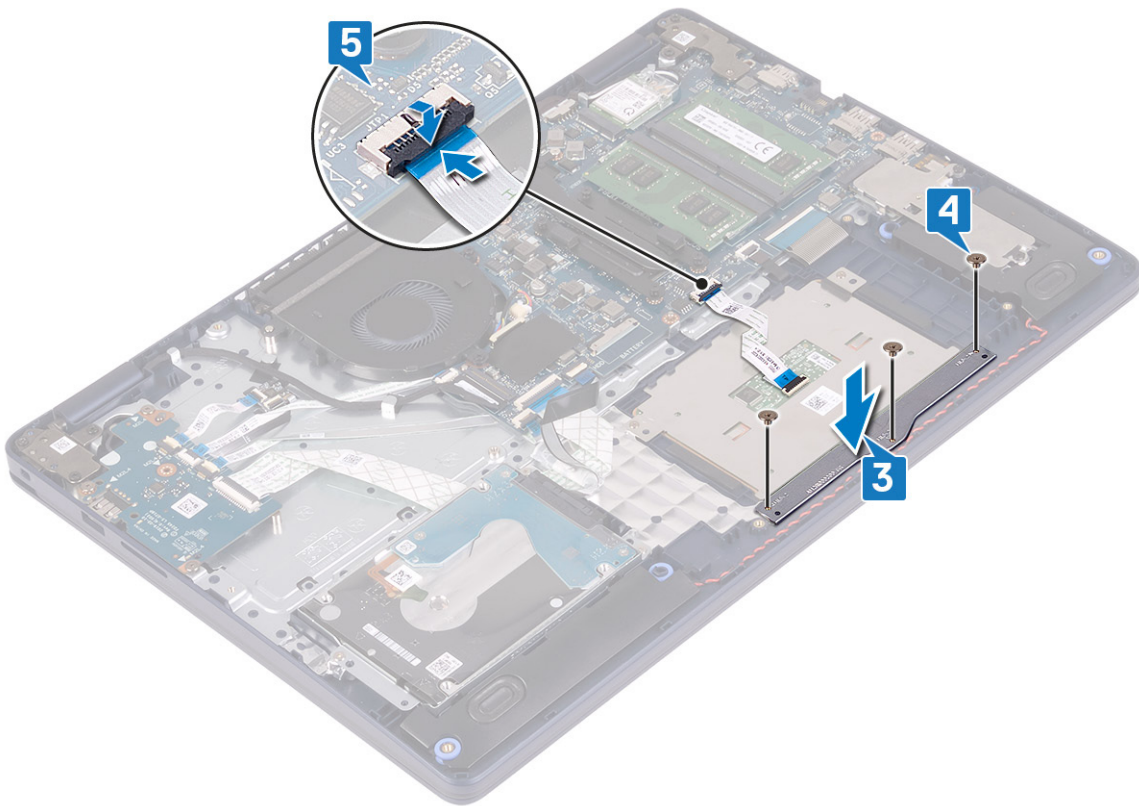

Post-requisites

1. Replace the [battery](#).
2. Replace the [base cover](#).

Speakers

Removing the speakers

NOTE: Before working inside your computer, read the safety information that shipped with your computer and follow the steps in [Before working inside your computer](#). After working inside your computer, follow the instructions in [After working inside your computer](#). For more safety best practices, see the Regulatory Compliance home page at www.dell.com/regulatory_compliance.

Prerequisites

1. Remove the [base cover](#).
2. Remove the [solid-state drive/Intel Optane](#).

Procedure

1. Disconnect the speaker cable from the system board.
2. Note the speaker cable routing and remove it from the routing guides on palm-rest and keyboard assembly.
3. Lift the speakers, along with the cable, off the palm-rest and keyboard assembly.

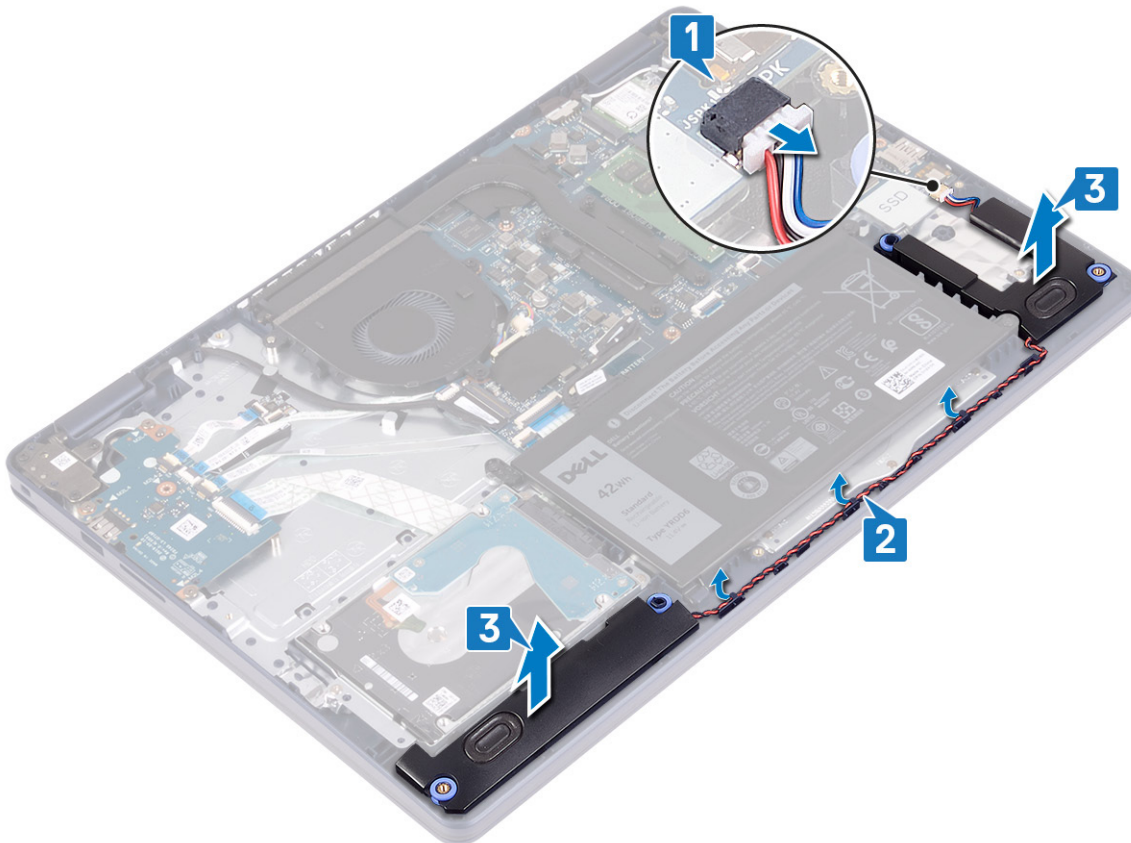

Replacing the speakers

NOTE: Before working inside your computer, read the safety information that shipped with your computer and follow the steps in [Before working inside your computer](#). After working inside your computer, follow the instructions in [After working inside your computer](#). For more safety best practices, see the Regulatory Compliance home page at www.dell.com/regulatory_compliance.

Procedure

NOTE: If the rubber grommets are pushed out when removing the speakers, push them back in before replacing the speakers.

1. Connect the speaker cable to the system board.
2. Using the alignment posts and the rubber grommets, place the speakers in the slots on the palm-rest and keyboard assembly and route the speaker cables along the routing guides.

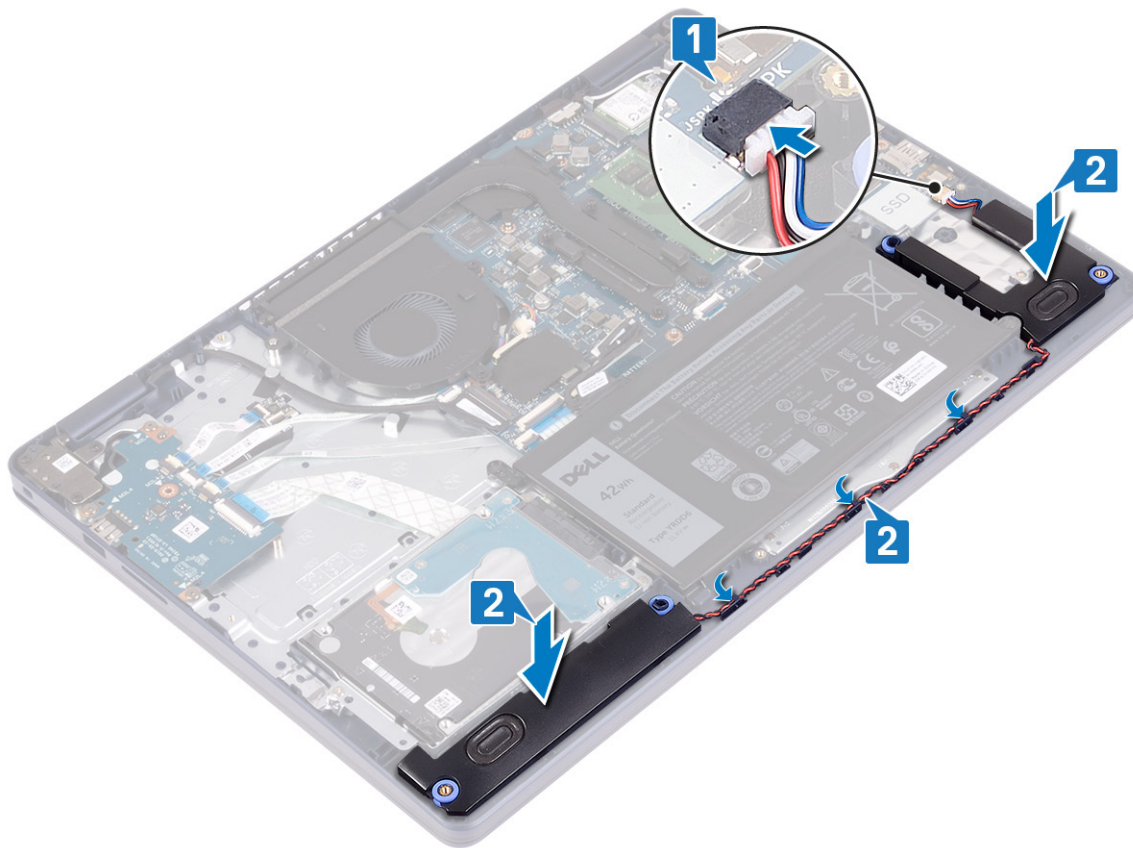

Post-requisites

1. Replace the [solid-state drive/Intel Optane](#).
2. Replace the [base cover](#).

Heat sink

Removing the heat sink

NOTE: Before working inside your computer, read the safety information that shipped with your computer and follow the steps in [Before working inside your computer](#). After working inside your computer, follow the instructions in [After working inside your computer](#). For more safety best practices, see the Regulatory Compliance home page at www.dell.com/regulatory_compliance.

NOTE: The heat sink may become hot during normal operation. Allow sufficient time for the heat sink to cool before you touch it.

CAUTION: For maximum cooling of the processor, do not touch the heat transfer areas on the heat sink. The oils in your skin can reduce the heat transfer capability of the thermal grease.

Prerequisites

Remove the [base cover](#).

Procedure

1. In reverse sequential order (4->3->2->1), loosen the four captive screws that secure the heat sink to the system board.
2. Remove the three (M2x3) screws that secure the heat sink to the system board.

NOTE: Applicable only to computers shipped with discrete graphics card.

3. Lift the heat sink off the system board.

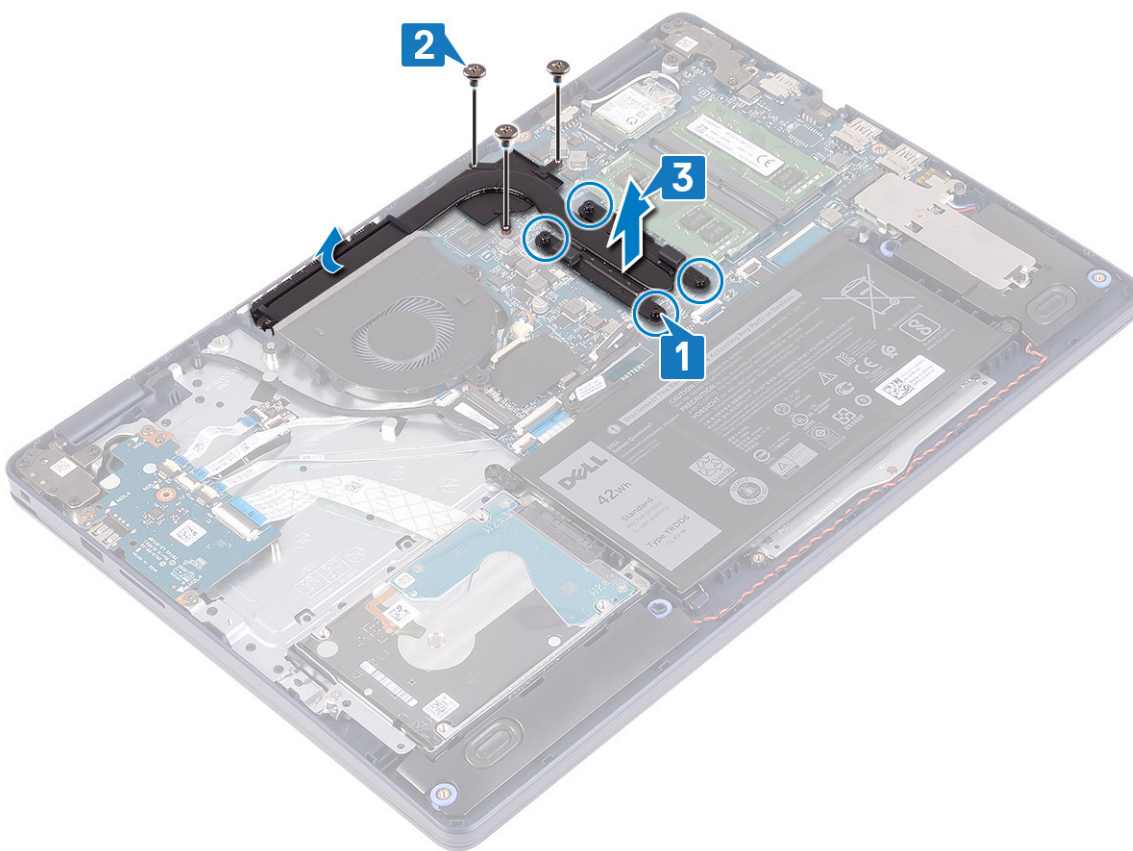

Replacing the heat sink

NOTE: Before working inside your computer, read the safety information that shipped with your computer and follow the steps in [Before working inside your computer](#). After working inside your computer, follow the instructions in [After working inside your computer](#). For more safety best practices, see the Regulatory Compliance home page at www.dell.com/regulatory_compliance.

CAUTION: Incorrect alignment of the heat sink can damage the system board and processor.

NOTE: If either the system board or the heat sink is replaced, use the thermal pad/paste provided in the kit to ensure that thermal conductivity is achieved.

Procedure

1. Place the heat sink on the system board and align the screw holes on the heat sink with the screw holes on the system board.
2. Replace the three (M2x3) screws that secure the heat sink to the system board.

NOTE: Applicable only to computers shipped with discrete graphics card.

3. In sequential order (1->2->3->4) as indicated on the heat sink, tighten the captive screws to secure the heat sink to the system board.

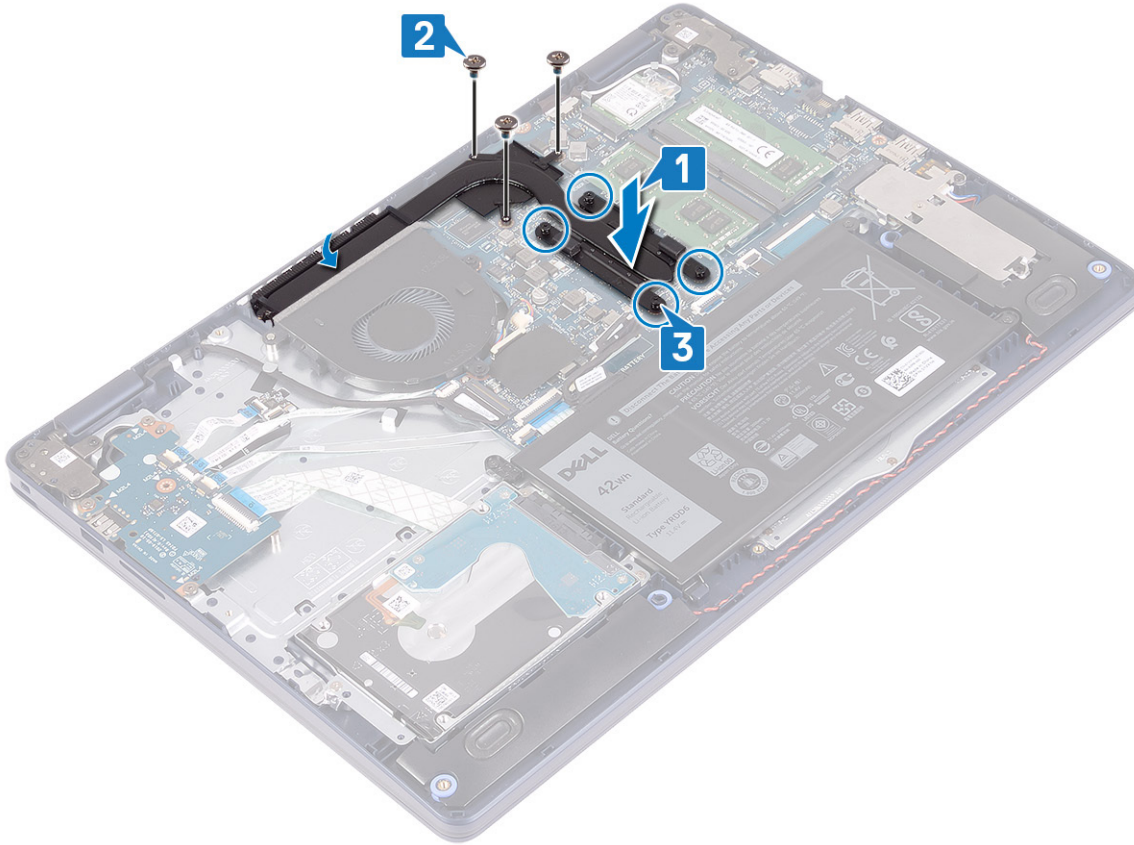

Post-requisites

Replace the [base cover](#).

Display assembly

Removing the display assembly

NOTE: Before working inside your computer, read the safety information that shipped with your computer and follow the steps in [Before working inside your computer](#). After working inside your computer, follow the instructions in [After working inside your computer](#). For more safety best practices, see the Regulatory Compliance home page at www.dell.com/regulatory_compliance.

Prerequisites

1. Remove the [base cover](#).
2. Remove the [wireless card](#).

Procedure

1. Open the latch and disconnect the display cable from the system board.

2. Note the display-cable routing and remove the cable from its routing guides on the fan and the palm-rest and keyboard assembly.
3. Remove the antenna cables from the routing guide.

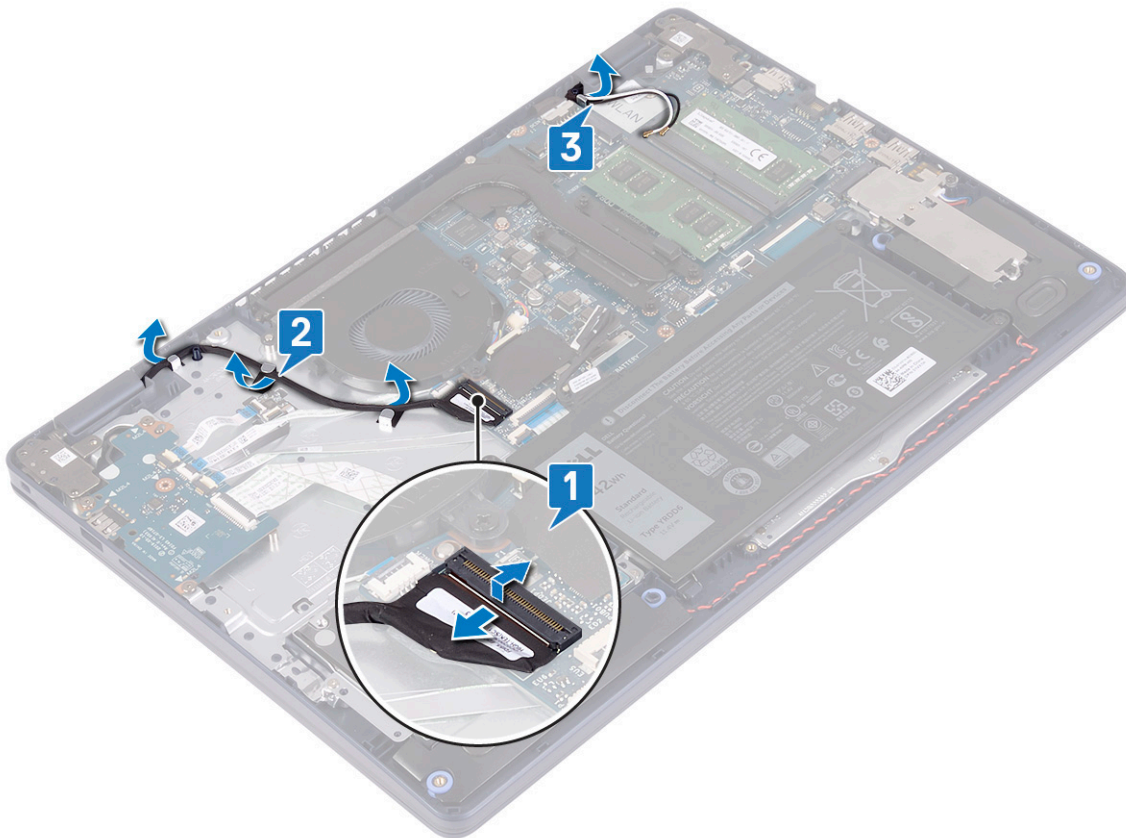

4. Open the display at an angle of 90 degrees and place it on the edge of the table in a position that allows access to the screws on the display hinges.
5. Remove the six screws (M2.5x5) that secure the left and the right hinges to the system board and the palm-rest and keyboard assembly.

NOTE: Hold the display assembly so that it does not fall off when the last screw is removed.

6. Lift the display assembly off the palm-rest and keyboard assembly.

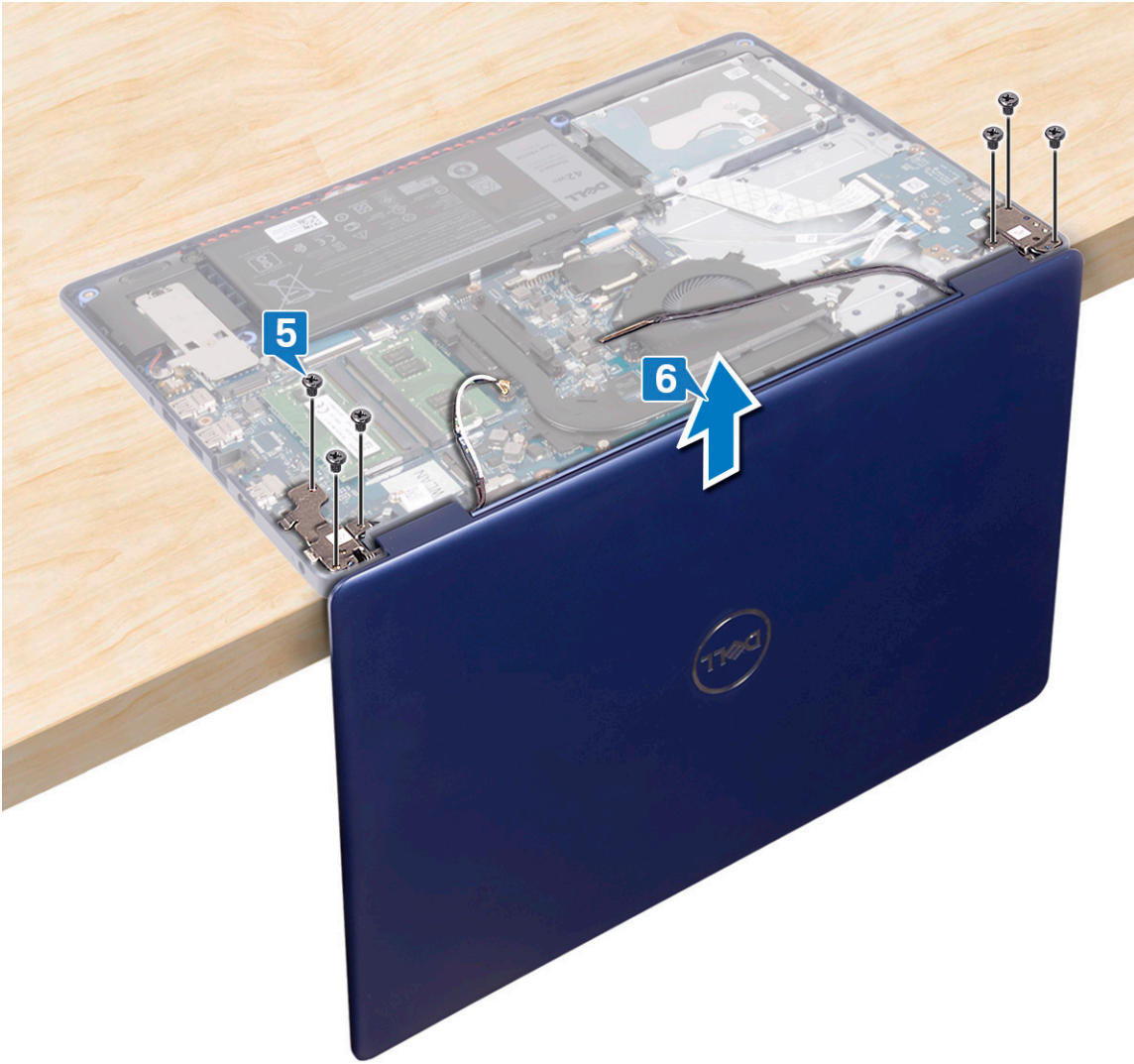

7. After performing all the above steps, you are left with display assembly.



Replacing the display assembly

NOTE: Before working inside your computer, read the safety information that shipped with your computer and follow the steps in [Before working inside your computer](#). After working inside your computer, follow the instructions in [After working inside your computer](#). For more safety best practices, see the Regulatory Compliance home page at www.dell.com/regulatory_compliance.

Procedure

- NOTE:** Ensure that the hinges are opened to 90 degrees before replacing the display assembly on the palm-rest and keyboard assembly.
1. With the palm-rest and keyboard assembly at the edge of the table, align the screw holes on the palm-rest and keyboard assembly with the screw holes on the display hinges.
 2. Replace the six screws (M2.5x5) that secure the left and the right hinges to the system board and the palm-rest and keyboard assembly.

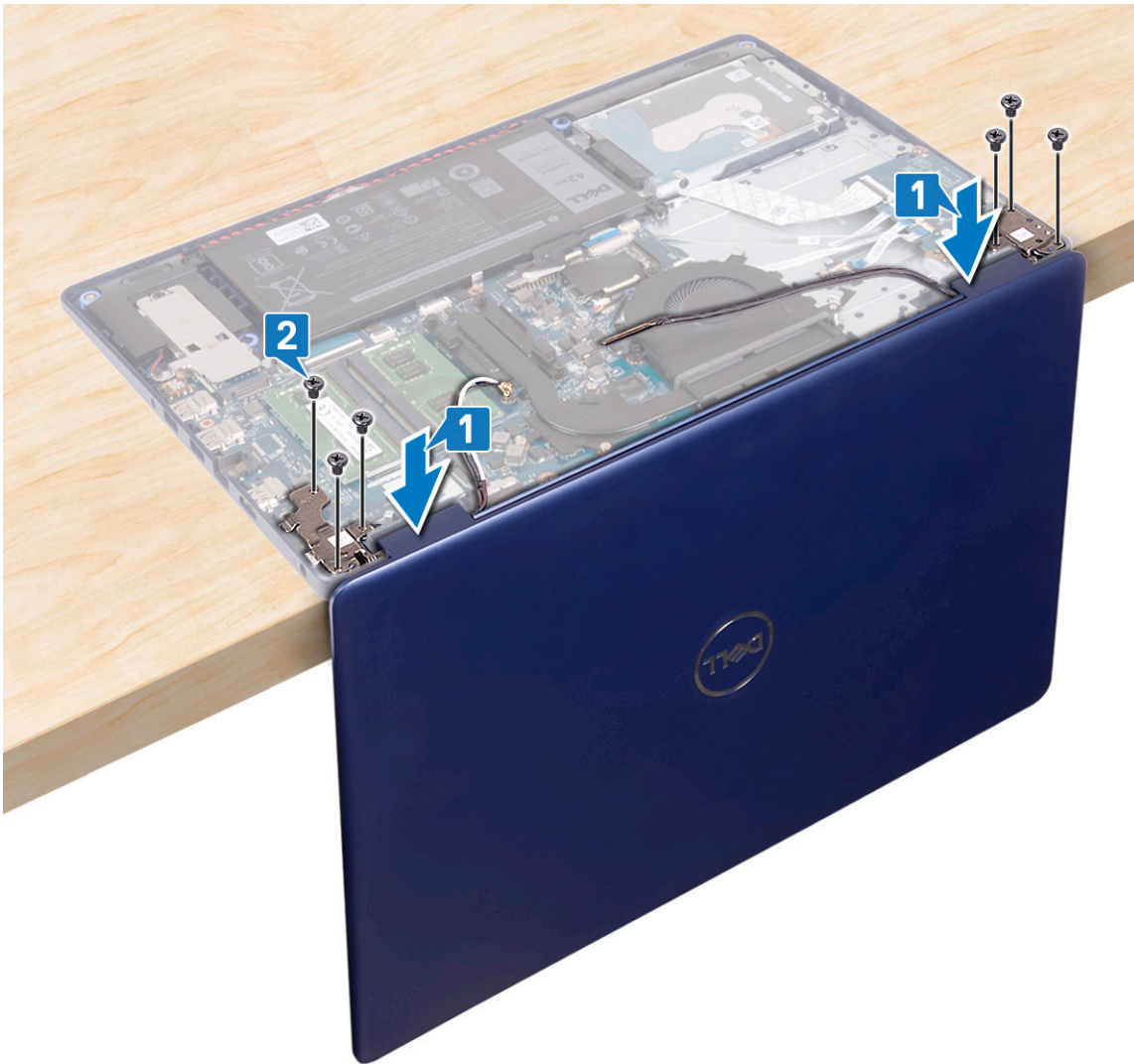

3. Close the display and place the computer on a clean and flat surface.
4. Route the antenna cables on the palm-rest and keyboard assembly.
5. Route the display cable through the routing guides on the fan and the palm-rest and keyboard assembly.
6. Slide the display cable to the connector on the system board and close the latch to secure the display cable.

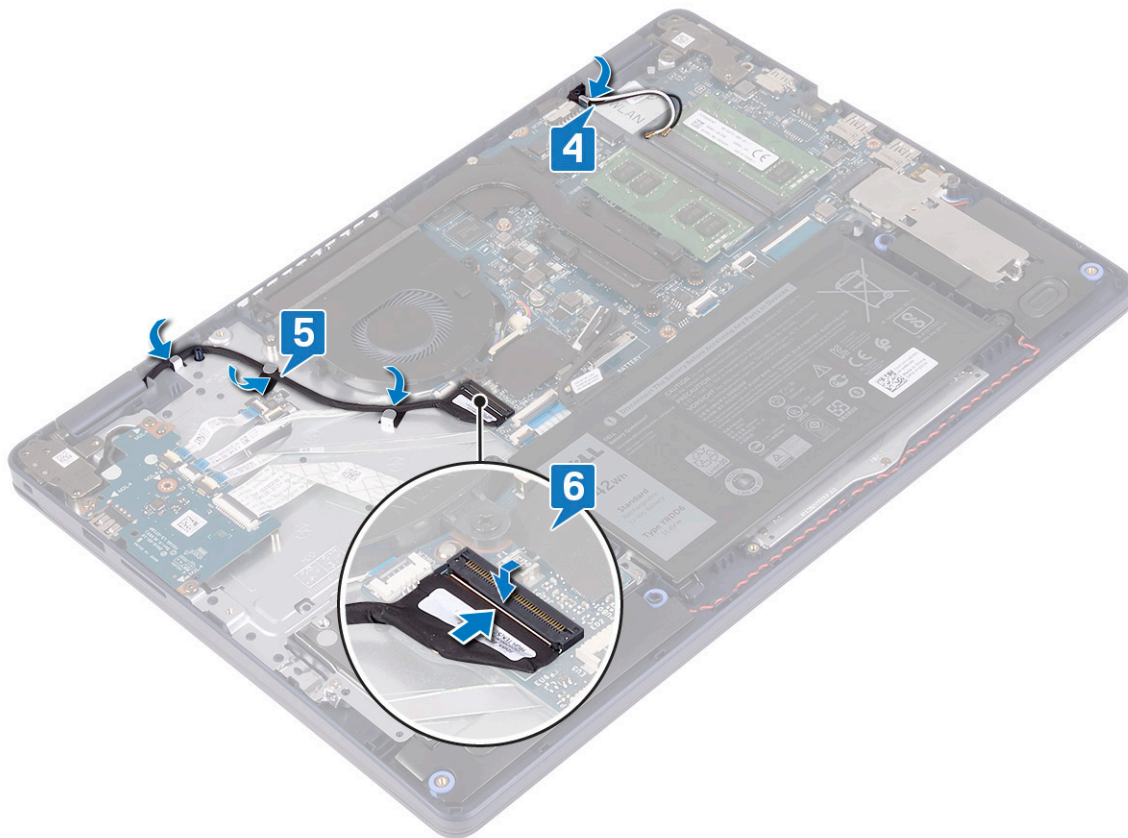

Post-requisites

1. Replace the [wireless card](#).
2. Replace the [base cover](#).

Power-adaptor port

Removing the power-adaptor port

NOTE: Before working inside your computer, read the safety information that shipped with your computer and follow the steps in [Before working inside your computer](#). After working inside your computer, follow the instructions in [After working inside your computer](#). For more safety best practices, see the Regulatory Compliance home page at www.dell.com/regulatory_compliance.

Prerequisites

1. Remove the [base cover](#).
2. Remove the [wireless card](#).

Procedure

1. Disconnect the power-adaptor port cable from the system board.
2. Note the power-adaptor port cable routing and remove it from the routing guides on the palm-rest and keyboard assembly.
3. Lift the power-adaptor port, along with its cable, off the palm-rest and keyboard assembly.

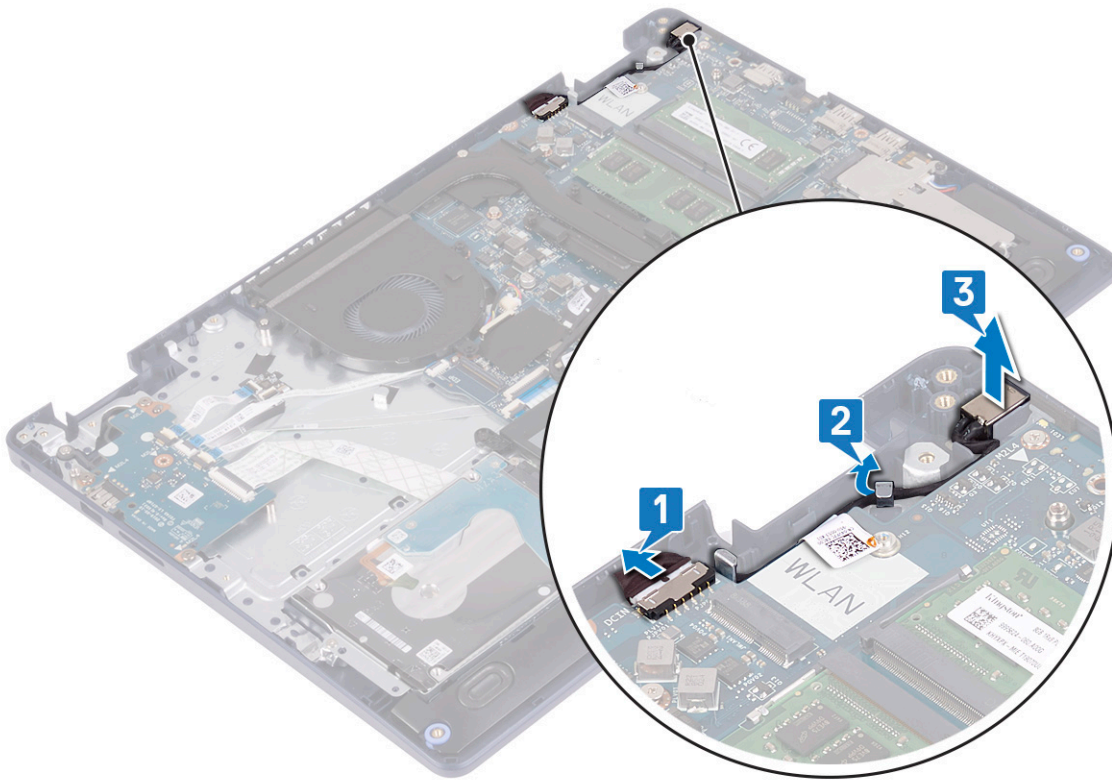

Replacing the power-adaptor port

NOTE: Before working inside your computer, read the safety information that shipped with your computer and follow the steps in [Before working inside your computer](#). After working inside your computer, follow the instructions in [After working inside your computer](#). For more safety best practices, see the Regulatory Compliance home page at www.dell.com/regulatory_compliance.

Procedure

1. Using the alignment post, place the power-adaptor port in the slot on the palm-rest and keyboard assembly.
2. Route the power-adaptor port cable through the routing guides on the palm-rest and keyboard assembly.
3. Connect the power-adaptor port cable to the system board.

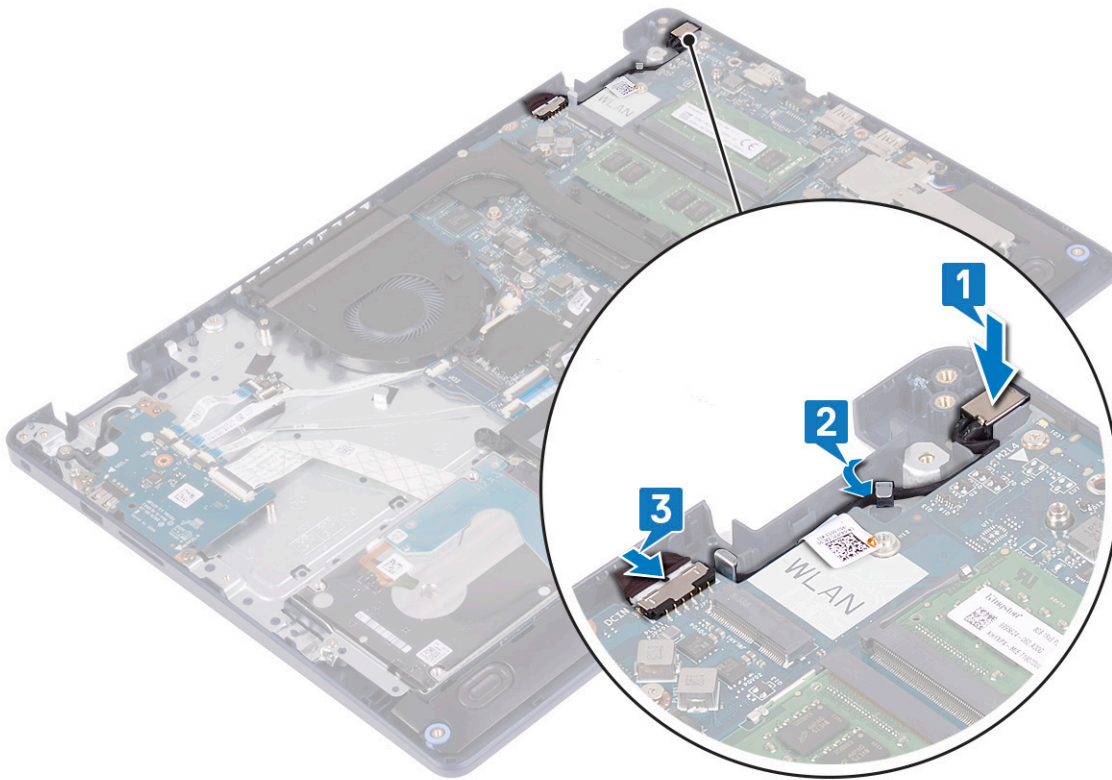

I/O board

Removing the I/O board

NOTE: Before working inside your computer, read the safety information that shipped with your computer and follow the steps in [Before working inside your computer](#). After working inside your computer, follow the instructions in [After working inside your computer](#). For more safety best practices, see the Regulatory Compliance home page at www.dell.com/regulatory_compliance.

Prerequisites

CAUTION: Removing the coin-cell battery resets the BIOS setup program's settings to default. Before removing the I/O board along with the coin-cell battery, it is recommended to note the BIOS setup program's settings.

1. Remove the [base cover](#).
2. Remove the [battery](#).
3. Remove the [hard drive with Intel optane](#).

Procedure

1. Open the latch and disconnect the fingerprint-reader board cable from the I/O board.

NOTE: This step is applicable only for computers shipped with the optional fingerprint reader.
2. Open the latch and disconnect the power-button board cable from the I/O board.
3. Open the latch and disconnect the fingerprint-reader cable from the I/O board.

NOTE: This step is applicable only for computers shipped with the optional fingerprint reader.
4. Open the latch and disconnect the I/O-board cable from the I/O board.
5. Remove the three screws (M2x4) that secure the I/O board to the palm-rest and keyboard assembly.
6. Lift the I/O board off the palm-rest and keyboard assembly.

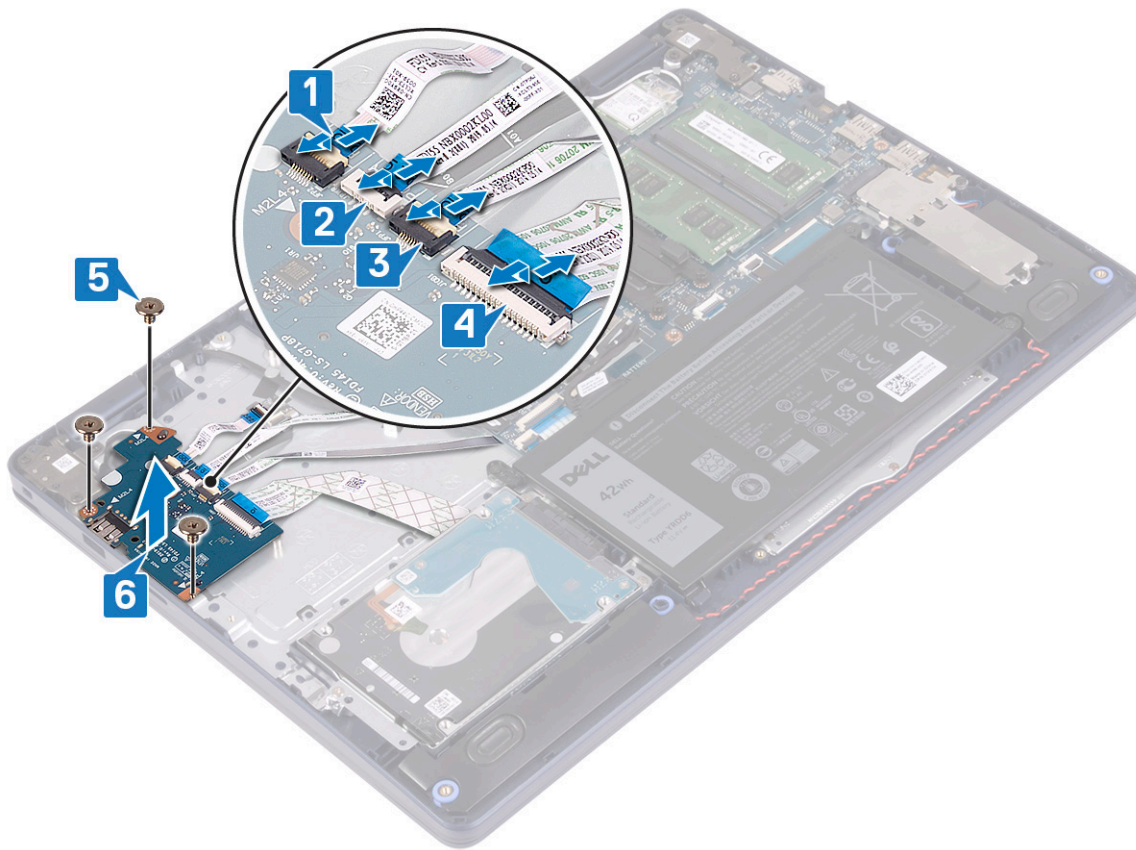

Replacing the I/O board

NOTE: Before working inside your computer, read the safety information that shipped with your computer and follow the steps in [Before working inside your computer](#). After working inside your computer, follow the instructions in [After working inside your computer](#). For more safety best practices, see the Regulatory Compliance home page at www.dell.com/regulatory_compliance.

Procedure

1. Using the alignment posts, place the I/O board on the palm-rest and keyboard assembly.
2. Replace the three screws (M2x4) that secure the I/O board to the palm-rest and keyboard assembly.
3. Connect the I/O-board cable to the I/O board and close the latch to secure the cable.
4. Connect the fingerprint-reader cable to the I/O board and close the latch to secure the cable.
- NOTE:** This step is applicable only for computers shipped with the optional fingerprint reader.
5. Connect the power-button board cable to the I/O board and close the latch to secure the cable.
6. Connect the fingerprint-reader board cable to the I/O board and close the latch to secure the cable.
- NOTE:** This step is applicable only for computers shipped with the optional fingerprint reader.

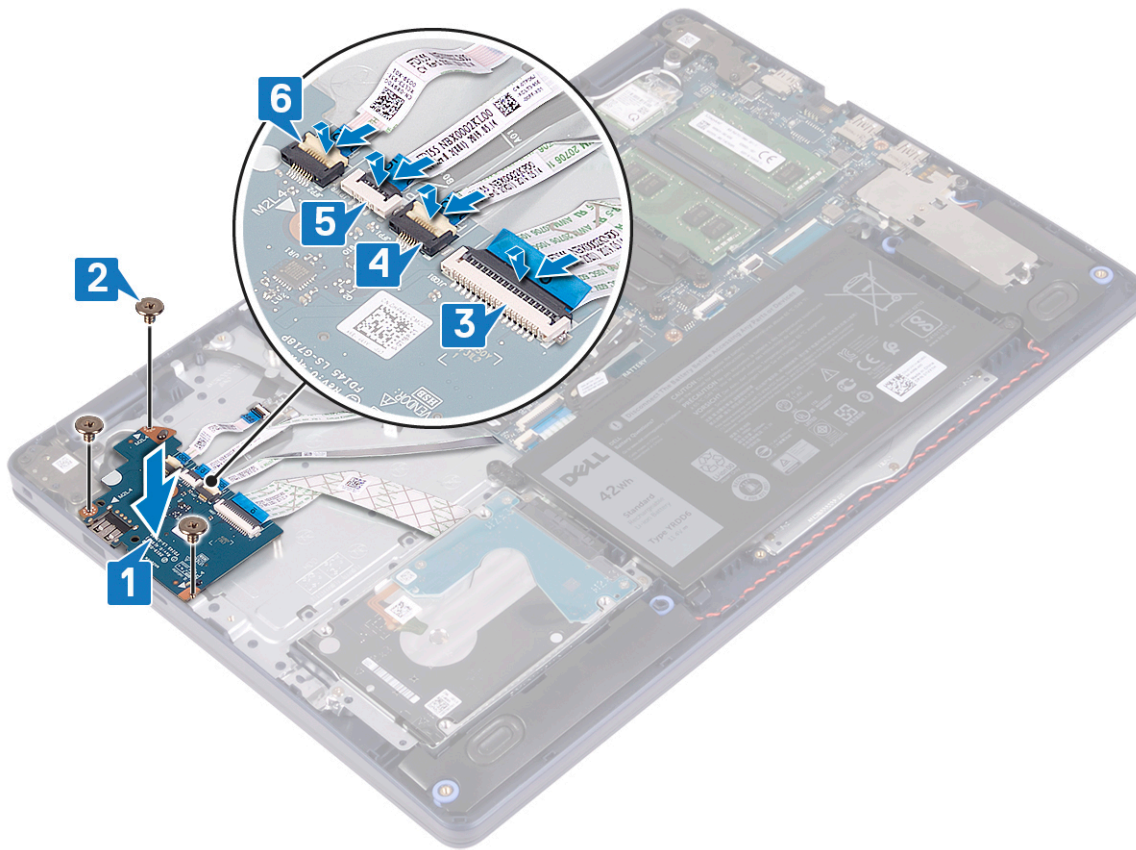

Post-requisites

1. Replace the [hard drive](#) with Intel optane..
2. Replace the [battery](#).
3. Replace the [base cover](#).

Coin-cell battery

Removing the coin-cell battery

NOTE: Before working inside your computer, read the safety information that shipped with your computer and follow the steps in [Before working inside your computer](#). After working inside your computer, follow the instructions in [After working inside your computer](#). For more safety best practices, see the Regulatory Compliance home page at www.dell.com/regulatory_compliance.

CAUTION: Removing the coin-cell battery resets the BIOS setup program's settings to default. It is recommended that you note the BIOS setup program's settings before removing the coin-cell battery.

Prerequisites

CAUTION: Removing the coin-cell battery resets the BIOS setup program's settings to default. Before removing the I/O board along with the coin-cell battery, it is recommended to note the BIOS setup program's settings.

1. Remove the [base cover](#).
2. Remove the [battery](#).
3. Remove the [I/O board](#).

Procedure

CAUTION: Removing the coin-cell battery resets the BIOS setup program's settings to default. Before removing the coin-cell battery, it is recommended to note the BIOS setup program's settings.

The coin-cell battery is located on the underside of the I/O board.

Using a plastic scribe, gently pry the coin-cell battery out of the battery socket on the I/O board.

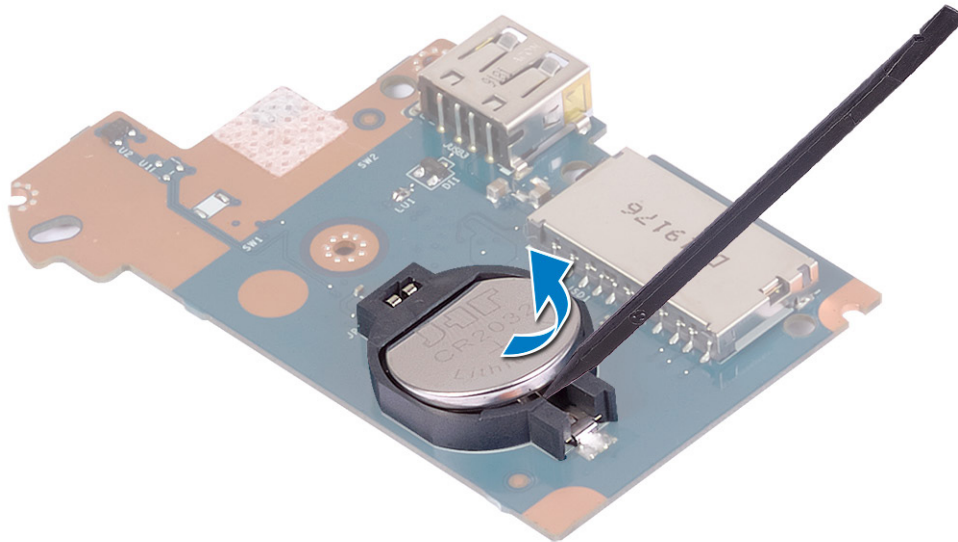

Replacing the coin-cell battery

NOTE: Before working inside your computer, read the safety information that shipped with your computer and follow the steps in [Before working inside your computer](#). After working inside your computer, follow the instructions in [After working inside your computer](#). For more safety best practices, see the Regulatory Compliance home page at www.dell.com/regulatory_compliance.

Procedure

The coin-cell battery is located on the underside of the I/O board.

With the positive-side facing up, snap the coin-cell battery into the battery socket on the I/O board.

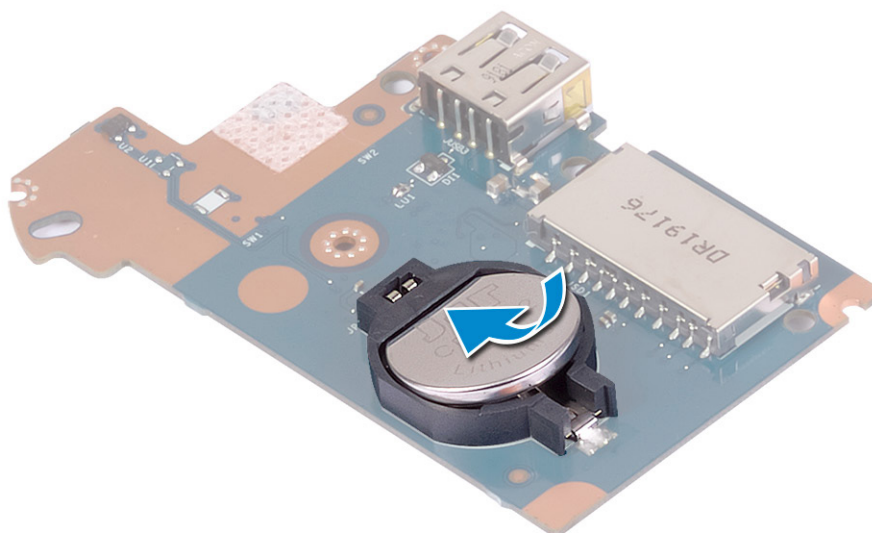

Post-requisites

1. Replace the [I/O board](#).
2. Replace the [battery](#).
3. Replace the [base cover](#).

Power button

Removing the power button

NOTE: Before working inside your computer, read the safety information that shipped with your computer and follow the steps in [Before working inside your computer](#). After working inside your computer, follow the instructions in [After working inside your computer](#). For more safety best practices, see the Regulatory Compliance home page at www.dell.com/regulatory_compliance.

Prerequisites

1. Remove the [base cover](#).
2. Remove the [battery](#).
3. Remove the [I/O board](#).

Procedure

1. Remove the two screws (M2x3) that secure the power button to the palm-rest and keyboard assembly.
2. Lift the power-button board, along with the cable, off the palm-rest and keyboard assembly.

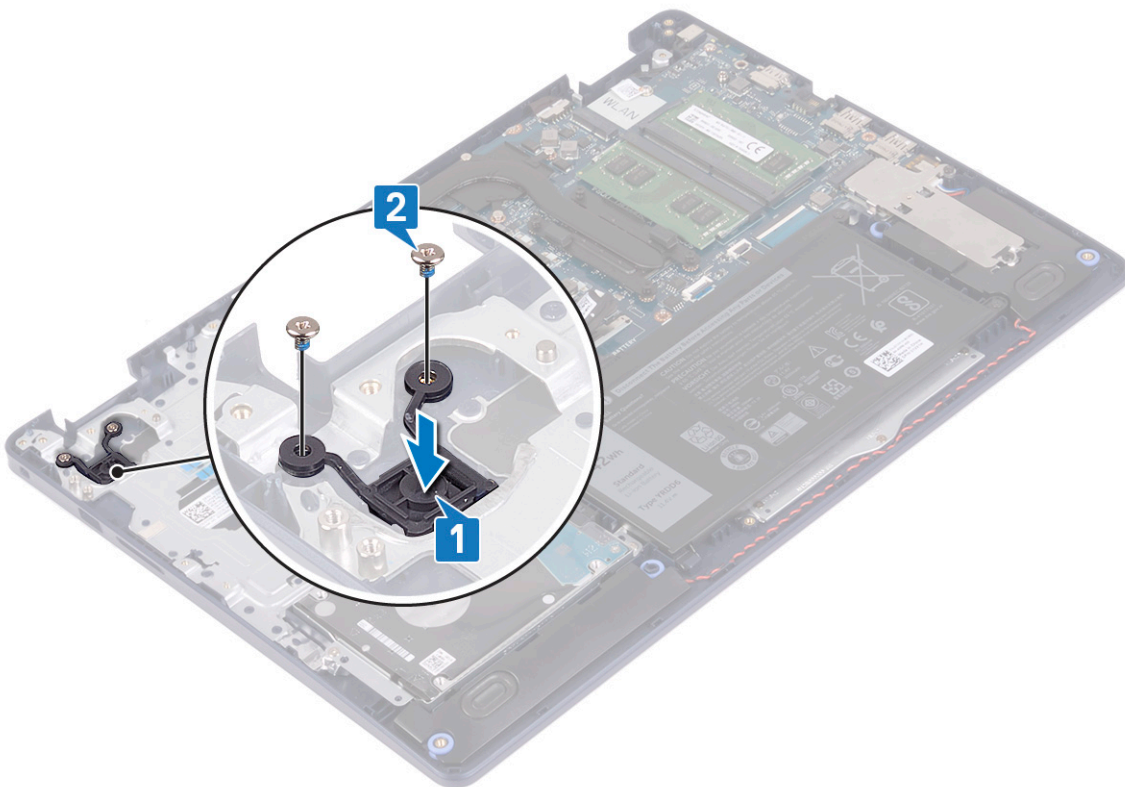

Replacing the power button

NOTE: Before working inside your computer, read the safety information that shipped with your computer and follow the steps in [Before working inside your computer](#). After working inside your computer, follow the instructions in [After working inside your computer](#). For more safety best practices, see the Regulatory Compliance home page at www.dell.com/regulatory_compliance.

Procedure

1. Align the screw holes on the power-button board with those on the palm-rest and keyboard assembly.
2. Replace the two screws (M2x3) that secure the power-button board to the palm-rest and keyboard assembly.

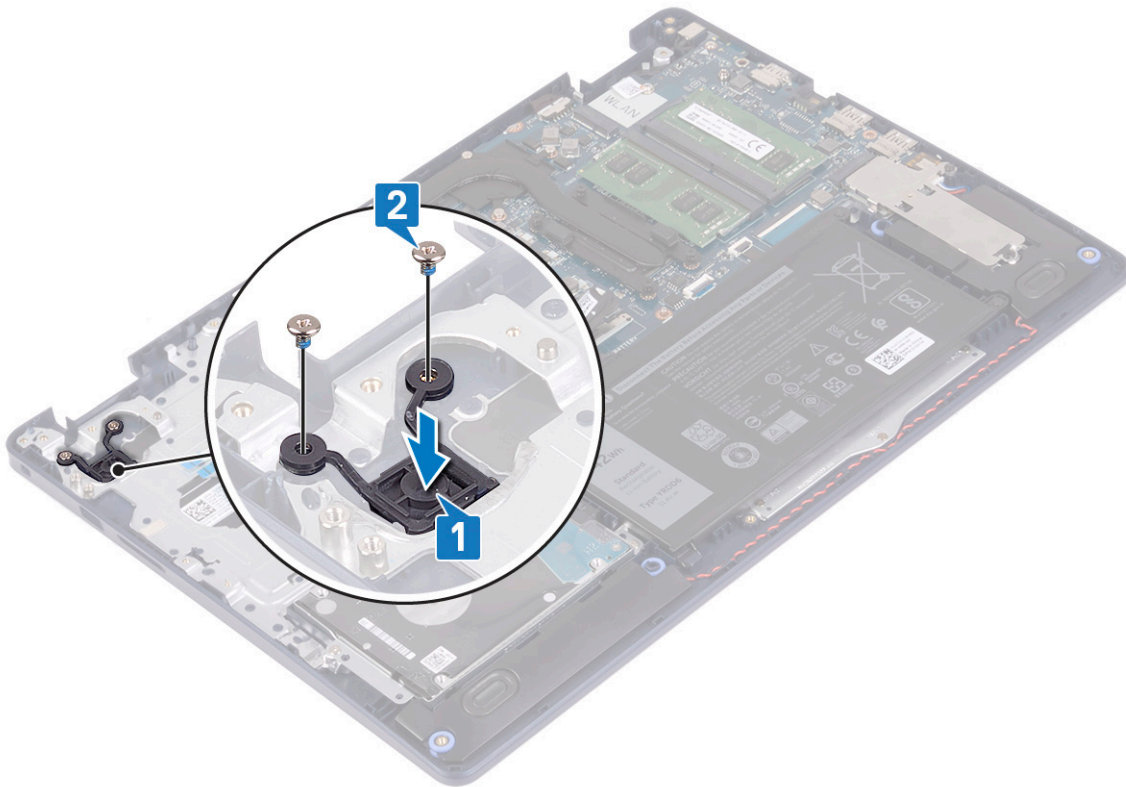

Post-requisites

1. Replace the [I/O board](#).
2. Replace the [battery](#).
3. Replace the [base cover](#).

System board

Removing the system board

NOTE: Before working inside your computer, read the safety information that shipped with your computer and follow the steps in [Before working inside your computer](#). After working inside your computer, follow the instructions in [After working inside your computer](#). For more safety best practices, see the Regulatory Compliance home page at www.dell.com/regulatory_compliance.

NOTE: Your computer's Service Tag is stored in the system board. You must enter the Service Tag in the BIOS setup program after you replace the system board.

NOTE: Replacing the system board removes any changes you have made to the BIOS using the BIOS setup program. You must make the appropriate changes again after you replace the system board.

NOTE: Before disconnecting the cables from the system board, note the location of the connectors so that you can reconnect the cables correctly after you replace the system board.

Prerequisites

1. Remove the [base cover](#).
2. Remove the [battery](#).
3. Remove the [memory modules](#).
4. Remove the [wireless card](#).
5. Remove the [solid-state drive/Intel Optane](#).
6. Remove the [fan](#).
7. Remove the [heat sink](#).
8. Remove the [display assembly](#).

Procedure

1. Disconnect the power-adapter port cable from the system board.
2. Disconnect the speaker cable from the system board.
3. Open the latch and disconnect the keyboard cable from the system board.
4. Open the latch and disconnect the keyboard back-light cable from the system board.
5. Open the latch and disconnect the touchpad cable from the system board.
6. Open the latch and disconnect the hard-drive cable from the system board.
7. Open the latch and disconnect the I/O-board cable from the system board.
8. Open the latch and disconnect the fingerprint-reader cable from the system board.

NOTE: This step is applicable only for computers shipped with the optional fingerprint reader.

9. Open the latch and disconnect the power-button board cable from the system board.

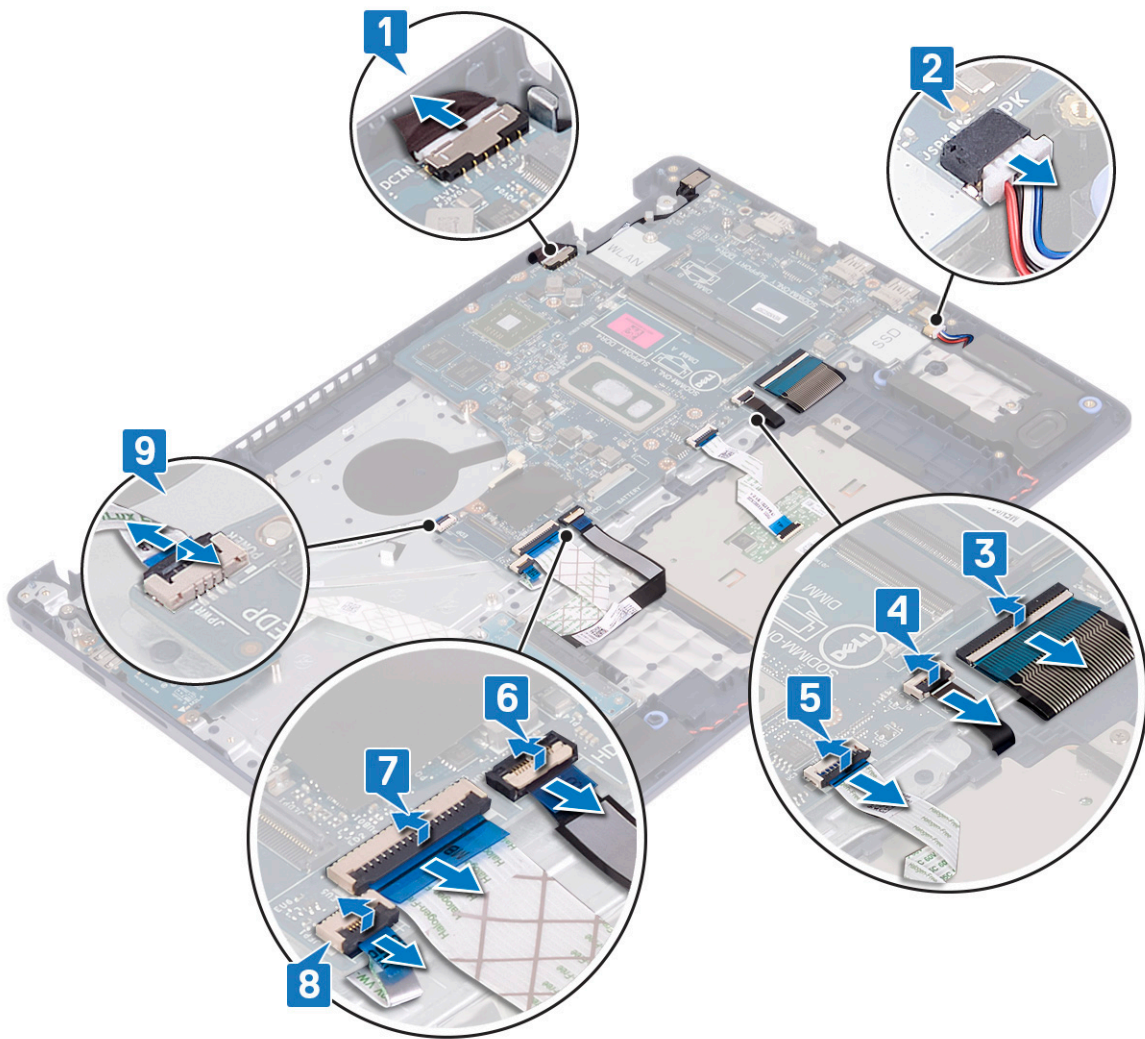

10. Remove the screw (M2x4) that secures the system board to palm-rest and keyboard assembly.
11. Lift the system board off the palm-rest and keyboard assembly.

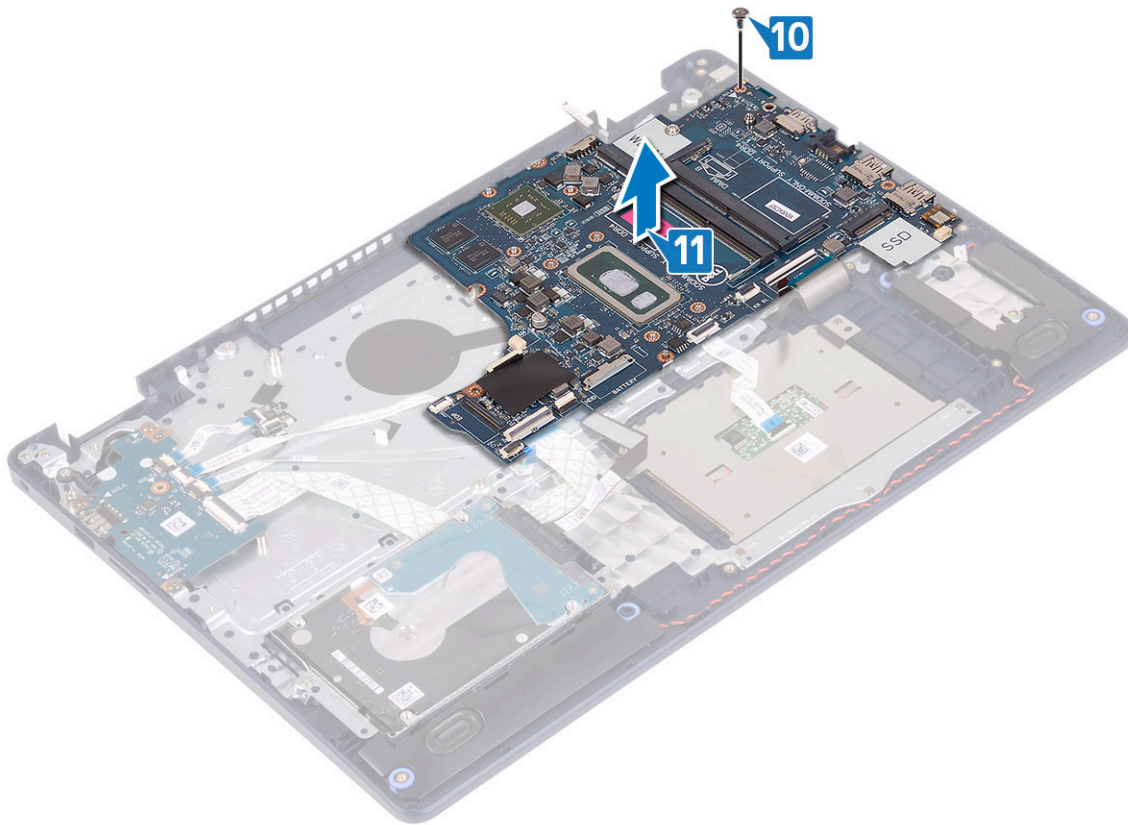

Replacing the system board

- NOTE:** Before working inside your computer, read the safety information that shipped with your computer and follow the steps in [Before working inside your computer](#). After working inside your computer, follow the instructions in [After working inside your computer](#). For more safety best practices, see the Regulatory Compliance home page at www.dell.com/regulatory_compliance.
- NOTE:** Your computer's Service Tag is stored in the system board. You must enter the Service Tag in the BIOS setup program after you replace the system board.
- NOTE:** Replacing the system board removes any changes you have made to the BIOS using the BIOS setup program. You must make the appropriate changes again after you replace the system board.

Procedure

1. Align the screw hole on the system board with the screw hole on the palm-rest and keyboard assembly.
2. Replace the screw (M2x4) that secures the system board to the palm-rest and keyboard assembly.

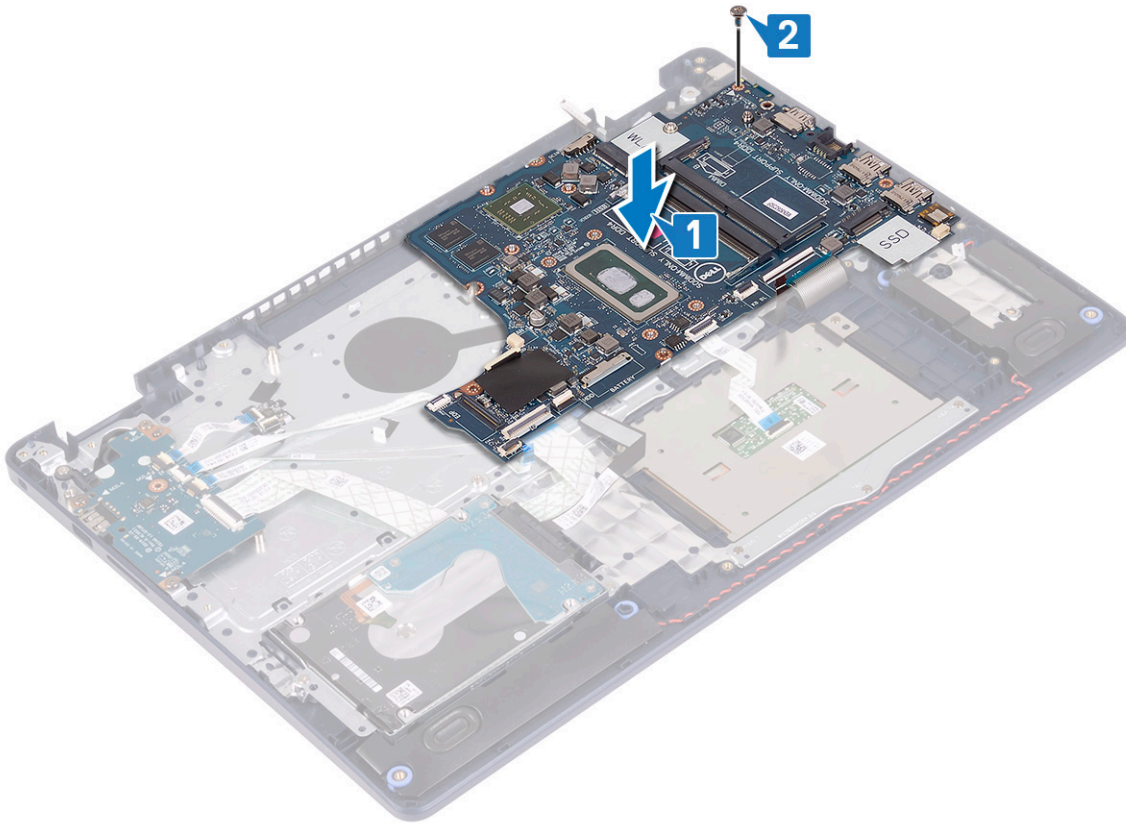

3. Slide the power-button board cable into the connector on the system board and close the latch.
4. Slide the fingerprint-reader cable into the connector on the system board and close the latch.

i **NOTE:** This step is applicable only for computers shipped with the optional fingerprint reader.

5. Slide the I/O-board cable into the connector on the system board and close the latch.
6. Slide the hard-drive cable into the connector on the system board and close the latch.
7. Slide the touchpad cable into the connector on the system board and close the latch.
8. Slide the keyboard back-light cable into the connector on the system board and close the latch.
9. Slide the keyboard cable into the connector on the system board and close the latch.
10. Connect the speaker cable to the system board.
11. Connect the power-adaptor port cable to the system board.

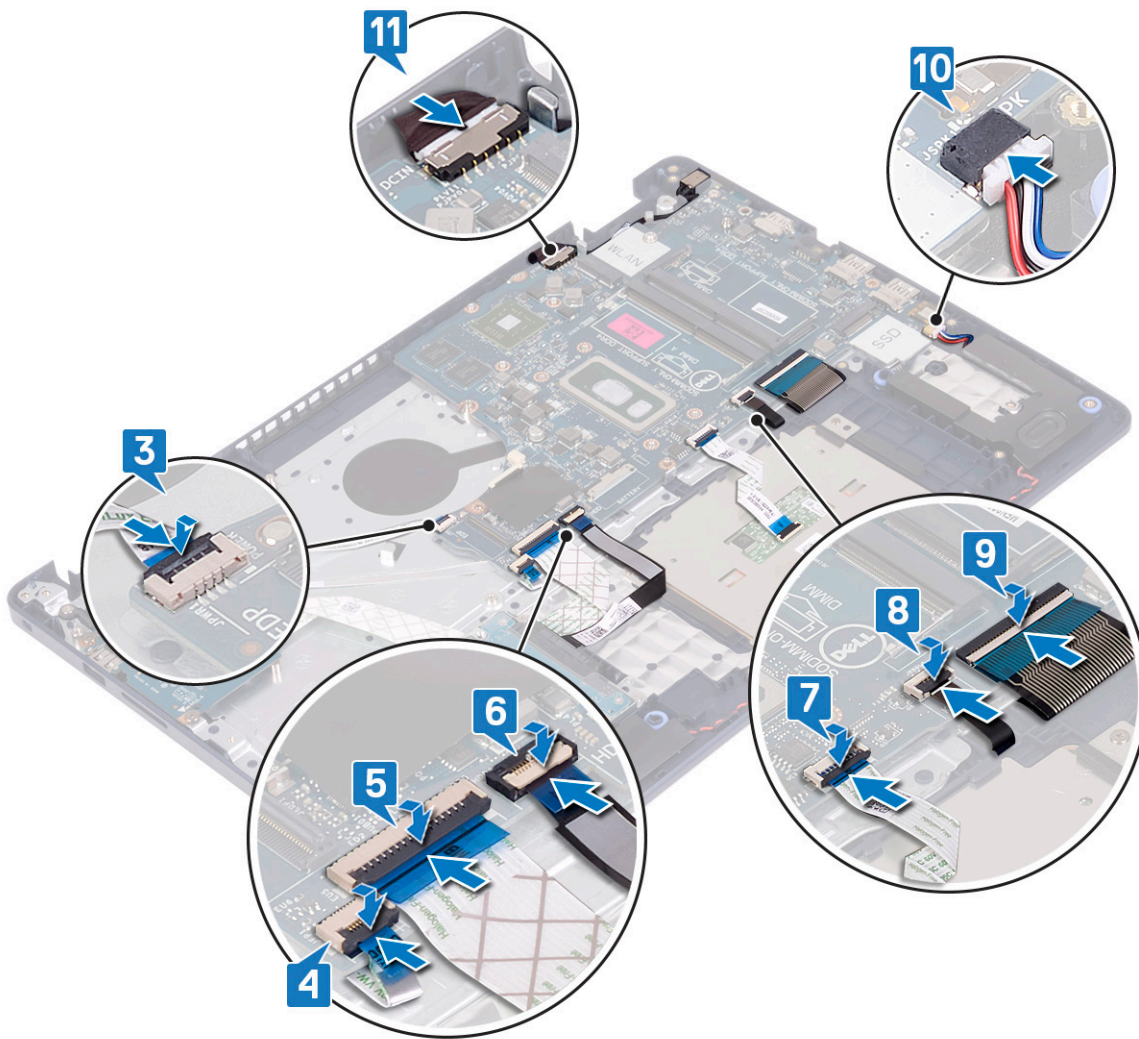

Post-requisites

1. Replace the [display assembly](#).
2. Replace the [heat sink](#).
3. Replace the [fan](#).
4. Replace the [solid-state drive/Intel Optane](#).
5. Replace the [wireless card](#).
6. Replace the [memory modules](#).
7. Replace the [battery](#).
8. Replace the [base cover](#).

Entering the Service Tag in the BIOS setup program

1. Turn on or restart your computer.
2. Press F2 when the Dell logo is displayed to enter the BIOS setup program.
3. Navigate to the **Main** tab and enter the Service Tag in the **Service Tag Input** field.

NOTE: Service tag is the alphanumeric identifier located at the back side of your computer.

Power button with fingerprint reader

Removing the power button with fingerprint reader

NOTE: Before working inside your computer, read the safety information that shipped with your computer and follow the steps in [Before working inside your computer](#). After working inside your computer, follow the instructions in [After working inside your computer](#). For more safety best practices, see the Regulatory Compliance home page at www.dell.com/regulatory_compliance.

NOTE: Applicable only for computers that are shipped with fingerprint reader.

Prerequisites

1. Remove the [base cover](#).
2. Remove the [battery](#).
3. Remove the [solid-state drive/Intel Optane](#).
4. Remove the [fan](#).
5. Remove the [heat sink](#).
6. Remove the [wireless card](#).
7. Remove the [system board](#).

NOTE: When removing and replacing the power button with fingerprint reader, do not remove the heat sink from the system board.

Procedure

1. Remove the two screws (M2x3) that secure the power button with fingerprint reader to the palm-rest and keyboard assembly.
2. Lift the power button off the palm-rest and keyboard assembly.
3. Peel the fingerprint-reader cable off the palm-rest and keyboard assembly.
4. Lift the power button with fingerprint reader, along with the fingerprint-reader board and its cable, off the palm-rest and keyboard assembly.

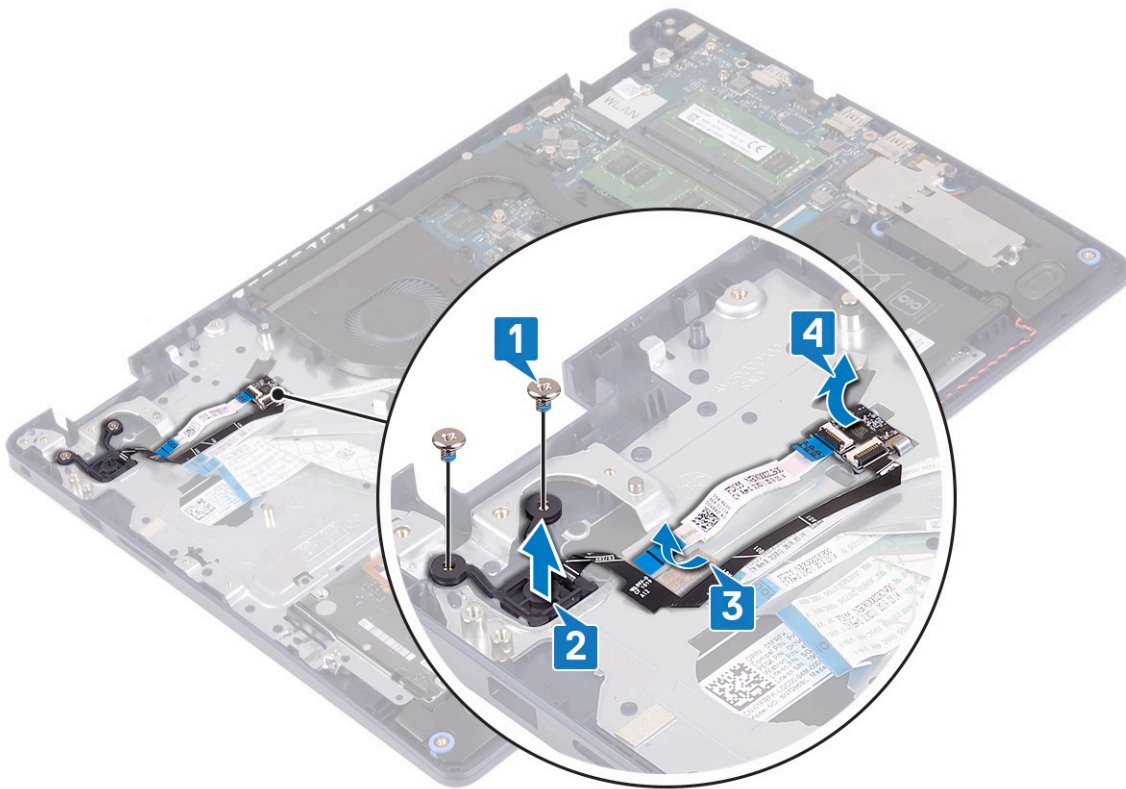

Replacing the power button with fingerprint reader

NOTE: Before working inside your computer, read the safety information that shipped with your computer and follow the steps in [Before working inside your computer](#). After working inside your computer, follow the instructions in [After working inside your computer](#). For more safety best practices, see the Regulatory Compliance home page at www.dell.com/regulatory_compliance.

NOTE: Applicable only for computers that are shipped with fingerprint reader.

Procedure

1. Using the alignment posts, align and place the fingerprint-reader board on the palm-rest and keyboard assembly.
2. Adhere the fingerprint-reader cable on the palm-rest and keyboard assembly.
3. Place the power button on the palm-rest and keyboard assembly.
4. Replace the two screws (M2x3) that secure the power button with fingerprint reader to the palm-rest and keyboard assembly.

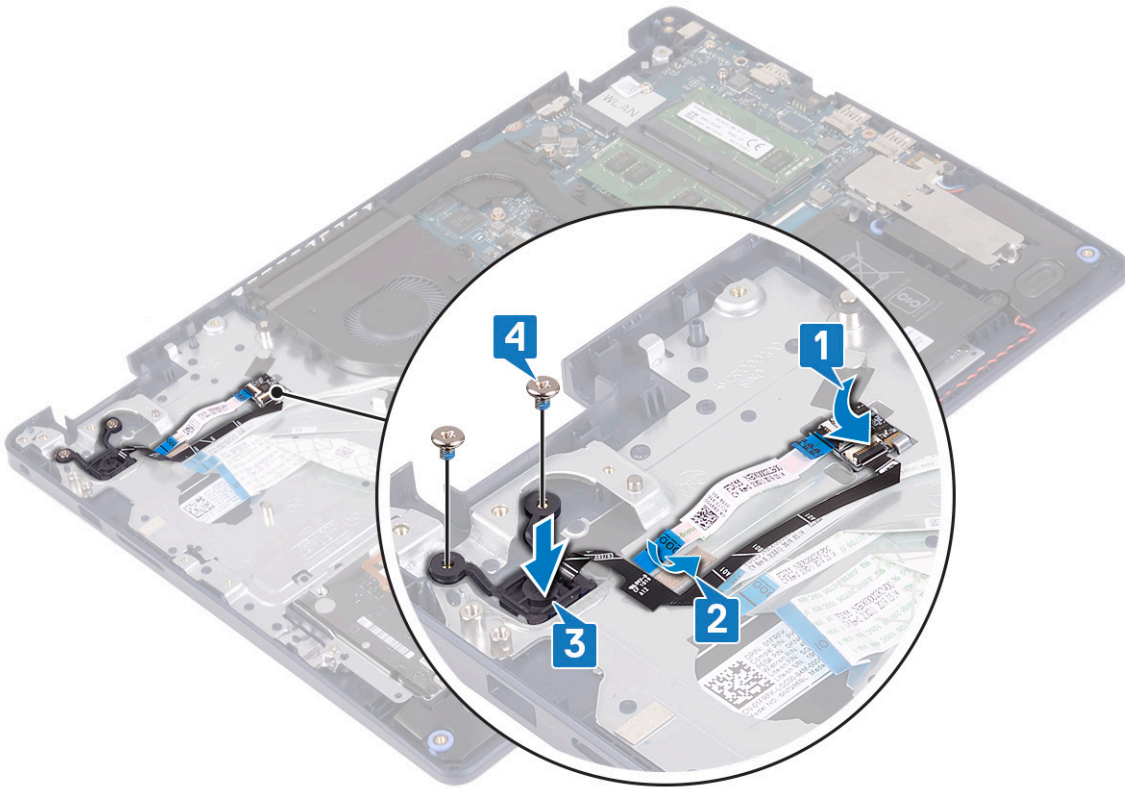

Post-requisites

1. Replace the [system board](#).
2. Replace the [wireless card](#).
3. Replace the [heat sink](#).
4. Replace the [fan](#).
5. Replace the [solid-state drive/Intel Optane](#).
6. Replace the [battery](#).
7. Replace the [base cover](#).

Palm-rest and keyboard assembly

Removing the palm-rest and keyboard assembly

NOTE: Before working inside your computer, read the safety information that shipped with your computer and follow the steps in [Before working inside your computer](#). After working inside your computer, follow the instructions in [After working inside your computer](#). For more safety best practices, see the Regulatory Compliance home page at www.dell.com/regulatory_compliance.

Prerequisites

1. Remove the [base cover](#).
2. Remove the [battery](#).
3. Remove the [fan](#).
4. Remove the [solid-state drive/Intel Optane](#).
5. Remove the [wireless card](#).
6. Remove the [speakers](#).
7. Remove the [hard drive with Intel optane](#).

8. Remove the [touchpad](#).
9. Remove the [power-adapter port](#).
10. Remove the [display assembly](#).
11. Remove the [I/O board](#).
12. Remove the [system board](#).

NOTE: When removing and replacing the palm-rest and keyboard assembly, do not remove the heat sink from the system board.

13. Remove the [power button with fingerprint reader](#) (optional).

Procedure

After performing the above steps, we are left with the palm-rest and keyboard assembly.



Replacing the palm-rest and keyboard assembly

NOTE: Before working inside your computer, read the safety information that shipped with your computer and follow the steps in [Before working inside your computer](#). After working inside your computer, follow the instructions in [After working inside your computer](#). For more safety best practices, see the Regulatory Compliance home page at www.dell.com/regulatory_compliance.

Procedure

Place the palm-rest and keyboard assembly on a flat surface.

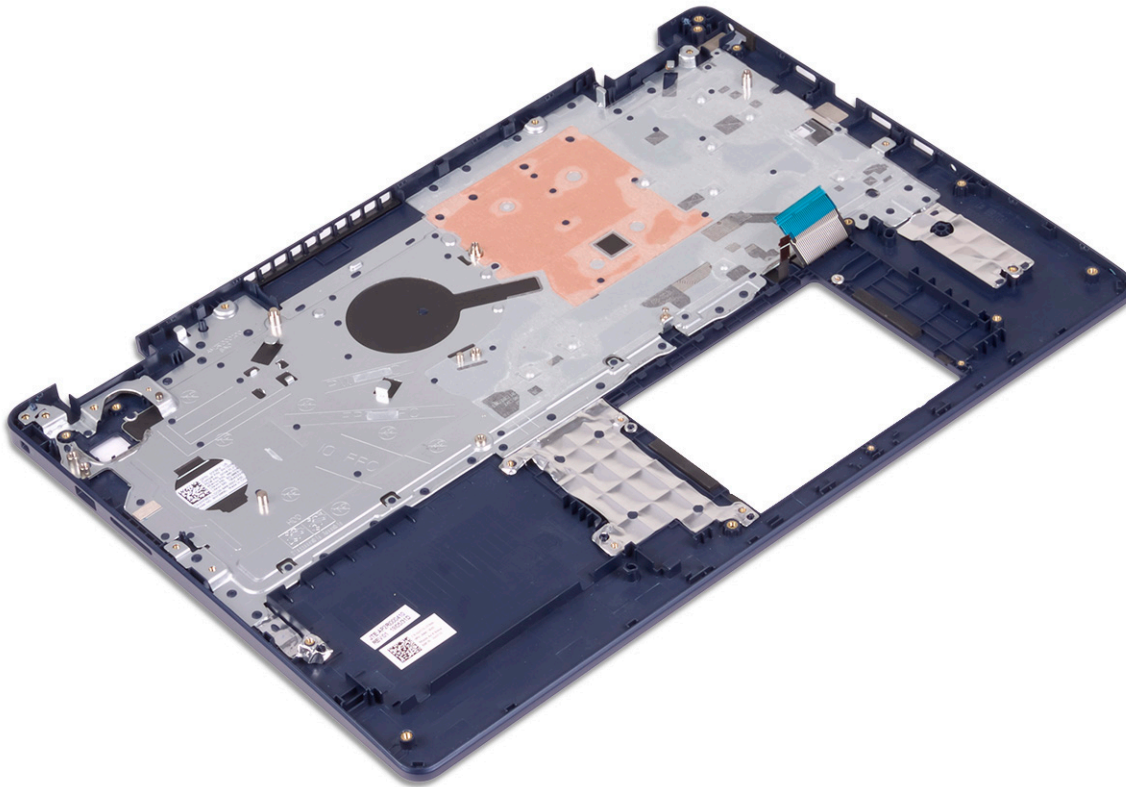

Post-requisites

1. Replace the [power button with fingerprint reader](#) (optional).
2. Replace the [system board](#).
3. Replace the [I/O board](#).
4. Replace the [display assembly](#).
5. Replace the [power-adapter port](#).
6. Replace the [touchpad](#).
7. Replace the [hard drive with Intel Optane](#).
8. Replace the [speakers](#).
9. Replace the [wireless card](#).
10. Replace the [solid-state drive/Intel Optane](#).
11. Replace the [fan](#).
12. Replace the [battery](#).
13. Replace the [base cover](#).

Display bezel

Removing the display bezel

NOTE: Before working inside your computer, read the safety information that shipped with your computer and follow the steps in [Before working inside your computer](#). After working inside your computer, follow the instructions in [After working inside your computer](#). For more safety best practices, see the Regulatory Compliance home page at www.dell.com/regulatory_compliance.

Prerequisites

1. Remove the [base cover](#).

2. Remove the [wireless card](#).
3. Remove the [display assembly](#).

Procedure

1. Pry up the display bezel from the top inner edge of the display back-cover and antenna assembly.
2. Remove the display bezel off the display back-cover and antenna assembly.

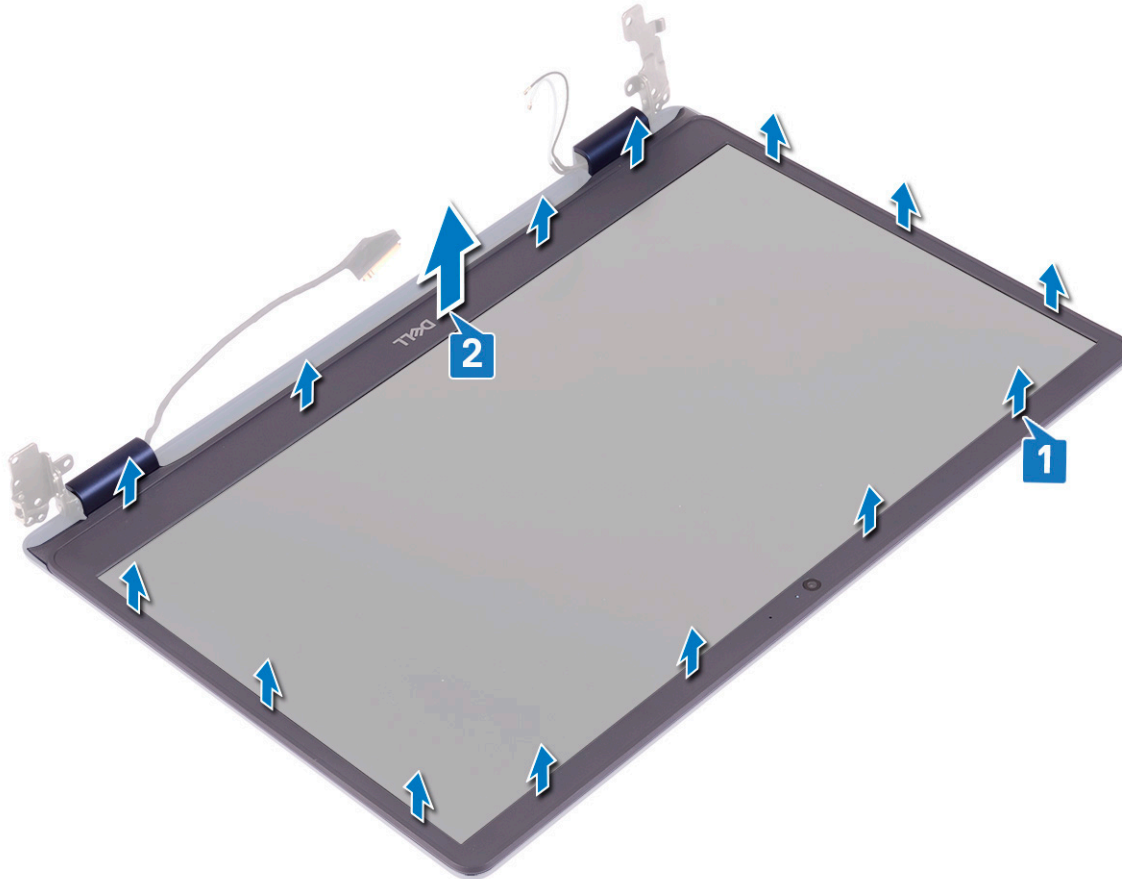

Replacing the display bezel

- NOTE:** Before working inside your computer, read the safety information that shipped with your computer and follow the steps in [Before working inside your computer](#). After working inside your computer, follow the instructions in [After working inside your computer](#). For more safety best practices, see the Regulatory Compliance home page at www.dell.com/regulatory_compliance.

Procedure

Align the display bezel with the display back-cover and antenna assembly, and then gently snap the display bezel into place.

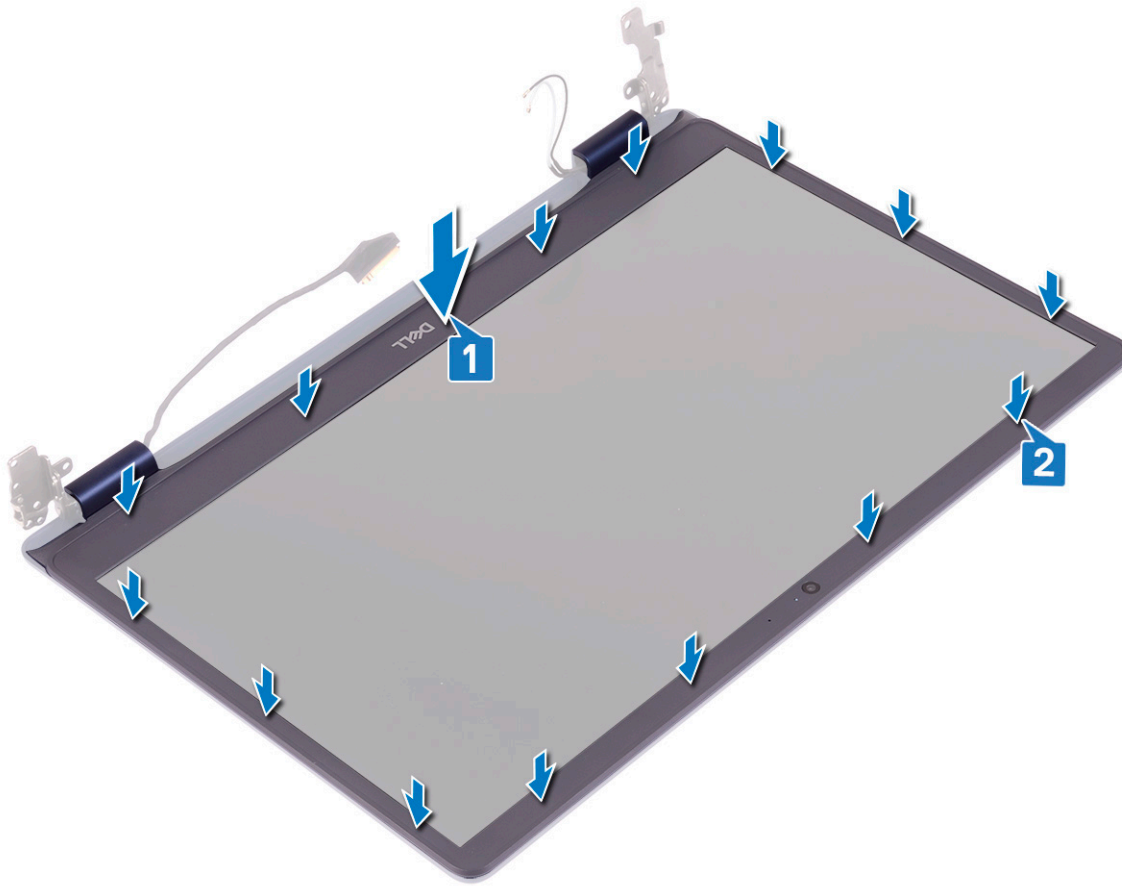

Post-requisites

1. Replace the [display assembly](#).
2. Replace the [wireless card](#).
3. Replace the [base cover](#).

Camera

Removing the camera

NOTE: Before working inside your computer, read the safety information that shipped with your computer and follow the steps in [Before working inside your computer](#). After working inside your computer, follow the instructions in [After working inside your computer](#). For more safety best practices, see the Regulatory Compliance home page at www.dell.com/regulatory_compliance.

Prerequisites

1. Remove the [base cover](#).
2. Remove the [wireless card](#).
3. Remove the [display assembly](#).
4. Remove the [display bezel](#).

Procedure

1. Using a plastic scribe, gently pry the camera off the display back-cover and antenna assembly.
2. Disconnect the camera cable from the camera module.

3. Lift the camera module from the display back-cover and antenna assembly.

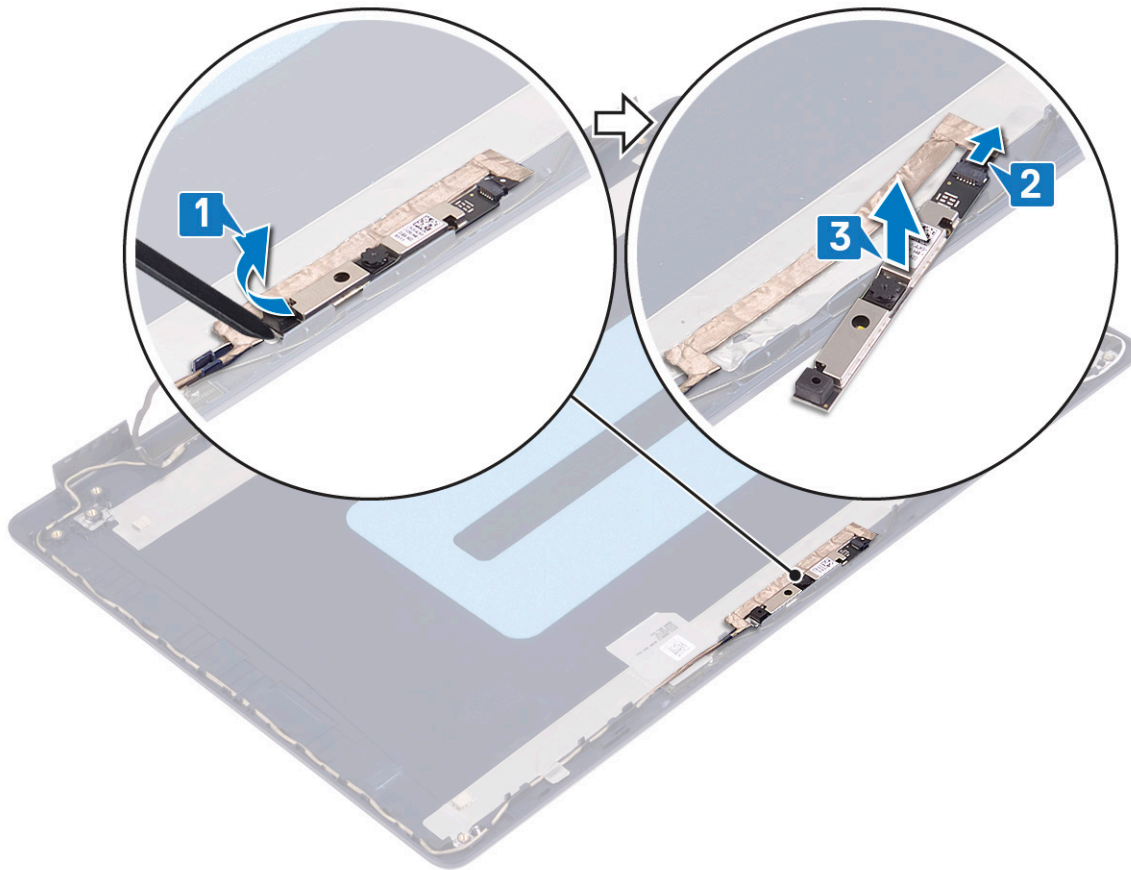

Replacing the camera

- NOTE:** Before working inside your computer, read the safety information that shipped with your computer and follow the steps in [Before working inside your computer](#). After working inside your computer, follow the instructions in [After working inside your computer](#). For more safety best practices, see the Regulatory Compliance home page at www.dell.com/regulatory_compliance.

Procedure

1. Connect the camera cable to the camera module.
2. Using the alignment post adhere the camera module to the display back-cover and antenna assembly.

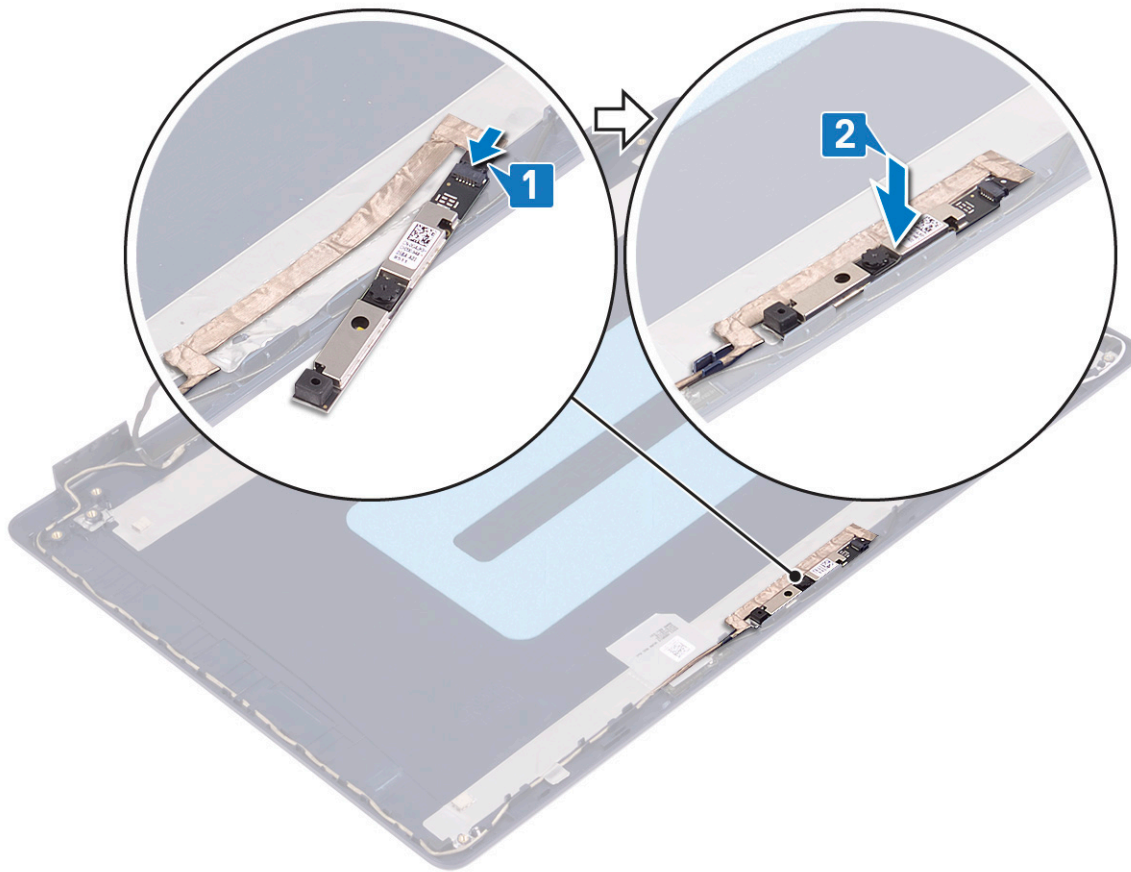

Post-requisites

1. Replace the [display bezel](#).
2. Replace the [display assembly](#).
3. Replace the [wireless card](#).
4. Replace the [base cover](#).

Display panel

Removing the display panel

NOTE: Before working inside your computer, read the safety information that shipped with your computer and follow the steps in [Before working inside your computer](#). After working inside your computer, follow the instructions in [After working inside your computer](#). For more safety best practices, see the Regulatory Compliance home page at www.dell.com/regulatory_compliance.

Prerequisites

1. Remove the [base cover](#).
2. Remove the [wireless card](#).
3. Remove the [display assembly](#).
4. Remove the [display bezel](#).

Procedure

1. Remove the six screws (M2.5x2.5) that secure the display panel to the display back-cover and antenna assembly.

2. Loosen the two screws (M2x3) that secure the display panel to the display back-cover and antenna assembly.
3. Lift the display panel and turn it over.

i **NOTE:** Do not pull and release the Stretch (SR) Tapes from the display panel. The display hinges and brackets are shipped together with the display panel as an assembly and do not need to be separated from the display panel.

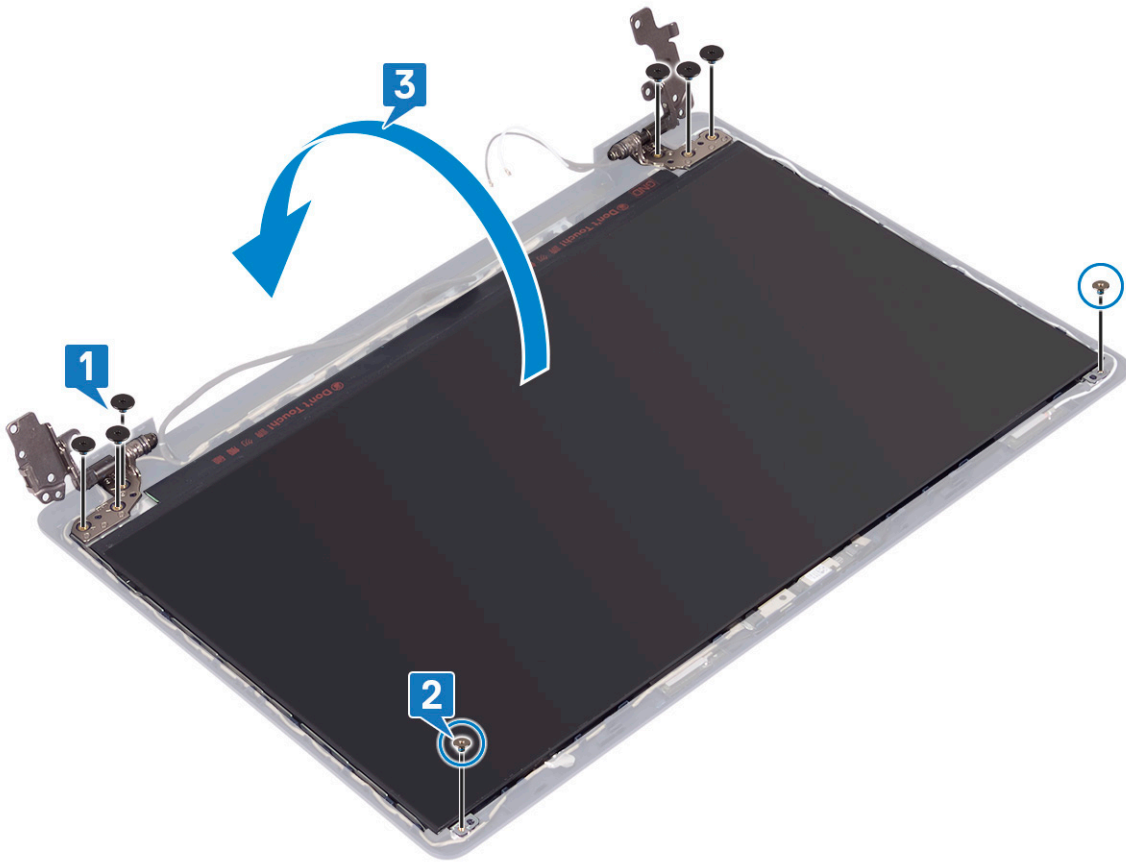

4. Peel the tape adhering the display cable to the back of the display panel.
5. Lift the latch and disconnect the display cable from the display-panel cable connector.
6. Lift the display panel away from the display back-cover and antenna assembly.

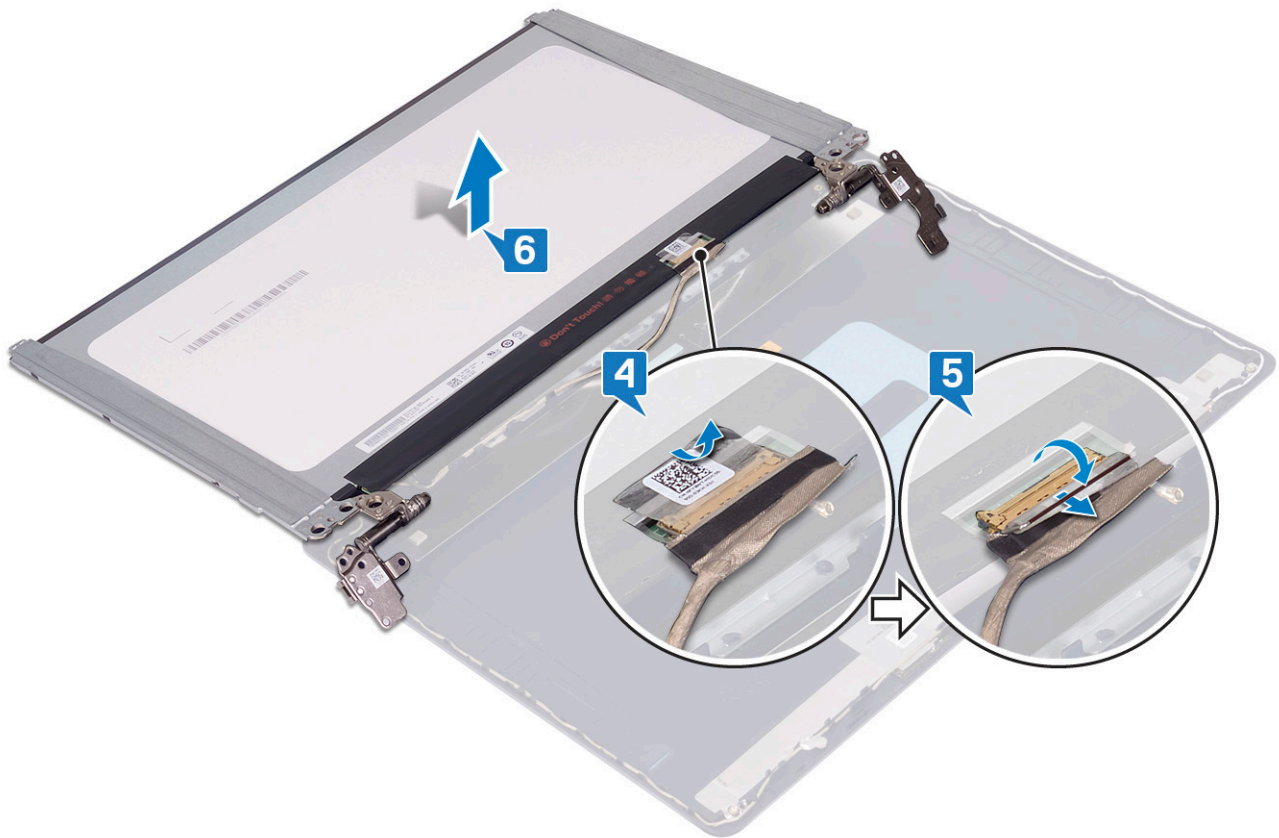

Replacing the display panel

NOTE: Before working inside your computer, read the safety information that shipped with your computer and follow the steps in [Before working inside your computer](#). After working inside your computer, follow the instructions in [After working inside your computer](#). For more safety best practices, see the Regulatory Compliance home page at www.dell.com/regulatory_compliance.

Procedure

1. Place the display panel on a flat and clean surface.
2. Connect the display cable to the connector at the back of the display panel and close the latch to secure the cable.
3. Adhere the tape that secures the display cable to the back of the display panel.

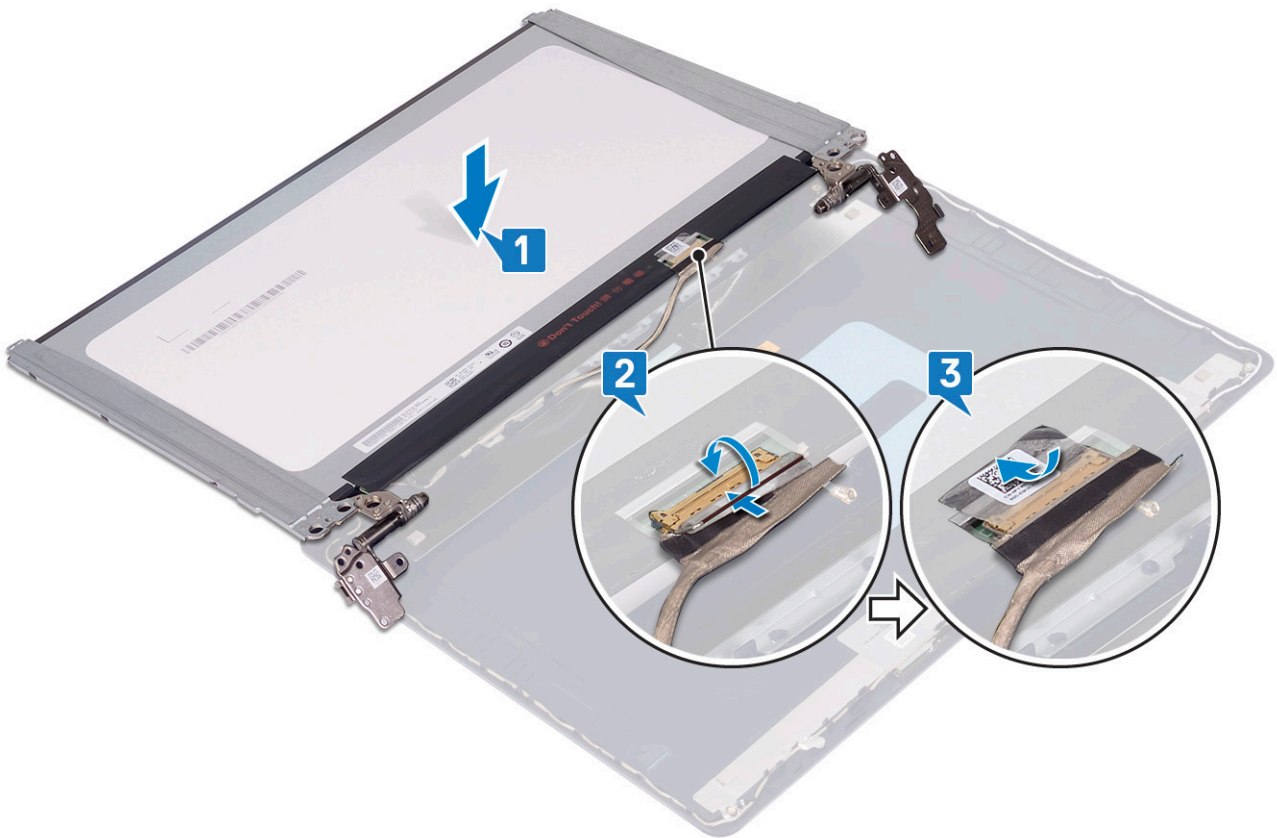

4. Place the display panel on the display back-cover and antenna assembly.
5. Replace the two screws (M2x3) that secure the display panel to the display back-cover and antenna assembly.
6. Replace the six screws (M2.5x2.5) that secure the display panel to the display back-cover and antenna assembly.

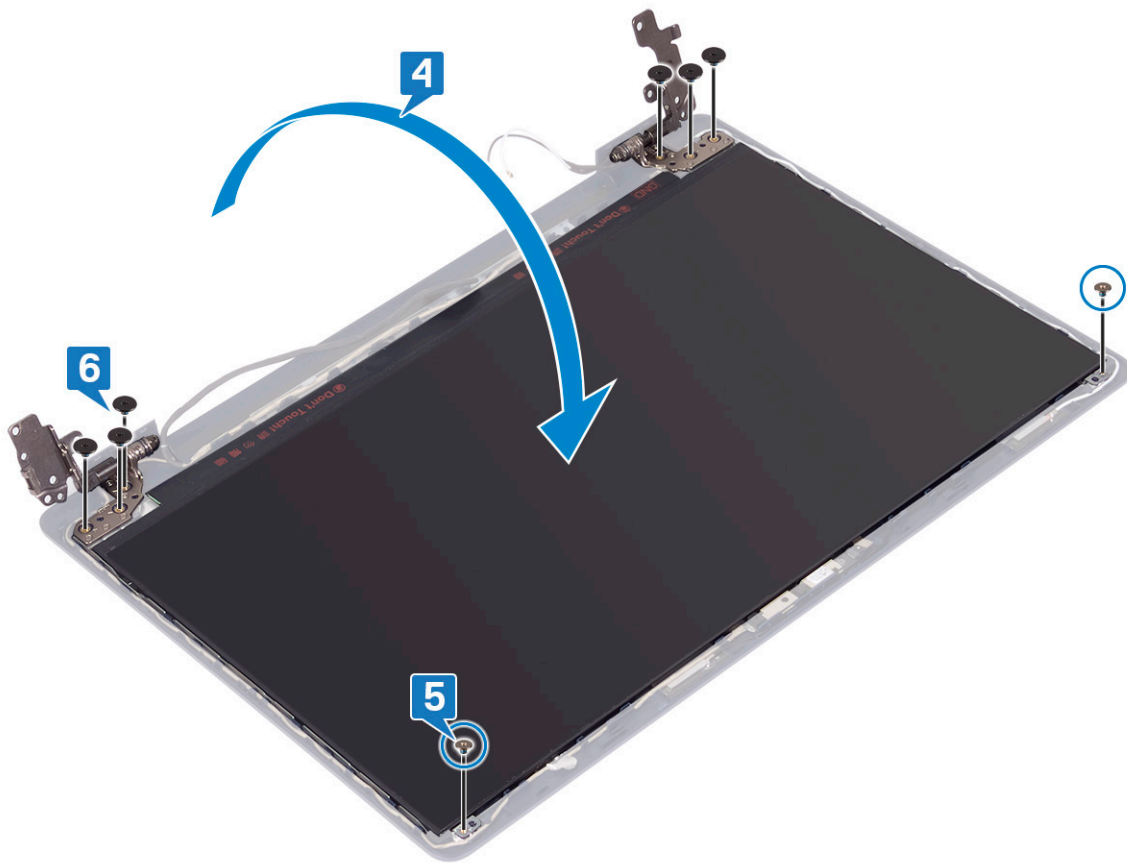

Post-requisites

1. Replace the [display bezel](#).
2. Replace the [display assembly](#).
3. Replace the [wireless card](#).
4. Replace the [base cover](#).

Display cable

Removing the display cable

i **NOTE:** Before working inside your computer, read the safety information that shipped with your computer and follow the steps in [Before working inside your computer](#). After working inside your computer, follow the instructions in [After working inside your computer](#). For more safety best practices, see the Regulatory Compliance home page at www.dell.com/regulatory_compliance.

Prerequisites

1. Remove the [base cover](#).
2. Remove the [wireless card](#).
3. Remove the [display assembly](#).
4. Remove the [display bezel](#).
5. Remove the [display panel](#).

Procedure

1. Disconnect the camera cable from the camera module.

2. Note the display cable routing and remove the cable from the routing guides on the display back-cover and antenna assembly.
3. Remove the display cable from the display back-cover and antenna assembly.

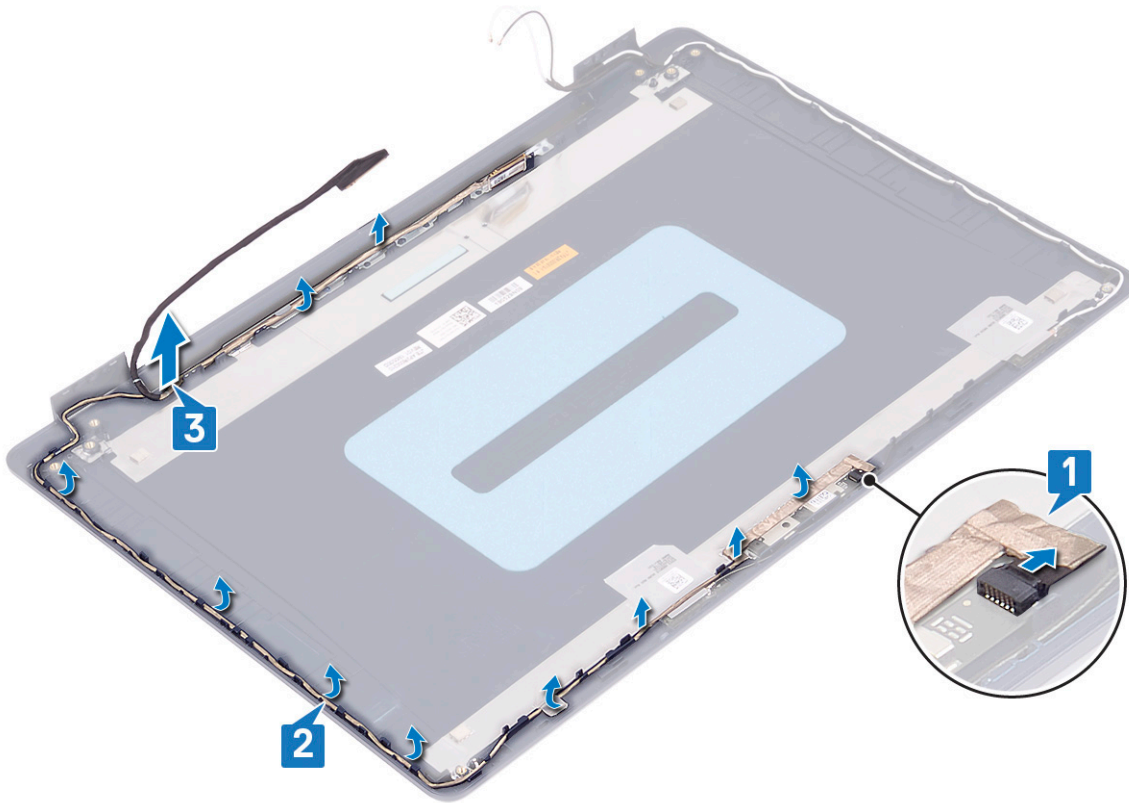

Replacing the display cable

NOTE: Before working inside your computer, read the safety information that shipped with your computer and follow the steps in [Before working inside your computer](#). After working inside your computer, follow the instructions in [After working inside your computer](#). For more safety best practices, see the Regulatory Compliance home page at www.dell.com/regulatory_compliance.

Procedure

1. Route the display cable along the routing guides, starting from the bottom of the display (near the hinges).
2. Route the rest of the display cable along the routing guides on the left side of the display back-cover and antenna assembly.
3. Slide the camera cable into the connector on the camera module to secure the cable.

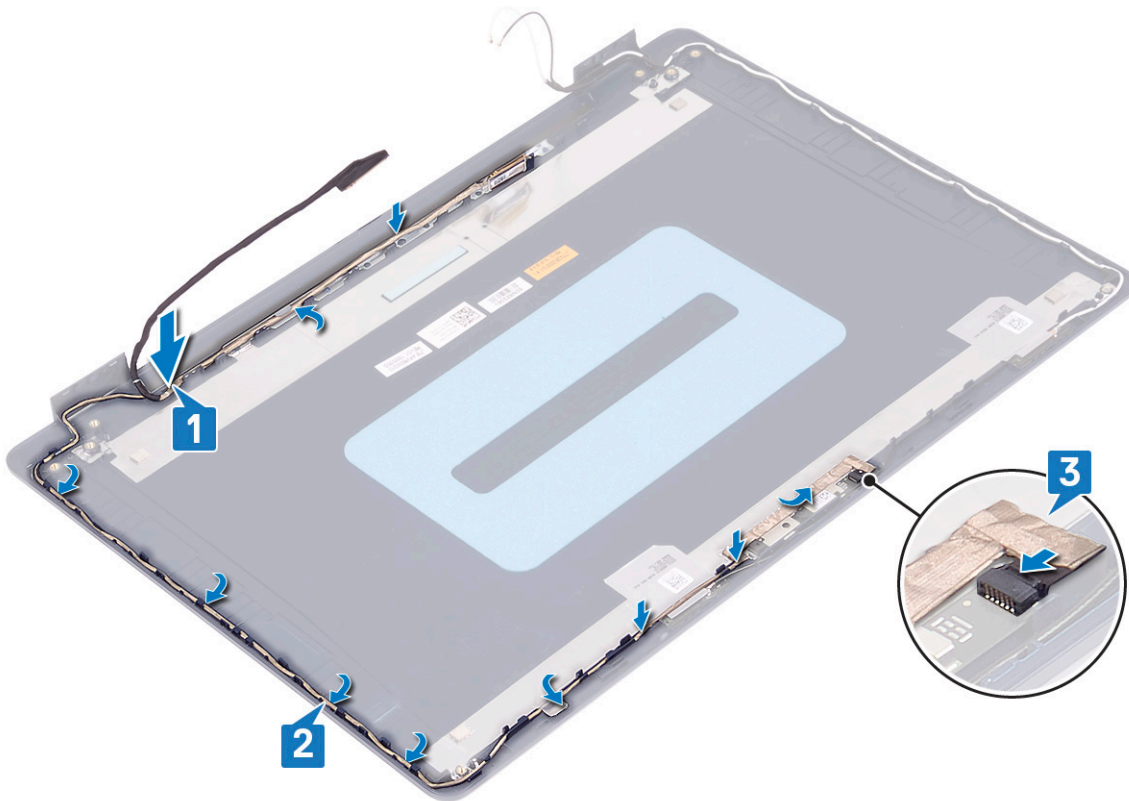

Post-requisites

1. Replace the [display panel](#).
2. Replace the [display bezel](#).
3. Replace the [display assembly](#).
4. Replace the [wireless card](#).
5. Replace the [base cover](#).

Display back-cover and antenna assembly

Removing the display back-cover and antenna assembly

NOTE: Before working inside your computer, read the safety information that shipped with your computer and follow the steps in [Before working inside your computer](#). After working inside your computer, follow the instructions in [After working inside your computer](#). For more safety best practices, see the Regulatory Compliance home page at www.dell.com/regulatory_compliance.

Prerequisites

1. Remove the [base cover](#).
2. Remove the [wireless card](#).
3. Remove the [display assembly](#).
4. Remove the [display bezel](#).
5. Remove the [camera](#).
6. Remove the [display panel](#).
7. Remove the [display cable](#).

Procedure

After performing all the above steps, we are left with the display back-cover and antenna assembly.

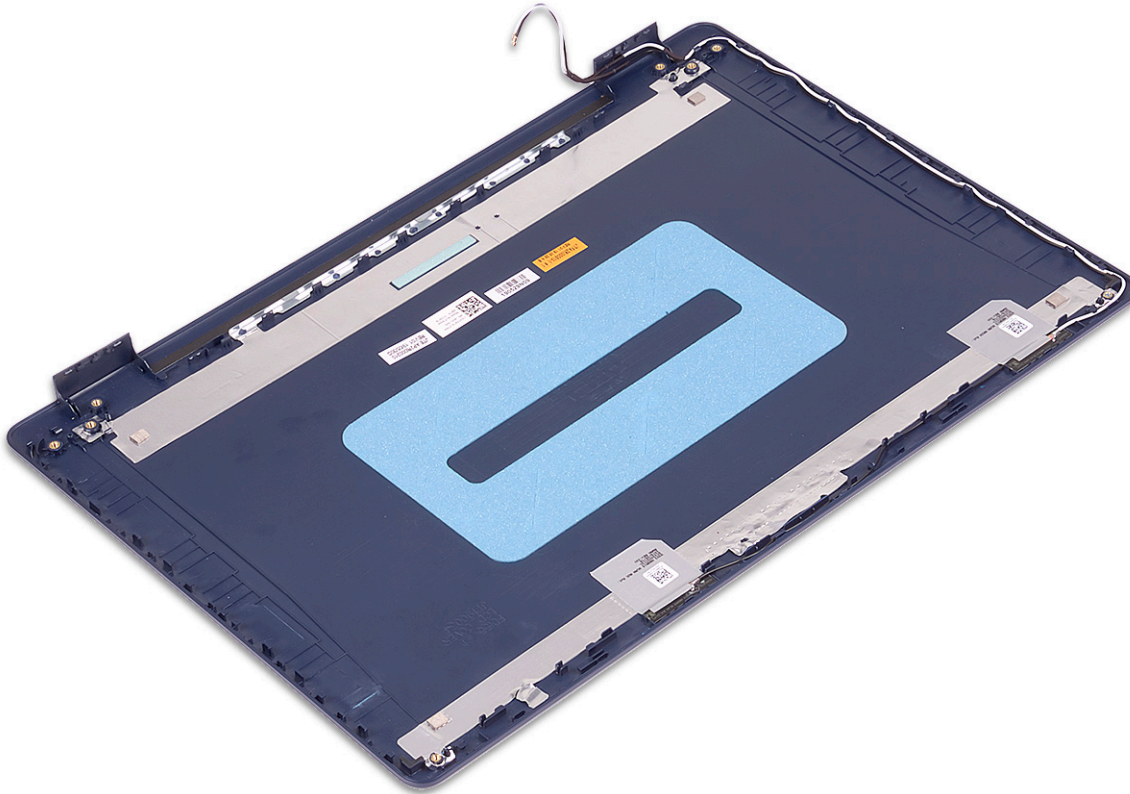

Replacing the display back-cover and antenna assembly

NOTE: Before working inside your computer, read the safety information that shipped with your computer and follow the steps in [Before working inside your computer](#). After working inside your computer, follow the instructions in [After working inside your computer](#). For more safety best practices, see the Regulatory Compliance home page at www.dell.com/regulatory_compliance.

Procedure

Place the display back-cover and antenna assembly on a clean and flat surface.



Post-requisites

1. Replace the [display cable](#).
2. Replace the [display panel](#).
3. Replace the [camera](#).
4. Replace the [display bezel](#).
5. Replace the [display assembly](#).
6. Replace the [wireless card](#).
7. Replace the [base cover](#).

Device drivers

Downloading the audio driver

1. Turn on your computer.
2. Go to www.dell.com/support.
3. Enter the Service Tag of your computer, and then click **Submit**.

 **NOTE: If you do not have the Service Tag, use the auto-detect feature or manually browse for your computer model.**

4. Click **Drivers & downloads**.
5. Click the **Detect Drivers** button.
6. Review and agree to the Terms and Conditions to use **SupportAssist**, then click **Continue**.
7. If necessary, your computer starts to download and install **SupportAssist**.

 **NOTE: Review on-screen instructions for browser-specific instructions.**

8. Click **View Drivers for My System**.
9. Click **Download and Install** to download and install all driver updates detected for your computer.
10. Select a location to save the files.
11. If prompted, approve requests from **User Account Control** to make changes on the system.
12. The application installs all drivers and updates identified.

 **NOTE: Not all files can be installed automatically. Review the installation summary to identify if manual installation is necessary.**

13. For manual download and installation, click **Category**.
14. Click **Audio** in the drop-down list.
15. Click **Download** to download the audio driver for your computer.
16. After the download is complete, navigate to the folder where you saved the audio driver file.
17. Double-click the audio driver file icon and follow the instructions on the screen to install the driver.

Downloading the network driver

1. Turn on your computer.
2. Go to www.dell.com/support.
3. Enter the Service Tag of your computer, and then click **Submit**.

 **NOTE: If you do not have the Service Tag, use the auto-detect feature or manually browse for your computer model.**

4. Click **Drivers & downloads**.
5. Click the **Detect Drivers** button.
6. Review and agree to the Terms and Conditions to use **SupportAssist**, then click **Continue**.
7. If necessary, your computer starts to download and install **SupportAssist**.



 **NOTE: Review on-screen instructions for browser-specific instructions.**

8. Click **View Drivers for My System**.
9. Click **Download and Install** to download and install all driver updates detected for your computer.
10. Select a location to save the files.
11. If prompted, approve requests from **User Account Control** to make changes on the system.
12. The application installs all drivers and updates identified.



 **NOTE: Not all files can be installed automatically. Review the installation summary to identify if manual installation is necessary.**

13. For manual download and installation, click **Category**.
14. Click **Network** in the drop-down list.
15. Click **Download** to download the network driver for your computer.
16. After the download is complete, navigate to the folder where you saved the network driver file.
17. Double-click the network driver file icon and follow the instructions on the screen to install the driver.

Downloading the chipset driver



1. Turn on your computer.
2. Go to www.dell.com/support.
3. Enter the Service Tag of your computer, and then click **Submit**.
 **NOTE: If you do not have the Service Tag, use the auto-detect feature or manually browse for your computer model.**
4. Click **Drivers & downloads**.
5. Click the **Detect Drivers** button.
6. Review and agree to the Terms and Conditions to use **SupportAssist**, then click **Continue**.
7. If necessary, your computer starts to download and install **SupportAssist**.
 **NOTE: Review on-screen instructions for browser-specific instructions.**
8. Click **View Drivers for My System**.
9. Click **Download and Install** to download and install all driver updates detected for your computer.
10. Select a location to save the files.
11. If prompted, approve requests from **User Account Control** to make changes on the system.
12. The application installs all drivers and updates identified.
 **NOTE: Not all files can be installed automatically. Review the installation summary to identify if manual installation is necessary.**
13. For manual download and installation, click **Category**.
14. Click **Chipset** in the drop-down list.
15. Click **Download** to download the chipset driver for your computer.
16. After the download is complete, navigate to the folder where you saved the saved the chipset driver file.
17. Double-click the chipset driver file icon and follow the instructions on the screen to install the driver.

Downloading the media-card reader driver



1. Turn on your computer.
2. Go to www.dell.com/support.
3. Enter the Service Tag of your computer, and then click **Submit**.
 **NOTE: If you do not have the Service Tag, use the auto-detect feature or manually browse for your computer model.**
4. Click **Drivers & downloads**.
5. Click the **Detect Drivers** button.
6. Review and agree to the Terms and Conditions to use **SupportAssist**, then click **Continue**.
7. If necessary, your computer starts to download and install **SupportAssist**.
 **NOTE: Review on-screen instructions for browser-specific instructions.**
8. Click **View Drivers for My System**.
9. Click **Download and Install** to download and install all driver updates detected for your computer.
10. Select a location to save the files.
11. If prompted, approve requests from **User Account Control** to make changes on the system.
12. The application installs all drivers and updates identified.
 **NOTE: Not all files can be installed automatically. Review the installation summary to identify if manual installation is necessary.**

13. For manual download and installation, click **Category**.
14. Click **Chipset** in the drop-down list.
15. Click **Download** to download the media-card reader driver for your computer.
16. After the download is complete, navigate to the folder where you saved the media-card reader driver file.
17. Double-click the media-card reader driver file icon and follow the instructions on the screen to install the driver.

Downloading the WiFi driver



1. Turn on your computer.
2. Go to www.dell.com/support.
3. Enter the Service Tag of your computer, and then click **Submit**.
 **NOTE: If you do not have the Service Tag, use the auto-detect feature or manually browse for your computer model.**
4. Click **Drivers & downloads**.
5. Click the **Detect Drivers** button.
6. Review and agree to the Terms and Conditions to use **SupportAssist**, then click **Continue**.
7. If necessary, your computer starts to download and install **SupportAssist**.
 **NOTE: Review on-screen instructions for browser-specific instructions.**
8. Click **View Drivers for My System**.
9. Click **Download and Install** to download and install all driver updates detected for your computer.
10. Select a location to save the files.
11. If prompted, approve requests from **User Account Control** to make changes on the system.
12. The application installs all drivers and updates identified.
 **NOTE: Not all files can be installed automatically. Review the installation summary to identify if manual installation is necessary.**
13. For manual download and installation, click **Category**.
14. Click **Network** in the drop-down list.
15. Click **Download** to download the WiFi driver for your computer.
16. After the download is complete, navigate to the folder where you saved the WiFi driver file.
17. Double-click the WiFi driver icon and follow the instructions on the screen to install the driver.

Downloading the USB driver

1. Turn on your computer.
2. Go to www.dell.com/support.
3. Enter the Service Tag of your computer, and then click **Submit**.
 **NOTE: If you do not have the Service Tag, use the auto-detect feature or manually browse for your computer model.**
4. Click **Drivers & downloads**.
5. Click the **Detect Drivers** button.
6. Review and agree to the Terms and Conditions to use **SupportAssist**, then click **Continue**.
7. If necessary, your computer starts to download and install **SupportAssist**.
 **NOTE: Review on-screen instructions for browser-specific instructions.**
8. Click **View Drivers for My System**.
9. Click **Download and Install** to download and install all driver updates detected for your computer.
10. Select a location to save the files.
11. If prompted, approve requests from **User Account Control** to make changes on the system.
12. The application installs all drivers and updates identified.
 **NOTE: Not all files can be installed automatically. Review the installation summary to identify if manual installation is necessary.**

13. For manual download and installation, click **Category**.
14. Click **Chipset** in the drop-down list.
15. Click **Download** to download the USB driver for your computer.
16. After the download is complete, navigate to the folder where you saved the USB driver file.
17. Double-click the USB driver file icon and follow the instructions on the screen to install the driver.

Downloading the graphics driver

1. Turn on your computer.
2. Go to www.dell.com/support.
3. Enter the Service Tag of your computer, and then click **Submit**.
 **NOTE: If you do not have the Service Tag, use the auto-detect feature or manually browse for your computer model.**
4. Click **Drivers & downloads**.
5. Click the **Detect Drivers** button.
6. Review and agree to the Terms and Conditions to use **SupportAssist**, then click **Continue**.
7. If necessary, your computer starts to download and install **SupportAssist**.
 **NOTE: Review on-screen instructions for browser-specific instructions.**
8. Click **View Drivers for My System**.
9. Click **Download and Install** to download and install all driver updates detected for your computer.
10. Select a location to save the files.
11. If prompted, approve requests from **User Account Control** to make changes on the system.
12. The application installs all drivers and updates identified.
 **NOTE: Not all files can be installed automatically. Review the installation summary to identify if manual installation is necessary.**
13. For manual download and installation, click **Category**.
14. Click **Video** in the drop-down list.
15. Click **Download** to download the graphics driver for your computer.
16. After the download is complete, navigate to the folder where you saved the graphics driver file.
17. Double-click the graphics driver file icon and follow the instructions on the screen to install the driver.

System setup

NOTE: Depending on the computer and its installed devices, the items listed in this section may or may not be displayed.

Topics:

- System setup
- Entering BIOS setup program
- Navigation keys
- Boot Sequence
- Clearing CMOS settings
- Clearing BIOS (System Setup) and System passwords

System setup

CAUTION: Unless you are an expert computer user, do not change the settings in the BIOS Setup program. Certain changes can make your computer work incorrectly.

NOTE: Before you change BIOS Setup program, it is recommended that you write down the BIOS Setup program screen information for future reference.

Use the BIOS Setup program for the following purposes:

- Get information about the hardware installed in your computer, such as the amount of RAM and the size of the hard drive.
- Change the system configuration information.
- Set or change a user-selectable option, such as the user password, type of hard drive installed, and enabling or disabling base devices.

Entering BIOS setup program

1. Turn on (or restart) your computer.
2. During POST, when the DELL logo is displayed, watch for the F2 prompt to appear, and then press F2 immediately.

NOTE: The F2 prompt indicates that the keyboard is initialized. This prompt can appear very quickly, so you must watch for it, and then press F2. If you press F2 before the F2 prompt, this keystroke is lost. If you wait too long and the operating system logo appears, continue to wait until you see the desktop. Then, turn off your computer and try again.

Navigation keys

NOTE: For most of the System Setup options, changes that you make are recorded but do not take effect until you restart the system.



Keys	Navigation
Up arrow	Moves to the previous field.
Down arrow	Moves to the next field.
Enter	Selects a value in the selected field (if applicable) or follow the link in the field.
Spacebar	Expands or collapses a drop-down list, if applicable.
Tab	Moves to the next focus area.
Esc	Moves to the previous page until you view the main screen. Pressing Esc in the main screen displays a message that prompts you to save any unsaved changes and restarts the system.

Boot Sequence

Boot Sequence allows you to bypass the System Setup–defined boot device order and boot directly to a specific device (for example: optical drive or hard drive). During the Power-on Self Test (POST), when the Dell logo appears, you can:

- Access System Setup by pressing F2 key
- Bring up the one-time boot menu by pressing F12 key

The one-time boot menu displays the devices that you can boot from including the diagnostic option. The boot menu options are:

- Removable Drive (if available)
- STXXXX Drive (if available)
 **NOTE: XXX denotes the SATA drive number.**
- Optical Drive (if available)
- SATA Hard Drive (if available)
- Diagnostics
 **NOTE: Choosing Diagnostics, will display the ePSA diagnostics screen.**

The boot sequence screen also displays the option to access the System Setup screen.

Clearing CMOS settings

 **CAUTION: Clearing CMOS settings will reset the BIOS settings on your computer.**

1. Remove the [base cover](#).
2. Disconnect the battery cable from the system board.
3. Remove the [coin-cell battery](#).
4. Wait for one minute.
5. Replace the [coin-cell battery](#).
6. Connect the battery cable to the system board.
7. Replace the [base cover](#).

Clearing BIOS (System Setup) and System passwords

To clear the system or BIOS passwords, contact Dell technical support as described at www.dell.com/contactdell.

 **NOTE: For information on how to reset Windows or application passwords, refer to the documentation accompanying Windows or your application.**

Troubleshooting

Enhanced Pre-Boot System Assessment (ePSA) diagnostics

The ePSA diagnostics (also known as system diagnostics) performs a complete check of your hardware. The ePSA is embedded with the BIOS and is launched by the BIOS internally. The embedded system diagnostics provides a set of options for particular devices or device groups allowing you to:

- Run tests automatically or in an interactive mode
- Repeat tests
- Display or save test results
- Run thorough tests to introduce additional test options to provide extra information about the failed device(s)
- View status messages that inform you if tests are completed successfully
- View error messages that inform you of problems encountered during testing

NOTE: Some tests for specific devices require user interaction. Always ensure that you are present at the computer terminal when the diagnostic tests are performed.

Running the ePSA diagnostics

1. Turn on your computer.
2. As the computer boots, press the F12 key as the Dell logo appears.
3. On the boot menu screen, select the **Diagnostics** option.
4. Click the arrow at the bottom left corner.
Diagnostics front page is displayed.
5. Click the arrow in the lower-right corner to go to the page listing.
The items detected are listed.
6. To run a diagnostic test on a specific device, press Esc and click **Yes** to stop the diagnostic test.
7. Select the device from the left pane and click **Run Tests**.
8. If there are any issues, error codes are displayed.
Note the error code and validation number and contact Dell.

System diagnostic lights

Battery-status light

Indicates the power and battery-charge status.

Solid white — Power adapter is connected and the battery has more than 5 percent charge.

Amber — Computer is running on battery and the battery has less than 5 percent charge.

Off

- Power adapter is connected and the battery is fully charged.
- Computer is running on battery and the battery has more than 5 percent charge.
- Computer is in sleep state, hibernation, or turned off.

The power and battery-status light blinks amber along with beep codes indicating failures.

For example, the power and battery-status light blinks amber two times followed by a pause, and then blinks white three times followed by a pause. This 2,3 pattern continues until the computer is turned off indicating no memory or RAM is detected.

The following table shows different power and battery-status light patterns and associated problems.

Table 3. LED codes

Diagnostic light codes	Problem description
2,1	Processor failure
2,2	System board: BIOS or ROM (Read-Only Memory) failure
2,3	No memory or RAM (Random-Access Memory) detected
2,4	Memory or RAM (Random-Access Memory) failure
2,5	Invalid memory installed
2,6	System-board or chipset error
2,7	Display failure
3,1	Coin-cell battery failure
3,2	PCI, video card/chip failure
3,3	Recovery image not found
3,4	Recovery image found but invalid
3,5	Power-rail failure
3,6	System BIOS Flash incomplete
3,7	Management Engine (ME) error

Camera status light: Indicates whether the camera is in use.

- Solid white — Camera is in use.
- Off — Camera is not in use.

Caps Lock status light: Indicates whether Caps Lock is enabled or disabled.

- Solid white — Caps Lock enabled.
- Off — Caps Lock disabled.

Recovering the operating system

When your computer is unable to boot to the operating system even after repeated attempts, it automatically starts Dell SupportAssist OS Recovery.

Dell SupportAssist OS Recovery is a standalone tool that is preinstalled in all Dell computers installed with Windows 10 operating system. It consists of tools to diagnose and troubleshoot issues that may occur before your computer boots to the operating system. It enables you to diagnose hardware issues, repair your computer, back up your files, or restore your computer to its factory state.

You can also download it from the Dell Support website to troubleshoot and fix your computer when it fails to boot into their primary operating system due to software or hardware failures.

For more information about the Dell SupportAssist OS Recovery, see *Dell SupportAssist OS Recovery User's Guide* at www.dell.com/support.

Flashing the BIOS

You may need to flash (update) the BIOS when an update is available or when you replace the system board.

Follow these steps to flash the BIOS:

1. Turn on your computer.
2. Go to www.dell.com/support.
3. Click **Product support**, enter the Service Tag of your computer, and then click **Submit**.

 **NOTE:** If you do not have the Service Tag, use the auto-detect feature or manually browse for your computer model.

4. Click **Drivers & downloads > Find it myself**.
5. Select the operating system installed on your computer.

6. Scroll down the page and expand **BIOS**.
7. Click **Download** to download the latest version of the BIOS for your computer.
8. After the download is complete, navigate to the folder where you saved the BIOS update file.
9. Double-click the BIOS update file icon and follow the instructions on the screen.

Enabling Intel Optane memory

1. On the taskbar, click the search box, and then type `Intel Rapid Storage Technology`.
2. Click **Intel Rapid Storage Technology**.
The **Intel Rapid Storage Technology** window is displayed.
3. On the **Status** tab, click **Enable** to enable the Intel Optane memory.
4. On the warning screen, select a compatible fast drive, and then click **Yes** to continue enabling Intel Optane memory.
5. Click **Intel Optane memory** > **Reboot** to complete enabling your Intel Optane memory.

 **NOTE:** Applications may take up to three subsequent launches after enablement to see the full performance benefits.

Disabling Intel Optane memory

 **CAUTION:** After disabling Intel Optane memory, do not uninstall the driver for Intel Rapid Storage Technology as it will result in a blue screen error. The Intel Rapid Storage Technology user interface can be removed without uninstalling the driver.

 **NOTE:** Disabling Intel Optane memory is required before removing the SATA storage device accelerated by the Intel Optane memory module from the computer.

1. On the taskbar, click the search box, and then type `Intel Rapid Storage Technology`.
2. Click **Intel Rapid Storage Technology**.
The **Intel Rapid Storage Technology** window is displayed.
3. On the **Intel Optane memory** tab, click **Disable** to disable the Intel Optane memory.

 **NOTE:** For computers in which Intel Optane memory acts as a primary storage, do not disable the Intel Optane memory. The **Disable** option will be grayed out.

4. Click **Yes** if you accept the warning.
The disabling progress is displayed.
5. Click **Reboot** to complete disabling your Intel Optane memory and restart your computer.

Flashing BIOS (USB key)

1. Follow the procedure from step 1 to step 7 in "[Flashing the BIOS](#)" to download the latest BIOS setup program file.
2. Create a bootable USB drive. For more information see the knowledge base article [SLN143196](#) at www.dell.com/support.
3. Copy the BIOS setup program file to the bootable USB drive.
4. Connect the bootable USB drive to the computer that needs the BIOS update.
5. Restart the computer and press **F12** when the Dell logo is displayed on the screen.
6. Boot to the USB drive from the **One Time Boot Menu**.
7. Type the BIOS setup program filename and press **Enter**.
8. The **BIOS Update Utility** appears. Follow the instructions on the screen to complete the BIOS update.

WiFi power cycle

If your computer is unable to access the internet due to WiFi connectivity issues a WiFi power cycle procedure may be performed. The following procedure provides the instructions on how to conduct a WiFi power cycle:

 **NOTE:** Some ISPs (Internet Service Providers) provide a modem/router combo device.

1. Turn off your computer.

2. Turn off the modem.
3. Turn off the wireless router.
4. Wait for 30 seconds.
5. Turn on the wireless router.
6. Turn on the modem.
7. Turn on your computer.

Flea power release

Flea power is the residual static electricity that remains on the computer even after it has been powered off and the battery has been removed. The following procedure provides the instructions on how to conduct flea power release:



1. Turn off your computer.
2. Disconnect the power adapter from your computer.
3. Press and hold the power button for 15 seconds to drain the flea power.
4. Connect the power adapter to your computer.
5. Turn on your computer.

Getting help and contacting Dell

Self-help resources

You can get information and help on Dell products and services using these self-help resources:

Table 4. Self-help resources

Self-help resources	Resource location
Information about Dell products and services	www.dell.com
My Dell	
Tips	
Contact Support	In Windows search, type <code>Contact Support</code> , and press Enter.
Online help for operating system	www.dell.com/support/windows www.dell.com/support/linux
Troubleshooting information, user manuals, setup instructions, product specifications, technical help blogs, drivers, software updates, and so on.	www.dell.com/support
Dell knowledge base articles for a variety of computer concerns.	<ol style="list-style-type: none"> 1. Go to www.dell.com/support. 2. Type the subject or keyword in the Search box. 3. Click Search to retrieve the related articles.
Learn and know the following information about your product: <ul style="list-style-type: none"> • Product specifications • Operating system • Setting up and using your product • Data backup • Troubleshooting and diagnostics • Factory and system restore • BIOS information 	<p>See <i>Me and My Dell</i> at www.dell.com/support/manuals.</p> <p>To locate the <i>Me and My Dell</i> relevant to your product, identify your product through one of the following:</p> <ul style="list-style-type: none"> • Select Detect Product. • Locate your product through the drop-down menu under View Products. • Enter the Service Tag number or Product ID in the search bar.

Contacting Dell

To contact Dell for sales, technical support, or customer service issues, see www.dell.com/contactdell.

 **NOTE: Availability varies by country/region and product, and some services may not be available in your country/region.**

 **NOTE: If you do not have an active internet connection, you can find contact information on your purchase invoice, packing slip, bill, or Dell product catalog.**