

Inspiron 15 5515

Service Manual



Notes, cautions, and warnings

 **NOTE:** A NOTE indicates important information that helps you make better use of your product.

 **CAUTION:** A CAUTION indicates either potential damage to hardware or loss of data and tells you how to avoid the problem.

 **WARNING:** A WARNING indicates a potential for property damage, personal injury, or death.

Chapter 1: Working inside your computer	6
Safety instructions.....	6
Before working inside your computer.....	6
Electrostatic discharge—ESD protection.....	7
ESD field service kit	7
Transporting sensitive components.....	8
After working inside your computer.....	8
Radiation Exposure Statement	8
Chapter 2: Removing and installing components	10
Recommended tools.....	10
Screw list.....	10
Major components of Inspiron 15 5515.....	11
Base cover.....	13
Removing the base cover.....	13
Installing the base cover.....	15
Battery.....	16
Lithium-ion battery precautions.....	16
Removing the 3-cell battery.....	17
Installing the 3-cell battery.....	18
Removing the 4-cell battery.....	18
Installing the 4-cell battery.....	19
Battery cable.....	20
Lithium-ion battery precautions.....	20
Removing the battery cable.....	21
Installing the battery cable.....	21
Memory module.....	22
Removing the memory module.....	22
Installing the memory module.....	23
Solid-state drive—M.2 slot one.....	25
Removing the 2230 solid-state drive from M.2 slot one.....	25
Installing the 2230 solid-state drive in M.2 slot one.....	25
Removing the 2280 solid-state drive from M.2 slot one.....	26
Installing the 2280 solid-state drive in M.2 slot one.....	27
Installing the solid-state drive mounting bracket on M.2 slot one.....	28
Solid-state drive—M.2 slot two.....	29
Removing the 2230 solid-state drive from M.2 slot two.....	29
Installing the 2230 solid-state drive in M.2 slot two.....	31
Wireless card.....	33
Removing the wireless card.....	33
Installing the wireless card.....	34
Fan.....	35
Removing the fan.....	35
Installing the fan.....	36

Coin-cell battery.....	36
Removing the coin-cell battery.....	36
Installing the coin-cell battery.....	37
Heat sink.....	38
Removing the heatsink.....	38
Installing the heatsink.....	39
I/O board.....	40
Removing the I/O board.....	40
Installing the I/O board.....	41
Speakers.....	42
Removing the speakers.....	42
Installing the speakers.....	43
Touchpad.....	45
Removing the touchpad.....	45
Installing the touchpad.....	45
Display assembly.....	47
Removing the display assembly.....	47
Installing the display assembly	49
Power button with optional fingerprint reader.....	51
Removing the power button with optional fingerprint reader.....	51
Installing the power button with optional fingerprint reader.....	51
System board.....	52
Removing the system board.....	52
Installing the system board.....	55
Power-adapter port.....	59
Removing the power-adapter port.....	59
Installing the power-adapter port.....	60
Palm-rest and keyboard assembly.....	61
Removing the palm-rest and keyboard assembly.....	61
Installing the palm-rest and keyboard assembly.....	62

Chapter 3: Drivers and downloads..... 64

Chapter 4: System setup..... 65











Entering BIOS setup program.....	65
Navigation keys.....	65
Boot Sequence.....	65
One time boot menu.....	66
System setup options.....	66
System and setup password.....	71
Assigning a system setup password.....	71
Deleting or changing an existing system setup password.....	72
Clearing CMOS settings.....	72
Clearing BIOS (System Setup) and System passwords.....	73
Updating the BIOS.....	73
Updating the BIOS in Windows.....	73
Updating the BIOS using the USB drive in Windows.....	73
Updating the BIOS from the F12 One-Time boot menu.....	73

Chapter 5: Troubleshooting.....	75
Handling swollen Lithium-ion batteries.....	75
Locate the Service Tag or Express Service Code of your Dell computer	75
Backup media and recovery options.....	76
System diagnostic lights.....	76
SupportAssist diagnostics.....	76
Built-in self-test (BIST).....	77
M-BIST.....	77
LCD Built-in Self Test (BIST).....	77
Recovering the operating system.....	78
WiFi power cycle.....	78
Drain residual flea power (perform hard reset).....	78
Real Time Clock—RTC reset.....	79
 Chapter 6: Getting help and contacting Dell.....	 80

Working inside your computer

Safety instructions

Use the following safety guidelines to protect your computer from potential damage and to ensure your personal safety. Unless otherwise noted, each procedure included in this document assumes that you have read the safety information that shipped with your computer.

-  **WARNING:** Before working inside your computer, read the safety information that is shipped with your computer. For more safety best practices, see the Regulatory Compliance home page at www.dell.com/regulatory_compliance.
-  **WARNING:** Disconnect your computer from all power sources before opening the computer cover or panels. After you finish working inside the computer, replace all covers, panels, and screws before connecting your computer to an electrical outlet.
-  **CAUTION:** To avoid damaging the computer, ensure that the work surface is flat, dry, and clean.
-  **CAUTION:** To avoid damaging the components and cards, handle them by their edges, and avoid touching the pins and the contacts.
-  **CAUTION:** You should only perform troubleshooting and repairs as authorized or directed by the Dell technical assistance team. Damage due to servicing that is not authorized by Dell is not covered by your warranty. See the safety instructions that is shipped with the product or at www.dell.com/regulatory_compliance.
-  **CAUTION:** Before touching anything inside your computer, ground yourself by touching an unpainted metal surface, such as the metal at the back of the computer. While you work, periodically touch an unpainted metal surface to dissipate static electricity which could harm internal components.
-  **CAUTION:** When you disconnect a cable, pull it by its connector or its pull tab, not the cable itself. Some cables have connectors with locking tabs or thumbscrews that you must disengage before disconnecting the cable. When disconnecting cables, keep them evenly aligned to avoid bending the connector pins. When connecting cables, ensure that the ports and the connectors are correctly oriented and aligned.
-  **CAUTION:** Press and eject any installed card from the media-card reader.
-  **CAUTION:** Exercise caution when handling Lithium-ion batteries in laptops. Swollen batteries should not be used and should be replaced and disposed properly.
-  **NOTE:** The color of your computer and certain components may appear differently than shown in this document.

Before working inside your computer

About this task

-  **NOTE:** The images in this document may differ from your computer depending on the configuration you ordered.

Steps

1. Save and close all open files and exit all open applications.
2. Shut down your computer. Click **Start** >  **Power** > **Shut down**.

 **NOTE:** If you are using a different operating system, see the documentation of your operating system for shut-down instructions.

3. Disconnect your computer and all attached devices from their electrical outlets.
4. Disconnect all attached network devices and peripherals, such as keyboard, mouse, and monitor from your computer.

 **CAUTION:** To disconnect a network cable, first unplug the cable from your computer and then unplug the cable from the network device.

5. Remove any media card and optical disc from your computer, if applicable.

Electrostatic discharge—ESD protection

ESD is a major concern when you handle electronic components, especially sensitive components such as expansion cards, processors, memory DIMMs, and system boards. Very slight charges can damage circuits in ways that may not be obvious, such as intermittent problems or a shortened product life span. As the industry pushes for lower power requirements and increased density, ESD protection is an increasing concern.

Due to the increased density of semiconductors used in recent Dell products, the sensitivity to static damage is now higher than in previous Dell products. For this reason, some previously approved methods of handling parts are no longer applicable.

Two recognized types of ESD damage are catastrophic and intermittent failures.

- **Catastrophic** – Catastrophic failures represent approximately 20 percent of ESD-related failures. The damage causes an immediate and complete loss of device functionality. An example of catastrophic failure is a memory DIMM that has received a static shock and immediately generates a "No POST/No Video" symptom with a beep code emitted for missing or nonfunctional memory.
- **Intermittent** – Intermittent failures represent approximately 80 percent of ESD-related failures. The high rate of intermittent failures means that most of the time when damage occurs, it is not immediately recognizable. The DIMM receives a static shock, but the tracing is merely weakened and does not immediately produce outward symptoms related to the damage. The weakened trace may take weeks or months to melt, and in the meantime may cause degradation of memory integrity, intermittent memory errors, etc.

The more difficult type of damage to recognize and troubleshoot is the intermittent (also called latent or "walking wounded") failure.

Perform the following steps to prevent ESD damage:

- Use a wired ESD wrist strap that is properly grounded. The use of wireless anti-static straps is no longer allowed; they do not provide adequate protection. Touching the chassis before handling parts does not ensure adequate ESD protection on parts with increased sensitivity to ESD damage.
- Handle all static-sensitive components in a static-safe area. If possible, use anti-static floor pads and workbench pads.
- When unpacking a static-sensitive component from its shipping carton, do not remove the component from the anti-static packing material until you are ready to install the component. Before unwrapping the anti-static packaging, ensure that you discharge static electricity from your body.
- Before transporting a static-sensitive component, place it in an anti-static container or packaging.

ESD field service kit

The unmonitored Field Service kit is the most commonly used service kit. Each Field Service kit includes three main components: anti-static mat, wrist strap, and bonding wire.

Components of an ESD field service kit

The components of an ESD field service kit are:

- **Anti-Static Mat** – The anti-static mat is dissipative and parts can be placed on it during service procedures. When using an anti-static mat, your wrist strap should be snug and the bonding wire should be connected to the mat and to any bare metal on the system being worked on. Once deployed properly, service parts can be removed from the ESD bag and placed directly on the mat. ESD-sensitive items are safe in your hand, on the ESD mat, in the system, or inside a bag.
- **Wrist Strap and Bonding Wire** – The wrist strap and bonding wire can be either directly connected between your wrist and bare metal on the hardware if the ESD mat is not required, or connected to the anti-static mat to protect hardware that is temporarily placed on the mat. The physical connection of the wrist strap and bonding wire between your skin, the ESD mat, and the hardware is known as bonding. Use only Field Service kits with a wrist strap, mat, and bonding wire. Never

use wireless wrist straps. Always be aware that the internal wires of a wrist strap are prone to damage from normal wear and tear, and must be checked regularly with a wrist strap tester in order to avoid accidental ESD hardware damage. It is recommended to test the wrist strap and bonding wire at least once per week.

- **ESD Wrist Strap Tester** – The wires inside of an ESD strap are prone to damage over time. When using an unmonitored kit, it is a best practice to regularly test the strap prior to each service call, and at a minimum, test once per week. A wrist strap tester is the best method for doing this test. If you do not have your own wrist strap tester, check with your regional office to find out if they have one. To perform the test, plug the wrist-strap's bonding-wire into the tester while it is strapped to your wrist and push the button to test. A green LED is lit if the test is successful; a red LED is lit and an alarm sounds if the test fails.
- **Insulator Elements** – It is critical to keep ESD sensitive devices, such as plastic heat sink casings, away from internal parts that are insulators and often highly charged.
- **Working Environment** – Before deploying the ESD Field Service kit, assess the situation at the customer location. For example, deploying the kit for a server environment is different than for a desktop or portable environment. Servers are typically installed in a rack within a data center; desktops or portables are typically placed on office desks or cubicles. Always look for a large open flat work area that is free of clutter and large enough to deploy the ESD kit with additional space to accommodate the type of system that is being repaired. The workspace should also be free of insulators that can cause an ESD event. On the work area, insulators such as Styrofoam and other plastics should always be moved at least 12 inches or 30 centimeters away from sensitive parts before physically handling any hardware components
- **ESD Packaging** – All ESD-sensitive devices must be shipped and received in static-safe packaging. Metal, static-shielded bags are preferred. However, you should always return the damaged part using the same ESD bag and packaging that the new part arrived in. The ESD bag should be folded over and taped shut and all the same foam packing material should be used in the original box that the new part arrived in. ESD-sensitive devices should be removed from packaging only at an ESD-protected work surface, and parts should never be placed on top of the ESD bag because only the inside of the bag is shielded. Always place parts in your hand, on the ESD mat, in the system, or inside an anti-static bag.
- **Transporting Sensitive Components** – When transporting ESD sensitive components such as replacement parts or parts to be returned to Dell, it is critical to place these parts in anti-static bags for safe transport.

ESD protection summary

It is recommended that all field service technicians use the traditional wired ESD grounding wrist strap and protective anti-static mat at all times when servicing Dell products. In addition, it is critical that technicians keep sensitive parts separate from all insulator parts while performing service and that they use anti-static bags for transporting sensitive components.

Transporting sensitive components

When transporting ESD sensitive components such as replacement parts or parts to be returned to Dell, it is critical to place these parts in anti-static bags for safe transport.

After working inside your computer

About this task

 **CAUTION:** Leaving stray or loose screws inside your computer may severely damage your computer.

Steps

1. Replace all screws and ensure that no stray screws remain inside your computer.
2. Connect any external devices, peripherals, or cables you removed before working on your computer.
3. Replace any media cards, discs, or any other parts that you removed before working on your computer.
4. Connect your computer and all attached devices to their electrical outlets.
5. Turn on your computer.

Radiation Exposure Statement

This device meets the government's requirements for exposure to radio waves.

This device is designed and manufactured not to exceed the emission limits for exposure to radio frequency (RF) energy set by the Federal Communications Commission (FCC) of the U.S. Government.

The exposure standard for wireless device employs a unit of measurement known as the Specific Absorption Rate, or SAR. The SAR limit set by the FCC is 1.6 W

 **NOTE:** Tests for SAR are conducted using standard operating positions accepted by the FCC with the device transmitting at its highest certified power level in all tested frequency bands.

Removing and installing components

NOTE: The images in this document may differ from your computer depending on the configuration you ordered.

Recommended tools

The procedures in this document may require the following tools:

- Phillips screwdriver #0
- Plastic scribe

Screw list

NOTE: When removing screws from a component, it is recommended to note the screw type, the quantity of screws, and then place them in a screw storage box. This is to ensure that the correct number of screws and correct screw type is restored when the component is replaced.

NOTE: Some computers have magnetic surfaces. Ensure that the screws are not left attached to such surfaces when replacing a component.

NOTE: Screw color may vary with the configuration ordered.

Table 1. Screw list

















Component	Screw type	Quantity	Screw image
Base cover	M2x7.5 - captive screws	2	
Base cover	M2x4	7	
3-cell battery	M2x3	3	
4-cell battery	M2x3	4	
Wireless card	M2x4	1	
Solid-state drive - Slot 1	M2x3	1	
Solid-state drive - Slot 2	M2x3	1	
Fan	M2x3	2	
System board	M2x2	3	

Table 1. Screw list (continued)

Component	Screw type	Quantity	Screw image
USB Type-C bracket	M2x4	2	
Power button with fingerprint reader	M2x3	1	
I/O board	M2x3	1	
Touchpad	M1.6x2	3	
Touchpad	M2x1.8	2	
Power-adaptor port	M2.5x4	2	
Display hinges	M2.5x4	6	

Major components of Inspiron 15 5515

The following image shows the major components of Inspiron 15 5515.

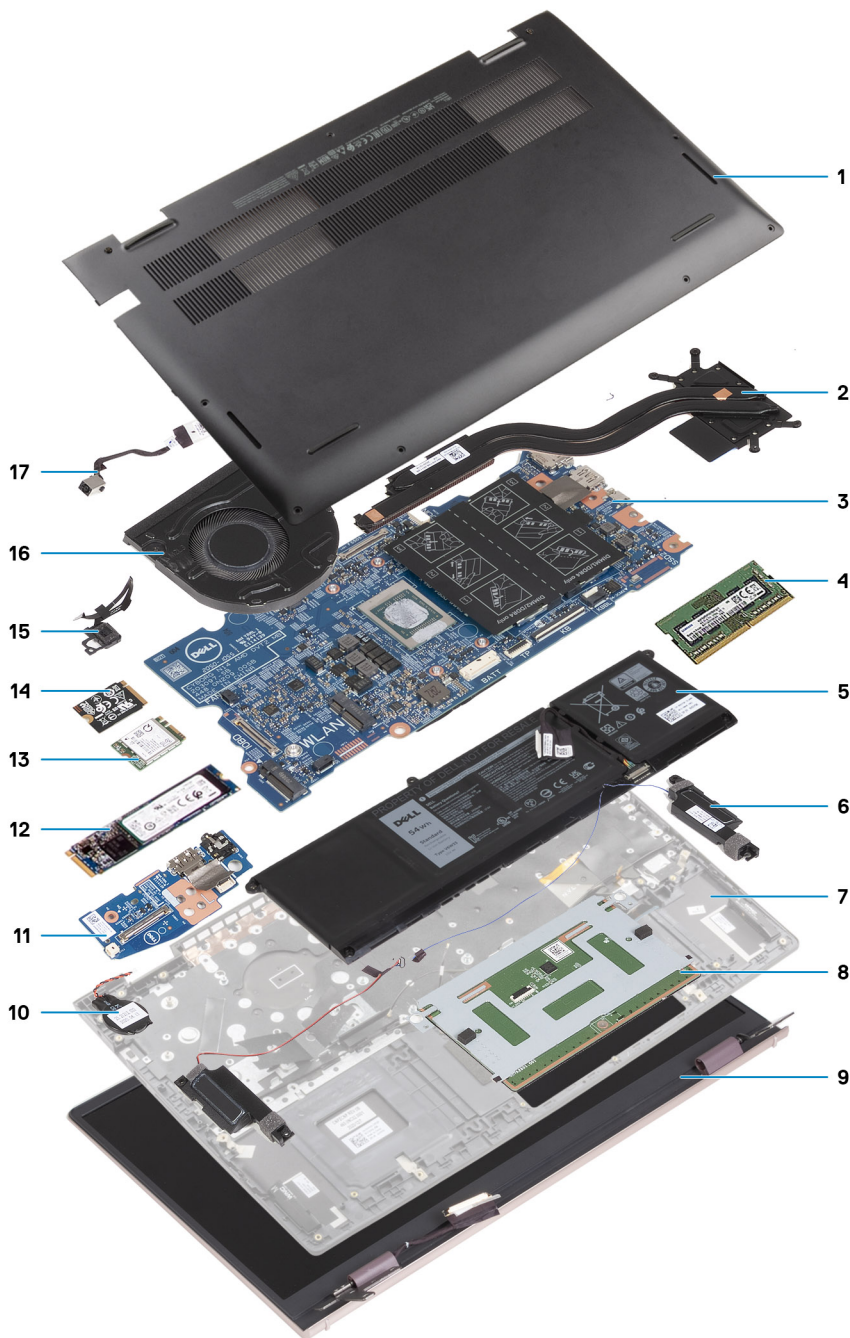

1. Base cover
2. Heat sink
3. System board
4. Memory
5. Battery
6. Right speaker
7. Palm-rest and keyboard assembly
8. Touchpad
9. Display assembly
10. Coin-cell battery
11. I/O board
12. M.2 2280 solid-state drive, if installed
13. Wireless card
14. M.2 2230 solid-state drive, if installed
15. Power-button with optional fingerprint-reader

- 16. Fan
- 17. Power-adaptor port

NOTE: Dell provides a list of components and their part numbers for the original system configuration purchased. These parts are available according to warranty coverages purchased by the customer. Contact your Dell sales representative for purchase options.

Base cover

Removing the base cover

Prerequisites

- 1. Follow the procedure in [Before working inside your computer](#).

About this task

The following images indicate the location of the base cover and provide a visual representation of the removal procedure.

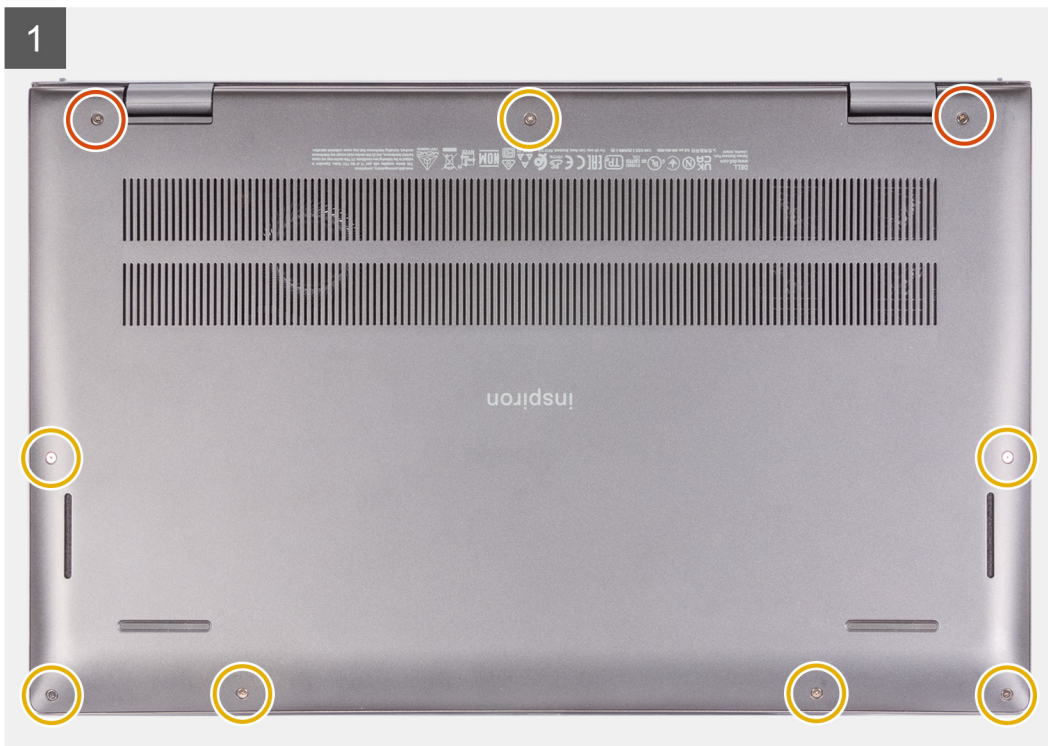
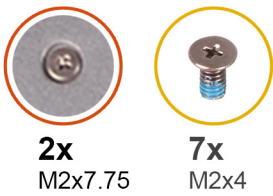

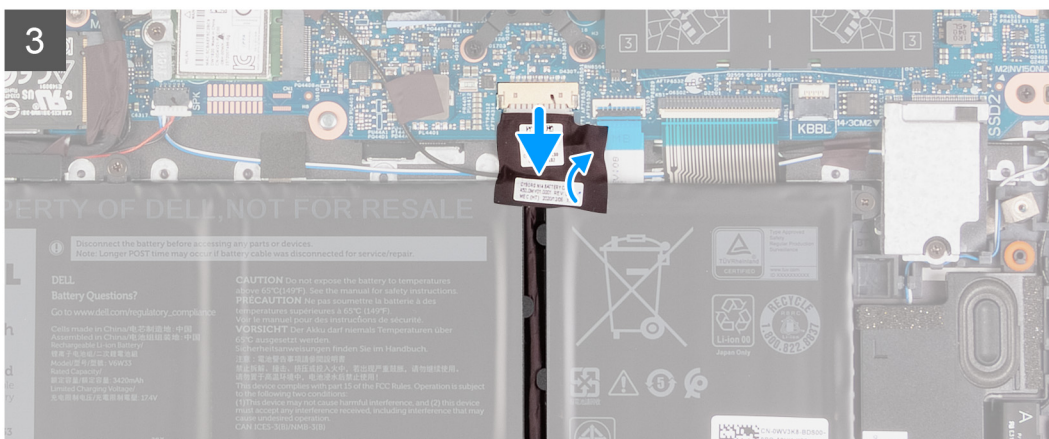
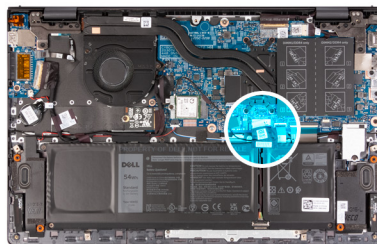
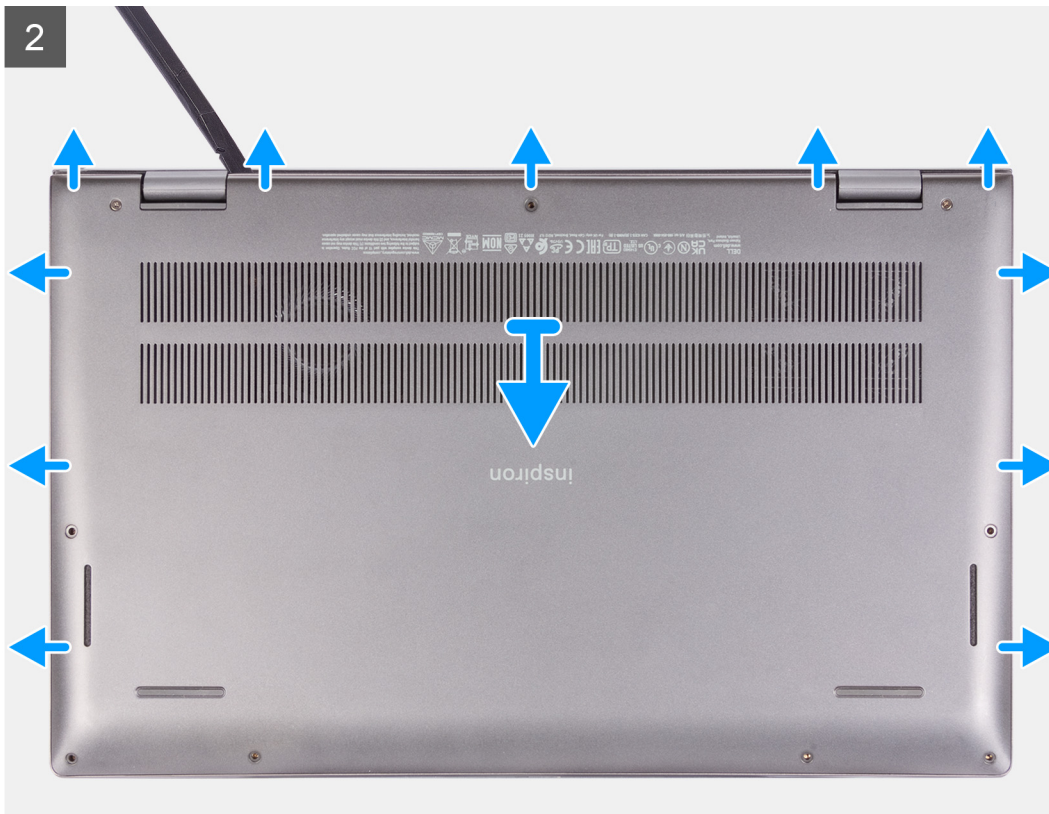

Steps

1. Loosen the two (M2x7.75) captive screws that secure the base cover to the palm-rest and keyboard assembly.
2. Remove the seven (M2x4) screws that secure the base cover to the palm-rest and keyboard assembly.
3. Using a plastic scribe, pry the base cover beside the display hinges, and then continue to work on the sides to open the base cover.
4. Lift the base cover off the palm-rest and keyboard assembly.
5. Peel the tape that secures the battery cable to the battery and palm-rest and keyboard assembly.

6. Disconnect the battery cable from the system board.
7. Press and hold the power button for 20 seconds to ground the computer and drain the flea power.

Installing the base cover

Prerequisites

If you are replacing a component, remove the existing component before performing the installation procedure.

About this task

The following images indicate the location of the base cover and provide a visual representation of the installation procedure.

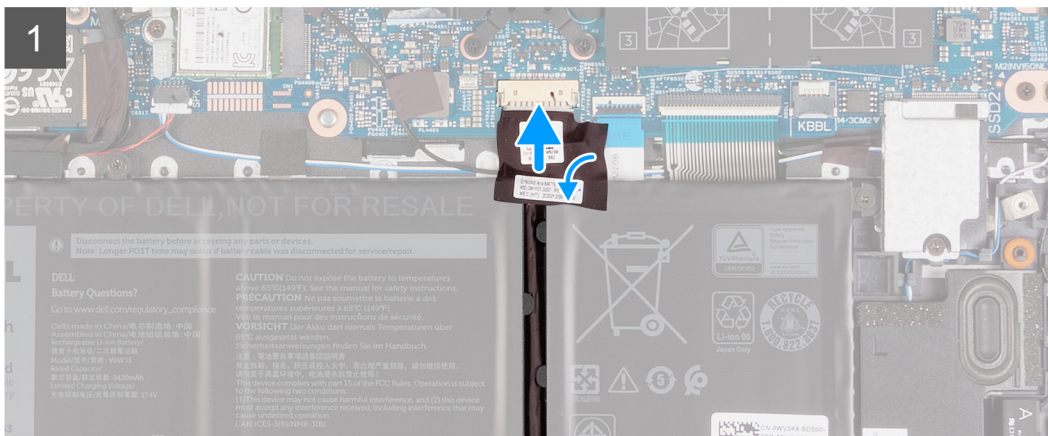
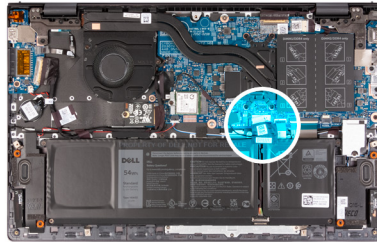

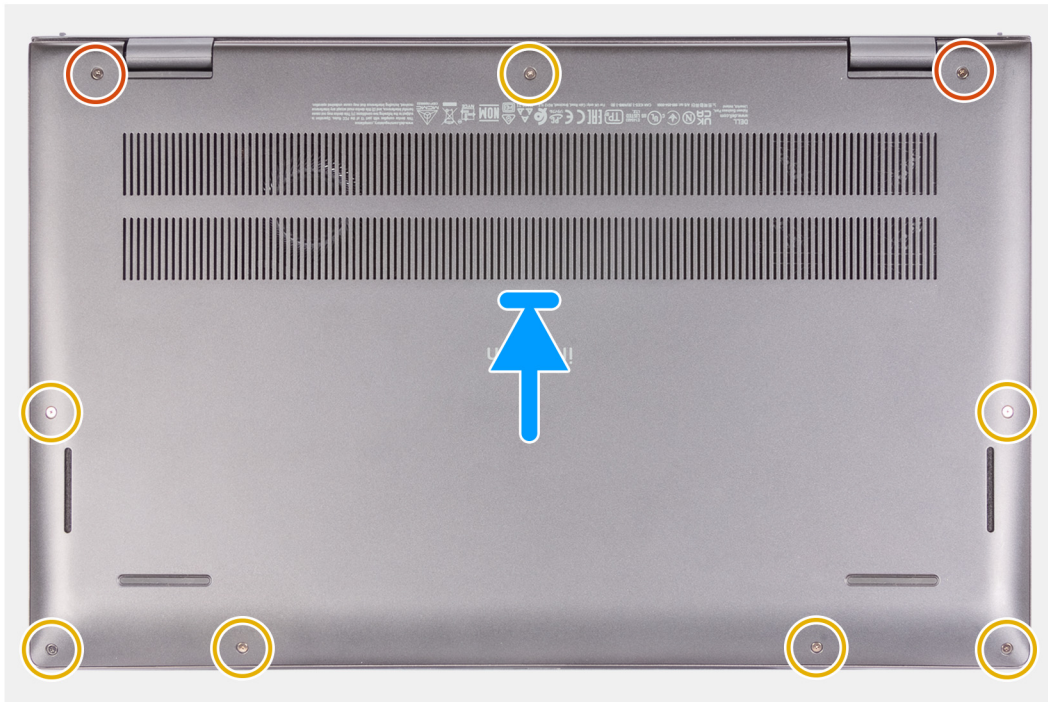
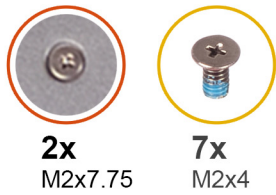

Steps

1. Connect the battery cable to the system board.
2. Adhere the tape to secure the battery cable.
3. Place the base cover on top of the palm-rest and keyboard assembly.
4. Align the screw holes on the base cover with the screw holes on the palm-rest and keyboard assembly, and then snap the base cover into place.
5. Tighten the two (M2x7.75) captive screws that secure the base cover to the palm-rest and keyboard assembly.
6. Replace the seven (M2x4) screws that secure the base cover to the palm-rest and keyboard assembly.

Next steps

1. Follow the procedure in [After working inside your computer](#).

Battery

Lithium-ion battery precautions

⚠ CAUTION:

- Exercise caution when handling Lithium-ion batteries.
- Discharge the battery completely before removing it. Disconnect the AC power adapter from the system and operate the computer solely on battery power—the battery is fully discharged when the computer no longer turns on when the power button is pressed.

- Do not crush, drop, mutilate, or penetrate the battery with foreign objects.
- Do not expose the battery to high temperatures, or disassemble battery packs and cells.
- Do not apply pressure to the surface of the battery.
- Do not bend the battery.
- Do not use tools of any kind to pry on or against the battery.
- Ensure any screws during the servicing of this product are not lost or misplaced, to prevent accidental puncture or damage to the battery and other system components.
- If the battery gets stuck inside your computer as a result of swelling, do not try to release it as puncturing, bending, or crushing a lithium-ion battery can be dangerous. In such an instance, contact Dell technical support for assistance. See www.dell.com/contactdell.
- Always purchase genuine batteries from www.dell.com or authorized Dell partners and resellers.
- Swollen batteries should not be used and should be replaced and disposed properly. For guidelines on how to handle and replace swollen Lithium-ion batteries, see [Handling swollen Lithium-ion batteries](#).

Removing the 3-cell battery

Prerequisites

1. Follow the procedure in [Before working inside your computer](#).
2. Remove the [base cover](#).

About this task

The following image indicates the location of the 3-cell (41 Wh) battery and provides a visual representation of the removal procedure.

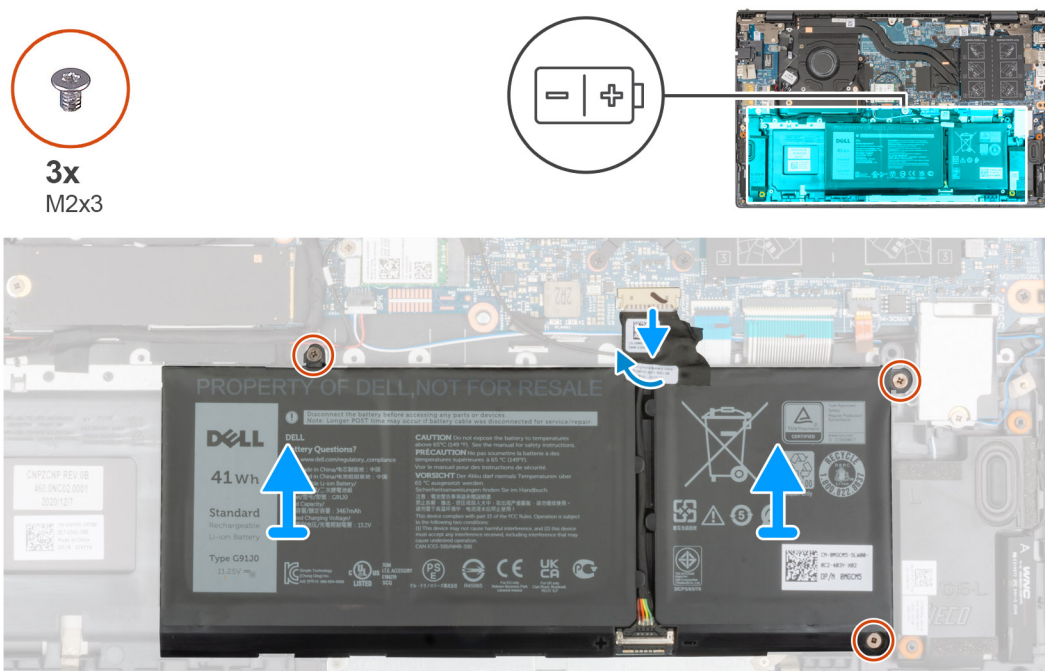

Steps

1. Peel the tape that secures the battery cable to the system board.
2. Disconnect the battery cable from the system board.
3. Remove the three (M2x3) screws that secure the 3-cell battery to the palm-rest and keyboard assembly.
4. Lift the 3-cell battery, along with its cable, off the palm-rest and keyboard assembly.

Installing the 3-cell battery

Prerequisites

If you are replacing a component, remove the existing component before performing the installation procedure.

About this task

The following image indicates the location of the 3-cell (41 Wh) battery and provides a visual representation of the installation procedure.

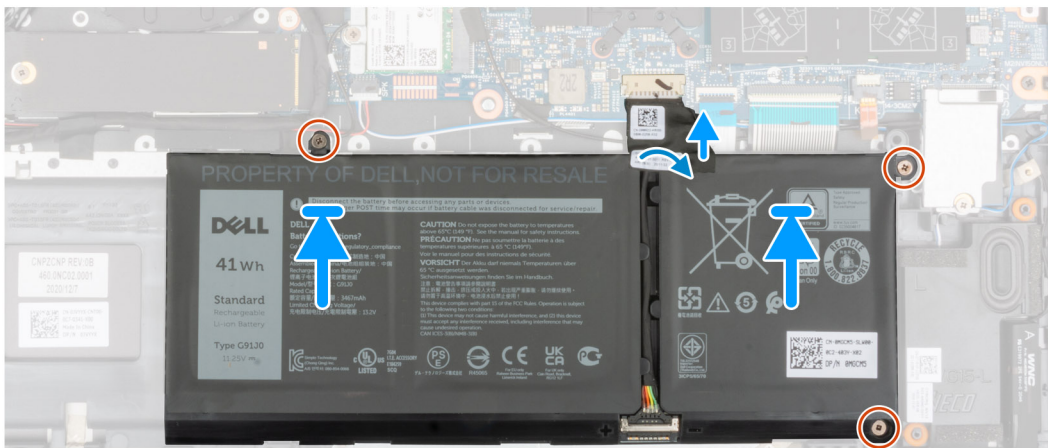
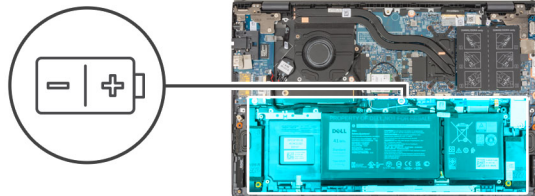

Steps

1. Using the alignment posts, place the 3-cell battery on the palm-rest and keyboard assembly.
2. Align the screw holes on the 3-cell battery with the screw holes on the palm-rest and keyboard assembly.
3. Replace the three (M2x3) screws that secure the 3-cell battery to the palm-rest and keyboard assembly.
4. Connect the battery cable to the system board.
5. Adhere the tape that secures the battery cable to the system board.

Next steps

1. Install the [base cover](#).
2. Follow the procedure in [After working on your computer](#).

Removing the 4-cell battery

Prerequisites

1. Follow the procedure in [Before working inside your computer](#).
2. Remove the [base cover](#).

About this task

The following image indicates the location of the 4-cell (54 Wh) battery and provides a visual representation of the removal procedure.



4x
M2x3

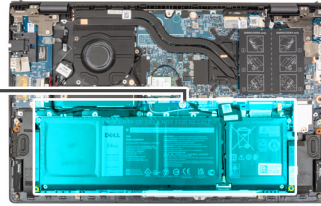
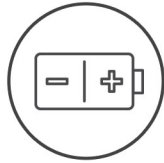

Steps

1. Peel the tape that secures the battery cable to the system board.
2. Disconnect the battery cable from the system board.
3. Remove the four (M2x3) screws that secure the 4-cell battery to the palm-rest and keyboard assembly.
4. Lift the 4-cell battery, along with its cable, off the palm-rest and keyboard assembly.

Installing the 4-cell battery

Prerequisites

If you are replacing a component, remove the existing component before performing the installation procedure.

About this task

The following image indicates the location of the 4-cell (54 Wh) battery and provides a visual representation of the installation procedure.



4x
M2x3

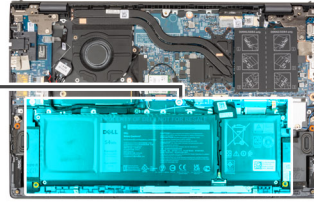

Steps

1. Using the alignment posts, place the 4-cell battery on the palm-rest and keyboard assembly.
2. Align the screw holes on the 4-cell battery with the screw holes on the palm-rest and keyboard assembly.
3. Replace the four (M2x3) screws that secure the 4-cell battery to the palm-rest and keyboard assembly.
4. Connect the battery cable to the system board.
5. Adhere the tape that secures the battery cable to the system board.

Next steps

1. Install the [base cover](#).
2. Follow the procedure in [After working on your computer](#).

Battery cable

Lithium-ion battery precautions

⚠ CAUTION:

- Exercise caution when handling Lithium-ion batteries.
- Discharge the battery completely before removing it. Disconnect the AC power adapter from the system and operate the computer solely on battery power—the battery is fully discharged when the computer no longer turns on when the power button is pressed.
- Do not crush, drop, mutilate, or penetrate the battery with foreign objects.
- Do not expose the battery to high temperatures, or disassemble battery packs and cells.
- Do not apply pressure to the surface of the battery.
- Do not bend the battery.
- Do not use tools of any kind to pry on or against the battery.
- Ensure any screws during the servicing of this product are not lost or misplaced, to prevent accidental puncture or damage to the battery and other system components.

- If the battery gets stuck inside your computer as a result of swelling, do not try to release it as puncturing, bending, or crushing a lithium-ion battery can be dangerous. In such an instance, contact Dell technical support for assistance. See www.dell.com/contactdell.
- Always purchase genuine batteries from www.dell.com or authorized Dell partners and resellers.
- Swollen batteries should not be used and should be replaced and disposed properly. For guidelines on how to handle and replace swollen Lithium-ion batteries, see [Handling swollen Lithium-ion batteries](#).

Removing the battery cable

Prerequisites

1. Follow the procedure in [Before working inside your computer](#).
2. Remove the [base cover](#).
3. Remove the [3-cell battery](#) or [4-cell battery](#), whichever applicable.

NOTE: If battery is disconnected from system board for service, then there is a delay during system boot as the system undergoes RTC battery reset.

About this task

The following images indicate the location of the battery cable and provide a visual representation of the removal procedure.

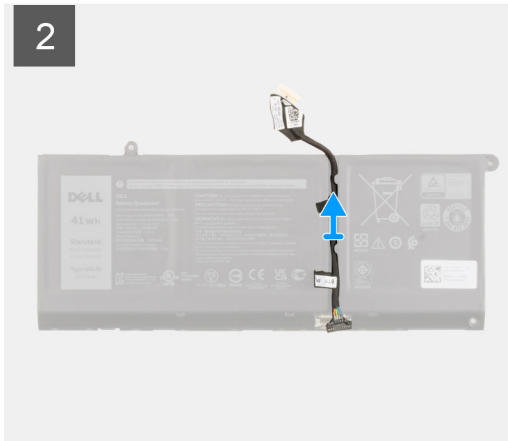
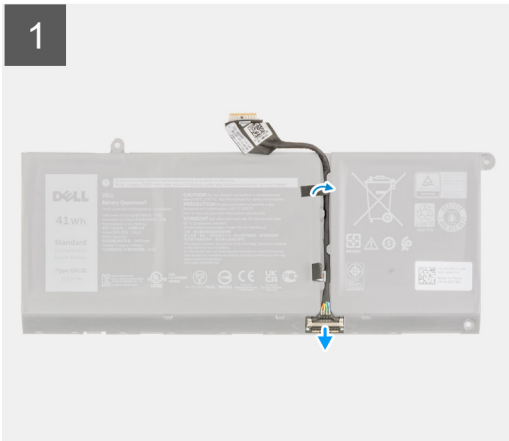

Steps

1. Flip the battery and remove the battery cable from the routing guides on the battery.
2. Disconnect the battery cable from the connector on the battery.
3. Lift the battery cable off the battery.

Installing the battery cable

Prerequisites

If you are replacing a component, remove the existing component before performing the installation procedure.

About this task

The following image indicates the location of the battery cable and provides a visual representation of the installation procedure.

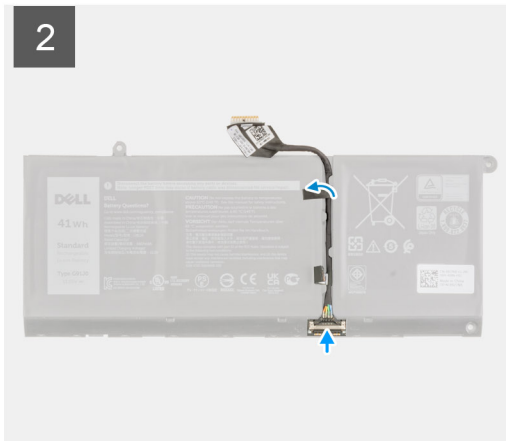
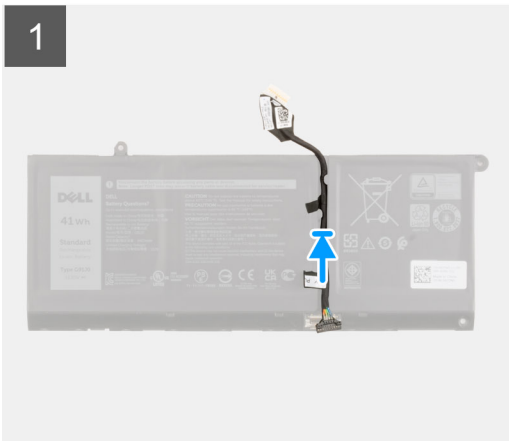

Steps

1. Align and place the battery cable on the battery.
2. Route the battery cable through the routing guides on the battery.
3. Connect the battery cable to the connector on the battery.

Next steps

1. Install the [3-cell battery](#) or [4-cell battery](#), whichever applicable.
2. Install the [base cover](#).
3. Follow the procedure in [After working on your computer](#).

Memory module

Removing the memory module

Prerequisites

1. Follow the procedure in [Before working inside your computer](#).
2. Remove the [base cover](#).

About this task

The following images indicate the location of the memory module and provide a visual representation of the removal procedure.

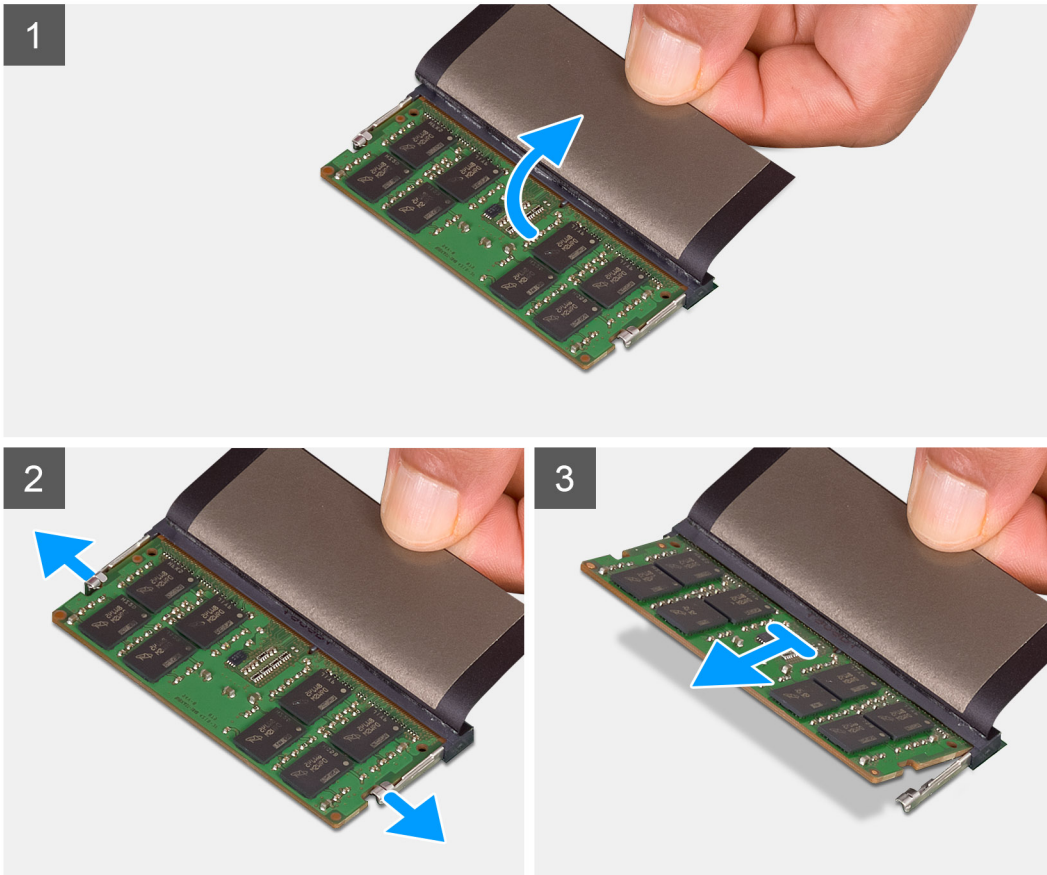
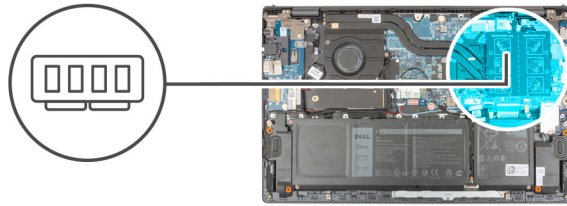

Steps

1. Lift the Mylar to access the memory module.
2. Use your fingertips to pull the securing clips from both sides of the memory module until the memory module pops-up.
3. Remove the memory module from the memory-module slot.

i **NOTE:** Repeat step 1 to step 3 to remove any other memory modules installed in your computer.

Installing the memory module

Prerequisites

If you are replacing a component, remove the existing component before performing the installation procedure.

About this task

The following image indicates the location of the memory module and provides a visual representation of the installation procedure.

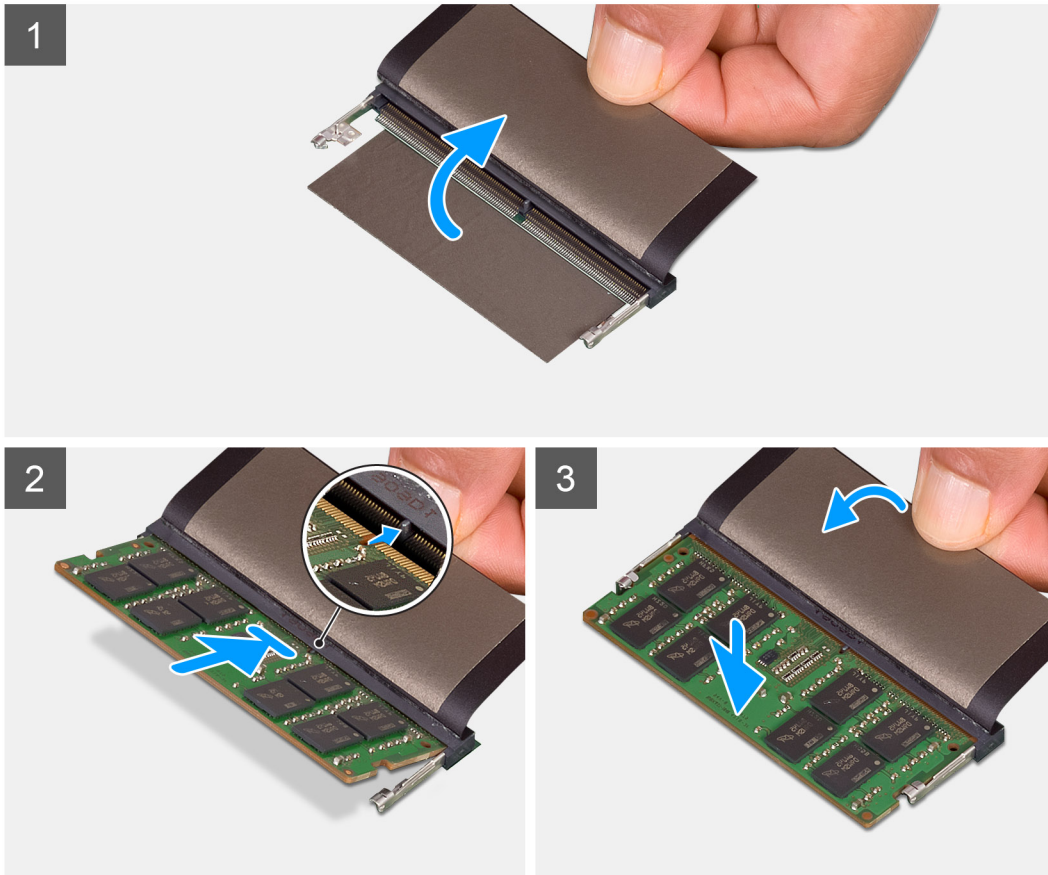
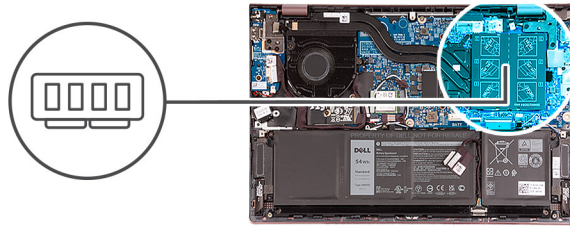

Steps

1. Lift the Mylar to access the memory-module slot.
 2. Align the notch on the memory module with the tab on the memory-module slot.
 3. Slide the memory module firmly at an angle, into the memory-module slot.
 4. Press the memory module down until it clicks into place.
- i** **NOTE:** If you do not hear the click, remove the memory module and reinstall it.

i **NOTE:** Repeat step 1 to step 4 to install any other memory modules in your computer.

Next steps

1. Install the [base cover](#).
2. Follow the procedure in [After working inside your computer](#).

Solid-state drive—M.2 slot one

Removing the 2230 solid-state drive from M.2 slot one

Prerequisites

1. Follow the procedure in [Before working inside your computer](#).
 - NOTE:** Solid-state drives are fragile. Exercise care when handling the solid-state drive.
 - NOTE:** To avoid data loss, do not remove the solid-state drive while the computer is in sleep or on state.
2. Remove the [base cover](#).

About this task

- NOTE:** Depending on the configuration ordered, your computer may support a 2230 solid-state drive, or a 2280 solid-state drive in M.2 slot one.
- NOTE:** This procedure applies only to computers shipped with a 2230 solid-state drive installed in M.2 slot one.

The following image indicates the location of the 2230 solid-state drive that is installed in M.2 slot one and provides a visual representation of the removal procedure.

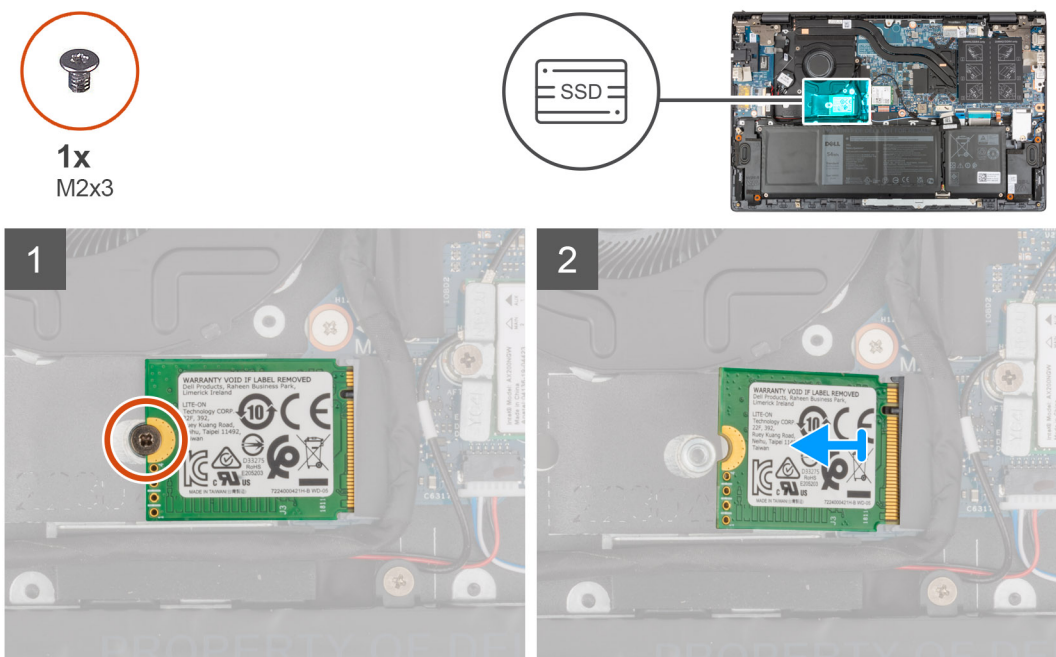

Steps

1. Remove the screw (M2x3) that secures the 2230 solid-state drive to the palm-rest and keyboard assembly.
2. Slide and remove the solid-state drive from the M.2 slot one.

Installing the 2230 solid-state drive in M.2 slot one

Prerequisites

If you are replacing a component, remove the existing component before performing the installation procedure.

About this task

- NOTE:** Solid-state drives are fragile. Exercise care when handling the solid-state drive.
- NOTE:** Depending on the configuration ordered, your computer may support a 2230 solid-state drive, or a 2280 solid-state drive in M.2 slot one.
- NOTE:** This procedure applies only if you are installing a 2230 solid-state drive in M.2 slot one.
- NOTE:** Before installing your 2230 or 2280 solid-state drive, ensure that the mounting bracket is in the correct location. For more information, see [Installing the solid-state drive mounting bracket](#).

The following image indicates the location of the 2230 solid-state drive that is installed in M.2 slot one and provides a visual representation of the installation procedure.

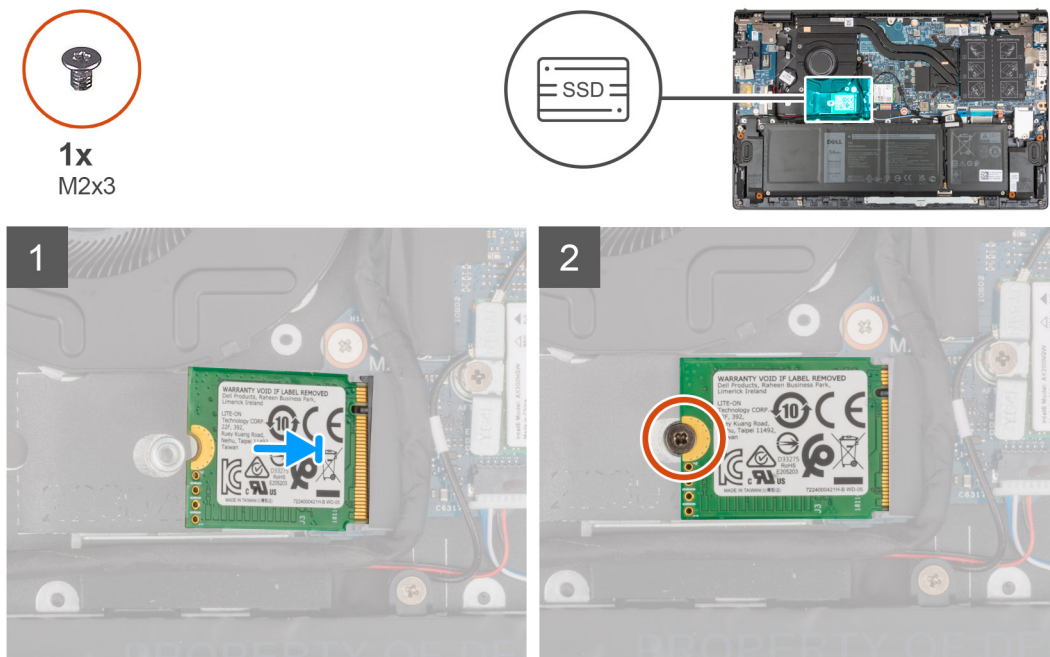

Steps

- Align the notch on the 2230 solid-state drive with the tab on the solid-state drive slot.
- Slide the 2230 solid-state drive firmly into the solid-state drive slot at an angle.
- Align the screw hole on the solid-state drive with the screw hole on the palm-rest and keyboard assembly.
- Replace the screw (M2x3) that secures the 2230 solid-state drive to the palm-rest and keyboard assembly.

Next steps

- Install the [base cover](#).
- Follow the procedure in [After working inside your computer](#).

Removing the 2280 solid-state drive from M.2 slot one

Prerequisites

- Follow the procedure in [Before working inside your computer](#).
 - NOTE:** Solid-state drives are fragile. Exercise care when handling the solid-state drive.
 - NOTE:** To avoid data loss, do not remove the solid-state drive while the computer is in sleep or on state.
- Remove the [base cover](#).

About this task

NOTE: Depending on the configuration ordered, your computer may support a 2280 solid-state drive, or a 2230 solid-state drive in M.2 slot one.

NOTE: This procedure applies only to computers shipped with a 2280 solid-state drive installed in M.2 slot one.

The following image indicates the location of the 2280 solid-state drive that is installed in M.2 slot one and provides a visual representation of the removal procedure.

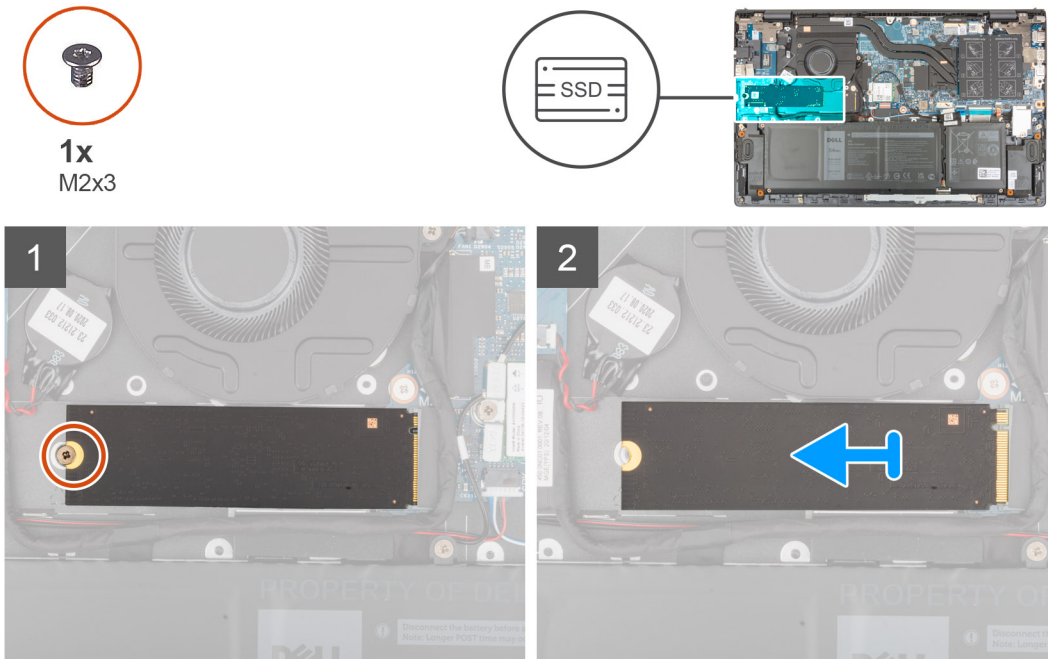

Steps

1. Remove the screw (M2x3) that secures the solid-state drive to the palm-rest and keyboard assembly.
2. Slide and lift the 2280 solid-state drive off the M.2 solid-state drive slot one on the system board.

Installing the 2280 solid-state drive in M.2 slot one

Prerequisites

If you are replacing a component, remove the existing component before performing the installation procedure.

About this task

NOTE: Solid-state drives are fragile. Exercise care when handling the solid-state drive.

NOTE: Depending on the configuration ordered, the computer one may support a 2280 solid-state drive, or a 2230 solid-state drive in M.2 slot one.

NOTE: This procedure is applicable if you are installing a 2280 solid-state drive in M.2 slot one.

NOTE: Before installing your 2230 or 2280 solid-state drive, ensure that the mounting bracket is in the correct location. For more information, see [Installing the solid-state drive mounting bracket](#).

The following image indicates the location of the 2280 solid-state drive that is installed in M.2 slot one and provides a visual representation of the installation procedure.



1x
M2x3

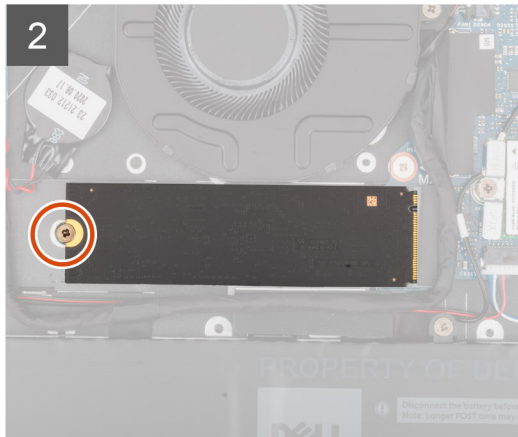
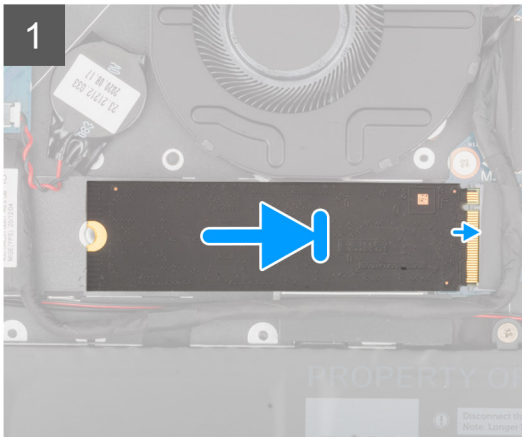
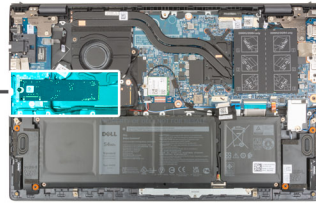

Steps

1. Align the notch on the 2280 solid-state drive with the tab on the solid-state drive slot.
2. Slide the 2280 solid-state drive firmly into the solid-state drive slot at an angle.
3. Align the screw hole on the solid-state drive with the screw hole on the palm-rest and keyboard assembly.
4. Replace the screw (M2x3) that secures the 2280 solid-state drive to the palm-rest and keyboard assembly.

Next steps

1. Install the [base cover](#).
2. Follow the procedure in [After working inside your computer](#).

Installing the solid-state drive mounting bracket on M.2 slot one

About this task

The following image provides a visual representation of the procedure to install the solid-state drive mounting bracket when replacing M.2 2230 solid-state drive with M.2 2280 solid-state drive in M.2 slot one.

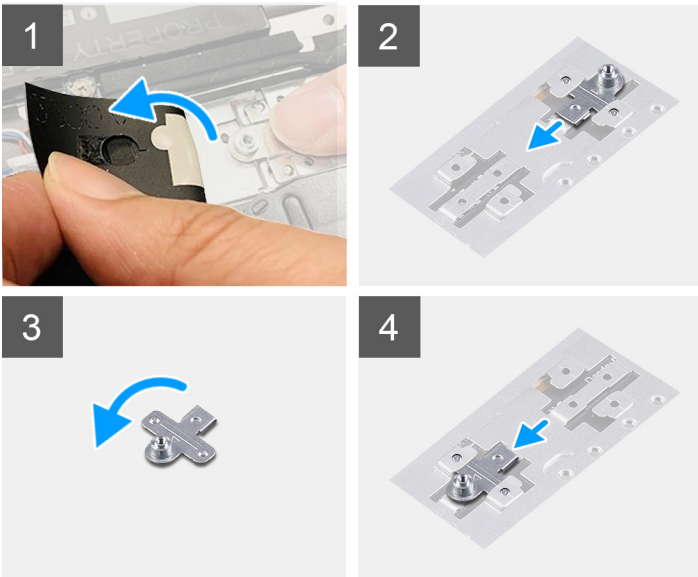

The following image provides a visual representation of the procedure to install the solid-state drive mounting bracket when replacing M.2 2280 solid-state drive with M.2 2230 solid-state drive in M.2 slot one.

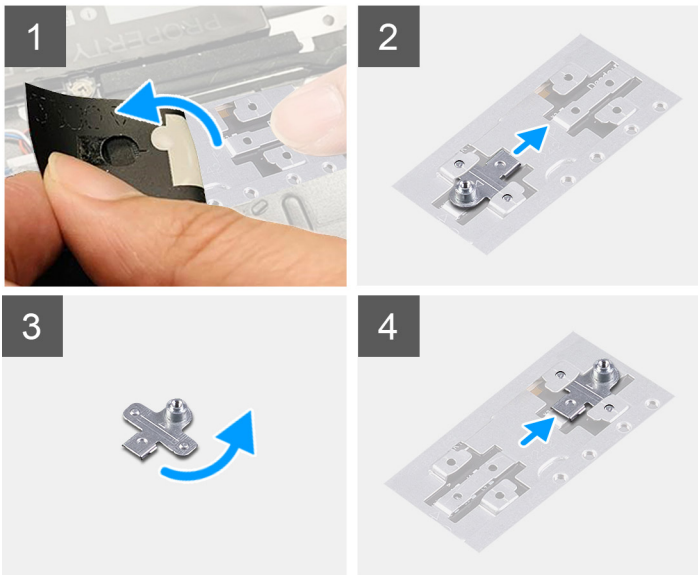

Steps

1. Slide and remove the solid-state drive mounting bracket from the mounting bracket slot on the palm-rest and keyboard assembly.
2. Rotate the solid-state drive mounting bracket to 180 degrees.
3. Slide the solid-state mounting bracket into the mounting slot on the palm-rest and keyboard assembly.
4. Install the [2230 solid-state drive](#) or [2280 solid-state drive](#), whichever applicable.

Solid-state drive—M.2 slot two

Removing the 2230 solid-state drive from M.2 slot two

Prerequisites

 **NOTE:** M.2 slot two supports only 2230 solid-state drive.

NOTE: This procedure applies only to computers shipped with a 2230 solid-state drive installed in M.2 slot two.

1. Follow the procedure in [Before working inside your computer](#).

NOTE: Solid-state drives are fragile. Exercise care when handling the solid-state drive.

NOTE: To avoid data loss, do not remove the solid-state drive while the computer is in sleep or on state.

2. Remove the [base cover](#).

About this task

The following image indicates the location of the 2230 solid-state drive that is installed in M.2 slot two and provides a visual representation of the removal procedure.

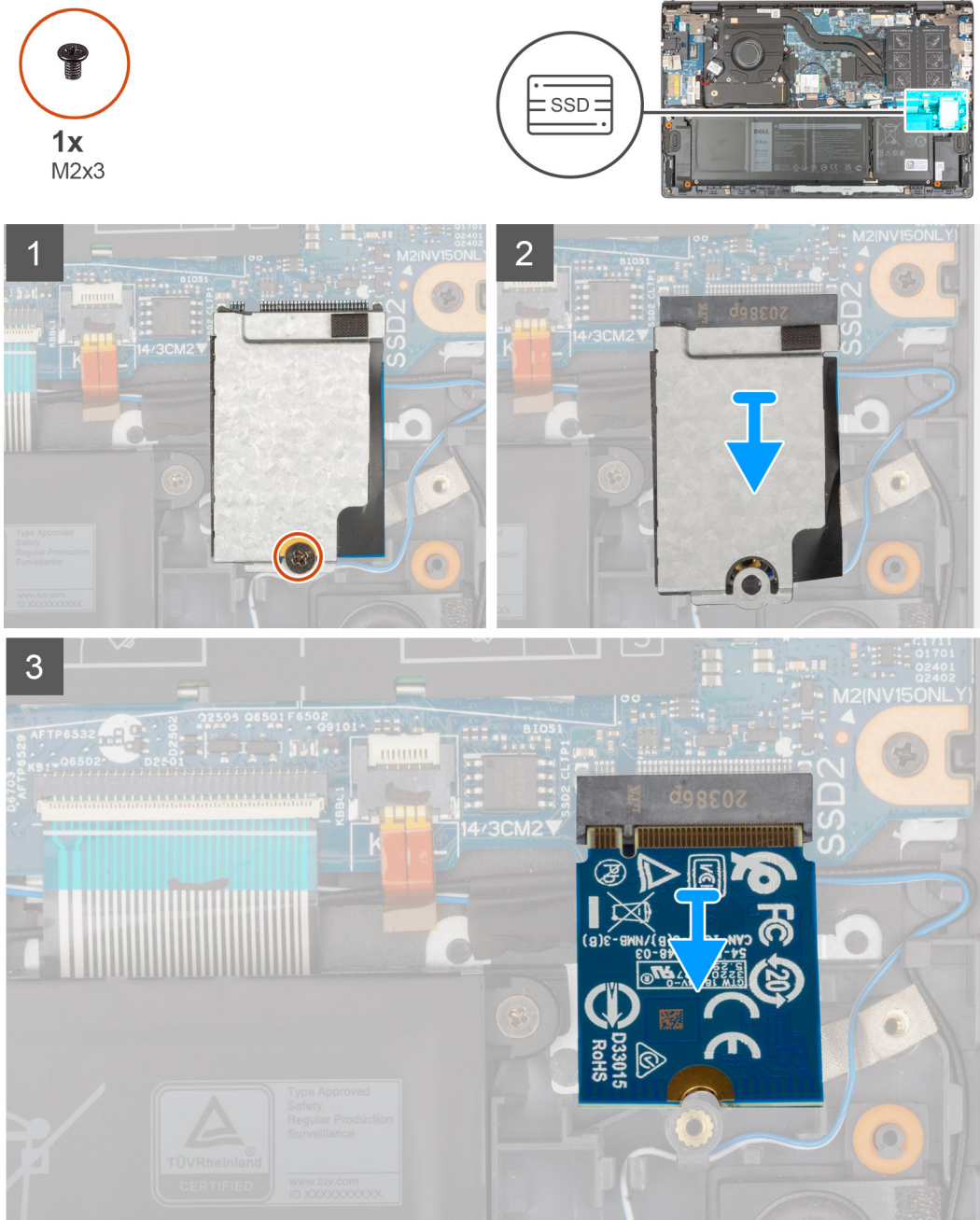

Steps

1. Remove the screw (M2x3) that secures the solid-state drive thermal shield and the solid-state drive to the palm-rest and keyboard assembly.
2. Slide and lift the solid-state drive thermal shield off the solid-state drive.
3. Slide and remove the solid-state drive from the M.2 slot two.

Installing the 2230 solid-state drive in M.2 slot two

Prerequisites

If you are replacing a component, remove the existing component before performing the installation procedure.

About this task

 **NOTE:** Solid-state drives are fragile. Exercise care when handling the solid-state drive.

 **NOTE:** M.2 slot two supports only 2230 solid-state drive.

 **NOTE:** This procedure applies only to computers shipped with a 2230 solid-state drive installed in M.2 slot two.

The following image indicates the location of the 2230 solid-state drive that is installed in M.2 slot two and provides a visual representation of the installation procedure.



1x
M2x3

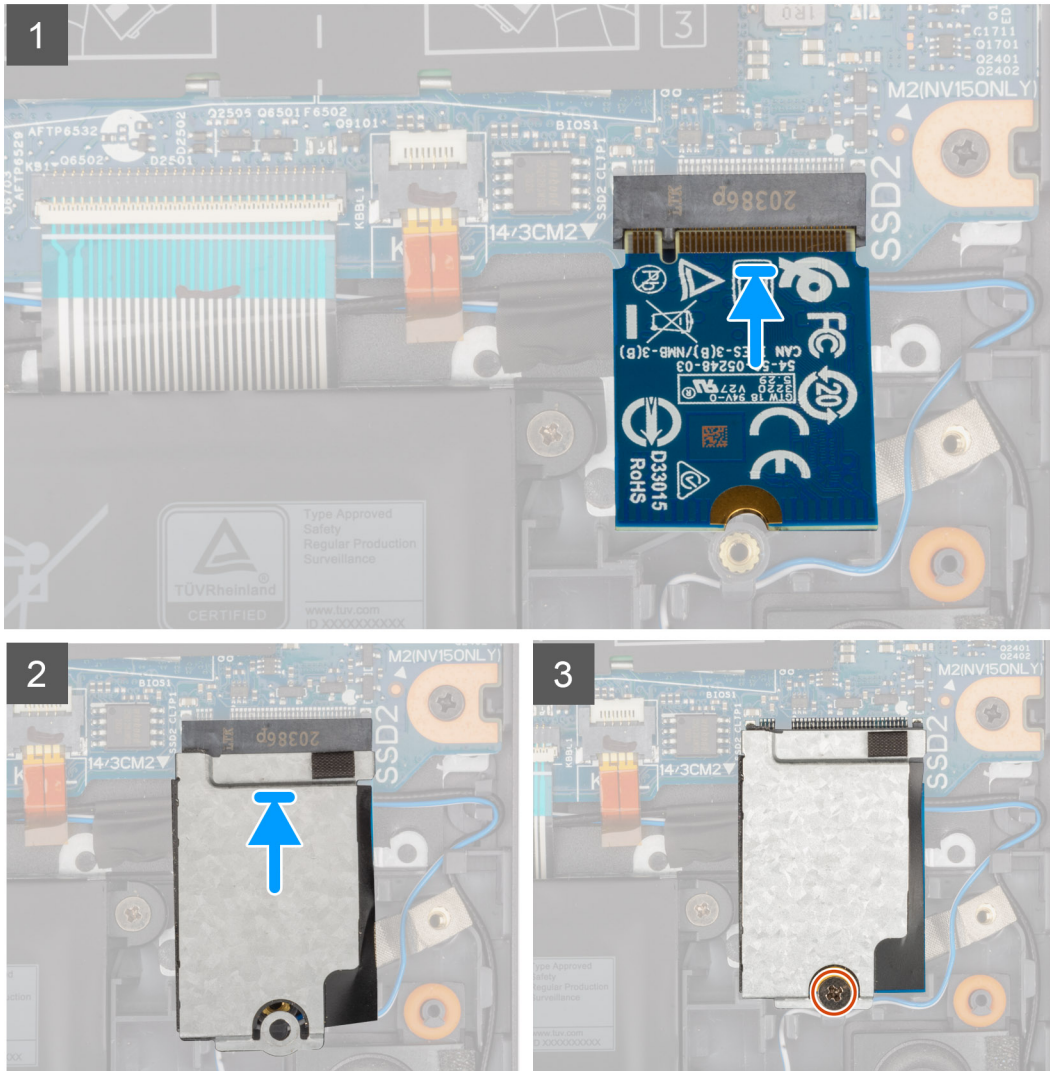
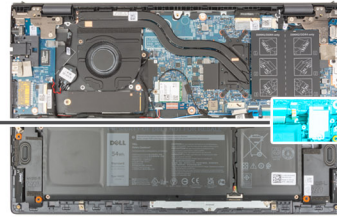

Steps

1. Align the notch on the 2230 solid-state drive with the tab on M.2 slot two on the system board.
2. Slide the 2230 solid-state drive into M.2 slot two on the system board.
3. Place the solid-state drive thermal shield on the solid-state drive.
4. Align the screw hole on the solid-state drive thermal shield with the screw hole on the palm-rest and keyboard assembly.
5. Replace the screw (M2x3) that secures the solid-state drive thermal shield and solid-state drive to the palm-rest and keyboard assembly.

Next steps

1. Install the [base cover](#).
2. Follow the procedure in [After working inside your computer](#).

Wireless card

Removing the wireless card

Prerequisites

1. Follow the procedure in [Before working inside your computer](#).
2. Remove the [base cover](#).

About this task

The following images indicate the location of the wireless card and provide a visual representation of the removal procedure.



1x
M2x4

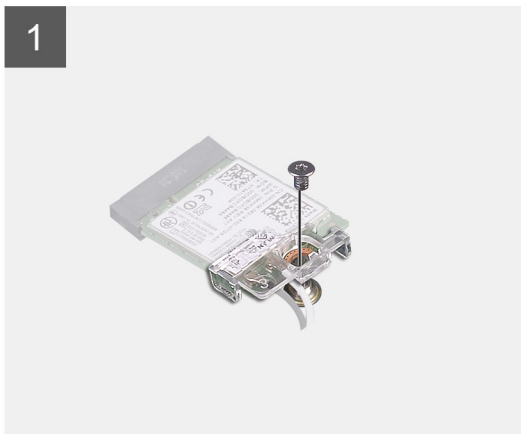

Steps

1. Remove the screw (M2x4) that secures the wireless-card bracket to the wireless card and system board.
2. Remove the wireless-card bracket from the wireless card.
3. Disconnect the antenna cables from the wireless card.
4. Slide and remove the wireless card from the wireless-card slot.

Installing the wireless card

Prerequisites

If you are replacing a component, remove the existing component before performing the installation procedure.

About this task

The following image indicates the location of the wireless card and provides a visual representation of the installation procedure.



1x
M2x4

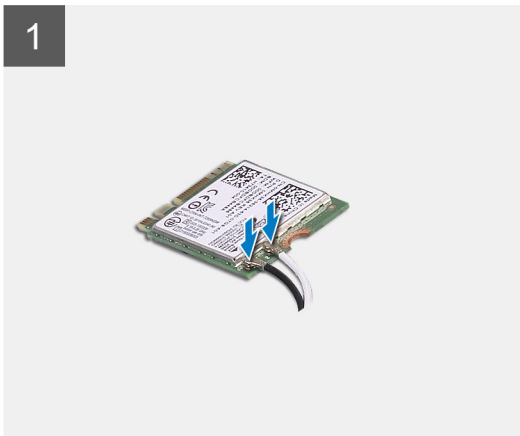
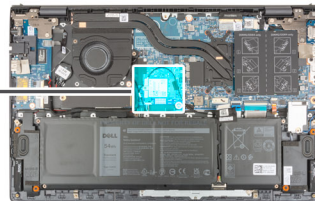

Steps

1. Connect the antenna cables to the wireless card.

The following table provides the antenna-cable color scheme for the wireless card that is supported by your computer.

Table 2. Antenna-cable color scheme

Connectors on the wireless card	Antenna-cable color	Silkscreen marking	
Main	White	MAIN	△ (white triangle)
Auxiliary	Black	AUX	▲ (black triangle)

2. Align the notch on the wireless card with the tab on the wireless-card slot on the system board.
3. Slide and insert the wireless card at an angle into the wireless-card slot on the system board.
4. Align the screw hole on the wireless-card bracket to the screw hole on the wireless card and system board.
5. Replace the screw (M2x4) that secures the wireless-card bracket to the wireless card and the system board.

Next steps

1. Install the [base cover](#).
2. Follow the procedure in [After working inside your computer](#).

Fan

Removing the fan

Prerequisites

1. Follow the procedure in [Before working inside your computer](#).
2. Remove the [base cover](#).

About this task

The following images indicate the location of the fan and provide a visual representation of the removal procedure.



2x
M2x3

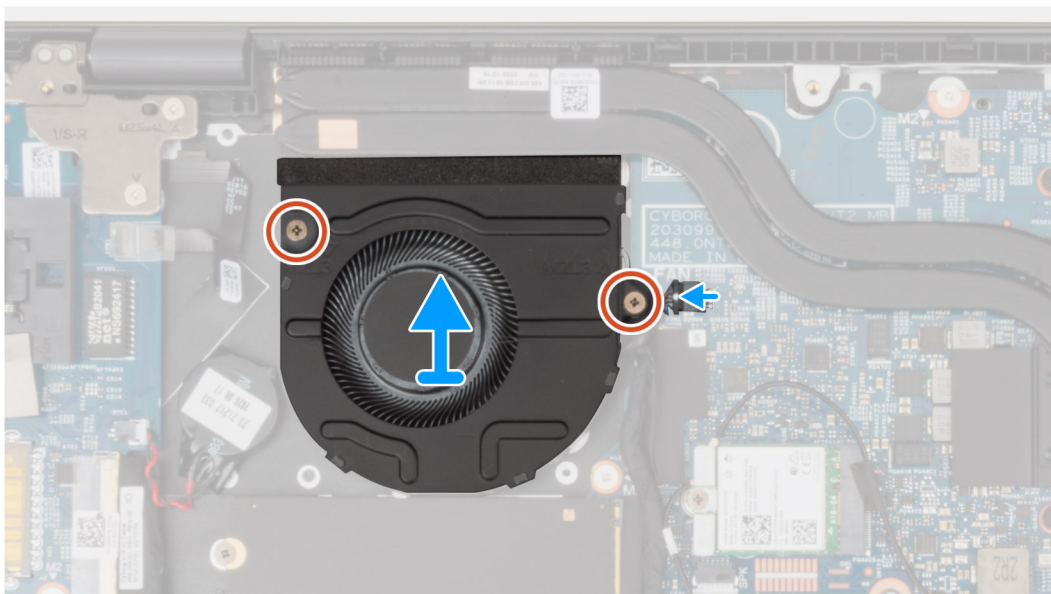
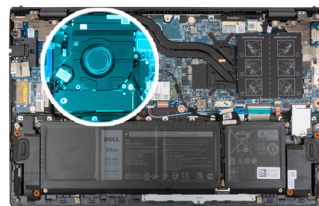

Steps

1. Disconnect the fan cable from the system board.
2. Remove the two (M2x3) screws that secure the fan to the palm-rest and keyboard assembly.
3. Lift the fan off the palm-rest and keyboard assembly.

Installing the fan

Prerequisites

If you are replacing a component, remove the existing component before performing the installation procedure.

About this task

The following image indicates the location of the fan and provides a visual representation of the installation procedure.



2x
M2x3

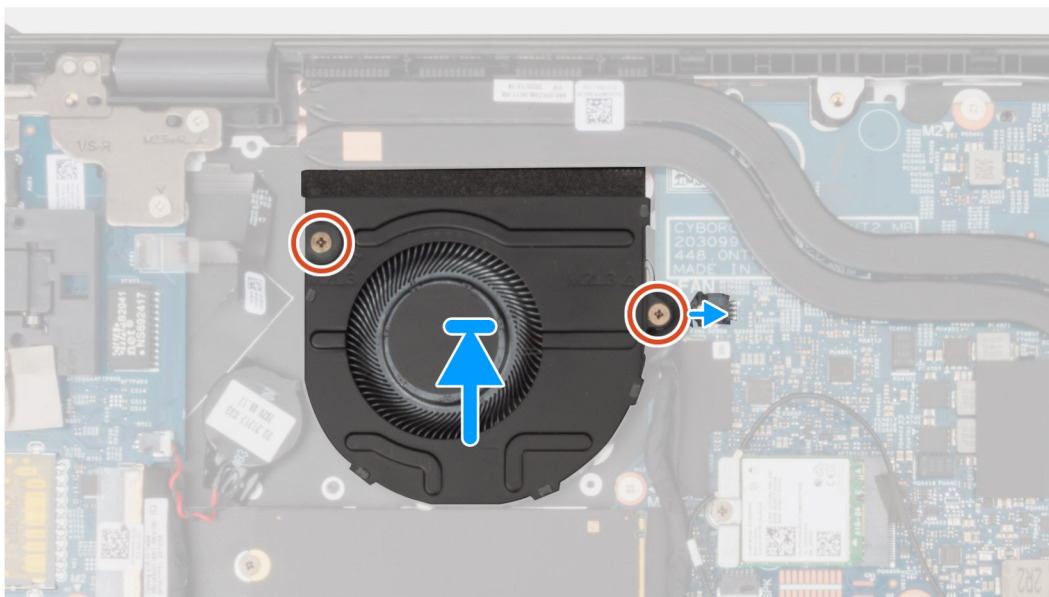
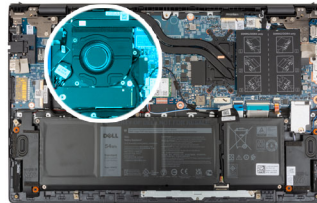

Steps

1. Using the alignment posts, place the fan on the palm-rest and keyboard assembly.
2. Replace the two (M2x3) screws to secure the fan to the palm-rest and keyboard assembly.
3. Connect the fan cable to the system board.

Next steps

1. Install the [base cover](#).
2. Follow the procedure in [After working inside your computer](#).

Coin-cell battery

Removing the coin-cell battery

Prerequisites

1. Follow the procedure in [Before working inside your computer](#).

CAUTION: Removing the coin-cell battery resets the BIOS setup program's settings to default. It is recommended that you note the BIOS setup program's settings before removing the coin-cell battery.

2. Remove the [base cover](#).

About this task

The following images indicate the location of the coin-cell battery and provide a visual representation of the removal procedure.

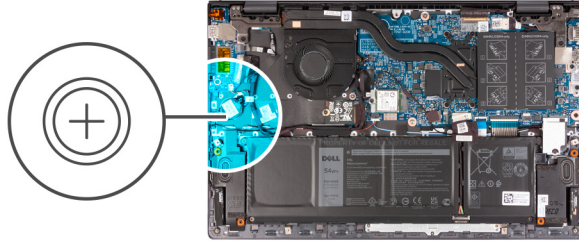

Steps

1. Disconnect the coin-cell battery cable from the I/O board.
2. Peel the coin-cell battery from the palm-rest and keyboard assembly.

Installing the coin-cell battery

Prerequisites

If you are replacing a component, remove the existing component before performing the installation procedure.

About this task

The following image indicates the location of the coin-cell battery and provides a visual representation of the installation procedure.

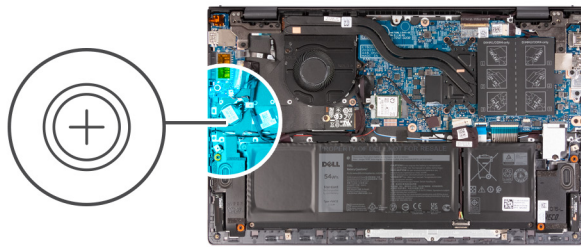

Steps

1. Adhere the coin-cell battery to the slot on the palm-rest and keyboard assembly.
2. Connect the coin-cell battery cable to the I/O board.

Next steps

1. Install the [base cover](#).
2. Follow the procedure in [After working inside your computer](#).

Heat sink

Removing the heatsink

Prerequisites

1. Follow the procedure in [Before working inside your computer](#).

CAUTION: For maximum cooling of the processor, do not touch the heat transfer areas on the heat sink. The oils in your skin can reduce the heat transfer capability of the thermal grease.

NOTE: The heat sink may become hot during normal operation. Allow sufficient time for the heat sink to cool before you touch it.

2. Remove the [base cover](#).

About this task

The following images indicate the location of the heatsink and provide a visual representation of the removal procedure.



4x

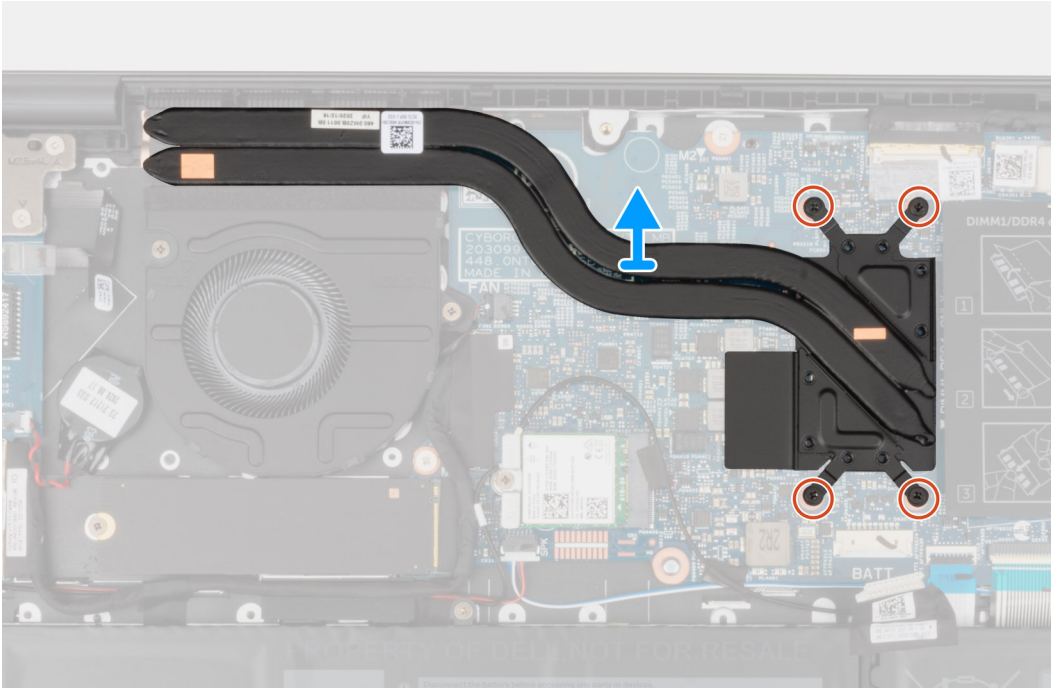
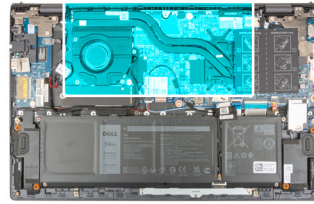

Steps

1. In reverse sequential order (as indicated on the heat sink), loosen the four captive screws that secure the heat sink to the system board.
2. Lift the heat sink off the system board.

Installing the heatsink

Prerequisites

If you are replacing a component, remove the existing component before performing the installation procedure.

⚠ CAUTION: Incorrect alignment of the heat sink can damage the system board and processor.

i NOTE: If either the system board or the heat sink is replaced, use the thermal pad/paste provided in the kit to ensure that thermal conductivity is achieved.

About this task

The following image indicates the location of the heatsink and provides a visual representation of the installation procedure.



4x

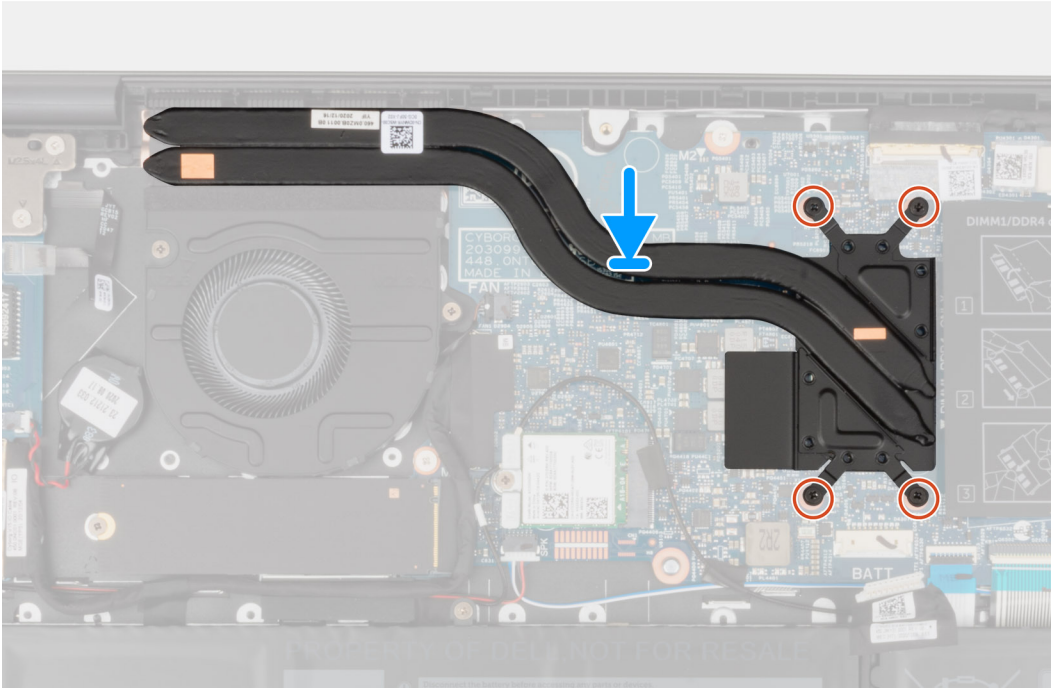
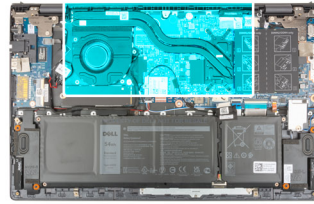

Steps

1. Align the screw holes on the heat sink with the screw holes on the system board.
2. In sequential order (as indicated on the heat sink), tighten the four captive screws that secure the heat sink to the system board.

Next steps

1. Install the [base cover](#).
2. Follow the procedure in [After working inside your computer](#).

I/O board

Removing the I/O board

Prerequisites

1. Follow the procedure in [Before working inside your computer](#).
2. Remove the [base cover](#).

About this task

The following images indicate the location of the I/O board and provide a visual representation of the removal procedure.

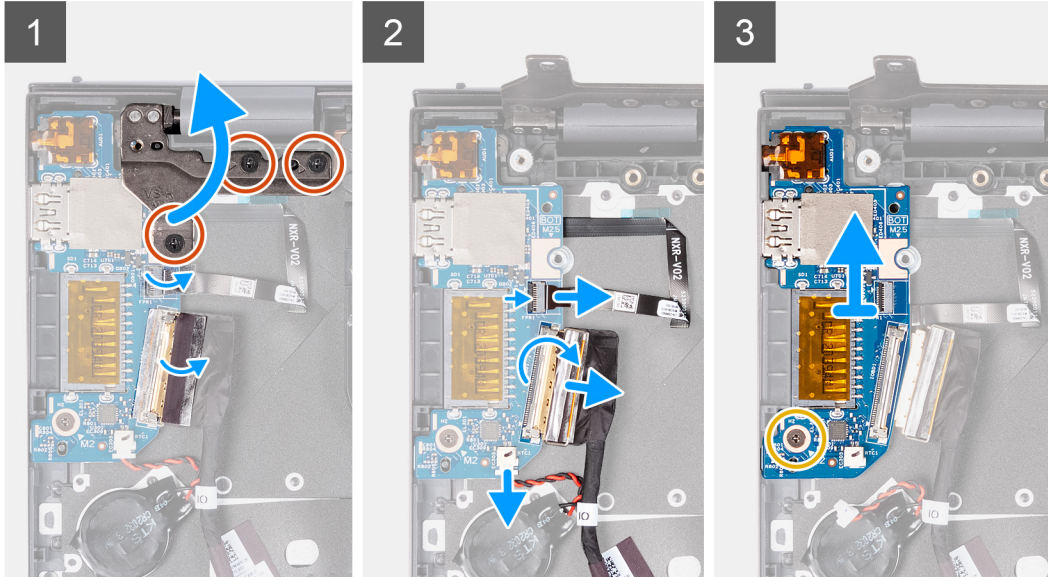
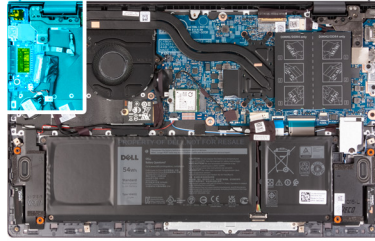

Steps

1. Remove the three (M2.5x4) screws that secure the left hinge to the palm-rest and keyboard assembly.
2. Open the display hinge at an angle of 90 degrees.
3. Open the latch, and disconnect the power button with optional fingerprint reader cable from the I/O board.
4. Disconnect the coin-cell battery cable from the I/O board.
5. Peel the tape that secures the I/O-board cable to the I/O board.
6. Open the latch and disconnect the I/O-board cable from the I/O board.
7. Remove the screw (M2x3) that secures the I/O board to the palm-rest and keyboard assembly.
8. Lift the I/O board off the palm-rest and keyboard assembly.

Installing the I/O board

Prerequisites

If you are replacing a component, remove the existing component before performing the installation procedure.

About this task

The following image indicates the location of the I/O board and provides a visual representation of the installation procedure.

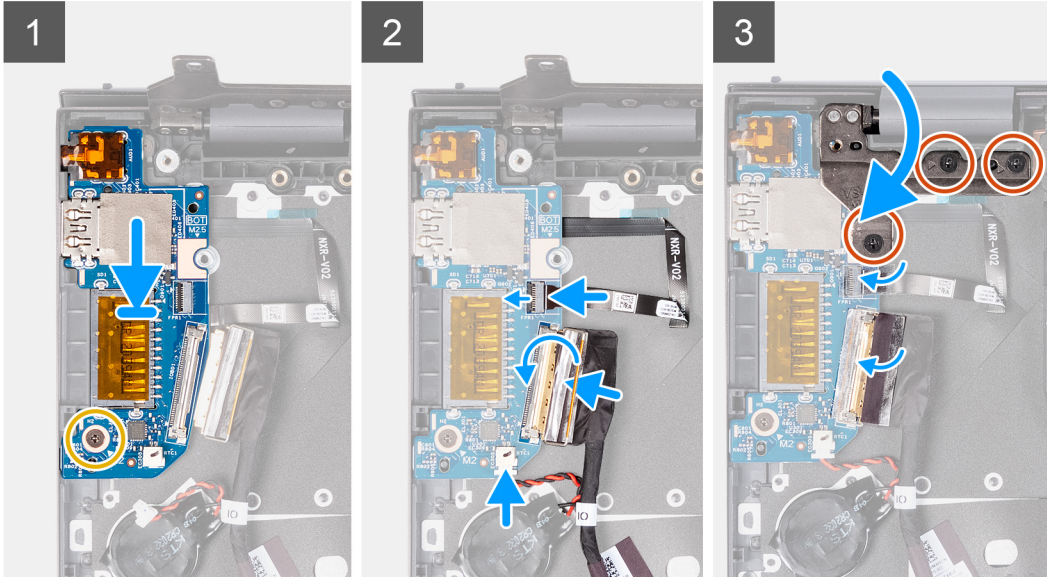
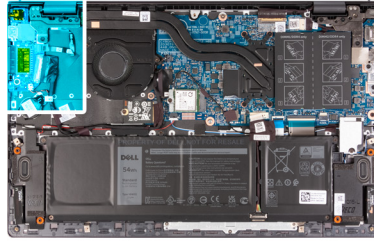

Steps

1. Slide the I/O board into the slots on the palm-rest and keyboard assembly.
2. Align the screw hole on the I/O board with the screw hole on the palm-rest and keyboard assembly.
3. Replace the screw (M2x3) that secures the I/O board to the palm-rest and keyboard assembly.
4. Connect the power-button with optional fingerprint reader cable into the connector on the I/O board and close the latch to secure the cable.
5. Connect the coin-cell battery cable to the I/O board.
6. Connect the I/O-board cable to the I/O board and close the latch to secure the cable.
7. Adhere the tape that secures the I/O-board cable to the I/O board.
8. Close the left display hinge.
9. Replace the three (M2.5x4) screws that secure the left display hinge to the palm-rest and keyboard assembly.

Next steps

1. Install the [base cover](#).
2. Follow the procedure in [After working inside your computer](#).

Speakers

Removing the speakers

Prerequisites

1. Follow the procedure in [Before working inside your computer](#).
2. Remove the [base cover](#).

About this task

The following images indicate the location of the speakers and provide a visual representation of the removal procedure.

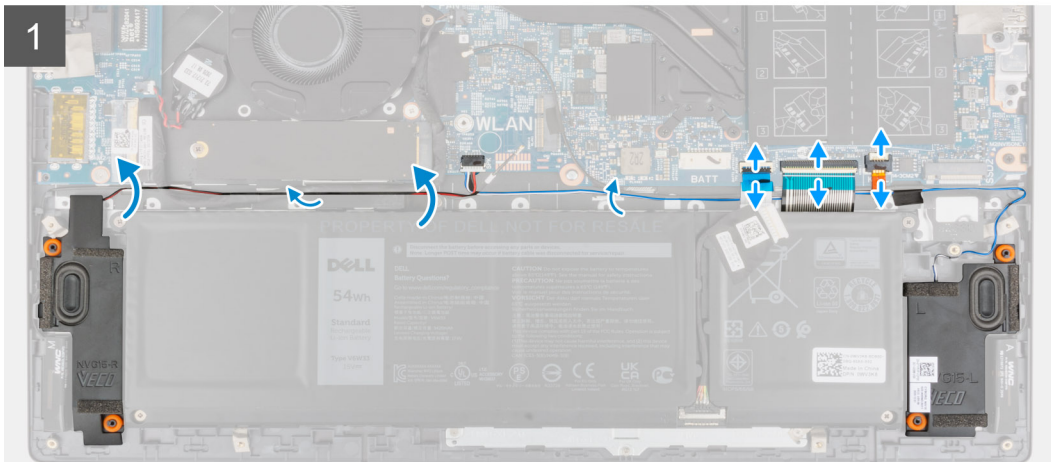
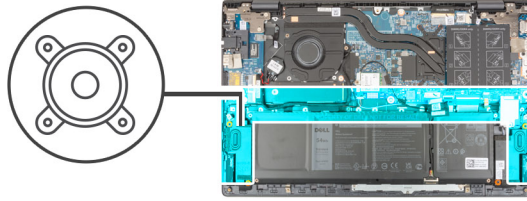

Steps

1. Open the latch and disconnect the keyboard backlit cable, keyboard cable, and the touchpad cable from the system board.
2. Note the speaker cable routing, and remove the speaker cable from the routing guides on the palm-rest and keyboard assembly.
3. Peel the tape that secures the speaker cable to the palm-rest and keyboard assembly.
4. Disconnect the speaker cable from the system board.
5. Lift the speakers, along with the cable, off the palm-rest and keyboard assembly.

Installing the speakers

Prerequisites

If you are replacing a component, remove the existing component before performing the installation procedure.

About this task

The following image indicates the location of the speaker and provides a visual representation of the installation procedure.

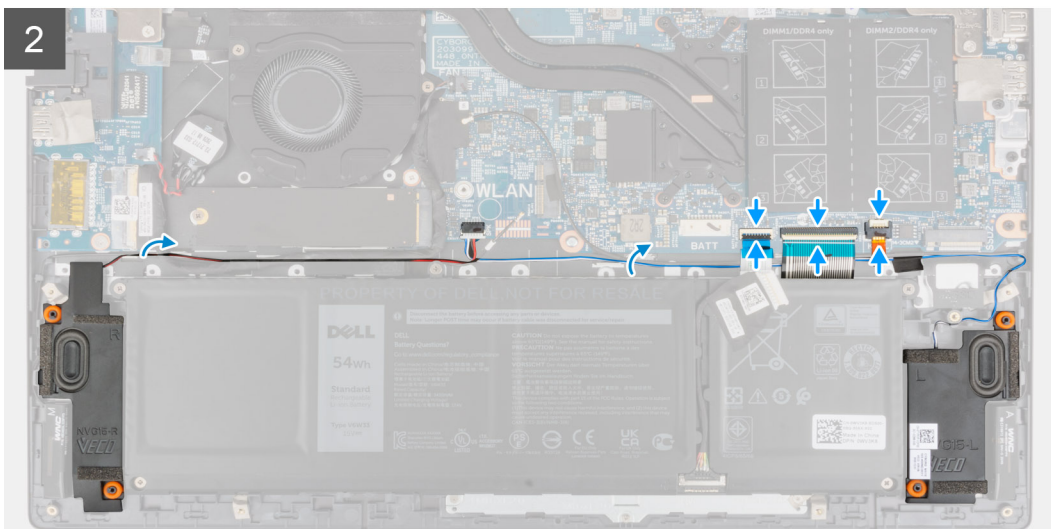
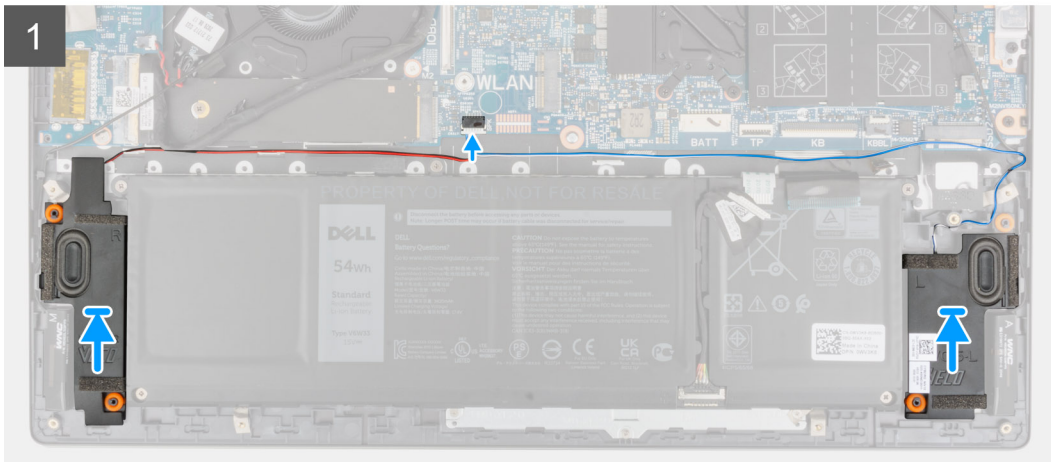
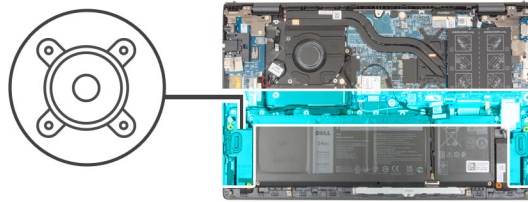

Steps

1. Using the alignment posts and rubber grommets, place the speakers on the slots of the palm-rest and keyboard assembly.
2. Connect the speaker cable to the system board.
3. Route the speaker cable through the routing guides on the palm-rest and keyboard assembly.
4. Connect the keyboard backlit cable, keyboard cable, and the touchpad cable to its connectors on the system board and close the latch to secure the cable.

Next steps

1. Install the [base cover](#).
2. Follow the procedure in [After working inside your computer](#).

Touchpad

Removing the touchpad

Prerequisites

1. Follow the procedure in [Before working inside your computer](#).
2. Remove the [base cover](#).
3. Remove the [battery](#).

About this task

The following images indicate the location of the touchpad and provide a visual representation of the removal procedure.

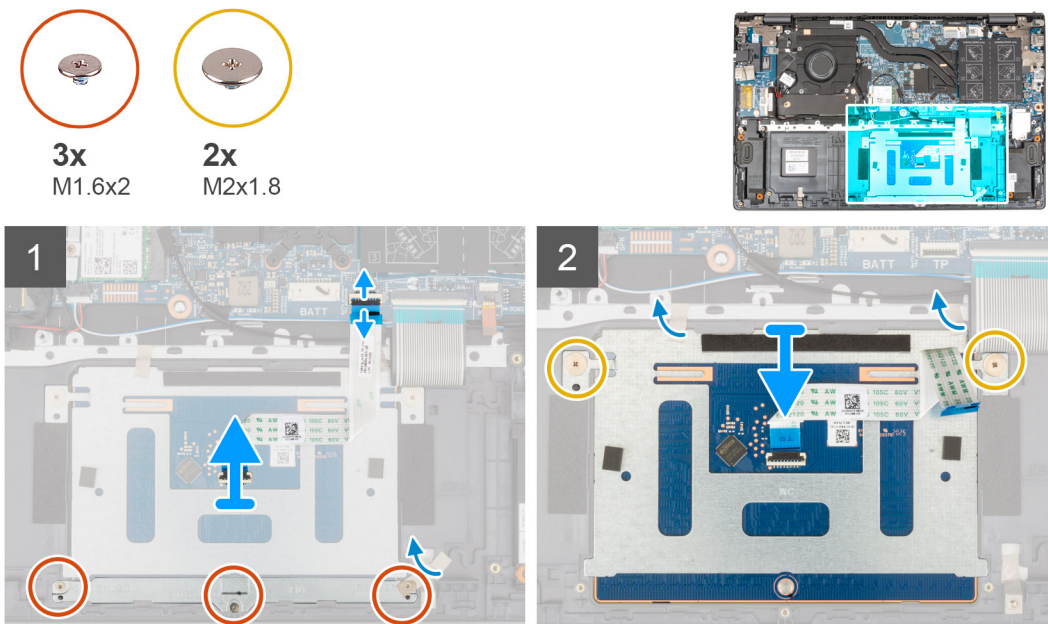

Steps

1. Open the latch and disconnect the touchpad cable from the system board.
2. Remove the three (M1.6x2) screws that secure the touchpad bracket to the palm-rest and keyboard assembly.
3. Peel the tape that secures the touchpad bracket to the palm-rest and keyboard assembly.
4. Lift the touchpad bracket off the palm-rest and keyboard assembly.
5. Remove the two (M2x1.8) screws that secure the touchpad to the palm-rest and keyboard assembly.
6. Peel the tapes that secure the touchpad to the palm-rest and keyboard assembly.
7. Lift the touchpad, along with the touchpad cable, off the palm-rest and keyboard assembly.

Installing the touchpad

Prerequisites

If you are replacing a component, remove the existing component before performing the installation procedure.

About this task

The following image indicates the location of the touchpad and provides a visual representation of the installation procedure.

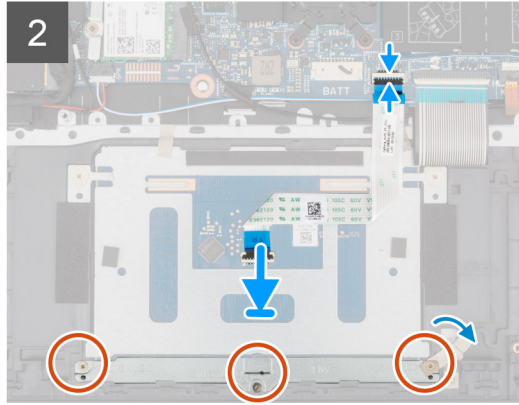
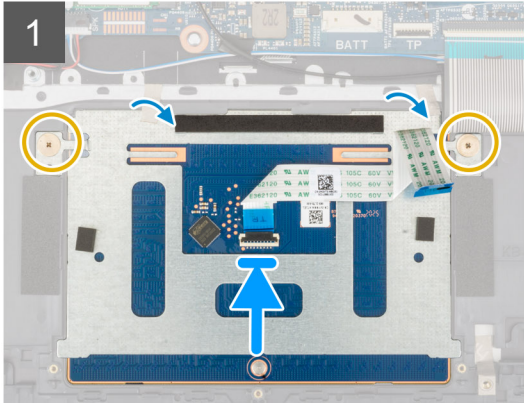
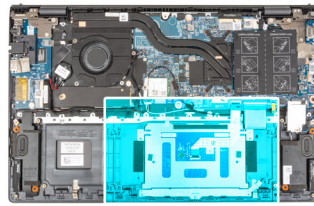
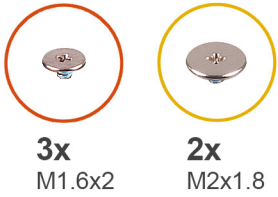

Steps

1. Slide the touchpad into the slot on the palm-rest and keyboard assembly.

NOTE: Turn the computer over and open the display. Ensure that the touchpad is equally aligned along all four sides.

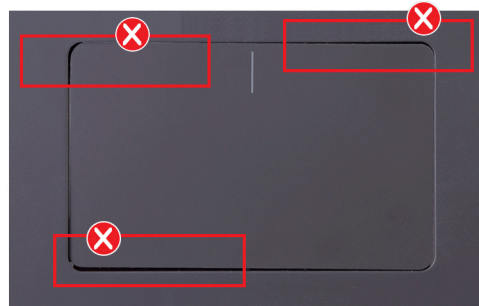

2. Replace the two (M2x1.8) screws that secure the touchpad to the palm-rest and keyboard assembly.
3. Adhere the tapes that secure the touchpad to the palm-rest and keyboard assembly.
4. Align the screw holes on the touchpad bracket with the screw holes on the palm-rest and keyboard assembly.
5. Replace the three (M1.6x2) screws that secure the touchpad bracket to the palm-rest and keyboard assembly.
6. Adhere the tape that secures the touchpad bracket to the palm-rest and keyboard assembly.
7. Slide the touchpad cable into the connector on the touchpad and close the latch to secure the cable.

Next steps

1. Install the [3-cell battery](#) or [4-cell battery](#), whichever applicable.
2. Install the [base cover](#).
3. Follow the procedure in [After working inside your computer](#).

Display assembly

Removing the display assembly

Prerequisites

1. Follow the procedure in [Before working inside your computer](#).
2. Remove the [base cover](#).

About this task

The following images indicate the location of the display assembly and provide a visual representation of the removal procedure.



6x
M2.5x4

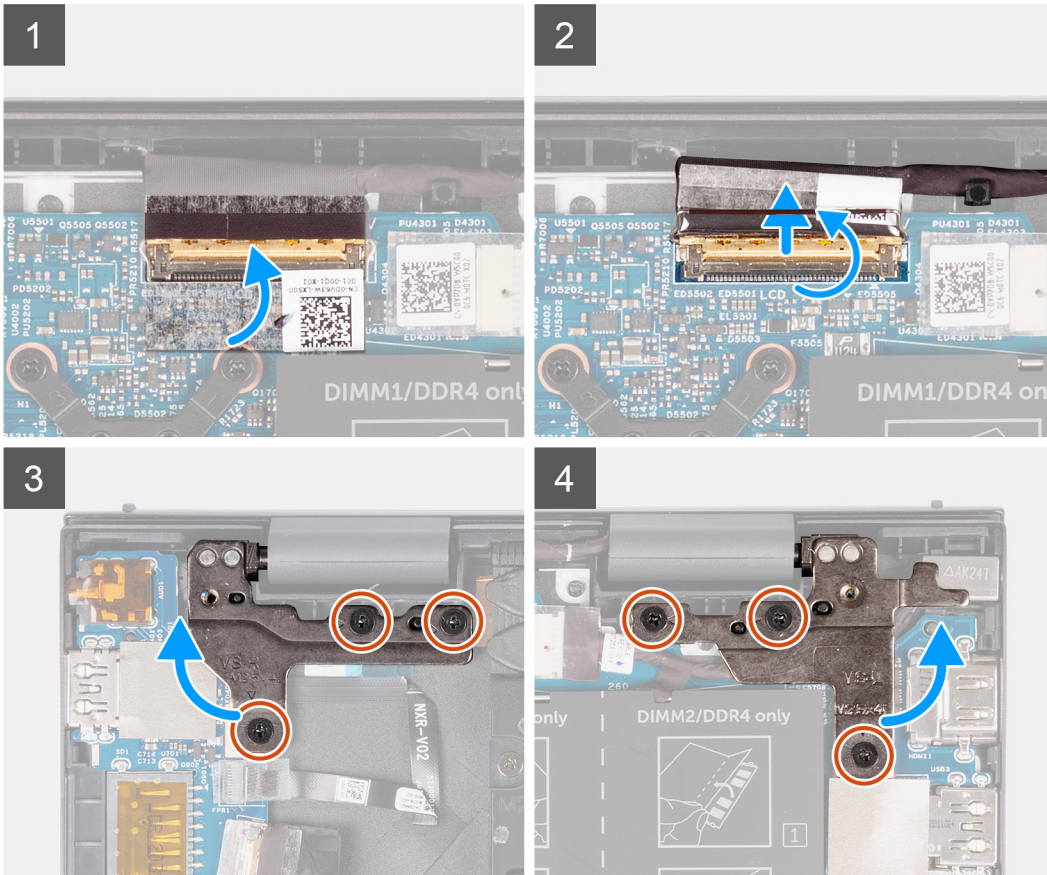
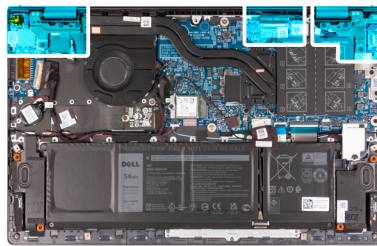

5

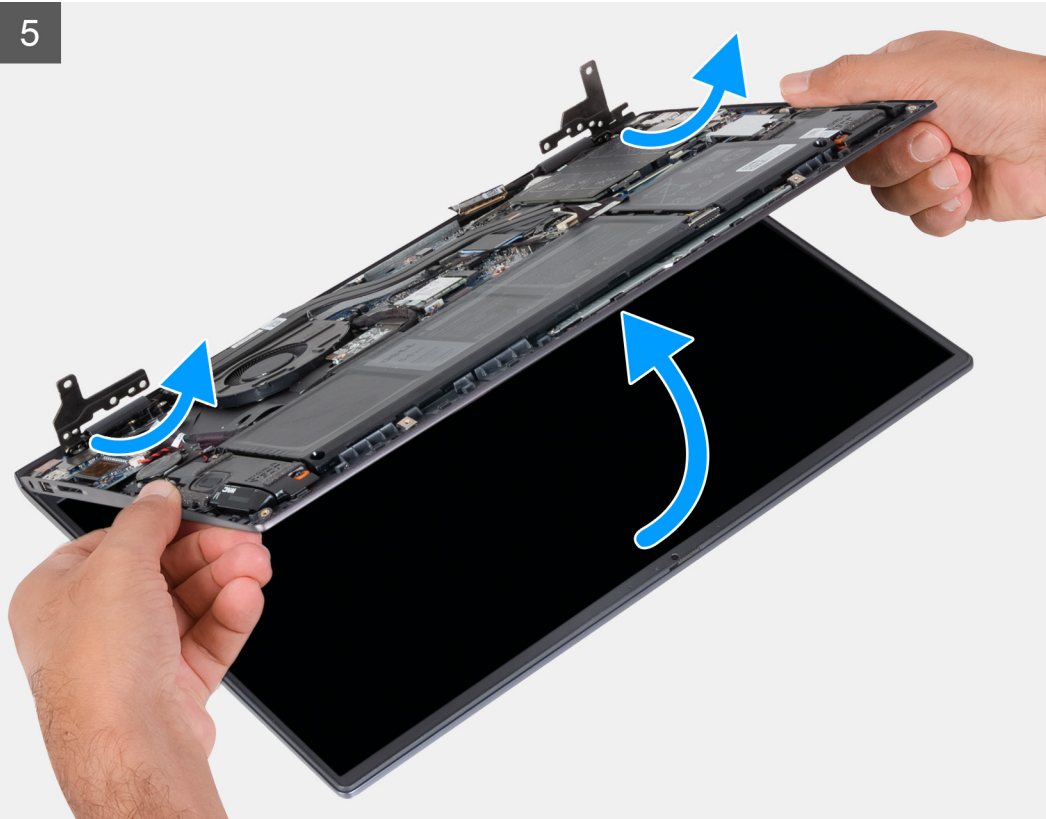

Steps

1. Peel the tape that secures the display cable to the system board.
2. Open the latch and disconnect the display cable from the system board.
3. Remove the three (M2.5x4) screws that secure the left-display hinge to the system board.
4. Remove the three (M2.5x4) screws that secure the right-display hinge to the system board.
5. Open the display hinges at an angle of 90 degrees.
6. Gently slide the palm-rest and keyboard assembly off the display assembly.

Installing the display assembly

Prerequisites

If you are replacing a component, remove the existing component before performing the installation procedure.

About this task

The following image indicates the location of the display assembly and provides a visual representation of the installation procedure.

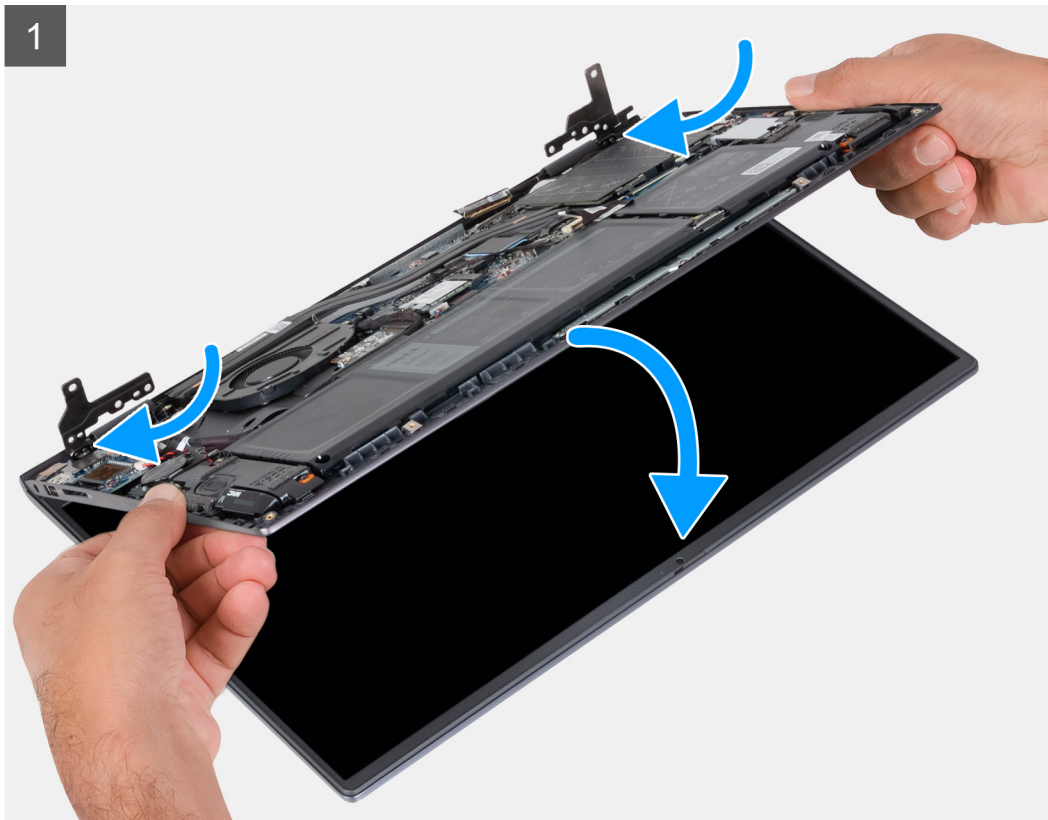



6x
M2.5x4

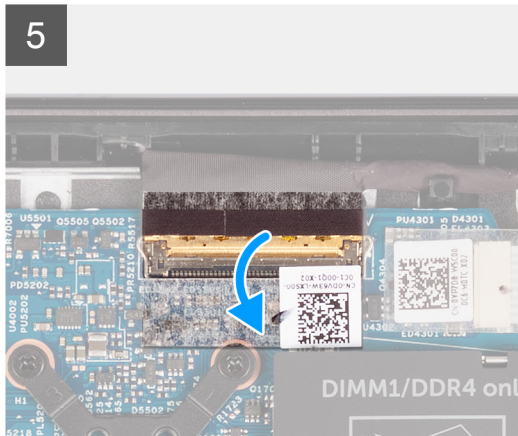
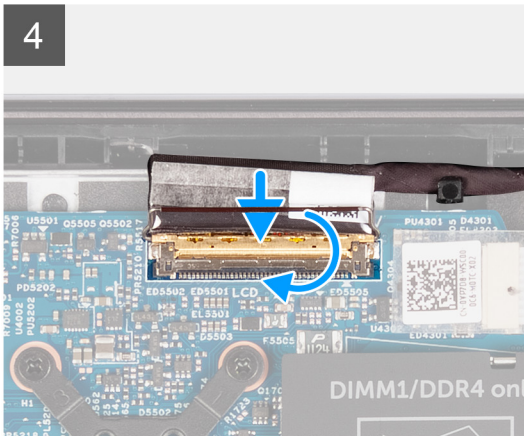
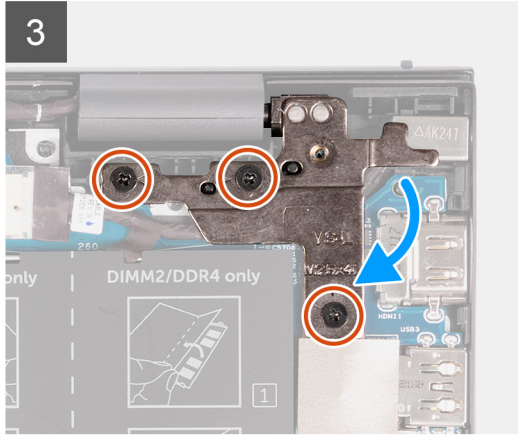
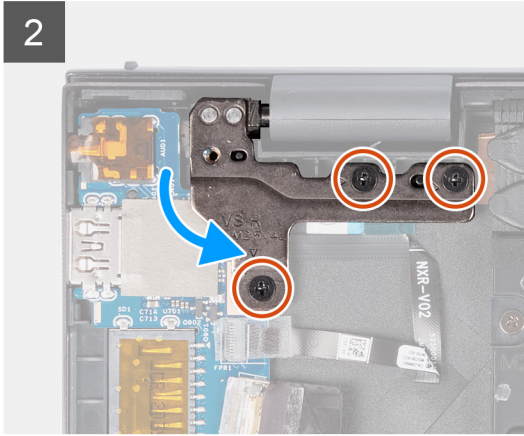
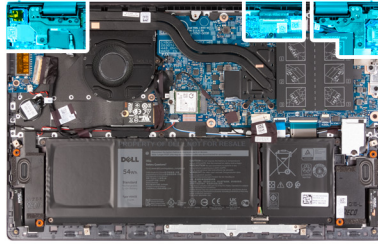

Steps

1. Slide the display assembly at an angle, and place the display assembly on the palm-rest and keyboard assembly.
2. Using the alignment posts, close the display hinges.
3. Replace the three (M2.5x4) screws that secure the right-display hinge to the system board.
4. Replace the three (M2.5x4) screws that secure the left-display hinge to the system board.
5. Slide the display cable into the connector on the system board and close the latch to secure the cable.
6. Adhere the tape that secures the display cable to the system board.

Next steps

1. Install the [base cover](#).
2. Follow the procedure in [After working inside your computer](#).

Power button with optional fingerprint reader

Removing the power button with optional fingerprint reader

Prerequisites

1. Follow the procedure in [Before working inside your computer](#).
2. Remove the [base cover](#).
3. Remove the [I/O board](#).

About this task

The following images indicate the location of the power-button with optional fingerprint reader and provide a visual representation of the removal procedure.



1x
M2x3

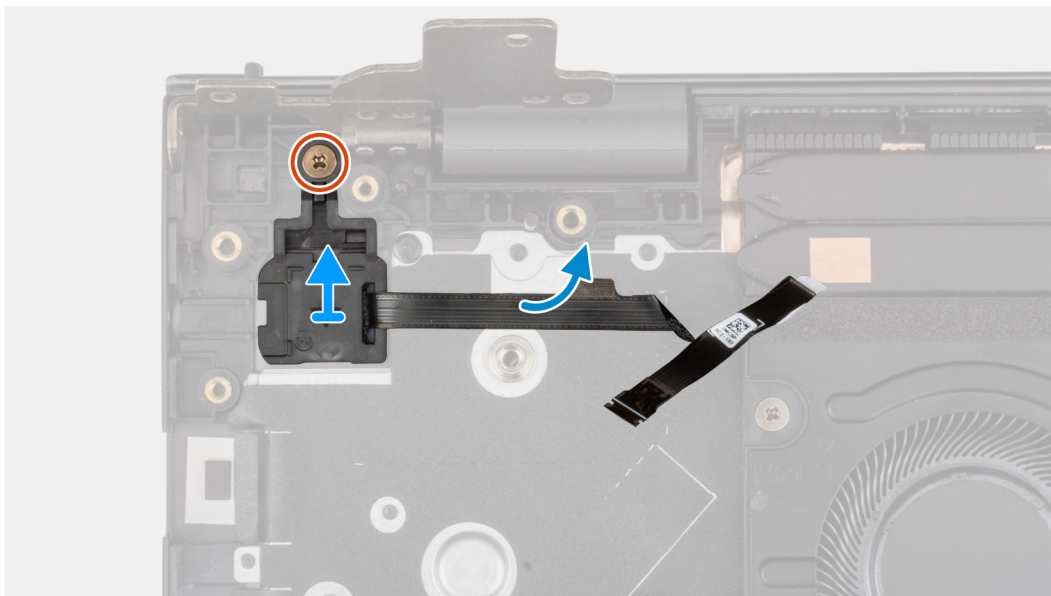
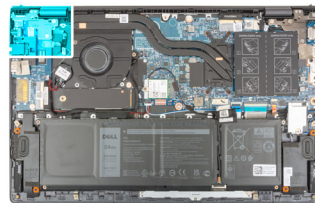

Steps

1. Remove the screw (M2x3) that secures the power button with optional fingerprint reader to the palm-rest and keyboard assembly.
2. Lift the power button with optional fingerprint reader off the palm-rest and keyboard assembly.

Installing the power button with optional fingerprint reader

About this task

The following images indicate the location of the power button with optional fingerprint reader and provide a visual representation of the installation procedure.



1x
M2x3

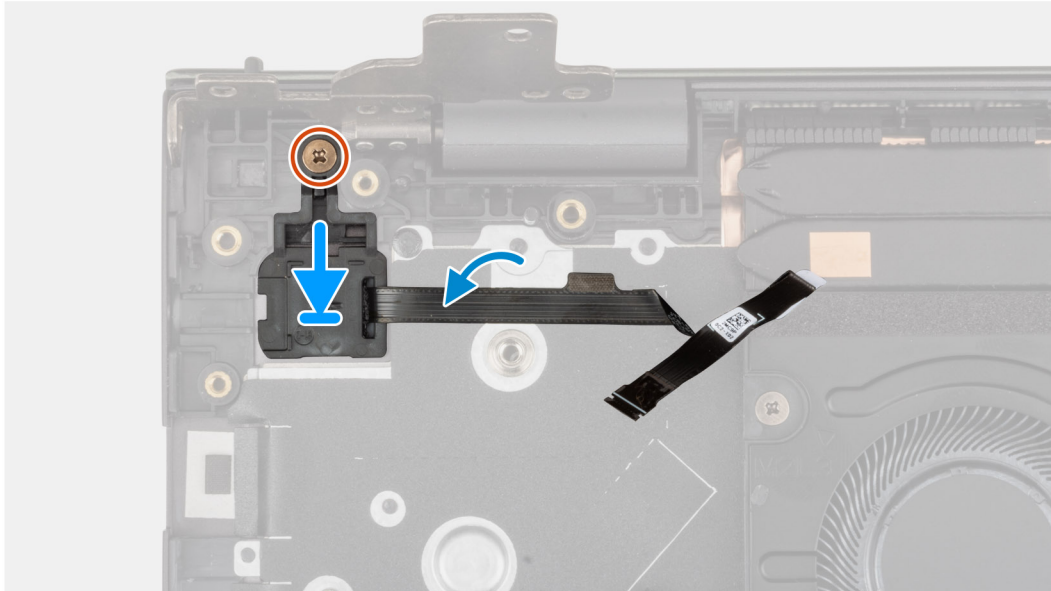
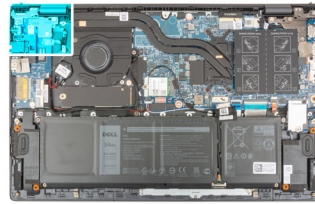

Steps

1. Align and place the power button with optional fingerprint reader on the palm-rest and keyboard assembly.
2. Replace the screw (M2x3) that secures the power button with optional fingerprint reader to the palm-rest and keyboard assembly.

Next steps

1. Install the [I/O board](#).
2. Install the [base cover](#).
3. Follow the procedure in [After working inside your computer](#).

System board

Removing the system board

Prerequisites

1. Follow the procedure in [Before working inside your computer](#).
 - i** **NOTE:** Your computer's Service Tag is stored in the system board. You must enter the Service Tag in the BIOS setup program after you replace the system board.
 - i** **NOTE:** Replacing the system board removes any changes that you have made to the BIOS using the BIOS setup program. You must make the appropriate changes again after you replace the system board.
 - i** **NOTE:** Before disconnecting the cables from the system board, note the location of the connectors so that you can reconnect the cables correctly after you replace the system board.
2. Remove the [base cover](#).
3. Remove the [3-cell battery](#) or [4-cell battery](#), whichever applicable.

4. Remove the [memory module](#).
5. Remove the [M.2 2280 solid-state drive](#) or [M.2 2230 solid-state drive](#) from M.2 slot one, whichever applicable.
6. Remove the [M.2 2230 solid-state drive](#) from M.2 slot two, if applicable.
7. Remove the [wireless card](#).
8. Remove the [fan](#).
9. Remove the [heat sink](#).

About this task

NOTE: When removing the system board to replace/access other parts, the system board can be removed and installed with the heat sink attached in order to simplify the procedure and preserve the thermal bond between the system board and heat-sink.

The following image indicates the connectors on your system board.

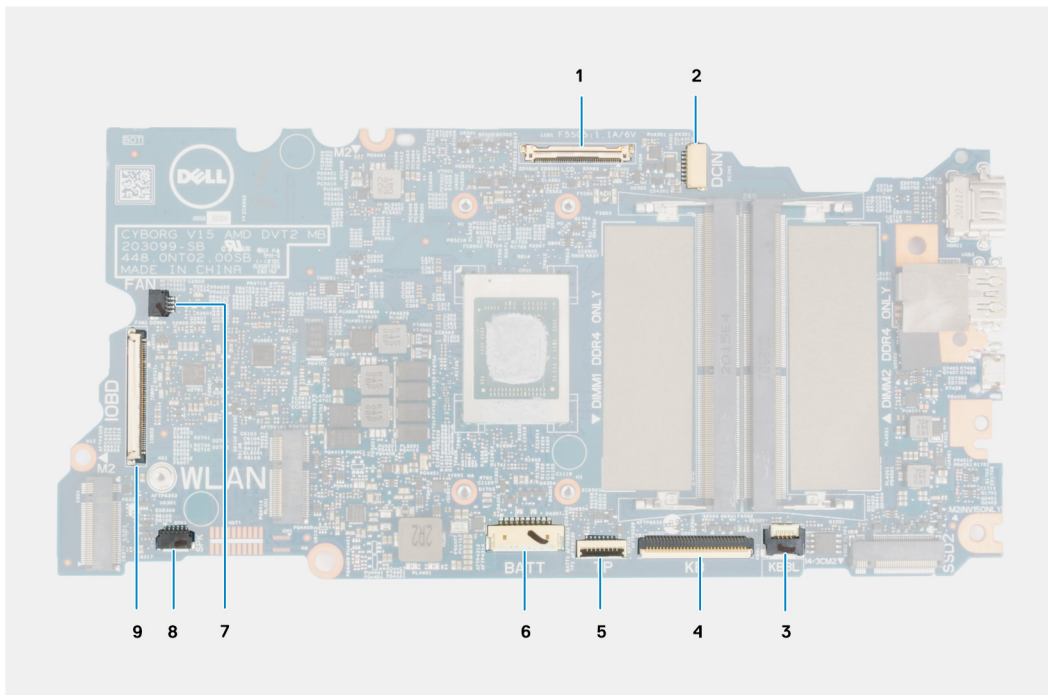
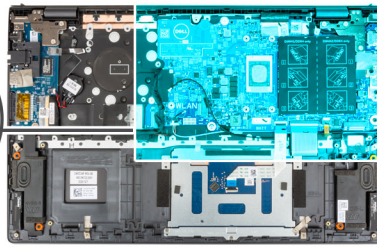
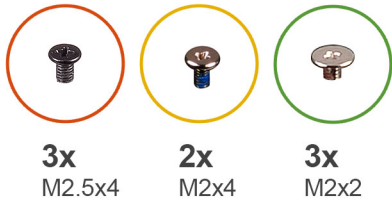

Figure 1. System board connectors

1. Display cable connector
2. Power-adaptor port cable connector
3. Keyboard backlit cable connector
4. Keyboard cable connector
5. Touchpad cable connector
6. Battery cable connector
7. Fan cable connector
8. Speaker cable connector
9. I/O-board cable connector

The following images indicate the location of the system board and provide a visual representation of the removal procedure.



1

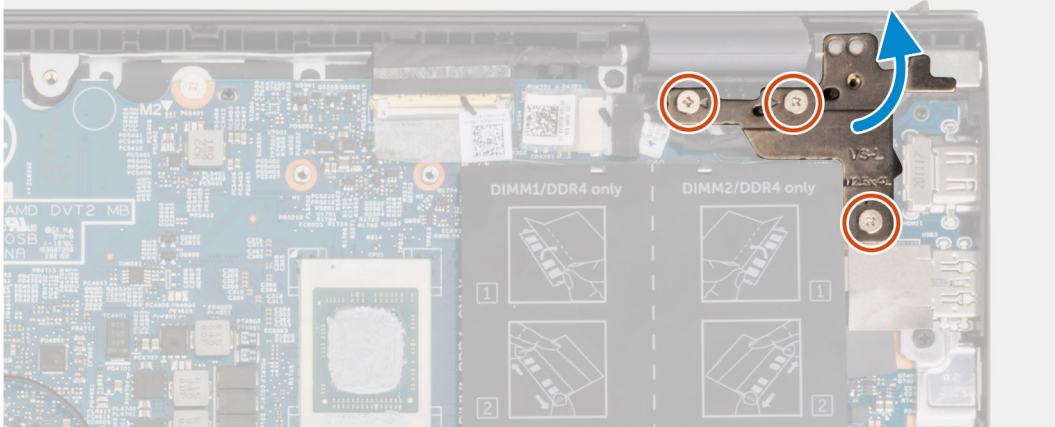

2

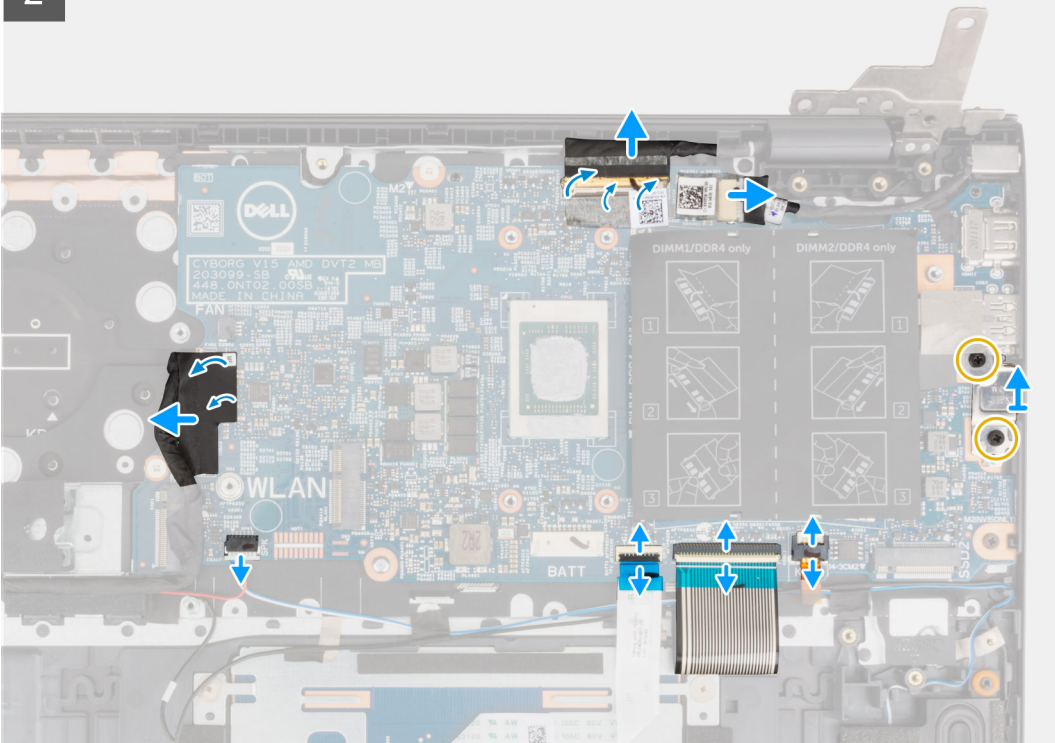

3

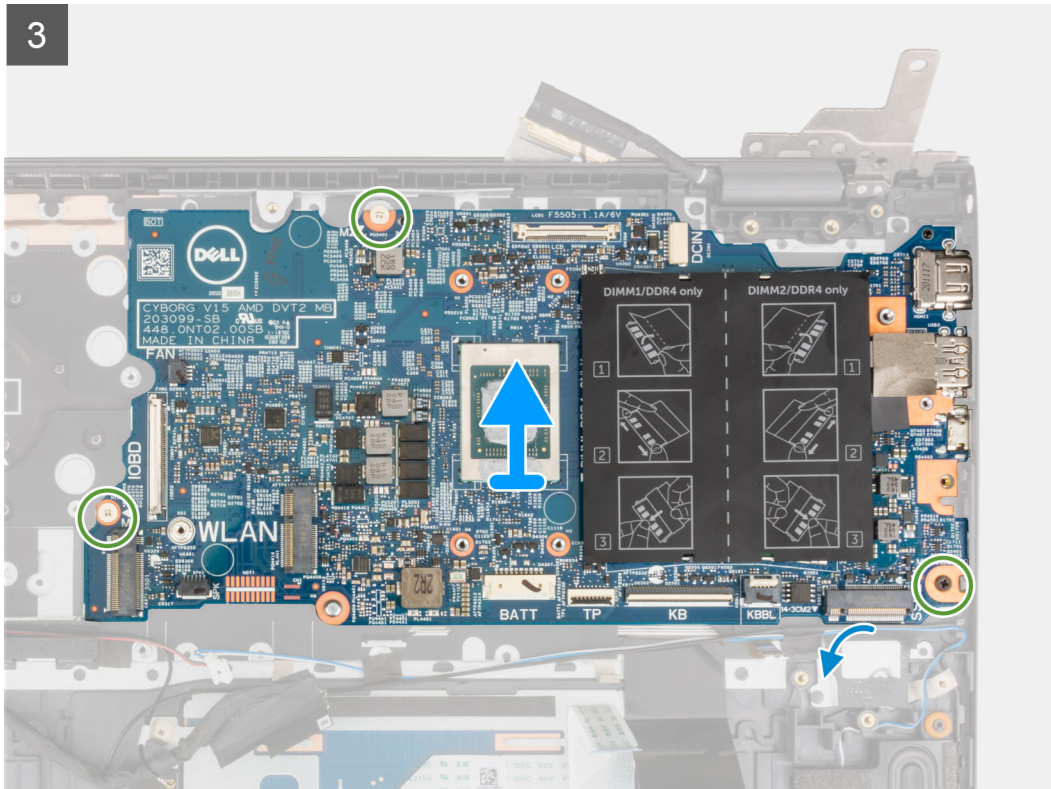

Steps

1. Remove the three (M2.5x4) screws that secure the right display hinge to the palm-rest and keyboard assembly.
2. Open the right display hinge at an angle of 90 degrees.
3. Peel the tape that secures the display cable to the system board.
4. Open the latch and disconnect the display cable from the system board.
5. Peel the tape and disconnect the power-adaptor port cable from the system board.
6. Remove the two (M2x4) screws that secure the USB Type-C bracket to the system board.
7. Open the latch, and disconnect the keyboard backlit cable from the system board.
8. Open the latch, and disconnect the keyboard cable from the system board.
9. Open the latch, and disconnect the touchpad cable from the system board.
10. Disconnect the speaker cable from the system board.
11. Peel the tape and disconnect the I/O-board cable from the system board.
12. Remove the three (M2x2) screws that secure the system board to the palm-rest and keyboard assembly.
13. Lift the system board off the palm-rest and keyboard assembly.

Installing the system board

Prerequisites

If you are replacing a component, remove the existing component before performing the installation procedure.

About this task

- NOTE:** When replacing/accessing other parts, the system board can be installed with the heat sink attached in order to simplify the procedure and preserve the thermal bond between the system board and heat-sink.
- NOTE:** Your computer's Service Tag is stored in the system board. You must enter the Service Tag in the BIOS setup program after you replace the system board.

NOTE: Replacing the system board removes any changes you have made to the BIOS using the BIOS setup program. You must make the appropriate changes again after you replace the system board.

The following image indicates the connectors on your system board.

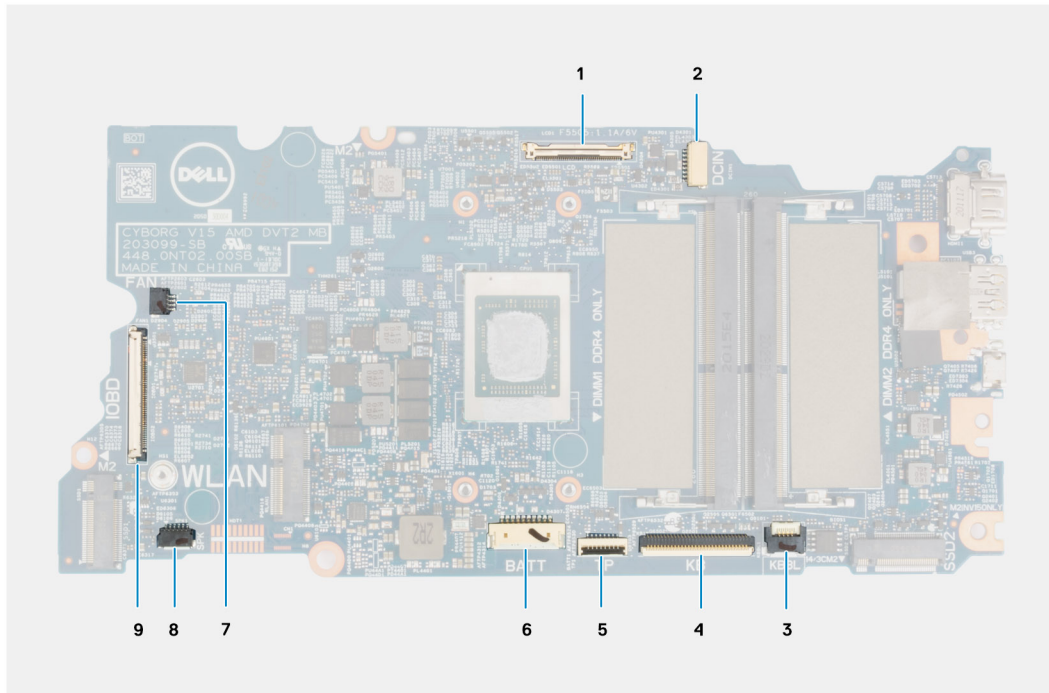

Figure 2. System board connectors

1. Display cable connector
2. Power-adaptor port cable connector
3. Keyboard backlit cable connector
4. Keyboard cable connector
5. Touchpad cable connector
6. Battery cable connector
7. Fan cable connector
8. Speaker cable connector
9. I/O-board cable connector

The following image indicates the location of the system board and provides a visual representation of the installation procedure.



3x
M2.5x4



2x
M2x4



3x
M2x2

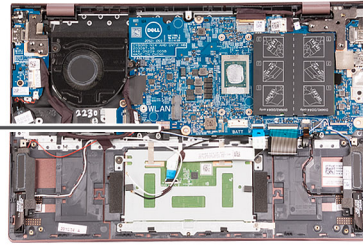

1

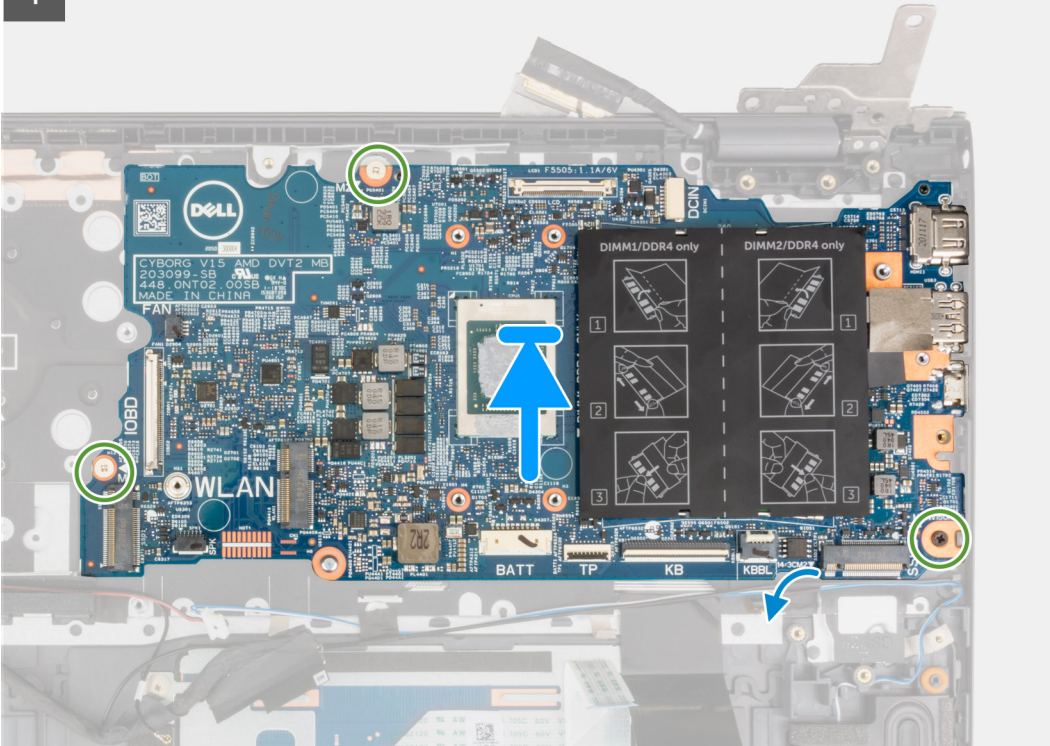

2

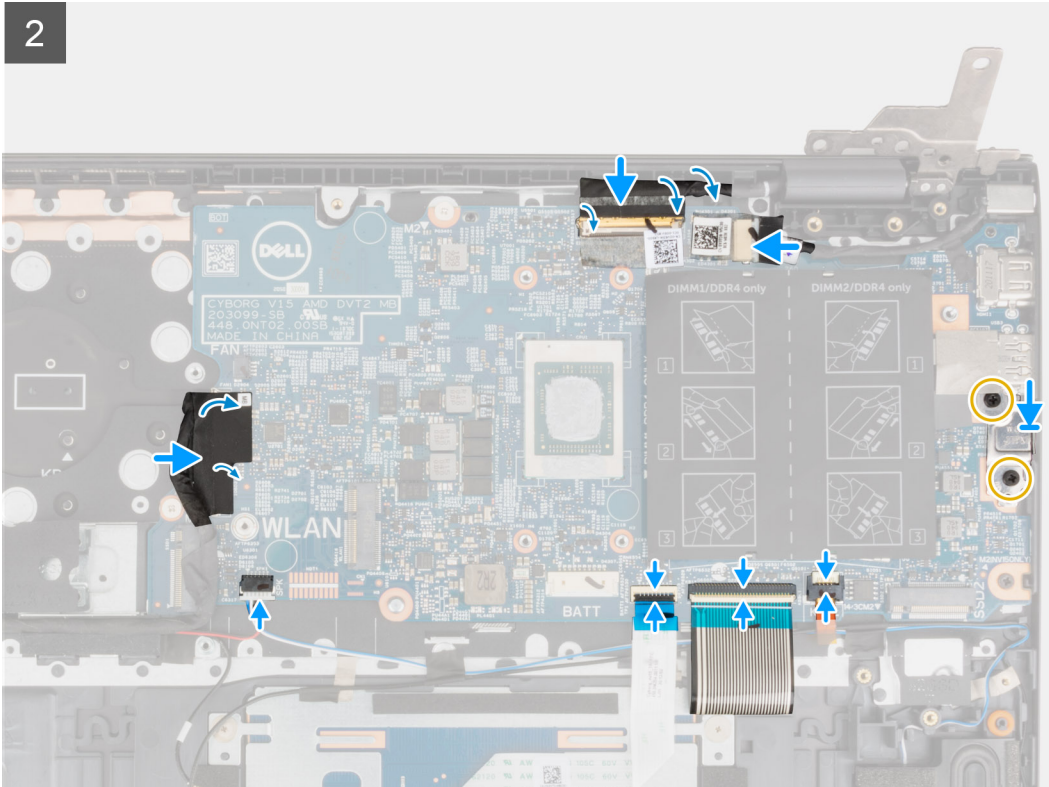

3

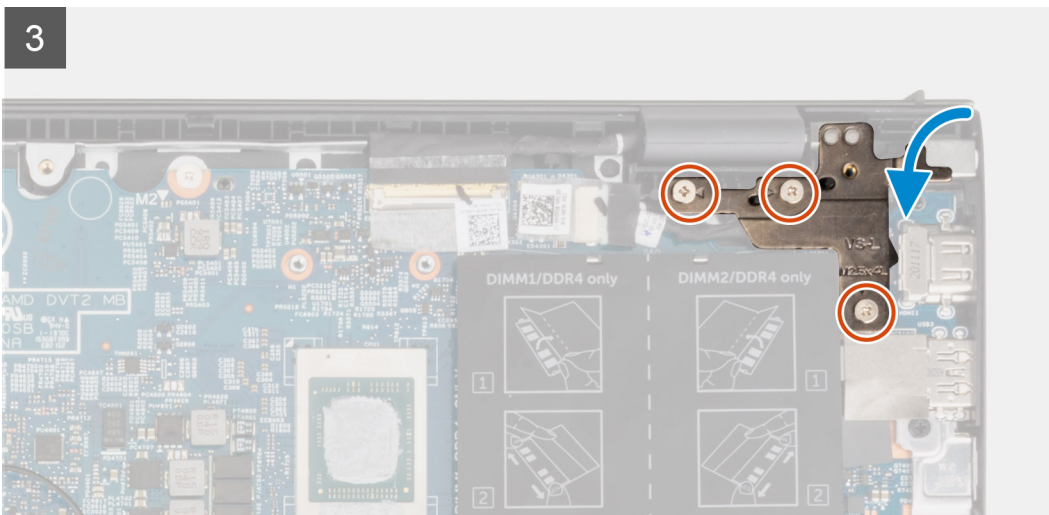

Steps

1. Align and place the system board on the palm-rest and keyboard assembly.
2. Replace the three (M2x2) screws that secure the system board to the palm-rest and keyboard assembly.
3. Connect the display cable to the system board and close the latch to secure the cable.
4. Adhere the tape that secures the display cable to the system board.
5. Connect the power-adaptor port cable to the system board.
6. Adhere the tape that secures the power-adaptor port cable to the system board.
7. Align the screw holes on the USB Type-C port bracket with the screw holes on the system board.
8. Replace the two (M2x4) screws that secure the USB Type-C port bracket to the system board.
9. Connect the keyboard backlit cable to the system board and close the latch to secure the cable.
10. Connect the keyboard cable to the system board and close the latch to secure the cable.
11. Connect the touchpad cable to the system board and close the latch to secure the cable.
12. Connect the speaker cable to the system board.

13. Connect the I/O-board cable to the system board.
14. Adhere the tape that secures the I/O-board cable to the system board.
15. Close the right display hinge.
16. Replace the three (M2.5x4) screws that secure the right display-hinge to the palm-rest and keyboard assembly.

Next steps

1. Install the [heat sink](#).
2. Install the [fan](#).
3. Install the [wireless card](#).
4. Install the [M.2 2280 solid-state drive](#) or [M.2 2230 solid-state drive](#) in M.2 slot one, whichever applicable.
5. Install the [M.2 2230 solid-state drive](#) in M.2 slot two, if applicable.
6. Install the [memory module](#).
7. Install the [3-cell battery](#) or [4-cell battery](#), whichever applicable.
8. Install the [base cover](#).
9. Follow the procedure in [After working inside your computer](#).

Power-adapter port

Removing the power-adapter port

Prerequisites

1. Follow the procedure in [Before working inside your computer](#).
2. Remove the [base cover](#).

About this task

The following images indicate the location of the power-adapter port and provide a visual representation of the removal procedure.



3x
M2.5x4

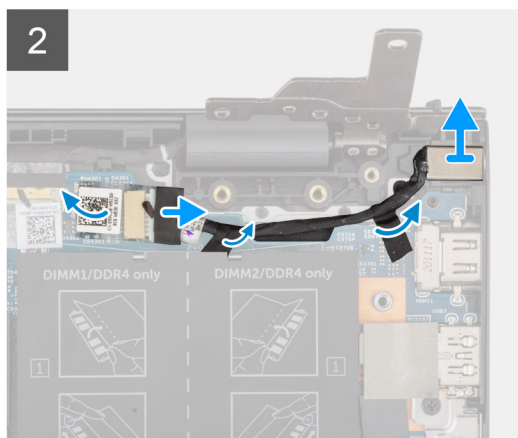
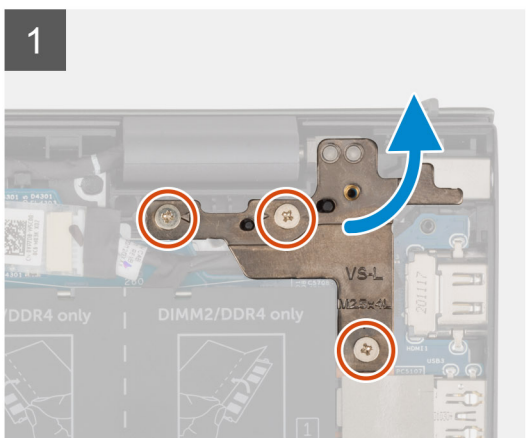
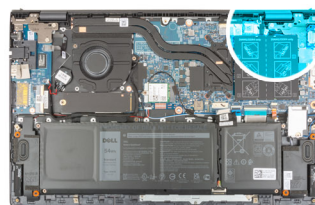

Steps

1. Remove the three (M2.5x4) screws that secure the right display-hinge to the system board.

2. Open the display hinge at an angle of 90 degrees.
3. Disconnect the power-adapter port cable from the system board.
4. Peel the tape that secures the power-adapter port cable to the system board.
5. Remove the power-adapter port cable from the routing guide on the palm-rest and keyboard assembly.
6. Lift the power-adapter port, along with its cable, off the palm-rest and keyboard assembly.

Installing the power-adapter port

Prerequisites

If you are replacing a component, remove the existing component before performing the installation procedure.

About this task

The following image indicates the location of the power-adapter port and provides a visual representation of the installation procedure.



3x
M2.5x4

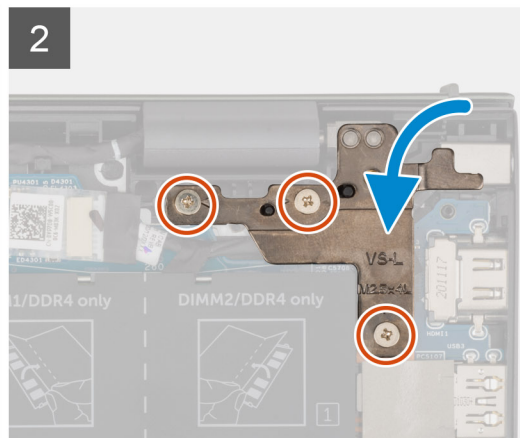
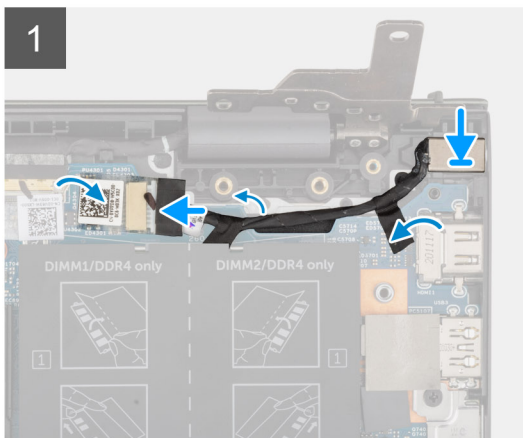
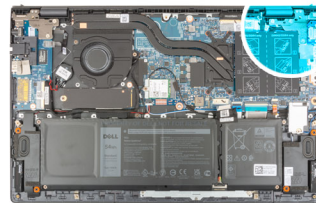

Steps

1. Place the power-adapter port, along with its cable, into the slot on the palm-rest and keyboard assembly.
2. Route the power-adapter port cable through the routing guide on the palm-rest and keyboard assembly.
3. Adhere the tape that secures the power-adapter port cable to the system board.
4. Connect the power-adapter port cable to the system board.
5. Close the right display-hinge and align the screw holes on the right display-hinge with the screw holes on the system board and palm-rest and keyboard assembly.
6. Replace the three (M2.5x4) screws that secure the right display-hinge to the system board and palm-rest and keyboard assembly.

Next steps

1. Install the [base cover](#).
2. Follow the procedure in [After working inside your computer](#).

Palm-rest and keyboard assembly

Removing the palm-rest and keyboard assembly

Prerequisites

1. Follow the procedure in [Before working inside your computer](#).
2. Remove the [base cover](#).
3. Remove the [3-cell battery](#) or [4-cell battery](#), whichever applicable.
4. Remove the [memory module](#).
5. Remove the [M.2 2280 solid-state drive](#) or [M.2 2230 solid-state drive](#) from M.2 slot one, whichever applicable.
6. Remove the [M.2 2230 solid-state drive](#) from M.2 slot two, if applicable.
7. Remove the [wireless card](#).
8. Remove the [fan](#).
9. Remove the [coin-cell battery](#).
10. Remove the [I/O board](#).
11. Remove the [system board](#).
 **NOTE:** The system board can be removed along with the heat sink.
12. Remove the [power-button with optional fingerprint reader](#).
13. Remove the [power-adaptor port](#).
14. Remove the [speakers](#).
15. Remove the [touchpad](#).
16. Remove the [display assembly](#).

About this task

After performing the steps in the pre-requisites, you are left with the palm-rest and keyboard assembly.

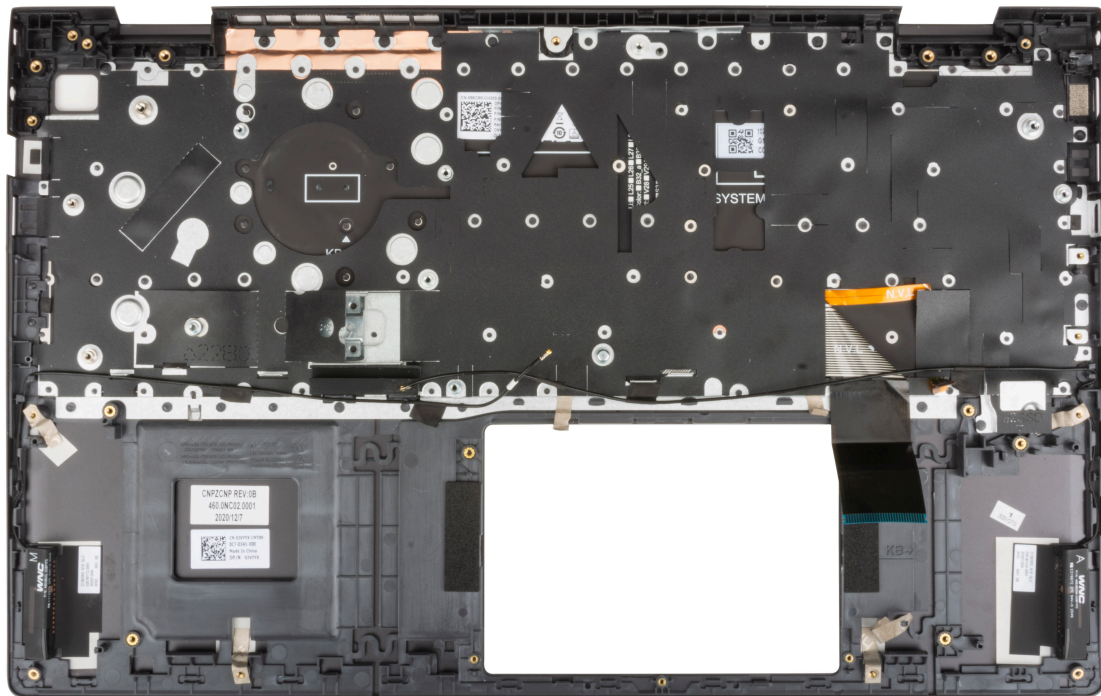

Installing the palm-rest and keyboard assembly

Prerequisites

If you are replacing a component, remove the existing component before performing the installation procedure.

About this task

Place the palm-rest and keyboard assembly on a flat surface.

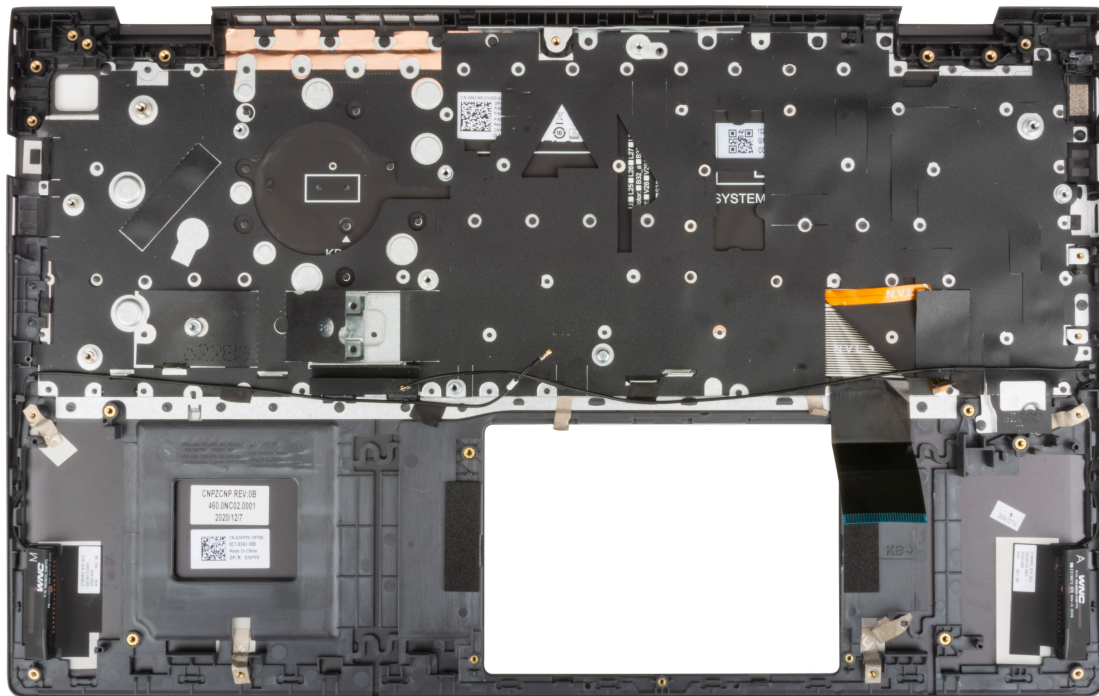

Next steps

1. Install the [display assembly](#).
2. Install the [touchpad](#).
3. Install the [speakers](#).
4. Install the [power-adaptor port](#).
5. Install the [power-button with optional fingerprint reader](#).
6. Install the [system board](#).
i **NOTE:** The system board can be installed along with the heat sink.
7. Install the [I/O board](#).
8. Install the [fan](#).
9. Install the [coin-cell battery](#).
10. Install the [wireless card](#).
11. Install the [M.2 2280 solid-state drive](#) or [M.2 2230 solid-state drive](#) in M.2 slot one, whichever applicable.
12. Install the [M.2 2230 solid-state drive](#) in M.2 slot two, if applicable.
13. Install the [memory module](#).
14. Install the [3-cell battery](#) or [4-cell battery](#), whichever applicable.
15. Install the [base cover](#).
16. Follow the procedure in [After working inside your computer](#).

Drivers and downloads

When troubleshooting, downloading or installing drivers it is recommended that you read the Dell Knowledge Based article, Drivers and Downloads FAQ [000123347](#).

System setup

CAUTION: Unless you are an expert computer user, do not change the settings in the BIOS Setup program. Certain changes can make your computer work incorrectly.

NOTE: Depending on the computer and its installed devices, the items listed in this section may or may not be displayed.

NOTE: Before you change BIOS Setup program, it is recommended that you write down the BIOS Setup program screen information for future reference.

Use the BIOS Setup program for the following purposes:

- Get information about the hardware installed in your computer, such as the amount of RAM and the size of the hard drive.
- Change the system configuration information.
- Set or change a user-selectable option, such as the user password, type of hard drive installed, and enabling or disabling base devices.

Entering BIOS setup program

About this task

Turn on (or restart) your computer and press F2 immediately.

Navigation keys

NOTE: For most of the System Setup options, changes that you make are recorded but do not take effect until you restart the system.

Table 3. Navigation keys

Keys	Navigation
Up arrow	Moves to the previous field.
Down arrow	Moves to the next field.
Enter	Selects a value in the selected field (if applicable) or follow the link in the field.
Spacebar	Expands or collapses a drop-down list, if applicable.
Tab	Moves to the next focus area. NOTE: For the standard graphics browser only.
Esc	Moves to the previous page until you view the main screen. Pressing Esc in the main screen displays a message that prompts you to save any unsaved changes and restarts the system.

Boot Sequence

Boot Sequence allows you to bypass the System Setup–defined boot device order and boot directly to a specific device (for example: optical drive or hard drive). During the Power-on Self Test (POST), when the Dell logo appears, you can:

- Access System Setup by pressing F2 key

- Bring up the one-time boot menu by pressing F12 key

The one-time boot menu displays the devices that you can boot from including the diagnostic option. The boot menu options are:

- Removable Drive (if available)
- STXXXX Drive (if available)
- **i** **NOTE:** XXX denotes the SATA drive number.
- Optical Drive (if available)
- SATA Hard Drive (if available)
- Diagnostics

The boot sequence screen also displays the option to access the System Setup screen.

One time boot menu

To enter **one time boot menu**, turn on your computer, and then press F12 immediately.

i **NOTE:** It is recommended to shutdown the computer if it is on.

The one-time boot menu displays the devices that you can boot from including the diagnostic option. The boot menu options are:

- Removable Drive (if available)
- STXXXX Drive (if available)
- **i** **NOTE:** XXX denotes the SATA drive number.
- Optical Drive (if available)
- SATA Hard Drive (if available)
- Diagnostics

The boot sequence screen also displays the option to access the System Setup screen.

System setup options

i **NOTE:** Depending on this computer and its installed devices, the items that are listed in this section may or may not be displayed.

Table 4. System setup options—Main menu

Main	
System Time	Displays the current system time of the computer in HH/MM/SS format.
System Date	Displays the ownership date of the computer in MM/DD/YYYY format.
BIOS Version	Displays the BIOS version of the computer.
Product Name	Displays the system model name of the computer.
Service Tag	Displays the service tag of the computer.
Asset Tag	Displays the asset tag of the computer.
CPU Type	Displays the processor type.
CPU Speed	Displays the maximum processor clock speed.
CPU ID	Displays the processor identification code.
CPU Cache	
L1 Cache	Displays the processor L1 Cache size.
L2 Cache	Displays the processor L2 Cache size.
L3 Cache	Displays the processor L3 Cache size.

Table 4. System setup options—Main menu (continued)

Main	
M.2 PCIe SSD	Displays the PCIe SSD information connected to the M.2 slot.
AC Adapter Type	Displays whether an AC adapter is installed.
System Memory	Displays the total computer memory installed.
Memory Speed	Displays the memory speed.
Keyboard Type	Displays the type of the keyboard (option could be backlit or non-backlit).

Table 5. System setup options—Advance menu

Advance	
Virtualization	Specify whether a Virtual Machine Monitor (VMM) can utilize the additional hardware capabilities provided by Onboard Virtualization Technology. Options are: <ul style="list-style-type: none"> • Enabled (Default) • Disabled
Integrated NIC	Allows pre-OS and early OS networking features to use any enabled NICs. Options are: <ul style="list-style-type: none"> • Enabled (Default) • Disabled
USB Emulation	Allows to enable USB emulation. Options are: <ul style="list-style-type: none"> • Enabled (Default) • Disabled
SATA Operation	Allows to select the SATA mode of the computer. Option is set to AHCI.
Adapter Warnings	Displays Adapter Warning during the POST when Battery Level is Critically low. Options are: <ul style="list-style-type: none"> • Enabled (Default) • Disabled
Function Key Behavior	Allows to reverse Function Key Primary behavior with secondary. Options are: <ul style="list-style-type: none"> • Multimedia Key(Default) • Function Key
Keyboard Illumination	Allows to Switch-on/switch-off the Keyboard backlight. Options are: <ul style="list-style-type: none"> • Disable • Dim • Bright (Default)
Keyboard Backlight with AC	Allows to permanently turn off/turn-on the Keyboard backlight without the AC adapter. Options are from 5 Seconds to 15 Minutes. Default option is set to 1 Minute.
Keyboard Backlight with Battery	Allows to permanently turn off/turn-on the Keyboard backlight without the AC adapter. Options are from 5 Seconds to 15 Minutes. Default option is set to 1 Minute.
Battery Health	Shows Battery Health and Charge Status.
External USB Ports	Allows to turn off the External USB ports in the Operating System.

Table 5. System setup options—Advance menu (continued)

Advance	
Microphone	Options are: <ul style="list-style-type: none"> ● Enabled (Default) ● Disabled Allows to Switch-on/switch-off the microphone.
Camera	Options are: <ul style="list-style-type: none"> ● Enabled (Default) ● Disabled Allows to Switch-on/switch-off the Camera.
Internal Bluetooth	Options are: <ul style="list-style-type: none"> ● Enabled (Default) ● Disabled Allows to Switch-on/switch-off the Bluetooth.
Internal WLAN	Options are: <ul style="list-style-type: none"> ● Enabled (Default) ● Disabled Allows to Switch-on/switch-off the Wireless Card.
Media Card Reader	Options are: <ul style="list-style-type: none"> ● Enabled (Default) ● Disabled Allows to enable/disable the Media Card reader.
Fingerprint Reader	Options are: <ul style="list-style-type: none"> ● Enabled (Default) ● Disabled Allows to enable/disable the Fingerprint reader.
Boot Disable	Options are: <ul style="list-style-type: none"> ● Enabled ● Disabled (Default) Disable the automatic Boot.
Battery Charge Configuration	Options are: <ul style="list-style-type: none"> ● Adaptive (Default) ● Standard ● ExpressCharge™ ● Primarily AC Use ● Custom Displays the Battery Charge configuration.
Advanced Battery Charge Configuration	Options are: <ul style="list-style-type: none"> ● Enabled ● Disabled (Default) Displays the Advanced Charge configuration.
Power on LID open	Controls the Power function on LID open action.

Table 5. System setup options—Advance menu (continued)

Advance	
	Options are: <ul style="list-style-type: none"> • Enabled (Default) • Disabled
Maintenance	Maintenance information.
Data Wipe on next boot	Performs Data wipe on next boot. Options are: <ul style="list-style-type: none"> • Disabled (Default) • Enabled
BIOS Recovery from Hard Drive	Performs reset of firmware to the factory image saved on the secondary storage. Options are: <ul style="list-style-type: none"> • Enabled (Default) • Disabled
BIOS Auto Recovery	Performs auto firmware reset when corrupted BIOS is detected. Options are: <ul style="list-style-type: none"> • Disabled (Default) • Enabled
SupportAssist System Resolution	Onboard Diagnostics
Auto OS Recovery Threshold	Performs SupportAssist OS recovery after the set value failed boot attempts. Options are: <ul style="list-style-type: none"> • Off • 1 • 2 (Default) • 3
Support Assist OS Recovery	Enabled Support Assist OS recovery on failed boot attempts. Options are: <ul style="list-style-type: none"> • Disabled • Enabled (Default)

Table 6. System setup options—Security menu

Security	
Admin Password	Displays the Status of the administrator password.
System Password	Displays the Status of the computer password.
Asset Tag	Displays and allows to edit the Asset Tag of the computer.
Admin Password	Set, change, or delete the administrator password.
System Password	Set, change, or delete the computer password.
Password Change	Set the status to allow User to set the System Password. The options are: <ul style="list-style-type: none"> • Permitted (Default) • Disabled
Password Bypass	Set the status to allow User to bypass System Password. The options are: <ul style="list-style-type: none"> • Disable (Default) • Reboot Bypass
Absolute®	Set the Status of the Absolute Module on the computer. The options are: <ul style="list-style-type: none"> • Activate • Deactivate
Absolute® Status	Displays the Status of the Absolute Module on the computer. The options are: <ul style="list-style-type: none"> • Disabled • Enabled (Default) • Permanently Disabled
Firmware TPM	Enable or disable TPM 2.0 security options.

Table 6. System setup options—Security menu (continued)

Security	
TPM Security	TPM 2.0 Security options.
TPM On	Turn On/Off TPM security option. The options are: <ul style="list-style-type: none"> • On • Off
PPI Bypass for Enable Commands	Controls the TPM Physical Presence Interface(PPI). When enabled, this setting allows the OS to skip BIOS PPI user prompts when issuing TPM PPI enable and activate commands. The Options are: <ul style="list-style-type: none"> • Enabled • Disabled (Default)
PPI Bypass for Disable Commands	Controls the TPM Physical Presence Interface(PPI). When enabled, this setting will allow the OS to skip BIOS PPI user prompts when issuing TPM PPI disable and deactivate commands(#2, 4, 7, 9, & 11). The options are: <ul style="list-style-type: none"> • Disabled (Default) • Enabled
Attestation Enable	Provides for the user to control whether the TPM Endorsement Hierarchy is available to the OS. The options are: <ul style="list-style-type: none"> • Disabled • Enabled (Default)
Key Storage Enable	Provides for the user to control whether TPM Storage Hierarchy is available to the operating system. The options are: <ul style="list-style-type: none"> • Disabled • Enabled (Default)
SHA-256	Provides the BIOS and the TPM to use the SHA-256 hash algorithm to extend measurements into the TPM PCRs during BIOS boot. The options are: <ul style="list-style-type: none"> • Disabled • Enabled (Default)
Clear	Clears the TPM owner information, and returns the TPM to the default state. The options are: <ul style="list-style-type: none"> • Disabled (Default) • Enabled
PPI Bypass for Clear Commands	Controls the TPM Physical Presence Interface(PPI). When enabled, this setting will allow the OS to skip BIOS PPI user prompts when issuing the Clear command. The options are: <ul style="list-style-type: none"> • Disabled (Default) • Enabled
TPM Status	Displays the Status of the TPM Module on the computer. The options are: <ul style="list-style-type: none"> • Disabled • Enabled (Default)
UEFI Firmware Capsule Updates	Enable or disable BIOS updates through UEFI capsule update packages. By default, the option is enabled.
Secure Boot	Ensures the system boots using only to validated boot software.

Table 7. System setup options—Boot menu

Boot	
File Browser Add Boot Option	
Windows Boot Manager:	Displays the Default UEFI Boot Path of the computer Operating System and allows to navigate and select the EFI file.  NOTE: Option may differ with the Linux Operating System.

Table 7. System setup options—Boot menu (continued)

Boot	
File Browser Del Boot Option	
Windows Boot Manager:	Displays the Dell Boot Path of the Default Boot Option..  NOTE: Option may differ with the Linux Operating System.
UEFI BOOT	
HDD1- Windows Boot Manager	Displays the Device ID of the Secondary Storage of the computer.
UEFI Onboard LAN IPv4	Displays the Device ID of the UEFI enabled Onboard IPv4 LAN controller.
UEFI Onboard LAN IPv6	Displays the Device ID of the UEFI enabled Onboard IPv6 LAN controller.

Table 8. System setup options—Exit menu

Exit	
Exit Saving Changes	Exit the System Setup saving the changes made to the Setup Options.
Save Change Without Exit	Save the Changes made to the System Setup and continue the Setup.
Exit Discarding Changes	Exit the System Setup without saving the changes made to the Setup Options.
Load Optional Defaults	Load the Factory Defaults in the System Setup Options.
Discard Changes	Discard any changes made to the System Setup and continue the Setup.

System and setup password

Table 9. System and setup password

Password type	Description
System password	Password that you must enter to log in to your system.
Setup password	Password that you must enter to access and make changes to the BIOS settings of your computer.

You can create a system password and a setup password to secure your computer.

 **CAUTION:** The password features provide a basic level of security for the data on your computer.

 **CAUTION:** Anyone can access the data that is stored on your computer if it is not locked and left unattended.

 **NOTE:** System and setup password feature is disabled.

Assigning a system setup password

Prerequisites

You can assign a new **System or Admin Password** only when the status is in **Not Set**.

About this task

To enter the system setup, press F12 immediately after a power-on or reboot.

Steps

1. In the **System BIOS** or **System Setup** screen, select **Security** and press Enter.
The **Security** screen is displayed.
2. Select **System/Admin Password** and create a password in the **Enter the new password** field.

Use the following guidelines to assign the system password:

- A password can have up to 32 characters.
 - At least one special character: ! " # \$ % & ' () * + , - . / : ; < = > ? @ [\] ^ _ ` { | }
 - Numbers 0 through 9.
 - Upper case letters from A to Z.
 - Lower case letters from a to z.
3. Type the system password that you entered earlier in the **Confirm new password** field and click **OK**.
 4. Press Esc and save the changes as prompted by the pop-up message.
 5. Press Y to save the changes.
The computer restarts.

Deleting or changing an existing system setup password

Prerequisites

Ensure that the **Password Status** is Unlocked (in the System Setup) before attempting to delete or change the existing System and/or Setup password. You cannot delete or change an existing System or Setup password, if the **Password Status** is Locked.

About this task

To enter the System Setup, press F12 immediately after a power-on or reboot.

Steps

1. In the **System BIOS** or **System Setup** screen, select **System Security** and press Enter.
The **System Security** screen is displayed.
2. In the **System Security** screen, verify that **Password Status** is **Unlocked**.
3. Select **System Password**, update, or delete the existing system password, and press Enter or Tab.
4. Select **Setup Password**, update, or delete the existing setup password, and press Enter or Tab.
 **NOTE:** If you change the System and/or Setup password, reenter the new password when prompted. If you delete the System and/or Setup password, confirm the deletion when prompted.
5. Press Esc and a message prompts you to save the changes.
6. Press Y to save the changes and exit from System Setup.
The computer restarts.

Clearing CMOS settings

About this task

 **CAUTION:** Clearing CMOS settings will reset the BIOS settings on your computer.

Steps

1. Remove the [base cover](#).
2. Disconnect the battery cable from the system board.
3. Remove the [coin-cell battery](#).
4. Wait for one minute.
5. Replace the [coin-cell battery](#).
6. Connect the battery cable to the system board.
7. Replace the [base cover](#).

Clearing BIOS (System Setup) and System passwords

About this task

To clear the system or BIOS passwords, contact Dell technical support as described at www.dell.com/contactdell.

 **NOTE:** For information on how to reset Windows or application passwords, refer to the documentation accompanying Windows or your application.

Updating the BIOS

Updating the BIOS in Windows

Steps

1. Go to www.dell.com/support.
2. Click **Product support**. In the **Search support** box, enter the Service Tag of your computer, and then click **Search**.
 **NOTE:** If you do not have the Service Tag, use the SupportAssist feature to automatically identify your computer. You can also use the product ID or manually browse for your computer model.
3. Click **Drivers & Downloads**. Expand **Find drivers**.
4. Select the operating system installed on your computer.
5. In the **Category** drop-down list, select **BIOS**.
6. Select the latest version of BIOS, and click **Download** to download the BIOS file for your computer.
7. After the download is complete, browse the folder where you saved the BIOS update file.
8. Double-click the BIOS update file icon and follow the on-screen instructions.
For more information, see knowledge base article [000124211](http://www.dell.com/support) at www.dell.com/support.

Updating the BIOS using the USB drive in Windows

Steps

1. Follow the procedure from step 1 to step 6 in [Updating the BIOS in Windows](#) to download the latest BIOS setup program file.
2. Create a bootable USB drive. For more information, see the knowledge base article [000145519](http://www.dell.com/support) at www.dell.com/support.
3. Copy the BIOS setup program file to the bootable USB drive.
4. Connect the bootable USB drive to the computer that needs the BIOS update.
5. Restart the computer and press **F12**.
6. Select the USB drive from the **One Time Boot Menu**.
7. Type the BIOS setup program filename and press **Enter**.
The **BIOS Update Utility** appears.
8. Follow the on-screen instructions to complete the BIOS update.

Updating the BIOS from the F12 One-Time boot menu

Update your computer BIOS using the BIOS update.exe file that is copied to a FAT32 USB drive and booting from the F12 One-Time boot menu.

About this task

BIOS Update

You can run the BIOS update file from Windows using a bootable USB drive or you can also update the BIOS from the F12 One-Time boot menu on the computer.

Most of the Dell computers built after 2012 have this capability, and you can confirm by booting your computer to the F12 One-Time Boot Menu to see if BIOS FLASH UPDATE is listed as a boot option for your computer. If the option is listed, then the BIOS supports this BIOS update option.

 **NOTE:** Only computers with BIOS Flash Update option in the F12 One-Time boot menu can use this function.

Updating from the One-Time boot menu

To update your BIOS from the F12 One-Time boot menu, you need the following:

- USB drive formatted to the FAT32 file system (key does not have to be bootable)
- BIOS executable file that you downloaded from the Dell Support website and copied to the root of the USB drive
- AC power adapter that is connected to the computer
- Functional computer battery to flash the BIOS

Perform the following steps to perform the BIOS update flash process from the F12 menu:

 **CAUTION: Do not turn off the computer during the BIOS update process. The computer may not boot if you turn off your computer.**

Steps

1. From a turn off state, insert the USB drive where you copied the flash into a USB port of the computer.
2. Turn on the computer and press F12 to access the One-Time Boot Menu, select BIOS Update using the mouse or arrow keys then press Enter.
The flash BIOS menu is displayed.
3. Click **Flash from file**.
4. Select external USB device.
5. Select the file and double-click the flash target file, and then click **Submit**.
6. Click **Update BIOS**. The computer restarts to flash the BIOS.
7. The computer will restart after the BIOS update is completed.

Troubleshooting

Handling swollen Lithium-ion batteries

Like most laptops, Dell laptops use lithium-ion batteries. One type of lithium-ion battery is the lithium-ion polymer battery. Lithium-ion polymer batteries have increased in popularity in recent years and have become standard in the electronics industry due to customer preferences for a slim form factor (especially with newer ultra-thin laptops) and long battery life. Inherent to lithium-ion polymer battery technology is the potential for swelling of the battery cells.

Swollen battery may impact the performance of the laptop. To prevent possible further damage to the device enclosure or internal components leading to malfunction, discontinue the use of the laptop and discharge it by disconnecting the AC adapter and letting the battery drain.

Swollen batteries should not be used and should be replaced and disposed of properly. We recommend contacting Dell product support for options to replace a swollen battery under the terms of the applicable warranty or service contract, including options for replacement by a Dell authorized service technician.

The guidelines for handling and replacing Lithium-ion batteries are as follows:

- Exercise caution when handling Lithium-ion batteries.
- Discharge the battery before removing it from the system. To discharge the battery, unplug the AC adapter from the system and operate the system only on battery power. When the system will no longer power on when the power button is pressed, the battery is fully discharged.
- Do not crush, drop, mutilate, or penetrate the battery with foreign objects.
- Do not expose the battery to high temperatures, or disassemble battery packs and cells.
- Do not apply pressure to the surface of the battery.
- Do not bend the battery.
- Do not use tools of any type to pry on or against the battery.
- If a battery gets stuck in a device as a result of swelling, do not try to free it as puncturing, bending, or crushing a battery can be dangerous.
- Do not attempt to reassemble a damaged or swollen battery into a laptop.
- Swollen batteries that are covered under warranty should be returned to Dell in an approved shipping container (provided by Dell)—this is to comply with transportation regulations. Swollen batteries that are not covered under warranty should be disposed of at an approved recycling center. Contact Dell product support at <https://www.dell.com/support> for assistance and further instructions.
- Using a non-Dell or incompatible battery may increase the risk of fire or explosion. Replace the battery only with a compatible battery purchased from Dell that is designed to work with your Dell computer. Do not use a battery from other computers with your computer. Always purchase genuine batteries from <https://www.dell.com> or otherwise directly from Dell.

Lithium-ion batteries can swell for various reasons such as age, number of charge cycles, or exposure to high heat. For more information on how to improve the performance and lifespan of the laptop battery and to minimize the possibility of occurrence of the issue, see [Dell Laptop Battery - Frequently Asked Questions](#).

Locate the Service Tag or Express Service Code of your Dell computer

Your Dell computer is uniquely identified by a Service Tag or Express Service Code. To view relevant support resources for your Dell computer, we recommend entering the Service Tag or Express Service Code at www.dell.com/support.

For more information on how to find the Service Tag for your computer, see [Locate the Service Tag for your Dell Laptop](#).

Backup media and recovery options

It is recommended to create a recovery drive to troubleshoot and fix problems that may occur with Windows. Dell proposes multiple options for recovering Windows operating system on your Dell PC. For more information, see [Dell Windows Backup Media and Recovery Options](#).

System diagnostic lights

Battery-status light

Indicates the power and battery-charge status.

Solid white — Power adapter is connected and the battery has more than 5 percent charge.

Amber — Computer is running on battery and the battery has less than 5 percent charge.

Off

- Power adapter is connected and the battery is fully charged.
- Computer is running on battery and the battery has more than 5 percent charge.
- Computer is in sleep state, hibernation, or turned off.

The power and battery-status light blinks amber along with beep codes indicating failures.

For example, the power and battery-status light blinks amber two times followed by a pause, and then blinks white three times followed by a pause. This 2,3 pattern continues until the computer is turned off indicating no memory or RAM is detected.

The following table shows different power and battery-status light patterns and associated problems.

Table 10. Diagnostic-light codes

Diagnostic light codes (Amber, white)	Problem description
2,1	Processor failure
2,2	System board: BIOS or ROM (Read-Only Memory) failure
2,3	No memory or RAM (Random-Access Memory) detected
2,4	Memory or RAM (Random-Access Memory) failure
2,5	Invalid memory installed
2,6	System-board or chipset error
2,7	Display failure - SBIOS message
2,8	Display failure - EC detection of power rail failure
3,1	CMOS battery failure
3,2	PCI, video card/chip failure

SupportAssist diagnostics

About this task

The SupportAssist diagnostics (previously known as ePSA diagnostics) performs a complete check of your hardware. The SupportAssist diagnostics is embedded in the BIOS and is launched by it internally. The SupportAssist diagnostics provides a set of options for particular devices or device groups. It allows you to:

- Run tests automatically or in an interactive mode.
- Repeat tests
- Display or save test results

- Run thorough tests to introduce additional test options and provide extra information about the failed device(s)
- View status messages that indicate if the tests are completed successfully
- View error messages that indicate if problems were encountered during the test

NOTE: Some tests are meant for specific devices and require user interaction. Ensure that you are present in front of the computer when the diagnostic tests are performed.

For more information, see [SupportAssist Pre-Boot System Performance Check](#).

Built-in self-test (BIST)

M-BIST

M-BIST (Built In Self-Test) is the system board's built-in self-test diagnostics tool that improves the diagnostics accuracy of system board embedded controller (EC) failures.

NOTE: M-BIST can be manually initiated before POST (Power On Self Test).

How to run M-BIST

NOTE: M-BIST must be initiated on the system from a power-off state either connected to AC power or with battery only.

1. Press and hold both the **M** key on the keyboard and the **power button** to initiate M-BIST.
2. With both the **M** key and the **power button** held down, the battery indicator LED may exhibit two states:
 - a. OFF: No fault detected with the system board
 - b. AMBER: Indicates a problem with the system board
3. If there is a failure with the system board, the battery status LED will flash one of the following error codes for 30 seconds:

Table 11. LED error codes

Blinking Pattern		Possible Problem
Amber	White	
2	1	CPU Failure
2	8	LCD Power Rail Failure
1	1	TPM Detection Failure
2	4	Unrecoverable SPI Failure

4. If there is no failure with the system board, the LCD will cycle through the solid color screens described in the LCD-BIST section for 30 seconds and then power off.

LCD Built-in Self Test (BIST)

Dell laptops have a built-in diagnostic tool that helps you determine if the screen abnormality you are experiencing is an inherent problem with the LCD (screen) of the Dell laptop or with the video card (GPU) and PC settings.

When you notice screen abnormalities like flickering, distortion, clarity issues, fuzzy or blurry image, horizontal or vertical lines, color fade etc., it is always a good practice to isolate the LCD (screen) by running the Built-In Self Test (BIST).

How to invoke LCD BIST Test

1. Power off the Dell laptop.
2. Disconnect any peripherals that are connected to the laptop. Connect only the AC adapter (charger) to the laptop.
3. Ensure that the LCD (screen) is clean (no dust particles on the surface of the screen).
4. Press and hold **D** key and **Power on** the laptop to enter LCD built-in self test (BIST) mode. Continue to hold the D key, until the system boots up.

5. The screen will display solid colors and change colors on the entire screen to white, black, red, green, and blue twice.
6. Then it will display the colors white, black and red.
7. Carefully inspect the screen for abnormalities (any lines, fuzzy color or distortion on the screen).
8. At the end of the last solid color (red), the system will shut down.

 **NOTE:** Dell SupportAssist Pre-boot diagnostics upon launch, initiates an LCD BIST first, expecting a user intervention confirm functionality of the LCD.

Recovering the operating system

When your computer is unable to boot to the operating system even after repeated attempts, it automatically starts Dell SupportAssist OS Recovery.

Dell SupportAssist OS Recovery is a standalone tool that is preinstalled in all Dell computers installed with Windows operating system. It consists of tools to diagnose and troubleshoot issues that may occur before your computer boots to the operating system. It enables you to diagnose hardware issues, repair your computer, back up your files, or restore your computer to its factory state.

You can also download it from the Dell Support website to troubleshoot and fix your computer when it fails to boot into their primary operating system due to software or hardware failures.

For more information about the Dell SupportAssist OS Recovery, see *Dell SupportAssist OS Recovery User's Guide* at www.dell.com/serviceabilitytools. Click **SupportAssist** and then, click **SupportAssist OS Recovery**.

WiFi power cycle

About this task

If your computer is unable to access the internet due to WiFi connectivity issues a WiFi power cycle procedure may be performed. The following procedure provides the instructions on how to conduct a WiFi power cycle:

 **NOTE:** Some ISPs (Internet Service Providers) provide a modem/router combo device.

Steps

1. Turn off your computer.
2. Turn off the modem.
3. Turn off the wireless router.
4. Wait for 30 seconds.
5. Turn on the wireless router.
6. Turn on the modem.
7. Turn on your computer.

Drain residual flea power (perform hard reset)

About this task

Flea power is the residual static electricity that remains in the computer even after it has been powered off and the battery is removed.

For your safety, and to protect the sensitive electronic components in your computer, you are requested to drain residual flea power before removing or replacing any components in your computer.

Draining residual flea power, also known as a performing a "hard reset", is also a common troubleshooting step if your computer does not power on or boot into the operating system.

To drain residual flea power (perform a hard reset)

Steps

1. Turn off your computer.

2. Disconnect the power adapter from your computer.
3. Remove the base cover.
4. Remove the battery.
5. Press and hold the power button for 20 seconds to drain the flea power.
6. Install the battery.
7. Install the base cover.
8. Connect the power adapter to your computer.
9. Turn on your computer.

 **NOTE:** For more information about performing a hard reset, see the knowledge base article [000130881](https://www.dell.com/support) at www.dell.com/support.

Real Time Clock—RTC reset

The Real Time Clock (RTC) reset function allows you or the service technician to recover the recently launched model Dell Latitude and Precision systems from **No POST/No Boot/No Power** situations. You can initiate the RTC reset on the system from a power-off state only if it is connected to AC power. Press and hold the power button for 25 seconds. The system RTC reset occurs after you release the power button.

 **NOTE:** If AC power is disconnected from the system during the process or the power button is held longer than 40 seconds, the RTC reset process gets aborted.

The RTC reset will reset the BIOS to Defaults, un-provision Intel vPro and reset the system date and time. The following items are unaffected by the RTC reset:

- Service Tag
- Asset Tag
- Ownership Tag
- Admin Password
- System Password
- HDD Password
- Key Databases
- System Logs

 **NOTE:** The IT administrator's vPro account and password on the system will be un-provisioned. The system needs to go through the setup and configuration process again to reconnect it to the vPro server.

The below items may or may not reset based on your custom BIOS setting selections:



- Boot List
- Enable Legacy Option ROMs
- Secure Boot Enable
- Allow BIOS Downgrade

Getting help and contacting Dell

Self-help resources

You can get information and help on Dell products and services using these self-help resources:

Table 12. Self-help resources

Self-help resources	Resource location
Information about Dell products and services	www.dell.com
My Dell app	
Tips	
Contact Support	In Windows search, type <code>Contact Support</code> , and press Enter.
Online help for operating system	www.dell.com/support/windows
Access top solutions, diagnostics, drivers and downloads, and learn more about your computer through videos, manuals and documents.	Your Dell computer is uniquely identified by a Service Tag or Express Service Code. To view relevant support resources for your Dell computer, enter the Service Tag or Express Service Code at www.dell.com/support . For more information on how to find the Service Tag for your computer, see Locate the Service Tag on your computer .
Dell knowledge base articles for a variety of computer concerns	<ol style="list-style-type: none"> 1. Go to www.dell.com/support. 2. On the menu bar at the top of the Support page, select Support > Knowledge Base. 3. In the Search field on the Knowledge Base page, type the keyword, topic, or model number, and then click or tap the search icon to view the related articles.

Contacting Dell

To contact Dell for sales, technical support, or customer service issues, see www.dell.com/contactdell.

 **NOTE:** Availability varies by country/region and product, and some services may not be available in your country/region.

 **NOTE:** If you do not have an active Internet connection, you can find contact information about your purchase invoice, packing slip, bill, or Dell product catalog.