

Inspiron 5508

Service Manual



Notes, cautions, and warnings

 **NOTE:** A NOTE indicates important information that helps you make better use of your product.

 **CAUTION:** A CAUTION indicates either potential damage to hardware or loss of data and tells you how to avoid the problem.

 **WARNING:** A WARNING indicates a potential for property damage, personal injury, or death.

Chapter 1: Working inside your computer	6
Before working inside your computer.....	6
Safety instructions.....	6
Electrostatic discharge—ESD protection.....	7
ESD field service kit	7
Transporting sensitive components.....	8
After working inside your computer.....	9
Chapter 2: Removing and installing components	10
Recommended tools.....	10
Screw list.....	10
Major components of Inspiron 15 5508.....	11
Base cover.....	13
Removing the base cover.....	13
Installing the base cover.....	15
Battery.....	17
Removing the 3-cell battery.....	17
Installing the 3-cell battery.....	18
Removing the 4-cell battery.....	19
Installing the 4-cell battery.....	20
Memory modules.....	21
Removing the memory modules.....	21
Installing the memory modules.....	22
Solid-state drive—M.2 slot one.....	24
Removing the M.2 2230 solid-state drive from M.2 slot one.....	24
Installing the M.2 2230 solid-state drive in M.2 slot one.....	24
Removing the M.2 2280 solid-state drive from M.2 slot one.....	25
Installing the M.2 2280 solid-state drive in M.2 slot one.....	26
Installing the solid-state drive mounting bracket on M.2 slot one.....	27
Solid-state drive—M.2 slot two.....	28
Removing the M.2 2230 solid-state drive from M.2 slot two.....	28
Installing the M.2 2230 solid-state drive in M.2 slot two.....	29
Removing the M.2 2280 solid-state drive from M.2 slot two.....	30
Installing the M.2 2280 solid-state drive in M.2 slot two.....	31
Installing the solid-state drive mounting bracket on M.2 slot two.....	32
Wireless card.....	33
Removing the wireless card.....	33
Installing the wireless card.....	34
Fan.....	36
Removing the fan.....	36
Installing the fan.....	37
Coin-cell battery.....	38
Removing the coin-cell battery.....	38
Installing the coin-cell battery.....	38

Heat sink.....	39
Removing the heat sink.....	39
Installing the heat sink.....	40
Display assembly.....	41
Removing the display assembly.....	41
Installing the display assembly.....	43
Power-adaptor port.....	44
Removing the power-adaptor port.....	44
Installing the power-adaptor port.....	45
Speakers.....	46
Removing the speakers.....	46
Installing the speakers.....	47
Power button with optional fingerprint reader.....	49
Removing the power button with optional fingerprint reader.....	49
Installing the power button with optional fingerprint reader.....	49
Touchpad.....	50
Removing the touchpad.....	50
Installing the touchpad.....	51
I/O board.....	53
Removing the I/O board.....	53
Installing the I/O board.....	53
System board.....	54
Removing the system board.....	54
Installing the system board.....	56
Palm-rest and keyboard assembly.....	59
Removing the palm-rest and keyboard assembly.....	59
Installing the palm-rest and keyboard assembly.....	60
Chapter 3: Drivers and downloads.....	62
Chapter 4: System setup.....	63
Entering BIOS setup program.....	63
Navigation keys.....	63
One time boot menu.....	64
System setup options.....	64
Updating the BIOS in Windows	72
Updating BIOS on systems with BitLocker enabled.....	72
Updating your system BIOS using a USB flash drive.....	72
Updating the Dell BIOS in Linux and Ubuntu environments.....	73
Flashing the BIOS from the F12 One-Time boot menu.....	73
System and setup password.....	76
Assigning a system setup password.....	76
Deleting or changing an existing system setup password.....	77
Clearing CMOS settings.....	77
Clearing BIOS (System Setup) and System passwords.....	77
Chapter 5: Troubleshooting.....	79
SupportAssist diagnostics.....	79
Built-in self-test (BIST).....	79

Recovering the operating system.....	80
System diagnostic lights.....	80
Enabling Intel Optane memory.....	81
Disabling Intel Optane memory.....	81
Drain residual flea power (perform hard reset).....	82
WiFi power cycle.....	82

Chapter 6: Getting help and contacting Dell..... 83

Working inside your computer

Before working inside your computer

About this task

 **NOTE:** The images in this document may differ from your computer depending on the configuration you ordered.

Steps

1. Save and close all open files and exit all open applications.

2. Shut down your computer. Click **Start** >  **Power** > **Shut down**.

 **NOTE:** If you are using a different operating system, see the documentation of your operating system for shut-down instructions.

3. Disconnect your computer and all attached devices from their electrical outlets.

4. Disconnect all attached network devices and peripherals, such as keyboard, mouse, and monitor from your computer.

 **CAUTION:** To disconnect a network cable, first unplug the cable from your computer and then unplug the cable from the network device.

5. Remove any media card and optical disc from your computer, if applicable.

Safety instructions

Use the following safety guidelines to protect your computer from potential damage and to ensure your personal safety. Unless otherwise noted, each procedure included in this document assumes that you have read the safety information that shipped with your computer.

 **WARNING:** Before working inside your computer, read the safety information that is shipped with your computer. For more safety best practices, see the Regulatory Compliance home page at www.dell.com/regulatory_compliance.

 **WARNING:** Disconnect your computer from all power sources before opening the computer cover or panels. After you finish working inside the computer, replace all covers, panels, and screws before connecting your computer to an electrical outlet.

 **CAUTION:** To avoid damaging the computer, ensure that the work surface is flat, dry, and clean.

 **CAUTION:** To avoid damaging the components and cards, handle them by their edges, and avoid touching the pins and the contacts.

 **CAUTION:** You should only perform troubleshooting and repairs as authorized or directed by the Dell technical assistance team. Damage due to servicing that is not authorized by Dell is not covered by your warranty. See the safety instructions that is shipped with the product or at www.dell.com/regulatory_compliance.

 **CAUTION:** Before touching anything inside your computer, ground yourself by touching an unpainted metal surface, such as the metal at the back of the computer. While you work, periodically touch an unpainted metal surface to dissipate static electricity which could harm internal components.

CAUTION: When you disconnect a cable, pull it by its connector or its pull tab, not the cable itself. Some cables have connectors with locking tabs or thumbscrews that you must disengage before disconnecting the cable. When disconnecting cables, keep them evenly aligned to avoid bending the connector pins. When connecting cables, ensure that the ports and the connectors are correctly oriented and aligned.

CAUTION: Press and eject any installed card from the media-card reader.

NOTE: The color of your computer and certain components may appear differently than shown in this document.

Electrostatic discharge—ESD protection

ESD is a major concern when you handle electronic components, especially sensitive components such as expansion cards, processors, memory DIMMs, and system boards. Very slight charges can damage circuits in ways that may not be obvious, such as intermittent problems or a shortened product life span. As the industry pushes for lower power requirements and increased density, ESD protection is an increasing concern.

Due to the increased density of semiconductors used in recent Dell products, the sensitivity to static damage is now higher than in previous Dell products. For this reason, some previously approved methods of handling parts are no longer applicable.

Two recognized types of ESD damage are catastrophic and intermittent failures.

- **Catastrophic** – Catastrophic failures represent approximately 20 percent of ESD-related failures. The damage causes an immediate and complete loss of device functionality. An example of catastrophic failure is a memory DIMM that has received a static shock and immediately generates a "No POST/No Video" symptom with a beep code emitted for missing or nonfunctional memory.
- **Intermittent** – Intermittent failures represent approximately 80 percent of ESD-related failures. The high rate of intermittent failures means that most of the time when damage occurs, it is not immediately recognizable. The DIMM receives a static shock, but the tracing is merely weakened and does not immediately produce outward symptoms related to the damage. The weakened trace may take weeks or months to melt, and in the meantime may cause degradation of memory integrity, intermittent memory errors, etc.

The more difficult type of damage to recognize and troubleshoot is the intermittent (also called latent or "walking wounded") failure.

Perform the following steps to prevent ESD damage:

- Use a wired ESD wrist strap that is properly grounded. The use of wireless anti-static straps is no longer allowed; they do not provide adequate protection. Touching the chassis before handling parts does not ensure adequate ESD protection on parts with increased sensitivity to ESD damage.
- Handle all static-sensitive components in a static-safe area. If possible, use anti-static floor pads and workbench pads.
- When unpacking a static-sensitive component from its shipping carton, do not remove the component from the anti-static packing material until you are ready to install the component. Before unwrapping the anti-static packaging, ensure that you discharge static electricity from your body.
- Before transporting a static-sensitive component, place it in an anti-static container or packaging.

ESD field service kit

The unmonitored Field Service kit is the most commonly used service kit. Each Field Service kit includes three main components: anti-static mat, wrist strap, and bonding wire.

Components of an ESD field service kit

The components of an ESD field service kit are:

- **Anti-Static Mat** – The anti-static mat is dissipative and parts can be placed on it during service procedures. When using an anti-static mat, your wrist strap should be snug and the bonding wire should be connected to the mat and to any bare metal on the system being worked on. Once deployed properly, service parts can be removed from the ESD bag and placed directly on the mat. ESD-sensitive items are safe in your hand, on the ESD mat, in the system, or inside a bag.
- **Wrist Strap and Bonding Wire** – The wrist strap and bonding wire can be either directly connected between your wrist and bare metal on the hardware if the ESD mat is not required, or connected to the anti-static mat to protect hardware that is temporarily placed on the mat. The physical connection of the wrist strap and bonding wire between your skin, the ESD

mat, and the hardware is known as bonding. Use only Field Service kits with a wrist strap, mat, and bonding wire. Never use wireless wrist straps. Always be aware that the internal wires of a wrist strap are prone to damage from normal wear and tear, and must be checked regularly with a wrist strap tester in order to avoid accidental ESD hardware damage. It is recommended to test the wrist strap and bonding wire at least once per week.

- **ESD Wrist Strap Tester** – The wires inside of an ESD strap are prone to damage over time. When using an unmonitored kit, it is a best practice to regularly test the strap prior to each service call, and at a minimum, test once per week. A wrist strap tester is the best method for doing this test. If you do not have your own wrist strap tester, check with your regional office to find out if they have one. To perform the test, plug the wrist-strap's bonding-wire into the tester while it is strapped to your wrist and push the button to test. A green LED is lit if the test is successful; a red LED is lit and an alarm sounds if the test fails.
- **Insulator Elements** – It is critical to keep ESD sensitive devices, such as plastic heat sink casings, away from internal parts that are insulators and often highly charged.
- **Working Environment** – Before deploying the ESD Field Service kit, assess the situation at the customer location. For example, deploying the kit for a server environment is different than for a desktop or portable environment. Servers are typically installed in a rack within a data center; desktops or portables are typically placed on office desks or cubicles. Always look for a large open flat work area that is free of clutter and large enough to deploy the ESD kit with additional space to accommodate the type of system that is being repaired. The workspace should also be free of insulators that can cause an ESD event. On the work area, insulators such as Styrofoam and other plastics should always be moved at least 12 inches or 30 centimeters away from sensitive parts before physically handling any hardware components
- **ESD Packaging** – All ESD-sensitive devices must be shipped and received in static-safe packaging. Metal, static-shielded bags are preferred. However, you should always return the damaged part using the same ESD bag and packaging that the new part arrived in. The ESD bag should be folded over and taped shut and all the same foam packing material should be used in the original box that the new part arrived in. ESD-sensitive devices should be removed from packaging only at an ESD-protected work surface, and parts should never be placed on top of the ESD bag because only the inside of the bag is shielded. Always place parts in your hand, on the ESD mat, in the system, or inside an anti-static bag.
- **Transporting Sensitive Components** – When transporting ESD sensitive components such as replacement parts or parts to be returned to Dell, it is critical to place these parts in anti-static bags for safe transport.

ESD protection summary

It is recommended that all field service technicians use the traditional wired ESD grounding wrist strap and protective anti-static mat at all times when servicing Dell products. In addition, it is critical that technicians keep sensitive parts separate from all insulator parts while performing service and that they use anti-static bags for transporting sensitive components.

Transporting sensitive components

When transporting ESD sensitive components such as replacement parts or parts to be returned to Dell, it is critical to place these parts in anti-static bags for safe transport.

Lifting equipment

Adhere to the following guidelines when lifting heavy weight equipment:

 **CAUTION: Do not lift greater than 50 pounds. Always obtain additional resources or use a mechanical lifting device.**

1. Get a firm balanced footing. Keep your feet apart for a stable base, and point your toes out.
2. Tighten stomach muscles. Abdominal muscles support your spine when you lift, offsetting the force of the load.
3. Lift with your legs, not your back.
4. Keep the load close. The closer it is to your spine, the less force it exerts on your back.
5. Keep your back upright, whether lifting or setting down the load. Do not add the weight of your body to the load. Avoid twisting your body and back.
6. Follow the same techniques in reverse to set the load down.

After working inside your computer

About this task

 **CAUTION:** Leaving stray or loose screws inside your computer may severely damage your computer.

Steps

1. Replace all screws and ensure that no stray screws remain inside your computer.
2. Connect any external devices, peripherals, or cables you removed before working on your computer.
3. Replace any media cards, discs, or any other parts that you removed before working on your computer.
4. Connect your computer and all attached devices to their electrical outlets.
5. Turn on your computer.

Removing and installing components

NOTE: The images in this document may differ from your computer depending on the configuration you ordered.

Recommended tools

The procedures in this document may require the following tools:

- Phillips screwdriver #1
- Phillips screwdriver #0
- Plastic scribe

Screw list

NOTE: When removing screws from a component, it is recommended to note the screw type, the quantity of screws, and then place them in a screw storage box. This is to ensure that the correct number of screws and correct screw type is restored when the component is replaced.

NOTE: Some computers have magnetic surfaces. Ensure that the screws are not left attached to such surfaces when replacing a component.

NOTE: Screw color may vary with the configuration ordered.

Table 1. Screw list

















Component	Secured to	Screw type	Quantity	Screw image
Base cover	Palm-rest and keyboard assembly	M2x4	7	 <p>NOTE: Screw color may vary depending on the configuration ordered.</p>
Solid-state drive bracket	Palm-rest and keyboard assembly	M2x3	1	
Solid-state drive (slot one)	Palm-rest and keyboard assembly	M2x3	1	
Solid-state drive (slot two)	Palm-rest and keyboard assembly	M2x3	1	
Wireless-card bracket	System board	M2x3	1	
Battery (3-cell)	Palm-rest and keyboard assembly	M2x3	4	 <p>NOTE: Screw color may vary depending on the configuration ordered.</p>

Table 1. Screw list (continued)

Component	Secured to	Screw type	Quantity	Screw image
Battery (4-cell)	Palm-rest and keyboard assembly	M2x3	5	 <p>i NOTE: Screw color may vary depending on the configuration ordered.</p>
Fan	Palm-rest and keyboard assembly	M2x2	2	
Left hinge	Palm-rest and keyboard assembly	M2.5x5 M2.5x3.5	2 1	 
Right hinge	Palm-rest and keyboard assembly	M2.5x5	3	
Power-adaptor port	Palm-rest and keyboard assembly	M2x3	1	
Power button with fingerprint reader (optional)	Palm-rest and keyboard assembly	M1.6x2	2	
Touchpad bracket	Palm-rest and keyboard assembly	M2x2	5	
I/O board	Palm-rest and keyboard assembly	M2x2	2	
USB 3.2 Gen 1 Type-C port bracket	System board	M2x5	2	
System board	Palm-rest and keyboard assembly	M2x2	2	

Major components of Inspiron 15 5508

The following image shows the major components of Inspiron 15 5508.

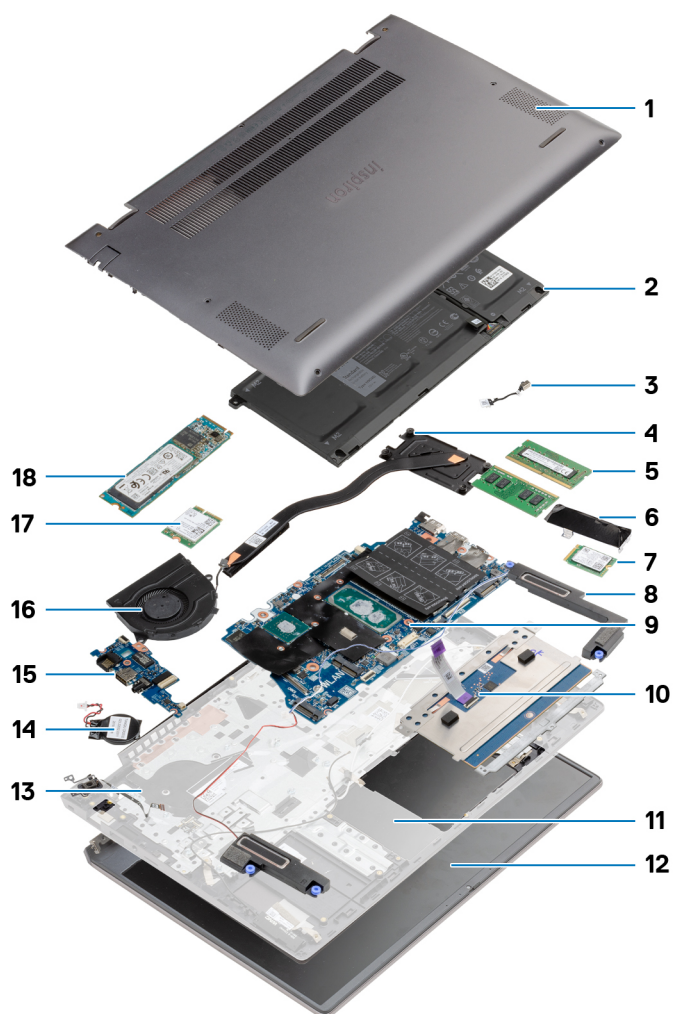

1. Base cover
2. Battery
3. Power-adaptor port
4. Heat sink
5. Memory module
6. Solid-state drive bracket
7. M.2 2230 solid-state drive in M.2 slot two
8. Speakers
9. System board
10. Touchpad
11. Palm-rest and keyboard assembly
12. Display assembly
13. Power button with optional fingerprint reader
14. Coin-cell battery
15. I/O board
16. Fan
17. Wireless card
18. M.2 2280 solid-state drive in M.2 slot one

Base cover

Removing the base cover

Prerequisites

Follow the procedure in [Before working inside your computer](#).

About this task

The figure indicates the location of the base cover and provides a visual representation of the removal procedure.

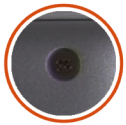

2x
M2x7.5



7x
M2x4

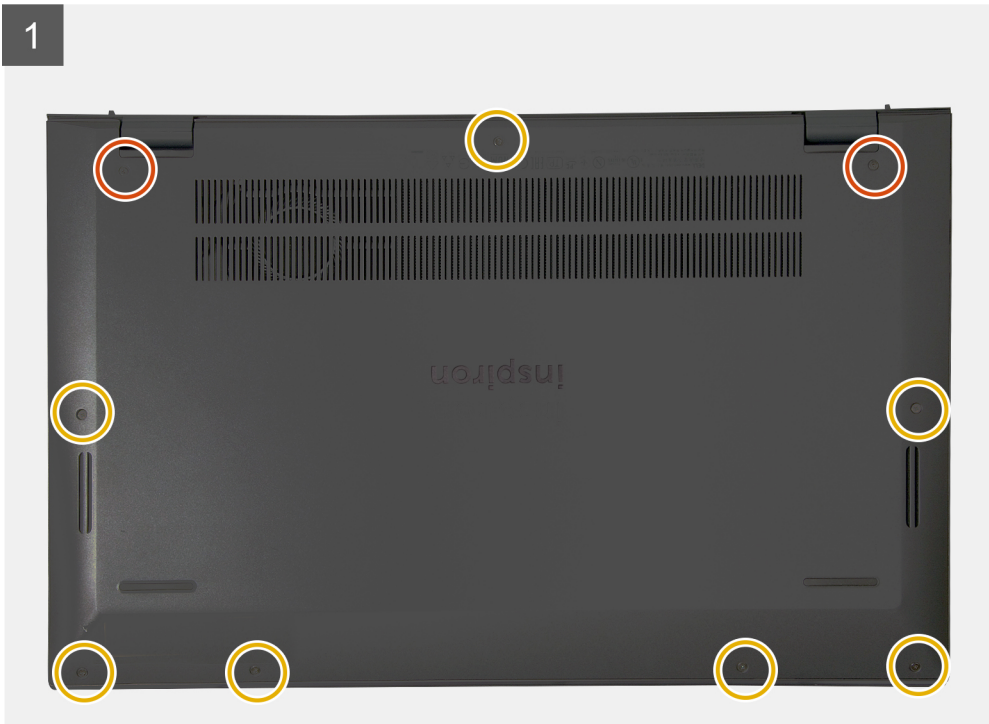

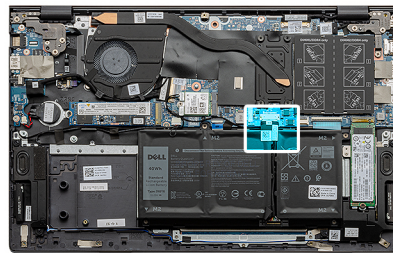
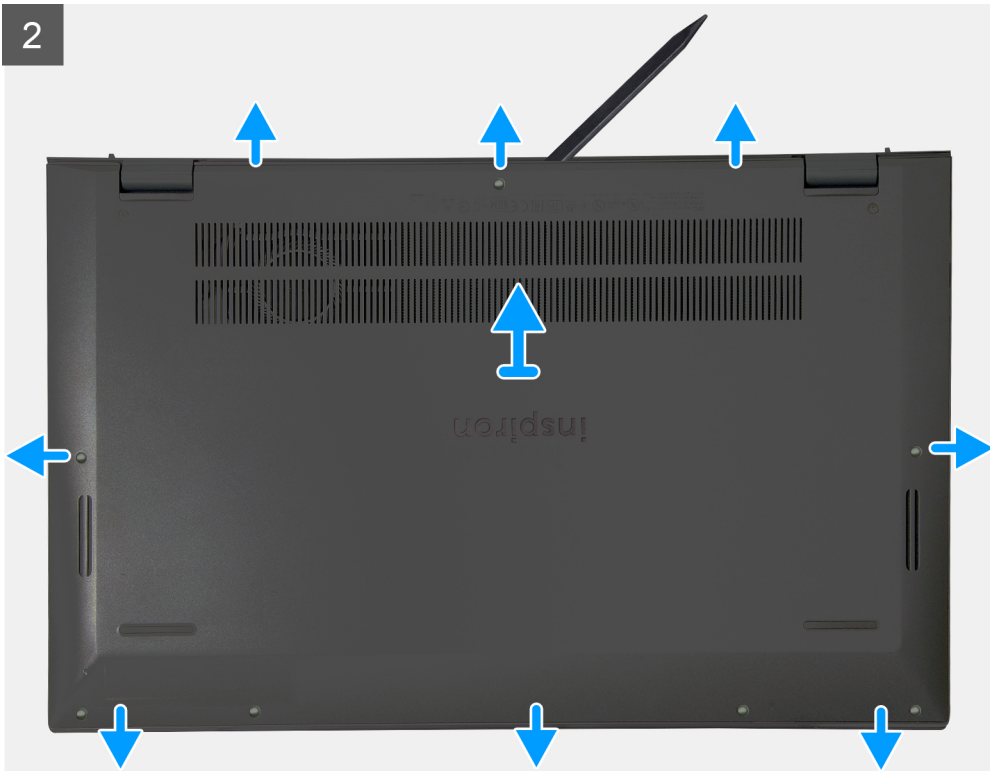



Steps

1. Loosen the two captive screws (M2x7.5) that secure the base cover to the palm-rest and keyboard assembly.
2. Remove the seven screws (M2x4) that secure the base cover to the palm-rest and keyboard assembly.
3. Using a plastic scribe, pry the base cover starting from the recess at the display hinge and work your way around the sides to remove the base cover.
4. Lift the base cover off the palm-rest and keyboard assembly.
5. Peel the tape and disconnect the battery cable from the system board.
 - NOTE:** Disconnect the battery cable only when you are continuing to remove other components from your computer.
6. Press and hold the power button for five seconds to ground the computer and drain the flea power.

Installing the base cover

Prerequisites

If you are replacing a component, remove the existing component before performing the installation procedure.

About this task

The figure indicates the location of the base cover and provides a visual representation of the installation procedure.

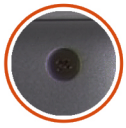

2x
M2x7.5



7x
M2x4

3

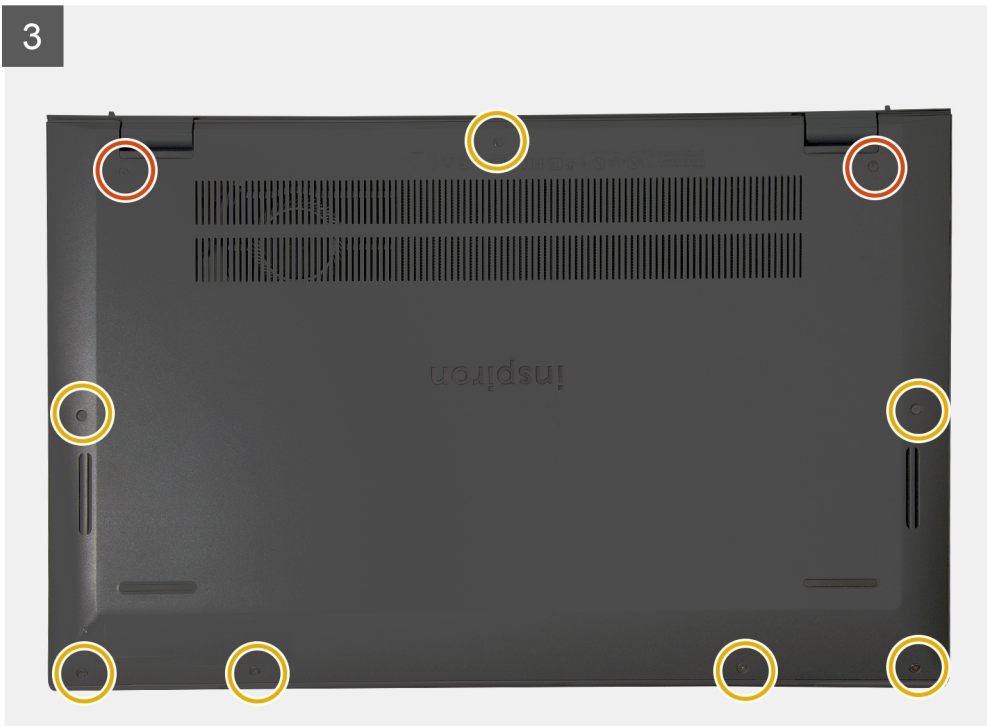

Steps

1. Adhere the tape and connect the battery cable to the system board, if applicable.
2. Place the base cover over the palm-rest and keyboard assembly.
3. Align the screw holes on the base cover with the screw holes on the palm-rest and keyboard assembly, and then snap the base cover into place.
4. Tighten the two captive screws that secure the base cover to the palm-rest and keyboard assembly.
5. Replace the seven screws (M2x4) that secure the base cover to the palm-rest and keyboard assembly.

Next steps

Follow the procedure in [After working inside your computer](#).

Battery

Removing the 3-cell battery

Prerequisites

1. Follow the procedure in [Before working inside your computer](#).
2. Remove the [base cover](#).

About this task

The figure indicates the location of the 3-cell battery and provides a visual representation of the removal procedure.



4x
M2x3

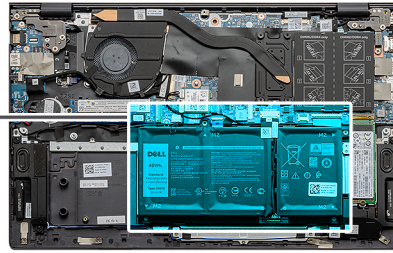

Steps

1. Peel off the tape and disconnect the battery cable, if applicable.
2. Remove the four screws (M2x3) that secure the 3-cell battery to the palm-rest and keyboard assembly.
3. Lift the battery, along with its cable, off the palm-rest and keyboard assembly.

Installing the 3-cell battery

Prerequisites

If you are replacing a component, remove the existing component before performing the installation procedure.

About this task

The figure indicates the location of the 3-cell battery and provides a visual representation of the installation procedure.



4x
M2x3

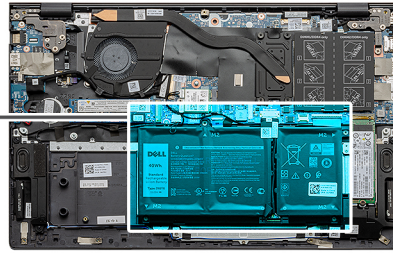
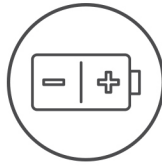

Steps

1. Place the battery on the palm-rest and keyboard assembly.
2. Align the screw holes on the battery with the screw holes on the palm-rest and keyboard assembly.
3. Install the four screws (M2x3) that secure the battery to the palm-rest and keyboard assembly.
4. Connect the battery cable to the system board and adhere the tape that secures the battery cable to the system board.

Next steps

1. Install the [base cover](#).
2. Follow the procedure in [After working inside your computer](#).

Removing the 4-cell battery

Prerequisites

1. Follow the procedure in [Before working inside your computer](#).
2. Remove the [base cover](#).

About this task

The figure indicates the location of the 4-cell battery and provides a visual representation of the removal procedure.



5x
M2x3

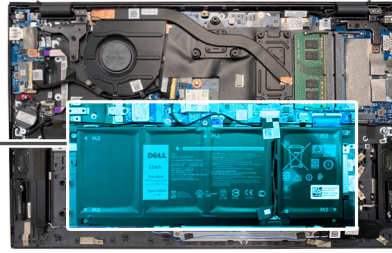
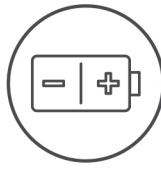

Steps

1. Peel off the tape and disconnect the battery cable, if applicable.
2. Remove the five screws (M2x3) that secure the 4-cell battery to the palm-rest and keyboard assembly.
3. Lift the battery, along with its cable, off the palm-rest and keyboard assembly.

Installing the 4-cell battery

Prerequisites

If you are replacing a component, remove the existing component before performing the installation procedure.

About this task

The figure indicates the location of the 4-cell battery and provides a visual representation of the installation procedure.



5x
M2x3

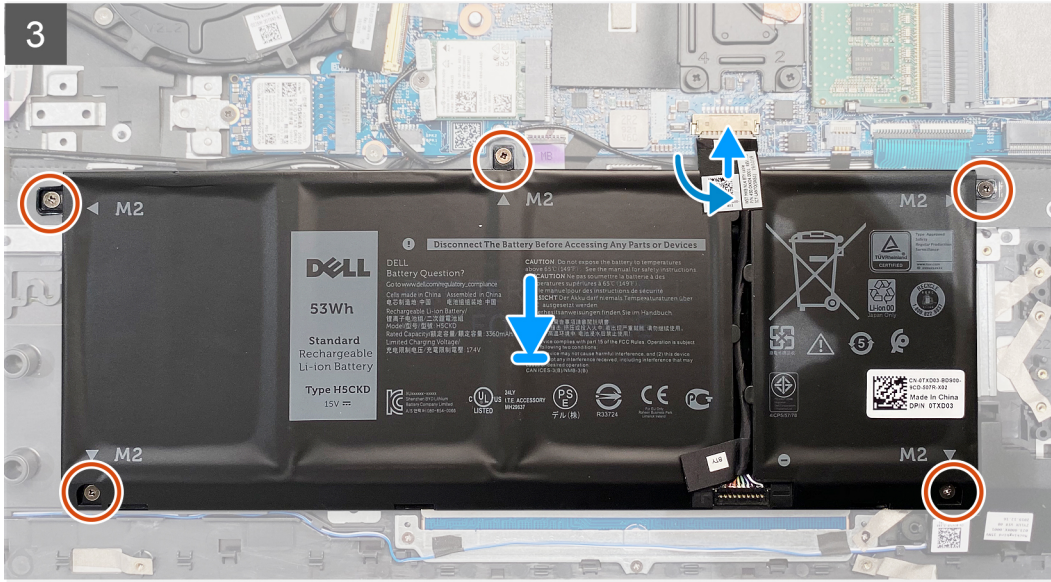
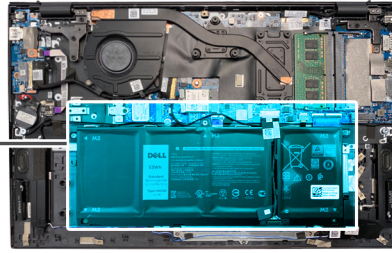
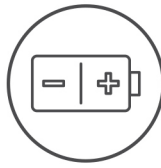

Steps

1. Place the battery on the palm-rest and keyboard assembly.
2. Align the screw holes on the battery with the screw holes on the palm-rest and keyboard assembly.
3. Install the five screws (M2x3) that secure the 4-cell battery to the palm-rest and keyboard assembly.
4. Connect the battery cable to the system board and adhere the tape that secures the battery cable to the system board.

Next steps

1. Install the [base cover](#).
2. Follow the procedure in [After working inside your computer](#).

Memory modules

Removing the memory modules

Prerequisites

1. Follow the procedure in [Before working inside your computer](#).
2. Remove the [base cover](#).

About this task

The figure indicates the location of the memory module and provides a visual representation of the removal procedure.

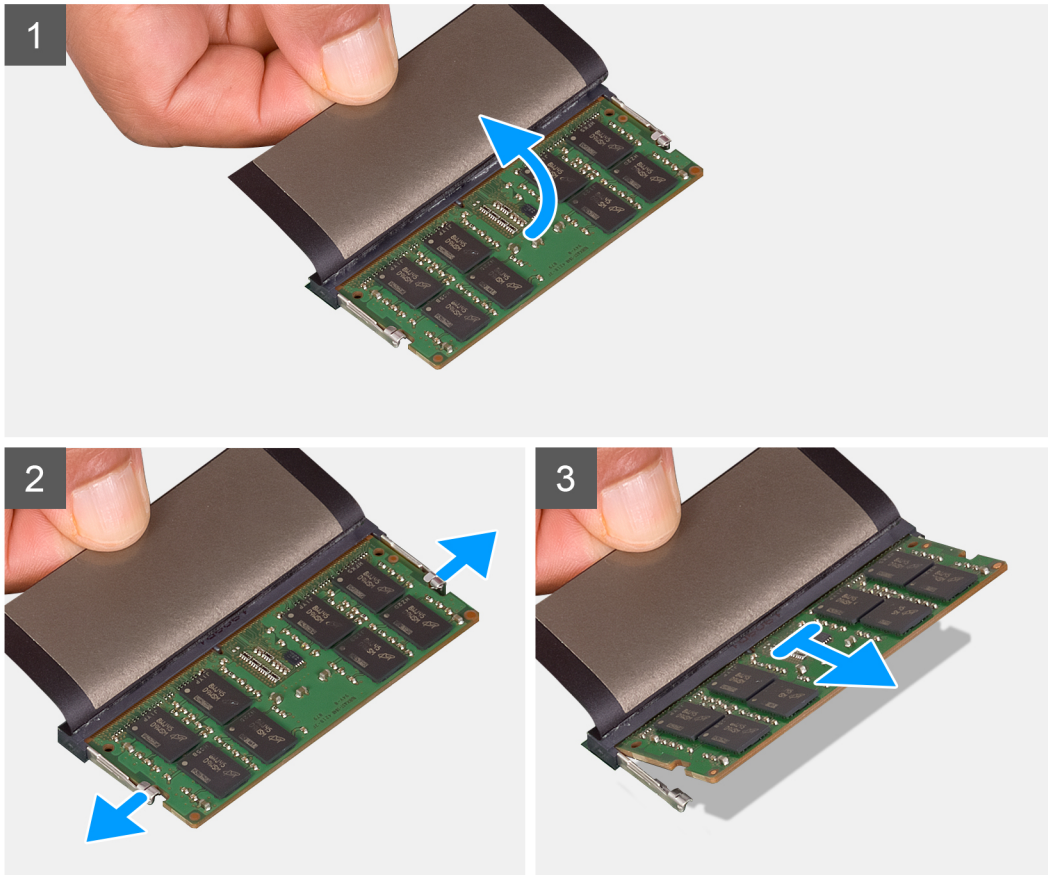
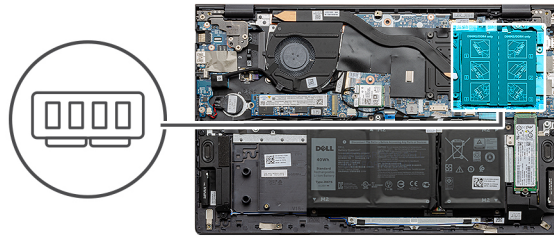

Steps

1. Lift the mylar to uncover the memory module.
2. Use your fingertips to carefully spread apart the securing clips on each end of the memory-module slot until the memory module pops up.
3. Remove the memory module from the memory-module slot.

i **NOTE:** Repeat step 1 to step 3 to remove any other memory modules installed in your computer.

Installing the memory modules

Prerequisites

If you are replacing a component, remove the existing component before performing the installation procedure.

About this task

The figure indicates the location of the memory module and provides a visual representation of the installation procedure.

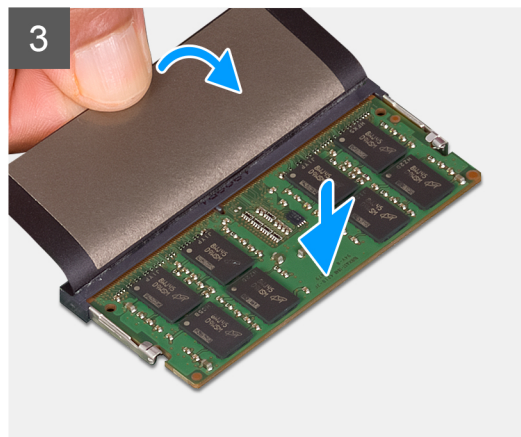
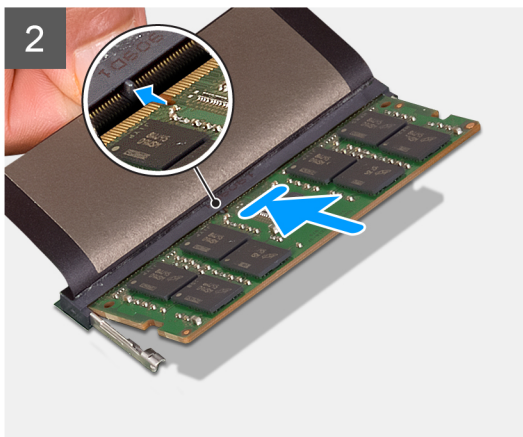
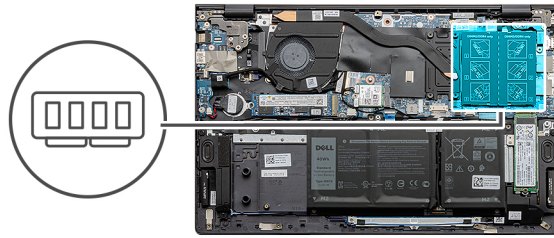

Steps

1. Lift the mylar and align the notch on the memory module with the tab on the memory-module slot.
2. Slide the memory module firmly into the slot at an angle.
3. Press the memory module down until it clicks into place.

i **NOTE:** If you do not hear the click, remove the memory module and reinstall it.

i **NOTE:** Repeat step 1 to step 3 to if you are installing other memory module.

Next steps

1. Install the [base cover](#).
2. Follow the procedure in [After working inside your computer](#).

Solid-state drive—M.2 slot one

Removing the M.2 2230 solid-state drive from M.2 slot one

Prerequisites

1. Follow the procedure in [Before working inside your computer](#).
2. Remove the [base cover](#).

About this task

NOTE: Depending on the configuration ordered, your computer may support an M.2 2230 solid-state drive or an M.2 2280 solid-state drive in M.2 slot one.

NOTE: This procedure applies only to computers shipped with an M.2 2230 solid-state drive installed in M.2 slot one.

The figure indicates the location of the M.2 2230 solid-state drive that is installed in M.2 slot one and provides a visual representation of the removal procedure.

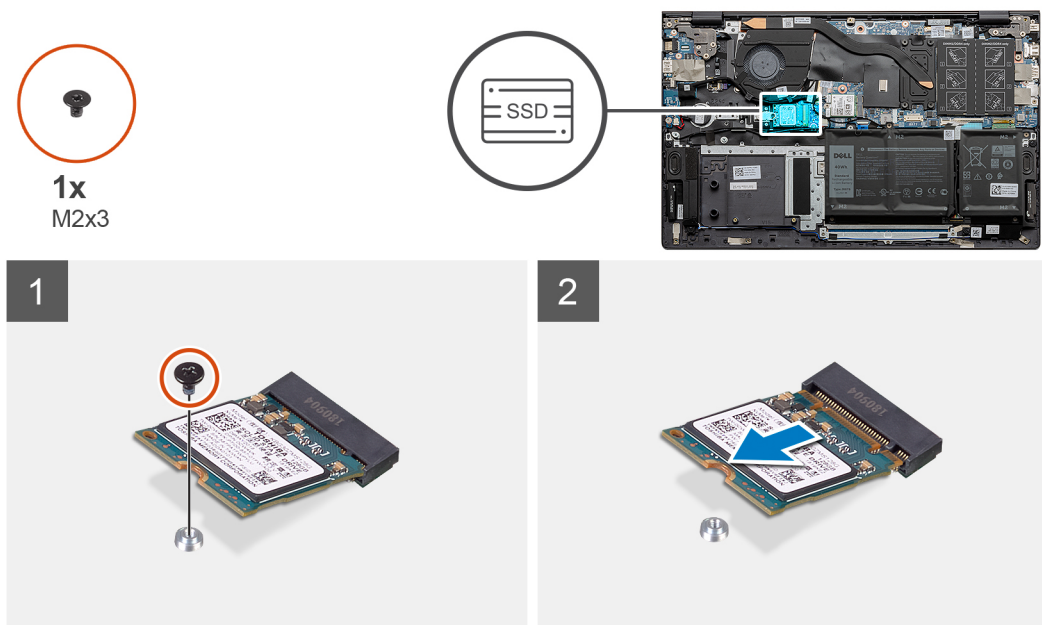

Steps

1. Remove the screw (M2x3) that secures the M.2 2230 solid-state drive to the solid-state drive mounting bracket.
2. Slide and lift the M.2 2230 solid-state drive off M.2 slot one on the system board.

Installing the M.2 2230 solid-state drive in M.2 slot one

Prerequisites

If you are replacing a component, remove the existing component before performing the installation procedure.

About this task

NOTE: Depending on the configuration ordered, your computer may support an M.2 2230 solid-state drive or an M.2 2280 solid-state drive in M.2 slot one.

NOTE: If there is only one solid-state drive in the configuration you ordered, you can install another solid-state drive in the other M.2 slot. However, you may need a solid-state drive mounting bracket (sold separately) to install the additional solid-state drive.

NOTE: This procedure applies only if you are installing an M.2 2230 solid-state drive in M.2 slot one.

NOTE: Before installing your M.2 2230 or M.2 2280 solid-state drive, ensure that the mounting bracket is in the correct location. For more information, see [Installing the solid-state drive mounting bracket](#).

The figure indicates the location of the M.2 2230 solid-state drive that is installed in M.2 slot one and provides a visual representation of the installation procedure.

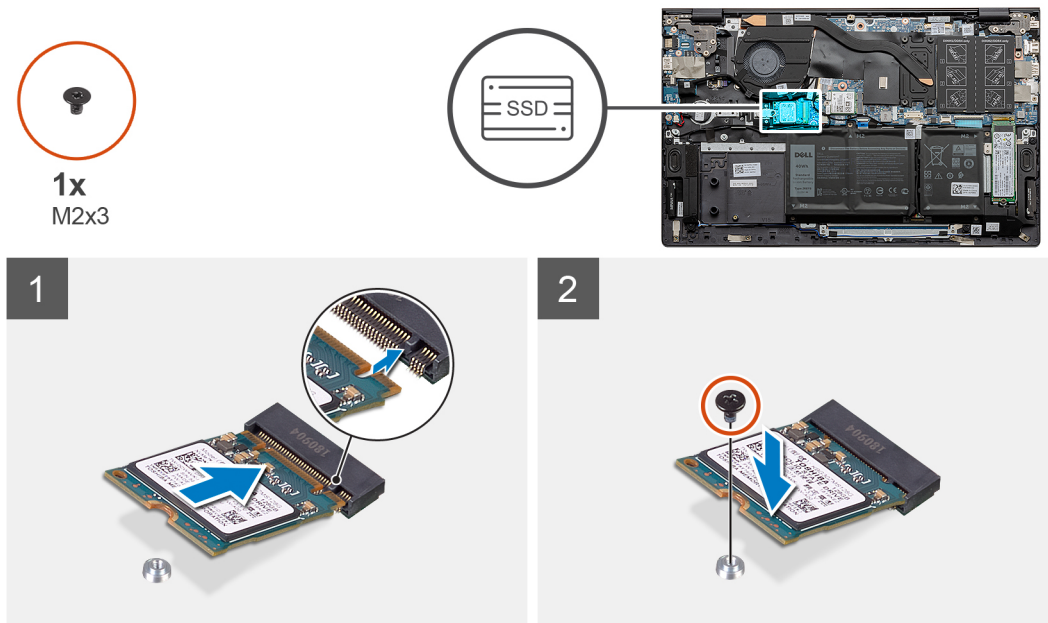

Steps

1. Align the notch on the M.2 2230 solid-state drive with the tab on M.2 slot one on the system board.
2. Slide the M.2 2230 solid-state drive into M.2 slot one on the system board.
3. Replace the screw (M2x3) that secures the M.2 2230 solid-state drive to the solid-state drive mounting bracket.

Next steps

1. Install the [base cover](#).
2. Follow the procedure in [After working inside your computer](#).

Removing the M.2 2280 solid-state drive from M.2 slot one

Prerequisites

1. Follow the procedure in [Before working inside your computer](#).
2. Remove the [base cover](#).

About this task

NOTE: Depending on the configuration ordered, your computer may support an M.2 2230 solid-state drive or an M.2 2280 solid-state drive in M.2 slot one.

NOTE: This procedure applies only to computers shipped with an M.2 2280 solid-state drive installed in M.2 slot one.

The figure indicates the location of the M.2 2280 solid-state drive that is installed in M.2 slot one and provides a visual representation of the removal procedure.



1x
M2x3

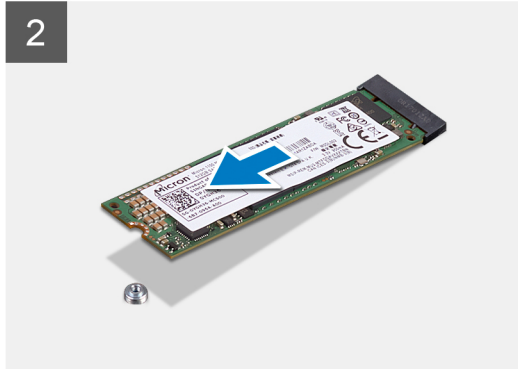

Steps

1. Remove the screw (M2x3) that secures the M.2 2280 solid-state drive/Intel Optane memory module to the palm-rest and keyboard assembly.
2. Slide and lift the M.2 2280 solid-state drive/Intel Optane memory module off the M.2 slot one on the system board.

Installing the M.2 2280 solid-state drive in M.2 slot one

Prerequisites

If you are replacing a component, remove the existing component before performing the installation procedure.

About this task

- NOTE:** Depending on the configuration ordered, your computer may support an M.2 2230 solid-state drive or an M.2 2280 solid-state drive in M.2 slot one.
- NOTE:** If there is only one solid-state drive in the configuration you ordered, you can install another solid-state drive in the other M.2 slot. However, you may need a solid-state drive mounting bracket (sold separately) to install the additional solid-state drive.
- NOTE:** This procedure is applicable if you are installing an M.2 2280 solid-state drive in M.2 slot one.
- NOTE:** Before installing your M.2 2230 or M.2 2280 solid-state drive, ensure that the mounting bracket is in the correct location. For more information, see [Installing the solid-state drive mounting bracket](#).

The figure indicates the location of the M.2 2280 solid-state drive/Intel Optane memory module that is installed in M.2 slot one and provides a visual representation of the installation procedure.



1x
M2x3

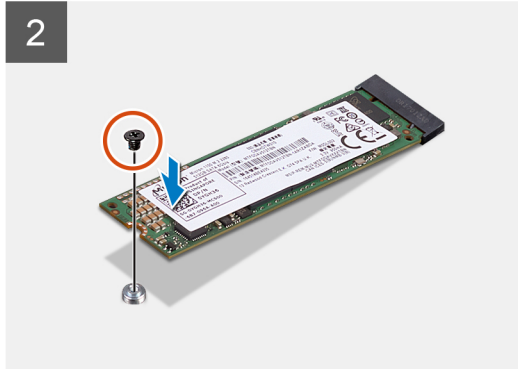
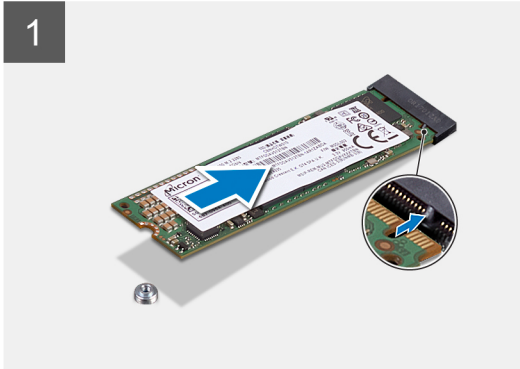

Steps

1. Align the notches on the solid-state drive/Intel Optane memory module with the tabs in M.2 slot one on the system board.
2. Slide the solid-state drive/Intel Optane memory module into the M.2 slot one on the system board.
3. Replace the screw (M2x3) that secures the solid-state drive/Intel Optane memory module to the palm-rest and keyboard assembly.

Next steps

1. Install the [base cover](#).
2. Follow the procedure in [After working inside your computer](#).

Installing the solid-state drive mounting bracket on M.2 slot one

Prerequisites

1. Follow the procedure in [Before working inside your computer](#).
2. Remove the [base cover](#).
3. Remove the [M.2 2230 solid-state drive](#) or the [M.2 2280 solid-state drive](#) from M.2 slot one.

About this task

i **NOTE:** If there is only one solid-state drive in the configuration you ordered, you can install another solid-state drive in the other M.2 slot. However, you may need a solid-state drive mounting bracket (sold separately) to install the additional solid-state drive.

The figure provides a visual representation of the procedure to install the solid-state drive mounting bracket when replacing M.2 2230 solid-state drive with M.2 2280 solid-state drive in M.2 slot one.

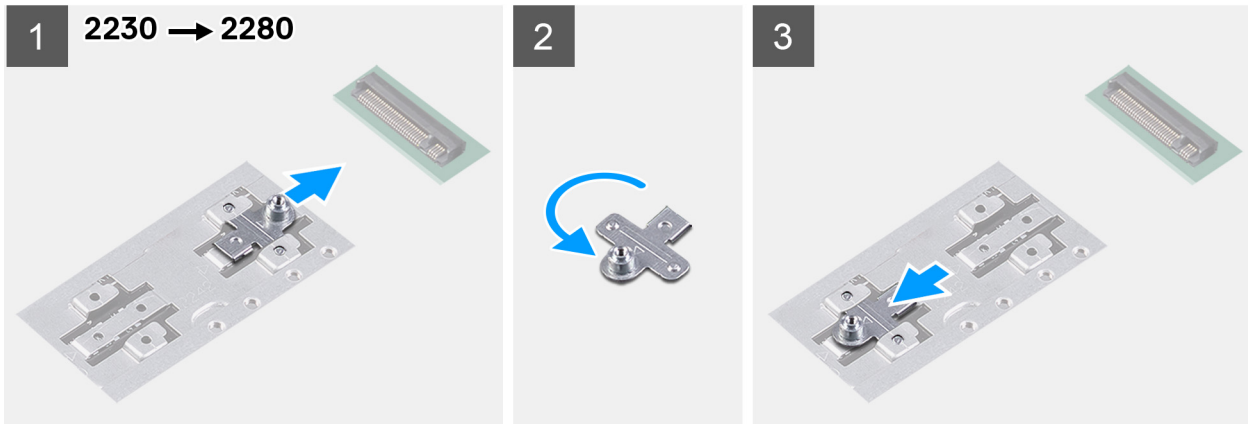

The figure provides a visual representation of the procedure to install the solid-state drive mounting bracket when replacing M.2 2280 solid-state drive with M.2 2230 solid-state drive in M.2 slot one.

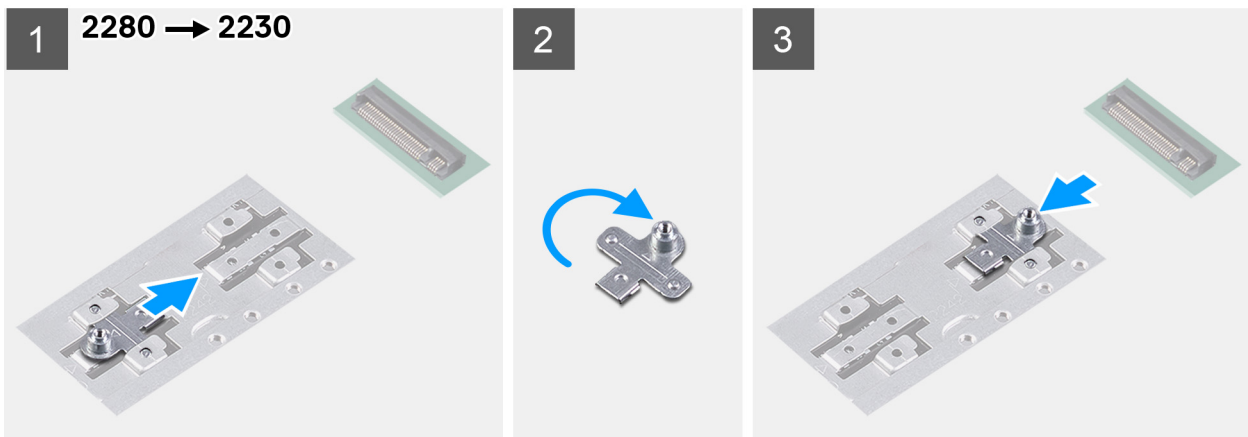

Steps

1. Slide and remove the solid-state drive mounting bracket from the mounting bracket slot on the palm-rest and keyboard assembly.
2. Rotate the solid-state drive mounting bracket.
3. Slide the solid-state mounting bracket into the mounting slot on the palm-rest and keyboard assembly.
4. Install the [M.2 2230 solid-state drive](#) or the [M.2 2280 solid-state drive](#), whichever applicable.

Solid-state drive—M.2 slot two

Removing the M.2 2230 solid-state drive from M.2 slot two

Prerequisites

1. Follow the procedure in [Before working inside your computer](#).
2. Remove the [base cover](#).

About this task

NOTE: Depending on the configuration ordered, your computer may support an M.2 2230 solid-state drive or an M.2 2280 solid-state drive in M.2 slot two.

NOTE: This procedure applies only to computers shipped with an M.2 2230 solid-state drive installed in M.2 slot two.

The figure indicates the location of the M.2 2230 solid-state drive that is installed in M.2 slot two and provides a visual representation of the removal procedure.



1x
M2x3

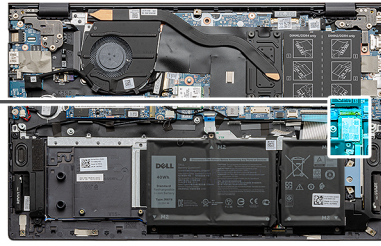

Steps

1. Remove the screw (M2x3) that secures the M.2 2230 solid-state drive to the palm-rest and keyboard assembly.
2. Slide and lift the M.2 2230 solid-state drive off M.2 slot two on the system board.

Installing the M.2 2230 solid-state drive in M.2 slot two

Prerequisites

If you are replacing a component, remove the existing component before performing the installation procedure.

About this task

- NOTE:** Depending on the configuration ordered, your computer may support an M.2 2230 solid-state drive or an M.2 2280 solid-state drive in M.2 slot two.
- NOTE:** If there is only one solid-state drive in the configuration you ordered, you can install another solid-state drive in the other M.2 slot. However, you may need a solid-state drive mounting bracket (sold separately) to install the additional solid-state drive.
- NOTE:** This procedure applies only if you are installing an M.2 2230 solid-state drive in M.2 slot two.
- NOTE:** Before installing your M.2 2230 or M.2 2280 solid-state drive, ensure that the mounting bracket is in the correct location. For more information, see [Installing the solid-state drive mounting bracket](#).

The figure indicates the location of the M.2 2230 solid-state drive that is installed in M.2 slot two and provides a visual representation of the installation procedure.



1x
M2x3

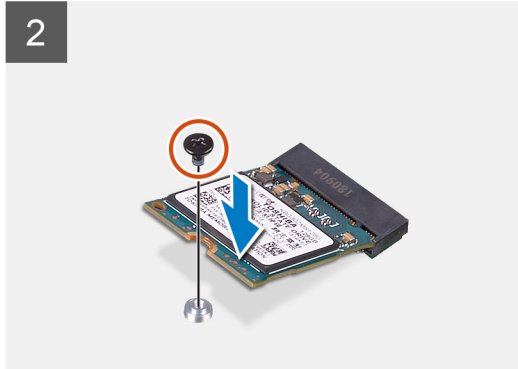
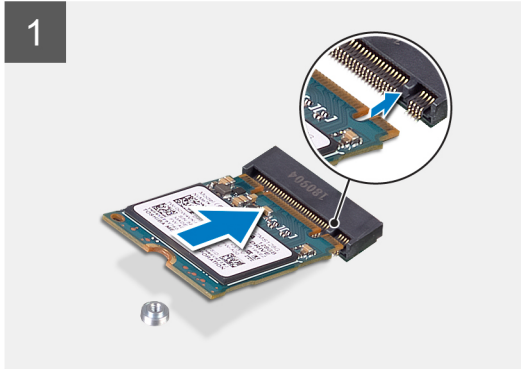
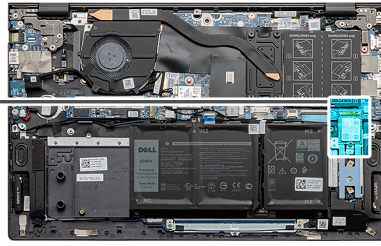

Steps

1. Slide the solid-state drive mounting bracket into the slot on the palm-rest and keyboard assembly, if it is not installed.
2. Align the notches on the M.2 2230 solid-state drive with the tabs in the M.2 slot two on the system board.
3. Slide the M.2 2230 solid-state drive into M.2 slot two on the system board.
4. Replace the screw (M2x3) that secures the M.2 2230 solid-state drive to the palm-rest and keyboard assembly.

Next steps

1. Install the [base cover](#).
2. Follow the procedure in [After working inside your computer](#).

Removing the M.2 2280 solid-state drive from M.2 slot two

Prerequisites

1. Follow the procedure in [Before working inside your computer](#).
2. Remove the [base cover](#).

About this task

NOTE: Depending on the configuration ordered, your computer may support an M.2 2230 solid-state drive or an M.2 2280 solid-state drive in M.2 slot two.

NOTE: This procedure applies only to computers shipped with an M.2 2280 solid-state drive installed in M.2 slot two.

The figure indicates the location of the M.2 2280 solid-state drive/Intel Optane memory module that is installed in M.2 slot two and provides a visual representation of the removal procedure.



1x
M2x3

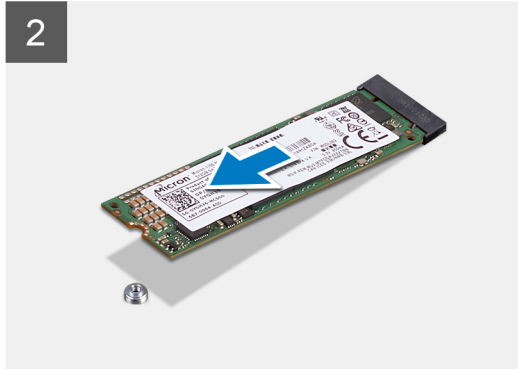
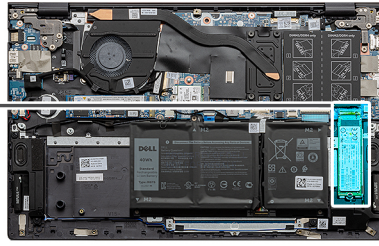

Steps

1. Remove the screw (M2x3) that secures the M.2 2280 solid-state drive to the palm-rest and keyboard assembly.
2. Slide and lift the M.2 2280 solid-state drive/Intel Optane memory module off M.2 slot two on the system board.

Installing the M.2 2280 solid-state drive in M.2 slot two

Prerequisites

If you are replacing a component, remove the existing component before performing the installation procedure.

About this task

- NOTE:** Depending on the configuration ordered, your computer may support an M.2 2230 solid-state drive or an M.2 2280 solid-state drive in M.2 slot two.
- NOTE:** If there is only one solid-state drive in the configuration you ordered, you can install another solid-state drive in the other M.2 slot. However, you may need a solid-state drive mounting bracket (sold separately) to install the additional solid-state drive.
- NOTE:** This procedure applies only if you are installing a 2280 solid-state drive in M.2 slot two.
- NOTE:** Before installing your M.2 2230 or M.2 2280 solid-state drive, ensure that the mounting bracket is in the correct location. For more information, see [Installing the solid-state drive mounting bracket](#).

The figure indicates the location of the M.2 2280 solid-state drive/Intel Optane memory module that is installed in M.2 slot two and provides a visual representation of the installation procedure.



1x
M2x3

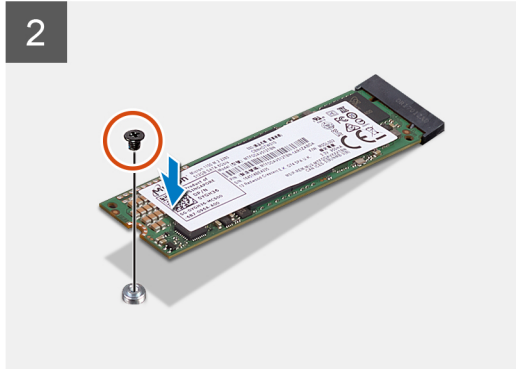
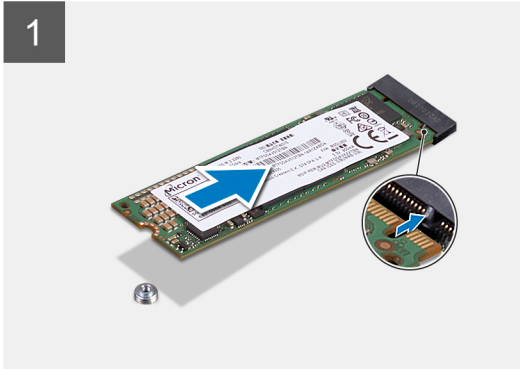
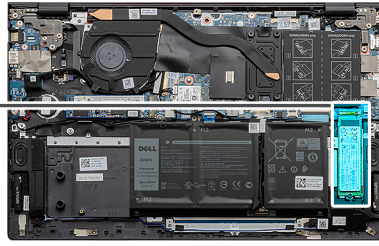

Steps

1. Align the notches on the M.2 2280 solid-state drive/Intel Optane memory module with the tabs in M.2 slot two on the system board.
2. Slide the M.2 2280 solid-state drive/Intel Optane memory module into M.2 slot two on the system board.
3. Replace the screw (M2x3) that secures the M.2 2280 solid-state drive/Intel Optane memory module to the palm-rest and keyboard assembly.

Next steps

1. Install the [base cover](#).
2. Follow the procedure in [After working inside your computer](#).

Installing the solid-state drive mounting bracket on M.2 slot two

Prerequisites

1. Follow the procedure in [Before working inside your computer](#).
2. Remove the [base cover](#).
3. Remove the [M.2 2230 solid-state drive](#) or the [M.2 2280 solid-state drive](#) from M.2 slot two.

About this task

i **NOTE:** If there is only one solid-state drive in the configuration you ordered, you can install another solid-state drive in the other M.2 slot. However, you may need a solid-state drive mounting bracket (sold separately) to install the additional solid-state drive.

The figure provides a visual representation of the procedure to move the solid-state drive mounting bracket on M.2 slot two.



1x
M1.6x2.5

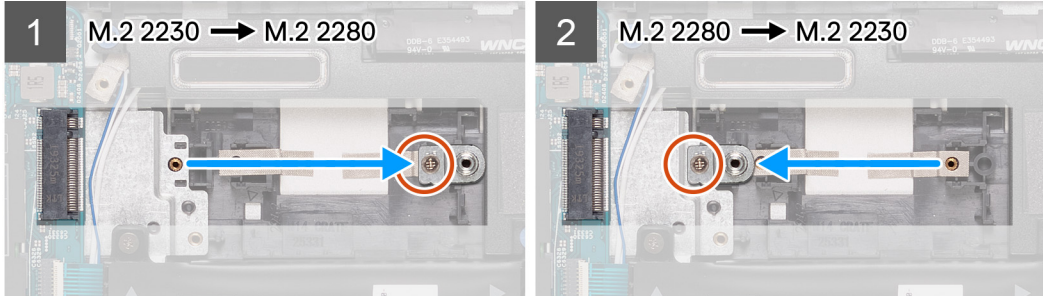

Steps

1. Remove the screw (M1.6x2.5) that secures the solid-state drive mounting bracket to the M.2 2230/2280 bracket slot on the palm-rest and keyboard assembly.
2. Lift the solid-state drive mounting bracket from the M.2 2230/2280 bracket slot on the palm-rest and keyboard assembly.
3. Place the solid-state drive mounting bracket into the M.2 2230/2280 bracket slot on the palm-rest and keyboard assembly.
4. Replace the screw (M1.6x2.5) that secures the solid-state drive mounting bracket to M.2 2230/2280 bracket slot on the palm-rest and keyboard assembly.
5. Install the [M.2 2230 solid-state drive](#) or the [M.2 2280 solid-state drive](#), whichever applicable.

Wireless card

Removing the wireless card

Prerequisites

1. Follow the procedure in [Before working inside your computer](#).
2. Remove the [base cover](#).

About this task

The figure indicates the location of the wireless card and provides a visual representation of the removal procedure.



1x
M2x3



Steps

1. Remove the screw (M2x3) that secures the wireless-card bracket to the wireless card.
2. Remove the bracket that secures the wireless card to the system board.
3. Disconnect the antenna cables from the wireless card.
4. Slide and remove the wireless card from the wireless-card slot.

Installing the wireless card

Prerequisites

If you are replacing a component, remove the existing component before performing the installation procedure.

About this task

The figure indicates the location of the wireless card and provides a visual representation of the installation procedure.



1x
M2x3



Steps

1. Align the notch on the wireless card with the tab on the wireless-card slot and insert the wireless card at an angle into the wireless-card slot.
2. Connect the antenna cables to the wireless card.

The following table provides the antenna-cable color scheme for the wireless card that is supported by your computer.

Table 2. Antenna-cable color scheme

Connectors on the wireless card	Antenna-cable color	Silkscreen marking	
Main	White	MAIN	(white triangle)
Auxiliary	Black	AUX	(black triangle)

3. Place the wireless-card bracket on the wireless card.
4. Align the screw hole on the wireless-card bracket with the screw hole on the system board.
5. Replace the screw (M2x3) that secures the wireless card to the system board.

Next steps

1. Install the [base cover](#).
2. Follow the procedure in [After working inside your computer](#).

Fan

Removing the fan

Prerequisites

1. Follow the procedure in [Before working inside your computer](#).
2. Remove the [base cover](#).

About this task

The figure indicates the location of the fan and provides a visual representation of the removal procedure.

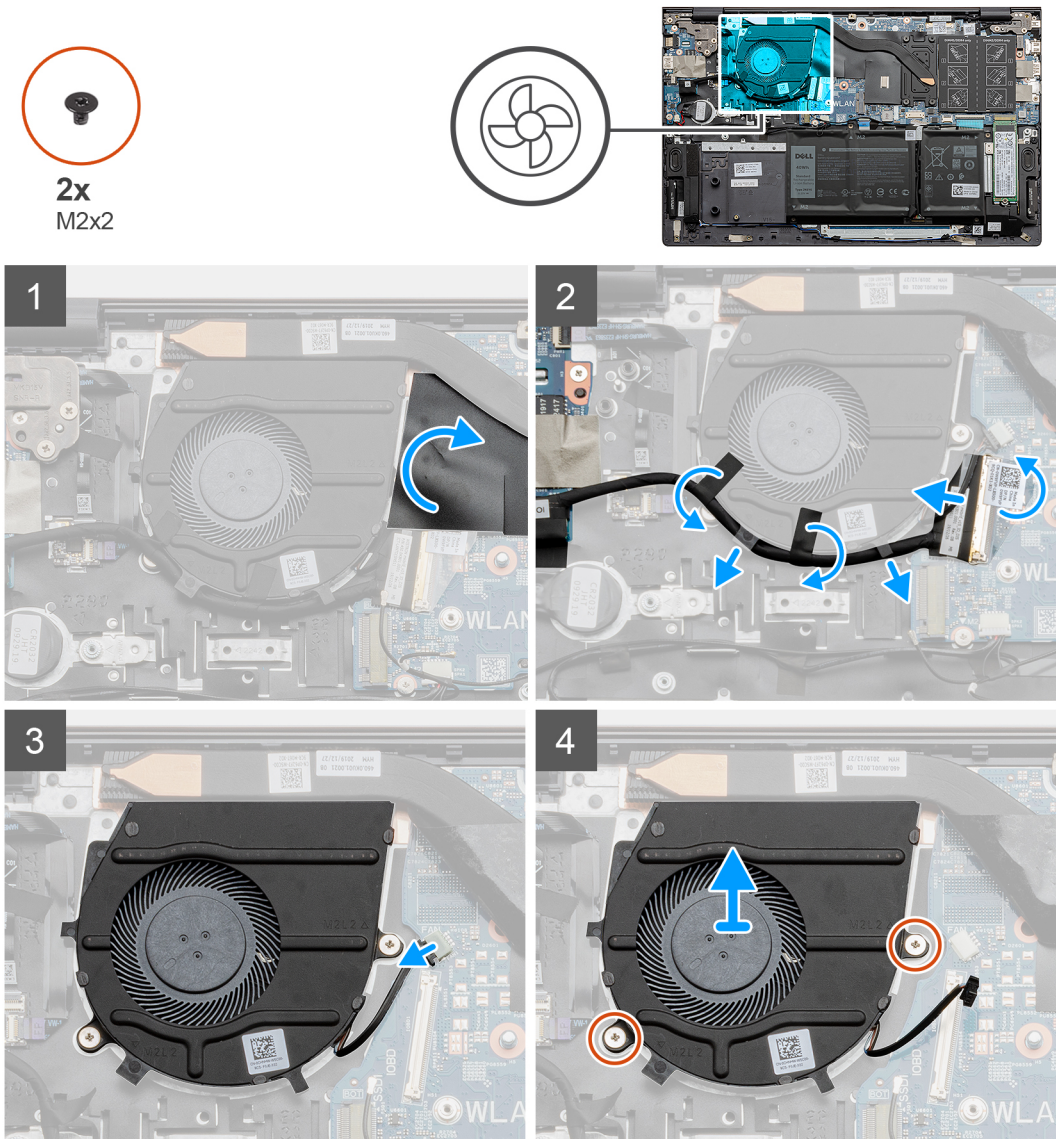

Steps

1. Peel and lift the mylar covering the fan cable.
2. Peel the tape, lift the latch, and then disconnect the I/O-board cable from the system board.
3. Remove the I/O-board cable from the routing guides on the fan.
4. Disconnect the fan cable from the system board.
5. Remove the two screws (M2x2) that secure the fan to the palm-rest and keyboard assembly.

6. Lift the fan off the palm-rest and keyboard assembly.

Installing the fan

Prerequisites

If you are replacing a component, remove the existing component before performing the installation procedure.

About this task

The figure indicates the location of the fan and provides a visual representation of the installation procedure.



2x
M2x2

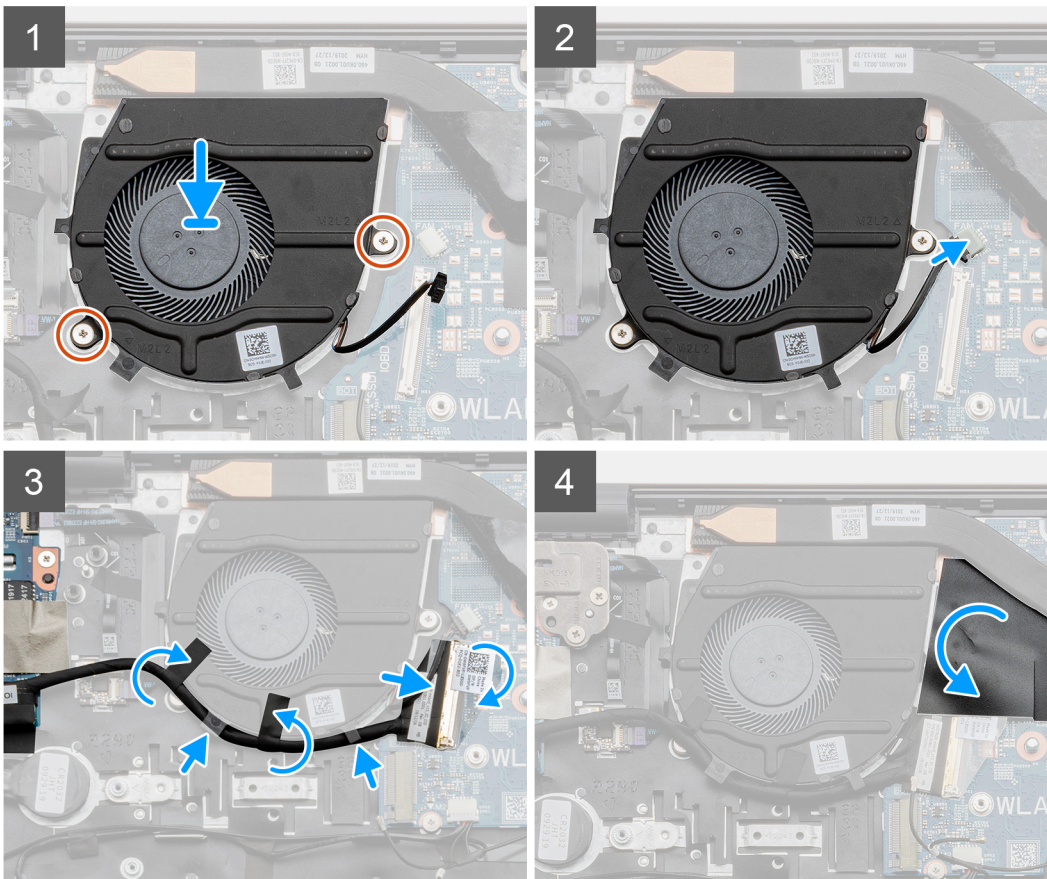
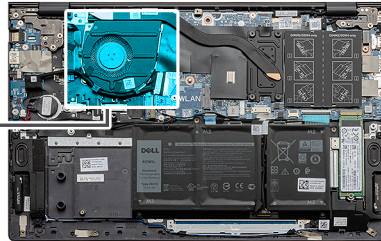

Steps

1. Place the fan on the palm-rest and keyboard assembly.
2. Align the screw holes on the fan with the screw holes on the palm-rest and keyboard assembly.
3. Replace the two screws (M2x2) that secure the fan to the palm-rest and keyboard assembly.
4. Route the I/O-board cable through the routing guides on the fan.
5. Connect the fan cable to the system board.
6. Connect the I/O-board cable to the system board and close the latch.
7. Adhere the tape that secures the I/O-board cable to the system board.

8. Adhere the mylar that covers the fan cable.

Next steps

1. Install the [base cover](#).
2. Follow the procedure in [After working inside your computer](#).

Coin-cell battery

Removing the coin-cell battery

Prerequisites

1. Follow the procedure in [Before working inside your computer](#).
2. Remove the [base cover](#).

i **NOTE:** Removing the coin-cell battery resets the BIOS setup program settings to default. It is recommended that you note the BIOS setup program settings before removing the coin-cell battery.

About this task

The figure indicates the location of the coin-cell battery and provides a visual representation of the removal procedure.

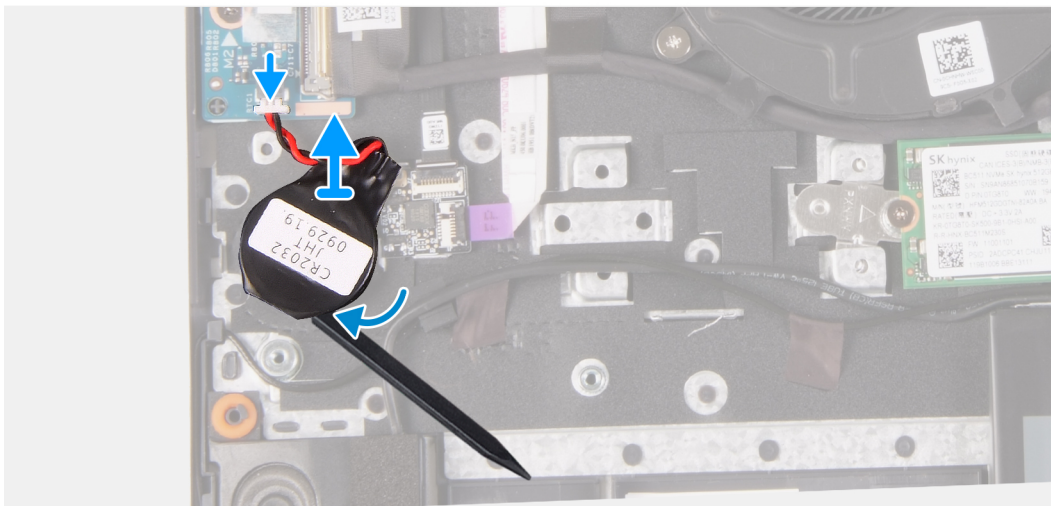
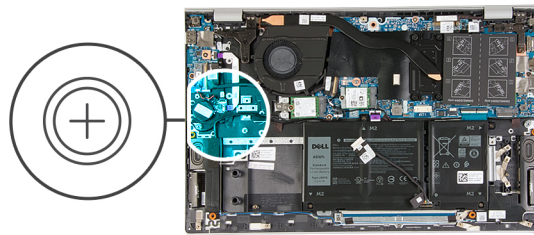

Steps

1. Disconnect the coin-cell battery cable from the I/O board.
2. Peel the coin-cell battery from the palm-rest and keyboard assembly.

Installing the coin-cell battery

Prerequisites

If you are replacing a component, remove the existing component before performing the installation procedure.

About this task

The figure indicates the location of the coin-cell battery and provides a visual representation of the installation procedure.

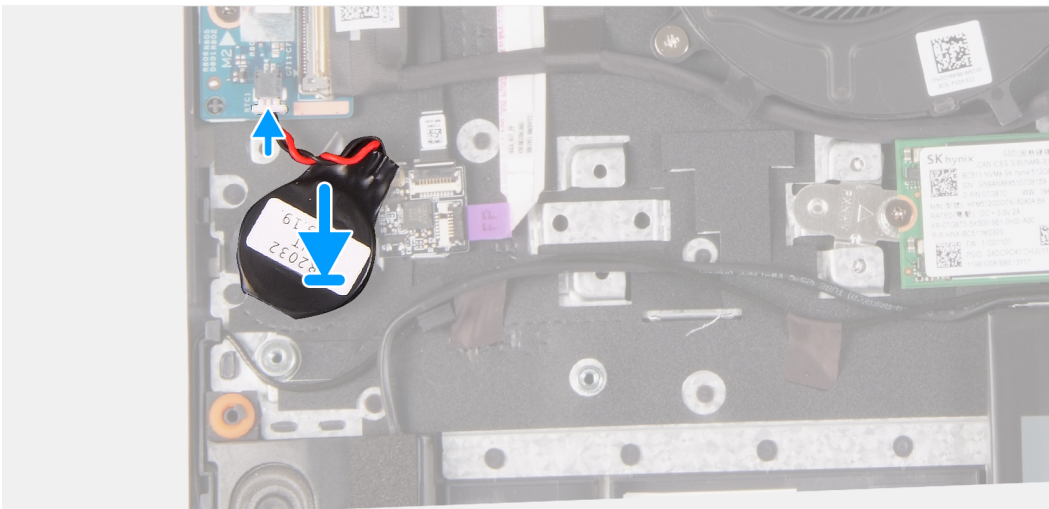
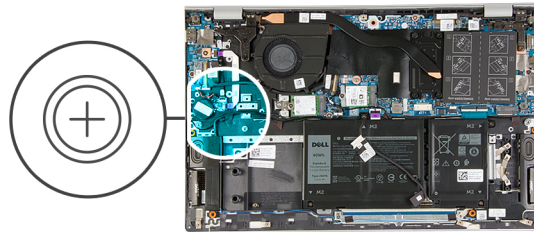

Steps

1. Adhere the coin-cell battery to the coin-cell battery slot on the palm-rest and keyboard assembly.
2. Route the coin-cell battery cable as illustrated and connect it to the I/O board.

Next steps

1. Install the [base cover](#).
2. Follow the procedure in [After working inside your computer](#).

Heat sink

Removing the heat sink

Prerequisites

CAUTION: For maximum cooling of the processor, do not touch the heat transfer areas on the heat sink. The oils in your skin can reduce the heat transfer capability of the thermal grease.

CAUTION: The heat sink may become hot during normal operation. Allow sufficient time for the heat sink to cool before you touch it.

NOTE: The appearance of the heat sink and the number of captive screws vary depending on the graphics card installed in your computer.

1. Follow the procedure in [Before working inside your computer](#).
2. Remove the [base cover](#).

About this task

The figure indicates the location of the heat sink and provides a visual representation of the removal procedure.

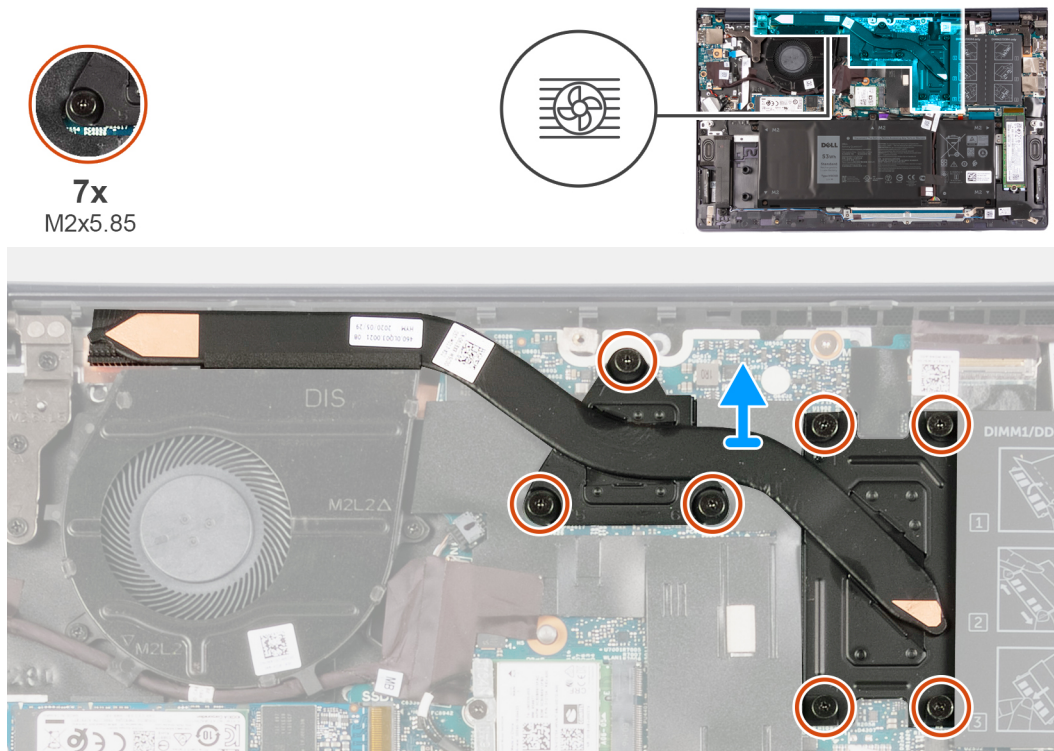

Steps

1. In reverse order (following the numeral markings on the heat sink, from 7 to 1), loosen the seven captive screws that secure the heat sink to the system board.
2. Lift and remove the heat sink off the palm-rest and keyboard assembly.

Installing the heat sink

Prerequisites

If you are replacing a component, remove the existing component before performing the installation procedure.

About this task

The figure indicates the location of the heat sink and provides a visual representation of the installation procedure.



7x
M2x5.85

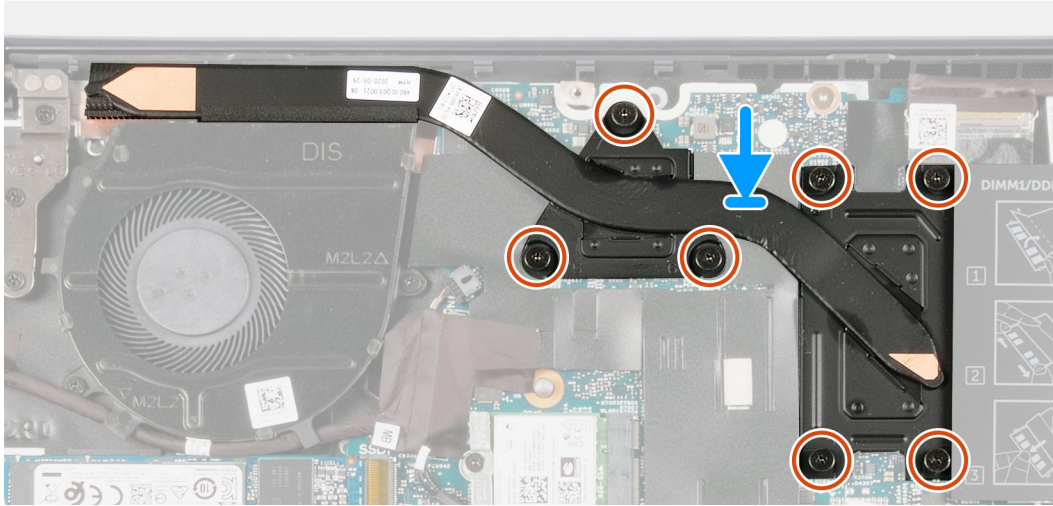

Steps

1. Place the heat sink on the system board and align the screw holes on the heat sink with the screw holes on the system board.
2. In sequential order (following the numeral markings on the heat sink, from 1 to 7), tighten the seven captive screws that secure the heat sink to the system board.

Next steps

1. Install the [base cover](#).
2. Follow the procedure in [After working inside your computer](#).

Display assembly

Removing the display assembly

Prerequisites

1. Follow the procedure in [Before working inside your computer](#).
2. Remove the [base cover](#).

About this task

The figure indicates the location of the display assembly and provides a visual representation of the removal procedure.



5x
M2.5x5



1x
M2.5x3.5

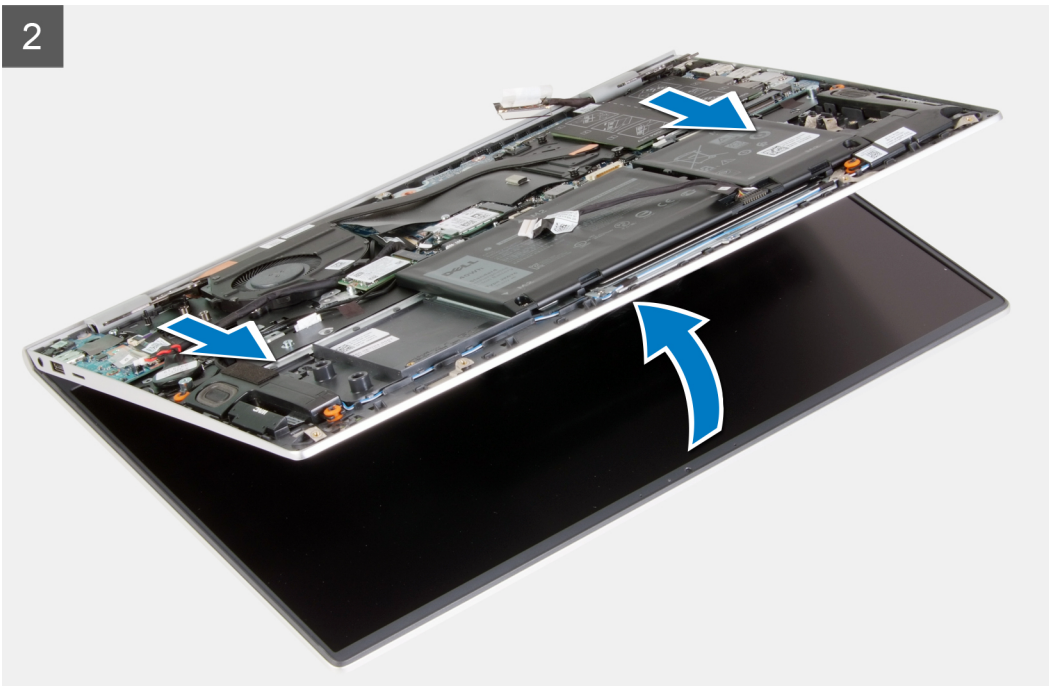
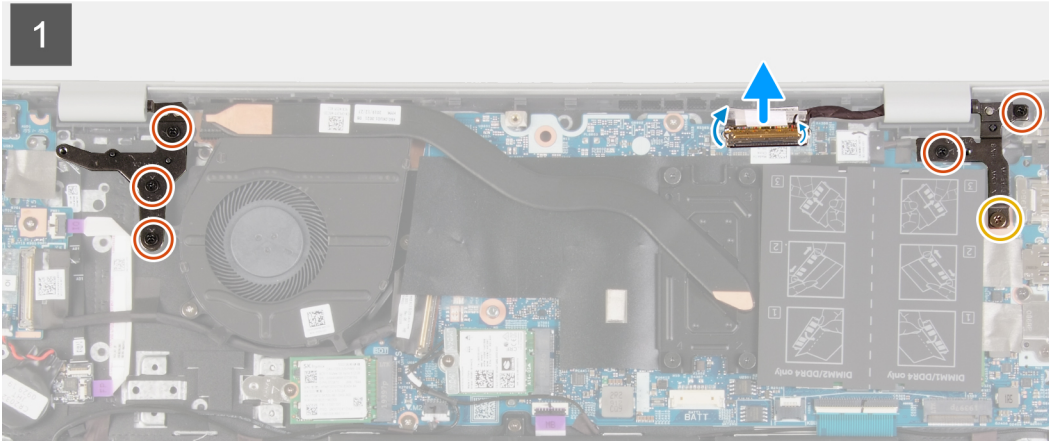
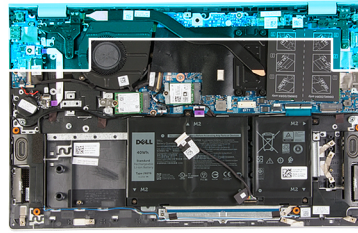

Steps

1. Peel off the tape that secures the display cable to the system board.
2. Open the latch, and disconnect the display cable from the system board.
3. Remove the screw (M2.5x3.5) and the two screws (M2.5x5) that secure the right display hinge to the system board.
4. Remove the three screws (M2.5x5) that secure the left display hinge to the system board.
5. Lift the palm-rest and keyboard assembly up to raise the display hinges.
6. Slide the palm-rest and keyboard assembly carefully off the display assembly.

NOTE: To avoid damaging the display, do not slide the palm-rest and keyboard assembly over the display assembly.

Installing the display assembly

Prerequisites

If you are replacing a component, remove the existing component before performing the installation procedure.

About this task

The figure indicates the location of the display assembly and provides a visual representation of the installation procedure.

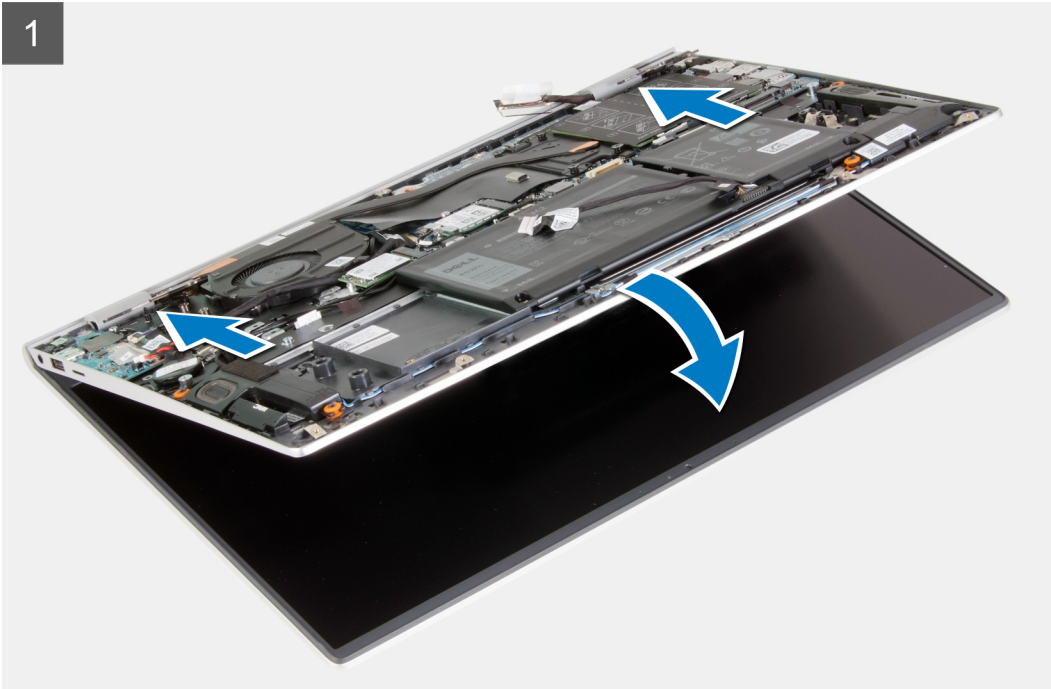

5x
M2.5x5



1x
M2.5x3.5

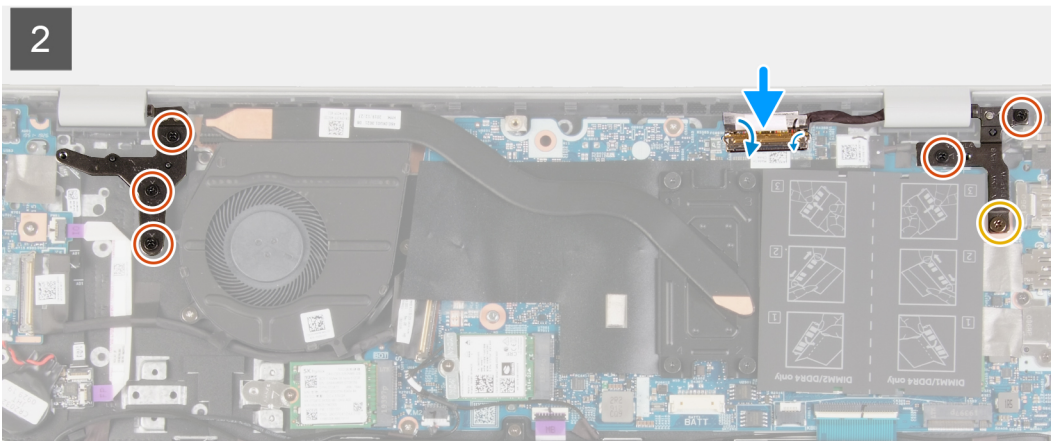
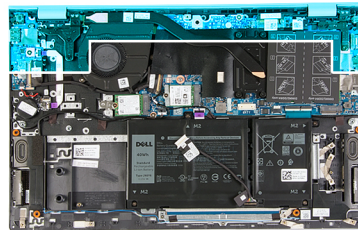

Steps

1. Place the display assembly on a clean and flat surface.
2. Align and slide the palm-rest and keyboard assembly under the display hinges.

NOTE: To avoid damaging the display, do not slide the palm-rest and keyboard assembly over the display assembly.

3. Press down the display hinges and align the screw holes on the display hinges with the screw holes on the palm-rest and keyboard assembly.
4. Replace the screw (M2.5x3.5) and the two screws (M2.5x5) that secure the right display hinge to the system board.
5. Replace the three screws (M2.5x5) that secure the left display hinge to the system board.
6. Connect the display cable to the system board, close the latch, and adhere the tape that secures the display cable to the system board.

Next steps

1. Install the [base cover](#).
2. Follow the procedure in [After working inside your computer](#).

Power-adapter port

Removing the power-adapter port

Prerequisites

1. Follow the procedure in [Before working inside your computer](#).
2. Remove the [base cover](#).

About this task

The figure indicates the location of the power-adapter port and provides a visual representation of the removal procedure.



2x
M2.5x5



1x
M2.5x3.5



1x
M2x3

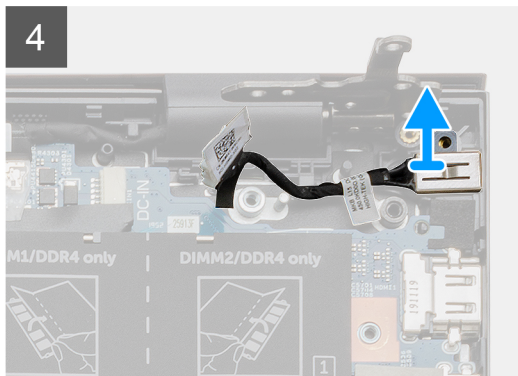
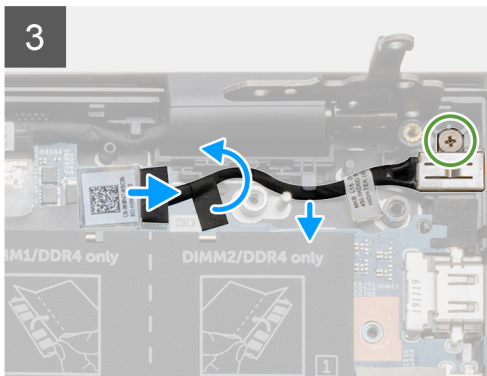
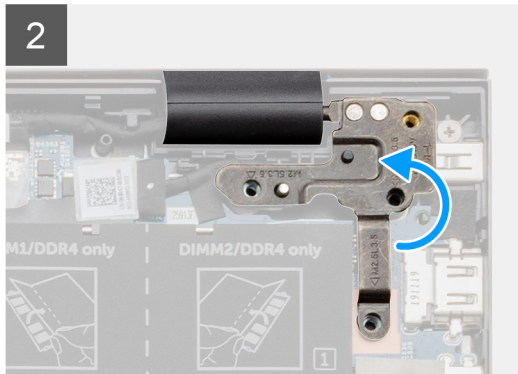
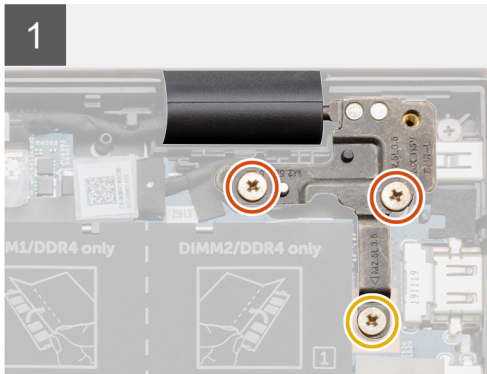
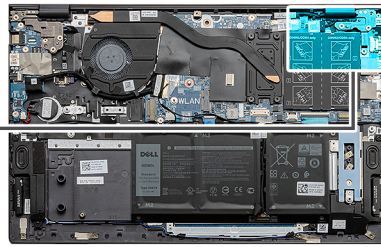
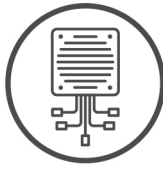

Steps

1. Remove the screw (M2.5x3.5) and the two screws (M2.5x5) that secure the right display hinge to the system board.
2. Lift the right display-hinge plate to uncover the power-adapter port cable.
3. Peel off the tape that secures the power-adapter port cable to the system board.
4. Disconnect the power-adapter port cable from its connector on the system board.
5. Remove the power-adapter port cable from the routing guides on the system board.
6. Remove the screw (M2x3), and lift the power-adapter port off the palm-rest and keyboard assembly.

Installing the power-adapter port

Prerequisites

If you are replacing a component, remove the existing component before performing the installation procedure.

About this task

The figure indicates the location of the power-adapter port and provides a visual representation of the installation procedure.



2x
M2.5x5



1x
M2.5x3.5



1x
M2x3

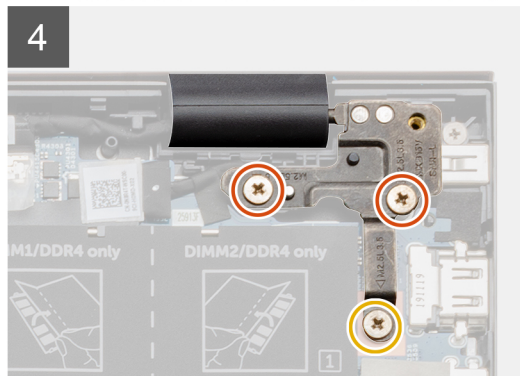
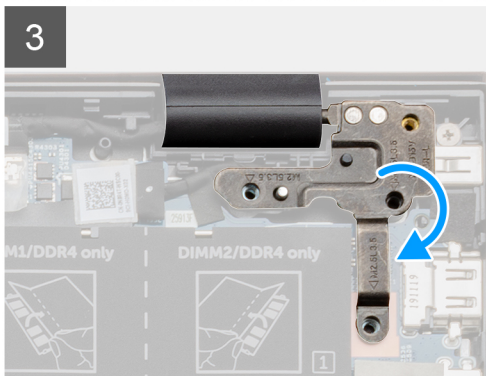
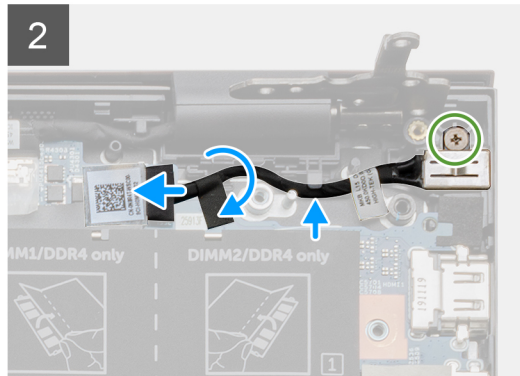
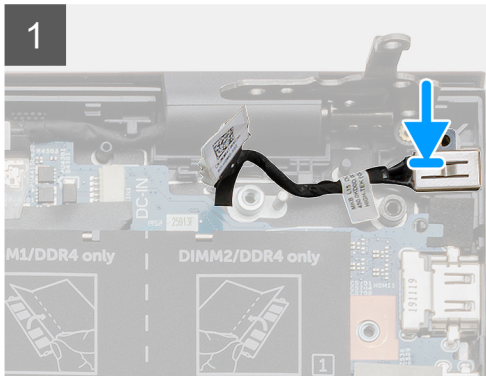
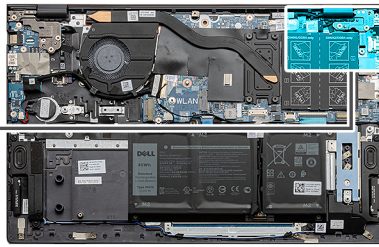
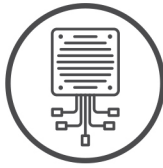

Steps

1. Place the power-adapter port into the slot on the palm-rest and keyboard assembly.
2. Replace the screw (M2x3) that secures the power-adapter port to the palm-rest and keyboard assembly.
3. Route the power-adapter port cable along the routing guide on the system board.
4. Connect the power-adapter port cable to the system board.
5. Adhere the tape to secure the power-adapter port cable to the system board.
6. Lower the right display-hinge plate and ensure that the screw holes are aligned with the screw holes on the system board.
7. Replace the screw (M2.5x3.5) and the two screws (M2.5x5) that secure the right display hinge to the system board.

Next steps

1. Install the [base cover](#).
2. Follow the procedure in [After working inside your computer](#).

Speakers

Removing the speakers

Prerequisites

1. Follow the procedure in [Before working inside your computer](#).
2. Remove the [base cover](#).

3. Remove the 3-cell battery or 4-cell battery.

About this task

The figure indicates the location of the speakers and provides a visual representation of the removal procedure.

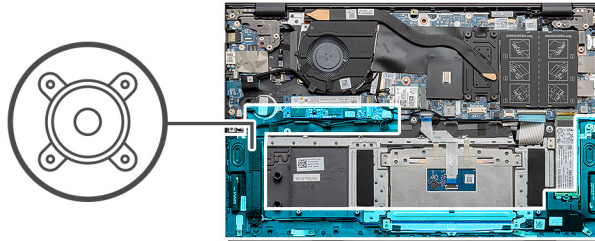

Steps

1. Disconnect the speaker cable from the system board.
2. Note the routing of the speaker cables.
3. Peel off the black tapes that secure the speaker cable to the touchpad bracket.
4. Remove the speaker cable from the routing guides on the palm-rest and keyboard assembly.
i **NOTE:** Note the position of the rubber grommets before lifting the speakers.
5. Lift the speakers, along with the cables, off the palm-rest and keyboard assembly.

Installing the speakers

Prerequisites

If you are replacing a component, remove the existing component before performing the installation procedure.

About this task

The figure indicates the location of the speakers and provides a visual representation of the installation procedure.

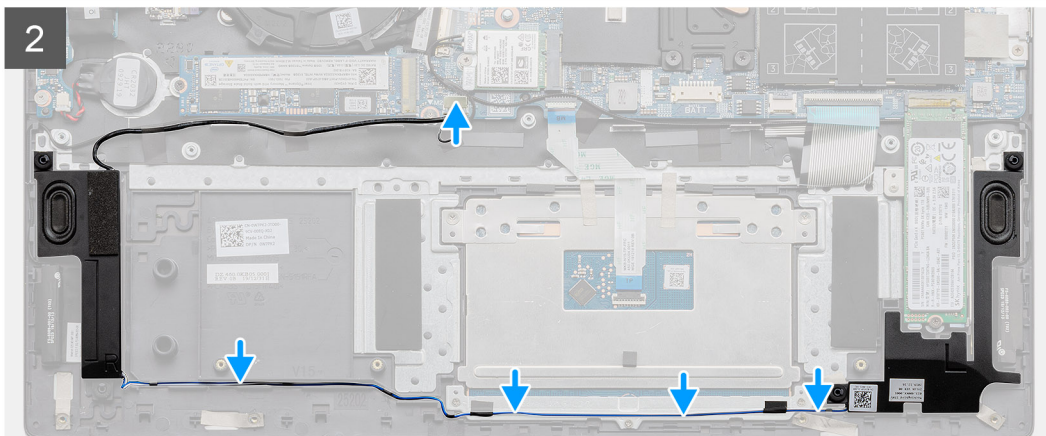
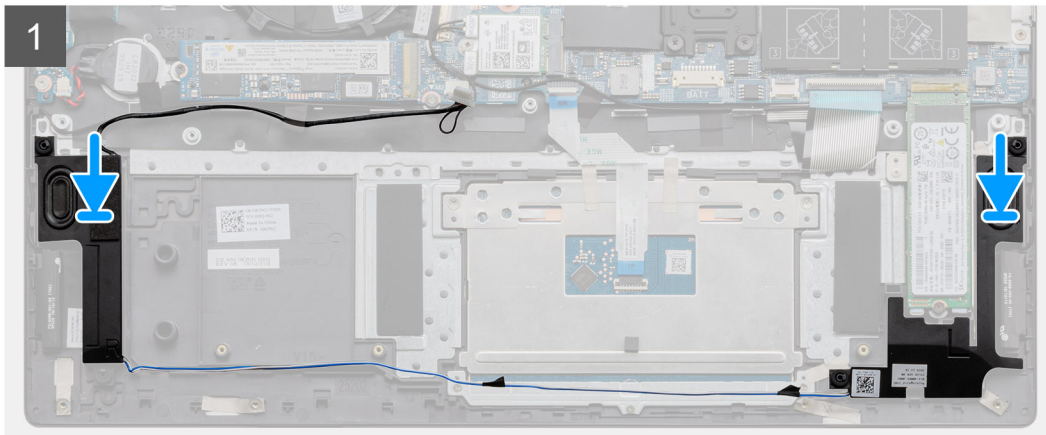
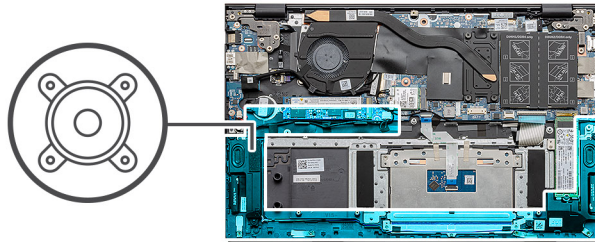

Steps

1. Using the alignment posts and rubber grommets, place the speakers in the slots on the palm-rest and keyboard assembly.
i **NOTE:** If the rubber grommets are pushed out of the speakers when the speakers were removed, push the grommets back in place before replacing the speakers.
2. Route the speaker cable through the routing guides on the palm-rest and keyboard assembly.
3. Adhere the black tapes that secure the speaker cable to the touchpad bracket.
4. Connect the speaker cable to the system board.

Next steps

1. Install the [3-cell battery](#) or [4-cell battery](#).
2. Install the [base cover](#).
3. Follow the procedure in [After working inside your computer](#).

Power button with optional fingerprint reader

Removing the power button with optional fingerprint reader

Prerequisites

1. Follow the procedure in [Before working inside your computer](#).
2. Remove the [base cover](#).
3. Remove the [display assembly](#).
4. Remove the [I/O board](#).

About this task

The figure indicates the location of the power button with optional fingerprint reader and provides a visual representation of the removal procedure.

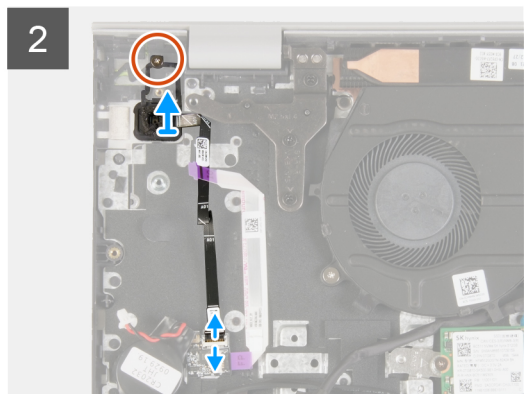
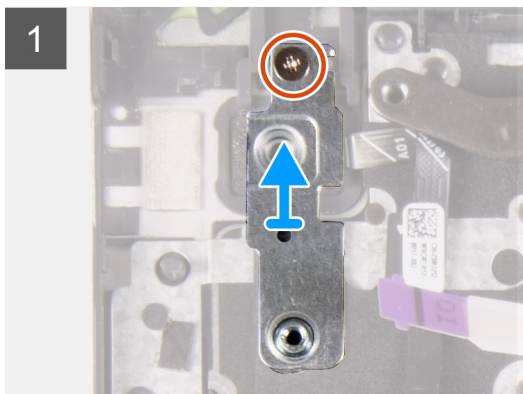
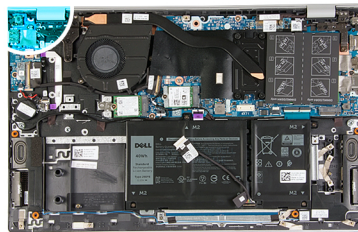

Steps

1. Remove the screw (M1.6x2) that secures the power-button bracket to the palm-rest and keyboard assembly.
2. Lift the power-button bracket off the power-button with optional fingerprint reader.
3. Remove the screw (M1.6x2) that secures the power button to the palm-rest and keyboard assembly.
4. Lift the latch and disconnect the power-button cable (or the optional fingerprint-reader cable) from the connector on the palm-rest and keyboard assembly.
5. Lift the power button, along with its cable, off the palm-rest and keyboard assembly.

Installing the power button with optional fingerprint reader

Prerequisites

If you are replacing a component, remove the existing component before performing the installation procedure.

About this task

The figure indicates the location of the power button with optional fingerprint reader and provides a visual representation of the installation procedure.



2x
M1.6x2

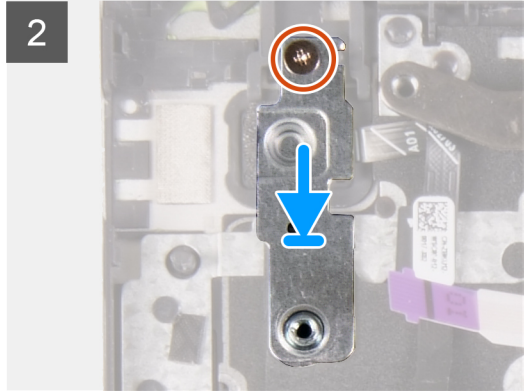
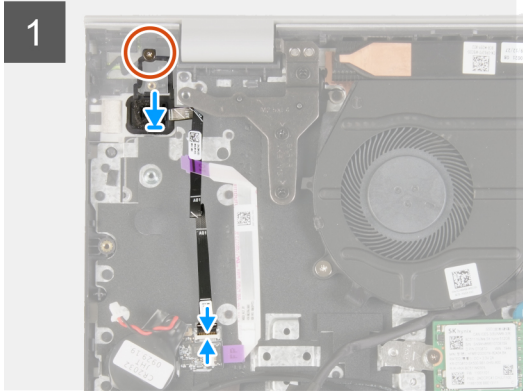
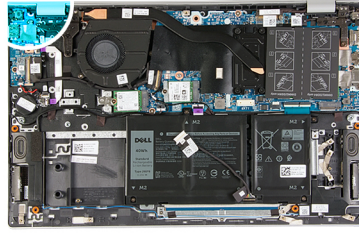

Steps

1. Align the screw holes on the power-button with optional fingerprint reader to the screw holes on the palm-rest and keyboard assembly.
2. Replace the screw (M1.6x2) that secures the power button to the palm-rest and keyboard assembly.
3. Connect the power-button cable (or the optional fingerprint-reader cable) to the connector on palm-rest and keyboard assembly, and close the latch to secure the cable to the palm-rest and keyboard assembly.
4. Align the screw hole on the power-button bracket with the screw hole on the palm-rest and keyboard assembly.
5. Replace the screw (M1.6x2) that secures the power-button bracket to the palm-rest and keyboard assembly.

Next steps

1. Install the [I/O board](#).
2. Install the [display assembly](#).
3. Install the [base cover](#).
4. Follow the procedure in [After working inside your computer](#).

Touchpad

Removing the touchpad

Prerequisites

1. Follow the procedure in [Before working inside your computer](#).
2. Remove the [base cover](#).
3. Remove the [3-cell battery](#) or [4-cell battery](#).

About this task

The figure indicates the location of the touchpad and provides a visual representation of the removal procedure.



5x
M2x2

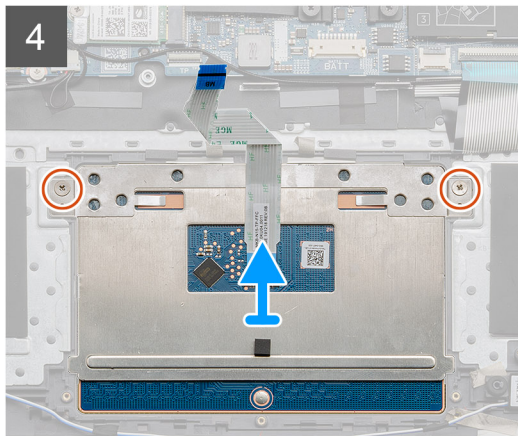
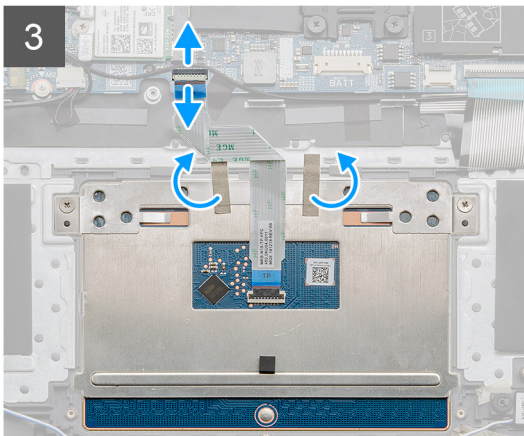
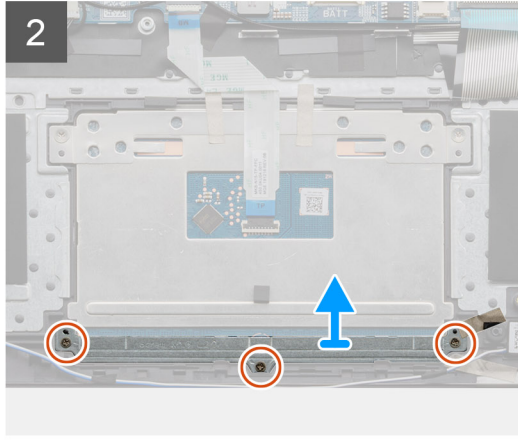
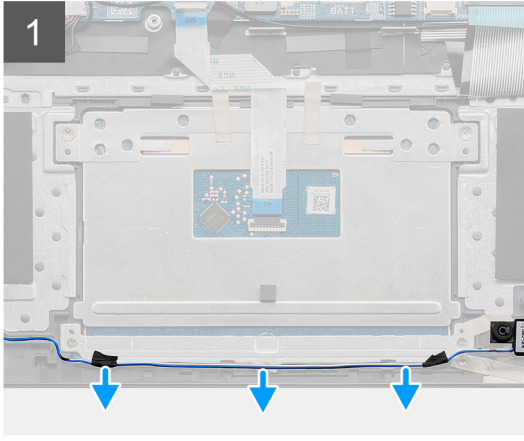
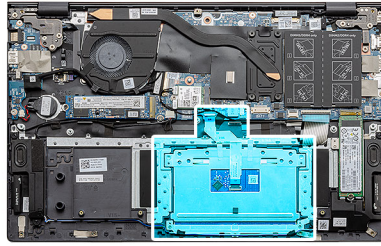

Steps

1. Peel the tapes that secure the speaker cable to the touchpad bracket.
2. Remove the speaker cable from the routing guide.
3. Remove the three screws (M2x2) that secure the touchpad bracket to the palm-rest and keyboard assembly.
4. Lift the touchpad bracket off the palm-rest and keyboard assembly.
5. Open the latch and disconnect the touchpad cable from the system board.
6. Peel the tapes that secure the touchpad to the palm-rest and keyboard assembly.
7. Remove the two screws (M2x2) that secure the touchpad to the palm-rest and keyboard assembly.
8. Lift the touchpad, along with the cable, off the palm-rest and keyboard assembly.

Installing the touchpad

Prerequisites

If you are replacing a component, remove the existing component before performing the installation procedure.

About this task

The figure indicates the location of the component and provides a visual representation of the installation procedure.



5x
M2x2

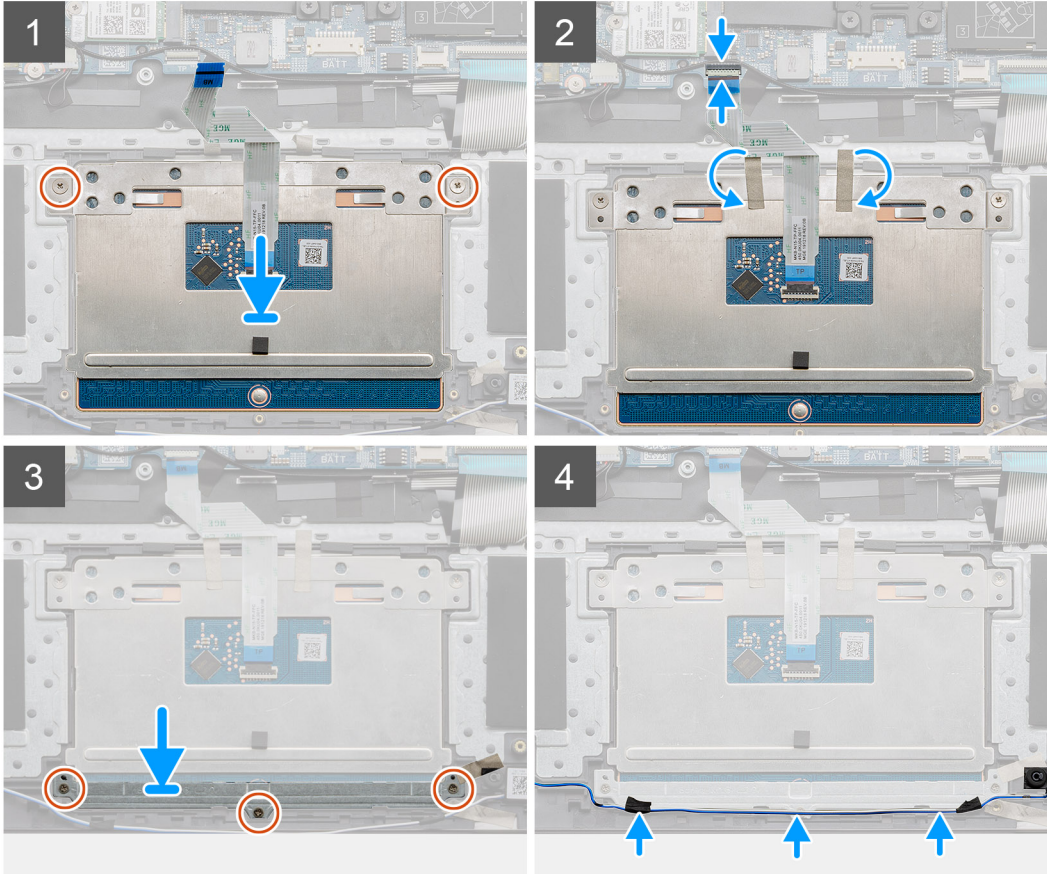
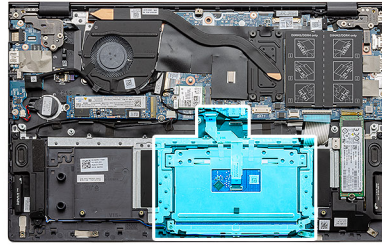

Steps

1. Align and place the touchpad into the slot on the palm-rest and keyboard assembly.
i **NOTE:** Turn the computer over and open the display. Ensure that the touchpad is equally aligned along all four sides.
2. Align the screw holes on the touchpad with the screw holes on the palm-rest and keyboard assembly.
3. Replace the two screws (M2x2) to secure the touchpad to the palm-rest and keyboard assembly.
4. Connect the touchpad cable to the system board and close the latch to secure the touchpad cable.
5. Adhere the tapes that secure the touchpad to the palm-rest and keyboard assembly.
6. Align the screw holes on the touchpad bracket with the screw holes on the palm-rest and keyboard assembly.
7. Replace the three screws (M2x2) that secure the touchpad bracket to the palm-rest and keyboard assembly.
8. Route the speaker cable along the routing guide and adhere the tapes to the touchpad bracket.

Next steps

1. Install the [3-cell battery](#) or [4-cell battery](#).
2. Install the [base cover](#).
3. Follow the procedure in [After working inside your computer](#).

I/O board

Removing the I/O board

Prerequisites

1. Follow the procedure in [Before working inside your computer](#).
2. Remove the [base cover](#).
3. Remove the [coin-cell battery](#).
4. Remove the [display assembly](#).

About this task

The figure indicates the location of the I/O board and provides a visual representation of the removal procedure.



2x
M2x2

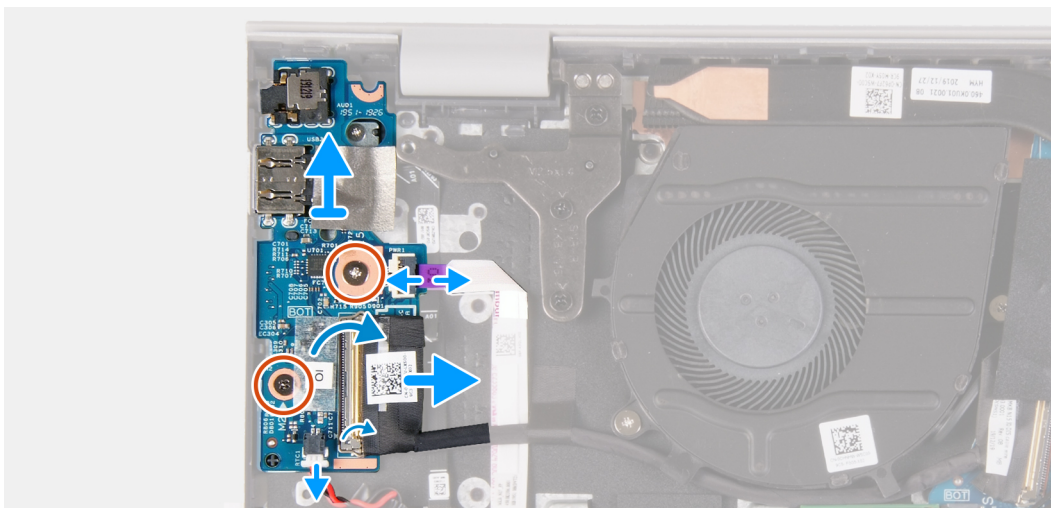
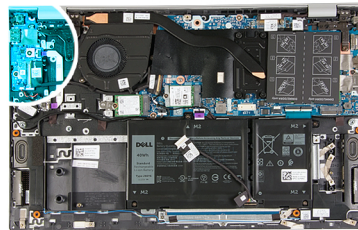

Steps

1. Peel off the tape that secures the I/O-board cable to the I/O board.
2. Open the latch and disconnect the I/O-board cable from the I/O board.
3. Open the latch and disconnect the fingerprint-reader cable from the I/O board.
4. Remove the two screws (M2x2) that secure the I/O board to the palm-rest and keyboard assembly.
5. Lift the I/O board off the palm-rest and keyboard assembly.

Installing the I/O board

Prerequisites

If you are replacing a component, remove the existing component before performing the installation procedure.

About this task

The figure indicates the location of the I/O board and provides a visual representation of the installation procedure.



2x
M2x2

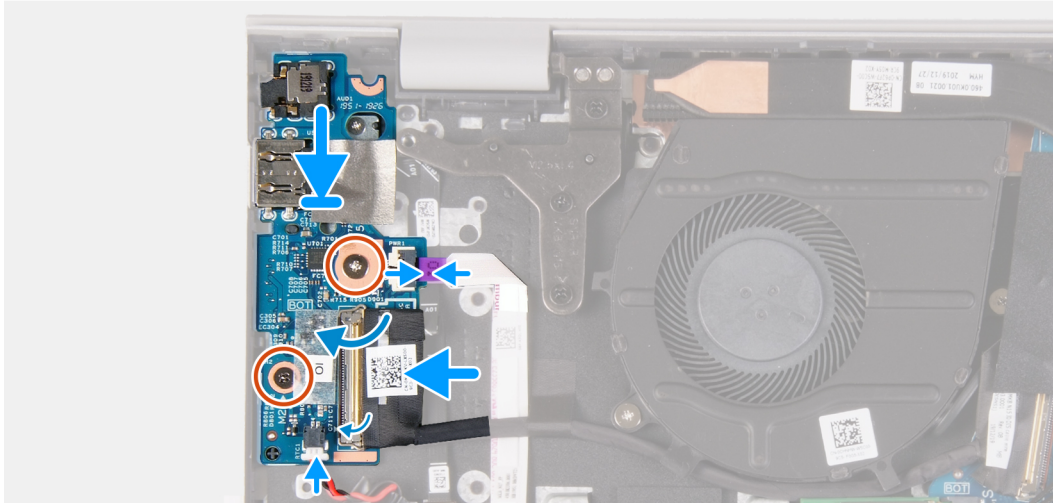
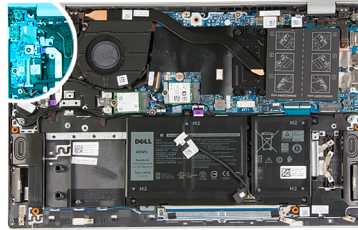

Steps

1. Place the I/O board on the palm-rest and keyboard assembly.
2. Align the screw holes on the I/O board with the screw holes on the palm-rest and keyboard assembly.
3. Replace the two screws (M2x2) that secure the I/O board to the palm-rest and keyboard assembly.
4. Connect the fingerprint reader cable to the I/O board and close the latch to secure the cable.
5. Connect the I/O-board cable to the I/O board and close the latch to secure the cable.
6. Adhere the tape that secures the I/O-board cable to the I/O board.

Next steps

1. Install the [display assembly](#).
2. Install the [coin-cell battery](#).
3. Install the [base cover](#).
4. Follow the procedure in [After working inside your computer](#).

System board

Removing the system board

Prerequisites

1. Follow the procedure in [Before working inside your computer](#).
2. Remove the [base cover](#).
3. Remove the [3-cell battery](#) or [4-cell battery](#).
4. Remove the [memory modules](#).
5. Remove the [M.2 2230 solid-state drive](#) or the [M.2 2280 solid-state drive](#) from M.2 slot one.
6. Remove the [M.2 2230 solid-state drive](#) or the [M.2 2280 solid-state drive](#) from M.2 slot two.
7. Remove the [wireless card](#).
8. Remove the [heat sink](#).
9. Remove the [power button with optional fingerprint reader](#).

About this task

The figure indicates the location of the system board and provides a visual representation of the removal procedure.

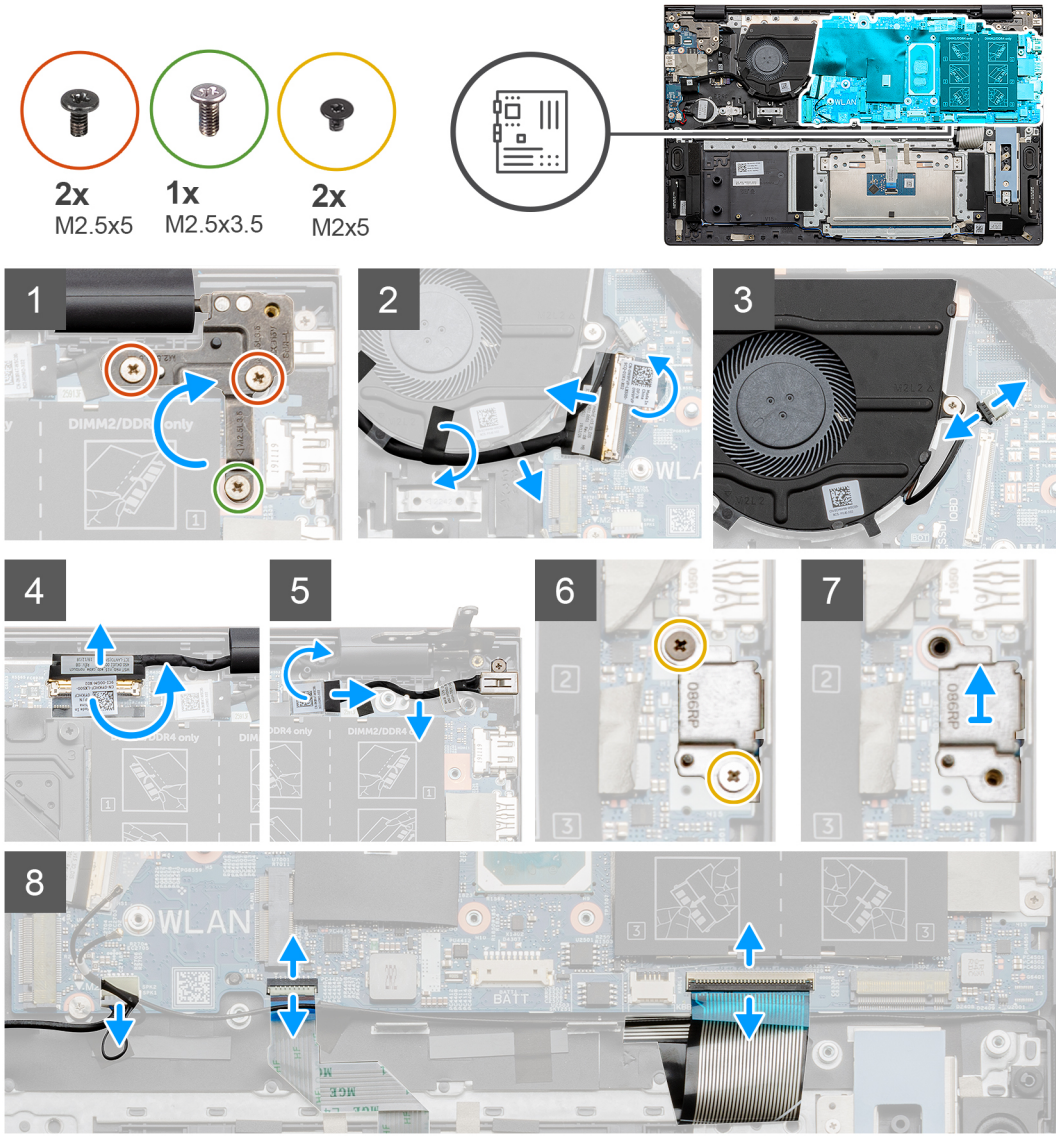



2x
M2x2



Steps

1. Remove the screw (M2.5x3.5) and the two screws (M2.5x5) that secure the right display hinge to the system board.
2. Pry open the right display hinge.
3. Peel the black tape that secures the I/O-board cable to fan.
4. Peel the transparent tape, open the latch, and disconnect the I/O-board cable from the system board.
5. Disconnect the fan cable from the system board.
6. Peel the tape, open the latch, and then disconnect the display cable from the system board.
7. Peel the black tape off the power-adapter port cable.
8. Disconnect the power-adapter port cable from the system board.
9. Remove the two screws (M2x5) that secure the USB Type-C port bracket to the system board.
10. Lift the USB Type-C port bracket off the palm-rest and keyboard assembly.
11. Disconnect the speaker cable from the system board.
12. Open the latch and disconnect the touchpad cable from the system board.
13. Open the latch and disconnect the keyboard cable from the system board.
14. Open the latch and disconnect the keyboard-backlight cable from the system board, if applicable.
15. Remove the two screws (M2x2) that secure the system board to the palm-rest and keyboard assembly.

Installing the system board

Prerequisites

If you are replacing a component, remove the existing component before performing the installation procedure.

About this task

The figure indicates the location of the system board and provides a visual representation of the installation procedure.



2x
M2x2

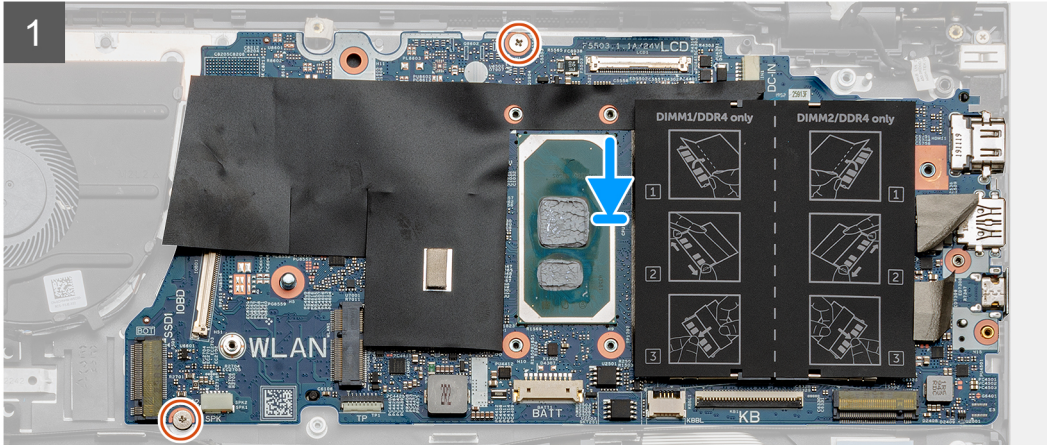
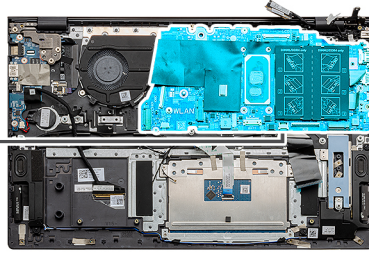

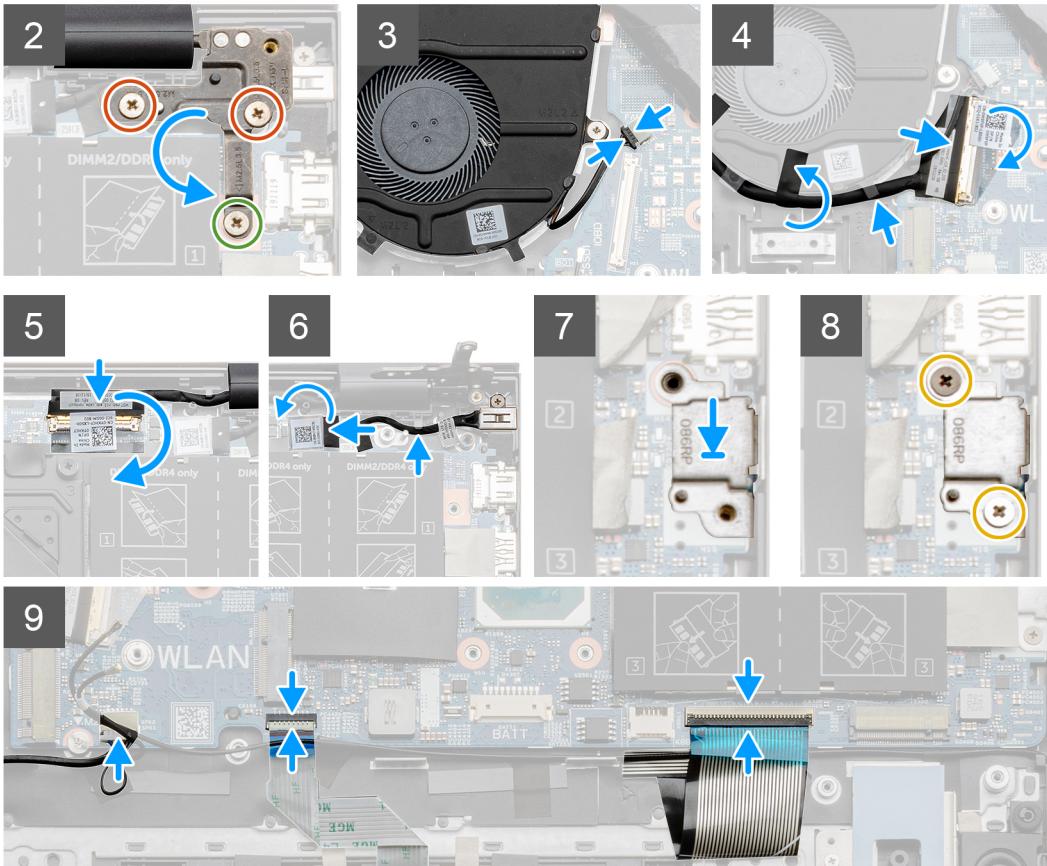
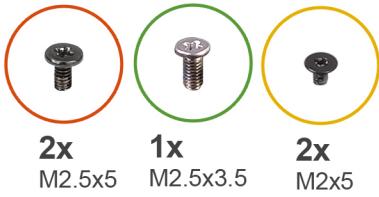

Steps

1. Place the system board on the palm-rest and keyboard assembly.
2. Replace the two screws (M2x2) that secure the system board to the palm-rest and keyboard assembly.
3. Lower the left display-hinge plate and replace the screw (M2.5x3.5) and the two screws (M2.5x5) that secure the right display-hinge plate to the system board.
4. Connect the fan cable to the system board.
5. Connect the I/O cable to the system board and close the latch.
6. Adhere the black tape that secures the I/O cable to the fan.
7. Connect the display cable to the system board and adhere the tape to secure the cable.
8. Connect the power-adaptor port cable to the system board.
9. Adhere the black tape that secures the power-adaptor port cable to the system board.
10. Place the USB Type-C port bracket in its slot on the palm-rest and keyboard assembly.
11. Replace the two screws (M2x5) that secure the USB Type-C port bracket to the system board.
12. Connect the speaker cable to the system board.
13. Connect the touchpad cable to the system board and close the latch to secure the touchpad cable.
14. Connect the keyboard cable to the system board and close the latch to secure the keyboard cable.
15. Connect the keyboard-backlight cable to the system board and close the latch to secure the keyboard cable, if applicable.

Next steps

1. Install the [power button with optional fingerprint reader](#).
2. Install the [memory modules](#).
3. Install the [heat sink](#).
4. Install the [wireless card](#).
5. Install the [M.2 2230 solid-state drive](#) or the [M.2 2280 solid-state drive](#) in M.2 slot two.
6. Install the [M.2 2230 solid-state drive](#) or the [M.2 2280 solid-state drive](#) in M.2 slot one.
7. Install the [3-cell battery](#) or [4-cell battery](#).
8. Install the [base cover](#).
9. Follow the procedure in [After working inside your computer](#).

Palm-rest and keyboard assembly

Removing the palm-rest and keyboard assembly

Prerequisites

1. Follow the procedure in [Before working inside your computer](#).
2. Remove the [base cover](#).
3. Remove the [3-cell battery](#) or [4-cell battery](#).
4. Remove the [memory modules](#).
5. Remove the [M.2 2230 solid-state drive](#) or the [M.2 2280 solid-state drive](#) from M.2 slot one.
6. Remove the [M.2 2230 solid-state drive](#) or the [M.2 2280 solid-state drive](#) from M.2 slot two.
7. Remove the [wireless card](#).
8. Remove the [fan](#).
9. Remove the [coin-cell battery](#).
10. Remove the [heat sink](#).
11. Remove the [display assembly](#).
12. Remove the [power-adaptor port](#).
13. Remove the [speakers](#).
14. Remove the [power button with optional fingerprint reader](#).
15. Remove the [touchpad](#).
16. Remove the [I/O board](#).
17. Remove the [system board](#).

 **NOTE:** The system board can be removed along with the heat sink.

About this task

The figure indicates the location of the palm-rest and keyboard assembly and provides a visual representation of the removal procedure.

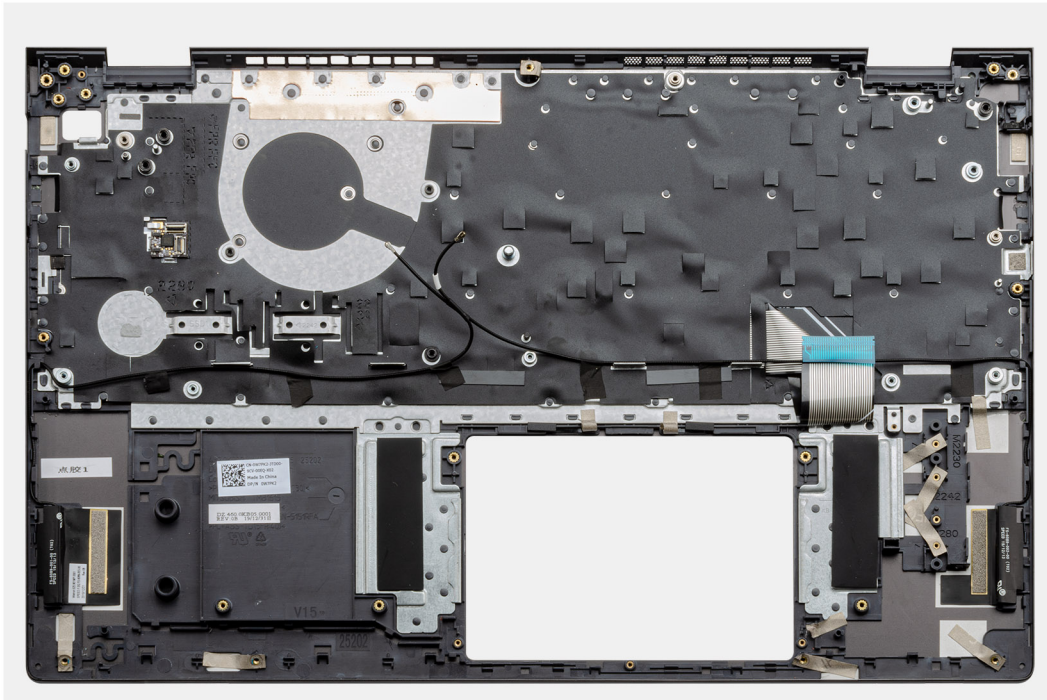

Steps

After performing the steps in the pre-requisites, we are left with the palm-rest and keyboard assembly.

Installing the palm-rest and keyboard assembly

Prerequisites

If you are replacing a component, remove the existing component before performing the installation procedure.

About this task

The figure indicates the location of the palm-rest and keyboard assembly and provides a visual representation of the installation procedure.

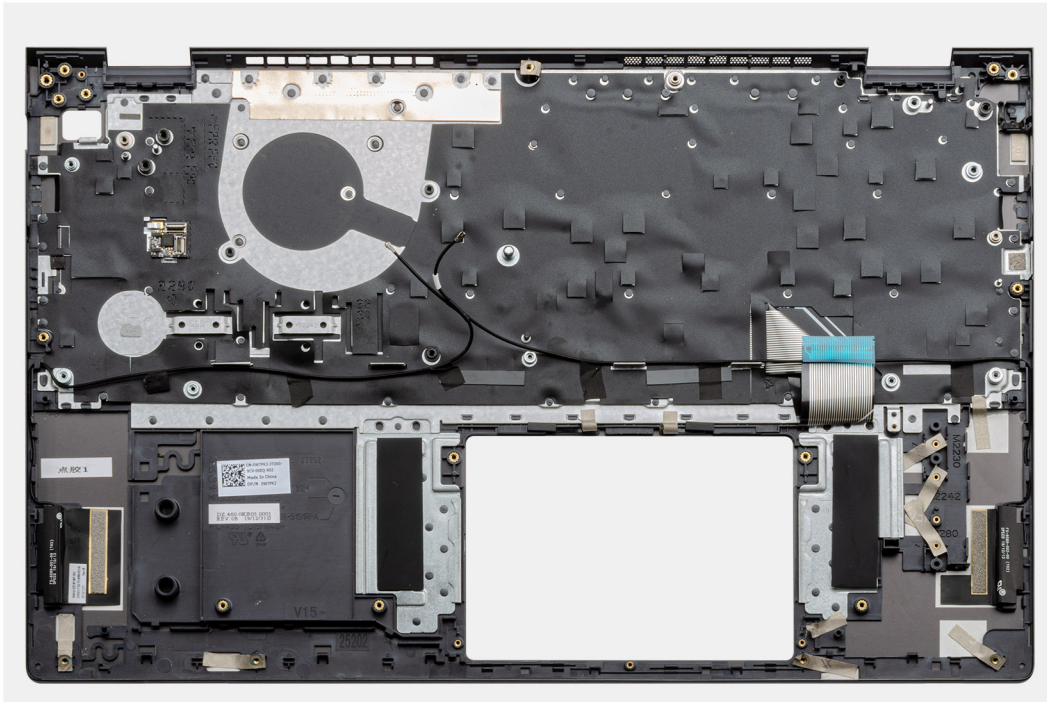

Steps

Place the palm-rest and keyboard assembly on a flat surface.

Next steps

1. Install the [system board](#).
2. Install the [I/O board](#).
3. Install the [touchpad](#).
4. Install the [power button with optional fingerprint reader](#).
5. Install the [speakers](#).
6. Install the [power-adaptor port](#).
7. Install the [display assembly](#).
8. Install the [heat sink](#).
9. Install the [coin-cell battery](#).
10. Install the [fan](#).
11. Install the [wireless card](#).
12. Install the [M.2 2230 solid-state drive](#) or the [M.2 2280 solid-state drive](#) in M.2 slot two.
13. Install the [M.2 2230 solid-state drive](#) or the [M.2 2280 solid-state drive](#) in M.2 slot one.
14. Install the [memory modules](#).
15. Install the [3-cell battery](#) or [4-cell battery](#).
16. Install the [base cover](#).
17. Follow the procedure in [After working inside your computer](#).

Drivers and downloads

When troubleshooting, downloading or installing drivers it is recommended that you read the Dell Knowledge Based article, Drivers and Downloads FAQ [SLN128938](#).

System setup

CAUTION: Unless you are an expert computer user, do not change the settings in the BIOS Setup program. Certain changes can make your computer work incorrectly.

NOTE: Depending on the computer and its installed devices, the items listed in this section may or may not be displayed.

NOTE: Before you change BIOS Setup program, it is recommended that you write down the BIOS Setup program screen information for future reference.

Use the BIOS Setup program for the following purposes:

- Get information about the hardware installed in your computer, such as the amount of RAM and the size of the hard drive.
- Change the system configuration information.
- Set or change a user-selectable option, such as the user password, type of hard drive installed, and enabling or disabling base devices.

Entering BIOS setup program

Steps

1. Turn on your computer.
2. Press F2 immediately to enter the BIOS setup program.

NOTE: If you wait too long and the operating system logo appears, continue to wait until you see the desktop. Then, turn off your computer and try again.

Navigation keys

NOTE: For most of the System Setup options, changes that you make are recorded but do not take effect until you restart the system.

Table 3. Navigation keys

Keys	Navigation
Up arrow	Moves to the previous field.
Down arrow	Moves to the next field.
Enter	Selects a value in the selected field (if applicable) or follow the link in the field.
Spacebar	Expands or collapses a drop-down list, if applicable.
Tab	Moves to the next focus area. NOTE: For the standard graphics browser only.
Esc	Moves to the previous page until you view the main screen. Pressing Esc in the main screen displays a message that prompts you to save any unsaved changes and restarts the system.

One time boot menu

To enter **one time boot menu**, turn on your computer, and then press F2 immediately.

NOTE: It is recommended to shutdown the computer if it is on.

The one-time boot menu displays the devices that you can boot from including the diagnostic option. The boot menu options are:

- Removable Drive (if available)
- STXXXX Drive (if available)

NOTE: XXX denotes the SATA drive number.

- Optical Drive (if available)
- SATA Hard Drive (if available)
- Diagnostics

NOTE: Choosing **Diagnostics**, will display the **ePSA diagnostics** screen.

The boot sequence screen also displays the option to access the System Setup screen.

System setup options

NOTE: Depending on this computer and its installed devices, the items that are listed in this section may or may not be displayed.

Table 4. System setup options—System information menu

Overview	
BIOS Version	Displays the BIOS version number.
Service Tag	Displays the Service Tag of the computer.
Asset Tag	Displays the Asset Tag of the computer.
Ownership Tag	Displays the ownership tag of the computer.
Manufacture Date	Displays the manufacture date of the computer.
Ownership Date	Displays the ownership date of the computer.
Express Service Code	Displays the express service code of the computer.
Ownership Tag	Displays the ownership tag of the computer.
Signed Firmware Update	Displays whether the signed firmware update is enabled.
Battery	Displays the battery health information.
Primary	Displays the primary battery.
Battery Level	Displays the battery level.
Battery State	Displays the battery state.
Health	Displays the battery health.
AC Adapter	Displays whether an AC adapter is installed.
Processor Information	
Processor Type	Displays the processor type.
Maximum Clock Speed	Displays the maximum processor clock speed.
Core Count	Displays the number of cores on the processor.
Processor L2 Cache	Displays the processor L2 Cache size.
Processor ID	Displays the processor identification code.

Table 4. System setup options—System information menu (continued)

Overview	
Processor L3 Cache	Displays the processor L3 Cache size.
Current Clock Speed	Displays the current processor clock speed.
Minimum Clock Speed	Displays the minimum processor clock speed.
Microcode Version	Displays the microcode version.
Intel Hyper-Threading Capable	Displays whether the processor is Hyper-Threading (HT) capable.
64-Bit Technology	Displays whether 64-bit technology is used.
Memory Information	
Memory Installed	Displays the total computer memory installed.
Memory Available	Displays the total computer memory available.
Memory Speed	Displays the memory speed.
Memory Channel Mode	Displays single or dual channel mode.
Memory Technology	Displays the technology that is used for the memory.
Device Information	
Video Controller	Displays the integrate graphics information of the computer.
dGPU Video Controller	Displays the discrete graphics information of the computer.
Video BIOS Version	Displays the video BIOS version of the computer.
Video Memory	Displays the video memory information of the computer.
Panel Type	Displays the Panel Type of the computer.
Native Resolution	Displays the native resolution of the computer.
Audio Controller	Displays the audio controller information of the computer.
Wi-Fi Device	Displays the wireless device information of the computer.
Bluetooth Device	Displays the Bluetooth device information of the computer.

Table 5. System setup options—Boot options menu

Boot options	
Advanced Boot Options	
Enable UEFI Network Stack	Enables or disables UEFI Network Stack. Default: OFF.
Boot Mode	
Boot Mode: UEFI only	Displays the boot mode of this computer.
Enable Boot Devices	Enables or disables boot devices for this computer.
Boot Sequence	Displays the boot sequence.
BIOS Setup Advanced Mode	
	Enables or disables advanced BIOS settings. Default: ON.
UEFI Boot Path Security	
	Enables or disables the system to prompt the user to enter the Admin password when booting a UEFI boot path from the F12 boot menu. Default: Always Except Internal HDD.

Table 6. System setup options—System Configuration menu

System Configuration	
Date/Time	
Date	Sets the computer date in MM/DD/YYYY format. Changes to the date take effect immediately.
Time	Sets the computer time in HH/MM/SS 24-hour format. You can switch between 12-hour and 24-hour clock. Changes to the time take effect immediately.
Enable SMART Reporting	Enables or disables SMART (Self-Monitoring, Analysis, and Reporting Technology) during computer startup to report hard drive errors. Default: OFF.
Enable Audio	Enables or disables all integrated audio controller. Default: ON.
Enable Microphone	Enables or disables microphone. Default: ON.
Enable Internal Speaker	Enables or disables internal speaker. Default: ON.
USB Configuration	
Enable Boot Support	Enables or disables booting from USB mass storage devices such as external hard drive, optical drive, and USB drive.
Enable External USB Ports	Enables or disables USB ports to be functional in an operating system environment.
SATA Operation	Configures operating mode of the integrated SATA hard drive controller. Default: RAID. SATA is configured to support RAID (Intel Rapid Restore Technology).
Drives	
M.2 PCIe SSD-0/SATA-2	Default: ON.
SATA-0	Default: ON.
Drive Information	Displays the information of various onboard drives.
Miscellaneous Devices	
Enable Camera	Enables or disables the camera. Default: ON.
Keyboard Illumination	Configures the operating mode of the keyboard illumination feature. Default: Disabled. The keyboard illumination will always be off.
Keyboard Backlight Timeout on AC	Configures the timeout value for the keyboard when an AC adapter is connected to the computer. The keyboard backlight timeout value is only effect when the backlight is enabled. Default: 10 seconds.
Keyboard Backlight Timeout on Battery	Configures the timeout value for the keyboard when the computer is running on battery. The keyboard backlight timeout value is only effect when the backlight is enabled. Default: 10 seconds.
Touchscreen	Enables or disables the touchscreen for the operating system. NOTE: Touchscreen will always work in the BIOS setup irrespective of this setting.

Table 6. System setup options—System Configuration menu (continued)

System Configuration	
	Default: ON.

Table 7. System setup options—Video menu

Video	
LCD Brightness	
Brightness on battery power	Sets the screen brightness when the computer is running on battery power.
Brightness on AC power	Sets the screen brightness when the computer is running on AC power.
EcoPower	
	Enables or disables EcoPower which increases the battery life by reducing the screen brightness when appropriate.
	Default: ON.

Table 8. System setup options—Security menu

Security	
Enable Admin Setup Lockout	Enables or disables the user from entering BIOS Setup when an Admin Password is set. Default: OFF.
Password Bypass	Bypass the System (Boot) Password and the internal hard drive password prompts during a system restart. Default: Disabled.
Enable Non-Admin Password Changes	Enables or disables the user to change the system and hard drive password without the need for admin password. Default: ON.
Non-Admin Setup Changes	
Allow Wireless Switch Changes	Enables or disables changes to the setup option when an Administrator password is set. Default: OFF.
Enable UEFI Capsule Firmware Updates	Enables or disables BIOS updates through UEFI capsule update packages.
Computrace	
Enable or disable the BIOS module interface of the optional Computrace(R) Service from Absolute Software.	
Intel Platform Trust Technology On	
	Enables or disables Platform Trust Technology (PTT) visibility to the operating system. Default: ON.
PPI Bypass for Clear Commands	Enables or disables the operating system to skip BIOS Physical Presence Interface (PPI) user prompts when issuing the Clear command. Default: OFF.
Clear	Enables or disables the computer to clear the PTT owner information, and returns the PTT to the default state. Default: OFF.
Intel SGX	
	Enables or disables the Intel Software Guard Extensions (SGX) to provide a secured environment for running code/storing sensitive information. Default: Software Control
SMM Security Mitigation	
	Enables or disables additional UEFI SMM Security Mitigation protections. Default: OFF.

Table 8. System setup options—Security menu (continued)

Security	
Enable Strong Passwords	<p>NOTE: This feature may cause compatibility issues or loss of functionality with some legacy tools and applications.</p> <p>Enables or disables strong passwords.</p> <p>Default: OFF.</p>
Password Configuration	Control the minimum and maximum number of characters that are allowed for Admin and System passwords.
Admin Password	Sets, Changes, or deletes the administrator (admin) password (sometimes called the "setup" password).
System Password	Sets, Changes, or deletes the system password.
Enable Master Password Lockout	<p>Enables or disables the master password support.</p> <p>Default: OFF.</p>

Table 9. System setup options—Secure Boot menu

Secure Boot	
Enable Secure Boot	<p>Enables or disables the computer to boot using only validated boot software.</p> <p>Default: OFF.</p> <p>NOTE: For Secure Boot to be enabled, the computer needs to be in UEFI boot mode and the Enable Legacy Option ROMs option needs to be turned off.</p>
Secure Boot Mode	<p>Selects the Secure Boot operation mode.</p> <p>Default: Deployed Mode.</p> <p>NOTE: Deployed Mode should be selected for normal operation of Secure Boot.</p>

Table 10. System setup options—Expert Key Management menu

Expert Key Management	
Enable Custom Mode	<p>Enables or disables the keys in the PK, KEK, db, and dbx security key databases to be modified.</p> <p>Default: OFF.</p>
Custom Mode Key Management	<p>Selects the custom values for expert key management.</p> <p>Default: PK.</p>

Table 11. System setup options—Performance menu

Performance	
Intel Hyper-Threading Technology	<p>Enables or disables the Intel Hyper-Threading Technology to use processor resources more efficiently.</p> <p>Default: ON.</p>
Intel SpeedStep	<p>Enables or disables the Intel SpeedStep Technology to dynamically adjust processor voltage and core frequency, decreasing average power consumption and heat production.</p> <p>Default: ON.</p>
Intel TurboBoost Technology	<p>Enabled or disabled the Intel TurboBoost mode of the processor. If enabled, the Intel TurboBoost driver increases the performance of the CPU or graphics processor.</p>

Table 11. System setup options—Performance menu (continued)

Performance	
	Default: ON.
Multi-Core Support	Changes the number of CPU cores available to the operating system. The default value is set to the maximum number of cores. Default: All Cores.
Enable C-State Control	Enables or disables the CPU's ability to enter and exit low-power states. Default: ON.

Table 12. System setup options—Power Management menu

Power Management	
Wake on AC	Enables the computer to turn on and go to boot when AC power is supplied to the computer. Default: OFF.
Auto on Time	Enables the computer to automatically power on for defined days and times. Default: Disabled. The system will not automatically power up.
Battery Charge Configuration	Enables the computer to run on battery during power usage hours. Use the below options to prevent AC power usage between certain times of each day. Default: Adaptive. Battery settings are adaptively optimized based on your typical battery usage pattern.
Enable Advanced Battery Charge Configuration	Enables Advanced Battery Charge Configuration from the beginning of the day to a specified work period. Advanced Battery Charged maximizes battery health while still supporting heavy use during the work day. Default: OFF.
Block Sleep	Blocks the computer from entering Sleep (S3) mode in the operating system. Default: OFF. NOTE: If enabled, the computer will not go to sleep, Intel Rapid Start will be disabled automatically, and the operating system power option will be blank if it was set to Sleep.
Enable USB Wake Support	Enables the USB devices to wake the computer from Standby mode. Default: OFF.
Enable Intel Speed Shift Technology	Enables or disables Intel Speed Shift Technology support which enables the operating system to select the appropriate processor performance automatically. Default: ON.
Lid Switch	Enables the computer to power up from the off state whenever the lid is opened. Default: ON.

Table 13. System setup options—Wireless menu

Wireless	
Wireless Switch	Determines which wireless devices can be controlled by the Wireless Switch. For Windows 8 systems, this is controlled by an operating system drive directly. As a result, the setting does not affect the Wireless Switch behavior. NOTE: When both WLAN and WiGig are present, enable/disable controls are tied together. Thus, they cannot be enabled or disabled independently.

Table 13. System setup options—Wireless menu (continued)

Wireless	
WLAN	Default: ON.
Bluetooth	Default: ON.
Wireless Device Enable	Enable or disable internal WLAN/Bluetooth devices.
WLAN	Default: ON.
Bluetooth	Default: ON.

Table 14. System setup options—POST Behavior menu

POST Behavior	
Numlock Enable	Enables or disables Numlock when the computer boots. Default: ON.
Enable Adapter Warnings	Enables the computer to display adapter warning messages during boot. Default: ON.
Extend BIOS POST Time	Configures the BIOS POST (Power-On Self-Test) load time. Default: 0 seconds.
Fastboot	Configures the speed of the UEFI boot process. Default: Thorough. Performs complete hardware and configuration initialization during boot.
Fn Lock Options	Enables or disables the Fn lock mode. Default: ON.
Lock Mode	Default: Lock Mode Secondary. Lock Mode Secondary = If this option is selected, the F1-F12 keys scan the code for their secondary functions.
Pull Screen Logo	Enabled or disabled the computer to display full screen logo if the image match screen resolution. Default: OFF.
Warnings and Errors	Selects an action on encountering a warning or error during boot. Default: Prompt on Warnings and Errors. Stop, prompt and wait for user input when warnings or errors are detected.
	 NOTE: Errors deemed critical to the operation of the computer hardware will always halt the computer.

Table 15. System setup options—Virtualization menu

Virtualization	
Intel Virtualization Technology	Enables the computer to run a virtual machine monitor (VMM). Default: ON.
VT for Direct I/O	Enables the computer to perform Virtualization Technology for Direct I/O (VT-d). VT-d is an Intel method that provides virtualization for memory map I/O. Default: ON.

Table 16. System setup options—Maintenance menu



Maintenance	
Asset Tag	Creates a system Asset Tag that can be used by an IT administrator to uniquely identify a particular system. Once set in BIOS, the Asset Tag cannot be changed.
Service Tag	Displays the Service Tag of the computer.
BIOS Recovery from Hard Drive	<p>Enables the computer to recover from a bad BIOS image, as long as the Boot Block portion is intact and functioning.</p> <p>Default: ON.</p> <p> NOTE: BIOS recovery is designed to fix the main BIOS block and cannot work if the Boot Block is damaged. In addition, this feature cannot work in the event of EC corruption, ME corruption, or a hardware issue. The recovery image must exist on an unencrypted partition on the drive.</p>
BIOS Auto-Recovery	<p>Enables the computer to automatically recover the BIOS without user actions. This feature requires BIOS Recovery from Hard Drive to be set to Enabled.</p> <p>Default: OFF.</p>
Start Data Wipe	<p> CAUTION: This Secure Wipe Operation will delete information in a way that it cannot be reconstructed.</p> <p>If enabled, the BIOS will queue up a data wipe cycle for storage devices that are connected to the motherboard on the next reboot.</p> <p>Default: OFF.</p>
Allow BIOS Downgrade	<p>Controls flashing of the system firmware to previous revisions.</p> <p>Default: ON.</p>

Table 17. System setup options—System Logs menu

System Logs	
Power Event Log	<p>Displays Power events.</p> <p>Default: Keep.</p>
BIOS Event Log	<p>Displays BIOS events.</p> <p>Default: Keep.</p>
Thermal Event Log	<p>Displays Thermal events.</p> <p>Default: Keep.</p>

Table 18. System setup options—SupportAssist menu

SupportAssist	
Dell Auto operating system Recovery Threshold	<p>Controls the automatic boot flow for SupportAssist System Resolution Console and for Dell operating system Recovery tool.</p> <p>Default: 2.</p>
SupportAssist operating system Recovery	<p>Enables or disables the boot flow for SupportAssist operating system Recovery tool in the even of certain system errors.</p> <p>Default: ON.</p>

Updating the BIOS in Windows

Prerequisites

It is recommended to update your BIOS (System Setup), when you replace the system board or if an update is available.

About this task

 **NOTE:** If BitLocker is enabled, it must be suspended before updating the system BIOS, and then re-enabled after the BIOS update is completed.

Steps

1. Restart the computer.
2. Go to www.dell.com/support.
 - Enter the **Service Tag** or **Express Service Code** and click **Search**.
 - Click **Drivers & Downloads**.
 - Click **Detect Drivers** and follow the on-screen instructions.
3. If you are unable to detect or find the Service Tag, click **Browse all products**.
4. Choose the appropriate category to reach the product page.
5. Select your computer model, followed by its model number.

 **NOTE:** The **Product Support** page of your computer appears.
6. Click **Drivers & Downloads**.

 **NOTE:** The Drivers & Downloads section is displayed.
7. Click **Category**, and select **BIOS** from the drop-down list.
8. Click the toggle button **Show downloads for only THIS PC XXXXXXXX**.

 **NOTE:** XXXXXXXX denotes the Service Tag.
9. Select the latest BIOS file and click **Download**.
10. After the download is complete, browse to the folder where you saved the system BIOS executable file.
11. Double-click the system BIOS executable file.

 **NOTE:** Follow the on-screen instructions.

Updating BIOS on systems with BitLocker enabled

 **CAUTION:** If BitLocker is not suspended before updating the BIOS, the next time you reboot the system it will not recognize the BitLocker key. You will then be prompted to enter the recovery key to progress and the system will ask for this on each reboot. If the recovery key is not known this can result in data loss or an unnecessary operating system re-install. For more information on this subject, see Knowledge Article: <https://www.dell.com/support/article/sln153694>

Updating your system BIOS using a USB flash drive

About this task

If the computer cannot load into Windows but there is still a need to update the BIOS, download the BIOS file using another computer and save it to a bootable USB flash drive.

 **NOTE:** You must use a bootable USB flash drive. For more information, see the knowledge base article [SLN143196](https://www.dell.com/support/article/sln143196).

Steps

1. Download the BIOS update .exe file to another computer.

2. Copy the .exe file onto the bootable USB flash drive.
3. Insert the USB flash drive into the computer that requires the BIOS update.
4. Restart the computer and press F12 when the Dell logo appears to display the One Time Boot Menu.
5. Using arrow keys, select **USB Storage Device** and press Enter.
6. The computer restarts to a Diag C:\> prompt.
7. Run the file by typing the complete filename and press Enter.
8. The BIOS Update Utility is displayed. Follow the on-screen instructions.



Figure 1. DOS BIOS Update Screen

Updating the Dell BIOS in Linux and Ubuntu environments

If you want to update the system BIOS in a Linux environment such as Ubuntu, see <https://www.dell.com/support/article/sln171755/>.

Flashing the BIOS from the F12 One-Time boot menu

Updating your system BIOS using a BIOS update.exe file copied to a FAT32 USB key and booting from the F12 one time boot menu.

About this task

BIOS Update

You can run the BIOS update file from Windows using a bootable USB key or you can also update the BIOS from the F12 One-Time boot menu on the system.

Most Dell systems built after 2012 have this capability and you can confirm by booting your system to the F12 One-Time Boot Menu to see if BIOS FLASH UPDATE is listed as a boot option for your system. If the option is listed, then the BIOS supports this BIOS update option.

NOTE: Only systems with BIOS Flash Update option in the F12 One-Time Boot Menu can use this function.

Updating from the One-Time Boot Menu

To update your BIOS from the F12 One-Time boot menu, you will need:

- USB key formatted to the FAT32 file system (key does not have to be bootable)

- BIOS executable file that you downloaded from the Dell Support website and copied to the root of the USB key
- AC power adapter connected to the system
- Functional system battery to flash the BIOS

Perform the following steps to execute the BIOS update flash process from the F12 menu:

CAUTION: Do not power off the system during the BIOS update process. Powering off the system could make the system fail to boot.

Steps

1. From a power off state, insert the USB key where you copied the flash into a USB port of the system .
2. Power on the system and press the F12 key to access the One-Time Boot Menu, Highlight BIOS Update using the mouse or arrow keys then press **Enter**.

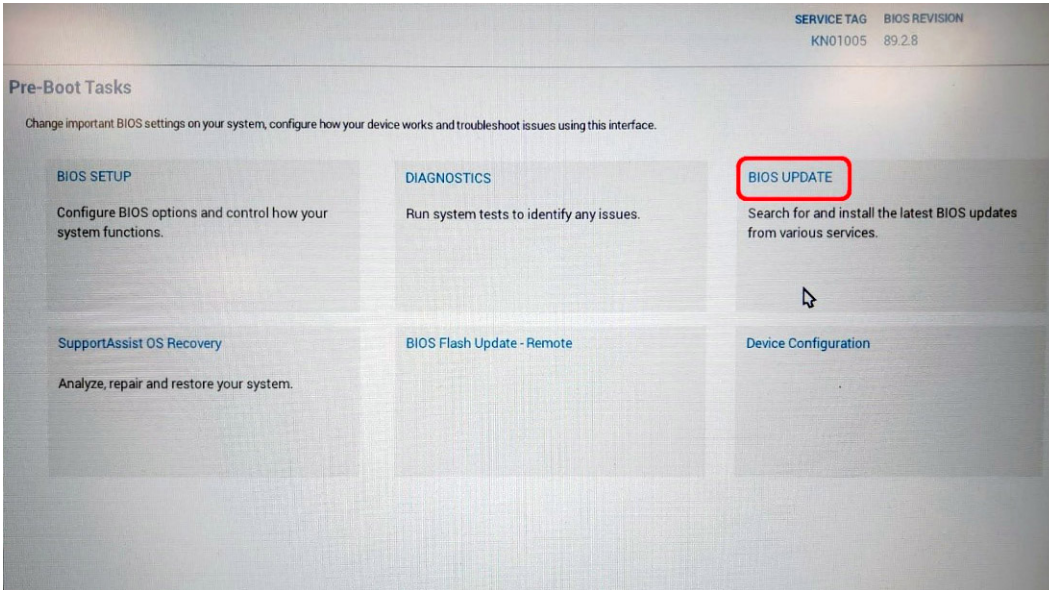

3. The flash BIOS menu will open, and then click the **Flash from file**.

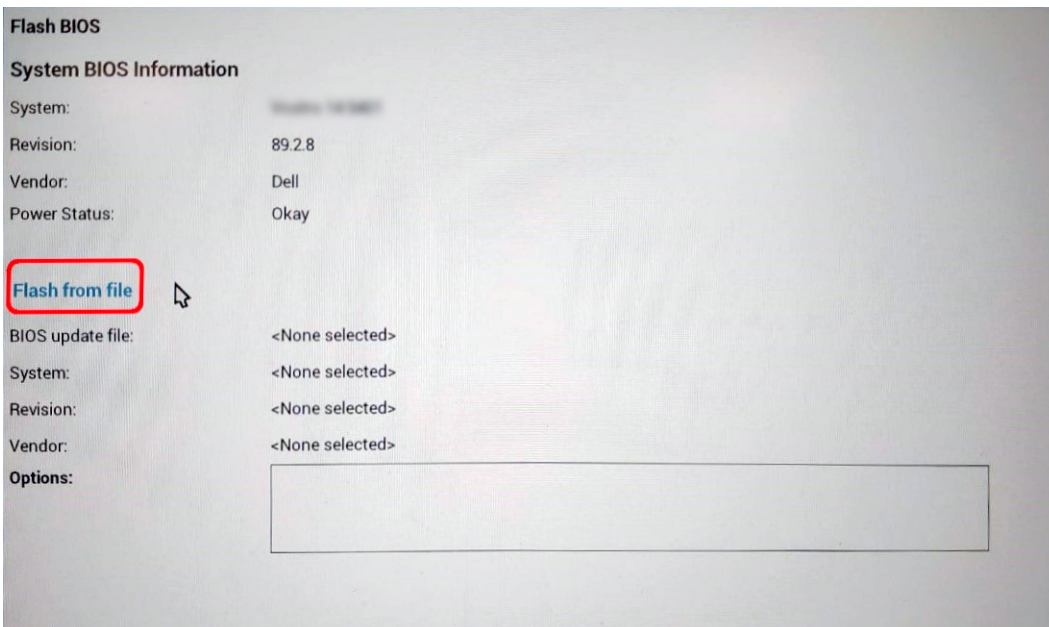

4. Select external USB device.

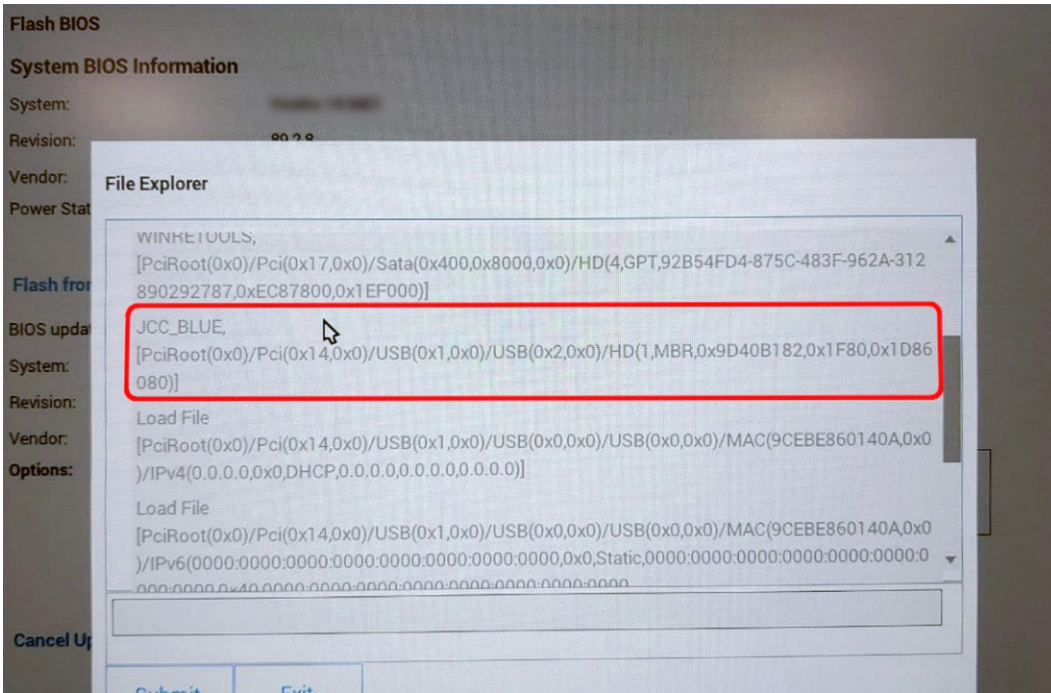

5. Once the file is selected, Double click the flash target file, then press submit.

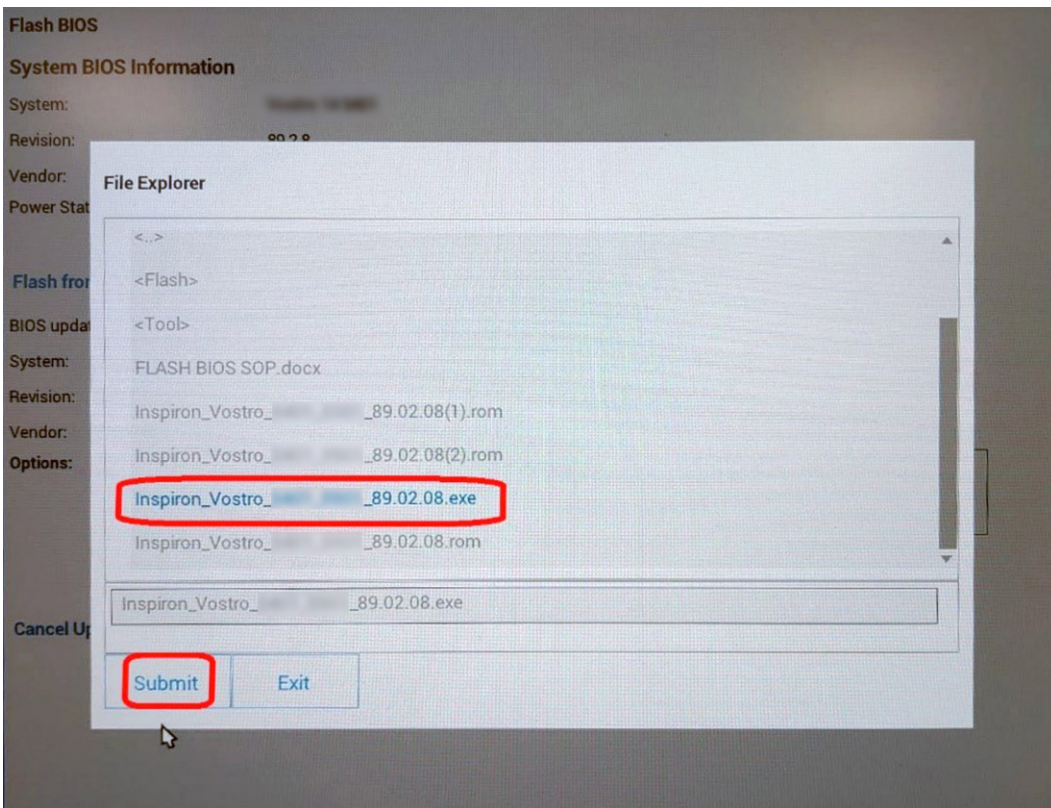

6. Click the **Update BIOS** then system will reboot to flash the BIOS.

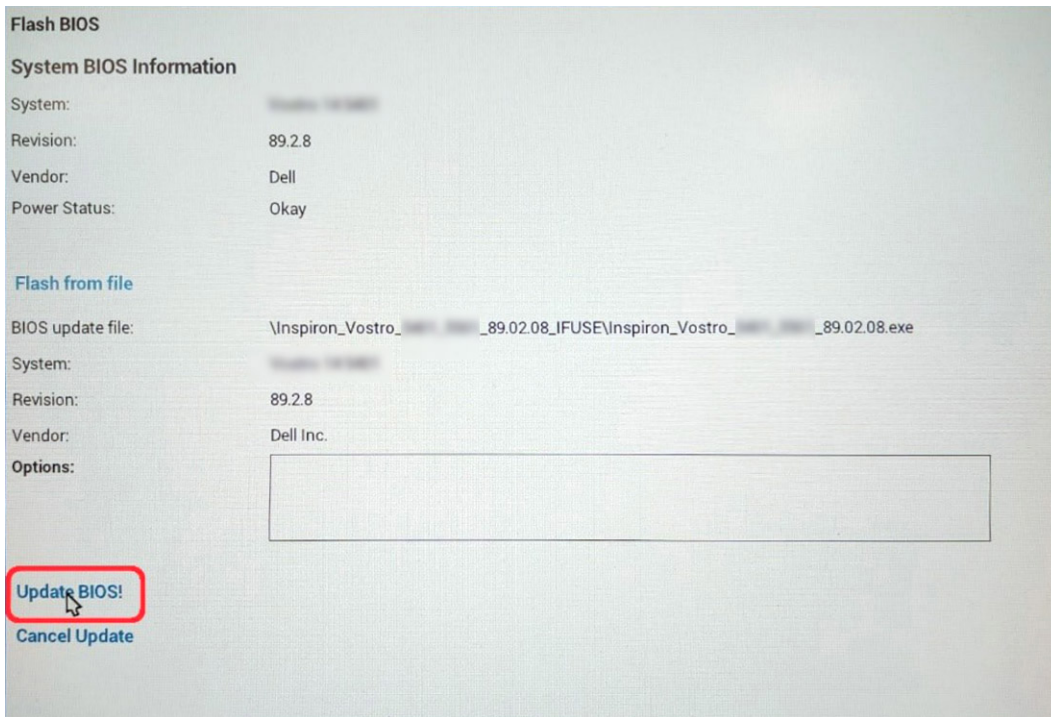

7. Once complete, the system will reboot and the BIOS update process is completed.

System and setup password

Table 19. System and setup password

Password type	Description
System password	Password that you must enter to log in to your system.
Setup password	Password that you must enter to access and make changes to the BIOS settings of your computer.

You can create a system password and a setup password to secure your computer.

CAUTION: The password features provide a basic level of security for the data on your computer.

CAUTION: Anyone can access the data that is stored on your computer if it is not locked and left unattended.

NOTE: System and setup password feature is disabled.

Assigning a system setup password

Prerequisites

You can assign a new **System or Admin Password** only when the status is in **Not Set**.

About this task

To enter the system setup, press F12 immediately after a power-on or reboot.

Steps

1. In the **System BIOS** or **System Setup** screen, select **Security** and press Enter. The **Security** screen is displayed.
2. Select **System/Admin Password** and create a password in the **Enter the new password** field.

Use the following guidelines to assign the system password:

- A password can have up to 32 characters.
 - The password can contain the numbers 0 through 9.
 - Only lower case letters are valid, upper case letters are not valid.
 - Only the following special characters are valid: Space, ("), (+), (.), (-), (.), (/), (:), ([), (\), (]), (`).
3. Type the system password that you entered earlier in the **Confirm new password** field and click **OK**.
 4. Press Esc and a message prompts you to save the changes.
 5. Press Y to save the changes.
The computer restarts.

Deleting or changing an existing system setup password

Prerequisites

Ensure that the **Password Status** is Unlocked (in the System Setup) before attempting to delete or change the existing System and/or Setup password. You cannot delete or change an existing System or Setup password, if the **Password Status** is Locked.

About this task

To enter the System Setup, press F12 immediately after a power-on or reboot.

Steps

1. In the **System BIOS** or **System Setup** screen, select **System Security** and press Enter.
The **System Security** screen is displayed.
2. In the **System Security** screen, verify that **Password Status** is **Unlocked**.
3. Select **System Password**, update, or delete the existing system password, and press Enter or Tab.
4. Select **Setup Password**, update, or delete the existing setup password, and press Enter or Tab.
 **NOTE:** If you change the System and/or Setup password, reenter the new password when prompted. If you delete the System and/or Setup password, confirm the deletion when prompted.
5. Press Esc and a message prompts you to save the changes.
6. Press Y to save the changes and exit from System Setup.
The computer restarts.

Clearing CMOS settings

About this task

 **CAUTION:** Clearing CMOS settings will reset the BIOS settings on your computer.

Steps

1. Remove the [base cover](#).
2. Remove the [coin-cell battery](#).
3. Wait for one minute.
4. Install the [coin-cell battery](#).
5. Install the [base cover](#).

Clearing BIOS (System Setup) and System passwords

About this task

To clear the system or BIOS passwords, contact Dell technical support as described at www.dell.com/contactdell.

 **NOTE:** For information on how to reset Windows or application passwords, refer to the documentation accompanying Windows or your application.

Troubleshooting

SupportAssist diagnostics

About this task

The SupportAssist diagnostics (previously known as ePSA diagnostics) performs a complete check of your hardware. The SupportAssist diagnostics is embedded in the BIOS and is launched by it internally. The SupportAssist diagnostics provides a set of options for particular devices or device groups. It allows you to:

- Run tests automatically or in an interactive mode.
- Repeat tests
- Display or save test results
- Run thorough tests to introduce additional test options and provide extra information about the failed device(s)
- View status messages that indicate if the tests are completed successfully
- View error messages that indicate if problems were encountered during the test

NOTE: Some tests are meant for specific devices and require user interaction. Ensure that you are present in front of the computer when the diagnostic tests are performed.

For more information, see [SupportAssist Pre-Boot System Performance Check](#).

Built-in self-test (BIST)

About this task

There are three different types of BIST to check the performance of display, power rail, and system board. These tests are important to evaluate if an LCD or system board needs a replacement.

1. M-BIST: M-BIST is the system board built-in self-test diagnostics tool that improves the diagnostics accuracy of system board embedded controller (EC) failures. M-BIST must be manually initiated before POST and can also run on a dead system .
2. L-BIST: L-BIST is an enhancement to the single LED error code diagnostics and is automatically initiated during POST.
3. LCD-BIST: LCD BIST is an enhanced diagnostic test that is introduced through Preboot System Assessment (PSA) on legacy systems.

Table 20. Functions

	M-BIST	L-BIST
Purpose	Evaluates the health condition of the system board.	Checks if the system board is supplying power to the LCD by performing an LCD Power Rail test.
Trigger	Press the <M> key and the power button.	Integrated into the single LED error code diagnostics. Automatically initiated during POST.
Indicator of fault	Battery LED light with Solid Amber	Battery LED error code of [2,8] blinks Amber x2, then pause, then blinks White x8.
Repair instruction	Indicates a problem with the system board.	Indicates a problem with the system board.

Recovering the operating system

When your computer is unable to boot to the operating system even after repeated attempts, it automatically starts Dell SupportAssist OS Recovery.

Dell SupportAssist OS Recovery is a standalone tool that is preinstalled in all Dell computers installed with Windows 10 operating system. It consists of tools to diagnose and troubleshoot issues that may occur before your computer boots to the operating system. It enables you to diagnose hardware issues, repair your computer, back up your files, or restore your computer to its factory state.

You can also download it from the Dell Support website to troubleshoot and fix your computer when it fails to boot into their primary operating system due to software or hardware failures.

For more information about the Dell SupportAssist OS Recovery, see *Dell SupportAssist OS Recovery User's Guide* at www.dell.com/support.

System diagnostic lights

Power and battery-status light

The power and battery status light indicates the power and battery status of the computer. These are the power states:

Solid white:Power adapter is connected and the battery has more than 5% charge.

Amber:Computer is running on battery and the battery has less than 5% charge.

Off:

- Power adapter is connected, and the battery is fully charged.
- Computer is running on battery, and the battery has more than 5% charge.
- Computer is in sleep state, hibernation, or turned off.

The power and battery-status light may blink amber or white according to pre-defined "beep codes" indicating various failures.

For example, the power and battery-status light blinks amber two times followed by a pause, and then blinks white three times followed by a pause. This 2,3 pattern continues until the computer is turned off, indicating no memory or RAM is detected.

The following table shows different power and battery-status light patterns and associated problems.

i NOTE: The following diagnostic light codes and recommended solutions are intended for Dell service technicians to troubleshoot problems. You should only perform troubleshooting and repairs as authorized or directed by the Dell technical assistance team. Damage due to servicing that is not authorized by Dell is not covered by your warranty.

Table 21. Diagnostic-light LED codes

Diagnostic light codes (Amber, white)	Problem description
1,1	TPM detection failure
1,2	Unrecoverable SPI flash failure
1,5	i-Fuse failure
1,6	EC internal Failure
2,1	Processor failure
2,2	System board: BIOS or ROM (Read-Only Memory) failure
2,3	No memory or RAM (Random-Access Memory) detected
2,4	Memory or RAM (Random-Access Memory) failure
2,5	Invalid memory installed
2,6	System-board or chipset error
2,7	Display failure - SBIOS message

Table 21. Diagnostic-light LED codes (continued)

Diagnostic light codes (Amber, white)	Problem description
2,8	Display failure - EC detection of power rail failure
3,1	CMOS battery failure
3,2	PCI, video card/chip failure
3,3	BIOS recovery image not found
3,4	Recovery image found but invalid
3,5	Power-rail failure
3,6	System BIOS Flash incomplete
3,7	Management Engine (ME) error

Enabling Intel Optane memory

Steps

1. On the taskbar, click the search box, and then type **Intel Rapid Storage Technology**.
2. Click **Intel Rapid Storage Technology**.
The **Intel Rapid Storage Technology** window is displayed.
3. On the **Status** tab, click **Enable** to enable the Intel Optane memory.
4. On the warning screen, select a compatible fast drive, and then click **Yes** to continue enabling Intel Optane memory.
5. Click **Intel Optane memory** > **Reboot** to complete enabling your Intel Optane memory.
 **NOTE:** Applications may take up to three subsequent launches after enablement to see the full performance benefits.

Disabling Intel Optane memory

About this task

 **CAUTION:** After disabling Intel Optane memory, do not uninstall the driver for Intel Rapid Storage Technology as it will result in a blue screen error. The Intel Rapid Storage Technology user interface can be removed without uninstalling the driver.

 **NOTE:** Disabling Intel Optane memory is required before removing the SATA storage device accelerated by the Intel Optane memory module from the computer.

Steps

1. On the taskbar, click the search box, and then type **Intel Rapid Storage Technology**.
2. Click **Intel Rapid Storage Technology**.
The **Intel Rapid Storage Technology** window is displayed.
3. On the **Intel Optane memory** tab, click **Disable** to disable the Intel Optane memory.
 **NOTE:** For computers in which Intel Optane memory acts as a primary storage, do not disable the Intel Optane memory.
The **Disable** option will be grayed out.
4. Click **Yes** if you accept the warning.
The disabling progress is displayed.
5. Click **Reboot** to complete disabling your Intel Optane memory and restart your computer.

Drain residual flea power (perform hard reset)

About this task

Flea power is the residual static electricity that remains in the computer even after it has been powered off and the battery is removed.

For your safety, and to protect the sensitive electronic components in your computer, you are requested to drain residual flea power before removing or replacing any components in your computer.

Draining residual flea power, also known as performing a "hard reset", is also a common troubleshooting step if your computer does not power on or boot into the operating system.

To drain residual flea power (perform a hard reset)

Steps

1. Turn off your computer.
2. Disconnect the power adapter from your computer.
3. Remove the base cover.
4. Remove the battery.
5. Press and hold the power button for 20 seconds to drain the flea power.
6. Install the battery.
7. Install the base cover.
8. Connect the power adapter to your computer.
9. Turn on your computer.

 **NOTE:** For more information about performing a hard reset, see the knowledge base article [SLN85632](https://www.dell.com/support) at www.dell.com/support.

WiFi power cycle

About this task

If your computer is unable to access the internet due to WiFi connectivity issues a WiFi power cycle procedure may be performed. The following procedure provides the instructions on how to conduct a WiFi power cycle:

 **NOTE:** Some ISPs (Internet Service Providers) provide a modem/router combo device.

Steps



1. Turn off your computer.
2. Turn off the modem.
3. Turn off the wireless router.
4. Wait for 30 seconds.
5. Turn on the wireless router.
6. Turn on the modem.
7. Turn on your computer.

Getting help and contacting Dell

Self-help resources

You can get information and help on Dell products and services using these self-help resources:

Table 22. Self-help resources

Self-help resources	Resource location
Information about Dell products and services	www.dell.com
My Dell	
Tips	
Contact Support	In Windows search, type <code>Contact Support</code> , and press Enter.
Online help for operating system	www.dell.com/support/windows www.dell.com/support/linux
Access top solutions, diagnostics, drivers and downloads, and learn more about your computer through videos, manuals and documents.	Your Dell computer is uniquely identified by a Service Tag or Express Service Code. To view relevant support resources for your Dell computer, enter the Service Tag or Express Service Code at www.dell.com/support . For more information on how to find the Service Tag for your computer, see Locate the Service Tag for your Dell Laptop .
Dell knowledge base articles for a variety of computer concerns	<ol style="list-style-type: none"> 1. Go to www.dell.com/support. 2. On the menu bar at the top of the Support page, select Support > Knowledge Base. 3. In the Search field on the Knowledge Base page, type the keyword, topic, or model number, and then click or tap the search icon to view the related articles.

Contacting Dell

To contact Dell for sales, technical support, or customer service issues, see www.dell.com/contactdell.

 **NOTE:** Availability varies by country/region and product, and some services may not be available in your country/region.

 **NOTE:** If you do not have an active Internet connection, you can find contact information about your purchase invoice, packing slip, bill, or Dell product catalog.