

Inspiron 14 5408

Service Manual



Notes, cautions, and warnings

 **NOTE:** A NOTE indicates important information that helps you make better use of your product.

 **CAUTION:** A CAUTION indicates either potential damage to hardware or loss of data and tells you how to avoid the problem.

 **WARNING:** A WARNING indicates a potential for property damage, personal injury, or death.

Chapter 1: Working inside your computer	6
Before working inside your computer.....	6
Safety instructions.....	6
Electrostatic discharge—ESD protection.....	7
ESD field service kit	7
Transporting sensitive components.....	8
After working inside your computer.....	8
Chapter 2: Removing and installing components	9
Recommended tools.....	9
Screw list.....	9
Major components of Inspiron 14 5408.....	10
Base cover.....	12
Removing the base cover.....	12
Installing the base cover.....	14
Battery.....	16
Lithium-ion battery precautions.....	16
Removing the 4-cell battery.....	17
Installing the 4-cell battery.....	18
Removing the 3-cell battery.....	18
Installing the 3-cell battery.....	19
Memory module.....	20
Removing the memory module.....	20
Installing the memory module.....	21
Solid-state drive—M.2 slot one.....	23
Removing the M.2 2230 solid-state drive from M.2 slot one.....	23
Installing the M.2 2230 solid-state drive in M.2 slot one.....	23
Removing the M.2 2280 solid-state drive/Intel Optane storage from M.2 slot one.....	24
Installing the M.2 2280 solid-state drive/Intel Optane storage in M.2 slot one.....	25
Installing the solid-state drive bracket.....	26
Solid-state drive—M.2 slot two.....	27
Removing the M.2 2230 solid-state drive from M.2 slot two.....	27
Installing the M.2 2230 solid-state drive in M.2 slot two.....	28
Removing the M.2 2280 solid-state drive/Intel Optane storage from M.2 slot two.....	30
Installing the M.2 2280 solid-state drive/Intel Optane storage in M.2 slot two.....	31
Installing the solid-state drive bracket.....	32
WLAN card.....	33
Removing the WLAN card.....	33
Installing the WLAN card.....	34
Fan.....	36
Removing the fan.....	36
Installing the fan.....	37
Coin-cell battery.....	38
Removing the coin-cell battery.....	38

Installing the coin-cell battery.....	38
Power-adapter port.....	39
Removing the power-adapter port.....	39
Installing the power-adapter port.....	40
Display assembly.....	41
Removing the display assembly.....	41
Installing the display assembly.....	43
I/O board.....	45
Removing the I/O board.....	45
Installing the I/O board.....	46
Touchpad.....	47
Removing the touchpad.....	47
Installing the touchpad.....	48
Speakers.....	49
Removing the speakers (in 4-cell battery configuration).....	49
Installing the speakers (in 4-cell battery configuration).....	50
Removing the speakers (in 3-cell battery configuration).....	51
Installing the speakers (in 3-cell battery configuration).....	52
Heat sink.....	54
Removing the heat sink (for integrated GPU).....	54
Installing the heat sink (for integrated GPU).....	54
Removing the heat sink (for discrete GPU).....	55
Installing the heat sink (for discrete GPU).....	56
Power button with optional fingerprint reader.....	57
Removing the power button with optional fingerprint reader.....	57
Installing the power button with optional fingerprint reader.....	58
System board.....	59
Removing the system board.....	59
Installing the system board.....	61
Palm-rest and keyboard assembly.....	63
Removing the palm-rest and keyboard assembly.....	63
Installing the palm-rest and keyboard assembly.....	64

Chapter 3: Drivers and downloads..... 65

Chapter 4: System setup..... 66

Entering BIOS setup program.....	66
Navigation keys.....	66
Boot Sequence.....	66
One time boot menu.....	67
System setup options.....	67
System and setup password.....	75
Assigning a system setup password.....	75
Deleting or changing an existing system setup password.....	76
Clearing CMOS settings.....	76
Clearing BIOS (System Setup) and System passwords.....	76
Updating the BIOS.....	76
Updating the BIOS in Windows.....	76
Updating the BIOS using the USB drive in Windows.....	77

Updating the BIOS in Linux and Ubuntu.....	77
Updating the BIOS from the F12 One-Time boot menu.....	77
Chapter 5: Troubleshooting.....	79
Handling swollen Lithium-ion batteries.....	79
Locate the Service Tag or Express Service Code of your Dell computer	79
System diagnostic lights.....	80
SupportAssist diagnostics.....	81
Built-in self-test (BIST).....	81
Display panel built-in self-test (LCD-BIST).....	81
System board built-in self-test (M-BIST).....	82
Display panel power rail built-in self-test (L-BIST).....	82
Outcome.....	82
Recovering the operating system.....	83
WiFi power cycle.....	83
Drain residual flea power (perform hard reset).....	83
Enabling Intel Optane memory.....	84
Disabling Intel Optane memory.....	84
Real Time Clock—RTC reset.....	85
Chapter 6: Getting help and contacting Dell.....	86

Working inside your computer

Before working inside your computer

About this task

 **NOTE:** The images in this document may differ from your computer depending on the configuration you ordered.

Steps

1. Save and close all open files and exit all open applications.

2. Shut down your computer. Click **Start** >  **Power** > **Shut down**.

 **NOTE:** If you are using a different operating system, see the documentation of your operating system for shut-down instructions.

3. Disconnect your computer and all attached devices from their electrical outlets.

4. Disconnect all attached network devices and peripherals, such as keyboard, mouse, and monitor from your computer.

 **CAUTION:** To disconnect a network cable, first unplug the cable from your computer and then unplug the cable from the network device.

5. Remove any media card and optical disc from your computer, if applicable.

Safety instructions

Use the following safety guidelines to protect your computer from potential damage and to ensure your personal safety. Unless otherwise noted, each procedure included in this document assumes that you have read the safety information that shipped with your computer.

 **WARNING:** Before working inside your computer, read the safety information that is shipped with your computer. For more safety best practices, see the Regulatory Compliance home page at www.dell.com/regulatory_compliance.

 **WARNING:** Disconnect your computer from all power sources before opening the computer cover or panels. After you finish working inside the computer, replace all covers, panels, and screws before connecting your computer to an electrical outlet.

 **CAUTION:** To avoid damaging the computer, ensure that the work surface is flat, dry, and clean.

 **CAUTION:** To avoid damaging the components and cards, handle them by their edges, and avoid touching the pins and the contacts.

 **CAUTION:** You should only perform troubleshooting and repairs as authorized or directed by the Dell technical assistance team. Damage due to servicing that is not authorized by Dell is not covered by your warranty. See the safety instructions that is shipped with the product or at www.dell.com/regulatory_compliance.

 **CAUTION:** Before touching anything inside your computer, ground yourself by touching an unpainted metal surface, such as the metal at the back of the computer. While you work, periodically touch an unpainted metal surface to dissipate static electricity which could harm internal components.

CAUTION: When you disconnect a cable, pull it by its connector or its pull tab, not the cable itself. Some cables have connectors with locking tabs or thumbscrews that you must disengage before disconnecting the cable. When disconnecting cables, keep them evenly aligned to avoid bending the connector pins. When connecting cables, ensure that the ports and the connectors are correctly oriented and aligned.

CAUTION: Press and eject any installed card from the media-card reader.

CAUTION: Exercise caution when handling Lithium-ion batteries in laptops. Swollen batteries should not be used and should be replaced and disposed properly.

NOTE: The color of your computer and certain components may appear differently than shown in this document.

Electrostatic discharge—ESD protection

ESD is a major concern when you handle electronic components, especially sensitive components such as expansion cards, processors, memory DIMMs, and system boards. Very slight charges can damage circuits in ways that may not be obvious, such as intermittent problems or a shortened product life span. As the industry pushes for lower power requirements and increased density, ESD protection is an increasing concern.

Due to the increased density of semiconductors used in recent Dell products, the sensitivity to static damage is now higher than in previous Dell products. For this reason, some previously approved methods of handling parts are no longer applicable.

Two recognized types of ESD damage are catastrophic and intermittent failures.

- **Catastrophic** – Catastrophic failures represent approximately 20 percent of ESD-related failures. The damage causes an immediate and complete loss of device functionality. An example of catastrophic failure is a memory DIMM that has received a static shock and immediately generates a "No POST/No Video" symptom with a beep code emitted for missing or nonfunctional memory.
- **Intermittent** – Intermittent failures represent approximately 80 percent of ESD-related failures. The high rate of intermittent failures means that most of the time when damage occurs, it is not immediately recognizable. The DIMM receives a static shock, but the tracing is merely weakened and does not immediately produce outward symptoms related to the damage. The weakened trace may take weeks or months to melt, and in the meantime may cause degradation of memory integrity, intermittent memory errors, etc.

The more difficult type of damage to recognize and troubleshoot is the intermittent (also called latent or "walking wounded") failure.

Perform the following steps to prevent ESD damage:

- Use a wired ESD wrist strap that is properly grounded. The use of wireless anti-static straps is no longer allowed; they do not provide adequate protection. Touching the chassis before handling parts does not ensure adequate ESD protection on parts with increased sensitivity to ESD damage.
- Handle all static-sensitive components in a static-safe area. If possible, use anti-static floor pads and workbench pads.
- When unpacking a static-sensitive component from its shipping carton, do not remove the component from the anti-static packing material until you are ready to install the component. Before unwrapping the anti-static packaging, ensure that you discharge static electricity from your body.
- Before transporting a static-sensitive component, place it in an anti-static container or packaging.

ESD field service kit

The unmonitored Field Service kit is the most commonly used service kit. Each Field Service kit includes three main components: anti-static mat, wrist strap, and bonding wire.

Components of an ESD field service kit

The components of an ESD field service kit are:

- **Anti-Static Mat** – The anti-static mat is dissipative and parts can be placed on it during service procedures. When using an anti-static mat, your wrist strap should be snug and the bonding wire should be connected to the mat and to any bare metal on the system being worked on. Once deployed properly, service parts can be removed from the ESD bag and placed directly on the mat. ESD-sensitive items are safe in your hand, on the ESD mat, in the system, or inside a bag.

- **Wrist Strap and Bonding Wire** – The wrist strap and bonding wire can be either directly connected between your wrist and bare metal on the hardware if the ESD mat is not required, or connected to the anti-static mat to protect hardware that is temporarily placed on the mat. The physical connection of the wrist strap and bonding wire between your skin, the ESD mat, and the hardware is known as bonding. Use only Field Service kits with a wrist strap, mat, and bonding wire. Never use wireless wrist straps. Always be aware that the internal wires of a wrist strap are prone to damage from normal wear and tear, and must be checked regularly with a wrist strap tester in order to avoid accidental ESD hardware damage. It is recommended to test the wrist strap and bonding wire at least once per week.
- **ESD Wrist Strap Tester** – The wires inside of an ESD strap are prone to damage over time. When using an unmonitored kit, it is a best practice to regularly test the strap prior to each service call, and at a minimum, test once per week. A wrist strap tester is the best method for doing this test. If you do not have your own wrist strap tester, check with your regional office to find out if they have one. To perform the test, plug the wrist-strap's bonding-wire into the tester while it is strapped to your wrist and push the button to test. A green LED is lit if the test is successful; a red LED is lit and an alarm sounds if the test fails.
- **Insulator Elements** – It is critical to keep ESD sensitive devices, such as plastic heat sink casings, away from internal parts that are insulators and often highly charged.
- **Working Environment** – Before deploying the ESD Field Service kit, assess the situation at the customer location. For example, deploying the kit for a server environment is different than for a desktop or portable environment. Servers are typically installed in a rack within a data center; desktops or portables are typically placed on office desks or cubicles. Always look for a large open flat work area that is free of clutter and large enough to deploy the ESD kit with additional space to accommodate the type of system that is being repaired. The workspace should also be free of insulators that can cause an ESD event. On the work area, insulators such as Styrofoam and other plastics should always be moved at least 12 inches or 30 centimeters away from sensitive parts before physically handling any hardware components
- **ESD Packaging** – All ESD-sensitive devices must be shipped and received in static-safe packaging. Metal, static-shielded bags are preferred. However, you should always return the damaged part using the same ESD bag and packaging that the new part arrived in. The ESD bag should be folded over and taped shut and all the same foam packing material should be used in the original box that the new part arrived in. ESD-sensitive devices should be removed from packaging only at an ESD-protected work surface, and parts should never be placed on top of the ESD bag because only the inside of the bag is shielded. Always place parts in your hand, on the ESD mat, in the system, or inside an anti-static bag.
- **Transporting Sensitive Components** – When transporting ESD sensitive components such as replacement parts or parts to be returned to Dell, it is critical to place these parts in anti-static bags for safe transport.

ESD protection summary

It is recommended that all field service technicians use the traditional wired ESD grounding wrist strap and protective anti-static mat at all times when servicing Dell products. In addition, it is critical that technicians keep sensitive parts separate from all insulator parts while performing service and that they use anti-static bags for transporting sensitive components.

Transporting sensitive components

When transporting ESD sensitive components such as replacement parts or parts to be returned to Dell, it is critical to place these parts in anti-static bags for safe transport.

After working inside your computer

About this task

 **CAUTION:** Leaving stray or loose screws inside your computer may severely damage your computer.

Steps

1. Replace all screws and ensure that no stray screws remain inside your computer.
2. Connect any external devices, peripherals, or cables you removed before working on your computer.
3. Replace any media cards, discs, or any other parts that you removed before working on your computer.
4. Connect your computer and all attached devices to their electrical outlets.
5. Turn on your computer.

Removing and installing components

NOTE: The images in this document may differ from your computer depending on the configuration you ordered.

Recommended tools

The procedures in this document may require the following tools:

- Phillips screwdriver #1 (for M2.5 screw types)
- Phillips screwdriver #0 (or M1.6, M2 screw types)
- Plastic scribe

Screw list

NOTE: When removing screws from a component, it is recommended to note the screw type, the quantity of screws, and then place them in a screw storage box. This is to ensure that the correct number of screws and correct screw type is restored when the component is replaced.

NOTE: Some computers have magnetic surfaces. Ensure that the screws are not left attached to such surfaces when replacing a component.

NOTE: Screw color may vary with the configuration ordered.

Table 1. Screw list

















Component	Secured to	Screw type	Quantity	Screw image
Base cover	Palm-rest and keyboard assembly	M2 x 4	5	 <p>NOTE: Screw color may vary depending on the configuration ordered.</p>
Base cover	Palm-rest and keyboard assembly	M2x8 (captive)	2	
Battery	Palm-rest and keyboard assembly	M2 x 3	<ul style="list-style-type: none"> • 3-cell battery: 4 • 4-cell battery: 5 	 <p>NOTE: Screw color may vary depending on the configuration ordered.</p>
Solid-state drive bracket (for M.2 slot two)	Palm-rest and keyboard assembly	M2 x 3	1	
Solid-state drive	Palm-rest and keyboard assembly	M2 x 3	1	
Fan	Palm-rest and keyboard assembly	M2 x 2	2	

Table 1. Screw list (continued)

Component	Secured to	Screw type	Quantity	Screw image
Heat sink	System board	M2x5.85 (captive)	<ul style="list-style-type: none"> Integrated GPU: 4 Discrete GPU: 7 	
Wireless-card bracket	System board	M2 x 3	1	
Touchpad	Palm-rest and keyboard assembly	M2 x 2	2	
Touchpad bracket	Palm-rest and keyboard assembly	M1.6 x 2	3	
Power-button bracket	Palm-rest and keyboard assembly	M2 x 2	1	
Power button with (optional) fingerprint reader	Palm-rest and keyboard assembly	M2 x 2.5	2	
Power-adaptor port bracket	Palm-rest and keyboard assembly	M2 x 3	1	
USB 3.1 Type-C port bracket	System board	M2 x 3	2	
Hinge brackets	Palm-rest and keyboard assembly	M2.5 x 5	4	
I/O board	Palm-rest and keyboard assembly	M2 x 3	1	
System board	Palm-rest and keyboard assembly	M2 x 3	2	

Major components of Inspiron 14 5408

The following image shows the major components of Inspiron 14 5408.

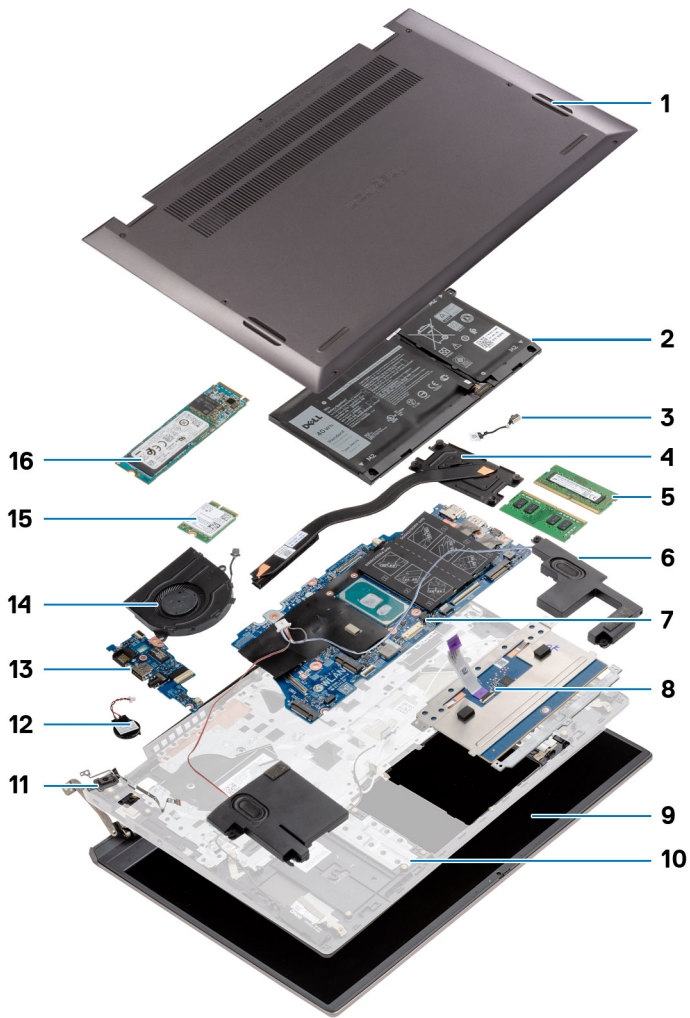

1. Base cover
2. Battery
3. Power-adaptor port
4. Heat sink
5. Memory module
6. Speakers
7. System board
8. Touchpad
9. Display assembly
10. Palm-rest and keyboard assembly
11. Power button with fingerprint reader
12. Coin-cell battery
13. I/O board
14. Fan
15. Wireless card
16. M.2 2280 solid-state drive in M.2 slot one

Base cover

Removing the base cover

Prerequisites

1. Follow the procedure in [Before working inside your computer.](#)

About this task

The following images indicate the location of the base cover and provide a visual representation of the removal procedure.



2x
M2x8



5x
M2x4



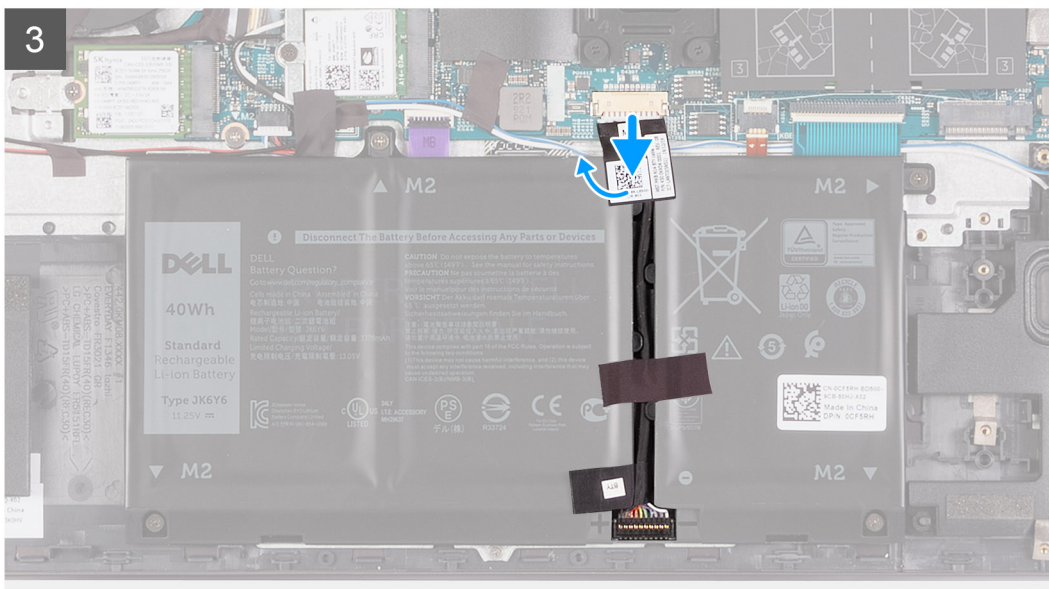
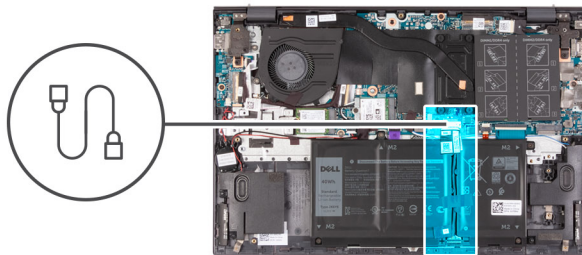
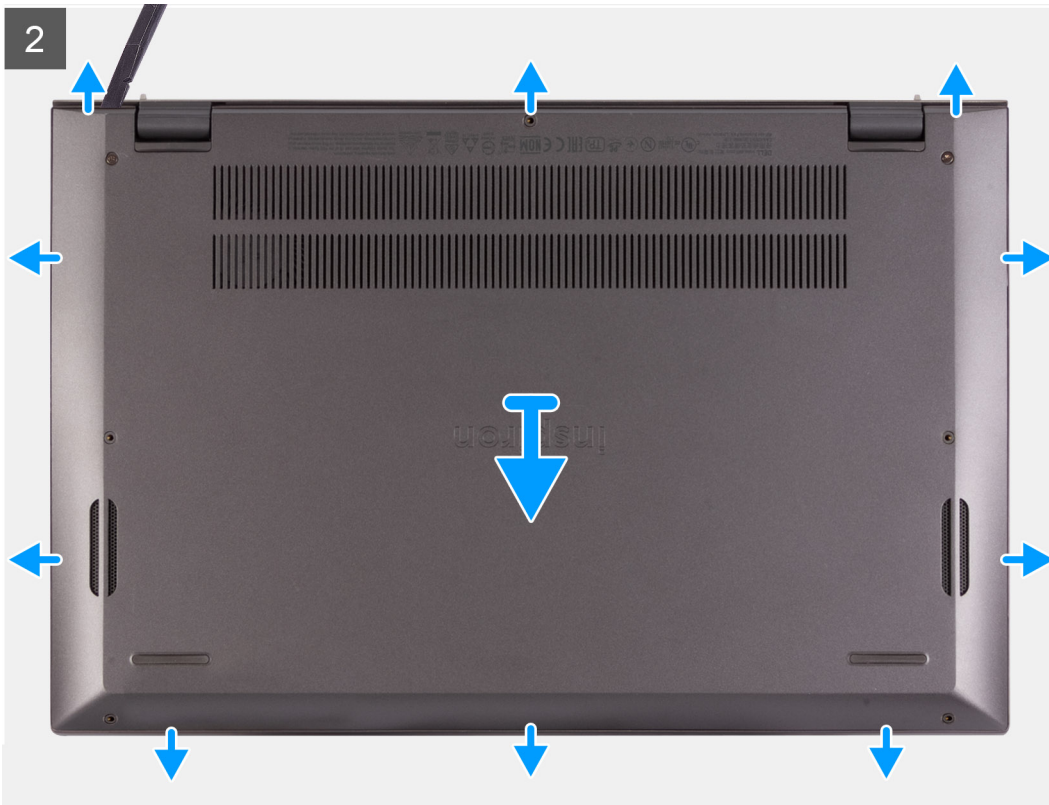

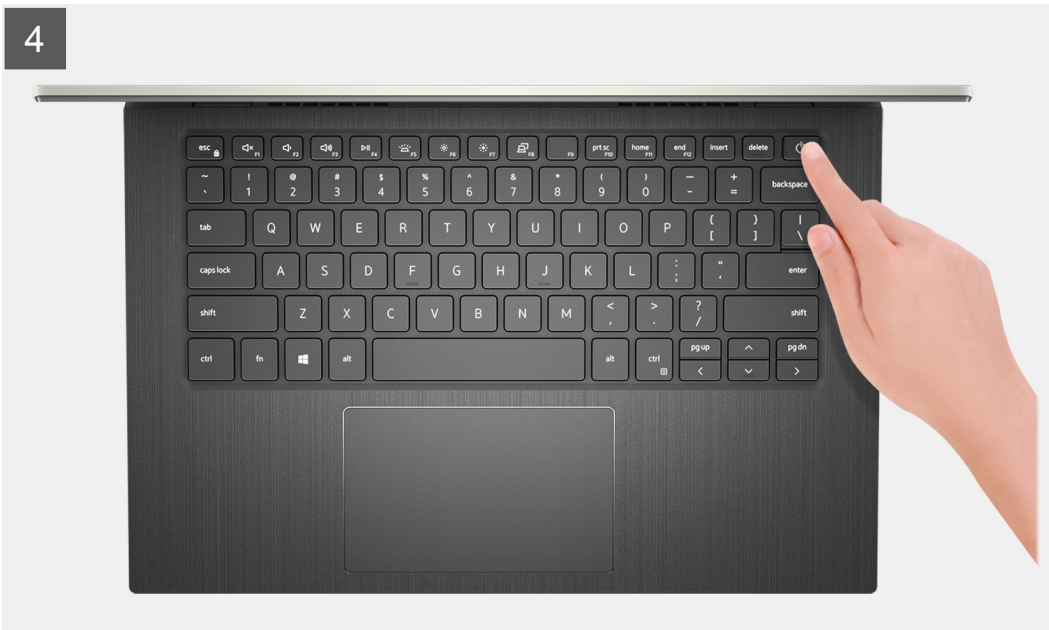

Steps

1. Remove the five screws (M2x4) that secure the base cover to the palm-rest and keyboard assembly.
2. Loosen the two captive screws (M2x8) that secure the base cover to the palm-rest and keyboard assembly.
3. Using a plastic scribe, pry the base cover beside the display hinges, and then continue to work on the sides to open the base cover.
4. Disconnect the battery cable from the system board.
i **NOTE:** Disconnect the battery cable only when you are continuing to remove other components from your computer.
5. Press and hold the power button for five seconds to ground the computer and drain the flea power.

Installing the base cover

Prerequisites

If you are replacing a component, remove the existing component before performing the installation procedure.

About this task

The following image indicates the location of the battery and provides a visual representation of the installation procedure.

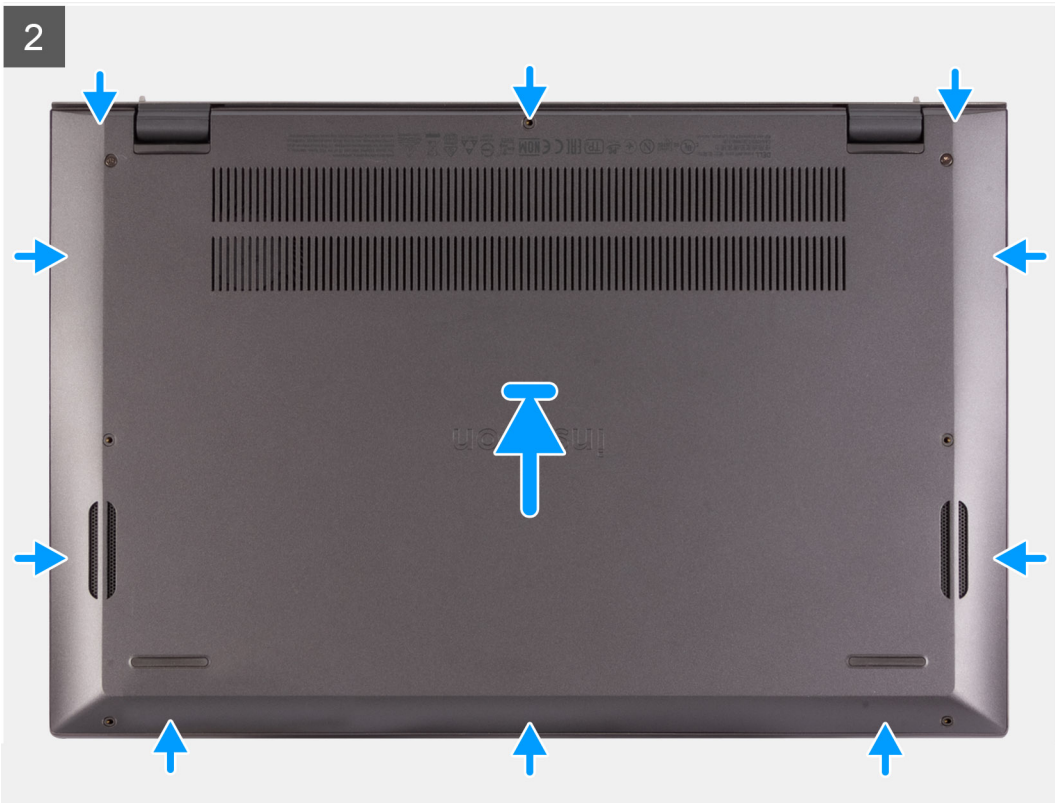
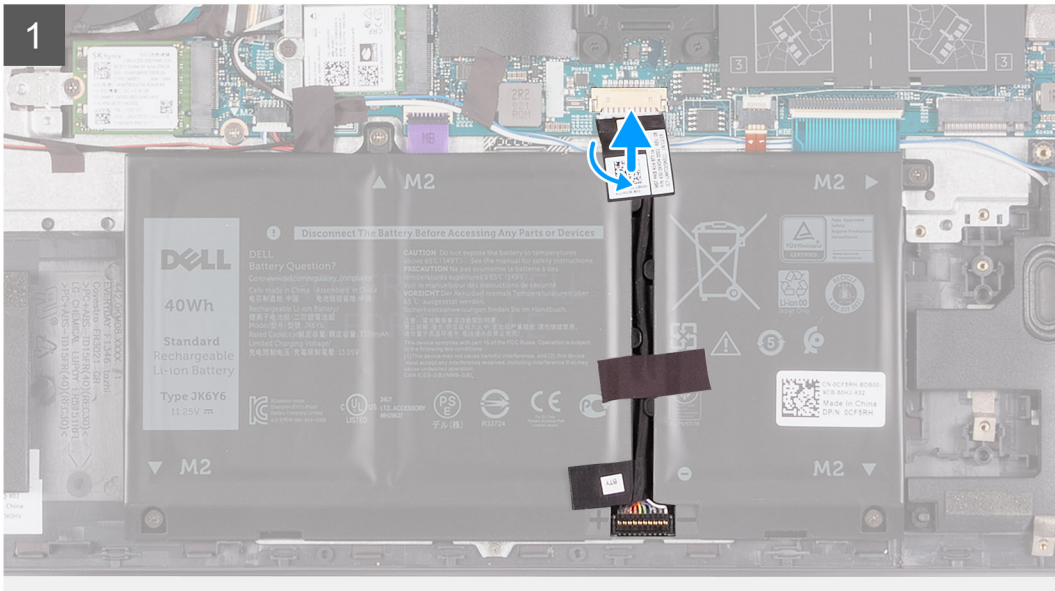
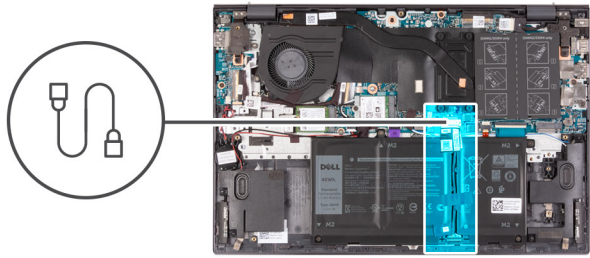



2x
M2x8



5x
M2x4

3



Steps

1. Connect the battery cable to the system board, if applicable.
2. Place the base cover on top of the palm-rest and keyboard assembly.
3. Align the screw holes on the base cover with the screw holes on the palm-rest and keyboard assembly, and then snap the base cover into place.
4. Tighten the two captive screws (M2x8) that secure the base cover to the palm-rest and keyboard assembly.
5. Replace the five screws (M2x4) that secure the base cover to the palm-rest and keyboard assembly.

Next steps

1. Follow the procedure in [After working inside your computer](#).

Battery

Lithium-ion battery precautions

⚠ CAUTION:

- Exercise caution when handling Lithium-ion batteries.
- Discharge the battery completely before removing it. Disconnect the AC power adapter from the system and operate the computer solely on battery power—the battery is fully discharged when the computer no longer turns on when the power button is pressed.
- Do not crush, drop, mutilate, or penetrate the battery with foreign objects.

- Do not expose the battery to high temperatures, or disassemble battery packs and cells.
- Do not apply pressure to the surface of the battery.
- Do not bend the battery.
- Do not use tools of any kind to pry on or against the battery.
- Ensure any screws during the servicing of this product are not lost or misplaced, to prevent accidental puncture or damage to the battery and other system components.
- If the battery gets stuck inside your computer as a result of swelling, do not try to release it as puncturing, bending, or crushing a lithium-ion battery can be dangerous. In such an instance, contact Dell technical support for assistance. See www.dell.com/contactdell.
- Always purchase genuine batteries from www.dell.com or authorized Dell partners and resellers.
- Swollen batteries should not be used and should be replaced and disposed properly. For guidelines on how to handle and replace swollen Lithium-ion batteries, see [Handling swollen Lithium-ion batteries](#).

Removing the 4-cell battery

Prerequisites

1. Follow the procedure in [Before working inside your computer](#).
2. Remove the [base cover](#).

About this task

The following images indicate the location of the battery and provide a visual representation of the removal procedure.

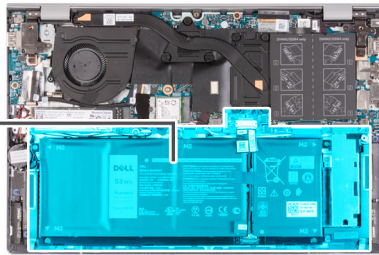
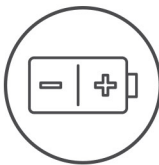

Steps

1. Peel the tape and disconnect the battery cable, if applicable.
2. Remove the five screws (M2x3) that secure the battery to the palm-rest and keyboard assembly.
3. Lift the battery, along with its cable off the palm-rest and keyboard assembly.

Installing the 4-cell battery

Prerequisites

If you are replacing a component, remove the existing component before performing the installation procedure.

About this task

The following image indicates the location of the battery and provides a visual representation of the installation procedure.

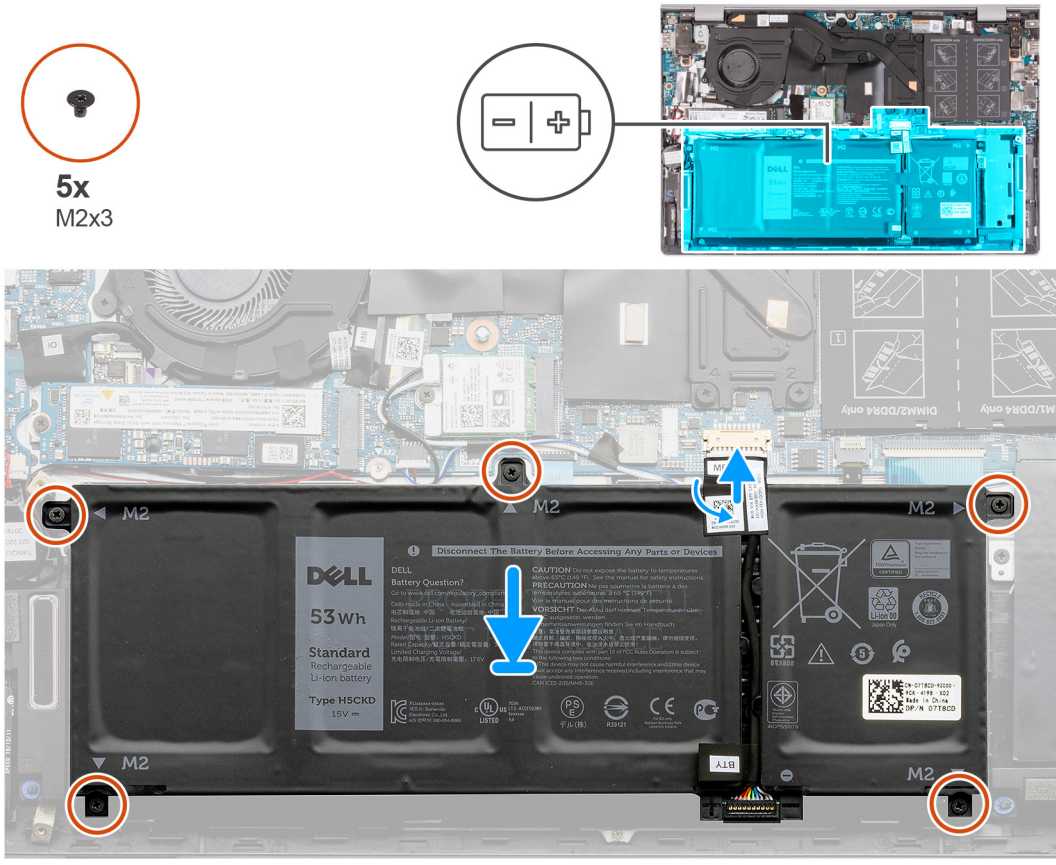

Steps

1. Place the battery on the palm-rest and keyboard assembly.
2. Align the screw holes on the battery with the screw holes on the palm-rest and keyboard assembly.
3. Replace the five screws (M2x3) that secure the battery to the palm-rest and keyboard assembly.
4. Connect the battery cable to the system board and adhere the tape that secures the battery cable to the system board.

Next steps

1. Install the [base cover](#).
2. Follow the procedure in [After working inside your computer](#).

Removing the 3-cell battery

Prerequisites

1. Follow the procedure in [Before working inside your computer](#).
2. Remove the [base cover](#).

About this task

The following images indicate the location of the battery and provide a visual representation of the removal procedure.

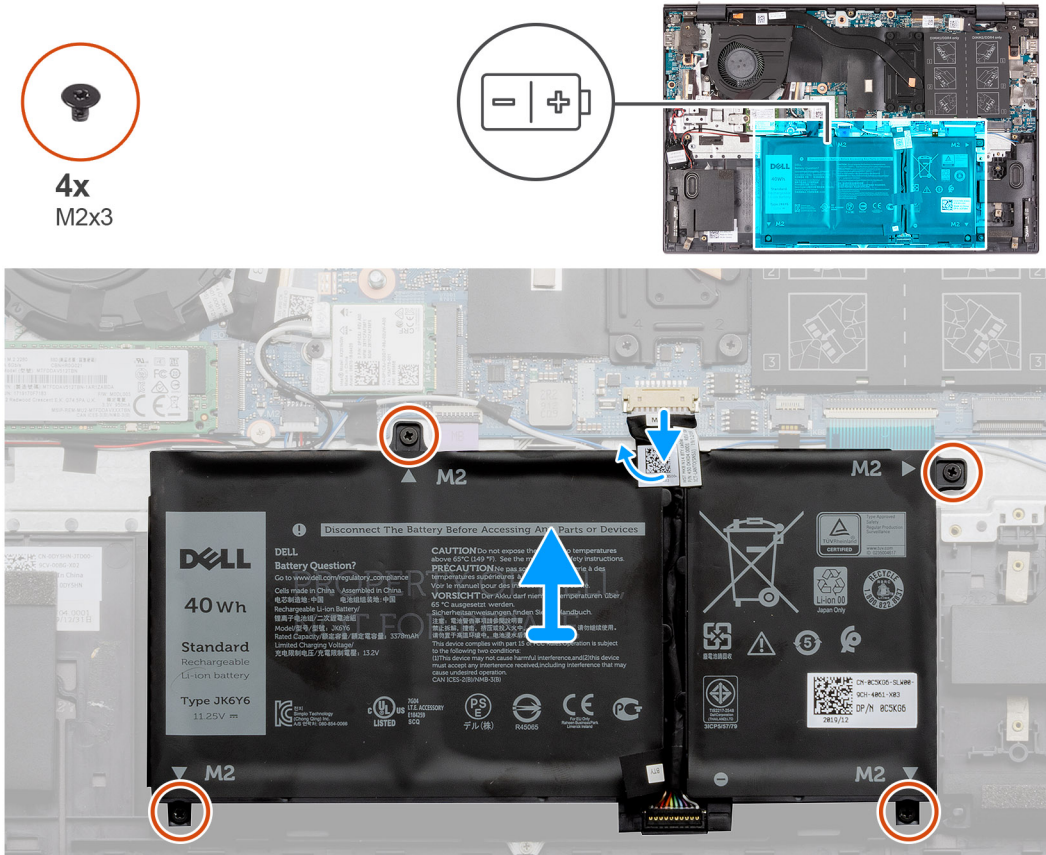

Steps

1. Peel the tape and disconnect the battery cable, if applicable.
2. Remove the four screws (M2x3) that secure the battery to the palm-rest and keyboard assembly.
3. Lift the battery, along with its cable off the palm-rest and keyboard assembly.

Installing the 3-cell battery

Prerequisites

If you are replacing a component, remove the existing component before performing the installation procedure.

About this task

The following image indicates the location of the battery and provides a visual representation of the installation procedure.



4x
M2x3

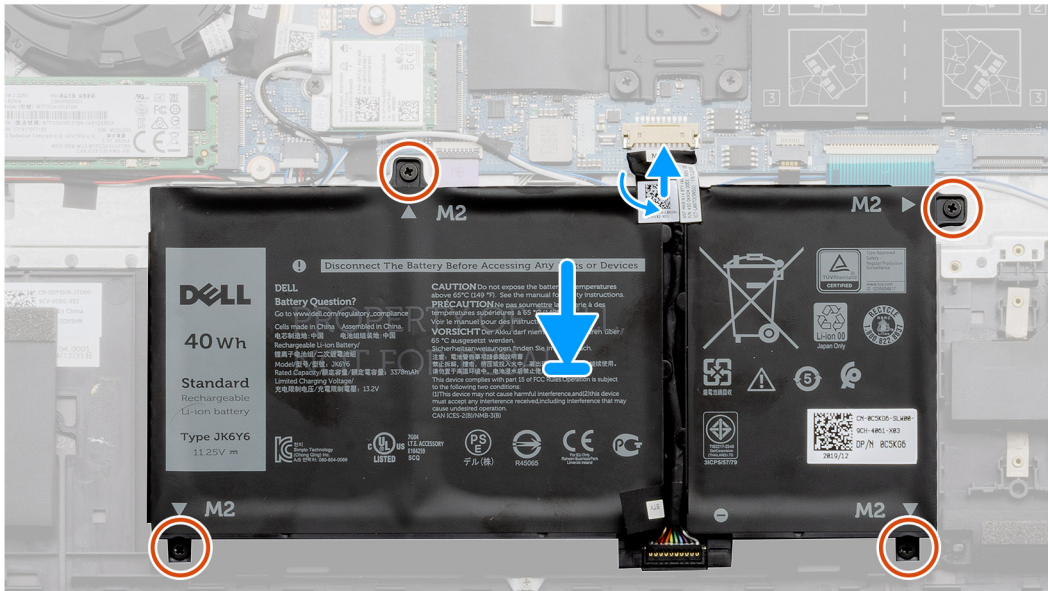
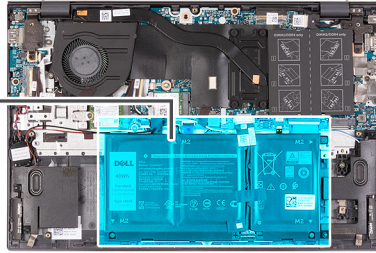
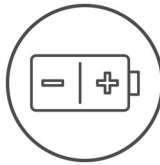

Steps

1. Place the battery on the palm-rest and keyboard assembly.
2. Align the screw holes on the battery with the screw holes on the palm-rest and keyboard assembly.
3. Replace the four screws (M2x3) that secure the battery to the palm-rest and keyboard assembly.
4. Connect the battery cable to the system board and adhere the tape that secures the battery cable to the system board.

Next steps

1. Install the [base cover](#).
2. Follow the procedure in [After working inside your computer](#).

Memory module

Removing the memory module

Prerequisites

1. Follow the procedure in [Before working inside your computer](#).
2. Remove the [base cover](#).

About this task

The following images indicate the location of the memory module and provide a visual representation of the removal procedure.

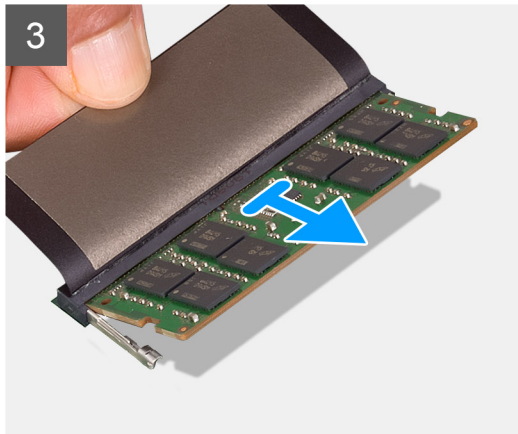
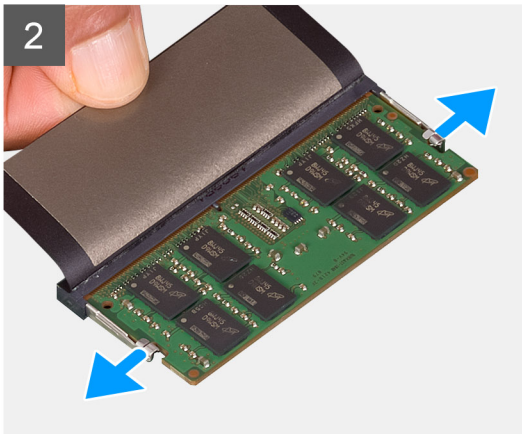
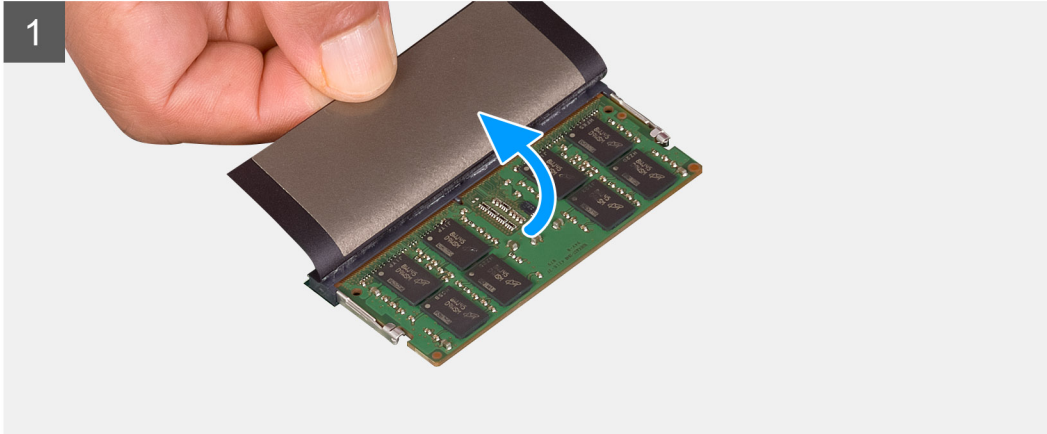
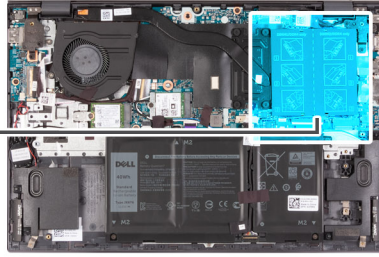
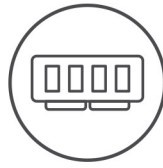

Steps

1. Lift the mylar to uncover the memory module.
2. Use your fingertips to carefully spread apart the securing-clips on each end of the memory-module slot until the memory module pops-up.
3. Remove the memory module from the memory-module slot.

Installing the memory module

Prerequisites

If you are replacing a component, remove the existing component before performing the installation procedure.

About this task

The following image indicates the location of the memory module and provides a visual representation of the installation procedure.

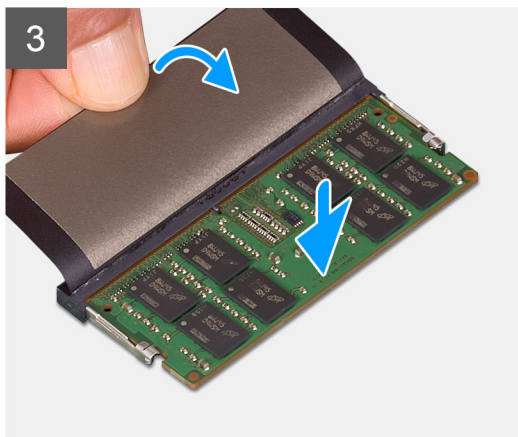
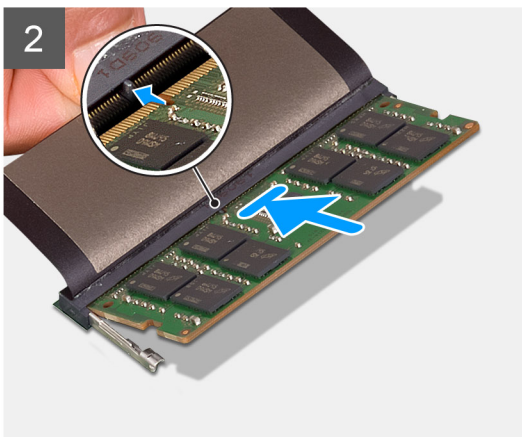
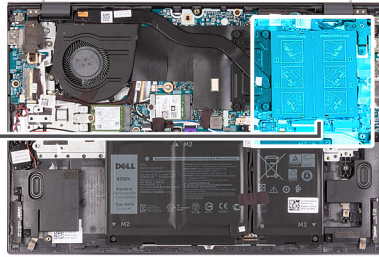
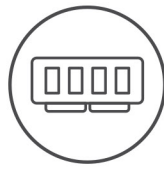

Steps

1. Lift the mylar to find the memory-module slot.
2. Align the notch on the memory module with the tab on the memory-module slot.
3. Slide the memory module firmly into the slot at an angle.
4. Press the memory module down until it clicks into place.

i **NOTE:** If you do not hear the click, remove the memory module and reinstall it.

Next steps

1. Install the [base cover](#).
2. Follow the procedure in [After working inside your computer](#).

Solid-state drive—M.2 slot one

Removing the M.2 2230 solid-state drive from M.2 slot one

Prerequisites

1. Follow the procedure in [Before working inside your computer](#).
2. Remove the [base cover](#).

About this task

NOTE: This procedure applies only to computers shipped with an M.2 2230 solid-state drive installed in M.2 slot one.

NOTE: Depending on the configuration ordered, your computer may support an M.2 2230 solid-state drive or an M.2 2280 solid-state drive in M.2 slot one.

The following image indicates the location of the M.2 2230 solid-state drive that is installed in M.2 slot one and provides a visual representation of the removal procedure.

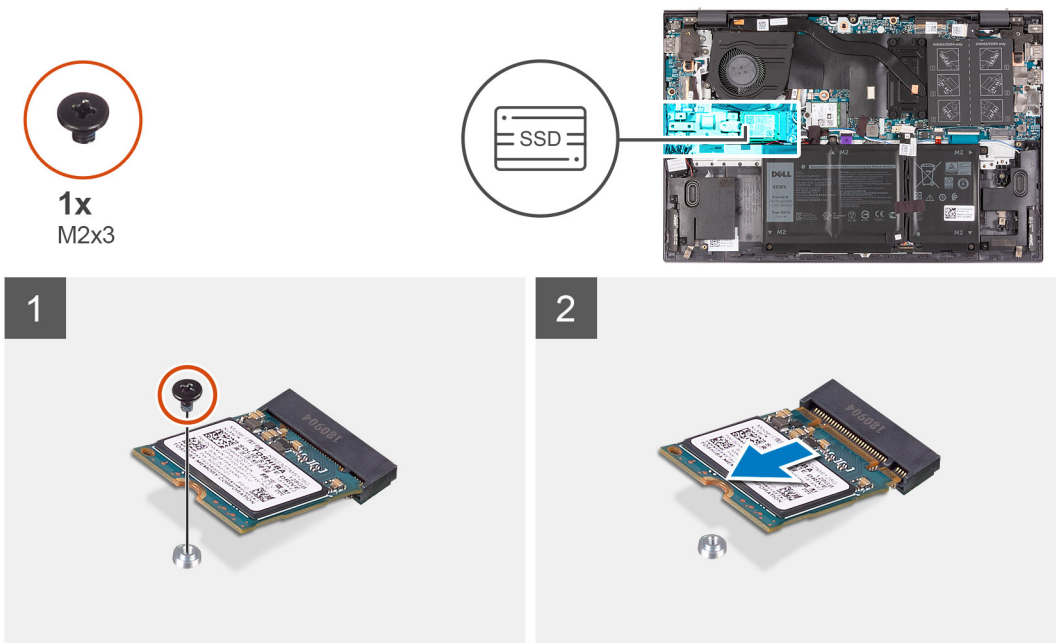

Steps

1. Remove the screw (M2x3) that secures the solid-state drive to the palm-rest and keyboard assembly.
2. Slide and lift the solid-state drive off the M.2 slot one on the system board.

Installing the M.2 2230 solid-state drive in M.2 slot one

Prerequisites

If you are replacing a component, remove the existing component before performing the installation procedure.

About this task

NOTE: This procedure applies only to computers shipped with an M.2 2230 solid-state drive installed in M.2 slot one.

NOTE: Depending on the configuration ordered, your computer may support an M.2 2230 solid-state drive or an M.2 2280 solid-state drive in M.2 slot one.

NOTE: Install the solid-state drive mounting bracket, if it is not installed.

NOTE: If there is only one solid-state drive in the configuration you ordered, you can install another solid-state drive in the other M.2 slot. However, you may need a solid-state drive bracket (sold separately; please contact Dell support) to install the additional solid-state drive.

The following image indicates the location of the M.2 2230 solid-state drive that is installed in M.2 slot one and provides a visual representation of the installation procedure.

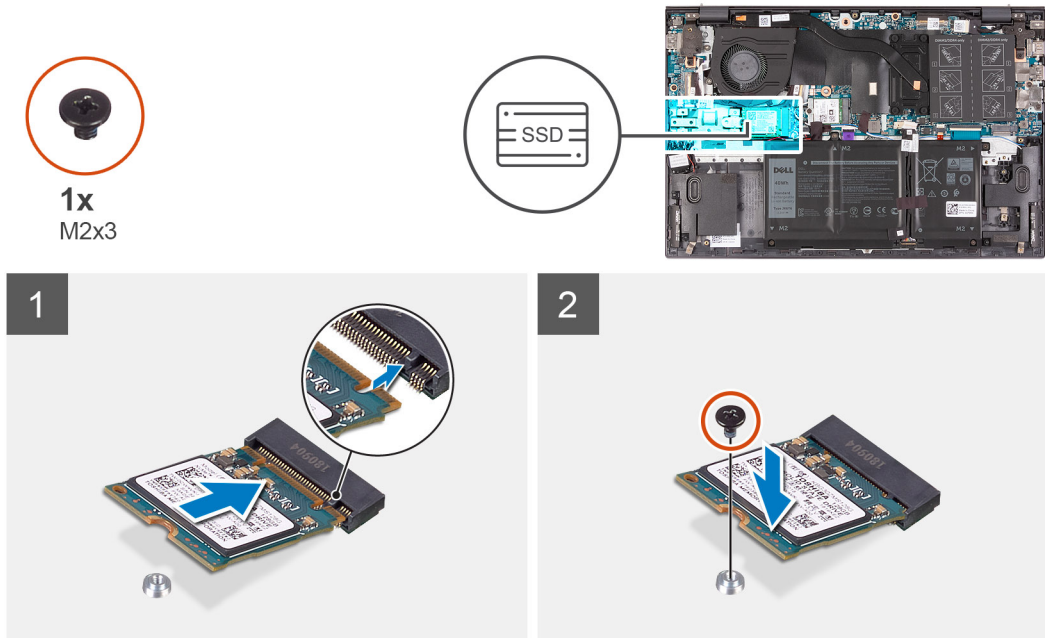

Steps

1. Align the notches on the solid-state drive with the M.2 slot one on the system board.
2. Slide the solid-state drive into the M.2 slot one on the system board.
3. Replace the screw (M2x3) that secures the solid-state drive to the palm-rest and keyboard assembly.

Next steps

1. Install the [base cover](#).
2. Follow the procedure in [After working inside your computer](#).

Removing the M.2 2280 solid-state drive/Intel Optane storage from M.2 slot one

Prerequisites

1. Follow the procedure in [before working inside your computer](#).
2. Remove the [base cover](#).

About this task

NOTE: This procedure applies only to computers shipped with an M.2 2280 solid-state drive installed in M.2 slot one.

NOTE: Depending on the configuration ordered, your computer may support an M.2 2230 solid-state drive or an M.2 2280 solid-state drive in M.2 slot one.

The following image indicates the location of the M.2 2280 solid-state drive/Intel Optane storage that is installed in M.2 slot one and provides a visual representation of the removal procedure.



1x
M2x3

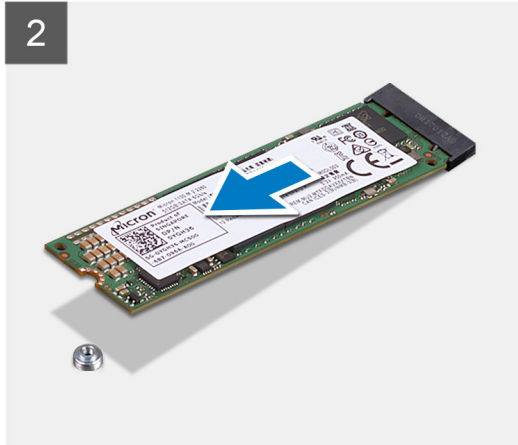
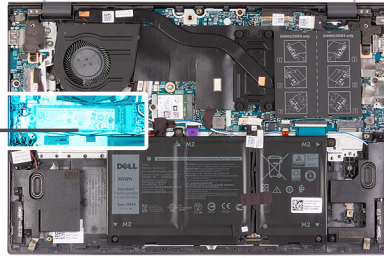

Steps

1. Remove the screw (M2x3) that secures the solid-state drive/Intel Optane storage to the palm-rest and keyboard assembly.
2. Slide and lift the solid-state drive/Intel Optane storage off M.2 slot one on the system board.

Installing the M.2 2280 solid-state drive/Intel Optane storage in M.2 slot one

Prerequisites

If you are replacing a component, remove the existing component before performing the installation procedure.

About this task

- NOTE:** This procedure applies only to computers shipped with an M.2 2280 solid-state drive installed in M.2 slot one.
- NOTE:** Depending on the configuration ordered, your computer may support an M.2 2230 solid-state drive or an M.2 2280 solid-state drive in M.2 slot one.
- NOTE:** Install the solid-state drive mounting bracket, if it is not installed.

The following image indicates the location of the M.2 2280 solid-state drive/Intel Optane storage that is installed in M.2 slot one and provides a visual representation of the installation procedure.



1x
M2x3

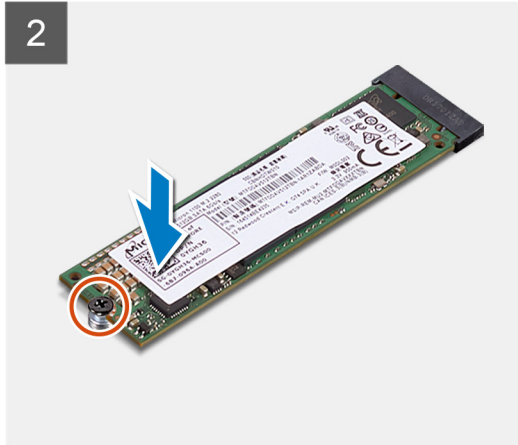
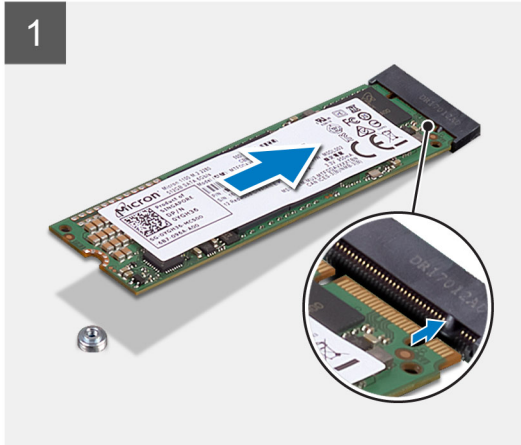
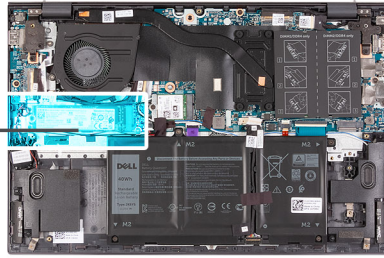

Steps

1. Align the notches on the solid-state drive/Intel Optane storage with M.2 slot one on the system board.
2. Slide the solid-state drive/Intel Optane storage into M.2 slot one on the system board.
3. Replace the screw (M2x3) that secures the solid-state drive/Intel Optane storage to the palm-rest and keyboard assembly.

Next steps

1. Install the [base cover](#).
2. Follow the procedure in [after working inside your computer](#).

Installing the solid-state drive bracket

Prerequisites

1. Follow the procedure in [Before working inside your computer](#).
2. Remove the [base cover](#).
3. Remove the [solid-state drive from M.2 slot one](#).

About this task

NOTE: If there is only one solid-state drive in the configuration you ordered, you can install another solid-state drive in the other M.2 slot. However, you may need a solid-state drive bracket (sold separately; please contact Dell support) to install the additional solid-state drive.

The following image provides a visual representation of the installation procedure.

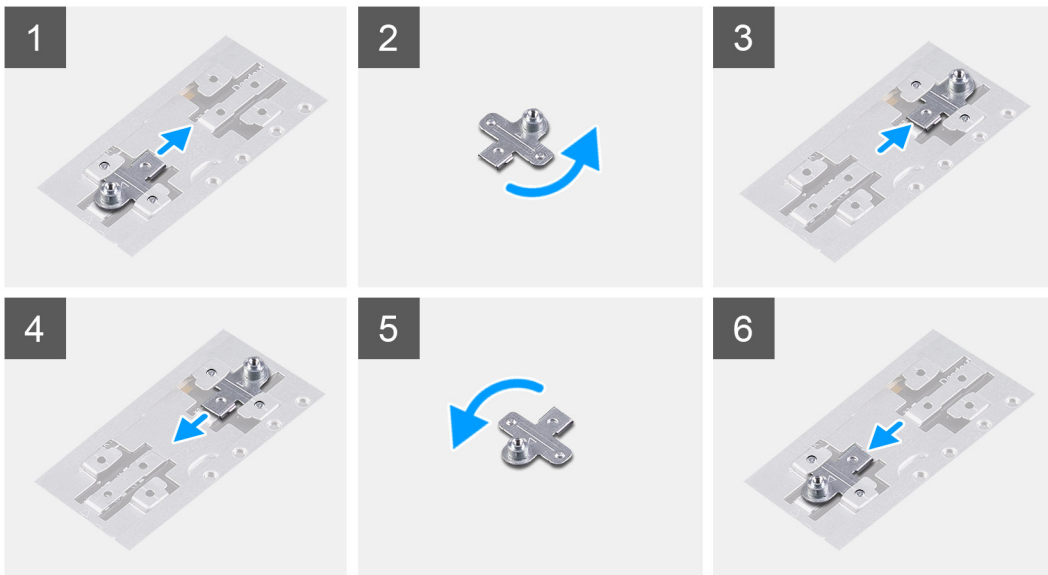



Steps

1. Slide and remove the solid-state drive bracket from the support bracket slot.
2. Depending on the type of solid-state drive (M.2 2230/M.2 2280), align and insert the SSD bracket into the bracket slot.
3. Install the solid-state drive.

Solid-state drive—M.2 slot two

Removing the M.2 2230 solid-state drive from M.2 slot two

Prerequisites

-  **NOTE:** If you have ordered a 3-cell (40 Wh) battery configuration, your computer will not have a solid-state drive/Intel Optane storage installed in M.2 slot two.
-  **NOTE:** If you have ordered a 4-cell (53 Wh) battery configuration, your computer may have an M.2 2230 solid-state drive or an M.2 2280 solid-state drive/Intel Optane storage installed in M.2 slot two.
-  **NOTE:** This procedure applies only to computers shipped with an M.2 2230 solid-state drive installed in M.2 slot two.

1. Follow the procedure in [before working inside your computer](#).
2. Remove the [base cover](#).

About this task

The following image indicates the location of the M.2 2230 solid-state drive that is installed in M.2 slot two and provides a visual representation of the removal procedure.



2x
M2x3

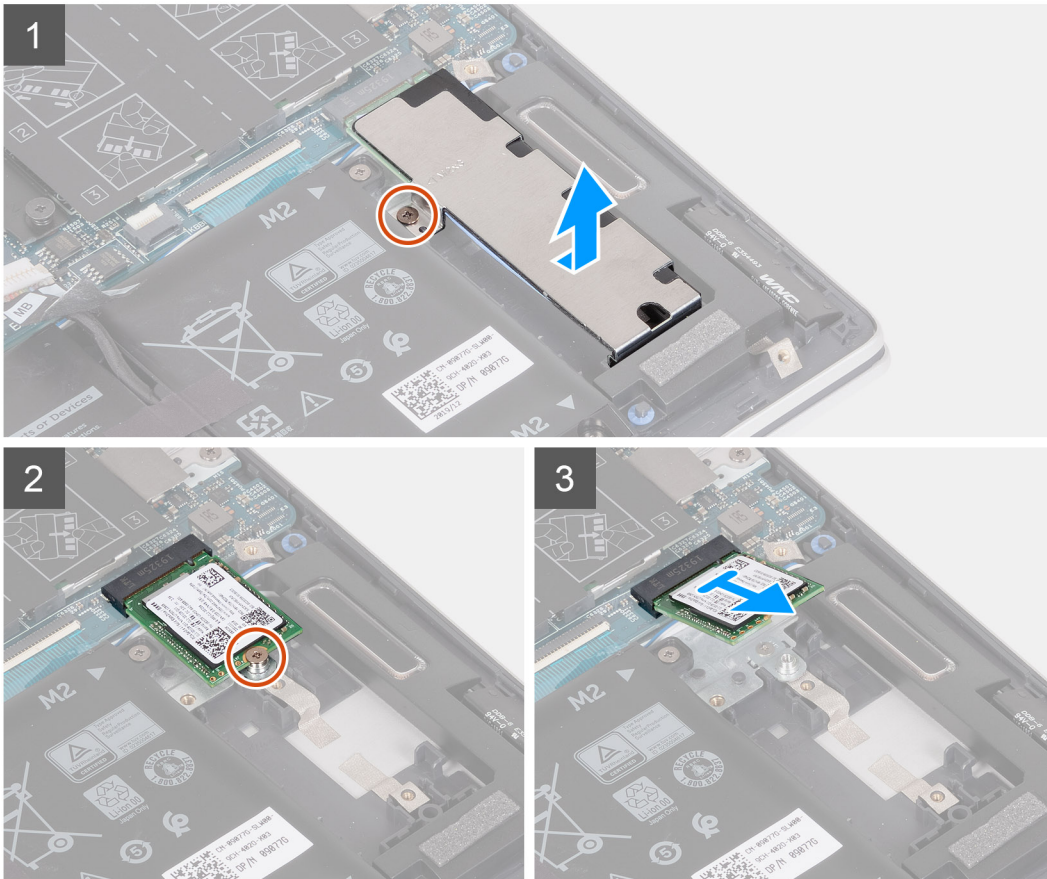
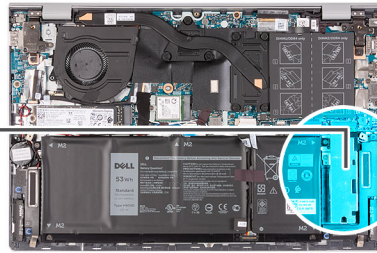

Steps

1. Remove the screw (M2x3) that secures the solid-state drive bracket to the palm-rest and keyboard assembly.
2. Slide and lift the solid-state drive bracket off the solid-state drive.
3. Remove the screw (M2x3) that secures the solid-state drive to the palm-rest and keyboard assembly.
4. Slide and lift the solid-state drive off M.2 slot two on the system board.

Installing the M.2 2230 solid-state drive in M.2 slot two

Prerequisites

If you are replacing a component, remove the existing component before performing the installation procedure.

About this task

- NOTE:** If you have ordered a 3-cell (40 Wh) battery configuration, your computer will not support a solid-state drive/Intel Optane storage in M.2 slot two.
- NOTE:** If you have ordered a 4-cell (53 Wh) battery configuration, your computer may support an M.2 2230 solid-state drive, or an M.2 2280 solid-state drive/Intel Optane storage in M.2 slot two.

NOTE: Before installing your M.2 2230 solid-state drive, ensure that the mounting bracket is in the correct location. For more information, see [Replacing the solid-state drive mounting bracket](#).

The following image indicates the location of the M.2 2230 solid-state drive that is installed in M.2 slot two and provides a visual representation of the installation procedure.

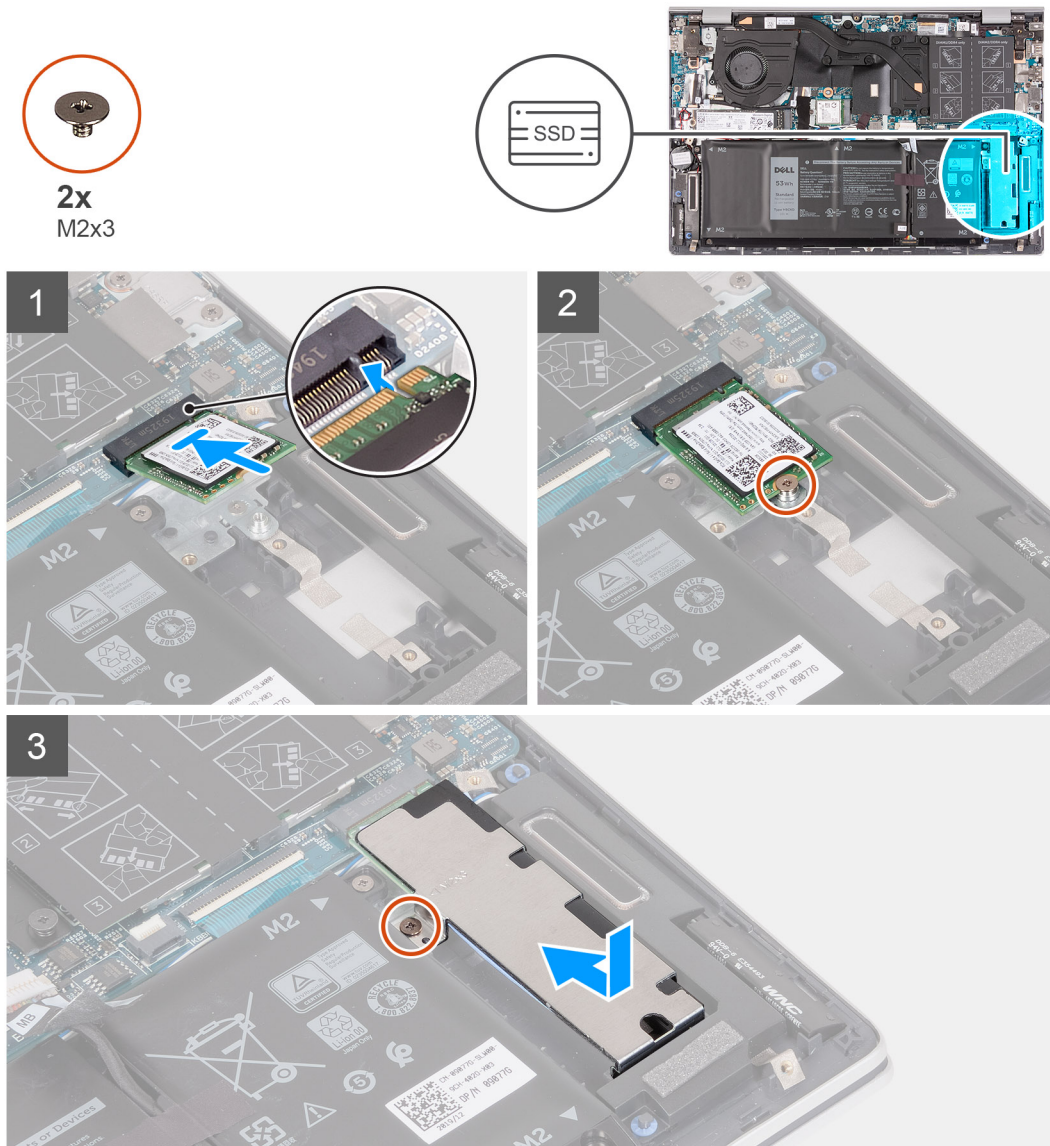

Steps

1. Align the notches on the solid-state drive with M.2 slot two on the system board.
2. Slide the solid-state drive into M.2 slot two on the system board.
3. Replace the screw (M2x3) that secures the solid-state drive to the palm-rest and keyboard assembly.
4. Place the solid-state drive bracket on the solid-state drive.
5. Align the screw holes on the solid-state drive bracket with the screw holes on the system board and the palm-rest and keyboard assembly.
6. Replace the screw (M2x3) that secures the solid-state drive bracket to the palm-rest and keyboard assembly.

Next steps

1. Install the [base cover](#).
2. Follow the procedure in [after working inside your computer](#).

Removing the M.2 2280 solid-state drive/Intel Optane storage from M.2 slot two

Prerequisites

1. Follow the procedure in [before working inside your computer](#).
2. Remove the [base cover](#).

About this task

- NOTE:** If you have ordered a 3-cell (40 Wh) battery configuration, your computer will not have a solid-state drive/Intel Optane storage installed in M.2 slot two.
- NOTE:** If you have ordered a 4-cell (53 Wh) battery configuration, your computer may have an M.2 2230 solid-state drive or an M.2 2280 solid-state drive/Intel Optane storage installed in M.2 slot two.
- NOTE:** This procedure applies only to computers shipped with an M.2 2280 solid-state drive/Intel Optane storage installed in M.2 slot two.

The following image indicates the location of the M.2 2280 solid-state drive/Intel Optane storage that is installed in M.2 slot two and provides a visual representation of the removal procedure.

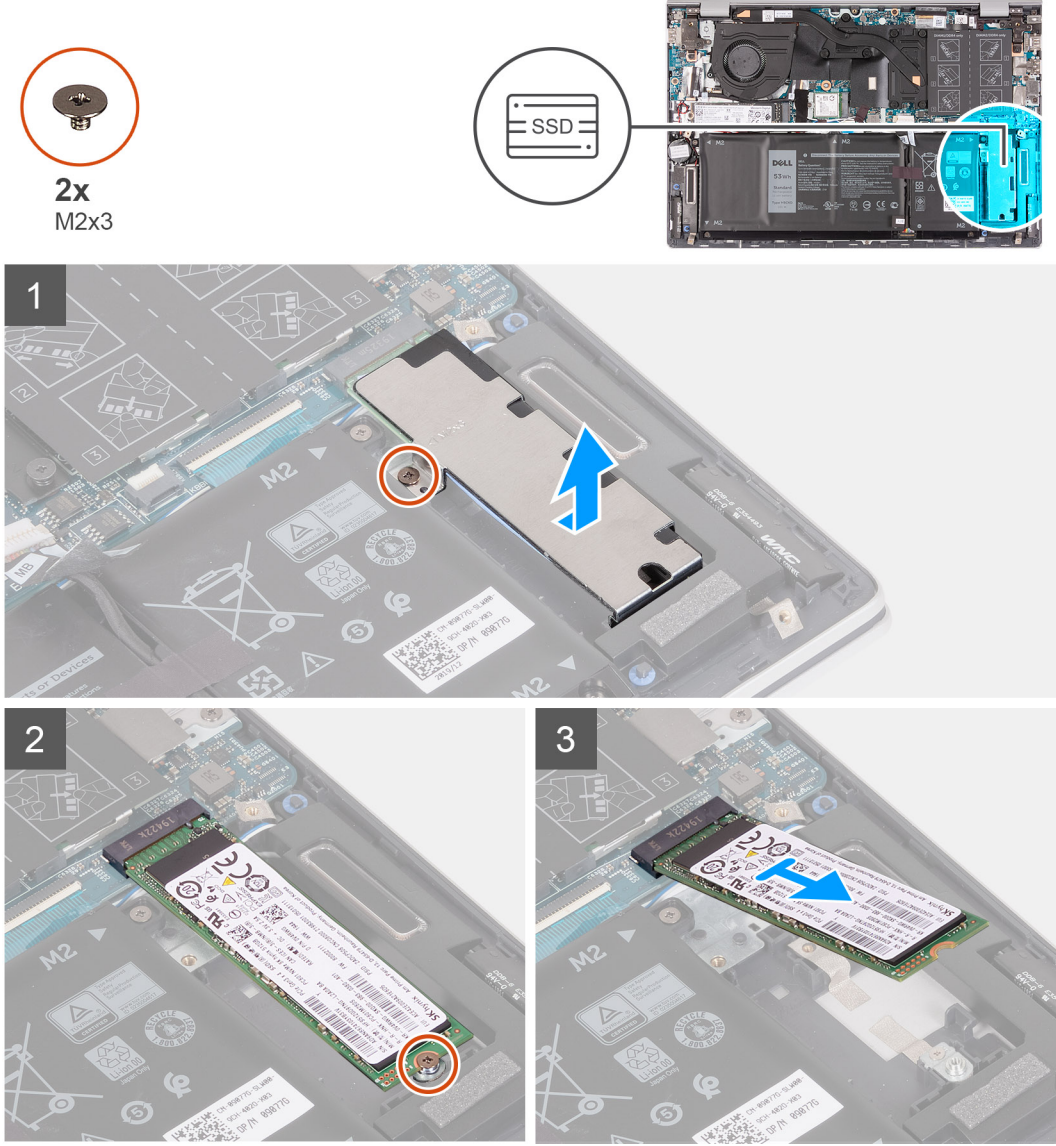

Steps

1. Remove the screw (M2x3) that secures the solid-state drive bracket to the palm-rest and keyboard assembly.
2. Slide and lift the solid-state drive bracket off the solid-state drive/Intel Optane storage.
3. Remove the screw (M2x3) that secures the solid-state drive/Intel Optane storage to the palm-rest and keyboard assembly.
4. Slide and lift the solid-state drive/Intel Optane storage off the M.2 slot two on the system board.

Installing the M.2 2280 solid-state drive/Intel Optane storage in M.2 slot two

Prerequisites

If you are replacing a component, remove the existing component before performing the installation procedure.

About this task

- NOTE:** If you have ordered a 3-cell (40 Wh) battery configuration, your computer will not support a solid-state drive/Intel Optane storage in M.2 slot two.
- NOTE:** If you have ordered a 4-cell (53 Wh) battery configuration, your computer may support an M.2 2230 solid-state drive, or a 2280 solid-state drive/Intel Optane storage in M.2 slot two.
- NOTE:** Before installing your M.2 2280 solid-state drive/Intel Optane storage, ensure that the mounting bracket is in the correct location. For more information, see [Replacing the solid-state drive mounting bracket](#).

The following image indicates the location of the M.2 2280 solid-state drive/Intel Optane storage that is installed in M.2 slot two and provides a visual representation of the installation procedure.



2x
M2x3

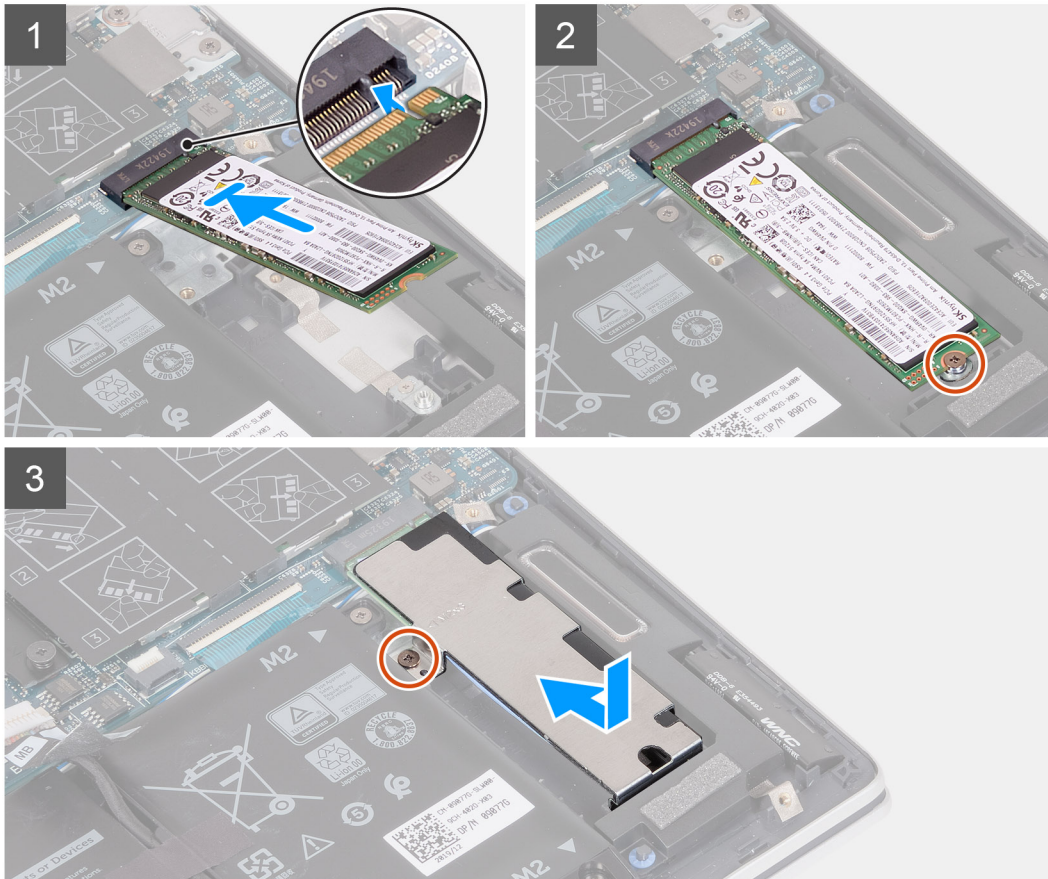
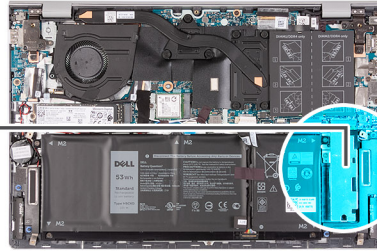

Steps

1. Align the notches on the solid-state drive/Intel Optane storage with the M.2 slot two on the system board.
2. Slide the solid-state drive/Intel Optane storage into the M.2 slot two on the system board.
3. Replace the screw (M2x3) that secures the solid-state drive/Intel Optane storage to the palm-rest and keyboard assembly.
4. Place the solid-state drive bracket on the solid-state drive.
5. Align the screw holes on the solid-state drive bracket with the screw holes on the system board and the palm-rest and keyboard assembly.
6. Replace the screw (M2x3) that secures the solid-state drive bracket to the palm-rest and keyboard assembly.

Next steps

1. Install the [base cover](#).
2. Follow the procedure in [after working inside your computer](#).

Installing the solid-state drive bracket

Prerequisites

1. Follow the procedure in [Before working inside your computer](#).
2. Remove the [base cover](#).

3. Remove the [solid-state drive from M.2 slot two](#).

About this task

NOTE: If there is only one solid-state drive in the configuration you ordered, you can install another solid-state drive in the other M.2 slot. However, you may need a solid-state drive bracket (sold separately; please contact Dell support) to install the additional solid-state drive.

The following image provides a visual representation of the installation procedure.

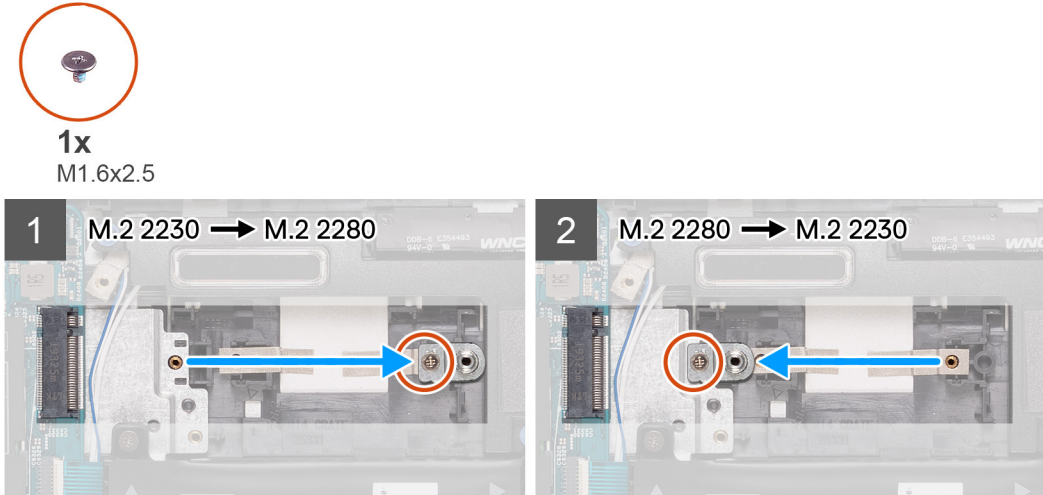

Steps

1. Remove the screw (M1.6x2.5) that secures the solid-state drive bracket to the palm-rest and keyboard assembly.
2. Remove the solid-state drive bracket from the support bracket slot.
3. Depending on the type of solid-state drive (M.2 2230/M.2 2280), align and insert the solid-state drive bracket into the bracket slot.
4. Replace the screw (M1.6x2.5) that secures the solid-state drive bracket to the palm-rest and keyboard assembly.
5. Install the solid-state drive.

WLAN card

Removing the WLAN card

Prerequisites

1. Follow the procedure in [Before working inside your computer](#).
2. Remove the [base cover](#).

About this task

The following images indicate the location of the WLAN card and provide a visual representation of the removal procedure.



1x
M2x3

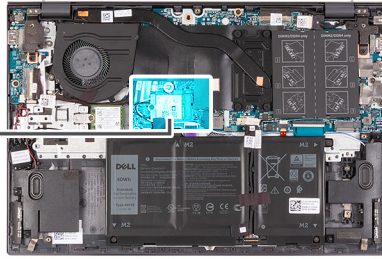

Steps

1. Remove the screw (M2x3) that secures the WLAN card to the system board.
2. Remove the bracket that secures the WLAN card to the system board.
3. Disconnect the antenna cables from the WLAN card.
4. Slide and remove the WLAN card from the WLAN-card slot.

Installing the WLAN card

Prerequisites

If you are replacing a component, remove the existing component before performing the installation procedure.

About this task

The following image indicates the location of the WLAN card and provides a visual representation of the installation procedure.



1x
M2x3

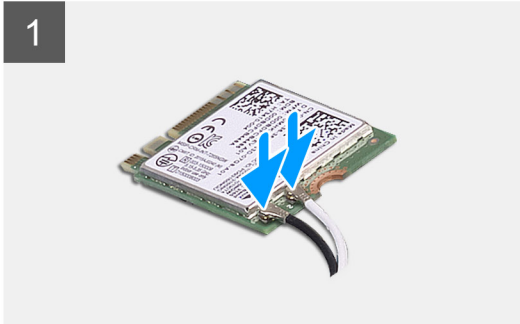
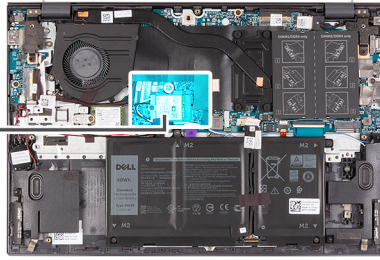

Steps

1. Connect the antenna cables to the WLAN card.

The following table provides the antenna-cable color scheme for the wireless card that is supported by your computer.

Table 2. Antenna-cable color scheme

Connectors on the wireless card	Antenna-cable color	Silkscreen marking	
Main	White	MAIN	△ (white triangle)
Auxiliary	Black	AUX	▲ (black triangle)

2. Align the notch on the WLAN card with the tab on the WLAN-card slot and insert the WLAN card at an angle into the WLAN-card slot.
3. Place the WLAN-card bracket on the WLAN card.
4. Align the screw hole on the WLAN-card bracket and the screw hole on the system board.
5. Replace the screw (M2x3) that secures the WLAN card to the system board.

Next steps

1. Install the [base cover](#).
2. Follow the procedure in [After working inside your computer](#).

Fan

Removing the fan

Prerequisites

1. Follow the procedure in [Before working inside your computer](#).
2. Remove the [base cover](#).

About this task

The following images indicate the location of the system fan and provide a visual representation of the removal procedure.

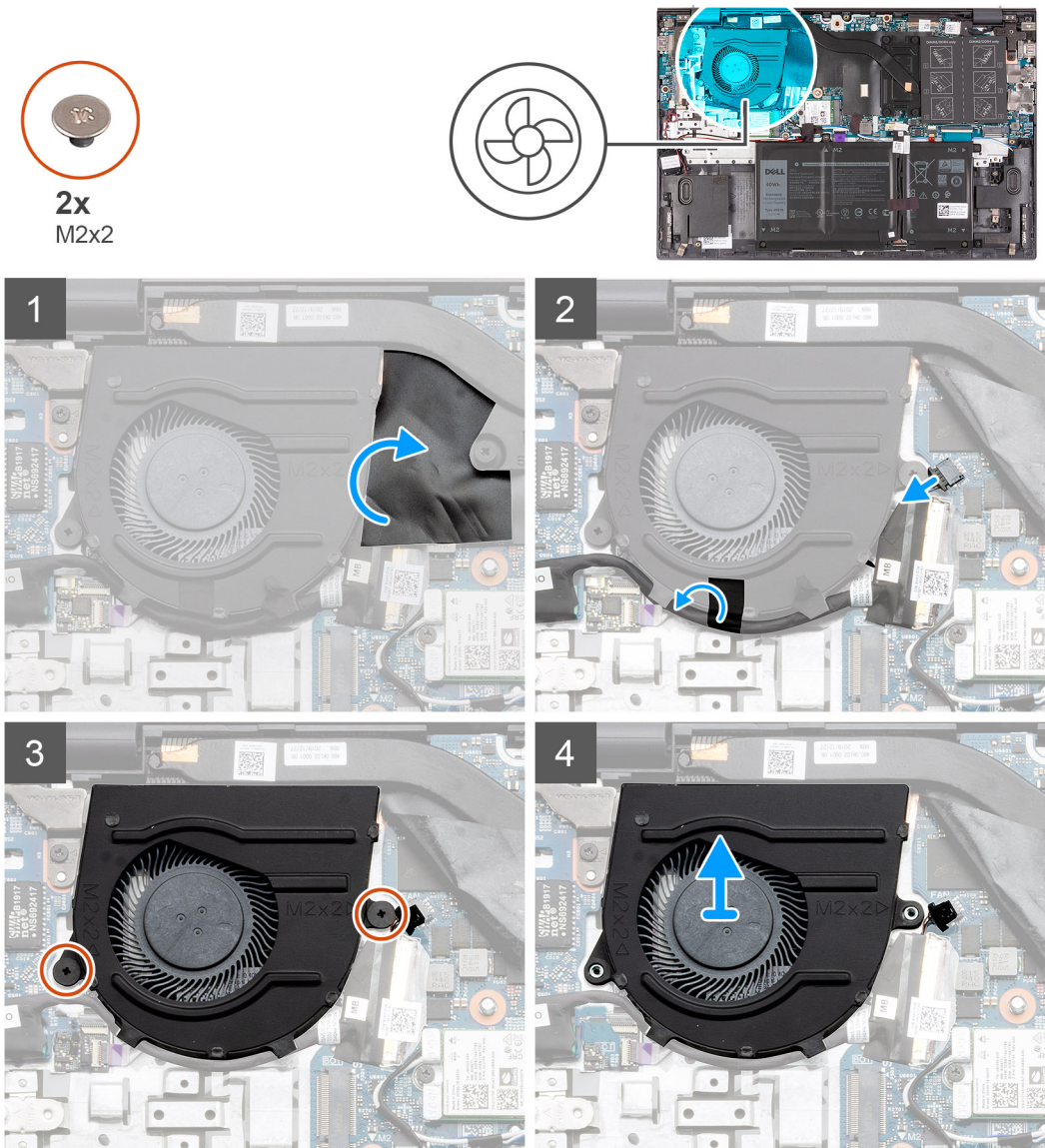

Steps

1. Peel and lift the mylar covering the fan cable.
2. Peel the tape and disconnect the I/O-board cable from the system board.
3. Disconnect the fan cable from the system board.
4. Remove the two screws (M2x2) that secure the fan to the palm-rest and keyboard assembly.
5. Lift the fan off the palm-rest and keyboard assembly.

Installing the fan

Prerequisites

If you are replacing a component, remove the existing component before performing the installation procedure.

About this task

The following image indicates the location of the system fan and provides a visual representation of the installation procedure.

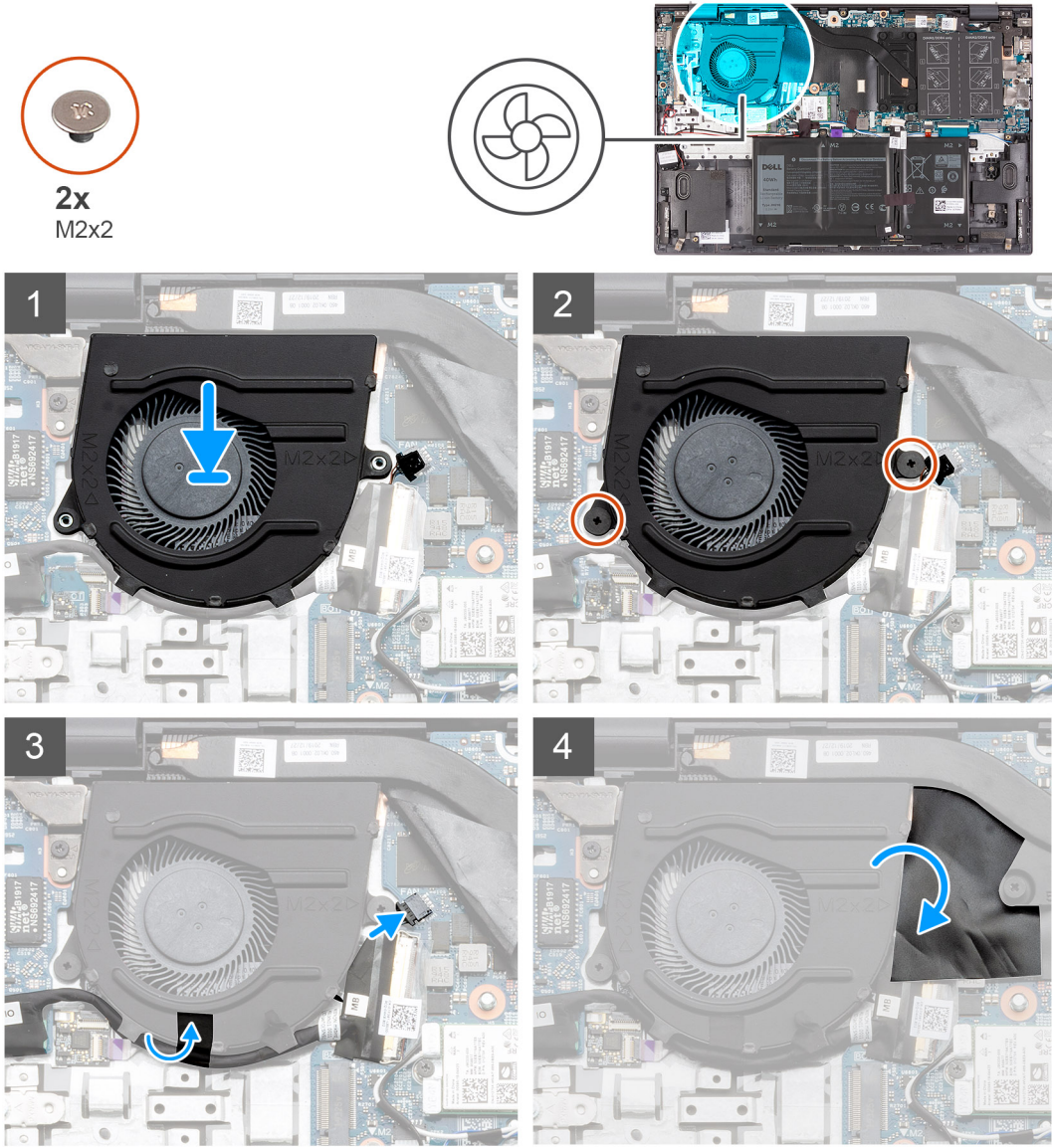

Steps

1. Align and place the fan on the palm-rest and keyboard assembly.
2. Replace the two screws (M2x2) that secure the fan to the palm-rest and keyboard assembly.
3. Route the I/O-board cable through the routing guides on the fan.
4. Connect the fan cable to the system board.
5. Connect the I/O-board cable to the system board and close the latch.
6. Adhere the tape that secures the I/O-board cable to the system board.
7. Adhere the mylar that covers the fan cable.

Next steps

1. Install the [base cover](#).
2. Follow the procedure in [After working inside your computer](#).

Coin-cell battery

Removing the coin-cell battery

Prerequisites

NOTE: Removing the coin-cell battery resets the BIOS setup program's settings to default. It is recommended that you note the BIOS setup program's settings before removing the coin-cell battery.

1. Follow the procedure in [Before working inside your computer](#).
2. Remove the [base cover](#).

About this task

The following images indicate the location of the base cover and provide a visual representation of the removal procedure.

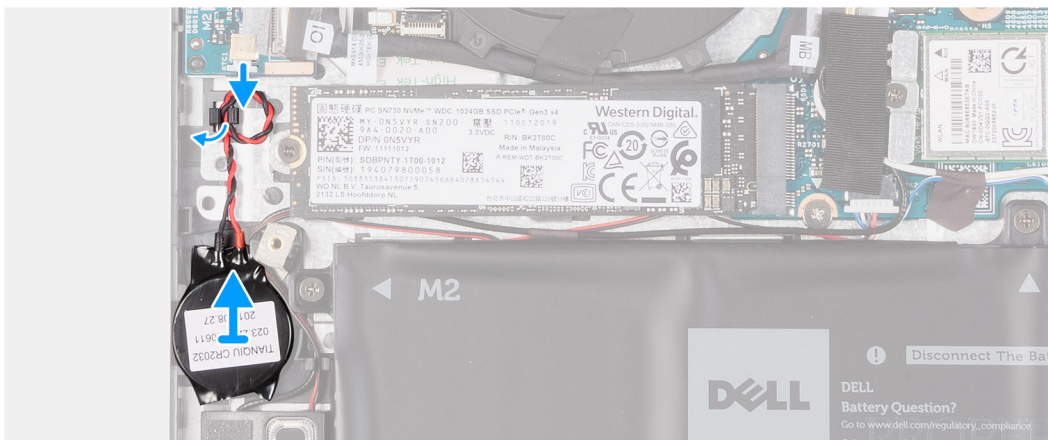
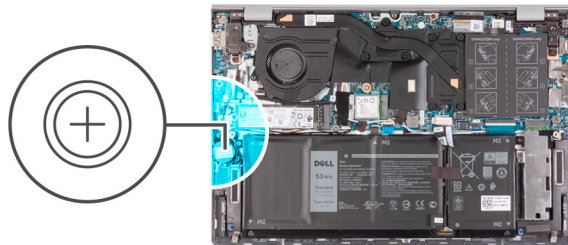

Steps

1. Disconnect the coin-cell battery cable from the I/O board.
2. Remove the coin-cell battery cable from the routing guides on the palm-rest and keyboard assembly.
3. Peel the coin-cell battery from the palm-rest and keyboard assembly.

Installing the coin-cell battery

Prerequisites

If you are replacing a component, remove the existing component before performing the installation procedure.

About this task

The following image indicates the location of the coin-cell battery and provides a visual representation of the installation procedure.

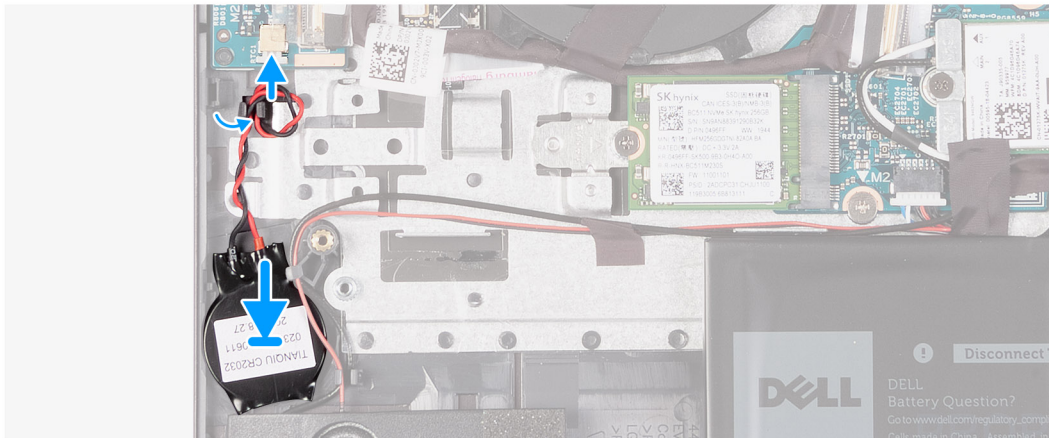
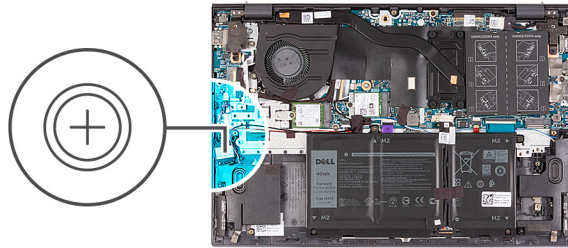

Steps

1. Adhere the coin-cell battery in the coin-cell battery slot on the palm-rest and keyboard assembly.
2. Route the coin-cell battery cable through the routing guides on the palm-rest and keyboard assembly.
3. Connect the coin-cell battery cable to the I/O board.

Next steps

1. Install the [base cover](#).
2. Follow the procedure in [After working inside your computer](#).

Power-adapter port

Removing the power-adapter port

Prerequisites

1. Follow the procedure in [Before working inside your computer](#).
2. Remove the [base cover](#).

About this task

The following images indicate the location of the power-adapter port and provide a visual representation of the removal procedure.

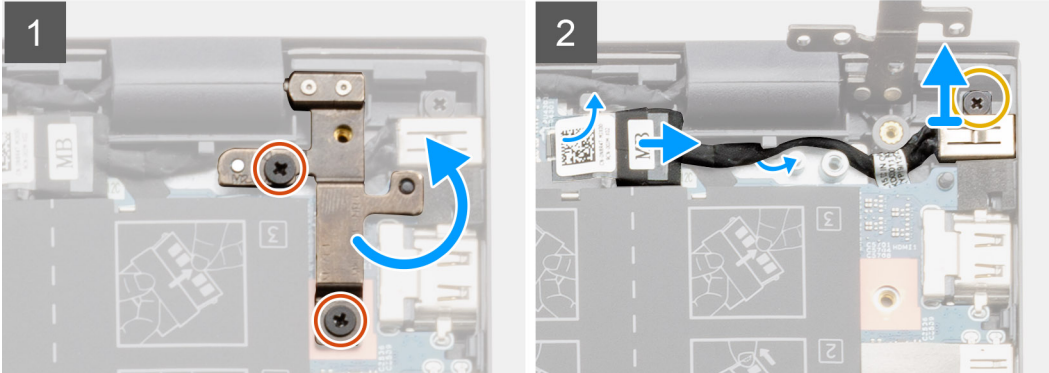
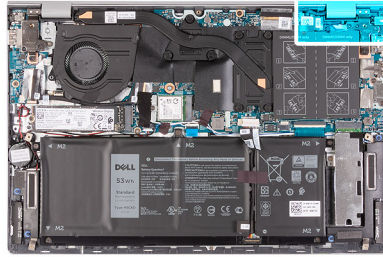

Steps

1. Remove the two screws (M2.5x5) that secure the right display-hinge to the system board.
2. Disconnect the power-adapter port cable from the system board.
3. Remove the screw (M2x3) that secures the power-adapter port to the palm-rest and keyboard assembly.
4. Lift the power-adapter port off the palm-rest and keyboard assembly.

Installing the power-adapter port

Prerequisites

If you are replacing a component, remove the existing component before performing the installation procedure.

About this task

The following image indicates the location of the power-adapter port and provides a visual representation of the installation procedure.

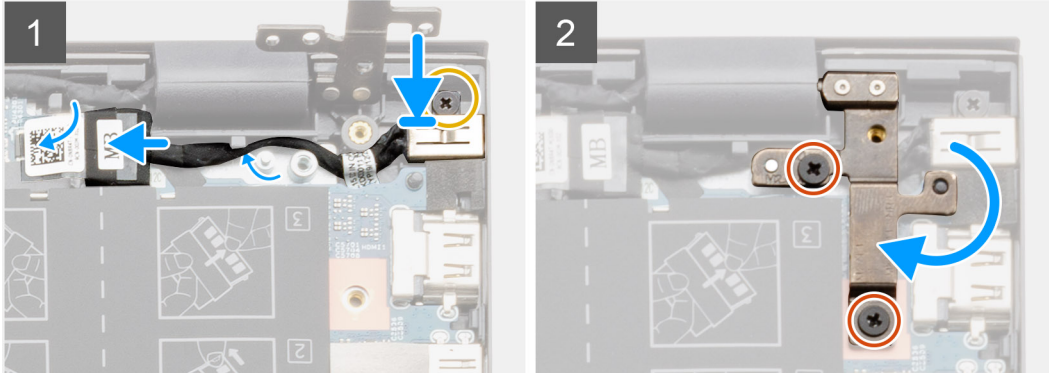
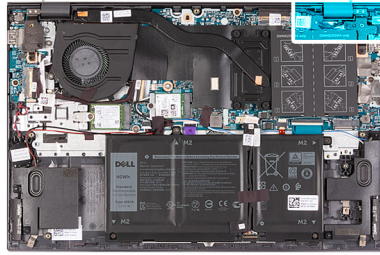

Steps

1. Place the power-adapter port into the slot on the palm rest and keyboard assembly.
2. Replace the screw (M2x3) that secures the power-adapter port on the palm-rest and keyboard assembly.
3. Route the power-adapter port cable through the routing guides on the palm-rest and keyboard assembly.
4. Connect the power-adapter port cable to the system board.
5. Press down the right display-hinge and align the screw holes on the display hinges with the screw holes on the system board.
6. Replace the two screws (M2.5x5) that secure the right display-hinge to the system board.

Next steps

1. Install the [base cover](#).
2. Follow the procedure in [After working inside your computer](#).

Display assembly

Removing the display assembly

Prerequisites

1. Follow the procedure in [Before working inside your computer](#).
2. Remove the [base cover](#).

About this task

The following images indicate the location of the display assembly and provide a visual representation of the removal procedure.



4x
M2.5x5

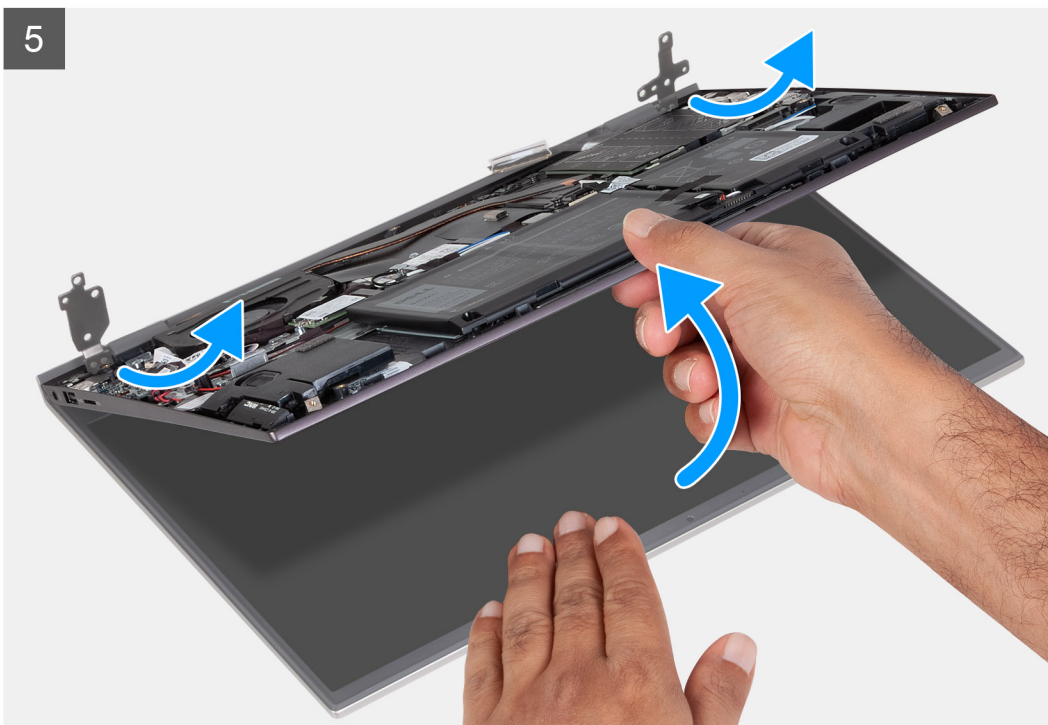
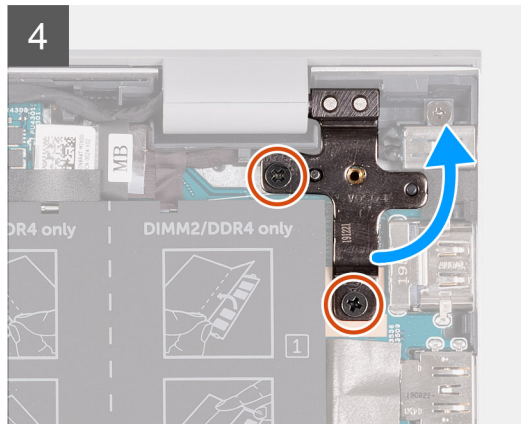
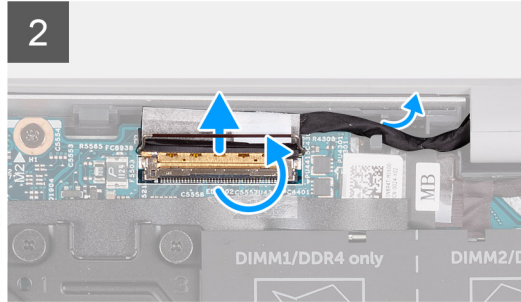
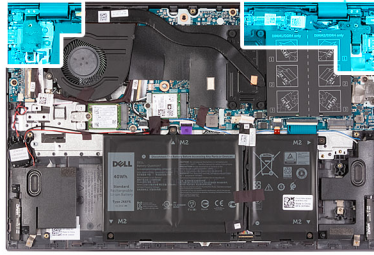

Steps

1. Peel the tape that secures the display cable to the system board.
2. Open the latch, and then disconnect the display cable from the system board.
3. Remove the display cable from the routing guides on the palm-rest and keyboard assembly.
4. Remove the four screws (M2.5x5) that secure the display hinges to the palm-rest and keyboard assembly.
5. Lift the left and right display hinges.
6. Slide the palm-rest and keyboard assembly off the display assembly.
7. After performing the above steps, you are left with the display assembly.



Installing the display assembly

Prerequisites

If you are replacing a component, remove the existing component before performing the installation procedure.

About this task

The following image indicates the location of the display assembly and provides a visual representation of the installation procedure.

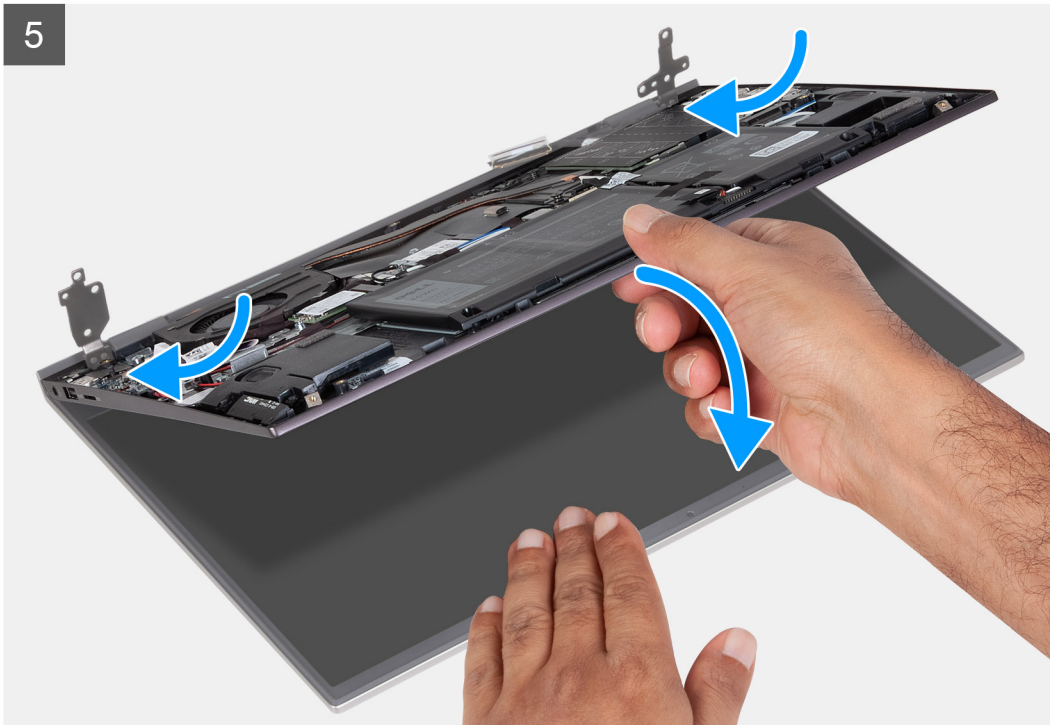

4x
M2.5x5

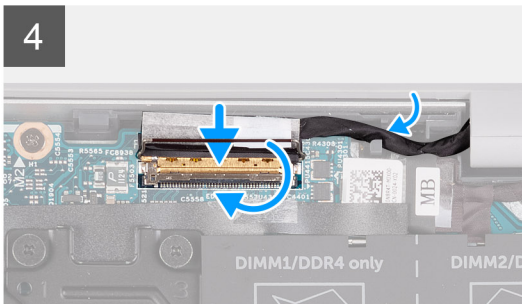
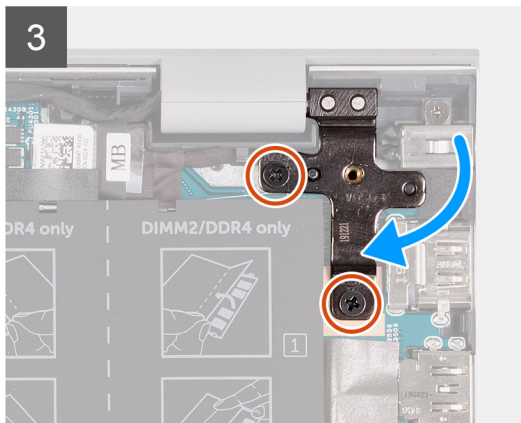
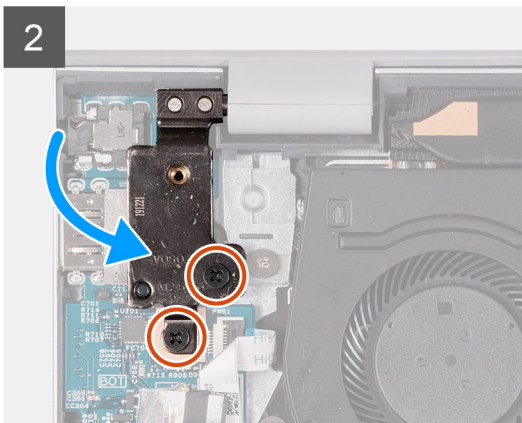
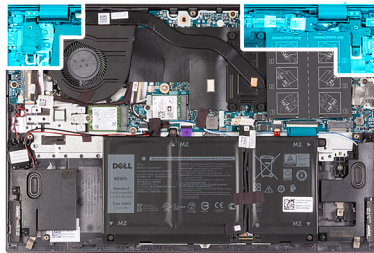

Steps

1. Place the display assembly on a clean and flat surface with the display panel facing up.
2. Slide the palm-rest and keyboard assembly under the display hinges.
3. Press down the display hinges and align the screw holes on the display hinges with the screw holes on the palm-rest and keyboard assembly.
4. Replace the four screws (M2.5x5) that secure the display assembly to the palm-rest and keyboard assembly.
5. Align the display-cable connector on the system board, then firmly press into position.

Next steps

1. Install the [base cover](#).
2. Follow the procedure in [After working inside your computer](#).

I/O board

Removing the I/O board

Prerequisites

NOTE: Removing the I/O-board requires the coin-cell battery to be disconnected, the action of which resets the BIOS setup program's settings to default. It is recommended that you note the BIOS setup program's settings before removing the coin-cell battery.

1. Follow the procedure in [Before working inside your computer](#).
2. Remove the [base cover](#).
3. Remove the [display assembly](#).

About this task

The following images indicate the location of the I/O board and provide a visual representation of the removal procedure.



1x
M2x3

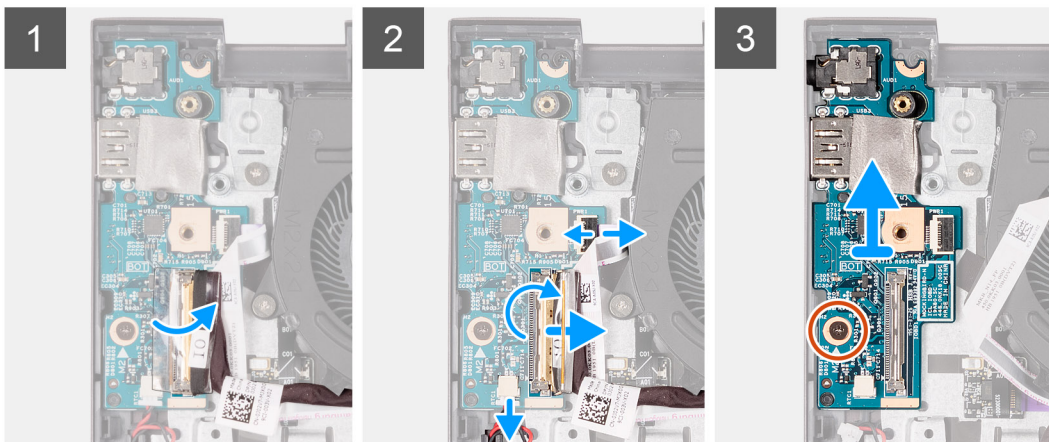
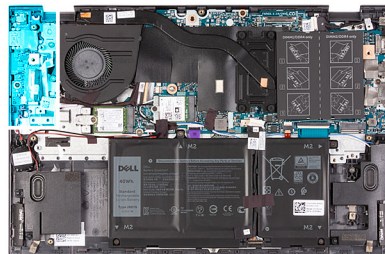

Steps

1. Peel the tape that secures the I/O-board cable to the I/O board.

2. Open the latch and disconnect the power-button cable (or fingerprint-reader cable, if applicable) from the I/O board.
3. Open the latch and disconnect the I/O-board cable from the I/O board.
4. Disconnect the coin-cell battery cable from the I/O board.
5. Remove the screw (M2x3) that secures the I/O board to the palm-rest and keyboard assembly.
6. Lift the I/O board off the palm-rest and keyboard assembly.

Installing the I/O board

Prerequisites

If you are replacing a component, remove the existing component before performing the installation procedure.

About this task

The following image indicates the location of the I/O board and provides a visual representation of the installation procedure.



1x
M2x3

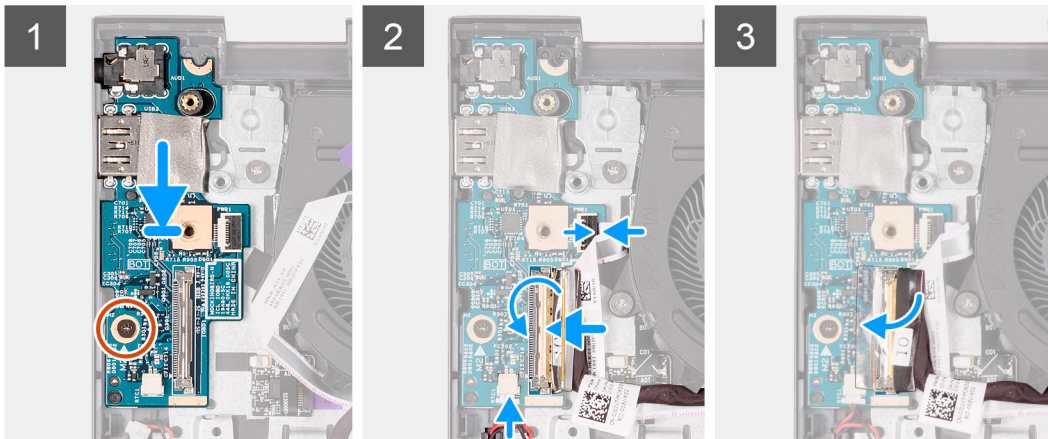
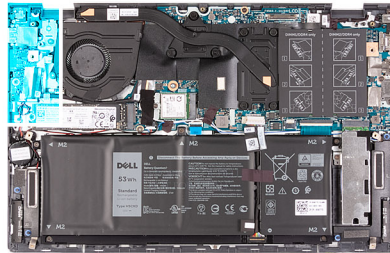

Steps

1. Place the I/O board on the palm-rest and keyboard assembly.
2. Replace the screw (M2x3) that secures the I/O board to the palm-rest and keyboard assembly.
3. Connect the power-button cable (or the fingerprint-reader cable, if applicable) to the I/O board and close the latch.
4. Connect the I/O-board cable to the I/O board and close the latch.
5. Connect the coin-cell battery cable to the I/O board.
6. Adhere the tape that secures the I/O-board cable to the I/O board.

Next steps

1. Install the [display assembly](#).
2. Install the [base cover](#).
3. Follow the procedure in [After working inside your computer](#).

Touchpad

Removing the touchpad

Prerequisites

1. Follow the procedure in [Before working inside your computer](#).
2. Remove the [base cover](#).
3. Remove the battery ([3-cell](#) or [4-cell](#)).

About this task

The following images indicate the location of the touchpad and provide a visual representation of the removal procedure.

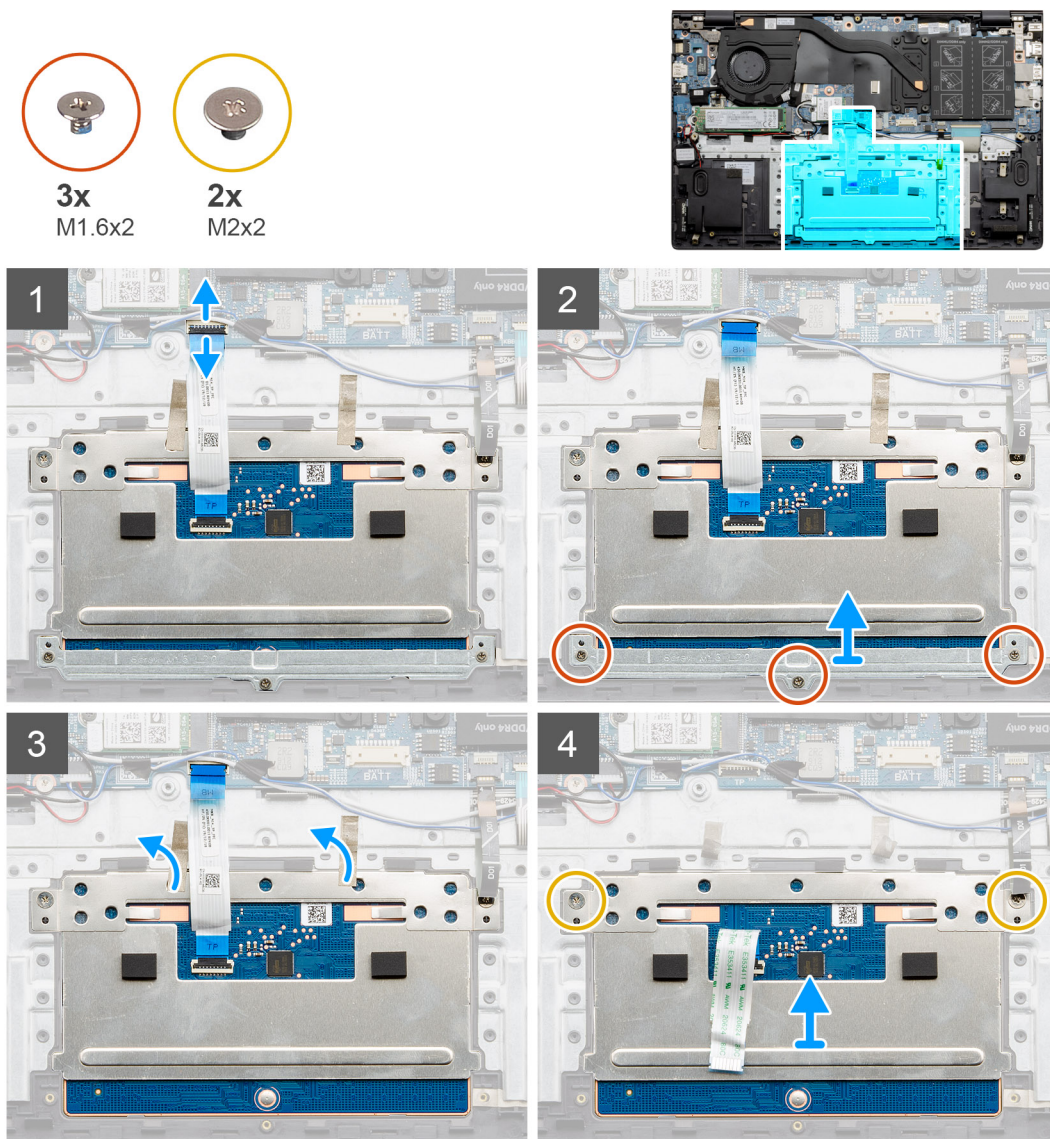

Steps

1. Open the latch and disconnect the touchpad cable from the system board.
2. Remove the three screws (M1.6x2) that secure the touchpad bracket to the palm-rest and keyboard assembly.
3. Lift the touchpad bracket off the palm-rest and keyboard assembly.
4. Peel the tape off the touchpad.

- Remove the two screws (M2x2) that secure the touchpad to the palm-rest and keyboard assembly.
- Lift the touchpad off the palm-rest and keyboard assembly.

Installing the touchpad

Prerequisites

If you are replacing a component, remove the existing component before performing the installation procedure.

About this task

The following image indicates the location of the touchpad and provides a visual representation of the installation procedure.

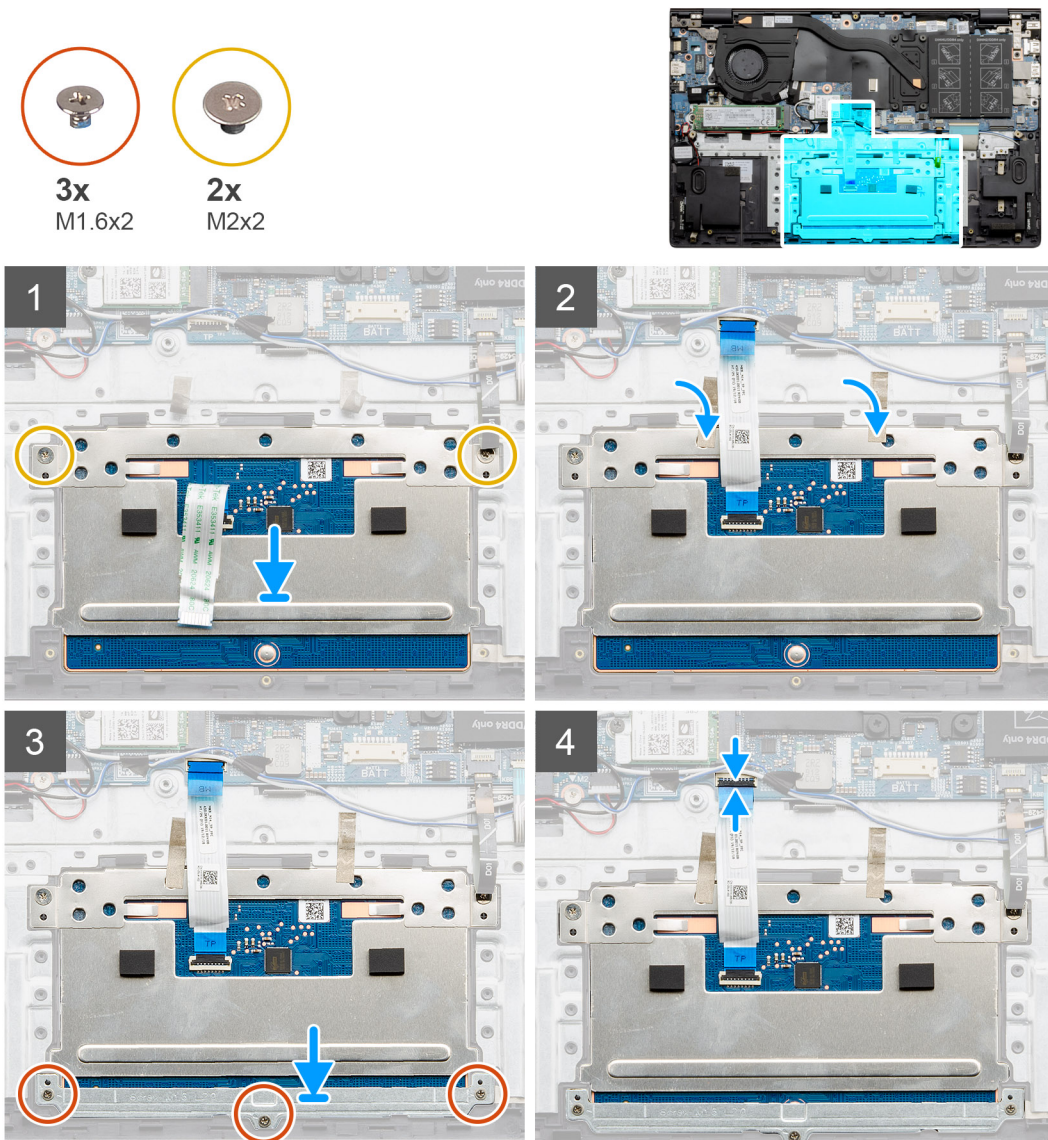

Steps

- Align and place the touchpad into the slot on the palm-rest and keyboard assembly.
- Replace the two screws (M2x2) and adhere the tape that secures the touchpad to the palm-rest and keyboard assembly.
- Adhere the tape to secure the touchpad to the palm-rest and keyboard assembly.
- Align and place the touchpad bracket into the slot on the palm-rest and keyboard assembly.
- Replace the three screws (M1.6x2) that secure the touchpad bracket to the palm-rest and keyboard assembly.
- Connect the touchpad cable to the system board and close the latch.

Next steps

1. Install the battery (3-cell or 4-cell).
2. Install the [base cover](#).
3. Follow the procedure in [After working inside your computer](#).

Speakers

Removing the speakers (in 4-cell battery configuration)

Prerequisites

1. Follow the procedure in [Before working inside your computer](#).
2. Remove the [base cover](#).
3. Remove the [battery](#).

About this task

The following images indicate the location of the speaker and provide a visual representation of the removal procedure.

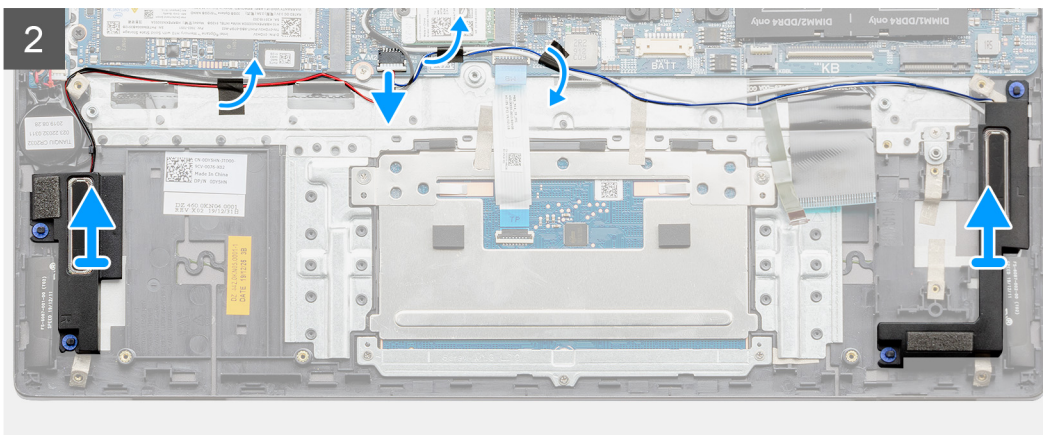
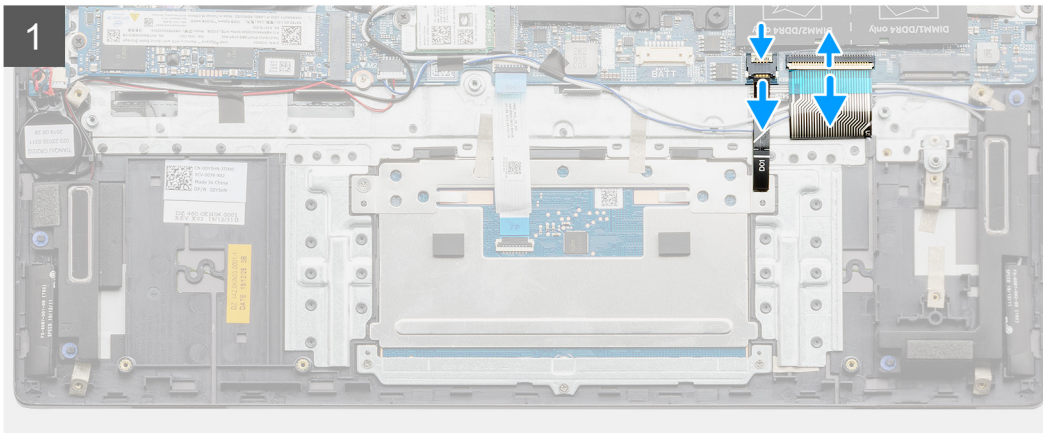
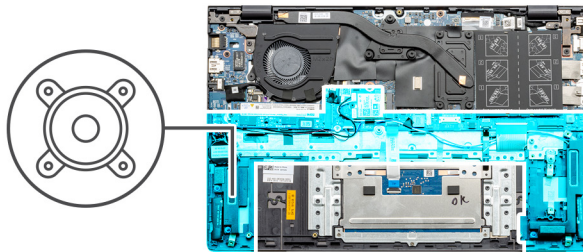

Steps

1. Disconnect the speaker cable from the system board.
2. Disconnect the keyboard-backlight cable and the keyboard cable from the system board.
3. Note the routing of the speaker cable, and remove the speaker cable from the routing guides on the palm-rest and keyboard assembly.

i **NOTE:** Note the position of the rubber grommets before lifting the speakers.

4. Lift the speakers, along with the cable, off the palm-rest and keyboard assembly.

Installing the speakers (in 4-cell battery configuration)

Prerequisites

If you are replacing a component, remove the existing component before performing the installation procedure.

About this task

The following image indicates the location of the speaker and provides a visual representation of the installation procedure.

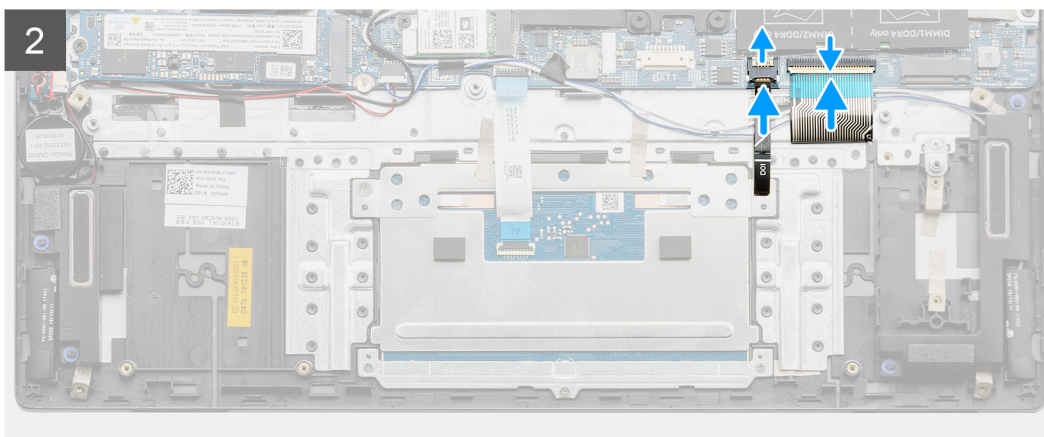
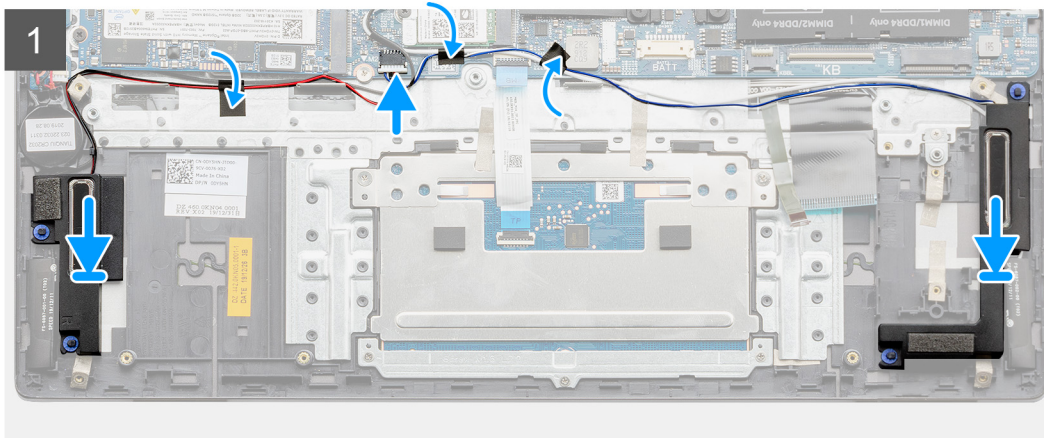
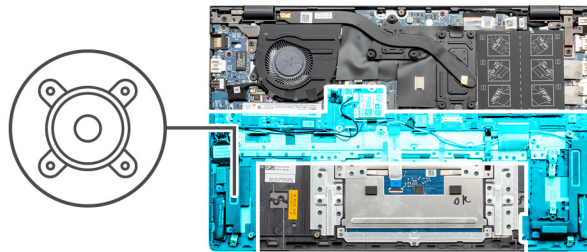

Steps

1. Using the alignment posts and rubber grommets, place the speakers in the slots on the palm-rest and keyboard assembly.
i **NOTE:** If the rubber grommets are pushed out of the speakers when removing the speakers, push them back in place before replacing the speakers.
2. Route the speaker cable through the routing guides on the palm-rest and keyboard assembly.
3. Connect the speaker cable to the system board.
4. Connect the keyboard-backlight cable and the keyboard cable to the system board.

Next steps

1. Install the [battery](#).
2. Install the [base cover](#).
3. Follow the procedure in [After working inside your computer](#).

Removing the speakers (in 3-cell battery configuration)

Prerequisites

1. Follow the procedure in [Before working inside your computer](#).
2. Remove the [base cover](#).
3. Remove the [battery](#).

About this task

The following images indicate the location of the speaker and provide a visual representation of the removal procedure.

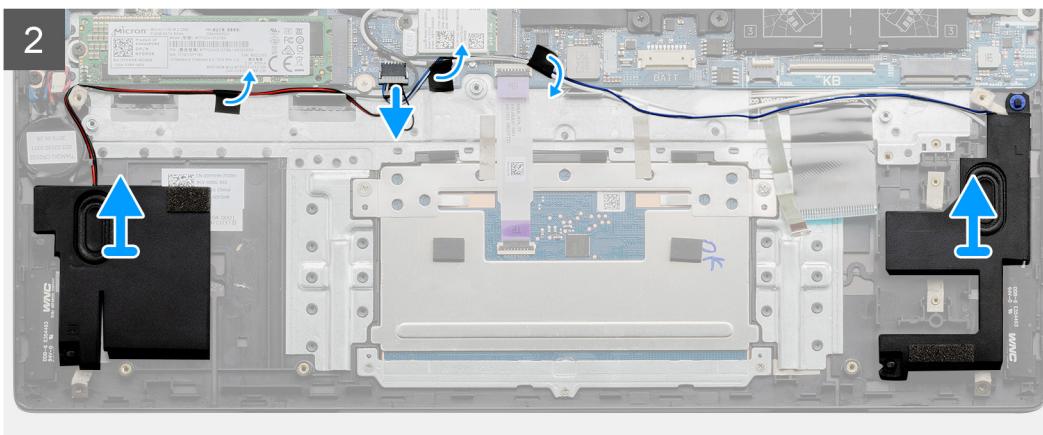
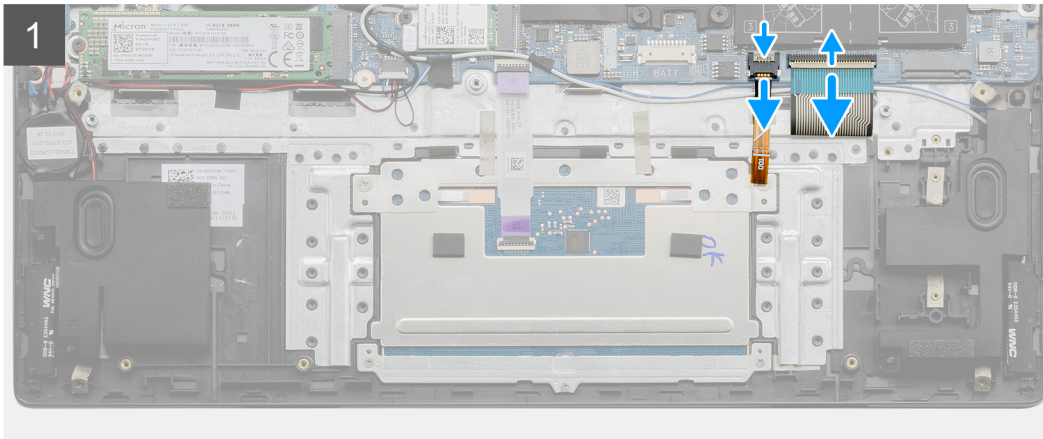
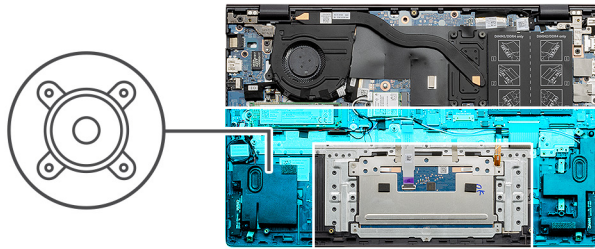

Steps

1. Disconnect the speaker cable from the system board.
2. Disconnect the keyboard-backlight cable and the keyboard cable from the system board.
3. Note the routing of the speaker cable, and remove the speaker cable from the routing guides on the palm-rest and keyboard assembly.

NOTE: Note the position of the rubber grommets before lifting the speakers.

4. Lift the speakers, along with the cable, off the palm-rest and keyboard assembly.

Installing the speakers (in 3-cell battery configuration)

Prerequisites

If you are replacing a component, remove the existing component before performing the installation procedure.

About this task

The following image indicates the location of the speaker and provides a visual representation of the installation procedure.

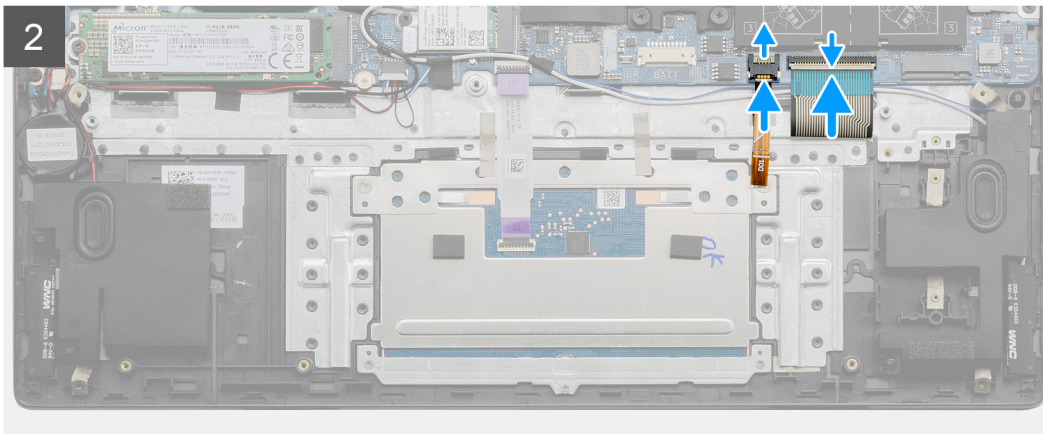
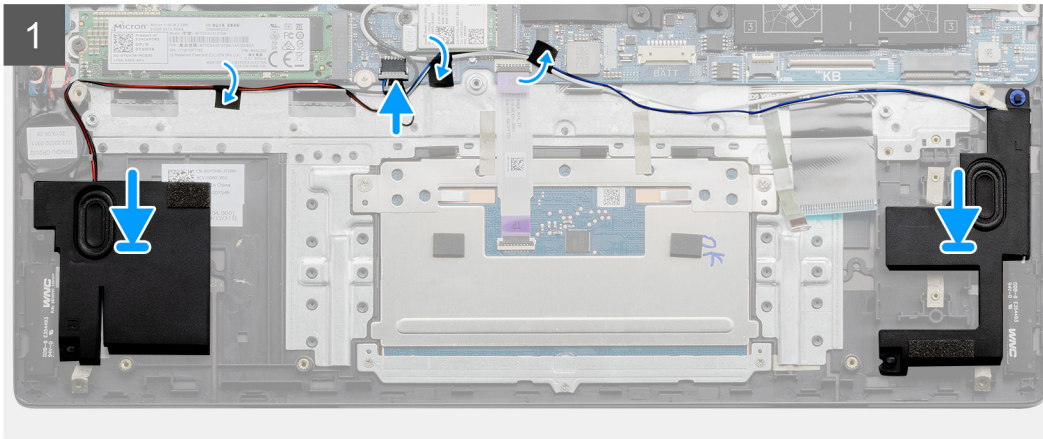
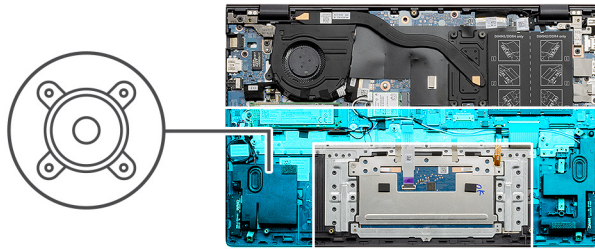

Steps

1. Using the alignment posts and rubber grommets, place the speakers in the slots on the palm-rest and keyboard assembly.
 - i** **NOTE:** If the rubber grommets are pushed out of the speakers when removing the speakers, push them back in place before replacing the speakers.
2. Route the speaker cable through the routing guides on the palm-rest and keyboard assembly.
3. Connect the speaker cable to the system board.
4. Connect the keyboard-backlight cable and the keyboard cable to the system board.

Next steps

1. Install the [battery](#).
2. Install the [base cover](#).
3. Follow the procedure in [After working inside your computer](#).

Heat sink

Removing the heat sink (for integrated GPU)

Prerequisites

1. Follow the procedure in [before working inside your computer](#).
2. Remove the [base cover](#).

About this task

CAUTION: For maximum cooling of the processor, do not touch the heat transfer areas on the heat sink. The oils in your skin can reduce the heat transfer capability of the thermal grease.

NOTE: The heat sink may become hot during normal operation. Allow sufficient time for the heat sink to cool before you touch it.

The following images indicate the location of the heat sink and provide a visual representation of the removal procedure.

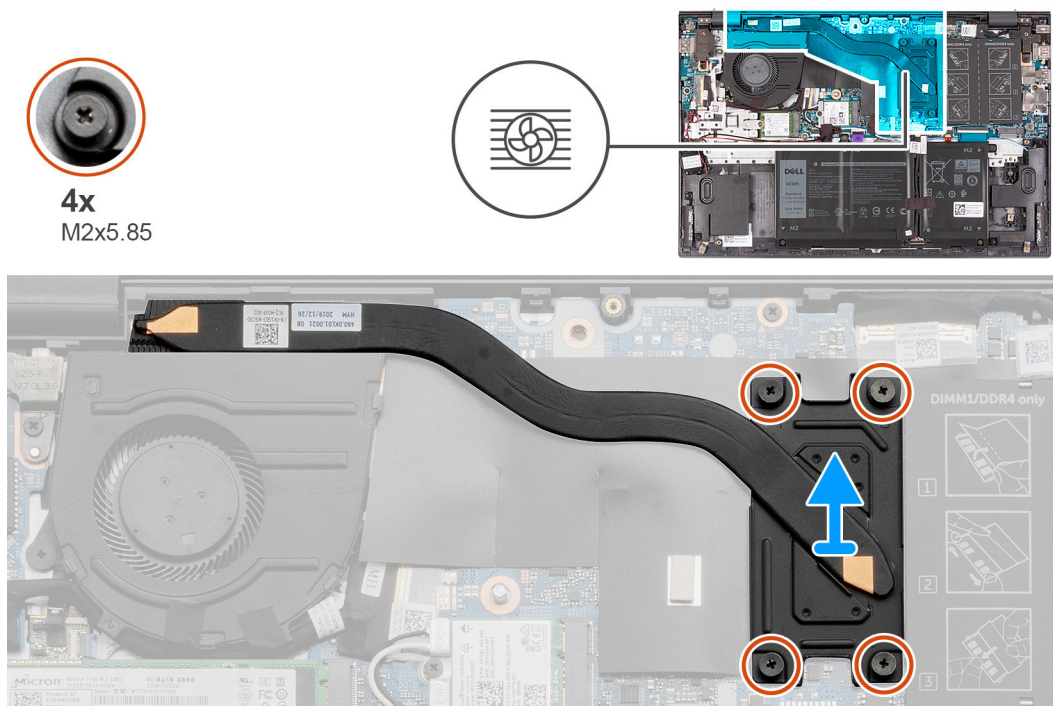

Steps

1. In the reverse order (4>3>2>1), loosen the four captive screws (M2x5.85) that secure the heat sink to the system board.

NOTE: The number of screws varies depending on the configuration ordered.

2. Lift the heat sink off the system board.

Installing the heat sink (for integrated GPU)

Prerequisites

If you are replacing a component, remove the existing component before performing the installation procedure.

About this task

CAUTION: Incorrect alignment of the heat sink can damage the system board and processor.

NOTE: If either the system board or the heat sink is replaced, use the thermal pad or thermal paste provided in the kit to ensure that the thermal conductivity is achieved.

The following image indicates the location of the heat sink and provides a visual representation of the installation procedure.

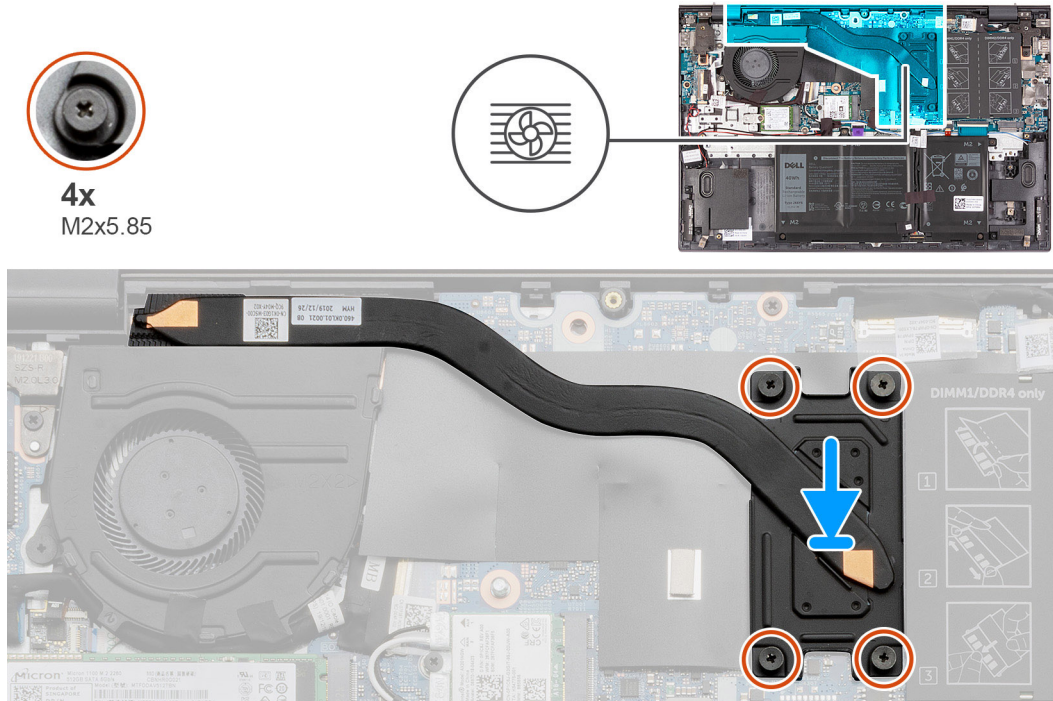

Steps

1. Place the heat sink on the system board and align the screw holes on the heat sink with the screw holes on the system board.
2. In sequential order (1>2>3>4), tighten the four captive screws (M2x5.85) that secure the heat sink to the system board.

NOTE: The number of screws varies depending on the configuration ordered.

Next steps

1. Install the [base cover](#).
2. Follow the procedure in [after working inside your computer](#).

Removing the heat sink (for discrete GPU)

Prerequisites

1. Follow the procedure in [before working inside your computer](#).
2. Remove the [base cover](#).

About this task

CAUTION: For maximum cooling of the processor, do not touch the heat transfer areas on the heat sink. The oils in your skin can reduce the heat transfer capability of the thermal grease.

NOTE: The heat sink may become hot during normal operation. Allow sufficient time for the heat sink to cool before you touch it.

The following images indicate the location of the heat sink and provide a visual representation of the removal procedure.

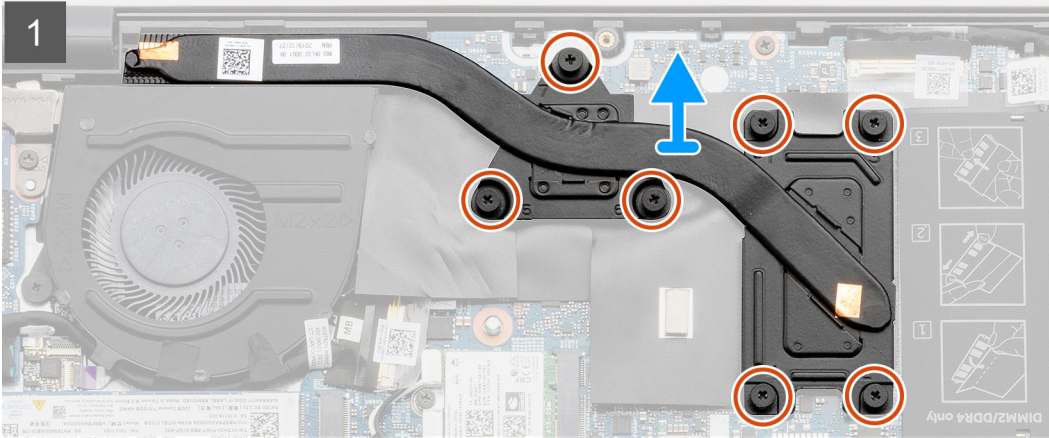
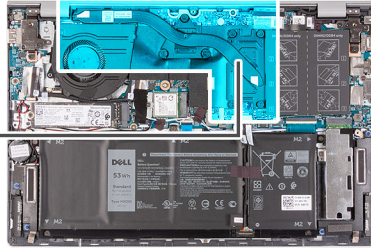

Steps

1. In the reverse order (7>6>5>4>3>2>1), loosen the seven captive screws (M2x5.85) that secure the heat sink to the system board.

 **NOTE:** The number of screws varies depending on the configuration ordered.

2. Lift the heat sink off the system board.

Installing the heat sink (for discrete GPU)

Prerequisites

If you are replacing a component, remove the existing component before performing the installation procedure.

About this task

 **CAUTION:** Incorrect alignment of the heat sink can damage the system board and processor.

 **NOTE:** If either the system board or the heat sink is replaced, use the thermal pad or thermal paste provided in the kit to ensure that the thermal conductivity is achieved.

The following image indicates the location of the heat sink and provides a visual representation of the installation procedure.

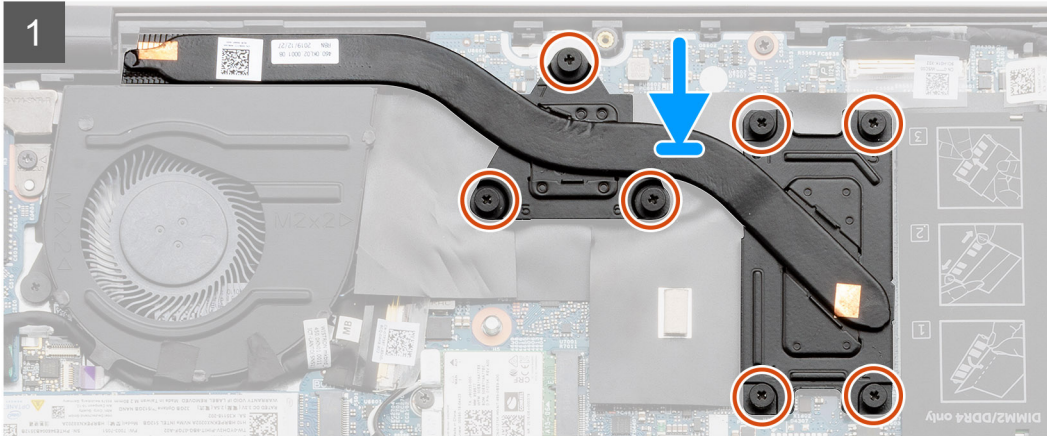
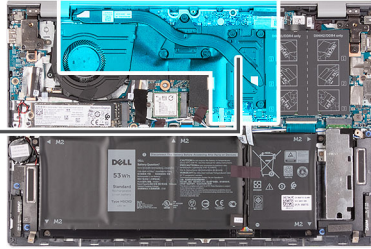

Steps

1. Place the heat sink on the system board and align the screw holes on the heat sink with the screw holes on the system board.
2. In sequential order (1>2>3>4>5>6>7), tighten the seven captive screws (M2x5.85) that secure the heat sink to the system board.

 **NOTE:** The number of screws varies depending on the configuration ordered.

Next steps

1. Install the [base cover](#).
2. Follow the procedure in [after working inside your computer](#).

Power button with optional fingerprint reader

Removing the power button with optional fingerprint reader

Prerequisites

1. Follow the procedure in [Before working inside your computer](#).
2. Remove the [base cover](#).
3. Remove the battery (3-cell or 4-cell).
4. Remove the [fan](#).
5. Remove the [I/O board](#).

About this task

The following images indicate the location of the base cover and provide a visual representation of the removal procedure.

 **NOTE:** The following image may differ slightly, depending if your computer is shipped with a fingerprint reader on the power button.

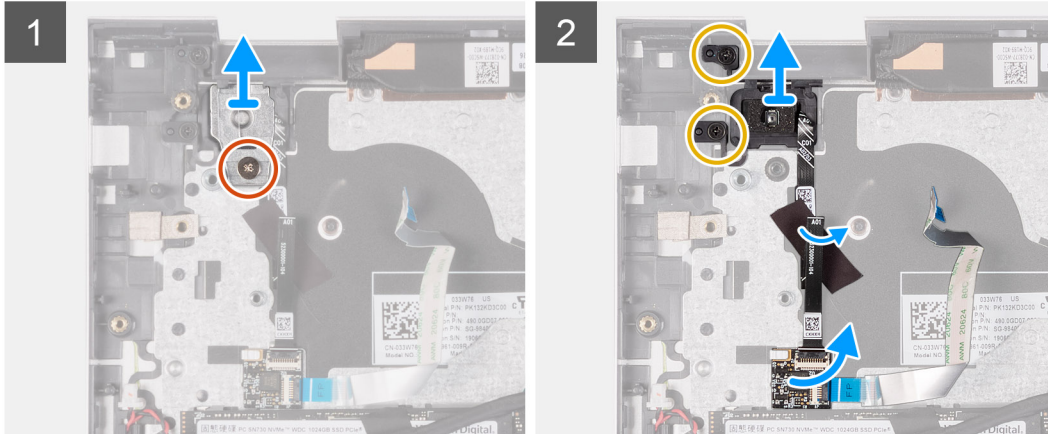
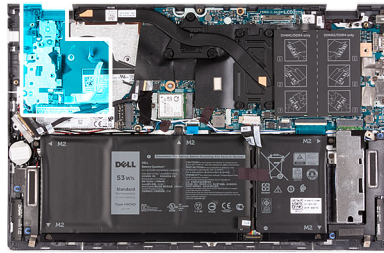

Steps

1. Remove the screw (M2x2) that secures the power-button bracket to the palm-rest and keyboard assembly.
2. Lift the power-button bracket off the palm-rest and keyboard assembly.
3. Remove the two screws (M2x2.5) that secure the power button to the palm-rest and keyboard assembly.
4. Peel the tape that secures the power-button cable to the palm-rest and keyboard assembly.
5. Lift the fingerprint-reader board (if applicable) off the palm-rest and keyboard assembly.
6. Lift the power button with optional fingerprint-reader (if applicable), along with the fingerprint-reader cable (if applicable), off the palm-rest and keyboard assembly.

Installing the power button with optional fingerprint reader

Prerequisites

If you are replacing a component, remove the existing component before performing the installation procedure.

About this task

The following image indicates the location of the power button with optional fingerprint reader and provides a visual representation of the installation procedure.

NOTE: The following image may differ slightly, depending if your computer is shipped with a fingerprint reader on the power button.

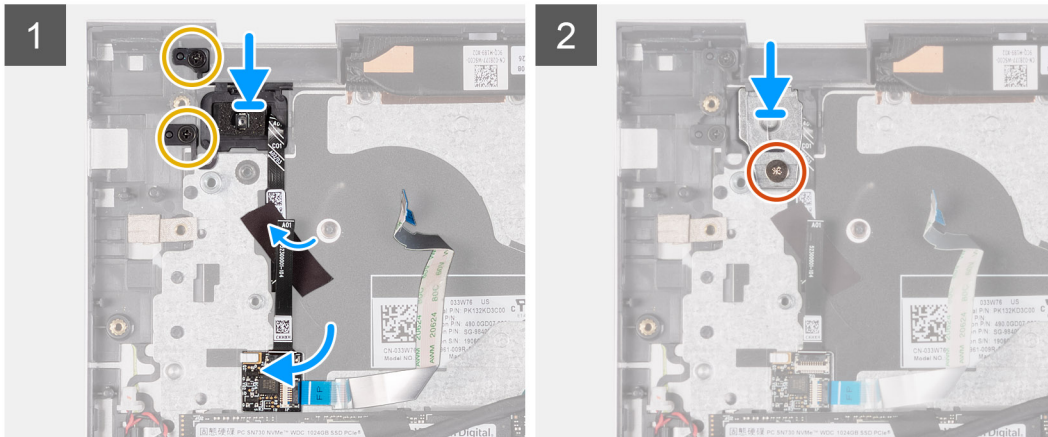
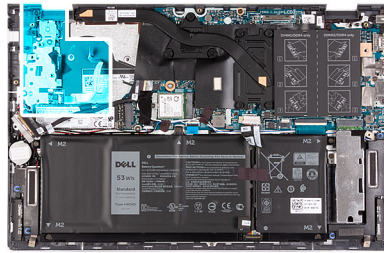
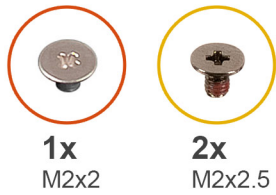

Steps

1. Align and place the power button on the palm-rest and keyboard assembly.
2. Place the fingerprint-reader board (if applicable) on the palm-rest and keyboard assembly.
3. Replace the two screws (M2x2.5) that secure the power button with fingerprint reader to the palm-rest and keyboard assembly.
4. Adhere the power-button cable to the palm-rest and keyboard assembly with the tape.
5. Align and place the power-button bracket on the power button.
6. Replace the screw (M2x2) that secures the power-button bracket to the palm-rest and keyboard assembly.

Next steps

1. Install the [I/O board](#).
2. Install the battery (3-cell or 4-cell).
3. Install the [fan](#).
4. Install the [base cover](#).
5. Follow the procedure in [After working inside your computer](#).

System board

Removing the system board

Prerequisites

1. Follow the procedure in [before working inside your computer](#).
2. Remove the [base cover](#).
3. Remove the [memory module](#).
4. Remove the [WLAN card](#).
5. Remove the [solid-state drive in M.2 slot one](#).
6. Remove the [solid-state drive in M.2 slot two](#).
7. Remove the battery (3-cell or 4-cell).
8. Remove the [heat sink](#).

About this task

The following images indicate the location of the system board and provide a visual representation of the removal procedure.



Steps

1. Remove the two screws (M2.5x5) that secure the right display hinge to the system board.
2. Peel the transparent tape, open the latch, and disconnect the display cable.

3. Disconnect the power-adaptor port cable from the system board.
4. Peel and lift the mylar that covers the I/O-board cable.
5. Disconnect the fan cable.
6. Open the latch and disconnect the I/O-board cable.
7. Peel the tape that covers the USB Type-C port bracket.
8. Remove the two screws (M2x3) that secure the USB Type-C port bracket to the system board.
9. Lift the USB Type-C port bracket off the system board.
10. Disconnect the speaker cable from the system board.
11. Disconnect the touchpad cable from the system board.
12. Disconnect the keyboard backlight cable from the system board.
13. Disconnect the keyboard cable from the system board.
14. Remove the two screws (M2x3) that secure the system board to the palm-rest and keyboard assembly.

Installing the system board

Prerequisites

If you are replacing a component, remove the existing component before performing the installation procedure.

About this task

The following image indicates the location of the system board and provides a visual representation of the installation procedure.

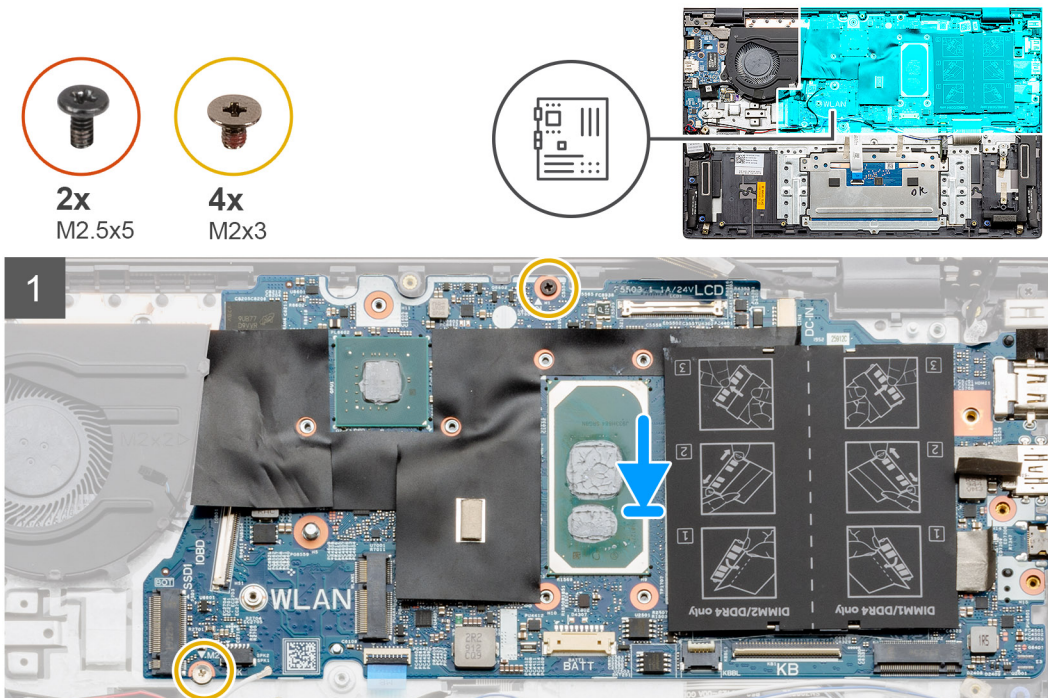

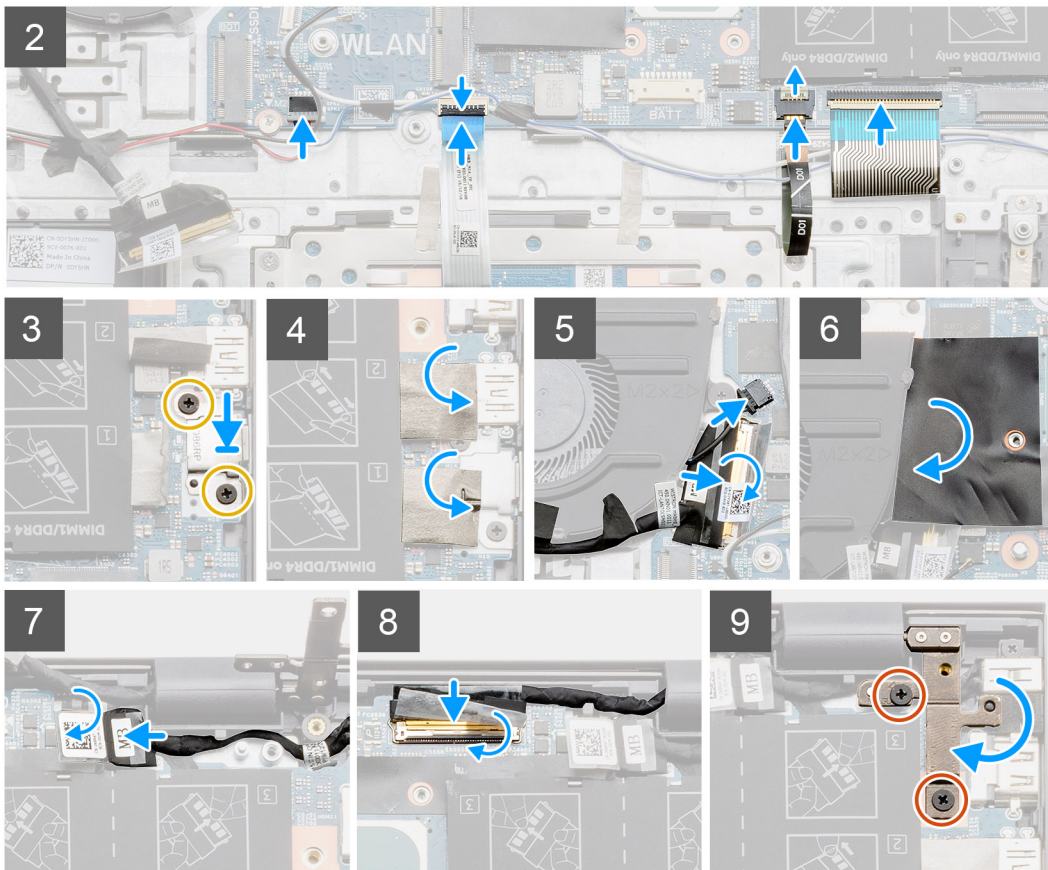

Steps

1. Place the system board on the palm-rest and keyboard assembly.
2. Replace the two screws (M2x3) that secure the system board to the palm-rest and keyboard assembly.
3. Connect the speaker cable to the system board.
4. Connect the touchpad cable to the system board.
5. Connect the keyboard backlight cable to the system board.
6. Connect the keyboard cable to the system board.
7. Place the USB Type-C port bracket on the system board.
8. Replace the two screws (M2x3) that secure the USB Type-C port bracket to the system board.
9. Adhere the tape that covers the USB Type-C port bracket.
10. Connect the I/O-board cable to the system board and close the latch.
11. Connect the fan cable to the system board.
12. Adhere the mylar that covers the I/O-board cable.
13. Connect the power-adaptor port cable to the system board.
14. Connect the display cable to the system board and close the latch.
15. Adhere the transparent tape that secures the display cable to the system board.
16. Push down the right display hinge, and align the screw holes on the display hinge with the screw holes on the system board.
17. Replace the two screws (M2.5x5) that secure the right display hinge to the system board.

Next steps

1. Install the [heat sink](#).
2. Install the [display assembly](#).
3. Install the battery (3-cell or 4-cell).
4. Install the [solid-state drive in M.2 slot two](#).
5. Install the [solid-state drive in M.2 slot one](#).
6. Install the [WLAN card](#).

7. Install the [memory module](#).
8. Install the [base cover](#).
9. Follow the procedure in [after working inside your computer](#).

Palm-rest and keyboard assembly

Removing the palm-rest and keyboard assembly

Prerequisites

1. Follow the procedure in [before working inside your computer](#).
2. Remove the [base cover](#).
3. Remove the [memory module](#).
4. Remove the [WLAN card](#).
5. Remove the [solid-state drive in M.2 slot one](#).
6. Remove the [solid-state drive in M.2 slot two](#).
7. Remove the [fan](#).
8. Remove the battery ([3-cell](#) or [4-cell](#)).
9. Remove the [power-adaptor port](#).
10. Remove the [display assembly](#).
11. Remove the [I/O board](#).
12. Remove the [touchpad](#).
13. Remove the [coin-cell battery](#).
14. Remove the [heat sink](#).
15. Remove the [power-button board with optional fingerprint reader](#).
16. Remove the [system board](#).
i **NOTE:** The system board can be removed along with the heat sink.
17. Remove the [speakers](#).

About this task

After performing the steps in the pre-requisites, we are left with the palm-rest and keyboard assembly.

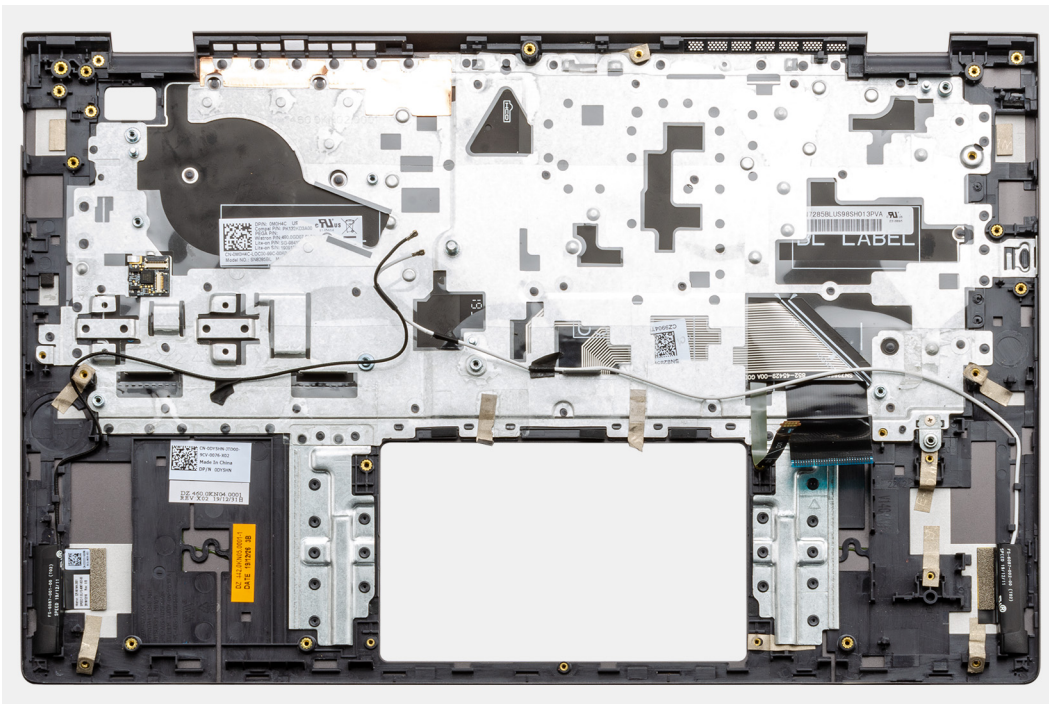

Installing the palm-rest and keyboard assembly

Prerequisites

If you are replacing a component, remove the existing component before performing the installation procedure.

About this task

Place the palm-rest and keyboard assembly on a flat surface.

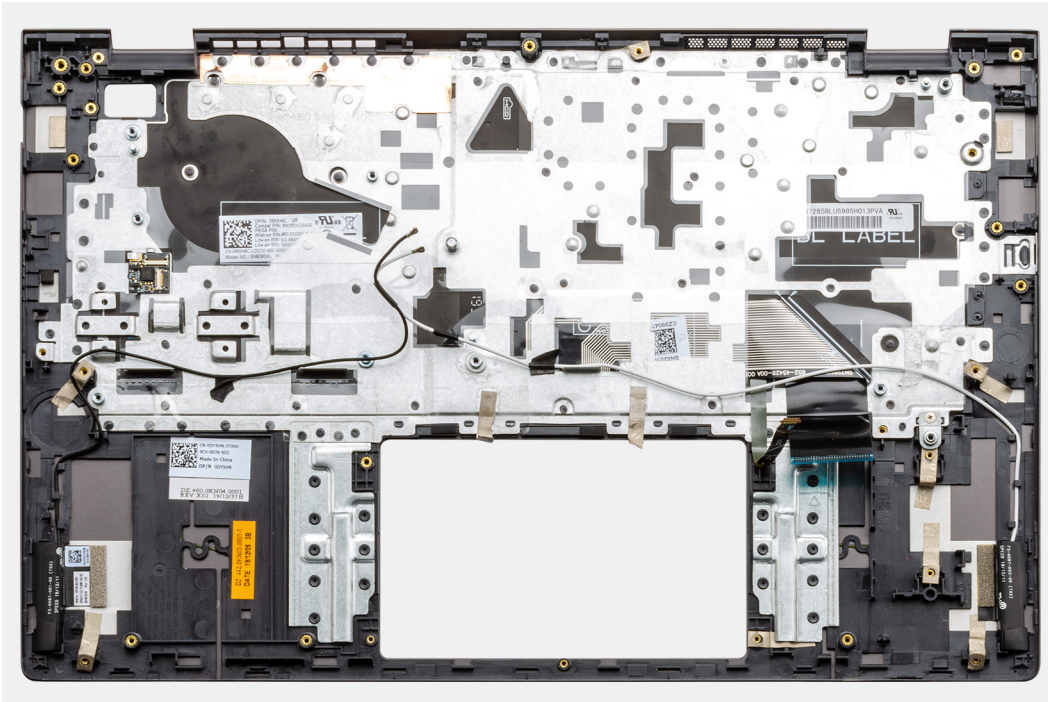

Next steps

1. Install the [speakers](#).
2. Install the [system board](#).
3. Install the [power-button board with optional fingerprint reader](#).
4. Install the [heat sink](#).
5. Install the [coin-cell battery](#).
6. Install the [touchpad](#).
7. Install the [I/O board](#).
8. Install the [display assembly](#).
9. Install the [power-adapter port](#).
10. Install the battery (3-cell or 4-cell).
11. Install the [fan](#).
12. Install the [solid-state drive in M.2 slot two](#).
13. Install the [solid-state drive in M.2 slot one](#).
14. Install the [WLAN card](#).
15. Install the [memory module](#).
16. Install the [base cover](#).
17. Follow the procedure in [after working inside your computer](#).

Drivers and downloads

When troubleshooting, downloading or installing drivers it is recommended that you read the Dell Knowledge Based article, Drivers and Downloads FAQ [000123347](#).

System setup

CAUTION: Unless you are an expert computer user, do not change the settings in the BIOS Setup program. Certain changes can make your computer work incorrectly.

NOTE: Depending on the computer and its installed devices, the items listed in this section may or may not be displayed.

NOTE: Before you change BIOS Setup program, it is recommended that you write down the BIOS Setup program screen information for future reference.

Use the BIOS Setup program for the following purposes:

- Get information about the hardware installed in your computer, such as the amount of RAM and the size of the hard drive.
- Change the system configuration information.
- Set or change a user-selectable option, such as the user password, type of hard drive installed, and enabling or disabling base devices.

Entering BIOS setup program

About this task

Turn on (or restart) your computer and press F2 immediately.

Navigation keys

NOTE: For most of the System Setup options, changes that you make are recorded but do not take effect until you restart the system.

Table 3. Navigation keys

Keys	Navigation
Up arrow	Moves to the previous field.
Down arrow	Moves to the next field.
Enter	Selects a value in the selected field (if applicable) or follow the link in the field.
Spacebar	Expands or collapses a drop-down list, if applicable.
Tab	Moves to the next focus area. NOTE: For the standard graphics browser only.
Esc	Moves to the previous page until you view the main screen. Pressing Esc in the main screen displays a message that prompts you to save any unsaved changes and restarts the system.

Boot Sequence

Boot Sequence allows you to bypass the System Setup–defined boot device order and boot directly to a specific device (for example: optical drive or hard drive). During the Power-on Self Test (POST), when the Dell logo appears, you can:

- Access System Setup by pressing F2 key

- Bring up the one-time boot menu by pressing F12 key

The one-time boot menu displays the devices that you can boot from including the diagnostic option. The boot menu options are:

- Removable Drive (if available)
- STXXXX Drive (if available)
 - **NOTE:** XXX denotes the SATA drive number.
- Optical Drive (if available)
- SATA Hard Drive (if available)
- Diagnostics

The boot sequence screen also displays the option to access the System Setup screen.

One time boot menu

To enter **one time boot menu**, turn on your computer, and then press F2 immediately.

NOTE: It is recommended to shutdown the computer if it is on.

The one-time boot menu displays the devices that you can boot from including the diagnostic option. The boot menu options are:

- Removable Drive (if available)
- STXXXX Drive (if available)
 - **NOTE:** XXX denotes the SATA drive number.
- Optical Drive (if available)
- SATA Hard Drive (if available)
- Diagnostics
 - **NOTE:** Choosing **Diagnostics**, will display the **ePSA diagnostics** screen.

The boot sequence screen also displays the option to access the System Setup screen.

System setup options

NOTE: Depending on this computer and its installed devices, the items that are listed in this section may or may not be displayed.

Table 4. System setup options—System information menu

Overview	
BIOS Version	Displays the BIOS version number.
Service Tag	Displays the Service Tag of the computer.
Asset Tag	Displays the Asset Tag of the computer.
Ownership Tag	Displays the ownership tag of the computer.
Manufacture Date	Displays the manufacture date of the computer.
Ownership Date	Displays the ownership date of the computer.
Express Service Code	Displays the express service code of the computer.
Ownership Tag	Displays the ownership tag of the computer.
Signed Firmware Update	Displays whether the signed firmware update is enabled.
Battery	Displays the battery health information.
Primary	Displays the primary battery.
Battery Level	Displays the battery level.

Table 4. System setup options—System information menu (continued)

Overview	
Battery State	Displays the battery state.
Health	Displays the battery health.
AC Adapter	Displays whether an AC adapter is installed.
Processor Information	
Processor Type	Displays the processor type.
Maximum Clock Speed	Displays the maximum processor clock speed.
Core Count	Displays the number of cores on the processor.
Processor L2 Cache	Displays the processor L2 Cache size.
Processor ID	Displays the processor identification code.
Processor L3 Cache	Displays the processor L3 Cache size.
Current Clock Speed	Displays the current processor clock speed.
Minimum Clock Speed	Displays the minimum processor clock speed.
Microcode Version	Displays the microcode version.
Intel Hyper-Threading Capable	Displays whether the processor is Hyper-Threading (HT) capable.
64-Bit Technology	Displays whether 64-bit technology is used.
Memory Information	
Memory Installed	Displays the total computer memory installed.
Memory Available	Displays the total computer memory available.
Memory Speed	Displays the memory speed.
Memory Channel Mode	Displays single or dual channel mode.
Memory Technology	Displays the technology that is used for the memory.
Device Information	
Video Controller	Displays the integrate graphics information of the computer.
dGPU Video Controller	Displays the discrete graphics information of the computer.
Video BIOS Version	Displays the video BIOS version of the computer.
Video Memory	Displays the video memory information of the computer.
Panel Type	Displays the Panel Type of the computer.
Native Resolution	Displays the native resolution of the computer.
Audio Controller	Displays the audio controller information of the computer.
Wi-Fi Device	Displays the wireless device information of the computer.
Bluetooth Device	Displays the Bluetooth device information of the computer.

Table 5. System setup options—Boot options menu

Boot options	
Advanced Boot Options	
Enable UEFI Network Stack	Enables or disables UEFI Network Stack. Default: OFF.
Boot Mode	
Boot Mode: UEFI only	Displays the boot mode of this computer.
Enable Boot Devices	Enables or disables boot devices for this computer.

Table 5. System setup options—Boot options menu (continued)

Boot options	
Boot Sequence	Displays the boot sequence.
BIOS Setup Advanced Mode	Enables or disables advanced BIOS settings. Default: ON.
UEFI Boot Path Security	Enables or disables the system to prompt the user to enter the Admin password when booting a UEFI boot path from the F12 boot menu. Default: Always Except Internal HDD.

Table 6. System setup options—System Configuration menu

System Configuration	
Date/Time	
Date	Sets the computer date in MM/DD/YYYY format. Changes to the date take effect immediately.
Time	Sets the computer time in HH/MM/SS 24-hour format. You can switch between 12-hour and 24-hour clock. Changes to the time take effect immediately.
Enable SMART Reporting	Enables or disables SMART (Self-Monitoring, Analysis, and Reporting Technology) during computer startup to report hard drive errors. Default: OFF.
Enable Audio	Enables or disables all integrated audio controller. Default: ON.
Enable Microphone	Enables or disables microphone. Default: ON.
Enable Internal Speaker	Enables or disables internal speaker. Default: ON.
USB Configuration	
Enable Boot Support	Enables or disables booting from USB mass storage devices such as external hard drive, optical drive, and USB drive.
Enable External USB Ports	Enables or disables USB ports to be functional in an operating system environment.
SATA Operation	Configures operating mode of the integrated SATA hard drive controller. Default: RAID. SATA is configured to support RAID (Intel Rapid Restore Technology).
Drives	
M.2 PCIe SSD-0/SATA-2	Default: ON.
SATA-0	Default: ON.
Drive Information	Displays the information of various onboard drives.
Miscellaneous Devices	
Enable Camera	Enables or disables the camera. Default: ON.
Keyboard Illumination	Configures the operating mode of the keyboard illumination feature. Default: Disabled. The keyboard illumination will always be off.

Table 6. System setup options—System Configuration menu (continued)

System Configuration	
Keyboard Backlight Timeout on AC	Configures the timeout value for the keyboard when an AC adapter is connected to the computer. The keyboard backlight timeout value is only effect when the backlight is enabled. Default: 10 seconds.
Keyboard Backlight Timeout on Battery	Configures the timeout value for the keyboard when the computer is running on battery. The keyboard backlight timeout value is only effect when the backlight is enabled. Default: 10 seconds.
Touchscreen	Enables or disables the touchscreen for the operating system. i NOTE: Touchscreen will always work in the BIOS setup irrespective of this setting. Default: ON.

Table 7. System setup options—Video menu

Video	
LCD Brightness	
Brightness on battery power	Sets the screen brightness when the computer is running on battery power.
Brightness on AC power	Sets the screen brightness when the computer is running on AC power.
EcoPower	Enables or disables EcoPower which increases the battery life by reducing the screen brightness when appropriate. Default: ON.

Table 8. System setup options—Security menu

Security	
Enable Admin Setup Lockout	Enables or disables the user from entering BIOS Setup when an Admin Password is set. Default: OFF.
Password Bypass	Bypass the System (Boot) Password and the internal hard drive password prompts during a system restart. Default: Disabled.
Enable Non-Admin Password Changes	Enables or disables the user to change the system and hard drive password without the need for admin password. Default: ON.
Non-Admin Setup Changes	
Allow Wireless Switch Changes	Enables or disables changes to the setup option when an Administrator password is set. Default: OFF.
Enable UEFI Capsule Firmware Updates	Enables or disables BIOS updates through UEFI capsule update packages.
Computrace	Enable or disable the BIOS module interface of the optional Computrace(R) Service from Absolute Software.
Intel Platform Trust Technology On	Enables or disables Platform Trust Technology (PTT) visibility to the operating system. Default: ON.

Table 8. System setup options—Security menu (continued)

Security	
PPI Bypass for Clear Commands	Enables or disables the operating system to skip BIOS Physical Presence Interface (PPI) user prompts when issuing the Clear command. Default: OFF.
Clear	Enables or disables the computer to clear the PTT owner information, and returns the PTT to the default state. Default: OFF.
Intel SGX	Enables or disables the Intel Software Guard Extensions (SGX) to provide a secured environment for running code/storing sensitive information. Default: Software Control
SMM Security Mitigation	Enables or disables additional UEFI SMM Security Mitigation protections. Default: OFF. i NOTE: This feature may cause compatibility issues or loss of functionality with some legacy tools and applications.
Enable Strong Passwords	Enables or disables strong passwords. Default: OFF.
Password Configuration	Control the minimum and maximum number of characters that are allowed for Admin and System passwords.
Admin Password	Sets, Changes, or deletes the administrator (admin) password (sometimes called the "setup" password).
System Password	Sets, Changes, or deletes the system password.
Enable Master Password Lockout	Enables or disables the master password support. Default: OFF.

Table 9. System setup options—Secure Boot menu

Secure Boot	
Enable Secure Boot	Enables or disables the computer to boots using only validated boot software. Default: OFF. i NOTE: For Secure Boot to be enabled, the computer needs to be in UEFI boot mode and the Enable Legacy Option ROMs option needs to be turned off.
Secure Boot Mode	Selects the Secure Boot operation mode. Default: Deployed Mode. i NOTE: Deployed Mode should be selected for normal operation of Secure Boot.

Table 10. System setup options—Expert Key Management menu

Expert Key Management	
Enable Custom Mode	Enables or disables the keys in the PK, KEK, db, and dbx security key databases to be modified. Default: OFF.
Custom Mode Key Management	Selects the custom values for expert key management. Default: PK.

Table 11. System setup options—Performance menu

Performance	
Intel Hyper-Threading Technology	Enables or disables the Intel Hyper-Threading Technology to use processor resources more efficiently. Default: ON.
Intel SpeedStep	Enables or disables the Intel SpeedStep Technology to dynamically adjust processor voltage and core frequency, decreasing average power consumption and heat production. Default: ON.
Intel TurboBoost Technology	Enabled or disabled the Intel TurboBoost mode of the processor. If enabled, the Intel TurboBoost driver increases the performance of the CPU or graphics processor. Default: ON.
Multi-Core Support	Changes the number of CPU cores available to the operating system. The default value is set to the maximum number of cores. Default: All Cores.
Enable C-State Control	Enables or disables the CPU's ability to enter and exit low-power states. Default: ON.

Table 12. System setup options—Power Management menu

Power Management	
Wake on AC	Enables the computer to turn on and go to boot when AC power is supplied to the computer. Default: OFF.
Auto on Time	Enables the computer to automatically power on for defined days and times. Default: Disabled. The system will not automatically power up.
Battery Charge Configuration	Enables the computer to run on battery during power usage hours. Use the below options to prevent AC power usage between certain times of each day. Default: Adaptive. Battery settings are adaptively optimized based on your typical battery usage pattern.
Enable Advanced Battery Charge Configuration	Enables Advanced Battery Charge Configuration from the beginning of the day to a specified work period. Advanced Battery Charged maximizes battery health while still supporting heavy use during the work day. Default: OFF.
Block Sleep	Blocks the computer from entering Sleep (S3) mode in the operating system. Default: OFF. NOTE: If enabled, the computer will not go to sleep, Intel Rapid Start will be disabled automatically, and the operating system power option will be blank if it was set to Sleep.
Enable USB Wake Support	Enables the USB devices to wake the computer from Standby mode. Default: OFF.
Enable Intel Speed Shift Technology	Enables or disables Intel Speed Shift Technology support which enables the operating system to select the appropriate processor performance automatically. Default: ON.

Table 12. System setup options—Power Management menu (continued)

Power Management	
Lid Switch	Enables the computer to power up from the off state whenever the lid is opened. Default: ON.

Table 13. System setup options—Wireless menu

Wireless	
Wireless Switch	Determines which wireless devices can be controlled by the Wireless Switch. For Windows 8 systems, this is controlled by an operating system drive directly. As a result, the setting does not affect the Wireless Switch behavior. NOTE: When both WLAN and WiGig are present, enable/disable controls are tied together. Thus, they cannot be enabled or disabled independently.
WLAN	Default: ON.
Bluetooth	Default: ON.
Wireless Device Enable	Enable or disable internal WLAN/Bluetooth devices.
WLAN	Default: ON.
Bluetooth	Default: ON.

Table 14. System setup options—POST Behavior menu

POST Behavior	
Numlock Enable	Enables or disables Numlock when the computer boots. Default: ON.
Enable Adapter Warnings	Enables the computer to display adapter warning messages during boot. Default: ON.
Extend BIOS POST Time	Configures the BIOS POST (Power-On Self-Test) load time. Default: 0 seconds.
Fastboot	Configures the speed of the UEFI boot process. Default: Thorough. Performs complete hardware and configuration initialization during boot.
Fn Lock Options	Enables or disables the Fn lock mode. Default: ON.
Lock Mode	Default: Lock Mode Secondary. Lock Mode Secondary = If this option is selected, the F1-F12 keys scan the code for their secondary functions.
Pull Screen Logo	Enabled or disabled the computer to display full screen logo if the image match screen resolution. Default: OFF.
Warnings and Errors	Selects an action on encountering a warning or error during boot. Default: Prompt on Warnings and Errors. Stop, prompt and wait for user input when warnings or errors are detected. NOTE: Errors deemed critical to the operation of the computer hardware will always halt the computer.

Table 15. System setup options—Virtualization menu

Virtualization	
Intel Virtualization Technology	Enables the computer to run a virtual machine monitor (VMM). Default: ON.
VT for Direct I/O	Enables the computer to perform Virtualization Technology for Direct I/O (VT-d). VT-d is an Intel method that provides virtualization for memory map I/O. Default: ON.

Table 16. System setup options—Maintenance menu

Maintenance	
Asset Tag	Creates a system Asset Tag that can be used by an IT administrator to uniquely identify a particular system. Once set in BIOS, the Asset Tag cannot be changed.
Service Tag	Displays the Service Tag of the computer.
BIOS Recovery from Hard Drive	Enables the computer to recover from a bad BIOS image, as long as the Boot Block portion is intact and functioning. Default: ON. i NOTE: BIOS recovery is designed to fix the main BIOS block and cannot work if the Boot Block is damaged. In addition, this feature cannot work in the event of EC corruption, ME corruption, or a hardware issue. The recovery image must exist on an unencrypted partition on the drive.
BIOS Auto-Recovery	Enables the computer to automatically recover the BIOS without user actions. This feature requires BIOS Recovery from Hard Drive to be set to Enabled. Default: OFF.
Start Data Wipe	⚠ CAUTION: This Secure Wipe Operation will delete information in a way that it cannot be reconstructed. If enabled, the BIOS will queue up a data wipe cycle for storage devices that are connected to the motherboard on the next reboot. Default: OFF.
Allow BIOS Downgrade	Controls flashing of the system firmware to previous revisions. Default: ON.

Table 17. System setup options—System Logs menu

System Logs	
Power Event Log	Displays Power events. Default: Keep.
BIOS Event Log	Displays BIOS events. Default: Keep.
Thermal Event Log	Displays Thermal events. Default: Keep.

Table 18. System setup options—SupportAssist menu

SupportAssist	
Dell Auto operating system Recovery Threshold	Controls the automatic boot flow for SupportAssist System Resolution Console and for Dell operating system Recovery tool.

Table 18. System setup options—SupportAssist menu (continued)

SupportAssist	
	Default: 2.
SupportAssist operating system Recovery	Enables or disables the boot flow for SupportAssist operating system Recovery tool in the even of certain system errors.
	Default: ON.

System and setup password

Table 19. System and setup password

Password type	Description
System password	Password that you must enter to log in to your system.
Setup password	Password that you must enter to access and make changes to the BIOS settings of your computer.

You can create a system password and a setup password to secure your computer.

 **CAUTION:** The password features provide a basic level of security for the data on your computer.

 **CAUTION:** Anyone can access the data that is stored on your computer if it is not locked and left unattended.

 **NOTE:** System and setup password feature is disabled.

Assigning a system setup password

Prerequisites

You can assign a new **System or Admin Password** only when the status is in **Not Set**.

About this task

To enter the system setup, press F12 immediately after a power-on or reboot.

Steps

- In the **System BIOS** or **System Setup** screen, select **Security** and press Enter.
The **Security** screen is displayed.
- Select **System/Admin Password** and create a password in the **Enter the new password** field.
Use the following guidelines to assign the system password:
 - At least one special character: ! " # \$ % & ' () * + , - . / : ; < = > ? @ [\] ^ _ ` { | }
 - Numbers 0 through 9.
 - Upper case letters from A to Z.
 - Lower case letters from a to z.
- Type the system password that you entered earlier in the **Confirm new password** field and click **OK**.
- Press Esc and save the changes as prompted by the pop-up message.
- Press Y to save the changes.
The computer restarts.

Deleting or changing an existing system setup password

Prerequisites

Ensure that the **Password Status** is Unlocked (in the System Setup) before attempting to delete or change the existing System and/or Setup password. You cannot delete or change an existing System or Setup password, if the **Password Status** is Locked.

About this task

To enter the System Setup, press F12 immediately after a power-on or reboot.

Steps

1. In the **System BIOS** or **System Setup** screen, select **System Security** and press Enter.
The **System Security** screen is displayed.
2. In the **System Security** screen, verify that **Password Status** is **Unlocked**.
3. Select **System Password**, update, or delete the existing system password, and press Enter or Tab.
4. Select **Setup Password**, update, or delete the existing setup password, and press Enter or Tab.
 **NOTE:** If you change the System and/or Setup password, reenter the new password when prompted. If you delete the System and/or Setup password, confirm the deletion when prompted.
5. Press Esc and a message prompts you to save the changes.
6. Press Y to save the changes and exit from System Setup.
The computer restarts.

Clearing CMOS settings

About this task

 **CAUTION:** Clearing CMOS settings will reset the BIOS settings on your computer.

Steps

1. Remove the [base cover](#).
2. Remove the [coin-cell battery](#).
3. Wait for one minute.
4. Replace the [coin-cell battery](#).
5. Replace the [base cover](#).

Clearing BIOS (System Setup) and System passwords

About this task

To clear the system or BIOS passwords, contact Dell technical support as described at www.dell.com/contactdell.

 **NOTE:** For information on how to reset Windows or application passwords, refer to the documentation accompanying Windows or your application.

Updating the BIOS

Updating the BIOS in Windows

Steps

1. Go to www.dell.com/support.

2. Click **Product support**. In the **Search support** box, enter the Service Tag of your computer, and then click **Search**.

 **NOTE:** If you do not have the Service Tag, use the SupportAssist feature to automatically identify your computer. You can also use the product ID or manually browse for your computer model.

3. Click **Drivers & Downloads**. Expand **Find drivers**.
4. Select the operating system installed on your computer.
5. In the **Category** drop-down list, select **BIOS**.
6. Select the latest version of BIOS, and click **Download** to download the BIOS file for your computer.
7. After the download is complete, browse the folder where you saved the BIOS update file.
8. Double-click the BIOS update file icon and follow the on-screen instructions.
For more information, see knowledge base article [000124211](https://www.dell.com/support) at www.dell.com/support.

Updating the BIOS using the USB drive in Windows

Steps

1. Follow the procedure from step 1 to step 6 in [Updating the BIOS in Windows](#) to download the latest BIOS setup program file.
2. Create a bootable USB drive. For more information, see the knowledge base article [000145519](https://www.dell.com/support) at www.dell.com/support.
3. Copy the BIOS setup program file to the bootable USB drive.
4. Connect the bootable USB drive to the computer that needs the BIOS update.
5. Restart the computer and press **F12**.
6. Select the USB drive from the **One Time Boot Menu**.
7. Type the BIOS setup program filename and press **Enter**.
The **BIOS Update Utility** appears.
8. Follow the on-screen instructions to complete the BIOS update.

Updating the BIOS in Linux and Ubuntu

To update the system BIOS on a computer that is installed with Linux or Ubuntu, see the knowledge base article [000131486](https://www.dell.com/support) at www.dell.com/support.

Updating the BIOS from the F12 One-Time boot menu

Update your computer BIOS using the BIOS update.exe file that is copied to a FAT32 USB drive and booting from the F12 One-Time boot menu.

About this task

BIOS Update

You can run the BIOS update file from Windows using a bootable USB drive or you can also update the BIOS from the F12 One-Time boot menu on the computer.

Most of the Dell computers built after 2012 have this capability, and you can confirm by booting your computer to the F12 One-Time Boot Menu to see if BIOS FLASH UPDATE is listed as a boot option for your computer. If the option is listed, then the BIOS supports this BIOS update option.

 **NOTE:** Only computers with BIOS Flash Update option in the F12 One-Time boot menu can use this function.

Updating from the One-Time boot menu

To update your BIOS from the F12 One-Time boot menu, you need the following:

- USB drive formatted to the FAT32 file system (key does not have to be bootable)
- BIOS executable file that you downloaded from the Dell Support website and copied to the root of the USB drive
- AC power adapter that is connected to the computer
- Functional computer battery to flash the BIOS

Perform the following steps to perform the BIOS update flash process from the F12 menu:

 **CAUTION:** Do not turn off the computer during the BIOS update process. The computer may not boot if you turn off your computer.

Steps

1. From a turn off state, insert the USB drive where you copied the flash into a USB port of the computer.
2. Turn on the computer and press F12 to access the One-Time Boot Menu, select BIOS Update using the mouse or arrow keys then press Enter.
The flash BIOS menu is displayed.
3. Click **Flash from file**.
4. Select external USB device.
5. Select the file and double-click the flash target file, and then click **Submit**.
6. Click **Update BIOS**. The computer restarts to flash the BIOS.
7. The computer will restart after the BIOS update is completed.

Troubleshooting

Handling swollen Lithium-ion batteries

Like most laptops, Dell laptops use lithium-ion batteries. One type of lithium-ion battery is the lithium-ion polymer battery. Lithium-ion polymer batteries have increased in popularity in recent years and have become standard in the electronics industry due to customer preferences for a slim form factor (especially with newer ultra-thin laptops) and long battery life. Inherent to lithium-ion polymer battery technology is the potential for swelling of the battery cells.

Swollen battery may impact the performance of the laptop. To prevent possible further damage to the device enclosure or internal components leading to malfunction, discontinue the use of the laptop and discharge it by disconnecting the AC adapter and letting the battery drain.

Swollen batteries should not be used and should be replaced and disposed of properly. We recommend contacting Dell product support for options to replace a swollen battery under the terms of the applicable warranty or service contract, including options for replacement by a Dell authorized service technician.

The guidelines for handling and replacing Lithium-ion batteries are as follows:

- Exercise caution when handling Lithium-ion batteries.
- Discharge the battery before removing it from the system. To discharge the battery, unplug the AC adapter from the system and operate the system only on battery power. When the system will no longer power on when the power button is pressed, the battery is fully discharged.
- Do not crush, drop, mutilate, or penetrate the battery with foreign objects.
- Do not expose the battery to high temperatures, or disassemble battery packs and cells.
- Do not apply pressure to the surface of the battery.
- Do not bend the battery.
- Do not use tools of any type to pry on or against the battery.
- If a battery gets stuck in a device as a result of swelling, do not try to free it as puncturing, bending, or crushing a battery can be dangerous.
- Do not attempt to reassemble a damaged or swollen battery into a laptop.
- Swollen batteries that are covered under warranty should be returned to Dell in an approved shipping container (provided by Dell)—this is to comply with transportation regulations. Swollen batteries that are not covered under warranty should be disposed of at an approved recycling center. Contact Dell product support at <https://www.dell.com/support> for assistance and further instructions.
- Using a non-Dell or incompatible battery may increase the risk of fire or explosion. Replace the battery only with a compatible battery purchased from Dell that is designed to work with your Dell computer. Do not use a battery from other computers with your computer. Always purchase genuine batteries from <https://www.dell.com> or otherwise directly from Dell.

Lithium-ion batteries can swell for various reasons such as age, number of charge cycles, or exposure to high heat. For more information on how to improve the performance and lifespan of the laptop battery and to minimize the possibility of occurrence of the issue, see [Dell Laptop Battery - Frequently Asked Questions](#).

Locate the Service Tag or Express Service Code of your Dell computer

Your Dell computer is uniquely identified by a Service Tag or Express Service Code. To view relevant support resources for your Dell computer, we recommend entering the Service Tag or Express Service Code at www.dell.com/support.

For more information on how to find the Service Tag for your computer, see [Locate the Service Tag for your Dell Laptop](#).

System diagnostic lights

Power and battery-status light

The power and battery status light indicates the power and battery status of the computer. These are the power states:

Solid white:Power adapter is connected and the battery has more than 5% charge.

Amber:Computer is running on battery and the battery has less than 5% charge.

Off:

- Power adapter is connected, and the battery is fully charged.
- Computer is running on battery, and the battery has more than 5% charge.
- Computer is in sleep state, hibernation, or turned off.

The power and battery-status light may blink amber or white according to pre-defined "beep codes" indicating various failures.

For example, the power and battery-status light blinks amber two times followed by a pause, and then blinks white three times followed by a pause. This 2,3 pattern continues until the computer is turned off, indicating no memory or RAM is detected.

The following table shows different power and battery-status light patterns and associated problems.

i NOTE: The following diagnostic light codes and recommended solutions are intended for Dell service technicians to troubleshoot problems. You should only perform troubleshooting and repairs as authorized or directed by the Dell technical assistance team. Damage due to servicing that is not authorized by Dell is not covered by your warranty.

Table 20. Diagnostic-light LED codes

Diagnostic light codes (Amber, white)	Problem description
1,1	TPM detection failure
1,2	Unrecoverable SPI flash failure
1,5	i-Fuse failure
1,6	EC internal Failure
2,1	Processor failure
2,2	System board: BIOS or ROM (Read-Only Memory) failure
2,3	No memory or RAM (Random-Access Memory) detected
2,4	Memory or RAM (Random-Access Memory) failure
2,5	Invalid memory installed
2,6	System-board or chipset error
2,7	Display failure - SBIOS message
2,8	Display failure - EC detection of power rail failure
3,1	CMOS battery failure
3,2	PCI, video card/chip failure
3,3	BIOS recovery image not found
3,4	Recovery image found but invalid
3,5	Power-rail failure
3,6	System BIOS Flash incomplete
3,7	Management Engine (ME) error

SupportAssist diagnostics

About this task

The SupportAssist diagnostics (previously known as ePSA diagnostics) performs a complete check of your hardware. The SupportAssist diagnostics is embedded in the BIOS and is launched by it internally. The SupportAssist diagnostics provides a set of options for particular devices or device groups. It allows you to:

- Run tests automatically or in an interactive mode.
- Repeat tests
- Display or save test results
- Run thorough tests to introduce additional test options and provide extra information about the failed device(s)
- View status messages that indicate if the tests are completed successfully
- View error messages that indicate if problems were encountered during the test

i **NOTE:** Some tests are meant for specific devices and require user interaction. Ensure that you are present in front of the computer when the diagnostic tests are performed.

For more information, see [SupportAssist Pre-Boot System Performance Check](#).

Built-in self-test (BIST)

Display panel built-in self-test (LCD-BIST)

About this task

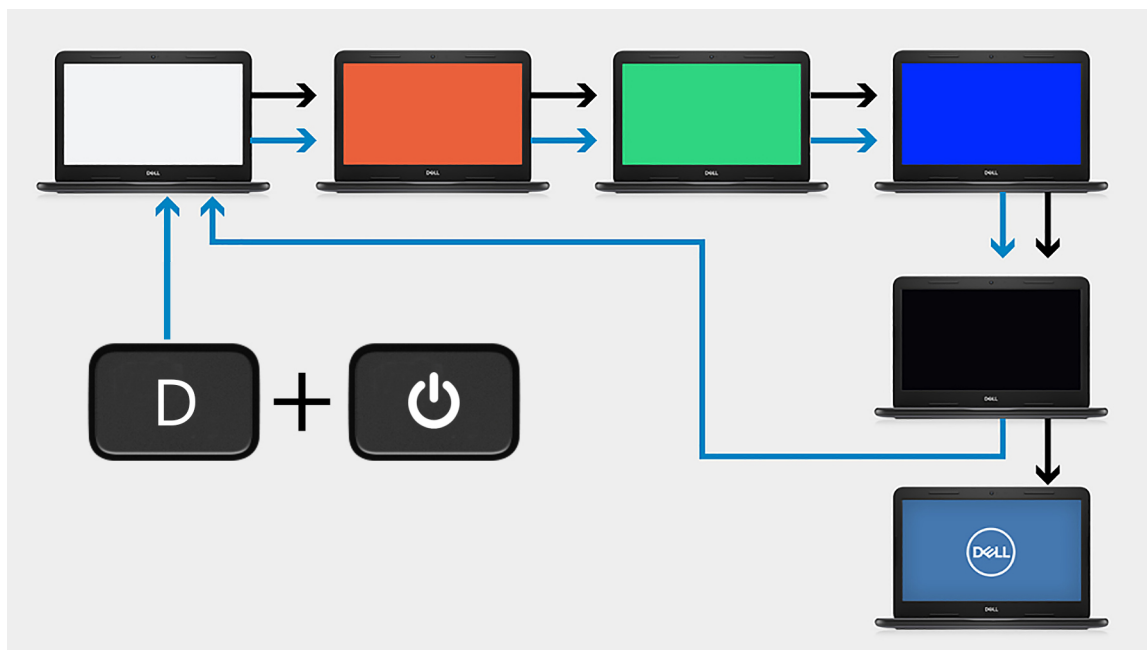

Steps

1. Press and hold the D key and then press the power button.
2. Release both the D key and the power button when the computer begins POST.
3. The display panel begins to display a solid color, or cycling through different colors.

i **NOTE:** The sequence of colors may vary due to different display panel vendor. The user only needs to ensure that the colors are being displayed correctly without distortion or graphical anomalies.

4. The computer reboots at the end of the last solid color.

System board built-in self-test (M-BIST)

About this task



Steps

1. Press and hold both the M key and the power button to initiate M-BIST.
2. The battery-status light illuminates in amber when there is a failure with the system board.
3. Replace the system board to fix the issue.

NOTE: The battery status LED will not illuminate if there is no failure present with the system board. If further troubleshooting is required, proceed with the applicable Guided Resolution for No Power/No POST, etc.

Display panel power rail built-in self-test (L-BIST)

About this task

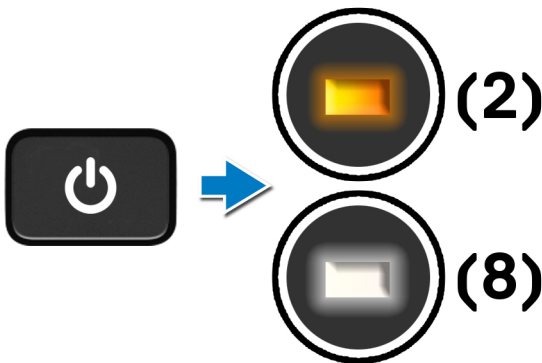

Next steps

L-BIST (LCD Power Rail Test) is an enhancement to the single LED error code diagnostics and is **automatically initiated** during **POST**. L-BIST isolates if the LCD is receiving power from the system board. L-BIST checks if the system board is supplying power to the LCD by performing an LCD Power Rail test. If there is no power going to the LCD, the battery status LED flashes a **[2,8] LED error code**.

Outcome

About this task

The following table shows the outcome of running different types of BIST.

Table 21. BIST outcome

M-BIST	
Off	No fault detected with system board.
Solid amber	Indicates a problem with the system board.

Table 21. BIST outcome

L-BIST	
Off	No fault detected with system board.
LED error code of [2,8] blinks Amber x2, then pause, then blinks White x8	Indicates a problem with the system board.

Table 21. BIST outcome

LCD-BIST
The LCD that flashes White, Red, Green, and Blue shows that the display is working fine and there is no fault with the LCD panel.

Recovering the operating system

When your computer is unable to boot to the operating system even after repeated attempts, it automatically starts Dell SupportAssist OS Recovery.

Dell SupportAssist OS Recovery is a standalone tool that is preinstalled in all Dell computers installed with Windows operating system. It consists of tools to diagnose and troubleshoot issues that may occur before your computer boots to the operating system. It enables you to diagnose hardware issues, repair your computer, back up your files, or restore your computer to its factory state.

You can also download it from the Dell Support website to troubleshoot and fix your computer when it fails to boot into their primary operating system due to software or hardware failures.

For more information about the Dell SupportAssist OS Recovery, see *Dell SupportAssist OS Recovery User's Guide* at www.dell.com/serviceabilitytools. Click **SupportAssist** and then, click **SupportAssist OS Recovery**.

WiFi power cycle

About this task

If your computer is unable to access the internet due to WiFi connectivity issues a WiFi power cycle procedure may be performed. The following procedure provides the instructions on how to conduct a WiFi power cycle:

 **NOTE:** Some ISPs (Internet Service Providers) provide a modem/router combo device.

Steps

1. Turn off your computer.
2. Turn off the modem.
3. Turn off the wireless router.
4. Wait for 30 seconds.
5. Turn on the wireless router.
6. Turn on the modem.
7. Turn on your computer.

Drain residual flea power (perform hard reset)

About this task

Flea power is the residual static electricity that remains in the computer even after it has been powered off and the battery is removed.

For your safety, and to protect the sensitive electronic components in your computer, you are requested to drain residual flea power before removing or replacing any components in your computer.

Draining residual flea power, also known as a performing a "hard reset", is also a common troubleshooting step if your computer does not power on or boot into the operating system.

To drain residual flea power (perform a hard reset)

Steps

1. Turn off your computer.
2. Disconnect the power adapter from your computer.
3. Remove the base cover.
4. Remove the battery.
5. Press and hold the power button for 20 seconds to drain the flea power.
6. Install the battery.
7. Install the base cover.
8. Connect the power adapter to your computer.
9. Turn on your computer.

 **NOTE:** For more information about performing a hard reset, see the knowledge base article [000130881](https://www.dell.com/support) at www.dell.com/support.

Enabling Intel Optane memory

Steps

1. On the taskbar, click the search box, and then type **Intel Rapid Storage Technology**.
2. Click **Intel Rapid Storage Technology**.
The **Intel Rapid Storage Technology** window is displayed.
3. On the **Status** tab, click **Enable** to enable the Intel Optane memory.
4. On the warning screen, select a compatible fast drive, and then click **Yes** to continue enabling Intel Optane memory.
5. Click **Intel Optane memory** > **Reboot** to complete enabling your Intel Optane memory.

 **NOTE:** Applications may take up to three subsequent launches after enablement to see the full performance benefits.

Disabling Intel Optane memory

About this task

 **CAUTION:** After disabling Intel Optane memory, do not uninstall the driver for Intel Rapid Storage Technology as it will result in a blue screen error. The Intel Rapid Storage Technology user interface can be removed without uninstalling the driver.

 **NOTE:** Disabling Intel Optane memory is required before removing the SATA storage device accelerated by the Intel Optane memory module from the computer.

Steps

1. On the taskbar, click the search box, and then type **Intel Rapid Storage Technology**.
2. Click **Intel Rapid Storage Technology**.
The **Intel Rapid Storage Technology** window is displayed.
3. On the **Intel Optane memory** tab, click **Disable** to disable the Intel Optane memory.

 **NOTE:** For computers in which Intel Optane memory acts as a primary storage, do not disable the Intel Optane memory.
The **Disable** option will be grayed out.

4. Click **Yes** if you accept the warning.
The disabling progress is displayed.
5. Click **Reboot** to complete disabling your Intel Optane memory and restart your computer.

Real Time Clock—RTC reset

The Real Time Clock (RTC) reset function allows you or the service technician to recover the recently launched model Dell Latitude and Precision systems from **No POST/No Boot/No Power** situations. You can initiate the RTC reset on the system from a power-off state only if it is connected to AC power. Press and hold the power button for 25 seconds. The system RTC reset occurs after you release the power button.

 **NOTE:** If AC power is disconnected from the system during the process or the power button is held longer than 40 seconds, the RTC reset process gets aborted.

The RTC reset will reset the BIOS to Defaults, un-provision Intel vPro and reset the system date and time. The following items are unaffected by the RTC reset:

- Service Tag
- Asset Tag
- Ownership Tag
- Admin Password
- System Password
- HDD Password
- Key Databases
- System Logs

 **NOTE:** The IT administrator's vPro account and password on the system will be un-provisioned. The system needs to go through the setup and configuration process again to reconnect it to the vPro server.

The below items may or may not reset based on your custom BIOS setting selections:



- Boot List
- Enable Legacy Option ROMs
- Secure Boot Enable
- Allow BIOS Downgrade

Getting help and contacting Dell

Self-help resources

You can get information and help on Dell products and services using these self-help resources:

Table 22. Self-help resources

Self-help resources	Resource location
Information about Dell products and services	www.dell.com
My Dell app	
Tips	
Contact Support	In Windows search, type <code>Contact Support</code> , and press Enter.
Online help for operating system	www.dell.com/support/windows www.dell.com/support/linux
Access top solutions, diagnostics, drivers and downloads, and learn more about your computer through videos, manuals and documents.	Your Dell computer is uniquely identified by a Service Tag or Express Service Code. To view relevant support resources for your Dell computer, enter the Service Tag or Express Service Code at www.dell.com/support . For more information on how to find the Service Tag for your computer, see Locate the Service Tag on your computer .
Dell knowledge base articles for a variety of computer concerns	<ol style="list-style-type: none"> 1. Go to www.dell.com/support. 2. On the menu bar at the top of the Support page, select Support > Knowledge Base. 3. In the Search field on the Knowledge Base page, type the keyword, topic, or model number, and then click or tap the search icon to view the related articles.

Contacting Dell

To contact Dell for sales, technical support, or customer service issues, see www.dell.com/contactdell.

 **NOTE:** Availability varies by country/region and product, and some services may not be available in your country/region.

 **NOTE:** If you do not have an active Internet connection, you can find contact information about your purchase invoice, packing slip, bill, or Dell product catalog.