

# Inspiron 7306 2-in-1 Silver

## Service Manual



## Notes, cautions, and warnings

 **NOTE:** A NOTE indicates important information that helps you make better use of your product.

 **CAUTION:** A CAUTION indicates either potential damage to hardware or loss of data and tells you how to avoid the problem.

 **WARNING:** A WARNING indicates a potential for property damage, personal injury, or death.

<b>Chapter 1: Working inside your computer</b> .....	<b>5</b>
Before working inside your computer.....	5
Safety instructions.....	5
Electrostatic discharge—ESD protection.....	6
ESD field service kit .....	6
Transporting sensitive components.....	7
After working inside your computer.....	7
<b>Chapter 2: Removing and installing components</b> .....	<b>8</b>
Recommended tools.....	8
Screw list.....	8
Major components of Inspiron 7306 2-in-1 Silver.....	9
Base cover.....	11
Removing the base cover.....	11
Installing the base cover.....	13
Battery.....	15
Lithium-ion battery precautions.....	15
Removing the battery.....	15
Installing the battery.....	16
Solid-state drive/Intel Optane.....	17
Removing the M.2 2230 solid-state drive.....	17
Installing the M.2 2230 solid-state drive.....	18
Removing the M.2 2280 solid-state drive/Intel Optane H10.....	19
Installing the M.2 2280 solid-state drive/Intel Optane H10.....	20
Display assembly.....	21
Removing the display assembly.....	21
Installing the display assembly.....	23
Fans.....	26
Removing the fan.....	26
Installing the fan.....	26
Power-adaptor port.....	27
Removing the power-adaptor port.....	27
Installing the power-adaptor port.....	28
Coin-cell battery.....	30
Removing the coin-cell battery.....	30
Installing the coin-cell battery.....	30
I/O board.....	31
Removing the I/O board.....	31
Installing the I/O board.....	32
Touchpad.....	33
Removing the touchpad.....	33
Installing the touchpad.....	34
Speakers.....	35
Removing the speakers.....	35

Installing the speakers.....	36
Heat sink.....	37
Removing the heat sink.....	37
Installing the heat sink.....	38
Power button with fingerprint reader.....	39
Removing the power-button with fingerprint reader.....	39
Installing the power-button with fingerprint reader.....	40
System board.....	41
Removing the system board.....	41
Installing the system board.....	43
Palm-rest and keyboard assembly.....	46
Removing the palm-rest and keyboard assembly.....	46
Installing the palm-rest and keyboard assembly.....	47
<b>Chapter 3: Drivers and downloads.....</b>	<b>49</b>
<b>Chapter 4: System setup.....</b>	<b>50</b>
Entering BIOS setup program.....	50
Navigation keys.....	50
Boot Sequence.....	50
One time boot menu.....	51
System setup options.....	51
Clearing CMOS settings.....	60
Clearing BIOS (System Setup) and System passwords.....	60
Updating the BIOS.....	60
Updating the BIOS in Windows.....	60
Updating the BIOS using the USB drive in Windows.....	61
Updating the BIOS from the F12 One-Time boot menu.....	61
<b>Chapter 5: Troubleshooting.....</b>	<b>63</b>
Handling swollen Lithium-ion batteries.....	63
SupportAssist diagnostics.....	63
<b>Locate the Service Tag or Express Service Code of your Dell computer</b> .....	64
System diagnostic lights.....	64
Recovering the operating system.....	65
Backup media and recovery options.....	65
WiFi power cycle.....	65
Flea power release.....	65
<b>Chapter 6: Getting help and contacting Dell.....</b>	<b>67</b>



# Working inside your computer

## Before working inside your computer

### About this task

 **NOTE:** The images in this document may differ from your computer depending on the configuration you ordered.

### Steps

1. Save and close all open files and exit all open applications.

2. Shut down your computer. Click **Start** >  **Power** > **Shut down**.

 **NOTE:** If you are using a different operating system, see the documentation of your operating system for shut-down instructions.

3. Disconnect your computer and all attached devices from their electrical outlets.

4. Disconnect all attached network devices and peripherals, such as keyboard, mouse, and monitor from your computer.

 **CAUTION:** To disconnect a network cable, first unplug the cable from your computer and then unplug the cable from the network device.

5. Remove any media card and optical disc from your computer, if applicable.

## Safety instructions

Use the following safety guidelines to protect your computer from potential damage and to ensure your personal safety. Unless otherwise noted, each procedure included in this document assumes that you have read the safety information that shipped with your computer.

 **WARNING:** Before working inside your computer, read the safety information that is shipped with your computer. For more safety best practices, see the Regulatory Compliance home page at [www.dell.com/regulatory\\_compliance](http://www.dell.com/regulatory_compliance).

 **WARNING:** Disconnect your computer from all power sources before opening the computer cover or panels. After you finish working inside the computer, replace all covers, panels, and screws before connecting your computer to an electrical outlet.

 **CAUTION:** To avoid damaging the computer, ensure that the work surface is flat, dry, and clean.

 **CAUTION:** To avoid damaging the components and cards, handle them by their edges, and avoid touching the pins and the contacts.

 **CAUTION:** You should only perform troubleshooting and repairs as authorized or directed by the Dell technical assistance team. Damage due to servicing that is not authorized by Dell is not covered by your warranty. See the safety instructions that is shipped with the product or at [www.dell.com/regulatory\\_compliance](http://www.dell.com/regulatory_compliance).

 **CAUTION:** Before touching anything inside your computer, ground yourself by touching an unpainted metal surface, such as the metal at the back of the computer. While you work, periodically touch an unpainted metal surface to dissipate static electricity which could harm internal components.

**CAUTION:** When you disconnect a cable, pull it by its connector or its pull tab, not the cable itself. Some cables have connectors with locking tabs or thumbscrews that you must disengage before disconnecting the cable. When disconnecting cables, keep them evenly aligned to avoid bending the connector pins. When connecting cables, ensure that the ports and the connectors are correctly oriented and aligned.

**CAUTION:** Press and eject any installed card from the media-card reader.

**CAUTION:** Exercise caution when handling Lithium-ion batteries in laptops. Swollen batteries should not be used and should be replaced and disposed properly.

**NOTE:** The color of your computer and certain components may appear differently than shown in this document.

## Electrostatic discharge—ESD protection

ESD is a major concern when you handle electronic components, especially sensitive components such as expansion cards, processors, memory DIMMs, and system boards. Very slight charges can damage circuits in ways that may not be obvious, such as intermittent problems or a shortened product life span. As the industry pushes for lower power requirements and increased density, ESD protection is an increasing concern.

Due to the increased density of semiconductors used in recent Dell products, the sensitivity to static damage is now higher than in previous Dell products. For this reason, some previously approved methods of handling parts are no longer applicable.

Two recognized types of ESD damage are catastrophic and intermittent failures.

- **Catastrophic** – Catastrophic failures represent approximately 20 percent of ESD-related failures. The damage causes an immediate and complete loss of device functionality. An example of catastrophic failure is a memory DIMM that has received a static shock and immediately generates a "No POST/No Video" symptom with a beep code emitted for missing or nonfunctional memory.
- **Intermittent** – Intermittent failures represent approximately 80 percent of ESD-related failures. The high rate of intermittent failures means that most of the time when damage occurs, it is not immediately recognizable. The DIMM receives a static shock, but the tracing is merely weakened and does not immediately produce outward symptoms related to the damage. The weakened trace may take weeks or months to melt, and in the meantime may cause degradation of memory integrity, intermittent memory errors, etc.

The more difficult type of damage to recognize and troubleshoot is the intermittent (also called latent or "walking wounded") failure.

Perform the following steps to prevent ESD damage:

- Use a wired ESD wrist strap that is properly grounded. The use of wireless anti-static straps is no longer allowed; they do not provide adequate protection. Touching the chassis before handling parts does not ensure adequate ESD protection on parts with increased sensitivity to ESD damage.
- Handle all static-sensitive components in a static-safe area. If possible, use anti-static floor pads and workbench pads.
- When unpacking a static-sensitive component from its shipping carton, do not remove the component from the anti-static packing material until you are ready to install the component. Before unwrapping the anti-static packaging, ensure that you discharge static electricity from your body.
- Before transporting a static-sensitive component, place it in an anti-static container or packaging.

## ESD field service kit

The unmonitored Field Service kit is the most commonly used service kit. Each Field Service kit includes three main components: anti-static mat, wrist strap, and bonding wire.

### Components of an ESD field service kit

The components of an ESD field service kit are:

- **Anti-Static Mat** – The anti-static mat is dissipative and parts can be placed on it during service procedures. When using an anti-static mat, your wrist strap should be snug and the bonding wire should be connected to the mat and to any bare metal on the system being worked on. Once deployed properly, service parts can be removed from the ESD bag and placed directly on the mat. ESD-sensitive items are safe in your hand, on the ESD mat, in the system, or inside a bag.

- **Wrist Strap and Bonding Wire** – The wrist strap and bonding wire can be either directly connected between your wrist and bare metal on the hardware if the ESD mat is not required, or connected to the anti-static mat to protect hardware that is temporarily placed on the mat. The physical connection of the wrist strap and bonding wire between your skin, the ESD mat, and the hardware is known as bonding. Use only Field Service kits with a wrist strap, mat, and bonding wire. Never use wireless wrist straps. Always be aware that the internal wires of a wrist strap are prone to damage from normal wear and tear, and must be checked regularly with a wrist strap tester in order to avoid accidental ESD hardware damage. It is recommended to test the wrist strap and bonding wire at least once per week.
- **ESD Wrist Strap Tester** – The wires inside of an ESD strap are prone to damage over time. When using an unmonitored kit, it is a best practice to regularly test the strap prior to each service call, and at a minimum, test once per week. A wrist strap tester is the best method for doing this test. If you do not have your own wrist strap tester, check with your regional office to find out if they have one. To perform the test, plug the wrist-strap's bonding-wire into the tester while it is strapped to your wrist and push the button to test. A green LED is lit if the test is successful; a red LED is lit and an alarm sounds if the test fails.
- **Insulator Elements** – It is critical to keep ESD sensitive devices, such as plastic heat sink casings, away from internal parts that are insulators and often highly charged.
- **Working Environment** – Before deploying the ESD Field Service kit, assess the situation at the customer location. For example, deploying the kit for a server environment is different than for a desktop or portable environment. Servers are typically installed in a rack within a data center; desktops or portables are typically placed on office desks or cubicles. Always look for a large open flat work area that is free of clutter and large enough to deploy the ESD kit with additional space to accommodate the type of system that is being repaired. The workspace should also be free of insulators that can cause an ESD event. On the work area, insulators such as Styrofoam and other plastics should always be moved at least 12 inches or 30 centimeters away from sensitive parts before physically handling any hardware components
- **ESD Packaging** – All ESD-sensitive devices must be shipped and received in static-safe packaging. Metal, static-shielded bags are preferred. However, you should always return the damaged part using the same ESD bag and packaging that the new part arrived in. The ESD bag should be folded over and taped shut and all the same foam packing material should be used in the original box that the new part arrived in. ESD-sensitive devices should be removed from packaging only at an ESD-protected work surface, and parts should never be placed on top of the ESD bag because only the inside of the bag is shielded. Always place parts in your hand, on the ESD mat, in the system, or inside an anti-static bag.
- **Transporting Sensitive Components** – When transporting ESD sensitive components such as replacement parts or parts to be returned to Dell, it is critical to place these parts in anti-static bags for safe transport.

## ESD protection summary

It is recommended that all field service technicians use the traditional wired ESD grounding wrist strap and protective anti-static mat at all times when servicing Dell products. In addition, it is critical that technicians keep sensitive parts separate from all insulator parts while performing service and that they use anti-static bags for transporting sensitive components.

## Transporting sensitive components

When transporting ESD sensitive components such as replacement parts or parts to be returned to Dell, it is critical to place these parts in anti-static bags for safe transport.

## After working inside your computer

### About this task

 **CAUTION:** Leaving stray or loose screws inside your computer may severely damage your computer.

### Steps

1. Replace all screws and ensure that no stray screws remain inside your computer.
2. Connect any external devices, peripherals, or cables you removed before working on your computer.
3. Replace any media cards, discs, or any other parts that you removed before working on your computer.
4. Connect your computer and all attached devices to their electrical outlets.
5. Turn on your computer.

# Removing and installing components

**NOTE:** The images in this document may differ from your computer depending on the configuration you ordered.

## Recommended tools

The procedures in this document may require the following tools:

- Philips screwdriver #0
- Philips screwdriver #1
- Plastic scribe









## Screw list

**NOTE:** When removing screws from a component, it is recommended to note the screw type, the quantity of screws, and then place them in a screw storage box. This is to ensure that the correct number of screws and correct screw type is restored when the component is replaced.







**NOTE:** Some computers have magnetic surfaces. Ensure that the screws are not left attached to such surfaces when replacing a component.

**NOTE:** Screw color may vary with the configuration ordered.

**Table 1. Screw list**

Component	Secured to	Screw type	Quantity	Screw image
Base cover	Palm-rest assembly	M2x4	4	
Battery	Palm-rest assembly	M2x3	4	
M.2 2230 mounting bracket	System board	M2x2	1	
M.2 2280 solid-state drive/Intel Optane H10	System board	M2x2	1	
Display assembly	Palm-rest assembly	M2x5	<ul style="list-style-type: none"> <li>• Left hinge: 1</li> <li>• Right hinge: 1</li> </ul>	
Display assembly	Palm-rest assembly	M2x3.5	<ul style="list-style-type: none"> <li>• Left hinge: 1</li> <li>• Right hinge: 1</li> </ul>	
Fan	Palm-rest assembly	M2x3	2	
Power-adaptor port	Palm-rest assembly	M2x3	1	
I/O board	Palm-rest assembly	M2x2	1	

**Table 1. Screw list (continued)**

<b>Component</b>	<b>Secured to</b>	<b>Screw type</b>	<b>Quantity</b>	<b>Screw image</b>
Touchpad	Palm-rest assembly	M2x2	2	
Touchpad bracket	Palm-rest assembly	M1.6x2	3	
Power-button with fingerprint reader	Palm-rest assembly	M2x3	1	
Power-button bracket	Palm-rest assembly	M2x3	1	
Wireless-card bracket	Palm-rest assembly	M2x3	1	
System board	Palm-rest assembly	M2x2	3	

## Major components of Inspiron 7306 2-in-1 Silver

The following image shows the major components of Inspiron 7306 2-in-1 Silver.

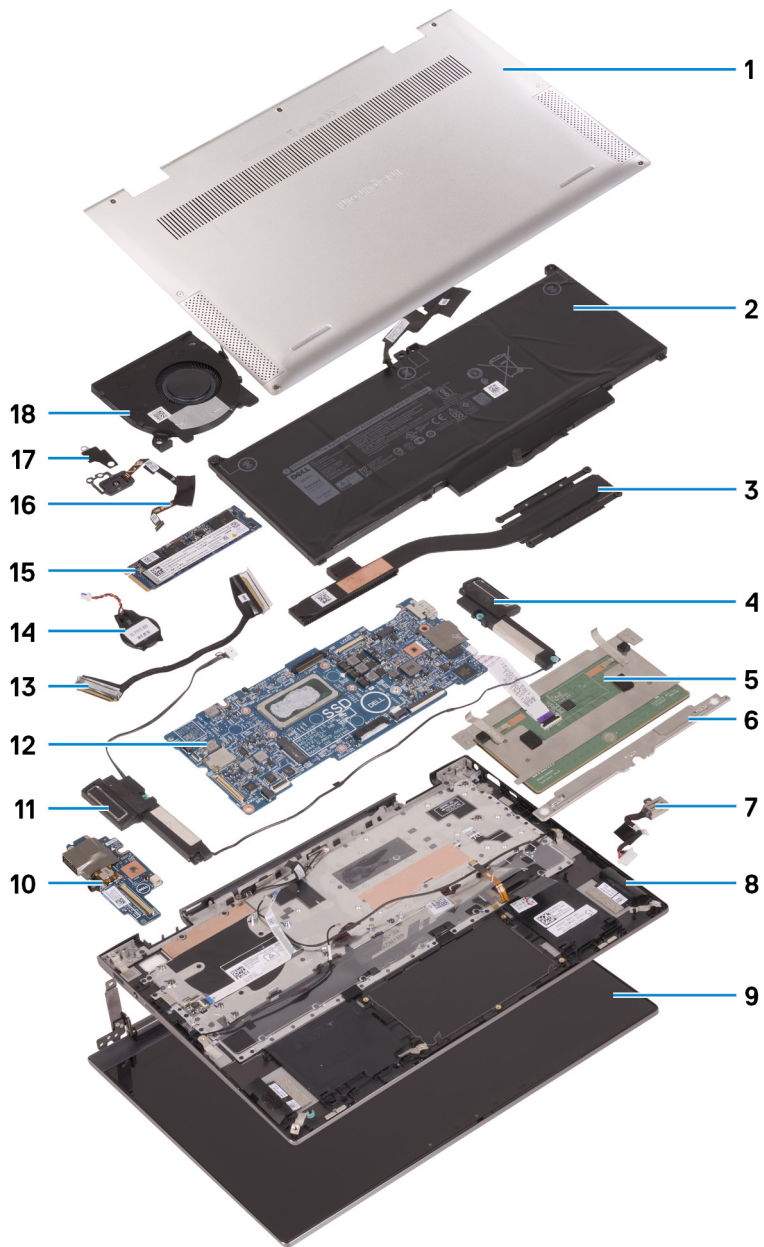

1. Base cover
2. Battery
3. Heat sink
4. Left speaker
5. Touchpad
6. Touchpad bracket
7. Power-adaptor port
8. Palm-rest assembly
9. Display assembly
10. I/O board
11. Right speaker
12. System board
13. I/O-board cable
14. Coin-cell battery
15. M.2 2280 solid-state drive (if applicable)
16. Power-button with fingerprint reader
17. Power-button bracket

18. Fan

**NOTE:** Dell provides a list of components and their part numbers for the original system configuration purchased. These parts are available according to warranty coverages purchased by the customer. Contact your Dell sales representative for purchase options.

**NOTE:** Depending on the configuration ordered, some components may not be installed in your computer.

## Base cover

### Removing the base cover

#### Prerequisites

1. Follow the procedure in [Before working inside your computer](#).

#### About this task

The following image(s) indicate the location of the base cover and provides a visual representation of the removal procedure.

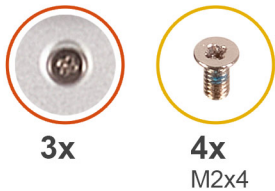



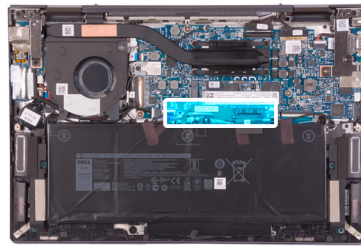
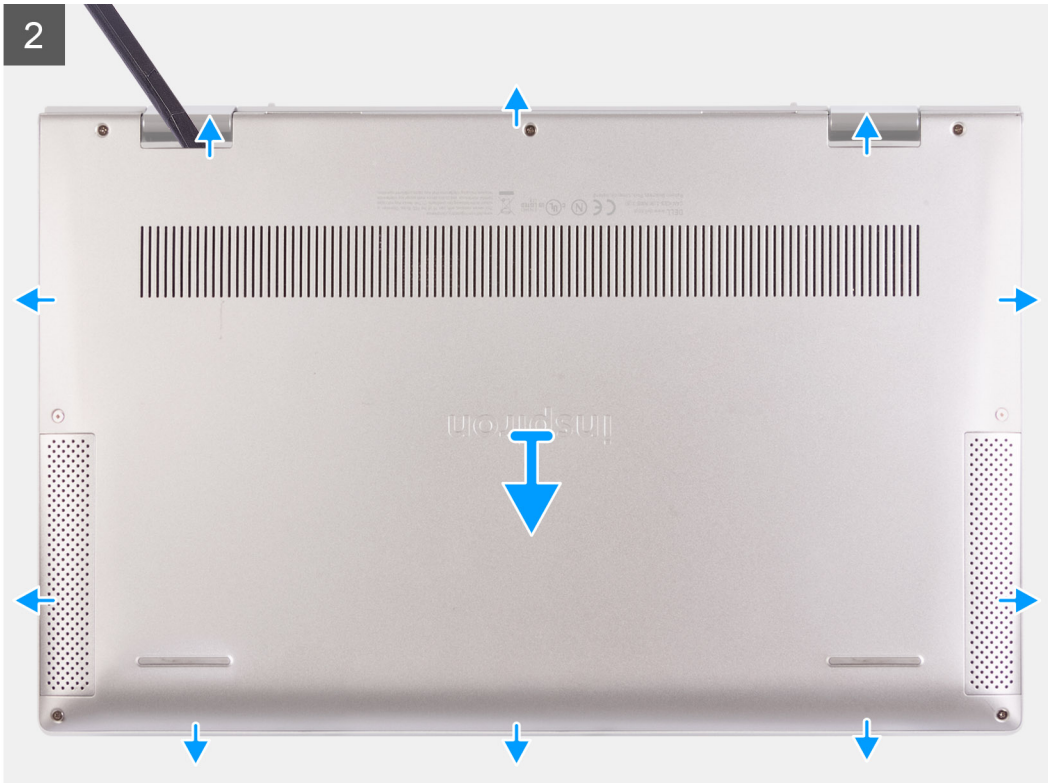



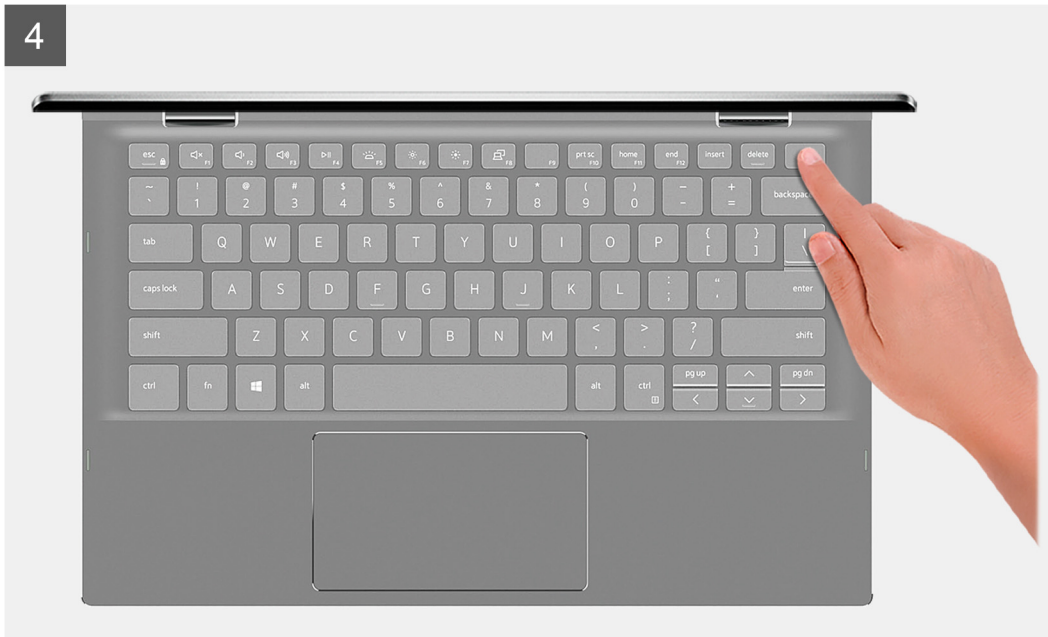

### Steps

1. Loosen the three captive screws that secure the base cover to the palm-rest assembly.
2. Remove the four screws (M2x4) that secure the base cover to the palm-rest assembly.
3. Using a plastic scribe, pry the base cover from the tabs at the hinges and continue to work on the sides to release the base cover from the palm-rest assembly.
4. Lift the base cover off the palm-rest assembly.
5. Using the pull tab, disconnect the battery cable from the system board.
6. Turn your computer over and press the power button for 15 seconds to drain the flea power.

## Installing the base cover

### Prerequisites

If you are replacing a component, remove the existing component before performing the installation process.

### About this task

The following image(s) indicate the location of the base cover and provides a visual representation of the installation procedure.

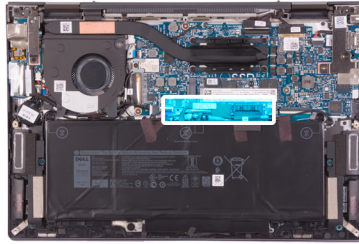

3x



4x  
M2x4



### Steps

1. Connect the battery cable to the system board.

2. Align the tabs on the base cover with the slots on the palm-rest assembly and snap the base cover to the palm-rest assembly.
3. Replace the four screws (M2x4) that secure the base cover to the palm-rest assembly.
4. Tighten the three captive screws that secure the base cover to the palm-rest assembly.

#### Next steps

1. Follow the procedure in [After working inside your computer](#).

## Battery

### Lithium-ion battery precautions

#### ⚠ CAUTION:

- Exercise caution when handling Lithium-ion batteries.
- Discharge the battery completely before removing it. Disconnect the AC power adapter from the system and operate the computer solely on battery power—the battery is fully discharged when the computer no longer turns on when the power button is pressed.
- Do not crush, drop, mutilate, or penetrate the battery with foreign objects.
- Do not expose the battery to high temperatures, or disassemble battery packs and cells.
- Do not apply pressure to the surface of the battery.
- Do not bend the battery.
- Do not use tools of any kind to pry on or against the battery.
- Ensure any screws during the servicing of this product are not lost or misplaced, to prevent accidental puncture or damage to the battery and other system components.
- If the battery gets stuck inside your computer as a result of swelling, do not try to release it as puncturing, bending, or crushing a lithium-ion battery can be dangerous. In such an instance, contact Dell technical support for assistance. See [www.dell.com/contactdell](http://www.dell.com/contactdell).
- Always purchase genuine batteries from [www.dell.com](http://www.dell.com) or authorized Dell partners and resellers.
- Swollen batteries should not be used and should be replaced and disposed properly. For guidelines on how to handle and replace swollen Lithium-ion batteries, see [Handling swollen Lithium-ion batteries](#).

## Removing the battery

#### Prerequisites

1. Follow the procedure in [Before working inside your computer](#).
2. Remove the [base cover](#).

#### About this task

The following image(s) indicate the location of the battery and provides a visual representation of the removal procedure.



4x  
M2x3

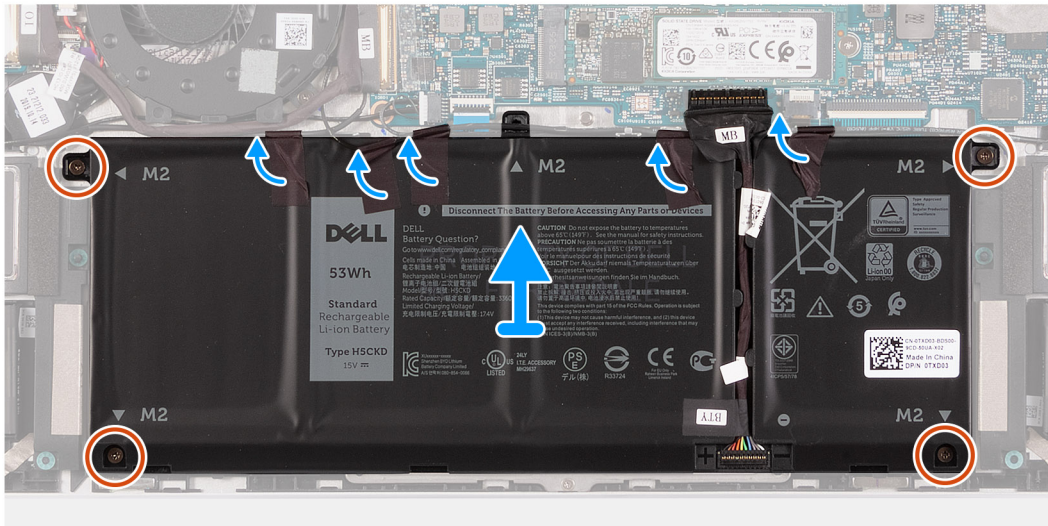
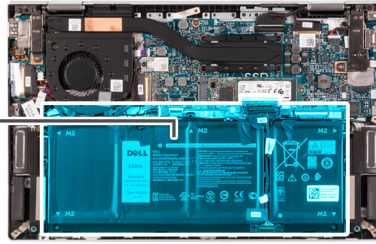
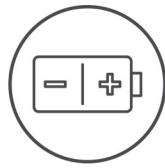

### Steps

1. Remove the four screws (M2x3) that secure the battery to the palm-rest assembly.
2. Peel off the tapes that secure the battery to the palm-rest assembly.
3. Lift the battery off the palm-rest assembly.

## Installing the battery

### Prerequisites

If you are replacing a component, remove the existing component before performing the installation process.

### About this task

The following image(s) indicate the location of the battery and provides a visual representation of the installation procedure.





4x  
M2x3

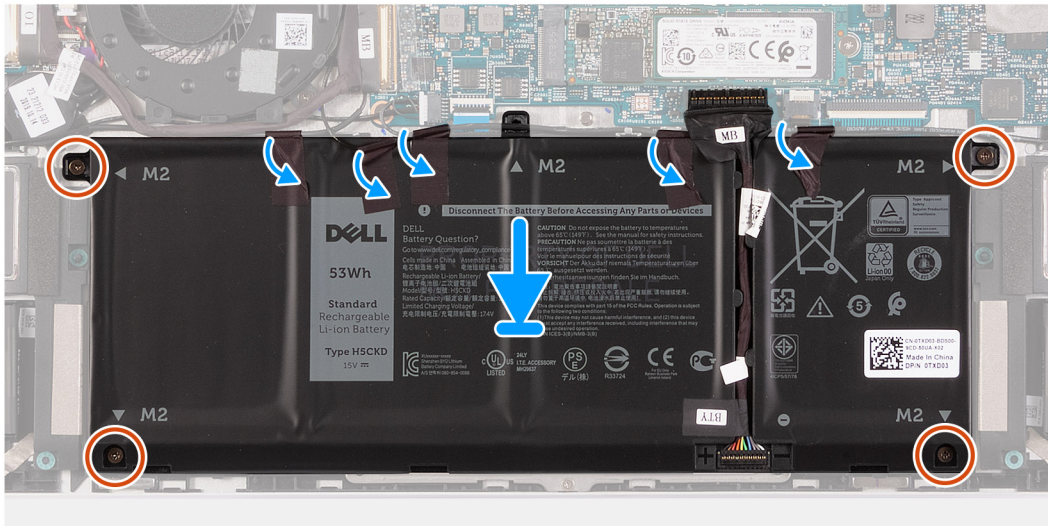
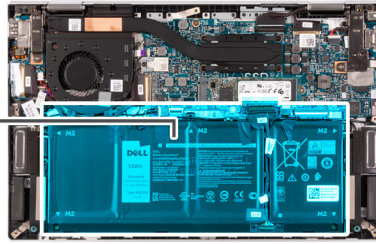
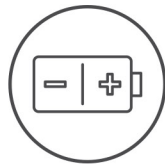

## Steps

1. Place the battery on the palm-rest assembly.

**NOTE:** Ensure that the battery cable is not under the battery when placing the battery on the palm-rest assembly to avoid damage to your computer.

2. Align the screw holes on the battery to the screw holes on the palm-rest assembly.
3. Replace the four screws (M2x3) that secure the battery to the palm-rest assembly.
4. Adhere the tapes that secure the battery to the palm-rest assembly.

## Next steps

1. Install the [base cover](#).
2. Follow the procedure in [After working inside your computer](#).

# Solid-state drive/Intel Optane

## Removing the M.2 2230 solid-state drive

### Prerequisites

1. Follow the procedure in [Before working inside your computer](#).
2. Remove the [base cover](#).

### About this task

**NOTE:** This procedure applies only to computers shipped with a M.2 2230 solid-state drive installed.

**NOTE:** The M.2 card installed on your computer will depend on the configuration ordered. Supported card configurations on the M.2 card slot:

- M.2 2230 solid-state drive + 2230 mounting bracket
- M.2 2280 solid-state drive
- M.2 2280 Intel Optane Memory H10

The following image(s) indicate the location of the M.2 2230 solid-state drive and provides a visual representation of the removal procedure.

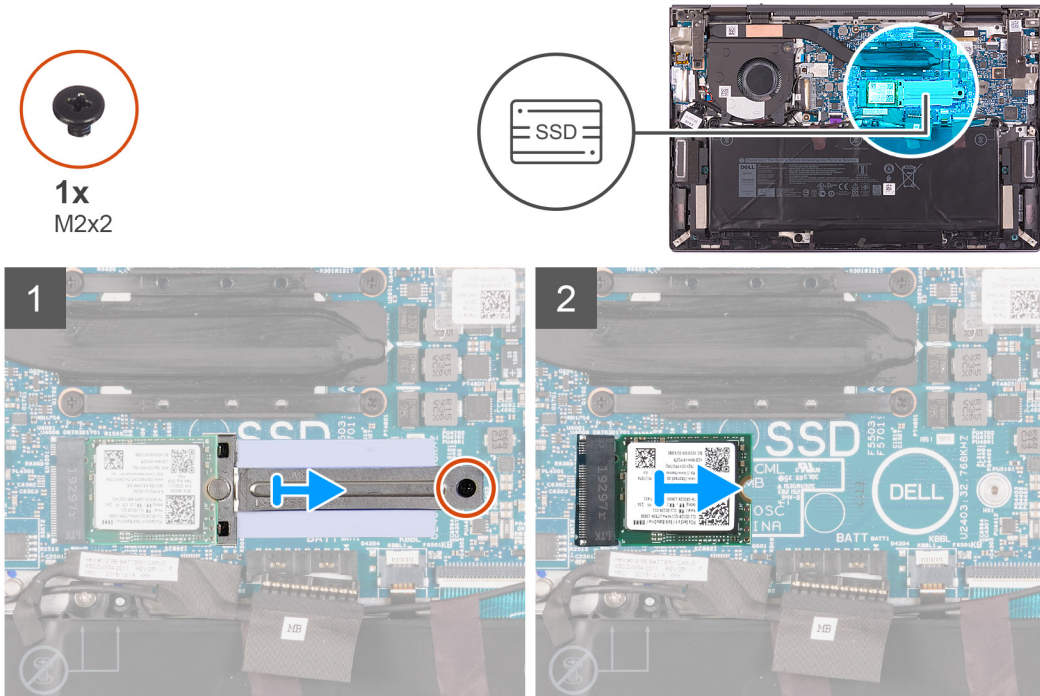

### Steps

1. Remove the screw (M2x2) that secures the M.2 2230 mounting bracket to the system board.
2. Slide and remove the M.2 2230 mounting bracket off the system board.
3. Slide and remove the M.2 2230 solid-state drive off the system board.

## Installing the M.2 2230 solid-state drive

### Prerequisites

If you are replacing a component, remove the existing component before performing the installation process.

### About this task

- NOTE:** This procedure applies if you are installing a M.2 2230 solid-state drive.
- NOTE:** The M.2 card installed on your computer will depend on the configuration ordered. Supported card configurations on the M.2 card slot:
  - M.2 2230 solid-state drive + 2230 mounting bracket
  - M.2 2280 solid-state drive
  - M.2 2280 Intel Optane Memory H10

The following image(s) indicate the location of the M.2 2230 solid-state drive and provides a visual representation of the installation procedure.



1x  
M2x2

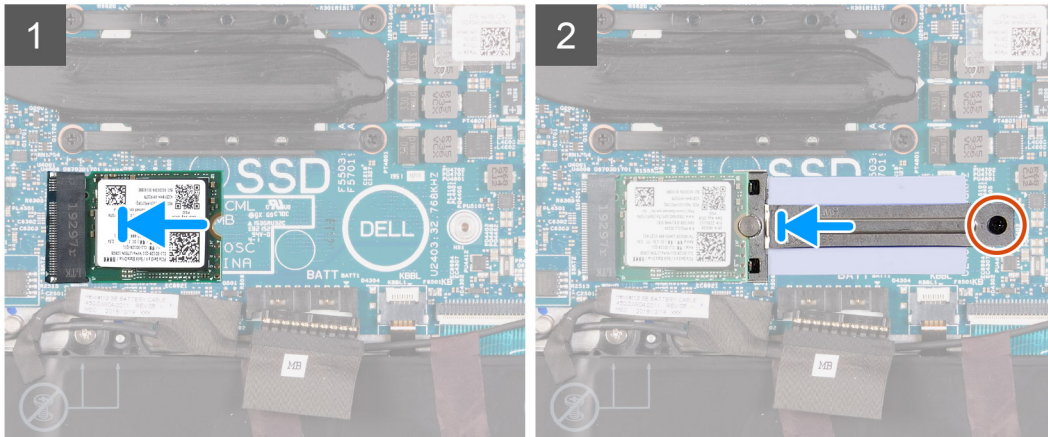
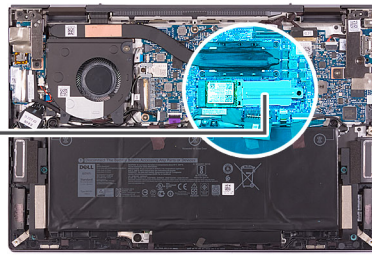

### Steps

1. Align the notch on the M.2 2230 solid-state drive with the tab on the M.2 card slot on the system board.
2. Slide the M.2 2230 solid-state drive into the M.2 card slot on the system board.
3. Slide the M.2 2230 mounting bracket into place, aligning the peg on the bracket with the notch on the M.2 2230 solid-state drive.
4. Align the screw hole on the M.2 2230 mounting bracket to the screw hole on the system board.
5. Replace the screw (M2x2) that secures the M.2 2230 mounting bracket to the system board.

### Next steps

1. Follow the procedure in [After working inside your computer](#).

## Removing the M.2 2280 solid-state drive/Intel Optane H10

### Prerequisites

1. Follow the procedure in [Before working inside your computer](#).
2. Remove the [base cover](#).

### About this task

- NOTE:** This procedure applies only to computers shipped with a M.2 2280 solid-state drive or a M.2 2280 Intel Optane H10 installed.
- NOTE:** The M.2 card installed on your computer will depend on the configuration ordered. Supported card configurations on the M.2 card slot:
- M.2 2230 solid-state drive + 2230 mounting bracket
  - M.2 2280 solid-state drive
  - M.2 2280 Intel Optane Memory H10

The following image(s) indicate the location of the M.2 2280 solid-state drive/Intel Optane H10 and provides a visual representation of the removal procedure.





1x  
M2x2

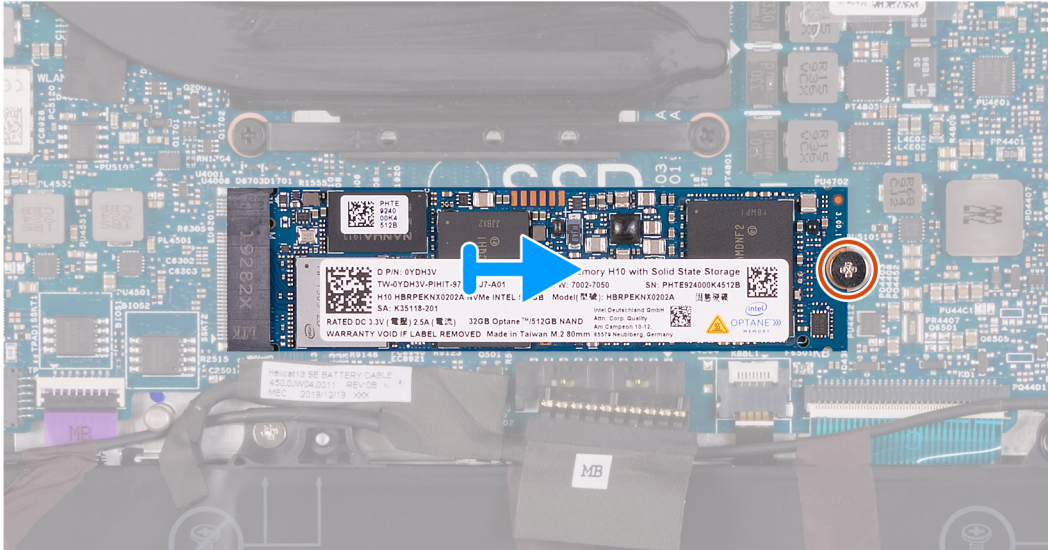
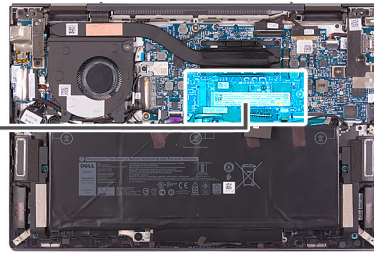

## Steps

1. Remove the screw (M2x2) that secures the M.2 2280 solid-state drive/Intel Optane to the system board.
2. Slide and remove the M.2 2280 solid-state drive/Intel Optane from the M.2 card slot on the system board.

## Installing the M.2 2280 solid-state drive/Intel Optane H10

### Prerequisites

If you are replacing a component, remove the existing component before performing the installation process.

### About this task

- NOTE:** This procedure applies if you are installing a M.2 2280 solid-state drive or M.2 2280 Intel Optane H10.
- NOTE:** The M.2 card installed on your computer will depend on the configuration ordered. Supported card configurations on the M.2 card slot:
  - M.2 2230 solid-state drive + 2230 mounting bracket
  - M.2 2280 solid-state drive
  - M.2 2280 Intel Optane Memory H10

The following image(s) indicate the location of the M.2 2280 solid-state drive/Intel Optane H10 and provides a visual representation of the installation procedure.





1x  
M2x2

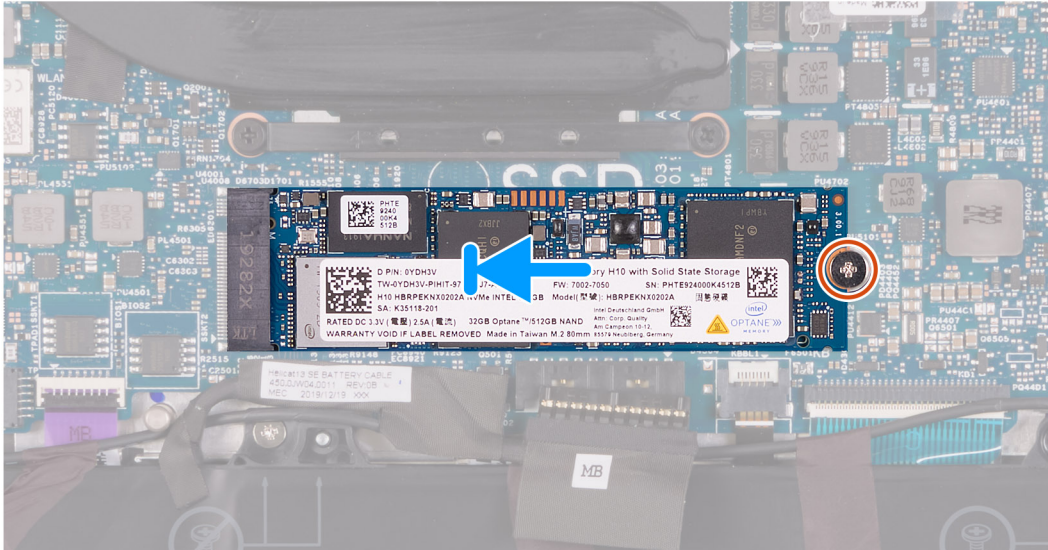
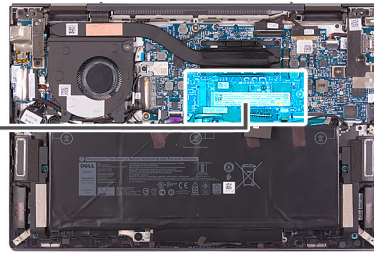

### Steps

1. Align the notch on the M.2 2280 solid-state drive/Intel Optane with the tab on the M.2 card slot on the system board.
2. Slide the M.2 2280 solid-state drive/Intel Optane into the M.2 card slot on the system board.
3. Replace the screw (M2x2) that secures the M.2 2280 solid-state drive/Intel Optane to the system board.

### Next steps

1. Install the [base cover](#).
2. Follow the procedure in [After working inside your computer](#).

## Display assembly

### Removing the display assembly

#### Prerequisites

1. Follow the procedure in [Before working inside your computer](#).
2. Remove the [base cover](#).

#### About this task

The following image(s) indicate the location of the display assembly and provides a visual representation of the removal procedure.



2x  
M2x5



2x  
M2x3.5

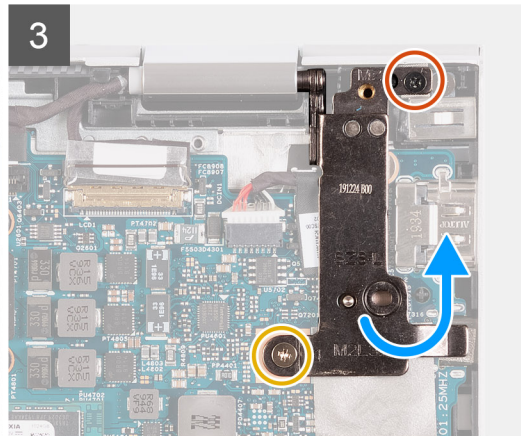
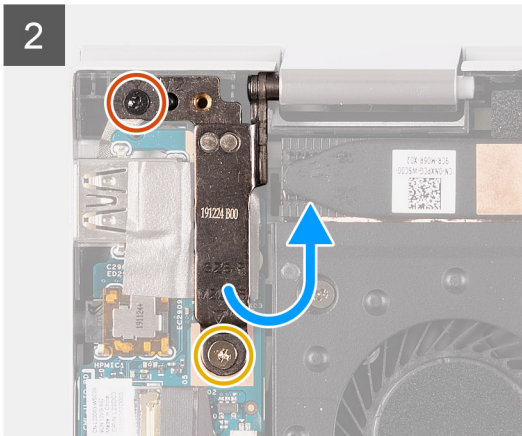
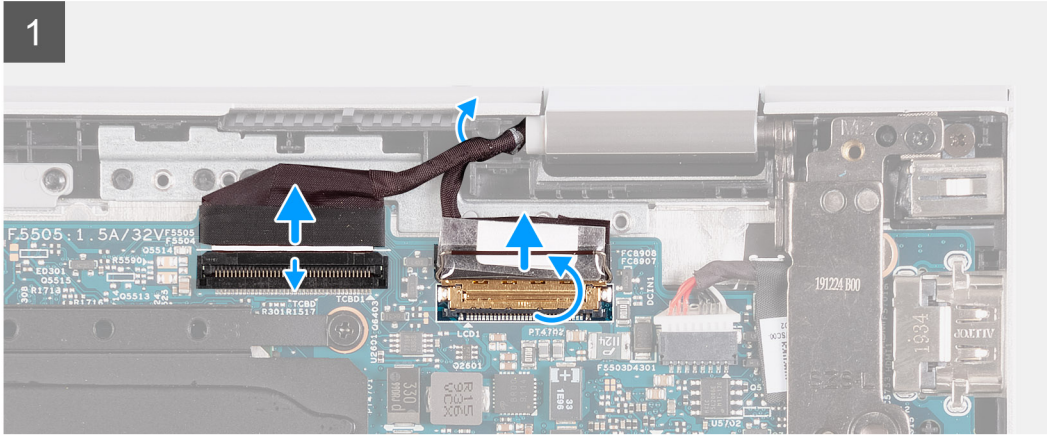

4

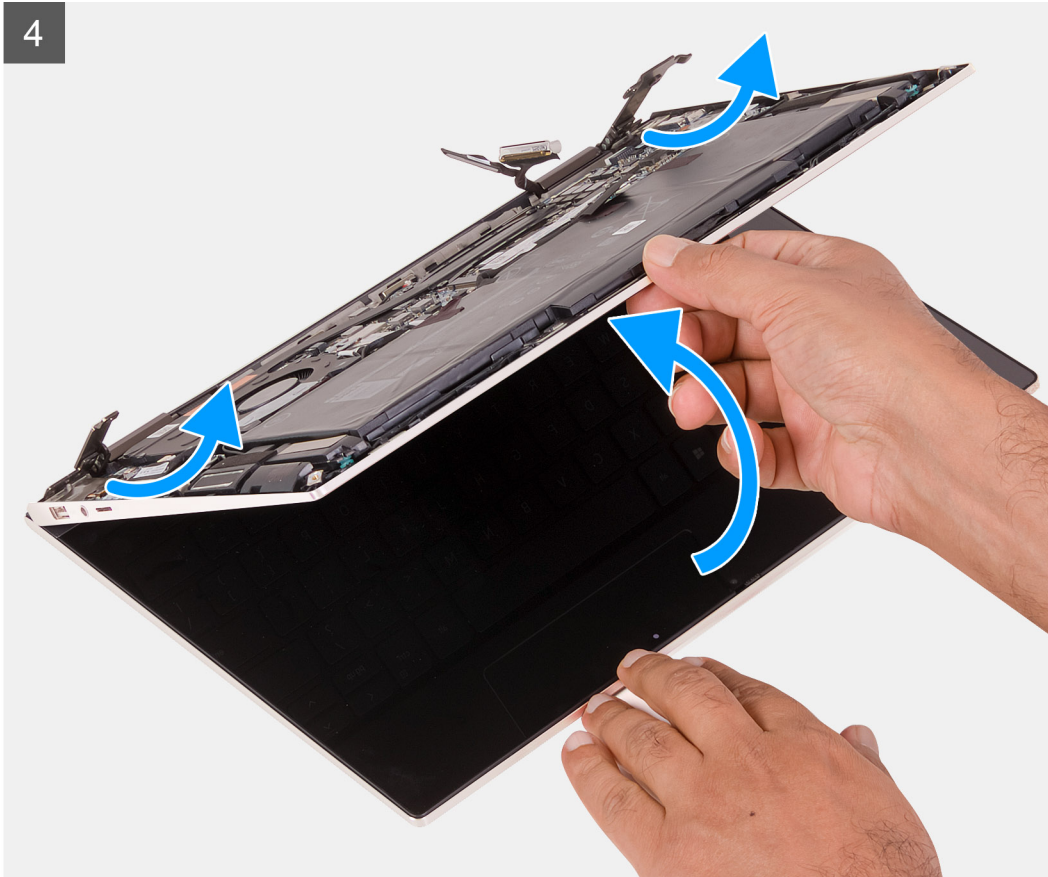

### Steps

1. Open the latch and disconnect the touchscreen cable from the system board.
2. Peel the tape that secures the display-cable latch to the system board.
3. Open the latch and disconnect the display cable from the system board.
4. Remove the touchscreen cable and display cable from the routing guide on the palm-rest assembly.
5. Remove the screw (M2x5) that secures the left display-hinge to the palm-rest assembly.
6. Remove the screw (M2x3.5) that secures the left display-hinge to the I/O board and palm-rest assembly.
7. Pry open the left display-hinge.
8. Remove the screw (M2x5) that secures the right display-hinge to the palm-rest assembly.
9. Remove the screw (M2x3.5) that secures the right display-hinge to the palm-rest assembly and system board.
10. Pry open the right display-hinge.
11. Lift and remove the palm-rest assembly from the display assembly.

## Installing the display assembly

### Prerequisites

If you are replacing a component, remove the existing component before performing the installation process.

### About this task

The following image(s) indicate the location of the display assembly and provides a visual representation of the installation procedure.

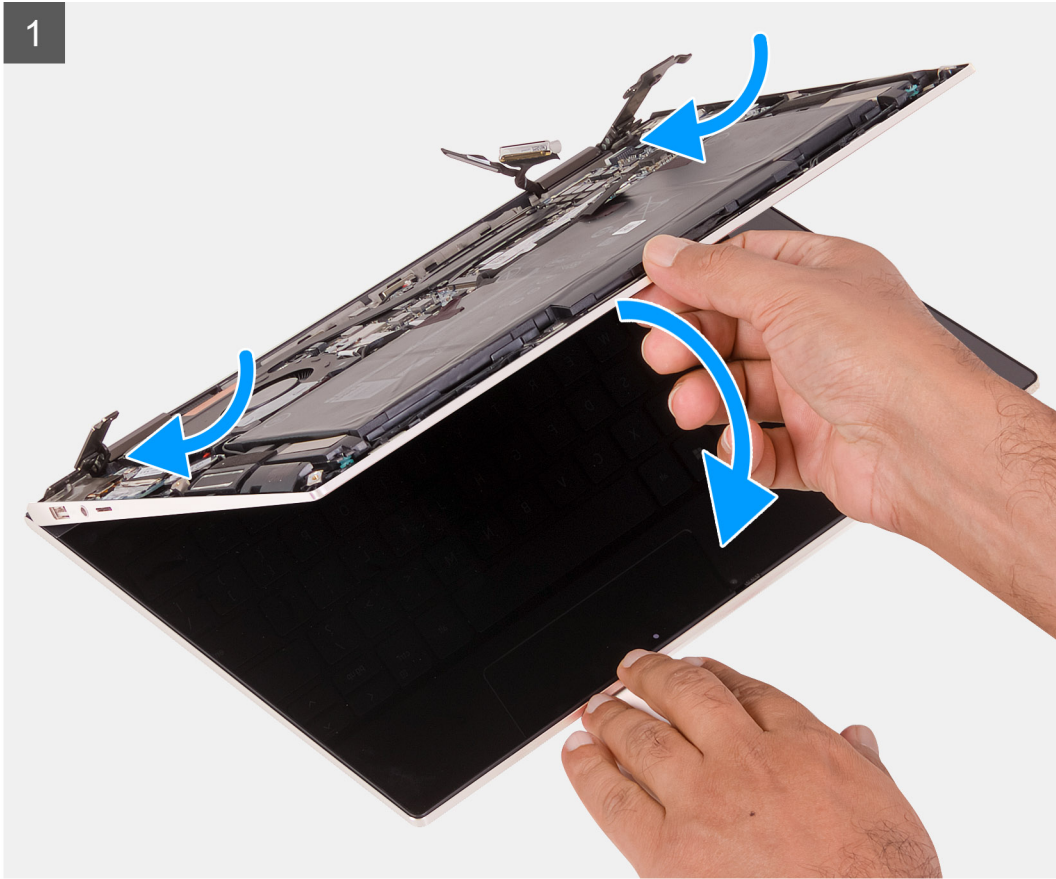



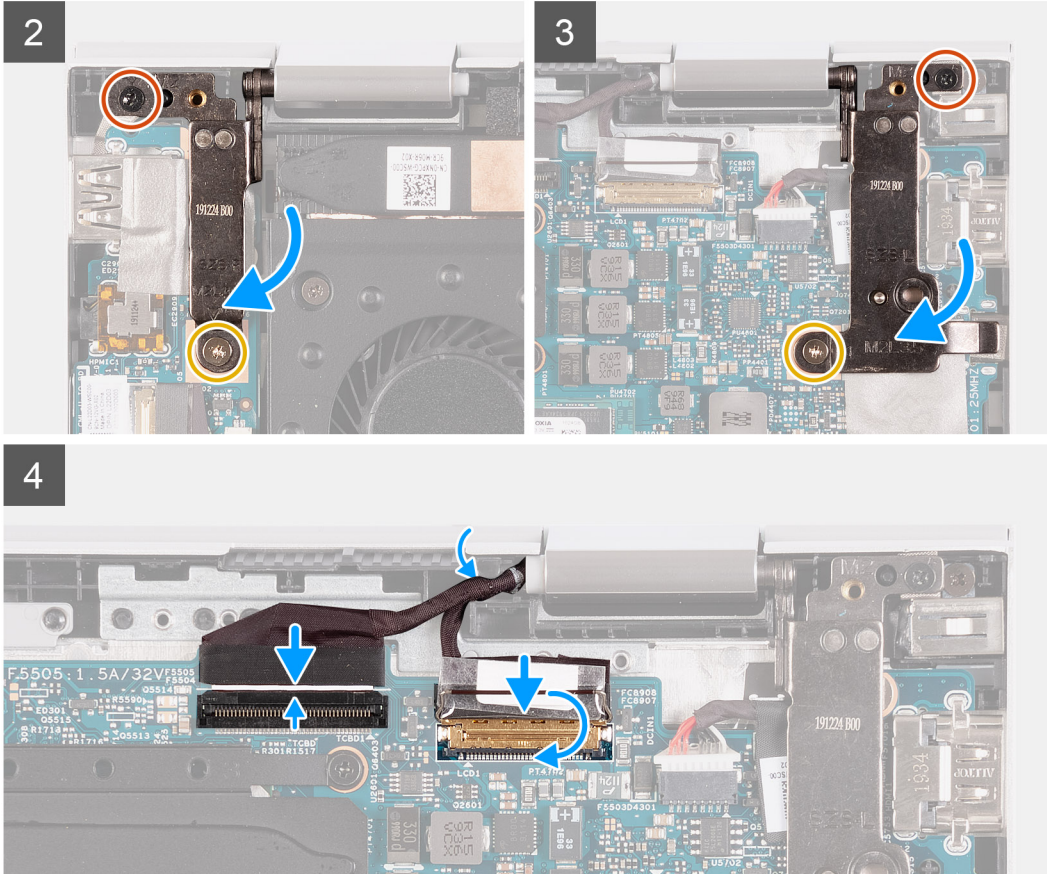

## Steps

- Align the hinges on the display assembly with the slots on the palm-rest assembly.
- Place the palm-rest assembly on the display assembly at an angle.
  - NOTE:** To avoid damaging your system do not slide the palm-rest assembly on the display assembly.
- Close the left display-hinge.
  - NOTE:** Ensure that the screw holes on the left display-hinge are aligned with the screw holes on the system board and palm-rest assembly
- Replace the screw (M2x5) that secures the left display-hinge to the palm-rest assembly.
- Replace the screw (M2x3.5) that secures the left display-hinge to the system board and palm-rest assembly.
- Close the right display-hinge.
  - NOTE:** Ensure that the screw holes on the right display-hinge are aligned with the screw holes on the I/O board and palm-rest assembly
- Replace the screw (M2x5) that secures the right display-hinge to the palm-rest assembly.
- Replace the screw (M2x3.5) that secures the right display-hinge to the system board and palm-rest assembly.
- Route the touchscreen cable and display cable through the routing guide on the palm-rest assembly.
- Connect the touchscreen cable to the system board and close the latch.

11. Connect the display cable to the system board and close the latch.
12. Adhere the tape that secures the display-cable latch to the system board.

### Next steps

1. Install the [base cover](#).
2. Follow the procedure in [After working inside your computer](#).

## Fans

### Removing the fan

#### Prerequisites

1. Follow the procedure in [Before working inside your computer](#).
2. Remove the [base cover](#).

#### About this task

The following image(s) indicate the location of the fan and provides a visual representation of the removal procedure.

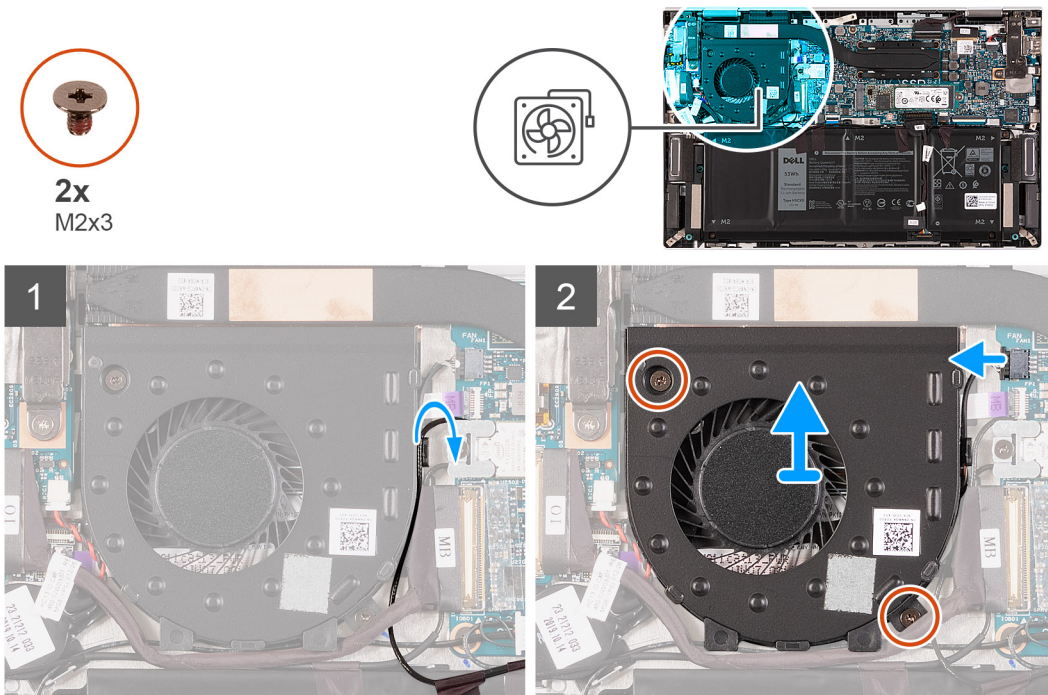

#### Steps

1. Remove the antenna cables from the routing guides on the fan.
2. Disconnect the fan cable from the system board.
3. Remove the two screws (M2x3) that secure the fan to the palm-rest assembly.
4. Lift the fan off the palm-rest assembly.

### Installing the fan

#### Prerequisites

If you are replacing a component, remove the existing component before performing the installation process.

### About this task

The following image(s) indicate the location of the fan and provides a visual representation of the installation procedure.

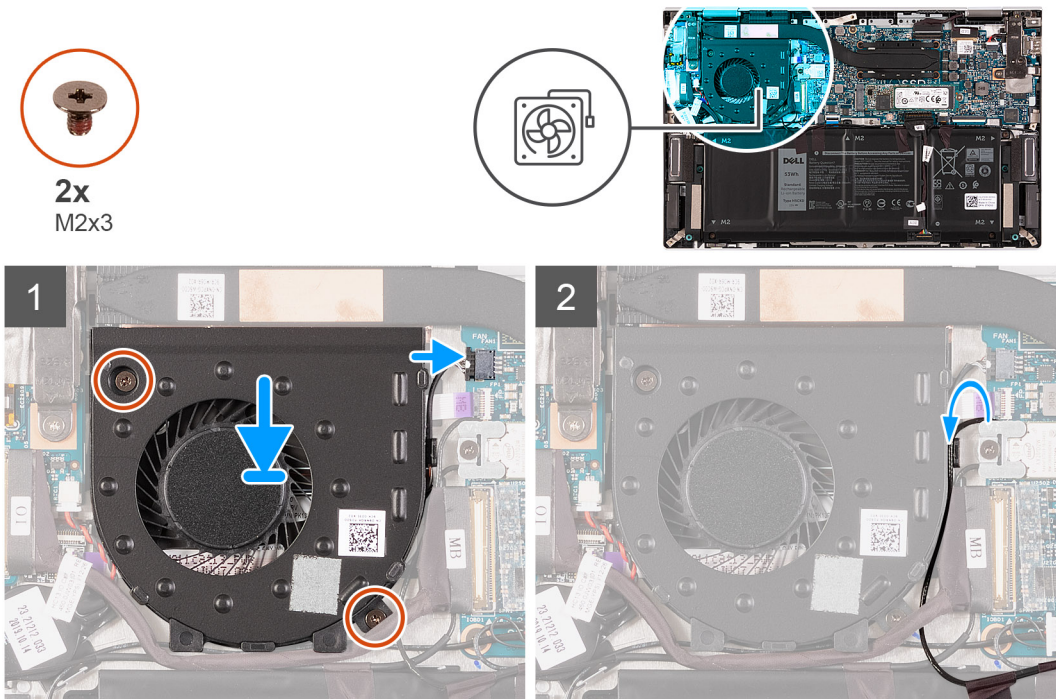

### Steps

1. Using the alignment posts, place the fan on the palm-rest assembly.
2. Replace the two screws (M2x3) that secure the fan to the palm-rest assembly.
3. Connect the fan cable to the system board.
4. Route the antenna cables through the routing guides on the fan.

### Next steps

1. Install the [base cover](#).
2. Follow the procedure in [After working inside your computer](#).

## Power-adapter port

### Removing the power-adapter port

#### Prerequisites

1. Follow the procedure in [Before working inside your computer](#).
2. Remove the [base cover](#).

### About this task

The following image(s) indicate the location of the power-adapter port and provides a visual representation of the removal procedure.



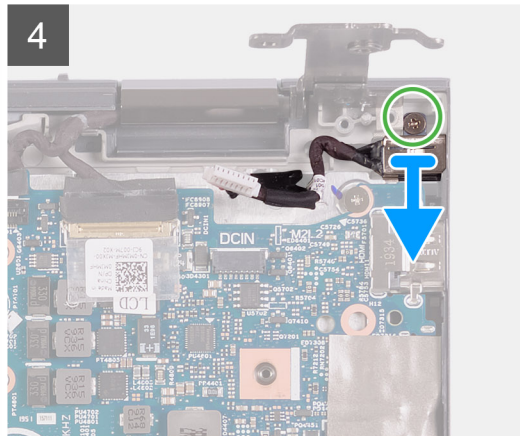
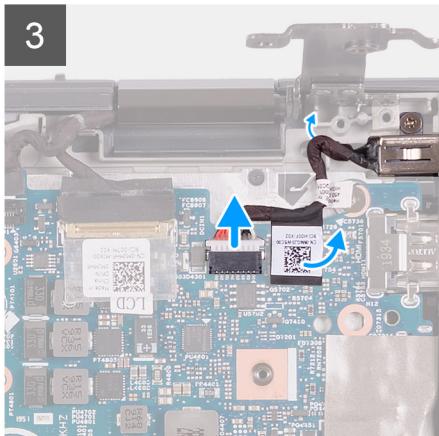
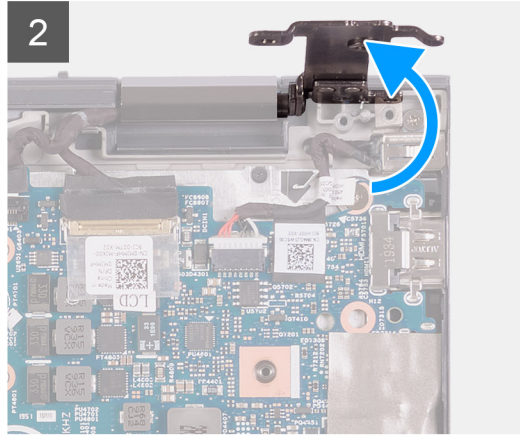
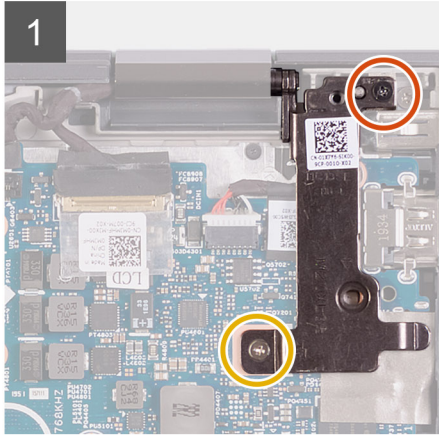
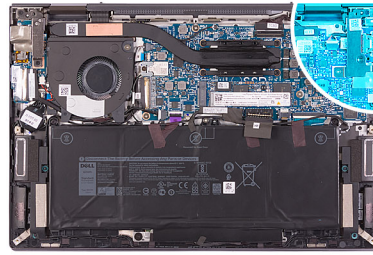

## Steps

1. Remove the screw (M2x5) that secures the right display-hinge to the palm-rest assembly.
2. Remove the screw (M2x3.5) that secures the right display-hinge to the system board and palm-rest assembly.
3. Pry open the right display-hinge.
4. Peel off the tape the secures the power-adaptor port cable to the system board.
5. Disconnect the power-adaptor port cable from the system board.
6. Remove the screw (M2x3) that secures the power-adaptor port to the palm-rest assembly.
7. Remove the power-adaptor port cable from the routing guide on the palm-rest assembly.
8. Lift the power-adaptor port along with its cable off the palm-rest assembly.

## Installing the power-adaptor port

### Prerequisites

If you are replacing a component, remove the existing component before performing the installation process.



## About this task

The following image(s) indicate the location of the power-adaptor port and provides a visual representation of the installation procedure.

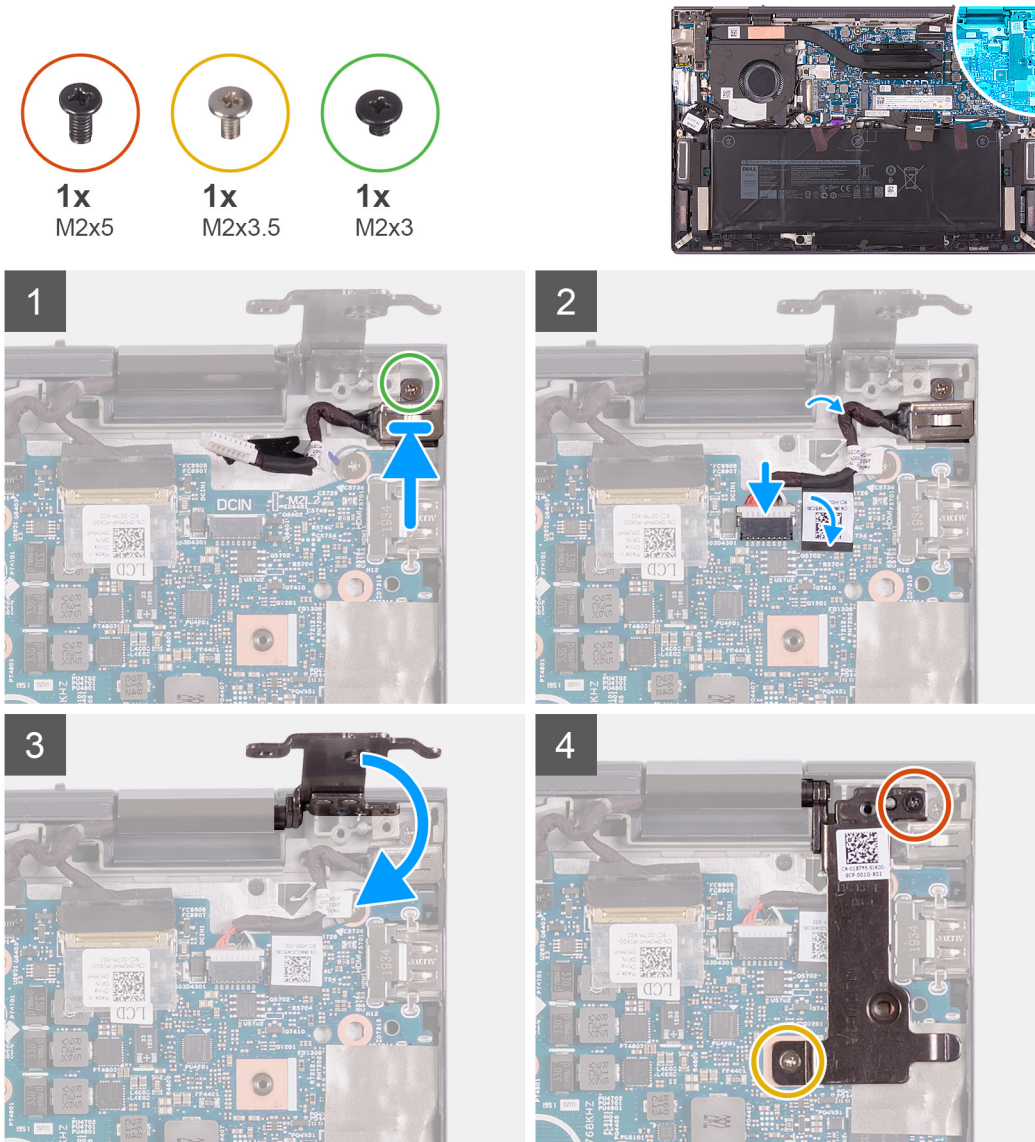

## Steps

1. Place the power-adaptor port into the slot on the palm-rest assembly.
2. Replace the screw (M2x3) that secures the power-adaptor port to the palm-rest assembly.
3. Route the power-adaptor port cable through the routing guide on the palm-rest assembly.
4. Connect the power-adaptor port cable to the system board.
5. Adhere the tape that secures the power-adaptor port cable to the system board.
6. Close the right display-hinge.

**NOTE:** Ensure that the screw holes on the left display-hinge are aligned with the screw holes on the system board and palm-rest assembly

7. Replace the screw (M2x5) that secures the right display-hinge to the palm-rest assembly.
8. Replace the screw (M2x3.5) that secures the right display-hinge to the system board and palm-rest assembly.

## Next steps

1. Install the [base cover](#).

2. Follow the procedure in [After working inside your computer](#).

# Coin-cell battery

## Removing the coin-cell battery

### Prerequisites

1. Follow the procedure in [Before working inside your computer](#).
2. Remove the [base cover](#).

### About this task

**NOTE:** Removing the coin-cell battery resets the BIOS setup program's settings to default. It is recommended that you note the BIOS setup program's settings before removing the coin-cell battery.

The following image(s) indicate the location of the coin-cell battery and provides a visual representation of the removal procedure.

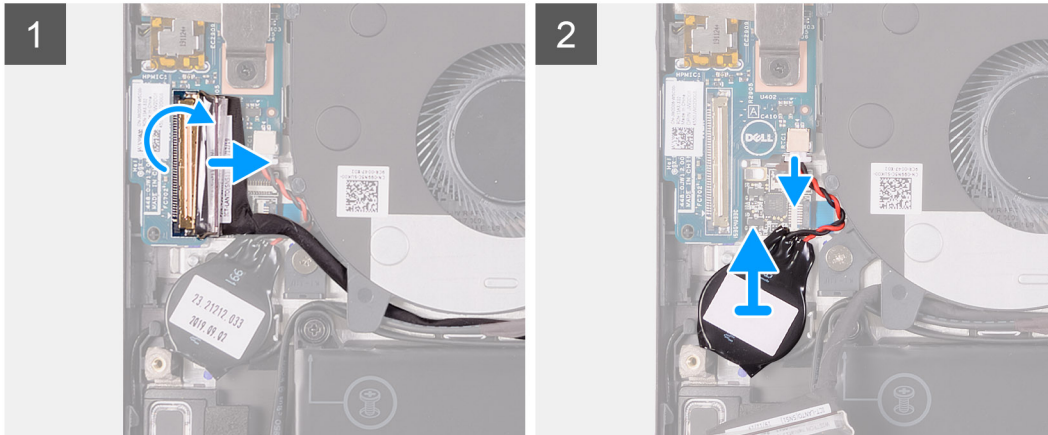
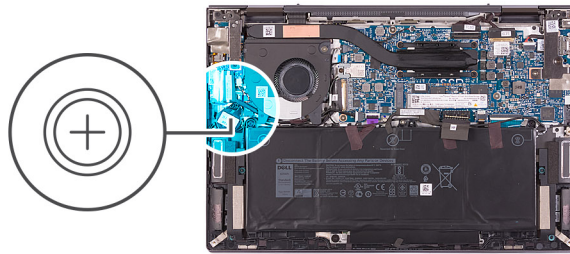

### Steps

1. Peel the tape that secures the I/O-board cable-latch to the I/O board.
2. Open the latch and disconnect the I/O-board cable from the I/O board.
3. Disconnect the coin-cell battery cable from the I/O board.
4. Peel and lift the coin-cell battery off the palm-rest assembly.

## Installing the coin-cell battery

### Prerequisites

If you are replacing a component, remove the existing component before performing the installation process.

### About this task

The following image(s) indicate the location of the coin-cell battery and provides a visual representation of the installation procedure.

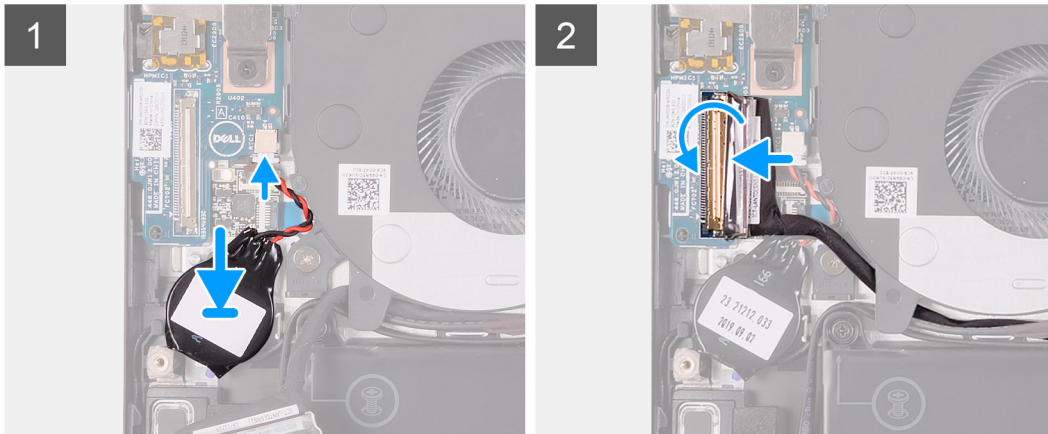
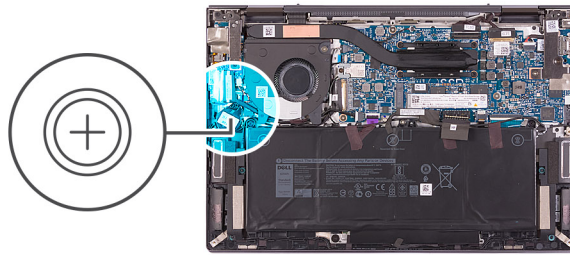

### Steps

1. Connect the coin-cell battery cable to the I/O board.
2. Adhere the coin-cell battery to the palm-rest assembly.
3. Connect the I/O-board cable to the I/O board and close the latch.
4. Adhere the tape that secures the I/O-board cable-latch to the I/O board.

### Next steps

1. Install the [base cover](#).
2. Follow the procedure in [After working inside your computer](#).

## I/O board

### Removing the I/O board

#### Prerequisites

1. Follow the procedure in [Before working inside your computer](#).
2. Remove the [base cover](#).

### About this task

The following image(s) indicate the location of the I/O board and provides a visual representation of the removal procedure.

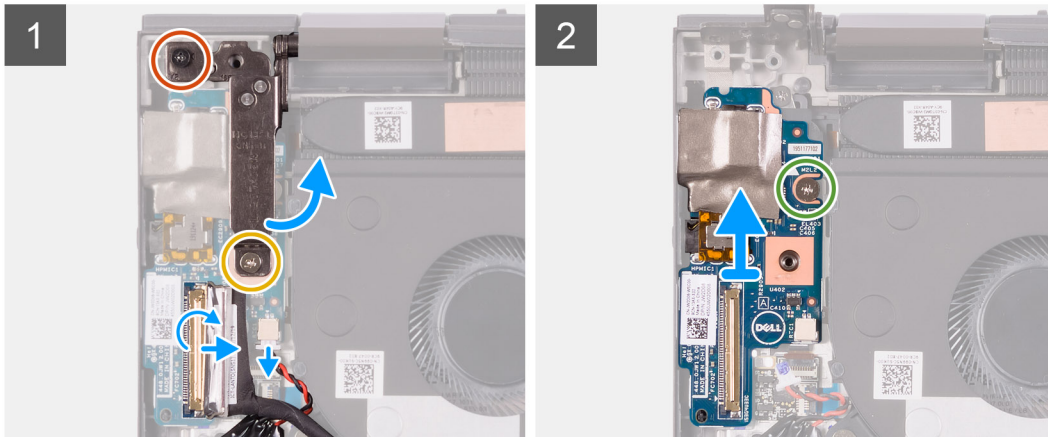
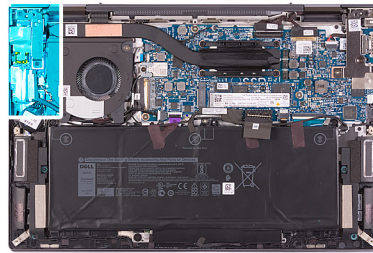

### Steps

1. Remove the screw (M2x3.5) that secures the left display-hinge to the I/O board and palm-rest assembly.
2. Remove the screw (M2x5) that secures the left display-hinge to the palm-rest assembly.
3. Pry open the left display-hinge.
4. Peel the tape that secures the I/O-board cable-latch to the I/O board.
5. Open the latch and disconnect the I/O-board cable from the I/O board.
6. Disconnect the coin-cell battery from the I/O board.
7. Remove the screw (M2x2) that secures the I/O board to the palm-rest assembly.
8. Lift the I/O-board from the palm-rest assembly.

## Installing the I/O board

### Prerequisites

If you are replacing a component, remove the existing component before performing the installation process.

### About this task

The following image(s) indicate the location of the I/O board and provides a visual representation of the installation procedure.



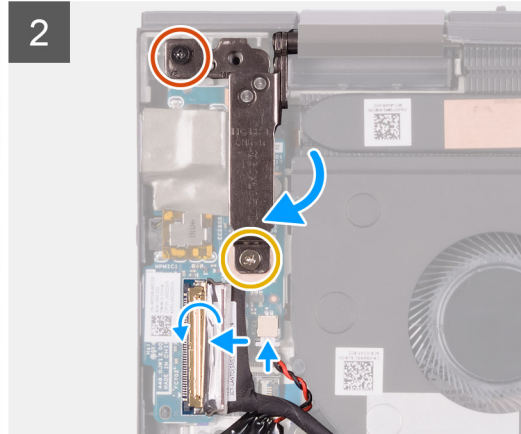
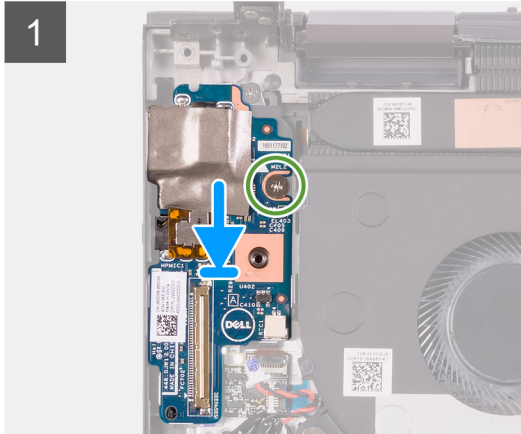
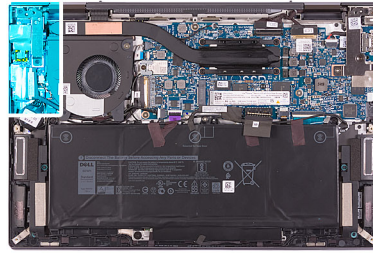

### Steps

1. Using the alignment posts, place the I/O board on the palm-rest assembly.
2. Replace the screw (M2x2) that secures the I/O board to the palm-rest assembly.
3. Close the left display-hinge.
4. Replace the screw (M2x5) that secures the left display-hinge to the palm-rest assembly.
5. Replace the screw (M2x3.5) that secures the left display-hinge to the I/O board and palm-rest assembly.
6. Connect the I/O-board cable to the I/O board and close the latch.
7. Adhere the tape that secures the I/O-board cable-latch to the I/O-board.
8. Connect the coin-cell battery cable to the I/O board.

### Next steps

1. Install the [base cover](#).
2. Follow the procedure in [After working inside your computer](#).

## Touchpad

### Removing the touchpad

#### Prerequisites

1. Follow the procedure in [Before working inside your computer](#).
2. Remove the [base cover](#).
3. Remove the [battery](#).

#### About this task

The following image(s) indicate the location of the touchpad and provides a visual representation of the removal procedure.

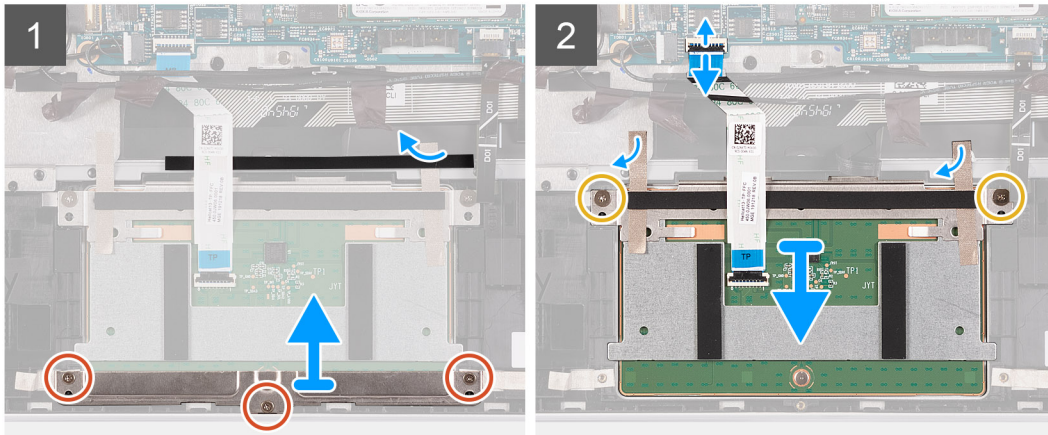
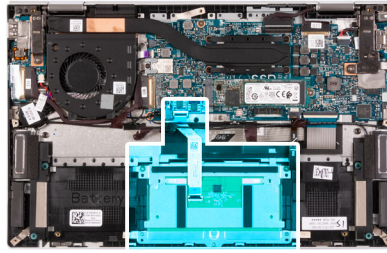
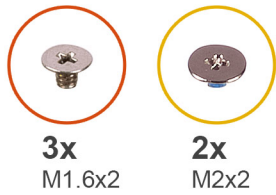

### Steps

1. Remove the three screws (M1.6x2) that secure the touchpad bracket to the palm-rest assembly.
2. Peel the mylar that covers the tape that secures the touchpad to the palm-rest assembly.
3. Lift the touchpad bracket off the palm-rest assembly.
4. Open the latch and disconnect the touchpad cable from the system board.
5. Remove the two screws (M2x2) that secure the touchpad to the palm-rest assembly.
6. Peel the tapes that secure the touchpad to the palm-rest assembly.
7. Lift the touchpad from the palm-rest assembly.

## Installing the touchpad

### Prerequisites

If you are replacing a component, remove the existing component before performing the installation process.

### About this task

The following image(s) indicate the location of the touchpad and provides a visual representation of the installation procedure.

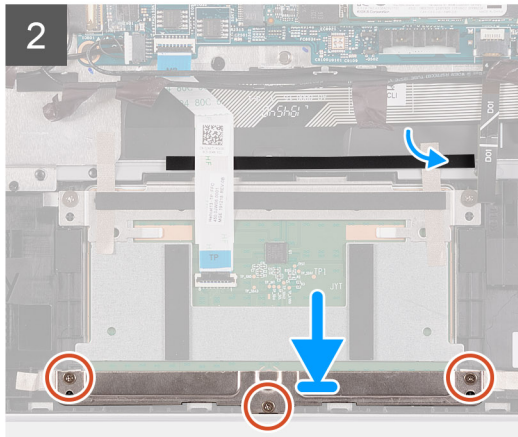
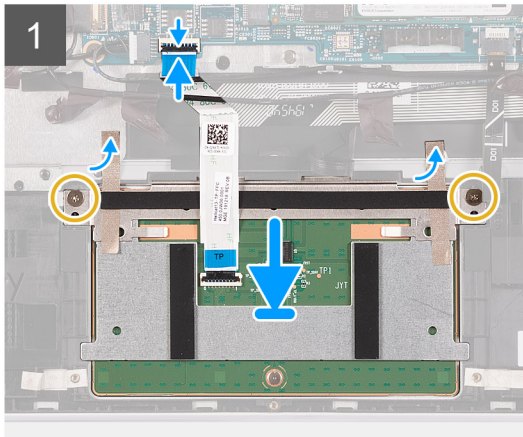
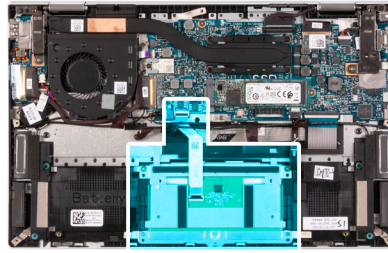
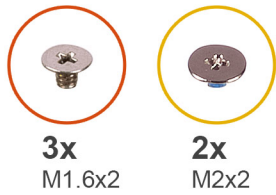

### Steps

1. Slide the touchpad into the slot on the palm-rest assembly.
2. Replace the two screws (M2x2) that secure the touchpad to the palm-rest assembly.
3. Adhere the tapes that secure the touchpad to the palm-rest assembly.
4. Connect the touchpad cable to the system board and close the latch.
5. Align the screw holes on the touchpad bracket with the screw holes on the palm-rest assembly.
6. Replace the three screws (M1.6x2) that secure the touchpad bracket to the palm-rest assembly.
7. Adhere the mylar that covers the tape that secures the touchpad to the palm-rest assembly.

### Next steps

1. Install the [battery](#).
2. Install the [base cover](#).
3. Follow the procedure in [After working inside your computer](#).

## Speakers

### Removing the speakers

#### Prerequisites

1. Follow the procedure in [Before working inside your computer](#).
2. Remove the [base cover](#).
3. Remove the [battery](#).

#### About this task

The following image(s) indicate the location of the speakers and provides a visual representation of the removal procedure.

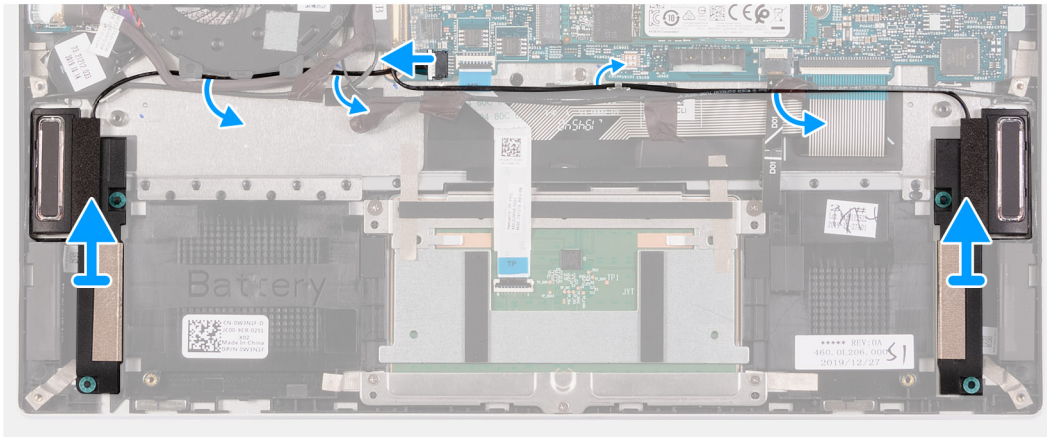
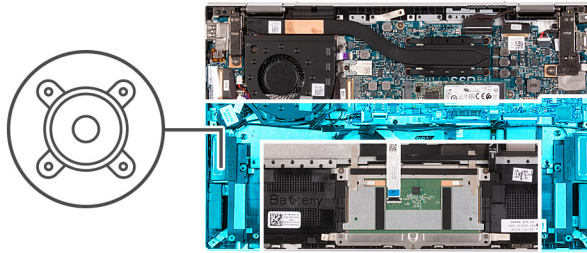

### Steps

1. Disconnect the speaker cable from the system board.
2. Remove the speaker cable from the routing guide on the fan.
3. Lift the left speaker from the palm-rest assembly.
4. Remove the speaker cable from the routing guide on the palm-rest assembly.
5. Lift both the speakers along with the speaker cable off the palm-rest assembly.

## Installing the speakers

### Prerequisites

If you are replacing a component, remove the existing component before performing the installation process.

### About this task

The following image(s) indicate the location of the speakers and provides a visual representation of the installation procedure.



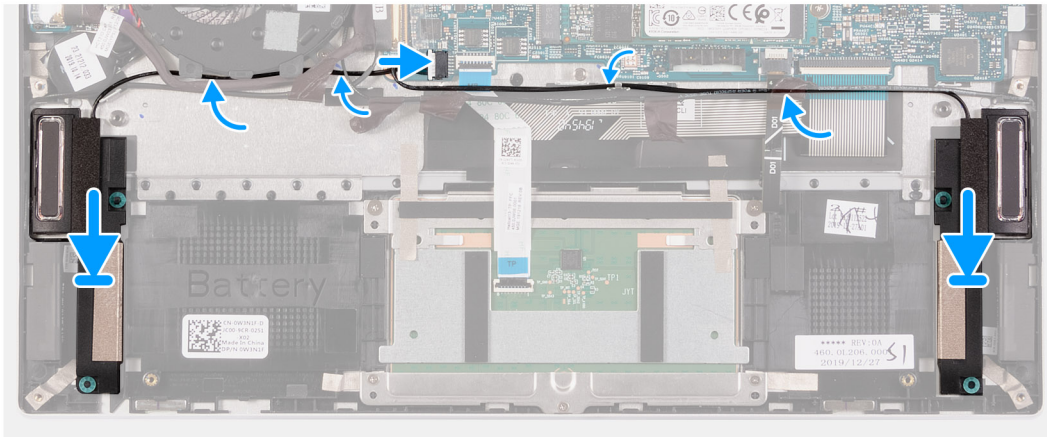
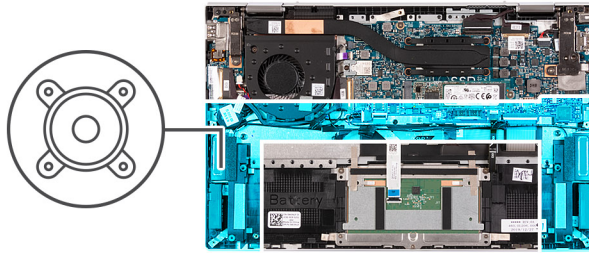

### Steps

1. Using the alignment posts, place the right speaker on the palm-rest assembly.  
**i** **NOTE:** Ensure that the alignment posts are threaded through the rubber grommets on the speaker.
2. Route the speaker cable through the routing guides on the palm-rest assembly.
3. Using the alignment posts, place the left speaker on the palm-rest assembly.  
**i** **NOTE:** Ensure that the alignment posts are threaded through the rubber grommets on the speaker.
4. Route the speaker cable through the routing guides on the fan.
5. Connect the speaker cable to the system board.

### Next steps

1. Install the [base cover](#).
2. Follow the procedure in [After working inside your computer](#).

## Heat sink

### Removing the heat sink

#### Prerequisites

1. Follow the procedure in [Before working inside your computer](#).
2. Remove the [base cover](#).

#### About this task

- i** **NOTE:** The heat sink may become hot during normal operation. Allow sufficient time for the heat sink to cool before you touch it.
- i** **NOTE:** For maximum cooling of the processor, do not touch the heat transfer areas on the heat sink. The oils in your skin can reduce the heat transfer capability of the thermal grease.

The following image(s) indicate the location of the heat sink and provides a visual representation of the removal procedure.

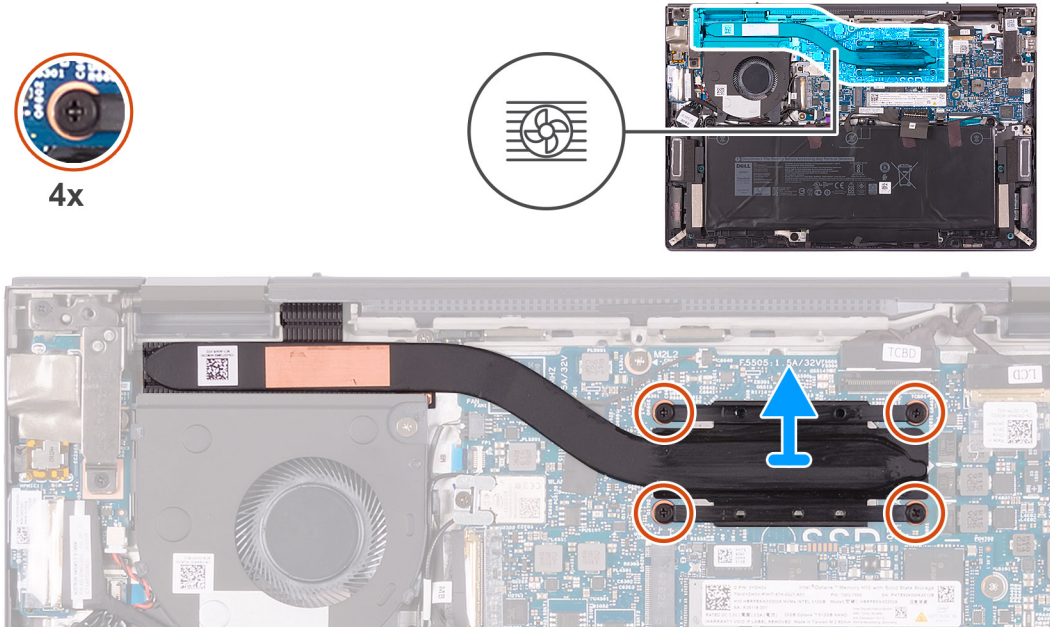

### Steps

1. In reverse sequential order (4>3>2>1) loosen the four captive screws that secure the heat sink to the system board.
2. Lift the heat sink from the system board.

## Installing the heat sink

### Prerequisites

If you are replacing a component, remove the existing component before performing the installation process.

### About this task

**i** **NOTE:** If either the system board or the heat sink is replaced, use the thermal grease provided in the kit to ensure that thermal conductivity is achieved.

The following image(s) indicate the location of the heat sink and provides a visual representation of the installation procedure.

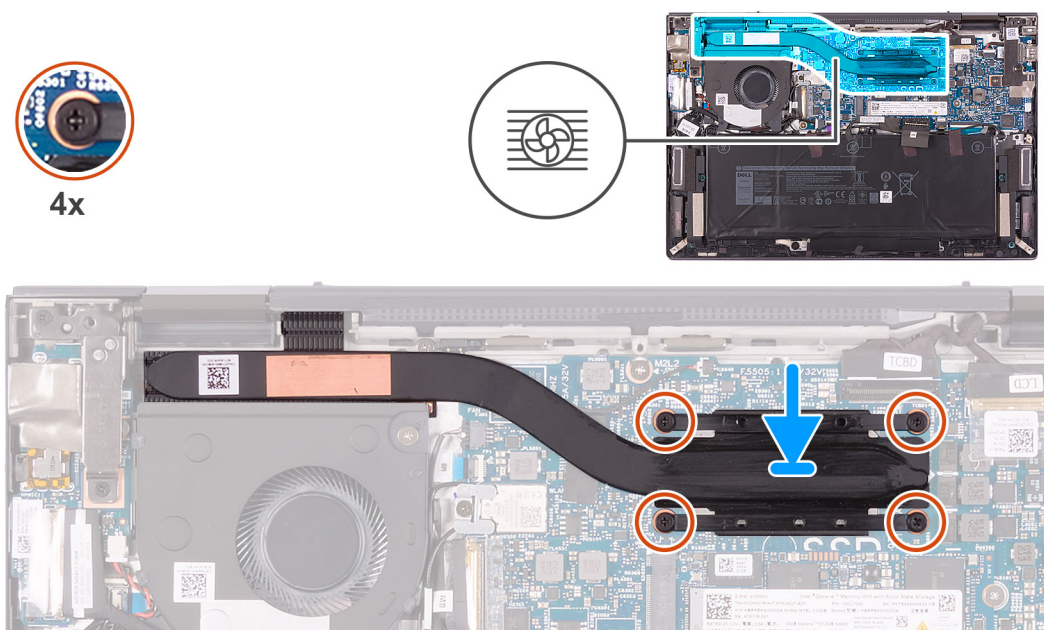

### Steps

1. Place the heat sink on the system board.
2. In sequential order (1>2>3>4) tighten the four captive screws that secure the heat sink to the system board.

### Next steps

1. Install the [base cover](#).
2. Follow the procedure in [After working inside your computer](#).

## Power button with fingerprint reader

### Removing the power-button with fingerprint reader

#### Prerequisites

1. Follow the procedure in [Before working inside your computer](#).
2. Remove the [base cover](#).
3. Remove the [fan](#).
4. Remove the [I/O board](#).

#### About this task

The following image(s) indicate the location of the power-button with fingerprint reader and provides a visual representation of the removal procedure.



2x  
M2x3

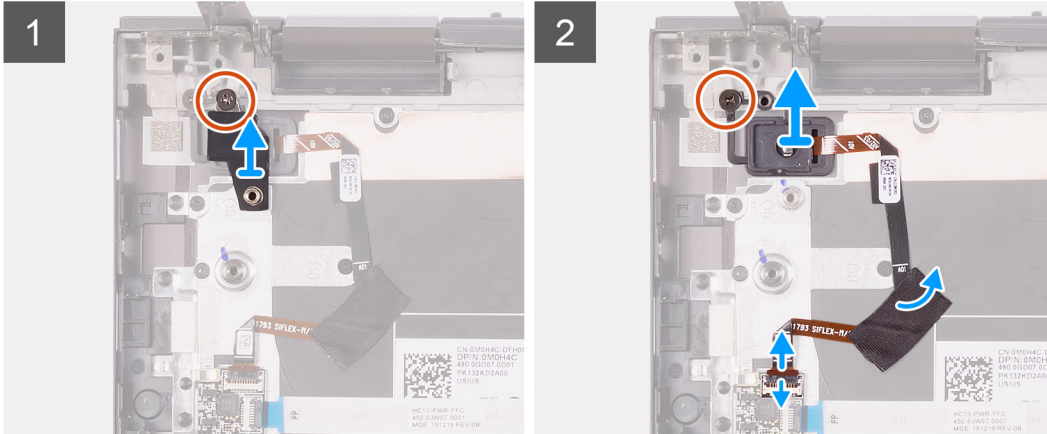
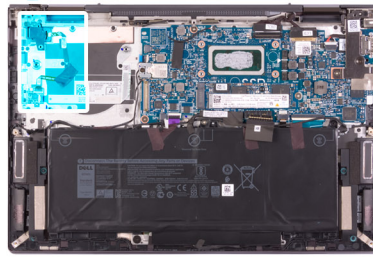

### Steps

1. Remove the screw (M2x3) that secures the power-button bracket to the palm-rest assembly.
2. Lift the power-button bracket off the palm-rest assembly.
3. Open the latch and disconnect the power-button with fingerprint reader cable from the power-button board.
4. Remove the screw (M2x3) that secures the power-button with fingerprint reader to the palm-rest assembly.
5. Peel the tape that secures the power-button with fingerprint reader cable to the palm-rest assembly.
6. Lift the power-button and fingerprint reader and its cable off the palm-rest assembly.

## Installing the power-button with fingerprint reader

### Prerequisites

If you are replacing a component, remove the existing component before performing the installation process.

### About this task

The following image(s) indicate the location of the power-button with fingerprint reader and provides a visual representation of the installation procedure.





2x  
M2x3

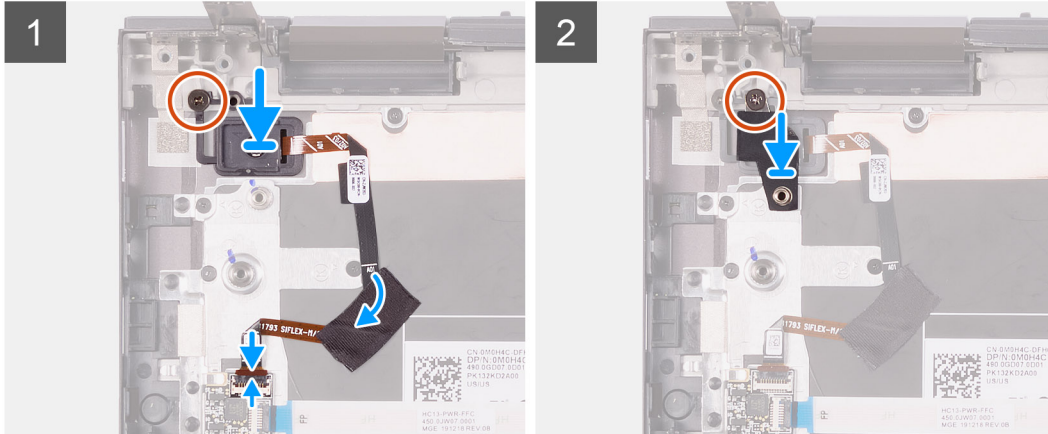
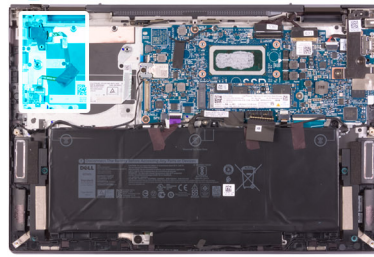

### Steps

1. Place the power-button with fingerprint reader into the slot on the palm-rest assembly.
2. Replace the screw (M2x3) that secures the power-button with fingerprint reader to the palm-rest assembly.
3. Adhere the tape that secures the power-button with fingerprint reader cable to the palm-rest assembly.
4. Connect the power-button with fingerprint-reader cable to the power-button board and close the latch.
5. Adhere the tape that secures the power-button with fingerprint reader cable to the palm-rest assembly.
6. Place the power-button bracket on the power-button with fingerprint reader.
7. Replace the screw (M2x3) that secures the power-button bracket to the palm-rest assembly.

### Next steps

1. Install the [I/O board](#).
2. Install the [fan](#).
3. Install the [base cover](#).
4. Follow the procedure in [After working inside your computer](#).

## System board

### Removing the system board

#### Prerequisites

1. Follow the procedure in [Before working inside your computer](#).
2. Remove the [base cover](#).
3. Remove the [M.2 2230 solid-state drive](#). (if applicable)
4. Remove the [M.2 2280 solid-state drive/Intel Optane H10](#). (if applicable)
5. Remove the [battery](#).
6. Remove the [fan](#).
7. Remove the [heat sink](#).



### About this task

The following image(s) indicate the location of the system board and provides a visual representation of the removal procedure.

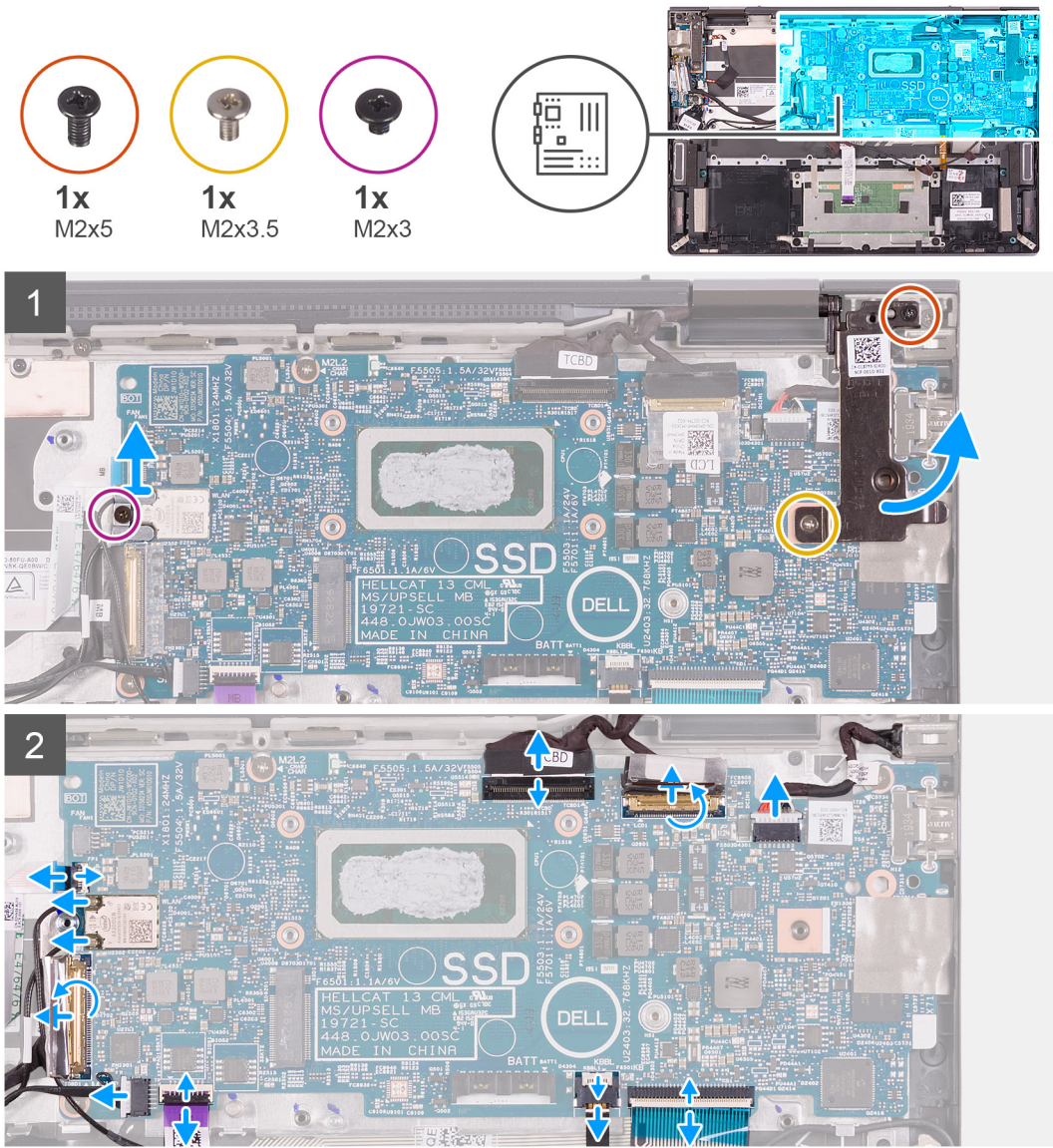



3x  
M2x2

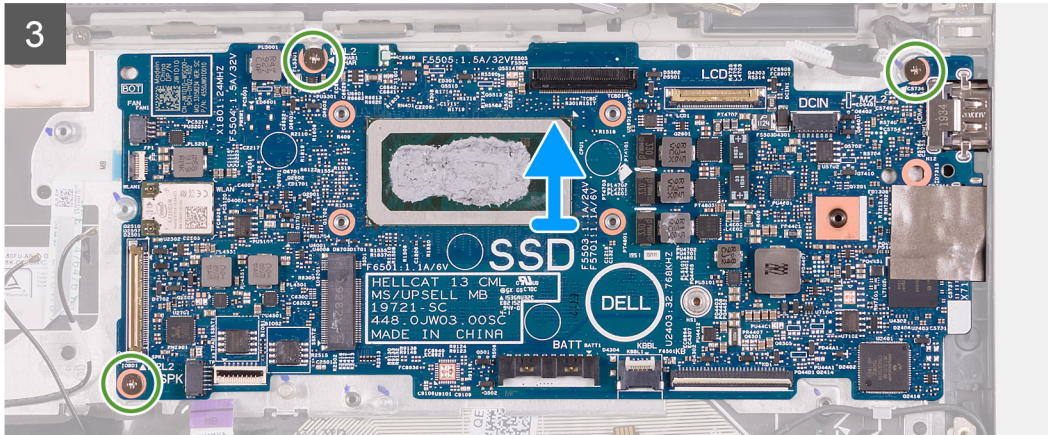

### Steps

1. Remove the screw (M2x5) that secures the right display-hinge to the palm-rest assembly.
2. Remove the screw (M2x3.5) that secures the right display-hinge to the system board and palm-rest assembly.
3. Pry open the right display-hinge.
4. Remove the screw (M2x3) that secures the wireless-card bracket to the palm-rest assembly.
5. Lift the wireless-card bracket off the system board.
6. Disconnect the power-adapter port cable from the system board.
7. Peel the tape that secures the display-cable latch to the system board.
8. Open the latch and disconnect the display cable from the system board.
9. Open the latch and disconnect the touchscreen cable from the system board.
10. Open the latch and disconnect the power-button board cable from the system board.
11. Disconnect the antenna cables from the wireless card on the system board.
12. Peel the tape that secures the I/O-board cable-latch to the system board.
13. Open the latch and disconnect the I/O-board cable from the system board.
14. Disconnect the speaker cable from the system board.
15. Open the latch and disconnect the touchpad cable from the system board.
16. Open the latch and disconnect the keyboard-backlight cable from the system board.
17. Peel the Mylar that secures the keyboard-cable latch to the system board.
18. Open the latch and disconnect the keyboard cable from the system board.
19. Remove the three screws (M2x2) that secure the system board to the palm-rest assembly.
20. Lift the system board off the palm-rest assembly.

## Installing the system board

### Prerequisites

If you are replacing a component, remove the existing component before performing the installation process.

### About this task

The following image(s) indicate the location of the system board and provides a visual representation of the installation procedure.



3x  
M2x2

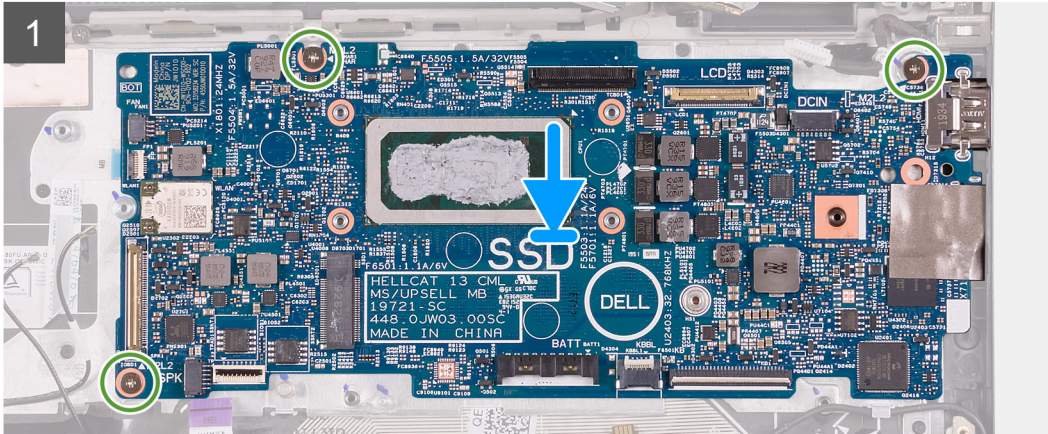
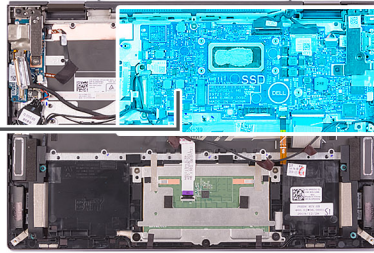



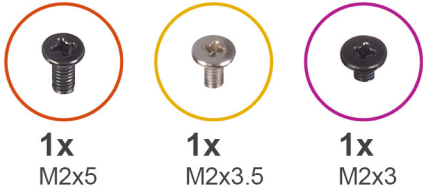

1x  
M2x5

1x  
M2x3.5

1x  
M2x3

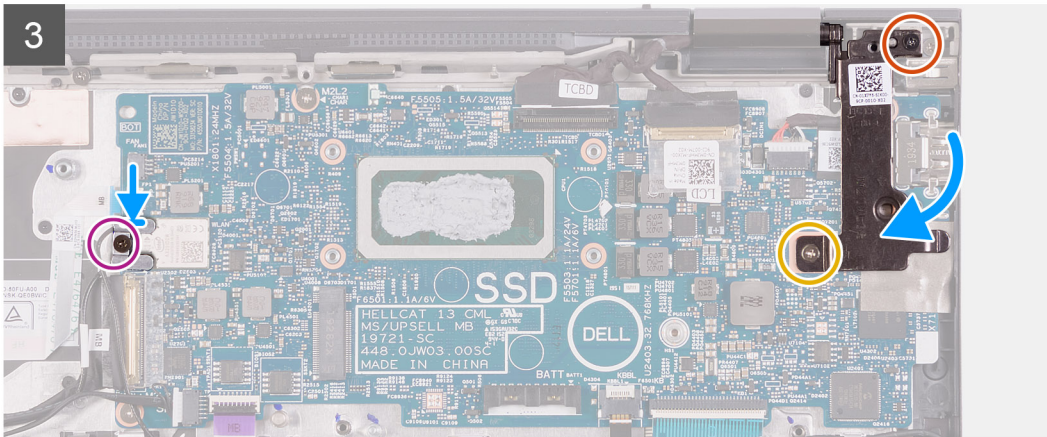
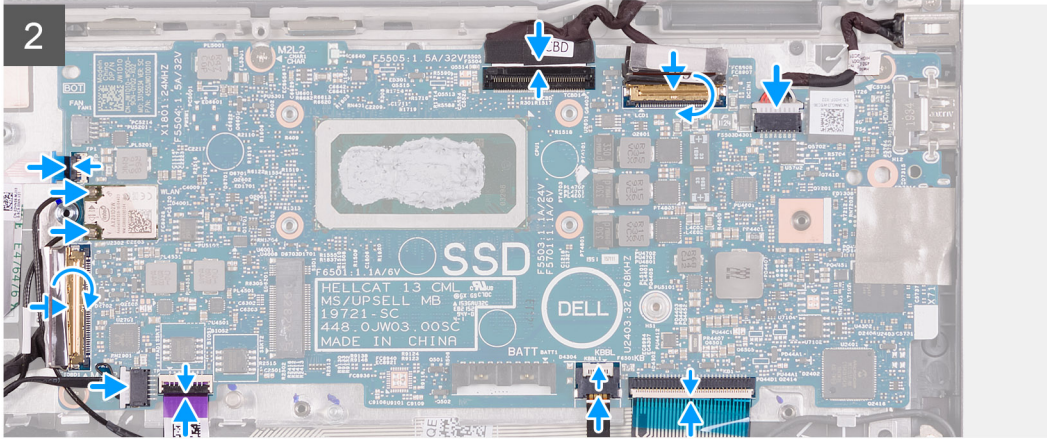

### Steps

1. Place the system board on the palm-rest assembly.
2. Replace the three screws (M2x2) that secure the system board to the palm-rest assembly.
3. Connect the power-adapter port cable to the system board.
4. Connect the display cable to the system board and close the latch.
5. Adhere the tape that secures the display-cable latch to the system board.
6. Connect the touchscreen cable to the system board and close the latch.
7. Connect the power-button board cable to the system board and close the latch.
8. Connect the antenna cables to the wireless card on the system board.

The following table provides the antenna-cable color scheme for the wireless card supported by your computer.

**Table 2. Antenna-cable color scheme**

Connectors on the wireless card	Antenna-cable color	Silkscreen marking	
Main	White	MAIN	△ (white triangle)
Auxiliary	Black	AUX	▲ (black triangle)

9. Connect the I/O-board cable to the system board and close the latch.

10. Adhere the tape that secures the I/O-board cable-latch to the system board.
11. Connect the speaker cable to the system board.
12. Connect the touchpad cable to the system board and close the latch.
13. Connect the keyboard-backlight cable from the system board and close the latch.
14. Connect the keyboard cable to the system board and close the latch.
15. Adhere the Mylar that secures the keyboard-cable latch to the system board.
16. Place the wireless-card bracket on the wireless card.
17. Replace the screw (M2x3) that secures the wireless-card bracket to the palm-rest assembly.
18. Close the right display-hinge.

 **NOTE:** Ensure that the screw holes on the left display-hinge are aligned with the screw holes on the system board and palm-rest assembly

19. Replace the screw (M2x5) that secures the right display-hinge to the palm-rest assembly.
20. Replace the screw (M2x3.5) that secures the right display-hinge to the system board and palm-rest assembly.

### Next steps

1. Install the [heat sink](#).
2. Install the [fan](#).
3. Install the [battery](#).
4. Install the [M.2 2230 solid-state drive](#). (if applicable)
5. Install the [M.2 2280 solid-state drive/Intel Optane H10](#). (if applicable)
6. Install the [base cover](#).
7. Follow the procedure in [After working inside your computer](#).

## Palm-rest and keyboard assembly

### Removing the palm-rest and keyboard assembly

#### Prerequisites

1. Follow the procedure in [Before working inside your computer](#).
2. Remove the [base cover](#).
3. Remove the [battery](#).
4. Remove the [display assembly](#).
5. Remove the [fan](#).
6. Remove the [power-adapter port](#).
7. Remove the [coin-cell battery](#).
8. Remove the [I/O board](#).
9. Remove the [touchpad](#).
10. Remove the [speakers](#).
11. Remove the [power-button with fingerprint reader](#).
12. Remove the [system board](#).

 **NOTE:** The system board can be removed along with the heat sink.

#### About this task

The following image(s) indicate the location of the palm-rest and keyboard assembly and provides a visual representation of the removal procedure.



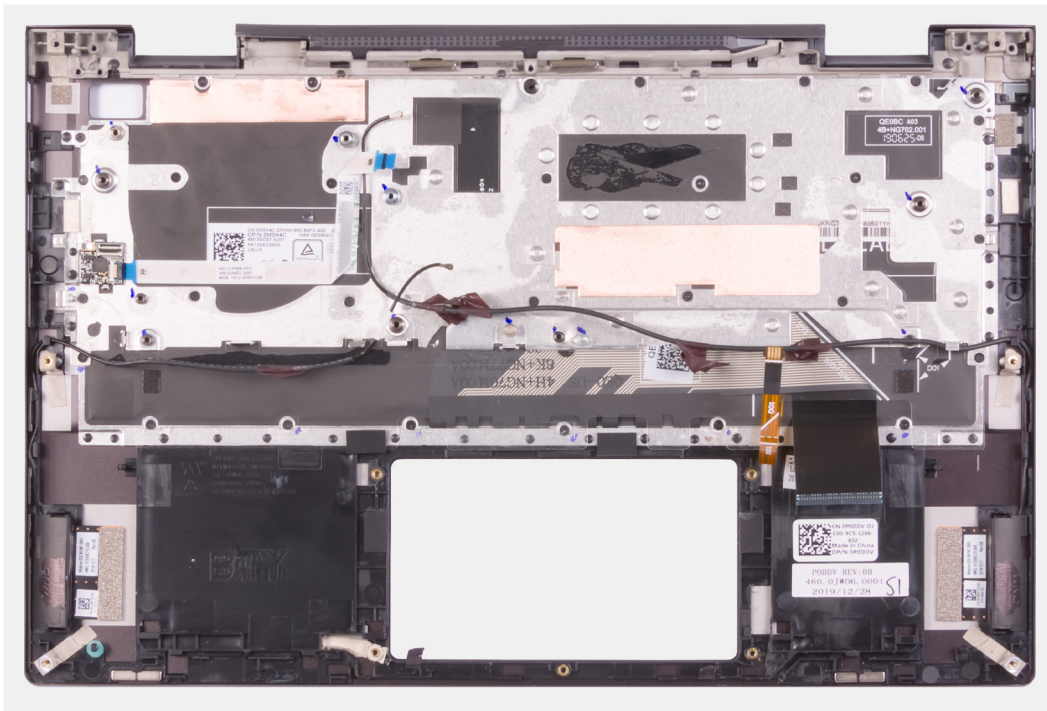

### Steps

After performing the pre-requisites, you are left with the palm-rest and keyboard assembly.

## Installing the palm-rest and keyboard assembly

### Prerequisites

If you are replacing a component, remove the existing component before performing the installation process.

### About this task

The following image(s) indicate the location of the palm-rest and keyboard assembly and provides a visual representation of the installation procedure.

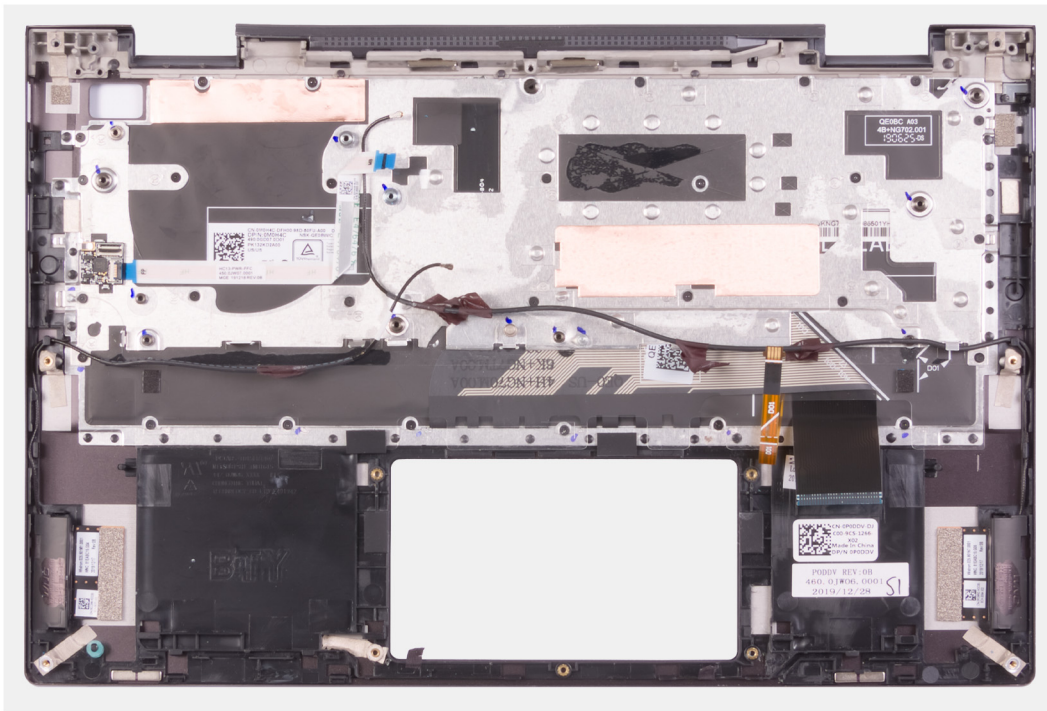

## Steps

To install the palm-rest and keyboard assembly perform the post-requisites.

## Next steps

1. Install the [system board](#).
2. Install the [power-button with fingerprint reader](#).
3. Install the [speakers](#).
4. Install the [touchpad](#).
5. Install the [I/O board](#).
6. Install the [coin-cell battery](#).
7. Install the [power-adapter port](#).
8. Install the [fan](#).
9. Install the [display assembly](#).
10. Install the [battery](#).
11. Install the [base cover](#).
12. Follow the procedure in [After working inside your computer](#).

## Drivers and downloads

When troubleshooting, downloading or installing drivers it is recommended that you read the Dell Knowledge Based article, Drivers and Downloads FAQ [000123347](#).

# System setup

**CAUTION:** Unless you are an expert computer user, do not change the settings in the BIOS Setup program. Certain changes can make your computer work incorrectly.

**NOTE:** Depending on the computer and its installed devices, the items listed in this section may or may not be displayed.

**NOTE:** Before you change BIOS Setup program, it is recommended that you write down the BIOS Setup program screen information for future reference.

Use the BIOS Setup program for the following purposes:

- Get information about the hardware installed in your computer, such as the amount of RAM and the size of the hard drive.
- Change the system configuration information.
- Set or change a user-selectable option, such as the user password, type of hard drive installed, and enabling or disabling base devices.

## Entering BIOS setup program

### About this task

Turn on (or restart) your computer and press F2 immediately.

## Navigation keys

**NOTE:** For most of the System Setup options, changes that you make are recorded but do not take effect until you restart the system.

**Table 3. Navigation keys**

Keys	Navigation
Up arrow	Moves to the previous field.
Down arrow	Moves to the next field.
Enter	Selects a value in the selected field (if applicable) or follow the link in the field.
Spacebar	Expands or collapses a drop-down list, if applicable.
Tab	Moves to the next focus area. <b>NOTE:</b> For the standard graphics browser only.
Esc	Moves to the previous page until you view the main screen. Pressing Esc in the main screen displays a message that prompts you to save any unsaved changes and restarts the system.

## Boot Sequence

Boot Sequence allows you to bypass the System Setup–defined boot device order and boot directly to a specific device (for example: optical drive or hard drive). During the Power-on Self Test (POST), when the Dell logo appears, you can:

- Access System Setup by pressing F2 key

- Bring up the one-time boot menu by pressing F12 key

The one-time boot menu displays the devices that you can boot from including the diagnostic option. The boot menu options are:

- Removable Drive (if available)
- STXXXX Drive (if available)
- **i** **NOTE:** XXX denotes the SATA drive number.
- Optical Drive (if available)
- SATA Hard Drive (if available)
- Diagnostics

The boot sequence screen also displays the option to access the System Setup screen.

## One time boot menu

To enter **one time boot menu**, turn on your computer, and then press F2 immediately.

**i** **NOTE:** It is recommended to shutdown the computer if it is on.

The one-time boot menu displays the devices that you can boot from including the diagnostic option. The boot menu options are:

- Removable Drive (if available)
- STXXXX Drive (if available)
- **i** **NOTE:** XXX denotes the SATA drive number.
- Optical Drive (if available)
- SATA Hard Drive (if available)
- Diagnostics

The boot sequence screen also displays the option to access the System Setup screen.

## System setup options

**i** **NOTE:** Depending on this computer and its installed devices, the items that are listed in this section may or may not be displayed.

**Table 4. System setup options—System information menu**

Overview	
<b>Inspiron 7306 2-in-1</b>	
BIOS Version	Displays the BIOS version number.
Service Tag	Displays the Service Tag of the computer.
Asset Tag	Displays the Asset Tag of the computer.
Manufacture Date	Displays the manufacture date of the computer.
Ownership Date	Displays the ownership date of the computer.
Express Service Code	Displays the express service code of the computer.
Ownership Tag	Displays the ownership tag of the computer.
Signed Firmware Update	Displays whether the signed firmware update is enabled. Default: Enabled
<b>Battery</b>	
Primary	Displays the primary battery.
Battery Level	Displays the battery level.



**Table 4. System setup options—System information menu (continued)**

<b>Overview</b>	
Battery State	Displays the battery state.
Health	Displays the battery health.
AC Adapter	Displays whether an AC adapter is connected. If connected, the AC adapter type.
<b>PROCESSOR</b>	
Processor Type	Displays the processor type.
Maximum Clock Speed	Displays the maximum processor clock speed.
Minimum Clock Speed	Displays the minimum processor clock speed.
Current Clock Speed	Displays the current processor clock speed.
Core Count	Displays the number of cores on the processor.
Processor ID	Displays the processor identification code.
Processor L2 Cache	Displays the processor L2 Cache size.
Processor L3 Cache	Displays the processor L3 Cache size.
Microcode Version	Displays the microcode version.
Intel Hyper-Threading Capable	Displays whether the processor is Hyper-Threading (HT) capable.
64-Bit Technology	Displays whether 64-bit technology is used.
<b>MEMORY</b>	
Memory Installed	Displays the total computer memory installed.
Memory Available	Displays the total computer memory available.
Memory Speed	Displays the memory speed.
Memory Channel Mode	Displays single or dual channel mode.
Memory Technology	Displays the technology that is used for the memory.
<b>DEVICES</b>	
Panel Type	Displays the Panel Type of the computer.
Video Controller	Displays the integrate graphics information of the computer.
Video Memory	Displays the video memory information of the computer.
Wi-Fi Device	Displays the Wi-Fi device installed in the computer.
Native Resolution	Displays the native resolution of the computer.
Video BIOS Version	Displays the video BIOS version of the computer.
Audio Controller	Displays the audio controller information of the computer.
Bluetooth Device	Displays whether a Bluetooth device is installed in the computer.

**Table 5. System setup options—Boot Configuration menu**

<b>Boot Configuration</b>	
<b>Boot Sequence</b>	
Boot Mode: UEFI only	Displays the boot mode of this computer.
Boot Sequence	Enables or disables Windows Boot Manager and UEFI Hard Drive. By default, Windows Boot Manager is selected By default, UEFI Hard Drive is selected
<b>Secure Boot</b>	

**Table 5. System setup options—Boot Configuration menu (continued)**

<b>Boot Configuration</b>	
Enable Secure Boot	Enables secure boot using only validated boot software. Default: OFF
Secure Boot Mode	Changes to the Secure Boot operation mode. Allows to switch between Deployed Mode and Audit Mode. Default: Deployed Mode
<b>Expert Key Management</b>	
Enable Custom Mode	Allows the PK, KEK, db, and dbx security key databases to be modified.
Custom Mode Key Management	Allows for selection of key database.

**Table 6. System setup options—Integrated Devices menu**

<b>Integrated Devices</b>	
<b>Date/Time</b>	
Date	Sets the computer date in MM/DD/YYYY format. Changes to the date take effect immediately.
Time	Sets the computer time in HH/MM/SS 24-hour format. You can switch between 12-hour and 24-hour clock. Changes to the time take effect immediately.
<b>Camera</b>	
Enable Camera	Enables or disables the camera. By default, Enable Camera is selected.
<b>Audio</b>	
<b>Enable Audio</b>	
	Enables or disables all integrated audio controller. Default: ON
Enable Microphone	Enables or disables microphone. By default, Enable Microphone is selected.
Enable Internal Speaker	Enables or disables internal speaker. By default, Enable Internal Speaker is selected.
<b>USB/Thunderbolt Configuration</b>	
Enable External USB Ports	Enables or disables all external USB ports in an OS environment. By default, Enable External USB Ports is selected.
Enable USB Boot Support	Enables or disables booting from USB mass storage devices such as external hard drive, optical drive, and USB drive. By default, Enable USB Boot Support is selected.
Enable Thunderbolt Boot Support	Enables or disables Thunderbolt Boot Support. Default: OFF
Enable Thunderbolt (and PCIe behind TBT) pre-boot modules	Enables or disables to allow or disallow PCIe devices to be connected through a Thunderbolt adapter during pre-boot. Default: OFF

**Table 7. System setup options—Storage menu**

Storage	
<b>SATA/NVMe Operation</b>	
SATA/NVMe Operation	Configures operating mode of the integrated storage device controller. Default: RAID On. Storage device is configured to support RAID functions. When enabled, all NVMe and SATA devices will be mapped under VMD controller. Windows RST (Intel Rapid Restore Technology) driver, or Linux kernel VMD driver must be loaded in order to boot the OS.
<b>Storage Interface</b>	
Port Enablement	Enables or disables the onboard drives. Default: ON
<b>SMART Reporting</b>	
Enable SMART Reporting	Enables or disables Self-Monitoring, Analysis, and Reporting Technology (SMART). Default: OFF
<b>Drive Information</b>	Displays the information of various onboard drives.

**Table 8. System setup options—Display menu**

Display	
<b>Display Brightness</b>	
Brightness on battery power	Sets the screen brightness when the computer is running on battery power. Default: 50
Brightness on AC power	Sets the screen brightness when the computer is running on AC power. Default: 100
Full Screen Logo	When turned on, the full screen logo is displayed if the image matches the screen resolution. Default: OFF

**Table 9. System setup options—Connection menu**

Connection	
<b>Wireless Device Enable</b>	
WLAN	Enable or disable internal WLAN devices. By default, WLAN is selected.
Bluetooth	Enable or disable internal Bluetooth devices. By default, Bluetooth is selected.
<b>Enable UEFI Network Stack</b>	Enables or disables UEFI networking protocols, if they are installed and available. Default: ON

**Table 10. System setup options—Power menu**

Power	
<b>Battery Configuration</b>	Enables the computer to run on battery during power usage hours. Use the below options to prevent AC power usage between certain times of each day. Default: Adaptive. Battery settings are adaptively optimized based on your typical battery usage pattern.

**Table 10. System setup options—Power menu (continued)**

<b>Power</b>	
<b>Advanced Configuration</b>	
Enable Advanced Battery Charge Configuration	Enables Advanced Battery Charge Configuration from the beginning of the day to a specified work period. Advanced Battery Charged maximizes battery health while still supporting heavy use during the work day. Default: OFF
<b>Thermal Management</b>	
	Enables the cooling fan and processor heat management to adjust system performance, noise, and temperature. Default: Optimized. Standard settings for cooling fan and processor heat management. This setting is a balance of performance, noise, and temperature.
<b>USB Wake Support</b>	
Wake on Dell USB-C Dock	Enables connecting a Dell USB-C Dock to wake the computer from Standby. Default: ON
<b>Block Sleep</b>	
	Blocks the computer from entering Sleep (S3) mode in the operating system. Default: OFF
	<b>NOTE:</b> If enabled, the computer will not go to sleep, Intel Rapid Start will be disabled automatically, and the operating system power option will be blank if it was set to Sleep.
<b>Lid Switch</b>	
Enable Lid Switch	Enable or disable the lid switch. Default: ON
Power On Lid Open	Enables the computer to power up from the off state whenever the lid is opened. Default: ON
<b>Intel Speed Shift Technology</b>	
	Enables or disables the Intel Speed Shift Technology support. Setting this option to enable allows the operating system to select the appropriate processor performance automatically. Default: ON

**Table 11. System setup options—Security menu**

<b>Security</b>	
<b>Intel Platform Trust Technology</b>	
Intel Platform Trust Technology On	Enable or disable the Intel Platform Trust Technology (PPT) feature in the OS. Default: ON
PPI Bypass for Clear Commands	Enables or disables the Trusted Platform Model (TPM) Physical Presence Interface (PPI). When enabled, the OS will skip BIOS Physical Presence Interface (PPI) user prompts when issuing the Clear command. Default: OFF
Clear	Enables or disables the computer to clear the PTT owner information, and returns the PTT to the default state. Default: OFF
<b>SMM Security Mitigation</b>	
	Enables or disables additional UEFI SMM Security Mitigation protections. Default: OFF

**Table 11. System setup options—Security menu (continued)**

Security	
	 <b>NOTE:</b> This feature may cause compatibility issues or loss of functionality with some legacy tools and applications.
<b>Data Wipe on Next Boot</b>	When enabled, the BIOS will schedule a data wipe cycle for all storage devices connected to the system board on the next reboot. Default: OFF
<b>Absolute</b>	Enables, disables or permanently disable the BIOS module interface of the optional Absolute Persistence Module service from Absolute Software. Default: Enabled
<b>UEFI Boot Path Security</b>	Determines if the system will prompt the user to enter the admin password (if set) when booting to a UEFI boot path device from the F12 boot menu. Default: Always Except Internal HDD.

**Table 12. System setup options—Passwords menu**

Passwords	
<b>Admin Password</b>	Enables the user to set, change, or delete the administrator (admin) password. The admin password enables several security features
<b>System Password</b>	Enables the user to set, change, or delete the system password.
<b>Password Configuration</b>	
Upper Case Letter	Enforces password restriction that the password must contain at least one upper case letter. Default: OFF
Lower Case Letter	Enforces password restriction that the password must contain at least one lower case letter. Default: OFF
Digit	Enforces password restriction that the password must contain at least one digit. Default: OFF
Special Character	Enforces password restriction that the password must contain at least one special character. Default: OFF
Minimum Characters	Controls the minimum number of characters allowed for password. Default: 04
<b>Password Bypass</b>	Bypass the System (Boot) Password and the internal hard drive password prompts during a system restart. Default: Disabled
<b>Password Changes</b>	
Enable Non-Admin Password Changes	Enables or disables the user to change the system and hard drive password without the need for admin password. Default: ON
<b>Admin Setup Lockout</b>	
Enable Admin Setup Lockout	Enables or disables the user from entering BIOS Setup when an Admin Password is set.



**Table 12. System setup options—Passwords menu (continued)**

Passwords	
	Default: OFF
<b>Master Password Lockout</b>	
Enable Master Password Lockout	Enables or disables master password support. Default: OFF
	 <b>NOTE:</b> Hard drive passwords must be cleared before the setting can be changed.

**Table 13. System setup options—Update, Recovery menu**

Update, Recovery	
<b>UEFI Capsule Firmware Updates</b>	Enable or disable internal WLAN/Bluetooth devices. By default, WLAN is selected. By default, Bluetooth is selected.
Enable UEFI Capsule Firmware Updates	Enables or disables BIOS updates through UEFI capsule update packages. Default: ON
<b>BIOS Recovery from Hard Drive</b>	Enables the computer to recover from a bad BIOS image, as long as the Boot Block portion is intact and functioning. Default: ON
	 <b>NOTE:</b> BIOS recovery is designed to fix the main BIOS block and cannot work if the Boot Block is damaged. In addition, this feature cannot work in the event of EC corruption, ME corruption, or a hardware issue. The recovery image must exist on an unencrypted partition on the drive.
<b>BIOS Downgrade</b>	
Allow BIOS Downgrade	Controls flashing of the system firmware to previous revisions. Default: ON
<b>SupportAssist OS Recovery</b>	Enables or disables the boot flow for SupportAssist OS Recovery tool, in the event of certain system error. Default: ON
<b>BIOSConnect</b>	Enables or disables cloud Service OS recovery if the main OS fails to boot within the number of failures equal or greater than the value specified by Dell Auto OS Recovery Threshold, and local Service does not boot, or is not installed. Default: ON
<b>Dell Auto OS Recovery Threshold</b>	Controls the automatic boot flow for SupportAssist System Resolution Console and for Dell operating system Recovery tool. Default: 2

**Table 14. System setup options—System Management menu**

System Management	
<b>Service Tag</b>	Displays the Service Tag of the computer.
<b>Asset Tag</b>	Creates a system Asset Tag that can be used by an IT administrator to uniquely identify a particular system. Once set in BIOS, the Asset Tag cannot be changed.
<b>AC Behavior</b>	

**Table 14. System setup options—System Management menu (continued)**

System Management	
Wake on AC	Enables or disables basic checks when AC power is applied to the device. The checks include determining how the AC Recovery option is set. The system will boot up if Wake on AC is enabled, the system will power off, if Wake on AC is disabled.  Default: OFF
<b>Auto On Time</b>	Controls automatic powering up of system for defined days and times.  Default: Disabled

**Table 15. System setup options—Keyboard menu**

Keyboard	
<b>Numlock Enable</b> Enable Numlock	Enables or disables Numlock when the computer boots.  Default: ON
<b>Fn Lock Options</b> Lock Mode	Enables or disables the Fn lock mode.  Default: ON  Controls operation of function keys F1-F12. Default: Lock Mode Secondary
<b>Keyboard Illumination</b>	Enables the user to change the keyboard illumination settings.  Default: Bright
<b>Keyboard Backlight Timeout on AC</b>	Enables the user to define the timeout value for the keyboard backlight when an AC adapter is plugged into the system.  Default: 1 minute
<b>Keyboard Backlight Timeout on Battery</b>	Enables the user to define the timeout value for the keyboard backlight when the system is operating only on battery power.  Default: 1 minute

**Table 16. System setup options—Pre-boot Behavior menu**

Pre-boot Behavior	
<b>Adapter warnings</b> Enable Adapter warnings	Enables or disables the computer to display adapter warning messages when adapters with too little power capacity are detected.  Default: ON
<b>Warnings and Errors</b>	Selects an action on encountering a warning or error during boot.  Default: Prompt on Warnings and Errors. Stop, prompt, and wait for user input when warnings or errors are detected.  <b>i</b> <b>NOTE:</b> Errors deemed critical to the operation of the computer hardware will always halt the computer.
<b>USB-C Warnings</b>	Specify the maximum number of characters allowed for Admin password.  Default: 32
Enable Dock Warning Messages	Enable or disable dock warning messages.  Default: ON
<b>Fastboot</b>	Configures the speed of the UEFI boot process.

**Table 16. System setup options—Pre-boot Behavior menu (continued)**

Pre-boot Behavior	
	Default: Thorough. Performs complete hardware and configuration initialization during boot.
<b>Extend BIOS POST Time</b>	Configures the BIOS POST (Power-On Self-Test) load time. Default: 0 seconds

**Table 17. System setup options—Virtualization menu**

Virtualization	
<b>Intel Virtualization Technology</b>	
Enable Intel Virtualization Technology (VT)	Enables the computer to run a virtual machine monitor (VMM). Default: ON
<b>VT for Direct I/O</b>	
Enable Intel VT for Direct I/O	Enables the computer to perform Virtualization Technology for Direct I/O (VT-d). VT-d is an Intel method that provides virtualization for memory map I/O. Default: ON

**Table 18. System setup options—Performance menu**

Performance	
<b>Multi-Core Support</b>	
Active Cores	Changes the number of CPU cores available to the operating system. The default value is set to the maximum number of cores. Default: All Cores
<b>Intel SpeedStep</b>	
Enable Intel SpeedStep Technology	Enables or disables the Intel SpeedStep Technology to dynamically adjust processor voltage and core frequency, decreasing average power consumption and heat production. Default: ON
<b>C-State Control</b>	
Enable C-State Control	Enables or disables the CPU's ability to enter and exit low-power states. Default: ON
<b>Intel Turbo Boost Technology</b>	
Enable Intel Turbo Boost Technology	Enabled or disabled the Intel TurboBoost mode of the processor. If enabled, the Intel TurboBoost driver increases the performance of the CPU or graphics processor. Default: ON
<b>Intel Hyper-Threading Technology</b>	
Enable Intel Hyper-Threading Technology	Enabled or disabled the Intel Hyper-Threading mode of the processor. If enabled, the Intel Hyper-Threading increases the efficiency of the processor resources when multiple threads run on each core. Default: ON

**Table 19. System setup options—System Logs menu**

System Logs
<b>BIOS Event Log</b>

**Table 19. System setup options—System Logs menu (continued)**

System Logs	
Clear Bios Event Log	Select keep or clear BIOS events. Default: Keep
<b>Thermal Event Log</b>	
Clear Thermal Event Log	Select keep or clear Thermal events. Default: Keep
<b>Power Event Log</b>	
Clear POWER Event Log	Select keep or clear Power events. Default: Keep

## Clearing CMOS settings

### About this task

 **CAUTION:** Clearing CMOS settings will reset the BIOS settings on your computer.

### Steps

1. Turn off your computer.
2. Follow the steps in [Removing the base cover](#).  
 **NOTE:** Ensure that the battery cable is disconnected from the system board.
3. Press and hold the power button for 15 seconds to drain the flea power.
4. Before you turn on your computer, follow the steps in [Installing the base cover](#).
5. Turn on your computer.

## Clearing BIOS (System Setup) and System passwords

### About this task

To clear the system or BIOS passwords, contact Dell technical support as described at [www.dell.com/contactdell](http://www.dell.com/contactdell).

 **NOTE:** For information on how to reset Windows or application passwords, refer to the documentation accompanying Windows or your application.

## Updating the BIOS

### Updating the BIOS in Windows

#### Steps

1. Go to [www.dell.com/support](http://www.dell.com/support).
2. Click **Product support**. In the **Search support** box, enter the Service Tag of your computer, and then click **Search**.  
 **NOTE:** If you do not have the Service Tag, use the SupportAssist feature to automatically identify your computer. You can also use the product ID or manually browse for your computer model.
3. Click **Drivers & Downloads**. Expand **Find drivers**.
4. Select the operating system installed on your computer.

5. In the **Category** drop-down list, select **BIOS**.
6. Select the latest version of BIOS, and click **Download** to download the BIOS file for your computer.
7. After the download is complete, browse the folder where you saved the BIOS update file.
8. Double-click the BIOS update file icon and follow the on-screen instructions.  
For more information, see knowledge base article [000124211](https://www.dell.com/support/article/000124211) at [www.dell.com/support](https://www.dell.com/support).

## Updating the BIOS using the USB drive in Windows

### Steps

1. Follow the procedure from step 1 to step 6 in [Updating the BIOS in Windows](#) to download the latest BIOS setup program file.
2. Create a bootable USB drive. For more information, see the knowledge base article [000145519](https://www.dell.com/support/article/000145519) at [www.dell.com/support](https://www.dell.com/support).
3. Copy the BIOS setup program file to the bootable USB drive.
4. Connect the bootable USB drive to the computer that needs the BIOS update.
5. Restart the computer and press **F12**.
6. Select the USB drive from the **One Time Boot Menu**.
7. Type the BIOS setup program filename and press **Enter**.  
The **BIOS Update Utility** appears.
8. Follow the on-screen instructions to complete the BIOS update.

## Updating the BIOS from the F12 One-Time boot menu

Update your computer BIOS using the BIOS update.exe file that is copied to a FAT32 USB drive and booting from the F12 One-Time boot menu.

### About this task

#### BIOS Update

You can run the BIOS update file from Windows using a bootable USB drive or you can also update the BIOS from the F12 One-Time boot menu on the computer.

Most of the Dell computers built after 2012 have this capability, and you can confirm by booting your computer to the F12 One-Time Boot Menu to see if BIOS FLASH UPDATE is listed as a boot option for your computer. If the option is listed, then the BIOS supports this BIOS update option.

 **NOTE:** Only computers with BIOS Flash Update option in the F12 One-Time boot menu can use this function.

### Updating from the One-Time boot menu

To update your BIOS from the F12 One-Time boot menu, you need the following:

- USB drive formatted to the FAT32 file system (key does not have to be bootable)
- BIOS executable file that you downloaded from the Dell Support website and copied to the root of the USB drive
- AC power adapter that is connected to the computer
- Functional computer battery to flash the BIOS

Perform the following steps to perform the BIOS update flash process from the F12 menu:

 **CAUTION:** Do not turn off the computer during the BIOS update process. The computer may not boot if you turn off your computer.

### Steps

1. From a turn off state, insert the USB drive where you copied the flash into a USB port of the computer.
2. Turn on the computer and press F12 to access the One-Time Boot Menu, select BIOS Update using the mouse or arrow keys then press Enter.  
The flash BIOS menu is displayed.
3. Click **Flash from file**.
4. Select external USB device.



5. Select the file and double-click the flash target file, and then click **Submit**.
6. Click **Update BIOS**. The computer restarts to flash the BIOS.
7. The computer will restart after the BIOS update is completed.

# Troubleshooting

## Handling swollen Lithium-ion batteries

Like most laptops, Dell laptops use lithium-ion batteries. One type of lithium-ion battery is the lithium-ion polymer battery. Lithium-ion polymer batteries have increased in popularity in recent years and have become standard in the electronics industry due to customer preferences for a slim form factor (especially with newer ultra-thin laptops) and long battery life. Inherent to lithium-ion polymer battery technology is the potential for swelling of the battery cells.

Swollen battery may impact the performance of the laptop. To prevent possible further damage to the device enclosure or internal components leading to malfunction, discontinue the use of the laptop and discharge it by disconnecting the AC adapter and letting the battery drain.

Swollen batteries should not be used and should be replaced and disposed of properly. We recommend contacting Dell product support for options to replace a swollen battery under the terms of the applicable warranty or service contract, including options for replacement by a Dell authorized service technician.

The guidelines for handling and replacing Lithium-ion batteries are as follows:

- Exercise caution when handling Lithium-ion batteries.
- Discharge the battery before removing it from the system. To discharge the battery, unplug the AC adapter from the system and operate the system only on battery power. When the system will no longer power on when the power button is pressed, the battery is fully discharged.
- Do not crush, drop, mutilate, or penetrate the battery with foreign objects.
- Do not expose the battery to high temperatures, or disassemble battery packs and cells.
- Do not apply pressure to the surface of the battery.
- Do not bend the battery.
- Do not use tools of any type to pry on or against the battery.
- If a battery gets stuck in a device as a result of swelling, do not try to free it as puncturing, bending, or crushing a battery can be dangerous.
- Do not attempt to reassemble a damaged or swollen battery into a laptop.
- Swollen batteries that are covered under warranty should be returned to Dell in an approved shipping container (provided by Dell)—this is to comply with transportation regulations. Swollen batteries that are not covered under warranty should be disposed of at an approved recycling center. Contact Dell product support at <https://www.dell.com/support> for assistance and further instructions.
- Using a non-Dell or incompatible battery may increase the risk of fire or explosion. Replace the battery only with a compatible battery purchased from Dell that is designed to work with your Dell computer. Do not use a battery from other computers with your computer. Always purchase genuine batteries from <https://www.dell.com> or otherwise directly from Dell.

Lithium-ion batteries can swell for various reasons such as age, number of charge cycles, or exposure to high heat. For more information on how to improve the performance and lifespan of the laptop battery and to minimize the possibility of occurrence of the issue, see [Dell Laptop Battery - Frequently Asked Questions](#).

## SupportAssist diagnostics

### About this task

The SupportAssist diagnostics (previously known as ePSA diagnostics) performs a complete check of your hardware. The SupportAssist diagnostics is embedded in the BIOS and is launched by it internally. The SupportAssist diagnostics provides a set of options for particular devices or device groups. It allows you to:

- Run tests automatically or in an interactive mode.
- Repeat tests
- Display or save test results

- Run thorough tests to introduce additional test options and provide extra information about the failed device(s)
- View status messages that indicate if the tests are completed successfully
- View error messages that indicate if problems were encountered during the test

**NOTE:** Some tests are meant for specific devices and require user interaction. Ensure that you are present in front of the computer when the diagnostic tests are performed.

For more information, see [SupportAssist Pre-Boot System Performance Check](#).

## Locate the Service Tag or Express Service Code of your Dell computer

Your Dell computer is uniquely identified by a Service Tag or Express Service Code. To view relevant support resources for your Dell computer, we recommend entering the Service Tag or Express Service Code at [www.dell.com/support](http://www.dell.com/support).

For more information on how to find the Service Tag for your computer, see [Locate the Service Tag for your Dell Laptop](#).

## System diagnostic lights

### Battery-status light

Indicates the power and battery-charge status.

**Solid white** — Power adapter is connected and the battery has more than 5 percent charge.

**Amber** — Computer is running on battery and the battery has less than 5 percent charge.

### Off

- Power adapter is connected, and the battery is fully charged.
- Computer is running on battery, and the battery has more than 5 percent charge.
- Computer is in sleep state, hibernation, or turned off.

The battery-status light blinks amber along with beep codes indicating failures.

For example, the battery-status light blinks amber two times followed by a pause, and then blinks white three times followed by a pause. This 2,3 pattern continues until the computer is turned off indicating no memory or RAM is detected.

The following table shows different power and battery-status light patterns and associated problems.

**Table 20. LED codes**

Diagnostic light codes	Problem description
2,1	Processor failure
2,2	System board: BIOS or ROM (Read-Only Memory) failure
2,3	No memory or RAM (Random-Access Memory) detected
2,4	Memory or RAM (Random-Access Memory) failure
2,5	Invalid memory installed
2,6	System-board or chipset error
2,7	Display failure
3,1	Coin-cell battery failure
3,2	PCI, video card/chip failure
3,3	Recovery image not found
3,4	Recovery image found but invalid

**Camera status light:** Indicates whether the camera is in use.

- Solid white — Camera is in use.
- Off — Camera is not in use.

**Caps Lock status light:** Indicates whether Caps Lock is enabled or disabled.

- Solid white — Caps Lock enabled.
- Off — Caps Lock disabled.

## Recovering the operating system

When your computer is unable to boot to the operating system even after repeated attempts, it automatically starts Dell SupportAssist OS Recovery.

Dell SupportAssist OS Recovery is a standalone tool that is preinstalled in all Dell computers installed with Windows operating system. It consists of tools to diagnose and troubleshoot issues that may occur before your computer boots to the operating system. It enables you to diagnose hardware issues, repair your computer, back up your files, or restore your computer to its factory state.

You can also download it from the Dell Support website to troubleshoot and fix your computer when it fails to boot into their primary operating system due to software or hardware failures.

For more information about the Dell SupportAssist OS Recovery, see *Dell SupportAssist OS Recovery User's Guide* at [www.dell.com/serviceabilitytools](http://www.dell.com/serviceabilitytools). Click **SupportAssist** and then, click **SupportAssist OS Recovery**.

## Backup media and recovery options

It is recommended to create a recovery drive to troubleshoot and fix problems that may occur with Windows. Dell proposes multiple options for recovering Windows operating system on your Dell PC. For more information, see [Dell Windows Backup Media and Recovery Options](#).

## WiFi power cycle

### About this task

If your computer is unable to access the Internet due to WiFi connectivity issues, a WiFi power cycle procedure may be performed. The following procedure provides the instructions on how to conduct a WiFi power cycle:

 **NOTE:** Some ISPs (Internet Service Providers) provide a modem/router combo device.

### Steps

1. Turn off your computer.
2. Turn off the modem.
3. Turn off the wireless router.
4. Wait for 30 seconds.
5. Turn on the wireless router.
6. Turn on the modem.
7. Turn on your computer.

## Flea power release

### About this task

Flea power is the residual static electricity that remains on the computer even after it has been powered off and the battery has been disconnected from the system board. The following procedure provides the instructions on how to release the flea power:

### Steps

1. Turn off your computer.

2. Follow the steps in [Removing the base cover](#).

 **NOTE:** Ensure that the battery is disconnected from the system board.

3. Press and hold the power button for 15 seconds to drain the flea power.
4. Follow the steps in [Installing the base cover](#).
5. Turn on your computer.





# Getting help and contacting Dell

## Self-help resources

You can get information and help on Dell products and services using these self-help resources:

**Table 21. Self-help resources**

Self-help resources	Resource location
Information about Dell products and services	<a href="http://www.dell.com">www.dell.com</a>
My Dell app	
Tips	
Contact Support	In Windows search, type <code>Contact Support</code> , and press Enter.
Online help for operating system	<a href="http://www.dell.com/support/windows">www.dell.com/support/windows</a> <a href="http://www.dell.com/support/linux">www.dell.com/support/linux</a>
Access top solutions, diagnostics, drivers and downloads, and learn more about your computer through videos, manuals and documents.	Your Dell computer is uniquely identified by a Service Tag or Express Service Code. To view relevant support resources for your Dell computer, enter the Service Tag or Express Service Code at <a href="http://www.dell.com/support">www.dell.com/support</a> .  For more information on how to find the Service Tag for your computer, see <a href="#">Locate the Service Tag on your computer</a> .
Dell knowledge base articles for a variety of computer concerns	<ol style="list-style-type: none"> <li>1. Go to <a href="http://www.dell.com/support">www.dell.com/support</a>.</li> <li>2. On the menu bar at the top of the Support page, select <b>Support &gt; Knowledge Base</b>.</li> <li>3. In the Search field on the Knowledge Base page, type the keyword, topic, or model number, and then click or tap the search icon to view the related articles.</li> </ol>

## Contacting Dell

To contact Dell for sales, technical support, or customer service issues, see [www.dell.com/contactdell](http://www.dell.com/contactdell).

 **NOTE:** Availability varies by country/region and product, and some services may not be available in your country/region.

 **NOTE:** If you do not have an active Internet connection, you can find contact information about your purchase invoice, packing slip, bill, or Dell product catalog.