

# Dell G7 15

## Service Manual



## Notes, cautions, and warnings

 | **NOTE:** A NOTE indicates important information that helps you make better use of your product.

 | **CAUTION:** A CAUTION indicates either potential damage to hardware or loss of data and tells you how to avoid the problem.

 | **WARNING:** A WARNING indicates a potential for property damage, personal injury, or death.

© 2018 Dell Inc. or its subsidiaries. All rights reserved. Dell, EMC, and other trademarks are trademarks of Dell Inc. or its subsidiaries. Other trademarks may be trademarks of their respective owners.

# Contents

<b>1 Before working inside your computer</b> .....	<b>9</b>
Before you begin .....	9
Safety instructions.....	9
Recommended tools.....	9
Screw list.....	10
<b>2 After working inside your computer</b> .....	<b>12</b>
<b>3 Removing the base cover</b> .....	<b>13</b>
Procedure.....	13
<b>4 Replacing the base cover</b> .....	<b>15</b>
Procedure.....	15
<b>5 Removing the battery</b> .....	<b>17</b>
Prerequisites.....	17
Procedure.....	17
<b>6 Replacing the battery</b> .....	<b>18</b>
Procedure.....	18
Post-requisites.....	18
<b>7 Removing the memory modules</b> .....	<b>19</b>
Prerequisites.....	19
Procedure.....	19
<b>8 Replacing the memory modules</b> .....	<b>21</b>
Procedure.....	21
Post-requisites.....	21
<b>9 Removing the solid-state drive</b> .....	<b>22</b>
Prerequisites.....	22
Procedure.....	22
<b>10 Replacing the solid-state drive</b> .....	<b>23</b>
Procedure.....	23
Post-requisites.....	23
<b>11 Removing the hard drive</b> .....	<b>24</b>
Prerequisites.....	24
Procedure.....	24
<b>12 Replacing the hard drive</b> .....	<b>26</b>
Procedure.....	26

Post-requisites.....	27
<b>13 Removing the coin-cell battery.....</b>	<b>28</b>
Prerequisites.....	28
Procedure.....	28
<b>14 Replacing the coin-cell battery.....</b>	<b>29</b>
Procedure.....	29
Post-requisites.....	29
<b>15 Removing the wireless card.....</b>	<b>30</b>
Prerequisites.....	30
Procedure.....	30
<b>16 Replacing the wireless card.....</b>	<b>32</b>
Procedure.....	32
Post-requisites.....	32
<b>17 Removing the rear cover.....</b>	<b>33</b>
Prerequisites.....	33
Procedure.....	33
<b>18 Replacing the rear cover.....</b>	<b>34</b>
Procedure.....	34
Post-requisites.....	34
<b>19 Removing the computer base.....</b>	<b>35</b>
Prerequisites.....	35
Procedure.....	35
<b>20 Replacing the computer base.....</b>	<b>39</b>
Procedure.....	39
Post-requisites.....	43
<b>21 Removing the status-light board.....</b>	<b>44</b>
Prerequisites.....	44
Procedure.....	44
<b>22 Replacing the status-light board.....</b>	<b>45</b>
Procedure.....	45
Post-requisites.....	45
<b>23 Removing the speakers.....</b>	<b>46</b>
Prerequisites.....	46
Procedure.....	46
<b>24 Replacing the speakers.....</b>	<b>47</b>
Procedure.....	47

Post-requisites.....	47
<b>25 Removing the system board.....</b>	<b>48</b>
Prerequisites.....	48
Procedure.....	48
<b>26 Replacing the system board.....</b>	<b>51</b>
Procedure.....	51
Post-requisites.....	53
Entering the Service Tag in the BIOS setup program.....	53
<b>27 Removing the power-adapter port.....</b>	<b>54</b>
Prerequisites.....	54
Procedure.....	54
<b>28 Replacing the power-adapter port.....</b>	<b>55</b>
Procedure.....	55
Post-requisites.....	55
<b>29 Removing the heat sink.....</b>	<b>56</b>
Prerequisites.....	56
Procedure.....	56
<b>30 Replacing the heat sink.....</b>	<b>58</b>
Procedure.....	58
Post-requisites.....	59
<b>31 Removing the fans.....</b>	<b>60</b>
Prerequisites.....	60
Procedure.....	60
<b>32 Replacing the fans.....</b>	<b>62</b>
Procedure.....	62
Post-requisites.....	63
<b>33 Removing the power-button board.....</b>	<b>64</b>
Prerequisites.....	64
Procedure.....	64
<b>34 Replacing the power-button board.....</b>	<b>65</b>
Procedure.....	65
Post-requisites.....	65
<b>35 Removing the fingerprint-reader board.....</b>	<b>66</b>
Prerequisites.....	66
Procedure.....	66
<b>36 Replacing the fingerprint-reader board.....</b>	<b>67</b>

Procedure.....	67
Post-requisites.....	67
<b>37 Removing the touchpad.....</b>	<b>68</b>
Prerequisites.....	68
Procedure.....	68
<b>38 Replacing the touchpad.....</b>	<b>69</b>
Procedure.....	69
Post-requisites.....	69
<b>39 Removing the display assembly.....</b>	<b>70</b>
Prerequisites.....	70
Procedure.....	70
<b>40 Replacing the display assembly.....</b>	<b>72</b>
Procedure.....	72
Post-requisites.....	73
<b>41 Removing the palm rest.....</b>	<b>74</b>
Prerequisites.....	74
Procedure.....	74
<b>42 Replacing the palm rest.....</b>	<b>75</b>
Procedure.....	75
Post-requisites.....	75
<b>43 Removing the keyboard.....</b>	<b>76</b>
Prerequisites.....	76
Procedure.....	76
<b>44 Replacing the keyboard.....</b>	<b>78</b>
Procedure.....	78
Post-requisites.....	79
Folding the keyboard cables.....	79
<b>45 Removing the display bezel.....</b>	<b>81</b>
Prerequisites.....	81
Procedure.....	81
<b>46 Replacing the display bezel.....</b>	<b>83</b>
Procedure.....	83
Post-requisites.....	83
<b>47 Removing the display hinges.....</b>	<b>84</b>
Prerequisites.....	84
Procedure.....	84

<b>48 Replacing the display hinges.....</b>	<b>85</b>
Procedure.....	85
Post-requisites.....	85
<b>49 Removing the display panel.....</b>	<b>86</b>
Prerequisites.....	86
Procedure.....	86
<b>50 Replacing the display panel.....</b>	<b>88</b>
Procedure.....	88
Post-requisites.....	89
<b>51 Removing the display cable.....</b>	<b>90</b>
Prerequisites.....	90
Procedure.....	90
<b>52 Replacing the display cable.....</b>	<b>91</b>
Procedure.....	91
Post-requisites.....	91
<b>53 Removing the camera.....</b>	<b>92</b>
Prerequisites.....	92
Procedure.....	92
<b>54 Replacing the camera.....</b>	<b>93</b>
Procedure.....	93
Post-requisites.....	93
<b>55 Removing the display back-cover and antenna assembly.....</b>	<b>94</b>
Prerequisites.....	94
Procedure.....	94
<b>56 Replacing the display back-cover and antenna assembly.....</b>	<b>96</b>
Procedure.....	96
Post-requisites.....	97
<b>57 Downloading drivers.....</b>	<b>98</b>
Downloading the audio driver.....	98
Downloading the graphics driver.....	98
Downloading the USB 3.0 driver.....	98
Downloading the Wi-Fi driver.....	98
Downloading the media-card reader driver.....	99
Downloading the chipset driver.....	99
Downloading the network driver.....	99
<b>58 System setup.....</b>	<b>100</b>
Boot Sequence.....	100

Navigation keys.....	100
BIOS overview.....	101
Entering BIOS setup program.....	101
Enabling or disabling the USB in BIOS setup program.....	101
Identifying the hard drive in BIOS setup program.....	101
Checking the system memory in BIOS setup program.....	101
System setup options.....	101
<b>59 System and setup password.....</b>	<b>107</b>
Assigning a system password and setup password.....	107
Deleting or changing an existing system setup password.....	107
Clearing CMOS settings.....	108
Clearing forgotten passwords.....	108
<b>60 Troubleshooting.....</b>	<b>109</b>
Flashing BIOS (USB key).....	109
Flashing the BIOS.....	109
Enhanced Pre-Boot System Assessment (ePSA) diagnostics.....	109
Running the ePSA diagnostics.....	110
System diagnostic lights.....	110
Wi-Fi power cycle.....	111
Flea power release.....	111
Reinstall Windows using a USB recovery drive.....	112
<b>61 Getting help and contacting Dell.....</b>	<b>113</b>
Self-help resources.....	113
Contacting Dell.....	113



# Before working inside your computer

 **NOTE:** The images in this document may differ from your computer depending on the configuration you ordered.

## Before you begin









- 1 Save and close all open files and exit all open applications.
- 2 Shut down your computer. Click **Start > Power > Shut down**.

 **NOTE:** If you are using a different operating system, see the documentation of your operating system for shut-down instructions.

- 3 Disconnect your computer and all attached devices from their electrical outlets.
- 4 Disconnect all attached network devices and peripherals, such as keyboard, mouse, and monitor from your computer.
- 5 Remove any media card and optical disc from your computer, if applicable.

## Safety instructions

Use the following safety guidelines to protect your computer from potential damage and ensure your personal safety.

-  **WARNING:** Before working inside your computer, read the safety information that shipped with your computer. For more safety best practices, see the Regulatory Compliance home page at [www.dell.com/regulatory\\_compliance](http://www.dell.com/regulatory_compliance).
-  **WARNING:** Disconnect all power sources before opening the computer cover or panels. After you finish working inside the computer, replace all covers, panels, and screws before connecting to the electrical outlet.
-  **CAUTION:** To avoid damaging the computer, ensure that the work surface is flat and clean.
-  **CAUTION:** To avoid damaging the components and cards, handle them by their edges, and avoid touching pins and contacts.
-  **CAUTION:** You should only perform troubleshooting and repairs as authorized or directed by the Dell technical assistance team. Damage due to servicing that is not authorized by Dell is not covered by your warranty. See the safety instructions that shipped with the product or at [www.dell.com/regulatory\\_compliance](http://www.dell.com/regulatory_compliance).
-  **CAUTION:** Before touching anything inside your computer, ground yourself by touching an unpainted metal surface, such as the metal at the back of the computer. While you work, periodically touch an unpainted metal surface to dissipate static electricity, which could harm internal components.
-  **CAUTION:** When you disconnect a cable, pull on its connector or on its pull tab, not on the cable itself. Some cables have connectors with locking tabs or thumb-screws that you must disengage before disconnecting the cable. When disconnecting cables, keep them evenly aligned to avoid bending any connector pins. When connecting cables, ensure that the ports and connectors are correctly oriented and aligned.
-  **CAUTION:** Press and eject any installed card from the media-card reader.



















## Recommended tools





The procedures in this document may require the following tools:

- Phillips screwdriver #1
- Plastic scribe

# Screw list

**Table 1. Screw list**

Component	Secured to	Screw type	Quantity	Screw image
Battery	Computer base	M2.5x6	3	
Solid-state drive	Computer base	M3x3	1	
Hard-drive assembly	Computer base	M2.5x3+3	4	
Hard-drive bracket	Hard drive	M3x3	4	
Wireless card	Wireless card bracket and system board	M2x3	1	
Rear cover	Computer base	M2x2	4	
Display-cable bracket	Computer base	M2x3	1	
Computer base	Palm-rest assembly	M2.5x6	19	
Computer base	Palm-rest assembly	M2x3	4	
Touchpad	Palm-rest assembly	M2x2	4	
Fans	Heat sink	M2x1.4	5	
Fans	System board	M2x3	4	
Status-light board	Computer base	M2x3	1	
Power-button board	Palm-rest assembly	M2x3	2	
Power-adaptor port bracket	Computer base	M2.5x5	2	
Fingerprint-reader board bracket	Palm-rest assembly	M2x2	2	
USB Type-C port bracket	System board	M2.5x5	2	
System board	Computer base	M2.5x5	3	

<b>Component</b>	<b>Secured to</b>	<b>Screw type</b>	<b>Quantity</b>	<b>Screw image</b>
Keyboard bracket	Palm-rest assembly	M1.6x2.2	30	
Heat-sink assembly	System board	M2x3	6	
Display assembly	Palm-rest assembly	M2.5x5	2	
Display hinges	Display back-cover and antenna assembly	M2.5x2.5	8	
Display panel	Display back-cover and antenna assembly	M2x2.5	4	

## After working inside your computer

 **CAUTION:** Leaving stray or loose screws inside your computer may severely damage your computer.

- 1 Replace all screws and ensure that no stray screws remain inside your computer.
- 2 Connect any external devices, peripherals, or cables you removed before working on your computer.
- 3 Replace any media cards, discs, or any other parts that you removed before working on your computer.
- 4 Connect your computer and all attached devices to their electrical outlets.
- 5 Turn on your computer.

## Removing the base cover

**⚠ WARNING:** Before working inside your computer, read the safety information that shipped with your computer and follow the steps in [Before working inside your computer](#). After working inside your computer, follow the instructions in [After working inside your computer](#). For more safety best practices, see the Regulatory Compliance home page at [www.dell.com/regulatory\\_compliance](http://www.dell.com/regulatory_compliance).

### Procedure

- 1 Loosen the captive screw that secures the base cover to the computer base.
- 2 Using your fingertips, gently pry the base cover to release the tabs from the slots on the computer base.
- 3 Lift the base cover off the computer base.

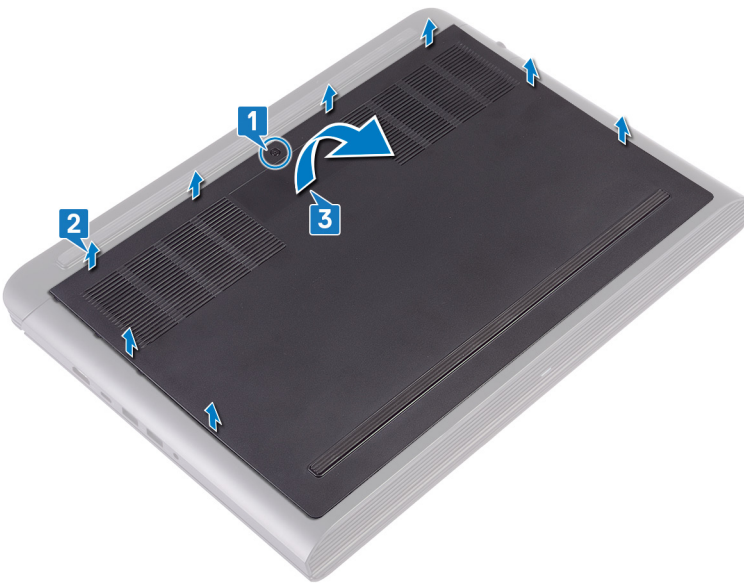

- 4 Disconnect the battery cable from the system board.



# Replacing the base cover

**⚠ WARNING:** Before working inside your computer, read the safety information that shipped with your computer and follow the steps in [Before working inside your computer](#). After working inside your computer, follow the instructions in [After working inside your computer](#). For more safety best practices, see the Regulatory Compliance home page at [www.dell.com/regulatory\\_compliance](http://www.dell.com/regulatory_compliance).

## Procedure

- 1 Connect the battery cable to the system board.

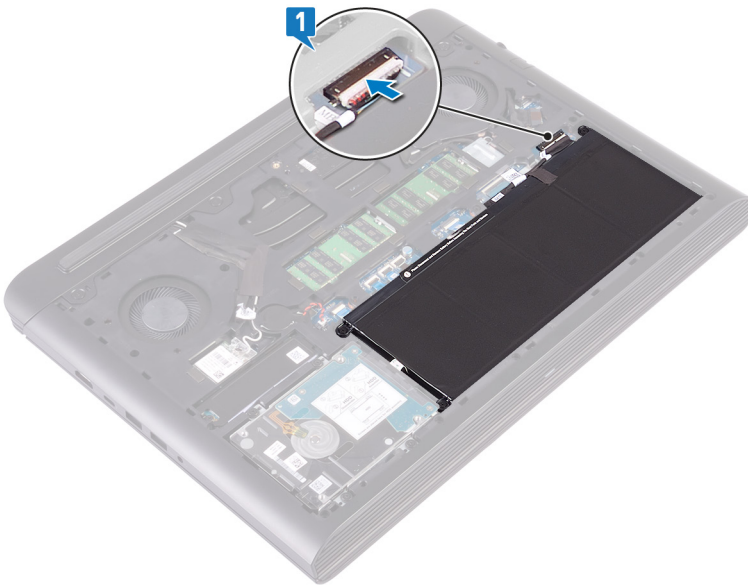

- 2 Slide the tabs on the base cover into the slots on the computer base and snap the base cover into place.
- 3 Tighten the captive screw that secures the base cover to the computer base.

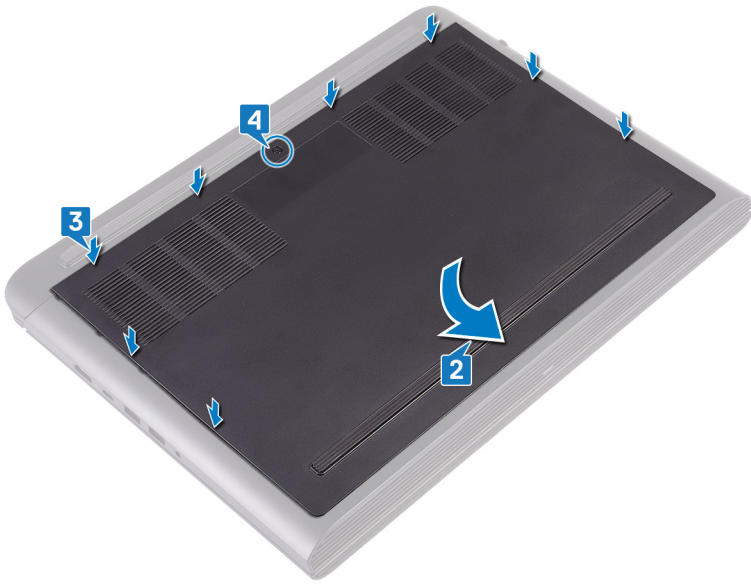



# Removing the battery

**⚠ WARNING:** Before working inside your computer, read the safety information that shipped with your computer and follow the steps in [Before working inside your computer](#). After working inside your computer, follow the instructions in [After working inside your computer](#). For more safety best practices, see the Regulatory Compliance home page at [www.dell.com/regulatory\\_compliance](http://www.dell.com/regulatory_compliance).

## Prerequisites

Remove the [base cover](#).

## Procedure

- 1 Remove the three screws (M2.5x6) that secure the battery to the computer base.
- 2 Lift the battery at an angle off the computer base.

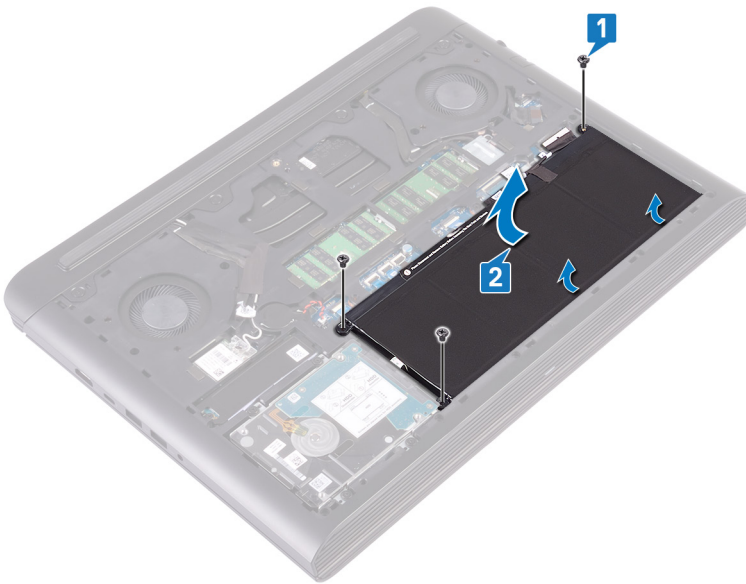

- 3 Turn the computer over, open the display, and press and hold the power button for five seconds to ground the system board.

# Replacing the battery

**⚠ WARNING:** Before working inside your computer, read the safety information that shipped with your computer and follow the steps in [Before working inside your computer](#). After working inside your computer, follow the instructions in [After working inside your computer](#). For more safety best practices, see the Regulatory Compliance home page at [www.dell.com/regulatory\\_compliance](http://www.dell.com/regulatory_compliance).

## Procedure

- 1 Slide the battery in the slot on the computer base and align the screw holes on the battery with the screw holes on the computer base.
- 2 Replace the three screws (M2.5x6) that secure the battery to the computer base.

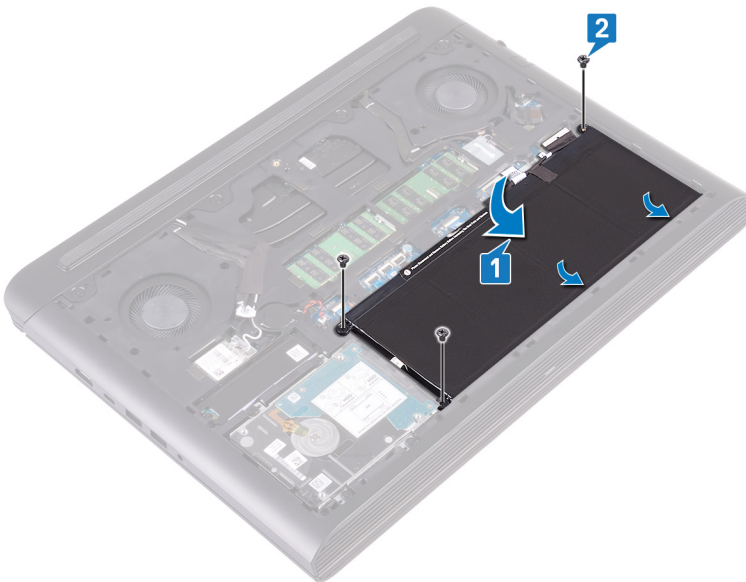

## Post-requisites

Replace the [base cover](#).

# Removing the memory modules

**⚠ WARNING:** Before working inside your computer, read the safety information that shipped with your computer and follow the steps in [Before working inside your computer](#). After working inside your computer, follow the instructions in [After working inside your computer](#). For more safety best practices, see the Regulatory Compliance home page at [www.dell.com/regulatory\\_compliance](http://www.dell.com/regulatory_compliance).

## Prerequisites

Remove the [base cover](#).

## Procedure

- 1 Locate the memory module on the system board.

**ⓘ NOTE:** Depending on the configuration ordered, the computer may have up to two memory modules.



- 2 Use your fingertips to carefully spread apart the securing-clips on each end of the memory-module slot until the memory module pops up.
- 3 Remove the memory module from the memory-module slot.

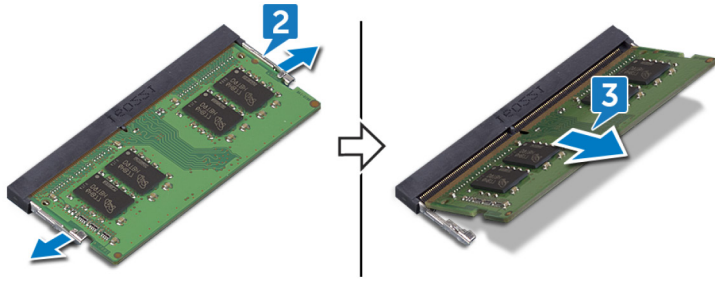

# Replacing the memory modules

**⚠ WARNING:** Before working inside your computer, read the safety information that shipped with your computer and follow the steps in [Before working inside your computer](#). After working inside your computer, follow the instructions in [After working inside your computer](#). For more safety best practices, see the Regulatory Compliance home page at [www.dell.com/regulatory\\_compliance](http://www.dell.com/regulatory_compliance).

## Procedure

- 1 Align the notch on the memory module with the tab on the memory-module slot.
- 2 Slide the memory module firmly into the slot at an angle.
- 3 Press the memory module down until it clicks into place.

**📌 NOTE:** If you do not hear the click, remove the memory module and reinstall it.

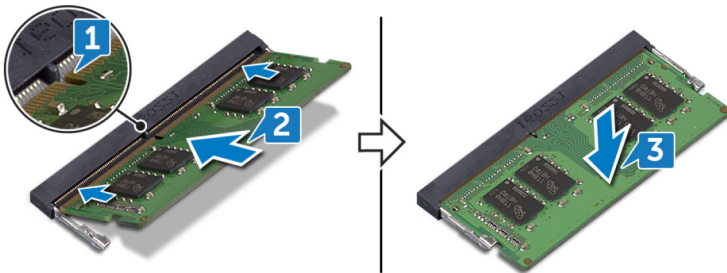

## Post-requisites

Replace the [base cover](#).

# Removing the solid-state drive

**⚠ WARNING:** Before working inside your computer, read the safety information that shipped with your computer and follow the steps in [Before working inside your computer](#). After working inside your computer, follow the instructions in [After working inside your computer](#). For more safety best practices, see the Regulatory Compliance home page at [www.dell.com/regulatory\\_compliance](http://www.dell.com/regulatory_compliance).

**⚠ CAUTION:** Solid-state drives are fragile. Exercise care when handling the solid-state drive.

**⚠ CAUTION:** To avoid data loss, do not remove the solid-state drive while the computer is in sleep or on state.

## Prerequisites

Remove the [base cover](#).

## Procedure

- 1 Remove the screw (M3x3) that secures the solid-state drive to the computer base.
- 2 Slide and lift the solid-state drive from the solid-state drive slot.
- 3 Peel and remove the solid-state drive shield from the solid-state drive.

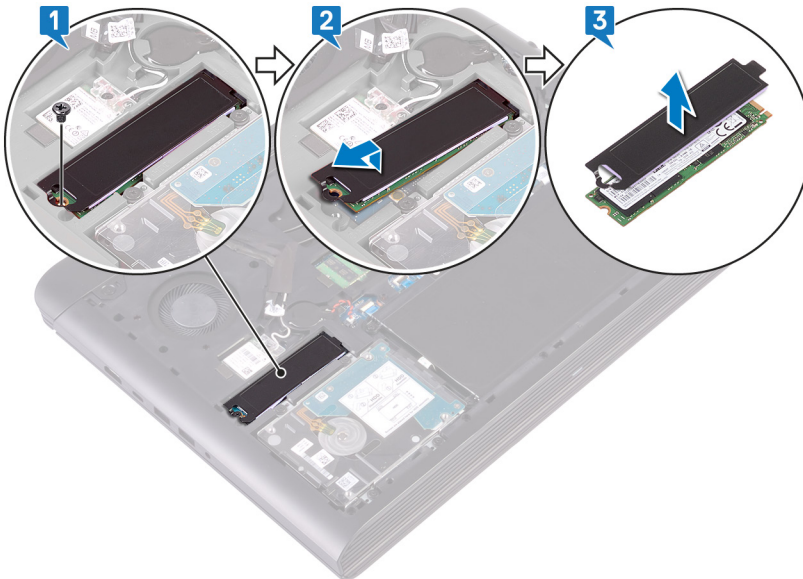

# Replacing the solid-state drive

**⚠ WARNING:** Before working inside your computer, read the safety information that shipped with your computer and follow the steps in [Before working inside your computer](#). After working inside your computer, follow the instructions in [After working inside your computer](#). For more safety best practices, see the Regulatory Compliance home page at [www.dell.com/regulatory\\_compliance](http://www.dell.com/regulatory_compliance).

**⚠ CAUTION:** Solid-state drives are fragile. Exercise care when handling the solid-state drive.

## Procedure

- 1 Place and adhere the solid-state drive shield onto the solid-state drive.
- 2 Align the notch on the solid-state drive with the tab on the solid-state drive slot and slide the solid-state drive into the solid-state drive slot.
- 3 Press the other end of the solid-state drive to align the screw hole on the solid-state drive with the screw hole on the computer base.
- 4 Replace the screw (M3x3) that secures the solid-state drive to the computer base.

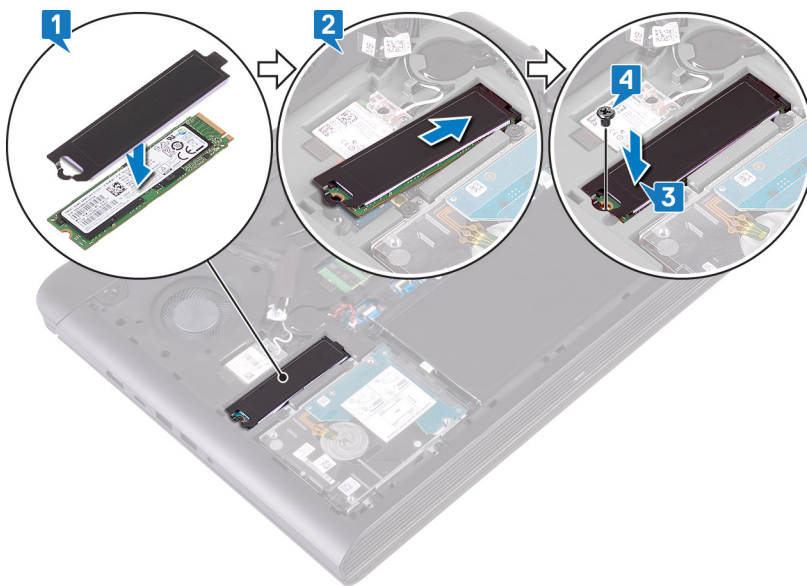

## Post-requisites

Replace the [base cover](#).

# Removing the hard drive

**⚠ WARNING:** Before working inside your computer, read the safety information that shipped with your computer and follow the steps in [Before working inside your computer](#). After working inside your computer, follow the instructions in [After working inside your computer](#). For more safety best practices, see the Regulatory Compliance home page at [www.dell.com/regulatory\\_compliance](http://www.dell.com/regulatory_compliance).

**⚠ CAUTION:** Hard drives are fragile. Exercise care when handling the hard drive.

**⚠ CAUTION:** To avoid data loss, do not remove the hard drive while the computer is in sleep or on state.

## Prerequisites

- 1 Remove the [base cover](#).
- 2 Remove the [battery](#).

## Procedure

**ⓘ NOTE:** The latch on the hard-drive locking connector is fragile. Pulling the latch forcefully may damage the hard-drive locking connector. Exercise care when handling the latch on the hard-drive locking connector.

- 1 Open the latch and disconnect the hard-drive cable from the system board.
- 2 Peel off the hard-drive cable from the computer base.
- 3 Remove the four screws (M2.5x3+3) that secure the hard-drive assembly to the computer base.
- 4 Lift the hard-drive assembly, along with its cable, off the computer base.

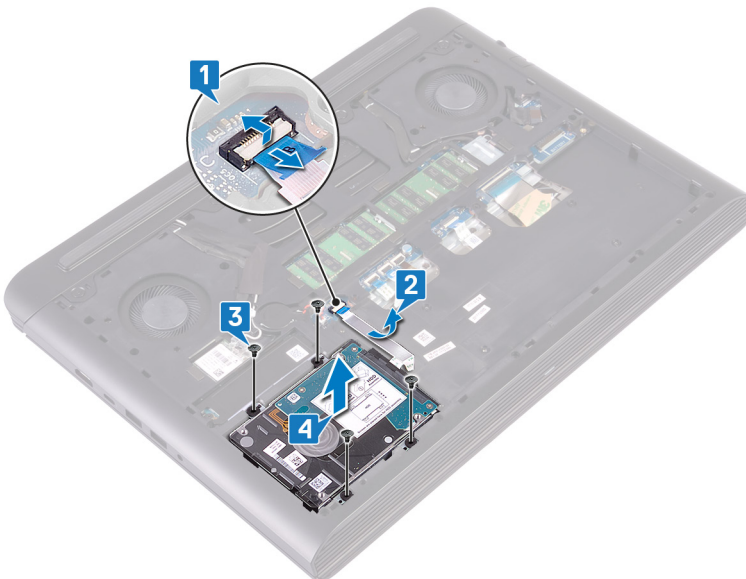

- 5 Disconnect the interposer from the hard-drive assembly.



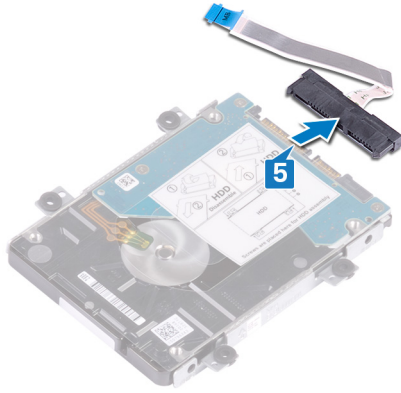

- 6 Remove the four screws (M3x3) that secure the hard-drive bracket to the hard drive.
- 7 Lift the hard-drive bracket off the hard drive.

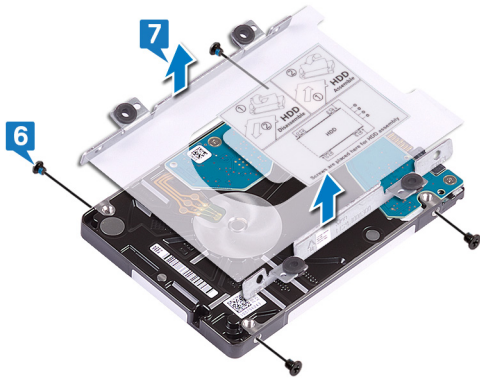

# Replacing the hard drive

**⚠ WARNING:** Before working inside your computer, read the safety information that shipped with your computer and follow the steps in [Before working inside your computer](#). After working inside your computer, follow the instructions in [After working inside your computer](#). For more safety best practices, see the Regulatory Compliance home page at [www.dell.com/regulatory\\_compliance](http://www.dell.com/regulatory_compliance).

**⚠ CAUTION:** Hard drives are fragile. Exercise care when handling the hard drive.

## Procedure

- 1 Align the screw holes on the hard-drive bracket with the screw holes on the hard drive.
- 2 Replace the four screws (M3x3) that secure the hard-drive bracket to the hard drive.

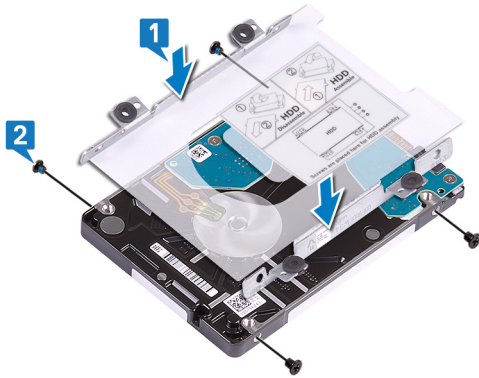

- 3 Connect the interposer to the hard-drive assembly.

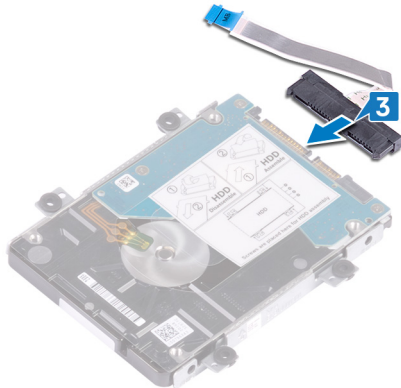

- 4 Align the screw holes on the hard-drive assembly with the screw holes on the computer base.
- 5 Replace the four screws (M2.5x3+3) that secure the hard-drive assembly to the computer base.
- 6 Adhere the hard-drive cable to the computer base.
- 7 Slide the hard-drive cable into the connector on the system board and close the latch to secure the hard-drive cable.

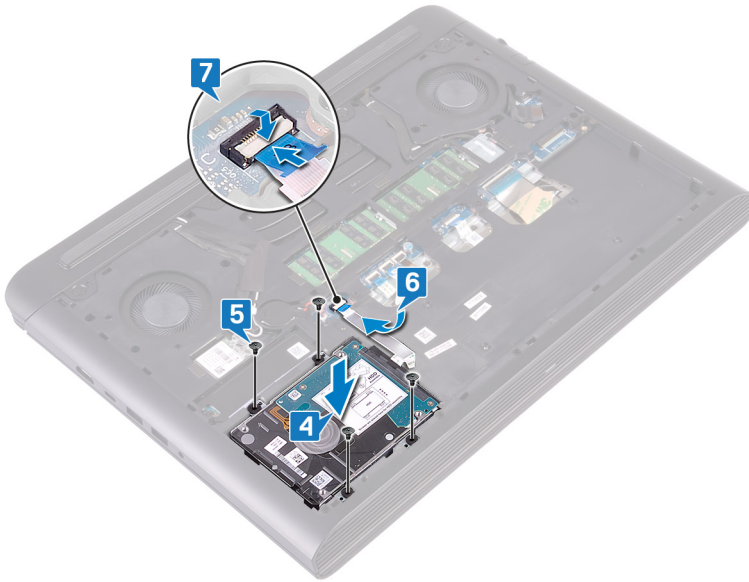

## Post-requisites

- 1 Replace the [battery](#).
- 2 Replace the [base cover](#).

# Removing the coin-cell battery

**⚠ WARNING:** Before working inside your computer, read the safety information that shipped with your computer and follow the steps in [Before working inside your computer](#). After working inside your computer, follow the instructions in [After working inside your computer](#). For more safety best practices, see the Regulatory Compliance home page at [www.dell.com/regulatory\\_compliance](http://www.dell.com/regulatory_compliance).

**⚠ CAUTION:** Removing the coin-cell battery resets the BIOS setup program's settings to default. It is recommended that you note the BIOS setup program's settings before removing the coin-cell battery.

## Prerequisites

Remove the [base cover](#).

## Procedure

- 1 Disconnect the coin-cell battery cable from the system board.
- 2 Peel off the coin-cell battery from the battery socket on the computer base.



# Replacing the coin-cell battery

**⚠ WARNING:** Before working inside your computer, read the safety information that shipped with your computer and follow the steps in [Before working inside your computer](#). After working inside your computer, follow the instructions in [After working inside your computer](#). For more safety best practices, see the Regulatory Compliance home page at [www.dell.com/regulatory\\_compliance](http://www.dell.com/regulatory_compliance).

## Procedure

- 1 Adhere the coin-cell battery into the battery socket on the computer base.
- 2 Connect the coin-cell battery cable to the system board.



## Post-requisites

Replace the [base cover](#).

# Removing the wireless card

**⚠ WARNING:** Before working inside your computer, read the safety information that shipped with your computer and follow the steps in [Before working inside your computer](#). After working inside your computer, follow the instructions in [After working inside your computer](#). For more safety best practices, see the Regulatory Compliance home page at [www.dell.com/regulatory\\_compliance](http://www.dell.com/regulatory_compliance).

## Prerequisites

Remove the [base cover](#).

## Procedure

- 1 Locate the wireless card on the system board.



- 2 Remove the screw (M2x3) that secures the wireless-card bracket to the wireless card and system board.
- 3 Remove the wireless-card bracket from the wireless card.
- 4 Disconnect the antenna cables from the wireless card.
- 5 Slide and remove the wireless card from the wireless-card slot.

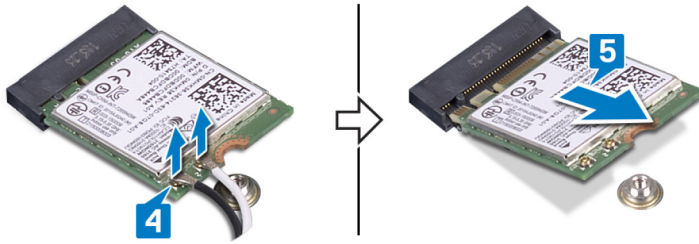
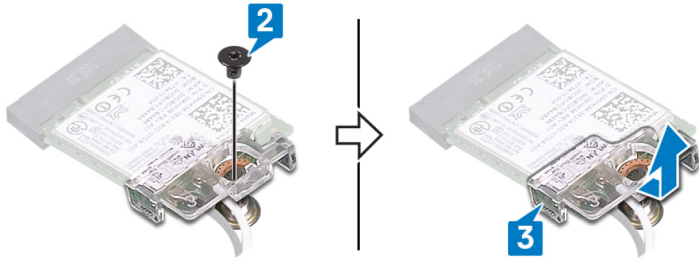

# Replacing the wireless card

**⚠ WARNING:** Before working inside your computer, read the safety information that shipped with your computer and follow the steps in [Before working inside your computer](#). After working inside your computer, follow the instructions in [After working inside your computer](#). For more safety best practices, see the Regulatory Compliance home page at [www.dell.com/regulatory\\_compliance](http://www.dell.com/regulatory_compliance).

## Procedure

**⚠ CAUTION:** To avoid damage to the wireless card, do not place any cables under it.

- 1 Align the notch on the wireless card with the tab on the wireless-card slot and slide the wireless card at an angle into the wireless-card slot.
- 2 Connect the antenna cables to the wireless card.  
The following table provides the antenna-cable color scheme for the wireless card supported by your computer.

**Table 2. Antenna-cable color scheme**

Connectors on the wireless card	Antenna-cable color
Main (white triangle)	White
Auxiliary (black triangle)	Black

- 3 Align the screw hole on the wireless-card bracket with the screw hole on the wireless card and the system board.
- 4 Replace the screw (M2x3) that secures the wireless-card bracket to the wireless card and system board.

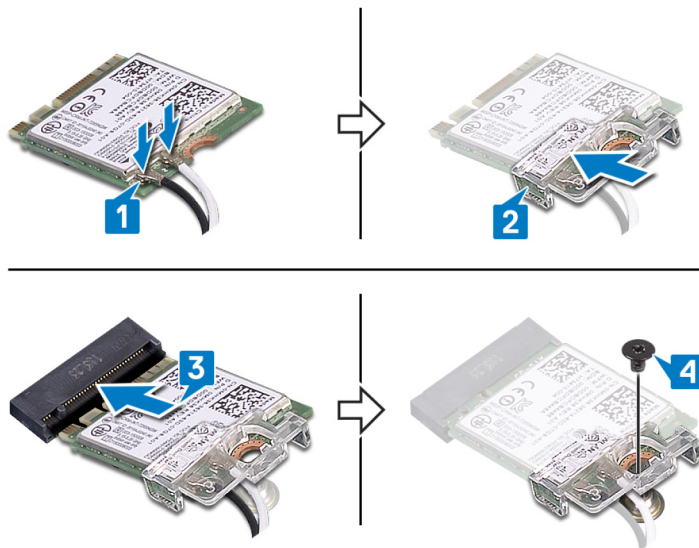

## Post-requisites

Replace the [base cover](#).



# Removing the rear cover

**⚠ WARNING:** Before working inside your computer, read the safety information that shipped with your computer and follow the steps in [Before working inside your computer](#). After working inside your computer, follow the instructions in [After working inside your computer](#). For more safety best practices, see the Regulatory Compliance home page at [www.dell.com/regulatory\\_compliance](http://www.dell.com/regulatory_compliance).

## Prerequisites

Remove the [base cover](#).

## Procedure

- 1 Remove the four screws (M2x2) that secure the rear cover to the computer base.
- 2 Pry the rear cover starting from the center, to the left and then to the right.
- 3 Remove the rear cover from the computer base.

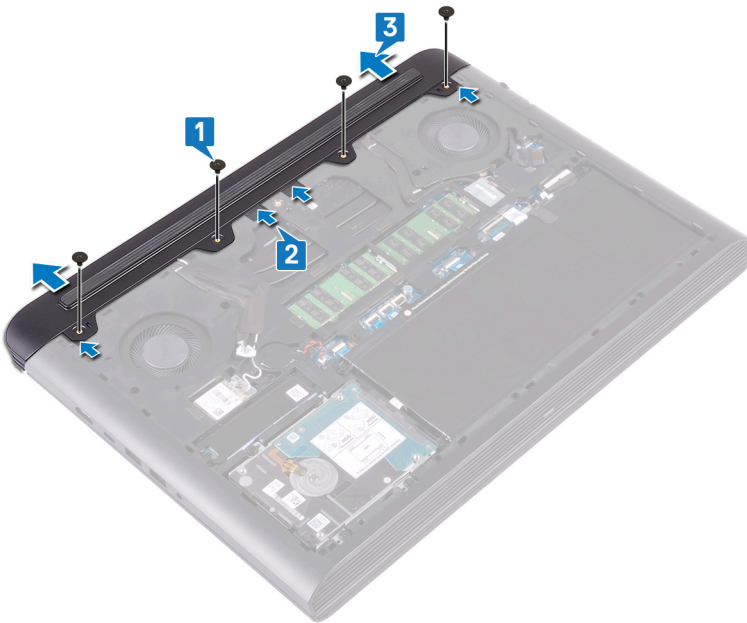

# Replacing the rear cover

**WARNING:** Before working inside your computer, read the safety information that shipped with your computer and follow the steps in [Before working inside your computer](#). After working inside your computer, follow the instructions in [After working inside your computer](#). For more safety best practices, see the Regulatory Compliance home page at [www.dell.com/regulatory\\_compliance](http://www.dell.com/regulatory_compliance).

## Procedure

- 1 Slide the tabs on the rear cover into the slots on the computer base and snap the rear cover into place aligning the screw holes on the rear cover with the screw holes on the computer base.
- 2 Replace the four screws (M2x2) that secure the rear cover to the computer base.

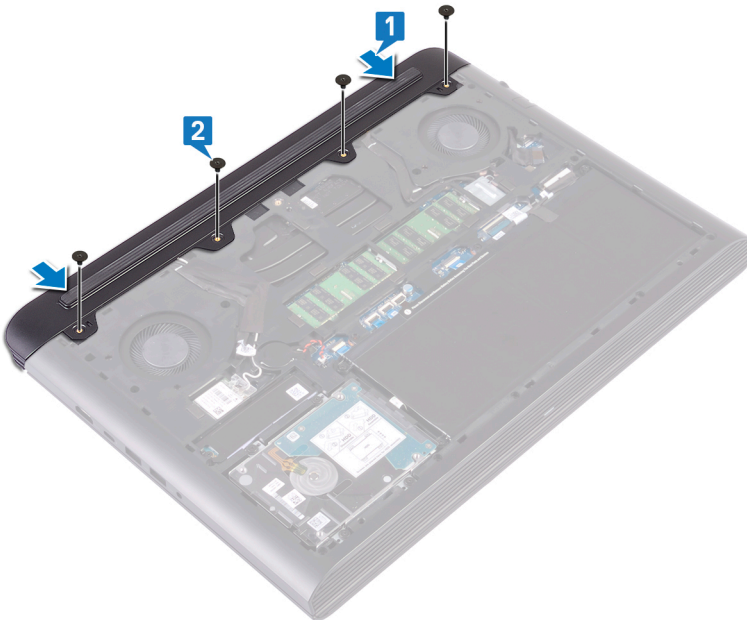

## Post-requisites

Replace the [base cover](#).

# Removing the computer base

**⚠ WARNING:** Before working inside your computer, read the safety information that shipped with your computer and follow the steps in [Before working inside your computer](#). After working inside your computer, follow the instructions in [After working inside your computer](#). For more safety best practices, see the Regulatory Compliance home page at [www.dell.com/regulatory\\_compliance](http://www.dell.com/regulatory_compliance).

## Prerequisites

- 1 Remove the [base cover](#).
- 2 Remove the [battery](#).
- 3 Remove the [rear cover](#).
- 4 Remove the [wireless card](#).

## Procedure

- 1 Peel off the tapes that secure the display cable, camera, and antenna cables to the computer base.



- 2 Using the pull tab, disconnect the camera cable from the system board.
- 3 Peel the camera cable off the computer base.
- 4 Remove the antenna cables from the routing guides on the computer base.
- 5 Remove the screw (M2x3) that secures the display-cable bracket to the computer base.
- 6 Lift the display-cable bracket off the computer base.
- 7 Using the pull tab, disconnect the display-cable from the system board.
- 8 Remove the display cable from the routing guides on the computer base and peel the display cable from the computer base.

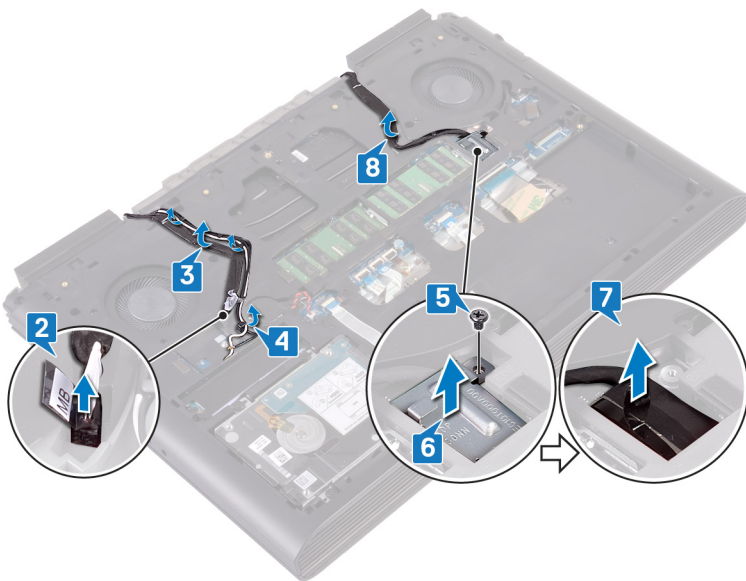

- 9 Open the latch and disconnect the power-button board cable from the system board.
- 10 Open the latch and disconnect the keyboard-backlight cable from the system board.
- 11 Open the latch and disconnect the touchpad cable from the system board.
- 12 Peel off the Mylar that secures the keyboard-cable latch to the system board.
- 13 Open the latch and disconnect the keyboard cable to the system board.

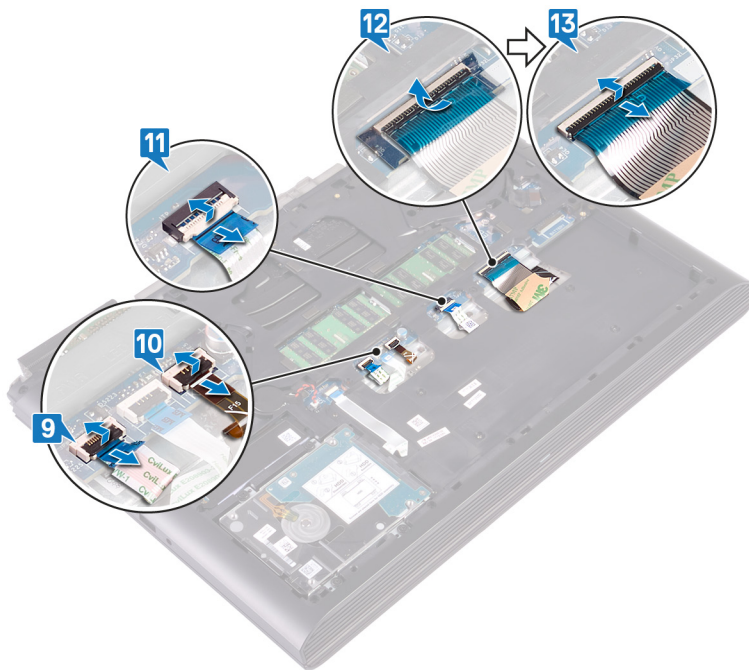

- 14 Remove the 19 screws (M2.5x6) that secure the computer base to the palm-rest assembly.
- 15 Remove the four screws (M2x3) that secure the computer base to the palm-rest assembly.

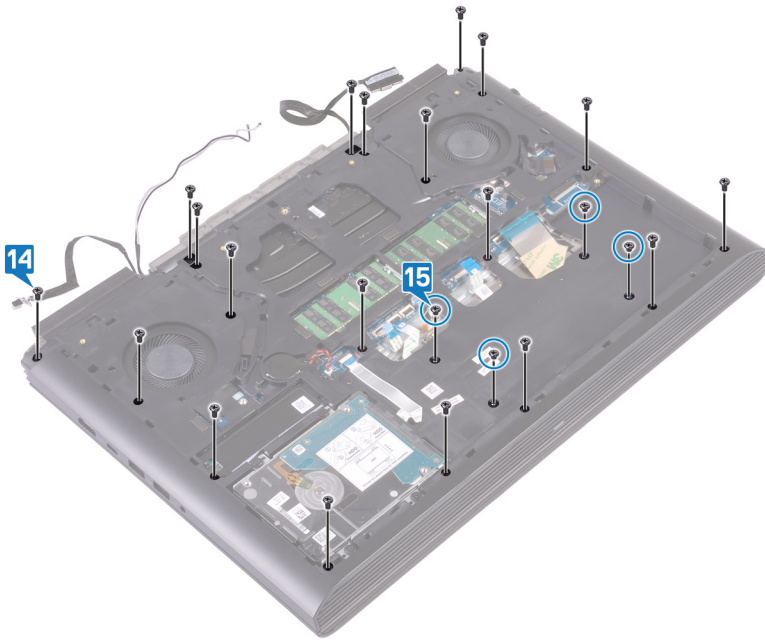

- 16 Turn the computer over and open the display.
- 17 Using a plastic scribe, release the tabs on palm-rest assembly from the slots on the computer base.
- 18 Lift the palm-rest assembly, along with the display assembly, off the computer base.



- 19 After performing all the above steps, you are left with the computer-base assembly.



- 20 Remove the [system board](#).
- 21 Remove the [power-adapter port](#).
- 22 Remove the [status-light board](#).
- 23 Remove the [speakers](#).

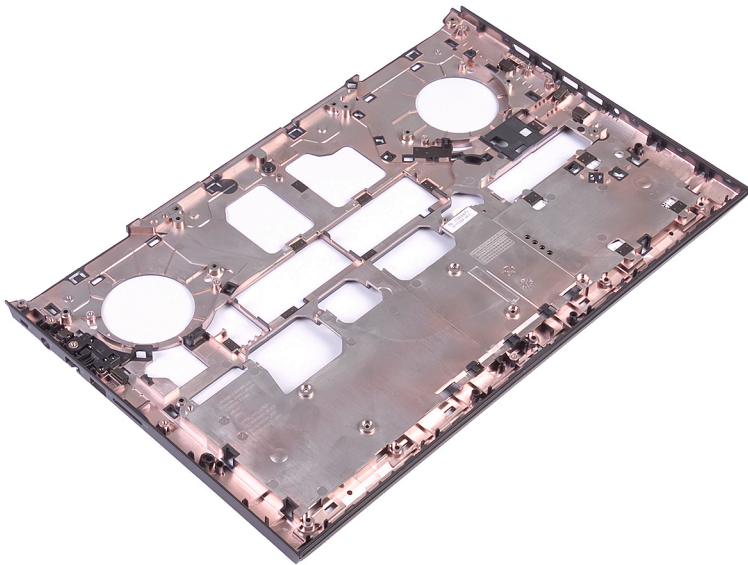

# Replacing the computer base

**⚠ WARNING:** Before working inside your computer, read the safety information that shipped with your computer and follow the steps in [Before working inside your computer](#). After working inside your computer, follow the instructions in [After working inside your computer](#). For more safety best practices, see the Regulatory Compliance home page at [www.dell.com/regulatory\\_compliance](http://www.dell.com/regulatory_compliance).

## Procedure

- 1 Place the computer base on a flat and clean surface.

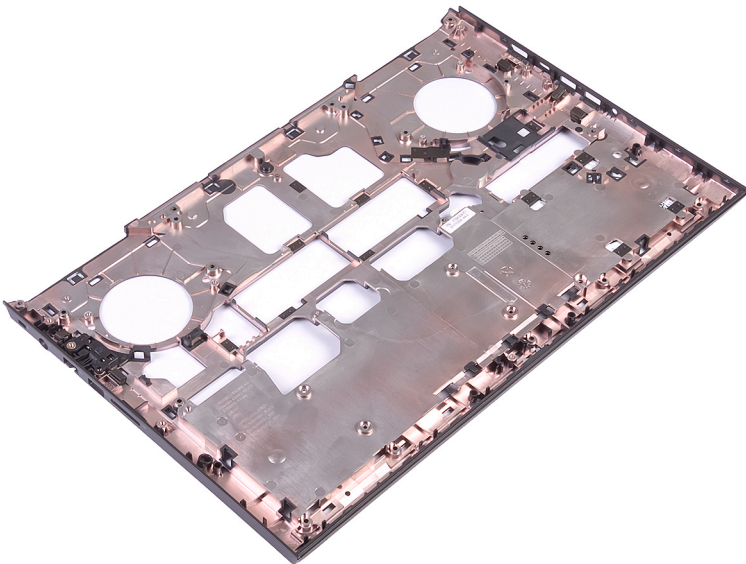

- 2 Replace the [speakers](#).
- 3 Replace the [status-light board](#).
- 4 Replace the [power-adaptor port](#).
- 5 Replace the [system board](#).
- 6 After performing the above steps, you are left with the computer-base assembly.



- 7 Turn over the computer-base assembly.
- 8 Place the display assembly, palm-rest, and keyboard assembly face down on a clean and flat surface.

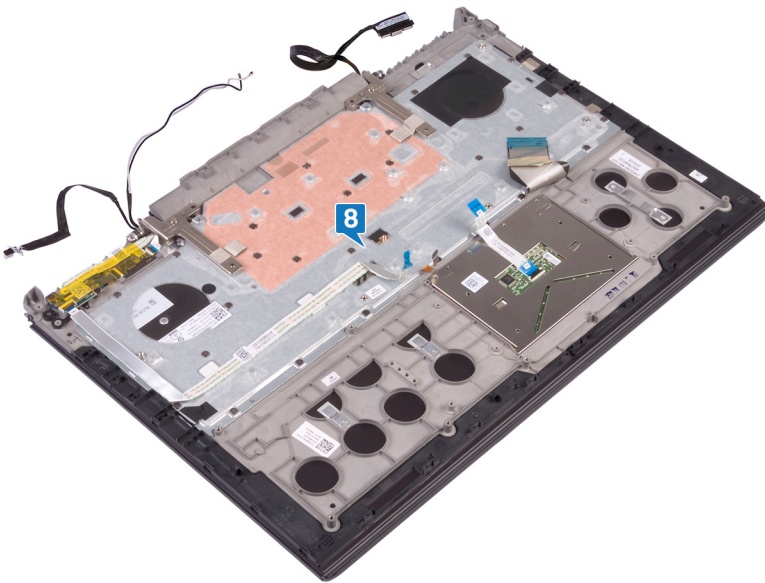

- 9 Place the computer-base assembly on the display, palm-rest, and keyboard assembly. Then slide the cables on the display, palm-rest and keyboard assembly through the respective slots on the computer-base assembly, aligning the latches on the palm-rest and keyboard assembly with the slots on the computer-base assembly.
- 10 Press down the edges of the computer base assembly and snap it into place.





- 11 Replace the four screws (M2x3) that secure the computer base to the palm-rest assembly.
- 12 Replace the 19 screws (M2.5x6) that secure the computer base to the palm-rest assembly.

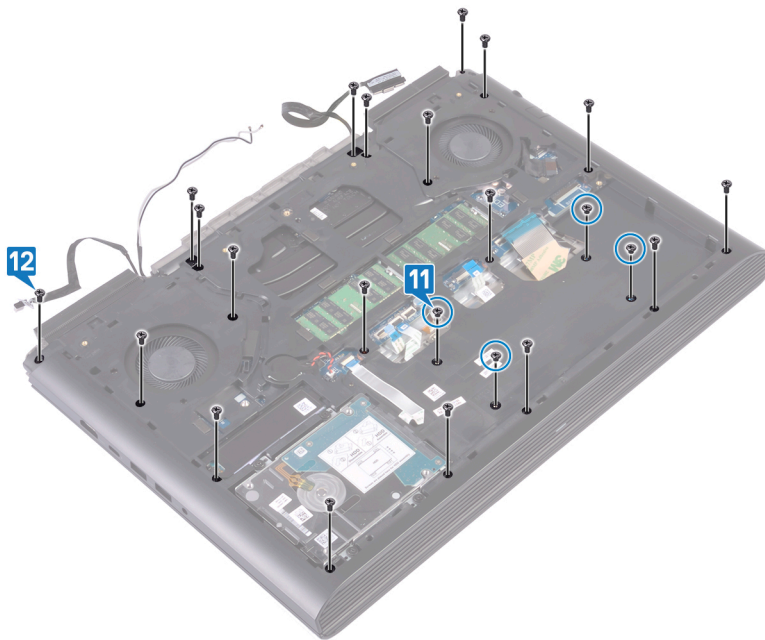

- 13 Slide the keyboard cable into the connector on the system board and close the latch to secure the cable.
- 14 Adhere the tape that secures the keyboard cable to the system board.
- 15 Slide the touchpad cable into the connector on the system board and close the latch to secure the cable.
- 16 Slide the keyboard-backlight cable into the connector on the system board and close the latch to secure the cable.
- 17 Slide the power-button board cable into the connector on the system board and close the latch to secure the cable.

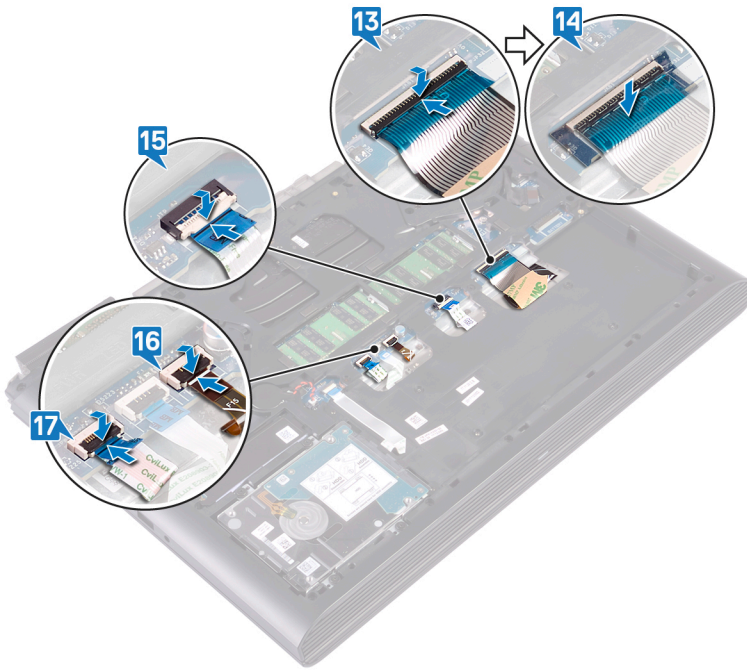

- 18 Adhere the display cable to the computer base and route the display cable through the routing guides on the computer base.
- 19 Connect the display-cable to the system board.
- 20 Align and place the display-cable bracket on the computer base.
- 21 Replace the screw (M2x3) that secures the display-cable bracket to the computer base.
- 22 Route the antenna cables through the routing guides on the computer base.
- 23 Adhere the camera cable to the computer base.
- 24 Connect the camera cable to the system board.

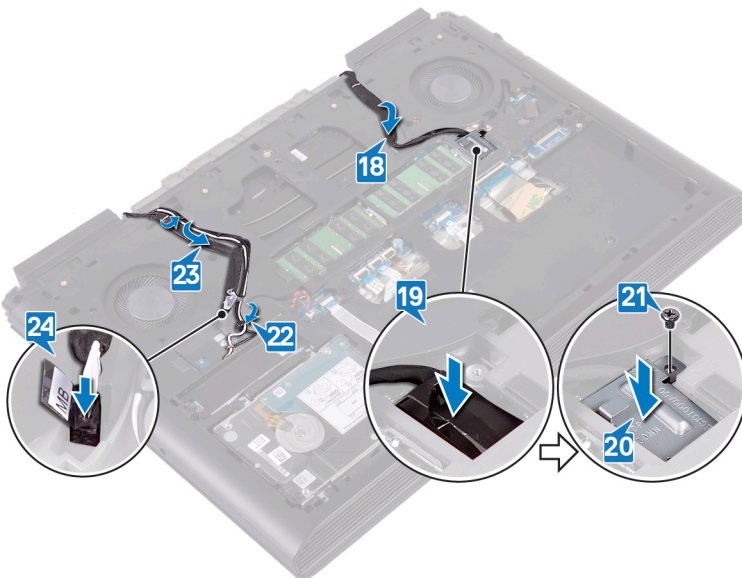

- 25 Adhere the tapes that secure the display cable, camera, and antenna cables to the computer base.



## Post-requisites

- 1 Replace the [wireless card](#).
- 2 Replace the [rear cover](#).
- 3 Replace the [battery](#).
- 4 Replace the [base cover](#).

# Removing the status-light board

**⚠ WARNING:** Before working inside your computer, read the safety information that shipped with your computer and follow the steps in [Before working inside your computer](#). After working inside your computer, follow the instructions in [After working inside your computer](#). For more safety best practices, see the Regulatory Compliance home page at [www.dell.com/regulatory\\_compliance](http://www.dell.com/regulatory_compliance).

## Prerequisites

- 1 Remove the [base cover](#).
- 2 Remove the [battery](#).
- 3 Remove the [rear cover](#).
- 4 Remove the [wireless card](#).
- 5 Follow the procedure from step 1 to step 18 in "[Removing the computer base](#)".

## Procedure

**① NOTE:** The status-light board includes an LED indicator for power and battery-status light/hard-drive activity light.

- 1 Open the latch and disconnect the status-light board cable from the status light board.
- 2 Remove the screw (M2x3) that secures the status-light board to the computer base.
- 3 Lift the status-light board off the computer base.

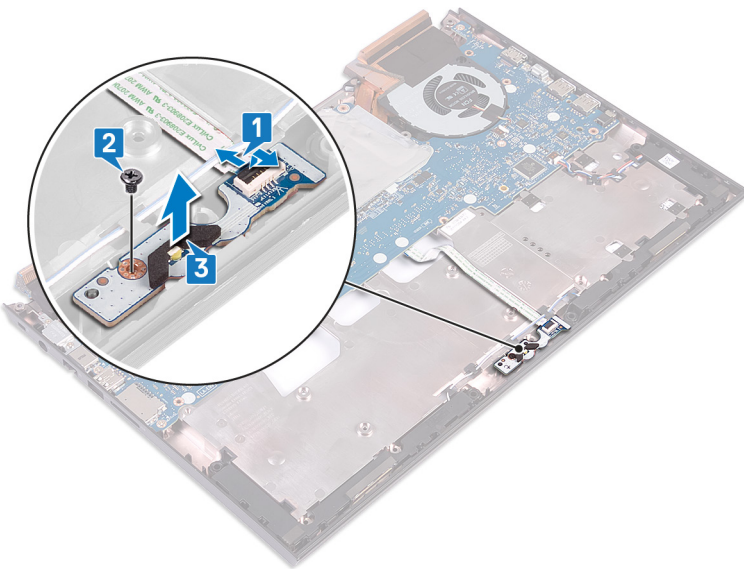

## Replacing the status-light board

**⚠ WARNING:** Before working inside your computer, read the safety information that shipped with your computer and follow the steps in [Before working inside your computer](#). After working inside your computer, follow the instructions in [After working inside your computer](#). For more safety best practices, see the Regulatory Compliance home page at [www.dell.com/regulatory\\_compliance](http://www.dell.com/regulatory_compliance).

### Procedure

- 1 Align the screw hole on the status-light board with the screw hole on the computer base.
- 2 Replace the screw (M2x3) that secures the status-light board to the computer base.
- 3 Slide the status-light board cable into the connector on the status-light board and close the latch to secure the cable.

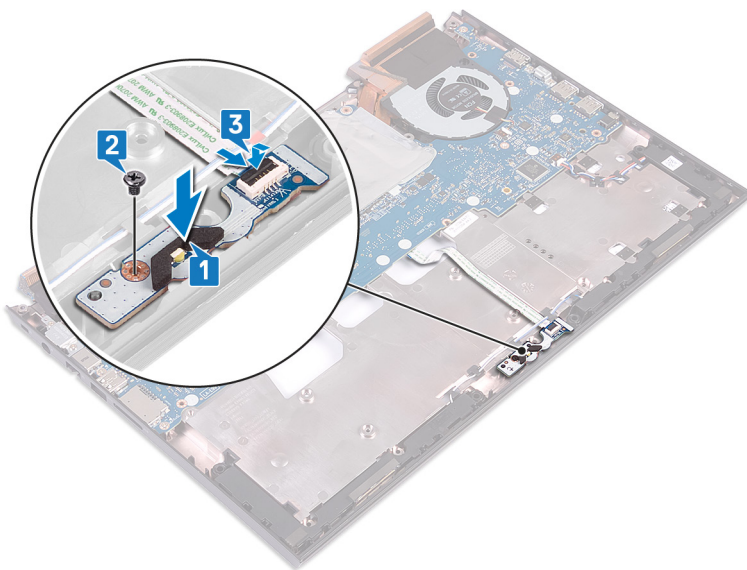

### Post-requisites

- 1 Follow the procedure from step 7 to step 23 in "[Replacing the computer base](#)".
- 2 Replace the [wireless card](#).
- 3 Replace the [rear cover](#).
- 4 Replace the [battery](#).
- 5 Replace the [base cover](#).

# Removing the speakers

**⚠ WARNING:** Before working inside your computer, read the safety information that shipped with your computer and follow the steps in [Before working inside your computer](#). After working inside your computer, follow the instructions in [After working inside your computer](#). For more safety best practices, see the Regulatory Compliance home page at [www.dell.com/regulatory\\_compliance](http://www.dell.com/regulatory_compliance).

## Prerequisites

- 1 Remove the [base cover](#).
- 2 Remove the [battery](#).
- 3 Remove the [rear cover](#).
- 4 Remove the [wireless card](#).
- 5 Follow the procedure from step 1 to step 18 in "[Removing the computer base](#)".

## Procedure

- 1 Disconnect the speaker cable from the system board.
- 2 Note the routing of the speaker cable and remove the speaker cable from the routing guides on the computer base.
- 3 Note the position of the rubber grommets before lifting the speakers.
- 4 Lift the right speaker off the computer base.
- 5 Note the routing of the speaker cable and remove the speaker cable from the routing guides on the computer base.
- 6 Lift the left speaker off the computer base.

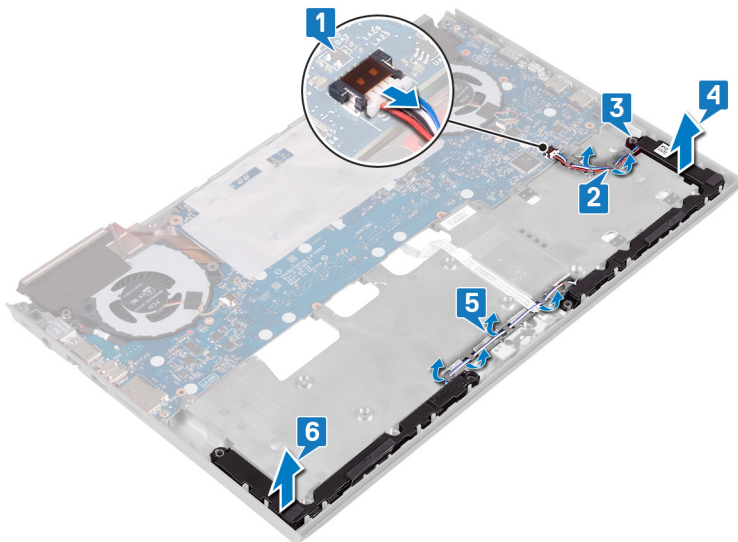

# Replacing the speakers

**⚠ WARNING:** Before working inside your computer, read the safety information that shipped with your computer and follow the steps in [Before working inside your computer](#). After working inside your computer, follow the instructions in [After working inside your computer](#). For more safety best practices, see the Regulatory Compliance home page at [www.dell.com/regulatory\\_compliance](http://www.dell.com/regulatory_compliance).

## Procedure

**① NOTE:** The rubber grommets may get pushed out while replacing the speaker. Ensure that the rubber grommets are in their position after placing the speaker on the system board.

- 1 Using the alignment posts, place the left speaker on the computer base.
- 2 Route the speaker cable through the routing guides on the computer base.
- 3 Using the alignment posts, place the right speaker on the computer base.
- 4 Route the speaker cable through the routing guides on the computer base.
- 5 Connect the speaker cable to the system board.

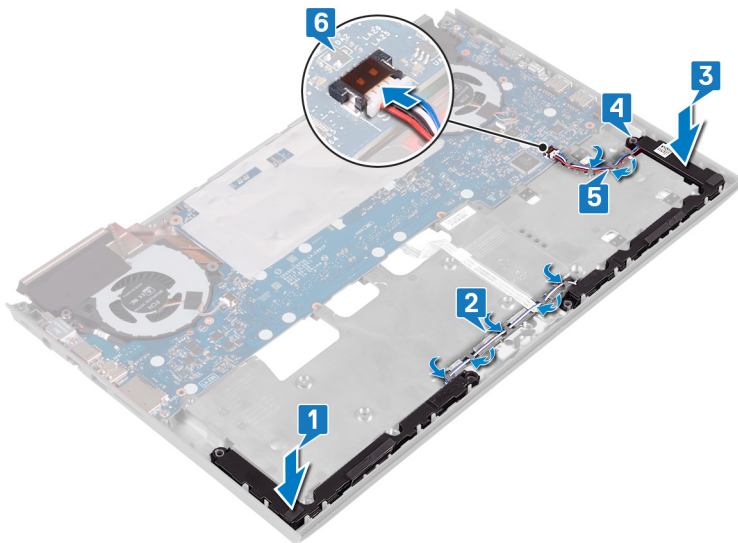

## Post-requisites

- 1 Follow the procedure from step 7 to step 23 in "[Replacing the computer base](#)".
- 2 Replace the [wireless card](#).
- 3 Replace the [rear cover](#).
- 4 Replace the [battery](#).
- 5 Replace the [base cover](#).

# Removing the system board

- ⚠ WARNING:** Before working inside your computer, read the safety information that shipped with your computer and follow the steps in [Before working inside your computer](#). After working inside your computer, follow the instructions in [After working inside your computer](#). For more safety best practices, see the Regulatory Compliance home page at [www.dell.com/regulatory\\_compliance](http://www.dell.com/regulatory_compliance).
- ⓘ NOTE:** Your computer's Service Tag is stored in the system board. You must enter the Service Tag in the BIOS setup program after you replace the system board.
- ⓘ NOTE:** Replacing the system board removes any changes you have made to the BIOS using the BIOS setup program. You must make the appropriate changes again after you replace the system board.
- ⓘ NOTE:** Before disconnecting the cables from the system board, note the location of the connectors so that you can reconnect the cables correctly after you replace the system board.

## Prerequisites

- 1 Remove the [base cover](#).
- 2 Remove the [battery](#).
- 3 Remove the [coin-cell battery](#).
- 4 Remove the [rear cover](#).
- 5 Remove the [memory modules](#).
- 6 Remove the [solid-state drive](#).
- 7 Remove the [wireless card](#).
- 8 Follow the procedure from step 1 to step 18 in "[Removing the computer base](#)".

## Procedure

- 1 Disconnect the coin-cell battery from the system board.
- 2 Open the latch and disconnect the hard-drive cable from the system board.
- 3 Open the latch and disconnect the status-light board cable from the system board.
- 4 Disconnect the power-adaptor port cable from the system board.



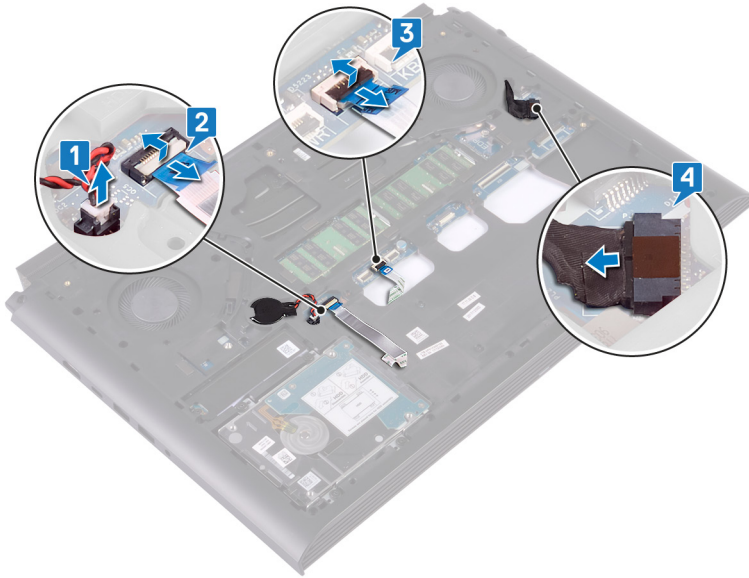

- 5 Turn the computer base over.
- 6 Remove the two screws (M2.5x5) that secure the power-adaptor port bracket to the computer base.
- 7 Lift the power-adaptor port bracket off the computer base.
- 8 Remove the two screws (M2.5x5) that secure the USB Type-C port bracket to the system board.
- 9 Lift the USB Type-C port bracket from the system board.
- 10 Disconnect the speaker cable from the system board.

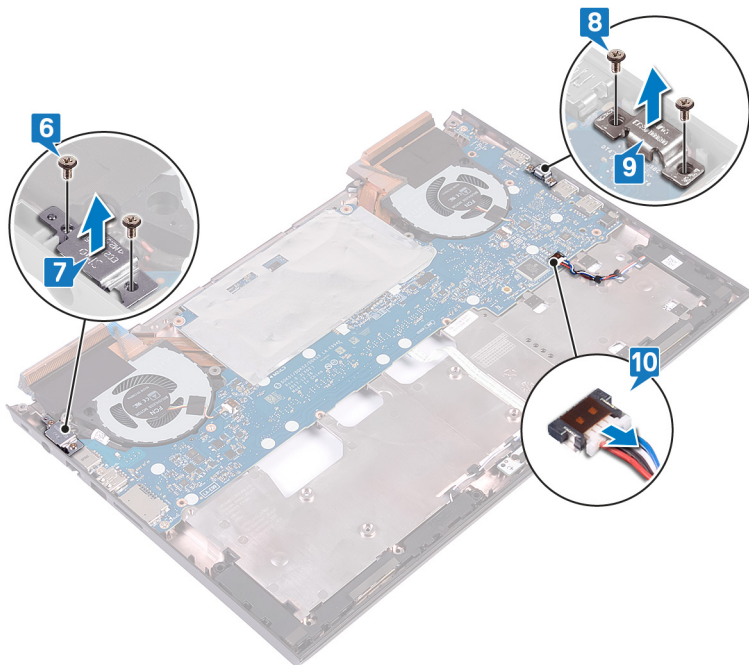

- 11 Remove the four screws (M2x3) that secure the fans to the system board.
- 12 Remove the three screws (M2.5x5) that secure the system board to the computer base.
- 13 Gently release the ports on the system board from the slots on the computer base and lift the system board off the computer base.

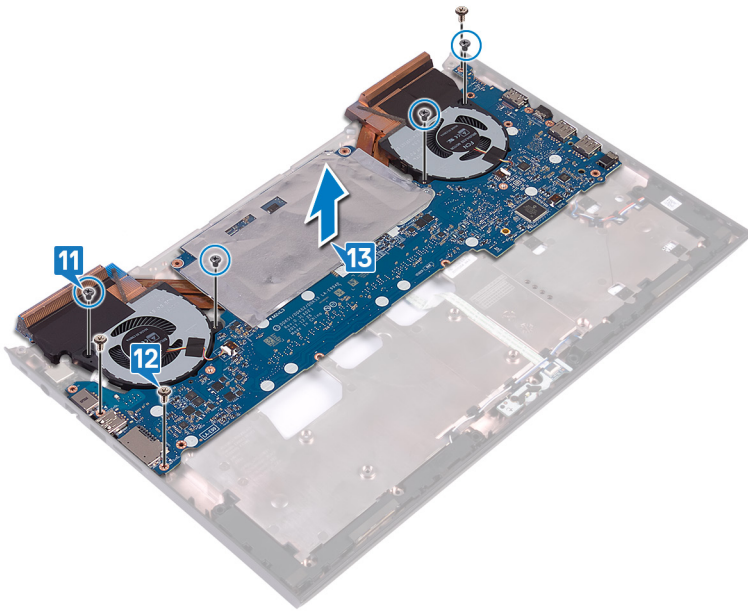

- 14 Turn the system board over.
- 15 Remove the [heat sink](#).
- 16 After performing the steps above, you are left with the system board.

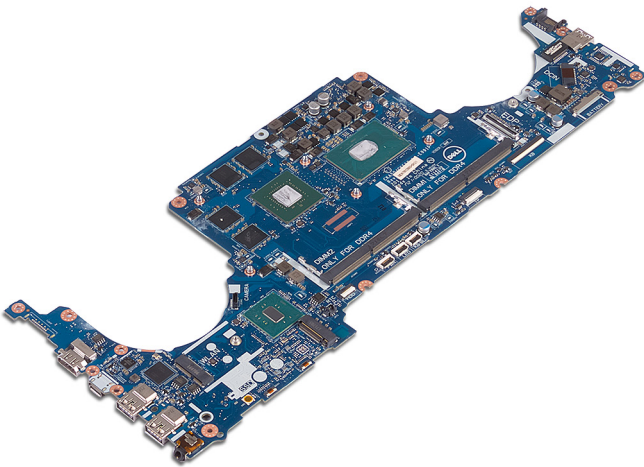

# Replacing the system board

**⚠ WARNING:** Before working inside your computer, read the safety information that shipped with your computer and follow the steps in [Before working inside your computer](#). After working inside your computer, follow the instructions in [After working inside your computer](#). For more safety best practices, see the Regulatory Compliance home page at [www.dell.com/regulatory\\_compliance](http://www.dell.com/regulatory_compliance).

**ⓘ NOTE:** Your computer's Service Tag is stored in the system board. You must enter the Service Tag in the BIOS setup program after you replace the system board.

**ⓘ NOTE:** Replacing the system board removes any changes you have made to the BIOS using the BIOS setup program. You must make the appropriate changes again after you replace the system board.

## Procedure

- 1 Place the system board on a clean and flat surface.

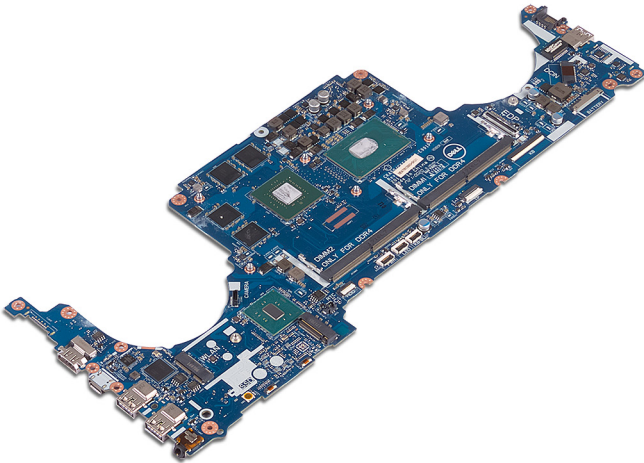

- 2 Replace the [heat sink](#).
- 3 Slide the ports on the system board into the slots on the computer base and align the screw holes on the system board with the screw holes on the computer base.
- 4 Replace the four screws (M2x3) that secure the fans to the system board.
- 5 Replace the three screws (M2.5x5) that secure the system board to the computer base.

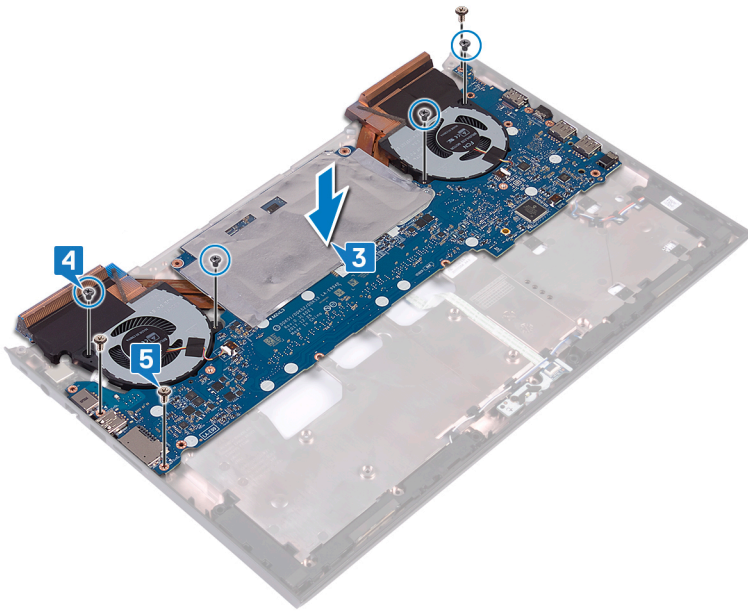

- 6 Connect the speaker cable to the system board.
- 7 Align and place the USB Type-C port bracket on the system board.
- 8 Replace the two screws (M2.5x5) that secure the USB Type-C port bracket to the computer base.
- 9 Align and place the power-adaptor port bracket on the computer base.
- 10 Replace the two screws (M2.5x5) that secure the power-adaptor port bracket to the computer base.

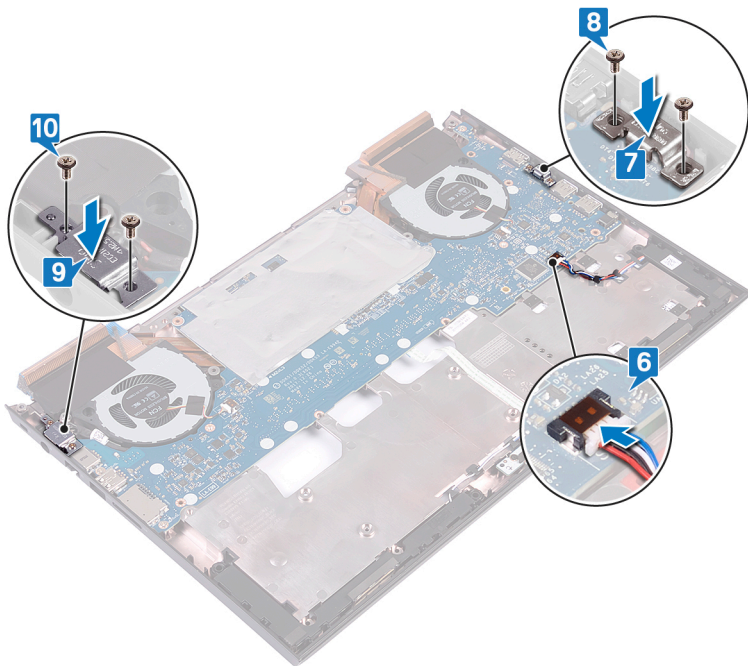

- 11 Turn the computer base over.
- 12 Connect the power-adaptor port cable to the system board.
- 13 Slide the status-light board cable into the connector on the system board and close the latch to secure the cable.
- 14 Slide the hard-drive cable into the connector on the system board and close the latch to secure the cable.
- 15 Connect the coin-cell battery to the system board.

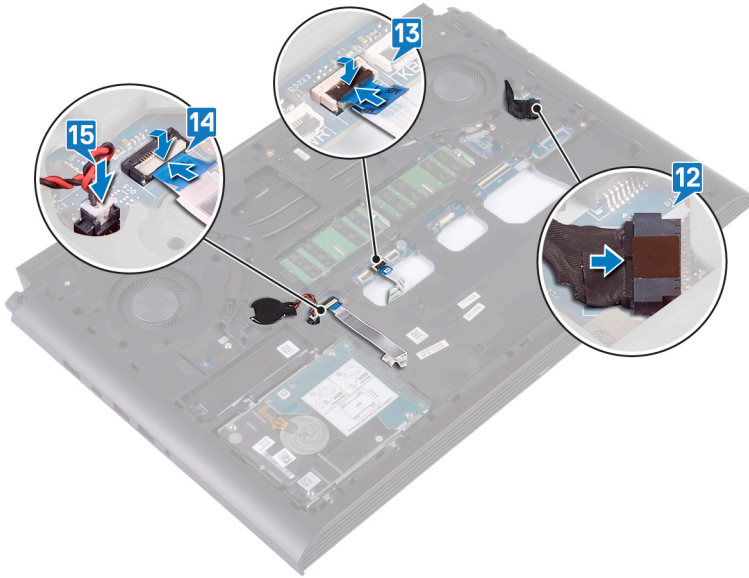

## Post-requisites

- 1 Follow the procedure from step 7 to step 23 in "Replacing the computer base".
- 2 Replace the [wireless card](#).
- 3 Replace the [solid-state drive](#).
- 4 Replace the [memory modules](#).
- 5 Replace the [rear cover](#).
- 6 Replace the [coin-cell battery](#).
- 7 Replace the [battery](#).
- 8 Replace the [base cover](#).

## Entering the Service Tag in the BIOS setup program

- 1 Turn on or restart your computer.
- 2 Press F2 when the Dell logo is displayed to enter the BIOS setup program.
- 3 Navigate to the **Main** tab and enter the Service Tag in the **Service Tag Input** field.

**NOTE:** Service tag is the alphanumeric identifier located at the back side of your computer.

# Removing the power-adapter port

**⚠ WARNING:** Before working inside your computer, read the safety information that shipped with your computer and follow the steps in [Before working inside your computer](#). After working inside your computer, follow the instructions in [After working inside your computer](#). For more safety best practices, see the Regulatory Compliance home page at [www.dell.com/regulatory\\_compliance](http://www.dell.com/regulatory_compliance).

## Prerequisites

- 1 Remove the [base cover](#).
- 2 Remove the [battery](#).
- 3 Remove the [rear cover](#).
- 4 Remove the [solid-state drive](#).
- 5 Remove the [memory modules](#).
- 6 Remove the [wireless card](#).
- 7 Follow the procedure from step 1 to step 18 in "[Removing the computer base](#)".
- 8 Remove the [system board](#).

## Procedure

Lift the power-adapter port, along with its cable, off the computer base.

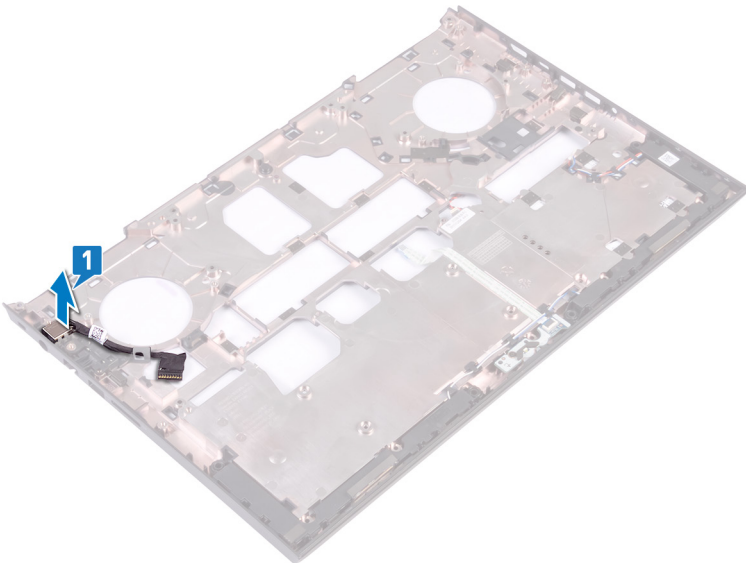

# Replacing the power-adapter port

**WARNING:** Before working inside your computer, read the safety information that shipped with your computer and follow the steps in [Before working inside your computer](#). After working inside your computer, follow the instructions in [After working inside your computer](#). For more safety best practices, see the Regulatory Compliance home page at [www.dell.com/regulatory\\_compliance](http://www.dell.com/regulatory_compliance).

## Procedure

Place the power-adapter port along with its cable into the slot on the computer base.

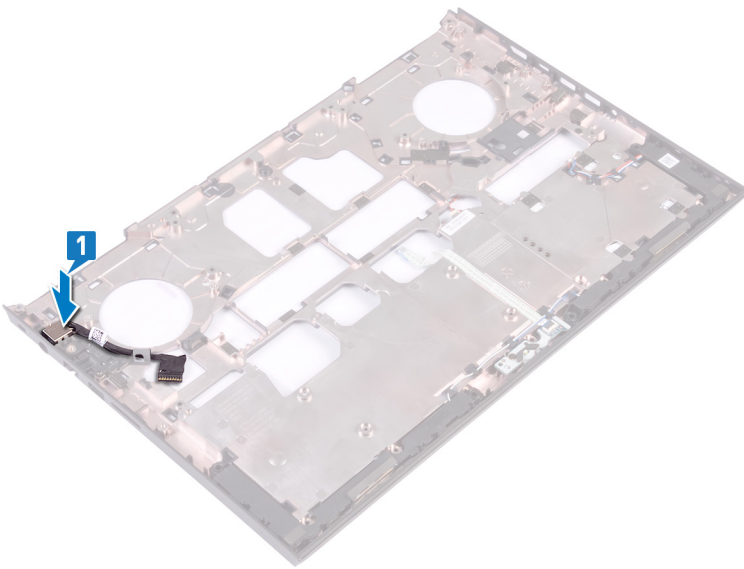

## Post-requisites

- 1 Replace the [system board](#).
- 2 Follow the procedure from step 7 to step 23 in "[Replacing the computer base](#)".
- 3 Replace the [wireless card](#).
- 4 Replace the [memory modules](#).
- 5 Replace the [solid-state drive](#).
- 6 Replace the [rear cover](#).
- 7 Replace the [battery](#).
- 8 Replace the [base cover](#).

# Removing the heat sink

- ⚠ WARNING:** Before working inside your computer, read the safety information that shipped with your computer and follow the steps in [Before working inside your computer](#). After working inside your computer, follow the instructions in [After working inside your computer](#). For more safety best practices, see the Regulatory Compliance home page at [www.dell.com/regulatory\\_compliance](http://www.dell.com/regulatory_compliance).
- ⚠ WARNING:** The heat sink may become hot during normal operation. Allow sufficient time for the heat sink to cool before you touch it.
- ⚠ CAUTION:** For maximum cooling of the processor, do not touch the heat transfer areas on the heat sink. The oils in your skin can reduce the heat transfer capability of the thermal grease.

## Prerequisites

- 1 Remove the [base cover](#).
- 2 Remove the [battery](#).
- 3 Remove the [coin-cell battery](#).
- 4 Remove the [rear cover](#).
- 5 Remove the [memory modules](#).
- 6 Remove the [solid-state drive](#).
- 7 Remove the [wireless card](#).
- 8 Remove the [computer base](#).

## Procedure

**ⓘ NOTE:** The appearance of the heat-sink assembly on your computer may differ from the image shown in this chapter.

- 1 Disconnect the left-fan cable from the system board.
- 2 Disconnect the right-fan cable from the system board.

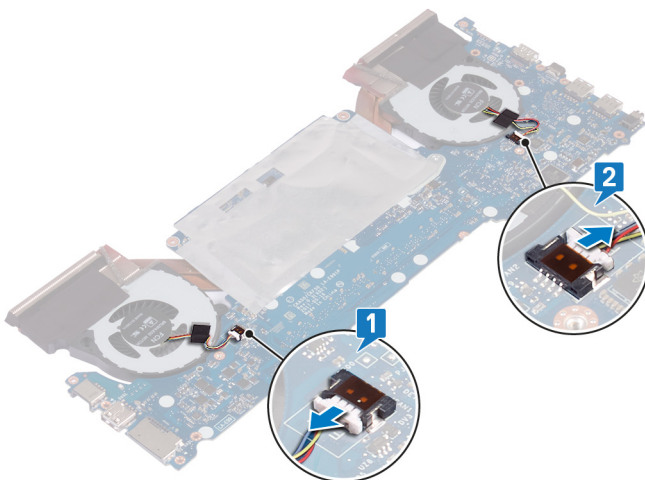

- 3 Turn the system board over.



- 4 In sequential order (indicated on the heat-sink assembly), remove the six screws (M2x3) that secure the heat sink assembly to the system board.
- 5 Lift the heat sink assembly off the system board.

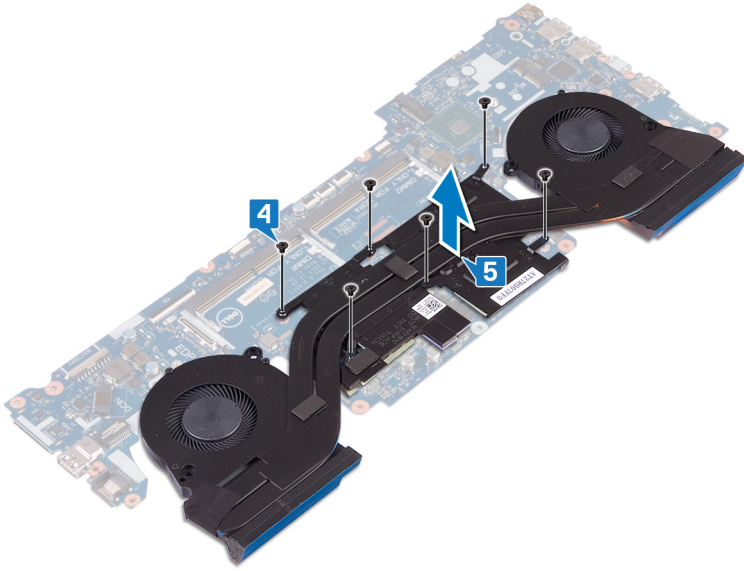

# Replacing the heat sink

**⚠ WARNING:** Before working inside your computer, read the safety information that shipped with your computer and follow the steps in [Before working inside your computer](#). After working inside your computer, follow the instructions in [After working inside your computer](#). For more safety best practices, see the Regulatory Compliance home page at [www.dell.com/regulatory\\_compliance](http://www.dell.com/regulatory_compliance).

**⚠ CAUTION:** Incorrect alignment of the heat sink can damage the system board and processor.

**ⓘ NOTE:** If either the system board or the heat sink is replaced, use the thermal pad provided in the kit to ensure that thermal conductivity is achieved.

## Procedure

- 1 Align the screw holes on the heat-sink assembly with the screw holes on the system board.
- 2 In sequential order (indicated on the heat-sink assembly), replace the six screws (M2x3) that secure the heat-sink assembly to the system board.

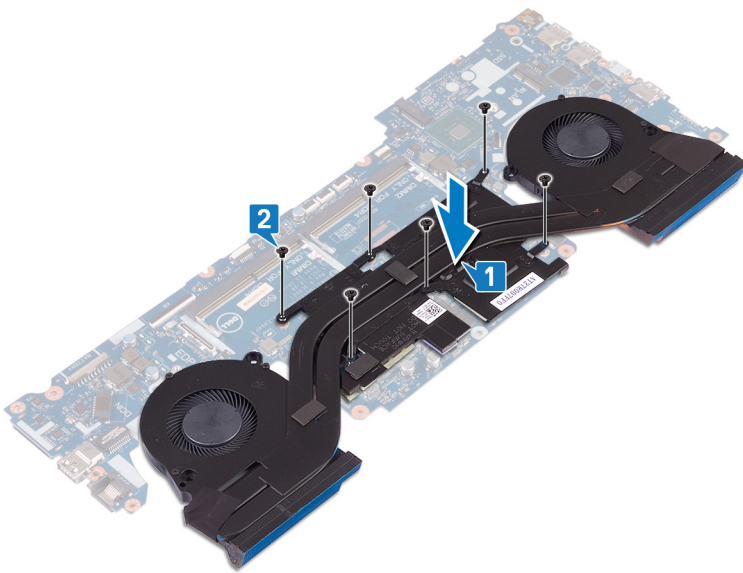

- 3 Turn the system board over.
- 4 Connect the right-fan cable.
- 5 Connect the left-fan cable.

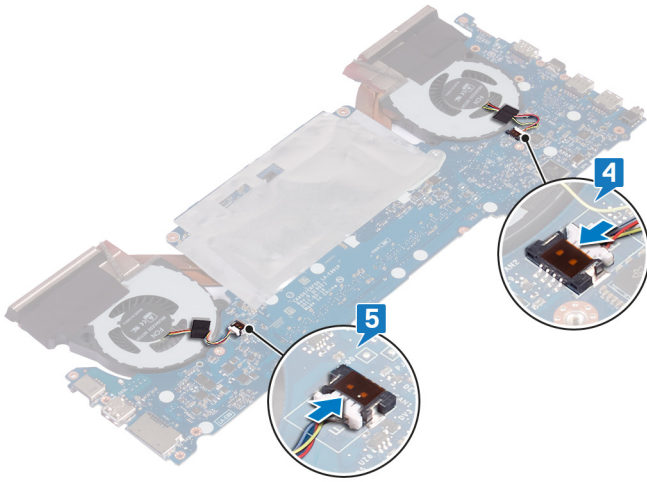

## Post-requisites

- 1 Replace the [computer base](#).
- 2 Replace the [wireless card](#).
- 3 Replace the [solid-state drive](#).
- 4 Replace the [memory modules](#).
- 5 Replace the [rear cover](#).
- 6 Replace the [coin-cell battery](#).
- 7 Replace the [battery](#).
- 8 Replace the [base cover](#).

# Removing the fans

**⚠ WARNING:** Before working inside your computer, read the safety information that shipped with your computer and follow the steps in [Before working inside your computer](#). After working inside your computer, follow the instructions in [After working inside your computer](#). For more safety best practices, see the Regulatory Compliance home page at [www.dell.com/regulatory\\_compliance](http://www.dell.com/regulatory_compliance).

## Prerequisites

- 1 Remove the [base cover](#).
- 2 Remove the [battery](#).
- 3 Remove the [rear cover](#).
- 4 Follow the procedure from step 1 to step 18 in [Removing the computer base](#).

## Procedure

- 1 Remove the five screws (M2x1.4) that secure the fans to the heat sink.



- 2 Turn the computer base over.
- 3 Disconnect the left-fan cable and right-fan cable from the system board.
- 4 Peel the tape that secure the left and right fans to the heat sink.
- 5 Remove the four screws (M2x3) that secure the fan to the system board.

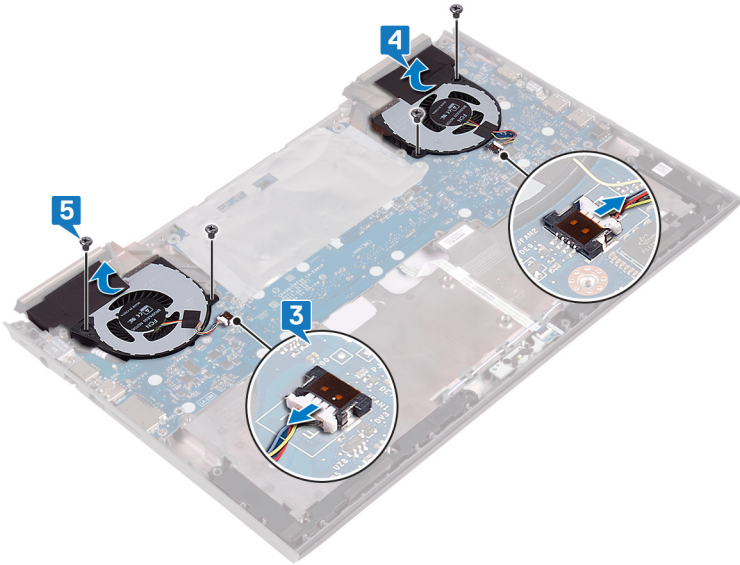

6 Lift the left and right fans off the heat sink.

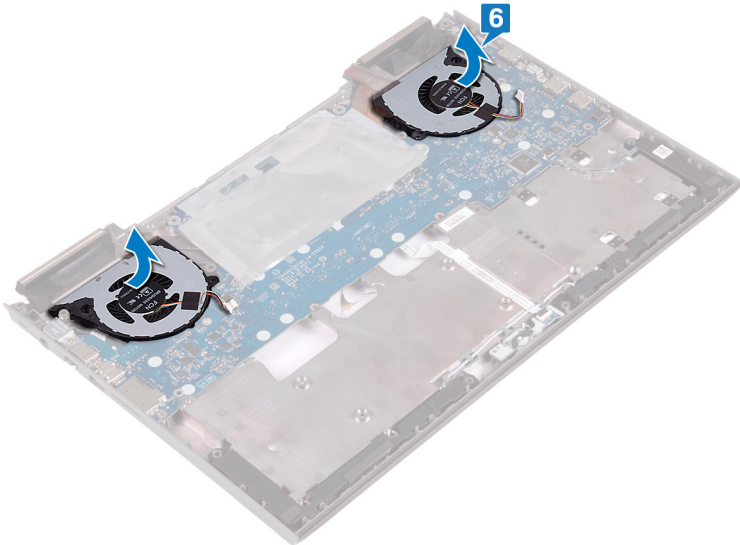

# Replacing the fans

**⚠ WARNING:** Before working inside your computer, read the safety information that shipped with your computer and follow the steps in [Before working inside your computer](#). After working inside your computer, follow the instructions in [After working inside your computer](#). For more safety best practices, see the Regulatory Compliance home page at [www.dell.com/regulatory\\_compliance](http://www.dell.com/regulatory_compliance).

## Procedure

- 1 Align and place the fans on the heat sink.

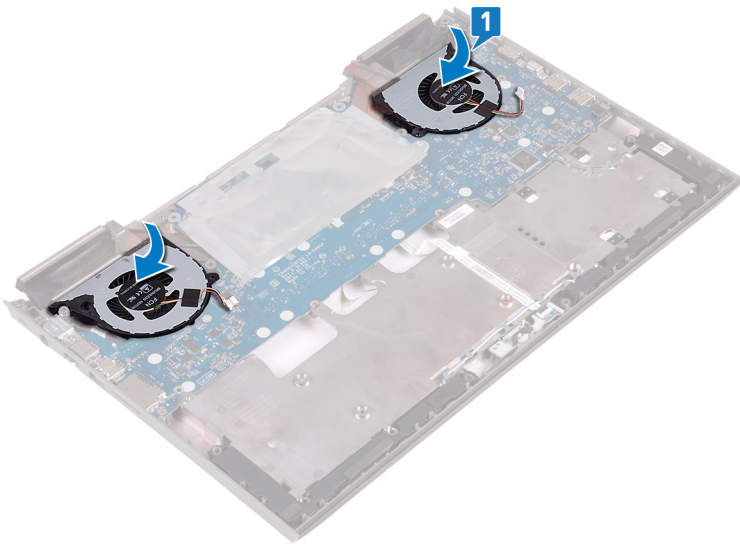

- 2 Replace the four screws (M2x3) that secure the fan to the system board.
- 3 Connect the left-fan cable and the right-fan cable to the system board.
- 4 Adhere the tape that secures the fans to the heat sink.

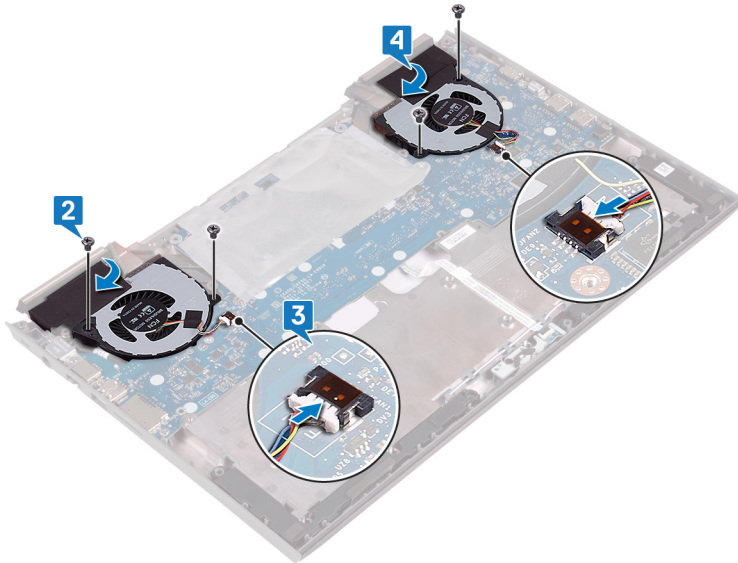

- 5 Turn the computer base over.
- 6 Replace the five screws (M2x1.4) that secure the fans to the heat sink.



## Post-requisites

- 1 Follow the procedure from step 7 to step 23 in [Replacing the computer base](#).
- 2 Replace the [rear cover](#).
- 3 Replace the [battery](#).
- 4 Replace the [base cover](#).

# Removing the power-button board

**⚠ WARNING:** Before working inside your computer, read the safety information that shipped with your computer and follow the steps in [Before working inside your computer](#). After working inside your computer, follow the instructions in [After working inside your computer](#). For more safety best practices, see the Regulatory Compliance home page at [www.dell.com/regulatory\\_compliance](http://www.dell.com/regulatory_compliance).

## Prerequisites

- 1 Remove the [base cover](#).
- 2 Remove the [battery](#).
- 3 Remove the [rear cover](#).
- 4 Remove the [computer base](#).
- 5 Follow the procedure from step 1 to step 17 in [Removing the computer base](#).

## Procedure

- 1 Peel off the Mylar securing the fingerprint-reader board cable latches to the power-button board and the finger-print reader board.
- 2 Peel and lift the power-button board cable from the palm-rest assembly.
- 3 Open the latch and disconnect the fingerprint-reader board cable from the fingerprint-reader board.
- 4 Remove the two screws (M2x3) that secure the power-button board to the palm-rest assembly.
- 5 Lift the power-button board, along with the cable, off the palm-rest assembly.

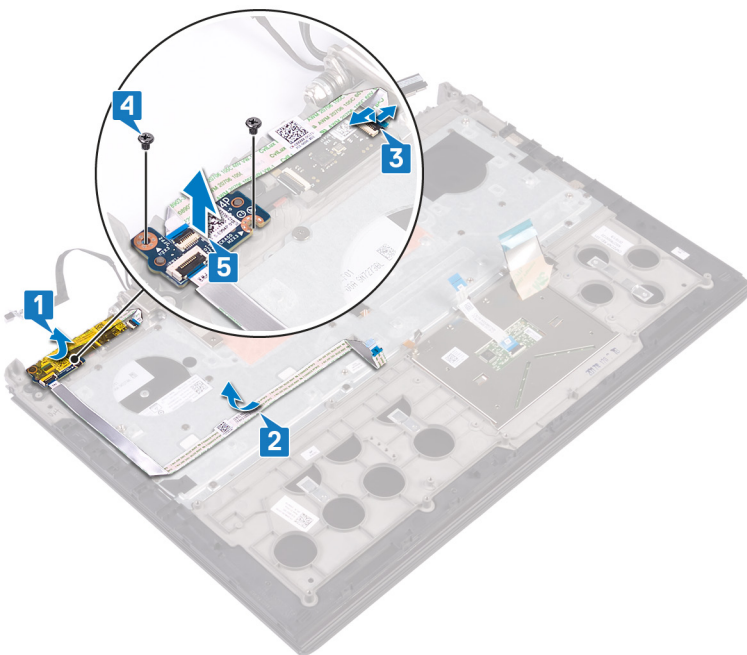



# Replacing the power-button board

**⚠ WARNING:** Before working inside your computer, read the safety information that shipped with your computer and follow the steps in [Before working inside your computer](#). After working inside your computer, follow the instructions in [After working inside your computer](#). For more safety best practices, see the Regulatory Compliance home page at [www.dell.com/regulatory\\_compliance](http://www.dell.com/regulatory_compliance).

## Procedure

- 1 Align the screw holes on the power-button board with the screw holes on the palm-rest assembly.
- 2 Replace the two screws (M2x3) that secure the power-button board to the palm-rest assembly.
- 3 Adhere the power-button board cable to the palm-rest assembly.
- 4 Slide the fingerprint-reader board cable into the connector on the fingerprint-reader board and close the latch to secure the cable.
- 5 Adhere the Mylar securing the fingerprint-reader board cable latches to the power-button board and the finger-print reader board.

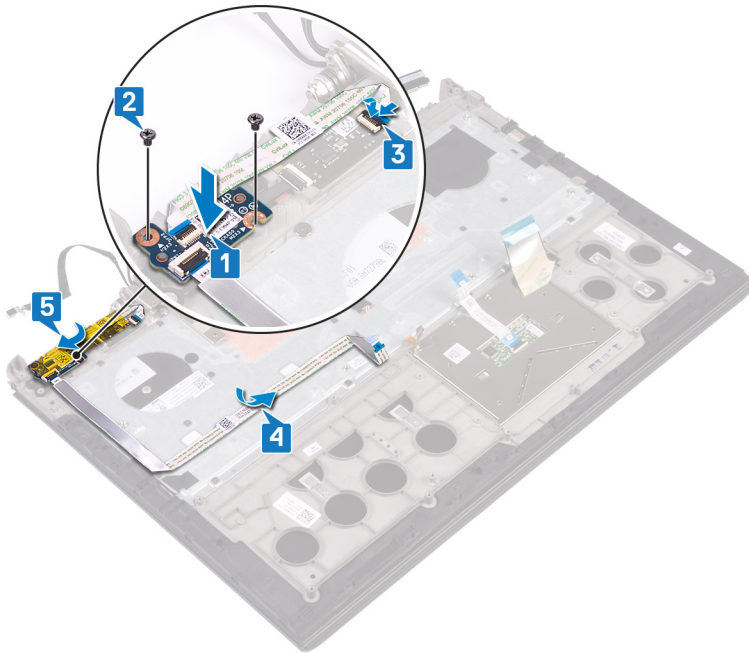

## Post-requisites

- 1 Follow the procedure from step 8 to step 23 in [Replacing the computer base](#).
- 2 Replace the [rear cover](#).
- 3 Replace the [battery](#).
- 4 Replace the [base cover](#).

# Removing the fingerprint-reader board

**⚠ WARNING:** Before working inside your computer, read the safety information that shipped with your computer and follow the steps in [Before working inside your computer](#). After working inside your computer, follow the instructions in [After working inside your computer](#). For more safety best practices, see the Regulatory Compliance home page at [www.dell.com/regulatory\\_compliance](http://www.dell.com/regulatory_compliance).

## Prerequisites

- 1 Remove the [base cover](#).
- 2 Remove the [battery](#).
- 3 Remove the [rear cover](#).
- 4 Remove the [computer base](#).
- 5 Remove the [power-button board](#).

## Procedure

- 1 Remove the two screws (M2x2) that secure the fingerprint-reader board bracket to the palm-rest assembly.
- 2 Using a plastic scribe, pry the fingerprint-reader board from the palm-rest assembly. Then, lift the fingerprint-reader board bracket and the fingerprint-reader board off the palm-rest assembly.

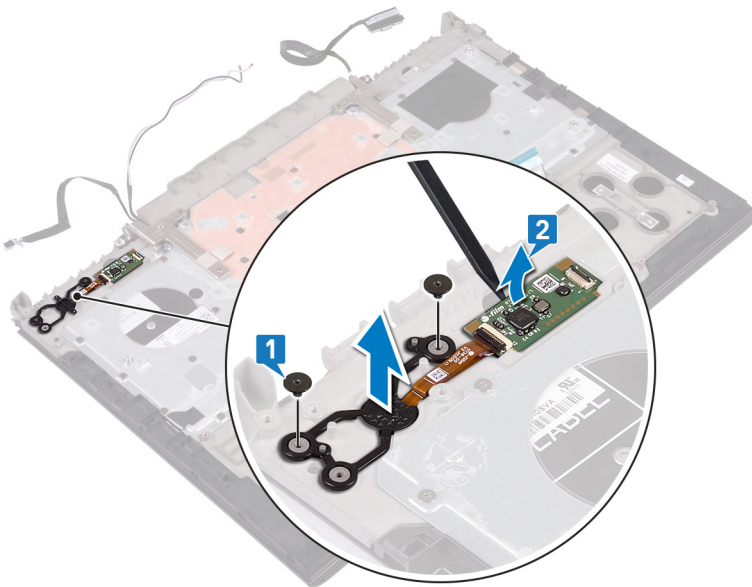

# Replacing the fingerprint-reader board

**⚠ WARNING:** Before working inside your computer, read the safety information that shipped with your computer and follow the steps in [Before working inside your computer](#). After working inside your computer, follow the instructions in [After working inside your computer](#). For more safety best practices, see the Regulatory Compliance home page at [www.dell.com/regulatory\\_compliance](http://www.dell.com/regulatory_compliance).

## Procedure

- 1 Place the fingerprint-reader board in its slot on the palm-rest assembly, then align the screw holes on the fingerprint-reader board bracket to the screw holes on the palm-rest assembly.
- 2 Replace the two screws (M2x2) that secure the fingerprint-reader board to the palm-rest assembly.

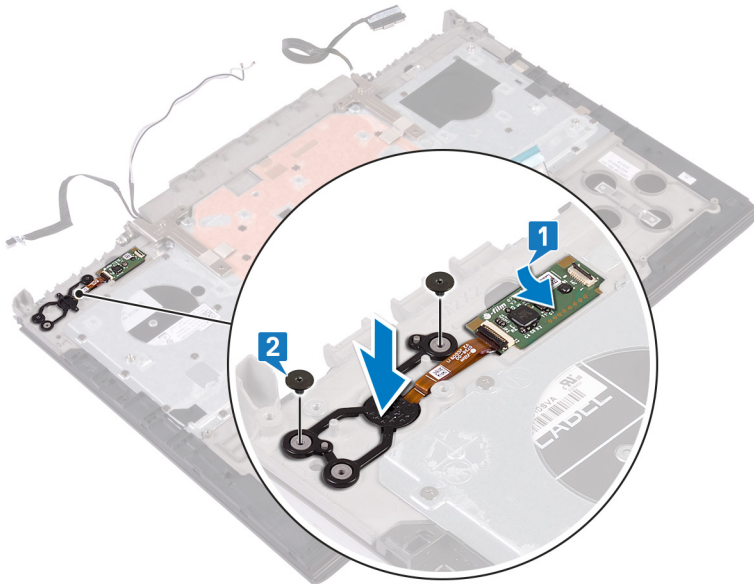

## Post-requisites

- 1 Replace the [power-button board](#).
- 2 Replace the [computer base](#).
- 3 Replace the [rear cover](#).
- 4 Replace the [battery](#).
- 5 Replace the [base cover](#).

# Removing the touchpad

**⚠ WARNING:** Before working inside your computer, read the safety information that shipped with your computer and follow the steps in [Before working inside your computer](#). After working inside your computer, follow the instructions in [After working inside your computer](#). For more safety best practices, see the Regulatory Compliance home page at [www.dell.com/regulatory\\_compliance](http://www.dell.com/regulatory_compliance).

## Prerequisites

- 1 Remove the [base cover](#).
- 2 Remove the [battery](#).
- 3 Remove the [rear cover](#).
- 4 Follow the procedure from step 1 to step 17 in [Removing the computer base](#).

## Procedure

- 1 Remove the four screws (M2x2) that secure the touchpad to the palm-rest assembly.
- 2 Slide and lift the touchpad, along with the cable, at an angle off the palm-rest assembly.

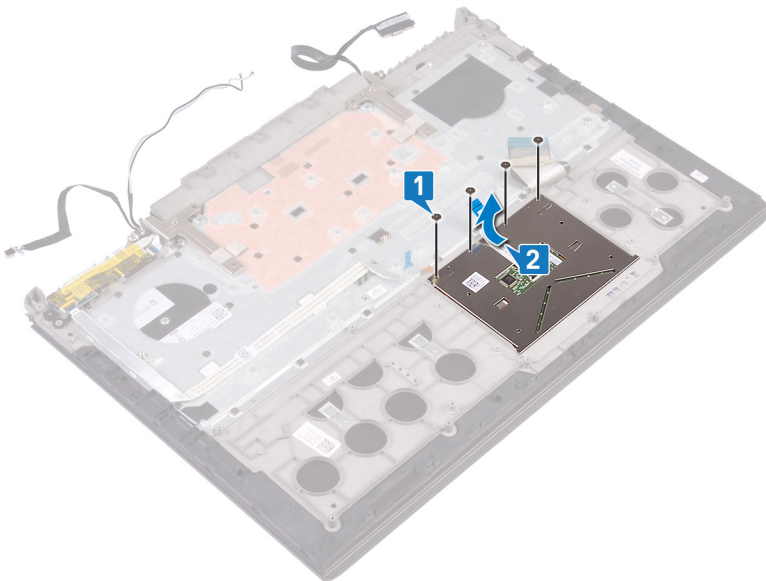

# Replacing the touchpad

**⚠ WARNING:** Before working inside your computer, read the safety information that shipped with your computer and follow the steps in [Before working inside your computer](#). After working inside your computer, follow the instructions in [After working inside your computer](#). For more safety best practices, see the Regulatory Compliance home page at [www.dell.com/regulatory\\_compliance](http://www.dell.com/regulatory_compliance).

## Procedure

- 1 Slide the touchpad under the touchpad bracket, then align the screw holes on the touchpad with the screw holes on the palm-rest assembly.  
**ⓘ NOTE:** Ensure that the touchpad is aligned with the guides available on the palm-rest assembly, and the gap on either sides of the touchpad is equal.
- 2 Replace the four screws (M2x2) that secure the touchpad to the palm-rest assembly.

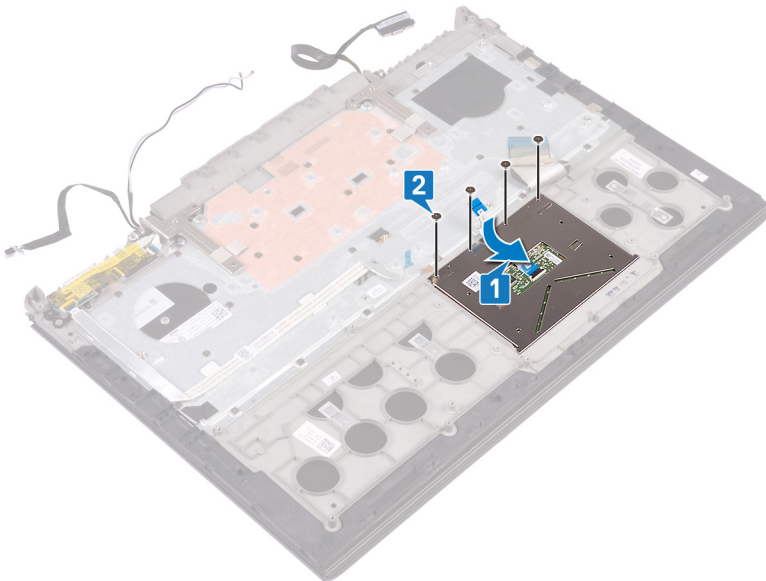

## Post-requisites

- 1 Follow the procedure from step 7 to step 23 in [Replacing the computer base](#).
- 2 Replace the [rear cover](#).
- 3 Replace the [battery](#).
- 4 Replace the [base cover](#).

# Removing the display assembly

**⚠ WARNING:** Before working inside your computer, read the safety information that shipped with your computer and follow the steps in [Before working inside your computer](#). After working inside your computer, follow the instructions in [After working inside your computer](#). For more safety best practices, see the Regulatory Compliance home page at [www.dell.com/regulatory\\_compliance](http://www.dell.com/regulatory_compliance).

## Prerequisites

- 1 Remove the [base cover](#).
- 2 Remove the [battery](#).
- 3 Remove the [rear cover](#).
- 4 Remove the [wireless card](#).
- 5 Follow the procedure from step 1 to step 17 in [Removing the computer base](#).

## Procedure

- 1 Peel off the tape that secure the display hinges to the palm-rest assembly.
- 2 Remove the two screws (M2.5x5) that secure the display hinges to the palm-rest assembly.
- 3 Open the display hinges at an angle of 90 degrees.

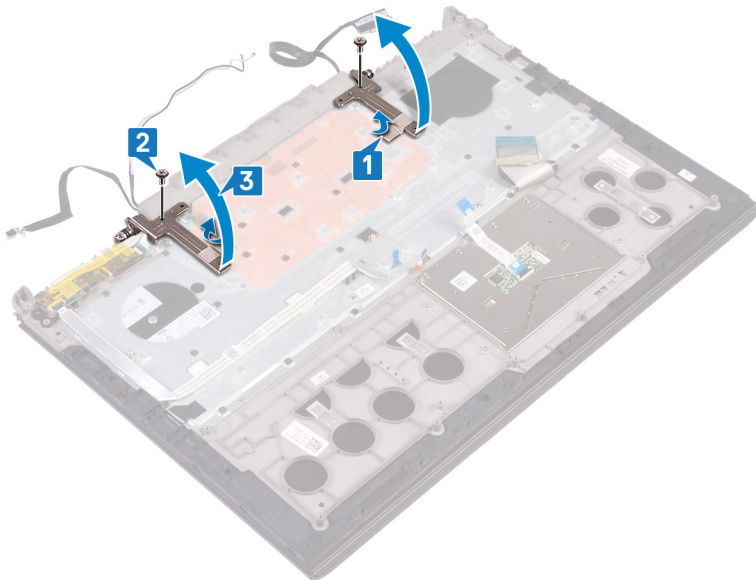

- 4 Lift the palm-rest assembly off the display assembly.

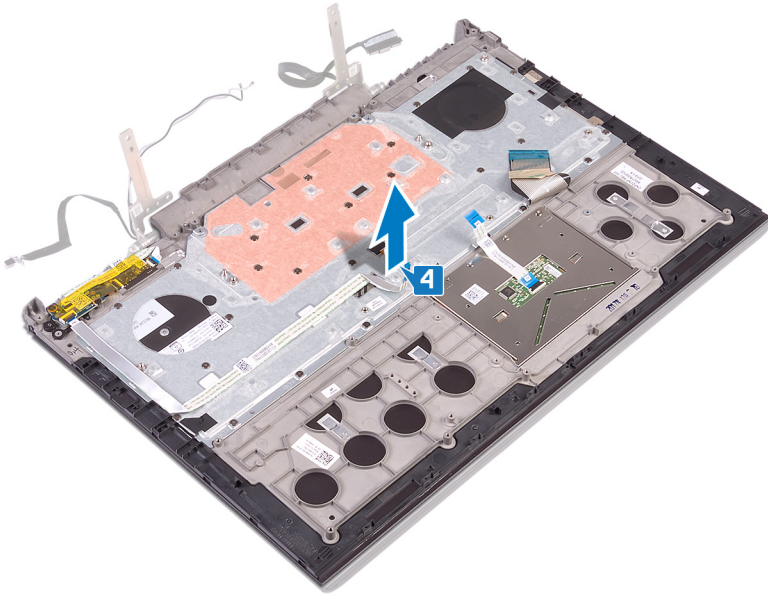

5 After performing the steps above, you are left with the display assembly.



# Replacing the display assembly

**⚠ WARNING:** Before working inside your computer, read the safety information that shipped with your computer and follow the steps in [Before working inside your computer](#). After working inside your computer, follow the instructions in [After working inside your computer](#). For more safety best practices, see the Regulatory Compliance home page at [www.dell.com/regulatory\\_compliance](http://www.dell.com/regulatory_compliance).

## Procedure

- 1 Place the palm-rest assembly on the display assembly.

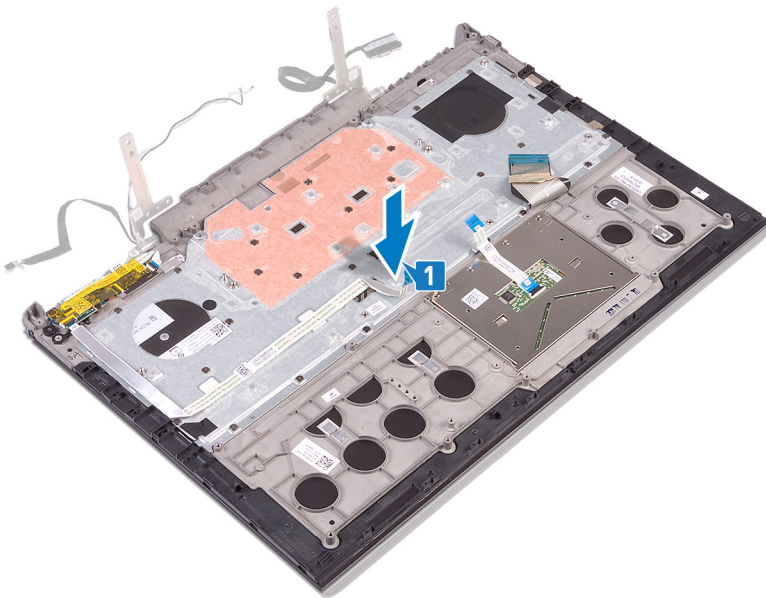

- 2 Close the display hinges at an angle of 90 degrees.
- 3 Replace the two screws (M2.5x5) that secure the display hinges to the palm-rest assembly.
- 4 Adhere the tape that secure the display hinges to the palm-rest assembly.



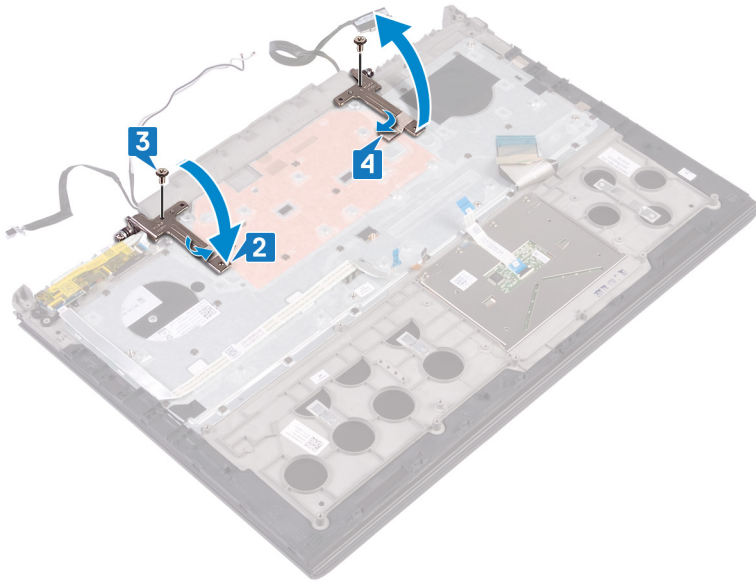

## Post-requisites

- 1 Follow the procedure from step 7 to step 23 in [Replacing the computer base](#).
- 2 Replace the [wireless card](#).
- 3 Replace the [rear cover](#).
- 4 Replace the [battery](#).
- 5 Replace the [base cover](#).

# Removing the palm rest

**⚠ WARNING:** Before working inside your computer, read the safety information that shipped with your computer and follow the steps in [Before working inside your computer](#). After working inside your computer, follow the instructions in [After working inside your computer](#). For more safety best practices, see the Regulatory Compliance home page at [www.dell.com/regulatory\\_compliance](http://www.dell.com/regulatory_compliance).

## Prerequisites

- 1 Remove the [base cover](#).
- 2 Remove the [battery](#).
- 3 Remove the [rear cover](#).
- 4 Remove the [wireless card](#).
- 5 Follow the procedure from step 1 to step 17 in [Removing the computer base](#).
- 6 Remove the [display assembly](#).
- 7 Remove the [power-button board](#).
- 8 Remove the [fingerprint-reader board](#).
- 9 Remove the [touchpad](#).
- 10 Remove the [keyboard](#).

## Procedure

After performing the prerequisites you are left with the palm-rest and keyboard assembly.



# Replacing the palm rest

**⚠ WARNING:** Before working inside your computer, read the safety information that shipped with your computer and follow the steps in [Before working inside your computer](#). After working inside your computer, follow the instructions in [After working inside your computer](#). For more safety best practices, see the Regulatory Compliance home page at [www.dell.com/regulatory\\_compliance](http://www.dell.com/regulatory_compliance).

## Procedure

Place the palm rest on a flat surface.



## Post-requisites

- 1 Replace the [keyboard](#).
- 2 Replace the [touchpad](#).
- 3 Replace the [fingerprint-reader board](#).
- 4 Replace the [power-button board](#).
- 5 Replace the [display assembly](#).
- 6 Follow the procedure from step 7 to step 23 in [Replacing the computer base](#).
- 7 Replace the [wireless card](#).
- 8 Replace the [rear cover](#).
- 9 Replace the [battery](#).
- 10 Replace the [base cover](#).

# Removing the keyboard

**⚠ WARNING:** Before working inside your computer, read the safety information that shipped with your computer and follow the steps in [Before working inside your computer](#). After working inside your computer, follow the instructions in [After working inside your computer](#). For more safety best practices, see the Regulatory Compliance home page at [www.dell.com/regulatory\\_compliance](http://www.dell.com/regulatory_compliance).

## Prerequisites

- 1 Remove the [base cover](#).
- 2 Remove the [battery](#).
- 3 Remove the [rear cover](#).
- 4 Remove the [wireless card](#).
- 5 Follow the procedure from step 1 to step 17 in [Removing the computer base](#).
- 6 Remove the [display assembly](#).

## Procedure

- 1 Open the latch and disconnect the power-adaptor port cable off the palm-rest assembly.
- 2 Peel the power-adaptor port cable off the palm-rest assembly.
- 3 Peel the tape that secures the keyboard bracket to the palm-rest assembly.

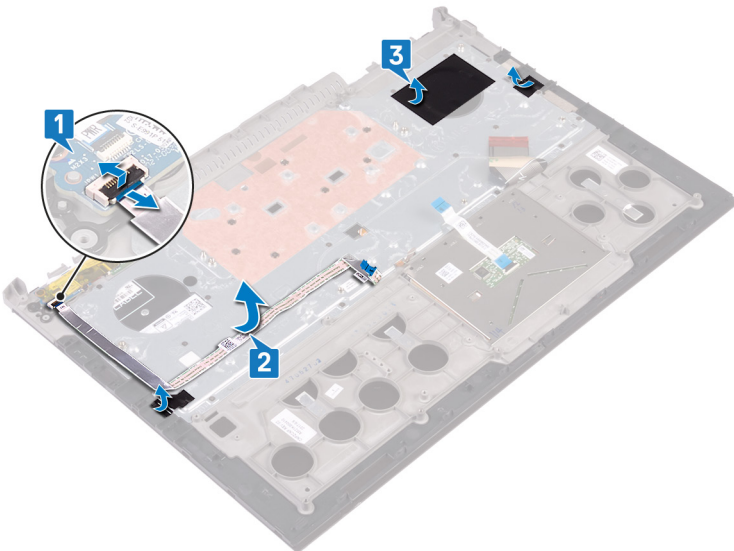

- 4 Remove the 30 screws (M1.6x2.2) that secure the keyboard bracket to the palm-rest assembly.
- 5 Lift the keyboard bracket off the palm-rest assembly.

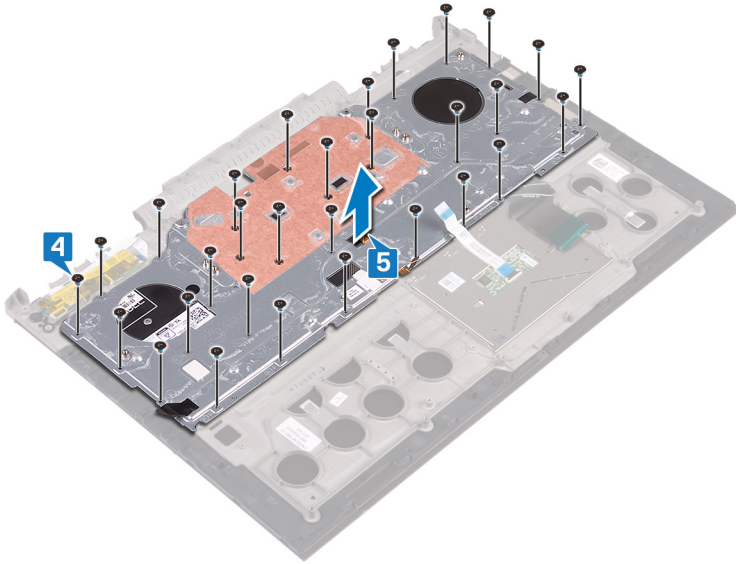

6 Lift the keyboard, along with the cables, off the palm-rest assembly.

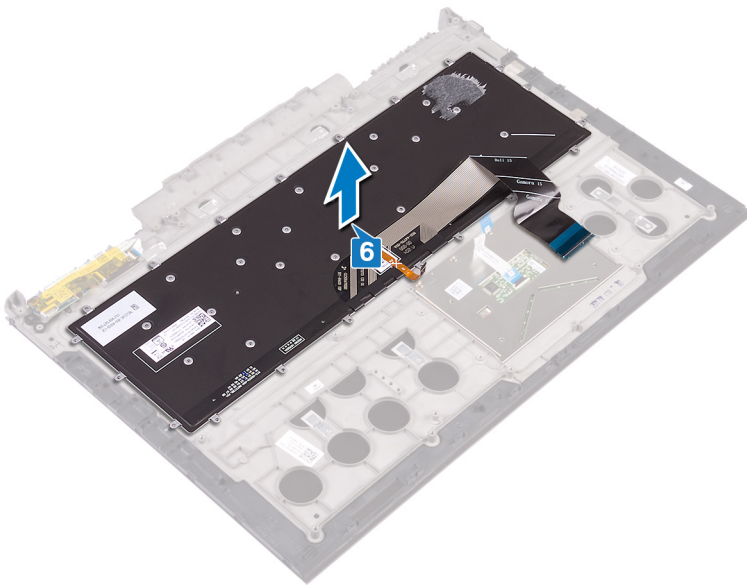

# Replacing the keyboard

**⚠ WARNING:** Before working inside your computer, read the safety information that shipped with your computer and follow the steps in [Before working inside your computer](#). After working inside your computer, follow the instructions in [After working inside your computer](#). For more safety best practices, see the Regulatory Compliance home page at [www.dell.com/regulatory\\_compliance](http://www.dell.com/regulatory_compliance).

## Procedure

**① NOTE:** If you are installing a new keyboard, fold the cables the same way they are folded on the old keyboard. For more information, see [“Folding the keyboard cables”](#).

- 1 Align and place the keyboard on the palm-rest assembly.

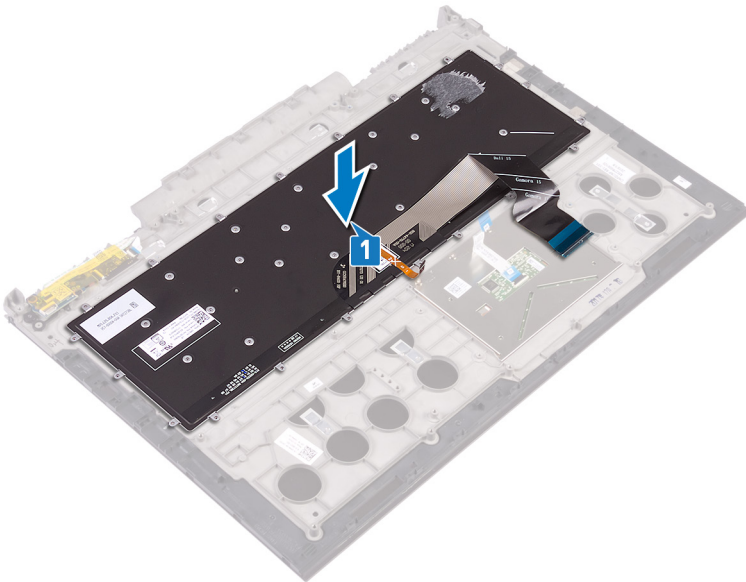

- 2 Align and place the keyboard bracket on the palm-rest assembly.
- 3 Replace the 30 screws (M1.6x2.2) that secure the keyboard bracket to the palm-rest assembly.

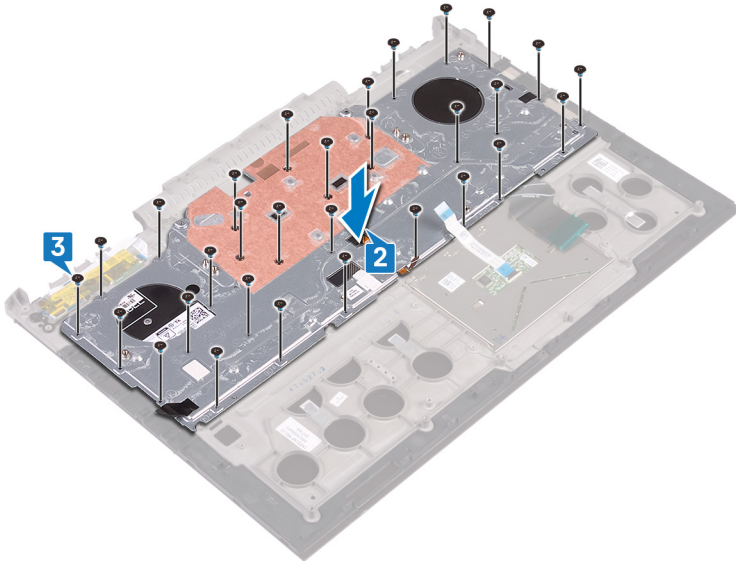

- 4 Adhere the tape that secures the keyboard bracket to the palm-rest assembly.
- 5 Connect the power-adaptor port cable to the palm-rest assembly and close the latch to secure the cable.
- 6 Adhere the power-adaptor port cable to the palm-rest assembly.

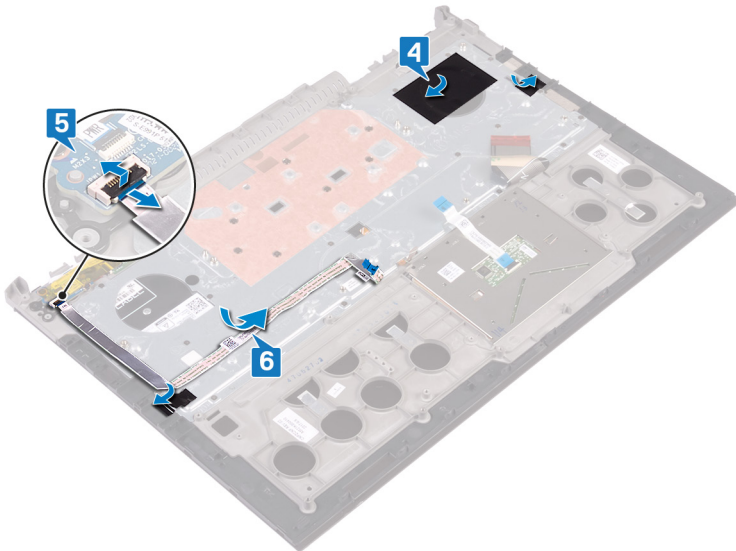

## Post-requisites

- 1 Replace the [display assembly](#).
- 2 Follow the procedure from step 7 to step 23 in [Replacing the computer base](#).
- 3 Replace the [wireless card](#).
- 4 Replace the [rear cover](#).
- 5 Replace the [battery](#).
- 6 Replace the [base cover](#).

## Folding the keyboard cables

**⚠ CAUTION:** Do not apply excess pressure while folding the cables.

The cables on the keyboard are not folded when you receive a replacement keyboard. Follow these instructions to fold the cables on the replacement keyboard the same way they are folded on the old keyboard.

① **NOTE: Keyboard-backlight cable is present only on a backlit-keyboard.**

- 1 Note the position to fold the new keyboard cable.

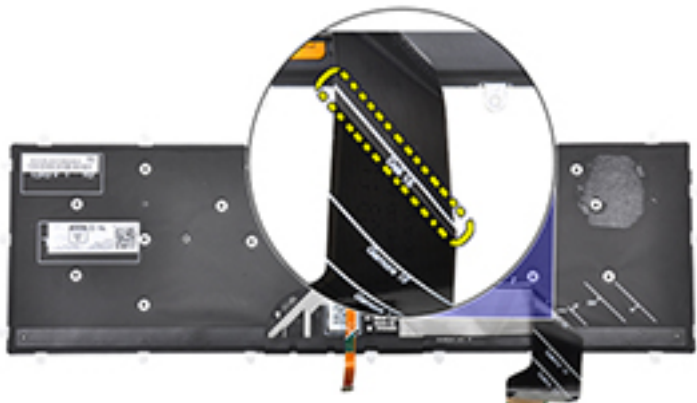

- 2 Gently fold the keyboard cable with the end aligned at the fold line as shown in the image. Once folded correctly, the right edge of the keyboard cable should be lined up next to the line indicated on the palm-rest assembly.

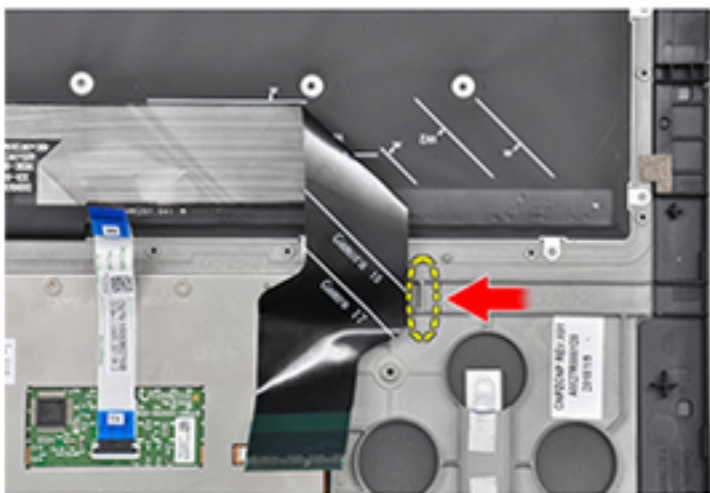



# Removing the display bezel

**⚠ WARNING:** Before working inside your computer, read the safety information that shipped with your computer and follow the steps in [Before working inside your computer](#). After working inside your computer, follow the instructions in [After working inside your computer](#). For more safety best practices, see the Regulatory Compliance home page at [www.dell.com/regulatory\\_compliance](http://www.dell.com/regulatory_compliance).

## Prerequisites

- 1 Remove the [base cover](#).
- 2 Remove the [battery](#).
- 3 Remove the [rear cover](#).
- 4 Remove the [wireless card](#).
- 5 Follow the procedure from step 1 to step 17 in [Removing the computer base](#).
- 6 Remove the [display assembly](#).

## Procedure

- 1 Using a plastic scribe, gently pry up the inside edges of the display bezel.
- 2 Using a plastic scribe, gently pry up the outside edges of the display bezel.
- 3 Lift the display bezel off the display assembly.

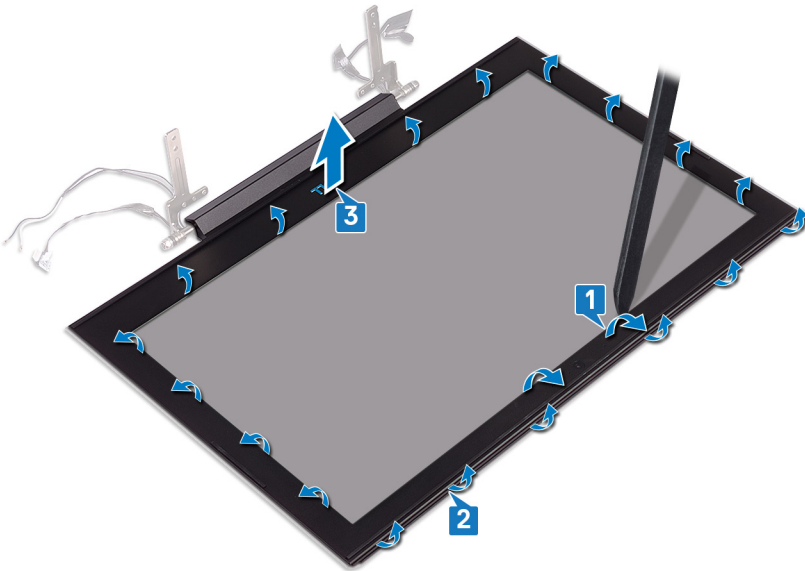



# Replacing the display bezel

**WARNING:** Before working inside your computer, read the safety information that shipped with your computer and follow the steps in [Before working inside your computer](#). After working inside your computer, follow the instructions in [After working inside your computer](#). For more safety best practices, see the Regulatory Compliance home page at [www.dell.com/regulatory\\_compliance](http://www.dell.com/regulatory_compliance).

## Procedure

- 1 Align the display bezel with the display back-cover.
- 2 Pressing down on the inside edges of the display bezel, gently snap the display bezel into place.

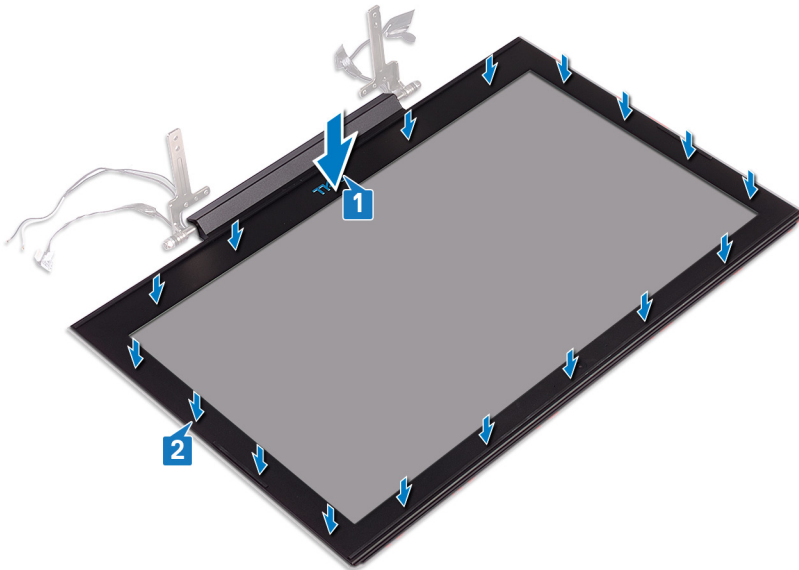

## Post-requisites

- 1 Replace the [display assembly](#).
- 2 Follow the procedure from step 7 to step 23 in [Replacing the computer base](#).
- 3 Replace the [wireless card](#).
- 4 Replace the [rear cover](#).
- 5 Replace the [battery](#).
- 6 Replace the [base cover](#).

# Removing the display hinges

**⚠ WARNING:** Before working inside your computer, read the safety information that shipped with your computer and follow the steps in [Before working inside your computer](#). After working inside your computer, follow the instructions in [After working inside your computer](#). For more safety best practices, see the Regulatory Compliance home page at [www.dell.com/regulatory\\_compliance](http://www.dell.com/regulatory_compliance).

## Prerequisites

- 1 Remove the [base cover](#).
- 2 Remove the [battery](#).
- 3 Remove the [rear cover](#).
- 4 Remove the [wireless card](#).
- 5 Follow the procedure from step 1 to step 17 in [Removing the computer base](#).
- 6 Remove the [display assembly](#).
- 7 Remove the [display bezel](#).

## Procedure

- 1 Remove the eight screws (M2.5x2.5) that secure the display hinges to the display back-cover.
- 2 Lift the display hinges off the display back-cover.

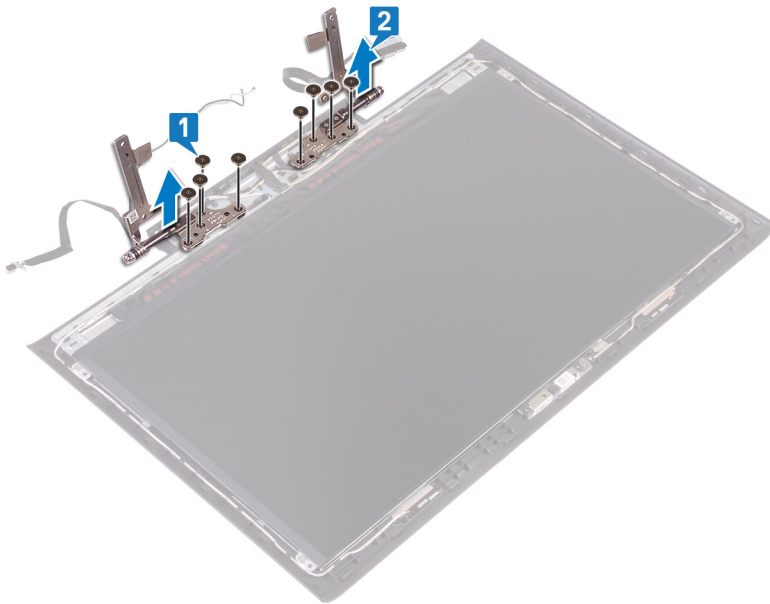

# Replacing the display hinges

**⚠ WARNING:** Before working inside your computer, read the safety information that shipped with your computer and follow the steps in [Before working inside your computer](#). After working inside your computer, follow the instructions in [After working inside your computer](#). For more safety best practices, see the Regulatory Compliance home page at [www.dell.com/regulatory\\_compliance](http://www.dell.com/regulatory_compliance).

## Procedure

- 1 Align the screw holes on the display hinges with the screw holes on the display back-cover.
- 2 Replace the eight screws (M2.5x2.5) that secure the display hinges to the display back-cover.

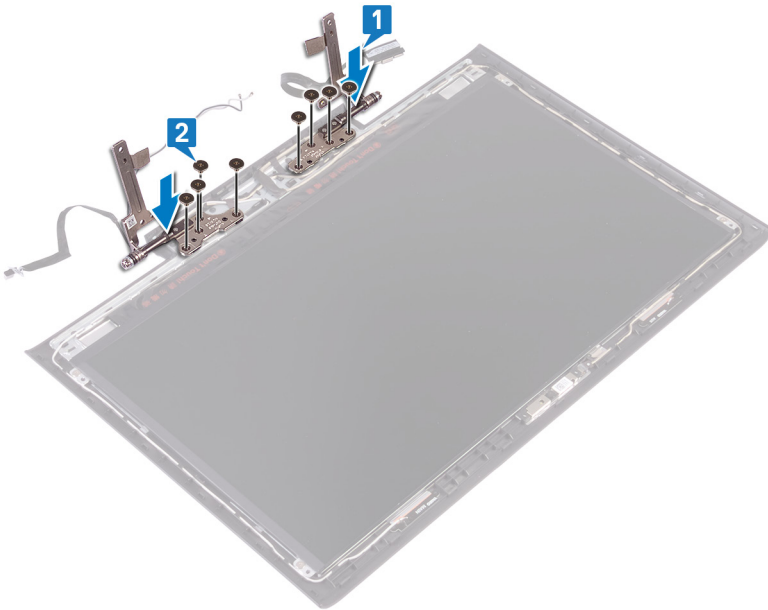

## Post-requisites

- 1 Replace the [display bezel](#).
- 2 Replace the [display assembly](#).
- 3 Follow the procedure from step 7 to step 23 in [Replacing the computer base](#).
- 4 Replace the [wireless card](#).
- 5 Replace the [rear cover](#).
- 6 Replace the [battery](#).
- 7 Replace the [base cover](#).

# Removing the display panel

**⚠ WARNING:** Before working inside your computer, read the safety information that shipped with your computer and follow the steps in [Before working inside your computer](#). After working inside your computer, follow the instructions in [After working inside your computer](#). For more safety best practices, see the Regulatory Compliance home page at [www.dell.com/regulatory\\_compliance](http://www.dell.com/regulatory_compliance).

## Prerequisites

- 1 Remove the [base cover](#).
- 2 Remove the [battery](#).
- 3 Remove the [rear cover](#).
- 4 Remove the [wireless card](#).
- 5 Follow the procedure from step 1 to step 17 in [Removing the computer base](#).
- 6 Remove the [display assembly](#).
- 7 Remove the [display bezel](#).

## Procedure

- 1 Remove the four screws (M2x2.5) that secure the display panel to the display back-cover.
- 2 Gently lift the display panel and turn it over.

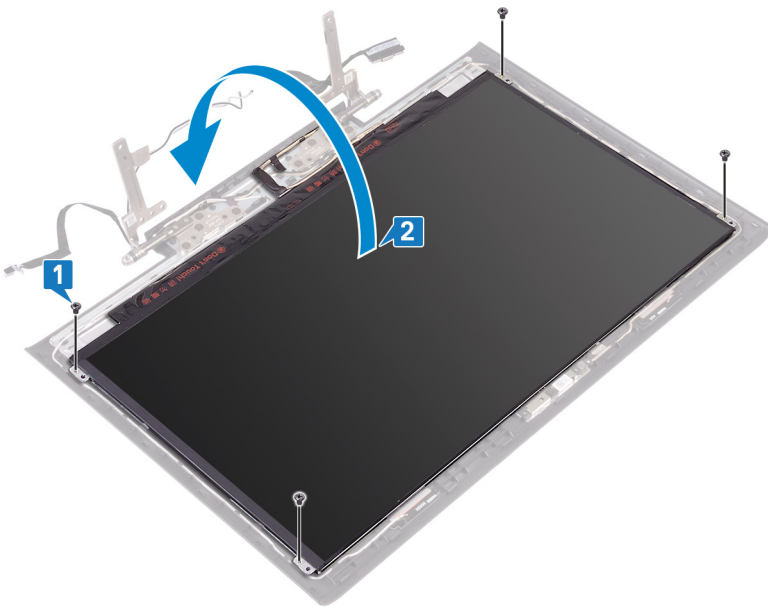

- 3 Peel off the tape that secures the display-cable latch to the display panel.
- 4 Open the latch and disconnect the display cable from the display panel.
- 5 Lift the display panel away from the display back-cover.

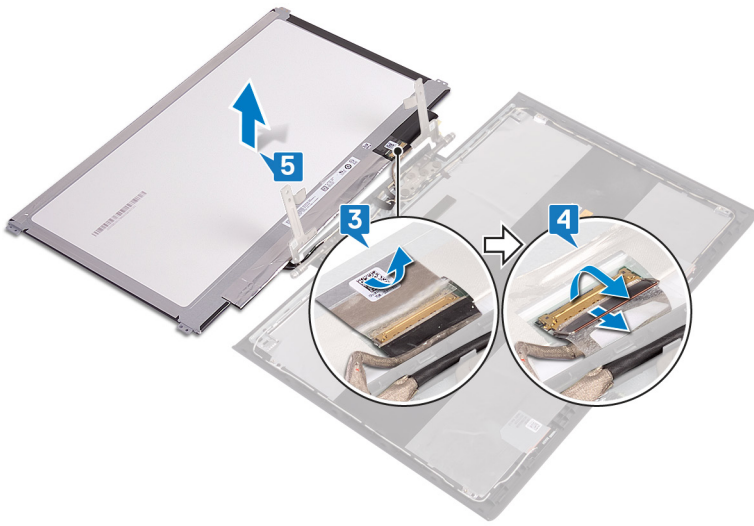

6 After performing the above steps you are left with the display panel.



# Replacing the display panel

**⚠ WARNING:** Before working inside your computer, read the safety information that shipped with your computer and follow the steps in [Before working inside your computer](#). After working inside your computer, follow the instructions in [After working inside your computer](#). For more safety best practices, see the Regulatory Compliance home page at [www.dell.com/regulatory\\_compliance](http://www.dell.com/regulatory_compliance).

## Procedure

- 1 Gently place the display panel onto the display back-cover.
- 2 Open the latch and slide the display cable into the connector on the display panel and close the latch to secure the cable.
- 3 Adhere the tape that secures the display-cable latch to the display panel.

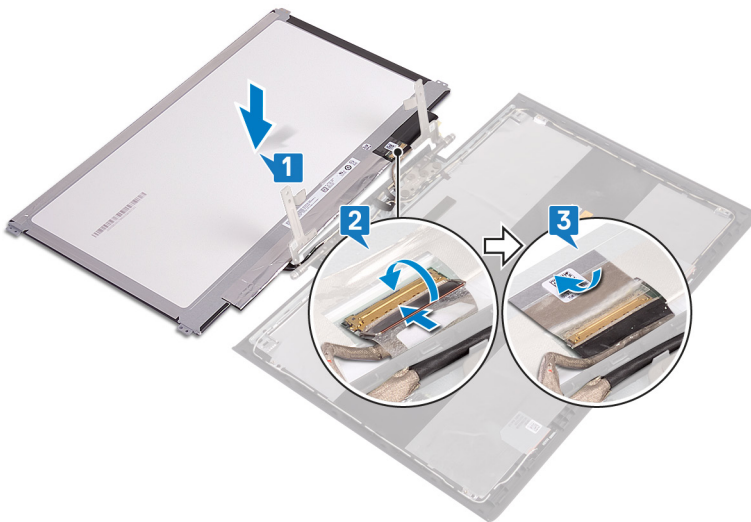

- 4 Align the screw holes on the display panel with the screw holes on the display back-cover.
- 5 Replace the four screws (M2x2.5) that secure the display panel to the display back-cover.



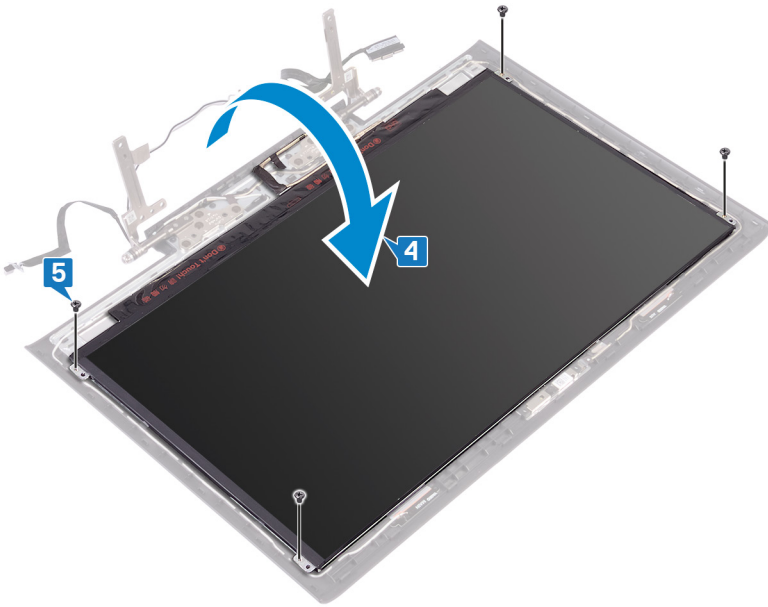

## Post-requisites

- 1 Replace the [display bezel](#).
- 2 Replace the [display assembly](#).
- 3 Follow the procedure from step 7 to step 23 in [Replacing the computer base](#).
- 4 Replace the [wireless card](#).
- 5 Replace the [rear cover](#).
- 6 Replace the [battery](#).
- 7 Replace the [base cover](#).

# Removing the display cable

**⚠ WARNING:** Before working inside your computer, read the safety information that shipped with your computer and follow the steps in [Before working inside your computer](#). After working inside your computer, follow the instructions in [After working inside your computer](#). For more safety best practices, see the Regulatory Compliance home page at [www.dell.com/regulatory\\_compliance](http://www.dell.com/regulatory_compliance).

## Prerequisites

- 1 Remove the [base cover](#).
- 2 Remove the [battery](#).
- 3 Remove the [rear cover](#).
- 4 Remove the [wireless card](#).
- 5 Follow the procedure from step 1 to step 17 in [Removing the computer base](#).
- 6 Remove the [display assembly](#).
- 7 Remove the [display bezel](#).
- 8 Remove the [display panel](#).

## Procedure

- 1 Note the antenna-cable routing and remove the display cable from the routing guides on the display back-cover and antenna assembly.
- 2 Lift the display cable off the display back-cover and antenna assembly.



# Replacing the display cable

**⚠ WARNING:** Before working inside your computer, read the safety information that shipped with your computer and follow the steps in [Before working inside your computer](#). After working inside your computer, follow the instructions in [After working inside your computer](#). For more safety best practices, see the Regulatory Compliance home page at [www.dell.com/regulatory\\_compliance](http://www.dell.com/regulatory_compliance).

## Procedure

- 1 Align and place the display cable on the display back-cover and antenna assembly.
- 2 Route the display cable through the routing guides on the display back-cover and antenna assembly.



## Post-requisites

- 1 Replace the [display panel](#).
- 2 Replace the [display bezel](#).
- 3 Replace the [display assembly](#).
- 4 Follow the procedure from step 7 to step 23 in [Replacing the computer base](#).
- 5 Replace the [wireless card](#).
- 6 Replace the [rear cover](#).
- 7 Replace the [battery](#).
- 8 Replace the [base cover](#).

# Removing the camera

**⚠ WARNING:** Before working inside your computer, read the safety information that shipped with your computer and follow the steps in [Before working inside your computer](#). After working inside your computer, follow the instructions in [After working inside your computer](#). For more safety best practices, see the Regulatory Compliance home page at [www.dell.com/regulatory\\_compliance](http://www.dell.com/regulatory_compliance).

## Prerequisites

- 1 Remove the [base cover](#).
- 2 Remove the [battery](#).
- 3 Remove the [rear cover](#).
- 4 Remove the [wireless card](#).
- 5 Follow the procedure from step 1 to step 17 in [Removing the computer base](#).
- 6 Remove the [display assembly](#).
- 7 Remove the [display bezel](#).
- 8 Remove the [display panel](#).

## Procedure

- 1 Using a plastic scribe, gently pry the camera module from the display back-cover and antenna assembly.
- 2 Open the latch and disconnect the camera cable from the camera module.
- 3 Lift the camera off the display back-cover and antenna assembly.

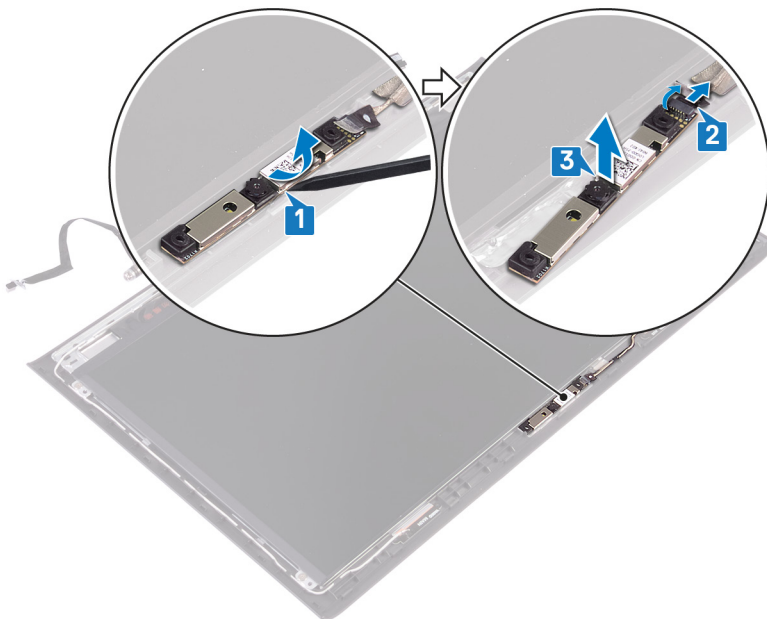

# Replacing the camera

**⚠ WARNING:** Before working inside your computer, read the safety information that shipped with your computer and follow the steps in [Before working inside your computer](#). After working inside your computer, follow the instructions in [After working inside your computer](#). For more safety best practices, see the Regulatory Compliance home page at [www.dell.com/regulatory\\_compliance](http://www.dell.com/regulatory_compliance).

## Procedure

- 1 Connect the camera cable to the camera module and close the latch to secure the cable.
- 2 Align the camera module to the alignment posts on the display back-cover and antenna assembly and adhere the camera module in place.

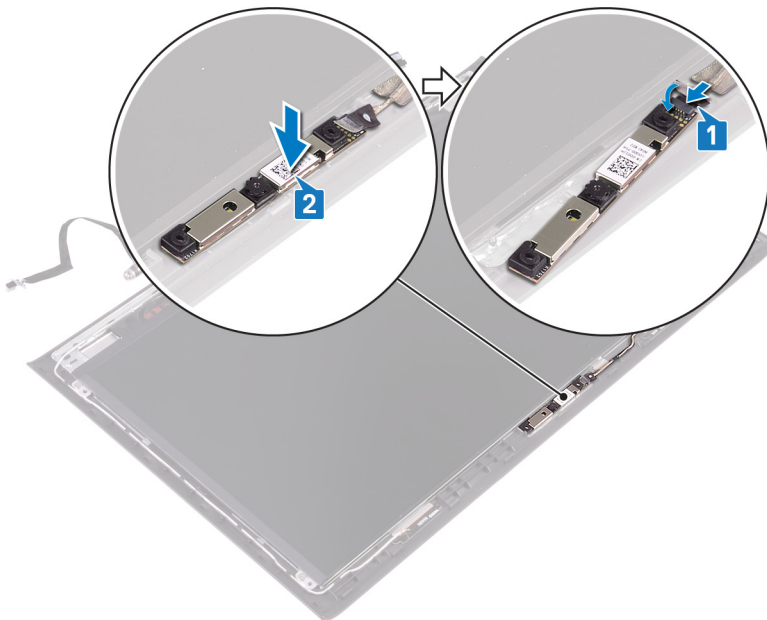

## Post-requisites

- 1 Replace the [display panel](#).
- 2 Replace the [display bezel](#).
- 3 Replace the [display assembly](#).
- 4 Follow the procedure from step 7 to step 23 in [Replacing the computer base](#).
- 5 Replace the [wireless card](#).
- 6 Replace the [rear cover](#).
- 7 Replace the [battery](#).
- 8 Replace the [base cover](#).

# Removing the display back-cover and antenna assembly

**⚠ WARNING:** Before working inside your computer, read the safety information that shipped with your computer and follow the steps in [Before working inside your computer](#). After working inside your computer, follow the instructions in [After working inside your computer](#). For more safety best practices, see the Regulatory Compliance home page at [www.dell.com/regulatory\\_compliance](http://www.dell.com/regulatory_compliance).

## Prerequisites

- 1 Remove the [base cover](#).
- 2 Remove the [battery](#).
- 3 Remove the [wireless card](#).
- 4 Remove the [rear cover](#).
- 5 Follow the procedure from step 1 to step 17 in [Removing the computer base](#).
- 6 Remove the [display assembly](#).
- 7 Remove the [display bezel](#).
- 8 Remove the [display hinges](#).
- 9 Remove the [display panel](#).
- 10 Remove the [display cable](#).
- 11 Remove the [camera](#).

## Procedure

- 1 Peel the tape that secures the camera cable to the display back-cover and antenna assembly.
- 2 Note the antenna-cable routing and remove the camera cable from the routing guides on the display back-cover and antenna assembly.
- 3 Lift the camera cable off the display back-cover and antenna assembly.

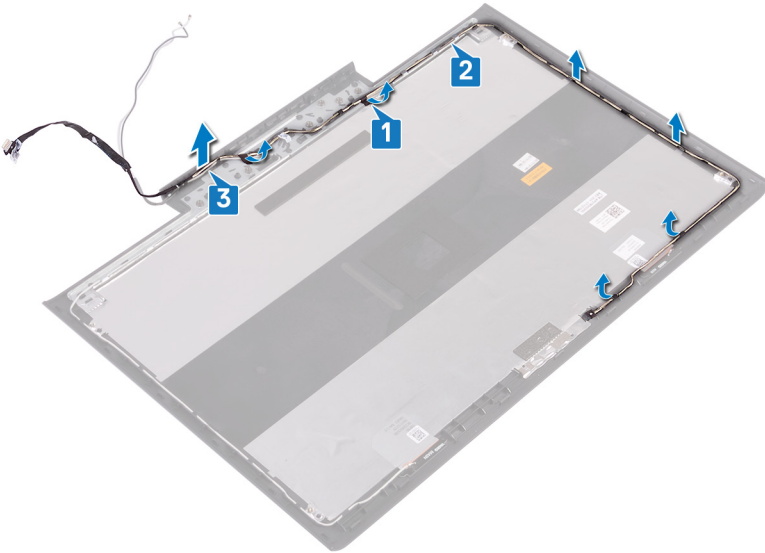

4 After performing the above steps you are left with the display back-cover and antenna assembly.

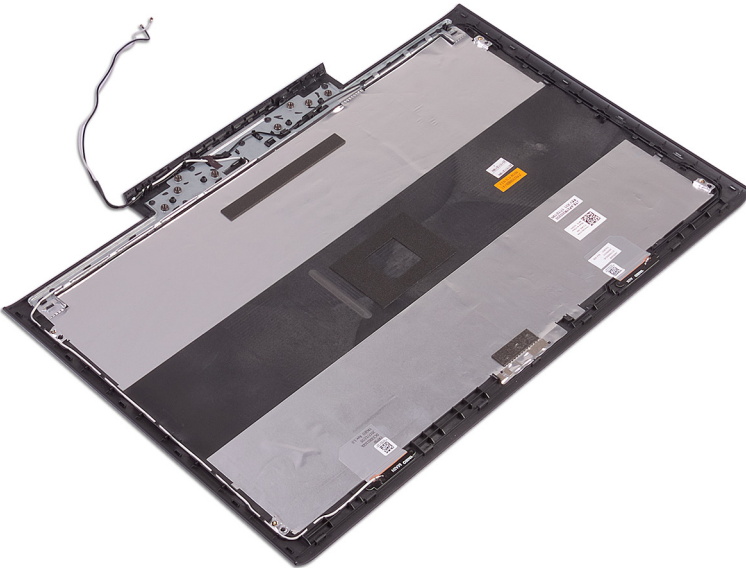

# Replacing the display back-cover and antenna assembly

**⚠ WARNING:** Before working inside your computer, read the safety information that shipped with your computer and follow the steps in [Before working inside your computer](#). After working inside your computer, follow the instructions in [After working inside your computer](#). For more safety best practices, see the Regulatory Compliance home page at [www.dell.com/regulatory\\_compliance](http://www.dell.com/regulatory_compliance).

## Procedure

- 1 Place the display back-cover and antenna assembly on a flat and clean surface.

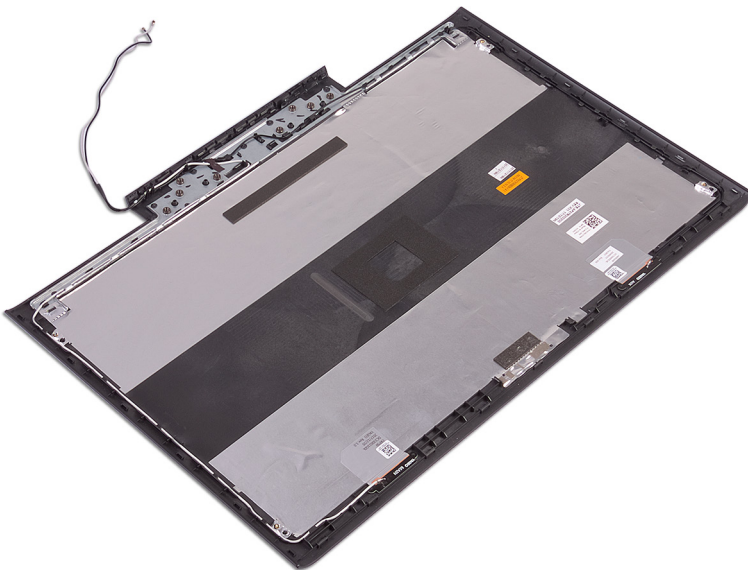

- 2 Place the camera cable on the display back-cover and antenna assembly.
- 3 Route the camera cable through the routing guides on the display back-cover and antenna assembly.
- 4 Adhere the tape that secures the camera cable to the display back-cover and antenna assembly.



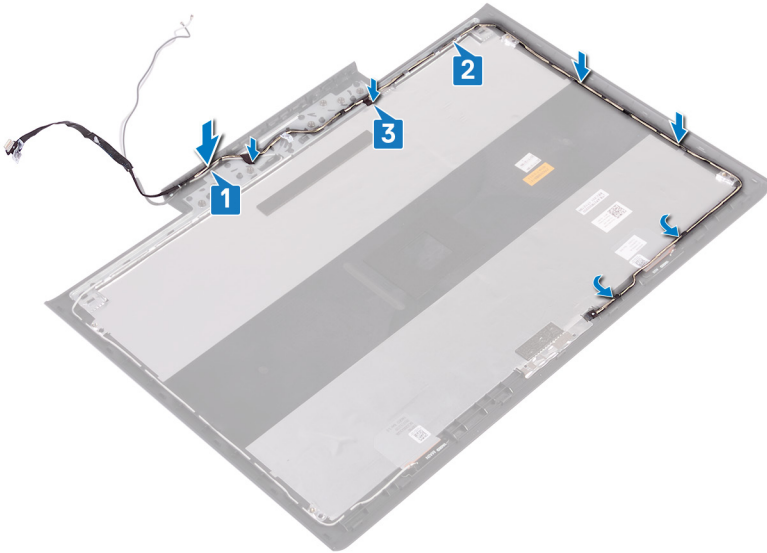

## Post-requisites

- 1 Replace the [camera](#).
- 2 Replace the [display cable](#).
- 3 Replace the [display panel](#).
- 4 Replace the [display hinges](#).
- 5 Replace the [display bezel](#).
- 6 Replace the [display assembly](#).
- 7 Follow the procedure from step 7 to step 23 in [Replacing the computer base](#).
- 8 Replace the [rear cover](#).
- 9 Replace the [wireless card](#).
- 10 Replace the [battery](#).
- 11 Replace the [base cover](#).

## Downloading drivers

### Downloading the audio driver

- 1 Turn on your computer.
- 2 Go to [www.dell.com/support](http://www.dell.com/support).
- 3 Click **Product support**, enter the Service Tag of your computer, and then click **Submit**.  
**i** | **NOTE: If you do not have the Service Tag, use the auto-detect feature or manually browse for your computer model.**
- 4 Click **Drivers & downloads > Find it myself**.
- 5 Scroll down the page and expand **Audio**.
- 6 Click **Download** to download the audio driver for your computer.
- 7 After the download is complete, navigate to the folder where you saved the audio driver file.
- 8 Double-click the audio driver file icon and follow the instructions on the screen.

### Downloading the graphics driver

- 1 Turn on your computer.
- 2 Go to [www.dell.com/support](http://www.dell.com/support).
- 3 Click **Product support**, enter the Service Tag of your computer, and then click **Submit**.  
**i** | **NOTE: If you do not have the Service Tag, use the auto-detect feature or manually browse for your computer model.**
- 4 Click **Drivers & downloads > Find it myself**.
- 5 Scroll down the page and expand **Video**.
- 6 Click **Download** to download the graphics driver for your computer.
- 7 After the download is complete, navigate to the folder where you saved the graphics driver file.
- 8 Double-click the graphics driver file icon and follow the instructions on the screen.

### Downloading the USB 3.0 driver

- 1 Turn on your computer.
- 2 Go to [www.dell.com/support](http://www.dell.com/support).
- 3 Click **Product support**, enter the Service Tag of your computer, and then click **Submit**.  
**i** | **NOTE: If you do not have the Service Tag, use the auto-detect feature or manually browse for your computer model.**
- 4 Click **Drivers & downloads > Find it myself**.
- 5 Scroll down the page and expand **Chipset**.
- 6 Click **Download** to download the USB 3.0 driver for your computer.
- 7 After the download is complete, navigate to the folder where you saved the driver file.
- 8 Double-click the driver file icon and follow the instructions on the screen.

### Downloading the Wi-Fi driver

- 1 Turn on the computer.
- 2 Go to [www.dell.com/support](http://www.dell.com/support).

- 3 Click **Product support**, enter the Service Tag of your computer, and then click **Submit**.

 **NOTE:** If you do not have the Service Tag, use the auto-detect feature or manually browse for your computer model.

- 4 Click **Drivers & downloads > Find it myself**.
- 5 Scroll down the page and expand **Network**.
- 6 Click **Download** to download the Wi-Fi driver for your computer.
- 7 After the download is complete, navigate to the folder where you saved the Wi-Fi driver file.
- 8 Double-click the driver file icon and follow the instructions on the screen.

## Downloading the media-card reader driver

- 1 Turn on your computer.
- 2 Go to [www.dell.com/support](http://www.dell.com/support).
- 3 Click **Product support**, enter the Service Tag of your computer, and then click **Submit**.

 **NOTE:** If you do not have the Service Tag, use the auto-detect feature or manually browse for your computer model.

- 4 Click **Drivers & downloads > Find it myself**.
- 5 Scroll down the page, and expand **Chipset**.
- 6 Click **Download** to download the media-card reader driver for your computer.
- 7 After the download is complete, navigate to the folder where you saved the card reader driver file.
- 8 Double-click the card reader driver file icon, and follow the instructions on the screen.

## Downloading the chipset driver

- 1 Turn on your computer.
- 2 Go to [www.dell.com/support](http://www.dell.com/support).
- 3 Click **Product support**, enter the Service Tag of your computer, and then click **Submit**.

 **NOTE:** If you do not have the Service Tag, use the auto-detect feature or manually browse for your computer model.

- 4 Click **Drivers & downloads > Find it myself**.
- 5 Scroll down the page and expand **Chipset**.
- 6 Click **Download** to download the chipset driver for your computer.
- 7 After the download is complete, navigate to the folder where you saved the chipset driver file.
- 8 Double-click the chipset driver file icon and follow the instructions on the screen.

## Downloading the network driver

- 1 Turn on your computer.
- 2 Go to [www.dell.com/support](http://www.dell.com/support).
- 3 Click **Product support** enter the Service Tag of your computer and click **Submit**.

 **NOTE:** If you do not have the Service Tag, use the auto-detect feature or manually browse for your computer model.

- 4 Click **Drivers & downloads > Find it myself**.
- 5 Scroll down the page and expand **Network**.
- 6 Click **Download** to download the network driver for your computer.
- 7 Save the file, and after the download is complete, navigate to the folder where you saved the network driver file.
- 8 Double-click the network driver file icon and follow the instructions on screen.

# System setup

**NOTE:** Depending on the computer and its installed devices, the items listed in this section may or may not be displayed.

## Boot Sequence

Boot Sequence allows you to bypass the System Setup–defined boot device order and boot directly to a specific device (for example: optical drive or hard drive). During the Power-on Self Test (POST), when the Dell logo appears, you can:

- Access System Setup by pressing F2 key
- Bring up the one-time boot menu by pressing F12 key

The one-time boot menu displays the devices that you can boot from including the diagnostic option. The boot menu options are:

- Removable Drive (if available)
- STXXXX Drive

**NOTE:** XXX denotes the SATA drive number.

- Optical Drive (if available)
- SATA Hard Drive (if available)
- Diagnostics

**NOTE:** Choosing Diagnostics, will display the ePSA diagnostics screen.

The boot sequence screen also displays the option to access the System Setup screen.

## Navigation keys

**NOTE:** For most of the System Setup options, changes that you make are recorded but do not take effect until you restart the system.

Keys	Navigation
Up arrow	Moves to the previous field.
Down arrow	Moves to the next field.
Enter	Selects a value in the selected field (if applicable) or follow the link in the field.
Spacebar	Expands or collapses a drop-down list, if applicable.
Tab	Moves to the next focus area.
	<b>NOTE:</b> For the standard graphics browser only.
Esc	Moves to the previous page until you view the main screen. Pressing Esc in the main screen displays a message that prompts you to save any unsaved changes and restarts the system.

# BIOS overview

**⚠ CAUTION:** Unless you are an expert computer user, do not change the settings in the BIOS Setup program. Certain changes can make your computer work incorrectly.

**📘 NOTE:** Before you change BIOS Setup program, it is recommended that you write down the BIOS Setup program screen information for future reference.

Use the BIOS Setup program for the following purposes:

- Get information about the hardware installed in your computer, such as the amount of RAM and the size of the hard drive.
- Change the system configuration information.
- Set or change a user-selectable option, such as the user password, type of hard drive installed, and enabling or disabling base devices.

## Entering BIOS setup program

- 1 Turn on (or restart) your computer.
- 2 During POST, when the DELL logo is displayed, watch for the F2 prompt to appear, and then press F2 immediately.

**📘 NOTE:** The F2 prompt indicates that the keyboard is initialized. This prompt can appear very quickly, so you must watch for it, and then press F2. If you press F2 before the F2 prompt, this keystroke is lost. If you wait too long and the operating system logo appears, continue to wait until you see the desktop. Then, turn off your computer and try again.

## Enabling or disabling the USB in BIOS setup program

- 1 Turn on or restart your computer.
- 2 Press F2 when the Dell logo is displayed on the screen to enter the BIOS setup program.  
The BIOS setup program is displayed.
- 3 On the left pane, select **Settings > System Configuration > USB Configuration**.  
The USB configuration is displayed on the right pane.
- 4 Select or clear the **Enable External USB Port** check box to enable or disable it respectively.
- 5 Save the BIOS setup program settings and exit.

## Identifying the hard drive in BIOS setup program

- 1 Turn on or restart your computer.
- 2 Press F2 when the Dell logo is displayed on the screen to enter the BIOS setup program.  
A list of hard drives is displayed under the **System Information** in the **General** group.

## Checking the system memory in BIOS setup program

- 1 Turn on or restart your computer.
- 2 Press F2 when the Dell logo is displayed on the screen to enter the BIOS setup program.
- 3 On the left pane, select **Settings > General > System Information**.  
The memory information is displayed on the right pane.

## System setup options

**📘 NOTE:** Depending on this computer and its installed devices, the items listed in this section may or may not appear.

**Table 3. System setup options—System information menu**

**General-System Information**

---

**System Information**

BIOS Version	Displays the BIOS version number.
Service Tag	Displays the Service Tag of the computer.
Asset Tag	Displays the Asset Tag of the computer.
Ownership Tag	Displays the ownership tag of the computer.
Manufacture Date	Displays the manufacture date of the computer.
Ownership Date	Displays the ownership date of the computer.
Express Service Code	Displays the express service code of the computer.

**Memory Information**

Memory Installed	Displays the total computer memory installed.
Memory Available	Displays the total computer memory available.
Memory Speed	Displays the memory speed.
Memory Channel Mode	Displays single or dual channel mode.
Memory Technology	Displays the technology used for the memory.
DIMM A Size	Displays the DIMM A memory size.
DIMM B Size	Displays the DIMM B memory size.

**Processor Information**

Processor Type	Displays the processor type.
Core Count	Displays the number of cores on the processor.
Processor ID	Displays the processor identification code.
Current Clock Speed	Displays the current processor clock speed.
Minimum Clock Speed	Displays the minimum processor clock speed.
Maximum Clock Speed	Displays the maximum processor clock speed.
Processor L2 Cache	Displays the processor L2 Cache size.
Processor L3 Cache	Displays the processor L3 Cache size.
HT Capable	Displays whether the processor is HyperThreading (HT) capable.
64-Bit Technology	Displays whether 64-bit technology is used.

**Device Information**

SATA-0	Displays the SATA-0 device information of the computer.
SATA-2	Displays the SATA-2 device information of the computer.
M.2 PCIe SSD-0	Displays the M.2 PCIe SSD information of the computer.
Video Controller	Displays the video controller type of the computer.
dGPU Video Controller	Displays the discrete graphics information of the computer.
Video BIOS Version	Displays the video BIOS version of the computer.
Video Memory	Displays the video memory information of the computer.
Panel Type	Displays the Panel Type of the computer.
Native Resolution	Displays the native resolution of the computer.
Audio Controller	Displays the audio controller information of the computer.

## General-System Information

---

Wi-Fi Device	Displays the wireless device information of the computer.
Bluetooth Device	Displays the bluetooth device information of the computer.
<b>Battery Information</b>	Displays the battery health information.
<b>Boot Sequence</b>	
Boot Sequence	Displays the boot sequence.
Boot List Option	Displays the available boot options.
<b>Advanced Boot Options</b>	
Enable Legacy Option ROMs	Enable or disable the Legacy Option ROMs.
Enable UEFI Network Stack	Enable or disable UEFI Network Stack.
<b>UEFI Boot Path Security</b>	Enable or disable the system to prompt the user to enter the Admin password when booting a UEFI boot path from the F12 boot menu.
<b>Date/Time</b>	Displays the current date in MM/DD/YY format and current time in HH:MM:SS AM/PM format.

**Table 4. System setup options—System Configuration menu**

### System Configuration

---

<b>SATA Operation</b>	Configure operating mode of the integrated SATA hard drive controller.
<b>Drives</b>	Enable or disable various drives on board.
<b>SMART Reporting</b>	Enable or disable SMART Reporting during system startup.
<b>USB Configuration</b>	
Enable Boot Support	Enable or disable booting from USB mass storage devices such as external hard drive, optical drive, and USB drive.
Enable External USB Port	Enable or disable booting from USB mass storage devices connected to external USB port.
<b>USB PowerShare</b>	Enable or disable charging external devices through the USB PowerShare port.
<b>Audio</b>	Enable or disable the integrated audio controller.
<b>Keyboard Illumination</b>	Configure the operating mode of the keyboard illumination feature.
<b>Keyboard Backlight with AC</b>	Enable or disable the keyboard backlight.
<b>Miscellaneous Devices</b>	Enable or disable various onboard devices.
Enable Camera	Enable or disable the camera.
Enable Secure Digital (SD) Card	Enable or disable the SD card.

**Table 5. System setup options—Video menu**

### Video

---

LCD Brightness	Set the panel brightness independently for Battery and AC power.
----------------	--

**Table 6. System setup options—Security menu****Security**

Strong Password	Enable or disable strong passwords.
Password Configuration	Control the minimum and maximum number of characters allowed for Admin and System passwords.
Password Bypass	Bypass the System (Boot) Password and the internal HDD password prompts during a system restart.
Password Change	Enable or disable changes to the System and Hard Disk passwords when an administrator password is set.
Non-Admin Setup Changes	Determines whether changes to the setup option are permitted when an administrator password is set.
UEFI Capsule Firmware Updates	Enable or disable BIOS updates through UEFI capsule update packages.
PTT Security	Enable or disable Platform Trust Technology (PTT) visibility to the operating system.
Computrace(R)	Enable or disable the BIOS module interface of the optional Computrace(R) Service from Absolute Software.
CPU XD Support	Enable or disable the Execute Disable mode of the Processor.
Admin Setup Lockout	Enable to prevent users from entering Setup when an Admin Password is set.

**Table 7. System setup options—Secure Boot menu****Secure Boot**

Secure Boot Enable	Enable or disable the secure boot feature.
<b>Expert Key Management</b>	
Expert Key Management	Enable or disable Expert Key Management.
Custom Mode Key Management	Select the custom values for expert key management.

**Table 8. System setup options—Intel Software Guard Extensions menu****Intel Software Guard Extensions**

Intel SGX Enable	Enable or disable Intel Software Guard Extensions.
Enclave Memory Size	Set the Intel Software Guard Extensions Enclave Reserve Memory Size.

**Performance**

Multi Core Support	Enable multiple cores. Default: Enabled.
Intel SpeedStep	Enable or disable Intel Speedstep Technology. Default: Enabled.
<p><b>i</b> <b>NOTE: If enabled, the processor clock speed and core voltage are adjusted dynamically based on the processor load.</b></p>	
C-States Control	Enable or disable additional processor sleep states. Default: Enabled.
Intel TurboBoost	Enable or disable Intel TurboBoost mode of the processor. Default: Enabled.
HyperThread control	Enable or disable HyperThreading in the processor.



## Intel Software Guard Extensions

---

Default: Enabled.

### Power Management

AC Behavior	Enables the system to turn on automatically, when AC is inserted.
Enable Intel Speed Shift Technology	Enable or disable Intel Speed Shift Technology.
Auto on Time	Enable to set the computer to turn on automatically every day or on a preselected date and time. This option can be configured only if the Auto On Time is set to Everyday, Weekdays or Selected Days. Default: Disabled.
USB Wake Support	Enable the USB devices to wake the computer from Standby.
Advanced Battery Charge Configuration	Enable Advanced Battery Charge Configuration from the beginning of the day to a specified work period.
Primary Battery Charge Configuration	Set the primary battery charge settings with a preselected custom charge start and stop. Default: Adaptive.

### POST Behavior

Adapter Warnings	Enable adapter warnings. Default: Enabled.
Numlock Enable	Enable or disable Numlock. Default: Enable Numlock.
Fn Lock Options	Enable or disable the Fn lock mode.
Fastboot	Enable to set the speed of the boot process. Default: Thorough.
Extend BIOS POST Time	Configure additional pre-boot delay.
Pull Screen Logo	Enable or disable to display full screen logo.
Warnings and Errors	Select an action on encountering a warning or error.

**Table 9. System setup options—Virtualization Support menu**

### Virtualization Support

---

Virtualization	Specify whether a Virtual Machine Monitor (VMM) can utilize the additional hardware capabilities provided by Intel Virtualization Technology.
VT for Direct I/O	Specify whether a Virtual Machine Monitor (VMM) can utilize the additional hardware capabilities provided by Intel Virtualization Technology for Direct I/O.

**Table 10. System setup options—Wireless menu**

### Wireless

---

Wireless Switch	Determine which wireless devices can be controlled by the Wireless Switch.
Wireless Device Enable	Enable or disable internal wireless devices.

**Table 11. System setup options—Maintenance menu**

**Maintenance**

---

Service Tag	Display the system's Service Tag.
Asset Tag	Create a system Asset Tag.
BIOS Downgrade	Control flashing of the system firmware to previous revisions.
Data Wipe	Enable to securely erase data from all internal storage devices.
BIOS Recovery	Enable the user to recover from certain corrupted BIOS conditions from a recovery file on the user primary hard drive or an external USB key.

**Table 12. System setup options—System Logs menu**

**System Logs**

---

BIOS Events	Display BIOS events.
Thermal Events	Display Thermal events.
Power Events	Display Power events.

**Table 13. System setup options—SupportAssist System Resolution menu**

**SupportAssist System Resolution**

---

Auto OS Recovery Threshold	Control the automatic boot flow for SupportAssist System Resolution Console and for Dell OS Recovery tool.
SupportAssist OS Recovery	Enable or disable the boot flow for SupportAssist OS Recovery tool in the even of certain system errors.

# System and setup password

**Table 14. System and setup password**

Password type	Description
System password	Password that you must enter to log on to your system.
Setup password	Password that you must enter to access and make changes to the BIOS settings of your computer.

You can create a system password and a setup password to secure your computer.

**⚠ CAUTION:** The password features provide a basic level of security for the data on your computer.

**⚠ CAUTION:** Anyone can access the data stored on your computer if it is not locked and left unattended.

**ℹ NOTE:** System and setup password feature is disabled.

## Assigning a system password and setup password

You can assign a new **System Password** only when the status is in **Not Set**.

To enter the system setup, press F2 immediately after a power-on or re-boot.

- In the **System BIOS** or **System Setup** screen, select **Security** and press Enter.  
The **Security** screen is displayed.
- Select **System Password** and create a password in the **Enter the new password** field.  
Use the following guidelines to assign the system password:
  - A password can have up to 32 characters.
  - The password can contain the numbers 0 through 9.
  - Only lower case letters are valid, upper case letters are not allowed.
  - Only the following special characters are allowed: space, ("), (+), (,), (-), (.), (/), (;), ([), (\), (]), (`).
- Type the system password that you entered earlier in the **Confirm new password** field and click **OK**.
- Press Esc and a message prompts you to save the changes.
- Press Y to save the changes.  
The computer reboots.

## Deleting or changing an existing system setup password

Ensure that the **Password Status** is Unlocked (in the System Setup) before attempting to delete or change the existing System and/or Setup password. You cannot delete or change an existing System or Setup password, if the **Password Status** is Locked.

To enter the System Setup, press F2 immediately after a power-on or reboot.

- In the **System BIOS** or **System Setup** screen, select **System Security** and press Enter.

The **System Security** screen is displayed.

- 2 In the **System Security** screen, verify that **Password Status** is **Unlocked**.
- 3 Select **System Password**, alter or delete the existing system password and press Enter or Tab.
- 4 Select **Setup Password**, alter or delete the existing setup password and press Enter or Tab.

 **NOTE: If you change the System and/or Setup password, re-enter the new password when prompted. If you delete the System and/or Setup password, confirm the deletion when prompted.**

- 5 Press Esc and a message prompts you to save the changes.
- 6 Press Y to save the changes and exit from System Setup.

The computer reboot.

## Clearing CMOS settings

 **CAUTION: Clearing CMOS settings will reset the BIOS settings on your computer.**

- 1 Remove the [base cover](#).
- 2 Remove the [battery](#).
- 3 Remove the [coin-cell battery](#).
- 4 Wait for one minute.
- 5 Replace the [coin-cell battery](#).
- 6 Replace the [battery](#).
- 7 Replace the [base cover](#).

## Clearing forgotten passwords

Contact Dell technical support to clear the forgotten passwords, see [www.dell.com/contactdell](http://www.dell.com/contactdell).

## Troubleshooting

### Flashing BIOS (USB key)

- 1 Follow the procedure from step 1 to step 7 in "Flashing the BIOS" to download the latest BIOS setup program file.
- 2 Create a bootable USB drive. For more information see the knowledge base article [SLN143196](https://www.dell.com/support) at [www.dell.com/support](https://www.dell.com/support).
- 3 Copy the BIOS setup program file to the bootable USB drive.
- 4 Connect the bootable USB drive to the computer that needs the BIOS update.
- 5 Restart the computer and press **F12** when the Dell logo is displayed on the screen.
- 6 Boot to the USB drive from the **One Time Boot Menu**.
- 7 Type the BIOS setup program filename and press **Enter**.
- 8 The **BIOS Update Utility** appears. Follow the instructions on the screen to complete the BIOS update.

### Flashing the BIOS

You may need to flash (update) the BIOS when an update is available or when you replace the system board. Follow these steps to flash the BIOS:

- 1 Turn on your computer.
- 2 Go to [www.dell.com/support](https://www.dell.com/support).
- 3 Click **Product support**, enter the Service Tag of your computer, and then click **Submit**.

 **NOTE:** If you do not have the Service Tag, use the auto-detect feature or manually browse for your computer model.

- 4 Click **Drivers & downloads > Find it myself**.
- 5 Select the operating system installed on your computer.
- 6 Scroll down the page and expand **BIOS**.
- 7 Click **Download** to download the latest version of the BIOS for your computer.
- 8 After the download is complete, navigate to the folder where you saved the BIOS update file.
- 9 Double-click the BIOS update file icon and follow the instructions on the screen.

### Enhanced Pre-Boot System Assessment (ePSA) diagnostics

 **CAUTION:** Use the ePSA diagnostics to test only your computer. Using this program with other computers may cause invalid results or error messages.

The ePSA diagnostics (also known as system diagnostics) performs a complete check of your hardware. The ePSA is embedded with the BIOS and is launched by the BIOS internally. The embedded system diagnostics provides a set of options for particular devices or device groups allowing you to:

- Run tests automatically or in an interactive mode
- Repeat tests
- Display or save test results
- Run thorough tests to introduce additional test options to provide extra information about the failed device(s)
- View status messages that inform you if tests are completed successfully
- View error messages that inform you of problems encountered during testing

**NOTE:** Some tests for specific devices require user interaction. Always ensure that you are present at the computer terminal when the diagnostic tests are performed.

For more information, see [Dell EPSA Diagnostic 3.0](#).

## Running the ePSA diagnostics

- 1 Turn on your computer.
- 2 As the computer boots, press the F12 key as the Dell logo appears.
- 3 On the boot menu screen, select the **Diagnostics** option.
- 4 Click the arrow at the bottom left corner.  
Diagnostics front page is displayed.
- 5 Click the arrow in the lower-right corner to go to the page listing.  
The items detected are listed.
- 6 To run a diagnostic test on a specific device, press Esc and click **Yes** to stop the diagnostic test.
- 7 Select the device from the left pane and click **Run Tests**.
- 8 If there are any issues, error codes are displayed.  
Note the error code and validation number and contact Dell.

## System diagnostic lights

### Power and battery-status light/hard-drive activity light

Indicates the battery-charge status or the hard-drive activity.

**NOTE:** Press Fn+H to toggle this light between power and battery-status light and hard-drive activity light.

#### Hard-drive activity light

Turns on when the computer reads from or writes to the hard drive.

**NOTE:** Hard-drive activity light is supported only on computers shipped with hard drive.

#### Power and battery-status light

Indicates the power and battery-charge status

**Solid white** — Power adapter is connected and the battery has more than 5 percent charge.

**Amber** — Computer is running on battery and the battery has less than 5 percent charge.

#### Off

- Power adapter is connected and the battery is fully charged.
- Computer is running on battery and the battery has more than 5 percent charge.
- Computer is in sleep state, hibernation, or turned off

The power and battery-status light blinks amber along with beep codes indicating failures.

For example, the power and battery-status light blinks amber two times followed by a pause, and then blinks white three times followed by a pause. This 2,3 pattern continues until the computer is turned off indicating no memory or RAM is detected.

The following table shows different light patterns and describes what they indicate.

**Table 15. Diagnostics**

Light pattern	Problem description
2,1	CPU failure
2,2	System board: BIOS and ROM failure
2,3	No memory or RAM detected
2,4	Memory or RAM failure
2,5	Invalid memory installed
2,6	System board or chipset error
2,7	LCD failure
3,1	CMOS battery failure
3,2	PCI or video card or chip failure
3,3	Recovery image not found
3,4	Recovery image found but invalid
3,5	Power sequencing failure
3,6	Flash corruption detected by SBIOS
3,7	ME error

**Camera status light:** Indicates whether the camera is in use.

- Solid white — Camera is in use.
- Off — Camera is not in use.

**Caps Lock status light:** Indicates whether Caps Lock is enabled or disabled.

- Solid white — Caps Lock enabled.
- Off — Caps Lock disabled.

## Wi-Fi power cycle

If your computer is unable to access the internet due to Wi-Fi connectivity issues a Wi-Fi power cycle procedure may be performed. The following procedure provides the instructions on how to conduct a Wi-Fi power cycle:

**① | NOTE: Some ISPs (Internet Service Providers) provide a modem/router combo device.**

- 1 Turn off your computer.
- 2 Turn off the modem.
- 3 Turn off the wireless router.
- 4 Wait for 30 seconds.
- 5 Turn on the wireless router.
- 6 Turn on the modem.
- 7 Turn on your computer.

## Flea power release

Flea power is the residual static electricity that remains on the computer even after it has been powered off and the battery has been removed. The following procedure provides the instructions on how to conduct flea power release:

- 1 Turn off your computer.
- 2 Remove the [base cover](#).

- 3 Press and hold the power button for 15 seconds to drain the flea power.
- 4 Replace the [base cover](#).
- 5 Turn on your computer.

## Reinstall Windows using a USB recovery drive

**⚠ CAUTION:** This process formats the hard drive and removes all data on your computer. Ensure that you back up data on your computer before beginning this task.

**ⓘ NOTE:** Before reinstalling Windows, ensure your computer has more than 2 GB of memory and more than 32 GB of storage space.

**ⓘ NOTE:** This process may take up to an hour to complete and your computer will restart during the recovery process.

- 1 Connect the USB recovery drive to your computer.
- 2 Restart your computer.
- 3 Press F12 after the Dell logo is displayed on the screen to access the boot menu.  
A **Preparing one-time boot menu** message appears.
- 4 After the boot menu loads, select the USB recovery device under **UEFI BOOT**.  
The system reboots and a screen to **Choose the keyboard layout** is displayed.
- 5 Choose your keyboard layout.
- 6 In the **Choose an option** screen, click **Troubleshoot**.
- 7 Click **Recover from a drive**.
- 8 Choose one of the following options:
  - **Just remove my files** to do a quick format.
  - **Fully clean the drive** to do a complete format.
- 9 Click **Recover** to start the recovery process.





# Getting help and contacting Dell

## Self-help resources

You can get information and help on Dell products and services using these self-help resources:

**Table 16. Self-help resources**

Information about Dell products and services	<a href="http://www.dell.com">www.dell.com</a>
Dell Help & Support app	
Tips	
Contact Support	In Windows search, type <code>Contact Support</code> , and press Enter.
Online help for operating system	<a href="http://www.dell.com/support/windows">www.dell.com/support/windows</a> <a href="http://www.dell.com/support/linux">www.dell.com/support/linux</a>
Troubleshooting information, user manuals, setup instructions, product specifications, technical help blogs, drivers, software updates, and so on.	<a href="http://www.dell.com/support">www.dell.com/support</a>
Dell knowledge base articles for a variety of computer concerns.	<ol style="list-style-type: none"> <li>1 Go to <a href="http://www.dell.com/support">www.dell.com/support</a>.</li> <li>2 Type the subject or keyword in the <b>Search</b> box.</li> <li>3 Click <b>Search</b> to retrieve the related articles.</li> </ol>
Learn and know the following information about your product:	See <i>Me and My Dell</i> at <a href="http://www.dell.com/support/manuals">www.dell.com/support/manuals</a> .
<ul style="list-style-type: none"> <li>• Product specifications</li> <li>• Operating system</li> <li>• Setting up and using your product</li> <li>• Data backup</li> <li>• Troubleshooting and diagnostics</li> <li>• Factory and system restore</li> <li>• BIOS information</li> </ul>	To locate the <i>Me and My Dell</i> relevant to your product, identify your product through one of the following: <ul style="list-style-type: none"> <li>• Select <b>Detect Product</b>.</li> <li>• Locate your product through the drop-down menu under <b>View Products</b>.</li> <li>• Enter the <b>Service Tag number</b> or <b>Product ID</b> in the search bar.</li> </ul>

## Contacting Dell

To contact Dell for sales, technical support, or customer service issues, see [www.dell.com/contactdell](http://www.dell.com/contactdell).

**NOTE:** Availability varies by country and product, and some services may not be available in your country.

**NOTE:** If you do not have an active internet connection, you can find contact information on your purchase invoice, packing slip, bill, or Dell product catalog.