

Dell EMC XC640 Series XC Series Appliance and XC Core System

Installation and Service Manual

Notes, cautions, and warnings

 **NOTE:** A NOTE indicates important information that helps you make better use of your product.

 **CAUTION:** A CAUTION indicates either potential damage to hardware or loss of data and tells you how to avoid the problem.

 **WARNING:** A WARNING indicates a potential for property damage, personal injury, or death.

© 2017 - 2018 Dell Inc. or its subsidiaries. All rights reserved. Dell, EMC, and other trademarks are trademarks of Dell Inc. or its subsidiaries. Other trademarks may be trademarks of their respective owners.

Contents

1 XC640 Series and XC Core system overview.....	8
Front view of the system.....	8
Left control panel view.....	9
Right control panel view.....	12
Back view of the system.....	13
NIC indicator codes.....	14
Power supply unit indicator codes.....	15
Hard drive indicator codes.....	16
LCD panel.....	17
Locating Service Tag.....	19
2 Documentation resources.....	20
3 Technical specifications.....	21
System dimensions.....	22
Chassis weight.....	22
Processor specifications.....	23
PSU specifications.....	23
System battery specifications.....	23
Expansion bus specifications.....	23
Memory specifications.....	23
Storage controller specifications.....	24
Drive specifications.....	24
Hard drives.....	24
Ports and connectors specifications.....	24
USB ports.....	24
NIC ports.....	25
Serial port.....	25
VGA port.....	25
IDSDM/vFlash card.....	26
Environmental specifications.....	26
Standard operating temperature.....	27
Expanded operating temperature.....	28
Particulate and gaseous contamination specifications.....	30
4 Initial system setup and configuration.....	31
Setting up your system.....	31
iDRAC configuration.....	31
Options to set up iDRAC IP address.....	31
Log in to iDRAC.....	32
Methods to download firmware and drivers.....	32
Downloading drivers and firmware.....	32

Important information about the BOSS device (PCIe cards M.2 Drive).....	33
Examples of write intensive applications not to be run on the boot device.....	33
5 Pre-operating system management applications.....	34
Options to manage the pre-operating system applications.....	34
System Setup.....	34
Viewing System Setup.....	34
System Setup details.....	35
System BIOS.....	35
iDRAC Settings utility.....	55
Device Settings.....	55
Dell Lifecycle Controller.....	55
Embedded systems management.....	56
Boot Manager.....	56
Viewing Boot Manager.....	56
Boot Manager main menu.....	56
One-shot BIOS boot menu.....	57
System Utilities.....	57
PXE boot.....	57
6 Installing and removing system components.....	58
Safety instructions.....	58
Before working inside your system.....	59
After working inside your system.....	59
Recommended tools.....	59
Optional front bezel.....	60
Removing the optional front bezel.....	60
Installing the optional front bezel.....	60
System cover.....	61
Removing the system cover.....	61
Installing the system cover.....	62
Backplane cover.....	63
Removing the backplane cover.....	63
Installing the backplane cover.....	64
Inside the system.....	65
Air shroud.....	66
Removing the air shroud.....	66
Installing the air shroud.....	67
Cooling fans.....	68
Removing a cooling fan.....	68
Installing a cooling fan.....	69
System memory.....	70
System memory guidelines.....	70
General memory module installation guidelines.....	72
Mode-specific guidelines.....	73
Removing a memory module.....	77

Installing a memory module.....	78
Processors and heat sinks.....	79
Removing a processor and heat sink module.....	79
Removing a processor from processor heat sink module.....	80
Installing the processor into a processor and heat sink module.....	82
Installing a processor and heat sink module.....	84
Expansion cards and expansion card risers.....	85
Expansion bus specifications.....	85
Removing an expansion card riser.....	86
Installing an expansion card riser.....	87
Removing an expansion card from the expansion card riser.....	89
Installing an expansion card into expansion card riser.....	91
IDSDM/vFlash card.....	92
Removing a micro SD card.....	93
Installing a micro SD card.....	93
Removing the IDSDM/vFlash card.....	93
Installing the IDSDM/vFlash card.....	94
Network daughter card.....	95
Removing the network daughter card.....	95
Installing the network daughter card.....	96
Integrated storage controller card.....	97
Removing the integrated storage controller card.....	97
Installing the integrated storage controller card.....	99
Hard drives.....	100
Removing a hard drive blank.....	100
Installing a hard drive blank.....	101
Removing a hard drive.....	101
Installing a hard drive.....	102
Removing the hard drive from the hard drive carrier.....	103
Installing a hard drive into the hard drive carrier.....	104
Hard drive backplane.....	105
Removing the hard drive backplane	106
Installing the hard drive backplane	107
Cable routing.....	109
System battery.....	110
Replacing the system battery.....	110
USB module.....	111
Removing the USB module.....	111
Installing the USB module.....	112
Power supply units.....	113
Hot spare feature.....	114
Removing a power supply unit blank.....	114
Installing a power supply unit blank.....	115
Removing a power supply unit.....	115
Installing a power supply unit.....	116

Wiring instructions for a DC power supply unit.....	117
System board.....	119
Removing the system board.....	119
Installing the system board.....	120
Trusted Platform Module.....	122
Replacing the Trusted Platform Module.....	122
Initializing the TPM 1.2 for TXT users.....	123
Control panel.....	123
Removing the left control panel.....	123
Installing the left control panel.....	124
Removing the right control panel.....	125
Installing the right control panel.....	126
7 Using system diagnostics.....	128
Dell Embedded System Diagnostics.....	128
Running the Embedded System Diagnostics from Boot Manager.....	128
Running the Embedded System Diagnostics from the Dell Lifecycle Controller.....	128
System diagnostic controls.....	129
8 Jumpers and connectors	130
System board jumper settings.....	130
System board jumpers and connectors.....	131
Disabling forgotten password.....	133
9 Getting help.....	134
Receiving automated support with SupportAssist	134
Contacting Dell EMC.....	134
Documentation feedback.....	135
Accessing system information by using QRL.....	135
Quick Resource Locator.....	135
A BOSS card.....	136
Introduction to BOSS card.....	136
Supported operating systems.....	136
Supported XC Series Appliance and XC Core System	136
BOSS card features.....	137
Foreign Import.....	137
SMART Info.....	137
Auto-Rebuild.....	137
Deploying the BOSS card.....	137
Removing the BOSS card.....	138
Installing the BOSS card.....	140
Driver installation.....	141
BOSS troubleshooting.....	141
Physical disks not visible to operating system.....	141
Virtual disk not visible to operating system.....	142
Drive failure.....	142

Fault in controller.....	142
BOSS card is not detected.....	142
Unable to boot to M.2 drive installed in slot 1.....	142
CLI reports unsupported features	143

XC640 Series and XC Core system overview

NOTE: The information in this document applies to both Dell EMC XC640 Series Appliances, and Dell EMC XC Core System offering. Sections or information that apply to only one of the offerings (XC Series or XC Core) will be called out explicitly.

The XC640 Series system is a 1U rack server that supports up to:

- Two Intel Xeon Processor Scalable Family processors
- 10 x 2.5 inch hard drives on the front panel or 4 x 3.5 inch hard drives on the front panel
- 24 DIMM slots
- Two AC or DC redundant power supply units

Topics:

- [Front view of the system](#)
- [Back view of the system](#)

Front view of the system

The front view displays the features available on the front of the system.

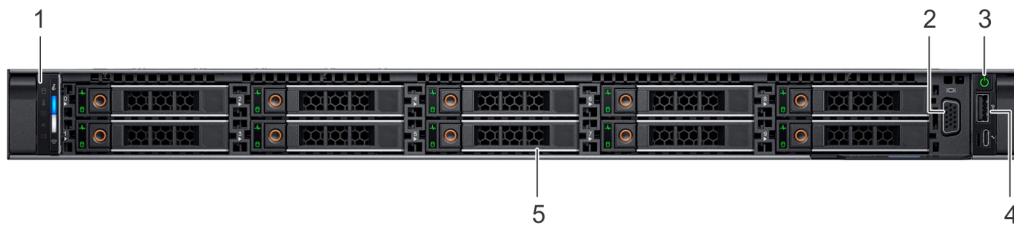

Figure 1. Front view of 10 x 2.5 inch hard drive system

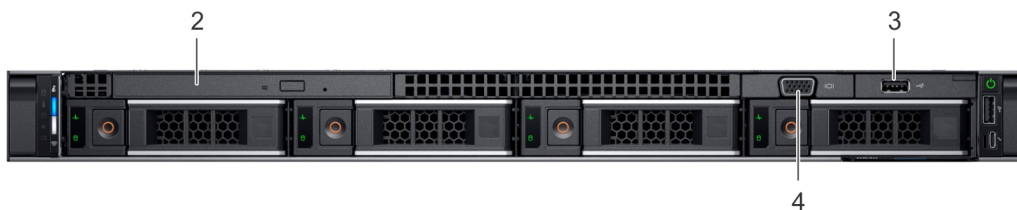



Figure 2. Front view of 4 x 3.5 inch drive system

Table 1. Features available on the front of the system

Item	Ports, panels, and slots	Icon	Description
1	Left control panel	N/A	Contains the system health and system ID, status LED, and the iDRAC Quick Sync 2 (wireless) indicator.

NOTE: The iDRAC Quick Sync 2 indicator is available only on certain configurations.

Item	Ports, panels, and slots	Icon	Description
			<ul style="list-style-type: none"> Status LED: Enables you to identify any failed hardware components. There are up to five status LEDs and an overall system health LED (Chassis health and system ID) bar. For more information, see Status LED indicators. Quick Sync 2 (wireless): Indicates a Quick Sync enabled system. The Quick Sync feature is optional. This feature allows management of the system by using mobile devices. This feature aggregates hardware or firmware inventory and various system level diagnostic and error information that can be used in troubleshooting the system. For more information, see the <i>Integrated Dell Remote Access Controller User's Guide</i> at Dell.com/idracmanuals.
2	Video connector		Enables you to connect a display device to the system. For more information, see Technical specifications .
3	Right control panel	N/A	Contains the power button, USB port, iDRAC Direct micro port, and the iDRAC Direct status LED.
4	USB port (optional)		The USB port is USB 3.0 compliant.
5	Hard drive slots	N/A	Enable you to install hard drives that are supported on your system. For more information about hard drives, see Technical specifications .

Left control panel view

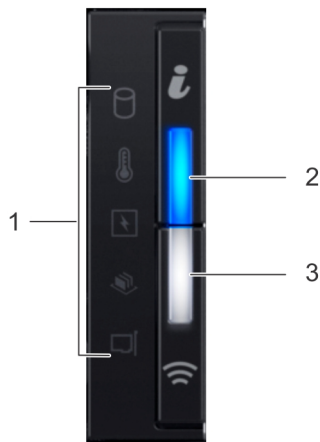



Figure 3. Left control panel with optional iDRAC Quick Sync 2.0 indicator

Table 2. Left control panel





Item	Indicator or button	Icon	Description
1	Status LED indicators	N/A	Indicate the status of the system. For more information, see Status LED indicators .
2	System health and system ID indicator		Indicates the system health. For more information, see System health and system ID indicator codes .
3	iDRAC Quick Sync 2 wireless indicator (optional)		Indicates if the iDRAC Quick Sync 2 wireless option is activated. The Quick Sync 2 feature allows management of the system using mobile devices. This feature aggregates hardware/firmware inventory and

Item	Indicator or button	Icon	Description
			various system level diagnostic/error information that can be used in troubleshooting the system. You can access system inventory, Dell Lifecycle Controller logs or system logs, system health status, and also configure iDRAC, BIOS, and networking parameters. You can also launch the virtual Keyboard, Video, and Mouse (KVM) viewer and virtual Kernel based Virtual Machine (KVM), on a supported mobile device. For more information, see the <i>Integrated Dell Remote Access Controller User's Guide</i> at Dell.com/idracmanuals .

Status LED indicators

NOTE: The status LED indicators are always off and only turns on to a solid amber if any error occurs.

Table 3. Status LED indicators and descriptions

Icon	Description	Condition	Corrective action
	Drive indicator	The indicator turns solid amber if there is a drive error.	<ul style="list-style-type: none"> Check the System Event Log to determine if the drive has an error. Run the appropriate Online Diagnostics test. Restart the system and run embedded diagnostics (ePSA).
	Temperature indicator	The indicator turns solid amber if the system experiences a thermal error (for example, the ambient temperature is out of range or there is a fan failure).	<p>Ensure that none of the following conditions exist:</p> <ul style="list-style-type: none"> A cooling fan has been removed or has failed. System cover, air shroud, memory module blank, or back filler bracket is removed. Ambient temperature is too high. External airflow is obstructed. <p>If the problem persists, see Getting help.</p>
	Electrical indicator	The indicator turns solid amber if the system experiences an electrical error (for example, voltage out of range, or a failed power supply unit (PSU) or voltage regulator).	Check the System Event Log or system messages for the specific issue. If it is due to a problem with the PSU, check the LED on the PSU. Reseat the PSU. If the problem persists, see Getting help .
	Memory indicator	The indicator turns solid amber if a memory error occurs.	Check the System Event Log or system messages for the location of the failed memory. Reseat the memory module. If the problem persists, see Getting help .
	PCIe indicator	The indicator turns solid amber if a PCIe card experiences an error.	Restart the system. Update any required drivers for the PCIe card. Reinstall the card. If the problem persists, see Getting help .

NOTE: For more information about the supported PCIe cards, see [Expansion card installation guidelines](#).

System health and system ID indicator codes

The system health and system ID is located on the left control panel of your system.



Figure 4. System health and system ID indicators

Table 4. System health and system ID indicator codes

System health and system ID indicator code	Condition
Solid blue	Indicates that the system is turned on, system is healthy, and system ID mode is not active. Press the system health and system ID button to switch to system ID mode.
Blinking blue	Indicates that the system ID mode is active. Press the system health and system ID button to switch to system health mode.
Solid amber	Indicates that the system is in fail-safe mode. If the problem persists, see Getting help .
Blinking amber	Indicates that the system is experiencing a fault. Check the System Event Log or the LCD panel, if available on the bezel, for specific error messages. For more information about error messages, see the <i>Dell Event and Error Messages Reference Guide</i> at Dell.com/openmanagemanuals > OpenManage software .

iDRAC Quick Sync 2 indicator codes

iDRAC Quick Sync 2 module (optional) is located on the on the left control panel of your system.



Figure 5. iDRAC Quick Sync 2 indicators

Table 5. iDRAC Quick Sync 2 indicators and descriptions

iDRAC Quick Sync 2 indicator code	Condition	Corrective action
Off (default state)	Indicates that the iDRAC Quick Sync 2 feature is turned off. Press the iDRAC Quick Sync 2 button to turn on the iDRAC Quick Sync 2 feature.	If the LED fails to turn on, reseal the left control panel flex cable and check. If the problem persists, see Getting help .
Solid white	Indicates that iDRAC Quick Sync 2 is ready to communicate. Press the iDRAC Quick Sync 2 button to turn off.	If the LED fails to turn off, restart the system. If the problem persists, see Getting help .

iDRAC Quick Sync 2 indicator code	Condition	Corrective action
Blinks white rapidly	Indicates data transfer activity.	If the indicator continues to blink indefinitely, see Getting help .
Blinks white slowly	Indicates that firmware update is in progress.	If the indicator continues to blink indefinitely, see Getting help .
Blinks white five times rapidly and then turns off	Indicates that the iDRAC Quick Sync 2 feature is disabled.	Check if iDRAC Quick Sync 2 feature is configured to be disabled by iDRAC. If the problem persists, see Getting help . For more information, see <i>Integrated Dell Remote Access Controller User's Guide</i> at Dell.com/idracmanuals or <i>Dell OpenManage Server Administrator User's Guide</i> at Dell.com/openmanagemanuals .
Solid amber	Indicates that the system is in fail-safe mode.	Restart the system. If the problem persists, see Getting help .
Blinking amber	Indicates that the iDRAC Quick Sync 2 hardware is not responding properly.	Restart the system. If the problem persists, see Getting help .

Right control panel view

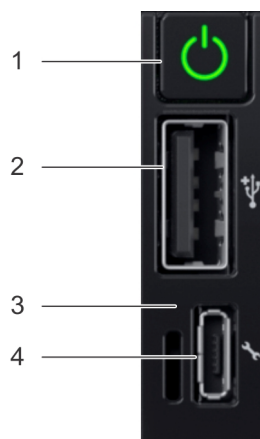



Figure 6. Right control panel

Table 6. Right control panel

Item	Indicator or button	Icon	Description
1	Power button		Indicates if the system is turned on or off. Press the power button to manually turn on or off the system. NOTE: Press the power button to gracefully shut down an ACPI-compliant operating system.
2	USB port		The USB ports are 4-pin, 2.0-compliant. These ports enable you to connect USB devices to the system.

Item	Indicator or button	Icon	Description
3	iDRAC Direct LED	N/A	The iDRAC Direct LED indicator lights up to indicate that the iDRAC Direct port is actively connected to a device.
4	iDRAC Direct port		The iDRAC Direct port is micro USB 2.0-compliant. This port enables you to access the iDRAC Direct features. For more information, see the <i>Integrated Dell Remote Access Controller User's Guide</i> at Dell.com/idracmanuals .

iDRAC Direct LED indicator codes

The iDRAC Direct LED indicator lights up to indicate that the port is connected and is being used as a part of the iDRAC subsystem. You can configure iDRAC Direct by using a USB to micro USB (type AB) cable, which you can connect to your laptop or tablet. The following table describes iDRAC Direct activity when the iDRAC Direct port is active:

Table 7. iDRAC Direct LED indicator codes

iDRAC Direct LED indicator code	Condition
Solid green for two seconds	Indicates that the laptop or tablet is connected.
Flashing green (on for two seconds and off for two seconds)	Indicates that the laptop or tablet connected is recognized.
Turns off	Indicates that the laptop or tablet is unplugged.

Back view of the system

The back view displays the features available on the back of the system.

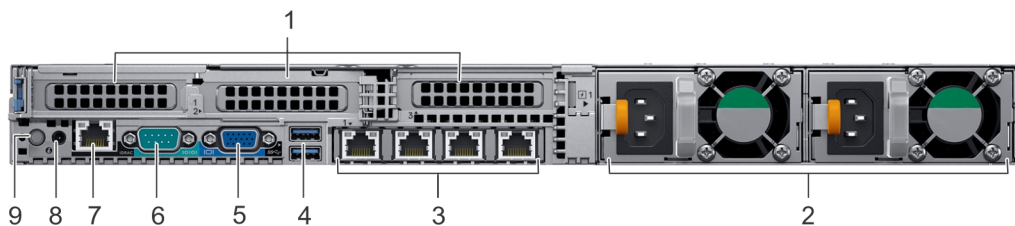

Figure 7. Back view of system with 3 PCIe expansion slots

Table 8. 3 PCIe expansion slot

Item	Ports, panels, or slots	Icon	Description
1	PCIe expansion card slot(s)	N/A	The expansion slot(s) enable you to connect PCI Express expansion cards. For more information on the expansion cards that are supported on your system, see Expansion card installation guidelines .
2	Power supply unit (2)	N/A	For more information about the PSU configurations, see Technical specifications .

Status	Condition
Link indicator is amber, and activity indicator is off.	The NIC is connected to a valid network at less than its maximum port speed, and data is not being sent or received.
Link indicator is blinking green, and activity is off.	NIC identify is enabled through the NIC configuration utility.

Power supply unit indicator codes

AC power supply units (PSUs) have an illuminated translucent handle that serves as an indicator and DC PSUs have an LED that serves as an indicator. The indicator shows whether power is present or if a power fault has occurred.

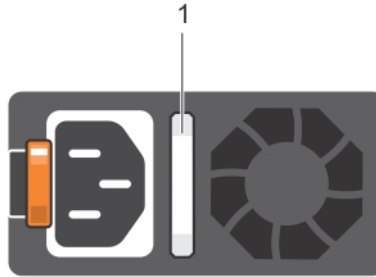

Figure 9. AC PSU status indicator

1 AC PSU status indicator/handle

Table 10. AC PSU status indicator codes

Power indicator codes	Condition
Green	A valid power source is connected to the PSU and the PSU is operational.
Blinking amber	Indicates a problem with the PSU.
Not illuminated	Power is not connected to the PSU.
Blinking green	When the firmware of the PSU is being updated, the PSU handle blinks green. <ul style="list-style-type: none"> ⚠ CAUTION: Do not disconnect the power cord or unplug the PSU when updating firmware. If firmware update is interrupted, the PSUs do not function.
Blinking green and turns off	When hot-plugging a PSU, the PSU handle blinks green five times at a rate of 4 Hz and turns off. This indicates a PSU mismatch with respect to efficiency, feature set, health status, or supported voltage. <ul style="list-style-type: none"> ⚠ CAUTION: If two PSUs are installed, both the PSUs must have the same type of label; for example, Extended Power Performance (EPP) label. Mixing PSUs from previous generations of XC Series Appliance and XC Core System is not supported, even if the PSUs have the same power rating. This results in a PSU mismatch condition or failure to turn the system on. ⚠ CAUTION: When correcting a PSU mismatch, replace only the PSU with the blinking indicator. Swapping the PSU to make a matched pair can result in an error condition and unexpected system shutdown. To change from a high output configuration to a low output configuration or vice versa, you must turn off the system. ⚠ CAUTION: AC PSUs support both 240 V and 120 V input voltages with the exception of Titanium PSUs, which support only 240 V. When two identical PSUs receive different input voltages, they can output different wattages, and trigger a mismatch.

Power indicator codes	Condition
-----------------------	-----------

- | | |
|---|-------------------------------------------------------------------------------------------------------------|
| ⚠ | CAUTION: If two PSUs are used, they must be of the same type and have the same maximum output power. |
| ⚠ | CAUTION: Combining AC and DC PSUs is not supported and triggers a mismatch. |

Hard drive indicator codes

Each hard drive carrier has an activity LED indicator and a status LED indicator. The indicators provide information about the current status of the hard drive. The activity LED indicator indicates whether the hard drive is currently in use or not. The status LED indicator indicates the power condition of the hard drive.

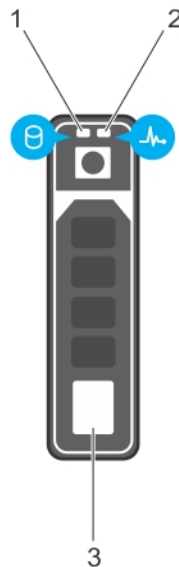

Figure 10. Hard drive indicators

- | | | | |
|---|-----------------------------------|---|---------------------------------|
| 1 | hard drive activity LED indicator | 2 | hard drive status LED indicator |
| 3 | hard drive | | |

NOTE: If the hard drive is in the Advanced Host Controller Interface (AHCI) mode, the status LED indicator does not turn on.

Table 11. Hard drive indicator codes

Hard drive status indicator code	Condition
Flashes green twice per second	Identifying hard drive or preparing for removal.
Off	Hard drive ready for removal.
	NOTE: The hard drive status indicator remains off until all hard drives are initialized after the system is turned on. Hard drives are not ready for removal during this time.
Flashes green, amber, and then turns off	Predicted hard drive failure.
Flashes amber four times per second	Hard drive failed.
Flashes green slowly	Hard drive rebuilding.

Hard drive status indicator code

Condition

Solid green	Hard drive online.
Flashes green for three seconds, amber for three seconds, and then turns off after six seconds	Rebuild stopped.

LCD panel

The LCD panel provides system information, status, and error messages to indicate if the system is functioning correctly or requires attention. The LCD panel can be used to configure or view the system's iDRAC IP address. For more information about error messages, see the *Dell Event and Error Messages Reference Guide* at Dell.com/openmanagemanuals > **OpenManage software**.

The LCD panel is available only on the optional LCD bezel. The optional LCD bezel is hot pluggable.

The statuses and conditions of the LCD panel are outlined here:

- The LCD backlight is white during normal operating conditions.
- When the system needs attention, the LCD backlight turns amber, and displays an error code followed by descriptive text.

NOTE: If the system is connected to a power source and an error is detected, the LCD turns amber regardless of whether the system is turned on or off.

- When the system turns off and there are no errors, LCD enters the standby mode after five minutes of inactivity. Press any button on the LCD to turn it on.
- If the LCD panel stops responding, remove the bezel and reinstall it. If the problem persists, see [Getting help](#).
- The LCD backlight remains off if LCD messaging is turned off using the iDRAC utility, the LCD panel, or other tools.

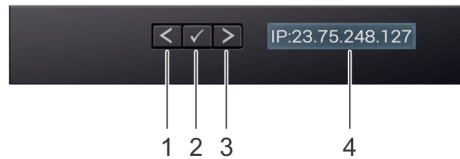

Figure 11. LCD panel features



Table 12. LCD panel features

Item	Button or display	Description
1	Left	Moves the cursor back in one-step increments.
2	Select	Selects the menu item highlighted by the cursor.
3	Right	Moves the cursor forward in one-step increments. During message scrolling: <ul style="list-style-type: none">• Press and hold the right button to increase scrolling speed.• Release the button to stop.
4	LCD display	Displays system information, status, and error messages or iDRAC IP address.

NOTE: The display stops scrolling when the button is released. After 45 seconds of inactivity, the display starts scrolling.

Viewing Home screen

The **Home** screen displays user-configurable information about the system. This screen is displayed during normal system operation when there are no status messages or errors. When the system turns off and there are no errors, LCD enters the standby mode after five minutes of inactivity. Press any button on the LCD to turn it on.

- 1 To view the **Home** screen, press one of the three navigation buttons (Select, Left, or Right).
- 2 To navigate to the **Home** screen from another menu, complete the following steps:
 - a Press and hold the navigation button till the up arrow  is displayed.
 - b Navigate to the **Home** icon  using the up arrow .
 - c Select the **Home** icon.
 - d On the **Home** screen, press the **Select** button to enter the main menu.

Setup menu

 **NOTE:** When you select an option in the Setup menu, you must confirm the option before proceeding to the next action.

Option	Description
iDRAC	Select DHCP or Static IP to configure the network mode. If Static IP is selected, the available fields are IP , Subnet (Sub) , and Gateway (Gtw) . Select Setup DNS to enable DNS and to view domain addresses. Two separate DNS entries are available.
Set error	Select SEL to view LCD error messages in a format that matches the IPMI description in the SEL. This enables you to match an LCD message with an SEL entry. Select Simple to view LCD error messages in a simplified user-friendly description. For more information about error messages, see the <i>Dell Event and Error Messages Reference Guide</i> at Dell.com/openmanagemanuals > OpenManage software .
Set home	Select the default information to be displayed on the Home screen. See View menu for the options and option items that can be set as the default on the Home screen.

View menu

 **NOTE:** When you select an option in the View menu, you must confirm the option before proceeding to the next action.

Option	Description
iDRAC IP	Displays the IPv4 or IPv6 addresses for iDRAC9. Addresses include DNS (Primary and Secondary) , Gateway , IP , and Subnet (IPv6 does not have Subnet).
MAC	Displays the MAC addresses for iDRAC , iSCSI , or Network devices.
Name	Displays the name of the Host , Model , or User String for the system.
Number	Displays the Asset tag or the Service tag for the system.
Power	Displays the power output of the system in BTU/hr or Watts. The display format can be configured in the Set home submenu of the Setup menu.
Temperature	Displays the temperature of the system in Celsius or Fahrenheit. The display format can be configured in the Set home submenu of the Setup menu.

Locating Service Tag

Your system is identified by a unique Express Service Code and Service Tag number. This information is used by Dell EMC to route support calls to the appropriate service provider.

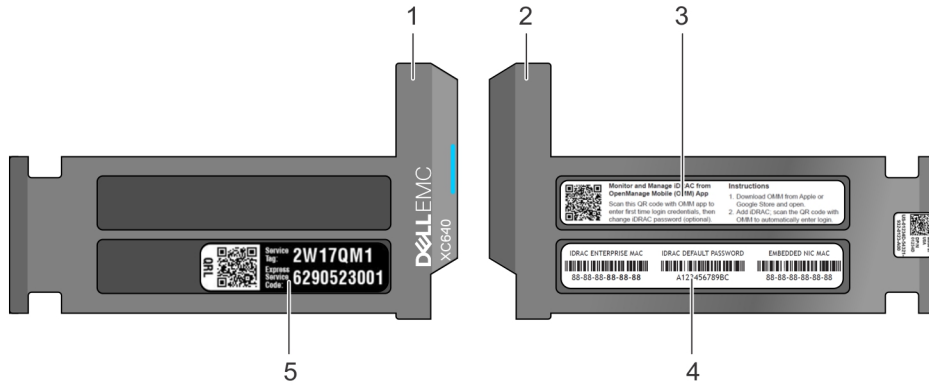

Figure 12. Locating Service Tag of your system

- 1 information tag (top view)
- 2 information tag (back view)
- 3 OpenManage Mobile (OMM) label
- 4 iDRAC MAC address and iDRAC secure password label
- 5 Service Tag

Documentation resources

Dell EMC documentation is either included with your shipment or available at the Dell website at Dell.com/XCSeriesmanuals.

Dell EMC documentation for Dell EMC iDRAC is available at Dell.com/idracmanuals.

To access the Dell EMC documentation:

- 1 On the Dell EMC Support page, in the **Enter a Service Tag, Serial Number, Service Request, Model, or Keyword** box, type the Service Tag of your Dell EMC appliance, and then click **Submit**.

NOTE: If you do not have a Service Tag, select **Detect My Product** to enable the system to automatically detect your Service Tag, or select **Browse all products** to select your product from the **All product** page.

- 2 On the **Product Support** page, click **Manuals & documents** and select the documentation you require.

Table 13. Reference documentation for Dell EMC XC640 Series Hyper-converged Appliance

To learn about...	See...
Set up instructions of your Dell EMC XC640 Series, including the technical specifications	<i>Getting Started Guide</i>
Hardware details of your Dell EMC XC640 Series	<i>Installation and Service Manual</i>
How to install your Dell EMC XC640 Series in a rack	<i>Rail Installation Guide</i>
How to deploy your and set up this solution	<i>Solutions Guide</i>
Deploying Azure Log Analytics Solution	<i>Dell EMC XC Series Azure Log Analytics Solution Deployment Guide</i>
ESXi Best Practices Guide	<i>Dell EMC Best Practices for Running VMware ESXi 6.5 or Later Clusters on XC Series Family Appliances</i>
Windows Hyper-V Best Practices Guide	<i>Dell EMC XC Series Best Practices for Running Windows Server 2016 with Hyper-V</i>
Known issues and workarounds	<i>Release Notes for XC Series Hyper-Converged Appliances</i>
Support Matrix	<i>Dell EMC XC640 Series Hyper-Converged Appliance Support Matrix</i>
Troubleshooting your system	Troubleshooting Guide at Dell.com/poweredge manuals

Technical specifications

The technical and environmental specifications of your system are outlined in this section.

Topics:

- System dimensions
- Chassis weight
- Processor specifications
- PSU specifications
- System battery specifications
- Expansion bus specifications
- Memory specifications
- Storage controller specifications
- Drive specifications
- Ports and connectors specifications
- Environmental specifications

System dimensions

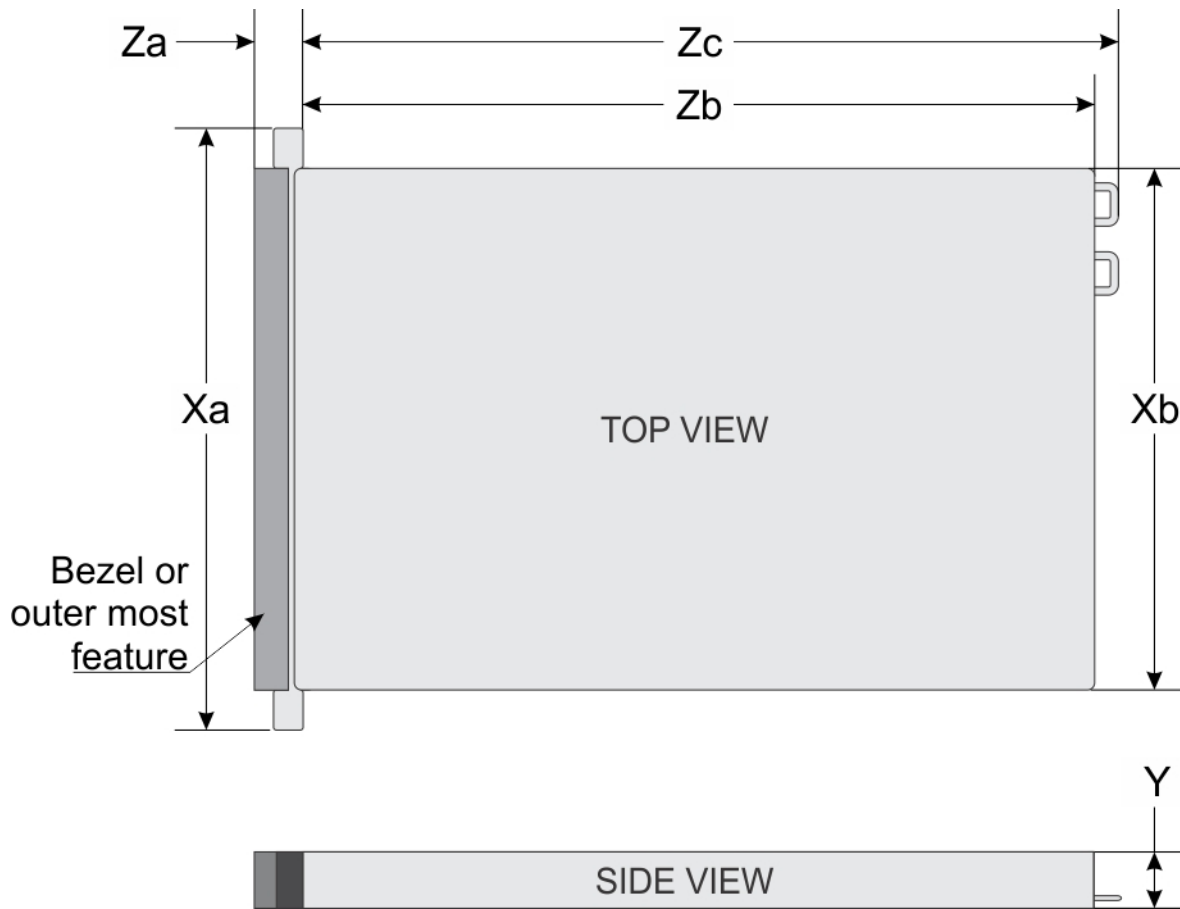

Figure 13. System dimensions

Table 14. Dimensions

System	Xa	Xb	Y	Za (with bezel)	Za (without bezel)	Zb*	Zc
4 x 3.5 inch or 10 x 2.5 inches	482.0 mm (18.97 inches)	434.0 mm (17.08 inches)	42.8 mm (1.68 inches)	35.84 mm (1.41 inches)	22.0 mm (0.87 inches)	733.82 mm (29.61 inches)	772.67 mm (30.42 inches)

* indicates that Zb goes to the nominal rear wall external surface, where the system board I/O connectors are located.

Chassis weight

Table 15. Chassis weight

System	Maximum weight (with all hard drives/SSDs)
XC640 Series	21.9 kg

Processor specifications

The XC640 Series system supports two Intel Xeon Processor Scalable Family processors.

PSU specifications

The XC640 Series system supports up to two AC or DC power supply units (PSUs).

Table 16. PSU specifications

PSU	Class	Heat dissipation (maximum)	Frequency	Voltage
750 W AC	Platinum	2891 BTU/hr	50/60 Hz	100–240 V AC, autoranging
750 W AC	Titanium	2843 BTU/hr	50/60 Hz	200–240 V AC, autoranging
1100 W DC	Gold	4416 BTU/hr	50/60 Hz	–(48–60) V DC
1100 W AC	Platinum	4100 BTU/hr	50/60 Hz	100–240 V AC, autoranging
1600 W AC		6000 BTU/hr	50/60 Hz	100–240 V AC, autoranging

NOTE: If a system with 1100 W AC PSU operates from 100 to 120V, the power rating per PSU is derated to 1050 W.

NOTE: If a system with 1600 W PSUs operates from 100 to 120 V, then the power rating per PSU is derated to 800 W.

NOTE: Heat dissipation is calculated using the PSU wattage rating.

NOTE: This system is also designed to connect to the IT power systems with a phase to phase voltage not exceeding 230 V.

System battery specifications

The XC640 Series system supports CR 2032 lithium coin cell system battery.

Expansion bus specifications

The XC640 Series system supports PCI express (PCIe) generation 3 expansion cards, which are installed on the system, using expansion card risers. This system supports 1A, 2A, and expansion card risers.

Memory specifications

Table 17. Memory specifications

Memory module sockets	Architecture	Memory capacity	Minimum RAM	Maximum RAM
Twenty four 288-pins	2666 MT/s DDR4 RDIMMs and LRDIMMs with support for memory optimized operation	64 GB quad rank (LRDIMMs)	32 GB (minimum LRDIMM size) with single processor	LRDIMM: up to 786 GB with single processor LRDIMM: up to 1536 GB with dual processors

Memory module sockets	Architecture	Memory capacity	Minimum RAM	Maximum RAM
		16 GB or 32 GB dual rank (RDIMMs)		RDIMM: up to 384 GB with single processor RDIMM: up to 786 GB with dual processors

Storage controller specifications

The XC640 Series system supports internal storage controller cards: HBA330, and Boot Optimized Server Storage (BOSS).

Drive specifications

The XC640 Series system supports SAS, SATA, and Nearline SAS hard drives.

Hard drives

The XC640 Series system supports SAS, SATA, Nearline SAS hard drives or SSDs.

Table 18. Supported hard drive options for the XC640 Series system

Number of drives	Supported drive options
Ten drive systems	Up to ten 2.5 inch, hot swappable SAS, SATA, SAS/SATA SSD, or Nearline SAS hard drives.
Four drive systems	Up to four 3.5 inch, hot swappable hard drives.

Ports and connectors specifications

The XC640 Series system supports USB ports, NIC ports, VGA ports, serial connector, and an IDSDM/vFlash card that supports an optional flash memory card and one internal dual SD module.

USB ports

The XC640 Series system supports:

- USB 2.0-compliant port on the front panel
- Micro USB 2.0-compliant port in the front panel
- ① | **NOTE: The micro USB 2.0-compliant port on the front panel can only be used as an iDRAC Direct or a management port.**
- USB 3.0-compliant ports on the back panel
- Internal USB 3.0-compliant port

The following table provides more information about the USB specifications:

Table 19. USB specifications

System	Front panel	Back panel	Internal
Four hard drive systems	One 4-pin, USB 2.0-compliant ports	Two 9-pin, USB 3.0-compliant ports	N/A
	One 5-pin micro USB 2.0 management port	N/A	N/A
Ten hard drive systems	One 4-pins, USB 2.0-compliant port	Two 9-pin, USB 3.0-compliant ports	One 9-pin, USB 3.0-compliant ports
	One 5-pin micro USB 2.0 management port	N/A	N/A

NIC ports

The XC640 Series system supports four Network Interface Controller (NIC) ports on the back panel, which are available in the following configurations:

- Four RJ-45 ports that support 10, 100 and 1000 Mbps
- Four RJ-45 ports that support 100 M, 1 G and 10 Gbps
- Four RJ-45 ports, where two ports support maximum of 10 G and the other two ports maximum of 1 Gbps
- Two RJ-45 ports that support up to 1 Gbps and 2 SFP+ ports that support up to 10 Gbps
- Four SFP+ ports that support up to 10 Gbps
- Two SFP28 ports that support up to 25 Gbps

NOTE: You can install up to three PCIe add-on NIC cards.

Serial port

The XC640 Series system supports one serial port on the back panel. This port is a 9-pin connector, Data Terminal Equipment (DTE), 16550-compliant.

VGA port

The Video Graphic Array (VGA) port enables you to connect the system to a VGA display. The XC640 Series system supports one 15-pin VGA port on the front and back of system.

Video specifications

The XC640 Series system supports integrated VGA controller with 4 MB SPI capacity.

Table 20. Supported video resolution options

Resolution	Refresh rate (Hz)	Color depth (bits)
640 x 480	60, 70	8, 16, 32
800 x 600	60, 75, 85	8, 16, 32
1024 x 768	60, 75, 85	8, 16, 32

Resolution	Refresh rate (Hz)	Color depth (bits)
1152 x 864	60, 75, 85	8, 16, 32
1280 x 1024	60, 75	8, 16, 32
1440 x 900	60	8, 16, 32
1920 x 1200	60	8, 16, 32

IDSDM/vFlash card

The XC640 Series system supports Internal Dual SD module (IDSDM) and vFlash card. In the 14th generation of XC Series Appliance and XC Core System, IDSDM and vFlash card are combined into a single module, and are available in the following options:

- vFlash or
- vFlash and IDSDM

The IDSDM/vFlash card can be connected in a Dell-proprietary PCIe x1 slot using a USB 3.0 interface to host. IDSDM/vFlash module supports two micro SD cards for IDSDM and one card for vFlash. Micro SD cards capacity for IDSDM are 16, 32, or 64 GB, while for vFlash the microSD card capacity is 16 GB.

NOTE: One IDSDM card slot is dedicated for redundancy.

NOTE: It is recommended to use Dell branded micro SD cards associated with the IDSDM/vFlash configured systems.

Environmental specifications

NOTE: For additional information about environmental measurements for specific system configurations, see Dell.com/environmental_datasheets.

Table 21. Temperature specifications

Temperature	Specifications
Storage	-40°C to 65°C (-40°F to 149°F)
Continuous operation (for altitude less than 950 m or 3117 ft)	10°C to 35°C (50°F to 95°F) with no direct sunlight on the equipment. <ul style="list-style-type: none"> NOTE: Maximum of 205 W, 28 core processor is supported in systems with eight 2.5 inch processor direct attached PCIe SSD drives, and three PCIe slot chassis. NOTE: Certain configurations may have ambient temperature restrictions. For more information see Ambient temperature limitations.
Maximum temperature gradient (operating and storage)	20°C/h (68°F/h)

Table 22. Relative humidity specifications

Relative humidity	Specifications
Storage	5% to 95% RH with 33°C (91°F) maximum dew point. Atmosphere must be non-condensing at all times.
Operating	10% to 80% relative humidity with 29°C (84.2°F) maximum dew point.

Table 23. Maximum vibration specifications

Maximum vibration	Specifications
Operating	0.26 G _{rms} at 5 Hz to 350 Hz (all operation orientations).
Storage	1.88 G _{rms} at 10 Hz to 500 Hz for 15 min (all six sides tested).

Table 24. Maximum shock specifications

Maximum shock	Specifications
Operating	Six consecutively executed shock pulses in the positive and negative x, y, and z axes of 6 G for up to 11 ms.
Storage	Six consecutively executed shock pulses in the positive and negative x, y, and z axes (one pulse on each side of the system) of 71 G for up to 2 ms.

Table 25. Maximum altitude specifications

Maximum altitude	Specifications
Operating	3048 m (10,000 ft)
Storage	12,000 m (39,370 ft)

Table 26. Operating temperature de-rating specifications

Operating temperature de-rating	Specifications
Up to 35°C (95°F)	Maximum temperature is reduced by 1°C/300 m (1°F/547 ft) above 950 m (3,117 ft).
35°C to 40°C (95°F to 104°F)	Maximum temperature is reduced by 1°C/175 m (1°F/319 ft) above 950 m (3,117 ft).
40°C to 45°C (104°F to 113°F)	Maximum temperature is reduced by 1°C/125 m (1°F/228 ft) above 950 m (3,117 ft).

Standard operating temperature

Table 27. Standard operating temperature specifications

Standard operating temperature	Specifications
Continuous operation (for altitude less than 950 m or 3117 ft)	10°C to 35°C (50°F to 95°F) with no direct sunlight on the equipment.

Expanded operating temperature

Table 28. Expanded operating temperature specifications

Expanded operating temperature	Specifications
Continuous operation	<p>5°C–40°C at 5% to 85% RH with 29°C dew point.</p> <p>NOTE: Outside the standard operating temperature (10°C–35°C), the system can operate continuously in temperatures as low as 5°C and as high as 40°C.</p> <p>For temperatures between 35°C–40°C, de-rate maximum allowable temperature by 1°C per 175 m above 950 m (1°F per 319 ft).</p>
≤ 1% of annual operating hours	<p>–5°C–45°C at 5% to 90% RH with 29°C dew point.</p> <p>NOTE: Outside the standard operating temperature (10°C–35°C), the system can operate down to –5°C or up to 45°C for a maximum of 1% of its annual operating hours.</p> <p>For temperatures between 40°C and 45°C, de-rate maximum allowable temperature by 1°C per 125 m above 950 m (1°F per 228 ft).</p>

NOTE: When operating in the expanded temperature range, system performance may be impacted.

NOTE: When operating in the expanded temperature range, ambient temperature warnings may be reported on the LCD panel and in the System Event Log.

Expanded operating temperature restrictions

- Do not perform a cold startup below 5°C.
- The operating temperature specified is for a maximum altitude of 3050 m (10,000 ft).
- 150 W/8 C, 165 W/12 C and higher wattage processor (TDP>165 W) are not supported.
- Redundant power supply unit is required.
- Non-Dell qualified peripheral cards and/or peripheral cards greater than 25 W are not supported.
- PCIe SSD is not supported.
- 3DX Point DIMMs and NVDIMMs-N are not supported.
- Rear installed drives are not supported
- Tape backup unit is not supported.

Thermal restrictions

The following table lists the configurations required for efficient cooling.

Table 29. Thermal restrictions configuration

Configuration	Number of processors	Heatsink	Processor/DIMM blank	DIMM blanks	Maximum number of DIMM blanks	Fan
XC640 Series (2.5 inch hard drives x 10)	1	Two 1U 2-pipe heat sink for	Not required	Required	22 blanks	Eight high performance fans

Configuration	Number of processors	Heatsink	Processor/ DIMM blank	DIMM blanks	Maximum number of DIMM blanks	Fan
XC640 Series (3.5 inch hard drives x 4)	1	CPU=200/205 W and 150 W/165 W FO*	No	Required for processor 1	11 blanks	Five standard fans
		One 1U standard heat sink for CPU ≤ 165 W				
	2	One 1U 2-pipe heat sink for CPU=150 W/165 W FO*	Yes	Required	22 blanks	Eight high performance fans
		One 1U 2-pipe heat sink for CPU=200/205 W				
		Two 1U standard heat sink for CPU ≤ 165 W	No	Required	22 blanks	Eight standard fans Eight high performance fans
		Two 1U 2-pipe heat sink for CPU=150 W/165 W				
		Two 1U 2-pipe heat sink for CPU=200/205 W				

NOTE: *165 W and 150 W frequency optimized includes Intel Xeon Gold 6146 and 6144 processors.

Ambient temperature limitations

The following table lists configurations that require ambient temperature less than 35°C.

NOTE: The ambient temperature limit must be adhered to ensure proper cooling and to avoid excess processor throttling, which may impact system performance.

Table 30. Configuration based ambient temperature restrictions

System	Front Backplane	Processor Thermal Design Power	Processor Heat Sink	Fan Type	Ambient Restriction
XC640 Series	10 x 2.5 inch SAS/SATA hard drives	200 W, 205 W	2 pipe 1U high performance	High performance fan	30°C
	4 x 3.5 inch SAS/SATA and NVMe drives				
	10 x 2.5 inch SAS/SATA and NVMe drives(4)	165 W, 200 W, 205 W	2 pipe 1U high performance	High performance fan	30°C

Particulate and gaseous contamination specifications

The following table defines the limitations that help avoid any equipment damage or failure from particulate and gaseous contamination. If the levels of particulate or gaseous pollution exceed the specified limitations and result in equipment damage or failure, you may need to rectify the environmental conditions. Remediation of environmental conditions is the responsibility of the customer.

Table 31. Particulate contamination specifications

Particulate contamination	Specifications
Air filtration	<p>Data center air filtration as defined by ISO Class 8 per ISO 14644-1 with a 95% upper confidence limit.</p> <p>NOTE: This condition applies to data center environments only. Air filtration requirements do not apply to IT equipment designed to be used outside a data center, in environments such as an office or factory floor.</p> <p>NOTE: Air entering the data center must have the MERV11 or MERV13 filtration.</p>
Conductive dust	<p>Air must be free of conductive dust, zinc whiskers, or other conductive particles.</p> <p>NOTE: This condition applies to data center and non-data center environments.</p>
Corrosive dust	<ul style="list-style-type: none"> Air must be free of corrosive dust. Residual dust present in the air must have a deliquescent point less than 60% relative humidity. <p>NOTE: This condition applies to data center and non-data center environments.</p>

Table 32. Gaseous contamination specifications

Gaseous contamination	Specifications
Copper coupon corrosion rate	<300 Å/month per Class G1 as defined by ANSI/ISA71.04-1985.
Silver coupon corrosion rate	<200 Å/month as defined by AHSRAE TC9.9.

NOTE: Maximum corrosive contaminant levels measured at ≤50% relative humidity.

Initial system setup and configuration

Topics:

- [Setting up your system](#)
- [iDRAC configuration](#)
- [Methods to download firmware and drivers](#)
- [Important information about the BOSS device \(PCIe cards M.2 Drive\)](#)

Setting up your system

Complete the following steps to set up your system:

- 1 Unpack the system.
- 2 Install the system into the rack. For more information about installing the system into the rack, see the *Rail Installation Guide* at [Dell.com/XCseriesmanuals](https://www.dell.com/xcseriesmanuals).
- 3 Connect the peripherals to the system.
- 4 Connect the system to its electrical outlet.
- 5 Turn the system on by pressing the power button or by using iDRAC.
- 6 Turn on the attached peripherals.

For more information about setting up your system, see your *Getting Started Guide* shipped with your system.

iDRAC configuration

The Integrated Dell Remote Access Controller (iDRAC) is designed to make system administrators more productive and improve the overall availability of Dell EMC systems. iDRAC alerts administrators to system issues, helps them perform remote system management, and reduces the need for physical access to the system.

Options to set up iDRAC IP address

You must configure the initial network settings based on your network infrastructure to enable the communication to and from iDRAC.

You must use the default iDRAC IP address 192.168.0.120 to configure the initial network settings, including setting up DHCP or a static IP for iDRAC. You can set up the IP address by using one of the following interfaces:

Interfaces	Document/Section
iDRAC Settings utility	See <i>Dell Integrated Dell Remote Access Controller User's Guide</i> at Dell.com/idracmanuals
Dell Deployment Toolkit	See <i>Dell Deployment Toolkit User's Guide</i> at Dell.com/openmanagemanuals
Dell Lifecycle Controller	See <i>Dell Lifecycle Controller User's Guide</i> at Dell.com/idracmanuals

Interfaces	Document/Section
Chassis or System LCD panel	See LCD panel .
iDRAC Direct and Quick Sync 2 (optional)	See <i>Dell Integrated Dell Remote Access Controller User's Guide</i> at Dell.com/idracmanuals

NOTE: To access iDRAC, ensure that you connect the Ethernet cable to the iDRAC direct port. You can also access iDRAC through the shared LOM mode, if you have opted for a system that has the shared LOM mode enabled.

Log in to iDRAC

You can log in to iDRAC as:

- iDRAC user
- Microsoft Active Directory user
- Lightweight Directory Access Protocol (LDAP) user

If you have opted for secure default access to iDRAC, the iDRAC secure default password is available on the back of the system Information tag. If you have not opted for secure default access to iDRAC, then the default user name and password are `root` and `calvin`. You can also log in by using Single Sign-On or Smart Card.

NOTE: You must have the iDRAC credentials to log in to iDRAC.

NOTE: Ensure that you change the default user name and password after setting up the iDRAC IP address.

For more information about logging in to the iDRAC and iDRAC licenses, see the latest *Integrated Dell Remote Access Controller User's Guide* at Dell.com/idracmanuals.

You can also access iDRAC by using RACADM. For more information, see the *RACADM Command Line Interface Reference Guide* at Dell.com/idracmanuals.

Methods to download firmware and drivers

You can download the firmware and drivers by using any of the following methods:

Table 33. Firmware and drivers

Methods	Location
From the Dell Support site	Dell.com/support/home
Using Dell Remote Access Controller Lifecycle Controller (iDRAC with LC)	Dell.com/idracmanuals

Downloading drivers and firmware

Dell EMC recommends that you download and install the latest BIOS, drivers, and systems management firmware on your system.

Prerequisite

Ensure that you clear the web browser cache before downloading the drivers and firmware.

Steps

- 1 Go to Dell.com/support/drivers.
- 2 In the **Drivers & Downloads** section, type the Service Tag of your system in the **Enter a Service Tag or product ID** box, and then click **Submit**.
NOTE: If you do not have the Service Tag, select **Detect Product** to allow the system to automatically detect your Service Tag, or click **View products**, and navigate to your product.
- 3 Click **Drivers & Downloads**.
The drivers that are applicable to your selection are displayed.
- 4 Download the drivers to a USB drive, CD, or DVD.

Important information about the BOSS device (PCIe cards M.2 Drive)

The Boot Optimized Server Storage (BOSS) card shipped with XC Series Appliance and XC Core System is the appliance boot device. This PCIe card supports up to two M.2 SATA SSDs configured in RAID1 for high availability.

- NOTE:** Write intensive activities and processes leveraged by XC Series Appliance and XC Core System, are intended to take place on the SSDs and HDDs and not the BOSS boot device. Any applications defaulting write activity to the BOSS boot drive should be redirected accordingly.

Examples of write intensive applications not to be run on the boot device

Following are the examples of write intensive applications not to be run on the boot device:

- System Center Agents.
 - System Center Configuration Manager (CCMExec.exe).
 - System Center Operations Manager (MonitoringHost.exe).
- Write-intensive Agents.
- Databases.
- Disk management utilities (third-party disk defragmentation or partitioning tools).
- Additional roles outside of the appliance's intended use (web server, domain controller, RDS, and so on.).
- Client-based Antivirus (Hyper-V only).
- Virtual machines. Ensure that the Virtual Machines run only on Solid State Drives (SSDs) and Hard Disk Drives (HDDs).

Pre-operating system management applications

You can manage basic settings and features of a system without booting to the operating system by using the system firmware.

Topics:

- [Options to manage the pre-operating system applications](#)
- [System Setup](#)
- [Dell Lifecycle Controller](#)
- [Boot Manager](#)
- [PXE boot](#)

Options to manage the pre-operating system applications

Your system has the following options to manage the pre-operating system applications:

- System Setup
- Dell Lifecycle Controller
- Boot Manager
- Preboot Execution Environment (PXE)

System Setup

By using the **System Setup** screen, you can configure the BIOS settings, iDRAC settings, and device settings of your system.

i **NOTE:** Help text for the selected field is displayed in the graphical browser by default. To view the help text in the text browser, press F1.

You can access system setup by using two methods:

- Standard graphical browser—The browser is enabled by default.
- Text browser—The browser is enabled by using Console Redirection.

Viewing System Setup

To view the **System Setup** screen, perform the following steps:

- 1 Turn on, or restart your system.
- 2 Press F2 immediately after you see the following message:

```
F2 = System Setup
```

i **NOTE:** If your operating system begins to load before you press F2, wait for the system to finish booting, and then restart your system and try again.

System Setup details

The **System Setup Main Menu** screen details are explained as follows:

NOTE: The XC Series Appliance and XC Core System does not support the NVDIMM-N, RAID, or UEFI settings.

Option	Description
System BIOS	Enables you to configure BIOS settings.
iDRAC Settings	Enables you to configure the iDRAC settings. The iDRAC settings utility is an interface to set up and configure the iDRAC parameters by using UEFI (Unified Extensible Firmware Interface). You can enable or disable various iDRAC parameters by using the iDRAC settings utility. For more information about this utility, see <i>Integrated Dell Remote Access Controller User's Guide</i> at Dell.com/idracmanuals .
Device Settings	Enables you to configure device settings.

System BIOS

You can use the **System BIOS** screen to edit specific functions such as boot order, system password, setup password, PCIe NVMe RAID mode, and set the SATA enable or disable USB ports.

NOTE: The XC Series Appliance and XC Core System does not support the NVDIMM-N, RAID, or UEFI settings.

Viewing System BIOS

To view the **System BIOS** screen, perform the following steps:

- 1 Turn on, or restart your system.
- 2 Press F2 immediately after you see the following message:

F2 = System Setup

NOTE: If your operating system begins to load before you press F2, wait for the system to finish booting, and then restart your system and try again.

- 3 On the **System Setup Main Menu** screen, click **System BIOS**.

System BIOS Settings details

NOTE: The XC Series Appliance and XC Core System does not support the NVDIMM-N, RAID, or UEFI settings.

The **System BIOS Settings** screen details are explained as follows:

Option	Description
System Information	Specifies information about the system such as the system model name, BIOS version, and Service Tag.
Memory Settings	Specifies information and options related to the installed memory.
Processor Settings	Specifies information and options related to the processor such as speed and cache size.
SATA Settings	Specifies options to enable or disable the integrated SATA controller and ports.

Option	Description
NVMe Settings	Specifies options to change the NVMe settings. If the system contains the NVMe drives that you want to configure in a RAID array, you must set this field and the Embedded SATA field on the SATA Settings menu to RAID mode. You might also need to change the Boot Mode setting to UEFI . Otherwise, you should set this field to Non-RAID mode.
Boot Settings	Allows you to set the boot mode — BIOS or UEFI.
Network Settings	Specifies options to manage the UEFI network settings and boot protocols. Legacy network settings are managed from the Device Settings menu.
Integrated Devices	Specifies options to manage integrated device controllers and ports, specifies related features and options.
Serial Communication	Specifies options to manage the serial ports, related features and options.
System Profile Settings	Specifies options to change the processor power management settings, memory frequency.
System Security	Specifies options to configure the system security settings, such as system password, setup password, Trusted Platform Module (TPM) security, and UEFI secure boot. It also manages the power button on the system.
Redundant OS Settings	Specifies the options to configure the Redundant OS settings.
Miscellaneous Settings	Specifies options to change the system date and time.

System Information

You can use the **System Information** screen to view system properties such as Service Tag, system model name, and the BIOS version.

 **NOTE:** The XC Series Appliance and XC Core System does not support the NVDIMM-N, RAID, or UEFI settings.

Viewing System Information

To view the **System Information** screen, perform the following steps:

- 1 Turn on, or restart your system.
- 2 Press F2 immediately after you see the following message:

```
F2 = System Setup
```
- 3 On the **System Setup Main Menu** screen, click **System BIOS**.
- 4 On the **System BIOS** screen, click **System Information**.

 **NOTE:** If your operating system begins to load before you press F2, wait for the system to finish booting, and then restart your system and try again.

System Information details

 **NOTE:** The XC Series Appliance and XC Core System does not support the NVDIMM-N, RAID, or UEFI settings.

The **System Information** screen details are explained as follows:

Option	Description
System Model Name	Specifies the system model name.

Option	Description
System BIOS Version	Specifies the BIOS version installed on the system.
System Management Engine Version	Specifies the current version of the Management Engine firmware.
System Service Tag	Specifies the system Service Tag.
System Manufacturer	Specifies the name of the system manufacturer.
System Manufacturer Contact Information	Specifies the contact information of the system manufacturer.
System CPLD Version	Specifies the current version of the system complex programmable logic device (CPLD) firmware.
UEFI Compliance Version	Specifies the UEFI compliance level of the system firmware.

Memory Settings

You can use the **Memory Settings** screen to view all the memory settings and enable or disable specific memory functions, such as system memory testing and node interleaving.

 **NOTE:** The XC Series Appliance and XC Core System does not support the NVDIMM-N, RAID, or UEFI settings.

Viewing Memory Settings

To view the **Memory Settings** screen, perform the following steps:

- 1 Turn on, or restart your system.
- 2 Press F2 immediately after you see the following message:

```
F2 = System Setup
```
- 3 On the **System Setup Main Menu** screen, click **System BIOS**.
- 4 On the **System BIOS** screen, click **Memory Settings**.

 **NOTE:** If your operating system begins to load before you press F2, wait for the system to finish booting, and then restart your system and try again.

Memory Settings details

The **Memory Settings** screen details are explained as follows:

Option	Description
System Memory Size	Specifies the memory size in the system.
System Memory Type	Specifies the type of memory installed in the system.
System Memory Speed	Specifies the system memory speed.

Option	Description
System Memory Voltage	Specifies the system memory voltage.
Video Memory	Specifies the amount of video memory.
System Memory Testing	Specifies whether the system memory tests are run during system boot. Options are Enabled and Disabled . This option is set to Disabled by default.
Memory Operating Mode	Specifies the memory operating mode. The options available are Optimizer Mode , Single Rank Spare Mode , Multi Rank Spare Mode , Mirror Mode , and Dell Fault Resilient Mode . This option is set to Optimizer Mode by default. <p>NOTE: The Memory Operating Mode option can have different default and available options based on the memory configuration of your system.</p> <p>NOTE: The Dell Fault Resilient Mode option establishes an area of memory that is fault resilient. This mode can be used by an operating system that supports the feature to load critical applications or enables the operating system kernel to maximize system availability.</p>
Current State of Memory Operating Mode	Specifies the current state of the memory operating mode.
Node Interleaving	Specifies if Non-Uniform Memory Architecture (NUMA) is supported. If this field is set to Enabled , memory interleaving is supported if a symmetric memory configuration is installed. If the field is set to Disabled , the system supports NUMA (asymmetric) memory configurations. This option is set to Disabled by default.
Opportunistic Self-Refresh	Enables or disables opportunistic self-refresh feature. This option is set to Disabled by default.

Persistent Memory details

The **Persistent Memory** screen details are explained as follows:

NOTE: The XC Series Appliance and XC Core System does not support the NVDIMM-N, RAID, or UEFI settings.

Option	Description
Persistent Memory	Enables or disables persistency for NVDIMM-N. If this option is set to Off , persistency for all NVDIMM-N is disabled and is not presented to OS (data is not preserved). If this option is set to Non-Volatile DIMM , persistency for all NVDIMM-N is enabled and presented to OS (data is preserved). This option is set to Non-Volatile DIMM by default.
NVDIMM-N Read-Only	Enables or disables the read-only option for the NVDIMM-N. If set to Enable , all NVDIMM-N is forced to read-only. Read-only is intended to be for debug or maintenance when customers would like to access the NVDIMM-N data and also to lock it from being updated. This option is set to Disable by default.
NVDIMM-N Factory Reset and Secure Erase All Dimms	Enables or disables clearing data on the NVDIMM-N. If set to Enable , all data on the NVDIMM-N is lost. This option is used to remove data on the NVDIMM-N, repurpose your system. This option is set to Disable by default.
NVDIMM-N Interleave	Enables or disables interleaving on NVDIMM-N. Volatile RDIMM interleaving policy is not affected by this option. This option is set to Disable by default.
Battery Status	Indicates if the NVDIMM-N battery is ready. Battery Status can display one of the following states: <ul style="list-style-type: none"> Present-Ready Present-Offline Not-Ready

The following settings are applicable for every NVDIMM-N present in the system:

Option	Description
NVDIMM-N Memory Location	Specifies the location of the NVDIMM-N in each channel.
NVDIMM-N Memory Size	Specifies information on the capacity of the NVDIMM-N.
NVDIMM-N Memory Speed	Specifies information on the speed of the NVDIMM-N.
NVDIMM-N Memory Firmware version	Specifies information on the current firmware version on the NVDIMM-N.
NVDIMM-N Memory Serial Number	Specifies information on the serial number of the NVDIMM-N.
NVDIMM-N Factory Reset and Secure Erase	Enables clearing data on specific NVDIMM-N and results in loss of data on that specific NVDIMM-N.

Processor Settings

You can use the **Processor Settings** screen to view the processor settings, and perform specific functions such as enabling virtualization technology, hardware prefetcher, logical processor idling, and opportunistic self-refresh.

Viewing Processor Settings

To view the **Processor Settings** screen, perform the following steps:

- 1 Turn on, or restart your system.
- 2 Press F2 immediately after you see the following message:

- 3 On the **System Setup Main Menu** screen, click **System BIOS**.
- 4 On the **System BIOS** screen, click **Processor Settings**.

NOTE: If your operating system begins to load before you press F2, wait for the system to finish booting, and then restart your system and try again.

Processor Settings details

The **Processor Settings** screen details are explained as follows:

Option	Description
Logical Processor	Enables or disables the logical processors and displays the number of logical processors. If this option is set to Enabled , the BIOS displays all the logical processors. If this option is set to Disabled , the BIOS displays only one logical processor per core. This option is set to Enabled by default.
CPU Interconnect Speed	Enables you to govern the frequency of the communication links among the CPUs in the system. NOTE: The standard and basic bin processors support lower link frequencies.

Option	Description
	<p>The options available are Maximum data rate, 10.4 GT/s, and 9.6 GT/s. This option is set to Maximum data rate by default.</p> <p>Maximum data rate indicates that the BIOS runs the communication links at the maximum frequency supported by the processors. You can also select specific frequencies that the processors support, which can vary.</p> <p>For best performance, you should select Maximum data rate. Any reduction in the communication link frequency affects the performance of non-local memory accesses and cache coherency traffic. In addition, it can slow access to non-local I/O devices from a particular CPU.</p> <p>However, if power saving considerations outweigh performance, you might want to reduce the frequency of the CPU communication links. If you do this, you should localize memory and I/O accesses to the nearest NUMA node to minimize the impact to system performance.</p>
Virtualization Technology	Enables you to control the QuickPath Interconnect data rate settings.
Adjacent Cache Line Prefetch	Optimizes the system for applications that need high utilization of sequential memory access. This option is set to Enabled by default. You can disable this option for applications that need high utilization of random memory access.
Hardware Prefetcher	Enables or disables the hardware prefetcher. This option is set to Enabled by default.
DCU Streamer Prefetcher	Enables or disables the Data Cache Unit (DCU) streamer prefetcher. This option is set to Enabled by default.
DCU IP Prefetcher	Enables or disables the Data Cache Unit (DCU) IP prefetcher. This option is set to Enabled by default.
Sub NUMA Cluster	Enables or disables the Sub NUMA Cluster. This option is set to Disabled by default.
Logical Processor Idling	Enables you to improve the energy efficiency of a system. It uses the operating system core parking algorithm and parks some of the logical processors in the system which in turn allows the corresponding processor cores to transition into a lower power idle state. This option can only be enabled if the operating system supports it. It is set to Disabled by default.
X2APIC Mode	Enables or disables the X2APIC mode. This option is set to Disabled by default.
Dell Controlled Turbo	Controls the turbo engagement. Enable this option only when System Profile is set to Disabled .
Number of Cores per Processor	Controls the number of enabled cores in each processor. This option is set to All by default.
Processor Core Speed	Specifies the maximum core frequency of the processor.

Processor n

 **NOTE: Depending on the number of processors, there might be up to four processors listed.**

The following settings are displayed for each processor installed in the system:

Option	Description
Family-Model-Stepping	Specifies the family, model, and stepping of the processor as defined by Intel.
Brand	Specifies the brand name.
Level 2 Cache	Specifies the total L2 cache.
Level 3 Cache	Specifies the total L3 cache.
Number of Cores	Specifies the number of cores per processor.

SATA Settings

You can use the **SATA Settings** screen to view the SATA settings of SATA devices and enable SATA on your system.

NOTE: The XC Series Appliance and XC Core System does not support the NVDIMM-N, RAID, or UEFI settings.

Viewing SATA Settings

To view the **SATA Settings** screen, perform the following steps:

- 1 Turn on, or restart your system.
- 2 Press F2 immediately after you see the following message:

F2 = System Setup

NOTE: If your operating system begins to load before you press F2, wait for the system to finish booting, and then restart your system and try again.

- 3 On the **System Setup Main Menu** screen, click **System BIOS**.
- 4 On the **System BIOS** screen, click **SATA Settings**.

SATA Settings details

The **SATA Settings** screen details are explained as follows:

NOTE: The XC Series Appliance and XC Core System does not support the NVDIMM-N, RAID, or UEFI settings.

Option	Description
Embedded SATA	Enables the embedded SATA option to be set to AHCI , or RAID modes. This option is set to AHCI by default.
Security Freeze Lock	Sends Security Freeze Lock command to the embedded SATA drives during POST. This option is applicable only for ATA and AHCI Mode. This option is set to Enabled by default.
Write Cache	Enables or disables the command for the embedded SATA drives during POST. This option is set to Disabled by default.
Port n	Sets the drive type of the selected device. For AHCI Mode or RAID Mode , BIOS support is always enabled.
Option	Description
Model	Specifies the drive model of the selected device.
Drive Type	Specifies the type of drive attached to the SATA port.
Capacity	Specifies the total capacity of the hard drive.

Boot Settings

You can use the **Boot Settings** screen to set the boot mode to either **BIOS** or **UEFI**. It also enables you to specify the boot order.

NOTE: The XC Series Appliance and XC Core System does not support the NVDIMM-N, RAID, or UEFI settings.

- **UEFI:** The Unified Extensible Firmware Interface (UEFI) is a new interface between operating systems and platform firmware. The interface consists of data tables with platform related information, also boot and runtime service calls that are available to the operating system and its loader. The following benefits are available when the **Boot Mode** is set to **UEFI**:

- Support for hard drive partitions larger than 2 TB.
 - Enhanced security (e.g., UEFI Secure Boot).
 - Faster boot time.
- **BIOS:** The **BIOS Boot Mode** is the legacy boot mode. It is maintained for backward compatibility.

Viewing Boot Settings

To view the **Boot Settings** screen, perform the following steps:

- 1 Turn on, or restart your system.
- 2 Press F2 immediately after you see the following message:

F2 = System Setup

NOTE: If your operating system begins to load before you press F2, wait for the system to finish booting, and then restart your system and try again.

- 3 On the **System Setup Main Menu** screen, click **System BIOS**.
- 4 On the **System BIOS** screen, click **Boot Settings**.

Boot Settings details

NOTE: The NVDIMM-N, RAID or UEFI settings are not supported.

The **Boot Settings** screen details are explained as follows:

Option	Description
Boot Mode	<p>Enables you to set the boot mode of the system.</p> <p>CAUTION: Switching the boot mode may prevent the system from booting if the operating system is not installed in the same boot mode.</p> <p>If the operating system supports UEFI, you can set this option to UEFI. Setting this field to BIOS allows compatibility with non-UEFI operating systems. This option is set to UEFI by default.</p> <p>NOTE: Setting this field to UEFI disables the BIOS Boot Settings menu.</p>
Boot Sequence Retry	<p>Enables or disables the Boot Sequence Retry feature. If this option is set to Enabled and the system fails to boot, the system re-attempts the boot sequence after 30 seconds. This option is set to Enabled by default.</p>
Hard-Disk Failover	<p>Specifies the hard drive that is booted in the event of a hard drive failure. The devices are selected in the Hard-Disk Drive Sequence on the Boot Option Setting menu. When this option is set to Disabled, only the first hard drive in the list is attempted to boot. When this option is set to Enabled, all hard drives are attempted to boot in the order selected in the Hard-Disk Drive Sequence. This option is not enabled for UEFI Boot Mode. This option is set to Disabled by default.</p>
Boot Option Settings	<p>Configures the boot sequence and the boot devices.</p>
BIOS Boot Settings	<p>Enables or disables BIOS boot options.</p> <p>NOTE: This option is enabled only if the boot mode is BIOS.</p>
UEFI Boot Settings	<p>Enables or disables UEFI Boot options.</p> <p>The Boot options include IPv4 PXE and IPv6 PXE. This option is set to IPv4 by default.</p> <p>NOTE: This option is enabled only if the boot mode is set to UEFI.</p>

Choosing system boot mode

System Setup enables you to specify one of the following boot modes for installing your operating system:

NOTE: The XC Series Appliance and XC Core System does not support the NVDIMM-N, RAID, or UEFI settings.

- BIOS boot mode (the default) is the standard BIOS-level boot interface.
- UEFI boot mode is an enhanced 64-bit boot interface.
If you have configured your system to boot to UEFI mode, it replaces the system BIOS.

NOTE: The system supports only BIOS boot mode.

- 1 From the **System Setup Main Menu**, click **Boot Settings**, and select **Boot Mode**.
- 2 Select the UEFI boot mode, you want the system to boot into.

CAUTION: Switching the boot mode may prevent the system from booting if the operating system is not installed in the same boot mode.

- 3 After the system boots in the specified boot mode, proceed to install your operating system from that mode.

NOTE: Operating systems must be UEFI-compatible to be installed from the UEFI boot mode. DOS and 32-bit operating systems do not support UEFI and can only be installed from the BIOS boot mode.

NOTE: For the latest information about supported operating systems, go to Dell.com/ossupport.

Changing boot order

About this task

You may have to change the boot order if you want to boot from a USB key. The following instructions may vary if you have selected **BIOS** for **Boot Mode**.

NOTE: The XC Series Appliance and XC Core System does not support the NVDIMM-N, RAID, or UEFI settings.

Steps

- 1 On the **System Setup Main Menu** screen, click **System BIOS > Boot Settings > UEFI/BIOS Boot Settings > UEFI/BIOS Boot Sequence**.
- 2 Use the arrow keys to select a boot device, and use the plus (+) and minus (-) sign keys to move the device down or up in the order.
- 3 Click **Exit**, and then click **Yes** to save the settings on exit.

Network Settings

You can use the **Network Settings** screen to modify UEFI PXE, iSCSI, and HTTP boot settings. The network settings option is available only in the UEFI mode.

NOTE: The BIOS does not control network settings in the BIOS mode. For the BIOS boot mode, the option ROM of the network controllers handles the network settings.

NOTE: The XC Series Appliance and XC Core System does not support the NVDIMM-N, RAID, or UEFI settings.

Viewing Network Settings

To view the **Network Settings** screen, perform the following steps:

- 1 Turn on, or restart your system.
- 2 Press F2 immediately after you see the following message:

F2 = System Setup

NOTE: If your operating system begins to load before you press F2, wait for the system to finish booting, and then restart your system and try again.

- 3 On the **System Setup Main Menu** screen, click **System BIOS**.
- 4 On the **System BIOS** screen, click **Network Settings**.

Network Settings screen details

The **Network Settings** screen details are explained as follows:

NOTE: The XC Series Appliance and XC Core System does not support the NVDIMM-N, RAID, or UEFI settings.

Option	Description
PXE Device n (n = 1 to 4)	Enables or disables the device. When enabled, a UEFI PXE boot option is created for the device.
UEFI PXE Settings	Enables or disables the device. When enabled, a UEFI PXE boot option is created for the device.
PXE Device n Settings (n = 1 to 4)	Enables you to control the configuration of the PXE device.
HTTP Device n (n = 1 to 4)	Enables or disables the device. When enabled, a UEFI HTTP boot option is created for the device.
HTTP Device n Settings (n = 1 to 4)	Enables you to control the configuration of the HTTP device.

UEFI iSCSI Settings

You can use the iSCSI Settings screen to modify iSCSI device settings. The iSCSI Settings option is available only in the UEFI boot mode. BIOS does not control network settings in the BIOS boot mode. For the BIOS boot mode, the option ROM of the network controller handles the network settings.

NOTE: The XC Series Appliance and XC Core System does not support the NVDIMM-N, RAID, or UEFI settings.

Viewing UEFI iSCSI Settings

To view the **UEFI iSCSI Settings** screen, perform the following steps:

About this task

NOTE: The XC Series Appliance and XC Core System does not support the NVDIMM-N, RAID, or UEFI settings.

Steps

- 1 Turn on, or restart your system.
- 2 Press F2 immediately after you see the following message:

F2 = System Setup

NOTE: If your operating system begins to load before you press F2, wait for the system to finish booting, and then restart your system and try again.

- 3 On the **System Setup Main Menu** screen, click **System BIOS**.
- 4 On the **System BIOS** screen, click **Network Settings**.
- 5 On the **Network Settings** screen, click **UEFI iSCSI Settings**.

UEFI iSCSI Settings details

The **UEFI iSCSI Settings** screen details are explained as follows:

NOTE: The XC Series Appliance and XC Core System does not support the NVDIMM-N, RAID, or UEFI settings.

Option	Description
iSCSI Initiator Name	Specifies the name of the iSCSI initiator (iqn format).
iSCSI Device1	Enables or disables the iSCSI device. When disabled, a UEFI boot option is created for the iSCSI device automatically.
iSCSI Device1 Settings	Enables you to control the configuration of the iSCSI device.

Integrated Devices

You can use the **Integrated Devices** screen to view and configure the settings of all integrated devices including the video controller, integrated RAID controller, and the USB ports.

NOTE: The XC Series Appliance and XC Core System does not support the NVDIMM-N, RAID, or UEFI settings.

Viewing Integrated Devices

To view the **Integrated Devices** screen, perform the following steps:

About this task

NOTE: The XC Series Appliance and XC Core System does not support the NVDIMM-N, RAID, or UEFI settings.

Steps

- 1 Turn on, or restart your system.
- 2 Press F2 immediately after you see the following message:



F2 = System Setup

NOTE: If your operating system begins to load before you press F2, wait for the system to finish booting, and then restart your system and try again.

- 3 On the **System Setup Main Menu** screen, click **System BIOS**.
- 4 On the **System BIOS** screen, click **Integrated Devices**.

Integrated Devices details

The **Integrated Devices** screen details are explained as follows:

Option	Description
User Accessible USB Ports	<p>Configures the user accessible USB ports. Selecting Only Back Ports On disables the front USB ports; selecting All Ports Off disables all front and back USB ports; selecting All Ports Off (Dynamic) disables all front and back USB ports during POST and front ports can be enabled or disabled dynamically by authorized user without resetting the system.</p> <p>The USB keyboard and mouse still function in certain USB ports during the boot process, depending on the selection. After the boot process is complete, the USB ports will be enabled or disabled as per the setting.</p>
Internal USB Port	Enables or disables the internal USB port. This option is set to Enabled by default.
Integrated RAID Controller	Enables or disables the integrated RAID controller. This option is set to Enabled by default.
Integrated Network Card 1	<p>Enables or disables the integrated network card (NDC). When set to Disabled, the NDC is not available to the operating system (OS). This option is set to Enable by default.</p> <p> NOTE: If set to Disabled (OS), the Integrated NICs might still be available for shared network access by iDRAC.</p>
I/OAT DMA Engine	Enables or disables the I/O Acceleration Technology (I/OAT) option. I/OAT is a set of DMA features designed to accelerate network traffic and lower CPU utilization. Enable only if the hardware and software support the feature.
Embedded Video Controller	<p>Enables or disables the use of Embedded Video Controller as the primary display. When set to Enabled, the Embedded Video Controller will be the primary display even if add-in graphic cards are installed. When set to Disabled, an add-in graphics card will be used as the primary display. BIOS will output displays to both the primary add-in video and the embedded video during POST and pre-boot environment. The embedded video will then be disabled right before the operating system boots. This option is set to Enabled by default.</p> <p> NOTE: When there are multiple add-in graphic cards installed in the system, the first card discovered during PCI enumeration is selected as the primary video. You might have to re-arrange the cards in the slots in order to control which card is the primary video.</p>
Current State of Embedded Video Controller	Displays the current state of the embedded video controller. The Current State of Embedded Video Controller option is a read-only field. If the Embedded Video Controller is the only display capability in the system (that is, no add-in graphics card is installed), then the Embedded Video Controller is automatically used as the primary display even if the Embedded Video Controller setting is set to Disabled .
SR-IOV Global Enable	Enables or disables the BIOS configuration of Single Root I/O Virtualization (SR-IOV) devices. This option is set to Disabled by default.
Internal SD Card Port	Enables or disables the internal SD card port of the Internal Dual SD Module (IDSDM). This option is set to On by default.
Internal SD Card Redundancy	<p>Configures the redundancy mode of the Internal Dual SD Module (IDSDM). When set to Mirror Mode, data is written on both SD cards. After failure of either card and replacement of the failed card, the data of the active card is copied to the offline card during the system boot.</p> <p>When Internal SD Card Redundancy is set to Disabled, only the primary SD card is visible to the OS. This option is set to Disabled by default.</p>
Internal SD Primary Card	When Redundancy is set to Disabled , either one of the SD card can be selected to present itself as mass storage device by setting it to be primary card. By default primary SD card is selected to be SD Card 1. If SD Card 1 is not present, then the controller will select SD Card 2 to be the primary SD card.
OS Watchdog Timer	If your system stops responding, this watchdog timer aids in the recovery of your operating system. When this option is set to Enabled , the operating system initializes the timer. When this option is set to Disabled (the default), the timer does not have any effect on the system.
Memory Mapped I/O above 4 GB	Enables or disables the support for the PCIe devices that need large amounts of memory. Enable this option only for 64-bit operating systems. This option is set to Enabled by default.
Memory Mapped I/O above Base	When set to 12 TB , the system will map MMIO base to 12 TB. Enable this option for an OS that requires 44 bit PCIe addressing. When set to 512 GB , the system will map MMIO base to 512 GB, and reduce the maximum

Option	Description
	support for memory to less than 512 GB. Enable this option only for the 4 GPU DGMA issue. This option is set to 56 TB by default.
Slot Disablement	Enables or disables the available PCIe slots on your system. The slot disablement feature controls the configuration of the PCIe cards installed in the specified slot. Slots must be disabled only when the installed peripheral card prevents booting into the operating system or causes delays in system startup. If the slot is disabled, both the Option ROM and UEFI drivers are disabled. Only slots that are present on the system will be available for control.

Table 34. Slot Disablement

Option	Description
Slot 1	Enables or disables the PCIe slot 1. This option is set to Enabled by default.
Slot 3	Enables or disables or only the boot driver is disabled for the PCIe slot 3. This option is set to Enabled by default.
Slot 4	Enables or disables or only the boot driver is disabled for the PCIe slot 4. This option is set to Enabled by default.
Slot 5	Enables or disables or only the boot driver is disabled for the PCIe slot 5. This option is set to Enabled by default.

 **NOTE:** If your system supports four processors, you may have 13 PCIe slots.

Slot Bifurcation	Allows Platform Default Bifurcation , Auto discovery of Bifurcation and Manual bifurcation Control . The default is set to Platform Default Bifurcation . The slot bifurcation field is accessible when set to Manual bifurcation Control and is grayed out when set to Platform Default Bifurcation or Auto discovery of Bifurcation .
-------------------------	------------------------------------------------------------------------------------------------------------------------------------------------------------------------------------------------------------------------------------------------------------------------------------------------------------------------------------------------------------------------------------------

Table 35. Slot Bifurcation

Option	Description
Slot 1 Bifurcation	X4 or X8 or X4X4X4X8 or X8X4X4 Bifurcation
Slot 3 Bifurcation	X4 or X8 or X4X4X4X8 or X8X4X4 Bifurcation
Slot 4 Bifurcation	X16 or X4 or X8 or X4X4X4X8 or X8X4X4 Bifurcation
Slot 5 Bifurcation	X4 Bifurcation or X8 Bifurcation

Serial Communication

You can use the **Serial Communication** screen to view the properties of the serial communication port.

Viewing Serial Communication

To view the **Serial Communication** screen, perform the following steps:

- 1 Turn on, or restart your system.
- 2 Press F2 immediately after you see the following message:

F2 = System Setup

NOTE: If your operating system begins to load before you press F2, wait for the system to finish booting, and then restart your system and try again.

- 3 On the **System Setup Main Menu** screen, click **System BIOS**.
- 4 On the **System BIOS** screen, click **Serial Communication**.

Serial Communication details

The **Serial Communication** screen details are explained as follows:

Option	Description
Serial Communication	Selects serial communication devices (Serial Device 1 and Serial Device 2) in BIOS. BIOS console redirection can also be enabled, and the port address can be specified. This option is set to Auto by default.
Serial Port Address	Enables you to set the port address for serial devices. This option is set to Serial Device1=COM2, Serial Device 2=COM1 by default. NOTE: You can use only Serial Device 2 for the Serial Over LAN (SOL) feature. To use console redirection by SOL, configure the same port address for console redirection and the serial device. NOTE: Every time the system boots, the BIOS syncs the serial MUX setting saved in iDRAC. The serial MUX setting can independently be changed in iDRAC. Loading the BIOS default settings from within the BIOS setup utility may not always revert the serial MUX setting to the default setting of Serial Device 1.
External Serial Connector	Enables you to associate the External Serial Connector to Serial Device 1, Serial Device 2, or the Remote Access Device by using this option. This option is set to Serial Device 1 by default. NOTE: Only Serial Device 2 can be used for Serial Over LAN (SOL). To use console redirection by SOL, configure the same port address for console redirection and the serial device. NOTE: Every time the system boots, the BIOS syncs the serial MUX setting saved in iDRAC. The serial MUX setting can independently be changed in iDRAC. Loading the BIOS default settings from within the BIOS setup utility may not always revert this setting to the default setting of Serial Device 1.
Failsafe Baud Rate	Specifies the failsafe baud rate for console redirection. The BIOS attempts to determine the baud rate automatically. This failsafe baud rate is used only if the attempt fails, and the value must not be changed. This option is set to 115200 by default.
Remote Terminal Type	Sets the remote console terminal type. This option is set to VT100/VT220 by default.
Redirection After Boot	Enables or disables the BIOS console redirection when the operating system is loaded. This option is set to Enabled by default.

System Profile Settings

You can use the **System Profile Settings** screen to enable specific system performance settings such as power management.

Viewing System Profile Settings

To view the **System Profile Settings** screen, perform the following steps:

- 1 Turn on, or restart your system.
- 2 Press F2 immediately after you see the following message:

F2 = System Setup

NOTE: If your operating system begins to load before you press F2, wait for the system to finish booting, and then restart your system and try again.

- 3 On the **System Setup Main Menu** screen, click **System BIOS**.
- 4 On the **System BIOS** screen, click **System Profile Settings**.

System Profile Settings details

The **System Profile Settings** screen details are explained as follows:

Option	Description
System Profile	Sets the system profile. If you set the System Profile option to a mode other than Custom , the BIOS automatically sets the rest of the options. You can only change the rest of the options if the mode is set to Custom . This option is set to Performance Per Watt Optimized (DAPC) by default. DAPC is Dell Active Power Controller. NOTE: All the parameters on the system profile setting screen are available only when the System Profile option is set to Custom.
CPU Power Management	Sets the CPU power management. This option is set to System DBPM (DAPC) by default. DBPM is Demand-Based Power Management.
Memory Frequency	Sets the speed of the system memory. You can select Maximum Performance , Maximum Reliability , or a specific speed. This option is set to Maximum Performance by default.
Turbo Boost	Enables or disables the processor to operate in the turbo boost mode. This option is set to Enabled by default.
C1E	Enables or disables the processor to switch to a minimum performance state when it is idle. This option is set to Enabled by default.
C States	Enables or disables the processor to operate in all available power states. This option is set to Enabled by default.
Write Data CRC	Enables or disables the Write Data CRC. This option is set to Enabled by default.
Memory Patrol Scrub	Sets the memory patrol scrub frequency. This option is set to Standard by default.
Memory Refresh Rate	Sets the memory refresh rate to either 1x or 2x. This option is set to 1x by default.
Uncore Frequency	Enables you to select the Processor Uncore Frequency option. Dynamic mode enables the processor to optimize power resources across the cores and uncore during runtime. The optimization of the uncore frequency to either save power or optimize performance is influenced by the setting of the Energy Efficiency Policy option.
Energy Efficient Policy	Enables you to select the Energy Efficient Policy option.

Option	Description
	The CPU uses the setting to manipulate the internal behavior of the processor and determines whether to target higher performance or better power savings.
Number of Turbo Boot Enabled Cores for Processor 1	<p>NOTE: If there are four processors installed in the system, you will see an entry for Number of Turbo Boost Enabled Cores for Processor 4.</p> <p>Controls the number of turbo boost enabled cores for Processor 1. The maximum number of cores is enabled by default.</p>
Monitor/Mwait	<p>Enables the Monitor/Mwait instructions in the processor. This option is set to Enabled for all system profiles, except Custom by default.</p> <p>NOTE: This option can be disabled only if the C States option in the Custom mode is set to disabled.</p> <p>NOTE: When C States is set to Enabled in the Custom mode, changing the Monitor/Mwait setting does not impact the system power or performance.</p>
CPU Interconnect Bus Link Power Management	Enables or disables the CPU Interconnect Bus Link Power Management. This option is set to Enabled by default.
PCI ASPM L1 Link Power Management	Enables or disables the PCI ASPM L1 Link Power Management. This option is set to Enabled by default.

System Security

You can use the **System Security** screen to perform specific functions such as setting the system password, setup password and disabling the power button.

Viewing System Security

To view the **System Security** screen, perform the following steps:

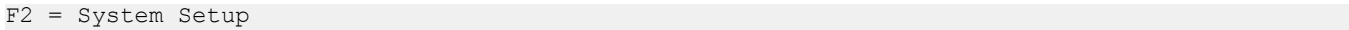
- 1 Turn on, or restart your system.
- 2 Press F2 immediately after you see the following message:

- 3 On the **System Setup Main Menu** screen, click **System BIOS**.
- 4 On the **System BIOS** screen, click **System Security**.



NOTE: If your operating system begins to load before you press F2, wait for the system to finish booting, and then restart your system and try again.

System Security Settings details

The **System Security Settings** screen details are explained as follows:

NOTE: The **XC Series Appliance** and **XC Core System** does not support the **NVDIMM-N**, **RAID**, or **UEFI** settings.

Option	Description
In-Band Manageability Interface	When set to Disabled , this setting will hide the Management Engine's (ME), HECI devices, and the system's IPMI devices from the operating system. This prevents the operating system from changing the ME power capping settings, and blocks access to all in-band management tools. All management should be managed through out-of-band. This option is set to Enabled by default.

Option	Description
	<p> NOTE: BIOS update requires HECI devices to be operational, and DUP updates require IPMI interface to be operational. This setting needs to be set to Enabled to avoid updating errors.</p>
Intel AES-NI	Improves the speed of applications by performing encryption and decryption by using the Advanced Encryption Standard Instruction Set (AES-NI). This option is set to Enabled by default.
System Password	Sets the system password. This option is set to Enabled by default and is read-only if the password jumper is not installed in the system.
Setup Password	Sets the setup password. This option is read-only if the password jumper is not installed in the system.
Password Status	Locks the system password. This option is set to Unlocked by default.
TPM Security	<p> NOTE: The TPM menu is available only when the TPM module is installed.</p> <p>Enables you to control the reporting mode of the TPM. The TPM Security option is set to Off by default. You can only modify the TPM Status, TPM Activation, and the Intel TXT fields if the TPM Status field is set to either On with Pre-boot Measurements or On without Pre-boot Measurements.</p>
TPM Information	Changes the operational state of the TPM. This option is set to No Change by default.
TPM Status	Specifies the TPM status.
TPM Command	<p>Controls the Trusted Platform Module (TPM). When set to None, no command is sent to the TPM. When set to Activate, the TPM is enabled and activated. When set to Deactivate, the TPM is disabled and deactivated. When set to Clear, all the contents of the TPM are cleared. This option is set to None by default.</p> <p> CAUTION: Clearing the TPM results in the loss of all keys in the TPM. The loss of TPM keys may affect booting to the operating system.</p> <p>This field is read-only when TPM Security is set to Off. The action requires an additional reboot before it can take effect.</p>
Intel(R) TXT	Enables or disables the Intel Trusted Execution Technology (TXT) option. To enable the Intel TXT option, virtualization technology and TPM Security must be enabled with Pre-boot measurements. This option is set to Off by default.
Power Button	Enables or disables the power button on the front of the system. This option is set to Enabled by default.
AC Power Recovery	Sets how the system behaves after AC power is restored to the system. This option is set to Last by default.
AC Power Recovery Delay	Sets the time delay for the system to power up after AC power is restored to the system. This option is set to Immediate by default.
User Defined Delay (60 s to 240 s)	Sets the User Defined Delay option when the User Defined option for AC Power Recovery Delay is selected.
UEFI Variable Access	Provides varying degrees of securing UEFI variables. When set to Standard (the default), UEFI variables are accessible in the operating system per the UEFI specification. When set to Controlled , selected UEFI variables are protected in the environment and new UEFI boot entries are forced to be at the end of the current boot order.
Secure Boot	Enables Secure Boot, where the BIOS authenticates each pre-boot image by using the certificates in the Secure Boot Policy. Secure Boot is set to Disabled by default.
Secure Boot Policy	When Secure Boot policy is set to Standard , the BIOS uses the system manufacturer's key and certificates to authenticate pre-boot images. When Secure Boot policy is set to Custom , the BIOS uses the user-defined key and certificates. Secure Boot policy is set to Standard by default.
Secure Boot Policy Summary	Specifies the list of certificates and hashes that secure boot uses to authenticate images.
Secure Boot Custom Policy Settings	Configures the Secure Boot Custom Policy. To enable this option, set the Secure Boot Policy to Custom option.

Creating a system and setup password

Prerequisite

Ensure that the password jumper is enabled. The password jumper enables or disables the system password and setup password features. For more information, see [System board jumpers and connectors](#) .

NOTE: If the password jumper setting is disabled, the existing system password and setup password are deleted and you need not provide the system password to boot the system.

Steps

- 1 To enter System Setup, press F2 immediately after turning on or rebooting your system.
- 2 On the **System Setup Main Menu** screen, click **System BIOS > System Security**.
- 3 On the **System Security** screen, verify that **Password Status** is set to **Unlocked**.
- 4 In the **System Password** field, type your system password, and press Enter or Tab.
Use the following guidelines to assign the system password:system password:
 - A password can have up to 32 characters.
 - The password can contain the numbers 0 through 9.
 - Only the following special characters are allowed: space, ("), (+), (,), (-), (.), (/), (:), ([), (\), (]), (').

A message prompts you to reenter the system password.
- 5 Reenter the system password, and click **OK**.
- 6 In the **Setup Password** field, type your setup password and press Enter or Tab.
A message prompts you to reenter the setup password.
- 7 Reenter the setup password, and click **OK**.
- 8 Press Esc to return to the System BIOS screen. Press Esc again.
A message prompts you to save the changes.

NOTE: Password protection does not take effect until the system reboots.

Using your system password to secure your system

About this task

If you have assigned a setup password, the system accepts your setup password as an alternate system password.

Steps

- 1 Turn on or reboot your system.
- 2 Type the system password and press Enter.

Next step

When **Password Status** is set to **Locked**, type the system password and press Enter when prompted at reboot.

NOTE: If an incorrect system password is typed, the system displays a message and prompts you to reenter your password. You have three attempts to type the correct password. After the third unsuccessful attempt, the system displays an error message that the system has stopped functioning and must be turned off. Even after you turn off and restart the system, the error message is displayed until the correct password is entered.

Deleting or changing system and setup password

Prerequisite

NOTE: You cannot delete or change an existing system or setup password if the Password Status is set to Locked.

Steps

- 1 To enter System Setup, press F2 immediately after turning on or restarting your system.
- 2 On the **System Setup Main Menu** screen, click **System BIOS > System Security**.
- 3 On the **System Security** screen, ensure that **Password Status** is set to **Unlocked**.
- 4 In the **System Password** field, alter or delete the existing system password, and then press Enter or Tab.
- 5 In the **Setup Password** field, alter or delete the existing setup password, and then press Enter or Tab.
If you change the system and setup password, a message prompts you to reenter the new password. If you delete the system and setup password, a message prompts you to confirm the deletion.
- 6 Press Esc to return to the **System BIOS** screen. Press Esc again, and a message prompts you to save the changes.

Operating with setup password enabled

If **Setup Password** is set to **Enabled**, type the correct setup password before modifying the system setup options.

If you do not type the correct password in three attempts, the system displays the following message:

```
Invalid Password! Number of unsuccessful password attempts: <x> System Halted! Must power down.
```

```
Password Invalid. Number of unsuccessful password attempts: <x> Maximum number of password attempts exceeded. System halted.
```

Even after you turn off and restart the system, the error message is displayed until the correct password is typed. The following options are exceptions:

- If **System Password** is not set to **Enabled** and is not locked through the **Password Status** option, you can assign a system password. For more information, see [System Security Settings details](#).
- You cannot disable or change an existing system password.

NOTE: You can use the password status option with the setup password option to protect the system password from unauthorized changes.

Redundant OS Control

You can use the **Redundant OS Control** screen to set the redundant OS info for redundant OS control. It enables you to set up a physical recovery disk on your system.

Viewing Redundant OS Control

To view the **Redundant OS Control** screen, perform the following steps:

- 1 Turn on, or restart your system.
- 2 Press F2 immediately after you see the following message:
F2 = System Setup

NOTE: If your operating system begins to load before you press F2, wait for the system to finish booting, and then restart your system and try again.

- 3 On the **System Setup Main Menu** screen, click **System BIOS**.

4 On the **System BIOS** screen, click **Redundant OS Control**.

Redundant OS Control screen details

NOTE: The XC Series Appliance and XC Core System does not support the NVDIMM-N, RAID, or UEFI settings.

The **Redundant OS Control** screen details are explained as follows:

Option	Description
Redundant OS Location	<p>Enables you to select a backup disk from the following devices:</p> <ul style="list-style-type: none">· None· IDSDM (Internal SD card)· SATA Ports in AHCI mode· BOSS PCIe Cards (Internal M.2 Drives)· Internal USB <p>NOTE: RAID configurations and NVMe cards are not included as BIOS does not have the ability to distinguish between individual drives in those configurations.</p>
Redundant OS State	<p>NOTE: This option is disabled if Redundant OS Location is set to None.</p> <p>When set to Visible, the backup disk is visible to the boot list and OS. When set to Hidden, the backup disk is disabled and is not visible to the boot list and OS. This option is set to Visible by default.</p> <p>NOTE: BIOS disables the device in hardware, so it cannot be accessed by the OS.</p>
Redundant OS Boot	<p>NOTE: This option is disabled if Redundant OS Location is set to None or if Redundant OS State is set to Hidden.</p> <p>When set to Enabled, BIOS boots to the device specified in Redundant OS Location. When set to Disabled, BIOS preserves the current boot list settings. This option is set to Enabled by default.</p>

Miscellaneous Settings

You can use the **Miscellaneous Settings** screen to perform specific functions such as updating the asset tag and changing the system date and time.

Viewing Miscellaneous Settings

To view the **Miscellaneous Settings** screen, perform the following steps:

- 1 Turn on, or restart your system.
- 2 Press F2 immediately after you see the following message:

F2 = System Setup

NOTE: If your operating system begins to load before you press F2, wait for the system to finish booting, and then restart your system and try again.

- 3 On the **System Setup Main Menu** screen, click **System BIOS**.
- 4 On the **System BIOS** screen, click **Miscellaneous Settings**.

Miscellaneous Settings details

NOTE: The XC Series Appliance and XC Core System does not support the NVDIMM-N, RAID, or UEFI settings.

The **Miscellaneous Settings** screen details are explained as follows:

Option	Description
System Time	Enables you to set the time on the system.
System Date	Enables you to set the date on the system.
Asset Tag	Specifies the asset tag and enables you to modify it for security and tracking purposes.
Keyboard NumLock	Enables you to set whether the system boots with the NumLock enabled or disabled. This option is set to On by default. NOTE: This option does not apply to 84-key keyboards.
F1/F2 Prompt on Error	Enables or disables the F1/F2 prompt on error. This option is set to Enabled by default. The F1/F2 prompt also includes keyboard errors.
Load Legacy Video Option ROM	Enables you to determine whether the system BIOS loads the legacy video (INT 10H) option ROM from the video controller. Selecting Enabled in the operating system does not support UEFI video output standards. This field is available only for UEFI boot mode. You cannot set the option to Enabled if UEFI Secure Boot mode is enabled.
Dell Wyse P25/P45 BIOS Access	Enables or disables the Dell Wyse P25/P45 BIOS Access. This option is set to Enabled by default.
Power Cycle Request	Enables or disables the Power Cycle Request. This option is set to None by default.

iDRAC Settings utility

The iDRAC settings utility is an interface to set up and configure the iDRAC parameters by using UEFI. You can enable or disable various iDRAC parameters by using the iDRAC settings utility.

NOTE: The XC Series Appliance and XC Core System does not support the NVDIMM-N, RAID, or UEFI settings.

NOTE: Accessing some of the features on the iDRAC settings utility needs the iDRAC Enterprise License upgrade.

For more information about using iDRAC, see *Dell Integrated Dell Remote Access Controller User's Guide* at Dell.com/idracmanuals.

Device Settings

Device Settings enables you to configure device parameters.

Dell Lifecycle Controller

Dell Lifecycle Controller (LC) provides advanced embedded systems management capabilities including system deployment, configuration, update, maintenance, and diagnosis. LC is delivered as part of the iDRAC out-of-band solution and Dell system embedded Unified Extensible Firmware Interface (UEFI) applications.

NOTE: The XC Series Appliance and XC Core System does not support the NVDIMM-N, RAID, or UEFI settings.

Embedded systems management

The Dell Lifecycle Controller provides advanced embedded systems management throughout the system's lifecycle. The Dell Lifecycle Controller can be started during the boot sequence and can function independently of the operating system.

NOTE: Certain platform configurations may not support the full set of features provided by the Dell Lifecycle Controller.

For more information about setting up the Dell Lifecycle Controller, configuring hardware and firmware, and deploying the operating system, see the Dell Lifecycle Controller documentation at Dell.com/idracmanuals.

Boot Manager

The **Boot Manager** screen enables you to select boot options and diagnostic utilities.

NOTE: The XC Series Appliance and XC Core System does not support the NVDIMM-N, RAID, or UEFI settings.

Viewing Boot Manager

About this task

To enter Boot Manager:

Steps

- 1 Turn on, or restart your system.
- 2 Press F11 when you see the following message:

```
F11 = Boot Manager
```

If your operating system begins to load before you press F11, allow the system to complete the booting, and then restart your system and try again.

Boot Manager main menu

NOTE: The XC Series Appliance and XC Core System does not support the NVDIMM-N, RAID, or UEFI settings.

Menu item	Description
Continue Normal Boot	The system attempts to boot to devices starting with the first item in the boot order. If the boot attempt fails, the system continues with the next item in the boot order until the boot is successful or no more boot options are found.
One-shot Boot Menu	Enables you to access boot menu, where you can select a one-time boot device to boot from.
Launch System Setup	Enables you to access System Setup.
Launch Lifecycle Controller	Exits the Boot Manager and invokes the Dell Lifecycle Controller program.
System Utilities	Enables you to launch System Utilities menu such as System Diagnostics and UEFI shell.

One-shot BIOS boot menu

One-shot BIOS boot menu enables you to select a boot device to boot from.

System Utilities

System Utilities contains the following utilities that can be launched:

- Launch Diagnostics
- BIOS Update File Explorer
- Reboot System

PXE boot

You can use the Preboot Execution Environment (PXE) option to boot and configure the networked systems, remotely.

To access the **PXE boot** option, boot the system and then press F12 during POST instead of using standard Boot Sequence from BIOS Setup. It does not pull any menu or allow managing of network devices.

Installing and removing system components

NOTE: When you replace any system component, you must update the system with the latest available BIOS and iDRAC versions. For more information, go to Dell.com/XCSeriesmanuals.

Topics:

- Safety instructions
- Before working inside your system
- After working inside your system
- Recommended tools
- Optional front bezel
- System cover
- Backplane cover
- Inside the system
- Air shroud
- Cooling fans
- System memory
- Processors and heat sinks
- Expansion cards and expansion card risers
- IDSDM/vFlash card
- Network daughter card
- Integrated storage controller card
- Hard drives
- Hard drive backplane
- System battery
- USB module
- Power supply units
- System board
- Trusted Platform Module
- Control panel

Safety instructions

- WARNING:** Whenever you need to lift the system, get others to assist you. To avoid injury, do not attempt to lift the system by yourself.
- WARNING:** Opening or removing the system cover while the system is powered on may expose you to a risk of electric shock.
- CAUTION:** Do not operate the system without the cover for a duration exceeding five minutes. Operating the system without the system cover can result in component damage.
- CAUTION:** Many repairs may only be done by a certified service technician. You should only perform troubleshooting and simple repairs as authorized in your product documentation, or as directed by the online or telephone service and support team. Damage due to servicing that is not authorized by Dell is not covered by your warranty. Read and follow the safety instructions that are shipped with your product.

NOTE: It is recommended that you always use an antistatic mat and antistatic strap while working on components inside the system.

NOTE: To ensure proper operation and cooling, all bays in the system and system fans must be always populated with a component or a blank.

Before working inside your system

Prerequisite

Follow the safety guidelines listed in [Safety instructions](#).

Steps

- 1 Turn off the system, including any attached peripherals.
- 2 Disconnect the system from the electrical outlet and disconnect the peripherals.
- 3 If applicable, remove the system from the rack.
For more information, see the *Rail Installation Guide* at Dell.com/XCSeriesmanuals.
- 4 Remove the [system cover](#).

After working inside your system

Prerequisite

Follow the safety guidelines listed in [Safety instructions](#).

Steps

- 1 Install the [system cover](#).
- 2 If applicable, install the system into the rack.
For more information, see the *Rail Installation Guide* at Dell.com/XCSeriesmanuals.
- 3 Reconnect the peripherals and connect the system to the electrical outlet.
- 4 Turn on the system, including any attached peripherals.

Recommended tools

You need the following tools to perform the removal and installation procedures:

- Key to the bezel lock
The key is needed only if your system includes a bezel.
- Phillips #1 screwdriver
- Phillips #2 screwdriver
- 1/4 inch flat head screwdriver
- Torx #T30 screwdriver
- Wrist grounding strap

You need the following tools to assemble the cables for a DC power supply unit.

- AMP 90871-1 hand-crimping tool or equivalent
- Tyco Electronics 58433-3 or equivalent
- Wire-stripper pliers to remove insulation from size 10 AWG solid or stranded, insulated copper wire

NOTE: Use alpha wire part number 3080 or equivalent (65/30 stranding).

Optional front bezel

An optional metal bezel is mounted on the front of the system to display system branding. A lock on the bezel is used to protect unauthorized access to the hard drives. There are two versions of bezel available:

- With LCD panel
- Without LCD panel

For bezels with LCD panel, the system status can be viewed on the LCD panel. For more information, see [LCD panel](#).

The LCD bezel is hot pluggable and can be used in any XC Series Appliance and XC Core System of the same branding even if that system was originally not ordered with that LCD bezel.

Removing the optional front bezel

The procedure to remove the optional front bezel with the LCD panel and the front bezel without the LCD panel is the same.

Prerequisite

Follow the safety guidelines listed in [Safety instructions](#).

Steps

- 1 Unlock the bezel by using the bezel key.
- 2 Press the release button, and pull the left end of the bezel.
- 3 Unhook the right end, and remove the bezel.

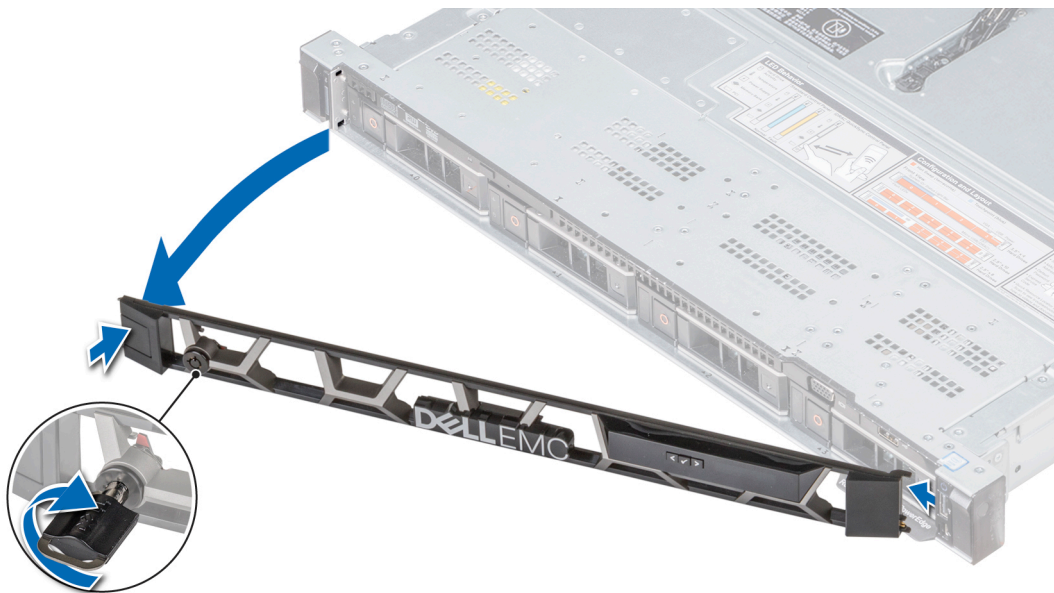

Figure 14. Removing the optional front bezel with the LCD panel

Installing the optional front bezel

The procedure to install the optional front bezel with the LCD panel and the front bezel without the LCD panel is the same.

Prerequisite

Follow the safety guidelines listed in [Safety instructions](#).

Steps

- 1 Locate and remove the bezel key.
- 2 Align and insert the right end of the bezel onto the system.
- 3 Press the release button and fit the left end of the bezel onto the system.
- 4 Lock the bezel by using the key.

NOTE: The bezel key is part of the LCD bezel package.

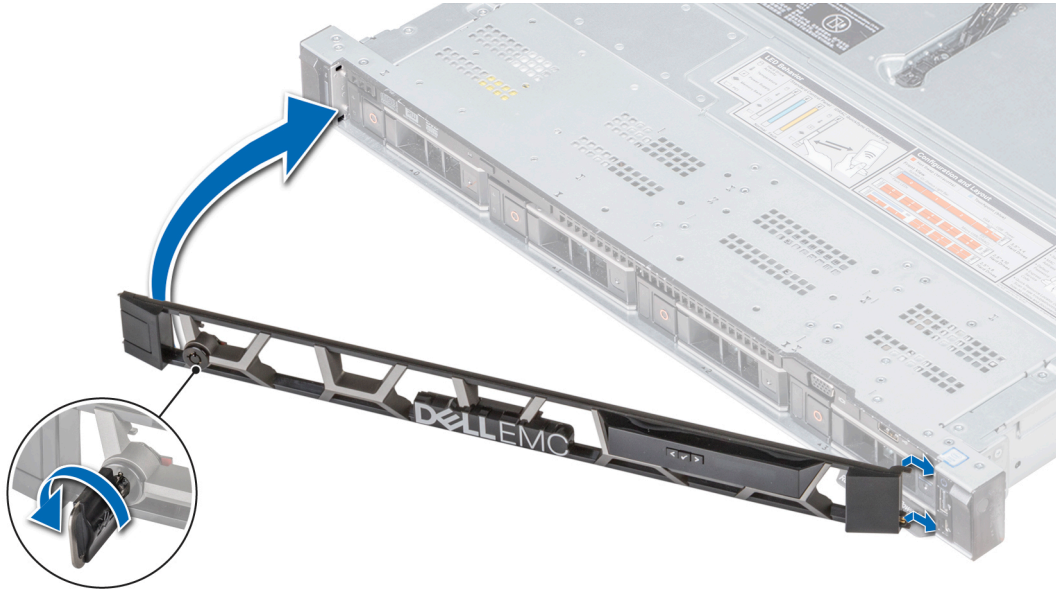

Figure 15. Installing the optional front bezel with the LCD panel

System cover

System cover provides security for the entire system and also helps in maintaining proper air flow inside the system.

Removing the system cover

Prerequisites

- 1 Follow the safety guidelines listed in [Safety instructions](#).
- 2 Turn off the system, including any attached peripherals.
- 3 Disconnect the system from the electrical outlet and disconnect the peripherals.

Steps

- 1 Using a flat or a Phillips head screwdriver, rotate the latch release lock counter clockwise to the unlocked position.
- 2 Lift the latch till the system cover slides back and the tabs on the system cover disengage from the guide slots on the system.
- 3 Hold the cover on both sides, and lift the cover away from the system.



Figure 16. Removing the system cover

Installing the system cover

Prerequisites

- 1 Follow the safety guidelines listed in [Safety instructions](#).
- 2 Ensure that all internal cables are routed correctly and connected, and no tools or extra parts are left inside the system.

Steps

- 1 Align the tabs on the system cover with the guide slots on the system.
- 2 Push the system cover latch down.
The system cover slides forward, the tabs on the system cover engage with the guide slots on the system and the system cover latch locks into place.
- 3 Using a flat or Phillips head screwdriver, rotate the latch release lock clockwise to the locked position.



Figure 17. Installing the system cover

Next steps

- 1 Reconnect the peripherals and connect the system to the electrical outlet.
- 2 Turn on the system, including any attached peripherals.

Backplane cover

Removing the backplane cover

Prerequisites

- 1 Follow the safety guidelines listed in [Safety instructions](#).
- 2 Follow the procedure listed in [Before working inside your system](#).

Steps

- 1 Slide the backplane cover in the direction of the arrows marked on the backplane cover.
- 2 Lift the backplane cover away from the system.

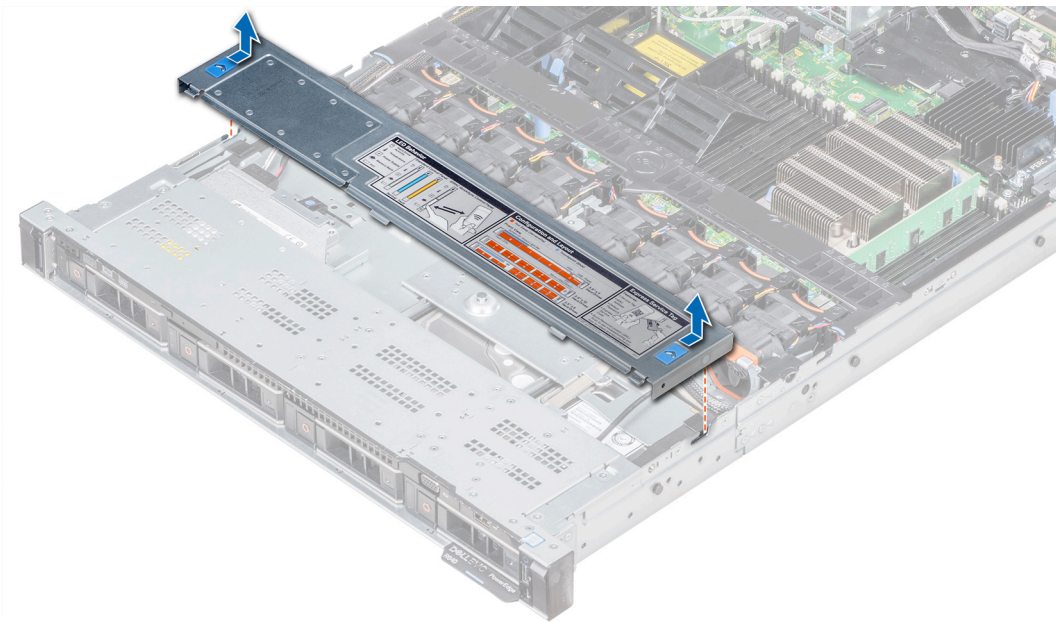

Figure 18. Removing the backplane cover

Installing the backplane cover

Prerequisite

Follow the safety guidelines listed in [Safety instructions](#).

Steps

- 1 Align the backplane cover with the guide slots on the system.
- 2 Slide the backplane cover toward the front of the system until the cover locks into place.

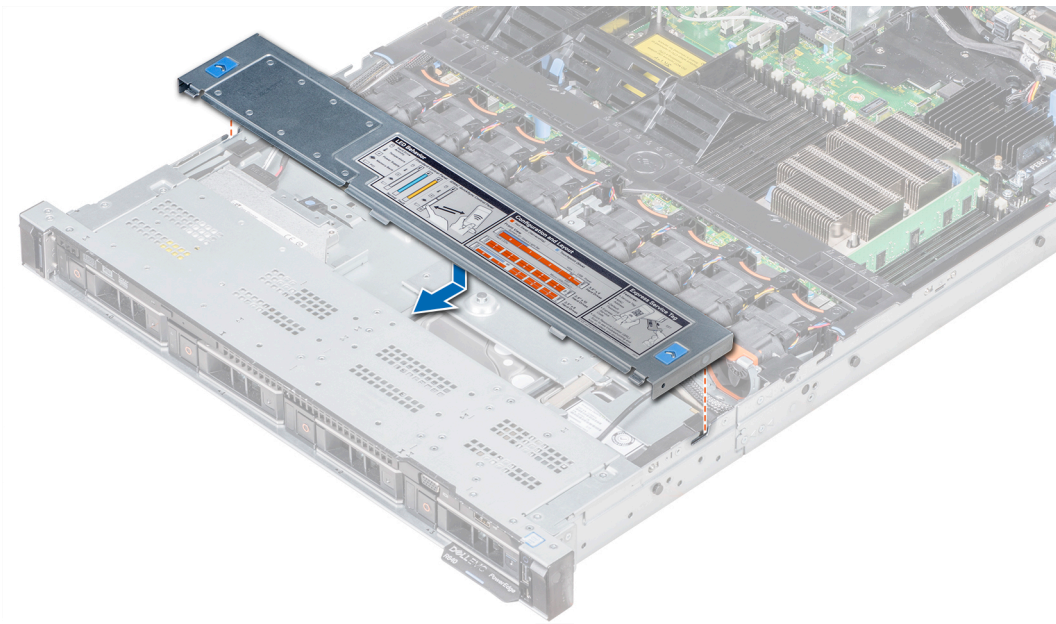

Figure 19. Installing the backplane cover

Next step

Follow the procedure listed in [After working inside your system.](#)

Inside the system

⚠ CAUTION: Many repairs may only be done by a certified service technician. You should only perform troubleshooting and simple repairs as authorized in your product documentation, or as directed by the online or telephone service and support team. Damage due to servicing that is not authorized by Dell is not covered by your warranty. Read and follow the safety instructions that are shipped with your product.

ℹ NOTE: Components that are hot swappable are marked orange and touch points on the components are marked blue.

Figure 20. Inside the system - 3 PCIe expansion risers

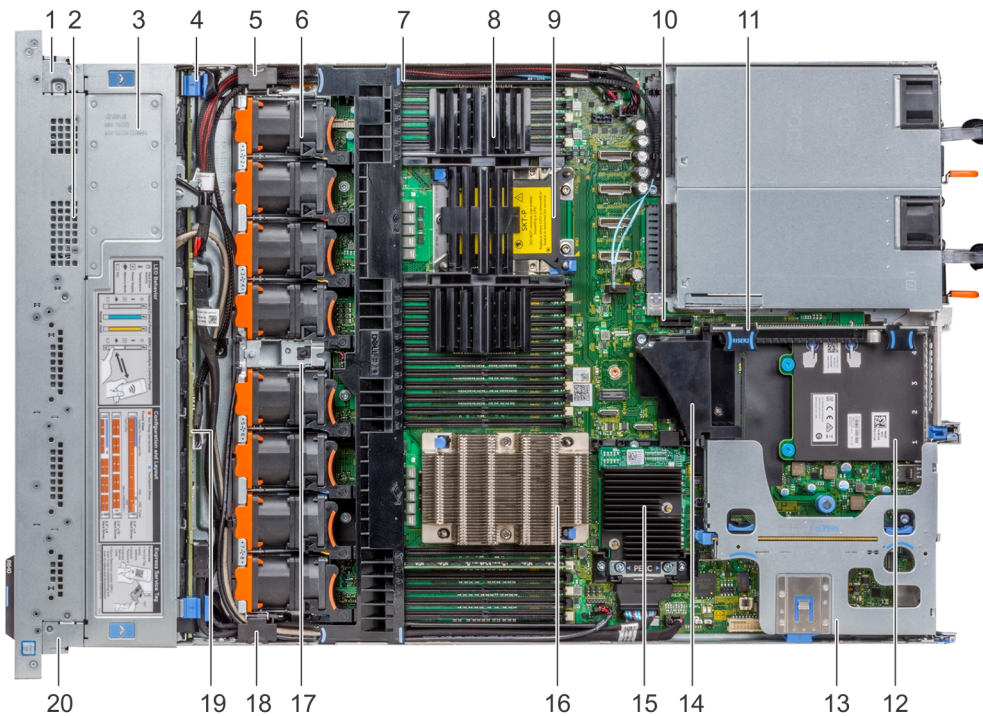

- | | | | |
|----|------------------------------------|----|--------------------------------|
| 1 | right control panel cable cover | 2 | hard drive cage |
| 3 | backplane cover | 4 | backplane release latch |
| 5 | cabling latch | 6 | cooling fan (8) |
| 7 | air shroud | 8 | processor and DIMM blank |
| 9 | processor 2 slot | 10 | IDSDM/vFlash module slot |
| 11 | expansion riser 2 A | 12 | network daughter card |
| 13 | expansion riser 1 A | 14 | PCIe shroud |
| 15 | integrated storage controller card | 16 | processor 1 |
| 17 | intrusion switch | 18 | cabling latch |
| 19 | hard drive backplane | 20 | left control panel cable cover |

Air shroud

The air shroud directs the airflow across the entire system. Air shroud prevents the system from overheating and is used to maintain uniform airflow inside the system.

Removing the air shroud

Prerequisites

⚠ CAUTION: Never operate your system with the air shroud removed. The system may get overheated quickly, resulting in shutdown of the system and loss of data.

- 1 Follow the safety guidelines listed in [Safety instructions](#).
- 2 Follow the procedure listed in [Before working inside your system](#).

Step

Hold the air shroud at both ends and lift it away from the system.

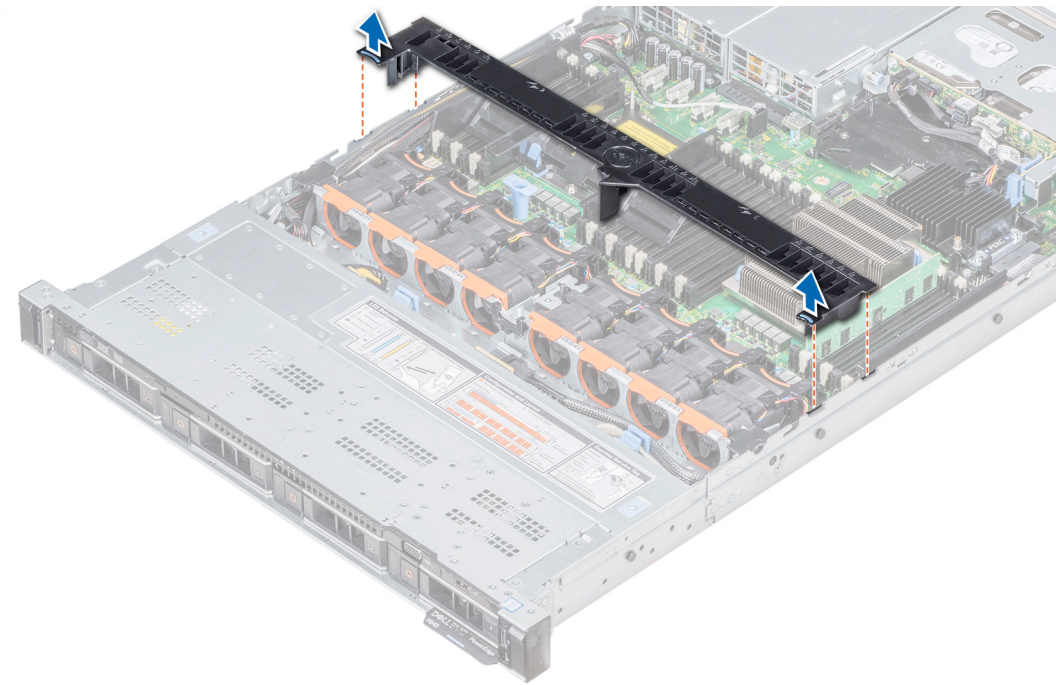

Figure 21. Removing the air shroud

Next step

If applicable, install the [air shroud](#).

Installing the air shroud

Prerequisites

- 1 Follow the safety guidelines listed in [Safety instructions](#).
- 2 If applicable, route the cables inside the system along the system wall and secure the cables by using the cable latch.

Steps

- 1 Align the tabs on the air shroud with the slots on the system.
- 2 Lower the air shroud into the system until it is firmly seated.
When firmly seated, the memory socket numbers marked on the air shroud align with the respective memory sockets.

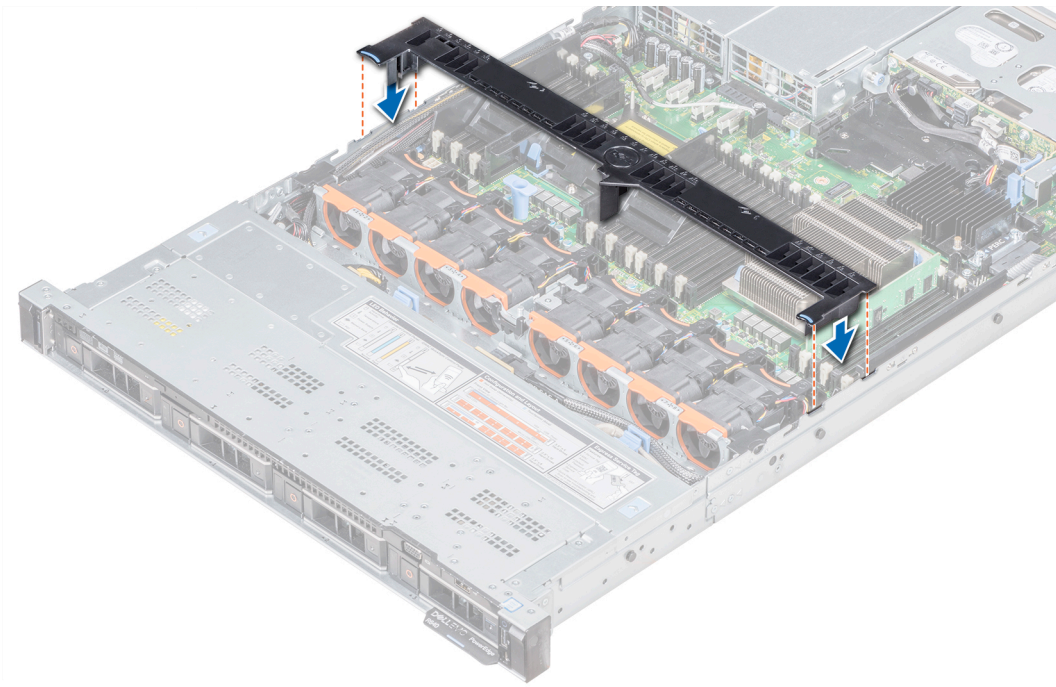

Figure 22. Installing the air shroud

Next step

- 1 Follow the procedure listed in [After working inside your system](#).

Cooling fans

Your system supports up to eight standard or high performance cooling fans.

NOTE:

- High performance fans can be identified by a blue label on top of the cooling fan.
- Mixing of standard and high performance cooling fans is not supported.
- Each fan is listed in the systems management software, referenced by the respective fan number. If there is a problem with a particular fan, you can easily identify and replace the proper fan by noting the fan number on the system.

Removing a cooling fan

The procedure for removing standard and high performance fans is identical.

Prerequisites

⚠ WARNING: Opening or removing the cover when the system is on may expose you to a risk of electric shock. Exercise utmost care while removing or installing cooling fans.

⚠ CAUTION: The cooling fans are hot swappable. To maintain proper cooling while the system is on, replace only one fan at a time.

- 1 Follow the safety guidelines listed in [Safety instructions](#).
- 2 Remove the [air shroud](#).

Steps

- 1 Holding the touch points on the cooling fan, lift the fan to disconnect the connector on the fan from the connector on the system board.

- 2 Lift the fan out of the system.

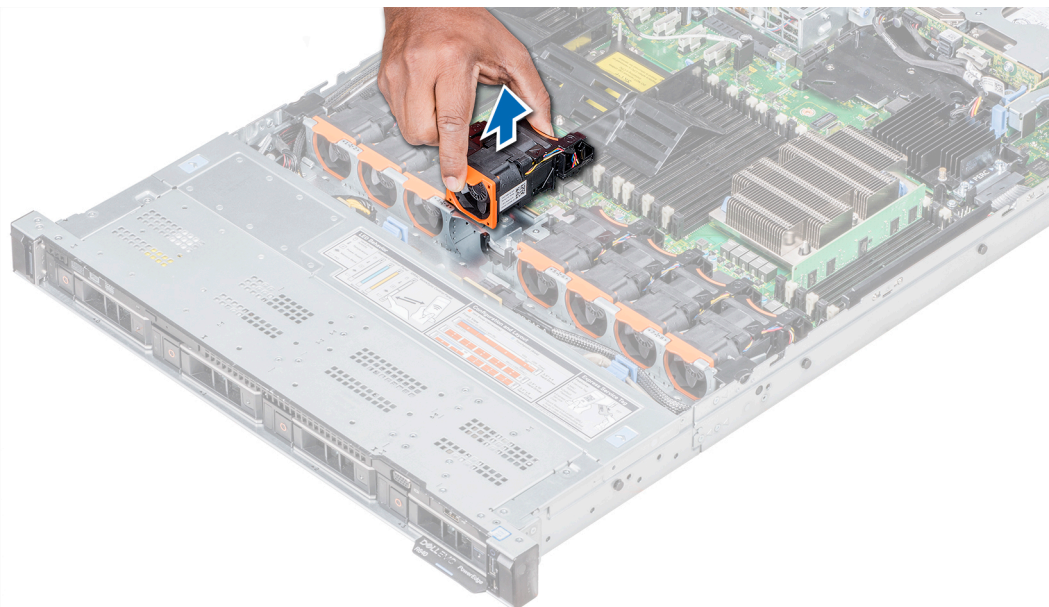

Figure 23. Removing the cooling fan

Next step

If applicable, install the [cooling fan](#).

Installing a cooling fan

The procedure for installing standard and high performance fans is identical.

Prerequisites

⚠ WARNING: Opening or removing the system cover when the system is on may expose you to a risk of electric shock. Exercise utmost care while removing or installing cooling fans.

⚠ CAUTION: The cooling fans are hot swappable. To maintain proper cooling while the system is on, replace only one fan at a time.

Follow the safety guidelines listed in [Safety instructions](#).

Steps

- 1 Holding the touch points on the cooling fan, align the connector on the cooling fan with the connector on the system board.
- 2 Push the cooling fan, by pressing on the touch point, till the fan is firmly seated on the connector.

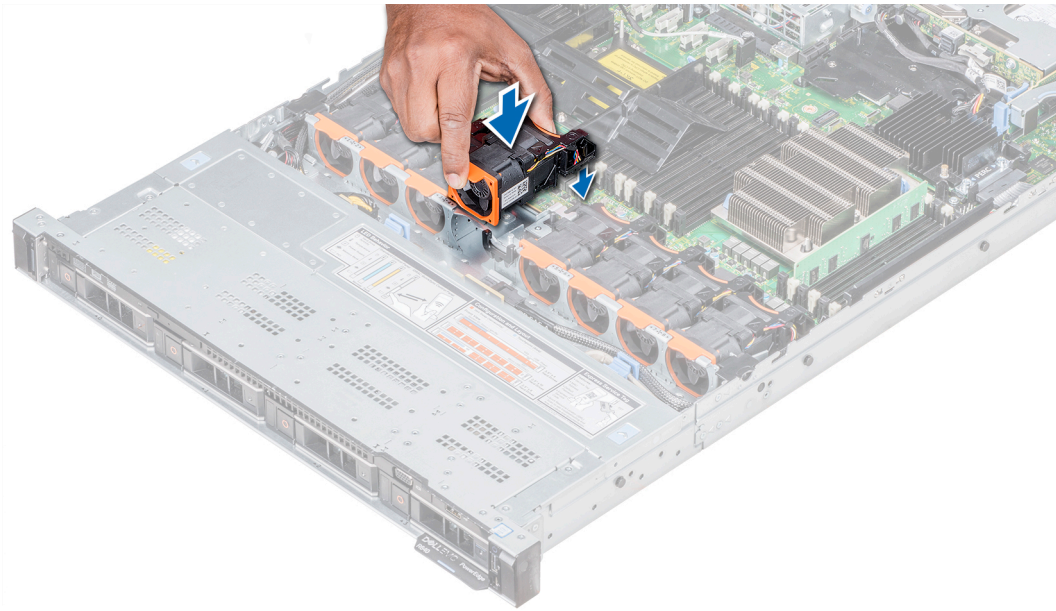

Figure 24. Installing the cooling fan

Next step

Install the [air shroud](#).

System memory

System memory guidelines

The system support DDR4 Registered DIMMs (RDIMMs), Load Reduced DIMMs (LRDIMMs), and Non-Volatile DIMMs (NVDIMM-Ns). System memory holds the instructions that are executed by the processor.

Your system contains 24 memory sockets split into two sets of 12 sockets, one set per processor. Each 12-socket set is organized into six channels. Six memory channels are allocated to each processor. In each channel, the release tabs of the first socket are marked white, and the second socket black.

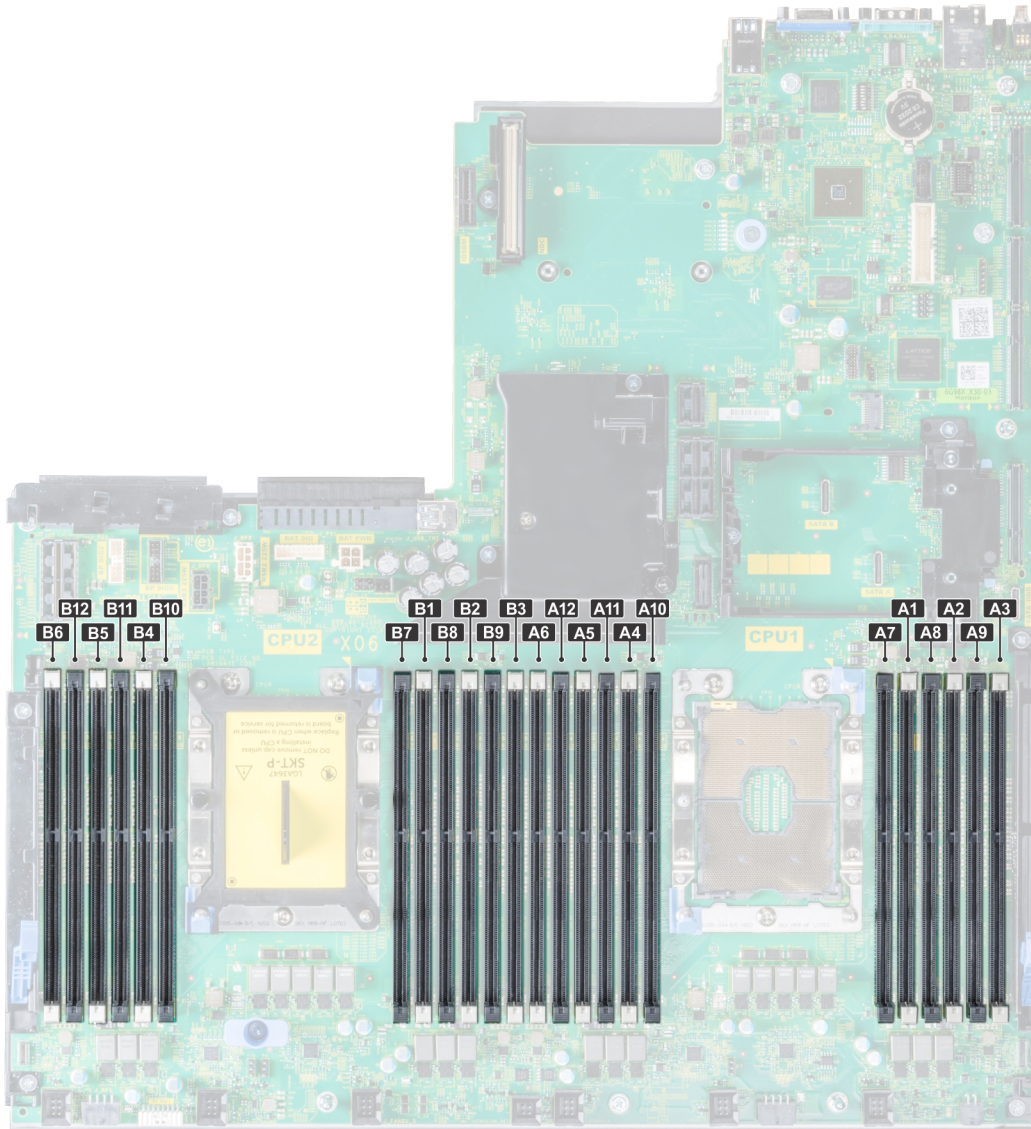

Figure 25. Memory socket locations

Memory channels are organized as follows:

Table 36. Memory channels

Processor	Channel 0	Channel 1	Channel 2	Channel 3	Channel 4	Channel 5
Processor 1	Slots A1 and A7	Slots A2 and A8	Slots A3 and A9	Slots A4 and A10	Slots A5 and A11	Slots A6 and A12
Processor 2	Slots B1 and B7	Slots B2 and B8	Slots B3 and B9	Slots B4 and B10	Slots B5 and B11	Slots B6 and B12

General memory module installation guidelines

To ensure optimal performance of your system, observe the following general guidelines when configuring your system memory. If your system's memory configurations fail to observe these guidelines, your system might not boot, stop responding during memory configuration, or operate with reduced memory.

Memory bus operating frequency can be 2666 MT/s, 2400 MT/s, or 2133 MT/s depending on the following factors:

- System profile selected (for example, Performance Optimized, or Custom [can be run at high speed or lower])
- Maximum supported DIMM speed of the processors
- Maximum supported speed of the DIMMs

NOTE: MT/s indicates DIMM speed in MegaTransfers per second.

The system supports Flexible Memory Configuration, enabling the system to be configured and run in any valid chipset architectural configuration. The following are the recommended guidelines for installing memory modules:

- All DIMMs must be DDR4.
- RDIMMs and LRDIMMs must not be mixed.
- NVDIMMs and LRDIMMs must not be mixed.
- NVDIMMs and RDIMMs can be mixed.
- 64 GB LRDIMMs that are DDP (Dual Die Package) LRDIMMs must not be mixed with 128 GB LRDIMMs that are TSV (Through Silicon Via/3DS) LRDIMMs.
- x4 and x8 DRAM based memory modules can be mixed.
- Up to two RDIMMs can be populated per channel regardless of rank count.
- Up to two LRDIMMs can be populated per channel regardless of rank count.
- A maximum of two different ranked DIMMs can be populated in a channel regardless of rank count.
- If memory modules with different speeds are installed, they will operate at the speed of the slowest installed memory module(s).
- Populate memory module sockets only if a processor is installed.
 - For single-processor systems, sockets A1 to A12 are available.
 - For dual-processor systems, sockets A1 to A12 and sockets B1 to B12 are available.
 - For single-processor systems, sockets A1 to A8 are available.
 - For dual-processor systems, sockets A1 to A8 and sockets B1 to B8 are available.
- Populate all the sockets with white release tabs first, followed by the black release tabs.
- When mixing memory modules with different capacities, populate the sockets with memory modules with the highest capacity first. For example, if you want to mix 8 GB and 16 GB memory modules, populate 16 GB memory modules in the sockets with white release tabs and 8 GB memory modules in the sockets with black release tabs.
- Memory modules of different capacities can be mixed provided other memory population rules are followed. For example, 8 GB and 16 GB memory modules can be mixed.
- In a dual-processor configuration, the memory configuration for each processor must be identical. For example, if you populate socket A1 for processor 1, then populate socket B1 for processor 2, and so on.
- Mixing of more than two memory module capacities in a system is not supported.
- Unbalanced memory configurations will result in a performance loss so always populate memory channels identically with identical DIMMs for best performance.
- Populate six identical memory modules per processor (one DIMM per channel) at a time to maximize performance.

DIMM population update for Performance Optimized mode with quantity of 4 and 8 DIMMs per processor.

- When the DIMM quantity is 4, the population is slot 1, 2, 4, 5.
- When the DIMM quantity is 8, the population is slot 1, 2, 4, 5, 7, 8, 10, 11.

Mode-specific guidelines

The configurations allowed depend on the memory mode selected in the System BIOS.

Table 37. Memory operating modes

Memory Operating Mode	Description
Optimizer Mode	The Optimizer Mode if enabled, the DRAM controllers operate independently in the 64-bit mode and provide optimized memory performance.
Mirror Mode	The Mirror Mode if enabled, the system maintains two identical copies of data in memory, and the total available system memory is one half of the total installed physical memory. Half of the installed memory is used to mirror the active memory modules. This feature provides maximum reliability and enables the system to continue running even during a catastrophic memory failure by switching over to the mirrored copy. The installation guidelines to enable Mirror Mode require that the memory modules be identical in size, speed, and technology, and they must be populated in sets of 6 per processor.
Single Rank Spare Mode	Single Rank Spare Mode allocates one rank per channel as a spare. If excessive correctable errors occur in a rank or channel, while the operating system is running, they are moved to the spare area to prevent errors from causing an uncorrectable failure. Requires two or more ranks to be populated in each channel.
Multi Rank Spare Mode	Multi Rank Spare Mode allocates two ranks per channel as a spare. If excessive correctable errors occur in a rank or channel, while the operating system is running, they are moved to the spare area to prevent errors from causing an uncorrectable failure. Requires three or more ranks to be populated in each channel. With single rank memory sparing enabled, the system memory available to the operating system is reduced by one rank per channel. For example, in a dual-processor configuration with 24x 16 GB dual-rank memory modules, the available system memory is: $\frac{3}{4}$ (ranks/channel) \times 24 (memory modules) \times 16 GB = 288 GB, and not 24 (memory modules) \times 16 GB = 384 GB. For example, in a dual-processor configuration with sixteen 16 GB single-rank memory modules, the available system memory is: $\frac{3}{4}$ (ranks/channel) \times 16 (memory modules) \times 16 GB = 192 GB, and not 16 (memory modules) \times 16 GB = 256 GB. For multi rank sparing, the multiplier changes to $\frac{1}{2}$ (ranks/channel). NOTE: To use memory sparing, this feature must be enabled in the BIOS menu of System Setup. NOTE: Memory sparing does not offer protection against a multi-bit uncorrectable error.

Memory Operating Mode

Description

Dell Fault Resilient Mode

The **Dell Fault Resilient Mode** if enabled, the BIOS creates an area of memory that is fault resilient. This mode can be used by an OS that supports the feature to load critical applications or enables the OS kernel to maximize system availability.

Optimizer Mode

This mode supports Single Device Data Correction (SDDC) only for memory modules that use x4 device width. It does not impose any specific slot population requirements.

- Dual processor: Populate the slots in round robin sequence starting with processor 1.

NOTE: Processor 1 and processor 2 population should match.

Table 38. Memory population rules

Processor	Configuration	Memory population	Memory population information
Single processor	Optimizer (Independent channel) population order	1, 2, 3, 4, 5, 6, 7, 8	Odd amount of DIMMs per processor allowed.
	Mirror population order	{1, 2, 3, 4, 5, 6}	Mirroring is supported with 6 DIMMs per processor
	Single rank sparing population order	1, 2, 3, 4, 5, 6, 7, 8	Populate in this order, odd amount per processor allowed. Requires two ranks or more per channel.
	Multi rank sparing population order	1, 2, 3, 4, 5, 6, 7, 8	Populate in this order, odd amount per processor allowed. Requires three ranks or more per channel.
	Fault resilient population order	{1, 2, 3, 4, 5, 6}	Supported with 6 DIMMs per processor.
Dual processor (Start with processor1. processor1 and processor 2 population should match)	Optimized (Independent channel) population order	A{1}, B{1}, A{2}, B{2}, A{3}, B{3} ...	Odd amount of DIMMs per processor allowed.
	Mirroring population order	A{1,2,3,4,5,6}, B{1,2,3,4,5,6}	Mirroring is supported with 6 DIMMs per processor.
	Single rank sparing population order	A{1}, B{1}, A{2}, B{2}, A{3}, B{3} ...	Populate in this order, odd amount per processor allowed. Requires two ranks or more per channel.
	Multi rank spare population order	A{1}, B{1}, A{2}, B{2}, A{3}, B{3} ...	Populate in this order, odd amount per processor allowed. Requires three ranks or more per channel.
	Fault resilient population order	A{1,2,3,4,5,6}, B{1,2,3,4,5,6}	Supported with 6 DIMMs per processor.

Table 39. Memory population rules

Processor	Configuration	Memory population	Memory population information
Single processor	Optimizer (Independent channel) population order	1, 2, 3, 4, 5, 6, 7, 8, 9, 10, 11, 12	<ul style="list-style-type: none"> DIMMs must be populated in the order specified. Odd number of DIMM population is allowed <p>NOTE: Odd number of DIMMs will result in unbalanced memory configurations, which in turn will result in performance loss. It is recommended to populate all memory channels identically with identical DIMMs for best performance.</p> <ul style="list-style-type: none"> Optimizer population order is not traditional for 4 and 8 DIMM installations of single processor. <ul style="list-style-type: none"> For 4 DIMMs: A1, A2, A4, A5 For 8 DIMMs: A1, A2, A4, A5, A7, A8, A10, A11
	Mirror population order	{1, 2, 3, 4, 5, 6} {7, 8, 9, 10, 11, 12}	Mirroring is supported with 6 or 12 DIMMs per processor.
	Single rank sparing population order	1, 2, 3, 4, 5, 6, 7, 8, 9, 10, 11, 12	<ul style="list-style-type: none"> DIMMs must be populated in the order specified. Requires two ranks or more per channel.
	Multi rank sparing population order	1, 2, 3, 4, 5, 6, 7, 8, 9, 10, 11, 12	<ul style="list-style-type: none"> DIMMs must be populated in the order specified. Requires three ranks or more per channel.
	Fault resilient population order	{1, 2, 3, 4, 5, 6} {7, 8, 9, 10, 11, 12}	Supported with 6 or 12 DIMMs per processor.
Dual processor (Start with processor1. processor1 and processor 2 population should match)	Optimized (Independent channel) population order	A{1}, B{1}, A{2}, B{2}, A{3}, B{3}, A{4}, B{4}, A{5}, B{5}, A{6}, B{6}	<p>Odd number of DIMM population per processor is allowed.</p> <p>NOTE: Odd number of DIMMs will result in unbalanced memory configurations, which in turn will result in performance loss. It is recommended to populate all memory channels identically with identical DIMMs for best performance.</p> <p>Optimizer population order is not traditional for 8 and 16 DIMMs installations for dual processor.</p> <ul style="list-style-type: none"> For 8 DIMMs: A1, A2, A4, A5, B1, B2, B4, B5 For 16 DIMMs: A1, A2, A4, A5, A7, A8, A10, A11 B1, B2, B4, B5, B7, B8, B10, B11
	Mirroring population order	A{1, 2, 3, 4, 5, 6}, B{1, 2, 3, 4, 5, 6}, A{7, 8, 9, 10, 11, 12}, B{7, 8, 9, 10, 11, 12}	Mirroring is supported with 6 or 12 DIMMs per processor.

Processor	Configuration	Memory population	Memory population information
	Single rank sparing population order	A{1}, B{1}, A{2}, B{2}, A{3}, B{3}, A{4}, B{4}, A{5}, B{5}, A{6}, B{6}	<ul style="list-style-type: none"> DIMMs must be populated in the order specified. Requires two ranks or more per channel.
	Multi rank sparing population order	A{1}, B{1}, A{2}, B{2}, A{3}, B{3}, A{4}, B{4}, A{5}, B{5}, A{6}, B{6}	<ul style="list-style-type: none"> DIMMs must be populated in the order specified. Requires three ranks or more per channel.
	Fault resilient population order	A{1, 2, 3, 4, 5, 6}, B{1, 2, 3, 4, 5, 6}, A{7, 8, 9, 10, 11, 12}, B{7, 8, 9, 10, 11, 12}	Supported with 6 or 12 DIMMs per processor.

Memory optimized (independent channel) mode

This mode supports Single Device Data Correction (SDDC) only for memory modules that use x4 device width. It does not impose any specific slot population requirements.

Memory sparing

NOTE: To use memory sparing, this feature must be enabled in BIOS menu of System Setup.

Table 40. Memory sparing

Type	Description
Memory sparing (Single Rank)	Memory sparing allocates one rank per channel as a spare. If excessive correctable errors occur in a rank or channel, they are moved to the spare area while the operating system is running to prevent errors from causing an uncorrectable failure. Requires population of two ranks or more per channel.
Memory sparing (Multi Rank)	Memory sparing allocates two ranks per channel as a spare. If excessive correctable errors occur in a rank or channel, they are moved to the spare area while the operating system is running to prevent errors from causing an uncorrectable failure. Requires population of three ranks or more per channel.

With single rank memory sparing enabled, the system memory available to the operating system is reduced by one rank per channel. For example, in a dual-processor configuration with twenty four 16 GB dual-rank memory modules, the available system memory is: 3/4 (ranks/channel) × 24 (memory modules) × 16 GB = 288 GB, and not 24 (memory modules) × 16 GB = 384 GB. This calculation changes based on if it is single rank sparing or multi rank sparing. For multi rank sparing, the multiplier changes to 1/2 (ranks/channel).

NOTE: Memory sparing does not offer protection against a multi-bit uncorrectable error.

Memory mirroring

Memory mirroring offers the strongest memory module reliability mode, providing improved uncorrectable multi-bit failure protection. In a mirrored configuration, the total available system memory is one half of the total installed physical memory. Half of the installed memory is used to mirror the active memory modules. In the event of an uncorrectable error, the system switches over to the mirrored copy. This ensures Single Device Data Correction (SDDC) and multi-bit protection.

The installation guidelines for memory modules are as follows:

- Memory modules must be identical in size, speed, and technology.
- Memory modules must be populated in sets of 6 per CPU to enable memory mirroring.

Table 41. Memory population rules

Processor	Configuration	Memory population	Memory population information
Dual CPU (Starting with CPU1, CPU1 and CPU2 population should match)	Optimized (Independent channel population order)	C1{1}, C2{1}, C1{2}, C2{2}, C1{3}, C2{3}...	Odd amount of DIMMs per CPU allowed.

Removing a memory module

Prerequisites

- 1 Follow the safety guidelines listed in [Safety instructions](#).
- 2 Follow the procedure listed in [Before working inside your system](#).
- 3 If applicable, remove the [air shroud](#).

⚠ WARNING: Allow the memory modules to cool after you power off the system. Handle the memory modules by the card edges and avoid touching the components or metallic contacts on the memory module.

⚠ CAUTION: To ensure proper system cooling, memory module blanks must be installed in any memory socket that is not occupied. Remove memory module blanks only if you intend to install memory modules in those sockets.

Steps

- 1 Locate the appropriate memory module socket.

⚠ CAUTION: Handle each memory module only by the card edges, ensuring not to touch the middle of the memory module or metallic contacts.

- 2 Push the ejectors outward on both ends of the memory module socket to release the memory module from the socket.
- 3 Lift and remove the memory module from the system.

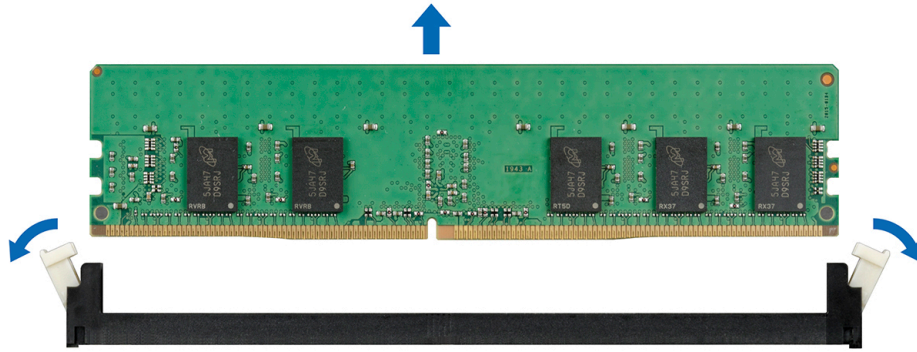

Figure 26. Removing a memory module

Next steps

- 1 Install the [memory module](#).
- 2 If you are removing the memory module permanently, install a memory module blank. The procedure to install a memory module blank is identical to that of the memory module.

Installing a memory module

Prerequisite

Follow the safety guidelines listed in [Safety instructions](#).

- CAUTION:** To ensure proper system cooling, memory module blanks must be installed in any memory socket that is not occupied. Remove memory module blanks only if you intend to install memory modules in those sockets.

Steps

- 1 Locate the appropriate memory module socket.
 - CAUTION:** Handle each memory module only by the card edges, ensuring not to touch the middle of the memory module or metallic contacts.
 - CAUTION:** To prevent damage to the memory module or the memory module socket during installation, do not bend or flex the memory module. You must insert both ends of the memory module simultaneously.
- 2 Open the ejectors on the memory module socket outward to allow the memory module to be inserted into the socket.
- 3 Align the edge connector of the memory module with the alignment key of the memory module socket, and insert the memory module in the socket.
 - CAUTION:** Do not apply pressure at the center of the memory module; apply pressure at both ends of the memory module evenly.
 - NOTE:** The memory module socket has an alignment key that enables you to install the memory module in the socket in only one orientation.
- 4 Press the memory module with your thumbs until the socket levers firmly click into place.

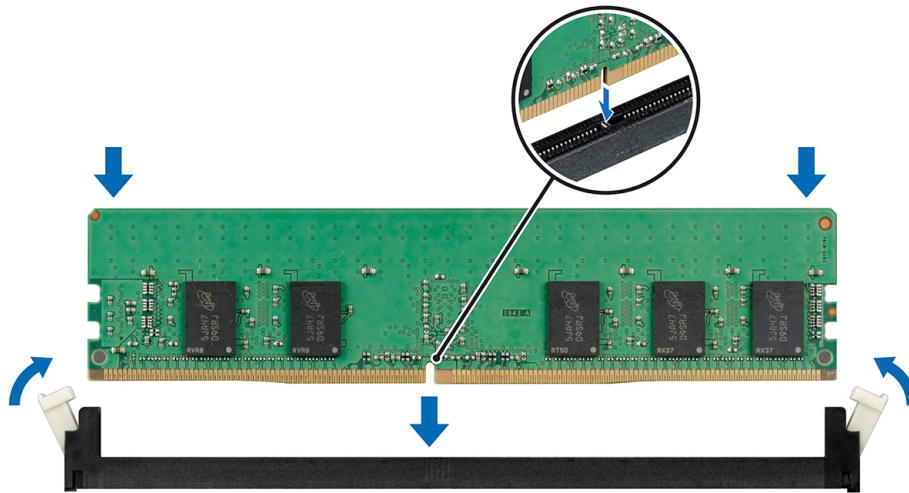

Figure 27. Installing a memory module

Next steps

- 1 If applicable, install the [air shroud](#).
- 2 Follow the procedure listed in [After working inside your system](#).
- 3 To verify if the memory module has been installed properly, press F2 and navigate to **System Setup Main Menu > System BIOS > Memory Settings**. In the **Memory Settings** screen, the System Memory Size must reflect the updated capacity of the installed memory.
- 4 If the value is incorrect, one or more of the memory modules may not be installed properly. Ensure that the memory module is firmly seated in the memory module socket.
- 5 Run the system memory test in system diagnostics.

Processors and heat sinks

The processor contains memory, peripheral interfaces, and other components of the system. It may have multiple cores. The system can have more than one processor configurations.

The heat sink absorbs the heat generated by the processor, and helps the processor to maintain its optimal temperature level.

Removing a processor and heat sink module

Prerequisites

⚠ WARNING: The heat sink may be hot to touch for some time after the system has been powered down. Allow the heat sink to cool before removing it.

- 1 Follow the safety guidelines listed in [Safety instructions](#).
- 2 Follow the procedure listed in [Before working inside your system](#).

Steps

- 1 Using a Torx #T30 screwdriver, loosen the screws on the heat sink.

ⓘ NOTE: Ensure that you loosen one screw before moving on to the next screw.

- 2 Pushing both retention clips simultaneously, lift the processor heat sink module (PHM) out of the system.
- 3 Set the PHM aside with the processor side facing up.

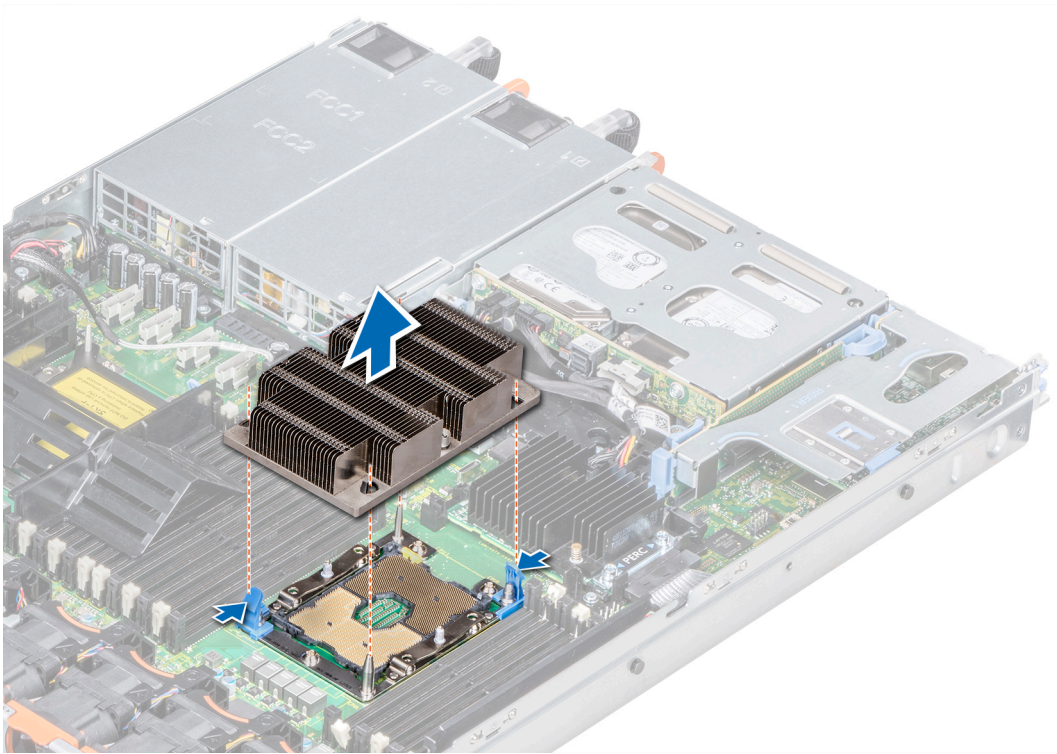

Figure 28. Removing the processor and heat sink module

Next step

- 1 Install the [processor heat sink module](#).

Removing a processor from processor heat sink module

Prerequisites

⚠ WARNING: The heat sink may be hot to touch for some time after the system has been powered down. Allow the heat sink to cool before removing it.

- 1 Follow the safety guidelines listed in [Safety instructions](#).
- 2 Follow the procedure listed in [Before working inside your system](#).
- 3 Remove the [processor and heat sink module](#).

Steps

- 1 Place the heat sink with the processor side facing up.
- 2 Insert a flat sled screwdriver into the release slot marked with a yellow label. Twist (do not pry) the screwdriver to break the thermal paste seal.
- 3 Push the retaining clips on the processor bracket to unlock the bracket from the heat sink.

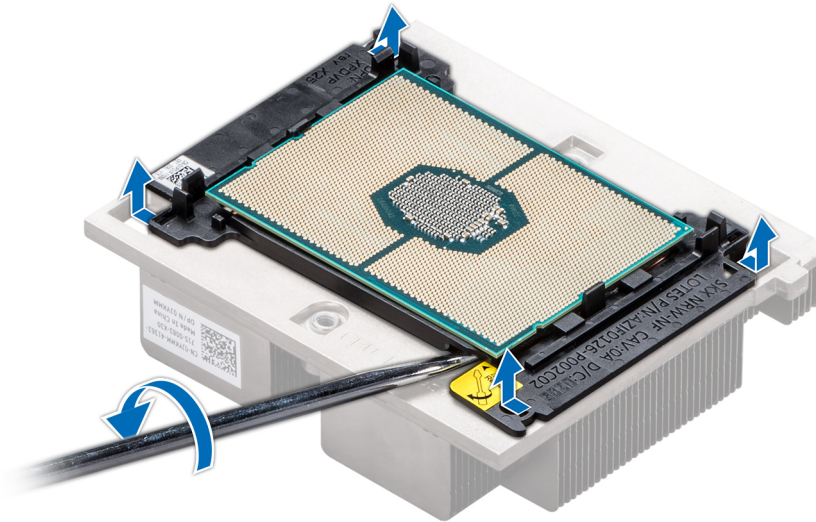

Figure 29. Loosening the processor bracket

- 4 Lift the bracket and the processor away from the heat sink, and place the processor connector side down on the processor tray.
- 5 Flex the outer edges of the bracket to release the processor from the bracket.

NOTE: Ensure that the processor and the bracket are placed in the tray after you remove the heat sink.



Figure 30. Removing the processor bracket

Next step

Install the processor into the [processor and heat sink module](#) .

Installing the processor into a processor and heat sink module

Prerequisite

Follow the safety guidelines listed in [Safety instructions](#).

Steps

- 1 Place the processor in the processor tray.
 - ① **NOTE:** Ensure that the pin 1 indicator on the processor tray is aligned with the pin 1 indicator on the processor.
- 2 Flex the outer edges of the bracket around the processor ensuring that the processor is locked into the clips on the bracket.
 - ① **NOTE:** Ensure that the pin 1 indicator on the bracket is aligned with the pin 1 indicator on the processor before placing the bracket on the processor.
 - ① **NOTE:** Ensure that the processor and the bracket are placed in the tray before you install the heat sink.



Figure 31. Installing the processor bracket

- 3 If you are using an existing heat sink, remove the thermal grease from the heat sink by using a clean lint-free cloth.
- 4 Use the thermal grease syringe included with your processor kit to apply the grease in a quadrilateral design on the top of the processor.
 - ⚠ **CAUTION:** Applying too much thermal grease can result in excess grease coming in contact with and contaminating the processor socket.
 - ① **NOTE:** The thermal grease syringe is intended for single use only. Dispose the syringe after you use it.

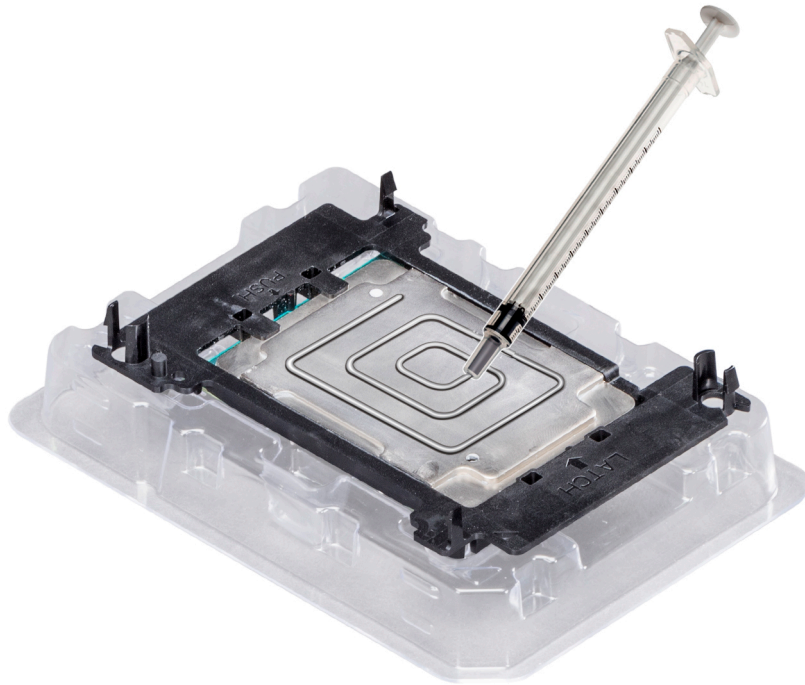

Figure 32. Applying thermal grease on top of the processor

- 5 Place the heat sink on the processor and push down until the bracket locks onto the heat sink.

NOTE:

- Ensure that the two guide pin holes on the bracket match the guide holes on the heat sink.
- Ensure that the pin 1 indicator on the heat sink is aligned with the pin 1 indicator on the bracket before placing the heat sink onto the processor and bracket.

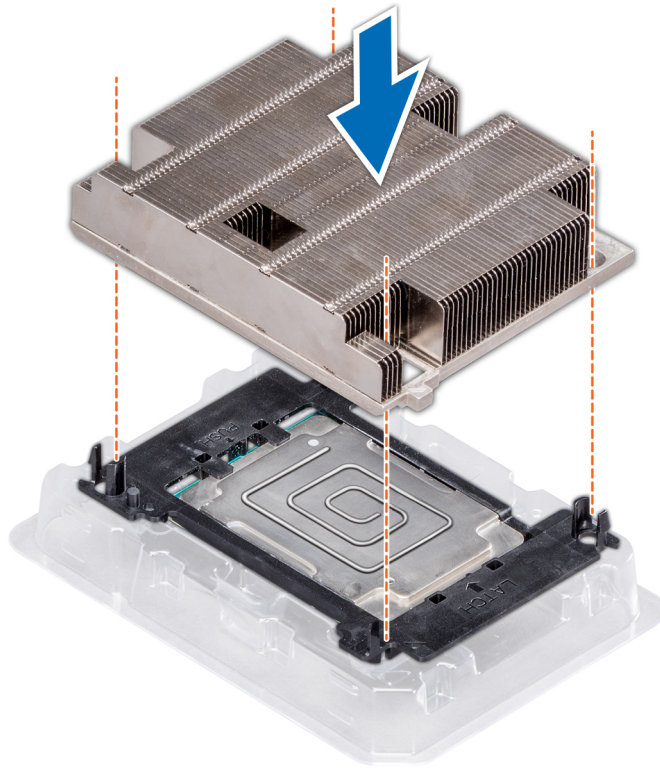

Figure 33. Installing the heat sink onto the processor

Next steps

- 1 Install the [processor and heat sink module](#) .
- 2 Install the [air shroud](#) .
- 3 Follow the procedure listed in [After working inside your system](#).

Installing a processor and heat sink module

Prerequisites

CAUTION: Never remove the heat sink from a processor unless you intend to replace the processor. The heat sink is necessary to maintain proper thermal conditions.

WARNING: The heat sink may be hot to touch for some time after the system has been powered down. Allow the heat sink to cool before removing it.

- 1 Follow the safety guidelines listed in [Safety instructions](#).
- 2 If installed, remove the [processor/DIMM blank](#) and CPU dust cover.
The procedure to remove the DIMM blank is identical to that of the memory module.

Steps

- 1 Align the pin 1 indicator of the heat sink to the system board and then place the processor heat sink module (PHM) on the processor socket.

CAUTION: To avoid damaging the fins on the heat sink, do not press down on the heat sink fins.

① **NOTE:** Ensure that the PHM is held parallel to the system board to prevent damaging the components.

2 Push the blue retention clips inward to allow the heat sink to drop into place.

3 Using the T30 Torx screwdriver, tighten one screw at a time.

① **NOTE:** Ensure that the screw is tightened completely before moving onto the next screw.

① **NOTE:** The processor and heat sink module retention screws should not be tightened to more than 0.13 kgf-m (1.35 N.m or 12 in-lbf).

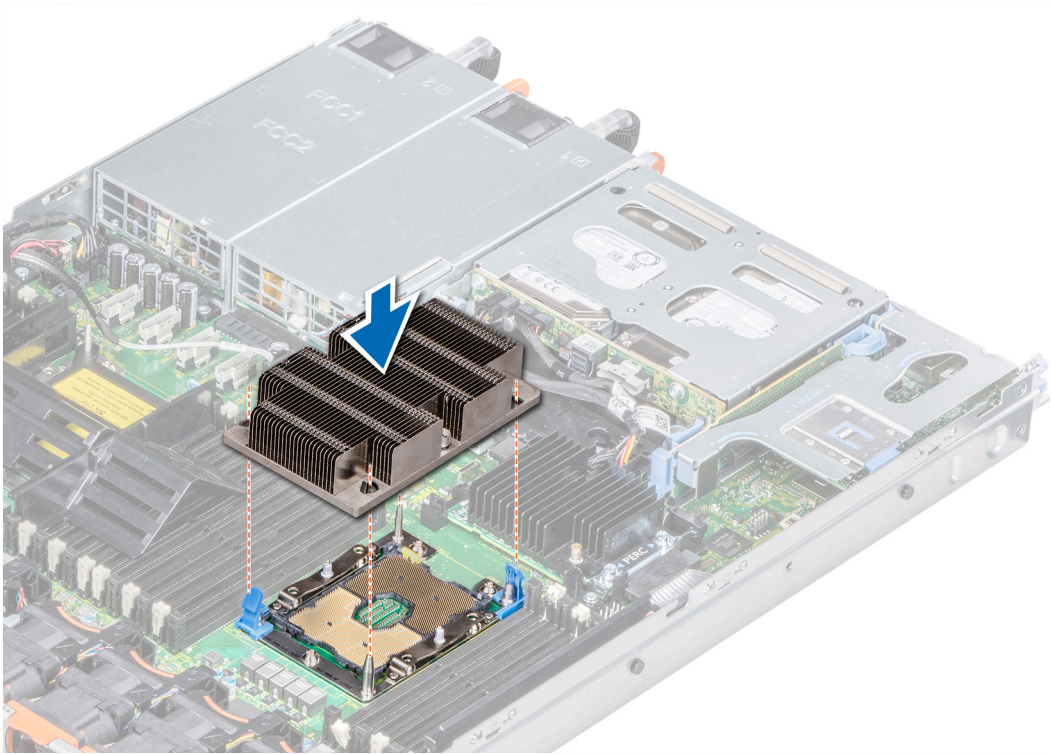

Figure 34. Installing a processor and heat sink module

Next step

Follow the procedure listed in [After working inside your system](#).

Expansion cards and expansion card risers

An expansion card in the system is an add-on card that can be inserted into an expansion slot on the system board or riser card to add enhanced functionality to the system through the expansion bus.

① **NOTE:** A System Event Log (SEL) event is logged if an expansion card riser is not supported or missing. It does not prevent your system from turning on. However, if F1/F2 pause occurs and an error message is displayed.

Expansion bus specifications

The XC640 Series system supports PCI express (PCIe) generation 3 expansion cards, which are installed on the system, using expansion card risers. This system supports 1A, and 2A expansion card risers.

Expansion card installation guidelines

Depending on your system configuration, the following PCI Express (PCIe) generation 3 expansion cards are supported:

Table 42. Expansion card riser configurations

Expansion card riser	PCIe slots on the riser	Processor connection	Height	Length	Slot width
Riser 1A	Slot 1	Processor 1	Low Profile	Half Length	x16
	Slot 2	Processor 1	Low Profile	Half Length	x16
Riser 2A	Slot 3	Processor 2	Full Height	Half Length	x16

NOTE: The expansion card slots are not hot-swappable.

The following table provides guidelines for installing expansion cards to ensure proper cooling and mechanical fit. The expansion cards with the highest priority should be installed first using the slot priority indicated. All the other expansion cards should be installed in the card priority and slot priority order.

Table 43. Riser configurations: 1A + 2A

Card type	Slot priority	Form factor
HWRAID BOSS (ODM)	1, 2, 3	Low Profile
25G NICs (Mellanox)	1, 2, 3	Low Profile
10Gb NICs (Intel)	1, 2, 3	Low Profile
1Gb NICs (Intel)	1, 2, 3	Low Profile
HBA 330	Integrated Slot	NONE
rNDC (Intel)	Integrated Slot	NONE
rNDC (Mellanox)	Integrated Slot	NONE

NOTE: When you replace any system component, you must update the system with the latest available BIOS and iDRAC versions. For more information, go to Dell.com/XCSeriesmanuals.

Removing an expansion card riser

Prerequisites

- 1 Follow the safety guidelines listed in [Safety instructions](#).
- 2 Follow the procedure listed in [Before working inside your system](#).
- 3 Before removing the expansion card riser 2A, remove the [expansion card from the riser](#), if installed.
- 4 Disconnect any cables connected to the expansion card.

Step

Hold the touch points, and lift the expansion card riser, from the riser connector, on the system board.

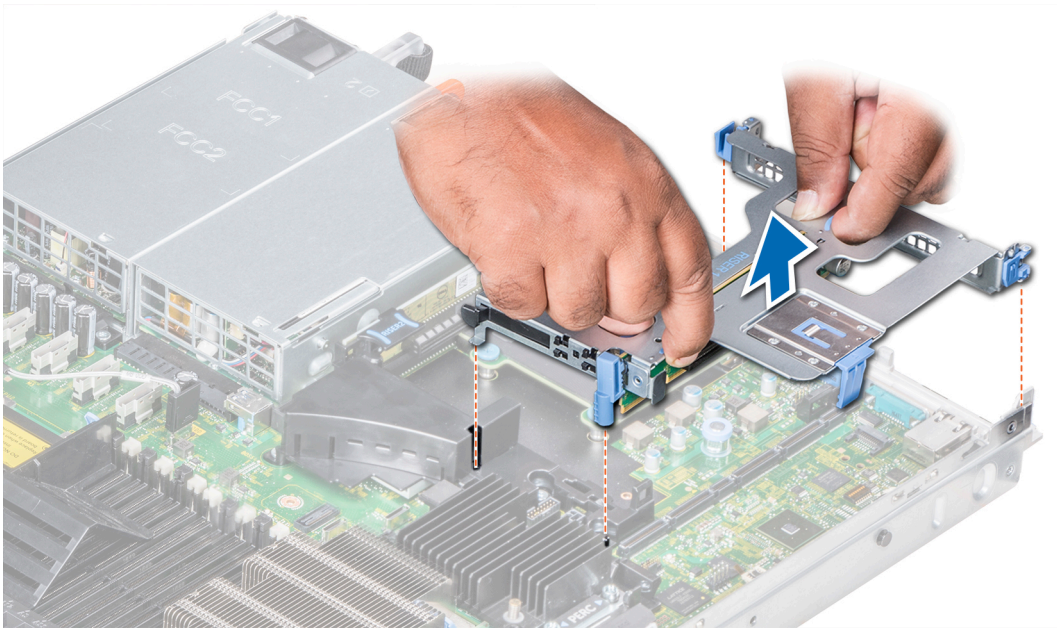

Figure 35. Removing the expansion riser 1A

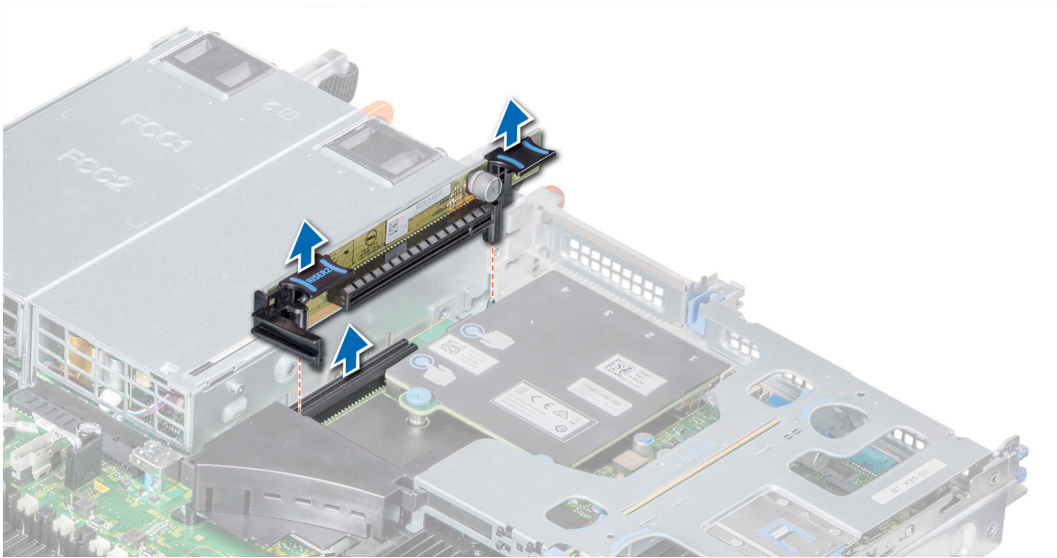

Figure 36. Removing the expansion riser 2A

Next step

Install the [expansion card riser](#).

Installing an expansion card riser

Prerequisites

- 1 Follow the safety guidelines listed in [Safety instructions](#).
- 2 Before installing the expansion card riser 2A, install an [expansion card into the riser](#), if applicable.

Steps

- 1 If removed, install the [expansion cards into the expansion card riser](#).
- 2 Holding the touch points, align the expansion card riser with the connector and the riser guide pin on the system board.

NOTE: While installing riser 1 B, press the tabs and hold the touch point to align the expansion card riser and the riser guide pin on the system board.

- 3 Lower the expansion card riser into place until the expansion card riser connector is fully seated in the connector.

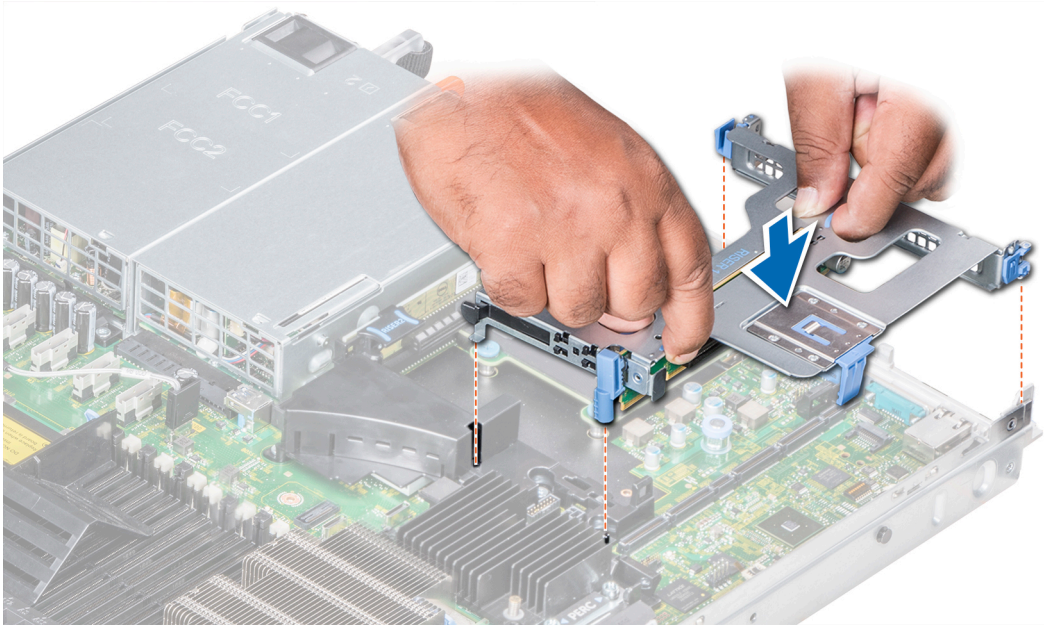

Figure 37. Installing the expansion riser 1A

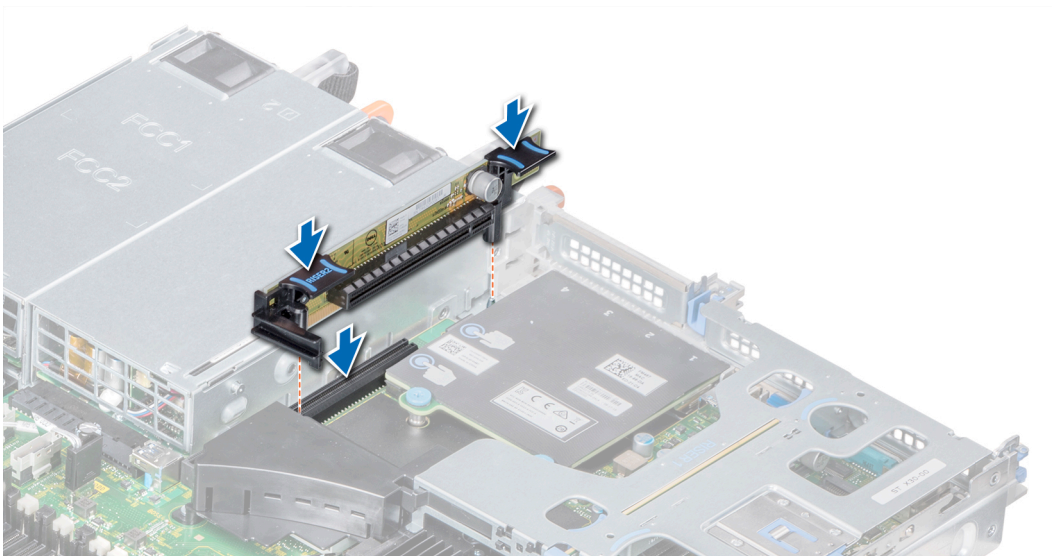

Figure 38. Installing the expansion riser 2A

Next steps

- 1 Follow the procedure listed in [After working inside your system](#).
- 2 Install any device drivers required for the card as described in the documentation for the card.

Removing an expansion card from the expansion card riser

Prerequisites

- 1 Follow the safety guidelines listed in [Safety instructions](#).
- 2 Follow the procedure listed in [Before working inside your system](#).
- 3 If applicable, remove the [air shroud](#).
- 4 If applicable, disconnect the cables from the expansion card.

NOTE: When removing a card from the riser 1, open the PCIe card holder latch. If applicable, remove the PCIe guide and then remove the expansion card.

Steps

- 1 If applicable, lift the expansion card latches out of the slot.
- 2 Hold the expansion card by its edges, and pull the card until the card edge connector disengages from the expansion card connector on the riser.

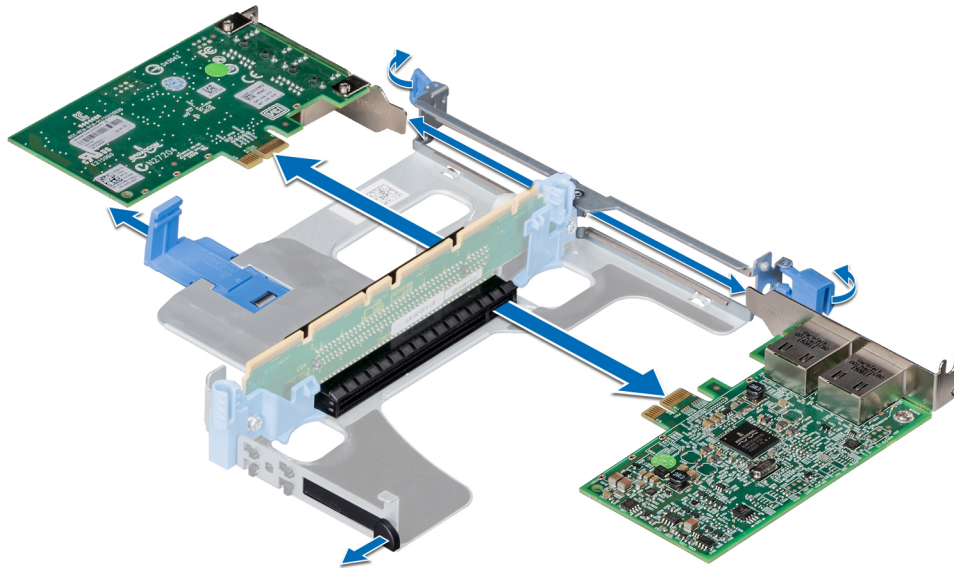

Figure 39. Removing an expansion card from riser 1A

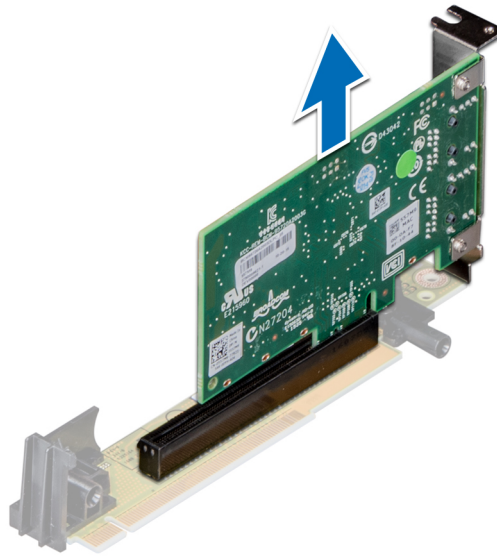

Figure 40. Removing an expansion card from riser 2A

- 3 If you are removing the card permanently, install a metal filler bracket over the empty expansion slot opening and close the expansion card latch.

NOTE: You must install a filler bracket over an empty expansion card slot to maintain Federal Communications Commission (FCC) certification of the system. The brackets also keep dust and dirt out of the system and aid in proper cooling and airflow inside the system.

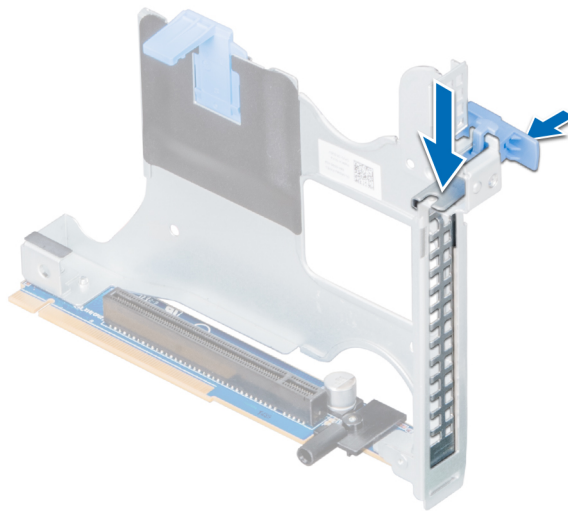

Figure 41. Installing a filler bracket into riser 1A

- 4 Insert the expansion card latch into the slot to secure the bracket.

Next steps

- 1 Install the [expansion card in to expansion card riser](#).
- 2 If you are removing the card permanently, install a metal filler bracket over the empty expansion slot opening and push the expansion card latch.

Installing an expansion card into expansion card riser

Prerequisites

- 1 Follow the safety guidelines listed in [Safety instructions](#).
- 2 Unpack the expansion card and prepare it for installation.

NOTE: For instructions, see the documentation accompanying the card.

- NOTE:** When installing a card into the riser 1, open the PCIe card holder latch. If applicable, open the PCIe guide and then install the expansion card.

Steps

- 1 If applicable, lift the expansion card latch and remove the filler bracket.

NOTE: Store the filler bracket for future use. Filler brackets must be installed in empty expansion card slots to maintain Federal Communications Commission (FCC) certification of the system. The brackets also keep dust and dirt out of the system and aid in proper cooling and airflow inside the system.

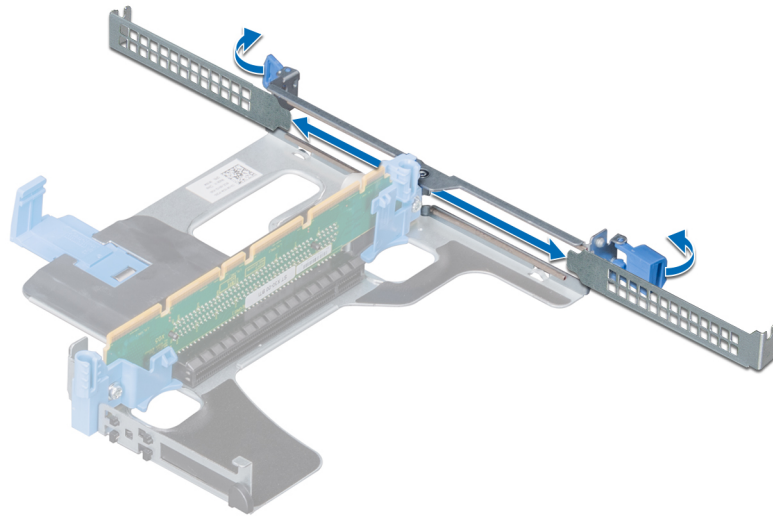

Figure 42. Removing the metal filler bracket on Riser 1A

- 2 Hold the card by its edges, and align the card edge connector with the expansion card connector on the riser.
- 3 Insert the card edge connector firmly into the expansion card connector until the card is fully seated.
- 4 Close the expansion card latch.

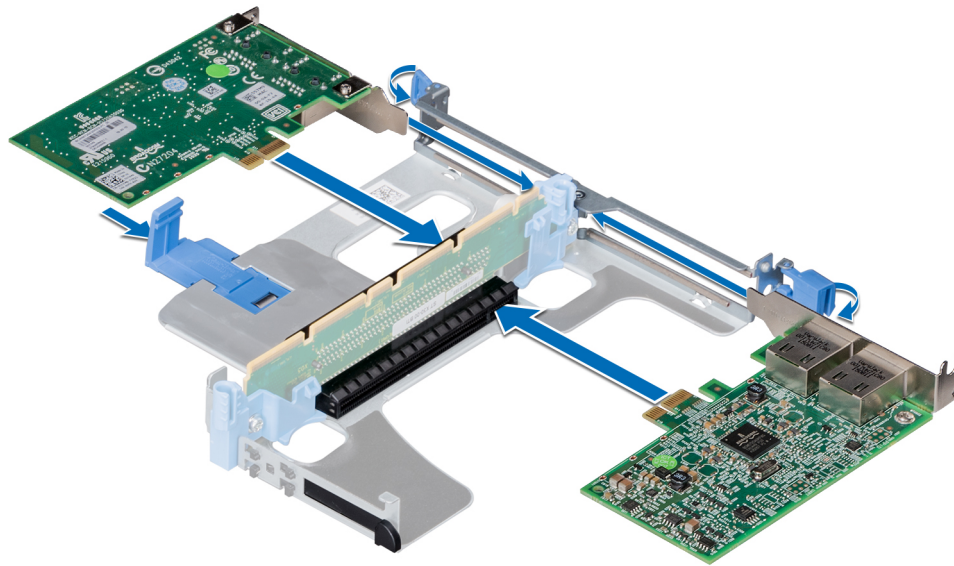

Figure 43. Installing expansion cards into the expansion riser 1A

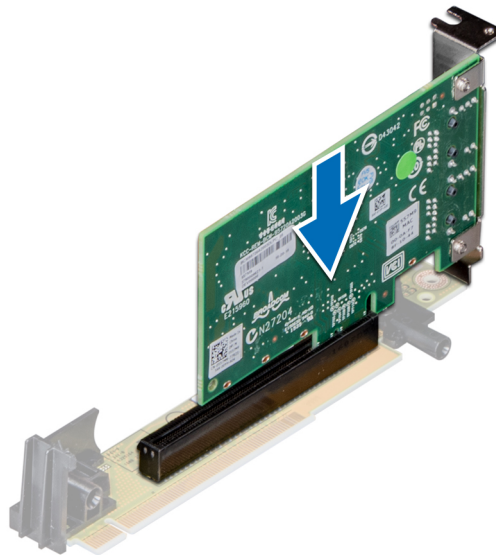

Figure 44. Installing an expansion card into the expansion riser 2A

Next steps

- 1 After installing a card into the riser 1, close the PCIe card holder latch. If applicable, close the PCIe guide after installing the expansion card.
- 2 Follow the procedure listed in [After working inside your system](#).
- 3 Install any device drivers required for the card as described in the documentation for the card.

IDSDM/vFlash card

The IDSDM/vFlash card combines the IDSDM and/or vFlash features into a single module.

Removing a micro SD card

Prerequisites

- 1 Follow the safety guidelines listed in [Safety instructions](#) .
- 2 Follow the procedure listed in [Before working inside your system](#) .

Steps

- 1 Locate the SD card slot on the IDSDM module, and press the card to partially release it from the slot.
- 2 Hold the SD card and remove it from the slot.

NOTE: Temporarily label each SD card with its corresponding slot number after removal.

Next step

Install a [micro SD cards](#) .

Installing a micro SD card

Prerequisites

Follow the safety guidelines listed in [Safety instructions](#).

NOTE: To use an SD card with your system, ensure that the Internal SD Card Port is enabled in System Setup.

NOTE: Re-install the micro SD cards into the same slots based on the labels you had marked on the cards during removal.

Steps

- 1 Locate the SD card connector on the internal dual SD module. Orient the SD card appropriately and insert the contact-pin end of the card into the slot.

NOTE: The slot is keyed to ensure correct insertion of the card.

- 2 Press the card into the card slot to lock it into place.

Next step

Follow the procedure listed in [After working inside your system](#).

Removing the IDSDM/vFlash card

Prerequisites

- 1 Follow the safety guidelines listed in [Safety instructions](#).
- 2 Follow the procedure listed in [Before working inside your system](#).
- 3 If you are replacing the IDSDM/vFlash card, remove the [micro SD card](#).

NOTE: Temporarily label each micro SD card with its corresponding slot number after removal.

Steps

- 1 Locate the IDSDM/vFlash connector on the system board.
To locate IDSDM/vFlash, see [System board jumpers and connectors](#).
- 2 Holding the pull tab, lift the IDSDM/vFlash card out of the system.

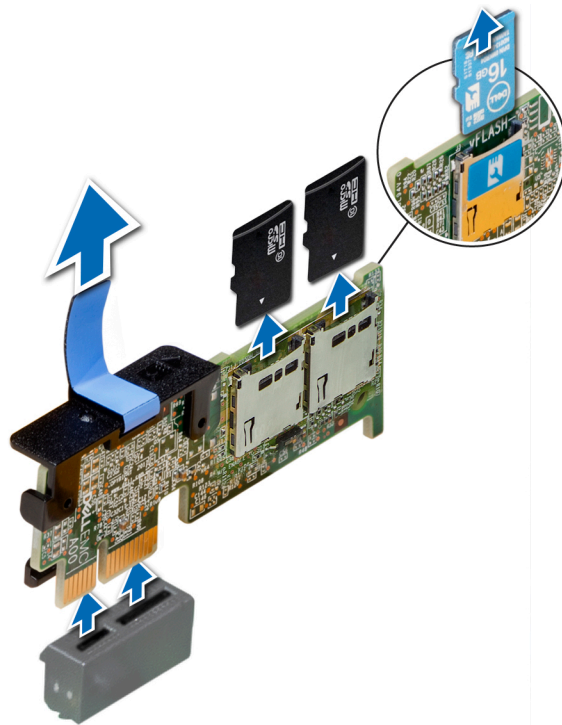

Figure 45. Removing the optional IDSDM/vFlash card

Next step

Install the [IDSDM/vFlash card](#).

Installing the IDSDM/vFlash card

Prerequisite

Follow the safety guidelines listed in [Safety instructions](#).

Steps

- 1 Locate the IDSDM/vFlash connector on the system board.
To locate IDSDM/vFlash, see [System board jumpers and connectors](#).
- 2 Align IDSDM/vFlash card with the connector on the system board.
- 3 Push IDSDM/vFlash card until it is firmly seated on the system board.

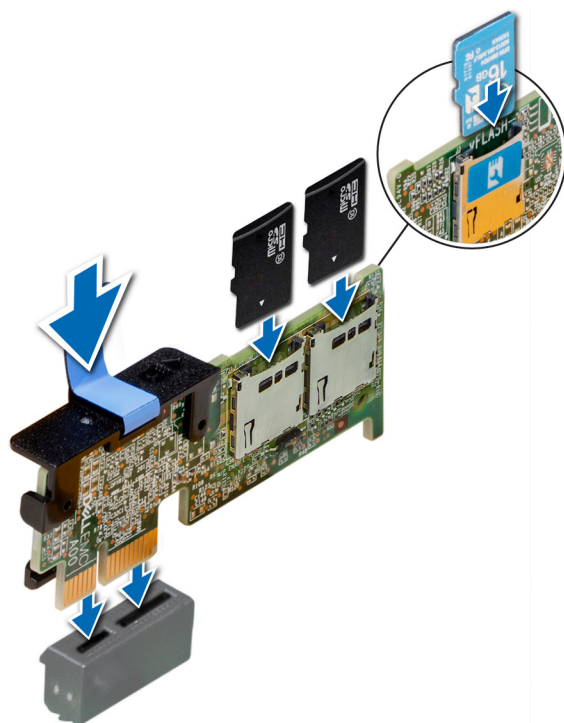

Figure 46. Installing IDSDM/vFlash card

Next steps

- 1 Install the [micro SD card](#).
- 1 **NOTE:** Re-install the micro SD cards into the same slots based on the labels you had marked on the cards during removal.
- 2 Follow the procedure listed in [After working inside your system](#).

Network daughter card

The network daughter card (NDC) is a small, removable mezzanine card, which provides the flexibility of selecting different network connectivity options.

Removing the network daughter card

Prerequisites

- 1 Follow the safety guidelines listed in [Safety instructions](#).
- 2 Follow the procedure listed in [Before working inside your system](#).
- 3 Remove the [expansion card riser 2](#) or the rear hard drive cage, depending on the configuration of your system.

Steps

- 1 Using a Phillips #2 screwdriver, loosen the captive screws that secure the network daughter card (NDC) to the system board.
- 2 Hold the NDC by the edges on either side of the touch points, and lift to remove it from the connector on the system board.
- 3 Slide the NDC towards the front of the system until the Ethernet connectors are clear of the slot in the back panel.

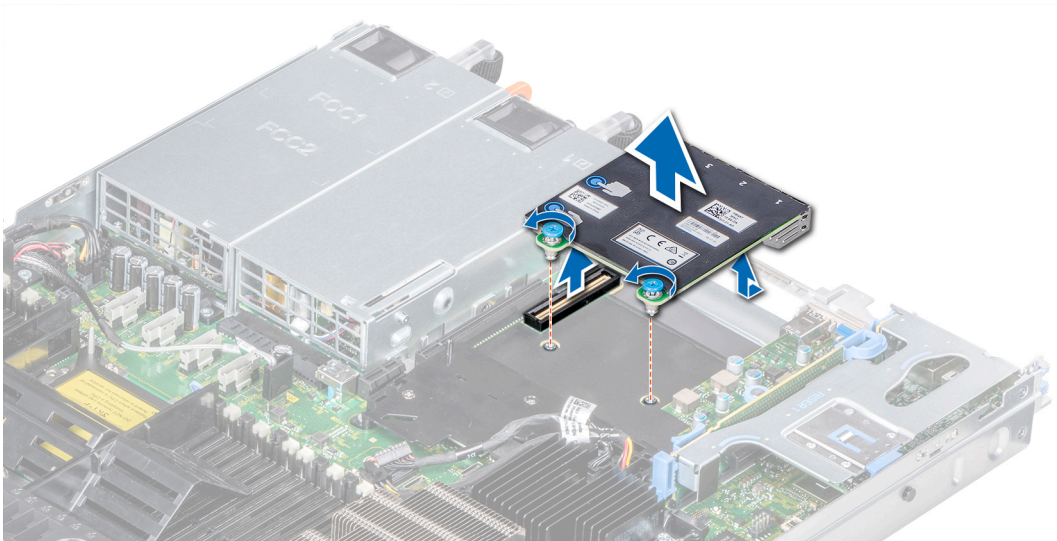

Figure 47. Removing the network daughter card

Next step

Install the [network daughter card](#).

Installing the network daughter card

Prerequisite

Follow the safety guidelines listed in [Safety instructions](#).

Steps

- 1 Orient the NDC so that the Ethernet connectors fit through the slot in the chassis.
- 2 Align the captive screws at the back-end of the card with the screw holes on the system board.
- 3 Press the touch points on the card until the card connector is firmly seated on the system board connector.
- 4 Using a Phillips #2 screwdriver, tighten the captive screws to secure the NDC to the system board.

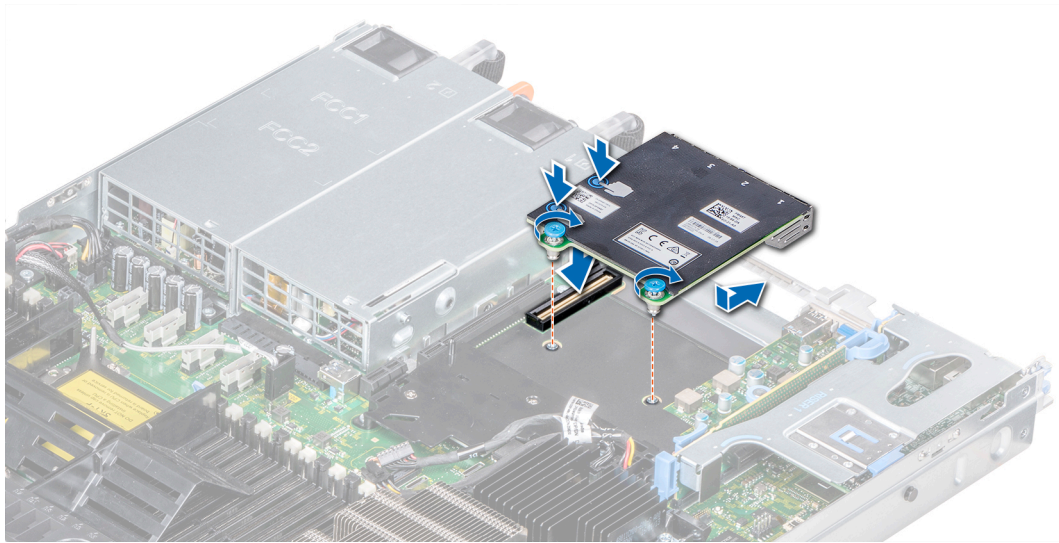

Figure 48. Installing the network daughter card

Next steps

- 1 Install the [expansion card riser 2](#) or the rear hard drive cage, depending on the configuration of your system.
- 2 Follow the procedure listed in [After working inside your system](#).

Integrated storage controller card

Your system includes a dedicated expansion card slot on the system board for the primary storage controller card. The storage controller card provides the storage subsystem for internal hard drives of your system. The controller supports SAS and SATA hard drives.

Removing the integrated storage controller card

Prerequisites

- 1 Follow the safety guidelines listed in [Safety instructions](#).
- 2 Follow the procedure listed in [Before working inside your system](#).
- 3 Remove the [air shroud](#).
- 4 Remove the [expansion card riser 1](#).

Steps

- 1 Using Phillips #2 screwdriver, loosen the screws that secure the integrated storage controller cable to the connector on the system board.
- 2 Lift the integrated storage controller cable to disconnect it from the connector on the system board.

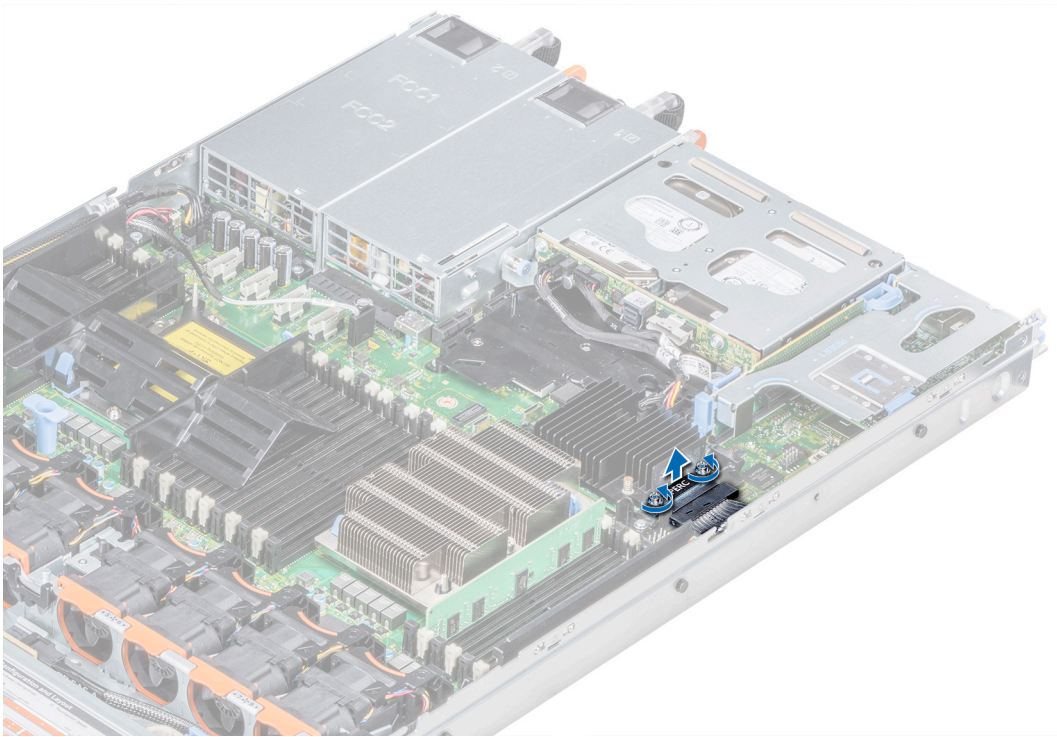

Figure 49. Removing the integrated storage controller cable

- 3 Lift one end of the card and angle it to disengage the card from the card holder on the system board.
- 4 Lift the card out of the system.

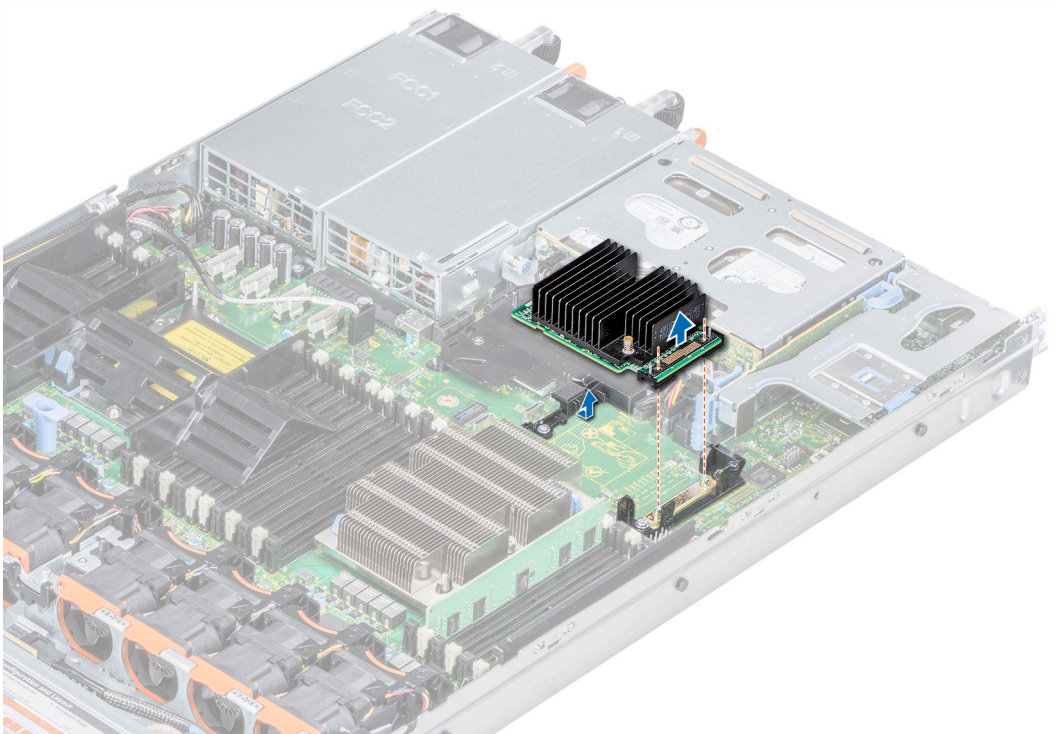

Figure 50. Removing the integrated storage controller card

Next step

Install the [integrated storage controller card](#).

Installing the integrated storage controller card

Prerequisite

Follow the safety guidelines listed in [Safety instructions](#).

Steps

- 1 Angle the integrated storage controller card and align the end of the card with the controller card connector on the system board.
- 2 Lower the connector side of the integrated storage controller card into the integrated storage controller card connector on the system board.

NOTE: Ensure that the slots on the system board align with the screw holes on the integrated storage controller card connector.

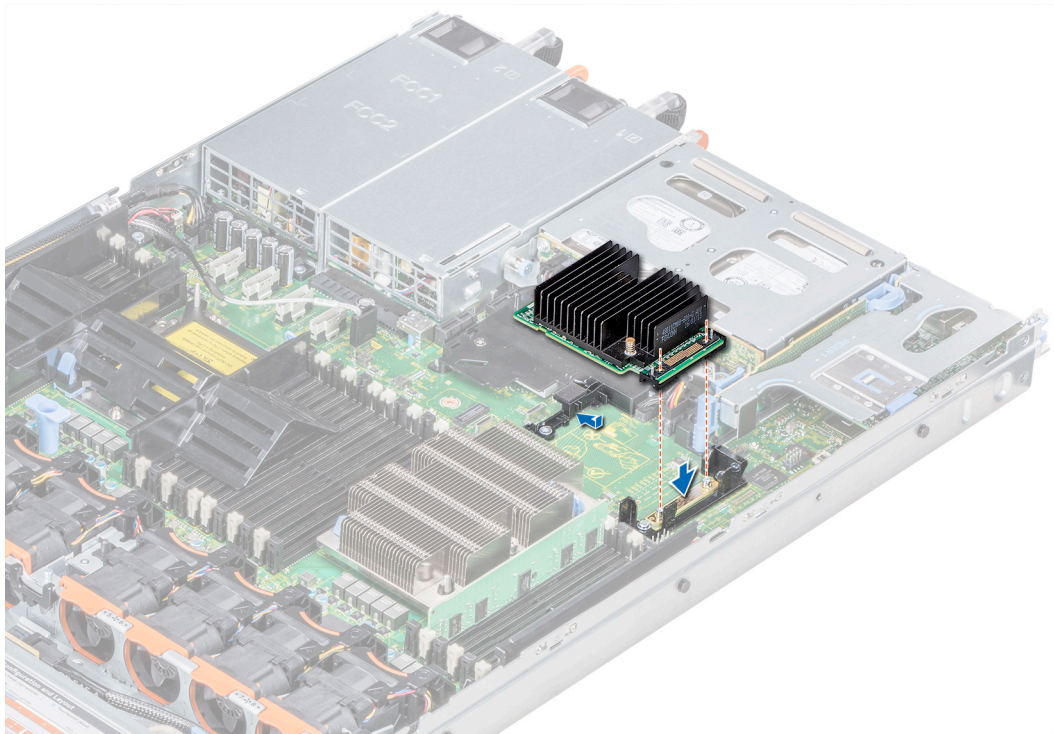

Figure 51. Installing the integrated storage controller card

- 3 Route the integrated storage controller card cable along the wall of the system.
- 4 Align the screws on the integrated storage controller card cable with the screw holes on the connector.
- 5 Using Phillips #2 screwdriver, tighten the screws to secure the integrated storage controller card cable to the card connector on the system board.

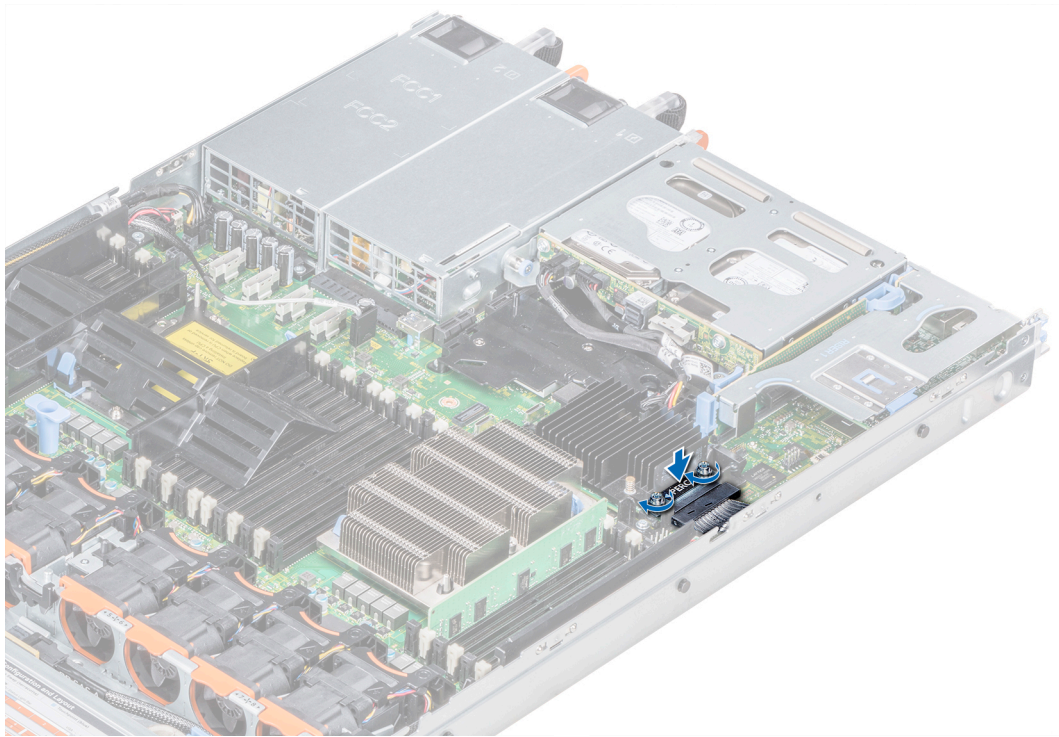

Figure 52. Installing the integrated storage controller card cable

Next steps

- 1 Install the [air shroud](#).
- 2 Follow the procedure listed in [After working inside your system](#).

Hard drives

Hard drives are supplied in hot swappable hard drive carriers that fit in the hard drive slots.

⚠ CAUTION: Before attempting to remove or install a hard drive while the system is running, see the documentation for the storage controller card to ensure that the host adapter is configured correctly.

⚠ CAUTION: Do not turn off or restart your system while a hard drive is being formatted. Doing so can cause a hard drive failure.

When you format a hard drive, allow enough time for the formatting to complete. Be aware that high-capacity hard drives can take a long time to format.

Removing a hard drive blank

Prerequisites

- 1 Follow the safety guidelines listed in [Safety instructions](#).
- 2 If installed, remove the [front bezel](#).

⚠ CAUTION: To maintain proper system cooling, hard drive blanks must be installed in all empty hard-drive slots.

⚠ CAUTION: Mixing hard drive blanks from previous generations of XC Series Appliance and XC Core System is not supported.

Step

Press the release button, and slide the hard drive blank out of the hard drive slot.

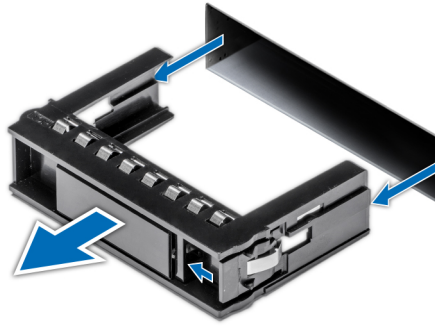

Figure 53. Removing a hard drive blank

Next step

Install a [hard drive](#) or a [hard drive blank](#).

Installing a hard drive blank

Prerequisite

Follow the safety guidelines listed in [Safety instructions](#).

⚠ CAUTION: Mixing hard drive blanks from previous generations of XC Series Appliance and XC Core System is not supported.

Step

Insert the hard drive blank into the hard drive slot, and push until the release button clicks into place.

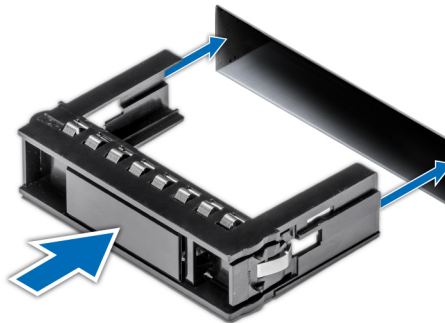

Figure 54. Installing a hard drive blank

Next steps

- 1 If removed, install the [front bezel](#).
- 2 Follow the procedure listed in [After working inside your system](#).

Removing a hard drive

Prerequisites

- 1 Follow the safety guidelines listed in [Safety instructions](#).
- 2 If applicable, remove the [front bezel](#).

- 3 Using the management software, prepare the hard drive for removal.

If the hard drive is online, the green activity or fault indicator flashes while the drive is turning off. When the hard drive indicators are off, the hard drive is ready for removal. For more information, see the documentation for the storage controller.

- ⚠ **CAUTION:** Before attempting to remove or install a hard drive while the system is running, see the documentation for the storage controller card to ensure that the host adapter is configured correctly to support hard drive removal and insertion.
- ⚠ **CAUTION:** Mixing hard drives from previous generations of XC Series Appliance and XC Core System is not supported.
- ⚠ **CAUTION:** To prevent data loss, ensure that your operating system supports drive installation. See the documentation supplied with your operating system.

Steps

- 1 Press the release button to open the hard drive release handle.
- 2 Holding the handle, slide the hard drive out of the hard drive slot.



Figure 55. Removing a hard drive

Next steps

- 1 Install a [hard drive](#).
- 2 If you are not replacing the hard drive immediately, insert a hard drive blank in the empty hard drive slot to maintain proper system cooling.

Installing a hard drive

Prerequisites

- ⚠ **CAUTION:** Before attempting to remove or install a hard drive while the system is running, see the documentation for the storage controller card to ensure that the host adapter is configured correctly to support hard drive removal and insertion.
- ⚠ **CAUTION:** Mixing hard drives from previous generations of XC Series Appliance and XC Core System is not supported.
- ⚠ **CAUTION:** When installing a hard drive, ensure that the adjacent drives are fully installed. Inserting a hard drive carrier and attempting to lock its handle next to a partially installed carrier can damage the partially installed carrier's shield spring and make it unusable.
- ⚠ **CAUTION:** Combining SAS and SATA drives in the same RAID volume is not supported.

⚠ **CAUTION:** To prevent data loss, ensure that your operating system supports hot-swap drive installation. See the documentation supplied with your operating system.

⚠ **CAUTION:** When a replacement hot swappable drive is installed and the system is powered on, the drive automatically begins to rebuild. Ensure that the replacement drive is blank or contains data that you wish to overwrite. Any data on the replacement drive is immediately lost after the drive is installed.

- 1 Follow the safety guidelines listed in [Safety instructions](#).
- 2 If applicable, remove the [hard drive blank](#).

Steps

- 1 Press the release button on the front of the hard drive to open the release handle.
- 2 Insert the hard drive into the hard drive slot and slide until the hard drive connects with the backplane.
- 3 Close the hard drive release handle to lock the hard drive in place.



Figure 56. Installing a hard drive

Next step

If applicable, install the [front bezel](#).

Removing the hard drive from the hard drive carrier

Prerequisite

Follow the safety guidelines listed in [Safety instructions](#).

⚠ **CAUTION:** Mixing hard drives from previous generations of XC Series Appliance and XC Core System is not supported.

Steps

- 1 Using Phillips #1 screwdriver, remove the screws from the slide rails on the hard drive carrier.
- 2 Lift the hard drive out of the hard drive carrier.

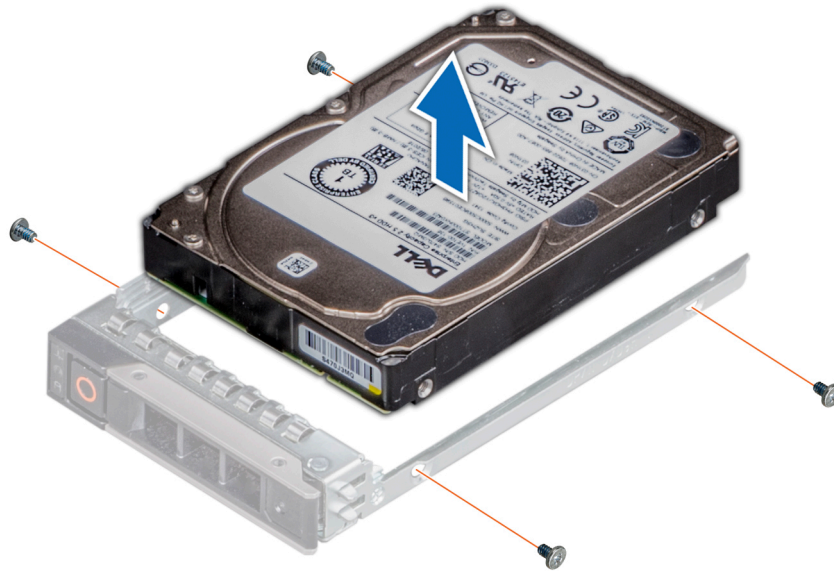

Figure 57. Removing the hard drive from the hard drive carrier

Next step

If applicable, install the [hard drive into the hard drive carrier](#).

Installing a hard drive into the hard drive carrier

Prerequisite

Follow the safety guidelines listed in [Safety instructions](#).

⚠ CAUTION: Mixing hard drives from previous generations of XC Series Appliance and XC Core System is not supported.

Steps

- 1 Insert the hard drive into the hard drive carrier with the connector end of the hard drive towards the back of the carrier.
- 2 Align the screw holes on the hard drive with the screws holes on the hard drive carrier.
When aligned correctly, the back of the hard drive is flush with the back of the hard drive carrier.
- 3 Using the Phillips #1 screwdriver, replace the screws to secure the hard drive to the hard drive carrier.



Figure 58. Installing a hard drive into the hard drive carrier

Hard drive backplane

NOTE: NVMe drive slots are 6, 7, 8, and 9. XC640-4 does not support NVMe drives.

Drive slot numbering is 0 relative for chassis. All NVMe drives are installed in the last slots. Maximum of four NVMe drives are supported.

Depending on your system configuration, the drive backplanes that are supported in XC640 Series are listed here:

Table 44. Supported backplane options for XC640 Series Appliance and Core Systems

System	Supported drives options
XC640 Series	2.5 inch (x10) SAS, SATA, or NVMe backplane 3.5 inch (x4) SAS or SATA backplane

NOTE: Mixing of 2.5 inch 10K or 15 K SAS hard drives with 2.5 inch 7.2 K SATA or Nearline SAS hard drives on the same backplane is not supported. You can mix solid-state drives with hard drives on the same backplane.



For NVME models only (right-most are NVME)

Figure 59. XC640-10



The settings for XC640-10 are listed here.

Table 45. Settings for XC640-10

Name	State	Slot Number	Size	Security Status	Bus Protocol	Media Type
PCIe SSD in Slot 6 in Bay 1	Ready	6	1490.42 GB	Not Applicable	PCIe	SSD
PCIe SSD in Slot 7 in Bay 1	Ready	7	1490.42 GB	Not Applicable	PCIe	SSD
PCIe SSD in Slot 8 in Bay 1	Ready	8	1490.42 GB	Not Applicable	PCIe	SSD
PCIe SSD in Slot 9 in Bay 1	Ready	9	1490.42 GB	Not Applicable	PCIe	SSD

Removing the hard drive backplane

Prerequisites

-  **CAUTION:** To prevent damage to the drives and backplane, remove the hard drives from the system before removing the backplane.
-  **CAUTION:** Note the number of each hard drive and temporarily label them before you remove the hard drive so that you can replace them in the same location.
-  **NOTE:** The procedure to remove the backplane is similar for all backplane configurations.

- 1 Follow the safety guidelines listed in [Safety instructions](#).
- 2 Follow the procedure listed in [Before working inside your system](#).
- 3 Remove the [air shroud](#).
- 4 Remove the [backplane cover](#).
- 5 Remove all hard drives from the front bay.
- 6 Disconnect all the cables from the backplane.

Step

Press the release tabs and lift the backplane to disengage the backplane from the hooks on the system.

-  **NOTE:** If your backplane has an expander board, the loosen the screws on the expander board before you remove the backplane.

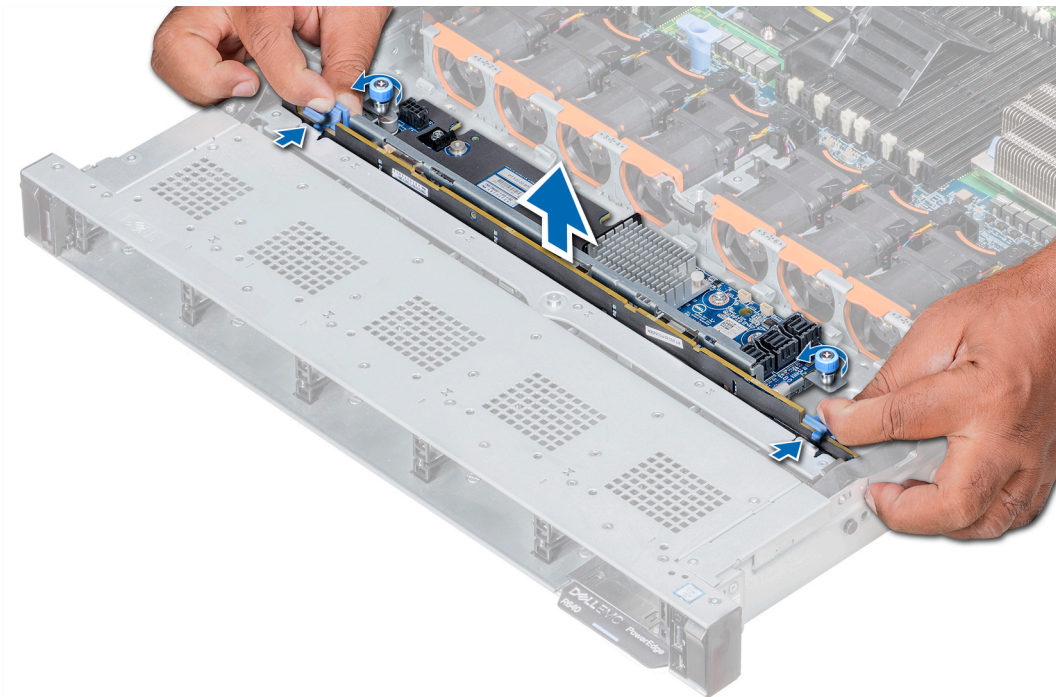

Figure 60. Removing the hard drive backplane

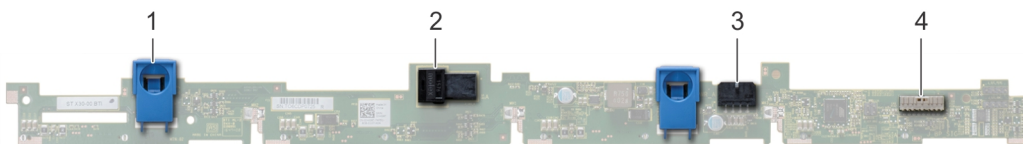

Figure 61. 4 X 3.5 hard drive backplane

- | | | | |
|---|-----------------------|---|----------------------------------|
| 1 | release tab (2) | 2 | SAS cable connector |
| 3 | power cable connector | 4 | backplane signal cable connector |

Next step

Install the [hard drive backplane](#).

Installing the hard drive backplane

Prerequisites

Follow the safety guidelines listed in [Safety instructions](#).

CAUTION: To prevent damage to the control panel flex cable, do not bend the control panel flex cable after it is inserted into the connector.

NOTE: The procedure to install the backplane is identical for all backplane configurations.

Steps

- 1 Use the hooks on the system as guides to align the slots on the backplane with the guides on the system.
- 2 Lower the hard drive backplane until the release tabs snap into place.

NOTE: If you are installing a backplane with an expander board, then tighten the captive screws after installing the backplane.

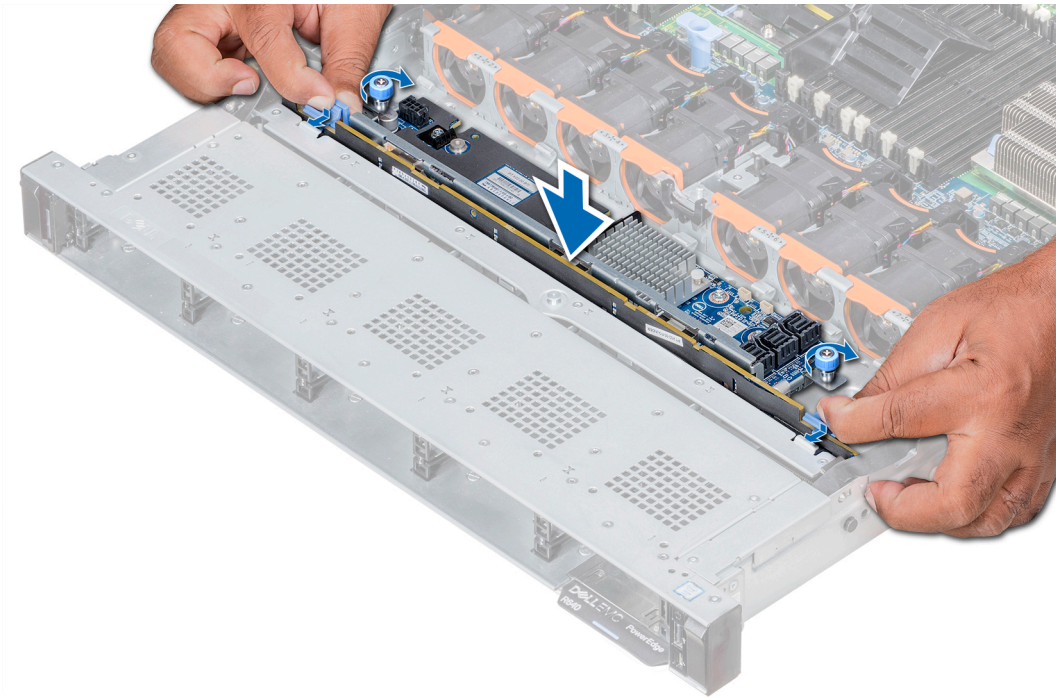

Figure 62. Installing the hard drive backplane

Next steps

- 1 Connect all the cables to the backplane.
- 2 Install all the [hard drives](#).
- 3 Install the [backplane cover](#).
- 4 Install the [air shroud](#).
- 5 Follow the procedure listed in [After working inside your system](#).

Cable routing

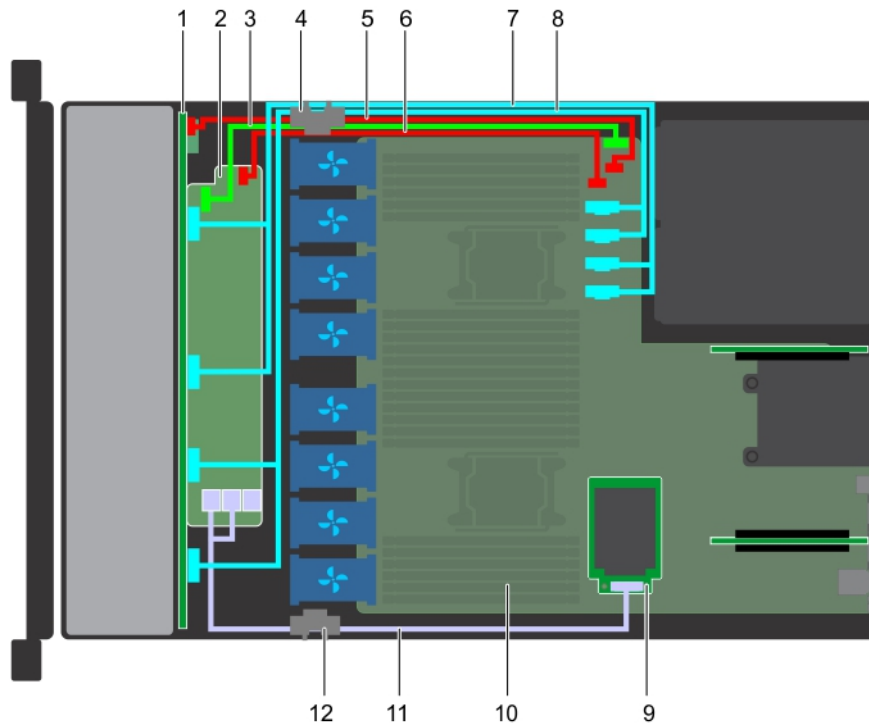

Figure 63. Cable routing - 10 x 2.5 hard drive backplane

- | | | | |
|----|-------------------------------|----|--------------------------------|
| 1 | backplane | 2 | backplane expander |
| 3 | backplane signal cable | 4 | cable routing clip |
| 5 | backplane power cable | 6 | backplane expander power cable |
| 7 | SAS cable (SAS A1 and SAS B1) | 8 | SAS cable (SAS A0 and SAS B0) |
| 9 | mini PERC card | 10 | system board |
| 11 | SAS cable | 12 | cable routing clip |

NOTE: PERC card is not supported.

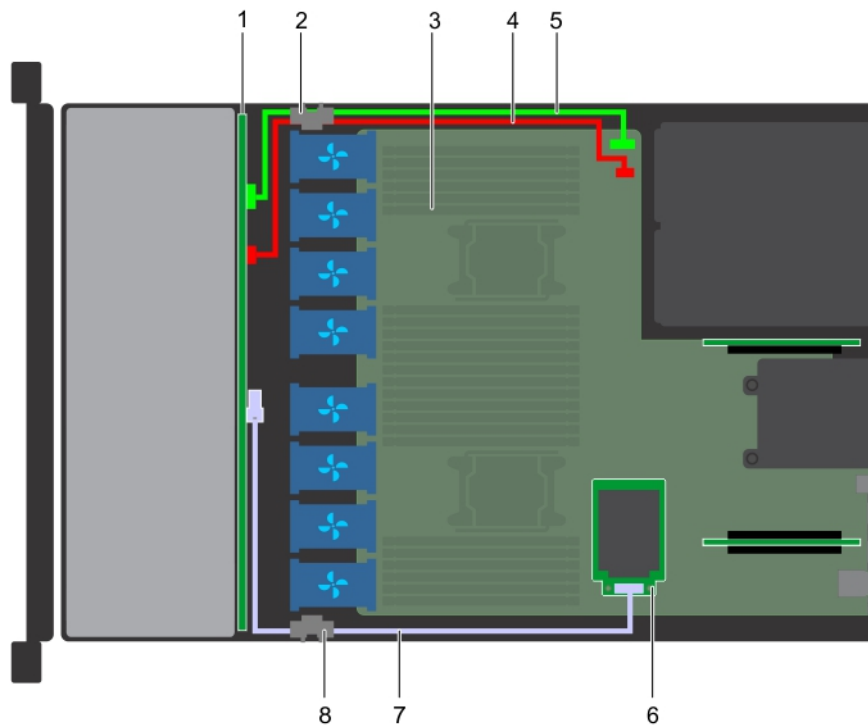

Figure 64. Cable routing - 4 x 3.5 hard drive backplane

- | | | | |
|---|------------------------|---|-----------------------|
| 1 | hard drive backplane | 2 | cable routing clip |
| 3 | system board | 4 | backplane power cable |
| 5 | backplane signal cable | 6 | mini PERC card |
| 7 | SAS cable | 8 | cable routing clip |

NOTE: PERC card is not supported.

System battery

The system battery is used for low-level system functions such as powering the real-time and date settings of the system.

Replacing the system battery

Prerequisites

WARNING: There is a danger of a new battery exploding if it is incorrectly installed. Replace the battery only with the same or equivalent type recommended by the manufacturer. For more information, see the safety information that shipped with your system.

- 1 Follow the safety guidelines listed in [Safety instructions](#).
- 2 Follow the procedure listed in [Before working inside your system](#).
- 3 If applicable, disconnect the power or data cables from expansion card(s) in the expansion card riser 1A.
- 4 Remove the [expansion card riser 1A](#).

Steps

- 1 Locate the battery socket. For more information, see [System board jumpers and connectors](#).

CAUTION: To avoid damage to the battery connector, you must firmly support the connector while installing or removing a battery.

- 2 Use a plastic scribe to pry out the system battery as shown in the following illustration:



Figure 65. Removing the system battery

- 3 To install a new system battery, hold the battery with the positive side facing up and slide it under the securing tabs.
- 4 Press the battery into the connector until it snaps into place.

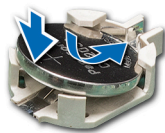

Figure 66. Installing the system battery

Next steps

- 1 Install the [expansion card riser 1A](#).
- 2 If applicable, connect the cables to the expansion card(s) in the expansion card riser 1A.
- 3 Follow the procedure listed in [After working inside your system](#).
- 4 While booting, press F2 to enter the System Setup and ensure that the battery is operating properly.
- 5 Enter the correct time and date in the System Setup **Time** and **Date** fields.
- 6 Exit the System Setup.

USB module

An additional USB port can be added to the front of the system. Depending on the configuration of your system, you can add either a USB 3.0 or USB 2.0 module. The USB module cable connects to the internal USB port on the system board.

Removing the USB module

Prerequisites

- 1 Follow the safety guidelines listed in [Safety instructions](#).
- 2 Follow the procedure listed in [Before working inside your system](#).
- 3 Remove the [backplane cover](#).
- 4 Remove the [air shroud](#).

NOTE: Ensure that you note the routing of the cables as you remove them from the system board. Route these cables properly when you replace them to prevent them from being pinched or crimped.

NOTE: The procedure to remove the USB 3.0 and USB 2.0 modules is similar.

Steps

- 1 Disconnect the USB cable from the USB connector on the system board. For more information, see [System board jumpers and connectors](#).
- 2 Using Phillips #1 screwdriver, remove the screws on the USB module.
- 3 Slide the module out of the system until it is free of the USB module slot on the front panel.

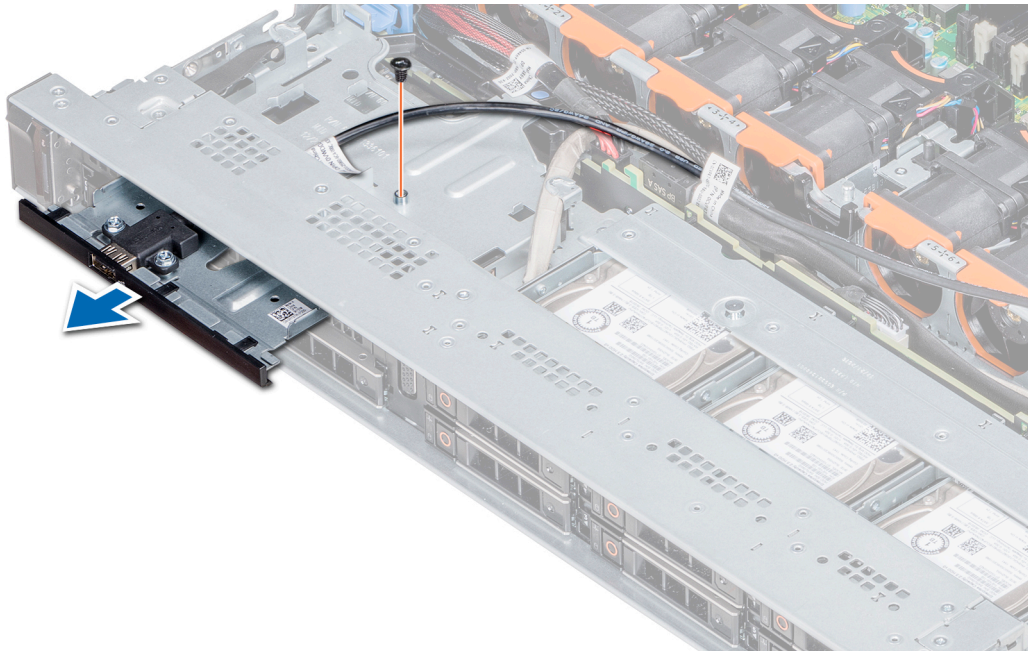

Figure 67. Removing the USB module

Next step

Install the [USB module](#).

Installing the USB module

Prerequisite

Follow the safety guidelines listed in [Safety instructions](#).

NOTE: The procedure to install the USB 3.0 and USB 2.0 modules is similar.

Steps

- 1 Route the USB cable on the USB module, through the USB slot on the front panel.
- 2 Insert the USB module into the slot on the front panel.
- 3 Align the screw on the module with the screw hole on the system.
- 4 Using the Phillips #1 screwdriver, replace the screw to secure the module to the system.
- 5 Route the USB cable and connect it to the USB connector on the system board. For more information, see [System board jumpers and connectors](#).

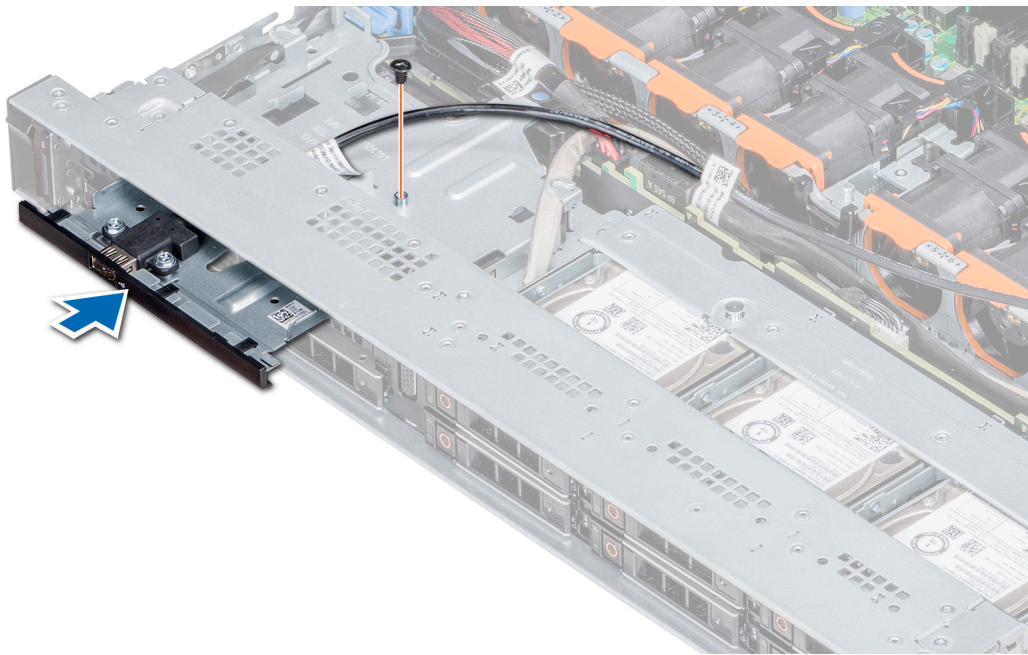

Figure 68. Installing the USB module

Next steps

- 1 Install the [air shroud](#).
- 2 Install the [backplane cover](#).
- 3 Follow the procedure listed in [Before working inside your system](#).

Power supply units

The power supply unit (PSU) is an internal hardware component which supplies power to the components in the system.

Your system supports one of the following:

- Two 2000 W, 1600 W, 1100 W, or 750 W AC PSUs
- Two 1100 W DC PSUs

NOTE: For more information, see [Technical specifications](#).

CAUTION: If two PSUs are installed, both the PSUs must have the same type of label. For example, Extended Power Performance (EPP) label. Mixing PSUs from previous generations of XC Series Appliance and XC Core System is not supported, even if the PSUs have the same power rating. Mixing PSUs will result in mismatch condition or failure to turn the system on.

NOTE: Titanium PSU is nominally rated for 200 V AC to 240 V AC input only.

NOTE: When two identical PSUs are installed, power supply redundancy (1+1 – with redundancy or 2+0 – without redundancy) is configured in system BIOS. In redundant mode, power is supplied to the system equally from both PSUs when Hot Spare is disabled. When Hot Spare is enabled, one of the PSUs is put into the sleep mode when system utilization is low in order to maximize efficiency.

NOTE: If two PSUs are used, they must be of the same maximum output power.

Hot spare feature

Your system supports the hot spare feature that significantly reduces the power overhead associated with power supply unit (PSU) redundancy.

When the hot spare feature is enabled, one of the redundant PSUs is switched to the sleep state. The active PSU supports 100 percent of the system load, thus operating at higher efficiency. The PSU in the sleep state monitors output voltage of the active PSU. If the output voltage of the active PSU drops, the PSU in the sleep state returns to an active output state.

If having both PSUs active is more efficient than having one PSU in the sleep state, the active PSU can also activate the sleeping PSU.

The default PSU settings are as follows:

- If the load on the active PSU is more than 50 percent of PSU rated power wattage, then the redundant PSU is switched to the active state.
- If the load on the active PSU falls below 20 percent of PSU rated power wattage, then the redundant PSU is switched to the sleep state.

You can configure the hot spare feature by using the iDRAC settings. For more information, see the iDRAC User's Guide available at Dell.com/idracmanuals.

Removing a power supply unit blank

Prerequisite

Follow the safety guidelines listed in [Safety instructions](#).

Step

If you are installing a second PSU, remove the PSU blank in the bay by pulling the blank outward.

CAUTION: To ensure proper system cooling, the PSU blank must be installed in the second PSU bay in a non-redundant configuration. Remove the PSU blank only if you are installing a second PSU.

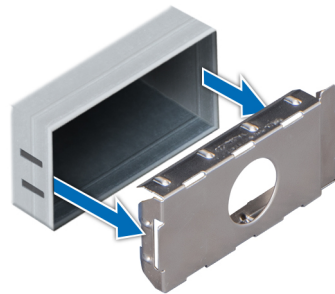

Figure 69. Removing a power supply unit blank

Next step

Install the [PSU blank](#).

Installing a power supply unit blank

The procedure for installing AC and DC PSUs is identical.

Prerequisites

- 1 Follow the safety guidelines listed in [Safety instructions](#).
- 2 Install the power supply unit (PSU) blank only in the second PSU bay.

Step

Align the PSU blank with the PSU slot and push it into the PSU slot until it clicks into place.

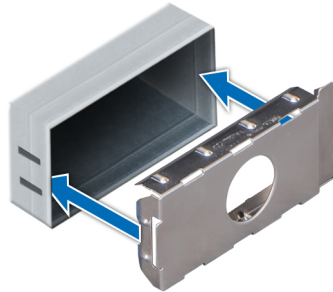

Figure 70. Installing a power supply unit blank

Removing a power supply unit

The procedure for removing AC and DC PSUs is identical.

Prerequisites

⚠ CAUTION: The system needs one power supply unit (PSU) for normal operation. On power-redundant systems, remove and replace only one PSU at a time in a system that is powered on.

- 1 Follow the safety guidelines listed in [Safety instructions](#).
- 2 Disconnect the power cable from the power source and from the PSU you intend to remove, and then remove the cable from the strap on the PSU handle.
- 3 Unlatch and lift the optional cable management arm if it interferes with the PSU removal.

For information about the cable management arm, see the system's rack documentation at Dell.com/XCSeriesmanuals.

Step

Press the orange release latch and slide the PSU out of the system by using the PSU handle.

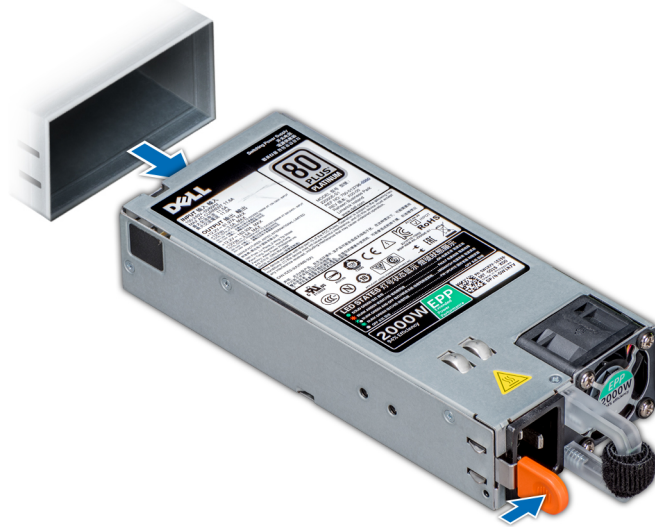

Figure 71. Removing a power supply unit

Next step

Install the [PSU](#) or the [PSU blank](#).

Installing a power supply unit

The procedure for installing AC and DC PSUs is identical.

Prerequisites

- 1 Follow the safety guidelines listed in [Safety instructions](#).
- 2 For systems that support redundant PSU, ensure that both the PSUs are of the same type and have the same maximum output power.

NOTE: The maximum output power (shown in watts) is listed on the PSU label.

Step

Slide the PSU into the system until the PSU is fully seated and the release latch snaps into place.

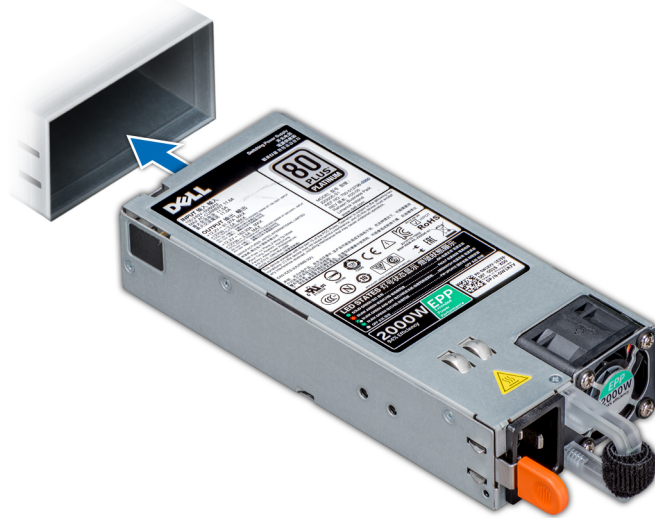

Figure 72. Installing a power supply unit

Next steps

- 1 If you have unlatched the cable management arm, relatch it. For information about the cable management arm, see the system's rack documentation at Dell.com/XCseriesmanuals.
- 2 Connect the power cable to the PSU, and plug the cable into a power outlet.

⚠ **CAUTION:** When connecting the power cable to the PSU, secure the cable to the PSU with the strap.

ℹ **NOTE:** When installing, hot swapping, or hot adding a new PSU, wait for 15 seconds for the system to recognize the PSU and determine its status. The PSU redundancy may not occur until discovery is complete. Wait until the new PSU is discovered and enabled before you remove the other PSU. The PSU status indicator turns green to signify that the PSU is functioning properly.

Wiring instructions for a DC power supply unit

Your system supports up to two $-(48-60)$ V DC power supply units (PSUs).

⚠ **WARNING:** For equipment using $-(48-60)$ V DC power supply units (PSUs), a qualified electrician must perform all connections to DC power and to safety grounds. Do not attempt connecting to DC power or installing grounds yourself. All electrical wiring must comply with applicable local or national codes and practices. Damage due to servicing that is not authorized by Dell is not covered by your warranty. Read and follow all safety instructions that came with the product.

⚠ **CAUTION:** Wire the unit with copper only, unless otherwise specified, use only 10 American Wire Gauge (AWG) wire rated minimum 90°C for source and return. Protect the $-(48-60)$ V DC (1 wire) with a branch circuit over-current protection rated 50 A for DC with a high interrupt current rating.

⚠ **CAUTION:** Connect the equipment to a $-(48-60)$ V DC supply source that is electrically isolated from the AC source (reliably grounded $-(48-60)$ V DC SELV source). Ensure that the $-(48-60)$ V DC source is efficiently secured to earth (ground).

ℹ **NOTE:** A readily accessible disconnect device that is suitably approved and rated shall be incorporated in the field wiring.

Input requirements

- Supply voltage: $-(48-60)$ V DC

- Current consumption: 32 A (maximum)

Kit contents

- Dell part number 6RYJ9 terminal block or equivalent (1)
- #6-32 nut equipped with lock washer (1)

Required tools

Wire-stripper pliers capable of removing insulation from size 10 AWG solid or stranded, insulated copper wire.

 **NOTE:** Use alpha wire part number 3080 or equivalent (65/30 stranding).

Required wires

- One UL 10 AWG, 2 m maximum (stranded) black wire [–(48–60) V DC].
- One UL 10 AWG, 2 m maximum (stranded) red wire (V DC return).
- One UL 10 AWG, 2 m maximum, green with a yellow stripe, stranded wire (safety ground).

Assembling and connecting safety ground wire

Prerequisite

 **WARNING:** For equipment using –(48–60) V DC power supply units (PSUs), a qualified electrician must perform all connections to DC power and to safety grounds. Do not attempt connecting to DC power or installing grounds yourself. All electrical wiring must comply with applicable local or national codes and practices. Damage due to servicing that is not authorized by Dell is not covered by your warranty. Read and follow all safety instructions that came with the product.

Steps



- 1 Strip the insulation from the end of the green or yellow wire, exposing approximately 4.5 mm (0.175 inch) of copper wire.
- 2 Using a hand-crimping tool (Tyco Electronics, 58433-3 or equivalent), crimp the ring-tongue terminal (Jeeson Terminals Inc., R5-4SA or equivalent) to the green and yellow wire (safety ground wire).
- 3 Connect the safety ground wire to the grounding post on the back of the system by using a #6-32 nut equipped with a locking washer.

Assembling DC input power wires

Prerequisite

 **WARNING:** For equipment using –(48–60) V DC power supply units (PSUs), a qualified electrician must perform all connections to DC power and to safety grounds. Do not attempt connecting to DC power or installing grounds yourself. All electrical wiring must comply with applicable local or national codes and practices. Damage due to servicing that is not authorized by Dell is not covered by your warranty. Read and follow all safety instructions that came with the product.

Steps

- 1 Strip the insulation from the ends of the DC power wires, exposing approximately 13 mm (0.5 inch) of copper wire.
 **WARNING:** Reversing polarity when connecting DC power wires can permanently damage the power supply or the system.
- 2 Insert the copper ends into the mating connectors and tighten the captive screws at the top of the mating connector using a Phillips #2 screwdriver.
 **WARNING:** To protect the power supply from electrostatic discharge, the captive screws must be covered with the rubber cap before inserting the mating connector into the power supply.

- 3 Rotate the rubber cap clockwise to fix it over the captive screws.
- 4 Insert the mating connector into the power supply.

System board

A system board (also known as the motherboard) is the main printed circuit board in the system with different connectors used to connect different components or peripherals of the system. A system board provides the electrical connections to the components in the system to communicate.

NOTE: After the system board is replaced, you must update the system with the latest available BIOS and iDRAC versions. For more information, go to Dell.com/XCSeriesmanuals.

Removing the system board

Prerequisites

CAUTION: If you are using the Trusted Platform Module (TPM) with an encryption key, you may be prompted to create a recovery key during program or System Setup. Be sure to create and safely store this recovery key. If you replace this system board, you must supply the recovery key when you restart your system or program before you can access the encrypted data on your hard drives.

CAUTION: Do not attempt to remove the TPM plug-in module from the system board. Once the TPM plug-in module is installed, it is cryptographically bound to that specific system board. Any attempt to remove an installed TPM plug-in module breaks the cryptographic binding, and it cannot be re-installed or installed on another system board.

- 1 Follow the safety guidelines listed in [Safety instructions](#).
- 2 Follow the procedure listed in [Before working inside your system](#).
- 3 Remove the following:
 - a [Air shroud](#)
 - b [Power supply unit\(s\)](#)
 - c All [expansion card risers](#)
 - d [Integrated storage controller card](#)
 - e [vFlash/iDSDM module](#)
 - f [USB 3.0 module](#) (if installed)
 - g [Processors and heat sink modules](#)
 - h Processors and memory blanks (if applicable)

CAUTION: To prevent damage to the processor pins when replacing a faulty system board, ensure that you cover the processor socket with the processor protective cap.

- i [Memory modules](#) and memory module blanks
- j [Network daughter card](#)

Steps

- 1 Disconnect all cables from the system board.

CAUTION: Take care not to damage the system identification button while removing the system board from the chassis.

CAUTION: Do not lift the system board by holding a memory module, processor, or other components.

- 2 Holding the system board holder, loosen the release pin, slightly lift the system board, and then slide it toward the front of the chassis. Sliding the system board toward the front of the chassis disengages the connectors from the back of the chassis slots.
- 3 Lift the system board out of the chassis.

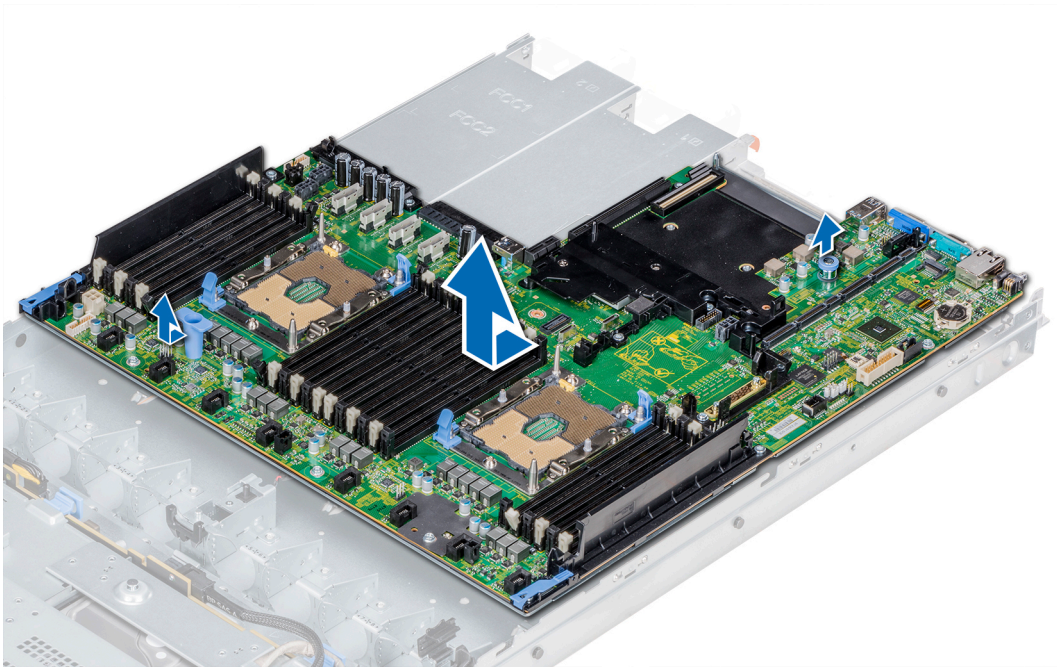

Figure 73. Removing the system board

Next step

Install the [system board](#).

Installing the system board

Prerequisite

Follow the safety guidelines listed in [Safety instructions](#).

Steps

- 1 Unpack the new system board assembly.

⚠ CAUTION: Do not lift the system board by holding a memory module, processor, or other components.

⚠ CAUTION: Take care not to damage the system identification button while placing the system board into the chassis.

- 2 Holding the system board holder and release pin, insert the system board into the system.
- 3 Holding the system board holder, push the system board toward the back of the system until the release pin clicks into place.

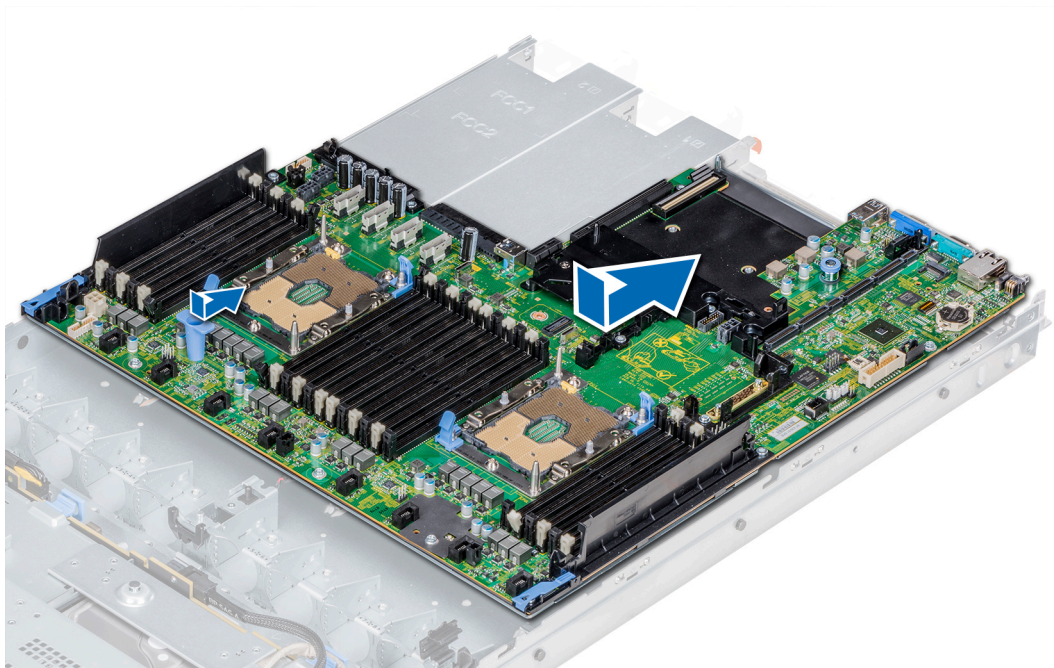

Figure 74. Installing the system board

Next steps

- 1 Install the [Trusted Platform Module \(TPM\)](#).

NOTE: The TPM plug-in module is attached to the system board and cannot be removed. A replacement TPM plug-in module is provided for all system board replacements, where a TPM plug-in module was installed.

- 2 Replace the following:
 - a [Integrated storage controller card](#)
 - b [USB 3.0 module](#) (if applicable)
 - c [iDSDM/vFlash card](#)
 - d All [expansion card risers](#)
 - e [Processors and heat sink modules](#)
 - f Processors and memory blanks (if applicable)
 - g [Memory modules](#) and memory module blanks
 - h [Network daughter card](#)
 - i [Air shroud](#)
 - j [Power supply unit\(s\)](#)

- 3 Reconnect all cables to the system board.

NOTE: Ensure that the cables inside the system are routed along the chassis wall and secured using the cable securing bracket.

- 4 Follow the procedure listed in [After working inside your system](#).
- 5 Ensure that you:
 - a If the Service Tag is not backed up in the backup flash device, enter the Service Tag manually.
 - b Update the BIOS and iDRAC versions.
 - c Re-enable the Trusted Platform Module (TPM). For more information, see [Replacing the Trusted Platform Module](#).

Trusted Platform Module

Trusted Platform Module (TPM) is a dedicated microprocessor designed to secure hardware by integrating cryptographic keys into devices. Software can use a TPM to authenticate hardware devices. Because each TPM chip has a unique and secret RSA key which is embedded during the manufacture of the TPM, it is capable of performing platform authentication operation.

Replacing the Trusted Platform Module

Prerequisites

- 1 Follow the safety guidelines listed in [Safety instructions](#).
- 2 Follow the procedure listed in [Before working inside your system](#).

NOTE:

- Ensure that your operating system supports the version of the TPM module being installed.
- Ensure that you download and install the latest BIOS firmware on your system.
- Ensure that the BIOS is configured to enable UEFI boot mode.

Steps

- 1 Locate the TPM connector on the system board.
NOTE: To locate the TPM connector on the system board, see [System board jumpers and connectors](#).
- 2 Press to hold the module down and remove the screw using the security Torx 8-bit shipped with the TPM module.
- 3 Slide the TPM module out from its connector.
- 4 Push the plastic rivet away from the TPM connector and rotate it 90° counterclockwise to release it from the system board.
- 5 Pull the plastic rivet out of its slot on the system board.
- 6 To install the TPM, align the edge connectors on the TPM with the slot on the TPM connector.
- 7 Insert the TPM into the TPM connector such that the plastic rivet aligns with the slot on the system board.
- 8 Press the plastic rivet until the rivet snaps into place.

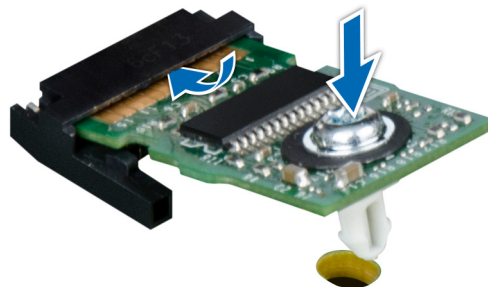

Figure 75. Installing the TPM

Next steps

- 1 Install the [system board](#).
- 2 Follow the procedure listed in [After working inside your system](#).

Initializing the TPM 1.2 for TXT users

- 1 While booting your system, press F2 to enter System Setup.
- 2 On the **System Setup Main Menu** screen, click **System BIOS > System Security Settings**.
- 3 From the **TPM Security** option, select **On with Pre-boot Measurements**.
- 4 From the **TPM Command** option, select **Activate**.
- 5 Save the settings.
- 6 Restart your system.
- 7 Enter **System Setup** again.
- 8 On the **System Setup Main Menu** screen, click **System BIOS > System Security Settings**.
- 9 From the **Intel TXT** option, select **On**.

Control panel

The control panel allows you to manually control the inputs to the XC Series Appliance and XC Core System.

Your system supports:

- Left control panel: Left control panel contains status LEDs, system ID button, and iDRAC Quick Sync 2 (optional).
- Right control panel: Right control panel contains power button, USB 2.0 ports, micro USB for iDRAC Direct, and status LED for iDRAC Direct.

Removing the left control panel

Prerequisites

- 1 Follow the safety guidelines listed in [Safety instructions](#).
- 2 Follow the procedure listed in [Before working inside your system](#).
- 3 Remove the [air shroud](#).

NOTE: Ensure that you note the routing of the cables as you remove them from the system board. You must route the cables properly when you replace them to prevent the cables from being pinched or crimped.

- 4 For ease of removal of the left control panel, remove the cooling fan #1 to access the cable latch.

Steps

- 1 Pull the cable latch and disconnect the control panel cable from the system board connector.
- 2 Using Phillips #1 screwdriver, remove the screws that secure the cable cover.

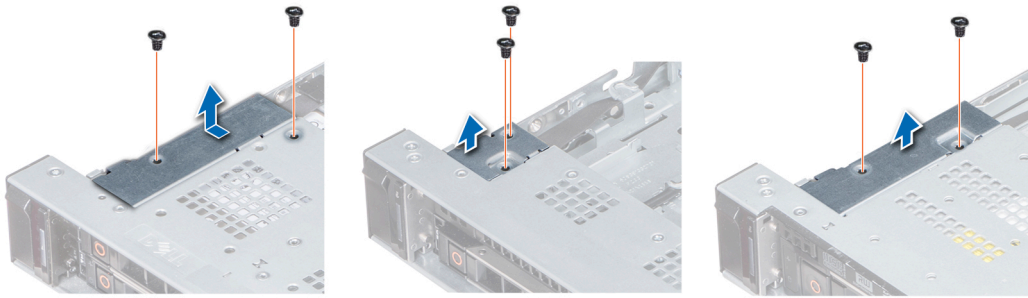

Figure 76. Removing the cable cover

- Using Phillips #1 screwdriver, remove the screws that connect the control panel to the system.

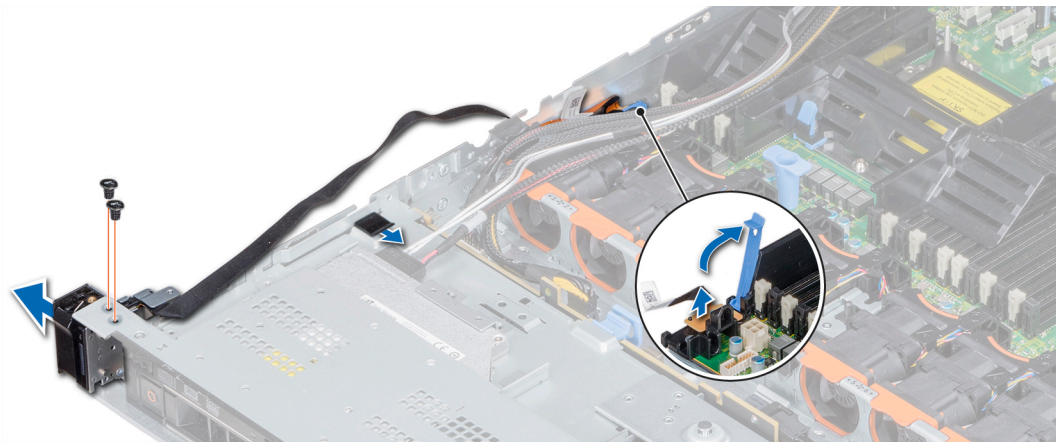

Figure 77. Removing left control panel

- Holding the control panel by its sides, remove the control panel away from the system.

Next step

Install the [left control panel](#).

Installing the left controlpanel

Prerequisite

Follow the safety guidelines listed in [Safety instructions](#).

Steps

- Route the control panel cable through the side wall of the system.
- Align the control panel with the control panel slot on the system and attach the control panel to the system.
- Connect the control panel cable to the system board connector and secure it using cable latch.
- Using Phillips #1 screwdriver, install the screws that secure the control panel to the system.

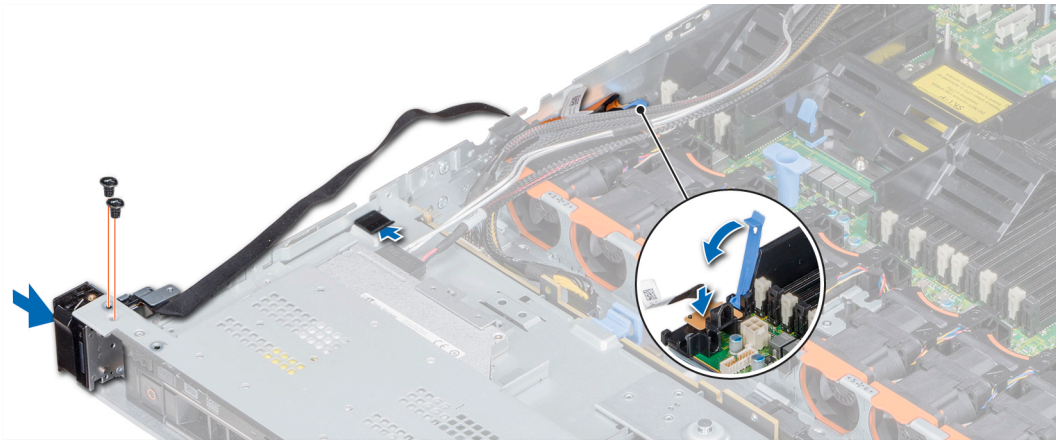

Figure 78. Installing the left control panel

- 5 Using Phillips #1 screwdriver, install the screws that secure the cable cover to the system.

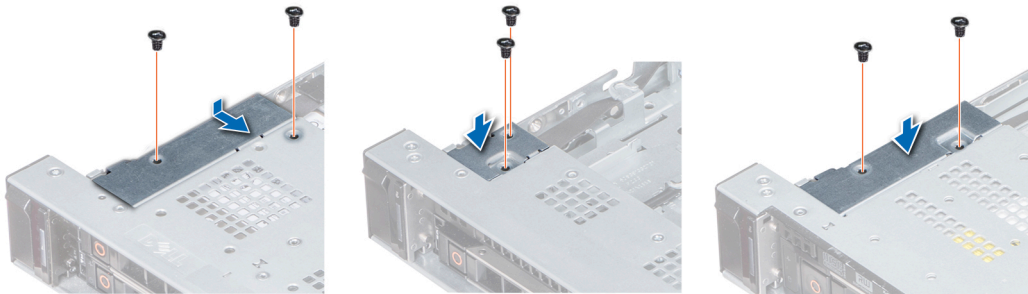

Figure 79. Installing the cable cover

Next steps

- 1 Install the [air shroud](#).
- 2 If applicable, install the [cooling fan #1](#).
- 3 Follow the procedure listed in [After working inside your system](#).

Removing the right control panel

Prerequisites

- 1 Follow the safety guidelines listed in [Safety instructions](#).
- 2 Follow the procedure listed in [Before working inside your system](#).

NOTE: Ensure that you note the routing of the cables as you remove them from the system board. You must route the cables properly when you replace them to prevent the cables from being pinched or crimped.

- 3 For ease of removal of the right control panel, remove the [cooling fan #8](#) to access the cable latch.

Steps

- 1 Pull the cable latch and disconnect the control panel cable from the system board connector.
- 2 Using Phillips #1 screwdriver, remove the screws that secure the cable cover.

Figure 80. Removing the cable cover

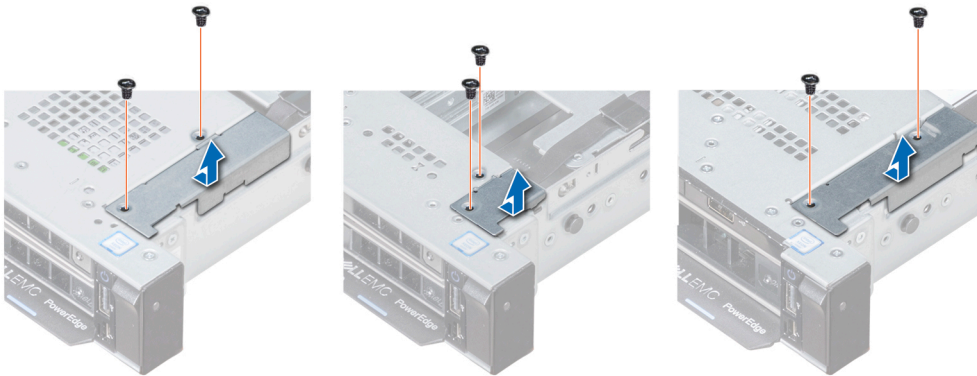

- 3 Using Phillips #1 screwdriver, remove the screws that connect the control panel to the system.

Figure 81. Removing right control panel

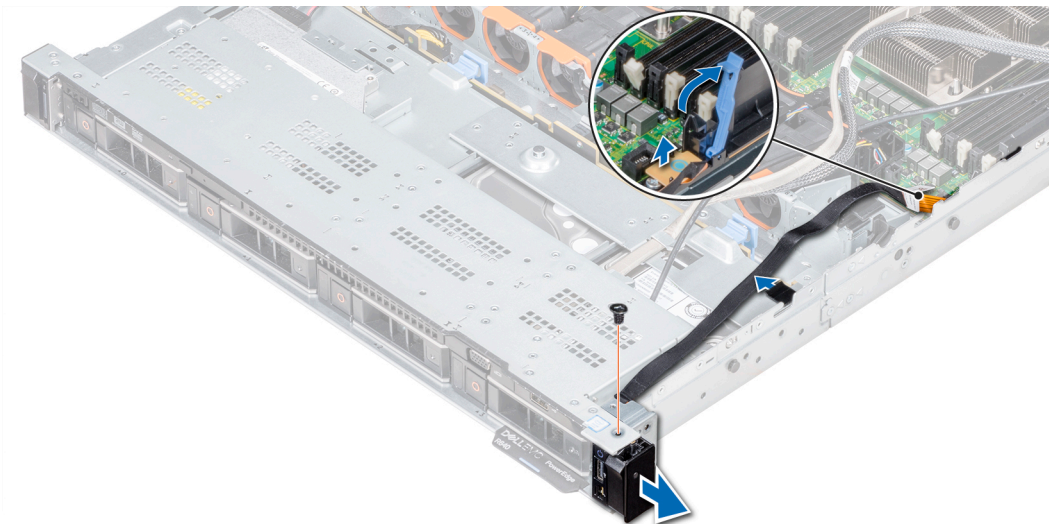

- 4 Holding the control panel by its sides, remove the control panel away from the system.

Next step

Install the [right control panel](#).

Installing the right control panel

Prerequisite

Follow the safety guidelines listed in [Safety instructions](#).

Steps

- 1 Route the control panel cable through the side wall of the system.
- 2 Align the control panel with the control panel slot on the system and attach the control panel to the system.
- 3 Connect the control panel cable to the system board and secure it using cable latch.
- 4 Using Phillips #1 screwdriver, install the screw that secures the control panel to the system.

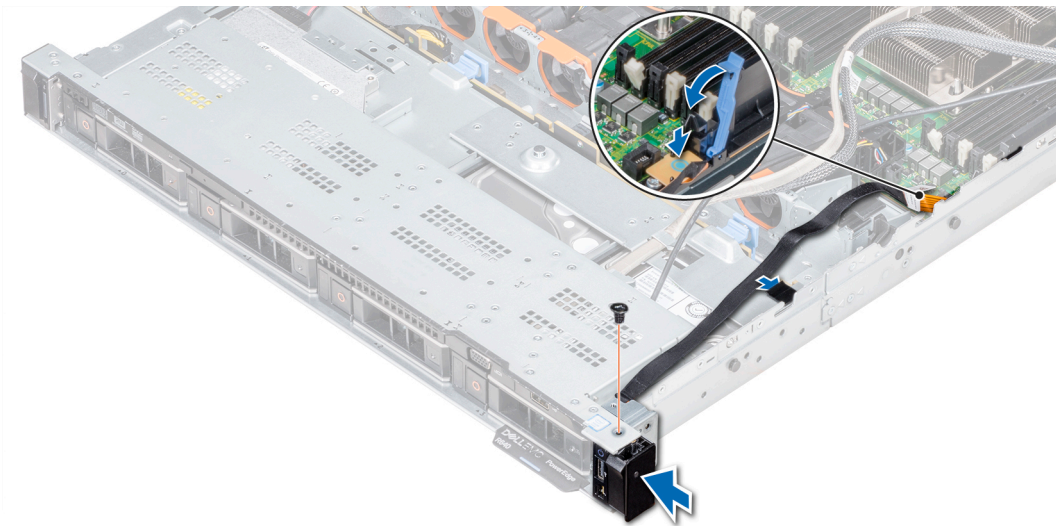

Figure 82. Installing the right control panel

- 5 Using Phillips #1 screwdriver, install the screws that secure the cable cover to the system.

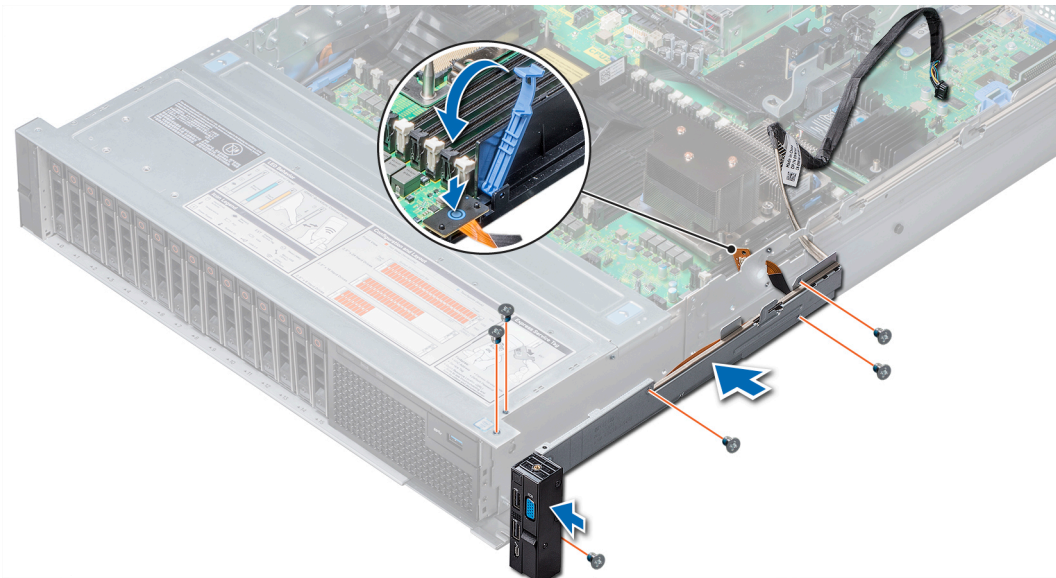

Figure 83. Installing the cable cover

Next steps

- 1 If applicable, install the [cooling fan #8](#).
- 2 Follow the procedure listed in [After working inside your system](#).

Using system diagnostics

If you experience a problem with your system, run the system diagnostics before contacting Dell for technical assistance. The purpose of running system diagnostics is to test your system hardware without using additional equipment or risking data loss. If you are unable to fix the problem yourself, service and support personnel can use the diagnostics results to help you solve the problem.

Dell Embedded System Diagnostics

NOTE: The Dell Embedded System Diagnostics is also known as Enhanced Pre-boot System Assessment (ePSA) diagnostics.

The Embedded System Diagnostics provides a set of options for particular device groups or devices allowing you to:

- Run tests automatically or in an interactive mode
- Repeat tests
- Display or save test results
- Run thorough tests to introduce additional test options to provide extra information about the failed device(s)
- View status messages that inform you if tests are completed successfully
- View error messages that inform you of problems encountered during testing

Running the Embedded System Diagnostics from Boot Manager

Run the Embedded System Diagnostics (ePSA) if your system does not boot.

- 1 When the system is booting, press F11.
- 2 Use the up arrow and down arrow keys to select **System Utilities > Launch Diagnostics**.
- 3 Alternatively, when the system is booting, press F10, select **Hardware Diagnostics > Run Hardware Diagnostics**.
The **ePSA Pre-boot System Assessment** window is displayed, listing all devices detected in the system. The diagnostics starts executing the tests on all the detected devices.

Running the Embedded System Diagnostics from the Dell Lifecycle Controller

- 1 As the system boots, press F10.
- 2 Select **Hardware Diagnostics → Run Hardware Diagnostics**.
The **ePSA Pre-boot System Assessment** window is displayed, listing all devices detected in the system. The diagnostics starts executing the tests on all the detected devices.

System diagnostic controls

Menu	Description
Configuration	Displays the configuration and status information of all detected devices.
Results	Displays the results of all tests that are run.
System health	Provides the current overview of the system performance.
Event log	Displays a time-stamped log of the results of all tests run on the system. This is displayed if at least one event description is recorded.

Jumpers and connectors

This topic provides specific information about the jumpers. It also provides some basic information about jumpers and switches and describes the connectors on the various boards in the system. Jumpers on the system board help to disable the system and setup passwords. You must know the connectors on the system board to install components and cables correctly.





Topics:

- [System board jumper settings](#)
- [System board jumpers and connectors](#)
- [Disabling forgotten password](#)

System board jumper settings

For information on resetting the password jumper to disable a password, see the [Disabling a forgotten password](#) section.

Table 46. System board jumper settings

Jumper	Setting	Description
PWRD_EN	 2 4 6 (default)	The BIOS password feature is enabled.
	 2 4 6	The BIOS password feature is disabled. iDRAC local access is unlocked at next AC power cycle. iDRAC password reset is enabled in F2 iDRAC settings menu.
NVRAM_CLR	 1 3 5 (default)	The BIOS configuration settings are retained at system boot.
	 1 3 5	The BIOS configuration settings are cleared at system boot.

System board jumpers and connectors

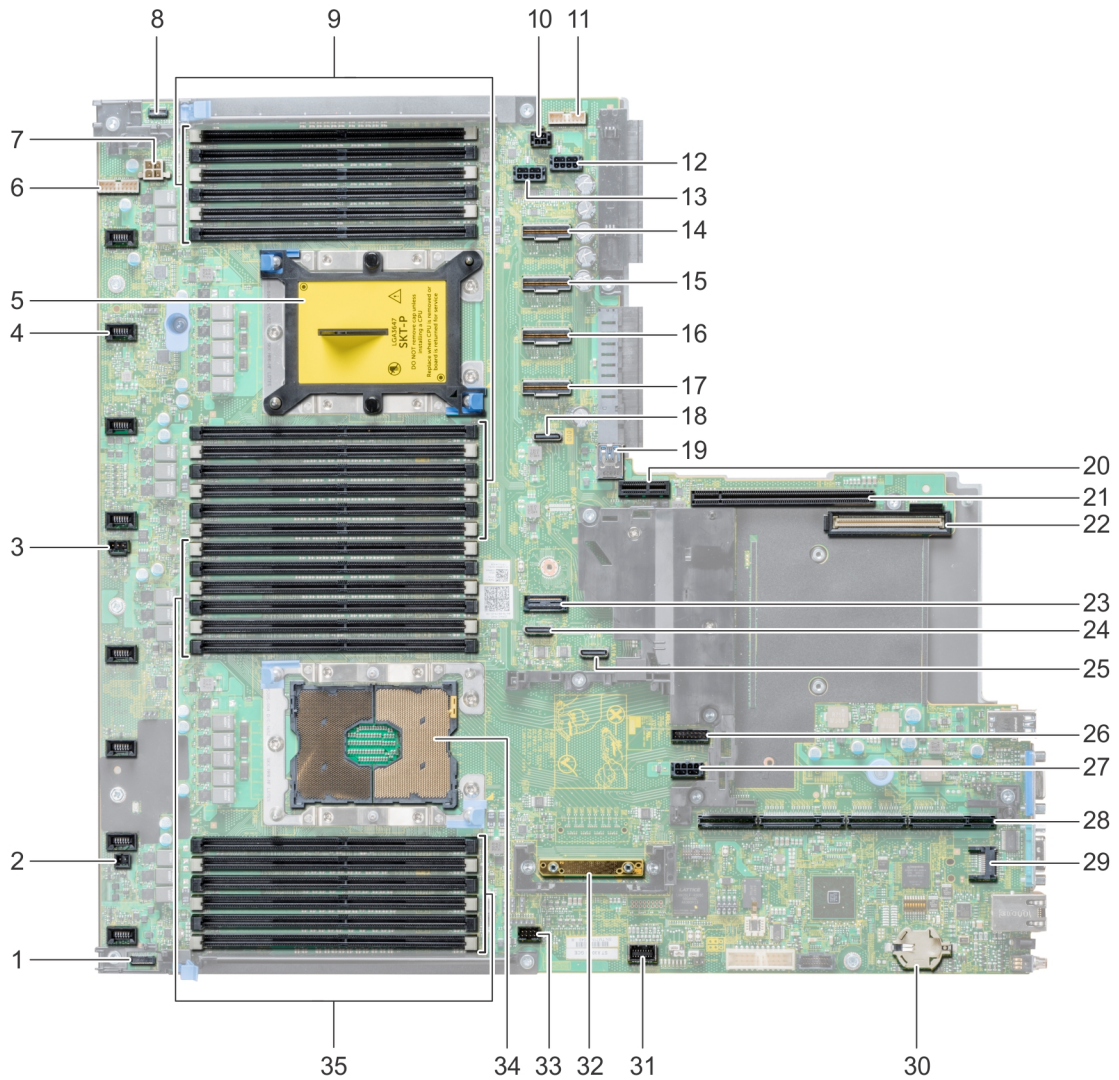

Figure 84. System board jumpers and connectors

Table 47. System board jumpers and connectors

Item	Connector	Description
1.	P_RG1_CP	Right panel connector
2.	J_WS_PWRBTN	Power button connector
3.	J_INTRUSION_DET1	Intrusion switch connector
4.	J_FAN1U_2	Cooling fan connector
5.	CPU2	Processor socket 2
6.	J_BATT_SIG	Battery signal connector
7.	J_BATT_PWR	Battery power connector

Item	Connector	Description
8.	CP	Left control panel connector
9.	B6, B12, B5, B11, B4, B10, B7, B1, B8, B2, B9, B3	Memory module sockets
10.	J_ODD	Optical drive connector
11	J_BP_SIG1	Backplane signal connector 1
12	J_BP1	Backplane connector 1
13	J_BP2	Backplane connector 2
14	J_STORAGE_M4	SAS connector 4
15	J_STORAGE_M3	SAS connector 3
16	J_STORAGE_M2	SAS connector 2
17	J_STORAGE_M1	SAS connector 1
18	J_SATA_C	SATA connector
19	J_USB_INT	Internal USB port
20	J_IDSDM_vFLASH	IDSMD/vFlash module connector
21	J_RISER2	Riser 2 connector
22	J_NDC	Network Daughter Card connector
23	J1	SATA connector
24	J_SATA_B	SATA connector
25	J_SATA_A	SATA connector
26	J_BP_SIG0	Backplane signal connector 0
27	J_BPO	Backplane power connector
28	J_R1_SS82_2	Riser 1 connector
29	J_TPM_MODULE1	TPM module connector
30	BATTERY	Battery connector
31	J_VGA	VGA connector
32	J_STORAGE1	Mini PERC controller connector
33	J_USB_INT1	USB connector
34	CPU1	Processor socket 1
35	A6, A12, A5, A11, A4, A10, A7, A1, A8, A2, A9, A3	Memory module sockets

NOTE: PERC card is not supported.

Disabling forgotten password

The software security features of the system include a system password and a setup password. The password jumper enables or disables password features and clears any password(s) currently in use.

Prerequisite

⚠ CAUTION: Many repairs may only be done by a certified service technician. You should only perform troubleshooting and simple repairs as authorized in your product documentation, or as directed by the online or telephone service and support team. Damage due to servicing that is not authorized by Dell is not covered by your warranty. Read and follow the safety instructions that are shipped with your product.

Steps

- 1 Turn off the system, including any attached peripherals, and disconnect the system from the electrical outlet.
- 2 Remove the system cover.
- 3 Move the jumper on the system board jumper from pins 2 and 4 to pins 4 and 6.
- 4 Install the system cover.

The existing passwords are not disabled (erased) until the system boots with the jumper on pins 4 and 6. However, before you assign a new system and/or setup password, you must move the jumper back to pins 2 and 4.

ⓘ NOTE: If you assign a new system and/or setup password with the jumper on pins 4 and 6, the system disables the new password(s) the next time it boots.

- 5 Reconnect the system to its electrical outlet and turn on the system, including any attached peripherals.
- 6 Turn off the system, including any attached peripherals, and disconnect the system from the electrical outlet.
- 7 Remove the system cover.
- 8 Move the jumper on the system board jumper from pins 4 and 6 to pins 2 and 4.
- 9 Install the system cover.
- 10 Reconnect the system to its electrical outlet and turn on the system, including any attached peripherals.
- 11 Assign a new system and/or setup password.

Getting help

Topics:

- [Receiving automated support with SupportAssist](#)
- [Contacting Dell EMC](#)
- [Documentation feedback](#)
- [Accessing system information by using QRL](#)

Receiving automated support with SupportAssist

Dell EMC SupportAssist is an optional Dell EMC Services offering that automates technical support for your Dell EMC server, storage, and networking devices. By installing and setting up a SupportAssist application in your IT environment, you can receive the following benefits:

- **Automated issue detection** — SupportAssist monitors your Dell EMC devices and automatically detects hardware issues, both proactively and predictively.
- **Automated case creation** — When an issue is detected, SupportAssist automatically opens a support case with Dell EMC Technical Support.
- **Automated diagnostic collection** — SupportAssist automatically collects system state information from your devices and uploads it securely to Dell EMC. This information is used by Dell EMC Technical Support to troubleshoot the issue.
- **Proactive contact** — A Dell EMC Technical Support agent contacts you about the support case and helps you resolve the issue.

The available benefits vary depending on the Dell EMC Service entitlement purchased for your device. For more information about SupportAssist, go to Dell.com/supportassist.

Contacting Dell EMC

Prerequisite

NOTE: If you do not have an active internet connection, you can find contact information on your purchase invoice, packing slip, bill, or Dell EMC product catalog.

About this task

Dell EMC provides several online and telephone-based support and service options. Availability varies by country and product, and some services may not be available in your area. To contact Dell EMC for sales, technical support, or customer service issues:

Steps

- 1 Go to Dell.com/support.
- 2 Select your country from the drop-down menu on the bottom right corner of the page.
- 3 For customized support:
 - a Enter your system Service Tag in the **Enter your Service Tag** field.
 - b Click **Submit**.The support page that lists the various support categories is displayed.
- 4 For general support:
 - a Select your product category.
 - b Select your product segment.
 - c Select your product.The support page that lists the various support categories is displayed.

- 5 For contact details of Dell EMC Global Technical Support:
 - a Click **Global Technical Support**.
 - b The **Contact Technical Support** page is displayed with details to call, chat, or e-mail the Dell EMC Global Technical Support team.

Documentation feedback

You can rate the documentation or write your feedback on any of our Dell EMC documentation pages and click **Send Feedback** to send your feedback.

Accessing system information by using QRL

You can use the Quick Resource Locator (QRL) to get immediate access to the information about your system.

Prerequisites

Ensure that your smartphone or tablet has the QR code scanner installed.

The QRL includes the following information about your system:

- How-to videos
- Reference materials, including the Installation and Service Manual, LCD diagnostics, and mechanical overview
- Your system service tag to quickly access your specific hardware configuration and warranty information
- A direct link to Dell to contact technical support and sales teams

Steps

- 1 Go to **Dell.com/QRL**, and go to to your specific product or
- 2 Use your smartphone or tablet to scan the model-specific Quick Resource (QR) code on your Dell EMC XC Series Appliance and XC Core System or in the Quick Resource Locator section.

Quick Resource Locator

Use the Quick Resource Locator (QRL) to get immediate access to system information and how-to videos. This can be done by visiting **Dell.com/QRL** or by using your smartphone or tablet and a model-specific Quick Resource (QR) code located on your Dell EMC system. To try out the QR code, scan the following image.



Figure 85. Quick Resource Locator

BOSS card

Introduction to BOSS card

BOSS is a simple RAID solution card designed specifically for booting a system's operating system. The card supports up to two 6 Gbps M.2 SATA drives. The BOSS adapter card has a x8 connector using PCIe gen 2.0 x2 lanes, available only in the low-profile and half-height form factor. The BOSS modular card has a dedicated slot in blade systems.

NOTE: There are no status LEDs on the BOSS card.

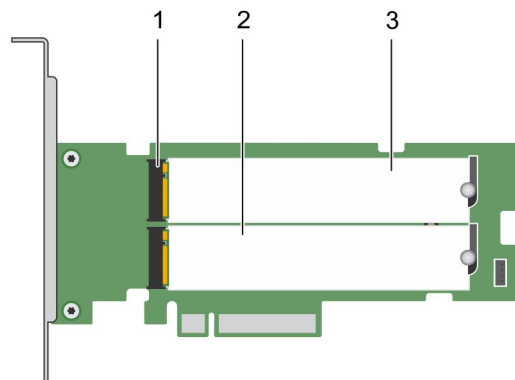

Figure 86. Features of BOSS card

- | | | | |
|---|--------------------------|---|------------------------|
| 1 | SATA drive connector (2) | 2 | 80 mm M.2 SATA drive 1 |
| 3 | 80 mm M.2 SATA drive 2 | | |

Supported operating systems

The BOSS card supports the following minimum supported versions of operating systems:

- Microsoft Windows Server 2016
- VMware ESXi 6.0 Update 3
- VMware ESXi 6.5

NOTE: For the latest list of supported operating systems and driver installation instructions, see the system documentation at Dell.com/operatingsystemmanuals. For specific operating system service pack requirements, see the Drivers and Downloads section at Dell.com/support/manuals.

Supported XC Series Appliance and XC Core System

The following XC Series Appliance and XC Core System support the BOSS adapter card:

- XC640
- XC6420
- XC740xd
- XC940

BOSS card features

BOSS card supports the following features:

- Foreign Import
- SMART Info
- Auto-Rebuild

Foreign Import

A virtual disk is considered foreign if it is not native to the adapter.

- A virtual disk is considered native to the adapter if:
 - The virtual disk was created or imported on the adapter.
- A physical disk is considered native to the adapter if:
 - There is no previous virtual disk metadata on the adapter and the physical disk(s) are unconfigured.
 - All configured virtual disk(s) on the physical disk(s) are deleted.

SMART Info

SMART monitors certain physical aspects of all motors, heads, and physical disk electronics to help detect predictable physical disk failures. Data on SMART-compliant physical disks can be monitored to identify changes in values and determine whether the values are within threshold limits. Many mechanical and electrical failures display some degradation in performance before failure.

A SMART failure is also referred to as predicted failure. There are numerous factors that are predicted physical disk failures, such as a bearing failure, a broken read/write head, and changes in spin-up rate. In addition, there are factors related to read/write surface failure, such as seek error rate and excessive bad sectors.

Auto-Rebuild

A virtual disk rebuild will begin on system boot automatically if the native virtual disk is degraded and a valid rebuild target is present. A valid rebuild target is any functional drive attached to the BOSS-S1 device which is not part of the native virtual disk and is of equal or greater storage capacity. An auto-rebuild occurs without prompting the user, and any data on the rebuild target is overwritten.

Deploying the BOSS card

This section provides a set of high-level installation and removal instructions for the BOSS-S1 card.

Removing the BOSS card

About this task

CAUTION: Many repairs may only be done by a certified service technician. You should only perform troubleshooting and simple repairs as authorized in your product documentation, or as directed by the online or telephone service and support team. Damage due to servicing that is not authorized by Dell is not covered by your warranty. Read and follow the safety instructions that are shipped with your product.

Steps

1 Turn off the system, including any attached peripherals, and disconnect the system from the electrical outlet and peripherals.

NOTE: It is recommended that you always use a static mat and static strap while working on components inside system.

2 Open the system cover.

3 Locate the BOSS card on the system board.

CAUTION: To prevent damage to the card, you must hold the card by its edges only.

4 After ensuring that the PCIe bracket is unobstructed, lift the card to remove it from the connector on the system board.

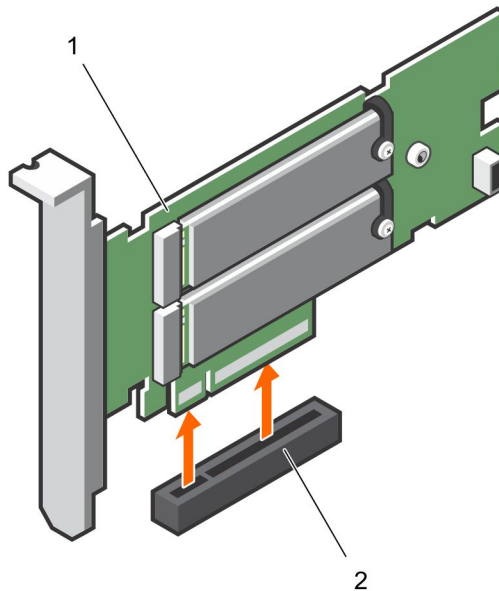

Figure 87. Removing the BOSS card

1 BOSS-S1 card

2 card connector on the system board

Removing the M.2 SSD module

About this task

CAUTION: Many repairs may only be done by a certified service technician. You should only perform troubleshooting and simple repairs as authorized in your product documentation, or as directed by the online or telephone service and support team. Damage due to servicing that is not authorized by Dell EMC is not covered by your warranty. Read and follow the safety instructions that are shipped with your product.

Steps

1 Turn off the system, including any attached peripherals, and disconnect the system from the electrical outlet and peripherals.

NOTE: It is recommended that you always use a static mat and static strap while working on components inside the system.

- 2 Open the system cover.
- 3 Remove the card. See [Removing the BOSS card](#).
- 4 Loosen the screws and lift the retention straps that secure the M.2 SSD module on the BOSS card.
- 5 Pull the M.2 SSD module away from the BOSS card.

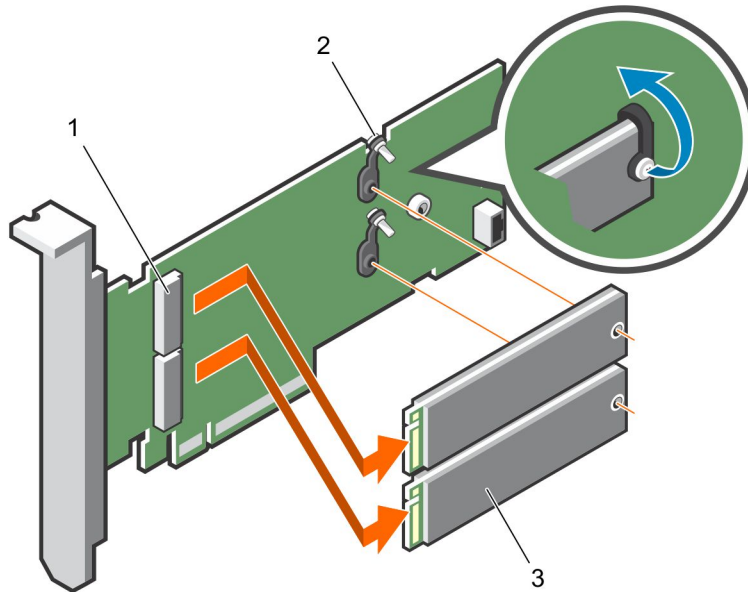

Figure 88. Removing the M.2 SSD module

- | | | | |
|---|----------------------|---|-----------|
| 1 | module connector (2) | 2 | screw (2) |
| 3 | module (2) | | |

Installing the M.2 SSD module

About this task

CAUTION: Many repairs may only be done by a certified service technician. You should only perform troubleshooting and simple repairs as authorized in your product documentation, or as directed by the online or telephone service and support team. Damage due to servicing that is not authorized by Dell is not covered by your warranty. Read and follow the safety instructions that are shipped with your product.

Steps

- 1 Align the M.2 SSD module connectors with the connectors on the BOSS card.
- 2 Align the M.2 SSD module downwards until the module is seated firmly on the card.
- 3 Secure the M.2 SSD module on the BOSS card with the screw.

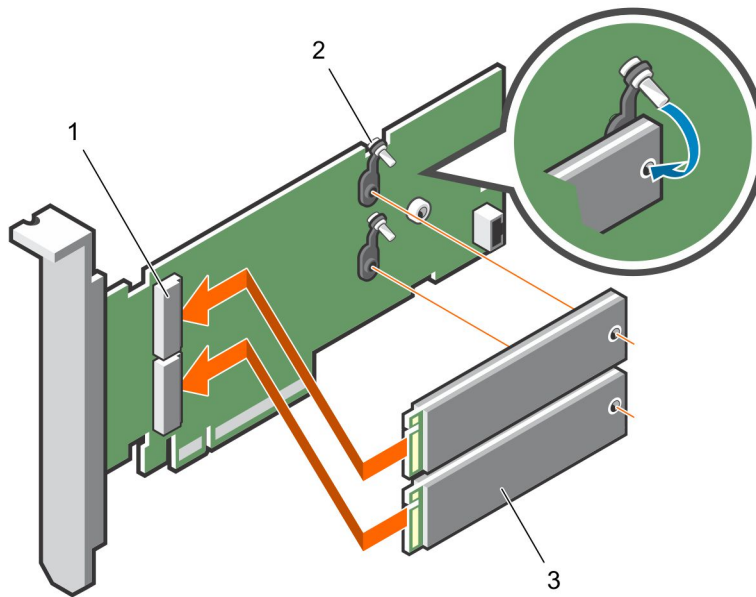

Figure 89. Installing the M.2 SSD module

- | | |
|------------------------------------------------------------------------------------------------|---------------------------------------------------------------|
| <ul style="list-style-type: none"> 1 module connector (2) 3 module (2) | <ul style="list-style-type: none"> 2 screw (2) |
|------------------------------------------------------------------------------------------------|---------------------------------------------------------------|

Installing the BOSS card

About this task

⚠ CAUTION: Many repairs may only be done by a certified service technician. You should only perform troubleshooting and simple repairs as authorized in your product documentation, or as directed by the online or telephone service and support team. Damage due to servicing that is not authorized by Dell is not covered by your warranty. Read and follow the safety instructions that are shipped with your product.

Steps

- 1 Turn off the system, including any attached peripherals, and disconnect the system from the electrical outlet and peripherals.
 - ⓘ NOTE:** It is recommended that you always use a static mat and static strap while working on components inside the system.
- 2 Open the system cover.
- 3 Hold the card by its edges and align the card connector with the connector on the system board.
 - ⚠ CAUTION:** To prevent damage to the card, you must hold the card by its edges only.
- 4 Press the card-edge down until the card is fully seated.
- 5 Close the system cover.
- 6 Reconnect the system to its electrical outlet and turn the system on, including any attached peripherals.

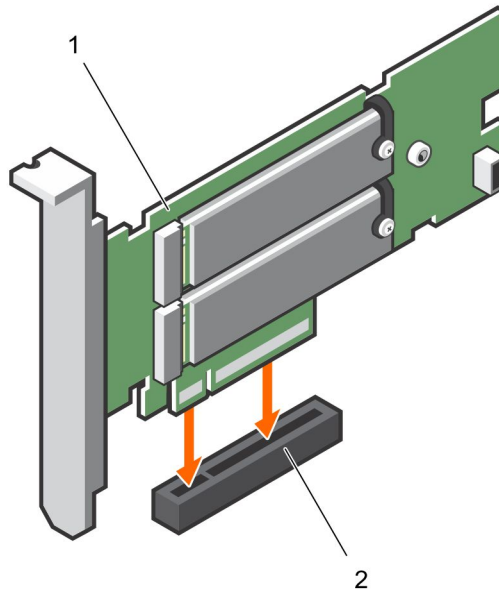

Figure 90. Installing the BOSS card

1 BOSS card

2 card connector on the system board

Driver installation

The BOSS card uses the native AHCI driver of the supported operating systems.

Windows driver installation — Dell provides the Dell Update Package (DUP) to update drivers on systems running Windows Server 2012 R2 and newer operating system. DUP is an executable application that updates drivers for specific devices. DUP supports command line interface and silent execution. For more information, see Dell.com/support.

① | **NOTE:** For more information about supported drivers, see the [Support Matrix](http://Dell.com/XCseriesmanuals) available at Dell.com/XCseriesmanuals.

BOSS troubleshooting

To get help with your Dell EMC BOSS card, you can contact your Dell EMC Technical Service representative or see Dell.com/support.

Physical disks not visible to operating system

- Issue:** One or both physical disks are not appearing for use by an operating system.
- Probable cause:** A physical disk will not be presented to the operating system in the following scenarios:
- There is RAID metadata on the physical disk and no RAID metadata on the controller.
 - The BOSS controller has RAID metadata on it and the physical disks do not have the RAID metadata on it.
- Corrective action:** If the RAID metadata is on the controller, clear the controller configuration.
If the RAID metadata is on the physical disk, erase the data available in physical disk.
- Alternatively, if you want to keep the RAID drives, see [Virtual disk not visible to operating system](#).

Virtual disk not visible to operating system

- Issue:** In RAID mode a virtual disk is not appearing for use by an operating system.
- Probable cause:** Virtual disks will not be presented to the system if they are not native to the controller.
- Corrective action:** Import the virtual disk using Hardware-Independent Imaging (HII).

Drive failure

- Issue:** An installed drive is not listed in the BOSS configuration utility. OpenManage reports **Physical Disk offline** state.
- Probable cause:** Drive is either in failure state or has corrupted firmware.
- Corrective action:** Reseat drive to ensure drive is inserted correctly. If error persists, attempt to update drive firmware using DUP. If error is still present, replace erroneous drive.

Fault in controller

- Issue:** Controller's UEFI Configuration Utility Menu entry is not appearing.
- Probable cause:** Either a firmware or a hardware fault
- Corrective action:**
- 1 Flash the latest firmware on the BOSS adapter.
 - 2 If the problem persists, shutdown the system, and then unplug the BOSS adapter.
 - 3 Plug the BOSS adapter into the PCIe slot.
 - 4 Boot the system and check the UEFI Configuration Utility Menu again.
- If the problem still persists, see [BOSS card is not detected](#).

NOTE: Ensure that the system is completely disconnected from all power sources before making any hardware changes.

NOTE: If you replace the SAS HBA330 controller you must update to the latest HBA firmware version.

BOSS card is not detected

- Issue:** BOSS device is not detected in the system.
- Probable cause:** Hardware fault on the card.
- Corrective action:** Replace the BOSS adapter with a new one.

Unable to boot to M.2 drive installed in slot 1

- Issue:** When two unconfigured bootable M.2 drives are inserted into the BOSS device, only the slot 0 drive boots.

Probable cause: Working as designed, BIOS only allows booting from the first listed boot device (in this case, slot 0) per peripheral controller. This only occurs in legacy BIOS boot mode.

Corrective action: Swap the drive in slot 1 to slot 0.

CLI reports unsupported features

Issue: Several commands, options, or other features listed by the Marvell CLI state that they are unsupported when run.

Probable cause: CLI shows the same information on all Marvell products, but only implements the functions which are pertinent to that platform or system.

Corrective action: Use supported features.