

Dell Premier Wireless ANC Headset

WL7022

User Guide

Notes, cautions, and warnings

 **NOTE:** A NOTE indicates important information that helps you make better use of your product.

 **CAUTION:** A CAUTION indicates either potential damage to hardware or loss of data and tells you how to avoid the problem.

 **WARNING:** A WARNING indicates a potential for property damage, personal injury, or death.

Chapter 1: Overview	5
Headset	5
Charge stand (charge stand model only).....	6
USB Bluetooth adapter.....	6
Chapter 2: Connect and pair	7
Connect to PC.....	7
Configure USB adapter.....	7
Pair to mobile device.....	8
Pair USB adapter again.....	8
Chapter 3: Fit and charge	10
Wear on the right or left.....	10
Charge your headset.....	10
Check headset battery status.....	11
Chapter 4: Load software	13
Chapter 5: Make/Take/End Calls	14
The basics.....	14
Answer or end a call.....	15
Call back last call (smartphone).....	15
Voice dial (smartphone).....	15
Mute	15
Mute on reminder*.....	15
OpenMic.....	15
Volume.....	15
Play or pause music.....	16
Track selection.....	16
Use sensors.....	17
ANC.....	17
Interact with Microsoft softphone.....	17
Chapter 6: More Features	18
DeepSleep Mode.....	18
Answer calls from a second device.....	18
Change language.....	18
Update firmware.....	18
What's in the box.....	19
Accessories.....	20
Chapter 7: Troubleshooting	21
Troubleshoot.....	21

Chapter 8: Safety information.....	23
Safety information.....	23
Additional information.....	24
Chapter 9: Statutory information.....	25
Chapter 10: Getting help and contacting Dell.....	26

Overview

Headset

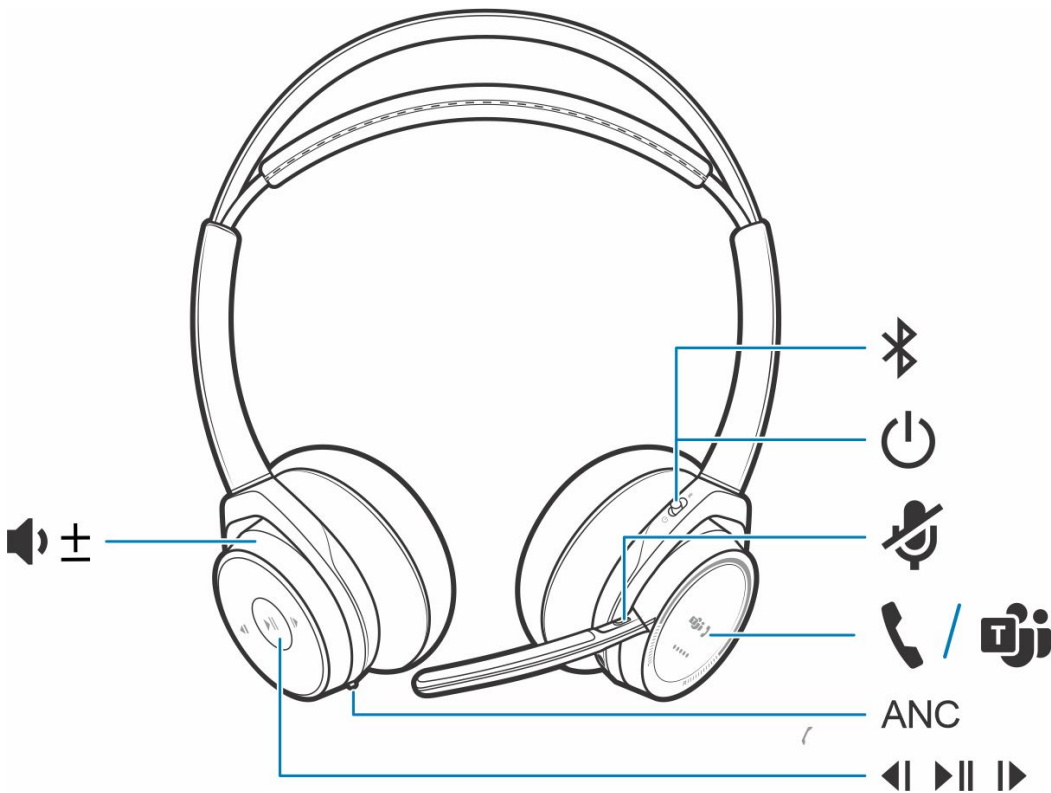



Table 1. Controls

	Volume up/down
	Track backward*
	Play/pause music*
	Track forward*
ANC	Active noise cancelling
	Charge port
	Active call = mute/unmute Idle = OpenMic (hear your surroundings)
	Headset LEDs for pairing, battery status, online indicator
	Call button ([])/Press to interact with Microsoft Teams (app required)
	Power button

Table 1. Controls (continued)

	Bluetooth pair button
---	-----------------------

NOTE: *Functionality varies by application. Does not function with web-based apps.

Charge stand (charge stand model only)

NOTE: The charge stand plugs into a computer or wall charger's USB port.

USB Bluetooth adapter

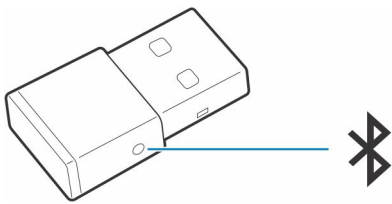

Your high-fidelity Bluetooth USB adapter comes pre-paired to your Poly device. Plug it into your computer to connect to computer audio.

NOTE: Adapter design may vary

Table 2. USB LED codes

Standard LEDs	
USB LEDs	What they mean
Flashing red and blue	Pairing
Solid blue	Headset connected
Flashing blue	On a call
Solid red	Mute active
Flashing purple	Streaming media from computer

Table 3. LED codes for Teams

LEDs when Microsoft Teams* is detected	
USB LEDs	What they mean
Flashing red and blue	Pairing
Solid purple	Microsoft Teams connected
Flashing blue	On a call
Solid red	Mute active
Pulsing purple	Microsoft Teams notification

NOTE: *Requires Microsoft Teams desktop application

Connect and pair

Connect to PC

Your Bluetooth USB adapter comes pre-paired to your headset.

Steps

1. Turn on your headset and insert the Bluetooth USB adapter into your laptop or PC.

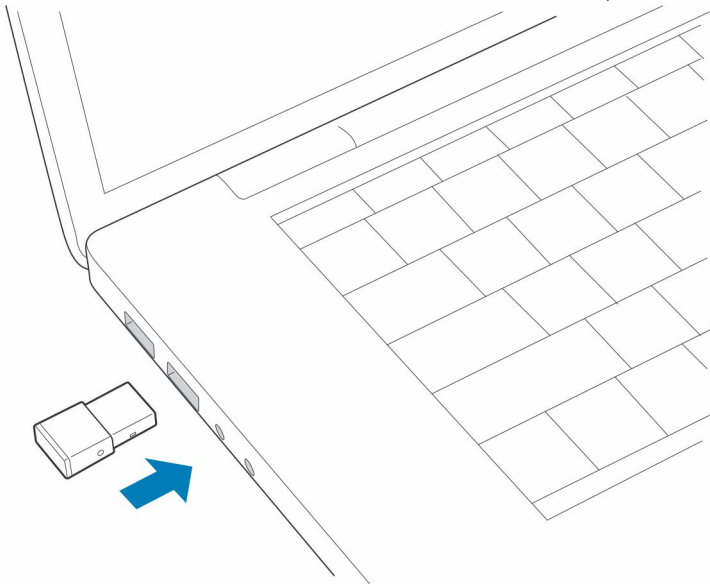

2. The USB adapter LED flashes and then turns solid to indicate the headset is connected to the USB adapter. If you are wearing your headset you hear "PC connected" to indicate the connection has been established. When on a call, the LED on the USB adapter flashes blue. When not on a call the LED is solid.
3. **OPTIONAL** Load Plantronics Hub for Windows/Mac by visiting poly.com/software or visit www.dell.com/support. This allows you to customize your headset behavior through advanced settings and options.

Configure USB adapter

Your high-fidelity Bluetooth USB adapter comes ready to take calls. If you want to listen to music, you will need to configure your Bluetooth USB adapter.

Steps

Windows

1. To configure your Bluetooth USB adapter to play music, go to **Start menu > Control Panel > Sound > Playback tab**. Select **Dell BT 100**, set it as the Default Device and click OK.
2. To pause music when you place or receive calls, go to **Start menu > Control Panel > Sound > Communications tab** and select the desired parameter.

Mac

3. To configure the Bluetooth USB adapter, go to **Apple menu > System Preferences > Sound**. On both the Input and Output tabs, select **Dell BT 100**.

Pair to mobile device

Steps

1. To put your headset in pair mode, slide and hold the Power  switch away from the off position until you hear "pairing" and the headset LEDs flash red and blue.

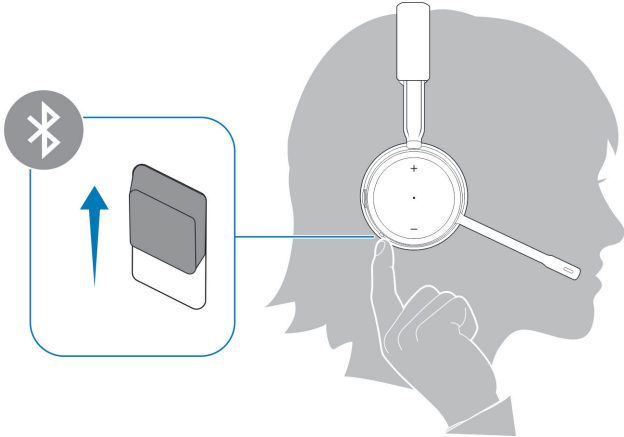

2. Activate Bluetooth on your phone and set it to search for new devices.

- *iPhone* **Settings** > **Bluetooth** > **On***
- *Android* **Settings** > **On** > **Scan for devices***

 **NOTE:** *Menus may vary by device.

3. Select **Dell ANC Headset WL7022**.

If necessary, enter four zeros (0000) for the passcode or accept the connection.

Once successfully paired, you hear "pairing successful" and the headset LEDs stop flashing.

 **NOTE:** Your headset can pair with up to 8 devices but only maintain 2 connections simultaneously; this includes the Bluetooth USB adapter.

Pair USB adapter again

Typically, your USB adapter is pre-paired to your headset. In the event that your adapter is disconnected or bought separately, you will need to pair the adapter to your headset.

Steps

1. Insert the high-fidelity Bluetooth USB adapter into your laptop or computer and wait for your computer to recognize it.
2. Put your headset in pair mode.
3. Put your Bluetooth USB adapter into pair mode by pressing and holding the recessed pair button with a pen or paperclip until the Bluetooth USB adapter flashes red and blue.

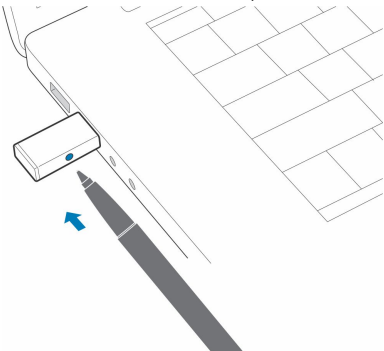

 **NOTE:** Adapter design may vary

Pairing is successful when you hear "pairing successful" and "PC connected" and the Bluetooth USB adapter LED is solid.

Fit and charge

Wear on the right or left

Steps

To position the microphone on the right or left side, rotate the microphone boom up and over. Gently bend the boom so it is approximately 2 finger widths from the corner of your mouth.

i **NOTE:** For true stereo sound, wear the boom on your right side.

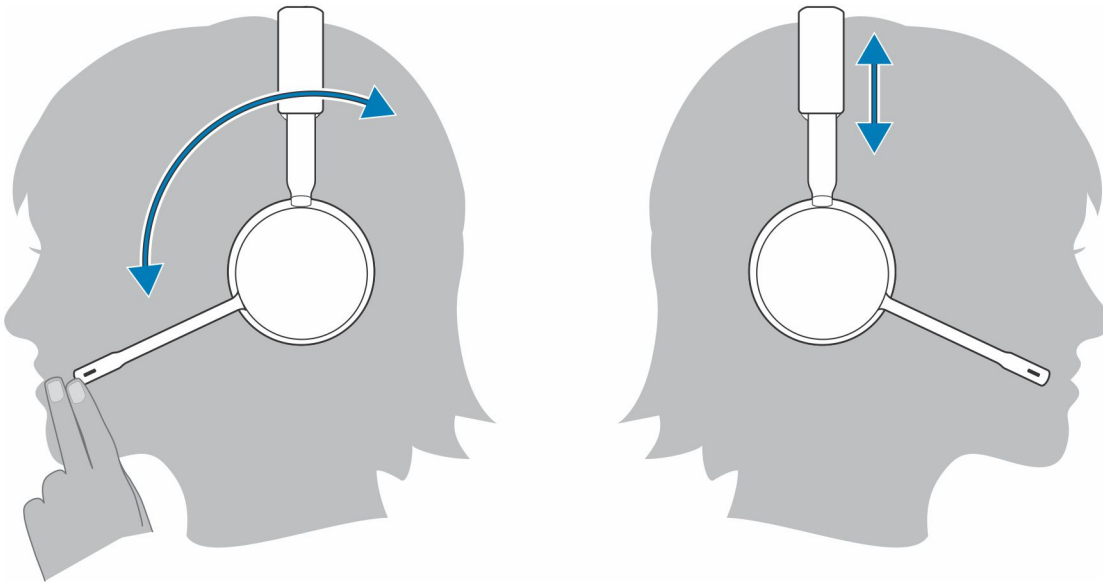

Charge your headset

Prerequisites

⚠ CAUTION: Before using, charge the headset fully to reset the accuracy of the talk time prompts.

Steps

Charge your headset with the charge stand or the micro USB cable. The headset LEDs flash when charging. It takes up to 2 hours to fully charge your headset. The LEDs turn off once charging is complete.

i **NOTE:** Both the charge stand and micro USB cable can be plugged into either a computer or wall charger. It is only necessary to plug into a computer to update firmware.

Table 4. Charging

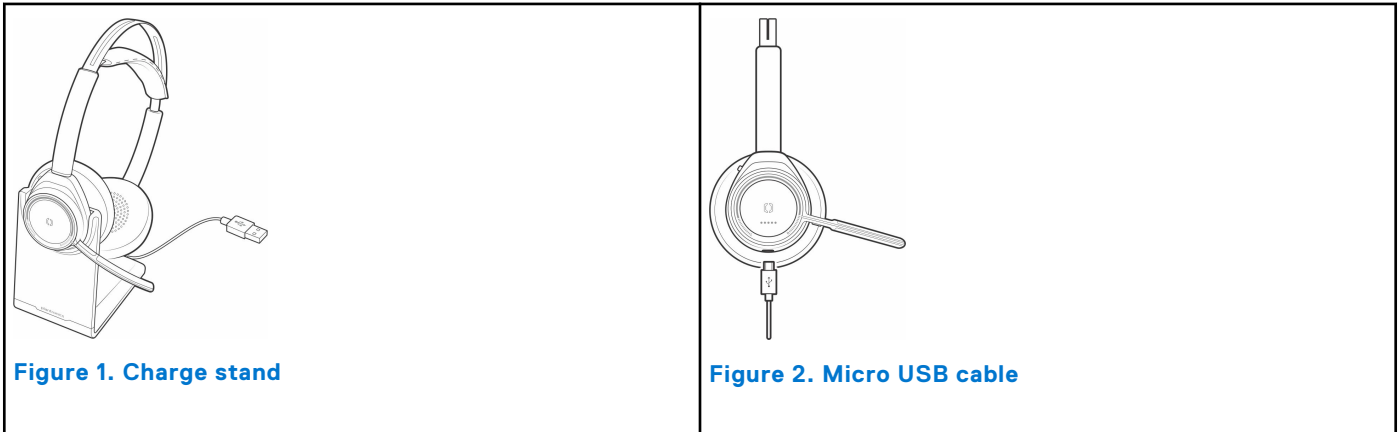



Table 5. Battery Status LEDs

Headset LEDs	Battery status
4–5 blue blinks	Battery high
2–3 blue blinks	Battery medium
1 red blink	Battery low
flashing red	Battery critical; Recharge headset

Check headset battery status

There are 3 ways to check the headset battery status. Choose:

Steps

- Plantronics Hub for iOS/Android: check the home screen
- Plantronics Hub for Windows/Mac: click on the Plantronics Hub headset icon in the system tray or menu bar to view battery status
- Slide and release the Power  switch away from the off position. Listen to the voice alert or observe the headset LEDs.

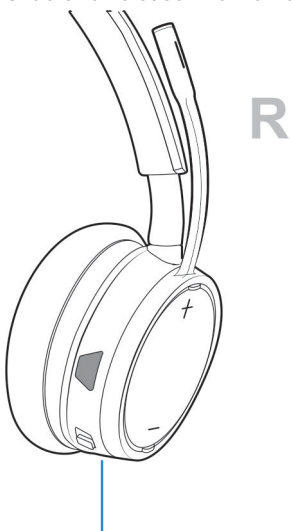



Table 6. Headset LED behavior while charging

Off	Charging complete
○○○	Battery high
○○	Battery medium
●	Battery low
⊗	Battery critical

 **NOTE:** To reset the accuracy of the talk time alert, deplete the headset battery then charge fully.

Load software

Some softphones require the installation of Plantronics Hub for Windows/Mac to enable headset call control (answer/end and mute) functionality.

Steps

Download Plantronics Hub for Windows/Mac by visiting poly.com/software or visit www.dell.com/support.

Manage your headset settings on your computer with Plantronics Hub:

- Call control for softphones
- Change headset language
- Update firmware
- Turn features on/off

Make/Take/End Calls

The basics

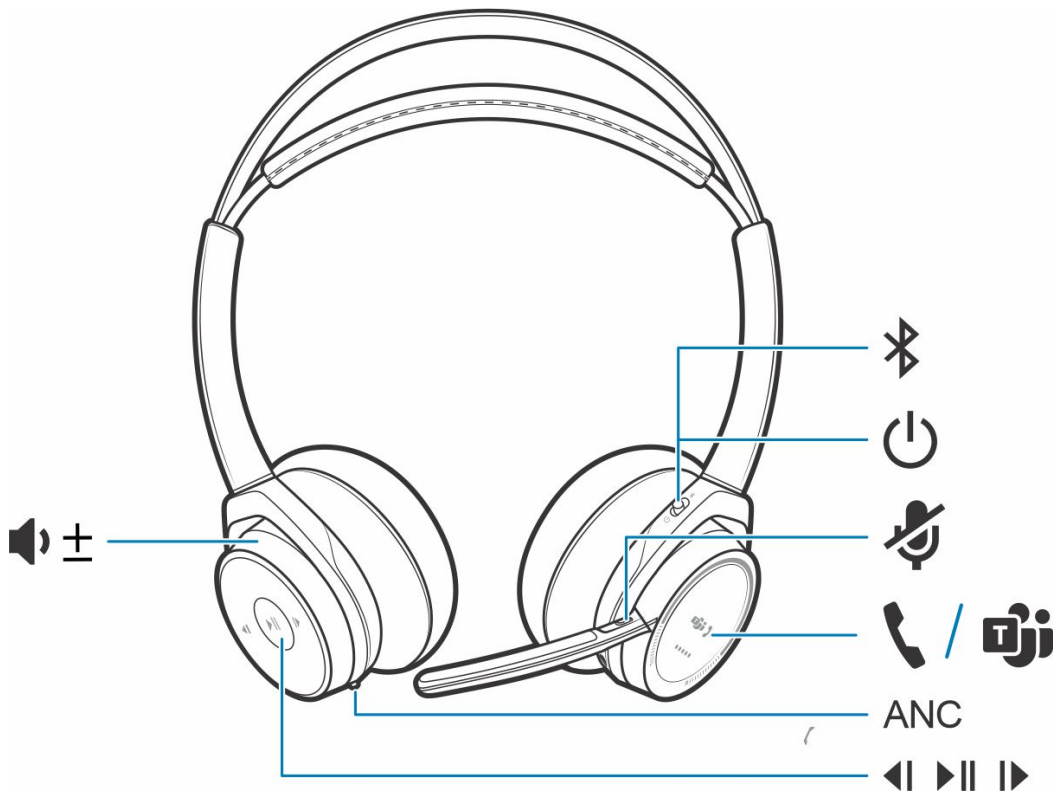



Table 7. Overview

	Volume up/down
	Track backward*
	Play/pause music*
	Track forward*
ANC	Active noise cancelling
	Charge port
	Active call = mute/unmute Idle = OpenMic (hear your surroundings)
	Headset LEDs for pairing, battery status, online indicator
	Call button ([])
	Power button

Table 7. Overview (continued)

	Bluetooth pair button
---	-----------------------

 **NOTE:** *Functionality varies by application. Does not function with web-based apps.

Answer or end a call

Steps

Tap the Call  button or use your softphone.

Call back last call (smartphone)

Steps

To dial your last number you dialed, double-tap the Call  button.

Voice dial (smartphone)

Steps

If your smartphone has a voice-enabled assistant, press and hold the Call  button for 2 seconds and wait for the phone prompt and then tell the phone to dial the number of a stored contact.

Mute

Steps

During a call, briefly press the mute button  to mute the microphone on the inline controller. To unmute press the button again.

Mute on reminder*

* Plantronics Hub for Windows and Mac required (poly.com/software or visit www.dell.com/support)

If you have muted an active call and you start to speak, then a desktop notification reminds you that you are on mute. You can add a voice prompt notification by managing your mute features with Plantronics Hub for Windows and Mac.

OpenMic

Steps

While not on a call, tap the red Mute button to activate OpenMic and hear your surroundings. Control the level of ambient noise you hear by adjusting the volume wheel.

Volume

Steps

Rotate the volume wheel  forward (+) or backward (-) to control the volume.

Play or pause music

Steps



Choose:

- Put on/take off the headset (requires active smart sensors)
- Tap the Play/pause  button

 **NOTE:** Functionality varies by application. Does not function with web-based apps.

Track selection

Steps

Double-tap the Call  button to skip to the next track or triple-tap the Call  button to play the previous track.

 **NOTE:** Functionality varies by application. May not function with web-based apps.

Use sensors

Smart sensors respond when you put on or take off your headphones.

Table 8. Sensors: Basics

With active sensors	putting on the headset will:	taking off the headset will:
Call	Answer the call	Mute the headset
Music/media	Resume music/media (if playing previous to taking off)*	Pause music/media (if playing)*
Mute	Unmute if on an active call	Mute if on an active call



 **NOTE:** *Functionality varies by application. Does not function with web-based apps.

Reset sensors

You may need to reset the sensors if they are not working as expected.

Steps



There are two ways to reset the headset sensors. Choose:

- With your headset powered on, charge your headset on the charge stand for 10 seconds
- Press and hold both the Mute  and Play/pause  buttons for more than 4 seconds until the LEDs flash purple twice, being careful to not touch the earcup padding or allow it to come in contact with surfaces

Disable sensors

Steps

You can disable your headset smart sensors several ways:

- Manage sensors through Plantronics Hub software
- Hold both the Mute  and Call  buttons for more than 4 seconds until the LED flashes purple then red. Repeat to reactivate; the LED flashes purple then blue

 **NOTE:** Sensors cannot be disabled while streaming audio.

ANC



Active Noise Canceling (ANC) reduces external noise and enhances your music and sound quality.

Steps

Your headset ships with ANC on. To turn ANC off, slide the switch away from "ANC."

Interact with Microsoft softphone

Steps

- For Microsoft Teams, tap the headset's Call  button to interact (application required).
- For Skype for Business, press and hold the headset's Call  button for 2 seconds to interact (application required).
- Set your target phone by going to Plantronics Hub for Windows/Mac > **Softphones** > **Software Settings** > **Target Softphone**

More Features

DeepSleep Mode

If you leave your headphones powered on but out of range of your paired phone or USB adapter for more than 7 days, your headset conserves its battery power by entering into DeepSleep mode.

Steps

Once back in range with your phone or USB adapter, press the Call control  button to exit DeepSleep mode.

Answer calls from a second device

It's easy to answer calls from two devices (including softphone).

About this task

When on a call, you hear a ringtone notification of the incoming call from the second paired device.

Steps

To answer a second call from the other device, first tap the Call  button to end the current call and tap the Call button again to answer the new call. If you choose to not answer the second call, it will go to voicemail.

Change language

You can change the voice prompts language of your headset (for example "mute on").

Steps

1. Download Plantronics Hub for Windows/Mac at poly.com/software or visit www.dell.com/support.
2. Dock your headset in the charge stand and plug it directly into your computer.
3. Disconnect your headset from other devices; this includes unplugging your USB adapter from the computer.
4. Open Plantronics Hub for Windows/Mac and go to **Settings** > **Language** to view language choices for voice prompts.

Update firmware

Firmware updates are designed to keep your headset current with the latest technology.

Prerequisites

Update your firmware to:

- Change voice alert/command languages
- Improve performance
- Add new features to your device

Steps

1. Download Plantronics Hub for Windows/Mac at poly.com/software or visit www.dell.com/support.

2. To update your **headset** firmware, dock your headset in the charge stand and plug it directly into your computer. Disconnect your headset from other devices; this includes unplugging your USB adapter from the computer.
3. Open Plantronics Hub for Windows/Mac and check the Updates tab for firmware update alerts.

i **NOTE:**

- Do not answer or place a call during the update

What's in the box

Contents may vary by product.

Headset

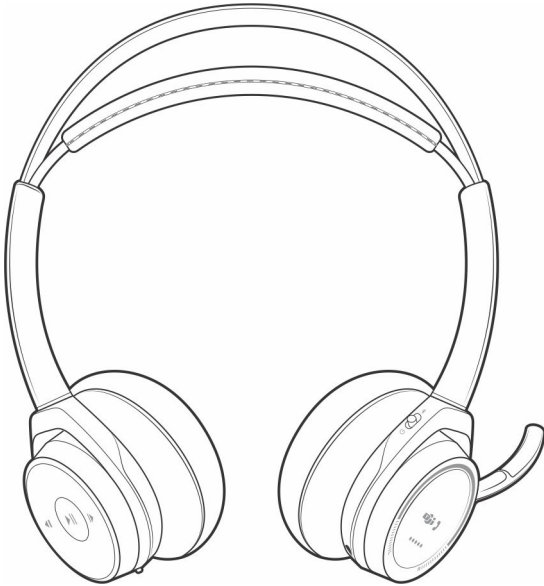

Charging stand

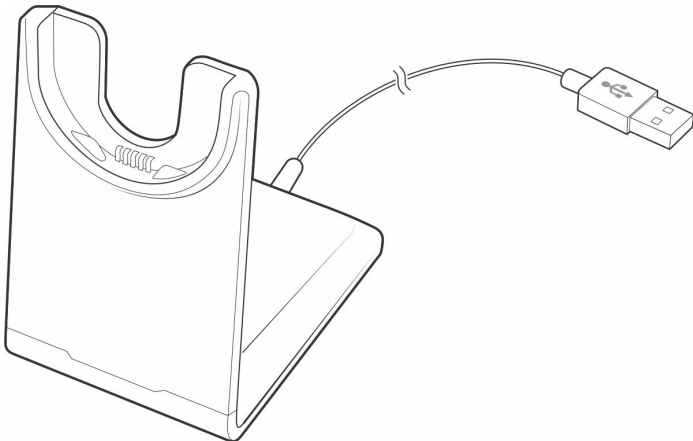

Micro USB cable

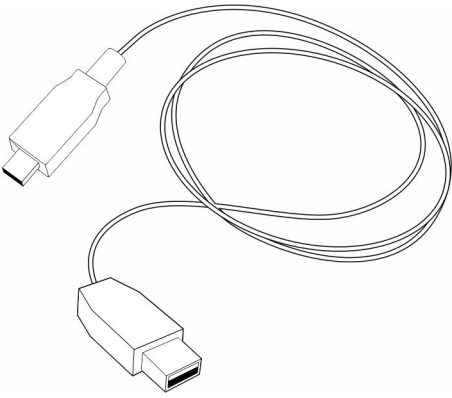

Carrying case

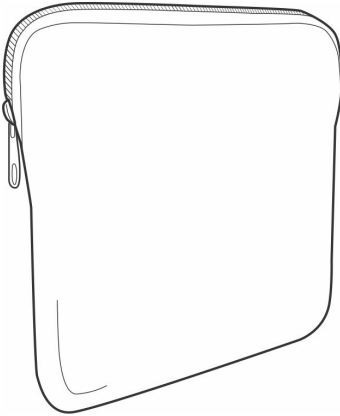

Bluetooth USB Adapter

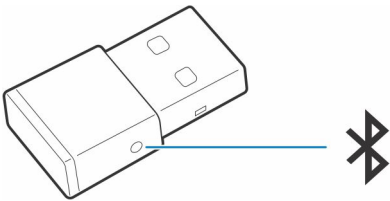

Accessories

Sold separately at poly.com/accessories.

Wall charger

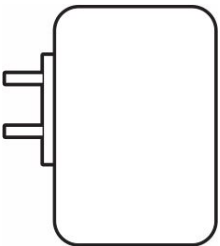

Troubleshooting

Troubleshoot

Table 9. Troubleshooting your headset



<p>When I use my headset with a softphone, the headset call control and mute buttons don't work.</p>	<p>Check the following:</p> <ul style="list-style-type: none"> • Make sure the softphone you are using is supported by viewing our software compatibility guide. • If required to enable headset control (answer/end and mute) functionality, ensure you have Plantronics Hub for Windows/Mac (v. 3.6 or later) installed. See Load software.
<p>I can't unmute my headset when I'm on a softphone call.</p>	<p>Ensure that you have Plantronics Hub for Windows/Mac v. 3.6 or later installed.</p>
<p>How do I interact with Microsoft Teams or Skype for Business?</p>	<ul style="list-style-type: none"> • For Microsoft Teams, tap the Call  button to interact. • For Skype for Business, press and hold the Call  button for 2 seconds to interact. • Set your target phone by going to Plantronics Hub for Windows/Mac > Softphones > Software Settings > Target Softphone
<p>Does my Microsoft Teams-enabled headset work with other softphones?</p>	<p>Yes, while your headset is optimized for Microsoft Teams, it can be configured to use with other supported softphones. Set your target phone by going to Plantronics Hub for Windows/Mac > Softphones > Software Settings > Target Softphone</p> <p>When you configure another softphone, the Call button:</p> <ul style="list-style-type: none"> • doesn't interact with Teams • doesn't go to Teams notifications • will not launch Cortana
<p>The headset sensors are not working as expected.</p> <ul style="list-style-type: none"> • A call is not automatically answered when I put on my headset • Mute/unmute is not working when I take on/off my headset during a call • During a call, mute unexpectedly turns on. 	<p>If your headset sensors are not working as expected, you may need to reset the sensors. See Reset sensors.</p>
<p>During a call, nobody can hear me.</p>	<p>Configure the headset as the recording/output default device.</p> <p>For Windows, go to Start menu > Control Panel > Sound > Recording tab. Select Dell BT 100, right-click, select "Select as Default Device" and click OK.</p> <p>For Mac, go to Apple menu > System Preferences > Sound > Output tab and select Dell BT 100.</p>
<p>During a call, I can't hear anybody.</p>	<p>Configure the headset as the playback/input default device.</p> <p>For Windows, go to Start menu > Control Panel > Sound > Playback tab. Select Dell BT 100, right-click, select "Select as Default Device" and click OK.</p> <p>For Mac, go to Apple menu > System Preferences > Sound > Input tab and select Dell BT 100.</p>

Table 9. Troubleshooting your headset (continued)

During a call, I get interference and drops in sound.	Your headset is configured for optimal performance during conference calls. Stereo telephony is on by default. To increase Bluetooth density, change the setting from stereo telephony to mono telephony by holding the Mute button for four seconds while not on a call, until you hear "Wideband stereo off." You can also change the setting in Plantronics Hub for Windows/Mac by going to Settings > Wireless > Extended Range Mode .
Music is not coming through my headset.	To configure your USB adapter to play music, see Configure USB adapter .
On my Mac, if I'm listening to streaming audio and take off the headset, iTunes starts playing when I put the headset back on.	This is a known issue. Turn off play/pause setting in the sensors tab of Plantronics Hub for Windows/Mac.
When I play music and a call comes in, the music is too loud or doesn't pause.	To configure your USB adapter to play music, see Configure USB adapter .
The headset talk time is not accurate.	Charge the headset fully to reset the accuracy of the talk time prompts.
I hear an echo when not on a call.	Check and see if OpenMic is on by pressing the red mute button on the boom when you are not on a call. Our exclusive OpenMic feature lets you control the level of ambient noise you hear.

Safety information

Safety information

About this task

To reduce the risk of fire, electric shock, personal injury, and property damage, read all operating instructions and the following safety instructions before using this device.

- Use only products and accessories designated for this device.
- If skin irritation develops after using this device, stop using the device and contact DELL.
- Do not let children play with small parts of the device, as they may enter the child's airways and cause choking.
- Do not disassemble the device as this may result in electric shock and other risks. Improper disassembly may cause electric shock if the phone is used again.
- If the device overheats or is damaged to the case, cord, or plug, unplug it and discontinue use.
- Using the device at high volume levels or at elevated sound pressure levels may cause temporary or permanent damage to your hearing. There is no specific volume setting that works for everyone, however, you should always adjust the volume of your headset or headphones to a medium level and avoid prolonged exposure to high volumes. The louder the sound, the faster it will lead to hearing impairment. When you use a headset or headphones with different devices, the volume of the playback sound may differ. The volume of the emitted sound depends on the device used and its settings. If you experience any discomfort, you should stop using this device with a headset or headphones and have your hearing checked by a doctor. To protect your hearing, experts recommend the following
 1. Decrease the audio volume before turning on the headset / headphones, and use the volume as low as possible.
 2. Do not try to increase the volume in order to drown out the surrounding noise. If possible, use the headset / headphones in a calm environment with low background noise.
 3. Limit the time you use your headset / headphones at high volume levels.
 4. Decrease the volume if the sound from the headphones or headset interferes with the speech of people around you. For more information on headsets or headphones and hearing related aspects, see plantronics.com/healthandsafety.
- If you use a headset or headphones while driving, check your local laws for mobile phones or headsets and focus on ensuring safe driving. Using a headset or earbuds covering both ears when driving, including bicycle, reduces your ability to hear other sounds and can pose a significant risk to you and others, and is illegal in most countries.
- If in-ear / in-ear headphones were supplied with this unit, connect and use them according to the instructions provided. Do not use force to insert the in-ear / in-ear headphones into the ear canal. If they get stuck in the ear canal, consult your doctor.
- Use only chargers supplied by DELL to charge your device and follow the charging instructions provided. In addition, if the headset is to be charged using a cell phone charger, use only chargers approved and supplied by the cell phone manufacturer for that model. Do not use the charger for any other purpose. Make sure the operating voltage matches the voltage of the power supply.

Battery Safety

- If your device has a built-in, non-replaceable battery, do not attempt to open the device or replace the battery as this could result in personal injury and / or damage to the device.
- Do not throw the product or used batteries into fire or leave in places with temperatures above 40°C (104° F).

The equipment is intended for use in residential, commercial and non-congested industrial areas. The equipment belongs to class B for electromagnetic compatibility.

Operating environment: temperature 10° C to 40° C, relative humidity: 5% to 95%.

Service life is 7 years.

Storage and transportation conditions: temperature from -20° C to 30° C, relative humidity from 5% to 95%.

Shelf life is 7 years.

Terms and conditions of sale are specified in agreements with authorized resellers.

The crossed out wheeled bin symbol indicates that used electrical and electronic equipment and batteries should not be disposed of with unsorted municipal waste; disposal of this type of waste should be carried out separately from other waste. For more information visit poly.com

The equipment meets the requirements of the Technical Regulations of the Customs Union "Electromagnetic compatibility of technical equipment" (TR CU 020/2011).

The equipment meets the requirements of the Technical Regulations of the Eurasian Economic Union "On the Restriction of the Use of Hazardous Substances in Electrical and Electronic Products" (TR EAEU 037/2016).

Additional information

Manufacturer

Plantronics Inc.

345 Encinal Street,

Santa Cruz, CA95060, United States of America

COUNTRY OF ORIGIN

China or Mexico and the date of manufacture (indicated on the package label)

AUTHORIZED PERSON

Limited Liability Company "PLANTRONICS Rus"

Russian Federation, 115054, Moscow,

Paveletskaya square, house 2, building 2, floor 23,

room I, room 1B

Tel: +7 495 213 12 16

Email: SERGEY.KHOMYAKOV@POLY.COM

Statutory information

Warranty

Limited warranty and return policy

Dell-branded products carry a 3-year limited hardware warranty. If purchased together with a Dell system, it will follow the system warranty.

For U.S. customers:

This purchase and your use of this product are subject to Dell's end-user agreement, which you can find at www.dell.com/terms. This document contains a binding arbitration clause.

For European, Middle Eastern and African customers:

Dell-branded products that are sold and used are subject to applicable national consumer legal rights, the terms of any retailer sale agreement that you have entered into (which will apply between you and the retailer) and Dell's end user contract terms.

Dell may also provide an additional hardware warranty—full details of the Dell end user contract and warranty terms can be found by going to www.dell.com, selecting your country from the list at the bottom of the “home” page and then clicking the “terms and conditions” link for the end user terms or the “support” link for the warranty terms.

For non-U.S. customers:



Dell-branded products that are sold and used are subject to applicable national consumer legal rights, the terms of any retailer sale agreement that you have entered into (which will apply between you and the retailer) and Dell's warranty terms. Dell may also provide an additional hardware warranty—full details of Dell's warranty terms can be found by going to www.dell.com, selecting your country from the list at the bottom of the “home” page and then clicking the “terms and conditions” link or the “support” link for the warranty terms.

Getting help and contacting Dell

Self-help resources

You can get information and help on Dell products and services using these self-help resources:

Table 10. Self-help resources

Self-help resources	Resource location
Information about Dell products and services	www.dell.com
My Dell	
Tips	
Contact Support	In Windows search, type <code>Contact Support</code> , and press Enter.
Online help for operating system	www.dell.com/support/windows www.dell.com/support/linux
Access top solutions, diagnostics, drivers and downloads, and learn more about your computer through videos, manuals and documents.	Your Dell computer is uniquely identified by a Service Tag or Express Service Code. To view relevant support resources for your Dell computer, enter the Service Tag or Express Service Code at www.dell.com/support . For more information on how to find the Service Tag for your computer, see Locate the Service Tag on your computer .
Dell knowledge base articles for a variety of computer concerns	<ol style="list-style-type: none"> 1. Go to www.dell.com/support. 2. On the menu bar at the top of the Support page, select Support > Knowledge Base. 3. In the Search field on the Knowledge Base page, type the keyword, topic, or model number, and then click or tap the search icon to view the related articles.

Contacting Dell

To contact Dell for sales, technical support, or customer service issues, see www.dell.com/contactdell.

 **NOTE:** Availability varies by country/region and product, and some services may not be available in your country/region.

 **NOTE:** If you do not have an active Internet connection, you can find contact information about your purchase invoice, packing slip, bill, or Dell product catalog.