

Dell Dock With Monitor Stand DS1000 User Guide



Notes, cautions, and warnings

 **NOTE:** A NOTE indicates important information that helps you make better use of your computer.

 **CAUTION:** A CAUTION indicates either potential damage to hardware or loss of data and tells you how to avoid the problem.

 **WARNING:** A WARNING indicates a potential for property damage, personal injury, or death.

Copyright © 2016 Dell Inc. All rights reserved. This product is protected by U.S. and international copyright and intellectual property laws. Dell™ and the Dell logo are trademarks of Dell Inc. in the United States and/or other jurisdictions. All other marks and names mentioned herein may be trademarks of their respective companies.

2016 - 03

Rev. A00

Contents

1 Introduction.....	4
Important information.....	4
2 Before you begin.....	5
Package contents.....	5
Identifying components and features.....	6
3 Setting up the docking stand.....	9
Installing the stand riser assembly.....	9
4 Configuring the Intel HD Graphics utility.....	16
5 Technical specifications.....	19
Display resolution.....	21
6 Troubleshooting the Dell Dock with Monitor Stand DS1000.....	22
Symptoms and solutions.....	22
7 Contacting Dell.....	25

Introduction

The Dell Dock with Monitor Stand DS1000 is a device that links all your electronic devices to your computer using a USB Type-C cable interface. Connecting the computer to the docking station allows you to access all peripherals (mouse, keyboard, stereo speakers, external hard drive, and large-screen displays) without having to plug each one into the computer.

Important information

Update your computer's BIOS and the Dell Dock with Monitor Stand DS1000 drivers to the latest versions available at [Dell.com/support](https://www.dell.com/support) before using the docking station. Older BIOS versions and drivers could result in your computer not recognizing the docking station or not functioning optimally.

Before you begin

Package contents

Your docking stand ships with the following components. Ensure that you have received all the components and contact Dell (see your invoice for contact information) if something is missing.

The components shipped are:

- Stand riser
- Riser front cover
- Docking base with USB Type-C cable
- Power cord
- VESA adapter plate set
- Safety, Environmental, and Regulatory Information
- Quick Setup Guide
- Important Information Tech Sheet

Identifying components and features

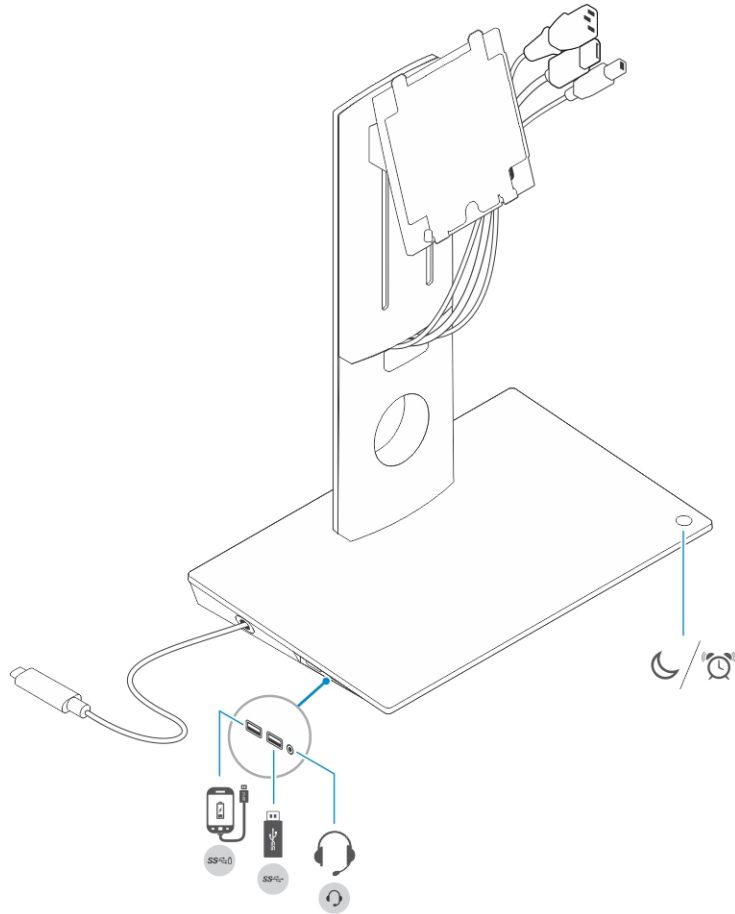

Figure 1. Identifying components and features – Side panel

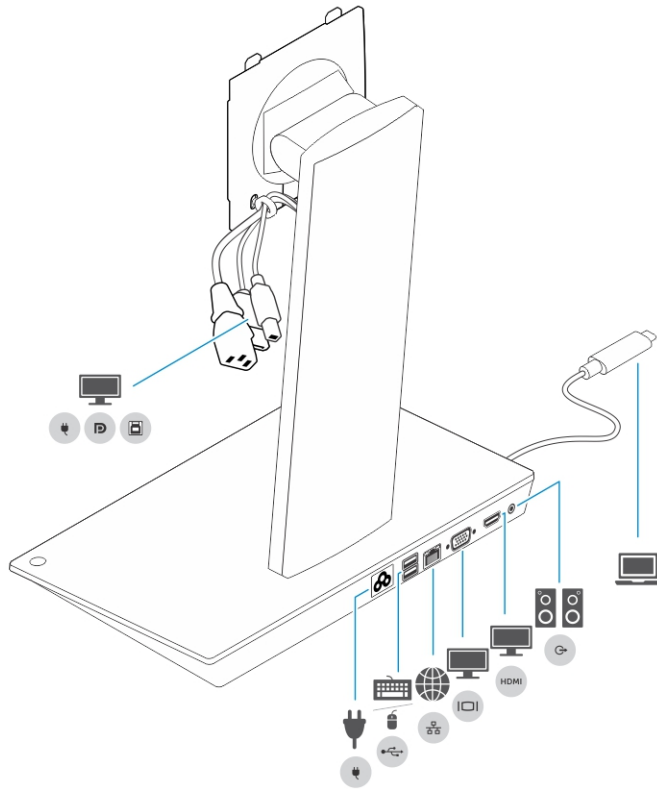











Figure 2. Identifying components and features — Back panel

Icon	I/O ports and button
	USB 3.0 port
	
	USB 3.0 port with PowerShare
	
	Audio headset connector
	Sleep/wake up button
	Power connector
	USB 2.0 port to connect keyboard and mouse
	

Icon



I/O ports and button

Network connector (RJ – 45)

VGA port

HDMI port

Line-out connector

USB type-C connector to connect to the computer

Combo cable to the monitor consisting of the power cable, USB 2.0 cable, and the display cable.

Setting up the docking stand

Installing the stand riser assembly

1. Open and pull the screw handle on the stand riser to loosen the screw.

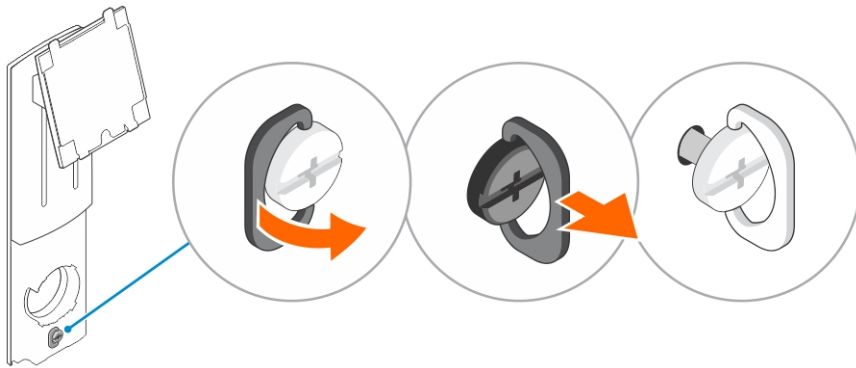

2. Insert the stand riser assembly onto the tab on the docking stand.

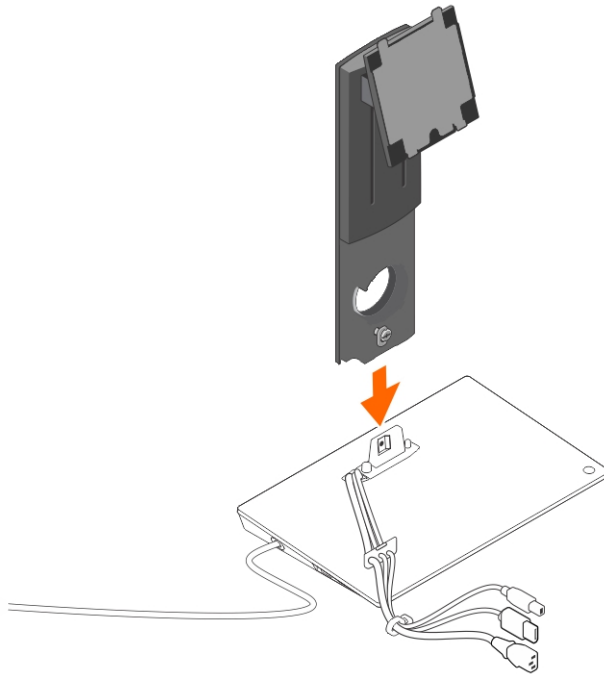

3. Open the screw handle and rotate it to lock the screw into place.

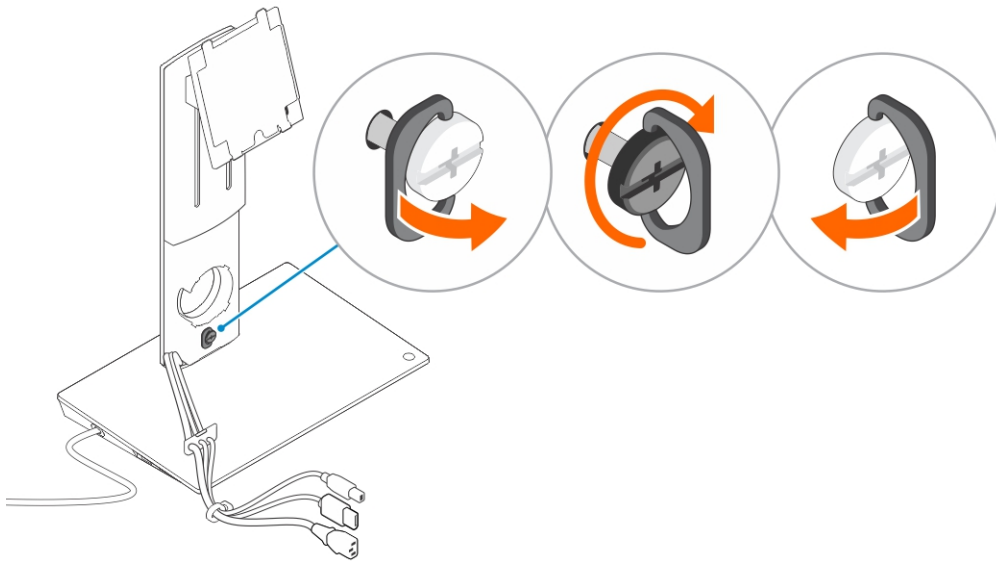

4. Route the cables through the cable routing channel and insert the cable holder into the slot on the stand riser assembly.

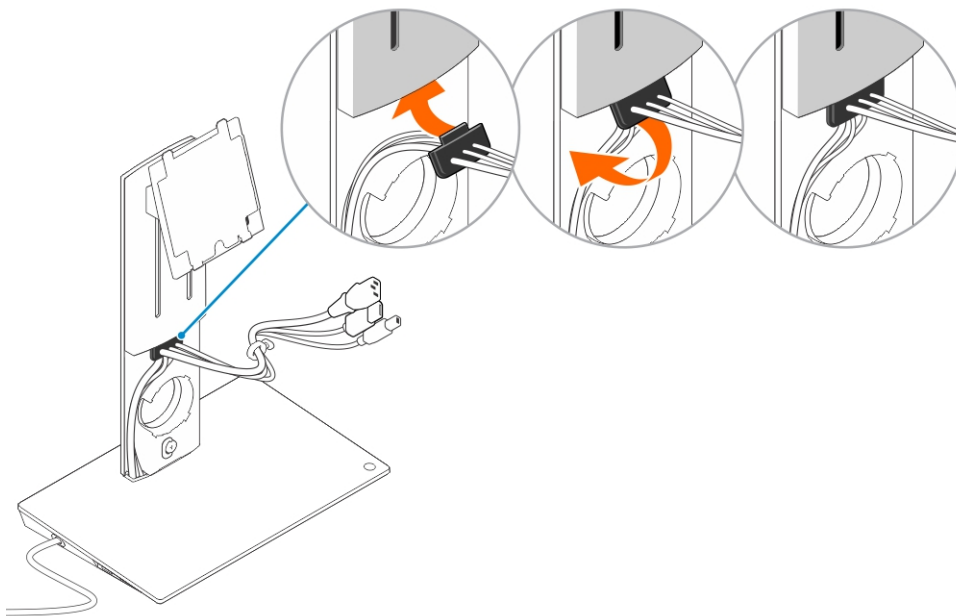

5. Align the tabs on the stand riser cover with the slots on the stand riser assembly and insert it into the slots.

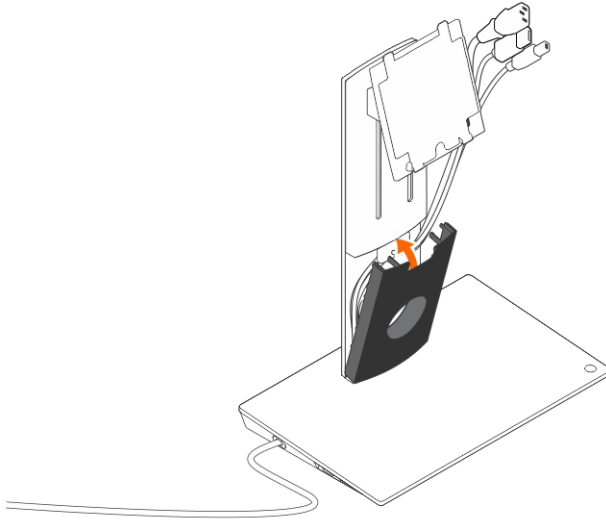

6. Insert the cable clip into the slot on the back of the VESA cover and rotate it to lock the cable clip into place.

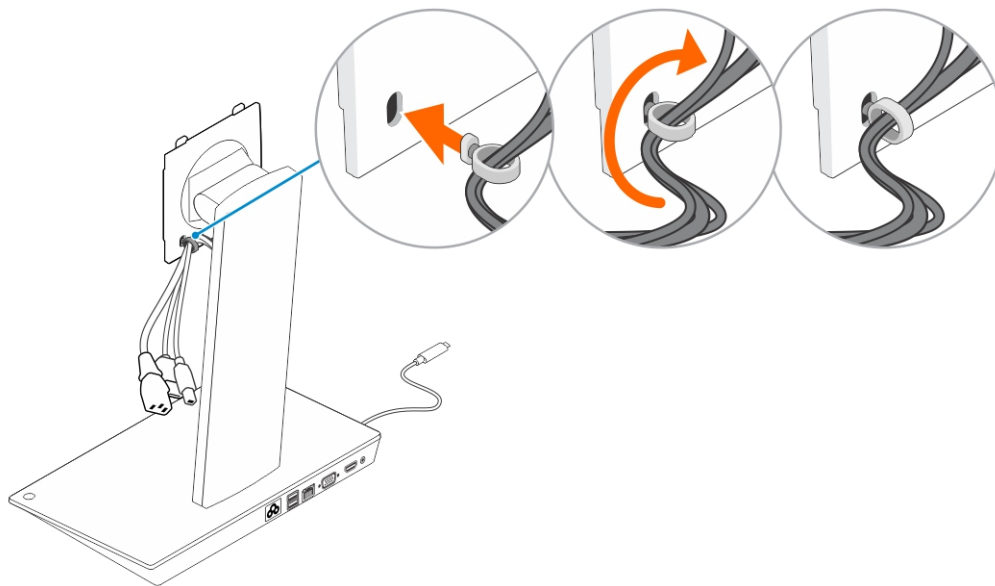

7. Place the monitor face-down and slide the tabs on the VESA plate into the slots on the monitor.

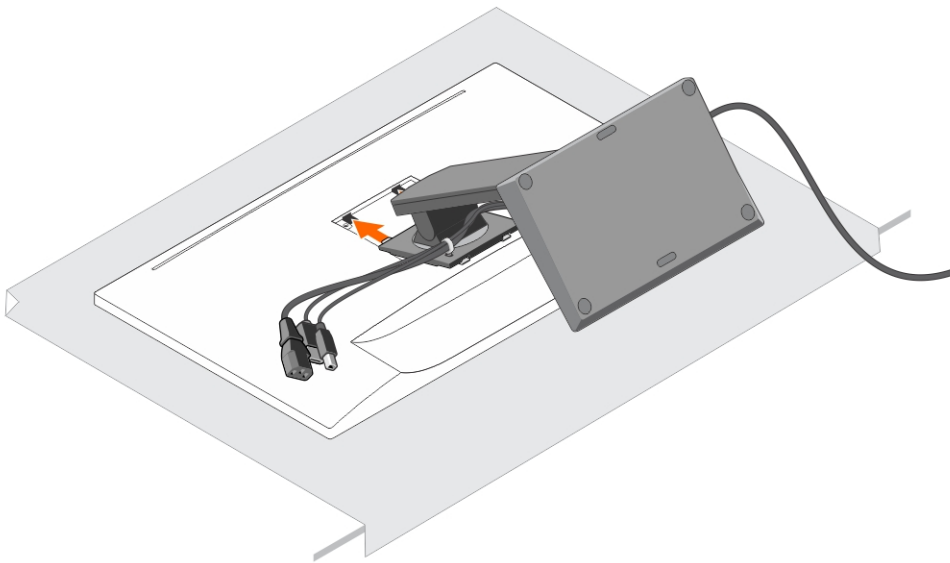

8. Insert the tabs on the VESA plate into the slots on the monitor.

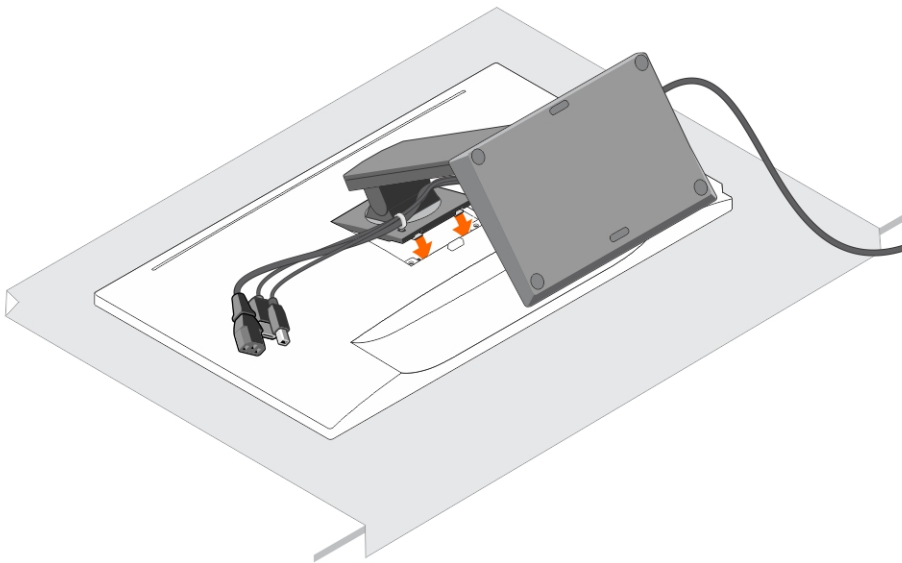

9. Rotate the monitor to the vertical position to connect the cables.

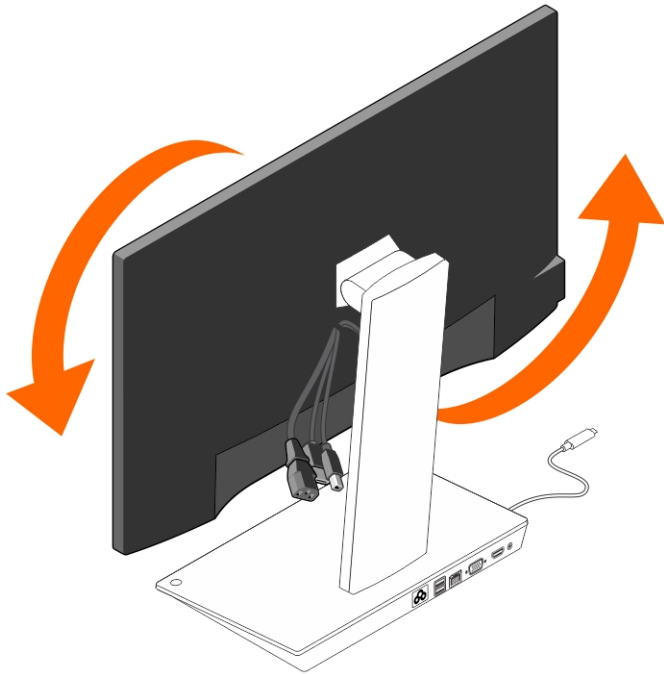

10. Connect the cables to the monitor.

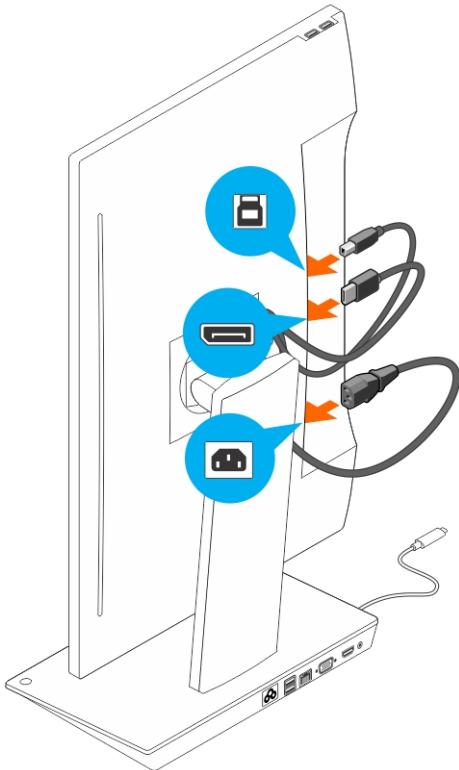

11. Connect the power cable to the docking stand and a power source.

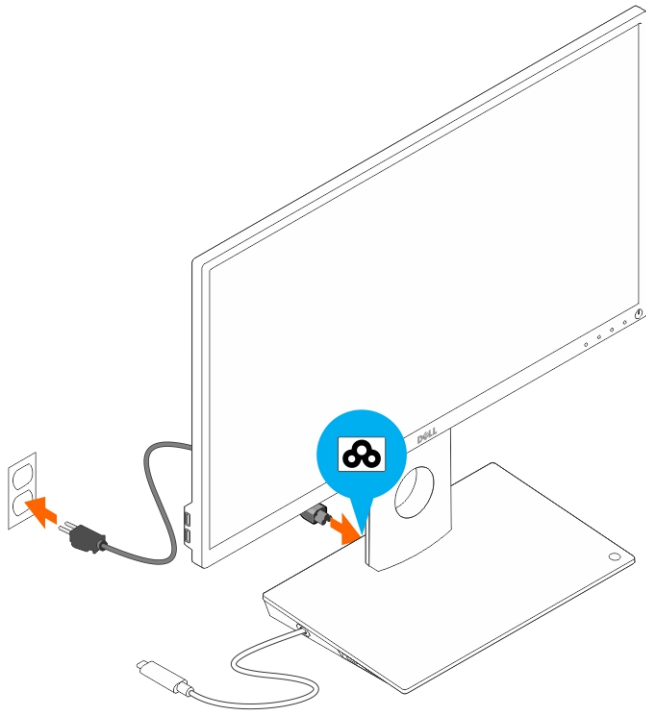

12. Connect the USB Type-C connector to the computer.

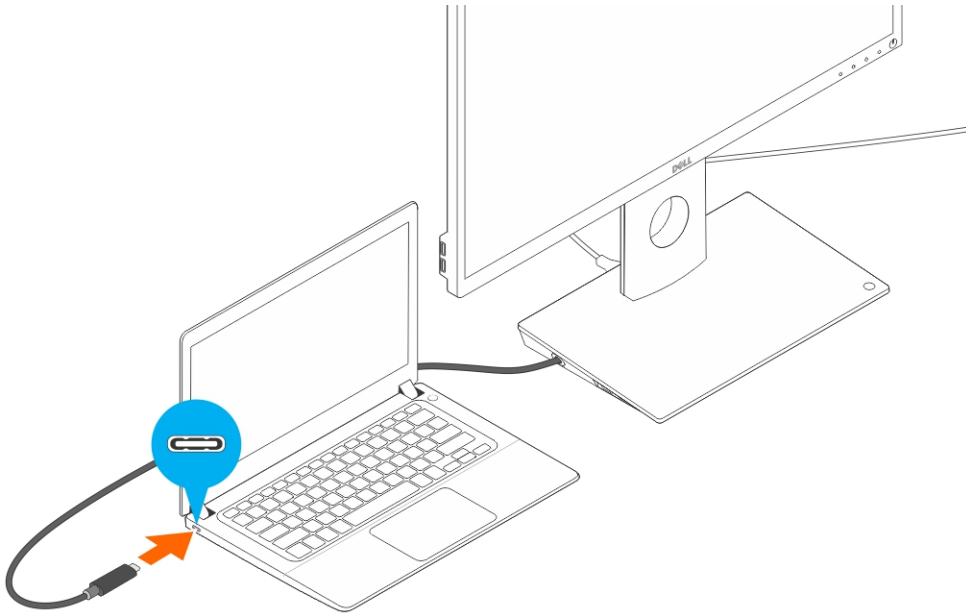

13. Turn on the monitor.



Configuring the Intel HD Graphics utility

If connecting two displays, follow these steps:

1. Click the icon list on the task bar.



2. Click the **Intel HD Graphics** utility on your taskbar as shown here.



3. Click **Graphics Properties**.



4. Click **Display**.

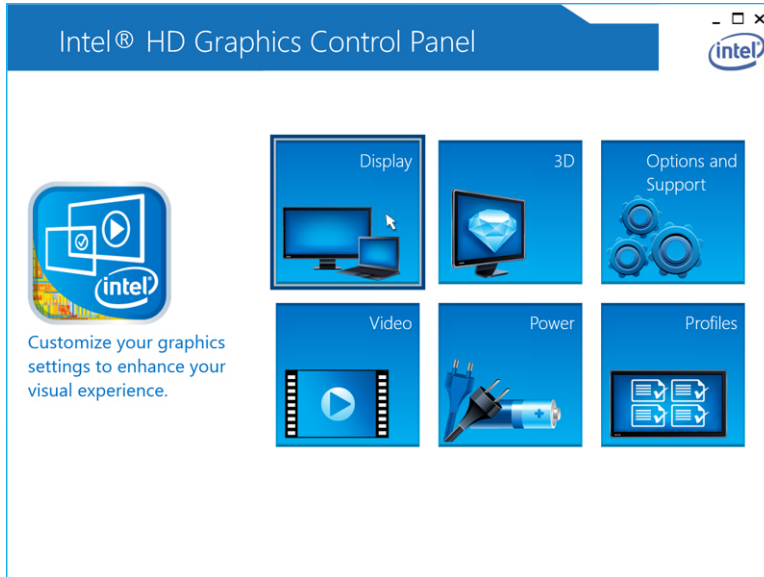

5. Click **Display** and select **Multiple Displays**.

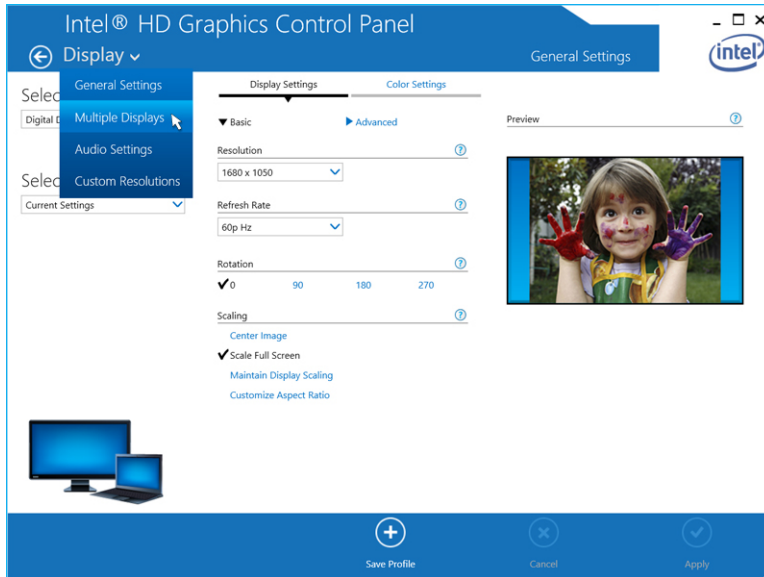

6. Select your preferred Display Mode.

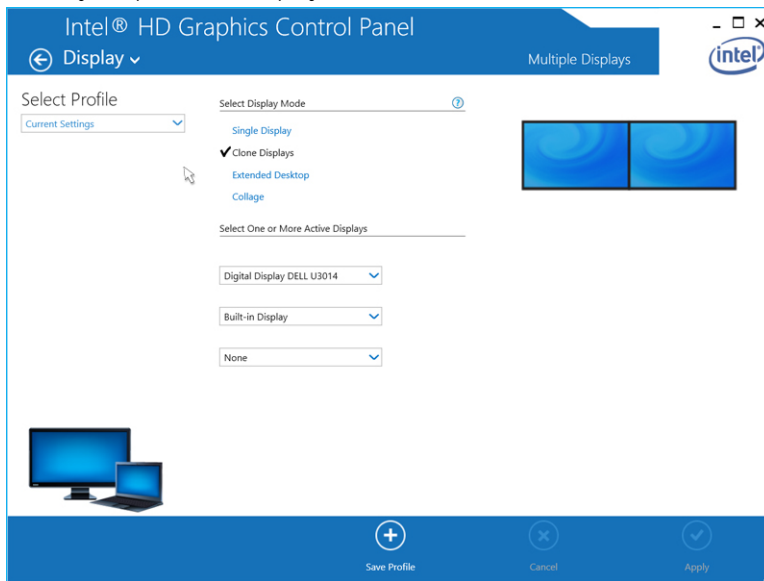

7. Select and arrange your displays to your preferred positions and then click **Apply** for the changes to take effect.

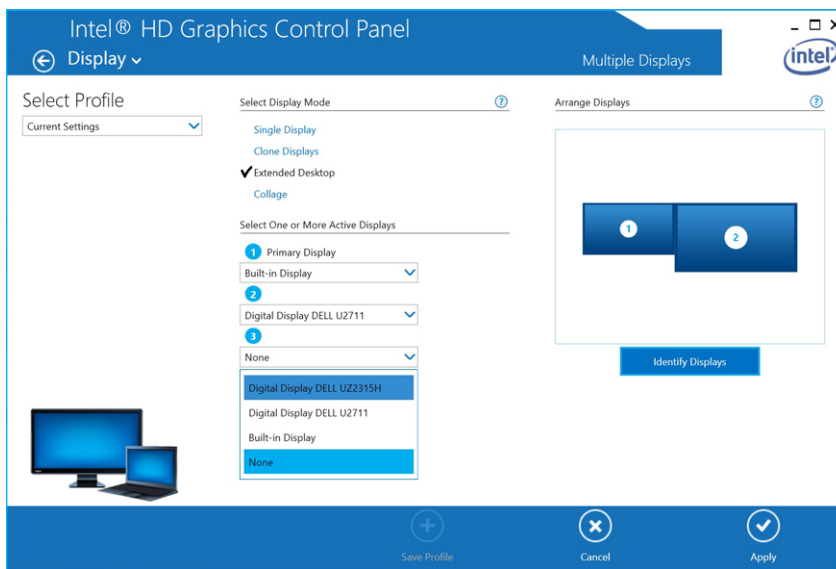

Technical specifications

Input standard USB Type-C

Power delivery on Dell computer Up to 90 W

Video ports

- One DisplayPort (supports DP 1.2)
- One HDMI (supports HDMI 1.4a)
- One VGA port

I/O ports

- One headset connector
- One speaker out

USB ports

- Two USB 3.0 ports on the side panel (one with PowerShare)

 **NOTE:** Ports with PowerShare support high current charging up to 1.5 A for BC 1.2 compliant devices.

- Two USB 2.0 ports on the back panel

Network port

- Gigabit Ethernet (RJ-45)

Table 1. LED indicators

Link speed indicators	Ethernet activity indicator
10 Mb = Green	Flashing Yellow
1000 Mb = Orange	
1 Gb = Green + Orange	

Temperature

- Operating: 0°C to 35°C
- Non operating:
 - Storage: –20°C to 60°C
 - Shipping: –20°C to 60°C

Humidity

- Operating: 10% to 80% (non condensing)
- Non operating:
 - Storage: 5% to 90% (non condensing)

- Shipping: 5% to 90% (non condensing)

Physical dimension

- Dimension — Base: 315 mm (12.4 inches) x 195 mm (7.7 inches) x 426 mm (16.7 inches)
- Weight — 2.8 kg (6.17 lb)
- Monitor weight — 2.2 kg to 5.7 kg (4.9 lb to 12.6 lb)
- Panel mount — Supports Dell Quick Release monitors, VESA adapter plate for use with any VESA-compliant monitor up to 27 inches
- Height adjustment range — 130 mm
- Tilt range — -5° to 21°
- Pivot range — 90° bidirectional
- Button — computer sleep/wakeup; computer power off

Minimum system requirements



















- Microsoft Windows 10 (32-bit or 64-bit)
- Microsoft Windows 8.1 (32-bit or 64-bit)
- Microsoft Windows 8 (32-bit or 64-bit)
- Microsoft Windows 7 (32-bit or 64-bit)
- 1 GB memory
- 1.6 GHz of dual-core Central Processing Unit (CPU)
- 30 MB of free space on the hard drive

AC power input voltage/current AC 100–240 V
3.3 A–2.2 A

Standby power (without power) <1.0 W

Display resolution

Table 2. Maximum resolution and refresh rate supported on your display

Support max dual display output	 	 	 
 +  + 	1920 x 1200 60 Hz	1920 x 1200 60 Hz	Not applicable
 + 	1920 x 1200 60 Hz	1920 x 1200 60 Hz	Not applicable
 + 	1920 x 1200 60 Hz	Not Applicable	1920 x 1200 60 Hz
 + 	Not applicable	1920 x 1200 60 Hz	1920 x 1200 60 Hz
	3840 x 2160 30 Hz	Not applicable	Not applicable
	Not applicable	3840 x 2160 30 Hz	Not applicable
	Not applicable	Not applicable	1920 x 1200 60 Hz

 **NOTE:** Resolution support is also dependent on the Extended Display Identification Data (EDID) resolution of your monitor.

Troubleshooting the Dell Dock with Monitor Stand DS1000

Symptoms and solutions

 **NOTE:** The Dell Dock with Monitor Stand DS1000 only works with DisplayPort over USB-C or Thunderbolt protocols and is not compatible with all USB-C ports.

Table 3. Symptoms and solutions

Symptoms	Suggested solutions
No video on the monitors attached to the HDMI, DP cable, or the VGA port on the docking station.	<ul style="list-style-type: none"> • Ensure that the computer is connected with the docking station to disconnect and reconnect to the docking station. • Ensure that the: <ul style="list-style-type: none"> – Video cable attached to the panel is tightly secured to the video port in the docking station – Monitor's display output setting is set to the correct output. • This may be due to the monitor(s) supporting higher resolutions than docking station is able to support. In the Intel Graphics Control Panel, under General Settings, ensure that the resolution is set to 1920 x 1200 or 1920 x 1080 at 59 Hz or 60 Hz for both the monitors. • If only one monitor is shown, while the other is not, go to the Intel Graphics Control Panel, and under Multiple Displays, select the output for the second monitor. • If your monitor is connected to a docking station, then the video output on your computer may be disabled. Consult your computer's user manual or contact your computer manufacturer for assistance on enabling this feature.
The video on the attached monitor is distorted or flickering.	<ul style="list-style-type: none"> • Make sure the video cable attached to the monitor is tightly secured to the video port in the docking station. • When the monitor is distorted or flickering, please reset your monitor to restore it to its original settings. You can reset the monitor by pressing the Menu button on the monitor itself, and selecting Restore Factory Settings. Or disconnect the monitor from your docking station and power off and on to reset.

Symptoms	Suggested solutions
The video on the attached monitor is not displaying as an extended monitor.	<ul style="list-style-type: none"> • Make sure the Intel HD Graphics software is installed in the Windows Device Manager. • Open the Intel HD Graphics Control Panel and go to the Multiple Displays control to set the display to the extended mode.
The audio connector is not functioning or there is a lag in the audio.	<ul style="list-style-type: none"> • Ensure that the correct playback device is selected in the computer. • If your BIOS setup has an Audio Enabled/ Disabled option, make sure that it is set to Enabled. • The most likely cause of audio output problems on the docking station is a bad audio-out connector. First try powering off and then powering on the docking station. If that fails, try to replug in the audio cable to the docking station from the external speaker output.
The USB ports are not functioning on the docking station.	<ul style="list-style-type: none"> • Ensure that the computer is connected with the docking station. Try to disconnect and reconnect again with the docking station. • If your BIOS setup has a USB Enabled/Disabled option, make sure that it is set to Enabled. • Check the USB ports. Try plugging the USB device into another port. • Please check if the plugged device is shown in the Windows Device Manager.
The HDCP content is not displayed on the attached monitor.	The docking station does not support HDCP content.
The LAN port is not functioning.	<ul style="list-style-type: none"> • Ensure that the Ethernet cable connections are secured at the firewall and the hub or workstation. • If your BIOS setup has a LAN/GBE Enabled/ Disabled option, make sure that it is set to Enabled. • Make sure the Realtek Gigabit Ethernet controller is installed in the Windows Device Manager. • Please reinstall the Realtek Ethernet Driver or update your BIOS from Dell.com/support.
Cable LED is not ON after it is connected to your host.	<ul style="list-style-type: none"> • Ensure that your DS1000 is connected to AC. • Ensure that the computer is connected to the docking station. Try to disconnect and reconnect again with the docking station.
USB port does not function in pre-OS environment.	<p>If your BIOS has a USB/Thunderbolt Configuration page, please make sure that the following options are checked:</p> <ol style="list-style-type: none"> 1. Enable USB Boot Support 2. Enable External USB Port

Symptoms	Suggested solutions
	<ol style="list-style-type: none"> 3. Enable Thunderbolt Boot Support
<p>PXE boot on dock does not function.</p>	<ul style="list-style-type: none"> • If your BIOS has an Integrated NIC page, please select Enabled w/PXE. • If your BIOS has a USB/Thunderbolt Configuration page, please make sure that the following options are checked: <ol style="list-style-type: none"> a. Enable USB Boot Support b. Enable Thunderbolt Boot Support
<p>USB Boot does not function.</p>	<p>If your BIOS has a USB/Thunderbolt Configuration page, please make sure that the following options are checked:</p> <ol style="list-style-type: none"> 1. Enable USB Boot Support 2. Enable External USB Port 3. Enable Thunderbolt Boot Support

Contacting Dell

 **NOTE:** If you do not have an active Internet connection, you can find contact information on your purchase invoice, packing slip, bill, or Dell product catalog.

Dell provides several online and telephone-based support and service options. Availability varies by country and product, and some services may not be available in your area. To contact Dell for sales, technical support, or customer service issues:

1. Go to **Dell.com/support**.
2. Select your support category.
3. Verify your country or region in the **Choose a Country/Region** drop-down list at the bottom of the page.
4. Select the appropriate service or support link based on your need.