

# Alienware Area-51 R3 Threadripper Edition Service Manual

## Notes, cautions, and warnings

 **NOTE:** A NOTE indicates important information that helps you make better use of your product.

 **CAUTION:** A CAUTION indicates either potential damage to hardware or loss of data and tells you how to avoid the problem.

 **WARNING:** A WARNING indicates a potential for property damage, personal injury, or death.

# Contents

<b>Chapter 1: Before working inside your computer.....</b>	<b>10</b>
Before you begin .....	10
Safety instructions.....	10
Recommended tools.....	11
Screw list.....	11
<b>Chapter 2: After working inside your computer.....</b>	<b>14</b>
<b>Chapter 3: Technical overview.....</b>	<b>15</b>
Inside view of your computer.....	15
Left view.....	15
Right view.....	16
System-board components.....	16
I/O-board components.....	17
<b>Chapter 4: Lifting the computer.....</b>	<b>18</b>
Procedure.....	18
<b>Chapter 5: Removing the stability foot.....</b>	<b>19</b>
Procedure.....	19
<b>Chapter 6: Replacing the stability foot.....</b>	<b>21</b>
Procedure.....	21
<b>Chapter 7: Removing the side panels.....</b>	<b>22</b>
Procedure.....	22
<b>Chapter 8: Replacing the side panels.....</b>	<b>23</b>
Procedure.....	23
<b>Chapter 9: Removing the battery.....</b>	<b>24</b>
Prerequisites.....	24
Procedure.....	24
<b>Chapter 10: Replacing the battery.....</b>	<b>25</b>
Procedure.....	25
Post-requisites.....	25
<b>Chapter 11: Removing the battery case.....</b>	<b>26</b>
Prerequisites.....	26
Procedure.....	26

<b>Chapter 12: Replacing the battery case.....</b>	<b>28</b>
Procedure.....	28
Post-requisites.....	28
<b>Chapter 13: Removing the hard drive.....</b>	<b>29</b>
Prerequisites.....	29
Procedure.....	29
<b>Chapter 14: Replacing the hard drive.....</b>	<b>31</b>
Procedure.....	31
Post-requisites.....	31
<b>Chapter 15: Removing the optical drive.....</b>	<b>32</b>
Prerequisites.....	32
Procedure.....	32
<b>Chapter 16: Replacing the optical drive.....</b>	<b>34</b>
Procedure.....	34
Post-requisites.....	34
<b>Chapter 17: Removing the right AlienFX side-panel connector.....</b>	<b>35</b>
Prerequisites.....	35
Procedure.....	35
<b>Chapter 18: Replacing the right AlienFX side-panel connector.....</b>	<b>37</b>
Procedure.....	37
Post-requisites.....	37
<b>Chapter 19: Removing the left AlienFX side-panel connector.....</b>	<b>38</b>
Prerequisites.....	38
Procedure.....	38
<b>Chapter 20: Replacing the left AlienFX side-panel connector.....</b>	<b>40</b>
Procedure.....	40
Post-requisites.....	40
<b>Chapter 21: Removing the I/O board.....</b>	<b>41</b>
Prerequisites.....	41
Procedure.....	41
<b>Chapter 22: Replacing the I/O board.....</b>	<b>43</b>
Procedure.....	43
Post-requisites.....	43
<b>Chapter 23: Removing the drive-bay heat sensor cable.....</b>	<b>44</b>

Prerequisites.....	44
Procedure.....	44
<b>Chapter 24: Replacing the drive-bay heat sensor cable.....</b>	<b>46</b>
Procedure.....	46
Post-requisites.....	46
<b>Chapter 25: Removing the memory modules.....</b>	<b>47</b>
Prerequisites.....	47
Procedure.....	47
<b>Chapter 26: Replacing the memory modules.....</b>	<b>48</b>
Procedure.....	48
Post-requisites.....	48
<b>Chapter 27: Removing the graphics card.....</b>	<b>49</b>
Prerequisites.....	49
Procedure.....	49
<b>Chapter 28: Replacing the graphics card.....</b>	<b>51</b>
Procedure.....	51
Post-requisites.....	51
<b>Chapter 29: Removing multiple graphics cards.....</b>	<b>52</b>
Prerequisites.....	52
Procedure.....	52
<b>Chapter 30: Replacing multiple graphics cards.....</b>	<b>54</b>
Procedure.....	54
Post-requisites.....	54
<b>Chapter 31: Removing the full-length graphics cards.....</b>	<b>55</b>
Prerequisites.....	55
Procedure.....	55
<b>Chapter 32: Replacing the full-length graphics cards.....</b>	<b>57</b>
Procedure.....	57
Post-requisites.....	57
<b>Chapter 33: Removing the wireless card.....</b>	<b>58</b>
Prerequisites.....	58
Procedure.....	58
<b>Chapter 34: Replacing the wireless card.....</b>	<b>60</b>
Procedure.....	60
Post-requisites.....	60

<b>Chapter 35: Removing the coin-cell battery.....</b>	<b>61</b>
Prerequisites.....	61
Procedure.....	61
<b>Chapter 36: Replacing the coin-cell battery.....</b>	<b>62</b>
Procedure.....	62
Post-requisites.....	62
<b>Chapter 37: Removing the top fan.....</b>	<b>63</b>
Prerequisites.....	63
Procedure.....	63
<b>Chapter 38: Replacing the top fan.....</b>	<b>64</b>
Procedure.....	64
Post-requisites.....	64
<b>Chapter 39: Removing the logo board.....</b>	<b>65</b>
Prerequisites.....	65
Procedure.....	65
<b>Chapter 40: Replacing the logo board.....</b>	<b>67</b>
Procedure.....	67
Post-requisites.....	67
<b>Chapter 41: Removing the solid-state drive.....</b>	<b>68</b>
Prerequisites.....	68
Procedure.....	68
<b>Chapter 42: Replacing the solid-state drive.....</b>	<b>69</b>
Procedure.....	69
Post-requisites.....	69
<b>Chapter 43: Removing the PCI fan.....</b>	<b>70</b>
Prerequisites.....	70
Procedure.....	70
<b>Chapter 44: Replacing the PCI fan.....</b>	<b>73</b>
Procedure.....	73
Post-requisites.....	73
<b>Chapter 45: Removing the front-bezel heat sensor cable.....</b>	<b>74</b>
Prerequisites.....	74
Procedure.....	74
<b>Chapter 46: Replacing the front-bezel heat-sensor cable.....</b>	<b>75</b>

Procedure.....	75
Post-requisites.....	75
<b>Chapter 47: Removing the processor liquid-cooling assembly.....</b>	<b>76</b>
Prerequisites.....	76
Procedure.....	76
<b>Chapter 48: Replacing the processor liquid-cooling assembly.....</b>	<b>79</b>
Procedure.....	79
Post-requisites.....	79
<b>Chapter 49: Removing the processor.....</b>	<b>80</b>
Prerequisites.....	80
Procedure.....	80
<b>Chapter 50: Replacing the processor.....</b>	<b>82</b>
Procedure.....	82
Post-requisites.....	83
<b>Chapter 51: Removing the power-supply unit.....</b>	<b>84</b>
Prerequisites.....	84
Procedure.....	84
<b>Chapter 52: Replacing the power-supply unit.....</b>	<b>86</b>
Procedure.....	86
Post-requisites.....	87
<b>Chapter 53: Removing the system board.....</b>	<b>88</b>
Prerequisites.....	88
Procedure.....	88
<b>Chapter 54: Replacing the system board.....</b>	<b>90</b>
Procedure.....	90
Post-requisites.....	90
<b>Chapter 55: Removing the handle bars.....</b>	<b>91</b>
Prerequisites.....	91
Procedure.....	91
<b>Chapter 56: Replacing the handle bars.....</b>	<b>95</b>
Procedure.....	95
Post-requisites.....	95
<b>Chapter 57: Removing the front bezel .....</b>	<b>96</b>
Prerequisites.....	96
Procedure.....	96

<b>Chapter 58: Replacing the front bezel.....</b>	<b>98</b>
Procedure.....	98
Post-requisites.....	98
<b>Chapter 59: Removing the optical-drive eject-button board.....</b>	<b>99</b>
Prerequisites.....	99
Procedure.....	99
<b>Chapter 60: Replacing the optical-drive eject-button board.....</b>	<b>101</b>
Procedure.....	101
Post-requisites.....	101
<b>Chapter 61: Removing the rear bezel.....</b>	<b>102</b>
Prerequisites.....	102
Procedure.....	102
<b>Chapter 62: Replacing the rear bezel.....</b>	<b>106</b>
Procedure.....	106
Post-requisites.....	106
<b>Chapter 63: Removing the base panel.....</b>	<b>107</b>
Prerequisites.....	107
Procedure.....	107
<b>Chapter 64: Replacing the base panel.....</b>	<b>110</b>
Procedure.....	110
Post-requisites.....	110
<b>Chapter 65: Removing the top tron-lighting cable.....</b>	<b>111</b>
Prerequisites.....	111
Procedure.....	111
<b>Chapter 66: Replacing the top tron-lighting cable.....</b>	<b>113</b>
Procedure.....	113
Post-requisites.....	113
<b>Chapter 67: Removing the bottom tron-lighting cable.....</b>	<b>114</b>
Prerequisites.....	114
Procedure.....	114
<b>Chapter 68: Replacing the bottom tron-lighting cable.....</b>	<b>116</b>
Procedure.....	116
Post-requisites.....	116
<b>Chapter 69: Removing the antenna cables.....</b>	<b>117</b>

Prerequisites.....	117
Procedure.....	117
<b>Chapter 70: Replacing the antenna cables.....</b>	<b>120</b>
Procedure.....	120
Post-requisites.....	120
<b>Chapter 71: Downloading drivers.....</b>	<b>121</b>
Downloading the audio driver.....	121
Downloading the graphics driver.....	121
Downloading the USB 3.0 driver.....	121
Downloading the Wi-Fi driver.....	122
Downloading the chipset driver.....	122
Downloading the network driver.....	122
<b>Chapter 72: BIOS setup program.....</b>	<b>123</b>
Boot Sequence.....	123
Navigation keys.....	123
BIOS overview.....	123
Entering BIOS setup program.....	124
System setup options.....	124
System and setup password.....	127
Assigning a system password and setup password.....	128
Deleting or changing an existing system and/or setup password.....	128
Clearing Forgotten Passwords.....	128
Clearing CMOS Settings.....	129
<b>Chapter 73: Troubleshooting.....</b>	<b>130</b>
Flashing the BIOS.....	130
Flashing BIOS (USB key).....	130
Enhanced Pre-Boot System Assessment (ePSA) diagnostics.....	130
Running the SupportAssist Pre-Boot System Performance Check.....	131
Diagnostics.....	131
Wi-Fi power cycle.....	131
<b>Chapter 74: Getting help and contacting Alienware.....</b>	<b>132</b>



# Before working inside your computer

 **NOTE:** The images in this document may differ from your computer depending on the configuration you ordered.

## Topics:









- [Before you begin](#)
- [Safety instructions](#)
- [Recommended tools](#)
- [Screw list](#)

## Before you begin

1. Save and close all open files and exit all open applications.
2. Shut down your computer. Click **Start** >  **Power** > **Shut down**.  
 **NOTE:** If you are using a different operating system, see the documentation of your operating system for shut-down instructions.
3. Disconnect your computer and all attached devices from their electrical outlets.
4. Disconnect all attached network devices and peripherals, such as keyboard, mouse, and monitor from your computer.
5. Remove any media card and optical disc from your computer, if applicable.
6. After the computer is unplugged, press and hold the power button for 5 seconds to ground the system board.

## Safety instructions

Use the following safety guidelines to protect your computer from potential damage and ensure your personal safety.

-  **NOTE:** Before working inside your computer, read the safety information that shipped with your computer. For more safety best practices, see the Regulatory Compliance home page at [www.dell.com/regulatory\\_compliance](http://www.dell.com/regulatory_compliance).
-  **NOTE:** Disconnect all power sources before opening the computer cover or panels. After you finish working inside the computer, replace all covers, panels, and screws before connecting to the electrical outlet.
-  **CAUTION:** To avoid damaging the computer, ensure that the work surface is flat and clean.
-  **CAUTION:** Handle components and cards with care. Do not touch the components or contacts on a card. Hold a card by its edges or by its metal mounting bracket. Hold a component such as a processor by its edges, not by its pins.
-  **CAUTION:** You should only perform troubleshooting and repairs as authorized or directed by the Dell technical assistance team. Damage due to servicing that is not authorized by Dell is not covered by your warranty. See the safety instructions that shipped with the product or at [www.dell.com/regulatory\\_compliance](http://www.dell.com/regulatory_compliance).
-  **CAUTION:** Before touching anything inside your computer, ground yourself by using a wrist grounding strap or by periodically touching an unpainted metal surface, such as the metal at the back of the computer. While you work, periodically touch an unpainted metal surface to dissipate static electricity, which could harm internal components.
-  **CAUTION:** When you disconnect a cable, pull on its connector or on its pull tab, not on the cable itself. Some cables have connectors with locking tabs or thumb-screws that you must disengage before disconnecting the cable. When disconnecting cables, keep them evenly aligned to avoid bending any connector pins. When connecting cables, ensure that the ports and connectors are correctly oriented and aligned.
-  **CAUTION:** Press and eject any installed card from the media-card reader.

# Recommended tools











The procedures in this document may require the following tools:

- Philips screwdriver #1
- Philips screwdriver #2
- Torx #20 (T20) screwdriver
- Allen screw 2.5 mm
- Flat-head screwdriver
- Plastic scribe



# Screw list

The following table provides the list of screws that are used for securing different components.











**Table 1. Screw list**

Component	Secured to	Screw type	Quantity	Screw image
Stability foot	Computer	#6-32x6	2	
Security-cable slot latch	Computer	M2x3	1	
Battery-case door	Battery case	M2x5.7	1	
Battery case	Chassis	#6-32x5.2	2	
Hard-drive assembly	Chassis	#6-32x6	1	
Hard drive	Hard-drive bracket	#6-32x3.6	4	
Optical-drive assembly	Chassis	#6-32x6	1	
Optical-drive bracket	Optical drive	M2x3	2	
Right AlienFX side-panel connector assembly	Chassis	#6-32x6	2	
Right AlienFX side-panel connector	Bracket	#6-32x6	1	
Left AlienFX side-panel connector assembly	Chassis	#6-32x6	2	

**Table 1. Screw list (continued)**

Component	Secured to	Screw type	Quantity	Screw image
Left AlienFX side-panel connector	Bracket	#6-32x6	1	
I/O board	Chassis	#6-32x6	5	
Graphics card (multiple, full-length)	Chassis	#6-32x6	2	
Graphics-card bracket	Chassis	#6-32x6	4	
Wireless card	Chassis	M2x3	1	
Top fan	Chassis	#6-32x6	1	
Logo board	Chassis	#6-32x6	1	
Logo board	Bracket	#6-32x6	6	
Solid-state drive	System board	M2x2.5	1	
PCI fan	Chassis	M3x5.25	2	
Fan shroud	PCI fan	M5x10	4	
Processor liquid-cooling assembly	Chassis	#6-32x6	4	
Power-supply unit	Chassis	#6-32x6	4	
System-board	Chassis	#6-32x6	9	
Rear-handle bar	Chassis	#6-32x6.5	14	

**Table 1. Screw list (continued)**

<b>Component</b>	<b>Secured to</b>	<b>Screw type</b>	<b>Quantity</b>	<b>Screw image</b>
Front-handle bar	Chassis	#6-32x6.5	14	
Bottom-handle bar	Chassis	#6-32x6.5	14	
Front bezel	Chassis	#6-32x6	4	
Front bezel	Chassis	6-32x5.2	3	
Optical-drive eject-button board	Chassis	#6-32x6	2	
Rear bezel	Chassis	#6-32x6	4	
Rear bezel	Chassis	M3x5	2	
Base panel	Chassis	#6-32x6	4	
Base panel	Chassis	#6-32x6	5	
Antennas	Chassis	#6-32x6	6	

# After working inside your computer

 **CAUTION: Leaving stray or loose screws inside your computer may severely damage your computer.**

1. Replace all screws and ensure that no stray screws remain inside your computer.
2. Connect any external devices, peripherals, or cables you removed before working on your computer.
3. Replace any media cards, discs, or any other parts that you removed before working on your computer.
4. Connect your computer and all attached devices to their electrical outlets.
5. Turn on your computer.

# Technical overview

**NOTE:** Before working inside your computer, read the safety information that shipped with your computer and follow the steps in [Before working inside your computer](#). After working inside your computer, follow the instructions in [After working inside your computer](#). For more safety best practices, see the Regulatory Compliance home page at [www.dell.com/regulatory\\_compliance](http://www.dell.com/regulatory_compliance).

## Topics:

- [Inside view of your computer](#)
- [System-board components](#)
- [I/O-board components](#)

## Inside view of your computer

To view the different components installed in your computer. See "[Left view](#)" and "[Right view](#)".

### Left view

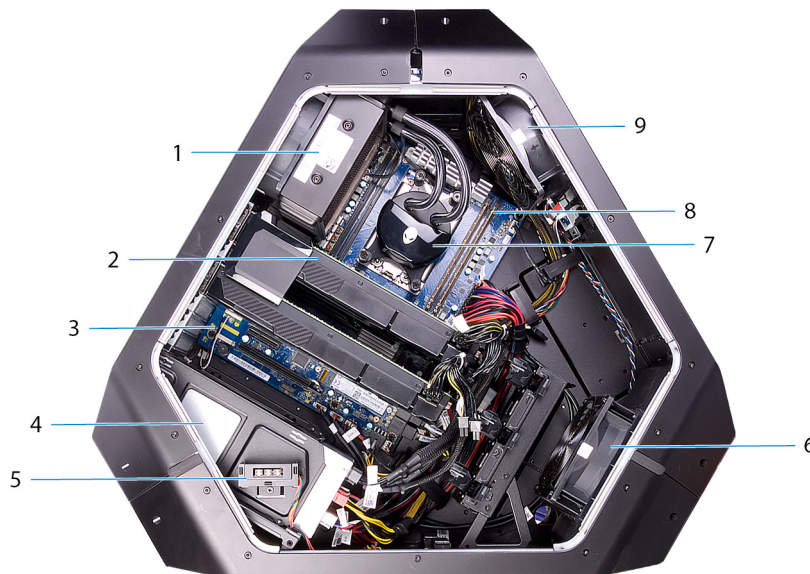

- |                                           |                      |
|-------------------------------------------|----------------------|
| 1. processor liquid-cooling assembly-fan  | 2. graphics card     |
| 3. system board                           | 4. power-supply unit |
| 5. AlienFX side-panel connector           | 6. PCI fan           |
| 7. processor liquid-cooling assembly pump | 8. memory modules    |
| 9. top fan                                |                      |

## Right view

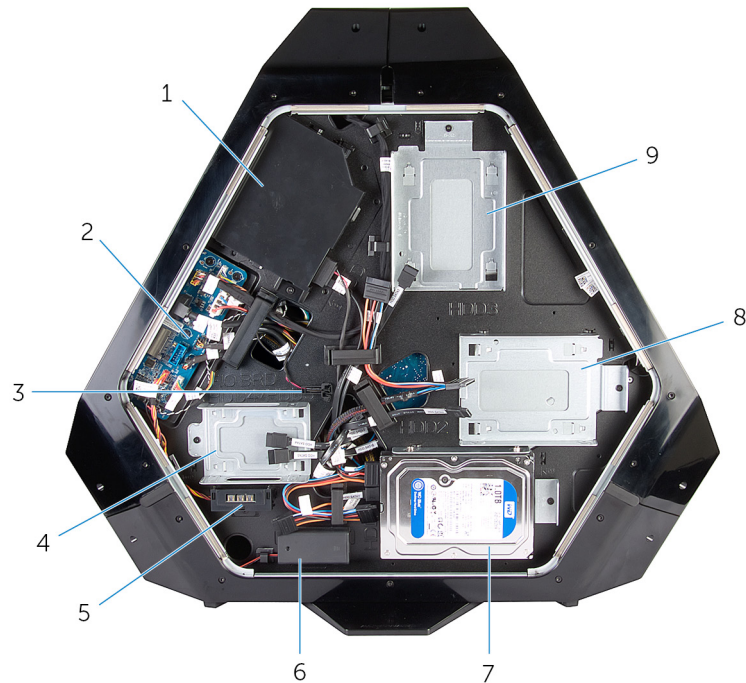

1. optical drive (ODD)
2. I/O board (IO BRD)
3. drive-bay heat-sensor
4. 2.5-inch drive bracket (HDD4/HDD5)
5. AlienFX side-panel connector
6. rear I/O accessibility lighting batteries
7. 3.5-inch drive bracket (HDD1)
8. 3.5-inch drive bracket (HDD2)
9. 3.5-inch drive bracket (HDD3)

## System-board components

1. processor-power connector (CPU\_PWR1)
2. processor liquid-cooling assembly pump-fan connector (PUMP\_FAN1)
3. processor liquid cooling-assembly fan (LCM\_FAN1)
4. audio connector (FP\_AUDIO1)
5. PCI-Express slot (SLOT1)
6. CMOS reset jumper (CMOS\_CLR)
7. coin-cell battery socket (BAT1)
8. PCI-Express slot (SLOT3)
9. PCI-Express slot (SLOT4)
10. WLAN connector (M2\_WLAN1)
11. PCI-Express slot (SLOT5)
12. PCI-Express slot (SLOT6)
13. solid-state drive slot (M2\_SSD1)
14. PCI-Express slot (SLOT7)
15. low pin count debug header (LPC1)
16. LED Power Switch (PANEL1)
17. USB connector (USB1)
18. chassis heat-sensor connector (SENSOR2)
19. drive-bay heat-sensor connector (SENSOR1)
20. PCI-Express power connector (PCIE\_PWR1)

- 21. PCI-Express fan 1 connector (PCI\_FAN1)
- 22. password reset jumper (PW\_CLR)
- 23. SATA drive connector (HDD\_SATA\_3\_4)
- 24. SATA drive connector (HDD\_SATA\_1\_2)
- 25. USB connector (USB3\_MB2)
- 26. USB connector (USB3\_MB1)
- 27. SATA drive connector (SATA6)
- 28. SATA drive connector (SATA5)
- 29. Advanced Technology xTended (ATX) power connector (ATX\_PWR1)
- 30. processor liquid-cooling assembly fan connector (MID\_FAN1)
- 31. top fan connector (TOP\_FAN1)
- 32. memory-module slot (DIMM2)
- 33. memory-module slot (DIMM1)
- 34. processor socket (CPU1)
- 35. memory-module slot (DIMM3)
- 36. memory-module slot (DIMM4)

## I/O-board components

**NOTE:** The location of the connectors may vary based on the selections you made at the time of purchase.

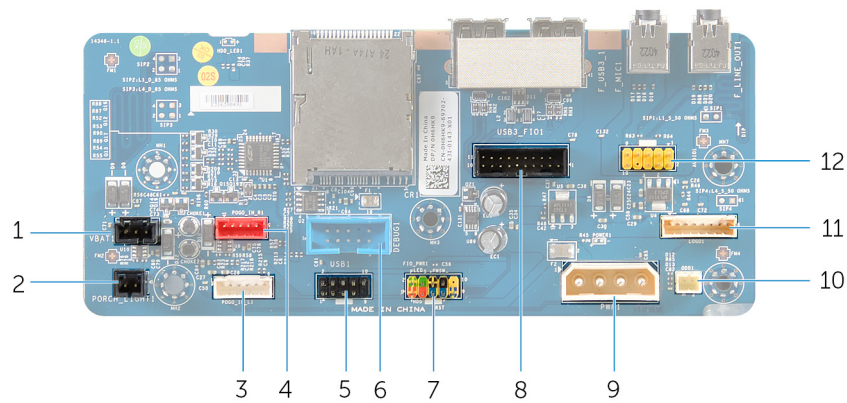

- 1. rear I/O accessibility lighting battery connector (VBAT1)
- 2. rear I/O accessibility lighting connector (PORCH\_LIGHT1)
- 3. left theater-lighting connector (POGO\_IN\_L1)
- 4. right theater-lighting connector (POGO\_IN\_R1)
- 5. USB connector (USB1)
- 6. debug connector (DEBUG1)
- 7. front I/O control connector (FIO\_PWR1)
- 8. front I/O connector (USB3\_FIO1)
- 9. main-power connector (PWR1)
- 10. optical drive power connector (ODD1)
- 11. logo board connector (LOGO1)
- 12. audio connector (AUDIOIO1)

# Lifting the computer

## Topics:

- [Procedure](#)

## Procedure

1. With both hands, hold the handle on top of the computer.
2. Lift the computer.



- a. handle
- b. computer

# Removing the stability foot

**NOTE:** Before working inside your computer, read the safety information that shipped with your computer and follow the steps in [Before working inside your computer](#). After working inside your computer, follow the instructions in [After working inside your computer](#). For more safety best practices, see the Regulatory Compliance home page at [www.dell.com/regulatory\\_compliance](http://www.dell.com/regulatory_compliance).

## Topics:

- [Procedure](#)

## Procedure

1. Tilt the computer towards the front until the base is facing up.



2. Remove the two screws (#6-32x6) that secure the stability foot to the computer.
3. Lift the stability foot off the computer.

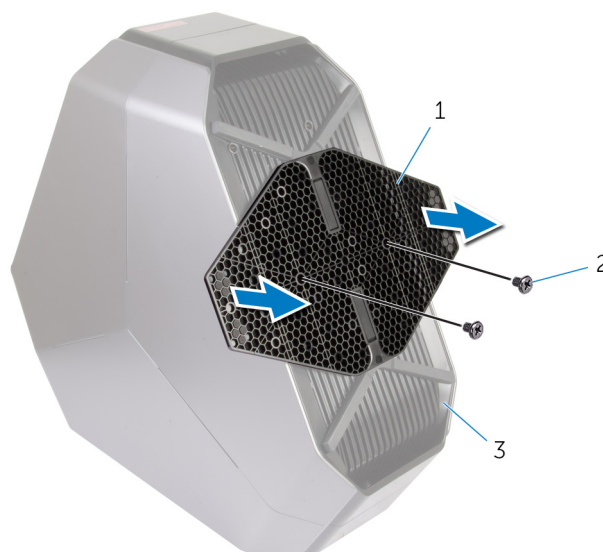

- a. stability foot

b. screws (2)

c. computer

4. Tilt the computer back to the upright position.

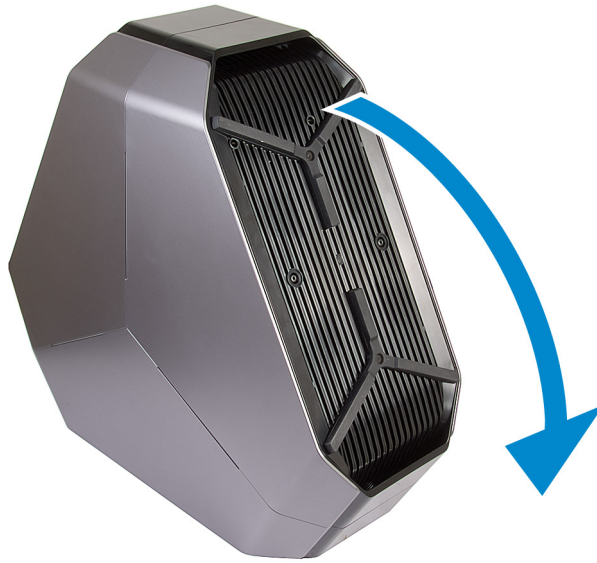

# Replacing the stability foot

**NOTE:** Before working inside your computer, read the safety information that shipped with your computer and follow the steps in [Before working inside your computer](#). After working inside your computer, follow the instructions in [After working inside your computer](#). For more safety best practices, see the Regulatory Compliance home page at [www.dell.com/regulatory\\_compliance](http://www.dell.com/regulatory_compliance).

## Topics:

- [Procedure](#)

## Procedure

1. Tilt the computer towards the front until the base is facing up.
2. Align the screw holes on the stability foot with the screw holes on the base of the computer and replace the two screws (#6-32x6).
3. Tilt the computer back to the upright position.

# Removing the side panels

**NOTE:** Before working inside your computer, read the safety information that shipped with your computer and follow the steps in [Before working inside your computer](#). After working inside your computer, follow the instructions in [After working inside your computer](#). For more safety best practices, see the Regulatory Compliance home page at [www.dell.com/regulatory\\_compliance](http://www.dell.com/regulatory_compliance).

## Topics:

- [Procedure](#)

## Procedure

**NOTE:** Make sure that you remove the security cable from the security-cable slot (if applicable).

1. Remove the screw (M2x3) that secures the security-cable slot latch. The security-cable slot slides to the unlocked position.
2. Lift the release panel to open the right side-panel.
3. Pull and lift the right side-panel away from the chassis.



- |                  |                              |
|------------------|------------------------------|
| 1. screw         | 2. security-cable slot latch |
| 3. release panel | 4. right side-panel          |

4. Repeat the procedure from step 2 to step 3 on the left side-panel.

# Replacing the side panels

**NOTE:** Before working inside your computer, read the safety information that shipped with your computer and follow the steps in [Before working inside your computer](#). After working inside your computer, follow the instructions in [After working inside your computer](#). For more safety best practices, see the Regulatory Compliance home page at [www.dell.com/regulatory\\_compliance](http://www.dell.com/regulatory_compliance).

## Topics:

- [Procedure](#)

## Procedure

1. Align the tabs on the right side-panel with the slots on the right side of the computer and snap the panel to lock it in place.
2. Repeat step 1 to replace the left side-panel.
3. Slide and hold the security-cable slot latch in the locked position.
4. Replace the screw (M2x3) that secures the security-cable slot latch.

# Removing the battery

**NOTE:** Before working inside your computer, read the safety information that shipped with your computer and follow the steps in [Before working inside your computer](#). After working inside your computer, follow the instructions in [After working inside your computer](#). For more safety best practices, see the Regulatory Compliance home page at [www.dell.com/regulatory\\_compliance](http://www.dell.com/regulatory_compliance).

## Topics:

- [Prerequisites](#)
- [Procedure](#)

## Prerequisites

Remove the right side-panel. See "[Removing the side panels](#)".

## Procedure

1. Remove the screw (M2x5.7) that secures the battery-case door to the battery case.
2. Slide and open the battery-case door and remove the batteries from the battery case.

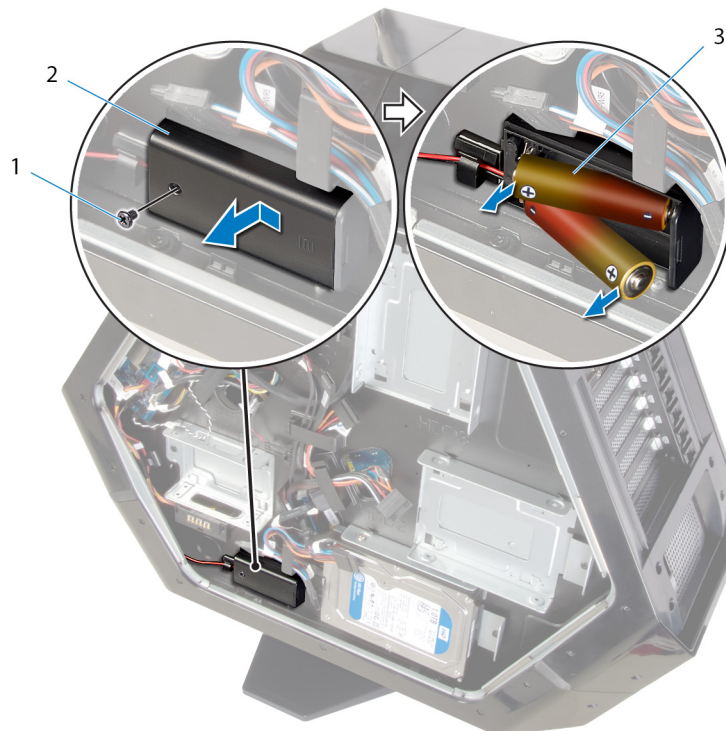

- a. screw
- b. battery-case door
- c. AA batteries (2)

# Replacing the battery

**NOTE:** Before working inside your computer, read the safety information that shipped with your computer and follow the steps in [Before working inside your computer](#). After working inside your computer, follow the instructions in [After working inside your computer](#). For more safety best practices, see the Regulatory Compliance home page at [www.dell.com/regulatory\\_compliance](http://www.dell.com/regulatory_compliance).

## Topics:

- [Procedure](#)
- [Post-requisites](#)

## Procedure

1. Insert the batteries into the battery-case.
2. Slide and close the battery-case door.
3. Replace the screw (M2x5.7) that secures the battery-case door to the battery case.

## Post-requisites

Replace the right side-panel. See "[Replacing the side panels](#)".

# Removing the battery case

**NOTE:** Before working inside your computer, read the safety information that shipped with your computer and follow the steps in [Before working inside your computer](#). After working inside your computer, follow the instructions in [After working inside your computer](#). For more safety best practices, see the Regulatory Compliance home page at [www.dell.com/regulatory\\_compliance](http://www.dell.com/regulatory_compliance).

## Topics:

- [Prerequisites](#)
- [Procedure](#)

## Prerequisites

1. Remove the [stability foot](#).
2. Remove the right side-panel. See "[Removing the side panels](#)".
3. Remove the [battery](#).

## Procedure

1. Lay the chassis on the left side.
2. Press the release tabs on the cable connector to disconnect the battery-case cable from the I/O board.
3. Remove the two screws (#6-32x5.2) that secure the battery case to the chassis.
4. Lift the battery case off the chassis.

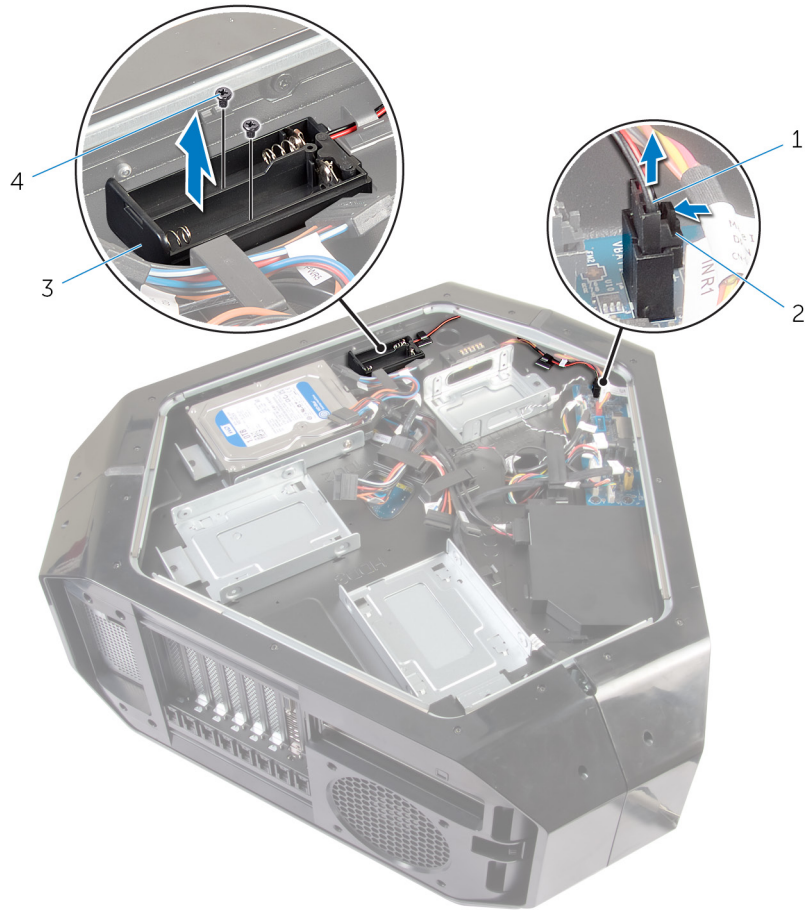

- 1. battery-case cable
- 3. battery case

- 2. battery-case connector
- 4. screws (2)

# Replacing the battery case

**NOTE:** Before working inside your computer, read the safety information that shipped with your computer and follow the steps in [Before working inside your computer](#). After working inside your computer, follow the instructions in [After working inside your computer](#). For more safety best practices, see the Regulatory Compliance home page at [www.dell.com/regulatory\\_compliance](http://www.dell.com/regulatory_compliance).

## Topics:

- [Procedure](#)
- [Post-requisites](#)

## Procedure

1. Align the screw holes on the battery case with the screw holes on the chassis.
2. Replace the two screws (#6-32x5.2) that secure the battery case to the chassis.
3. Connect the battery-case cable to the I/O board.

## Post-requisites

1. Replace the [battery](#).
2. Replace the right side-panel. See "[Replacing the side panels](#)".
3. Replace the [stability foot](#).

# Removing the hard drive

**NOTE:** Before working inside your computer, read the safety information that shipped with your computer and follow the steps in [Before working inside your computer](#). After working inside your computer, follow the instructions in [After working inside your computer](#). For more safety best practices, see the Regulatory Compliance home page at [www.dell.com/regulatory\\_compliance](http://www.dell.com/regulatory_compliance).

**CAUTION:** Hard drives are fragile. Exercise care when handling the hard drive.

**CAUTION:** To avoid data loss, do not remove the hard drive while the computer is in sleep or on state.

## Topics:

- [Prerequisites](#)
- [Procedure](#)

## Prerequisites

1. Remove the [stability foot](#).
2. Remove the left and right side-panels. See "[Removing the side panels](#)".

## Procedure

1. Lay the chassis on the left side.
2. Disconnect the power cable and data cable from the hard-drive assembly (HDD1).
3. Remove the screw (#6-32x6) that secures the hard-drive assembly (HDD1) to the chassis.
4. Using the tab, slide and remove the hard-drive assembly (HDD1) from the chassis.

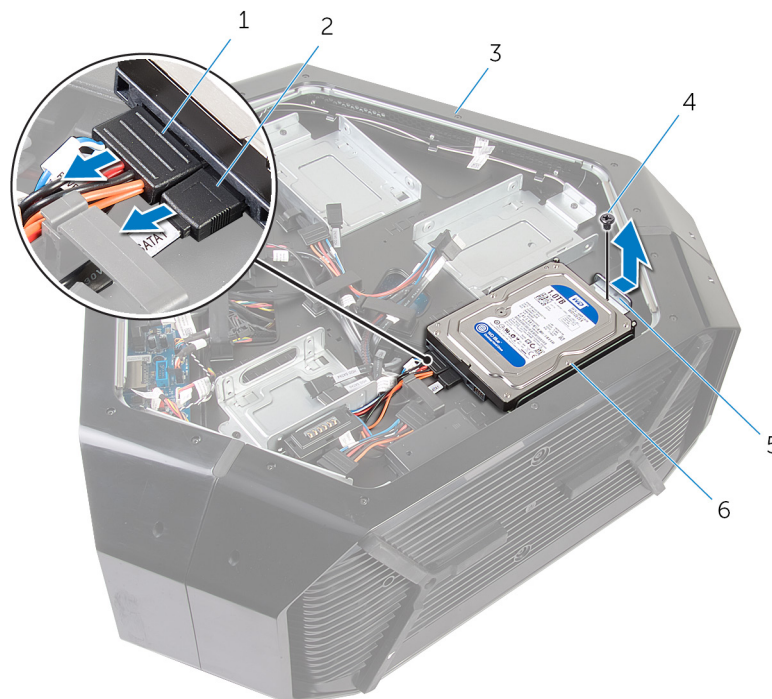

1. power cable
3. chassis

2. data cable
4. screw

5. tab

6. hard-drive assembly (HDD1)

5. Remove the four screws (#6-32x3.6) that secure the hard-drive bracket to the hard drive.
6. Slide and remove the hard drive from the hard-drive bracket.

**i** **NOTE:** Repeat step 2 to step 6 to remove any other hard drives (HDD2 and HDD3) installed in your computer.

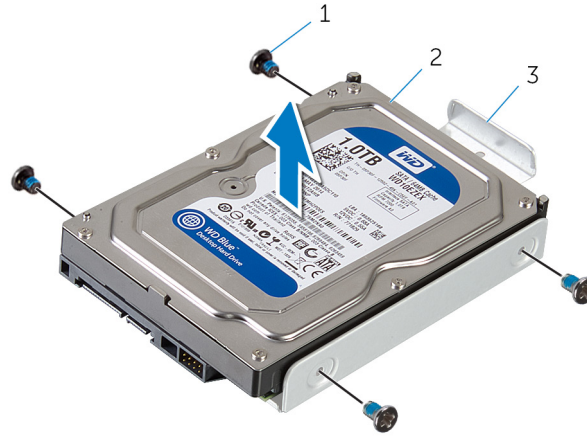

- a. screws (4)
- b. hard drive
- c. hard-drive bracket

# Replacing the hard drive

**NOTE:** Before working inside your computer, read the safety information that shipped with your computer and follow the steps in [Before working inside your computer](#). After working inside your computer, follow the instructions in [After working inside your computer](#). For more safety best practices, see the Regulatory Compliance home page at [www.dell.com/regulatory\\_compliance](http://www.dell.com/regulatory_compliance).

**CAUTION:** Hard drives are fragile. Exercise care when handling the hard drive.

## Topics:

- [Procedure](#)
- [Post-requisites](#)

## Procedure

1. Align the screw holes on the hard-drive bracket with the screw holes on the hard drive (HDD1).
2. Replace the four screws (#6-32x3.6) that secure the hard drive to the hard-drive bracket.
3. Place the hard-drive assembly (HDD1) in the chassis.
4. Replace the screw (#6-32x6) that secures the hard-drive assembly (HDD1) to the chassis.
5. Connect the power cable and data cable to the hard drive (HDD1).

**NOTE:** Repeat step 2 to step 5 to replace any other hard drives (HDD2 and HDD3) installed in your computer.

## Post-requisites

1. Replace the left and right side-panels. See "[Replacing the side panels](#)".
2. Replace the [stability foot](#).

# Removing the optical drive

**NOTE:** Before working inside your computer, read the safety information that shipped with your computer and follow the steps in [Before working inside your computer](#). After working inside your computer, follow the instructions in [After working inside your computer](#). For more safety best practices, see the Regulatory Compliance home page at [www.dell.com/regulatory\\_compliance](http://www.dell.com/regulatory_compliance).

## Topics:

- [Prerequisites](#)
- [Procedure](#)

## Prerequisites

1. Remove the [stability foot](#).
2. Remove the left and right side-panels. See "[Removing the side panels](#)".

## Procedure

1. Lay the chassis on the left side.
2. Disconnect the power and data cable from the optical drive.
3. Remove the screw (#6-32x6) that secures the optical-drive assembly to the chassis.
4. Slide and lift the optical-drive assembly off the chassis.



- a. screw
- b. optical-drive assembly
- c. data cable and power cable

5. Remove the two screws (M2x3) that secure the optical-drive bracket to the optical drive.
6. Slide and remove the optical drive from the optical-drive bracket.

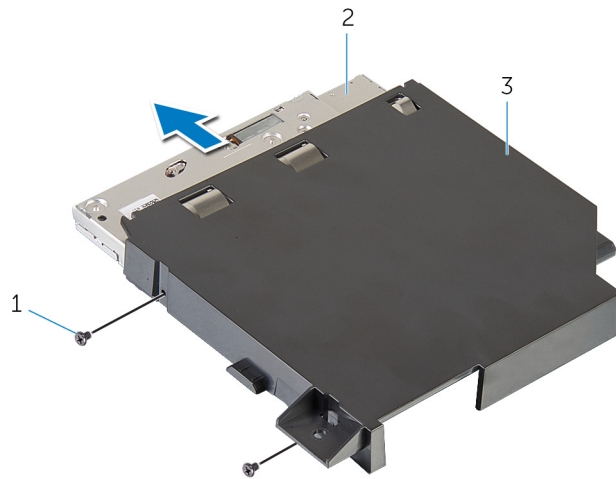

- a. screws (2)
- b. optical drive
- c. optical-drive bracket

# Replacing the optical drive

**NOTE:** Before working inside your computer, read the safety information that shipped with your computer and follow the steps in [Before working inside your computer](#). After working inside your computer, follow the instructions in [After working inside your computer](#). For more safety best practices, see the Regulatory Compliance home page at [www.dell.com/regulatory\\_compliance](http://www.dell.com/regulatory_compliance).

## Topics:

- [Procedure](#)
- [Post-requisites](#)

## Procedure

1. Align the screw holes on the optical-drive bracket with the screw holes on the optical drive.
2. Replace the two screws (M2x3) that secure the optical drive to the optical-drive bracket.
3. Align the screw hole on the optical-drive assembly with the screw hole on the chassis.
4. Replace the screw (#6-32x6) that secures the optical-drive bay assembly to the chassis.
5. Plug the power cable and data cable to the optical drive.

## Post-requisites

1. Replace the left and right side-panels. See "[Replacing the side panels](#)".
2. Replace the [stability foot](#).

# Removing the right AlienFX side-panel connector

**NOTE:** Before working inside your computer, read the safety information that shipped with your computer and follow the steps in [Before working inside your computer](#). After working inside your computer, follow the instructions in [After working inside your computer](#). For more safety best practices, see the Regulatory Compliance home page at [www.dell.com/regulatory\\_compliance](http://www.dell.com/regulatory_compliance).

## Topics:

- [Prerequisites](#)
- [Procedure](#)

## Prerequisites

1. Remove the [stability foot](#).
2. Remove the left and right side-panels. See "[Removing the side panels](#)".

## Procedure

1. Lay the chassis on the left side.
2. Disconnect the right AlienFX side-panel cable that connects the right AlienFX side-panel connector to the I/O board. See "[I/O-board components](#)".
3. Remove the screw (#6-32x6) that secures the right AlienFX side-panel connector assembly to the chassis.
4. Remove the right AlienFX side-panel connector assembly from the chassis.

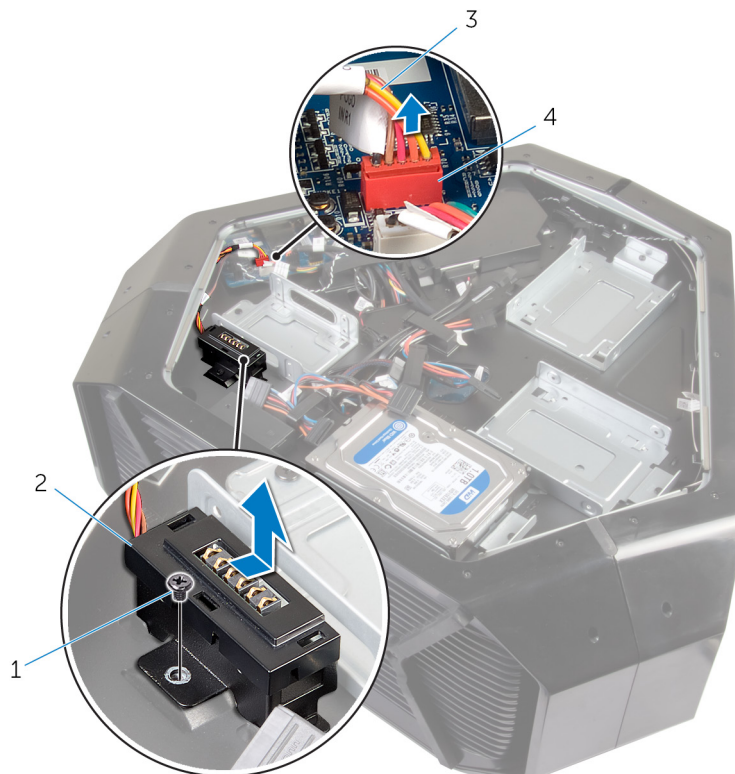

1. screw
2. right AlienFX side-panel connector assembly
3. right AlienFX side-panel cable
4. right AlienFX side-panel connector

5. Remove the two screws (#6-32x6) that secure the right AlienFX side-panel connector to the bracket.

6. Remove the cable routing through the slot on the bracket and lift the right AlienFX side-panel connector off the bracket.

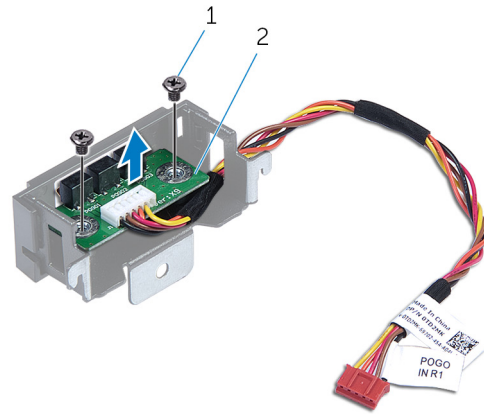

- a. screws (2)
- b. right AlienFX side-panel connector

# Replacing the right AlienFX side-panel connector

**NOTE:** Before working inside your computer, read the safety information that shipped with your computer and follow the steps in [Before working inside your computer](#). After working inside your computer, follow the instructions in [After working inside your computer](#). For more safety best practices, see the Regulatory Compliance home page at [www.dell.com/regulatory\\_compliance](http://www.dell.com/regulatory_compliance).

## Topics:

- [Procedure](#)
- [Post-requisites](#)

## Procedure

1. Route the cable through the slot on the bracket and align the screw holes on the right AlienFX side-panel connector with the screw holes on the bracket.
2. Replace the two screws (#6-32x6) that secure the right AlienFX side-panel connector to the bracket.
3. Align the screw hole on the right AlienFX side-panel connector assembly with the screw hole on the chassis.
4. Replace the screw (#6-32x6) that secures the right AlienFX side-panel connector assembly to the chassis.
5. Connect the cable that connects the right AlienFX side-panel connector to the I/O board. See "[I/O-board components](#)".

## Post-requisites

1. Replace the left and right side-panels. See "[Replacing the side panels](#)".
2. Replace the [stability foot](#).

# Removing the left AlienFX side-panel connector

**NOTE:** Before working inside your computer, read the safety information that shipped with your computer and follow the steps in [Before working inside your computer](#). After working inside your computer, follow the instructions in [After working inside your computer](#). For more safety best practices, see the Regulatory Compliance home page at [www.dell.com/regulatory\\_compliance](http://www.dell.com/regulatory_compliance).

## Topics:

- [Prerequisites](#)
- [Procedure](#)

## Prerequisites

1. Remove the [stability foot](#).
2. Remove the left and right side-panels. See "[Removing the side panels](#)".

## Procedure

1. Lay the chassis on the left side.
2. Disconnect the cable that connects the left AlienFX side-panel connector to the I/O board. See "[I/O-board components](#)".



- a. left AlienFX side-panel connector
  - b. left AlienFX side-panel cable
  - c. I/O board
3. Turn the chassis over.
  4. Remove the AlienFX side-panel cable through the routing guides on the chassis.
  5. Remove the screw (#6-32x6) that secures the left AlienFX side-panel connector assembly to the chassis.
  6. Remove the left AlienFX side-panel connector assembly from the chassis.



- a. screw
- b. left AlienFX side-panel connector assembly

7. Remove the two screws (#6-32x6) that secure the AlienFX side-panel connector to the bracket.
8. Remove the cable routing through the slot on the bracket and lift the left AlienFX side-panel connector off the bracket.

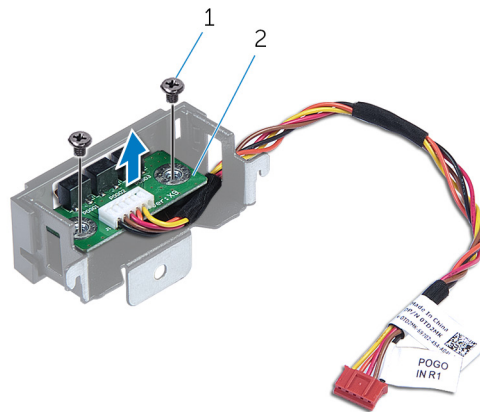

- a. screw
- b. left AlienFX side-panel connector

# Replacing the left AlienFX side-panel connector

**NOTE:** Before working inside your computer, read the safety information that shipped with your computer and follow the steps in [Before working inside your computer](#). After working inside your computer, follow the instructions in [After working inside your computer](#). For more safety best practices, see the Regulatory Compliance home page at [www.dell.com/regulatory\\_compliance](http://www.dell.com/regulatory_compliance).

## Topics:

- [Procedure](#)
- [Post-requisites](#)

## Procedure

1. Route the cable through the slot on the bracket and align the screw holes on the left AlienFX side-panel connector with the screw holes on the bracket.
2. Replace the two screws (#6-32x6) that secure the AlienFX side-panel connector to the bracket.
3. Align the screw hole on the left AlienFX side-panel connector with the screw hole on the chassis.
4. Replace the screw (#6-32x6) that secures the left AlienFX side-panel connector to the chassis.
5. Connect the cable that connects the left AlienFX side-panel connector to the system board. See "[I/O-board components](#)".

## Post-requisites

1. Replace the left and right side-panels. See "[Replacing the side panels](#)".
2. Replace the [stability foot](#).

# Removing the I/O board

**NOTE:** Before working inside your computer, read the safety information that shipped with your computer and follow the steps in [Before working inside your computer](#). After working inside your computer, follow the instructions in [After working inside your computer](#). For more safety best practices, see the Regulatory Compliance home page at [www.dell.com/regulatory\\_compliance](http://www.dell.com/regulatory_compliance).

## Topics:

- [Prerequisites](#)
- [Procedure](#)

## Prerequisites

1. Remove the [stability foot](#).
2. Remove left and right side-panels. See "[Removing the side panels](#)".

## Procedure

1. Lay the chassis on the left side.
2. Disconnect all cables from the I/O board.

**NOTE:** Note the routing of all cables as you remove them so that you can route them correctly after you replace the I/O board.

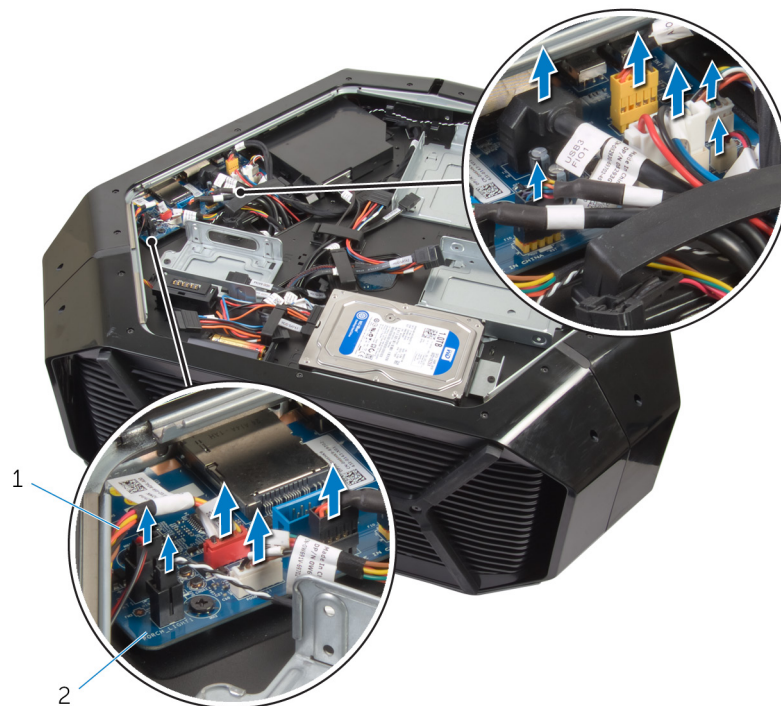

- a. cables
- b. I/O board

3. Remove the five screws (#6-32x6) that secure the I/O board to the chassis.
4. Slide and lift the I/O board out of the chassis.

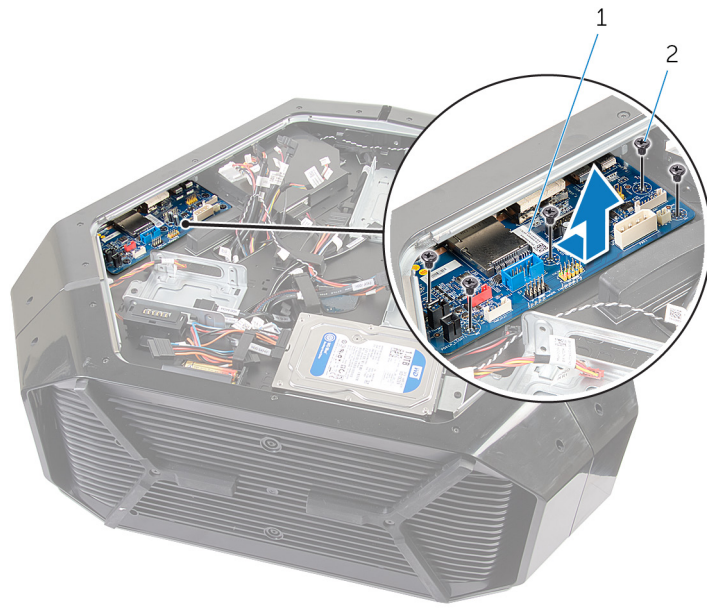

- a. I/O board
- b. screws (5)

# Replacing the I/O board

**NOTE:** Before working inside your computer, read the safety information that shipped with your computer and follow the steps in [Before working inside your computer](#). After working inside your computer, follow the instructions in [After working inside your computer](#). For more safety best practices, see the Regulatory Compliance home page at [www.dell.com/regulatory\\_compliance](http://www.dell.com/regulatory_compliance).

## Topics:

- [Procedure](#)
- [Post-requisites](#)

## Procedure

1. Align the ports on the I/O board with their respective slots on the chassis and slide it into place.
2. Align the screw holes on the I/O board to the screw holes on the chassis.
3. Replace the five screws (#6-32x6) that secure the I/O board to the chassis.
4. Connect the cables to the I/O board.

**NOTE:** The connectors on the I/O board are color coded. Make sure that you match the color of the I/O board connector with the cable connector. For more information on I/O connectors, see [I/O-board components](#).

## Post-requisites

1. Replace left and right side-panels. See "[Replacing the side panels](#)".
2. Replace the [stability foot](#).

# Removing the drive-bay heat sensor cable

**NOTE:** Before working inside your computer, read the safety information that shipped with your computer and follow the steps in [Before working inside your computer](#). After working inside your computer, follow the instructions in [After working inside your computer](#). For more safety best practices, see the Regulatory Compliance home page at [www.dell.com/regulatory\\_compliance](http://www.dell.com/regulatory_compliance).

## Topics:

- [Prerequisites](#)
- [Procedure](#)

## Prerequisites

1. Remove the [stability foot](#).
2. Remove the left and right side-panels. See "[Removing the side panels](#)".

## Procedure

1. Lay the chassis on the right side.
2. Locate the drive-bay heat-sensor connector (SENSOR2) on the system board. For more information on the drive-bay heat-sensor connector, see "[system-board components](#)".
3. Disconnect the drive-bay heat-sensor cable from the system board.

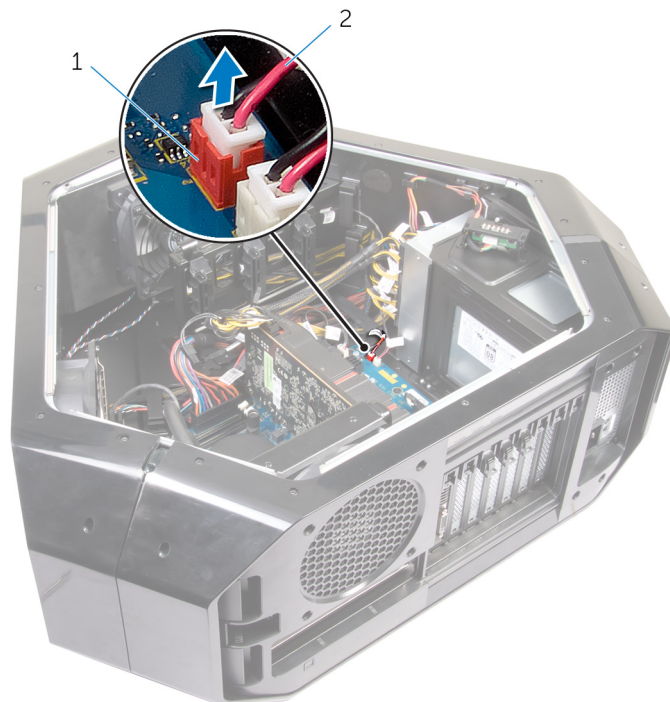

- a. drive-bay heat-sensor connector
  - b. drive-bay heat-sensor cable
4. Turn the chassis over.
  5. Remove the cable through the slot on the chassis.
  6. Locate the drive-bay heat-sensor. See "[right view](#)".
  7. Push the release tab and pry the drive-bay heat-sensor cable off the chassis.

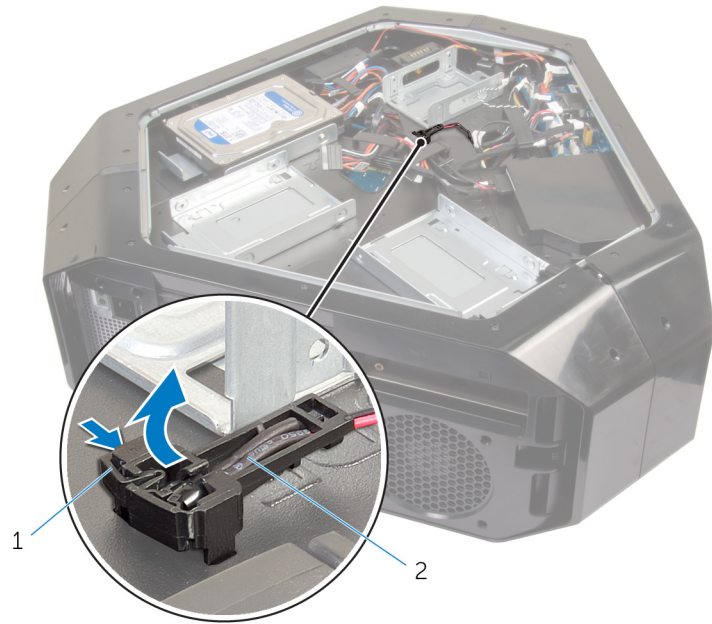

- a.** release tab
- b.** drive-bay heat-sensor cable

# Replacing the drive-bay heat sensor cable

**NOTE:** Before working inside your computer, read the safety information that shipped with your computer and follow the steps in [Before working inside your computer](#). After working inside your computer, follow the instructions in [After working inside your computer](#). For more safety best practices, see the Regulatory Compliance home page at [www.dell.com/regulatory\\_compliance](http://www.dell.com/regulatory_compliance).

## Topics:

- [Procedure](#)
- [Post-requisites](#)

## Procedure

1. Route the drive-bay heat-sensor cable through the slot on the chassis.
2. Align the tab on the drive-bay heat-sensor cable on the chassis.
3. Push the release tab on the drive-bay heat-sensor cable and press it into place.
4. Lay the chassis on the left side.
5. Connect the drive-bay heat-sensor cable to the system board. See "[system-board components](#)".

## Post-requisites

1. Replace the left and right side-panels. See "[Replacing the side panels](#)".
2. Replace the [stability foot](#).

# Removing the memory modules

**NOTE:** Before working inside your computer, read the safety information that shipped with your computer and follow the steps in [Before working inside your computer](#). After working inside your computer, follow the instructions in [After working inside your computer](#). For more safety best practices, see the Regulatory Compliance home page at [www.dell.com/regulatory\\_compliance](http://www.dell.com/regulatory_compliance).

## Topics:

- [Prerequisites](#)
- [Procedure](#)

## Prerequisites

1. Remove the [stability foot](#).
2. Remove the left and right side-panels. See "[Removing the side panels](#)".

## Procedure

1. Lay the chassis on the right side.
2. Locate the memory modules on the system board. For more information on the memory modules see "[system-board components](#)".
3. Push the securing clip away from the memory module.
4. Remove the memory module from the memory-module slot.

**NOTE:** Repeat step 2 to step 4 to remove any other memory modules installed in your computer.

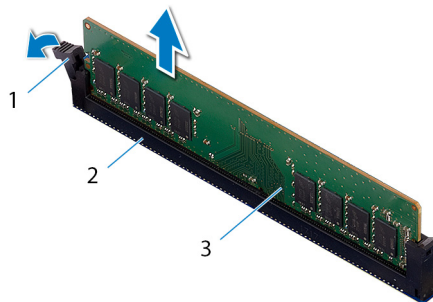

- a. securing clip
- b. memory-module slot
- c. memory module

# Replacing the memory modules

**NOTE:** Before working inside your computer, read the safety information that shipped with your computer and follow the steps in [Before working inside your computer](#). After working inside your computer, follow the instructions in [After working inside your computer](#). For more safety best practices, see the Regulatory Compliance home page at [www.dell.com/regulatory\\_compliance](http://www.dell.com/regulatory_compliance).

## Topics:

- [Procedure](#)
- [Post-requisites](#)

## Procedure

1. Align the notch on the bottom of the memory module with the tab on the memory-module slot.
2. Insert the memory module into the memory-module connector until the memory module snaps into position and the securing clip locks in place.

**NOTE:** If you do not hear the click, remove the memory module and reinstall it.

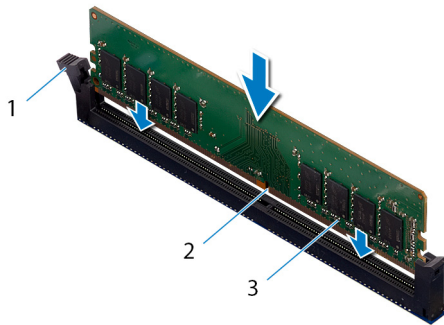

- a. memory module
- b. memory-module slot
- c. notch

## Post-requisites

1. Replace the left and right side-panels. See "[Replacing the side panels](#)".
2. Replace the [stability foot](#).

# Removing the graphics card

**(i)** **NOTE:** Before working inside your computer, read the safety information that shipped with your computer and follow the steps in [Before working inside your computer](#). After working inside your computer, follow the instructions in [After working inside your computer](#). For more safety best practices, see the Regulatory Compliance home page at [www.dell.com/regulatory\\_compliance](http://www.dell.com/regulatory_compliance).

## Topics:

- [Prerequisites](#)
- [Procedure](#)

## Prerequisites

1. Remove the [stability foot](#).
2. Remove the left and right side-panels. See "[Removing the side panels](#)".

## Procedure

1. Lay the chassis on the right side.
2. Locate the graphics card on the system board. For more information on graphics card see "[system-board components](#)".
3. Press the releasing clip on the power-cable connectors and disconnect the power cables from the graphics card.
4. Press and push the screw covers covering the screws that secure the graphics card to the chassis.
5. Remove the two screws (#6-32x6) that secure the graphics card to the chassis.
6. Press the release tabs on the power-cable connectors to disconnect the power cables from the graphics card.

**(i)** **NOTE:** The location of the power supply connector (PCI-E1, PCI-E2 and PCI-E3) varies depending on the video card installed.

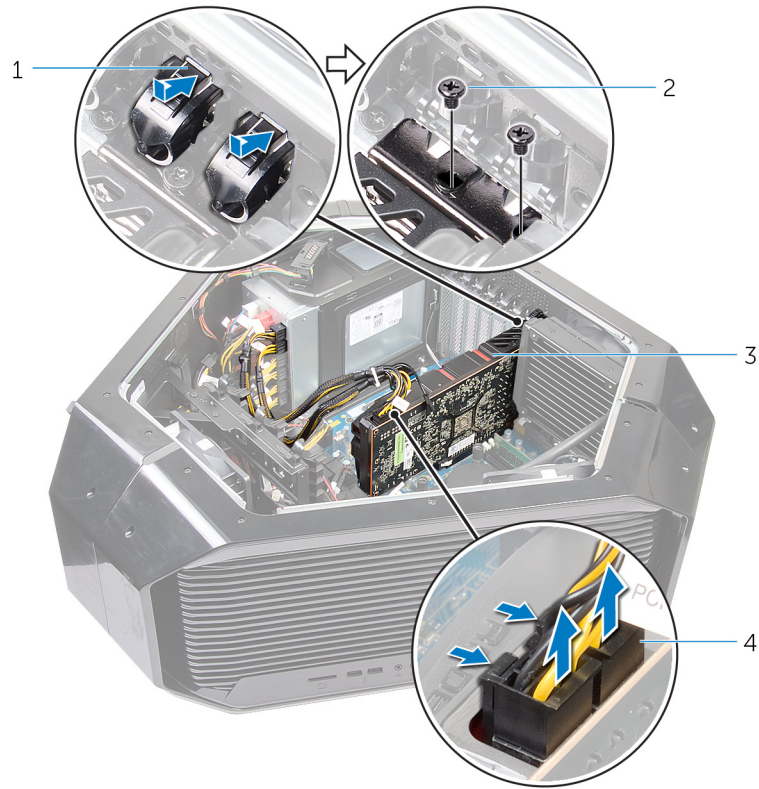

- 1. screw cover
- 3. graphics card

- 2. screws (2)
- 4. power cables (2)

7. Press and hold the securing tab on the graphics-card connector, grasp the card by its top corners, and then ease the card out of the slot.

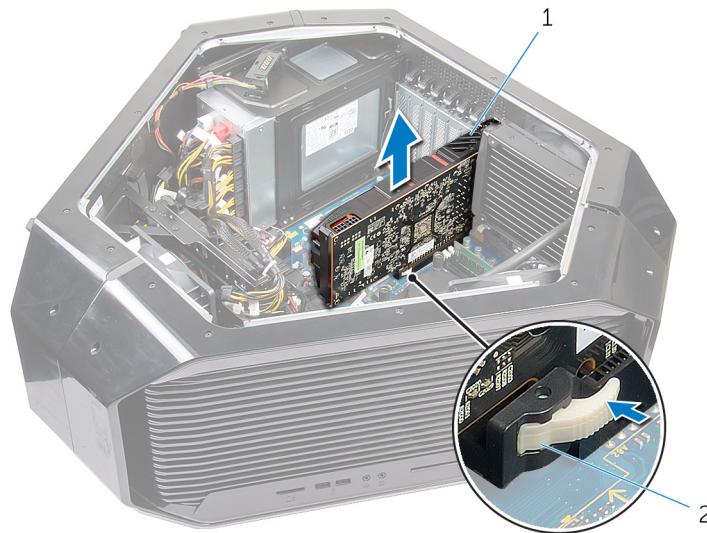

- a. graphics card
- b. securing tab

# Replacing the graphics card

**NOTE:** Before working inside your computer, read the safety information that shipped with your computer and follow the steps in [Before working inside your computer](#). After working inside your computer, follow the instructions in [After working inside your computer](#). For more safety best practices, see the Regulatory Compliance home page at [www.dell.com/regulatory\\_compliance](http://www.dell.com/regulatory_compliance).

## Topics:

- [Procedure](#)
- [Post-requisites](#)

## Procedure

1. Align the graphics card with the PCI-Express card connector on the system board.
2. Place the card in the connector and press down firmly. Ensure that the card is firmly seated.
3. Replace the two screws (#6-32x6) that secure the graphics card to the chassis.
4. Connect the power cables to the graphics card.

**NOTE:** The location of the power supply connector (PCIE1, PCIE2 and PCIE3) varies depending on the video card installed.

5. From outside the chassis, push the screw covers inside to cover the screws that secure the graphics card to the chassis.
6. Connect the power cables to the graphics card.

## Post-requisites

1. Replace the left and right side-panels. See "[Replacing the side panels](#)".
2. Replace the [stability foot](#).

# Removing multiple graphics cards

**NOTE:** Before working inside your computer, read the safety information that shipped with your computer and follow the steps in [Before working inside your computer](#). After working inside your computer, follow the instructions in [After working inside your computer](#). For more safety best practices, see the Regulatory Compliance home page at [www.dell.com/regulatory\\_compliance](http://www.dell.com/regulatory_compliance).

## Topics:

- [Prerequisites](#)
- [Procedure](#)

## Prerequisites

1. Remove the [stability foot](#).
2. Remove the left and right side-panels. See "[Removing the side panels](#)".

## Procedure

1. Lay the chassis on the right side.
2. Locate the graphics cards (PCI-Express card connector) on the system board. For more information on the graphics card connector, see "[system-board components](#)".
3. Lift the graphics bridge that connects the graphics cards.

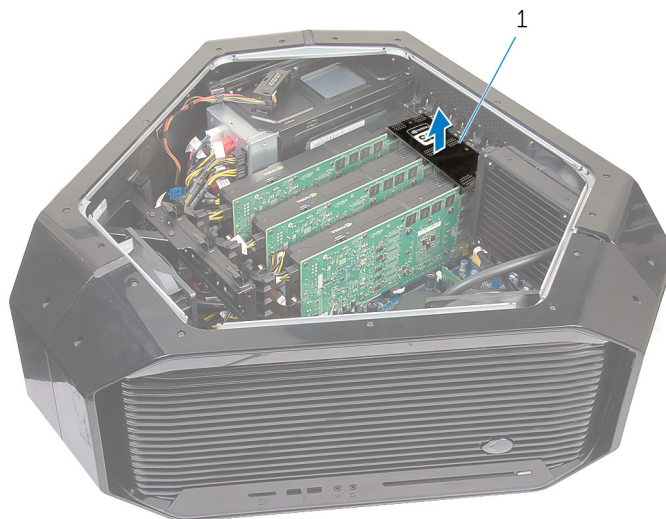

### a. graphics bridge

4. Starting with the graphics card on the PCI-Express card connector (SLOT1), press and push the screw covers covering the screws that secure the graphics card.
5. Remove the two screws (#6-32x6) that secure the graphics card to the chassis.
6. Press the release tabs on the power-cable connectors to disconnect the power cables from the graphics card.

**NOTE:** The location of the power supply connector (PCIE1, PCIE2 and PCIE3) varies depending on the video card installed.

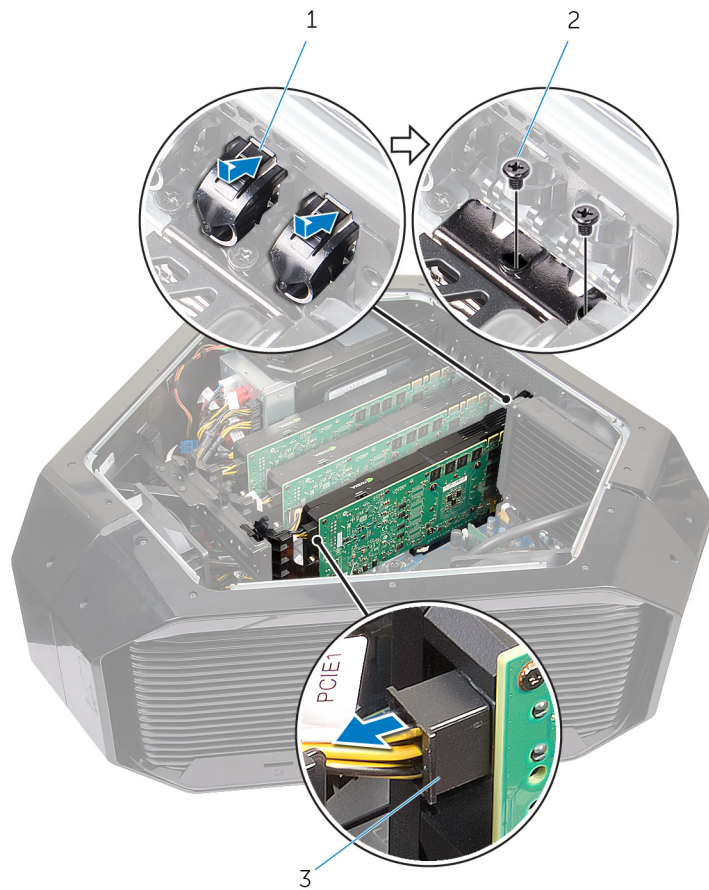

- a. screw cover
- b. screws (2)
- c. power cables (2)

7. Press and hold the securing tab on the card connector, grasp the card by its top corners, and then ease the card out of the card connector.



- a. graphics card
- b. securing tab

8. Repeat steps 2 to 7 to remove graphics card on the PCI-Express card connector (SLOT4) and PCI-Express x16 card connector (SLOT7).

# Replacing multiple graphics cards

**NOTE:** Before working inside your computer, read the safety information that shipped with your computer and follow the steps in [Before working inside your computer](#). After working inside your computer, follow the instructions in [After working inside your computer](#). For more safety best practices, see the Regulatory Compliance home page at [www.dell.com/regulatory\\_compliance](http://www.dell.com/regulatory_compliance).

## Topics:

- [Procedure](#)
- [Post-requisites](#)

## Procedure

1. Locate the graphics (PCI-Express card connector (SLOT7)) on the system board. For more information on the graphics connector, see "[system-board components](#)".
2. Align the graphics card with the PCI-Express card connector (SLOT7) on the system board.
3. Place the card in the connector and press the card down firmly. Ensure that the card is firmly seated in the slot.

**NOTE:** Repeat steps 2 to 3 to install graphics card on the PCI-Express card connector (SLOT4) and PCI-Express card connector (SLOT1).

4. Replace the two screws (#6-32x6) that secure the graphics card to the chassis.
5. Place the graphics bridge that connects the graphics cards.
6. Connect the power cables to the graphics card.

**NOTE:** The location of the power supply connector (PCIE1, PCIE2 and PCIE3) varies depending on the video card installed.

7. From outside the chassis, push the screw covers inside to cover the screws that secure the graphics card.

## Post-requisites

1. Replace the left and right side-panels. See "[Replacing the side panels](#)".
2. Replace the [stability foot](#).

# Removing the full-length graphics cards

**NOTE:** Before working inside your computer, read the safety information that shipped with your computer and follow the steps in [Before working inside your computer](#). After working inside your computer, follow the instructions in [After working inside your computer](#). For more safety best practices, see the Regulatory Compliance home page at [www.dell.com/regulatory\\_compliance](http://www.dell.com/regulatory_compliance).

## Topics:

- [Prerequisites](#)
- [Procedure](#)

## Prerequisites

1. Remove the [stability foot](#).
2. Remove the left and right side-panels. See "[Removing the side panels](#)".

## Procedure

1. Lay the chassis on the right side.
2. Locate the graphics card (PCI-Express card connector) on the system board. For more information on the graphics connector, see "[system-board components](#)".
3. Press and hold the securing tab on the clamp.
4. Pull the clamp away from the bracket.

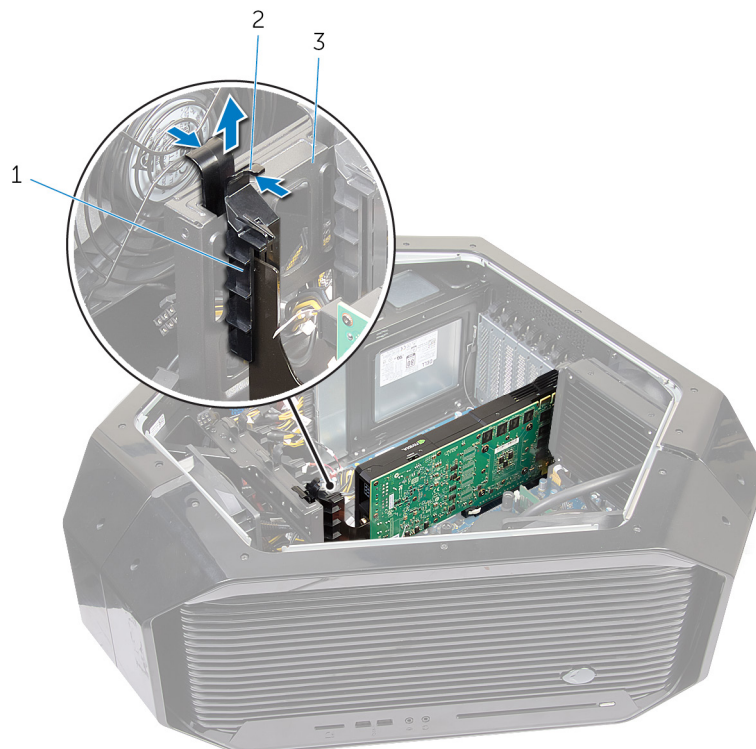

- a. clamp
- b. securing tab
- c. bracket

5. Press and push the screw covers covering the screws that secure the graphics card to the chassis.
6. Remove the two screws (#6-32x6) that secure the graphics card to the chassis.

7. Press the release tabs on the power-cable connectors to disconnect the power cables from the graphics card.

**i** **NOTE:** The location of the power supply connector (PCI-E1, PCI-E2 and PCI-E3) varies depending on the video card installed.

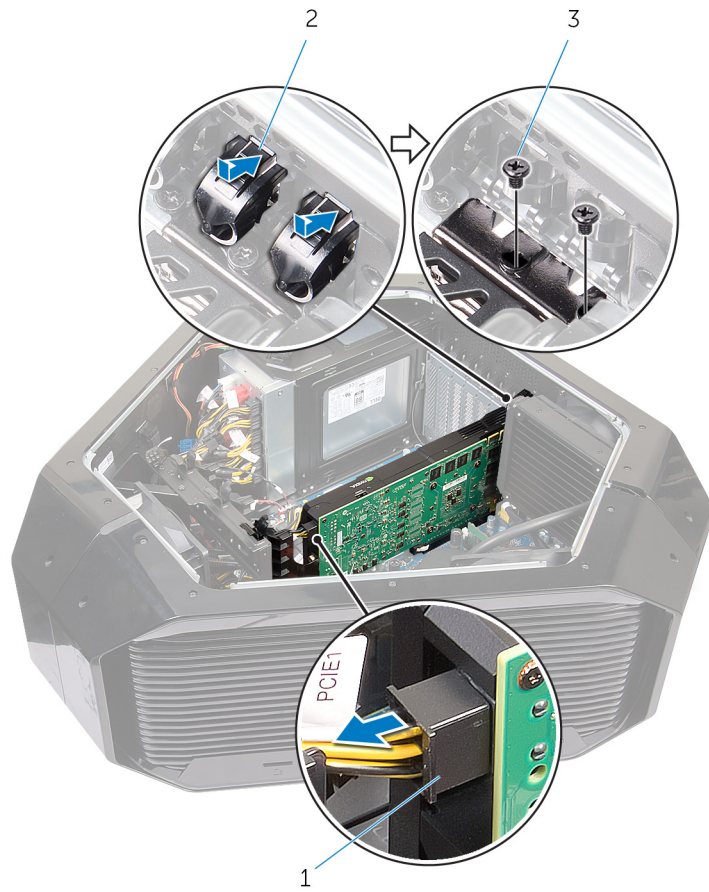

- a. screw cover
- b. screws (2)
- c. power cables (2)

8. Press and hold the securing tab on the card connector, grasp the card by its top corners, and then ease the card out of the card connector.

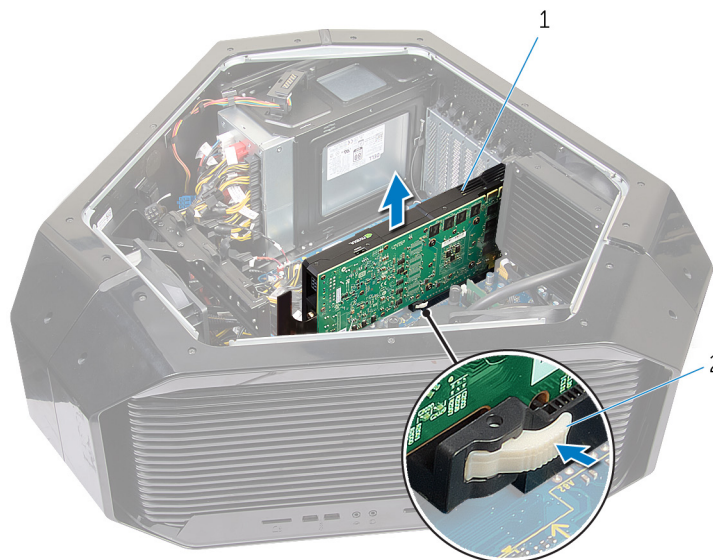

- a. graphics card
- b. securing tab

# Replacing the full-length graphics cards

**NOTE:** Before working inside your computer, read the safety information that shipped with your computer and follow the steps in [Before working inside your computer](#). After working inside your computer, follow the instructions in [After working inside your computer](#). For more safety best practices, see the Regulatory Compliance home page at [www.dell.com/regulatory\\_compliance](http://www.dell.com/regulatory_compliance).

## Topics:

- [Procedure](#)
- [Post-requisites](#)

## Procedure

1. Align the graphics card with the PCI-Express card connector on the system board.
2. Place the card in the connector and press the card down firmly. Ensure that the card is firmly seated.
3. Press and hold the securing tab on the clamp.
4. Push the clamp back towards the bracket.
5. Replace the two screws (#6-32x6) that secure the graphics card to the chassis.
6. Connect the power cables to the graphics card.

**NOTE:** The location of the power supply connector (PCI-E1, PCI-E2 and PCI-E3) varies depending on the video card installed.

7. From outside the chassis, push the screw covers inside to cover the screws that secure the graphics card.

## Post-requisites

1. Replace the left and right side-panels. See "[Replacing the side panels](#)".
2. Replace the [stability foot](#).

# Removing the wireless card

**NOTE:** Before working inside your computer, read the safety information that shipped with your computer and follow the steps in [Before working inside your computer](#). After working inside your computer, follow the instructions in [After working inside your computer](#). For more safety best practices, see the Regulatory Compliance home page at [www.dell.com/regulatory\\_compliance](http://www.dell.com/regulatory_compliance).

## Topics:

- [Prerequisites](#)
- [Procedure](#)

## Prerequisites

1. Remove the stability foot. See "[Removing the stability foot](#)".
2. Remove the left and right side-panels. See "[Removing the side panels](#)".
3. If you have multiple graphics cards installed, remove the graphics card. See "[Removing multiple graphics cards](#)".

## Procedure

1. Lay the chassis on the right side.
2. Disconnect the antenna cables from the wireless card.
3. Remove the screw (M2x3) that secures the wireless card to the chassis.
4. Slide and remove the wireless card from the wireless-card slot.

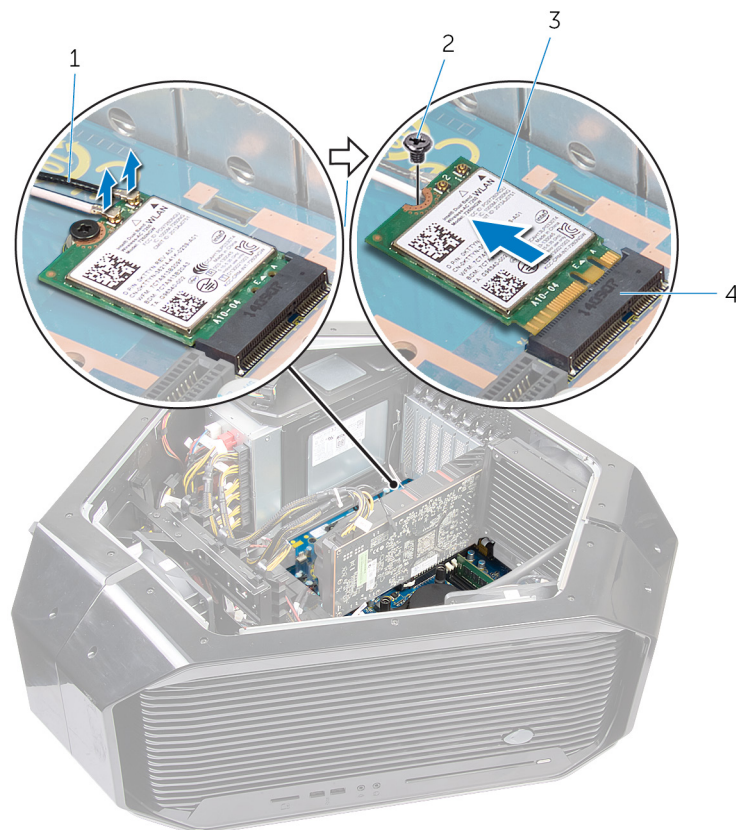

1. antenna cables

2. screw

3. wireless card

4. wireless-card slot

# Replacing the wireless card

**NOTE:** Before working inside your computer, read the safety information that shipped with your computer and follow the steps in [Before working inside your computer](#). After working inside your computer, follow the instructions in [After working inside your computer](#). For more safety best practices, see the Regulatory Compliance home page at [www.dell.com/regulatory\\_compliance](http://www.dell.com/regulatory_compliance).

## Topics:

- [Procedure](#)
- [Post-requisites](#)

## Procedure

1. Align the notch on the wireless card with the tab on the wireless-card slot.
2. Insert the wireless card at an angle into the connector.
3. Replace the screw (M2x3) that secures the wireless card to the chassis.
4. Connect the antenna cables to the wireless card.

A label at the tip of the antenna cables indicates the color scheme for the wireless card supported by your computer.

**Table 2. Antenna-cable color scheme**

Connectors on the wireless card	Antenna-cable sticker color
Auxiliary (1)	Black
Main (2)	White

## Post-requisites

1. If you have multiple graphics cards, replace the graphics card. See "[Replacing multiple graphics cards](#)".
2. Replace the left and right side-panels. See "[Replacing the side panels](#)".
3. Replace the [stability foot](#).

# Removing the coin-cell battery

**NOTE:** Before working inside your computer, read the safety information that shipped with your computer and follow the steps in [Before working inside your computer](#). After working inside your computer, follow the instructions in [After working inside your computer](#). For more safety best practices, see the Regulatory Compliance home page at [www.dell.com/regulatory\\_compliance](http://www.dell.com/regulatory_compliance).

**CAUTION:** Removing the coin-cell battery resets the BIOS setup program's settings to default. It is recommended that you note the BIOS setup program's settings before removing the coin-cell battery.

## Topics:

- [Prerequisites](#)
- [Procedure](#)

## Prerequisites

1. Remove the [stability foot](#).
2. Remove the left and right side-panels. See "[Removing the side panels](#)".
3. If you have multiple graphics cards installed, remove the graphics card. See "[Removing multiple graphics cards](#)".

## Procedure

1. Lay the chassis on the right side.
2. Push the coin-cell battery-release lever to remove the coin-cell battery.

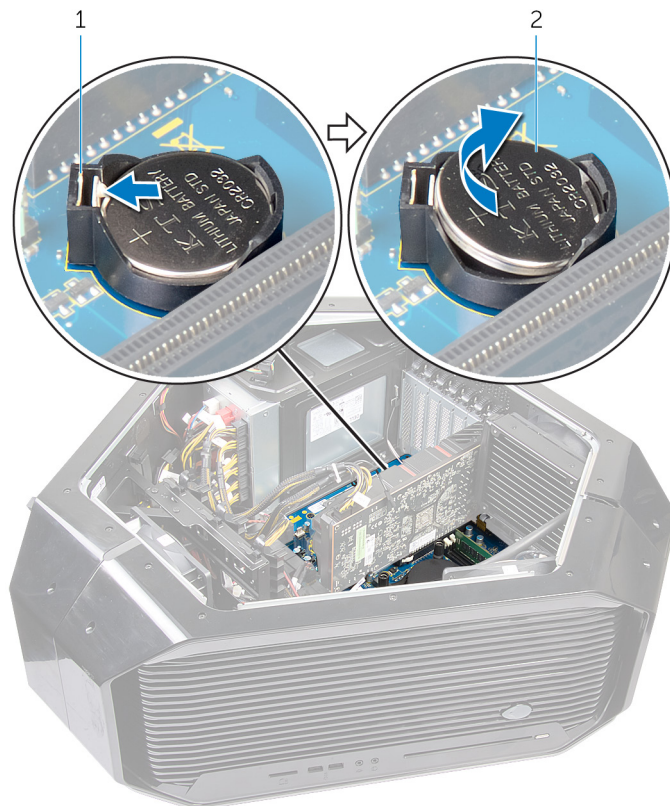

- a. coin-cell battery-release lever
- b. coin-cell battery

# Replacing the coin-cell battery

**NOTE:** Before working inside your computer, read the safety information that shipped with your computer and follow the steps in [Before working inside your computer](#). After working inside your computer, follow the instructions in [After working inside your computer](#). For more safety best practices, see the Regulatory Compliance home page at [www.dell.com/regulatory\\_compliance](http://www.dell.com/regulatory_compliance).

## Topics:

- [Procedure](#)
- [Post-requisites](#)

## Procedure

Insert the coin-cell battery into the socket with the side labeled + facing up and press down the battery in the socket.

## Post-requisites

1. If you have multiple graphics cards installed, replace the graphics cards. See "[Replacing multiple graphics cards](#)".
2. Replace the left and right side-panels. See "[Replacing the side panels](#)".
3. Remove the [stability foot](#).

# Removing the top fan

**NOTE:** Before working inside your computer, read the safety information that shipped with your computer and follow the steps in [Before working inside your computer](#). After working inside your computer, follow the instructions in [After working inside your computer](#). For more safety best practices, see the Regulatory Compliance home page at [www.dell.com/regulatory\\_compliance](http://www.dell.com/regulatory_compliance).

## Topics:

- [Prerequisites](#)
- [Procedure](#)

## Prerequisites

1. Remove the [stability foot](#).
2. Remove the left and right side-panels. See "[Removing the side panels](#)".

## Procedure

1. Lay the chassis on the right side.
2. Disconnect the top-fan cable from the connector on the system board. For more information on the top-fan cable connector, see "[system-board components](#)".
3. Remove the screw (#6-32x6) that secures the top fan on the chassis.
4. Pull the release tab away from the chassis and move the top fan towards the right side.
5. Lift the top fan out of the chassis.

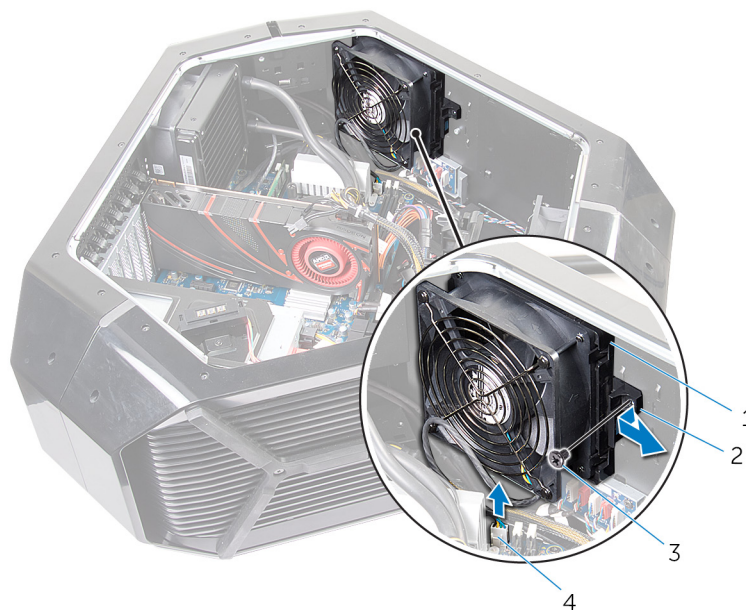

1. top fan
3. screw

2. release tab
4. memory-fan cable

# Replacing the top fan

**NOTE:** Before working inside your computer, read the safety information that shipped with your computer and follow the steps in [Before working inside your computer](#). After working inside your computer, follow the instructions in [After working inside your computer](#). For more safety best practices, see the Regulatory Compliance home page at [www.dell.com/regulatory\\_compliance](http://www.dell.com/regulatory_compliance).

## Topics:

- [Procedure](#)
- [Post-requisites](#)

## Procedure

1. Align the tabs on the top fan with the slots on the chassis and slide the fan until it snaps into position.
2. Replace the screw (#6-32x6) that secures the top fan on the chassis.
3. Connect the top fan cable from the connector on the system board. For more information on the top fan cable connector, see "[system-board components](#)".

## Post-requisites

1. Replace the left and right side-panels. See "[Replacing the side panels](#)".
2. Replace the [stability foot](#).

# Removing the logo board

**NOTE:** Before working inside your computer, read the safety information that shipped with your computer and follow the steps in [Before working inside your computer](#). After working inside your computer, follow the instructions in [After working inside your computer](#). For more safety best practices, see the Regulatory Compliance home page at [www.dell.com/regulatory\\_compliance](http://www.dell.com/regulatory_compliance).

## Topics:

- [Prerequisites](#)
- [Procedure](#)

## Prerequisites

1. Remove the [stability foot](#).
2. Remove the left and right side-panels. See "[Removing the side panels](#)".
3. Remove the [top fan](#).

## Procedure

**NOTE:** Note the routing of all cables as you remove them so that you can route them correctly after you replace the logo board.

1. Lay the chassis on the right side.
2. Disconnect all the cables from the logo board.
3. Remove the screw (#6-32x6) that secures the logo board to the chassis.
4. Slide the logo board out of the chassis.

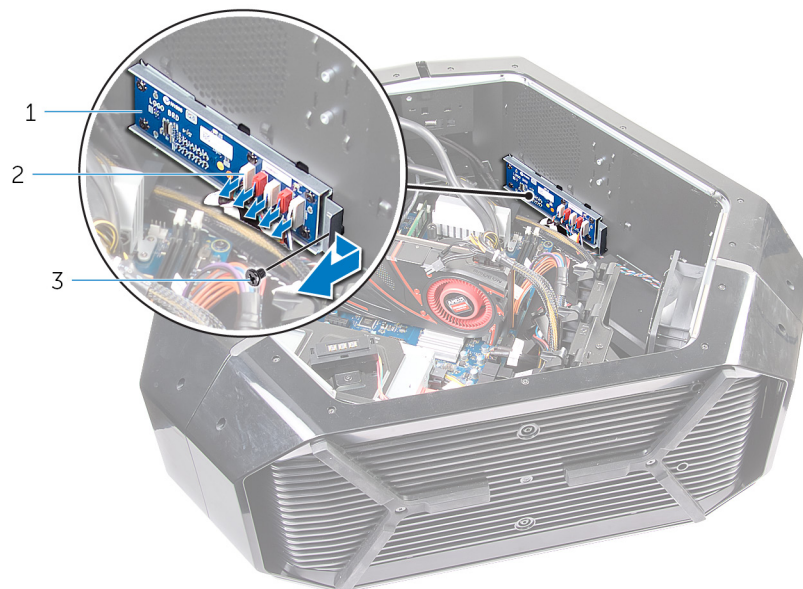

- a. logo board
- b. connector
- c. screw

5. Remove the six screws (#6-32x6) that secure the logo board to the bracket.
6. Remove the logo board from the bracket.

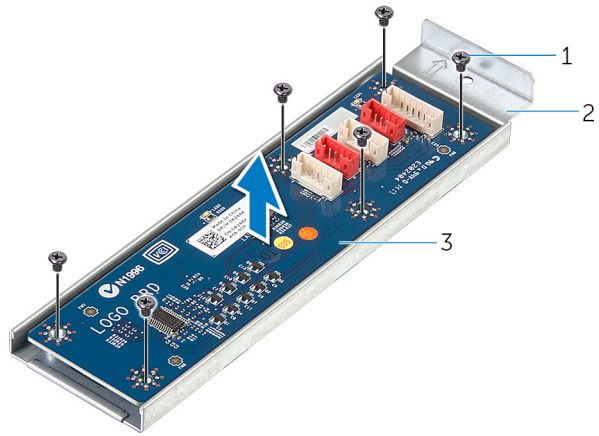

- a. screws (6)
- b. logo-board bracket
- c. logo board

# Replacing the logo board

**NOTE:** Before working inside your computer, read the safety information that shipped with your computer and follow the steps in [Before working inside your computer](#). After working inside your computer, follow the instructions in [After working inside your computer](#). For more safety best practices, see the Regulatory Compliance home page at [www.dell.com/regulatory\\_compliance](http://www.dell.com/regulatory_compliance).

## Topics:

- [Procedure](#)
- [Post-requisites](#)

## Procedure

1. Align the screw holes on the logo board to the screw holes on the bracket and slide the logo board in place.
2. Replace the six screws (#6-32x6) that secure the logo board to the bracket.
3. Slide the logo board inside the chassis.
4. Replace the screw (#6-32x6) that secures the logo board to the bracket.
5. Route and connect the respective to the logo board.

## Post-requisites

1. Replace the left and right side-panels. See "[Replacing the side panels](#)".
2. Replace the [stability foot](#).

# Removing the solid-state drive

**NOTE:** Before working inside your computer, read the safety information that shipped with your computer and follow the steps in [Before working inside your computer](#). After working inside your computer, follow the instructions in [After working inside your computer](#). For more safety best practices, see the Regulatory Compliance home page at [www.dell.com/regulatory\\_compliance](http://www.dell.com/regulatory_compliance).

**CAUTION:** Solid-state drives are fragile. Exercise care when handling the solid-state drive.

**CAUTION:** To avoid data loss, do not remove the solid-state drive while the computer is in sleep or on state.

## Topics:

- [Prerequisites](#)
- [Procedure](#)

## Prerequisites

1. Remove the [stability foot](#).
2. Remove the left and right side-panels. See "[Removing the side panels](#)".

## Procedure

1. Lay the chassis on the right side.
2. Locate the solid-state drive on the system board. For more information on the solid-state drive see "[system-board components](#)".
3. Remove the screw (M2x2.5) that secures the solid-state drive to the system board.
4. Slide and remove the solid-state drive from the solid-state drive slot on the system board.

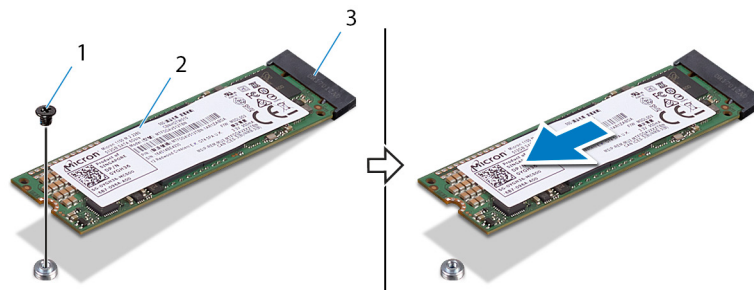

- a. screw
- b. solid-state drive
- c. solid-state drive slot

# Replacing the solid-state drive

**NOTE:** Before working inside your computer, read the safety information that shipped with your computer and follow the steps in [Before working inside your computer](#). After working inside your computer, follow the instructions in [After working inside your computer](#). For more safety best practices, see the Regulatory Compliance home page at [www.dell.com/regulatory\\_compliance](http://www.dell.com/regulatory_compliance).

**CAUTION:** Solid-state drives are fragile. Exercise care when handling the solid-state drive.

## Topics:

- [Procedure](#)
- [Post-requisites](#)

## Procedure

1. Align the notch on the solid-state drive with the tab on the solid-state drive slot and slide the solid-state drive into the solid-state drive slot.
2. Align the screw hole on the solid-state drive with the screw hole on the system board.
3. Replace the screw (M2x2.5) that secures the solid-state drive to the system board.

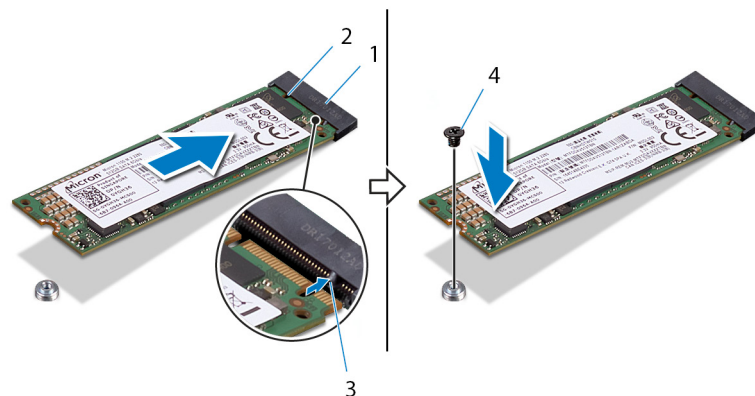

1. solid-state drive slot
3. tab

2. notch
4. screw

## Post-requisites

1. Replace the left and right side-panels. See "[Replacing the side panels](#)".
2. Replace the [stability foot](#).

# Removing the PCI fan

**NOTE:** Before working inside your computer, read the safety information that shipped with your computer and follow the steps in [Before working inside your computer](#). After working inside your computer, follow the instructions in [After working inside your computer](#). For more safety best practices, see the Regulatory Compliance home page at [www.dell.com/regulatory\\_compliance](http://www.dell.com/regulatory_compliance).

## Topics:

- [Prerequisites](#)
- [Procedure](#)

## Prerequisites

1. Remove the [stability foot](#).
2. Remove the left and right side-panels. See "[Removing the side panels](#)".
3. Remove the [full-length graphics cards](#).

## Procedure

1. Lay the chassis on the right side.
2. Remove the four screws (#6-32x6) that secure the graphics-card bracket to the chassis.
3. Slide the graphics-card bracket out of the chassis.

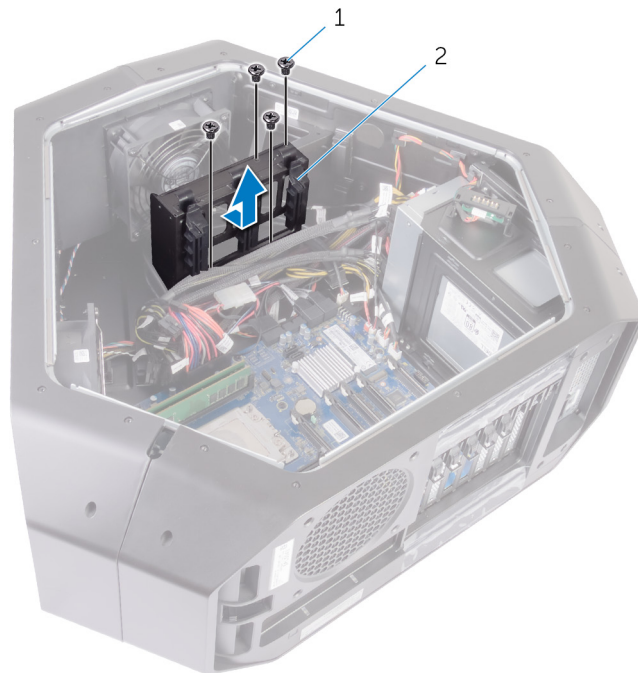

- a. screws (4)
  - b. graphics-card bracket
4. Remove the two screws (M3x5.25) that secure the PCI fan to the chassis.



- a. PCI fan
- b. screws (2)

5. Disconnect the PCI-fan cable and front-bezel heat-sensor cable from their respective connectors on the system board.
6. Remove the PCI fan from the tabs securing it to the chassis.

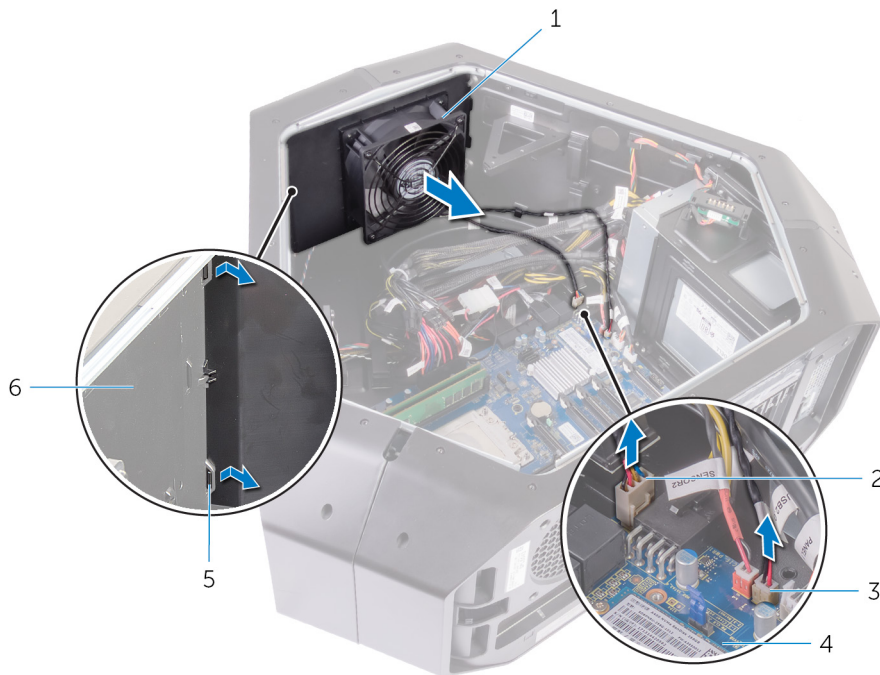

- 1. PCI fan
- 2. front-bezel heat-sensor cable
- 3. PCI-fan cable
- 4. system board
- 5. tabs
- 6. chassis

7. Remove the four screws (M5x10) securing the fan shroud to the PCI fan.
8. Lift and remove the fan shroud off the PCI fan.

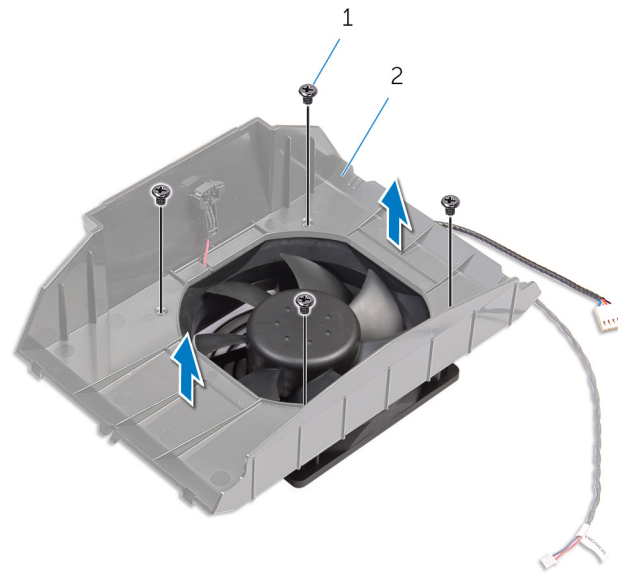

- a. screws (4)
- b. fan shroud

# Replacing the PCI fan

**NOTE:** Before working inside your computer, read the safety information that shipped with your computer and follow the steps in [Before working inside your computer](#). After working inside your computer, follow the instructions in [After working inside your computer](#). For more safety best practices, see the Regulatory Compliance home page at [www.dell.com/regulatory\\_compliance](http://www.dell.com/regulatory_compliance).

## Topics:

- [Procedure](#)
- [Post-requisites](#)

## Procedure

1. Align the tabs on the fan shroud with the slots on the PCI fan.
2. Replace the four screws (M5x10) securing the fan shroud to the PCI fan.
3. Align the tabs on the PCI-fan shroud with the slots on the chassis and slide the fan until it snaps into position.
4. Connect the PCI-fan cable and front-bezel heat-sensor cable to the connectors on the system board.
5. Replace the two screws (M3x5.25) that secure the PCI fan to the chassis.
6. Place and align the screw holes on the graphics-card bracket with the screw holes on the chassis.
7. Replace the four screws (#6-32x6) that secure the graphics-card bracket to the chassis.

## Post-requisites

1. Replace the [full-length graphics cards](#).
2. Replace the left and right side-panels. See "[Replacing the side panels](#)".
3. Replace the [stability foot](#).

# Removing the front-bezel heat sensor cable

**NOTE:** Before working inside your computer, read the safety information that shipped with your computer and follow the steps in [Before working inside your computer](#). After working inside your computer, follow the instructions in [After working inside your computer](#). For more safety best practices, see the Regulatory Compliance home page at [www.dell.com/regulatory\\_compliance](http://www.dell.com/regulatory_compliance).

## Topics:

- [Prerequisites](#)
- [Procedure](#)

## Prerequisites

1. Remove the [stability foot](#).
2. Remove the left and right side-panels. See "[Removing the side panels](#)".
3. Remove the [PCI fan](#).

## Procedure

**NOTE:** After removing the PCI fan, locate the sensor on the fan shroud.

1. Lay the chassis on the right side.
2. Push the release tab and pry the front-bezel heat-sensor cable off the chassis.

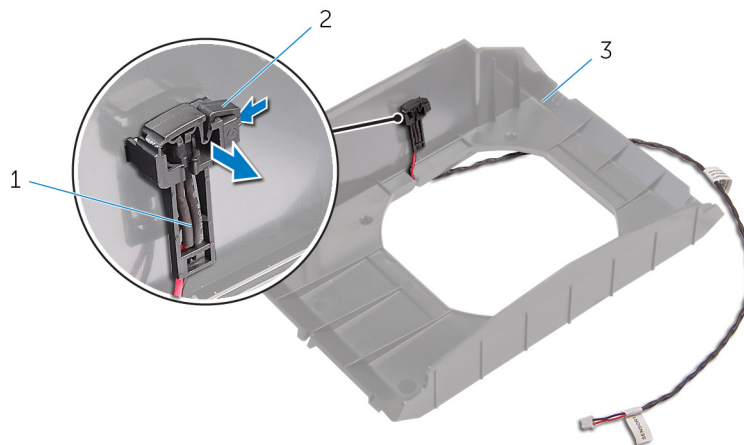

- a. front-bezel heat-sensor cable
- b. release tab
- c. fan shroud

# Replacing the front-bezel heat-sensor cable

**NOTE:** Before working inside your computer, read the safety information that shipped with your computer and follow the steps in [Before working inside your computer](#). After working inside your computer, follow the instructions in [After working inside your computer](#). For more safety best practices, see the Regulatory Compliance home page at [www.dell.com/regulatory\\_compliance](http://www.dell.com/regulatory_compliance).

## Topics:

- [Procedure](#)
- [Post-requisites](#)

## Procedure

1. Route the front-bezel heat-sensor cable through the bracket.
2. Align the tab on the front-bezel heat-sensor cable on the chassis.
3. Push the release tab on the front-bezel heat-sensor cable and press it into place.

## Post-requisites

1. Replace the [PCI fan](#).
2. Replace the left and right side-panels. See "[Replacing the side panels](#)".
3. Replace the [stability foot](#).

# Removing the processor liquid-cooling assembly

**NOTE:** Before working inside your computer, read the safety information that shipped with your computer and follow the steps in [Before working inside your computer](#). After working inside your computer, follow the instructions in [After working inside your computer](#). For more safety best practices, see the Regulatory Compliance home page at [www.dell.com/regulatory\\_compliance](http://www.dell.com/regulatory_compliance).

## Topics:

- [Prerequisites](#)
- [Procedure](#)

## Prerequisites

1. Remove the [stability foot](#).
2. Remove the left and right side-panels. See "[Removing the side panels](#)".
3. Remove the [memory modules](#).

## Procedure

**WARNING:** Despite having a plastic shield, the processor liquid-cooling assembly may be very hot during normal operation. Ensure that it had sufficient time to cool before you touch it.

**CAUTION:** To ensure maximum cooling for the processor, do not touch the heat transfer areas on the processor liquid-cooling assembly. The oils in your skin can reduce the heat transfer capability of the thermal grease.

1. Lay the chassis on the right side.
2. Disconnect the processor liquid-cooling assembly pump-fan cable from the system board. For more information on the processor liquid-cooling assembly pump-fan cable connector, see "[system-board components](#)".
3. Disconnect the processor liquid-cooling assembly fan cable from the system board. For more information on the processor liquid-cooling assembly fan cable connector, see "[system-board components](#)".
4. In sequential order as indicated on the processor cooling-assembly pump, loosen the captive screws that secure the processor liquid-cooling assembly pump to the system board.
5. Remove the four screws (#6-32x6) that secure the processor liquid-cooling assembly fan to the chassis.

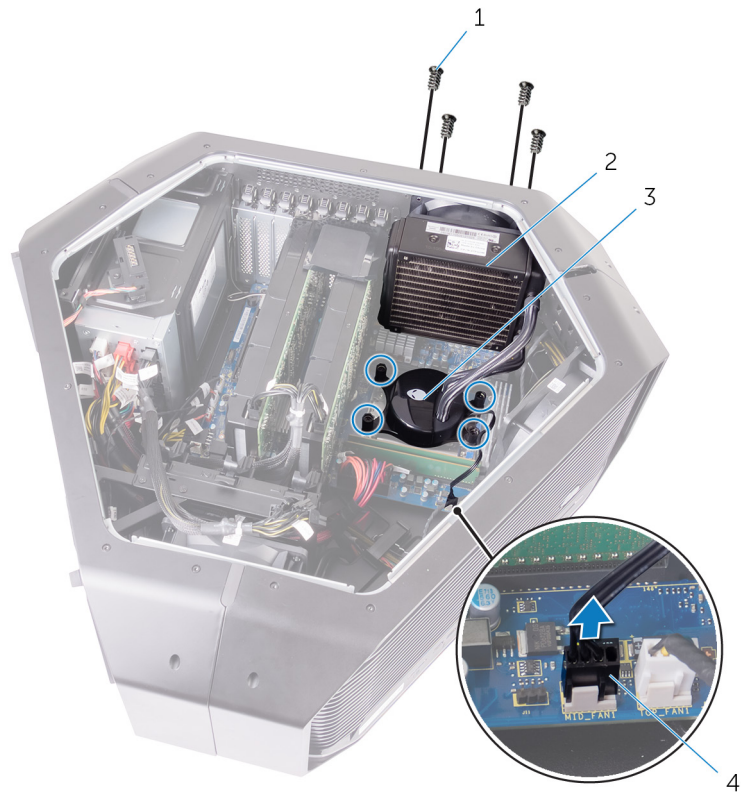

- 1. screws (4)
- 2. processor liquid-cooling assembly fan
- 3. processor liquid-cooling assembly pump
- 4. processor liquid-cooling assembly fan cable

6. Slide and lift the processor liquid-cooling assembly fan and processor liquid-cooling assembly pump out of the chassis.

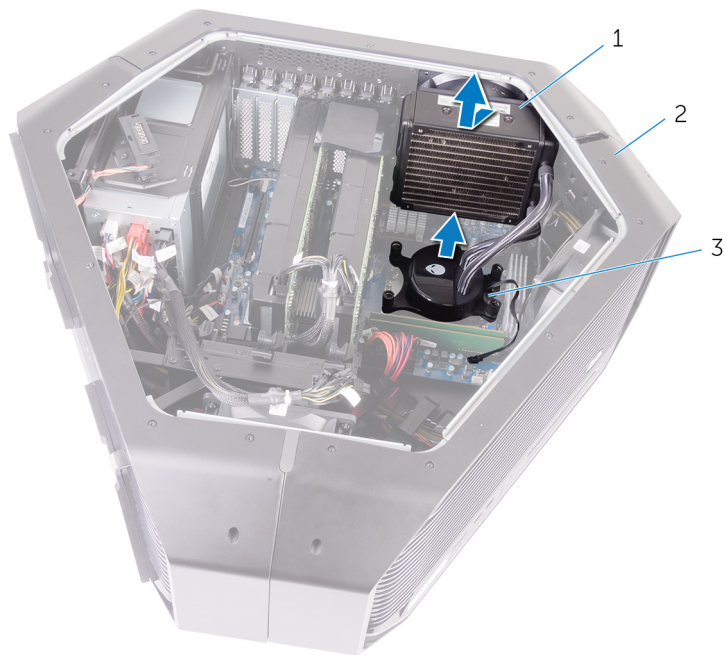

- a. processor liquid-cooling assembly fan
- b. chassis

c. processor liquid-cooling assembly pump

# Replacing the processor liquid-cooling assembly

**NOTE:** Before working inside your computer, read the safety information that shipped with your computer and follow the steps in [Before working inside your computer](#). After working inside your computer, follow the instructions in [After working inside your computer](#). For more safety best practices, see the Regulatory Compliance home page at [www.dell.com/regulatory\\_compliance](http://www.dell.com/regulatory_compliance).

## Topics:

- [Procedure](#)
- [Post-requisites](#)

## Procedure

**CAUTION:** Incorrect alignment of the processor liquid-cooling assembly can damage the system board and processor.

1. Apply thermal grease between the processor liquid-cooling assembly pump and the processor.

**NOTE:** The original thermal grease can be reused if the original processor and processor liquid-cooling are reinstalled together. If either the processor or the processor liquid-cooling is replaced, use the thermal grease provided in the kit to ensure that thermal conductivity is achieved.

2. Hold the processor liquid-cooling assembly pump in one hand and processor liquid-cooling assembly fan in another.
3. Align the processor liquid-cooling assembly pump over the processor, while holding the processor liquid-cooling assembly fan outside the chassis and secure the processor liquid-cooling assembly pump.
4. Connect the processor liquid-cooling assembly fan and the processor liquid-cooling assembly pump-fan cable to the connectors on the system board.
5. Align the screw holes on the processor liquid-cooling assembly fan with the screw holes on the chassis.
6. Replace the four screws (#6-32x6) that secure the processor liquid-cooling assembly fan to the chassis.
7. In sequential order as indicated on the processor cooling-assembly, tighten the captive screws that secure the processor liquid-cooling assembly to the system board.

## Post-requisites

1. Replace the [memory modules](#).
2. Replace the left and right side-panels. See "[Removing the side panels](#)".
3. Replace the [stability foot](#).

# Removing the processor

 **NOTE:** Before working inside your computer, read the safety information that shipped with your computer and follow the steps in [Before working inside your computer](#). After working inside your computer, follow the instructions in [After working inside your computer](#). For more safety best practices, see the Regulatory Compliance home page at [www.dell.com/regulatory\\_compliance](http://www.dell.com/regulatory_compliance).

## Topics:

- [Prerequisites](#)
- [Procedure](#)

## Prerequisites

1. Remove the [stability foot](#).
2. Remove the left and right side-panels. See "[Removing the side panels](#)".
3. Remove the [processor liquid-cooling assembly fan](#).

## Procedure

 **WARNING:** The processor might still be hot after the computer is shut down. Allow the processor to cool down before removing it.

1. In the order as indicated on the processor shield (3,2,1), loosen the captive screws that secure the processor shield to the system board.
2. Open the processor shield.
3. Press down and push the left-release lever and right-release lever away from the processor cover to release it from the securing tab.
4. Slide the processor cover off the processor slot

 **CAUTION:** When removing the processor, do not touch any of the pins inside the socket or allow any objects to fall on the pins in the socket.

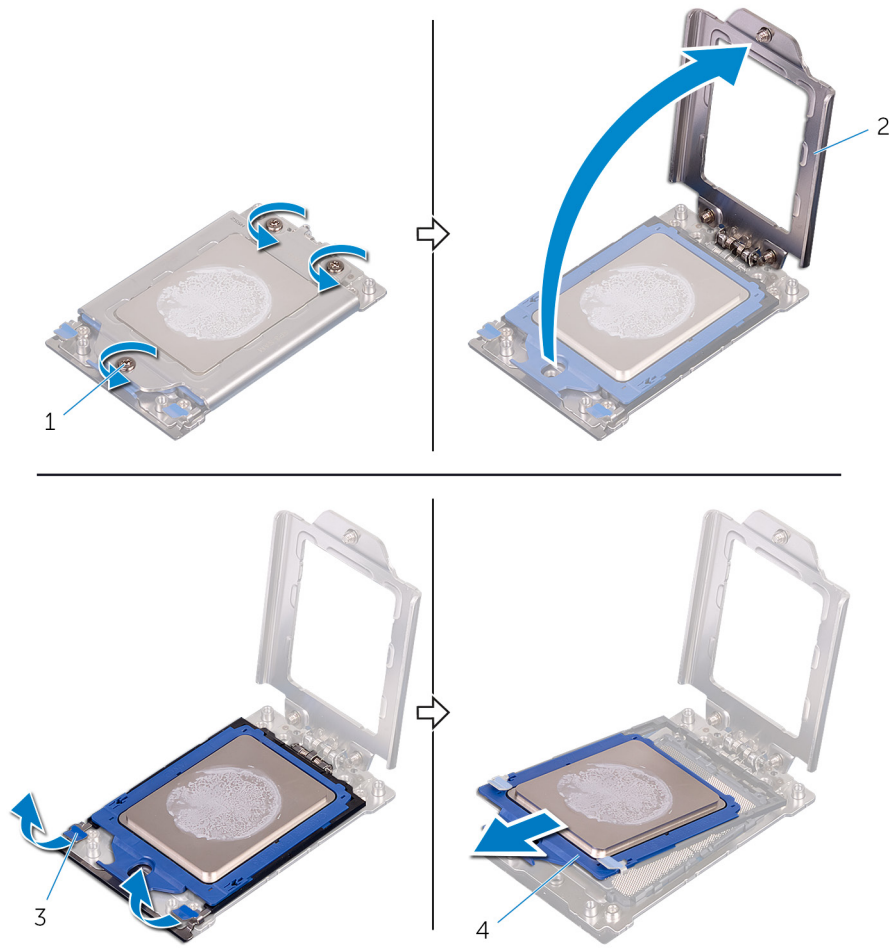

1. screws (3)

3. release-levers (2)

2. processor shield

4. processor slot

# Replacing the processor

**NOTE:** Before working inside your computer, read the safety information that shipped with your computer and follow the steps in [Before working inside your computer](#). After working inside your computer, follow the instructions in [After working inside your computer](#). For more safety best practices, see the Regulatory Compliance home page at [www.dell.com/regulatory\\_compliance](http://www.dell.com/regulatory_compliance).

**CAUTION:** If either the processor or the heat sink is replaced, use the thermal grease provided in the kit to ensure that thermal conductivity is achieved.

**NOTE:** A new processor ships with a thermal pad in the package. In some cases, the processor may ship with the thermal pad attached to it.

## Topics:

- [Procedure](#)
- [Post-requisites](#)

## Procedure

1. Slide the processor cover into the processor slot.
2. Press the left-release lever and right-release lever on the processor cover to secure the tab.
3. Place the processor shield.
4. In the order as indicated on the processor shield (1,2,3), tighten the captive screws that secure the processor shield to the system board.

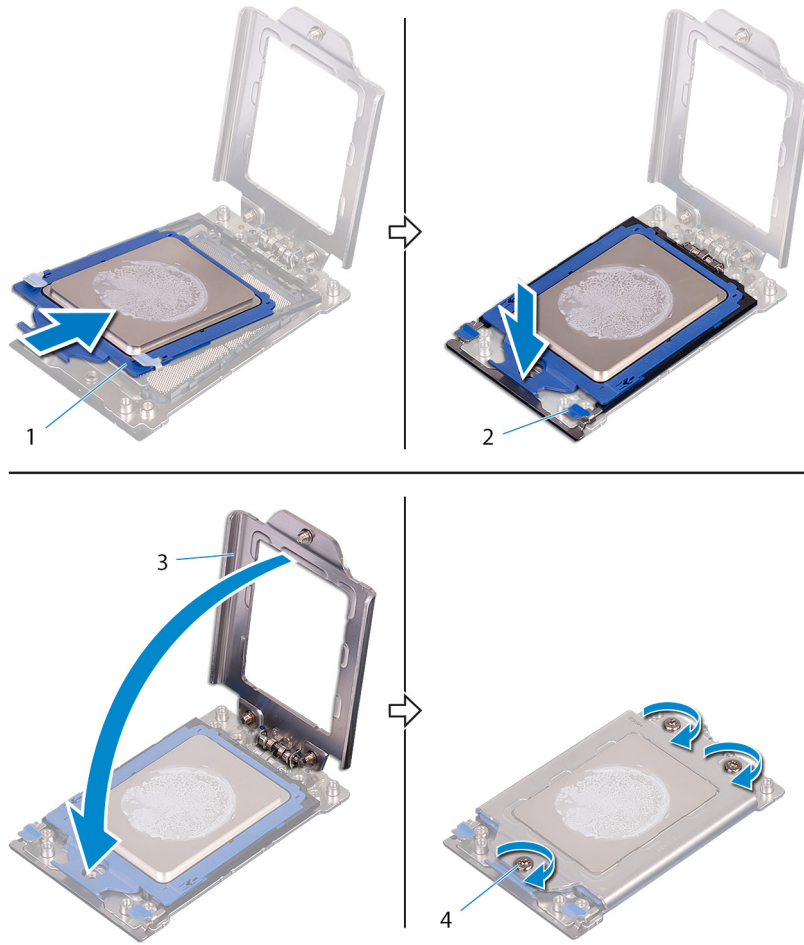

1. processor
3. processor shield

2. release-levers (2)
4. screws (3)

## Post-requisites

1. Replace the [processor liquid-cooling assembly fan](#).
2. Replace the left and right side-panels. See "[Replacing the side panels](#)".
3. Replace the [stability foot](#).

# Removing the power-supply unit

**NOTE:** Before working inside your computer, read the safety information that shipped with your computer and follow the steps in [Before working inside your computer](#). After working inside your computer, follow the instructions in [After working inside your computer](#). For more safety best practices, see the Regulatory Compliance home page at [www.dell.com/regulatory\\_compliance](http://www.dell.com/regulatory_compliance).

## Topics:

- [Prerequisites](#)
- [Procedure](#)

## Prerequisites

1. Remove the [stability foot](#).
2. Remove the left and right side-panels. See "[Removing the side panels](#)".
3. Remove the [multiple graphics cards](#).
4. Remove the [full length graphics cards](#).

## Procedure

**NOTE:** Note the routing of all cables as you remove them so that you can route them correctly after you replace the power-supply unit.

1. Lay the chassis on the right side.
2. Press the release tabs on the power cables and disconnect all the cables from the power-supply unit.
3. Remove the four screws (#6-32x6) that secure the power-supply unit to the back of the chassis.

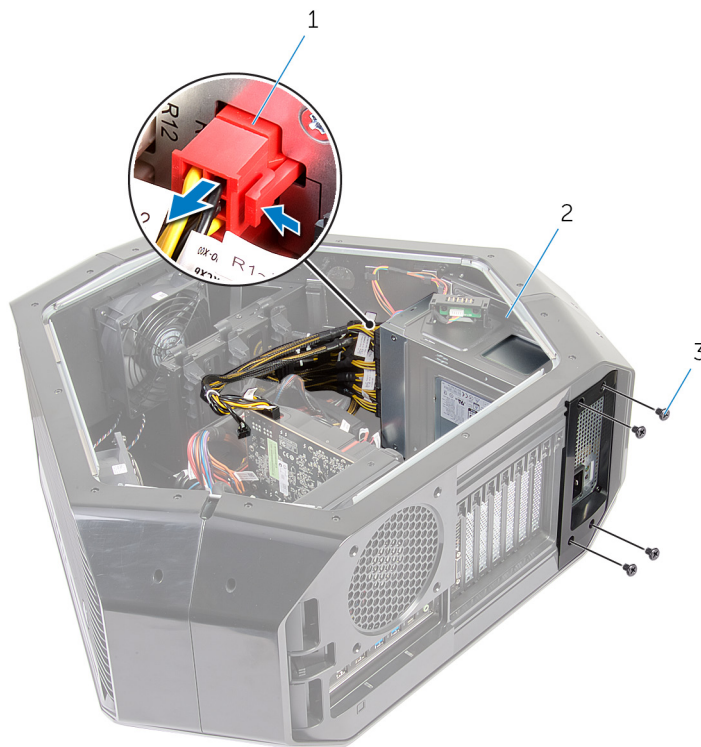

- a. power cable
- b. power-supply unit

c. screws (4)

4. Lift the power-supply unit cover away from the chassis.



a. power-supply unit

b. power-supply unit cover

5. Slide the power-supply unit out through the back of the chassis and remove it from the computer.



a. chassis

b. power-supply unit

6. Slide and remove the metal bracket from the power-supply unit.

# Replacing the power-supply unit

**NOTE:** Before working inside your computer, read the safety information that shipped with your computer and follow the steps in [Before working inside your computer](#). After working inside your computer, follow the instructions in [After working inside your computer](#). For more safety best practices, see the Regulatory Compliance home page at [www.dell.com/regulatory\\_compliance](http://www.dell.com/regulatory_compliance).

## Topics:

- [Procedure](#)
- [Post-requisites](#)

## Procedure

**WARNING:** The cables and ports on the back of the power-supply unit are color-coded to indicate the different power wattage. Ensure that you plug in the cable to the correct port. Failure to do so may result in damaging the power-supply unit and/or system components.

1. Slide the power-supply unit into the metal bracket.
2. Press and hold the securing tab on the chassis and slide the power-supply unit into the chassis until it snaps into position.

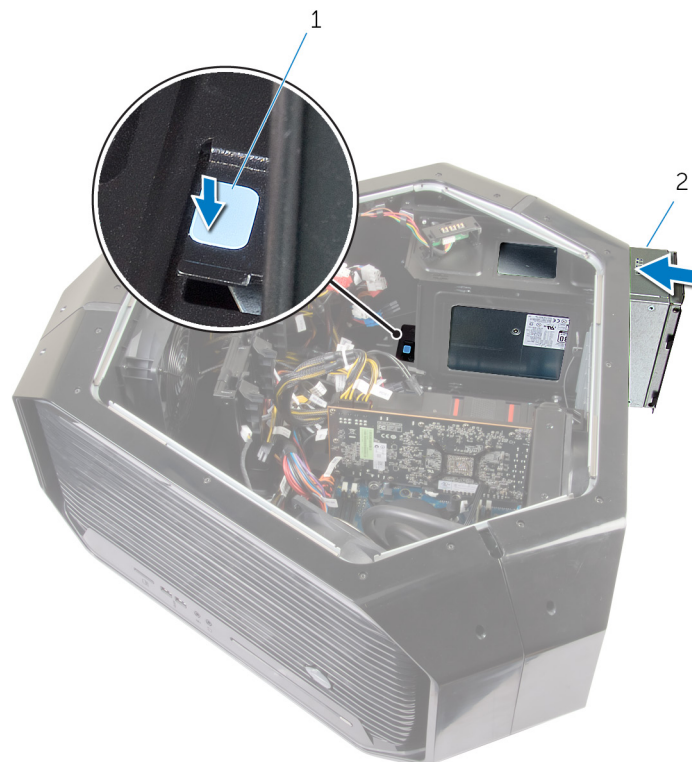

- a. securing tab
  - b. power-supply unit
3. Align the notch on the power-supply unit cover with the tab on the chassis.
  4. Slide the power-supply unit cover towards the tabs until it locks in place.
  5. Replace the four screws (#6-32x6) that secure the power-supply unit to the bezel.
  6. Connect the power cable to the power-supply unit.

# Post-requisites

1. Replace the [full length graphics cards](#).
2. Replace the [multiple graphics cards](#).
3. Replace the left and right side-panels. See "[Removing the side panels](#)".
4. Replace the [stability foot](#).

# Removing the system board

- NOTE:** Before working inside your computer, read the safety information that shipped with your computer and follow the steps in [Before working inside your computer](#). After working inside your computer, follow the instructions in [After working inside your computer](#). For more safety best practices, see the Regulatory Compliance home page at [www.dell.com/regulatory\\_compliance](http://www.dell.com/regulatory_compliance).
- NOTE:** Your computer's Service Tag is stored in the system board. You must enter the Service Tag in the BIOS setup program after you replace the system board.
- NOTE:** Replacing the system board removes any changes you have made to the BIOS using the BIOS setup program. You must make the appropriate changes again after you replace the system board.
- NOTE:** Before disconnecting the cables from the system board, note the location of the connectors so that you can reconnect the cables correctly after you replace the system board.

## Topics:

- [Prerequisites](#)
- [Procedure](#)

## Prerequisites

1. Remove the left and right side-panels. See "[Removing the side panels](#)".
2. Remove the [top fan](#).
3. Remove the [graphics card](#).
4. Remove the [multiple graphics cards](#).
5. Remove the [memory modules](#).
6. Remove the [processor liquid-cooling assembly](#).
7. Remove the [wireless card](#).

## Procedure

- NOTE:** Note the routing of all cables as you remove them so that you can route them correctly after you replace the system board. For information on system-board connectors, see "[system-board components](#)".
1. Lay the chassis on the right side.
  2. Disconnect all the cables connected to the system-board assembly.
  3. Remove the nine screws (#6-32x6) that secure the system-board assembly to the chassis.
  4. Lift the system-board assembly out of the chassis.

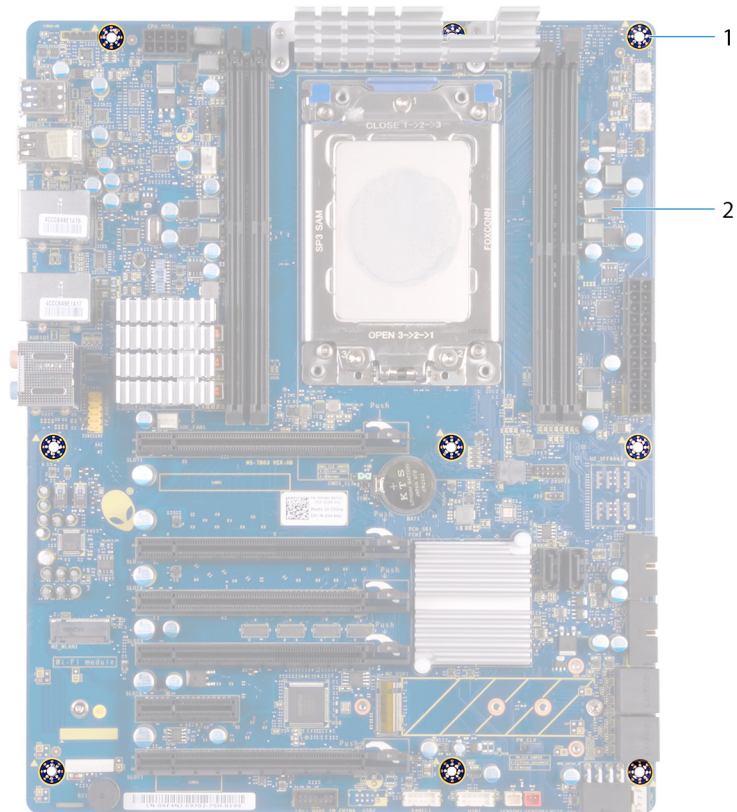

a. screws (9)

b. system board

5. Remove the [processor](#).

# Replacing the system board

- ① **NOTE:** Before working inside your computer, read the safety information that shipped with your computer and follow the steps in [Before working inside your computer](#). After working inside your computer, follow the instructions in [After working inside your computer](#). For more safety best practices, see the Regulatory Compliance home page at [www.dell.com/regulatory\\_compliance](http://www.dell.com/regulatory_compliance).
- ① **NOTE:** Your computer's Service Tag is stored in the system board. You must enter the Service Tag in the BIOS setup program after you replace the system board.
- ① **NOTE:** Replacing the system board removes any changes you have made to the BIOS using the BIOS setup program. You must make the appropriate changes again after you replace the system board.

## Topics:

- [Procedure](#)
- [Post-requisites](#)

## Procedure

1. Replace the [processor](#).
2. Align the ports on the system-board assembly with the slots on the chassis and align the system-board assembly in place.
3. Replace the nine screws (#6-32x6) that secure the system-board assembly to the chassis.
4. Route and connect the cables that you disconnected from the system-board assembly.

① **NOTE:** For information on system-board connectors, see "[system-board components](#)".

## Post-requisites

1. Replace the [processor liquid-cooling assembly fan](#).
2. Replace the [memory modules](#).
3. Replace the [graphics card](#).
4. Replace the [multiple graphics cards](#).
5. Replace the [top fan](#).
6. Replace the [wireless card](#).
7. Replace the left and right side-panels. See "[Replacing the side panels](#)".
8. Replace the [stability foot](#).

# Removing the handle bars

**NOTE:** Before working inside your computer, read the safety information that shipped with your computer and follow the steps in [Before working inside your computer](#). After working inside your computer, follow the instructions in [After working inside your computer](#). For more safety best practices, see the Regulatory Compliance home page at [www.dell.com/regulatory\\_compliance](http://www.dell.com/regulatory_compliance).

## Topics:

- [Prerequisites](#)
- [Procedure](#)

## Prerequisites

1. Remove the [stability foot](#).
2. Remove the left and right side-panels. See "[Removing the side panels](#)".

## Procedure

1. Remove the seven screws (#6-32x6.5) that secure the rear handle-bar to the left side of the chassis.

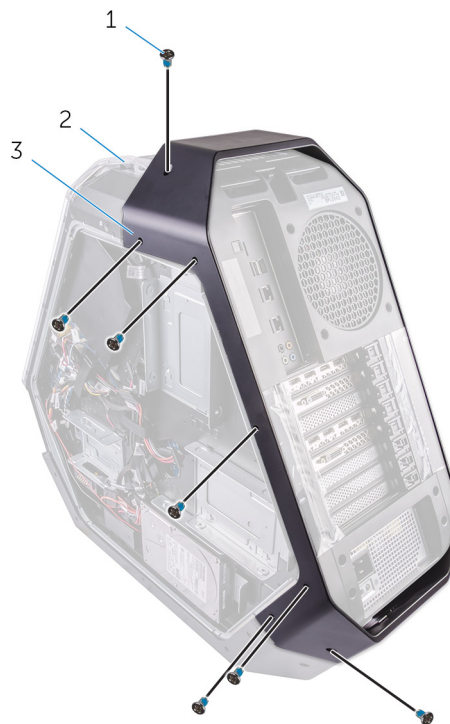

- a. screws (7)
  - b. chassis
  - c. rear-handle bar
2. Remove the seven screws (#6-32x6.5) that secure the rear handle-bar to the right side of the chassis.
  3. Press the rear-handle bar to release the securing tab and remove the rear-handle bar.



- a. screws (7)
- b. rear-handle bar
- c. chassis

4. Remove the seven screws (#6-32x6.5) that secure the front handle-bar to the left side of the chassis.



- a. screws (7)
- b. chassis
- c. front-handle bar

5. Remove the seven screws (#6-32x6.5) that secure the front handle-bar to the right side of the chassis.

6. Press the front-handle bar to release the securing tab and remove the front-handle bar.

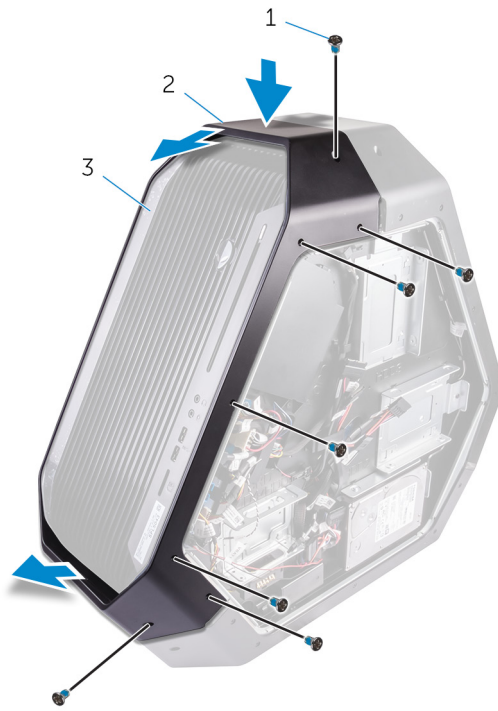

- a. screws (7)
- b. front-handle bar
- c. chassis

7. Remove the seven screws (#6-32x6.5) that secure the bottom handle-bar to the left side of the chassis.

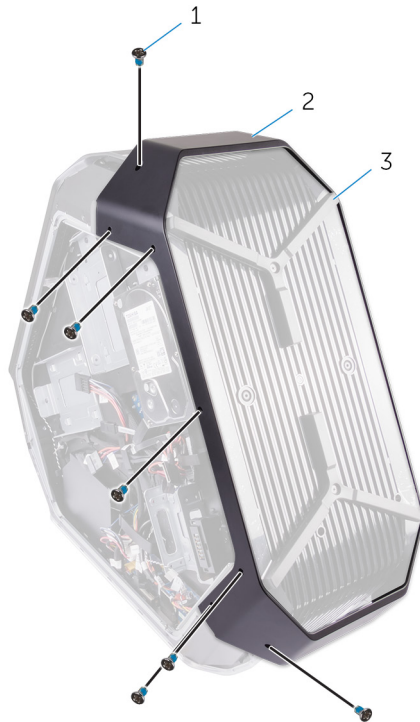

- a. screws (7)
- b. bottom-handle bar
- c. chassis

8. Remove the seven screws (#6-32x6.5) that secure the bottom handle-bar to the right side of the chassis.

9. Press the bottom-handle bar to release the securing tab and remove the bottom-handle bar.



- a. screws (7)
- b. chassis
- c. bottom-handle bar

# Replacing the handle bars

**NOTE:** Before working inside your computer, read the safety information that shipped with your computer and follow the steps in [Before working inside your computer](#). After working inside your computer, follow the instructions in [After working inside your computer](#). For more safety best practices, see the Regulatory Compliance home page at [www.dell.com/regulatory\\_compliance](http://www.dell.com/regulatory_compliance).

## Topics:

- [Procedure](#)
- [Post-requisites](#)

## Procedure

1. Align and place the bottom-handle bar on the slot and snap the bottom-handle bar to the chassis.
2. Replace the seven screws (#6-32x6.5) that secure the bottom-handle bar to the left side of the chassis.
3. Replace the seven screws (#6-32x6.5) that secure the bottom-handle bar to the right side of the chassis.
4. Align and place the front-handle bar on the slot and snap the front-handle bar to the chassis.
5. Replace the seven screws (#6-32x6.5) that secure the front-handle bar to the left side of the chassis.
6. Replace the seven screws (#6-32x6.5) that secure the front-handle bar to the right side of the chassis.
7. Align and place the rear-handle bar on the slot and snap the rear-handle bar to the chassis.
8. Replace the seven screws (#6-32x6.5) that secure the rear-handle bar to the left side of the chassis.
9. Replace the seven screws (#6-32x6.5) that secure the rear-handle bar to the right side of the chassis.

## Post-requisites

1. Replace the left and right side-panels. See "[Replacing the side panels](#)".
2. Replace the [stability foot](#).

# Removing the front bezel

**NOTE:** Before working inside your computer, read the safety information that shipped with your computer and follow the steps in [Before working inside your computer](#). After working inside your computer, follow the instructions in [After working inside your computer](#). For more safety best practices, see the Regulatory Compliance home page at [www.dell.com/regulatory\\_compliance](http://www.dell.com/regulatory_compliance).

## Topics:

- [Prerequisites](#)
- [Procedure](#)

## Prerequisites

1. Remove the [stability foot](#).
2. Remove the left and right side-panels. See "[Removing the side panels](#)".
3. Remove the [handle bars](#).

## Procedure

1. Remove the four screws (#6-32x6) that secure the front bezel to the bottom and top of the chassis.



- a. screws (4)
  - b. front bezel
2. Remove the two screws (6-32x5.2) from inside, securing the front bezel to the left side of the chassis.
  3. Remove the screw (6-32x5.2) from inside, securing the front bezel to the right side of the chassis.
  4. Release the tabs from inside the chassis on the right side, securing the front bezel to the chassis.

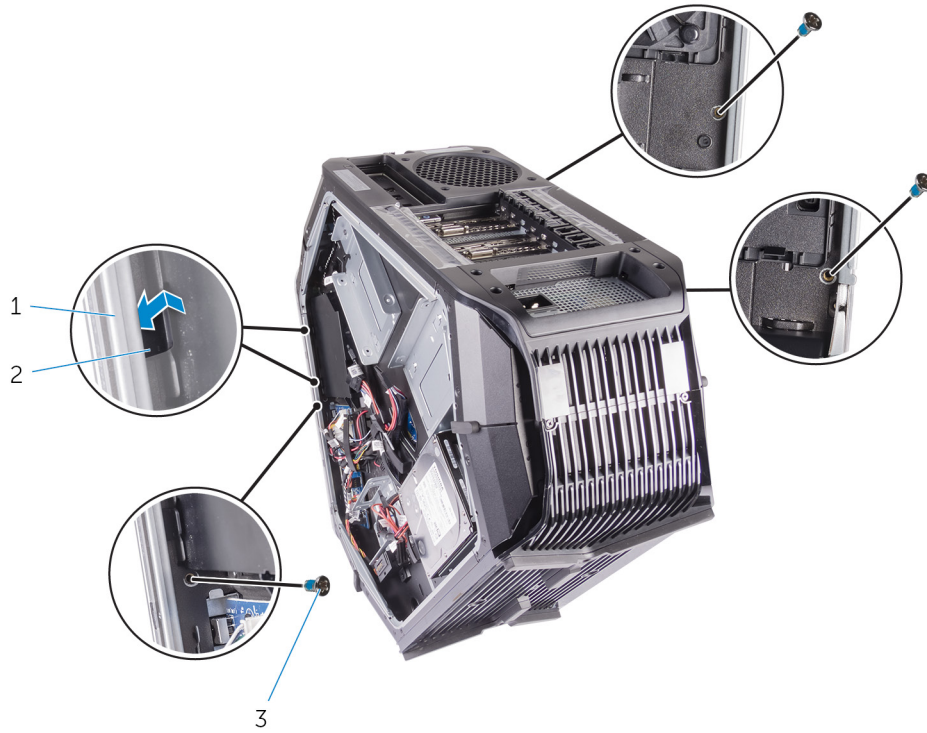

- a. chassis
- b. tabs (2)
- c. screws (3)

5. Pull the connector downwards and then disconnect the bottom tron light-cables from the front bezel.
6. Pull the connector downwards and then disconnect the top tron light-cables from the front bezel.
7. Pull the front bezel off the chassis.

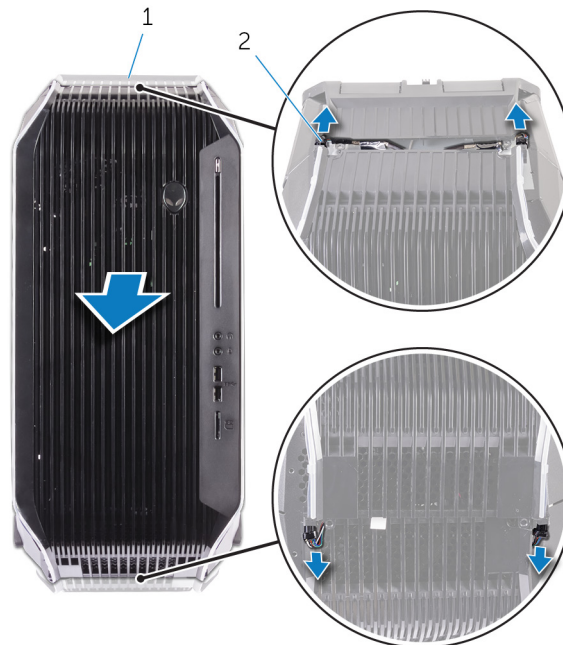

- a. front bezel
- b. tron-light cables

# Replacing the front bezel

**NOTE:** Before working inside your computer, read the safety information that shipped with your computer and follow the steps in [Before working inside your computer](#). After working inside your computer, follow the instructions in [After working inside your computer](#). For more safety best practices, see the Regulatory Compliance home page at [www.dell.com/regulatory\\_compliance](http://www.dell.com/regulatory_compliance).

## Topics:

- [Procedure](#)
- [Post-requisites](#)

## Procedure

1. Align the tabs from inside the chassis on the right and left side and place the front bezel and snap it in place.
2. Connect the top tron light-cables to the front bezel.
3. Connect the bottom tron light-cables to the front bezel.
4. Replace the screw (6-32x5.2) from inside, securing the front bezel to the right side of the chassis.
5. Replace the two screws (6-32x5.2) from inside, securing the front bezel to the left side of the chassis.
6. Replace the four screws (#6-32x6) that secure the front bezel to the bottom and top of the chassis.

## Post-requisites

1. Replace the [handle bars](#).
2. Replace the left and right side-panels. See "[Replacing the side panels](#)".
3. Replace the [stability foot](#).

# Removing the optical-drive eject-button board

**NOTE:** Before working inside your computer, read the safety information that shipped with your computer and follow the steps in [Before working inside your computer](#). After working inside your computer, follow the instructions in [After working inside your computer](#). For more safety best practices, see the Regulatory Compliance home page at [www.dell.com/regulatory\\_compliance](http://www.dell.com/regulatory_compliance).

## Topics:

- [Prerequisites](#)
- [Procedure](#)

## Prerequisites

1. Remove the [stability foot](#).
2. Remove the left and right side-panels. See "[Removing the side panels](#)".
3. Remove the [handle bars](#).
4. Remove the [front bezel](#).

## Procedure

1. Disconnect the optical-drive eject-button board cable from the I/O board.

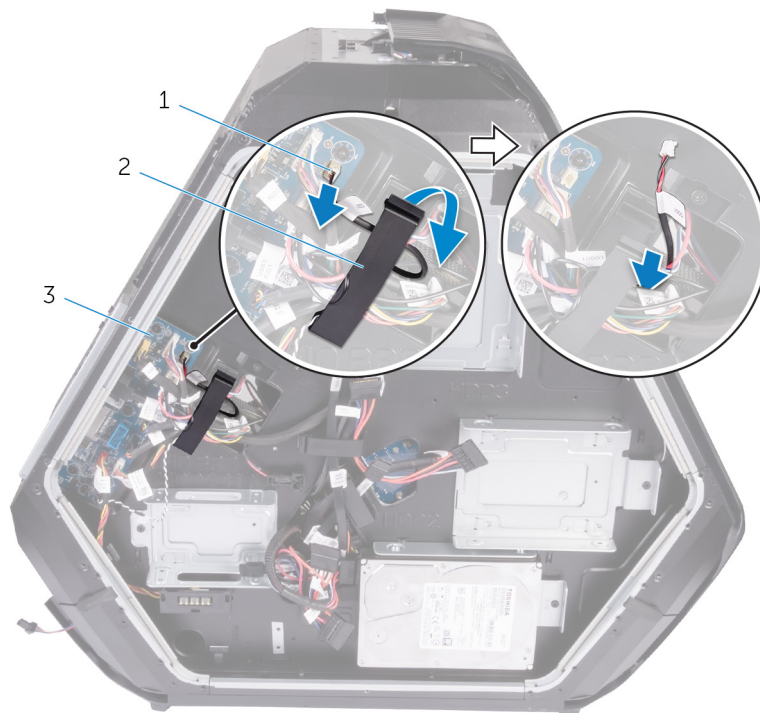

- a. optical-drive eject-button board cable
  - b. securing clip
  - c. I/O board
2. Open the securing clips which secure the optical-drive eject-button board cable to the chassis.

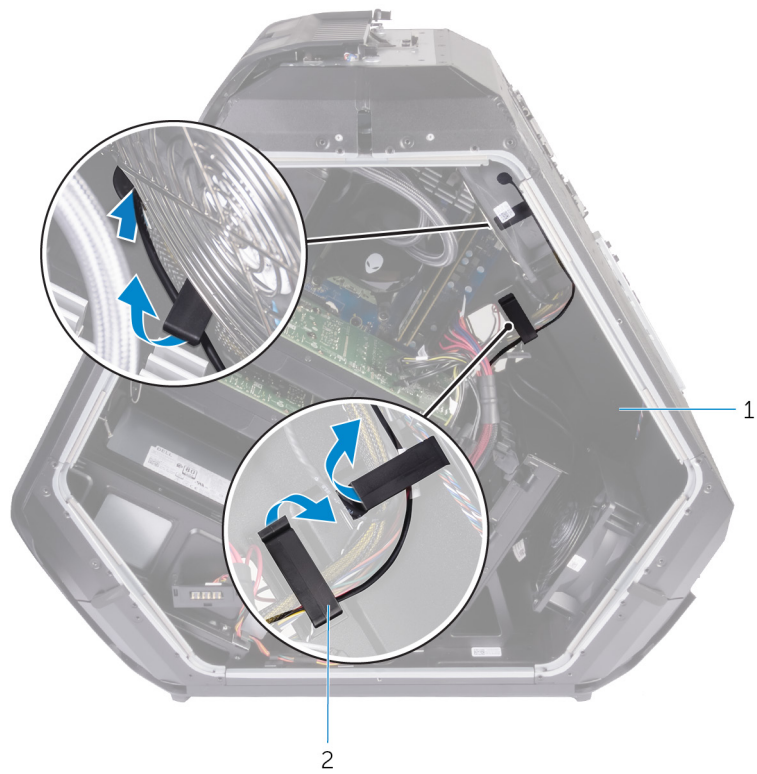

- a. chassis
- b. securing clips

3. Remove the two screws (#6-32x6) that secure the optical-drive eject-button board to the chassis.
4. Remove the optical-drive eject-button board, along with the cable, off the chassis.

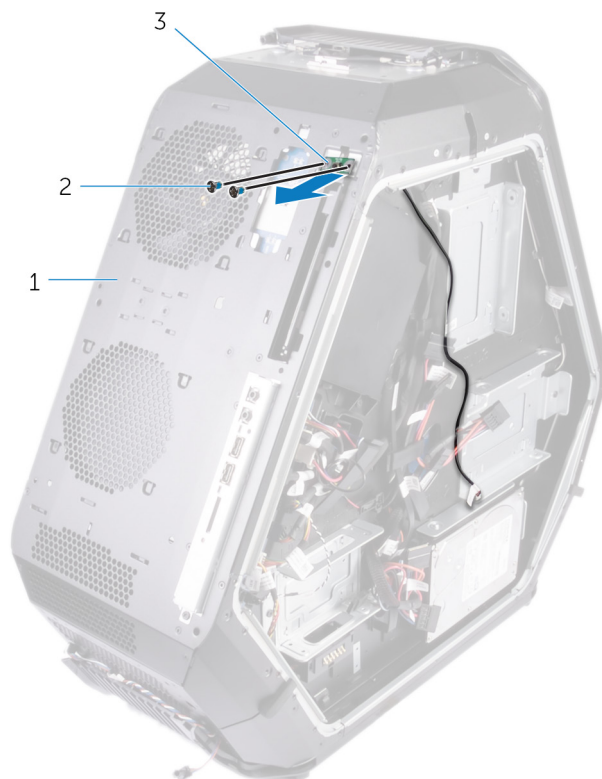

- a. optical-drive eject-button board
- b. screws (2)
- c. chassis

# Replacing the optical-drive eject-button board

**NOTE:** Before working inside your computer, read the safety information that shipped with your computer and follow the steps in [Before working inside your computer](#). After working inside your computer, follow the instructions in [After working inside your computer](#). For more safety best practices, see the Regulatory Compliance home page at [www.dell.com/regulatory\\_compliance](http://www.dell.com/regulatory_compliance).

## Topics:

- [Procedure](#)
- [Post-requisites](#)

## Procedure

1. Align and place the optical-drive eject-button board, along with the cable on the chassis.
2. Replace the two screws (#6-32x6) that secure the optical-drive eject-button board to the chassis.
3. Secure the optical-drive eject-button board cable to the chassis using the securing clips.
4. Connect the optical-drive eject-button board cable to the I/O board.

## Post-requisites

1. Replace the [front bezel](#).
2. Replace the [handle bars](#).
3. Replace the left and right side-panels. See "[Replacing the side panels](#)".
4. Replace the [stability foot](#).

# Removing the rear bezel

**NOTE:** Before working inside your computer, read the safety information that shipped with your computer and follow the steps in [Before working inside your computer](#). After working inside your computer, follow the instructions in [After working inside your computer](#). For more safety best practices, see the Regulatory Compliance home page at [www.dell.com/regulatory\\_compliance](http://www.dell.com/regulatory_compliance).

## Topics:

- [Prerequisites](#)
- [Procedure](#)

## Prerequisites

1. Remove the [stability foot](#).
2. Remove the left and right side-panels. See "[Removing the side panels](#)".
3. Follow the procedure from step 1 to step 3 in [Removing the handle bars](#) to remove the rear handle bar.

## Procedure

1. Disconnect the rear I/O accessibility lighting cable from the I/O board.

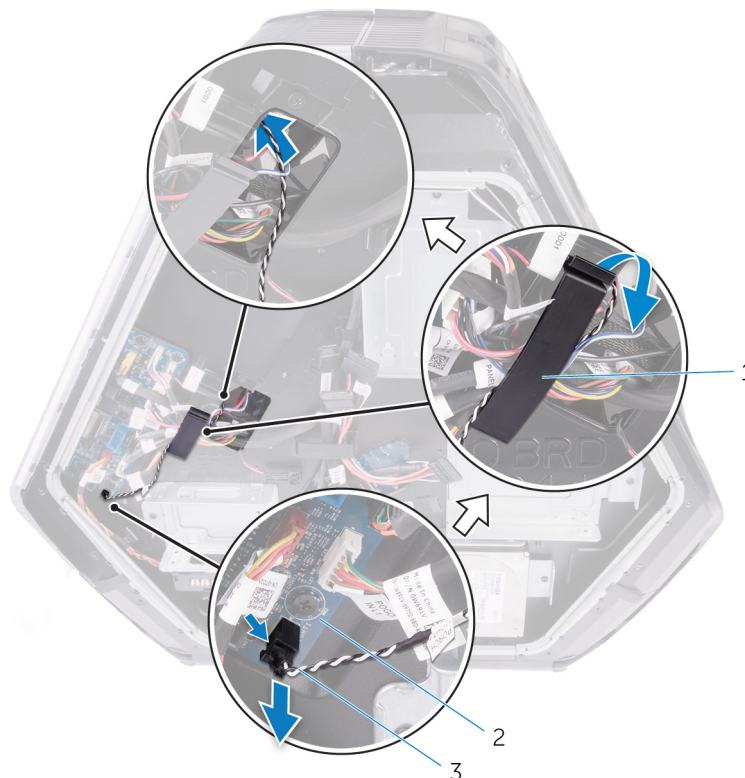

- a. securing clip
- b. I/O board
- c. rear I/O accessibility lighting cable

2. Open the securing clip which secures the rear I/O accessibility lighting cable to the chassis.
3. Remove the rear I/O accessibility lighting cable through the slot on the chassis.

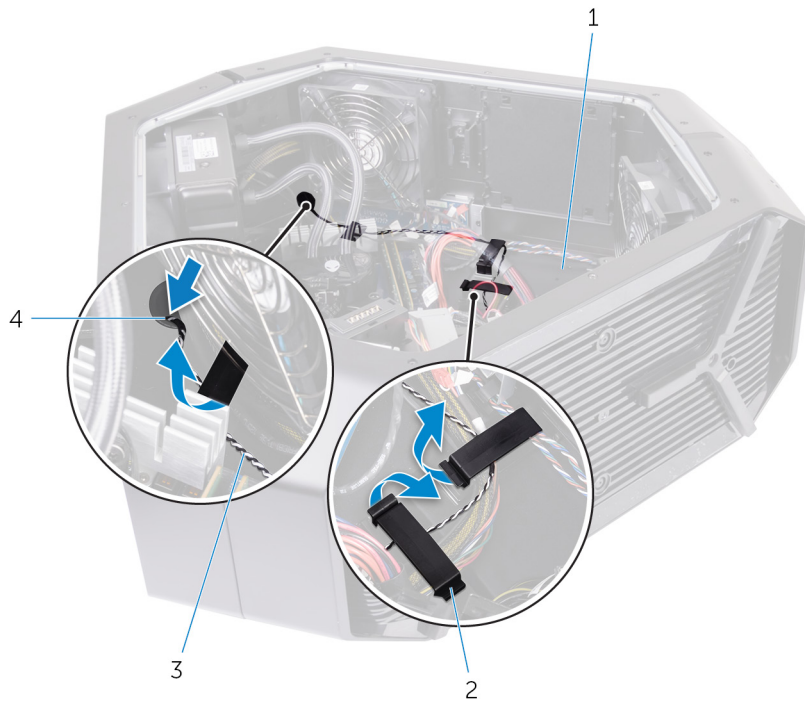

- 1. chassis
- 2. securing clip
- 3. rear I/O accessibility lighting cable
- 4. slot

- 4. Remove the four screws (#6-32x6) that secure the power-supply unit to the back of the chassis.
- 5. Lift the power-supply unit cover away from the chassis.
- 6. Remove the rear I/O accessibility lighting cable from the routing guides on the chassis.



- 1. rear bezel
- 2. power-supply unit cover
- 3. screws (4)
- 4. rear I/O accessibility lighting cable

5. routing guides (2)

6. chassis

7. Remove the four screws (#6-32x6) that secure the rear bezel to the top and bottom of the chassis.



- a. screws (4)
- b. rear bezel

8. Remove the two screws (M3x5) from inside, that secure the rear bezel to the left side and right side of the chassis.  
9. Release the tabs from inside the chassis on the right side and left side, securing the rear bezel to the chassis.

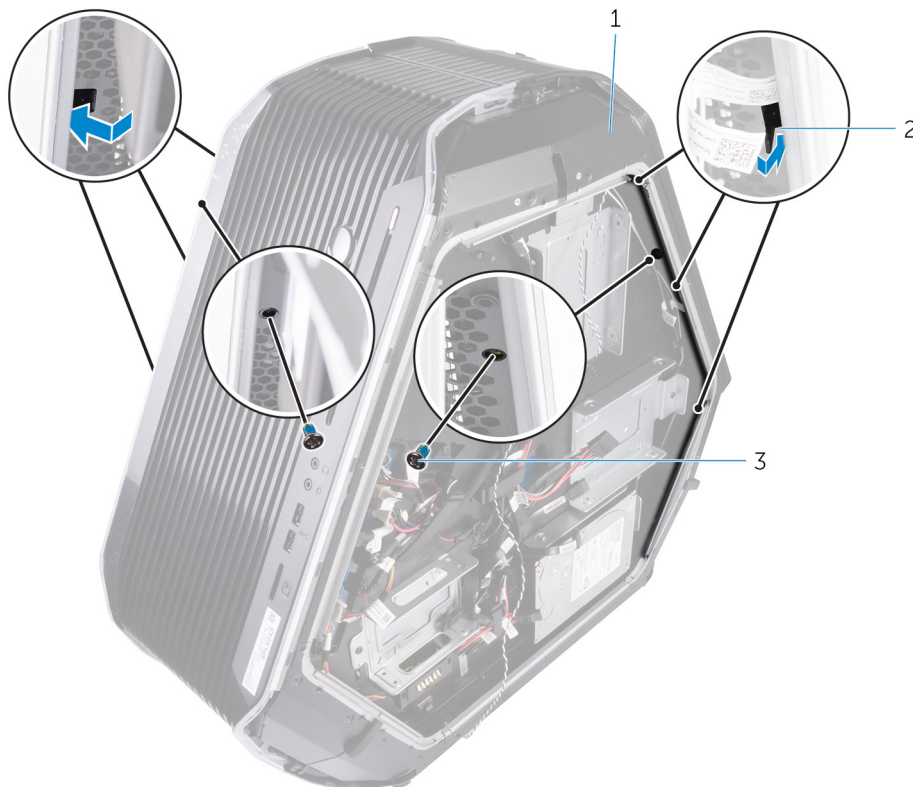

- a. chassis
- b. tabs (6)

c. screws (2)

10. Remove the rear bezel from the chassis and remove the rear I/O accessibility lighting cable from the slot on the chassis.



a. rear bezel  
b. chassis

# Replacing the rear bezel

**NOTE:** Before working inside your computer, read the safety information that shipped with your computer and follow the steps in [Before working inside your computer](#). After working inside your computer, follow the instructions in [After working inside your computer](#). For more safety best practices, see the Regulatory Compliance home page at [www.dell.com/regulatory\\_compliance](http://www.dell.com/regulatory_compliance).

## Topics:

- [Procedure](#)
- [Post-requisites](#)

## Procedure

1. Route the rear I/O accessibility lighting cable through the slot on the chassis.
2. Align the tabs from inside the chassis on the right side and left side, securing the rear bezel to the chassis and snap it in place.
3. Replace the two screws (M3x5) from inside, that secure the rear bezel to the right side and left side of the chassis.
4. Replace the four screws (#6-32x6) that secures the rear bezel to the top and bottom of the chassis.
5. Route the rear I/O accessibility lighting cable through the routing guides on the chassis.
6. Align and place the power-supply cover on the chassis.
7. Replace the four screws (#6-32x6) that secure the power-supply unit to the back of the chassis.
8. Insert the rear I/O accessibility lighting cable through the slot on the chassis.
9. Secure the rear I/O accessibility lighting cable to the chassis using the securing clip.
10. Connect the rear I/O accessibility lighting cable to the I/O board.

## Post-requisites

1. Follow the procedure from step 7 to step 9 in [Replacing the handle bars](#) to replace the rear handle bar.
2. Replace the left and right side-panels. See "[Replacing the side panels](#)".
3. Replace the [stability foot](#).

# Removing the base panel

**NOTE:** Before working inside your computer, read the safety information that shipped with your computer and follow the steps in [Before working inside your computer](#). After working inside your computer, follow the instructions in [After working inside your computer](#). For more safety best practices, see the Regulatory Compliance home page at [www.dell.com/regulatory\\_compliance](http://www.dell.com/regulatory_compliance).

## Topics:

- [Prerequisites](#)
- [Procedure](#)

## Prerequisites

1. Remove the [stability foot](#).
2. Remove the left and right side-panels. See "[Removing the side panels](#)".
3. Remove the [battery case](#).
4. Remove the [hard drive](#) (HDD1).

## Procedure

**CAUTION:** If the front bezel and rear bezel have been removed, place the chassis carefully on a flat surface to avoid damaging the I/O ports.

1. Remove the four screws (#6-32x6) that secure the base panel to the chassis.



- a. screws (4)
  - b. base panel
2. Remove the three screws (#6-32x6) from inside, securing the base panel to the left side of the chassis.
  3. Release the tabs from inside the chassis on the left side, securing the base panel to the left side of the chassis.

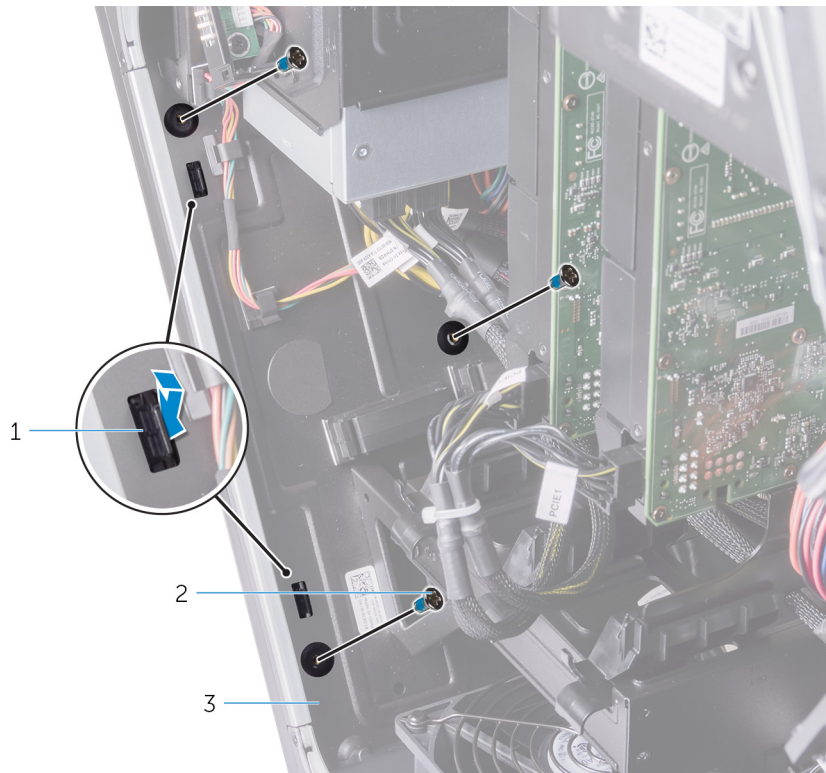

- a. tabs (2)
- b. screws (3)
- c. chassis

4. Remove the two screws (#6-32x6) from inside, securing the base panel to the right side of the chassis.
5. Release the tabs from inside the chassis on the right side, securing the base panel to the right side of the chassis.

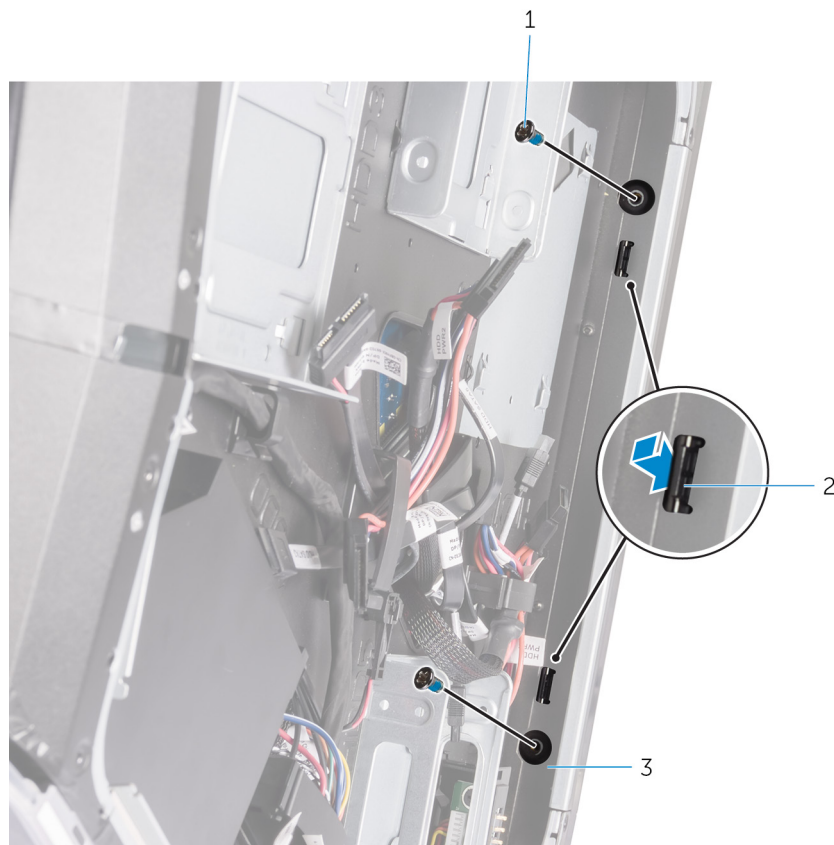

- a. screws (2)

- b. tabs (2)
- c. chassis

6. Remove the base panel from the chassis.



- a. base panel
- b. chassis

# Replacing the base panel

**NOTE:** Before working inside your computer, read the safety information that shipped with your computer and follow the steps in [Before working inside your computer](#). After working inside your computer, follow the instructions in [After working inside your computer](#). For more safety best practices, see the Regulatory Compliance home page at [www.dell.com/regulatory\\_compliance](http://www.dell.com/regulatory_compliance).

## Topics:

- [Procedure](#)
- [Post-requisites](#)

## Procedure

1. Align the tabs from inside the chassis on the right side and left side, securing the base panel to the chassis and snap it in place.
2. Replace the two screws ((#6-32x6) from inside, securing the base panel to the right side of the chassis.
3. Replace the three screws ((#6-32x6) from inside, securing the base panel to the left side of the chassis.
4. Replace the four screws (#6-32x6) that secure the base panel to the chassis.

## Post-requisites

1. Replace the [hard drive](#) (HDD1).
2. Replace the [battery case](#).
3. Replace the left and right side-panels. See "[Replacing the side panels](#)".
4. Replace the [stability foot](#).

# Removing the top tron-lighting cable

**NOTE:** Before working inside your computer, read the safety information that shipped with your computer and follow the steps in [Before working inside your computer](#). After working inside your computer, follow the instructions in [After working inside your computer](#). For more safety best practices, see the Regulatory Compliance home page at [www.dell.com/regulatory\\_compliance](http://www.dell.com/regulatory_compliance).

## Topics:

- [Prerequisites](#)
- [Procedure](#)

## Prerequisites

1. Remove the [stability foot](#).
2. Remove the left and right side-panels. See "[Removing the side panels](#)".
3. Remove the [handle bars](#).
4. Remove the [front bezel](#).
5. Remove the [rear bezel](#).
6. Remove the [base panel](#).

## Procedure

1. Disconnect the top tron-lighting cables from the logo board.
2. Remove the top tron-lighting cables from the routing-guides on the chassis.

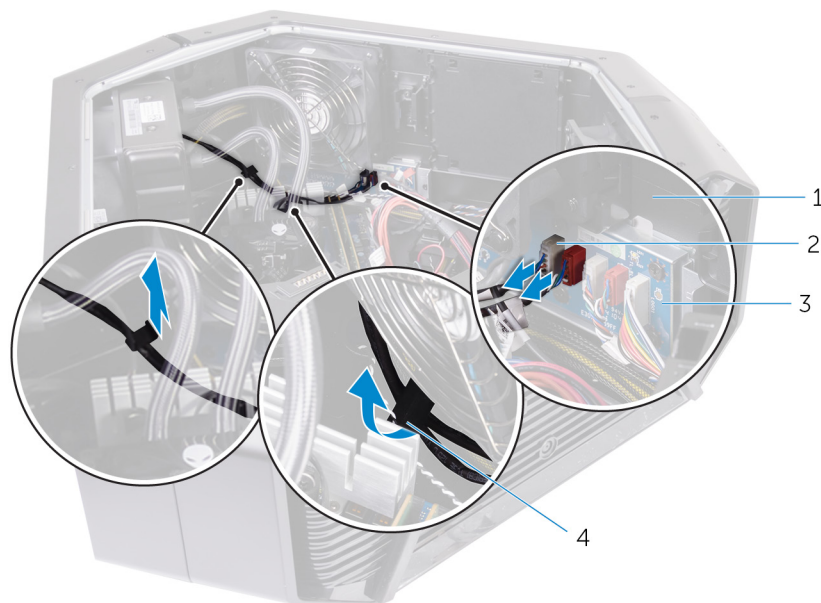

- |               |                         |
|---------------|-------------------------|
| 1. chassis    | 2. tron-lighting cables |
| 3. logo board | 4. routing guides       |

3. Peel the tape that secures the top tron-lighting cables to the chassis and lift the top tron-lighting cables.

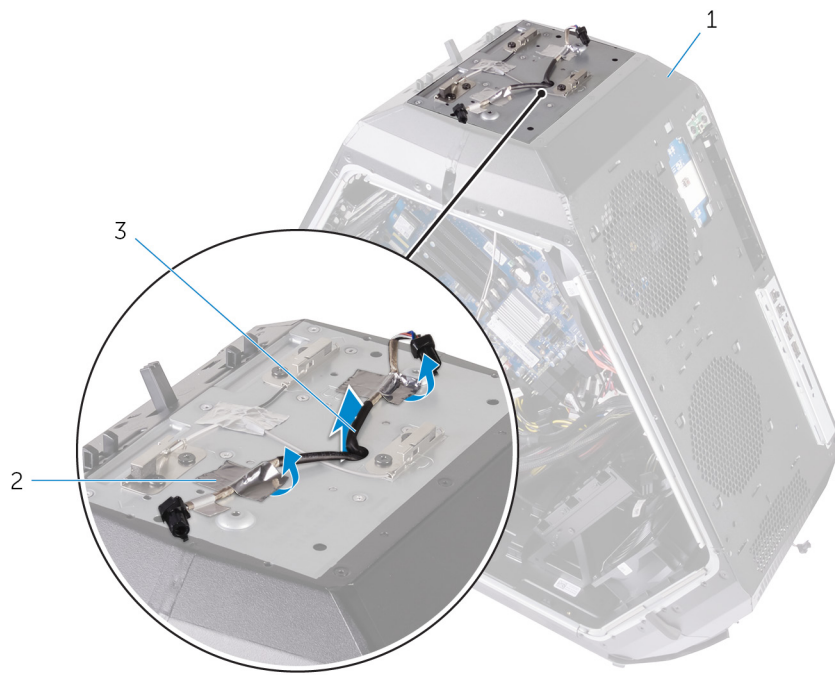

- a. chassis
- b. tape
- c. top tron-lighting cables

# Replacing the top tron-lighting cable

**NOTE:** Before working inside your computer, read the safety information that shipped with your computer and follow the steps in [Before working inside your computer](#). After working inside your computer, follow the instructions in [After working inside your computer](#). For more safety best practices, see the Regulatory Compliance home page at [www.dell.com/regulatory\\_compliance](http://www.dell.com/regulatory_compliance).

## Topics:

- [Procedure](#)
- [Post-requisites](#)

## Procedure

1. Align and place the top tron-lighting cables on the chassis.
2. Adhere the tape that secures the top tron-lighting cables to the chassis.
3. Route the top tron-lighting cables through the routing-guides on the chassis.
4. Connect the top tron-lighting cables to the logo board.

## Post-requisites

1. Replace the [base panel](#).
2. Replace the [rear bezel](#).
3. Replace the [front bezel](#).
4. Replace the [handle bars](#).
5. Replace the left and right side-panels. See "[Replacing the side panels](#)".
6. Replace the [stability foot](#).

# Removing the bottom tron-lighting cable

**NOTE:** Before working inside your computer, read the safety information that shipped with your computer and follow the steps in [Before working inside your computer](#). After working inside your computer, follow the instructions in [After working inside your computer](#). For more safety best practices, see the Regulatory Compliance home page at [www.dell.com/regulatory\\_compliance](http://www.dell.com/regulatory_compliance).

## Topics:

- [Prerequisites](#)
- [Procedure](#)

## Prerequisites

1. Remove the [stability foot](#).
2. Remove the left and right side-panels. See "[Removing the side panels](#)".
3. Remove the [full-length graphics cards](#).
4. Remove the [PCI fan](#).
5. Remove the [handle bars](#).
6. Remove the [front bezel](#).
7. Remove the [rear bezel](#).
8. Remove the [base panel](#).

## Procedure

1. Disconnect the bottom tron-lighting cables from the logo board.
2. Open the securing clip which secures the bottom tron-lighting cables to the chassis.
3. Remove the bottom tron-lighting cables from the routing guide on the chassis.

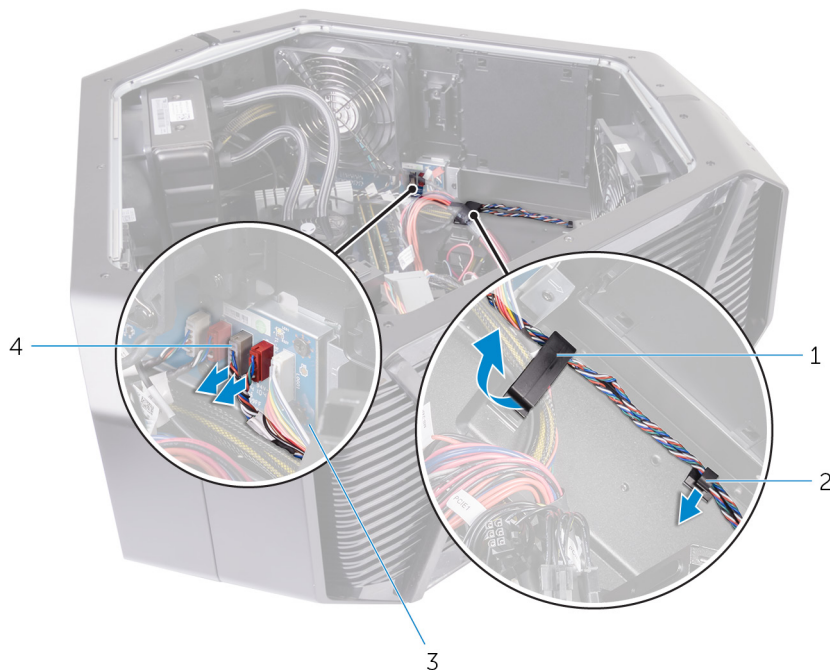

1. securing clip
3. logo board

2. routing guide
4. tron-lighting cables

4. Remove the bottom tron-lighting cables from the slot on the chassis.



- a. top tron-lighting cables
- b. slot

# Replacing the bottom tron-lighting cable

**NOTE:** Before working inside your computer, read the safety information that shipped with your computer and follow the steps in [Before working inside your computer](#). After working inside your computer, follow the instructions in [After working inside your computer](#). For more safety best practices, see the Regulatory Compliance home page at [www.dell.com/regulatory\\_compliance](http://www.dell.com/regulatory_compliance).

## Topics:

- [Procedure](#)
- [Post-requisites](#)

## Procedure

1. Route the bottom tron-lighting cables through the slot on the chassis.
2. Route the bottom tron-lighting cables through the routing guide on the chassis.
3. Secure the bottom tron-lighting cables to the chassis using the securing clip.
4. Connect the bottom tron-lighting cables to the logo board.

## Post-requisites

1. Replace the [base panel](#).
2. Replace the [rear bezel](#).
3. Replace the [front bezel](#).
4. Replace the [handle bars](#).
5. Replace the [PCI fan](#).
6. Replace the [full-length graphics cards](#).
7. Replace the left and right side-panels. See "[Replacing the side panels](#)".
8. Replace the [stability foot](#).

# Removing the antenna cables

**NOTE:** Before working inside your computer, read the safety information that shipped with your computer and follow the steps in [Before working inside your computer](#). After working inside your computer, follow the instructions in [After working inside your computer](#). For more safety best practices, see the Regulatory Compliance home page at [www.dell.com/regulatory\\_compliance](http://www.dell.com/regulatory_compliance).

## Topics:

- [Prerequisites](#)
- [Procedure](#)

## Prerequisites

1. Remove the [stability foot](#).
2. Remove the left and right side-panels. See "[Removing the side panels](#)".
3. Remove the [handle bars](#).
4. Remove the [graphics card](#).
5. Remove the [wireless card](#).
6. Remove the [front bezel](#).
7. Remove the [rear bezel](#).

## Procedure

1. Disconnect the antenna cables from the wireless card.
2. Remove the gray antenna cable from the routing guide on the chassis.

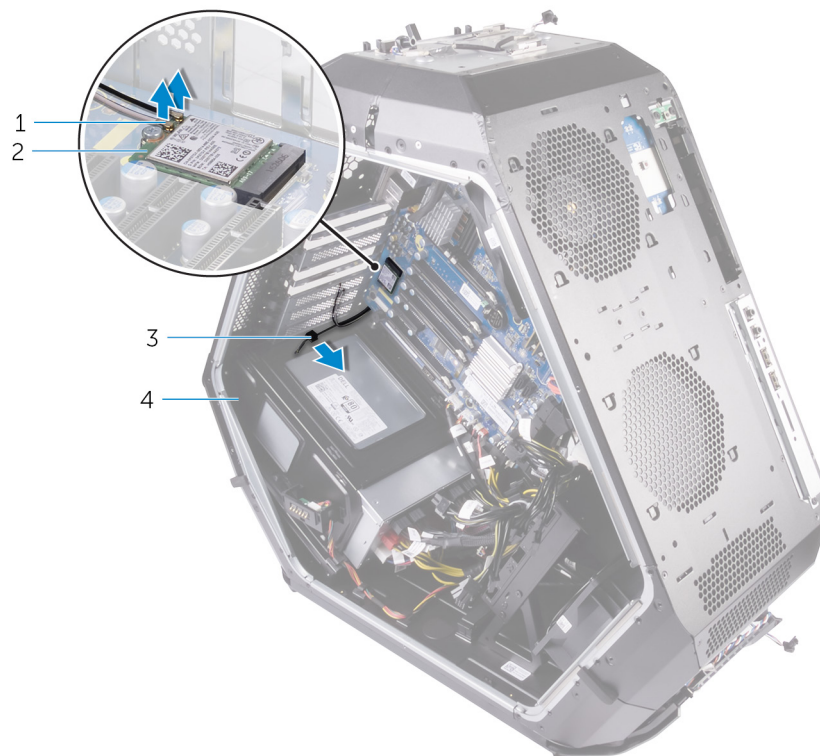

1. antenna cables
3. routing guide

2. wireless card
4. chassis

3. Remove the antenna cables from the routing guides on the chassis.

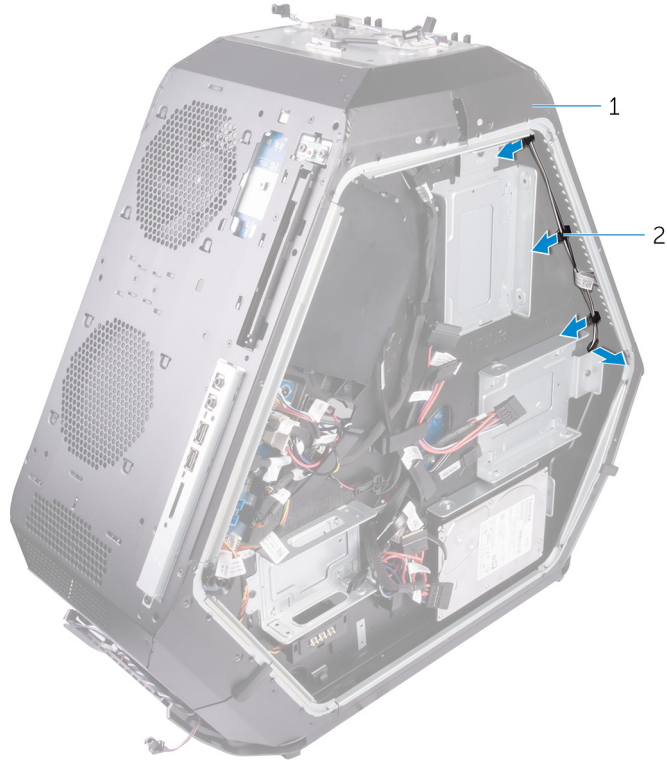

- a. chassis
- b. routing guides

4. Remove the antenna cables from the routing guide on the chassis and slide the antenna cable through the slot on the chassis.

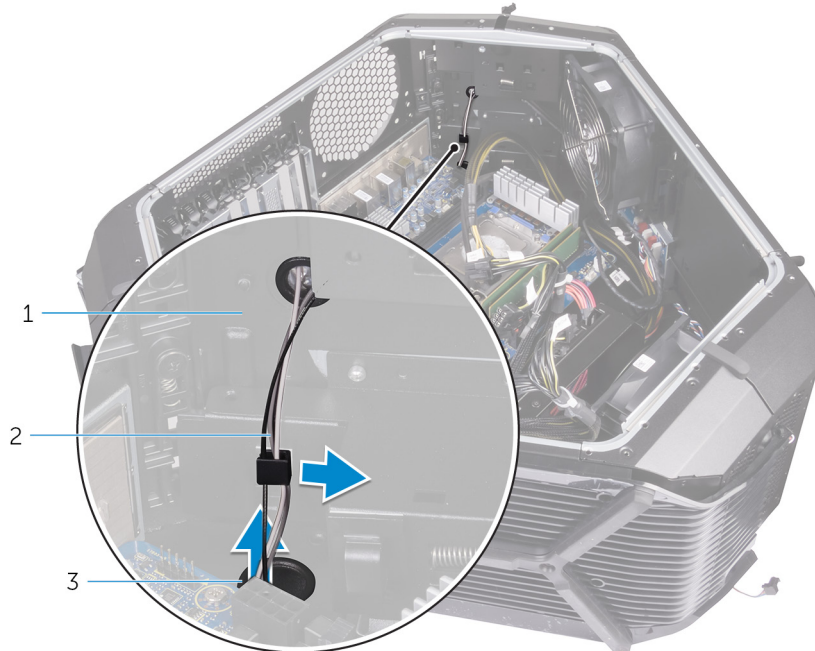

- a. antenna cables
- b. routing guide
- c. slot

5. Peel the tape that secures the antenna cables to the chassis.

6. Remove the six screws (#6-32x6) that secure the antenna cables to the chassis.

7. Pull the antenna cables from the slot on the chassis and remove.

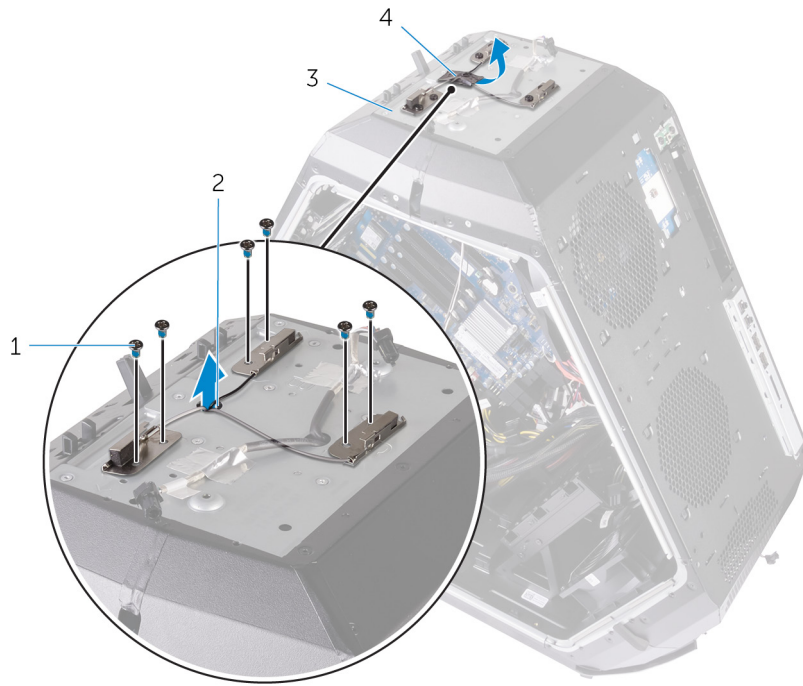

- 1. screws
- 3. chassis

- 2. slot
- 4. antenna cables

# Replacing the antenna cables

**NOTE:** Before working inside your computer, read the safety information that shipped with your computer and follow the steps in [Before working inside your computer](#). After working inside your computer, follow the instructions in [After working inside your computer](#). For more safety best practices, see the Regulatory Compliance home page at [www.dell.com/regulatory\\_compliance](http://www.dell.com/regulatory_compliance).

## Topics:

- [Procedure](#)
- [Post-requisites](#)

## Procedure

1. Place the antenna cables in place and slide the antenna cables through the slot on the chassis.
2. Replace the six screws (#6-32x6) that secure the antenna cables to the chassis.
3. Adhere the tape that secures the antenna cables to the chassis.
4. Route the antenna cable through the slot on the chassis and then through the routing guides on the chassis.
5. Route the gray antenna cable through the routing guide on the chassis.
6. Connect the antenna cables from the wireless card.

## Post-requisites

1. Replace the [rear bezel](#).
2. Replace the [front bezel](#).
3. Replace the [wireless card](#).
4. Replace the [graphics card](#).
5. Replace the [handle bars](#).
6. Replace the left and right side-panels. See "[Replacing the side panels](#)".
7. Replace the [stability foot](#).

# Downloading drivers

## Topics:

- [Downloading the audio driver](#)
- [Downloading the graphics driver](#)
- [Downloading the USB 3.0 driver](#)
- [Downloading the Wi-Fi driver](#)
- [Downloading the chipset driver](#)
- [Downloading the network driver](#)

## Downloading the audio driver

1. Turn on your computer.
2. Go to [www.dell.com/support](http://www.dell.com/support).
3. Click **Product Support**, enter the Service Tag of your computer, and then click **Submit**.  
 **NOTE:** If you do not have the Service Tag, use the auto-detect feature or manually browse for your computer model.
4. Click **Drivers & Downloads > Find it myself**.
5. Scroll down the page and expand **Audio**.
6. Click **Download** to download the audio driver for your computer.
7. After the download is complete, navigate to the folder where you saved the audio driver file.
8. Double-click the audio driver file icon and follow the instructions on the screen to install the driver.

## Downloading the graphics driver

1. Turn on your computer.
2. Go to [www.dell.com/support](http://www.dell.com/support).
3. Click **Product Support**, enter the Service Tag of your computer, and then click **Submit**.  
 **NOTE:** If you do not have the Service Tag, use the auto-detect feature or manually browse for your computer model.
4. Click **Drivers & downloads > Find it myself**.
5. Scroll down the page and expand **Video**.
6. Click **Download** to download the graphics driver for your computer.
7. After the download is complete, navigate to the folder where you saved the graphics driver file.
8. Double-click the graphics driver file icon and follow the instructions on the screen to install the driver.

## Downloading the USB 3.0 driver

1. Turn on your computer.
2. Go to [www.dell.com/support](http://www.dell.com/support).
3. Click **Product Support**, enter the Service Tag of your computer, and then click **Submit**.  
 **NOTE:** If you do not have the Service Tag, use the auto-detect feature or manually browse for your computer model.
4. Click **Drivers & Downloads > Find it myself**.
5. Scroll down the page and expand **Chipset**.
6. Click **Download** to download the USB 3.0 driver for your computer.
7. After the download is complete, navigate to the folder where you saved USB 3.0 driver file.

8. Double-click the USB 3.0 driver file icon and follow the instructions on screen to install the driver.

## Downloading the Wi-Fi driver

1. Turn on the computer.
2. Go to [www.dell.com/support](http://www.dell.com/support).
3. Click **Product support**, enter the Service Tag of your computer, and then click **Submit**.

 **NOTE:** If you do not have the Service Tag, use the auto-detect feature or manually browse for your computer model.

4. Click **Drivers & downloads > Find it myself**.
5. Scroll down the page and expand **Network**.
6. Click **Download** to download the Wi-Fi driver for your computer.
7. After the download is complete, navigate to the folder where you saved the Wi-Fi driver file.
8. Double-click the driver file icon and follow the instructions on the screen.

## Downloading the chipset driver

1. Turn on your computer.
2. Go to [www.dell.com/support](http://www.dell.com/support).
3. Click **Product Support**, enter the Service Tag of your computer, and then click **Submit**.

 **NOTE:** If you do not have the Service Tag, use the auto-detect feature or manually browse for your computer model.

4. Click **Drivers & downloads > Find it myself**.
5. Scroll down the page and expand **Chipset**.
6. Click **Download** to download the appropriate chipset driver for your computer.
7. After the download is complete, navigate to the folder where you saved the chipset driver file.
8. Double-click the chipset driver file icon and follow the instructions on the screen to install the driver.

## Downloading the network driver

1. Turn on your computer.
2. Go to [www.dell.com/support](http://www.dell.com/support).
3. Click **Product support** enter the Service Tag of your computer and click **Submit**.

 **NOTE:** If you do not have the Service Tag, use the auto-detect feature or manually browse for your computer model.

4. Click **Drivers & downloads > Find it myself**.
5. Scroll down the page and expand **Network**.
6. Click **Download** to download the network driver for your computer.
7. Save the file, and after the download is complete, navigate to the folder where you saved the network driver file.
8. Double-click the network driver file icon and follow the instructions on screen.

# BIOS setup program

## Topics:

- [Boot Sequence](#)
- [Navigation keys](#)
- [BIOS overview](#)
- [Entering BIOS setup program](#)
- [System setup options](#)
- [System and setup password](#)

## Boot Sequence

Boot Sequence allows you to bypass the System Setup–defined boot device order and boot directly to a specific device (for example: optical drive or hard drive). During the Power-on Self Test (POST), when the Dell logo appears, you can:

- Access System Setup by pressing F2 key
- Bring up the one-time boot menu by pressing F12 key

The one-time boot menu displays the devices that you can boot from including the diagnostic option. The boot menu options are:

- Removable Drive (if available)
- STXXXX Drive
  - ⓘ **NOTE:** XXX denotes the SATA drive number.
- Optical Drive (if available)
- Diagnostics
  - ⓘ **NOTE:** Choosing **Diagnostics**, will display the **ePSA diagnostics** screen.

The boot sequence screen also displays the option to access the System Setup screen.

## Navigation keys

ⓘ **NOTE:** For most of the System Setup options, changes that you make are recorded but do not take effect until you restart the system.

Keys	Navigation
<b>Up arrow</b>	Moves to the previous field.
<b>Down arrow</b>	Moves to the next field.
<b>Enter</b>	Selects a value in the selected field (if applicable) or follow the link in the field.
<b>Spacebar</b>	Expands or collapses a drop-down list, if applicable.
<b>Tab</b>	Moves to the next focus area. <ul style="list-style-type: none"><li>ⓘ <b>NOTE:</b> For the standard graphics browser only.</li></ul>
<b>Esc</b>	Moves to the previous page until you view the main screen. Pressing Esc in the main screen displays a message that prompts you to save any unsaved changes and restarts the system.

## BIOS overview

⚠ **CAUTION:** Unless you are an expert computer user, do not change the settings in the BIOS Setup program. Certain changes can make your computer work incorrectly.

**NOTE:** Before you change BIOS Setup program, it is recommended that you write down the BIOS Setup program screen information for future reference.

Use the BIOS Setup program for the following purposes:

- Get information about the hardware installed in your computer, such as the amount of RAM and the size of the hard drive.
- Change the system configuration information.
- Set or change a user-selectable option, such as the user password, type of hard drive installed, and enabling or disabling base devices.

## Entering BIOS setup program

1. Turn on (or restart) your computer.
2. During POST, when the DELL logo is displayed, watch for the F2 prompt to appear, and then press F2 immediately.

**NOTE:** The F2 prompt indicates that the keyboard is initialized. This prompt can appear very quickly, so you must watch for it, and then press F2. If you press F2 before the F2 prompt, this keystroke is lost. If you wait too long and the operating system logo appears, continue to wait until you see the desktop. Then, turn off your computer and try again.

## System setup options

**NOTE:** Depending on your computer and its installed devices, the items listed in this section may or may not appear.

**Table 3. System setup options—Main menu**

Main	
<b>BIOS Information</b>	
BIOS Version	Displays the BIOS version number.
Build Date	Displays the BIOS release date.
<b>Product Information</b>	
Product Name	Displays the product name. Default: Alienware Area-51 R3.
Set Service Tag	Allows you to enter the service tag of your computer.
Asset Tag	Displays the asset tag of your computer.
<b>EC Information</b>	
EC Firmware Version	Displays the Embedded Controller firmware version.
<b>Memory Information</b>	
Total Memory	Displays the total computer memory installed.
Memory Available	Displays the amount of memory available on the computer.
Memory Technology	Displays the type of memory technology used.
Memory Speed	Displays the memory speed.
<b>CPU Information</b>	
Processor Type	Displays the processor type
Processor ID	Displays the processor identification code.
CPU Speed	Displays the CPU speed.
Cache L2	Displays the processor L2 cache size.
Cache L3	Displays the processor L3 cache size.
Discrete Graphics 1	Displays the first discrete graphics installed on your computer.

**Table 3. System setup options—Main menu (continued)**

<b>Main</b>	
Discrete Graphics 2	Displays the second discrete graphics installed on your computer.
Discrete Graphics 3	Displays the third discrete graphics installed on your computer.
<b>Device Information</b>	
First HDD	Displays the first HDD device information.
SATA ODD	Displays the SATA ODD device information.
Second HDD	Displays the second HDD device information.
mSATA Device	Displays the mSATA device information.
M.2 PCIe SSD	Displays the M.2 PCIe SSD device information.
System Date	Displays the current date in mm/dd/yyyy format.
System Time	Displays the current time in hh:mm:ss format.

**Table 4. System setup options—Advanced menu**

<b>Advanced</b>	
<b>Advanced BIOS Features</b>	
BIOS Recovery via Hard Drive	Allows you to store the recovery image file on the primary hard drive. Default: Enabled.
BIOS Auto-Recovery	Enable the user to recover from certain corrupted BIOS conditions from a recovery file on the user primary hard drive. Default: Enabled
Always Perform Integrity Check	Allows you to perform the Integrity check. Default: Enabled
<b>Integrated Devices</b>	
Front USB Ports	Allows you to enable or disable the front USB ports. Default: Disabled.
Rear USB Ports	Allows you to enable or disable the rear USB ports. Default: Disabled.
HD Audio	Allows you to enable or disable the integrated audio controller. Default: Enabled.
Integrated NIC1/Wireless LAN	Allows you to enable or disable the NIC1. Default: Enabled.
Integrated NIC2	Allows you to enable or disable the NIC2. Default: Enabled.
Pxe Option	Allows you to enable or disable the boot option for legacy network devices. Default: Disabled.
SATA Operation	Allows you to configure the operating mode of the integrated SATA hard drive controller. Default: AHCI
PCIE GEN3	Allows you to enable or disable the PCIE GEN3. Default: Enabled.
<b>Power Management Setup</b>	
AC Recovery	Sets what action the computer takes when power is restored. Default: Last State.
Deep Sleep Control	Allows you to define the controls when Deep Sleep is enabled. Default: Enabled in S5 Only.
Auto Power On	Enable to set the computer to turn on automatically every day or on a preselected date and time. This option can be configured only

**Table 4. System setup options—Advanced menu (continued)**

Advanced	
Numlock Key	<p>if the Auto On Time is set to Everyday, Weekdays, or Selected Days.</p> <p>Default: Disabled.</p> <p>Enable or disable Numlock.</p> <p>Default: Enable Numlock.</p>

**Table 5. System setup options—OC menu**

OC	
AMD CPU	Allows you to set OC mode and Custom Pstate0 for the CPU.
AMD Memory	Allows you to set the overclocking and adjust MEM VDDIO,

**Table 6. System setup options—Security menu**

Security	
Unlock Setup	Displays if the setup status is unlocked.
Admin Password	Allows you to set the administrator password. The administrator password controls access to the system setup utility.
System Password	Allows you to set the system password. The system password controls access to the computer at boot.
HDD Password Status	Displays if the HDD password is clear or set. Default: Not set.
HDD1 Password Status	Displays if the HDD password is clear or set. Default: Not set.
HDD2 Password Status	Displays if the HDD password is clear or set. Default: Not set.
HDD3 Password Status	Displays if the HDD password is clear or set. Default: Not set.
Password Change	Allows you to permit or deny system password or HDD password changes. Default: Permitted
Computrace	Enable or disable the BIOS module interface of the optional Computrace Service from Absolute Software.
HDD protection	Allows you to set, change, or delete the hard-disk drive password. Default: Disabled.
Firmware TPM	Enable or disable the firmware TPM. Default: Enabled.
UEFI Firmware Capsule Updates	Enable or disable BIOS updates through UEFI capsule update packages. Default: Enabled.

**Table 7. System setup options—Boot menu**

Boot	
Boot Configuration	
Wait for 'F1' If Error	Allows you to enable or disable the F1 screen. Default: All, but KB.
Secure Boot Control	Allows you to enable or disable the secure boot control. Default: Disabled.
Load Legacy OPROM	Default: Enabled.
Set Boot Priority	
Boot List Option	Allows you to select the boot list option. Default: Legacy
USB Boot Support	Allows you to enable or disable USB Boot support. Default: Enabled.
1st Boot	Allows you to enable or disable the 1st boot device. Default: Hard Disk.
2nd Boot	Allows you to enable or disable the 2nd boot device. Default: USB Hard Disk.
3rd Boot	Allows you to enable or disable the 3rd boot device. Default: CD/DVD.
4th Boot	Allows you to enable or disable the 4th boot device. Default: Floppy.
5th Boot	Allows you to enable or disable the 5th boot device. Default: Network.

**Table 8. System setup options—Exit menu**

Save & Exit	
Save Changes and Reset	Allows you to exit system setup and save your changes.
Discard Changes and Reset	Allows you to exit system setup and load previous values for all system setup options.
Restore Defaults	Allows you to load default values for all system setup options.

## System and setup password

You can create a system password and a setup password to secure your computer.

### Password type    Description

**System password**    Password that you must enter to log on to your system.

**Setup password**    Password that you must enter to access and make changes to the BIOS settings of your computer.

 **CAUTION: The password features provide a basic level of security for the data on your computer.**

 **CAUTION: Anyone can access the data stored on your computer if it is not locked and left unattended.**

 **NOTE:** Your computer is shipped with the system and setup password feature is disabled.

## Assigning a system password and setup password

You can assign a new **System Password** only when the status is in **Not Set**.

To enter the system setup, press F2 immediately after a power-on or re-boot.

1. In the **System BIOS** or **System Setup** screen, select **Security** and press Enter.  
The **Security** screen is displayed.
2. Select **System Password** and create a password in the **Enter the new password** field.  
Use the following guidelines to assign the system password:
  - A password can have up to 32 characters.
  - The password can contain the numbers 0 through 9.
  - Only lower case letters are valid, upper case letters are not allowed.
  - Only the following special characters are allowed: space, ("), (+), (,), (-), (.), (/), (:), ([), (\), (]), (^).
3. Type the system password that you entered earlier in the **Confirm new password** field and click **OK**.
4. Press Esc and a message prompts you to save the changes.
5. Press Y to save the changes.  
The computer reboots.

## Deleting or changing an existing system and/or setup password

Ensure that the **Password Status** is Unlocked (in the System Setup) before attempting to delete or change the existing System and/or Setup password. You cannot delete or change an existing System or Setup password, if the **Password Status** is Locked.

To enter the System Setup, press F2 immediately after a power-on or reboot.

1. In the **System BIOS** or **System Setup** screen, select **System Security** and press Enter.  
The **System Security** screen is displayed.
2. In the **System Security** screen, verify that **Password Status** is **Unlocked**.
3. Select **System Password**, alter or delete the existing system password and press Enter or Tab.
4. Select **Setup Password**, alter or delete the existing setup password and press Enter or Tab.  
 **NOTE:** If you change the System and/or Setup password, re-enter the new password when promoted. If you delete the System and/or Setup password, confirm the deletion when promoted.
5. Press Esc and a message prompts you to save the changes.
6. Press Y to save the changes and exit from System Setup.  
The computer reboots.

## Clearing Forgotten Passwords

 **NOTE:** Before working inside your computer, read the safety information that shipped with your computer and follow the steps in [Before working inside your computer](#). After working inside your computer, follow the instructions in [After working inside your computer](#). For more safety best practices, see the Regulatory Compliance home page at [www.dell.com/regulatory\\_compliance](http://www.dell.com/regulatory_compliance).

1. Lay the chassis on the left side.
2. Remove the [stability foot](#)
3. Remove the left and right side-panels. See "[Removing the side panels](#)".
4. Locate the password reset jumper (PW\_CLR) on the system board. See "[system-board components](#)".
5. Remove the jumper plug from pins 2 and 3 and fix it on pins 1 and 2.
6. Wait for approximately five seconds to clear the password setting.
7. Remove the jumper plug from pins 1 and 2 and replace it on pins 2 and 3.

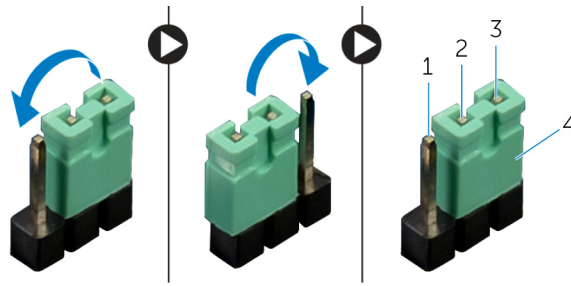

1. pin 1
3. pin 3

2. pin 2
4. jumper plug

8. Replace the left and right side panels. See "[Replacing the side panels](#)".
9. Replace the [stability foot](#).

## Clearing CMOS Settings

**NOTE:** Before working inside your computer, read the safety information that shipped with your computer and follow the steps in [Before working inside your computer](#). After working inside your computer, follow the instructions in [After working inside your computer](#). For more safety best practices, see the Regulatory Compliance home page at [www.dell.com/regulatory\\_compliance](http://www.dell.com/regulatory_compliance).

**NOTE:** The computer must be disconnected from the electrical outlet to clear the CMOS setting.

1. Lay the system on the right side.
2. Remove the [stability foot](#)
3. Remove the left and right side-panels. See "[Removing the side panels](#)".
4. Locate the CMOS jumper (CMOS\_CLR) on the system board. See "[system-board components](#)".
5. Remove the jumper plug from pins 2 and 3 and fix it on pins 1 and 2.
6. Wait for approximately five seconds to clear the CMOS setting.
7. Remove the jumper plug from pins 1 and 2 and replace it on pins 2 and 3.

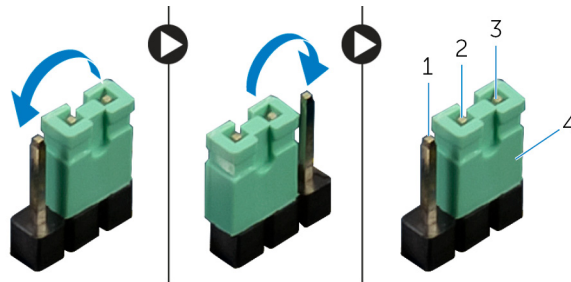

1. pin 1
3. pin 3

2. pin 2
4. jumper plug

8. Replace the left and right side panels. See "[Replacing the side panels](#)".
9. Replace the [stability foot](#).

# Troubleshooting

## Topics:

- [Flashing the BIOS](#)
- [Flashing BIOS \(USB key\)](#)
- [Enhanced Pre-Boot System Assessment \(ePSA\) diagnostics](#)
- [Diagnostics](#)
- [Wi-Fi power cycle](#)

## Flashing the BIOS

You may need to flash (update) the BIOS when an update is available or when you replace the system board.

Follow these steps to flash the BIOS:

1. Turn on your computer.
2. Go to [www.dell.com/support](http://www.dell.com/support).
3. Click **Product support**, enter the Service Tag of your computer, and then click **Submit**.

 **NOTE:** If you do not have the Service Tag, use the auto-detect feature or manually browse for your computer model.

4. Click **Drivers & downloads > Find it myself**.
5. Select the operating system installed on your computer.
6. Scroll down the page and expand **BIOS**.
7. Click **Download** to download the latest version of the BIOS for your computer.
8. After the download is complete, navigate to the folder where you saved the BIOS update file.
9. Double-click the BIOS update file icon and follow the instructions on the screen.

## Flashing BIOS (USB key)

1. Follow the procedure from step 1 to step 7 in "[Flashing the BIOS](#)" to download the latest BIOS setup program file.
2. Create a bootable USB drive. For more information see the knowledge base article [SLN143196](#) at [www.dell.com/support](http://www.dell.com/support).
3. Copy the BIOS setup program file to the bootable USB drive.
4. Connect the bootable USB drive to the computer that needs the BIOS update.
5. Restart the computer and press **F12** when the Dell logo is displayed on the screen.
6. Boot to the USB drive from the **One Time Boot Menu**.
7. Type the BIOS setup program filename and press **Enter**.
8. The **BIOS Update Utility** appears. Follow the instructions on the screen to complete the BIOS update.

## Enhanced Pre-Boot System Assessment (ePSA) diagnostics

The ePSA diagnostics (also known as system diagnostics) performs a complete check of your hardware. The ePSA is embedded with the BIOS and is launched by the BIOS internally. The embedded system diagnostics provides a set of options for particular devices or device groups allowing you to:

- Run tests automatically or in an interactive mode
- Repeat tests
- Display or save test results
- Run thorough tests to introduce additional test options to provide extra information about the failed device(s)
- View status messages that inform you if tests are completed successfully

- View error messages that inform you of problems encountered during testing

**CAUTION:** Use the system diagnostics to test only your computer. Using this program with other computers may cause invalid results or error messages.

**NOTE:** Some tests for specific devices require user interaction. Always ensure that you are present at the computer terminal when the diagnostic tests are performed.

For more information, see [Dell EPSA Diagnostic 3.0](#).

## Running the SupportAssist Pre-Boot System Performance Check

1. Turn on your computer.
2. As the computer boots, press the F12 key as the Dell logo appears.
3. On the boot menu screen, select the **Diagnostics** option.
4. Click the arrow at the bottom left corner.  
Diagnostics front page is displayed.
5. Click the arrow in the lower-right corner to go to the page listing.  
The items detected are listed.
6. To run a diagnostic test on a specific device, press Esc and click **Yes** to stop the diagnostic test.
7. Select the device from the left pane and click **Run Tests**.
8. If there are any issues, error codes are displayed.  
Note the error code and validation number and contact Dell.

## Diagnostics

The following table shows different beep codes and what they indicate.

**Table 9. Diagnostics**

Beep code	Problem description
1	Motherboard: BIOS ROM failure
2	No Memory/RAM detected
3	Chipset error
4	Memory or RAM failure
5	CMOS battery failure
6	Video card/chip failure

## Wi-Fi power cycle

If your computer is unable to access the internet due to Wi-Fi connectivity issues a Wi-Fi power cycle procedure may be performed. The following procedure provides the instructions on how to conduct a Wi-Fi power cycle:



1. Turn off your computer.
2. Turn off the modem.
3. Turn off the wireless router.
4. Wait for 30 seconds.
5. Turn on the router.
6. Turn on the modem.
7. Turn on your computer.

# Getting help and contacting Alienware

## Self-help resources

You can get information and help on Alienware products and services using these online self-help resources:

**Table 10. Alienware products and online self-help resources**

Information about Alienware products and services	<a href="http://www.alienware.com">www.alienware.com</a>
Dell Help & Support app	
Get started app	Get started app 
Accessing help	In Windows search, type <b>Help and Support</b> , and press <b>Enter</b> .
Online help for operating system	<a href="http://www.dell.com/support/windows">www.dell.com/support/windows</a> <a href="http://www.dell.com/support/linux">www.dell.com/support/linux</a>
Troubleshooting information, user manuals, setup instructions, product specifications, technical help blogs, drivers, software updates, and so on	<a href="http://www.alienware.com/gamingservices">www.alienware.com/gamingservices</a>
VR Support	<a href="http://www.dell.com/VRsupport">www.dell.com/VRsupport</a>
Videos providing step-by-step instructions to service your computer	<a href="http://www.youtube.com/alienwareservices">www.youtube.com/alienwareservices</a>

## Contacting Alienware

To contact Alienware for sales, technical support, or customer service issues, see [www.alienware.com](http://www.alienware.com).

 **NOTE:** Availability varies by country and product, and some services may not be available in your country.

 **NOTE:** If you do not have an active internet connection, you can find contact information on your purchase invoice, packing slip, bill, or Dell product catalog.