

Alienware 17 R4 Service Manual

Computer Model: Alienware 17 R4
Regulatory Model: P31E
Regulatory Type: P31E001

A L I E N W A R E™ 

Notes, cautions, and warnings

 **NOTE:** A NOTE indicates important information that helps you make better use of your product.

 **CAUTION:** A CAUTION indicates either potential damage to hardware or loss of data and tells you how to avoid the problem.

 **WARNING:** A WARNING indicates a potential for property damage, personal injury, or death.

Copyright © 2016 Dell Inc. or its subsidiaries. All rights reserved. Dell, EMC, and other trademarks are trademarks of Dell Inc. or its subsidiaries. Other trademarks may be trademarks of their respective owners.

2016 - 12

Rev. A01

Contents

Before working inside your computer.....	11
Before you begin	11
Safety instructions.....	11
Recommended tools.....	12
Screw list.....	13
After working inside your computer.....	15
Removing the base cover.....	16
Procedure.....	16
Replacing the base cover.....	19
Procedure.....	19
Removing the hard drive.....	20
Prerequisites.....	20
Procedure.....	20
Replacing the hard drive.....	23
Procedure.....	23
Post-requisites.....	23
Removing the wireless card.....	24
Prerequisites.....	24
Procedure.....	24

Replacing the wireless card.....	26
Procedure.....	26
Post-requisites.....	27
Removing the solid-state drive.....	28
Prerequisites.....	28
Procedure.....	28
Replacing the solid-state drive.....	30
Procedure.....	30
Post-requisites.....	31
Removing the memory modules.....	32
Prerequisites.....	32
Procedure.....	32
Replacing the memory modules.....	34
Procedure.....	34
Post-requisites.....	35
Removing the rear-I/O cover.....	36
Prerequisites.....	36
Procedure.....	36
Replacing the rear-I/O cover.....	38
Procedure.....	38
Post-requisites.....	38
Removing the computer base.....	39
Prerequisites.....	39
Procedure.....	39

Replacing the computer base.....	43
Procedure.....	43
Post-requisites.....	43
Removing the coin-cell battery.....	44
Prerequisites.....	44
Procedure.....	44
Replacing the coin-cell battery.....	46
Procedure.....	46
Post-requisites.....	46
Removing the speakers.....	47
Prerequisites.....	47
Procedure.....	47
Replacing the speakers.....	49
Procedure.....	49
Post-requisites.....	49
Removing the I/O board.....	50
Prerequisites.....	50
Procedure.....	50
Replacing the I/O board.....	53
Procedure.....	53
Post-requisites.....	53
Removing the subwoofer.....	54
Prerequisites.....	54
Procedure.....	54

Replacing the subwoofer.....	56
Procedure.....	56
Post-requisites.....	56
Removing the system-board assembly.....	57
Prerequisites.....	57
Procedure.....	57
Replacing the system board.....	63
Procedure.....	63
Post-requisites.....	64
Removing the heat-sink assembly.....	65
Prerequisites.....	65
Procedure.....	65
Replacing the heat-sink assembly.....	68
Procedure.....	68
Post-requisites.....	68
Removing the power-adapter port.....	70
Prerequisites.....	70
Procedure.....	70
Replacing the power-adapter port.....	72
Procedure.....	72
Post-requisites.....	72
Removing the power-button board.....	73
Prerequisites.....	73
Procedure.....	73

- Replacing the power-button board..... 75**
 - Procedure..... 75
 - Post-requisites..... 75

- Removing the display assembly..... 76**
 - Prerequisites..... 76
 - Procedure..... 76

- Replacing the display assembly..... 78**
 - Procedure..... 78
 - Post-requisites..... 78

- Removing the battery..... 79**
 - Prerequisites..... 79
 - Procedure..... 79

- Replacing the battery..... 81**
 - Procedure..... 81
 - Post-requisites..... 81

- Removing the touch pad..... 82**
 - Prerequisites..... 82
 - Procedure..... 82

- Replacing the touch pad..... 85**
 - Procedure..... 85
 - Post-requisites..... 85

- Removing the keyboard..... 86**
 - Prerequisites..... 86
 - Procedure..... 86

Replacing the keyboard.....	89
Procedure.....	89
Post-requisites.....	89
Removing the palm rest.....	90
Prerequisites.....	90
Procedure.....	91
Replacing the palm rest.....	92
Procedure.....	92
Post-requisites.....	92
Removing the display bezel.....	93
Prerequisites.....	93
Procedure.....	93
Replacing the display bezel.....	96
Procedure.....	96
Post-requisites.....	96
Removing the tobii eye-tracker module.....	97
Prerequisites.....	97
Procedure.....	97
Replacing the tobii eye-tracker module.....	99
Procedure.....	99
Post-requisites.....	99
Removing the logo board.....	100
Prerequisites.....	100
Procedure.....	100

- Replacing the logo board..... 103**
 - Procedure..... 103
 - Post-requisites..... 103

- Removing the display panel..... 104**
 - Prerequisites..... 104
 - Procedure..... 104

- Replacing the display panel..... 107**
 - Procedure..... 107
 - Post-requisites..... 107

- Removing the camera..... 108**
 - Prerequisites..... 108
 - Procedure..... 108

- Replacing the camera.....110**
 - Procedure..... 110
 - Post-requisites..... 110

- Removing the display hinges..... 111**
 - Prerequisites..... 111
 - Procedure..... 112

- Replacing the display hinges..... 115**
 - Procedure..... 115
 - Post-requisites..... 115



- Removing the display back-cover and antenna assembly..... 117**
 - Prerequisites.....117
 - Procedure..... 118

Replacing the display back-cover and antenna assembly.....	120
Procedure.....	120
Post-requisites.....	120
BIOS overview.....	122
Entering the BIOS setup program.....	122
Timing key sequences.....	122
System Setup Options.....	122
Clearing forgotten passwords.....	128
Clearing CMOS settings.....	128
Flashing the BIOS.....	129
Boot menu.....	129
Boot menu enhancements.....	129
Diagnostics.....	130
Getting help and contacting Alienware.....	132
Self-help resources.....	132
Contacting Alienware.....	133

Before working inside your computer



 **NOTE:** The images in this document may differ from your computer depending on the configuration you ordered.

Before you begin

- 1 Save and close all open files and exit all open applications.
- 2 Shut down your computer. Click **Start** →  **Power** → **Shut down**.
 **NOTE:** If you are using a different operating system, see the documentation of your operating system for shut-down instructions.
- 3 Disconnect your computer and all attached devices from their electrical outlets.
- 4 Disconnect all attached network devices and peripherals, such as keyboard, mouse, and monitor from your computer.
- 5 Remove any media card and optical disc from your computer, if applicable.
- 6 Close the display and turn the computer over.

Safety instructions

Use the following safety guidelines to protect your computer from potential damage and ensure your personal safety.

-  **WARNING:** Before working inside your computer, read the safety information that shipped with your computer. For more safety best practices, see the Regulatory Compliance home page at www.dell.com/regulatory_compliance.
-  **WARNING:** Disconnect all power sources before opening the computer cover or panels. After you finish working inside the computer, replace all covers, panels, and screws before connecting to the electrical outlet.

- △ **CAUTION:** To avoid damaging the computer, ensure that the work surface is flat and clean.
- △ **CAUTION:** To avoid damaging the components and cards, handle them by their edges, and avoid touching pins and contacts.
- △ **CAUTION:** You should only perform troubleshooting and repairs as authorized or directed by the Dell technical assistance team. Damage due to servicing that is not authorized by Dell is not covered by your warranty. See the safety instructions that shipped with the product or at www.dell.com/regulatory_compliance.
- △ **CAUTION:** Before touching anything inside your computer, ground yourself by touching an unpainted metal surface, such as the metal at the back of the computer. While you work, periodically touch an unpainted metal surface to dissipate static electricity, which could harm internal components.
- △ **CAUTION:** When you disconnect a cable, pull on its connector or on its pull tab, not on the cable itself. Some cables have connectors with locking tabs or thumb-screws that you must disengage before disconnecting the cable. When disconnecting cables, keep them evenly aligned to avoid bending any connector pins. When connecting cables, ensure that the ports and connectors are correctly oriented and aligned.
- △ **CAUTION:** Press and eject any installed card from the media-card reader.











Recommended tools













The procedures in this document may require the following tools:

- Phillips screwdriver
- Plastic scribe

Screw list

Table 1. Screw list

Component	Secured to	Screw type	Quantity	Screw image
Base cover	Palm-rest assembly	M2.5x13	6	
Battery	Palm-rest assembly	M2.5x5	4	
Computer base	Palm-rest assembly	M2.5x8	14	
Computer base	Palm-rest assembly	M2.5x5	2	
Display assembly	Palm-rest assembly	M2.5x5	6	
Display hinges	Display back-cover and antenna assembly	M2.5x3	12	
Display panel	Display back-cover and antenna assembly	M2x3	4	
Hard-drive assembly	Computer base	M2.5x5	4	
Hard-drive bracket	Hard-drive assembly	M3x3	4	
Heat-sink assembly	System board	M2x3	7	

Component	Secured to	Screw type	Quantity	Screw image
I/O board	Palm-rest assembly	M2.5x5	2	
Keyboard bracket	Palm-rest assembly	M2x3	17	
Logo board	Display back-cover and antenna assembly	M2x3	2	
Power-adaptor port bracket	Palm-rest assembly	M2x3	1	
Power-button board	Palm-rest assembly	M2x3	2	
Rear-I/O cover	Computer base	M2.5x7	2	
Solid-state drive	Computer base	M2x3	1	
Subwoofer	Palm-rest assembly	M2x2	2	
System-board assembly	Palm-rest assembly	M2.5x5	7	
Touch-pad bracket	Palm-rest assembly	M2x3	5	
Tron-light holder	Computer base	M2x3	2	
Wireless-card bracket	Computer base	M2x3	1	

After working inside your computer



CAUTION: Leaving stray or loose screws inside your computer may severely damage your computer.

- 1 Replace all screws and ensure that no stray screws remain inside your computer.
- 2 Connect any external devices, peripherals, or cables you removed before working on your computer.
- 3 Replace any media cards, discs, or any other parts that you removed before working on your computer.
- 4 Connect your computer and all attached devices to their electrical outlets.
- 5 Turn on your computer.

Removing the base cover

⚠ WARNING: Before working inside your computer, read the safety information that shipped with your computer and follow the steps in [Before working inside your computer](#). After working inside your computer, follow the instructions in [After working inside your computer](#). For more safety best practices, see the Regulatory Compliance home page at www.dell.com/regulatory_compliance.

Procedure

- 1 Remove the six screws (M2.5x13) that secure the base cover to the computer base.
- 2 Loosen the captive screw that secures the base cover to the computer base.



- 3 Using a plastic scribe, gently pry the base cover to release the tabs on the base cover from the slots on the computer base.
- 4 Lift the base cover off the computer base.



- 5 Disconnect the battery cable from the system board.

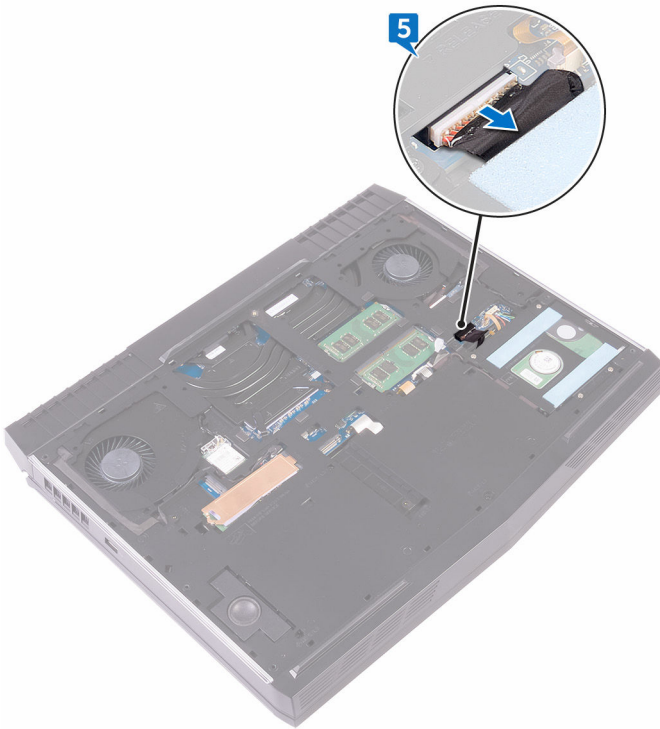

- 6 Press and hold the power button for five seconds to ground the system board.

Replacing the base cover

 **WARNING:** Before working inside your computer, read the safety information that shipped with your computer and follow the steps in [Before working inside your computer](#). After working inside your computer, follow the instructions in [After working inside your computer](#). For more safety best practices, see the Regulatory Compliance home page at www.dell.com/regulatory_compliance.

Procedure

- 1 Connect the battery cable to the system board.
- 2 Slide the tabs on the base cover into the slots on the computer base and snap the base cover into place.
- 3 Tighten the captive screw that secures the base cover to the computer base.
- 4 Replace the six screws (M2.5x13) that secure the base cover to the computer base.

Removing the hard drive

 **WARNING:** Before working inside your computer, read the safety information that shipped with your computer and follow the steps in [Before working inside your computer](#). After working inside your computer, follow the instructions in [After working inside your computer](#). For more safety best practices, see the Regulatory Compliance home page at www.dell.com/regulatory_compliance.

 **CAUTION:** Hard drives are fragile. Exercise care when handling the hard drive.

 **CAUTION:** To avoid data loss, do not remove the hard drive while the computer is in sleep or on state.

Prerequisites

Remove the [base cover](#).

Procedure

- 1 Using the pull-tab, disconnect the hard-drive cable from the system board.
- 2 Remove the hard-drive cable from the routing guides on the computer base.
- 3 Remove the four screws (M2.5x5) that secure the hard-drive assembly to the computer base.

- 4 Lift the hard-drive assembly along with its cable off the computer base.

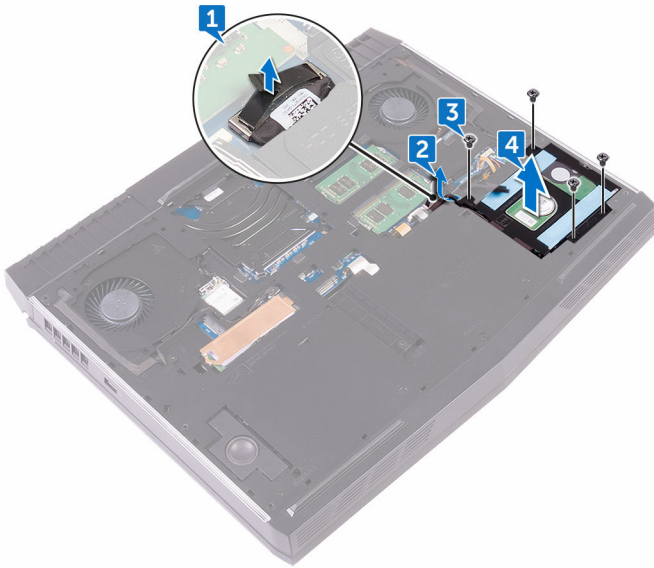

- 5 Remove the four screws (M3x3) that secure the hard-drive bracket to the hard-drive assembly.
- 6 Lift the hard-drive bracket off the hard-drive assembly.

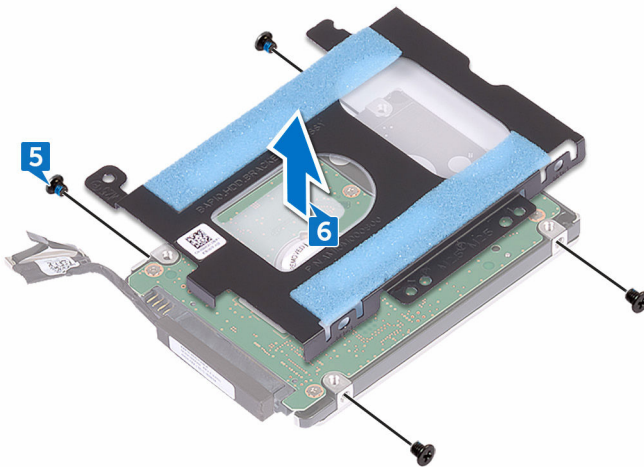

- 7 Disconnect the interposer from the hard drive.

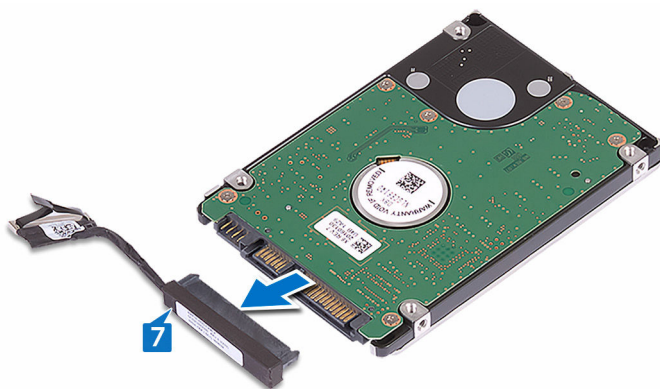

Replacing the hard drive

 **WARNING:** Before working inside your computer, read the safety information that shipped with your computer and follow the steps in [Before working inside your computer](#). After working inside your computer, follow the instructions in [After working inside your computer](#). For more safety best practices, see the Regulatory Compliance home page at www.dell.com/regulatory_compliance.

 **CAUTION:** Hard drives are fragile. Exercise care when handling the hard drive.

Procedure

- 1 Connect the interposer to the hard drive.
- 2 Align the screw holes on the hard-drive bracket with the screw holes on the hard-drive assembly.
- 3 Replace the four screws (M3x3) that secure the hard-drive bracket to the hard-drive assembly.
- 4 Align the screw holes on the hard-drive assembly with the screw holes on the computer base.
- 5 Replace the four screws (M2.5x5) that secure the hard-drive assembly to the computer base.
- 6 Route the hard-drive cable through the routing guides on the computer base.
- 7 Connect the hard-drive cable to the system board.

Post-requisites

Replace the [base cover](#).

Removing the wireless card

 **WARNING:** Before working inside your computer, read the safety information that shipped with your computer and follow the steps in [Before working inside your computer](#). After working inside your computer, follow the instructions in [After working inside your computer](#). For more safety best practices, see the Regulatory Compliance home page at www.dell.com/regulatory_compliance.

Prerequisites

Remove the [base cover](#).

Procedure

- 1 Remove the screw (M2x3) that secures the wireless-card bracket to the computer base.
- 2 Slide and remove the wireless-card bracket from the wireless card.
- 3 Disconnect the antenna cables from the wireless card.

4 Slide the wireless card out of the wireless-card slot.

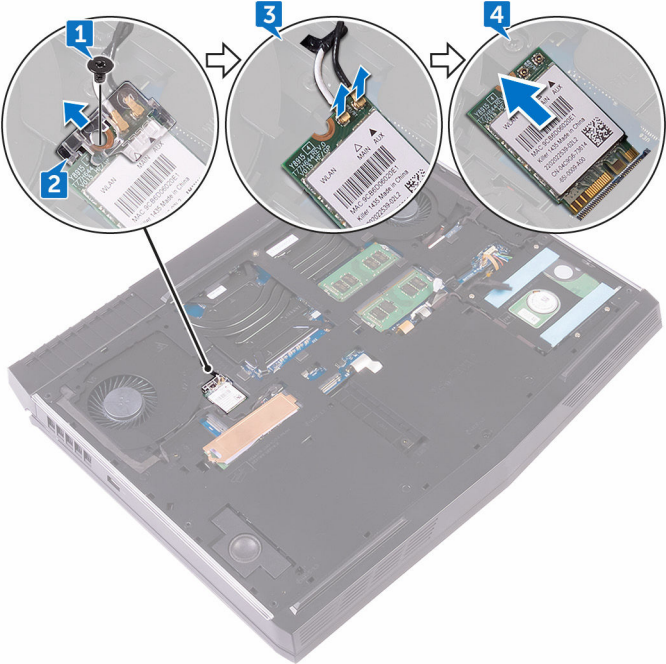

Replacing the wireless card

 **WARNING:** Before working inside your computer, read the safety information that shipped with your computer and follow the steps in [Before working inside your computer](#). After working inside your computer, follow the instructions in [After working inside your computer](#). For more safety best practices, see the Regulatory Compliance home page at www.dell.com/regulatory_compliance.

Procedure

 **CAUTION:** To avoid damaging the wireless card, do not place any cables under it.

- 1 Align the notch on the wireless card with the tab on the wireless-card slot.
- 2 Slide the wireless card at an angle into the wireless-card slot.
- 3 Connect the antenna cables to the wireless card.

The following table provides the antenna-cable color scheme for the wireless card supported by your computer.

Table 2. Antenna-cable color scheme

Connectors on the wireless card	Antenna cable color
Auxiliary (black triangle)	Black
Main (white triangle)	White

- 4 Slide the wireless card bracket on to the wireless card, and align the screw hole on the wireless-card bracket with the screw hole on the wireless card and the computer base.

- 5 Press the other end of the wireless card and replace the screw (M2x3) that secures the wireless-card bracket to the computer base.

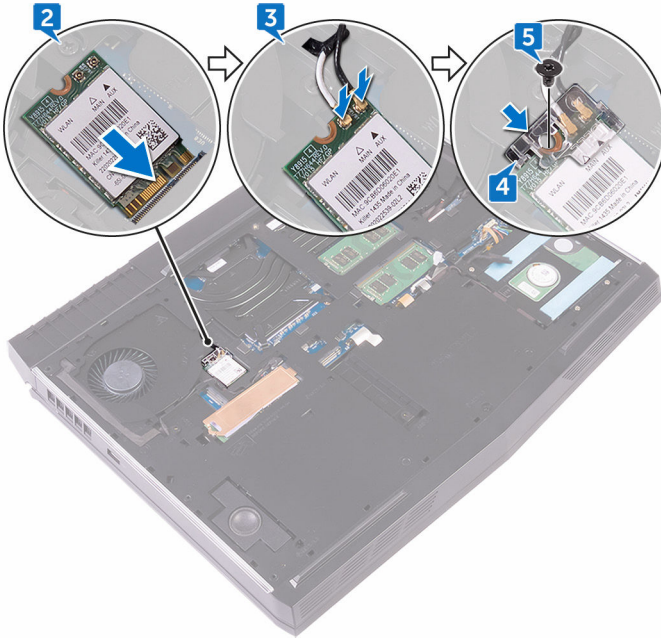

Post-requisites

Replace the [base cover](#).

Removing the solid-state drive

 **WARNING:** Before working inside your computer, read the safety information that shipped with your computer and follow the steps in [Before working inside your computer](#). After working inside your computer, follow the instructions in [After working inside your computer](#). For more safety best practices, see the Regulatory Compliance home page at www.dell.com/regulatory_compliance.

 **CAUTION:** Solid-state drives are fragile. Exercise care when handling the solid-state drive.

 **CAUTION:** To avoid data loss, do not remove the solid-state drive while the computer is in sleep or on state.

Prerequisites

Remove the [base cover](#).

Procedure

- 1 Remove the screw (M2x3) that secures the solid-state drive shield and solid-state drive to the computer base.
- 2 Peel off the solid-state drive shield from the solid-state drive.

 **NOTE:** Solid-state drive shield is applicable to computers that are shipped with 1 TB solid-state drive.

3 Slide and remove the solid-state drive from the solid-state drive slot.

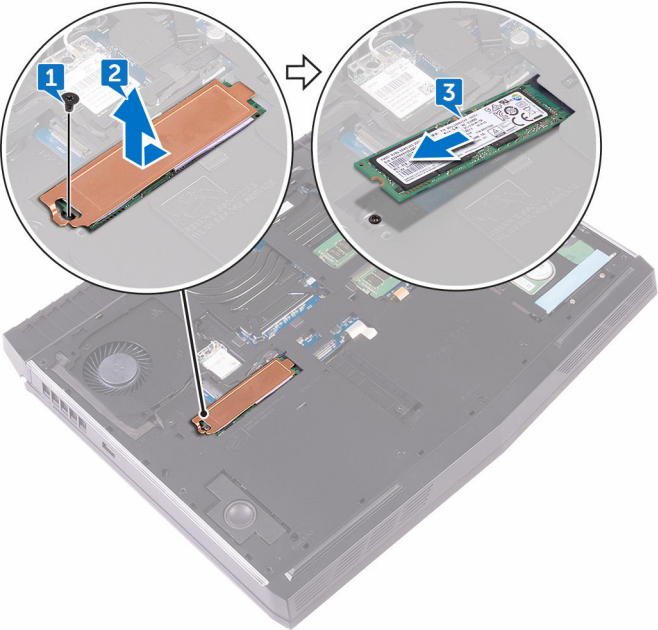

Replacing the solid-state drive

 **WARNING:** Before working inside your computer, read the safety information that shipped with your computer and follow the steps in [Before working inside your computer](#). After working inside your computer, follow the instructions in [After working inside your computer](#). For more safety best practices, see the Regulatory Compliance home page at www.dell.com/regulatory_compliance.

 **CAUTION:** Solid-state drives are fragile. Exercise care when handling the solid-state drive.

Procedure

- 1 Align the notch on the solid-state drive with the tab on the solid-state drive slot.
- 2 Slide the solid-state drive into the solid-state drive slot.
- 3 Slide and adhere the solid-state drive shield on the solid-state drive.
- 4 Align the screw hole on the solid-state drive and solid-state drive shield with the screw hole on the computer base.

- 5 Replace the screw (M2x3) that secures the solid-state drive to the computer base.

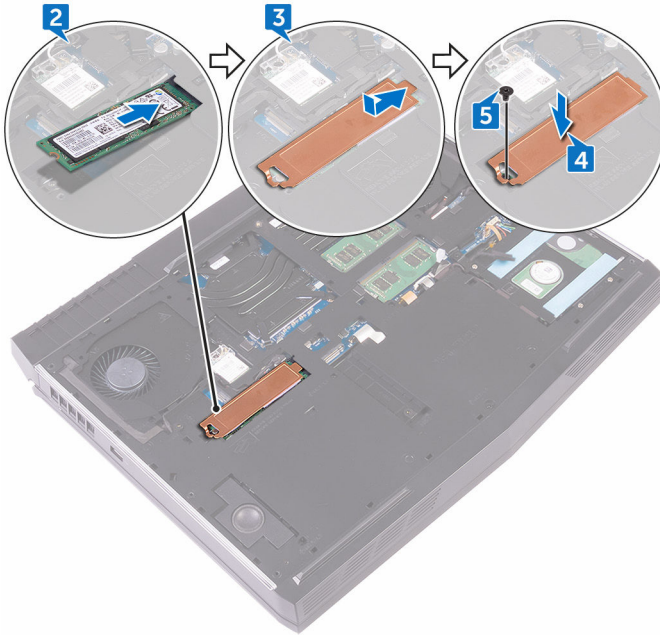

Post-requisites

Replace the [base cover](#).

Removing the memory modules

 **WARNING:** Before working inside your computer, read the safety information that shipped with your computer and follow the steps in [Before working inside your computer](#). After working inside your computer, follow the instructions in [After working inside your computer](#). For more safety best practices, see the Regulatory Compliance home page at www.dell.com/regulatory_compliance.

Prerequisites

Remove the [base cover](#).

Procedure

- 1 Using your fingertips, carefully spread apart the securing clips on each end of the memory-module slot until the memory module pops up.

2 Slide and remove the memory module from the memory-module slot.

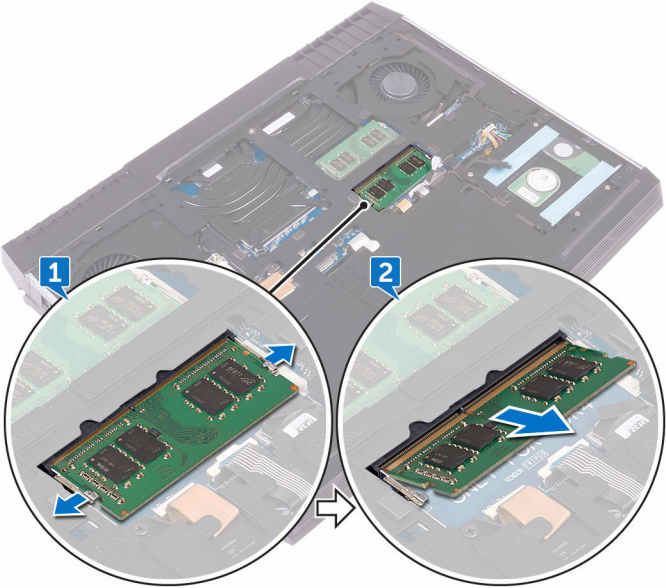

Replacing the memory modules

⚠ WARNING: Before working inside your computer, read the safety information that shipped with your computer and follow the steps in [Before working inside your computer](#). After working inside your computer, follow the instructions in [After working inside your computer](#). For more safety best practices, see the Regulatory Compliance home page at www.dell.com/regulatory_compliance.

Procedure

- 1 Align the notch on the memory module with the tab on the memory-module slot and slide the memory module firmly into the slot at an angle.
- 2 Press the memory module down until it clicks into place.

🔧 NOTE: If you do not hear the click, remove the memory module and reinstall it.

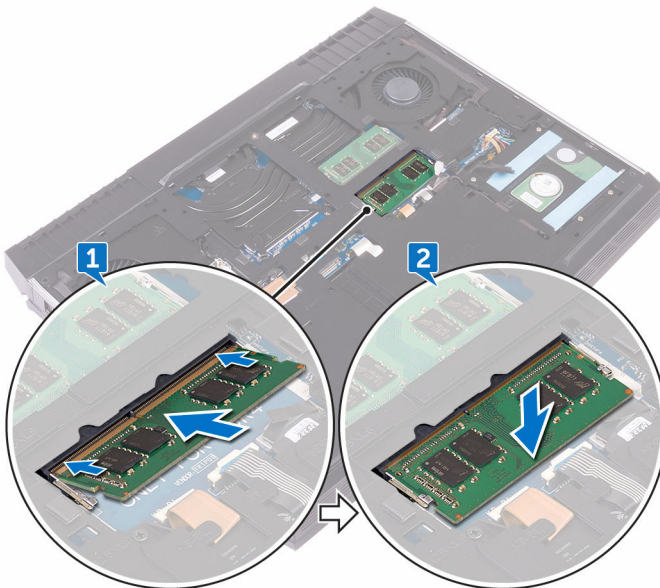

Post-requisites

Replace the [base cover](#).

Removing the rear-I/O cover

 **WARNING:** Before working inside your computer, read the safety information that shipped with your computer and follow the steps in [Before working inside your computer](#). After working inside your computer, follow the instructions in [After working inside your computer](#). For more safety best practices, see the Regulatory Compliance home page at www.dell.com/regulatory_compliance.

Prerequisites

Remove the [base cover](#).

Procedure

- 1 Remove the two screws (M2.5x7) that secure the rear-I/O cover to the palm-rest assembly.
- 2 Using a plastic scribe, gently release the tabs that secure rear-I/O cover to the computer base.

3 Slide and remove the rear-I/O cover from the computer base.

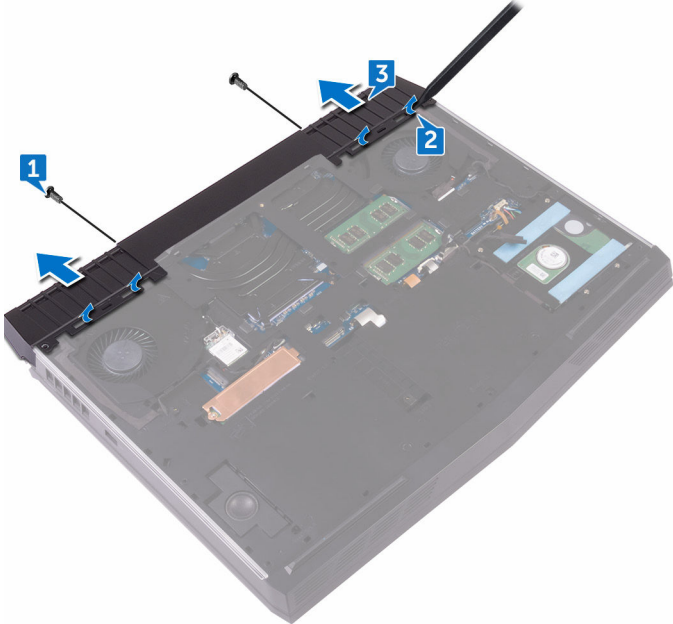

Replacing the rear-I/O cover

 **WARNING:** Before working inside your computer, read the safety information that shipped with your computer and follow the steps in [Before working inside your computer](#). After working inside your computer, follow the instructions in [After working inside your computer](#). For more safety best practices, see the Regulatory Compliance home page at www.dell.com/regulatory_compliance.

Procedure

- 1 Slide the tabs on the rear-I/O cover into the slots on the computer base and snap the rear-I/O cover into place.
- 2 Replace the two screws (M2.5x7) that secure the rear-I/O cover to the palm-rest assembly.

Post-requisites

Replace the [base cover](#).

Removing the computer base

 **WARNING:** Before working inside your computer, read the safety information that shipped with your computer and follow the steps in [Before working inside your computer](#). After working inside your computer, follow the instructions in [After working inside your computer](#). For more safety best practices, see the Regulatory Compliance home page at www.dell.com/regulatory_compliance.

Prerequisites

- 1 Remove the [base cover](#).
- 2 Follow the procedure from step 1 to step 4 in "[Removing the hard drive](#)".
- 3 Remove the [wireless card](#).
- 4 Remove the [solid-state drive](#).
- 5 Remove the [rear-I/O cover](#).

Procedure

- 1 Note the cable routing and remove the antenna cables from the routing guides on the computer base.
- 2 Disconnect the tron-light cable from the system board.

- 3 Disconnect the tron-light cable from the system board.

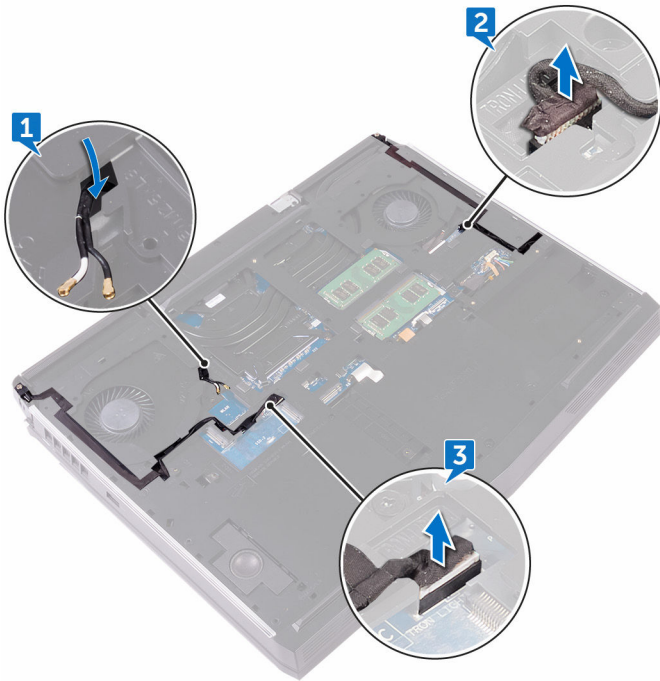

- 4 Remove the two screws (M2.5x5) that secure the computer base to the palm-rest assembly.

- 5 Remove the 14 screws (M2.5x8) that secure the computer base to the palm-rest assembly.

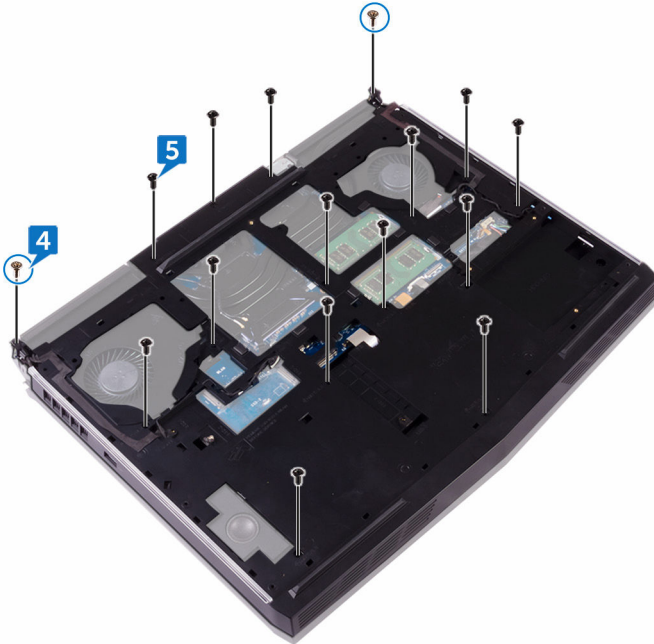

- 6 Using a plastic scribe, gently release the tabs on the computer base from the slots on the palm-rest assembly.

7 Lift the computer base off the palm-rest assembly.

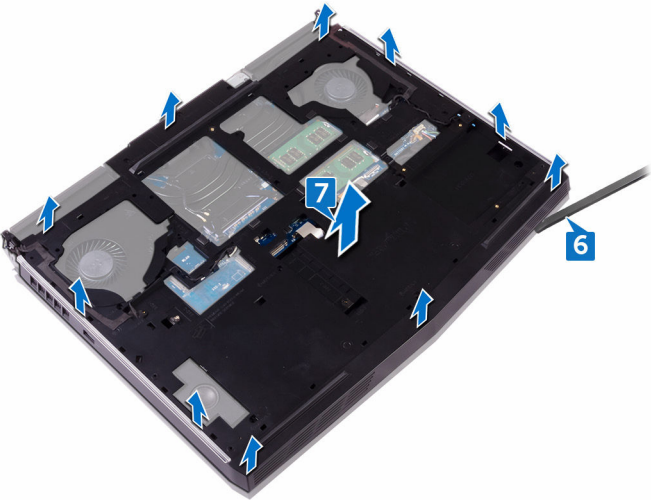

Replacing the computer base

 **WARNING:** Before working inside your computer, read the safety information that shipped with your computer and follow the steps in [Before working inside your computer](#). After working inside your computer, follow the instructions in [After working inside your computer](#). For more safety best practices, see the Regulatory Compliance home page at www.dell.com/regulatory_compliance.

Procedure

- 1 Align the screw holes on the computer base with the screw holes on the palm-rest assembly.
- 2 Replace the 14 screws (M2.5x8) that secure the computer base to the palm-rest assembly.
- 3 Replace the two screws (M2.5x5) that secure the computer base to the palm-rest assembly.
- 4 Connect the tron-light cables to the system board.
- 5 Route the antenna cables through the routing guides on the computer base.

Post-requisites

- 1 Replace the [rear-I/O cover](#).
- 2 Replace the [solid-state drive](#).
- 3 Replace the [wireless card](#).
- 4 Follow the procedure from step 4 to step 7 in "[Replacing the hard drive](#)".
- 5 Replace the [base cover](#).

Removing the coin-cell battery

 **WARNING:** Before working inside your computer, read the safety information that shipped with your computer and follow the steps in [Before working inside your computer](#). After working inside your computer, follow the instructions in [After working inside your computer](#). For more safety best practices, see the Regulatory Compliance home page at www.dell.com/regulatory_compliance.

 **CAUTION:** Removing the coin-cell battery resets the BIOS setup program's settings to default. It is recommended that you note the BIOS setup program's settings before removing the coin-cell battery.

Prerequisites

- 1 Remove the [base cover](#).
- 2 Follow the procedure from step 1 to step 4 in "[Removing the hard drive](#)".
- 3 Remove the [wireless card](#).
- 4 Remove the [solid-state drive](#).
- 5 Remove the [rear-I/O cover](#).
- 6 Remove the [computer base](#).

Procedure

- 1 Disconnect the coin-cell battery cable from the system board.
- 2 Peel off the tape that secures the coin-cell battery cable to the system board.
- 3 Peel off the tape that secures the coin-cell battery to the palm-rest assembly.
- 4 Note the cable routing and remove the coin-cell battery cable from the routing guide on the palm-rest assembly.

- 5 Gently peel off the coin-cell battery along with its cable off the palm-rest assembly.

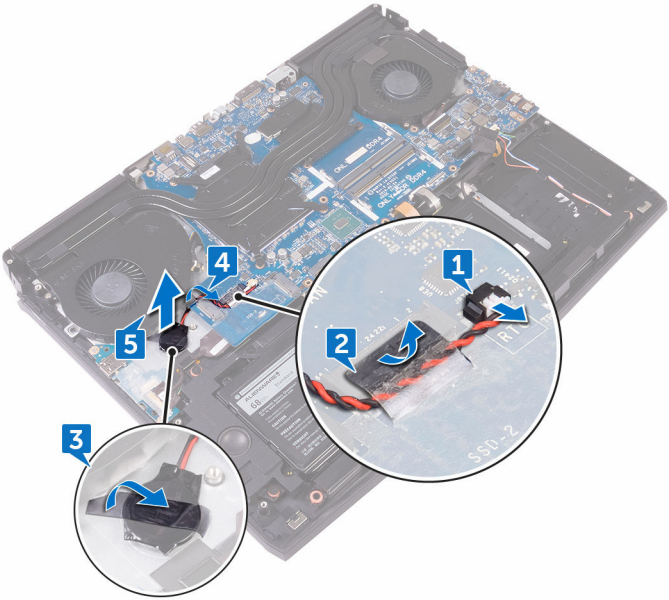

Replacing the coin-cell battery

 **WARNING:** Before working inside your computer, read the safety information that shipped with your computer and follow the steps in [Before working inside your computer](#). After working inside your computer, follow the instructions in [After working inside your computer](#). For more safety best practices, see the Regulatory Compliance home page at www.dell.com/regulatory_compliance.

Procedure

- 1 Adhere the coin-cell battery to the palm-rest assembly.
- 2 Adhere the tape that secures the coin-cell battery to the palm-rest assembly.
- 3 Route the coin-cell battery cable through the routing guide on the palm-rest assembly.
- 4 Adhere the tape that secures the coin-cell battery cable to the system board.
- 5 Connect the coin-cell battery cable to the system board.

Post-requisites

- 1 Replace the [computer base](#).
- 2 Replace the [rear-I/O cover](#).
- 3 Replace the [solid-state drive](#).
- 4 Replace the [wireless card](#).
- 5 Follow the procedure from step 4 to step 7 in "[Replacing the hard drive](#)".
- 6 Replace the [base cover](#).

Removing the speakers

 **WARNING:** Before working inside your computer, read the safety information that shipped with your computer and follow the steps in [Before working inside your computer](#). After working inside your computer, follow the instructions in [After working inside your computer](#). For more safety best practices, see the Regulatory Compliance home page at www.dell.com/regulatory_compliance.

Prerequisites

- 1 Remove the [base cover](#).
- 2 Follow the procedure from step 1 to step 4 in "[Removing the hard drive](#)".
- 3 Remove the [wireless card](#).
- 4 Remove the [solid-state drive](#).
- 5 Remove the [rear-I/O cover](#).
- 6 Remove the [computer base](#).

Procedure

- 1 Disconnect the speaker cable from the system board.
- 2 Remove the speaker cable from the routing guides on the palm-rest assembly.

3 Lift the speakers along with its cable off the palm-rest assembly.

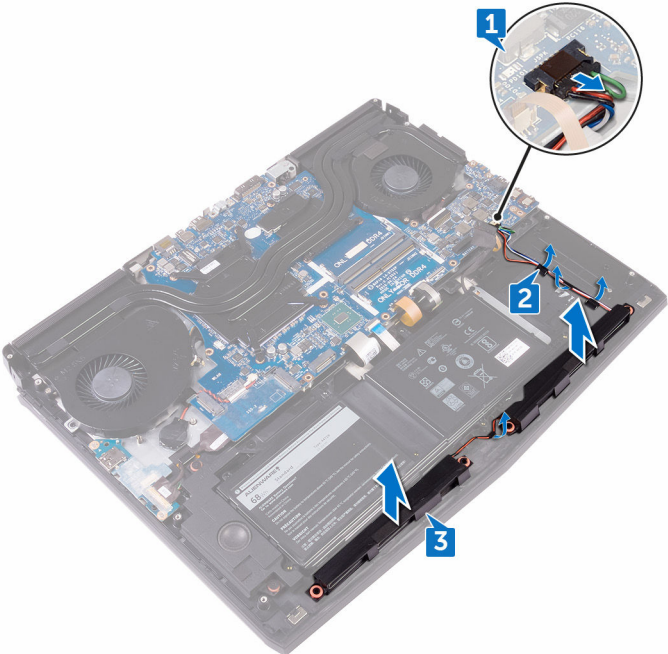

Replacing the speakers

 **WARNING:** Before working inside your computer, read the safety information that shipped with your computer and follow the steps in [Before working inside your computer](#). After working inside your computer, follow the instructions in [After working inside your computer](#). For more safety best practices, see the Regulatory Compliance home page at www.dell.com/regulatory_compliance.

Procedure

- 1 Using the alignment posts, place the speakers on the palm-rest assembly.
- 2 Route the speaker cable through the routing guides on the palm-rest assembly.
- 3 Connect the speaker cable to the system board.

Post-requisites

- 1 Replace the [computer base](#).
- 2 Replace the [rear-I/O cover](#).
- 3 Replace the [solid-state drive](#).
- 4 Replace the [wireless card](#).
- 5 Follow the procedure from step 4 to step 7 in "[Replacing the hard drive](#)".
- 6 Replace the [base cover](#).

Removing the I/O board

 **WARNING:** Before working inside your computer, read the safety information that shipped with your computer and follow the steps in [Before working inside your computer](#). After working inside your computer, follow the instructions in [After working inside your computer](#). For more safety best practices, see the Regulatory Compliance home page at www.dell.com/regulatory_compliance.

Prerequisites

- 1 Remove the [base cover](#).
- 2 Follow the procedure from step 1 to step 4 in "[Removing the hard drive](#)".
- 3 Remove the [wireless card](#).
- 4 Remove the [solid-state drive](#).
- 5 Remove the [rear-I/O cover](#).
- 6 Remove the [computer base](#).

Procedure

- 1 Peel the tape that secures the I/O-board cable to the I/O board.
- 2 Open the latch and disconnect the I/O-board cable from the I/O board.
- 3 Remove the two screws (M2.5x5) that secure the I/O board to the palm-rest assembly.

4 Turn the I/O board over.

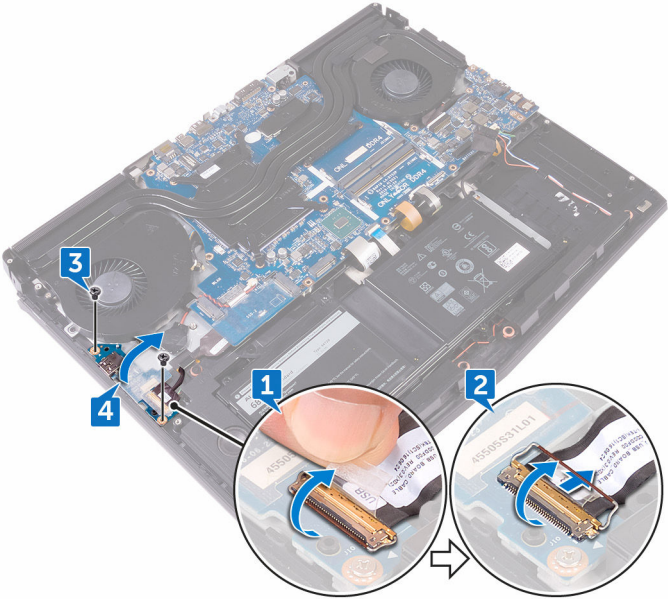

5 Disconnect the subwoofer cable.

6 Lift the I/O board off the palm-rest assembly.

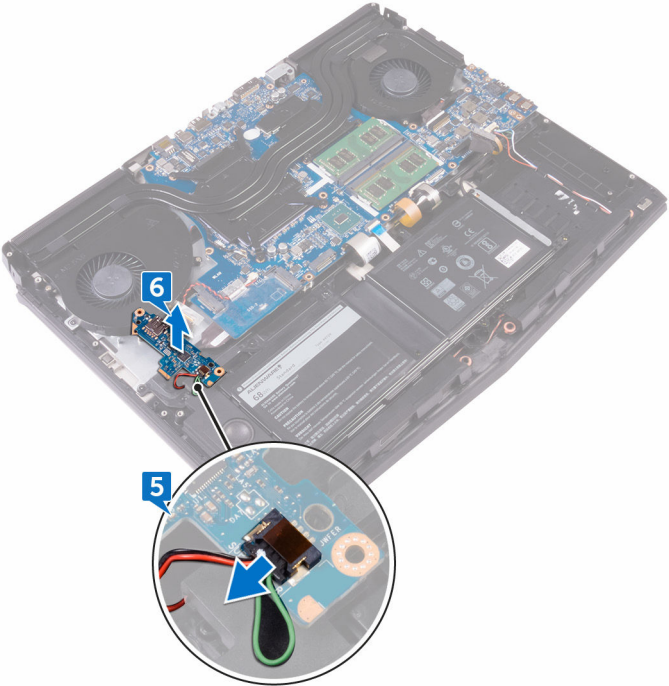

Replacing the I/O board

 **WARNING:** Before working inside your computer, read the safety information that shipped with your computer and follow the steps in [Before working inside your computer](#). After working inside your computer, follow the instructions in [After working inside your computer](#). For more safety best practices, see the Regulatory Compliance home page at www.dell.com/regulatory_compliance.

Procedure

- 1 Connect the subwoofer cable to the I/O board.
- 2 Turn the I/O board over.
- 3 Using the alignment posts, place the I/O board on the palm-rest assembly and align the screw holes on the I/O board with the screw holes on the palm-rest assembly.
- 4 Replace the two screws (M2.5x5) that secure the I/O board to the palm-rest assembly.
- 5 Slide the I/O-board cable into the connector on the I/O board and close the latch to secure the cable.
- 6 Adhere the tape that secures the I/O-board cable to the I/O board.

Post-requisites

- 1 Replace the [computer base](#).
- 2 Replace the [rear-I/O cover](#).
- 3 Replace the [solid-state drive](#).
- 4 Replace the [wireless card](#).
- 5 Follow the procedure from step 4 to step 7 in "[Replacing the hard drive](#)".
- 6 Replace the [base cover](#).

Removing the subwoofer

 **WARNING:** Before working inside your computer, read the safety information that shipped with your computer and follow the steps in [Before working inside your computer](#). After working inside your computer, follow the instructions in [After working inside your computer](#). For more safety best practices, see the Regulatory Compliance home page at www.dell.com/regulatory_compliance.

Prerequisites

- 1 Remove the [base cover](#).
- 2 Follow the procedure from step 1 to step 4 in "[Removing the hard drive](#)".
- 3 Remove the [wireless card](#).
- 4 Remove the [solid-state drive](#).
- 5 Remove the [rear-I/O cover](#).
- 6 Remove the [computer base](#).
- 7 Remove the [I/O board](#).

Procedure

- 1 Remove the two screws (M2x2) that secure the subwoofer to the palm-rest assembly.

2 Lift the subwoofer along with its cable off the palm-rest assembly.

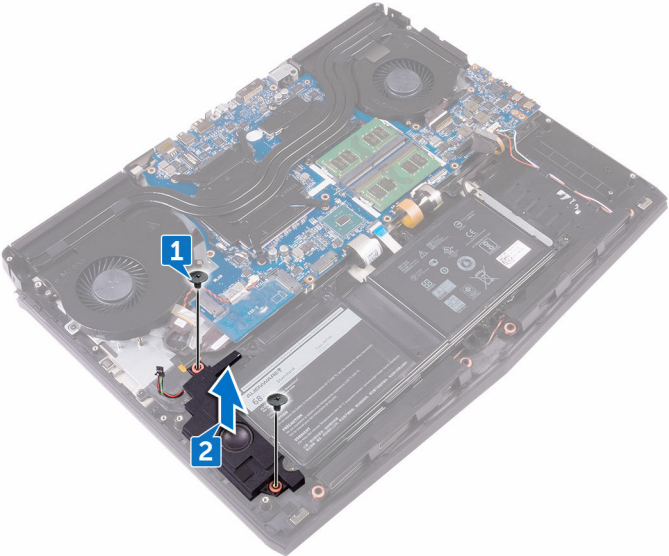

Replacing the subwoofer

 **WARNING:** Before working inside your computer, read the safety information that shipped with your computer and follow the steps in [Before working inside your computer](#). After working inside your computer, follow the instructions in [After working inside your computer](#). For more safety best practices, see the Regulatory Compliance home page at www.dell.com/regulatory_compliance.

Procedure

- 1 Align the screw holes on the subwoofer with the screw holes on the palm-rest assembly.
- 2 Replace the two screws (M2x2) that secure the subwoofer to the palm-rest assembly.

Post-requisites

- 1 Replace the [I/O board](#).
- 2 Replace the [computer base](#).
- 3 Replace the [rear-I/O cover](#).
- 4 Replace the [solid-state drive](#).
- 5 Replace the [wireless card](#).
- 6 Follow the procedure from step 4 to step 7 in "[Replacing the hard drive](#)".
- 7 Replace the [base cover](#).

Removing the system-board assembly



WARNING: Before working inside your computer, read the safety information that shipped with your computer and follow the steps in [Before working inside your computer](#). After working inside your computer, follow the instructions in [After working inside your computer](#). For more safety best practices, see the Regulatory Compliance home page at www.dell.com/regulatory_compliance.



NOTE: Your computer's Service Tag is stored in the system board. You must enter the Service Tag in the BIOS setup program after you replace the system board.



NOTE: Replacing the system board removes any changes you have made to the BIOS using the BIOS setup program. You must make the appropriate changes again after you replace the system board.



NOTE: Before disconnecting the cables from the system board, note the location of the connectors so that you can reconnect the cables correctly after you replace the system board.

Prerequisites

- 1 Remove the [base cover](#).
- 2 Follow the procedure from step 1 to step 4 in "[Removing the hard drive](#)".
- 3 Remove the [wireless card](#).
- 4 Remove the [solid-state drive](#).
- 5 Remove the [rear-I/O cover](#).
- 6 Remove the [computer base](#).

Procedure

- 1 Turn the computer over.
- 2 Peel the tape that secures the display cable to the system board.
- 3 Open the latch and disconnect the display cable from the system board.

- 4 Disconnect the tobii eye-tracker board cable from the system board.
- 5 Using the pull-tab, disconnect the power-button board cable from the system board.
- 6 Disconnect the logo-board cable from the system board.

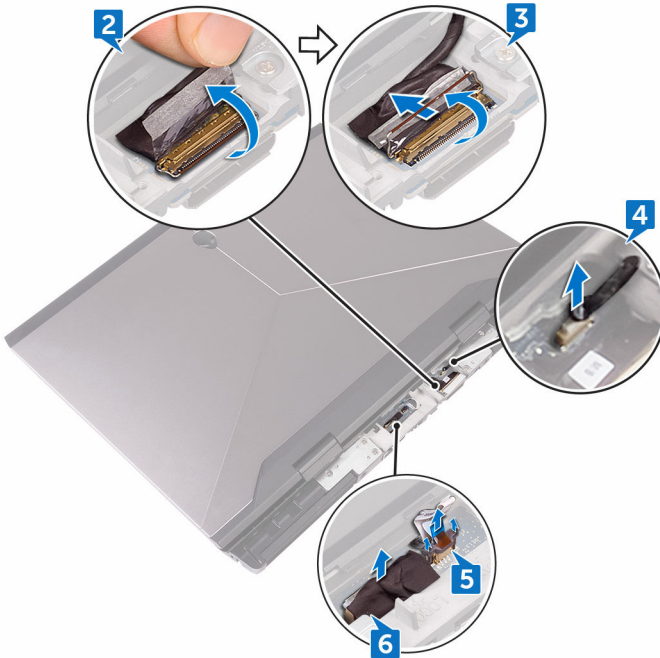

- 7 Turn the computer over.
- 8 Disconnect the coin-cell battery cable from the system board.
- 9 Peel off the tape that secures the coin-cell battery cable to the system board.
- 10 Disconnect the power-adapter port cable from the system board.
- 11 Disconnect the speaker cable from the system board.
- 12 Lift the latch and disconnect the macro-keys backlight cable from the system board.
- 13 Lift the latch and disconnect the keyboard-backlight cable from the system board.

14 Lift the latch and disconnect the macro-keys cable from the system board.

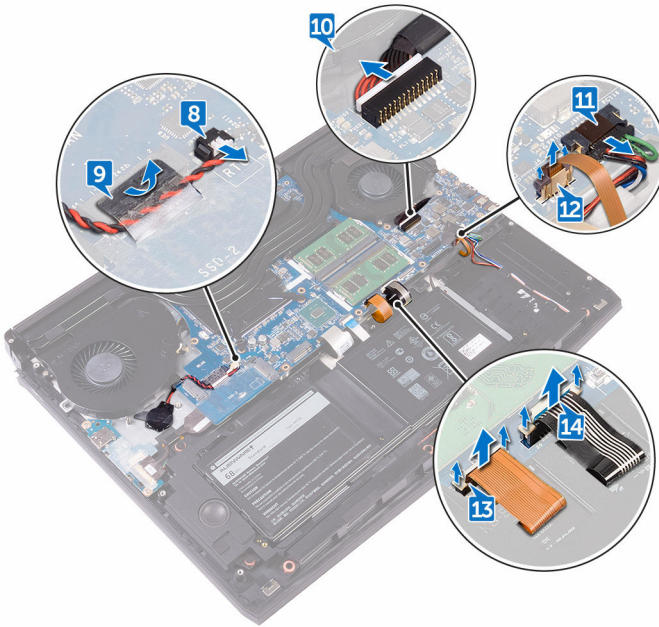

15 Peel the tape that secures the I/O-board cable to the I/O board.

16 Open the latch and disconnect the I/O-board cable from the I/O board.

17 Open the latch and disconnect the keyboard cable from the system board.

18 Open the latch and disconnect the touch-pad cable from the system board.

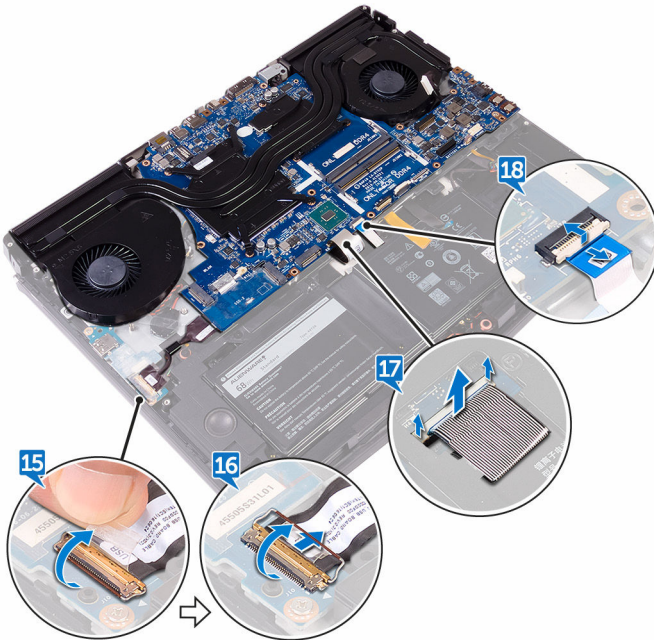

19 Remove the screw (M2.5x5) that secures the USB Type-C port bracket to the system board and lift the USB Type-C port bracket off the system board.

20 Remove the seven screws (M2.5x5) that secure the system-board assembly to the palm-rest assembly.

21 Lift the system-board assembly off the palm-rest assembly.

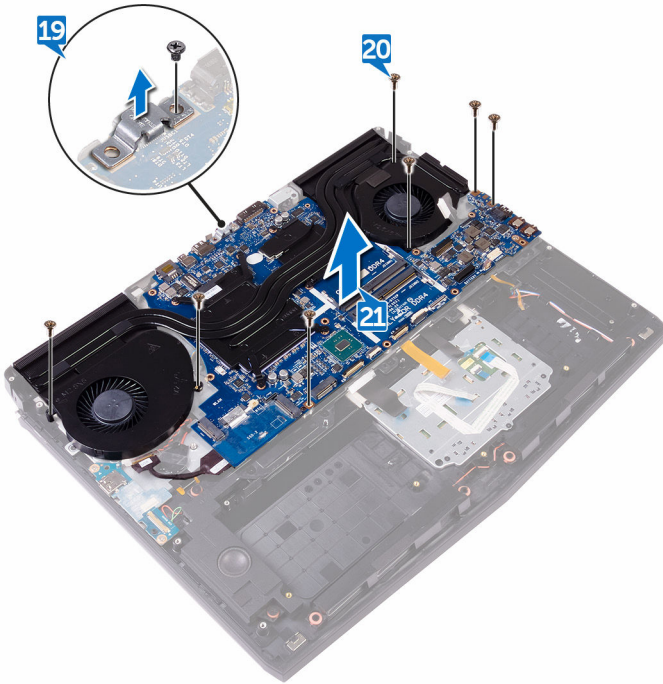

22 Remove the [heat-sink assembly](#).

23 After performing all the above steps, you are left with the system board.

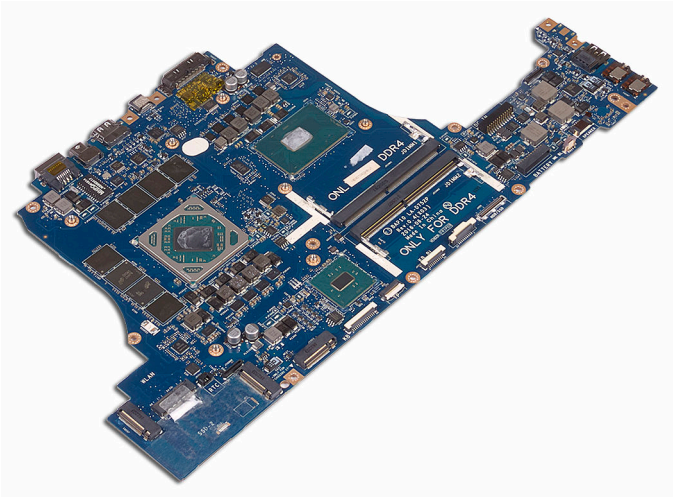

Replacing the system board

 **WARNING:** Before working inside your computer, read the safety information that shipped with your computer and follow the steps in [Before working inside your computer](#). After working inside your computer, follow the instructions in [After working inside your computer](#). For more safety best practices, see the Regulatory Compliance home page at www.dell.com/regulatory_compliance.

 **NOTE:** Your computer's Service Tag is stored in the system board. You must enter the Service Tag in the BIOS setup program after you replace the system board.

 **NOTE:** Replacing the system board removes any changes you have made to the BIOS using the BIOS setup program. You must make the appropriate changes again after you replace the system board.

Procedure

 **CAUTION:** Ensure that no cables are under the system board.



- 1 Replace the [heat-sink assembly](#).
- 2 Align the screw holes on the system board with the screw holes on the palm-rest assembly.
- 3 Replace the seven screws (M2.5x5) that secure the system-board assembly to the palm-rest assembly.
- 4 Align the screw hole on the USB Type-C port bracket with the screw hole on the system board.
- 5 Replace the screw (M2.5x5) that secures the USB Type-C port bracket to the system board.
- 6 Slide the I/O-board cable into the connector on the I/O-board and close the latch to secure the cable.
- 7 Adhere the tape that secures the I/O-board cable to the I/O board.
- 8 Slide the touch-pad cable into the connector on the system board and close the latch to secure the cable.

- 9 Insert the keyboard cable, macro-keys backlight cable, and keyboard-backlight cable into their connectors and press down the latches to secure the cables.
- 10 Connect the macro-keys cable, speaker cable, power-adaptor port cable, and coin-cell battery cable to the system board.
- 11 Route the coin-cell battery through the routing channel and adhere the tape to secure the cable.
- 12 Turn the computer over.
- 13 Connect the logo-board cable, power-button board cable, and tobii eye-tracker board cable to the system board.
- 14 Slide the display cable into the connector on the system board and close the latch to secure the cable.
- 15 Adhere the tape that secures the display cable to the system board.

Post-requisites

- 1 Replace the [computer base](#).
- 2 Replace the [rear-I/O cover](#).
- 3 Replace the [solid-state drive](#).
- 4 Replace the [wireless card](#).
- 5 Follow the procedure from step 4 to step 7 in "[Replacing the hard drive](#)".
- 6 Replace the [base cover](#).

Removing the heat-sink assembly

-  **WARNING:** Before working inside your computer, read the safety information that shipped with your computer and follow the steps in [Before working inside your computer](#). After working inside your computer, follow the instructions in [After working inside your computer](#). For more safety best practices, see the Regulatory Compliance home page at www.dell.com/regulatory_compliance.
-  **WARNING:** The heat sink may become hot during normal operation. Allow sufficient time for the heat sink to cool before you touch it.
-  **CAUTION:** For maximum cooling of the processor, do not touch the heat transfer areas on the heat sink. The oils in your skin can reduce the heat transfer capability of the thermal grease.

Prerequisites

- 1 Remove the [base cover](#).
- 2 Follow the procedure from step 1 to step 4 in "[Removing the hard drive](#)".
- 3 Remove the [wireless card](#).
- 4 Remove the [solid-state drive](#).
- 5 Remove the [memory modules](#).
- 6 Remove the [rear-I/O cover](#).
- 7 Remove the [computer base](#).
- 8 Follow the procedure from step 1 to step 21 in "[Removing the system board](#)".

Procedure

- 1 Turn the system-board assembly over.
- 2 Disconnect the fan cable from the system board.

- 3 Disconnect the fan cable from the system board.

 **NOTE:** For computers shipped with NVIDIA GeForce GTX 1060 graphics controller, remove the fans after disconnecting the fan cables from the system board.

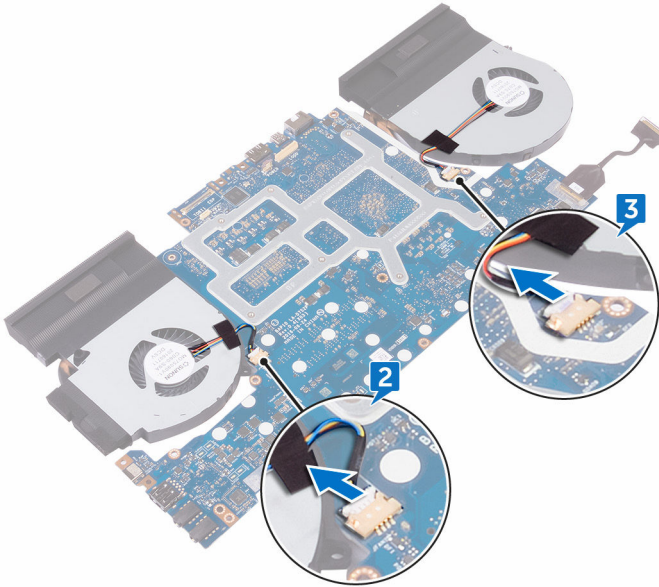

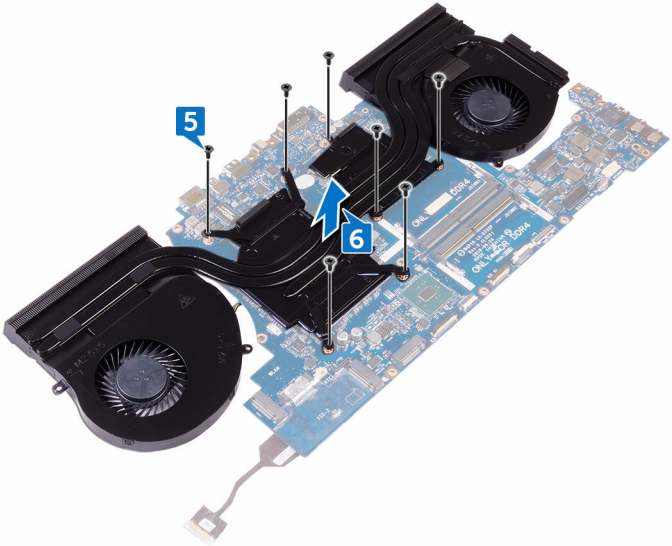

- 4 Turn the system-board assembly over.
- 5 Remove the seven screws (M2x3) that secure the heat-sink assembly to the system board.

6 Lift the heat-sink assembly off the system board.



Replacing the heat-sink assembly

-  **WARNING:** Before working inside your computer, read the safety information that shipped with your computer and follow the steps in [Before working inside your computer](#). After working inside your computer, follow the instructions in [After working inside your computer](#). For more safety best practices, see the Regulatory Compliance home page at www.dell.com/regulatory_compliance.
-  **CAUTION:** Incorrect alignment of the heat sink can damage the system board and processor.
-  **NOTE:** The original thermal grease can be reused if the original system board and fan are reinstalled together. If either the system board or the fan is replaced, use the thermal pad provided in the kit to ensure that thermal conductivity is achieved.

Procedure

- 1 Align the screw holes on the heat-sink assembly with the screw holes on the system board.
- 2 Replace the seven screws (M2x3) that secure the heat-sink assembly to the system board.
- 3 Turn the system-board assembly over.
 -  **NOTE:** For computers shipped with NVIDIA GeForce GTX 1060 graphics controller, place the fans on the slots on the system board.
- 4 Connect the fan cables to their respective connectors on the system board.

Post-requisites

- 1 Follow the procedure from step 2 to step 15 in "[Replacing the system board](#)".
- 2 Replace the [computer base](#).
- 3 Replace the [rear-I/O cover](#).
- 4 Replace the [memory modules](#).
- 5 Replace the [solid-state drive](#).
- 6 Replace the [wireless card](#).

- 7** Follow the procedure from step 4 to step 7 in "[Replacing the hard drive](#)".
- 8** Replace the [base cover](#).

Removing the power-adapter port

 **WARNING:** Before working inside your computer, read the safety information that shipped with your computer and follow the steps in [Before working inside your computer](#). After working inside your computer, follow the instructions in [After working inside your computer](#). For more safety best practices, see the Regulatory Compliance home page at www.dell.com/regulatory_compliance.

Prerequisites

- 1 Remove the [base cover](#).
- 2 Follow the procedure from step 1 to step 4 in "[Removing the hard drive](#)".
- 3 Remove the [wireless card](#).
- 4 Remove the [solid-state drive](#).
- 5 Remove the [memory modules](#).
- 6 Remove the [rear-I/O cover](#).
- 7 Remove the [computer base](#).
- 8 Follow the procedure from step 1 to step 21 in "[Removing the system board](#)".

Procedure

- 1 Remove the screw (M2x3) that secures the power-adapter port bracket to the palm-rest assembly.
- 2 Lift the power-adapter port bracket off the power-adapter port.
- 3 Lift the power-adapter port off the palm-rest assembly.
- 4 Peel the tape that secures the power-adapter-port cable to the palm-rest assembly.

5 Remove the cable from the routing guides on the palm-rest assembly.

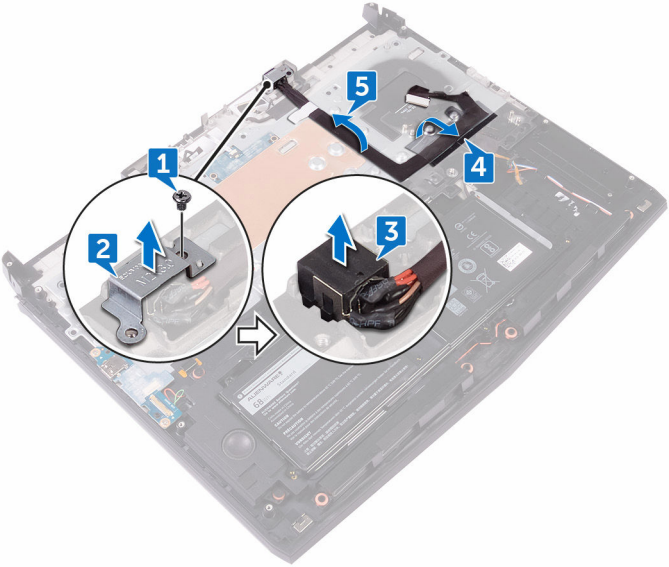

Replacing the power-adapter port

 **WARNING:** Before working inside your computer, read the safety information that shipped with your computer and follow the steps in [Before working inside your computer](#). After working inside your computer, follow the instructions in [After working inside your computer](#). For more safety best practices, see the Regulatory Compliance home page at www.dell.com/regulatory_compliance.

Procedure

- 1 Slide the power-adapter port into the slot on the palm-rest assembly.
- 2 Route the power-adapter port cable through the routing guides on the palm-rest assembly.
- 3 Using the alignment post, place the power-adapter port bracket on the power-adapter port.
- 4 Align the screw hole on the power-adapter port bracket with the screw hole on the palm-rest assembly.
- 5 Replace the screw (M2x3) that secures the power-adapter port bracket to the palm-rest assembly.

Post-requisites

- 1 Follow the procedure from step 2 to step 15 in "[Replacing the system board](#)".
- 2 Replace the [computer base](#).
- 3 Replace the [rear-I/O cover](#).
- 4 Replace the [memory modules](#).
- 5 Replace the [solid-state drive](#).
- 6 Replace the [wireless card](#).
- 7 Follow the procedure from step 4 to step 7 in "[Replacing the hard drive](#)".
- 8 Replace the [base cover](#).

Removing the power-button board

 **WARNING:** Before working inside your computer, read the safety information that shipped with your computer and follow the steps in [Before working inside your computer](#). After working inside your computer, follow the instructions in [After working inside your computer](#). For more safety best practices, see the Regulatory Compliance home page at www.dell.com/regulatory_compliance.

Prerequisites

- 1 Remove the [base cover](#).
- 2 Follow the procedure from step 1 to step 4 in "[Removing the hard drive](#)".
- 3 Remove the [wireless card](#).
- 4 Remove the [solid-state drive](#).
- 5 Remove the [memory modules](#).
- 6 Remove the [rear-I/O cover](#).
- 7 Remove the [computer base](#).
- 8 Follow the procedure from step 1 to step 21 in "[Removing the system board](#)".

Procedure

- 1 Remove the two screws (M2x3) that secure the power-button board to the palm-rest assembly.

2 Lift the power-button board along with its cable off the palm-rest assembly.

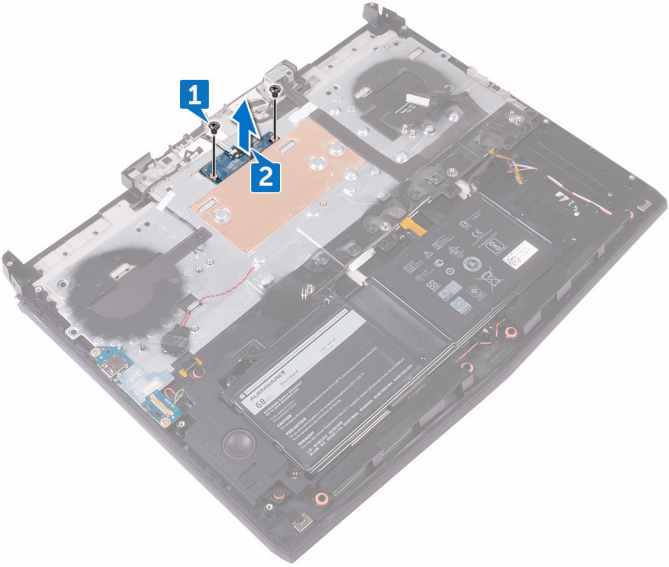

Replacing the power-button board

 **WARNING:** Before working inside your computer, read the safety information that shipped with your computer and follow the steps in [Before working inside your computer](#). After working inside your computer, follow the instructions in [After working inside your computer](#). For more safety best practices, see the Regulatory Compliance home page at www.dell.com/regulatory_compliance.

Procedure

- 1 Using the alignment posts, place the power-button board on the palm-rest assembly.
- 2 Align the screw holes on the power-button board with the screw holes on the palm-rest assembly.
- 3 Replace the two screws (M2x3) that secure the power-button board to the palm-rest assembly.

Post-requisites

- 1 Follow the procedure from step 2 to step 15 in "[Replacing the system board](#)".
- 2 Replace the [computer base](#).
- 3 Replace the [rear-I/O cover](#).
- 4 Replace the [memory modules](#).
- 5 Replace the [solid-state drive](#).
- 6 Replace the [wireless card](#).
- 7 Follow the procedure from step 4 to step 7 in "[Replacing the hard drive](#)".
- 8 Replace the [base cover](#).

Removing the display assembly

 **WARNING:** Before working inside your computer, read the safety information that shipped with your computer and follow the steps in [Before working inside your computer](#). After working inside your computer, follow the instructions in [After working inside your computer](#). For more safety best practices, see the Regulatory Compliance home page at www.dell.com/regulatory_compliance.

Prerequisites

- 1 Remove the [base cover](#).
- 2 Follow the procedure from step 1 to step 4 in "[Removing the hard drive](#)".
- 3 Remove the [wireless card](#).
- 4 Remove the [solid-state drive](#).
- 5 Remove the [memory modules](#).
- 6 Remove the [rear-I/O cover](#).
- 7 Remove the [computer base](#).
- 8 Follow the procedure from step 1 to step 21 in "[Removing the system board](#)".

Procedure

- 1 Remove the six screws (M2.5x5) that secure the display assembly to the palm-rest assembly.

2 Lift the display assembly off the computer base.

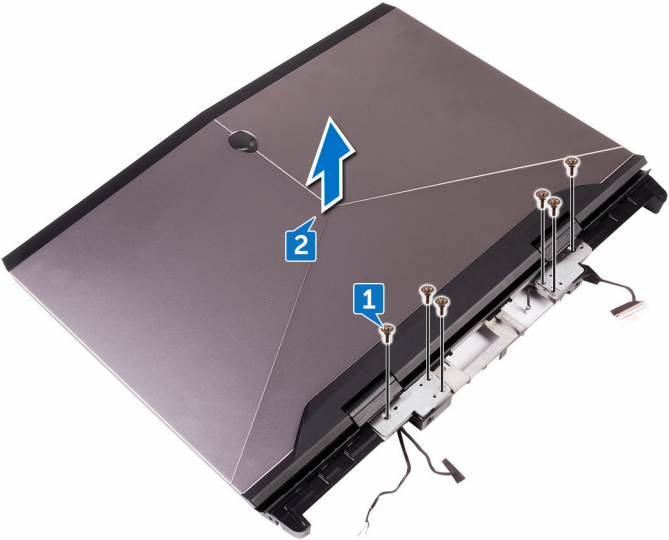

Replacing the display assembly

 **WARNING:** Before working inside your computer, read the safety information that shipped with your computer and follow the steps in [Before working inside your computer](#). After working inside your computer, follow the instructions in [After working inside your computer](#). For more safety best practices, see the Regulatory Compliance home page at www.dell.com/regulatory_compliance.

Procedure

- 1 Align the screw holes on the display hinges with the screw holes on the palm-rest assembly.
- 2 Replace the six screws (M2.5x5) that secure the display assembly to the palm-rest assembly.

Post-requisites

- 1 Follow the procedure from step 2 to step 15 in "[Replacing the system board](#)".
- 2 Replace the [computer base](#).
- 3 Replace the [rear-I/O cover](#).
- 4 Replace the [memory modules](#).
- 5 Replace the [solid-state drive](#).
- 6 Replace the [wireless card](#).
- 7 Follow the procedure from step 4 to step 7 in "[Replacing the hard drive](#)".
- 8 Replace the [base cover](#).

Removing the battery

 **WARNING:** Before working inside your computer, read the safety information that shipped with your computer and follow the steps in [Before working inside your computer](#). After working inside your computer, follow the instructions in [After working inside your computer](#). For more safety best practices, see the Regulatory Compliance home page at www.dell.com/regulatory_compliance.

Prerequisites

- 1 Remove the [base cover](#).
- 2 Follow the procedure from step 1 to step 4 in "[Removing the hard drive](#)".
- 3 Remove the [wireless card](#).
- 4 Remove the [solid-state drive](#).
- 5 Remove the [rear-I/O cover](#).
- 6 Remove the [computer base](#).

Procedure

- 1 Remove the four screws (M2.5x5) that secure the battery to the palm-rest assembly.

2 Lift the battery off the palm-rest assembly.

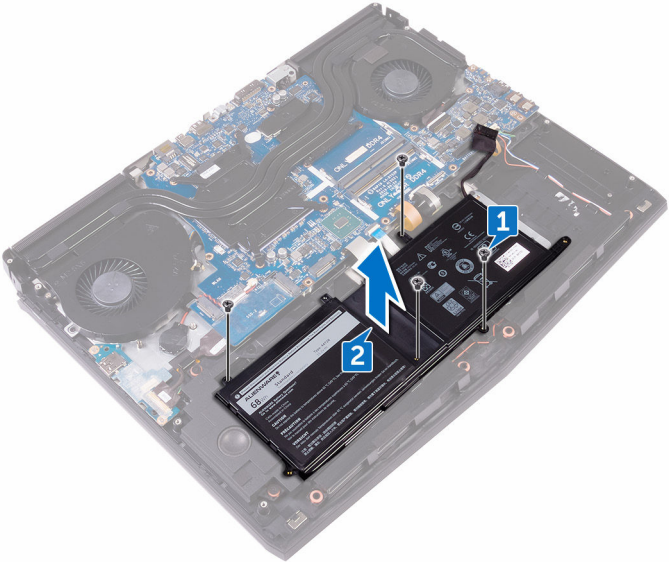

Replacing the battery

 **WARNING:** Before working inside your computer, read the safety information that shipped with your computer and follow the steps in [Before working inside your computer](#). After working inside your computer, follow the instructions in [After working inside your computer](#). For more safety best practices, see the Regulatory Compliance home page at www.dell.com/regulatory_compliance.

Procedure

- 1 Using the alignment post, place the battery on the palm-rest assembly.
- 2 Align the screw holes on the battery with the screw holes on the palm-rest assembly.
- 3 Replace the four screws (M2.5x5) that secure the battery to the palm-rest assembly.

Post-requisites

- 1 Replace the [computer base](#).
- 2 Replace the [rear-I/O cover](#).
- 3 Replace the [solid-state drive](#).
- 4 Replace the [wireless card](#).
- 5 Follow the procedure from step 4 to step 7 in "[Replacing the hard drive](#)".
- 6 Replace the [base cover](#).

Removing the touch pad

 **WARNING:** Before working inside your computer, read the safety information that shipped with your computer and follow the steps in [Before working inside your computer](#). After working inside your computer, follow the instructions in [After working inside your computer](#). For more safety best practices, see the Regulatory Compliance home page at www.dell.com/regulatory_compliance.

Prerequisites

- 1 Remove the [base cover](#).
- 2 Follow the procedure from step 1 to step 4 in "[Removing the hard drive](#)".
- 3 Remove the [wireless card](#).
- 4 Remove the [solid-state drive](#).
- 5 Remove the [rear-I/O cover](#).
- 6 Remove the [computer base](#).
- 7 Remove the [battery](#).

Procedure

- 1 Open the latch and disconnect the touch-pad cable from the system board.
- 2 Open the latches and disconnect the touch-pad cable and the touch-pad buttons cable from the touch pad.
- 3 Remove the five screws (M2x3) that secure the touch-pad bracket to the palm-rest assembly.

4 Lift the touch-pad bracket off the palm-rest assembly.

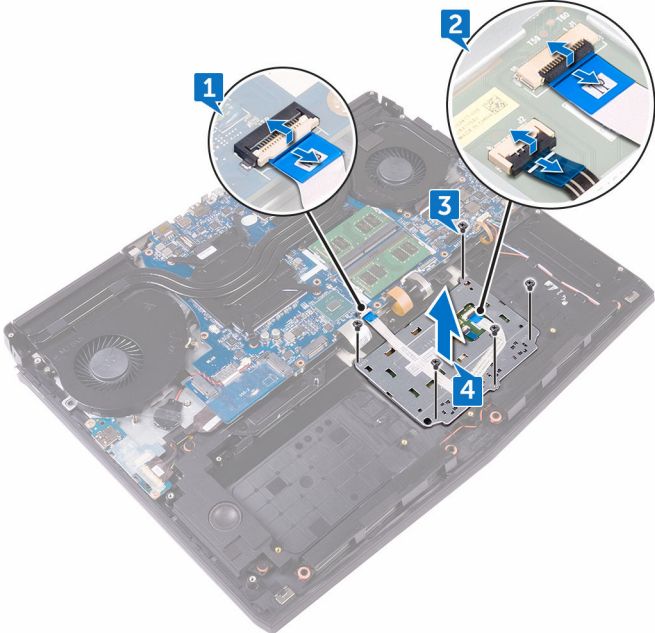

5 Lift the touch pad off the palm-rest assembly.

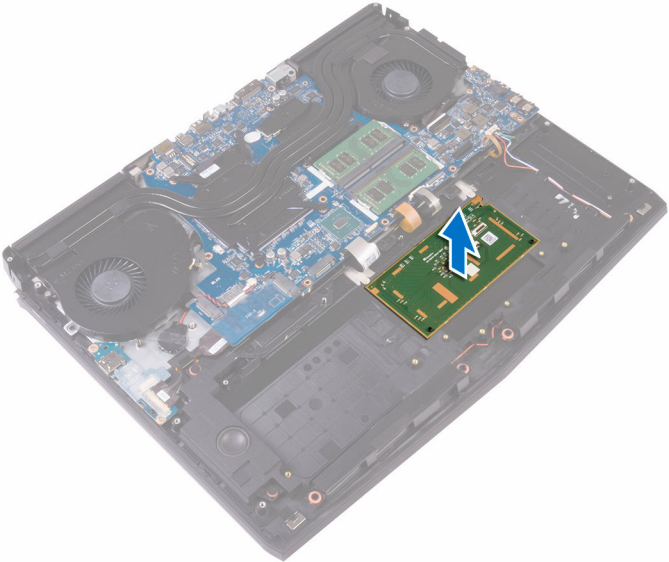

Replacing the touch pad

 **WARNING:** Before working inside your computer, read the safety information that shipped with your computer and follow the steps in [Before working inside your computer](#). After working inside your computer, follow the instructions in [After working inside your computer](#). For more safety best practices, see the Regulatory Compliance home page at www.dell.com/regulatory_compliance.

Procedure

- 1 Using the alignment posts on the palm rest, place the touch pad on the palm-rest assembly.
- 2 Align the screw holes on the touch-pad bracket with the screw holes on the palm-rest assembly.
- 3 Replace the five screws (M2x3) that secure the touch-pad bracket to the palm-rest assembly.
- 4 Slide the touch-pad cable and touch-pad buttons cable into their respective connectors on the touch pad and close the latches to secure the cables.
- 5 Slide the touch-pad cable into the connector on the system board and close the latch to secure the cable.

Post-requisites

- 1 Replace the [battery](#).
- 2 Replace the [computer base](#).
- 3 Replace the [rear-I/O cover](#).
- 4 Replace the [solid-state drive](#).
- 5 Replace the [wireless card](#).
- 6 Follow the procedure from step 4 to step 7 in "[Replacing the hard drive](#)".
- 7 Replace the [base cover](#).

Removing the keyboard

 **WARNING:** Before working inside your computer, read the safety information that shipped with your computer and follow the steps in [Before working inside your computer](#). After working inside your computer, follow the instructions in [After working inside your computer](#). For more safety best practices, see the Regulatory Compliance home page at www.dell.com/regulatory_compliance.

Prerequisites

- 1 Remove the [base cover](#).
- 2 Follow the procedure from step 1 to step 4 in "[Removing the hard drive](#)".
- 3 Remove the [wireless card](#).
- 4 Remove the [solid-state drive](#).
- 5 Remove the [memory modules](#).
- 6 Remove the [rear-I/O cover](#).
- 7 Remove the [computer base](#).
- 8 Follow the procedure from step 1 to step 21 in "[Removing the system board](#)".
- 9 Remove the [battery](#).

Procedure

- 1 Remove the 17 screws (M2x3) that secure the keyboard bracket to the palm-rest assembly.

2 Lift the keyboard bracket off the palm-rest assembly.

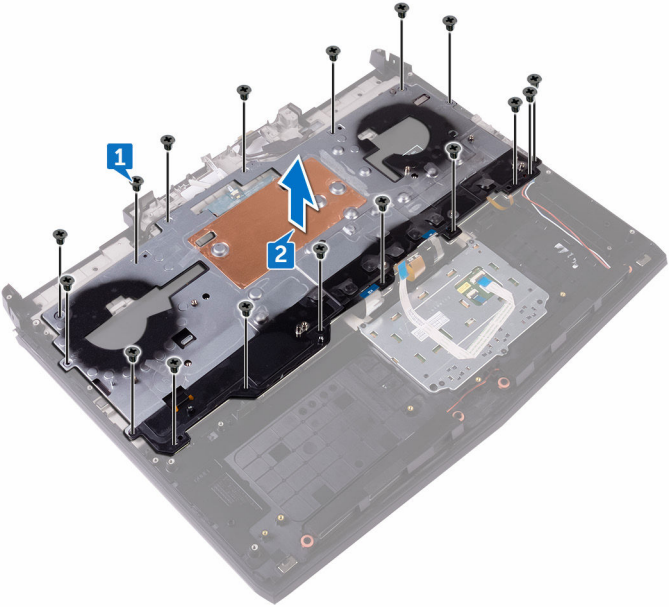

- 3** Lift the keyboard at an angle and remove it from the tabs on the palm-rest assembly.

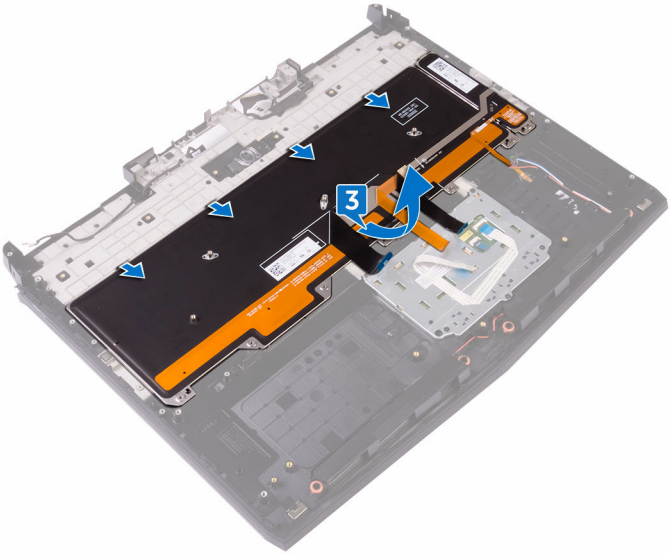

Replacing the keyboard

 **WARNING:** Before working inside your computer, read the safety information that shipped with your computer and follow the steps in [Before working inside your computer](#). After working inside your computer, follow the instructions in [After working inside your computer](#). For more safety best practices, see the Regulatory Compliance home page at www.dell.com/regulatory_compliance.

Procedure

 **CAUTION:** Ensure that no cables are under the keyboard.

- 1 Slide the keyboard under the tabs on the palm-rest assembly.
- 2 Align the screw holes on the keyboard bracket with the screw holes on the palm-rest assembly.
- 3 Replace the palm-rest assembly screws (M2x3) that secure the keyboard bracket to the palm-rest assembly.

Post-requisites

- 1 Replace the [battery](#).
- 2 Follow the procedure from step 2 to step 15 in "[Replacing the system board](#)".
- 3 Replace the [computer base](#).
- 4 Replace the [rear-I/O cover](#).
- 5 Replace the [memory modules](#).
- 6 Replace the [solid-state drive](#).
- 7 Replace the [wireless card](#).
- 8 Follow the procedure from step 4 to step 7 in "[Replacing the hard drive](#)".
- 9 Replace the [base cover](#).

Removing the palm rest

 **WARNING:** Before working inside your computer, read the safety information that shipped with your computer and follow the steps in [Before working inside your computer](#). After working inside your computer, follow the instructions in [After working inside your computer](#). For more safety best practices, see the Regulatory Compliance home page at www.dell.com/regulatory_compliance.

Prerequisites

- 1 Remove the [base cover](#).
- 2 Follow the procedure from step 1 to step 4 in "[Removing the hard drive](#)".
- 3 Remove the [wireless card](#).
- 4 Remove the [solid-state drive](#).
- 5 Remove the [rear-I/O cover](#).
- 6 Remove the [computer base](#).
- 7 Remove the [coin-cell battery](#).
- 8 Remove the [speakers](#).
- 9 Remove the [I/O board](#).
- 10 Remove the [subwoofer](#).
- 11 Remove the [memory modules](#).
- 12 Follow the procedure from step 1 to step 21 in "[Removing the system board](#)".
- 13 Remove the [power-button board](#).
- 14 Remove the [power-adapter port](#).
- 15 Remove the [battery](#).
- 16 Remove the [touch pad](#).
- 17 Remove the [keyboard](#).
- 18 Remove the [display assembly](#).

Procedure

After performing all the prerequisites, we are left with the palm rest.

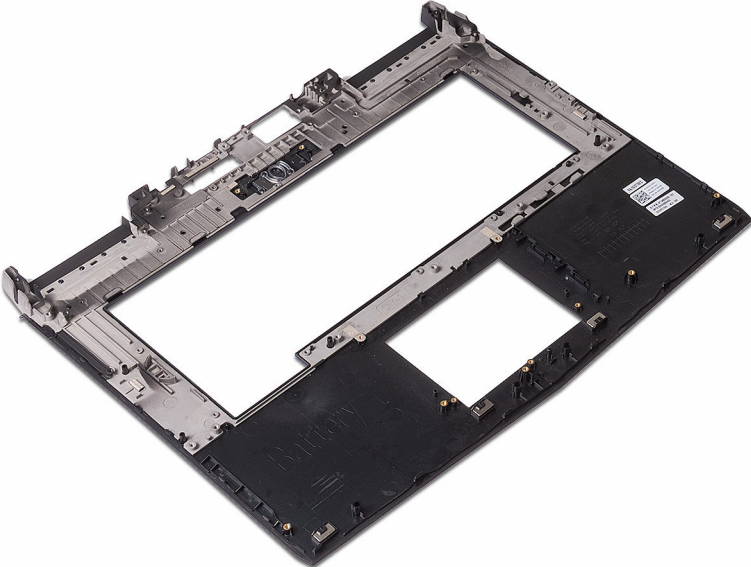

Replacing the palm rest

 **WARNING:** Before working inside your computer, read the safety information that shipped with your computer and follow the steps in [Before working inside your computer](#). After working inside your computer, follow the instructions in [After working inside your computer](#). For more safety best practices, see the Regulatory Compliance home page at www.dell.com/regulatory_compliance.

Procedure

Place the palm rest on a flat surface.

Post-requisites

- 1 Replace the [display assembly](#).
- 2 Replace the [keyboard](#).
- 3 Replace the [touch pad](#).
- 4 Replace the [battery](#).
- 5 Replace the [power-adapter port](#).
- 6 Replace the [power-button board](#).
- 7 Follow the procedure from step 2 to step 15 in "[Replacing the system board](#)".
- 8 Replace the [memory modules](#).
- 9 Replace the [subwoofer](#).
- 10 Replace the [I/O board](#).
- 11 Replace the [speakers](#).
- 12 Replace the [coin-cell battery](#).
- 13 Replace the [computer base](#).
- 14 Replace the [rear-I/O cover](#).
- 15 Replace the [solid-state drive](#).
- 16 Replace the [wireless card](#).
- 17 Follow the procedure from step 4 to step 7 in "[Replacing the hard drive](#)".
- 18 Replace the [base cover](#).

Removing the display bezel

 **WARNING:** Before working inside your computer, read the safety information that shipped with your computer and follow the steps in [Before working inside your computer](#). After working inside your computer, follow the instructions in [After working inside your computer](#). For more safety best practices, see the Regulatory Compliance home page at www.dell.com/regulatory_compliance.

Prerequisites

- 1 Remove the [base cover](#).
- 2 Follow the procedure from step 1 to step 4 in "[Removing the hard drive](#)".
- 3 Remove the [wireless card](#).
- 4 Remove the [solid-state drive](#).
- 5 Remove the [memory modules](#).
- 6 Remove the [rear-I/O cover](#).
- 7 Remove the [computer base](#).
- 8 Follow the procedure from step 1 to step 21 in "[Removing the system board](#)".
- 9 Remove the [display assembly](#).
- 10 Remove the [display hinges](#).

Procedure

- 1 Using your fingertips, carefully pry up the inside edges of the display bezel.

- 2 Carefully lift the display bezel and turn it over.

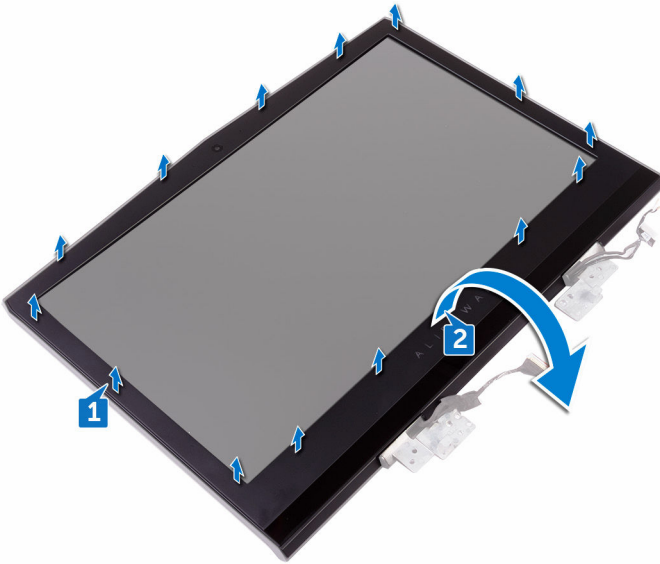

- 3 Disconnect the tobii eye-tracker board cable from the tobii eye-tracker module.

- 4 Lift the display bezel off the display assembly.

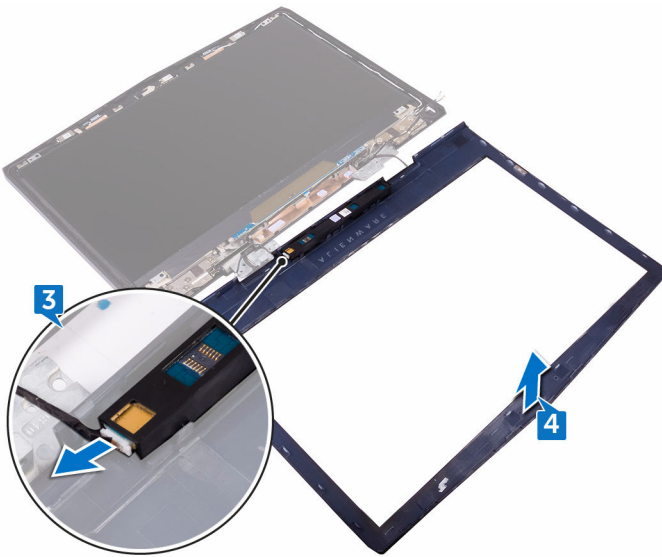

- 5 Remove the [tobii eye-tracker module](#).

Replacing the display bezel

 **WARNING:** Before working inside your computer, read the safety information that shipped with your computer and follow the steps in [Before working inside your computer](#). After working inside your computer, follow the instructions in [After working inside your computer](#). For more safety best practices, see the Regulatory Compliance home page at www.dell.com/regulatory_compliance.

Procedure

- 1 Replace the [tobii eye-tracker module](#).
- 2 Connect the tobii eye-tracker board cable to the tobii eye-tracker module.
- 3 Carefully turn the display bezel over.
- 4 Align the display bezel with the display back-cover and antenna assembly and gently snap the display bezel into place.

Post-requisites

- 1 Replace the [display hinges](#).
- 2 Replace the [display assembly](#).
- 3 Follow the procedure from step 2 to step 15 in "[Replacing the system board](#)".
- 4 Replace the [computer base](#).
- 5 Replace the [rear-I/O cover](#).
- 6 Replace the [memory modules](#).
- 7 Replace the [solid-state drive](#).
- 8 Replace the [wireless card](#).
- 9 Follow the procedure from step 4 to step 7 in "[Replacing the hard drive](#)".
- 10 Replace the [base cover](#).

Removing the tobii eye-tracker module



WARNING: Before working inside your computer, read the safety information that shipped with your computer and follow the steps in [Before working inside your computer](#). After working inside your computer, follow the instructions in [After working inside your computer](#). For more safety best practices, see the Regulatory Compliance home page at www.dell.com/regulatory_compliance.

Prerequisites

- 1 Remove the [base cover](#).
- 2 Follow the procedure from step 1 to step 4 in "[Removing the hard drive](#)".
- 3 Remove the [wireless card](#).
- 4 Remove the [solid-state drive](#).
- 5 Remove the [memory modules](#).
- 6 Remove the [rear-I/O cover](#).
- 7 Remove the [computer base](#).
- 8 Follow the procedure from step 1 to step 21 in "[Removing the system board](#)".
- 9 Remove the [display assembly](#).
- 10 Follow the procedure from step 1 to step 3 in "[Removing the display bezel](#)".

Procedure

Using a plastic scribe, pry the tobii eye-tracker module out of the display bezel.

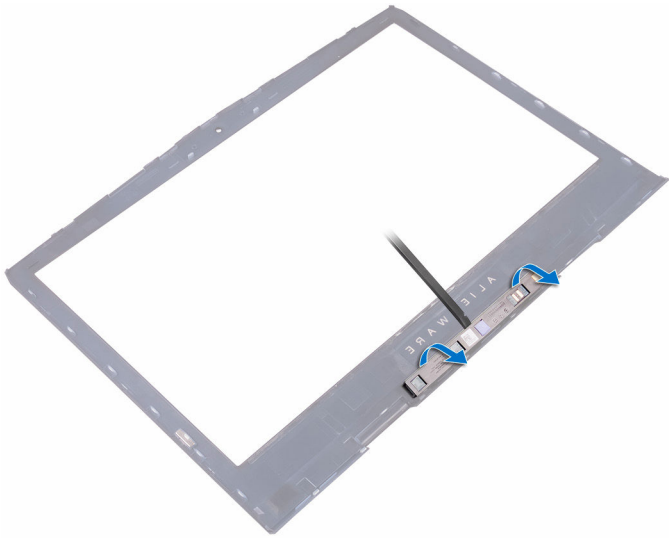

Replacing the tobii eye-tracker module



WARNING: Before working inside your computer, read the safety information that shipped with your computer and follow the steps in [Before working inside your computer](#). After working inside your computer, follow the instructions in [After working inside your computer](#). For more safety best practices, see the Regulatory Compliance home page at www.dell.com/regulatory_compliance.

Procedure



NOTE: After replacing the Tobii eye-tracker module, launch the EyeX application with internet connection to update the firmware automatically.

Using the alignment posts, place the tobii eye-tracker module on the display bezel and snap it into place.

Post-requisites

- 1 Follow the procedure from step 2 to step 4 in "[Replacing the display bezel](#)".
- 2 Replace the [display assembly](#).
- 3 Follow the procedure from step 2 to step 15 in "[Replacing the system board](#)".
- 4 Replace the [computer base](#).
- 5 Replace the [rear-I/O cover](#).
- 6 Replace the [memory modules](#).
- 7 Replace the [solid-state drive](#).
- 8 Replace the [wireless card](#).
- 9 Follow the procedure from step 4 to step 7 in "[Replacing the hard drive](#)".
- 10 Replace the [base cover](#).

Removing the logo board

 **WARNING:** Before working inside your computer, read the safety information that shipped with your computer and follow the steps in [Before working inside your computer](#). After working inside your computer, follow the instructions in [After working inside your computer](#). For more safety best practices, see the Regulatory Compliance home page at www.dell.com/regulatory_compliance.

Prerequisites

- 1 Remove the [base cover](#).
- 2 Follow the procedure from step 1 to step 4 in "[Removing the hard drive](#)".
- 3 Remove the [wireless card](#).
- 4 Remove the [solid-state drive](#).
- 5 Remove the [rear-I/O cover](#).
- 6 Remove the [computer base](#).
- 7 Remove the [memory modules](#).
- 8 Follow the procedure from step 1 to step 21 in "[Removing the system board](#)".
- 9 Remove the [display assembly](#).
- 10 Remove the [display bezel](#).

Procedure

- 1 Remove the two screws (M2x3) that secure the logo board to the display back-cover and antenna assembly.

- 2 Turn the logo board over.

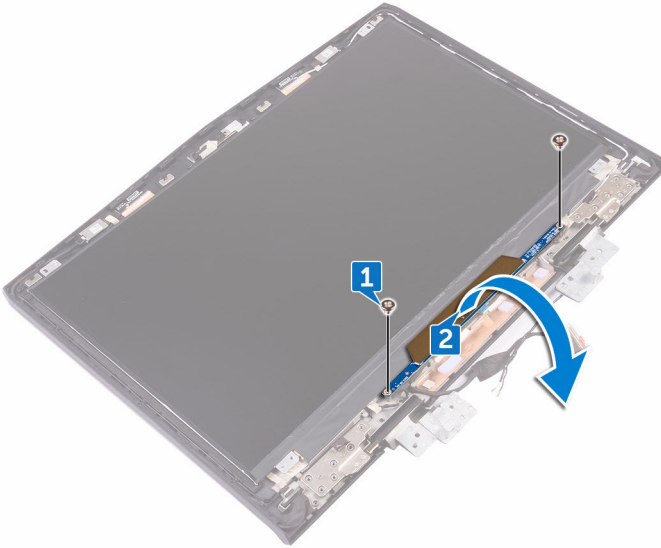

- 3 Disconnect the tron-light cable from the logo board.
- 4 Pull the latch that secures the Alienhead cable to the logo board.
- 5 Disconnect the Alienhead cable from the logo board.
- 6 Disconnect the logo-board cable from the logo board.
- 7 Disconnect the tron-light cable from the logo board.

8 Lift the logo board off the display back-cover and antenna assembly.

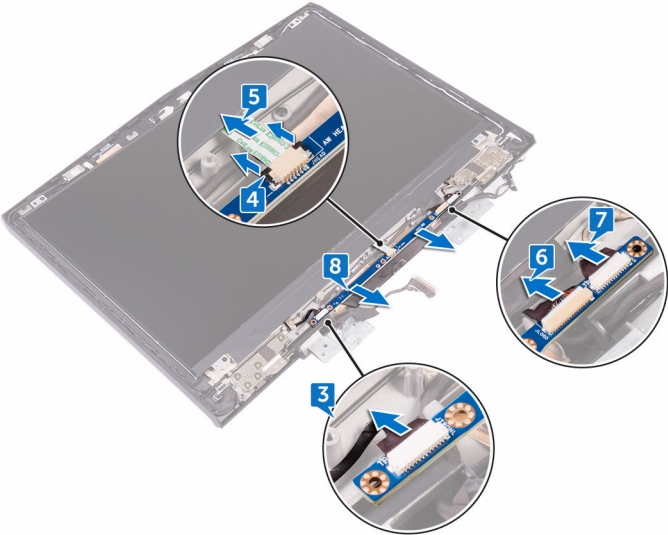

Replacing the logo board

 **WARNING:** Before working inside your computer, read the safety information that shipped with your computer and follow the steps in [Before working inside your computer](#). After working inside your computer, follow the instructions in [After working inside your computer](#). For more safety best practices, see the Regulatory Compliance home page at www.dell.com/regulatory_compliance.

Procedure

- 1 Connect the tron-light cables, the logo-board cable, and the Alienhead cable to the logo board.
- 2 Push the latch that secures the Alienhead cable to the logo board.
- 3 Turn the logo board over.
- 4 Using the alignment post, place the logo board on the display back-cover and antenna assembly.
- 5 Align the screw holes on the logo board with the screw holes on the display back-cover and antenna assembly.
- 6 Replace the two screws (M2x3) that secure the logo board to the display back-cover and antenna assembly.

Post-requisites

- 1 Replace the [display bezel](#).
- 2 Replace the [display assembly](#).
- 3 Follow the procedure from step 2 to step 15 in "[Replacing the system board](#)".
- 4 Replace the [memory modules](#).
- 5 Replace the [computer base](#).
- 6 Replace the [rear-I/O cover](#).
- 7 Replace the [solid-state drive](#).
- 8 Replace the [wireless card](#).
- 9 Follow the procedure from step 4 to step 7 in "[Replacing the hard drive](#)".
- 10 Replace the [base cover](#).

Removing the display panel

 **WARNING:** Before working inside your computer, read the safety information that shipped with your computer and follow the steps in [Before working inside your computer](#). After working inside your computer, follow the instructions in [After working inside your computer](#). For more safety best practices, see the Regulatory Compliance home page at www.dell.com/regulatory_compliance.

Prerequisites

- 1 Remove the [base cover](#).
- 2 Follow the procedure from step 1 to step 4 in "[Removing the hard drive](#)".
- 3 Remove the [wireless card](#).
- 4 Remove the [solid-state drive](#).
- 5 Remove the [memory modules](#).
- 6 Remove the [rear-I/O cover](#).
- 7 Remove the [computer base](#).
- 8 Follow the procedure from step 1 to step 21 in "[Removing the system board](#)".
- 9 Remove the [display assembly](#).
- 10 Remove the [display bezel](#).
- 11 Remove the [logo board](#).

Procedure

- 1 Remove the four screws (M2x3) that secure the display panel to the display back-cover and antenna assembly.

-
- 2 Gently lift the display panel and turn it over.

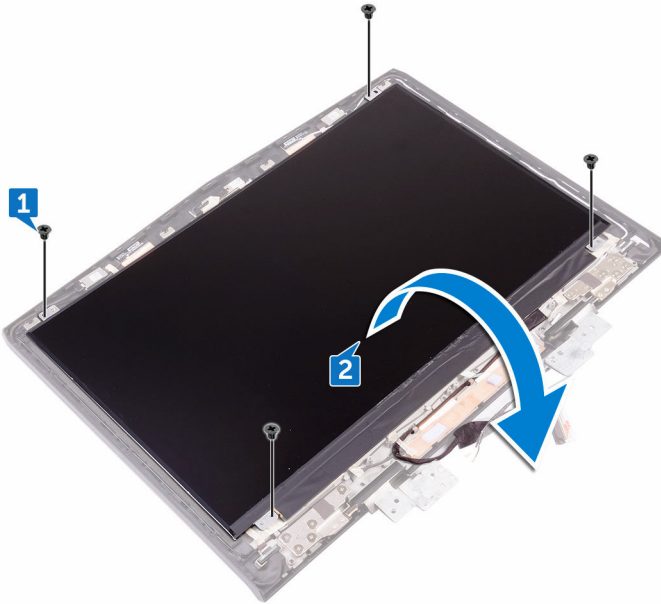

-
-
- 3 Peel the tape that secures the display cable to the display panel.
- 4 Open the latch and disconnect the display cable from the display panel.

5 Lift the display panel off the display back-cover and antenna assembly.

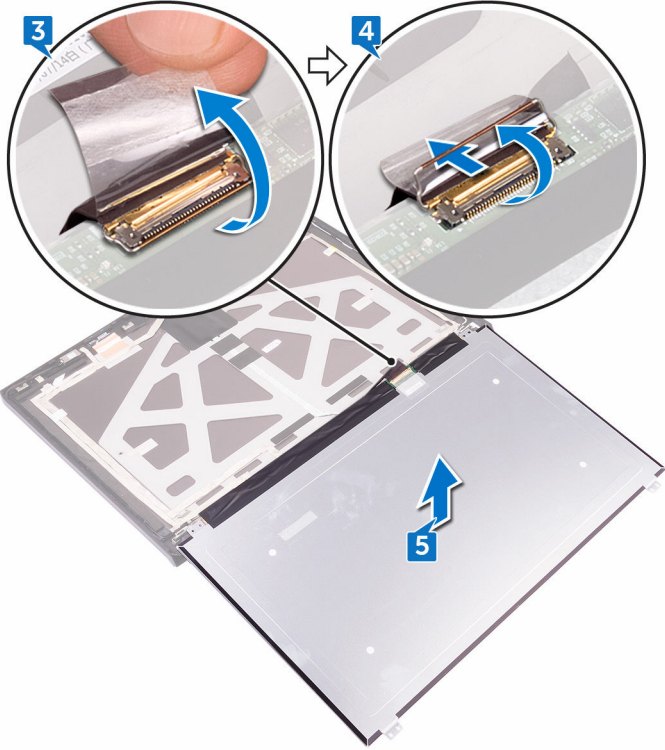

Replacing the display panel

 **WARNING:** Before working inside your computer, read the safety information that shipped with your computer and follow the steps in [Before working inside your computer](#). After working inside your computer, follow the instructions in [After working inside your computer](#). For more safety best practices, see the Regulatory Compliance home page at www.dell.com/regulatory_compliance.

Procedure

- 1 Slide the display cable into the connector on the display panel and close the latch to secure the cable.
- 2 Adhere the tape that secures the display cable to the display panel.
- 3 Turn the display panel over and gently place it on the display back-cover and antenna assembly.
- 4 Align the screw holes on the display panel with the screw holes on the display back-cover and antenna assembly.
- 5 Replace the four screws (M2x3) that secure the display panel to the display back-cover and antenna assembly.

Post-requisites

- 1 Replace the [logo board](#).
- 2 Replace the [display bezel](#).
- 3 Replace the [display assembly](#).
- 4 Follow the procedure from step 2 to step 15 in "[Replacing the system board](#)".
- 5 Replace the [computer base](#).
- 6 Replace the [rear-I/O cover](#).
- 7 Replace the [memory modules](#).
- 8 Replace the [solid-state drive](#).
- 9 Replace the [wireless card](#).
- 10 Follow the procedure from step 4 to step 7 in "[Replacing the hard drive](#)".
- 11 Replace the [base cover](#).

Removing the camera

 **WARNING:** Before working inside your computer, read the safety information that shipped with your computer and follow the steps in [Before working inside your computer](#). After working inside your computer, follow the instructions in [After working inside your computer](#). For more safety best practices, see the Regulatory Compliance home page at www.dell.com/regulatory_compliance.

Prerequisites

- 1 Remove the [base cover](#).
- 2 Follow the procedure from step 1 to step 4 in "[Removing the hard drive](#)".
- 3 Remove the [wireless card](#).
- 4 Remove the [solid-state drive](#).
- 5 Remove the [rear-I/O cover](#).
- 6 Remove the [computer base](#).
- 7 Remove the [memory modules](#).
- 8 Follow the procedure from step 1 to step 21 in "[Removing the system board](#)".
- 9 Remove the [display assembly](#).
- 10 Remove the [display bezel](#).

Procedure

- 1 Using a plastic scribe, pry the camera module from the display back-cover and antenna assembly.
- 2 Disconnect the camera cable from the camera module.

3 Lift the camera module from the display back-cover and antenna assembly.

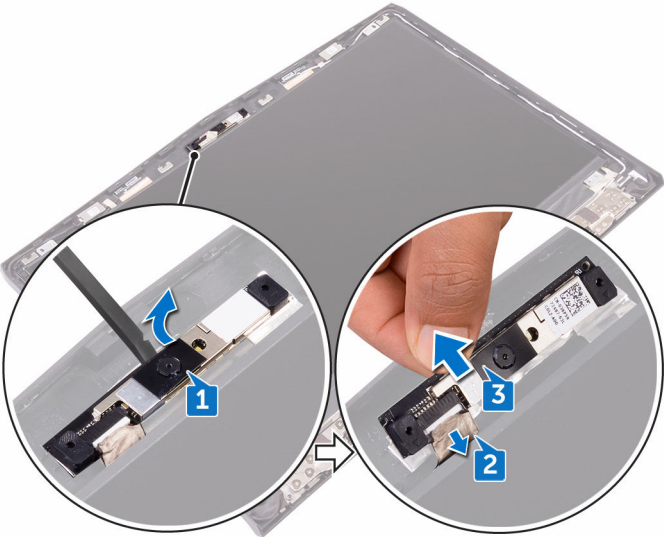

Replacing the camera

 **WARNING:** Before working inside your computer, read the safety information that shipped with your computer and follow the steps in [Before working inside your computer](#). After working inside your computer, follow the instructions in [After working inside your computer](#). For more safety best practices, see the Regulatory Compliance home page at www.dell.com/regulatory_compliance.

Procedure

- 1 Connect the camera cable to the camera module.
- 2 Using the alignment posts, place the camera module on the display back-cover and antenna assembly.
- 3 Adhere the camera module to the display back-cover and antenna assembly.

Post-requisites

- 1 Replace the [display bezel](#).
- 2 Replace the [display assembly](#).
- 3 Follow the procedure from step 2 to step 15 in "[Replacing the system board](#)".
- 4 Replace the [memory modules](#).
- 5 Replace the [computer base](#).
- 6 Replace the [rear-I/O cover](#).
- 7 Replace the [solid-state drive](#).
- 8 Replace the [wireless card](#).
- 9 Follow the procedure from step 4 to step 7 in "[Replacing the hard drive](#)".
- 10 Replace the [base cover](#).

Removing the display hinges

 **WARNING:** Before working inside your computer, read the safety information that shipped with your computer and follow the steps in [Before working inside your computer](#). After working inside your computer, follow the instructions in [After working inside your computer](#). For more safety best practices, see the Regulatory Compliance home page at www.dell.com/regulatory_compliance.

Prerequisites

- 1 Remove the [base cover](#).
- 2 Follow the procedure from step 1 to step 4 in "[Removing the hard drive](#)".
- 3 Remove the [wireless card](#).
- 4 Remove the [solid-state drive](#).
- 5 Remove the [rear-I/O cover](#).
- 6 Remove the [computer base](#).
- 7 Remove the [memory modules](#).
- 8 Follow the procedure from step 1 to step 21 in "[Removing the system board](#)".
- 9 Remove the [display assembly](#).
- 10 Remove the [display bezel](#).

Procedure

- 1 Remove the hinge caps and lift them off the hinges.

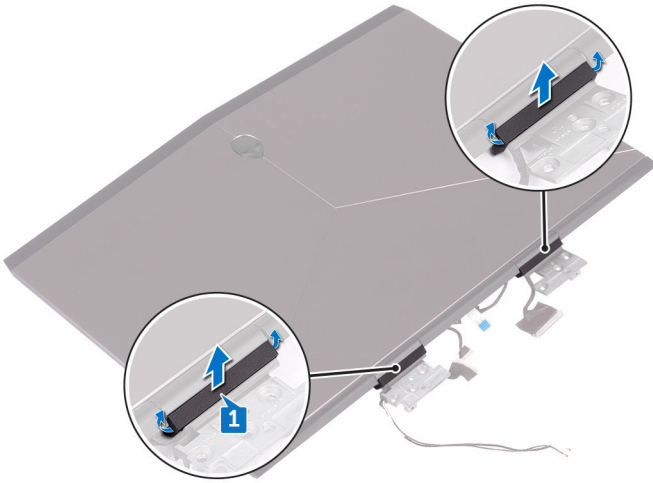

- 2 Turn the display assembly over.
- 3 Remove the display cable from the routing guide on the display back-cover and antenna assembly.
- 4 Remove the tobii eye-tracker board cable from the routing guide on the display back-cover and antenna assembly.
- 5 Remove the logo board cable from the routing guide on the display back-cover and antenna assembly.

- 6 Remove the wireless-antenna cables from the routing guide on the display back-cover and antenna assembly.

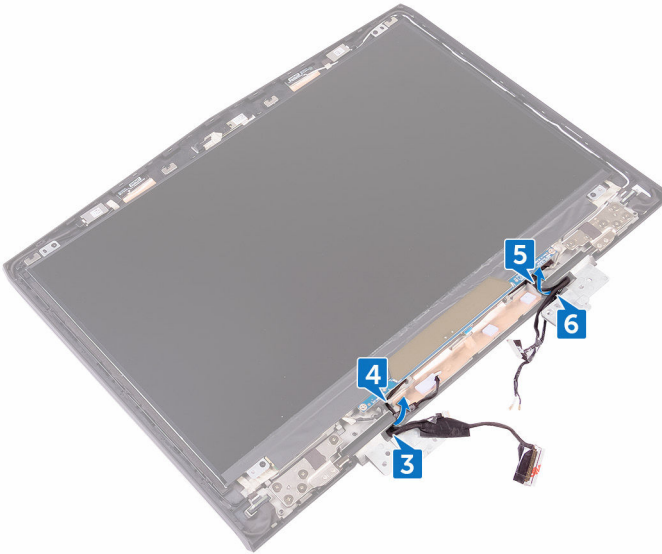

- 7 Peel off the tape that secures the display hinge to the display back-cover and antenna assembly.
- 8 Remove the 12 screws (M2.5x3) that secure the hinges to the display back-cover and antenna assembly.

9 Lift the hinges from the display back-cover and antenna assembly.

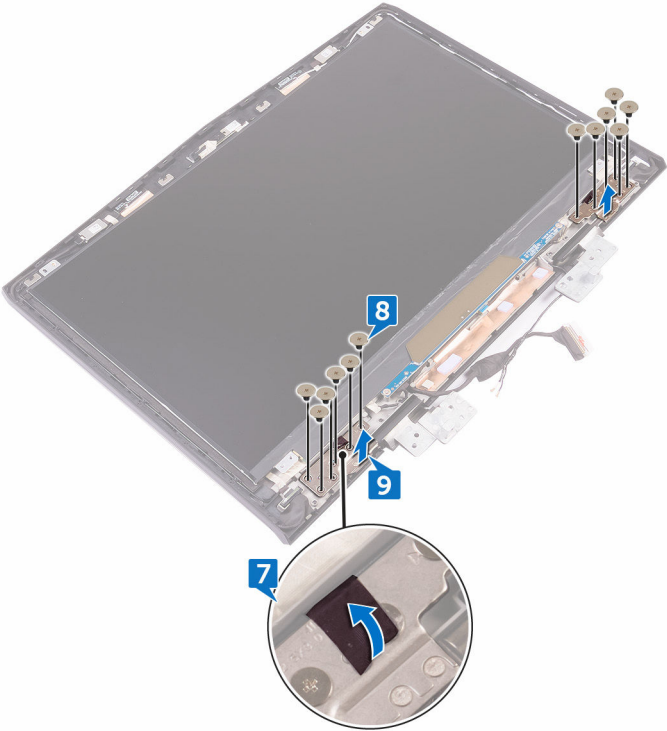

Replacing the display hinges

 **WARNING:** Before working inside your computer, read the safety information that shipped with your computer and follow the steps in [Before working inside your computer](#). After working inside your computer, follow the instructions in [After working inside your computer](#). For more safety best practices, see the Regulatory Compliance home page at www.dell.com/regulatory_compliance.

Procedure

- 1 Align the screw holes on the display hinges with the screw holes on the display back-cover and antenna assembly.
- 2 Replace the 12 screws (M2.5x3) that secure the display hinges to the display back-cover and antenna assembly.
- 3 Replace the tape that secures the display hinge to the display back-cover and antenna assembly.
- 4 Route the antenna cables, power-button board cable, logo-board cable, tobi eye-tracker board cable, and display cable through the routing guides on the display back-cover and antenna assembly.
- 5 Turn the display assembly over.
- 6 Place the hinge caps on the display hinges and press down to snap them into place.

Post-requisites

- 1 Replace the [display bezel](#).
- 2 Replace the [display assembly](#).
- 3 Follow the procedure from step 2 to step 15 in "[Replacing the system board](#)".
- 4 Replace the [memory modules](#).
- 5 Replace the [computer base](#).
- 6 Replace the [rear-I/O cover](#).
- 7 Replace the [solid-state drive](#).
- 8 Replace the [wireless card](#).

- 9 Follow the procedure from step 4 to step 7 in "[Replacing the hard drive](#)".
- 10 Replace the [base cover](#).

Removing the display back-cover and antenna assembly



WARNING: Before working inside your computer, read the safety information that shipped with your computer and follow the steps in [Before working inside your computer](#). After working inside your computer, follow the instructions in [After working inside your computer](#). For more safety best practices, see the Regulatory Compliance home page at www.dell.com/regulatory_compliance.

Prerequisites

- 1 Remove the [base cover](#).
- 2 Remove the [wireless card](#).
- 3 Follow the procedure from step 1 to step 3 in "[Removing the hard drive](#)".
- 4 Remove the [solid-state drive](#).
- 5 Remove the [rear-I/O cover](#).
- 6 Remove the [computer base](#).
- 7 Remove the [battery](#).
- 8 Remove the [memory modules](#).
- 9 Follow the procedure from step 1 to step 21 in "[Removing the system board](#)".
- 10 Remove the [display assembly](#).
- 11 Remove the [display bezel](#).
- 12 Remove the [camera](#).
- 13 Remove the [logo board](#).
- 14 Remove the [display panel](#).
- 15 Remove the [display hinges](#).

Procedure

- 1 Peel off the display cable, logo-board cable, and camera cable from the display back-cover and antenna assembly.

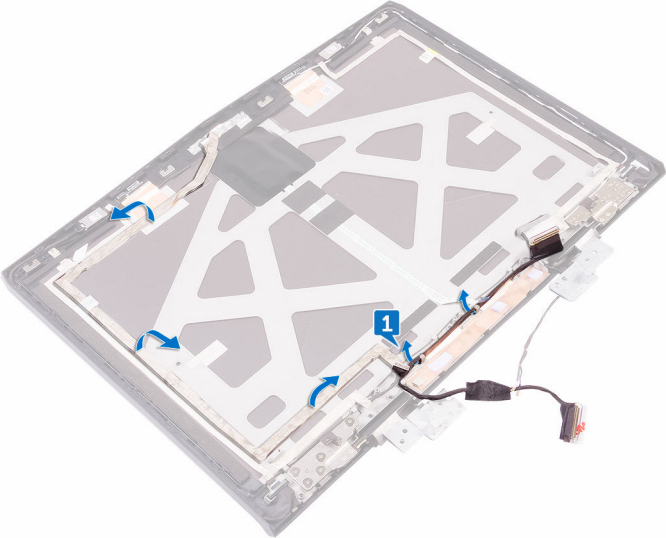

- 2 After performing all the above steps, you are left with the display back-cover and antenna assembly.

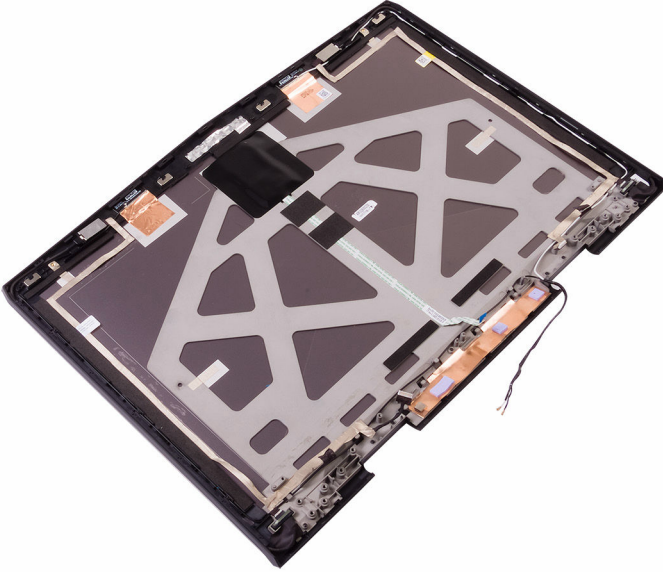

Replacing the display back-cover and antenna assembly



WARNING: Before working inside your computer, read the safety information that shipped with your computer and follow the steps in [Before working inside your computer](#). After working inside your computer, follow the instructions in [After working inside your computer](#). For more safety best practices, see the Regulatory Compliance home page at www.dell.com/regulatory_compliance.

Procedure

- 1 Place the display back-cover and antenna assembly on a clean and flat surface.
- 2 Adhere the display cable, logo-board cable, and camera cable to the display back-cover and antenna assembly.

Post-requisites

- 1 Replace the [display hinges](#).
- 2 Replace the [display panel](#).
- 3 Replace the [logo board](#).
- 4 Replace the [camera](#).
- 5 Replace the [display bezel](#).
- 6 Replace the [display assembly](#).
- 7 Follow the procedure from step 2 to step 15 in "[Replacing the system board](#)".
- 8 Replace the [memory modules](#).
- 9 Replace the [battery](#).
- 10 Replace the [computer base](#).
- 11 Replace the [rear-I/O cover](#).
- 12 Replace the [solid-state drive](#).
- 13 Follow the procedure from step 4 to step 6 in "[Replacing the hard drive](#)".
- 14 Replace the [wireless card](#).

15 Replace the [base cover](#).

BIOS overview

The BIOS manages data flow between the computer's operating system and attached devices such as the hard disk, video adapter, keyboard, mouse, and printer.

Entering the BIOS setup program

- 1 Turn on or restart your computer.
- 2 Press F2 when the Dell logo is displayed on the screen to enter the BIOS setup program.

You can change the user-definable settings in BIOS setup program.

Timing key sequences

The keyboard is not the first device initialized by the BIOS setup program. As a result, if you press a keystroke too early, the keyboard is locked out. In such cases, a keyboard error message is displayed on the screen, and you cannot restart your computer with the Ctrl+Alt+Del key combination.

To prevent the keyboard from locking, wait until the keyboard is initialized completely. The keyboard is initialized if one of the following occurs:

- The keyboard lights flash.
- The F2=Setup prompt appears at the top-right corner of the screen during boot.

System Setup Options



NOTE: Depending on your computer and its installed devices, the items listed in this section may or may not appear.

Table 3. System setup options—Main menu

Main	
System Time	Displays the current time in hh:mm:ss format.
System Date	Displays the current date in mm/dd/yyyy format.
BIOS Version	Displays the BIOS version.
Product Name	Displays the model number of your computer.
Service Tag	Displays the service tag of your computer.
Asset Tag	Displays the asset tag of your computer.
CPU Type	Displays the processor type.
CPU Speed	Displays the processor speed.
CPU ID	Displays the processor identification code.
CPU L1 Cache	Displays the processor L1 cache size.
CPU L2 Cache	Displays the processor L2 cache size.
CPU L3 Cache	Displays the processor L3 cache size.
Integrated Graphics	Displays the integrated graphics.
Discrete Graphics 1	Displays the first discrete graphics installed on your computer.
First HDD	Displays the type of hard drive installed.
Second HDD	Displays the type of secondary hard-drive installed.
Third HDD	Displays the type of third hard-drive installed.
Fourth HDD	Displays the type of fourth hard-drive installed.

Main

M.2 PCIe SSD-1	Displays the type of primary SSD installed.
M.2 PCIe SSD-2	Displays the type of secondary SSD installed.
M.2 PCIe SSD-3	Displays the type of third SSD installed.

Table 4. System setup options—Advanced menu

Advanced

Intel(R) SpeedStep Technology	Allows you to enable or disable Intel (R) Speedstep Technology.  NOTE: If enabled, the processor clock speed and core voltage are adjusted dynamically based on the processor load.
	Default: Enabled
Virtualization	Allows you to enable or disable the Intel Virtualization technology. Default: Enabled
VT for Direct I/O	Specify whether a Virtual Machine Monitor (VMM) can utilize the additional hardware capabilities provided by Intel Virtualization Technology for Direct I/O.
Integrated NIC	Allows you to enable or disable the on-board LAN controller. Default: Enabled
USB Emulation	Allows you to enable or disable the USB emulation feature. This feature defines how the BIOS, in the absence of a USB-aware operating system, handles USB devices. USB emulation is always enabled during POST.

Advanced



NOTE: You cannot boot any type of USB device (floppy, hard drive, or memory key) when this option is off.

Default: Enabled

USB PowerShare

Allows you to charge USB devices when the computer is turned off or in standby mode.

Default: Enabled

USB Wake Support

Allows you to enable USB devices to wake the computer from standby or to disable the USB wake support feature.



NOTE: If USB PowerShare is enabled, a device connected to the USB PowerShare connector may not wake the computer.

Default: Disabled

SATA Operation

Allows you to configure the operating mode of the integrated SATA hard drive controller.

Default: AHCI

Adapter Warnings

Allows you to choose if the computer should display warning messages when you use AC adapters that are not supported by your computer.

Default: Enabled

Function Key Behavior

Allows you to set function key or multimedia key as the default function key behavior.

Default: Function key

Express Charge

Allows you to charge your computer battery using Standard Charge or Express Charge mode.

Default: Express Charge

Advanced

Touchpad Backlight	Allows you to configure the touchpad backlight option.
Battery Health	Displays the battery health.
Intel Software Guard Extensions	Allows you to enable or disable the Intel Software Guard Extensions Default: Disabled
BIOS Recovery	Enable the user to recover from certain corrupted BIOS conditions from a recovery file on the user primary hard drive Default: Enabled
Performance Options	

SupportAssist System Resolution

Auto OS Recovery Threshold	Control the automatic boot flow for SupportAssist System Resolution Console and for Dell OS Recovery tool.
----------------------------	--

Table 5. System setup options—Security menu

Security

Unlock Setup Status	Displays if the setup status is unlocked.
Admin Password Status	Displays if the administrator password is clear or set. Default: Not set
System password Status	Displays if the system password is clear or set. Default: Not set
HDD password Status	Displays if the HDD password is clear or set. Default: Not set
Admin Password	Allows you to set the administrator password. The administrator password

Security

	controls access to the system setup utility.
System Password	Allows you to set the system password. The system password controls access to the computer at boot.
HDD password	Allows you to set, change or delete the hard-disk drive password.
Password Change	Allows you to permit or deny system password or HDD password changes. Default: Permitted
Computrace	Enable or disable the BIOS module interface of the optional Computrace Service from Absolute Software.
Firmware TPM	
UEFI Capsule Firmware Updates	Enable or disable BIOS updates through UEFI capsule update packages.

Table 6. System setup options—Boot menu

Boot

Boot List Option	Displays the available boot options.
File Browser Add Boot Option	Allows to add the boot options.
File Browser Del Boot Option	Allows to delete the boot options
Secure Boot	Enable or disable the secure boot feature.
Legacy Option ROMs	Enable or disable the Legacy Option ROMs.
Boot Option Priorities	Displays the boot sequence.
Boot Option #1	Displays the available first boot option.

Boot	
Boot Option #2	Displays the available second boot option.
Boot Option #3	Displays the available third boot option.

Table 7. System setup options—Exit menu

Exit	
Save Changes and Reset	Allows you to exit system setup and save your changes.
Discard Changes and Reset	Allows you to exit system setup and load previous values for all system setup options.
Restore Defaults	Allows you to restore default values for all system setup options.
Discard Changes	Allows you to load previous values for all system setup options.
Save Changes	Allows you to save the changes for all system setup options.

Clearing forgotten passwords

Contact Dell technical support to clear the forgotten passwords, see www.dell.com/contactdell.

Clearing CMOS settings

- 1 Remove the [base cover](#).
- 2 Remove the [battery](#).
- 3 Remove the [coin-cell battery](#).
- 4 Wait for one minute.
- 5 Replace the [coin-cell battery](#).
- 6 Replace the [battery](#).
- 7 Replace the [base cover](#).

Flashing the BIOS

You may need to flash (update) the BIOS when an update is available or when you replace the system board. To flash the BIOS:

- 1 Turn on your computer.
- 2 Go to www.dell.com/support.
- 3 Click **Product support**, enter the Service Tag of your computer, and then click **Submit**.



NOTE: If you do not have the Service Tag, use the auto-detect feature or manually browse for your computer model.

- 4 Click **Drivers & downloads** → **Find it myself**.
- 5 Select the operating system installed on your computer.
- 6 Scroll down the page and expand **BIOS**.
- 7 Click **Download** to download the latest version of the BIOS for your computer.
- 8 After the download is complete, navigate to the folder where you saved the BIOS update file.
- 9 Double-click the BIOS update file icon and follow the instructions on the screen.

Boot menu

This computer includes a one-time boot menu. By using this feature, you can change the sequence of devices that your computer attempts to boot from, for example, CD-ROM, hard drive, or network.

Boot menu enhancements

The boot menu enhancements are as follows:

- **Easier access** — Press F12 to access the boot selection menu.
- **User prompting** — The user is prompted to use the keystroke on the BIOS screen.
- **Diagnostics options** — The boot menu includes the ePSA diagnostic options.

Diagnostics

Power and battery-status light: Indicates the power and battery-charge status.

Solid amber – Computer is running on battery and the battery has less than 10 percent charge.

User-defined color (AC mode) – Power adapter is connected and the battery is fully charged.

User-defined color (Battery mode) – Computer is running on battery and the battery has more than 10 percent charge.

User-defined color (Breath) – Computer is in sleep state.

Off – Computer is in hibernation, or turned off.

The power and battery-status light blinks red and blue along with beep codes indicating failures.

For example, the power and battery-status light blinks red two times followed by a pause, and then blinks blue three times followed by a pause. This 2,3 pattern continues until the computer is turned off indicating no memory or RAM is detected.

The following table shows different light patterns and what they indicate.

Table 8. Diagnostics

Light Pattern	Problem description
2,1	CPU failure
2,2	System board: BIOS and ROM failure
2,3	No memory or RAM detected
2,4	Memory or RAM failure
2,5	Invalid memory installed
2,6	System board or chipset error
2,7	LCD failure
3,1	CMOS battery failure
3,2	PCI/video card failure
3,3	Recovery image not found

Light Pattern	Problem description
3,4	Recovery image found but invalid

Camera status light: Indicates whether the camera is in use.

- Solid white – Camera is in use.
- Off – Camera is not in use.

Caps Lock status light: Indicates whether Caps Lock is enabled or disabled.

- Solid white – Caps Lock enabled.
- Off – Caps Lock disabled.

Network port light: Indicates network connectivity.



- Off – No network connection.
- Solid green – 10 Mbps connection.
- Solid orange – 100 Mbps connection.
- Solid yellow – 1000 Mbps connection.
- Flicker yellow – Network activity.

Getting help and contacting Alienware

Self-help resources

You can get information and help on Alienware products and services using these online self-help resources:

Table 9. Alienware products and online self-help resources

Information about Alienware products and services	www.alienware.com
Dell Help & Support app	
Get started app	
Accessing help	In Windows search, type Help and Support , and press Enter .
Online help for operating system	www.dell.com/support/windows www.dell.com/support/linux
Tobii Eye Tracker and Tobii Eye Tracking	www.tobii.com
VR Support	www.dell.com/VRsupport
Troubleshooting information, user manuals, setup instructions, product specifications, technical help blogs, drivers, software updates, and so on	www.alienware.com/gamingservices
Videos providing step-by-step instructions to service your computer	www.youtube.com/alienwareservices

Contacting Alienware

To contact Alienware for sales, technical support, or customer service issues, see www.alienware.com.



NOTE: Availability varies by country and product, and some services may not be available in your country.



NOTE: If you do not have an active internet connection, you can find contact information on your purchase invoice, packing slip, bill, or Dell product catalog.