

Dell PowerEdge M520 Systems (For Dell PowerEdge VRTX Enclosure) Owner's Manual

Regulatory Model: HHB
Regulatory Type: HHB004



Notes, Cautions, and Warnings



NOTE: A NOTE indicates important information that helps you make better use of your computer.



CAUTION: A CAUTION indicates either potential damage to hardware or loss of data and tells you how to avoid the problem.



WARNING: A WARNING indicates a potential for property damage, personal injury, or death.

© 2013 Dell Inc.

Trademarks used in this text: Dell™, the Dell logo, Dell Boomi™, Dell Precision™, OptiPlex™, Latitude™, PowerEdge™, PowerVault™, PowerConnect™, OpenManage™, EqualLogic™, Compellent™, KACE™, FlexAddress™, Force10™ and Vostro™ are trademarks of Dell Inc. Intel®, Pentium®, Xeon®, Core® and Celeron® are registered trademarks of Intel Corporation in the U.S. and other countries. AMD® is a registered trademark and AMD Opteron™, AMD Phenom™ and AMD Sempron™ are trademarks of Advanced Micro Devices, Inc. Microsoft®, Windows®, Windows Server®, Internet Explorer®, MS-DOS®, Windows Vista® and Active Directory® are either trademarks or registered trademarks of Microsoft Corporation in the United States and/or other countries. Red Hat® and Red Hat® Enterprise Linux® are registered trademarks of Red Hat, Inc. in the United States and/or other countries. Novell® and SUSE® are registered trademarks of Novell Inc. in the United States and other countries. Oracle® is a registered trademark of Oracle Corporation and/or its affiliates. Citrix®, Xen®, XenServer® and XenMotion® are either registered trademarks or trademarks of Citrix Systems, Inc. in the United States and/or other countries. VMware®, vMotion®, vCenter®, vCenter SRM™ and vSphere® are registered trademarks or trademarks of VMware, Inc. in the United States or other countries. IBM® is a registered trademark of International Business Machines Corporation.

2013 - 05

Rev. A00

Contents

Notes, Cautions, and Warnings.....	2
1 About Your System.....	7
Introduction.....	7
Front-Panel Features And Indicators.....	8
Using USB Diskette Or USB DVD/CD Drives.....	8
Hard-Drive Indicator Patterns.....	8
Other Information You May Need.....	9
2 Using The System Setup And Boot Manager.....	11
Choosing The System Boot Mode.....	11
Entering System Setup.....	12
Responding To Error Messages.....	12
Using The System Setup Navigation Keys.....	12
System Setup Options.....	12
System Setup Main Screen.....	13
System BIOS Screen.....	13
System Information Screen.....	13
Memory Settings Screen.....	14
Processor Settings Screen.....	14
SATA Settings Screen.....	15
Boot Settings Screen.....	16
Integrated Devices Screen.....	16
Serial Communications Screen.....	17
System Profile Settings Screen.....	18
System Security Screen.....	19
Miscellaneous Settings.....	19
System And Setup Password Features.....	20
Assigning A System And/Or Setup Password.....	20
Using Your System Password To Secure Your System.....	21
Deleting Or Changing An Existing System And/Or Setup Password.....	21
Operating With A Setup Password Enabled.....	22
Entering The UEFI Boot Manager.....	22
Using The Boot Manager Navigation Keys.....	23
Boot Manager Screen.....	23
UEFI Boot Menu.....	23
Embedded System Management.....	24

iDRAC Settings Utility.....	24
Entering The iDRAC Settings Utility.....	24

3 Installing Server Module Components..... 25

Recommended Tools.....	25
Installing And Removing A Server Module.....	25
Removing A Server Module.....	25
Installing A Server Module.....	27
Opening And Closing The Server Module.....	27
Opening The Server Module.....	27
Closing The Server Module.....	28
Inside The System.....	28
Cooling Shroud.....	29
Removing The Cooling Shroud.....	29
Installing The Cooling Shroud.....	30
System Memory.....	30
General Memory Module Installation Guidelines.....	32
Mode-Specific Guidelines.....	32
PCIe Mezzanine Cards.....	37
Removing A PCIe Mezzanine Card.....	37
Installing A PCIe Mezzanine Card.....	38
Management Riser Card.....	39
Replacing The SD Card.....	39
Internal USB Key.....	40
SD vFlash Card.....	41
Replacing The SD vFlash Card.....	41
Processors.....	42
Removing A Processor.....	42
Installing A Processor.....	44
Hard Drives/SSDs.....	45
Hard Drive/SSD Installation Guidelines.....	46
Removing A Hard Drive/SSD.....	46
Installing A Hard Drive/SSD.....	47
Shutdown Procedure For Servicing a Hard Drive/SSD.....	47
Configuring The Boot Drive.....	47
Removing A Hard Drive/SSD From A Hard-Drive/SSD Carrier.....	47
Installing A Hard Drive/SSD In A Hard-Drive/SSD Carrier.....	48
Hard-Drive/SSD Backplane.....	48
Removing The Hard-Drive/SSD Backplane.....	48
Installing The Hard-Drive/SSD Backplane.....	49
System Board.....	50
Removing The System Board.....	50

Installing The System Board.....	51
NVRAM Backup Battery.....	52
Replacing The NVRAM Backup Battery.....	52
Storage Controller Card.....	53
Removing The Storage Controller Card.....	53
Installing The Storage Controller Card.....	54
4 Troubleshooting Your System.....	55
Safety First—For You and Your System.....	55
Troubleshooting System Memory.....	55
Troubleshooting Hard Drives.....	56
Troubleshooting USB Devices.....	56
Troubleshooting An Internal SD Card.....	57
Troubleshooting Processors.....	57
Troubleshooting The Server Module System Board.....	57
Troubleshooting The NVRAM Backup Battery.....	58
5 Using System Diagnostics.....	59
Dell Online Diagnostics.....	59
Dell Embedded System Diagnostics.....	59
When To Use The Embedded System Diagnostics.....	59
Running The Embedded System Diagnostics.....	60
System Diagnostic Controls.....	60
6 Jumpers And Connectors.....	61
System Board Jumper Settings.....	61
System Board Connectors.....	62
Disabling A Forgotten Password.....	63
7 Technical Specifications.....	65
8 System Messages.....	69
LCD Status Messages.....	69
Viewing LCD Messages.....	69
Removing LCD Messages.....	69
System Error Messages.....	69
Warning Messages.....	138
Diagnostic Messages.....	138
Alert Messages.....	138
9 Getting Help.....	139
Contacting Dell.....	139

About Your System

Introduction

This document provides information on the Dell PowerEdge M520 server module that is specifically configured for the PowerEdge VRTX enclosure, and can be identified by a label marked **PCIe** on the server module.

 **NOTE:** This server module is not supported on the Dell PowerEdge M1000e enclosure with the PowerEdge VRTX mezzanine card.

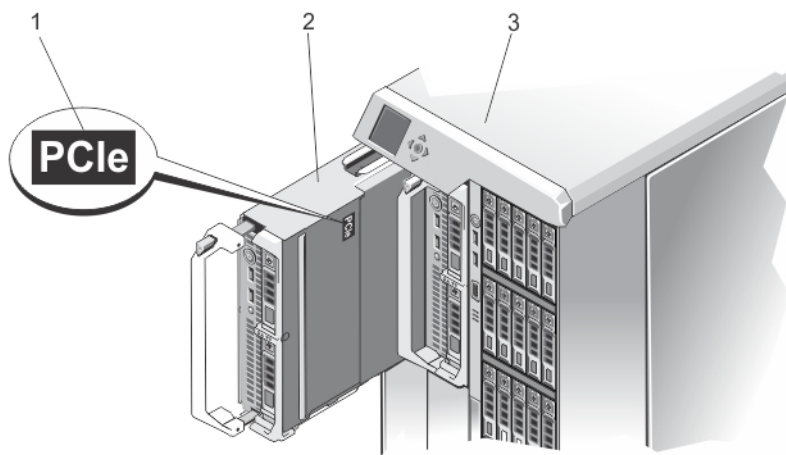

Figure 1. Identifying Server Module Configured for the VRTX Enclosure

1. **PCIe** label on the server module
2. server module

Front-Panel Features And Indicators

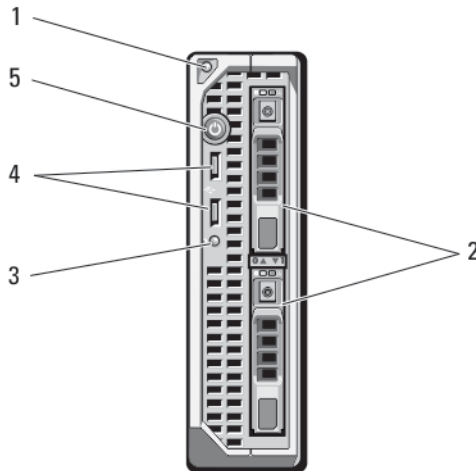

Figure 2. Front-Panel Features and Indicators

1. server module handle release button
2. hard drives/SSDs (2)
3. status/identification indicator
4. USB connectors (2)
5. server module power button

Using USB Diskette Or USB DVD/CD Drives

The server module has USB ports on the front which allow you to connect a USB diskette drive, USB flash drive, USB DVD/CD drive, keyboard, or mouse. The USB drives can be used to configure the server module.

NOTE: Your server module supports only Dell-branded USB 2.0 drives. Use the optional external drive storage tray to support the drive while in use.

NOTE: If the drive must be designated as the boot drive, connect the USB drive, restart the system, then enter the System Setup and set the drive as first in the boot sequence. The USB device is displayed in the boot order setup screen only if it is attached to the system before you run the System Setup. You can also select the boot device by pressing <F11> during system start-up and selecting a boot device for the current boot sequence.

Hard-Drive Indicator Patterns

Your system supports two 2.5 inch SSD, SAS or SATA hard drives.

NOTE: SSD/SAS/SATA hard drives cannot be mixed within a server module.

The hard-disk drives plug into the hard-drive backplane inside the server module. On server modules with a diskless configuration, all hard drive slots must be filled with hard-drive blanks, and the hard-drive backplane must still be installed to maintain proper airflow.

The hard-drive indicators display different patterns as drive events occur in the system.



 **NOTE:** The server module must have a hard drive or a hard-drive blank installed in each hard-drive bay.



Figure 3. Hard-Drive Indicators

1. hard-drive activity indicator (green)
2. hard-drive status indicator (green and amber)

 **NOTE:** If the hard drive is in Advanced Host Controller Interface (AHCI) mode, the status LED (on the right side) does not function and remains off.

Drive-Status Indicator Pattern	Condition
Blinks green two times per second	Identifying drive or preparing for removal
Off	Drive ready for insertion or removal
	 NOTE: The drive status indicator remains off until all hard drives are initialized after system power is applied. Drives are not ready for insertion or removal during this time.
Blinks green, amber, and off	Drive predicted failure
Blinks amber four times per second	Drive failed
Blinks green slowly	Drive rebuilding
Steady green	Drive online
Blinks green three seconds, amber three seconds, and off six seconds	Rebuild aborted

Other Information You May Need

 **WARNING:** See the safety and regulatory information that shipped with your system. Warranty information may be included within this document or as a separate document.

- The Getting Started Guide for the VRTX enclosure provides an overview of the VRTX enclosure and the server modules, setting up your system, and technical specifications.
- The *Dell PowerEdge VRTX Enclosure Owner's Manual* provides information about the VRTX enclosure features and describes how to troubleshoot the enclosure and install or replace the enclosure's components. This document is available online at dell.com/poweredgemanuals.
- The *Dell Chassis Management Controller for Dell PowerEdge VRTX User's Guide* provides information on installing, configuring and using the Chassis Management Controller (CMC) for the VRTX enclosure. This document is available online at dell.com/esmanuals.
- Dell systems management application documentation provides information about installing and using the systems management software.
- Any media that ships with your system that provides documentation and tools for configuring and managing your system, including those pertaining to the operating system, system management software, system updates, and system components that you purchased with your system.



NOTE: Always check for updates on dell.com/support/manuals and read the updates first because they often supersede information in other documents.

Using The System Setup And Boot Manager

System Setup enables you to manage your system hardware and specify BIOS-level options.

 **NOTE:** You can access System Setup by mapping the server module to the KVM on the VRTX enclosure. To map the server to the KVM using LCD — From the **Main Menu** screen on the LCD, go to **KVM Mapping** and select the server, and then press **OK**. You can also access the System Setup through iDRAC remote console.

You can also map a server module to the KVM using the CMC web interface. For more information, see the *Dell Chassis Management Controller for Dell PowerEdge VRTX User's Guide* at dell.com/esmanuals.

The following keystrokes provide access to system features during startup:

Keystroke	Description
<F2>	Enters the System Setup.
<F10>	Enters System Services, which opens the Dell Lifecycle Controller 2 (LC2). The Dell LC2 allows you to access utilities such as embedded system diagnostics. For more information, see the Dell LC2 documentation.
<F11>	Enters the BIOS Boot Manager or the Unified Extensible Firmware Interface (UEFI) Boot Manager, depending on the system's boot configuration.
<F12>	Starts Preboot eXecution Environment (PXE) boot.

From the System Setup, you can:

- Change the NVRAM settings after you add or remove hardware
- View the system hardware configuration
- Enable or disable integrated devices
- Set performance and power management thresholds
- Manage system security

You can access the System Setup using the:

- Standard graphical browser, which is enabled by default
- Text browser, which is enabled using **Console Redirection**

To enable **Console Redirection**, in **System Setup**, select **System BIOS** → **Serial Communication screen** → **Serial Communication**, select **On with Console Redirection**.

 **NOTE:** By default, help text for the selected field is displayed in the graphical browser. To view the help text in the text browser, you must press <F1>.

Choosing The System Boot Mode

System Setup enables you to specify the boot mode for installing your operating system:

- BIOS boot mode (the default) is the standard BIOS-level boot interface.

- UEFI boot mode is an enhanced 64-bit boot interface based on Unified Extensible Firmware Interface (UEFI) specifications that overlays the system BIOS.

You must select the boot mode in the **Boot Mode** field of the **Boot Settings Screen** of System Setup. Once you specify the boot mode, the system boots in the specified boot mode and you proceed then to install your operating system from that mode. Thereafter, you must boot the system in the same boot mode (BIOS or UEFI) to access the installed operating system. Trying to boot the operating system from the other boot mode will cause the system to halt at startup.

 **NOTE:** Operating systems must be UEFI-compatible to be installed from the UEFI boot mode. DOS and 32-bit operating systems do not support UEFI and can only be installed from the BIOS boot mode.

 **NOTE:** For the latest information on supported operating systems, see dell.com/support.

Entering System Setup

1. Turn on or restart your system.
2. Press <F2> immediately after you see the following message:
<F2> = System Setup

If your operating system begins to load before you press <F2>, allow the system to finish booting, and then restart your system and try again.

Responding To Error Messages

If an error message is displayed while the system is booting, make a note of the message. See System Error Messages section of this manual for an explanation of the message and suggestions for correcting errors.

 **NOTE:** After installing a memory upgrade, it is normal for your system to display a message the first time you start your system.

Using The System Setup Navigation Keys

Keys	Action
Up arrow	Moves to the previous field.
Down arrow	Moves to the next field.
<Enter>	Allows you to type in a value in the selected field (if applicable) or follow the link in the field.
Spacebar	Expands or collapses a drop-down list, if applicable.
<Esc>	Moves to the previous page until you view the main screen. Pressing <Esc> in the main screen exits System Setup. A message prompts you to save any unsaved changes.
<F1>	Displays the System Setup help file.

 **NOTE:** For most of the options, any changes that you make are recorded but do not take effect until you restart the system.

System Setup Options

System Setup Main Screen

 **NOTE:** Press <Alt><F> to reset the BIOS or UEFI settings to their default settings.

Menu Item	Description
System BIOS	This option is used to view and configure BIOS settings.
iDRAC Settings	This option is used to view and configure iDRAC settings.
Device Settings	This option is used to view and configure device settings.

System BIOS Screen

 **NOTE:** The options for System Setup change based on the system configuration.

 **NOTE:** System Setup defaults are listed under their respective options in the following sections, where applicable.

Menu Item	Description
System Information	Displays information about the system such as the system model name, BIOS version, Service Tag, and so on.
Memory Settings	Displays information and options related to installed memory.
Processor Settings	Displays information and options related to the processor such as speed, cache size, and so on.
SATA Settings	Displays options to enable or disable the integrated SATA controller and ports.
Boot Settings	Displays options to specify the boot mode (BIOS or UEFI). Enables you to modify UEFI and BIOS boot settings.
Integrated Devices	Displays options to enable or disable integrated device controllers and ports, and to specify related features and options.
Serial Communication	Displays options to enable or disable the serial ports and specify related features and options.
System Profile Settings	Displays options to change the processor power management settings, memory frequency, and so on.
System Security	Displays options to configure the system security settings like, system password, setup password, TPM security, and so on. It also enables or disables support for local BIOS update and the power button on the system.
Miscellaneous Settings	Displays options to change the system date, time, and so on.

System Information Screen

Menu Item	Description
System Model Name	Displays the system model name.
System BIOS Version	Displays the BIOS version installed on the system.

Menu Item	Description
System Service Tag	Displays the system Service Tag.
System Manufacturer	Displays the name of system manufacturer.
System Manufacturer Contact Information	Displays the contact information of the system manufacturer.

Memory Settings Screen

Menu Item	Description
System Memory Size	Displays the amount of memory installed in the system.
System Memory Type	Displays the type of memory installed in the system.
System Memory Speed	Displays the system memory speed.
System Memory Voltage	Displays the system memory voltage.
Video Memory	Displays the amount of video memory.
System Memory Testing	Specifies whether system memory tests are run during system boot. Options are Enabled and Disabled . By default, the System Memory Testing option is set to Disabled .
Memory Operating Mode	Specifies the memory operating mode. The options available depending on the memory configuration of your system are Optimizer Mode , Advanced ECC Mode , Mirror Mode , Spare Mode , and Spare with Advanced ECC Mode . By default, the Memory Operating Mode option is set to Optimizer Mode .  NOTE: The Memory Operating Mode can have different defaults and available options based on the memory configuration.
Node Interleaving	If this field is Enabled , memory interleaving is supported if a symmetric memory configuration is installed. If Disabled , the system supports Non-Uniform Memory architecture (NUMA) (asymmetric) memory configurations. By default, Node Interleaving option is set to Disabled .
Serial Debug Output	By default, it is set to disabled.

Processor Settings Screen





Menu Item	Description
Logical Processor	Allows you to enable or disable logical processors and display the number of logical processors. If the Logical Processor option is set to Enabled , the BIOS displays all the logical processors. If this option is set to Disabled , the BIOS only displays one logical processor per core. By default, the Logical Processor option is set to Enabled .
QPI Speed	Allows you to set the QuickPath Interconnect data rate settings. By default, the QPI Speed option is set to Maximum data rate .  NOTE: The QPI Speed option is displayed only when both the processors are installed.

Menu Item	Description
Alternate RTID (Requestor Transaction ID) Setting	Allows you to allocate more RTIDs to the remote socket increasing cache performance between the sockets or work in normal mode for NUMA. By default, the Alternate RTID (Requestor Transaction ID) Setting is set to Disabled .
Virtualization Technology	Allows you enable or disable the additional hardware capabilities provided for virtualization. By default, the Virtualization Technology option is set to Enabled .
Adjacent Cache Line Prefetch	Allows you to optimize the system for applications that require high utilization of sequential memory access. By default, the Adjacent Cache Line Prefetch option is set to Enabled . You can disable this option for applications that require high utilization of random memory access.
Hardware Prefetcher	Allows you to enable or disable hardware prefetcher. By default, the Hardware Prefetcher option is set to Enabled .
DCU Streamer Prefetcher	Allows you to enable or disable DCU streamer prefetcher. By default, the DCU Streamer Prefetcher option is set to Enabled .
DCU IP Prefetcher	Allows you to enable or disable DCU IP prefetcher. By default, the DCU IP Prefetcher option is set to Enabled .
Execute Disable	Allows you enable or disable execute disable memory protection technology. By default, the Execute Disable option is set to Enabled .
Number of Cores per Processor	Allows you to control the number of enabled cores in each processor. By default, the Number of Cores per Processor option is set to All .
Processor 64-bit Support	Specifies if the processor(s) support 64-bit extensions.
Processor Core Speed	Displays the maximum core frequency of the processor.
Processor Bus Speed	Displays the bus speed of the processors.
	 NOTE: The processor bus speed option is displayed only when both the processors are installed.
Processor XFamily-Model-Stepping	Displays the family and model number of each processor. A submenu displays the core speed, the amount of cache memory, and the number of cores of the processor(s).

SATA Settings Screen





Menu Item	Description
Embedded SATA	Allows the embedded SATA to be set to Off, ATA, AHCI, or RAID modes. By default, Embedded SATA is set to AHCI .
Port A	Auto enables BIOS support for the device attached to SATA port A. Off disables BIOS support for the device. By default, Port A is set to Auto .
Port B	Auto enables BIOS support for the device attached to SATA port B. Off disables BIOS support for the device. By default, Port B is set to Auto .

Boot Settings Screen

Menu Item	Description
Boot Mode	<p>Allows you to set the boot mode of the system.</p> <p> CAUTION: Switching the boot mode may prevent the system from booting if the operating system is not installed in the same boot mode.</p> <p>If the operating system supports UEFI, you can set this option to UEFI. Setting this field to BIOS allows compatibility with non-UEFI operating systems. By default, the Boot Mode option is set to BIOS.</p> <p> NOTE: Setting this field to UEFI disables BIOS Boot Settings menu. Setting this field to BIOS disables the UEFI Boot Settings menu.</p>
Boot Sequence Retry	<p>Allows you to enable or disable the boot sequence retry feature. If this field is enabled and the system fails to boot, the system reattempts the boot sequence after 30 seconds. By default, the Boot Sequence Retry option is set to Disabled.</p>
BIOS Boot Settings	<p>Allows you to enable or disable BIOS Boot options.</p> <p> NOTE: This option is enabled only if the boot mode is BIOS.</p>
UEFI Boot Settings	<p>Allows you to enable or disable UEFI Boot options.</p> <p> NOTE: This option is enabled only if the boot mode is UEFI.</p>
One-Time Boot	<p>Allows you to enable or disable a one-time boot from a selected device.</p>

Integrated Devices Screen

Menu Item	Description
Integrated RAID Controller	<p>Allows you to enable or disable the integrated RAID controller. By default, the Integrated RAID Controller option is set to Enabled.</p>
User Accessible USB Ports	<p>Allows you enable or disable the user accessible USB ports. Selecting Only Back Ports On disables the front USB ports and selecting All Ports Off disables both front and back USB ports. By default, the User Accessible USB Ports option is set to All Ports On.</p>
Internal USB Port	<p>Allows you to enable or disable the internal USB port. By default, the Internal USB Port option is set to On.</p>
Internal SD Card Port	<p>Enables or disables the system's internal SD card port. By default, Internal SD Card Port option is set to On.</p> <p> NOTE: This option is displayed only if IDSDM is installed on the system board.</p>
Internal SD Card Redundancy	<p>If set to Mirror mode, data is written on both SD cards. If any one of the SD card fails, data is written to the active SD card. Data from this card is copied to the replacement SD card at the next boot. By default, Internal SD Card Redundancy option is set to Mirror.</p>



Menu Item	Description
	 NOTE: This option is displayed only if IDSDM is installed on the system board.
Integrated Network Card 1	Allows you to enable or disable the integrated network card 1. By default, the Integrated Network Card 1 option is set to Enabled .
OS Watchdog Timer	Allows you to enable or disable the OS watchdog timer. When this field is enabled, the operating system initializes the timer and the OS watchdog timer helps in recovering the operating system. By default, the OS Watchdog Timer option is set to Disabled .
Embedded Video Controller	Allows you to enable or disable the Embedded Video Controller . By default, the embedded video controller is Enabled .
SR-IOV Global Enable	Allows you to enable or disable the BIOS configuration of Single Root I/O Virtualization (SR-IOV) devices. By default, the SR-IOV Global Enable option is set to Disabled .
Mezzanine Slot Disablement	<p>Allows you to enable or disable available PCIe mezzanine card slots on your system. The Slot Disablement feature controls the configuration of PCIe mezzanine cards installed in the specified slot.</p> <p> CAUTION: Slot disablement must be used only when the installed peripheral card is preventing booting into the Operating System or causing delays in system startup. If the slot is disabled, both the Option ROM and UEFI driver are disabled.</p> <p> NOTE: Use this option only for troubleshooting purposes. If one or more of the PCIe mezzanine card slots are disabled, an error message is displayed during system startup. For proper operation, make sure that the server module has two Dell PCIe mezzanine cards installed and both cards are set to Enabled.</p> <p> NOTE: The Boot Driver Disabled option does not apply to the M520 when operating in the PowerEdge VRTX chassis. Selecting this option will have the same result as selecting Enabled.</p>

Serial Communications Screen



Menu Item	Description
Serial Communication	Allows you to enable the COM port or Console Redirection options.
Serial Port Address	<p>Allows you to set the port address for serial devices. By default, the Serial Port Address option is set to COM1.</p> <p> NOTE: Only Serial Device 2 can be used for Serial Over LAN (SOL). To use console redirection by SOL, configure the same port address for console redirection and the serial device.</p>
Failsafe Baud Rate	Displays the failsafe baud rate for console redirection. The BIOS attempts to determine the baud rate automatically. This failsafe baud rate is used only if the attempt fails and the value must not be changed. By default, the Failsafe Baud Rate option is set to 11520 .
Remote Terminal Type	Allows you to set the remote console terminal type. By default, the Remote Terminal Type option is set to VT 100/VT220 .

Menu Item	Description
Redirection After Boot	Allows you to enable or disable to the BIOS console redirection when the operating system is loaded. By default, the Redirection After Boot option is set to Enabled .

System Profile Settings Screen

Menu Item	Description
System Profile	Allows you to set the system profile. If you set the System Profile option to a mode other than Custom , the BIOS automatically sets the rest of the options. You can only change the rest of the options if the mode is set to Custom . By default, the System Profile option is set to Performance Per Watt Optimized (DAPC) . DAPC is Dell Active Power Controller.  NOTE: The following parameters are available only when the System Profile is set to Custom .
CPU Power Management	Allows you to set the CPU power management. By default, the CPU Power Management option is set to System DBPM (DAPC) . DBPM is Demand-Based Power Management.
Memory Frequency	Allows you to set the memory frequency. By default, the Memory Frequency option is set to Maximum Performance .
Turbo Boost	Allows you to enable or disable the processor to operate in turbo boost mode. By default, the Turbo Boost option is set to Enabled .
C1E	Allows you to enable or disable the processor to switch to a minimum performance state when it is idle. By default, the C1E option is set to Enabled .
C States	Allows you to enable or disable the processor to operate in all available power states. By default, the C States option is set to Enabled .
Monitor/Mwait	Allows you to enable Monitor/Mwait instructions in the processor. By default, the Monitor/Mwait option is set to Enabled for all system profiles, except Custom .  NOTE: This option can be disabled only if the C States option in Custom mode is disabled.  NOTE: When C States is enabled in Custom mode, changing the Monitor/Mwait setting does not impact system power/performance.
Memory Patrol Scrub	Allows you to set the memory patrol scrub frequency. By default, the Memory Patrol Scrub option is set to Standard .
Memory Refresh Rate	Allows you to set the memory refresh rate. By default, the Memory Refresh Rate option is set to 1x .
Memory Operating Voltage	Allows you to set the DIMM voltage selection. When set to Auto , the system automatically sets the system voltage to the optimal setting based on the DIMM capacity and the numbers of DIMMs installed. By default, the Memory Operating Voltage option is set to Auto .
Collaborative CPU Performance Control	When set to enabled, the CPU power management is controlled by the OS DBPM and the System DBPM (DAPC). By default, the option is set to Disabled

System Security Screen

Menu Item	Description
Intel AES-NI	The Intel AES-In option improves the speed of applications by performing encryption and decryption using the Advanced Encryption Standard set and is set to Enabled by default.
System Password	Allows you to set the system password. This option is read-only if the password jumper is not installed in the system.
Setup Password	Allows you to set the setup password. This option is read-only if the password jumper is not installed in the system.
Password Status	Allows you to lock the system password. By default, the Password Status option is set to Unlocked .
TPM Security	Allows you to control the reporting mode of the Trusted Platform Module (TPM). By default, the TPM Security option is set to Off . You can only modify the TPM Status, TPM Activation , and Intel TXT fields if the TPM Status field is set to either On with Pre-boot Measurements or On without Pre-boot Measurements .
TPM Activation	Allows you to change the operational state of the TPM. By default, the TPM Activation option is set to No Change .
TPM Status	Displays the TPM status.
TPM Clear	 CAUTION: Clearing the TPM results in loss of all keys in the TPM. The loss of TPM keys may affect booting to the operating system. Allows you to clear all the contents of the TPM. By default, the TPM Clear option is set to No .
Intel TXT	Allows you enable or disable Intel Trusted Execution Technology. To enable Intel TXT, Virtualization Technology must be enabled and TPM Security must be enabled with Pre-boot measurements. By default, the Intel TXT option is set to Off .
BIOS Update Control	Allows you to update the BIOS using either DOS or UEFI shell-based flash utilities. For environments that do not require local BIOS updates, it is recommended to set this field to Limited . By default, the Local BIOS Update Support option is set to Unlocked .  NOTE: BIOS updates using Dell Update Package is not affected by this option.
Power Button	Allows you to enable or disable the power button on the front of the system. By default, the Power Button option is set to Enabled .
AC Power Recovery	Allows you to set how the system reacts after AC power is restored to the system. By default, the AC Power Recovery option is set to Last .

Miscellaneous Settings

Menu Item	Description
System Time	Allows you to set the time on the system.
System Date	Allows you to set the date on the system.

Menu Item	Description
Asset Tag	Displays the asset tag and allows you to modify it for security and tracking purposes.
Keyboard NumLock	Allows you to set whether the system boots with the NumLock enabled or disabled. By default the Keyboard NumLock is set to On .  NOTE: This field does not apply to 84-key keyboards.
Report Keyboard Errors	Allows you to set whether keyboard-related error messages are reported during system boot. By default, the Report Keyboard Errors field is set to Report .
F1/F2 Prompt on Error	Allows you to enable or disable the F1/F2 prompt on error. By default, F1/F2 Prompt on Error is set to Enabled .
In-System Characterization	This field enables or disables In-System Characterization . By default, In-System Characterization is set to Enabled .

System And Setup Password Features

You can create a system password and a setup password to secure your system. To enable creation of the system and setup password, the password jumper must be set to enabled. For more information on the password jumper settings, see System Board Jumper Settings.

System password	This is the password that you must enter to log on to your system.
Setup password	This is the password that you must enter to access and make changes to the BIOS or UEFI settings of your system.

 **CAUTION:** The password features provide a basic level of security for the data on your system.

 **CAUTION:** Anyone can access the data stored on your system if the system is running and unattended.

 **NOTE:** Your system is shipped with the system and setup password feature disabled.

Assigning A System And/Or Setup Password

 **NOTE:** The password jumper enables or disables the System Password and Setup Password features. For more information on the password jumper settings, see System Board Jumper Settings.

You can assign a new **System Password** and/or **Setup Password** or change an existing **System Password** and/or **Setup Password** only when the password jumper setting is enabled and **Password Status** is **Unlocked**. If the Password Status is **Locked**, you cannot change the System Password and/or Setup Password.

If the password jumper setting is disabled, the existing System Password and Setup Password is deleted and you need not provide the system password to log on to the system.

To assign a system and/or setup password:

1. To enter System Setup, press <F2> immediately after a power-on or reboot.
2. In the **System Setup Main Menu**, select **System BIOS** and press <Enter>. The **System BIOS** screen is displayed.
3. In the **System BIOS** screen, select **System Security** and press <Enter>. The **System Security** screen is displayed.

4. In the **System Security** screen, verify that **Password Status** is **Unlocked**.
5. Select **System Password** , enter your system password, and press <Enter> or <Tab>.

Use the following guidelines to assign the system password:

- A password can have up to 32 characters.
- The password can contain the numbers 0 through 9.
- Only lower case letters are valid, upper case letters are not allowed.
- Only the following special characters are allowed: space, ("), (+), (,), (-), (.), (/), (:), (D), (\), (I), (^).

A message prompts you to re-enter the system password.

6. Re-enter the system password that you entered earlier and click **OK**.
7. Select **Setup Password**, enter your system password and press <Enter> or <Tab>.
A message prompts you to re-enter the setup password.
8. Re-enter the setup password that you entered earlier and click **OK**.
9. Press <Esc> to return to the System BIOS screen. Press <Esc> again, and a message prompts you to save the changes.

 **NOTE:** Password protection does not take effect until the system reboots.

Using Your System Password To Secure Your System

 **NOTE:** If you have assigned a setup password , the system accepts your setup password as an alternate system password.

1. Turn on or reboot your system by pressing <Ctrl><Alt><Delete>.
2. Type your password and press <Enter>.

When Password Status is Locked, you must type the password and press <Enter> when prompted at reboot.

If an incorrect system password is entered, the system displays a message and prompts you to re-enter your password. You have three attempts to enter the correct password. After the third unsuccessful attempt, the system displays an error message that the system has halted and will shut down.

Even after you shut down and restart the system, the error message continues to be displayed until the correct password is entered.



 **NOTE:** You can use the Password Status option in conjunction with the System Password and Setup Password options to protect your system from unauthorized changes.

Deleting Or Changing An Existing System And/Or Setup Password

Ensure that the Password jumper is set to enabled and the **Password Status** is **Unlocked** before attempting to delete or change the existing System and/or Setup password. You cannot delete or change an existing System or Setup password if the **Password Status** is **Locked**.

To delete or change the existing System and/or Setup password:

1. To enter System Setup, press <F2> immediately after a power-on or reboot.
2. In the **System Setup Main Menu**, select **System BIOS** and press <Enter>.
The **System BIOS** screen is displayed.
3. In the **System BIOS Screen**, select **System Security** and press <Enter>.
The **System Security** screen is displayed.

4. In the **System Security** screen, verify that **Password Status** is **Unlocked**.
5. Select **System Password**, alter or delete the existing system password and press <Enter> or <Tab>.
6. Select **Setup Password**, alter or delete the existing setup password and press <Enter> or <Tab>.
 **NOTE:** If you change the System and/or Setup password a message prompts you to re-enter the new password. If you delete the System and/or Setup password, a message prompts you to confirm the deletion.
7. Press <Esc> to return to the System BIOS screen. Press <Esc> again, and a message prompts you to save the changes.
 **NOTE:** You can disable password security while logging on to the system. To disable the password security, turn on or reboot your system, type your password and press <Ctrl><Enter>.

Operating With A Setup Password Enabled

If **Setup Password** is **Enabled**, enter the correct setup password before modifying most of the System Setup options.

If you do not enter the correct password in three attempts, the system displays the message

```
Invalid Password! Number of unsuccessful password attempts: <x> System Halted!  
Must power down.
```

Even after you shut down and restart the system, the error message is displayed until the correct password is entered. The following options are exceptions:

- If **System Password** is not **Enabled** and is not locked through the **Password Status** option, you can assign a system password.
- You cannot disable or change an existing system password.

 **NOTE:** You can use the Password Status option in conjunction with the **Setup Password** option to protect the system password from unauthorized changes.

Entering The UEFI Boot Manager

 **NOTE:** Operating systems must be 64-bit UEFI-compatible (for example, Microsoft Windows Server 2008 x64 version) to be installed from the UEFI boot mode. DOS and 32-bit operating systems can only be installed from the BIOS boot mode.

The Boot Manager enables you to:

- Add, delete, and arrange boot options
- Access System Setup and BIOS-level boot options without rebooting

To enter the Boot Manager:

1. Turn on or restart your system.
2. Press <F11> after you see the following message:
<F11> = UEFI Boot Manager

If your operating system begins to load before you press <F11>, allow the system to finish booting, and then restart your system and try again.

Using The Boot Manager Navigation Keys

Key	Description
Up arrow	Moves to the previous field.
Down arrow	Moves to the next field.
<Enter>	Allows you to type in a value in the selected field (if applicable) or follow the link in the field.
Spacebar	Expands or collapses a drop-down list, if applicable.
<Tab>	Moves to the next focus area.
	 NOTE: For the standard graphics browser only.
<Esc>	Moves to the previous page till you view the main screen. Pressing <Esc> in the main screen exits the Boot Manager and proceeds with system boot.
<F1>	Displays the System Setup help file.

 **NOTE:** For most of the options, any changes that you make are recorded but do not take effect until you restart the system.

Boot Manager Screen

Menu Item	Description
Continue Normal Boot	The system attempts to boot to devices starting with the first item in the boot order. If the boot attempt fails, the system continues with the next item in the boot order until the boot is successful or no more boot options are found.
BIOS Boot Menu	Displays the list of available BIOS boot options (marked with asterisks). Select the boot option you wish to use and press <Enter>.
UEFI Boot Menu	Displays the list of available UEFI boot options (marked with asterisks). Select the boot option you wish to use and press <Enter>. The UEFI Boot Menu enables you to Add Boot Option , Delete Boot Option , or Boot From File .
Driver Health Menu	Displays a list of the drivers installed on the system and their health status.
Launch System Setup	Enables you to access the System Setup.
System Utilities	Enables you to access the BIOS Update File Explorer, run the Dell Diagnostics program, and reboot the system.

UEFI Boot Menu

Menu Item	Description
Boot From File	Sets a one-time boot option not included in the boot option list.
Select UEFI Boot Option	Displays the list of available UEFI boot options (marked with asterisks), select the boot option you wish to use and press <Enter>.

Menu Item	Description
Add Boot Option	Adds a new boot option.
Delete Boot Option	Deletes an existing boot option.

Embedded System Management

The Dell Lifecycle Controller provides advanced embedded systems management throughout the server's lifecycle. The Lifecycle Controller can be started during the boot sequence and can function independently of the operating system.

 **NOTE:** Certain platform configurations may not support the full set of features provided by the Lifecycle Controller.

For more information about setting up the Lifecycle Controller, configuring hardware and firmware, and deploying the operating system, see the Lifecycle Controller documentation at dell.com/support/manuals.

iDRAC Settings Utility

The iDRAC Settings utility is an interface to setup and configure the iDRAC parameters using UEFI. You can enable or disable various iDRAC parameters using the iDRAC7 Settings Utility, for example:

 **NOTE:** Some of the features mentioned in the list may require the iDRAC7 Enterprise License upgrade.

- Configure, enable, or disable the iDRAC local area network through the dedicated iDRAC Enterprise card port or the embedded NIC
- Enable or disable IPMI over LAN
- Enable a LAN Platform Event Trap (PET) destination
- Attach or detach the Virtual Media devices

For more information on using iDRAC7, see the iDRAC7 User's Guide, at dell.com/supoort/manuals.

Entering The iDRAC Settings Utility

1. Turn on or restart the managed system.
2. Press <F2> during Power-on Self-test (POST).
3. In the **System Setup Main Menu** page, click **iDRAC Settings**.

The iDRAC Settings page is displayed.

Installing Server Module Components

Recommended Tools

You may need the following items to perform the procedures in this section:

- #1 and #2 Phillips screwdrivers
- T8 and T10 Torx drivers
- Wrist grounding strap

Installing And Removing A Server Module

 **NOTE:** Server modules that are specifically configured for the PowerEdge VRTX enclosure, can be identified by a label marked **PCIe** on the server module.

 **NOTE:** Ensure that you have downloaded the latest BIOS on the server module(s) from dell.com/support.

Removing A Server Module

1. Remove the front bezel.
2. Power down the server module using the operating system commands or the CMC, and ensure that the server module's power is off.

When a server module is powered off, its front-panel power indicator is off.

3. Press the release button on the server module handle.
4. Pull out the server module handle to unlock the server module from the enclosure.

 **CAUTION:** If you are permanently removing the server module, install a server module blank(s). Operating the system for extended periods of time without a server module blank installed can cause the enclosure to overheat.

5. Slide the server module out of the enclosure.

 **CAUTION:** To protect the I/O connector pins, install the I/O connector covers any time a server module is removed from the enclosure.

6. Install the I/O connector cover over the I/O connector.

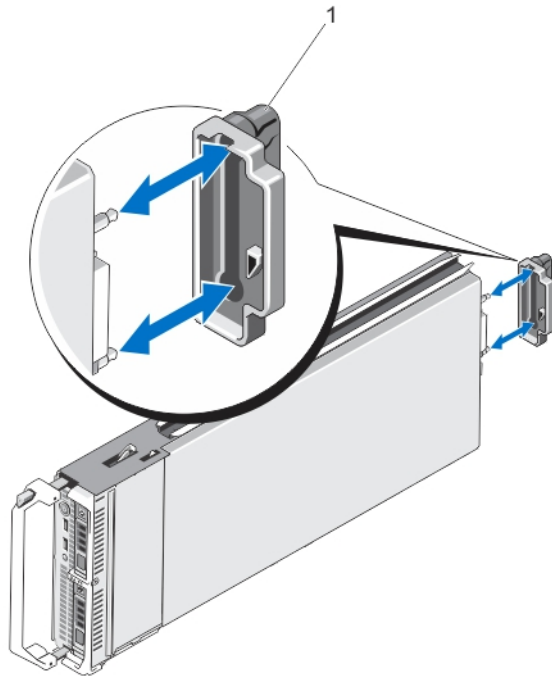

Figure 4. Removing and Installing the I/O Connector Cover

1. I/O connector cover

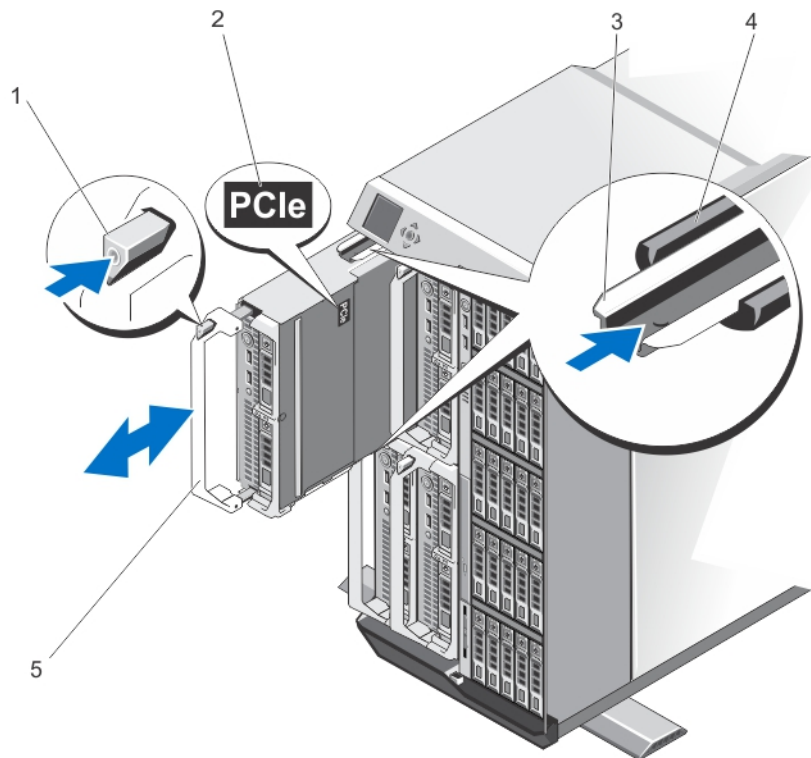



Figure 5. Removing and Installing a Server Module

1. release button
2. **PCIe** label on server module

 **NOTE:** This label indicates that the server module is configured specifically for the VRTX enclosure.

3. guide rail on server module (or server module blank)
4. guide rail on enclosure
5. server module handle

Installing A Server Module

1. If you are installing a new server module, remove the plastic cover from the I/O connector(s) and save for future use.
2. Orient the server module so that the module handle is on the left side of the server module.
3. Slide the server module into the enclosure until the module release handle engages and locks the server module in place.
4. Reinstall the front bezel.

Opening And Closing The Server Module

Opening The Server Module

 **CAUTION:** Many repairs may only be done by a certified service technician. You should only perform troubleshooting and simple repairs as authorized in your product documentation, or as directed by the online or telephone service and support team. Damage due to servicing that is not authorized by Dell is not covered by your warranty. Read and follow the safety instructions that came with the product.

 **NOTE:** It is recommended that you always use a static mat and static strap while working on components in the interior of the system.

1. Remove the server module from the enclosure.
2. Install the I/O connector cover.
3. Press the release button and slide the cover toward the back of the server module.
4. Carefully lift the cover away from the server module.

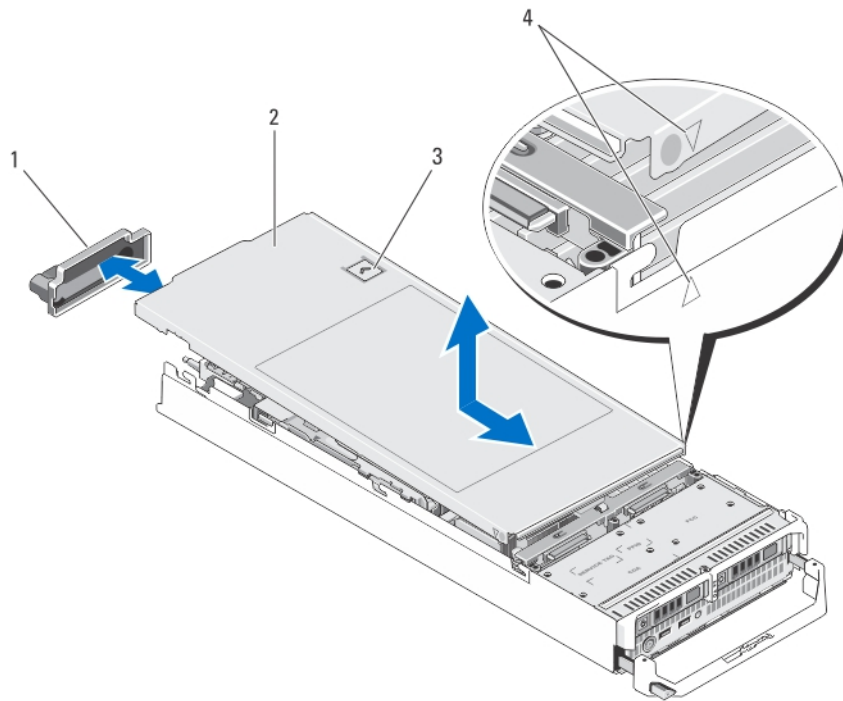

Figure 6. Opening and Closing the server module

1. I/O connector cover
2. server module cover
3. release button
4. cover alignment pins and notches

Closing The Server Module

1. Ensure that no tools or parts are left inside the server module.
2. Align the notches in the edges of the chassis with the cover alignment pins on the inner sides of the cover.
3. Lower the cover onto the chassis.
4. Slide the cover until it clicks into position.
A properly seated cover is flush with the surface of the chassis.

Inside The System

△ CAUTION: Many repairs may only be done by a certified service technician. You should only perform troubleshooting and simple repairs as authorized in your product documentation, or as directed by the online or telephone service and support team. Damage due to servicing that is not authorized by Dell is not covered by your warranty. Read and follow the safety instructions that came with the product.

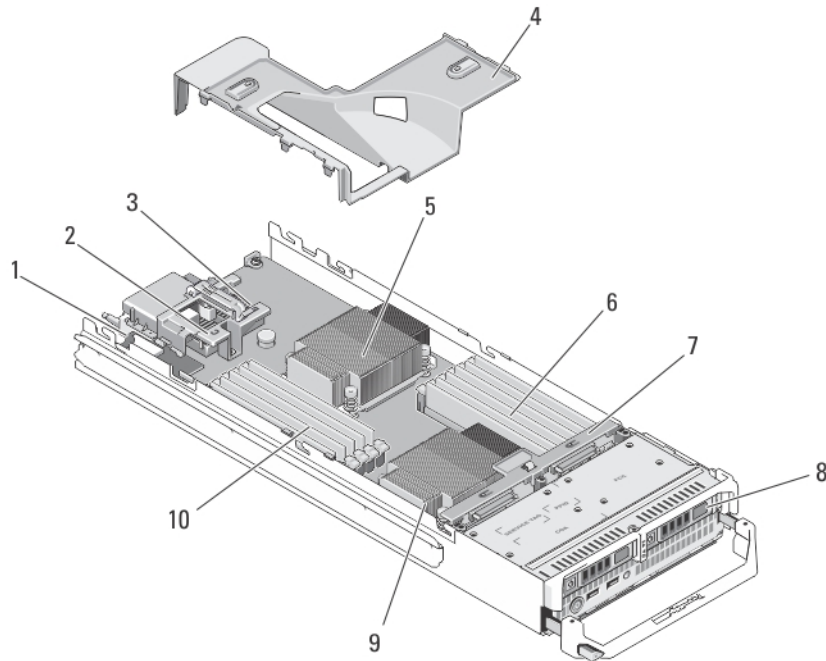

Figure 7. Inside the Server Module

- | | |
|-------------------------------------|------------------------------|
| 1. management riser card | 7. hard-drive/SSD backplane |
| 2. PCIe Mezzanine card 1 - Fabric C | 8. hard drives/SSDs (2) |
| 3. PCIe Mezzanine card 2 - Fabric B | 9. processor 2 and heat sink |
| 4. cooling shroud | 10. memory modules (A1 - A6) |
| 5. processor 1 and heat sink | |
| 6. memory modules (B1 - B6) | |

Cooling Shroud

The cooling shroud covers the memory modules and directs air flow in the system.

Removing The Cooling Shroud

⚠ CAUTION: Many repairs may only be done by a certified service technician. You should only perform troubleshooting and simple repairs as authorized in your product documentation, or as directed by the online or telephone service and support team. Damage due to servicing that is not authorized by Dell is not covered by your warranty. Read and follow the safety instructions that came with the product.

⚠ CAUTION: Never operate your system with the cooling shroud removed. The system may get overheated quickly, resulting in shutdown and loss of data.

1. Remove the server module from the enclosure.
2. Open the server module.
3. Hold the cooling shroud at both ends near the server module chassis and lift it up and away from the server module.

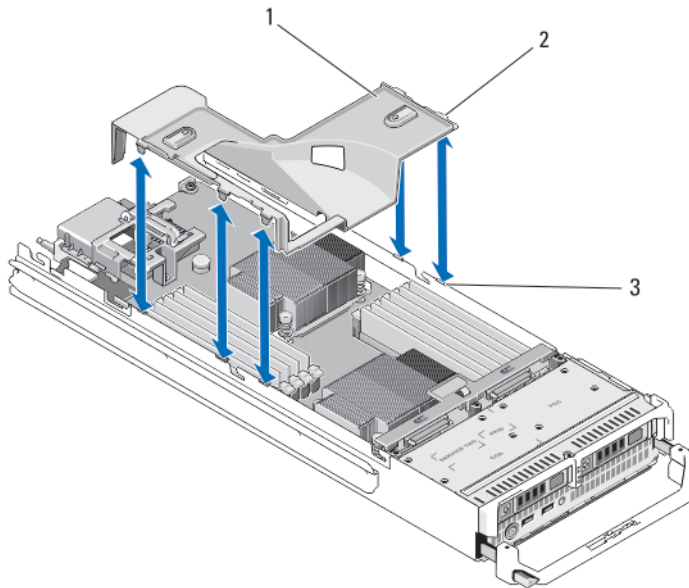

Figure 8. Removing and Installing a Cooling Shroud

1. cooling shroud
2. tabs (5)
3. slots on the chassis (5)

Installing The Cooling Shroud

⚠ CAUTION: Many repairs may only be done by a certified service technician. You should only perform troubleshooting and simple repairs as authorized in your product documentation, or as directed by the online or telephone service and support team. Damage due to servicing that is not authorized by Dell is not covered by your warranty. Read and follow the safety instructions that came with the product.

1. Align the tabs on the cooling shroud with the slots on the chassis.
2. Lower the cooling shroud into the system until the tabs seat securely on the slots on the server module chassis.
3. Close the server module.
4. Install the server module in the enclosure.

System Memory

Your system supports DDR3 unbuffered ECC DIMMs (UDIMM ECC) and registered DIMMs (RDIMMs). It supports DDR3 and DDR3L voltage specifications.

📌 NOTE: MT/s indicates DIMM speed in MegaTransfers per second.

Memory bus operating frequency can be 1600 MT/s, 1333 MT/s, 1066 MT/s, or 800 MT/s depending on:

- DIMM type (UDIMM or RDIMM)
- DIMM configuration (number of ranks)
- maximum frequency of the DIMMs
- number of DIMMs populated per channel

- DIMM operating voltage
- system profile selected (for example, Performance Optimized, Custom, or Dense Configuration Optimized)
- maximum supported DIMM frequency of the processors

The following table shows the memory populations and operating frequencies for the supported configurations.

DIMM Type	DIMMs Populated/ Channel	Operating Frequency (in MT/s)		Maximum DIMM Rank/ Channel
		1.5 V	1.35 V	
UDIMM ECC	1	1333, 1066, and 800	1333, 1066, and 800	Dual rank
	2	1333, 1066, and 800	1333, 1066, and 800	Dual rank
RDIMM	1	1600, 1333, 1066 and 800	1333, 1066 and 800	Dual rank
		1333	1066	Quad rank
	2	1600, 1333, and 1066	1333 and 1066	Dual rank
		1066	1066	Quad rank

The system contains 12 memory sockets split into two sets of six sockets, one set per processor. Each six-socket set is organized into three channels. In each channel, the release levers of the first socket is marked white and the second black.

NOTE: DIMMs in sockets A1 to A6 are assigned to processor 1 and DIMMs in sockets B1 to B6 are assigned to processor 2.

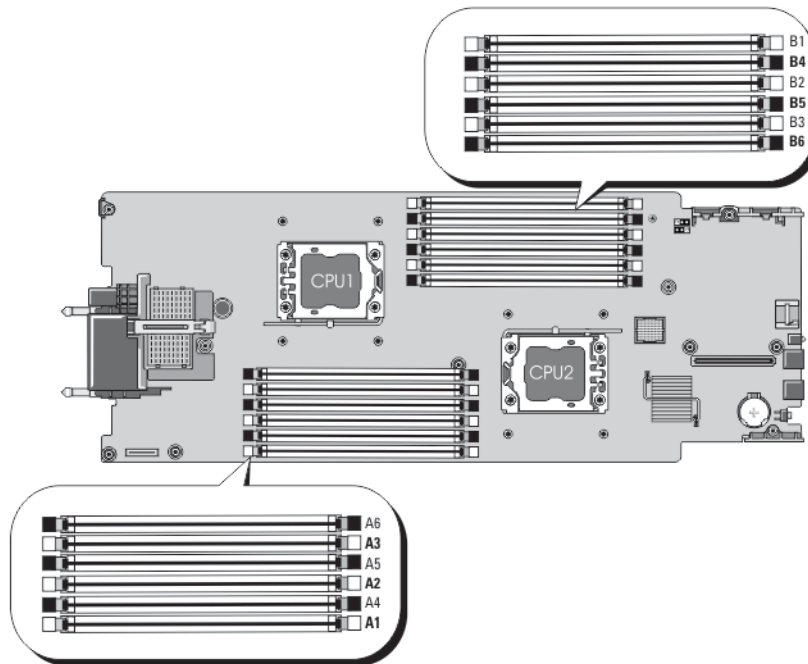

Figure 9. Memory Socket Locations

Memory channels are organized as follows:

Processor 1	channel 1: memory sockets A1 and A4
	channel 2: memory sockets A2 and A5
	channel 3: memory sockets A3 and A6
Processor 2	channel 1: memory sockets B1 and B4
	channel 2: memory sockets B2 and B5
	channel 3: memory sockets B3 and B6

General Memory Module Installation Guidelines

This system supports Flexible Memory Configuration, enabling the system to be configured and run in any valid chipset architectural configuration. The following are the recommended guidelines for best performance:

- UDIMMs and RDIMMs must not be mixed.
- x4 and x8 DRAM based DIMMs can be mixed. For more information, see Mode-Specific Guidelines.
- A maximum of two UDIMMs can be populated in a channel.
- A maximum of two quad-rank RDIMMs can be populated in a channel.
- A maximum of two single- or dual-rank RDIMMs can be populated in a channel.
- One quad-rank RDIMM and one single- or dual-rank RDIMM can be populated per channel.
- Populate DIMM sockets only if a processor is installed. For single-processor systems, sockets A1 to A6 are available. For dual-processor systems, sockets A1 to A6 and sockets B1 to B6 are available.
- Populate all sockets with white release tabs first and then black.
- Populate the sockets by highest rank count in the following order - first in sockets with white release levers and then black. For example, if you want to mix quad-rank and dual-rank DIMMs, populate quad-rank DIMMs in the sockets with white release tabs and dual-rank DIMMs in the sockets with black release tabs.
- In a dual-processor configuration, the memory configuration for each processor must be identical. For example, if you populate socket A1 for processor 1, then populate socket B1 for processor 2, and so on.
- Memory modules of different sizes can be mixed provided that other memory population rules are followed (for example, 2 GB and 4 GB memory modules can be mixed).
- Depending on mode-specific guidelines, populate two or three DIMMs per processor (one DIMM per channel) at a time to maximize performance. For more information, see Mode-Specific Guidelines.
- If memory modules with different speeds are installed, they will operate at the speed of the slowest installed memory module(s) or slower depending on system DIMM configuration.

Mode-Specific Guidelines

Three memory channels are allocated to each processor. The allowable configurations depend on the memory mode selected.

 **NOTE:** x4 and x8 DRAM based DIMMs can be mixed providing support for (Reliability, Availability, and Serviceability) RAS features. However, all guidelines for specific RAS features must be followed. x4 DRAM based DIMMs retain Single Device Data Correction (SDDC) in either memory optimized (independent channel) or Advanced ECC modes. x8 DRAM based DIMMs require Advanced ECC mode to gain SDDC.

The following sections provide additional slot population guidelines for each mode.

Advanced ECC (Lockstep)

Advanced ECC mode extends SDDC from x4 DRAM based DIMMs to both x4 and x8 DRAMs. This protects against single DRAM chip failures during normal operation.

Memory installation guidelines:

- Memory sockets A1, A4, B1, and B4 are disabled and do not supported Advanced ECC mode.
- DIMMs must be installed in matched pairs — DIMMs installed in memory sockets (A2, B2) must match DIMMs installed in memory sockets (A3, B3) and DIMMs installed in memory sockets (A5, B5) must match DIMMs installed in memory sockets (A6, B6).

 **NOTE:** Advanced ECC with mirroring is not supported.

Memory Optimized (Independent Channel) Mode

This mode supports SDDC only for memory modules that use x4 device width and does not impose any specific slot population requirements.

Memory Sparing

 **NOTE:** To use memory sparing, this feature must be enabled in the System Setup.

In this mode, one rank per channel is reserved as a spare. If persistent correctable errors are detected on a rank, the data from this rank is copied to the spare rank and the failed rank is disabled.

With memory sparing enabled, the system memory available to the operating system is reduced by one rank per channel. For example, in a system with three 8 GB dual-rank DIMMs, the available system memory is: $1/2$ (ranks/channel) \times 3 (DIMMs) \times 8 GB = 12 GB, and not 3 (DIMMs) \times 8 GB = 24 GB.

 **NOTE:** Memory sparing does not offer protection against a multi-bit uncorrectable error.

 **NOTE:** Both Advanced ECC/Lockstep and Optimizer modes support Memory Sparing.

Memory Mirroring

Memory Mirroring offers the strongest DIMM reliability mode compared to all other modes, providing improved uncorrectable multi-bit failure protection. In a mirrored configuration, the total available system memory is one half of the total installed physical memory. Half of the installed memory is used to mirror the active DIMMs. In the event of an uncorrectable error, the system will switch over to the mirrored copy. This ensures SDDC and multi-bit protection.

Memory installation guidelines:

 **NOTE:** The first memory channel for each processor (Channel 1) is disabled and not available for Memory Mirroring.

- Memory channels 2 and 3 must be populated.
- Memory modules must be identical in size, speed, and technology.
- DIMMs installed in memory sockets with white release tabs must be identical and similar rule applies for sockets with black release tabs. For example, DIMMs installed in sockets A2 and A3 must be identical.

Sample Memory Configurations

The following tables show sample memory configurations that follow the appropriate memory guidelines stated in this section.

 **NOTE:** 16 GB quad-rank RDIMMs are not supported.

 **NOTE:** 1R, 2R, and 4R in the following tables indicate single-, dual-, and quad-rank DIMMs respectively.

Table 1. Memory Configurations — Single Processor

System Capacity (in GB)	DIMM Size (in GB)	Number of DIMMs	Organization and Speed	DIMM Slot Population
2	2	1	1R x8, 1333 MT/s 1R x8, 1600 MT/s	A1
4	2	2	1R x8, 1333 MT/s 1R x8, 1600 MT/s	A1, A2
10	2	5	1R x8, 1333 MT/s 1R x8, 1600 MT/s	A1, A2, A3, A4, A5
12	4	3	1R x8, 1333 MT/s 1R x8, 1600 MT/s	A1, A2, A3
20	4	5	1R x8, 1333 MT/s 1R x8, 1600 MT/s	A1, A2, A3, A4, A5
24	8	3	2R x4, 1333 MT/s 2R x4, 1600 MT/s	A1, A2, A3
32	8	4	2R x4, 1333 MT/s 2R x4, 1600 MT/s	A1, A2, A3, A4
48	16	3	2R x4, 1333 MT/s 2R x4, 1600 MT/s	A1, A2, A3
96	16	6	2R x4, 1333 MT/s 2R x4, 1600 MT/s	A1, A2, A3, A4, A5, A6
128	32	4	4R x4, 1333 MT/s	A1, A2, A3, A4
192	32	6	4R x4, 1333 MT/s	A1, A2, A3, A4, A5, A6

Table 2. Memory Configurations — Two Processors

System Capacity (in GB)	DIMM Size (in GB)	Number of DIMMs	Organization and Speed	DIMM Slot Population
4	2	2	1R x8, 1333 MT/s 1R x8, 1600 MT/s	A1, B1
8	2	4	1R x8, 1333 MT/s 1R x8, 1600 MT/s	A1, A2, B1, B2
12	2	6	1R x8, 1333 MT/s 1R x8, 1600 MT/s	A1, A2, A3, B1, B2, B3
24	4	6	2R x8, 1333 MT/s 2R x8, 1600 MT/s	A1, A2, A3, B1, B2, B3
48	8	6	2R x4, 1333 MT/s 2R x4, 1600 MT/s	A1, A2, A3, B1, B2, B3
96	16	6	2R x4, 1333 MT/s 2R x4, 1600 MT/s	A1, A2, A3, B1, B2, B3
128	16	8	2R x4, 1333 MT/s 2R x4, 1600 MT/s	A1, A2, A3, A4, B1, B2, B3, B4

System Capacity (in GB)	DIMM Size (in GB)	Number of DIMMs	Organization and Speed	DIMM Slot Population
160	16	10	2R x4, 1333 MT/s 2R x4, 1600 MT/s	A1, A2, A3, A4, A5, B1, B2, B3, B4, B5
192	16	12	2R x4, 1333 MT/s 2R x4, 1600 MT/s	A1, A2, A3, A4, A5, A6, B1, B2, B3, B4, B5, B6
256	32	8	4R x4, 1333 MT/s	A1, A2, A3, A4, B1, B2, B3, B4
384	32	12	4R x4, 1333 MT/s	A1, A2, A3, A4, A5, A6, B1, B2, B3, B4, B5, B6

Removing Memory Modules



WARNING: The DIMMs are hot to touch for some time after the server module has been powered down. Allow time for the DIMMs to cool before handling them. Handle the DIMMs by the card edges and avoid touching the DIMM components.



CAUTION: Many repairs may only be done by a certified service technician. You should only perform troubleshooting and simple repairs as authorized in your product documentation, or as directed by the online or telephone service and support team. Damage due to servicing that is not authorized by Dell is not covered by your warranty. Read and follow the safety instructions that came with the product.



CAUTION: To ensure proper system cooling, memory-module blanks must be installed in any memory socket that is not occupied. Remove memory-module blanks only if you intend to install memory in those sockets.



CAUTION: If you are permanently removing a processor, you must install a socket protective cap and a processor/DIMM blank in the vacant socket to ensure proper system cooling. The processor/DIMM blank covers the vacant sockets for the DIMMs and the processor.

1. Remove the server module from the enclosure.
2. Open the server module.
3. Remove the cooling shroud.
4. Locate the memory module socket(s).



CAUTION: Handle each memory module only on either card edge, making sure not to touch the middle of the memory module.

5. Press down and out on the ejectors on each end of the socket until the memory module pops out of the socket.
6. Install the cooling shroud.
7. Close the server module.
8. Install the server module in the enclosure.

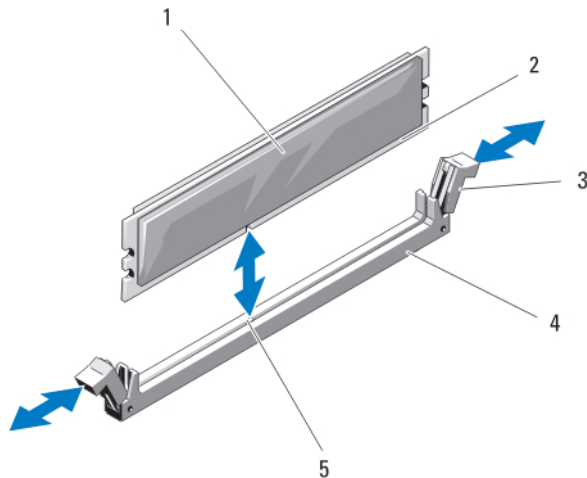

Figure 10. Installing and Removing a Memory Module or Memory Module Blank

- | | |
|----------------------------------|------------------|
| 1. memory module or memory blank | 4. socket |
| 2. edge connector | 5. alignment key |
| 3. ejectors (2) | |

Installing Memory Modules

- ⚠ WARNING:** The memory modules are hot to the touch for some time after the system has been powered down. Allow time for the memory modules to cool before handling them. Handle the memory modules by the card edges and avoid touching the components on the memory module.
- ⚠ CAUTION:** Many repairs may only be done by a certified service technician. You should only perform troubleshooting and simple repairs as authorized in your product documentation, or as directed by the online or telephone service and support team. Damage due to servicing that is not authorized by Dell is not covered by your warranty. Read and follow the safety instructions that came with the product.
- ⚠ CAUTION:** To ensure proper system cooling, memory-module blanks must be installed in any memory socket that is not occupied. Remove memory-module blanks only if you intend to install memory in those sockets.
- ⚠ CAUTION:** If you are permanently removing a processor, you must install a socket protective cap and a processor/DIMM blank in the vacant socket to ensure proper system cooling. The processor/DIMM blank covers the vacant sockets for the DIMMs and the processor.

1. Remove the server module from the enclosure.
2. Open the server module.
3. Remove the cooling shroud.
4. Locate the appropriate memory module socket(s).
5. Press the ejectors on the memory module socket down and out to allow the memory module to be inserted into the socket.

If a memory module blank is installed in the socket, remove it. Retain removed memory-module blank(s) for future use.

- ⚠ CAUTION:** Handle each memory module only on either card edge, making sure not to touch the middle of the memory module.

6. Align the memory module's edge connector with the alignment key on the memory module socket, and insert the memory module in the socket.

 **NOTE:** The memory module socket has an alignment key that allows you to install the memory module in the socket in only one way.

7. Press down on the memory module with your thumbs to lock the memory module into the socket.
When the memory module is properly seated in the socket, the ejectors on the memory module socket align with the ejectors on the other sockets that have memory modules installed.
8. Repeat step 5 through step 7 of this procedure to install the remaining memory modules.
9. Install the cooling shroud.
10. Close the server module.
11. Install the server module in the enclosure.
12. (Optional) Press <F2> to enter the System Setup, and check the **System Memory** setting.
The system should have already changed the value to reflect the newly installed memory.
13. If the value is incorrect, one or more of the memory modules may not be installed properly. Check to ensure that the memory modules are firmly seated in their sockets.
14. Run the system memory test in the system diagnostics.

PCIe Mezzanine Cards

The server module supports Dell PCIe mezzanine cards. x8 PCIe Gen 2 cards are supported. No other mezzanine cards, such as Ethernet, Fibre Channel, or InfiniBand are supported on server modules configured for the VRTX enclosure.

The PCIe mezzanine cards provide an interface between server modules and the PCIe switches in the enclosure.

 **NOTE:** Single PCIe mezzanine card operation is not supported. Two PCIe mezzanine cards are required per server module to support the PCIe expansion cards and PERC card-based shared storage on the enclosure.

 **NOTE:** For proper operation, make sure that both PCIe mezzanine cards are set to **Enabled** in the system setup.

Removing A PCIe Mezzanine Card

 **CAUTION:** Many repairs may only be done by a certified service technician. You should only perform troubleshooting and simple repairs as authorized in your product documentation, or as directed by the online or telephone service and support team. Damage due to servicing that is not authorized by Dell is not covered by your warranty. Read and follow the safety instructions that came with the product.

1. Remove the server module from the enclosure.
2. Open the server module.
3. Open the PCIe mezzanine card latch by pressing the ridged area on the latch with your thumb, and lifting the end of the latch.

 **NOTE:** Hold the PCIe mezzanine card by its edges only.

4. Lift the PCIe mezzanine card up and away from the system board.
5. Close the retention latch.
6. Close the server module.
7. Install the server module in the enclosure.

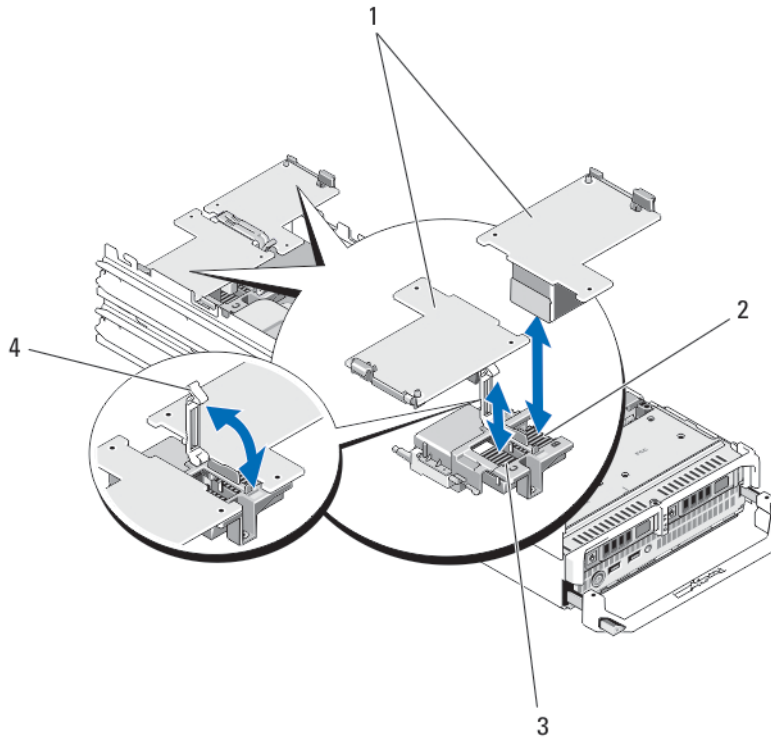

Figure 11. Removing and Installing a PCIe mezzanine Card

1. PCIe mezzanine cards (2)
2. Fabric B PCIe mezzanine card slot
3. Fabric C PCIe mezzanine card slot
4. retention latch

Installing A PCIe Mezzanine Card

⚠ CAUTION: Many repairs may only be done by a certified service technician. You should only perform troubleshooting and simple repairs as authorized in your product documentation, or as directed by the online or telephone service and support team. Damage due to servicing that is not authorized by Dell is not covered by your warranty. Read and follow the safety instructions that came with the product.

1. Remove the server module from the enclosure.
2. Open the server module.
3. Open the retention latch by pressing the ridged area on the latch with your thumb and lifting the end of the latch.
4. If present, remove the connector cover from the PCIe Mezzanine card bay.
 - ✍ NOTE:** Hold the PCIe Mezzanine card by its edges only.
5. PCIe Mezzanine cards are designed to fit in either card slot. Rotate the card to align the connector on the bottom of the PCIe Mezzanine card with the corresponding socket on the system board.
6. Lower the card into place until it is fully seated and the plastic clip on the outer edge of the card fits over the side of the server module chassis.
7. Close the retention latch to secure the PCIe Mezzanine card.

8. Close the server module.
9. Install the server module in the enclosure.

Management Riser Card

The management riser card provides two SD card slots and a USB interface dedicated for the embedded hypervisor. This card offers the following features:

- Internal Dual SD interface — maintains a mirrored configuration using SD cards in both slots and provides redundancy.
- Single card operation — single card operation is supported, but without redundancy.

Replacing The SD Card

 **NOTE:** The SD card in the lower card slot is the primary card (SD1) and the SD card in the upper card slot is the secondary card (SD2).

1. Enter the System Setup and ensure that the **Internal SD Card Port** is enabled.

 **CAUTION:** If the **Internal SD Card Redundancy** option is set to **Mirror Mode** in the **Integrated Devices** screen of the system setup, you must follow the instructions in step 4 through step 6 to avoid loss of data.

 **NOTE:** When an SD card failure occurs, the **Internal SD Card Redundancy** option in the System Setup is set to disabled and the internal dual SD module controller notifies the system. On the next reboot, the system displays a message indicating the failure.

2. Remove the server module from the enclosure.
3. If the **Internal SD Card Redundancy** option is set to **Disabled**, replace the failed SD card with a new SD card.
4. Install the server module in the enclosure.
5. Enter the System Setup and ensure that the **Internal SD Card Port** and **Internal SD Card Redundancy** mode is enabled.
6. Check if the new SD card is functioning properly.
If the problem persists, see [Getting Help](#).

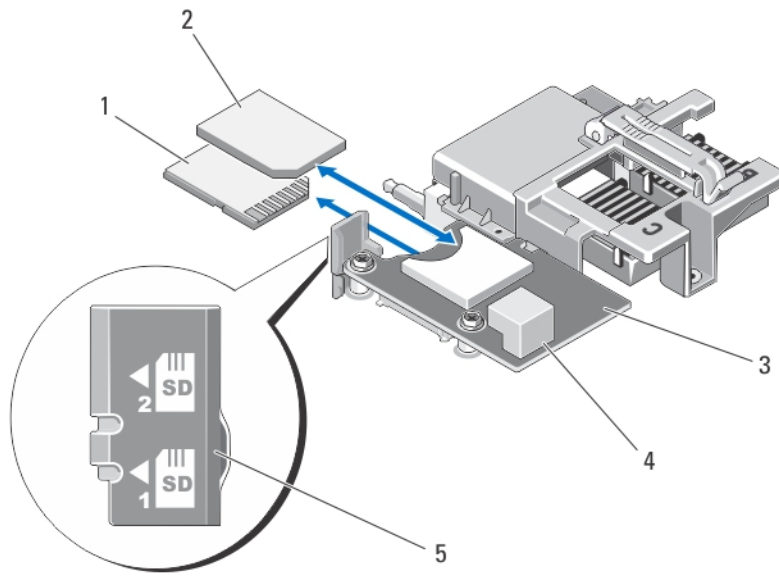

Figure 12. Replacing the SD Card

- | | |
|--------------------------|--------------------------------------|
| 1. SD card 1 | 4. USB connector |
| 2. SD card 2 | 5. SD card slot identification label |
| 3. management riser card | |

Internal USB Key

The server module provides an internal USB connector for a USB flash memory key. The USB memory key can be used as a boot device, security key, or mass storage device. To use the internal USB connector, the **Internal USB Port** option must be enabled in the **Integrated Devices** screen of the System Setup.

To boot from the USB memory key, you must configure the USB memory key with a boot image, and then specify the USB memory key in the boot sequence in the System Setup. For information on creating a bootable file on the USB memory key, see the user documentation that accompanied the USB memory key.

Replacing The Internal USB Key

△ CAUTION: Many repairs may only be done by a certified service technician. You should only perform troubleshooting and simple repairs as authorized in your product documentation, or as directed by the online or telephone service and support team. Damage due to servicing that is not authorized by Dell is not covered by your warranty. Read and follow the safety instructions that came with the product.

△ CAUTION: To avoid interference with other components in the server module, the maximum allowable dimensions of the USB key are 15.9 mm wide x 57.15 mm long x 7.9 mm high.

1. Remove the server module from the enclosure.
2. Open the server module.
3. Locate the USB connector / USB key.
4. If installed, remove the USB key.
5. Insert the new USB memory key into the USB connector.

6. Close the server module.
7. Install the server module in the enclosure.
8. Enter the System Setup and verify that the USB key is detected by the system.

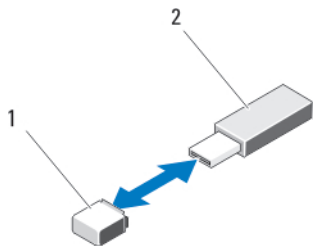



Figure 13. Replacing the USB Memory Key

1. USB memory key connector
2. USB memory key

SD vFlash Card

Replacing The SD vFlash Card

1. Remove the server module from the enclosure.
2. If installed, remove the SD vFlash card from the card slot.
 **NOTE:** The SD vFlash card slot is near the Fabric B PCIe mezzanine card slot at the back corner of the server module.
3. To install the SD vFlash card, insert the contact-pin end of the SD card into the card slot on the VFlash media unit with the card label side facing up.
 **NOTE:** The slot is keyed to ensure correct insertion of the card.
4. Press inward on the card to lock it into the slot.
5. Install the server module in the enclosure.

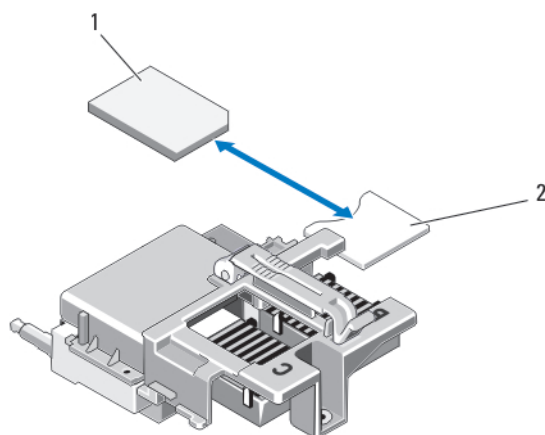

Figure 14. Replacing the SD vFlash Card

1. SD vFlash card
2. SD vFlash card slot

Processors

Use the following procedure when:

- Installing an additional processor
- Replacing a processor

Removing A Processor

 **CAUTION:** Many repairs may only be done by a certified service technician. You should only perform troubleshooting and simple repairs as authorized in your product documentation, or as directed by the online or telephone service and support team. Damage due to servicing that is not authorized by Dell is not covered by your warranty. Read and follow the safety instructions that came with the product.

1. Remove the server module from the enclosure.
2. Open the server module.

 **WARNING:** The processor and heat sink can become extremely hot. Be sure the processor has had sufficient time to cool before handling.

3. If required, remove the cooling shroud.

 **CAUTION:** Never remove the heat sink from a processor unless you intend to remove the processor. The heat sink is necessary to maintain proper thermal conditions.

4. Loosen the retention sockets that secure the heat sink to the server module system board.
5. Remove the heat sink.

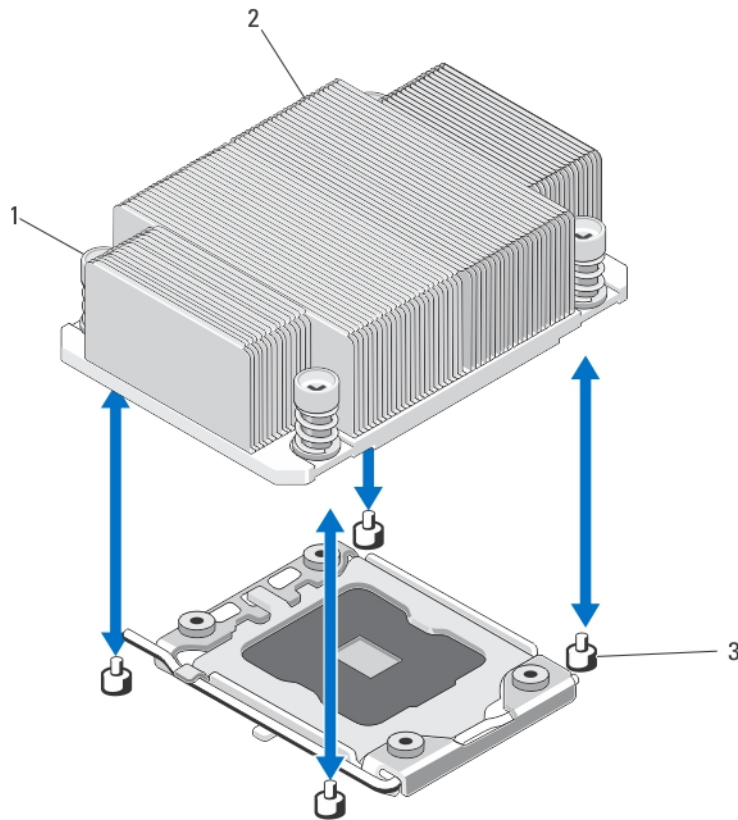

Figure 15. Removing and Installing a Heat Sink

- 1. retention sockets (4)
- 2. heat sink
- 3. retention screws (4)

6. Use a clean, lint-free cloth to remove any thermal grease from the surface of the processor shield.

⚠ CAUTION: The processor is held in its socket under strong pressure. Be aware that the release lever can spring up suddenly if not firmly grasped.

7. Position your thumb firmly over the processor socket-release lever and release the lever from the locked position. Rotate the lever 90 degrees upward until the processor is released from the socket.
8. Hold the tab on the processor shield and rotate it upward and out of the way.
9. If applicable, remove the socket protective cap from the processor shield. To remove the socket protective cap, push the cap from the inside of the processor shield and move it away from the socket pins.

✍ NOTE: It is recommended that you install/remove the socket protective cap from the processor shield with the processor shield in the open position.

⚠ CAUTION: The socket pins are fragile and can be permanently damaged. Be careful not to bend the pins in the socket when removing the processor out of the socket.

10. Lift the processor out of the socket and leave the release lever up so that the socket is ready for the new processor.

CAUTION: If you are permanently removing a processor, you must install a socket protective cap and a processor/DIMM blank in the vacant socket to ensure proper system cooling. The processor/DIMM blank covers the vacant sockets for the DIMMs and the processor.

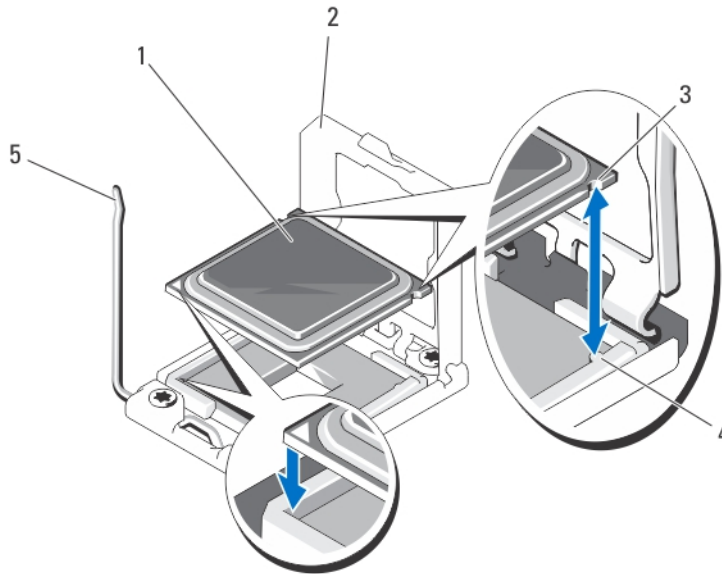

Figure 16. Removing and Installing a Processor

- | | |
|-----------------------------|-------------------------|
| 1. processor | 4. socket keys (2) |
| 2. processor shield | 5. socket-release lever |
| 3. notches in processor (2) | |

Installing A Processor

CAUTION: Many repairs may only be done by a certified service technician. You should only perform troubleshooting and simple repairs as authorized in your product documentation, or as directed by the online or telephone service and support team. Damage due to servicing that is not authorized by Dell is not covered by your warranty. Read and follow the safety instructions that came with the product.

NOTE: If you are installing just one processor, it must be installed in socket CPU1.

1. If applicable, remove the processor/DIMM blank.
2. Unlatch and rotate the socket-release lever 90 degrees upward and ensure that the socket-release lever is fully open.
3. Use the tab on the processor shield to rotate the processor shield upward and out of the way.
4. If applicable, remove the socket protective cap from the processor shield. To remove the socket protective cap, push the cap from the inside of the processor shield and move it away from the socket pins.

NOTE: It is recommended that you install/remove the socket protective cap from the processor shield with the processor shield in the open position.

 **CAUTION: Positioning the processor incorrectly can permanently damage the system board or the processor. Be careful not to bend the pins in the socket.**

 **CAUTION: Do not use force to seat the processor. When the processor is positioned correctly, it engages easily into the socket.**

5. Install the processor in the socket:

- a) Align the processor with the socket keys on the ZIF socket.
- b) Set the processor lightly in the socket.

Because the system uses a ZIF processor socket, do not use force. When the processor is positioned correctly, it drops down into the socket with minimal pressure.

- c) Close the processor shield.
- d) Rotate the socket release lever down until it is locked in position.

 **CAUTION: Applying too much thermal grease can result in excess grease coming in contact with and contaminating the processor socket.**

6. Install the heat sink:

If you are:

Reinstalling a heat sink Use a clean, lint-free cloth to remove the existing thermal grease from the heat sink.

Upgrading a processor If a new heat sink was supplied with the processor, install it.

Reinstalling a processor Clean any remnants of thermal grease from the processor.

- a) Open the grease applicator included with your processor kit and apply all of the thermal grease in the applicator to the center of the topside of the new processor.
- b) Place the heat sink on the processor.
- c) Tighten the four retention sockets to secure the heat sink to the server module system board.

 **NOTE:** Do not over-tighten the heat sink retention screws when installing the heat sink. To prevent over-tightening, tighten the retention screw until resistance is felt, and stop once the screw is seated. The screw tension should be no more than 6 in-lb (6.9 kg-cm).

7. If applicable, install the cooling shroud.

8. Close the server module.

9. Install the server module in the enclosure.

As the system boots, it detects the presence of the new processor and automatically changes the system configuration information in the System Setup.

10. Press <F2> to enter the System Setup and check that the processor information matches the new system configuration.

11. Run the system diagnostics to verify that the new processor operates correctly.

12. Update the system BIOS.

Hard Drives/SSDs

- The system supports up to two 2.5 inch SSD, SAS, or SATA hard drives.
- All drives connect to the server module system board through the SAS/SATA/SSD backplane board.
- Hard drives/SSDs are supplied in special hot-swappable drive carriers that fit in the drive bays.
- SSD/SAS/SATA hard drives cannot be mixed within a server module.

Hard Drive/SSD Installation Guidelines

For a single-drive configuration, a hard-drive blank must be installed in the other drive bay to maintain proper cooling airflow.

Removing A Hard Drive/SSD

 **NOTE:** Not all operating systems support hot-swappable drive installation. See the documentation supplied with your operating system.

1. Take the hard drive/SSD offline and wait until the hard-drive/SSD indicator codes on the drive carrier signal that the drive may be removed safely.

When all indicators are off, the drive is ready for removal.

See your operating system documentation for more information on taking the drive offline.

2. Open the hard-drive/SSD carrier handle to release the drive.
3. Slide the hard drive/SSD out until it is free of the drive bay.
If you are permanently removing the hard drive/SSD, install a blank insert.

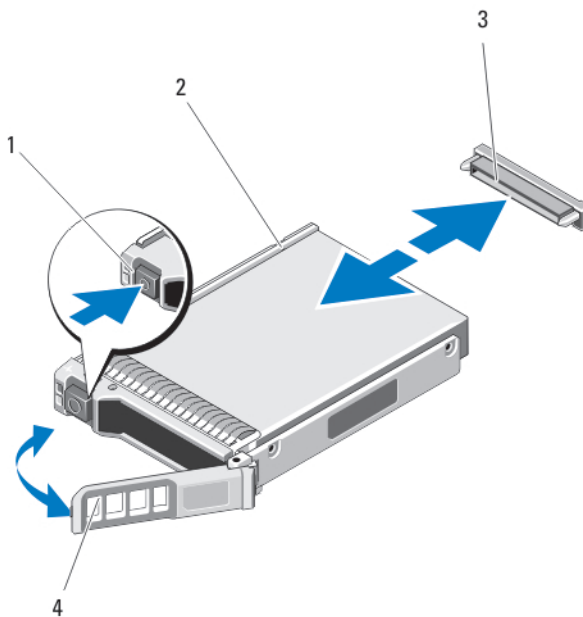



Figure 17. Removing and Installing a Hard Drive/SSD

1. release button
2. hard drive/SSD
3. hard-drive/SSD connector (on backplane)
4. hard-drive/SSD carrier handle

Installing A Hard Drive/SSD

 **CAUTION:** When a replacement hot-swappable hard drive/SSD is installed and the server module is powered on, the drive automatically begins to rebuild. Make absolutely sure that the replacement hard drive/SSD is blank or contains data that you wish to have over-written. Any data on the replacement hard drive/SSD is immediately lost after the drive is installed.

 **NOTE:** Not all operating systems support hot-swappable drive installation. See the documentation supplied with your operating system.

1. Open the hard-drive/SSD carrier handle.
2. Insert the hard-drive/SSD carrier into the drive bay. Carefully align the channel on the hard-drive/SSD carrier with the appropriate drive slot on the server module.
3. Push the drive carrier into the slot until the handle makes contact with the server module.
4. Rotate the carrier handle to the closed position while pushing the carrier into the slot until it locks into place.
The status LED indicator displays a steady green light if the drive is installed correctly. The drive carrier LED green indicator flashes as the drive rebuilds.

Shutdown Procedure For Servicing a Hard Drive/SSD

 **NOTE:** This section applies only to situations where the server module must be powered down to service a hard drive/SSD. In many situations, the hard drive/SSD can be serviced while the server module is powered on.

 **CAUTION:** If you need to power off the server module to service a hard drive/SSD, wait 30 seconds after the server module's power indicator turns off before removing the hard drive/SSD. Otherwise, the hard drive/SSD may not be recognized after it is reinstalled and the server module is powered on again.

Configuring The Boot Drive

The drive or device from which the system boots is determined by the boot order specified in the System Setup.

Removing A Hard Drive/SSD From A Hard-Drive/SSD Carrier

1. Remove the four screws from the slide rails on the hard-drive/SSD carrier.
2. Lift the hard drive/SSD out of the hard-drive/SSD carrier.

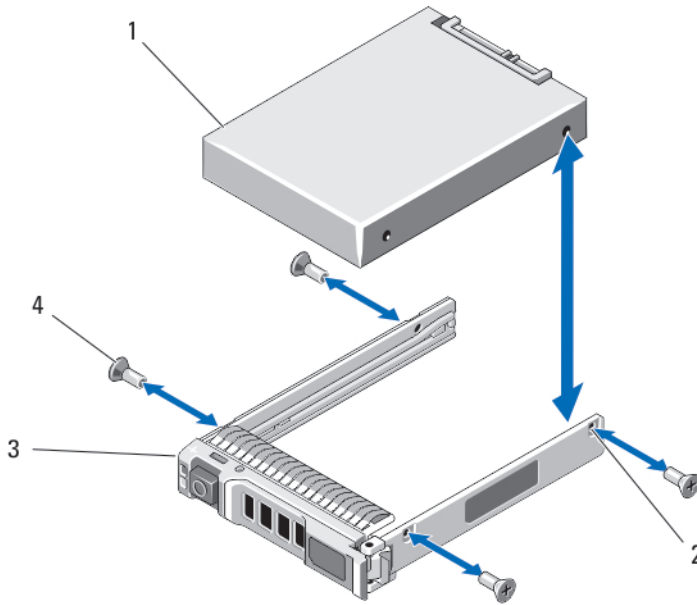

Figure 18. Removing and Installing a Hard Drive/SSD in a Hard-Drive/SSD Carrier

- 1. hard drive/SSD
- 2. screw holes (4)
- 3. hard-drive/SSD carrier
- 4. screws (4)

Installing A Hard Drive/SSD In A Hard-Drive/SSD Carrier

1. Insert the hard drive/SSD into the hard-drive/SSD carrier with the drive's controller board's connector end of the drive at the back of the carrier.
2. From the back of the carrier, slide the drive into the carrier.
3. Align the screw holes on the hard drive/SSD with the holes on the hard-drive/SSD carrier.
 - △ **CAUTION: To avoid damaging the drive or the carrier, do not overtighten the screws.**
4. Attach the four screws to secure the hard drive/SSD to the hard-drive/SSD carrier.

Hard-Drive/SSD Backplane

Removing The Hard-Drive/SSD Backplane

- △ **CAUTION: Many repairs may only be done by a certified service technician. You should only perform troubleshooting and simple repairs as authorized in your product documentation, or as directed by the online or telephone service and support team. Damage due to servicing that is not authorized by Dell is not covered by your warranty. Read and follow the safety instructions that came with the product.**

1. Remove the server module from the enclosure.
2. Open the server module.

CAUTION: You must note the number of each hard drive/SSD and temporarily label them before removal so that you can replace them in the same locations.

CAUTION: To prevent damage to the hard drives/SSDs and the hard-drive/SSD backplane, you must remove the hard drives/SSDs from the server module before removing the hard-drive/SSD backplane.

3. Remove the hard drive(s)/SSD(s).
4. Hold both edges of the hard-drive/SSD backplane near the server module chassis and lift the backplane away from the server module.

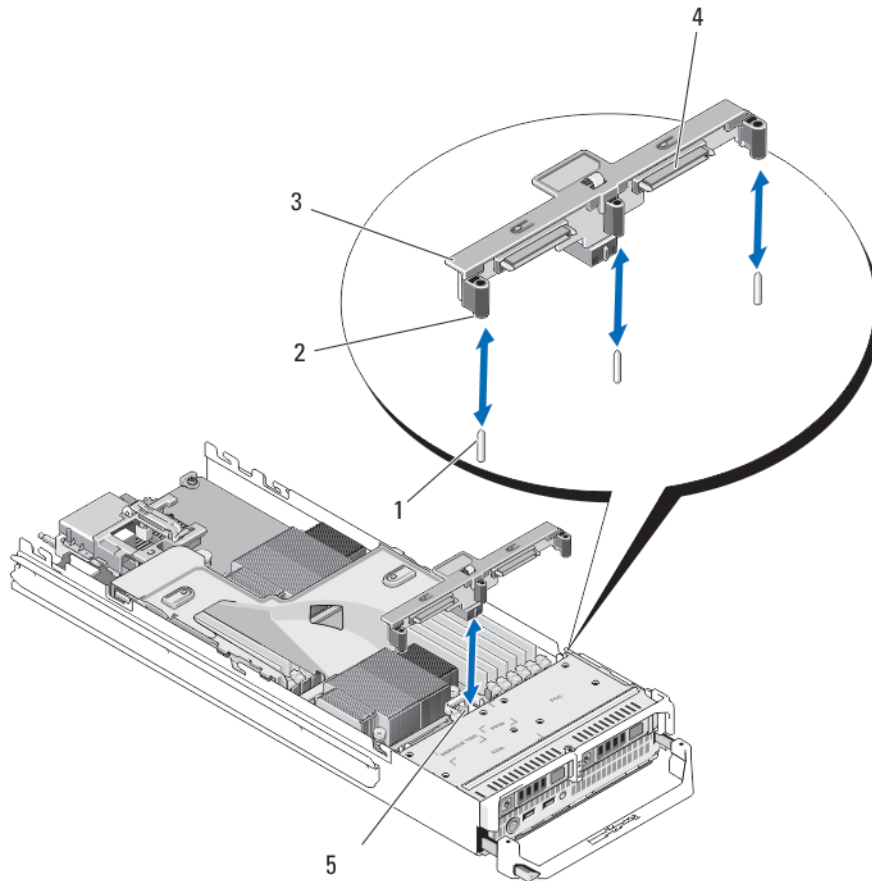

Figure 19. Removing and Installing the Hard-Drive/SSD Backplane

- | | |
|-----------------------------|---------------------------------------|
| 1. guide pins (3) | 4. hard-drive/SSD connectors (2) |
| 2. guides (3) | 5. hard-drive backplane/SSD connector |
| 3. hard-drive/SSD backplane | |

Installing The Hard-Drive/SSD Backplane

1. Open the server module.
2. Align the guides on the hard-drive/SSD backplane with the guide pins on the system board.
3. Press down the backplane until the connectors on the backplane and the system board are fully engaged.
4. Install the hard drives/SSDs in their original locations.

5. Close the server module.
6. Install the server module in the enclosure.

System Board

Removing The System Board

 **CAUTION:** Many repairs may only be done by a certified service technician. You should only perform troubleshooting and simple repairs as authorized in your product documentation, or as directed by the online or telephone service and support team. Damage due to servicing that is not authorized by Dell is not covered by your warranty. Read and follow the safety instructions that came with the product.

1. Remove the server module from the enclosure.
2. Open the server module.
3. Install an I/O connector cover on the I/O connector(s) at the back of the board.

 **WARNING:** The processor and heat sink can become extremely hot. Be sure the processor has had sufficient time to cool before handling.

 **WARNING:** The memory modules are hot to the touch for some time after the system has been powered down. Allow time for the memory modules to cool before handling them. Handle the memory modules by the card edges and avoid touching the components.

 **NOTE:** If you are removing more than one hard drive/SSD, label them so you can replace them in their original locations.

4. Remove the hard drives/SSDs.
5. Remove the hard-drive/SSD backplane.
6. Remove the cooling shroud.
7. If present, remove both PCIe mezzanine cards.

 **CAUTION:** Do not lift the system board assembly by grasping a memory module, processor, or other components.

8. Hold the server module chassis with one hand, lift and pull the system board retention latch with the other hand, and then slide the system board out of the open end of the chassis.
9. Ensure that the I/O connector cover is still in place on the I/O connector at the back of the board.
10. Remove the memory modules and memory module blanks.
11. Remove the processor(s).
12. Remove the storage controller card.

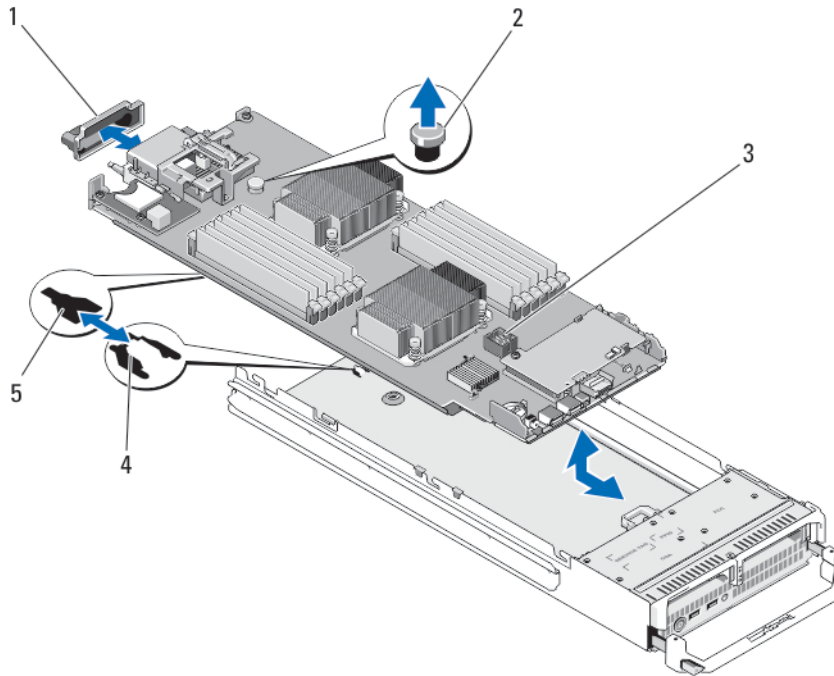

Figure 20. Removing and Installing the System Board

- | | |
|------------------------|-------------------------------|
| 1. I/O connector cover | 4. tabs on system chassis |
| 2. retention latch | 5. slots in system board tray |
| 3. system board | |

Installing The System Board

1. Transfer the following components to the new system board:
 - a. internal USB key
 - b. storage controller card
 - c. SD vFlash card
 - d. memory modules and memory module blanks
 - e. processor(s) and heat sink(s), or processor filler blank

⚠ CAUTION: Ensure that the system board plate is parallel with the chassis.

2. Slide the new system board into the open end of the server module chassis until the retention latch engages. When the board assembly is installed correctly, the tabs on the system board pan snap into the corresponding openings in the floor of the server module chassis.
3. Replace the PCIe mezzanine card(s) in their original locations.
4. Reinstall the hard-drive/SSD backplane.
5. Replace the hard drive(s)/SSD(s).
If there are two drives, ensure that you reinstall them in their original locations.
6. Reinstall the cooling shroud.

7. Close the server module.
8. Remove the plastic I/O connector covers from the back of the server module.
9. Install the server module in the enclosure.
10. Import your new or existing iDRAC Enterprise license. For more information, see the *iDRAC7 User's Guide*, at dell.com/support/manuals.

NVRAM Backup Battery

Replacing The NVRAM Backup Battery

 **WARNING:** There is a danger of a new battery exploding if it is incorrectly installed. Replace the battery only with the same or equivalent type recommended by the manufacturer. Discard used batteries according to the manufacturer's instructions. See the safety instructions that came with your system for additional information.

 **CAUTION:** Many repairs may only be done by a certified service technician. You should only perform troubleshooting and simple repairs as authorized in your product documentation, or as directed by the online or telephone service and support team. Damage due to servicing that is not authorized by Dell is not covered by your warranty. Read and follow the safety instructions that came with the product.

1. Remove the server module from the enclosure.
2. Open the server module.
3. Remove the system board to access the battery.
4. To remove the battery, press down firmly on the positive side of the connector and lift the battery out of the securing tabs at the negative side of the connector.
5. To install a new system battery:
 - a) Support the battery connector by pressing down firmly on the positive side of the connector.
 - b) Hold the battery with the "+" facing up and slide it under the securing tabs at the positive side of the connector.
6. Press the battery straight down into the connector until it snaps into place.
7. Reinstall the system board.
8. Close the server module.
9. Install the server module in the enclosure.
10. Enter the System Setup to confirm that the battery is operating properly.
11. Enter the correct time and date in the System Setup's **Time** and **Date** fields.
12. Exit the System Setup.
13. To test the newly installed battery, remove the server module for at least an hour.
14. After an hour, reinstall the server module.
15. Enter the System Setup and if the time and date are still incorrect, see [Getting Help](#).

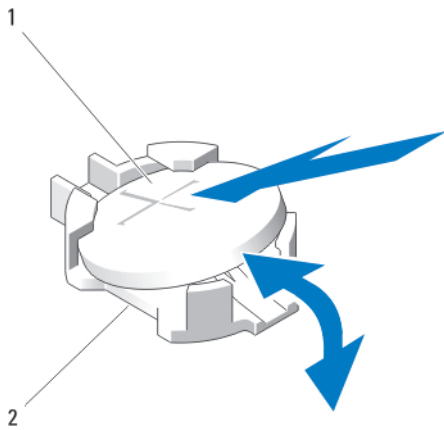



Figure 21. Replacing the NVRAM Backup Battery

1. positive side of battery
2. negative side of battery connector

Storage Controller Card

Your system includes a dedicated expansion-card slot on the server module system board for the storage controller card that provides the integrated storage subsystem for your system's hard drives. The storage controller card supports SAS and SATA hard drives.

 **NOTE:** The storage controller card is located underneath the drive bays.

Removing The Storage Controller Card

 **CAUTION:** Many repairs may only be done by a certified service technician. You should only perform troubleshooting and simple repairs as authorized in your product documentation, or as directed by the online or telephone service and support team. Damage due to servicing that is not authorized by Dell is not covered by your warranty. Read and follow the safety instructions that came with the product.

 **CAUTION:** To ensure proper system cooling, a storage controller blank must be installed on the storage controller card connector that is not occupied. Remove the storage controller blank only if you intend to install a storage controller card.

1. Remove the server module from the enclosure.
2. Open the server module.
3. Remove the server module system board and place it on the work surface.
4. Remove the two screws from the storage controller card.
5. Pull the storage controller card straight up and out of the connector.

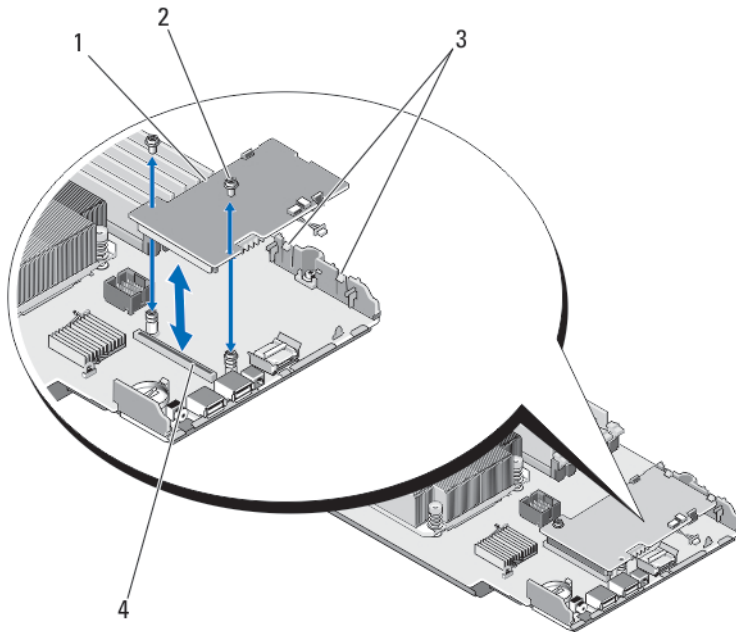

Figure 22. Removing and Installing a Storage Controller Card

1. storage controller card
2. screws (2)
3. tabs (2)
4. connector

Installing The Storage Controller Card

1. If installed, remove the storage controller blank.
2. Holding by its edges, position the storage controller card so that the card-connector aligns with the system board connector.
3. Adjust the other end of the card so that the card edge is secured under the two tabs on the plastic bracket.
4. Insert the controller card-connector firmly into the system board connector until the card is fully seated.
5. Install the two screws to secure the storage controller card to the server module system board.
6. Reinstall the system board.
7. Install the server module in the enclosure.

Troubleshooting Your System

Safety First—For You and Your System

 **CAUTION:** Many repairs may only be done by a certified service technician. You should only perform troubleshooting and simple repairs as authorized in your product documentation, or as directed by the online or telephone service and support team. Damage due to servicing that is not authorized by Dell is not covered by your warranty. Read and follow the safety instructions that came with the product.

 **NOTE:** For troubleshooting information on the Dell PowerEdge VRTX enclosure components, see “Troubleshooting The Enclosure” in the *Dell PowerEdge VRTX Enclosure Owner’s Manual* at dell.com/poweredgemanuals.

Troubleshooting System Memory

 **CAUTION:** Many repairs may only be done by a certified service technician. You should only perform troubleshooting and simple repairs as authorized in your product documentation, or as directed by the online or telephone service and support team. Damage due to servicing that is not authorized by Dell is not covered by your warranty. Read and follow the safety instructions that came with the product.

 **NOTE:** Before performing the following procedure, ensure that you have installed the memory modules according to the memory installation guidelines for the server module.

1. Restart the server module:
 - a) Press the power button once to turn off the server module
 - b) Press the power button again to apply power to the server module.If no error messages appear, go to step 8.
2. Enter the System Setup and check the system memory setting.
If the amount of memory installed matches the system memory setting, go to step 8.
3. Remove the server module from the enclosure.
4. Open the server module.

 **CAUTION:** The memory modules are hot to touch for some time after the server module has been powered down. Allow time for the memory modules to cool before handling them. Handle the memory modules by the card edges and avoid touching the components.

5. Reseat the memory modules in their sockets.
6. Close the server module.
7. Install the server module in the enclosure.
8. Run the appropriate diagnostic test. For more information, see Using System Diagnostics.
If the test fails, see [Getting Help](#).

Troubleshooting Hard Drives

 **CAUTION:** Many repairs may only be done by a certified service technician. You should only perform troubleshooting and simple repairs as authorized in your product documentation, or as directed by the online or telephone service and support team. Damage due to servicing that is not authorized by Dell is not covered by your warranty. Read and follow the safety instructions that came with the product.

 **CAUTION:** This troubleshooting procedure can destroy data stored on the hard drive. Before you proceed, back up all the files on the hard drive, if possible.

1. Run the appropriate controllers test and the hard drive tests in system diagnostics.
If the tests fail, go to step 3.
2. Take the hard drive offline and wait until the hard-drive indicator codes on the drive carrier signal that the drive may be removed safely, then remove and reseal the drive carrier in the server module.
3. Restart the server module, enter the System Setup and confirm that the drive controller is enabled.
4. Ensure that any required device drivers are installed and are configured correctly.
 **NOTE:** Installing a hard drive into another bay may break the mirror if the mirror state is optimal.
5. Remove the hard drive and install it in the other drive bay.
6. If the problem is resolved, reinstall the hard drive in the original bay.
If the hard drive functions properly in the original bay, the drive carrier could have intermittent problems. Replace the drive carrier.
7. If the hard drive is the boot drive, ensure that the drive is configured and connected properly.
8. Partition and logically format the hard drive.
9. If possible, restore the files to the drive.
If the problem persists, see [Getting Help](#).

Troubleshooting USB Devices

 **CAUTION:** Many repairs may only be done by a certified service technician. You should only perform troubleshooting and simple repairs as authorized in your product documentation, or as directed by the online or telephone service and support team. Damage due to servicing that is not authorized by Dell is not covered by your warranty. Read and follow the safety instructions that came with the product.

1. Ensure that the server module is turned on.
2. Check the USB device connection to the server module.
3. Swap the USB device with a known-working USB device.
4. Connect the USB devices to the server module using a powered USB hub.
5. If another server module is installed, connect the USB device to that server module. If the USB device works with a different server module, the first server module may be faulty. See [Getting Help](#).

Troubleshooting An Internal SD Card

 **CAUTION:** Many repairs may only be done by a certified service technician. You should only perform troubleshooting and simple repairs as authorized in your product documentation, or as directed by the online or telephone service and support team. Damage due to servicing that is not authorized by Dell is not covered by your warranty. Read and follow the safety instructions that came with the product.

1. Enter the System Setup and ensure that the **Internal SD Card Port** is enabled.
2. Note the **Internal SD Card Redundancy** option enabled in the **Integrated Devices** screen of the System Setup (Mirror or Disabled).
3. Remove the server module from the enclosure.
4. If the **Internal SD Card Redundancy** option in the **Integrated Devices** screen of the System Setup is set to Mirror mode and SD card 1 has failed:
 - a) Remove the SD card from SD card slot 1.
 - b) Remove the SD card present in SD card slot 2 and insert it into SD card slot 1.
 - c) Install a new SD card in slot 2.
5. If the **Internal SD Card Redundancy** option in the **Integrated Devices** screen of the System Setup is set to Mirror mode and SD card 2 has failed, insert the new SD card into SD card slot 2.
6. If the **Internal SD Card Redundancy** option in **Integrated Devices** screen of the System Setup is set to Disabled, replace the failed SD card with a new SD card.
7. Install the server module in the enclosure.
8. Enter the System Setup and ensure that the **Internal SD Card Port** option is enabled and **Internal SD Card Redundancy** option is set to Mirror mode.
9. Check if the SD card is functioning properly.
If the problem persists, see [Getting Help](#).

Troubleshooting Processors

1. Remove the server module from the enclosure.
2. Open the server module.
3. Ensure that the processor(s) and heat sink(s) are properly installed.
4. If your system only has one processor installed, ensure that it is installed in the primary processor socket (CPU1).
5. Close the server module.
6. Install the server module in the enclosure.
7. Run the appropriate diagnostic test. For more information, see Using System Diagnostics.
If the problem persists, see [Getting Help](#).

Troubleshooting The Server Module System Board

 **CAUTION:** Many repairs may only be done by a certified service technician. You should only perform troubleshooting and simple repairs as authorized in your product documentation, or as directed by the online or telephone service and support team. Damage due to servicing that is not authorized by Dell is not covered by your warranty. Read and follow the safety instructions that came with the product.

1. Remove the server module from the enclosure.
2. Open the server module.
3. Clear the server module NVRAM.

4. If there is a still a problem with the server module, remove and reinstall the server module in the enclosure.
5. Turn on the server module.
6. Run the appropriate diagnostic test. For more information, see Using System Diagnostics.
If the tests fail, see [Getting Help](#).

Troubleshooting The NVRAM Backup Battery

 **CAUTION:** Many repairs may only be done by a certified service technician. You should only perform troubleshooting and simple repairs as authorized in your product documentation, or as directed by the online or telephone service and support team. Damage due to servicing that is not authorized by Dell is not covered by your warranty. Read and follow the safety instructions that came with the product.

The battery maintains the server module configuration, date, and time information in the NVRAM when the server module is turned off. You may need to replace the battery if an incorrect time or date is displayed during the boot routine.

You can operate the server module without a battery; however, the server module configuration information maintained by the battery in NVRAM is erased each time you remove power from the server module. Therefore, you must re-enter the system configuration information and reset the options each time the server module boots until you replace the battery.

1. Re-enter the time and date through the System Setup.
2. Remove the server module from the enclosure for at least one hour.
3. Install the server module in the enclosure.
4. Enter the System Setup.

If the date and time are not correct in the System Setup, replace the battery. If the problem is not resolved by replacing the battery, see [Getting Help](#).

 **NOTE:** If the server module is turned off for long periods of time (for weeks or months), the NVRAM may lose its system configuration information. This situation is caused by a defective battery.

 **NOTE:** Some software may cause the server module's time to speed up or slow down. If the server module operates normally except for the time maintained by the System Setup, the problem may be caused by a software rather than by a defective battery.

Using System Diagnostics

If you experience a problem with your system, run the system diagnostics before contacting Dell for technical assistance. The purpose of running system diagnostics is to test your system hardware without requiring additional equipment or risking data loss. If you are unable to fix the problem yourself, service and support personnel can use the diagnostics results to help you solve the problem.

Dell Online Diagnostics

Dell Online Diagnostics, a stand-alone suite of diagnostic programs or test modules, allows you to run diagnostic tests on the systems in a production environment, and helps you ensure maximum uptime of your systems. Online Diagnostics allows you to run diagnostic tests on chassis and storage components such as hard drives, physical memory, and network interface cards (NICs). You can use the graphical user interface (GUI) or the command line interface (CLI) to run diagnostic tests on the hardware that Online Diagnostics discovers on your system. For information about using diagnostics, see the *Dell Online PowerEdge Diagnostics User's Guide* under **Software** → **Serviceability Tools**, at dell.com/support/manuals.

Dell Embedded System Diagnostics

 **NOTE:** Also known as Enhanced Pre-boot System Assessment (ePSA) diagnostics.

The embedded system diagnostics provides a set of options for particular device groups or devices allowing you to:

- Run tests automatically or in an interactive mode
- Repeat tests
- Display or save test results
- Run thorough tests to introduce additional test options to provide extra information about the failed device(s)
- View status messages that inform you if tests are completed successfully
- View error messages that inform you of problems encountered during testing

When To Use The Embedded System Diagnostics

If a major component or device in the system does not operate properly, running the embedded system diagnostics may indicate component failure.

Running The Embedded System Diagnostics

The embedded system diagnostics program is run from the Dell Lifecycle Controller.

 **CAUTION: Use the embedded system diagnostics to test only your system. Using this program with other systems may cause invalid results or error messages.**

1. As the system boots, press <F11>.
2. Use the up and down arrow keys to select **System Utilities** → **Launch Dell Diagnostics** .
The **ePSA Pre-boot System Assessment** window is displayed, listing all devices detected in the system. The diagnostics starts executing the tests on all the detected devices.

System Diagnostic Controls

Menu	Description
Configuration	Displays the configuration and status information of all detected devices.
Results	Displays the results of all tests that are executed.
System Health	Provides the current overview of the system performance.
Event Log	Displays a time-stamped log of the results of all tests run on the system. This is displayed if at least one event description is recorded.

For information about embedded system diagnostics, see the *Dell Enhanced Pre-boot System Assessment User Guide* at dell.com/support/manuals.





Jumpers And Connectors

System Board Jumper Settings

△ CAUTION: Many repairs may only be done by a certified service technician. You should only perform troubleshooting and simple repairs as authorized in your product documentation, or as directed by the online or telephone service and support team. Damage due to servicing that is not authorized by Dell is not covered by your warranty. Read and follow the safety instructions that came with the product.

For information on resetting the password jumper to disable a password, see [Disabling A Forgotten Password](#).

Table 3. System Board Jumper Settings

Jumper	Setting	Description
PWRD_EN	 (default)	The password feature is enabled.
		The password feature is disabled.
NVRAM_CLR	 (default)	The configuration settings are retained at system boot.
		The configuration settings are cleared at the next system boot. (If the configuration settings become corrupted to the point where the system does not boot, install the jumper and boot the system. Remove the jumper before restoring the configuration information.)

System Board Connectors

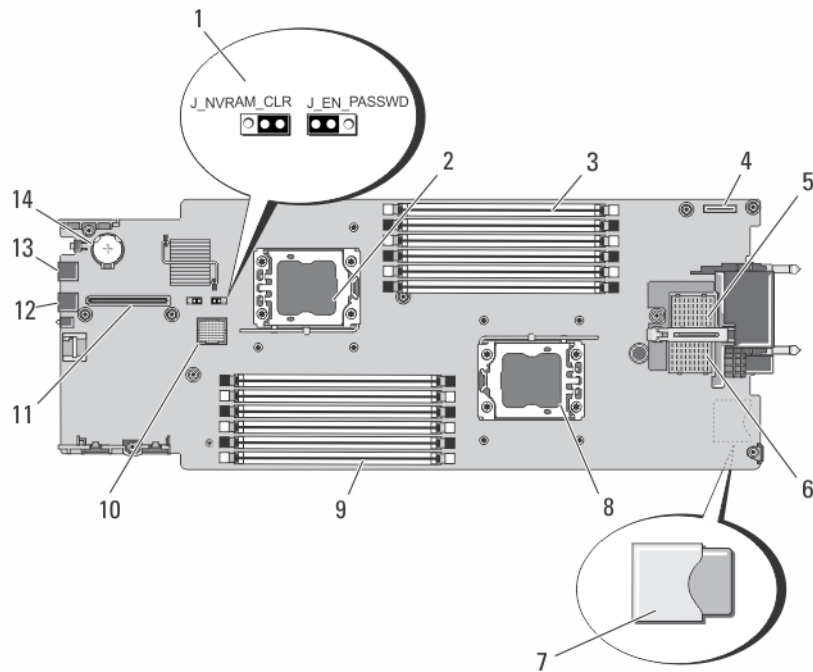



Figure 23. System Board Connectors

Table 4. System Board Connectors

Item	Connector	Description
1	PWRD_EN, NVRAM_CLR	System configuration jumpers
2	CPU2	Processor socket 2
3	A1, A4, A2, A5, A3, A6	Memory module sockets (for processor 1)
4	MANAGEMENT RISER	Management riser card connector
5	MEZZ1_FAB_C	PCIe mezzanine card connector for Fabric C
6	MEZZ2_FAB_B	PCIe mezzanine card connector for Fabric B
7	-	SD vFlash card connector
		 NOTE: The SD vFlash card connector is located underneath the system board.
8	CPU1	Processor socket 1
9	B1, B4, B2, B5, B3, B6	Memory module sockets (for processor 2)
10	HD_BP	Hard-drive backplane connector
11	STORAGE	storage controller card connector
12	USB2	USB connector

Item	Connector	Description
13	USB1	USB connector
14	BATTERY	Connector for the 3.0 V coin cell battery

Disabling A Forgotten Password

The server modules software security features include a system password and a setup password. The password jumper enables these password features or disables them, and clears any password(s) currently in use.

 **CAUTION:** Many repairs may only be done by a certified service technician. You should only perform troubleshooting and simple repairs as authorized in your product documentation, or as directed by the online or telephone service and support team. Damage due to servicing that is not authorized by Dell is not covered by your warranty. Read and follow the safety instructions that came with the product.

1. Remove the server module from the enclosure.
2. Open the server module.
3. Remove the system board to gain access to the jumpers.
4. Relocate the jumper plug to disable the password feature.
5. Reinstall the system board.
6. Close the server module.
7. Install the server module in the enclosure.

When the server module is on, the power-on indicator is solid green. Allow the server module to finish booting.

The existing passwords are not disabled (erased) until the system boots with the password removed. However, before you assign a new system and/or setup password, you must reinstall the password jumper.

 **NOTE:** If you assign a new system and/or setup password with the jumper removed, the system disables the new password(s) the next time it boots.

8. Remove the server module from the enclosure.
9. Open the server module.
10. Remove the system board to gain access to the jumpers.
11. Relocate the jumper plug to enable the password feature.
12. Reinstall the system board.
13. Close the server module.
14. Install the server module in the enclosure.
15. Assign a new system and/or setup password.

Technical Specifications

Processor	
Processor type	One or two Intel Xeon processor E5-2400 product family
Memory	
Architecture	1600 MT/s, 1333 MT/s, or 1066 MT/s DDR3 and LV-DDR3 DIMMs
Memory module sockets	Twelve 240-pin
Memory module capacities	
RDIMMs	2 GB (single-rank), 4 GB (single- and dual-rank), 8 GB (dual-rank), 16 GB (dual-rank), and 32 GB (quad-rank)
UDIMMs	2 GB (single-rank) and 4 GB (dual-rank)
Minimum RAM	2 GB (single processor configuration)
Maximum RAM	384 GB
Drives	
Hard drives	Up to two 2.5-inch, hot-pluggable SSD/SAS/SATA hard drives
Optical drive	External optional USB DVD
	 NOTE: DVD devices are data only.
Flash drive	Internal optional USB Internal optional SD card Optional vFlash card (with integrated iDRAC7 Enterprise)
Connectors	
Front	
USB	Two 4-pin, USB 2.0-compliant
Internal	
SD	Two internal SD cards dedicated for the hypervisor One dedicated for future vFlash support

PCIe mezzanine Cards

PCIe mezzanine card slots Two PCIe x8 Gen 2 slots supporting dual-port PCIe mezzanine cards

Video

Video type Matrox G200 integrated with iDRAC

Video memory 8 MB shared with iDRAC application memory

Battery

NVRAM backup battery CR 2032 3.0 V Lithium coin cell

Environmental

 **NOTE:** For additional information about environmental measurements for specific system configurations, see dell.com/environmental_datasheets.

Storage temperature -40 °C to 65 °C (-40 °F to 149 °F) with a maximum temperature gradation of 20 °C per hour.

Standard operating temperature Continuous operation: 10 °C to 35 °C at 10% to 80% relative humidity (RH), with 26 °C max dew point. De-rate maximum allowable dry bulb temperature at 1 °C per 300 m above 900 m (1 °F per 550 ft).

Expanded operating temperature

 **NOTE:** When operating in the expanded temperature range, system performance may be impacted.

 **NOTE:** When operating in the expanded temperature range, ambient temperature warnings may be reported on the LCD and in the System Event Log.

≤ 10% of annual operating hours 5 °C to 40 °C at 5% to 85% RH with 26 °C dew point.

 **NOTE:** Outside the standard operating temperature (10 °C to 35 °C), the system can operate down to 5 °C or up to 40 °C for a maximum of 10% of its annual operating hours.

For temperatures between 35 °C and 40 °C, de-rate maximum allowable dry bulb temperature by 1 °C per 175 m above 950 m (1 °F per 319 ft).

≤ 1% of annual operating hours -5 °C to 45 °C at 5% to 90% RH with 26 °C dew point.

 **NOTE:** Outside the standard operating temperature (10 °C to 35 °C), the system can operate down to -5 °C or up to 45 °C for a maximum of 1% of its annual operating hours.

Environmental

For temperatures between 40 °C and 45 °C, de-rate maximum allowable dry bulb temperature by 1 °C per 125 m above 950 m (1 °F per 228 ft).

System Messages

LCD Status Messages

The LCD messages consist of brief text messages that refer to events recorded in the System Event Log (SEL). For information on the SEL and configuring system management settings, see the systems management software documentation.

Viewing LCD Messages

If a system error occurs, the LCD screen will turn amber. Press the **Select** button to view the list of errors or status messages. Use the left and right buttons to highlight an error number, and press **Select** to view the error.

Removing LCD Messages

For faults associated with sensors, such as temperature, voltage, fans, and so on, the LCD message is automatically removed when that sensor returns to a normal state. For other faults, you must take action to remove the message from the display:

- Clear the SEL — You can perform this task remotely, but you will lose the event history for the system.
- Power cycle — Turn off the system and disconnect it from the electrical outlet; wait approximately 10 seconds, reconnect the power cable, and restart the system.

System Error Messages

System messages appear on the monitor to notify you of a possible problem with the system. These messages refer to events recorded in the System Event Log (SEL). For information on the SEL and configuring system management settings, see the systems management software documentation.

Some messages are also displayed in abbreviated form on the system's LCD, if the system includes that feature.

 **NOTE:** The LCD error messages listed here are displayed in the simple format. See Setup Menu to select the format in which the messages are displayed.

 **NOTE:** If you receive a system message not listed here, check the documentation for the application that was running when the message was displayed or the operating system's documentation for an explanation of the message and recommended action.

 **NOTE:** In some messages, a particular system component is identified by name ("*<name>*"), component number ("*<number>*"), or location ("*bay*").

Error Code	Message Information	
AMP0300	Message	The system board <i><name></i> current is less than the lower warning threshold.

Error Code	Message Information	
	Details	System board <name> current is outside of the optimum range.
	Action	<ol style="list-style-type: none"> 1. Review system power policy. 2. Check system logs for power related failures. 3. Review system configuration changes. 4. If the issue persists, see Getting Help.
AMP0301	Message	The system board <name> current is less than the lower warning threshold.
	LCD Message	System board <name> current is outside of range.
	Details	System board <name> current is outside of the optimum range.
	Action	<ol style="list-style-type: none"> 1. Review system power policy. 2. Check system logs for power related failures. 3. Review system configuration changes. 4. If the issue persists, see Getting Help.
AMP0302	Message	The system board <name> current is greater than the upper warning threshold.
	Details	System board <name> current is outside of the optimum range.
	Action	<ol style="list-style-type: none"> 1. Review system power policy. 2. Check system logs for power related failures. 3. Review system configuration changes. 4. If the issue persists, see Getting Help.
AMP0303	Message	The system board <name> current is greater than the upper critical threshold.
	LCD Message	System board <name> current is outside of range.
	Details	System board <name> current is outside of the optimum range.
	Action	<ol style="list-style-type: none"> 1. Review system power policy. 2. Check system logs for power related failures. 3. Review system configuration changes. 4. If the issue persists, see Getting Help.
AMP0304	Message	The system board <name> current is outside of range.

Error Code	Message Information	
	LCD Message	System board <name> current is outside of range.
	Details	System board <name> current is outside of the optimum range.
	Action	<ol style="list-style-type: none"> 1. Review system power policy. 2. Check system logs for power related failures. 3. Review system configuration changes. 4. If the issue persists, see Getting Help.
AMP0306	Message	Disk drive bay <name> current is less than the lower warning threshold.
	Details	Disk drive bay <name> current is outside of the optimum range.
	Action	<ol style="list-style-type: none"> 1. Review system power policy. 2. Check system logs for power related failures. 3. Review system configuration changes. 4. If the issue persists, see Getting Help.
AMP0307	Message	Disk drive bay <name> current is less than the lower critical threshold.
	LCD Message	Disk drive bay <name> current is outside of range.
	Details	Disk drive bay <name> current is outside of the optimum range.
	Action	<ol style="list-style-type: none"> 1. Review system power policy. 2. Check system logs for power related failures. 3. Review system configuration changes. 4. If the issue persists, see Getting Help.
AMP0308	Message	Disk drive bay <name> current is greater than the upper warning threshold.
	Details	Disk drive bay <name> current is outside of the optimum range.
	Action	<ol style="list-style-type: none"> 1. Review system power policy. 2. Check system logs for power related failures. 3. Review system configuration changes. 4. If the issue persists, see Getting Help.

Error Code	Message Information	
AMP0309	Message	Disk drive bay <name> current is greater than the upper critical threshold.
	LCD Message	Disk drive bay <name> current is outside of range.
	Details	Disk drive bay <name> current is outside of the optimum range.
	Action	<ol style="list-style-type: none"> 1. Review system power policy. 2. Check system logs for power related failures. 3. Review system configuration changes. 4. If the issue persists, see Getting Help.
AMP0310	Message	Disk drive bay <name> current is outside of range.
	LCD Message	Disk drive bay <name> current is outside of range.
	Details	Disk drive bay <name> current is outside of the optimum range.
	Action	<ol style="list-style-type: none"> 1. Review system power policy. 2. Check system logs for power related failures. 3. Review system configuration changes. 4. If the issue persists, see Getting Help.
AMP0312	Message	System level current is less than the lower warning threshold.
	Details	System level current is outside of the optimum range.
	Action	<ol style="list-style-type: none"> 1. Review system power policy. 2. Check system logs for power related failures. 3. Review system configuration changes. 4. If the issue persists, see Getting Help.
AMP0313	Message	System level current is less than the lower warning threshold.
	LCD Message	System level current is outside of range.
	Details	System level current is outside of the optimum range.
	Action	<ol style="list-style-type: none"> 1. Review system power policy. 2. Check system logs for power related failures. 3. Review system configuration changes. 4. If the issue persists, see Getting Help.

Error Code	Message Information	
AMP0314	Message	System level current is greater than the upper warning threshold.
	Details	System level current is outside of the optimum range.
	Action	<ol style="list-style-type: none"> 1. Review system power policy. 2. Check system logs for power related failures. 3. Review system configuration changes. 4. If the issue persists, see Getting Help.
AMP0315	Message	System level current is greater than the upper critical threshold.
	LCD Message	System level current is outside of range.
	Details	System level current is outside of the optimum range.
	Action	<ol style="list-style-type: none"> 1. Review system power policy. 2. Check system logs for power related failures. 3. Review system configuration changes. 4. If the issue persists, see Getting Help.
AMP0316	Message	System level current is outside of range.
	LCD Message	System level current is outside of range.
	Details	System level current is outside of the optimum range.
	Action	<ol style="list-style-type: none"> 1. Review system power policy. 2. Check system logs for power related failures. 3. Review system configuration changes. 4. If the issue persists, see Getting Help.
AMP0318	Message	Chassis power level current is less than the lower warning threshold.
	Details	Chassis power level current is outside of the optimum range.
	Action	<ol style="list-style-type: none"> 1. Review system power policy. 2. Check system logs for power related failures. 3. Review system configuration changes. 4. If the issue persists, see Getting Help.
AMP0319	Message	Chassis power level current is less than the lower critical threshold
	Details	Chassis power level current is outside of the optimum range.

Error Code	Message Information	
AMP0320	Action	<ol style="list-style-type: none"> 1. Review system power policy. 2. Check system logs for power related failures. 3. Review system configuration changes. 4. If the issue persists, see Getting Help.
	Message	Chassis power level current is greater than the upper warning threshold.
	Details	Chassis power level current is outside of the optimum range.
AMP0321	Action	<ol style="list-style-type: none"> 1. Review system power policy. 2. Check system logs for power related failures. 3. Review system configuration changes. 4. If the issue persists, see Getting Help.
	Message	Chassis power level current is greater than the upper critical threshold.
	Details	Chassis power level current is outside of the optimum range.
AMP0322	Action	<ol style="list-style-type: none"> 1. Review system power policy. 2. Check system logs for power related failures. 3. Review system configuration changes. 4. If the issue persists, see Getting Help.
	Message	Chassis power level current is outside of range.
	Details	Chassis power level current is outside of the optimum range.
ASR0000	Action	<ol style="list-style-type: none"> 1. Review system power policy. 2. Check system logs for power related failures. 3. Review system configuration changes. 4. If the issue persists, see Getting Help.
	Message	The watchdog timer expired.
	Details	The operating system or an application failed to communicate within the time-out period.
ASR0000	Action	Check the operating system, application, hardware, and system event log for exception events.

Error Code	Message Information	
ASR0001	Message	The watchdog timer reset the system.
	Details	The operating system or an application failed to communicate within the time-out period. The system was reset.
	Action	Check the operating system, application, hardware, and system event log for exception events.
ASR0002	Message	The watchdog timer powered off the system.
	Details	The operating system or an application failed to communicate within the time-out period. The system was shut down.
	Action	Check the operating system, application, hardware, and system event log for exception events.
ASR0003	Message	The watchdog timer power cycled the system.
	Details	The operating system or an application failed to communicate within the time-out period. The system was power-cycled.
	Action	Check the operating system, application, hardware, and system event log for exception events.
ASR0008	Message	The watchdog timer interrupt was initiated.
	Details	The operating system or an application failed to communicate within the time-out period. No action was taken.
	Action	Check the operating system, application, hardware, and system event log for exception events.
ASR0100	Message	The BIOS watchdog timer reset the system.
	Details	The operating system or an application failed to communicate within the time-out period. The system was reset.
	Action	Check the operating system, application, hardware, and system event log for exception events.
ASR0101	Message	The OS watchdog timer reset the system.
	Details	The operating system or an application failed to communicate within the time-out period. The system was reset.
	Action	Check the operating system, application, hardware, and system event log for exception events.
ASR0102	Message	The OS watchdog timer shutdown the system.

Error Code	Message Information	
	Details	The operating system or an application failed to communicate within the time-out period. The system was shutdown.
	Action	Check the operating system, application, hardware, and system event log for exception events.
ASR0103	Message	The OS watchdog timer powered down the system.
	Details	The operating system or an application failed to communicate within the time-out period. The system was powered down.
	Action	Check the operating system, application, hardware, and system event log for exception events.
ASR0104	Message	The OS watchdog timer power-cycled the system.
	Details	The operating system or an application failed to communicate within the time-out period. The system was power-cycled.
	Action	Check the operating system, application, hardware, and system event log for exception events.
ASR0105	Message	The operating system watchdog timer powered off the system.
	Details	The operating system or an application failed to communicate within the time-out period. The system was powered off.
	Action	Check the operating system, application, hardware, and system event log for exception events.
ASR0106	Message	The watchdog timer expired.
	Details	The operating system or an application failed to communicate within the time-out period.
	Action	Check the operating system, application, hardware, and system event log for exception events.
ASR0107	Message	The watchdog timer pre-timeout interrupt was initiated.
	Details	The operating system or an application failed to communicate within the time-out period.
	Action	Check the operating system, application, hardware, and system event log for exception events.
BAT0000	Message	The system board battery is low.

Error Code	Message Information	
	Details	The system board battery is either missing, bad, or unable to charge due to thermal issues.
	Action	Check system fans. Replace the system board battery.
BAT0002	Message	The system board battery has failed.
	LCD Message	The system board battery has failed. Check battery.
	Details	The system board battery is either missing or bad.
	Action	See Getting Help .
BAT0004	Message	The system board battery is absent.
	LCD Message	The system board battery is absent. Check battery.
	Action	Reinstall the system board battery.
BAT0005	Message	The storage battery is low.
	Details	System has to remain powered on to charge the battery.
	Action	Allow the battery to charge. If the issue persists, see Getting Help .
BAT0007	Message	The storage battery has failed.
	LCD Message	The storage battery has failed. Check battery.
	Details	Verify the cable connection between the storage battery and the controller.
	Action	Verify the storage battery installation.
BAT0010	Message	The storage battery for disk drive bay <bay> is low.
	Details	System has to remain powered on to charge the storage battery.
	Action	Allow the storage battery to charge. If the issue persists, see Getting Help .
BAT0012	Message	The storage battery for disk drive bay <bay> has failed.
	LCD Message	Battery for disk drive bay <bay> has failed. Check battery.
	Details	Verify the cable connection between the storage battery and the controller.
	Action	Verify the storage battery installation.
BAT0014	Message	The storage battery for disk drive bay <bay> is absent.

Error Code	Message Information	
	LCD Message	Battery for disk drive bay <bay> is absent. Check battery.
	Details	Verify the cable connection between the storage battery and the controller.
	Action	Verify the storage battery installation.
BAT0015	Message	The <name> battery is low.
	Details	The low <name> battery may impact system performance negatively.
	Action	Recharge the <name> battery if possible. If the problem continues replace the <name> battery.
BAT0017	Message	The <name> battery has failed.
	LCD Message	The <name> battery has failed. Check battery.
	Details	The <name> battery is either missing, bad, or unable to charge due to thermal issues.
	Action	Check system fans. Replace the <name> battery.
BAT0019	Message	The <name> battery is absent.
	LCD Message	The <name> battery is absent. Check battery.
	Details	The failed or missing <name> battery may reduce system performance.
	Action	Check system fans. Replace the <name> battery.
CBL0006	Message	Multiple storage controllers are incorrectly connected to the same backplane <Bay ID>.
	Details	Unsupported backplane configuration.
	Action	Check backplane configuration. Reconnect cable. If the issue persists, see Getting Help .
CPU0000	Message	CPU <number> has an internal error (IERR).
	LCD Message	CPU <number> has an internal error (IERR).
	Details	System event log and OS logs may indicate that the exception is external to the processor.
	Action	Review System Event Log and Operating System Logs. If the issue persists, see Getting Help .
CPU0001	Message	CPU <number> has a thermal trip (over-temperature) event.

Error Code	Message Information	
	LCD Message	CPU <number> has a thermal trip. Check CPU heat sink.
	Details	The processor temperature increased beyond the operational range.
	Action	Review logs for fan failures, replace failed fans. If no fan failures are detected, check inlet temperature (if available) and reinstall processor heat-sink.
CPU0002	Message	CPU <number> has failed the built-in self-test (BIST).
	Action	<ol style="list-style-type: none"> 1. Turn system off and remove input power for one minute. Reapply input power and turn system on. 2. Make sure the processor is seated correctly. 3. If the issue persists, see Getting Help.
CPU0003	Message	CPU <number> is stuck in POST.
	Action	<ol style="list-style-type: none"> 1. Turn system off and remove input power for one minute. Reapply input power and turn system on. 2. Reduce system configuration to minimum memory and remove all PCI devices. If system completes POST, update system BIOS. reinstall memory and PCI one component at a time to meet the original configuration. 3. If the issue persists, see Getting Help.
CPU0004	Message	CPU <number> failed to initialize.
	Action	<ol style="list-style-type: none"> 1. Turn system off and remove input power for one minute. Reapply input power and turn system on. 2. Make sure the processor is seated correctly. 3. If the issue persists, see Getting Help.
CPU0005	Message	CPU <number> configuration is unsupported.
	LCD Message	CPU <number> configuration is unsupported. Check CPU or BIOS revision.
	Details	System is unable to boot or may run in a degraded state.
	Action	Review the technical specifications for supported processor types.
CPU0006	Message	Unrecoverable CPU complex error detected on CPU <number>.
	Details	System is unable to boot or may run in a degraded state.

Error Code	Message Information	
	Action	<ol style="list-style-type: none"> 1. Turn system off and remove input power for one minute. Reapply input power and turn system on. 2. Make sure the processor is seated correctly. 3. If the issue persists, see Getting Help.
CPU0008	Message	CPU <number> is disabled.
	Details	System is unable to boot or may run in a degraded state.
	Action	If unexpected, check presence, and system setup (BIOS) configuration.
CPU0010	Message	CPU <number> is throttled.
	Details	The CPU is throttled due to thermal or power conditions.
	Action	Review system logs for power or thermal exceptions.
CPU0023	Message	CPU <number> is absent.
	LCD Message	CPU <number> is absent. Check CPU.
	Action	Verify processor installation. If present, re-seat the processor.
CPU0100	Message	CPU <number> temperature is less than the lower warning threshold.
	Details	System performance may be degraded.
	Action	Check system operating environment.
CPU0101	Message	CPU <number> temperature is less than the lower critical threshold.
	LCD Message	CPU <number> temperature is outside of range.
	Details	System performance may be degraded.
	Action	Check system operating environment, fans, and heat-sinks.
CPU0102	Message	CPU <number> temperature is greater than the upper warning threshold.
	Details	System performance may be degraded.
	Action	Check system operating environment, fans, and heat-sinks.
CPU0103	Message	CPU <number> temperature is greater than the upper critical threshold.

Error Code	Message Information	
	LCD Message	CPU <number> temperature is outside of range. Check fans.
	Details	System performance may be degraded.
	Action	Check system operating environment, fans, and heat-sinks.
CPU0104	Message	CPU <number> temperature is outside of range.
	LCD Message	CPU <number> temperature is outside of range. Check fans.
	Details	System performance may be degraded.
	Action	Check system operating environment, fans, and heat-sinks.
CPU0200	Message	CPU <number> <name> voltage is less than the lower warning threshold.
	Details	Low voltages may be the result of a problem with the voltage regulator or a problem with the processor. The low voltage may cause the processor to fail to operate.
	Action	<ol style="list-style-type: none"> 1. Turn system off and remove input power for one minute. 2. Reapply input power and turn system on. 3. Ensure the processor is seated correctly. 4. If the issue persists, see Getting Help.
CPU0201	Message	CPU <number> <name> voltage is less than the lower critical threshold.
	LCD Message	CPU <number> <name> voltage is outside of range. Re-seat CPU.
	Details	Low voltages may be the result of a problem with the voltage regulator or a problem with the processor. When the critical threshold is crossed, the processor will fail to operate. The system may power down.
	Action	<ol style="list-style-type: none"> 1. Turn system off and remove input power for one minute. 2. Reapply input power and turn system on. 3. Ensure the processor is seated correctly. 4. If the issue persists, see Getting Help.
CPU0202	Message	CPU <number> <name> voltage is greater than the upper warning threshold.
	Details	High voltages may be the result of problem with the voltage regulator or a problem with the processor. Elevated voltages may result in

Error Code	Message Information	
		damage to the processor or other electronic components inside the system.
	Action	<ol style="list-style-type: none"> 1. Turn system off and remove input power for one minute. 2. Reapply input power and turn system on. 3. Ensure the processor is seated correctly. 4. If the issue persists, see Getting Help.
CPU0203	Message	CPU <number> <name> voltage is greater than the upper critical threshold.
	LCD Message	CPU <number> <name> voltage is outside of range. Re-seat CPU.
	Details	High voltages may be the result of a problem with the voltage regulator or a problem with the processor. Elevated voltages may result in damage to the processor or other system electrical components. The system may power down.
	Action	<ol style="list-style-type: none"> 1. Turn system off and remove input power for one minute. 2. Reapply input power and turn system on. 3. Ensure the processor is seated correctly. 4. If the issue persists, see Getting Help.
CPU0204	Message	CPU <number> <name> voltage is outside of range.
	LCD Message	CPU <number> <name> voltage is outside of range. Re-seat CPU.
	Details	Voltages outside the allowable range may damage electrical components or may cause the system to shutdown.
	Action	<ol style="list-style-type: none"> 1. Turn system off and remove input power for one minute. 2. Ensure the processor is seated correctly. 3. Reapply input power and turn system on. 4. If the issue persists, see Getting Help.
CPU0700	Message	CPU <number> initialization error detected.
	LCD Message	CPU <number> initialization error detected. Power cycle system.
	Details	System BIOS was unable to initialize the processor.
	Action	<ol style="list-style-type: none"> 1. Turn system off and remove input power for one minute. 2. Ensure the processor is seated correctly. 3. Reapply input power and turn system on.

Error Code	Message Information	
CPU0701	Message	4. If the issue persists, see Getting Help . CPU <number> protocol error detected.
	LCD Message	CPU <number> protocol error detected. Power cycle system.
	Details	System event log and operating system logs may indicate that the exception is external to the processor.
	Action	<ol style="list-style-type: none"> 1. Check system and operating system logs for exceptions. If no exceptions are found, continue. 2. Turn system off and remove input power for one minute. 3. Ensure the processor is seated correctly. 4. Reapply input power and turn system on. 5. If the issue persists, see Getting Help.
CPU0702	Message	CPU bus parity error detected.
	LCD Message	CPU bus parity error detected. Power cycle system.
	Details	System event log and operating system logs may indicate that the exception is external to the processor.
	Action	<ol style="list-style-type: none"> 1. Check system and operating system logs for exceptions. If no exceptions are found, continue. 2. Turn system off and remove input power for one minute. 3. Ensure the processor is seated correctly. 4. Reapply input power and turn system on. 5. If the issue persists, see Getting Help.
CPU0703	Message	CPU bus initialization error detected.
	LCD Message	CPU bus initialization error detected. Power cycle system.
	Details	System event log and operating system logs may indicate that the exception is external to the processor.
	Action	<ol style="list-style-type: none"> 1. Check system and operating system logs for exceptions. If no exceptions are found, continue. 2. Turn system off and remove input power for one minute. 3. Ensure the processor is seated correctly. 4. Reapply input power and turn system on. 5. If the issue persists, see Getting Help.

Error Code	Message Information	
CPU0704	Message	CPU <number> machine check error detected.
	LCD Message	CPU <number> machine check error detected. Power cycle system.
	Details	System event log and operating system logs may indicate that the exception is external to the processor.
	Action	<ol style="list-style-type: none"> 1. Check system and operating system logs for exceptions. If no exceptions are found, continue. 2. Turn system off and remove input power for one minute. 3. Ensure the processor is seated correctly. 4. Reapply input power and turn system on. 5. If the issue persists, see Getting Help.
CPU0801	Message	CPU <number> voltage regulator module failed.
	LCD Message	CPU <number> voltage regulator module failed. Re-seat module.
	Details	System performance may be degraded or the system may fail to operate.
	Action	<ol style="list-style-type: none"> 1. Turn system off and remove input power for one minute. 2. Reapply input power and turn system on. 3. Ensure the processor is seated correctly. 4. If the issue persists, see Getting Help.
CPU0802	Message	A predictive failure detected on CPU <number> voltage regulator module.
	Details	System performance may be degraded or the system may fail to operate.
	Action	<ol style="list-style-type: none"> 1. Turn system off and remove input power for one minute. 2. Reapply input power and turn system on. 3. Ensure the processor is seated correctly. 4. If the issue persists, see Getting Help.
CPU0803	Message	The power input for CPU <number> voltage regulator module is lost.
	LCD Message	Lost power input for CPU <number>voltage regulator module. Re-seat module.
	Details	System performance may be degraded or the system may fail to operate.

Error Code	Message Information	
CPU0804	Action	<ol style="list-style-type: none"> 1. Turn system off and remove input power for one minute. 2. Reapply input power and turn system on. 3. Ensure the processor is seated correctly. 4. If the issue persists, see Getting Help.
	Message	The power input for CPU <number> voltage regulator module is outside of range.
	LCD Message	The power input for CPU <number> voltage regulator module is outside of range. Re-seat module.
	Details	System performance may be degraded or the system may fail to operate.
CPU0805	Action	<ol style="list-style-type: none"> 1. Turn system off and remove input power for one minute. 2. Reapply input power and turn system on. 3. Ensure the processor is seated correctly. 4. If the issue persists, see Getting Help.
	Message	The power input for CPU <number> voltage regulator module is outside of range, but it is attached to the system.
	Details	System performance may be degraded or the system may fail to operate.
	Action	<ol style="list-style-type: none"> 1. Turn system off and remove input power for one minute. 2. Reapply input power and turn system on. 3. Ensure the processor is seated correctly. 4. If the issue persists, see Getting Help.
CPU0806	Message	CPU <number> voltage regulator module is incorrectly configured.
	LCD Message	CPU <number> voltage regulator module incorrectly configured. Check configuration.
	Details	System performance may be degraded or the system may fail to operate.
	Action	Review this manual for proper configuration and installation procedures.
CPU0816	Message	CPU <number> voltage regulator module is absent.
	LCD Message	CPU <number> voltage regulator module absent. Check module.

Error Code	Message Information	
	Details	System performance may be degraded or the system may fail to operate.
	Action	If removal was unintended, check presence and reinstall.
HWC1001	Message	The <name> is absent.
	LCD Message	The <name> is absent. Check hardware.
	Details	The absent device may be necessary for proper operation. System functionality may be degraded.
	Action	Reinstall or reconnect the hardware.
HWC1002	Message	The <name> is disabled.
	Action	If device disabled unexpectedly, re-enable device.
HWC1005	Message	The storage adapter is absent.
	LCD Message	The storage adapter is absent. Check hardware.
	Details	The storage adapter may be necessary for proper operation. System functionality may be degraded.
	Action	Install storage adapter.
HWC1006	Message	The storage adapter is disabled.
	Action	If adapter disabled unexpectedly, re-enable the storage adapter.
HWC1009	Message	The backplane is absent.
	LCD Message	The backplane is absent. Check hardware.
	Details	The backplane may be necessary for proper operation. System functionality may be degraded.
	Action	If removal was unintended, check presence, then reinstall or reconnect.
HWC1010	Message	The backplane is disabled.
	Action	If disabled unexpectedly, re-enable backplane.
HWC1015	Message	The PCIe mezzanine card <number> is absent.
	Details	The PCIe mezzanine card may be necessary for proper operation. System functionality may be degraded.

Error Code	Message Information	
	Action	If removal was unintended, check presence, then reinstall or reconnect.
HWC2006	Message	The <name> is not installed correctly.
	LCD Message	The <name> is not installed correctly. Check connection.
	Details	The device may be necessary for proper operation. System functionality may be degraded.
	Action	Check presence, then re-install or reconnect.
HWC2008	Message	A fabric mismatch detected between IOM and PCIe mezzanine card <number>.
	Details	The fabric type for the IOM and PCIe mezzanine cards must match.
	Action	Check chassis fabric type in CMC GUI and compare to the type of IOM or PCIe mezzanine card.
HWC2011	Message	The riser board cable or interconnect is not connected, or is improperly connected.
	LCD Message	Riser board cable or interconnect failure. Check connection.
	Details	The riser server module cable may be necessary for proper operation. System functionality may be degraded.
	Action	Check the riser board or interconnect presence, then reinstall or reconnect.
HWC3000	Message	The <name> is removed.
	Details	The removed device may be necessary for proper operation. System functionality may be degraded.
	Action	If removal was unintended, check presence of the removed device, then reinstall or reconnect
HWC3002	Message	Server <number> is removed.
	Action	If removal was unintended, check presence of the server, then reinsert.
HWC3004	Message	IO module <number> is removed.
	Action	If removal was unintended, check presence of the IO module, then reinsert.

Error Code	Message Information	
HWC4000	Message	A hardware incompatibility detected between BMC/iDRAC firmware and CPU.
	LCD Message	Incompatibility between BMC/iDRAC firmware and CPU. Update firmware.
	Details	A hardware incompatibility was detected between BMC/iDRAC firmware and Processor(s). An iDRAC or BMC firmware update is needed.
	Action	Update the BMC/iDRAC firmware. If the issue persists, see Getting Help .
HWC4002	Message	A hardware incompatibility detected between BMC/iDRAC firmware and other hardware.
	Details	A hardware incompatibility was detected between BMC/iDRAC firmware and other hardware. An iDRAC or BMC firmware update is needed.
	Action	Update the BMC/iDRAC firmware. If the issue persists, see Getting Help .
HWC4011	Message	Hardware unsuccessfully updated for PCIe mezzanine card <i><number></i> .
	Action	Check presence of the hardware, reinstall or reconnect, then reattempt the update. If the issue persists, see Getting Help .
HWC4013	Message	Hardware unsuccessfully updated for embedded NIC.
	Action	Check presence, reinstall or reconnect, then reattempt the update. If the issue persists, see Getting Help .
HWC4015	Message	Link Tuning error detected.
	Details	CMC has old firmware. After updating the firmware the CMC will recognize the device.
	Action	Update the CMC firmware. If the issue persists, see Getting Help .
HWC5001	Message	<i><name></i> is offline.
	Action	If unexpected, check presence, then reinstall or reconnect.
HWC5002	Message	A fabric mismatch detected on <i><name></i> .
	Details	The fabric type for the IOM and PCIe mezzanine cards must match.

Error Code	Message Information	
HWC5004	Action	Check chassis fabric type in CMC GUI and compare to the type of IOM or PCIe mezzanine card.
	Message	A link tuning failure detected on <name>.
	Details	CMC has old firmware. After updating the firmware the CMC will recognize the device.
HWC5006	Action	Update the CMC firmware. If the issue persists, see Getting Help .
	Message	A failure is detected on <name>.
	Action	If the issue persists, see Getting Help .
HWC5008	Message	Console is not available for the <name>.
	Action	If the issue persists, see Getting Help .
	Message	<name> cannot detect any hosts.
HWC5010	Action	If the issue persists, see Getting Help .
	Message	<name> is not functional and is powered off.
	Action	If the issue persists, see Getting Help .
HWC5031	Message	IO module <number> is offline.
	Details	The CMC has powered off the IOM.
	Action	If the issue persists, see Getting Help .
HWC5032	Message	A fabric mismatch detected on IO module <number>.
	Details	The fabric type for IOM's on the same chassis fabric must match.
	Action	Check chassis fabric type in CMC GUI and compare to the type of both IOM's.
HWC5034	Message	A link tuning failure detected on IO module <number>.
	Details	Link tuning table not supported for this IO modular.
	Action	Update the CMC firmware. If the issue persists, see Getting Help .
HWC5036	Message	A failure is detected on IO module <number>.

Error Code	Message Information	
	Details	The IOM module performance may be impacted.
	Action	If the issue persists, see Getting Help .
HWC6000	Message	The <name> controller is offline.
	Details	Information and status from the controller is unavailable.
	Action	Remove and reapply input power. If the issue persists, see Getting Help .
HWC6002	Message	The <name> controller is stuck in boot mode.
	Details	Information and status from the controller is unavailable.
	Action	Remove and reapply input power. If the issue persists, see Getting Help .
HWC6003	Message	The <name> controller is booting.
HWC6004	Message	Cannot communicate with <name> controller.
	Details	Information and status from the controller is unavailable.
	Action	Remove and reapply input power. If the issue persists, see Getting Help .
HWC7002	Message	Server <number> health changed to a warning state from a normal state.
	Details	Server <number> health changed to a warning state from a normal state.
	Action	Review System Log or front panel for additional information.
HWC7004	Message	Server <number> health changed to a critical state from either a normal or warning state.
	Details	Server <number> health changed to a warning state from a normal state.
	Action	Review System Log or front panel for additional information.
HWC7006	Message	Server <number> health changed to a nonrecoverable state from a less severe state.
	Details	Server <number> health changed to a warning state from a normal state.

Error Code	Message Information	
	Action	Review System Log or front panel for additional information.
HWC7008	Message	Server <number> health changed to a warning state from more severe state. Server <number> health changed to a critical state from a non-recoverable state.
	Details	Server <number> health changed to a warning state from a normal state.
	Action	Review System Log or front panel for additional information.
HWC7010	Message	Server <number> health changed to a critical state from a nonrecoverable state.
	Details	Server <number> health changed to a warning state from a normal state.
	Action	Review System Log or front panel for additional information.
HWC7012	Message	Server <number> health changed to a nonrecoverable state.
	Details	Server <number> health changed to a warning state from a normal state.
	Action	Review System Log or front panel for additional information.
LNK2700	Message	The <name> LAN heartbeat is lost.
	Details	CMC has lost network connection.
	Action	Check network cable and network connections.
MEM0000	Message	Persistent correctable memory errors detected on a memory device at location(s) <location>.
	Details	This is an early indicator of a possible future uncorrectable error.
	Action	Re-seat the memory modules. If the issue persists, see Getting Help .
MEM0001	Message	Multi-bit memory errors detected on a memory device at location(s) <location>.
	LCD Message	Multi-bit memory error on <location>. Re-seat memory.
	Details	The memory module has encountered an uncorrectable error. System performance may be degraded. The operating system and/or applications may fail as a result.
	Action	Re-seat the memory modules. If the issue persists, see Getting Help .

Error Code	Message Information	
MEM0002	Message	Parity memory errors detected on a memory device at location <i><location></i> .
	Details	The memory is operational. This is an early indicator of a possible future uncorrectable error.
	Action	Re-seat the memory modules. If the issue persists, see Getting Help .
MEM0003	Message	Stuck bit memory error detected on a memory device at location <i><location></i> .
	Details	This is an early indicator of a possible future uncorrectable error.
	Action	Re-seat the memory modules. If the issue persists, see Getting Help .
MEM0004	Message	Memory device at location <i><location></i> is disabled.
	Details	The memory may not be seated correctly, misconfigured, or has failed. Memory size is reduced.
	Action	Re-seat the memory modules. If the issue persists, see Getting Help .
MEM0005	Message	Persistent correctable memory error limit reached for a memory device at location(s) <i><location></i> .
	LCD Message	Persistent correctable memory error limit reached for <i><location></i> . Re-seat memory.
	Details	The memory is operational. This is an early indicator of a possible future uncorrectable error.
	Action	Re-seat the memory modules. If the issue persists, see Getting Help .
MEM0007	Message	Unsupported memory configuration; check memory device at location <i><location></i> .
	LCD Message	Unsupported memory configuration. Check memory <i><location></i> .
	Details	The memory may not be seated correctly, misconfigured, or has failed. Memory size is reduced.
	Action	Check the memory configuration. Re-seat the memory modules. If the issue persists, see Getting Help .
MEM0009	Message	Memory device at location <i><location></i> is throttled.
	Details	System performance is degraded.
	Action	If unexpected, review system logs for power or thermal exceptions.

Error Code	Message Information	
MEM0010	Message	Memory device at location <location> is over heating.
	LCD Message	Memory device <location> is over heating. Check fans.
	Details	System performance is degraded.
	Action	If unexpected, review system logs for power or thermal exceptions.
MEM0022	Message	Memory device at location <location> is absent.
	Details	The memory may not be seated correctly, misconfigured, or has failed. Memory size is reduced.
	Action	Re-seat the memory modules. If the issue persists, see Getting Help .
MEM0701	Message	Correctable memory error rate exceeded for <location>.
	Details	The memory may not be operational. This an early indicator of a possible future uncorrectable error.
	Action	Re-seat the memory modules. If the issue persists, see Getting Help .
MEM0702	Message	Correctable memory error rate exceeded for <location>.
	LCD Message	Correctable memory error rate exceeded for <location>. Re-seat memory.
	Details	The memory may not be operational. This an early indicator of a possible future uncorrectable error.
	Action	Re-seat the memory modules. If the issue persists, see Getting Help .
MEM1001	Message	Memory device at location <location> failed to transition to a running state.
	LCD Message	Memory device <location> failed to transition to a running state. Re-seat memory
	Details	The memory may not be operational. This an early indicator of a possible future uncorrectable error.
	Action	Re-seat the memory modules. If the issue persists, see Getting Help .
MEM1003	Message	Memory device at location <location> failed to transition to in test.
	Details	The memory may not be operational. This an early indicator of a possible future uncorrectable error.
	Action	Re-seat the memory modules. If the issue persists, see Getting Help .

Error Code	Message Information	
MEM1012	Message	Memory device at location <i><location></i> is in a degraded state.
	Details	The memory may not be operational. This an early indicator of a possible future uncorrectable error.
	Action	Re-seat the memory modules. If the issue persists, see Getting Help .
MEM1016	Message	Memory device at location <i><location></i> is not installed correctly.
	LCD Message	Memory <i><location></i> is not installed correctly. Reinstall.
	Details	The memory may not be seated correctly, misconfigured, or has failed. Memory size is reduced.
	Action	Check the memory configuration. Re-seat the memory modules. If the issue persists, see Getting Help .
MEM1205	Message	Memory mirror redundancy is lost. Check memory device at location(s) <i><location></i> .
	LCD Message	Memory mirror lost on <i><location></i> . Power cycle system.
	Details	The memory may not be seated correctly, misconfigured, or has failed.
	Action	Check the memory configuration. Re-seat the memory modules. If the issue persists, see Getting Help .
MEM1206	Message	Memory mirror redundancy is degraded. Check memory device at location <i><location></i> .
	Details	The memory may not be seated correctly, misconfigured, or has failed.
	Action	Check the memory configuration. Re-seat the memory modules. If the issue persists, see Getting Help .
MEM1208	Message	Memory spare redundancy is lost. Check memory device at location <i><location></i> .
	LCD Message	Memory spare lost on <i><location></i> . Power cycle system.
	Details	Memory sparing is no longer available.
	Action	Re-seat the memory modules. If the issue persists, see Getting Help .
MEM1212	Message	Memory redundancy is lost.
	Details	The memory may not be seated correctly, misconfigured, or has failed.

Error Code	Message Information	
	Action	Review system logs for memory exceptions. reinstall memory at location <i><location></i>
MEM1214	Message	Memory redundancy is degraded.
	Details	The memory may not be seated correctly, misconfigured, or has failed.
	Action	Check the memory configuration. Re-seat the memory modules. If the issue persists, see Getting Help .
MEM7002	Message	A hardware mismatch detected for memory riser.
	LCD Message	Memory riser mismatch detected. Check memory riser.
	Details	Memory riser is installed incorrectly, or failed.
	Action	Check that the memory riser is installed correctly. If the issue persists, see Getting Help .
MEM8000	Message	Correctable memory error logging disabled for a memory device at location <i><location></i> .
	LCD Message	SBE log disabled on <i><location></i> . Re-seat memory.
	Details	Errors are being corrected but no longer logged.
	Action	Review system logs for memory exceptions. reinstall memory at location <i><location></i> .
OSE0000	Message	A critical stop occurred during OS load.
	Details	The system halted due to an exception during operating system load or operating system initialization.
	Action	Review operating system logs and system video for additional information.
OSE0001	Message	A runtime critical stop occurred.
	Details	The system halted due to an exception while the operating system was running. This is a kernel panic or bug check event.
	Action	Review operating system logs and system video for additional information.
OSE0004	Message	A soft shut-down initiated by platform event filter.
	Details	A separate exception or status condition shutdown the operating system. (IPMI sensor type 20h - offset 04h).

Error Code	Message Information	
	Action	Review system event log for platform events capable of shutting the system down.
OSE0005	Message	Agent is not responding.
	Details	Graceful shutdown request to an agent via the BMC did not occur due to a system hardware or software exception.
	Action	Review operating system logs and system video for additional information.
OSE1001	Message	Failed to boot from A.
	Action	Review system boot configuration and boot media. Verify the media in a: is bootable. See system video for additional information.
OSE1003	Message	Failed to boot from C.
	Action	Review system boot configuration and boot media. Verify the media in C: is bootable. See system video for additional information.
OSE1005	Message	PXE boot failed.
	Action	Review system boot configuration, local PXE configuration, and PXE server configuration.
OSE1007	Message	Diagnostic boot failed.
	Action	Review system boot configuration and boot media. See system video for additional information.
OSE1009	Message	Failed to boot from CD-ROM.
	Action	Review system boot configuration and boot media. Verify the media in the CDROM is bootable. See system video for additional information.
OSE1011	Message	Failed to boot from ROM.
	Action	Check system event logs for additional exception information. Power down the system and attempt to boot again.
OSE1013	Message	Failed to boot.
	Action	Review system boot configuration and boot media. See system video for additional information.

Error Code	Message Information	
PCI1302	Message	A bus time-out was detected on a component at bus <bus>device<device>function <func>.
	Details	System performance may be degraded. The device has failed to respond to a transaction.
	Action	Cycle input power, update component drivers, if device is removable, reinstall the device.
PCI1304	Message	An I/O channel check error was detected.
	LCD Message	I/O channel check error detected. Power cycle system.
	Action	Cycle input power, update component drivers, if device is removable, reinstall the device.
PCI1306	Message	A software error was detected on a component at bus <bus>device<device>function <func>.
	Action	Reboot the system and update the component drivers.
PCI1308	Message	A PCI parity error was detected on a component at bus <bus>device<device>function <func>.
	LCD Message	PCI parity error on bus <bus> device <device> function <func>. Power cycle system.
	Details	System performance may be degraded, PCI device may fail to operate, or system may fail to operate.
	Action	Cycle input power, update component drivers, if device is removable, reinstall the device.
PCI1310	Message	A PCI system error was detected on a component at bus <bus>device<device>function <func>.
	LCD Message	PCI system error on bus <bus> device <device> function <func>. Power cycle system.
	Details	System performance may be degraded, or system may fail to operate.
	Action	Cycle input power, update component drivers, if device is removable, reinstall the device.
PCI1314	Message	A bus correctable error was detected on a component at bus <bus>device<device>function <func>.
	Details	System performance may be degraded.

Error Code	Message Information	
	Action	Cycle input power, update component drivers, if device is removable reinstall the device at the next scheduled service time.
PCI1316	Message	A bus uncorrectable error was detected on a component at bus <bus>device<device>function <func>.
	Details	System performance may be degraded, or system may fail to operate.
	Action	Cycle input power, update component drivers, if device is removable, reinstall the device.
PCI1318	Message	A fatal error was detected on a component at bus <bus>device<device>function <func>.
	LCD Message	Fatal error on bus <bus> device <device> function <func>. Power cycle system.
	Details	System performance may be degraded, or system may fail to operate.
	Action	Cycle input power, update component drivers, if device is removable, reinstall the device.
PCI1320	Message	A bus fatal error was detected on a component at bus <bus>device<device>function <func>.
	LCD Message	Bus fatal error on bus <bus> device <device> function <func>. Power cycle system.
	Details	System performance may be degraded, or system may fail to operate.
	Action	Cycle input power, update component drivers, if device is removable, reinstall the device.
PCI1322	Message	Bus performance degraded for a component at bus <bus>device<device>function <func>.
	Details	System performance may be degraded. The bus is not operating at maximum speed or width.
	Action	Cycle input power, update component drivers, if device is removable, reinstall the device.
PCI1342	Message	A bus time-out was detected on a component at slot <number>.
	Details	System performance may be degraded, or system may fail to operate.
	Action	Cycle input power, update component drivers, if device is removable, reinstall the device.

Error Code	Message Information	
PCI1344	Message	An I/O channel check error was detected.
	LCD Message	An I/O channel check error was detected. Power cycle system.
	Action	Cycle input power, update component drivers, if device is removable, reinstall the device.
PCI1346	Message	A software error was detected on a component at slot <number>.
	Action	Reboot the system and update the component drivers.
PCI1348	Message	A PCI parity error was detected on a component at slot <number>.
	LCD Message	PCI parity error on slot <number>. Re-seat PCI card.
	Details	System performance may be degraded, or system may fail to operate.
	Action	Cycle input power, update component drivers, if device is removable, reinstall the device.
PCI1350	Message	A PCI system error was detected on a component at slot <number>.
	LCD Message	PCI parity error on slot <number>. Re-seat PCI card.
	Details	System performance may be degraded, or system may fail to operate.
	Action	Cycle input power, update component drivers, if device is removable, reinstall the device.
PCI1354	Message	A bus correctable error was detected on a component at slot <number>.
	Details	System performance may be degraded.
	Action	Cycle input power, update component drivers, remove and reinstall the device at the next scheduled service time.
PCI1356	Message	A bus uncorrectable error was detected on a component at slot <number>.
	Details	System performance may be degraded, or system may fail to operate.
	Action	Cycle input power, update component drivers, if device is removable, reinstall the device.
PCI1358	Message	A fatal error was detected on a component at slot <number>.
	LCD Message	Fatal error on slot <number>. Re-seat PCI card.
	Details	System performance may be degraded, or system may fail to operate.

Error Code	Message Information	
PCI1360	Action	Cycle input power, update component drivers, if device is removable, reinstall the device.
	Message	A bus fatal error was detected on a component at slot <i><number></i> .
	LCD Message	Bus fatal error on slot <i><number></i> . Re-seat PCI card.
	Details	System performance may be degraded, or system may fail to operate.
PCI1362	Action	Cycle input power, update component drivers, if device is removable, reinstall the device.
	Message	Bus performance degraded for a component at slot <i><number></i> .
	Details	System performance may be degraded. The bus is not operating at maximum speed or width.
	Action	Cycle input power, update component drivers, remove and reinstall the device at the next scheduled service time.
PCI2000	Message	A fatal IO error detected on a component at bus <i><bus></i> device <i><device></i> function <i><func></i> .
	LCD Message	Fatal IO error on bus <i><bus></i> device <i><device></i> function <i><func></i> .
	Details	System performance may be degraded, or system may fail to operate.
	Action	Cycle input power, update component drivers, remove and reinstall the device.
PCI2002	Message	A fatal IO error detected on a component at slot <i><number></i> .
	LCD Message	Fatal IO error on slot <i><number></i> .
	Details	System performance may be degraded, or system may fail to operate.
	Action	Cycle input power, update component drivers, remove and reinstall the device.
PCI3000	Message	Device option ROM on embedded NIC failed to support Link Tuning or FlexAddress.
	Details	Either the BIOS, BMC/iDRAC, or LOM firmware is out of date and does not support FlexAddress.
	Action	Update BIOS, BMC/iDRAC, and LOM firmware. If the issue persists, see Getting Help .
PCI3002	Message	Failed to program virtual MAC address on a component at bus <i><bus></i> device <i><device></i> function <i><func></i> .

Error Code	Message Information	
	Details	Either the BIOS, BMC/iDRAC, LOM, or NIC firmware is out of date and does not support FlexAddress.
	Action	Update BIOS, BMC/iDRAC, LOM, and PCIe mezzanine card firmware. If the issue persists, see Getting Help .
PCI3004	Message	Device option ROM on PCIe mezzanine card <i><number></i> failed to support Link Tuning or FlexAddress.
	Details	Either the BIOS, BMC/iDRAC, or PCIe mezzanine card firmware is out of date and does not support FlexAddress.
	Action	Update BIOS, BMC/iDRAC, and PCIe mezzanine card firmware. If the issue persists, see Getting Help .
PCI3006	Message	Failed to get Link Tuning or FlexAddress data from iDRAC.
	Details	Either the BIOS or BMC/iDRAC firmware is out of date and does not support FlexAddress.
	Action	Update BIOS, and BMC/iDRAC firmware. If the issue persists, see Getting Help .
PCI3008	Message	A non-fatal PCIe error detected on a component at bus <i><bus></i> device <i><device></i> function <i><func></i> .
	Details	System performance may be degraded.
	Action	Cycle input power, update component drivers, remove and reinstall the device at the next service window.
PCI3010	Message	A non-fatal IO error detected on a component at bus <i><bus></i> device <i><device></i> function <i><func></i> .
	Details	System performance may be degraded.
	Action	Cycle input power, update component drivers, remove and reinstall the device at the next service window.
PCI3012	Message	The QuickPath Interconnect (QPI) width degraded.
	Details	System performance may be degraded. The bus is not operating at maximum speed or width.
	Action	Reset the system, if the problem persists reinstall processors.
PCI3014	Message	A non-fatal PCIe error detected on a component at slot <i><number></i> .
	Details	System performance may be degraded.

Error Code	Message Information	
	Action	Cycle input power, update component drivers, remove and reinstall the device at the next scheduled service time.
PDR0001	Message	Fault detected on drive <number>.
	LCD Message	Fault detected on drive <number>. Check drive.
	Details	The controller detected a failure on the disk and has taken the disk offline.
	Action	Remove and re-seat the failed disk. If the issue persists, see Getting Help .
PDR0002	Message	A predictive failure detected on drive <number>.
	Details	The controller received a SMART error from the drive. The drive is operational but needs replacement.
	Action	The drive will need replacement at the next service window.
PDR0016	Message	Drive <number> is removed.
	LCD Message	Drive <number> is removed. Check drive.
	Details	The controller detected a drive removal.
	Action	If unintended, verify drive installation. Remove and re-seat the indicated disk. If the issue persists, see Getting Help .
PDR1001	Message	Fault detected on drive <number> in disk drive bay <bay>.
	LCD Message	Fault detected on drive <number> in disk drive bay <bay>. Check drive.
	Details	The controller detected a failure on the disk and has taken the disk offline.
	Action	Re-seat the failed drive. If the issue persists, see Getting Help .
PDR1002	Message	A predictive failure detected on drive <number> in disk drive bay<bay>.
	Details	The controller received a SMART error from the drive. The drive is operational but needs replacement.
	Action	The drive will need replacement at the next service window.
PDR1016	Message	Drive <number> is removed from disk drive bay <bay>.
	LCD Message	Drive <number> removed from disk drive bay <bay>. Check drive.

Error Code	Message Information	
	Details	The controller detected that the drive was removed.
	Action	Verify drive installation. Re-seat the failed drive. If the issue persists, see Getting Help .
PDR1024	Message	Drive mismatch detected for drive <number> in disk drive bay <bay>.
	LCD Message	Drive mismatch detected for drive <number> in bay <bay>. Install correct drive type.
	Details	The installed disk does not meet the array requirements, for example a SATA disk may not operate in an array containing SAS drives.
	Action	Verify that the disk meets the array requirements.
PST0128	Message	No memory is detected.
	LCD Message	No memory is detected. Inspect memory devices.
	Details	System BIOS was unable to detect memory in the system .
	Action	Re-seat the memory modules. If the issue persists, see Getting Help .
PST0129	Message	Memory is detected, but is not configurable.
	LCD Message	Memory is detected, but is not configurable. Check memory devices.
	Details	System BIOS detected memory, but was unable to configure the memory for system operation.
	Action	Compare system memory installation to supported system memory configurations.
PST0130	Message	Memory is configured, but not usable.
	LCD Message	Memory is configured, but not usable. Check memory devices
	Details	The system BIOS encountered device failures or speed configurations that resulted in unused memory.
	Action	Re-seat the memory modules. If the issue persists, see Getting Help .
PST0131	Message	System BIOS shadow failed.
	LCD Message	System BIOS shadow failed. Check memory devices.
	Details	Memory errors occurred copying BIOS image into system memory.
	Action	Remove input power. Reduce system memory to minimum configuration and apply input power.

Error Code	Message Information	
PST0132	Message	CMOS failed.
	LCD Message	CMOS failed. Power cycle system.
	Details	System BIOS detected a failure with CMOS memory during system POST.
	Action	Check system event log for CMOS battery exceptions. Remove and reapply input power. If the issue persists, see Getting Help .
PST0133	Message	DMA controller failed.
	LCD Message	DMA controller failed. Power cycle system.
	Details	System BIOS detected a failure with the DMA controller during system POST.
	Action	Remove and reapply input power.
PST0134	Message	Interrupt controller failed.
	LCD Message	Interrupt controller failed. Power cycle system.
	Details	System BIOS detected a failure with the interrupt controller during system POST.
	Action	Remove and reapply input power. If the issue persists, see Getting Help .
PST0135	Message	Timer refresh failed.
	LCD Message	Timer refresh failed. Power cycle system..
	Details	System BIOS detected a timer refresh failure during system POST.
	Action	Remove and reapply input power. If the issue persists, see Getting Help .
PST0136	Message	Programmable interval timer error.
	LCD Message	Programmable interval timer error. Power cycle system.
	Details	System BIOS detected an failure with the programmable interval timer during POST.
	Action	Remove and reapply input power. If the issue persists, see Getting Help .
PST0137	Message	Parity error.
	LCD Message	Parity error. Power cycle system.

Error Code	Message Information	
	Details	System BIOS detected a parity error during post.
	Action	Remove and reapply input power. If the issue persists, see Getting Help .
PST0138	Message	SuperIO failed.
	LCD Message	SuperIO failure. Power cycle system.
	Details	System BIOS detected a failure with the SIO.
	Action	Remove and reapply input power. If the issue persists, see Getting Help .
PST0139	Message	Keyboard controller failed.
	LCD Message	Keyboard controller failed. Power cycle system.
	Details	System BIOS detected a failure with the Keyboard Controller.
	Action	Remove and reapply input power. If the issue persists, see Getting Help .
PST0140	Message	System management interrupt initialization failed.
	LCD Message	SMI initialization failed. Power cycle system.
	Details	System BIOS failed to initialize the system management interrupt.
	Action	Remove and reapply input power. If the issue persists, see Getting Help .
PST0141	Message	QuickPath Interconnect (QPI) fatal error.
	LCD Message	QuickPath Interconnect (QPI) fatal error.
	Details	Quick Path Interconnect failed during system POST.
	Action	Reboot the system. If problem persists, remove input power and re-seat processors.
PST0142	Message	MRC fatal error.
	LCD Message	Memory initialization error.
	Details	BIOS Memory testing failed.
	Action	Compare system memory installation to supported system memory configurations. Reduce system configuration to minimum memory configuration.

Error Code	Message Information	
PST0143	Message	Intel Trusted Execution Technology (TXT) fatal error.
	LCD Message	Intel Trusted Execution Technology (TXT) fatal error.
	Details	TXT boot failed. This could be related to memory errors or an error with the system TXT configuration. A socketed TPM module may have been removed.
	Action	Check TPM presence. Remove and reapply input power. If the issue persists, see Getting Help .
PST0192	Message	Shut-down test failed.
	LCD Message	Shut-down test failed. Power cycle system.
	Details	System BIOS shutdown test failed during POST.
	Action	Check system event log for CMOS battery exceptions. Remove and reapply input power. If the issue persists, see Getting Help .
PST0193	Message	BIOS POST memory test failed.
	LCD Message	BIOS POST memory test failed. Check memory devices.
	Details	System BIOS POST memory test failed.
	Action	Compare system memory installation to supported system memory configurations. Reduce system configuration to minimum memory configuration.
PST0194	Message	Remote access controller configuration failed.
	LCD Message	Remote access controller configuration failed. Check screen message.
	Details	System BIOS could not configure the Remote Access controller.
	Action	Cycle input power and power on the system. If the issue persists, see Getting Help .
PST0195	Message	CPU configuration failed.
	LCD Message	CPU configuration failed. Check screen message.
	Details	The current processor configuration is unsupported or encountered a fatal exception during POST.
	Action	Review system processor configuration and reduce the system to the minimum configuration.
PST0196	Message	Incorrect memory configuration.

Error Code	Message Information	
	LCD Message	Incorrect memory configuration. Review User Guide.
	Details	System BIOS detected an invalid memory population.
	Action	Reinstall memory to match supported memory configuration.
PST0254	Message	General failure after video.
	LCD Message	General failure after video. Check screen message.
	Details	System BIOS detected a functional or configuration issue during system POST.
	Action	Check system video and review event log for additional information.
PST0256	Message	POST fatal error detected.
	LCD Message	POST fatal error detected.
	Details	System BIOS detected a functional or configuration issue during system POST.
	Action	Check system video and review event log for additional information.
PSU0001	Message	Power supply <number> failed.
	LCD Message	PSU <number> failed. Check PSU.
	Action	Remove and reinstall the power supply. If the issue persists, see Getting Help .
PSU0002	Message	A predictive failure detected on power supply <number>.
	LCD Message	Predictive failure on PSU <number>. Check PSU.
	Details	System performance and power redundancy may be degraded or lost.
	Action	Remove and reinstall the power supply at the next service window. If the issue persists, see Getting Help .
PSU0003	Message	The power input for power supply <number> is lost.
	LCD Message	Power input for PSU <number> is lost. Check PSU cables.
	Details	The power supply is installed correctly but an input source is not connected or is not functional.
	Action	Verify the input source is attached to the power supply. Verify the input power is within the operating requirements for the power supply.

Error Code	Message Information	
PSU0004	Message	The power input for power supply <number> is outside of the allowable range.
	LCD Message	Power input for PSU <number> is outside of range. Check PSU cables.
	Details	The operating requirements for the power supply may be found in this manual or on the power supply itself.
	Action	Verify the input source is attached to the power supply. Verify the input power is within the operating requirements for the power supply.
PSU0005	Message	The power input for power supply <number> is outside of the allowable range, but it is attached to the system.
	Details	The operating requirements for the power supply may be found in this manual or on the power supply itself.
	Action	Verify the input power is within the operating requirements for the power supply.
PSU0006	Message	Power supply <number> type mismatch.
	LCD Message	Power supply <number> is incorrectly configured. Check PSU.
	Details	Power supplies should be of the same input type and power rating.
	Action	Install matched power supplies and review proper configuration in this manual.
PSU0007	Message	Power supply <number> is operating at 110 volts, and could cause a circuit breaker fault.
	Details	A power supply that is designed to operate at 220V, but is connected to a 110V power source requires additional current for operation. The additional current may trip circuit-breakers or cause other electrical issues with the input source.
	Action	Check input power source and cabling. Use recommended input power. Review this Manual. If the issue persists, see Getting Help .
PSU0008	Message	Power supply <number> voltage rating does not match the system's requirements.
	Details	The system does not support mixed voltage power supplies.
	Action	Install a power supply with the correct voltage rating.
PSU0016	Message	Power supply <number> is absent.

Error Code	Message Information	
	LCD Message	PSU <number> is absent. Check PSU.
	Details	The supply has been removed or has failed.
	Action	<ol style="list-style-type: none"> 1. Remove and reinstall the power supply. 2. Check cables and subsystem components in the system for damage. 3. If the issue persists, see Getting Help.
PSU0031	Message	Cannot communicate with power supply <number>.
	LCD Message	Cannot communicate with PSU <number>. Re-seat PSU.
	Details	The power supply may operate, however power supply monitoring will be degraded. System performance may be degraded.
	Action	Remove and reinstall the power supply. If the issue persists, see Getting Help .
PSU1201	Message	Power supply redundancy is lost.
	Details	The power supply will try to operate in a degraded state. System Performance and power redundancy may be degraded or lost.
	Action	Check input power. Reinstall the power supply. If the issue persists, see Getting Help .
PSU1202	Message	Power supply redundancy is degraded.
	Details	The power supply will try to operate in a degraded state. System Performance and power redundancy may be degraded or lost.
	Action	Remove input power and reinstall supply at the next service window.
PSU1203	Message	The power supplies are not redundant.
	LCD Message	Lost PSU redundancy. Check PSU cables.
	Details	The current power operational mode is non-redundant because of a power supply exception, a power supply inventory change, or a system power inventory change.
	Action	Check the event log for power supply failures. Review system configuration and power consumption.
PSU1204	Message	The power supplies are not redundant. Insufficient resources to maintain normal operations.
	LCD Message	PSU redundancy degraded. Check PSU cables.

Error Code	Message Information	
	Details	The current power operational mode is non-redundant because of a power supply exception, a power supply inventory change, or a system power inventory change.
	Action	Check the event log for power supply failures. Review system configuration and power consumption.
PWR1001	Message	The system performance was degraded.
	LCD Message	System performance degraded. Check PSUs and system configuration.
	Details	To avoid shutdown, system performance has been degraded.
	Action	Review system configuration and system logs for thermal or environmental failures and warnings.
PWR1002	Message	The system performance degraded because of thermal protection.
	Details	To avoid shutdown, system performance has been degraded.
	Action	Review system configuration and system logs for thermal or environmental failures and warnings.
PWR1003	Message	The system performance degraded because cooling capacity has changed.
	Details	The current power supply configuration does not meet the platform requirements to enable redundancy. If a power supply fails the system may shutdown.
	Action	If unintended, review system configuration and power consumption and install power supplies accordingly. Check power supply status for failures.
PWR1004	Message	The system performance degraded because power capacity has changed.
	Details	The system may power down or operate in a performance degraded state.
	Action	Check the event log for power supply failures. Review system configuration and power consumption and upgrade or install power supplies accordingly.
PWR1005	Message	The system performance degraded because the user-defined power capacity has changed.
	Details	The user-defined power settings have affected system operation.

Error Code	Message Information	
PWR1006	Action	If unintended, review system configuration changes and power policy.
	Message	The system halted because system power exceeds capacity.
	LCD Message	System power demand exceeds capacity. System halted.
	Details	The system halted because system power exceeds capacity.
PWR1007	Action	Review system configuration, upgrade power supplies or reduce system power consumption.
	Message	The system performance degraded because power exceeds capacity.
	LCD Message	System power exceeds capacity. Performance degraded. Check PSU configuration.
	Details	The system is currently operating in a performance degraded state to attempt protect from a power shutdown.
PWR1008	Action	Review system configuration, upgrade power supplies or reduce system power consumption.
	Message	The system performance degraded because power draw exceeds the power threshold.
	LCD Message	System power exceeds threshold. Performance degraded. Check PSU configuration.
	Details	The power threshold is configured by the user or automatically by software based on system configuration.
RFM1003	Action	Review system configuration, upgrade power supplies or reduce system power consumption.
	Message	Removable Flash Media <name> is not IPMI-function ready.
	Details	The removable flash media is installed but improperly configured or failed to initialize.
RFM1005	Action	If unintended, reinstall the flash media and module.
	Message	Removable Flash Media <name> is not ready.
	Details	The media is being prepared or is under maintenance. If the problem persists, reinstall the card.
RFM1005	Action	Wait for the media to be ready.

Error Code	Message Information	
RFM1006	Message	Removable Flash Media <name> is offline.
	Details	At boot, the Card Identification (CID) signature of the card is different from the Non-volatile (NV) storage value or the card is the destination of a copy operation that is in-progress.
	Action	If unintended, reinstall the flash media.
RFM1008	Message	Failure detected on Removable Flash Media <name>.
	LCD Message	Removable Flash Media <name> failed. Check SD Card.
	Details	An error was reported during a SD card read or write.
	Action	Reseat the flash media, if the issue persists replace the media.
RFM1014	Message	Removable Flash Media <name> is write protected.
	LCD Message	Removable Flash Media <name> is write protected. Check SD Card.
	Details	The card is write-protected by the physical latch on the SD card. A write-protected card cannot be used.
	Action	If unintended, remove the media and disable write protection.
RFM1016	Message	Media not present for Removable Flash Media <name>.
	Details	The SD card is not detected or not installed.
	Action	If unintended, reinstall the flash media.
RFM1021	Message	Removable Flash Media is not IPMI-function ready.
	Details	The removable flash media is installed but improperly configured or failed to initialize.
	Action	If unintended, reinstall the flash media.
RFM1022	Message	Removable Flash Media is ready.
	Action	If unintended, reinstall the flash media.
RFM1023	Message	Removable Flash Media is not ready.
	Details	The media is being prepared or is under maintenance. If the problem persists, reinstall the card.
	Action	If unintended, reinstall the flash media.

Error Code	Message Information	
RFM1024	Message	Removable Flash Media is offline.
	Details	At boot, the Card Identification (CID) signature of the card is different from the Non-volatile (NV) storage value or the card is the destination of a copy operation that is in-progress.
	Action	If unintended, reinstall the flash media.
RFM1026	Message	Failure detected on Removable Flash Media.
	Details	An error is reported during a SD card read or write.
	Action	Reinstall the flash media, if the issue persists replace the media.
RFM1032	Message	Removable Flash Media is write protected.
	Details	The card is write-protected by the physical latch on the SD card. IDSDM cannot use a write-protected card.
	Action	If unintended, remove the media and disable write protection.
RFM1034	Message	Media not present for Removable Flash Media.
	Details	The SD card is not detected or not installed.
	Action	If unintended, reinstall the flash media.
RFM1201	Message	Internal Dual SD Module redundancy is lost.
	LCD Message	Internal Dual SD Module redundancy is lost. Check SD Card.
	Details	Either one of the SD card or both the SD cards are not functioning properly.
	Action	Replace the failed SD card.
RFM1202	Message	Internal Dual SD Module redundancy is degraded.
	Details	Either one of the SD card or both the SD cards are not functioning properly.
	Action	Replace the failed SD card.
RFM1203	Message	Internal Dual SD Module is not redundant.
	Details	Internal Dual SD Module is not redundant.
	Action	Install additional SD card and configure for redundancy if redundancy is desired.

Error Code	Message Information	
RFM1205	Message	Internal Dual SD Module is not redundant. Insufficient resources to maintain normal operations.
	LCD Message	Internal Dual SD Module is not redundant. Insufficient resources. Check SD Card.
	Details	The current operating configuration cannot maintain redundancy. The unit may operate in a degraded state.
	Action	Review this manual and SD card configuration.
RFM2001	Message	Internal Dual SD Module <name> is absent.
	LCD Message	Internal Dual SD Module <name> is absent. Check SD Card.
	Details	The SD card module is not detected or not installed.
	Action	If unintended, reinstall the SD module.
RFM2002	Message	Internal Dual SD Module <name> is offline.
	Details	The SD card module is installed but may be improperly installed or configured incorrectly.
	Action	Reinstall the SD module.
RFM2004	Message	Failure detected on Internal Dual SD Module <name>.
	LCD Message	Internal Dual SD Module <name> failed. Check SD Card.
	Details	The SD card module is installed but improperly configured or failed to initialize.
	Action	Reinstall the SD module and remove and reinstall SD cards.
RFM2006	Message	Internal Dual SD Module <name> is write protected.
	Details	The module is write-protected. Changes may not be written to the media.
	Action	If unintended, remove the media and disable write protection.
SEC0000	Message	The chassis is open.
	LCD Message	Intrusion detected. Check chassis cover.
	Details	The chassis is open. System performance may be degraded, and security may be compromised.
	Action	Close the chassis. Check system logs.

Error Code	Message Information	
SEC0001	Message	The drive bay is open.
	Details	The drive bay is open. A drive may be added or removed. System performance may be degraded.
	Action	Close the drive bay. Check system logs.
SEC0002	Message	The I/O card area is open.
	Details	The I/O card area is open. I/O cards may be added or removed. System performance may be degraded.
	Action	Close the I/O card area. Check system logs.
SEC0003	Message	The processor area is open.
	Details	The processor area is open. A drive may be added or removed. System performance may be degraded.
	Action	Close the processor area. Check system logs.
SEC0004	Message	The LAN is disconnected.
	Details	The LAN is disconnected. Network performance may be degraded.
	Action	If unintentional, connect network cable.
SEC0005	Message	Unauthorized docking is detected.
	Details	A removable component may have been tampered with, or installed incorrectly, or does not meet system requirements.
	Action	Check removable hardware components for correct installation. Review installation documentation.
SEC0006	Message	The fan area is open.
	Details	The fan area is open. System performance may be degraded.
	Action	Close the fan area. Check system logs.
SEC0031	Message	The chassis is open while the power is on.
	LCD Message	Intrusion detected. Check chassis cover.
	Details	The chassis is open. System performance may be degraded, and security may be compromised.
	Action	Close the chassis. Check system logs.

Error Code	Message Information	
SEC0033	Message	The chassis is open while the power is off.
	LCD Message	Intrusion detected. Check chassis cover.
	Details	The chassis was opened while the power was off. System security may have been comprised.
	Action	Close the chassis and verify hardware inventory. Check system logs.
SEC0040	Message	A critical stop occurred during OS load.
	Details	Operating system generated critical stop IPMI event. (Sensor type code = 20H)
	Action	Check video and operating system logs for additional information
SEC0041	Message	BIOS detected an error configuring the Intel Trusted Execution Technology (TXT).
	LCD Message	BIOS detected an error configuring TXT. Check system configuration.
	Details	TXT initialization failure. System configuration may have changed.
	Action	Check system hardware inventory and software configuration.
SEC0042	Message	Processor detected an error while performing an Intel Trusted Execution Technology (TXT) operation.
	LCD Message	CPU detected an error while performing a TXT operation. Check system configuration.
	Details	TXT CPU microcode boot failure. System configuration may have changed.
	Action	Check system hardware inventory and software configuration.
SEC0043	Message	BIOS Authenticated Code Module detected an Intel Trusted Execution Technology (TXT) error during POST.
	LCD Message	BIOS detected a TXT error during POST. Check system configuration.
	Details	TXT Post failure. System configuration may have changed.
	Action	Check system hardware inventory and software configuration.
SEC0044	Message	SINIT Authenticated Code Module detected an Intel Trusted Execution Technology (TXT) error at boot.
	LCD Message	SINIT detected a TXT error at boot. Check system configuration.
	Details	TXT initialization failure. System configuration may have changed.

Error Code	Message Information	
	Action	Check system hardware inventory and software configuration.
SEC0600	Message	A secure mode violation detected.
	Details	This may apply to a physical or remote access attempt.
	Action	Check system logs for intrusion attempts, and ensure strong password policies.
SEC0602	Message	User password violation detected.
	Details	This may apply to a physical or remote access attempt.
	Action	Check system logs for intrusion attempts, and ensure strong password policies.
SEC0604	Message	A setup password violation detected.
	Details	This may apply to a physical or remote access attempt.
	Action	Check system logs for intrusion attempts, and ensure strong password policies.
SEC0606	Message	The network boot password violation detected.
	Details	This may apply to a physical or remote access attempt.
	Action	Check system logs for intrusion attempts, and ensure strong password policies.
SEC0608	Message	A password violation detected.
	Details	This may apply to a physical or remote access attempt.
	Action	Check system logs for intrusion attempts, and ensure strong password policies.
SEC0610	Message	An Out-of-band password violation detected.
	Details	This may apply to a remote access attempt.
	Action	Check system logs for intrusion attempts, and ensure strong password policies.
SEL0002	Message	Logging is disabled.
	Details	This message is displayed when event logging of a specific type is disabled by the user.

Error Code	Message Information	
	Action	If unintended, re-enable logging.
SEL0006	Message	All event logging is disabled.
	Details	This message is displayed when all event logging has been disabled by the user.
	Action	If unintended, re-enable logging.
SEL0008	Message	Log is full.
	Details	When the event log is full, additional events are not written to the log. Older events may be overwritten and lost. This message may also appear if the user disabled event logging.
	Action	Backup and clear log.
SEL0010	Message	Log is almost full.
	Details	When the event log is full, additional events are not written to the log. Older events may be overwritten and lost.
	Action	Backup and clear log at the next maintained time.
SEL0012	Message	Could not create or initialize the system event log.
	Details	If the system event log fails to initialize, platform status and failure events are not captured. Some management software do not report platform exceptions.
	Action	Reboot the management controller or iDRAC. Cycle system input power. If problem persists call support.
SEL1204	Message	An unknown system hardware failure detected.
	LCD Message	Unknown system hardware failure.
	Details	If the system event log failed to initialize platform status and failure events are not captured. Some management software will not report platform exceptions.
	Action	Re-configure system to minimum supported configuration. If issues persists, contact support.
SEL1209	Message	The platform event filter action failed.
	Details	System policies or permissions may prevent the action from executing. If configured, the system does not execute the action on

Error Code	Message Information	
		a platform event (such as power down, cycle, interrupt, and send alert).
	Action	Review platform event configuration.
SEL1211	Message	The time-stamp clock could not be synchronized.
	Details	The time stamp on system event log events may not correlate to the system time.
	Action	Cycle system input power. If problem persists, contact support.
SEL1300	Message	No bootable media found.
	Details	System setup displays the system boot order. The local video screen may also show additional information. (IPMI sensor type code 1eh - offset 00h).
	Action	Check system boot settings. Check if mass storage controller configuration settings are applicable.
SEL1302	Message	Non-bootable diskette detected.
	Details	The disk in the drive is not formatted correctly or does not contain the necessary operating system files.
	Action	Replace diskette with a bootable disk.
SEL1304	Message	The PXE server not found.
	Details	PXE is one way to boot a system from the network.
	Action	Check the network and PXE server configuration.
SEL1306	Message	Invalid boot sector found.
	Details	The disk in the drive is not formatted correctly or does not contain the necessary operating system files.
	Action	Replace diskette with a bootable disk.
SEL1308	Message	A time-out occurred while waiting for user to select a boot source.
	Details	The system has failed to boot to an operating system and needs the user to select a boot source.
	Action	Select boot source within the time allowed.
SEL1501	Message	Chassis management controller (CMC) redundancy is lost.

Error Code	Message Information	
	Details	An action or failure has taken place that breaks CMC redundancy.
	Action	Check the CMC network cables and network connections. Check that CMC firmware versions match.
SEL1502	Message	Chassis management controller (CMC) redundancy is degraded.
	Details	An action or failure has taken place that breaks CMC redundancy.
	Action	Check the CMC network cables and network connections. Check that CMC firmware versions match.
SEL1504	Message	The chassis management controller (CMC) is not redundant. Insufficient resources to maintain normal operations.
	Details	There is not enough available power for two CMC's to operate.
	Action	Check the overall power consumption and power status.
SEL1506	Message	Lost communications with Chassis Group Member <i><number></i> .
	Details	The primary CMC has lost communication with the indicated member CMC.
	Action	Check the network cable and network connections.
SEL1508	Message	Member <i><number></i> could not join the Chassis Group.
	Details	The indicated member CMC is a leader of a different CMC stacking group.
	Action	Check if member CMC is a leader of a different chassis group.
SEL1510	Message	An authentication error detected for Chassis Group Member <i><number></i> .
	Details	Group master CMC could not log into the group member CMC.
	Action	Check the login credentials of CMC.
SEL9900	Message	An unsupported event occurred.
	Details	The current software version cannot decode this event. You may need to review this event using a tool which displays raw data such as Ipmitool with the -vvv option or Racadm with the -E option.
	Action	Upgrade the management software.

Error Code	Message Information	
SWC4004	Message	A firmware or software incompatibility detected between iDRAC in slot <number> and CMC.
	Details	FlexAddress is not implemented in one of the versions of firmware.
	Action	Check the firmware versions of iDRAC and CMC. Update with the latest version.
SWC4006	Message	A firmware or software incompatibility detected between system BIOS in slot <number> and CMC.
	Details	FlexAddress is not implemented in one of the versions of firmware.
	Action	Check the firmware versions of BIOS and CMC. Update with the latest version.
SWC4008	Message	A firmware or software incompatibility detected between CMC 1 and CMC 2.
	Details	FlexAddress is not implemented in one of the versions of firmware. Please update the firmware.
	Action	Check firmware versions. Update CMC 1 and CMC 2 firmware to match.
SWC5001	Message	<name> upgrade failed.
	Action	Reboot the system and attempt the upgrade again.
TMP0100	Message	The system board <name> temperature is less than the lower warning threshold.
	LCD Message	System board <name> temperature is outside of range.
	Details	Ambient air temperature is too cool.
	Action	Check the system operating environment.
TMP0101	Message	The system board <name> temperature is less than the lower critical threshold.
	LCD Message	System board <name> temperature is outside of range.
	Details	Ambient air temperature is too cool.
	Action	Check the system operating environment.
TMP0102	Message	The system board <name> temperature is greater than the upper warning threshold

Error Code	Message Information	
	LCD Message	System board <name> temperature is outside of range.
	Details	Ambient air temperature is too warm or one or more fans may have failed.
	Action	The system board <name> temperature is outside of the optimum range. Check the fans.
TMP0103	Message	The system board <name> temperature is greater than the upper critical threshold.
	LCD Message	System board <name> temperature is outside of range.
	Details	Ambient air temperature is too warm or one or more fans may have failed.
Action	The system board <name> temperature is outside of the optimum range. Check the fans.	
TMP0104	Message	The system board <name> temperature is outside of range.
	LCD Message	System board <name> temperature is outside of range.
	Details	Ambient air temperature is too warm or cool.
Action	The system board <name> temperature is outside of the optimum range. Check Fans.	
TMP0106	Message	The memory module <number> temperature is less than the lower warning threshold.
	LCD Message	Memory module <number> temperature is outside of range.
	Details	Ambient air temperature is too cool.
Action	Check the system operating environment.	
TMP0107	Message	The memory module <number> temperature is less than the lower critical threshold.
	LCD Message	Memory module <number> temperature is outside of range.
	Details	Ambient air temperature is too cool.
Action	Check the system operating environment.	
TMP0108	Message	The memory module <number> temperature is greater than the upper warning threshold.
	LCD Message	Memory module <number> temperature is outside of range. Check Fans.

Error Code	Message Information	
	Details	Ambient air temperature is too warm or one or more fans may have failed.
	Action	The system board <name> temperature is outside of the optimum range. Check Fans.
TMP0109	Message	The memory module <number> temperature is greater than the upper critical threshold.
	LCD Message	Memory module <number> temperature is outside of range. Check Fans.
	Details	Ambient air temperature is too warm or one or more fans may have failed.
	Action	The system board <name> temperature is outside of the optimum range. Check Fans.
TMP0110	Message	The memory module <number> temperature is outside of range.
	LCD Message	Memory module <number> temperature is outside of range. Check Fans.
	Details	Ambient air temperature is too warm or cool.
	Action	Check the system operating environment.
TMP0112	Message	The <name> temperature is less than the lower warning threshold.
	LCD Message	The <name> temperature is outside of range.
	Details	Ambient air temperature is too cool.
	Action	Check the system operating environment.
TMP0113	Message	The <name> temperature is less than the lower critical threshold.
	LCD Message	The <name> temperature is outside of range.
	Details	Ambient air temperature is too cool.
	Action	Check the system operating environment.
TMP0114	Message	The <name> temperature is greater than the upper warning threshold.
	LCD Message	The <name> temperature is outside of range. Check Fans
	Details	Ambient air temperature is too warm or one or more fans may have failed.

Error Code	Message Information	
	Action	Check the system operating environment and review event log for fan failures.
TMP0115	Message	The <name> temperature is greater than the upper critical threshold.
	LCD Message	The <name> temperature is outside of range. Check Fans
	Details	Ambient air temperature is too warm or one or more fans may have failed.
	Action	Check the system operating environment and review event log for fan failures.
TMP0116	Message	The <name> temperature is outside of range.
	LCD Message	The <name> temperature is outside of range. Check Fans
	Action	Check the system operating environment and review event log for fan failures.
TMP0118	Message	The system inlet temperature is less than the lower warning threshold.
	LCD Message	System inlet temperature is outside of range.
	Details	Ambient air temperature is too cool.
	Action	Check the system operating environment.
TMP0119	Message	The system inlet temperature is less than the lower critical threshold.
	LCD Message	System inlet temperature is outside of range.
	Details	Ambient air temperature is too cool.
	Action	Check the system operating environment.
TMP0120	Message	The system inlet temperature is greater than the upper warning threshold.
	LCD Message	System inlet temperature is outside of range.
	Details	Ambient air temperature is too warm or one or more fans may have failed.
	Action	Check the system operating environment and review event log for fan failures.
TMP0121	Message	The system inlet temperature is greater than the upper critical threshold.

Error Code	Message Information	
	LCD Message	System inlet <name> temperature is outside of range. Check Fans.
	Details	Ambient air temperature is too warm or one or more fans may have failed.
	Action	Check the system operating environment and review event log for fan failures.
TMP0122	Message	The system inlet temperature is outside of range.
	LCD Message	System inlet <name> temperature is outside of range. Check Fans.
	Details	Ambient air temperature is too warm or cool.
	Action	Check the system operating environment and review event log for fan failures.
TMP0100	Message	Disk drive bay temperature is less than the lower warning threshold.
	Details	Ambient air temperature is too cool.
	Action	Check the system operating environment.
TMP0104	Message	Disk drive bay temperature is less than the lower critical threshold.
	LCD Message	Disk drive bay temperature is outside of range. Check Fans.
	Details	Ambient air temperature is too cool.
	Action	Check the system operating environment.
TMP0126	Message	Disk drive bay temperature is greater than the upper warning threshold.
	LCD Message	Disk drive bay temperature is outside of range. Check Fans.
	Details	Ambient air temperature is too warm or one or more fans may have failed.
	Action	Check the system operating environment and review event log for fan failures.
TMP0128	Message	Disk drive bay temperature is outside of the allowable range.
	LCD Message	Disk drive bay temperature is outside of range. Check Fans.
	Details	Ambient air temperature is too warm or cool.
	Action	Check the system operating environment and review event log for fan failures.

Error Code	Message Information	
TMP0130	Message	The control panel temperature is less than the lower warning threshold.
	LCD Message	Control panel temperature is outside of range.
	Details	Ambient air temperature is too cool.
	Action	Check the system operating environment.
TMP0132	Message	The control panel temperature is greater than the upper warning threshold.
	LCD Message	Control panel temperature is outside of range.
	Details	Ambient air temperature is too warm or one or more fans may have failed.
	Action	Check the system operating environment and review event log for fan failures.
TMP0134	Message	The control panel temperature is outside of the allowable range.
	LCD Message	Control panel temperature is outside of range.
	Details	Ambient air temperature is too warm or cool.
	Action	Check the system operating environment and review event log for fan failures.
VLT0100	Message	Processor module <name> voltage is less than the lower warning threshold.
	LCD Message	Processor module <name> voltage is outside of range.
	Details	System hardware detected an over voltage or under voltage condition. If multiple voltage exceptions occur consecutively the system may power down in fail-safe mode.
	Action	<ol style="list-style-type: none"> 1. Review system logs for power supply exceptions. 2. Remove the processor module. Inspect processor socket for bent pins. 3. If the issue persists, see Getting Help.
VLT0101	Message	Processor module <name> voltage is less than the lower critical threshold.
	LCD Message	Processor module <name> voltage is outside of range.

Error Code	Message Information	
	Details	<p>System hardware detected an over voltage or under voltage condition.</p> <p>If multiple voltage exceptions occur consecutively the system may power down in fail-safe mode.</p>
	Action	<ol style="list-style-type: none"> 1. Review system logs for power supply exceptions. 2. Remove the processor module. Inspect processor socket for bent pins. 3. If the issue persists, see Getting Help.
VLT0102	Message	Processor module <i><name></i> voltage is greater than the upper warning threshold.
	LCD Message	Processor module <i><name></i> voltage is outside of range.
	Details	<p>System hardware detected an over voltage or under voltage condition.</p> <p>If multiple voltage exceptions occur consecutively the system may power down in fail-safe mode.</p>
	Action	<ol style="list-style-type: none"> 1. Review system logs for power supply exceptions. 2. Remove the processor module. Inspect processor socket for bent pins. 3. If the issue persists, see Getting Help.
VLT0103	Message	Processor module <i><name></i> voltage is greater than the upper critical threshold.
	LCD Message	Processor module <i><name></i> voltage is outside of range.
	Details	<p>System hardware detected an over voltage or under voltage condition.</p> <p>If multiple voltage exceptions occur consecutively the system may power down in fail-safe mode.</p>
	Action	<ol style="list-style-type: none"> 1. Review system logs for power supply exceptions. 2. Remove the processor module. Inspect processor socket for bent pins. 3. If the issue persists, see Getting Help.
VLT0104	Message	Processor module <i><name></i> voltage is outside of the allowable range.
	LCD Message	Processor module <i><name></i> voltage is outside of range.

Error Code	Message Information	
VLT0200	Details	<p>System hardware detected an over voltage or under voltage condition.</p> <p>If multiple voltage exceptions occur consecutively the system may power down in fail-safe mode.</p>
	Action	<ol style="list-style-type: none"> 1. Review system logs for power supply exceptions. 2. Remove the processor module. Inspect processor socket for bent pins. 3. If the issue persists, see Getting Help.
	Message	<p>The system board <name> voltage is less than the lower critical threshold.</p>
	LCD Message	<p>System board voltage is outside of range.</p>
VLT0201	Details	<p>System hardware detected an over voltage or under voltage condition.</p> <p>If multiple voltage exceptions occur consecutively the system may power down in fail-safe mode.</p>
	Action	<ol style="list-style-type: none"> 1. Review system logs for power supply exceptions. 2. Remove the processor module. Inspect processor socket for bent pins. 3. If the issue persists, see Getting Help.
	Message	<p>The system board <name> voltage is less than the lower warning threshold.</p>
	LCD Message	<p>System board voltage is outside of range.</p>
VLT0202	Details	<p>System hardware detected an over voltage or under voltage condition.</p> <p>If multiple voltage exceptions occur consecutively the system may power down in fail-safe mode.</p>
	Action	<ol style="list-style-type: none"> 1. Review system logs for power supply exceptions. 2. Re-configure the system to minimum configuration, inspect and reinstall system cables. 3. If the issue persists, see Getting Help.
Message	<p>The system board <name> voltage is greater than the upper warning threshold.</p>	
LCD Message	<p>System board voltage is outside of range.</p>	

Error Code	Message Information	
VLT0203	Details	System hardware detected an over voltage or under voltage condition. If multiple voltage exceptions occur consecutively the system may power down in fail-safe mode.
	Action	<ol style="list-style-type: none"> 1. Review system logs for power supply exceptions. 2. Re-configure the system to minimum configuration, inspect and reinstall system cables. 3. If the issue persists, see Getting Help.
	Message	The system board <i><name></i> voltage is greater than the upper critical threshold.
	LCD Message	System board voltage is outside of range.
VLT0204	Details	System hardware detected an over voltage or under voltage condition. If multiple voltage exceptions occur consecutively the system may power down in fail-safe mode.
	Action	<ol style="list-style-type: none"> 1. Review system logs for power supply exceptions. 2. Re-configure the system to minimum configuration, inspect and reinstall system cables. 3. If the issue persists, see Getting Help.
	Message	The system board <i><name></i> voltage is outside of the allowable range.
	LCD Message	System board voltage is outside of range.
VLT0206	Details	System hardware detected an over voltage or under voltage condition. If multiple voltage exceptions occur consecutively the system may power down in fail-safe mode.
	Action	<ol style="list-style-type: none"> 1. Review system logs for power supply exceptions. 2. Re-configure the system to minimum configuration, inspect and reinstall system cables. 3. If the issue persists, see Getting Help.
Message	The memory module <i><number></i> <i><name></i> voltage is less than the lower warning threshold.	
LCD Message	Memory module <i><number></i> <i><name></i> voltage is outside of range.	

Error Code	Message Information	
	Details	<p>System hardware detected an over voltage or under voltage condition.</p> <p>If multiple voltage exceptions occur consecutively the system may power down in fail-safe mode.</p>
	Action	<ol style="list-style-type: none"> 1. Review system logs for power supply exceptions. 2. Re-configure the system to minimum configuration, inspect and reinstall system cables. 3. If the issue persists, see Getting Help.
VLT0207	Message	The memory module <i><number></i> <i><name></i> voltage is less than the lower critical threshold.
	LCD Message	Memory module <i><number></i> <i><name></i> voltage is outside of range.
	Details	<p>System hardware detected an over voltage or under voltage condition.</p> <p>If multiple voltage exceptions occur consecutively the system may power down in fail-safe mode.</p>
	Action	<ol style="list-style-type: none"> 1. Review system logs for power supply exceptions. 2. Re-configure the system to minimum configuration, inspect and reinstall system cables. 3. If the issue persists, see Getting Help.
VLT0208	Message	The memory module <i><number></i> <i><name></i> voltage is greater than the upper warning threshold.
	LCD Message	Memory module <i><number></i> <i><name></i> voltage is outside of range.
	Details	<p>System hardware detected an over voltage or under voltage condition.</p> <p>If multiple voltage exceptions occur consecutively the system may power down in fail-safe mode.</p>
	Action	<ol style="list-style-type: none"> 1. Review system logs for power supply exceptions. 2. Re-configure the system to minimum configuration, inspect and reinstall system cables. 3. If the issue persists, see Getting Help.
VLT0209	Message	The memory module <i><number></i> <i><name></i> voltage is greater than the upper critical threshold.
	LCD Message	Memory module <i><number></i> <i><name></i> voltage is outside of range.

Error Code	Message Information	
	Details	<p>System hardware detected an over voltage or under voltage condition.</p> <p>If multiple voltage exceptions occur consecutively the system may power down in fail-safe mode.</p>
	Action	<ol style="list-style-type: none"> 1. Review system logs for power supply exceptions. 2. Re-configure the system to minimum configuration, inspect and reinstall system cables. 3. If the issue persists, see Getting Help.
VLT0210	Message	The memory module <i><number></i> <i><name></i> voltage is outside of range.
	LCD Message	Memory module <i><number></i> <i><name></i> voltage is outside of range.
	Details	<p>System hardware detected an over voltage or under voltage condition.</p> <p>If multiple voltage exceptions occur consecutively the system may power down in fail-safe mode.</p>
	Action	<ol style="list-style-type: none"> 1. Review system logs for power supply exceptions. 2. Re-configure the system to minimum configuration, inspect and reinstall system cables. 3. If the issue persists, see Getting Help.
VLT0212	Message	The disk drive bay <i><name></i> voltage is less than the lower warning threshold.
	LCD Message	The disk drive bay <i><name></i> voltage is outside of range.
	Details	<p>System hardware detected an over voltage or under voltage condition.</p> <p>If multiple voltage exceptions occur consecutively the system may power down in fail-safe mode.</p>
	Action	<ol style="list-style-type: none"> 1. Review system logs for power supply exceptions. 2. Re-configure the system to minimum configuration, inspect and reinstall system cables. 3. If the issue persists, see Getting Help.
VLT0213	Message	The disk drive bay <i><name></i> voltage is less than the lower critical threshold.
	LCD Message	The disk drive bay <i><name></i> voltage is outside of range.

Error Code	Message Information	
VLT0214	Details	<p>System hardware detected an over voltage or under voltage condition.</p> <p>If multiple voltage exceptions occur consecutively the system may power down in fail-safe mode.</p>
	Action	<ol style="list-style-type: none"> 1. Review system logs for power supply exceptions. 2. Re-configure the system to minimum configuration, inspect and reinstall system cables. 3. If the issue persists, see Getting Help.
	Message	The disk drive bay <name> voltage is greater than the upper critical threshold.
	LCD Message	The disk drive bay <name> voltage is outside of range.
VLT0215	Details	<p>System hardware detected an over voltage or under voltage condition.</p> <p>If multiple voltage exceptions occur consecutively the system may power down in fail-safe mode.</p>
	Action	<ol style="list-style-type: none"> 1. Review system logs for power supply exceptions. 2. Re-configure the system to minimum configuration, inspect and reinstall system cables. 3. If the issue persists, see Getting Help.
	Message	The disk drive bay <name> voltage is greater than the upper critical threshold.
	LCD Message	The disk drive bay <name> voltage is outside of range.
VLT0216	Details	<p>System hardware detected an over voltage or under voltage condition.</p> <p>If multiple voltage exceptions occur consecutively the system may power down in fail-safe mode.</p>
	Action	<ol style="list-style-type: none"> 1. Review system logs for power supply exceptions. 2. Re-configure the system to minimum configuration, inspect and reinstall system cables. 3. If the issue persists, see Getting Help.
	Message	The <name> voltage is outside of range.
	LCD Message	The <name> voltage is outside of range.

Error Code	Message Information	
	Details	System hardware detected an over voltage or under voltage condition. If multiple voltage exceptions occur consecutively the system may power down in fail-safe mode.
	Action	<ol style="list-style-type: none"> 1. Review system logs for power supply exceptions. 2. Re-configure the system to minimum configuration, inspect and reinstall system cables. 3. If the issue persists, see Getting Help.
VLT0218	Message	The <name> voltage is less than the lower warning threshold.
	LCD Message	The <name> voltage is outside of range.
	Details	System hardware detected an over voltage or under voltage condition. If multiple voltage exceptions occur consecutively the system may power down in fail-safe mode.
	Action	<ol style="list-style-type: none"> 1. Review system logs for power supply exceptions. 2. Re-configure the system to minimum configuration, inspect and reinstall system cables. 3. If the issue persists, see Getting Help.
VLT0219	Message	The <name> voltage is less than the lower critical threshold.
	LCD Message	The <name> voltage is outside of range.
	Details	System hardware detected an over voltage or under voltage condition. If multiple voltage exceptions occur consecutively the system may power down in fail-safe mode.
	Action	<ol style="list-style-type: none"> 1. Review system logs for power supply exceptions. 2. Re-configure the system to minimum configuration, inspect and reinstall system cables. 3. If the issue persists, see Getting Help.
VLT0220	Message	The <name> voltage is greater than the upper warning threshold.
	LCD Message	The <name> voltage is outside of range.
	Details	System hardware detected an over voltage or under voltage condition.

Error Code	Message Information	
		If multiple voltage exceptions occur consecutively the system may power down in fail-safe mode.
	Action	<ol style="list-style-type: none"> 1. Review system logs for power supply exceptions. 2. Re-configure the system to minimum configuration, inspect and reinstall system cables. 3. If the issue persists, see Getting Help.
VLT0221	Message	The <name> voltage is greater than the upper critical threshold.
	LCD Message	The <name> voltage is outside of range.
	Details	System hardware detected an over voltage or under voltage condition.
		If multiple voltage exceptions occur consecutively the system may power down in fail-safe mode.
	Action	<ol style="list-style-type: none"> 1. Review system logs for power supply exceptions. 2. Re-configure the system to minimum configuration, inspect and reinstall system cables. 3. If the issue persists, see Getting Help.
VLT0222	Message	The <name> voltage is outside of range.
	LCD Message	The <name> voltage is outside of range.
	Details	System hardware detected an over voltage or under voltage condition.
		If multiple voltage exceptions occur consecutively the system may power down in fail-safe mode.
	Action	<ol style="list-style-type: none"> 1. Review system logs for power supply exceptions. 2. Re-configure the system to minimum configuration, inspect and reinstall system cables. 3. If the issue persists, see Getting Help.
VLT0224	Message	The memory module <name> voltage is less than the lower warning threshold.
	LCD Message	Memory module <number> <name> voltage is outside of range.
	Details	System hardware detected an over voltage or under voltage condition.

Error Code	Message Information	
VLT0225		If multiple voltage exceptions occur consecutively the system may power down in fail-safe mode.
	Action	<ol style="list-style-type: none"> 1. Review system logs for power supply exceptions. 2. Re-configure the system to minimum configuration, inspect and reinstall system cables. 3. If the issue persists, see Getting Help.
	Message	The memory module <name> voltage is less than the lower critical threshold.
	LCD Message	Memory module <number> <name> voltage is outside of range.
VLT0226	Details	System hardware detected an over voltage or under voltage condition.
	Action	<p>If multiple voltage exceptions occur consecutively the system may power down in fail-safe mode.</p> <ol style="list-style-type: none"> 1. Review system logs for power supply exceptions. 2. Re-configure the system to minimum configuration, inspect and reinstall system cables. 3. If the issue persists, see Getting Help.
	Message	The memory module <name> voltage is greater than the upper warning threshold.
	LCD Message	Memory module <number> <name> voltage is outside of range.
VLT0227	Details	System hardware detected an over voltage or under voltage condition.
	Action	<p>If multiple voltage exceptions occur consecutively the system may power down in fail-safe mode.</p> <ol style="list-style-type: none"> 1. Review system logs for power supply exceptions. 2. Re-configure the system to minimum configuration, inspect and reinstall system cables. 3. If the issue persists, see Getting Help.
	Message	The memory module <name> voltage is greater than the upper critical threshold.
LCD Message	Memory module <number> <name> voltage is outside of range.	
Details	System hardware detected an over voltage or under voltage condition.	

Error Code	Message Information	
		If multiple voltage exceptions occur consecutively the system may power down in fail-safe mode.
	Action	<ol style="list-style-type: none"> 1. Review system logs for power supply exceptions. 2. Re-configure the system to minimum configuration, inspect and reinstall system cables. 3. If the issue persists, see Getting Help.
VLT0228	Message	The memory module <name> voltage is outside of range.
	LCD Message	Memory module <number> <name> voltage is outside of range.
	Details	System hardware detected an over voltage or under voltage condition.
		If multiple voltage exceptions occur consecutively the system may power down in fail-safe mode.
	Action	<ol style="list-style-type: none"> 1. Review system logs for power supply exceptions. 2. Re-configure the system to minimum configuration, inspect and reinstall system cables. 3. If the issue persists, see Getting Help.
VLT0230	Message	The PCIe mezzanine card <number> <name> voltage is less than the lower warning threshold.
	Details	System hardware detected an over voltage or under voltage condition.
		If multiple voltage exceptions occur consecutively the system may power down in fail-safe mode.
	Action	<ol style="list-style-type: none"> 1. Review system logs for power supply exceptions. 2. Re-seat the PCIe mezzanine card. 3. If the issue persists, see Getting Help.
VLT0231	Message	The PCIe mezzanine card <number> <name> voltage is less than the lower critical threshold.
	Details	System hardware detected an over voltage or under voltage condition.
		If multiple voltage exceptions occur consecutively the system may power down in fail-safe mode.
	Action	<ol style="list-style-type: none"> 1. Review system logs for power supply exceptions.

Error Code	Message Information	
VLT0232	Message	<ol style="list-style-type: none"> 2. Re-seat the PCIe mezzanine card. 3. If the issue persists, see Getting Help.
	Details	<p>The PCIe mezzanine card <number> <name> voltage is greater than the upper warning threshold.</p> <p>System hardware detected an over voltage or under voltage condition.</p> <p>If multiple voltage exceptions occur consecutively the system may power down in fail-safe mode.</p>
	Action	<ol style="list-style-type: none"> 1. Review system logs for power supply exceptions. 2. Re-seat the PCIe mezzanine card. 3. If the issue persists, see Getting Help.
VLT0233	Message	<p>The PCIe mezzanine card <number> <name> voltage is greater than the upper critical threshold.</p>
	Details	<p>System hardware detected an over voltage or under voltage condition.</p> <p>If multiple voltage exceptions occur consecutively the system may power down in fail-safe mode.</p>
	Action	<ol style="list-style-type: none"> 1. Review system logs for power supply exceptions. 2. Re-seat the PCIe mezzanine card. 3. If the issue persists, see Getting Help.
VLT0234	Message	<p>The PCIe mezzanine card <number> <name> voltage is outside of range.</p>
	Details	<p>System hardware detected an over voltage or under voltage condition.</p> <p>If multiple voltage exceptions occur consecutively the system may power down in fail-safe mode.</p>
	Action	<ol style="list-style-type: none"> 1. Review system logs for power supply exceptions. 2. Re-seat the PCIe mezzanine card. 3. If the issue persists, see Getting Help.

Warning Messages

A warning message alerts you to a possible problem and prompts you to respond before the system continues a task. For example, before you format a hard drive, a message warns you that you may lose all data on the hard drive. Warning messages usually interrupt the task and require you to respond by typing y (yes) or n (no).

 **NOTE:** Warning messages are generated by either the application or the operating system. For more information, see the documentation that accompanied the operating system or application.

Diagnostic Messages

The system diagnostic utilities may issue messages if you run diagnostic tests on your system. See [Running The Embedded System Diagnostics](#) for more information about system diagnostics.

Alert Messages

Systems management software generates alert messages for your system. Alert messages include information, status, warning, and failure messages for drive, temperature, fan, and power conditions. For more information, see the systems management software documentation.

Getting Help

Contacting Dell

 **NOTE:** If you do not have an active Internet connection, you can find contact information on your purchase invoice, packing slip, bill, or Dell product catalog.

Dell provides several online and telephone-based support and service options. Availability varies by country and product, and some services may not be available in your area. To contact Dell for sales, technical support, or customer service issues:

1. Visit dell.com/support.
2. Select your support category.
3. Verify your country or region in the Choose a Country/Region drop-down menu at the top of page.
4. Select the appropriate service or support link based on your need.