

Dell EMC SC Series Storage with SAS Front-end Support for VMware vSphere

Abstract

This document describes how to configure VMware® vSphere® hosts equipped with supported SAS HBAs to access SAN storage on select Dell EMC™ SC Series arrays with SAS front-end ports.

September 2017

Revisions

Date	Description
October 2015	Initial release
February 2016	Updated technical support information
July 2016	Updated to include support for SC4020 storage arrays with the release of SCOS 7.1
September 2017	Updated to include support for SCv3000 and SC5020 storage arrays

Acknowledgments

Author: Chuck Armstrong, Midrange Storage Technical Solutions

The information in this publication is provided "as is." Dell Inc. makes no representations or warranties of any kind with respect to the information in this publication, and specifically disclaims implied warranties of merchantability or fitness for a particular purpose.

Use, copying, and distribution of any software described in this publication requires an applicable software license.

Copyright © 2015 - 2017 Dell Inc. or its subsidiaries. All Rights Reserved. Dell, EMC, and other trademarks are trademarks of Dell Inc. or its subsidiaries. Other trademarks may be the property of their respective owners. Published in the USA [10/10/2017] [Configuration/Deployment]

Dell EMC believes the information in this document is accurate as of its publication date. The information is subject to change without notice.

Table of contents

Revisions.....	2
Acknowledgments.....	2
Table of contents	3
Executive summary.....	4
Audience	4
1 Introduction.....	5
1.1 Supported Hardware	5
1.2 VMware vSphere	6
1.3 Transport options.....	6
2 SAS FE host path configuration options	7
2.1 Multipath configuration	7
3 Configure VMware hosts to access SC Series arrays with SAS FE ports.....	15
3.1 Prepare the environment.....	15
3.2 Install and configure SAS HBAs in the VMware hosts	16
3.3 Configure SAS FE fault domains.....	17
3.4 Connect VMware hosts to the SC Series array with SAS cables.....	20
3.5 Create server objects on the SC Series array.....	21
3.6 Create server cluster object on the SC Series array	24
3.7 Create and map storage volumes to vSphere hosts	25
3.8 Create datastores and configure Multipath settings.....	27
A Additional resources.....	36

Executive summary

Select Dell EMC SC Series arrays support serial-attached SCSI (SAS) front-end (FE) ports for connecting host servers equipped with a supported SAS host bus adapter (HBA) directly to SC Series array SAN storage. SAS FE is a simple, cost-effective transport option that is ideal for locations such as a branch office with a limited number of host servers.

The focus of this paper is SAS FE support for environments with VMware vSphere hosts, and includes cabling diagrams and step-by-step configuration guidance. Similar information on SAS FE support for Microsoft® Windows Server® Hyper-V® environments can be found in [Dell EMC SC Series Storage with SAS Front-end Support for Microsoft Hyper-V](#).

Audience

This document is for SAN and VMware administrators seeking additional guidance for configuring vSphere hosts with SAS HBAs to access SAN storage on select SC Series arrays equipped with SAS FE ports. Readers should have a working knowledge of SC Series storage and VMware vSphere environments.

1 Introduction

SC Series arrays configured with Fibre Channel or iSCSI continue to be the preferred front-end transport option for most environments due to their flexible, robust, and highly scalable configurations. However, for smaller locations, such as a branch office, SAS FE is an appealing solution. SAS FE SC Series environments do not require any additional switching hardware, as the hosts are connected directly to the array, and can include as many as four hosts.

1.1 Supported Hardware

The following SC Series arrays support SAS FE:

- SCv2000
- SCv3000
- SC4020
- SC5020

The SCv2000 and SCv3000 arrays are affordable, entry-level systems that offer many of the same enterprise-class features as other SC Series arrays, and the SC4020 and SC5020 are fully featured arrays. Each of these SC Series arrays support three different front-end transport options: FC, iSCSI, or SAS FE. Customers can decide at the time of purchase the type of front-end connectivity that is right for each SC Series array in their environment.

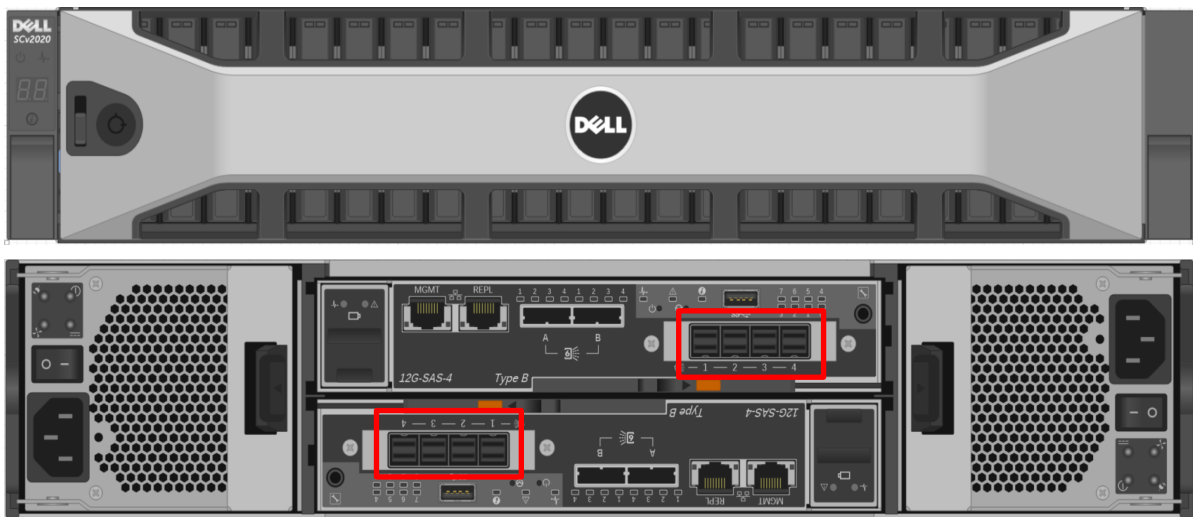

Figure 1 Front and rear views of an SCv2000/SC4020 array with SAS FE ports



Figure 2 Front and rear views of an SCv3000/SC5020 array with SAS FE ports

For more information about the SC Series arrays in this paper, including the release notes, getting started guides, system deployment guides, and owner's manuals, see the resources available at [Dell Support](#).

1.2 VMware vSphere

This document assumes the reader is familiar with the basics of VMware vSphere and its components. Several online sites offer detailed information on vSphere and vCenter, and therefore, that information will not be replicated here. This guide focuses specifically on how to configure vSphere hosts with SAS HBAs to access SAN storage on SC Series arrays configured with SAS FE ports.

For more information on VMware platforms, visit the [VMware Knowledge Base](#).

1.3 Transport options

For most environments, FC or iSCSI are the preferred method for configuring front-end connectivity between host servers and SC Series SAN storage. Fibre Channel and iSCSI are mature, robust, proven technologies that can scale to include a large number of hosts and SC Series arrays across multiple locations. When configured with redundant fabrics, these transports offer highly resilient and reliable data transfer between SAN storage and hosts. However, they require additional components including switches, HBAs, and cabling, along with expertise to support the technology.

For small environments with a limited number of physical hosts, SAS FE connectivity provides comparable performance and resiliency to FC or iSCSI, but without the extra cost and complexity of additional hardware components. There are, however, considerations to keep in mind when choosing SAS over FC or iSCSI:

Scale: With SAS FE, the number of physical hosts for each SC Series array is limited to a maximum of four (path redundancy is required).

Design: With SAS FE, physical hosts must be in close proximity to the SC Series array, typically in the same or an adjacent rack that is within reach of SAS cabling (typically one to six meters in length).

2 SAS FE host path configuration options

When an SC Series array is configured with SAS FE ports, eight ports (four on each controller) are available to connect hosts with SAS HBAs. SC Series arrays with SAS-FE connectivity support a maximum of four hosts (path redundancy is required for each host SAS HBA).

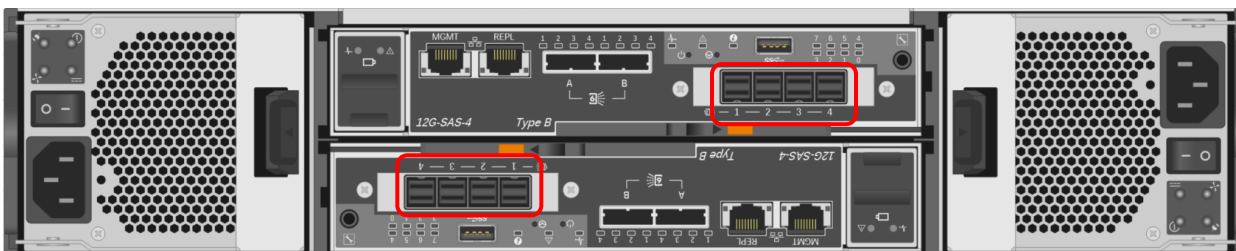

Figure 3 SCv2000/SC4020 with SAS FE ports (4 ports on each controller)



Figure 4 SCv3000/SC5020 with SAS FE ports (4 ports on each controller)

2.1 Multipath configuration

To provide redundancy and ensure uptime, each host should be configured with at least two data paths to external storage. With MPIO, if a data path fails, another data path provides the host with uninterrupted access to SAN storage.

VMware vSphere provides native Multi-path I/O (MPIO) support that is easy to configure. More information on MPIO for VMware vSphere can be found in [Dell EMC SC Series Best Practices with VMware vSphere 5.x-6.x](#).

With SAS FE, up to four hosts can be connected to each SC Series array in any combination of standalone hosts or cluster nodes. Figures 5 through 10 show several different MPIO cabling options for vSphere hosts and clusters.

Each cable color in figures 5 through 12 represents a separate SAS FE fault domain. Fault domains protect hosts against a single path or single controller failure.

Each SAS FE fault domain consists of two SAS FE ports. The SAS FE ports in each SAS FE fault domain are corresponding ports on each controller, for example: SAS FE port 1 on both top and bottom controllers. This is shown in the following images.

Note: When using more than one dual-port SAS HBA in a physical host, each dual-port SAS HBA must connect to only one SAS FE fault domain – one port to the top controller and one port to the bottom controller.

Note: The SCv2000 and SC4020 arrays utilize a 2U chassis, whereas the SCv3000 and SC5020 arrays utilize a 3U chassis. SAS FE functionality is similar on all supported SC models.

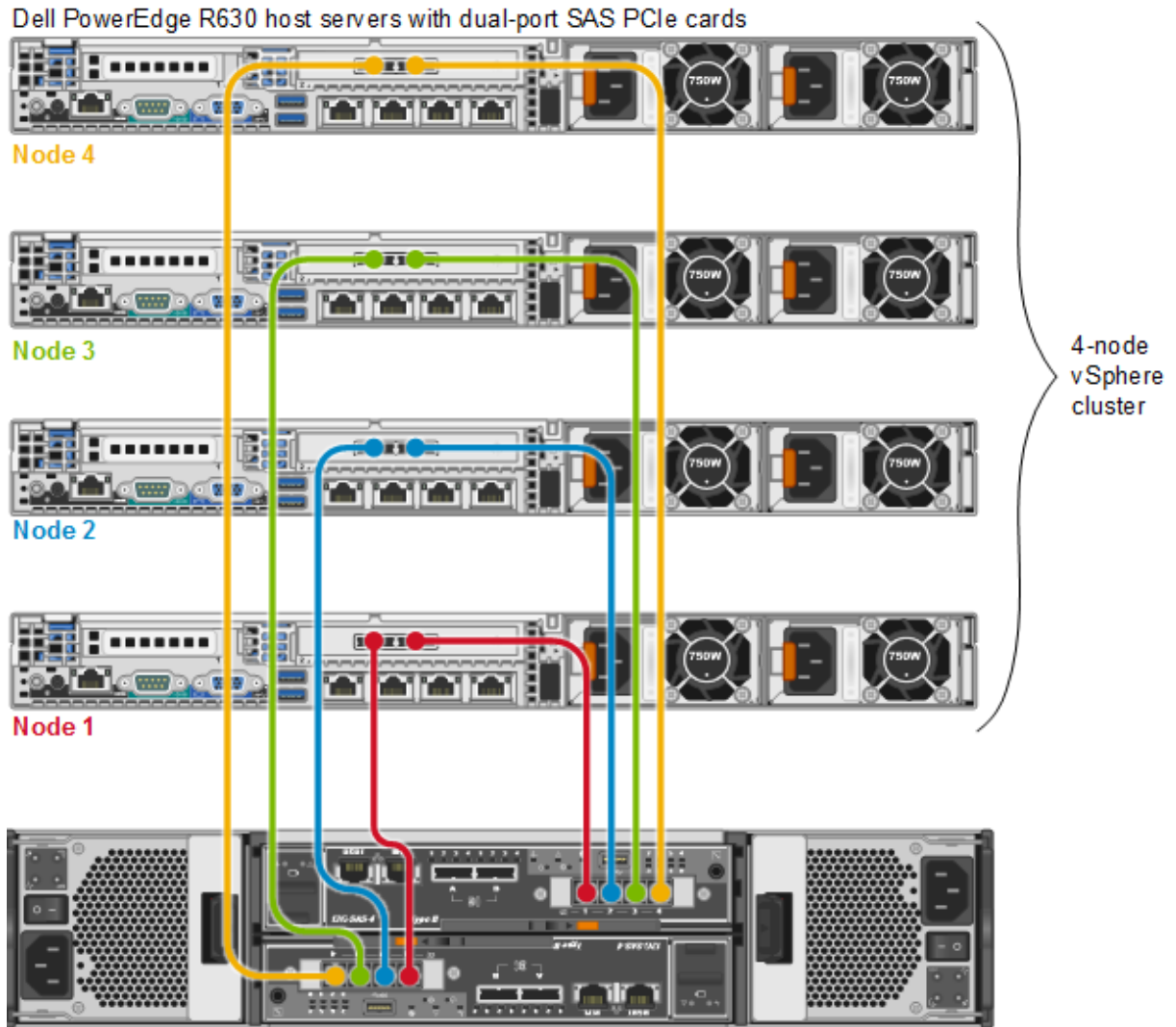

Figure 5 SCv2000/SC4020 with a 4-node vSphere cluster

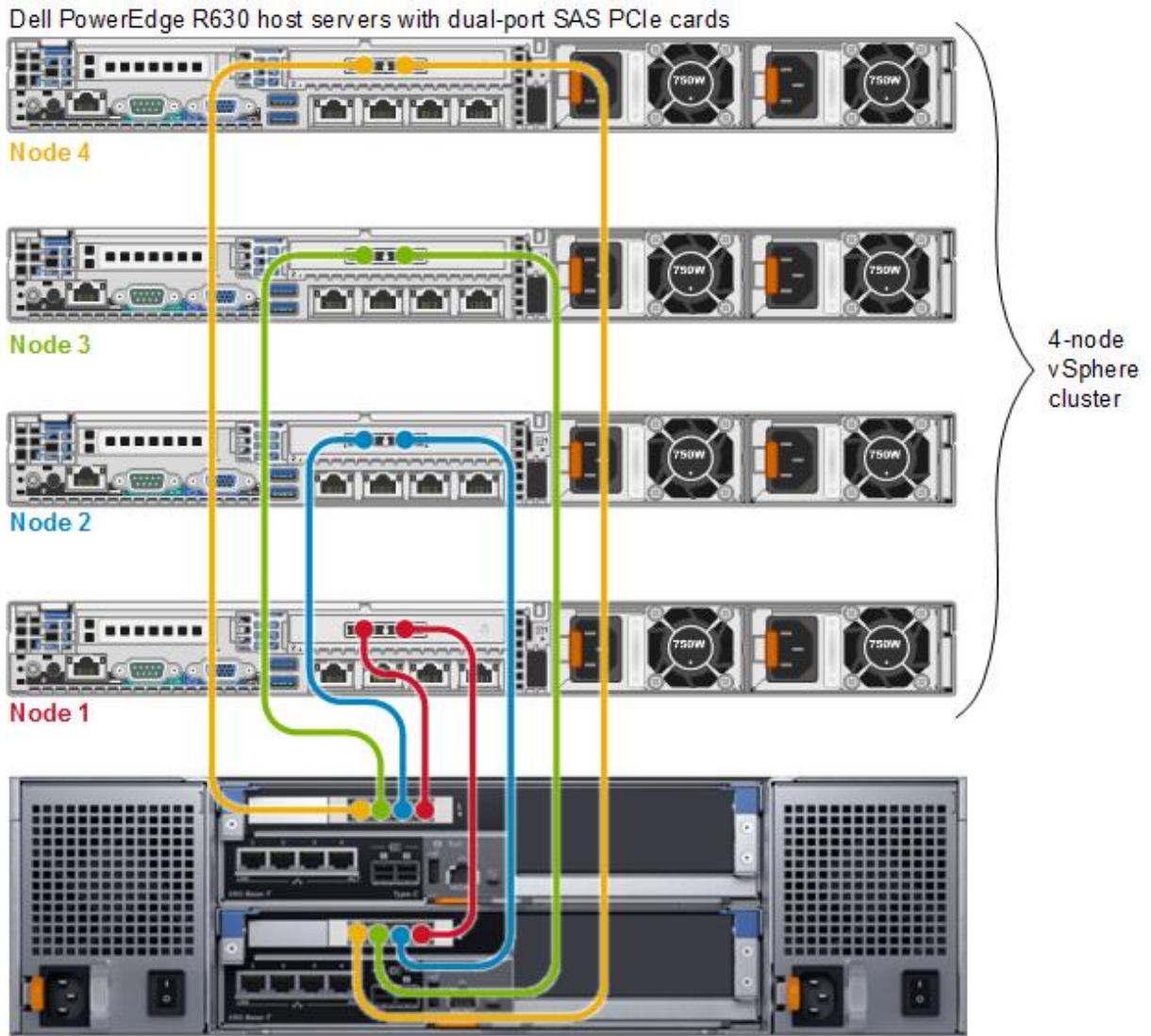

Figure 6 SCv3000/SC5020 with a 4-node vSphere cluster

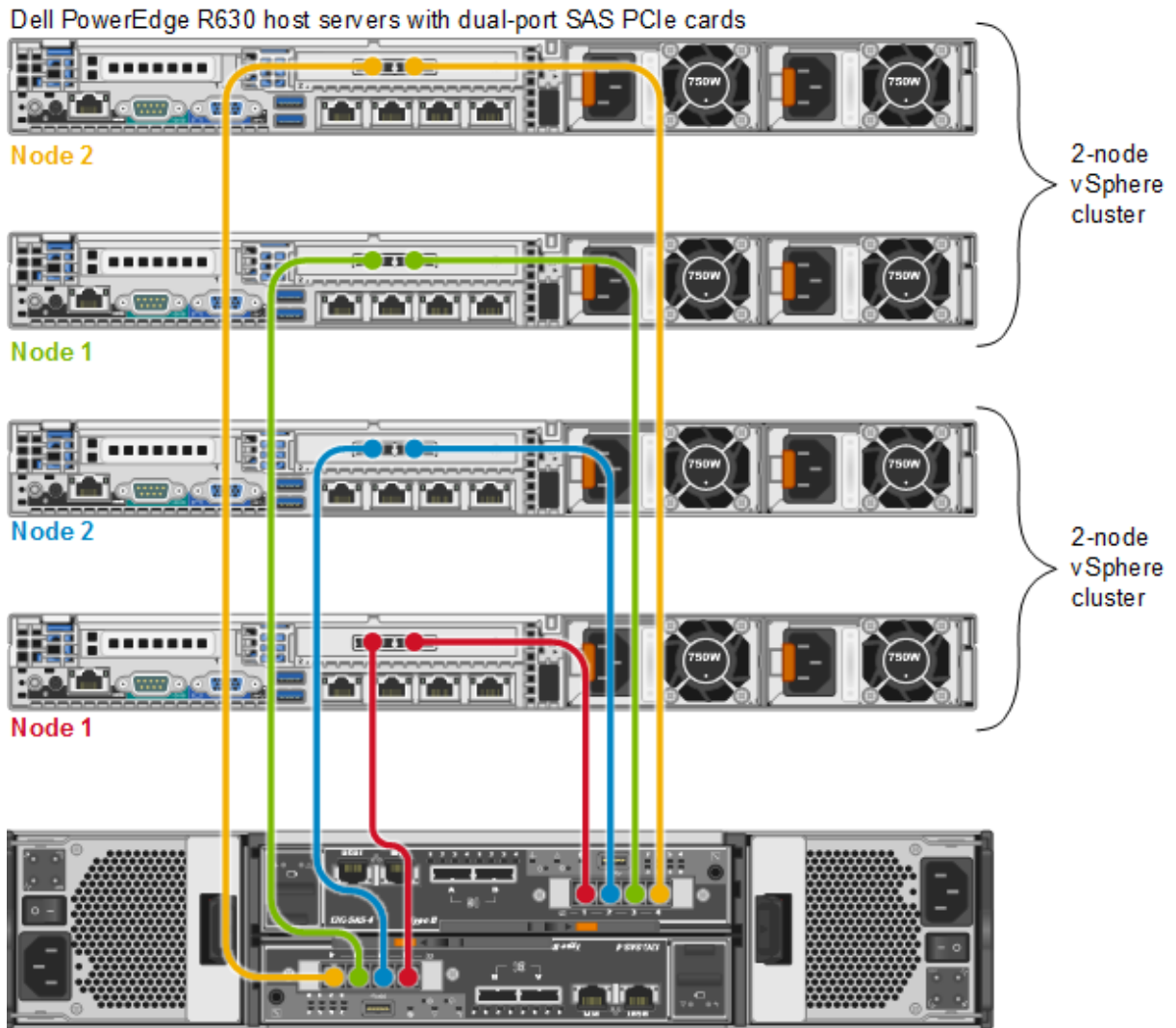

Figure 7 SCv2000/SC4020 with two 2-node vSphere clusters

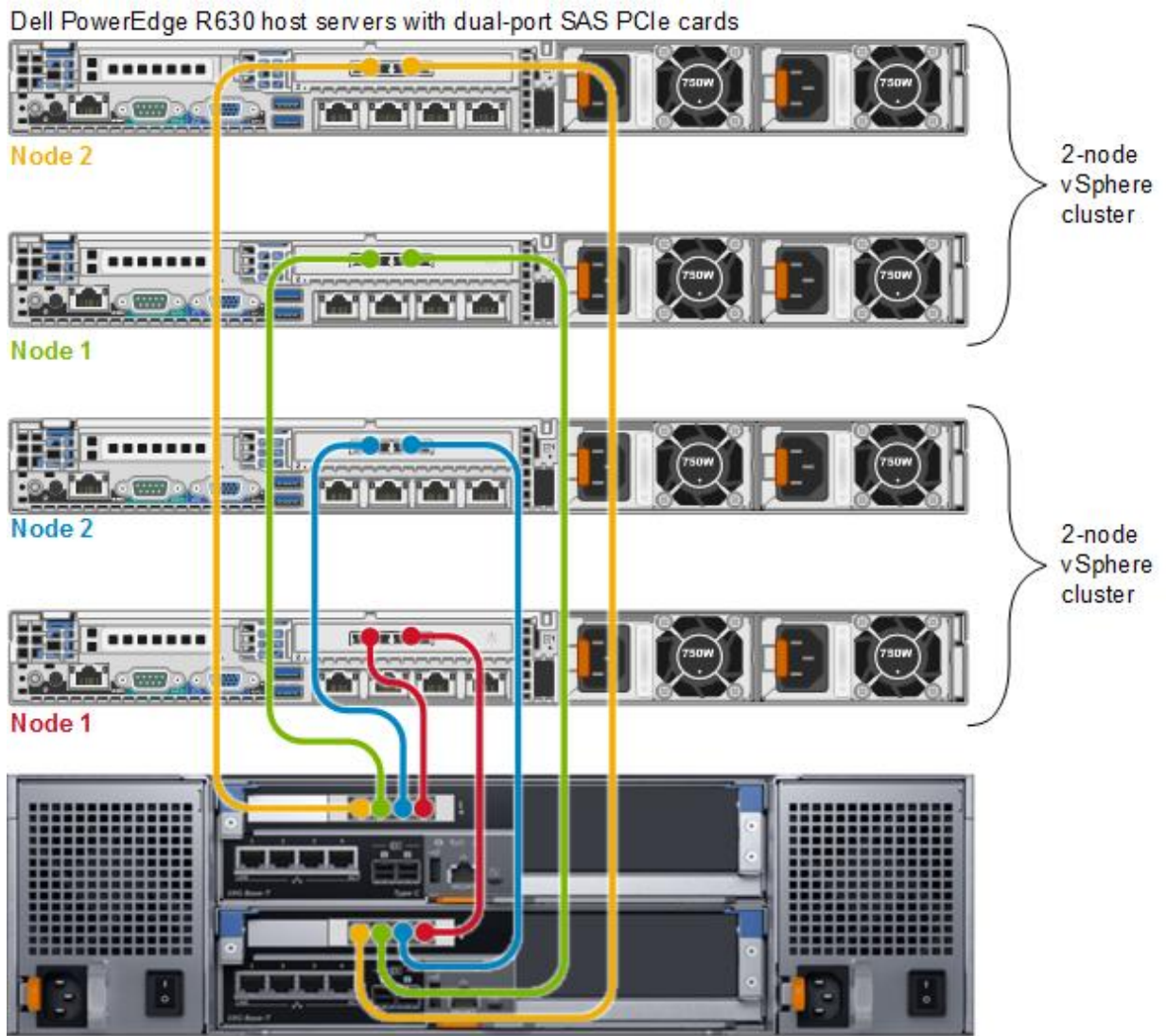

Figure 8 SCv3000/SC5020 with two 2-node vSphere clusters

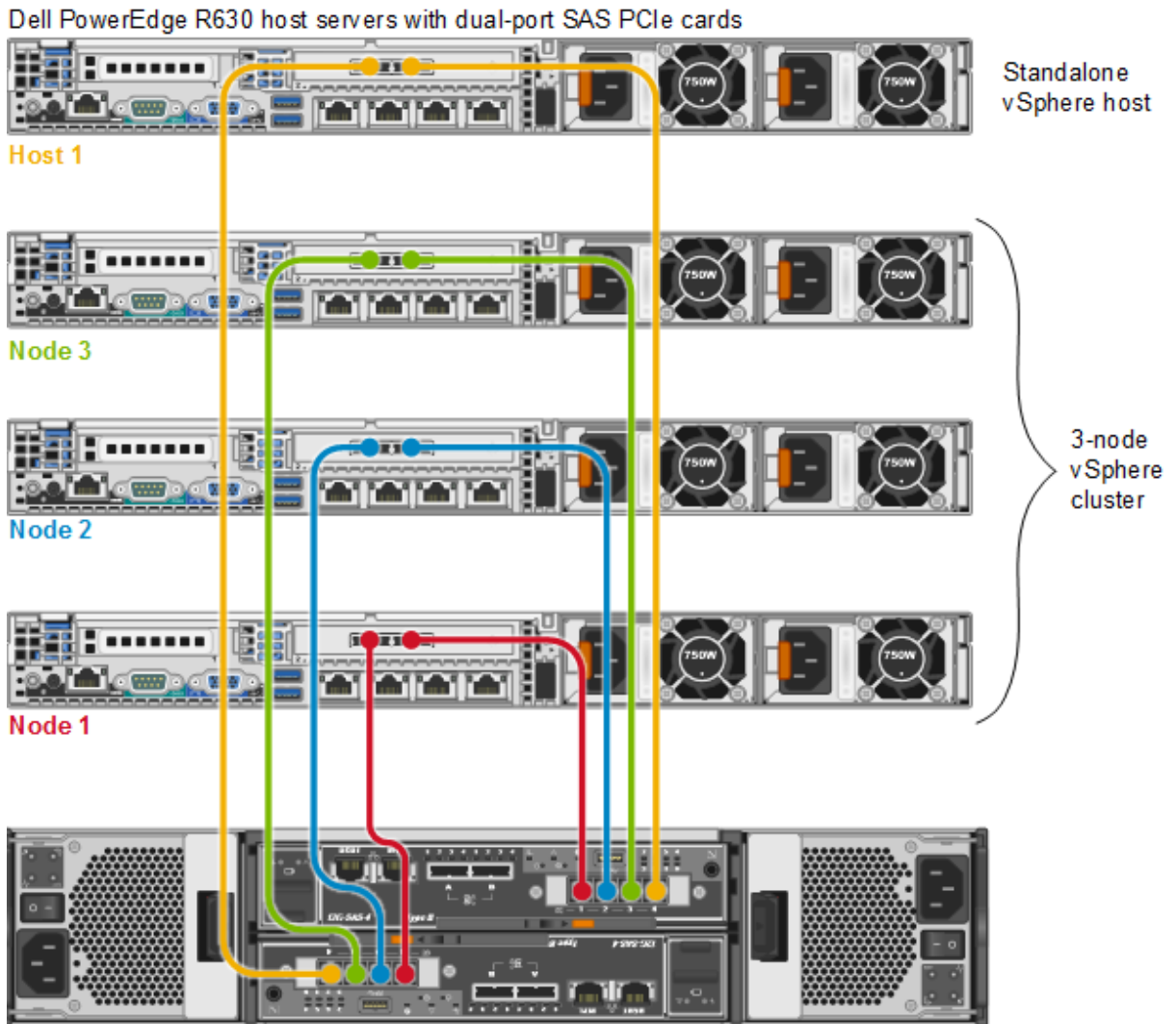

Figure 9 SCv2000/SC4020 with a 3-node vSphere cluster and one standalone host

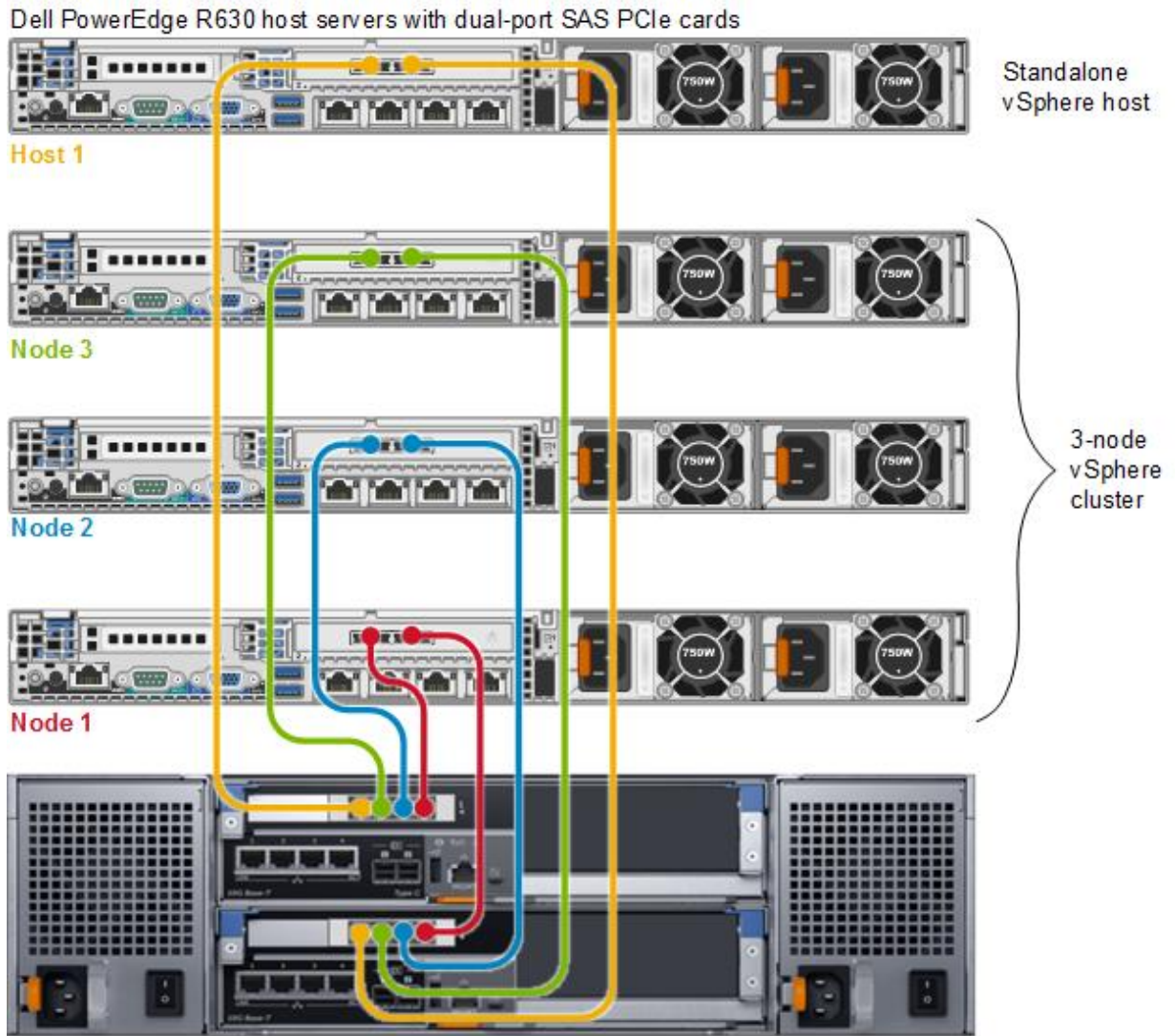

Figure 10 SCv3000/SC5020 with a 3-node vSphere cluster and one standalone host

Dell PowerEdge R630 host servers with two dual-port SAS PCIe cards each

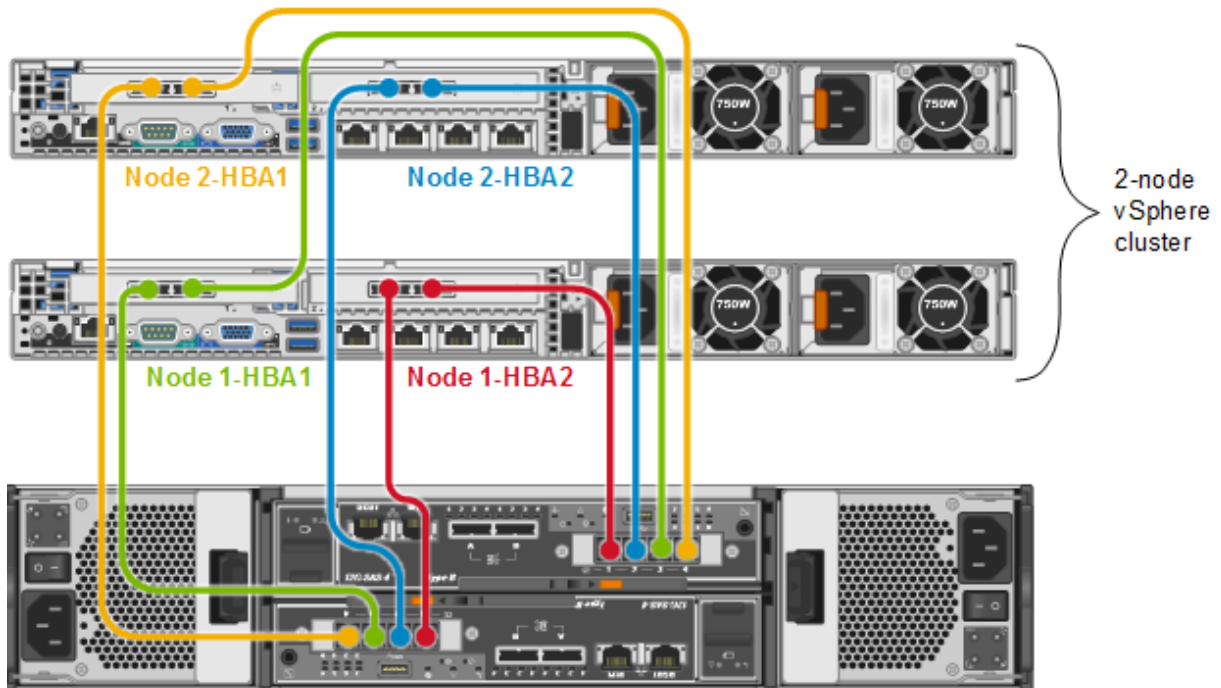

Figure 11 SCv2000/SC4020 with a 2-node vSphere cluster – each with two dual-port SAS HBAs

Dell PowerEdge R630 host servers with two dual-port SAS PCIe cards each

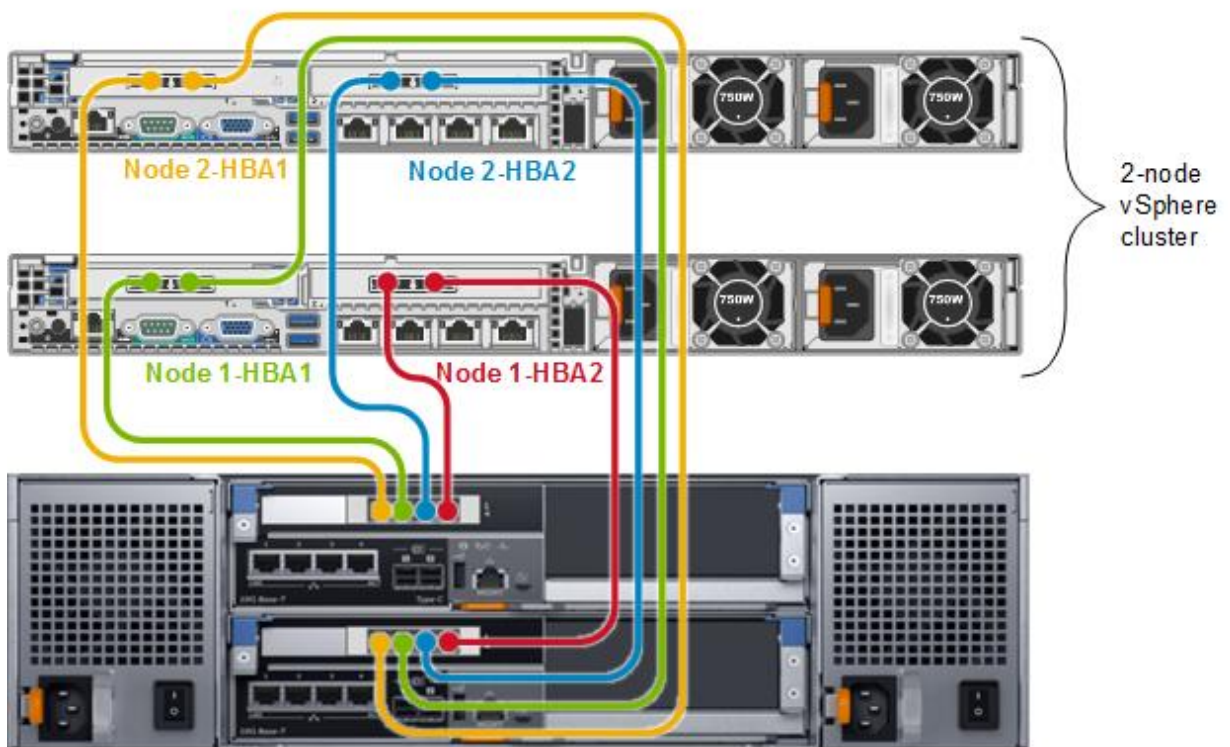

Figure 12 SCv3000/SC5020 with a 2-node vSphere cluster – each with two dual-port SAS HBAs

3 Configure VMware hosts to access SC Series arrays with SAS FE ports

This section provides instructions for configuring VMware vSphere hosts with SAS HBAs to access SAN storage on SC Series arrays with equipped with SAS FE ports.

3.1 Prepare the environment

Before configuring the vSphere hosts with SAS HBAs to access an SC Series array with SAS FE ports, verify compliance with the prerequisites listed in Table 1.

Table 1 Prerequisite steps checklist

✓	Tasks
	Verify at least one SC Series array equipped with SAS FE ports is configured and available.
	<p>Verify software version are compatible with SAS FE:</p> <ul style="list-style-type: none"> • SCv2000 arrays require Dell Enterprise Manager (EM) Client software version 2015 R1 or newer. Use this software to discover, configure and manage the SCv2000 array. Installing a Data Collector is supported but not required. Refer to the release notes and administrator's guide as needed. • SC4020 arrays require Dell Storage Center Operating System (SCOS) 7.1 or newer and Dell Storage Manager (DSM) version 2016 R2 or newer. • SCv3000 and SC5020 arrays require SCOS 7.2.10 or newer and DSM 2016 R3 or newer. <p>Running the latest version of SCOS and DSM for the SC Series array is recommended to take advantage of the latest enhancements.</p> <hr/> <p>Note: Enterprise Manager was rebranded as Dell Storage Manager in 2016.</p>
	<p>Ensure a supported PCIe SAS HBA interface card is present in each vSphere host along with SAS cables of the appropriate length. Each host must have a compatible PCIe slot available for each HBA.</p> <hr/> <p>Note: If multiple PCIe SAS HBAs are installed in a single host, all HBAs in that host must be the same model.</p> <hr/> <p>Only SAS HBAs listed in the Dell EMC Storage Compatibility Matrix are supported and drivers listed in the matrix can be found using the VMware Compatibility Guide. The example configurations shown in the guide use the Dell 12Gb SAS HBA.</p> <hr/> <p>Note: Only Dell PowerEdge™ servers (13G or newer) are supported when using the Dell 12Gb SAS HBA.</p> <hr/> <p>For more information, refer to the Dell PowerEdge Controller 9 HBA User's Guide</p>
	Ensure hosts have an on-board disk controller and disk configuration to support a local boot disk. Boot-from-SAN is not supported with SAS FE
	Ensure hosts are located in close proximity to the SC Series array. SAS cables are typically one to six meters in length.

✓	Tasks
	<p>Stage hosts with a supported VMware vSphere ESXi version and patch them to the required level. vSphere ESXi 5.1 Update 2 or newer is required to support the Dell 12Gbps SAS HBA drivers. vSphere 6.5 Update 1 is used in the examples shown in this document.</p> <p>As a best practice, use the Dell PowerEdge Server Lifecycle Controller to update the internal hardware components of your host and to broker the OS install using the latest Dell PowerEdge Server OS driver pack and the latest Dell EMC Customized version of vSphere ESXi.</p>

3.2 Install and configure SAS HBAs in the VMware hosts

After the prerequisite steps are complete, install one or more supported SAS HBAs in each host.

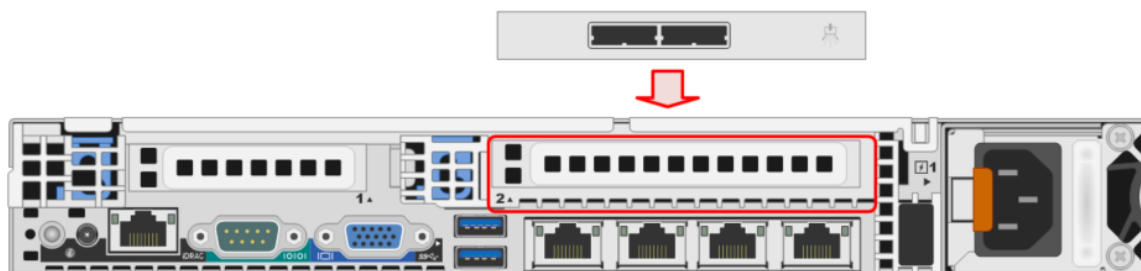

Figure 13 Install a SAS HBA in an available full- or half-height PCIe slot

1. While observing safe electrostatic discharge (ESD) precautions, power off the vSphere host and install a supported PCIe SAS HBA into an available full or half-height slot. In this example, a Dell 12Gb SAS HBA is installed in a full-height PCIe slot in a Dell PowerEdge R630 (13G) server.
2. Power on the vSphere host and press F10 at boot to access the Dell Server Lifecycle Controller (LC). Use the LC to verify and update the firmware version (preferred method).

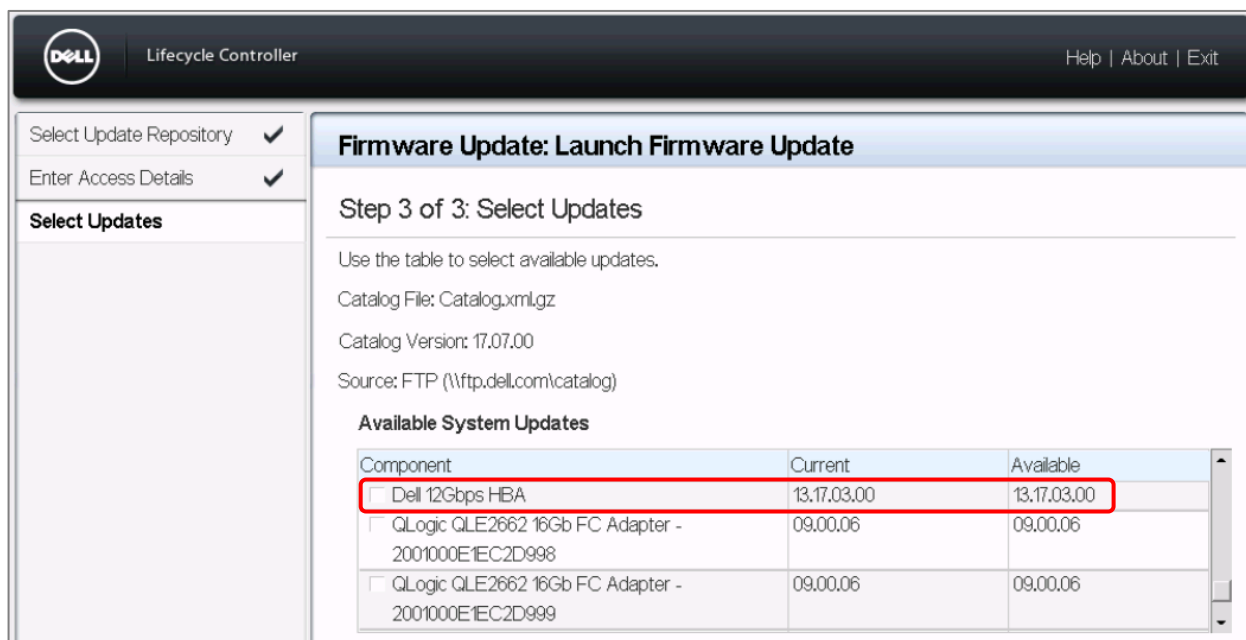

Figure 14 Dell server Lifecycle Controller

Note: If the Dell 12 Gbps SAS HBA is installed in the server before it is staged with the OS, the server Lifecycle Controller (press [F10] at boot) can be used to update the firmware and install the drivers from the latest Dell server driver pack (from ftp.dell.com – no user name or password required)

Note: vSphere may detect and install a native driver for the SAS HBA. It is important to update this driver, adhering to the [Dell EMC Storage Compatibility Matrix](#), using the Dell EMC Knowledge Base Article [Preparing VMware ESXi Hosts To Attach to SCv20x0, SC4020, SC5020 SAS Arrays](#) as a guide.

3. Repeat steps **Error! Reference source not found.** and **Error! Reference source not found.** above to install and update SAS HBAs in additional vSphere hosts.

3.3 Configure SAS FE fault domains

And SC5020 array is used in this example to show how to complete the configuration. The configuration steps for other SC Series arrays with SAS FE are similar.

1. Launch the **Dell EMC Storage Manager Client** and connect to the SC Series array directly, or to a Data Collector. In this example, the connection is made directly to the SC5020 by entering the management IP address.

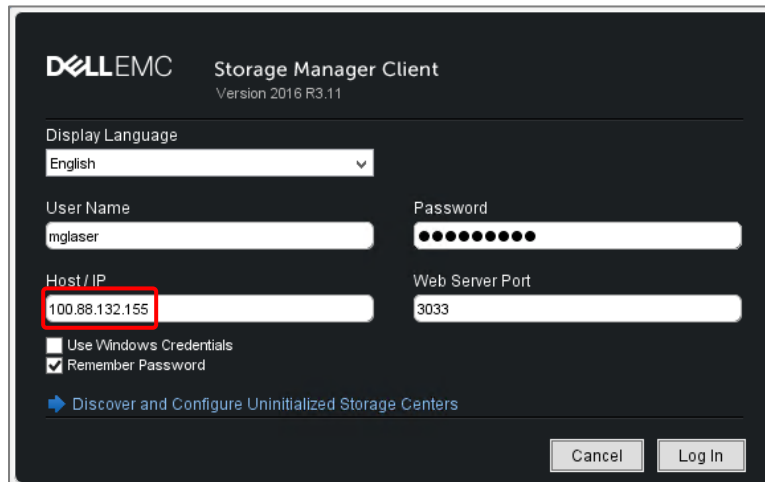

2. Click **Storage > Fault domains**. In this example, no fault domains are configured on the SC5020. Click **Front End SAS Port Configuration** to start the configuration wizard.

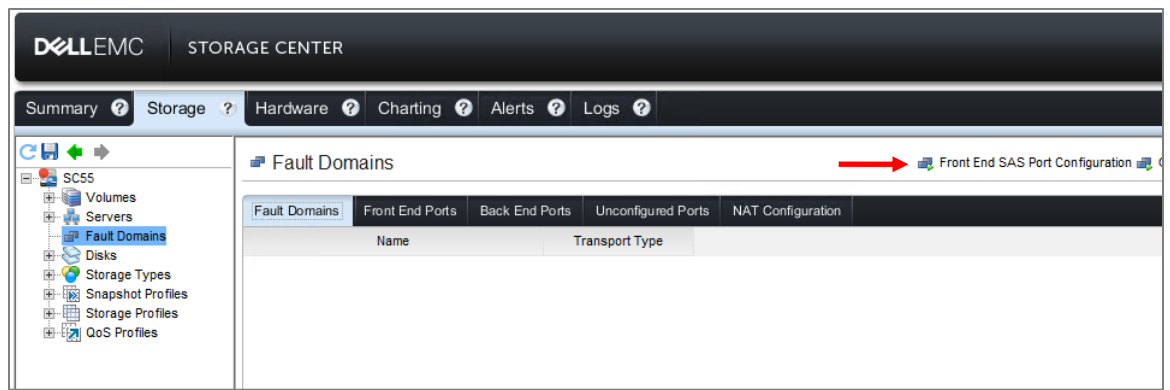

3. Specify to create 4 fault domains (the maximum number) and click **Next**.

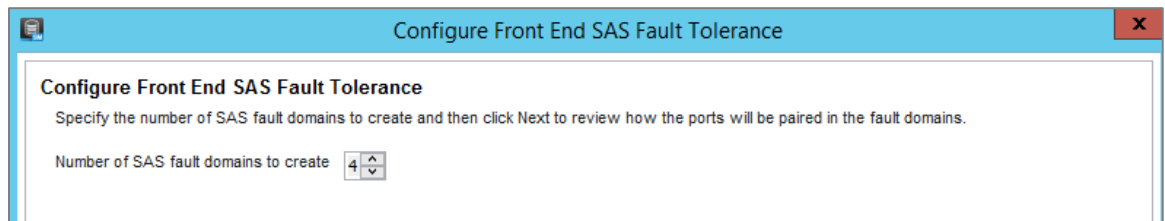

4. Review the fault domain information. A matching port on each SAS controller is automatically paired to create each fault domain. Click **Next**.

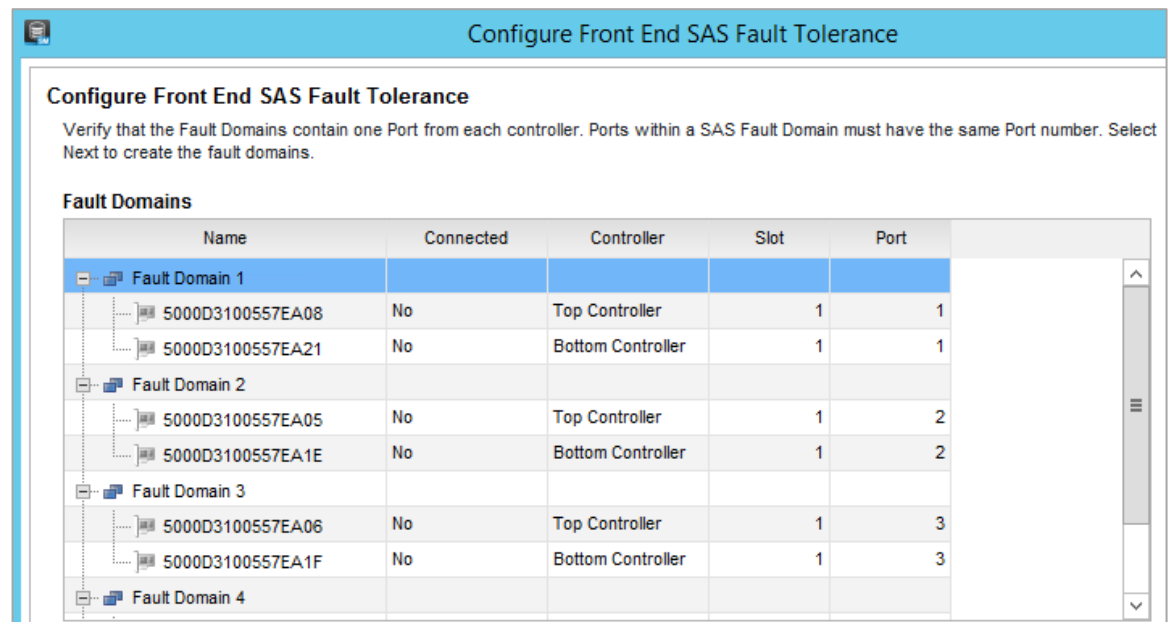

Note: SAS FE ports must be assigned to a fault domain before the ports become available to hosts.

5. Allow the wizard to complete and click **Finish**.
6. Expand the **Fault Domains > SAS** and click each fault domain to view the port details. The fault domains and ports will display a status of **Down** until the SAS cables are connected to host SAS ports.

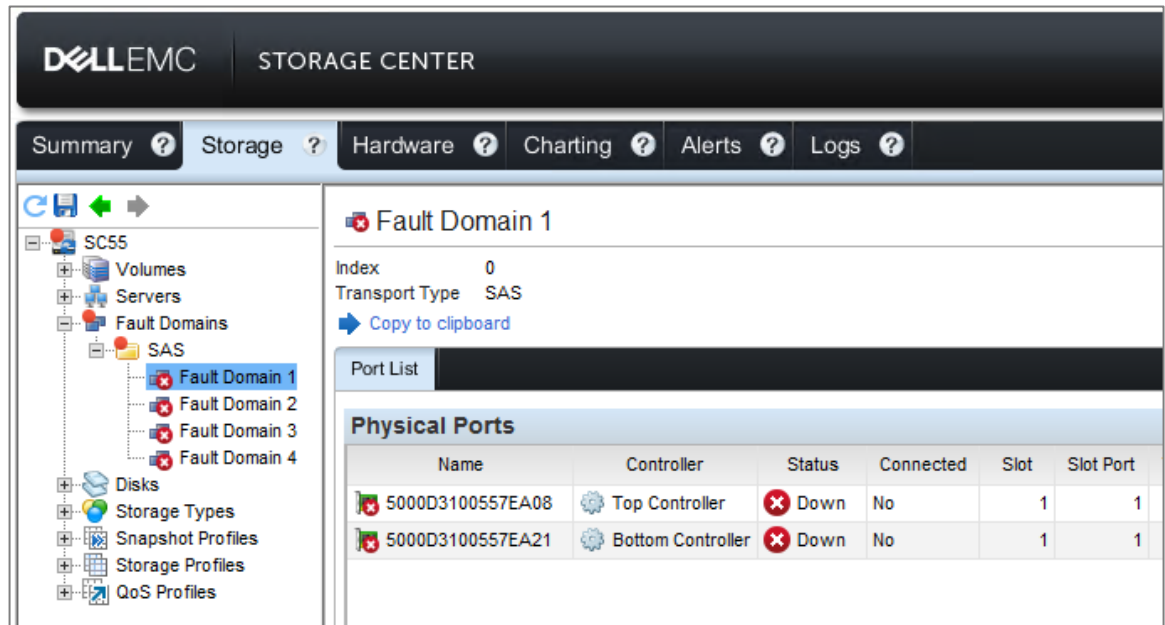

- Right-click a fault domain and select **Edit** to view additional information or to perform actions such as renaming the fault domain or assigning friendly names to each physical port.

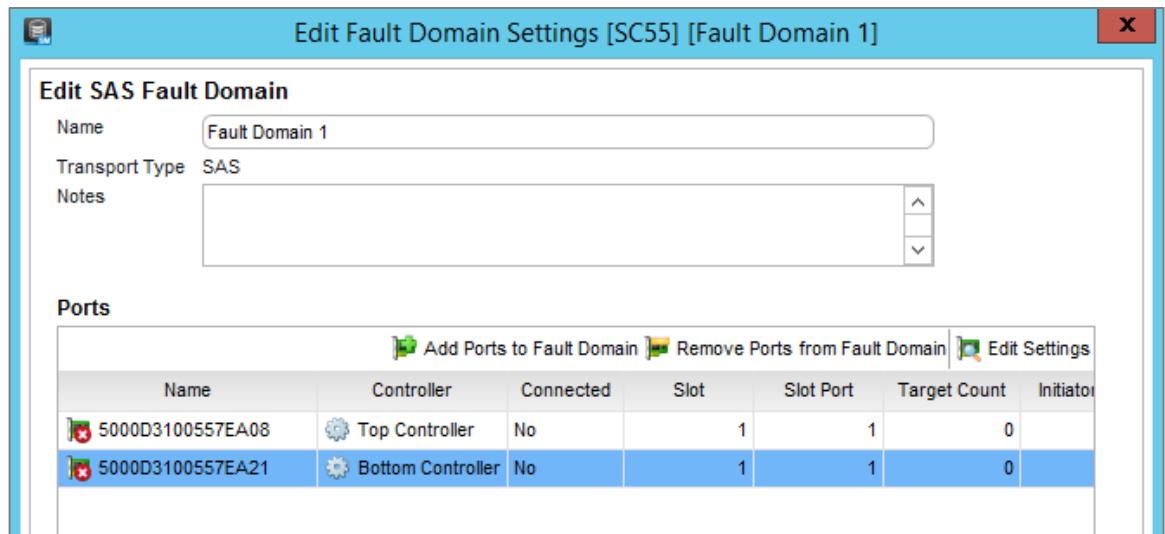

- As a best practice, modify the fault domain names and port names. This enables intuitive administration in later steps and makes troubleshooting easier. In this example, a host name is added to each component (the hosts are named **S13xx**).

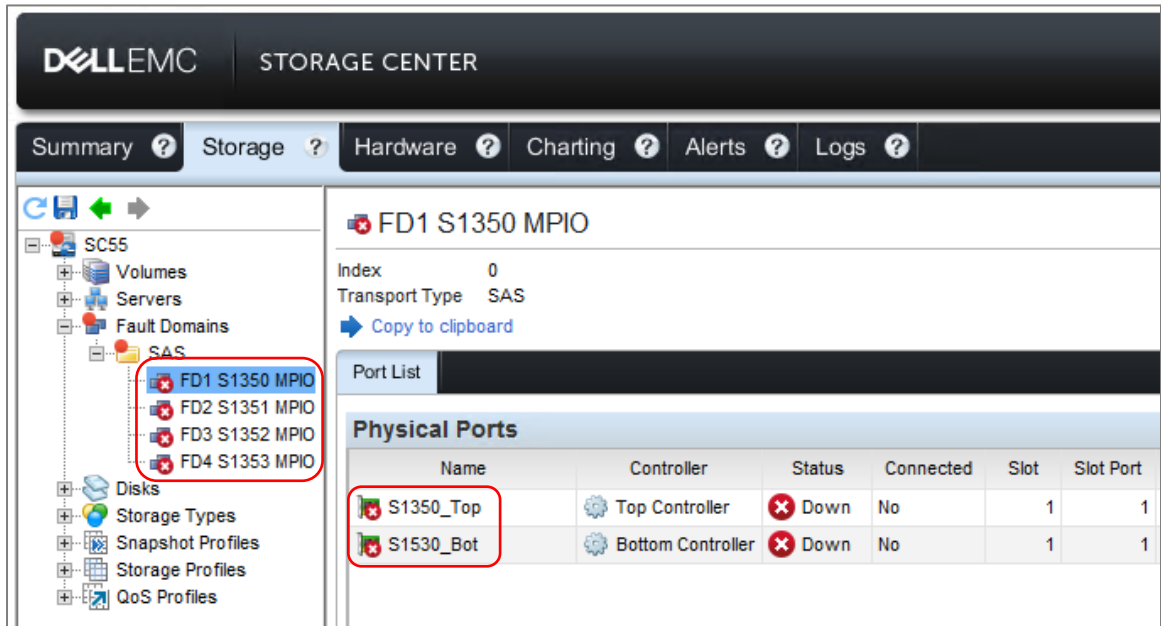

3.4 Connect VMware hosts to the SC Series array with SAS cables

The following example provides step-by-step guidance for configuring a two-node vSphere cluster using two Dell PowerEdge R630 servers, two Dell 12Gb SAS HBAs, four SAS cables, and an SC5020 array equipped with SAS FE ports.

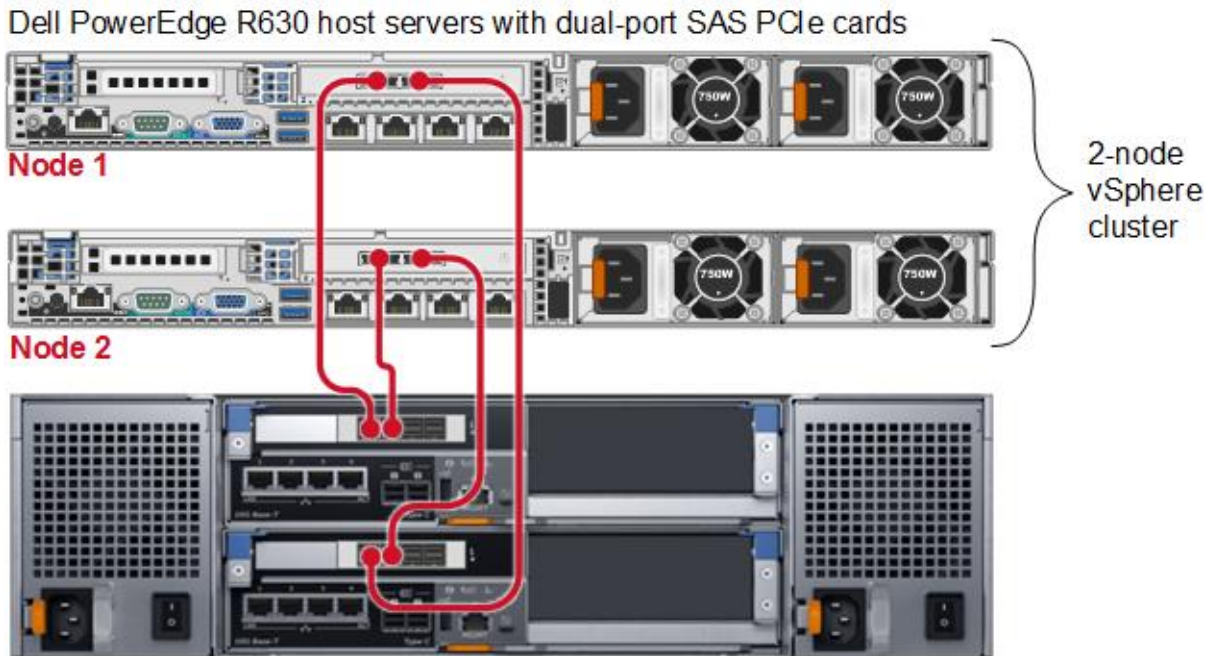
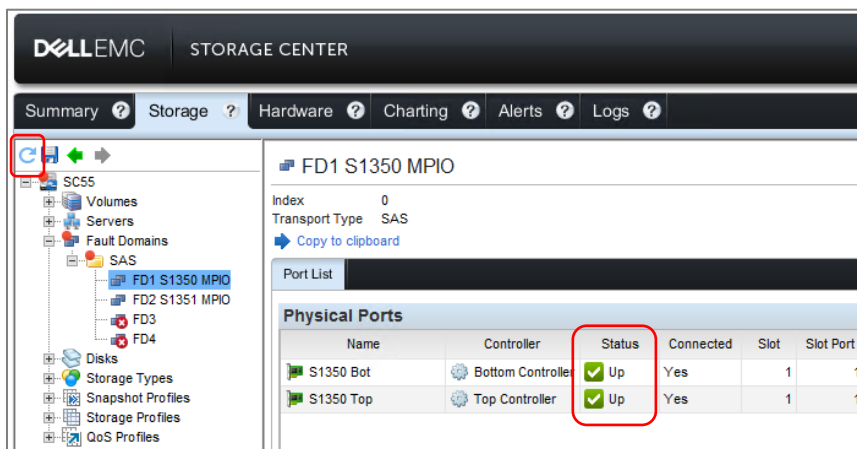

Figure 15 Configuration example with two R630 hosts and SC5020

Modify these steps to fit the design of your environment.

9. Starting with the first vSphere host, connect a SAS cable from the server to SAS Port 1 on the host to SAS FE port 1 in the top controller of the SC Series array. The host does not need to be turned off before connecting or removing SAS cables.
10. Connect a second SAS cable from the other host SAS Port to SAS FE port 1 in the bottom controller of the SC Series array. Make sure both host SAS ports are cabled to the same SAS FE fault domain.
11. Repeat steps 1 and 2 for each additional host until all are connected.
12. Refresh the view in DSM and verify the connected SAS ports show as status of **Up**. Resolve any connectivity issues before continuing.



Note: Cabling and configuring (configuration is described in the next section) one server at a time can make troubleshooting easier if there is a path issue.

3.5 Create server objects on the SC Series array

13. In the DSM client, click **Storage > Volumes** and create folders and subfolders to logically group volumes. Do the same under **Storage > Servers** to logically group server objects. In this example, a simple tree is created for the objects associated with the vSphere cluster.

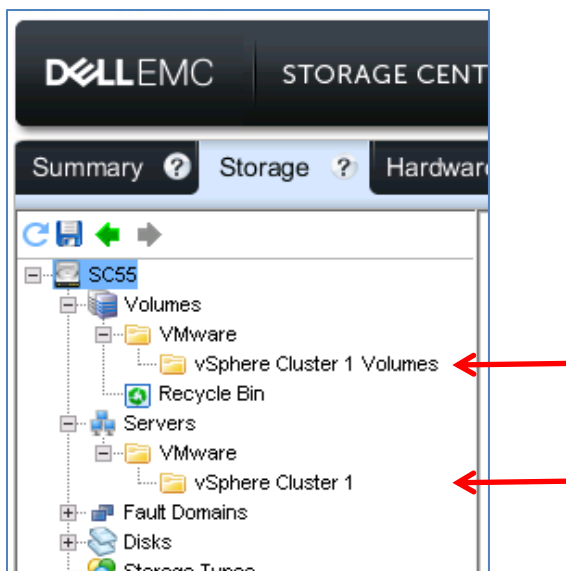

- In the **Hardware** tab, click **Chassis > Controllers > Top Controller > IO Ports > SAS** and then select the SAS port that is connected to the first host (**S1350 Top** in this example). Ports that are assigned intuitive names before this step will make this process easier. Click the **Connectivity** tab and note the initiator WWN for the host SAS port (ending in **4C00** in this example).

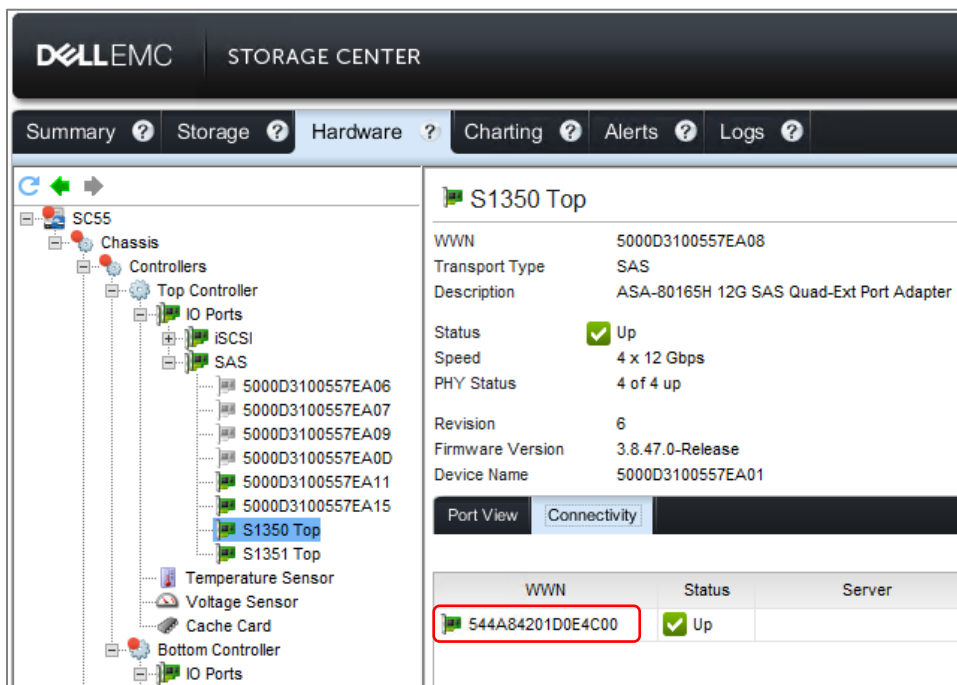

- Repeat step 2 and note the initiator WWNs for the other host SAS ports. In this example, the initiator WWN for port **S1351 Top** ends in **4801**.
- Repeat this process for the second (bottom) controller. In this example, the initiator WWNs end in **4C01** and **4800**.

- Host S1350: Top = **4C00** Bot = **4C01**
- Host S1351: Top = **4801** Bot = **4800**

- Under **Storage**, right click the desired Servers subfolder and select **Create Server**.

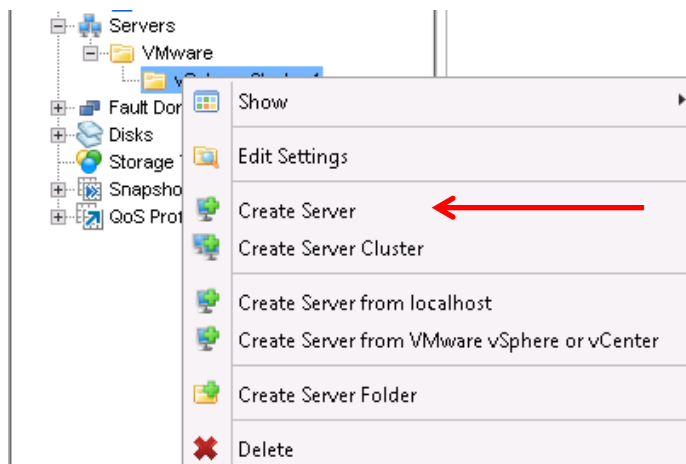

Note: The Create Server from VMware vSphere or vCenter option is currently not operational for SAS FE connected servers. This functionality with SAS FE configurations is expected in the next release of DSM.

18. In the wizard, configure the following:
19. Provide a name for the host. In this example, the server is named **S1350-ESXi**.
20. Select the correct operating system from the drop down list. **VMware ESXi 6.5** is used in this example.
21. Use the information from step 4 to determine the correct initiator SAS port (HBA). In this example, the WWN ending in **4C00** is correct for host **S1350**.
22. Click **OK**.

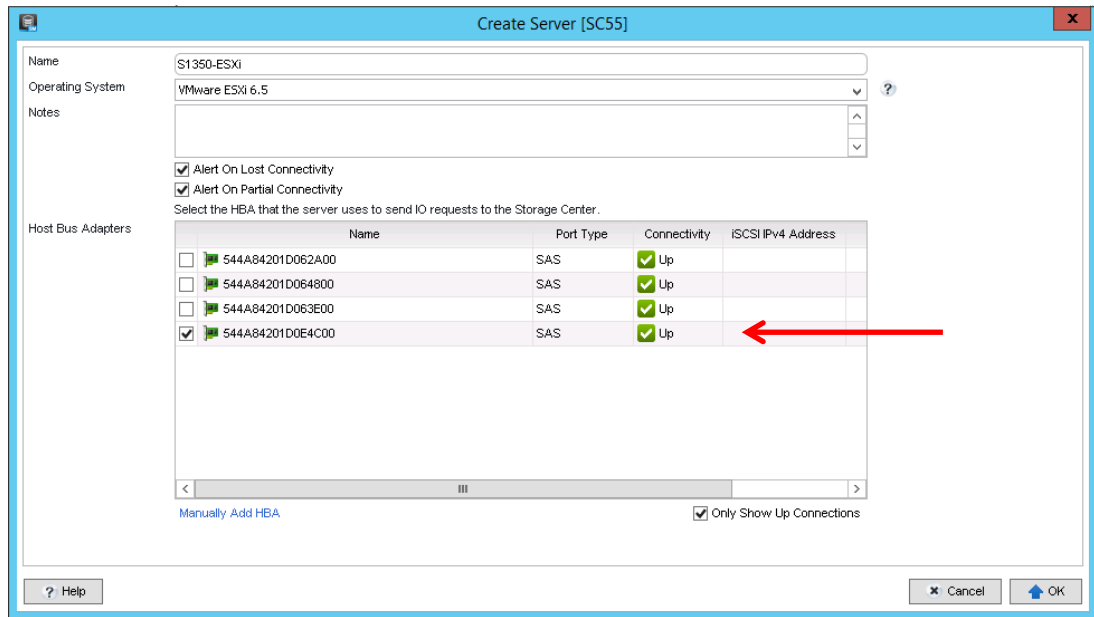

23. Click the new server object. Under the **Connectivity** tab, verify the top and bottom controller ports are correct. Assigning intuitive names to these ports ahead of time facilitates easy verification.

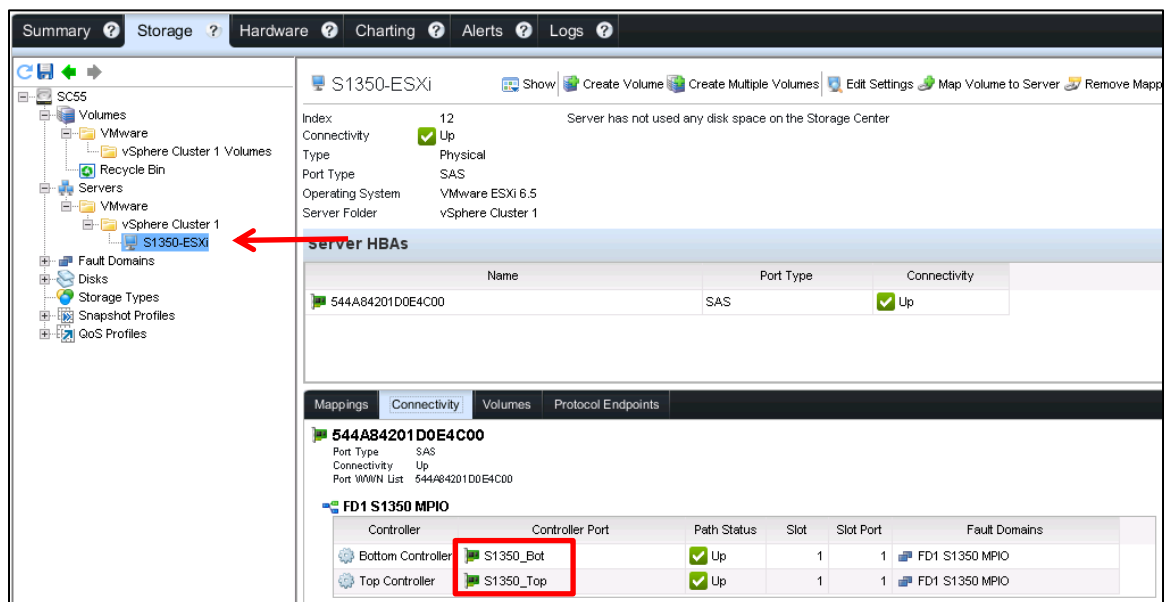

- Repeat the steps 5-7 to create additional hosts on the SC Series array. In this example, a second host is added named **S1351-ESXi**.

3.6 Create server cluster object on the SC Series array

To simplify managing volumes on the SC Series array that will be used by clustered hosts, create a server cluster object with selected server objects as members of the cluster. In this example, the hosts that are members of the cluster are **S1350-ESXi** and **S1351-ESXi**.

- In DSM, right-click the desired server folder and select **Create Server Cluster**.

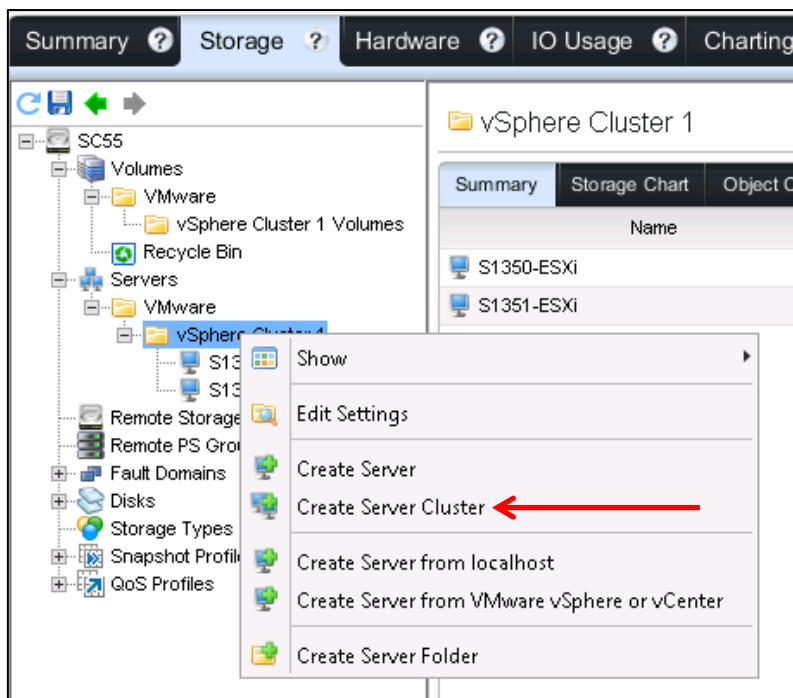

- Provide a name for the cluster object, click **Add Server to Cluster**, and add the desired vSphere hosts (in this example **S1350-ESXi** and **S1351-ESXi**).

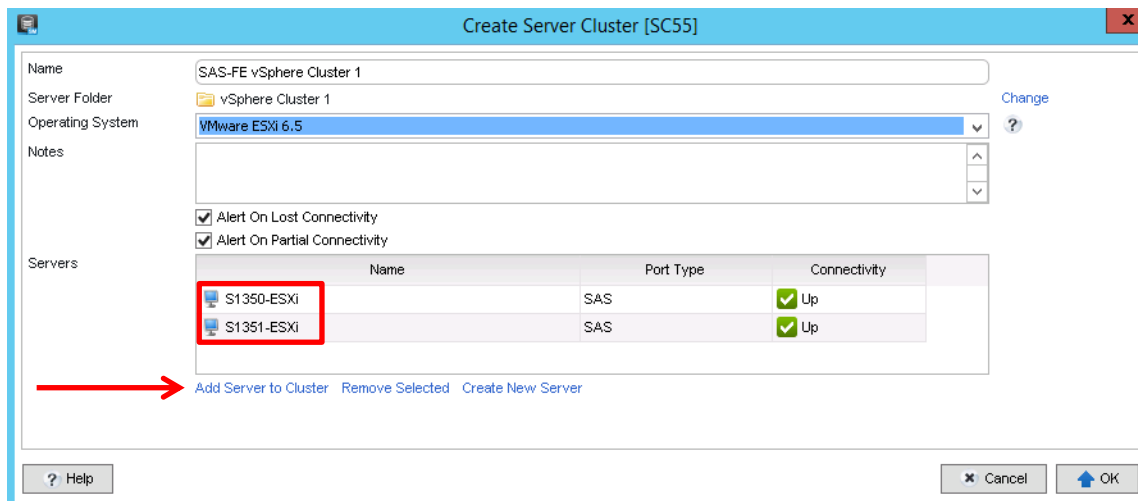

3. The selected vSphere hosts are now listed below the server cluster object.

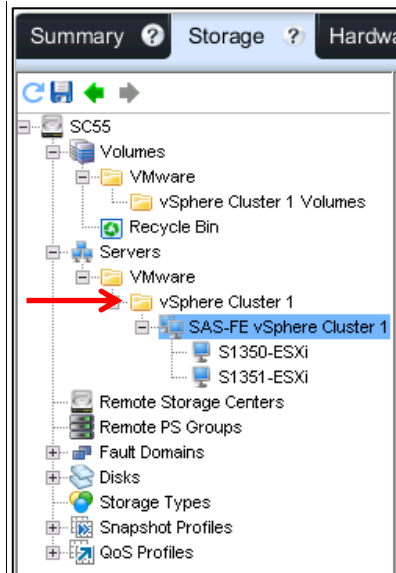

3.7 Create and map storage volumes to vSphere hosts

With cluster object created on the SC Series array, the next step is to create and map storage to the cluster object. In this example, two volumes (150GB and 170GB) are created and mapped to the cluster object.

1. Right-click the desired **Volumes** folder and select **Create Volume**.

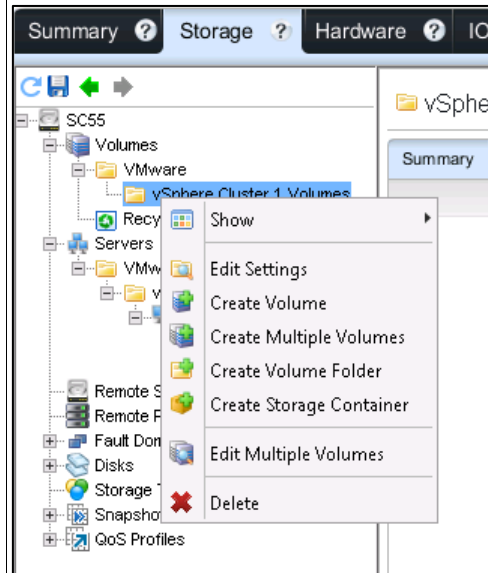

2. Provide an intuitive name for the volume, set the volume size, select a snapshot profile, and select the data reduction profile. For **Server**, select the server cluster object. Configure the remaining volume settings as desired, and click **OK**. In this example, the first volume created is SC-SAS-DS-01-150GB.

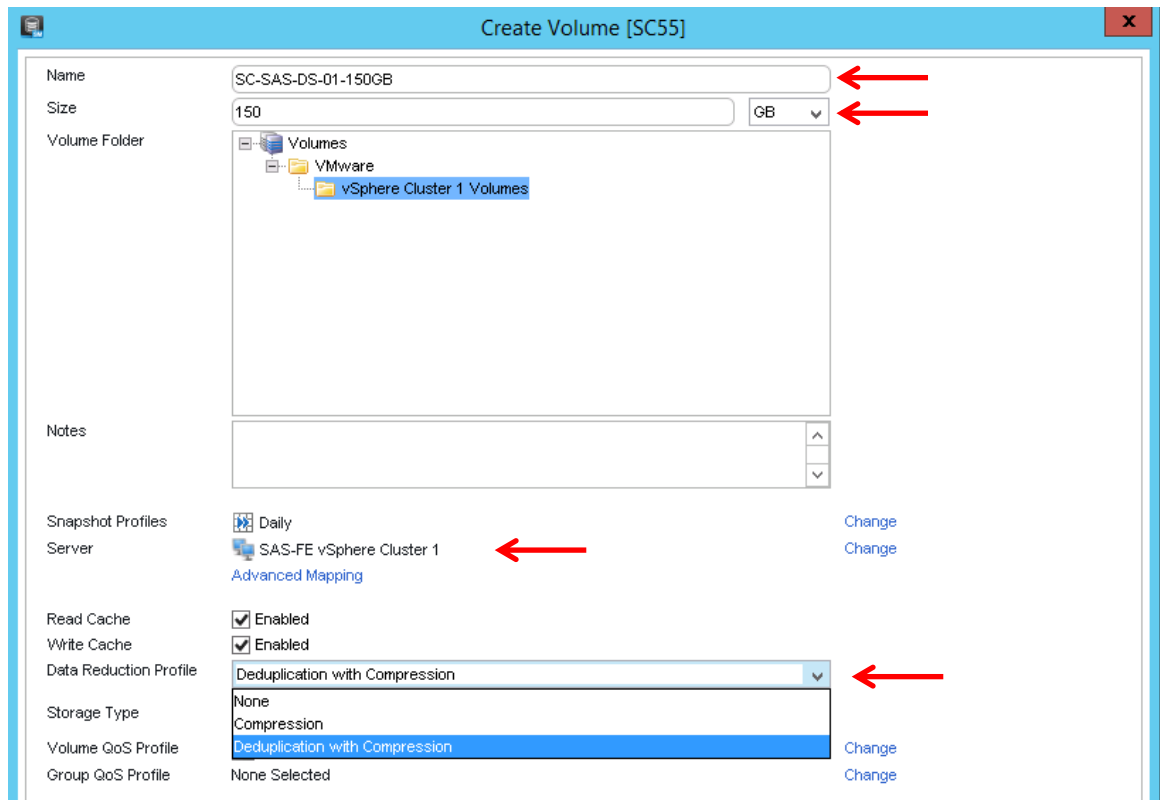

- Repeat steps 1 and 2 to create and map any additional data volumes to the server cluster object. In this example, a 170 GB volume named **SC-SAS-DS-02-170GB** is created and mapped to the **SAS vSphere ESXi Cluster 01** server cluster object.
- Click the server cluster object and under the **Mappings** tab, the two new volumes along with the mapping details are displayed. Each volume has two paths listed for each host in the cluster; totaling four paths.

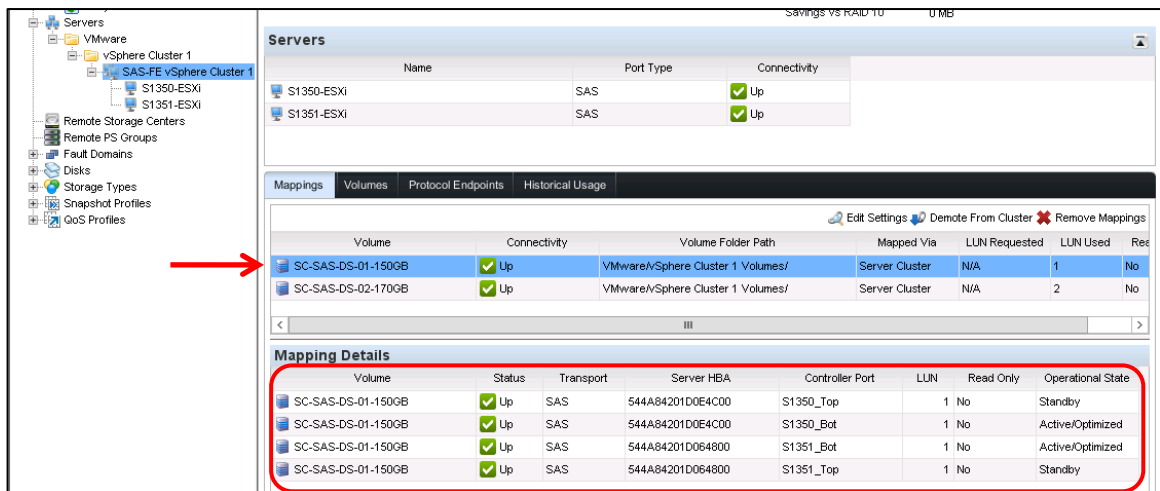

3.8 Create datastores and configure Multipath settings

This section covers connecting vSphere hosts to storage presented from SC Series SAS FE arrays. Steps are provided for both environments managed by VMware vCenter, as well as standalone host environments.

Note: Mapping volumes to VMware vSphere clusters or stand-alone VMware vSphere hosts one at a time helps to properly correlate volumes to datastores.

3.8.1 vCenter environment

VMware vCenter is an enterprise management platform used to manage multiple VMware vSphere hosts through a single application. The interface used to connect to and manage a vCenter environment is the VMware vSphere Web Client.

The following steps were used to connect to storage mapped from an SC Series array and create a new datastore from that storage when in a vCenter-managed environment. Configuration of the native VMware MPIO is covered as well.

3.8.1.1 Connect to mapped storage

1. From the vSphere Web Client, click **Hosts and Clusters** and then select a host.
2. In the **Configure** tab, click **Storage > Storage Adapters** and then select the SAS HBA adapter. In this case, the SAS HBA is **Dell 12Gb SAS HBA**.
3. Click the Rescan Adapter icon.

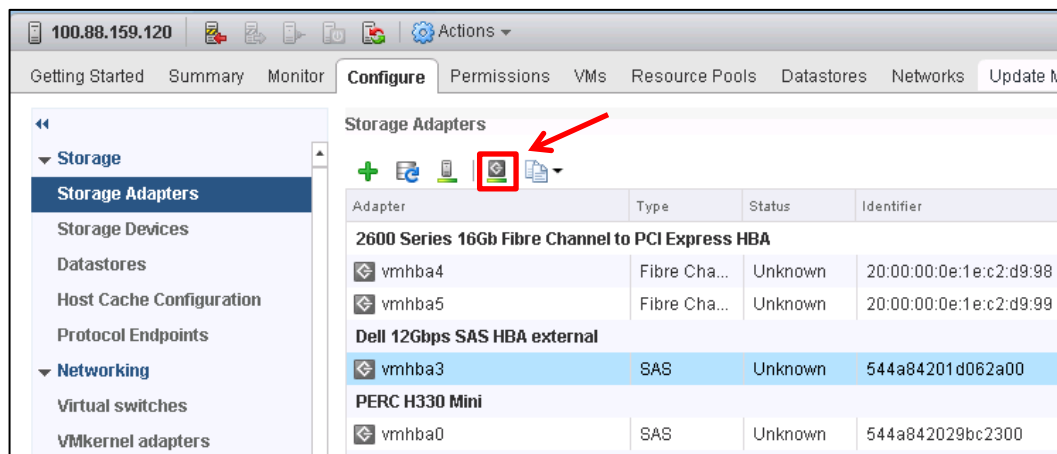

4. Following the rescan of the SAS HBA, the new storage appears on the **Devices** tab under **Adapter Details**.

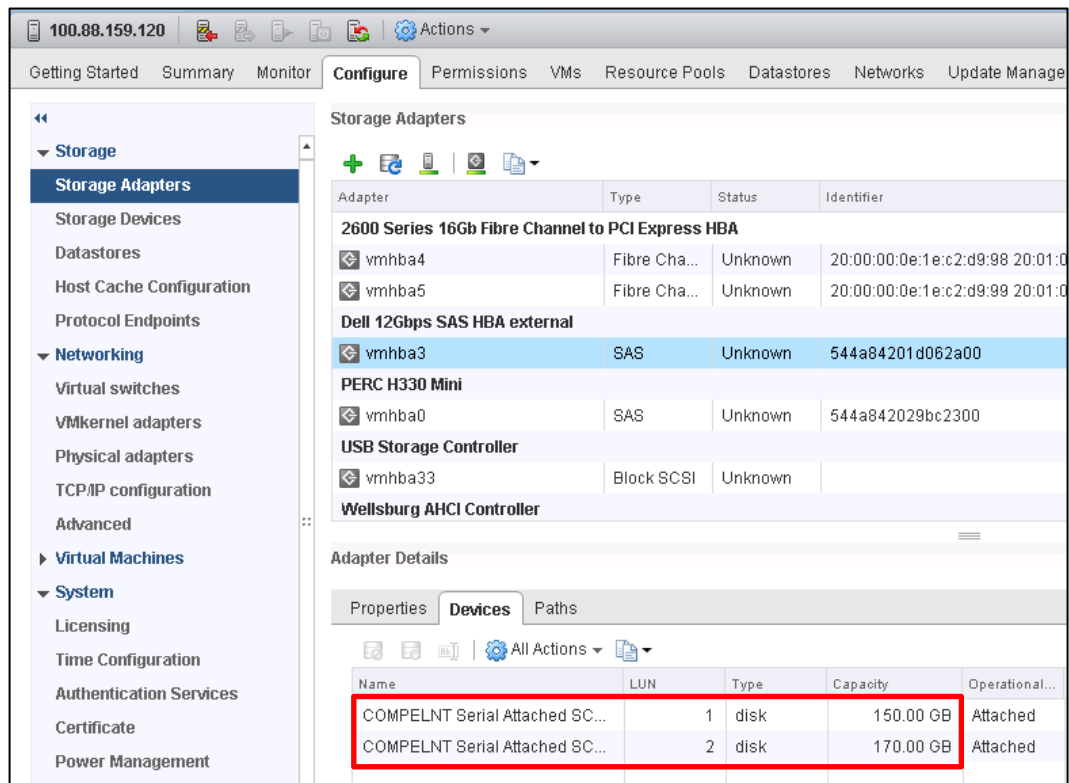

3.8.1.2 Create datastore

1. From the vSphere Web Client, select **Hosts** and **Clusters** and select a host.
2. In the **Configure** tab, click **Storage** > **Datastores** to display the existing datastores.
3. Click the Add Storage icon (it has a green plus sign) to start the Add Storage Wizard.

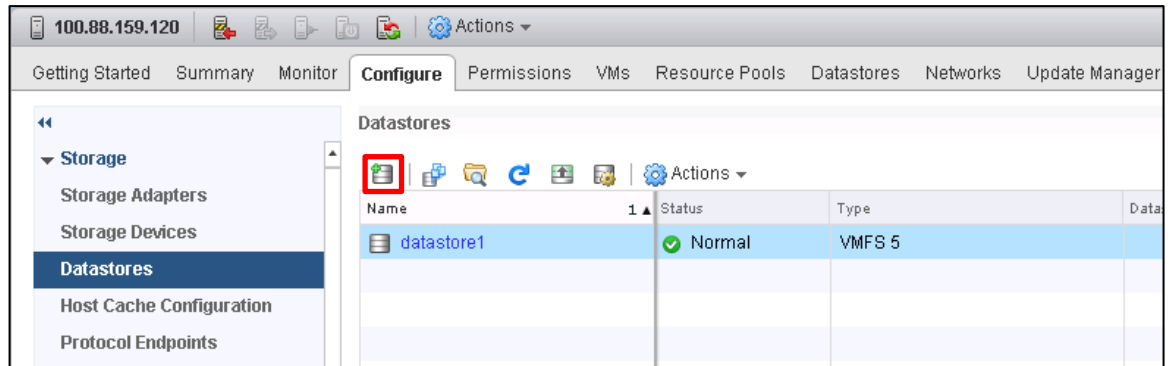

4. Select the type of Datastore. In this example, VMFS is selected. Click **Next**.

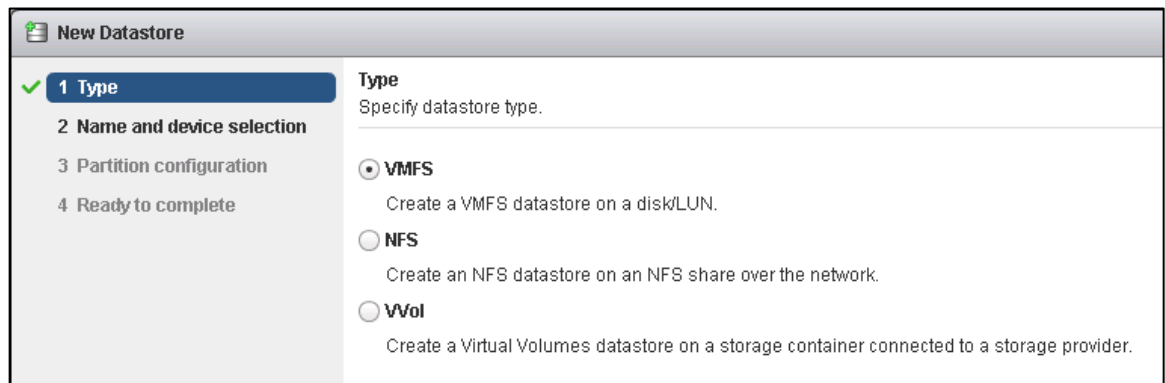

5. Enter the name for the new datastore (SCv2020-SAS-DS-01-150GB) and select the storage device. Click **Next**.

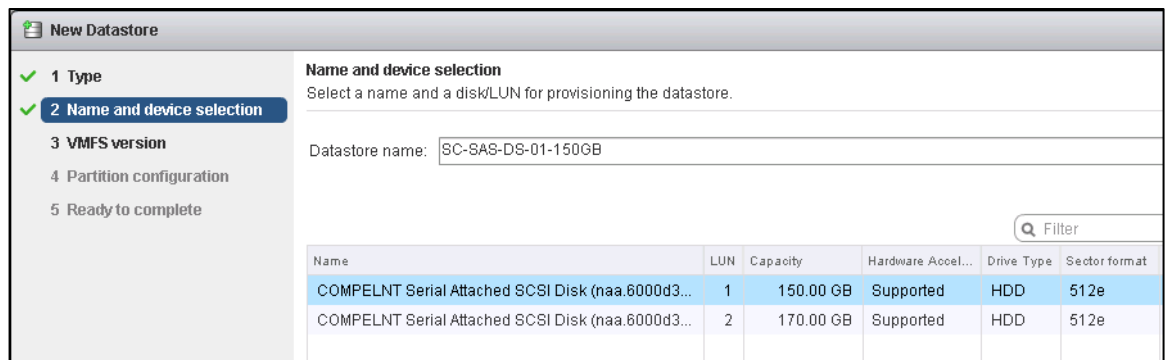

Note: Best practices include giving the datastore the same name as (or one containing) the volume name on the storage array.

6. Select the VMFS version and click **Next**.

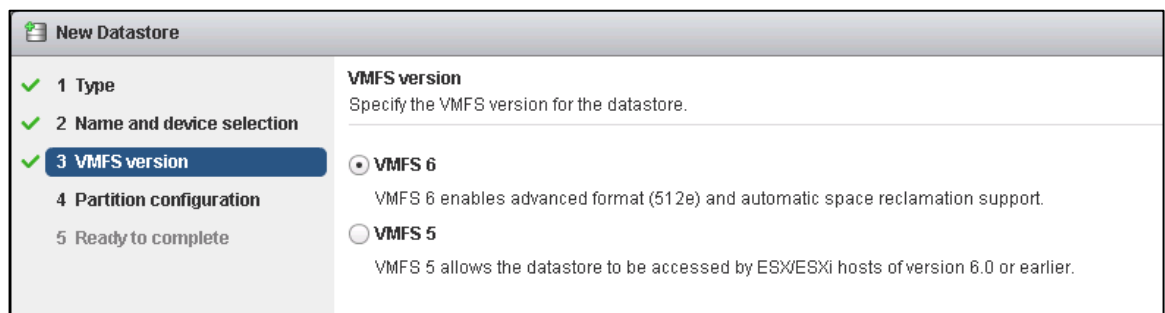

Note: If vSphere hosts running ESXi version 6.0 or earlier require access to the datastore, select VMFS version 5 for backward compatibility. If only ESXi version 6.5 or newer require access to the datastore, select VMFS 6.

7. Define the desired partition layout (or accept the defaults) and click **Next**.

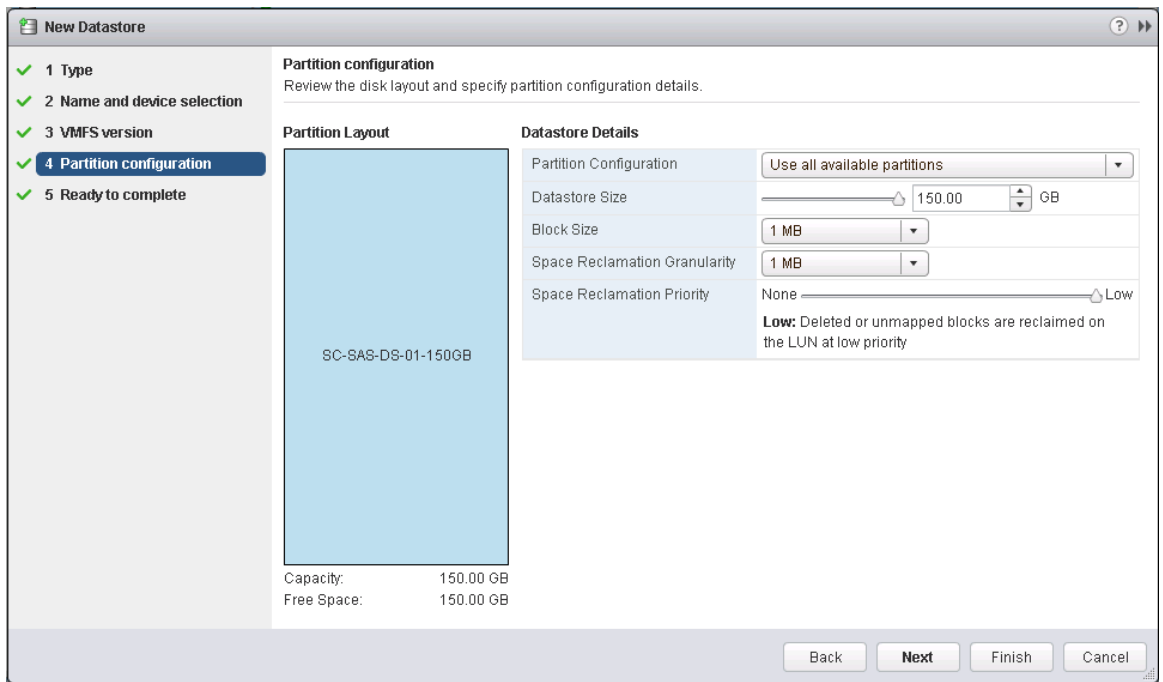

8. Upon completing the New Datastore wizard, verify the information and click **Finish**.

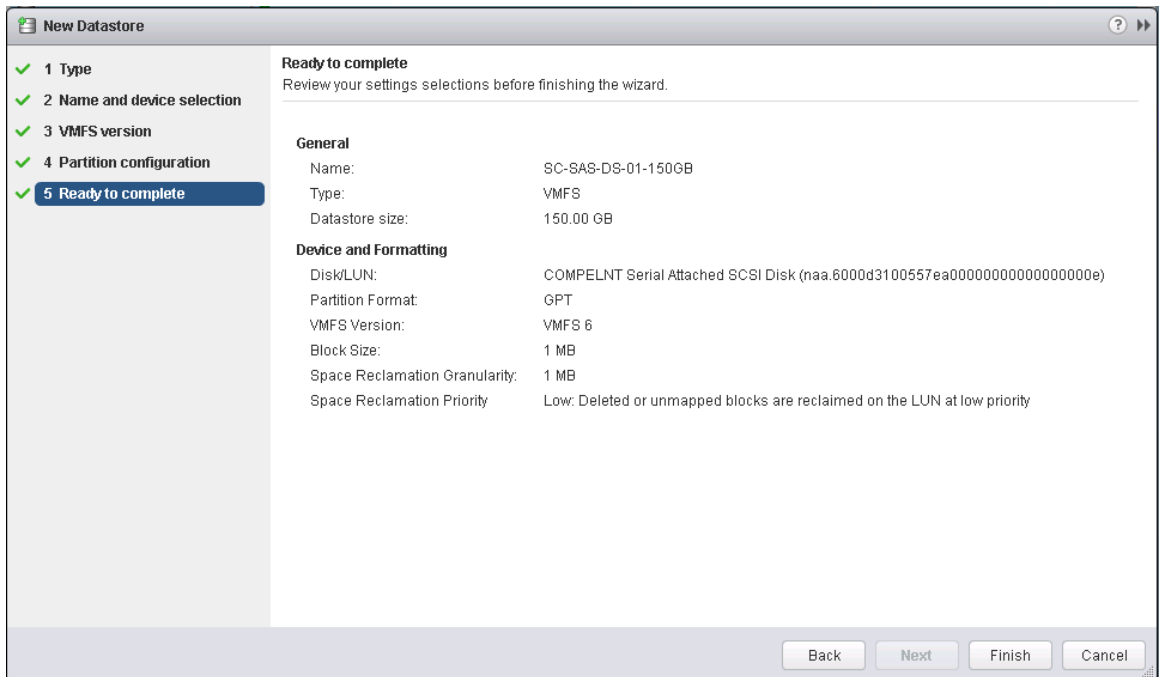

9. Click the Refresh icon for the new datastore to be displayed in the **Datastores** list.

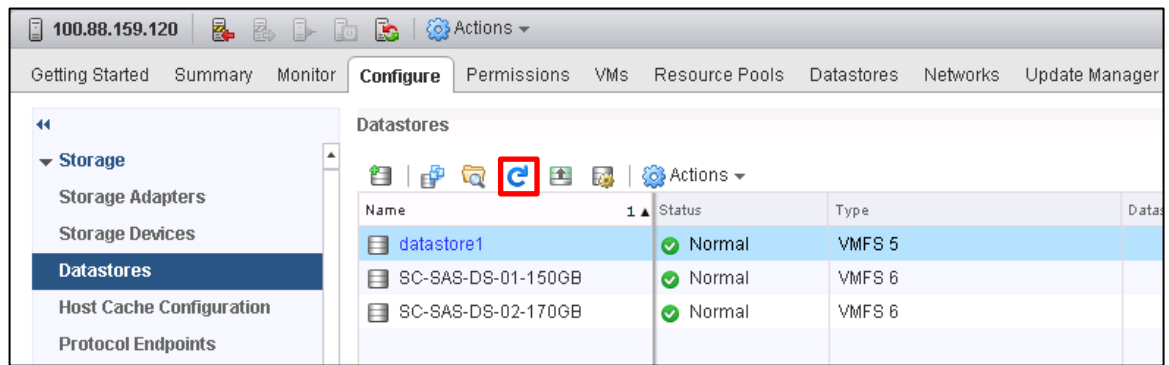

10. Repeat steps 1 – 9 for each additional datastore.
11. For additional VMware vSphere hosts to which the storage volumes are mapped, rescan the SAS HBA to refresh and populate the datastores list.

3.8.1.3 Configure Multi-path settings

The VMware native Multi-path uses a default Path Selection Policy (PSP). For best results, modify the default PSP to Round Robin, as described in [Dell EMC SC Series Best Practices with VMware vSphere 5.x-6.x](#).

3.8.2 Standalone vSphere host

A standalone vSphere host environment refers to the absence of vCenter management. In this type of environment, the vSphere Embedded Host Client is used for management of the host. The following steps were used to connect to storage mapped from an SC Series array and create a new datastore from that storage on a standalone vSphere host. Configuration of the native VMware MPIO is also covered.

3.8.2.1 Connect to mapped storage

1. In the vSphere Embedded Host Client, select **Host > Manage > Storage**.
2. In the **Adapters** tab, select the HBA (in this case, the **Dell 12Gb SAS HBA**) and click the **Rescan** button.

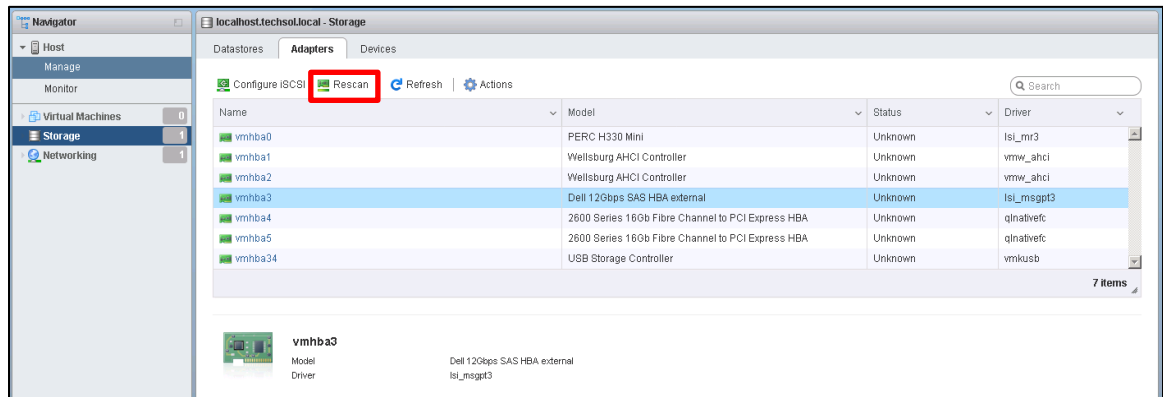

3. Open the **Devices** tab to view the new SAS storage devices.

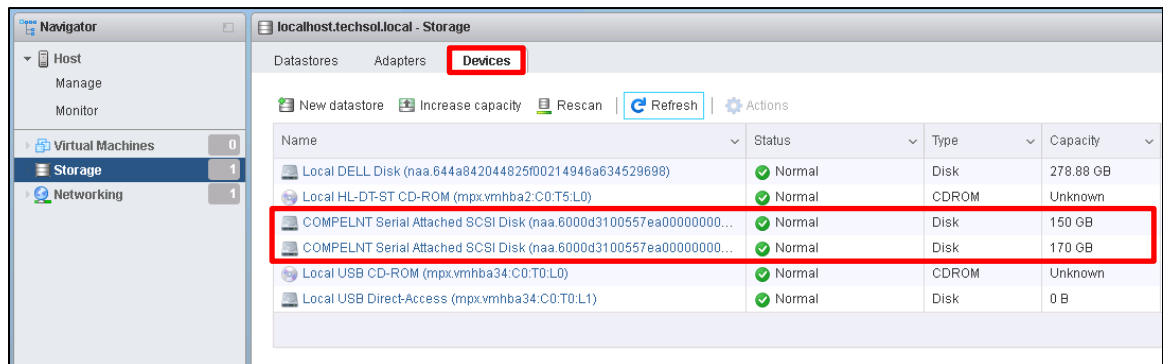

3.8.2.2 Create a datastore

1. To create a new datastore from newly discovered SAS storage from the vSphere Embedded Host Client, navigate to **Host > Manage > Storage**, and in the **Datstores** tab click the **New datastore** button.

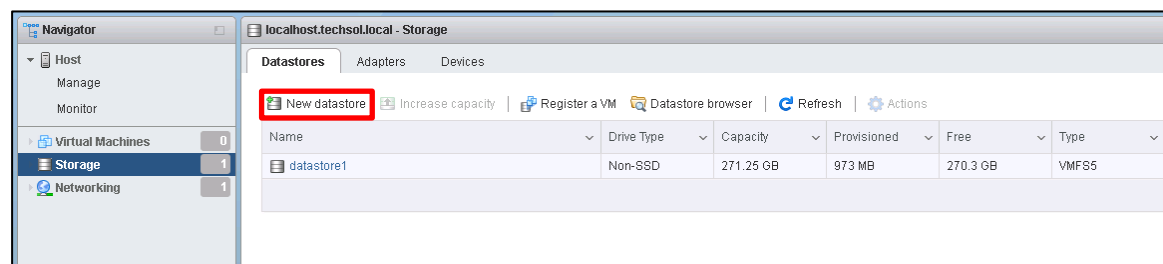

2. Follow the New datastore wizard:
3. Select the type of datastore to create. Click **Next**. (**VMFS** datastore in this case)

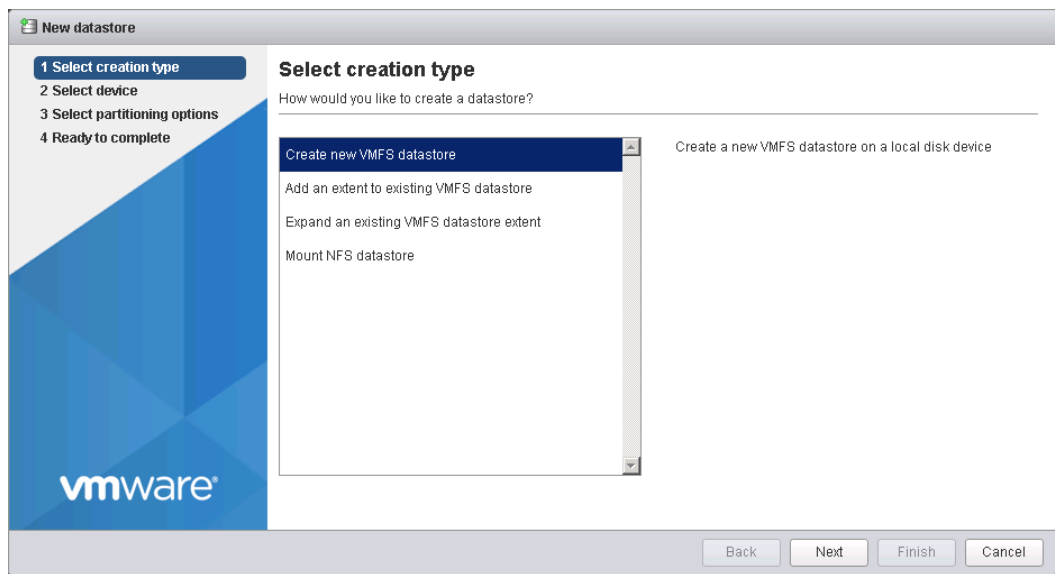

4. Enter the name for the new datastore and select the storage device on which it will be created. Click **Next**. (**SC-SAS-DS-01-150GB** in this case)

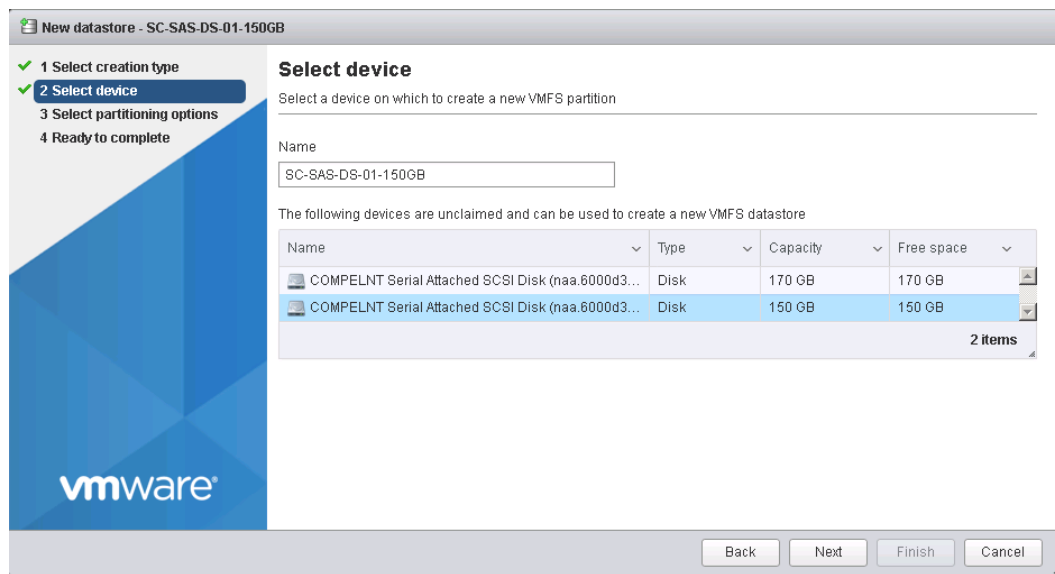

5. Select the partitioning options (or leave the defaults). Click **Next**. (defaults were used in this case)

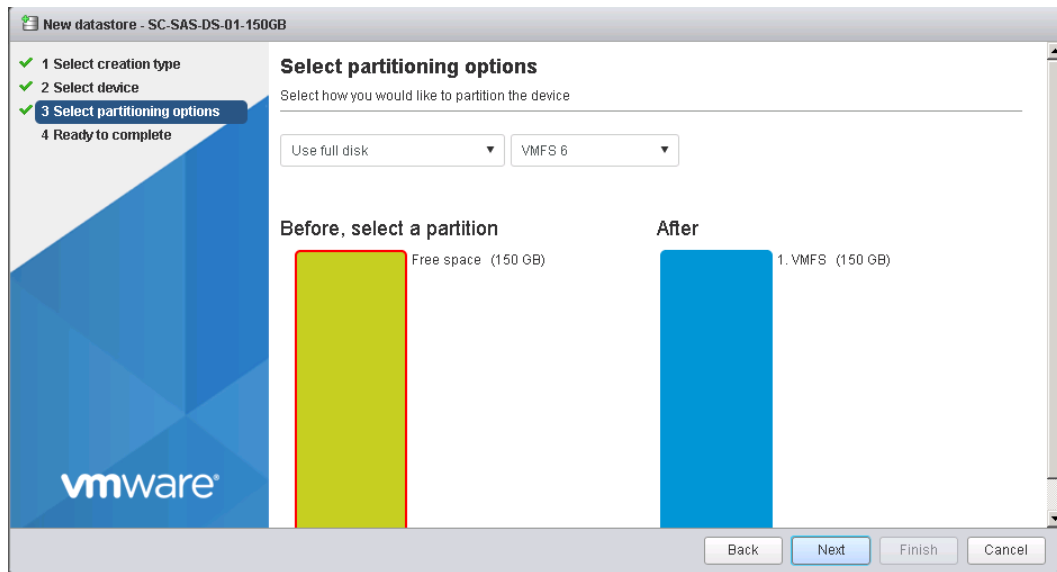

6. Review the information and click **Finish**.

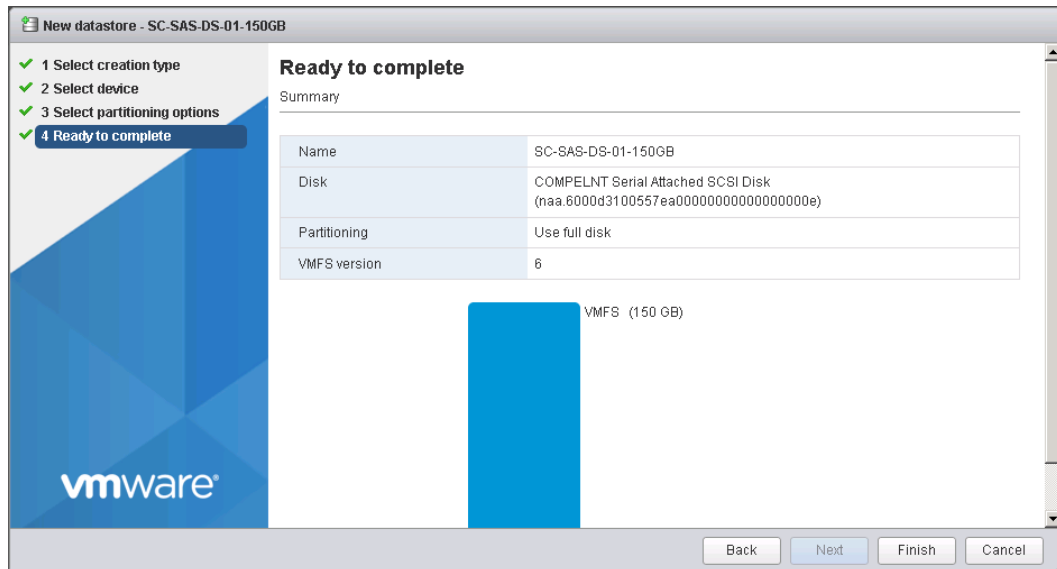

7. Confirm erasure of the disk by clicking **Yes**.

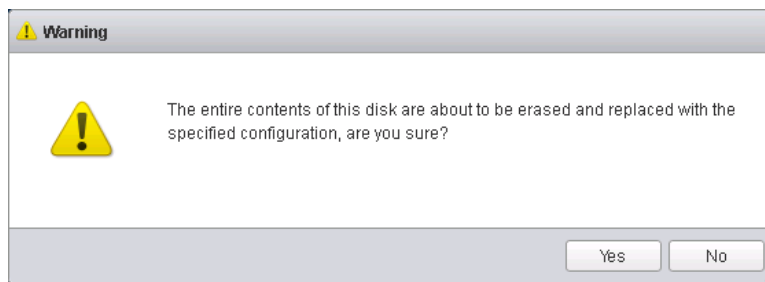

8. Repeat steps 1 - 7 for each additional datastore as needed.

- After completing the New datastore wizard, the new datastore(s) will appear in the datastores list for the host. In this example, the datastores were named **SC-SAS-DS-01-150GB** and **SC-SAS-DS-02-170GB**.

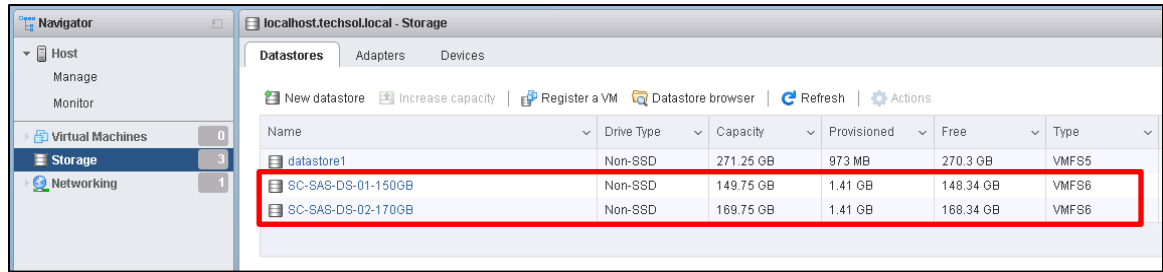

Note: Best practices include giving the datastore the same name as (or one containing) the volume name on the storage array.

3.8.2.3 Configure Multi-path settings

The VMware native Multi-path uses a default Path Selection Policy (PSP). For best results, modify the default PSP to Round Robin, as described in [Dell EMC SC Series Best Practices with VMware vSphere 5.x-6.x](#).

A Additional resources

[Dell.com/support](https://dell.com/support) is focused on meeting customer needs with proven services and support.

[Dell EMC TechCenter](https://dell.com/techcenter) is an online technical community where IT professionals have access to numerous resources for Dell EMC software, hardware, and services.

[Storage Solutions Technical Documents](#) on Dell TechCenter provide expertise that helps to ensure customer success on Dell EMC storage platforms.

Referenced or recommended Dell EMC publications:

- [Dell EMC SC Series Storage product page](#)
- [Dell EMC Storage Compatibility Matrix](#)
- [Dell EMC SC Series Best Practices with VMware vSphere 5.x-6.x](#)
- [Preparing VMware ESXi hosts to Attach to SCv20x0, SC4020, SC5020 SAS Arrays](#)
- [Dell PowerEdge Controller 9 HBA User's Guide](#)
- [Dell EMC SC Series Storage with SAS Front-end Support for Microsoft Hyper-V](#)

Referenced or recommended Microsoft publications:

- [VMware Knowledge Base](#)
- [VMware Compatibility Guide](#)