

Wyse 3000 Series Thin Client

Wyse 3040

Quick Start Guide

Snelstartgids

Guide de démarrage rapide

Schnellstart-Handbuch



1 Install wall mount — optional

Installeer de wandmontage - optioneel

Installez le support mural (en option)

Installieren Sie die Wandhalterung (optional)

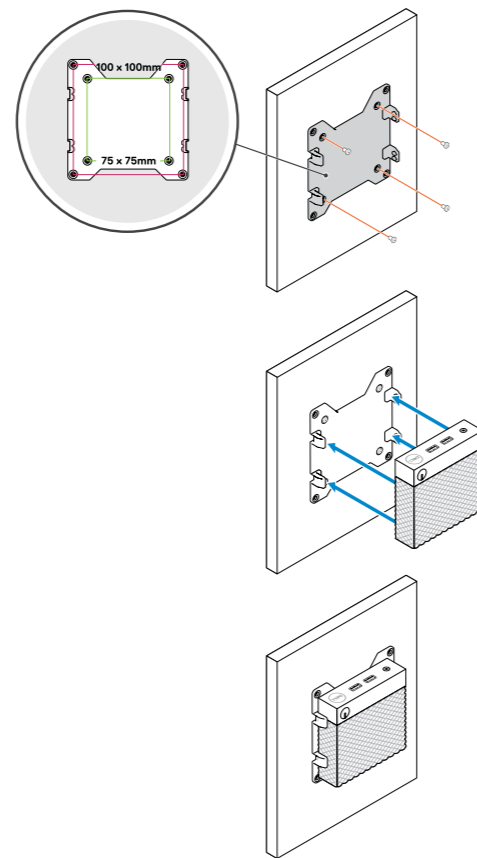

2 Connect the network cable — optional

Sluit de netwerkkabel aan - optioneel

Branchez le câble réseau (facultatif)

Schließen Sie das Netzkabel an (optional)

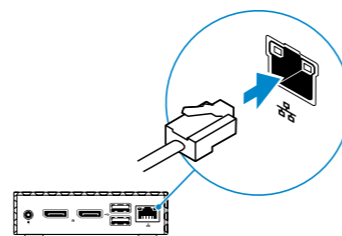

3 Connect the keyboard and mouse

Sluit het toetsenbord en de muis aan

Connectez le clavier et la souris

Schließen Sie die Tastatur und Maus an

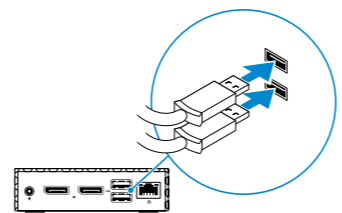

4 Connect the display and press the power button

Sluit de display aan en druk op de aan-uitknop

Connectez l'écran et appuyez sur le bouton d'alimentation

Schließen Sie den Monitor an und drücken Sie den Betriebsschalter

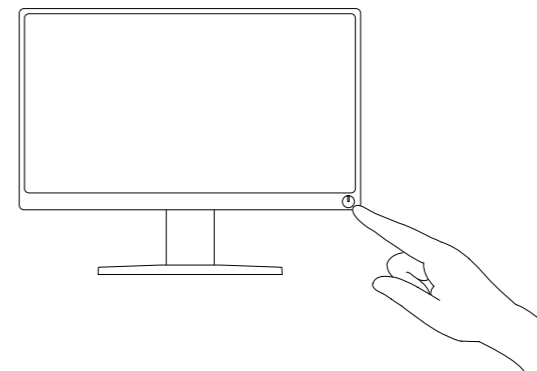
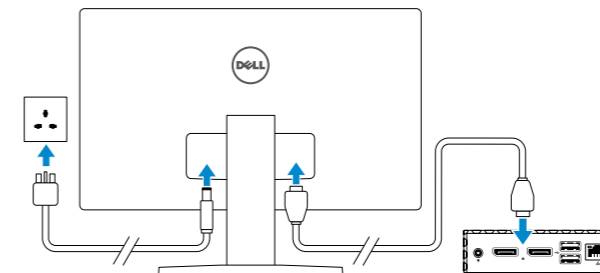

5 Connect the power cable and press the power button

Sluit de stroomkabel aan en druk op de aan-uitknop

Branchez le câble d'alimentation et appuyez sur le bouton d'alimentation

Schließen Sie das Netzkabel an und drücken Sie den Betriebsschalter

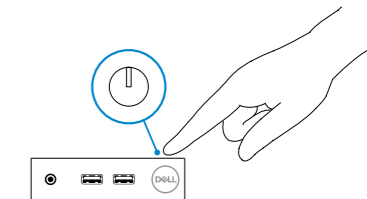
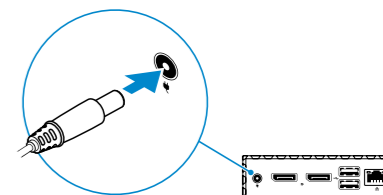

Product support and manuals

Productsupport en handleidingen
Assistance produits et manuels
Produktsupport und Handbücher

Contact Dell

Contact opnemen met Dell | Contacter Dell |
Dell kontaktieren

Regulatory and safety

Kennisgevingen en veiligheidsvoorschriften |
Réglementations et sécurité | Informationen zu
Vorschriften und Sicherheit

Regulatory model

Voorgescreven model | Modèle
réglementaire | Vorschriftenmodell

Regulatory type

Gereguleerde type | Type
réglementaire | Vorschriftentyp

Computer model

Computermodel | Modèle de l'ordinateur |
Computermodell

[Dell.com/support](https://www.dell.com/support)

[Dell.com/support/manuals](https://www.dell.com/support/manuals)

[Dell.com/contactdell](https://www.dell.com/contactdell)

[Dell.com/regulatory_compliance](https://www.dell.com/regulatory_compliance)

N10D

N10D001

Wyse 3040

Features

Kenmerken | Caractéristiques | Funktionen

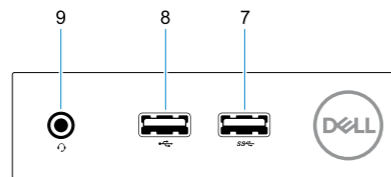
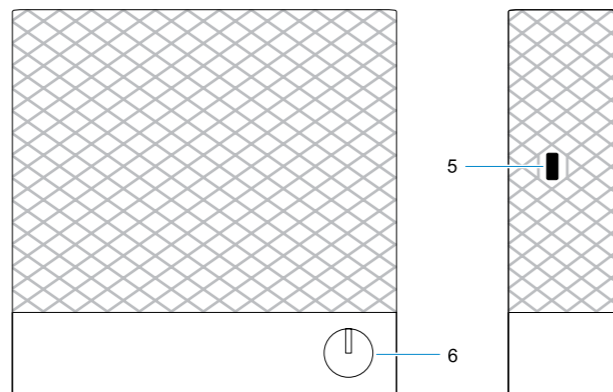
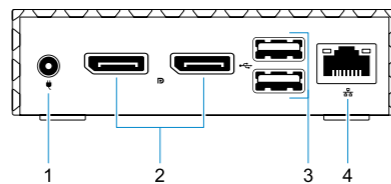

1. +5V/+12V Power adapter input
2. DisplayPort (2x)
3. USB 2.0 port (2x)
4. Network port, 10/100/1000 Base-T
5. Lock receptacle
6. Power on/off button and light

7. USB 3.0 port
8. USB 2.0 port
9. Universal headset jack

1. Entrée de l'adaptateur secteur +5V/+12V
2. Ports DisplayPort (2)
3. Ports USB 2.0 (2)
4. Port réseau 10/100/1000 Base-T
5. Emplacement pour verrou

6. Bouton et voyant de mise sous/hors tension
7. Port USB 3.0
8. Port USB 2.0
9. Prise jack pour casque universelle

1. +5V/+12V Power adapteringang
2. DisplayPort 2 (2x)
3. USB 2.0-poort (2x)
4. Netwerkpoot, 10/100/1000 Base-T
5. Vergrendelbare opvang
6. Voeding aan/uit-knop met lampje

7. USB 3.0-poort
8. USB 2.0-poort
9. Universele audio-aansluiting

1. +5V/+12V Netadaptareingang
2. DisplayPort (2x)
3. USB 2.0-Anschluss (2x)
4. Netzwerkanschluss, 10/100/1000Base-T
5. Steckplatz für Schloss
6. Betriebsschalter und -anzeige

7. USB 3.0-Anschluss
8. USB 2.0-Anschluss
9. Universelle Headset-Buchse

Mounts

Ophangsystemen | Montage | Halterungen

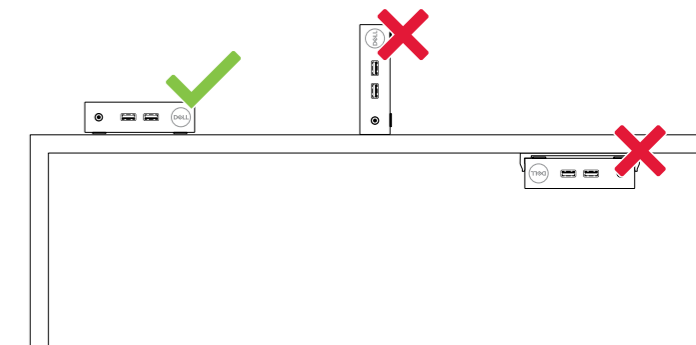

QJTKHNA01

Printed in China.

2019-09

© 2019 Dell Inc. or its subsidiaries.