



Dell EqualLogic Best Practices Series

# Sizing and Best Practices for Deploying Virtual Desktops with Dell EqualLogic Virtual Desktop Deployment Utility in a VMware Environment

A Dell Technical Whitepaper

This document has been archived and will no longer be maintained or updated. For more information go to the [Storage Solutions Technical Documents page on Dell TechCenter](#) or contact support.

**Storage Infrastructure and Solutions Engineering**

Dell Product Group

May 2012

THIS WHITE PAPER IS FOR INFORMATIONAL PURPOSES ONLY, AND MAY CONTAIN TYPOGRAPHICAL ERRORS AND TECHNICAL INACCURACIES. THE CONTENT IS PROVIDED AS IS, WITHOUT EXPRESS OR IMPLIED WARRANTIES OF ANY KIND.

© 2012 Dell Inc. All rights reserved. Reproduction of this material in any manner whatsoever without the express written permission of Dell Inc. is strictly forbidden. For more information, contact Dell.

Dell, the DELL logo, and the DELL badge, PowerConnect™, EqualLogic™, PowerEdge™ and PowerVault™ are trademarks of Dell Inc. Adobe®, Acrobat®, Flash®, Reader®, and Shockwave® are either registered trademarks or trademarks of Adobe Systems Incorporated in the United States and/or other countries. Broadcom® is a registered trademark of Broadcom Corporation. Intel® is a registered trademark of Intel Corporation in the U.S. and other countries. Login Consultants is a trademark or registered trademark of Login Consultants in the Netherlands and/or other countries. VMware®, Virtual SMP®, vMotion®, vCenter®, and vSphere® are registered trademarks or trademarks of VMWare, Inc. in the United States or other countries. Microsoft®, Windows®, Windows Server®, and Active Directory® are either trademarks or registered trademarks of Microsoft Corporation in the United States and/or other countries.

# Table of contents

1	Executive summary.....	5
1.1	Audience.....	5
2	Introduction.....	6
2.1	Benefits of VDI.....	6
2.2	Storage requirements for VDI.....	6
2.3	Addressing VDI storage challenges with EqualLogic SANs and EqualLogic HIT/VE.....	7
2.4	Separation of user data and virtual desktop data.....	8
3	VMware View solution infrastructure.....	9
3.1	VMware View components.....	9
3.2	Virtual desktops.....	9
3.3	VMware View desktop pools.....	10
4	EqualLogic Virtual Desktop Deployment Utility.....	12
5	Infrastructure and test configuration.....	17
5.1	Component design.....	17
5.2	iSCSI SAN configuration.....	18
5.3	ESXi host network configuration.....	19
5.4	VMware View configuration.....	20
6	VMware View test methodology.....	21
6.1	Test objectives.....	21
6.2	Test approach.....	21
6.3	Test tools.....	21
6.3.1	Load generation.....	21
6.3.2	Monitoring tools.....	22
6.4	Test criteria.....	22
6.4.1	Storage capacity and I/O latency.....	22
6.4.2	System utilization at the hypervisor layer.....	22
6.4.3	Virtual desktop user experience.....	22
6.5	Test setup.....	23
7	Test results and analysis.....	24
7.1	Test scenarios.....	24
7.2	Boot storm I/O.....	24
7.3	Task worker – Login storm and steady state.....	27

7.3.1	Login storm I/O .....	27
7.3.2	Steady state I/O .....	30
7.3.3	Desktop host server performance.....	31
8	Sizing guidelines for EqualLogic SANs .....	35
8.1	iSCSI connection considerations for thin clone volumes.....	35
8.2	Capacity sizing considerations .....	35
8.3	Performance sizing considerations.....	39
8.3.1	Boot storm sizing considerations.....	39
8.3.2	Login storm and steady state sizing considerations .....	39
9	Best practices.....	40
9.1	Application layer .....	40
9.1.1	Implement roaming profiles and folder redirection .....	40
9.1.2	Boot and login storm considerations .....	40
9.1.3	Windows 7 Master Image for desktop VMs .....	40
9.1.4	VMware View Pool .....	40
9.2	Server host layer .....	40
9.3	Network.....	41
9.4	Storage .....	41
9.5	EqualLogic Virtual Desktop Deployment Utility.....	42
Appendix A	EqualLogic Virtual Desktop Deployment Utility.....	43
Appendix B	VMware View solution configuration.....	58
Appendix C	Network design and VLAN configuration .....	60
C.1	Management LAN configuration .....	60
C.2	VDI LAN configuration.....	61
Appendix D	ESXi network configuration .....	62
D.1	vSwitch0.....	62
D.2	vSwitch1 .....	63
D.3	vSwitch2.....	64

# Acknowledgements

This whitepaper was produced by the PG Storage Infrastructure and Solutions team based on testing conducted between August 2011 and February 2012 at the Dell Labs facility in Austin, Texas.

The team that created this whitepaper:

**Sujit Somandepalli, Chhandomay Mandal, and Margaret Boeneke**

We would like to thank the following Dell team members for providing significant support during development and review:

**Kirk Hutchinson, David Glynn, Ananda Sankaran, Mark Welker, and Bob Ganley**

## Feedback

We encourage readers of this publication to provide feedback on the quality and usefulness of this information. You can submit feedback to us by sending an email to [SISfeedback@Dell.com](mailto:SISfeedback@Dell.com).



[SISfeedback@Dell.com](mailto:SISfeedback@Dell.com)

# 1 Executive summary

The Dell™ EqualLogic® Host Integration Toolkit VMware Edition (HIT/VE) provides a suite of tools including Datastore Manager, Automatic Snapshot Manager, EqualLogic VASA Provider, and Virtual Desktop Deployment Utility for VMware environments. The purpose of this paper is to demonstrate how the Virtual Desktop Deployment Utility leverages the thin clone feature introduced in the EqualLogic PS Series Firmware version 5.0 to efficiently provision and deploy virtual desktops in a VMware View Virtual Desktop Infrastructure (VDI) environment.

Additionally, the EqualLogic hybrid arrays – EqualLogic PS6100XS and PS6110XS – are well suited for supporting VDI deployments, because they are specifically designed for VDI type workloads where a relatively small portion of the storage system can become very hot (very high read I/O rates). With high performance SSD drives and high capacity SAS hard disk drives within the same chassis, the hybrid arrays automatically move hot data from the SAS tier to the SSD tier. The automatic tiering function makes the hybrid EqualLogic SAN a very cost efficient option for VDI environments where the peak load in an I/O storm from hundreds of virtual desktops is typically concentrated on the relatively small capacity base image volumes.

In this paper, we present the results of a series of storage I/O performance tests conducted by Dell Labs and provide storage sizing guidance and best practices based on those results for designing and deploying VMware View 5.0 (View) based VDI using the Dell EqualLogic Virtual Desktop Deployment Utility and the Dell EqualLogic PS6100XS array. Our test infrastructure included VMware View 5.0, VMware vSphere 5.0, Dell PowerEdge blade servers, Dell PowerConnect switches, and Dell EqualLogic storage devices.

The paper demonstrates how a 700 task worker virtual desktop environment can be deployed in the chosen VDI infrastructure with EqualLogic Virtual Desktop Deployment Utility while leveraging a single PS6100XS array. The benefits of separating virtual desktop VM data and user data, the suitability of using an EqualLogic FS7500 NAS appliance for hosting user shares, and storage I/O characteristics under various VDI workload scenarios like boot and login storms are also demonstrated in this paper. In our test environment, the PS6100XS array delivered 9500 IOPS during a boot storm with a read/write ratio of about 85% / 15%. More in depth capacity and sizing guidelines are provided in section 8 and best practices are provided in section 9.

## 1.1 Audience

This paper is intended for solution architects, storage network engineers, system administrators, and IT managers who need to understand how to design, properly size, and deploy View based VDI Solutions using Dell EqualLogic storage. It is expected that the reader has a working knowledge of the View architecture, VMware vSphere system administration, iSCSI SAN network design, and Dell EqualLogic iSCSI SAN operation.

## 2 Introduction

Desktop virtualization is an important strategy for organizations seeking to reduce the cost and complexity of managing an expanding variety of client desktops, laptops, and mobile handheld devices. VDI provides a method for achieving greater management efficiencies and increasing reliability of existing desktop computing resources in larger organizations. In a VDI environment, user desktops are hosted as virtual machines (VMs) in a centralized infrastructure and delivered over the network to an end user client device.

### 2.1 Benefits of VDI

- **Centralized Management:** Patching and upgrading desktops becomes much less time and resource intensive because they can be applied to the base "gold" image, then propagated to the end user desktop images without having to worry about any application or device incompatibilities that may exist on the end-point devices. With VDI, the desktop environment is now effectively managed in a manner that is similar to any enterprise application in the data center.
- **Security and compliance:** Desktops delivered through VDI are inherently more secure. A VDI infrastructure allows you to prevent data and file storage on the end-point devices. Also, traditional risks associated with potentially malicious applications installed on desktop computers are significantly reduced.
- **Data Protection and reliability:** Since the desktop images are hosted in a data center, it is easier to provide backup and disaster recovery for persisted desktops as well as for user data. In addition, it is very easy to restore a persisted desktop image to a known-good previous state, free from viruses or data corruption.
- **Quick and efficient deployment:** IT organizations can more easily transition to new operating systems and/or newer versions of applications when using a VDI model. Rolling out new systems can be done in a matter of hours versus days or even weeks in traditional "thick client" desktop computing environments.
- **Device independence:** VDI allows the use of a variety of client devices to access the virtual desktops. There is no restriction on the device used as long as it can securely access the virtual desktop. VDI can be used to enable bring your own device (BYOD) functionality in a company.

### 2.2 Storage requirements for VDI

A VDI deployment must be carefully designed to ensure that it delivers the performance and scalability needed to support an enterprise-wide client community. When moving from a distributed standalone desktop model, all components—storage, processors, memory, and networking—are moved to a centralized data center for all the users, making appropriate design and sizing critical to success.

A VDI deployment can place high capacity and performance demands on the storage platform. For example, consolidating large amounts of inexpensive stand-alone desktop storage into a centralized infrastructure can create tremendous capacity demands on centrally managed shared storage used in VDI deployments. Performance demands are determined by the number of I/O operations per second (IOPS) generated by basic desktop client operations such as system boot, logon and logoff, and by desktop usage operations from different users. Storm events such as morning logons and afternoon logoffs by many users at approximately the same time can cause I/O spikes that place high

performance demands on the storage infrastructure. There may also be situations like an unexpected power shutdown which requires booting of all the virtual desktops at the same time. This boot storm creates significantly higher IOPS on the underlying storage platform.

To be successful, storage designs for a VDI deployment must take these demands into account. In particular, the storage platform should have not only the high performance and scalability required to handle a large number of I/O and system resource utilization spikes, but also the ability to cost-effectively handle the large capacity requirements. A VDI storage infrastructure should also be virtualization-aware, so that the virtualization layer can offload storage-intensive tasks (such as copying hundreds of VMs for desktop provisioning) to the storage layer, where it can be done more efficiently.

### **2.3 Addressing VDI storage challenges with EqualLogic SANs and EqualLogic HIT/VE**

Dell EqualLogic PS Series iSCSI SANs are well suited for supporting VDI deployments. They offer scalable, high-performance virtualized storage that is designed for reliability, manageability, and efficiency. EqualLogic SANs come with a range of features designed to enhance utilization, lower costs, and reduce complexity. For example, automated workload tiering and load balancing features help to optimize storage performance. Storage virtualization coupled with thin provisioning at the volume level simplifies SAN configuration and management and provides tremendous capacity while reducing physical storage requirements.

EqualLogic storage is designed to be fully VMware virtualization aware. This enables automation and optimization of key storage functions such as desktop provisioning. For example, EqualLogic SANs integrate with VMware vStorage APIs for Array Integration (VAAI). This integration enables vSphere to offload the copy operation involved in deploying VMs from template directly to EqualLogic SANs. This reduces the time required to provision and deploy new VMs. The hardware-assisted locking feature in VAAI reduces boot time in a VDI environment by eliminating contention for SCSI reservations. The EqualLogic Multipath Extension Module (MEM) for VMware vSphere provides advanced multi-path I/O functionality resulting in fault tolerance, lower latency and increased bandwidth to the storage.

The EqualLogic PS6100XS and EqualLogic PS6110XS hybrid arrays further enhance the performance and efficiency of VDI deployments by accelerating VDI workloads. These hybrid arrays combine both SSD and SAS drives within a single chassis. The intelligence within the EqualLogic firmware provides automatic tiering and balancing of stored data between the SSD and SAS tiers. This data tiering within the array creates a flexible and powerful balance between the performance and responsiveness provided by the low latency SSD tier and capacity provided by the SAS tier.

Finally, EqualLogic PS Series arrays also include HIT/VE software at no extra charge. HIT/VE software contains several virtual appliances that are software packages integrated into the vCenter management framework. One of these is the Virtual Desktop Deployment Utility that leverages the template volume and thin clone technologies of the EqualLogic array to space-efficiently and time-efficiently provision and deploy virtual desktops in View-based VDI environments. The Auto-Snapshot Manager virtual appliance within HIT/VE provides automatic virtual machine protection using VMware-based and SAN-based snapshots.



In this paper, we demonstrate the benefits of the EqualLogic platform – specifically, Dell EqualLogic Virtual Desktop Deployment Utility and the Dell EqualLogic PS6100XS arrays – for deploying VDI in the enterprise.

## **2.4 Separation of user data and virtual desktop data**

The centralized virtual desktop model is comprised of two data types, VM data and user data. VM data consists of the virtual desktop image, including OS and common applications. User data is the daily work, including documents, spreadsheets, images, and individual preferences. User data can be persisted on the same storage alongside OS and application data. But mixing this data causes the VM size to grow over time, leading to additional capacity requirements, slow access to data, high latency, and ultimately a degraded user experience.

Separation of VM data and user data has many benefits. If the user data is stored in a central location separate from OS and application data, then multiple virtual desktops can be cloned from a single master image, and each time an authorized user logs in, a random desktop from a desktop pool can be assigned to the user. The corresponding user data is mounted on the VM from the separate, central storage location. As the end user performs his or her tasks, the user data continues to be updated in the central location. When the user logs off and the desktop is rebooted, the temporary OS and application data are discarded but the user data continues to be retained in the separate, central location. This model provides enhanced capacity utilization, high performance and low latency, and an improved user experience.

Deploying the EqualLogic FS7500 scale-out NAS for user data provides multiple data protection, data management, data portability, and access control advantages. These advantages include file-level snapshots for fast, simple backup and individual restoration of user files; unified management of NAS and SAN storage through a single interface; and expansion of file services performance on the fly. The EqualLogic FS7500 appliance is also integrated with the Microsoft Active Directory® and Lightweight Directory Access Protocol (LDAP), enabling user roles, quotas, permissions, and files to be managed from one location.

Combined, Dell EqualLogic PS Series SAN arrays and the EqualLogic FS7500 scale-out NAS provide a cost-effective way for organizations to implement VDI while minimizing the complexities of managing VM and authorized user data.

## 3 VMware View solution infrastructure

VMware View is a VDI solution that includes a complete suite of tools for delivering desktops as a secure, managed service from a centralized infrastructure. The components of a View VDI deployment include client connection devices (desktops, laptops or thin clients), VMware View Manager for connection brokering and virtual desktop management, VMware View Composer (optional) for space-efficient provisioning of desktop VMs, and vSphere ESXi server virtualization for hosting the virtual desktops.

### 3.1 VMware View components

A View infrastructure consists of many different software, network, and hardware layer components. Here is a functional list of View components relevant to this white paper:

<b>Client Devices</b>	Personal computing devices used by end users to run the View Client.
<b>View Connection Server</b>	Software that authenticates users through Microsoft Active Directory and brokers client connections.
<b>View Client</b>	Software that is used to access View desktops.
<b>View Agent</b>	A service that runs on all systems used as sources for View desktops and facilitates communication between the View Clients and View Server.
<b>View Administrator</b>	Web-based administration platform for View Infrastructure components.
<b>vCenter Server</b>	Central administration platform for configuring, provisioning, and managing VMware virtualized datacenters.
<b>View Composer</b>	A service running on the View Servers; used to create pools of linked clone VM images in order to reduce storage requirements.

### 3.2 Virtual desktops

Virtual Desktops can be classified into two major categories: persistent and non-persistent. In a persistent desktop, a user keeps all configuration and personalization between sessions on their assigned desktop. When using persistent desktops, the administrator usually has to provision for additional storage and other administrative requirements.

In a non-persistent desktop environment, users are assigned virtual desktop VMs from a pool of resources during login. This type of virtual desktop does not maintain any user data or other information between sessions. At logoff, all the changes are simply discarded and the virtual desktop is returned to the original state. Patching and upgrading non-persistent desktops is as simple as making the change to the base image and redeploying the pool. Thus, these desktops are easier to manage but lack the potential for persistent user customization or storage.

### 3.3 VMware View desktop pools

A Desktop Pool is a VMware term that is used to describe the entity that is managed by the View Administration interface. View Desktop Pools allow you to group users depending on the type of service the user requires. There are two types of pools – Automated Pools and Manual Pools.

In View, an Automated Pool is a collection of VMs cloned from a base template, while a Manual Desktop pool is created by the View Manager from existing desktop sources. For each desktop in the Manual Desktop pool, the administrator selects a desktop source to deliver View access to the clients.

In this paper, we use Manual Desktop Pools with the EqualLogic Virtual Desktop Deployment Utility, because this tool offers Automated Pool-like functionality (as well as View Composer-like functionality) in the View environment. These are explained in the next section.

We provided persistent desktop-like behavior on non-persistent desktops by using Microsoft Active Directory folder redirection and roaming profile features. By using these features, the administrator can design a user account so that all the configuration settings can be written to a remote profile that is stored separately from the virtual desktop image files. This reduces the need for additional management on individual virtual desktops. The disadvantage in using this method is the additional time required to sync the remote profiles at logon and logoff. This can be improved by using a high performance file service appliance like the Dell EqualLogic FS7500 Unified NAS appliance.

For more information on the various types of View Pools, see: <http://pubs.vmware.com/view-50/topic/com.vmware.view.administration.doc/GUID-0A9CA985-3A78-428A-BCFB-B3E2DCCA90AD.html>

The core View infrastructure components used in our test configuration are shown in Figure 1:

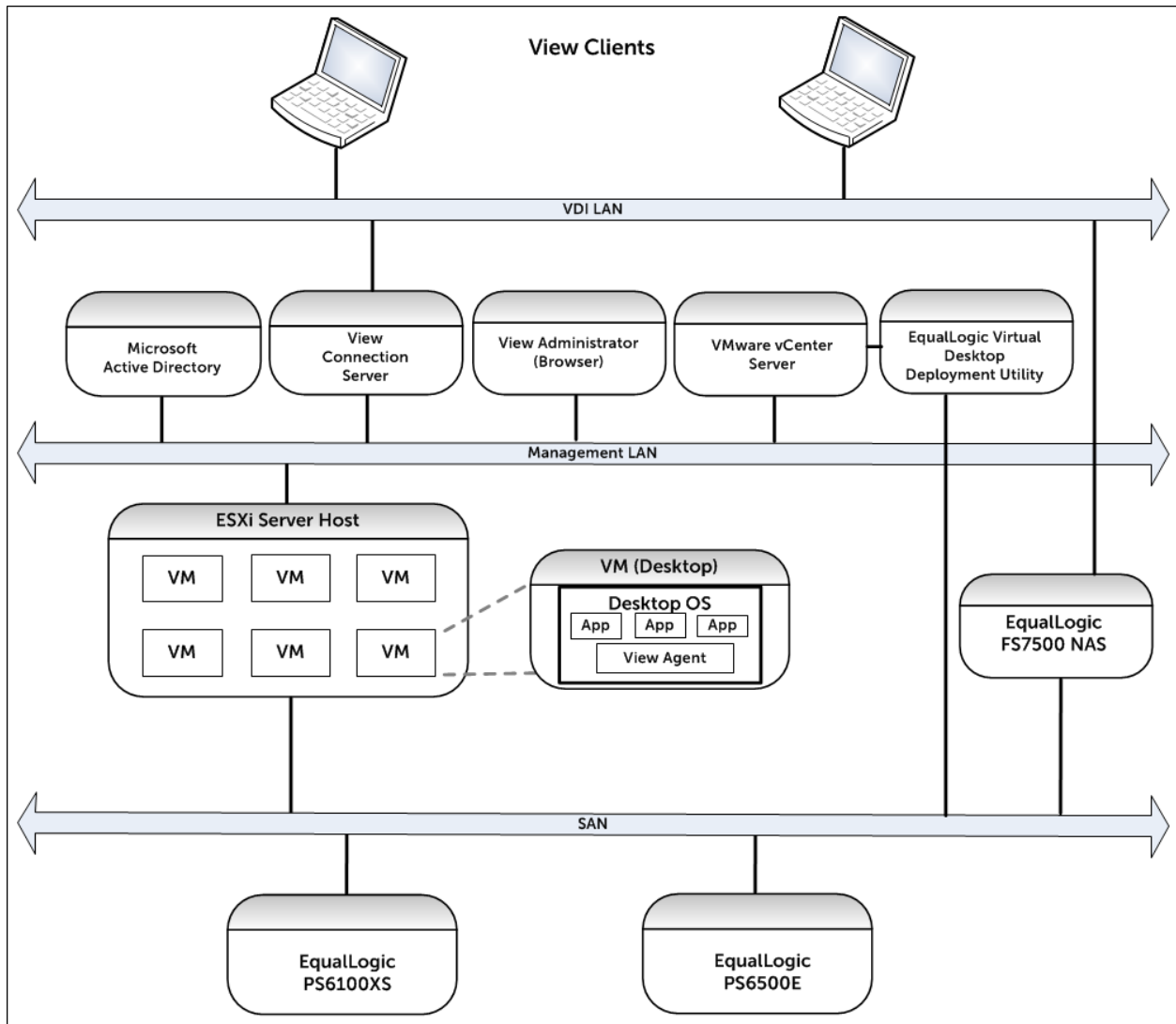

Figure 1 VDI architecture using Unified Storage: Dell EqualLogic FS7500 and EqualLogic PS Series

## 4 EqualLogic Virtual Desktop Deployment Utility

The Virtual Desktop Deployment Utility is installed as part of the Dell EqualLogic HIT/VE virtual appliance and is launched from vSphere client for vCenter. The EqualLogic Virtual Desktop Deployment Utility is available under the "Solutions and Applications" tab on the home page of the vSphere client.

The Virtual Desktop Deployment Utility, first released as part of HIT/VE 3.0, leverages the thin clone technology introduced with Dell EqualLogic PS Series firmware version 5.0 to space-efficiently and time-efficiently provision and deploy virtual desktops in a View Manual Desktop Pool environment. This tool, available with no additional cost to EqualLogic customers, automates the steps required to create View Manual Desktop Pools and delivers considerable space savings in a manner similar to View Composer (available in higher-end VMware license packages). The tool creates VDI environments similar to View automated pools, thereby offering more choices to the VDI administrators.

One of the advantages of the Virtual Desktop Deployment Utility is that there is no need to create datastores before deploying a pool – all operations for creating datastores and providing access to the ESXi hosts are done automatically by the tool itself. This is in contrast to the View management interface, where the datastores need to be created in advance and presented to View during the creation of the automated pool. The tool achieves virtual desktop deployment efficiencies by eliminating the need to manually create volumes on the SAN and by automatically provisioning them as datastores with the ESXi hosts.

The EqualLogic Virtual Desktop Deployment Utility further enhances VDI capabilities with its automatic mapping of VM desktops to pools through direct import of VDI pool metadata into View, as well as with its ability to automate virtual desktop deployment by managing operations on storage arrays directly inside vCenter.

The virtual desktop deployment process using the EqualLogic Virtual Desktop Deployment Utility and linked clones is shown in Figure 2 below:

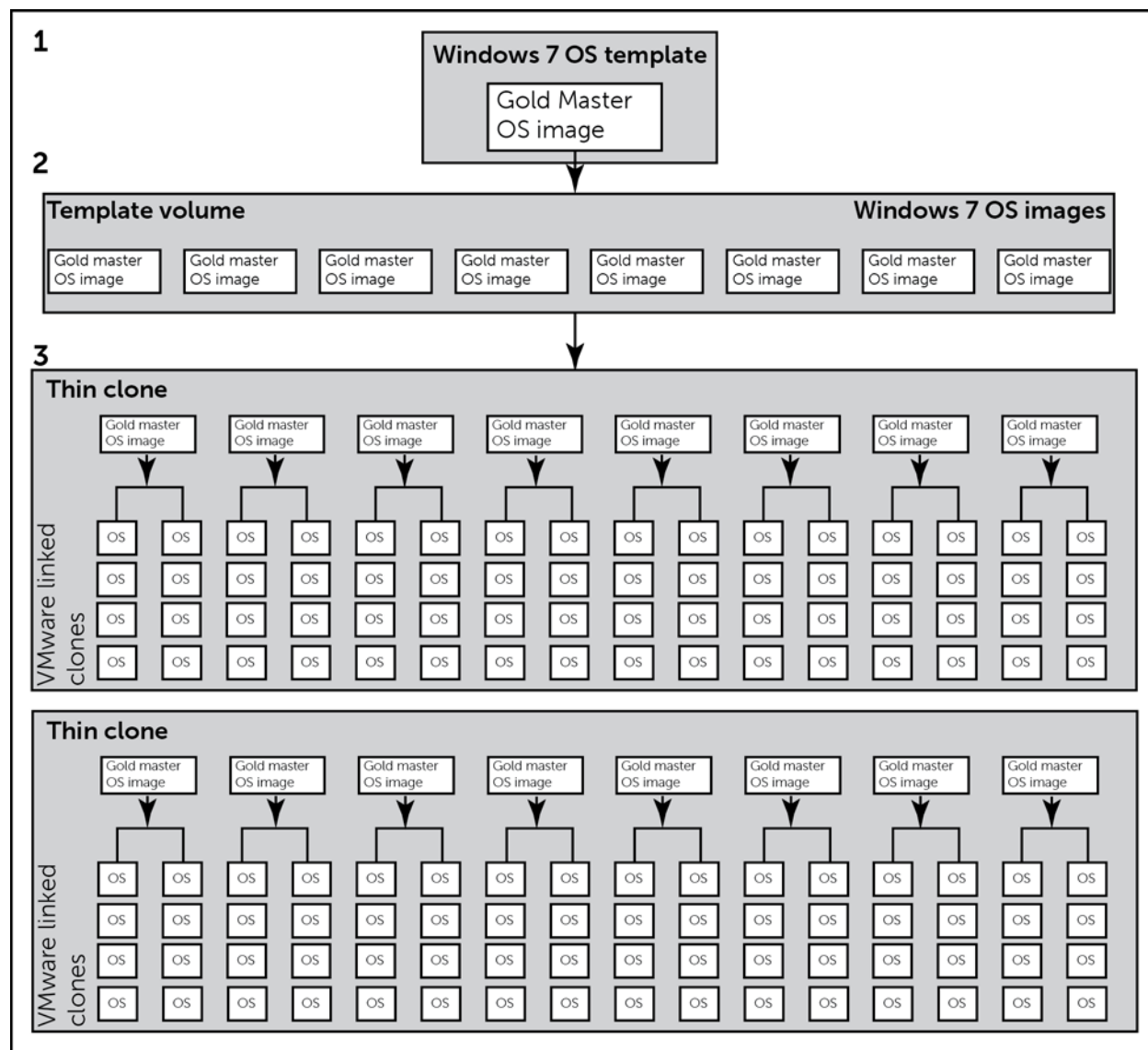

**Figure 2 Virtual desktop deployment process with EqualLogic Virtual Desktop Deployment Tool**

In step 1, the administrator creates a gold master desktop image that is optimized for VDI deployment. As part of step 2, the administrator provides the gold master image to the Virtual Desktop Deployment Utility. The tool then automatically copies the gold master image eight times in an EqualLogic volume when the linked clone option is chosen<sup>1</sup>. This volume is now converted to a template volume by the tool.

<sup>1</sup> EqualLogic Virtual Desktop Deployment Tool does offer the capabilities of using full clones instead of linked clones. In the full clone case, the tool copies the gold master image for the specified number of VMs per datastore (instead of just eight as in the linked clone case) to create the template volume outlined in Step 2. However, we use the linked clone example because of the significant capacity saving opportunities with this approach.

In step 3, the EqualLogic Desktop Deployment Utility creates thin clones of the template volume created in the previous step. The tool creates appropriate number of thin clones to deploy the required number of virtual desktops. VMware linked clones are created from these eight gold master images in the thin clones to provide the required number of VMs per datastore. These VMs are registered and then customized on the vCenter server. All the available virtual desktops are then imported into View so that they can be managed by View as a Manual Desktop Pool.

Once the administrator creates the gold desktop image and provides it to the EqualLogic Desktop Deployment Utility, the tool automatically performs all the remaining steps outlined above and also takes care of rescanning the ESXi hosts for the new datastores that it has created

The EqualLogic Virtual Desktop Deployment Utility concepts presented in Figure 2 are illustrated with an example below. Figure 3 shows the template volume layout example where the gold master image is 25 GB and the administrator is planning to allocate 20% of the VM image size for the differential data after the desktop is deployed. In this example, the administrator allocates 32 VMs per datastore. The tool creates eight copies of the gold image. The total size of the template volume is 360 GB which is made up of:

- Gold master copies =  $25 \text{ GB} * 8 = 200 \text{ GB}$   
plus
- Differential VM data =  $20\% * 25 \text{ GB} * 32 = 160 \text{ GB}$

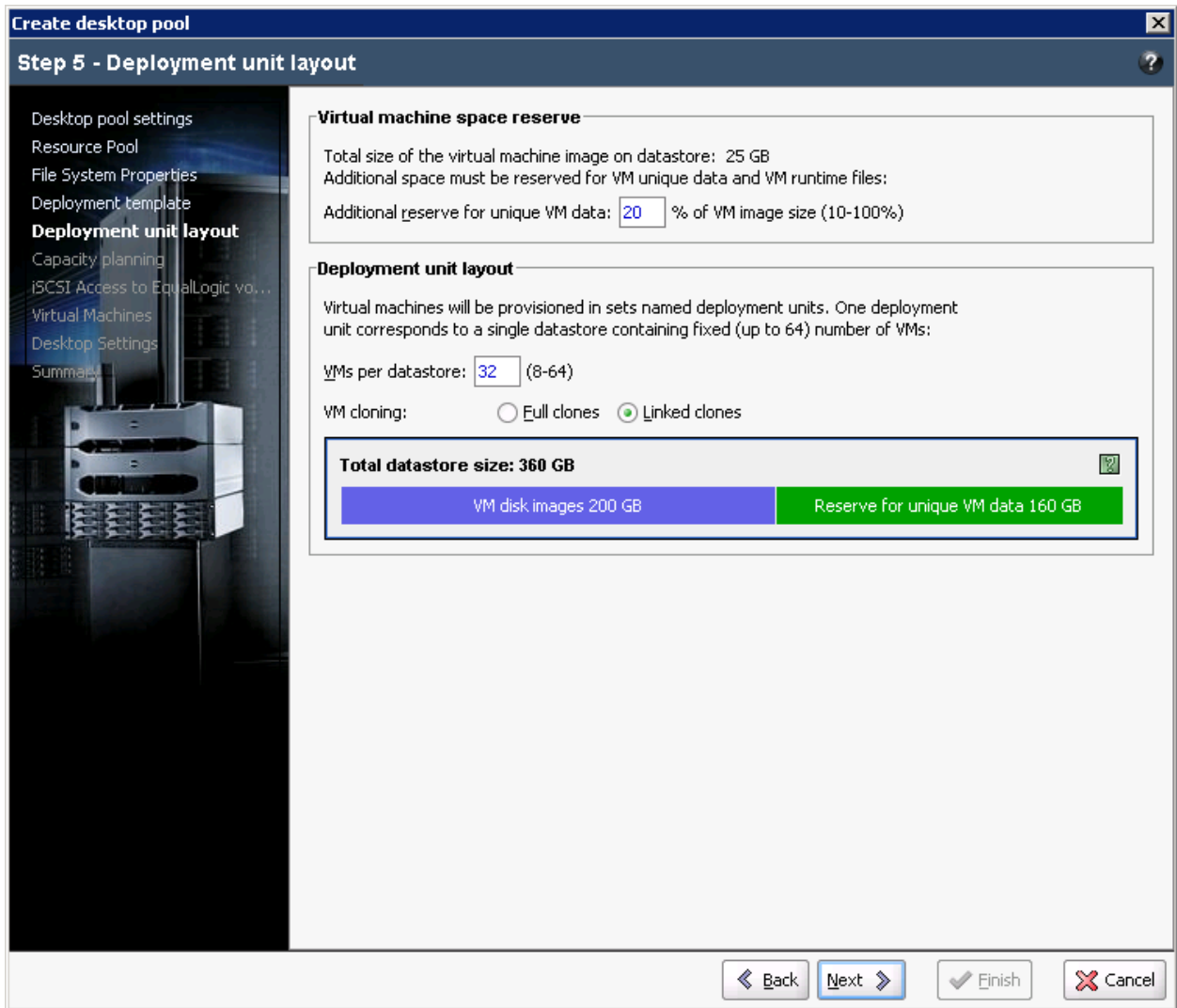

Figure 3 Template volume considerations

Figure 4 shows the capacity planning needed to deploy 512 desktops using the template volume created above. Each datastore contains 32 VMs, so 16 datastores will be needed to deploy 512 VMs. Each datastore is a thin clone volume which is expected to grow up to 160 GB in this example for differential data of all the VMs contained within it. Thus, the total volume reserve is approximately  $16 * 160 \text{ GB} = 2.5 \text{ TB}$  for this 512 virtual desktop deployment scenario.



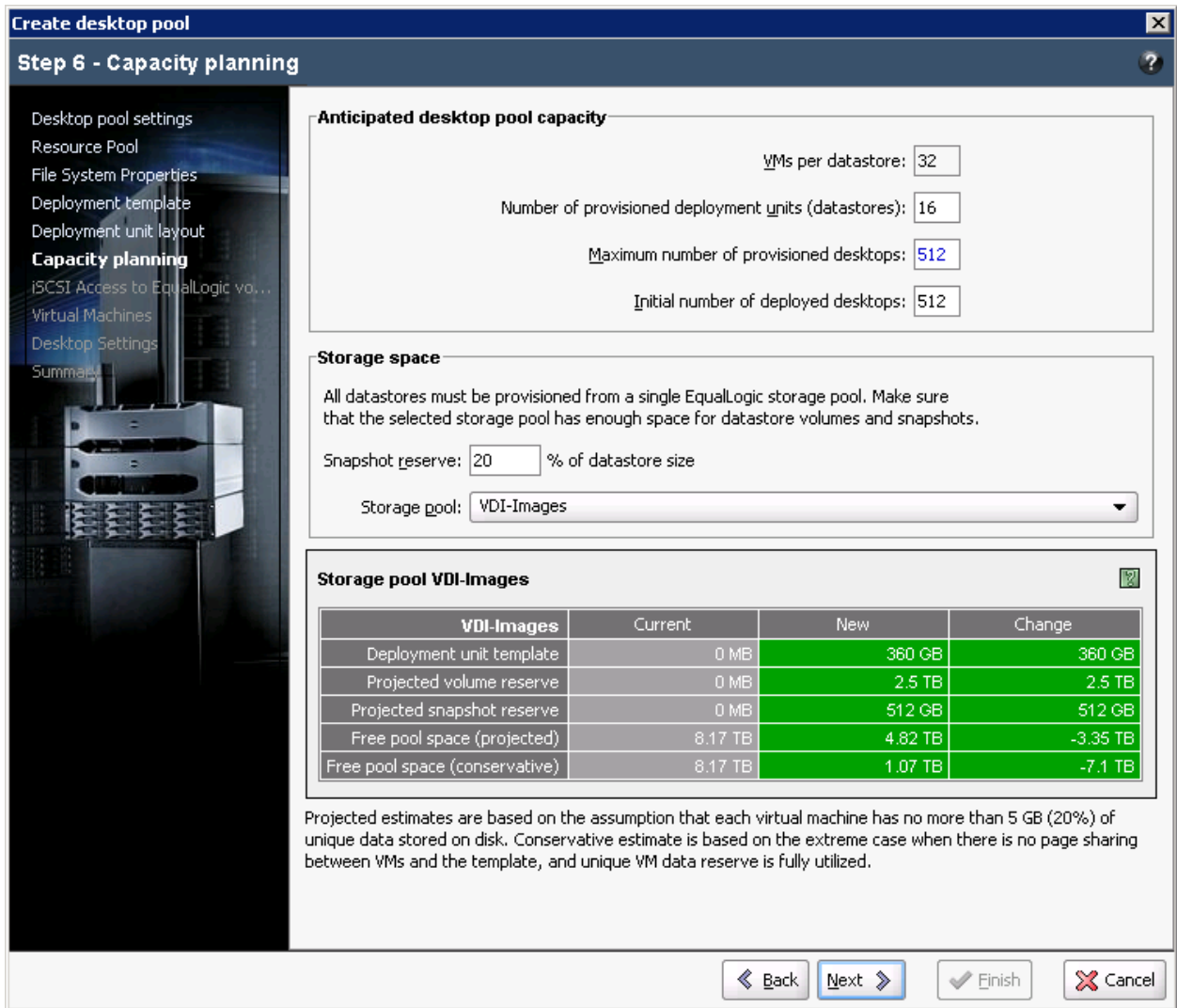

Figure 4 Capacity considerations

A detailed step-by-step sample deployment using the wizard available in EqualLogic Desktop Deployment Utility is presented in Appendix A. A complete discussion on various sizing considerations is presented in section 8 of this document.

## 5 Infrastructure and test configuration

In this chapter we provide information about the test setup used for hosting View virtual desktops, infrastructure components, networking, and storage subsystems.

### 5.1 Component design

The entire infrastructure and test configuration was held within a Dell PowerEdge M1000e blade chassis. As shown in Figure 5, the 16 PowerEdge M610 servers were divided into three ESXi clusters.

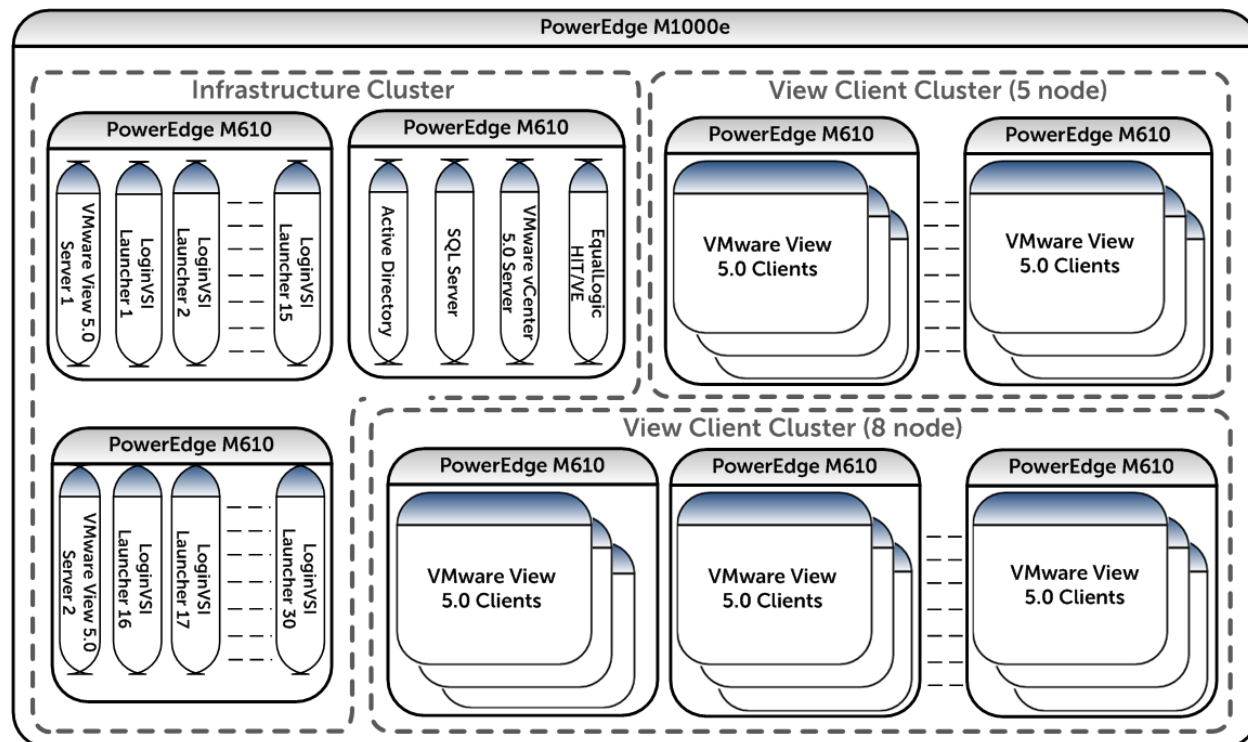

Figure 5 ESXi Blade Clusters on PowerEdge M1000e

These clusters were:

- Infrastructure Cluster: Three M610 Blade servers with a combined computing power of 119 GHz and 288 GB of memory.
- Two View Clusters: One with eight M610 Blade servers and another with five M610 Blade servers, as View allows a maximum of eight servers in a cluster. Thirteen M610 Blade servers total in View clusters, with a combined computing power of 520 GHz and 1248 GB of memory.

The back plane of the blade chassis consisted of the following switches:

- Two PowerConnect M6220 switches in fabrics A1 and A2 for connectivity to a Management LAN
- Four PowerConnect M6348 switches in fabrics B1, B2, C1, and C2.

- Switches in fabrics B1 and C1 were uplinked to a pair of PowerConnect 7048 switches for dedicated access to the iSCSI SAN.
- Switches in fabrics B2 and C2 were connected to the VDI LAN and provided client connectivity to the virtual desktops.

There are three physical networks that allow for segregation of different types of traffic.

- **Management LAN**  
This network provides a separate management network for all the physical ESXi hosts, network switches, and EqualLogic arrays. It also allows communication between various infrastructure components such as the Microsoft Active Directory server, Microsoft SQL server, and VMware vCenter server.
- **iSCSI SAN**  
Dedicated iSCSI SAN network through which all the virtual desktops and other infrastructure components access the EqualLogic storage.
- **VDI LAN**  
This is the network on which clients access the virtual desktops in the View desktop pools.

For more detailed information on how the Management LAN and the VDI LAN were set up, please refer to Appendix C .

## 5.2 iSCSI SAN configuration

Figure 6 shows the network connectivity between a single M610 blade server and the storage array through the blade server chassis. Even though the figure shows only one M610, the topology is identical for the remaining blades in the chassis.

- Each PowerEdge M610 server included two Broadcom NetXtreme II 5709s quad-port NIC mezzanine cards. One card was assigned to Fabric B and the other to Fabric C on the blade chassis.
- Dual PowerConnect M6348 switches were installed in Fabric B and Fabric C on the blade server chassis. The NIC mezzanine cards were connected to each of these switches through the blade chassis mid-plane.
- Two PowerConnect 7048 switches were used for the external SAN switches. Each of the EqualLogic storage arrays were connected to these switches. The SAN connections and internal network connections for the EqualLogic FS7500 NAS appliance were also on this switch.
- Each EqualLogic PS6100XS array has two controllers with four iSCSI network ports and one management port. Two ports on each storage controller were connected to one PowerConnect 7048 switch while the other two ports were connected to the other 7048 switch. The management port was connected to the 6248 switches on the Management LAN.
- The PowerConnect 7048 switches were configured with a 10GbE SFP+ uplink module and stacking modules in the expansion bays.
- The uplink module was used to create a 2 x 10GbE LAG uplink to the PowerConnect M6348 blade switches.
- The stacking module was used to connect the two 7048 switches together to provide a highly available storage network.

Note: For this whitepaper we used only 2 NIC ports per mezzanine card.

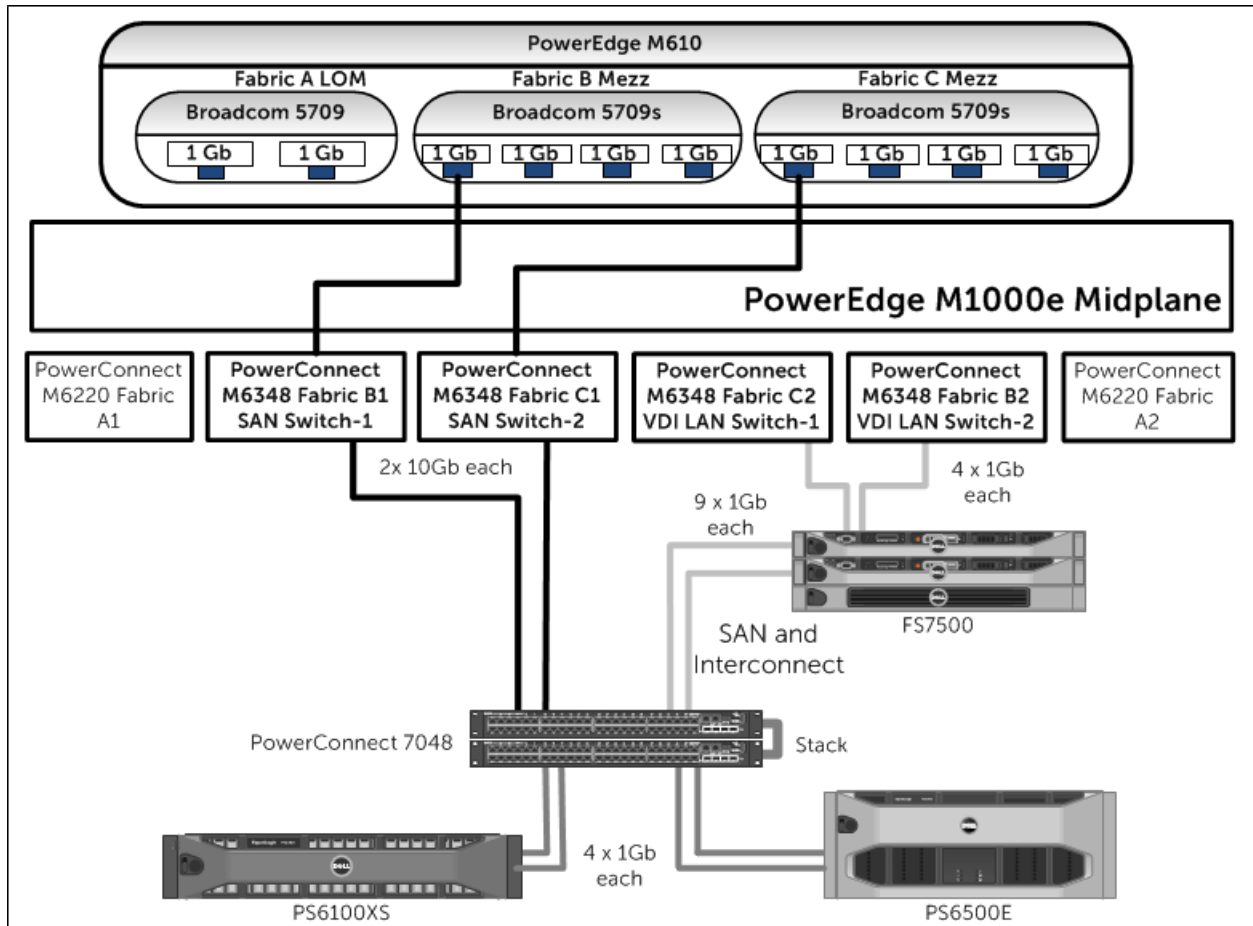

Figure 6 iSCSI SAN connectivity

### 5.3 ESXi host network configuration

VMware ESXi 5.0 hypervisor was installed on all 16 blades. The network configuration on each of those hosts is described below.

Each ESXi host was configured with three virtual switches: vSwitch0, vSwitch1, and vSwitch2 to separate the different types of traffic on the system.

Table 1 vSwitch configuration in ESXi

vSwitch	Description
vSwitch0	Management network
vSwitch1	iSCSI SAN
vSwitch2	VDI LAN

For additional information on individual vSwitch configuration, refer to Appendix D.

## 5.4 VMware View configuration

View was installed by following the documentation provided by VMware.

View 5.0 Documentation: <http://pubs.vmware.com/view-50/index.jsp>

Here are the specific configuration choices we used in our setup:

- Two View Servers were setup to provide load balancing and high availability.
- The View Servers were installed as VMs on two separate hosts with two virtual CPUs, 10 GB of RAM and a 40 GB virtual hard drive.
- The first View Server was installed as a "View Standard Server" during the installation, while the second View Server was installed as a "View Replica Server".

## 6 VMware View test methodology

### 6.1 Test objectives

- Develop best practices and sizing guidelines for a View-based VDI solution deployed on EqualLogic PS Series storage, Dell PowerConnect switches, and Dell PowerEdge Blade Servers with VMware ESXi 5.0 as the server virtualization platform while utilizing the EqualLogic Virtual Desktop Deployment Utility.
- Determine how many virtual desktops can be deployed in this environment using a single PS6100XS array with acceptable user experience indicators for task worker profiles.
- Determine the performance impact on the storage array during peak I/O activity such as boot and login storms.

### 6.2 Test approach

The key VDI use cases that were validated are:

- Task worker workload characterization
- Boot storm
- Login storm

The virtual desktops were restarted to get a consistent state for each test. Only non-persistent desktops were used where any changes made to the desktop images are lost when the user logs off. However, changes to the user profiles were preserved by storing them on a CIFS share on the FS7500 which was achieved through folder and profile redirection.

### 6.3 Test tools

All tests were conducted using Login VSI 3.0 as the workload generator. Login VSI, developed by Login Consultants, is a widely adopted VDI benchmarking/load generation tool.

Login Virtual Session Indexer (Login VSI) is a unique benchmarking tool to measure the performance and scalability of centralized desktop environments such as Server Based Computing (SBC) and VDI. More information can be found at: <http://www.loginvsi.com>

#### 6.3.1 Load generation

The "Light" workload from Login VSI was used to simulate the task worker workload. The characteristics of this "Light" workload are:

- Only two applications are open simultaneously
- Applications include IE, Word, Outlook, and Notepad
- Once a session is started, the light workload is repeated every 12 minutes
- Idle time total is about one minute and 45 seconds between each 12 minute loop
- During each loop, the response time is measured every two minutes.

Although Login VSI provides other workloads, we used the Light workload in our tests because it closely resembles the workload of a task worker.

### 6.3.2 Monitoring tools

We used the following monitoring tools:

- Dell EqualLogic SAN Headquarters (SAN HQ) for monitoring storage array performance
- VMware vCenter statistics for ESXi performance
- Login VSI Analyzer
- Custom script polling array counters for monitoring TCP retransmissions

Detailed performance metrics were captured from the storage arrays, hypervisors, virtual desktops, and the load generators while the tests were running.

## 6.4 Test criteria

The primary focus of the tests was to determine the maximum number of desktops which can be deployed using a PS6100XS array in this environment while utilizing the EqualLogic Virtual Desktop Deployment Utility.

VDI configurations involve many components at different layers - application, hypervisor, network, and storage. As a result, multiple metrics need to be monitored at different layers to ensure that the environment is healthy and performing appropriately for the users.

The specific test criteria are described in the following sections.

### 6.4.1 Storage capacity and I/O latency

The typical industry standard latency limit for storage disk I/O is 20 ms. Maintaining this limit ensures good user application response times when there are no other bottlenecks at the infrastructure layer.

### 6.4.2 System utilization at the hypervisor layer

Even though the primary focus of these tests was storage characterization, additional metrics at the hypervisor infrastructure layer were defined to ensure solution consistency. These are:

- Average CPU utilization on any ESXi server should not exceed 90%
- Minimal or no memory ballooning on ESXi servers
- Total network bandwidth utilization should not exceed 90%
- TCP/IP Network retransmission should be less than 0.5%

### 6.4.3 Virtual desktop user experience

Login VSI Dynamic VSIMax metric was used to ensure that all desktops had acceptable levels of application performance.

More information about the Login VSI Analyzer is available at: <http://www.loginvsi.com/en/admin-guide/analyzing-results>

## 6.5 Test setup

We setup two virtual desktop pools using the EqualLogic Virtual Desktop Deployment Utility. Each pool was built from a Microsoft Windows 7 base image, which was optimized for VDI deployment.

View Optimization Guide for Windows 7: <http://www.vmware.com/resources/techresources/10157>

Windows 7 base image properties:

- One virtual CPU
- 1 GB RAM
- 25 GB hard drive
- One virtual NIC connected to vSwitch3

Desktop Pool properties:

- Two desktop pools
- 400 virtual desktops each
- 32 VMs per datastore (deployment template volume)
- 13 provisioned thin clone volumes per desktop pool
- 20% of base image size reserved for writing changes (5 GB)

We created a total of 800 virtual desktops split into two pools of 400 each. When creating these pools with the EqualLogic Virtual Desktop Deployment Utility, we chose to have 32 VMs per datastore and the utility automatically created 13 thin clone volumes to generate the required 400 desktops.

Detailed tests were conducted with various combinations of VMs per datastore and the number of thin clone volumes before settling on the combination above. More information about sizing for your environment can be found in section 8.2 of this paper.

We use 700 of the available desktops for the test results reported in section 7 because our tests demonstrated that 700 is the optimal number of task worker desktops that a single PS6100XS can host in the VDI environment with View combined with EqualLogic Virtual Desktop Deployment Utility. During the tests, all virtual desktops were pre-booted and allowed to settle for about 20 minutes before the Login VSI workload was started.



## 7 Test results and analysis

This section shows the different View VDI characterization tests executed as well as the key findings from each test. The task worker user type represents the majority of the VDI users in the industry today, and we focused our testing on this workload profile.

### 7.1 Test scenarios

- **Boot storm**

Boot storm represents the worst-case scenario where many virtual desktops are started at the same time and they all contend for the system resources simultaneously. We wanted to evaluate if the storage array hosting the desktops is capable of handling huge spikes in storage I/O within acceptable latency limits.

- **Task worker – Login storm and steady state**

In this test we pre-booted all 700 virtual desktops and allowed the desktops to be in an idle state for more than 20 minutes to let their I/O settle, before executing the Login VSI workload to simulate the light workload for a task worker profile.

### 7.2 Boot storm I/O

Virtual desktops were restarted simultaneously from VMware vSphere client to simulate a boot storm. Figure 7 shows the storage characteristics during the boot storm – the PS6100XS array delivered approximately 9500 IOPS under the peak load during this test. The average latency on the storage array was within the industry accepted limits of 20 ms. This boot storm workload was created by restarting 100 virtual desktops simultaneously, as the View environment with the EqualLogic Virtual Desktop Deployment Utility creates significant I/O loads per VM during a boot storm.

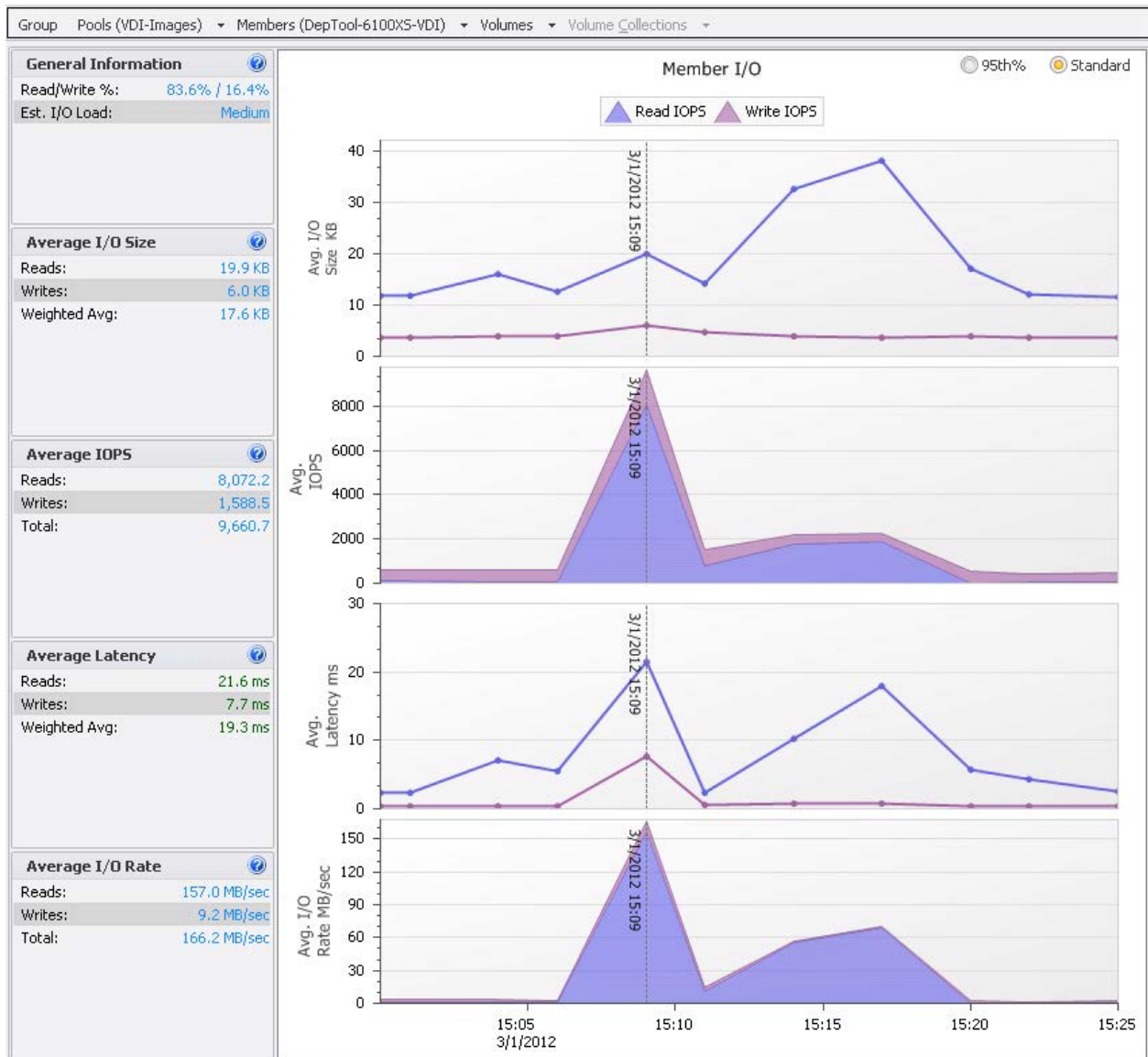

**Figure 7 SAN HQ data showing storage performance during boot storm**

The spike seen in the figure was caused primarily by read I/O – the boot process of the virtual desktops creates many simultaneous reads to the master gold image(s). In this test, the capacity needed for all the VM data was less than the SSD capacity provided by the PS6100XS array; therefore all the IOPS were delivered by SSDs and no data movement was involved.

The ESXi hosts did not show any bottlenecks with respect to meeting the CPU and memory resource requirements during the boot operation. The peak CPU utilization during the boot storm was about 50% and there was no memory ballooning activity. Other infrastructure services like the View servers and Active Directory servers did not show any additional load during the boot storm.

As Figure 8 shows, storage network utilization was also well within the available bandwidth. The peak network utilization during boot storm reached approximately 30% of the network bandwidth, and then it gradually declined once all the machines were booted up.

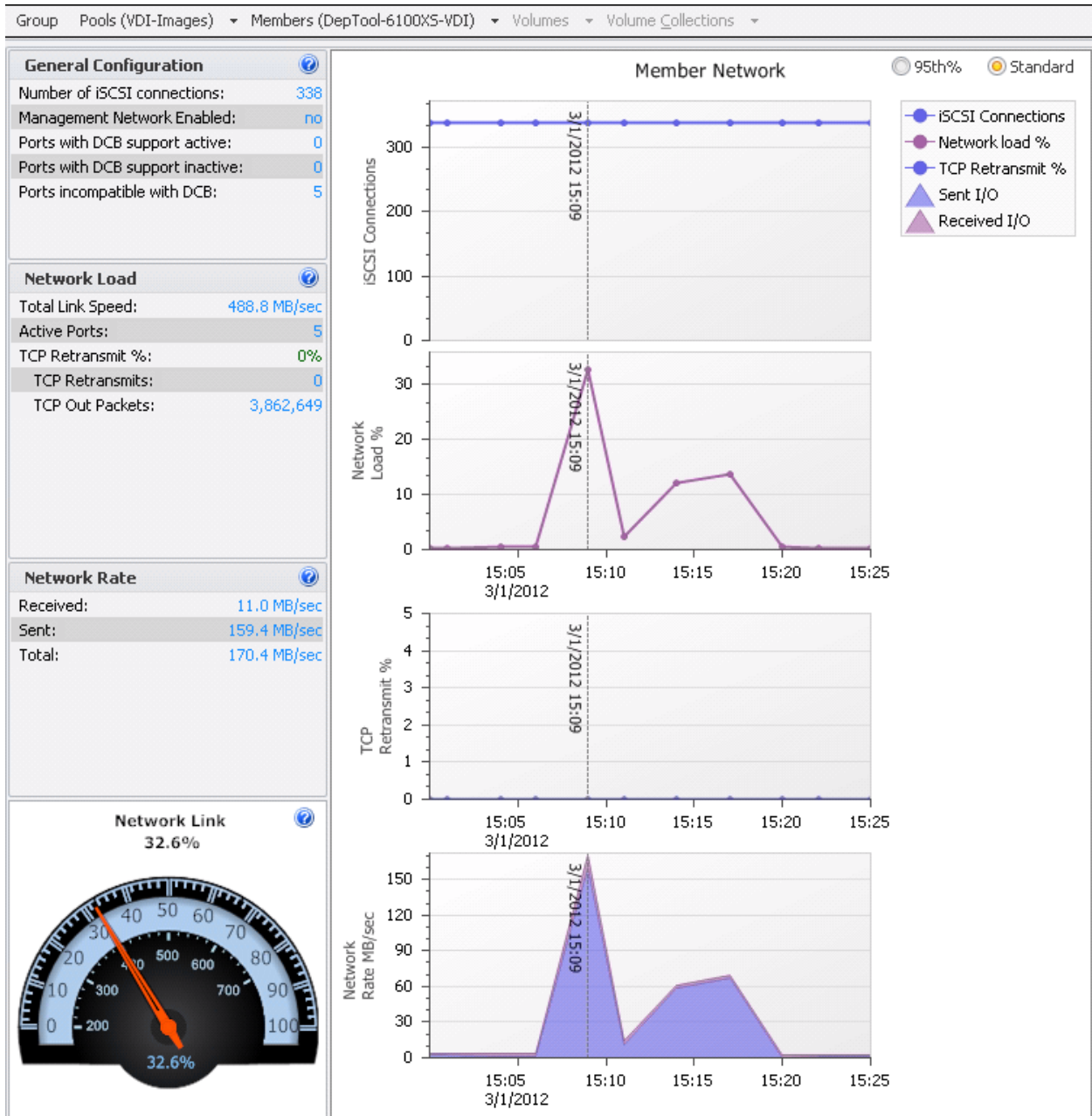

Figure 8 SAN HQ data showing network performance during boot storm

The above results demonstrate that a boot storm places a heavy load on system resources, and the PS6100XS array handled the simulated boot storm workload well. Typically, boot storms are only seen very rarely, for example after a power failure or a major system outage. To alleviate extra loads on various systems, it is advised that the desktops are booted over a period of time.

## 7.3 Task worker – Login storm and steady state

### 7.3.1 Login storm I/O

Login VSI was configured to launch 700 virtual desktops over a period of about one hour after pre-booting the virtual desktops. The peak IOPS observed during the login storm was about 6400 IOPS.

Login storms generate significant IOPS due to multiple factors, including:

- User profile activity
- OS services on the virtual desktop
- First launch of applications

Once the virtual desktop has achieved a steady state after the user login, the OS does not need to access storage each time the application is launched because of application caching in memory. This is why IOPS tend to be lower during the steady state.

Figure 9 below shows the IOPS and latency observed during the login storm.

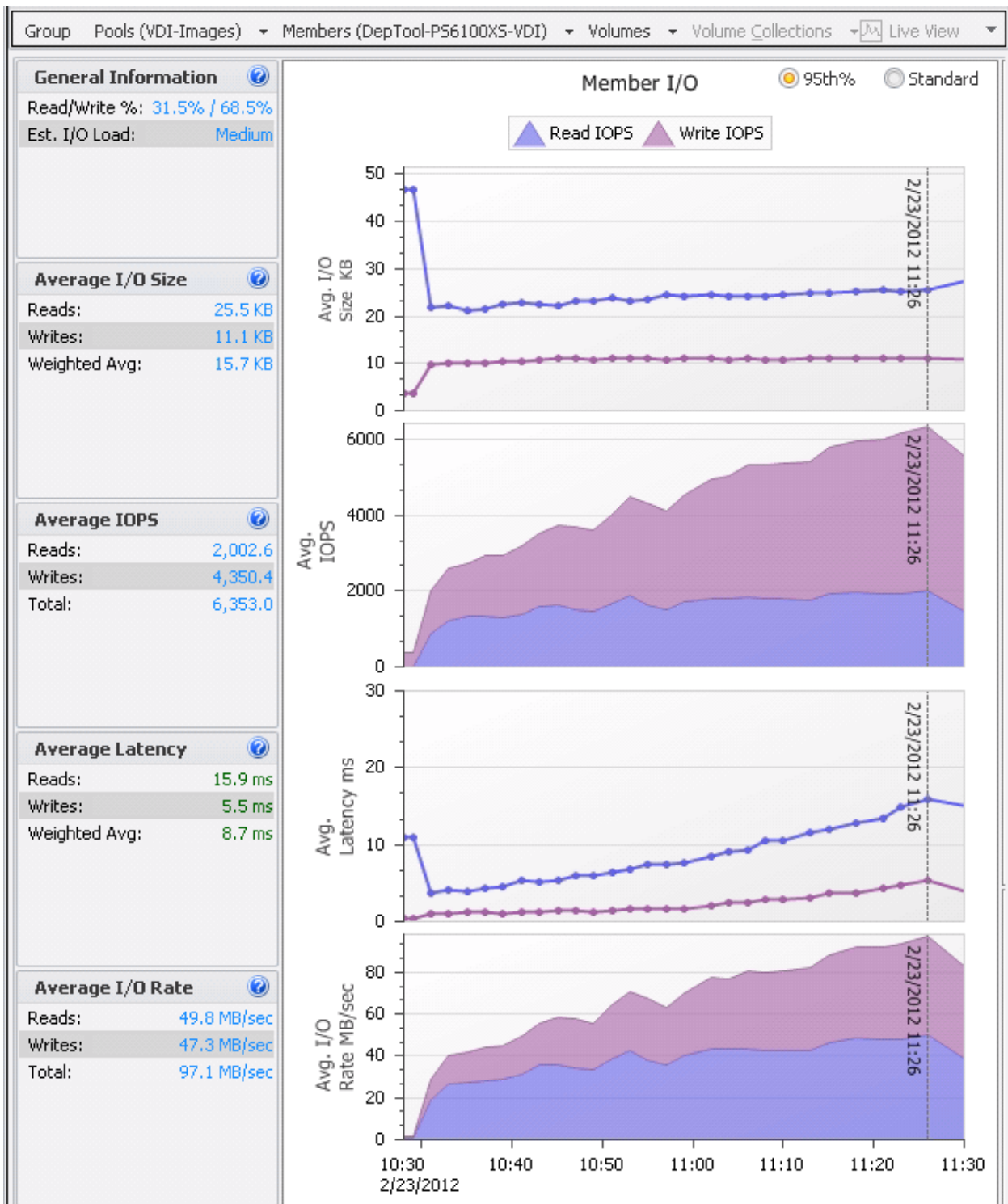

Figure 9 SAN HQ data showing login storm I/O

The following table shows the overall usage of the disks in the array during the login storm as collected by SAN HQ for the individual disks.

**Table 2 Disk usage on EqualLogic PS6100XS array during login storm**

Member	Pool	Disk	Description	Average IOPS	Read I/O Rate	Write I/O Rate
DepTool-PS6100XS-VDI	VDI-Images	0	SSD 400GB SAS	2,198.20	25.0 MB/sec	19.4 MB/sec
DepTool-PS6100XS-VDI	VDI-Images	1	SSD 400GB SAS	2,177.20	24.8 MB/sec	19.1 MB/sec
DepTool-PS6100XS-VDI	VDI-Images	2	SSD 400GB SAS	2,174.40	24.7 MB/sec	19.0 MB/sec
DepTool-PS6100XS-VDI	VDI-Images	3	SSD 400GB SAS	2,180.10	24.7 MB/sec	19.2 MB/sec
DepTool-PS6100XS-VDI	VDI-Images	4	SSD 400GB SAS	2,172.20	24.7 MB/sec	19.2 MB/sec
DepTool-PS6100XS-VDI	VDI-Images	5	SSD 400GB SAS	2,193.10	24.8 MB/sec	19.2 MB/sec
DepTool-PS6100XS-VDI	VDI-Images	6	SSD 400GB SAS	2,212.70	24.9 MB/sec	19.4 MB/sec
DepTool-PS6100XS-VDI	VDI-Images	7	10K 600GB SAS	<1.0	22.8 KB/sec	0 KB/sec
DepTool-PS6100XS-VDI	VDI-Images	8	10K 600GB SAS	0	0 KB/sec	0 KB/sec
DepTool-PS6100XS-VDI	VDI-Images	9	10K 600GB SAS	<1.0	11.4 KB/sec	0 KB/sec
DepTool-PS6100XS-VDI	VDI-Images	10	10K 600GB SAS	0	0 KB/sec	0 KB/sec
DepTool-PS6100XS-VDI	VDI-Images	11	10K 600GB SAS	0	0 KB/sec	0 KB/sec
DepTool-PS6100XS-VDI	VDI-Images	12	10K 600GB SAS	0	0 KB/sec	0 KB/sec
DepTool-PS6100XS-VDI	VDI-Images	13	10K 600GB SAS	0	0 KB/sec	0 KB/sec
DepTool-PS6100XS-VDI	VDI-Images	14	10K 600GB SAS	0	0 KB/sec	0 KB/sec
DepTool-PS6100XS-VDI	VDI-Images	15	10K 600GB SAS	0	0 KB/sec	0 KB/sec
DepTool-PS6100XS-VDI	VDI-Images	16	10K 600GB SAS	0	0 KB/sec	0 KB/sec
DepTool-PS6100XS-VDI	VDI-Images	17	10K 600GB SAS	0	0 KB/sec	0 KB/sec
DepTool-PS6100XS-VDI	VDI-Images	18	10K 600GB SAS	0	0 KB/sec	0 KB/sec
DepTool-PS6100XS-VDI	VDI-Images	19	10K 600GB SAS	0	0 KB/sec	0 KB/sec
DepTool-PS6100XS-VDI	VDI-Images	20	10K 600GB SAS	0	0 KB/sec	0 KB/sec
DepTool-PS6100XS-VDI	VDI-Images	21	10K 600GB SAS	0	0 KB/sec	0 KB/sec

DepTool-PS6100XS-VDI	VDI-Images	22	10K 600GB SAS	0	0 KB/sec	0 KB/sec
DepTool-PS6100XS-VDI	VDI-Images	23	10K 600GB SAS	0	0 KB/sec	0 KB/sec

Table 2 clearly shows that most of the data is handled by the SSD drives during long storm and therefore provides the best performance.

### 7.3.2 Steady state I/O

To support the 700 virtual desktops, we used thirteen M610 blade servers hosting around 58 VMs on each server. A single PS6100XS array was used to host all the virtual desktops.

The total IOPS on the PS6100XS array during steady state when all the users were logged in was around 4500 (6.4 IOPS per VM). Of this, the read IOPS accounted for around 713 IOPS (approximately 16% of the total I/O load) and the remaining 3800 IOPS or 84% were write IOPS. Read and write latencies were also below 20 ms throughout the test. This is because all changes that occur on the desktop (including temporary OS writes such as paging) are being written to the disk. The I/O pattern is primarily writes due to this activity. Once desktops are booted and in steady state, the read I/O becomes minimal as shown in Figure 10.

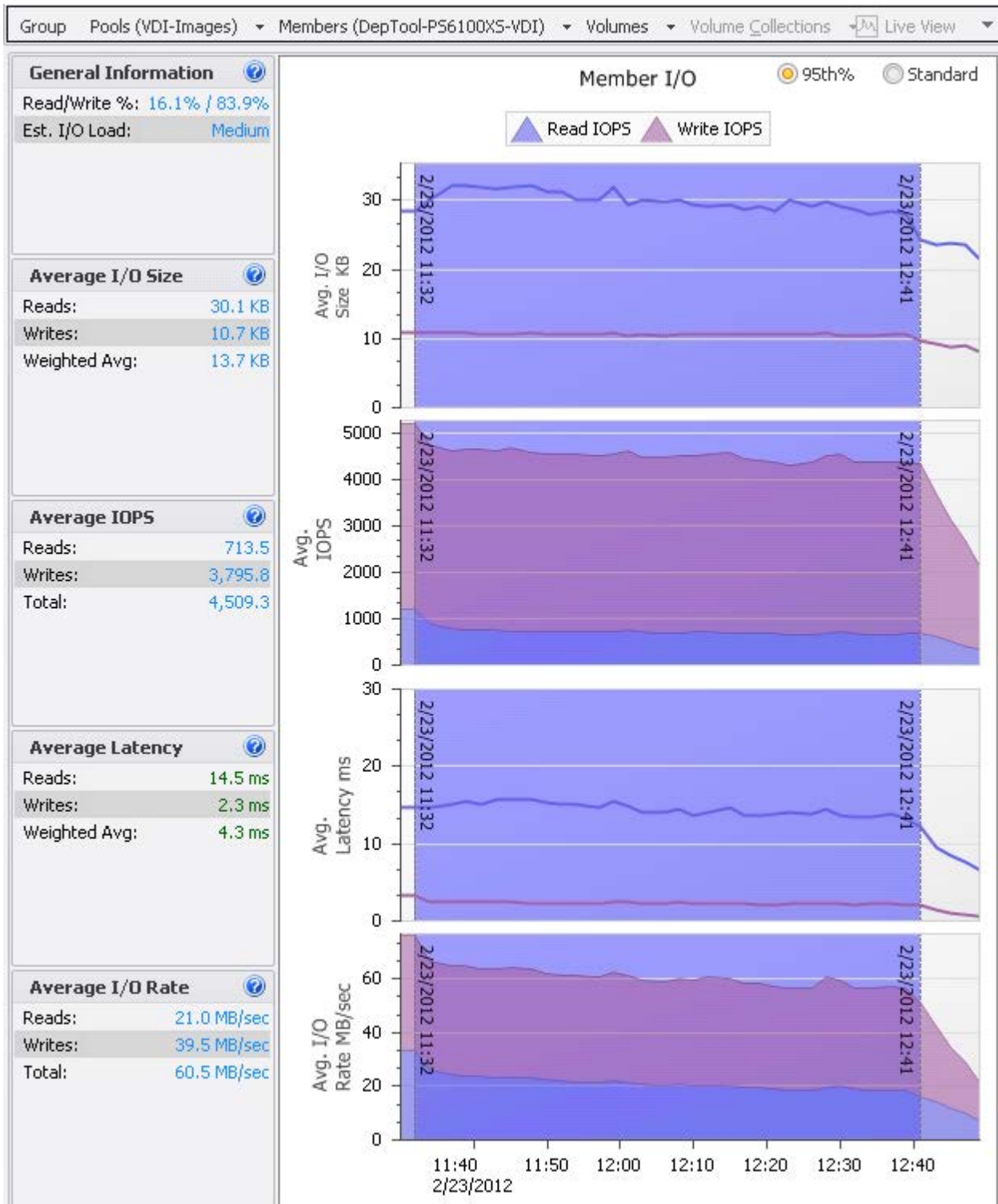

Figure 10 SAN HQ data showing steady state I/O

### 7.3.3 Desktop host server performance

During the steady state portion of the test, CPU, memory, network, and storage system performance were measured on all ESXi servers hosting the virtual desktops. The performance of one ESXi server is presented here. The other ESXi servers had similar performance characteristics.



Statistics for the ESXi hosts were captured using VMware vCenter server. The figures below show the CPU, memory, and network utilization on one of the ESXi servers hosting the virtual desktops.

The key observations from the statistics were:

- CPU utilization was well below 80% through the entire test. (see Figure 11)
- Active memory usage was about 35% and there was no memory ballooning observed. (see Figure 12)
- Network utilization was about 10 MBps which included an average of 5 MBps storage and there was very minimal traffic on the management and server LANs. (see Figure 13)
- Average Read and Write latencies at the software iSCSI storage adapter level nearly matched the observed latencies on SAN HQ. (see Figure 14)

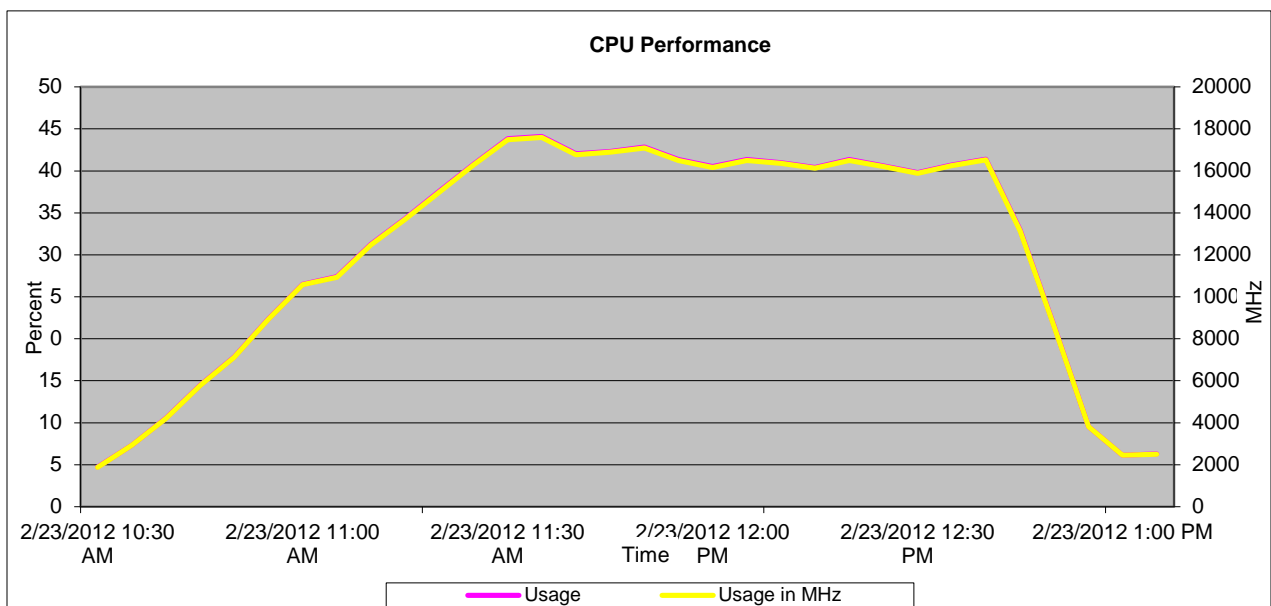

Figure 11 ESXi host CPU utilization

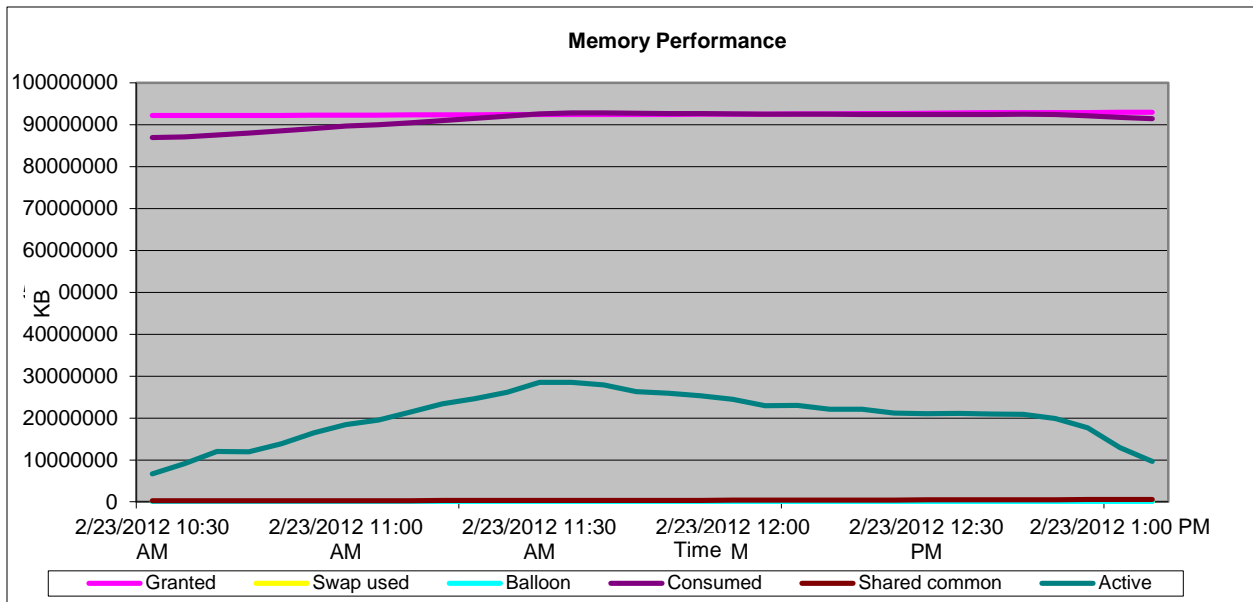

Figure 12 ESXi host memory utilization

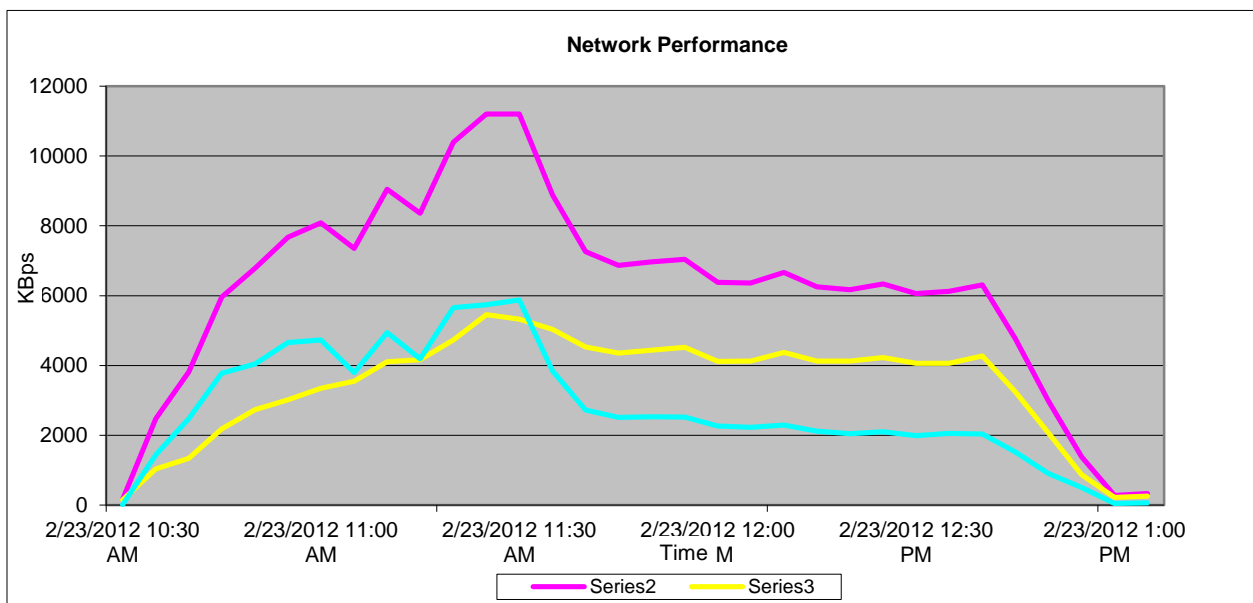

Figure 13 Combined ESXi host network utilization

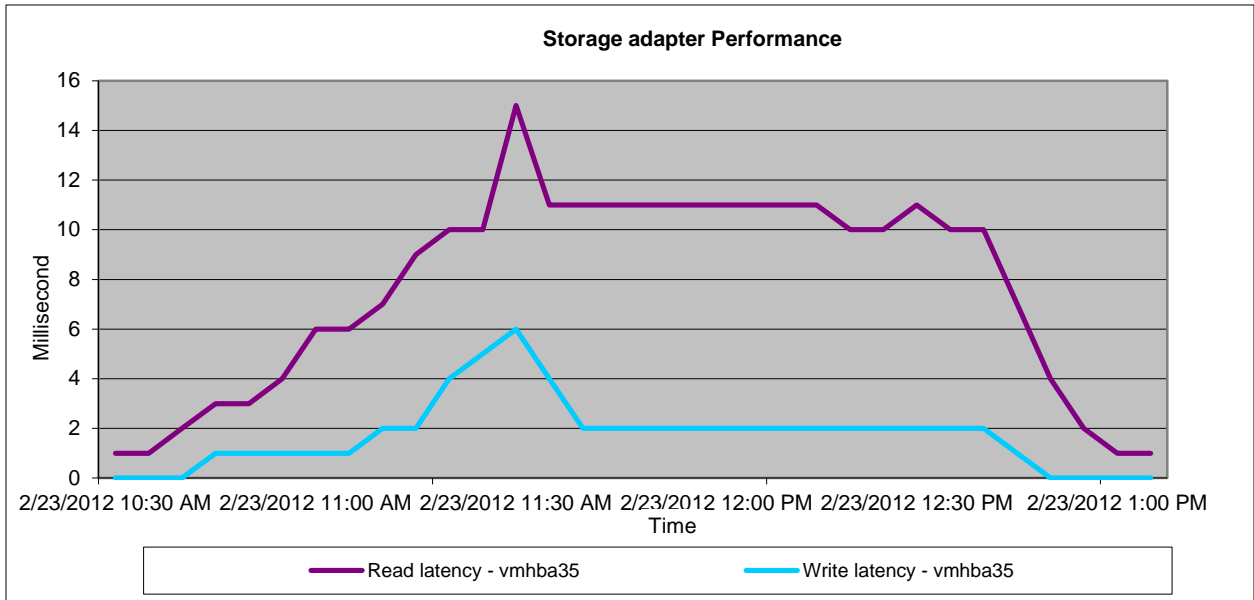

Figure 14 ESXi storage adapter read and write latencies

## 8 Sizing guidelines for EqualLogic SANs

The storage array should be able to handle various I/O patterns that occur throughout the day for a VDI solution. These include the login storm that occurs at the beginning of a shift or a workday when the majority of employees login to their virtual desktops in a relatively short period of time. Once they are logged in, the virtual desktops reach a steady state where they generate predictable IOPS as the employees go about their work day. The same storage array should also be able to handle recovery situations due to unexpected events such as power outages which might cause boot and login storms.

A good way to deploy a storage infrastructure for VDI is to understand the VDI workload characteristics including the performance characteristics of the applications being deployed. These include:

- Capacity requirements
- Performance requirements
  - IOPS
  - Average disk latency
  - Read and Write ratios

The following sections summarize the key capacity and performance guidelines that are specifically focused for a View-based VDI solution while using the EqualLogic Virtual Desktop Deployment Utility. These guidelines are based on the test results and key findings from the previous sections.

A small template volume with a large number of thin clones will create the most space savings on a storage array. However, it should be noted that there are other considerations (for example, the iSCSI connection limit described in the next section) that will come into play when deciding the optimal number of virtual desktops that should be placed in a single template volume to maximize the performance and space savings for a given gold master image.

### 8.1 iSCSI connection considerations for thin clone volumes

For EqualLogic based iSCSI SANs, each storage pool can have a maximum of 1024 iSCSI connections. To maximize the number of connections to a single member, it might be placed in a pool of its own. However, this decision should be based on other considerations as well. For example, if multiple arrays are being used for virtual desktop storage, then all of those arrays should be in the same pool to take advantage of EqualLogic Automated Performance Load Balancing (APLB).

For more information on sizing EqualLogic PS series arrays for virtual environments, specifically with regards to making connections to EqualLogic volumes and ways to manage connection counts, see: <http://en.community.dell.com/dell-groups/dtcmmedia/m/mediagallery/19992296.aspx>

For more information about EqualLogic load balancers, see: <http://www.equallogic.com/WorkArea/DownloadAsset.aspx?id=10752>

### 8.2 Capacity sizing considerations

The sizing of the template volume and the number of thin clone volumes that will be created to host all the desktops require additional considerations.

A trade off needs to be made between maximizing the number of virtual desktops in a template volume versus maximizing the number of thin clone volumes (for most space savings), so that the total number of connections created are below the 1024 connections per pool limit and the end user receives the best possible performance from the virtual desktop.

If we use the minimum number of virtual desktops per template volume (eight), then the EqualLogic Virtual Desktop Deployment Utility will provision a higher number of thin clone volumes for deploying a given number of virtual desktops. This will create more connections to the EqualLogic pool and may quickly reach the limit of 1024 connections per pool.

If we use the maximum number of virtual desktops per template volume (64), then the space required to create the template volume will be quite large and the tool may not provide the best utilization of capacity available in the EqualLogic array.

The following equation gives the total number of virtual desktops deployed for a given combination of VMs in a template volume and the number of provisioned deployment units (number of thin clone volumes).

**Equation 1**      **Number of thin clone volumes**

$$\text{Number of Thin Clone Volumes} = \frac{\text{Number of VMs to be deployed}}{\text{Number of VMs in a Template Volume}}$$

If the number of thin clone volumes determined by the equation above is a decimal number, then the nearest integer higher than the decimal number needs to be chosen. For example, if the number of thin clone volumes turns out to be 10.25, then 11 thin clone volumes will be needed. Additionally, the number of thin clone volumes should not exceed the 1024 connections per pool limit.

The size of the template volume needed to host the virtual desktops on an EqualLogic array is given by the following equation<sup>2</sup>:

**Equation 2**      **Template volume size**

$$\text{Template Volume Size} = (8 \times \text{Gold Image Size}) + \text{Reserve Space}$$

Where, *Reserve Space* for differential data in template volume is given by:

**Equation 3**      **Reserve space**

$$\text{Reserve Space} = \text{Number of VMs in Template Volume} \\ \times (\text{Gold Image Size} \times \text{Space Reserved for Differential Data})$$

The projected total volume reserve space that will be utilized by all the desktops deployed in the solution is given by:

**Equation 4**      **Projected total volume reserve**

$$\text{Projected Total Volume Reserve} = \text{Number of Thin Clone Volumes} \times \text{Reserve Space}$$

---

<sup>2</sup> As noted in section 4, EqualLogic Virtual Desktop Deployment Tool does offer the capabilities of using full clones instead of linked clones. However, we continue to use the linked clone example for capacity sizing considerations because of the significant capacity saving opportunities with this approach.

It is important to note that the projected total volume reserve is an estimate based on the assumption that each virtual machine uses no more than the space reserved for its differential data (see Equation 4).

Using Equation 3 and Equation 5 above, we can determine the capacity requirements for hosting a given number of virtual desktops:

**Equation 5 Projected capacity requirements**

$$\text{Projected Capacity Requirements} = \text{Projected Total Volume Reserve} + \text{Template Volume Size}$$

For example, to deploy a virtual desktop pool of 512 desktops with 32 VMs in a template volume, we would require (512 / 32), or 16 thin clone volumes.

Assuming that the gold image for the OS is 25 GB and each virtual desktop uses 20% of the gold image size as reserve space for differential data, we have:

Template volume size = ( 8 x 25 GB ) + ( 32 x 25 GB x 20% ) = 360 GB and,

Projected total volume reserve = ( 16 x (32 x 25 GB x 20% ) ) = 2560 GB.

Therefore, the projected capacity requirements for this example is (2560 + 360) or 2920 GB or 2.85 TB (using 1024 GB = 1 TB).

Table 3 provides additional information about the projected capacity requirements for deploying a given number of desktops using different combinations of number of VMs in the template volume and the number of required thin clones, assuming:

- Windows 7 base image size: 25 GB
- Space reserve for each virtual desktop: 20% of base image, or 5 GB
- 8 ESXi hosts for hosting the virtual desktops
- Each ESXi host with two paths (iSCSI connections) for connecting to each EqualLogic volume
- Maximum iSCSI connections per pool: 1024
- Maximum thin clones that can be deployed = (1024 / (8x2)), or 64

**Table 3 Capacity requirements for various deployment scenarios**

<b>Total Desktops to be Deployed</b>	<b>VMs per Template Volume</b>	<b>Number of Thin clone volumes</b>	<b>Template Volume Size (GB)</b>	<b>Projected volume reserve for pool (GB)</b>	<b>Total Capacity Required (GB)</b>
80	8	10	240	400	640
80	16	5	280	400	680
80	32	3	360	480	840
80	64	2	520	640	1160
160	8	20	240	800	1040
160	16	10	280	800	1080
160	32	5	360	800	1160
160	64	3	520	960	1480
320	8	40	240	1600	1840
320	16	20	280	1600	1880
320	32	10	360	1600	1960
320	64	5	520	1600	2120
480	8	60	240	2400	2640
480	16	30	280	2400	2680
480	32	15	360	2400	2760
480	64	8	520	2560	3080
512	8	64	240	2560	2800
512	16	32	280	2560	2840
512	32	16	360	2560	2920
512	64	8	520	2560	3080

This table is for sample demonstration of various capacity requirement scenarios only and is not exhaustive of all possible combinations.

During our tests, we have found that there is no noticeable performance difference on the number of VMs in a template volume for a given number of virtual desktops to be deployed. For example, if we are deploying 512 desktops, the following combinations will have similar performance characteristics:

- 16 VMs on the template volume, 32 thin clones
- 32 VMs on the template volume, 16 thin clones
- 64 VMs on the template volume, 8 thin clones

We used 32 VMs on the template volume as a good trade off point between capacity optimization and limiting the number of iSCSI connections used.

### **8.3 Performance sizing considerations**

The storage platform used in a VDI deployment should be able to sustain the maximum IOPS that a boot storm and login storm create within acceptable latency limits.

#### **8.3.1 Boot storm sizing considerations**

Boot storm is a worst case I/O workload pattern for virtual desktops. In our testing, we confirmed that boot storm generated much higher storage system performance demands than during a login storm or steady state application usage.

In our test environment, a PS6100XS array delivered 9500 IOPS during a boot storm with a read/write ratio of about 85% / 15%. The block sizes seen during this storm were nearly 18 KB for reads and 6 KB for writes. As noted in section 7.2, this boot storm workload was created by restarting 100 virtual desktops simultaneously, as the View environment with the EqualLogic Virtual Desktop Deployment Utility creates significant I/O loads per VM during a boot storm.

It is recommended to stagger the boot storms so that only a limited number of desktops, say 100, are booted at a time. This reduces the load on the storage and allows you to size your solution to handle the IOPS generated by those desktops.

#### **8.3.2 Login storm and steady state sizing considerations**

In our testing, logging in all 700 users over a period of less than an hour generated a total of about 6400 IOPS which is about 8-10 IOPS per desktop. The maximum read/write ratio seen during the login storm is about 30% / 70% with block sizes of about 26 KB and 12 KB respectively for reads and writes.

During the steady state, after all the users have logged in, we observed that the total IOPS generated were only about 4500 IOPS which translates to 6-8 IOPS per desktop. The read/write ratio seen here is still write heavy – at about 15% / 85% with block sizes in the vicinity of 30 KB and 12 KB for reads and writes respectively.

The IOPS generated during the login storm were much higher than those seen during steady state. Quantifying the average I/O workload generated is important for performance and sizing considerations. The storage platform should be able to sustain the maximum IOPS these workloads create within acceptable latency limits.



## 9 Best practices

### 9.1 Application layer

#### 9.1.1 Implement roaming profiles and folder redirection

It is highly recommended that all users in the VDI deployment be configured with roaming profiles and folder redirection. This allows the virtual desktops to be non-persistent by preserving user profiles across boots.

#### 9.1.2 Boot and login storm considerations

To avoid I/O bursts due to boot storms, it is recommended that all desktops are pre-booted, preferably with the boots staggered over time, before users begin logging in at the beginning of a shift or workday.

The storage subsystem should be designed to handle these storms in addition to the steady state IOPS. When a storage system is based on the steady state IOPS, users will experience degraded performance during a boot or login storm. It is important to size storage based on IOPS needs of boot and login storms.

#### 9.1.3 Windows 7 Master Image for desktop VMs

It is recommended that the operating system be customized in order to provide the best performance in a VDI environment. VMware recommends specific settings and configurations for Windows 7 that allow for faster logins, quicker screen refreshes and generally better performance. There are also recommendations for disabling unnecessary services which generally improve the usability of the virtual desktop.

The VMware recommendations for Windows 7 image customization can be found here:

<http://www.vmware.com/resources/techresources/10157>

#### 9.1.4 VMware View Pool

It is recommended that a Desktop Pool be limited to using PCoIP as the default display protocol for the virtual desktops. Depending on the actual applications and the actual usage of the virtual desktop, it is recommended to adjust the Adobe Flash settings for the remote sessions based on the View recommendations.

It is also recommended that when creating a manual pool using the Virtual Desktop Deployment Utility, the maximum number of desktops deployed is kept below 512 per View pool. It is important to note that this entity is different from the EqualLogic Storage pool within an EqualLogic storage group. It is also recommended to deploy all the required desktops when deploying the pool.

### 9.2 Server host layer

The ESXi servers hosting the Infrastructure service providers and the virtual desktops are recommended to be configured as follows:

- Follow VMware and Dell best practices for installing and configuring ESXi
- Install and configure EqualLogic Multipathing Extension Module (MEM) for vSphere 5.0

- Separate virtual switches to segregate iSCSI SAN traffic, VDI traffic, and Management network traffic
- Each network path should be assigned to a minimum of two physical NICs for high availability.

More information is available at the following links:

VMware KB article on best practices for installing ESXi 5.0: <http://kb.vmware.com/kb/2005099>

Installing and configuring the Dell EqualLogic MEM for VMware vSphere 5:

<http://www.equallogic.com/WorkArea/DownloadAsset.aspx?id=10798>

### 9.3 Network

It is recommended that at least two physical NICs on each server be dedicated to each of the following logical networks:

- VDI Network
- Management network for Infrastructure and vMotion
- iSCSI SAN

Use VLANs to segregate different types of network traffic on the same physical network. In this case, it is recommended to separate the Infrastructure and vMotion traffic into separate VLANs. Do not use VLANs to segregate SAN traffic. SAN traffic should ideally be running on a separate physical network.

Virtual Switches in ESXi have a default limit of 120 ports. If the number of virtual desktops on each host exceeds the available ports, vSwitch properties should be changed to support the required number of virtual desktops.

On iSCSI SAN switches, Spanning tree should be disabled on switch ports connecting to end devices like server and storage ports. The Portfast setting should be enabled in the switch configuration for these ports. Jumbo frames and flow control (if the NICs support it) should be enabled for all components of the iSCSI network.

### 9.4 Storage

Detailed storage performance and capacity sizing guidelines are presented in section 8. Additionally, it is generally recommended that each array host at least three or more volumes to provide better performance. Using multiple volumes helps improve performance by enabling the array controllers to perform I/O in parallel to these volumes.

It is also recommended to use the EqualLogic PS6100XS hybrid arrays, which consist of seven SSD drives and 17 10K RPM SAS drives within a single chassis, for VDI environments. These hybrid arrays automatically move hot data to the SSD tier, thereby improving performance in VDI environments where the workloads are bursty in nature due to I/O storms. It is also generally recommended to maintain 10-15% headroom both in capacity and IOPS on the storage array to accommodate future requirements for optimal array performance.

It is important to make sure that the SAN switches on the blade chassis are uplinked to dedicated external SAN switches. This will ensure future upgradability by adding additional storage arrays without any downtime.

## 9.5 EqualLogic Virtual Desktop Deployment Utility

- Limit the total number of desktops per pool to no more than 512. This is a limitation on the current HIT/VE version.
- Provide at least 20% VM space reserve per virtual desktop when deploying the pool.
- If using VMware View 5.0 and ESXi 5.0, make sure to use the VMFS-5 filesystem for formatting datastores.

Information on known issues and limitations from the EqualLogic HIT/VE are available here:

[https://support.equallogic.com/support/download\\_file.aspx?id=1265](https://support.equallogic.com/support/download_file.aspx?id=1265)

# Appendix A EqualLogic Virtual Desktop Deployment Utility

Here is an example deployment of a Virtual Desktop Pool using the EqualLogic Virtual Desktop Deployment Tool.

## 1. Launch the EqualLogic Virtual Desktop Deployment Utility in VMware vSphere Client

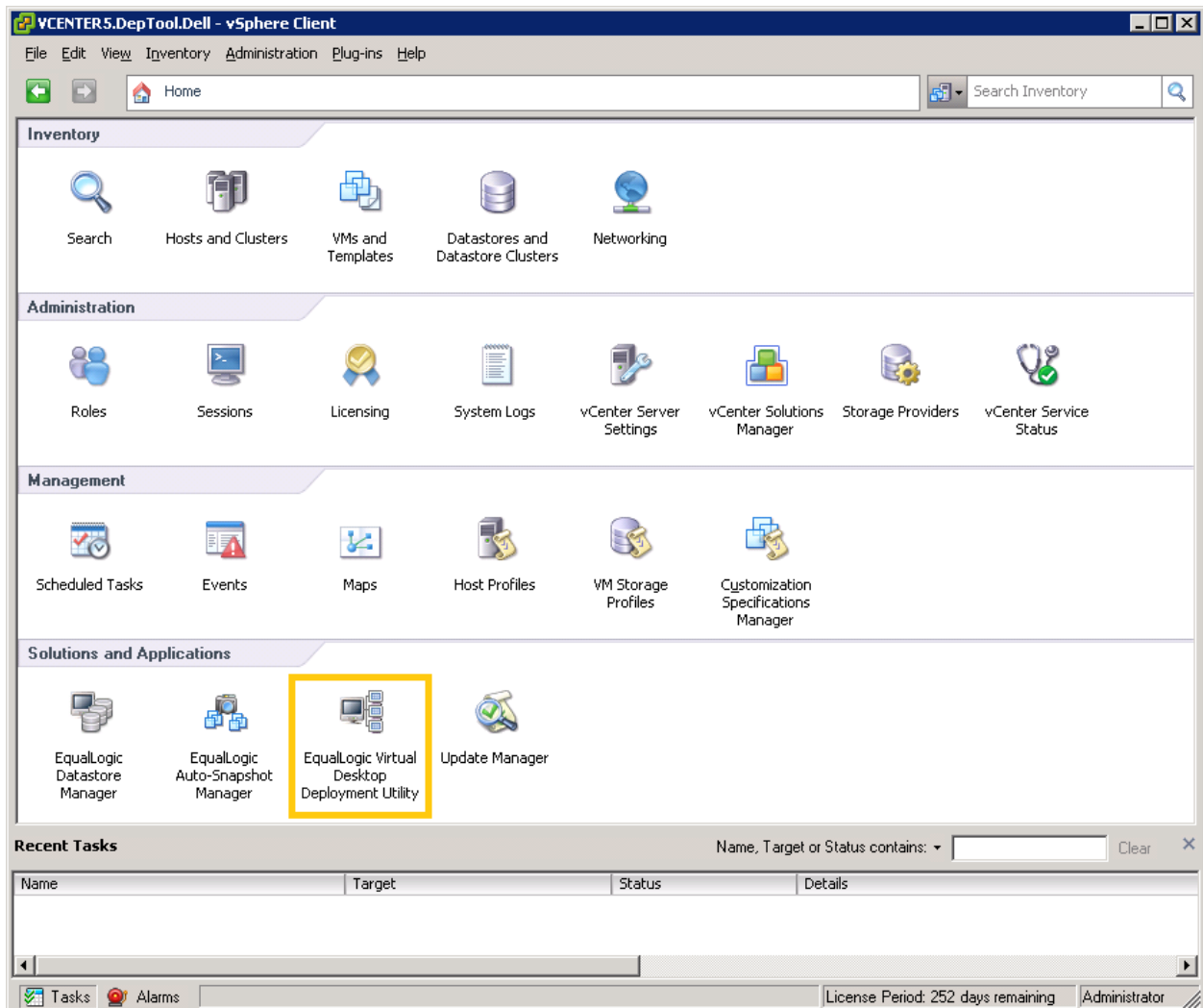

Figure 15 vCenter Home screen

## 2. Login with VMware vCenter credentials

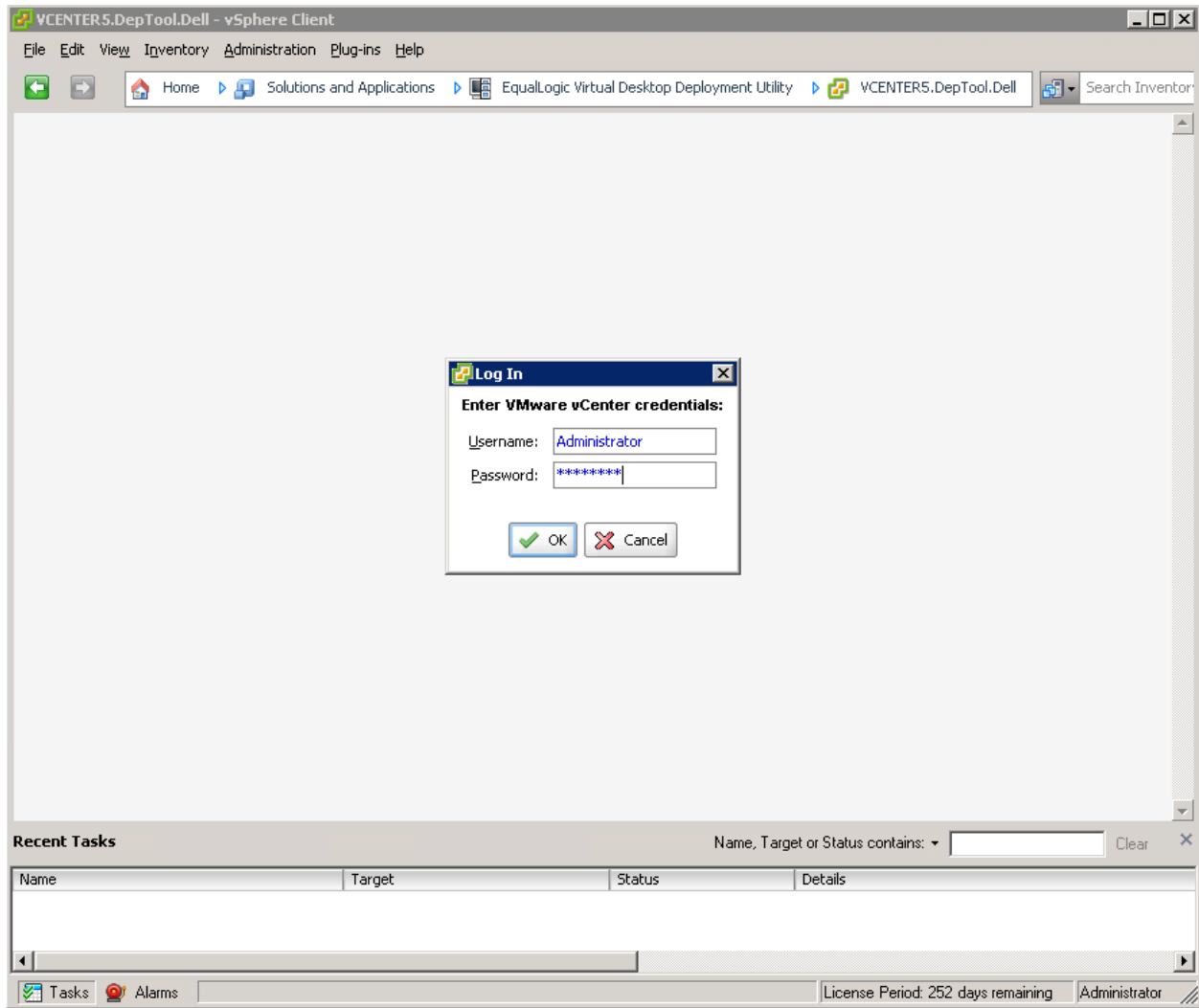

Figure 16 EqualLogic Virtual Desktop Deployment Utility – Login screen

### 3. Create a Desktop Pool

Click on the “Create desktop pool” button in either of the two locations to launch the Virtual Desktop Deployment Utility.

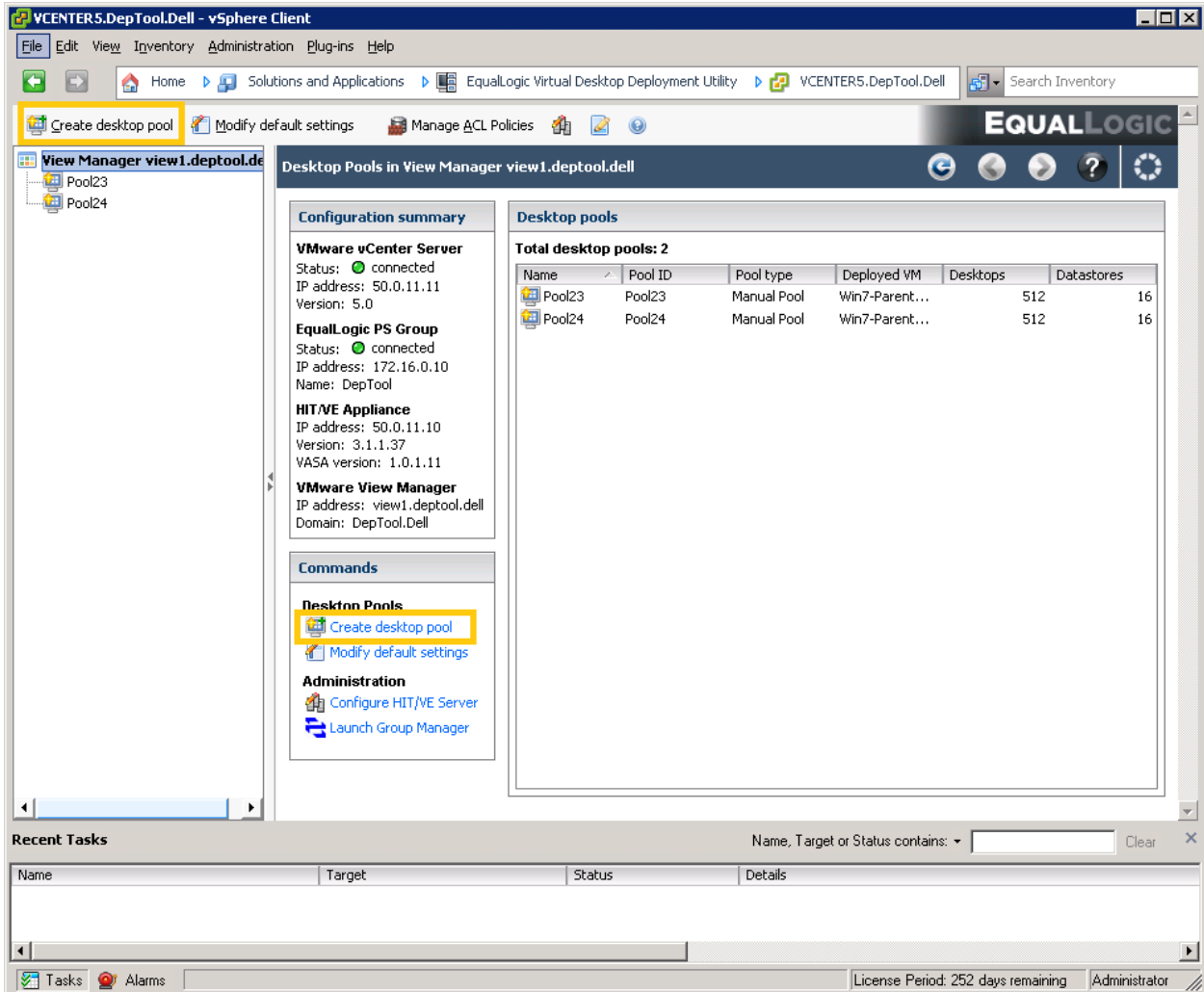

Figure 17 Creating a virtual desktop pool

#### 4. Desktop Pool Settings

The following table provides a short description of the fields on this screen:

Table 4 Desktop Pool settings options

Field	Description
Display Name	Name of the virtual desktop pool
Description	Optional description for the virtual desktop pool.
Desktop persistence	Type of virtual desktops created: <ul style="list-style-type: none"> <li>Floating – a user is assigned a virtual desktop dynamically at each login</li> <li>Dedicated – each user has a dedicated virtual desktop assigned to him</li> </ul>
Desktop pool identifier	Unique identifier for naming all the virtual desktops, volumes and data stores that will be created by the utility.

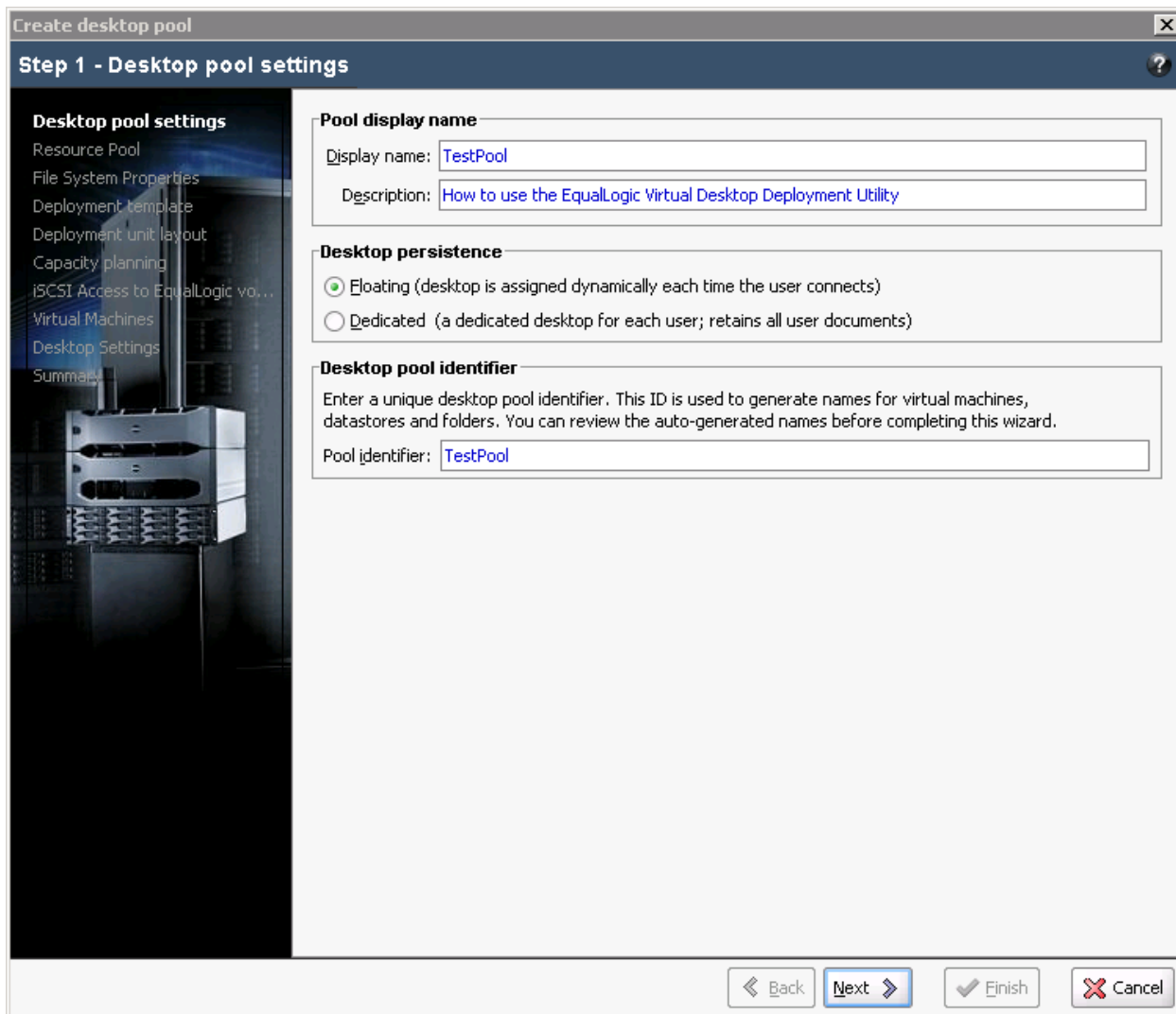

Figure 18 Desktop pool settings

## 5. Resource Pool Selection

Select the resource pool (cluster or host) that will be used to host the deployed VMs.

NOTE: View limits the maximum hosts in a VMware cluster to eight. See the following publication for more information:

<http://pubs.vmware.com/view-50/topic/com.vmware.view.planning.doc/GUID-E5BEA591-D474-4CEE-9646-E9FB3CAF87B4.html>

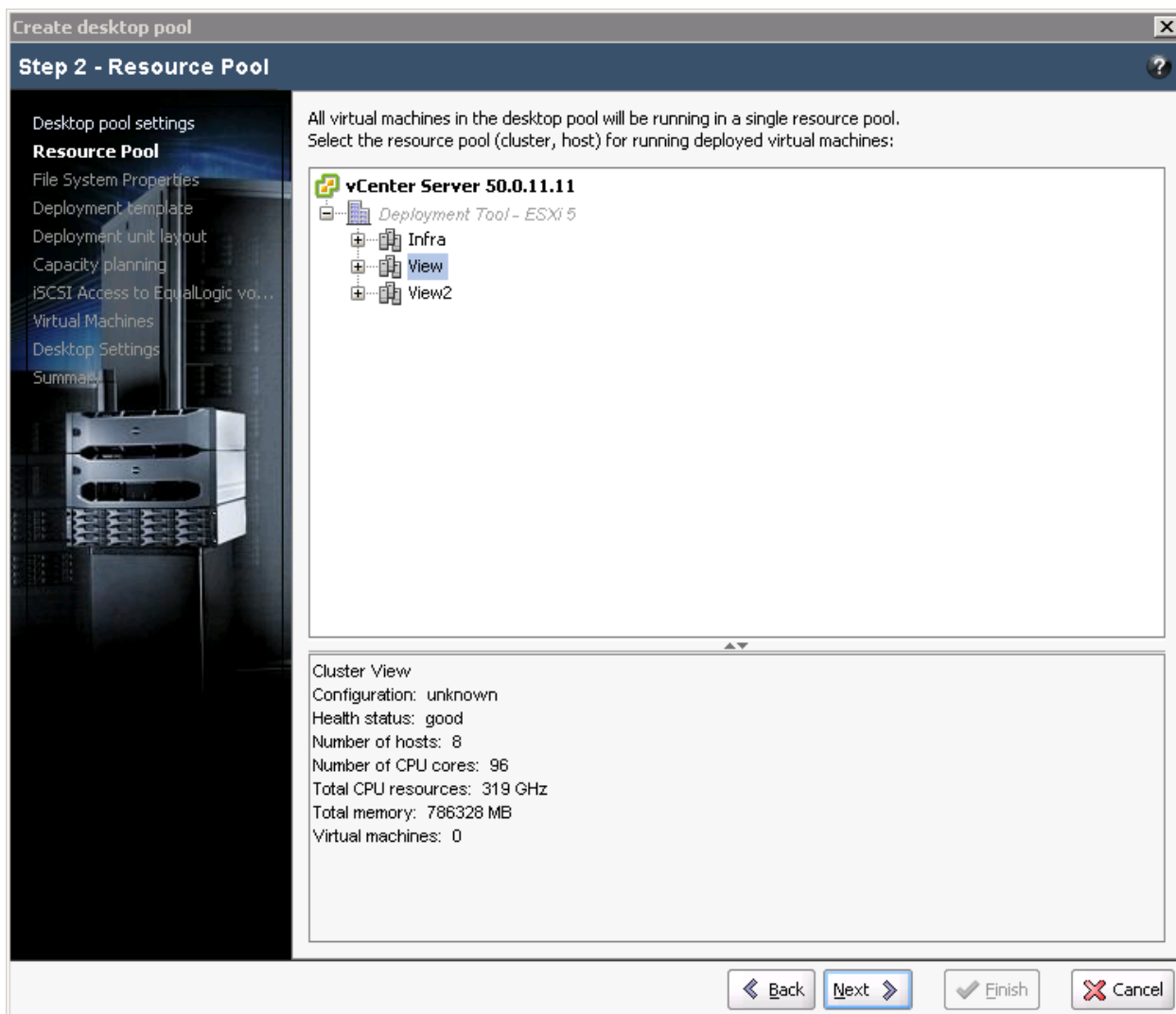

Figure 19 Resource pool selection

## 6. File System Properties

The following table contains a short description of each of the fields on this screen:

Table 5 File system options

Field	Description
File system version	VMware file system version that the data stores will be formatted with. (VMware ESXi 5.0 supports VMFS-3 or VMFS-5, hosts with an older version of ESXi do not support VMFS-5)
File system block size	Block size for each file on the datastore. Pull-down to select the desired block size. VMFS-5 has a fixed block size. Use VMFS-3 file system to use alternative block sizes.



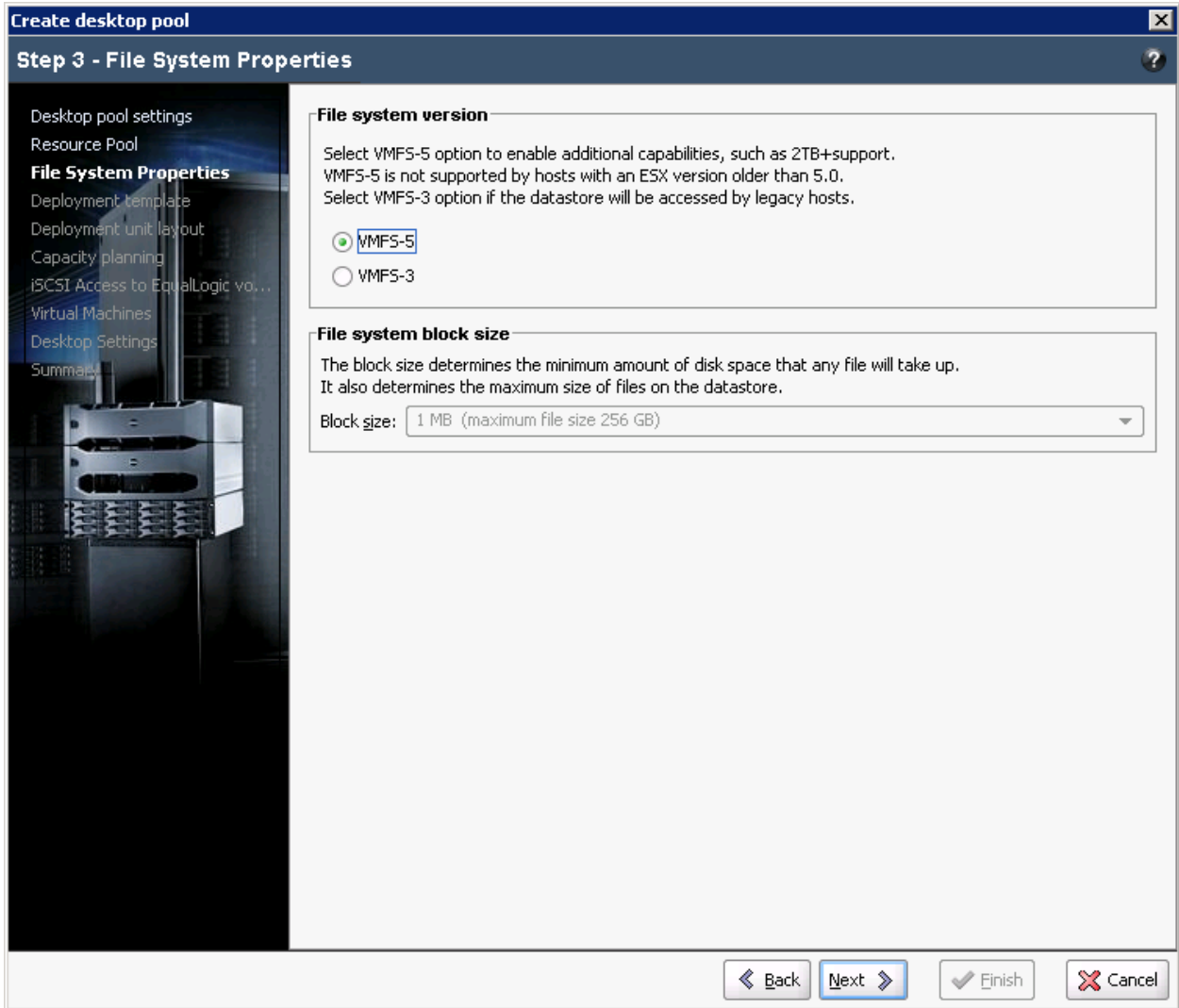

Figure 20 File system options

## 7. Select the Virtual Machine to use as Deployment Template

Select the VM that was customized to be the base image for the virtual desktops to be created. In this example we are using the template named "Win7Image".

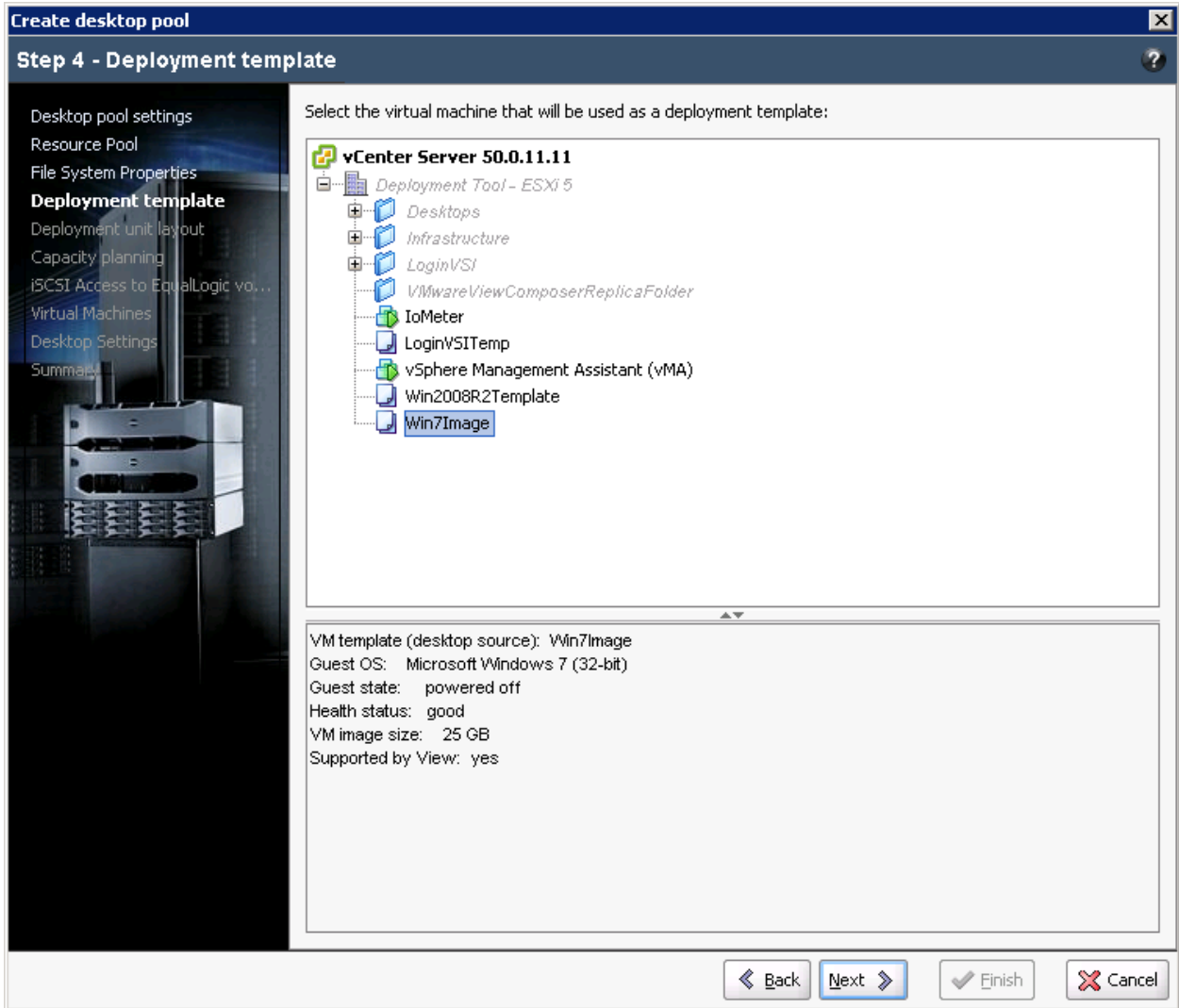

Figure 21 Base image selection

## 8. Deployment Unit Layout

The following table contains short descriptions of the fields on this screen:

**Table 6** Deployment unit layout options

Field	Description
Virtual machine space reserve <i>Range 10 - 100%</i>	Each VM requires some reserve space to store unique data for each VM and other VM runtime files in addition to the base OS image. These are stored in the reserve space that is allocated on the volume created. Recommended minimum space is 20% for each VM
VMs per datastore <i>Range 8 - 64</i>	The number of VMs that will be provisioned on a single data store. This forms the template volume that will be cloned to generate the required number of virtual desktops.
VM cloning	Types of VM clones created: <ul style="list-style-type: none"> <li>• Full Clones – creates full clones of the template VM (base image).</li> <li>• Linked Clones – creates linked clones that share common data with the template VM (base image) providing additional space savings.</li> </ul>

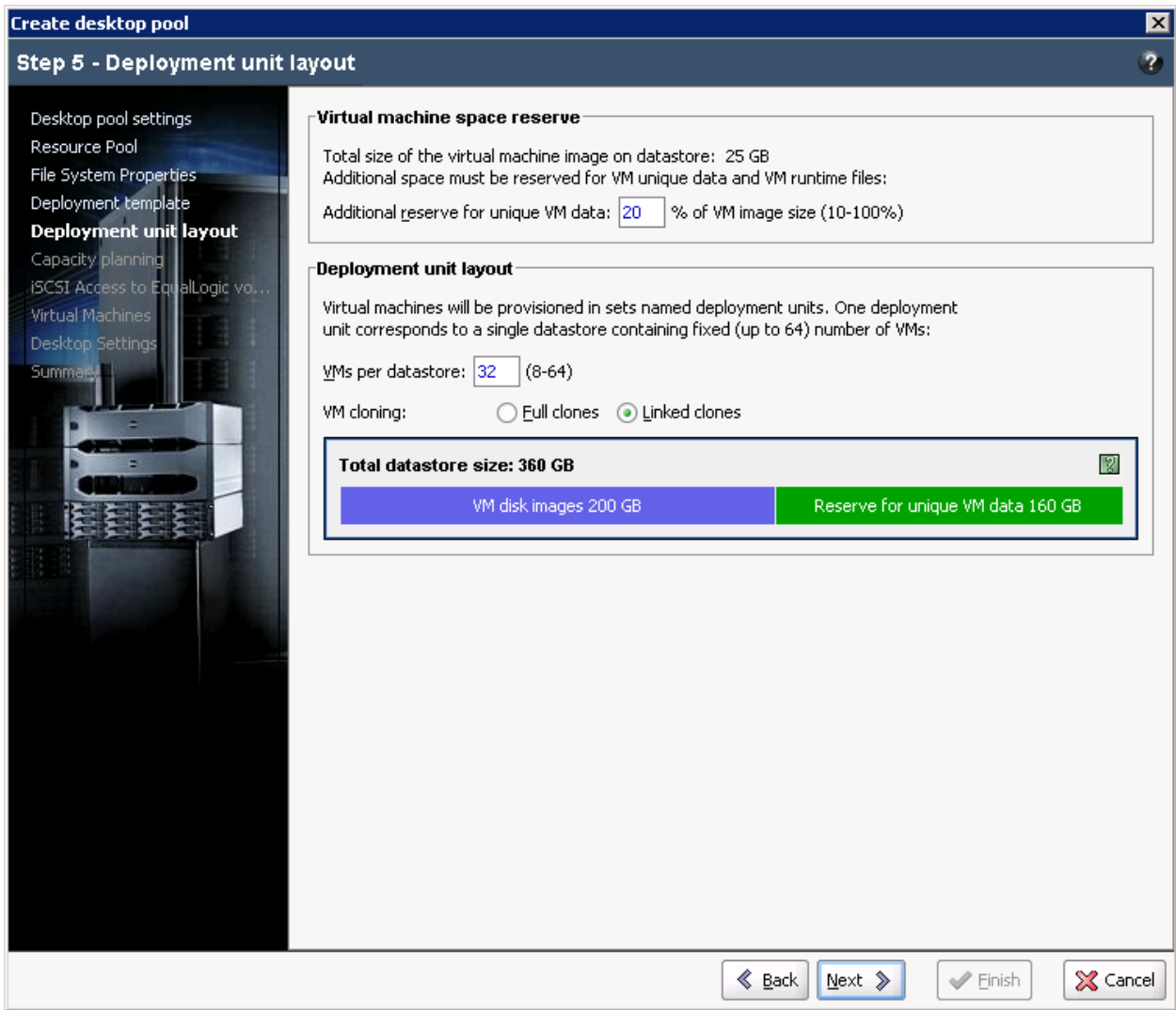

**Figure 22** Deployment unit layout

## 9. Capacity Planning

The following table provides a short description of each of the fields on this screen:

**Table 7 Capacity planning options**

Field	Description
VMs per datastore	This value is carried forward from the previous screen.
Number of provisioned deployment units (datastores)	Specifies the number of datastores that need to be provisioned. This is the same as the number of EqualLogic volumes that will be created on the Member. This value may be automatically filled if the <i>Maximum number of provisioned desktops</i> is entered instead.
Maximum number of provisioned desktops	The total number of virtual desktops that need to be provisioned. This will be the total capacity of the desktop pool when deployed.
Initial number of deployed desktops	In some cases it is possible for the administrator to make available fewer than the maximum desktops to View. This way the administrator can foresee demand and provision as required. To change the number of desktops provisioned at a later time, the administrator can follow the wizard by right-clicking on the <i>Pool Name -&gt; Modify Pool Capacity or Deploy Additional Desktops</i>
Snapshot reserve	Percentage of datastore size that should be reserved on the EqualLogic member for snapshots.
Storage pool	All datastores must be provisioned from a single EqualLogic storage pool. This pull down allows the selection of the storage pool that will be used to host the virtual desktops.

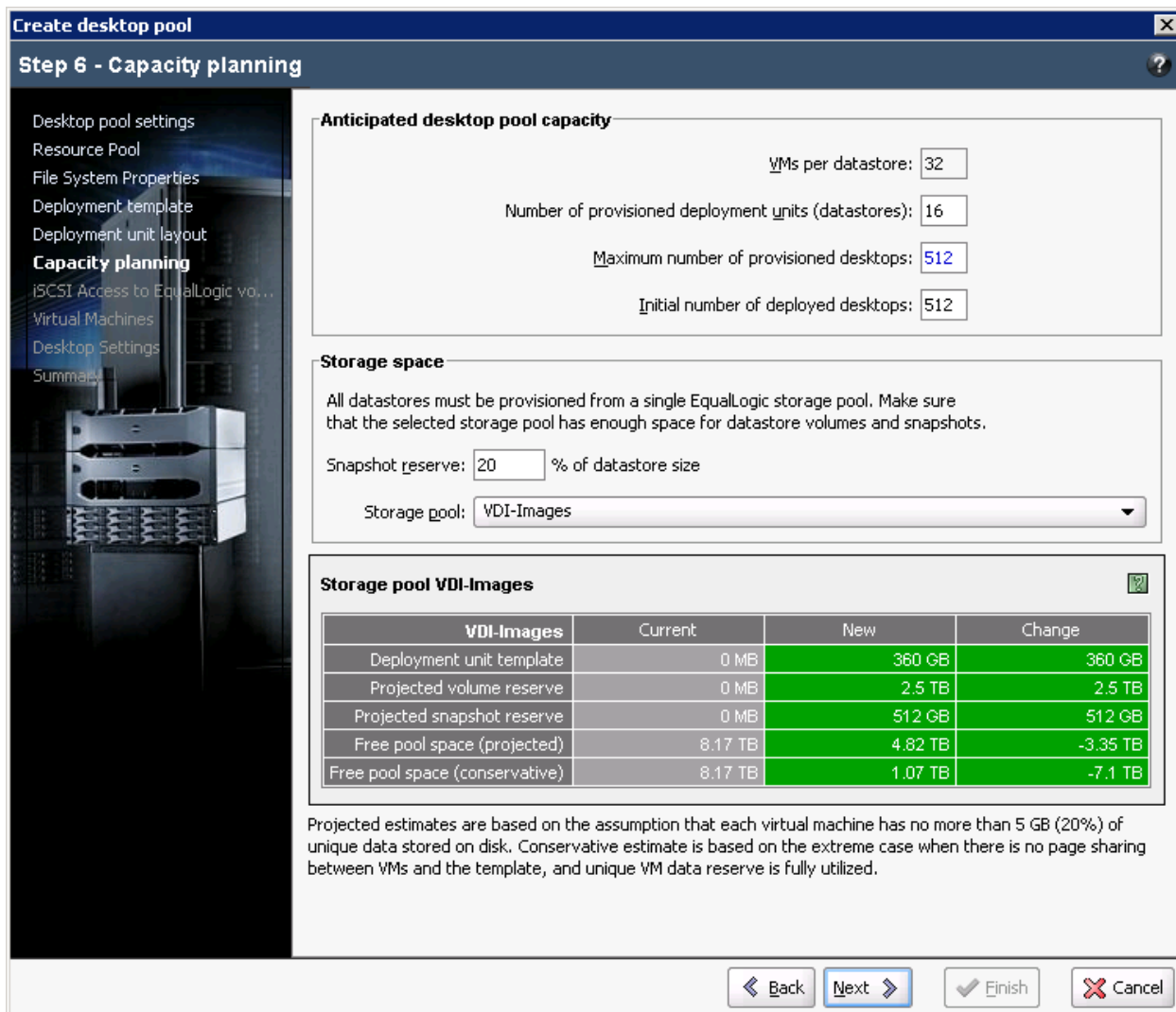

Figure 23 Capacity planning for desktop pool

## 10. iSCSI Access Control for EqualLogic Volumes

This screen allows for the auto generation of ACL records for the volumes created by the Virtual Desktop Deployment Utility. It is important to note that a datastore can have a maximum of 16 ACL records and if additional ACL records are required, you should look into using alternative ways including CHAP authentication. It is possible to create a new ACL from this screen or to use an already existing ACL policy defined for the group.

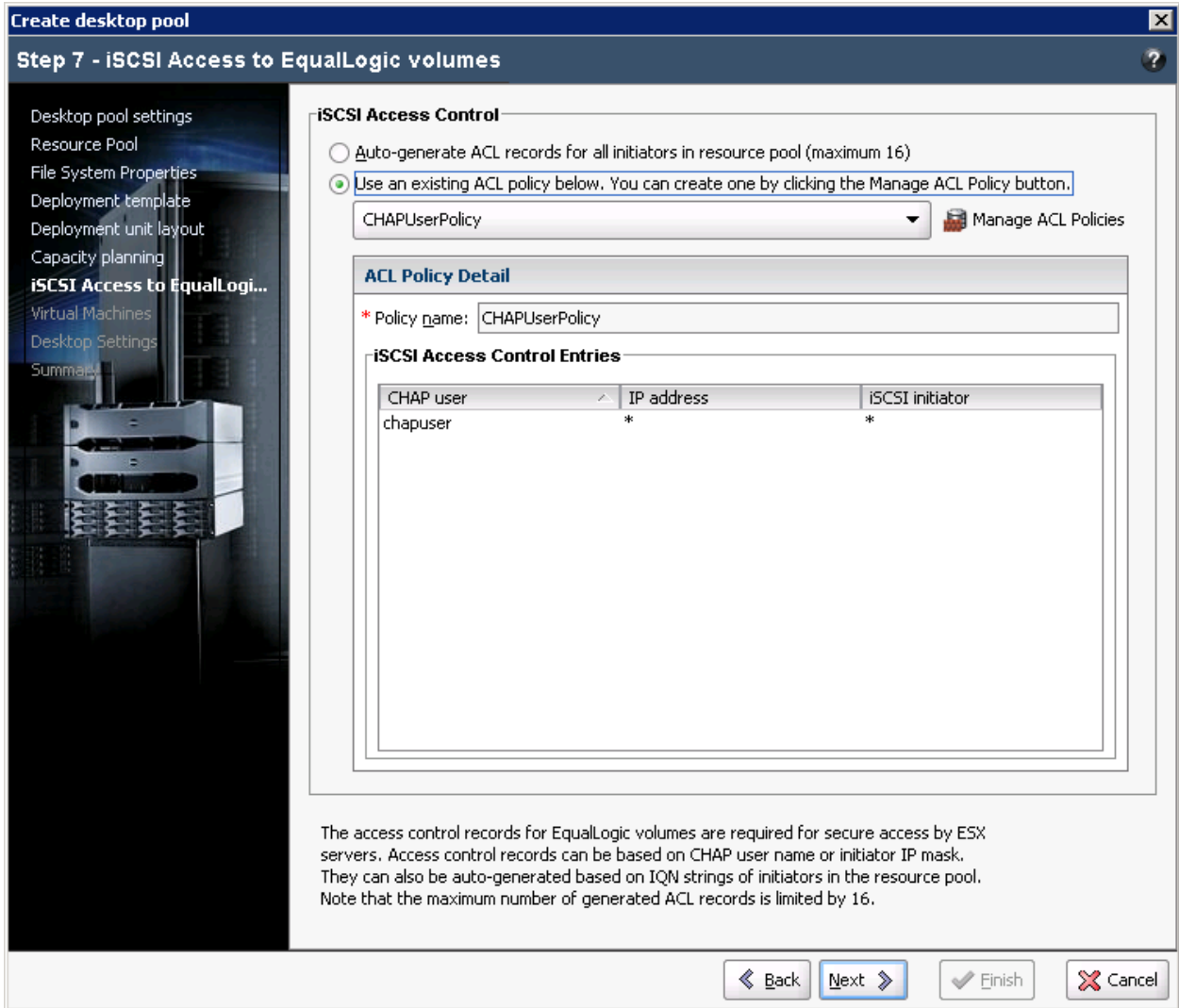

Figure 24 iSCSI access control

### 11. Naming the Virtual Machines and storing them in vCenter

This screen allows the administrator to select where the generated virtual desktops will be seen on VMware vCenter. The utility uses the virtual desktop pool name to group all desktops that are part of a desktop pool into a logical folder structure.

This screen also allows administrators to pick a naming pattern for the virtual desktops that will be generated. The naming pattern rules used here are identical to the rules used by View; however, the total length of the virtual desktop name including the pattern modifiers is limited to 15 characters.

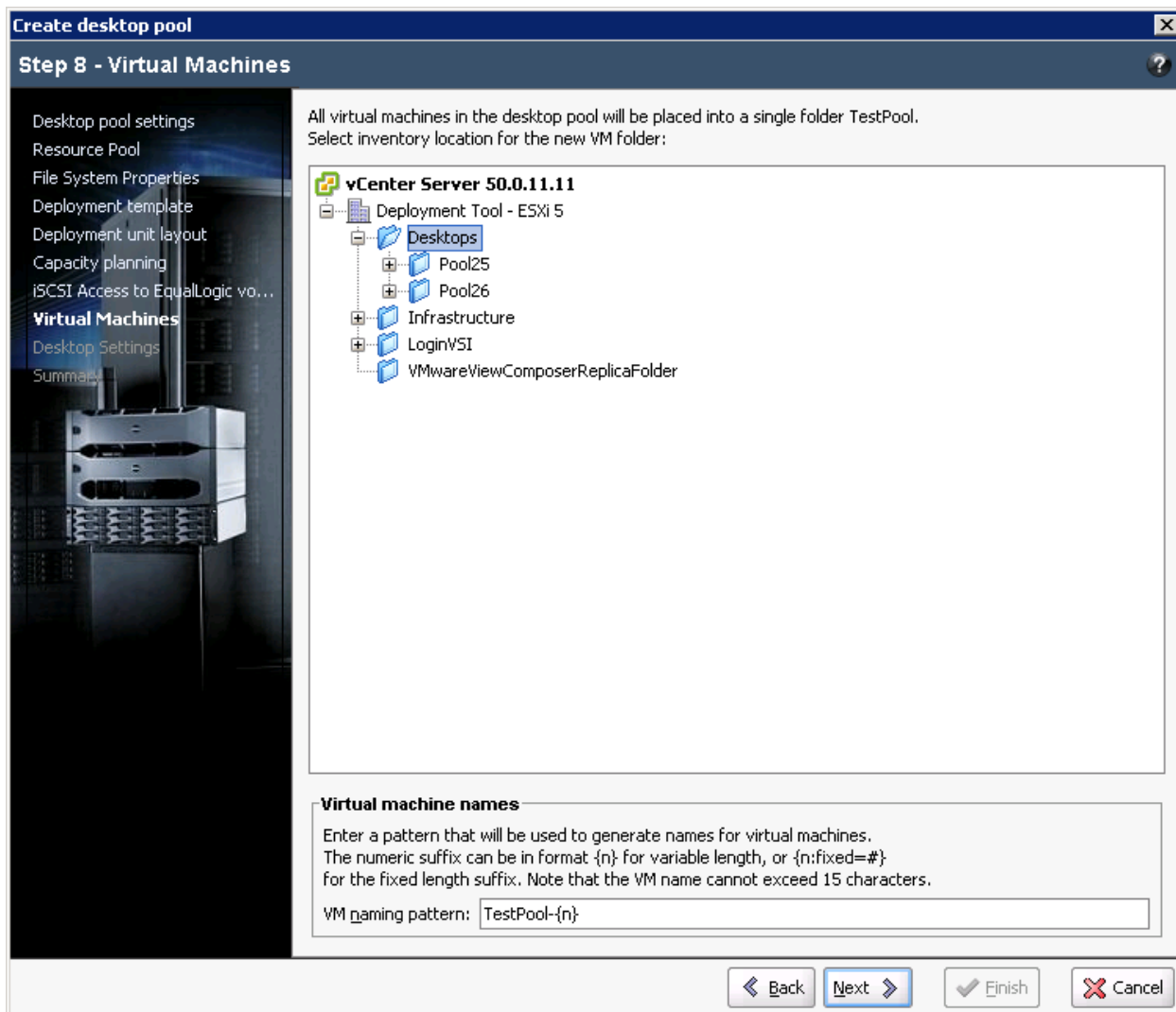

Figure 25 Virtual machine options

## 12. Desktop Pool Settings

All the generated virtual desktops need to be initialized for Microsoft Windows with the sysprep utility. This screen allows the selection of a pre-configured customization specification that VMware will use to prepare these desktops.

VMware vCenter Customization Specifications Manager can be used to create or modify the customization specifications used here.

Each virtual desktop in the virtual desktop pool has additional settings that mirror those in View. These settings govern policies for type of access, connection policies to the virtual desktop, and Adobe Flash quality settings that the administrator may set to provide the best performance possible to the end-user.

The View Administration Guide has additional information on these settings:

<http://pubs.vmware.com/view-50/index.jsp?topic=/com.vmware.view.administration.doc/GUID-E20AE465-0400-4766-BFFD-DC6F55FCB53F.html>

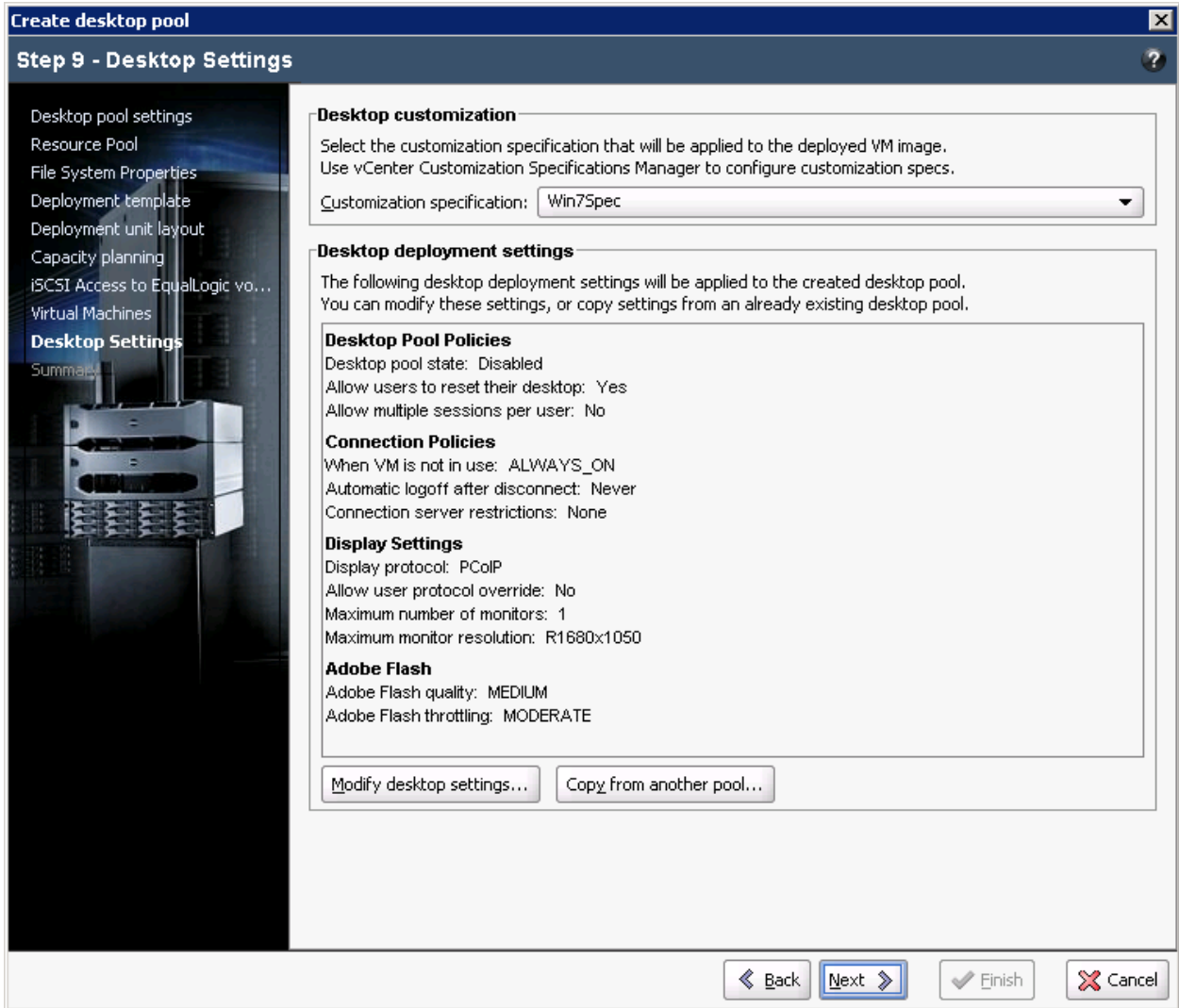

Figure 26 Virtual desktop customization

### 13. Summary of Desktop Pool

This last screen allows the administrator to see all the settings and options for the virtual desktop pool being generated. This is a summary screen and has no options that the administrator can change.



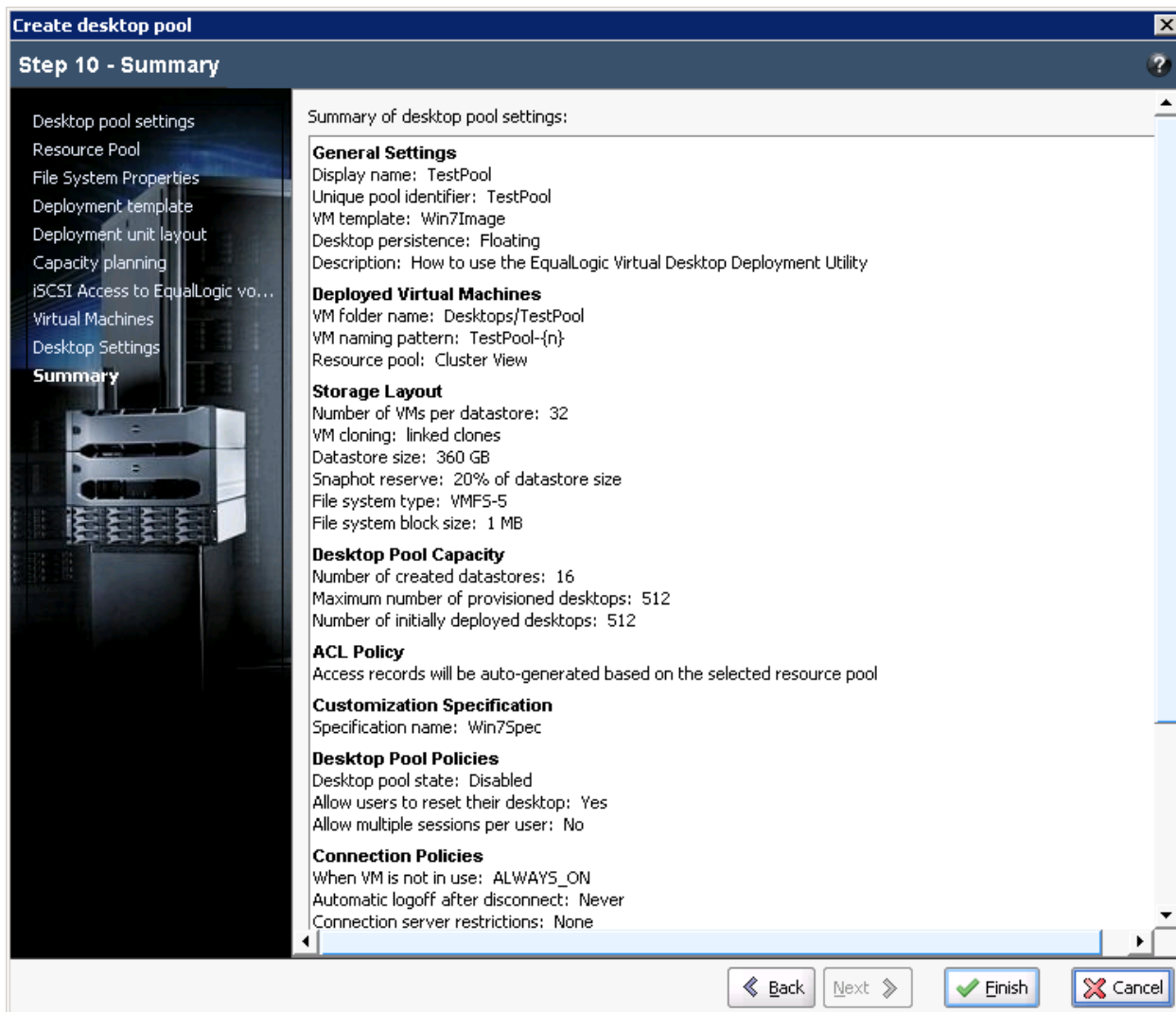

Figure 27 Virtual desktop pool summary

#### 14. Job History Screen

The job history screen is available any time by clicking the highlighted icon on the top right side of the screen in Figure 28. This screen shows the status of the current job with detailed information available in the lower half of the screen.

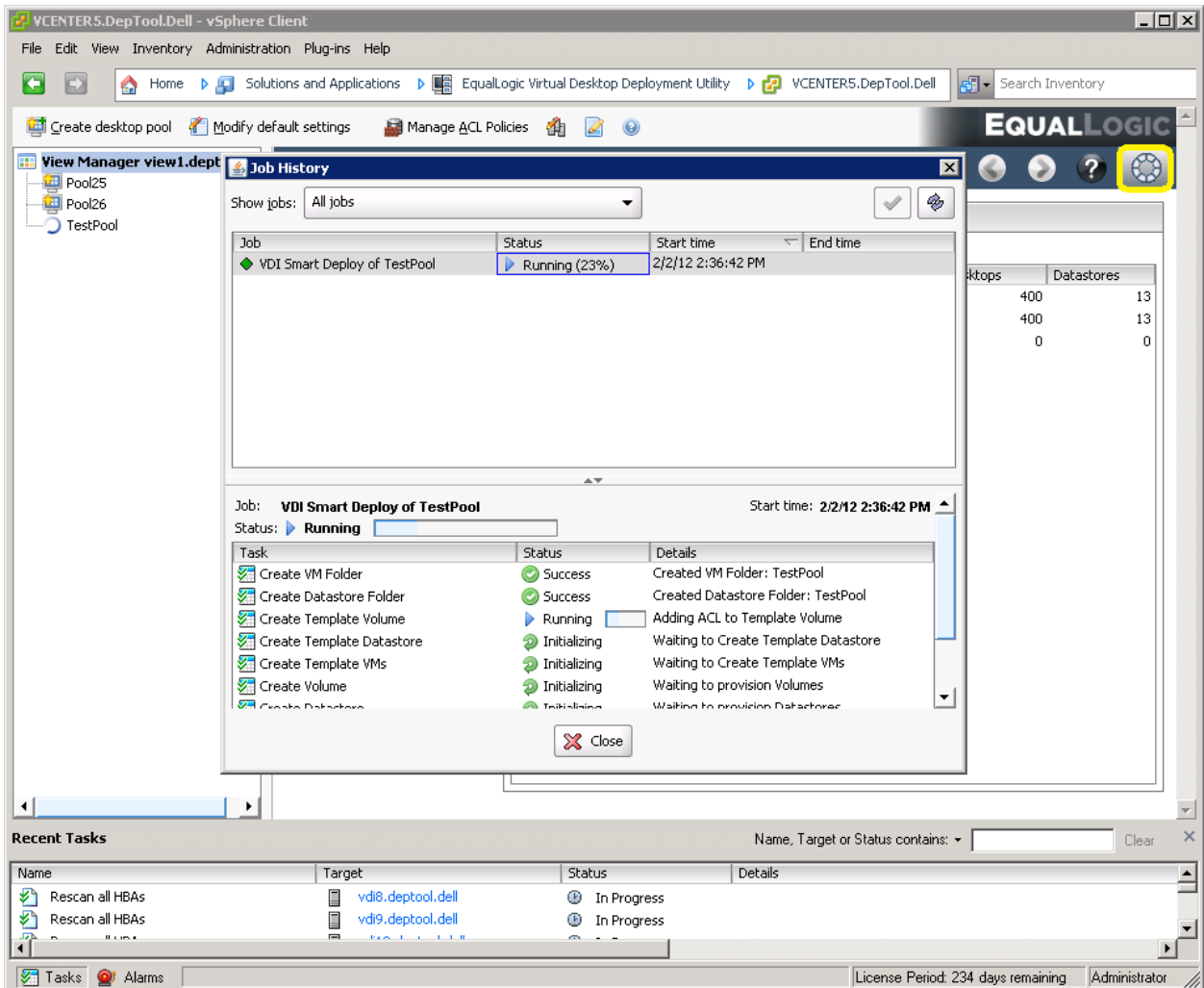

Figure 28 Job history

## Appendix B VMware View solution configuration

Solution configuration - Hardware components:	Description
<b>Virtual Desktops</b>	<ul style="list-style-type: none"> <li>• 13 x Dell PowerEdge M610 Servers:               <ul style="list-style-type: none"> <li>○ ESXi 5.0</li> <li>○ BIOS Version: 3.0.0</li> <li>○ 2 x Hexa Core Intel® Xeon® X5680 3.33Ghz Processors</li> <li>○ 96 GB RAM</li> <li>○ 2 x 146GB 10K SAS internal disk drives</li> <li>○ 1 x Dual-port Broadcom 5709 1GbE NIC (LAN on motherboard)</li> <li>○ 2 x Broadcom NetXtreme II 5709s 1GbE NIC, Quad-Port</li> </ul> </li> </ul>
<b>VMware View Servers</b>  <b>Login VSI Launchers [VDI Workload Generator]</b>  <b>Infrastructure Servers</b>	<ul style="list-style-type: none"> <li>• 3 x Dell PowerEdge M610 servers:               <ul style="list-style-type: none"> <li>○ ESXi 5.0</li> <li>○ BIOS Version: 3.0.0</li> <li>○ 2 x Hexa Core Intel® Xeon® X5680 3.33Ghz Processors</li> <li>○ 96 GB RAM,</li> <li>○ 2 x 146GB 10K SAS internal disk drives</li> <li>○ 1 x Dual-port Broadcom 5709 1GbE NIC (LAN on motherboard)</li> <li>○ 2 x Broadcom NetXtreme II 5709s 1GbE NIC, Quad-Port</li> </ul> </li> </ul>
<b>File server</b>	<ul style="list-style-type: none"> <li>• 1 x Dell EqualLogic FS7500</li> </ul>
<b>Network</b>	<ul style="list-style-type: none"> <li>• 2 x Dell PowerConnect M6220 1Gb Ethernet Switch Firmware: 4.1.0.19,</li> <li>• 4 x Dell PowerConnect M6348 1Gb Ethernet Switch Firmware:3.3.1.10</li> <li>• 2 x Dell PowerConnect 7048 1Gb</li> </ul>

	Ethernet Switch Firmware: 4.1.0.19	
<b>Storage</b>	<ul style="list-style-type: none"> <li>• 1 x Dell EqualLogic PS6100XS: <ul style="list-style-type: none"> <li>○ 7 x 400GB SSD</li> <li>○ 17 x 600GB 10K SAS disks</li> <li>○ Dual 4 port 1GbE controllers</li> <li>○ Firmware: 5.2.1</li> </ul> </li> <li>• 1 x Dell EqualLogic PS6500E: <ul style="list-style-type: none"> <li>○ 48 x 1TB 7.2K SATA disks</li> <li>○ Dual 4 port 1GbE controllers</li> <li>○ Firmware: 5.2.1</li> </ul> </li> </ul>	<p>Pools of desktops are stored on the PS6100XS array.</p> <p>User data is presented to all virtual desktops using a CIFS share from the FS7500, which has a PS6500E at the backend for storage.</p>
<b>Performance Monitoring</b>	<ul style="list-style-type: none"> <li>• SAN Head Quarters – 2.2.0</li> <li>• vCenter Performance monitoring</li> </ul>	<ul style="list-style-type: none"> <li>• Performance monitoring on EqualLogic arrays.</li> <li>• Performance monitoring and capture at the ESXi host.</li> </ul>
<b>Solution Configuration - Software Components:</b>		<b>Description / Version</b>
VMware View Server		5.0.0 build-481677
VMware View Agent		5.0.0 build-481677
VMware View Client 64bit.		5.0.0 build-481677
VMware vSphere 5.0 (ESXi 5.0) Hypervisor		5.0.0 build-504890
Microsoft SQL Server		Version 2008 Enterprise Edition (64-Bit)
Microsoft Windows 7 Enterprise		VDI Clients for characterization tests
Microsoft Windows Server 2008 Enterprise R2 x64		VMs for hosting VMware View, vCenter Server, MS-SQL server, Login VSI launchers and other infrastructure VMs.
Login VSI		Version 3.0, Load generator for VDI clients
Microsoft Office 2007 Standard		Service Pack 3 (12.0.6607.1000)

# Appendix C Network design and VLAN configuration

## C.1 Management LAN configuration

- Each PowerEdge M610 Server has an onboard Broadcom 5709 dual-port 1GbE NIC.
- Dual PowerConnect M6220 switches are installed in fabric A of the blade chassis. The onboard LOM NICs are connected to each of the M6220 switches.
- The two PowerConnect M6220 switches are inter-connected using 2 x 10GbE stacking interconnects.

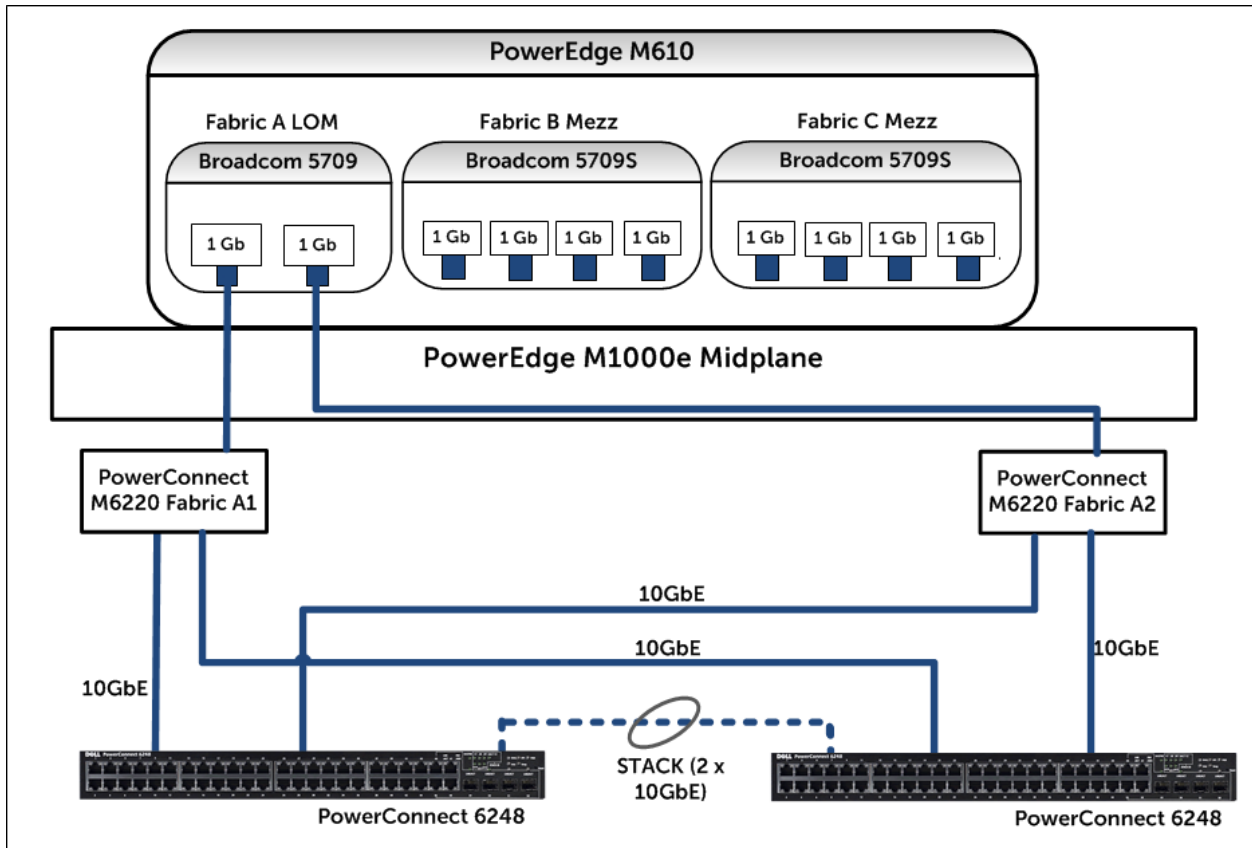

Figure 29 Management LAN connectivity

## C.2 VDI LAN configuration

- Users wanting to access the Virtual Desktops hosted by View connect on this LAN.
- The client network connections of the FS7500 are connected to this switch to provide file share capabilities to the network.
- These switches may be uplinked to external switches to provide connectivity to the rest of the organization.

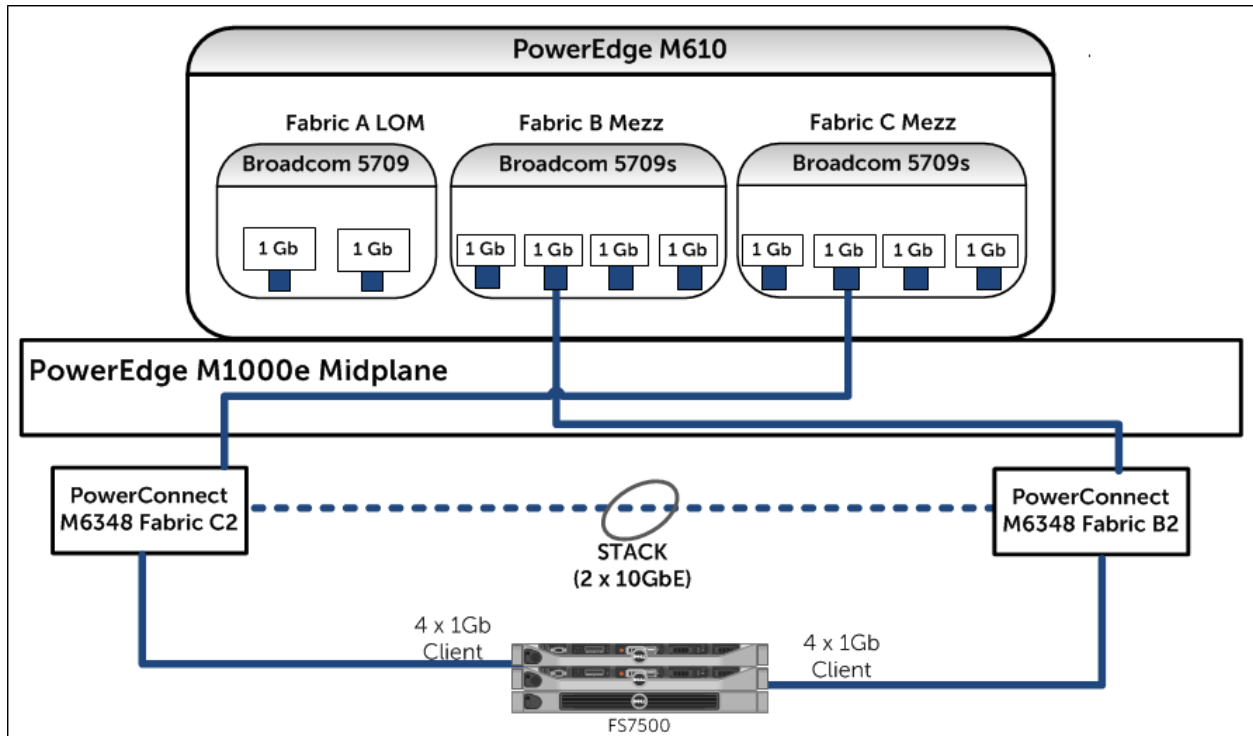

Figure 30 VDI LAN connectivity

# Appendix D ESXi network configuration

Each ESXi host was configured with three virtual switches, vSwitch0, vSwitch1, and vSwitch2.

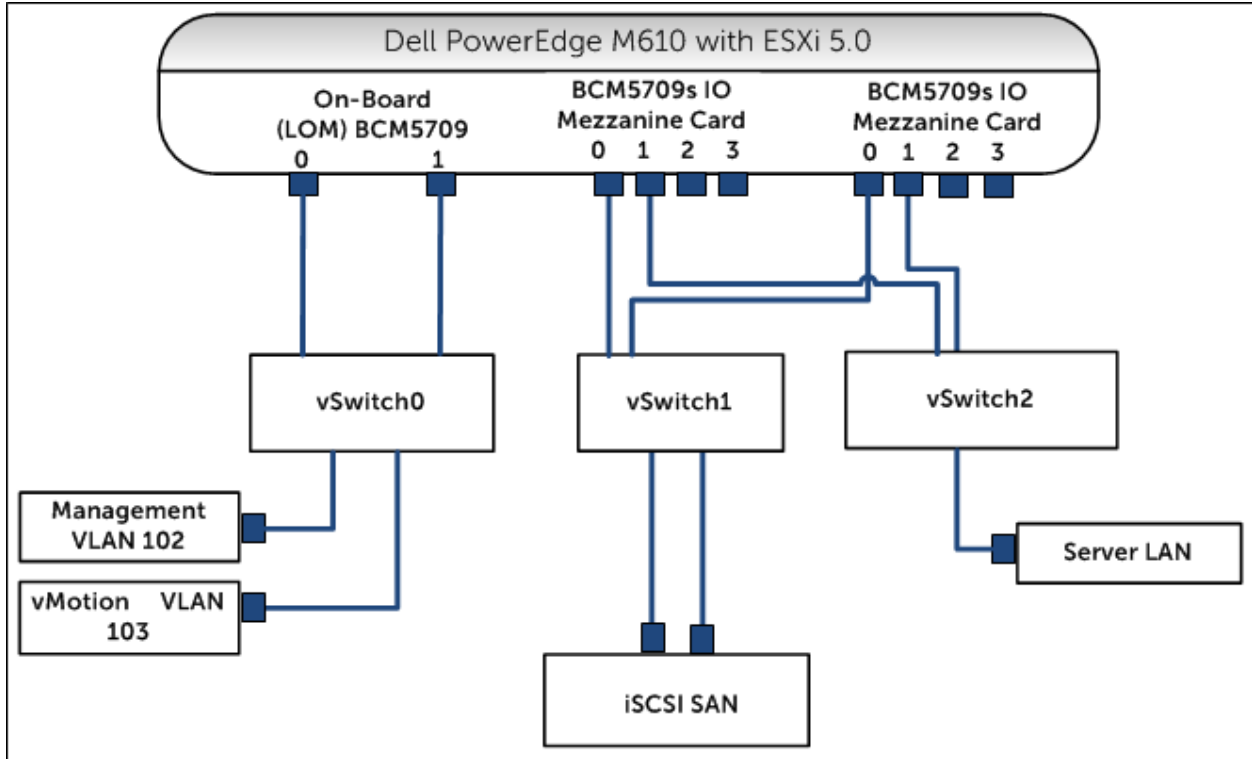

Figure 31 ESXi vSwitch logical connection paths

## D.1 vSwitch0

vSwitch0 provides connection paths for all management LAN traffic. The physical adapters from the two onboard NICs (Fabric A) were assigned to this switch.

VLANs are used to segregate network traffic into different classes (tagged packets) within this LAN. They are shown in Table 8:

Table 8 Management network VLANs

Port Group	VLAN ID	Description
Management Network	102	vCenter Management
vMotion	103	vMotion Network

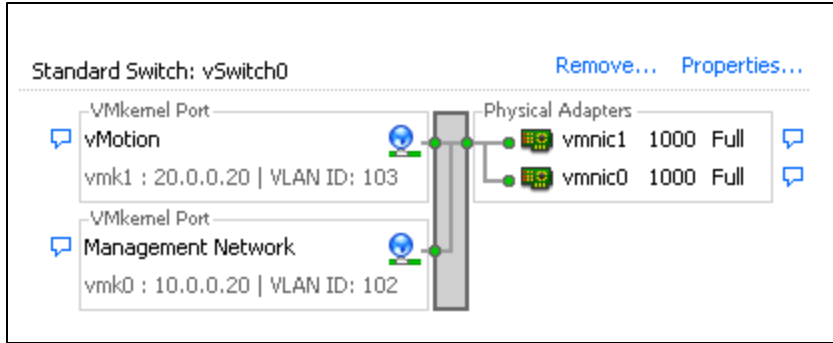

Figure 32 vSwitch0

## D.2 vSwitch1

This virtual switch provided paths for all the iSCSI SAN traffic. Two physical adapters were assigned, one each from the mezzanine cards on Fabric B and Fabric C.

In our configuration we used the software iSCSI initiator provided by the ESXi host. To take advantage of EqualLogic-aware multi-path I/O, the EqualLogic Multipathing Extension Module (MEM) for VMware vSphere was installed on each ESXi host.

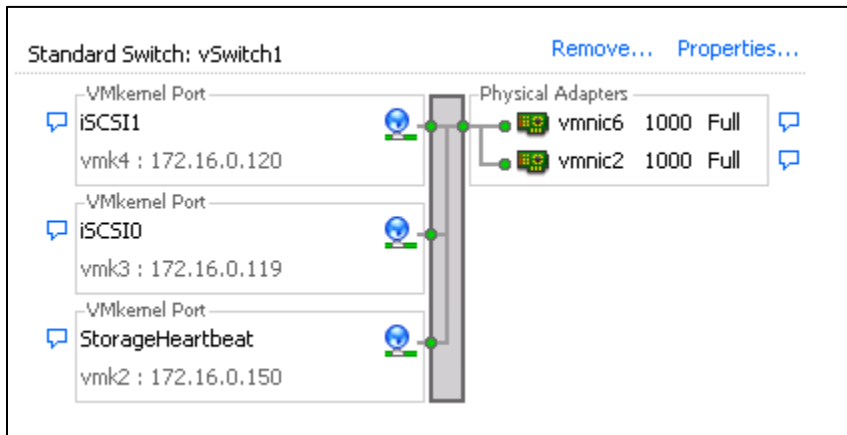

Figure 33 vSwitch1



### D.3 vSwitch2

Two physical adapters, one each from mezzanine cards on Fabric B and C were assigned to this switch. This virtual switch carries all traffic for the Server LAN.

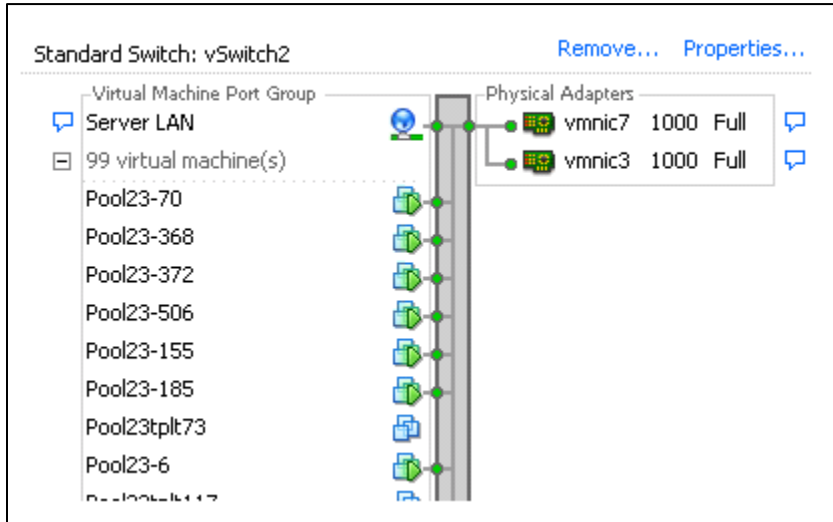

Figure 34 vSwitch2

## Related Publications

The following Dell publications are referenced in this document or are recommended sources for additional information.

- Dell EqualLogic PS Series Network Performance Guidelines:  
<http://www.equallogic.com/resourcecenter/assetview.aspx?id=5229>
- Dell EqualLogic HIT/VE Documentation (EqualLogic Support login required):  
[https://support.equallogic.com/support/download\\_file.aspx?id=1268](https://support.equallogic.com/support/download_file.aspx?id=1268)
- Dell EqualLogic PS series arrays – Scalability and Growth in Virtual Environments:  
<http://en.community.dell.com/dell-groups/dtcmmedia/m/mediagallery/19992296.aspx>
- Installing and configuring the Dell EqualLogic MEM for VMware vSphere 5:  
<http://www.equallogic.com/WorkArea/DownloadAsset.aspx?id=10798>
- Dell EqualLogic PS Series Architecture: Load Balancers:  
<http://www.equallogic.com/WorkArea/DownloadAsset.aspx?id=10752>
- Known issues and limitations from the EqualLogic Host Integration Toolkit – VMware Edition:  
[https://support.equallogic.com/support/download\\_file.aspx?id=1265](https://support.equallogic.com/support/download_file.aspx?id=1265)

The following VMware publications are referenced in this document or are recommended sources for additional information.

- VMware View 5.0 Documentation:  
<http://pubs.vmware.com/view-50/index.jsp>
- VMware View Optimization Guide for Windows 7:  
<http://www.vmware.com/resources/techresources/10157>
- VMware KB article on best practices for installing ESXi 5.0:  
<http://kb.vmware.com/kb/2005099>

The following Login Consultants publications are referenced in this document or are recommended sources for additional information.

- Login VSI product overview:  
<http://www.loginvsi.com/en/product-overview>
- Login VSI workloads:  
<http://www.loginvsi.com/en/admin-guide/workloads>
- Login VSI Analyzer:  
<http://www.loginvsi.com/en/admin-guide/analyzing-results>

For EqualLogic best practices white papers, reference architectures, and sizing guidelines for enterprise applications and SANs, refer to Storage Infrastructure and Solutions Team Publications at:

- <http://dell.to/sM4hJT>





THIS WHITE PAPER IS FOR INFORMATIONAL PURPOSES ONLY, AND MAY CONTAIN TYPOGRAPHICAL ERRORS AND TECHNICAL INACCURACIES. THE CONTENT IS PROVIDED AS IS, WITHOUT EXPRESS OR IMPLIED WARRANTIES OF ANY KIND.