



Dell™ PowerEdge™ 700 Systems Installation and Troubleshooting Guide

[Introduction](#)
[Indicators and Codes](#)
[Finding Software Solutions](#)
[Running System Diagnostics](#)
[Troubleshooting Your System](#)
[Installing System Options](#)
[Installing Drives](#)
[Getting Help](#)
[Jumpers and Connectors](#)
[I/O Connectors](#)
[Abbreviations and Acronyms](#)

Notes, Notices, and Cautions

-  **NOTE:** A NOTE indicates important information that helps you make better use of your computer.
-  **NOTICE:** A NOTICE indicates either potential damage to hardware or loss of data and tells you how to avoid the problem.
-  **CAUTION:** A CAUTION indicates a potential for property damage, personal injury, or death.

Abbreviations and Acronyms

For a complete list of abbreviations and acronyms, see "[Abbreviations and Acronyms](#)."

Information in this document is subject to change without notice.
© 2003 Dell Inc. All rights reserved.

Reproduction in any manner whatsoever without the written permission of Dell Inc. is strictly forbidden.

Trademarks used in this text: *Dell*, the *DELL* logo, *PowerEdge*, *Dell OpenManage*, *Dell Precision*, *Dimension*, *Inspiron*, *OptiPlex*, *Latitude*, *DellNet*, *PowerVault*, *PowerApp*, and *Axim* are trademarks of Dell Inc.; *Intel*, *Pentium*, and *Celeron* are registered trademarks of Intel Corporation; *Microsoft*, *MS-DOS*, and *Windows* are registered trademarks of Microsoft Corporation.

Other trademarks and trade names may be used in this document to refer to either the entities claiming the marks and names or their products. Dell Inc. disclaims any proprietary interest in trademarks and trade names other than its own.

Initial release: November 2003

[Back to Contents Page](#)

Jumpers and Connectors

Dell™ PowerEdge™ 700 Systems Installation and Troubleshooting Guide

- [Jumpers—A General Explanation](#)
- [System Board Jumpers](#)
- [System Board Connectors](#)
- [Disabling a Forgotten Password](#)

This section provides specific information about the system jumpers. It also provides some basic information on jumpers and switches and describes the connectors on the various boards in the system.

Jumpers—A General Explanation

Jumpers provide a convenient and reversible way of reconfiguring the circuitry on a printed circuit board. When reconfiguring the system, you may need to change jumper settings on circuit boards or drives.

Jumpers

Jumpers are small blocks on a circuit board with two or more pins emerging from them. Plastic plugs containing a wire fit down over the pins. The wire connects the pins and creates a circuit. To change a jumper setting, pull the plug off its pin(s) and carefully fit it down onto the pin(s) indicated. [Figure A-1](#) shows an example of a jumper.

Figure A-1. Example Jumpers

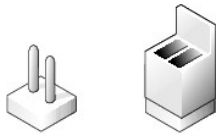

⚠ CAUTION: Ensure that the system is turned off before you change a jumper setting. Otherwise, damage to the system or unpredictable results may occur.

A jumper is referred to as open or unjumped when the plug is pushed down over only one pin or if there is no plug at all. When the plug is pushed down over two pins, the jumper is referred to as jumped. The jumper setting is often shown in text as two numbers, such as 1–2. The number 1 is printed on the circuit board so that you can identify each pin number based on the location of pin 1.

[Figure A-2](#) shows the location and default settings of the system jumper blocks. See [Table A-1](#) for the designations, default settings, and functions of the system's jumpers.

System Board Jumpers

[Figure A-2](#) shows the location of the configuration jumpers on the system board. [Table A-1](#) lists the jumpers settings.

Figure A-2. System Board Jumpers

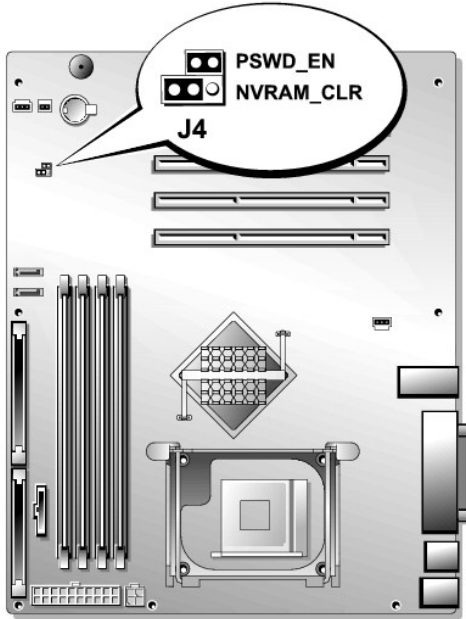







Table A-1. System Board Jumper Settings

Jumper	Setting	Description
PSWD_EN	 (default)	The password feature is enabled.
		The password feature is disabled.
NVRAM_CLR	 (default)	The configuration settings are retained at system startup.
		The configuration settings are cleared at next system startup.
<p>NOTE: You can store a spare, unused jumper plug on one pin of the NVRAM_CLR jumper block.</p>		
<p> jumpered  unjumpered</p>		

System Board Connectors

See [Figure A-3](#) and [Table A-2](#) for the location and description of system board connectors. [Figure A-3](#) also lists expansion slot numbers, buses, and bus operating speeds.

Figure A-3. System Board Connectors

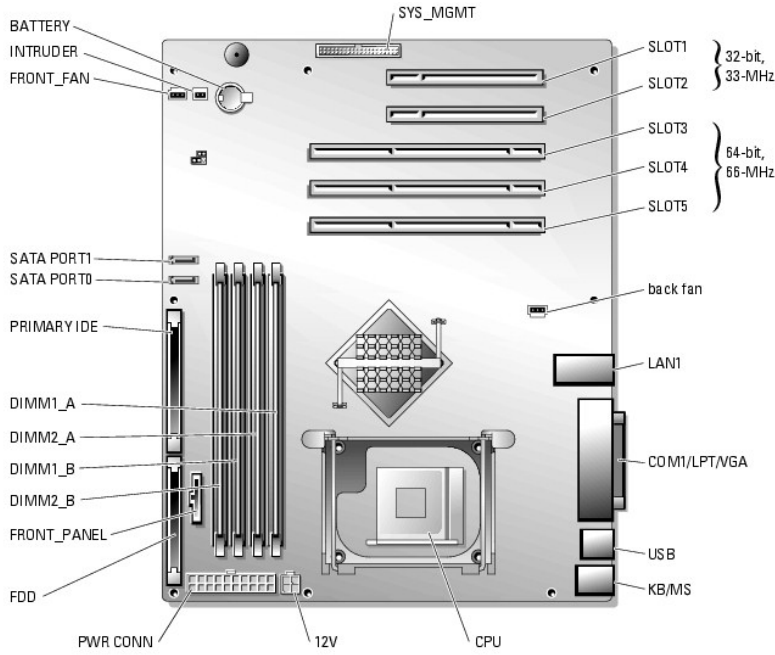



Table A-2. System Board Connectors

Connector	Description
12V	Power supply
BACK FAN	Back system fan
BATTERY	System battery
COM1/LPT/VGA	Serial, parallel, and video
CPU	Processor
DIMM _n _x	Memory modules (4)
FDD	Diskette
FRONT_FAN	Front system fan
FRONT_PANEL	Front panel
INTRUDER	Chassis intrusion
KB/MS	PS/2 keyboard and mouse
LAN1	NIC
PRIMARY IDE	Primary IDE
PWR CONN	Power supply
SATA PORT0	SATA port 0
SATA PORT1	SATA port 1
SLOT _n	Expansion slots: 1 1-2: 32-bit/33-MHz 1 3-5: 64-bit/66-MHz
SYS_MGMT	Remote access controller
USB	USB

Disabling a Forgotten Password

The system's software security features include a system password and a setup password, which are discussed in detail in "Using the System Setup Program" in your *User's Guide*. The PSWD_EN jumper enables these password features or disables them and clears any password(s) currently in use.

 **CAUTION:** See your *System Information Guide* for complete information about safety precautions, working inside the computer, and protecting against electrostatic discharge.

1. Turn off the system, including any attached peripherals, and disconnect the system from the electrical outlet.
2. Remove the bezel. See "[Removing the Bezel](#)" in "Troubleshooting Your System."
3. Lay the system on its right side.
4. Remove the cover. See "[Removing the Cover](#)" in "Troubleshooting Your System."
5. Remove the PSWD_EN jumper plug.

See [Figure A-2](#) to locate the jumper on the system board.

6. Install the cover. See "[Replacing the Cover](#)" in "[Troubleshooting Your System](#)."
7. Stand the system upright.
8. Replace the bezel. See "[Installing the Bezel](#)" in "Troubleshooting Your System."
9. Reconnect the system to its electrical outlet and turn the system on, including any attached peripherals.

The existing passwords are not disabled (erased) until the system boots with the PSWD_EN jumper plug removed. However, before you assign a new system and/or setup password, you must install the jumper plug.

 **NOTE:** If you assign a new system and/or setup password with the jumper plug still removed, the system disables the new password(s) the next time it boots.

10. Turn off the system, including any attached peripherals, and disconnect the system from the electrical outlet.
11. Remove the bezel. See "[Removing the Bezel](#)" in "Troubleshooting Your System."
12. Lay the system on its right side.
13. Remove the cover "[Removing the Cover](#)" in "Troubleshooting Your System."
14. Install the PSWD_EN jumper plug.

See [Figure A-2](#) to locate the jumper on the system board.

15. Install the cover. See "[Replacing the Cover](#)" in "[Troubleshooting Your System](#)."
16. Stand the system upright.
17. Replace the bezel. See "[Installing the Bezel](#)" in "Troubleshooting Your System."
18. Reconnect the system to its electrical outlet and turn the system on, including any attached peripherals.
19. Assign a new system and/or setup password.

To assign a new passwords using the System Setup program, see "Assigning a System Password" in your *User's Guide*.

I/O Connectors

Dell™ PowerEdge™ 700 Systems Installation and Troubleshooting Guide

- [Serial Connector](#)
- [Parallel Connector](#)
- [PS/2-Compatible Keyboard and Mouse Connectors](#)
- [Video Connector](#)
- [USB Connector](#)
- [Integrated NIC Connector](#)
- [Network Cable Requirements](#)

I/O connectors are the gateways that the system uses to communicate with external devices, such as a keyboard, mouse, printer, or monitor. This section describes the various connectors on your system. If you reconfigure the hardware connected to the system, you may also need the pin number and signal information for these connectors. [Figure B-1](#) illustrates the connectors on the system.

Figure B-1. I/O Connectors

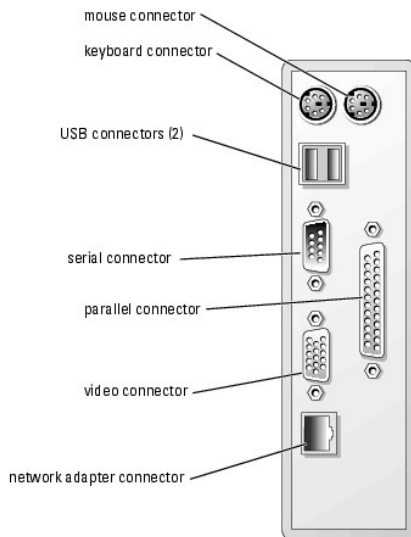

[Table B-1](#) shows the icons used to label the connectors on the system.

Table B-1. I/O Connector Icons

Icon	Connector
	Serial connector
	Parallel connector
	Mouse connector
	Keyboard connector
	Video connector
	USB connector
	NIC connector

Serial Connector

Serial connectors support devices such as external modems, printers, and mice that require serial data transmission. The serial connector uses a 9-pin D-subminiature connector.

Serial Connector Autoconfiguration

The default designation of the integrated serial connector is COM1. When you add an expansion card containing a serial connector that has the same designation as the integrated connector, the system's autoconfiguration feature remaps (reassigns) the integrated serial connector to the next available designation. Both the new and the remapped COM connectors share the same IRQ setting. COM1 and COM3 share IRQ4, while COM2 and COM4 share IRQ3.

NOTE: COM2 is reserved for a remote access controller.

NOTE: If two COM connectors share an IRQ setting, you may not be able to use them both at the same time. In addition, if you install one or more expansion cards with serial connectors designated as COM1 and COM3, the integrated serial connector is disabled.

Before adding a card that remaps the COM connectors, check the documentation that came with the software to make sure that the software can accommodate the new COM connector designation.

[Figure B-2](#) illustrates the pin numbers for the serial connector and [Table B-2](#) defines the pin assignments for the connector.

Figure B-2. Serial Connector Pin Numbers

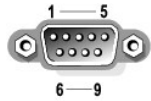

Table B-2. Serial Connector Pin Assignments

Pin	Signal	I/O	Definition
1	DCD	I	Data carrier detect
2	SIN	I	Serial input
3	SOUT	O	Serial output
4	DTR	O	Data terminal ready
5	GND	N/A	Signal ground
6	DSR	I	Data set ready
7	RTS	O	Request to send
8	CTS	I	Clear to send
9	RI	I	Ring indicator
Shell	N/A	N/A	Chassis ground

Parallel Connector

The integrated parallel connector, intended primarily for use by printers that require data in parallel format, uses a 25-pin D-subminiature connector on the system's back panel. The default designation of the system's parallel connector is LPT1. If you add an expansion card containing a parallel connector configured as LPT1 (IRQ7, I/O address 378h), use the System Setup program to remap the integrated parallel connector. See "Using the System Setup Program" in the *User's Guide*. [Figure B-3](#) illustrates the pin numbers for the parallel connector and [Table B-3](#) defines the pin assignments for the connector.

Figure B-3. Parallel Connector Pin Numbers

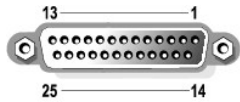

Table B-3. Parallel Connector Pin Assignments

Pin	Signal	I/O	Definition
1	STB#	I/O	Strobe
2	PD0	I/O	Printer data bit 0
3	PD1	I/O	Printer data bit 1
4	PD2	I/O	Printer data bit 2
5	PD3	I/O	Printer data bit 3
6	PD4	I/O	Printer data bit 4
7	PD5	I/O	Printer data bit 5
8	PD6	I/O	Printer data bit 6
9	PD7	I/O	Printer data bit 7
10	ACK#	I	Acknowledge
11	BUSY	I	Busy
12	PE	I	Paper end
13	SLCT	I	Select
14	AFD#	O	Automatic feed
15	ERR#	I	Error
16	INIT#	O	Initialize printer
17	SLIN#	O	Select in
18-25	GND	N/A	Ground

PS/2-Compatible Keyboard and Mouse Connectors

The PS/2-compatible keyboard and mouse cables attach to 6-pin, miniature DIN connectors. [Figure B-4](#) illustrates the pin numbers for these connectors and [Table B-4](#) defines the pin assignments for these connectors.

Figure B-4. PS/2-Compatible Keyboard and Mouse Connector Pin Numbers



Table B-4. Keyboard and Mouse Connector Pin Assignments

Pin	Signal	I/O	Definition
1	KBDATA or MFDATA	I/O	Keyboard data or mouse data
2	NC	N/A	No connection
3	GND	N/A	Signal ground
4	FVcc	N/A	Fused supply voltage
5	KBCLK or MFCLK	I/O	Keyboard clock or mouse clock
6	NC	N/A	No connection
Shell	N/A	N/A	Chassis ground

Video Connector

You can attach a VGA-compatible monitor to the system's integrated video controller using a 15-pin high-density D-subminiature connector. [Figure B-5](#) illustrates the pin numbers for the video connector and [Table B-5](#) defines the pin assignments for the connector.

NOTE: Installing a video card automatically disables the system's integrated video controller.

Figure B-5. Video Connector Pin Numbers

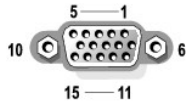

Table B-5. Video Connector Pin Assignments

Pin	Signal	I/O	Definition
1	RED	O	Red video
2	GREEN	O	Green video
3	BLUE	O	Blue video
4	NC	N/A	No connection
5-8, 10	GND	N/A	Signal ground
9	VCC	N/A	Vcc
11	NC	N/A	No connection
12	DDC data out	O	Monitor detect data
13	HSYNC	O	Horizontal synchronization
14	VSYNC	O	Vertical synchronization
15	NC	N/A	No connection

USB Connector

The system's USB connector supports USB-compliant peripherals such as keyboards, mice, and printers and may also support USB-compliant devices such as diskette drives and CD drives. [Figure B-6](#) illustrates the pin numbers for the USB connector and [Table B-6](#) defines the pin assignments for the connector.

NOTICE: Do not attach a USB device or a combination of USB devices that draw a maximum current of more than 500 mA per channel or +5 V. Attaching devices that exceed this threshold may cause the USB connectors to shut down. See the documentation that accompanied the USB devices for their maximum current ratings.

Figure B-6. USB Connector Pin Numbers



Table B-6. USB Connector Pin Assignments

Pin	Signal	I/O	Definition
1	Vcc	N/A	Supply voltage
2	DATA	I	Data in
3	+DATA	O	Data out
4	GND	N/A	Signal ground

Integrated NIC Connector

The system's integrated NIC functions as a separate network expansion card while providing fast communication between servers and workstations. [Figure B-7](#) illustrates the pin numbers for the NIC connector and [Table B-7](#) defines the pin assignments for the connector.

Figure B-7. NIC Connector

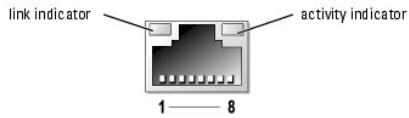

Table B-7. NIC Connector Pin Assignments

Pin	Signal	I/O	Definition
1	TD+	O	Data out (+)
2	TD-	O	Data out (-)
3	RD+	I	Data in (+)
4	NC	N/A	No connection
5	NC	N/A	No connection
6	RD-	I	Data in (-)
7	NC	N/A	No connection
8	NC	N/A	No connection

Network Cable Requirements

The NIC supports a UTP Ethernet cable equipped with a standard RJ45-compatible plug. Observe the following cabling restrictions.

➡ **NOTICE:** To avoid line interference, voice and data lines must be in separate sheaths.

- 1 Use Category 5 or greater wiring and connectors.
- 1 Do not exceed a cable run length (from a workstation to a hub) of 100 m (328 ft).

For detailed guidelines on operation of a network, see "Systems Considerations of Multi-Segment Networks" in the IEEE 802.3 standard.

[Back to Contents Page](#)

[Back to Contents Page](#)

Abbreviations and Acronyms

Dell™ PowerEdge™ 700 Systems Installation and Troubleshooting Guide

A

ampere(s)

AC

alternating current

ADC

analog-to-digital converter

ANSI

American National Standards Institute

APIC

Advanced Peripheral Interrupt Controller

ASIC

application-specific integrated circuit

BIOS

basic input/output system

BMC

baseboard management controller

bpi

bits per inch

bps

bits per second

BTU

British thermal unit

C

Celsius

CD

compact disc

CGA

color graphics adapter

cm

centimeter(s)

CMOS

complementary metal oxide semiconductor

COM

communications

cpi

characters per inch

cpl

characters per line

CPU

central processing unit

DAC

digital-to-analog converter

DAT

digital audio tape

dB

decibel(s)

dBA

adjusted decibel(s)

DC

direct current

DDR

double-data rate

DIMM

dual in-line memory module

DIN

Deutsche Industrie Norm

DIP

dual in-line package

DMA

direct memory access

DOC

Department of Communications (in Canada)

dpi

dots per inch

DRAM

dynamic random-access memory

DS/DD

double-sided double-density

DS/HD

double-sided high-density

ECC

error checking and correction

EDO

extended-data out

EGA

enhanced graphics adapter

EIDE

enhanced integrated drive electronics

EMI

electromagnetic interference

EMM

expanded memory manager

EMS

Expanded Memory Specification

EPP

Enhanced Parallel Port

EPROM

erasable programmable read-only memory

ESD

electrostatic discharge

ESDI

enhanced small-device interface

ESM

embedded server management

F

Fahrenheit

FAT

file allocation table

FCC

Federal Communications Commission

ft

feet

g

gram(s)

G

gravities

GB

gigabyte(s)

GUI

graphical user interface

Hz

hertz

I/O

input/output

ID

identification

IDE

integrated drive electronics

IRQ

interrupt request

K

kilo- (1024)

KB

kilobyte(s)

KB/sec

kilobyte(s) per second

Kb

kilobit(s)

Kbps

kilobit(s) per second

kg

kilogram(s)

kHz

kilohertz

LAN

local area network

lb

pound(s)

LCD

liquid crystal display

LED

light-emitting diode

LIF

low insertion force

LN

load number

lpi

lines per inch

LVD

low voltage differential

m

meter(s)

mA

milliampere(s)

mAh

milliampere-hour(s)

MB

megabyte(s)

Mb

megabit(s)

Mbps

megabit(s) per second

MBR

master boot record

MDA

monochrome display adapter

MGA

monochrome graphics adapter

MHz

megahertz

mm

millimeter(s)

ms

millisecond(s)

MTBF

mean time between failures

mV

millivolt(s)

NIC

network interface controller

NiCad

nickel cadmium

NiMH

nickel-metal hydride

NMI

nonmaskable interrupt

ns

nanosecond(s)

NTFS

NT File System

NVRAM

nonvolatile random-access memory

OTP

one-time programmable

PAL

programmable array logic

PCI

Peripheral Component Interconnect

PCMCIA

Personal Computer Memory Card International Association

PDB

power distribution board

PDU

power distribution unit

PGA

pin grid array

PIC

personal identification code

POST

power-on self-test

ppm

pages per minute

PQFP

plastic quad flat pack

PSDB

power-supply distribution board

PS/2

Personal System/2

PXE

preboot execution environment

RAID

redundant arrays of independent disks

RAC

remote access controller

RAM

random-access memory

RCU

Resource Configuration Utility

REN

ringer equivalence number

RFI

radio frequency interference

RGB

red/green/blue

ROM

read-only memory

rpm

revolutions per minute

RTC

real-time clock

SATA

serial ATA

SBE

single bit ECC

SCSI

small computer system interface

sec

second(s)

SEC

single-edge contact

SEL

system event log

SDRAM

synchronous dynamic random-access memory

SIMM

single in-line memory module

SMB

server management bus

SMI

system management interrupt

SNMP

Simple Network Management Protocol

SRAM

static random-access memory

SVGA

super video graphics array

TFT

thin film transistor

tpi

tracks per inch

UMB

upper memory block

UPS

uninterruptible power supply

USB

universal serial bus

V

volt(s)

VAC

volt(s) alternating current

VDC

volt(s) direct current

VGA

video graphics array

VLSI

very-large-scale integration

VRAM

video random-access memory

VRM

voltage regulator module

W

watt(s)

WH

watt-hour(s)

XMM

extended memory manager

XMS

eXtended Memory Specification

ZIF

zero insertion force

[Back to Contents Page](#)

[Back to Contents Page](#)

Introduction

Dell™ PowerEdge™ 700 Systems Installation and Troubleshooting Guide

- [Other Documents You May Need](#)
- [Obtaining Technical Assistance](#)

The system includes the following service features to make troubleshooting and repair easy and effective:

- 1 Embedded server management hardware, which monitors temperatures and voltages throughout the system.
- 1 System diagnostics, which checks for hardware problems (if the system can boot)

System upgrade options are offered, including:

- 1 Processors
- 1 System memory
- 1 Expansion-card options, including RAID controller cards
- 1 SATA or SCSI hard drives
- 1 IDE or SCSI tape backup devices
- 1 IDE CD, DVD, and CD-RW/DVD drives

Other Documents You May Need

 The *System Information Guide* provides important safety and regulatory information. Warranty information may be included within this document or as a separate document.

- 1 The *Getting Started Guide* provides an overview of initially setting up your system.
- 1 The *User's Guide* provides information about system features and technical specifications.
- 1 Systems management software documentation describes the features, requirements, installation, and basic operation of the software.
- 1 Operating system documentation describes how to install (if necessary), configure, and use the operating system software.
- 1 Documentation for any components you purchased separately provides information to configure and install these options.
- 1 Updates are sometimes included with the system to describe changes to the system, software, and/or documentation.

 **NOTE:** Always read the updates first because they often supersede information in other documents.

- 1 Release notes or readme files may be included to provide last-minute updates to the system or documentation or advanced technical reference material intended for experienced users or technicians.

Obtaining Technical Assistance

Dell Enterprise Training and Certification is available; see www.dell.com/training for more information. This service may not be offered in all locations.

[Back to Contents Page](#)

Indicators and Codes

Dell™ PowerEdge™ 700 Systems Installation and Troubleshooting Guide

- [Front-Panel Indicators and Features](#)
 - [Back-Panel Features](#)
 - [NIC Indicator Codes](#)
 - [Hot-Plug SCSI Hard-Drive Indicator Codes](#)
 - [System Messages](#)
- [System Beep Codes](#)
 - [Warning Messages](#)
 - [Diagnostics Messages](#)
 - [Alert Messages](#)

The system, applications, and operating systems can identify problems and alert you to them. Any of the following can indicate when the system is not operating properly:

- 1 System indicators
- 1 System messages
- 1 Beep codes
- 1 Warning messages
- 1 Diagnostics messages
- 1 Alert messages

This section describes each type of message, lists the possible causes, and provides steps to resolve any problems indicated by a message. The system indicators and features are illustrated in this section.

Front-Panel Indicators and Features

[Figure 2-1](#) shows the front-panel features of the system. [Table 2-1](#) describes the front-panel features.

Figure 2-1. Front Panel Features

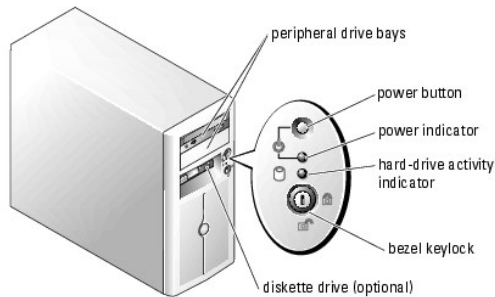

Table 2-1. Front-Panel Features and Indicators

Indicator or Feature	Description
Power button	<p>Turns system power off and on.</p> <ul style="list-style-type: none"> 1 If you turn off the system using the power button and the system is running an ACPI-compliant operating system, the system can perform an orderly shutdown before power is turned off. If the power button is pressed for more than 4 seconds, the system power will turn off regardless of the current operating system state. 1 If the system is not running an ACPI-compliant operating system, power is turned off immediately after the power button is pressed. <p>The power button is enabled in the System Setup program. When disabled, the button can only turn the system power on. For more information, see your <i>User's Guide</i> and the operating system's documentation.</p>
Power indicator	<p>When the power indicator is on, the system is in a normal operating state. When the indicator is off, the system is off.</p>

	To exit from a power-saving state, briefly press the power button or click or move the mouse.
Hard-drive activity indicator	Flashes when data is being read from or written to the SATA hard drives that are connected to the integrated drive controller.

Back-Panel Features

[Figure 2-2](#) shows the back-panel features of the system. [Table 2-2](#) describes the back-panel features.

Figure 2-2. Back-Panel Features

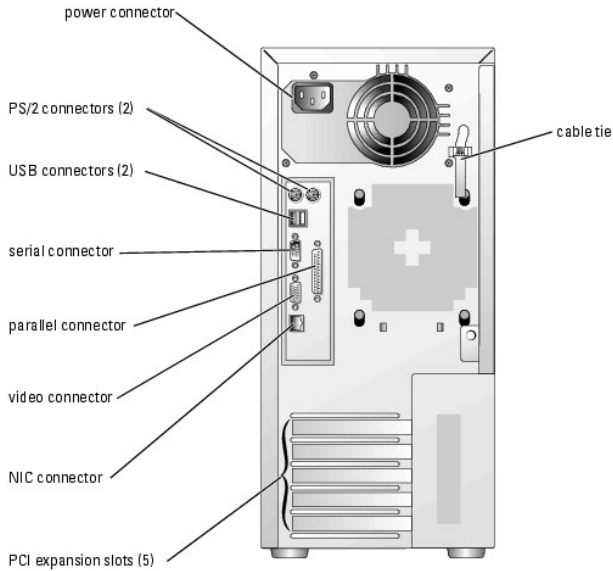

Table 2-2. Back-Panel Features

Component	Description
Power connector	Connects the system's power supply to a power source.
Cable tie	Relieves strain on the power cable.
NIC indicators	Provide information on NIC status. See " NIC Indicator Codes ."
Expansion slots	Provide two 32-bit/33-MHz, 5-V PCI slots and three 64-bit/33-MHz, 3.3-V PCI-X slots.
I/O ports and connectors	Connect peripheral devices to the system.

NIC Indicator Codes

The NIC connector on the back panel has indicators that provide information on network activity and link status (see [Figure 2-3](#)). [Table 2-3](#) lists the NIC indicator codes.

Figure 2-3. NIC Indicators

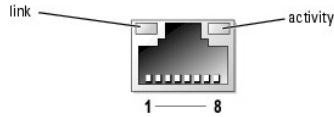

Table 2-3. NIC Indicator Codes

Indicator	Normal Operation	Error Condition
Activity	Flashing amber indicates that network data is being sent or received	When off at the same time that the link indicator is off, the network adapter is not connected to the network.
Link	Steady green indicates that the network adapter is connected to a valid link partner on the network.	When off at the same time that the activity indicator is off, the network adapter is not connected to the network.

Hot-Plug SCSI Hard-Drive Indicator Codes

Each SCSI hard-drive carrier has two indicators: a busy indicator and a status indicator (see [Figure 2-4](#)). The indicators provide information on the status of the respective hard drive.

Figure 2-4. Hard-Drive Indicators

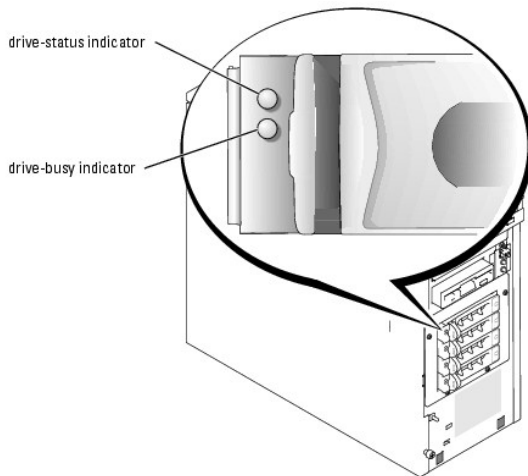

[Table 2-4](#) lists the drive-status indicator codes. Different codes display as drive events occur in the system. For example, in the event of a hard-drive failure, the "drive fail" code appears. After the drive is selected for removal, the "preparing for removal" code appears. After the replacement drive is installed, the "preparing for operation, drive online" code appears.

The drive-busy indicator signifies whether the hard drive is active on the SCSI bus. This indicator is controlled by the hard drive.

Table 2-4. SCSI Hard-Drive Status Indicator Codes

Drive-Status Indicator	Indicator Code
Drive bay empty	Off
Drive being prepared for operation, drive online	Steady green
Drive being identified, prepared for removal, or drive offline	Blinks green 3 times per second at equal intervals
Drive rebuilding	Blinks green once per second
Drive failed	Steady amber

System Messages

System messages appear on the screen to notify you of a possible problem with the system. [Table 2-5](#) lists the system messages that can occur and the probable cause and corrective action for each message.

 **NOTE:** If you receive a system message that is not listed in [Table 2-5](#), check the documentation for the application that is running when the message appears or the operating system's documentation for an explanation of the message and recommended action.

Table 2-5. System Messages

Message	Causes	Corrective Actions
Address mark not found	Faulty CD/diskette-drive subsystem or hard-drive subsystem; faulty system board.	See " Troubleshooting a Diskette Drive ," " Troubleshooting a CD, DVD, or CD-RW/DVD Drive ," " Troubleshooting SCSI Hard Drives ," or " Troubleshooting SATA Hard Drives " in " Troubleshooting Your System ."
Alert! Back system fan was not detected.	Specified fan is missing, faulty, or improperly installed.	See " Troubleshooting System Cooling Problems " in " Troubleshooting Your System ."
Alert! Front system fan was not detected.		
Alert! Cover was previously removed.	The chassis has been opened.	Information only.
Alert! DIMM(s) <i>n</i> are unsupported	BIOS detected DIMM SPD contains invalid value or SPD checksum failed.	Replace the defective memory module. See " Memory Modules " in " Installing System Options ."
Alert! Invalid configuration! When using a single hard disk drive, SATA Port 0 must be used.	SATA hard drive not connected to correct connector on system board.	If the system is configured with one hard drive, ensure that the drive's interface cable is connected to the SATA PORT0 connector on the system board. See Figure A-3 for connector location.
Alert! Mismatched DIMMs are detected in bank(s): Bank <i>n</i>	Memory modules installed in the specified bank are not the same type and size; faulty memory module(s).	Ensure that all banks contain memory modules of the same type and size and that they are properly installed. If the problem persists, see " Troubleshooting System Memory " in " Troubleshooting Your System ."
Alert! Previous back system fan failure.	Specified fan failed before last system startup.	Information only.
Alert! Previous front system fan failure.		
Alert! Previous thermal event.	BIOS detected a thermal event before the last system startup.	Ensure that thermal grease is applied to the heat sink and the heat sink is installed properly. Ensure that the front and back system fans are functioning properly. See " Replacing the Processor " in " Installing System Options " and " Troubleshooting System Cooling Problems " in " Troubleshooting Your System ."
Alert! Previous voltage failure.	ESM detected sensor voltage out of range before last system startup.	Information only.
Amount of available memory limited to 256 MB!	OS Install Mode is enabled in the System Setup program.	Disable OS Install Mode in the System Setup program (see "Using the System Setup Program" in your <i>User's Guide</i>).
Auxiliary device failure	Loose or improperly connected mouse or keyboard cable; faulty mouse or keyboard.	See " Troubleshooting the Mouse " and " Troubleshooting the Keyboard " in " Troubleshooting Your System ."
BIOS Update Attempt Failed!	Remote BIOS firmware update attempt failed.	Retry the BIOS firmware update (see " Getting Help ").
Caution! NVRAM_CLR jumper is installed on system board. Please run setup.	NVRAM_CLR jumper is installed.	Remove the NVRAM_CLR jumper (see Figure A-2 for jumper location). Check the System Setup configuration settings (see "Using the System Setup Program" in your <i>User's Guide</i>).
	Faulty diskette, diskette drive, CD drive, tape	Replace the diskette. If the problem persists, see " Troubleshooting a

Data error	drive, or hard drive.	Diskette Drive , " Troubleshooting a CD, DVD, or CD-RW/DVD Drive ," " Troubleshooting SATA Hard Drives ," or " Troubleshooting SCSI Hard Drives " in " Troubleshooting Your System ."
Decreasing available memory	Faulty or improperly installed memory modules.	See " Troubleshooting System Memory " in " Troubleshooting Your System ."
Diskette drive n seek failure	Incorrect configuration settings in the System Setup program.	Run the System Setup program to correct the settings (see "Using the System Setup Program" in your <i>User's Guide</i>).
	Faulty or improperly installed diskette drive.	See " Troubleshooting a Diskette Drive " in " Troubleshooting Your System ."
Diskette read failure	Faulty or improperly inserted diskette.	Replace the diskette.
Diskette subsystem reset failed	Faulty or improperly installed diskette drive.	See " Troubleshooting a Diskette Drive " in " Troubleshooting Your System ."
Diskette write protected	Diskette write-protect feature activated.	Move the write-protect tab on the diskette to the disabled position.
Drive not ready	Diskette missing or improperly inserted in diskette drive.	Reinsert or replace the diskette.
Embedded server management error	Faulty or improperly installed remote access controller (RAC) or loose cable connection.	Ensure that the RAC's cable is properly connected. Ensure that the RAC is properly installed. See " Expansion Cards " in " Installing System Options ." If the problem persists, see " Getting Help ."
Error: More than one RAC detected, system halted.	Two RACs are installed, or faulty or improperly installed RAC.	Ensure that there is only one RAC installed and that it is installed in the correct slot. Ensure that the RAC is properly installed. See " Expansion Cards " in " Installing System Options ." If the problem persists, see " Getting Help ."
Error: RAC cannot be used with an add-in video card in this slot.	Add-in video card is installed.	Ensure that the RAC is installed in the correct slot. See " Expansion Cards " in " Installing System Options ."
Error: RAC is not in the correct PCI slot, system halted.	The RAC card is not installed in the proper PCI slot.	Ensure that the RAC is installed in the correct PCI slot. See " Troubleshooting Expansion Cards " in " Troubleshooting Your System ."
Error: Remote Access Card initialization failure.	Faulty or improperly installed RAC.	Ensure that the RAC is properly installed. See " Troubleshooting Expansion Cards " in " Troubleshooting Your System ."
Gate A20 failure	Faulty keyboard controller; faulty system board.	See " Getting Help ."
General failure	Operating system corrupted or improperly installed.	Reinstall the operating system.
Hard disk controller failure	Incorrect configuration settings in System Setup program; improperly installed hard drive; loose interface or power cable; faulty hard-drive controller subsystem.	Run the System Setup program to correct the drive type setting (see "Using the System Setup Program" in your <i>User's Guide</i>). If the problem persists, see " Troubleshooting SCSI Hard Drives " or " Troubleshooting SATA Hard Drives " in " Troubleshooting Your System ."
Invalid memory configuration detected. Potential corruption exists!	Memory module installation guidelines have not been properly followed.	See " Memory Module Installation Guidelines " in " Installing System Options ."
Keyboard controller failure	Faulty keyboard controller; faulty system board.	See " Getting Help ."
Keyboard data line failure	Loose or improperly connected keyboard cable; faulty keyboard; faulty keyboard controller.	See " Troubleshooting the Keyboard " in " Troubleshooting Your System ."
Keyboard failure		
Keyboard stuck key failure		
Memory address line failure at address, read value expecting value	Faulty or improperly installed memory modules.	See " Troubleshooting System Memory " in " Troubleshooting Your System ."

Memory double word logic failure at <i>address</i> , read value expecting value		
Memory odd/even logic failure at <i>start address</i> to <i>end address</i>		
Memory write/read failure at <i>address</i> , read value expecting value		
Memory allocation error	Faulty application program.	Restart the application program.
Memory bank population error!	Memory module installation guidelines have not been properly followed.	See " Memory Module Installation Guidelines " in " Installing System Options ."
Memory parity interrupt at <i>address</i>	Faulty or improperly installed memory modules.	See " Troubleshooting System Memory " in " Troubleshooting Your System ."
Memory tests terminated by keystroke	The spacebar was pressed during POST to terminate the memory test.	Information only.
No boot device available	Faulty or missing CD/diskette-drive subsystem, hard drive, or hard-drive subsystem.	Use a bootable diskette, CD, or hard drive. If the problem persists, see " Troubleshooting a Diskette Drive ," " Troubleshooting a CD, DVD, or CD-RW/DVD Drive ," " Troubleshooting SATA Hard Drives ," or " Troubleshooting SCSI Hard Drives " in " Troubleshooting Your System ."
No boot sector on hard- disk drive	No operating system on hard drive.	Check the hard-drive configuration settings in the System Setup program (see "Using the System Setup Program" in your <i>User's Guide</i>).
No timer tick interrupt	Faulty system board.	See " Getting Help ."
Non-system disk or disk error	Faulty diskette, CD/diskette-drive subsystem, or hard-drive subsystem.	See " Troubleshooting a Diskette Drive ," " Troubleshooting a CD, DVD, or CD-RW/DVD Drive ," " Troubleshooting SATA Hard Drives ," or " Troubleshooting SCSI Hard Drives " in " Troubleshooting Your System ." If the problem persists, see " Getting Help ."
Not a boot diskette	No operating system on diskette.	Use a bootable diskette.
PCI BIOS failed to install	Loose cable(s) to expansion card(s); faulty or improperly installed expansion card.	Ensure that all appropriate cable(s) are securely connected to the expansion card(s). If the problem persists, see " Troubleshooting Expansion Cards " in " Troubleshooting Your System ."
Plug & Play Configuration error	Error encountered while initializing PCI devices.	Install the NVRAM_CLR jumper and reboot the system (see Figure A-2 for jumper location). If the problem persists, see " Troubleshooting Expansion Cards " in " Troubleshooting Your System ."
Primary drive <i>n</i> configuration error	Faulty or improperly installed hard drive.	Ensure that the CD drive cables are properly connected. See " Troubleshooting a CD, DVD, or CD-RW/DVD Drive " in " Troubleshooting Your System ."
Primary drive <i>n</i> failure		
Primary drive <i>n</i> not found	The specified drive on the primary channel of the integrated hard drive controller is set to Auto in the System Setup program, but no drive is attached; improperly installed hard drive; loose interface or power cable.	Run the System Setup program to correct the drive settings (see "Using the System Setup Program" in your <i>User's Guide</i>). If the problem persists, see " Troubleshooting SATA Hard Drives " or " Troubleshooting SCSI Hard Drives " in " Troubleshooting Your System ."
Read fault	Faulty diskette, CD/diskette-drive subsystem, or hard-drive subsystem.	See " Troubleshooting a Diskette Drive ," " Troubleshooting a CD, DVD, or CD-RW/DVD Drive ," " Troubleshooting SATA Hard Drives ," or " Troubleshooting SCSI Hard Drives " in " Troubleshooting Your System ." If the problem persists, see " Getting Help ."
Requested sector not found		
Reset failed	Improperly connected diskette drive, tape drive, hard drive, or power cable.	Ensure that all cables are securely connected. If the problem persists, see " Getting Help ."

ROM bad checksum = address	Faulty or improperly installed expansion card.	See " Troubleshooting Expansion Cards " in " Troubleshooting Your System ."
SATA port n hard disk drive auto-sensing error	Faulty or improperly installed hard drive.	Ensure that the hard drive cables are properly connected. See " Troubleshooting a SATA Hard Drive Connected to the Integrated Drive Controller " and " Troubleshooting a SATA Hard Drive in a RAID Configuration (When Available) " in " Troubleshooting Your System ."
SATA port n hard disk drive configuration error		
SATA port n hard drive failure		
SATA port n hard drive not found	Incorrect configuration settings in the System Setup program. The drive setting is Auto but no drive is installed.	Run the System Setup program to correct the settings. See "Using the System Setup Program" in your <i>User's Guide</i> .
Sector not found	Faulty diskette or hard drive.	Replace the diskette. If the problem persists, replace the hard drive. See " Hard Drives " in " Installing Drives ."
Seek error		
Seek operation failed		
Shutdown failure	Shutdown test failure.	See " Troubleshooting System Memory " in " Troubleshooting Your System ."
Time-of-day clock stopped	Faulty battery.	See " Troubleshooting the System Battery " in " Troubleshooting Your System ."
Time-of-day not set - please run SETUP program	Incorrect Time or Date settings; faulty system battery.	Check the Time and Date settings (see "Using the System Setup Program" in your <i>User's Guide</i>). If the problem persists, replace the system battery (see " System Battery " in " Installing System Options ").
Timer chip counter 2 failed	Faulty system board.	See " Getting Help ."
Unexpected interrupt in protected mode	Faulty or improperly installed memory modules or faulty system board.	See " Troubleshooting System Memory " in " Troubleshooting Your System ." If the problem persists, see " Getting Help ."
Unsupported CPU stepping detected	Processor is not supported by the system.	Update the BIOS firmware (see " Getting Help ").
Utility partition not available	The <F10> key was pressed during POST, but no utility partition exists on the boot hard drive.	Create a utility partition on the boot hard drive (see the <i>Dell OpenManage Server Assistant</i> CD).
Warning! No microcode update loaded for processor n	BIOS error.	Update the BIOS firmware (see " Getting Help ").
Write fault	Faulty diskette, CD/diskette-drive subsystem, hard drive, or hard-drive subsystem.	See " Troubleshooting a Diskette Drive ," " Troubleshooting a CD, DVD, or CD-RW/DVD Drive ," " Troubleshooting SATA Hard Drives ," or " Troubleshooting SCSI Hard Drives " in " Troubleshooting Your System ."
Write fault on selected drive		

System Beep Codes

If an error that cannot be reported on the screen occurs during POST, the system may emit a series of beeps that identifies the problem.

 **NOTE:** If the system boots without a keyboard, mouse, or monitor attached, the system does not issue beep codes related to those peripherals.

If a beep code is emitted, write down the series of beeps and then look it up in [Table 2-6](#). If you are unable to resolve the problem by looking up the meaning of the beep code, use system diagnostics to identify the possible cause. If you are still unable to resolve the problem, see ["Getting Help."](#)

Table 2-6. System Beep Codes

Code	Cause	Corrective Action
1-1-2	CPU register test failure	See "Troubleshooting the Processor" in "Troubleshooting Your System."
1-1-3	CMOS write/read test failure	See "Getting Help."
1-1-4	BIOS ROM checksum failure	Reflash the BIOS firmware (see "Getting Help.").
1-2-1	Programmable interval-timer test failure	See "Getting Help."
1-2-2	DMA initialization failure	See "Troubleshooting System Memory" in "Troubleshooting Your System."
1-2-3	DMA page register write/read test failure	
1-3-1	Main-memory refresh verification failure	
1-3-2	No memory installed	
1-3-3	Chip or data line failure in the first 64 KB of main memory	
1-3-4	Odd/even logic failure in the first 64 KB of main memory	
1-4-1	Address line failure in the first 64 KB of main memory	
1-4-2	Parity failure in the first 64 KB of main memory	
1-4-3	Fail-safe timer test failure	
1-4-4	Software NMI port test failure	
2-1-1 through 2-4-4	Bit failure in the first 64 KB of main memory	
3-1-1	Slave DMA-register failure	See "Getting Help."
3-1-2	Master DMA-register failure	
3-1-3	Master interrupt-mask register test failure	
3-1-4	Slave interrupt-mask register failure	
3-2-2	Interrupt vector loading failure	
3-2-4	Keyboard-controller test failure	See "Troubleshooting the Keyboard" in "Troubleshooting Your System."
3-3-1	CMOS power-fail and checksum checks failure	See "Getting Help."
3-3-2	System configuration check failure	
3-3-3	Keyboard controller not detected	
3-3-4	Video memory test failure	
3-4-1	Screen initialization failure	
3-4-2	Screen-retrace test failure	
3-4-3	Video ROM search failure	
4-2-1	No timer tick	
4-2-2	Shutdown test failure	
4-2-3	Gate A20 failure	
4-2-4	Unexpected interrupt in protected mode	See "Troubleshooting Expansion Cards" in "Troubleshooting Your System."
4-3-1	Improperly installed or faulty memory modules	See "Troubleshooting System Memory" in "Troubleshooting Your System."
4-3-2	No memory modules installed in bank <i>n</i>	Install memory modules of the same type and size in bank <i>n</i> (see "Memory Modules" in "Installing System Options").
4-3-3	Interval timer channel 2 test failure	See "Getting Help."
4-3-4	Time-of-day clock stopped	See "Troubleshooting the System Battery" in "Troubleshooting Your System."
4-4-1	Super I/O chip failure: faulty system board	See "Getting Help."
4-4-4	Cache test failure: faulty processor	See "Troubleshooting the Processor" in "Troubleshooting Your System."

Warning Messages

A warning message alerts you to a possible problem and prompts you to respond before the system continues a task. For example, before you format a diskette, a message will warn you that you may lose all data on the diskette. Warning messages usually interrupt the task and require you to respond by typing *y* (yes) or *n* (no).

 **NOTE:** Warning messages are generated by either the application or the operating system. For more information, see ["Finding Software Solutions"](#) and the documentation that accompanied the operating system or application.

Diagnostics Messages

When you run system diagnostics, an error message may result. Diagnostic error messages are not covered in this section. Record the message on a copy of the Diagnostics Checklist in "[Getting Help](#)," and then follow the instructions in that section for obtaining technical assistance.

Alert Messages

Systems management software generates alert messages for your system. Alert messages include information, status, warning, and failure messages for drive, temperature, fan, and power conditions. For more information, see the systems management software documentation.

[Back to Contents Page](#)

[Back to Contents Page](#)

Finding Software Solutions

Dell™ PowerEdge™ 700 Systems Installation and Troubleshooting Guide

- [Before You Begin](#)
- [Troubleshooting Errors and Conflicts](#)

Software problems can be caused by:

- 1 Improper installation or configuration of an application
- 1 Application conflicts
- 1 Input errors
- 1 Interrupt assignment conflicts

Ensure that you are installing the software application according to the software manufacturer's recommended procedures. If a problem occurs after you install the software, you might need to troubleshoot your software application and your system.

See the documentation that accompanied the software or contact the software manufacturer for detailed troubleshooting information.



NOTE: If all of the system diagnostic tests complete successfully, then the problem is most likely caused by the software and not the hardware.

Before You Begin

- 1 Scan the software media with antivirus software.
- 1 Read the software documentation before you run the installation utility.
- 1 Be prepared to respond to prompts from the installation utility.

The installation utility may require you to enter information about your system, such as how the operating system is configured, and the type of peripherals that are connected to the system. Have this information available before running the installation utility.

Troubleshooting Errors and Conflicts

While configuring and running software, problems might occur that are caused by input errors, application conflicts, and/or IRQ assignment conflicts. The problems are sometimes indicated by error messages.

Error messages are generated by system hardware or software. "[Indicators and Codes](#)" provides information about error messages that are hardware-based. If you receive an error message that is not listed, see your operating system or software program documentation for troubleshooting information.

Input Errors

Pressing a specific key or set of keys at the wrong time may produce unexpected results. See the documentation that came with the software application to ensure that the values or characters you are entering are valid.

Ensure that your operating system is configured properly to run the application. Remember that whenever you change the parameters of the operating system, the changes can conflict with an application's operating requirements. After you configure the operating system, you may need to reinstall or reconfigure a software application so that it can run properly in its new environment.

Application Conflicts

Some applications can leave unnecessary files or data behind after they are deleted from your system. Device drivers can also create application errors. If application errors occur, see your application device driver or operating system documentation for troubleshooting information.

IRQ Assignment Conflicts

Most PCI devices can share an IRQ with another device, but they cannot use an IRQ simultaneously. To avoid this type of conflict, see the documentation for each PCI device for specific IRQ requirements.

Table 3-1. IRQ Assignment Defaults

IRQ Line	Assignment
IRQ0	System timer
IRQ1	Keyboard controller
IRQ2	Interrupt controller 1 to enable IRQ8 through IRQ15
IRQ3	Serial port 2 (COM2 and COM4)
IRQ4	Serial port 1 (COM1 and COM3)
IRQ5	<i>Available</i>
IRQ6	Diskette drive controller
IRQ7	Parallel port
IRQ8	Real-time clock
IRQ9	ACPI functions (used for power management)
IRQ10	<i>Available</i>
IRQ11	<i>Available</i>
IRQ12	PS/2 mouse port unless the mouse is disabled through the System Setup program
IRQ13	Math coprocessor
IRQ14	Integrated drive controller (primary channel) for the IDE CD drive and tape backup device
IRQ15	Integrated drive controller (secondary channel) for the SATA ports

[Back to Contents Page](#)

[Back to Contents Page](#)

Running System Diagnostics

Dell™ PowerEdge™ 700 Systems Installation and Troubleshooting Guide

- [Using Server Administrator Diagnostics](#)
- [System Diagnostics Features](#)
- [When to Use the System Diagnostics](#)
- [Running the System Diagnostics](#)
- [System Diagnostics Testing Options](#)
- [Using the Advanced Testing Options](#)
- [Error Messages](#)

If you experience a problem with your system, run the diagnostics before calling for technical assistance. The purpose of the diagnostics is to test your system's hardware without requiring additional equipment or risking data loss. If you are unable to fix the problem yourself, service and support personnel can use diagnostics test results to help you solve the problem.

Using Server Administrator Diagnostics

To assess a system problem, first use the online Server Administrator diagnostics. If you are unable to identify the problem, then use the system diagnostics.

To access the online diagnostics, log into the Server Administrator home page, and then click the **Diagnostics** tab. For information about using diagnostics, see the online help. For additional information, see the *Server Administrator User's Guide*.

System Diagnostics Features

The system diagnostics provides a series of menus and options for particular device groups or devices. The system diagnostics menus and options allow you to:

- 1 Run tests individually or collectively.
 - 1 Control the sequence of tests.
 - 1 Repeat tests.
 - 1 Display, print, or save test results.
 - 1 Temporarily suspend testing if an error is detected or terminate testing when a user-defined error limit is reached.
 - 1 View help messages that briefly describe each test and its parameters.
 - 1 View status messages that inform you if tests are completed successfully.
 - 1 View error messages that inform you of problems encountered during testing.
-

When to Use the System Diagnostics

If a major component or device in the system does not operate properly, component failure may be indicated. As long as the processor and the system's input/output devices (monitor, keyboard, and diskette drive) are functioning, you can use the system diagnostics to help identify the problem.

Running the System Diagnostics

The system diagnostics can be run either from the utility partition on your hard drive or from a set of diskettes that you create using the *Dell OpenManage Server Assistant* CD.

 **NOTICE:** Use the system diagnostics to test only your system. Using this program with other systems may cause invalid results or error messages. In addition, use only the program that came with your system (or an updated version of that program).

From the Utility Partition

1. As the system boots, press <F10> during POST.
2. From the utility partition main menu under **Run System Utilities**, select **Run System Diagnostics**.

From the Diagnostics Diskettes

1. Create a set of diagnostics diskettes from the *Dell OpenManage Server Assistant CD*. See "Using the Dell OpenManage Server Assistant CD" in your *User's Guide* for information on creating the diskettes.
2. Insert the first diagnostics diskette.
3. Reboot the system.

If the system fails to boot, see "[Getting Help](#)."

When you start the system diagnostics, a message is displayed stating that the diagnostics are initializing. Next, the **Diagnostics** menu appears. The menu allows you to run all or specific diagnostics tests or to exit the system diagnostics.

 **NOTE:** Before you read the rest of this section, start the system diagnostics so that you can see the utility on your screen.

System Diagnostics Testing Options

To select an option from the **Diagnostics** menu, highlight the option and press <Enter>, or press the key that corresponds to the highlighted letter in the option.

[Table 4-1](#) provides a brief explanation of testing options.

Table 4-1. System Diagnostics Testing Options

Testing Option	Function
Quick Tests	Performs a quick check of the system. Select Test All Devices and then select Quick Tests . This option runs device tests that do not require user interaction. Use this option to quickly identify the source of your problem.
Test One Device	Tests a particular device.
Extended Tests	Performs a more thorough check of the system. Select Test All Devices and then select Extended Tests .
Advanced Testing	Checks a particular area of the system.
Information and Results	Displays test results.
Program Options	Sets various test parameters.
Device Configuration	Displays an overview of the devices in the system.
Exit to MS-DOS	Exits the diagnostics and returns to the System Utilities menu.

Using the Advanced Testing Options

When you select **Advanced Testing** from the **Diagnostics** menu, the main screen of the diagnostics appears and displays the following information:

- 1 Two lines at the top of the screen identify the diagnostics utility, the version number, and the system's service tag number.
- 1 The left side of the screen under **Device Groups** lists the diagnostic device groups in the order that they are tested if you select **All** under the **Run Tests** submenu. Press the up- or down-arrow keys to highlight a particular device group. Press the left- or right-arrow keys to select the options on the menu. As you move from one menu option to another, a brief explanation of the highlighted option appears at the bottom of the screen.
- 1 The right side of the screen under **Devices for Highlighted Group** lists the specific devices within a particular test group.

- 1 The menu area consists of two lines at the bottom of the screen. The first line lists the menu options that you can select; press the left- or right-arrow key to highlight an option. The second line provides information about the highlighted option.

For more information about a device group or device, highlight the Help option and press <Enter>. Press <Esc> to return to the previous screen.

Error Messages

When you run a system diagnostics test, you may receive an error message during testing. Record the message on a copy of the Diagnostics Checklist. For a copy of the Diagnostics Checklist and instructions for obtaining technical assistance, see "[Getting Help](#)."

[Back to Contents Page](#)

Troubleshooting Your System

Dell™ PowerEdge™ 700 Systems Installation and Troubleshooting Guide

- [Safety First—For You and Your System](#)
- [Start-Up Routine](#)
- [Checking the Equipment](#)
- [Responding to a Systems Management Software Alert Message](#)
- [Bezel](#)
- [System Cover](#)
- [Inside the System](#)
- [Troubleshooting a Wet System](#)
- [Troubleshooting a Damaged System](#)
- [Troubleshooting the System Battery](#)
- [Troubleshooting the Power Supply](#)
- [Troubleshooting System Cooling Problems](#)
- [Troubleshooting System Memory](#)
- [Troubleshooting a Diskette Drive](#)
- [Troubleshooting a CD, DVD, or CD-RW/DVD Drive](#)
- [Troubleshooting SCSI Hard Drives](#)
- [Troubleshooting SATA Hard Drives](#)
- [Troubleshooting Expansion Cards](#)
- [Troubleshooting the Processor](#)

Safety First—For You and Your System

To perform certain procedures in this document, you must remove the system cover and work inside the system. While working inside the system, do not attempt to service the system except as explained in this guide and elsewhere in your system documentation.

- ⚠ Always follow the instructions closely, and ensure that you review all information in "Safety Instructions" in the *System Information Guide*.
- ⚠ **CAUTION:** See your *System Information Guide* for complete information about safety precautions, working inside the computer, and protecting against electrostatic discharge.

Start-Up Routine

Look and listen during the system's start-up routine for the indications described in [Table 5-1](#).

Table 5-1. Start-Up Routine Indications

Look/listen for:	Action
An error message displayed on the monitor.	See " System Messages " in " Indicators and Codes ."
A series of beeps emitted by the system.	See " System Beep Codes " in " Indicators and Codes ."
Alert messages from the systems management software.	See the systems management software documentation.
The monitor's power indicator.	See " Troubleshooting the Video Subsystem ."
The keyboard indicators.	See " Troubleshooting the Keyboard ."
The USB diskette drive activity indicator.	See " Troubleshooting a USB Device ."
The USB CD drive activity indicator.	See " Troubleshooting a USB Device ."
The diskette drive activity indicator.	See " Troubleshooting a Diskette Drive ."
The CD drive activity indicator.	See " Troubleshooting a CD, DVD, or CD-RW/DVD Drive ."
The hard-drive activity indicator.	See " Troubleshooting SCSI Hard Drives " and " Troubleshooting SATA Hard Drives "
An unfamiliar constant scraping or grinding sound when you access a drive.	See " Getting Help ."

Checking the Equipment

This section provides troubleshooting procedures for external devices attached to the system, such as the monitor, keyboard, or mouse. Before you perform any of the procedures, see "Troubleshooting External Connections."

Troubleshooting External Connections

Loose or improperly connected cables are the most likely source of problems for the system, monitor, and other peripherals (such as a printer, keyboard, mouse, or other external device). Ensure that all external cables are securely attached to the external connectors on your system. See [Figure 2-2](#) for the back-panel connectors on your system.

Troubleshooting the Video Subsystem

Problem

- 1 Monitor is not working properly.
- 1 Video memory is faulty.

Action

1. Check the system and power connections to the monitor.
2. Run the appropriate online diagnostic test. See "[Using Server Administrator Diagnostics](#)" in "[Running System Diagnostics](#)."

If the tests run successfully, the problem is not related to video hardware. See "[Finding Software Solutions](#)."

If the tests fail, see "[Getting Help](#)."

Troubleshooting the Keyboard

Problem

- 1 System message indicates a problem with the keyboard.
- 1 Keyboard is not functioning properly.

Action

1. Run the appropriate online diagnostic test. See "[Using Server Administrator Diagnostics](#)" in "[Running System Diagnostics](#)."

If the test fails, continue to the next step.

2. Press each key on the keyboard, and examine the keyboard and its cable for signs of damage.

If the keyboard is not damaged, go to [step 3](#).

If the keyboard is damaged, continue to the next step.

3. Swap the faulty keyboard with a working keyboard.

If the problem is resolved, replace the faulty keyboard. See "[Getting Help](#)."

4. Run the keyboard test in the system diagnostics. See "[Running System Diagnostics](#)."

If the test fails, see "[Getting Help](#)."

Troubleshooting the Mouse

Problem

- 1 System message indicates a problem with the mouse.
- 1 Mouse is not functioning properly.

Action

1. Run the appropriate online diagnostic test. See "[Using Server Administrator Diagnostics](#)" in "[Running System Diagnostics](#)."

If the test fails, continue to the next step.

2. Examine the mouse and its cable for signs of damage.

If the mouse is not damaged, go to [step 3](#).

If the mouse is damaged, continue to the next step.

3. Swap the faulty mouse with a working mouse.

If the problem is resolved, replace the faulty mouse. See "[Getting Help](#)."

4. Enter the System Setup program and ensure that the mouse controller is enabled. See "Using the System Setup Program" in your *User's Guide*.

If the problem is not resolved, continue to the next step.

5. Run the pointing devices test in the system diagnostics. See "[Running System Diagnostics](#)."

If the test fails, see "[Getting Help](#)."

Troubleshooting Basic I/O Functions

Problem

- 1 Error message indicates a problem with a serial or parallel port.
- 1 Device connected to a serial or parallel port is not operating properly.

Action

1. Enter the System Setup program and ensure that the serial port(s) and parallel port are enabled. See "Using the System Setup Program" in the *User's Guide*.
2. If the problem is confined to a particular application, see the application documentation for specific port configuration requirements that the program may require.
3. Run the appropriate online diagnostic test. See "[Using Server Administrator Diagnostics](#)" in "[Running System Diagnostics](#)."

If the tests run successfully but the problem persists, see "[Troubleshooting a Serial I/O Device](#)."

Troubleshooting a Serial I/O Device

Problem

- 1 Device connected to the serial port is not operating properly.

Action

1. Turn off the system and any peripheral devices connected to the serial port.
2. Swap the serial interface cable with a working cable, and turn on the system and the serial device.

If the problem is resolved, replace the interface cable. See "[Getting Help](#)."

3. Turn off the system and the serial device, and swap the device with a comparable device.
4. Turn on the system and the serial device.

If the problem is resolved, replace the serial device. See "[Getting Help](#)."

If the problem persists, see "[Getting Help](#)."

Troubleshooting a USB Device

Problem

1. System message indicates a problem with a USB device.
1. Device connected to a USB port is not operating properly.

Action

1. Enter the System Setup program, and ensure that the USB ports are enabled. See "Using the System Setup Program" in your *User's Guide*.
2. Turn off the system and any USB devices.
3. Disconnect the USB devices, and connect the malfunctioning device to the other USB connector.
4. Turn on the system and the reconnected device.

If the problem is resolved, the USB connector might be defective. See "[Getting Help](#)."

5. If possible, swap the interface cable with a working cable.

If the problem is resolved, replace the interface cable. See "[Getting Help](#)."

6. Turn off the system and the USB device, and swap the device with a comparable device.
7. Turn on the system and the USB device.

If the problem is resolved, replace the USB device. See "[Getting Help](#)."

If the problem persists, see "[Getting Help](#)."

Troubleshooting a NIC

Problem

1. NIC cannot communicate with network.

Action

1. Run the appropriate online diagnostic test. See "[Using Server Administrator Diagnostics](#)" in "[Running System Diagnostics](#)."

If the tests fail, continue to the next step.

2. Check the appropriate indicator on the NIC connector. See "[NIC Indicator Codes](#)" in "[Indicators and Codes](#)."
 1. If the link indicator does not light, check all cable connections.
 1. If the activity indicator does not light, the network driver files might be damaged or missing.

Remove and reinstall the drivers if applicable. See the NIC's documentation.

1. Change the autonegotiation setting, if possible.
1. Use another connector on the switch or hub.

If you are using a NIC card instead of an integrated NIC, see the documentation for the NIC card.

3. Ensure that the appropriate drivers are installed and the protocols are bound. See the NIC's documentation.
4. Enter the System Setup program and confirm that the NIC is enabled. See "Using the System Setup Program" in your *User's Guide*.
5. Ensure that the NICs, hubs, and switches on the network are all set to the same data transmission speed. See the network equipment documentation.
6. Ensure that all network cables are of the proper type and do not exceed the maximum length. See "Network Cable Requirements" in your *User's Guide*.

Responding to a Systems Management Software Alert Message

Systems management software monitors critical system voltages and temperatures, fans, and hard drives in the system. Alert messages appear in the **Alert Log** window. For information about the **Alert Log** window, see the systems management software documentation.

Bezel

The bezel has status and attention indicators. You must remove the bezel to remove the system cover.

Removing the Bezel

 **CAUTION:** See your *System Information Guide* for complete information about safety precautions, working inside the computer, and protecting against electrostatic discharge.

1. Using the system key, unlock the bezel. See [Figure 5-1](#).
2. Slide the bezel latch toward the right side of the system.
3. Swing the top of the bezel away from the system, disengage the hooks at the bottom of the bezel, and lift the bezel away from the system.

Figure 5-1. Removing the Bezel

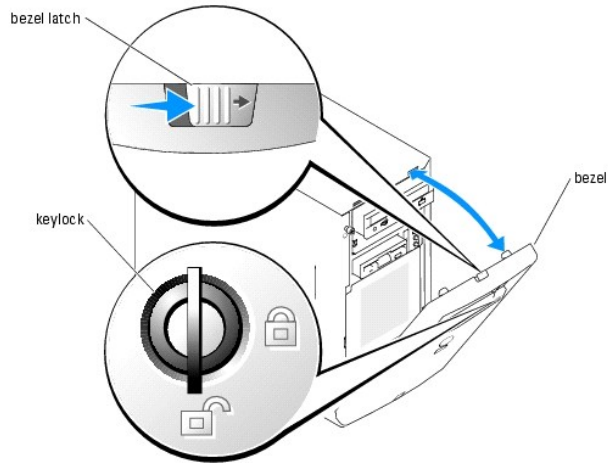

NOTE: [Figure 5-1](#) shows the system standing upright as the bezel is being removed. However, before you service components inside the system, lay the system on its right side.

Installing the Bezel

To install the bezel, align the hooks at the bottom of the bezel, swing the top of the bezel forward toward the system, and press the bezel to the system until it snaps into place. Using the system key, lock the bezel.

System Cover

To upgrade or troubleshoot the system, remove the system cover to gain access to internal components.

Removing the Cover

CAUTION: See your *System Information Guide* for complete information about safety precautions, working inside the computer, and protecting against electrostatic discharge.

1. Turn off the system and attached peripherals, and disconnect the system from the electrical outlet.
2. Remove the bezel. See "[Removing the Bezel](#)."
3. Lay the system on its right side.
4. Loosen the thumbscrews at the front of the system. See [Figure 5-2](#).
5. Slide the cover backward and grasp it at both ends.
6. Lift the front edge of the cover 2.5 cm (1 inch), slide the cover toward the top of the system, and then lift the cover away from the system.

Replacing the Cover

1. Ensure that all cables are connected, and fold cables out of the way.
2. Ensure that no tools or loose parts are left inside the system.
3. Fit the cover on the side of the system, and slide the cover forward.
4. Tighten the two cover thumbscrews to secure the cover. See [Figure 5-2](#).

Figure 5-2. Removing the Cover

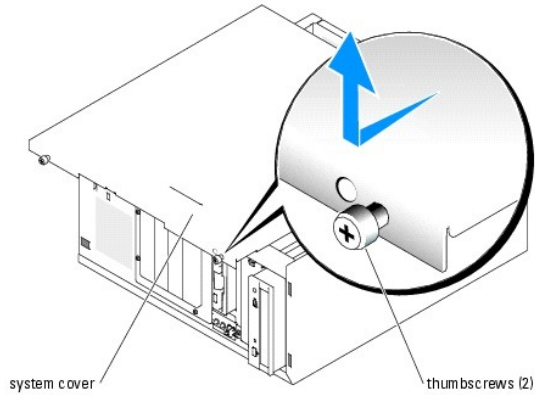

Inside the System

In [Figure 5-3](#), the bezel and system cover are removed to provide an interior view of the system.

The system board holds the system's circuitry and other electronic components. Several hardware options such as the processors and memory are installed directly on the system board. The system accommodates up to five half-length PCI expansion cards (two PCI 32-bit, 33-MHz, 5.0-V expansion cards and three PCI-X 64-bit, 66-MHz, 3.3-V expansion cards). System memory is contained in four memory module sockets.

Figure 5-3. Inside the System

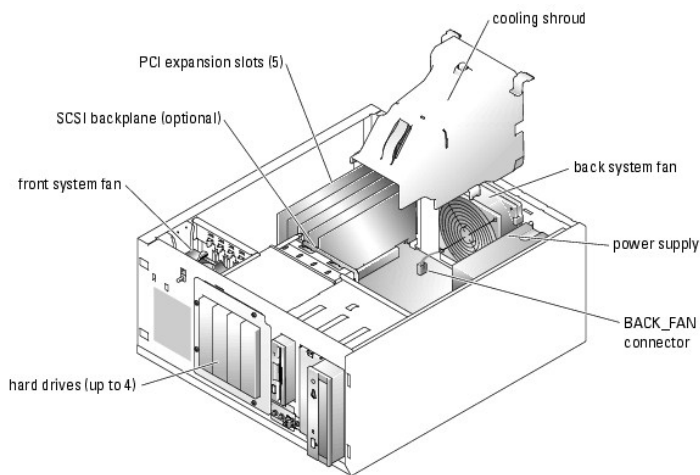

The drive bays provide space for up to four SATA or SCSI drives; a CD, DVD, or CD-RW/DVD drive; a diskette drive; and a SCSI or IDE tape backup device. The SCSI hard drives must be connected to a controller card or RAID controller card. Up to two SATA hard drives can be connected to the SATA port connectors on the system board. See [Figure A-3](#). Up to four SATA hard drives are supported with an optional SATA RAID controller card (when available). Power is supplied to the backplane board, the system board, and internal peripherals through a single nonredundant power supply.

Troubleshooting a Wet System

Problem

- 1 Liquid spilled on the system.

- 1 Excessive humidity.

Action

 **CAUTION:** See your *System Information Guide* for complete information about safety precautions, working inside the computer, and protecting against electrostatic discharge.

1. Turn off the system and attached peripherals, and disconnect the system from the electrical outlet.
2. Remove the bezel. See "[Removing the Bezel.](#)"
3. Lay the system on its right side.
4. Remove the cover. See "[Removing the Cover.](#)"
5. Remove all expansion cards installed in the system. See "[Removing an Expansion Card](#)" in "Installing System Options."
6. Let the system dry thoroughly for at least 24 hours.
7. Replace the cover. See "[Replacing the Cover.](#)"
8. Stand the system upright.
9. Install the bezel. See "[Installing the Bezel.](#)"
10. Reconnect the system to the electrical outlet, and turn on the system and attached peripherals.

If the system does not start properly, see "[Getting Help.](#)"

11. If the system starts properly, shut down the system and reinstall all of the expansion cards that you removed. See "[Installing an Expansion Card](#)" in "Installing System Options."
12. Run the system board tests in the system diagnostics to confirm that the system is working properly. See "[Running System Diagnostics.](#)"

If the tests fail, see "[Getting Help.](#)"

Troubleshooting a Damaged System

Problem

- 1 System was dropped or damaged.

Action

 **CAUTION:** See your *System Information Guide* for complete information about safety precautions, working inside the computer, and protecting against electrostatic discharge.

1. Turn off the system and attached peripherals, and disconnect the system from the electrical outlet.
2. Remove the bezel. See "[Removing the Bezel.](#)"
3. Lay the system on its right side.
4. Remove the cover. See "[Removing the Cover.](#)"
5. Ensure that the following components are properly installed:
 - 1 Expansion cards
 - 1 Power supplies
 - 1 Fans
 - 1 Drive-carrier connections to the SCSI backplane board, if applicable
6. Ensure that all cables are properly connected.
7. Replace the cover. See "[Replacing the Cover.](#)"
8. Stand the system upright.
9. Install the bezel. See "[Installing the Bezel.](#)"
10. Run the system board tests in the system diagnostics. See "[Running System Diagnostics.](#)"

If the tests fail, see "[Getting Help](#)."

Troubleshooting the System Battery

Problem

- 1 System message indicates a problem with the battery.
- 1 System Setup program loses system configuration information.
- 1 System date and time do not remain current.

 **NOTE:** If the system is turned off for long periods of time (for weeks or months), the NVRAM may lose its system configuration information. This situation is caused by a defective battery.

Action

1. Re-enter the time and date through the System Setup program. See "Using the System Setup Program" in your *User's Guide*.
2. Turn off the system and disconnect it from the electrical outlet for at least one hour.
3. Reconnect the system to the electrical outlet and turn on the system.
4. Enter the System Setup program.

If the date and time are not correct in the System Setup program, replace the battery. See "[System Battery](#)" in "Installing System Options."

If the problem is not resolved by replacing the battery, see "[Getting Help](#)."

 **NOTE:** Some software may cause the system time to speed up or slow down. If the system seems to operate normally except for the time kept in the System Setup program, the problem may be caused by software rather than by a defective battery.

Troubleshooting the Power Supply

Problem

- 1 Power indicator on the front panel does not light.
- 1 No power to the system.

Action

 **CAUTION:** See your *System Information Guide* for complete information about safety precautions, working inside the computer, and protecting against electrostatic discharge.

1. Run the appropriate online diagnostic test. See "[Using Server Administrator Diagnostics](#)" in "Running System Diagnostics."
2. Turn off the system and attached peripherals, and disconnect the system from the electrical outlet.
3. Remove the bezel. See "[Removing the Bezel](#)."
4. Lay the system on its right side.
5. Remove the cover. See "[Removing the Cover](#)."
6. Ensure that the power cables are properly connected to the power connectors on the system board and backplane.

To identify the system board connectors, see [Figure A-3](#).

7. Replace the cover. See "[Replacing the Cover](#)."
8. Stand the system upright.

9. Install the bezel. See "[Installing the Bezel.](#)"
10. Reconnect the system to its electrical outlet and turn the system on, including any attached peripherals.

If the problem persists, see "[Getting Help.](#)"

Troubleshooting System Cooling Problems

Problem

1. Cooling fan is not operating properly.
1. Systems management software issues a fan-related error message.

Action

Ensure that none of the following conditions exist:

1. Ambient temperature is too high.
1. Front and back external airflow is obstructed.
1. Cables inside the system obstruct airflow.
1. An individual cooling fan has failed. See "[Troubleshooting a Fan.](#)"

Troubleshooting a Fan

Problem

1. Systems management software issues a fan-related error message.

Action

 **CAUTION:** See your *System Information Guide* for complete information about safety precautions, working inside the computer, and protecting against electrostatic discharge.

1. Run the appropriate online diagnostic test. See "[Using Server Administrator Diagnostics](#)" in "Running System Diagnostics."
2. Turn off the system and attached peripherals, and disconnect the system from the electrical outlet.
3. Remove the bezel. See "[Removing the Bezel.](#)"
4. Lay the system on its right side.
5. Remove the cover. See "[Removing the Cover.](#)"
6. Ensure that the fan cables are properly connected to the fan connectors on the system board.

To identify the system board connectors, see [Figure A-3](#).

7. Replace the cover. See "[Replacing the Cover.](#)"
8. Stand the system upright.
9. Install the bezel. See "[Installing the Bezel.](#)"
10. Reconnect the system to its electrical outlet and turn the system on, including any attached peripherals.

If the problem persists, replace the faulty fan. See "[System Fans](#)" in "Installing System Options."

If the problem is not resolved after a replacement fan is installed, see "[Getting Help.](#)"

Troubleshooting System Memory

Problem

1. Faulty memory module.
1. Faulty system board.

Action

 **CAUTION:** See your *System Information Guide* for complete information about safety precautions, working inside the computer, and protecting against electrostatic discharge.

1. Run the appropriate online diagnostic test. See "[Using Server Administrator Diagnostics](#)" in "Running System Diagnostics."
2. Turn on the system and attached peripherals.

If an error message does not appear, continue to the next step.

If an error message appears, go to [step 15](#).

3. Enter the System Setup program and check the system memory setting. See "Using the System Setup Program" in your *User's Guide*.

If the amount of memory installed matches the system memory setting, go to [step 18](#).

4. Turn off the system and attached peripherals, and disconnect the system from the electrical outlet.
5. Remove the bezel. See "[Removing the Bezel](#)."
6. Lay the system on its right side.
7. Remove the cover. See "[Removing the Cover](#)."
8. Remove the cooling shroud. See "[Removing the Cooling Shroud](#)" in "Installing System Options."
9. Reseat the memory modules in their sockets. See "[Installing Memory Modules](#)" in "Installing System Options."
10. Install the cooling shroud. See "[Installing the Cooling Shroud](#)" in "Installing System Options."
11. Replace the cover. See "[Replacing the Cover](#)."
12. Stand the system upright.
13. Install the bezel. See "[Installing the Bezel](#)."
14. Reconnect the system to its electrical outlet, and turn on the system and attached peripherals.
15. Enter the System Setup program and check the system memory setting. See "Using the System Setup Program" in your *User's Guide*.

If the amount of memory installed does not match the system memory setting, then perform the following steps:

- a. Turn off the system and attached peripherals, and disconnect the system from its electrical outlet.
- b. Remove the bezel. See "[Removing the Bezel](#)."
- c. Lay the system on its right side.
- d. Remove the cover. See "[Removing the Cover](#)."
- e. Remove the cooling shroud. See "[Removing the Cooling Shroud](#)" in "Installing System Options."

 **NOTE:** Several configurations for memory modules exist; see "[Memory Module Installation Guidelines](#)" in "Installing System Options."

- f. Swap the memory module in socket 1 with another of the same capacity. See "[Installing Memory Modules](#)" in "Installing System Options."
- g. Install the cooling shroud. See "[Installing the Cooling Shroud](#)" in "Installing System Options."
- h. Replace the cover. See "[Replacing the Cover](#)."
- i. Stand the system upright.
- j. Install the bezel. See "[Installing the Bezel](#)."

16. Reconnect the system to its electrical outlet, and turn on the system and attached peripherals.
17. As the system boots, observe the monitor screen and the indicators on the keyboard.
18. If an error message still appears, perform [step 15](#) through [step 17](#) for each additional error message.

If the problem persists, see "[Getting Help](#)."

19. Run the system memory test in the system diagnostics. See "[Running System Diagnostics](#)."

If the test fails, see "[Getting Help](#)."

Troubleshooting a Diskette Drive

Problem

1. Error message indicates a diskette-drive problem.

Action

1. Enter the System Setup program and verify that the diskette drive is configured correctly. See "Using the System Setup Program" in the *User's Guide*.
2. Run the appropriate online diagnostic test. See "[Using Server Administrator Diagnostics](#)" in "Running System Diagnostics."

⚠ CAUTION: See your *System Information Guide* for complete information about safety precautions, working inside the computer, and protecting against electrostatic discharge.

3. Turn off the system and attached peripherals, and disconnect the system from the electrical outlet.
4. Remove the bezel. See "[Removing the Bezel](#)."
5. Lay the system on its right side.
6. Remove the cover. See "[Removing the Cover](#)."
7. Ensure that the diskette drive interface cable is securely connected to the diskette drive and the system board. To identify the connectors, see [Figure A-3](#).
8. Ensure that a power cable is properly connected to the drive.
9. Replace the cover. See "[Replacing the Cover](#)."
10. Stand the system upright.
11. Install the bezel. See "[Installing the Bezel](#)."
12. Reconnect the system to the electrical outlet, and turn on the system and attached peripherals.
13. Run the diskette drive tests to see whether the diskette drive works correctly.

If the tests fail, continue to the next step.

14. Turn off the system and attached peripherals, and disconnect the system from its electrical outlet.
15. Remove the bezel. See "[Removing the Bezel](#)."
16. Lay the system on its right side.
17. Remove the cover. See "[Removing the Cover](#)."
18. Remove all expansion cards installed in the system. See "[Removing an Expansion Card](#)" in "Installing System Options."
19. Replace the cover. See "[Replacing the Cover](#)."
20. Stand the system upright.
21. Install the bezel. See "[Installing the Bezel](#)."
22. Reconnect the system to the electrical outlet, and turn on the system and attached peripherals.
23. Run the diskette drive tests to see whether the diskette drive works correctly.

If the tests run successfully, an expansion card may be conflicting with the diskette drive logic, or an expansion card may be faulty. Continue to the next step.

If the tests fail, see "[Getting Help](#)."

24. Turn off the system and attached peripherals, and disconnect the system from the electrical outlet.
25. Remove the bezel. See "[Removing the Bezel](#)."
26. Lay the system on its right side.
27. Remove the cover. See "[Removing the Cover](#)."
28. Reinstall one of the expansion cards you removed in [step 18](#). See "[Installing an Expansion Card](#)" in "Installing System Options."
29. Replace the cover. See "[Replacing the Cover](#)."
30. Stand the system upright.
31. Install the bezel. See "[Installing the Bezel](#)."
32. Reconnect the system to the electrical outlet, and turn on the system and attached peripherals.
33. Run the diskette drive tests to see whether the diskette drive works correctly.
34. Repeat [step 24](#) through [step 33](#) until all expansion cards are reinstalled or one of the expansion cards causes the tests to fail.

If the problem is not resolved, see "[Getting Help](#)."

Troubleshooting a CD, DVD, or CD-RW/DVD Drive

Problem

- 1 System cannot read data from the disc in the drive.
- 1 The drive indicator does not blink during boot.

Action

1. Try using a different disc that you know works properly.
2. Enter the System Setup program and ensure that the drive's controller is enabled. See "Using the System Setup Program" in the *User's Guide*.
3. Run the appropriate online diagnostic test. See "[Using Server Administrator Diagnostics](#)" in "Running System Diagnostics."

⚠ CAUTION: See your *System Information Guide* for complete information about safety precautions, working inside the computer, and protecting against electrostatic discharge.

4. Turn off the system and attached peripherals, and disconnect the system from the electrical outlet.
 5. Remove the bezel. See "[Removing the Bezel](#)."
 6. Lay the system on its right side.
 7. Remove the cover. See "[Removing the Cover](#)."
 8. Ensure that the interface cable is securely connected to the drive and to the controller.
 9. Ensure that a power cable is properly connected to the drive.
 10. Replace the cover. See "[Replacing the Cover](#)."
 11. Stand the system upright.
 12. Install the bezel. See "[Installing the Bezel](#)."
 13. Reconnect the system to the electrical outlet, and turn on the system and attached peripherals.
 14. Run the IDE device tests in the system diagnostics to determine whether the drive works correctly.
 15. If the problem is not resolved, see "[Getting Help](#)."
-

Troubleshooting SCSI Hard Drives

Troubleshooting a Hot-Plug SCSI Hard Drive

Problem

- 1 Device driver error.
- 1 Hard drive not recognized by the system.

Action

 **NOTICE:** This procedure can destroy data stored on the hard drive. Before you continue, back up all files on the hard drive.

1. Run the appropriate online diagnostic test. See "[Using Server Administrator Diagnostics](#)" in "[Running System Diagnostics](#)."

If the test fails, continue to the next step.

2. Run the SCSI controllers test and the hard drive tests in the system diagnostics. See "[Running System Diagnostics](#)."

For information about testing the controller, see the RAID controller's documentation.

If the tests fail, continue to the next step.

3. Restart the system and enter the RAID configuration utility.

 **NOTE:** To enter the utility, press <Ctrl><h>, <Ctrl><a>, or <Ctrl><m>, depending on the utility. See the documentation supplied with the controller for information about the configuration utility.

4. Ensure that the primary SCSI channel is enabled, and restart the system.
5. Verify that the device drivers are installed and configured correctly. See the operating system documentation.
6. Remove the bezel. See "[Removing the Bezel](#)."
7. If your hard drive is not configured in a RAID array, remove the hard drive and install it in another drive bay. See "[Hot-Plug SCSI Hard Drives](#)" in "Installing Drives."

If your hard drive is configured in a RAID array with four hard drives, install a new hard drive.

If your hard drive is configured in a RAID array with up to three hard drives, remove the hard drive and install the drive in an empty drive bay.

 **NOTICE:** Do not swap the hard drives in a four hard-drive RAID configuration. Doing so may corrupt the data on both hard drives.

8. Install the bezel. See "[Installing the Bezel](#)."
9. If the system recognizes the hard drive, reinstall the hard drive in the original bay. See "[Hot-Plug SCSI Hard Drives](#)" in "Installing Drives."

If the hard drive functions properly in the original bay, the drive carrier could have intermittent problems. Replace the drive carrier. See "[Hot-Plug SCSI Hard Drives](#)" in "Installing Drives."

If the problem persists, the SCSI backplane board has a defective connector. See "[Getting Help](#)."

 **CAUTION:** See your *System Information Guide* for complete information about safety precautions, working inside the computer, and protecting against electrostatic discharge.

10. Check the SCSI cable connections inside the system:
 - a. Turn off the system, including any attached peripherals, and disconnect the system from the electrical outlet.
 - b. Remove the bezel. See "[Removing the Bezel](#)."
 - c. Lay the system on its right side.
 - d. Remove the cover. See "[Removing the Cover](#)."

- e. Verify that the SCSI cable is securely connected to the RAID controller card.
 - f. Replace the cover. See "[Replacing the Cover](#)."
 - g. Stand the system upright.
 - h. Install the bezel. See "[Installing the Bezel](#)."
11. Format and partition the hard drive. See the operating system documentation.
 12. If possible, restore the files to the drive.

If the problem persists, see "[Getting Help](#)."

Troubleshooting a Cabled SCSI Hard Drive

Problem

1. Device driver error.
1. Hard drive not recognized by the system.

Action

 **NOTICE:** This procedure can destroy data stored on the hard drive. Before you continue, back up all files on the hard drive.

1. Run the appropriate online diagnostic test. See "[Using Server Administrator Diagnostics](#)" in "Running System Diagnostics."

If the test fails, continue to the next step.

2. Run the SCSI controllers test and the hard drive tests in the system diagnostics. See "[Running System Diagnostics](#)."

For information about testing the controller, see the SCSI or RAID controller card's documentation.

If the tests fail, continue to the next step.

3. Restart the system and enter the configuration utility.

 **NOTE:** To enter the utility, press <Ctrl><h>, <Ctrl><a>, or <Ctrl><m>, depending on the utility. See the documentation supplied with the controller for information about the configuration utility.

4. Ensure that the primary SCSI channel is enabled, and restart the system. See the controller card's documentation.
5. Ensure that the required device drivers are installed and configured correctly. See the *Dell OpenManage Server Assistant CD*.

 **CAUTION:** See your *System Information Guide* for complete information about safety precautions, working inside the computer, and protecting against electrostatic discharge.

6. Turn off the system and attached peripherals, and disconnect the system from the electrical outlet.
7. Remove the bezel. See "[Removing the Bezel](#)."
8. Lay the system on its right side.
9. Remove the cover. See "[Removing the Cover](#)."
10. Ensure that the hard-drive interface cable is properly connected between the drive and the controller card. See the controller card's documentation.
11. If the hard drive is the boot drive, ensure that the drive is configured and connected properly. See "[Configuring the Boot Drive](#)" in "Installing Drives."
12. Ensure that a power cable is properly connected to the drive.
13. Ensure that the controller card is installed correctly.
14. Ensure that the hard drive is configured with a unique SCSI ID number and that the drive is terminated or not terminated as appropriate. See the documentation for the hard drive.
15. Install the cover. See "[Replacing the Cover](#)."
16. Stand the system upright.

17. Install the bezel. See "[Installing the Bezel.](#)"
18. Reconnect the system to the electrical outlet, and turn on the system and attached peripherals.
19. Format and partition the hard drive. See the operating system documentation.
20. If possible, restore the files to the drive.

If the problem persists, see "[Getting Help.](#)"

Troubleshooting SATA Hard Drives

Troubleshooting a SATA Hard Drive Connected to the Integrated Drive Controller

Problem

1. Faulty hard drive.
1. Damaged or improperly connected hard-drive cables.

Action

 **NOTICE:** This troubleshooting procedure can destroy data stored on the hard drive. Before you proceed, back up all files on the hard drive.

 **NOTE:** If the SATA hard drive is used in a RAID configuration, see "[Troubleshooting a SATA Hard Drive in a RAID Configuration \(When Available\).](#)"

1. Run the appropriate online diagnostic test. See "[Using Server Administrator Diagnostics](#)" in "Running System Diagnostics."

If the test fails, continue to the next step.

2. Enter the System Setup program and verify that the system is configured correctly. See "Using the System Setup Program" in your *User's Guide*.
3. Run the hard drive and SATA devices tests in the system diagnostics. See "[Running System Diagnostics.](#)"

If the tests fail, continue to the next step.

 **CAUTION:** See your *System Information Guide* for complete information about safety precautions, working inside the computer, and protecting against electrostatic discharge.

4. Turn off the system and attached peripherals, and disconnect the system from the electrical outlet.
5. Remove the bezel. See "[Removing the Bezel.](#)"
6. Stand the system upright.
7. Remove the cover. See "[Removing the Cover.](#)"
8. Ensure that the hard-drive interface cable is properly connected to the drive and to the appropriate SATA port connector on the system board.

To identify the SATA port connectors, see [Figure A-3](#).

9. If the hard drive is the boot drive, ensure that the drive is configured and connected properly. See "[Configuring the Boot Drive](#)" in "Installing Drives."
10. Ensure that the power cable is properly connected to the drive.
11. Replace the cover. See "[Replacing the Cover.](#)"
12. Stand the system upright.
13. Install the bezel. See "[Installing the Bezel.](#)"
14. Reconnect the system to the electrical outlet, and turn on the system and attached peripherals.
15. Format and partition the hard drive. See the operating system documentation.
16. If possible, restore the files to the drive.

If the problem persists, see "[Getting Help](#)."

Troubleshooting a SATA Hard Drive in a RAID Configuration (When Available)

Problem

- 1 Device driver error.
- 1 Damaged or improperly connected hard-drive cables.

Action

 **CAUTION:** See your *System Information Guide* for complete information about safety precautions, working inside the computer, and protecting against electrostatic discharge.

 **NOTICE:** This troubleshooting procedure can destroy data stored on the hard drive. Before you proceed, back up all files on the hard drive.

1. Run the appropriate online diagnostic test. See "[Using Server Administrator Diagnostics](#)" in "Running System Diagnostics."

If the test fails, continue to the next step.

2. Restart your system and enter the RAID configuration utility. See the RAID controller card's documentation.
3. Ensure that the required device drivers are installed and are configured correctly. See the *Dell OpenManage Server Assistant* CD and the RAID controller card's documentation.
4. Turn off the system and attached peripherals, and disconnect the system from the electrical outlet.
5. Remove the bezel. See "[Removing the Bezel](#)."
6. Lay the system on its right side.
7. Remove the cover. See "[Removing the Cover](#)."
8. Ensure that the hard-drive interface cable is properly connected to the drive and to the controller card. See the card's documentation.
9. Ensure that the RAID controller card is installed correctly. See "[Expansion Cards](#)" in "Installing System Options."
10. If the hard drive is the boot drive, ensure that the drive is configured and connected properly. See "[Configuring the Boot Drive](#)" in "Installing Drives."
11. Ensure that the power cable is properly connected to the drive.
12. Replace the cover. See "[Replacing the Cover](#)."
13. Stand the system upright.
14. Install the bezel. See "[Installing the Bezel](#)."
15. Reconnect the system to the electrical outlet, and turn on the system and attached peripherals.
16. Format and partition the hard drive. See the operating system documentation.
17. If possible, restore the files to the drive.

If the problem persists, see "[Getting Help](#)."

Troubleshooting Expansion Cards

 **NOTE:** When troubleshooting an expansion card, see the documentation for your operating system and the expansion card.

Problem

- 1 Error message indicates a problem with an expansion card.
- 1 Expansion card performs incorrectly or not at all.

Action

1. Run the appropriate online diagnostic test. See "[Using Server Administrator Diagnostics](#)" in "Running System Diagnostics."
2. Turn off the system and attached peripherals, and disconnect the system from the electrical outlet.
3. Remove the bezel. See "[Removing the Bezel](#)."
4. Lay the system on its right side.

⚠ CAUTION: See your *System Information Guide* for complete information about safety precautions, working inside the computer, and protecting against electrostatic discharge.

5. Remove the cover. See "[Removing the Cover](#)."
6. Ensure that each expansion card is firmly seated in its connector. See "[Installing an Expansion Card](#)" in "Installing System Options."
7. Replace the cover. See "[Replacing the Cover](#)."
8. Stand the system upright.
9. Install the bezel. See "[Installing the Bezel](#)."
10. Reconnect the system to the electrical outlet, and turn on the system and attached peripherals.
11. Run the appropriate tests in the system diagnostics. See "[Running System Diagnostics](#)."

If the problem persists, go to the next step.

12. Turn off the system and attached peripherals, and disconnect the system from the electrical outlet.
13. Remove the bezel. See "[Removing the Bezel](#)."
14. Lay the system on its right side.
15. Remove the cover. See "[Removing the Cover](#)."
16. Remove all expansion cards installed in the system. See "[Removing an Expansion Card](#)" in "Installing System Options."
17. Replace the cover. See "[Replacing the Cover](#)."
18. Stand the system upright.
19. Install the bezel. See "[Installing the Bezel](#)."
20. Reconnect the system to the electrical outlet, and turn on the system and attached peripherals.
21. Run **Quick Tests** in the system diagnostics.

If the tests fail, see "[Getting Help](#)."

22. For each expansion card you removed in [step 16](#), perform the following steps:
 - a. Turn off the system and attached peripherals, and disconnect the system from the electrical outlet.
 - b. Remove the bezel. See "[Removing the Bezel](#)."
 - c. Lay the system on its right side.
 - d. Remove the cover. See "[Removing the Cover](#)."
 - e. Reinstall one of the expansion cards.
 - f. Replace the cover. See "[Replacing the Cover](#)."
 - g. Stand the system upright.
 - h. Install the bezel. See "[Installing the Bezel](#)."
 - i. Run the appropriate tests in the system diagnostics.

If the tests fail, see "[Getting Help](#)."

If you reinstall all of the expansion cards and the tests fail, see "[Getting Help](#)."

Troubleshooting the Processor

Problem

- 1 Error message indicates a processor problem.
- 1 A heat sink is not installed for the processor.

Action

 **CAUTION:** See your *System Information Guide* for complete information about safety precautions, working inside the computer, and protecting against electrostatic discharge.

1. Ensure that you are running the latest BIOS version.

You can download the latest BIOS version from the Dell Support website at support.dell.com.

2. Run the appropriate online diagnostics test. See "[Using Server Administrator Diagnostics](#)" in "Running System Diagnostics."
3. Turn off the system and attached peripherals, and disconnect the system from the electrical outlet.
4. Remove the bezel. See "[Removing the Bezel](#)."
5. Lay the system on its right side.
6. Remove the cover. See "[Removing the Cover](#)."
7. Remove the cooling shroud. See "[Removing the Cooling Shroud](#)" in "Installing System Options."
8. Ensure that the processor and heat sink are properly installed. See "[Replacing the Processor](#)" in "Installing System Options."
9. Install the cooling shroud. See "[Installing the Cooling Shroud](#)" in "Installing System Options."
10. Install the cover. See "[Replacing the Cover](#)."
11. Stand the system upright.
12. Install the bezel. See "[Installing the Bezel](#)."
13. Reconnect the system to the electrical outlet, and turn on the system and attached peripherals.
14. Run **Quick Tests** in the system diagnostics. See "[Running System Diagnostics](#)."

If the tests fail or the problem persists, see "[Getting Help](#)."

[Back to Contents Page](#)

Installing System Options

Dell™ PowerEdge™ 700 Systems Installation and Troubleshooting Guide

- [Cooling Shroud](#)
- [System Fans](#)
- [Memory Modules](#)
- [Processor](#)
- [Expansion Cards](#)
- [System Battery](#)

This section describes how to remove and install the following components:

- 1 Cooling shroud
 - 1 System fans
 - 1 Memory modules
 - 1 Processor
 - 1 Expansion cards
 - 1 System battery
-

Cooling Shroud

The cooling shroud provides cooling for the processor and heat sink.

Removing the Cooling Shroud

⚠ CAUTION: See your *System Information Guide* for complete information about safety precautions working inside the computer and protecting against electrostatic discharge.

1. Turn off the system, including any attached peripherals, and disconnect the system from the electrical outlet.
2. Remove the bezel. See "[Removing the Bezel](#)" in "Troubleshooting Your System."
3. Lay the system on its right side.
4. Remove the cover. See "[Removing the Cover](#)" in "Troubleshooting Your System."
5. Disconnect the power cables and hard-drive interface cable connectors from the SCSI backplane (if applicable) or hard drives.
6. Press the shroud release tab on the back panel toward the top of the system. See [Figure 6-1](#).
7. Gently lift the cooling shroud away from the system board.

Figure 6-1. Removing the Cooling Shroud

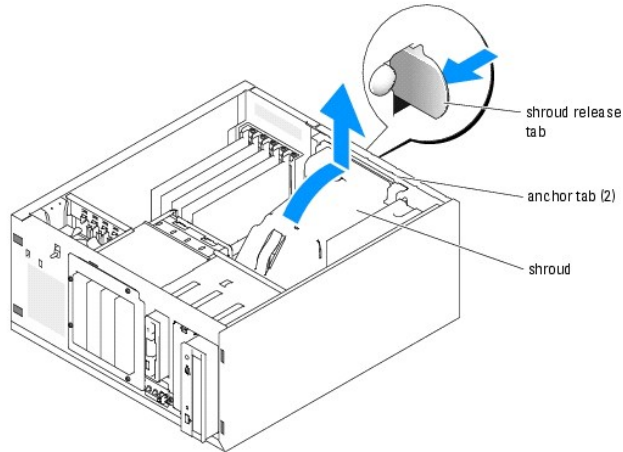

Installing the Cooling Shroud

1. Ensure that no tools or loose parts are left inside the system.
 2. Align the anchor tabs on the cooling shroud with the holes in the system chassis.
 3. Reposition the SCSI and power cables so they do not obstruct the DIMMs and interfere with installing the cooling shroud.
 4. Gently lower the cooling shroud until the shroud release tab on the back panel snaps into place.
 5. Reconnect the power cable(s) to the SCSI backplane (if applicable) or the hard drive(s).
-

System Fans

The system includes the following cooling fans:

- 1 Front system fan
- 1 Back system fan

Removing the Front System Fan

⚠ CAUTION: See your *System Information Guide* for complete information about safety precautions working inside the computer and protecting against electrostatic discharge.

[Figure 6-2](#) illustrates the front system fan inside the system and the fan cable routing hole in the expansion-card guide bracket.

1. Turn off the system, including any attached peripherals, and disconnect the system from the electrical outlet.
2. Remove the bezel. See "[Removing the Bezel](#)" in "Troubleshooting Your System."
3. Lay the system on its right side.
4. Remove the cover. See "[Removing the Cover](#)" in "Troubleshooting Your System."
5. Disconnect the fan cable from the FRONT_FAN connector on the system board.

To identify system board connectors, see [Figure A-3](#).

6. Press the release tabs on the top of the fan assembly and lift the fan assembly away from the system until the fan cable and connector are clear of the routing hole in the expansion-card guide bracket. See [Figure 6-2](#).

Figure 6-2. Removing and Replacing the Front System Fan

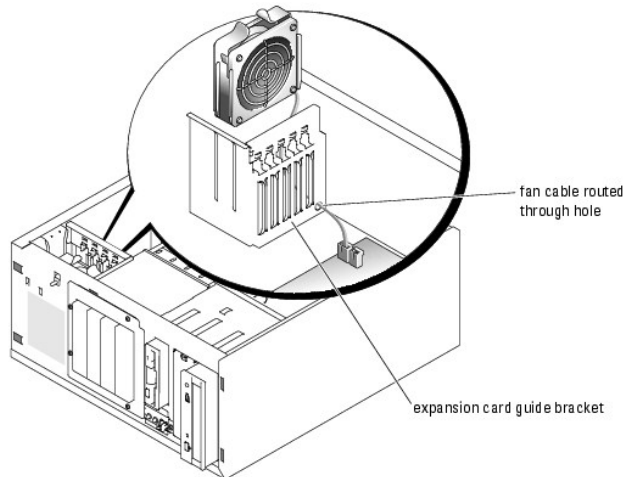

Installing the Front System Fan

⚠ CAUTION: See your *System Information Guide* for complete information about safety precautions working inside the computer and protecting against electrostatic discharge.

1. Insert the fan cable connector into the routing hole in the expansion-card guide bracket. See [Figure 6-2](#).
2. Align the fan assembly with the slots in the chassis and gently lower the assembly into the chassis. See [Figure 6-3](#).
3. Pull the fan cable through the routing hole in the expansion-card guide bracket. See [Figure 6-2](#).
4. Connect the fan cable connector to the FRONT_FAN connector on the system board.

To identify system board connectors, see [Figure A-3](#).

5. Install the cover. See "[Replacing the Cover](#)" in "Troubleshooting Your System."
6. Stand the system upright.
7. Install the bezel. See "[Installing the Bezel](#)" in "Troubleshooting Your System."

Reconnect the system to its electrical outlet and turn the system on, including any attached peripherals.

Figure 6-3. Removing and Replacing the Front System Fan

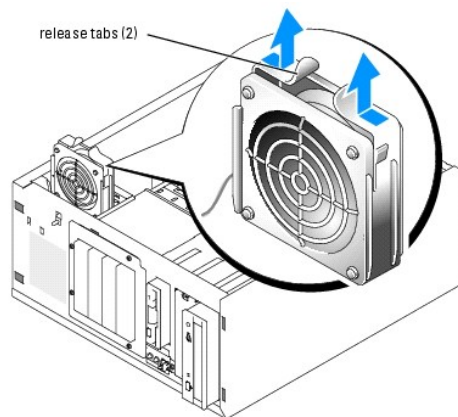

Removing the Back System Fan

⚠ CAUTION: See your *System Information Guide* for complete information about safety precautions working inside the computer and protecting against electrostatic discharge.

1. Turn off the system, including any attached peripherals, and disconnect the system from the electrical outlet.
2. Remove the bezel. See "[Removing the Bezel](#)" in "Troubleshooting Your System."
3. Lay the system on its right side.
4. Remove the cover. See "[Removing the Cover](#)" in "Troubleshooting Your System."
5. Remove the cooling shroud. See "[Removing the Cooling Shroud](#)."
6. Disconnect the fan cable from the BACK_FAN connector on the system board. To identify system board connectors, see [Figure A-3](#).
7. Pull the release tab on the fan assembly away from the back panel and slide the fan assembly about 0.63 cm (0.25 inch) toward the expansion-card slots. See [Figure 6-4](#).
8. Pull the fan assembly forward and lift the assembly out of the system. See [Figure 6-4](#).

Figure 6-4. Removing the Back System Fan

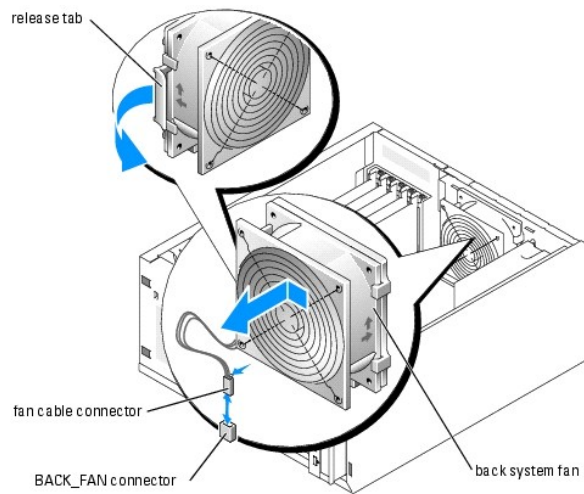

Installing the Back System Fan

⚠ CAUTION: See your *System Information Guide* for complete information about safety precautions working inside the computer and protecting against electrostatic discharge.

1. Align the tabs on the fan bracket with the mounting holes in the back panel and slide the fan assembly toward the power supply about 0.63 cm (0.25 inch) until the fan bracket release tab snaps into place. See [Figure 6-4](#).
2. Connect the fan cable to the BACK_FAN connector on the system board.

To identify system board connectors, see [Figure A-3](#).

3. Install the cooling shroud. See "[Installing the Cooling Shroud](#)."
4. Install the cover. See "[Replacing the Cover](#)" in "Troubleshooting Your System."
5. Stand the system upright.
6. Install the bezel. See "[Installing the Bezel](#)" in "Troubleshooting Your System."
7. Reconnect the system to its electrical outlet and turn the system on, including any attached peripherals.

Memory Modules

The four memory module connectors on the system board can accommodate up to 4 GB of memory by installing combinations of 256-MB, 512-MB, and 1-GB unbuffered DDR-400 SDRAM modules. You can purchase memory upgrade kits as needed.

Memory Module Installation Guidelines

The memory module sockets are arranged in banks (1 and 2) on two channels (A and B). Unless only one 256-MB memory module is installed, the modules must be installed in identical pairs. For example, if you are installing 512-MB of total system memory, sockets DIMM1_A and DIMM1_B (bank 1) must contain 256-MB memory modules.

Starting with the connector closest to the processor, the memory module sockets are labeled "DIMM1_A" through "DIMM2_B" (see [Figure A-3](#)). When installing the memory modules, use the following guidelines:

- 1 Use only DDR-400 memory modules.
- 1 If you are installing one 256-MB memory module, install the module in the DIMM1_A socket.
- 1 If you are installing 512-MB or more of total memory, install identical memory modules in a bank.

The memory module banks are identified as follows:

- o Bank 1: DIMM1_A and DIMM1_B
 - o Bank 2: DIMM2_A and DIMM2_B
- 1 Unless only one 256-MB memory module is installed, bank 1 must contain two identical memory modules. However, you can configure bank 1 and bank 2 with different size memory modules.
 - 1 Installing three memory modules is not supported.
 - 1 Install memory modules in bank 1 (DIMM1_x) before installing memory modules in bank 2 (DIMM2_x).

[Table 6-1](#) lists the supported memory module configurations for the system.

Table 6-1. Supported Memory Module Configurations

Total Memory	DIMM1_A	DIMM2_A	DIMM1_B	DIMM2_B
256 MB	256 MB	None	None	None
512 MB	256 MB	None	256 MB	None
1 GB	256 MB	256 MB	256 MB	256 MB
1 GB	512 MB	None	512 MB	None
1.5 GB	512 MB	256 MB	512 MB	256 MB
2 GB	512 MB	512 MB	512 MB	512 MB
2 GB	1 GB	None	1 GB	None
3 GB	1 GB	512 MB	1 GB	512 MB
4 GB	1 GB	1 GB	1 GB	1 GB

Performing a Memory Upgrade

 **CAUTION:** See your *System Information Guide* for complete information about safety precautions working inside the computer and protecting against electrostatic discharge.

1. Turn off the system, including any attached peripherals, and disconnect the system from the electrical outlet.
2. Remove the bezel. See "[Removing the Bezel](#)" in "Troubleshooting Your System."
3. Lay the system on its right side.
4. Remove the cover. See "[Removing the Cover](#)" in "Troubleshooting Your System."
5. Remove the cooling shroud. See "[Removing the Cooling Shroud](#)."
6. Install or remove memory modules as necessary to reach the desired memory total. See "[Installing Memory Modules](#)" and "[Removing Memory Modules](#)."

See [Figure A-3](#) to locate the memory module connectors.

7. Install the cooling shroud. See "[Installing the Cooling Shroud](#)."
8. Install the cover. See "[Replacing the Cover](#)" in "Troubleshooting Your System."

9. Stand the system upright.
10. Install the bezel. See "[Installing the Bezel](#)" in "Troubleshooting Your System."
11. Reconnect the system to its electrical outlet and turn the system on, including any attached peripherals.

After the system completes the POST routine, it runs a memory test.

If you installed new memory modules, the system detects the total amount of system memory and compares this value with the system configuration information, which is stored in NVRAM.

If you install a new memory module that does not modify the total system memory, the monitor does not display a memory message.

If you install a new memory module that increases the total system memory, the monitor displays the following message:

The amount of system memory has changed.

If the new memory module decreases the total system memory, the monitor displays the following message.

The amount of system memory has changed.

Press <F1> to continue; <F2> to enter System Setup

12. Press <F2> to enter the System Setup program, and check the **System Memory** setting.

The system should have already changed the value in the **System Memory** setting to reflect the newly installed memory.

13. If the **System Memory** value is incorrect, one or more of the memory modules may not be installed properly. Repeat [step 1](#) through [step 12](#), ensuring that the memory modules are firmly seated in their connectors.
14. Run the system memory test in the system diagnostics.

Installing Memory Modules

 **CAUTION:** See your *System Information Guide* for complete information about safety precautions working inside the computer and protecting against electrostatic discharge.

1. Turn off the system, including any attached peripherals, and disconnect the system from the electrical outlet.
2. Remove the bezel. See "[Removing the Bezel](#)" in "Troubleshooting Your System."
3. Lay the system on its right side.
4. Remove the cover. See "[Removing the Cover](#)" in "Troubleshooting Your System."
5. Remove the cooling shroud. See "[Removing the Cooling Shroud](#)."
6. Locate the memory module connectors in which you will install a memory module. See [Figure A-3](#).
7. Press down and outward on the memory module ejectors, as shown in [Figure 6-5](#), to allow the memory module to be inserted into the connector.

Figure 6-5. Removing and Installing a Memory Module

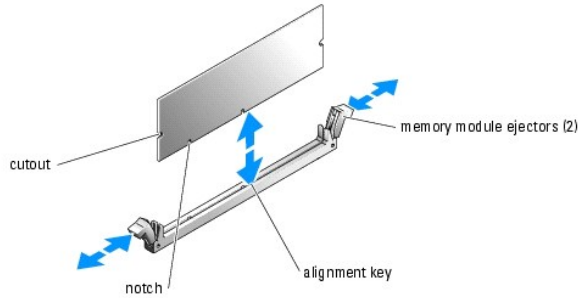

8. Align the memory module's edge connector with the alignment key, and insert the memory module in the connector. See [Figure 6-5](#).

The memory module connector has an alignment key that allows the memory module to be installed in the connector in only one way.

9. Press down on the memory module with your thumbs while pulling up on the ejectors with your index fingers to lock the memory module into the connector. See [Figure 6-5](#).

When the memory module is properly seated in the connector, the memory module ejectors should align with the ejectors on the other connectors with memory modules installed.

10. Repeat [step 6](#) through [step 9](#) of this procedure to install the remaining memory modules.
11. Install the cooling shroud. See "[Installing the Cooling Shroud](#)."
12. Install the cover. See "[Replacing the Cover](#)" in "Troubleshooting Your System."
13. Stand the system upright.
14. Install the bezel. See "[Installing the Bezel](#)" in "Troubleshooting Your System."
15. Perform [step 11](#) through [step 14](#) of the procedure in "[Performing a Memory Upgrade](#)."

Removing Memory Modules

⚠ CAUTION: See your *System Information Guide* for complete information about safety precautions working inside the computer and protecting against electrostatic discharge.

1. Turn off the system, including any attached peripherals, and disconnect the system from the electrical outlet.
2. Remove the bezel. See "[Removing the Bezel](#)" in "Troubleshooting Your System."
3. Lay the system on its right side.
4. Remove the cover. See "[Removing the Cover](#)" in "Troubleshooting Your System."
5. Remove the cooling shroud. See "[Removing the Cooling Shroud](#)."
6. Locate the memory module connectors from which you will remove memory modules. See [Figure A-3](#).
7. Press down and outward on the memory module connector ejectors until the memory module pops out of the connector. See [Figure 6-5](#).
8. Repeat [step 6](#) and [step 7](#) of this procedure to remove any other memory modules.
9. Install the cooling shroud. See "[Installing the Cooling Shroud](#)."
10. Install the cover. See "[Replacing the Cover](#)" in "Troubleshooting Your System."
11. Stand the system upright.
12. Install the bezel. See "[Installing the Bezel](#)" in "Troubleshooting Your System."
13. Perform [step 11](#) through [step 14](#) of the procedure in "[Performing a Memory Upgrade](#)."

Processor

To take advantage of future options in speed and functionality, you can upgrade the processor.

The processor and its associated cache memory are contained in a PGA package that is installed in a ZIF socket on the system board.

The following items are included in the processor upgrade kit:

- 1 A processor
- 1 A heat sink

Replacing the Processor

⚠ CAUTION: See your *System Information Guide* for complete information about safety precautions working inside the computer and protecting against electrostatic discharge.

1. Turn off the system, including any attached peripherals, and disconnect the system from the electrical outlet.
2. Remove the bezel. See "[Removing the Bezel](#)" in "Troubleshooting Your System."
3. Lay the system on its right side.
4. Remove the cover. See "[Removing the Cover](#)" in "Troubleshooting Your System."
5. Remove the cooling shroud. See "[Removing the Cooling Shroud](#)."

👉 NOTICE: The processor and heat sink can become extremely hot. Allow sufficient time for the processor and heat sink to cool before handling.

6. Remove the heat sink. See [Figure 6-6](#) and [Figure 6-7](#).

🔧 NOTE: Remove the heat sink while the processor is still warm.

- a. Remove one securing clip by pressing the tab on the clip until it clears the securing tab on the retention module, and then lift the clip up.
- b. Repeat [step a](#) for the remaining securing clip.
- c. Rotate the heat sink slightly and then lift the heat sink off the processor. Do not pry the processor off the heat sink.

Figure 6-6. Removing the Heat Sink (Low Profile)

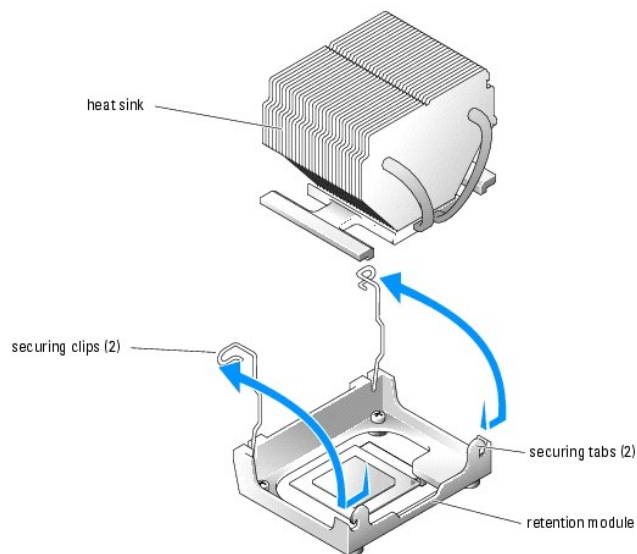
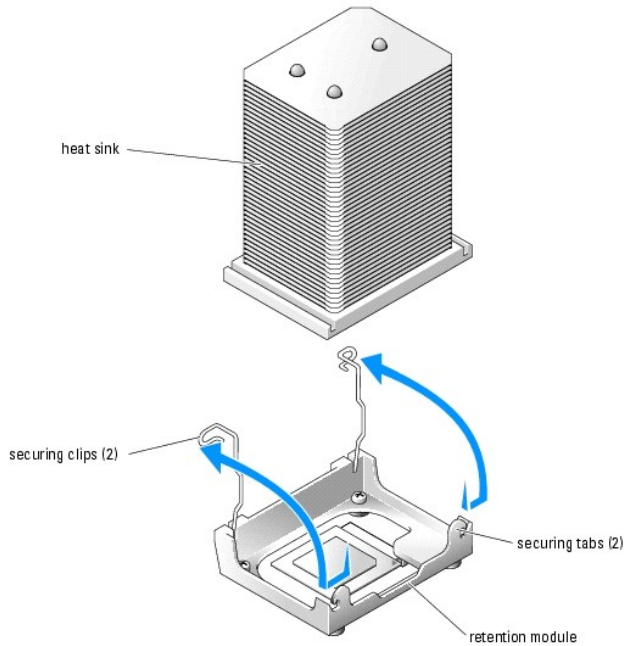

Figure 6-7. Removing the Heat Sink (High Profile)



7. Pull the socket release lever upward to the fully open position. See [Figure 6-8](#).

NOTICE: Be careful not to bend any of the pins when removing the processor. Bending the pins can permanently damage the processor.

8. Lift the processor out of the socket and leave the release lever in the open position so that the socket is ready for the new processor. See [Figure 6-8](#).

Figure 6-8. Replacing the Processor

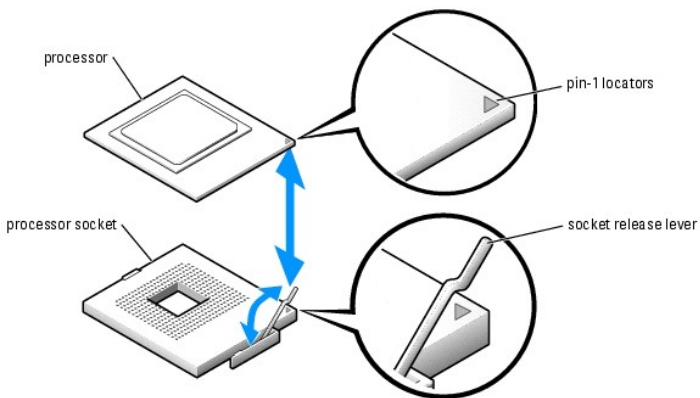

9. Unpack the new processor and heat sink.

If any of the pins on the processor appear bent, see "[Getting Help](#)" for instructions on obtaining technical assistance.

10. Ensure that the processor socket release lever is in the fully open position.
11. Align pin 1 on the processor (see [Figure 6-8](#)) with pin 1 on the processor socket.

NOTE: No force is needed to install the processor in the socket. When the processor is aligned correctly, it should drop into the socket.

12. Carefully install the processor in the socket and press it down lightly to seat it. See [Figure 6-8](#).

➡ **NOTICE:** Positioning the processor incorrectly can permanently damage the processor and the system when you turn on the system. When placing the processor in the socket, be sure that all of the pins on the processor go into the corresponding holes. Be careful not to bend the pins.

13. When the processor is fully seated in the socket, rotate the socket release lever back down until it snaps into place, securing the processor in the socket.

➡ **NOTICE:** Do not operate the system without the heat sink installed. The heat sink is required to maintain proper thermal conditions.

14. Remove the thermal grease protective cover from the new heat sink.

If you did not receive a new heat sink with the processor, see "[Getting Help](#)."

➡ **NOTICE:** If you are installing a heat sink with external cooling pipes, install the heat sink with the cooling pipes pointing towards the center of the system.

15. Lower the heat sink onto the processor. See [Figure 6-6](#) and [Figure 6-7](#).
16. Secure the heat sink to the retention module.
 - a. Gently press down on the heat sink and then press one securing clip to secure it.
 - b. Repeat [step a](#) for the remaining securing clip.
17. Ensure that the back fan connector is connected to the BACK_FAN connector on the system board. See [Figure 6-4](#) and [Figure A-3](#).
18. Install the cooling shroud. See "[Installing the Cooling Shroud](#)."
19. Install the cover. See "[Replacing the Cover](#)" in "Troubleshooting Your System."
20. Stand the system upright.
21. Install the bezel. See "[Installing the Bezel](#)" in "Troubleshooting Your System."
22. Reconnect the system to its electrical outlet and turn the system on, including any attached peripherals.
23. Enter the System Setup program, and ensure that the processor options match the new system configuration. See "Using the System Setup Program" in your *User's Guide*.

As the system boots, it detects the presence of the new processor and automatically changes the system configuration information in the System Setup program. A message similar to the following appears:

```
One 2.3 GHz Processor, Processor Bus: 400 MHz, L2 cache 128 KB Advanced
```

24. Confirm that the top line of the system data area in the System Setup program correctly identifies the installed processor(s). See "Using the System Setup Program" in your *User's Guide*.
25. Exit the System Setup program.
26. Ensure that your system is running the latest BIOS version.

You can download the latest BIOS version from the Dell Support website located at support.dell.com

27. Run the system diagnostics to verify that the new processor is operating correctly.

See "[Running the System Diagnostics](#)" for information on running the diagnostics and troubleshooting any problems that may occur.

Expansion Cards

The system supports up to five PCI expansion cards, which are installed in PCI slot connectors. Slots 1 and 2 supports PCI 32-bit, 33-MHz, 5.0-V expansion cards and slots 3, 4, and 5 support PCI-X 64-bit, 66-MHz, 3.3-V expansion cards. See [Figure A-3](#) to identify the expansion slots.

If you install a RAID controller card, it must be installed in slot 3, 4, or 5. If you install both a RAID controller card and an Ultra3 SCSI controller card, install the RAID controller card in PCI slot 5.

Installing an Expansion Card

⚠ CAUTION: See your *System Information Guide* for complete information about safety precautions working inside the computer and protecting against electrostatic discharge.

1. Unpack the expansion card, and prepare it for installation.

For instructions, see the documentation that accompanied the card.

2. Turn off the system, including any attached peripherals, and disconnect the system from the electrical outlet.
3. Remove the bezel. See "[Removing the Bezel](#)" in "Troubleshooting Your System."
4. Lay the system on its right side.
5. Remove the cover. See "[Removing the Cover](#)" in "Troubleshooting Your System."
6. Remove the filler bracket from the expansion slot.
7. Install the expansion card. See [Figure 6-9](#).
 - a. Position the expansion card so that the card-edge connector aligns with the expansion-card connector on the system board.
 - b. Insert the card-edge connector firmly into the expansion-card connector until the card is fully seated.
 - c. Install the screw that secures the expansion-card bracket to the back panel.
8. Connect any cables that should be attached to the card.

See the documentation that accompanied the card for information about its cable connections.

9. Install the cover. See "[Replacing the Cover](#)" in "Troubleshooting Your System."
10. Stand the system upright.
11. Install the bezel. See "[Installing the Bezel](#)" in "Troubleshooting Your System."
12. Reconnect the system to its electrical outlet and turn the system on, including any attached peripherals.
13. Install any device drivers required for the card as described in the documentation for the card.

Figure 6-9. Removing and Installing an Expansion Card

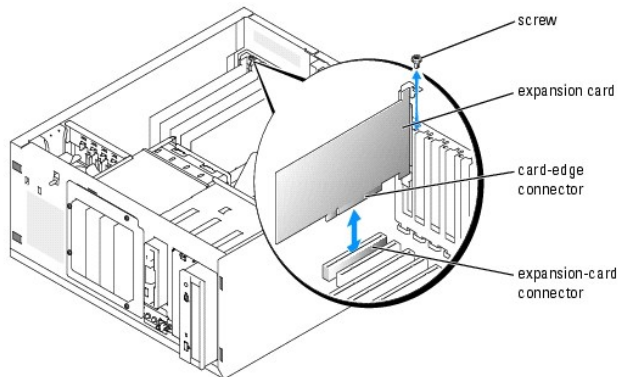

Removing an Expansion Card

⚠ CAUTION: See your *System Information Guide* for complete information about safety precautions working inside the computer and protecting against electrostatic discharge.

1. Turn off the system, including any attached peripherals, and disconnect the system from the electrical outlet.
2. Remove the bezel. See "[Removing the Bezel](#)" in "Troubleshooting Your System."
3. Lay the system on its right side.
4. Remove the cover. See "[Removing the Cover](#)" in "Troubleshooting Your System."
5. Disconnect any cables attached to the card.
6. Remove the expansion card (see [Figure 6-9](#)):
 - a. Remove the screw that secures the expansion-card bracket to the back panel.

- b. Grasp the expansion card by its top corners, and carefully remove it from the expansion- card connector.

NOTICE: You must install a filler bracket over an empty expansion slot to maintain Federal Communications Commission (FCC) certification of the system. The brackets also help keep dust and dirt out of the system and aid in proper cooling and airflow inside the system.

7. If you are removing the card permanently, install a metal filler bracket over the empty expansion slot opening and close the expansion-card latch.
8. Install the cover. See "[Replacing the Cover](#)" in "Troubleshooting Your System."
9. Stand the system upright.
10. Install the bezel. See "[Installing the Bezel](#)" in "Troubleshooting Your System."
11. Reconnect the system to its electrical outlet and turn the system on, including any attached peripherals.

System Battery

The system battery is a 3.0-volt (V), coin-cell battery.

Replacing the System Battery

CAUTION: See your *System Information Guide* for complete information about safety precautions working inside the computer and protecting against electrostatic discharge.

CAUTION: There is a danger of a new battery exploding if it is incorrectly installed. Replace the battery only with the same or equivalent type recommended by the manufacturer. Discard used batteries according to the manufacturer's instructions. See your *System Information Guide* for additional information.

1. Turn off the system, including any attached peripherals, and disconnect the system from the electrical outlet.
2. Remove the bezel. See "[Removing the Bezel](#)" in "Troubleshooting Your System."
3. Lay the system on its right side.
4. Remove the cover. See "[Removing the Cover](#)" in "Troubleshooting Your System."
5. Remove the expansion card(s) in slot 1 and slot 2 (if applicable). See "[Removing an Expansion Card](#)."
6. Remove the system battery. See [Figure 6-10](#).

See [Figure A-3](#) to locate the system battery on the system board.

You can pry the system battery out of its connector with your fingers or with a blunt, nonconductive object such as a plastic screwdriver.

7. Install the new system battery with the side labeled "+" facing up. See [Figure 6-10](#).

Figure 6-10. Replacing the System Battery

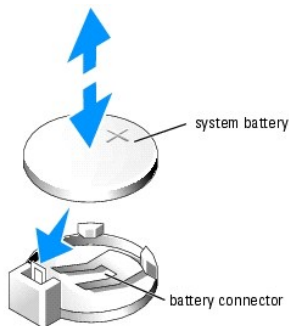

8. Install the expansion card(s) in slot 1 and slot 2 (if applicable). See "[Installing an Expansion Card](#)."
9. Replace the cover. See "[Replacing the Cover](#)" in "Troubleshooting Your System."

10. Stand the system upright.
 11. Install the bezel. See "[Installing the Bezel](#)" in "Troubleshooting Your System."
 12. Reconnect the system to its electrical outlet and turn the system on, including any attached peripherals.
 13. Enter the System Setup program to confirm that the battery is operating properly. See "Using the System Setup Program" in your *User's Guide*.
 14. Enter the correct time and date in the System Setup program's **Time** and **Date** fields.
 15. Exit the System Setup program.
 16. To test the newly installed battery, turn off the system and disconnect it from the electrical outlet for at least an hour.
 17. After an hour, reconnect the system to its electrical outlet and turn it on.
 18. Enter the System Setup program and if the time and date are still incorrect, see "[Getting Help](#)" for instructions on obtaining technical assistance.
-

[Back to Contents Page](#)

[Back to Contents Page](#)

Installing Drives

Dell™ PowerEdge™ 700 Systems Installation and Troubleshooting Guide

- [Connecting Drives](#)
- [Front-Panel Drive Inserts](#)
- [Diskette Drive](#)
- [5.25-Inch Drives](#)
- [Hard Drives](#)
- [Cabled SATA and SCSI Hard Drives](#)
- [Hot-Plug SCSI Hard Drives](#)
- [Installing a RAID Controller Card](#)

Your system supports the following drives:

- 1 Up to two externally accessible 5.25-inch drives (typically CD and tape backup drives). A CD drive is standard in the first external drive bay, and a tape backup device can be installed in the second external drive bay.
- 1 An externally accessible 3.5-inch diskette drive.
- 1 Up to four 1-inch SATA or SCSI hard drives.

Connecting Drives

Interface Cables

Most interface connectors are keyed for correct insertion. Keying ensures that the pin-1 wire in the cable connects to pin 1 in the connectors on both ends. When you disconnect an interface cable, take care to grasp the cable connector, rather than the cable itself, to avoid stress on the cable.

Drive Cable Configurations

Your system can accommodate many different drive configurations, each with specific cable requirements. [Table 7-1](#) shows the cable requirements for common drive configurations.

 **NOTE:** Installing SATA and SCSI hard drives in the same system is not supported.

Table 7-1. Drive Cable Configuration

Drives	Required Cable	Cable Connections
IDE CD, DVD, and CD-RW/DVD drives, and IDE and SCSI tape drives (See Figure 7-4 .)	40-pin IDE 2-drop cable or SCSI 1-drop cable (terminated)	IDE drive and primary IDE connector on system board or the SCSI tape device and the SCSI controller card
Up to two cabled SATA hard drives (See Figure 7-7 .)	7-pin SATA hard-drive cable (one cable per drive)	SATA hard drives and SATA port connectors on the system board
Three or four cabled SATA hard drives (See Figure 7-8 .)	One SATA hard-drive cable assembly for up to four drives	SATA hard drives and SATA RAID controller card (when available)
Up to four hot-plug SCSI hard drives (See Figure 7-10 .)	38-cm (15-inch) 68-pin SCSI 1-drop cable (unterminated)	SCSI backplane and the SCSI or RAID controller card
Up to four cabled (non-hot-plug) SCSI hard-drives (See Figure 7-9 .)	94-cm (37-inch) SCSI 4-drop cable (terminated)	SCSI hard drives and SCSI RAID controller or SCSI controller card

DC Power Cables

Each drive must connect to a DC power cable from the system power supply. These power cables are used for the 3.5-inch diskette drive, 5.25-inch devices, and hard drives.

🔔 **NOTICE:** To avoid electrical damage to internal system components, install a cover connector on any unused connectors on hard-drive power cables.

Front-Panel Drive Inserts

To help keep dust and dirt out of the system, a plastic insert in the bezel covers each empty external drive bay. Additionally, each empty external drive bay is covered by a metal insert in the chassis to maintain Federal Communications Commission (FCC) certification of the system.

Before you install a 5.25-inch drive in an empty external drive bay, you must first remove both front-panel drive inserts. If you remove a 5.25-inch drive permanently, you must install both inserts.

Removing the Front-Panel Drive Inserts

⚠️ **CAUTION:** See your *System Information Guide* for complete information about safety precautions working inside the computer and protecting against electrostatic discharge.

1. Turn off the system, including any attached peripherals, and disconnect the system from the electrical outlet.
2. Remove the bezel. See "[Removing the Bezel](#)" in "Troubleshooting Your System."
3. Remove the bezel drive insert (see [Figure 7-1](#)):
 - a. From inside the bezel, press the center of the insert outward with your thumbs to loosen the tabs on the sides of the insert.
 - b. Pull the insert out of the bezel.
4. Remove the chassis drive insert (see [Figure 7-1](#)):
 - a. Press both sides of the insert to loosen the tabs on the insert.
 - b. Pull the insert out of the chassis.

Figure 7-1. Removing the Front-Panel Drive Inserts

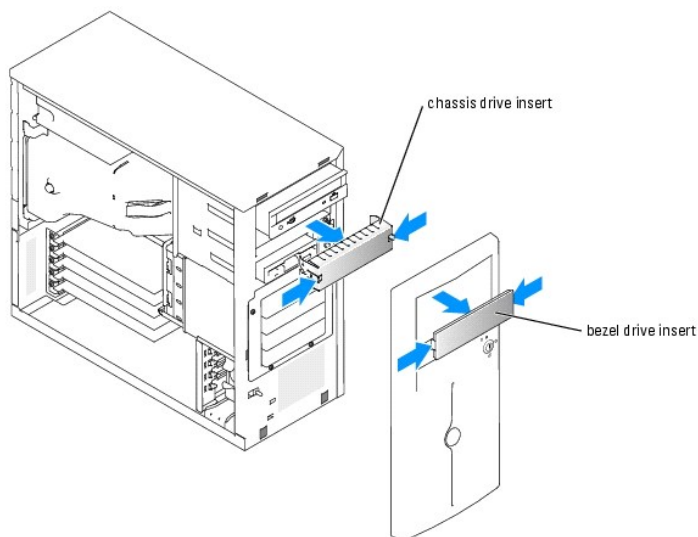

Installing the Front-Panel Drive Inserts

⚠️ **CAUTION:** See your *System Information Guide* for complete information about safety precautions working inside the computer and protecting against electrostatic discharge.

🔔 **NOTICE:** You must install both inserts in an empty 5.25-inch drive bay to maintain Federal Communications Commission (FCC) certification of the system. The inserts also help keep dust and dirt out of the system.

1. Install the chassis drive insert by sliding the insert into the chassis until tabs on the side of the insert snap into place. See [Figure 7-1](#).
 2. Install the bezel drive insert by sliding the insert into the bezel until the tabs on the side of the insert snap into place. See [Figure 7-1](#).
 3. Install the bezel. See "[Installing the Bezel](#)" in "Troubleshooting Your System."
 4. Reconnect the system to its electrical outlet and turn the system on, including any attached peripherals.
-

Diskette Drive

Removing a Diskette Drive

 **CAUTION:** See your *System Information Guide* for complete information about safety precautions working inside the computer and protecting against electrostatic discharge.

1. Turn off the system, including any attached peripherals, and disconnect the system from the electrical outlet.
2. Remove the bezel. See "[Removing the Bezel](#)" in "Troubleshooting Your System."
3. Lay the system on its right side.
4. Remove the cover. See "[Removing the Cover](#)" in "Troubleshooting Your System."
5. Disconnect the power cable and the interface cable from the diskette drive. See [Figure 7-2](#).
6. Remove the two screws that secure the diskette drive in the externally accessible drive bay. See [Figure 7-2](#).
7. Slide the diskette drive forward out of the drive bay.

Installing a Diskette Drive

 **CAUTION:** See your *System Information Guide* for complete information about safety precautions working inside the computer and protecting against electrostatic discharge.

1. Unpack the drive and prepare the drive for installation.

For instructions, see the documentation that accompanied the drive.

2. Slide the diskette drive into the externally accessible drive bay.
3. Install the two screws that secure the diskette drive in the drive bay. See [Figure 7-2](#).
4. Connect the power cable and the interface cable to the diskette drive. See [Figure 7-2](#).
5. Install the cover. See "[Replacing the Cover](#)" in "Troubleshooting Your System."
6. Stand the system upright.
7. Install the bezel. See "[Installing the Bezel](#)" in "Troubleshooting Your System."
8. Reconnect the system to its electrical outlet and turn the system on, including any attached peripherals.

Figure 7-2. Removing a Diskette Drive

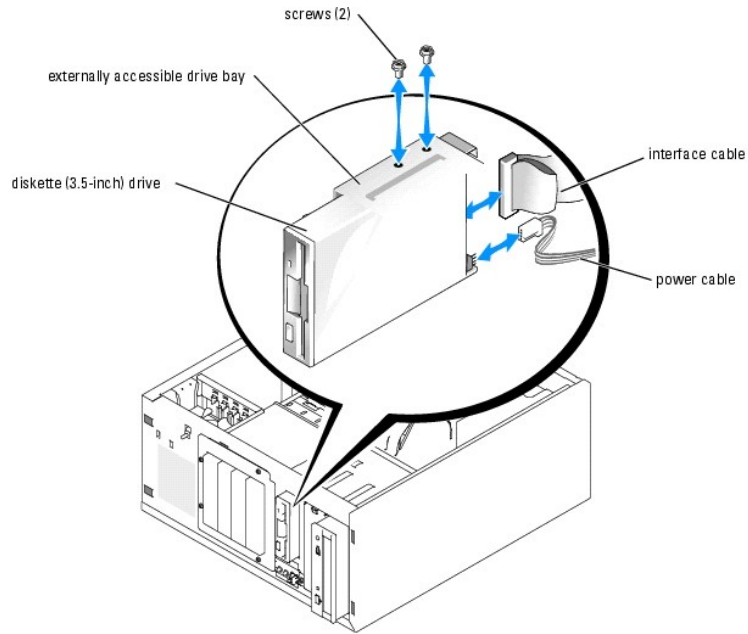

5.25-Inch Drives

A CD drive is standard in the first external drive bay. An additional IDE or SCSI tape backup device can be installed in the second external drive bay. These drives connect either to the system board or to an optional controller card.

 **NOTE:** Installing an additional CD, DVD, or CD-RW/DVD drive in the second external drive bay is not supported.

Installing a 5.25-Inch Drive

 **CAUTION:** See your *System Information Guide* for complete information about safety precautions working inside the computer and protecting against electrostatic discharge.

1. Unpack the drive (and controller card, if applicable), and prepare the drive for installation.

For instructions, see the documentation that accompanied the drive.

 **NOTE:** If you are installing a SCSI tape drive, you must install an Ultra 3 SCSI controller card. A RAID controller card does not support a SCSI tape drive.

2. Turn off the system, including any attached peripherals, and disconnect the system from the electrical outlet.
3. Remove the bezel. See "[Removing the Bezel](#)" in "Troubleshooting Your System."
4. Lay the system on its right side.
5. Remove the cover. See "[Removing the Cover](#)" in "Troubleshooting Your System."
6. Remove the cooling shroud. See "[Removing the Cooling Shroud](#)" in "Installing System Options."
7. Remove the front-panel inserts for the empty external drive bay. See "[Removing the Front-Panel Drive Inserts](#)."
8. Slide the drive into the external drive bay.
9. Install the screws that secure the drive in the drive bay. See [Figure 7-3](#).

Figure 7-3. Installing a 5.25-Inch Drive

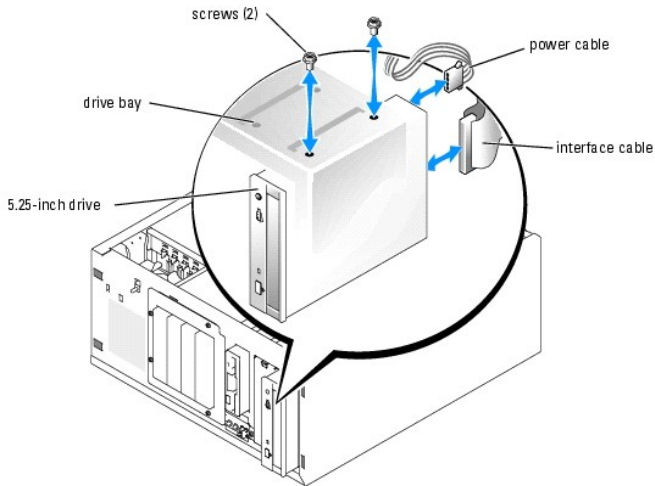

10. If a controller card was supplied with the drive, install the controller card in expansion slot 3, 4, or 5. See "[Installing an Expansion Card](#)" in "Installing System Options."
11. Connect a power cable to the drive. See [Figure 7-3](#).
12. Connect the interface cable to the drive and to the appropriate connector on the system board or controller card (if applicable).

NOTE: See the documentation that is included with the controller card for more information.

If you are installing an IDE device (such as a CD or DVD drive), connect the interface cable to the IDE device and the PRIMARY_IDE connector on the system board. See [Figure 7-4](#).

If you are installing a SCSI device in the second drive bay (such as a tape backup device), connect the interface cable to the device and the SCSI controller card. See [Figure 7-4](#).

See [Figure A-3](#) to locate the system board connectors.

NOTE: A SCSI device attached to a SCSI controller card and an IDE device attached to the system board can be installed together as shown in [Figure 7-4](#).

Figure 7-4. Connecting a Tape Drive to a SCSI Controller Card

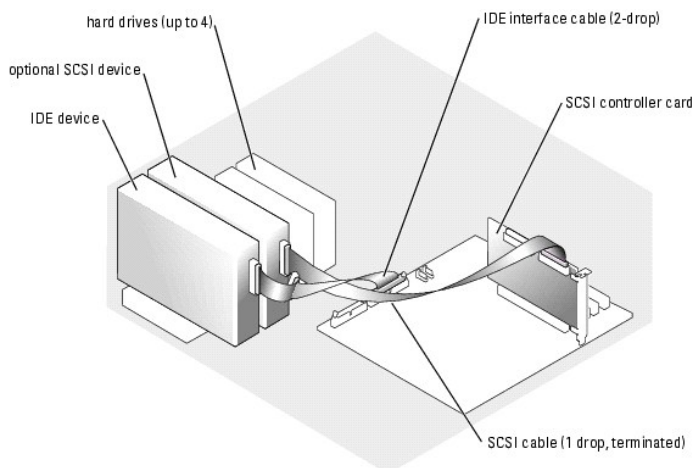

13. Ensure that all cables are firmly connected and arranged so that they will not catch on the computer covers or block airflow inside the system.
14. Install the cooling shroud. See "[Installing the Cooling Shroud](#)" in "Installing System Options."

15. Install the cover. See "[Replacing the Cover](#)" in "Troubleshooting Your System."
16. Stand the system upright.
17. Install the bezel. See "[Installing the Bezel](#)" in "Troubleshooting Your System."
18. Reconnect the system to its electrical outlet and turn the system on, including any attached peripherals.
19. Test the drive.

If you installed an IDE device, run the IDE devices tests in the system diagnostics to determine whether the device operates properly. See "[Running the System Diagnostics](#)."

If you installed a SCSI device, run the SCSI controllers test in the system diagnostics. See "[Running System Diagnostics](#)."

If you installed a tape drive, see the tape drive software documentation to perform a backup and verification test.

Hard Drives

Your system can contain up to four 1-inch SATA or SCSI hard drives in a removable drive bay. These drives connect either to the system board or to an optional controller card.

General Installation Guidelines

Use the following guidelines when installing hard drives:

- 1 You should only use drives that have been tested and approved by the system manufacturer.
- 1 Do not install SATA and SCSI hard drives together in the same system.
- 1 Do not install cabled and hot-plug SCSI hard drives together in the same system.
- 1 You may need to use different programs than those provided with the operating system to partition and format a hard drive. See the hard drive's documentation for information on setting up the drive.
- 1 When you format a high-capacity hard drive, allow enough time for the formatting to be completed. Long format times for these drives are normal. For example, a large drive can take over an hour to format.
- 1 Do not turn off or reboot your system while the drive is being formatted. Doing so can cause a drive failure.

 **NOTE:** The hard-drive activity indicator operates only when SATA hard drives are connected directly to the SATA port connectors on the system board. The indicator does not operate with SCSI drives or drives that are attached to a controller card. To identify the indicator, see [Figure 2-1](#).

Configuring the Boot Drive

The drive or device from which the system boots is determined by the boot order specified in the System Setup program (see "Using the System Setup Program" in your *User's Guide*). To boot the system from a hard drive or drive array, the drive(s) must be connected to the appropriate controller:

- 1 To boot from a single SATA hard drive, the master drive (drive 0) must be connected to the SATA_PORT0 connector on the system board. To identify system board connectors, see [Figure A-3](#).
 - 1 To boot from a single SCSI hard drive, the drive must be connected to the SCSI or RAID controller card. See the documentation that accompanied the controller card.
 - 1 To boot from a SATA RAID (when available) or SCSI RAID array, the drive must be connected to the RAID controller card. See the documentation that accompanied the controller card.
-

Cabled SATA and SCSI Hard Drives

Removing a Hard Drive

⚠ CAUTION: See your *System Information Guide* for complete information about safety precautions working inside the computer and protecting against electrostatic discharge.

1. Turn off the system, including any attached peripherals, and disconnect the system from the electrical outlet.
2. Remove the bezel. See "[Removing the Bezel](#)" in "Troubleshooting Your System."
3. Lay the system on its right side.
4. Remove the cover. See "[Removing the Cover](#)" in "Troubleshooting Your System."
5. Remove the cooling shroud. See "[Removing the Cooling Shroud](#)" in "Installing System Options."
6. Disconnect the interface and power cables to the hard drives in the drive bay.
7. Remove the hard-drive bay. See [Figure 7-5](#) and [Figure 7-6](#).
 - a. Loosen the four screws that secure the drive bay to the system.
 - b. Slide the hard-drive bay out of the system.
8. Remove the drive from the drive bay. See [Figure 7-5](#) and [Figure 7-6](#).
 - a. Remove the screws that secure the drive in the hard-drive bay.
 - b. Slide the drive out of the drive bay.

Figure 7-5. Removing a SATA Hard Drive

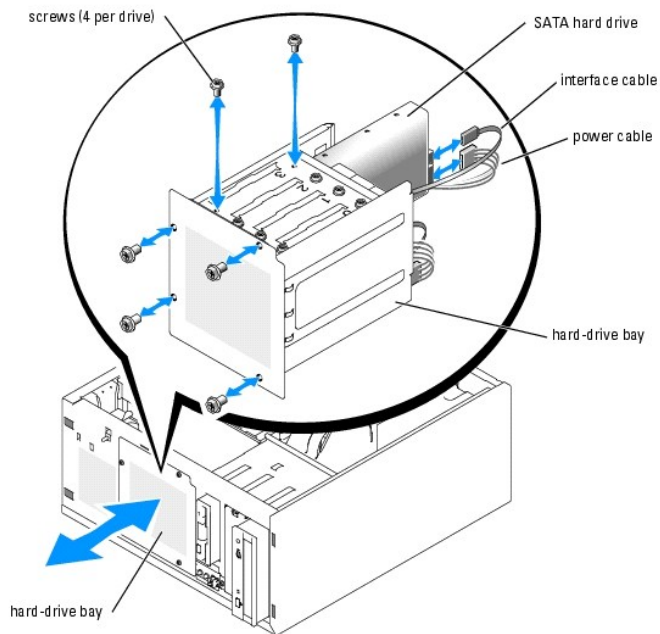
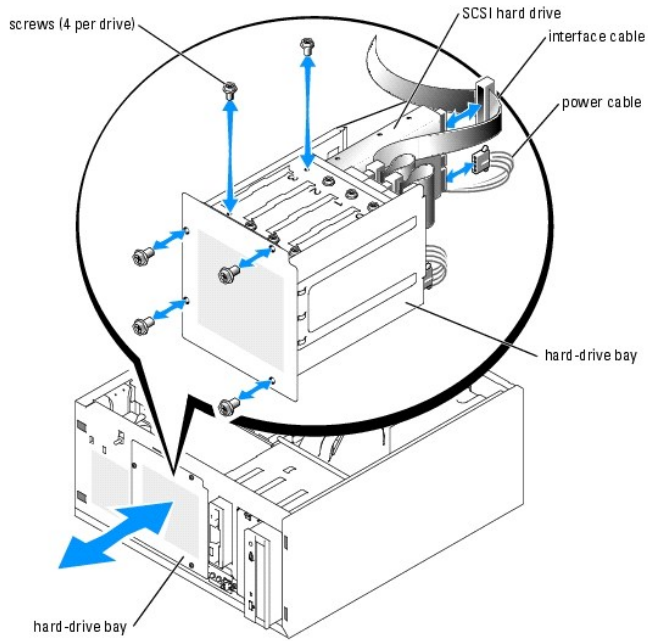

Figure 7-6. Removing a Cabled SCSI Hard Drive



Installing a Hard Drive

1. Unpack the drive (and controller card, if applicable), and prepare the drive for installation.

For instructions, see the documentation that accompanied the drive.

2. Install the hard drive in the hard-drive bay:
 - a. Slide the drive into the drive bay with the back of the drive toward the back of the drive bay.
 - b. Install the screws that secure the drive in the drive bay.
3. Install the hard-drive bay (see [Figure 7-5](#) and [Figure 7-6](#)):
 - a. Slide the drive bay into the system until the drive bay contacts the system.
 - b. Install the four screws that secure the drive bay in the system.

NOTICE: To prevent damage to internal system components, ensure that a connector cap is installed on each available power connector that is not connected to a hard drive.

4. Connect a power cable to each hard drive. See [Figure 7-5](#) and [Figure 7-6](#).
5. Connect the hard-drive interface cables to each hard drive. To identify the system board connectors, see [Figure A-3](#).

If you are installing up to two SATA drives, connect the interface cables from SATA_PORT0 and SATA_PORT1 on the system board to drive 0 and drive 1, respectively. See [Figure 7-7](#).

Figure 7-7. Connecting Two SATA Hard Drives to the Integrated Drive Controller

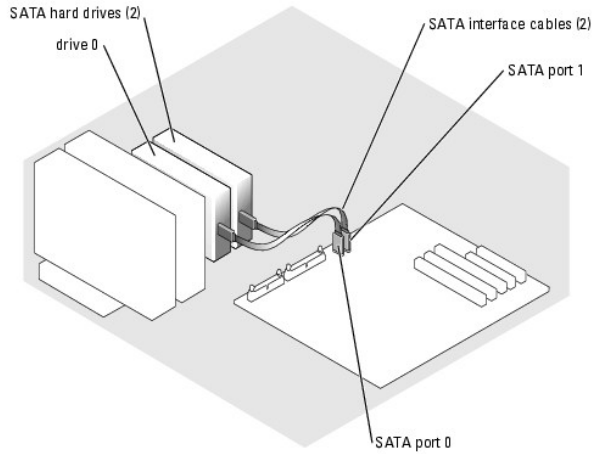

NOTE: The integrated drive controller on the system board can support only two SATA hard drives. If you are installing three or four SATA hard drives, you must connect the drives to a SATA RAID controller card in a RAID or non-RAID configuration.

If you are installing up to four SATA hard drives:

- a. Install a SATA RAID controller card in a 64-bit/66-MHz expansion slot. See [Figure A-3](#) to identify the expansion slots.
- b. Connect the SATA cable assembly to port 0 through port 3 on the SATA RAID controller card and to drive 0 through drive 3, respectively. See [Figure 7-8](#).

Figure 7-8. Connecting Four Drives to a SATA RAID Controller Card

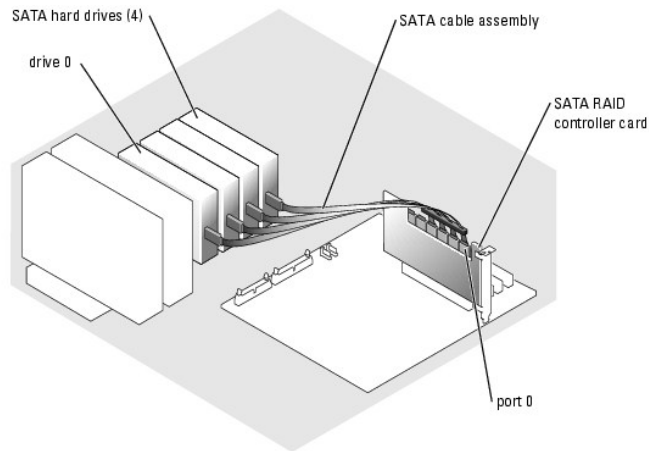

If you are installing a cabled SCSI drive, connect the SCSI interface cable to the hard drives and to the SCSI controller card. See [Figure 7-9](#).

Figure 7-9. Cabling Four SCSI Hard Drives to the SCSI Controller Card

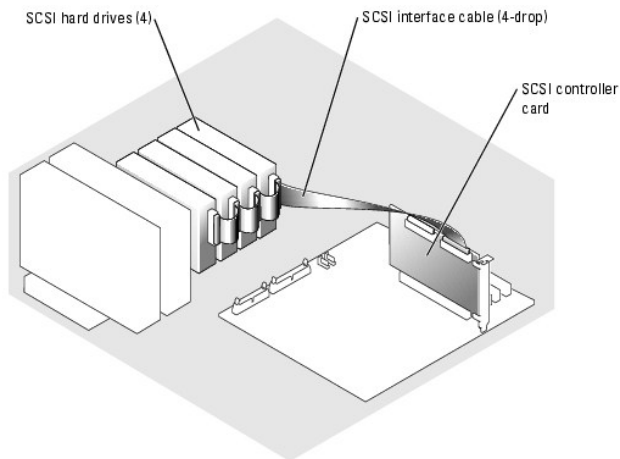

6. Ensure that all cables are firmly connected and arranged so that they will not catch on the computer covers or block airflow inside the system.
7. Install the cooling shroud. See "[Installing the Cooling Shroud](#)" in "Installing System Options."
8. Install the cover. See "[Replacing the Cover](#)" in "Troubleshooting Your System."
9. Stand the system upright.
10. Install the bezel. See "[Installing the Bezel](#)" in "Troubleshooting Your System."
11. Reconnect the system to its electrical outlet and turn the system on, including any attached peripherals.
12. Partition and logically format the hard drive. See the operating system documentation for more information.
13. Install any required device drivers.
14. Run the hard drive tests in the system diagnostics to determine whether the drive operates properly. See "[Running System Diagnostics](#)."

If the drive is connected to a SATA RAID controller card, see the RAID controller card documentation for information on testing the controller.

If the drive is connected to a SCSI controller card, run the SCSI controller tests and the hard drive tests in the system diagnostics. See "[Running System Diagnostics](#)."

If the hard drive fails the hard drive tests or does not operate properly, see "[Getting Help](#)."

Hot-Plug SCSI Hard Drives

The drive bays in a system with an optional SCSI backplane board provide space for up to four 1-inch hot-plug hard drives. The hard drives plug into the SCSI backplane board, which is connected to a SCSI RAID controller card. See [Figure 7-10](#).

Figure 7-10. Hot-Plug SCSI Hard Drives Connected to a SCSI RAID Controller Card

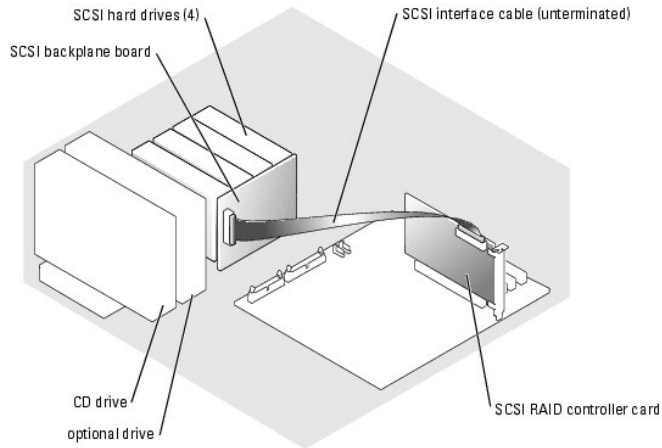

Removing a Hard Drive

NOTICE: Not all operating system support hot-plug drive installation. See the operating system documentation.

1. Remove the bezel. See "[Removing the Bezel](#)" in "Troubleshooting Your System."
2. Take the hard drive offline and wait until the hard-drive indicator codes on the drive carrier signal that the drive can be removed safely. See [Table 2-4](#) for a list of hard-drive indicator codes.

If the drive has been online, the drive status indicator will blink green 2 times per second as the drive is powered down. When all indicators are off, the drive is ready for removal.

See your operating system documentation for more information on taking the hard drive offline.

3. Open the hard-drive carrier handle to release the drive. See [Figure 7-11](#).
4. Slide the hard drive out until it is free of the drive bay.

Figure 7-11. Removing a Hot-Plug SCSI Drive

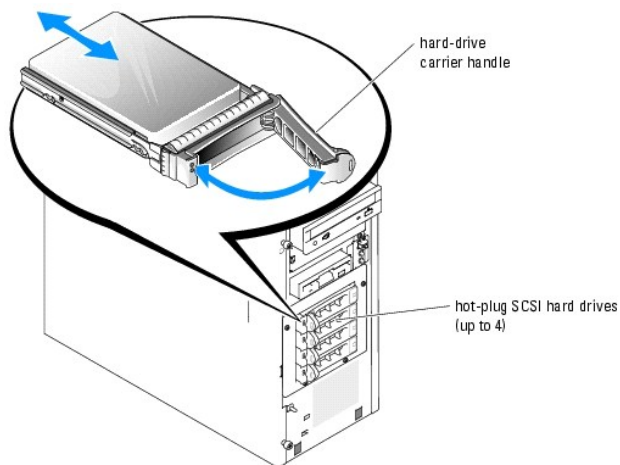

Installing a Hard Drive

1. Unpack the drive (and controller card, if applicable), and prepare the drive for installation.

For instructions, see the documentation that accompanied the drive.

2. Remove the bezel. See "[Removing the Bezel](#)" in "Troubleshooting Your System."
3. Open the hard-drive carrier handle. See [Figure 7-11](#).

 **NOTICE:** Do not insert a hard-drive carrier and attempt to lock its handle next to a partially installed carrier. Doing so can damage the partially installed carrier's shield spring and make it unusable. Ensure that the adjacent drive carrier is fully installed.

4. Insert the hard-drive carrier into the drive bay. See [Figure 7-11](#).
5. Close the hard-drive carrier handle to lock it in place.
6. Install the bezel. See "[Installing the Bezel](#)" in "Troubleshooting Your System."
7. Install any required SCSI device drivers.
8. Run the SCSI controllers tests and the hard drive tests in the system diagnostics. See "[Running System Diagnostics](#)."

If the hard drive fails the hard drive tests or does not operate properly, see "[Getting Help](#)."

Installing a RAID Controller Card

See "[Installing an Expansion Card](#)" in "Installing System Components" for instructions about installing the card.

 **NOTE:** Install a RAID controller card in expansion slot 3, 4, or 5. If you install both a RAID controller card and an Ultra 3 SCSI controller card, install the RAID controller card in expansion slot 5. See [Figure A-3](#) to identify the expansion slots.

[Back to Contents Page](#)

[Back to Contents Page](#)

Getting Help

Dell™ PowerEdge™ 700 Systems Installation and Troubleshooting Guide

- [Technical Assistance](#)
 - [Dell Enterprise Training and Certification](#)
 - [Problems With Your Order](#)
 - [Product Information](#)
 - [Returning Items for Warranty Repair or Credit](#)
 - [Before You Call](#)
 - [Contacting Dell](#)
-

Technical Assistance

If you need assistance with a technical problem, perform the following steps:

1. Complete the procedures in "[Troubleshooting Your System](#)."
2. Run the system diagnostics and record any information provided.
3. Make a copy of the [Diagnostics Checklist](#), and fill it out.
4. Use Dell's extensive suite of online services available at Dell Support at support.dell.com for help with installation and troubleshooting procedures.

For more information, see "[Online Services](#)."

5. If the preceding steps have not resolved the problem, call Dell for technical assistance.

 **NOTE:** Call technical support from a phone near or at the system so that technical support can assist you with any necessary procedures.

 **NOTE:** Dell's Express Service Code system may not be available in all countries.

When prompted by Dell's automated telephone system, enter your Express Service Code to route the call directly to the proper support personnel. If you do not have an Express Service Code, open the **Dell Accessories** folder, double-click the **Express Service Code** icon, and follow the directions.

For instructions on using the technical support service, see "[Technical Support Service](#)" and "[Before You Call](#)."

 **NOTE:** Some of the following services are not always available in all locations outside the continental U.S. Call your local Dell representative for information on availability.

Online Services

You can access Dell Support at support.dell.com. Select your region on the **WELCOME TO DELL SUPPORT** page, and fill in the requested details to access help tools and information.

You can contact Dell electronically using the following addresses:

- 1 World Wide Web

www.dell.com/

www.dell.com/ap/ (Asian/Pacific countries only)

www.dell.com/jp (Japan only)

www.euro.dell.com (Europe only)

www.dell.com/la (Latin American countries)

www.dell.ca (Canada only)

- 1 Anonymous file transfer protocol (FTP)

ftp.dell.com/

Log in as user: `anonymous`, and use your e-mail address as your password.

- 1 Electronic Support Service

`support@us.dell.com`

`apsupport@dell.com` (Asian/Pacific countries only)

support.jp.dell.com (Japan only)

support.euro.dell.com (Europe only)

- 1 Electronic Quote Service

`sales@dell.com`

`apmarketing@dell.com` (Asian/Pacific countries only)

`sales_canada@dell.com` (Canada only)

- 1 Electronic Information Service

`info@dell.com`

AutoTech Service

Dell's automated technical support service—AutoTech—provides recorded answers to the questions most frequently asked by Dell customers about their portable and desktop computer systems.

When you call AutoTech, use your touch-tone telephone to select the subjects that correspond to your questions.

The AutoTech service is available 24 hours a day, 7 days a week. You can also access this service through the technical support service. See the contact information for your region.

Automated Order-Status Service

To check on the status of any Dell™ products that you have ordered, you can go to support.dell.com, or you can call the automated order-status service. A recording prompts you for the information needed to locate and report on your order. See the contact information for your region.

Technical Support Service

Dell's technical support service is available 24 hours a day, 7 days a week, to answer your questions about Dell hardware. Our technical support staff use computer-based diagnostics to provide fast, accurate answers.

To contact Dell's technical support service, see "[Before You Call](#)" and then see the contact information for your region.

Dell Enterprise Training and Certification

Dell Enterprise Training and Certification is available; see www.dell.com/training for more information. This service may not be offered in all locations.

Problems With Your Order

If you have a problem with your order, such as missing parts, wrong parts, or incorrect billing, contact Dell for customer assistance. Have your invoice or packing slip available when you call. See the contact information for your region.

Product Information

If you need information about additional products available from Dell, or if you would like to place an order, visit the Dell website at www.dell.com. For the telephone number to call to speak to a sales specialist, see the contact information for your region.

Returning Items for Warranty Repair or Credit

Prepare all items being returned, whether for repair or credit, as follows:

1. Call Dell to obtain a Return Material Authorization Number, and write it clearly and prominently on the outside of the box.

For the telephone number to call, see the contact information for your region.

2. Include a copy of the invoice and a letter describing the reason for the return.
3. Include a copy of any diagnostic information (including the Diagnostics Checklist) indicating the tests you have run and any error messages reported by the system diagnostics.
4. Include any accessories that belong with the item(s) being returned (such as power cables, media such as CDs and diskettes, and guides) if the return is for credit.
5. Pack the equipment to be returned in the original (or equivalent) packing materials.

You are responsible for paying shipping expenses. You are also responsible for insuring any product returned, and you assume the risk of loss during shipment to Dell. Collect-on-delivery (C.O.D.) packages are not accepted.

Returns that are missing any of the preceding requirements will be refused at our receiving dock and returned to you.

Before You Call

NOTE: Have your Express Service Code ready when you call. The code helps Dell's automated-support telephone system direct your call more efficiently.

Remember to fill out the [Diagnostics Checklist](#). If possible, turn on your system before you call Dell for technical assistance and call from a telephone at or near the computer. You may be asked to type some commands at the keyboard, relay detailed information during operations, or try other troubleshooting steps possible only at the computer system itself. Ensure that the system documentation is available.

 **CAUTION:** Before servicing any components inside your computer, see your *System Information Guide* for important safety information.

Diagnostics Checklist
Name:
Date:
Address:
Phone number:
Service Tag (bar code on the back of the computer):
Express Service Code:
Return Material Authorization Number (if provided by Dell support technician):
Operating system and version:
Peripherals:
Expansion cards:
Are you connected to a network? Yes No
Network, version, and network card:
Programs and versions:
See your operating system documentation to determine the contents of the system's start-up files. If possible, print each file. Otherwise, record the contents of each file before calling Dell.
Error message, beep code, or diagnostic code:
Description of problem and troubleshooting procedures you performed:

Contacting Dell

To contact Dell electronically, you can access the following websites:

- 1 www.dell.com
- 1 support.dell.com (technical support)
- 1 premiersupport.dell.com (technical support for educational, government, healthcare, and medium/large business customers, including Premier, Platinum, and Gold customers)

For specific web addresses for your country, find the appropriate country section in the table below.

NOTE: Toll-free numbers are for use within the country for which they are listed.

When you need to contact Dell, use the electronic addresses, telephone numbers, and codes provided in the following table. If you need assistance in determining which codes to use, contact a local or an international operator.

Country (City) International Access Code Country Code City Code	Department Name or Service Area, Website and E-Mail Address	Area Codes, Local Numbers, and Toll-Free Numbers
Anguilla	General Support	toll-free: 800-335-0031
Antigua and Barbuda	General Support	1-800-805-5924
Argentina (Buenos Aires)	Website: www.dell.com.ar	
International Access Code: 00	Tech Support and Customer Care	toll-free: 0-800-444-0733

Country Code: 54	Sales	0-810-444-3355
	Tech Support Fax	11 4515 7139
City Code: 11	Customer Care Fax	11 4515 7138
Aruba	General Support	toll-free: 800-1578
Australia (Sydney)	E-mail (Australia): au_tech_support@dell.com	
	E-mail (New Zealand): nz_tech_support@dell.com	
International Access Code: 0011	Home and Small Business	1-300-65-55-33
Country Code: 61	Government and Business	toll-free: 1-800-633-559
	Preferred Accounts Division (PAD)	toll-free: 1-800-060-889
City Code: 2	Customer Care	toll-free: 1-800-819-339
	Corporate Sales	toll-free: 1-800-808-385
	Transaction Sales	toll-free: 1-800-808-312
	Fax	toll-free: 1-800-818-341
Austria (Vienna)	Website: support.euro.dell.com	
International Access Code: 900	E-mail: tech_support_central_europe@dell.com	
	Home/Small Business Sales	0820 240 530 00
Country Code: 43	Home/Small Business Fax	0820 240 530 49
	Home/Small Business Customer Care	0820 240 530 14
City Code: 1	Preferred Accounts/Corporate Customer Care	0820 240 530 16
	Home/Small Business Technical Support	0820 240 530 14
	Preferred Accounts/Corporate Technical Support	0660 8779
	Switchboard	0820 240 530 00
Bahamas	General Support	toll-free: 1-866-278-6818
Barbados	General Support	1-800-534-3066
Belgium (Brussels)	Website: support.euro.dell.com	
International Access Code: 00	E-mail: tech_be@dell.com	
	E-mail for French Speaking Customers: support.euro.dell.com/be/fr/emaildell/	
Country Code: 32	Technical Support	02 481 92 88
	Customer Care	02 481 91 19
City Code: 2	Corporate Sales	02 481 91 00
	Fax	02 481 92 99
	Switchboard	02 481 91 00
Bermuda	General Support	1-800-342-0671
Bolivia	General Support	toll-free: 800-10-0238
Brazil	Website: www.dell.com/br	
International Access Code: 00	Customer Support, Technical Support	0800 90 3355
	Tech Support Fax	51 481 5470
Country Code: 55	Customer Care Fax	51 481 5480
	Sales	0800 90 3390
British Virgin Islands	General Support	toll-free: 1-866-278-6820
Brunei	Customer Technical Support (Penang, Malaysia)	604 633 4966
	Customer Service (Penang, Malaysia)	604 633 4949
	Transaction Sales (Penang, Malaysia)	604 633 4955
Canada (North York, Ontario)	Online Order Status: www.dell.ca/ostatus	
International Access Code: 011	AutoTech (automated technical support)	toll-free: 1-800-247-9362
	TechFax	toll-free: 1-800-950-1329
	Customer Care (Home Sales/Small Business)	toll-free: 1-800-847-4096
	Customer Care (med./large business, government)	toll-free: 1-800-326-9463
	Technical Support (Home Sales/Small Business)	toll-free: 1-800-847-4096
	Technical Support (med./large bus., government)	toll-free: 1-800-387-5757
	Sales (Home Sales/Small Business)	toll-free: 1-800-387-5752
	Sales (med./large bus., government)	toll-free: 1-800-387-5755
	Spare Parts Sales & Extended Service Sales	1 866 440 3355
Cayman Islands	General Support	1-800-805-7541
Chile (Santiago)	Sales, Customer Support, and Technical Support	toll-free: 1230-020-4823
Country Code: 56		
City Code: 2		

China (Xiamen)	Tech Support website: support.ap.dell.com/china	
Country Code: 86	Tech Support E-mail: cn_support@dell.com	
City Code: 592	Tech Support Fax	818 1350
	Home and Small Business Technical Support	toll-free: 800 858 2437
	Corporate Accounts Technical Support	toll-free: 800 858 2333
	Customer Experience	toll-free: 800 858 2060
	Home and Small Business	toll-free: 800 858 2222
	Preferred Accounts Division	toll-free: 800 858 2557
	Large Corporate Accounts GCP	toll-free: 800 858 2055
	Large Corporate Accounts Key Accounts	toll-free: 800 858 2628
	Large Corporate Accounts North	toll-free: 800 858 2999
	Large Corporate Accounts North Government and Education	toll-free: 800 858 2955
	Large Corporate Accounts East	toll-free: 800 858 2020
	Large Corporate Accounts East Government and Education	toll-free: 800 858 2669
	Large Corporate Accounts Queue Team	toll-free: 800 858 2222
	Large Corporate Accounts South	toll-free: 800 858 2355
	Large Corporate Accounts West	toll-free: 800 858 2811
	Large Corporate Accounts Spare Parts	toll-free: 800 858 2621
Colombia	General Support	980-9-15-3978
Costa Rica	General Support	0800-012-0435
Czech Republic (Prague)	Website: support.euro.dell.com	
International Access Code: 00	E-mail: czech_dell@dell.com	
Country Code: 420	Technical Support	02 2186 27 27
City Code: 2	Customer Care	02 2186 27 11
	Fax	02 2186 27 14
	TechFax	02 2186 27 28
	Switchboard	02 2186 27 11
Denmark (Copenhagen)	Website: support.euro.dell.com	
International Access Code: 00	E-mail Support (portable computers): den_nbk_support@dell.com	
Country Code: 45	E-mail Support (desktop computers): den_support@dell.com	
	E-mail Support (servers): Nordic_server_support@dell.com	
	Technical Support	7023 0182
	Customer Care (Relational)	7023 0184
	Home/Small Business Customer Care	3287 5505
	Switchboard (Relational)	3287 1200
	Fax Switchboard (Relational)	3287 1201
	Switchboard (Home/Small Business)	3287 5000
	Fax Switchboard (Home/Small Business)	3287 5001
Dominica	General Support	toll-free: 1-866-278-6821
Dominican Republic	General Support	1-800-148-0530
Ecuador	General Support	toll-free: 999-119
El Salvador	General Support	01-899-753-0777
Finland (Helsinki)	Website: support.euro.dell.com	
International Access Code: 990	E-mail: fin_support@dell.com	
Country Code: 358	E-mail Support (servers): Nordic_support@dell.com	
City Code: 9	Technical Support	09 253 313 60
	Technical Support Fax	09 253 313 81
	Relational Customer Care	09 253 313 38
	Home/Small Business Customer Care	09 693 791 94
	Fax	09 253 313 99
	Switchboard	09 253 313 00
France (Paris) (Montpellier)	Website: support.euro.dell.com	
International Access Code: 00	E-mail: support.euro.dell.com/fr/fr/emaildell/	
Country Code: 33	Home and Small Business	
City Codes: (1) (4)	Technical Support	0825 387 270
	Customer Care	0825 823 833
	Switchboard	0825 004 700
	Switchboard (calls from outside of France)	04 99 75 40 00
	Sales	0825 004 700

	Fax	0825 004 701
	Fax (calls from outside of France)	04 99 75 40 01
	Corporate	
	Technical Support	0825 004 719
	Customer Care	0825 338 339
	Switchboard	01 55 94 71 00
	Sales	01 55 94 71 00
	Fax	01 55 94 71 01
Germany (Langen)	Website: support.euro.dell.com	
International Access Code: 00	E-mail: tech_support_central_europe@dell.com	
Country Code: 49	Technical Support	06103 766-7200
City Code: 6103	Home/Small Business Customer Care	0180-5-224400
	Global Segment Customer Care	06103 766-9570
	Preferred Accounts Customer Care	06103 766-9420
	Large Accounts Customer Care	06103 766-9560
	Public Accounts Customer Care	06103 766-9555
	Switchboard	06103 766-7000
Greece	Website: support.euro.dell.com	
International Access Code: 00	E-mail: support.euro.dell.com/gr/en/emaildell/	
Country Code: 30	Technical Support	080044149518
	Gold Technical Support	08844140083
	Switchboard	2108129800
	Sales	2108129800
	Fax	2108129812
Grenada	General Support	toll-free: 1-866-540-3355
Guatemala	General Support	1-800-999-0136
Guyana	General Support	toll-free: 1-877-270-4609
Hong Kong	Website: support.ap.dell.com	
International Access Code: 001	E-mail: ap_support@dell.com	
Country Code: 852	Technical Support (Dimension™ and Inspiron™)	2969 3189
	Technical Support (OptiPlex™, Latitude™, and Dell Precision™)	2969 3191
	Technical Support (PowerEdge™ and PowerVault™)	2969 3196
	Gold Queue EEC Hotline	2969 3187
	Customer Advocacy	3416 0910
	Large Corporate Accounts	3416 0907
	Global Customer Programs	3416 0908
	Medium Business Division	3416 0912
	Home and Small Business Division	2969 3105
India	Technical Support	1600 33 8045
	Sales	1600 33 8044
Ireland (Cherrywood)	Website: support.euro.dell.com	
International Access Code: 16	E-mail: dell_direct_support@dell.com	
Country Code: 353	Technical Support	1850 543 543
City Code: 1	U.K. Technical Support (dial within U.K. only)	0870 908 0800
	Home User Customer Care	01 204 4014
	Small Business Customer Care	01 204 4014
	U.K. Customer Care (dial within U.K. only)	0870 906 0010
	Corporate Customer Care	1850 200 982
	Corporate Customer Care (dial within U.K. only)	0870 907 4499
	Ireland Sales	01 204 4444
	U.K. Sales (dial within U.K. only)	0870 907 4000
	Fax/SalesFax	01 204 0103
	Switchboard	01 204 4444
Italy (Milan)	Website: support.euro.dell.com	
International Access Code: 00	E-mail: support.euro.dell.com/it/it/emaildell/	
Country Code: 39	Home and Small Business	
City Code: 02	Technical Support	02 577 826 90
	Customer Care	02 696 821 14
	Fax	02 696 821 13

	Switchboard	02 696 821 12
	Corporate	
	Technical Support	02 577 826 90
	Customer Care	02 577 825 55
	Fax	02 575 035 30
	Switchboard	02 577 821
Jamaica	General Support (dial from within Jamaica only)	1-800-682-3639
Japan (Kawasaki)	Website: support.jp.dell.com	
International Access Code: 001	Technical Support (servers)	toll-free: 0120-198-498
Country Code: 81	Technical Support outside of Japan (servers)	81-44-556-4162
City Code: 44	Technical Support (Dimension™ and Inspiron™)	toll-free: 0120-198-226
	Technical Support outside of Japan (Dimension and Inspiron)	81-44-520-1435
	Technical Support (Dell Precision™, OptiPlex™, and Latitude™)	toll-free: 0120-198-433
	Technical Support outside of Japan (Dell Precision, OptiPlex, and Latitude)	81-44-556-3894
	Technical Support (Axim™)	toll-free: 0120-981-690
	Technical Support outside of Japan (Axim)	81-44-556-3468
	Faxbox Service	044-556-3490
	24-Hour Automated Order Service	044-556-3801
	Customer Care	044-556-4240
	Business Sales Division (up to 400 employees)	044-556-1465
	Preferred Accounts Division Sales (over 400 employees)	044-556-3433
	Large Corporate Accounts Sales (over 3500 employees)	044-556-3430
	Public Sales (government agencies, educational institutions, and medical institutions)	044-556-1469
	Global Segment Japan	044-556-3469
	Individual User	044-556-1760
	Switchboard	044-556-4300
Korea (Seoul)	Technical Support	toll-free: 080-200-3800
International Access Code: 001	Sales	toll-free: 080-200-3600
Country Code: 82	Customer Service (Seoul, Korea)	toll-free: 080-200-3800
City Code: 2	Customer Service (Penang, Malaysia)	604 633 4949
	Fax	2194-6202
	Switchboard	2194-6000
Latin America	Customer Technical Support (Austin, Texas, U.S.A.)	512 728-4093
	Customer Service (Austin, Texas, U.S.A.)	512 728-3619
	Fax (Technical Support and Customer Service) (Austin, Texas, U.S.A.)	512 728-3883
	Sales (Austin, Texas, U.S.A.)	512 728-4397
	SalesFax (Austin, Texas, U.S.A.)	512 728-4600
		or 512 728-3772
Luxembourg	Website: support.euro.dell.com	
International Access Code: 00	E-mail: tech_be@dell.com	
Country Code: 352	Technical Support (Brussels, Belgium)	3420808075
	Home/Small Business Sales (Brussels, Belgium)	toll-free: 080016884
	Corporate Sales (Brussels, Belgium)	02 481 91 00
	Customer Care (Brussels, Belgium)	02 481 91 19
	Fax (Brussels, Belgium)	02 481 92 99
	Switchboard (Brussels, Belgium)	02 481 91 00
Macao	Technical Support	toll-free: 0800 582
Country Code: 853	Customer Service (Penang, Malaysia)	604 633 4949
	Transaction Sales	toll-free: 0800 581
Malaysia (Penang)	Technical Support	toll-free: 1 800 888 298
International Access Code: 00	Customer Service	04 633 4949
Country Code: 60	Transaction Sales	toll-free: 1 800 888 202
City Code: 4	Corporate Sales	toll-free: 1 800 888 213
Mexico	Customer Technical Support	001-877-384-8979
International Access Code: 00		or 001-877-269-3383
Country Code: 52	Sales	50-81-8800

		or 01-800-888-3355
	Customer Service	001-877-384-8979
		or 001-877-269-3383
	Main	50-81-8800
		or 01-800-888-3355
Montserrat	General Support	toll-free: 1-866-278-6822
Netherlands Antilles	General Support	001-800-882-1519
Netherlands (Amsterdam)	Website: support.euro.dell.com	
International Access Code: 00	E-mail (Technical Support):	
Country Code: 31	(Enterprise): nl_server_support@dell.com	
City Code: 20	(Latitude): nl_latitude_support@dell.com	
	(Inspiron): nl_inspiron_support@dell.com	
	(Dimension): nl_dimension_support@dell.com	
	(OptiPlex): nl_optiplex_support@dell.com	
	(Dell Precision): nl_workstation_support@dell.com	
	Technical Support	020 674 45 00
	Technical Support Fax	020 674 47 66
	Home/Small Business Customer Care	020 674 42 00
	Relational Customer Care	020 674 4325
	Home/Small Business Sales	020 674 55 00
	Relational Sales	020 674 50 00
	Home/Small Business Sales Fax	020 674 47 75
	Relational Sales Fax	020 674 47 50
	Switchboard	020 674 50 00
	Switchboard Fax	020 674 47 50
New Zealand	E-mail (New Zealand): nz_tech_support@dell.com	
International Access Code: 00	E-mail (Australia): au_tech_support@dell.com	
Country Code: 64	Home and Small Business	0800 446 255
	Government and Business	0800 444 617
	Sales	0800 441 567
	Fax	0800 441 566
Nicaragua	General Support	001-800-220-1006
Norway (Lysaker)	Website: support.euro.dell.com	
International Access Code: 00	E-mail Support (portable computers):	
Country Code: 47	nor_nbk_support@dell.com	
	E-mail Support (desktop computers):	
	nor_support@dell.com	
	E-mail Support (servers):	
	nordic_server_support@dell.com	
	Technical Support	671 16882
	Relational Customer Care	671 17514
	Home/Small Business Customer Care	23162298
	Switchboard	671 16800
	Fax Switchboard	671 16865
Panama	General Support	001-800-507-0962
Peru	General Support	0800-50-669
Poland (Warsaw)	Website: support.euro.dell.com	
International Access Code: 011	E-mail: pl_support@dell.com	
Country Code: 48	Customer Service Phone	57 95 700
City Code: 22	Customer Care	57 95 999
	Sales	57 95 999
	Customer Service Fax	57 95 806
	Reception Desk Fax	57 95 998
	Switchboard	57 95 999
Portugal	Website: support.euro.dell.com	



International Access Code: 00 Country Code: 351	E-mail: support.euro.dell.com/pt/en/emaiddell/	
	Technical Support	707200149
	Customer Care	800 300 413
	Sales	800 300 410 or 800 300 411 or 800 300 412 or 21 422 07 10
	Fax	21 424 01 12
Puerto Rico	General Support	1-800-805-7545
St. Kitts and Nevis	General Support	toll-free: 1-877-441-4731
St. Lucia	General Support	1-800-882-1521
St. Vincent and the Grenadines	General Support	toll-free: 1-877-270-4609
Singapore (Singapore) International Access Code: 005 Country Code: 65	Technical Support	toll-free: 800 6011 051
	Customer Service (Penang, Malaysia)	604 633 4949
	Transaction Sales	toll-free: 800 6011 054
	Corporate Sales	toll-free: 800 6011 053
South Africa (Johannesburg) International Access Code: 09/091 Country Code: 27 City Code: 11	Website: support.euro.dell.com	
	E-mail: dell_za_support@dell.com	
	Technical Support	011 709 7710
	Customer Care	011 709 7707
	Sales	011 709 7700
	Fax	011 706 0495
	Switchboard	011 709 7700
Southeast Asian and Pacific Countries	Customer Technical Support, Customer Service, and Sales (Penang, Malaysia)	604 633 4810
Spain (Madrid) International Access Code: 00 Country Code: 34 City Code: 91	Website: support.euro.dell.com	
	E-mail: support.euro.dell.com/es/es/emaiddell/	
	Home and Small Business	
	Technical Support	902 100 130
	Customer Care	902 118 540
	Sales	902 118 541
	Switchboard	902 118 541
	Fax	902 118 539
	Corporate	
	Technical Support	902 100 130
	Customer Care	902 118 546
	Switchboard	91 722 92 00
	Fax	91 722 95 83
Sweden (Upplands Vasby) International Access Code: 00 Country Code: 46 City Code: 8	Website: support.euro.dell.com	
	E-mail: swe_support@dell.com	
	E-mail Support for Latitude and Inspiron: Swe-nbk_kats@dell.com	
	E-mail Support for OptiPlex: Swe_kats@dell.com	
	E-mail Support for Servers: Nordic_server_support@dell.com	
	Technical Support	08 590 05 199
	Relational Customer Care	08 590 05 642
	Home/Small Business Customer Care	08 587 70 527
	Employee Purchase Program (EPP) Support	20 140 14 44
	Fax Technical Support	08 590 05 594
	Sales	08 590 05 185
Switzerland (Geneva) International Access Code: 00 Country Code: 41 City Code: 22	Website: support.euro.dell.com	
	E-mail: swisstech@dell.com	
	E-mail for French-speaking HSB and Corporate Customers: support.euro.dell.com/ch/fr/emaiddell/	
	Technical Support (Home and Small Business)	0844 811 411
	Technical Support (Corporate)	0844 822 844
	Customer Care (Home and Small Business)	0848 802 202
	Customer Care (Corporate)	0848 821 721
	Fax	022 799 01 90
	Switchboard	022 799 01 01
Taiwan	Technical Support (portable and desktop computers)	toll-free: 00801 86 1011

International Access Code: 002	Technical Support (servers)	toll-free: 0080 60 1256
	Transaction Sales	toll-free: 0080 651 228
Country Code: 886	Corporate Sales	toll-free: 0080 651 227
Thailand International Access Code: 001 Country Code: 66	Technical Support	toll-free: 0880 060 07
	Customer Service (Penang, Malaysia)	604 633 4949
	Sales	toll-free: 0880 060 09
Trinidad/Tobago	General Support	1-800-805-8035
Turks and Caicos Islands	General Support	toll-free: 1-866-540-3355
U.K. (Bracknell) International Access Code: 00 Country Code: 44 City Code: 1344	Website: support.euro.dell.com	
	Customer Care website: support.euro.dell.com/uk/en/ECare/Form/Home.asp	
	E-mail: dell_direct_support@dell.com	
	Technical Support (Corporate/Preferred Accounts/PAD [1000+ employees])	0870 908 0500
	Technical Support (direct/PAD and general)	0870 908 0800
	Global Accounts Customer Care	01344 373 186
	Home and Small Business Customer Care	0870 906 0010
	Corporate Customer Care	01344 373 185
	Preferred Accounts (500-5000 employees) Customer Care	0870 906 0010
	Central Government Customer Care	01344 373 193
	Local Government & Education Customer Care	01344 373 199
	Health Customer Care	01344 373 194
	Home and Small Business Sales	0870 907 4000
	Corporate/Public Sector Sales	01344 860 456
	Home and Small Business Fax	0870 907 4006
Uruguay	General Support	toll-free: 000-413-598-2521
U.S.A. (Austin, Texas) International Access Code: 011 Country Code: 1	Automated Order-Status Service	toll-free: 1-800-433-9014
	AutoTech (portable and desktop computers)	toll-free: 1-800-247-9362
	Consumer (Home and Home Office)	
	Technical Support	toll-free: 1-800-624-9896
	Customer Service	toll-free: 1-800-624-9897
	DellNet™ Service and Support	toll-free: 1-877-Dellnet (1-877-335-5638)
	Employee Purchase Program (EPP) Customers	toll-free: 1-800-695-8133
	Financial Services website: www.dellfinancialservices.com	
	Financial Services (lease/loans)	toll-free: 1-877-577-3355
	Financial Services (Dell Preferred Accounts [DPA])	toll-free: 1-800-283-2210
	Business	
	Customer Service and Technical Support	toll-free: 1-800-822-8965
	Employee Purchase Program (EPP) Customers	toll-free: 1-800-695-8133
	Projectors Technical Support	toll-free: 1-877-459-7298
	Public (government, education, and healthcare)	
	Customer Service and Technical Support	toll-free: 1-800-456-3355
	Employee Purchase Program (EPP) Customers	toll-free: 1-800-234-1490
	Dell Sales	toll-free: 1-800-289-3355 or toll-free: 1-800-879-3355
	Dell Outlet Store (Dell refurbished computers)	toll-free: 1-888-798-7561
	Software and Peripherals Sales	toll-free: 1-800-671-3355
	Spare Parts Sales	toll-free: 1-800-357-3355
	Extended Service and Warranty Sales	toll-free: 1-800-247-4618
Fax	toll-free: 1-800-727-8320	
Dell Services for the Deaf, Hard-of-Hearing, or Speech-Impaired	toll-free: 1-877-DELLTTY (1-877-335-5889)	
U.S. Virgin Islands	General Support	1-877-673-3355
Venezuela	General Support	8001-3605

[Back to Contents Page](#)

[Back to Contents Page](#)

Dell™ PowerEdge™ 700 Systems Installation and Troubleshooting Guide

-  **NOTE:** A NOTE indicates important information that helps you make better use of your computer.
-  **NOTICE:** A NOTICE indicates either potential damage to hardware or loss of data and tells you how to avoid the problem.
-  **CAUTION:** A CAUTION indicates a potential for property damage, personal injury, or death.

For a complete list of abbreviations and acronyms, see "Abbreviations and Acronyms."

Information in this document is subject to change without notice.
© 2003 Dell Inc. All rights reserved.

Reproduction in any manner whatsoever without the written permission of Dell Inc. is strictly forbidden.

Trademarks used in this text: *Dell*, the *DELL* logo, *PowerEdge*, *Dell OpenManage*, *Dell Precision*, *Dimension*, *Inspiron*, *OptiPlex*, *Latitude*, *DellNet*, *PowerVault*, *PowerApp*, and *Axim* are trademarks of Dell Inc.; *Intel*, *Pentium*, and *Celeron* are registered trademarks of Intel Corporation; *Microsoft*, *MS-DOS*, and *Windows* are registered trademarks of Microsoft Corporation.

Other trademarks and trade names may be used in this document to refer to either the entities claiming the marks and names or their products. Dell Inc. disclaims any proprietary interest in trademarks and trade names other than its own.

[Back to Contents Page](#)