

# Dell™ PowerEdge™ 1750 Systems User's Guide

[System Overview](#)

[Using the Dell OpenManage Server Assistant CD](#)

[Using the System Setup Program](#)

[Technical Specifications](#)

[Using Console Redirection](#)

[Glossary](#)

---

 **NOTE:** A NOTE indicates important information that helps you make better use of your computer.

 **NOTICE:** A NOTICE indicates either potential damage to hardware or loss of data and tells you how to avoid the problem.

 **CAUTION:** A CAUTION indicates a potential for property damage, personal injury, or death.

---

## Abbreviations and Acronyms

For the full name of an abbreviation or acronym used in this document, see the "[Glossary](#)."

---

Information in this document is subject to change without notice.  
© 2002 Dell Computer Corporation. All rights reserved.

Reproduction in any manner whatsoever without the written permission of Dell Computer Corporation is strictly forbidden.

Trademarks used in this text: *Dell*, the *DELL* logo, *PowerEdge*, and *Dell OpenManage* are trademarks of Dell Computer Corporation; *Xeon* and *Intel386* are trademarks and *Intel* and *Pentium* are registered trademarks of Intel Corporation; *Microsoft*, *Windows*, *Windows NT*, and *MS-DOS*, are registered trademarks of Microsoft Corporation; *Novell* and *NetWare* are registered trademarks of Novell, Inc.

Other trademarks and trade names may be used in this document to refer to either the entities claiming the marks and names or their products. Dell Computer Corporation disclaims any proprietary interest in trademarks and trade names other than its own.

Model IMU

---

*Initial release: 6 Dec 2002*

## Technical Specifications

### Dell™ PowerEdge™ 1750 Systems User's Guide

● [Technical Specifications](#)

---

## Technical Specifications

Microprocessor	
Microprocessor type	up to two Intel® Xeon™ microprocessors with a minimum internal operating frequency of at least 2.0 GHz
Front-side bus speed	133 MHz
Address bus speed	266 MHz (doubled address transfer rate)
Data bus speed	533 MHz (quadrupled data transfer rate)
Internal cache	512 KB level 2 cache
Math coprocessor	internal to microprocessor

Expansion Bus	
Bus type	PCI, PCI-X
Expansion slots	two 3.3-V, 64-bit, 133-MHz PCI-X slots or one 3.3-V, 64-bit, 133-MHz PCI-X slot and one 5-V 64-bit, 33-MHz PCI slot

Memory	
Architecture	72-bit ECC PC-266 registered DDR SDRAM DIMMs, with 2-way interleaving
Memory module sockets	four 72-bit wide 184-pin DIMM sockets
Memory module capacities	128-MB, 256-MB, 512-MB, 1-GB, or 2-GB registered DDR SDRAM DIMMs, rated for 266-MHz operation
Minimum RAM	256 MB
Maximum RAM	8 GB

Drives	
Hard drives	up to three 1-inch, internal U320 SCSI
Diskette drive	3.5-inch, 1.44-MB diskette drive
CD or DVD drive	IDE CD or DVD drive

Connectors	
<b>Externally accessible:</b>	
<b>Back:</b>	
SCSI	68-pin U320 SCSI connector
Serial	9-pin connector
USB	4-pin connectors
NIC	two RJ45 connectors for integrated 10/100/1000 NICs
RAC	one RJ45 connector for optional RAC (100 Mbit Ethernet controller)
Video	15-pin connector
PS/2-style keyboard	6-pin mini-DIN connector
PS/2-compatible mouse	6-pin mini-DIN connector
<b>Front:</b>	
Video	15-pin connector
USB	4-pin connector

Video	
Video type	ATI Rage XL PCI video controller; VGA connector
Video memory	8 MB

Power	
<b>Power supply:</b>	
Wattage	320 W (AC)
Voltage	100–240 VAC, 50/60 Hz, 3.9–2.0 A
Heat dissipation	1026 BTU/hr maximum per power supply
Maximum inrush current	Under typical line conditions and over the entire system ambient operating range, the inrush current may reach 25 A per power supply for 10 ms or less.
System battery	3.0-V lithium ion coin cell

Physical	
Height	4.2 cm (1.67 inches)
Width	44.7 cm (17.6 inches)
Depth	68.3 cm (26.9 inches)
Weight (maximum)	15.9 kg (35 lb)

Environmental	
<b>Temperature:</b>	
Operating	10° to 35°C (50° to 95°F)
Storage	–40° to 65°C (–40° to 149°F)
<b>Relative humidity:</b>	
Operating	8% to 85% (noncondensing) with a humidity gradation of 10 % per hour
Storage	5% to 95% (noncondensing)
<b>Maximum vibration:</b>	
Operating	0.25 G at 3 to 200 Hz for 15 minutes in the positive z axis
Storage	0.5 G at 3 to 200 Hz for 15 minutes in the positive and negative x, y, and z axes
<b>Maximum shock:</b>	
Operating	one shock pulse in the positive z axis (one pulse on each side of the system) of 41 G for up to 2 ms
Storage (non-operational)	six consecutively executed shock pulses in the positive and negative x, y, and z axes (one pulse on each side of the system) of 71 G for up to 2 ms
<b>Altitude:</b>	
Operating	–16 to 3,048 m (–50 to 10,000 ft)
Storage	–16 to 10,600 m (–50 to 35,000 ft)

[Back to Contents Page](#)

[Back to Contents Page](#)

## Using Console Redirection

### Dell™ PowerEdge™ 1750 Systems User's Guide

- [Hardware Requirements](#)
- [Software Requirements](#)
- [Configuring the Host System](#)
- [Configuring the Client System](#)
- [Managing the Host System Remotely](#)
- [Configuring Special Key Functions](#)

Console redirection allows you to manage a host (local) system from a client (remote) system by redirecting keyboard input and text output through a serial port. You cannot redirect graphic output. You can use console redirection for tasks such as configuring BIOS or RAID settings.

You can also connect the client system to a port concentrator that can access numerous host systems using a shared modem. After logging into the port concentrator, you can select a host system to manage using console redirection.

This section describes the most basic connection possible: connecting systems using a null-modem serial cable, which directly connects the serial ports on two systems.

---

## Hardware Requirements

- 1 An available serial (COM) port on the host system
- 1 An available serial (COM) port on a client system

This port must not conflict with any other ports on the client system.

- 1 A null-modem serial cable to connect the host system to the client system
- 

## Software Requirements

- 1 VT 100/220 or ANSI terminal emulation with a window size of 80 x 25 characters
- 1 9600, 19.2 K, 57.6 K, or 115.2 K bps using serial (COM) ports
- 1 Ability to create keyboard command macros (recommended)

All versions of the Microsoft® Windows® operating system include Hilgraeve's HyperTerminal terminal emulation software. However, the included version does not provide many functions required during console redirection. Either upgrade to HyperTerminal Private Edition 6.1 or later, or select new terminal emulation software.

---

## Configuring the Host System

Configure console redirection on the host (local) system through the System Setup program. See "[Console Redirection Screen](#)" in "Using the System Setup Program". The **Console Redirection** screen allows you to enable or disable the console redirection feature, select the remote terminal type, and enable or disable console redirection after booting.

---

## Configuring the Client System

After configuring the host system, configure the ports and terminal settings for the client (remote) system.

 **NOTE:** The examples in this section assume that you have upgraded to Hilgraeve's HyperTerminal Private Edition 6.1 or later. If you are using other terminal emulation software, see the documentation for that software.

## Configuring the Serial Port

1. Click the **Start** button, point to **Programs**→**Accessories**→**Communications**, and then click **HyperTerminal**.
2. Enter a name for the new connection, select an icon, and then click **OK**.
3. From the **Connect to** dropdown menu, select an available COM port, and then click **OK**.

After you select an available COM port, the COM port properties window appears.

4. Configure the port with the following settings:
  - 1 Set **Bits per second**.

Console redirection supports only 9600, 19.2 K, 57.6 K, or 115.2 K bps.

1. Set **Data bits** to **8**.
  1. Set **Parity** to **None**.
  1. Set **Stop bits** to **1**.
  1. Set **Flow control** to **Hardware**.
5. Click **OK**.

## Configuring the Terminal Settings

1. In HyperTerminal, click **File**, click **Properties**, and then click the **Settings** tab.
2. Ensure that the **Function, arrow, and Ctrl keys act as** field is set to **Terminal Keys**.
3. Ensure that the **Backspace key sends** field is set to **Ctrl+H**.
4. Change the **Emulation** setting from **Auto detect** to **ANSI** or **VT 100/220**.

Ensure that this setting is the same as the setting you selected for the **Console Redirection** option on the host system.

5. Click **Terminal Setup**.

A setting for the number of rows and columns appears.

6. Change the number of rows from **24** to **25** and leave the number of columns at **80**.

If you do not have these settings, you must upgrade your terminal emulation software.

7. Click **OK** twice.

---

## Managing the Host System Remotely

After you configure the host and client systems, you can use console redirection to restart a host system or to change a host system's configuration settings. See "[Configuring the Host System](#)" and "[Configuring the Client System](#)."

1. Reboot the host system using the client system.  
  
See "[Configuring Special Key Functions](#)" for instructions.
2. When the host system begins to boot, use console redirection to:
  1. Enter the System Setup program
  1. Enter the SCSI setup menus
  1. Update firmware and BIOS (flash the system)
  1. Run utilities on the utility partition

 **NOTE:** To run utilities on the host system's utility partition, you must have created the utility partition using Dell OpenManage™ Server Assistant version 6.3.1 or later, or later.

---

## Configuring Special Key Functions

Console redirection uses ANSI or VT 100/220 terminal emulation, which is limited to basic ASCII characters. Function keys, arrow keys, and control keys are not available in the ASCII character set, and most utilities require function keys and control keys for ordinary operations. However, you can emulate a function key or control key using a special key sequence, called an escape sequence.

An escape sequence starts with an escape character. You can enter this character in different ways, depending on the requirements of your terminal emulation software. For example, 0x1b and <Esc> each represent the escape character. In HyperTerminal, you can create macros by selecting **Key Macros** from the **View** menu. You can assign a macro to almost any key for almost any key combination. Create a macro to represent each function key.

[Table B-1](#) lists the escape sequences that represent a special key or function.

 **NOTE:** When creating macros in HyperTerminal, press <Insert> before <Esc> to signify that you are sending an escape sequence rather than escaping out of the dialog box. If you do not have this function, you must upgrade HyperTerminal.

 **NOTE:** Escape-sequence key combinations listed in [Table B-1](#) are case-sensitive. For example, to generate the character <A> you must press <Shift><a>.

**Table B-1. Supported Escape Sequences**

Key(s)	Supported Sequence	Terminal Emulation
<Up arrow>	<Esc><[><A>	VT 100/220, ANSI

<Down arrow>	<Esc><[><B>	VT 100/220, ANSI
<Right arrow>	<Esc><[><C>	VT 100/220, ANSI
<Left arrow>	<Esc><[><D>	VT 100/220, ANSI
<F1>	<Esc><O><P>	VT 100/220, ANSI
<F2>	<Esc><O><Q>	VT 100/220, ANSI
<F3>	<Esc><O><R>	VT 100/220, ANSI
<F4>	<Esc><O><S>	VT 100/220, ANSI
<F5>	<Esc><O><T>	VT 100, ANSI
<F6>	<Esc><O><U>	VT 100, ANSI
	<Esc><[><1><7><->	VT 100/220
<F7>	<Esc><O><V>	VT 100, ANSI
	<Esc><[><1><8><->	VT 100/220
<F8>	<Esc><O><W>	VT 100, ANSI
	<Esc><[><1><9><->	VT 100/220
<F9>	<Esc><O><X>	VT 100, ANSI
	<Esc><[><2><0><->	VT 100/220
<F10>	<Esc><O><Y>	VT 100, ANSI
	<Esc><[><2><1><->	VT 100/220
<F11>	<Esc><O><Z>	VT 100, ANSI
	<Esc><[><2><3><->	VT 100/220
<F12>	<Esc><O><A>	VT 100, ANSI
	<Esc><[><2><4><->	VT 100/220
<Home>	<Esc><[><1><-> <Esc><h>	VT 220 ANSI
<End>	<Esc><[><4><-> <Esc><k>	VT 220 ANSI
<Insert>	<Esc><[><2><-> <Esc><Shift><+>	VT 220 ANSI
<Delete>	<Esc><[><3><-> <Esc><->	VT 220 ANSI
<Page Up>	<Esc><[><5><-> <Esc><Shift><?>	VT 220 ANSI
<Page Down>	<Esc><[><6><-> <Esc></>	VT 220 ANSI
<Shift><Tab>	<Esc><[><Z> <Esc><[><0><Z> <Esc><[><Shift><z>	VT 100 VT 220 ANSI

After creating macros for the keys listed in [Table B-1](#), press <F1> on the client system's keyboard during terminal emulation to send the escape sequence <Esc><O><P> to the host system. The host system then interprets the sequence as <F1>.

Additional escape sequences may be required by certain utilities or functions on the host system. Create macros for the additional sequences listed in [Table B-2](#).

 **NOTE:** Escape-sequence key combinations listed in [Table B-2](#) are case-sensitive. For example, to generate the character <A> you must press <Shift><a>.

**Table B-2. Additional Escape Sequences**

Key(s)	Supported Sequence
<Ctrl><Alt><Del> (Reboot host system)	<Esc><R><Esc><r><Esc><R>
<Alt><x>	<Esc><X><X>
<Ctrl><H>	<Esc><Ctrl><H>
<Ctrl><I>	<Esc><Ctrl><I>
<Ctrl><J>	<Esc><Ctrl><J>
<Ctrl><M>	<Esc><Ctrl><M>
<Ctrl><2>	<Esc><Ctrl><2>

[Back to Contents Page](#)

[Back to Contents Page](#)

## System Overview

### Dell™ PowerEdge™ 1750 Systems User's Guide

- [Indicators on the Optional Bezel](#)
- [Front-Panel Features and Indicators](#)
- [Back-Panel Features and Indicators](#)
- [System Features](#)
- [Supported Operating Systems](#)
- [Power Protection Devices](#)
- [Other Documents You May Need](#)
- [Obtaining Technical Assistance](#)

Your system is a rack-dense, full-featured, highly available, rack-mount system equipped with one or two Intel® Xeon™ microprocessors.

This section describes the major hardware and software features of your system and provides information about the indicators on the system's front and back panels. It also provides information about other documents you may need when setting up your system and how to obtain technical assistance.

## Indicators on the Optional Bezel

The optional system bezel incorporates a system status indicator divided into blue and amber system status indicators. See [Figure 1-1](#). The blue indicator lights up when the system is operating correctly. The amber indicator lights up when the system needs attention due to a problem with power supplies, fans, system temperature, or hard drives.

[Table 1-1](#) lists the system's indicator patterns. Different patterns are displayed as events occur in the system.

Figure 1-1. System Status Indicators

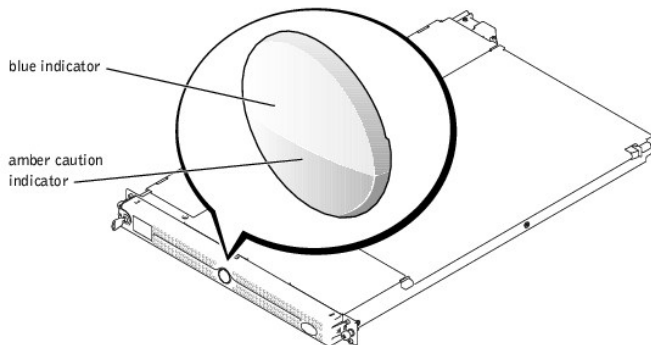

Table 1-1. System Status Indicator Patterns

Blue indicator	Amber indicator	Description
Off	Off	Power is not available to the system, or power is available to the system, but the system is not powered on. See your <i>Installation and Troubleshooting Guide</i> for more information.
Off	Blinking	The system has detected an error. See your <i>Installation and Troubleshooting Guide</i> for more information.
On	Off	Power is on, and the system is operational.
Blinking	Off	The indicator has been activated to identify the system in a rack.
<b>NOTE:</b> While the system is being identified, the blue indicator blinks even though an error has been detected. After the system is identified, the blue indicator stops blinking and the amber indicator resumes blinking.		

## Front-Panel Features and Indicators

[Figure 1-2](#) shows the controls, indicators, and connectors located behind the optional bezel on the system's front panel.

Figure 1-2. Front-Panel Features and Indicators

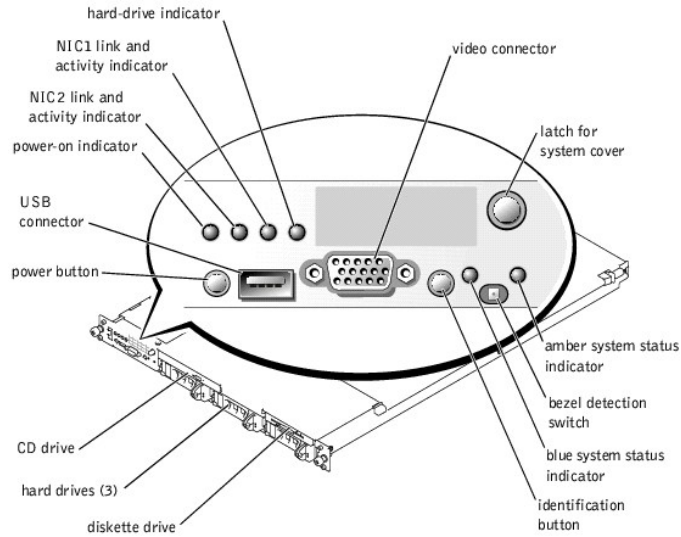

**Table 1-2. Front-Panel LED Indicators, Buttons, and Connectors**

Indicator, Button, or Connector	Icon	Description
blue system status indicator		The blue system status indicator lights up during normal system operation. Both the systems management software and the identification buttons located on the front and back of the system can cause the blue system status indicator to flash to identify a particular system.
amber system status indicator		The amber system status indicator flashes when the system needs attention due to a problem with power supplies, fans, system temperature, or hard drives. <b>NOTE:</b> If the system is connected to AC power and an error has been detected, the amber system status indicator flashes regardless of whether the system has been powered on.
NIC1 and NIC2 link and activity indicators		The link and activity indicators for the two integrated NICs light intermittently when the NICs are in use.
hard-drive indicator		The green hard-drive activity indicator flashes when the hard drives are in use. See <a href="#">Figure 1-3</a> for more information on hard-drive indicators.
power-on indicator, power button		The power-on indicator lights when the system power is on. The power button controls the DC power supply output to the system. <b>NOTE:</b> If you turn off the system using the power button and the system is running an ACPI-compliant operating system, the system performs a graceful shutdown before the power is turned off. If the system is not running an ACPI-compliant operating system, the power is turned off immediately after the power button is pressed.
identification button		The identification buttons on the front and back panels can be used to locate a particular system within a rack. When one of these buttons is pushed, the blue system status indicator on the front and back blinks until one of the buttons is pushed again.
USB connector		Connects a USB 1.1-compliant device to the system.
video connector		Connects a monitor to the system.

**SCSI Hard-Drive Indicator Codes**



If the optional RAID on motherboard (ROMB) card is activated, two indicators on each of the hard-drive carriers provide information on the status of the SCSI hard drives. See [Figure 1-3](#) and [Table 1-3](#). The SCSI backplane firmware controls the drive power-on/fault indicator.

**Figure 1-3. SCSI Hard-Drive Indicators**

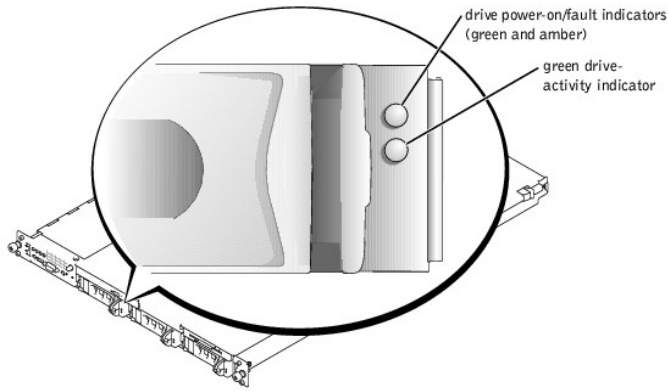

[Table 1-3](#) lists the drive indicator patterns. Different patterns are displayed as drive events occur in the system. For example, if a hard-drive fails, the "drive failed" pattern appears. After the drive is selected for removal, the "drive being prepared for removal" pattern appears, followed by the "drive ready for insertion or removal" pattern. After the replacement drive is installed, the "drive being prepared for operation" pattern appears, followed by the "drive online" pattern.

**NOTE:** If the optional ROMB card is not installed, only the "drive online" indicator pattern appears. The drive-activity indicator also blinks when the drive is being accessed.

**Table 1-3. Hard-Drive Indicator Patterns**

Condition	Indicator Pattern
Identify drive	The green power-on/fault indicator blinks four times per second.
Drive being prepared for removal	The green power-on/fault indicator blinks two times per second.
Drive ready for insertion or removal	Both drive indicators are off.
Drive being prepared for operation	The green power-on/fault indicator is on.
Drive predicted failure	The power-on/fault indicator slowly blinks green, amber, and off.
Drive failed	The amber power-on/fault indicator blinks four times per second.
Drive rebuilding	The green power-on/fault indicator blinks slowly.
Drive online	The green power-on/fault indicator is on.

## Back-Panel Features and Indicators

[Figure 1-4](#) shows the controls, indicators, and connectors located on the system's back panel.

**NOTE:** Connect the power cable to connector PS1 if your system only has one power supply. See [Figure 1-4](#).

**Figure 1-4. Back-Panel Features and Indicators**

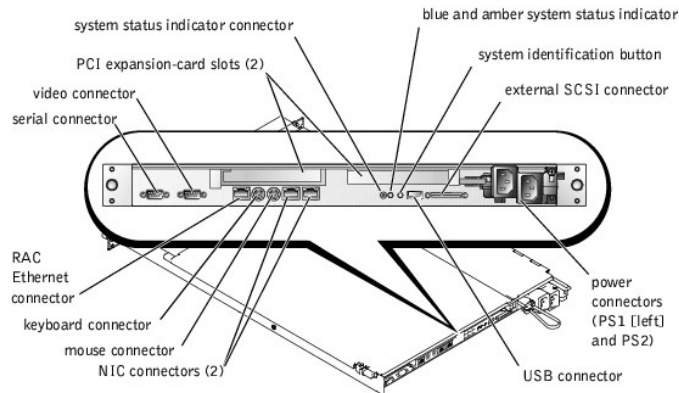

## Connecting External Devices

When connecting external devices to your system, follow these guidelines:

- 1 Most devices must be connected to a specific connector and device drivers must be installed before the device operates properly. (Device drivers are normally included with your operating system software or with the device itself.) See the documentation that accompanied the device for specific installation and configuration instructions.
- 1 Always attach external devices while your system is turned off. Next, turn on any external devices before turning on the system (unless the documentation for the device specifies otherwise).

For information about individual connectors, see your *Installation and Troubleshooting Guide*. For information about enabling, disabling, and configuring I/O ports and connectors, see "[Using the System Setup Program](#)."

## System Features

- 1 One or two Intel Xeon microprocessors with an internal operating speed of at least 2.0 GHz, a level 2 cache of 512 KB, and a front-side bus operating at 533 MHz.
- 1 Support for symmetric multiprocessing (SMP), which is available on systems with two Intel Xeon microprocessors. SMP greatly improves overall system performance by dividing microprocessor operations between independent microprocessors. To take advantage of this feature, you must use an operating system that supports multiprocessing.

**NOTE:** If you decide to upgrade your system by installing a second microprocessor, you must order the microprocessor upgrade kits from Dell. Not all versions of the Intel Xeon microprocessor will work properly as additional microprocessors. The upgrade kit from Dell contains the correct version of the microprocessor as well as the instructions for performing the upgrade. Both microprocessors must have the same internal operating frequency and cache size.

- 1 A minimum of 256 MB of PC-266 registered DDR SDRAM memory modules, upgradable to a maximum of 8 GB by installing combinations of 128-MB, 256-MB, 512-MB, 1-GB, or 2-GB 2-way interleaving memory modules in the four memory module sockets on the system board.
- 1 Support for up to three 1-inch, internal U320 SCSI hard drives (with hot-plug capability when using the optional ROMB card).
- 1 A single, 1.44-MB, 3.5-inch diskette drive.
- 1 An IDE CD or DVD drive.
- 1 Up to two hot-pluggable, 320-W power supplies in a 1 + 1 redundant configuration.
- 1 Seven hot-pluggable system cooling fans.

The system board includes the following features:

- 1 One of the following PCI expansion card slot options. Expansion card slots accommodate full-height, half-length expansion cards.
  - o Two connected riser cards that each have a 3.3-V, 64-bit, 133-MHz PCI-X expansion slot.
  - or
  - o Two connected riser cards, one with a 3.3-V, 64-bit, 133-MHz PCI-X expansion slot and one with a 5-V, 64-bit, 33-MHz PCI expansion slot.
- 1 An integrated VGA-compatible video subsystem with an ATI RAGE XL video controller. This video subsystem contains 8 MB of SDRAM video memory (nonupgradable). Maximum resolution is 1024 x 768 with 256 colors; 16.7 million colors are available for true-color graphics in the following resolutions: 640 x 480, 800 x 600, and 1024 x 768.
- 1 An integrated, dual-channel U320 SCSI host adapter. The internal channel supports up to three SCSI hard drives on the SCSI backplane. The SCSI backplane automatically configures SCSI ID numbers and SCSI termination, greatly simplifying drive installation. The second SCSI channel (an external SCSI channel) is available at the back of the system.
- 1 Optional ROMB through a separate RAID controller that incorporates 128 MB of cache memory and a RAID battery.
- 1 Two integrated Gigabit Ethernet NICs, capable of supporting 10-Mbps, 100-Mbps, and 1000-Mbps data rates.
- 1 Optional remote access controller (RAC) for remote systems management.

- 1 Systems management circuitry that monitors operation of the system fans as well as critical system voltages and temperatures. The systems management circuitry works in conjunction with the systems management software.
- 1 Back-panel connectors include mouse, keyboard, serial, video, USB, external SCSI, RAC Ethernet, and two NIC connectors.
- 1 Front-panel connectors include a video and a USB connector.

For more information about specific features, see "[Technical Specifications](#)."

The following software is included with your system:

- 1 A System Setup program for quickly viewing and changing system configuration information. For more information on this program, see "[Using the System Setup Program](#)."
- 1 Enhanced security features, including a system password and a setup password, available through the System Setup program.
- 1 System diagnostics for evaluating system components and devices. For information about using the system diagnostics, see "Running the System Diagnostics" in your *Installation and Troubleshooting Guide*.
- 1 Video drivers for displaying many popular application programs in high-resolution modes.
- 1 SCSI device drivers that allow the operating system to communicate with devices attached to the integrated SCSI subsystem. For more information about these drivers, see "Installing and Configuring Hard Drives" in your *Installation and Troubleshooting Guide*.
- 1 Systems management software and documentation CDs.

---

## Supported Operating Systems

- 1 Microsoft Windows 2000 Server and Advanced Server
- 1 Microsoft Windows.NET Server 2003 Standard Edition, Enterprise Edition, and Web Edition (when available)
- 1 Red Hat Linux 8.0 and Red Hat Linux Advanced Server 2.1
- 1 Novell® NetWare® 6.0

---

## Power Protection Devices

Certain devices protect your system from the effects of problems such as power surges and power failures.

- 1 PDU — Uses circuit breakers to ensure that the AC current load does not exceed the PDU's rating.
- 1 Surge protector — Prevents voltage spikes, such as those that may occur during an electrical storm, from entering the system through the electrical outlet. They do not protect against brownouts, which occur when the voltage drops more than 20 percent below the normal AC line voltage level.
- 1 Line conditioner — Maintains a system's AC power source voltage at a moderately constant level and provides protection from brownouts, but does not protect against a complete power loss.
- 1 UPS — Uses battery power to keep the system running when AC power is unavailable. The battery is charged by AC power while it is available so that after AC power is lost, the battery can provide power to the system for a limited amount of time—from 5 minutes to approximately an hour. A UPS that provides only 5 minutes of battery power allows you to shutdown the system. Use surge protectors and PDUs with all universal power supplies, and ensure that the UPS is UL-safety approved.

---

## Other Documents You May Need

 The *System Information Guide* provides important safety and regulatory information. Warranty information may be included within this document or as a separate document.

- 1 The *Rack Installation Guide* included with your rack solution describes how to install your system into a rack.
- 1 The *Setting Up Your System* document provides an overview of initially setting up your system.
- 1 The *Installation and Troubleshooting Guide* describes how to troubleshoot the system and install or replace system components.
- 1 The *Dell Remote Access Controller Installation and Setup Guide* provides complete information about installing, configuring, and using a RAC to remotely access a system.
- 1 Systems management software documentation describes the features, requirements, installation, and basic operation of the software.
- 1 Operating system documentation describes how to install (if necessary), configure, and use the operating system software.
- 1 Documentation for any components you purchased separately provides information to configure and install these options.
- 1 Updates are sometimes included with the system to describe changes to the system, software, and/or documentation.

 **NOTE:** Always read the updates first because they often supersede information in other documents.

- 1 Release notes or readme files may be included to provide last-minute updates to the system or documentation or advanced technical reference material intended for experienced users or technicians.
-

## Obtaining Technical Assistance

If you do not understand a procedure in this guide or if the system does not perform as expected, see your *Installation and Troubleshooting Guide*.

Dell Enterprise Training and Certification is available; see [www.dell.com/training](http://www.dell.com/training) for more information. This service may not be offered in all locations.

---

[Back to Contents Page](#)

[Back to Contents Page](#)

## Using the Dell OpenManage Server Assistant CD

### Dell™ PowerEdge™ 1750 Systems User's Guide

- [Starting the Server Assistant CD](#)
- [Using the Server Setup Program](#)
- [Updating Drivers and Utilities](#)
- [Using the Utility Partition](#)

The *Dell OpenManage Server Assistant* CD contains utilities, diagnostics, and drivers to help you configure your system. You begin the operating system installation with this CD if your operating system was not preinstalled on your system. A bootable utility partition on the system's hard drive contains some of the same functionality as the *Server Assistant* CD.

---

## Starting the Server Assistant CD

To configure your system and install your operating system, insert the Server Assistant CD, and turn on or reboot the system. The **Dell OpenManage Server Assistant** main screen appears.

The *Server Assistant* CD uses a standard Web browser interface. You can navigate the CD by using the mouse to click various icons and text links.

Click the **Exit** icon to exit Server Assistant. If you exit Server Assistant while in the Server Setup program, the system reboots to the standard operating system boot partition.

If the CD does not boot, verify that the CD drive is specified first in the **Boot Sequence** option in the System Setup program. See "[Using the System Setup Program](#)".

---

## Using the Server Setup Program

If the operating system is not preinstalled or if you install an operating system at a later date, use the Server Setup program on the *Server Assistant* CD to configure your system and install your operating system.

 **NOTE:** Use the *Server Assistant* CD only if your operating system is not preinstalled on your system. Locate the operating system's *Installation Instructions* document and follow the instructions to complete the installation process.

The Server Setup program guides you through tasks such as the following:

- 1 Setting the system date and time
- 1 Configuring your RAID controller (if applicable)
- 1 Selecting and installing your operating system; specifying operating system-specific information
- 1 Configuring hard drives
- 1 Viewing the installation summary

 **NOTE:** You must have your operating system media available to install your operating system.

To start the Server Setup program, click **Server Setup** on the **Dell OpenManage Server Assistant** main screen. Follow the instructions on the screen.

---

## Updating Drivers and Utilities

You can update drivers and utilities on any system that has Microsoft® Internet Explorer 4.0 or later or Netscape Navigator 6.0 or later installed. When you insert the CD into the CD drive on a system that uses a Microsoft Windows®-based operating system, the system automatically starts the browser and displays the **Dell OpenManage Server Assistant** main screen.

To update drivers and utilities, perform the following steps:

1. From the **Dell OpenManage Server Assistant** main screen, select the option for updating drivers and utilities.
2. Select the system model number from the drop-down box.
3. Select the type of drivers or utilities that you want to update.
4. Click **Continue**.
5. Select each driver or utility that you want to update.

You are prompted to either run the program or provide a location to save the files.

6. Run the program or specify the location to save the files.
-

## Using the Utility Partition

The utility partition is a bootable partition on the hard drive that contains system configuration and diagnostic utilities. When you start the utility partition, it boots and provides an executable environment for the partition's utilities.

To start the utility partition, turn on or reboot the system. During POST, press <F10> after the following message appears:

<F10> = Utility Mode

 **NOTE:** The utility partition provides only limited MS-DOS® functionality and cannot be used as a general-purpose MS-DOS partition.

The utility partition provides a text-based interface from which you can run the partition's utilities. To select a menu option, use either the arrow keys to highlight the option and press <Enter> or type the number of the menu option. To exit the utility partition, press <Esc> from the **Utility Partition** main menu.

[Table 2-1](#) provides a sample list and explanation of the options that appear on the utility partition menu. These options are available even when the *Server Assistant* CD is not in the CD drive.

**Table 2-1. Utility Partition Main Menu Options**

Option	Description
Run system diagnostics	Runs the system hardware diagnostics
Run RAID configuration utility	Runs the RAID configuration utility if a ROMB or RAID controller card is installed
<b>NOTE:</b> The options displayed may vary depending on your system configuration and may not include those listed here.	

[Back to Contents Page](#)

[Back to Contents Page](#)

## Using the System Setup Program

Dell™ PowerEdge™ 1750 Systems User's Guide

- [Entering the System Setup Program](#)
- [System Setup Options](#)
- [System and Setup Password Features](#)
- [Disabling a Forgotten Password](#)
- [Asset Tag Utility](#)

After you set up your system, run the System Setup program to familiarize yourself with your system configuration and optional settings. Print the System Setup screens by pressing <Print Screen> or record the information for future reference.

You can use the System Setup program to:

- 1 Change the system configuration stored in NVRAM after you add, change, or remove hardware
- 1 Set or change user-selectable options—for example, the time or date
- 1 Enable or disable integrated devices
- 1 Correct discrepancies between the installed hardware and configuration settings

---

## Entering the System Setup Program

1. Turn on or restart your system.
2. Press <F2> immediately after you see the following message:

```
<F2> = System Setup
```

If your operating system begins to load before you press <F2>, allow the system to finish booting, and then restart your system and try again.

 **NOTE:** To ensure an orderly system shutdown, see the documentation that accompanied your operating system.

## Responding to Error Messages

You can enter the System Setup program by responding to certain error messages. If an error message appears while the system is booting, make a note of the message. Before entering the System Setup program, see "System Beep Codes" and "System Messages" in your *Installation and Troubleshooting Guide* for an explanation of the message and suggestions for correcting errors.

 **NOTE:** After installing a memory upgrade, it is normal for your system to send a message the first time you start your system.

## Using the System Setup Program

[Table 3-1](#) lists the keys that you use to view or change information on the System Setup program screens and to exit the program.

**Table 3-1. System Setup Program Navigation Keys**

Keys	Action
Up arrow or <Shift><Tab>	Moves to the previous field.
Down arrow or <Tab>	Moves to the next field.
Spacebar, <+>, <->, left and right arrows	Cycles through the settings in a field. In many fields, you can also type the appropriate value.
<Esc>	Exits the System Setup program and restarts the system if any changes were made.
<F1>	Displays the System Setup program's help file.

 **NOTE:** For most of the options, any changes that you make are recorded but do not take effect until you restart the system.

---

## System Setup Options

### Main Screen

When you enter the System Setup program, the main System Setup program screen appears. See [Figure 3-1](#).

Figure 3-1. Main System Setup Program Screen

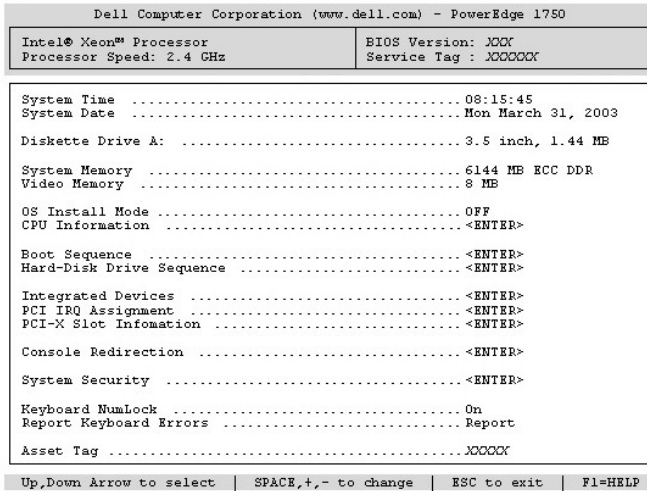

Table 3-2 lists the options and descriptions for the information fields that appear on the main System Setup program screen.

 **NOTE:** The System Setup program defaults are listed under their respective options, where applicable.

Table 3-2. System Setup Program Options

Option	Description
System Time	Resets the time on the system's internal clock.
System Date	Resets the date on the system's internal calendar.
Diskette Drive A:	Displays a screen that allows you to select the type of diskette drive for your system.
System Memory	Displays the amount of system memory. This option has does not have user-selectable settings.
Video Memory	Displays the amount of video memory. This option does not have user-selectable settings.
Redundant Memory	Enables or disables the redundant memory feature. When enabled, all memory banks except for the last one are reported back to the operating system. The last bank is reserved for failover conditions. When disabled, all of the available system memory is reported to the operating system.  <b>NOTE:</b> This feature can be enabled only if all memory banks are populated with memory modules of the same type.
OS Install Mode ( <b>Off</b> default)	Determines the maximum amount of memory available to the operating system. On sets the maximum memory to 256 MB. Off makes all of the system memory available to the operating system. Some operating systems cannot install with more than 2 GB of system memory. Enable this option (On) during operating system installation and disable (Off) after installation.
CPU Information (Logical Processor Enabled default)	Displays information related to microprocessors (speed, cache size, and so on). Enable or disable Hyper-Threading technology by changing the setting of the Logical Processor option.
Virtual Media ( <b>Disabled</b> default)	Enables or disables the virtual media feature (when available). Options are <b>Enabled</b> and <b>Disabled</b> . The default is <b>Disabled</b> until the option becomes available.
Boot Sequence	Determines the order in which the system searches for boot devices during system startup. Available options can include the diskette drive, CD drive, hard drives, and network.
Hard-Disk Drive Sequence	Determines the order in which the system searches the hard drives during system startup. The selections depend on the hard drives installed in your system.
Integrated Devices	See " <a href="#">Integrated Devices Screen</a> ."
PCI IRQ Assignment	Displays a screen to change the IRQ assigned to each of the integrated devices on the PCI bus, and any installed expansion cards that require an IRQ.
PCI Slot Information	Displays a menu of selectable fields. Selecting any of the fields displays the following information for the PCI bus you selected:  <ul style="list-style-type: none"> <li>1 Occupied or unoccupied</li> <li>1 For occupied slots, the operating frequency and mode of the slots (PCI or PCI-X)</li> <li>1 For unoccupied slots, the maximum operating frequency and the capable operating mode of the slots</li> </ul>
Console Redirection	See " <a href="#">Console Redirection Screen</a> ."
System Security	Displays a screen to configure the system password and setup password features. See " <a href="#">Using the System Password</a> " and " <a href="#">Using the Setup Password</a> " for more information.
Keyboard NumLock	Determines whether your system starts up with the <b>NumLock</b> mode activated on 101- or 102-key keyboards (does not apply to 84-key keyboards).
Report Keyboard Errors	Enables or disables reporting of keyboard errors during the POST. Enable this option for host systems that have keyboards attached. Select <b>Do Not Report</b> to suppress all error messages relating to the keyboard or keyboard controller during POST. This setting does not



	affect the operation of the keyboard itself if a keyboard is attached to the system.
Asset Tag	Displays the customer-programmable asset tag number for the system if an asset tag number has been assigned. To enter an asset tag number of up to 10 characters into NVRAM, see " <a href="#">Asset Tag Utility</a> ."

## Integrated Devices Screen

[Table 3-3](#) lists the options and descriptions for the information fields that appear on the **Integrated Devices** screen.

**Table 3-3. Integrated Devices Screen Options**

Option	Description
Embedded RAID Controller	Selects between <b>RAID</b> , <b>SCSI</b> , or <b>Off</b> . The configurable options vary, depending on whether the optional ROMB is installed. <ul style="list-style-type: none"> <li>1 With the ROMB installed — Select either <b>RAID Enabled</b>, <b>SCSI Enabled</b>, or <b>Off</b>.</li> <li>1 Without the ROMB installed — Select either <b>SCSI</b> or <b>Off</b>.</li> </ul>
IDE Controller	Enables the integrated IDE CD controller. When set to <b>Auto</b> , each channel of the integrated IDE controller is enabled if IDE devices are attached to the channel and an external IDE controller is not detected. Otherwise, the channel is disabled.
Diskette Controller ( <b>Auto</b> default)	Enables or disables the system's diskette drive controller. When <b>Auto</b> is selected, the system turns off the controller when necessary to accommodate a controller card installed in an expansion slot. You can also configure the drive as read-only. When using the read-only setting, the drive cannot be used to write to a disk.
USB Controller ( <b>On with BIOS support</b> default)	Enables or disables the system's USB ports. Options are <b>On with BIOS support</b> , <b>On without BIOS support</b> , or <b>Off</b> . Disabling the USB ports makes system resources available for other devices.
Embedded Gb NIC 1 and NIC 2	Enables or disables the system's integrated NICs. Options are <b>Enabled</b> and <b>Disabled</b> .
NIC 1 PXE	Enables or disables the NIC 1 PXE support. Options are <b>Enabled</b> and <b>Disabled</b> . PXE support allows the system to boot from the network. Changes take effect after the system reboots.
NIC 2 PXE	Enables or disables the NIC 2 PXE support. Options are <b>Enabled</b> and <b>Disabled</b> . PXE support allows the system to boot from the network. Changes take effect after the system reboots.
MAC Address	Displays the MAC address for the integrated Gb NIC. This field does not have user-selectable settings.
Serial Port ( <b>Auto</b> default)	Serial port options are <b>COM1</b> , <b>COM3</b> , <b>Auto</b> , and <b>Off</b> .  When the serial port is set to <b>Auto</b> , the integrated port automatically maps to the next available port. The serial port attempts to use COM1 first, and then COM3. If both addresses are in use for a specific port, the port is disabled.  If you set the serial port to <b>Auto</b> and add an expansion card with a port configured to the same designation, the system automatically remaps the integrated port to the next available port designation that shares the same IRQ setting.  If you set the serial port to <b>Off</b> , the system automatically remaps the integrated port to the ERA/O controller card.
Speaker ( <b>On</b> default)	Sets the integrated speaker <b>On</b> or <b>Off</b> . A change to this option takes effect immediately (rebooting the system is not required).

## Console Redirection Screen

[Table 3-4](#) lists the options and descriptions for the information fields that appear on the **Console Redirection** screen. For more information about using console redirection, see "[Using Console Redirection](#)."

**Table 3-4. Console Redirection Screen Options**

Option	Description
Console Redirection ( <b>Off</b> default)	Sets the console redirection feature to <b>On</b> or <b>Off</b> .
Remote Terminal Type ( <b>VT 100/VT 220</b> default)	Select either <b>VT 100/VT 220</b> or <b>ANSI</b> .
Redirection After Boot ( <b>Enabled</b> default)	Enables or disables console redirection after your system restarts.

## System Security Screen

[Table 3-5](#) lists the options and descriptions for the information fields that appear on the **System Security** screen.

**Table 3-5. System Security Screen Options**

Option	Description
System Password	Displays the current status of your system's password security feature and allows you to assign and verify a new system password.  <b>NOTE:</b> See " <a href="#">Using the System Password</a> " for instructions on assigning a system password and using or changing an existing system password.
Setup Password	Restricts access to the System Setup program in the same way that you restrict access to your system using the system password feature.

	<b>NOTE:</b> See " <a href="#">Using the Setup Password</a> " for instructions on assigning a setup password and using or changing an existing setup password.
Password Status	<p>Setting the <b>Setup Password</b> option to <b>Enabled</b> prevents the system password from being changed or disabled at system start-up.</p> <p>To <b>lock</b> the system password, assign a setup password in the <b>Setup Password</b> option and then change the <b>Password Status</b> option to <b>Locked</b>. In this state, you cannot change the system password using the <b>System Password</b> option and cannot be disabled at system start up by pressing &lt;Ctrl&gt;&lt;Enter&gt;.</p> <p>To <b>unlock</b> the system password, enter the setup password in the <b>Setup Password</b> field and then change the <b>Password Status</b> option to <b>Unlocked</b>. In this state, you can disable the system password at system start up by pressing &lt;Ctrl&gt;&lt;Enter&gt; and then change the password using the <b>System Password</b> option.</p>
Extended Security	When a system password is entered, setting the <b>Extended Security</b> option to <b>Enabled</b> locks all keys on the keyboard during BIOS POST, except for the <F2> key. Pressing the <F2> key during BIOS POST displays a password prompt that allows 20 seconds for a valid entry before continuing to boot the operating system.
Power Button	<p>Turns system's power off and on.</p> <ol style="list-style-type: none"> <li>If you turn off the system using the power button and the system is running an ACPI-compliant operating system, the system can perform an orderly shutdown before power is turned off.</li> <li>If the system is not running an ACPI-compliant operating system, power is turned off immediately after the power button is pressed.</li> </ol> <p>The button is enabled in the System Setup program. When disabled, the button can only turn on system power.</p>
NMI Button	<p><b>NOTICE:</b> Use the NMI button only if directed to do so by qualified support personnel or by the operating system's documentation. Pressing this button halts the operating system and displays a diagnostic screen.</p> <p>Sets the NMI feature <b>On</b> or <b>Off</b>.</p>

## Exit Screen

After you press <Esc> to exit the System Setup program, the **Exit** screen displays the following options:

- 1 Save Changes and Exit
- 1 Discard Changes and Exit
- 1 Return to Setup

## System and Setup Password Features

 **NOTICE:** The password features provide a basic level of security for the data on your system. If your data requires more security, use additional forms of protection, such as data encryption programs.

 **NOTICE:** Anyone can access the data stored on your system if you leave the system running and unattended without having a system password assigned or if you leave your system unlocked so that someone can disable the password by changing a jumper setting.

Your system is shipped to you without the system password feature enabled. If system security is a concern, operate your system only with system password protection.

To change or delete an existing password, you must know the password. See "[Deleting or Changing an Existing System Password](#)." If you forget your password, you cannot operate your system or change settings in the System Setup program until a trained service technician changes the password jumper setting to disable the passwords, and erases the existing passwords. This procedure is described in the *Installation and Troubleshooting Guide*.

## Using the System Password

After a system password is assigned, only those who know the password have full use of the system. When the **System Password** option is set to **Enabled**, the system prompts you for the system password after the system starts.

### Assigning a System Password

Before you assign a system password, enter the System Setup program and check the **System Password** option.

When a system password is assigned, the setting shown for the **System Password** option is **Enabled**. If the setting shown for the **Password Status** is **Unlocked**, you can change the system password. If the **Password Status** option is **Locked**, you cannot change the system password. When the system password feature is disabled by a jumper setting, the system password is **Disabled**, and you cannot change or enter a new system password.

When a system password is not assigned and the password jumper on the system board is in the enabled (default) position, the setting shown for the **System Password** option is **Not Enabled** and the **Password Status** field is **Unlocked**. To assign a system password:

- Verify that the **Password Status** option is set to **Unlocked**.
- Highlight the **System Password** option and press <Enter>.
- Type your new system password.

You can use up to 32 characters in your password.

As you press each character key (or the spacebar for a blank space), a placeholder appears in the field.

The password assignment is not case-sensitive. However, certain key combinations are not valid. If you enter one of these combinations, the system beeps. To erase a character when entering your password, press <Backspace> or the left-arrow key.

 **NOTE:** To escape from the field without assigning a system password, press <Enter> to move to another field, or press <Esc> at any time prior to completing step 5.

4. Press <Enter>.
5. To confirm your password, type it a second time and press <Enter>.

The setting shown for the **System Password** changes to **Enabled**. Exit the System Setup program and begin using your system.

6. Either reboot your system now for your password protection to take effect or continue working.

 **NOTE:** Password protection does not take effect until you reboot the system.

## Using Your System Password to Secure Your System

 **NOTE:** If you have assigned a setup password (see "[Using the Setup Password](#)"), the system accepts your setup password as an alternate system password.

When the **Password Status** option is set to **Unlocked**, you have the option to leave the password security enabled or to disable the password security.

To leave the password security enabled:

1. Turn on or reboot your system by pressing <Ctrl><Alt><Del>.
2. Press <Enter>.
3. Type your password and press <Enter>.

To disable the password security:

1. Turn on or reboot your system by pressing <Ctrl><Alt><Del>.
2. Press <Ctrl><Enter>.

When the **Password Status** option is set to **Locked** whenever you turn on your system or reboot your system by pressing <Ctrl><Alt><Del>, type your password and press <Enter> at the prompt.

After you type the correct system password and press <Enter>, your system operates as usual.

If an incorrect system password is entered, the system displays a message and prompts you to re-enter your password. You have three attempts to enter the correct password. After the third unsuccessful attempt, the system displays an error message showing the number of unsuccessful attempts and that the system has halted and will shut down. This message can alert you to an unauthorized person attempting to use your system.

Even after you shut down and restart the system, the error message continues to be displayed until the correct password is entered.

 **NOTE:** You can use the **Password Status** option in conjunction with the **System Password** and **Setup Password** options to further protect your system from unauthorized changes.

## Deleting or Changing an Existing System Password

1. When prompted, press <Ctrl><Enter> to disable the existing system password.  
If you are asked to enter your setup password, contact your network administrator.
2. Enter the System Setup program by pressing <F2> during POST.
3. Select the **System Security** screen field to verify that the **Password Status** option is set to **Unlocked**.
4. When prompted, type the system password.
5. Confirm that **Not Enabled** is displayed for the **System Password** option.

If **Not Enabled** is displayed for the **System Password** option, the system password has been deleted. If **Enabled** is displayed for the **System Password** option, press the <Alt><b> key combination to restart the system, and then repeat steps 2 through 5.

## Using the Setup Password

### Assigning a Setup Password

You can assign (or change) a setup password only when the **Setup Password** option is set to **Not Enabled**. To assign a setup password, highlight the **Setup Password** option and press the <+> or <-> key. The system prompts you to enter and verify the password. If a character is illegal for password use, the system beeps.

 **NOTE:** The setup password can be the same as the system password. If the two passwords are different, the setup password can be used as an alternate system password. However, the system password cannot be used in place of the setup password.

You can use up to 32 characters in your password.

As you press each character key (or the spacebar for a blank space), a placeholder appears in the field.

The password assignment is not case-sensitive. However, certain key combinations are not valid. If you enter one of these combinations, the system beeps.

To erase a character when entering your password, press <Backspace> or the left-arrow key.

After you verify the password, the **Setup Password** setting changes to **Enabled**. The next time you enter the System Setup program, the system prompts you for the setup password.

A change to the **Setup Password** option becomes effective immediately (restarting the system is not required).

## Operating With a Setup Password Enabled

If **Setup Password** is set to **Enabled**, you must enter the correct setup password before you can modify most of the System Setup options. When you start the System Setup program, the program prompts you to enter a password.

If you do not enter the correct password in three attempts, the system lets you view, but not modify, the System Setup screens—with the following exception: If **System Password** is not set to **Enabled** and is not locked through the **Password Status** option, you can assign a system password (however, you cannot disable or change an existing system password).

 **NOTE:** You can use the **Password Status** option in conjunction with the **Setup Password** option to protect the system password from unauthorized changes.

## Deleting or Changing an Existing Setup Password

1. Enter the System Setup program and select the **System Security** option.
2. Highlight the **Setup Password** option, press <Enter> to access the setup password window, and press <Enter> twice to clear the existing setup password.

The setting changes to **Not Enabled**.

3. If you want to assign a new setup password, perform the steps in "[Assigning a Setup Password](#)."

---

## Disabling a Forgotten Password

See your *Installation and Troubleshooting Guide*.

---

## Asset Tag Utility

You can use the Asset Tag utility to assign a unique tracking number to your system. This number is displayed on the System Setup program main screen.

 **NOTE:** The Asset Tag utility works only with operating systems that support MS-DOS®-based applications.

## Creating the Asset Tag Utility Diskette

1. Insert the *Dell OpenManage Server Assistant* CD into the CD drive of a Dell™ PowerEdge™ system running a Microsoft® Windows® operating system, and reboot the system.
2. Insert a blank diskette into the system's diskette drive.
3. Click **System Tools** on the **Dell OpenManage Server Assistant** main screen.
4. Select **Create CD Boot Diskette**.

## Assigning or Deleting an Asset Tag Number

1. Insert the Asset Tag utility diskette that you created into the diskette drive, and reboot the system.
2. You can either assign or delete an asset tag number.
  - 1 To assign an asset tag number, type `asset` and a space followed by the new string.

An asset tag number can have up to 10 characters. Any combination of characters is valid. For example, at the `a:\>` prompt, type the following command and press <Enter>:

```
asset 12345abcde
```
  - 1 To delete an asset tag number without assigning a new one, type `asset /d` and press <Enter>.
3. When prompted to verify the change to the asset tag number, type `y` and press <Enter>.

To view the Asset Tag utility help screen, type `asset /?` and press <Enter>.

---

[Back to Contents Page](#)

[Back to Contents Page](#)

## Glossary

### Dell™ PowerEdge™ 1750 Systems User's Guide

The following list defines or identifies technical terms, abbreviations, and acronyms used in your system documents.

#### A

Abbreviation for ampere(s).

#### AC

Abbreviation for alternating current.

#### ACPI

Abbreviation for Advanced Configuration and Power Interface.

#### adapter card

An expansion card that plugs into an expansion-card connector on the computer's system board. An adapter card adds some specialized function to the system by providing an interface between the expansion bus and a peripheral device. Examples of adapter cards include network cards, sound cards, and SCSI adapters.

#### ambient temperature

The temperature of the area or room where the system is located. Also known as room temperature.

#### ANSI

Abbreviation for American National Standards Institute.

#### application

Software, such as a spreadsheet or word processor, designed to help you perform a specific task or series of tasks. Application programs run from the operating system.

#### asset tag code

An individual code assigned to a system, usually by a system administrator, for security or tracking purposes.

#### backup

A copy of a program or data file. As a precaution, you should back up your system's hard drive on a regular basis. Before making a change to the configuration of your system, you should back up important start-up files from your operating system.

#### backup battery

The backup battery maintains system configuration, date, and time information in a special section of memory when the system is turned off.

#### beep code

A diagnostic message in the form of a pattern of beeps from your system's speaker. For example, one beep, followed by a second beep, and then a burst of three beeps is beep code 1-1-3.

#### BIOS

Acronym for basic input/output system. Your system's BIOS contains programs stored on a flash memory chip. The BIOS controls the following:

- 1 Communications between the microprocessor and peripheral devices, such as the keyboard and the video adapter
- 1 Miscellaneous functions, such as system messages

#### bit

The smallest unit of information interpreted by your system.

#### boot routine

When you start your system, it clears all memory, initializes devices, and loads the operating system. Unless the operating system fails to respond, you can **reboot** (also called *warm boot*) your system by pressing <Ctrl><Alt><Del>; otherwise, you must perform a cold boot by pressing the reset button or by turning the system off and then back on.

#### bootable diskette

You can start your system from a bootable diskette. To make a bootable diskette, insert a diskette in the diskette drive, type `sys a:` at the command line prompt, and press <Enter>. Use this bootable diskette if your system will not boot from the hard drive.

#### bps

Abbreviation for bits per second.

## **BTU**

Abbreviation for British thermal unit.

## **bus**

An information pathway between the components of a system. Your system contains an expansion bus that allows the microprocessor to communicate with controllers for all the various peripheral devices connected to the system. Your system also contains an address bus and a data bus for communications between the microprocessor and RAM.

## **byte**

Eight contiguous bits of information, the basic data unit used by your system.

## **C**

Abbreviation for Celsius.

## **cache**

A fast storage area that keeps a copy of data or instructions for quicker data retrieval. For example, your system's BIOS may cache ROM code in faster RAM. Or, a disk-cache utility may reserve RAM in which to store frequently accessed information from your system's disk drives: when a program makes a request to a disk drive for data that is in the cache, the disk-cache utility can retrieve the data from RAM faster than from the disk drive.

## **CD**

Abbreviation for compact disc. CD drives use optical technology to read data from CDs. CDs are read-only storage devices; you cannot write new data to a CD with standard CD drives.

## **COM<sub>n</sub>**

The device names for the first through fourth serial ports are COM1, COM2, COM3, and COM4. The default interrupt for COM1 and COM3 is IRQ4, and the default interrupt for COM2 and COM4 is IRQ3. Therefore, you must be careful when configuring software that runs a serial device so that you don't create an interrupt conflict.

## **controller**

A chip that controls the transfer of data between the microprocessor and memory or between the micro-processor and a peripheral device such as a disk drive or the keyboard.

## **control panel**

The part of the system that contains indicators and controls, such as the power switch, hard drive access indicator, and power indicator.

## **CPU**

Abbreviation for central processing unit. See *microprocessor*.

## **DC**

Abbreviation for direct current.

## **DDR**

Abbreviation for double-data rate.

## **device driver**

A program that allows the operating system or some other program to interface correctly with a peripheral device, such as a printer. Some device drivers—such as network drivers—must be loaded from the **config.sys** file (with a **device=** statement) or as memory-resident programs (usually, from the **autoexec.bat** file). Others—such as video drivers—must load when you start the program for which they were designed.

## **DHCP**

Acronym for Dynamic Host Configuration Protocol.

## **diagnostics**

A comprehensive set of tests for your system. See your *Installation and Troubleshooting Guide* for more information about using diagnostics.

## **DIMM**

Acronym for dual in-line memory module. A small circuit board containing DRAM chips that connects to the system board.

## **DIN**

Acronym for *Deutsche Industrie Norm*.

## **directory**

Directories help keep related files organized on a disk in a hierarchical, "inverted tree" structure. Each disk has a "root" directory; for example, a `c:\>` prompt normally indicates that you are at the root directory of hard drive C. Additional directories that branch off the root directory are called *subdirectories*. Subdirectories may contain additional directories branching off them.

#### **DMA**

Abbreviation for direct memory access. A DMA channel allows certain types of data transfer between RAM and a device to bypass the microprocessor.

#### **DNS**

Abbreviation for Domain Name System.

#### **DRAM**

Abbreviation for dynamic random-access memory. A system's RAM is usually made up entirely of DRAM chips. Because DRAM chips cannot store an electrical charge indefinitely, your system continually refreshes each DRAM microprocessor in the system.

#### **DVD**

Abbreviation for digital versatile disk.

#### **ECC**

Abbreviation for error checking and correction.

#### **EEPROM**

Acronym for electrically erasable programmable read-only memory.

#### **EMC**

Abbreviation for Electromagnetic Compatibility.

#### **EMI**

Abbreviation for electromagnetic interference.

#### **ERA/O**

Abbreviation for embedded remote access option. ERA/O allows you to perform remote, or "out-of-band," server management on your network server using an optional remote access controller (RAC) card.

#### **ESD**

Abbreviation for electrostatic discharge.

#### **expansion bus**

Your system contains an expansion bus that allows the microprocessor to communicate with controllers for peripheral devices, such as a network card.

#### **expansion-card connector**

A connector on the system board or riser board for plugging in an expansion card.

#### **F**

Abbreviation for Fahrenheit.

#### **FAT**

Acronym for file allocation table. The file system structure used by MS-DOS® to organize and keep track of file storage. The Windows NT® operating systems can optionally use a FAT file system structure.

#### **FCC**

Abbreviation for Federal Communications Commission.

#### **flash memory**

A type of EEPROM chip that can be reprogrammed from a utility on diskette while still installed in a system; most EEPROM chips can only be rewritten with special programming equipment.

#### **format**

To prepare a hard drive or diskette for storing files. An unconditional format deletes all data stored on the disk.

#### **FSB**

Abbreviation for front side bus. The FSB is the data path and physical interface between the microprocessor and the main memory (RAM).

#### **ft**

Abbreviation for feet.

## **FTP**

Abbreviation for file transfer protocol.

## **g**

Abbreviation for gram(s).

## **G**

Abbreviation for gravities.

## **guarding**

A type of data redundancy that uses a set of physical drives to store data and a single, additional drive to store parity data. Data is protected from the loss of a single drive. Guarding is sometimes preferred over mirroring because it is more cost-effective in systems with a very high storage capacity. However, guarded configurations are significantly slower for applications that frequently write to the array because each attempt to the array requires multiple read and write commands to maintain the parity information. If this is a problem, mirroring is a better choice. See also mirroring, RAID 4, and RAID 5.

## **GB**

Abbreviation for gigabyte(s). A gigabyte equals 1,024 megabytes or 1,073,741,824 bytes.

## **Gb**

Abbreviation for gigabit(s). A gigabit equals one billion bits.

## **graphics coprocessor**

See coprocessor.

## **graphics mode**

A video mode that can be defined as *x* horizontal by *y* vertical pixels by *z* colors.

## **h**

Abbreviation for hexadecimal. A base-16 numbering system, often used in programming to identify addresses in the system's RAM and I/O memory addresses for devices. The sequence of decimal numbers from 0 through 16, for example, is expressed in hexadecimal notation as 0, 1, 2, 3, 4, 5, 6, 7, 8, 9, A, B, C, D, E, F, 10. In text, hexadecimal numbers are often followed by *h*.

## **headless system**

A system or device that functions without having a keyboard, mouse, or monitor attached. Normally, headless systems are managed over an internet or intranet network using an internet browser. Some systems provide for attaching a keyboard, mouse, and monitor for specific management or service needs, others do not.

## **host adapter**

A host adapter implements communication between the system's bus and the controller for a peripheral device. (Hard drive controller subsystems include integrated host adapter circuitry.) To add a SCSI expansion bus to your system, you must install or connect the appropriate host adapter.

## **Hz**

Abbreviation for hertz.

## **IDE**

Abbreviation for integrated drive electronics

## **I/O**

Abbreviation for input/output. A keyboard is an input device, and a printer is an output device. In general, I/O activity can be differentiated from computational activity. For example, when a program sends a document to the printer, it is engaging in output activity; when the program sorts a list of terms, it is engaging in computational activity.

## **ID**

Abbreviation for identification.

## **interlacing**

A technique for increasing video resolution by only up-dating alternate horizontal lines on the screen. Because interlacing can result in noticeable screen flicker, most users prefer noninterlaced video adapter resolutions.

## **IP**

Abbreviation for Internet Protocol.

## **IPX**



Abbreviation for Internetwork Packet EXchange.

## **IRQ**

Abbreviation for interrupt request. A signal that data is about to be sent to or received by a peripheral device travels by an IRQ line to the microprocessor. Each peripheral connection must be assigned an IRQ number. For example, the first serial port in your system (COM1) is assigned to IRQ4 by default. Two devices can share the same IRQ assignment, but you cannot operate both devices simultaneously.

## **ITE**

Abbreviation for information technology equipment.

## **jumper**

Jumpers are small blocks on a circuit board with two or more pins emerging from them. Plastic plugs containing a wire fit down over the pins. The wire connects the pins and creates a circuit. Jumpers provide a simple and reversible method of changing the circuitry in a printed circuit board.

## **K**

Abbreviation for kilo-, indicating 1,000.

## **KB**

Abbreviation for kilobyte(s), 1,024 bytes.

## **KB/sec**

Abbreviation for kilobyte(s) per second.

## **Kbit(s)**

Abbreviation for kilobit(s), 1,024 bits.

## **Kbit(s)/sec**

Abbreviation for kilobit(s) per second.

## **key combination**

A command requiring you to press multiple keys at the same time. For example, you can reboot your system by pressing the <Ctrl><Alt><Del> key combination.

## **kg**

Abbreviation for kilogram(s), 1,000 grams.

## **kHz**

Abbreviation for kilohertz, 1,000 hertz.

## **LAN**

Acronym for local area network. A LAN system is usually confined to the same building or a few nearby buildings, with all equipment linked by wiring dedicated specifically to the LAN.

## **lb**

Abbreviation for pound(s).

## **LED**

Abbreviation for light-emitting diode. An electronic device that lights up when a current is passed through it.

## **Linux**

A version of UNIX® that runs on a variety of hardware systems. Linux is open source software, which is freely available; however, the full distribution of Linux along with technical support and training are available for a fee from vendors such as Red Hat Software ([www.redhat.com](http://www.redhat.com)).

## **local bus**

On a system with local-bus expansion capability, certain peripheral devices (such as the video adapter circuitry) can be designed to run much faster than they would with a traditional expansion bus. Some local-bus designs allow peripherals to run at the same speed and with the same width data path as the system's microprocessor.

## **m**

Abbreviation for meter(s).

## **mA**

Abbreviation for milliampere(s).

**MAC**

Abbreviation for Media Access Control.

**mAh**

Abbreviation for milliampere-hour(s).

**math coprocessor**

See coprocessor.

**Mb**

Abbreviation for megabit.

**MB**

Abbreviation for megabyte(s). The term *megabyte* means 1,048,576 bytes; however, when referring to hard drive storage, the term is often rounded to mean 1,000,000 bytes.

**MB/sec**

Abbreviation for megabytes per second.

**Mbps**

Abbreviation for megabits per second.

**MBR**

Abbreviation for master boot record.

**memory address**

A specific location, usually expressed as a hexadecimal number, in the system's RAM.

**memory module**

A small circuit board containing DRAM chips that connects to the system board.

**MHz**

Abbreviation for megahertz.

**microprocessor**

The primary computational chip inside the system that controls the interpretation and execution of arithmetic and logic functions. Software written for one microprocessor must usually be revised to run on another microprocessor. *CPU* is a synonym for microprocessor.

**mirroring**

A type of data redundancy that uses a set of physical drives to store data and one or more sets of additional drives to store duplicate copies of the data. Mirroring is the preferred data redundancy technique in lower-capacity systems and in systems where performance is extremely important. See also guarding, RAID 1, and RAID 10.

**mm**

Abbreviation for millimeter(s).

**MPEG**

Acronym for Motion Picture Experts Group. MPEG is a digital video file format.

**ms**

Abbreviation for millisecond(s).

**MS-DOS**

Abbreviation for Microsoft Disk Operating System.

**NAS**

Abbreviation for Network Attached Storage. Network-attached storage (NAS) is one of the concepts used for implementing shared storage on a network. The network communication uses Common Internet File System (CIFS) for Microsoft Windows environments, Network File System (NFS) for UNIX environments, FTP, http, and other networking protocols.

**NDIS**

Abbreviation for Network Driver Interface Specification.

## NIC

Acronym for network interface controller.

## NMI

Abbreviation for nonmaskable interrupt. A device sends an NMI to signal the microprocessor about hardware errors, such as a parity error.

## noninterlaced

A technique for decreasing screen flicker by sequentially refreshing each horizontal line on the screen.

## ns

Abbreviation for nanosecond(s), one billionth of a second.

## NTFS

Abbreviation for the NT File System option in the Windows NT operating system.

## NVRAM

Abbreviation for nonvolatile random-access memory. Memory that does not lose its contents when you turn off your system. NVRAM is used for maintaining the date, time, and system configuration information.

## partition

You can divide a hard drive into multiple physical sections called *partitions* with the **fdisk** command. Each partition can contain multiple logical drives.

After partitioning the hard drive, you must format each logical drive with the **format** command.

## parity

Redundant information that is associated with a block of information.

RAID 5 volumes, for example, stripe data and parity intermittently across a set of hard drives. Within each stripe, the data on one hard drive is parity data and the data on the other hard drives is normal data. RAID 5 volumes therefore require at least three hard drives to allow for this extra parity information. See RAID 0 and RAID 5.

## PCI

Abbreviation for Peripheral Component Interconnect. PCI is a standard for local-bus implementation developed by Intel Corporation.

## PDU

Abbreviation for power distribution unit. A PDU is a power source with multiple power outlets that provides electrical power to servers and storage systems in a rack.

## peripheral device

An internal or external device—such as a printer, a disk drive, or a keyboard—connected to a system.

## PGA

Abbreviation for pin grid array, a type of microprocessor socket that allows you to remove the microprocessor chip.

## pixel

A single point on a video display. Pixels are arranged in rows and columns to create an image. A video resolution, such as 640 x 480, is expressed as the number of pixels across by the number of pixels up and down.

## POST

Acronym for power-on self-test. Before the operating system loads when you turn on your system, the POST tests various system components such as RAM, the disk drives, and the keyboard.

## program diskette set

The set of diskettes from which you can perform a complete installation of an operating system or application program. When you reconfigure a program, you often need its program diskette set.

## protected mode

An operating mode supported by 80286 or higher microprocessors, protected mode allows operating systems to implement:

- 1 A memory address space of 16 MB (80286 micro--processor) to 4 GB (Intel386™ or higher micro-processor)
- 1 Multitasking
- 1 Virtual memory, a method for increasing addressable memory by using the hard drive

The Windows NT and UNIX 32-bit operating systems run in protected mode. MS-DOS cannot run in protected mode; however, some programs that you can start from MS-DOS, such as the Windows operating system, are able to put the system into protected mode.

## PS/2

Abbreviation for Personal System/2.

## PXE

Acronym for Preboot Execution Environment.

## RAC

Acronym for remote access controller.

## RAID

Acronym for redundant array of independent disks. An array of multiple independent hard drives that, in varying levels, provide high performance and fault tolerance.

The following RAID levels provide various mixes of performance, reliability, and cost: Level 0 (striping), Level 1 (mirroring), Level 5 (striping with parity), Level 10 (striping with mirroring) and Level 50 (linked Level 5 arrays).

### RAID 0

RAID 0 is commonly called striping. This was not originally defined as a RAID level but has since come into popular use. In this array configuration, data is written sequentially across the available disks and no redundancy is provided. RAID 0 configurations provide very high performance but relatively low reliability. RAID 0 is the best choice when controller cards are duplexed. See striping.

### RAID 1

RAID 1 is commonly called mirroring. RAID 1 also uses striping, so RAID 1 may be regarded as the mirroring of RAID 0 configurations. RAID 1 is the best choice in high-availability applications that require high performance or relatively low data capacity. See mirroring, RAID 10, and striping.

### RAID 3

RAID 3 is commonly called guarding. It uses data striping, like RAID 0, but adds a single, dedicated parity drive for redundancy and block-level parallel access. The parity data stored on this drive can be used to recover data lost from a single failed drive, and the generation of the parity data frequently requires reading data from multiple physical drives. RAID 3 is generally used in situations that require large sequential I/Os and a high data-transfer rate, such as video streaming. See guarding and striping.

### RAID 4

RAID 4 is commonly called guarding. It uses a single, dedicated parity drive, like RAID 3, but requires reading and writing large blocks of data to one physical drive at a time. See guarding and striping.

### RAID 5

RAID 5 is commonly called guarding. RAID 5 is identical to RAID 4, except that the parity data is distributed evenly across all physical drives instead of a parity drive. In configurations using a large number of physical drives in which a large number of simultaneous small write operations are being performed, RAID 5 offers potentially higher performance than RAID 4. RAID 4 and RAID 5 configurations are appropriate in high-availability applications where performance is less critical or where high data capacity is required. See guarding.

### RAID 10 (RAID 1+0)

RAID 10 is commonly called RAID 1+0. RAID 10 is a multilevel array that combines mirrored drives (RAID 1) with data striping (RAID 0). In a RAID 10 configuration, data is mirrored on two drives and then striped across two or more sets of mirrored drives. RAID 10 offers the data transfer advantages of striped arrays and the accessibility features of mirrored arrays. System performance during a drive rebuild is also better than parity-based arrays, since data does not need to be regenerated from parity information, but simply copied from a surviving drive.

### RAID 50

Two or more linked RAID 5 arrays. For example, a RAID 5 array that is implemented with three drives and then continues on with three more array drives would be a RAID 50 array. RAID 50 provides data redundancy through parity. See parity.

## RAM

Acronym for random-access memory. The system's primary temporary storage area for program instructions and data. Each location in RAM is identified by a number called a *memory address*. Any information stored in RAM is lost when you turn off your system.

## RAS

Abbreviation for Remote Access Service. This service allows users running the Windows operating system to remotely access a network from their system using a modem.

## read-only file

A read-only file is one that you are prohibited from editing or deleting. A file can have read-only status if:

- 1 Its read-only attribute is enabled.
- 1 It resides on a physically write-protected diskette or on a diskette in a write-protected drive.
- 1 It is located on a network in a directory to which the system administrator has assigned read-only rights to you.

## readme file

A text file included with a software package or hardware product that contains information supplementing or updating the documentation for the software or

hardware. Typically, readme files provide installation information, describe new product enhancements or corrections that have not yet been documented, and list known problems or other things you need to be aware of as you use the software or hardware.

## **ROM**

Acronym for read-only memory. Your system contains some programs essential to its operation in ROM code. Unlike RAM, a ROM chip retains its contents even after you turn off your system. Examples of code in ROM include the program that initiates your system's boot routine and the POST.

## **ROMB**

Acronym for RAID on Motherboard.

## **rpm**

Abbreviation for revolutions per minute.

## **RTC**

Abbreviation for real-time clock. Battery-powered clock circuitry inside the system that keeps the date and time after you turn off the system.

## **SCSI**

Acronym for small computer system interface. An I/O bus interface with faster data transmission rates than standard ports. You can connect up to seven devices (15 for some newer SCSI types) to one SCSI interface.

## **SDMS**

Abbreviation for SCSI device management system.

## **SDRAM**

Acronym for synchronous dynamic random-access memory.

## **sec**

Abbreviation for second(s).

## **serial port**

An I/O port used most often to connect a modem to your system. You can usually identify a serial port on your system by its 9-pin connector.

## **service tag number**

A bar code label on the system that identifies it when you call customer or technical support.

## **SIMM**

Acronym for single in-line memory module. A small circuit board containing DRAM chips that connects to the system board.

## **SMART**

Acronym for Self-Monitoring Analysis and Reporting Technology. A technology that allows hard drives to report errors and failures to the system BIOS, which then displays an error message on the screen. To take advantage of this technology, you must have a SMART-compliant hard drive and the proper support in the system BIOS.

## **SNMP**

Abbreviation for Simple Network Management Protocol. SNMP is an industry-standard interface that allows a network manager to remotely monitor and manage workstations.

## **SRAM**

Abbreviation for static random-access memory. Because SRAM chips do not require continual refreshing, they are substantially faster than DRAM chips.

## **Striping**

Disk striping writes data across 3 or more array disks. Each "stripe" spans 3 or more array disks but only consumes a portion of each disk. The amount of space consumed by a stripe is the same on each array disk included in the stripe. A virtual disk may use several stripes on the same set of array disks.

## **SVGA**

Abbreviation for super video graphics array. VGA and SVGA are video standards for video adapters with greater resolution and color display capabilities than previous standards.

To display a program at a specific resolution, you must install the appropriate video drivers and your monitor must support the resolution. Similarly, the number of colors that a program can display depends on the capabilities of the monitor, the video driver, and the amount of video memory installed in the system.

## **system board**

As the main circuit board, the system board usually contains most of your system's integral components, such as the following:

- 1 Microprocessor

- 1 RAM
- 1 Controllers for standard peripheral devices, such as the keyboard
- 1 Various ROM chips

Frequently used synonyms for system board are *motherboard* and *logic board*.

### system configuration information

Data stored in memory that tells a system what hardware is installed and how the system should be configured for operation.

### system diskette

System diskette is a synonym for *bootable diskette*.

### system memory

System memory is a synonym for *RAM*.

### System Setup program

A BIOS-based program that allows you to configure your system's hardware and customize the system's operation by setting such features as password protection and energy management. Some options in the System Setup program require that you reboot the system (or the system may reboot automatically) in order to make a hardware configuration change. Because the System Setup program is stored in NVRAM, any settings remain in effect until you change them again.

### system.ini file

A start-up file for the Windows operating system. When you start Windows, it consults the **system.ini** file to determine a variety of options for the Windows operating environment. Among other things, the **system.ini** file records which video, mouse, and keyboard drivers are installed for Windows.

Running the Control Panel or Windows Setup program may change options in the **system.ini** file. On other occasions, you may need to change or add options to the **system.ini** file manually with a text editor, such as Notepad.

### termination

Some devices (such as the last device at each end of a SCSI cable) must be terminated to prevent reflections and spurious signals in the cable. When such devices are connected in a series, you may need to enable or disable the termination on these devices by changing jumper or switch settings on the devices or by changing settings in the configuration software for the devices.

### text mode

A video mode that can be defined as *x* columns by *y* rows of characters.

### UL

Abbreviation for Underwriters Laboratories.

### UMB

Abbreviation for upper memory blocks.

### UNIX

Abbreviation for UNiversal Internet eXchange. UNIX, precursor to Linux, is an operating system written in the C programming language. Known for its portability and flexibility, UNIX has become a leading operating system for computer workstations.

### UPS

Abbreviation for uninterruptible power supply. A battery-powered unit that automatically supplies power to your system in the event of an electrical failure.

### USB

Abbreviation for Universal Serial Bus. A USB connector provides a single connection point for multiple USB-compliant devices, such as mice, keyboards, printers, and system speakers. USB devices can also be connected and disconnected while the system is running.

### utility

A program used to manage system resources—memory, disk drives, or printers, for example.

### UTP

Abbreviation for unshielded twisted pair.

### V

Abbreviation for volt(s).

### VAC

Abbreviation for volt(s) alternating current.

## VCCI

Abbreviation for Voluntary Control Council for Interference.

## VDC

Abbreviation for volt(s) direct current.

## VGA

Abbreviation for video graphics array. VGA and SVGA are video standards for video adapters with greater resolution and color display capabilities than previous standards.

To display a program at a specific resolution, you must install the appropriate video drivers and your monitor must support the resolution. Similarly, the number of colors that a program can display depends on the capabilities of the monitor, the video driver, and the amount of video memory installed for the video adapter.

### video adapter

The logical circuitry that provides—in combination with the monitor—your system's video capabilities. A video adapter may support more or fewer features than a specific monitor offers. Typically, a video adapter comes with video drivers for displaying popular application programs and operating systems in a variety of video modes.

On some systems, a video adapter is integrated into the system board. Also available are many video adapter cards that plug into an expansion-card connector.

Video adapters often include memory separate from RAM on the system board. The amount of video memory, along with the adapter's video drivers, may affect the number of colors that can be simultaneously displayed. Video adapters can also include their own coprocessor for faster graphics rendering.

### video driver

A program that allows graphics-mode application programs and operating systems to display at a chosen resolution with the desired number of colors. A software package may include some "generic" video drivers. Any additional video drivers may need to match the video adapter installed in the system.

### video memory

Most VGA and SVGA video adapters include memory chips in addition to your system's RAM. The amount of video memory installed primarily influences the number of colors that a program can display (with the appropriate video drivers and monitor capabilities).

### video mode

Video adapters normally support multiple text and graphics display modes. Character-based software displays in text modes that can be defined as *x* columns by *y* rows of characters. Graphics-based software displays in graphics modes that can be defined as *x* horizontal by *y* vertical pixels by *z* colors.

### video resolution

Video resolution is expressed as the number of pixels across by the number of pixels up and down. To display a program at a specific graphics resolution, you must install the appropriate video drivers and your monitor must support the resolution.

## VRAM

Abbreviation for video random-access memory. Some video adapters use VRAM chips (or a combination of VRAM and DRAM) to improve video performance. VRAM is dual-ported, allowing the video adapter to update the screen and receive new image data at the same time.

## W

Abbreviation for watt(s).

## WH

Abbreviation for watt-hour(s).

### win.ini file

A start-up file for the Windows operating system. When you start Windows, it consults the **win.ini** file to determine a variety of options for the Windows operating environment. Among other things, the **win.ini** file records what printer(s) and fonts are installed for Windows. The **win.ini** file also usually includes sections that contain optional settings for Windows application programs that are installed on the hard drive.

Running the Control Panel or Windows Setup program may change options in the **win.ini** file. On other occasions, you may need to change or add options to the **win.ini** file manually with a text editor such as Notepad.

### Windows.NET

A set of Microsoft software technologies that enable software integration through the use of XML Web services. XML Web services are small reusable applications written in XML that allow data to be communicated between otherwise unconnected sources.

### Windows 2000

An integrated and complete Microsoft Windows operating system that does not require MS-DOS and that provides advanced operating system performance, improved ease of use, enhanced workgroup functionality, and simplified file management and browsing.

---

[Back to Contents Page](#)





[Back to Contents Page](#)

## Dell™ PowerEdge™ 1750 Systems User's Guide

- [Notes, Notices, and Cautions](#)
  - [Abbreviations and Acronyms](#)
- 

## Notes, Notices, and Cautions

-  **NOTE:** A NOTE indicates important information that helps you make better use of your computer.
  -  **NOTICE:** A NOTICE indicates either potential damage to hardware or loss of data and tells you how to avoid the problem.
  -  **CAUTION:** A CAUTION indicates a potential for property damage, personal injury, or death.
- 

## Abbreviations and Acronyms

For the full name of an abbreviation or acronym used in this document, see the "[Glossary](#)."

Information in this document is subject to change without notice.  
© 2002 Dell Computer Corporation. All rights reserved.

Reproduction in any manner whatsoever without the written permission of Dell Computer Corporation is strictly forbidden.

Trademarks used in this text: *Dell*, the *DELL* logo, *PowerEdge*, and *Dell OpenManage* are trademarks of Dell Computer Corporation; *Xeon* and *Intel386* are trademarks and *Intel* and *Pentium* are registered trademarks of Intel Corporation; *Microsoft*, *Windows*, *Windows NT*, and *MS-DOS*, are registered trademarks of Microsoft Corporation; *Novell* and *NetWare* are registered trademarks of Novell, Inc.

Other trademarks and trade names may be used in this document to refer to either the entities claiming the marks and names or their products. Dell Computer Corporation disclaims any proprietary interest in trademarks and trade names other than its own.

---

[Back to Contents Page](#)