

Dell™ PowerConnect™ 35xx Systems

User's Guide

Notes, Cautions, and Warnings



NOTE: A NOTE indicates important information that helps you make better use of your computer.



CAUTION: A CAUTION indicates potential damage to hardware or loss of data if instructions are not followed.



WARNING: A WARNING indicates a potential for property damage, personal injury, or death.

Information in this document is subject to change without notice.

© 2007–2008 Dell Inc. All rights reserved.

Reproduction of these materials in any manner whatsoever without the written permission of Dell Inc. is strictly forbidden.

Trademarks used in this text: *Dell*, the *DELL* logo, *Dell OpenManage*, and *PowerConnect* are trademarks of Dell Inc. *Microsoft* and *Windows* are either trademarks or registered trademarks of Microsoft Corporation in the United States and/or other countries.

Other trademarks and trade names may be used in this document to refer to either the entities claiming the marks and names or their products. Dell Inc. disclaims any proprietary interest in trademarks and trade names other than its own.

Contents

1	Introduction	11
	System Description	11
	PowerConnect 3524	11
	PowerConnect 3524P	11
	PowerConnect 3548	12
	PowerConnect 3548P	12
	Stacking Overview	12
	Understanding the Stack Topology	13
	Stacking Failover Topology	13
	Stacking Members and Unit ID	13
	Removing and Replacing Stacking Members	14
	Exchanging Stacking Members	15
	Switching from the Stack Master to the Backup Stack Master	17
	Features Overview	17
	IP Version 6 (IPv6) Support	17
	Power over Ethernet	17
	Head of Line Blocking Prevention	18
	Flow Control Support (IEEE 802.3X)	18
	Back Pressure Support	18
	Virtual Cable Testing (VCT)	18
	MDI/MDIX Support	18
	Auto Negotiation	18
	MAC Address Supported Features	19
	Layer 2 Features	20
	VLAN Supported Features	21
	Spanning Tree Protocol Features	21
	Link Aggregation	22
	Quality of Service Features	23
	Device Management Features	23
	Security Features	25
	Additional CLI Documentation	26

2	Hardware Description	27
	Port Description	27
	PowerConnect 3524 Port Description	27
	The back panel contains an RPS connector, console port, and power connector.. . . .	28
	PowerConnect 3548 Port Description	28
	SFP Ports	29
	RS-232 Console Port	29
	Physical Dimensions	30
	LED Definitions	30
	Gigabit Port LEDs	32
	System LEDs	33
	Power Supplies	35
	Stack ID Button	36
	Reset Button	37
	Ventilation System	37
3	Installing the PowerConnect 3524/P and PowerConnect 3548/P	39
	Site Preparation	39
	Unpacking	39
	Package Contents.	39
	Unpacking the Device	40
	Mounting the Device.	40
	Installing in a Rack	40
	Installing on a Flat Surface	41
	Installing the Device on a Wall	42
	Connecting to a Terminal	43
	Connecting a Device to a Power Supply	43
	Installing a Stack	44
	Overview	44
	Stacking PowerConnect 35xx Series Systems Switches.	44
	Unit ID Selection Process.	46
	Starting and Configuring the Device	47
	Connecting to the Device.	47

4	Configuring PowerConnect 3524/P and 3548/P	49
	Configuration Procedures	49
	Booting the Switch	50
	Initial Configuration	50
	Advanced Configuration	54
	Retrieving an IP Address From a DHCP Server.	54
	Receiving an IP Address From a BOOTP Server	56
	Security Management and Password Configuration.	56
	Configuring Login Banners	59
	Startup Procedures	59
	Startup Menu Procedures	59
	Software Download Through TFTP Server	63
	Port Default Settings	65
	Auto-Negotiation	66
	MDI/MDIX.	66
	Flow Control.	66
	Back Pressure	66
	Switching Port Default Settings	67
5	Using Dell OpenManage Switch Administrator	69
	Starting the Application	69
	Understanding the Interface	69
	Device Representation	71
	Using the Switch Administrator Buttons	72
	Information Buttons.	72
	Device Management Buttons.	72
	Field Definitions	73
	Accessing the Device Through the CLI	73
	Terminal Connection	73
	Telnet Connection.	74

Using the CLI	74
Command Mode Overview	74
User EXEC Mode	75
Privileged EXEC Mode	75
Global Configuration Mode	76
6 Configuring System Information	77
Defining General Switch Information	78
Viewing Switch Asset Information	78
Asset	78
Defining System Time Settings	84
Viewing System Health Information	90
Managing Power over Ethernet	92
Viewing Version Information	98
Managing Stack Members	99
Resetting the Device	100
Configuring SNTP Settings	101
Defining SNTP Global Settings	103
Defining SNTP Authentication Methods	105
Defining SNTP Servers	107
Defining SNTP Interfaces	111
Managing Logs	113
Defining Global Log Parameters	114
Viewing the RAM Log Table	118
Viewing the Log File Table	120
Viewing the Device Login History	121
Modifying Remote Log Server Definitions	123
Defining IP Addressing	128
Configuring the Internet Protocol Version 6 (IPv6)	129
Defining IPv4 Default Gateways	129
Defining IPv4 Interfaces	131
Defining DHCP IPv4 Interface Parameters	134
Defining IPv6 Interfaces	137
Defining IPv6 Default Gateway	142
Defining IPv6 ISATAP Tunnels	145
Defining IPv6 Neighbors	148
Viewing the IPv6 Routes Table	152

Configuring Domain Name Systems	154
Defining Default Domains.	157
Mapping Domain Host	159
Defining ARP Settings	162
Running Cable Diagnostics	165
Viewing Copper Cable Diagnostics.	165
Viewing Optical Transceiver Diagnostics	167
Managing Management Security	170
Defining Access Profiles	170
Defining Authentication Profiles	177
Selecting Authentication Profiles	181
Managing Passwords.	184
Displaying Active Users	187
Defining the Local User Databases.	189
Defining Line Passwords	192
Defining Enable Passwords.	194
Defining TACACS+ Settings.	196
Configuring RADIUS Settings.	200
Configuring LLDP and MED	205
Defining LLDP Properties.	207
Configuring LLDP Using CLI Commands	208
Defining LLDP Port Settings	208
Defining LLDP MED Network Policy	211
Defining LLDP MED Port Settings	213
Viewing the LLDP Neighbors Information	217
Defining SNMP Parameters	219
Defining SNMP Global Parameters.	220
Defining SNMP View Settings	223
Defining SNMP Access Control	227
Assigning SNMP User Security	230
Defining SNMP Communities.	234
Defining SNMP Notification Filters.	238
Defining SNMP Notification Recipients	240
Managing Files.	246
Downloading Files	247
Uploading Files	250
Activating Image Files	253

Copying Files	255
Managing Device Files	257
Configuring Advanced Settings	259
Configuring General Settings	259
7 Configuring Switch Information.	261
Configuring Network Security.	261
Port Based Authentication	262
Configuring Advanced Port Based Authentication	268
Authenticating Users	271
Configuring Port Security.	273
ACL Overview	276
Defining IP based ACLs.	277
Defining MAC Based Access Control Lists.	283
Defining ACL Binding	286
Configuring DHCP Snooping.	288
Defining DHCP Snooping Global Parameters.	289
Defining DHCP Snooping on VLANs	291
Defining Trusted Interfaces.	292
Adding Interfaces to the DHCP Snooping Database	294
Configuring Ports.	297
Defining Port Configuration.	297
Defining LAG Parameters.	304
Enabling Storm Control	308
Defining Port Mirroring Sessions.	312
Configuring Address Tables	315
Defining Static Addresses	315
Viewing Dynamic Addresses	318
Configuring GARP	321
Defining GARP Timers	322
Configuring the Spanning Tree Protocol	325
Defining STP Global Settings	325
Defining STP Port Settings	331
Defining STP LAG Settings	336
Defining Rapid Spanning Tree	339

Configuring Multiple Spanning Tree	343
Defining MSTP Interface Settings	347
Configuring VLANs	351
Defining VLAN Membership	352
Defining VLAN Ports Settings.	357
Defining VLAN LAGs Settings.	359
Binding MAC Address to VLANs	362
Defining VLAN Protocol Groups	364
Adding Interfaces to Protocol Groups	367
Configuring GVRP Parameters	369
Configuring Voice VLAN	374
Defining Voice VLAN Global Parameters.	374
Defining Voice VLAN Port Settings	377
Defining OUIs	379
Aggregating Ports	382
Defining LACP Parameters	383
Defining LAG Membership	385
Multicast Forwarding Support.	387
Defining Multicast Global Parameters	387
Adding Bridge Multicast Address Members.	389
Assigning Multicast Forward All Parameters	394
IGMP Snooping	396
Unregistered Multicast.	401
8 Viewing Statistics	405
Viewing Tables.	405
Viewing Utilization Summary	405
Viewing Counter Summary	407
Viewing Interface Statistics	408
Viewing Etherlike Statistics.	411
Viewing GVRP Statistics	414
Viewing EAP Statistics	418
Viewing EAP Statistics Using the CLI Commands	419
Viewing RMON Statistics	420
Viewing RMON Statistics Group	420
Viewing RMON History Control Statistics	423

Viewing the RMON History Table	425
Defining Device RMON Events	428
Viewing the RMON Events Log	430
Defining RMON Device Alarms	431
Viewing Charts	435
Viewing Port Statistics	436
Viewing LAG Statistics	437
Viewing the CPU Utilization	438
Viewing CPU Utilization Using CLI Commands	440
9 Configuring Quality of Service	441
Quality of Service (QoS) Overview	441
CoS Services	442
Configuring QoS Global Settings	443
Defining QoS Interface Settings	445
Defining Bandwidth Settings	446
Mapping CoS Values to Queues	448
Mapping DSCP Values to Queues	450
10 Glossary	453
A Device Feature Interaction Information	467
Index	471

Introduction

Dell™ PowerConnect™ 3524/3548 and PowerConnect 3524P/3548P are stackable, advanced multi-layer devices. PowerConnect units can function either as stand-alone, multi-layer, switching devices or stackable devices with up to eight stacking members.

This *User Guide* contains the information needed for installing, configuring, and maintaining the device.

System Description

PowerConnect 3524/3548 and PowerConnect 3524P/3548P combine versatility with minimal management. The PowerConnect 3524 and 3548 series include the following device types:

- PowerConnect 3524
- PowerConnect 3524P
- PowerConnect 3548
- PowerConnect 3548P

PowerConnect 3524

The PowerConnect 3524 provides 24 10/100Mbps ports plus two SFP ports, and two Copper ports which can be used to forward traffic in a stand-alone device, or as stacking ports when the device is stacked. The device also provides one RS-232 console port. The PowerConnect 3524 is a stackable device, but also operates as a stand-alone device.

PowerConnect 3524P

The PowerConnect 3524P provides 24 10/100Mbps ports plus two SFP ports, and two Copper ports which can be used to forward traffic in a stand-alone device, or as stacking ports when the device is stacked. The device also provides one RS-232 console port. The PowerConnect 3524P is a stackable device, but also operates as a stand-alone device. The PowerConnect 3524P also provides Power over Ethernet (PoE).

Figure 1-1. PowerConnect 3524 and PowerConnect 3524P



PowerConnect 3548

The PowerConnect 3548 provides 48 10/100Mbps ports plus two SFP ports, and two Copper ports which can be used to forward traffic in a stand-alone device, or as stacking ports when the device is stacked. The device also provides one RS-232 console port. The PowerConnect 3548 is a stackable device, but also functions as a stand-alone device.

PowerConnect 3548P

The PowerConnect 3548P provides 48 10/100Mbps ports, two SFP ports, and two copper ports that can be used to forward traffic when the device is in stand-alone mode, or as stacking ports when the device is part of a stack. The device also provides one RS-232 console port. In addition, PowerConnect 3548P provides PoE.

Figure 1-2. PowerConnect 3548 and PowerConnect 3548P



Stacking Overview

PowerConnect 3524/P and PowerConnect 3548/P stacking provides multiple switch management through a single point as if all stack members are a single unit. All stack members are accessed through a single IP address through which the stack is managed. The stack is managed from a:

- Web-based interface
- SNMP Management Station
- Command Line Interface (CLI)

PowerConnect 3524/P and PowerConnect 3548/P devices support stacking up to eight units per stack, or can operate as stand-alone units.

During the Stacking setup, one switch is selected as the Stack Master and another stacking member can be selected as the Backup Master. All other devices are selected as stack members, and assigned a unique Unit ID.

Switch software is downloaded separately for each stack members. However, all units in the stack must be running the same software version.

Switch stacking and configuration is maintained by the Stack Master. The Stack Master detects and reconfigures the ports with minimal operational impact in the event of:

- Unit Failure
- Inter-unit Stacking Link Failure
- Unit Insertion
- Removal of a Stacking Unit

Understanding the Stack Topology

The PowerConnect 35xx series systems operates in a Ring topology. A stacked Ring topology is where all devices in the stack are connected to each other forming a circle. Each device in the stack accepts data and sends it to the device to which it is attached. The packet continues through the stack until it reaches its destination. The system discovers the optimal path on which to send traffic.

Figure 1-3. Stacking Ring Topology

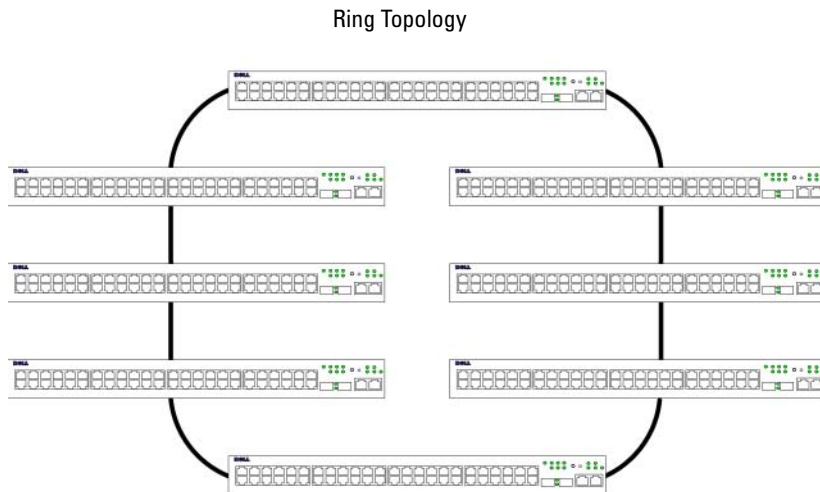

Most difficulties incurred in Ring topologies occur when a device in the ring becomes non-functional, or a link is severed. With the PowerConnect 3524/P and PowerConnect 3548/P stack, the system automatically switches to a Stacking Failover topology without any system downtime. An SNMP message is automatically generated, but no stack management action is required. However, the stacking link or stacking member must be repaired to ensure the stacking integrity.

After the stacking issues are resolved, the device can be reconnected to the stack without interruption, and the Ring topology is restored.

Stacking Failover Topology

If a failure occurs in the stacking topology, the stack reverts to Stacking Failover Topology. In the Stacking Failover topology, devices operate in a chain formation. The Stack Master determines where the packets are sent. Each unit is connected to two neighboring devices, except for the top and bottom units.

Stacking Members and Unit ID

Stacking Unit IDs are essential to the stacking configuration. The stacking operation is determined during the boot process. The operation mode is determined by the Unit ID selected during the initialization process. For example, if the user selected the stand-alone mode, the device boots in the boot-up process as a stand-alone device.

The device units are shipped with a default Unit ID of the stand-alone unit. If the device is operating as a stand-alone unit, all stacking LEDs are off.

Once the user selects a different Unit ID, it is not erased, and remains valid, even if the unit is reset.

Unit ID 1 and Unit ID 2 are reserved for Master enabled units. Unit IDs 3 to 8 can be defined for stack members.

When the Master unit boots or when inserting or removing a stack member, the Master unit initiates a stacking discovering process.

 **NOTE:** If two members are discovered with the same Unit ID the stack continues to function, however only the unit with the older join time joins the stack. A message is sent to the user, notifying that a unit failed to join the stack.

Removing and Replacing Stacking Members

Unit 1 and Unit 2 are Master enabled units. Unit 1 and Unit 2 are either designated as Master Unit or Backup Master Unit. The stack Master assignment is performed during the configuration process. One Master enabled stack member is elected as Master, and the other Master enabled stack member is elected as Backup Master, according to the following decision process:

- If only one Stack Master enabled unit is present, it is elected as the Master.
- If two Master enabled stacking members are present, and one has been manually configured as the Stack Master, the manually configured member is elected as Stack Master.
- If two Master enabled units are present and neither has been manually configured as the Master, the one with the longer up-time is elected as the Stack Master.
- If two Master enabled units are present and both have been manually configured as the Master, the one with the longer up-time is elected as the Stack Master.
- If the two Master enabled stacking members are the same age, Unit 1 is elected as the Stack Master.

 **NOTE:** Two stacking member are considered the same age if they were inserted within a ten minute interval.

For example, Unit 2 is inserted in the first minute of a ten-minute cycle, and Unit 1 is inserted in fifth minute of the same cycle, the units are considered to be the same age. If there are two Master enabled stack members that are the same age, then Unit 1 is elected master.

The Stack Master and the Backup Master maintain a Warm Standby. The Warm Standby ensures that the Backup Master takes over for the Stack Master if a failover occurs. This guarantees that the stack continues to operate normally.

During the Warm Standby, the Master and the Backup Master are synchronized with the static configuration only. When the Stacking Master is configured, the Stack Master must synchronize the Stacking Backup Master. The Dynamic configuration is not saved, for example, dynamically learned MAC addresses are not saved.

Each port in the stack has a specific Unit ID, port type, and port number, which are part of both the configuration commands and the configuration files. Configuration files are managed only from the device Stack Master, including:

- Saving to the FLASH
- Uploading Configuration files to an external TFTP Server/HTTP Client
- Downloading Configuration files from an external TFTP Server/HTTP Client

 **NOTE:** Stack configuration for all configured ports is saved, even if the stack is reset and/or the ports are no longer present.

Whenever a reboot occurs, topology discovery is performed, and the Master learns all units in the stack. Unit IDs are saved in the unit and are learned through topology discovery. If a unit attempts to boot without a selected Master, and the unit is not operating in stand-alone mode, the unit does not boot.

Configuration files are changed only through explicit user configuration. Configuration files are not automatically modified when:

- Units are Added
- Units are Removed
- Units are reassigned Unit IDs
- Units toggle between Stacking Mode and Stand-alone Mode

Each time the system reboots, the Startup Configuration file in the Master unit is used to configure the stack.

If a stack member is removed from the stack, and then replaced with a unit with the same Unit ID, the stack member is configured with the original device configuration. Only ports which are physically present are displayed in the PowerConnect OpenManage Switch Administrator home page, and can be configured through the web management system. Non-present ports are configured through the CLI or SNMP interfaces.

Exchanging Stacking Members

If a stack member with the same Unit ID replaces an existing Unit ID with the same Unit ID, the previous device configuration is applied to the inserted stack member. If the new inserted device has either more or fewer ports than the previous device, the relevant port configuration is applied to the new stack member. For example,

- If a PowerConnect 3524/P replaces PowerConnect 3524/P, all port configurations remain the same.
- If a PowerConnect 3548/P replaces the PowerConnect 3548/P, all port configurations remain the same.

Figure 1-4. PowerConnect 3548/P replaces PowerConnect 3548/P

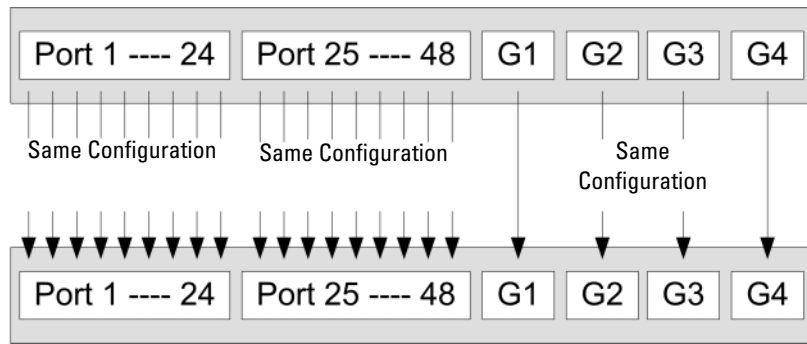

- If a PowerConnect 3548/P replaces PowerConnect 3524/P, the first 3548/P 24 FE ports receive the 3524/P 24 FE port configuration. The GE port configurations remain the same. The remaining ports receive the default port configuration.

Figure 1-5. PowerConnect 3524/P port replaces PowerConnect 3548/P port

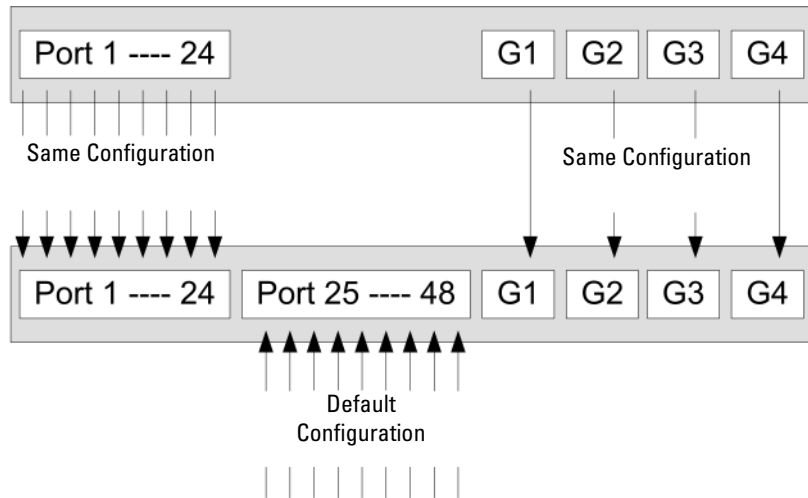

- If a PowerConnect 3524/P replaces PowerConnect 3548/P, the PowerConnect 3524/P 24 FE ports receives the first 24 FE PowerConnect 3548/P port configuration. The GE port configurations remain the same.

Figure 1-6. PowerConnect 3548/P port replaces PowerConnect 3524/P Port

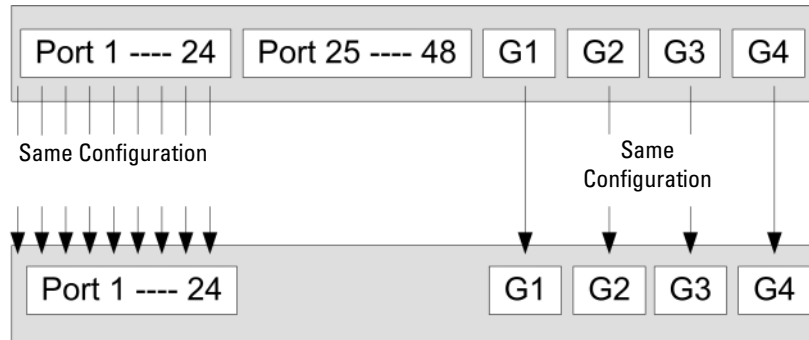

Switching from the Stack Master to the Backup Stack Master

The Backup Master replaces the Stack Master if the following events occur:

- The Stack Master fails or is removed from the stack.
- Links from the Stack Master to the stacking members fails.
- A soft switchover is performed with either via web interface or the CLI.

Switching between the Stack Master and the Backup Master results in a limited service loss. Any dynamic tables are relearned if a failure occurs. The running configuration file is synchronized between Stack Master and the Backup Master, and continues running on the Backup Master.

Features Overview

This section describes the device features. For a complete list of all updated device features, see the latest software version [Release Notes](#).

IP Version 6 (IPv6) Support

The device functions as an IPv6 compliant Host, as well as an IPv4 Host (also known as dual stack). This allows device operation in a pure IPv6 network as well as in a combined IPv4/IPv6 network.

Power over Ethernet

Power over Ethernet (PoE) provides power to devices over existing LAN cabling, without updating or modifying the network infrastructure. PoE removes the need for placing network devices next to power sources. PoE can be used in the following applications:

- IP Phones
- Wireless Access Points
- IP Gateways

- PDAs
- Audio and video remote monitoring

For more information about Power over Ethernet, see "Managing Power over Ethernet".

Head of Line Blocking Prevention

Head of Line (HOL) blocking results in traffic delays and frame loss caused by traffic competing for the same egress port resources. To prevent HOL blocking the device queues packets, and the packets at the head of the queue are forwarded before packets at the end of the queue.

Flow Control Support (IEEE 802.3X)

Flow control enables lower speed devices to communicate with higher speed devices, by requesting that the higher speed device refrains from sending packets. Transmissions are temporarily halted to prevent buffer overflows.

For information on configuring Flow Control for ports or LAGs, see "Defining Port Configuration" or "Defining LAG Parameters."

Back Pressure Support

On half-duplex links, the receiving port prevents buffer overflows by occupying the link so that it is unavailable for additional traffic.

For information on configuring Flow Control for ports or LAGs, see "Defining Port Configuration" or "Defining LAG Parameters."

Virtual Cable Testing (VCT)

VCT detects and reports copper link cabling occurrences such as open cables and cable shorts. For more information on testing cables, see "Running Cable Diagnostics".

MDI/MDIX Support

The device automatically detects whether the cable connected to an RJ-45 port is crossed or straight through, when auto-negotiation is enabled.

Standard wiring for end stations is **Media-Dependent Interface** (MDI) and the standard wiring for hubs and switches is known as **Media-Dependent Interface with Crossover** (MDIX).

For information on configuring MDI/MDIX for ports or LAGs, see "Defining Port Configuration" or "Defining LAG Parameters."

Auto Negotiation

Auto negotiation allows the device to advertise modes of operation. The auto negotiation function provides the means to exchange information between two devices that share a point-to-point link segment, and to automatically configure both devices to take maximum advantage of their transmission capabilities.

The PowerConnect 35xx series systems enhances auto negotiation by providing port advertisement. Port advertisement allows the system administrator to configure the port speeds that are advertised. For more information on auto-negotiation, see "Defining Port Configuration" or "Defining LAG Parameters."

Voice VLAN

Voice VLAN allows network administrators to enhance VoIP service by configuring ports to carry IP voice traffic from IP phones on a specific VLAN. VoIP traffic has a preconfigured OUI prefix in the source MAC address. Network Administrators can configure VLANs from which voice IP traffic is forwarded. Non-VoIP traffic is dropped from the Voice VLAN in auto Voice VLAN secure mode. Voice VLAN also provides QoS to VoIP, ensuring that the quality of voice does not deteriorate if the IP traffic is received unevenly.

For more information, see "Configuring Voice VLAN" on page 374.

Guest VLAN

Guest VLAN provides limited network access to unauthorized ports. If a port is denied network access via port-based authorization, but the Guest VLAN is enabled, the port receives limited network access.

MAC Address Supported Features

MAC Address Capacity Support

The device supports up to 8K MAC addresses. The device reserves specific MAC addresses for system use.

Static MAC Entries

MAC entries can be manually entered in the Bridging Table, as an alternative to learning them from incoming frames. These user-defined entries are not subject to aging, and are preserved across resets and reboots.

For more information, see "Defining Static Addresses."

Self-Learning MAC Addresses

The device enables controlled MAC address learning from incoming packets. The MAC addresses are stored in the Bridging Table.

Automatic Aging for MAC Addresses

MAC addresses, from which no traffic is received for a given period, are aged out. This prevents the Bridging Table from overflowing.

For more information on configuring the MAC Address Age Out Time, see "Viewing Dynamic Addresses."

VLAN-aware MAC-based Switching

The device always performs VLAN-aware bridging. Classic bridging(IEEE802.1D) is not performed, where frames are forwarded based only on their destination MAC address. However, a similar functionality can be configured for untagged frames. Frames addressed to a destination MAC address that is not associated with any port are flooded to all ports of the relevant VLAN.

MAC Multicast Support

Multicast service is a limited broadcast service, which allows one-to-many and many-to-many connections for information distribution. Layer 2 Multicast service is where a single frame is addressed to a specific Multicast address, from where copies of the frame are transmitted to the relevant ports. When Multicast groups are statically enabled, you can set the destination port of registered groups, as well as define the behavior of unregistered multicast frames.

For more information, see "Assigning Multicast Forward All Parameters."

Layer 2 Features

IGMP Snooping

Internet Group Membership Protocol (IGMP) Snooping examines IGMP frame contents, when they are forwarded by the device from work stations to an upstream Multicast router. From the frame, the device identifies work stations configured for Multicast sessions, and which Multicast routers are sending Multicast frames. IGMP Querier simulates the behavior of a multicast router; this allows snooping of the layer 2 multicast domain even if there is no multicast router.

For more information, see "IGMP Snooping."

Port Mirroring

Port mirroring monitors and mirrors network traffic by forwarding copies of incoming and outgoing packets from a monitored port to a monitoring port. Users specify which target port receives copies of all traffic passing through a specified source port.

For more information, see "Defining Port Mirroring Sessions."

Broadcast Storm Control

Storm Control enables limiting the amount of Multicast and Broadcast frames accepted and forwarded by the device.

When Layer 2 frames are forwarded, Broadcast and Multicast frames are flooded to all ports on the relevant VLAN. This occupies bandwidth, and loads all nodes connected on all ports.

For more information, see "Enabling Storm Control."

VLAN Supported Features

VLAN Support

VLANs are collections of switching ports that comprise a single broadcast domain. Packets are classified as belonging to a VLAN based on either the VLAN tag or based on a combination of the ingress port and packet contents. Packets sharing common attributes can be grouped in the same VLAN.

For more information, see "Configuring VLANs."

Port Based Virtual LANs (VLANs)

Port-based VLANs classify incoming packets to VLANs based on their ingress port.

For more information, see "Defining VLAN Ports Settings."

Full 802.1Q VLAN Tagging Compliance

IEEE 802.1Q defines an architecture for virtual bridged LANs, the services provided in VLANs, and the protocols and algorithms involved in the provision of these services.

GVRP Support

GARP VLAN Registration Protocol (GVRP) provides IEEE 802.1Q-compliant VLAN pruning and dynamic VLAN creation on 802.1Q trunk ports. When GVRP is enabled, the device registers and propagates VLAN membership on all ports that are part of the active underlying "Spanning Tree Protocol Features" on page 21 topology.

For more information, see "Configuring GVRP Parameters."

Private VLAN Edge

Ports can be assigned to Private VLAN Edge (PVE) groups. A port defined as PVE is protected by an uplink, so that it is isolated from other ports within the same VLAN. The uplink must be a GE port.

For more information on Private VLANs, see "Configuring Ports" on page 297.

Spanning Tree Protocol Features

Spanning Tree Protocol (STP)

802.1d Spanning tree is a standard Layer 2 switch requirement that allows bridges to automatically prevent and resolve L2 forwarding loops. Switches exchange configuration messages using specifically formatted frames and selectively enable and disable forwarding on ports.

For more information, see "Configuring the Spanning Tree Protocol."

Fast Link

STP can take up to 30-60 seconds to converge. During this time, STP detects possible loops, allowing time for status changes to propagate and for relevant devices to respond. 30-60 seconds is considered too long of a response time for many applications. The Fast Link option bypasses this delay, and can be used in network topologies where forwarding loops do not occur.

For more information enabling Fast Link for ports and LAGs, see "Defining STP Port Settings" or "Defining Static Addresses."

IEEE 802.1w Rapid Spanning Tree

Spanning Tree can take 30-60 seconds for each host to decide whether its ports are actively forwarding traffic. Rapid Spanning Tree (RSTP) detects uses of network topologies to enable faster convergence, without creating forwarding loops.

For more information, see "Defining Rapid Spanning Tree."

IEEE 802.1s Multiple Spanning Tree

Multiple Spanning Tree (MSTP) operation maps VLANs into STP instances. MSTP provides differing load balancing scenario. Packets assigned to various VLANs are transmitted along different paths within MSTP Regions (MST Regions). Regions are one or more MSTP bridges by which frames can be transmitted. The standard lets administrators assign VLAN traffic to unique paths.

For more information, see "Configuring the Spanning Tree Protocol."

Link Aggregation

Link Aggregation

Up to eight Aggregated Links may be defined, each with up to eight member ports, to form a single Link Aggregated Group (LAG). This enables:

- Fault tolerance protection from physical link disruption
- Higher bandwidth connections
- Improved bandwidth granularity
- High bandwidth server connectivity

LAG is composed of ports with the same speed, set to full-duplex operation.

For more information, see "Defining LAG Parameters."

Link Aggregation and LACP

LACP uses peer exchanges across links to determine, on an ongoing basis, the aggregation capability of various links, and continuously provides the maximum level of aggregation capability achievable between a given pair of devices. LACP automatically determines, configures, binds, and monitors the port binding within the system.

For more information, see "Aggregating Ports."

BootP and DHCP Clients

DHCP enables additional setup parameters to be received from a network server upon system startup. DHCP service is an on-going process. DHCP is an extension to BootP.

For more information on DHCP, see "Defining DHCP IPv4 Interface Parameters."

Quality of Service Features

Class Of Service 802.1p Support

The IEEE 802.1p signaling technique is an OSI Layer 2 standard for marking and prioritizing network traffic at the data link/MAC sub-layer. 802.1p traffic is classified and sent to the destination. No bandwidth reservations or limits are established or enforced. 802.1p is a spin-off of the 802.1Q (VLANs) standard. 802.1p establishes eight levels of priority, similar to the IP Precedence IP Header bit-field.

For more information, see "Configuring Quality of Service."

Device Management Features

SNMP Alarms and Trap Logs

The system logs events with severity codes and timestamps. Events are sent as SNMP traps to a Trap Recipient List.

For more information on SNMP Alarms and Traps, see "Defining SNMP Parameters."

SNMP Versions 1, 2 and 3

Simple Network Management Protocol (SNMP) over the UDP/IP protocol controls access to the system, a list of community entries is defined, each of which consists of a community string and its access privileges. There are 3 levels of SNMP security read-only, read-write, and super. Only a super user can access the community table.

For more information, see "Defining SNMP Parameters".

Web Based Management

With the web based management, the system can be managed from any web browser. The system contains an Embedded Web Server (EWS), which serves HTML pages, through which the system can be monitored and configured. The system internally converts web-based input into configuration commands, MIB variable settings and other management-related settings.

Configuration File Download and Upload

The device configuration is stored in a configuration file. The Configuration file includes both system wide and port specific device configuration. The system can display configuration files in the form of a collection of CLI commands, which are stored and manipulated as text files.

For more information, see "Managing Files."

TFTP Trivial File Transfer Protocol

The device supports boot image, software, and configuration upload/download via TFTP.

Remote Monitoring

Remote Monitoring (RMON) is an extension to SNMP, which provides comprehensive network traffic monitoring capabilities (as opposed to SNMP which allows network device management and monitoring). RMON is a standard MIB that defines current and historical MAC-layer statistics and control objects, allowing real-time information to be captured across the entire network.

For more information, see "Viewing Statistics."

Command Line Interface

Command Line Interface (CLI) syntax and semantics conform as much as possible to common industry practice. CLI is composed of mandatory and optional elements. The CLI interpreter provides command and keyword completion to assist user and shorten typing.

Syslog

Syslog is a protocol that enables event notifications to be sent to a set of remote servers, where they can be stored, examined and acted upon. The system sends notifications of significant events in real time, and keeps a record of these events for after-the-fact usage.

For more information on Syslog, see "Managing Logs."

SNTP

The Simple Network Time Protocol (SNTP) assures accurate network Ethernet Switch clock time synchronization up to the millisecond. Time synchronization is performed by a network SNTP server. Time sources are established by Stratum. Stratum define the distance from the reference clock. The higher the stratum (where zero is the highest), the more accurate the clock.

For more information, see "Configuring SNTP Settings."

Domain Name System

Domain Name System (DNS) converts user-defined domain names into IP addresses. Each time a domain name is assigned the DNS service translates the name into a numeric IP address. For example, www.ipexample.com is translated to 192.87.56.2. DNS servers maintain domain name databases and their corresponding IP addresses.

For more information, see "Configuring Domain Name Systems" on page 154.

Traceroute

Traceroute discovers IP routes that packets were forwarded along during the forwarding process. The CLI Traceroute utility can be executed from either the user-exec or privileged modes.

802.1ab (LLDP-MED)

The Link Layer Discovery Protocol (LLDP) allows network managers to troubleshoot and enhance network management by discovering and maintaining network topologies over multi-vendor environments. LLDP discovers network neighbors by standardizing methods for network devices to advertise themselves to other systems, and to store discovered information. The multiple advertisement sets are sent in the packet **Type Length Value (TLV)** field. LLDP devices must support chassis and port ID advertisement, as well as system name, system ID, system description, and system capability advertisements.

LLDP Media Endpoint Discovery (LLDP-MED) increases network flexibility by allowing different IP systems to co-exist on a single network LLDP. It provides detailed network topology information, emergency call service via IP Phone location information, and troubleshooting information.

Security Features

SSL

Secure Socket Layer (SSL) is an application-level protocol that enables secure transactions of data through privacy, authentication, and data integrity. It relies upon certificates and public and private keys.

Port Based Authentication (802.1x)

Port based authentication enables authenticating system users on a per-port basis via an external server. Only authenticated and approved system users can transmit and receive data. Ports are authenticated via the Remote Authentication Dial In User Service (RADIUS) server using the Extensible Authentication Protocol (EAP). Dynamic VLAN Assignment (DVA) allows network administrators to automatically assign users to VLANs during the RADIUS server authentication.

For more information, see "Port Based Authentication."

Locked Port Support

Locked Port increases network security by limiting access on a specific port only to users with specific MAC addresses. These addresses are either manually defined or learned on that port. When a frame is seen on a locked port, and the frame source MAC address is not tied to that port, the protection mechanism is invoked.

For more information, see "Configuring Port Security."

RADIUS Client

RADIUS is a client/server-based protocol. A RADIUS server maintains a user database, which contains per-user authentication information, such as user name, password and accounting information.

For more information, see "Configuring RADIUS Settings."

SSH

Secure Shell (SSH) is a protocol that provides a secure, remote connection to a device. SSH version 2 is currently supported. The SSH server feature enables an SSH client to establish a secure, encrypted connection with a device. This connection provides functionality that is similar to an inbound telnet connection. SSH uses RSA and DSA Public Key cryptography for device connections and authentication.

TACACS+

TACACS+ provides centralized security for validation of users accessing the device. TACACS+ provides a centralized user management system, while still retaining consistency with RADIUS and other authentication processes.

For more information, see "Defining TACACS+ Settings."

Password Management

Password management provides increased network security and improved password control. Passwords for SSH, Telnet, HTTP, HTTPS, and SNMP access are assigned security features. For more information on Password Management, see "Managing Passwords".

Access Control Lists (ACL)

Access Control Lists (ACL) allow network managers to define classification actions and rules for specific ingress ports. Packets entering an ingress port, with an active ACL, are either admitted or denied entry and the ingress port is disabled. If they are denied entry, the user can disable the port.

For more information, see "ACL Overview" on page 276.

DHCP Snooping

DHCP Snooping expands network security by providing firewall security between untrusted interfaces and DHCP servers. By enabling DHCP Snooping network administrators can differentiate between trusted interfaces connected to end-users or DHCP Servers and untrusted interfaces located beyond the network firewall.

For more information, see "Configuring DHCP Snooping" on page 288.

Additional CLI Documentation

The CLI Reference Guide, which is available on the Documentation CD, provides information about the CLI commands used to configure the device. The document provides information about the command description, syntax, default values, guidelines, and examples.

Hardware Description

Port Description

PowerConnect 3524 Port Description

The Dell™ PowerConnect™ 3524 device is configured with the following ports:

- 24 Fast Ethernet ports — RJ-45 ports designated as 10/100Base-T ports
- 2 Fiber ports — Designated as 1000Base-X SFP ports
- 2 Gigabit ports — Designated as 1000Base-T ports
- Console port — RS-232 based port

The following figure illustrates the PowerConnect 3524 front panel.

Figure 2-1. PowerConnect 3524 Front Panel

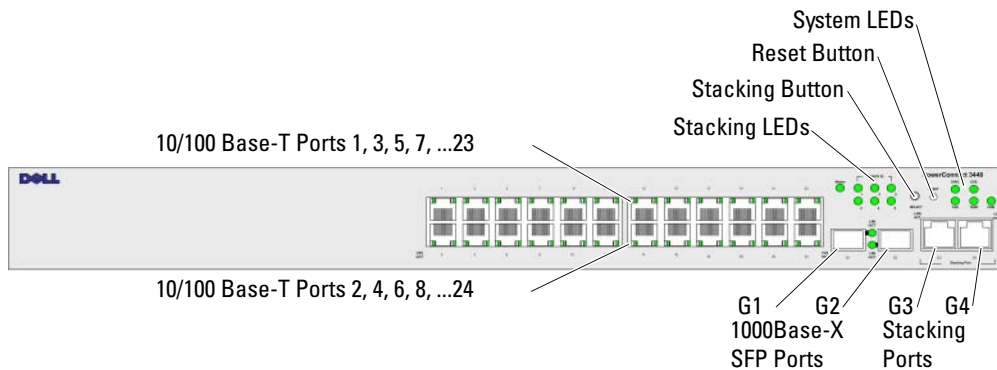

The front panel contains 24 RJ-45 ports number 1-24. The upper row of ports is marked with odd numbers 1-23, and the lower row of ports is marked with even numbers 2-24. In addition, the front panel also contains ports G1 - G2 which are fiber ports and ports G3- G4 which are copper ports. Ports G3 - G4 can either be used as stacking ports, or used to forward network traffic in a stand-alone device.

There are two buttons on the front panel. The Stack ID button is used to select the unit number. The second button is the Reset Button which is used to manually reset the device. The Reset button does not extend beyond the unit's front panel surface, so reset by pressing it accidentally is prevented. On the front panel are all the device LEDs.

The following figure illustrates the PowerConnect 3524 back:

Figure 2-2. PowerConnect 3524 Back Panel



The back panel contains an RPS connector, console port, and power connector.

PowerConnect 3548 Port Description

The PowerConnect 3548 device is configured with the following ports:

- 48 FE ports — RJ-45 ports designated as 10/100Base-T ports
- 2 Fiber ports — Designated as 1000Base-X SFP ports
- 2 Gigabit ports — Designated as 1000Base-T ports
- Console port — RS-232 Console based port

The following figure illustrates the PowerConnect 3548 front panel.

Figure 2-3. PowerConnect 3548 Front Panel

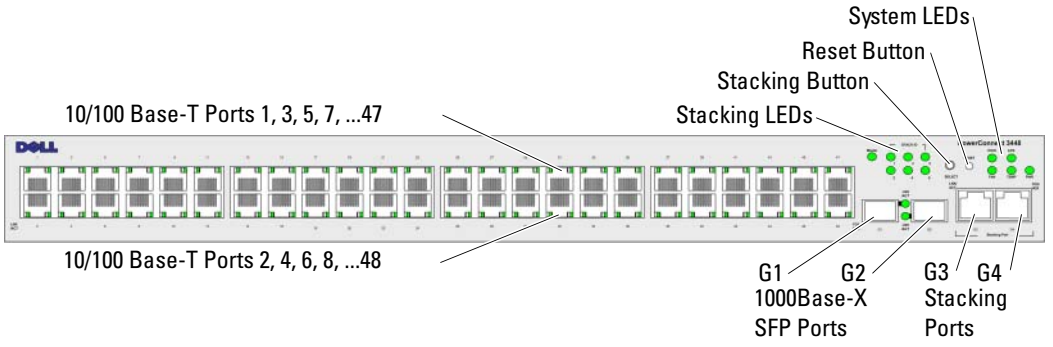

The front panel contains 48 RJ-45 ports number 1-48. The upper row of ports is marked by odd numbers 1-47, and the lower row of ports is marked with even numbers 2-48. In addition, the front panel also contains ports G1 - G2 which are fiber ports and ports G3- G4 which are copper ports. Ports G3- G4 can either be used as stacking ports, or used to forward network traffic in a stand-alone device.

There are two buttons on the front panel. The Stack ID button is used to select the unit number. The second button is the Reset Button which is used to manually reset the device. The Reset button does not extend beyond the unit's front panel surface, so reset by pressing it accidentally is prevented. On the front panel are all the device LEDs.

The following figure illustrates the PowerConnect 3548 back panel:

Figure 2-4. PowerConnect 3548 Back Panel

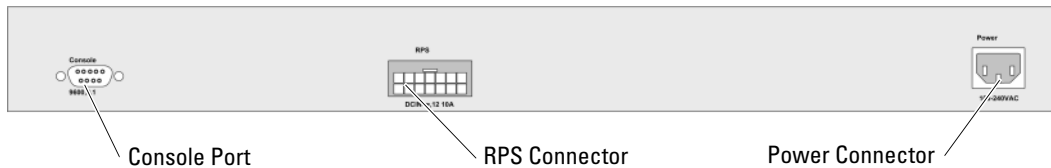

The back panel contains an RPS connector, console port and power connector.

SFP Ports

The Small Form Factor Pluggable (SFP) ports are fiber transceivers designated as 10000 Base-SX or LX. They include TWSI (Two-Wire Serial Interface) and internal EPROM.

RS-232 Console Port

One DB-9 connector for a terminal connection is used for debugging, software download etc. The default baud rate is 9,600 bps. The baud rate can be configured from 2400 bps up to 115,200 bps.

Figure 2-5. Console Port

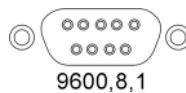

Physical Dimensions

The PowerConnect 3524/P and PowerConnect 3548/P devices have the following physical dimensions:

PoE Model:

- **Width** — 440 mm (17.32 inch)
- **Depth** — 387 mm (15.236 inch)
- **Height** — 43.2 mm (1.7 inch)

Non-PoE Device:

- **Width** — 440 mm (17.32 inch)
- **Depth** — 257 mm (10.118 inch)
- **Height** — 43.2 mm (1.7 inch)

LED Definitions

The front panel contains light emitting diodes (LED) that indicate the status of links, power supplies, fans, and system diagnostics.

Port LEDs

Each 10/100/1000 Base-T port and 10/100 Base-T port has two LEDs. The speed LED is located on the left side of the port, while the link/duplex/activity LED is located on the right side.

The following figure illustrates the 10/100 Base-T port LEDs on The PowerConnect 3524 /P and PowerConnect 3548/P switches:

Figure 2-6. RJ-45 Copper Based 10/100 BaseT LEDs

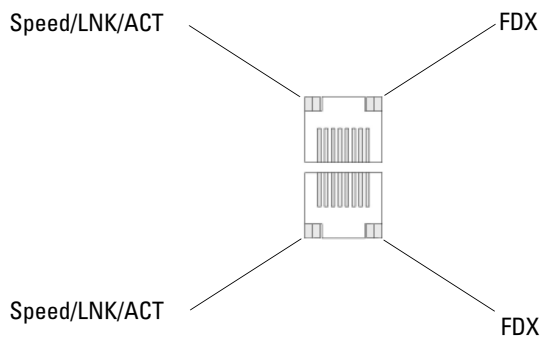

The RJ-45 100 Base-T port on the PowerConnect 3524 /P and PowerConnect 3548/P has two LEDs marked as LNK/ACT.

The following figure illustrates the 100 Base-T LEDs.

Figure 2-7. RJ-45 1000 BaseT LED

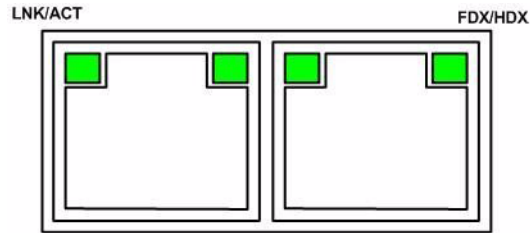

The RJ-45 LED indications for PowerConnect 3524 and PowerConnect 3548 are described in the following table:

Table 2-1. PowerConnect 3524 and PowerConnect 3548 RJ-45 100BaseT LED Indications

LED	Color	Description
Link/Activity/Speed	Green Static	The port is running at 100 Mbps.
	Green Flashing	The port is either transmitting or receiving data at 100 Mbps.
	Amber Static	The port is running at 10 Mbps.
	Yellow Flashing	The port is either transmitting or receiving data at 10 Mbps.
	OFF	The port is currently not operating.
FDX	Green Static	The port is currently operating in Full Duplex mode.
	OFF	The port is currently operating in Half Duplex mode,

The RJ-45 LED indications for PowerConnect 3524P and PowerConnect 3548P are described in the following table:

Table 2-2. PowerConnect 3524P and PowerConnect 3548P RJ-45 Copper based 100BaseT LED Indications

LED	Color	Description
Speed/Link/Act	Green Static	The port is currently linked at 100 Mbps.
	Green Flashing	The ports is currently operating at 100 Mbps.
	OFF	The port is currently operating at 10 Mbps or is not linked.
FDX	Green Static	The Powered Device (PD) is detected and is operating at normal load. For more information about Powered Devices, see " <i>Managing Power over Ethernet</i> ".
	Green Flashing	The port is operating at transitional mode. The PD is being detected, or is faulty. For more information about Power over Ethernet, see " <i>Managing Power over Ethernet</i> ".
	Amber Static	An overload or short has occurred on the Powered Device. For more information about Power over Ethernet faults, see " <i>Managing Power over Ethernet</i> ".
	Amber Flashing	The powered device power conception exceeds the predefined power allotment. For more information about Power over Ethernet power allotments, see " <i>Managing Power over Ethernet</i> ".
	OFF	No powered device is detected.

Gigabit Port LEDs

The following table describes the Gigabit (stacking port) LEDs:

Table 2-3. PowerConnect 3524 and PowerConnect 3548 RJ-45 Copper based 100BaseT LED Indications

LED	Color	Description
Link/Activity/Speed	Green Static	The port is running at 1000 Mbs.
	Green Flashing	The port is either transmitting or receiving data at 1000 Mbps.
	Yellow Static	The port is running at 10 or 100Mbps.
	Yellow Flashing	The port is either transmitting or receiving data at 10 or 100 Mbps.
	OFF	The port is currently not operating.
FDX	Green Static	The port is currently operating in Full Duplex mode.
	OFF	The port is currently operating in Half Duplex mode.

SFP LEDs

The SFP ports each have one LED marked as LNK/ACT. On the PowerConnect 3524/P and PowerConnect 3548/P devices, the LEDs are located between ports and are round in shape. The following figures illustrate the LEDs on each device.

Figure 2-8. SFP Port LEDs

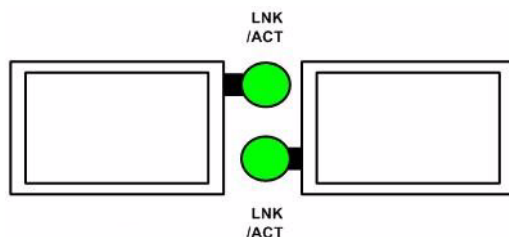

The SFP port LED indications are described in the following table:

Table 2-4. SFP Port LED Indications

LED	Color	Description
Link/Activity	Green Static	A link is established.
	Green Flashing	The port is currently transmitting or receiving data.
	OFF	The port is currently not linked.

System LEDs

The system LEDs of The PowerConnect 3524 /P and PowerConnect 3548/P devices provide information about the power supplies, fans, thermal conditions, and diagnostics. The following figure illustrates the system LEDs.

Figure 2-9. System LEDs



The following table describes the system LED indications.

Table 2-5. System LED Indicators

LED	Color	Description
Power Supply (PWR)	Green Static	The switch is turned on.
	OFF	The switch is turned off.
Redundant Power Supply (RPS) (models: 3524 and 3548)	Green Static	The RPS is currently operating.
	Red Static	The RPS failed.
	OFF	The redundant power supply is not plugged in.
Redundant Power Supply (RPS) (models: 3524P and 3548P)	Green Static	The RPS is currently operating.
	OFF	The redundant power supply has failed or is not plugged in.
Diagnostics (DIAG)	Green Flashing	The system diagnostic test is currently in progress.
	Green Static	The system diagnostic test passed successfully.
	Red Static	The system diagnostic test failed.
	OFF	The system is operating normally.
Temperature (TEMP)	Red Static	The device has crossed the permitted temperature range.
	OFF	The device is operating within the permitted temperature range.
Fan (FAN)	Green Static	All device fans are operating normally.
	Red Static	One or more of the device fans is not operating.

The Stacking LEDs indicate the unit position in the stack. The following figure illustrates the LEDs on the front panel.

Figure 2-10. Stacking LEDs

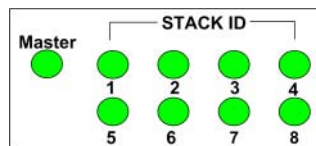

The Stacking LEDs are numbered 1- 8. Each stacking unit has one stacking LED lit, indicating its Unit ID number. If either Stacking LED 1 or 2 is lit, it indicates that the device is either the Stack Master or Backup Master.

Table 2-6. Stacking LED Indications

LED	Color	Description
All Stacking LEDs	OFF	The switch is currently a stand-alone device.
Stacking LED 1-8 (S1-S8)	Green Static	The device is designated as Stacking Unit N.
	OFF	The device is not designated as Stacking Unit N.
Stacking Master LED	Green Static	The device is the Stack Master
	OFF	The device is not the Stack Master.

Power Supplies

The device has an internal power supply unit (AC unit) and a connector to connect PowerConnect 3524/P and PowerConnect 3548/P devices to a PowerConnect EPS-470 unit, or to connect PowerConnect 3524 and PowerConnect 3548 devices to a PowerConnect RPS-600 unit.

The PowerConnect 3524/P and PowerConnect 3548/P devices have an internal power supply (12 Volt).

Operation with both power supply units is regulated through load sharing. Power supply LEDs indicate the status of the power supply.

The PowerConnect 3524/P and PowerConnect 3548/P devices have an internal power supply of 470W (12V/-48V), with a total of 370W for 24 ports PoE device.

AC Power Supply Unit

The AC power supply unit operates from 90 to 264 VAC, 47 to 63 Hz. The AC power supply unit uses a standard connector. LED indicator is on the front panel and indicates whether the AC unit is connected.

DC Power Supply Unit

The PowerConnect 3524 and PowerConnect 3548 switches connect to an external RPS-600 unit to provide a redundant power option. No configuration is required. The front panel "RPS" LED indicates whether the external RPS-600 is connected. See Table 2-5 for RPS LED definition.

The PowerConnect 3524/P and PowerConnect 3548/P switches connect to an external EPS-470 unit to provide a redundant power option. No configuration is required. The front panel "RPS" LED indicates whether the external EPS-470 is connected. See Table 2-5 for RPS LED definition.

Figure 2-11. Power Connection

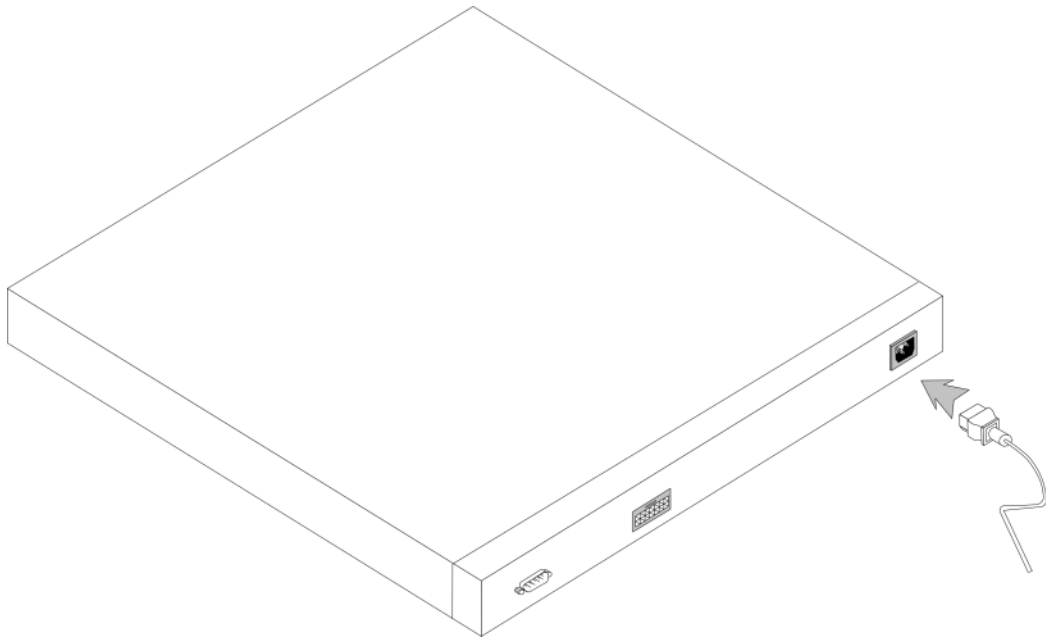

When the device is connected to a different power source, the probability of failure in the event of a power outage decreases.

Stack ID Button

The device front panel contains a Stack ID button used to manually select the Unit ID for the Stack Master and members.

The Stack Master and members must be selected within 15 seconds of booting the device. If the Stack Master is not selected within 15 seconds, the device is booted in stand-alone mode. To select a Unit ID for the device, reboot the device.

The Stack Master receives the Unit ID of 1 or 2. If both Unit 1 and Unit 2 are present, the unit that is not elected functions as the Backup Master. Stack members receive a separate Unit ID (3-8). For example, if there are four units in a stack, the Master unit is either 1 or 2, the backup Master is either 1 or 2 depending on the Unit ID of the Master unit, the third member is 3, and the fourth Stack member is 4.

 **NOTE:** The device does not automatically detect a stand-alone unit. If a Unit ID has already been selected, press the Stack ID button several times until no stacking LED is lit.

Reset Button

The PowerConnect 3524/P and PowerConnect 3548/P switches have a reset button, located on the front panel, for manual reset of the device. If the Master device is reset, the entire stack is reset. If only a member unit is reset, the remain stacking members are not reset.

The single reset circuit of the switch is activated by power-up or low-voltage conditions.

Ventilation System

The PowerConnect 3524/P and PowerConnect 3548/P switches with the PoE feature have five built-in fans. The non-PoE PowerConnect 3524 and PowerConnect 3548 devices have two built-in fans. Operation can be verified by observing the LED that indicates if one or more fans is faulty.

Installing the PowerConnect 3524/P and PowerConnect 3548/P

Site Preparation

The Dell™ PowerConnect™ 3524/P and PowerConnect 3548/P devices can be mounted in a standard 48.26-am (19-inch) equipment rack, placed on a tabletop or mounted on a wall. Before installing the unit, verify that the chosen location for installation meets the following site requirements:

- **Power** — The unit is installed near an easily accessible 100-240 VAC, 50-60 Hz outlet.
- **General** — The Redundant Power Supply (RPS) is correctly installed by checking that the LEDs on the front panel are illuminated.
- **PoE Models** — The RPS is currently installed by checking that the PoE LEDs on the front panel are illuminated.
- **Clearance** — There is adequate frontal clearance for operator access. Allow clearance for cabling, power connections, and ventilation.
- **Cabling** — The cabling is routed to avoid sources of electrical noise such as radio transmitters, broadcast amplifiers, power lines, and fluorescent lighting fixtures.
- **Ambient Requirements** — The ambient unit operating temperature range is 0 to 45°C (32 to 113°F) at a relative humidity of 10% to 90%, non-condensing.

Unpacking

Package Contents

While unpacking the device, ensure that the following items are included:

- Device/Switch
- AC power cable
- RS-232 crossover cable
- Self-adhesive rubber pads

- Rack-mount kit for rack installation or wall mounting kit
- Documentation CD
- Product Information Guide

Unpacking the Device

 **NOTE:** Before unpacking the device, inspect the package and immediately report any evidence of damage.

- 1 Place the box on a clean flat surface.
- 2 Open the box or remove the box top.
- 3 Carefully remove the device from the box and place it on a secure and clean surface.
- 4 Remove all packing material.
- 5 Inspect the device and accessories for damage. Report any damage immediately.

Mounting the Device

The following mounting instructions apply to The PowerConnect 3524/P and PowerConnect 3548/P devices. The Console port is on the back panel. The power connectors are positioned on the back panel. Connecting a Redundant Power Supply (RPS) is optional, but is recommended. The RPS connector is on the back panel of the devices.

Installing in a Rack



WARNING: Read the Safety Information included in the Product Information Guide for safety information on devices connected to or that support the SWI.



WARNING: Disconnect all cables from the unit before mounting the device in a rack or cabinet.



WARNING: When mounting multiple devices into a rack, mount the devices from the bottom up.

- 1 Place the supplied rack-mounting bracket on one side of the device, ensuring that the mounting holes on the device line up to the mounting holes on the rack-mounting bracket.

The following figure illustrates where to mount the brackets.

Figure 3-1. Bracket Installation for Rack Mounting

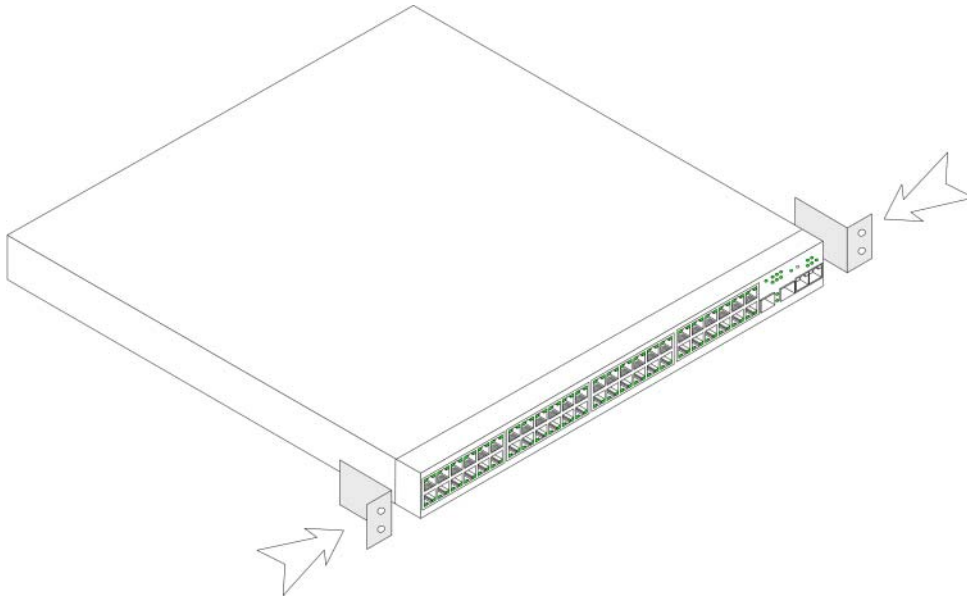

- 2 Insert the supplied screws into the rack-mounting holes and tighten with a screwdriver.
- 3 Repeat the process for the rack-mounting bracket on the other side of the device.
- 4 Insert the unit into the 48.26 cm (19 inch) rack, ensuring that the rack-mounting holes on the device line up to the mounting holes on the rack.
- 5 Secure the unit to the rack with the rack screws (not provided). Fasten the lower pair of screws before the upper pair of screws. Ensure that the ventilation holes are not obstructed.

Installing on a Flat Surface

The device must be installed on a flat surface if it is not installed on a rack. The surface must be able to support the weight of the device and the device cables.

- 1 Attach the self-adhesive rubber pads on each marked location on the bottom of the chassis.
- 2 Set the device on a flat surface, leaving 5.08 cm (2 inch) on each side and 12.7 cm (5 inch) at the back.
- 3 Ensure that the device has proper ventilation.

Installing the Device on a Wall

- 1 Place the supplied wall-mounting bracket on one side of the device, ensuring that the mounting holes on the device line up to the mounting holes on the rack-mounting bracket. The following figure illustrates where to mount the brackets.

Figure 3-2. Bracket Installation for Mounting on a Wall

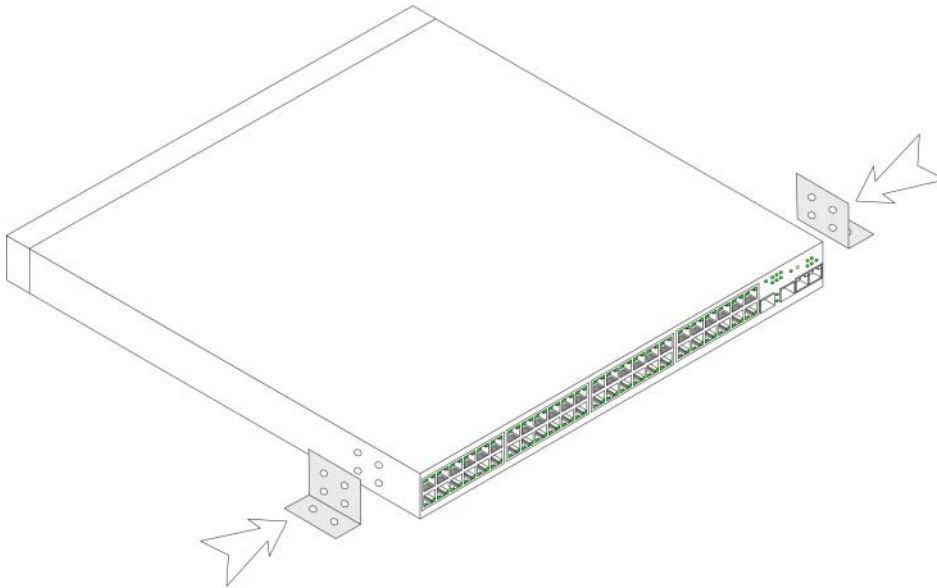

- 2 Insert the supplied screws into the rack-mounting holes and tighten with a screwdriver.
- 3 Repeat the process for the wall-mounting bracket on the other side of the device.
- 4 Place the device on the wall in the location where the device is being installed.
- 5 On the wall mark the locations where the screws to hold the device must be prepared.
- 6 Drill holes and place all plugs (not provided) in the holes, in the marked location.
- 7 Secure the unit to the wall with screws (not provided). Ensure that the ventilation holes are not obstructed.

Figure 3-3. Mounting a Device on a Wall

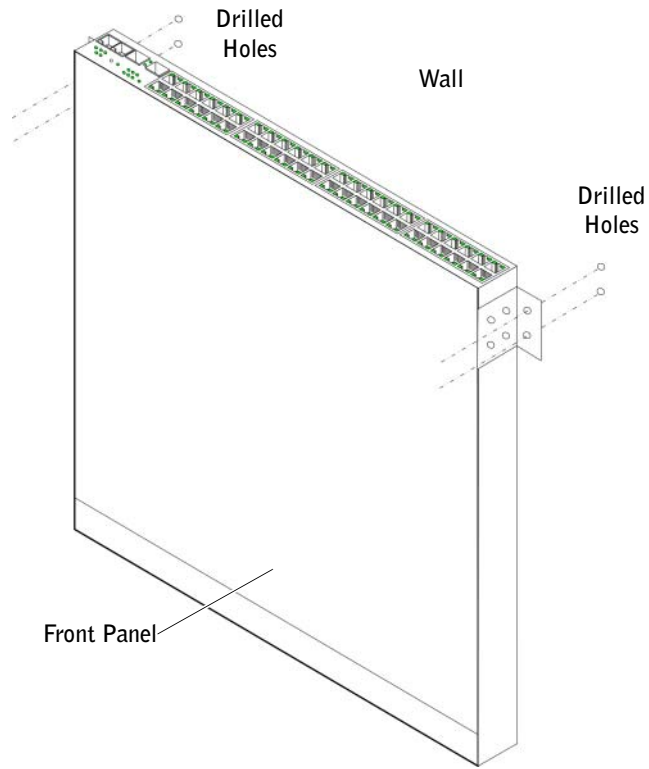

Connecting to a Terminal

- 1** Connect an RS-232 crossover cable to the ASCII terminal or the serial connector of a desktop system running terminal emulation software.
- 2** Connect the female DB-9 connector at the other end of the cable to the device serial port connector.

Connecting a Device to a Power Supply

Connect the supplied AC power cable to the AC power connector on the back panel.

NOTE: Do not connect the power cable to a grounded AC outlet at this time. Connect the device to a power source in the steps detailed in "Starting and Configuring the Device" on page 47.

Figure 3-4. Back-Panel Power Connector

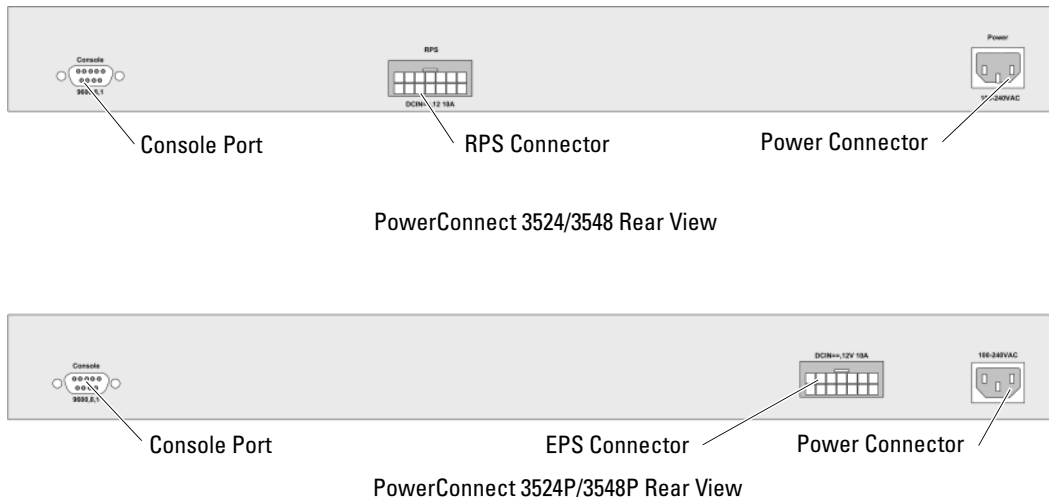

After connecting the device to a power source, confirm that the device is connected and operating correctly by examining the LEDs on the front panel.

Installing a Stack

Overview

Each device can operate as a stand-alone device or can be a member in a stack. Up to eight devices or up to 384 ports are supported per stack.

All stacks must have a Master unit, and may have a Master Backup unit, with any other devices connected to the stack as Members.

Stacking PowerConnect 35xx Series Systems Switches

Each PowerConnect 35xx series systems stack contains a single Master unit, and may have a Master Backup unit, while the remaining units are considered stacking Members.

PowerConnect 35xx series systems switches use the RJ-45 Gigabit Ethernet ports (G3 and G4) for stacking. This enables added stacking capabilities to the devices without adding additional device accessories. To stack the devices together, insert a standard Category 5 cable into port G3 in the uppermost device in the stack, and into port G4 of the device immediately below it in the stack. Repeat this process until all devices are connected. Connect the bottommost device's port G3 in the stack to port G4 of the uppermost device in the stack.

Figure 3-5. Stacking Cable Diagram

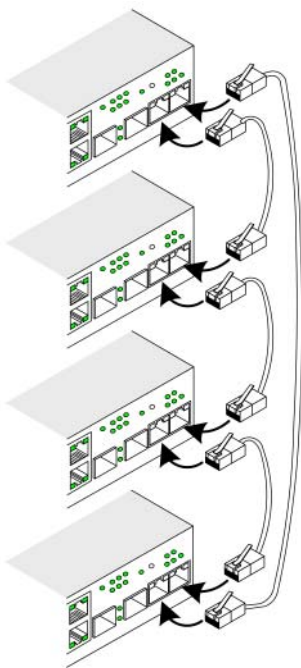

NOTE: In stacking mode ports designated as G3 and G4 are not displayed in the EWS. The effect is of not being present on the device. This is because the ports receive a different index for stacking.

Stack unit identification is performed on the device front panel using the Stack ID button.

Figure 3-6. Stacking Configuration and Identification Panel

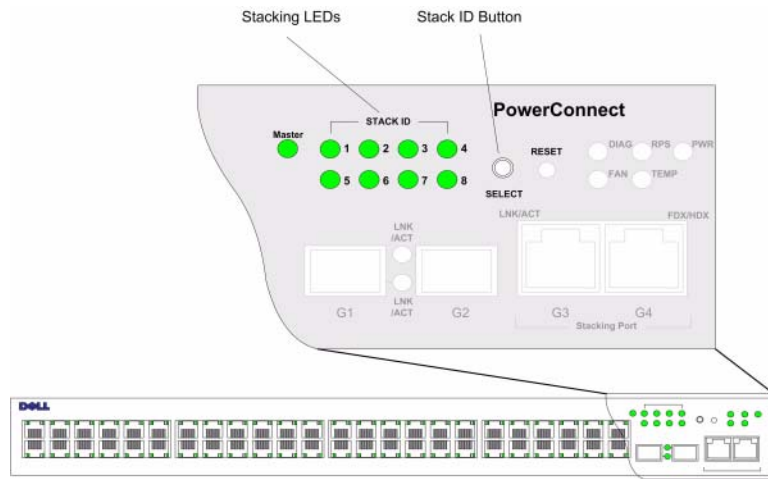

Each stack device has a unique identifying unit ID that defines the unit’s position and function in the stack. If the device is a stand-alone unit, the Stack LED is not illuminated. The default setting is stand-alone.

The unit ID is manually configured by using the Stack ID button. The unit ID is indicated by the Stack ID LEDs. Unit ID 1 and 2 are reserved for the Master and Backup Master unit, and unit ID 3 to 8 are for Member units.

Unit ID Selection Process

The unit ID selection process is as follows:

- 1 Ensure that the stand-alone/Master device Console port is connected to a VT100 terminal device or VT100 terminal emulator via the RS-232 crossover cable.
- 2 Locate an AC power receptacle.
- 3 Deactivate the AC power receptacle.
- 4 Connect the device to the AC receptacle.
- 5 Activate the AC power receptacle.

When powering up, the configured LED number (corresponding to the previously saved unit ID) begins to flash. The LED flashes for 15 seconds. During this period, select a specific Stack ID by pressing the Stack ID button until the appropriate Stack ID LED is illuminated.

- 6 Selection Process** — To advance the stacking ID LED number, continue pressing the Stack ID button. When LED 8 is flashing, pressing the Stack ID button results in the device being configured as a stand-alone. Pressing the Stack ID button again advances the Stack ID to 1. Unit 1 and Unit 2 are master-enabled units. See "Stacking Overview" on page 12 master-election process.
- 7 End selection process** — The unit ID selection process is completed when the 15-second flashing period has transpired. The Stack ID button becomes unresponsive and the unit ID is set to the LED ID flashing at the end of the period.

 **NOTE:** These steps should be performed one unit at a time until all stack members are powered up and their Stack IDs are selected. Performing the steps one unit at a time will allow for sufficient time to select the Stack ID for each unit. However, the entire stack should be cabled as per the "Stacking Cable Diagram" on page 45 before powering up the devices.

Starting and Configuring the Device

After completing all external connections, connect a terminal to the device to configure the device. Performing the additional advanced functions is described in the section "Advanced Configuration" on page 54.

 **NOTE:** Before proceeding, read the release notes for this product. Download the release notes from the Dell Support website at support.dell.com.

 **NOTE:** It is recommended that you obtain the most recent revision of the user documentation from the Dell Support website at support.dell.com.

Connecting to the Device

To configure the device, the device must be connected to a console. However, if the device is part of a stack, only one device called the Master unit in the stack needs to be connected to a terminal. Because the stack operates as a single device, only the Master unit is configured.

Connecting the Terminal to the Device

The device provides a Console port that enables a connection to a terminal desktop system running terminal emulation software for monitoring and configuring the device. The Console port connector is a male DB-9 connector, implemented as a data terminal equipment (DTE) connector.

To use the Console port, the following is required:

- VT100-compatible terminal or a desktop or portable system with a serial port and running VT100 terminal emulation software
- An RS-232 crossover cable with a female DB-9 connector for the Console port and the appropriate connector for the terminal

To connect a terminal to the device Console port:

- 1** Connect the supplied RS-232 crossover cable to the terminal running VT100 terminal emulation software.
- 2** Select the appropriate serial port (serial port 1 or serial port 2) to connect to the console.

- 3 Set the data rate to 9600 baud.
- 4 Set the data format to 8 data bits, 1 stop bit, and no parity.
- 5 Set flow control to *none*.
- 6 Under Properties, select VT100 for Emulation mode.
- 7 Select Terminal keys for Function, Arrow, and Ctrl keys. Ensure that the setting is for Terminal keys (*not* Windows keys).

CAUTION: When using HyperTerminal with Microsoft® Windows® 2000, ensure that you have Windows 2000 Service Pack 2 or later installed. With Windows 2000 Service Pack 2, the arrow keys function properly in HyperTerminal's VT100 emulation. Go to www.microsoft.com for information on Windows 2000 service packs.

- 8 Connect the female connector of the RS-232 crossover cable directly to the device Console port on the Master unit/stand-alone device, and tighten the captive retaining screws. The PowerConnect 35xx Series Systems Console port is on the rear panel.

Figure 3-7. Connecting to PowerConnect 35xx Series Systems Console Port

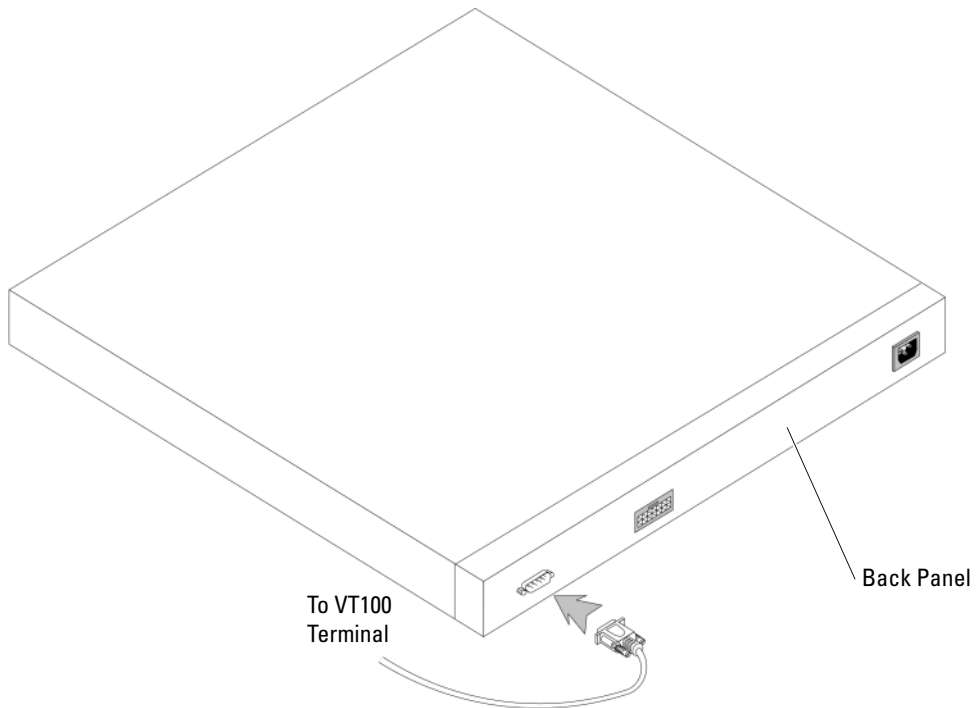

NOTE: A console can be connected to the Console port on any unit in the stack, but stack management is performed only from the stack master (unit ID 1 or 2).

Configuring PowerConnect 3524/P and 3548/P

Configuration Procedures

After all the device external connections are completed, a terminal is connected to the device to monitor the boot and other procedures. The order of installation and configuration procedures is illustrated in the following figure:

NOTE: Before proceeding, read the release notes for this product. Download the release notes from support.dell.com.

Figure 4-1. Installation and Configuration Flow

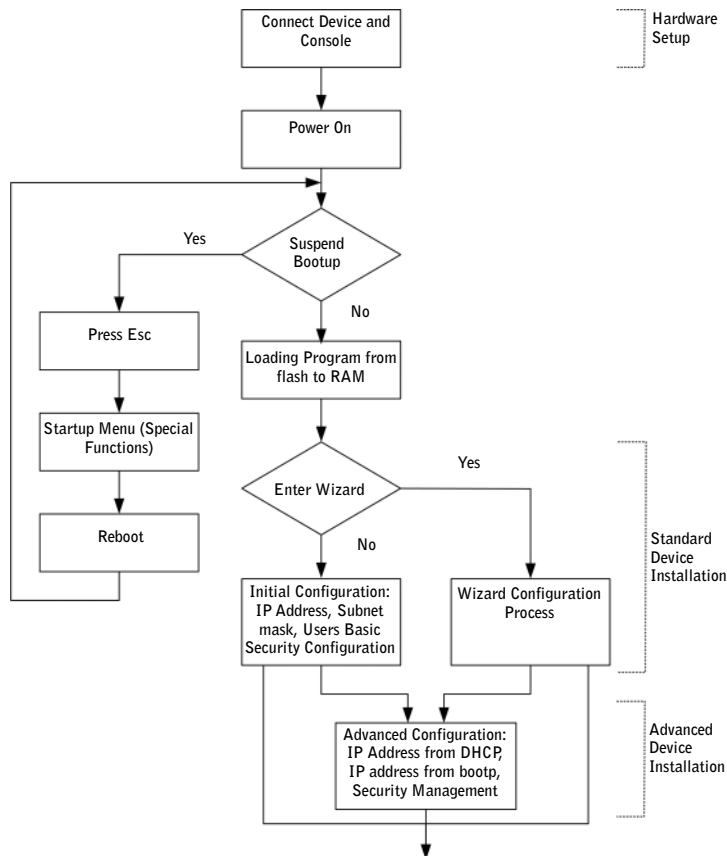

Booting the Switch

When the power is turned on with the local terminal already connected, the switch goes through power-on self-test (POST). POST runs every time the device is initialized and checks hardware components to determine if the device is fully operational before completely booting. If a critical problem is detected, the program flow stops. If POST passes successfully, a valid executable image is loaded into RAM. POST messages are displayed on the terminal and indicate test success or failure.

The boot process runs approximately 30 seconds.

Initial Configuration



NOTE: Before proceeding, read the release notes for this product. Download the release notes from the Dell Support website at support.dell.com.



NOTE: The initial configuration assumes the following:

- The Dell™ PowerConnect™ device was never configured before and is in the same state as when you received it.
- The PowerConnect device booted successfully.
- The console connection is established and the console prompt is displayed on the screen of a VT100 terminal device.

The initial device configuration is through the Console port. After the initial configuration, the device can be managed either from the already connected Console port or remotely through an interface defined during the initial configuration.

If this is the first time the device has booted up, or if the configuration file is empty because the device has not been configured, the user is prompted to use the Setup Wizard. The Setup Wizard provides guidance through the initial device configuration, and gets the device up and running as quickly as possible.



NOTE: Obtain the following information from the network administrator before configuring the device:

- The IP address to be assigned to the VLAN 1 interface through which the device is to be managed (by default, every port is a member of the VLAN 1)
- The IP subnet mask for the network
- The default gateway (next hop router) IP address for configuring the default route.
- SNMP community string and SNMP management system IP address (optional)
- Username and password

The Setup Wizard guides you through the initial switch configuration, and gets the system up and running as quickly as possible. You can skip the Setup Wizard, and manually configure the device through the device CLI mode.

The Setup Wizard configures the following fields.

- SNMP Community String and SNMP Management System IP address (optional)
- Username and Password

- Device IP address
- Default Gateway IP address

The following is displayed:

```
Welcome to Dell Easy Setup Wizard
```

```
The Setup Wizard guides you through the initial switch configuration,
and gets you up and running as quickly as possible. You can skip the
setup wizard, and enter CLI mode to manually configure the switch.
The system will prompt you with a default answer; by pressing enter,
you accept the default.
```

```
You must respond to the next question to run the setup wizard within
60 seconds, otherwise the system will continue with normal operation
using the default system configuration.
```

```
Would you like to enter the Setup Wizard (you must answer this
question within 60 seconds? (Y/N)[Y]Y
```

```
You can exit the Setup Wizard at any time by entering [ctrl+z].
```

If you enter [N], the Setup Wizard exits. If there is no response within 60 seconds, the Setup Wizard automatically exits and the CLI console prompt appears.

If you enter [Y], the Setup Wizard provides interactive guidance through the initial device configuration.



NOTE: If there is no response within 60 seconds, and there is a BootP server on the network, an address is retrieved from the BootP server.



NOTE: You can exit the Setup Wizard at any time by entering [ctrl+z].

Wizard Step 1

The following is displayed:

```
The system is not setup for SNMP management by default.
```

```
To manage the switch using SNMP (required for Dell Network Manager)
you can
```

- Setup the initial SNMP version 2 account now.
- Return later and setup additional SNMP v1/v3 accounts.

```
For more information on setting up SNMP accounts, please see the user
documentation.
```

```
Would you like to setup the SNMP management interface now? (Y/N)[Y]Y
```

Enter [N] to skip to Step 2.

Enter [Y] to continue the Setup Wizard. The following is displayed:

```
To setup the SNMP management account you must specify the management
system IP address and the "community string" or password that the
particular management system uses to access the switch. The wizard
automatically assigns the highest access level [Privilege Level 15]
to this account.
```

```
You can use Dell Network Manager or CLI to change this setting, and
to add additional management systems. For more information on adding
management systems, see the user documentation.
```

```
To add a management station:
```

```
Please enter the SNMP community string to be used:
```

```
[Dell_Network_Manager]
```

```
Please enter the IP address of the Management System (A.B.C.D) or
wildcard (0.0.0.0) to manage from any Management Station: [0.0.0.0]
```

Enter the following:

- SNMP community string, for example, Dell_Network_Manager.
- IP address of the Management System (A.B.C.D), or wildcard (0.0.0.0) to manage from any Management Station.



NOTE: IP addresses and masks beginning with zero cannot be used.

Press **Enter**.

Wizard Step 2

The following is displayed:

```
Now we need to setup your initial privilege (Level 15) user account.
This account is used to login to the CLI and Web interface.
You may setup other accounts and change privilege levels later.
For more information on setting up user accounts and changing
privilege levels, see the user documentation.
```

```
To setup a user account:
```

```
Enter the user name<1-20>:[admin]
```

```
Please enter the user password:*
```

```
Please reenter the user password:*
```

Enter the following:

- User name, for example "admin"
- Password and password confirmation.



NOTE: If the first and second password entries are not identical, the user is prompted until they are identical.

Press **Enter**.

Wizard Step 3

The following is displayed:

Next, an IP address is setup.

The IP address is defined on the default VLAN (VLAN #1), of which all ports are members. This is the IP address you use to access the CLI, Web interface, or SNMP interface for the switch. To setup an IP address:

Please enter the IP address of the device (A.B.C.D): [1.1.1.1]

Please enter the IP subnet mask (A.B.C.D or nn): [255.255.255.0]

Enter the IP address and IP subnet mask, for example 1.1.1.1 as the IP address and 255.255.255.0 as the IP subnet mask.

Press **Enter**.

Wizard Step 4

The following is displayed:

Finally, setup the default gateway.

Please enter the IP address of the gateway from which this network is reachable (e.g. 192.168.1.1). Default gateway (A.B.C.D): [0.0.0.0]

Enter the default gateway.

Press **Enter**. The following is displayed (as per the example parameters described):

This is the configuration information that has been collected:

```
=====
SNMP Interface = Dell_Network_Manager@0.0.0.0
User Account setup = admin
Password = *
Management IP address = 1.1.1.1 255.255.255.0
Default Gateway = 1.1.1.2
=====
```

Wizard Step 5

The following is displayed:

If the information is correct, please select (Y) to save the configuration, and copy to the start-up configuration file. If the information is incorrect, select (N) to discard configuration and restart the wizard: (Y/N)[Y]Y

Enter [N] to skip to restart the Setup Wizard.

Enter [Y] to complete the Setup Wizard. The following is displayed:

```
Configuring SNMP management interface
Configuring user account.....
Configuring IP and subnet.....
```

```
Thank you for using Dell Easy Setup Wizard. You will now enter CLI
mode.
```

Wizard Step 6

The CLI prompt is displayed.

Advanced Configuration

This section provides information about dynamic allocation of IP addresses and security management based on the Authentication, Authorization, and Accounting (AAA) mechanism, and includes the following topics:

- Configuring IP Addresses through DHCP
- Configuring IP Addresses through BOOTP
- Security Management and Password Configuration

When configuring/receiving IP addresses through DHCP and BOOTP, the configuration received from these servers includes the IP address and may include subnet mask and default gateway.

Retrieving an IP Address From a DHCP Server

When using the DHCP protocol to retrieve an IP address, the device acts as a DHCP client. When the device is reset, the DHCP command is saved in the configuration file, but the IP address is not.

To retrieve an IP address from a DHCP server, perform the following steps:

- 1 Select and connect any port to a DHCP server or to a subnet that has a DHCP server on it, in order to retrieve the IP address.
- 2 Enter the following commands to use the selected port for receiving the IP address. In the following example, the commands are based on the port type used for configuration.
 - Assigning Dynamic IP Addresses:

```
console# configure
console(config)# interface ethernet 1/e1
console(config-if)# ip address dhcp hostname powerconnect
console(config-if)# exit
console(config)#
```

- Assigning Dynamic IP Addresses (on a VLAN):

```
console# configure
console(config)# interface ethernet vlan 1
console(config-if)# ip address dhcp hostname device
console(config-if)# exit
console(config)#
```

The interface receives the IP address automatically.

- 3 To verify the IP address, enter the **show ip interface** command at the system prompt as shown in the following example.

```
console# show ip interface
IP Address      I/F      Type
-----
100.1.1.1/24    vlan 1    dynamic
```



NOTE: It is not necessary to delete the device configuration to retrieve an IP address for the DHCP server.



NOTE: When copying configuration files, avoid using a configuration file that contains an instruction to enable DHCP on an interface that connects to the same DHCP server, or to one with an identical configuration. In this instance, the device retrieves the new configuration file and boots from it. The device then enables DHCP as instructed in the new configuration file, and the DHCP instructs it to reload the same file again.



NOTE: If you configure a DHCP IP address, this address is dynamically retrieved, and the `ip address dhcp` command is saved in the configuration file. In the event of master failure, the backup will again attempt to retrieve a DHCP address. This could result in one of the following:

- The same IP address may be assigned.
- A different IP address may be assigned, which could result in loss of connectivity to the management station.
- The DHCP server may be down, which would result in IP address retrieval failure, and possible loss of connectivity to the management station.

Receiving an IP Address From a BOOTP Server

The standard BOOTP protocol is supported and enables the device to automatically download its IP host configuration from any standard BOOTP server in the network. In this case, the device acts as a BOOTP client.

To retrieve an IP address from a BOOTP server:

- 1 Select and connect any port to a BOOTP server or subnet containing such a server, to retrieve the IP address.
- 2 At the system prompt, enter the **delete startup configuration** command to delete the Startup Configuration from flash.

The device reboots with no configuration and in 60 seconds starts sending BOOTP requests. The device receives the IP address automatically.



NOTE: When the device reboot begins, any input at the ASCII terminal or keyboard automatically cancels the BOOTP process before completion and the device does not receive an IP address from the BOOTP server.

The following example illustrates the process:

```
console> enable
console# delete startup-config
Startup file was deleted
console# reload
You haven't saved your changes. Are you sure you want to continue
(y/n) [n]?
This command will reset the whole system and disconnect your current
session. Do you want to continue (y/n) [n]?
*****
/* the device reboots */
```

To verify the IP address, enter the **show ip interface** command.

The device is now configured with an IP address.

Security Management and Password Configuration

System security is handled through the Authentication, Authorization, and Accounting (AAA) mechanism that manages user access rights, privileges, and management methods. AAA uses both local and remote user databases. Data encryption is handled through the SSH mechanism.

The system is delivered with no default password configured; all passwords are user-defined. If a user-defined password is lost, a password recovery procedure can be invoked from the **Startup** menu. The procedure is applicable for the local terminal only and allows a one-time access to the device from the local terminal with no password entered.

Configuring Security Passwords

The security passwords can be configured for the following services:

- Terminal
- Telnet
- SSH
- HTTP
- HTTPS



NOTE: Passwords are user-defined.



NOTE: When creating a user name, the default priority is 1, which allows access but not configuration rights. A priority of 15 must be set to enable access and configuration rights to the device. Although user names can be assigned privilege level 15 without a password, it is recommended to always assign a password. If there is no specified password, privileged users can access the Web interface with any password.



NOTE: Passwords can be secured by using password management commands to force aging-out of passwords, or expiration of passwords. For more information, see "Security Management and Password Configuration" on page 56.

Configuring an Initial Terminal Password

To configure an initial terminal password, enter the following commands:

```
console(config)# aaa authentication login default line
console(config)# aaa authentication enable default line
console(config)# line console
console(config-line)# login authentication default
console(config-line)# enable authentication default
console(config-line)# password george
```

- When initially logging on to a device through a terminal session, enter `george` at the password prompt.
- When changing a device's mode to enable, enter `george` at the password prompt.

Configuring an Initial Telnet Password

To configure an initial Telnet password, enter the following commands:

```
console(config)# aaa authentication login default line
console(config)# aaa authentication enable default line
console(config)# line telnet
console(config-line)# login authentication default
```

```
console(config-line)# enable authentication default
console(config-line)# password bob
```

- When initially logging onto a device through a Telnet session, enter bob at the password prompt.
- When changing a device mode to enable, enter bob.

Configuring an Initial SSH password

To configure an initial SSH password, enter the following commands:

```
console(config)# aaa authentication login default line
console(config)# aaa authentication enable default line
console(config)# line ssh
console(config-line)# login authentication default
console(config-line)# enable authentication default
console(config-line)# password jones.
```

- When initially logging onto a device through a SSH session, enter jones at the password prompt.
- When changing a device's mode to enable, enter jones.

Configuring an Initial HTTP Password

To configure an initial HTTP password, enter the following commands:

```
console(config)# ip http authentication local
console(config)# username admin password user1 level 15
```

Configuring an initial HTTPS password

To configure an initial HTTPS password, enter the following commands:

```
console(config)# ip https authentication local
console(config)# username admin password user1 level 15
```

Enter the following commands once when configuring to use a terminal, a Telnet, or an SSH session in order to use an HTTPS session.



NOTE: In the Web browser enable SSL 2.0 or greater for the page content to be displayed.

```
console(config)# crypto certificate generate key_generate
console(config)# ip https server
```

When initially enabling an http or https session, enter admin for user name and user1 for password.



NOTE: Http and Https services require level 15 access and connect directly to the configuration level access.

Configuring Login Banners

You can define 3 types of login banners:

- **Message-of-the-Day Banner:** Displayed when the user is connected to the device, before the user has logged in.
- **Login Banner:** Displayed after the Message-of-the-Day Banner, and before the user has logged in.
- **Exec Banner:** Displayed after successful login (in all privileged levels and in all authentication methods).

To view and configure login banners:

```
console# banner motd Welcome
console# show banner motd
console# banner login Please log in
console# show banner login
console# banner exec Successfully logged in
console# show banner exec
```

Startup Procedures

Startup Menu Procedures

The procedures called from the Startup menu cover software download, flash handling and password recovery. The diagnostics procedures are for use by technical support personnel *only* and are not disclosed in the document.

You can enter the Startup menu when booting the device. The user input is to be entered immediately after the POST test.

To enter the Startup menu:

- 1 Turn the power on and watch for the auto-boot message.

```
*****
***** SYSTEM RESET *****
*****
Boot1 Checksum Test.....PASS
Boot2 Checksum Test.....PASS
Flash Image Validation Test.....PASS
BOOT Software Version 1.0.0.05 Built 06-Jan-xxxxx 14:46:49
```

Ryan board, based on PPC8247

128 MByte SDRAM. I-Cache 16 KB. D-Cache 16 KB. Cache Enabled.

Autoboot in 2 seconds - press RETURN or Esc. to abort and enter prom.

- 2 When the auto-boot message appears, press <Enter> to get the Startup menu. The Startup menu procedures can be done using the ASCII terminal or Windows HyperTerminal.

- [1] Download Software
- [2] Erase Flash File
- [3] Password Recovery Procedure
- [4] Enter Diagnostic Mode
- [5] Set Terminal Baud-Rate
- [6] Back

The following sections describe the available Startup menu options.

 **NOTE:** When selecting an option from the Startup menu, take time-out into account: if no selection is made within 35 seconds (default), the device times out. This default value can be changed through CLI.

 **NOTE:** Technical support personnel only can operate the Diagnostics Mode (option [4]). For this reason, Enter Diagnostics Mode is not described in this guide.

Download Software - option[1]

The software download procedure is performed when a new version must be downloaded to replace the corrupted files, update or upgrade the system software. To download software from the Startup menu:

- 1 From the Startup menu, press [1]. The following prompt appears:

```
Downloading code using XMODEM
```

```
*****
```

```
*** Running SW Ver. 21_08 Date 21-Aug-xxxx Time 17:22:25 ***
```

```
*****
```

```
HW version is 00.00.00
```

```
Base Mac address is: 00:14:47:78:89:96
```

```
Dram size is : 128M bytes
```

```
Dram first block size is : 102400K bytes
```

```
Dram first PTR is : 0x1800000
```

```
Dram second block size is : 4096K bytes
```

```
Dram second PTR is : 0x7C00000
```



```

Flash size is: 16M
01-Jan-xxxx 01:01:07 %CDB-I-LOADCONFIG: Loading running
configuration.
01-Jan-xxxx 01:01:07 %CDB-I-LOADCONFIG: Loading startup
configuration.
Device configuration:
CPLD revision: 1.01
Slot 1 - PowerConnect 35xx HW Rev. 1.1
-----
-- Unit Standalone --
-----
Tapi Version: v1.3.3.1
Core Version: v1.3.3.1
01-Jan-xxxx 01:01:19 %INIT-I-InitCompleted: Initialization task is
completed
01-Jan-xxxx 01:01:19 %SNMP-I-CDBITEMSNUM: Number of running
configuration items loaded: 0
01-Jan-xxxx 01:01:19 %SNMP-I-CDBITEMSNUM: Number of startup
configuration items loaded: 0
01-Jan-xxxx 01:01:20 %Box-I-SFP-PRESENT-CHNG: unit_id 1 SFP 0 status
is not present.
01-Jan-xxxx 01:01:20 %Box-I-SFP-PRESENT-CHNG: unit_id 1 SFP 1 status
is not present.

```

- 2 When using the HyperTerminal, click **Transfer** on the HyperTerminal Menu Bar.
- 3 In the **Filename** field, enter the file path for the file to be downloaded.
- 4 Ensure that the Xmodem protocol is selected in the **Protocol** field.
- 5 Press **Send**. The software is downloaded.

 **NOTE:** After software download, the device reboots automatically.

Erase FLASH File - option [2]

In some cases, the device configuration must be erased. If the configuration is erased, all parameters configured via CLI, EWS or SNMP must be reconfigured.

To erase the device configuration:

- 1 From the Startup menu, press [2] within two seconds to erase flash file. The following message is displayed:
Warning! About to erase a Flash file.
Are you sure (Y/N)? y
- 2 Press y. The following message is displayed.
Write Flash file name (Up to 8 characters, Enter for none.):config
File config (if present) will be erased after system initialization
===== Press Enter To Continue =====
- 3 Enter config as the name of the flash file. The configuration is erased and the device reboots.
- 4 Repeat the device initial configuration.

Password Recovery - option [3]

If a password is lost, the Password Recovery procedure can be called from the Startup menu. The procedure enables entry to the device once without password.

To recover a lost password when entering the local terminal only:

- 1 From the Startup menu, type [3] and press <Enter>. The password is deleted.
Enter your choice or press ESC to exit
Current password will be ignored!



NOTE: To ensure device security, reconfigure passwords for applicable management methods.

Enter Diagnostic Mode - option [4]

For Technical Support only.

Set Terminal Baud-Rate - option [5]

To set the terminal baud-rate, type [5] and press <Enter>.

Enter your choice or press 'ESC' to exit:

Set new device baud-rate: 38,400

Software Download Through TFTP Server

This section contains instructions for downloading device software (system and boot images) through a TFTP server. The TFTP server must be configured before downloading the software.

System Image Download

The device boots and runs when decompressing the system image from the flash memory area where a copy of the system image is stored. When a new image is downloaded, it is saved in the other area allocated for the other system image copy.

On the next boot, the device will decompress and run from the currently active system image unless chosen otherwise.

To download a system image through the TFTP server:

- 1 Ensure that an IP address is configured on one of the device ports and pings can be sent to a TFTP server.
- 2 Make sure that the file to be downloaded is saved on the TFTP server (the `arc` file).
- 3 Enter the `show version` command to verify which software version is currently running on the device. The following is an example of the information that appears:

```
console# show version  
  
SW version 1.0.0.30 (date 27-Jan-xxxx time 13:42:41)  
Boot version 1.0.0.05 (date 27-Jan-xxxx time 15:12:20)  
HW version
```

- 4 Enter the `show bootvar` command to verify which system image is currently active. The following is an example of the information that appears:

```
console# show bootvar  
  
Images currently available on the Flash  
Image-1 active (selected for next boot)  
Image-2 not active  
console#
```

- 5 Enter the **copy tftp://{tftp address}/{file name} image** command to copy a new system image to the device. When the new image is downloaded, it is saved in the area allocated for the other copy of system image (image-2, as given in the example). The following is an example of the information that appears:

```
console# copy tftp://176.215.31.3/file1.ros image
Accessing file 'file1' on 176.215.31.3
Loading file1 from 176.215.31.3:
!!!!!!!!!!!!!!!!!!!!!!!!!!!!!!!!!!!!!!!!!!!!!!!!!!!!!!!!!!!!!!!!!!!!!!!!!!!!
!!!!!!!!!!!!!!!!!!!!!!!!!!!!!!!!!!!!!!!!!!!!!!!!!!!!!!!!!!!!!!!!!!!!!!!!!!!!
Copy took 00:01:11 [hh:mm:ss]
```

Exclamation symbols indicate that a copying process is in progress. Each symbol (!) corresponds to 512 bytes transferred successfully. A period indicates that the copying process is timed out. Many periods in a row indicate that the copying process failed.

- 6 Select the image for the next boot by entering the **boot system** command. After this command, enter the **show bootvar** command to verify that the copy indicated as a parameter in the **boot system** command is selected for the next boot.

The following is an example of the information that appears:

```
console# boot system image-2
console# show bootvar
Images currently available on the Flash
Image-1 active
Image-2 not active (selected for next boot)
```

If the image for the next boot is not selected by entering the **boot system** command, the system boots from the currently active image.

- 7 Enter the **reload** command. The following message is displayed:

```
console# reload
This command will reset the whole system and disconnect your current
session. Do you want to continue (y/n) [n]?
```

- 8 Enter **y**. The device reboots.

Boot Image Download

Loading a new boot image from the TFTP server and programming it into the flash updates the boot image. The boot image is loaded when the device is powered on. A user has *no* control over the boot image copies. To download a boot image through the TFTP server:

- 1 Ensure that an IP address is configured on one of the device ports and pings can be sent to a TFTP server.
- 2 Ensure that the file to be downloaded is saved on the TFTP server (the `rfb` file).
- 3 Enter the `show version` command to verify which software version is currently running on the device. The following is an example of the information that appears:

```
console# show version  
  
SW version 1.0.0.30 (date 27-Jan-xxxx time 13:42:41)  
Boot version 1.0.0.05 (date 27-Jan-xxxx time 15:12:20)  
HW version
```

- 4 Enter the `copy tftp://{tftp address}/{file name} boot` command to copy the boot image to the device. The following is an example of the information that appears:

```
console# copy tftp://176.215.31.3/332448-10018.rfb boot  
  
Erasing file..done.  
  
!!!!!!!!!!!!!!!!!!!!!!!!!!!!!!!!!!!!!!!!!!!!!!!!!!!!!!!!!!!!!!!!!!!!!!!!!!!!  
!!!!!!!!!!!!!!!!!!!!!!!!!!!!!!!!!!!!!!!!!!!!!!!!!!!!!!!!!!!!!!!!!!!!!!!!!!!!  
  
Copy: 2739187 bytes copied in 00:01:13 [hh:mm:ss]
```

- 5 Enter the `reload` command. The following message is displayed:

```
console# reload  
  
This command will reset the whole system and disconnect your current  
session. Do you want to continue (y/n) [n]?
```

- 6 Enter `y`. The device reboots.

Port Default Settings

The general information for configuring the device ports includes the short description of the auto-negotiation mechanism and the default settings for switching ports.

Auto-Negotiation

Auto-negotiation enables automatic detection of speed, duplex mode and flow control on all switching 10/100/1000BaseT ports. Auto-negotiation is enabled per port by default.

Auto-negotiation is a mechanism established between two link partners to enable a port to advertise its transmission rate, duplex mode and flow control (the flow control default is disabled) abilities to its partner. The ports then both operate at the highest common denominator between them.

If connecting a NIC that does not support auto-negotiation or is not set to auto-negotiation, both the device switching port and the NIC must be manually set to the same speed and duplex mode.

If the station on the other side of the link attempts to auto-negotiate with a device 100BaseT port that is configured to full duplex, the auto-negotiation results in the station attempting to operate in half duplex.

MDI/MDIX

The device supports auto-detection of straight through and crossed cables on all switching 10/100/1000BaseT ports. The feature is part of the Auto-negotiation and is enabled when Auto-negotiation is enabled.

When the MDI/MDIX (Media Dependent Interface with Crossover) is enabled, the automatic correction of errors in cable selection is possible, thus making the distinction between a straight through cable and a crossover cable irrelevant. (The standard wiring for end stations is known as MDI (Media Dependent Interface), and the standard wiring for hubs and switches is known as MDIX.

Flow Control

The device supports 802.3x Flow Control for ports configured with the Full Duplex mode. By default, this feature is disabled. It can be enabled per port. The flow control mechanism allows the receiving side to signal to the transmitting side that transmission must temporarily be halted to prevent buffer overflow.

Back Pressure

The device supports back pressure for ports configured with the half duplex mode. By default, this feature is disabled. It can be enabled per port. The back-pressure mechanism prevents the sender from transmitting additional traffic temporarily. The receiver may occupy a link so it becomes unavailable for additional traffic.

Switching Port Default Settings

The following table gives the port default settings.

Table 4-1. Port Default Settings

Function	Default Setting
Port speed and mode	10/100BaseT copper: auto-negotiation 100 Mbps full duplex 10/100/1000BaseT copper / SFP: auto-negotiation 1000 Mbps full duplex
Port forwarding state	Enabled
Port tagging	No tagging
Flow Control	Off (disabled on ingress)
Back Pressure	Off (disabled on ingress)

Using Dell OpenManage Switch Administrator

This section provides an introduction to the Dell™ OpenManage™ Switch Administrator user interface.

Starting the Application

 **NOTE:** Before starting the application the IP address must be defined. For more information, see Initial Configuration.

- 1 Open a web browser.
- 2 Enter the device's IP address in the address bar and press <Enter>.
- 3 When the **Log In** window displays, enter a user name and password.

 **NOTE:** Passwords are both case sensitive and alpha-numeric.

- 4 Click OK.

The Dell OpenManage Switch Administrator home page displays.

Understanding the Interface

The home page contains the following views:

- **Tree view** — Located on the left side of the home page, the tree view provides an expandable view of the features and their components.
- **Device view** — Located on the right side of the home page, the device view provides a view of the device, an information or table area, and configuration instructions.

Figure 5-1. Switch Administrator Components

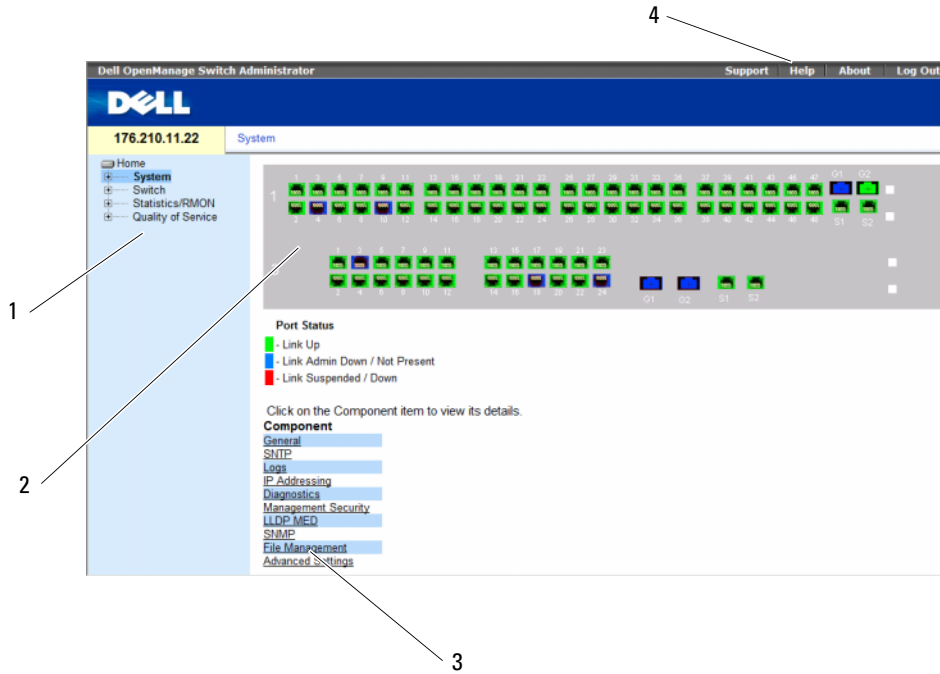

Table 5-1 lists the interface components with their corresponding numbers.

Table 5-1. Interface Components

Component	Description
1	The tree view contains a list of the different device features. The branches in the tree view can be expanded to view all the components under a specific feature, or retracted to hide the feature's components. By dragging the vertical bar to the right, the tree area can be expanded to display the full name of a component.
2	The device view provides information about device ports, current configuration and status, table information, and feature components. Depending on the option selected, the area at the bottom of the device view displays other device information and/or dialogs for configuring parameters.
3	The components list contains a list of the feature components. Components can also be viewed by expanding a feature in the tree view.
4	The information buttons provide access to information about the device and access to Dell Support. For more information, see "Information Buttons."

Device Representation

The home page contains a graphical representation of the device front panel.

Figure 5-2. Dell PowerConnect™ Device Port Indicators

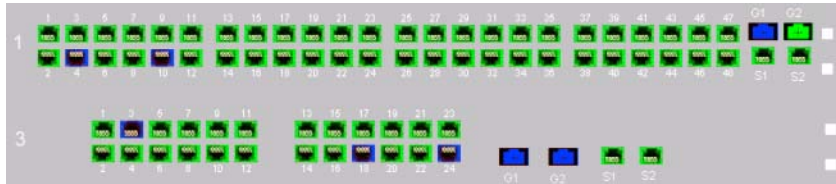

The port coloring indicates if a specific port is currently active. Ports can be the following colors:

Table 5-2. PowerConnect Port and Stacking Indicators

Component	Description
Port Indicators	
Green	The port is currently enabled.
Red	An error has occurred on the port.
Blue	The port is currently disabled.
Red	The device is not currently linked in a stack.



NOTE: The Port LEDs are not reflected in PowerConnect™ front panel in the OpenManage Switch Administrator. LED status can only be determined by viewing the actual device. However, the Stacking LEDs reflect the Stacking port status. For more information about LEDs, see LED Definitions.

Using the Switch Administrator Buttons

This section describes the buttons found on the OpenManage Switch Administrator interface. Interface buttons are divided into the following categories:

Information Buttons

Information buttons provide access to online support and online help, as well as information about the OpenManage Switch Administrator interfaces.

Table 5-3. Information Buttons

Button	Description
Support	Opens the Dell Support page at support.dell.com
Help	Online help that contains information to assist in configuring and managing the device. The online help pages are context-sensitive. For example, if the IP Addressing page is open, the help topic for that page displays when Help is clicked.
About	Contains the version and build number and Dell copyright information.
Log Out	Opens the Log Out window.

Device Management Buttons

Device Management buttons provide an easy method of configuring device information, and include the following:

Table 5-4. Device Management Buttons

Button	Description
Apply Changes	Applies set changes to the device.
Add	Adds information to tables or dialogs.
Telnet	Starts a Telnet session.
Query	Queries tables.
Show All	Displays the device tables.
Left arrow/Right Arrows	Moves information between lists.
Refresh	Refreshes device information.
Reset All Counters	Clears statistic counters.
Print	Prints the Network Management System page and/or table information.
Draw	Creates statistics charts on-the-fly.
Details	Shows further details relevant to the current page.
Back	Returns to the previous page.

Field Definitions

Fields which are user-defined can contain between 1 -159 characters, unless otherwise noted on the OpenManage Switch Administrator web page. All letters or characters can be used, except the following:

- \
- /
- :
- *
- ?
- <
- >
- |

Accessing the Device Through the CLI

You can manage the device over a direct connection to the Terminal port or via a Telnet connection. If access is via a Telnet connection, ensure that the device has an IP address defined and that the workstation used to access the device is connected to the device prior to beginning using CLI commands.

For information about configuring an initial IP Address, see "Initial Configuration" on page 50.



NOTE: Ensure that the software has been downloaded to the device before using the CLI to remotely access the device.

Terminal Connection

- 1 Power on the device and wait until the startup is complete.
- 2 When the Console> prompt displays, type enable and press <Enter>.
- 3 Configure the device and enter the necessary commands to complete the required tasks.
- 4 When finished, enter the exit Privileged EXEC mode command.

The session quits.



NOTE: If a different user logs into the system in the Privileged EXEC command mode, the current user is logged off and the new user is logged in.

Telnet Connection

Telnet is a terminal emulation TCP/IP protocol. RS-232 terminals can be virtually connected to the local device through a TCP/IP protocol network. Telnet is an alternative to a local login terminal where a remote login is required.

The device supports up to four simultaneous Telnet sessions to manage the device. All CLI commands can be used over a telnet session.

To start a Telnet session:

- 1 Select **Start**→**Run**.

The **Run** window opens.

- 2 In the **Run** window, type *Telnet <IP address>* in the **Open** field.

- 3 Click **OK**.

The Telnet session begins.

Using the CLI

This section provides information for using the CLI.

Command Mode Overview

The CLI is divided into command modes. Each command mode has a specific command set. Entering a question mark at the terminal prompt displays a list of commands available for that particular command mode.

In each mode, a specific command is used to navigate from one command mode to another.

During the CLI session initialization, the CLI mode is the User EXEC mode. Only a limited subset of commands are available in the User EXEC mode. This level is reserved for tasks that do not change the terminal configuration and is used to access configuration sub-systems such as the CLI. To enter the next level, the Privileged EXEC mode, a password is required (if configured).

The Privileged EXEC mode provides access to the device global configuration. For specific global configurations within the device, enter the next level, Global Configuration mode. A password is not required.

The Global Configuration mode manages the device configuration on a global level.

The Interface Configuration mode configures the device at the physical interface level. Interface commands which require subcommands have another level called the Subinterface Configuration mode. A password is not required.

User EXEC Mode

After logging into the device, the EXEC command mode is enabled. The user-level prompt consists of the host name followed by the angle bracket (>). For example:

```
console>
```



NOTE: The default host name is `console` unless it has been modified during initial configuration.

The User EXEC commands permit connecting to remote devices, changing terminal settings on a temporary basis, performing basic tests, and listing system information.

To list the User EXEC commands, enter a question mark at the command prompt.

Privileged EXEC Mode

Privileged access can be protected to prevent unauthorized access and ensure operating parameters. Passwords are displayed on the screen, and are case sensitive.

To access and list the Privileged EXEC mode commands:

- 1 At the prompt type `enable` and press <Enter>.
- 2 When a password prompt displays, enter the password and press <Enter>.

The Privileged EXEC mode prompt displays as the device host name followed by `#`. For example:

```
console#
```

To list the Privileged EXEC commands, type a question mark at the command prompt.

To return from Privileged EXEC mode to User EXEC mode, type `disable` and press <Enter>.

The following example illustrates accessing privileged EXEC mode and then returning to the User EXEC mode:

```
console> enable
```

```
Enter Password: *****
```

```
console#
```

```
console# disable
```

```
console>
```

Use the `exit` command to move back to a previous mode. For example, from Interface Configuration mode to Global Configuration mode, and from Global Configuration mode to Privileged EXEC mode.

Global Configuration Mode

Global Configuration commands apply to system features, rather than a specific protocol or interface.

To access Global Configuration mode, at the Privileged EXEC Mode prompt, type the **configure** command and press <Enter>. The Global Configuration mode displays as the device host name followed by (config) and the pound sign #.

```
console(config)#
```

To list the Global Configuration commands, enter a question mark at the command prompt.

To return from Global Configuration mode to Privileged EXEC mode, type the **exit** command or use the <Ctrl> + <Z> key combination.

The following example illustrates how to access Global Configuration mode and return back to the Privileged EXEC mode:

```
console#
```

```
console# configure
```

```
console(config)# exit
```

```
console#
```

For a complete list of the CLI modes, see the Dell™ PowerConnect™ 3524/P and PowerConnect 3548/P CLI Guide.

Configuring System Information

This section provides information This page provides links for defining system parameters including security features, downloading switch software, and resetting the switch. To open the **System** page, Click a link below to access on-line help for the indicated screen.

Click **System** in the tree view.

Figure 6-1. System

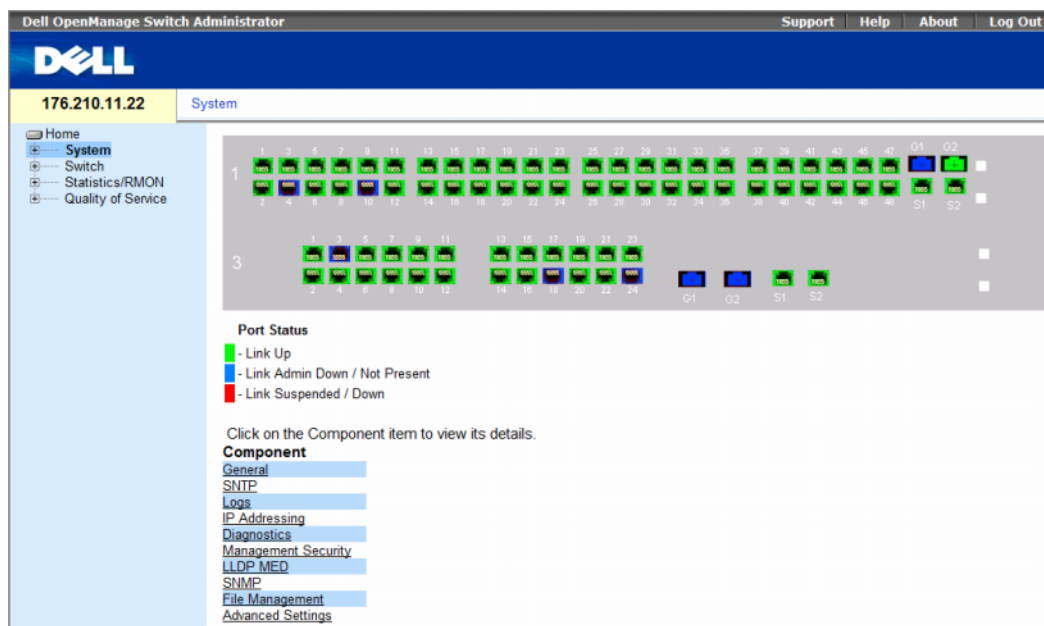

This section contains the following topics:

- "Defining General Switch Information" on page 78
- "Configuring SNTP Settings" on page 101
- "Managing Logs" on page 113
- "Defining IP Addressing" on page 128
- "Running Cable Diagnostics" on page 165

- "Managing Management Security" on page 170
- "Configuring LLDP and MED" on page 205
- "Defining SNMP Parameters" on page 219
- "Managing Files" on page 246
- "Configuring Advanced Settings" on page 259

Defining General Switch Information

The **General** page contains links to pages that allow network managers to configure switch parameters. This section contains the following topics:

- "Viewing Switch Asset Information" on page 78
- "Asset" on page 78
- "Defining System Time Settings" on page 84
- "Viewing System Health Information" on page 90
- "Managing Power over Ethernet" on page 92
- "Viewing Version Information" on page 98
- "Managing Stack Members" on page 99
- "Resetting the Device" on page 100

Viewing Switch Asset Information

Asset

The **Asset** page contains parameters for configuring and viewing general device information, including the system name, location, and contact, the system MAC Address, System Object ID, date, time, and System Up Time. To open the **Asset** page, click **System** → **General** → **Asset** in the tree view.

Figure 6-2. Asset

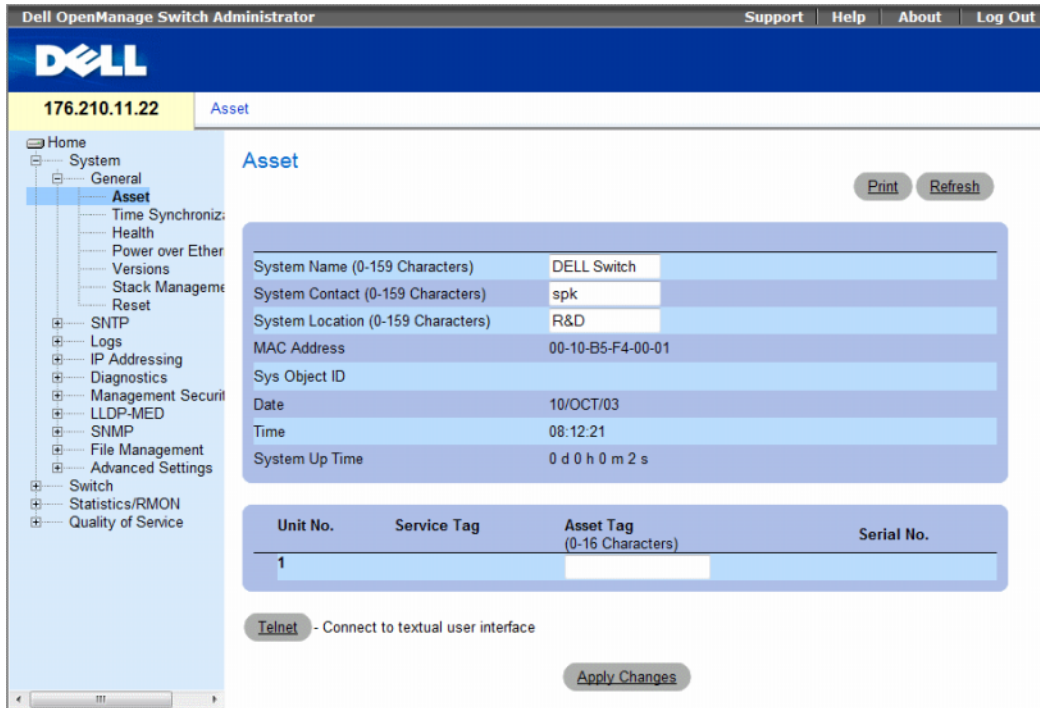

The Asset page contains the following fields:

- **System Name (0-159 Characters)** — Defines the user-defined device name.
- **System Contact (0-159 Characters)** — Indicates the name of the contact person.
- **System Location (0-159 Characters)** — The location where the system is currently running.
- **MAC Address** — Indicates the device MAC address.
- **Sys Object ID** — The vendor's authoritative identification of the network management subsystem contained in the entity.
- **Date** — The current date. The format is day, month, year, for example, 15/FEB/07 is February 15, 2007.
- **Time** — Indicates the time. The format is hour, minute, second, for example, 20:12:21 is eight twelve and twenty-one seconds in the evening.
- **System Up Time** — Specifies the amount of time since the last device reset. The system time is displayed in the following format: Days, Hours, Minutes and Seconds. For example, 41 days, 2 hours, 22 minutes and 15 seconds.

- **Unit No.** — Indicates the unit number for which the device asset information is displayed.
- **Service Tag** — The service reference number used when servicing the device.
- **Asset Tag (0-16 Characters)** — Indicates the user-defined device reference.
- **Serial No.** — The device serial number.

Defining System Information

- 1 Open the **Asset** page.
- 2 Define the relevant fields.
- 3 Click **Apply Changes**.

The system parameters are defined, and the device is updated.

Initiating a Telnet Session

- 1 Open the **Asset** page.
- 2 Click **Telnet**.

A Telnet session is initiated.

Configuring device Information Using the CLI Commands

The following table summarizes the equivalent CLI commands for viewing and setting fields displayed in the **Asset** page.

Table 6-1. Asset CLI Commands

CLI Command	Description
<code>hostname name</code>	Indicates or modifies the device host name.
<code>snmp-server contact text</code>	Sets up a system contact.
<code>snmp-server location text</code>	Enters information on where the device is located.
<code>clock set hh:mm:ss day month year</code>	Manually sets the system clock and date.
<code>show clock [detail]</code>	Displays the time and date from the system clock.
<code>show system id</code>	Displays the service tag information.
<code>show system</code>	Displays system information.
<code>asset-tag text</code>	Sets the device asset tag.
<code>show stack <1-8></code>	Displays the system stack information.
<code>show system [unit unit]</code>	Displays system information.
<code>show system id [unit unit]</code>	Displays system identity information.

The following is an example of defining the device host name, system contact and device location as well as setting the time and date of the system clock using the CLI commands:

```
console(config)# hostname dell
dell (config)# snmp-server contact Dell_Tech_Supp
dell (config)# snmp-server location New_York
dell (config)# exit

Console(config)# snmp-server host 10.1.1.1 management 2
Console# clock set 13:32:00 7 Mar 2002
Console# show clock
15:29:03 Jun 17 2002
```

The following is an example of displaying system information for a stand-alone device using the CLI commands:

```
console# show system id
Service tag      :
Serial number   : 51
Asset tag       :

console# show system
System Description:      Ethernet Switch
System Up Time          : 0,00:00:57
(days,hour:min:sec):
System Contact:
System Name:            PowerConnect-1
System Location:
System MAC Address:     00:00:00:08:12:51
System Object ID:       1.3.6.1.4.1.674.10895.3006
Type:                   PowerConnect 3524
```

```

Main Power Supply Status:      OK
Fan 1 Status:                  NOT OPERATIONAL
Fan 2 Status:                  NOT OPERATIONAL
Temperature (Celsius):        30
Temperature Sensor Status:     OK

```

The following is an example of displaying system information for a stacked devices using the CLI commands:

```

console# show system id

Unit      Serial number      Asset tag  Service tag
----      -
1         893658972         mkt-1     89788978
2         893658973         mkt-2     89788979
3         893658974         mkt-3     89788980
4         893658975         mkt-4     89788981
5         893658976         mkt-5     89788982
6         893658977         mkt-6     89788983
7         893658978         mkt-7     89788984
8         893658979         mkt-8     89788985

console# show system

Unit      Type
----      -
1         PowerConnect 3524
2         PowerConnect 3524
3         PowerConnect 3524
4         PowerConnect 3524P
5         PowerConnect 3524P
6         PowerConnect 3524P
7         PowerConnect 3524P
8         PowerConnect 3524P

```

Unit	Main Power Supply	Redundant Power Supply
----	-----	-----
1	OK	
2	OK	
3	OK	
4	OK	
5	OK	OK
6	OK	OK
7	OK	OK
8	OK	OK

Unit	Fan1	Fan2	Fan3	Fan4	Fan5
----	----	----	----	----	----
1	OK	OK			
2	OK	OK			
3	OK	OK			
4	OK	OK			
5	OK	OK	OK	OK	OK
6	OK	OK	OK	OK	OK
7	OK	OK	OK	OK	OK
8	OK	OK	OK	OK	OK

Unit	Temperature (Celsius)	Temperature Sensor Status
----	-----	-----
1	30	OK
2	30	OK
3	30	OK
4	30	OK
5	30	OK
6	30	OK
7	30	OK
8	30	OK

Defining System Time Settings

The **Time Synchronization** page contains fields for defining system time parameters for both the local hardware clock, and the external SNTP clock. If the system time is kept using an external SNTP clock, and the external SNTP clock fails, and the system time reverts to the local hardware clock. Daylight Savings Time can be enabled on the device. The following is a list of Daylight Time start and end times in specific countries:

- **Albania** — Last weekend of March until the last weekend of October.
- **Australia** — From the end of October until the end of March.
- **Australia - Tasmania** — From beginning of October until the end of March.
- **Armenia** — Last weekend of March until the last weekend of October.
- **Austria** — Last weekend of March until the last weekend of October.
- **Bahamas** — From April to October, in conjunction with U.S. summer hours.
- **Belarus** — Last weekend of March until the last weekend of October.
- **Belgium** — Last weekend of March until the last weekend of October.
- **Brazil** — From the 3rd Sunday in October until the 3rd Saturday in March. During the period of Daylight Saving Time, Brazilian clocks go forward one hour in most of the Brazilian southeast.
- **Chile** — Easter Island 9th March 12th October. The first Sunday in March or after 9th March.
- **China** — China does not operate Daylight Saving Time.
- **Canada** — From the first Sunday in April until the last Sunday of October. Daylight Saving Time is usually regulated by provincial and territorial governments. Exceptions may exist in certain municipalities.
- **Cuba** — From the last Sunday of March to the last Sunday of October.
- **Cyprus** — Last weekend of March until the last weekend of October.
- **Denmark** — Last weekend of March until the last weekend of October.
- **Egypt** — Last Friday in April until the last Thursday in September.
- **Estonia** — Last weekend of March until the last weekend of October.
- **Finland** — Last weekend of March until the last weekend of October.
- **France** — Last weekend of March until the last weekend of October.
- **Germany** — Last weekend of March until the last weekend of October.
- **Greece** — Last weekend of March until the last weekend of October.
- **Hungary** — Last weekend of March until the last weekend of October.
- **India** — India does not operate Daylight Saving Time.
- **Iran** — From 1st Farvardin until the 1st Mehr.
- **Iraq** — From 1st April until 1st October.

- **Ireland** — Last weekend of March until the last weekend of October.
- **Israel** — Varies year-to-year.
- **Italy** — Last weekend of March until the last weekend of October.
- **Japan** — Japan does not operate Daylight Saving Time.
- **Jordan** — Last weekend of March until the last weekend of October.
- **Latvia** — Last weekend of March until the last weekend of October.
- **Lebanon** — Last weekend of March until the last weekend of October.
- **Lithuania** — Last weekend of March until the last weekend of October.
- **Luxembourg** — Last weekend of March until the last weekend of October.
- **Macedonia** — Last weekend of March until the last weekend of October.
- **Mexico** — From the first Sunday in April at 02:00 to the last Sunday in October at 02:00.
- **Moldova** — Last weekend of March until the last weekend of October.
- **Montenegro** — Last weekend of March until the last weekend of October.
- **Netherlands** — Last weekend of March until the last weekend of October.
- **New Zealand** — From the first Sunday in October until the first Sunday on or after 15th March.
- **Norway** — Last weekend of March until the last weekend of October.
- **Paraguay** — From 6th April until 7th September.
- **Poland** — Last weekend of March until the last weekend of October.
- **Portugal** — Last weekend of March until the last weekend of October.
- **Romania** — Last weekend of March until the last weekend of October.
- **Russia** — From the 29th March until the 25th October.
- **Serbia** — Last weekend of March until the last weekend of October.
- **Slovak Republic** — Last weekend of March until the last weekend of October.
- **South Africa** — South Africa does not operate Daylight Saving Time.
- **Spain** — Last weekend of March until the last weekend of October.
- **Sweden** — Last weekend of March until the last weekend of October.
- **Switzerland** — Last weekend of March until the last weekend of October.
- **Syria** — From 31st March until 30th October.
- **Taiwan** — Taiwan does not operate Daylight Saving Time.
- **Turkey** — Last weekend of March until the last weekend of October.
- **United Kingdom** — Last weekend of March until the last weekend of October.
- **United States of America** — From the second Sunday of March at 02:00 to the first Sunday of November at 02:00.

For more information on SNTP, see "Configuring SNTP Settings" on page 104.

To open the Time Synchronization page, click System → General → Time Synchronization in the tree view.

Figure 6-3. Time Synchronization

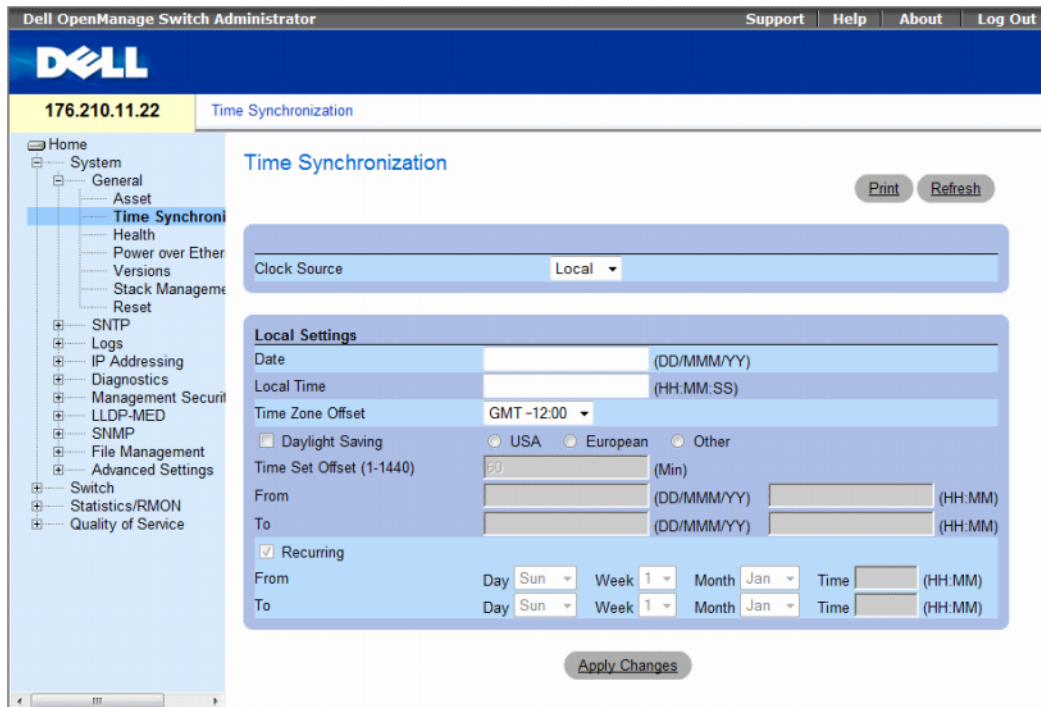

The Time Synchronization page contains the following fields:

- **Clock Source** — The source used to set the system clock. The possible field values:
 - **Local** — Specifies that the system time is not set by an external source.
 - **SNTP** — Specifies that the system time is set via an SNTP server. For more information, see "Configuring SNTP Settings" on page 104.

Local Settings

- **Date** — Defines the system date. The field format is DD/MMM/YY, for example, 04/May/07.
- **Local Time** — Defines the system time. The field format is HH:MM:SS, for example, 21:15:03.
- **Time Zone Offset** — The difference between Greenwich Mean Time (GMT) and local time. For example, the Time Zone Offset for Paris is GMT +1:00, while the local time in New York is GMT -5:00.

There are two types of daylight settings, either by a specific date in a particular year or a recurring setting irrespective of the year. For a specific setting in a particular year complete the **Daylight Savings** area, and for a recurring setting, complete the **Recurring** area.

- **Daylight Savings** — Enables the Daylight Savings Time (DST) on the device based on the device's location. The possible field values are:
 - **USA** — The device switches to DST at 2 a.m. on the second Sunday of March, and reverts to standard time at 2 a.m. on the first Sunday of November.
 - **European** — The device switches to DST at 1:00 am on the last Sunday in March, and reverts to standard time at 1:00 am on the last Sunday in October. The *European* option applies to EU members, and other European countries using the EU standard.
 - **Other** — The DST definitions are user-defined based on the device locality. If Other is selected, the **From** and **To** fields must be defined.
- **Time Set Offset (1-1440)** — Indicates the difference in minutes between DST and the local standard time. The default time is 60 minutes.
- **From** — Defines the time that DST begins in countries other than USA or Europe, in the format DayMonthYear in one field and time in another. For example, DST begins on the 25th October 2007 5:00 am, the two fields will be 25Oct07 and 5:00. The possible field values are:
 - **DD/MMM/YY** — The date , month, and year at which DST begins.
 - **HH/MM** — The time (hour and minutes) at which DST begins. The field format is HH/MM, for example, 05:30.
- **To** — Defines the time that DST ends in countries other than USA or Europe in the format DayMonthYear in one field and time in another. For example, DST ends on the 23rd March 2008 12:00 am, the two fields will be 23Mar08 and 12:00. The possible field values are:
 - **DD/MMM/YY** — The date , month, and year at which DST ends.
 - **HH/MM** — The time (hour and minutes) at which DST ends. The field format is HH/MM, for example, 05:30.
- **Recurring** — Defines the time that DST starts in countries other than USA or European where the DST is constant year to year. The possible field values are:

- **From** — Defines the time that DST begins each year. For example, DST begins locally every second Sunday in April at 5:00 am. The possible field values are:
 - **Day** — The day of the week from which DST begins every year. The possible field range is Sunday-Saturday.
 - **Week** — The week within the month from which DST begins every year. The possible field range is 1-5.
 - **Month** — The month of the year in which DST begins every year. The possible field range is Jan.-Dec.
 - **Time** — The time at which DST begins every year. The field format is Hour:Minute, for example, 02:10.
- **To** — Defines the recurring time that DST ends each year. For example, DST ends locally every fourth Friday in October at 5:00 am. The possible field values are:
 - **Day** — The day of the week at which DST ends every year. The possible field range is Sunday-Saturday.
 - **Week** — The week within the month at which DST ends every year. The possible field range is 1-5.
 - **Month** — The month of the year in which DST ends every year. The possible field range is Jan.-Dec.
 - **Time** — The time at which DST ends every year. The field format is Hour:Minute, for example, 05:30.

Selecting a Clock Source

- 1 Open the **Time Synchronization** page.
- 2 Define the **Clock Source** field.
- 3 Click **Apply Changes**.

The Clock source is selected, and the device is updated.

Defining Local Clock Settings

- 1 Open the **Time Synchronization** page.
- 2 Define the fields.
- 3 Click **Apply Changes**.

The local clock settings are applied.

Defining Clock Settings Using CLI Commands

The following table summarizes the equivalent CLI commands for setting fields displayed in the **Time Synchronization** page.

The following steps must be completed before setting the summer clock:

- 1 Configure the summer time.
- 2 Define the time zone.
- 3 Set the clock.

For example:

```
console(config)# clock summer-time recurring usa
console(config)# clock time zone 2 zone TMZ2
console(config)# clock set 10:00:00 apr 15 2004
```

Table 6-2. Clock Setting CLI Commands

CLI	Description
<code>clock source sntp</code>	Configures an external time source for the system clock.
<code>clock time zone <i>hours-offset</i> [<i>minutes minutes-offset</i>] [<i>zone acronym</i>]</code>	Sets the time zone for display purposes.
<code>clock summer-time</code>	Configures the system to automatically switch to summer time (Daylight Savings Time).
<code>clock summer-time recurring {<i>usa eu week day month hh:mm week day month hh:mm</i>} [<i>offset offset</i>] [<i>zone acronym</i>]</code>	Configures the system to automatically switch to summer time (according to the USA and European standards).
<code>clock summer-time date <i>date month year hh:mm date month year hh:mm</i> [<i>offset offset</i>] [<i>zone acronym</i>]</code>	Configures the system to automatically switch to summer time (Daylight Savings Time) for a specific period - date/month/year format.

The following is an example of the CLI commands:

```
console(config)# clock timezone -6 zone CST
console(config)# clock summer-time recurring first sun apr 2:00
last sun oct 2:00
console(config)# clock source sntp
console(config)# interface ethernet e14
console(config-if)# sntp client enable
console(config-if)# exit
console(config)# sntp broadcast client enable
```

Viewing System Health Information

The **System Health** page displays physical device information, including information about the device's power and ventilation sources. To open the **System Health** page, click **System**→**General**→**Health** in the tree view.

Figure 6-4. System Health



Unit No.	Power Supply Status		Fan Status					Temperature
1 1	PS1	RPS	Fan1	Fan2	Fan3	Fan4	Fan5	42° C
1 3	PS1	RPS	Fan1	Fan2	Fan3	Fan4	Fan5	33° C

The **System Health** page contains the following fields:





- **Unit No.** — Indicates the unit number for which the device health information is displayed.
- **Power Supply Status** — The device has two power supplies. The possible field values are:
 -  Checked — The power supply is operating normally.
 -  Unchecked — The power supply is not operating normally.
 - **Not Present** — The power supply is currently not present.
- **Fan Status** — The non-PoE devices have two fans, while the PoE devices have five fans. Each fan is denoted as fan plus the fan number in the interface. The possible field values are:
 -  Checked — The fan is operating normally.
 -  Unchecked — The fan is not operating normally.
 - **Not Present** — A fan is currently not present.
- **Temperature** — The temperature at which the device is currently running. The device temperature is displayed in Celsius. The device temperature threshold is 0-40 C (32-104 F). The following table displays the temperature in Fahrenheit in increments of 5.

Table 6-3. Celsius to Fahrenheit Conversion Table

Celsius	Fahrenheit
0	32
5	41
10	50
15	59
20	68
25	77
30	86
35	95
40	104

Viewing System Health Information Using the CLI Commands

The following table summarizes the equivalent CLI commands for viewing fields displayed on the System Health page.

Table 6-4. System Health CLI Command

CLI Command	Description
<code>show system [unit unit]</code>	Displays system information.

The following is an example of the system health CLI command.

```
console# show system

Unit      Type
1         PowerConnect
         3524

Unit      Main Power      Redundant
         Supply        Power
         Supply        Supply
1         OK
```

Fan1	Fan2	Fan3	Fan4	Fan5
1	OK	OK	OK	OK
Unit	Temperature (Celsius)	Temperature Sensor Status		
1	27	OK		
Unit	Up time			
1	00,09:30:36			

Managing Power over Ethernet

Power over Ethernet (PoE) provides power to devices over existing LAN cabling, without updating or modifying the network infrastructure. Power over Ethernet removes the necessity of placing network devices next to power sources.

Powered Devices are devices which receive power from the PowerConnect power supplies, for example IP phones. Powered Devices are connected to the PowerConnect device via Ethernet ports. Powered devices are connected via either all PowerConnect 3524P's 24 FE ports or all PowerConnect 3548P's 48 FE ports.

To open the **Power Over Ethernet** page, click **System**→**General**→**Power over Ethernet** in the tree view.

Figure 6-5. Power Over Ethernet

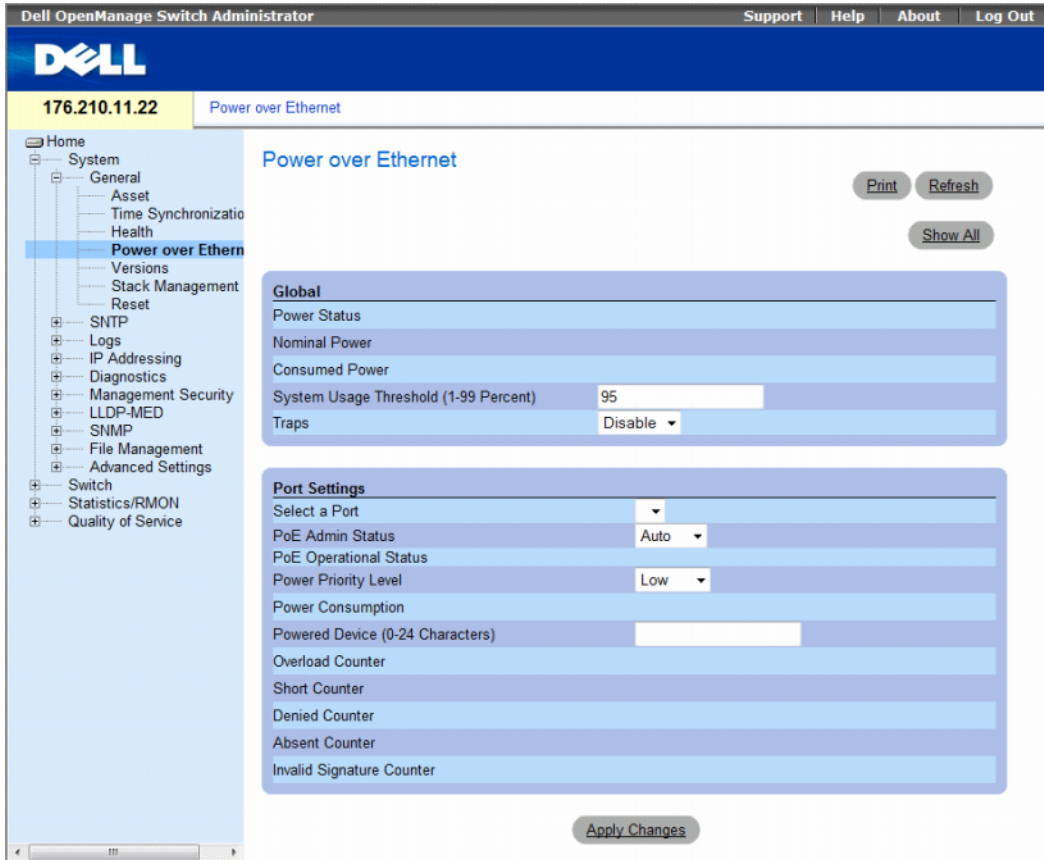

The Power Over Ethernet page contains the following sections:

- Global
- Port Settings

Global

The Power over Ethernet Global Settings section contains the following fields:

- **Power Status** — Indicates the inline power source status.
 - **On** — Indicates that the power supply unit is functioning.
 - **Off** — Indicates that the power supply unit is not functioning.
 - **Faulty** — Indicates that the power supply unit is functioning, but an error has occurred. For example, a power overload or a short circuit.
- **Nominal Power** — Indicates the actual amount of power the device can supply. The field value is displayed in Watts.
- **Consumed Power** — Indicates the amount of the power used by the device. The field value is displayed in Watts.
- **System Usage Threshold (1-99 Percent)** — Indicates the percentage of power consumed before an alarm is generated. The field value is 1-99 percent. The default is 95 percent.
- **Traps** — Enables or disables receiving PoE device traps.
 - **Enable** — Enables PoE traps on the device.
 - **Disable** — Disables PoE traps on the device. This is the default value.

Port Settings

- **Select a Port** — Indicates the specific interface for which PoE parameters are defined and assigned to the powered interface connected to the selected port.
- **PoE Admin Status** — Indicates the device PoE mode. The possible field values are:
 - **Auto** — Enables the Device Discovery protocol, and provides power to the device using the PoE module. The Device Discovery Protocol enables the device to discover Powered Devices attached to the device interfaces, and to learn their classification. This is the default setting.
 - **Never** — Disables the Device Discovery protocol, and stops the power supply to the device using the PoE module.
- **PoE Operational Status** — Indicates if the port is enabled to work on PoE. The possible field values are:
 - **Disabled** —
 - **Searching** — Indicates that the PowerConnect device is currently searching for a powered device. Searching is the default PoE operational status.
 - **Delevering Power** — Indicates that the PowerConnect device is delevering power.
 - **Fault** — Indicates that the PowerConnect device has detected a fault on the powered device. For example, the powered device memory could not be read.

- **Test** — Indicates the powered device is being tested. For example, a powered device is tested to confirm it is receiving power from the power supply.
- **Other Fault** —
- **Unknown** —
- **Power Priority Level** — Determines the port priority if the power supply is low. The port power priority is used if the power supply is low. The field default is low. For example, if the power supply is running at 99% usage, and port 1 is prioritized as high, but port 3 is prioritized as low, port 1 is prioritized to receive power, and port 3 may be denied power.
 - **Critical** — Assigns the highest power priority level.
 - **High** — Assigns the second highest power priority level.
 - **Low** — Assigns the lowest power priority level.
- **Power Classification** — Indicates the powered device is classed according to the following classification:
 - **Class 0: 0.44 – 12.95** — Indicates that the port is assigned a power consumption level of .44 to 12.95 Watts.
 - **Class 1: 0.44 – 3.8** — Indicates that the port is assigned a power consumption level of .44 to 3.8 Watts.
 - **Class 2: 3.84 – 6.49** — Indicates that the port is assigned a power consumption level of 3.84 to 6.49 Watts.
 - **Class 3: 6.49 – 12.95** — Indicates that the port is assigned a power consumption level of 6.49 to 12.95 Watts.
- **Powered Device (0-24 characters)** — Provides a user-defined powered device description. The field can contain up to 24 characters.
- **Overload Counter** — Indicates the total power overload occurrences.
- **Short Counter** — Indicates the total power shortage occurrences.
- **Denied Counter** — Indicates times the powered device was denied power.
- **Absent Counter** — Indicates the times the power supply was stopped to the powered device because the powered device was no longer detected.
- **Invalid Signature Counter** — Indicate the times an invalid signature was received. Signatures are the means by which the powered device identifies itself to the PSE. Signatures are generated during powered device detection, classification, or maintenance.

Defining PoE Settings

- 1 Open the Power Over Ethernet page.
- 2 Define the fields.
- 3 Click Apply Changes.
PoE settings are defined, and the device is updated.

Displaying PoE Settings for All Ports

- 1 Open the Power Over Ethernet page.
- 2 Click Show All.
The Power Over Ethernet Table opens.

Figure 6-6. Power Over Ethernet Table

Port	Admin Status	Oper. Status	Priority Level	Power Consumption	Powered Device
1					

Managing PoE Using the CLI Commands

The following table summarizes the equivalent CLI commands for viewing fields displayed on the Power Over Ethernet page.

Table 6-5. System Health CLI Commands

CLI Command	Description
<code>power inline {auto never}</code>	Configures the administrative mode of the inline power on an interface.
<code>power inline powered-device pd-type</code>	Adds a description of the powered device type.
<code>power inline priority {critical high low}</code>	Configures the priority of the interface from the point of view of inline power management.
<code>power inline usage-threshold</code>	Configures the threshold for triggering alarms
<code>power inline traps enable</code>	Enables PoE device traps
<code>show power inline [ethernet interface]</code>	Displays PoE configuration information

The following is an example of the PoE CLI commands.

```
Console> enable
Console# show power inline

Unit   Power           Nominal Power Consumed Power Usage Threshold
1      On              370 Watts      0 Watts (0%)  95  Disable
2      Off             1 Watts        0 Watts (0%)  95  Disable
3      Off             1 Watts        0 Watts (0%)  95  Disable
4      Off             1 Watts        0 Watts (0%)  95  Disable
5      Off             1 Watts        0 Watts (0%)  95  Disable
6      Off             1 Watts        0 Watts (0%)  95  Disable
7      Off             1 Watts        0 Watts (0%)  95  Disable
8      Off             1 Watts        0 Watts (0%)  95  Disable

Port   Powered Device  State           Status           Prior Class
ity
1/e1                   Auto           Searching        low  class0
1/e2                   Auto           Searching        low  class0
1/e3                   Auto           Searching        low  class0
1/e4                   Auto           Searching        low  class0
1/e5                   Auto           Searching        low  class0
1/e6                   Auto           Searching        low  class0
```

Viewing Version Information

The Versions page contains information about the hardware and software versions currently running. To open the Versions page, click **System** → **General** → **Versions** in the tree view.

Figure 6-7. Versions

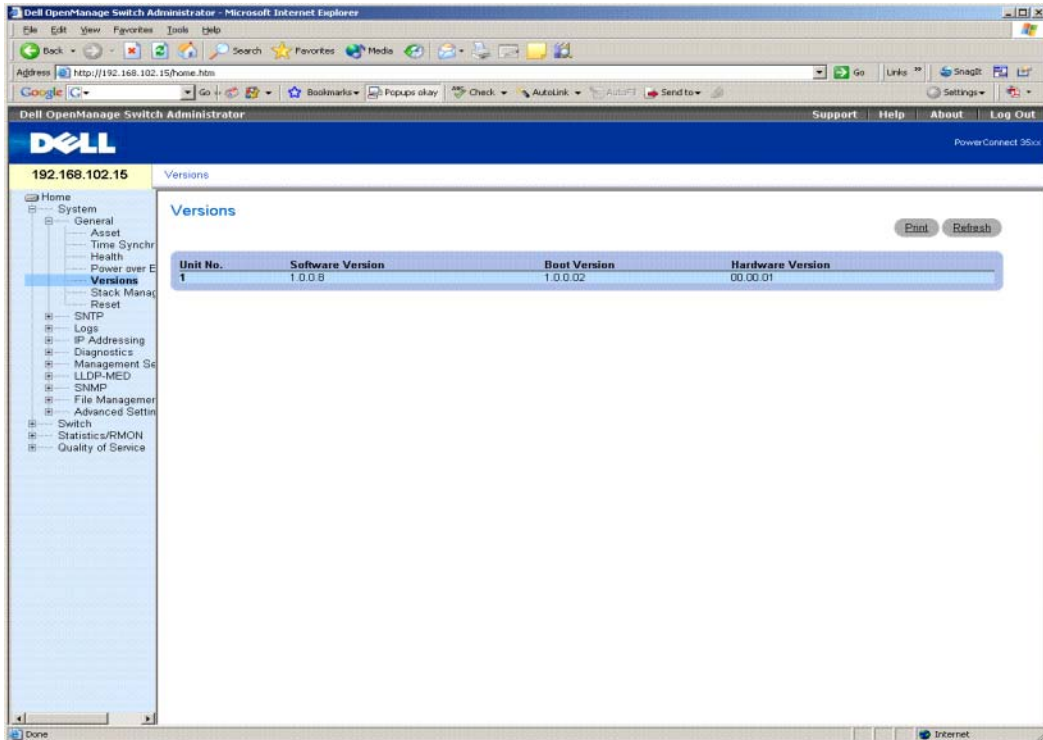

The Versions page contains the following fields:

- **Unit No.** — Indicates the unit number for which the device versions are displayed.
- **Software Version** — The current software version running on the device.
- **Boot Version** — The current Boot version running on the device.
- **Hardware Version** — The current device hardware version.

Displaying Device Versions Using the CLI

The following table summarizes the equivalent CLI commands for viewing fields displayed in the Versions page.

Table 6-6. Versions CLI Commands

CLI Command	Description
<code>show version</code>	Displays system version information.

The following is an example of the CLI commands:

```
console> show version
```

Unit	SW version	Boot version	HW version
1	1.0.0.8	1.0.0.02	00.00.01

Managing Stack Members

The **Stack Management** page allows network managers to switch stack control between unit 1 and unit 2 in the stack. To open the **Stack Management** page, click **System** → **General** → **Stack Management** in the tree view.

Figure 6-8. Stack Management

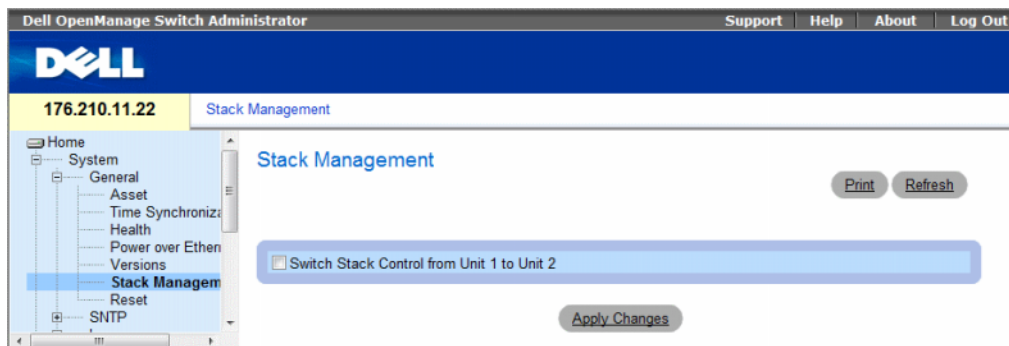

- **Switch Stack Control from Unit 1 to Unit 2** — Enables switching from the current stack Master to the backup Master unit.

Switching Between Stack Masters

- 1 Open the Stack Management page.
- 2 Check the Switch Stack Control from Unit 1 to Unit 2 check box.
- 3 Click Apply Changes.

A confirmation message displays.

- 4 Click OK.

The device is reset. After the device is reset, a prompt for a user name and password displays.

Managing Stacks Using the CLI Commands

The following table summarizes the equivalent CLI commands for viewing fields displayed in the Stack Management page.

Table 6-7. Stack Management CLI Commands

CLI Command	Description
stack reload	Reloads stack members.
stack master	Forces the stack master selection

Resetting the Device

The Reset page enables the device to be reset from a remote location. Save all changes to the Startup Configuration file before resetting the device. This prevents the current device configuration from being lost. For more information about saving Configuration files, see "Copy Files" on page 239. To open the Reset page, click System → General → Reset in the tree view.

Figure 6-9. Reset

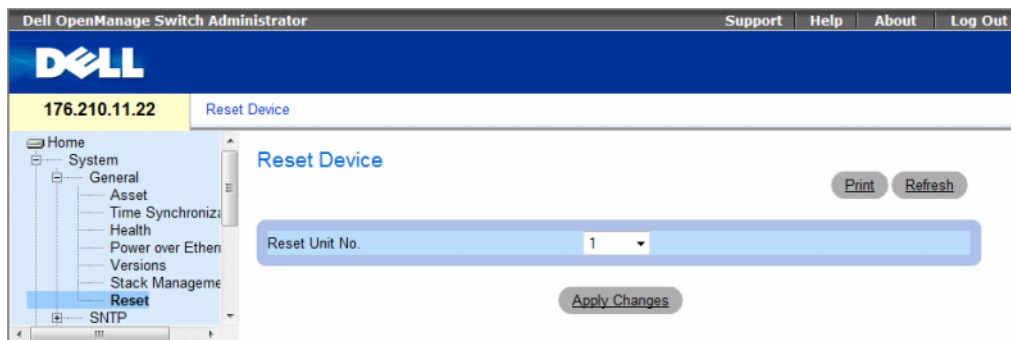

The Reset page contains the following field:

Reset Unit No. — Resets the selected stacking member.

Resetting the Device

- 1 Open the **Reset** page.
- 2 Select a unit in the **Reset Unit Number** field.
- 3 Click **Apply Changes**.
A confirmation message displays.
- 4 Click **OK**.
The device is reset. After the device is reset, a prompt for a user name and password is displayed.
- 5 Enter a user name and password to reconnect to the Web Interface.

Resetting the Device Using the CLI

The following table summarizes the equivalent CLI commands for performing a reset of the device via the CLI:

Table 6-8. Reset CLI Command

CLI Command	Description
reload	Reloads the device.

The following is an example of the CLI command:

```
console# reload
You haven't saved your changes. Are you sure you want to
continue? (Y/N)[N] Y
This command will reset the whole system and disconnect your
current session. Do you want to continue ? (Y/N)[N] Y
```

Configuring SNTP Settings

The switch supports the Simple Network Time Protocol (SNTP). SNTP assures accurate network switch clock time synchronization up to the millisecond. Time synchronization is performed by a network SNTP server. SNTP operates only as a client, and cannot provide time services to other systems.

The switch can poll the following server types for the server time:

- Unicast
- Anycast
- Broadcast

Time sources are established by Stratum. Stratum defines the accuracy of the reference clock. The higher the stratum (where zero is the highest), the more accurate the clock. The switch receives time from stratum 1 and above. The following is an example of stratum:

- **Stratum 0** — Indicates a real time clock is used as the time source, for example, a GPS system.
- **Stratum 1** — Indicates that a server that is directly linked to a Stratum 0 time source is used. Stratum 1 time servers provide primary network time standards.
- **Stratum 2** — Indicates that the time source is distanced from the Stratum 1 server over a network path. For example, a Stratum 2 server receives the time over a network link, via NTP, from a Stratum 1 server.

Information received from SNTP servers is evaluated based on the Time level and server type. SNTP time definitions are assessed and determined by the following time levels:

- **T1** — The time at which the original request was sent by the client.
- **T2** — The time at which the original request was received by the server.
- **T3** — The time at which the server sent the client a reply.
- **T4** — The time at which the client received the server's reply.

The device can poll the following server types for the server time: Unicast, Anycast and Broadcast.

Polling for Unicast information is used for polling a server for which the IP address is known. SNTP servers that are configured on the device are the only ones that are polled for synchronization information. T1-T4 are used to determine server time. This is the preferred method for synchronizing device time as it is most secure. If this method is selected, SNTP information is accepted only from SNTP servers defined on the device using the **SNTP Servers** page.

Polling for Anycast information is used when the server IP address is unknown. If this method is selected, all SNTP servers on the network can send synchronization information. The device is synchronized when it proactively requests synchronization information. The best response (lowest stratum) from the first 3 SNTP servers to respond to a request for synchronization information is used to set the time value. Time levels T3 and T4 are used to determine the server time.

Using Anycast polling to get time information for synchronizing device time is preferred to using Broadcast polling to get time information. However, this method is less secure than unicast polling, because SNTP packets are accepted from SNTP servers that are not configured on the device.

Broadcast information is used when the server IP address is unknown. When a Broadcast message is sent from an SNTP server, the SNTP client listens to the message. If Broadcast polling is enabled, any synchronization information is accepted, even if it has not been requested by the device. This is the least secure method.

The device retrieves synchronization information, either by actively requesting information or at every poll interval. If Unicast, Anycast and Broadcast polling are enabled, the information is retrieved in this order:

- Information from servers defined on the device is preferred. If Unicast polling is not enabled or if no servers are defined on the device, the device accepts time information from any SNTP server that responds.
- If more than one Unicast device responds, synchronization information is preferred from the device with the lowest stratum.
- If the servers have the same stratum, synchronization information is accepted from the SNTP server that responded first.

MD5 (Message Digest 5) Authentication safeguards device synchronization paths to SNTP servers. MD5 is an algorithm that produces a 128-bit hash. MD5 is a variation of MD4, and increases MD4 security. MD5 verifies the integrity of the communication, authenticates the origin of the communication.

To open the SNTP page, click **System** → **SNTP** in the tree view to open the **SNTP** page.

This section contains the following topics:

- "Defining SNTP Global Settings" on page 103
- "Defining SNTP Authentication Methods" on page 105
- "Defining SNTP Servers" on page 107
- "Defining SNTP Interfaces" on page 111

Defining SNTP Global Settings

The SNTP Global Settings page provides information for defining SNTP parameters globally. To open the SNTP Global Settings page, click **System** → **SNTP** → **Global Settings** in the tree view.

Figure 6-10. SNTP Global Settings

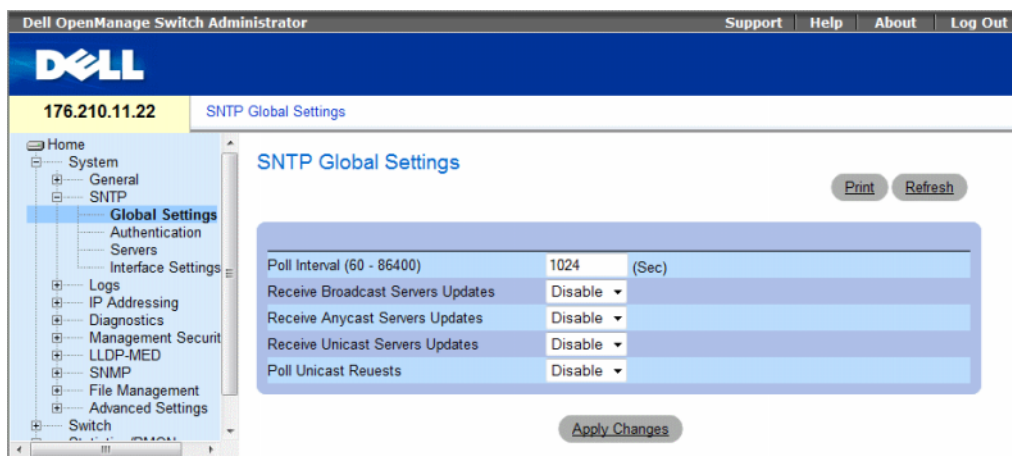

The **SNTP Global Settings** page contains the following fields:

- **Poll Interval (60-86400)** — Defines the interval (in seconds) at which the SNTP server is polled for Unicast information. By default, the poll interval is 1024 seconds.
- **Receive Broadcast Servers Updates** — Listens to the SNTP servers for Broadcast server time information on the selected interfaces, when enabled.
- **Receive Anycast Servers Updates** — Polls the SNTP server for Anycast server time information, when enabled. If both the **Receive Anycast Servers Update**, and the **Receive Broadcast Servers Update** fields are enabled, the system time is set according the Anycast server time information.
- **Receive Unicast Servers Updates** — Polls the SNTP server for Unicast server time information, when enabled. If the **Receive Broadcast Servers Updates**, **Receive Anycast Servers Updates**, and the **Receive Unicast Servers Updates** fields are all enabled, the system time is set according the Unicast server time information.
- **Poll Unicast Requests** — Sends SNTP Unicast server time information requests to the SNTP server, when enabled.

Defining SNTP Global Settings

- 1 Open the **SNTP Global Settings** page.
- 2 Define the fields.
- 3 Click **Apply Changes**.

The SNTP configuration changes are applied.

Defining SNTP Global Settings Using CLI Commands

The following table summarizes the equivalent CLI commands for setting fields displayed in the **SNTP Global Settings** page.

Table 6-9. SNTP Global Parameters CLI Commands

CLI Command	Description
<code>sntp broadcast client enable</code>	Enables SNTP broadcast clients
<code>sntp anycast client enable</code>	Enables SNTP anycast clients
<code>sntp unicast client enable</code>	Enables SNTP predefined unicast clients

The following is an example of the CLI commands:

```
console(config)# sntp anycast client enable
```

Defining SNMP Authentication Methods

The **SNMP Authentication** page enables SNMP authentication between the device and an SNMP server. The means by which the SNMP server is authenticated is also selected in the **SNMP Authentication** page. Click **System** → **SNMP** → **Authentication** in the tree view to open the **SNMP Authentication** page.

Figure 6-11. SNMP Authentication

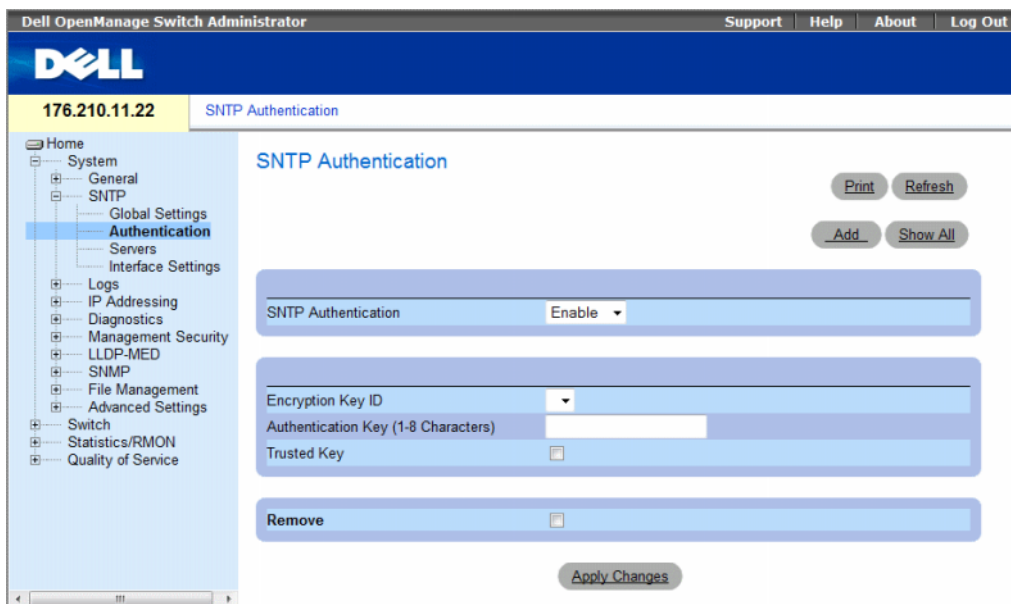

The **SNMP Authentication** page contains the following:

- **SNMP Authentication** — Enables or disables authenticating an SNMP session between the device and an SNMP server.
 - **Enable** — Authenticates SNMP sessions between the device and SNMP server.
 - **Disable** — Disables authenticating SNMP sessions between the device and SNMP server.
- **Encryption Key ID** — Defines the Key Identification used to authenticate the SNMP server and device. The field value is up to 4294967295.
- **Authentication Key (up to 8 Characters)** — The key used for authentication.
- **Trusted Key** — Indicates if the encryption key is used (Unicast) to authenticate the SNMP server.
 - **Checked** — Encryption key is used.
 - **Unchecked** — Encryption key is not used.
- **Remove** — Removes selected authentication keys.
 - **Checked** — Removes the selected Encryption Key ID.
 - **Unchecked** — Maintains the Encryption Key IDs. This is the default value.

Adding an SNMP Authentication Key

- 1 Open the SNMP Authentication page.
- 2 Click Add.

The Add Authentication Key page opens.

Figure 6-12. Add Authentication Key

Refresh

Add Authentication Key

Encryption Key ID (1-4294967295)	<input type="text"/>
Authentication Key (1- 8 Characters)	<input type="text"/>
Trusted Key	<input type="checkbox"/>

Apply Changes

- 3 Define the fields.
- 4 Click Apply Changes.

The SNMP authentication key is added, and the device is updated.

Displaying the Authentication Key Table

- 1 Open the SNMP Authentication page.
- 2 Click Show All.

The Authentication Key Table opens.

Figure 6-13. Authentication Key Table

Refresh

Encryption Key ID	Authentication Key	Trusted Key	Remove
1	<input type="text"/>	<input type="checkbox"/>	<input type="checkbox"/>

Apply Changes

Deleting the Authentication Key

- 1 Open the **SNTP Authentication** page.
- 2 Click **Show All**.
The **Authentication Key Table** opens.
- 3 Select an **Authentication Key Table** entry.
- 4 Select the **Remove** check box.
- 5 Click **Apply Changes**.
The entry is removed, and the device is updated.

Defining SNTP Authentication Settings Using CLI Commands

The following table summarizes the equivalent CLI commands for setting fields displayed in the **SNTP Authentication** page.

Table 6-10. SNTP Authentication CLI Commands

CLI Command	Description
<code>sntp authenticate</code>	Defines authentication for received Simple Network Time Protocol (SNTP) traffic from servers.
<code>sntp trusted key</code>	Authenticates the identity of a system to which SNTP will synchronize.
<code>sntp authentication-key <i>number</i> md5 <i>value</i></code>	Defines an authentication key for SNTP.

The following is an example of the CLI commands:

```
console(config)# sntp authentication-key 8 md5 Calked
console(config)# sntp trusted-key 8
Console(config)# sntp authenticate
```

Defining SNTP Servers

You can enable SNTP servers, as well as add new SNTP servers, from the **SNTP Servers** page. To open the **SNTP Servers** page, click **System** → **SNTP** → **Servers** in the tree view.

Figure 6-14. SNTP Servers

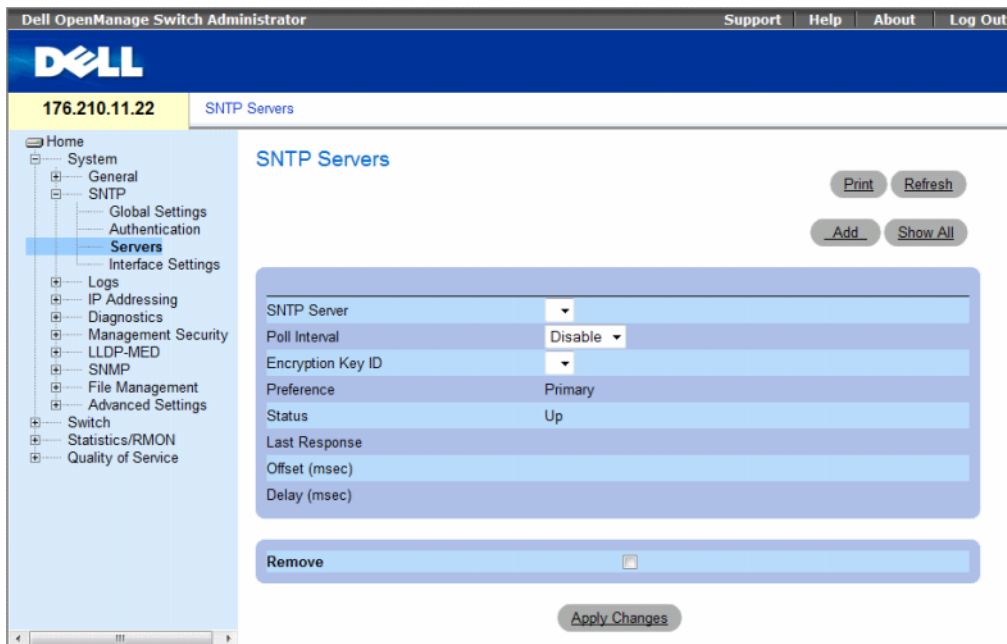

The SNTP Servers page contains the following fields:

- **SNTP Server** — Select a user-defined SNTP server IP address. Up to eight SNTP servers can be defined.
- **Poll Interval** — Polls the selected SNTP Server for system time information, when enabled.
- **Encryption Key ID** — Indicates the Key Identification used to communicate between the SNTP server and device. The range is 1 - 4294967295.
- **Preference** — The SNTP server providing SNTP system time information. The possible field values are:
 - **Primary** — The primary server provides SNTP information.
 - **Secondary** — The backup server provides SNTP information.
- **Status** — The operating SNTP server status. The possible field values are:
 - **Up** — The SNTP server is currently operating normally.
 - **Down** — Indicates that a SNTP server is currently not available. For example, the SNTP server is currently not connected or is currently down.
 - **In progress** — The SNTP server is currently sending or receiving SNTP information.
 - **Unknown** — The progress of the SNTP information currently being sent is unknown. For example, the device is currently looking for an interface.
- **Last Response** — The last time a response was received from the SNTP server.

- **Offset (msec)** — Timestamp difference between the device local clock and the acquired time from the SNTP server.
- **Delay (msec)** — The amount of time it takes to reach the SNTP server.
- **Remove** — Removes a specific SNTP server from the **SNTP Servers** list.
 - **Checked** — Removes the selected SNTP server.
 - **Unchecked** — Maintains the SNTP server in the configuration. This is the default value.

When adding an SNTP Server, the following additional parameters are available:

- **Supported IP Format** — Specifies the IP format supported by the SNTP server. The possible values are:
 - **IPv6** — IP version 6 is supported.
 - **IPv4** — IP version 4 is supported.
- **IPv6 Address Type** — When the server supports IPv6 (see previous parameter), this specifies the type of static address supported. The possible values are:
 - **Link Local** — A Link Local address that is non-routable and used for communication on the same network only.
 - **Global** — A globally unique IPv6 address; visible and reachable from different subnets.
- **Link Local Interface** — When the server supports an IPv6 Link Local address (see previous parameter), this specifies the the Link Local interface. The possible values are:
 - **VLAN1** — The IPv6 interface is configured on VLAN1.
 - **ISATAP** — The IPv6 interface is configured on ISATAP tunnel.

Adding an SNTP Server

- 1 Open the SNTP Servers page.
- 2 Click Add.

The Add SNTP Server page opens.

Figure 6-15. Add SNTP Server

The screenshot shows the 'Add SNTP Server' configuration page. The form includes the following fields and options:

- Supported IP Format:** Radio buttons for IPv6 and IPv4. IPv4 is selected.
- IPv6 Address Type:** Radio buttons for Link Local and Global.
- Link Local Interface:** Radio buttons for VLAN1 and ISATAP.
- SNTP Server:** A text input field containing the placeholder '(X.X.X.X)'.
- Poll Interval:** A dropdown menu currently set to 'Disable'.
- Encryption Key ID:** A checkbox followed by a dropdown menu.

Buttons for 'Refresh' (top right) and 'Apply Changes' (bottom center) are also visible.

- 3 Define the fields.
- 4 Click **Apply Changes**.
The SNTP Server is added, and the device is updated.

Displaying the SNTP Server Table

- 1 Open the SNTP Servers page.
- 2 Click **Show All**.
The SNTP Servers Table opens.

Figure 6-16. SNTP Servers Table

SNTP Server	Poll Interval	Encryption Key ID	Preference	Status	Last Response	Offset	Delay	Remove
1	Disable		Primary	Up				<input checked="" type="checkbox"/>

Modifying an SNTP Server

- 1 Open the SNTP Servers page.
- 2 Click **Show All**.
The SNTP Servers Table opens.
- 3 Select an SNTP Server entry.
- 4 Modify the relevant fields.
- 5 Click **Apply Changes**.
The SNTP Server information is updated.

Deleting the SNTP Server

- 1 Open the SNTP Servers page.
- 2 Click **Show All**.
The SNTP Servers Table opens.
- 3 Select an SNTP Server entry.
- 4 Select the **Remove** check box.
- 5 Click **Apply Changes**.
The entry is removed, and the device is updated.

Defining SNMP Servers Settings Using CLI Commands

The following table summarizes the equivalent CLI commands for setting fields displayed in the SNMP Server page.

Table 6-11. SNMP Server CLI Commands

CLI Command	Description
<code>snmp server <i>ipv4-address</i> <i>ipv6-address</i> <i>hostname</i> [poll] [key <i>keyid</i>]</code>	Configures the device to use SNMP to request and accept SNMP traffic from a server.

The following is an example of the CLI commands:

```
Console(config)# snmp server 100.1.1.1 poll key 10
```

Defining SNMP Interfaces

The SNMP Broadcast Interface Table page contains SNMP interface information. To open the SNMP Broadcast Interface Table page, click System → SNMP → Interface Settings.

Figure 6-17. SNMP Broadcast Interface Table

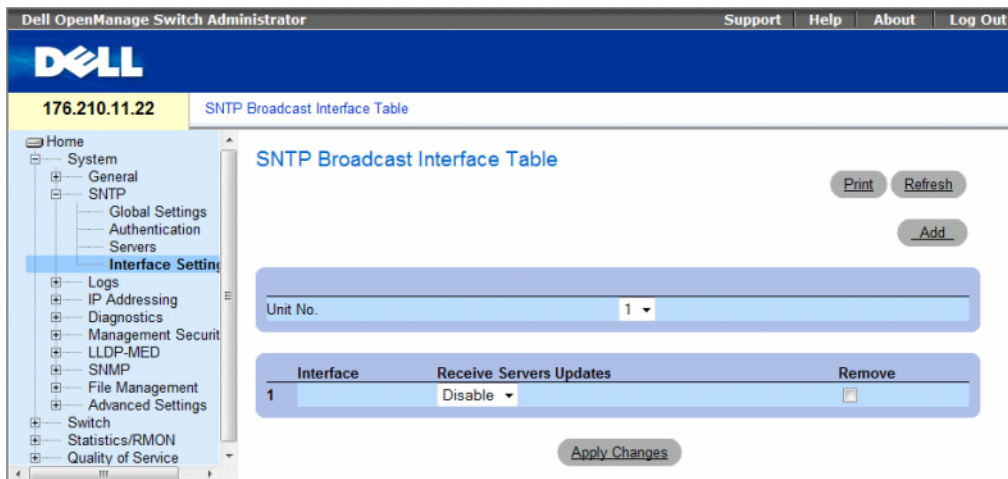

The **SNTP Broadcast Interface Table** page contains the following fields:

- **Unit No.** — Indicates the stacking member on which the SNTP interface is enabled.

Interface — Contains an interface list on which SNTP can be enabled:

- **Receive Servers Updates** — Enables or disables SNTP on the specific interface.
 - **Enable** — Enables the interface to receive updates from the SNTP server.
 - **Disable** — Interface does not receive updates from the SNTP server.
- **Remove** — Removes SNTP from a specific interface, when selected.
 - **Checked** — Removes the SNTP interface entry.
 - **Unchecked** — Maintains the SNTP interface entry.

Adding an SNTP Interface

- 1 Open the **SNTP Broadcast Interface Table** page.
- 2 Click **Add**.

The **Add SNTP Interface** page opens.

Figure 6-18. Add SNTP Interface

The screenshot shows a web interface for adding an SNTP interface. At the top, the title "Add SNTP Interface" is displayed in blue. To the right of the title is a "Refresh" button. Below the title is a configuration form with a blue header. The form contains two rows: "Interface" and "State". The "Interface" row has three radio buttons: "Port", "LAG", and "VLAN", each followed by a dropdown arrow. The "State" row has a dropdown menu currently set to "Disable". Below the form is an "Apply Changes" button.

- 3 Define the relevant fields.
- 4 Click **Apply Changes**.

The SNTP interface is added, and the device is updated.

Defining SNTP Interface Settings Using CLI Commands

The following table summarizes the equivalent CLI commands for setting fields displayed in the **SNTP Broadcast Interface Table** page.

Table 6-12. SNTP Interface Settings CLI Commands

CLI Command	Description
sntp client enable	Enables the Simple Network Time Protocol (SNTP) client on an interface.
show sntp configuration	Shows the configuration of the Simple Network Time Protocol (SNTP).

The following is an example of the CLI commands for displaying SNTP interfaces:

```
console# show sntp configuration
Polling interval: 7200 seconds.

MD5 Authentication keys: 8, 9
Authentication is required for synchronization.
Trusted Keys: 8,9

Unicast Clients Polling: Enabled.

Server                               Polling                               Encryption Key
-----                               -
176.1.1.8                             Enabled                               9
176.1.8.179                           Disabled                             Disabled

Broadcast Clients: Enabled
Broadcast Clients Poll: Enabled
Broadcast Interfaces:1/e1, 1/e3
```

Managing Logs

The **Logs** page contains links to various log pages. To open the **Logs** page, click **System** → **Logs** in the tree view.

This section contains the following topics:

- "Defining Global Log Parameters" on page 114
- "Viewing the RAM Log Table" on page 118
- "Viewing the Log File Table" on page 120
- "Viewing the Device Login History" on page 121
- "Modifying Remote Log Server Definitions" on page 123

Defining Global Log Parameters

The System Logs enable viewing device events in real time, and recording the events for later usage. System Logs record and manage events and report errors or informational messages.

Event messages have a unique format, as per the System Logs protocol recommended message format for all error reporting. For example, Syslog and local device reporting messages are assigned a severity code, and include a message mnemonic, which identifies the source application generating the message. It allows messages to be filtered based on their urgency or relevancy. The distribution of logging messages to the various destinations, such as the logging buffer, logging file or Syslog server, is controlled by the Syslog configuration parameters. Users can define up-to eight Syslog servers.

The following are the Log Severity Levels:

- **Emergency** — The highest warning level. If the device is down or not functioning properly, an emergency log message is saved to the specified logging location.
- **Alert** — The second highest warning level. An alert log is saved if there is a serious device malfunction, for example, all device features are down.
- **Critical** — The third highest warning level. A critical log is saved if a critical device malfunction occurs, for example, two device ports are not functioning, while the rest of the device ports remain functional.
- **Error** — A device error has occurred, for example, if a single port is offline.
- **Warning** — The lowest level of a device warning. The device is functioning, but an operational problem has occurred.
- **Notice** — Provides device information.
- **Informational** — Provides device information.
- **Debug** — Provides debugging messages.

Table 6-13. Log Severity Levels

Severity Type	Severity Level	Description
Emergency	0	The system is not functioning.
Alert	1	The system needs immediate attention.
Critical	2	The system is in a critical state.
Error	3	A system error has occurred.
Warning	4	A system warning has occurred.
Notice	5	The system is functioning properly, but system notice has occurred.
Informational	6	Provides device information.
Debug	7	Provides detailed information about the log. If a Debug error occurs, contact Dell Online Technical Support.

The **Logs - Global Parameters** page contains fields for defining which events are recorded to which logs. It contains fields for enabling logs globally, and fields for defining log parameters. The Severity log messages are listed from the highest severity to the lowest.

To open the **Logs - Global Parameters** page, click **System** → **Logs** → **Global Parameters** in the tree view.

Figure 6-19. Logs - Global Parameters

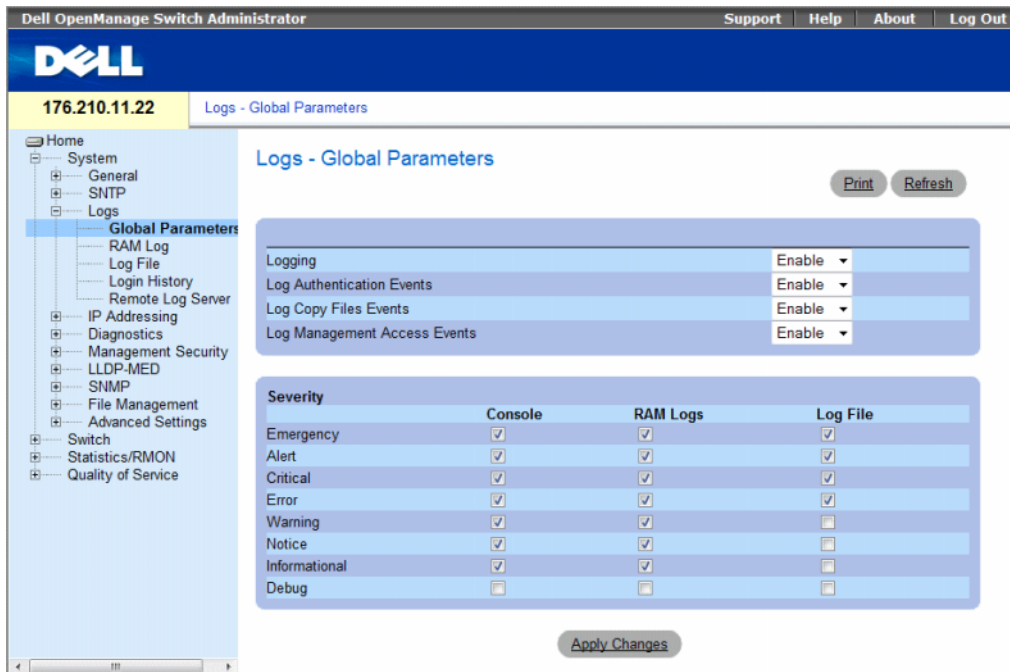

The **Logs - Global Parameters** page contains the following parameters:

- **Logging** — Enables or disables device global logs for Cache, File, and Server Logs. Console logs are enabled by default.
- **Log Authentication Events** — Enables or disables generating logs when users are authenticated.
- **Log Copy Files Events** — Enables or disables generating logs when files are copied.

- **Log Management Access Events** — Enables or disables generating logs when the device is accessed using a management method. For example, each time the device is accessed using SSH, a device log is generated.
- **Severity** — Displays the severity logs. The following are the severity log levels. When a severity level is selected, all severity level choices above the selection are selected automatically.
 - **Emergency** — The highest warning level. If the device is down or not functioning properly, an emergency log message is saved to the specified logging location.
 - **Alert** — The second highest warning level. An alert log is saved if there is a serious device malfunction, for example, an attempt was made to download a non-existing configuration file.
 - **Critical** — The third highest warning level. A critical log is saved if a critical device malfunction occurs, for example, two device ports are not functioning, while the rest of the device ports remain functional.
 - **Error** — A device error has occurred, for example, a copy operation has failed.
 - **Warning** — The lowest level of a device warning. For example, the device is functioning, but a port link is currently down.
 - **Notice** — Provides important device information.
 - **Informational** — Provides device information. For example, a port is currently up.
 - **Debug** — Provides debugging messages.

The **Global Log Parameters** page also contains check boxes which correspond to a distinct logging system:

- **Console** — The minimum severity level from which logs are sent to the console.
- **RAM Logs** — The minimum severity level from which logs are sent to the Log File kept in RAM (Cache).
- **Log File** — The minimum severity level from which logs are sent to the Log File kept in FLASH memory.

Enabling Logs

- 1 Open the **Global Log Parameters** page.
- 2 Select **Enable** in the **Logging** drop-down list.
- 3 Select the log type and log severity in the **Global Log Parameters** check boxes.
- 4 Click **Apply Changes**.

The log settings are saved, and the device is updated.

Enabling Logs Using CLI Commands

The following table summarizes the equivalent CLI commands for setting fields displayed in the **Global Log Parameters** page.

Table 6-14. Global Log Parameters CLI Commands

CLI Command	Description
<code>logging on</code>	Enables error message logging.
<code>logging {ipv4-address / ipv6-address hostname} [port port] [severity level] [facility facility] [description text]</code>	Logs messages to a syslog server. For a list of the Severity levels, see "Log Severity Levels" on page 117.
<code>logging console level</code>	Limits messages logged to the console based on severity.
<code>logging buffered level</code>	Limits syslog messages displayed from an internal buffer (RAM) based on severity.
<code>logging file level</code>	Limits syslog messages sent to the logging file based on severity.
<code>clear logging</code>	Clears logs.
<code>clear logging file</code>	Clears messages from the logging file.
<code>show syslog servers</code>	Displays the syslog servers settings.

The following is an example of the CLI commands:

```

console(config)# logging on
console(config)# logging console errors
console(config)# logging buffered debugging
console(config)# logging file alerts
console(config)# end
console# clear logging file
Clear Logging File [y/n]y

Console# show syslog-servers
Device Configuration
-----
IP address      Port  facility  Severity  Description
-----
  1.1.1.1       514   local7    info
fe80::11%vlan1 514   local7    info
  3211::22     514   local7    info

```

Viewing the RAM Log Table

The RAM Log Table contains information about log entries kept in RAM, including the time the log was entered, the log severity, and a description of the log. To open the RAM Log Table, click **System** → **Logs** → **RAM Log** in the tree view.

Figure 6-20. RAM Log Table

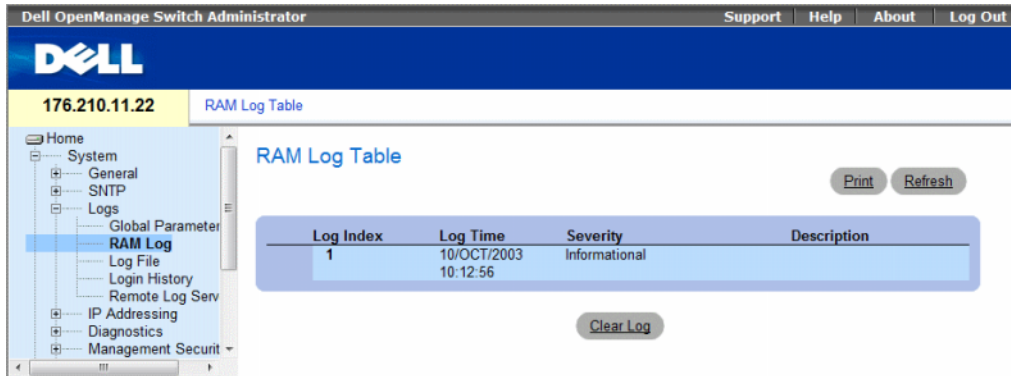

The RAM Log Table contains the following fields:

- **Log Index** — The log number in the RAM Log Table.
- **Log Time** — Indicates the time at which the log was entered into the RAM Log Table.
- **Severity** — Indicates the log severity.
- **Description** — Description of the log entry.

Removing Log Information:

- 1 Open the RAM Log Table.
- 2 Click **Clear Log**.

The log information is removed from the RAM Log Table, and the device is updated.

Viewing and Clearing the RAM Log Table Using the CLI Commands

The following table summarizes the equivalent CLI commands for viewing and clearing fields displayed in the RAM Log Table.

Table 6-15. RAM Log Table CLI Commands

CLI Command	Description
show logging	Displays the state of logging and the syslog messages stored in the internal buffer.
clear logging	Clears logs.

The following is an example of the CLI commands:

```
console# show logging
Logging is enabled.
Console Logging: Level info. Console Messages: 0 Dropped.
Buffer Logging: Level info. Buffer Messages: 124 Logged, 124
Displayed, 200 Max.
File Logging: Level error. File Messages: 164 Logged, 126
Dropped.
3 messages were not logged
Application filtering control
```

Application	Event	Status
AAA	Login	Enabled
File system	Copy	Enabled
File system	Delete-Rename	Enabled
Management ACL	Deny	Enabled

```
01-Jan-2000 09:23:34 :%Box-I-PS-STAT-CHNG: PS# 1 status is -
operational.
01-Jan-2000 09:23:29 :%Box-W-PS-STAT-CHNG: PS# 1 status is - not
operational.
01-Jan-2000 09:22:44 :%Box-I-PS-STAT-CHNG: PS# 1 status is -
operational.
01-Jan-2000 09:22:39 :%Box-W-PS-STAT-CHNG: PS# 1 status is - not
operational.
01-Jan-2000 09:10:34 :%Box-I-PS-STAT-CHNG: PS# 1 status is -
operational.
01-Jan-2000 09:10:29 :%Box-W-PS-STAT-CHNG: PS# 1 status is - not
operational.
01-Jan-2000 09:09:16 :%AAA-I-CONNECT: New http connection for
user admin, source 192.168.102.5 destination 192.168.102.15
ACCEPTED
01-Jan-2000 08:39:49 :%Box-I-PS-STAT-CHNG: PS# 1 status is -
operational.
```

Viewing the Log File Table

The **Log File Table** contains information about log entries saved to the Log File in FLASH, including the time the log was entered, the log severity, and a description of the log message. To open the **Log File Table**, click **System** → **Logs** → **Log File** in the tree view.

Figure 6-21. Log File Table

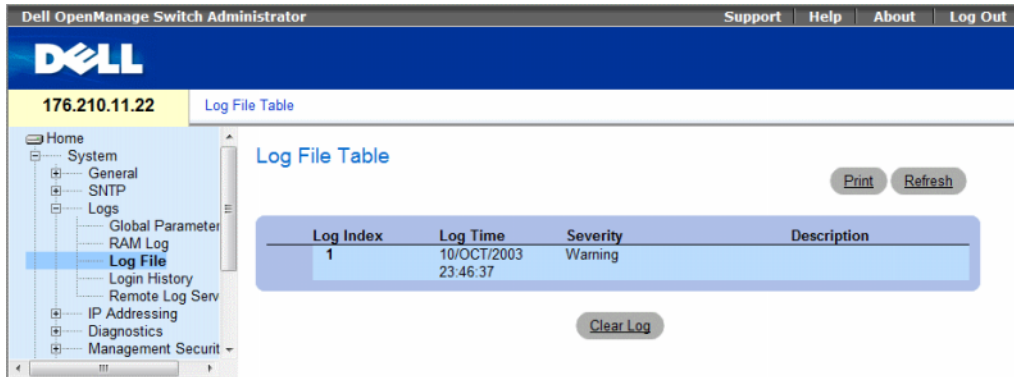

The **Log File Table** contains the following fields:

- **Log Index** — The log number in the **Log File Table**.
- **Log Time** — Indicates the time at which the log was entered in the **Log File Table**.
- **Severity** — Indicates the log severity.
- **Description** — The log message text.

Displaying the Log File Table Using the CLI Commands

The following table summarizes the equivalent CLI commands for viewing and setting fields displayed in the **Log File Table**.

Table 6-16. Log File Table CLI Commands

CLI Command	Description
show logging file	Displays the logging state and the syslog messages stored in the logging file.
clear logging file	Clears messages from the logging file.

The following is an example of the CLI commands:

```
console# show logging file
Logging is enabled.
Console Logging: Level info. Console Messages: 0 Dropped.
Buffer Logging: Level info. Buffer Messages: 62 Logged, 62
Displayed, 200 Max.
File Logging: Level debug. File Messages: 11 Logged, 51
Dropped.
SysLog server 12.1.1.2 Logging: warning. Messages: 14
Dropped.
SysLog server 1.1.1.1 Logging: info. Messages: 0 Dropped.
01-Jan-2000 01:12:01 :%COPY-W-TRAP: The copy operation was
completed successfully
01-Jan-2000 01:11:49 :%LINK-I-Up: 1/e11
01-Jan-2000 01:11:46 :%LINK-I-Up: 1/e12
01-Jan-2000 01:11:42 :%LINK-W-Down: 1/e13
01-Jan-2000 01:11:35 :%LINK-I-Up: 1/e14
```

Viewing the Device Login History

The **Login History** page contains information for viewing and monitoring device utilization, including the time the user logged in and the protocol used to log on to the device.

To open the **Login History** page, click **System**→**Logs**→**Login History** in the tree view.

Figure 6-22. Login History

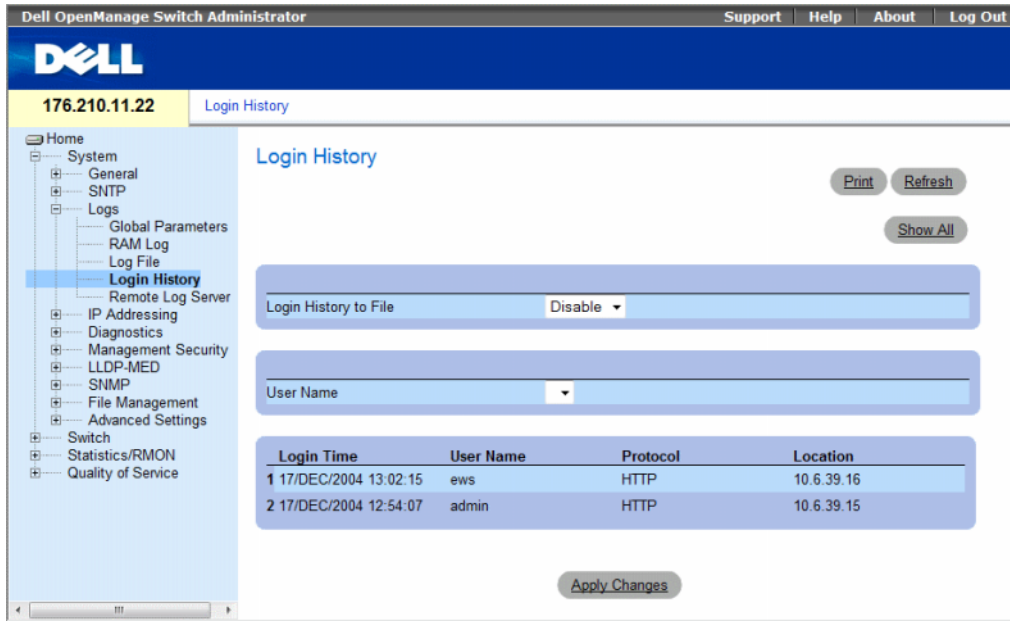

The **Login History** page contains the following fields:

- **User Name** — Contains a user-defined device user name list.
- **Login History** — Indicates if the Login History logs are enabled.
- **Login Time** — Indicates the time the selected user logged on to the device.
- **User Name** — Indicates the user that logged on to the device.
- **Protocol** — Indicates the means by which the user logged on to the device.
- **Location** — Indicates the IP address of the station from which the device was accessed.

Viewing Login History

- 1 Open the **Login History** page.
- 2 Select a user in the **User Name** field.
- 3 Click **Apply Changes**.

The login information for the selected user is displayed.

Displaying the Device Login History Using CLI Commands

The following table summarizes the equivalent CLI commands for viewing and setting fields displayed in the **Login History** page.

Table 6-17. Log File Table CLI Commands

CLI Command	Description
show users login-history	Displays password management history information.

The following is an example of the CLI commands:

```
console# show users login-history

Login Time      Username      Protocol      Location
-----
01-Jan-2005    Anna         HTTP         172.16.1.8
23:58:17
01-Jan-2005    Errol        HTTP         172.16.0.8
07:59:23
01-Jan-2005    Amy          Serial
08:23:48
01-Jan-2005    Alan         SSH          172.16.0.8
08:29:29
01-Jan-2005    Bob          HTTP         172.16.0.1
08:42:31
01-Jan-2005    Cindy       Telnet       172.16.1.7
08:49:52
```

Modifying Remote Log Server Definitions

The **Remote Log Server Settings** page contains fields for viewing and configuring the available Log Servers. In addition, new log servers can be defined, and the log severity sent to each server.

The event severity levels are listed on this page in descending order from the highest severity to the lowest. When a severity level is selected to appear in a log, all higher severity events are automatically selected to appear in the log. When a security level is not selected, no lower severity events appear in the log.

For example, if Warning is selected, all severity levels higher and including Warning will appear in the log. Additionally, no events with a lower security level than Warning will be listed.

To open the **Remote Log Server Settings** page, click **System** → **Logs** → **Remote Server Settings** in the tree view.

Figure 6-23. Remote Log Server Settings

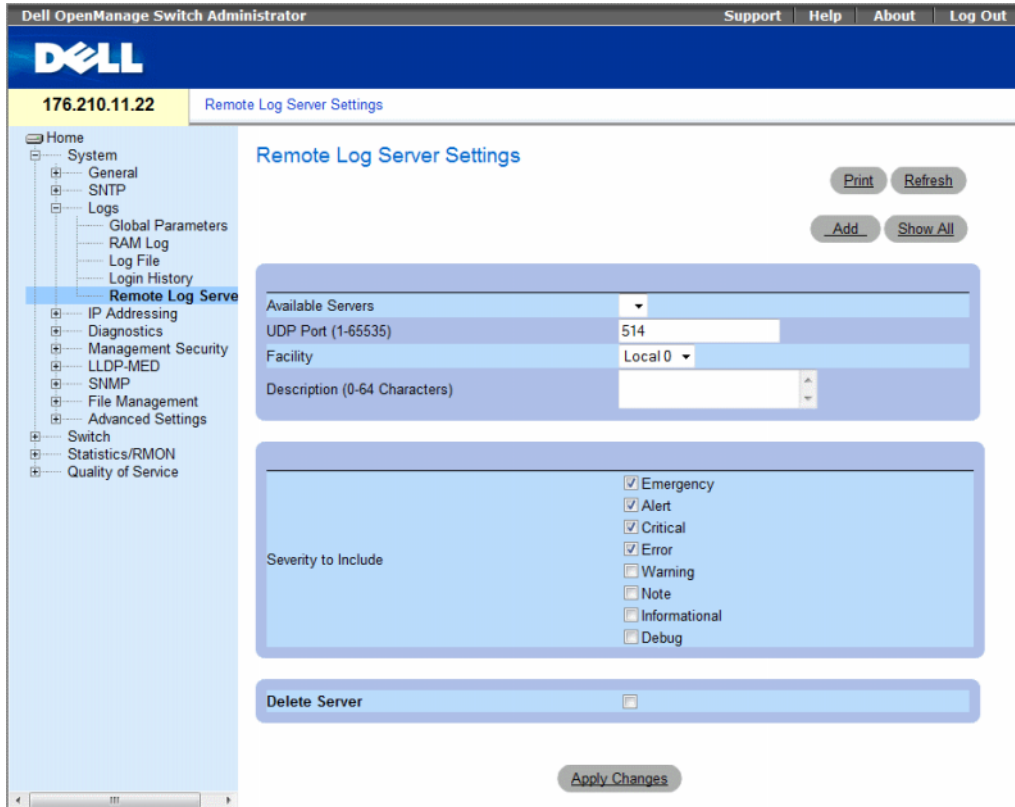

The Remote Log Server Settings page contains the following fields:

- **Available Servers** — Contains a list of servers to which logs can be sent.
- **UDP Port (1-65535)** — The UDP port to which the logs are sent for the selected server. The possible range is 1 - 65535. The default value is 514.
- **Facility** — Defines a user-defined application from which system logs are sent to the remote server. Only one facility can be assigned to a single server. If a second facility level is assigned, the first facility level is overridden. All applications defined for a device utilize the same facility on a server. The field default is Local 7. The possible field values are:
 - Local 0 to Local 7.
- **Description (0-64 Characters)** — The user-defined server description.

- **Severity to Include** — The following are the available severity levels:
 - **Emergency** — The system is not functioning.
 - **Alert** — The system needs immediate attention.
 - **Critical** — The system is in a critical state.
 - **Error** — A system error has occurred.
 - **Warning** — A system warning has occurred.
 - **Notice** — The system is functioning properly, but system notice has occurred.
 - **Informational** — Provides device information.
 - **Debug** — Provides detailed information about the log. If a Debug error occurs, contact Customer Tech Support.
- **Delete Server** — Deletes the currently selected server from the Available Servers list, when selected.

When adding a Log Server, the following additional parameters are available:

- **Supported IP Format** — Specifies the IP format supported by the server. The possible values are:
 - **IPv6** — IP version 6 is supported.
 - **IPv4** — IP version 4 is supported.
- **IPv6 Address Type** — When the server supports IPv6 (see previous parameter), this specifies the type of static address supported. The possible values are:
 - **Link Local** — A Link Local address that is non-routable and used for communication on the same network only.
 - **Global** — A globally unique IPv6 address; visible and reachable from different subnets.
- **Link Local Interface** — When the server supports an IPv6 Link Local address (see previous parameter), this specifies the the Link Local interface. The possible values are:
 - **VLAN1** — The IPv6 interface is configured on VLAN1.
- **ISATAP** — The IPv6 interface is configured on ISATAP tunnel.

Sending Logs to a Server:

- 1** Open the **Remote Log Server Settings** page.
- 2** Select a server from the **Available Servers** drop-down list.
- 3** Define the fields.
- 4** Select the log severity in the **Severity to Include** check boxes.
- 5** Click **Apply Changes**.

The log settings are saved, and the device is updated.

Defining a New Server:

1 Open the Remote Log Server Settings page.

2 Click Add.

The Add a Log Server page opens.

Figure 6-24. Add a Log Server

Refresh

Add a Log Server

Supported IP Format IPv6 IPv4

IPv6 Address Type Link Local Global

Link Local Interface VLAN1 ISATAP

New Log Server IP Address (X.X.X.X)

UDP Port (1-65535)

Facility

Description

Severity To Include

- Emergency
- Alert
- Critical
- Error
- Warning
- Note
- Informational
- Debug

Apply Changes

The Add a Log Server page contains the additional field:

– New Log Server IP Address — Defines the IP address of the new Log Server.

3 Define the fields.

4 Click Apply Changes.

The server is defined and added to the Available Servers list.

Displaying the Remote Log Servers Table:

- 1 Open the Remote Log Server Settings page.
- 2 Click Show All.
The Log Servers Table page opens.

Figure 6-25. Log Servers Table

Server	UDP Port	Facility	Description	Minimum Severity	Remove
1					<input type="checkbox"/>

Removing a Log Server from the Log Servers Table Page:

- 1 Open the Remote Log Server Settings page.
- 2 Click Show All.
The Log Servers Table page opens.
- 3 Select a Log Servers Table entry.
- 4 Select the Remove check box to remove the server(s).
- 5 Click Apply Changes.
The Log Servers Table entry is removed, and the device is updated.

Working with Remote Server Logs Using the CLI Commands

The following table summarizes the equivalent CLI command for working with remote log servers.

Table 6-18. Remote Log Server CLI Commands

CLI Command	Description
<code>logging</code> (<i>ipv4-address</i> <i>ipv6-address</i> <i>hostname</i>) [<i>port port</i>] [<i>severity level</i>] [<i>facility facility</i>] [<i>description text</i>]	Logs messages to a remote server.
<code>no logging</code>	Deletes a syslog server.
<code>show logging</code>	Displays the state of logging and the syslog messages.

The following is an example of the CLI commands:

```
console> enable
console# configure
console(config)# logging 10.1.1.1 severity critical
console(config)# end
console# show logging
Logging is enabled.
Console Logging: Level debug. Console Messages: 5 Dropped.
Buffer Logging: Level debug. Buffer Messages: 16 Logged, 16
Displayed, 200 Max.
File Logging: Level error. File Messages: 0 Logged, 209 Dropped.
SysLog server 31.1.1.2 Logging: error. Messages: 22 Dropped.
SysLog server 5.2.2.2 Logging: info. Messages: 0 Dropped.
SysLog server 10.2.2.2 Logging: critical. Messages: 21 Dropped.
SysLog server 10.1.1.1 Logging: critical. Messages: 0 Dropped.
1 messages were not logged
03-Mar-2004 12:02:03 :%LINK-I-Up: 1/e11
03-Mar-2004 12:02:01 :%LINK-W-Down: 1/e12
03-Mar-2004 12:02:01 :%LINK-I-Up: 1/e13
```

Defining IP Addressing

The **IP Addressing** page contains links for assigning interface and default gateway IP addresses, and defining ARP and DHCP parameters for the interfaces. To open the **IP Addressing** page, click **System** → **IP Addressing** in the tree view.

This section contains the following topics:

- "Defining IPv4 Default Gateways" on page 129
- "Defining IPv4 Interfaces" on page 131
- "Defining DHCP IPv4 Interface Parameters" on page 134
- "Configuring Domain Name Systems" on page 154

- "Defining Default Domains" on page 157
- "Mapping Domain Host" on page 159
- "Defining ARP Settings" on page 162

Configuring the Internet Protocol Version 6 (IPv6)

The device functions as an IPv6 compliant Host, as well as an IPv4 Host (also known as dual stack). This allows device operation in a pure IPv6 network as well as in a combined IPv4/IPv6 network.

The primary change from IPv4 to IPv6 is the length of network addresses. IPv6 addresses are 128 bits long, whereas IPv4 addresses are 32 bits; allowing a much larger address space.

IPv6 Syntax

The 128-bit IPv6 address format is divided into eight groups of four hexadecimal digits. Abbreviation of this format by replacing a group of zeros with "double colons" (::) is acceptable. IPv6 address representation can be further simplified by suppressing the leading zeros.

All different IPv6 address formats are acceptable for insertion, yet for display purposes, the system will display the most abbreviated form, which replaces groups of zeros with "double colons" and removes the "leading zeros".

IPv6 Prefixes

While unicast IPv6 addresses written with their prefix lengths are permitted, in practice their prefix lengths are always 64 bits and therefore are not required to be expressed. Any prefix that is less than 64 bits is a route or address range that is summarizing a portion of the IPv6 address space.

For every assignment of an IP address to an interface, the system runs the Duplicate Address Detection (DAD) algorithm to ensure uniqueness.

An intermediary transition mechanism is required for IPv6-only nodes to communicate with IPv6 nodes over an IPv4 infrastructure. The tunneling mechanism implemented is the Intra-Site Automatic Tunnel Addressing Protocol (ISATAP). This protocol treats the IPv4 network as a virtual IPv6 local-link, with each IPv4 address mapped to a Link Local IPv6 address.

Defining IPv4 Default Gateways

The **IPv4 Default Gateway** page contains fields for assigning Gateway to devices. Packets are forwarded to the default IP when packets are sent to a remote network. The configured IP address must belong to the same IP address subnet of one of the IP interfaces.

To open the **IPv4 Default Gateway** page, click **System** → **IP Addressing** → **IPv4 Default Gateway** in the tree view.

Figure 6-26. IPv4 Default Gateway

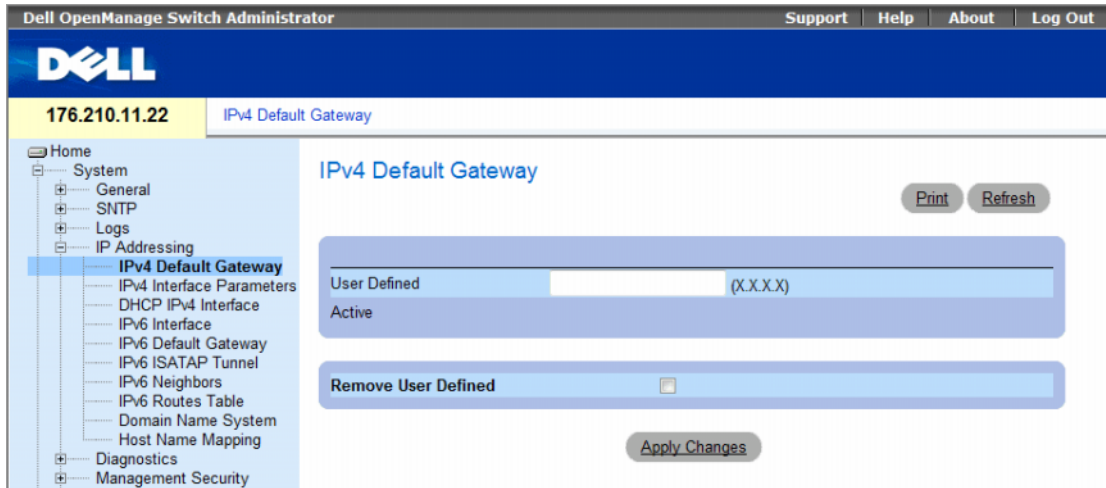

The IPv4 Default Gateway page contains the following fields:

- **User Defined** — The device's Gateway IP address.
- **Active** — Indicates if the Gateway is active.
- **Remove User Defined** — Removes the default gateway. The possible field values are:
 - **Checked** — Removes the selected default gateway.
 - **Unchecked** — Maintains the default gateway.

Selecting a Device's IPv4 Gateway

- 1 Open the **IPv4 Default Gateway** page.
- 2 Type an IP address in the **User Defined** field.
- 3 Select the **Active** check box.
- 4 Click **Apply Changes**.

The device's Default Gateway is selected and the device is updated.

Removing a Device's IPv4 Default Gateway Device

- 1 Open the **IPv4 Default Gateway** page.
- 2 Select the **Remove User Defined** check box to remove default gateways.
- 3 Click **Apply Changes**.

The default gateway entry is removed, and the device is updated.

Defining a Device's IPv4 Gateway Using the CLI Commands

The following table summarizes the equivalent CLI commands for setting fields displayed in the **Default Gateway** page

Table 6-19. Default Gateway CLI Commands

CLI Command	Description
<code>ip default-gateway ip-address</code>	Defines a default gateway.
<code>no ip default-gateway</code>	Removes a default gateway.

The following is an example of the CLI commands:

```
console(config)# ip default-gateway 196.210.10.1
console(config)# no ip default-gateway
```

Defining IPv4 Interfaces

The **IPv4 Interface Parameters** page contains fields for assigning IP parameter to interfaces.

To open the **IP Interface Parameters** page, click **System**→**IP Addressing**→**IPv4 Interface Parameters** in the tree view.

Figure 6-27. IPv4 Interface Parameters

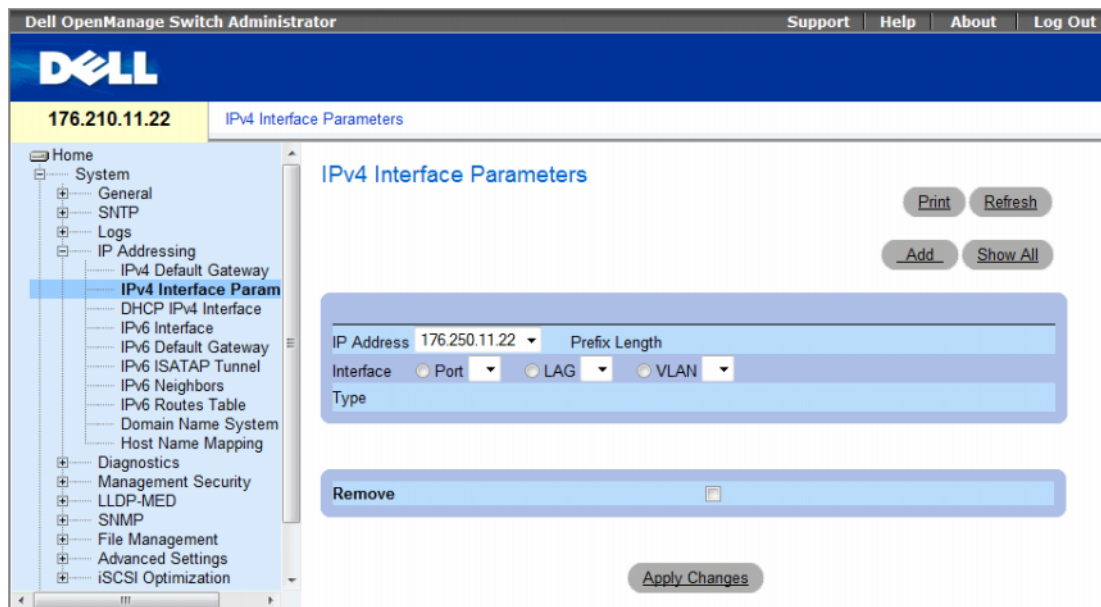

The **IP Interface Parameters** page contains the following parameters:

- **IP Address** — The interface IP address.
- **Prefix Length** — The number of bits that comprise the IP address prefix.
- **Interface** — The interface type for which the IP address is defined. Select **Port**, **LAG**, or **VLAN**.
- **Type** — Indicates whether or not the IP address was configured statically.
- **Remove** — Removes the interface from the **IP Address** drop-down menu.
 - **Checked** — Removes the selected interface.
 - **Unchecked** — Maintains the selected interface.

Adding an IPv4 IP Interface

- 1 Open the **IPv4 Interface Parameters** page.
- 2 Click **Add**.

The **Add a Static IPv4 Interface** page opens.

Figure 6-28. Add a Static IPv4 Interface

Add a Static IPv4 Interface

Refresh

IP Address (X.X.X.X) Network Mask (X.X.X.X) Prefix Length (XX)

Interface Port LAG VLAN

Apply Changes

In addition to the parameters on the **IP Interface Parameters** page, the **Add a Static IP Interface** page contains the following parameter:

- **Network Mask** — Indicates the subnetwork mask of the IP address.
- 3 Complete the fields on the page.
 - 4 Click **Apply Changes**.

The new IP address is added to the interface, and the device is updated.

Modifying IPv4 Address Parameters

- 1 Open the **IPv4 Interface Parameters** page.
- 2 Select an IP address in the **IP Address** drop-down menu.

- 3 Modify the interface type.
- 4 Click **Apply Changes**.
The parameters are modified, and the device is updated.

Deleting IPv4 Addresses

- 1 Open the **IPv4 Interface Parameters** page.
- 2 Click **Show All**.
The **Interface Parameters Table** page opens.

Figure 6-29. IPv4 Interface Parameter Table

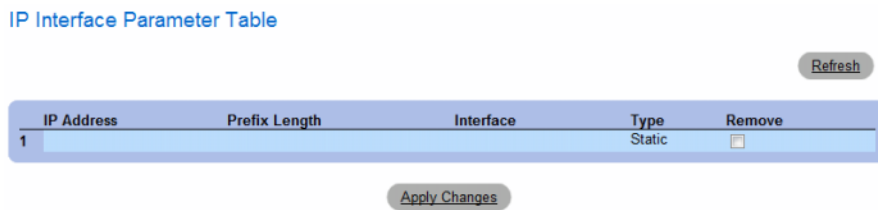

- 3 Select an IP address and select the **Remove** check box.
- 4 Click **Apply Changes**.
The selected IP address is deleted, and the device is updated.

Defining IPv4 Interfaces Using CLI Commands

The following table summarizes the equivalent CLI commands for setting fields displayed in the **IPv4 Interfaces Parameters** page.

Table 6-20. IPv4 Interface Parameters CLI Commands

CLI Command	Description
<code>ip address <i>ip-address</i> {<i>mask</i> <i>prefix-length</i>}</code>	Sets an IP address.
<code>no ip address [<i>ip-address</i>]</code>	Removes an IP address
<code>show ip interface [ethernet <i>interface-number</i> vlan <i>vlan-id</i> port-channel <i>number</i>]</code>	Displays the usability status of interfaces configured for IP.

The following is an example of the CLI commands:

```
console(config)# interface vlan 1
console(config-if)# ip address 92.168.1.123 255.255.255.0
console(config-if)# no ip address 92.168.1.123
console(config-if)# end
console# show ip interface vlan 1
Gateway IP Address          Activity status
-----
192.168.1.1                Active
IP address                  Interface          Type
-----
192.168.1.123/24          VLAN 1            Static
```

Defining DHCP IPv4 Interface Parameters

The DHCP IPv4 Interface page contains parameters for defining DHCP clients on device interfaces.

To open the DHCP IPv4 Interface page, click System → IP Addressing → DHCP IPv4 Interface in the tree view.

Figure 6-30. DHCP IPv4 Interface

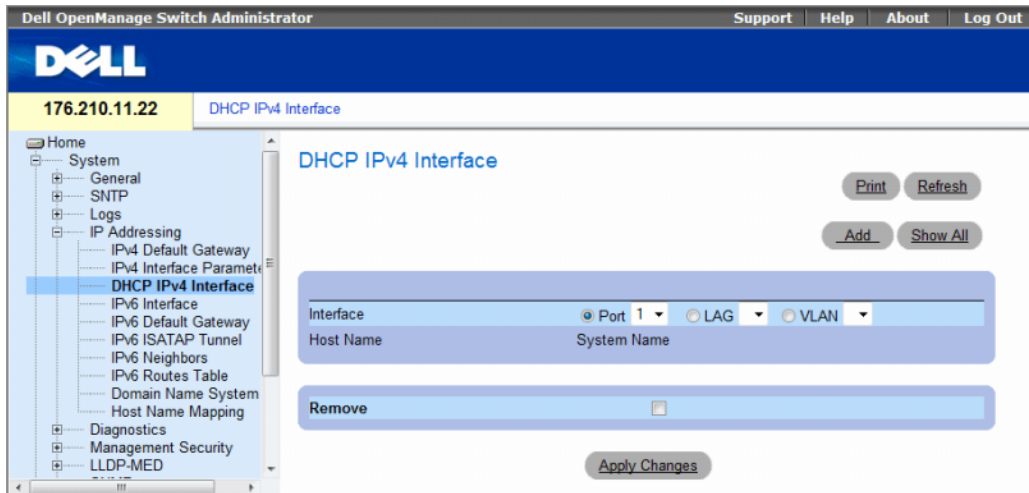

The **DHCP IP Interface** page contains the following fields:

- **Interface** — The DHCP client interface. Click the option button next to **Port**, **LAG**, or **VLAN** and select the DHCP client interface.
- **Host Name** — The system name as written in a DHCP Server log. This field can contain up to 20 characters.
- **Remove** — When selected, removes DHCP clients.
 - **Checked** — Removes the selected DHCP client.
 - **Unchecked** — Maintains the selected DHCP client.

Adding DHCP Clients

- 1 Open the **DHCP IPv4 Interface** page.
- 2 Click **Add**.

The **Add DHCP IPv4 Interface** page opens.

Figure 6-31. Add DHCP IPv4 Interface

The screenshot shows a web interface for adding a DHCP IPv4 interface. At the top right is a 'Refresh' button. The main heading is 'Add DHCP IPv4 Interface'. Below this is a form with a light blue background. The form has a section for 'Interface' with three radio buttons: 'Port 1' (selected), 'LAG', and 'VLAN'. Below the radio buttons is a text input field for 'Host Name (0-20 Characters)' containing the text 'System Name'. At the bottom of the form is an 'Apply Changes' button.

- 3 Complete the information on the page.
 - 4 Click **Apply Changes**.
- The DHCP Interface is added, and the device is updated.

Modifying a DHCP IPv4 Interface

- 1 Open the **DHCP IPv4 IP Interface** page.
 - 2 Modify the fields.
 - 3 Click **Apply Changes**.
- The entry is modified, and the device is updated.

Deleting a DHCP IPv4 Interface

- 1 Open the DHCP IPv4 Interface page.
- 2 Click Show All.

The DHCP IPv4 Interface Table opens.

Figure 6-32. DHCP IPv4 Interface Table

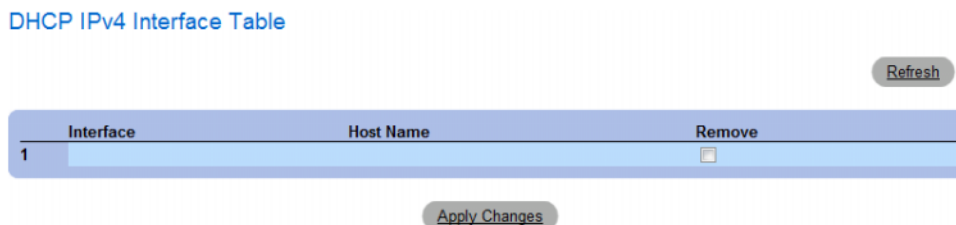

- 3 Select a DHCP client entry.
- 4 Select the **Remove** check box.
- 5 Click **Apply Changes**.

The selected entry is deleted, and the device is updated.

Defining DHCP IPv4 Interfaces Using CLI Commands

The following table summarizes the equivalent CLI commands for defining DHCP clients.

Table 6-21. DHCP IPv4 Interface CLI Commands

CLI Command	Description
<code>ip address dhcp</code> [<code>hostname host-name</code>]	To acquire an IP address on an Ethernet interface from the Dynamic Host Configuration Protocol (DHCP).

The following is an example of the CLI command:

```
console(config)# interface ethernet 1/e11  
console(config-if)# ip address dhcp
```

Defining IPv6 Interfaces

The system supports IPv6 hosts. The **IPv6 Interface** page contains fields for defining IPv6 interfaces. To open the **IPv6 Interface** page, click **System**→**IP Addressing**→**IPv6 Interface** in the tree view.

Figure 6-33. IPv6 Interface

The screenshot shows the Dell OpenManage Switch Administrator interface for configuring an IPv6 interface. The left sidebar shows a tree view with 'IPv6 Interface' selected. The main content area is titled 'IPv6 Interface' and includes several configuration sections:

- Interface:** A dropdown menu showing 'VLAN1'.
- Remove:** A checkbox that is currently unchecked.
- Parameters:** A table of configuration options:

DAD Attempts	3
Autoconfiguration	Enable
Send ICMP Unreachable	Enable
ICMP Error Rate limit Interval	100 (msec)
ICMP Error Rate limit Bucket Size	10 (1-200)
- IPv6 Address Table:** A table with columns: IPv6 Address, Prefix, IPv6 Address Type, IPv6 Address Origin Type, DAD Status, and Remove.

IPv6 Address	Prefix	IPv6 Address Type	IPv6 Address Origin Type	DAD Status	Remove
1		Link Local	Automatic	Active	<input type="checkbox"/>
2		Anycast	Static	Active	<input type="checkbox"/>

Buttons for 'Print', 'Refresh', 'Add IPv6 Interface', 'Add IPv6 Address', and 'Apply Changes' are also visible.

- **Interface** — The IPv6 interface that has been selected for configuration.
- **Remove** — When selected, removes the IPv6 attributes of the interface.
- **DAD Attempts** — Defines the number of consecutive neighbor solicitation messages that are sent on an interface while Duplicate Address Detection (DAD) is performed on unicast IPv6 addresses on this interface. New addresses remain in a tentative state while duplicate address detection is performed. A field value of 0, disables duplicate address detection processing on the specified interface. A field value of 1, indicates a single transmission without follow up transmissions. Range is 0-600, default is 1.

- **Autoconfiguration** — Specifies whether IPv6 address assignment on an interface is done by stateless autoconfiguration. When enabled, the router solicitation ND procedure is initiated (to discover a router in order to assign an IP address to the interface based on prefixes received with RA messages). When autoconfiguration is disabled, no automatic assignment of IPv6 Global Unicast addresses is performed, and existing automatically assigned IPv6 Global Unicast addresses are removed from the interface. Default is *Enabled*.
- **Send ICMP Unreachable** — Specifies whether transmission of ICMPv6 Address Unreachable messages is enabled. When enabled, unreachable messages are generated for any packet arriving on the interface with unassigned TCP/UDP port. Default is *Enabled*.
- **ICMP Error Rate Limit Interval** — The rate-limit interval for ICMPv6 error messages in milliseconds. The value of this parameter together with the Bucket Size parameter (below) determines how many ICMP error messages may be sent per time interval. For example, a rate-limit interval of 100 ms and a bucket size of 10 messages translates to 100 ICMP error messages per second.
- **ICMP Error Rate Limit Bucket Size** — The bucket size for ICMPv6 error messages. The value of this parameter together with the Interval parameter (above) determines how many ICMP error messages may be sent per time interval. For example, a rate-limit interval of 100 ms and a bucket size of 10 messages translates to 100 ICMP error messages per second. Default is 100 ICMP error messages per second; this corresponds to the default interval of 100 ms multiplied by the default bucket size of 10.
- **IPv6 Address** — Indicates the IPv6 address assigned to the interface. The address must be a valid IPv6 address, specified in hexadecimal using 16-bit values between colons. An example of an IPv6 address is 2031:0:130F:0:0:9C0:876A:130D and the compressed version is represented as 2031::0:9C0:876A:130D. Up to five IPv6 addresses (not including Link Local addresses) can be set per interface, with the limitation of up to 128 addresses per system.
- **Prefix** — Specifies the length of the IPv6 prefix. The length is a decimal value that indicates how many of the high-order contiguous bits of the address comprise the prefix (the network portion of the address). The Prefix field is applicable only on a static IPv6 address defined as a Global IPv6 address.
- **IPv6 Address Type** — Specifies the means by which the IP address was added to the interface. The possible field values are:
 - **Link Local** — Indicates the IP address is link local; non-routable and can be used for communication on the same network only. A Link Local address has a prefix of 'FE80'.
 - **Global Unicast** — Indicates the IP address is a globally unique IPv6 unicast address; visible and reachable from different subnets.
 - **Global Anycast** — Indicates the IP address is a globally unique IPv6 anycast address; visible and reachable from different subnets.
 - **Multicast** — Indicates the IP address is multicast.

- **IPv6 Address Origin Type** — Defines the type of configurable static IPv6 address for an interface. The possible values are:
 - **Dyanmic** — Indicates the IP address was received from RA.
 - **Static** — Indicates the IP address was configured by the user.
 - **System** — Indicates the IP address was generated by the system.
- **DAD Status** — Displays the Duplicate Address Detection (DAD) Status which is the process of verifying and assuring an inserted IPv6 address is unique. This is a read-only parameter with the following field values:
 - **Tentative** — Indicates the system is in process of IPv6 address duplication verification.
 - **Duplicate** — Indicates the IPv6 address is being used by an another host on the network. The duplicated IPv6 address is suspended and is not used for sending or receiving any traffic.
 - **Active** — Indicates the IPv6 address is set to active.
- **Remove** — When selected, removes the address from the table.

Adding an IPv6 Interface

- 1 Open the IPv6 Interface page.
- 2 Click Add IPv6 Interface.

The Add a Static IPv4 Interface page opens.

Figure 6-34. Add IPv6 Interface

- 3 Complete the fields on the page.
IPv6 Interface specifies whether the interface is a specific port, LAG or VLAN.
- 4 Click **Apply Changes**.
 The new interface is added, and the device is updated.

Adding an IPv6 Address to the Current Interface

- 1 Open the IPv6 Interface page.
- 2 Click Add IPv6 Address.

The Add IPv6 Address page opens.

Figure 6-35. Add IPv6 Address

Add IPv6 Address

Refresh

IPv6 Interface

IPv6 Address type Link Local Global Anycast

IPv6 Address Prefix Length EUI-64

Apply Changes

- 3 Complete the fields on the page.
- 4 Click Apply Changes.

The new address is added, and the device is updated.

Modifying IPv6 Interface Parameters

- 1 Open the IPv6 Interface page.
- 2 Select an interface in the Interface drop-down menu.
- 3 Modify the required fields.
- 4 Click Apply Changes.

The parameters are modified, and the device is updated.

Defining IPv6 Interfaces Using CLI Commands

The following table summarizes the equivalent CLI commands for setting fields displayed in the **IPv6 Interface** page.

Table 6-22. IPv6 Interface CLI Commands

CLI Command	Description
<code>ipv6 enable [no-autoconfig]</code>	Enables IPv6 processing on an interface.
<code>ipv6 address autoconfig</code>	Enables automatic configuration of IPv6 addresses using stateless auto-configuration on an interface.
<code>ipv6 icmp error-interval milliseconds [bucket-size]</code>	Configures the rate limit interval and bucket size parameters for IPv6 Internet Control Message Protocol (ICMP) error messages.
<code>show ipv6 icmp error-interval</code>	Displays the ipv6 icmp error interval.
<code>ipv6 address ipv6-address/prefix-length [eui-64] [anycast]</code>	Configures an IPv6 address for an interface.
<code>ipv6 address ipv6-address link-local</code>	Configures an IPv6 link-local address for an interface.
<code>ipv6 unreachable</code>	Enables the generation of Internet Control Message Protocol for IPv6 (ICMPv6) unreachable messages for any packets arriving on a specified interface.
<code>show ipv6 interface [ethernet interface-number vlan vlan-id port-channel number]</code>	Displays the usability status of interfaces configured for IPv6.
<code>ipv6 nd dad attempts attempts-number</code>	Configures the number of consecutive neighbor solicitation messages that are sent on an interface while duplicate address detection is performed on the unicast IPv6 addresses of the interface.
<code>ipv6 host name ipv6-address1 [ipv6-address2...ipv6-address4]</code>	Defines a static host name-to-address mapping in the host name cache.
<code>ipv6 set mtu {ethernet interface port-channel port-channel-number} {bytes default}</code>	Sets the maximum transmission unit (MTU) size of IPv6 packets sent on an interface.
<code>ping {ipv4-address hostname} [size packet_size] [count packet_count] [timeout time_out]</code>	Sends IPv4 ICMP echo request packets to another node on the network.
<code>ping ipv6 {ipv6-address hostname} [size packet_size] [count packet_count] [timeout time_out]</code>	Sends IPv6 ICMP echo request packets to another node on the network.

The following is an example of the CLI commands:

```
console# show ipv6 interface vlan 1
Number of ND DAD attempts: 1
MTU size: 1500
Stateless Address Autoconfiguration state: enabled
ICMP unreachable message state: enabled
MLD version: 2

IP addresses                Type          DAD State
-----
fe80::232:87ff:fe08:1700 linklayer     Active
ff02::1                    linklayer     N/A
ff02::1:ff08:1700         linklayer     N/A

console(config)# ipv6 icmp
    error-interval ICMP errors rate limiting
console(config)# ipv6 icmp error-interval
    <0-2147483647> The time interval between tokens being placed
                  in the bucket in milliseconds
console(config)# ipv6 icmp error-interval 100
    <1-200>       The maximum number of tokens stored in the bucket
```

Defining IPv6 Default Gateway

The **IPv6 Default Gateway** Page provides the ability to manually configure the router of all off-link traffic. The default gateway address is an interface that serves as an access point to another network. For IPv6, the configuration of the default gateway is not mandatory, as hosts can automatically learn of the existence of a router on the local network via the router advertisement procedure.

Unlike IPv4, the IPv6 default gateway can have multiple IPv6 addresses which may include up to one user-defined static address and multiple dynamic addresses learned via router solicitation message. The user-defined default gateway has a higher precedence over an automatically advertised router.

- When removing an IP interface, all of its default gateway IP addresses are removed.
- Dynamic IP addresses cannot be removed.
- An Alert message appears once a user attempts to insert more than one user-defined address.
- An Alert message appears when attempting to insert a none Link Local type address.

To open the IPv6 Default Gateway page, click System→ IP Addressing→ IPv6 Default Gateway in the tree view.

Figure 6-36. IPv6 Default Gateway

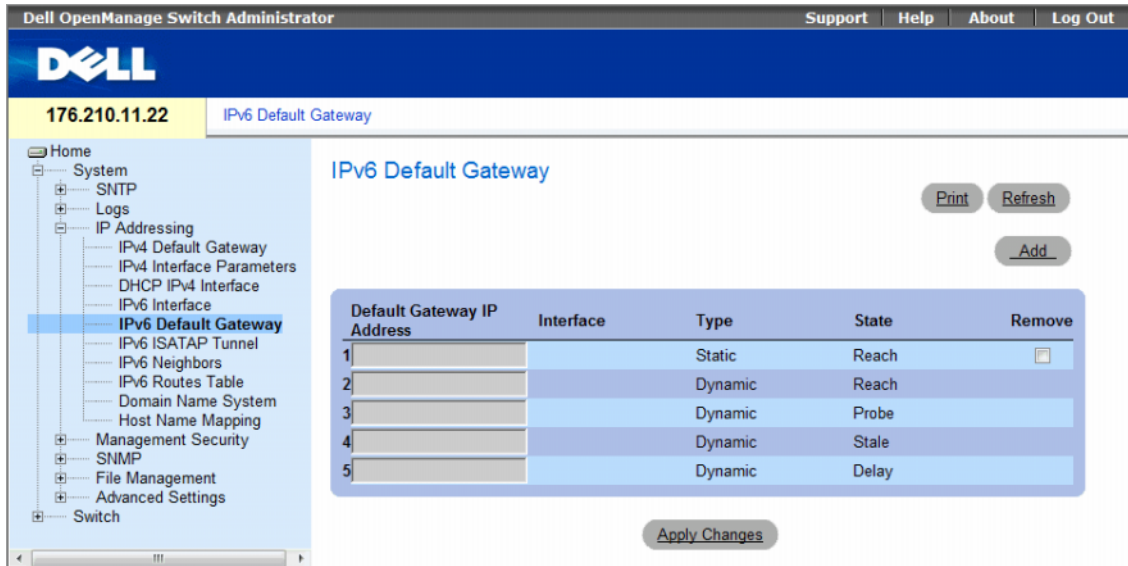

- **Default Gateway IP Address** — Displays the Link Local IPv6 address of the default gateway.
- **Interface** — Specifies the outgoing interface through which the default gateway can be reached. Interface refers to any Port/LAG/VLAN and/or Tunnel.
- **Type** — Specifies the means by which the default gateway was configured. The possible field values are:
 - **Static** — Indicates the default gateway is user-defined.
 - **Dynamic** — Indicates the default gateway is dynamically configured.

- **State** — Displays the default gateway status. The possible field values are:
 - **Incomplete** — Indicates that address resolution is in progress and the link-layer address of the default gateway has not yet been determined.
 - **Reachable** — Indicates that the default gateway is known to have been reachable recently (within tens of seconds ago).
 - **Stale** — Indicates that the default gateway is no longer known to be reachable but until traffic is sent to the default gateway, no attempt is made to verify its reachability.
 - **Delay** — Indicates that the default gateway is no longer known to be reachable, and traffic has recently been sent to the default gateway. Rather than probe the default gateway immediately, however, there is a delay sending probes for a short while in order to give upper-layer protocols a chance to provide reachability confirmation.
 - **Probe** — Indicates that the default gateway is no longer known to be reachable, and unicast Neighbor Solicitation probes are being sent to verify reachability.
 - **Unreachable** — Indicates that no reachability confirmation was received.
- **Remove** — When selected, removes the address from the list.

Adding an IPv6 Default Gateway

- 1 Open the IPv6 Default Gateway page.
- 2 Click Add.

The Add IPv6 Default Gateway page opens.

Figure 6-37. Add IPv6 Default Gateway

Add IPv6 Default Gateway Refresh

IPv6 Address type	Link Local
Link Local Interface	VLAN2
Default Gateway IP Address	<input type="text"/>

Apply Changes

- 3 Complete the fields on the page.
 - 4 Click **Apply Changes**.
- The new gateway is added, and the device is updated.

Defining IPv6 Default Gateway Parameters Using CLI Commands

The following table summarizes the equivalent CLI commands for setting fields displayed in the **IPv6 Default Gateway** page.

Table 6-23. IPv6 Default Gateway CLI Commands

CLI Command	Description
<code>ipv6 default-gateway ipv6-address</code>	Defines an IPv6 default gateway.

Defining IPv6 ISATAP Tunnels

The **IPv6 ISATAP Tunnel** Page defines the tunneling process on the device, which encapsulates IPv6 packets in IPv4 packets for delivery across an IPv4 network.

The *Intra-Site Automatic Tunnel Addressing Protocol (ISATAP)* is an IPv6 transition mechanism which is defined as a tunneling IPv6 interface and is meant to transmit IPv6 packets between dual-stack nodes on top of an IPv4 network.

When enabling ISATAP on a tunnel interface, an explicit IP address is configured as the tunnel source or an automatic mode exists where the lowest IPv4 address is assigned to an IP interface. This source IPv4 is used for setting the tunnel interface identifier according to ISATAP addressing convention. When a tunnel interface is enabled for ISATAP, the tunnel source must be set for the interface in order for the interface to become active.

An ISATAP address is represented using the [64-bit prefix]:0:5EFE:w.x.y.z, where 5EFE is the ISATAP identifier and w.x.y.z is a public or private IPv4 address. Thus, a Link Local address will be represented as FE80::5EFE:w.x.y.z

Once the last IPv4 address is removed from the interface, the ISATAP IP interface state becomes inactive and is represented as “Down”, however the Admin state remains enabled.

When defining tunneling, note the following:

- An IPv6 Link Local address is assigned to the ISATAP interface. The initial IP address is assigned to the interface, and the interface state becomes Active.
- If an ISATAP interface is active, the ISATAP router IPv4 address is resolved via DNS by using ISATAP-to-IPv4 mapping. If the ISATAP DNS record is not resolved, the ISATAP host name-to-address mapping is searched in the host name cache.
- When an ISATAP router IPv4 address is not resolved via DNS process, the status of the ISATAP IP interface remains *Active*. The system does not have a default gateway for ISATAP traffic until the DNS procedure is resolved.
- In order for an ISATAP Tunnel to work properly over an IPv4 network, an ISATAP Router is required to be set up.

To open the IPv6 ISATAP Tunnel page, click **System**→ **IP Addressing**→ **IPv6 ISATAP Tunnel** in the tree view.

Figure 6-38. IPv6 ISATAP Tunnel

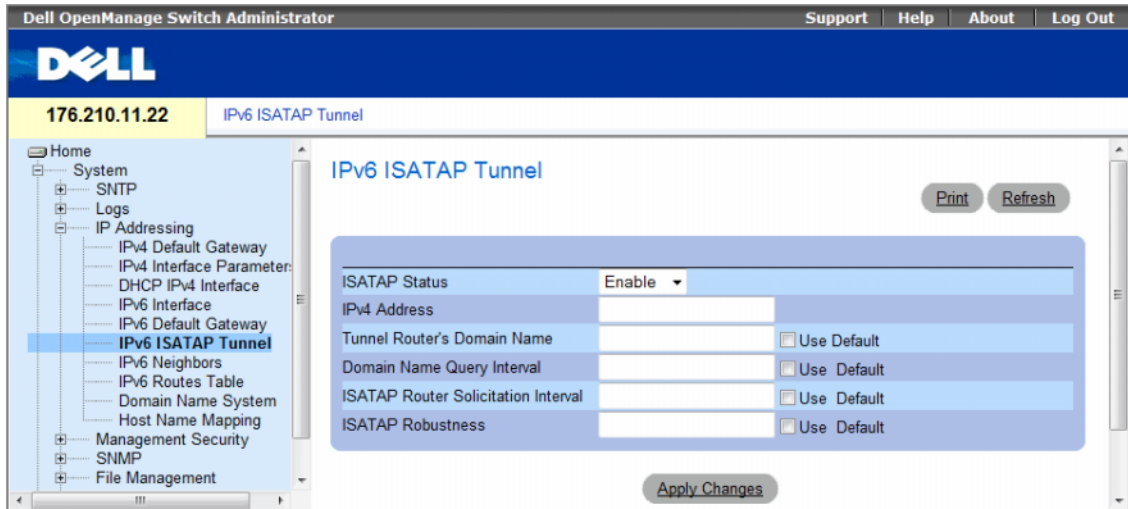

- **ISATAP Status** — Specifies the status of ISATAP on the device. The possible field values are:
 - **Enable** — ISATAP is enabled on the device.
 - **Disable** — ISATAP is disabled on the device. This is the default value.
- **IPv4 Address** — Specifies the local (source) IPv4 address of a tunnel interface.
- **Tunnel Router's Domain Name** — Specifies a global string that represents a specific automatic tunnel router domain name. The default value is ISATAP.
 - **Use Default** — Selecting the check box returns settings to default.
- **Domain Name Query Interval** — Specifies the interval between DNS Queries (before the IP address of the ISATAP router is known) for the automatic tunnel router domain name. The range is 10 - 3600 seconds. The default is 10 seconds.
 - **Use Default** — Selecting the check box returns settings to default.
- **ISATAP Router Solicitation Interval** — Specifies the interval between router solicitations messages when there is no active router. The range is 10 - 3600 seconds. The default is 10.
 - **Use Default** — Selecting the check box returns settings to default.
- **ISATAP Robustness** — Specifies the number of DNS Query/ Router Solicitation refresh messages that the device sends. The range is 1 - 20 seconds. The default is 3.
 - **Use Default** — Selecting the check box returns settings to default.

Defining IPv6 ISATAP Tunnel Parameters Using CLI Commands

The following table summarizes the equivalent CLI commands for setting fields displayed in the IPv6 ISATAP Tunnel page.

Table 6-24. IPv6 Default Gateway CLI Commands

CLI Command	Description
<code>interface tunnel <i>number</i></code>	Enters tunnel interface configuration mode.
<code>tunnel mode ipv6ip {isatap}</code>	Configures an IPv6 transition mechanism global support mode.
<code>tunnel isatap router <i>router_name</i></code>	Configures a global string that represents a specific automatic tunnel router domain name.
<code>tunnel source { auto ip-address <i>ipv4-address</i> interface }</code>	Sets the local (source) IPv4 address of a tunnel interface.
<code>tunnel isatap query-interval <i>seconds</i></code>	Configures the interval between DNS Queries (before the IP address of the ISATAP router is known) for the automatic tunnel router domain name.
<code>tunnel isatap solicitation-interval <i>seconds</i></code>	Configures the interval between ISATAP router solicitations messages (when there is no active ISATAP router).
<code>tunnel isatap robustness <i>number</i></code>	Configure the number of DNS Query / Router Solicitation refresh messages that the device sends.
<code>show ipv6 tunnel</code>	Displays information on the ISATAP tunnel.

The following is an example of the CLI commands:

```
Console> show ipv6 tunnel
Router DNS name: ISATAP
Router IPv4 address: 172.16.1.1
DNS Query interval: 10 seconds
Min DNS Query interval: 0 seconds
Router Solicitation interval: 10 seconds
Min Router Solicitation interval: 0 seconds
Robustness: 3
```

Defining IPv6 Neighbors

The **IPv6 Neighbors** Page contains information for defining IPv6 Neighbors which is similar to the functionality of the *IPv4 Address Resolution Protocol (ARP)*. IPv6 Neighbors enables detecting Link Local addresses within the same subnet, and includes a database for maintaining reachability information about the active neighbors paths.

The device supports a total of up to 256 neighbors obtained either statically or dynamically.

When removing an IPv6 interface, all neighbors learned statically and dynamically are removed.

To open the **IPv6 Neighbors** page, click **System**→**IP Addressing**→**IPv6 Neighbors** in the tree view.

Figure 6-39. IPv6 Neighbors

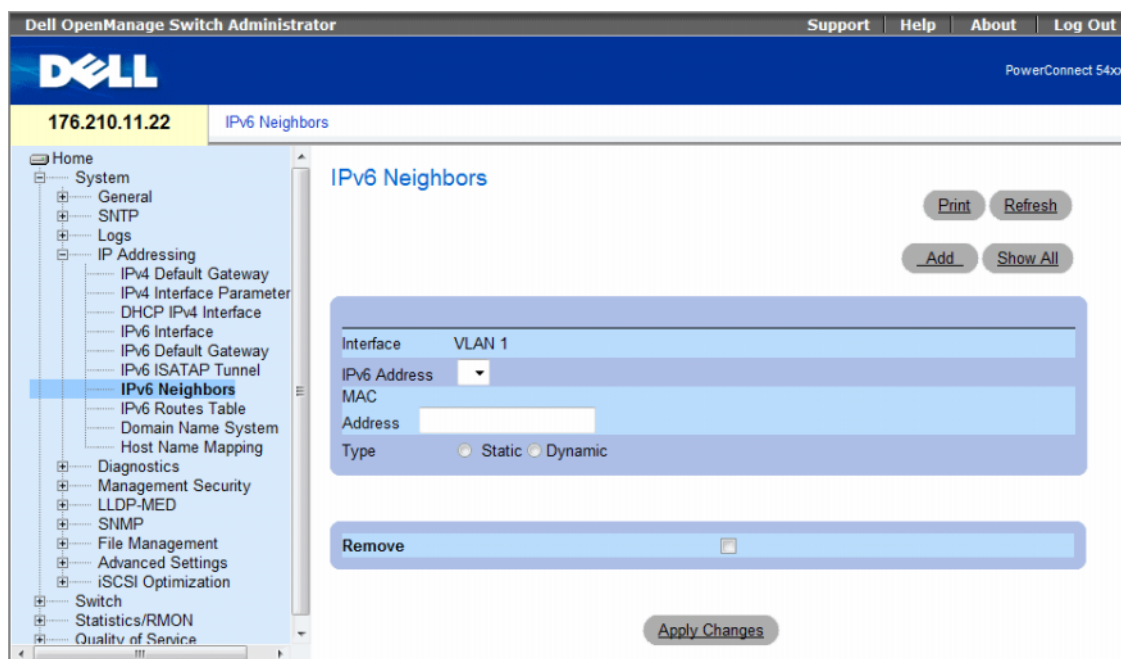

- **Interface** — Displays the interface on which IPv6 Interface is defined. Interfaces include Ports, LAGs, or VLANs.
- **IPv6 Address** — Defines the currently configured neighbor IPv6 address.
- **MAC Address** — Displays the MAC address assigned to the interface.

- **Type** — Displays the type of the neighbor discovery cache information entry. The possible field values are:
 - **Static** — Shows static neighbor discovery cache entries. If an entry for the specified IPv6 address already exists in the neighbor discovery cache—as learned through the IPv6 neighbor discovery process—you can convert the entry to a static entry.
 - **Dynamic** — Shows dynamic neighbor discovery cache entries.
- **Remove** — When selected, removes the neighbor from the list.

In the IPv6 Neighbors Table, the following additional parameter appears:

- **State** — Displays the IPv6 Neighbor status. The field possible values are:
 - **Incomplete** — Indicates that an address resolution is in progress and the link-layer address of the neighbor has not yet been determined.
 - **Reachable** — Indicates that the neighbor is known to have been reachable recently (within tens of seconds ago).
 - **Stale** — Indicates that the neighbor is no longer known to be reachable but until traffic is sent to the neighbor, no attempt is made to verify its reachability.
 - **Delay** — Indicates that the neighbor is no longer known to be reachable, and traffic has recently been sent to the neighbor. Rather than probe the neighbor immediately, however, there is a delay sending probes for a short while in order to give upper-layer protocols a chance to provide reachability confirmation.
 - **Probe** — Indicates that the neighbor is no longer known to be reachable, and unicast Neighbor Solicitation probes are being sent to verify reachability.

Adding an IPv6 Neighbor

- 1 Open the **IPv6 Neighbors** page.
- 2 Click **Add**.

The **Add IPv6 Neighbors** page opens.

Figure 6-40. Add IPv6 Neighbors

Add IPv6 Neighbors Refresh

Interface	VLAN 1
IPv6 Address	<input type="text"/>
MAC Address	<input type="text"/>

Apply Changes

- 3 Complete the fields on the page.
- 4 Click **Apply Changes**.

The new neighbor is added, and the device is updated.

Modifying Neighbor Parameters

- 1 Open the **IPv6 Neighbors** page.
- 2 Select an IP address in the **IPv6 Address** drop-down menu.
- 3 Modify the required fields.
- 4 Click **Apply Changes**.

The parameters are modified, and the device is updated.

Deleting Neighbors

- 1 Open the **IPv6 Neighbors** page.
- 2 Click **Show All**.

The **IPv6 Neighbors Table** opens.

Figure 6-41. IPv6 Neighbors Table

IPv6 Neighbors Table

Refresh

Clear Table None ▾

	Interface	IPv6 Address	MAC Address	Type	State	Remove Select All
1	VLAN 1	2031:0:130F::010:B504:D	00:10:B5:04:DB:4B	Static		<input type="checkbox"/>
2	VLAN 1	2031:0:130F::050:2200:2	00:50:22:00:2A:A4	Dynamic		<input type="checkbox"/>

Back Next

Apply Changes

- 3 Select the **Remove** check box in the desired entry. Alternatively, select the desired value in the **Clear Table** field. The possible field values are:
 - Static Only — Clears the IPv6 Neighbor Table static entries.
 - Dynamic Only — Clears the IPv6 Neighbor Table dynamic entries.
 - All Dynamic and Static — Clears the IPv6 Neighbor Table static and dynamic address entries.
 - None — Does not clear any entries.
- 4 Click **Apply Changes**.
The selected neighbors are deleted, and the device is updated.

Defining IPv6 Neighbors Using CLI Commands

The following table summarizes the equivalent CLI commands for setting fields displayed in the **IPv6 Neighbors** page.

Table 6-25. IPv6 Neighbors Parameters CLI Commands

CLI Command	Description
<code>ipv6 neighbor <i>ipv6_addr hw_addr</i> {ethernet <i>interface-number</i> vlan <i>vlan-id</i> port-channel <i>number</i> }</code>	Configures a static entry in the IPv6 neighbor discovery cache.
<code>show ipv6 neighbors {static dynamic}[<i>ipv6-address ipv6-address</i>] [<i>mac-address mac-address</i>] [ethernet <i>interface-number</i> vlan <i>vlan-id</i> port-channel <i>number</i>]</code>	Displays IPv6 neighbor discovery cache information.
<code>clear ipv6 neighbors</code>	Deletes all entries in the IPv6 neighbor discovery cache.

The following is an example of the CLI commands:

```

Console# show ipv6 neighbors dynamic
Interface  IPv6 address                HW address                State
-----  -
VLAN 1    2031:0:130F::010:B504:DBB4  00:10:B5:04:DB:4B       REACH
VLAN 1    2031:0:130F::050:2200:2AA4  00:50:22:00:2A:A4       REACH

```

Viewing the IPv6 Routes Table

The **IPv6 Routes Table** stores information about IPv6 destination prefixes and how they are reached, either directly or indirectly. The routing table is used to determine the next-hop address and the interface used for forwarding.

Each dynamic entry also has an associated invalidation timer value (extracted from Router Advertisements) used to delete entries that are no longer advertised.

To open the **IPv6 Routes Table** page, click **System**→**IP Addressing**→**IPv6 Routes Table** in the tree view.

Figure 6-42. IPv6 Routes Table

IPv6 Address	Prefix Length	Interface	Next Hop	Metric	Life-Time	Route Type
1						Local
2						Local

- **IPv6 Address** — Defines the destination IPv6 address.
- **Prefix Length** — Specifies the length of the IPv6 prefix. The Prefix field is applicable only when the IPv6 Static IP address is defined as a Global IPv6 address. The range is 5 - 128.
- **Interface** — Displays the interface that is used to forward the packet. Interface refers to any Port, LAG or VLAN.
- **Next Hop** — Defines the address to which the packet is forwarded on the route to the Destination address (typically the address of a neighboring router). This can be either a Link Local or Global IPv6 address.
- **Metric** — Indicates the value used for comparing this route to other routes with the same destination in the IPv6 route table. This is an administrative distance with the range of 0-255. The default value is 1.
- **Life-Time** — Indicates the life-time of the route.
- **Route Type** — Displays whether the destination is directly attached and the means by which the entry was learned. The following values are:
 - **Local** — Indicates a directly connected route entry.
 - **Static** — Indicates the route is learned through the ND process. The entry is automatically converted to a static entry.
 - **ICMP** — Indicates the route is learned through ICMP messages.
 - **ND** — Indicates the route is learned through RA messages.

Viewing IPv6 Routes Table Parameters Using CLI Commands

The following table summarizes the equivalent CLI commands for setting fields displayed in the IPv6 Routes Table page.

Table 6-26. IPv6 Default Gateway CLI Commands

CLI Command	Description
<code>traceroute {ipv4-address hostname} [size packet_size] [ttl max-ttl] [count packet_count] [timeout time_out] [source ip-address] [tos tos]</code>	Discovers the routes that IPv4 packets will actually take when traveling to their destination.
<code>traceroute ipv6 {ipv6-address hostname} [size packet_size] [ttl max-ttl] [count packet_count] [timeout time_out] [source ip-address] [tos tos]</code>	Discovers the routes that IPv6 packets will actually take when traveling to their destination.
<code>show ipv6 route</code>	Displays the current state of the ipv6 routing table.

The following is an example of the CLI commands:

```
Console> show ipv6 route
Codes: L - Local, S - Static, I - ICMP, ND - Router Advertisement
The number in the brackets is the metric.
S  ::/0 via fe80::77 [0] VLAN 1 Lifetime Infinite
ND ::/0 via fe80::200:cff:fe4a:dfa8 [0] VLAN 1 Lifetime 1784 sec
L  2001::/64 is directly connected, g2 Lifetime Infinite
L  2002:1:1:1::/64 is directly connected, VLAN 1 Lifetime 2147467 sec
L  3001::/64 is directly connected, VLAN 1 Lifetime Infinite
L  4004::/64 is directly connected, VLAN 1 Lifetime Infinite
L  6001::/64 is directly connected, g2 Lifetime Infinite
```

Configuring Domain Name Systems

Domain Name System (DNS) converts user-defined domain names into IP addresses. Each time a domain name is assigned the DNS service translates the name into a numeric IP address. For example, `www.ipexample.com` is translated into `192.87.56.2`. DNS servers maintain domain name databases and their corresponding IP addresses.

The **Domain Naming System (DNS)** page contains fields for enabling and activating specific DNS servers.

To open the Domain Naming System (DNS) page, click **System** → **IP Addressing** → **Domain Naming System (DNS)** in the tree view.

Figure 6-43. Domain Naming System (DNS)

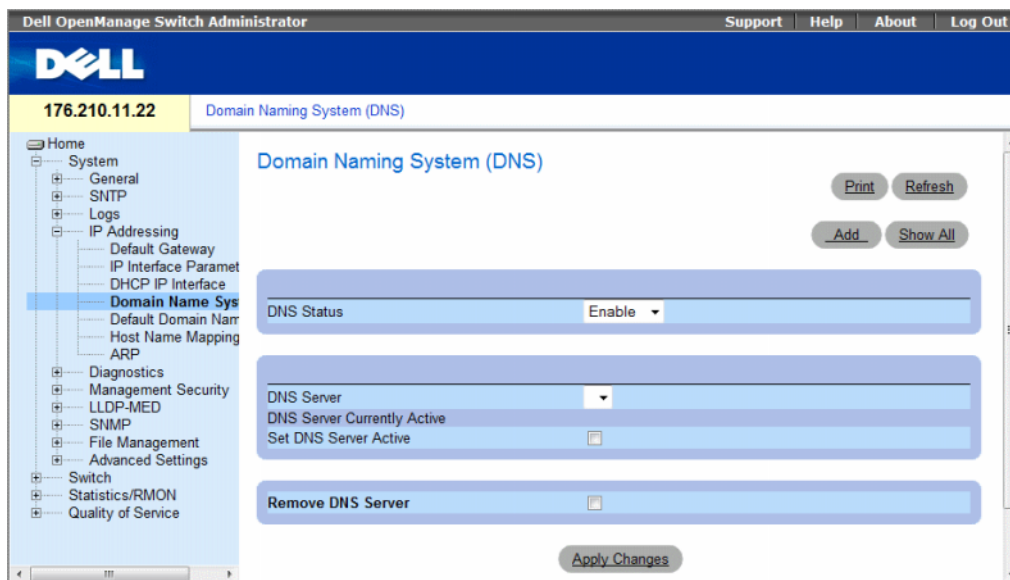

The **Domain Naming System (DNS)** page contains the following fields:

- **DNS Status** — Enables or disables translating DNS names into IP addresses.
- **DNS Server** — Contains a list of DNS servers. DNS servers are added from the **Add DNS Server** page.
- **DNS Server Currently Active** — The DNS server that is currently active.
- **Set DNS Server Active** — Activates the selected DNS server.
- **Remove DNS Server** — Removes the selected DNS server.
 - **Checked** — Removes the selected DNS server.
 - **Unchecked** — Maintains the selected DNS server.

When defining a new DNS server, the following additional parameters are available:

- **Supported IP Format** — Specifies the IP format supported by the server. The possible values are:
 - **IPv6** — IP version 6 is supported.
 - **IPv4** — IP version 4 is supported.
- **IPv6 Address Type** — When the server supports IPv6 (see previous parameter), this specifies the type of static address supported. The possible values are:
 - **Link Local** — A Link Local address that is non-routable and used for communication on the same network only.
 - **Global** — A globally unique IPv6 address; visible and reachable from different subnets.
- **Link Local Interface** — When the server supports an IPv6 Link Local address (see previous parameter), this specifies the the Link Local interface. The possible values are:
 - **VLAN1** — The IPv6 interface is configured on VLAN1.
 - **ISATAP** — The IPv6 interface is configured on ISATAP tunnel.

Adding a DNS Server

- 1 Open the **Domain Naming System (DNS)** page.
- 2 Click **Add**.

The **Add DNS Server** page opens.

Figure 6-44. Add DNS Server

The screenshot shows the 'Add DNS Server' configuration page. It features a title 'Add DNS Server' and a 'Refresh' button in the top right corner. The main configuration area is a blue-bordered box with the following fields:

- Supported IP Format:** Radio buttons for 'IPv6' and 'IPv4'. 'IPv4' is selected.
- IPv6 Address Type:** Radio buttons for 'Link Local' and 'Global'.
- Link Local Interface:** Radio buttons for 'VLAN1' and 'ISATAP'.
- DNS Server:** A text input field containing '(X.X.X.X)'.
- DNS Server Currently Active:** A checked checkbox.
- Set DNS Server Active:** An unchecked checkbox.

Below the configuration box is an 'Apply Changes' button.

In addition to the fields in the **Domain Naming System (DNS)** page, the **Add DNS Server** page contains the following field:

- **DNS Server** — DNS Server IP address.
- 3 Define the relevant fields.
 - 4 Click **Apply Changes**.

The new DNS server is defined, and the device is updated.

Displaying the DNS Servers Table

- 1 Open the Domain Naming System (DNS) page.
- 2 Click Show All.

The DNS Server Table opens.

Figure 6-45. DNS Server Table

DNS Servers Table

Refresh

	DNS Server	Active Server	Remove
1		<input type="radio"/>	<input type="checkbox"/>
2		<input type="radio"/>	<input type="checkbox"/>

Apply Changes

Removing DNS Servers

- 1 Open the Domain Naming System (DNS) page.
- 2 Click Show All.
The DNS Server Table page opens.
- 3 Select a DNS Server Table entry.
- 4 Select the Remove checkbox.
- 5 Click Apply Changes.

The selected DNS server is deleted, and the device is updated.

Configuring DNS Servers Using the CLI Commands

The following table summarizes the CLI commands for configuring device system information.

Table 6-27. DNS Server CLI Commands

CLI Command	Description
<code>ip name-server <i>server-address</i></code>	Sets the available name servers. Up to eight name servers can be set.
<code>no ip name-server <i>server-address</i></code>	Removes a name server.
<code>ip domain-name <i>name</i></code>	Defines a default domain name that the software uses to complete unqualified host names.
<code>clear host {<i>name</i> *}</code>	Deletes entries from the host name-to-address cache.
<code>show hosts [<i>name</i>]</code>	Displays the default domain name, list of name server hosts, the static and the cached list of host names and addresses.
<code>ip domain-lookup</code>	Enables DNS system for translating host names to IP addresses.

The following is an example of the CLI commands:

```
console(config)# ip name-server 176.16.1.18
```

Defining Default Domains

The Default Domain Name page provides information for defining default DNS domain names.

To open the Default Domain Name page, click **System** → **IP Addressing** → **Default Domain Name**.

Figure 6-46. Default Domain Name

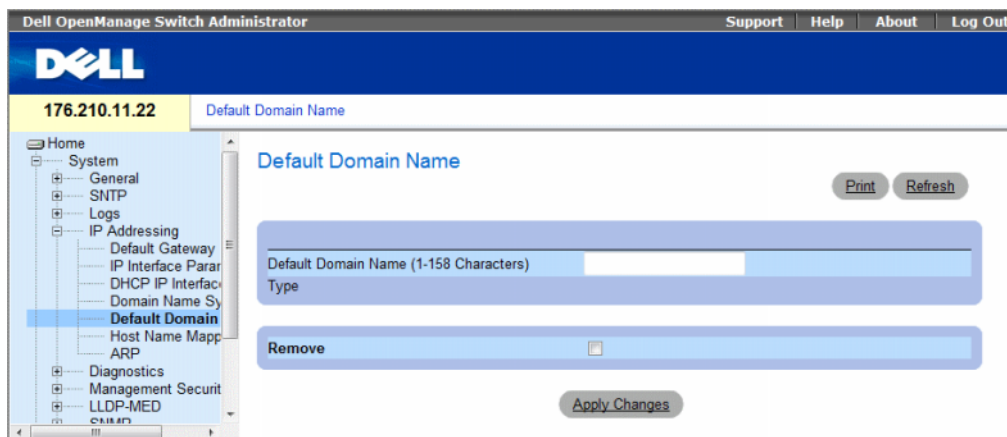

The **Default Domain Name** page contains the following fields:

- **Default Domain Name (1-158 characters)** — Contains a user-defined default domain name. When defined, the default domain name is applied to all unqualified host names.
- **Type** — The IP address type. The possible field values are:
 - **Dynamic** — The IP address is created dynamically.
 - **Static** — The IP address is a static IP address.
 - **Remove** — Removes the default domain name.
 - **Checked** — Removes the selected domain name.
 - **Unchecked** — Maintains the selected domain name.

Defining DNS Domain Names Using the CLI Commands

The following table summarizes the CLI commands for configuring DNS domain names:

Table 6-28. DNS Domain Name CLI Commands

CLI Command	Description
<code>ip domain-name <i>name</i></code>	Defines a default domain name that the software uses to complete unqualified host names.
<code>no ip domain-name</code>	Disable the use of the Domain Name System (DNS).
<code>show hosts [<i>name</i>]</code>	Displays the default domain name, list of name server hosts, the static and the cached list of host names and addresses.

The following is an example of the CLI commands:

```
console(config)# ip domain-name dell.com
```

Mapping Domain Host

The **Host Name Mapping** page provides parameters for assigning IP addresses to static host names. On this page, one IP address per host can be assigned.

To open the **Host Name Mapping** page, click **System** → **IP Addressing** → **Host Name Mapping** in the tree view.

Figure 6-47. Host Name Mapping

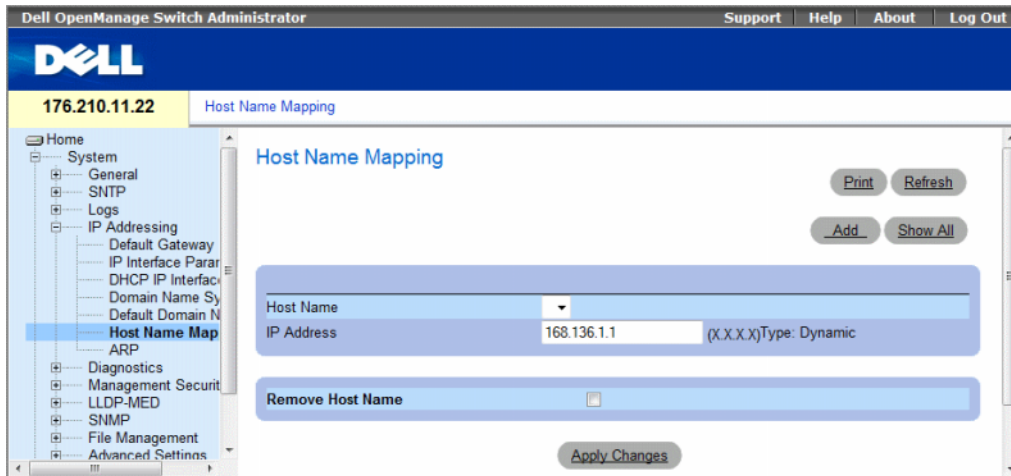

The **Host Name Mapping** page contains the following fields:

- **Host Name** — Contains a Host Name list. Host Names are defined in the **Add Host Name Mapping** page. Each host provides one IP address.
- **IP Address (X.X.X.X)** — Provides an IP address that is assigned to the specified host name.
- **Type** — The IP address type. The possible field values are:
 - **Dynamic** — The IP address is created dynamically.
 - **Static** — The IP address is a static IP address.
- **Remove Host Name** — Removes the DNS Host Mapping.
 - **Checked** — Removes the DNS host mapping
 - **Unchecked** — Maintains the DNS host mapping.

When defining a new host name mapping, the following additional parameters are available:

- **Supported IP Format** — Specifies the IP format supported by the host. The possible values are:
 - **IPv6** — IP version 6 is supported.
 - **IPv4** — IP version 4 is supported.
- **IPv6 Address Type** — When the host supports IPv6 (see previous parameter), this specifies the type of static address supported. The possible values are:
 - **Link Local** — A Link Local address that is non-routable and used for communication on the same network only.
 - **Global** — A globally unique IPv6 address; visible and reachable from different subnets.
- **Link Local Interface** — When the server supports an IPv6 Link Local address (see previous parameter), this specifies the the Link Local interface. The possible values are:
 - **VLAN1** — The IPv6 interface is configured on VLAN1.
 - **ISATAP** — The IPv6 interface is configured on ISATAP tunnel.

Adding Host Domain Names

- 1 Open the **Host Name Mapping** page.
- 2 Click **Add**.

The Add Host Name Mapping page opens.

Figure 6-48. Add Host Name Mapping

The screenshot shows a configuration form titled "Add Host Name Mapping" with a "Refresh" button in the top right corner. The form contains the following fields and options:

- Supported IP Format:** Radio buttons for IPv6 and IPv4. IPv4 is selected.
- IPv6 Address Type:** Radio buttons for Link Local and Global. Link Local is selected.
- Link Local Interface:** Radio buttons for VLAN1 and ISATAP. VLAN1 is selected.
- Host Name (1-158 Characters):** An empty text input field.
- IP Address:** An empty text input field with a "(X.X.X.X)" placeholder.

At the bottom of the form is an "Apply Changes" button.

- 3 Define the relevant fields.
- 4 Click **Apply Changes**.

The IP address is mapped to the Host Name, and the device is updated.

Displaying the Hosts Name Mapping Table

- 1 Open the Host Name Mapping page.
- 2 Click Show All.

The Hosts Name Mapping Table page opens.

Figure 6-49. Hosts Name Mapping Table

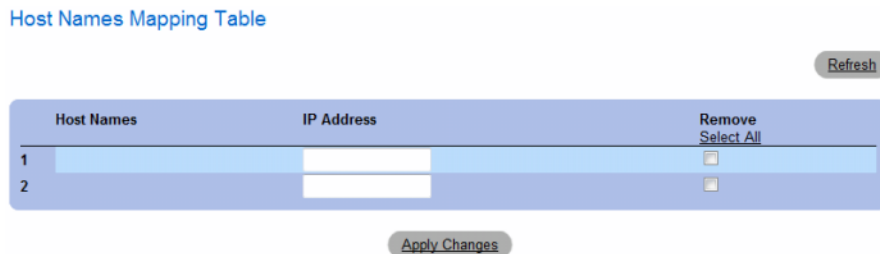

Removing Host Name from IP Address Mapping

- 1 Open the Host Name Mapping page.
- 2 Click Show All.
- 3 The Host Mapping Table page opens.
- 4 Select a Host Name Mapping Table entry.
- 5 Check the Remove checkbox.
- 6 Click Apply Changes.

The Host Mapping Table entry is deleted, and the device is updated.

Mapping IP addresses to Domain Host Names Using the CLI Commands

The following table summarizes the equivalent CLI commands for mapping Domain Host names to IP addresses.

Table 6-29. Domain Host Name CLI Commands

CLI Command	Description
<code>ip host name address</code>	Defines the static host name-to-address mapping in the host cache
<code>no ip host name</code>	Removes the name-to-address mapping.
<code>clear host {name *}</code>	Deletes entries from the host name-to-address cache.
<code>show hosts [name]</code>	Displays the default domain name, list of name server hosts, the static and the cached list of host names and addresses.

The following is an example of the CLI commands:

```
console(config)# ip host accounting.abc.com 176.10.23.1
```

Defining ARP Settings

The Address Resolution Protocol (ARP) converts IP addresses into physical addresses, and maps the IP address to a MAC address. ARP allows a host to communicate with other hosts only when the IP address of its neighbors is known.

To open the ARP Settings page, click System → IP Addressing → ARP in the tree view.

Figure 6-50. ARP Settings

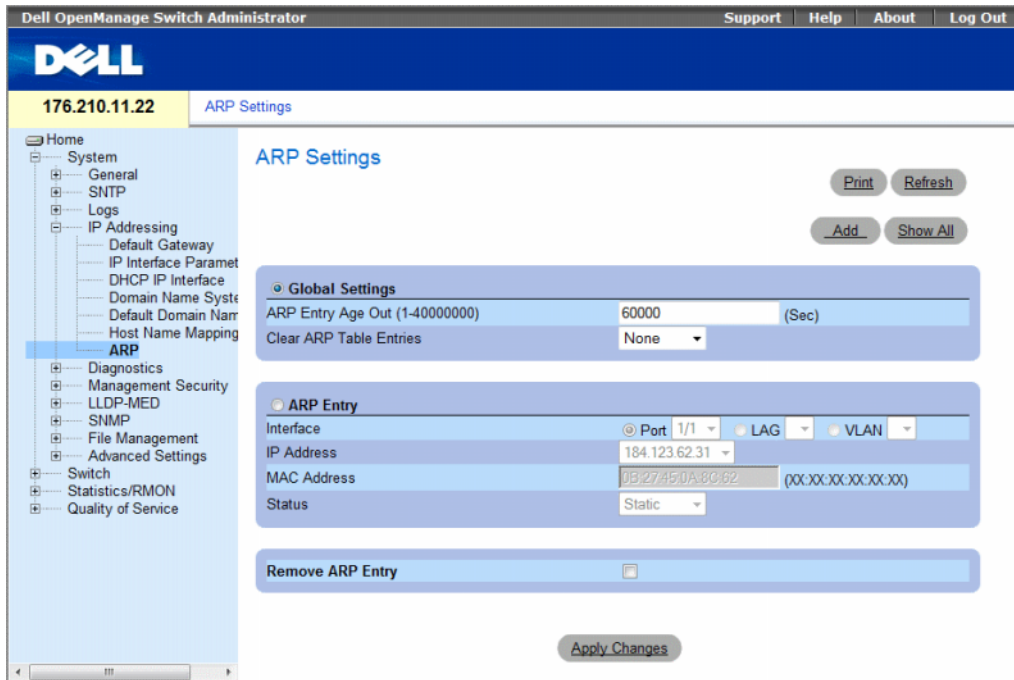

The **ARP Settings** page contains the following fields:

- **Global Settings** — Select this option to activate the fields for ARP global settings.
 - **ARP Entry Age Out (1-40000000)** — For all devices, the amount of time (seconds) that passes between ARP requests about an ARP table entry. After this period, the entry is deleted from the table. The range is 1 - 40000000 seconds. The default value is 60000 seconds.
 - **Clear ARP Table Entries** — The type of ARP entries that are cleared on all devices. The possible values are:
 - **None** — ARP entries are not cleared.
 - **All** — All ARP entries are cleared.
 - **Dynamic** — Only dynamic ARP entries are cleared.
 - **Static** — Only static ARP entries are cleared.
- **ARP Entry** — Select this option to activate the fields for ARP settings on a single Ethernet devices.
 - **Interface** — The interface number of the port, LAG, or VLAN that is connected to the device.
 - **IP Address** — The station IP address, which is associated with the MAC address filled in below.
 - **MAC Address** — The station MAC address, which is associated in the ARP table with the IP address.
 - **Status** — The ARP Table entry status. Possible field values are:
 - **Dynamic** — The ARP entry is learned dynamically.
 - **Static** — The ARP entry is a static entry.
- **Remove ARP Entry** — Removes an ARP entry.
 - **Checked** — Removes the ARP entry.
 - **Unchecked** — Maintains the ARP entry.

Adding a Static ARP Table Entry:

1 Open the **ARP Settings** page.

2 Click **Add**.

The **Add ARP Entry** page opens.

3 Select an interface.

4 Define the fields.

5 Click **Apply Changes**.

The **ARP Table** entry is added, and the device is updated.

Displaying the ARP Table

1 Open the **ARP Settings** page.

2 Click **Show All**.

The **ARP Table** page opens.

Deleting ARP Table Entry

- 1 Open the ARP Settings page
- 2 Click Show All.
The ARP Table page opens.
- 3 Select a table entry.
- 4 Select the Remove check box.
- 5 Click Apply Changes.

The selected ARP Table entry is deleted, and the device is updated.

Configuring ARP Using the CLI Commands

The following table summarizes the equivalent CLI commands for setting fields displayed in the ARP Settings page.

Table 6-30. ARP Settings CLI Commands

CLI Command	Description
<code>arp ip_addr hw_addr {ethernet interface-number vlan-id port-channel number}</code>	Adds a permanent entry in the ARP cache.
<code>arp timeout seconds</code>	Configures how long an entry remains in the ARP cache.
<code>clear arp-cache</code>	Deletes all dynamic entries from the ARP cache
<code>show arp</code>	Displays entries in the ARP Table.
<code>no arp</code>	Removes an ARP entry from the ARP Table.

The following is an example of the CLI commands:

```
console(config)# arp 198.133.219.232 00-00-0c-40-0f-bc
console(config)# arp timeout 12000
console(config)# exit
console# show arp
ARP timeout: 12000 Seconds
Interface      IP address      HW address      Status
-----
1/e11          10.7.1.102      00:10:B5:04:DB:4B  Dynamic
1/e12          10.7.1.135      00:50:22:00:2A:A4  Static
```

Running Cable Diagnostics

The **Diagnostics** page contains links to pages for performing virtual cable tests on copper and fiber optic cables. To open the **Diagnostics** page, click **System**→ **Diagnostics** in the tree view.

This section contains the following topics:

- "Viewing Copper Cable Diagnostics" on page 165
- "Viewing Optical Transceiver Diagnostics" on page 167

Viewing Copper Cable Diagnostics

The **Integrated Cable Test for Copper Cables** page contains fields for performing tests on copper cables. Cable testing provides information about where errors occurred in the cable, the last time a cable test was performed, and the type of cable error which occurred. The tests use Time Domain Reflectometry (TDR) technology to test the quality and characteristics of a copper cable attached to a port. Cables up to 120 meters long can be tested. Cables are tested when the ports are in the down state, with the exception of the Approximated Cable Length test.

To open the **Integrated Cable Test for Copper Cables** page, click **System** → **Diagnostics** → **Integrated Cable Test** in the tree view.

Figure 6-51. Integrated Cable Test for Copper Cables

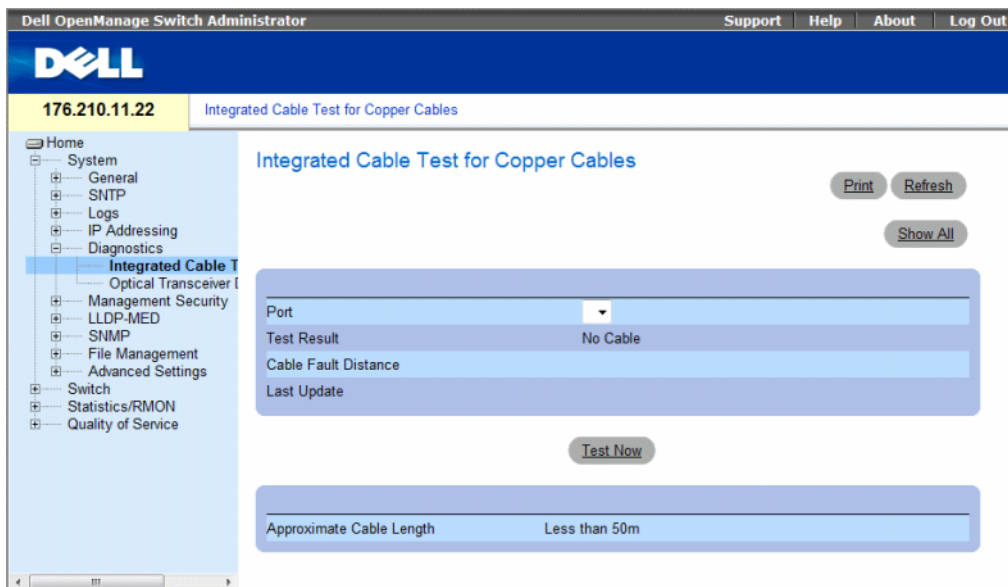

The **Integrated Cable Test for Copper Cables** page contains the following fields:

- **Port** — The port to which the cable is connected.
- **Test Result** — The cable test results. The possible field values are:
 - **No Cable** — There is no cable connected to the port.
 - **Open Cable** — The cable is connected on only one side.
 - **Short Cable** — A short has occurred in the cable.
 - **OK** — The cable passed the test.
- **Cable Fault Distance** — The distance from the port where the cable error occurred.
- **Last Update** — The last time the port was tested.
- **Approximate Cable Length** — The approximate cable length. This test can only be performed when the port is up and operating at 1 Gbps.

Performing a Cable Test

- 1 Ensure that both ends of the copper cable are connected to a device.
- 2 Open the **Integrated Cable Test for Copper Cables** page.
- 3 Select an interface to test.
- 4 Click **Test Now**.

The copper cable test is performed, and the results are displayed on the **Integrated Cable Test for Copper Cables** page.

Displaying Virtual Cable Test Results Table

This screen displays the results of tests that have been previously run, but does not actually perform the test on all ports now. The cable length returned by the Integrated Cable Test (VCT) is an approximation in the ranges of up to 50 meters, 50m-80m, 80m-110m, 110m-120m, or more than 120m. The deviation may be up to 20 meters, and cable length measurement does not operate for 10 Mbps links.

- 1 Open the **Integrated Cable Test for Copper Cables** page.
- 2 Click **Show All**.

The **Integrated Cable Test Results Table** page opens.

Figure 6-52. Integrated Cable Test Results Table

Port	Test Result	Cable Fault Distance	Last Update	Cable Length
------	-------------	----------------------	-------------	--------------

In addition to the fields in the **Integrated Cable Test for Copper Cables** page, the **Integrated Cable Test Results Table** contains the following field:

- **Unit No.** — The stacking member unit for which the cable is displayed.

Performing Copper Cable Tests Using CLI Commands

The following table contains the CLI commands for performing copper cable tests.

Table 6-31. Copper Cable Test CLI Commands

CLI Command	Description
<code>test copper-port tdr interface</code>	Performs VCT tests.
<code>show copper-port tdr interface</code>	Shows results of last VCT tests on ports.
<code>show copper-port cable-length interface</code>	Displays the estimated copper cable length attached to a port.

The following is an example of the CLI commands:

```
console> enable
Console# test copper-port tdr 1/e3
Cable is open at 100 meters.

Console# show copper-port cable-length
Port          Length (meters)
----          -
1/e3          110-140
1/e4          Fiber
```

Viewing Optical Transceiver Diagnostics

Use the **Optical Transceiver Diagnostics** page to perform tests on Fiber Optic cables. Optical transceiver diagnostics can be performed only when the link is present. Finisar transceivers do not support transmitter fault diagnostic testing. Fiber Optic analysis feature works only on SFPs that support the digital diagnostic standard SFF-872.

To open the **Optical Transceiver Diagnostics** page, click **System** → **Diagnostics** → **Optical Transceiver Diagnostics** in the tree view.

Figure 6-53. Optical Transceiver Diagnostics

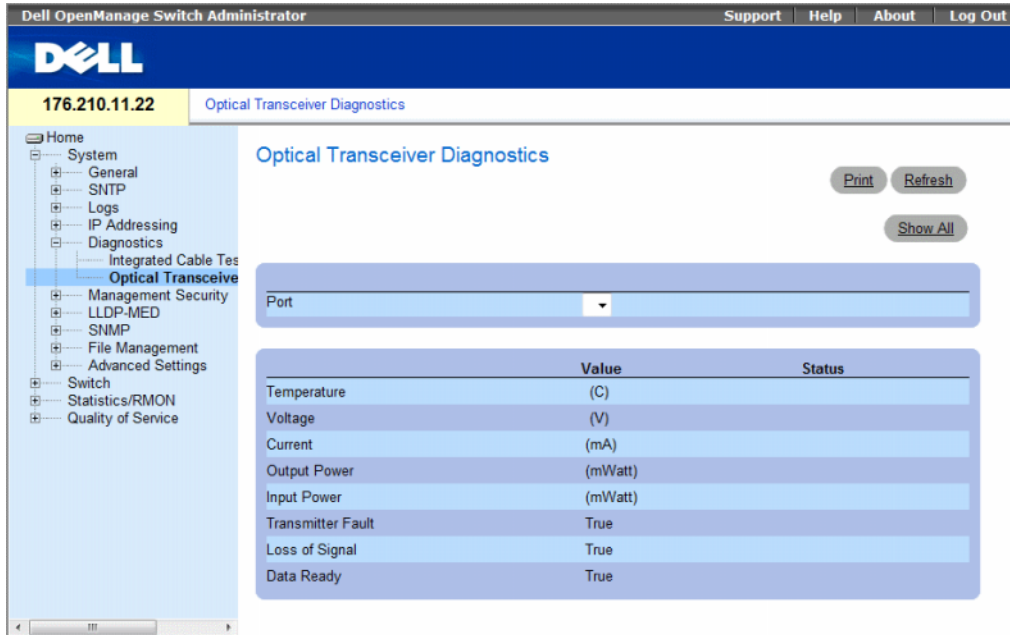

The Optical Transceiver Diagnostics page contains the following fields:

- **Port** — The port number on which the cable is tested.
- **Temperature** — The temperature (C) at which the cable is operating.
- **Voltage** — The voltage at which the cable is operating.
- **Current** — The current at which the cable is operating.
- **Output Power** — The rate at which the output power is transmitted.
- **Input Power** — The rate at which the input power is transmitted.
- **Transmitter Fault** — Indicates if a fault occurred during transmission.
- **Loss of Signal** — Indicates if a signal loss occurred in the cable.
- **Data Ready** — The transceiver has achieved power up and data is ready.

Displaying the Optical Transceiver Diagnostics Test Results Table

- 1 Open the Optical Transceiver Diagnostics page.
- 2 Click Show All.

The test runs and the Optical Transceiver Diagnostics Table page opens.

Figure 6-54. Optical Transceiver Diagnostics Table

Optical Transceiver Diagnostics Table Refresh

Unit No. 1 ▾

Port	Temperature	Voltage	Current	Output Power	Input Power	Transmitter Fault	Loss of Signal	Data Ready
1						True	True	True

In addition to the fields in the **Optical Transceiver Diagnostics** page, the **Optical Transceiver Diagnostics Table** contains the following field:

- **Unit No.** — The unit number for which the cable is displayed.
- **N/A** — Not Available, **N/S** - Not Supported, **W** - Warning, **E** - Error

Performing Fiber Optic Cable Tests Using CLI Commands

The following table contains the CLI command for performing fiber optic cable tests.

Table 6-32. Fiber Optic Cable Test CLI Commands

CLI Command	Description
<code>show fiber-ports optical-transceiver [interface] [detailed]</code>	Displays the optical transceiver diagnostics.

The following is an example of the CLI command:

```

Console# show fiber-ports optical-transceiver detailed

```

Port	Temp [C]	Voltage	Current [Volt]	Output [mA]	Input [mWatt]	POWER TX [mWatt]	LOS Fault
-----	-----	-----	-----	-----	-----	-----	-----
1/g1	48	5.15	50	1.789	1.789	No	No
1/g2	43	5.15	10	1.789	1.789	No	No

Managing Management Security

The **Management Security** page provides access to security pages that contain fields for setting security parameters for device management methods, user authentication databases and servers. To open the **Management Security** page, click **System**→**Management Security** in the tree view.

This section contains the following topics:

- "Defining Access Profiles" on page 170
- "Defining Authentication Profiles" on page 177
- "Selecting Authentication Profiles" on page 181
- "Managing Passwords" on page 184
- "Displaying Active Users" on page 187
- "Defining the Local User Databases" on page 189
- "Defining Line Passwords" on page 192
- "Defining Enable Passwords" on page 194
- "Defining TACACS+ Settings" on page 196
- "Configuring RADIUS Settings" on page 200

Defining Access Profiles

The **Access Profiles** page contains fields for defining profiles and rules for accessing the device. Access to management functions can be limited to user groups, which are defined by ingress interfaces and source IP address or source IP subnets.

Management access can be separately defined for each type of management access method, including Web (HTTP), Secure Web (HTTPS), Telnet, and Secure Telnet.

Access to different management methods may differ between user groups. For example, User Group 1 can access the device only via an HTTPS session, while User Group 2 can access the device via both HTTPS and Telnet sessions.

Management Access Lists contain up to 256 rules that determine which users can manage the device, and by which methods. Users can also be blocked from accessing the device.

The **Access Profiles** page contains fields for configuring Management Lists and applying them to specific interfaces.

To open the **Access Profiles** page, click **System** → **Management Security** → **Access Profiles** in the tree view.

Figure 6-55. Access Profiles

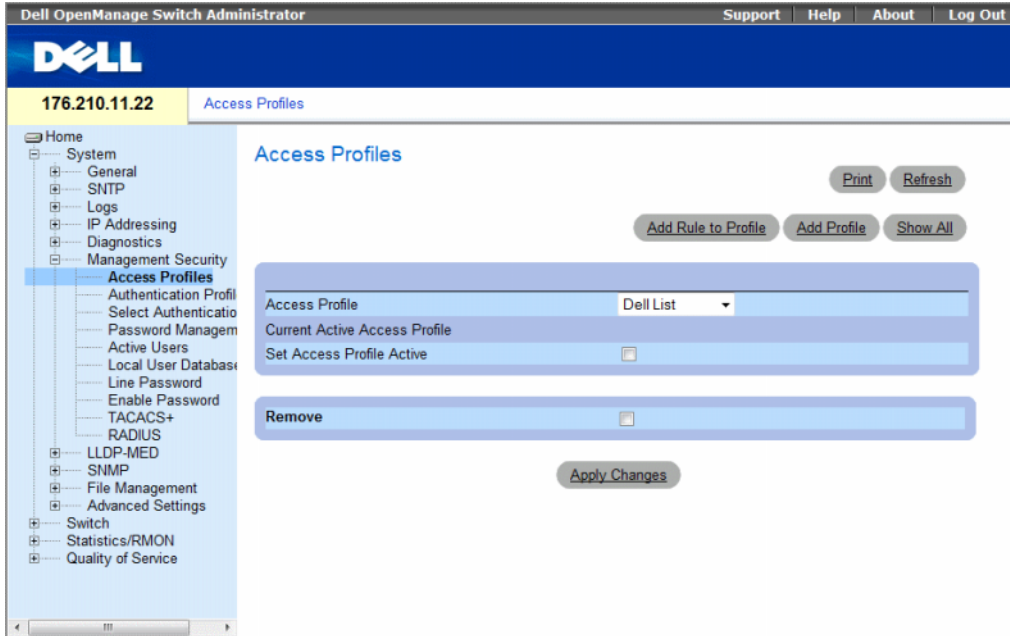

The **Access Profiles** page contains following fields:

- **Access Profile** — User-defined Access Profile lists. The Access Profile list contains a default value of **Console Only**. When this access profile is selected, active management of the device is performed using the console connection only.
- **Current Active Access Profile** — The access profile that is currently active.
- **Set Access Profile Active** — Activates an access profile.
- **Remove** — Removes an access profile from the **Access Profile Name** list.
 - **Checked** — Removes the access profile.
 - **Unchecked** — Maintains the access profile.

Activating a Profile

- 1 Open the **Access Profiles** page.
- 2 Select an Access Profile in the **Access Profile** field.
- 3 Select the **Set Access Profile Active** check box.
- 4 Click **Apply Changes**.

The Access Profile is activated.

Adding an Access Profile

Rules act as filters for determining rule priority, the device management method, interface type, source IP address and network mask, and the device management access action. Users can be blocked or permitted management access. Rule priority sets the order in which the rules are implemented. Assigning an access profile to an interface denies access via other interfaces. If an access profile is not assigned to any interface, the device can be accessed by all interfaces.

Defining Rules for an Access Profile:

- 1 Open the Access Profiles page.
- 2 Click Add Profile.

The Add an Access Profile page opens.

Figure 6-56. Add an Access Profile

Add an Access Profile Refresh

Access Profile Name (1-32 characters)

Priority (1-65535)

Management Method

Interface Port LAG VLAN ISATAP

Enable Source IP Address

Supported IP Format IPv6 IPv4

IPv6 Address Type Link Local Global

Source IP Address (X.X.X.X) Network Mask (X.X.X.X) Prefix Length (XX)

Action

Apply Changes

The Add an Access Profile page contains the following additional fields:

- **Access Profile Name (1-32 Characters)** — User-defined name for the access profile. The Access Profile name can contain up to 32 characters.
- **Rule Priority (1-65535)** — The rule priority. When the packet is matched to a rule, user groups are either granted access or denied access to device management. The rule order is set by defining a rule priority using this field. The rule number is essential to matching packets to rules, as packets are matched on a first-fit basis. The rule priorities can be viewed in the **Profile Rules Table**.

- **Management Method** — The management method for which the access profile is defined. Users with this access profile are denied or permitted access to the device from the selected management method (line). The possible field values are:
 - **All** — Assigns all management methods to the rule.
 - **Telnet** — Assigns Telnet access to the rule. If selected, users accessing the device using Telnet meeting access profile criteria are permitted or denied access to the device.
 - **Secure Telnet (SSH)** — Assigns SSH access to the rule. If selected, users accessing the device using Telnet meeting access profile criteria are permitted or denied access to the device.
 - **HTTP** — Assigns HTTP access to the rule. If selected, users accessing the device using HTTP meeting access profile criteria are permitted or denied access to the device.
 - **Secure HTTP (HTTPS)** — Assigns HTTPS access to the rule. If selected, users accessing the device using HTTPS meeting access profile criteria are permitted or denied access to the device.
 - **SNMP** — Assigns SNMP access to the rule. If selected, users accessing the device using SNMP meeting access profile criteria are permitted or denied access to the device.
- **Interface** — The interface type to which the rule applies. This is an optional field. This rule can be applied to a selected port, LAG, or VLAN by selecting the check box, then selecting the appropriate option button and interface.
- **Enable Source IP Address** — Check this parameter to restrict conditions based on the source IP address. When unchecked, the source IP address cannot be entered into a configured rule.
- **Supported IP Format** — Specifies the IP format. The possible values are:
 - **IPv6** — IP version 6 is supported.
 - **IPv4** — IP version 4 is supported.
- **IPv6 Address Type** — For IPv6 (see previous parameter), this specifies the type of static address supported. The possible values are:
 - **Link Local** — A Link Local address that is non-routable and used for communication on the same network only.
 - **Global** — A globally unique IPv6 address; visible and reachable from different subnets.
- **Source IP Address (X.X.X.X)** — The interface source IP address for which the rule applies. This is an optional field and indicates that the rule is valid for a subnetwork.
- **Network Mask (X.X.X.X)** — The IP subnetwork mask.
- **Prefix Length (/XX)** — The number of bits that comprise the source IP address prefix, or the network mask of the source IP address.
- **Action** — Defines whether to permit or deny management access to the defined interface.
 - **Permit** — Permits access to the device.
 - **Deny** — Denies access to the device. This is the default.

- 3 Define the Access Profile Name field.
- 4 Define the relevant fields.
- 5 Click **Apply Changes**.

The new Access Profile is added, and the device is updated.

Adding Rules to Access Profile

The first rule must be defined to beginning matching traffic to access profiles.

- 1 Open the Access Profile page.
- 2 Click **Add Rule to Profile**.

The Add an Access Profile Rule page opens.

Figure 6-57. Add an Access Profile Rule

- 3 Complete the fields.
- 4 Click **Apply Changes**.

The rule is added to the access profile, and the device is updated.

Viewing the Profile Rules Table

The order in which rules appear in the **Profile Rules Table** is important. Packets are matched to the first rule which meets the rule criteria.

- 1 Open the **Access Profiles** page.
- 2 Click **Show All**.

The **Profile Rules Table** page opens.

Figure 6-58. Profile Rules Table

The screenshot displays the 'Profile Rules Table' interface. At the top left, the title 'Profile Rules Table' is shown in blue. To the right is a 'Refresh' button. Below the title is a search bar labeled 'Access Profile Name'. Underneath is a table with the following columns: Priority, Interface, Management Method, Source IP Address, Prefix Length, Action, and Remove. The first row of the table contains the values: 1, (empty), All (with a dropdown arrow), (empty), (empty), Permit (with a dropdown arrow), and a checkbox. Below the table is an 'Apply Changes' button.

Priority	Interface	Management Method	Source IP Address	Prefix Length	Action	Remove
1		All			Permit	<input type="checkbox"/>

Removing a Rule

- 1 Open the **Access Profiles** page.
- 2 Click **Show All**.

The **Profile Rules Table** page opens.

- 3 Select a rule.
- 4 Select the **Remove** check box.
- 5 Click **Apply Changes**.

The selected rule is deleted, and the device is updated.

Defining Access Profiles Using CLI Commands

The following table summarizes the equivalent CLI commands for setting fields displayed in the Access Profiles page.

Table 6-33. Access Profiles CLI Commands

CLI Command	Description
<code>management access-list <i>name</i></code>	Defines an access-list for management, and enters the access-list context for configuration.
<code>permit [ethernet <i>interface-number</i> vlan <i>vlan-id</i> port-channel <i>number</i>] [service <i>service</i>]</code>	Sets port permitting conditions for the management access list.
<code>permit ip-source {<i>ipv4-address</i> <i>ipv6-address / prefix-length</i>} [mask <i>mask</i> <i>prefix-length</i>] [ethernet <i>interface-number</i> vlan <i>vlan-id</i> port-channel <i>number</i>] [service <i>service</i>]</code>	Sets port permitting conditions for the management access list, and the selected management method.
<code>deny [ethernet <i>interface-number</i> vlan <i>vlan-id</i> port-channel <i>number</i>] [service <i>service</i>]</code>	Sets port denying conditions for the management access list, and the selected management method.
<code>deny ip-source {<i>ipv4-address</i> <i>ipv6-address / prefix-length</i>} [mask <i>mask</i> <i>prefix-length</i>] [ethernet <i>interface-number</i> vlan <i>vlan-id</i> port-channel <i>number</i>] [service <i>service</i>]</code>	Sets port denying conditions for the management access list, and the selected management method.
<code>management access-class {console-only <i>name</i>}</code>	Defines which access-list is used as the active management connections.
<code>show management access-list [<i>name</i>]</code>	Displays the active management access-lists.
<code>show management access-class</code>	Displays information about management access-class.

The following is an example of the CLI commands:

```
console(config)# management access-list mlist
console(config-macl)# permit ethernet 1/e1
console(config-macl)# permit ethernet 1/e2
console(config-macl)# deny ethernet 1/e3
console(config-macl)# deny ethernet 1/e4
console(config-macl)# exit
console(config)# management access-class mlist
console(config)# exit
console# show management access-list
mlist
-----
permit ethernet 1/e1
permit ethernet 1/e2
deny ethernet 1/e3
deny ethernet 1/e4
! (Note: all other access implicitly denied)
Console# show management access-class
Management access-class is enabled, using access list mlist
```

Defining Authentication Profiles

The **Authentication Profiles** page contains fields for selecting the user authentication method on the device. User authentication occurs:

- Locally
- Via an external server

User authentication can also be set to *None*.

User authentication occurs in the order the methods are selected. For example, if both the *Local* and *RADIUS* options are selected, the user is authenticated first locally. If the local user database is empty, the user is then authenticated via the *RADIUS* server. If the authentication fails using the first method, the authentication process ends.

If an error occurs during the authentication, the next selected method is used.

To open the **Authentication Profiles** page, click **System** → **Management Security** → **Authentication Profiles** in the tree view.

Figure 6-59. Authentication Profiles

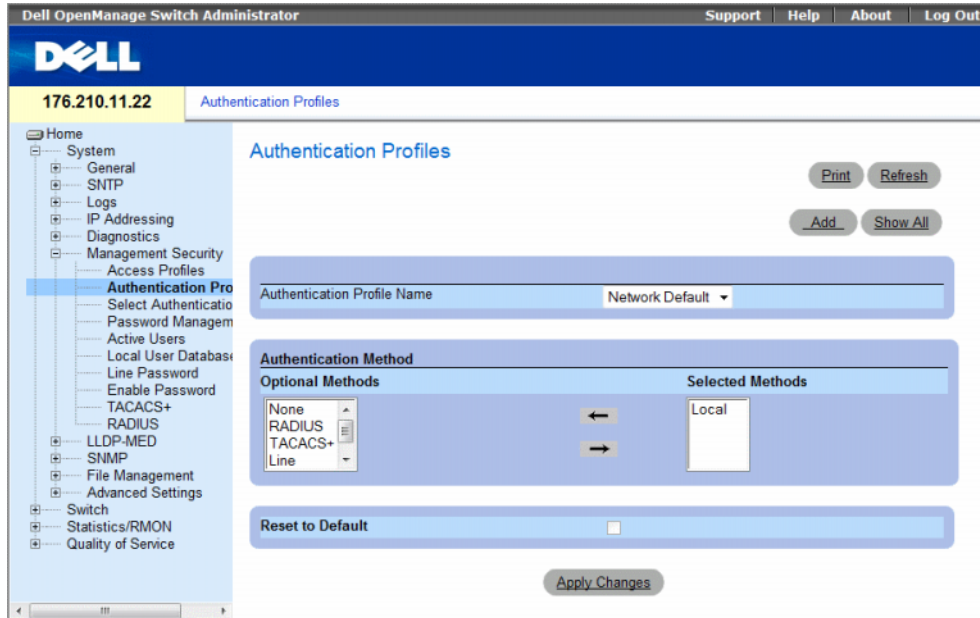

The **Authentication Profiles** page contains the following fields:

- **Authentication Profile Name** — User-defined authentication profile lists to which user-defined authentication profiles are added. The options are **Network Default** and **Console Default**. Profile names cannot include blank spaces.
- **Optional Methods** — User authentication methods. The possible options are:
 - **None** — No user authentication occurs.
 - **Local** — User authentication occurs at the device level. The device checks the user name and password for authentication.
 - **RADIUS** — User authentication occurs at the RADIUS server. For more information, see **Configuring RADIUS Settings**.
 - **TACACS+** — The user authentication occurs at the TACACS+ server.
 - **Line** — The line password is used for user authentication.
 - **Enable** — The enable password is used for authentication.
- **Reset to Default**— Restores the default user authentication method on the device. Available for default profile only.

Selecting an Authentication Profile:

- 1 Open the **Authentication Profiles** page.
- 2 Select a profile in the **Authentication Profile Name** field.
- 3 Select the authentication method using the navigation arrows. The authentication occurs in the order the authentication methods are listed.
- 4 Click **Apply Changes**.

The user authentication profile is updated to the device.

Adding an Authentication Profile:

- 1 Open the **Authentication Profiles** page.
- 2 Click **Add**.

The **Add Authentication Profile** page opens.

Figure 6-60. Add Authentication Profile

The screenshot shows the 'Add Authentication Profile' configuration page. At the top right is a 'Refresh' button. Below it is the title 'Add Authentication Profile'. A text input field for 'Profile Name (1-32 Characters)' is present. Below that is the 'Authentication Method' section, which is divided into two columns: 'Optional Methods' and 'Selected Methods'. The 'Optional Methods' column contains a list with 'Local', 'None', 'RADIUS', and 'TACACS'. Between the columns are left and right navigation arrows. The 'Selected Methods' column is currently empty. At the bottom center is an 'Apply Changes' button.

- 3 Configure the profile.
- 4 Click **Apply Changes**.

The authentication profile is updated to the device.

Displaying the Authentication Profiles Table:

- 1 Open the Authentication Profiles page.
- 2 Click Show All.

The Authentication Profiles Table page opens.

Figure 6-61. Authentication Profiles Table

	Profile Name	Methods	Remove
1	Network Default	Local	<input type="checkbox"/>
2	Console Default	None	<input type="checkbox"/>
3	Dell	Radius; Local; None	<input type="checkbox"/>

Deleting an Authentication Profile:

- 1 Open the Authentication Profiles page.
- 2 Click Show All.

The Authentication Profiles Table page opens.

- 3 Select an authentication profile.
- 4 Select the Remove check box.
- 5 Click Apply Changes.

The selected authenticating profile is deleted.

Configuring an Authentication Profile Using CLI Commands

The following table summarizes the equivalent CLI commands for setting fields displayed in the Authentication Profiles page.

Table 6-34. Authentication Profile CLI Commands

CLI Command	Description
<code>aaa authentication login {default list-name} method1 [method2.]</code>	Configures login authentication.
<code>no aaa authentication login {default list-name}</code>	Removes a login authentication profile.

The following is an example of the CLI commands:

```
console(config)# aaa authentication login default radius local
enable none
console(config)# no aaa authentication login default
```

Selecting Authentication Profiles

After Authentication Profiles are defined, the Authentication Profiles can be applied to Management Access methods. For example, console users can be authenticated by Authentication Method List 1, while Telnet users are authenticated by Authentication Method List 2.

To open the **Select Authentication** page, click **System** → **Management Security** → **Select Authentication** in the tree view.

Figure 6-62. Select Authentication

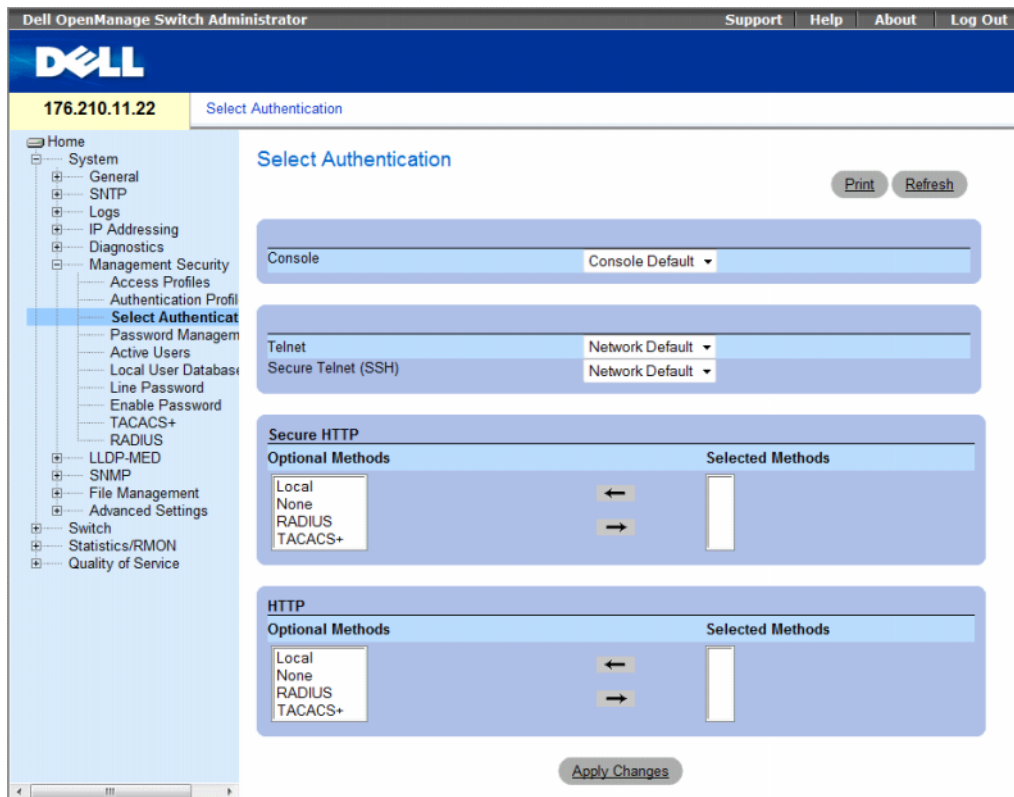

The **Select Authentication** page contains the following fields:

- **Console** — Authentication profiles used to authenticate console users.
- **Telnet** — Authentication profiles used to authenticate Telnet users.
- **Secure Telnet (SSH)** — Authentication profiles used to authenticate Secure Shell (SSH) users. SSH provides clients with secure and encrypted remote connections to a device.
- **Secure HTTP and HTTP** — Authentication method used for Secure HTTP access and HTTP access, respectively. Possible field values are:
 - **Local** — Authentication occurs locally.
 - **None** — No authentication method is used for access.
 - **RADIUS** — Authentication occurs at the RADIUS server.
 - **TACACS+** — Authentication occurs at the TACACS+ server.

Applying an Authentication List to Console Sessions

- 1 Open the **Select Authentication** page.
- 2 Select an Authentication Profile in the **Console** field.
- 3 Click **Apply Changes**.
Console sessions are assigned an Authentication List.

Applying an Authentication Profile to Telnet Sessions

- 1 Open the **Select Authentication** page.
- 2 Select an Authentication Profile in the **Telnet** field.
- 3 Click **Apply Changes**.
Telnet sessions are assigned an Authentication List.

Applying an Authentication Profile to Secure Telnet (SSH) Sessions

- 1 Open the **Select Authentication** page.
- 2 Select an Authentication Profile in the **Secure Telnet (SSH)** field.
- 3 Click **Apply Changes**.
Secure Telnet (SSH) sessions are assigned an Authentication Profile.

Assigning HTTP Sessions an Authentication Sequence

- 1 Open the **Select Authentication** page.
- 2 Select an authentication sequence in the **HTTP** field.
- 3 Click **Apply Changes**.
HTTP sessions are assigned an authentication sequence.

Assigning Secure HTTP Sessions an Authentication Sequence

- 1 Open the Select Authentication page.
- 2 Select an authentication sequence in the Secure HTTP field.
- 3 Click Apply Changes.

Secure HTTP sessions are assigned an authentication sequence.

Assigning Access Authentication Profiles or Sequences Using CLI Commands

The following table summarizes the equivalent CLI commands for setting fields displayed in the Select Authentication page.

Table 6-35. Select Authentication CLI Commands

CLI Command	Description
<code>enable authentication</code> [default <i>list-name</i>]	Indicates the authentication method list when accessing a higher privilege level from a remote Telnet, Console or SSH.
<code>login authentication</code> [default <i>list-name</i>]	Indicates the login authentication method list for a remote Telnet, Console or SSH.
<code>ip http authentication</code> <i>method1</i> [<i>method2</i> .]	Indicates authentication methods for HTTP servers.
<code>ip https authentication</code> <i>method1</i> [<i>method2</i> .]	Indicates authentication methods for HTTPS servers.
<code>show authentication methods</code>	Displays information about the authentication methods.

The following is an example of the CLI commands:

```
console(config-line)# enable authentication default
console(config-line)# login authentication default
console(config-line)# exit
console(config)# ip http authentication radius local
console(config)# ip https authentication radius local
console(config)# exit

console# show authentication methods
Login Authentication Method Lists
-----
Console_Default      : None
```

```

Network_Default      : Local

Enable Authentication Method Lists
-----
Console_Default    : Enable   None
Network_Default    : Enable
Line               Login Method List      Enable Method List
-----
Console            Default                 Default
Telnet             Default                 Default
SSH                Default                 Default

http               : Local
https              : Local
dot1x              :

```

Managing Passwords

Password management provides increased network security and improved password control. Passwords for SSH, Telnet, HTTP, HTTPS, and SNMP access are assigned security features, which include:

- Defining minimum password lengths
- Password expiration
- Prevents frequent password reuse
- Locks users out after failed login attempts

Password aging starts immediately, when password management is enabled. Passwords expire based on the user-defined time/day definition expiration. Ten days prior to password expiration, the device displays a password expiration warning message.

After the password has expired, users can login several additional times (number of times is configurable). During the remaining logins an additional warning message displays informing the user that the password must be changed immediately. If the password is not changed, users are locked out of the system, and can only log in using the console. Password warnings are logged in the Syslog file.

If a privilege level is redefined, the user must also be re-defined. However, the password age time expires from the initial user definition.

Users are notified before the password expires and that it must be changed. However, this notification is not displayed to the Web user.

To open the Password Management page, click System → Management Security → Password Management in the tree view.

Figure 6-63. Password Management

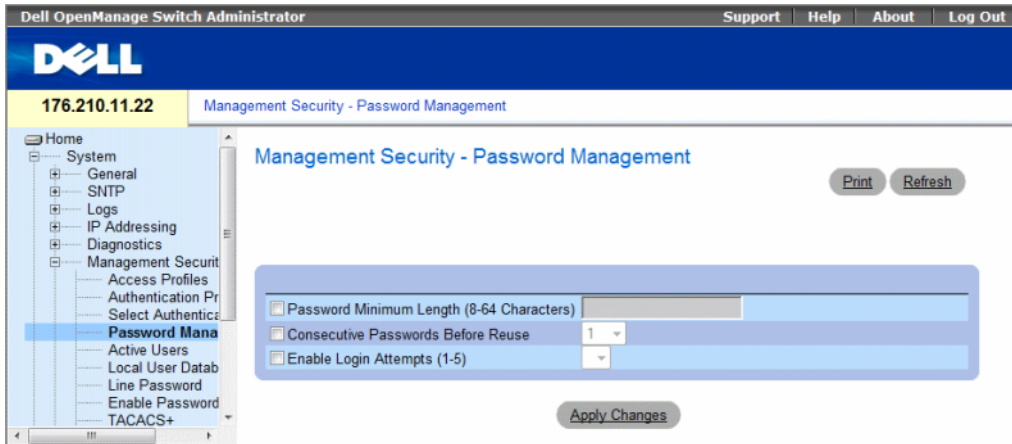

The Password Management page contains the following fields:

- **Password Minimum Length (8-64)** — Indicates the minimum password length, when checked. For example, the administrator can define that all passwords must have a minimum of 10 characters.
- **Consecutive Passwords Before Re-use** — Indicates the amount of times a password is changed, before the password can be reused. Possible field values are 1-10.
- **Enable Login Attempts (1-5)** — When checked, enables locking a user out of the device when a faulty password is used more than a user-defined number of times. For example, if this field is checked, configured to 5 and a user attempts to log on five times with an incorrect password, the device locks the user out on the sixth attempt. Possible field values are 1-5.

Defining Password Management

- 1 Open the Password Management page.
- 2 Define the fields.
- 3 Click Apply Changes.

Password management is defined, and the device is updated.

Password Management Using CLI Commands

The following table summarizes the equivalent CLI commands for setting fields displayed in the Password Management page.

Table 6-36. Password Management Using CLI Commands

CLI Command	Description
<code>password min-length <i>length</i></code>	Defines the minimum password length.
<code>password history <i>number</i></code>	Defines the amount of times a password is changed, before the password can be reused.
<code>password lock-out <i>number</i></code>	Defines the number of times a faulty password is entered before the user is locked out of the device.
<code>show password configuration</code>	Displays password management information.
<code>show users accounts</code>	Displays the userd account.

The following is an example of the CLI commands:

```
console # show passwords configuration

Minimal length: 0
History: Disabled
History hold time: no limit
Lockout control: disabled

Enable Passwords

Level          Password      Password      Lockout
              Aging        Expiry date
-----
1              -            -             -
15             -            -             -

Line Passwords
```

Line	Password Aging	Password Expiry date	Lockout
Telnet	-	-	-
SSH	-	-	-
Console	-	-	-

console # **show users accounts**

Username	Privilege	Password Aging	Password Expiry Date	Lockout
nim	15	39	18-Feb-2005	

Displaying Active Users

The Active Users page displays information about active users on the device.

To open the Active Users page, click **System** → **Management Security** → **Active Users** in the tree view.

Figure 6-64. Active Users

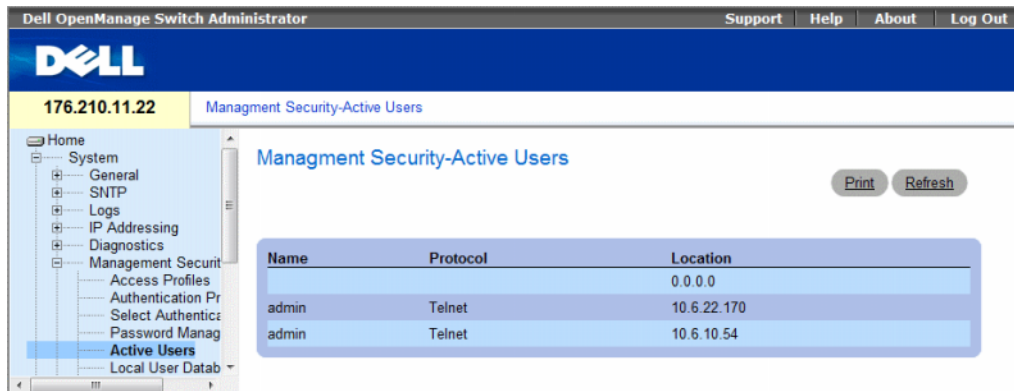

The Active Users page contains the following fields:

- **Name** — List of user names logged into the device.
- **Protocol** — The management method by which the user is connected to the device.
- **Location** — The user's IP address.

Displaying Active Users Using CLI Commands

The following table summarizes the equivalent CLI commands for viewing active users connected to the device.

Table 6-37. Active Users CLI Commands

CLI Command	Description
show users	Displays information about active users.

The following example shows an example of the CLI command:

```
console> show users

Username          Protocol          Location
-----          -
Bob               Serial
John              SSH               172.16.0.1
Robert            HTTP              172.16.0.8
Betty             Telnet            172.16.1.7
```

Defining the Local User Databases

The Local User Database page contains fields for defining users, passwords and access levels.

To open the Local User Database page, click System → Management Security → Local User Database in the tree view.

Figure 6-65. Local User Database

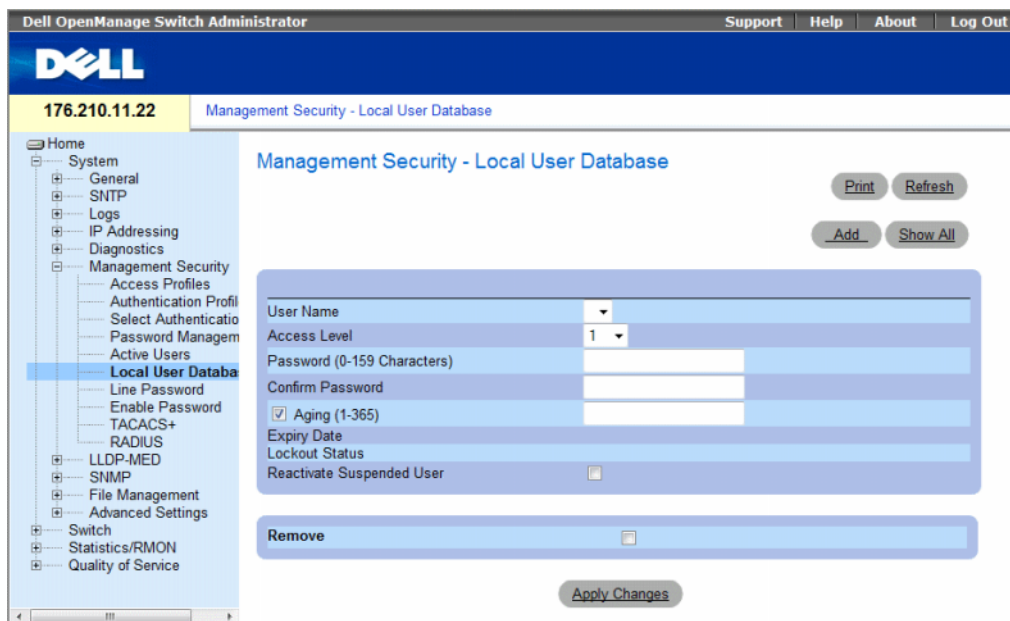

The Local User Database page contains the following fields:

- **User Name** — List of users.
- **Access Level** — User access level. The lowest user access level is 1 and 15 is the highest user access level. Users with access level 15 are Privileged Users, and only they can access and use the OpenManage Switch Administrator.
- **Password (0-159 Characters)** — User-defined password.
- **Confirm Password** — Confirms the user-defined password.
- **Aging (1-365)** — Indicates the amount of time in days that elapses before a password is aged out.
 - **Checked** — Password ages out after the specified number of days.
 - **Unchecked** — Password does not expire.
- **Expiry Date** — Indicates the expiration date of the user-defined password.

- **Lockout Status** — Indicates whether the user currently has access (status *Usable*), or whether the user is locked out due to too many failed authentication attempts since the user last logged in successfully (status *Locked*).
- **Reactivate Suspended User** — Reactivate the specified user’s access rights. Access rights can be suspended after unsuccessfully attempting to login.
 - **Checked** — Reactivate the specified user’s access rights.
 - **Unchecked** — Maintain the specified user’s access suspension.
- **Remove** — Removes users from the **User Name** list.
 - **Checked** — Removes the selected user.
 - **Unchecked** — Maintains the selected user.

Assigning Access Rights to a User:

- 1 Open the **Local User Database** page.
- 2 Select a user in the **User Name** field.
- 3 Define the fields.
- 4 Click **Apply Changes**.

The user access rights and passwords are defined, and the device is updated.

Defining a New User:

- 1 Open the **Local User Database** page.
- 2 Click **Add**.

The **Add User** page opens.

Figure 6-66. Add a User

The screenshot shows a web form titled "Add a User". At the top right is a "Refresh" button. The form itself is a light blue box with four rows of input fields:

- Row 1: "User Name (1-20 Characters)" with a text input field.
- Row 2: "Access Level" with a dropdown menu showing "1".
- Row 3: "Password (0-159 Characters)" with a text input field.
- Row 4: "Confirm Password" with a text input field.

 Below the form is an "Apply Changes" button.

- 3 Define the fields.
- 4 Click **Apply Changes**.

The new user is defined, and the device is updated.

Displaying the Local User Table:

- 1 Open the Local User Database page.
- 2 Click Show All.

The Local User Table opens.

Figure 6-67. Local User Table

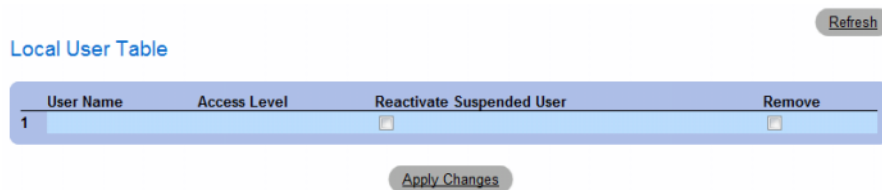

Reactivating a Suspended User:

- 1 Open the Local User Database page.
- 2 Select a User Name entry.
- 3 Select the Reactivate Suspended User check box.
- 4 Click Apply Changes.

The user access rights are reactivated, and the device is updated. You can also reactivate suspended users from the Local User Table.

Deleting Users:

- 1 Open the Local User Database page.
- 2 Select a User Name.
- 3 Select the Remove check box.
- 4 Click Apply Changes.

The selected user is deleted, and the device is updated.

Assigning Users Using CLI Commands

The following table summarizes the equivalent CLI commands for setting fields displayed in the Local User Database page.

Table 6-38. Local User Database CLI Commands

CLI Command	Description
<code>username <i>name</i> [<i>password password</i>] [<i>level level</i>] [<i>encrypted</i>]</code>	Establishes a username-based authentication system.
<code>set username <i>name</i> active</code>	Reactivates a suspended user's access rights.

The following is an example of the CLI commands:

```
console(config)# username bob password lee level 15
console# set username bob active
```

Defining Line Passwords

The **Line Password** page contains fields for defining line passwords for management methods.

To open the **Line Password** page, click **System** → **Management Security** → **Line Passwords** in the tree view.

Figure 6-68. Line Password



The **Line Password** page contains the following fields:

- **Line Password/Telnet Line Password/Secure Telnet Line Password** — Password settings for Console, Telnet, or Secure Telnet session, respectively.
- **Password** — The line password for accessing the device.
- **Confirm Password** — Confirms the new line password. The password appears in the ***** format, for security reasons.
- **Console/Telnet/Secure Telnet Line Aging (1-365)** — Indicates the amount of time in days that elapses before a line password is aged out.
 - **Checked** — Password ages out after the specified number of days.
 - **Unchecked** — Password does not expire.
- **Expiry Date** — Indicates the expiration date of the line password.
- **Lockout Status** — Indicates whether the user currently has access (status *Usable*), or whether the user is locked out due to too many failed authentication attempts since the user last logged in successfully (status *Locked*).
- **Reactivate Locked Line** — Reactivates the line password for a Console/Telnet/Secure Telnet session. Access rights can be suspended after unsuccessfully attempting to log in.
 - **Checked** — Reactivates the line password.
 - **Unchecked** — Maintains locked password.

Defining Line Passwords for Console Sessions

- 1** Open the **Line Password** page
- 2** Define the **Console Line Password** fields.
- 3** Click **Apply Changes**.

The line password for console sessions is defined, and the device is updated.

Defining Line Passwords for Telnet Sessions

- 1** Open the **Line Password** page.
- 2** Define the **Telnet Line Password** fields.
- 3** Click **Apply Changes**.

The line password for the Telnet sessions is defined, and the device is updated.

Defining Line Passwords for Secure Telnet Sessions

- 1** Open the **Line Password** page.
- 2** Define the **Secure Telnet Line Password** fields.
- 3** Click **Apply Changes**.

The line password for Secure Telnet sessions is defined, and the device is updated.

Assigning Line Passwords Using CLI Commands

The following table summarizes the equivalent CLI commands for setting fields displayed in the **Line Password** page.

Table 6-39. Line Password CLI Commands

CLI Command	Description
<code>password <i>password</i> [encrypted]</code>	Indicates a password on a line.

The following is an example of the CLI commands:

```
console(config-line)# password dell
```

Defining Enable Passwords

The **Enable Password** page sets a local password to control access to Normal and Privilege levels.

To open the **Enable Password** page, click **System** → **Management Security** → **Enable Passwords** in the tree view.

Figure 6-69. Enable Password

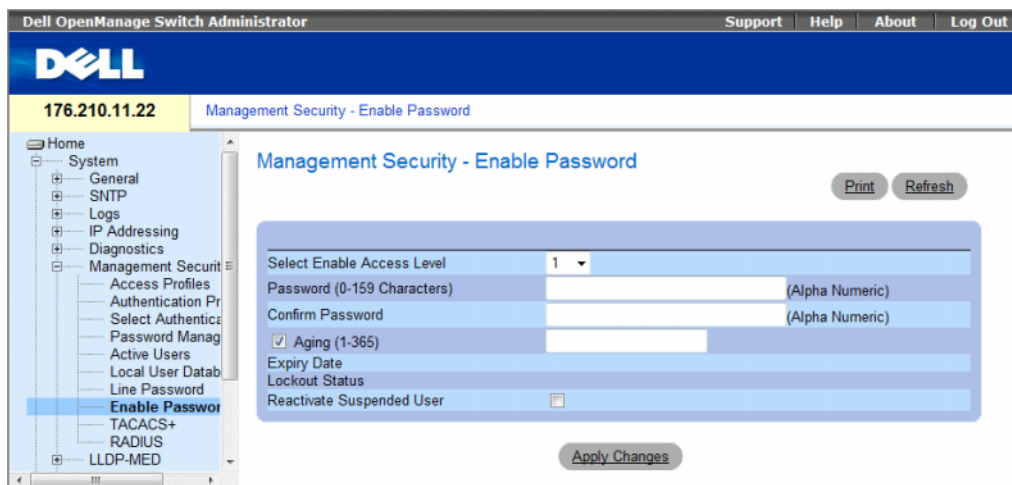

The **Enable Password** page contains the following fields:

- **Select Enable Access Level** — Access level associated with the enable password. The lowest user access level is 1 and 15 is the highest user access level. Users with access level 15 are Privileged Users, and only they can access and use the OpenManage Switch Administrator.
- **Password (0-159 characters)** — The password to enable.

- **Confirm Password** — Confirms the password. The password appears in the ***** format, for security reasons.
- **Aging (1-365)** — Indicates the amount of time in days that elapses before a password is aged out.
 - **Checked** — Password ages out after the specified number of days.
 - **Unchecked** — Password does not expire.
- **Expiry Date** — Indicates the expiration date of the enable password.
- **Lockout Status** — Specifies the number of failed authentication attempts since the user last logged in successfully, when the **Enable Login Attempts** checkbox is selected in the **Password Management** page. Specifies **LOCKOUT**, when the user account is locked.
- **Reactivate Suspended User** — Reactivates the specified user’s access rights. Access rights can be suspended after unsuccessfully attempting to login.
 - **Checked** — Reactivate the specified user’s access rights.
 - **Unchecked** — Maintain the specified user’s access suspension.

Defining a New Enable Password:

- 1 Open the **Enable Password** page.
- 2 Define the fields.
- 3 Click **Apply Changes**.

The new Enable password is defined, and the device is updated.

Assigning Enable Passwords Using CLI Commands

The following table summarizes the equivalent CLI commands for setting fields displayed in the **Enable Password** page.

Table 6-40. Modify Enable Password CLI Commands

CLI Command	Description
<code>enable password [level <i>level</i>] password [encrypted]</code>	Sets a local password to control access to user and privilege levels.

The following is an example of the CLI commands:

```
console(config)# enable password level 15 secret
```

Defining TACACS+ Settings

The devices provide Terminal Access Controller Access Control System (TACACS+) client support. TACACS+ provides centralized security for validation of users accessing the device.

TACACS+ provides a centralized user-management system, while still retaining consistency with RADIUS and other authentication processes. TACACS+ provides the following services:

- **Authentication** — Provides authentication during login and via user names and user-defined passwords.
- **Authorization** — Performed at login. Once the authentication session is completed, an authorization session starts using the authenticated user name. The TACACS+ server checks the user privileges.

The TACACS+ protocol ensures network integrity through encrypted protocol exchanges between the device and TACACS+ server.

To open the TACACS+ Settings page, click System → Management Security → TACACS+ in the tree view.

Figure 6-70. TACACS+ Settings

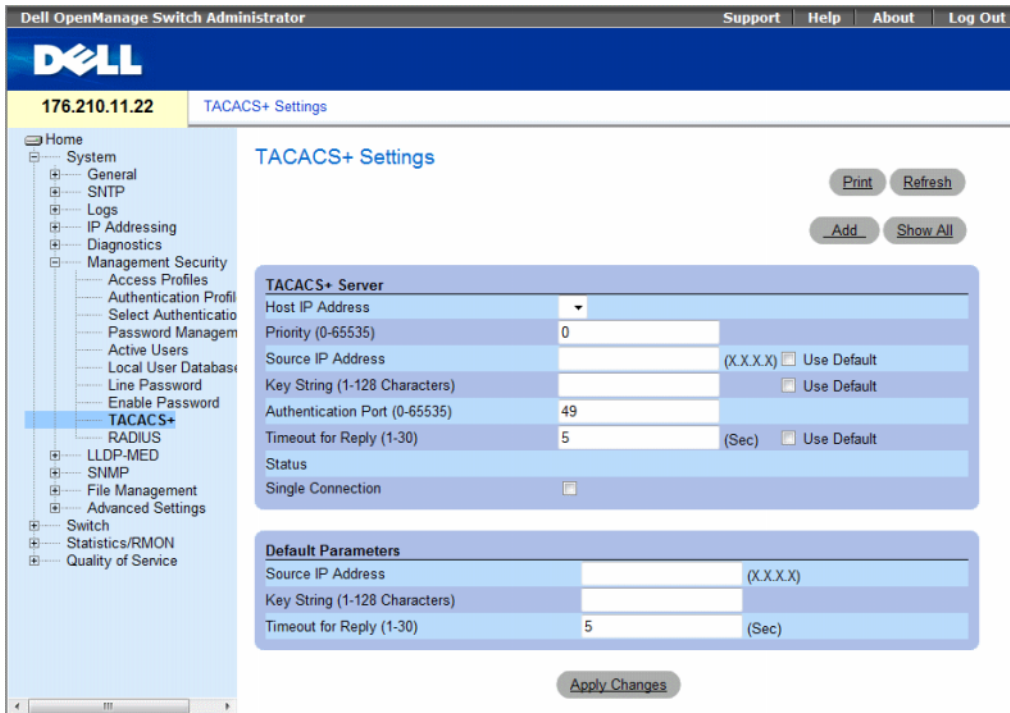

The **TACACS+ Settings** page contains the following fields:

- **Host IP Address** — Indicates the TACACS+ Server IP address.
- **Priority (0-65535)** — Indicates the order in which the TACACS+ servers are used. The default is 0.
- **Source IP Address** — The device source IP address used for the TACACS+ session between the device and the TACACS+ server.
- **Key String (1-128 Characters)** — Defines the authentication and encryption key for TACACS+ communications between the device and the TACACS+ server. This key must match the encryption key used on the TACACS+ server. This key is encrypted.
- **Authentication Port (0-65535)** — The port number through which the TACACS+ session occurs. The default is port 49.
- **Timeout for Reply (1-30)** — The amount of time that passes before the connection between the device and the TACACS+ server times out. The field range is 1-30 seconds.
- **Status** — The connection status between the device and the TACACS+ server. The possible field values are:
 - **Connected** — There is currently a connection between the device and the TACACS+ server.
 - **Not Connected** — There is not currently a connection between the device and the TACACS+ server.
- **Single Connection** — Maintains a single open connection between the device and the TACACS+ server when selected
- **Use Default** — Uses the default value for the parameter.

The TACACS+ default parameters are user-defined defaults. The default settings are applied to newly defined TACACS+ servers. If default values are not defined, the system defaults are applied to the new TACACS+ servers.

The following are the TACACS+ defaults:

- **Source IP Address** — The default device source IP address used for the TACACS+ session between the device and the TACACS+ server. The default source IP address is 0.0.0.0.
- **Key String (1-128 Characters)** — The default key string used for authenticating and encrypting all communications between the device and the TACACS+ server. This key is encrypted.
- **Timeout for Reply (1-30)** — The default time that passes before the device and the TACACS+ server connection times out. The default is 5 seconds.

Adding a TACACS+ Server

- 1 Open the **TACACS+ Settings** page.
- 2 Click **Add**.

The **Add TACACS+ Host** page opens.

Figure 6-71. Add TACACS+ Host

Host IP Address	<input type="text"/>	(X.X.X.X)	
Priority (0-65535)	<input type="text"/>	0	
Source IP Address	<input type="text"/>	(X.X.X.X)	<input type="checkbox"/> Use Default
Key String (1-128 Characters)	<input type="text"/>		<input type="checkbox"/> Use Default
Authentication Port (0-65535)	<input type="text"/>	49	
Timeout for Reply (1-30)	<input type="text"/>	(Sec)	<input type="checkbox"/> Use Default
Single Connection	<input type="checkbox"/>		

- 3 Define the fields.
- 4 Click **Apply Changes**.
The TACACS+ server is added, and the device is updated.

Displaying the TACACS+ Table

- 1 Open the TACACS+ Settings page.
- 2 Click **Show All**.
The TACACS+ Table opens.

Figure 6-72. TACACS+ Table

Host IP Address	Priority	Source IP Address	Authentication Port	Timeout for Reply	Single Connection	Status	Remove
1	<input type="text"/>	<input type="text"/>	<input type="text"/>	<input type="text"/>	<input type="checkbox"/>	<input type="checkbox"/>	<input type="checkbox"/>

Removing a TACACS+ Server

- 1 Open the TACACS+ Table page.
- 2 Click **Show All**.
The TACACS+ Table opens.
- 3 Select a TACACS+ Table entry.

- 4 Select the **Remove** check box.
- 5 Click **Apply Changes**.

The TACACS+ server is removed, and the device is updated.

Defining TACACS+ Settings Using CLI Commands

The following table summarizes the equivalent CLI commands for setting fields displayed in the TACACS+ Settings page.

Table 6-41. TACACS+ CLI Commands

CLI Command	Description
<code>tacacs-server host {<i>ip-address</i> <i>host-name</i>} [single-connection] [port <i>port-number</i>] [timeout <i>timeout</i>] [key <i>key-string</i>] [source <i>source</i>] [priority <i>priority</i>]</code>	Indicates a TACACS+ host.
<code>tacacs-server key <i>key-string</i></code>	Indicates the authentication and encryption key for all TACACS+ communications between the device and the TACACS+ server. This key must match the encryption used on the TACACS+ daemon. (Range: 0 - 128 characters.)
<code>tacacs-server timeout <i>timeout</i></code>	Indicates the timeout value in seconds. (Range: 1 - 30.)
<code>tacacs-server source-ip <i>source</i></code>	Indicates the source IP address. (Range: Valid IP Address.)
<code>show tacacs [<i>ip-address</i>]</code>	Displays configuration and statistics for a TACACS+ server.

The following is an example of the CLI commands:

```
console# show tacacs
Device Configuration

IP address      Status      Port  Single      TimeOut  Source IP  Priority
-----      -
12.1.1.2      Not        49    Yes         1        12.1.1.1   1
                Connected

Global values
-----
TimeOut : 5
Device Configuration
-----
Source IP : 0.0.0.0
console#
```

Configuring RADIUS Settings

Remote Authorization Dial-In User Service (RADIUS) servers provide additional security for networks. Up to four RADIUS servers can be defined. RADIUS servers provide a centralized authentication method for:

- Telnet Access
- Secure Shell Access
- Web Access
- Console Access

To open the **RADIUS Settings** page, click **System** → **Management Security** → **RADIUS** in the tree view.

Figure 6-73. RADIUS Settings

The screenshot shows the Dell OpenManage Switch Administrator interface. The top navigation bar includes 'Support', 'Help', 'About', and 'Log Out'. The main header displays the Dell logo and the IP address '176.210.11.22'. The left sidebar contains a tree view with categories like System, Management Security, and Switch. The 'RADIUS Settings' page is active, showing a form with the following fields:

- IP Address: [Dropdown menu]
- Priority (0-65535): [Text input]
- Authentication Port (0-65535): 1812
- Number of Retries (1-10): 3 [Use Default checkbox]
- Timeout for Reply (1-30): 3 (Sec) [Use Default checkbox]
- Dead Time (0-2000): 0 (Min) [Use Default checkbox]
- Key String (0-128 Characters): [Text input] (Alpha Numeric) [Use Default checkbox]
- Source IP Address: [Text input] (X.X.X.X) [Use Default checkbox]
- Usage Type: Login [Dropdown menu]

Below the main form is a 'Default Parameters' section with the following fields:

- Default Retries (1-10): 3
- Default Timeout for Reply (1-30): 3 (Sec)
- Default Dead Time (0-2000): 0 (Min)
- Default Key String (0-128 Characters): [Text input]
- Source IPv4 Address: [Text input] (X.X.X.X)
- Source IPv6 Address: [Text input] (X:X:X:X:X)

Buttons for 'Print', 'Refresh', 'Add', 'Show All', and 'Apply Changes' are located on the page.

The RADIUS Settings page contains the following pages:

- **IP Address** — The list of Authentication Server IP addresses.
- **Priority (0-65535)** — The server priority. The possible values are 0-65535, where 0 is the highest value. This is used to configure the order in which servers are queried.
- **Authentication Port (0-65535)** — Identifies the authentication port. The authentication port is used to verify the RADIUS server authentication.
- **Number of Retries (1-10)** — Indicates the number of transmitted requests sent to RADIUS server before a failure occurs. The possible field values are 1-10.
- **Timeout for Reply (1-30)** — Indicates the amount of the time in seconds the device waits for an answer from the RADIUS server before retrying the query, or switching to the next server. The possible field values are 1- 30.

- **Dead Time (0-2000)** — Indicates the amount of time (in minutes) that a RADIUS server is bypassed for service requests. The range is 0-2000.
- **Key String (0-128 Characters)** — The Key string used for authenticating and encrypting all RADIUS communications between the device and the RADIUS server. This key is encrypted.
- **Source IP Address** — Indicates the source IP address that is used for communication with RADIUS servers.
- **Usage Type** — Indicates the server usage type. Can be one of the following values: **login**, **802.1x** or **all**. If unspecified, defaults to all.
- **Use Default** — Uses the default value for the parameter.

If host-specific Timeouts, Retries, or Dead time values are not specified, the Global values (Defaults) are applied to each host. The following fields set the RADIUS default values:

- **Default Retries (1-10)** — Indicates the default number of transmitted requests sent to RADIUS server before a failure occurs.
- **Default Timeout for Reply (1-30)** — Indicates the default amount of the time (in seconds) the device waits for an answer from the RADIUS server before timing out. The default is 5 seconds.
- **Default Dead time (0-2000)** — Indicates the default amount of time (in minutes) that a RADIUS server is bypassed for service requests. The range is 0-2000.
- **Default Key String (0-128 Characters)** — The Default Key string used for authenticating and encrypting all RADIUS communications between the device and the RADIUS server. This key is encrypted.
- **Source IPv4 Address** — Specifies the source IP version 4 address that is used for communication with RADIUS servers.
- **Source IPv6 Address** — Specifies the source IP version 6 address that is used for communication with RADIUS servers.

When adding a new RADIUS server, the following additional parameter is available:

- **Supported IP Format** — Specifies the IP format supported by the server. The possible values are:
 - **IPv6 Global** — IP version 6 is supported.
 - **IPv4** — IP version 4 is supported.

Defining RADIUS Parameters:

- 1** Open the **RADIUS Settings** page.
- 2** Define the fields.
- 3** Click **Apply Changes**.

The RADIUS setting are updated to the device.

Adding a RADIUS Server:

- 1 Open the RADIUS Settings page.
- 2 Click Add.

The Add RADIUS Server page opens.

Figure 6-74. Add RADIUS Server

Add RADIUS Server Refresh

Supported IP Format	<input type="radio"/> IPv6 Global <input checked="" type="radio"/> IPv4	
IP Address	<input type="text"/>	(X.X.X.X)
Priority (0-65535)	<input type="text" value="0"/>	
Authentication Port (0-65535)	<input type="text" value="1812"/>	
Number of Retries (1-10)	<input type="text" value="Default"/>	<input checked="" type="checkbox"/> Use Default
Timeout for Reply (1-30)	<input type="text" value="Default"/>	(Sec) <input checked="" type="checkbox"/> Use Default
Dead Time (0-2000)	<input type="text" value="Default"/>	(Min) <input checked="" type="checkbox"/> Use Default
Key String (0-128 Characters)	<input type="text"/>	<input type="checkbox"/> Use Default
Source IP Address	<input type="text" value="Default"/>	(X.X.X.X) <input checked="" type="checkbox"/> Use Default
Usage Type	<input type="text" value="All"/>	

Apply Changes

- 3 Define the fields.
- 4 Click Apply Changes.

The new RADIUS server is added, and the device is updated.

Displaying the RADIUS Server List:

- 1 Open the RADIUS Settings page.
- 2 Click Show All.

The RADIUS Servers List opens.

Figure 6-75. RADIUS Servers List

RADIUS Servers List Refresh

IP Address	Priority	Authentication Port	Number of Retries	Timeout for Reply	Dead Time	Source IP Address	Usage Type	Remove
1 <input type="text" value="1.1.1.1"/>	<input type="text" value="0"/>	<input type="text" value="1812"/>	<input type="text" value="Default"/>	<input type="text" value="Default"/>	<input type="text" value="Default"/>	<input type="text" value="Default"/>	All <input type="text"/>	<input type="checkbox"/>
2 <input type="text" value="3246:55"/>	<input type="text" value="0"/>	<input type="text" value="1812"/>	<input type="text" value="Default"/>	<input type="text" value="Default"/>	<input type="text" value="Default"/>	<input type="text" value="Default"/>	All <input type="text"/>	<input type="checkbox"/>

Apply Changes

Removing a RADIUS Server

- 1 Open the RADIUS Settings page.
- 2 Click Show All.
The RADIUS Servers List opens.
- 3 Select a RADIUS Servers List entry.
- 4 Select the Remove check box.
- 5 Click Apply Changes.

The RADIUS server is removed, and the device is updated.

Defining RADIUS Servers Using CLI Commands

The following table summarizes the equivalent CLI commands for defining fields displayed on the RADIUS Settings page.

Table 6-42. RADIUS Server CLI Commands

CLI Command	Description
<code>radius-server timeout <i>timeout</i></code>	Sets the interval for which a device waits for a server host to reply.
<code>radius-server source-ip <i>source</i></code>	Specifies the source IPv4 address that will be used for the IPv4 communication with RADIUS servers.
<code>radius-server source-ipv6 <i>source</i></code>	Specifies the source IPv6 address that will be used for the IPv6 communication with RADIUS servers.
<code>radius-server retransmit <i>retries</i></code>	Specifies the number of times the software searches the list of RADIUS server hosts.
<code>radius-server deadtime <i>deadtime</i></code>	Configures unavailable servers to be skipped.
<code>radius-server key <i>key-string</i></code>	Sets the authentication and encryption key for all RADIUS communications between the router and the RADIUS server.
<code>radius-server host <i>ip-address</i> [<i>auth-port</i> <i>auth-port-number</i>] [<i>timeout</i> <i>timeout</i>] [<i>retransmit</i> <i>retries</i>] [<i>deadtime</i> <i>deadtime</i>] [<i>key</i> <i>key-string</i>] [<i>source</i> <i>source</i>] [<i>priority</i> <i>priority</i>]</code>	Specifies a RADIUS server host.
<code>show radius-servers</code>	Displays the RADIUS server settings.

The following is an example of CLI commands:

```
Console(config)# radius-server timeout 5
Console(config)# radius-server retransmit 5
Console(config)# radius-server deadtime 10
Console(config)# radius-server key dell-server
Console(config)# radius-server host 196.210.100.1 auth-port 127
timeout 20
Console# show radius-servers
```

IP address	Auth	Acct	TimeOut	Retransmit	Deadtime	Source IP	Priority
172.16.1.1	164	51646	3	3	0		01
172.16.1.2	164	51646	3	3	0		02

Configuring LLDP and MED

The Link Layer Discovery Protocol (LLDP) allows network managers to troubleshoot and enhance network management by discovering and maintaining network topologies over multi-vendor environments. LLDP discovers network neighbors by standardizing methods for network devices to advertise themselves to other system, and to store discovered information. Device discovery information includes:

- Device Identification
- Device Capabilities
- Device Configuration

The advertising device transmits multiple advertisement message sets in a single LAN packet. The multiple advertisement sets are sent in the packet Type Length Value (TLV) field. LLDP devices must support chassis and port ID advertisement, as well as system name, system ID, system description, and system capability advertisements.

This section includes the following topics:

- Defining Global LLDP Properties
- Defining LLDP Port Settings
- Defining Media Endpoint Discovery Network Policy
- Defining LLDP MED Port Settings
- Viewing the LLDP Neighbors Information

LLDP Media Endpoint Discovery (LLDP-MED) increases network flexibility by allowing different IP systems to co-exist on a single network LLDP.

Provides detailed network topology information, including what device are located on the network, and where the devices are located. For example, what IP phone is connect to what port, what software is running on what switch, and with port is connected to what PC. Automatically deploys policies over networks for:

- QoS Policies
- Voice VLANs

Provides Emergency Call Service (E-911) via IP Phone location information.

Provides troubleshooting information LLDP MED send network managers alerts for:

- Port speed and duplex mode conflicts
- QoS policy misconfigurations

This section contains the following topics:

- "Defining LLDP Properties" on page 207
- "Configuring LLDP Using CLI Commands" on page 208
- "Defining LLDP Port Settings" on page 208
- "Defining LLDP MED Network Policy" on page 211
- "Defining LLDP MED Port Settings" on page 213
- "Viewing the LLDP Neighbors Information" on page 217

Defining LLDP Properties

The LLDP Properties page contains fields for configuring LLDP.

To open the LLDP Properties page, click **System** → **LLDP-MED** → **LLDP Properties** in the tree view.

Figure 6-76. LLDP Properties

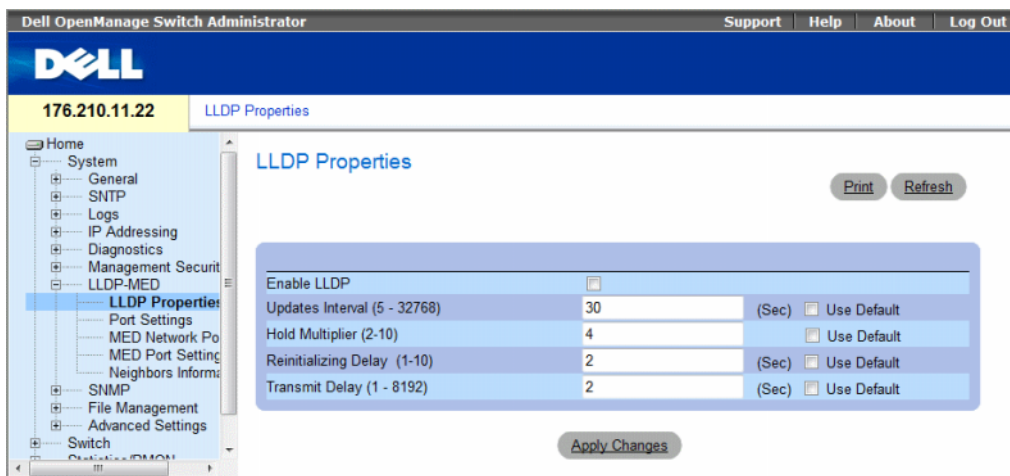

- **Enable LLDP** — Indicates if LLDP is enabled on the device. The possible field values are:
 - **Checked** — Indicates that LLDP is enabled on the device.
 - **Unchecked** — Indicates that LLDP is disabled on the device. This is the default value.
- **Updates Interval (5-32768)** — Indicates that rate at which LLDP advertisement updates are sent. The possible field range is 5 - 32768 seconds. The default value is 30 seconds.
- **Hold Multiplier (2-10)** — Specifies the hold time to be sent in the LLDP update packets as a multiple of the timer value. The possible field range is 2 - 10. The field default is 4.
- **Reinitializing Delay (1-10)** — Specifies the minimum time in seconds an LLDP port will wait before reinitializing LLDP transmission. The possible field range is 1 - 10 seconds. The field default is 2 seconds.
- **Transmit Delay (1-8192)** — Indicates the amount of time that passes between successive LLDP frame transmissions due to changes in the LLDP local systems MIB. The possible field value is 1 – 8192 seconds. The field default is 2 seconds.

Configuring LLDP Using CLI Commands

Table 6-43. LLDP Properties CLI Commands

CLI Command	Description
<code>lldp enable (global)</code>	Enables enable Link Layer Discovery Protocol.
<code>lldp hold-multiplier number</code>	Specifies the time that the receiving device should hold a Link Layer Discovery Protocol (LLDP) packet before discarding it.
<code>lldp reinit-delay Seconds</code>	Specifies the minimum time an LLDP port will wait before reinitializing.
<code>lldp tx-delay Seconds</code>	Specifies the delay between successive LLDP frame transmissions.

The following is an example of the CLI commands:

```
Console(config)# interface ethernet g1
Console(config-if)# lldp enable
```

Defining LLDP Port Settings

The **LLDP Port Settings** page allows network administrators to define LLDP port settings, including the port number, the LLDP port number, and the type of port information advertised.

The **Port Settings** page contains fields for configuring LLDP. To open the **Port Settings** page, click **System** → **LLDP-MED** → **Port Settings** in the tree view.

Figure 6-77. Port Settings

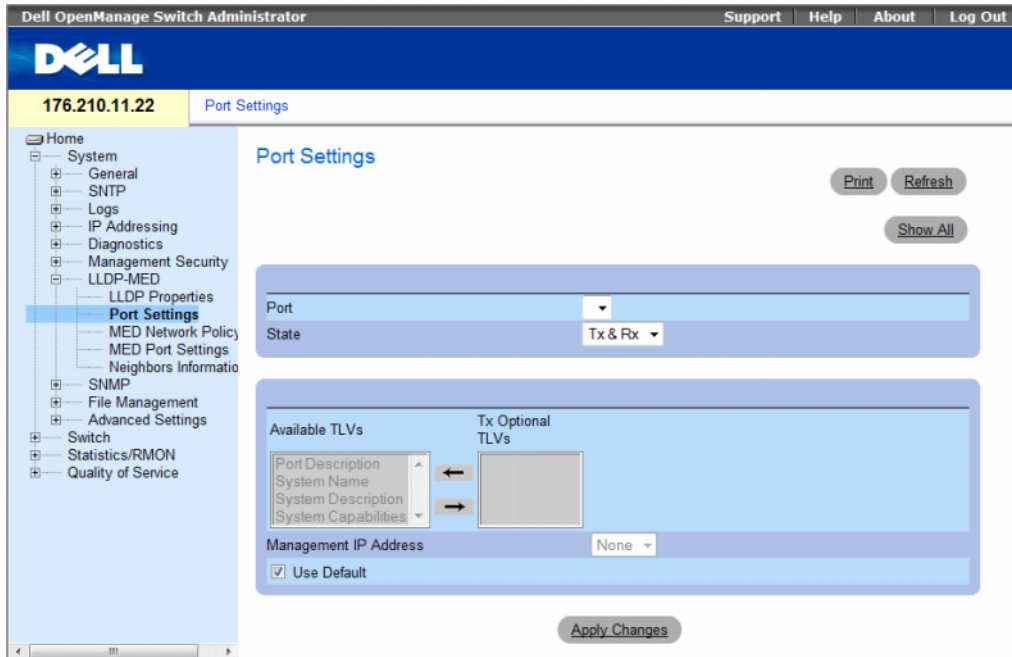

- **Port** — Contains a list of ports on which LLDP is enabled.
- **State** — Indicates the port type on which LLDP is enabled. The possible field values are:
 - **Tx Only** — Enables transmitting LLDP packets only.
 - **Rx Only** — Enables receiving LLDP packets only.
 - **Tx & Rx** — Enables transmitting and receiving LLDP packets. This is the default value.
 - **Disable** — Indicates that LLDP is disabled on the port.
- **Available TLVs** — Contains a list of available TLVs that can be advertised by the port. The possible field values are:
 - **Port Description**— Advertises the port description.
 - **System Name** — Advertises the system name.
 - **System Description** — Advertises the system description.
 - **System Capabilities** — Advertises the system capabilities.

- **Tx Optional TLVs** — Contains a list of optional TLVs advertised by the port. For the complete list, see the **Available TLVs** field.
- **Management IP Address** — Indicates the management IP address that is advertised from the interface.
 - **Use Default** — Specifies the way TLVs are included:
 - **Checked** — Only mandatory TLVs are used by default; they are Chassis subtype (MAC address), Port subtype (port number), and TTL (time-to-leave equal to 120s).
 - **Unchecked** — User-defined TLVs consisting of the 3 above mentioned mandatory TLVs plus optional TLVs that are moved by user from the Available set of TLVs.

The **LLDP Port Table** page displays the LLDP Port Configuration. To open the **LLDP Port Table**, click **Security** → **LLDP** → **Port Settings** → **Show All** in the tree view.

Figure 6-78. LLDP Port Table

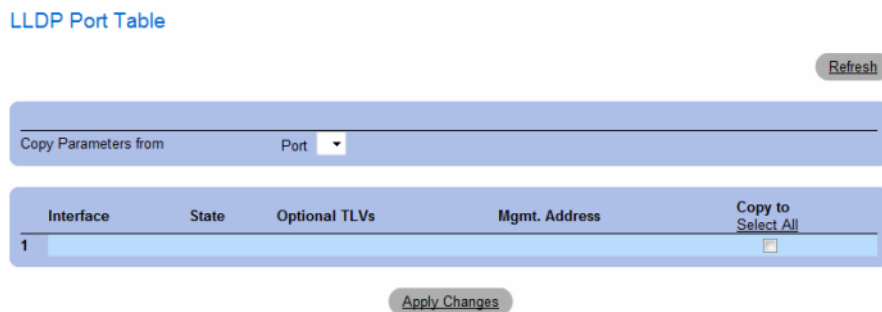

Table 6-44. LLDP Port settings CLI Commands

CLI Command	Description
<code>clear lldp rx interface</code>	Restarts the LLDP RX state machine and clearing the neighbors table
<code>lldp optional-tlv tlv1 [tlv2 ... tlv5]</code>	Specifies which optional TLVs from the basic set should be transmitted
<code>lldp enable [rx tx both]</code>	To enable Link Layer Discovery Protocol (LLDP) on an interface.

The following is an example of the CLI commands:

```
Console(config)# interface ethernet g1
Console(config-if)# lldp enable
```

Defining LLDP MED Network Policy

The MED Network Policy page contains fields for configuring LLDP.

To open the MED Network Policy page, click **System** → **LLDP-MED** → **MED Network Policy** in the tree view.

Figure 6-79. MED Network Policy

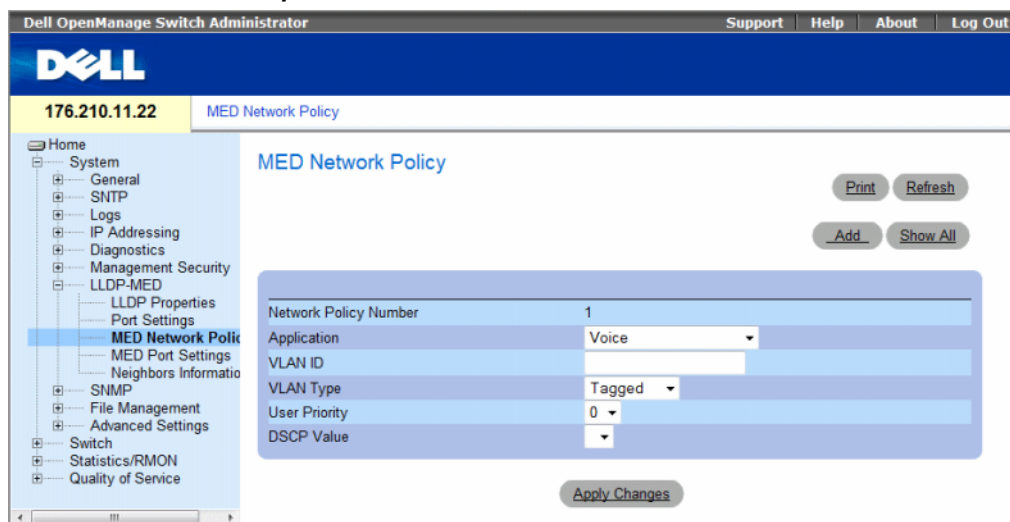

The *MED Network Policy* page contains the following fields:

- **Network Policy Number** — Displays the network policy number.
- **Application** — Displays the application for which the network policy is defined. The possible field values are:
 - **Voice** — Indicates that the network policy is defined for a Voice application.
 - **Voice Signaling** — Indicates that the network policy is defined for a Voice Signaling application.
 - **Guest Voice** — Indicates that the network policy is defined for a Guest Voice application.
 - **Guest Voice Signaling** — Indicates that the network policy is defined for a Guest Voice Signaling application.
 - **Softphone Voice** — Indicates that the network policy is defined for a Softphone Voice application.
 - **Video Conferencing** — Indicates that the network policy is defined for a Video Conferencing application.
 - **Streaming Video** — Indicates that the network policy is defined for a Streaming Video application.
 - **Video Signaling** — Indicates that the network policy is defined for a Video Signalling application.
- **VLAN ID** — Displays the VLAN ID for which the network policy is defined.

- **VLAN Type** — Indicates the VLAN type for which the network policy is defined. The possible field values are:
 - **Tagged** — Indicates the network policy is defined for tagged VLANs.
 - **Untagged** — Indicates the network policy is defined for untagged VLANs.
- **User Priority** — Defines the priority assigned to the network application. The range is 0-7.
- **DSCP Value** — Defines the DSCP value assigned to the network policy. The range is 0-63.

Adding an MED Network Policy

- 1 Open the MED Network Policy page.
- 2 Click Add.

The *Add Network Policy* page opens.

Figure 6-80. Add Network Policy

[Add Network Policy](#)

Network Policy Number	1
Application	Voice
VLAN ID	
VLAN Type	Tagged
User Priority	0
DSCP Value	

- 3 Define the fields.
- 4 Click **Apply Changes**.

The new network policy is added, and the device is updated.

Displaying the MED Network Policy Table:

- 1 Open the MED Network Policy page.
- 2 Click Show All.

The MED Network Policy Table opens.

Figure 6-81. MED Network Policy Table

[MED Network Policy Table](#)

Network Policy Number	Application	VLAN ID	VLAN Type	User Priority	DSCP Value	Remove
1						<input type="checkbox"/>

Defining LLDP MED Port Settings

The MED Port Settings contains parameters for assigning LLDP network policies to specific ports. To open the MED Port Settings page, click System → LLDP-MED → Port Settings in the tree view. The MED Port Settings opens.

Figure 6-82. MED Port Settings

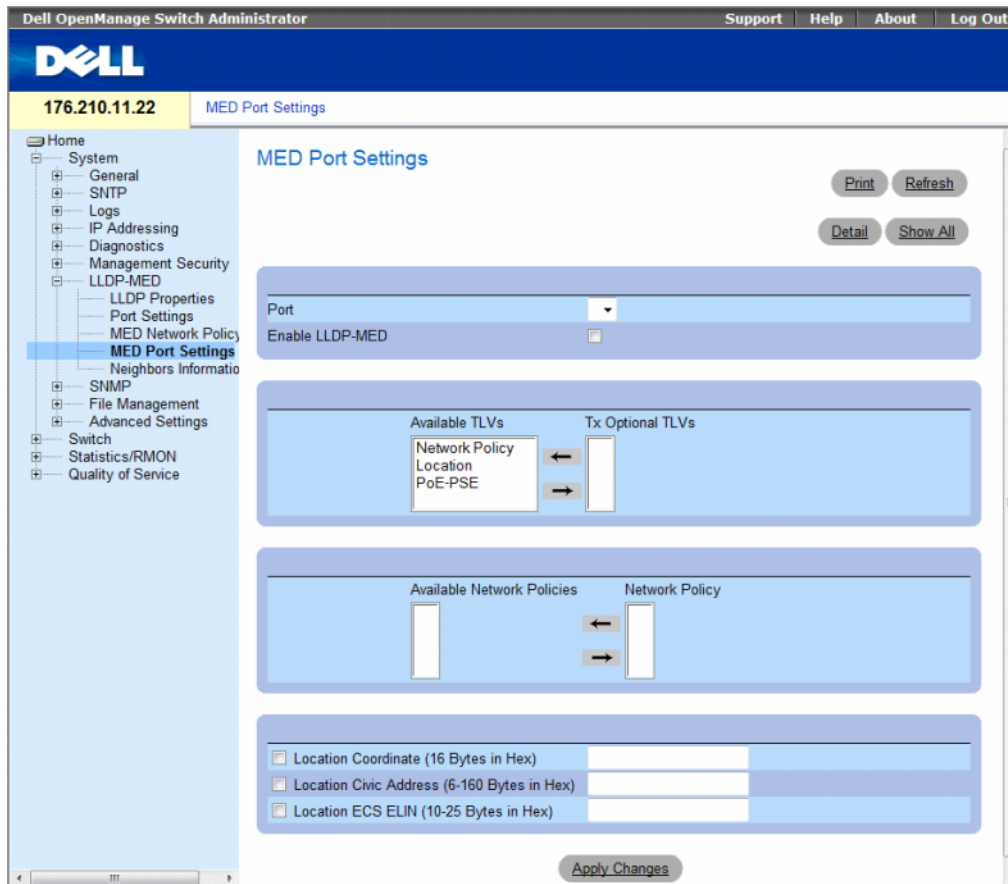

The MED Port Settings page contains the following fields:

- **Port** — Displays the port on which LLDP-MED is enabled or disabled.
- **Enable LLDP-MED** — Indicates if LLDP-MED is enabled on the selected port. The possible field values are:
 - **Checked** — Enables LLDP-MED on the port.
 - **Unchecked** — Disables LLDP-MED on the port. This is the default value.

- **Tx Optional TLVs/Available TLVs** — Contains a list of available TLVs that can be advertised by the port. The possible field values are:
 - **Network Policy** — Advertises the network policy attached to the port.
 - **Location** — Advertises the port's location.
 - **PoE-PSE** — Indicates if the connected media is a PoE or PSE (Power Sourcing Equipment) device.
- **Network Policy/Available Network Policy** — Contains a list of network policies that can be assigned to a port.
- **Location Coordinate (16 Bytes in Hex)**— Displays the device's location map coordinates (16 bytes in hex).
- **Location Civic Address (6-160 Bytes in Hex)** — Displays the device's civic or street address location, for example 414 23rd Ave E. The possible field value are 6 - 160 bytes in hex.
- **Location ECS ELIN (10-25 Bytes in Hex)** — Displays the device's ECS ELIN location. The field range is 10-25 bytes in hex.

Modifying MED Port Settings

- 1** Open the **MED Port Settings** page.
- 2** Modify the fields.
- 3** Click **Apply Changes**.

The parameters are saved to the device.

Displaying Advertise Information Details

- 1** Open the **MED Port Settings** page.
- 2** Click **Details**.

The **Details Advertise Information** page opens.

Figure 6-83. Details Advertise Information Page

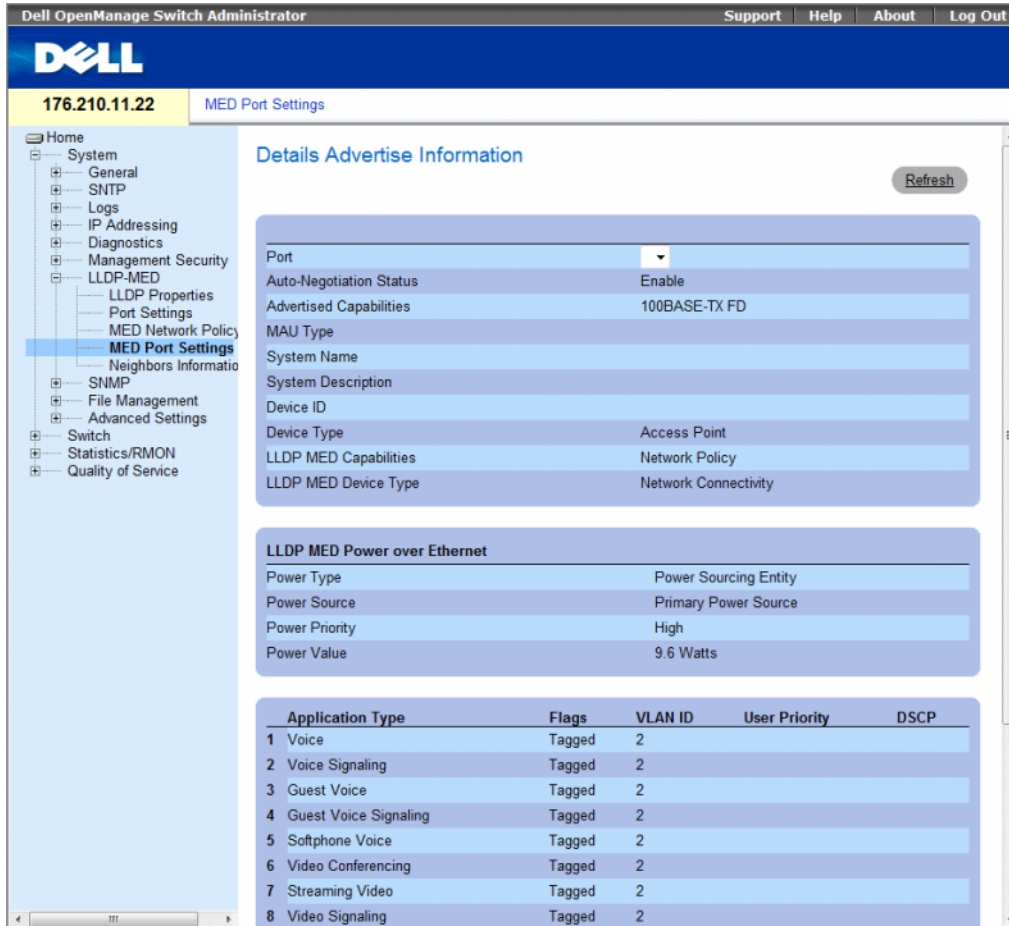

The Details Advertise Information page contains the following fields:

- **Port** — The port for which detailed information is displayed.
- **Auto-Negotiation Status** — The auto-negotiation status of the port. The possible field values are:
 - **Enabled** — Auto-negotiation is enabled on the port.
 - **Disabled** — Auto-negotiation is disabled on the port.
- **Advertised Capabilities** — The port capabilities advertised for the port.
- **MAU Type** — Indicates the media attachment unit type.
- **System Name** — The system name advertised.
- **System Description** — The system description advertised.

- **Device ID** — The device ID advertised, for example, the device MAC address.
- **Device Type** — The type of device.
- **LLDP MED Capabilities** — The TLV that is advertised by the port.
- **LLDP MED Device Type** — Indicates whether a sender is a network connectivity device or an endpoint device.
- **Power Type** — The port's power type.
- **Power Source** — The port's power source.
- **Power Priority** — The port's power priority.
- **Power Value** — The port's power value, in Watts.
- **LLDP MED Network Policy** — The port's LLDP Network Policy for each of the following application types:
 - Voice
 - Voice Signaling
 - Guest Voice
 - Guest Voice Signaling
 - Softphone Voice
 - Video Conferencing
 - Streaming Video
 - Video Signaling
- **Flags** — Displays the VLAN tagging status for the application type. The possible field values are:
 - **Tagged** — The packets are tagged.
 - **Untagged** — The packets are not tagged.
- **VLAN ID** — Displays the VLAN number for the application type.
- **User Priority** — Displays the VLAN number for the application type.
- **DSCP Value** — Defines the DSCP value assigned to the network policy. The possible field value is 1-64.
- **LLDP MED Location** — The port's advertised LLDP location:
 - **Coordinates** — Displays the device's location map coordinates.
 - **Civic Address** — Displays the device's civic or street address location, for example 414 23rd Ave E. The possible field value are 6 - 160 characters.
 - **ECS ELIN** — Displays the device's ECS ELIN location. The field range is 10 - 25.

Displaying the MED Port Settings Table

- 1 Open the MED Port Settings page.
- 2 Click Show All.

The MED Port Settings Table opens.

Figure 6-84. MED Port Settings Table

Port	LLDP MED Status	Network Policy	Location	PoE
1				

Viewing the LLDP Neighbors Information

The Neighbors Information page contains information received from neighboring device LLDP advertisements. To open the Neighbors Information page, click System → LLDP-MED → Neighbors Information in the tree view.

Figure 6-85. Neighbors Information

Port	Device ID	System Name	Port ID	Capabilities	Remove
					<input type="checkbox"/>

- Port — Displays the port number for which neighbouring information is displayed.
- Device ID — Displays the neighboring device ID.
- System Name — Displays the name of the neighboring system .
- Port ID — Displays the neighboring port ID
- Capabilities — Displays the neighboring device capabilities.

Removing a Port From the Table

- 1 Open the Neighbors Information page.
- 2 Check the Remove checkbox of each port to be removed.
- 3 Click Apply Changes. The ports are removed.

Clearing the Table

- 1 Open the Neighbors Information page.
- 2 Click Clear Neighbors Table. The table is cleared.

Viewing the Details of the LLDP MED Information Advertised by a Neighbor Device

- 1 Open the Neighbors Information page.
- 2 Click the Details button next to the desired entry. The Details Neighbors Information page appears:

Figure 6-86. Details Neighbors Information



For information on the fields, refer to the Details Advertise Information page above.

Table 6-45. LLDP Neighbors Information CLI Commands

CLI Command	Description
<code>show lldp neighbors interface</code>	Displays information about neighboring devices discovered using Link Layer Discovery Protocol (LLDP)

The following is an example of the CLI commands:

```
Switch# show lldp neighbors
```

Port	Device ID	Port ID	System Name	Capabilities
3/e31	00:00:77:77:00:00	1/g3		0

Defining SNMP Parameters

Simple Network Management Protocol (SNMP) provides a method for managing network devices. The switch supports the following SNMP versions:

- SNMPv1 (version 1)
- SNMPv2 (version 2)
- SNMPv3 (version 3)

SNMP v1 and v2

The SNMP agents maintains a list of variables, which are used to manage the switch. The variables are defined in the Management Information Base (MIB). The MIB presents the variables controlled by the agent. The SNMP agent defines the MIB specification format, as well as the format used to access the information over the network. Access rights to the SNMP agents are controlled by access strings.

SNMPv1 and v2 are enabled by default.

SNMP v3

SNMP v3 also applies access control and a new traps mechanism to SNMPv1 and SNMPv2 PDUs. In addition, a User Security Model (USM) is defined for SNMPv3, which includes:

- **Authentication** — Provides data integrity and data origin authentication.
- **Privacy** — Protects against disclosure message content. Cipher Block-Chaining (CBC) is used for encryption. Either authentication is enabled on an SNMP message, or both authentication and privacy are enabled on an SNMP message. However privacy cannot be enabled without authentication.
- **Timeliness** — Protects against message delay or message redundancy. The SNMP agent compares incoming message to the message time information.
- **Key Management** — Defines key generation, key updates, and key use.

The switch supports SNMP notification filters based on Object IDs (OID). OIDs are used by the system to manage switch features. SNMP v3 supports the following features:

- Security
- Feature Access Control
- Traps

Authentication or Privacy Keys are modified in the **User Security Model (USM)**.

SNMPv3 can be enabled on if the Local Engine ID is enabled.

This section contains the following topics:

- "Defining SNMP Global Parameters" on page 220
- "Defining SNMP View Settings" on page 223
- "Defining SNMP Access Control" on page 227
- "Assigning SNMP User Security" on page 230
- "Defining SNMP Communities" on page 234
- "Defining SNMP Notification Filters" on page 238
- "Defining SNMP Notification Recipients" on page 240

Defining SNMP Global Parameters

The SNMP Global Parameters page permits enabling both SNMP and Authentication notifications.

To open the SNMP Global Parameters page, click **System** → **SNMP** → **Global Parameters** in the tree view.

Figure 6-87. SNMP Global Parameters

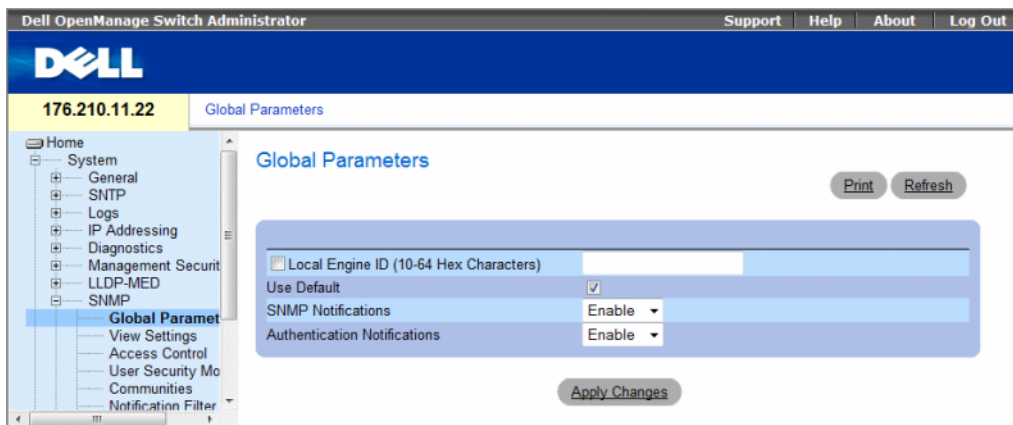

The **SNMP Global Parameters** page contains the following fields:

- **Local Engine ID (10-64 Hex Characters)** — Indicates the local device engine ID. The field value is a hexadecimal string. Each byte in hexadecimal character strings is two hexadecimal digits. Each byte can be separated by a period or a colon. The Engine ID must be defined before SNMPv3 is enabled.
 - For stand-alone devices select a default Engine ID that is comprised of Enterprise number and the default MAC address.
 - For a stackable system configure the Engine ID, and verify that the Engine ID is unique for the administrative domain. This prevents two devices in a network from having the same Engine ID.
- **Use Default** — Select to use the device generated Engine ID. The default Engine ID is based on the device MAC address and is defined per standard as:
 - **First 4 octets** — first bit = 1, the rest is IANA Enterprise number = 674.
 - **Fifth octet** — Set to 3 to indicate the MAC address that follows.
 - **Last 6 octets** — MAC address of the device.
- **SNMP Notifications** — Enables or disables the router sending SNMP notifications.
- **Authentication Notifications** — Enables or disables the router sending SNMP traps when authentication fails.

Enabling SNMP Notifications

- 1** Open the **SNMP Global Parameters** page.
- 2** Select **Enable** in the **SNMP Notifications** field.
- 3** Click **Apply Changes**.
SNMP notifications are enabled, and the device is updated.

Enabling Authentication Notifications

- 1** Open the **SNMP Global Parameters** page.
- 2** Select **Enable** in the **Authentication Notifications** field.
- 3** Click **Apply Changes**.

Enabling SNMP Notifications Using CLI Commands

The following table summarizes the equivalent CLI commands for viewing fields displayed in the SNMP Global Parameters page.

Table 6-46. SNMP Notification Commands

CLI Command	Description
<code>snmp-server enable traps</code>	Enables the router to send Simple Network Management Protocol traps
<code>snmp-server trap authentication</code>	Enables the router to send Simple Network Management Protocol traps when authentication fails
<code>show snmp</code>	Checks the status of SNMP communications.
<code>snmp-server engine ID local {engineid-string default}</code>	Indicates the local device engine ID. The field values is a hexadecimal string. Each byte in hexadecimal character strings is two hexadecimal digits. Each byte can be separated by a period or colon. The Engine ID must be defined before SNMPv3 is enabled.

The following is an example of the CLI commands:

```
Console(config)# snmp-server enable traps
Console(config)# snmp-server trap authentication
Console# show snmp

Community-String  Community-Access  View name  IP address
-----
public            read only         view-1     All

Community-String  Group name        IP address  Type
-----
Traps are enabled.
Authentication-failure trap is enabled.
```

Version 1,2 notifications							
Target Address	Type	Community	Version	Udp Port	Filter name	To Sec	Retries
-----	----	-----	-----	----	-----	---	-----
Version 3 notifications							
Target Address	Type	Username	Security Level	Udp Port	Filter name	To Sec	Retries
-----	----	-----	-----	----	-----	---	-----
				-	-		
System Contact: Robert							
System Location: Marketing							

Defining SNMP View Settings

SNMP Views provide access or block access to device features or feature aspects. For example, a view can be defined which states that SNMP group A has read only (R/O) access to Multicast groups, while SNMP group B has read-write (R/W) access to Multicast groups. Feature access is granted via the MIB name, or MIB Object ID.

The Up and Down arrows allow navigating through the MIB tree, and MIB branches.

To open the **SNMPv3 View Settings** page, click **System** → **SNMP** → **View Settings** in the tree view.

Figure 6-88. SNMPv3 View Settings

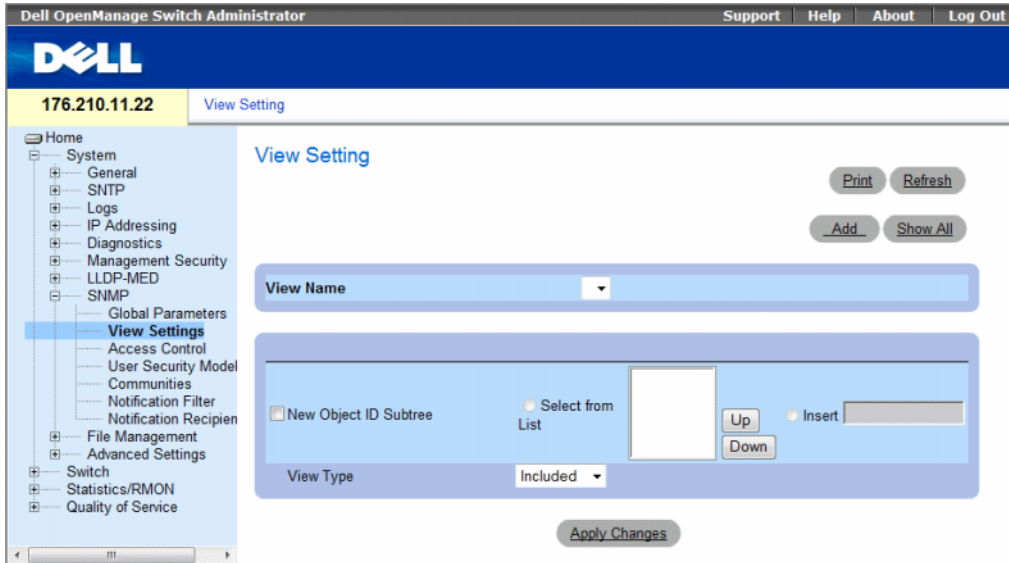

The SNMPv3 View Settings page contains the following fields:

- **View Name** — Contains a list of user-defined views. The view name can contain a maximum of 30 alphanumeric characters.
- **New Object ID Subtree** — Indicates the device feature OID included or excluded in the selected SNMP view.
 - **Selected from List** — Select the device feature OID by using the **Up** and **Down** buttons to scroll through a list of all device OIDs.
 - **Insert** — Specify the device feature OID.
- **View Type** — Indicates if the defined OID branch will be included or excluded in the selected SNMP view.

Adding a View

1 Open the SNMPv3 View Settings page.

2 Click Add.

The Add A View page opens.

Figure 6-89. Add A View

Add a View Refresh

View Name (1-30 Characters)

Apply Changes

3 Define the field.

4 Click Apply Changes.

The SNMP View is added, and the device is updated.

Displaying the View Table

1 Open the SNMPv3 View Settings page.

2 Click Show All.

The View Table page opens.

Figure 6-90. View Table

View Table Refresh

View Name

Object ID Subtree	View Type	Remove
1	Included	<input type="checkbox"/>

Apply Changes

Defining SNMPv3 Views Using CLI Commands

The following table summarizes the equivalent CLI commands for defining fields displayed in the SNMPv3 View Settings page.

Table 6-47. SNMP View CLI Commands

CLI Command	Description
<code>snmp-server view <i>view-name</i> <i>oid-tree</i> {included excluded}</code>	Creates or updates a view entry.
<code>show snmp views [<i>viewname</i>]</code>	Displays the configuration of views.

The following is an example of CLI commands:

```
Console(config)# snmp-server view user1 1 included
Console(config)# end
Console# show snmp views
Name                OID Tree            Type
-----            -
user1               iso                 included
Default             iso                 included
Default             snmpVacmMIB        excluded
Default             usmUser             excluded
Default             rndCommunityTable  excluded
DefaultSuper        iso                 included
```

Defining SNMP Access Control

The **Access Control** page provides information for creating SNMP groups, and assigning SNMP access control privileges to SNMP groups. Groups allow network managers to assign access rights to specific device features, or features aspects.

To open the **Access Control Group** page, click **System** → **SNMP** → **Access Control** in the tree view.

Figure 6-91. Access Control Group

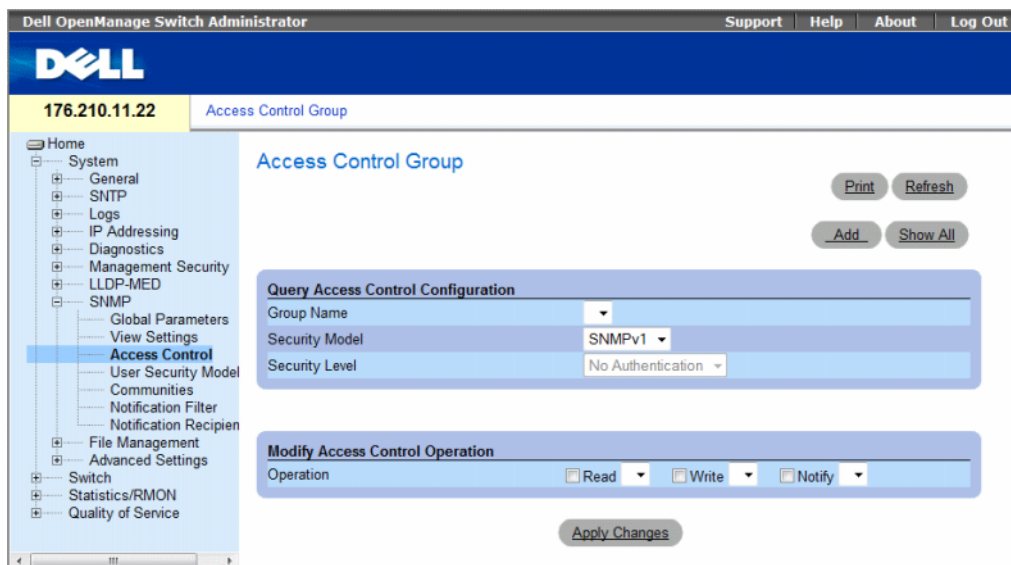

The **Access Control Group** contains the following fields:

- **Group Name** — The user-defined group to whom access control rules are applied. The field range is up to 30 characters.
- **Security Model** — Defines the SNMP version attached to the group. The possible field values are:
 - **SNMPv1** — SNMPv1 is defined for the group.
 - **SNMPv2** — SNMPv2 is defined for the group.
 - **SNMPv3** — SNMPv3 is defined for the group.

- **Security Level** — The security level attached to the group. Security levels apply to SNMPv3 only. The possible field values are:
 - **No Authentication** — Neither the Authentication nor the Privacy security levels are assigned to the group.
 - **Authentication** — Authenticates SNMP messages, and ensures the SNMP messages origin is authenticated.
 - **Privacy** — Encrypts SNMP message.
- **Operation** — Defines the group access rights. The possible field values are:
 - **Read** — The management access is restricted to read-only, and changes cannot be made to the assigned SNMP view.
 - **Write** — The management access is read-write and changes can be made to the assigned SNMP view.
 - **Notify** — Sends traps for the assigned SNMP view.

Defining SNMP Groups

- 1 Open the Access Control Group page.
- 2 Click Add.

The Add an Access Control Group page opens.

Figure 6-92. Add an Access Control Group

- 3 Define the fields in the Add an Access Control Group page.
- 4 Click Apply Changes.

The group is added, and the device is updated.

Displaying the Access Table

- 1 Open the Access Control Group page.
- 2 Click Show All.

The Access Table opens.

Figure 6-93. Access Table

Access Table

Group Name	Security Model	Security Level	Operation			Remove
			Read	Write	Notify	
1	SNMPv1	No Authentication				<input checked="" type="checkbox"/>

Refresh

Apply Changes

Removing SNMP Groups

- 1 Open the Access Control Group page.
- 2 Click Show All.

The Access Table opens.

- 3 Select a SNMP group.
- 4 Check the Remove checkbox.
- 5 Click Apply Changes.

The SNMP group is deleted, and the device is updated.

Defining SNMP Access Control Using CLI Commands

The following table summarizes the equivalent CLI commands for defining fields displayed in the Access Control Group page.

Table 6-48. SNMP Access Control CLI Commands

CLI Command	Description
<code>snmp-server group <i>groupname</i> {v1 v2 v3} {noauth auth priv} [read <i>readview</i>] [write <i>writeview</i>] [notify <i>notifyview</i>]</code>	Configure a new Simple Network Management Protocol (SNMP) group, or a table that maps SNMP users to SNMP views.
<code>show snmp groups [<i>groupname</i>]</code>	Displays the configuration of groups

The following is an example of the CLI commands:

```
console (config)# snmp-server group user-group v3 priv read user-view
```

Assigning SNMP User Security

The SNMPv3 User Security Model (USM) page enables assigning system users to SNMP groups, as well as defining the user authentication method.

To open the SNMPv3 User Security Model (USM) page, click **System** → **SNMP** → **User Security Model** in the tree view.

Figure 6-94. SNMPv3 User Security Model (USM)

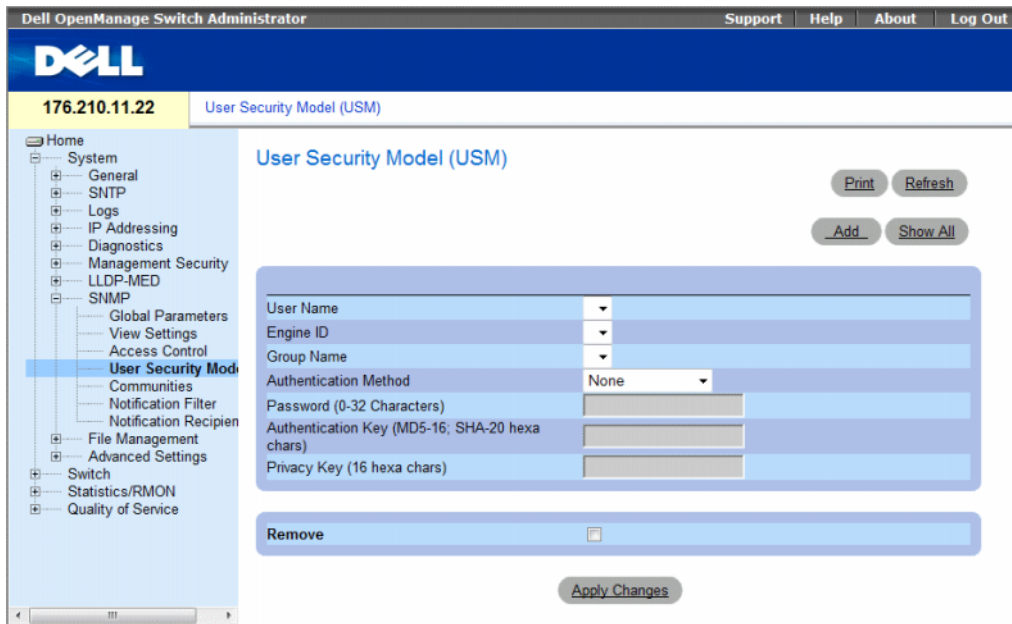

The SNMPv3 User Security Model (USM) page contains the following fields:

- **User Name** — Contains a list of user-defined user names. The field range is up to 30 alphanumeric characters.
- **Engine ID** — Indicates either the local or remote SNMP entity, to which the user is connected. Changing or removing the local SNMP Engine ID deletes the SNMPv3 User Database.
- **Group Name** — Contains a list of user-defined SNMP groups. SNMP groups are defined in the Access Control Group page.

- **Authentication Method** — The authentication method used to authenticate users. The possible field values are:
 - **None** — No user authentication is used.
 - **MD5 Password** — Indicates that HMAC-MD5-96 password is used for authentication. The user should enter a password.
 - **SHA Password** — Users are authenticated using the HMAC-SHA-96 authentication level. The user should enter a password.
 - **MD5 Key**— Users are authenticated using the HMAC-MD5 algorithm.
 - **SHA Key** — Users are authenticated using the HMAC-SHA-96 authentication level.
- **Password (0-32 Characters)** — Modifies the user-defined password for a group. Passwords can contain a maximum of 32 alphanumeric characters.
- **Authentication Key (MD5-16; SHA-20 hexa chars)** — Defines the HMAC-MD5-96 or HMAC-SHA-96 authentication level. The authentication and privacy keys are entered to define the authentication key. If only authentication is required, 16 bytes are defined for MD5. If both privacy and authentication are required, 32 bytes are defined for MD5. Each byte in hexadecimal character strings is two hexadecimal digits. Each byte can be separated by a period or a colon.
- **Privacy Key (16 hexa characters)** — If only authentication is required, 20 bytes are defined. If both privacy and authentication are required, 16 bytes are defined. Each byte in hexadecimal character strings is two hexadecimal digits. Each byte can be separated by a period or colon.
- **Remove** — When checked, removes users from a specified group.
 - **Checked** — Removes the user from the specified group.
 - **Unchecked** — Maintains the user in the specified group.

Adding Users to a Group

- 1 Open the SNMPv3 User Security Model (USM) page.
- 2 Click Add.

The Add SNMPv3 User Name page opens.

Figure 6-95. Add SNMPv3 User Name

Refresh

Add SNMPv3 User Name

User Name (1-30 Characters)

Engine ID Local Remote

Group Name

Authentication Method

Password (0-32 Characters)

Authentication Key (MD5-16; SHA-20 hexa chars)

Privacy Key (16 hexa chars)

Apply Changes

- 3 Define the relevant fields.
 - 4 Click **Apply Changes**.
- The user is added to the group, and the device is updated.

Displaying the User Security Model Table

- 1 Open the SNMPv3 User Security Model (USM) page.
- 2 Click Show All.

The User Security Model Table opens.

Figure 6-96. User Security Model Table

SNMPv3 User Security Model Table

Refresh

User Name	Remote Engine ID	Group Name	Authentication	Remove
1				<input type="checkbox"/>

Apply Changes

Deleting an User Security Model Table Entry

- 1 Open the SNMPv3 User Security Model (USM) page.
- 2 Click Show All.
The User Security Model Table opens.
- 3 Select a User Security Model Table entry.
- 4 Check the Remove checkbox.
- 5 Click Apply Changes.

The User Security Model Table entry is deleted, and the device is updated.

Defining SNMPv3 Users Using CLI Commands

The following table summarizes the equivalent CLI commands for defining fields displayed in the SNMPv3 User Security Model (USM) page.

Table 6-49. SNMPv3 User CLI Commands

CLI Command	Description
<code>snmp-server user <i>username groupname</i> [remote <i>engineid-string</i>] [auth-md5 <i>password</i> auth-sha <i>password</i> auth-md5-key <i>md5-des-key</i> auth-sha-key <i>sha-des-key</i>]</code>	Configures a new SNMP V3 user.
<code>show snmp users [<i>username</i>]</code>	Displays the configuration of users.

The following is an example of the CLI commands:

```
console (config)# snmp-server user John user-group auth-md5 1234
console (config)# end
console# show snmp users
Name           Group Name     Auth Method    Remote
-----
John           user-group     md5
```

Defining SNMP Communities

Access rights are managed by defining communities on the **SNMP Community** page. When the community names are changed, access rights are also changed. SNMP Communities are defined only for SNMP v1 and SNMP v2.

To open the **SNMP Community** page, click **System** → **SNMP** → **Communities** in the tree view.

Figure 6-97. SNMP Community

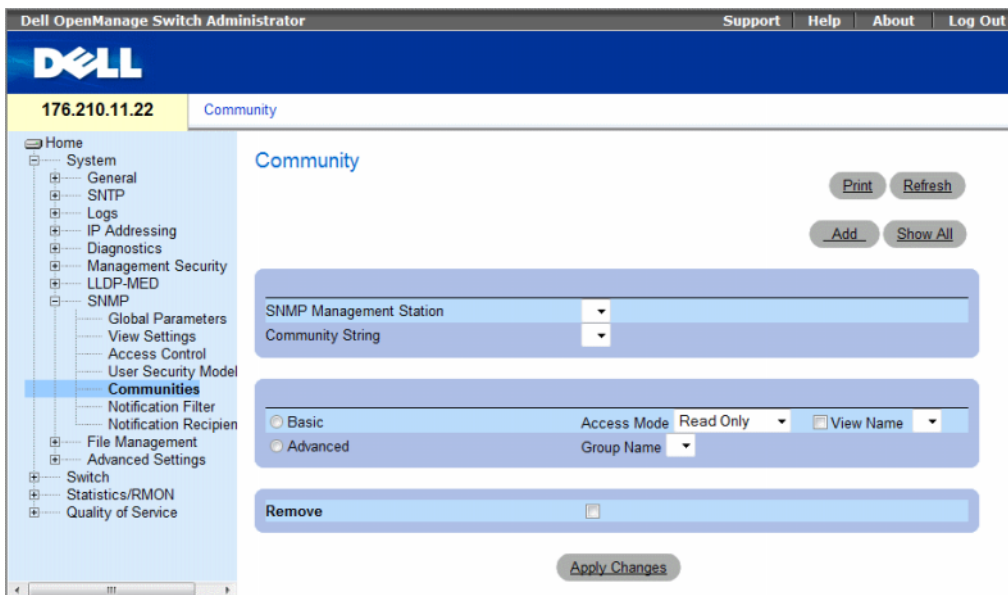

The **SNMP Community** page contains the following fields:

- **SNMP Management Station** — The management station IP address for which the SNMP community is defined.
- **Community String** — Functions as a password and used to authenticate the management station to the device.

- **Basic** — Enables SNMP Basic mode for a selected community. The possible field values are:
 - **Access Mode** — Defines the access rights of the community. The possible field values are:
 - Read-Only** — Management access is restricted to read-only, and changes cannot be made to the community.
 - Read-Write** — Management access is read-write and changes can be made to the device configuration, but not to the community.
 - SNMP-Admin** — User has access to all device configuration options, as well as permissions to modify the community.
 - **View Name** — Contains a list of user-defined SNMP views
- **Advanced** — Contains a list of user-defined groups. When SNMP Advanced mode is selected, the SNMP access control rules comprising the group are enabled for the selected community. The Advanced mode also enables SNMP groups for specific SNMP communities. The SNMP Advanced mode is defined only with SNMPv3. The possible field value is:
 - **Group Name** — Specifies the name of the group when working in SNMP Advanced mode.

Remove — Removes a community from the specified device.

- **Checked** — Removes the community.
- **Unchecked** — Maintains the community in the specified device.

When defining a new SNMP community, the following additional parameters are available:

- **Supported IP Format** — Specifies the IP format supported by the community. The possible values are:
 - **IPv6** — IP version 6 is supported.
 - **IPv4** — IP version 4 is supported.
- **IPv6 Address Type** — When the community supports IPv6 (see previous parameter), this specifies the type of static address supported. The possible values are:
 - **Link Local** — A Link Local address that is non-routable and used for communication on the same network only.
 - **Global** — A globally unique IPv6 address; visible and reachable from different subnets.
- **Link Local Interface** — When the server supports an IPv6 Link Local address (see previous parameter), this specifies the the Link Local interface. The possible values are:
 - **VLAN1** — The IPv6 interface is configured on VLAN1.
 - **ISATAP** — The IPv6 interface is configured on ISATAP tunnel.

Defining a New Community

- 1 Open the SNMP Community page.
- 2 Click Add.

The Add SNMP Community page opens.

Figure 6-98. Add SNMP Community

Add SNMPv1,2 SNMP Community Refresh

Supported IP Format IPv6 IPv4

IPv6 Address Type Link Local Global

Link Local Interface VLAN1 ISATAP

SNMP Management Station (X.X.X.X) All (0.0.0.0) / (::)

Community String (1-20 Characters)

Basic Advanced

Access Mode View Name

Group Name

Apply Changes

- 3 Complete the relevant fields.
 - 4 Click **Apply Changes**.
- The new community is saved, and the device is updated.

Deleting Communities

- 1 Open the SNMP Community page.
- 2 Click Show All.
The Community Table page opens.

Figure 6-99. Community Table

Community Table Refresh

Basic Table

Management Station	Community String	Access Mode	View Name	Remove
1		SNMP Admin		<input type="checkbox"/>

Advanced Table

Management Station	Community String	Group Name	Remove
1			<input type="checkbox"/>

Apply Changes

- 3 Select a community and check the **Remove** check box.
- 4 Click **Apply Changes**.
The community entry is deleted, and the device is updated.

Configuring Communities Using CLI Commands

The following table summarizes the equivalent CLI commands for viewing fields displayed in the SNMP Community.

Table 6-50. SNMP Community CLI Commands

CLI Command	Description
<code>snmp-server community <i>community</i> [ro rw su] [ipv4-address ipv6-address][view <i>view-name</i>]</code>	Sets up the community access string to permit access to the SNMP protocol.
<code>snmp-server community-group <i>community</i> <i>group-name</i> [ipv4-address ipv6-address]</code>	Sets up community access string to permit limited access to the SNMP protocol based on group access rights.
<code>show snmp</code>	Displays the current SNMP device configuration.

The following is an example of the CLI commands:

```
Console (config)# snmp-server community dell ro 10.1.1.1
```

Defining SNMP Notification Filters

The **Notification Filter** page permits filtering traps based on OIDs. Each OID is linked to a device feature or a feature aspect. The **Notification Filter** page also allows network managers to filter notifications.

To open the **Notification Filter** page, click **System** → **SNMP** → **Notification Filters** in the tree view.

Figure 6-100. Notification Filter

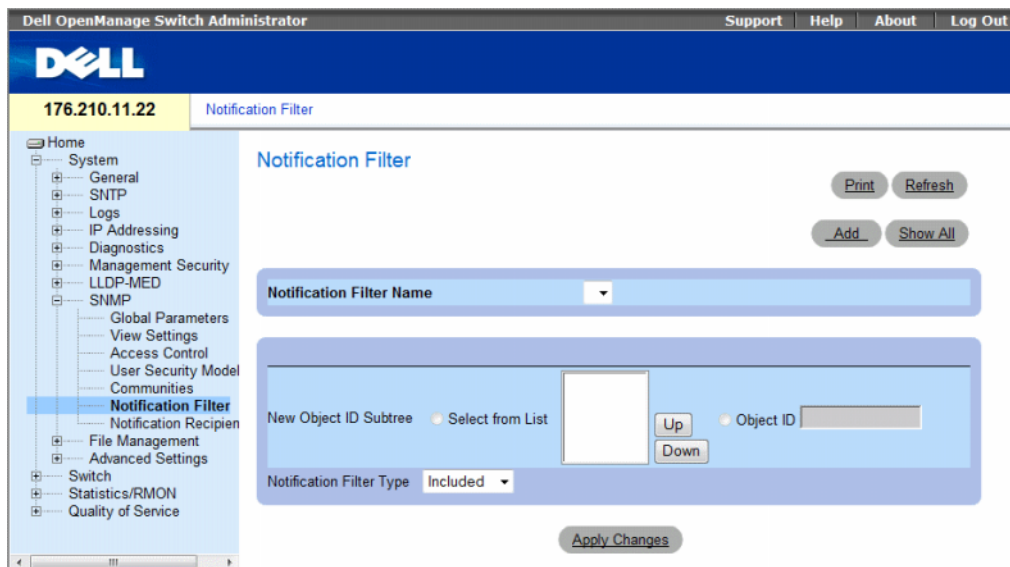

The **Notification Filter** page contains the following fields:

- **Notification Filter Name** — The user-defined notification filter.
- **New Object ID Tree** — The OID for which notifications are sent or blocked. If a filter is attached to an OID, traps or informs are generated and sent to the trap recipients. Object IDs are selected from either the **Select from List** or the **Object ID List**.
- **Notification Filter Type** — Indicates whether informs or traps are sent regarding the OID to the trap recipients.
 - **Excluded** — Restricts sending OID traps or informs.
 - **Included** — Sends OID traps or informs.

Adding SNMP Filters

- 1 Open the Notification Filter page.
- 2 Click Add.
The Add Filter page opens.

Figure 6-101. Add Filter

Refresh

Add Filter

Notification Filter Name (1-30 Characters)

New Object ID Subtree Select from List Object ID

Notification Filter Type

Apply Changes

- 3 Define the relevant fields.
- 4 Click Apply Changes.
The new filter is added, and the device is updated.

Displaying the Filter Table

- 1 Open the Notification Filter page.
- 2 Click Show All.
The Filter Table opens.

Figure 6-102. Filter Table

Refresh

Filter Table

Filter Name

Object Identifier Subtree	Filter Type	Remove
1	Included	<input type="checkbox"/>

Apply Changes

Removing a Filter

- 1 Open the **Notification Filter** page.
- 2 Click **Show All**.
The **Filter Table** opens.
- 3 Select a **Filter Table** entry.
- 4 Check the **Remove** checkbox.
The filter entry is deleted, and the device is updated.

Configuring Notification Filters Using CLI Commands

The following table summarizes equivalent CLI commands for defining fields displayed in the **Notification Filter** page.

Table 6-51. SNMP Notification Filter CLI Commands

CLI Command	Description
<code>snmp-server filter <i>filter-name</i> <i>oid-tree</i> {included excluded}</code>	Creates or updates an SNMP notification filter.
<code>show snmp filters [<i>filtername</i>]</code>	Displays the configuration of SNMP notification filters

The following is an example of CLI commands:

```
Console (config)# snmp-server filter user1 iso included
Console(config)# end
Console # show snmp filters

Name          OID Tree      Type
-----
user1         iso          Included
```

Defining SNMP Notification Recipients

The **Notification Recipients** page contains information for defining filters that determine whether traps are sent to specific users, and the trap type sent. SNMP notification filters provide the following services:

- Identifying Management Trap Targets
- Trap Filtering
- Selecting Trap Generation Parameters
- Providing Access Control Checks

To open the Notification Recipients page, click System → SNMP → Notification Recipient in the tree view.

Figure 6-103. Notification Recipients

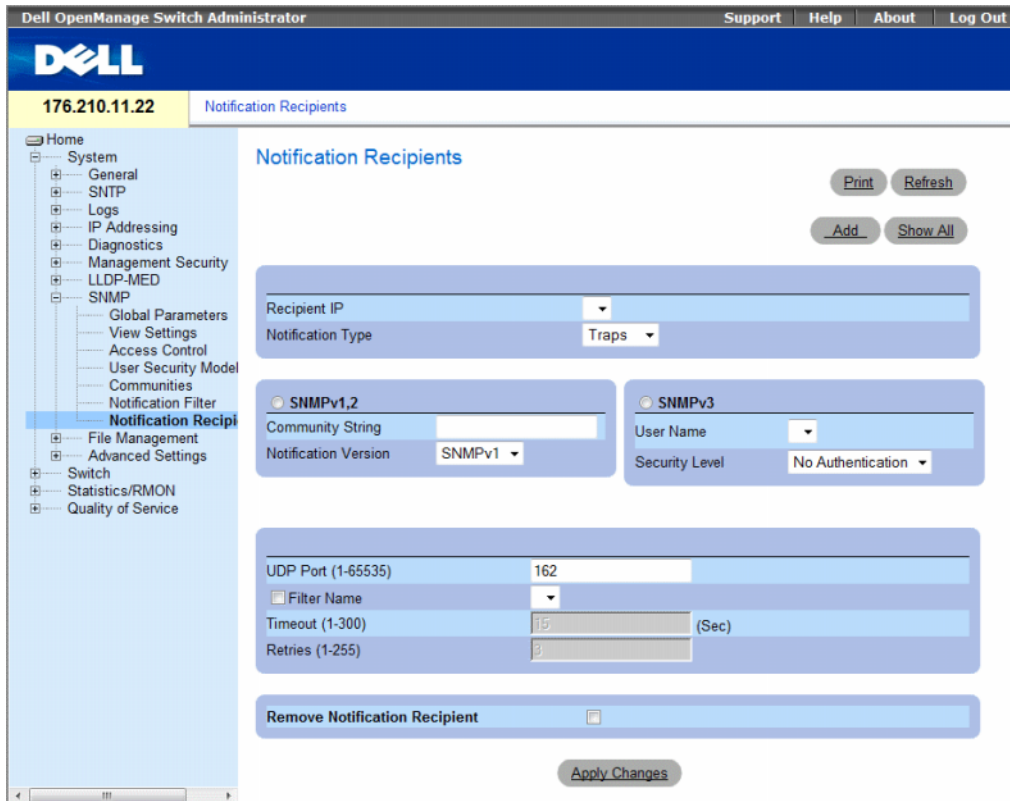

The Notification Recipients page contains the following fields:

- **Recipient IP** — Indicates the IP address to whom the traps are sent.
- **Notification Type** — The notification sent. The possible field values are:
 - **Trap** — Traps are sent.
 - **Inform** — Informs are sent.

SNMPv1,2

SNMP versions 1 and 2 are enabled for the selected recipient. Define the following fields for SNMPv1 and SNMPv2:

- **Community String (1-20 Characters)** — Identifies the community string of the trap manager.
- **Notification Version** — Determines the trap type. The possible field values are:
 - **SNMP V1** — SNMP Version 1 traps are sent.
 - **SNMP V2** — SNMP Version 2 traps are sent.

SNMPv3

SNMPv3 is used to send and receive traps. Define the following fields for SNMPv3:

- **User Name** — The user to whom SNMP notifications are sent.
- **Security Level** — Defines the means by which the packet is authenticated. The possible field values are:
 - **No Authentication** — The packet is neither authenticated nor encrypted.
 - **Authentication** — The packet is authenticated.
 - **Privacy** — The packet is both authenticated and encrypted.
- **UDP Port (1-65535)** — The UDP port used to send notifications. The default is 162.
- **Filter Name** — Includes or excludes SNMP filters.
 - **Checked** — Includes SNMP filters.
 - **Unchecked** — Excludes SNMP filters.
- **Timeout (1-300)** — The amount of time (seconds) the device waits before resending informs. The default is 15 seconds.
- **Retries (1-255)** — The amount of times the device resends an inform request. The default is 3.
- **Remove Notification Recipient** — Removes selected notification recipients.
 - **Checked** — Removes the specific notification recipient.
 - **Unchecked** — Maintains the notification recipient.

When adding a Notification Recipient, the following additional parameters are available:

- **Supported IP Format** — Specifies the IP format supported by the recipient. The possible values are:
 - **IPv6** — IP version 6 is supported.
 - **IPv4** — IP version 4 is supported.

- **IPv6 Address Type** — When the recipient supports IPv6 (see previous parameter), this specifies the type of static address supported. The possible values are:
 - **Link Local** — A Link Local address that is non-routable and used for communication on the same network only.
 - **Global** — A globally unique IPv6 address; visible and reachable from different subnets.
- **Link Local Interface** — When the server supports an IPv6 Link Local address (see previous parameter), this specifies the the Link Local interface. The possible values are:
 - **VLAN1** — The IPv6 interface is configured on VLAN1.
 - **ISATAP** — The IPv6 interface is configured on ISATAP tunnel.

Adding a new Trap Recipients

- 1 Open Notification Recipients page.
- 2 Click Add.

The Add Notification Recipients page opens.

Figure 6-104. Add Notification Recipients

- 3 Define the relevant fields.
- 4 Click **Apply Changes**.

The notification recipient is added, and the device is updated.

Displaying Notification Recipients Tables

- 1 Open Notification Recipients page.
- 2 Click Show All.

The Notification Recipients Tables page opens.

Figure 6-105. Notification Recipients Tables

Notification Recipients Tables Refresh

SNMPv1,2 Notification Recipient

Recipients IP	Notification Type	Community String	Notification Version	UDP Port	Filter Name	Timeout	Retries	Remove
1								<input type="checkbox"/>

SNMPv3 Notification Recipient

Recipients IP	Notification Type	User Name	Security Level	UDP Port	Filter Name	Timeout	Retries	Remove
1								<input type="checkbox"/>

Apply Changes

Deleting Notification Recipients

- 1 Open Notification Recipients page.
- 2 Click Show All.

The Notification Recipients Tables page opens.

- 3 Select a notification recipient in either the SNMPV1,2 Notification Recipient or SNMPv3 Notification Recipient Tables.
- 4 Check the Remove checkbox.
- 5 Click Apply Changes.

The recipient is deleted, and the device is updated.

Configuring SNMP Notification Recipients Using CLI Commands

The following table summarizes the equivalent CLI commands for viewing fields displayed in the Notification Recipients page.

Table 6-52. SNMP Community CLI Commands

CLI Command	Description
<code>snmp-server host {ipaddress hostname} community-string [traps informs] [1 2] [udp-port port] [filter filtername] [timeout seconds] [retries retries]</code>	Creates or updates a notification recipient receiving notifications in SNMP version 1 or 2.
<code>snmp-server v3-host {ip-address hostname} username [traps informs] {noauth auth priv} [udp-port port] [filter filtername] [timeout seconds] [retries retries]</code>	Creates or updates a notification recipient receiving notifications in SNMP version 3.
<code>show snmp</code>	Shows the current SNMP configuration.

The following is an example of the CLI commands:

```
console(config)# snmp-server host 172.16.1.1 private
console(config)# end
console# show snmp
Community-String  Community-Access  View name      IP address
-----
public           read only          user-view      All
private          read write         default        172.16.1.1
private          su                 DefaultSuper   172.17.1.1
```

Managing Files

Use the **File Management** page to manage device software, the image file, and the configuration files. Files can be downloaded or uploaded via a TFTP server. The management file structure consists of the following files:

- **Startup Configuration File** — Contains the commands required to configure device at startup or after reboot. The startup configuration file is created by copying the configuration commands from the Running Configuration file or an Image file.
- **Running Configuration File** — Contains all Startup Configuration file commands, as well as all commands entered during the current session. After the device is powered down or rebooted, all commands stored in the Running Configuration file are lost. During the startup process, all commands in the Startup Configuration file are copied to the Running Configuration file and applied to the device. During the session, all new commands are added to the commands existing in the Running Configuration file. To update the Startup Configuration file, before powering down the device, the Running Configuration file must be copied to the Startup Configuration file.
- **Image Files** — System file images are saved in two Flash Files called Image 1 and Image 2. The active image stores the active copy, while the other image stores a second copy. The device boots and runs from the active image. If the active image is corrupted, the system automatically boots from the non-active image. This is a safety feature for faults occurring during the Software Upgrade process.

To open the **File Management** page, click **System** → **File Management** in the tree view.

This section contains the following topics:

- "Downloading Files" on page 247
- "Uploading Files" on page 250
- "Activating Image Files" on page 253
- "Copying Files" on page 255
- "Managing Device Files" on page 257

Downloading Files

The **File Download from Server** page contains fields for downloading system image and Configuration files from the TFTP server or HTTP client to the device.

To open the **File Download from Server** page, click **System** → **File Management** → **File Download** in the tree view.

Figure 6-106. File Download from Server

The screenshot displays the Dell OpenManage Switch Administrator interface. The top navigation bar includes 'Support', 'Help', 'About', and 'Log Out'. The main header shows the IP address '176.210.11.22' and the page title 'File Download from Server'. A left-hand tree view shows the navigation structure, with 'File Download' selected under 'File Management'. The main content area is titled 'File Download from Server' and includes 'Print' and 'Refresh' buttons. The configuration is organized into several sections:

- Supported IP Format:** Radio buttons for IPv6 and IPv4 (selected).
- IPv6 Address Type:** Radio buttons for Link Local and Global.
- Link Local Interface:** Radio buttons for VLAN1 and ISATAP.
- Download Method:** Radio buttons for Firmware Download (selected), Configuration Download, and Download. Radio buttons for Download via TFTP (selected) and Download via HTTP.
- Firmware Download:** Fields for Server IP Address (placeholder: X.X.X.X), Source File Name (1-64 Characters), and Server Type (dropdown: Software Image).
- Active Image:** Fields for Active Image and Active Image After Reset (dropdown: Image 1).
- Configuration Download:** Fields for Server IP Address (placeholder: X.X.X.X), Source File Name (1-64 Characters), Destination File Name, and radio buttons for Running Configuration (selected) and New File Name (1-64 Characters).

An 'Apply Changes' button is located at the bottom of the configuration area.

The **File Download from Server** page contains the following fields:

- **Supported IP Format** — Specifies the IP format supported by the server. The possible values are:
 - **IPv6** — IP version 6 is supported.
 - **IPv4** — IP version 4 is supported.
- **IPv6 Address Type** — When the server supports IPv6 (see previous parameter), this specifies the type of static address supported. The possible values are:
 - **Link Local** — A Link Local address that is non-routable and used for communication on the same network only.
 - **Global** — A globally unique IPv6 address; visible and reachable from different subnets.
- **Link Local Interface** — When the server supports an IPv6 Link Local address (see previous parameter), this specifies the the Link Local interface. The possible values are:
 - **VLAN1** — The IPv6 interface is configured on VLAN1.
 - **ISATAP** — The IPv6 interface is configured on ISATAP tunnel.
- **Firmware Download** — The Firmware file is downloaded. If **Firmware Download** is selected, the **Configuration Download** fields are grayed out.
- **Configuration Download** — The Configuration file is downloaded. If **Configuration Download** is selected, the **Firmware Download** fields are grayed out.
- **Download via TFTP** — Enables initiating an image upload via the TFTP server.
- **Download via HTTP** — Enables initiating an image upload via the HTTP server.

Firmware Download

- **Server IP Address** — The Server IP Address from which the firmware files are downloaded.
- **Source File Name (1-64 characters)** — Indicates the file to be downloaded.
- **Destination File Name** — The destination file type to which the file is downloaded. The possible field values are:
 - **Software Image** — Downloads the Image file. The image file overwrites the non-active image. It is recommended to designate that the non-active image becomes the active image after reset, and then to reset the device following the download. During the Image file download a dialog box opens which displays the download progress. The window closes automatically when the download is complete.
 - **Boot Code** — Downloads the Boot file.

Configuration Download

- **Server IP Address** — The TFTP Server IP Address from which the configuration files are downloaded.
- **Source File Name (1-64 characters)** — Indicates the configuration files to be downloaded.
- **Destination File** — The destination file to which the configuration file is downloaded. The possible field values are:
 - **Running Configuration** — Downloads commands into the Running Configuration file.
 - **Startup Configuration** — Downloads the Startup Configuration file, and overwrites it.
 - **<filename>** — Downloads commands into a configuration backup file. The filename is determined by the user at download.

Downloading Files

- 1 Open the **File Download from Server** page.
- 2 Define the file type to download.
- 3 Define the fields.
- 4 Click **Apply Changes**.

The software is downloaded to the device. To activate the selected Image file, reset the device. For information on resetting the device, see **Switching Between Stack Masters**.

Downloading Files Using CLI Commands

The following table summarizes the equivalent CLI commands for setting fields displayed in the **File Download from Server** page.

Table 6-53. File Download CLI Commands

CLI Command	Description
<code>copy source-url destination-url</code>	Copies any file from a source to a destination.

The following is an example of the CLI commands:

```
console# copy tftp://10.6.6.64/pp.txt startup-config
....!
Copy: 575 bytes copied in 00:00:06 [hh:mm:ss]
01-Jan-2000 06:41:55 %COPY-W-TRAP: The copy operation was
completed successfully
```



NOTE: Each exclamation mark (!) indicates that ten packets were successfully transferred.

Uploading Files

The **File Upload to Server** page contains fields for uploading the software to the TFTP server from the device. The Image file can also be uploaded from the **File Upload to Server** page.

To open the **File Upload to Server** page, click **System** → **File Management** → **File Upload** in the tree view.

Figure 6-107. File Upload to Server

The screenshot displays the Dell OpenManage Switch Administrator interface for the 'File Upload to Server' page. The top navigation bar includes 'Support', 'Help', 'About', and 'Log Out'. The left sidebar shows a tree view with 'File Management' expanded to 'File Upload'. The main content area is titled 'File Upload to Server' and contains the following sections:

- Supported IP Format:** Radio buttons for IPv6 and IPv4 (selected).
- IPv6 Address Type:** Radio buttons for Link Local (selected) and Global.
- Link Local Interface:** Radio buttons for VLAN1 (selected) and ISATAP.
- Upload Methods:** Two columns of radio buttons. The first column has 'Firmware Upload' (selected) and 'Configuration Upload'. The second column has 'Upload via TFTP' (selected) and 'Upload via HTTP'.
- Software Image Upload:** Fields for 'TFTP Server IP Address' (placeholder: X.X.X.X) and 'Destination File Name (1-64 Characters)'. A file upload icon is present.
- Configuration Upload:** Fields for 'TFTP Server IP Address' (placeholder: X.X.X.X), 'Destination File Name (1-64 Characters)', and 'Transfer File Name' (dropdown menu with 'Running Configuration' selected).

Buttons for 'Print', 'Refresh', and 'Apply Changes' are located at the bottom of the page.

The **File Upload to Server** page contains the following fields:

- **Supported IP Format** — Specifies the IP format supported by the server. The possible values are:
 - **IPv6** — IP version 6 is supported.
 - **IPv4** — IP version 4 is supported.
- **IPv6 Address Type** — When the server supports IPv6 (see previous parameter), this specifies the type of static address supported. The possible values are:
 - **Link Local** — A Link Local address that is non-routable and used for communication on the same network only.
 - **Global** — A globally unique IPv6 address; visible and reachable from different subnets.
- **Link Local Interface** — When the server supports an IPv6 Link Local address (see previous parameter), this specifies the the Link Local interface. The possible values are:
 - **VLAN1** — The IPv6 interface is configured on VLAN1.
 - **ISATAP** — The IPv6 interface is configured on ISATAP tunnel.
- **Firmware Upload** — The Firmware file is uploaded. If **Firmware Upload** is selected, the **Configuration Upload** fields become unavailable.
- **Configuration Upload** — The Configuration file is uploaded. If **Configuration Upload** is selected, the **Software Image Upload** fields become unavailable.
- **Upload via TFTP** — Enables initiating an image upload via the TFTP server.
- **Upload via HTTP** — Enables initiating an image upload via the FTP server.

Software Image Upload

- **TFTP Server IP Address** — The TFTP Server IP Address to which the Software Image is uploaded.
- **Destination File Name (1-64 Characters)** — Indicates the Software Image file path to which the file is uploaded.

Configuration Upload

- **TFTP Server IP Address** — The TFTP Server IP Address to which the Configuration file is uploaded.
- **Destination File Name (1-64 Characters)** — Indicates the Configuration file path to which the file is uploaded.
- **Transfer File Name** — The software file to which the configuration is uploaded. The possible field values are:
 - **Running Configuration** — Uploads the Running Configuration file.
 - **Startup Configuration** — Uploads the Startup Configuration file.
 - **My Backup Configuration** — Uploads the Backup Configuration file. This list of user-defined configuration files only appears if the user had created backup configuration files. For example, if the user copied the running configuration file to a user-defined configuration file called BACKUP-SITE-1, this list appears on the File Upload to Server page and the BACKUP-SITE-1 configuration file appears in the list.

Uploading Files

- 1 Open the **File Upload to Server** page.
- 2 Define the file type to upload.
- 3 Define the fields.
- 4 Click **Apply Changes**.

The software is uploaded to the TFTP server.

Uploading Files Using CLI Commands

The following table summarizes the equivalent CLI commands for setting fields displayed in the **File Upload to Server** page.

Table 6-54. File Upload CLI Commands

CLI Command	Description
<code>copy source-url destination-url</code>	Copies any file from a source to a destination.

The **Active Images** page contains the following fields:

- **Unit No.** — The unit number for which the Image file is selected.
- **Active Image** — The Image file which is currently active on the unit.
- **After Reset** — The Image file which is active on the unit after the device is reset. The possible field values are:
 - **Image 1** — Activates Image file 1 after the device is reset.
 - **Image 2** — Activates Image file 2 after the device is reset.

Selecting an Image File

- 1 Open the **Active Images** page.
- 2 Select an Image file for a specific unit in the **After Reset** field.
- 3 Click **Apply Changes**.

The Image file is selected. The Image file reloads only after the next reset. The currently selected Image file continue to run until the next device reset.

Working with the Active Image File Using CLI Commands

The following table summarizes the equivalent CLI commands for viewing fields displayed in the **Active Images**.

Table 6-55. File Upload CLI Commands

CLI Command	Description
<code>boot system [unit unit] {image-1 image-2}</code>	Indicates the system image that the device loads at startup.
<code>show version [unit unit]</code>	Displays version information for the system

The following is an example of the CLI commands:

```
Console# boot system image-1
```

Copying Files

Files can be copied and deleted from the **Copy Files** page.

To open the **Copy Files** page, click **System** → **File Management** → **Copy Files** in the tree view.

Figure 6-109. Copy Files

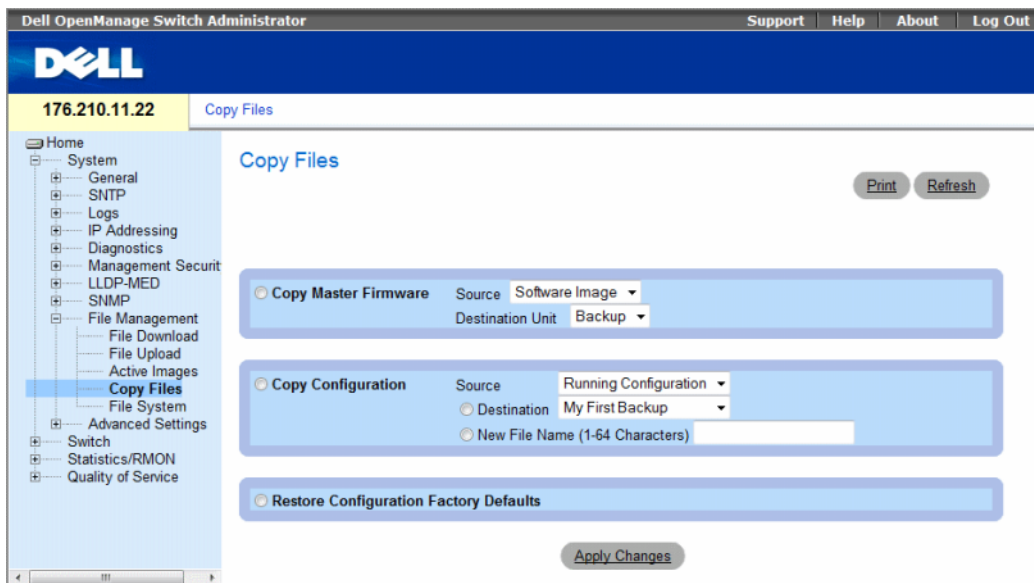

The **Copy Files** page contains the following fields:

- **Copy Master Firmware** — Indicates the firmware file to copy. The possible field values are:
 - **Source** — Copies the current Stacking Master's Software Image file or Boot Code file.
 - **Destination Unit** — Specifies the stacking member to upload the file.
- **Copy Configuration** — When selected, copies either the running, startup or backup configuration file of the Master file to the destination file.
 - **Source** — Indicates the type of file to be copied to the destination file. Select either the Running Configuration or Startup Configuration.
 - **Destination** — Indicates the destination configuration file to which the source file is copied. Select My First Backup or Startup Configuration.
 - **New File Name (1-64 characters)** — Indicates the name of the newly created backup configuration file.
- **Restore Configuration Factory Defaults** — When selected, indicates that the current configuration settings should be replaced by the factory configuration default settings. When clear, indicates that the current configuration settings should be maintained.

Copying Files

- 1 Open the Copy Files page.
- 2 Define the Source and Destination fields.
- 3 Click Apply Changes.
The file is copied, and the device is updated.

Restoring Company Factory Default Settings

- 1 Open the Copy Files page.
- 2 Click Restore Configuration Factory Defaults.
- 3 Click Apply Changes.

The company factory default settings are restored, and the device is updated.

Copying and Deleting Files Using CLI Commands

The following table summarizes the equivalent CLI commands for setting fields displayed in the Copy Files page.

Table 6-56. Copy Files CLI Commands

CLI Command	Description
<code>copy source-url destination-url</code>	Copies any file from a source to a destination.
<code>delete startup-config</code>	Deletes the startup-config file.
<code>delete url</code>	Deletes a file from the FLASH memory device.

The following is an example of the CLI commands:

```
console# delete startup-config
Startup file was deleted
console#
console# copy running-config startup-config
01-Jan-2000 06:55:32 %COPY-W-TRAP: The copy operation was
completed successfully
Copy succeeded
console#
```

Managing Device Files

The **Files on File System** page provides information about files currently stored on the system, including file names, file sizes, files modifications, and file permissions. The files system permits managing up to five files, with a maximum size of 0.5 MB per file.

To open the **Files on File System** page, click **System**→**File Management**→**File System** in the tree view.

Figure 6-110. Files on File System

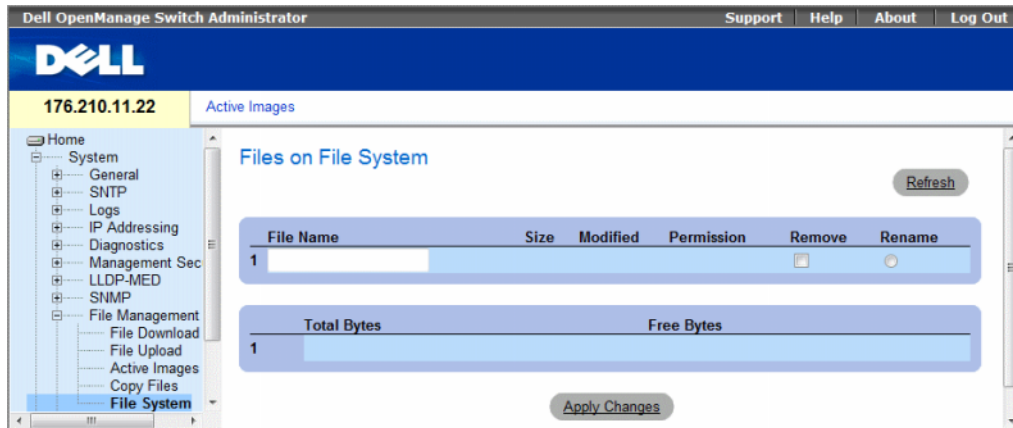

The **Files on File System** page contains the following fields:

- **File Name** — Indicates the file currently stored in the file management system.
- **Size** — Indicates the file size.
- **Modified** — Indicates the date the file was last modified.
- **Permission** — Indicates the permission type assigned to the file. The possible field values are:
 - **Read Only** — Indicates a read-only file.
 - **Read Write** — Indicates a read-write file.
- **Remove** — Deletes the file.
 - **Checked** — Removes the specified file from the file management system.
 - **Unchecked** — Maintains the specified file in the file management system.
- **Rename** — Permits renaming the file. The file name is renamed in the **File Name** field.
- **Total Bytes** — Indicates the total amount of the space currently used.
- **Free Bytes** — Indicates the remaining amount of the space currently free.

Managing Files Using CLI Commands

The following table summarizes the equivalent CLI commands for managing system files.

Table 6-57. Copy Files CLI Commands

CLI Command	Description
dir	Display list of files on a flash file system

The following is an example of the CLI commands:

```
console# dir
Directory of flash:

File Name           Permis-  Flash   Data   Modified
                   sion    Size    Size
-----
3.txt               rw      524288  523776  22-Feb-2005 18:49:27
setup              rw      524288   95     22-Feb-2005 15:58:19
setup2             rw      524288   95     22-Feb-2005 15:58:35
image-1            rw      4325376 4325376 06-Feb-2005 17:55:32
image-2            rw      4325376 4325376 06-Feb-2005 17:55:31
test.txt           rw      524288   95     22-Feb-2005 12:16:44
aaafilename.prv    --      131072   --     06-Feb-2005 19:09:02
syslog1.sys        r-      262144   --     22-Feb-2005 18:49:27
syslog2.sys        r-      262144   --     22-Feb-2005 18:49:27
directory.prv      --      262144   --     06-Feb-2005 17:55:31
startup-config     rw      524288   347    22-Feb-2005 11:56:03

Total size of flash: 16646144 bytes
Free size of flash: 4456448 bytes
```

Configuring Advanced Settings

Use Advanced Settings to set miscellaneous global attributes of the switch. The changes to these attributes are applied only after the switch is reset.

Click a link below to access on-line help for the indicated screen.

Click **System** → **Advanced Settings** in the tree view to open the **Advanced Settings** page.

The **Advanced Settings** page contains a link for configuring general settings.

This section contains the following topics:

- "Configuring General Settings" on page 259

Configuring General Settings

The **General Settings** page provides information for defining general device parameters.

To open the **General Settings** page, click **System** → **Advanced Settings** → **General Settings** in the tree view.

Figure 6-111. General Settings

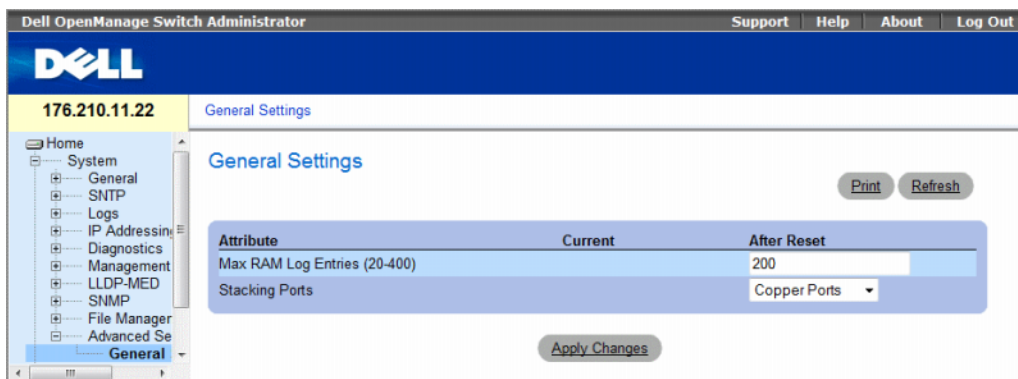

The **General Settings** page contains the following information:

- **Attribute** — The general setting attribute.
- **Current** — The currently configured value.
- **After Reset** — The future (after reset) value. By entering a value in the After Reset column, memory is allocated to the field table.
- **Max RAM Log Entries (20-400)** — The maximum number of RAM Log entries. When the Log entries are full, the log is cleared and the Log file is restarted.
- **Stacking Ports** — The type of stacking ports: copper or fiber ports.

Viewing RAM Log Entries Counter Using the CLI Commands

The following table summarizes the equivalent CLI commands for setting fields displayed in the General Settings page.

Table 6-58. General Settings CLI Commands

CLI Command	Description
<code>logging buffered size <i>number</i></code>	Sets the number of syslog messages stored in the internal buffer (RAM).

The following is an example of the CLI commands:

```
console(config)# logging buffered size 300
```

Configuring Switch Information

This section provides all system operation and general information for configuring network security, ports, Address tables, GARP, VLANs, Spanning Tree, Port Aggregation, and Multicast Support.

This section contains the following topics:

- "Configuring Network Security" on page 261
- "ACL Overview" on page 276
- "Configuring DHCP Snooping" on page 288
- "Configuring Ports" on page 297
- "Configuring Address Tables" on page 315
- "Configuring GARP" on page 321
- "Configuring the Spanning Tree Protocol" on page 325
- "Configuring VLANs" on page 351
- "Configuring Voice VLAN" on page 374
- "Aggregating Ports" on page 382
- "Multicast Forwarding Support" on page 387

Configuring Network Security

Use the **Network Security** page to set network security through both access control lists and locked ports. To open the **Network Security** page, select **Switch** → **Network Security**.

This section contains the following topics:

- "Port Based Authentication" on page 262
- "Configuring Advanced Port Based Authentication" on page 268
- "Authenticating Users" on page 271
- "Configuring Port Security" on page 273

Port Based Authentication

Port based authentication enables authenticating system users on a per-port basis via an external server. Only authenticated and approved system users can transmit and receive data. Ports are authenticated via the RADIUS server using the Extensible Authentication Protocol (EAP). Port Authentication includes:

- **Authenticators** — Specifies the device port which is authenticated before permitting system access.
- **Supplicants** — Specifies host connected to the authenticated port requesting to access the system services.
- **Authentication Server** — Specifies the external server, for example, the RADIUS server that performs the authentication on behalf of the authenticator, and indicates whether the supplicant is authorized to access system services.

Port based authentication creates two access states:

- **Controlled Access** — Permits communication between the supplicant and the system, if the supplicant is authorized.
- **Uncontrolled Access** — Permits uncontrolled communication regardless of the port state.

The device currently supports Port Based Authentication via RADIUS servers.

MAC Based Authentication

MAC based authentication is an alternative to 802.1x that allows network access to devices (such as printers and IP phones) that do not have the 802.1X supplicant capability. MAC authentication uses the MAC address of the connecting device to grant or deny network access.

Advanced Port Based Authentication

Advanced Port Based Authentication:

- Enables multiple hosts to be attached to a single port.
- Requires only one host to be authorized for all hosts to have system access. If the port is unauthorized, all attached hosts are denied access to the network.
- Enables user based authentication. Specific VLANs in the device are always available, even if specific ports attached to the VLAN are unauthorized.
 - For example, Voice over IP does not require authentication, while data traffic requires authentication. VLANs for which authorization is not required can be defined. Unauthenticated VLANs are available to users, even if the ports attached to the VLAN are defined as authorized.

Advanced Port Based Authentication is implemented in the following modes:

- **Single Host Mode** — Enables only the authorized host for single-session access to the port.
- **Multiple Host Mode** — Enables multiple hosts to be attached to a single port, for single-session access. Only one host must be authorized for all hosts to access the network. If the host authentication fails or an EAPOL-logoff message is received, all attached clients are denied network access.

- **Multiple Session Mode** — Enables only the authorized host for multiple-session access to the port.
- **Guest VLANs** — Provides limited network access authorized to ports. If a port is denied network access via port based authentication, but the Guest VLAN is enabled, the port receives limited network access. For example, a network administrator can use Guest VLANs to deny network access via port based authentication, but grant Internet access to unauthorized users.

The **Port Based Authentication** page allows network managers to configure port based authentication. To open the **Port Based Authentication** page, click **Switch** → **Network Security** → **Port Based Authentication**.

Figure 7-1. Port Based Authentication

The screenshot shows the Dell OpenManage Switch Administrator interface. The top navigation bar includes 'Support', 'Help', 'About', and 'Log Out'. The main header displays the IP address '176.210.11.22' and the page title 'Port Based Authentication'. A left-hand navigation tree shows the following structure:

- Home
- System
- Switch
 - Network Security
 - Port Based Authentication** (selected)
 - Multiple Hosts
 - Authenticated Users
 - Port Security
 - IP Based ACL
 - MAC Based ACL
 - ACL Bindings
 - DHCP Snooping
 - Ports
 - Address Tables
 - GARP
 - Spanning Tree
 - VLAN
 - VoiceVLAN
 - Link Aggregation
 - Multicast Support
 - Statistics/RMON
 - Quality of Service

The main content area is titled 'Port Based Authentication' and contains two sections:

Global Parameters

Port Based Authentication State	Enable
Authentication Method	RADIUS, None
Guest VLAN	Disable
VLAN List	1

Interface Parameters

Interface	g1
User Name	
Admin Interface Control	Authorized
Current Interface Control	
Authentication Type	802.1x Only
Dynamic VLAN Assignment	Disable
Guest VLAN	Disable
Periodic Reauthentication	Disable
Reauthentication Period (300-4294967295)	3600 (Sec)
Reauthenticate Now	<input type="checkbox"/>
Authentication Server Timeout (1-65535)	30 (Sec)
Resending EAP Identity Request (1-65535)	30 (Sec)
Quiet Period (0-65535)	60 (Sec)
Supplicant Timeout (1-65535)	30 (Sec)
Max EAP Requests (1-10)	2

Buttons for 'Print', 'Refresh', 'Show All', and 'Apply Changes' are visible on the page.

The **Port Based Authentication** page contains the following fields:

- **Port Based Authentication State** — Permits port based authentication on the device. The possible field values are:
 - **Enable** — Enables port based authentication on the device.
 - **Disable** — Disables port based authentication on the device.
- **Authentication Method** — Indicates the Authentication method used. The possible field values are:
 - **None** — Indicates that no authentication method is used to authenticate the port.
 - **RADIUS** — Indicates that port authentication is performed via RADIUS server.
 - **RADIUS, None** — Indicates that port authentication is performed first via the RADIUS server. If the port is not authenticated, then no authentication method is used, and the session is permitted.
- **Guest VLAN** — Specifies whether the Guest VLAN is enabled on the device. The possible field values are:
 - **Enable** — Enables use of a Guest VLAN for unauthorized ports. If a Guest VLAN is enabled, the unauthorized port automatically joins the VLAN selected in the *VLAN List* field.
 - **Disable** — Disables use of a Guest VLAN for unauthorized ports. This is the default.
- **VLAN List** — Contains a list of VLANs. The Guest VLAN is selected from the VLAN list.

Interface Parameters

- **Interface** — Contains an interface list for which port based authentication is enabled.
- **User Name** — Indicates the supplicant user-name.
- **Admin Interface Control** — Defines the port authorization state. The possible field values are:
 - **Auto** — Enables port based authentication on the device. The interface moves between an authorized or unauthorized state based on the authentication exchange between the device and the client.
 - **Authorized** — Places the interface into an authorized state without being authenticated. The interface resends and receives normal traffic without client port based authentication.
 - **Unauthorized** — Denies the selected interface system access by moving the interface into unauthorized state. The device cannot provide authentication services to the client through the interface.
- **Current Interface Control** — The current port authorization state.
- **Authentication Type** — Specifies the type of authentication on the port. The possible field values are:
 - **802.1x Only** — Sets the authentication type to 802.1x based authentication only.
 - **MAC Only** — Sets the authentication type to MAC based authentication only.
 - **802.1x & MAC** — Sets the authentication type to 802.1x based authentication and MAC based authentication.

- **Dynamic VLAN Assignment** — Indicates whether dynamic VLAN assignment is enabled for this port. This feature allows network administrators to automatically assign users to VLANs during the RADIUS server authentication. When a user is authenticated by the RADIUS server, the user is automatically joined to the VLAN configured on a RADIUS server.
 - Port Lock and Port Monitor should be disabled when DVA is enabled.
 - Dynamic VLAN Assignment (DVA) can occur only if a RADIUS server is configured, and port authentication is enabled and set to 802.1x multi-session mode.
 - If the Radius Accept Message doesn't contain the supplicant's VLAN, the supplicant is rejected.
 - Authenticated ports are added to the supplicant VLAN as untagged.
 - Authenticated ports remain unauthenticated VLAN and Guest VLAN members. Static VLAN configuration is not applied to the port.
 - The following list of VLANs cannot participate in DVA: an Unauthenticated VLAN, a Dynamic VLAN that was created by GVRP, a Voice VLAN, a Default VLAN and a Guest VLAN.
 - Network administrators can delete the supplicant VLAN while the supplicant is logged in. The supplicant is authorized during the next re-authentication if this supplicant VLAN is re-created or a new VLAN is configured on the RADIUS server.
- **Guest VLAN** — If enabled, indicates that unauthorized users connected to this interface can access the Guest VLAN.
 - **Enable** — Enables unauthorized users to access the guest VLAN.
 - **Disable** — Prevents unauthorized users from accessing the guest VLAN.
- **Periodic Reauthentication** — Reauthenticates the selected port periodically. The reauthentication period is defined in the **Reauthentication Period (300-4294967295)** field.
 - **Enable** — Enables periodic port reauthentication.
 - **Disable** — Disables periodic port reauthentication.
- **Reauthentication Period (300-4294967295)** — Indicate the time span in which the selected port is reauthenticated. The field value is seconds. The field default is 3600 seconds.
- **Reauthenticate Now** — Permits immediate port reauthentication.
 - **Checked** — Enables immediate port reauthentication.
 - **Disable** — Disables immediate port reauthentication.
- **Authentication Server Timeout (1-65535)** — Defines the amount of time that lapses before the device resends a request to the authentication server. The field value is specified in seconds. The field default is 30 seconds.
- **Resending EAP Identity Request (1-65535)** — Defines the amount of time that lapses before EAP request are resent. The field default is 30 seconds.
- **Quiet Period (0-65535)** — Indicates the number of seconds that the device remains in the quiet state following a failed authentication exchange. The possible field range is 0-65535. The field default is 60 seconds.

- **Supplicant Timeout (1-65535)** — Indicates the amount of time that lapses before EAP requests are resent to the supplicant. The field value is in seconds. The field default is 30 seconds.
- **Max EAP Requests (1-10)** — Indicates that total amount of EAP requests sent. If a response is not received after the defined period, the authentication process is restarted. The field default is 2 retries.

Displaying the Port Based Authentication Table

- 1 Open the **Port Based Authentication** page.
- 2 Click **Show All**.

The **Port Based Authentication Table** opens.

Figure 7-2. Port Based Authentication Table

Port	User Name	Admin Port Control	Authentication Type	Dynamic VLAN Assignment	Guest VLAN	Periodic Reauthentication	Reauth Per
1	1/e1	Authorized	802.1x Only	Disable		Enable	En
2	1/e2	Authorized	802.1x Only	Disable		Enable	En

In addition to the fields in the **Port Based Authentication Table** also displays the following fields:

- **Unit No.** — Selects a stacking member.
- **Copy Parameters from Port No.** — Copies parameters a the selected port.

Copying parameters in the Port Based Authentication Table

- 1 Open the page.
- 2 Click **Show All**.
The **Port Based Authentication Table** opens.
- 3 Select the interface in the **Copy Parameters from Port No.** field.
- 4 Select an interface in the **Port Based Authentication Table**.
- 5 Check the **Copy** to check box to define the interfaces to which the Port based authentication parameters are copied.
- 6 Click **Apply Changes**.

Enabling Port Based Authentication Using the CLI Commands

The following table summarizes the equivalent CLI commands for enabling the port based authentication as displayed in the **Port Based Authentication** table.

Table 7-1. Port Authentication CLI Commands

CLI Command	Description
<code>aaa authentication dot1x default method1 [method2.]</code>	Specifies one or more authentication, authorization, and accounting (AAA) methods for use on interfaces running IEEE 802.1X.
<code>dot1x auth-not-req</code>	Enables authorized devices access to the VLAN.
<code>dot1x guest-vlan</code>	Defines a Guest VLAN.
<code>dot1x guest-vlan enable</code>	Enables authorized users on the interface to access the Guest VLAN.
<code>dot1x mac-authentication</code>	Enables authentication based on the station's MAC address (MAC based authentication).
<code>dot1x max-req count</code>	Sets the maximum number of times that the device sends an EAP to the client, before restarting the authentication process.
<code>dot1x re-authenticate [ethernet interface]</code>	Manually initiates a re-authentication of all 802.1X-enabled ports or the specified 802.1X-enabled port.
<code>dot1x re-authentication</code>	Enables periodic re-authentication of the client.
<code>dot1x timeout quiet-period seconds</code>	Sets the number of seconds that the device remains in the quiet state following a failed authentication exchange.
<code>dot1x timeout re-authperiod seconds</code>	Sets the number of seconds between re-authentication attempts.
<code>dot1x timeout server-timeout seconds</code>	Sets the time for the retransmission of packets to the authentication server.
<code>dot1x timeout supp-timeout seconds</code>	Sets the time for the retransmission of an EAP request frame to the client.
<code>dot1x timeout tx-period seconds</code>	Sets the number of seconds that the device waits for a response to an EAP - request/identity frame, from the client, before resending the request.
<code>dot1x traps mac-authentication failure</code>	Enables sending traps when the MAC address failed authentication (MAC based authentication).
<code>dot1x radius-attributes vlan</code>	Enables user-based VLAN assignment.
<code>show dot1x [ethernet interface]</code>	Displays 802.1X status for the device or for the specified interface.
<code>show dot1x advanced</code>	Displays 802.1X advanced features for the switch or specified interface.
<code>show dot1x users [username username]</code>	Displays 802.1X users for the device.
<code>dot1x guest-vlan enable</code>	Enables using a guest VLAN for unauthorized ports. If a Guest VLAN is enabled, the unauthorized port automatically joins the VLAN selected in VLAN List field. The field default is disabled.
<code>dot1x guest-vlan</code>	Contains a list of VLANs. The guest VLAN is selected from the VLAN List

The following is an example of the CLI commands:

```
Console# show dot1x
```

Interface	Admin Mode	Oper Mode	Reauth Control	Reauth Period	Username
1/e1	Auto	Authorized	Ena	3600	Bob
1/e2	Auto	Authorized	Ena	3600	John
1/e3	Auto	Unauthorized	Ena	3600	Clark
1/e4	Force-auth	Authorized	Dis	3600	n/a

Configuring Advanced Port Based Authentication

The **Multiple Hosts** page provides information for defining advanced port based authentication settings for specific ports and VLANs. For more information on Advanced Port Based Authentication, see **Advanced Port Based Authentication**.

To open the **Multiple Hosts**, click **Switch** → **Network Security** → **Multiple Hosts**.

Figure 7-3. Multiple Hosts

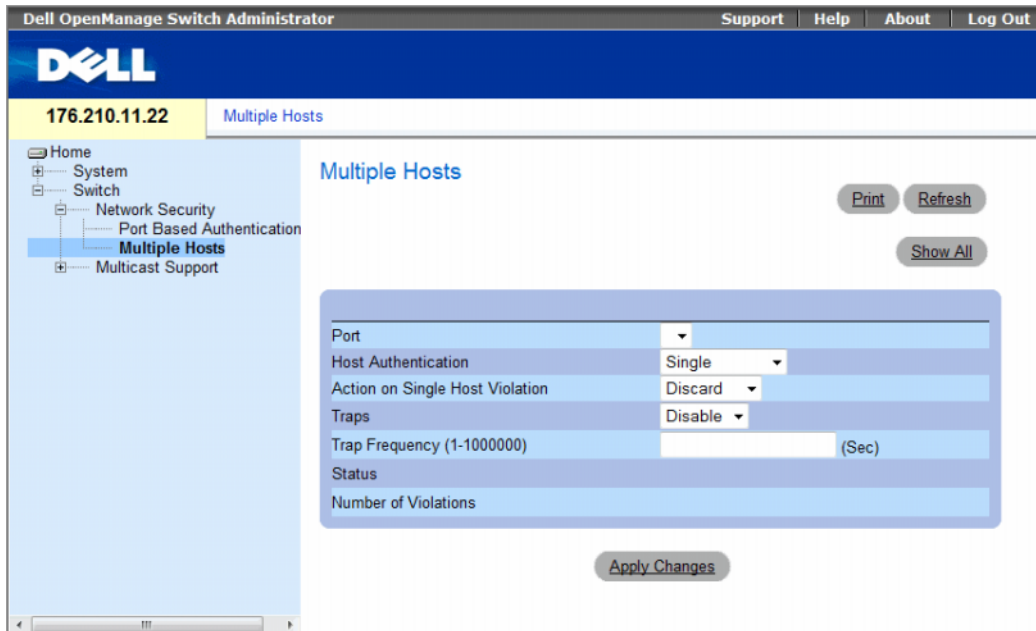

The **Multiple Hosts** page contains the following fields:

- **Port** — The port number for which Advanced Port Based Authentication is enabled.
- **Host Authentication** — Defines the host authentication type. The possible fields are:
 - **Single** — Enables a single authorized host for single-session access to the system.
 - **Multiple Host** — Enables a single host to authorize multiple hosts for single-session access to the system. This setting must be enabled in order to either disable the ingress-filter, or to use port-lock security on the selected port.
 - **Multiple Session** — Enables a single authorized host for multiple-session access to the system. This is the default value.
- **Action on Single Host Violation** — Defines the action to be applied to packets arriving in single-host mode, from a host whose MAC address is not the client (supplicant) MAC address. The possible field values are:
 - **Forward** — Forwards the packets from an unknown source, however, the MAC address is not learned.
 - **Discard** — Discards the packets from any unlearned source. This is the default value.
 - **Shutdown** — Discards the packet from any unlearned source and shuts down the port. Ports remain shut down until they are activated, or the switch is reset.
- **Traps** — Enables or disables sending traps to the host if a violation occurs.
 - **Enable** — Enables sending traps.
 - **Disable** — Disables sending traps.
- **Trap Frequency (1-1000000)** — Defines the time period in seconds by which traps are sent to the host. The **Trap Frequency (1-1000000)** field can be defined only if the **Multiple Hosts** field is defined as **Disable**. The default is 10 seconds.
- **Status** — The host status. The possible field values are:
 - **Unauthorized** — Indicates that the port control is *Force Unauthorized*, the port link is down or the port control is Auto, but a client has not been authenticated via the port.
 - **Not in Auto Mode** — Indicates that the port control is *Forced Authorized*, and clients have full port access.
 - **Single-host Lock** — Indicates that the port control is *Auto* and a single client has been authenticated via the port.
 - **No Single Host** — Indicates that Multiple Host is enabled.
- **Number of Violations** — The number of packets that arrived on the interface in single-host mode, from a host whose MAC address is not the client (supplicant) MAC address.

Displaying the Multiple Hosts Table

- 1 Open the Multiple Hosts page.
- 2 Click Show All.

The Multiple Hosts Table opens.

Figure 7-4. Multiple Hosts Table

Port	Multiple Hosts	Action on Violation	Enable Traps	Trap Frequency	Status	Number of Violations
1	Single	Discard	<input checked="" type="checkbox"/>			

The Multiple Hosts Table displays the following additional field:

- Unit No. — Selects a stacking member.

Enabling Multiple Hosts Using the CLI Commands

The following table summarizes the equivalent CLI commands for enabling the advanced port based authentication as displayed in the Multiple Hosts page.

Table 7-2. Multiple Hosts CLI Commands

CLI Command	Description
<code>dot1x multiple-hosts</code>	Allows multiple hosts (clients) on an 802.1X-authorized port that has the <code>dot1x port-control</code> interface configuration command set to <code>auto</code> .
<code>dot1x single-host-violation {forward discard discard-shutdown} [trap seconds]</code>	Configures the action to be taken when a station, whose MAC address is not the client (supplicant) MAC address, attempts to access the interface.

The following is an example of the CLI Command.

```
Console(config)# interface ethernet 1/e1
Console(config-if)# dot1x multiple-hosts
```

Authenticating Users

The **Authenticated Users** page displays user port access lists. The User Access Lists are defined in the **Add User Name** page.

To open the **Authenticated Users** page, click **Switch** → **Network Security** → **Authenticated Users**.

Figure 7-5. Authenticated Users

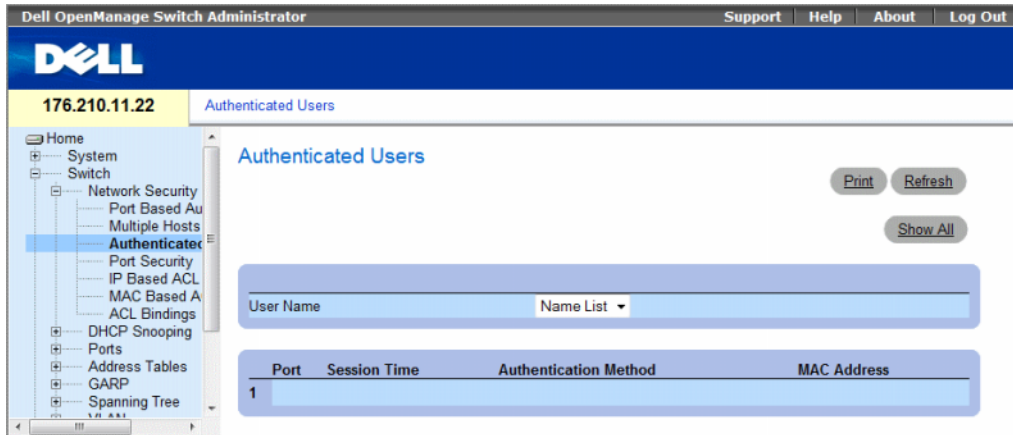

The **Authenticated Users** page contains the following fields:

- **User Name** — List of users authorized via the RADIUS Server.
- **Port** — The port number(s) used for authentication, per user name.
- **Session Time** — The amount of time the user was logged on to the device. The field format is **Day:Hour:Minute:Seconds**, for example, 3 days: 2 hours: 4 minutes: 39 seconds.
- **Authentication Method** — The method by which the last session was authenticated. The possible field values are:
 - **Remote** — The user was authenticated from a remote server.
 - **None** — The user was not authenticated.
- **MAC Address** — The supplicant MAC address.

Displaying the Authenticated Users Table

- 1 Open the Authenticated Users page.
- 2 Click Show All.

The Authenticated Users Table opens.

Figure 7-6. Authenticated Users Table



User Name	Port	Session Time	Authentication Method	MAC Address
1				

Authenticating Users Using the CLI Commands

The following table summarizes the equivalent CLI commands for authenticating users as displayed in the Authenticated Users page.

Table 7-3. Add User Name CLI Commands

CLI Command	Description
<code>show dot1x users [username <i>username</i>]</code>	Displays 802.1X users for the device.

The following is an example of the CLI commands:

```
console# show dot1x users
```

```
Port Username Session Time Auth Method MAC Address
```

```
-----  
1/e11 gili 00:09:27 Remote 00:80:c8:b9:dc:1d
```

Configuring Port Security

Network security can be enhanced by limiting access on a specific port only to users with specific MAC addresses. The MAC addresses can be dynamically learned, up to that point, or they can be statically configured. Locked port security monitors both received and learned packets that are received on specific ports. Access to the locked port is limited to users with specific MAC addresses.

These addresses are either manually defined on the port, or learned on that port up to the point when it is locked. When a packet is received on a locked port, and the packet's source MAC address is not tied to that port (either it was learned on a different port, or it is unknown to the system), the protection mechanism is invoked, and can provide various options. Unauthorized packets arriving to a locked port are either:

- Forwarded
- Discarded with no trap
- Discarded with a trap
- The port is shut down

Locked port security also enables storing a list of MAC addresses in the configuration file. The MAC address list can be restored after the device has been reset.

In order to enable port security, enable the **Multiple Hosts** feature on the required ports.

Disabled ports are activated from the **Port Security** page. The **Ports** page provides links for configuring port functionality including advanced features such as storm control and port mirroring, and for performing virtual port tests.

To open the **Port Security** page, click **Switch** → **Network Security** → **Port Security**.

Figure 7-7. Port Security



The **Port Security** page contains the following fields:

- **Interface** — The selected interface type on which Locked Port is enabled.
 - **Port** — The selected interface type is a port.
 - **LAG** — The selected interface type is a LAG.
- **Current Port Status** — The currently configured Port status.
- **Set Port** — The port is either locked or unlocked. The possible field values are:
 - **Unlocked** — Unlocks Port. This is the default value.
 - **Locked** — Locks Port.
- **Learning Mode** — Defines the locked port type. The **Learning Mode** field is enabled only if **Locked** is selected in the **Set Port** field. The possible field values are:
 - **Classic Lock** — Locks the port using the classic lock mechanism. The port is immediately locked, regardless of the number of addresses that have already been learned.
 - **Limited Dynamic Lock** — Locks the port by deleting the current dynamic MAC addresses associated with the port. The port learns up to the maximum addresses allowed on the port. Both relearning and aging MAC addresses are enabled.
- **Max Entries (1-128)** — Specifies the number of MAC address that can be learned on the port. The **Max Entries** field is enabled only if **Locked** is selected in the **Set Port** field. In addition, the Limited Dynamic Lock mode is selected. The default is 1.
- **Action on Violation** — The action to be applied to packets arriving on a locked port. The possible field values are:
 - **Forward** — Forwards the packets from an unknown source, however, the MAC address is not learned.
 - **Discard** — Discards the packets from any unlearned source. This is the default value.
 - **Shutdown** — Discards the packet from any unlearned source and shuts down the port. Ports remained shut down until they are reactivated, or the device is reset.
- **Trap** — Enables traps being sent when a packet is received on a locked port.
- **Trap Frequency (1-1000000)** — The amount of time (in seconds) between traps. The default value is 10 seconds.

Defining a Locked Port

- 1 Open the **Port Security** page.
- 2 Select an interface type and number.
- 3 Define the fields.
- 4 Click **Apply Changes**.

The locked port is added to the **Port Security Table**, and the device is updated.

Displaying the Port Security Table

- 1 Open the Port Security page.
- 2 Click Show All.

The Port Security Table opens.

Locked Ports are defined in the Port Security Table.

Figure 7-8. Port Security Table

Port Security Table Refresh

Unit No. 1

Copy Parameters from Port LAG

Port	Current Port Status	Set Port	Learning Mode	Max Entries	Action	Trap	Trap Frequency	Copy to Select All
11/e1	Locked	Unlocked	Classic Lock		Forward	Enable		<input type="checkbox"/>
21/e2	Locked	Unlocked	Classic Lock		Forward	Enable		<input type="checkbox"/>

Global System LAGs

1LAG1	Locked	Unlocked	Classic Lock		Forward	Enable		<input type="checkbox"/>
2LAG2	Locked	Unlocked	Classic Lock		Forward	Enable		<input type="checkbox"/>

Apply Changes

The Port Security Table contains the additional following fields:

- **Unit No.** — Specifies the stacking unit for which locked port information is displayed.
- **Copy Parameters from** — The port from which parameters will be copied and assigned to the selected unit number.

Configuring Locked Port Security with CLI Commands

The following table summarizes the equivalent CLI commands for configuring Locked Port security as displayed in the Port Security page.

Table 7-4. Port Security CLI Commands

CLI Command	Description
<code>shutdown</code>	Disables interfaces.
<code>set interface active {ethernet <i>interface</i> port-channel <i>port-channel-number</i>}</code>	Reactivates an interface that is shutdown due to port security reasons.
<code>port security learning {disabled dynamic}</code>	Defines the locked port type.
<code>port security max <i>max-addr</i></code>	Specifies the number of MAC address that can be learned on the port.
<code>port security [forward discard discard-shutdown] [trap <i>seconds</i>]</code>	Locks learning of new addresses on an interface.
<code>show ports security {ethernet <i>interface</i> port-channel <i>port-channel-number</i>}</code>	Displays port lock status.

The following is an example of the CLI commands:

```
console # show ports security
```

Port	Status	Action	Trap	Frequency	Counter
1/e1	locked	Discard	Enable	100	88
1/e2	locked	Discard, Shutdown	Disable		
1/e3	Unlocked	-	-	-	-

ACL Overview

Access Control Lists (ACL) allow network managers to define classification actions and rules for specific ingress ports. Packets entering an ingress port, with an active ACL, are either admitted or denied entry and the ingress port is disabled. If they are denied entry, the user can disable the port.

This section contains the following topics:

- "Defining IP based ACLs" on page 277
- "Defining MAC Based Access Control Lists" on page 283
- "Defining ACL Binding" on page 286

Defining IP based ACLs

Access Control Lists (ACL), which are comprised of Access Control Entries (ACE), allow network managers to define classification actions and rules for specific ingress ports. Packets entering an ingress port, with an active ACL, are either admitted or denied entry and the ingress port is disabled. If they are denied entry, the user can disable the port.

For example, a network administrator defines an ACL rule that states, port number 20 can receive TCP packets, however, if a UDP packet is received, the packet is dropped.

ACLs are composed of access control entries (ACEs) that are made of the filters that determine traffic classifications. Each ACE is a rule, and there are 256 rules available. But rules are not only used for user configuration purposes, they are also used for features like DHCP Snooping, Protocol Group VLAN and PVE, so not all 256 will be available for ACEs. It is expected that you will have at least 124 rules available. If you find that there are less rules available, this may be due to DHCP Snooping. You can reduce the number of entries in DHCP Snooping configuration in order to free rules for ACE's.

To define IP based ACLs, click **Switch**→**Network Security**→**IP Based ACL**. I

Figure 7-9. Network Security - IP Based ACL

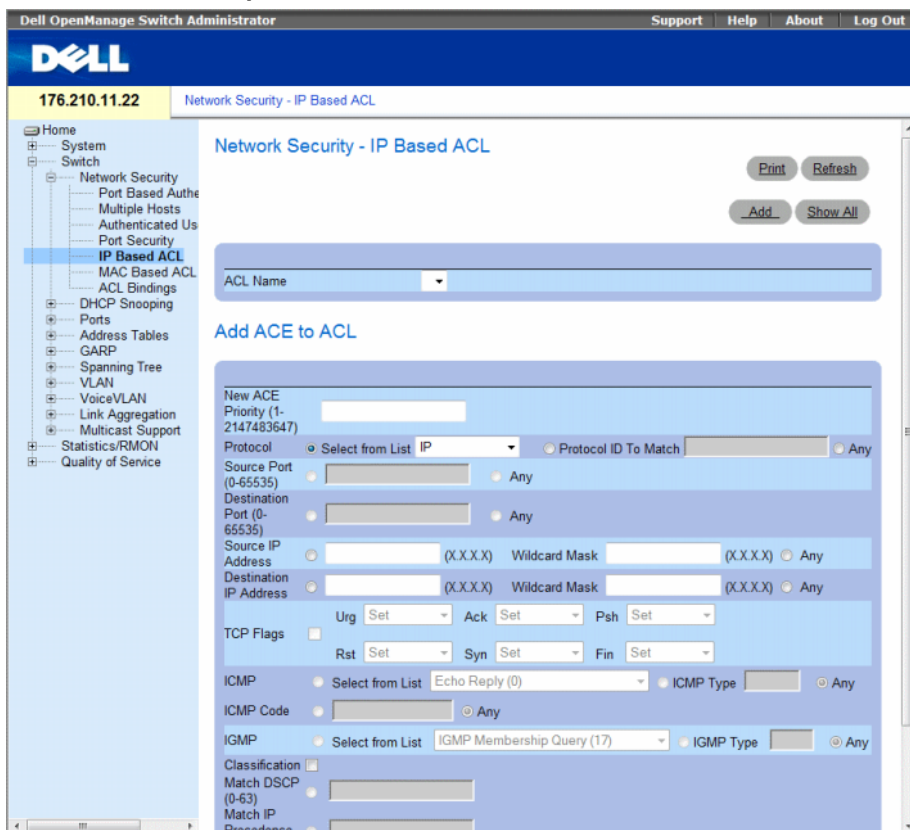

- **ACL Name** — User-defined ACLs.
- **New ACE Priority** — ACE priority that determines which ACE is matched to a packet based on a first-match basis.
- **Protocol** — Enables creating an ACE based on a specific protocol. The possible field values are:
 - **IP** — Internet Protocol (IP). Specifies the format of packets and their addressing method. IP addresses packets and forwards the packets to the correct port.
 - **ICMP** — Internet Control Message Protocol (ICMP). The ICMP allows the gateway or destination host to communicate with the source host. For example, to report a processing error.
 - **IGMP** — Internet Group Management Protocol (IGMP). Allows hosts to notify their local switch or router that they want to receive transmissions assigned to a specific multicast group.
 - **TCP** — Transmission Control Protocol (TCP). Enables two hosts to communicate and exchange data streams. TCP guarantees packet delivery, and guarantees packets are transmitted and received in the order they are sent.
 - **EGP** — Exterior Gateway Protocol (EGP). Permits exchanging routing information between two neighboring gateway hosts in an autonomous systems network.
 - **IGP** — Interior Gateway Protocol (IGP). Allows for routing information exchange between gateways in an autonomous network.
 - **UDP** — User Datagram Protocol (UDP). Communication protocol that transmits packets but does not guarantee their delivery.
 - **HMP** — Host Mapping Protocol (HMP). Collects network information from various networks hosts. HMP monitors hosts spread over the internet as well as hosts in a single network.
 - **RDP** — Remote Desktop Protocol (RDP). Allows a clients to communicate with the Terminal Server over the network.
 - **IDPR** — Matches the packet to the IDPR protocol.
 - **IPV6** — Matches the packet to the IPV6 protocol.
 - **IPV6 ROUTE** — Matches the packet to the IPV6 Route protocol.
 - **IPV6 FRAG** — Matches the packet to the IPV6 FRAG protocol.
 - **IDRP** — Matches the packet to the Inter-Domain Routing Protocol (IDRP).
 - **RVSP** — Matches the packet to the ReSerVation Protocol (RSVP).
 - **AH** — Authentication Header (AH). Provides source host authentication and data integrity.
 - **EIGRP** — Enhanced Interior Gateway Routing Protocol (EIGRP). Provides fast convergence, support for variable-length subnet mask, and supports multiple network layer protocols.
 - **OSPF** — The Open Shortest Path First (OSPF) protocol is a link-state, hierarchical interior gateway protocol (IGP) for network routing Layer Two (2) Tunneling Protocol, an extension to the PPP protocol that enables ISPs to operate Virtual Private Networks (VPNs).

- **IPIP** — IP over IP (IPIP). Encapsulates IP packets to create tunnels between two routers. This ensure that IPIP tunnel appears as a single interface, rather than several separate interfaces. IPIP enables tunnel intranets occur the internet, and provides an alternative to source routing.
- **PIM** — Matches the packet to Protocol Independent Multicast (PIM).
- **L2TP** — Matches the packet to Internet Protocol (L2IP).
- **ISIS** — Intermediate System - Intermediate System (ISIS). Distributes IP routing information throughout a single Autonomous System in IP networks
- **Protocol ID To Match** — Adds user-defined protocols by which packets are matched to the ACE. Each protocol has a specific protocol number which is unique. The possible field range is 0-255.
- **Any** — Matches the protocol to any protocol.
- **Source Port** — The TCP/UDP source port. Select **Any** to include all ports.
- **Destination Port** — The TCP/UDP destination port. Select **Any** to include all ports.
- **Source IP Address** — Matches the source port IP address to which packets are addressed to the ACE. Wildcard masks specify which bits are used and which bits are ignored. A wildcard of 0.0.0.0 indicates that all the bits are important.
- **Destination IP Address** — Matches the destination port IP address to which packets are addressed to the ACE. Wildcard masks specify which bits are used and which bits are ignored. A wildcard of 0.0.0.0 indicates that all the bits are important.
- **TCP Flags** — Sets the indicated TCP flag that can be triggered. To use TCP flags, check the **TCP Flag** checkbox and then set the desired flag(s).
- **ICMP** — Specifies an ICMP message type for filtering ICMP packets. You can choose from the list, type it in, or select **Any** for all ICMP message types. This field is available only when ICMP is selected in the **Protocol** field.
- **ICMP Code** — Specifies an ICMP message code for filtering ICMP packets that are filtered by ICMP message type or ICMP message code. This field is available only when ICMP is selected in the **Protocol** field.
- **IGMP** — IGMP packets can be filtered by IGMP message type. You can choose from the list, type it in, or select **Any** for all IGMP message types. This field is available only when IGMP is selected in the **Protocol** field.
- **Classification Mach DSCP** — Matches the packet DSCP value to the ACL. Either the DSCP value or the IP Precedence value is used to match packets to ACLs. The possible field range is 0-63.

- **Match IP Precedence** — Indicates matching ip-precedence with the packet ip-precedence value. IP Precedence enables marking frames that exceed CIR threshold. In a congested network, frames containing a higher are discarded before frames with a lower DP.
- **Action** — Indicates the ACL forwarding action. The possible field values are:
 - **Permit** — Forwards packets which meet the ACL criteria.
 - **Deny** — Drops packets which meet the ACL criteria.
 - **Shutdown** — Drops packet that meet the ACL criteria, and disables the port to which the packet was addressed.

Adding ACEs to IP based ACLs

- 1 Open the Network Security - IP Based ACL page.
- 2 Select an ACL.
- 3 Edit the relevant fields.
- 4 Click Apply Changes.

Adding IP based ACLs

- 1 Open the IP Based ACL page.:
- 2 Click Add.

The Network Security - IP Based ACL page opens.

Figure 7-10. Add IP Based ACL

The screenshot shows the 'Add IP Based ACL' configuration interface. It includes a 'Refresh' button in the top right corner. The main form area contains the following fields and options:

- ACL Name:** A text input field.
- New ACE Priority (1-2147483647):** A text input field.
- Protocol:** Radio button 'Select from List' and a dropdown menu set to 'Any'.
- Protocol ID To Match:** A text input field.
- Source Port (0-65535):** Radio button 'Any' and a text input field.
- Destination Port (0-65535):** Radio button 'Any' and a text input field.
- Source IP Address:** Radio button 'Any' and a text input field.
- Wild Card Mask:** A text input field.
- Destination IP Address:** Radio button 'Any' and a text input field.
- Wild Card Mask:** A text input field.
- TCP Flags:** A set of checkboxes and dropdown menus: 'Urg' (checkbox), 'Syn' (checkbox), 'Ack' (checkbox), 'Psh' (checkbox), 'Rst' (checkbox), 'Fin' (checkbox), each with a 'Set' dropdown.
- ICMP:** Radio button 'Select from List' and a dropdown menu set to 'Echo Reply (0)'. Radio button 'ICMP Type' and radio button 'Any'.
- ICMP Code:** A text input field.
- IGMP:** Radio button 'Select from List' and a dropdown menu. Radio button 'IGMP Type' and radio button 'Any'.
- Match DSCP (0-63):** Radio button 'Any' and a text input field.
- Match IP Precedence (0-7):** Radio button 'Any' and a text input field.
- Action:** A dropdown menu set to 'Permit'.

An 'Apply Changes' button is located at the bottom center of the form.

- 3 Define the relevant fields.
- 4 Click **Apply Changes**. The IP based protocol is defined, and the device is updated.

Displaying the ACEs Associated with IP based ACLs

- 1 Open the **Network Security - IP Based ACL** page.
- 2 Click **Show All**.

The **ACEs Associated with IP-ACL** opens.

Figure 7-11. ACEs Associated with IP-ACL

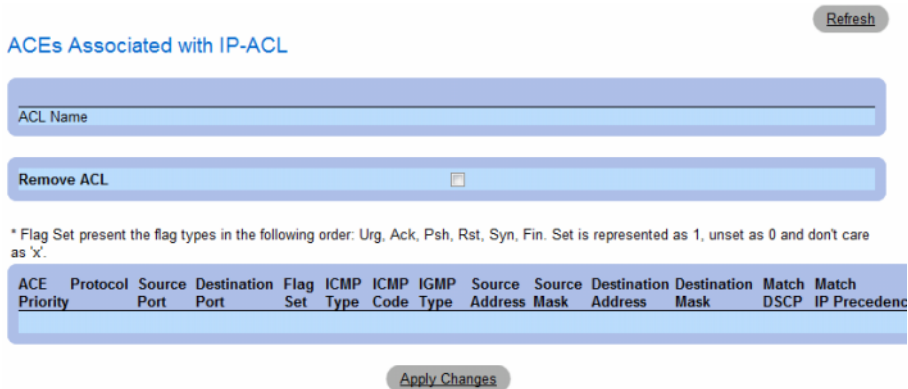

Removing an IP based ACL

- 1 Open the **Network Security - IP Based ACL** page.
- 2 Click **Show All**. The **ACEs Associated with IP-ACL Table** opens.
- 3 Check the **Remove ACL** checkbox.
- 4 Click **Apply Changes**.

Removing an IP based ACE

- 1 Open the **Network Security - IP Based ACL** page.
- 2 Click **Show All**. The **ACEs Associated with IP-ACL Table** opens.
- 3 Check the **Remove** checkbox next to an ACE.
- 4 Click **Apply Changes**.

Configuring IP Based ACLs with CLI Commands

The following table summarizes the equivalent CLI commands for configuring **IP Based ACLs**.

Table 7-5. IP Based ACL CLI Commands

CLI Command	Description
ip access-list <i>access-list-name</i> no ip access-list <i>access-list-name</i>	To define an IPv4 access list and to place the device in IPv4 access list configuration mode, use the ipv4 access-list command in global configuration mode. To remove the access list, use the no form of this command.
permit {any <i>protocol</i> } {any { <i>source source-wildcard</i> }} {any { <i>destination destination-wildcard</i> }} [dscp <i>number</i> ip-precedence <i>number</i>] [fragments]	To set conditions to allow a packet to pass a named IP access list, use the permit command in access list configuration mode.
permit-icmp {any { <i>source source-wildcard</i> }} {any { <i>destination destination-wildcard</i> }} {any <i>icmp-type</i> } {any <i>icmp-code</i> } [dscp <i>number</i> ip-precedence <i>number</i>]	
permit-igmp {any { <i>source source-wildcard</i> }} {any { <i>destination destination-wildcard</i> }} {any <i>igmp-type</i> } [dscp <i>number</i> ip-precedence <i>number</i>]	
permit-tcp {any { <i>source source-wildcard</i> }} {any <i>source-port</i> } {any { <i>destination destination-wildcard</i> }} {any <i>destination-port</i> } [dscp <i>number</i> ip-precedence <i>number</i>] [<i>flags list-of-flags</i>]	
permit-udp {any { <i>source source-wildcard</i> }} {any <i>source-port</i> } {any { <i>destination destination-wildcard</i> }} {any <i>destination-port</i> } [dscp <i>number</i> ip-precedence <i>number</i>]	
deny [disable-port] {any <i>protocol</i> } {any { <i>source source-wildcard</i> }} {any { <i>destination destination-wildcard</i> }} [dscp <i>number</i> ip-precedence <i>number</i>] [fragments]	To set conditions to allow a packet to pass a named IP access list, use the deny command in access list configuration mode.
deny-icmp [disable-port] {any { <i>source source-wildcard</i> }} {any { <i>destination destination-wildcard</i> }} {any <i>icmp-type</i> } {any <i>icmp- code</i> } [dscp <i>number</i> ip-precedence <i>number</i>]	
deny-igmp [disable-port] {any { <i>source source-wildcard</i> }} {any { <i>destination destination-wildcard</i> }} {any <i>igmp-type</i> } [dscp <i>number</i> ip-precedence <i>number</i>]	
deny-tcp [disable-port] {any { <i>source source-wildcard</i> }} {any <i>source- port</i> } {any { <i>destination destination-wildcard</i> }} {any <i>destination-port</i> } [dscp <i>number</i> ip-precedence <i>number</i>] [<i>flags list-of-flags</i>]	
deny-udp [disable-port] {any { <i>source source-wildcard</i> }} {any <i>source- port</i> } {any { <i>destination destination-wildcard</i> }} {any <i>destination-port</i> } [dscp <i>number</i> ip-precedence <i>number</i>]	

Defining MAC Based Access Control Lists

The Network Security - MAC Based ACL page allows a MAC-based ACL to be defined. ACEs can be added only if the ACL is not bound to an interface.

To define MAC Based ACLs, click **Switch** → **Network Security** → **MAC Based ACL**.

- Network Security - MAC Based ACL

The screenshot shows the Dell OpenManage Switch Administrator interface. The top navigation bar includes 'Support', 'Help', 'About', and 'Log Out'. The main header displays the Dell logo and the version '176.210.11.22'. The page title is 'Network Security - MAC Based ACL'. On the left, a navigation tree shows the following structure: Home, System, Switch, Network Security, Port Based Auth, Multiple Hosts, Authenticated Us, Port Security, IP Based ACL, MAC Based ACL (highlighted), ACL Bindings, DHCP Snooping, Ports, Address Tables, GARP, Spanning Tree, VLAN, VoiceVLAN, Link Aggregation, Multicast Support, Statistics/RMON, and Quality of Service. The main content area is titled 'Network Security - MAC Based ACL' and contains several buttons: 'Print', 'Refresh', 'Add', and 'Show All'. Below these buttons is a form for adding a new ACE to an ACL. The form includes a dropdown for 'ACL Name', a text field for 'New ACE Priority (1-2147483647)', and two sections for MAC addresses. The first section is for 'Source MAC Address' with a radio button for 'Any' and a 'Wild Card Mask' field. The second section is for 'Dest. MAC Address' with a radio button for 'Any' and a 'Wild Card Mask' field. Below these are fields for 'VLAN ID (1-4094)', 'CoS', 'CoS Mask', 'Ether Type', and 'Action' (set to 'Permit'). An 'Apply Changes' button is at the bottom.

- **ACL Name** — Displays the user-defined MAC based ACLs.
- **New ACE Priority** — Indicates the ACE priority, which determines which ACE is matched to a packet on a first-match basis. The possible field values are 1-2147483647.
- **Source Address** — Matches the source MAC address to which packets are addressed to the ACE. Wildcard masks specify which bits are used and which bits are ignored. A wildcard of 0.0.0.0 indicates that all the bits are important.
- **Destination Address** — Matches the destination MAC address to which packets are addressed to the ACE. Wildcard masks specify which bits are used and which bits are ignored. A wildcard of 0.0.0.0 indicates that all the bits are important.
- **VLAN ID** — Matches the packet's VLAN ID to the ACE. The possible field values are 1 to 4095.

- **CoS** — Indicates the CoS values by which the packets are filtered.
- **Cos Mask** — Indicates the CoS Mask by which the packets are filtered.
- **Ethertype** — Indicates the Ethertype packet by which the packets are filtered.
- **Action** — Indicates the ACL forwarding action. Possible field values are:
 - **Permit** — Forwards packets which meet the ACL criteria.
 - **Deny** — Drops packets which meet the ACL criteria.
 - **Shutdown** — Drops packet that meet the ACL criteria, and disables the port to which the packet was addressed.

Adding ACEs to IP based ACLs

- 1 Open the Network Security - MAC Based ACL page.
- 2 Select an ACL.
- 3 Edit the relevant fields.
- 4 Click **Apply Changes**.

Adding MAC based ACLs

- 1 Open the MAC Based ACL page.:
- 2 Click **Add**.
The Network Security - MAC Based ACL page opens.

Figure 7-12. Add Mac Based ACL

- 3 Define the relevant fields.
- 4 Click **Apply Changes**. The MAC based protocol is defined, and the device is updated.

Displaying the ACEs Associated with MAC based ACLs

- 1 Open the Network Security - MAC Based ACL page.
- 2 Click **Show All**.

The ACEs Associated with MAC Based ACL opens.

Refresh

ACEs Associated with MAC ACL

ACL Name

Remove ACL

Priority	Action	Source Address	Source Mask	Destination Address	Destination Mask	VLAN ID	CoS CoS Mask	Ether Type	Remove
									<input type="checkbox"/>

Apply Changes

Removing a MAC based ACL

- 1 Open the Network Security - MAC Based ACL page.
- 2 Click **Show All**. The ACEs Associated with MAC-ACL Table opens.
- 3 Check the **Remove ACL** checkbox.
- 4 Click **Apply Changes**.

Removing a MAC based ACE

- 1 Open the Network Security - MAC Based ACL page.
- 2 Click **Show All**. The ACEs Associated with MAC-ACL Table opens.
- 3 Check the **Remove** checkbox next to an ACE.
- 4 Click **Apply Changes**.

Configuring MAC Based ACLs with CLI Commands

The following table summarizes the equivalent CLI commands for configuring MAC Based ACLs.

Table 7-6. MAC Based ACL CLI Commands

CLI Command	Description
mac access-list <i>access-list-name</i>	To define a Layer 2 access list and to place the device in MAC access list configuration mode, use the mac access-list command in global configuration mode. To remove the access list, use the no form of this command.
no mac access-list <i>access-list-name</i>	
permit {any { <i>source source-wildcard</i> } {any { <i>destination destination-wildcard</i> }} [vlan <i>vlan-id</i>] [cos <i>cos cos-wildcard</i>] [eth-type <i>eth-type</i>] [inner-vlan <i>vlan-id</i> }	To set permit conditions for an MAC access list, use the permit command in MAC access list configuration mode.
deny [disable-port] {any { <i>source source-wildcard</i> } {any { <i>destination destination-wildcard</i> }} [vlan <i>vlan-id</i>] [cos <i>cos cos-wildcard</i>] [eth-type <i>eth-type</i>] [inner-vlan <i>vlan-id</i> }	To set deny conditions for an MAC access list, use the deny command in MAC access list configuration mode.

Defining ACL Binding

When an ACL is bound to an interface, all the ACE rules that have been defined are applied to the selected interface. Whenever an ACL is assigned on a port, LAG or, VLAN, flows from that ingress interface that do not match the ACL are matched to the default rule, which is Drop unmatched packets.

To bind ACLs to interfaces:

- 1 Open the Network Security - ACL Bindings page, click Switch → Network Security → ACL Bindings.

Figure 7-13. Network Security - ACL Binding

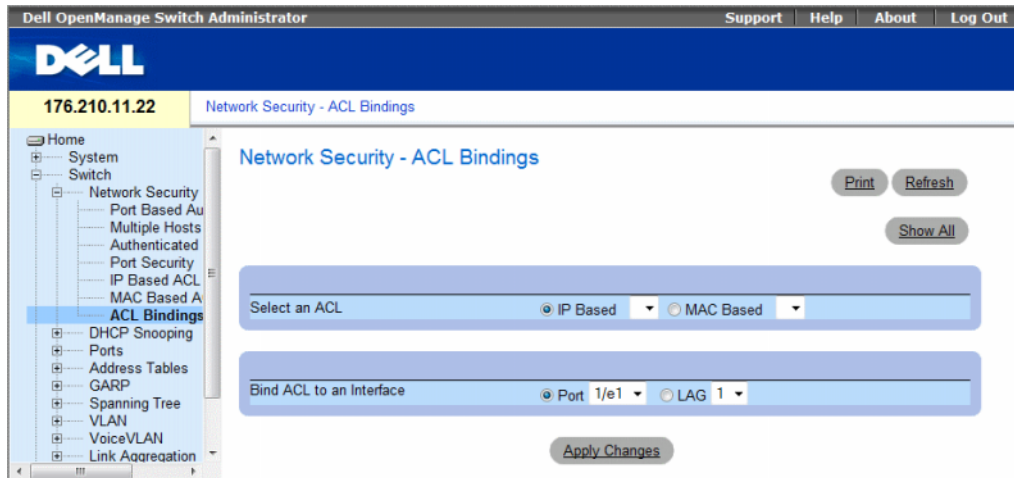

- 2 In the Select an ACL field, select an IP Based or MAC Based ACL.

- 3 In the **Bind ACL to an Interface** field, select a port or LAG.
- 4 Click **Apply Changes**.

The ACL is bound to the interface.

Displaying the ACL Bindings Table:

- 1 Open the **Network Security - ACL Binding** page.
- 2 Click **Show All**.

The **ACL Bindings Table** opens.

Figure 7-14. ACL Bindings Table

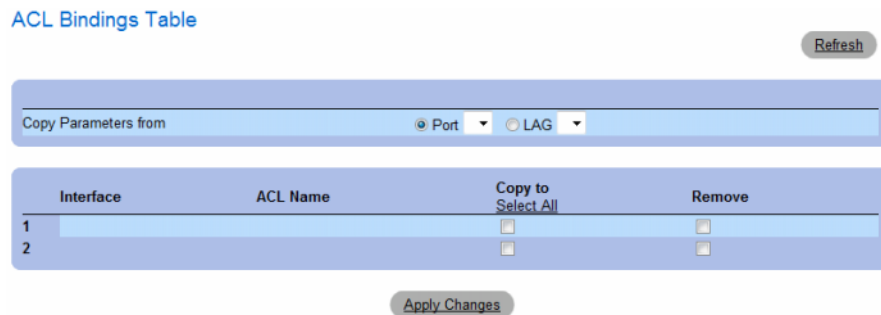

Copying ACL Parameters Between Interfaces

- 1 Open the **Network Security - ACL Binding** page.
- 2 Click **Show All**. The **ACL Bindings Table** opens.
- 3 In the **Copy Parameters from** field, select a Port or LAG from which you want to copy ACL settings.
- 4 In the table, check the **Copy to** checkbox for each entry to which you want to copy the settings.
- 5 Click **Apply Changes**.

Removing ACL Bindings

- 1 Open the **Network Security - ACL Binding** page.
- 2 Click **Show All**. The **ACL Bindings Table** opens.
- 3 In the table, check the **Remove** checkbox for each binding you want to remove.
- 4 Click **Apply Changes**.

Configuring ACL Bindings with CLI Commands

The following table summarizes the equivalent CLI commands for configuring ACL Bindings.

Table 7-7. ACL Bindings CLI Commands

CLI Command	Description
<code>service-acl input <i>acl-name</i></code>	To control access to an interface, use the <code>service-acl</code> command in interface configuration mode. To remove the access control, use the <code>no</code> form of this command.
<code>no service-acl input</code>	
<code>show access-lists [name]</code>	Use the <code>show access-lists</code> privileged EXEC command to display access control lists (ACLs) configured on the switch.

The following is an example of some of the CLI commands:

```
Switch# show access-lists
IP access list ACL1
permit 234 172.30.40.1 0.0.0.0 any
permit 234 172.30.8.8 0.0.0.0 any
```

Configuring DHCP Snooping

DHCP Snooping expands network security by providing firewall security between untrusted interfaces and DHCP servers. By enabling DHCP Snooping network administrators can differentiate between trusted interfaces connected to end-users or DHCP Servers and untrusted interfaces located beyond the network firewall.

DHCP Snooping filters untrusted messages. DHCP Snooping creates and maintains a DHCP Snooping Table which contains information received from untrusted packets. Interfaces are untrusted if the packet is received from an interface outside the network or from an interface beyond the network firewall. Trusted interfaces receive packets only from within the network or the network firewall.

The DHCP Snooping Table contains the untrusted interfaces' MAC address, IP address, Lease Time, VLAN ID, and interface information.

The DHCP section contains the following topics:

- Defining DHCP Snooping Properties
- Defining DHCP Snooping on VLANs
- Defining Trusted Interfaces
- Adding Interfaces to the DHCP Snooping Database

This section contains the following topics:

- "Defining DHCP Snooping Global Parameters" on page 289
- "Defining DHCP Snooping on VLANs" on page 291
- "Defining Trusted Interfaces" on page 292
- "Adding Interfaces to the DHCP Snooping Database" on page 294

Defining DHCP Snooping Global Parameters

The DHCP Snooping Global Parameters page contains parameters for enabling and configuring DHCP Snooping on the device.

To define DHCP global parameters, click **Switch** → **DHCP Snooping** → **Global Parameters**

Figure 7-15. Global Parameters

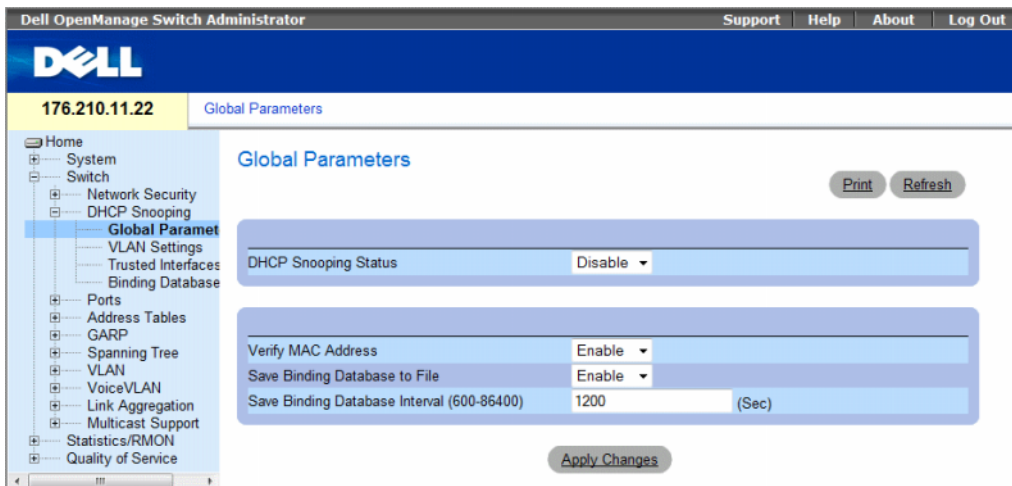

- **DHCP Snooping Status** — Indicates if DHCP Snooping is enabled on the device. The possible field values are:
 - **Enable** — Enables DHCP Snooping on the device.
 - **Disable** — Disables DHCP Snooping on the device. This is the default value.
- **Verify MAC Address** — Indicates if MAC addresses are verified. The possible field values are:
 - **Enable** — Verifies that an untrusted port source MAC address matches the client's MAC address.
 - **Disable** — Disables verifying that an untrusted port source MAC address matches the client's MAC address. This is the default value.

- **Save Binding Database to File** — Indicates if the DHCP Snooping Database is saved to file. The possible field values are:
 - **Enable** — Enables saving the database to file. This is the default value.
 - **Disable** — Disables saving the database to file.
- **Save Binding Database Internal** — Indicates how often the DHCP Snooping Database is updated. The possible field range is 600 – 86400 seconds. The field default is 1200 seconds.

Configuring DHCP Snooping Global Parameters with CLI Commands

The following table summarizes the equivalent CLI commands for configuring **DHCP Snooping global parameters**.

Table 7-8. DHCP Snooping Global Parameters CLI Commands

CLI Command	Description
ip dhcp snooping no ip dhcp snooping	Use the ip dhcp snooping global configuration command to globally enable DHCP snooping. Use the no form of this command to return to the default setting.
ip dhcp snooping verify no ip dhcp snooping verify	Use the ip dhcp snooping verify global configuration command to configure the switch to verify on an untrusted port that the source MAC address in a DHCP packet matches the client hardware address. Use the no form of this command to configure the switch to not verify the MAC addresses.
ip dhcp snooping database no ip dhcp snooping database	Use the ip dhcp snooping database global configuration command to configure the DHCP snooping binding file. Use the no form of this command to delete the binding file.
ip dhcp snooping database update-freq <i>seconds</i> no ip dhcp snooping database update-freq	Use the ip dhcp snooping database update-freq global configuration command to configure the update frequency of the DHCP snooping binding file. Use the no form of this command to return to default.
show ip dhcp snooping [<i>ethernet interface</i> <i>port-channel port-channel-number</i>]	Use the show ip dhcp snooping EXEC command to display the DHCP snooping configuration.

The following is an example of some of the CLI commands:

```

Console# show ip dhcp snooping

DHCP snooping is enabled
DHCP snooping is configured on following VLANs: 2, 7-18
DHCP snooping database: enabled
Option 82 on untrusted port is allowed
Verification of hwaddr field is enabled
  
```

	Interface	Trusted
	-----	-----
	1/1	yes
	1/2	yes

Defining DHCP Snooping on VLANs

The DHCP Snooping VLAN Settings Page allows network managers to enable DHCP Snooping on VLANs. DHCP snooping separates ports in the VLAN. To enable DHCP Snooping on VLAN, ensure that DHCP Snooping is enabled on the device. To enable DHCP Snooping on VLANs: To define DHCP snooping on VLANs, click **Switch** → **DHCP Snooping** → **VLAN Settings**

Figure 7-16. VLAN Settings

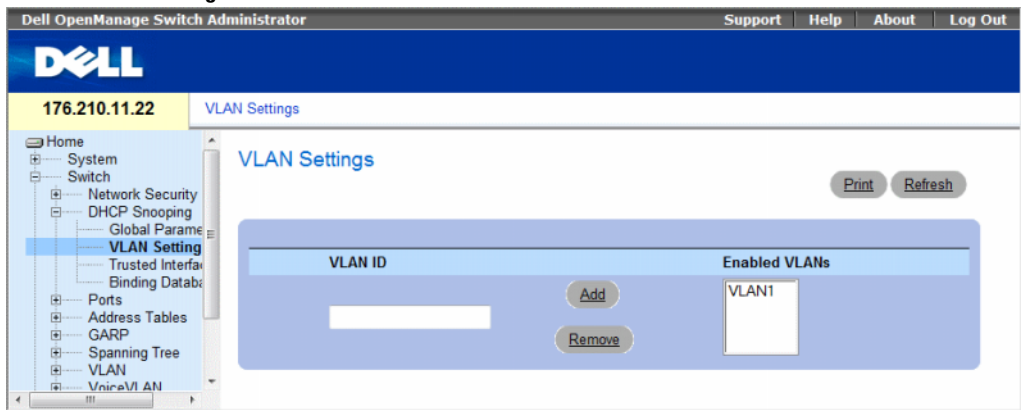

- **VLAN ID** — The VLAN on which DHCP snooping can be enabled.
- **Enabled VLANs** — Contains a list of VLANs on which DHCP snooping is enabled.

Defining DHCP Snooping on VLANs

- 1 Open the DHCP Snooping VLAN Settings page.
- 2 Click **Add** and **Remove** to add/remove VLAN IDs to or from the Enabled VLAN list.
- 3 Click **Apply Changes**.

Configuring DHCP Snooping on VLANs with CLI Commands

The following table summarizes the equivalent CLI commands for configuring **DHCP Snooping on VLANs**.

Table 7-9. DHCP Snooping on VLANs CLI Commands

CLI Command	Description
ip dhcp snooping vlan <i>vlan-id</i>	Use the ip dhcp snooping vlan global configuration command to enable DHCP snooping on a VLAN. Use the no form of this command to disable DHCP snooping on a VLAN.
no ip dhcp snooping <i>vlan-id</i>	

Defining Trusted Interfaces

The **Trusted Interfaces** page allows network managers to define Trusted interfaces. Interfaces are untrusted if the packet is received from an interface outside the network or from an interface beyond the network firewall. Trusted interfaces receive packets only from within the network or the network firewall. To define Trusted interfaces, click **Switch**→ **DHCP Snooping** → **Trusted Interface**

Figure 7-17. Trusted Interfaces

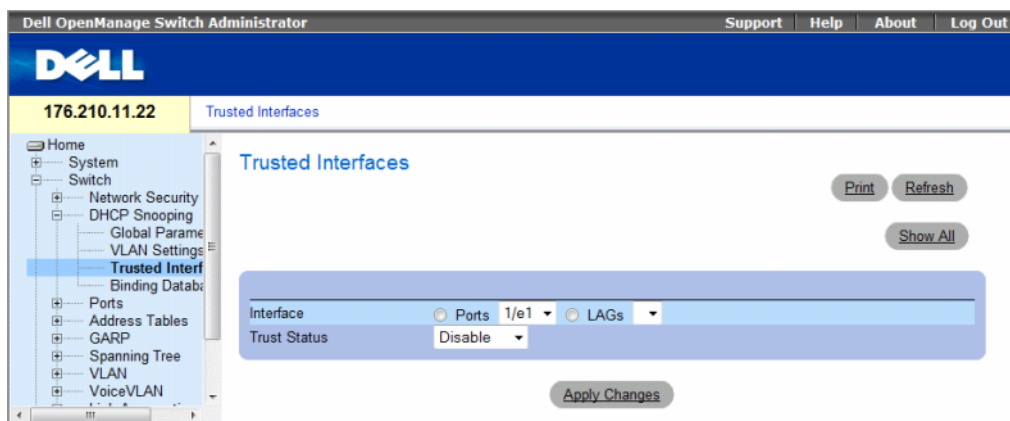

- **Interface** — Indicates the port or LAG on which DHCP Snooping Trust mode is enabled.
- **Trust Status** — Indicates if the DHCP Snooping Trust mode is enabled on the port or LAG. The possible field values are:
 - **Enable** — Indicates that DHCP Snooping Trust mode is enabled on the port or LAG.
 - **Disable** — Indicates that DHCP Snooping Trust mode is disabled on the port or LAG.

Displaying the Trusted Interfaces Table:

- 1 Open the Trusted Interfaces page.
- 2 Click Show All.
The Trusted Interfaces Table opens.

Figure 7-18. Trusted Interfaces Table

Trusted Interfaces Table Refresh

Unit No. 1
Copy Parameters from Port LAG

Interface	Trust	Copy to
1 1/e1	Disable	<input type="checkbox"/>

Apply Changes

Copying Trusted Interfaces Settings Between Interfaces

- 1 Open the Trusted Interfaces page.
- 2 Click Show All. The Trusted Interfaces Table opens.
- 3 In the Unit and Copy from fields, select a Port or LAG from which you want to copy settings.
- 4 In the table, check the Copy to checkbox for each entry to which you want to copy the settings.
- 5 Click Apply Changes.

Designating Interfaces as Trusted/Untrusted

- 1 Open the Trusted Interfaces page.
- 2 Click Show All. The Trusted Interfaces Table opens.
- 3 In the Trust column of the table, enable or disable the interface as trusted.
- 4 Click Apply Changes.

Configuring DHCP Snooping Trusted Interfaces with CLI Commands

The following table summarizes the equivalent CLI commands for configuring DHCP Snooping Trusted Interfaces.

Table 7-10. DHCP Snooping Trusted Interfaces CLI Commands

CLI Command	Description
ip dhcp snooping trust	Use the ip dhcp snooping trust interface configuration command to configure a port as trusted for DHCP snooping purposes. Use the no form of this command to return to the default setting.
no ip dhcp snooping trust	

Adding Interfaces to the DHCP Snooping Database

The DHCP Snooping Binding Database page contains parameters for querying and adding IP addresses to the DHCP Snooping Database.

To open the Binding Database page, click Switch → DHCP Snooping → Binding Database

Figure 7-19. Binding Database

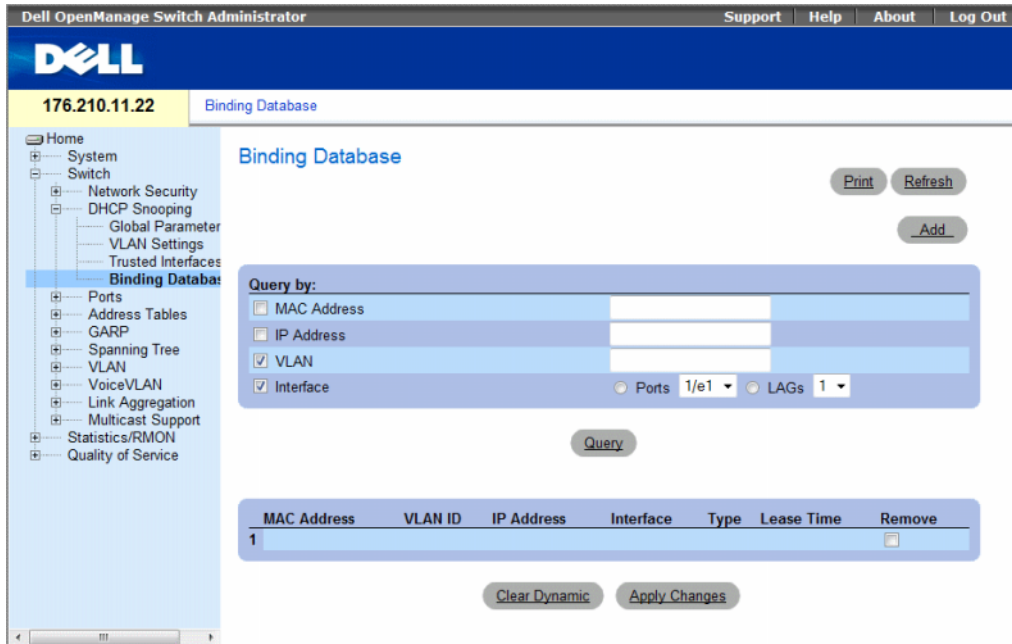

Querying the Database

- 1 Open the **Binding Database** page.
- 2 Select the following categories:
 - **MAC Address** — Indicates the MAC addresses recorded in the DHCP Snooping Database.
 - **IP Address** — Indicates the IP addresses recorded in the DHCP Snooping Database.
 - **VLAN** — Indicates the VLANs recorded in the DHCP Snooping Database.
 - **Interface** — Contains a list of interfaces recorded in the DHCP Snooping Database. The possible field values are: Port and LAG.

In addition to the fields above, the following fields appear in the Query result Table:

- **VLAN ID** — Displays the VLAN ID to which the IP address is attached in the DHCP Snooping Database.
 - **Type** — Displays the IP address binding type. The possible field values are **Static** which indicates that the IP address was statically configured, and **Dynamic** which indicates that the IP address was dynamically configured.
 - **Lease Time** — Displays the lease time. The Lease Time defines the amount of time the entry is active in the DHCP Database. Entries whose lease times are expired are ignored by the switch.
- 3 Click **Query**.

Removing a Database Entry

- 1 Open the **Binding Database** page.
- 2 In the table, click the checkbox in the **Remove** column next to the desired entry.
- 3 Click **Apply Changes**.

Clearing the Dynamic Database

- 1 Open the **Binding Database** page.
- 2 Click **Clear Dynamic**.

Binding a DHCP Snooping Database

- 1 Open the Binding Database page.
- 2 Click Add.

The Bind DHCP Snooping page opens.

Figure 7-20. Bind DHCP Snooping Page

Bind DHCP Snooping Refresh

Type Dynamic Static

MAC Address

VLAN ID

IP Address

Interface Ports 1/e1 LAGs 1

Lease Time Infinite

Apply Changes

- 3 Define the fields.
- 4 Click Apply Changes.

Configuring DHCP Snooping Binding Database with CLI Commands

The following table summarizes the equivalent CLI commands for configuring DHCP Snooping Binding Database .

Table 7-11. DHCP Snooping Binding Database CLI Commands

CLI Command	Description
<code>ip dhcp snooping binding mac-address vlan-id ip-address {ethernet interface port-channel port-channel-number} expiry seconds</code> <code>no ip dhcp snooping binding mac-address vlan-id</code>	Use the <code>ip dhcp snooping binding</code> privileged EXEC command to configure the DHCP snooping binding database and to add binding entries to the database. Use the <code>no</code> form of this command to delete entries from the binding database.
<code>clear ip dhcp snooping database</code>	Use the <code>clear ip dhcp snooping database</code> privileged EXEC command to clear the DHCP binding database.
<code>show ip dhcp snooping binding [mac-address mac-address] [ip-address ip-address] [vlan vlan] [ethernet interface port-channel port-channel-number]</code>	Use the <code>show ip dhcp snooping binding</code> user EXEC command to display the DHCP snooping binding database and configuration information for all interfaces on a switch.

The following is an example of some of the CLI commands:

```
Console# show ip dhcp snooping binding
Update frequency: 1200
Total number of binding: 2
```

Mac Address	IP Address	Lease (sec)	Type	VLAN	Interface
-----	-----	-----	-----	-----	-----
0060.704C.73FF	10.1.8.1	7983	snooping	3	1/21
0060.704C.7BC1	10.1.8.2	92332	snooping	(s)3	1/22

Configuring Ports

The **Ports** page provides links for configuring port functionality including advanced features such as storm control and port mirroring, and for performing virtual port tests.

To open the **Ports** page Select **Switch** → **Ports**.

This section contains the following topics:

- "Defining Port Configuration" on page 297
- "Defining LAG Parameters" on page 304
- "Enabling Storm Control" on page 308
- "Defining Port Mirroring Sessions" on page 312

Defining Port Configuration

Use the **Port Configuration** page to define port parameters. If port configuration is modified while the port is a LAG member, the configuration change is only effective after the port is removed from the LAG.

To open the **Port Configuration** page, click **Switch** → **Ports** → **Port Configuration** in the tree view.

Figure 7-21. Port Configuration

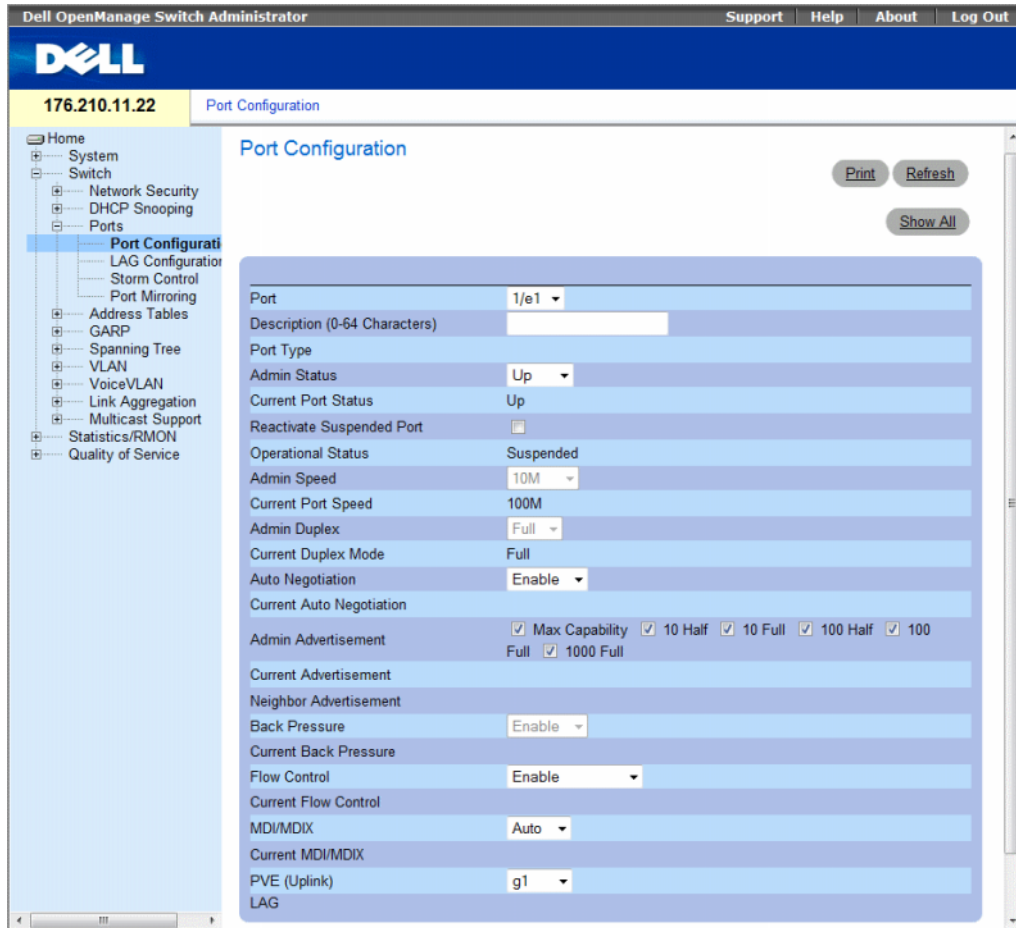

The Port Configuration page contains the following fields:

- **Port** — The port number for which port parameters are defined.
- **Description (0 - 64 Characters)** — A brief interface description, such as Ethernet.
- **Port Type** — The type of port.
- **Admin Status** — Enables or disables traffic forwarding through the port.
 - **Up** — Traffic is enabled through the port.
 - **Down** — Traffic is disabled through the port.
- **Current Port Status** — Specifies whether the port is currently operational or non-operational.

- **Reactivate Suspended Port** — Reactivates a port if the port has been disabled through the locked port security option.
 - **Checked** — Reactivates the port.
 - **Unchecked** — Maintains the port’s operational status.
- **Operational Status** — Indicates the port operational status. Possible field values are:
 - Suspended** — The port is currently active, and is not receiving or transmitting traffic.
 - Active** — The port is currently active and is receiving and transmitting traffic.
 - Disable** — The port is currently disabled, and is not receiving or transmitting traffic.
- **Admin Speed** — The configured rate for the port. The port type determines what speed setting options are available. Admin speed can only be designated when the port is disabled. The possible field values are:
 - **10M** — Indicates the port is currently operating at 10 Mbps.
 - **100M** — Indicates the port is currently operating at 100 Mbps.
 - **1000M** — Indicates the port is currently operating at 1000 Mbps.
- **Current Port Speed** — The actual synchronized port speed (bps).
- **Admin Duplex** — The port duplex mode in bps.
 - **Full** — Indicates that the interface supports transmission between the device and the client in both directions simultaneously.
 - **Half** — Indicates that the interface supports transmission between the device and the client in only one direction at a time.
- **Current Duplex Mode** — The synchronized port duplex mode.
- **Auto Negotiation** — Auto Negotiation is a protocol between two link partners that enables a port to advertise its transmission rate, duplex mode and flow control abilities to its partner.
 - **Enable** — Enables Auto Negotiation on the port.
 - **Disable** — Disables Auto Negotiation on the port.
- **Current Auto Negotiation** — The current Auto Negotiation setting.
- **Admin Advertisement** — Defines the auto-negotiation setting the port advertises. The possible field values are:
 - **Max Capability** — Indicates that all port speeds and Duplex mode settings are accepted.
 - **10 Half** — Indicates that the port advertises for a 10 mbps speed port and half duplex mode setting.
 - **10 Full** — Indicates that the port advertises for a 10 mbps speed port and full duplex mode setting.
 - **100 Half** — Indicates that the port advertises for a 100 mbps speed port and half duplex mode setting.
 - **100 Full** — Indicates that the port advertises for a 100 mbps speed port and full duplex mode setting.
 - **1000 Full** — Indicates that the port advertises for a 1000 mbps speed port and full duplex mode setting.

- **Current Advertisement** — The port advertises its speed to its neighbor port to start the negotiation process. The possible field values are those specified in the **Admin Advertisement** field.
- **Neighbor Advertisement** — Indicates the neighboring port's advertisement settings. The field values are identical to the **Admin Advertisement** field values.
- **Back Pressure** — Back Pressure mode is used with Half Duplex mode to disable ports from receiving messages. Back Pressure is not supported in OOB ports.
 - **Enable** — Enables Back Pressure mode on the port.
 - **Disable** — Disables Back Pressure mode on the port.
- **Current Back Pressure** — The current Back Pressure setting.
- **Flow Control** — Indicates the flow control status on the port.
 - **Enable** — Enables flow control on the port.
 - **Disable** — Disables flow control on the port.
 - **Auto-negotiation** — Enables the auto negotiation of flow control on the port.
- **Current Flow Control** — The current Flow Control setting.
- **MDI/MDIX** — Allows the device to decipher between crossed and uncrossed cables. Hubs and switches are deliberately wired opposite the way end stations are wired, so that when a hub or switch is connected to an end station, a straight through Ethernet cable can be used, and the pairs are match up properly. When two hubs/switches are connected to each other, or two end stations are connected to each other, a crossover cable is used ensure that the correct pairs are connected. Auto MDIX does not operate on FE ports if auto negotiation is disabled. The possible field values are:
 - **Auto** — Use to automatically detect the cable type.
 - **MDIX** — Use for hubs and switches.
 - **MDI** — Use for end stations.
- **Current MDI/MDIX** — Indicates the current device MDIX settings. The possible field values are:
 - **MDI** — The current MDI setting is MDI.
 - **MDIX** — The current MDI setting is MDIX.
- **Private VLAN Edge (PVE)**— Indicates the Private VLAN Edge (PVE) group to which the LAG is configured. A port defined as PVE is protected by an uplink, so that it is isolated from other ports within the same VLAN. The uplink must be a GE port.
- **LAG** — Specifies if the port is part of a LAG.

If port configuration is modified while the port is a LAG member, the configuration change is only effective after the port is removed from the LAG.

Defining Port Parameters

- 1 Open the **Port Configuration** page.
- 2 Select a port in the **Port** Field.
- 3 Define the available fields in the dialog.
- 4 Click **Apply Changes**.

The port parameters are saved to the device.

Displaying and Modifying Multiple Port Configurations

- 1 Open the **Port Configuration** page.
- 2 Click **Show All**.

The **Port Configuration Table** opens.

Figure 7-22. Port Configuration Table

Port Configuration Table

Refresh

Unit Number: 1

Port	Port Type	Port Status	Port Speed	Duplex Mode	Auto Negotiation	Back Pressure	Flow Control	Auto MDIX	PVE
1/e1	Ethernet	Up Up	100M 100M	Full Full	Enable Enable	Enable Enable	Enable On	MDI Auto	g1

Apply Changes

- 3 Define the available fields for the relevant port.
- 4 Click **Apply Changes**.

The port parameters are saved to the device.

Configuring Ports with CLI Commands

The following table summarizes the equivalent CLI commands for configuring ports as displayed in the [Port Configuration](#) page.

Table 7-12. Port Configuration CLI Commands

CLI Command	Description
<code>interface ethernet <i>interface</i></code>	Enters the interface configuration mode to configure an ethernet type interface.
<code>description <i>string</i></code>	Adds a description to an interface configuration.
<code>shutdown</code>	Disables interfaces that are part of the currently set context.
<code>set interface active { ethernet <i>interface</i> port-channel <i>port-channel-number</i> }</code>	Reactivates an interface that is shutdown due to security reasons.
<code>speed <i>Mbps</i></code>	Configures the speed of a given ethernet interface when not using auto negotiation.
<code>duplex {half full}</code>	Configures the full/half duplex operation of a given ethernet interface when not using auto negotiation.
<code>negotiation [capability1 [capability2...capability5]</code>	Enables auto negotiation operation for the speed and duplex parameters of a given interface.
<code>back-pressure</code>	Enables Back Pressure on a given interface.
<code>flowcontrol {auto on off}</code>	Configures the Flow Control on a given interface.
<code>mdix {on auto}</code>	Enables automatic crossover on a given interface or Port-channel.
<code>show interfaces configuration [ethernet <i>interface</i> port-channel <i>port-channel-number</i>]</code>	Displays the configuration for all configured interfaces.
<code>show interface advertise</code>	Displays the interface's negotiation advertisement settings.
<code>show interfaces status [ethernet <i>interface</i> port-channel <i>port-channel-number</i>]</code>	Displays the status for all configured interfaces.
<code>show interfaces description [ethernet <i>interface</i> port-channel <i>port-channel-number</i>]</code>	Displays the description for all configured interfaces.

The following is an example of the CLI commands:

```
console(config)# interface ethernet 1/e3
console(config-if)# description "RD SW#3"
console(config-if)# shutdown
console(config-if)# no shutdown
console(config-if)# speed 100
console(config-if)# duplex full
console(config-if)# negotiation
console(config-if)# back-pressure
console(config-if)# flowcontrol on
console(config-if)# mdix auto
console(config-if)# end
console# show interfaces configuration ethernet 1/e3
```

Port	Type	Duplex	Speed	Neg	Flow Control	Admin State	Back Pressure	Mdix Mode
1/e3	100	Full	100	Enabled	On	Up	Enable	Auto

```
Console# show interfaces status
```

Port	Type	Duplex	Speed	Neg	Flow Control	Link State	Back Pressure	Mdix Mode
1/e3	100	Full	100	Auto	On	Up	Enable	On
1/e4	100	Full	1000	Off	Off	Up	Disable	On

```
Ch
```

Ch	Type	Duplex	Speed	Neg	Flow Control	Back Pressure	Link State
Ch1	1000	Full	1000	Off	Off	Disable	Up

Defining LAG Parameters

The **Ports - LAG Configuration** page contains fields for configuring parameters for configured LAGs. The device supports up to fifteen LAGs per system. For information about Link Aggregated Groups (LAG) and assigning ports to LAGs, see **Aggregating Ports**.

To open the **Ports - LAG Configuration** page, click **Switch** → **Ports** → **LAG Configuration** in the tree view.

Figure 7-23. Ports - LAG Configuration

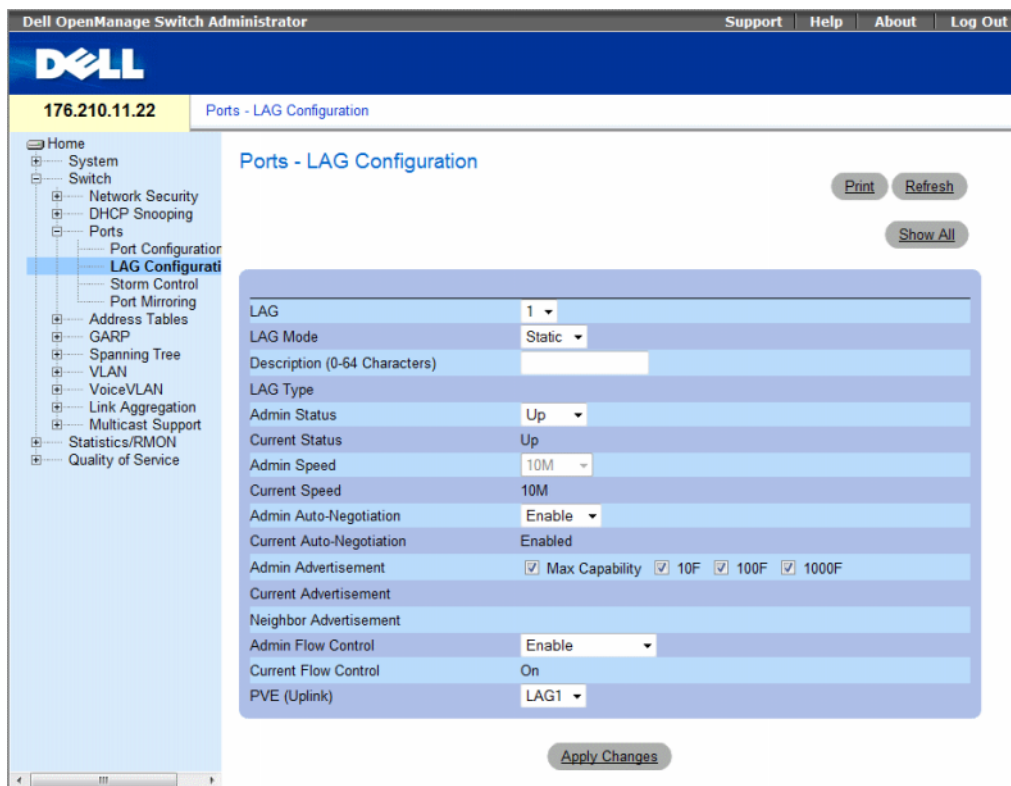

The **Ports - LAG Configuration** page contains the following fields:

- **LAG** — The LAG number.
- **LAG Mode** — Type of LAG. The possible field values are:
 - **Static** — The ports comprise a single logical port for high-speed connections between networking devices.
 - **LACP** — Link Aggregate Control Protocol. LACP-enabled LAGs can exchange information with other links in order to update and maintain LAG configurations automatically.
- **Description (0 - 64 Characters)** — Provides a user-defined description of the configured LAG.

- **LAG Type** — The port types that comprise the LAG.
- **Admin Status** — Enables or disables the selected LAG.
 - **Up** — Traffic is enabled through the LAG.
 - **Down** — Traffic is disabled through the LAG.
- **Current Status** — Indicates if the LAG is currently operating.
- **Admin Speed** — The configured speed at which the LAG is operating. The possible field values are:
 - **10M** — Indicates the LAG is currently operating at 10 Mbps.
 - **100M** — Indicates the LAG is currently operating at 100 Mbps.
 - **1000M** — Indicates the LAG is currently operating at 1000 Mbps.
- **Current Speed** — The speed at which the LAG is currently operating.
- **Admin Auto Negotiation** — Auto Negotiation is a protocol between two link partners that enables a LAG to advertise its transmission rate, duplex mode and flow control abilities to its partner.
 - **Enable** — Enables Auto Negotiation on the LAG.
 - **Disable** — Disables Auto Negotiation on the LAG.
- **Current Auto Negotiation** — The current Auto Negotiation setting.
- **Admin Advertisement** — Defines the auto-negotiation setting the LAG advertises. The possible field values are:
 - **Max Capability** — Indicates that all LAG speeds and Duplex mode settings are accepted.
 - **10 Full** — Indicates that the LAG advertises for a 10 mbps speed LAG and full duplex mode setting.
 - **100 Full** — Indicates that the LAG advertises for a 100 mbps speed LAG and full duplex mode setting.
 - **1000 Full** — Indicates that the LAG advertises for a 1000 mbps speed LAG and full duplex mode setting.
- **Current Advertisement** — The LAG advertises its speed to its neighbor LAG to start the negotiation process. The possible field values are those specified in the **Admin Advertisement** field.
- **Neighbor Advertisement** — Indicates the neighboring LAG advertisement settings. The field values are identical to the **Admin Advertisement** field values.
- **Admin Flow Control** — Indicates the flow control status on the LAG. Flow Control mode is effective on the ports operating in Full Duplex in the LAG.
 - **Enable** — Enables flow control on the LAG.
 - **Disable** — Disables flow control on the LAG.
 - **Auto-negotiation** — Enables the auto negotiation of flow control on the LAG.

- **Current Flow Control** — The current Flow Control setting.
- **Private VLAN Edge (PVE)**— Indicates the Private VLAN Edge (PVE) group to which the LAG is configured. A port defined as PVE is protected by an uplink, so that it is isolated from other ports within the same VLAN. The uplink must be a GE port or LAG.

Defining LAG Parameters

- 1 Open the **Ports - LAG Configuration** page.
- 2 Select a LAG in the **LAG** field.
- 3 Define the fields.
- 4 Click **Apply Changes**.
The LAG parameters are saved to the device.

Modifying LAG Parameters

- 1 Open the **Ports - LAG Configuration** page.
- 2 Select a LAG in the **LAG** field.
- 3 Modify the fields.
- 4 Click **Apply Changes**.
The LAG parameters are saved to the device.

Displaying and Modifying Multiple LAG Configurations

- 1 Open the **Ports - LAG Configuration** page.
- 2 Click **Show All**.
The LAG Configuration Table opens.

Figure 7-24. LAG Configuration Table

LAG Configuration Table Refresh

LAG	LAG Type	LAG Status	LAG Speed	Auto Negotiation	Flow Control	PVE
1		Up	100M	Enable	Enable	LAG1
		Up	100M	Enable	Enable	LAG1
2		Up	100M	Enable	Enable	LAG1
		Up	100M	Enable	Enable	LAG1
3		Up	100M	Enable	Enable	LAG1
		Up	100M	Enable	Enable	LAG1
4		Up	100M	Enable	Enable	LAG1
		Up	100M	Enable	Enable	LAG1

Apply Changes

- 3 Define the available fields for the relevant LAGs.
- 4 Click **Apply Changes**.

The LAG parameters are saved to the device.

Configuring LAGs with CLI Commands

The following table summarizes the equivalent CLI commands for configuring LAGs as displayed in the **Ports - LAG Configuration** page.

Table 7-13. LAG Configuration CLI Commands

CLI Command	Description
<code>interface port-channel <i>port-channel-number</i></code>	Enters the interface configuration mode of a specific port-channel.
<code>description <i>string</i></code>	Adds a description to an interface configuration.
<code>shutdown</code>	Disables interfaces that are part of the currently set context.
<code>speed <i>bps</i></code>	Configures the speed of a given ethernet interface when not using auto negotiation.
<code>negotiation [capability1 [capability2...capability5]</code>	Enables interface speed auto negotiation operation.
<code>back-pressure</code>	Enables Back Pressure on a given interface.
<code>flowcontrol {auto on off }</code>	Configures the Flow Control on a given interface.
<code>show interfaces configuration [ethernet <i>interface</i> port-channel <i>port-channel-number</i>]</code>	Displays the configuration for all configured interfaces.
<code>show interfaces status [ethernet <i>interface</i> port-channel <i>port-channel- number</i>]</code>	Displays the status for all configured interfaces.
<code>show interfaces description [ethernet <i>interface</i> port-channel <i>port-channel-number</i>]</code>	Displays the description for all configured interfaces.
<code>show interfaces port-channel [<i>port- channel-number</i>]</code>	Displays Port-channel information (which ports are members of that port-channel, and whether they are currently active or not).

The following is an example of the CLI commands:

```
console(config)# interface port-channel 2
console(config-if)# no negotiation
console(config-if)# speed 100
console(config-if)# flowcontrol on
console(config-if)# exit
console(config)# interface port-channel 3
console(config-if)# shutdown
console(config-if)# exit
console(config)# interface port-channel 4
console(config-if)# back-pressure
console(config-if)# description p4
console(config-if)# end
console# show interfaces port-channel
Channel          Ports
-----          -
ch1              Inactive: 1/e(11-13)
ch2              Active: 1/e14
```

Enabling Storm Control

A Broadcast Storm is a result of an excessive amount of Broadcast messages simultaneously transmitted across a network by a single port. Forwarded message responses are heaped onto the network, straining network resources or causing the network to time out.

Storm Control is enabled per port by defining the packet type and the rate the packets are transmitted.

The system measures the incoming Broadcast, Unicast, and Multicast frame rate separately on each port, and discard frames when the rate exceeds a user-defined rate.

The **Storm Control** page provides fields for enabling and configuring Storm Control. To open the **Storm Control** page, click **Switch** → **Ports** → **Storm Control** in the tree view.

Figure 7-25. Storm Control

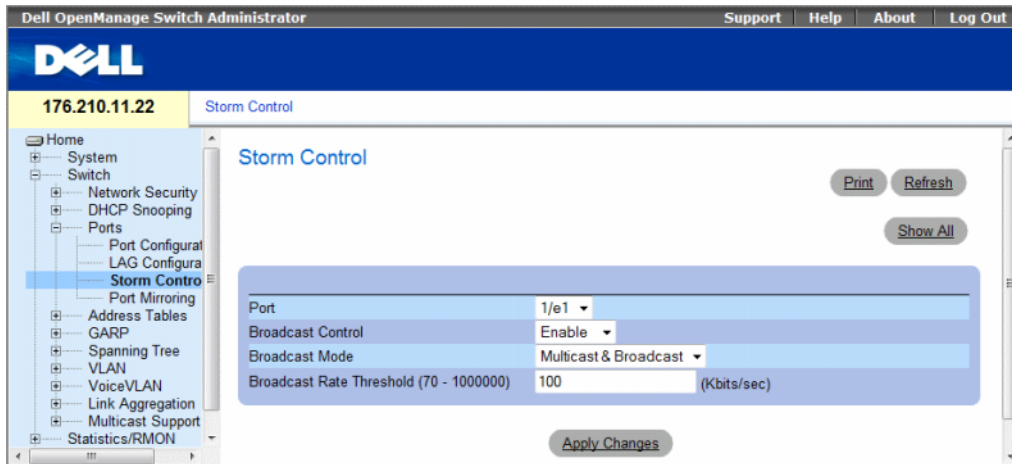

The **Storm Control** page contains the following fields:

- **Port** — The port from which storm control is enabled.
- **Broadcast Control** — Enables or disables forwarding Broadcast packet types on the specific interface.
 - **Enable** — Enables Broadcast packet types to be forwarded.
 - **Disable** — Disables Broadcast packet types to be forwarded.
- **Broadcast Mode** — Specifies the Broadcast mode currently enabled on the device or stack. The possible field values are:
 - **Multicast & Broadcast** — Counts Broadcast and Multicast traffic together.
 - **Broadcast Only** — Counts only Broadcast traffic.
- **Broadcast Rate Threshold (70-1000000)** — The maximum rate (Kbits/sec) at which unknown packets are forwarded. The field range is 70-1,000,000 Kbps.

Enabling Storm Control

- 1 Open the **Storm Control** page.
- 2 Select an interface on which to implement storm control.
- 3 Define the fields.
- 4 Click **Apply Changes**.

Storm Control is enabled.

Modifying Storm Control Port Parameters

- 1 Open the Storm Control page.
- 2 Modify the fields.
- 3 Click Apply Changes

The Storm Control port parameters are saved to the device.

Displaying the Port Parameters Table

- 1 Open the Storm Control page.
- 2 Click Show All.

The Storm Control Settings Table opens.

Figure 7-26. Storm Control Settings Table

Storm Control Settings Table Refresh

Unit No. 1 ▾
Copy Parameters from Port 1 ▾

Port	Broadcast Control	Broadcast Rate Threshold	Copy to Select All
1/e1	Disable ▾	0	<input type="checkbox"/>
1/e2	Disable ▾	0	<input type="checkbox"/>

Apply Changes

In addition to the fields in the Storm Control page, the Storm Control Settings Table contains the following additional fields:

- **Unit No.** — Indicates the stacking member for which the Storm Control information is displayed.
- **Copy Parameters from Port** — Indicates the specific port from which Storm Control parameters are copied.
- **Copy To** — Copies the Storm Control parameters to the selected ports.

Copying Parameters in the Storm Control Settings Table

- 1 Open the Storm Control page.
- 2 Click Show All.

The Storm Control Settings Table opens.

- 3 Select the port from which settings are copied from the Copy Parameters from Port field.

4 Check the **Copy to check box** to define the interfaces to which the storm control definitions are copied, or click **Select All** to copy the definitions to all ports.

5 Click **Apply Changes**.

The parameters are copied to the selected ports in the **Storm Control Settings Table**, and the device is updated.

Configuring Storm Control with CLI Commands

The following table summarizes the equivalent CLI commands for configuring Storm Control as displayed on the **Storm Control** page.

Table 7-14. Storm Control CLI Commands

CLI Command	Description
<code>port storm-control include-multicast</code>	Enables the device to count Multicast, Unicast, and Broadcast packets together.
<code>port storm-control broadcast enable</code>	Enables broadcast storm control.
<code>port storm-control broadcast rate</code>	Configures the maximum broadcast rate.
<code>show ports storm-control port</code>	Displays the storm control configuration.

The following is an example of the CLI commands:

```
console(config)# port storm-control include-multicast
console(config)# interface ethernet 1/e1
console(config-if)# port storm-control broadcast enable
console(config-if)# port storm-control broadcast rate 100000
console(config-if)# end
console# show ports storm-control
Port                Broadcast Storm control [kbytes/sec]
-----
1/e1                8000
2/e1                Disabled
3/e2                Disabled
```

Defining Port Mirroring Sessions

Port mirroring does the following:

- Monitors and mirrors network traffic by forwarding copies of incoming and outgoing packets from one port to a monitoring port.
- Can be used as a diagnostic tool and/or a debugging feature.
- Enables device performance and monitoring.

Port mirroring is configured by selecting a specific port to copy all packets, and different ports from which the packets are copied.

Before configuring Port Mirroring, note the following:

- Port mirroring monitors and mirrors network traffic by forwarding copies of incoming and outgoing packets, from a monitored port to a monitoring port.
- Monitored port cannot operate faster than the monitoring port.
- All the RX/TX packets should be monitored to the same port.

The following restrictions apply to ports configured to be destination ports:

- Ports cannot be configured as a source port.
- Ports cannot be a LAG member.
- IP interfaces are not configured on the port.
- GVRP is not enabled on the port.
- The port is not a VLAN member.
- Only one destination port can be defined.

The following restrictions apply to ports configured to be source ports:

- Source Ports cannot be a LAG member.
- Ports cannot be configured as a destination port.
- Mirroring supports 4 ports in this device.

To open the **Port Mirroring** page, click **Switch** → **Ports** → **Port Mirroring** in the tree view.

When a port is set to be a target port for a port-mirroring session, all normal operations on it are suspended. This includes Spanning Tree and LACP.

Figure 7-27. Port Mirroring

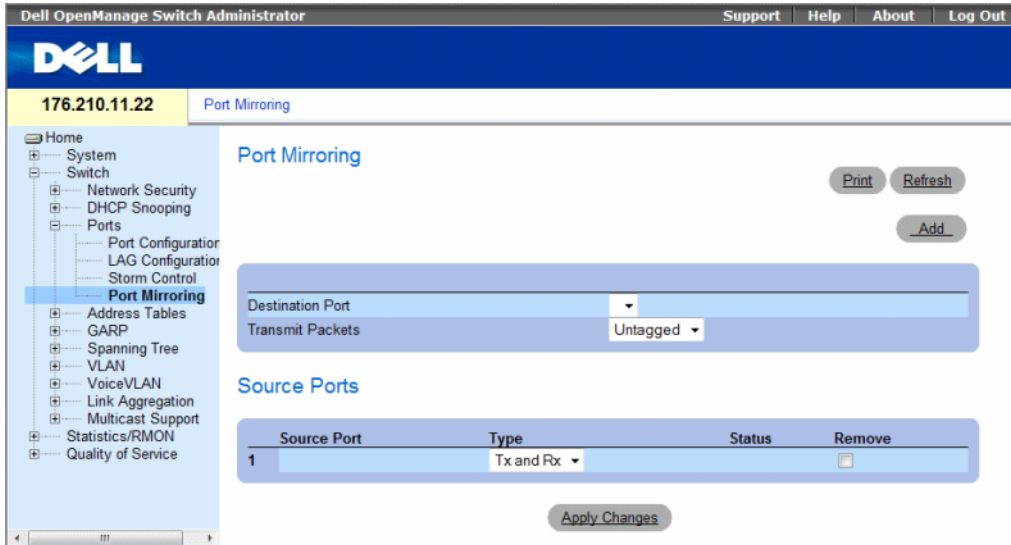

The **Port Mirroring** page contains the following fields:

- **Destination Port** — The port number to which port traffic is copied.
- **Transmit Packets** — Defines the how the packets are mirrored. The possible field values are:
 - **Untagged** — Mirrors packets as untagged vlan packets. This is the default value.
 - **Tagged** — Mirrors packets as tagged vlan packets.

Source Ports

- **Source Port** — Defines the port number from which port traffic is mirrored.
- **Type** — Indicates if the mirrored packets are RX, TX, or both RX and TX. The possible field values are:
 - **RxOnly** — Defines the port mirroring on receiving ports. This is the default value.
 - **TxOnly** — Defines the port mirroring on transmitting ports.
 - **Tx and Rx** — Defines the port mirroring on both receiving and transmitting ports.

- **Status** — Indicates if the port is currently monitored (**Active**) or not monitored (**Ready**).
- **Remove** — Removes the port mirroring session. The possible field values are:
 - **Checked** — Removes the selected port mirroring sessions.
 - **Unchecked** — Maintains the port mirroring session.

Adding a Port Mirroring Session

- 1 Open the **Port Mirroring** page.
- 2 Click **Add**.

The **Add Source Port** page opens.

Figure 7-28. Add Source Port

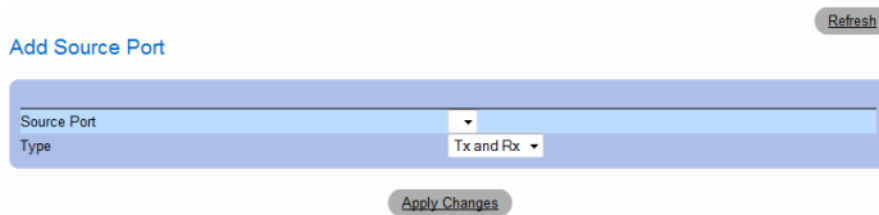

- 3 Define the **Source Port** and the **Type** fields.
 - 4 Click **Apply Changes**.
- The new source port is defined, and the device is updated.

Deleting a Copied Port from a Port Mirroring Session

- 1 Open the **Port Mirroring** page.
- 2 In the **Source Ports** table, select the port's **Remove** check box.
- 3 Click **Apply Changes**.

The selected port mirroring session is deleted, and the device is updated.

Configuring a Port Mirroring Session Using CLI Commands

The following table summarizes the equivalent CLI commands for configuring a Port Mirroring session as displayed in the **Port Mirroring** page.

Table 7-15. Port Mirroring CLI Commands

CLI Command	Description
<code>port monitor src-interface [rx tx]</code>	Starts a port monitoring session.

The following is an example of the CLI commands:

```
console(config)# interface ethernet 1/e1
console(config-if)# port monitor 1/e2
console (config-if)# end
console# show ports monitor
```

Source Port	Destination Port	Type	Status	VLAN Tagging
-----	-----	-----	-----	-----
1/e2	1/e1	RX, TX	Active	No

Configuring Address Tables

MAC addresses are stored in either the Static Address or the Dynamic Address databases. A packet addressed to a destination stored in one of the databases is forwarded immediately to the port.

The Dynamic Address Table can be sorted by interface, VLAN, and MAC Address. MAC addresses are dynamically learned as packets from sources arrive at the device. Addresses are associated with ports by learning the ports from the frames source address. Frames addressed to a destination MAC address that is not associated with any port, are flooded to all ports of the relevant VLAN. Static addresses are manually configured. In order to prevent the bridging table from overflowing, dynamic MAC addresses, from which no traffic is seen for a certain period, are erased.

To open the **Address Tables** page, click **Switch** → **Address Tables** in the tree view.

This section contains the following topics:

- "Defining Static Addresses" on page 315
- "Viewing Dynamic Addresses" on page 318

Defining Static Addresses

The **Static MAC Address** page contains a list of static MAC addresses. Static Address can be added and removed from the **Static MAC Address** page. In addition, several MAC Addresses can be defined for a single port.

To open the **Static MAC Address** page, click **Switch** → **Address Tables** → **Static Address Table** in the tree view.

Figure 7-29. Static MAC Address

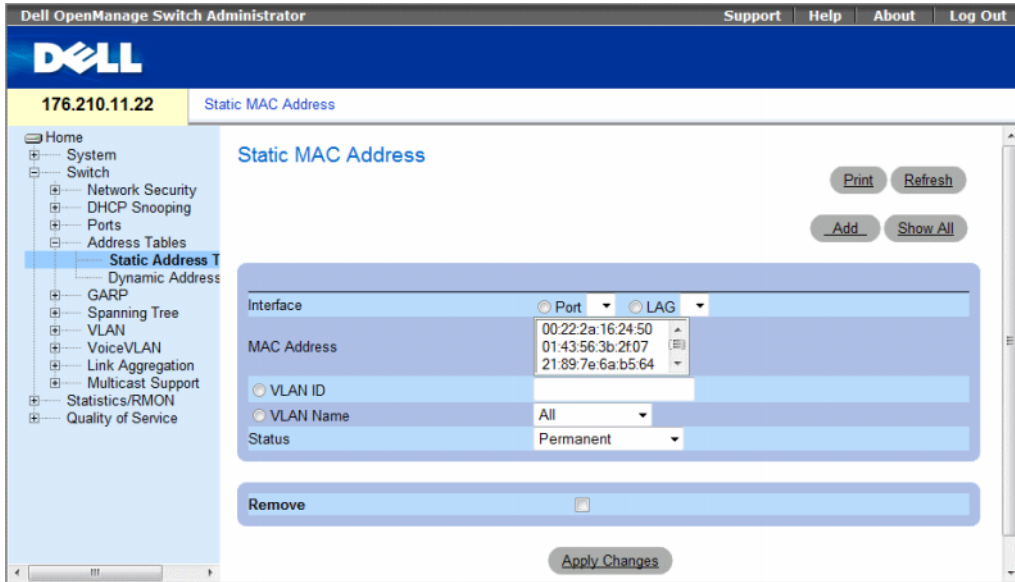

The Static MAC Address page contains the following fields:

- **Interface** — The specific port or LAG to which the static MAC address is applied.
- **MAC Address** — The MAC addresses listed in the current static addresses list.
- **VLAN ID** — The VLAN ID attached to the MAC.
- **VLAN Name** — User-defined VLAN name.
- **Status** — MAC address status. Possible values are:
 - **Secure** — Used for defining static MAC Addresses for Locked ports.
 - **Permanent** — The MAC address is permanent.
 - **Delete on Reset** — The MAC address is deleted when the device is reset.
 - **Delete on Timeout** — The MAC address is deleted when a timeout occurs.

To prevent Static MAC addresses from being deleted when the Ethernet device reset, ensure the port attached to the MAC address is locked.

- **Remove** — Removes the selected MAC address from the Static MAC Address Table. The possible field values are:
 - **Checked** — Removes the selected MAC address.
 - **Unchecked** — Maintains the selected MAC address.

Adding a Static MAC Address

- 1 Open the Static MAC Address page.
- 2 Click Add.

The Add Static MAC Address page opens.

Figure 7-30. Add Static MAC Address

Add Static MAC Address Refresh

Interface Port LAG

MAC Address

VLAN ID

VLAN Name

Status

Apply Changes

- 3 Complete the fields.
- 4 Click **Apply Changes**.

The new static address is added to the **Static MAC Address Table**, and the device is updated.

Modifying a Static Address Setting in the Static MAC Address Table

- 1 Open the Static MAC Address page.
- 2 Select an interface.
- 3 Modify the fields.
- 4 Click **Apply Changes**.

The static MAC address is modified, and the device is updated.

Removing a Static Address from the Static Address Table

- 1 Open the Static MAC Address page.
- 2 Choose an interface.
- 3 Click **Show All**.

The **Static MAC Address Table** opens.

Figure 7-31. Static MAC Address Table

Static MAC Address Table Refresh

MAC	VLAN ID	Interface	Status	Remove
1			Permanent	<input type="checkbox"/>

Apply Changes

- 4 Select a table entry.
- 5 Select the **Remove** check box.
- 6 Click **Apply Changes**.

The selected static address is deleted, and the device is updated.

Configuring Static Address Parameters Using CLI Commands

The following table summarizes the equivalent CLI commands for configuring static address parameters as displayed in the **Static MAC Address** page.

Table 7-16. Static Address CLI Commands

CLI Command	Description
<code>bridge address mac-address [permanent delete-on-reset delete-on-timeout secure] {ethernet interface port-channel port-channel-number}</code>	Adds a static MAC-layer station source address to the bridge table.
<code>show bridge address-table [vlan vlan] [ethernet interface port-channel port-channel-number]</code>	Displays entries in the bridge-forwarding database.

The following is an example of the CLI commands.

```

console(config-if)#bridge address 00:60:70:4C:73:FF permanent
ethernet g8

console# show bridge address-table

Aging time is 300 sec

vlan      mac address                port      type
----      -
1         00:60:70:4C:73:FF          1/e8     dynamic
1         00:60:70:8C:73:FF          1/e8     dynamic
200      00:10:0D:48:37:FF          1/e9     static

```

Viewing Dynamic Addresses

The **Dynamic Address Table** contains information for querying information in the dynamic address table, including the interface type, MAC addresses, VLAN, and table sorting. Packets forwarded to an address stored in the address table are forwarded directly to those ports. The **Dynamic Address Table** page also contains information about the aging time before a dynamic MAC address is erased, and includes parameters for querying and viewing the Dynamic Address list. The **Current Address Table** contains dynamic address parameters by which packets are directly forwarded to the ports.

To open the Dynamic Address Table page, click **Switch** → **Address Tables** → **Dynamic MAC Address** in the tree view.

Figure 7-32. Dynamic Address Table

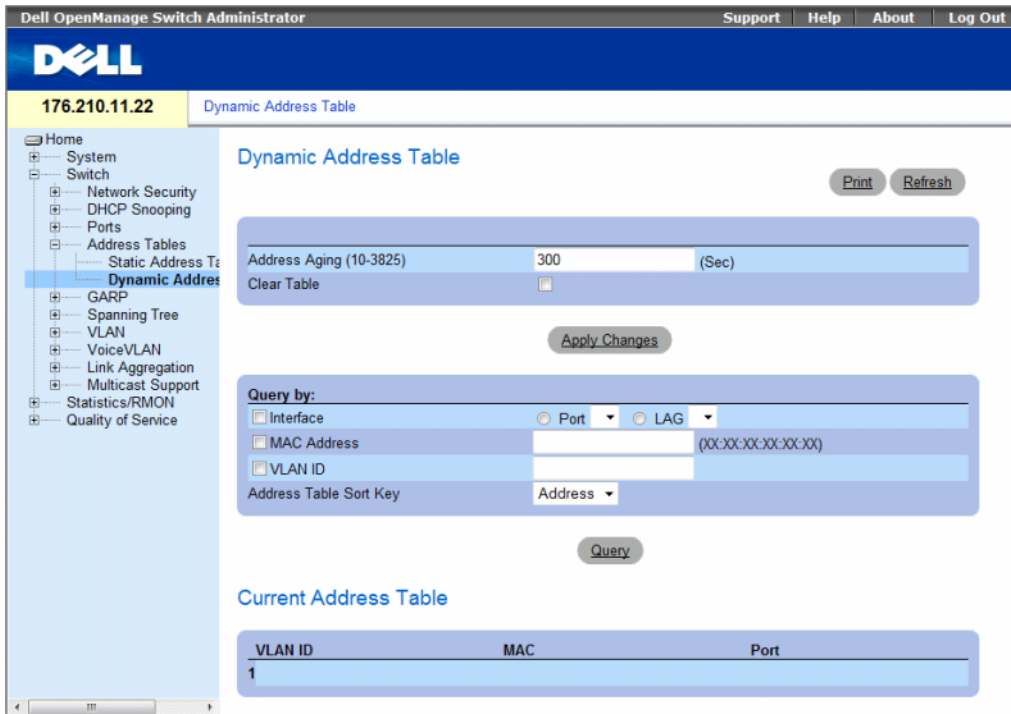

The Dynamic Address Table page contains the following fields:

- **Address Aging (10-3825)** — Specifies the amount of time (in seconds) the MAC Address remains in the Dynamic Address Table before it is timed out if no traffic from the source is detected. The default value is 300 seconds.
- **Clear Table** — Clears the Dynamic Address table.
 - **Checked** — Clears the Dynamic Address table.
 - **Unchecked** — Maintains the Dynamic Address table.

Query By

In the **Query By** section, select the preferred option for sorting the Dynamic Addresses Table:

- **Port** — Specifies the interface for which the table is queried. There are two interface types from which to select.
- **MAC Address** — Specifies the MAC address for which the table is queried.

- **VLAN ID** — The VLAN ID for which the table is queried.
- **Address Table Sort Key** — Specifies the means by which the Dynamic Address Table is sorted. The address table can be sorted by Address, VLAN or Interface.

Redefining the Aging Time

- 1 Open the **Dynamic Address Table**.
- 2 Define the **Address Aging** field.
- 3 Click **Apply Changes**.
The aging time is modified, and the device is updated.

Querying the Dynamic Address Table

- 1 Open the **Dynamic Address Table**.
- 2 Define the parameter by which to query the **Dynamic Address Table**.
Entries can be queried by **Port**, **MAC Address**, or **VLAN ID**.
- 3 Click **Query**.
The **Dynamic Address Table** is queried, and the results are displayed.

Sorting the Dynamic Address Table

- 1 Open the **Dynamic Address Table**.
- 2 From the **Address Table Sort Key** drop-down menu, select whether to sort addresses by address, VLAN ID, or interface.
- 3 Click **Query**.
The **Dynamic Address Table** is sorted.

Querying and Sorting Dynamic Addresses Using CLI Commands

The following table summarizes the equivalent CLI commands for aging, querying, and sorting dynamic addresses as displayed in the **Dynamic Address Table**.

Table 7-17. Query and Sort CLI Commands

CLI Command	Description
<code>bridge aging-time <i>seconds</i></code>	Sets the address table aging time.
<code>show bridge address-table [vlan <i>vlan</i>] [ethernet <i>interface</i> port-channel <i>port-channel-number</i>]</code>	Displays classes of dynamically created entries in the bridge-forwarding database.

The following is an example of the CLI commands:

```
console (config)# bridge aging-time 250
console (config)# end
console# show bridge address-table

Aging time is 250 sec

vlan      mac address          port    type
----      -
1         00:60:70:4C:73:FF    1/e8    dynamic
1         00:60:70:8C:73:FF    1/e8    dynamic
200      00:10:0D:48:37:FF    1/e8    static
```

Configuring GARP

Generic Attribute Registration Protocol (GARP) is a general-purpose protocol that registers any network connectivity or membership-style information. GARP defines a set of devices interested in a given network attribute, such as VLAN or multicast address.

When configuring GARP, ensure the following:

- The leave time must be greater than or equal to three times the join time.
- The leave-all time must be greater than the leave time.
- Set the same GARP timer values on all Layer 2-connected devices. If the GARP timers are set differently on the Layer 2-connected devices, GARP application does not operate successfully.

To open the **GARP** page, click **Switch** → **GARP** in the tree view.

This section contains the following topics:

- "Defining GARP Timers" on page 322

Defining GARP Timers

The GARP Timers page contains fields for enabling GARP on the device.

To open the GARP Timers page, click **Switch** → **GARP** → **GARP Timers** in the tree view.

Figure 7-33. GARP Timers

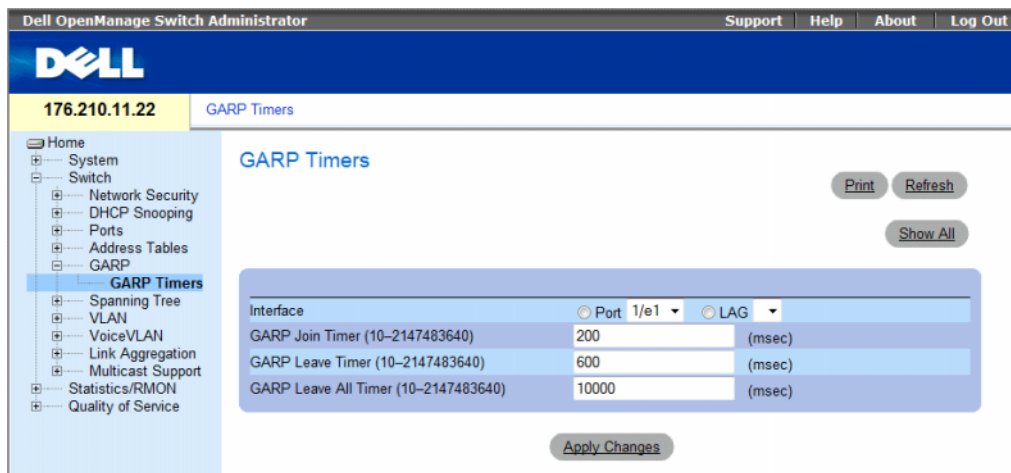

The GARP Timers page contains the following fields:

- **Interface** — Determines if enabled on a port or on a LAG..
- **GARP Join Timer (10 - 2147483640)** — Time, in milliseconds, that Protocol Data Units (PDU) are transmitted. The default value is 200 msec.
- **GARP Leave Timer (10 - 2147483640)** — Time lapse, in milliseconds, that the device waits before leaving its GARP state. Leave time is activated by a Leave All Time message sent/received, and cancelled by the Join message received. Leave time must be greater than or equal to three times the join time. The default value is 600 msec.
- **GARP Leave All Timer (10 - 2147483640)** — Time lapse, in milliseconds, that all devices wait before leaving the GARP state. The leave all time must be greater than the leave time. The default value is 10000 msec.

Defining GARP Timers

- 1 Open the GARP Timers page.
- 2 Select an interface.
- 3 Complete the fields.
- 4 Click **Apply Changes**.

The GARP parameters are saved to the device.

Copying Parameters in the GARP Timers Table

- 1 Open the GARP Timers page.
- 2 Click Show All.
The GARP Timers Table opens.

Figure 7-34. GARP Timers Table

GARP Timers Table Refresh

Unit No. 1

Copy Parameters from Port LAG

Interface	GARP Join Timer	GARP Leave Timer	GARP Leave All Timer	Copy to Select All
1				<input type="checkbox"/>
2				<input type="checkbox"/>
Global System LAGs				
1				<input type="checkbox"/>
2				<input type="checkbox"/>

Apply Changes

- 3 Select the interface in the **Copy Parameters from** field from either the **Port** or **LAG** drop-down menu. The definitions for this interface are copied to the selected interfaces. See step 4.
- 4 Select the **Copy to** check box to define the interfaces to which the GARP timer definitions (copied from **Copy Parameters from** field) are copied, or click **Select All** to copy the definitions to all ports or LAGs.
- 5 Click **Apply Changes**.
The parameters are copied to the selected ports or LAGs in the **GARP Timers Table**, and the device is updated.

Defining GARP Timers Using CLI Commands

This table summarizes the equivalent CLI commands for defining GARP timers as displayed in the GARP Timers page.

Table 7-18. GARP Timer CLI Commands

CLI Command	Description
<code>garp timer {join leave leaveall} timer_value</code>	Adjusts the GARP application join, leave, and leaveall GARP timer values.

The following is an example of the CLI commands:

```
console(config)# interface ethernet 1/e1
console(config-if)# garp timer leave 900
console(config-if)# end
console# show gvrp configuration ethernet 1/e1

GVRP Feature is currently Disabled on the device.
Maximum VLANs: 223

Port(s)  GVRP-      Registration  Dynamic VLAN  Timers      (milliseconds)
         Status                Creation      Join         Leave  Leave All
-----  -
1/e11    Disabled    Normal        Enabled       200     900     10000
```

Configuring the Spanning Tree Protocol

Spanning Tree Protocol (STP) provides tree topography for any bridge arrangement. STP eliminates loops by providing one path between end stations on a network.

Loops occur when alternate routes exist between hosts. Loops in an extended network can cause bridges to forward traffic indefinitely, resulting in increased traffic and reducing network efficiency.

The device supports the following Spanning Tree versions:

- **Classic STP** — Provides a single path between end stations, avoiding and eliminating loops. For more information on configuring Classic STP, see **Defining STP Global Settings**.
- **Rapid STP** — Detects and uses of network topologies that provide faster convergence of the spanning tree, without creating forwarding loops. If RSTP is enabled on the device, but the neighboring device is STP enabled, the local device uses STP.

For more information on configuring Rapid STP, see **Defining Rapid Spanning Tree**.

- **Multiple STP** — Provides full connectivity for packets allocated to any VLAN. Multiple STP is based on the RSTP. In addition, Multiple STP transmits packets assigned to different VLANs through different MST regions. MST regions act as a single bridge if MSTP is enabled on the device. However, if RSTP is enabled on the neighboring device and the local device uses STP, RSTP, and MSTP, then both the devices are interoperable.

For more information on configuring Multiple STP, see **Configuring Multiple Spanning Tree**.

To open the **Spanning Tree** page, click **Switch** → **Spanning Tree** in the tree view.

This section contains the following topics:

- "Defining STP Global Settings" on page 325
- "Defining STP Port Settings" on page 331
- "Defining STP LAG Settings" on page 336
- "Defining Rapid Spanning Tree" on page 339
- "Configuring Multiple Spanning Tree" on page 343
- "Defining MSTP Interface Settings" on page 347

Defining STP Global Settings

The **Spanning Tree Global Settings** page contains parameters for enabling STP on the device.

To open the **Spanning Tree Global Settings** page, click **Switch** → **Spanning Tree** → **Global Settings** in the tree view.

Figure 7-35. Spanning Tree Global Settings

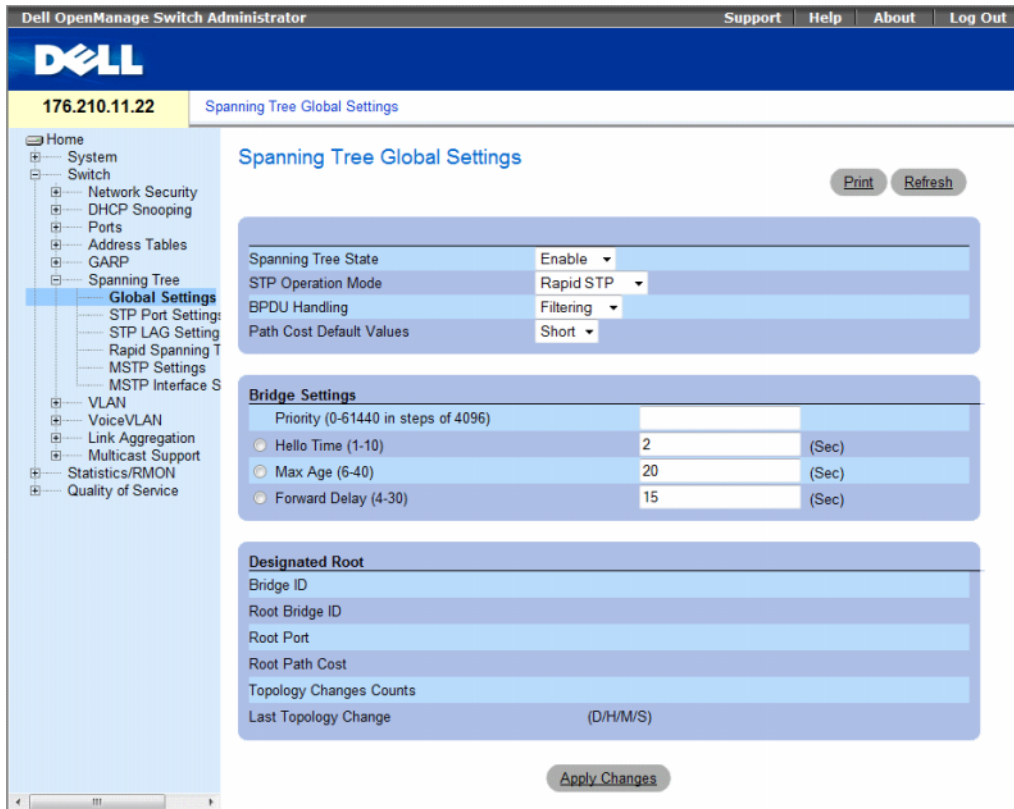

The Spanning Tree Global Settings page contains the following fields:

- **Spanning Tree State** — Enables or disables Spanning Tree on the device. The possible field values are:
 - **Enable** — Enables Spanning Tree.
 - **Disable** — Disables Spanning Tree.
- **STP Operation Mode** — Indicates the STP mode by which STP is enabled on the device. The possible field values are:
 - **Classic STP** — Enables Classic STP on the device. This is the default value.
 - **Rapid STP** — Enables Rapid STP on the device.
 - **Multiple STP** — Enables Multiple STP on the device.

- **BPDU Handling** — Determines how *Bridge Protocol Data Unit* (BPDU) packets are managed when STP is disabled on the port/ device. BPDUs are used to transmit spanning tree information. The possible field values are:
 - **Filtering** — Filters BPDU packets when spanning tree is disabled on an interface. This is the default value.
 - **Flooding** — Floods BPDU packets when spanning tree is disabled on an interface.
- **Path Cost Default Values** — Specifies the method used to assign default path costs to STP ports. The possible field values are:
 - **Short** — Specifies 1 through 65,535 range for port path costs. This is the default value.
 - **Long** — Specifies 1 through 200,000,000 range for port path costs.

The default path costs assigned to an interface vary according to the selected method:

Interface	Long	Short
LAG	20,000	4
1000 Mbps	20,000	4
100 Mbps	200,000	19
10 Mbps	2,000,000	100

Bridge Settings

- **Priority (0-61440 in steps of 4096)** — Specifies the bridge priority value. When switches or bridges are running STP, each is assigned a priority. After exchanging BPDUs, the device with the lowest priority value becomes the Root Bridge. The default value is 32768. The port priority value is provided in increments of 4096. For example, 4096, 8192, 12288, etc.
- **Hello Time (1-10)** — Specifies the device Hello Time. The Hello Time indicates the amount of time in seconds a root bridge waits between configuration messages. The default is 2 seconds.
- **Max Age (6-40)** — Specifies the device Maximum Age Time. The Maximum Age Time indicates the amount of time in seconds a bridge waits before sending configuration messages. The default max age is 20 seconds.
- **Forward Delay (4-30)** — Specifies the device forward delay time. The Forward Delay Time indicates the amount of time in seconds a bridge remains in a listening and learning state before forwarding packets. The default is 15 seconds.

Designated Root

- **Bridge ID** — Identifies the Bridge priority and MAC address.
- **Root Bridge ID** — Identifies the Root Bridge priority and MAC address.
- **Root Port** — Indicates the port number that offers the lowest cost path from this bridge to the Root Bridge. It is significant when the Bridge is not the Root.

- **Root Path Cost** — The cost of the path from this bridge to the root.
- **Topology Changes Counts** — Specifies the total amount of STP state changes that have occurred.
- **Last Topology Change** — Indicates the amount of time that has elapsed since the bridge was initialized or reset, and the last topographic change occurred. The time is displayed in a D/H/M/S format, for example, 2D/5H/10M/4S.

Defining STP Global Parameters

- 1 Open the [page](#).
- 2 Select **Enable** in the **Spanning Tree State** field.
- 3 Select the **STP** mode in the **STP Operation Mode** field, and define the bridge settings.
- 4 Click **Apply Changes**.

STP is enabled on the device.

Modifying STP Global Parameters

- 1 Open the [page](#).
- 2 Define the fields in the dialog.
- 3 Click **Apply Changes**.

The STP parameters are modified, and the device is updated.

Defining STP Global Parameters Using CLI Commands

The following table summarizes the equivalent CLI commands for defining STP global parameters as displayed in the Spanning Tree Global Settings page.

Table 7-19. STP Global Parameter CLI Commands

CLI Command	Description
<code>spanning-tree</code>	Enables spanning tree functionality.
<code>spanning-tree mode {stp rstp mstp}</code>	Configures the mode of the spanning tree protocol.
<code>spanning-tree priority priority</code>	Configures the spanning tree priority.
<code>spanning-tree hello-time seconds</code>	Configures the spanning tree bridge Hello Time, which is how often the device broadcasts Hello messages to other devices.
<code>spanning-tree max-age seconds</code>	Configures the spanning tree bridge maximum age.
<code>spanning-tree forward-time seconds</code>	Configures the spanning tree bridge forward time, which is the amount of time a port remains in the listening and learning states before entering the forwarding state.

Table 7-19. STP Global Parameter CLI Commands (continued)

CLI Command	Description
show spanning-tree [ethernet <i>interface</i> port-channel <i>port-channel-number</i>] [instance <i>instance-id</i>]	Displays spanning tree configuration.
show spanning-tree [detail] [active blockedports] [instance <i>instance-id</i>]	Displays detailed spanning tree information on active or blocked ports.
show spanning-tree mst-configuration	Displays spanning tree MST configuration identifier.

The following is an example of the CLI commands:

```
console(config)# spanning-tree
console(config)# spanning-tree mode rstp
console(config)# spanning-tree priority 12288
console(config)# spanning-tree hello-time 5
console(config)# spanning-tree max-age 12
console(config)# spanning-tree forward-time 25
console(config)# exit
console# show spanning-tree
Spanning tree enabled mode MSTP
Default port cost method: short

Gathering information .....
##### MST 0 Vlans Mapped: 16-4094
CST Root ID Priority 20480
    Address          00:30:ab:00:00:08
    Path Cost        4
    Root Port        ch2
    This switch is the IST master
    Hello Time 2 sec Max Age 20 sec Forward Delay 15 sec

Bridge ID Priority          32768
    Address          00:00:00:16:00:64
    Max hops         20
```

```

Name   State   Prio.Nbr  Cost   Sts   Role   PortFast   Type
-----
1/e2   enabled  128.2     100    DSBL  Dsbl   No         P2p Intr
1/e3   enabled  128.3     100    DSBL  Dsbl   No         P2p Intr
1/e4   enabled  128.4     100    DSBL  Dsbl   No         P2p Intr
1/e5   enabled  128.5     19     FRW   Desg   Yes        P2p Intr
1/e6   enabled  128.6     100    DSBL  Dsbl   No         P2p Intr
1/e7   enabled  128.7     100    DSBL  Dsbl   No         P2p Intr
1/e8   enabled  128.8     100    DSBL  Dsbl   No         P2p Intr
1/e9   enabled  128.9     100    DSBL  Dsbl   No         P2p Intr
1/e10  enabled  128.10    100    DSBL  Dsbl   No         P2p Intr
1/e11  enabled  128.11    19     DSBL  Desg   Yes        P2p Intr

console# show spanning-tree active
Spanning tree enabled mode MSTP
Default port cost method: short
Gathering information .....
##### MST 0 Vlans Mapped: 16-4094
CST Root ID Priority 20480
    Address          00:30:ab:00:00:08
    Path Cost        4
    Root Port        ch2
    This switch is the IST master
    Hello Time 2 sec Max Age 20 sec Forward Delay 15 sec

Bridge ID Priority          32768
    Address          00:00:00:16:00:64
    Max hops         20

```

Name	State	Prio.Nbr	Cost	Sts	Role	PortFast	Type
1/e5	enabled	128.2	19	FRW	Desg	Yes	P2p Intr
1/e7	enabled	128.7	19	DSCR	Altn	No	P2p Bound (STP)
1/e11	enabled	128.11	19	FRW	Desg	Yes	P2p Intr
1/e15	enabled	128.15	19	FRW	Desg	No	P2p Intr
1/e22	enabled	128.22	19	FRW	Desg	Yes	P2p Intr

Defining STP Port Settings

Use the STP Port Settings page to assign STP properties to individual ports.

To open the STP Port Settings page, click **Switch** → **Spanning Tree** → **Port Settings** in the tree view.

Figure 7-36. STP Port Settings

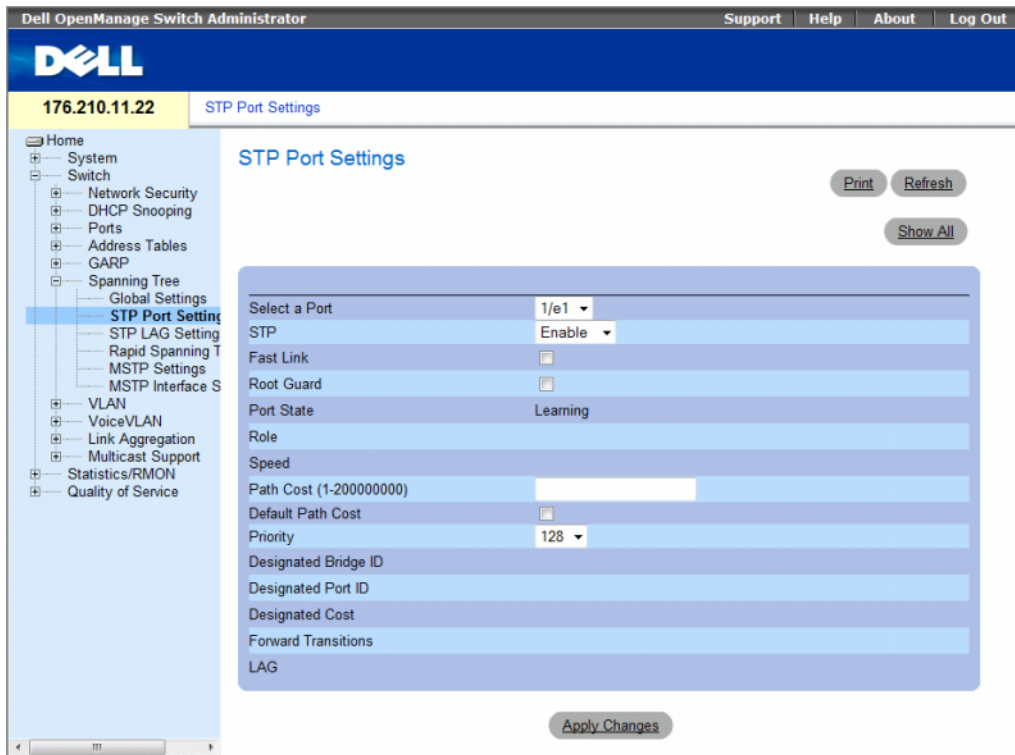

The **STP Port Settings** page contains the following fields:

- **Select a Port** — Specifies the port number on which STP settings are to be modified.
- **STP** — Enables or disables STP on the port. The possible field values are:
 - **Enable** — Indicates that STP is enabled on the port.
 - **Disable** — Indicates that STP is disabled on the port.
- **Fast Link** — Enables Fast Link mode for the port. If Fast Link mode is enabled for a port, the **Port State** is automatically placed in the **Forwarding** state when the port link is up. Fast Link mode optimizes the time it takes for the STP protocol to converge. STP convergence can take 30-60 seconds in large networks. The possible values are:
 - **Checked** — Fast Link is enabled.
 - **Unchecked** — Fast Link is disabled.
- **Root Guard** — Prevents devices outside the network core from being assigned the spanning tree root.
 - **Checked** — Root guard is enabled on the port.
 - **Unchecked** — Root guard is disabled on the port.
- **Port State** — Indicates the current STP state of a port. If enabled, the port state determines what forwarding action is taken on traffic. Possible port states are:
 - **Disabled** — STP is currently disabled on the port. The port forwards traffic while learning MAC addresses.
 - **Blocking** — The port is currently blocked and cannot be used to forward traffic or learn MAC addresses. Blocking is displayed when Classic STP is enabled.
 - **Listening** — The port is currently in the listening mode. The port cannot forward traffic nor can it learn MAC addresses.
 - **Learning** — The port is currently in the learning mode. The port cannot forward traffic however it can learn new MAC addresses.
 - **Forwarding** — The port is currently in the forwarding mode. The port can forward traffic and learn new MAC addresses.
- **Role** — Indicates the port role assigned by the STP algorithm that provides STP paths. The possible field values are:
 - **Root** — Provides the lowest cost path to forward packets to root switch.
 - **Designated** — Indicates that the port via which the designated switch is attached to the LAN.
 - **Alternate** — Provides an alternate path to the root switch from the root interface.
 - **Backup** — Provides a backup path to the designated port path toward the Spanning Tree leaves. Backup ports occur only when two ports are connected in a loop by a point-to-point link. Backup ports also occur when a LAN has two or more connections connected to a shared segment.
 - **Disabled** — Indicates the port is not participating in the Spanning Tree.
- **Speed** — Speed at which the port is operating.

- **Path Cost (1-200000000)** — The port contribution to the root path cost. The path cost is adjusted to a higher or lower value, and is used to forward traffic when a path being rerouted.
- **Default Path Cost** — Indicates if the device uses the default path cost. The possible field values are:
 - **Checked** — Device uses the default path cost.
 - **Unchecked** — Device uses path cost defined in the Path Cost field above.
- **Priority** — Priority value of the port. The priority value influences the port choice when a bridge has two ports connected in a loop. The priority value is between 0 -240. The priority value is provided in increments of 16.
- **Designated Bridge ID** — The bridge priority and the MAC Address of the designated bridge.
- **Designated Port ID** — The designated port's priority and interface.
- **Designated Cost** — Cost of the port participating in the STP topology. Ports with a lower cost are less likely to be blocked if STP detects loops.
- **Forward Transitions** — Number of times the port has changed from the **Forwarding** state to **Blocking**.
- **LAG** — The LAG to which the port is attached.

Enabling STP on a Port

- 1 Open the Spanning Tree **Port Settings** page.
- 2 Select the port.
- 3 Select **Enabled** in the **STP** field.
- 4 Define the **Fast Link**, **Root Guard**, **Path Cost**, **Default Path Cost**, and the **Priority** fields.
- 5 Click **Apply Changes**.
STP is enabled on the port.

Modifying STP Port Properties

- 1 Open the Spanning Tree **Port Settings** page.
- 2 Select the port.
- 3 Modify the relevant fields.
- 4 Click **Apply Changes**.
The STP port parameters are modified, and the device is updated.

Displaying the STP Port Table

- 1 Open the Spanning Tree Port Settings page.
- 2 Click Show All.

The STP Port Table opens.

Figure 7-37. STP Port Table

STP Port Table Refresh

Unit No. 1 ▾

Port	STP	Fast Link	Root Guard	Port State	Role	Speed	Path Cost	Default Path Cost	Priority	Designated Bridge ID	Designated Port ID	Design Cost
1/e1	Enable ▾	<input type="checkbox"/>	<input type="checkbox"/>	Disabled		1000M	19	<input type="checkbox"/>	128 ▾			

Apply Changes

Defining STP Port Settings Using CLI Commands

The following table summarizes the equivalent CLI commands for defining STP port parameters as displayed in the STP Port Settings page.

Table 7-20. STP Port Settings CLI Commands

CLI Command	Description
<code>spanning-tree disable</code>	Disables spanning tree on a specific port.
<code>spanning-tree cost cost</code>	Configures the spanning tree cost contribution of a port.
<code>spanning-tree port-priority priority</code>	Configures port priority.
<code>show spanning-tree [ethernet interface port-channel port-channel-number] [instance instance-id]</code>	Displays spanning tree configuration.
<code>spanning-tree portfast</code>	Enables Fast Link mode.
<code>spanning-tree guard root</code>	Enables root guard on all spanning tree instances on the interface.
<code>show spanning-tree [detail] [active blockedports] [instance instance-id]</code>	Displays detailed spanning tree information on active or blocked ports.
<code>show spanning-tree mst-configuration</code>	Displays spanning tree MST configuration identifier.

The following is an example of the CLI commands:

```
console> enable
console# configure
Console(config)# interface ethernet 1/e1
Console(config-if)# spanning-tree disable
Console(config-if)# spanning-tree cost 35000
Console(config-if)# spanning-tree port-priority 96
Console(config-if)# spanning-tree portfast
Console(config-if)# exit
Console(config)# exit
Console# show spanning-tree ethernet 1/e15
Port 1/e15 enabled
State: forwarding                Role: designated
Port id: 128.15                  Port cost: 19
Type: P2p (configured: Auto) Internal Port Fast: No (configured: No)
Designated bridge Priority : 32768 Address: 00:00:00:16:00:64
Designated port id: 128.15      Designated path cost: 4
Guard root: Disabled
Number of transitions to forwarding state: 2
BPDU: sent 483, received 1037

console# show spanning-tree ethernet 1/e15 instance 12
Port 1/e15 enabled
State: discarding                Role: alternate
Port id: 128.15                  Port cost: 19
Type: P2p (configured: Auto) Internal Port Fast: No (configured: No)
Designated bridge Priority : 32768 Address: 00:00:b0:07:07:49
Designated port id: 128.11      Designated path cost: 0
Guard root: Disabled
Number of transitions to forwarding state: 3
BPDU: sent 482, received 1035
```

Defining STP LAG Settings

Use the STP LAG Settings page to assign STP aggregating ports parameters.

To open the STP LAG Settings page, click **Switch** → **Spanning Tree** → **LAG Settings** in the tree view.

Figure 7-38. STP LAG Settings

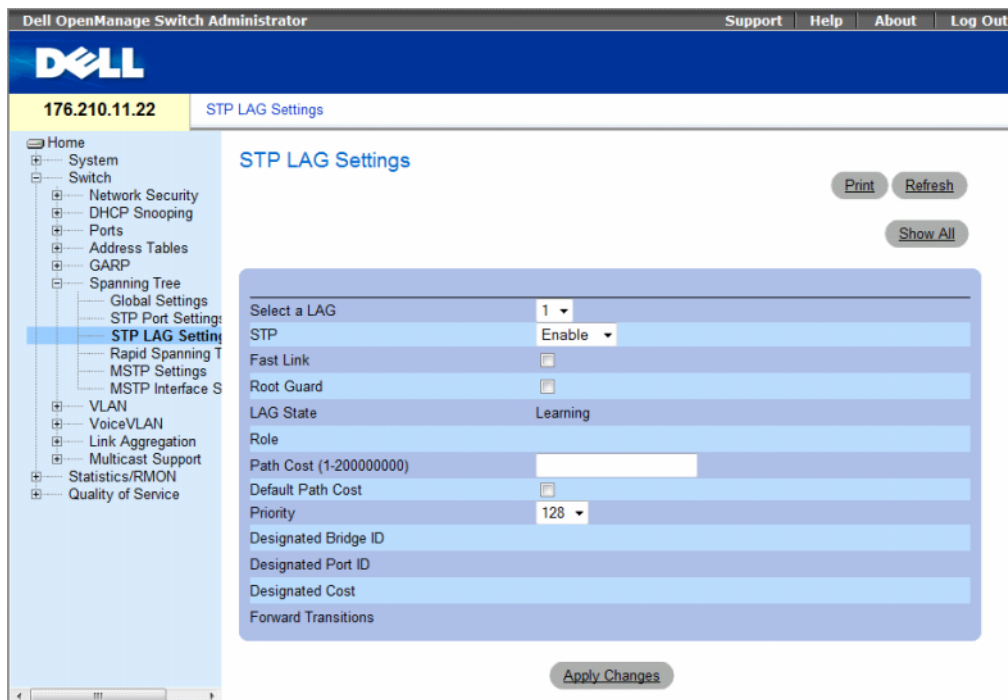

The Spanning Tree LAG Settings page contains the following fields:

- **Select a LAG** — The LAG number for which you want to modify STP settings.
- **STP** — Enables or disables STP on the LAG. The possible field values are:
 - **Enable** — Indicates that STP is enabled on the LAG.
 - **Disable** — Indicates that STP is disabled on the LAG.
- **Fast Link** — Enables Fast Link mode for the LAG. If Fast Link mode is enabled for a LAG, the **LAG State** is automatically placed in the **Forwarding** state when the LAG is up. Fast Link mode optimizes the time it takes for the STP protocol to converge. STP convergence can take 30-60 seconds in large networks. The possible values are:
 - **Checked** — Fast Link is enabled.
 - **Unchecked** — Fast Link is disabled.

- **Root Guard** — Prevents devices outside the network core from being assigned the spanning tree root.
 - **Checked** — Root guard is enabled on the port.
 - **Unchecked** — Root guard is disabled on the port.
- **LAG State** — Current STP state of a LAG. If enabled, the LAG state determines what forwarding action is taken on traffic. If the bridge discovers a malfunctioning LAG, the LAG is placed in the **Broken** state. Possible LAG states are:
 - **Disabled** — STP is currently disabled on the LAG. The LAG forwards traffic while learning MAC addresses.
 - **Blocking** — The LAG is blocked and cannot be used to forward traffic or learn MAC addresses.
 - **RSTP Discarding State** — In this state the port does not learn MAC addresses and do not forward frames.
 - This state is union of Blocking, and Listening state introduced in STP (802.1.D).
 - **Listening** — The LAG is in the listening mode and cannot forward traffic or learn MAC addresses.
 - **Learning** — The LAG is in the learning mode and cannot forward traffic, but it can learn new MAC addresses.
 - **Forwarding** — The LAG is currently in the forwarding mode, and it can forward traffic and learn new MAC addresses.
 - **Broken** — The LAG is currently malfunctioning and cannot be used for forwarding traffic.
- **Role** — Indicates the LAG role assigned by the STP algorithm that provides STP paths. The possible field values are:
 - **Root** — Provides the lowest cost path to forward packets to root switch.
 - **Designated** — Indicates that the via which the designated switch is attached to the LAN.
 - **Alternate** — Provides an alternate LAG to the root switch from the root interface.
 - **Backup** — Provides a backup path to the designated port path toward the Spanning Tree leaves. Backup ports occur only when two ports are connected in a loop by a point-to-point link. Backup ports also occur when a LAN has two or more connections connected to a shared segment.
 - **Disabled** — Indicates the LAG is not participating in the Spanning Tree.
- **Path Cost (1-200000000)** — Amount the LAG contributes to the root path cost. The path cost is adjusted to a higher or lower value, and is used to forward traffic when a path is being rerouted. The path cost has a value of 1 to 200000000.
- **Default Path Cost** — Indicates if the device uses the default path cost. The possible field values are:
 - **Checked** — Device uses the default path cost.
 - **Unchecked** — Device uses path cost defined in the Path Cost field above.
- **Priority** — Priority value of the LAG. The priority value influences the LAG choice when a bridge has looped ports. The priority value is between 0-240, in steps of 16.
- **Designated Bridge ID** — The priority and the MAC Address of the designated bridge.

- **Designated Port ID** — The ID of the selected interface.
- **Designated Cost** — Cost of the port participating in the STP topology. Ports with a lower cost are less likely to be blocked if STP detects loops.
- **Forward Transitions** — Number of times the **LAG State** has changed from the **Forwarding** state to a **Blocking** state.

Modifying the LAG STP Parameters

- 1 Open the **Spanning Tree LAG Settings** page.
- 2 Select a LAG from the **Select a LAG** drop-down menu.
- 3 Modify the fields as desired.
- 4 Click **Apply Changes**.

The STP LAG parameters are modified, and the device is updated.

Displaying the STP LAG Table

- 1 Open the **STP LAG Settings** page.
- 2 Click **Show All**.

The **STP LAG Table** opens.

Figure 7-39. STP LAG Table

STP LAG Table Refresh

LAG	Priority	Fast Link Guard	Root Guard STP	State	Role	Path Cost	Default Path Cost	Designated Bridge ID	Designated Port ID	Designated Cost	Forward Transitions
1	128	<input type="checkbox"/>	<input type="checkbox"/>	Enable	Disabled	4	<input type="checkbox"/>				

Apply Changes

Defining STP LAG Settings Using CLI Commands

The following table contains the CLI commands for defining STP LAG settings.

Table 7-21. STP LAG Settings CLI Commands

CLI Command	Description
<code>spanning-tree</code>	Enables spanning tree.
<code>spanning-tree disable</code>	Disables spanning tree on a specific LAG.
<code>spanning-tree cost <i>cost</i></code>	Configures the spanning tree cost contribution of a LAG.
<code>spanning-tree guard root</code>	Enables root guard on all spanning tree instances on the interface.
<code>spanning-tree port-priority <i>priority</i></code>	Configures port priority.
<code>show spanning-tree [ethernet interface port-channel <i>port-channel-number</i>] [instance <i>instance-id</i>]</code>	Displays spanning tree configuration.
<code>show spanning-tree [detail] [active blockedports] [instance <i>instance-id</i>]</code>	Displays detailed spanning tree information on active or blocked ports.

The following is an example of the CLI commands:

```
console(config)# interface port-channel 1
console(config-if)# spanning-tree disable
console(config-if)# spanning-tree cost 35000
console(config-if)# spanning-tree port-priority 96
console(config-if)# spanning-tree portfast
```

Defining Rapid Spanning Tree

While the classic spanning tree prevents Layer 2 forwarding loops on a general network topology, convergence can take 30-60 seconds. The delay allows time to detect possible loops, and propagate status changes.

Rapid Spanning Tree Protocol (RSTP) detects and uses network topologies that allow a faster convergence of the spanning tree, without creating forwarding loops.

To open the **Rapid Spanning Tree (RSTP)** settings page, click **Switch** → **Spanning Tree** → **Rapid Spanning Tree** in the tree view.

Figure 7-40. Rapid Spanning Tree (RSTP)



The Spanning Tree RSTP page contains the following fields:

- **Interface** — Port or LAG for which you can view and edit RSTP settings.
- **State** — Disables RSTP state of the selected interface.
- **Role**—Indicates the port role assigned by the STP algorithm in order to provide STP paths. The possible field values are:
 - **Root**—Provides the lowest cost path to forward packets to root switch.
 - **Designated**—Indicates that the port or LAG via which the designated switch is attached to the LAN.
 - **Alternate**—Provides an alternate path to the root switch from the root interface.
 - **Backup**—Provides a backup path to the designated port path toward the Spanning Tree leaves. Backup ports occur only when two ports are connected in a loop by a point-to-point link. Backup ports also occur when a LAN has two or more connections connected to a shared segment.
 - **Disabled**—Indicates the port is not participating in the Spanning Tree.
- **Mode**—Indicates the current Spanning Tree mode. The Spanning Tree mode is selected in the **Spanning Tree Global Settings** page. The possible field values are:
 - **Classic STP**—Indicates that Classic STP is enabled on the device.
 - **Rapid STP**—Indicates that Rapid STP is enabled on the device.
 - **Multiple STP**—Indicates that Multiple STP is enabled on the device.

- **Fast Link Operational Status** — Indicates if Fast Link is enabled or disabled for the port or LAG. If Fast Link is enabled for an interface, the interface is automatically placed in the forwarding state. The possible field values are:
 - **Enable** — Fast Link is enabled.
 - **Disable** — Fast Link is disabled.
 - **Auto** — Fast Link mode is enabled a few seconds after the interface becomes active.
- **Point-to-Point Admin Status** — Indicates if a point-to-point links is established, or permits the device to establish a point-to-point link. The possible field values are:
 - **Enable** — Enables the device to establish a point-to-point link, or specifies for the device to automatically establish a point-to-point link. To establish communications over a point-to-point link, the originating PPP first sends Link Control Protocol (LCP) packets to configure and test the data link. After a link is established and optional facilities are negotiated as needed by the LCP, the originating PPP sends Network Control Protocols (NCP) packets to select and configure one or more network layer protocols. When each of the chosen network layer protocols has been configured, packets from each network layer protocol can be sent over the link. The link remains configured for communications until explicit LCP or NCP packets close the link, or until some external event occurs. This is the actual switch port link type. It may differ from the administrative state.
 - **Disable** — Disables point-to-point link.
 - **Auto** — The device automatically establishes a point-to-point link.
- **Point-to-Point Operational Status** — The Point-to-Point operating state.
- **Activate Protocol Migrational** — Enables PPP sending Link Control Protocol (LCP) packets to configure and test the data link. The possible field values are:
 - **Checked** — Protocol Migration is enabled.
 - **Unchecked** — Protocol Migration is disabled.

Defining RSTP parameters

- 1 Open the Spanning Tree RSTP Settings page.
 - 2 Select an interface.
 - 3 Define the fields.
 - 4 Click **Apply Changes**.
- RSTP parameters are defined, and the device is updated.

Displaying the Rapid Spanning Tree (RSTP) Table

- 1 Open the Rapid Spanning Tree (RSTP) page.
- 2 Click Show All.

The Rapid Spanning Tree (RSTP) Table opens.

Figure 7-41. Rapid Spanning Tree (RSTP) Table

Interface	State	Role	Mode	Fast Link Operational Status	Point-to-Point Admin Status	Point-to-Point Operational Status	Activate Protocol Migration
1	STP	Enable	STP	Enable	Auto	Enable	Activate

Global System LAGs							
Interface	State	Role	Mode	Fast Link Operational Status	Point-to-Point Admin Status	Point-to-Point Operational Status	Activate Protocol Migration
1	STP	Enable	STP	Enable	Auto	Enable	Activate

Defining Rapid STP Parameters Using CLI Commands

The following table summarizes the equivalent CLI commands for defining Rapid STP parameters as displayed in the Rapid Spanning Tree (RSTP).

Table 7-22. RSTP Settings CLI Command

CLI Command	Description
<code>spanning-tree link-type {point-to-point shared}</code>	Overrides the default link-type setting.
<code>spanning tree mode {stp rstp mstp}</code>	Configure the spanning tree protocol currently running.
<code>clear spanning-tree detected-protocols [ethernet interface port-channel port-channel-number]</code>	Restarts the protocol migration process.
<code>show spanning-tree [ethernet interface port-channel port-channel-number]</code>	Displays spanning tree configuration.

The following is an example of the CLI commands:

```
console(config)# interface ethernet 1/e5
console(config-if)# spanning-tree link-type shared
console(config-if)# spanning tree mode rstp
```

Configuring Multiple Spanning Tree

MSTP operation maps VLANs into STP instances. Multiple Spanning Tree provides differing load balancing scenario. For example, while port A is blocked in one STP instance, the same port is placed in the *Forwarding State* in another STP instance.

In addition, packets assigned to various VLANs are transmitted along different paths within Multiple Spanning Trees Regions (MST Regions). Regions are one or more Multiple Spanning Tree bridges by which frames can be transmitted.

To open the MSTP Settings page, click **Switch** → **Spanning Tree** → **MSTP Settings** in the tree view.

Figure 7-42. MSTP Settings

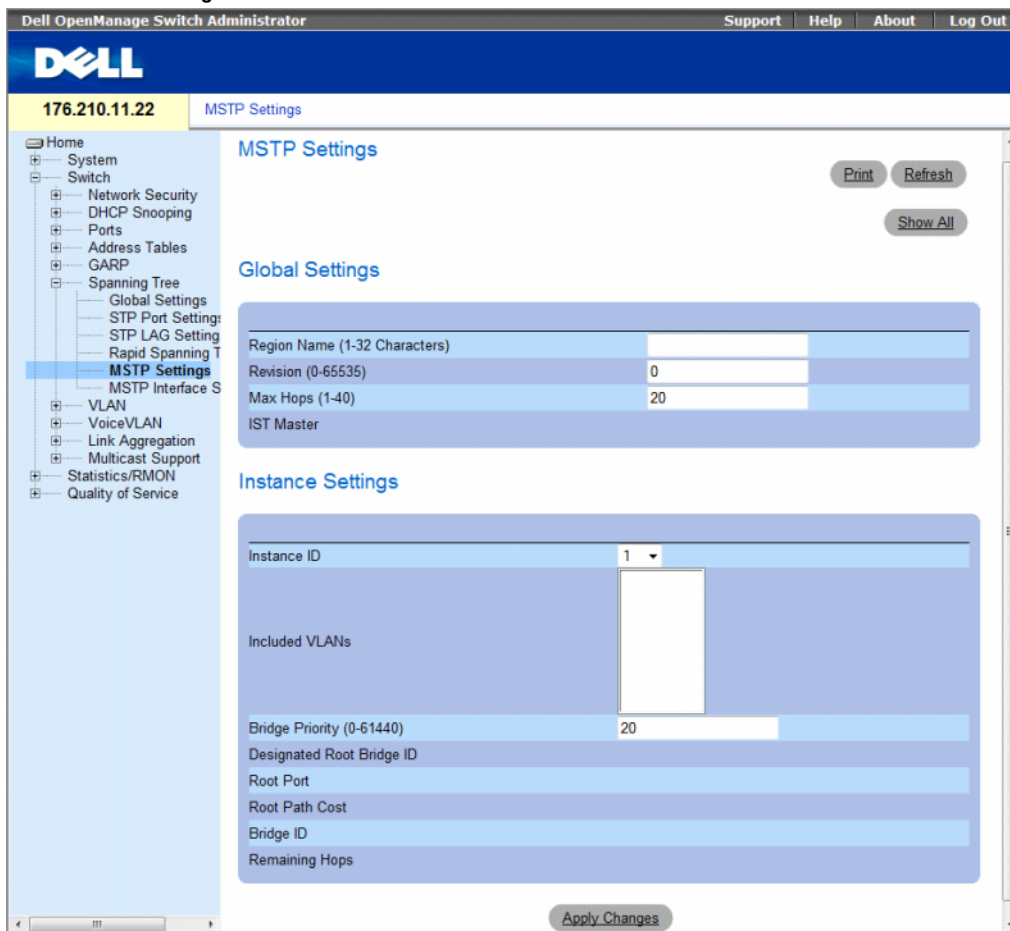

The **MSTP Settings** page contains the following fields:

- **Region Name (1-32 Characters)** — Indicates user-defined MSTP region name.
- **Revision (0-65535)** — Defines unsigned 16-bit number that identifies the current MST configuration revision. The revision number is required as part of the MST configuration. The possible field range is 0-65535.
- **Max Hops (1-40)** — Defines the total number of hops that occur in a specific region before the BPDU is discarded. Once the BPDU is discarded, the port information is aged out. The possible field range is 1-40. The field default is 20 hops.
- **IST Master** — Indicates the Internal Spanning Tree Master ID. The IST Master is the instance 0 root.
- **Instance ID** — Defines the MSTP instance. the field range is 1-15.
- **Included VLANs** — Displays VLANs mapped to the selected instance. Each VLAN belongs to one instance.
- **Bridge Priority (0-61440)** — Specifies the selected spanning tree instance device priority. The field range is 0-61440 in steps of 4096.
- **Designated Root Bridge ID** — Indicates the ID of the bridge which is the root of the selected instance.
- **Root Port** — Indicates the selected instance's root port.
- **Root Path Cost** — Indicates the selected instance's path cost.
- **Bridge ID** — Indicates the bridge ID of the selected instance.
- **Remaining Hops** — Indicates the number of hops remaining to the next destination.

Displaying the MSTP VLAN to Instance Mapping Table

- 1 Open the Spanning Tree MSTP Settings page.
- 2 Click Show All to open the MSTP VLAN to Instance Mapping Table.

Figure 7-43. MSTP VLAN to Instance Mapping Table

[Refresh](#)

MSTP VLAN to Instance Mapping Table

	VLAN	Instance ID (0-15)
1	VLAN 1	0
2	VLAN 2	0
3	VLAN 3	0
4	VLAN 4	0
5	VLAN 5	0
6	VLAN 6	0
7	VLAN 7	0
8	VLAN 8	0
9	VLAN 9	0
10	VLAN 10	0
11	VLAN 11	0
12	VLAN 12	0
13	VLAN 13	0
14	VLAN 14	0

Defining MST Instances Using CLI Commands

The following table summarizes the equivalent CLI commands for defining MST instance groups as displayed in the Spanning Tree MSTP Settings page.

Table 7-23. MSTP Instances CLI Commands

CLI Command	Description
<code>spanning-tree mst configuration</code>	Enters MST Configuration mode.
<code>instance <i>instance-id</i> {add remove} vlan <i>vlan-range</i></code>	Maps VLANs to the MST instance.
<code>name <i>string</i></code>	Sets the configuration name.
<code>revision <i>value</i></code>	Sets the configuration revision number
<code>spanning-tree mst <i>instance-id</i> port-priority <i>priority</i></code>	Sets the priority of a port.
<code>spanning-tree mst <i>instance-id</i> priority <i>priority</i></code>	Sets the device priority for the specified spanning tree instance.
<code>spanning-tree mst max-hops <i>hop-count</i></code>	Sets the number of hops in an MST region before the BPDU is discarded and the information held for a port is aged.

Table 7-23. MSTP Instances CLI Commands (continued)

CLI Command	Description
<code>spanning-tree mst instance-id cost cost</code>	Sets the path cost of the port for MST calculations
<code>exit</code>	Exits the MST region configuration mode and applies configuration changes.
<code>abort</code>	Exits the MST region configuration mode without applying configuration changes.
<code>show {current pending}</code>	Displays the current or pending MST region configuration.

The following is an example of the CLI commands:

```
console(config)# spanning-tree mst configuration
console(config-mst)# instance 1 add vlan 10-20
console(config-mst)# name region1
console(config-mst)# revision 1
console(config)# spanning-tree mst configuration
console(config-mst)# instance 2 add vlan 21-30
console(config-mst)# name region1
console(config-mst)# revision 1
console(config-mst)# show pending
Pending MST configuration
Name: Region1
Revision: 1
Instance    Vlans Mapped
-----
0           1-9,31-4094
1           10-20
2           21-30
```

Defining MSTP Interface Settings

The MSTP Interface Settings page contains parameters assigning MSTP settings to specific interfaces. To open the MSTP Interface Settings page, click **Switch** → **Spanning Tree** → **MSTP Interface Settings** in the tree view.

Figure 7-44. MSTP Interface Settings

The screenshot shows the Dell OpenManage Switch Administrator interface. The top navigation bar includes 'Support', 'Help', 'About', and 'Log Out'. The main header displays the Dell logo and the IP address '176.210.11.22'. The left sidebar shows a tree view with 'MSTP Interface' selected. The main content area is titled 'MSTP Interface Setting' and contains the following configuration fields:

Instance ID	0
Interface	<input type="radio"/> Port <input type="radio"/> LAG
Port State	
Type	Boundary
Role	Designated port
Interface Priority	128
Path Cost (1-200,000,000)	4
Default Path Cost	<input type="checkbox"/>
Designated Bridge ID	
Designated Port ID	
Designated Cost	
Forward Transitions	
Remain Hops	

Buttons for 'Print', 'Refresh', 'Show All', and 'Apply Changes' are also visible.

The MSTP Interface Settings page contains the following fields:

- **Instance ID** — Lists the MSTP instances configured on the device. Possible field range is 0-15.
- **Interface** — Assigns either ports or LAGs to the selected MSTP instance.
- **Port State** — Indicates whether the port is enabled or disabled in the specific instance.
- **Type** — Indicates whether MSTP treats the port as a point-to-point port, or a port connected to a hub, and whether the port is internal to the MST region or a boundary port. A Master port provides connectivity from a MSTP region to the outlying CIST root. A Boundary port attaches MST bridges to LAN in an outlying region. If the port is a boundary port, it also indicates whether the device on the other side of the link is working in RSTP or STP mode.

- **Role** — Indicates the port role assigned by the STP algorithm in order to provide to STP paths. The possible field values are:
 - **Root** — Provides the lowest cost path to forward packets to root device.
 - **Designated** — Indicates the port or LAG via which the designated device is attached to the LAN.
 - **Alternate** — Provides an alternate path to the root device from the root interface.
 - **Backup** — Provides a backup path to the designated port path toward the Spanning Tree leaves. Backup ports occur only when two ports are connected in a loop by a point-to-point link. Backup ports also occur when a LAN has two or more connections connected to a shared segment.
 - **Disabled** — Indicates the port is not participating in the Spanning Tree.
- **Interface Priority** — Defines the interface priority for specified instance. The default value is 128.
- **Path Cost** — Indicates the port contribution to the Spanning Tree instance. The possible range is 1-200,000,000.
- **Default Path Cost** — Indicates if the default path cost is used. The possible values are:
 - **Checked** — Default path cost is used.
 - **Unchecked** — Path cost is user-defined.
- **Designated Bridge ID** — The bridge ID number that connects the link or shared LAN to the root.
- **Designated Port ID** — The Port ID number on the designated bridge that connects the link or the shared LAN to the root.
- **Designated Cost** — Cost of the path from the link or the shared LAN to the root.
- **Forward Transitions** — Number of times the port changed to the forwarding state.
- **Remain Hops** — Indicates the number of hops remaining to the next destination.

Defining MSTP Interface Settings

- 1 Open the **MSTP Interface Settings** page.
 - 2 Select an interface.
 - 3 Define the fields.
 - 4 Click **Apply Changes**.
- MSTP parameters are defined, and the device is updated.

Viewing the MSTP Interface Table

- 1 Open the MSTP Interface Settings page.
- 2 Click Show All.

The MSTP Interface Table page opens.

Figure 7-45. MSTP Interface Table

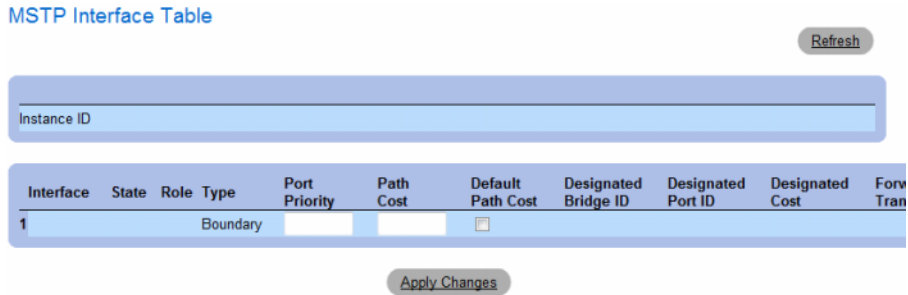

Defining MSTP Interfaces Using CLI Commands

The following table summarizes the equivalent CLI commands for defining MSTP interfaces as displayed in the Spanning Tree MSTP Interface Settings page.

Table 7-24. MSTP Interface CLI Commands

CLI Command	Description
<code>spanning-tree mst <i>instance-id</i> cost <i>cost</i></code>	Sets the path cost of the port for MST calculations
<code>spanning-tree mst <i>instance-id</i> priority <i>priority</i></code>	Sets the device priority for the specified ST instance.
<code>show spanning-tree mst-configuration</code>	Displays the MST configuration.

The following is an example of the CLI commands:

```
console# show spanning-tree mst-configuration
Gathering information .....
Current MST configuration
Name: Gili
Revision: 65000
Instance          Vlans Mapped          State
-----          -
0                 16-4094               enabled
1                 1                     enabled
2                 2                     enabled
3                 3                     enabled
4                 4                     enabled
5                 5                     enabled
6                 6                     enabled
7                 7                     enabled
8                 8                     enabled
9                 9                     enabled
10                10                    enabled
11                11                    enabled
12                12                    enabled
13                13                    enabled
14                14                    enabled
15                15                    enabled
```

Configuring VLANs

VLANs are logical subgroups with a LAN created via software, rather than defining a hardware solution. VLANs combine user stations and network devices into a single unit, regardless of the physical LAN segment to which they are attached. VLANs allow network traffic to flow more efficiently within subgroups. VLANs managed through software reduce the amount of time network changes, additions, and moves are implemented.

Click a link below to access on-line help for the indicated screen.

VLANs have no minimum number of ports, and can be created per unit, per device, per stack, or any other logical connection combination, as VLANs are software-based and not defined by physical attributes.

VLANs function at Layer 2 level. Since VLANs isolate traffic within the VLAN, a router working at the Layer 3 protocol level is needed to allow traffic flow between VLANs. Layer 3 routers identify segments and coordinate with VLANs. VLANs are Broadcast and Multicast domain. Broadcast and Multicast traffic is transmitted only in the VLAN in which the traffic is generated.

VLAN tagging provides a method of transferring VLAN information between VLAN groups. VLAN tagging attaches a 4-byte tag to packet headers. The VLAN tag indicates to which VLAN the packet belongs. VLAN tags are attached to the VLAN by either the end station or by the network device. VLAN tags also contains VLAN network priority information.

QinQ tagging allows network managers to add an additional tag to previously tagged packets. Customer VLANs are configured using QinQ. Adding additional tags to the packets helps create more VLAN space. The added tag provides VLAN ID to each customer, this ensures private and segregated network traffic. The VLAN ID tag is assigned to a customer port in the service providers network. The designated port then provides additional services to the packets with the double-tags. This allows administrators to expand service to VLAN users.

Combining VLANs and GVRP allows network managers to define network nodes into Broadcast domains. Broadcast and Multicast traffic is confined to the originating group.

To open the VLAN page, click **Switch** → **VLAN** in the tree view.

This section contains the following topics:

- "Defining VLAN Membership" on page 352
- "Defining VLAN Ports Settings" on page 357
- "Defining VLAN LAGs Settings" on page 359
- "Binding MAC Address to VLANs" on page 362
- "Defining VLAN Protocol Groups" on page 364
- "Adding Interfaces to Protocol Groups" on page 367
- "Configuring GVRP Parameters" on page 369

Defining VLAN Membership

The **VLAN Membership** page contains fields for defining VLAN groups. The device supports the mapping of 4094 VLAN IDs to 256 VLANs. All ports must have a defined PVID. If no other value is configured the default VLAN PVID is used. VLAN ID #1 is the default VLAN, and cannot be deleted from the system.

To open the **VLAN Membership** page, click **Switch**→**VLAN**→**VLAN Membership** in the tree view.

Figure 7-46. VLAN Membership

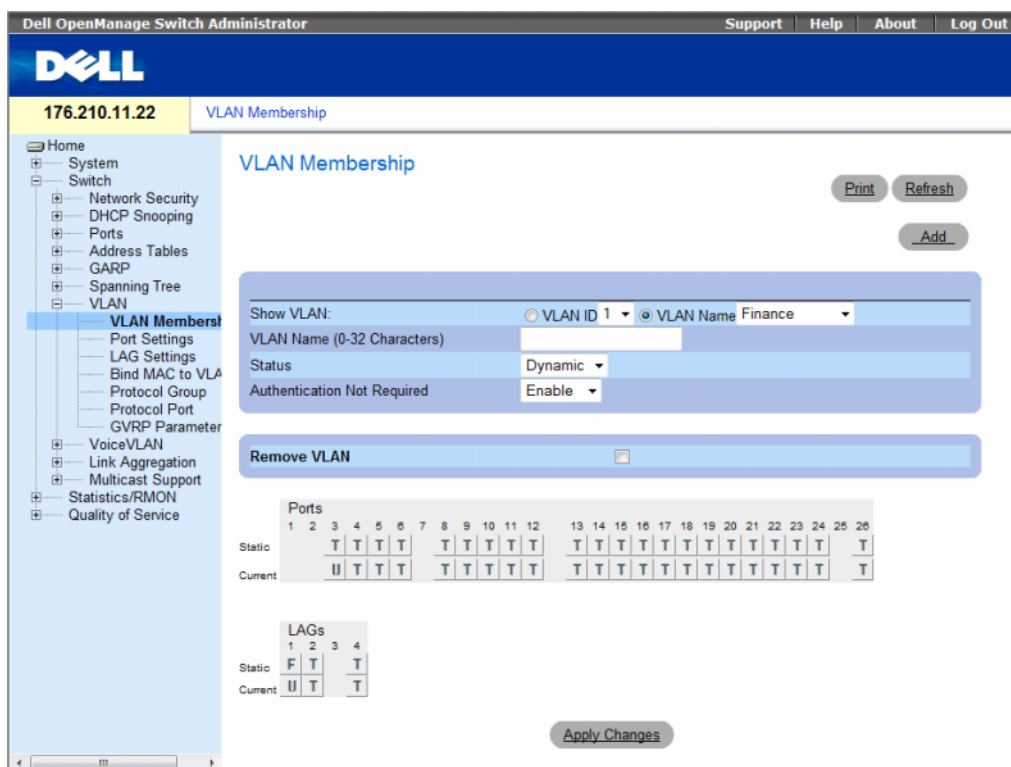

The **VLAN Membership** page contains the following fields:

- **Show VLAN** — Lists and displays specific VLAN information according to VLAN ID or VLAN name.
- **VLAN Name (0-32 Characters)** — The user-defined VLAN name.
- **Status** — The VLAN type. Possible values are:
 - **Dynamic** — The VLAN was dynamically created through GVRP.
 - **Static** — The VLAN is user-defined.

- **Authentication Not Required** — Indicates whether unauthorized users can access a VLAN. The possible field values are:
 - **Enable** — Enables unauthorized users to use a VLAN.
 - **Disable** — Prevents unauthorized users from using a VLAN.
- **Remove VLAN** — Indicates whether to removes the VLAN from the VLAN Membership Table.
 - **Checked** — Removes the VLAN.
 - **Unchecked** — Maintains the VLAN in the VLAN Membership Table.

Adding New VLANs

1 Open the **VLAN Membership** page.

2 Click **Add**.

The **Create New VLAN** page opens.

Figure 7-47. Create New VLAN

The screenshot shows a web interface for creating a new VLAN. At the top right is a 'Refresh' button. The main form area is titled 'Create New VLAN' and contains three input fields: 'VLAN ID (2-4094)', 'VLAN Name (0-32 Characters)', and 'Authentication Not Required'. The 'Authentication Not Required' field is a dropdown menu currently set to 'Enable'. Below the form is an 'Apply Changes' button.

3 Enter the VLAN ID and name.

4 Click **Apply Changes**.

The new VLAN is added, and the device is updated.

Modifying VLAN Membership Groups

1 Open the **VLAN Membership** page.

2 Select a VLAN from the **Show VLAN** drop-down menu.

3 Modify the fields as desired.

4 Click **Apply Changes**.

The VLAN membership information is modified, and the device is updated.

VLAN Port Membership Table

The **VLAN Port Membership Table** contains a **Port Table** for assigning ports to VLANs. Ports are assigned to a VLAN by toggling through the **Port Control** settings. Ports can have the following values:

Table 7-25. VLAN Port Membership Table

Port Control	Definition
T	The interface is a member of a VLAN. All packets forwarded by the interface are tagged. The packets contain VLAN information.
U	The interface is a VLAN member. Packets forwarded by the interface are untagged.
F	The interface is denied membership to a VLAN.
Blank	The interface is not a VLAN member. Packets associated with the interface are not forwarded.

The **VLAN Port Membership Table** displays the ports and the ports states, as well as LAGs.

Assigning Ports to a VLAN Group

- 1 Open the **VLAN Membership** page.
- 2 Click the **VLAN ID** or **VLAN Name** option button and select a VLAN from the drop-down menu.
- 3 Select a port in the **Port Membership Table**, and assign the port a value.
- 4 Click **Apply Changes**.
The port is assigned to the VLAN group, and the device is updated.

Deleting a VLAN

- 1 Open the **VLAN Membership** page.
- 2 Click the **VLAN ID** or **VLAN Name** option button and select a VLAN from the drop-down menu.
- 3 Select the **Remove VLAN** check box.
- 4 Click **Apply Changes**.
The selected VLAN is deleted, and the device is updated.

Defining VLAN Membership Groups Using CLI Commands

The following table summarizes the equivalent CLI commands for defining VLAN membership groups as displayed in the [VLAN Membership](#) page.

Table 7-26. VLAN Membership Group CLI Commands

CLI Command	Description
vlan database	Enters the VLAN configuration mode.
vlan { <i>vlan-range</i> }	Creates a VLAN.
name <i>string</i>	Adds a name to a VLAN.

The following is an example of the CLI commands:

```
console(config)# vlan database
console(config-vlan)# vlan 1972
console(config-vlan)# end
console(config)# interface vlan 1972
console(config-if)# name Marketing
console(config-if)# end
```

Assigning Ports to VLAN Groups Using CLI Commands

The following table summarizes the equivalent CLI commands for assigning ports to VLAN groups.

Table 7-27. Port-to-VLAN Group Assignments CLI Commands

CLI Command	Description
switchport general acceptable-frame-types tagged-only	Discards untagged frames at ingress.
switchport forbidden vlan {add <i>vlan-list</i> remove <i>vlan-list</i> }	Forbids adding specific VLANs to the port.
switchport mode {access trunk general}	Configures the VLAN membership mode of a port.
switchport access vlan <i>vlan-id</i>	Configures the VLAN ID when the interface is in access mode.
switchport trunk allowed vlan {add <i>vlan-list</i> remove <i>vlan-list</i> }	Adds or removes VLANs from a trunk port.

Table 7-27. Port-to-VLAN Group Assignments CLI Commands (continued)

CLI Command	Description
<code>switchport trunk native vlan <i>vlan-id</i></code>	Defines the port as a member of the specified VLAN, and the VLAN ID as the port default VLAN ID (PVID).
<code>switchport general allowed vlan add <i>vlan-list</i> [tagged untagged]</code>	Adds or removes VLANs for a port in general mode.
<code>switchport general pvid <i>vlan-id</i></code>	Configures the PVID when the interface is in general mode.

The following is an example of the CLI commands:

```
console(config)# vlan database
console(config-vlan)# vlan 23-25
console(config-vlan)# end
console(config)# interface vlan 23
console(config-if)# name Marketing
console(config-if)# end
console(config)# interface ethernet 1/e8
console(config-if)# switchport mode access
console(config-if)# switchport access vlan 23
console(config-if)# end
console(config)# interface ethernet 1/e9
console(config-if)# switchport mode trunk
console(config-if)# switchport mode trunk allowed vlan
add 23-25
console(config-if)# end
console(config)# interface ethernet 1/e11
console(config-if)# switchport mode general
console(config-if)# switchport general allowed vlan add
23,25 tagged
console(config-if)# switchport general pvid 25
```

Defining VLAN Ports Settings

The **VLAN Port Settings** page contains fields for managing ports that are part of a VLAN. The port default VLAN ID (PVID) is configured on the **VLAN Port Settings** page. All untagged packets arriving to the device are tagged by the ports PVID.

To open the **VLAN Port Settings** page, click **Switch** → **VLAN** → **Port Settings** in the tree view.

Figure 7-48. VLAN Port Settings

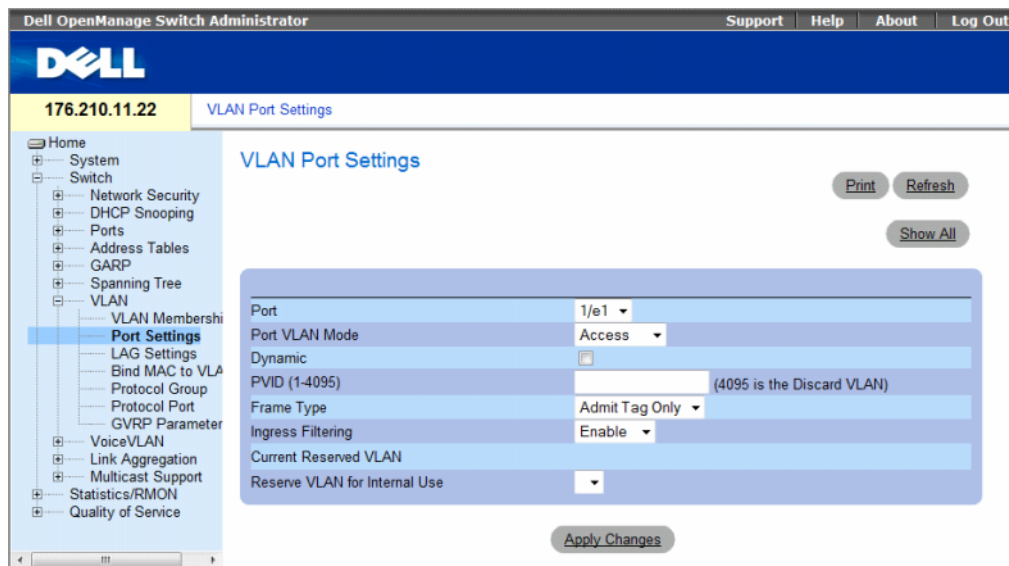

The **VLAN Port Settings** page contains the following fields:

- **Port** — The port number included in the VLAN.
- **Port VLAN Mode** — The port mode. Possible values are:
 - **Customer** — The port belongs to VLANs. When a port is in Customer mode, the added tag provides a VLAN ID to each customer, ensuring private and segregated network traffic.
 - **General** — The port belongs to VLANs, and each VLAN is user-defined as tagged or untagged (full 802.1Q mode).
 - **Access** — The port belongs to a single untagged VLAN. When a port is in Access mode, the packet types which are accepted on the port cannot be designated. Ingress filtering cannot be enabled/disabled on an access port.
 - **Trunk** — The port belongs to VLANs in which all ports are tagged (except for one port that can be untagged).

- **Dynamic** — Assigns a port to a VLAN based on the host source MAC address connected to the port.
 - **Checked** — The port may be registered in a dynamic VLAN.
 - **Unchecked** — The port is not allowed to register in a dynamic VLAN.
- **PVID (1-4095)** — Assigns a VLAN ID to untagged packets. The possible values are 1-4095. VLAN 4095 is defined as per standard and industry practice as the Discard VLAN. Packets classified to the Discard VLAN are dropped.
- **Frame Type** — Packet type accepted on the port. Possible values are:
 - **Admit Tag Only** — Only tagged packets are accepted on the port.
 - **Admit All** — Both tagged and untagged packets are accepted on the port.
- **Ingress Filtering** — Ingress filtering discards packets that are destined to VLANs of which the specific port is not a member.
 - **Enable** — Ingress filtering is activated on the port.
 - **Disable** — Ingress filtering is not activated on the port.
- **Current Reserved VLAN** — The VLAN currently designated by the system as the reserved VLAN.
- **Reserve VLAN for Internal Use** — The VLAN selected by the user to be the reserved VLAN if not in use by the system.

Assigning Port Settings

- 1 Open the **VLAN Port Settings** page.
- 2 Select the port to which settings need to be assigned from the **Port** drop-down menu.
- 3 Complete the remaining fields on the page
- 4 Click **Apply Changes**.

The VLAN port settings are defined, and the device is updated.

Displaying the VLAN Port Table

- 1 Open the VLAN Port Settings page.
- 2 Click Show All.

The VLAN Port Table opens.

Figure 7-49. VLAN Port Table

Port	Port VLAN Mode	Dynamic PVID	Frame Type	Ingress Filtering	Current Reserved VLAN	Reserve VLAN for Internal Use
1	Access	<input type="checkbox"/>	Admit Tag Only	Enable		

Defining VLAN LAGs Settings

The VLAN LAG Settings page provides parameters for managing LAGs that are part of a VLAN. VLANs can either be composed of individual ports or of LAGs. Untagged packets entering the device are tagged with the LAGs ID specified by the PVID.

To open the VLAN LAG Settings page, click Switch → VLAN → LAG Settings in the tree view.

Figure 7-50. VLAN LAG Settings

VLAN LAG Settings

LAG: 1

LAG VLAN Mode: Access

Dynamic:

PVID (1-4095): [1-4095] (VLAN 4095 is the Discard VLAN)

Frame Type: Admit Tag Only

Ingress Filtering: Enable

Current Reserved VLAN: []

Reserve VLAN for Internal Use: []

[Apply Changes](#)

The **VLAN LAG Settings** page contains the following fields:

- **LAG** — The LAG number included in the VLAN.
- **LAG VLAN Mode** — The LAG VLAN mode. Possible values are:
 - **Customer** — The LAG belongs to VLANs. When LAGs are in Customer mode, the added tag provides a VLAN ID to each customer, ensuring private and segregated network traffic.
 - **General** — The LAG belongs to VLANs, and each VLAN is user-defined as tagged or untagged (full 802.1Q mode).
 - **Access** — The LAG belongs to a single, untagged VLAN.
 - **Trunk** — The LAG belongs to VLANs in which all ports are tagged (except for one port that can be untagged).
- **Dynamic** — Assigns a LAG to a VLAN based on the host source MAC address connected to the LAG. The possible values are:
 - **Checked** — The LAG may be registered in a dynamic VLAN.
 - **Unchecked** — The LAG is not allowed to register in a dynamic VLAN.
- **PVID (1-4095)** — Assigns a VLAN ID to untagged packets. The possible field values are 1-4095. VLAN 4095 is defined as per standard and industry practice, as the Discard VLAN. Packets classified to this VLAN are dropped.
- **Frame Type** — Packet type accepted by the LAG. The possible values are:
 - **Admit Tag Only** — Only tagged packets are accepted by the LAG.
 - **Admit All** — Tagged and untagged packets are both accepted by the LAG.
- **Ingress Filtering** — Enables or disables Ingress filtering by the LAG. Ingress filtering discards packets that are destined to VLANs of which the specific LAG is not a member. The possible values are:
 - **Enable** — Ingress filtering is activated on the LAG.
 - **Disable** — Ingress filtering is not activated on the LAG.
- **Current Reserve VLAN** — The VLAN currently designated as the reserved VLAN.
- **Reserve VLAN for Internal Use** — The VLAN that is designated as the reserved VLAN after the device is reset.

Assigning VLAN LAG Settings:

- 1** Open the **VLAN LAG Settings** page.
- 2** Select a LAG from the **LAG** drop-down menu and complete the fields on the page.
- 3** Click **Apply Changes**.

The VLAN LAG parameters are defined, and the device is updated.

Displaying the VLAN LAG Table

- 1 Open the VLAN LAG Settings page.
- 2 Click Show All.

The VLAN LAG Table opens.

Figure 7-51. VLAN LAG Table

VLAN LAG Table Refresh

LAG	LAG VLAN Mode	Dynamic	PVID	Frame Type	Ingress Filtering	Current Reserved VLAN	Reserve VLAN for Internal Use
1	Access	<input type="checkbox"/>		Admit Tag Only	Enable		

Apply Changes

- 3 To change LAG settings, modify the fields for any LAGs in the table.
- 4 Click Apply Changes.

The VLAN LAG parameters are defined, and the device is updated.

Assigning LAGs to VLAN Groups Using CLI Commands

The following table summarizes the equivalent CLI commands for assigning LAGs to VLAN groups as displayed in the VLAN LAG Settings page.

Table 7-28. LAG VLAN Assignments CLI Commands

CLI Command	Description
switchport mode {access trunk general}	Configures a LAG VLAN membership mode.
switchport trunk native vlan <i>vlan-id</i>	Defines the port as a member of the specified VLAN, and the VLAN ID as the LAG default VLAN ID (PVID).
switchport general pvid <i>vlan-id</i>	Configure the LAG VLAN ID (PVID) when the interface is in general mode.
switchport general allowed vlan add <i>vlan-list</i> [tagged untagged]	Adds or removes VLANs from a general LAG.
switchport general acceptable-frame-type tagged-only	Discards untagged packets at ingress.
switchport access vlan dynamic	Binds the MAC address to the VLAN.
switchport general ingress-filtering disable	Disables LAG ingress filtering.

The following is an example of the CLI commands:

```
console(config)# interface port-channel 1
console(config-if)# switchport mode access
console(config-if)# switchport access vlan 2
console(config-if)# exit
console(config)# interface port-channel 2
console(config-if)# switchport mode general
console(config-if)# switchport general allowed vlan add 2-3
tagged
console(config-if)# switchport general pvid 2
console(config-if)# switchport general acceptable-frame-type
tagged-only
console(config-if)# switchport general ingress-filtering
disable
console(config-if)# exit
console(config)# interface port-channel 3
console(config-if)# switchport mode trunk
console(config-if)# switchport trunk native vlan 3
console(config-if)# switchport trunk allowed vlan add 2
```

Binding MAC Address to VLANs

Binding MAC addresses to VLANs provides port to VLAN assignment based on MAC addresses. Once a VLAN is assigned a MAC address, and the MAC address is learned on a port, the port joins the bound VLAN. When the MAC address is aged out, the port leaves the VLAN. Only dynamic VLANs can be bound to MAC addresses.



NOTE: The Bind MAC to VLAN feature (MAC to VLAN Assignment) is deprecated in versions that include the Dynamic VLAN Assignment feature (DVA). DVA provides the same functionality as MAC to VLAN Assignment, but does so in a standard way.

To bind MAC addresses to a VLAN, ensure the VLAN ports were dynamically added, and are not static VLAN ports.

To open the Bind MAC to VLAN page, click **Switch**→**VLAN**→**Bind MAC to VLAN**.

Figure 7-52. Bind MAC to VLAN

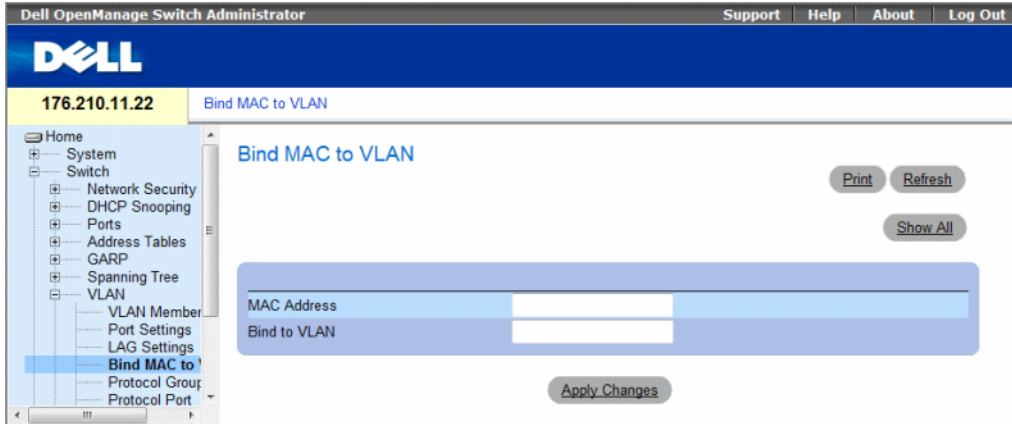

The Bind MAC to VLAN page contains the following fields:

- **MAC Address** — Indicates the MAC Address which is bound to the VLAN.
- **Bind to VLAN** — Indicates the VLAN to which the MAC address is bound. The possible values are 1-4094.

Displaying the MAC to VLAN Table:

- 1 Open the Bind MAC to VLAN page.
- 2 Click Show All.

The MAC to VLAN Table opens.

Figure 7-53. MAC to VLAN Table

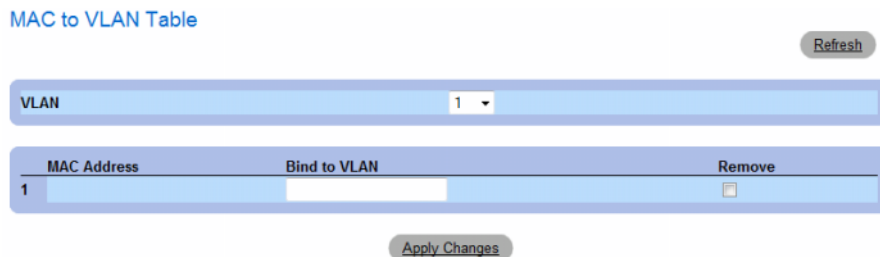

Removing a MAC to VLAN Binding:

- 1 Open the Bind MAC to VLAN page.
- 2 Click Show All. The MAC to VLAN Table opens.
- 3 Select the desired VLAN, or select All to see bindings for all VLANs.
- 4 Select the Remove checkbox next to the desired bindings.
- 5 Click Apply Changes.

Binding MAC address to VLAN using CLI commands:

The following table summarizes the equivalent CLI commands for binding MAC addresses to VLAN.

Table 7-29. Binding MAC address to VLANs CLI Commands

CLI Command	Description
<code>mac-to-vlan mac-address vlan-id</code>	Binds the MAC address to the VLAN.
<code>switchport access vlan dynamic</code>	Configures private VLANs.
<code>show mac-to-vlan</code>	Displays the MAC to VLAN database
<code>no mac-to-vlan mac-address</code>	Unbinds the MAC address from the VLAN.

The following is an example of the CLI commands:

```
console(config-vlan)# mac-to-vlan 0060.704c.73ff 123
console(config-vlan)# exit
console(config)# exit
console# show vlan mac-to-vlan
MAC Address  VLAN
-----
0060.704c.73ff 123
```

Defining VLAN Protocol Groups

The Protocol Group page provides parameters for configuring frame types to specific protocol groups. To open the Protocol Group page, click Switch → VLAN → Protocol Group in the tree view.

Figure 7-54. Protocol Group

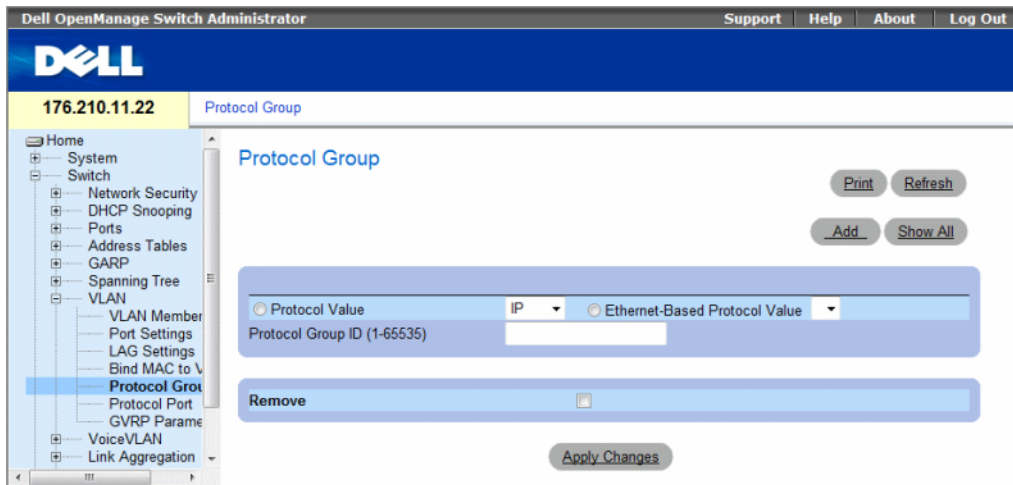

- **Protocol Value** — Displays the User-defined protocol value. The options are as follows:
 - **Protocol Value** — User-defined protocol name. The possible field values are **IP**, **IPX** and **ARP**.
 - **Ethernet-Based Protocol Value** — The Ethernet protocol group type.
- **Protocol Group ID (1-65535)** — The VLAN Group ID number.
- **Remove** — Indicates whether to remove frame-to-protocol group mapping, if the protocol group to be removed is not configured on this protocol port.
 - **Checked** — Removes the protocol group mapping.
 - **Unchecked** — Maintains the protocol group mapping.

Assigning a Protocol to a Group

- 1 Open the **Protocol Group** page.
- 2 Click **Add**.

The **Assign Protocol To Group** page opens.

Figure 7-55. Assign Protocol To Group

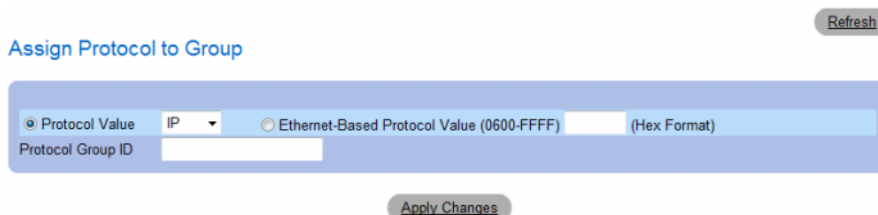

- 3 Complete the fields on the page.
- 4 Click **Apply Changes**.

The protocol group is assigned, and the device is updated.

Assigning VLAN Protocol Group Settings

- 1 Open the **Protocol Group** page.
- 2 Complete the fields on the page.
- 3 Click **Apply Changes**.

The VLAN protocol group parameters are defined, and the device is updated.

Removing Protocols From the Protocol Group Table

- 1 Open the **Protocol Group** page.
- 2 Click **Show All**.

The **Protocol Group Table** opens.

Figure 7-56. Protocol Group Table

Protocol Group Table

Protocol Value	Protocol Group ID	Remove
1		<input type="checkbox"/>

Refresh

Apply Changes

- 3 Select **Remove** for the protocol groups that need to be removed.
- 4 Click **Apply Changes**.

The protocol is removed, and the device is updated.

Defining VLAN Protocol Groups Using CLI Commands

The following table summarizes the equivalent CLI commands for configuring Protocol Groups.

Table 7-30. VLAN Protocol Groups CLI Commands

CLI Command	Description
<code>map protocol <i>protocol</i> [<i>encapsulation</i>] protocols-group <i>group</i></code>	Maps a protocol to a protocol group. Protocol groups are used for protocol-based VLAN assignment.

The following example maps ip-arp protocol to group "213":

```
Console (config)# vlan database
Console (config-vlan)# map protocol ip-arp protocols-group 213
```

Adding Interfaces to Protocol Groups

The Protocol Port page adds interfaces to Protocol groups.

To open the Protocol Port page, click Switch → VLAN → Protocol Port in the tree view.

Figure 7-57. Protocol Port

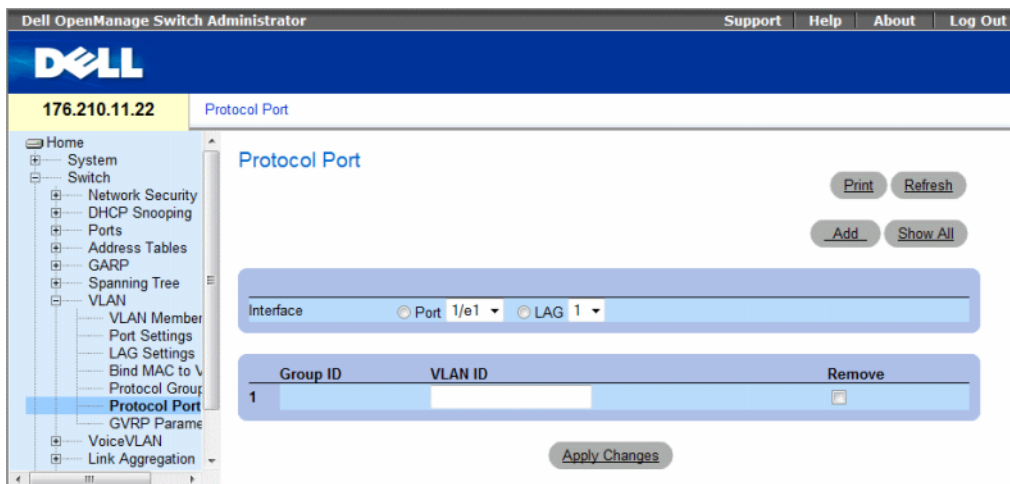

- **Interface** — Port or LAG number added to a protocol group.
- **Group ID** — Protocol group ID to which the interface is added. Protocol group IDs are defined in the Protocol Group Table.

- **VLAN ID** — Attaches the interface to a user-defined VLAN ID. The VLAN ID is defined on the **Create a New VLAN** page. Protocol ports can either be attached to a VLAN ID or a VLAN name. The possible values are 1-4095. VLAN 4095 is the discard VLAN.
- **Remove** — Indicates whether to remove the selected interface from its protocol group.
 - **Checked** — Removes the selected interface.
 - **Unchecked** — Maintains the selected interface.

Adding a New Protocol Port to a VLAN

Protocol ports can be defined only on ports that are defined as **General** in the **VLAN Port Settings** page.

- 1 Open the **Protocol Port** page.
- 2 Click **Add**.

The **Assign Protocol Port To VLAN** page opens.

Figure 7-58. Assign Protocol Port To VLAN

- 3 Complete the fields in the dialog.
- 4 Click **Apply Changes**.

The new VLAN protocol group is added to the **Protocol Port Table**, and the device is updated.

Displaying Protocols Assigned to Ports

- 1 Open the Protocol Port page.
- 2 Click Show All.

The Protocol Based VLAN Table opens.

Figure 7-59. Protocol Based VLAN Table

Interface	Group ID	VLAN ID	Remove
1			<input type="checkbox"/>

Defining Protocol Ports Using CLI Commands

The following table summarizes the equivalent CLI command for defining Protocol Ports.

Table 7-31. Protocol Port CLI Commands

CLI Command	Description
<code>switchport general map protocols-group <i>group</i> vlan <i>vlan-id</i></code>	Sets a protocol-based classification rule.

The following example sets a protocol-based classification rule of protocol group 1 to VLAN 8:

```
Console (config-if)# switchport general map protocols-group 1  
vlan 8
```

Configuring GVRP Parameters

GARP VLAN Registration Protocol (GVRP) is specifically provided for automatic distribution of VLAN membership information among VLAN-aware bridges. GVRP allows VLAN-aware bridges to automatically learn VLANs to bridge ports mapping, without having to individually configure each bridge and register VLAN membership.

To ensure the correct operation of the GVRP protocol, it is advised to set the maximum number of GVRP VLANs equal to a value which significantly exceeds the sum of:

- The number of all static VLANs both currently configured and expected to be configured.
- The number of all dynamic VLANs participating in GVRP, both currently configured (initial number of dynamic GVRP VLANs is 128) and expected to be configured.

The GVRP Global Parameters page enables GVRP globally. GVRP can also be enabled on a per-interface basis.

To open the GVRP Global Parameters page, click **Switch** → **VLAN** → **GVRP Parameters** in the tree view.

Figure 7-60. GVRP Global Parameters

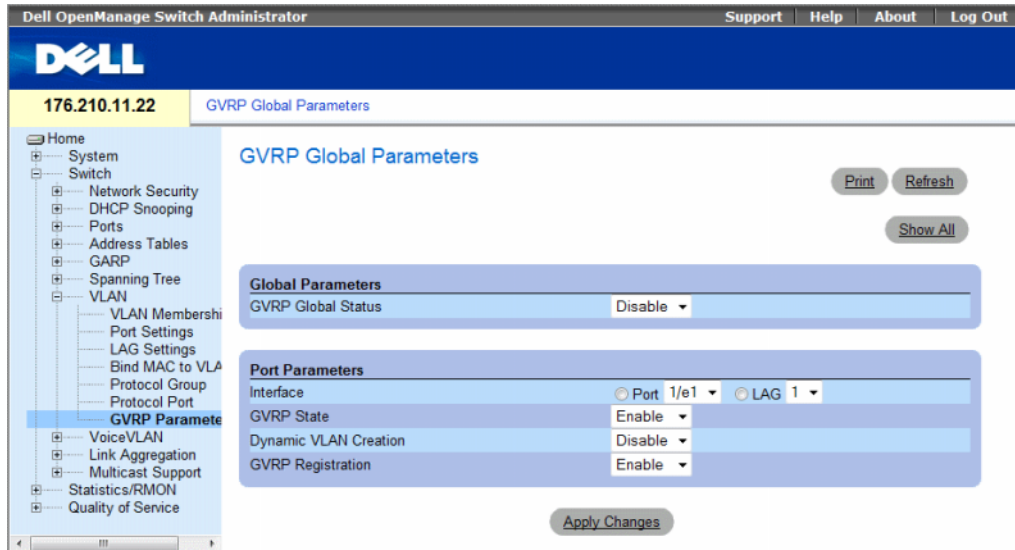

The GVRP Global Parameters page contains the following fields:

Global Parameters

- **GVRP Global Status** — Indicates if GVRP is enabled on the device. The possible field values are:
 - **Enable** — Enables GVRP on the selected device.
 - **Disable** — Disables GVRP on the selected device. GVRP is disabled by default.

Port Parameters

- **Interface** — Specifies port or LAG for editing GVRP settings.
- **GVRP State** — Indicates if GVRP is enabled on the interface. The possible field values are:
 - **Enabled** — Enables GVRP on the selected interface.
 - **Disabled** — Disables GVRP on the selected interface.

- **Dynamic VLAN Creation** — Indicates if Dynamic VLAN creation is enabled on the interface. The possible field values are:
 - **Enabled** — Enables Dynamic VLAN creation on the interface.
 - **Disabled** — Disables Dynamic VLAN creation on the interface.
- **GVRP Registration** — Indicates if VLAN registration through GVRP is enabled on the interface. The possible field values are:
 - **Enabled** — Enables GVRP registration on the interface.
 - **Disabled** — Disables GVRP registration on the interface.

Enabling GVRP on the Device

- 1** Open the **GVRP Global Parameters** page.
- 2** Select **Enable** in the **GVRP Global Status** field.
- 3** Click **Apply Changes**.
GVRP is enabled on the device.

Enabling VLAN Registration Through GVRP

- 1** Open the **GVRP Global Parameters** page.
- 2** Select **Enable** in the **GVRP Global Status**.
- 3** Select **Enable** in the **GVRP State** field for the desired interface.
- 4** Select **Enable** in the **GVRP Registration** field.
- 5** Click **Apply Changes**.
GVRP VLAN Registration is enabled on the port, and the device is updated.

Displaying the GVRP Port Parameters Table

- 1 Open the GVRP Global Parameters page.
- 2 Click Show All.

The GVRP Port Parameters Table opens.

Figure 7-61. GVRP Port Parameters Table

GVRP Port Parameters Table Refresh

Unit No.

Copy Parameters from Port LAG

Interface	GVRP State	Dynamic VLAN Creation	GVRP Registration	Copy to Select All
1	Enable	Enable	Enable	<input type="checkbox"/>
2	Enable	Enable	Enable	<input type="checkbox"/>

Global System LAGs

1	Enable	Enable	Enable	<input type="checkbox"/>
2	Enable	Enable	Enable	<input type="checkbox"/>

Apply Changes

In addition to the GVRP Global Parameters screen, the GVRP Port Parameters Table contains the following field:

Copy Parameters from — The port or LAG from which parameters will be copied and assigned to other interfaces.

Configuring GVRP Using CLI Commands

The following table summarizes the equivalent CLI commands for configuring GVRP as displayed in the GVRP Global Parameters page.

Table 7-32. GVRP Global Parameters CLI Commands

CLI Command	Description
<code>gvrp enable (global)</code>	Enables GVRP globally.
<code>gvrp enable (interface)</code>	Enables GVRP on an interface.
<code>gvrp vlan-creation-forbid</code>	Enables or disables dynamic VLAN creation.
<code>gvrp registration-forbid</code>	De-registers all dynamic VLANs, and prevents dynamic VLAN registration on the port.

Table 7-32. GVRP Global Parameters CLI Commands (continued)

CLI Command	Description
<code>show gvrp configuration [ethernet interface port-channel port-channel-number]</code>	Displays GVRP configuration information, including timer values, whether GVRP and dynamic VLAN creation is enabled, and which ports are running GVRP.
<code>show gvrp error-statistics [ethernet interface port-channel port-channel-number]</code>	Displays GVRP error statistics.
<code>show gvrp statistics [ethernet interface port-channel port-channel-number]</code>	Displays GVRP statistics.
<code>clear gvrp statistics [ethernet interface port-channel port-channel-number]</code>	Clears all the GVRP statistics information.

The following is an example of the CLI commands:

```

console(config)# gvrp enable
console(config)# interface ethernet 1/e1
console(config-if)# gvrp enable
console(config-if)# gvrp vlan-creation-forbid
console(config-if)# gvrp registration-forbid
console(config-if)# end
console# show gvrp configuration
GVRP Feature is currently Enabled on the device
Maximum VLANs: 223
Port(s)   GVRP-      Registration   Dynamic      Timers        Leave   Leave
          Status                VLAN          (milliseconds)
                                        Creation      Join
-----
1/e11     Enabled    Forbidden     Disabled     200          900    10000
1/e12     Disabled   Normal        Enabled      200          600    10000

```

Configuring Voice VLAN

Voice VLAN allows network administrators enhance VoIP service by configuring ports to carry IP voice traffic from IP phones on a specific VLAN. VoIP traffic has a preconfigured OUI prefix in the source MAC address. Network Administrators can configure VLANs on which voice IP traffic is forwarded. Non-VoIP traffic is dropped from the Voice VLAN in auto Voice VLAN secure mode. Voice VLAN also provides QoS to VoIP, ensuring that the quality of voice does not deteriorate if the IP traffic is received unevenly. The system supports one Voice VLAN.

There are two operational modes for IP Phones:

- IP phones are configured with VLAN-mode as enabled, ensuring that tagged packets are used for all communications.
- If the IP phone's VLAN-mode is disabled, the phone uses untagged packets. The phone uses untagged packets while retrieving the initial IP address through DHCP. The phone eventually use the Voice VLAN and start sending tagged packets.

This section contains the following topics:

- Defining Voice VLAN Properties Page
- Defining Voice VLAN Port Settings
- Defining OUIs

This section contains the following topics:

- "Defining Voice VLAN Global Parameters" on page 374
- "Defining Voice VLAN Port Settings" on page 377
- "Defining OUIs" on page 379

Defining Voice VLAN Global Parameters

The **Voice VLAN Global Parameters** page contains parameters that apply to all Voice VLANs on the device.

To open the **Voice VLAN Global Parameters** page, click **Switch** → **Voice VLAN** → **Global Parameters** in the tree view.

Figure 7-62. Voice VLAN Global Parameters

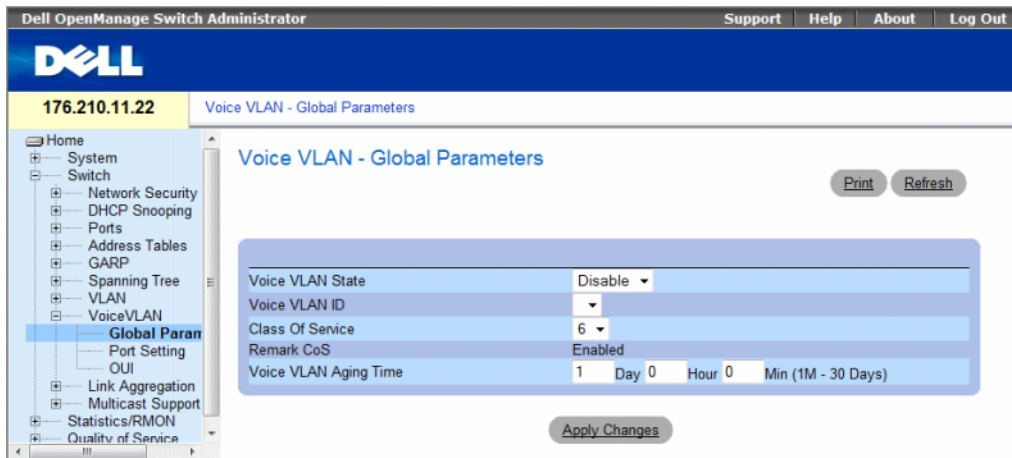

- **Voice VLAN Status** — Indicates if Voice VLAN is enabled on the device. The possible field values are:
 - **Enable** — Enables Voice VLAN on the device.
 - **Disable** — Disables Voice VLAN on the device. This is the default value.
- **Voice VLAN ID** — Defines the Voice VLAN ID number.
- **Class of Service** — Enables adding a CoS tag to untagged packets received on the voice VLAN. The possible field values are 0-7, where zero is the lowest priority, and seven is the highest priority.
- **Remark CoS** — Indicates that the Remark CoS is always enabled.
- **Voice VLAN Aging Time** — Indicates the amount of time after the last IP phone's OUI is aged out for a specific port. The port will age out after the bridge and voice aging time. The default time is one day. The field format is Day, Hour, Minute. The aging time starts after the MAC Address is aged out from the Dynamic MAC Address table. The default time is 300 sec. For more information on defining MAC address age out time, see Defining Aging Time.

Configuring Voice VLAN global parameters:

- 1 Open the **Voice VLAN Global Parameters** page.
- 2 Complete the fields on the page.
- 3 Click **Apply Changes**.

The Voice VLAN global parameters are defined, and the device is updated.

Defining Voice VLAN Global Parameters Using CLI Commands

The following table summarizes the equivalent CLI command for defining **Voice VLAN global parameters**.

Table 7-33. Voice VLAN Global Parameters CLI Commands

CLI Command	Description
<code>voice vlan id <i>vlan-id</i></code> <code>no voice vlan id</code>	To enable the voice VLAN and to configure the voice VLAN ID, use the <code>voice vlan id</code> command in global configuration mode. To disable the voice VLAN, enter the <code>no</code> form of this command.
<code>voice vlan cos <i>cos</i></code> <code>no voice vlan cos</code>	To set the voice VLAN Class Of Service, use the <code>voice vlan cos</code> command in global configuration mode. To return to default, use the <code>no</code> form of this command.
<code>voice vlan aging-timeout <i>minutes</i></code> <code>no voice aging-timeout</code>	To set the voice VLAN aging timeout, use the <code>voice vlan aging-timeout</code> command in global configuration mode. To return to default, use the <code>no</code> form of this command.
<code>voice vlan enable</code>	Use the <code>voice vlan enable</code> interface configuration command to enable automatic voice VLAN configuration for a port. Use the <code>no</code> form of this command to disable automatic voice VLAN configuration.
<code>show voice vlan [ethernet <i>interface</i> port-channel <i>port-channel-number</i>]</code>	Use the <code>show voice vlan EXEC</code> command to display the voice VLAN status.

The following is an example of some of the CLI commands:

```
Switch# show voice  
vlan
```

```
Aging timeout: 1440  
minutes
```

```
OUI table
```

```
MAC Address - Prefix      Description  
00:E0:BB                  3COM  
00:03:6B                  Cisco  
00:E0:75                  Veritel  
00:D0:1E                  Pingtel  
00:01:E3                  Siemens  
00:60:B9                  NEC/Philips
```

00:0F:E2

Huawei-3COM

Voice VLAN VLAN ID: 8

CoS: 6

Remark: Yes

Interface	Enabled	Secure	Activated
-----	-----	-----	-----
1/e1	Yes	Yes	Yes
1/e2	Yes	Yes	Yes
1/e3	Yes	Yes	Yes
1/e4	Yes	Yes	Yes
1/e5	No	No	-
1/e6	No	No	-
1/e7	No	No	-
1/e8	No	No	-
1/e9	No	No	-

Defining Voice VLAN Port Settings

The Voice VLAN Port Settings Page contains fields for adding ports or LAGs to voice VLAN.

To open the Voice VLAN Port Setting page, click Switch→ Voice VLAN → Port Setting in the tree view.

Figure 7-63. Voice VLAN Port Setting

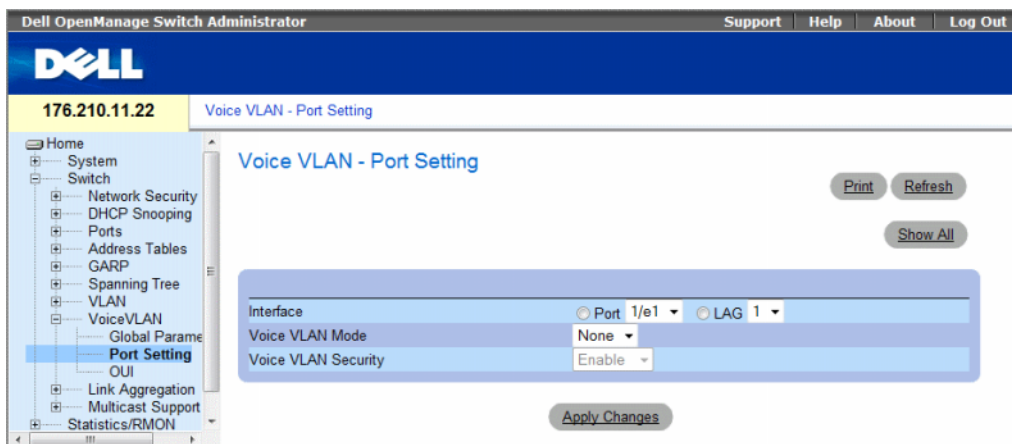

- **Interface** — Indicates the specific port or and LAG to which the Voice VLAN settings are applied.
- **Voice VLAN Mode** — Defines the Voice VLAN mode. The possible field values are:
 - **None** — Disables the selected port/LAG on the Voice VLAN.
 - **Static** — Maintains the current Voice VLAN port/LAG settings. This is the default value.
 - **Auto** — Indicates that if traffic with an IP Phone MAC Address is transmitted on the port/LAG, the port/LAG joins the Voice VLAN. The port/LAG is aged out of the voice VLAN if the IP phone’s MAC address (with an OUI prefix) is aged out and exceeds the defined. If the MAC Address of the IP phones OUI was added manually to a port/LAG in the Voice VLAN, the user cannot add it to the Voice VLAN in Auto mode, only in Manual mode.
- **Voice VLAN Port/LAG Security** — Indicates if port/LAG security is enabled on the Voice VLAN. Port Security ensures that packets arriving with an unrecognized OUI are dropped.
 - **Enable** — Enables port security on the Voice VLAN.
 - **Disable** — Disables port security on the Voice VLAN. This is the default value.

Configuring Port Settings

- 1 Open the **Voice VLAN Port Settings** page.
- 2 Select a port or LAG.
- 3 Modify the fields as desired.
- 4 Click **Apply Changes**.
The settings are modified and the device is updated.

Displaying the Port Setting Table

- 1 Open the **Voice VLAN Port Settings** page.
- 2 Click **Show All**. The Port Setting Table opens.

Figure 7-64. Voice VLAN Port Setting Table

Port Setting Refresh

Unit No. 1

Interface	Voice VLAN Mode	Voice VLAN Security	Membership
1 1/1	None	Enable	Static
1 LAG1	None	Enable	Dynamic

Apply Changes

The **Voice VLAN Port Setting Table** includes the **Membership** field which indicates if the Voice VLAN member is a static or dynamic member. The field value *Dynamic* indicates the VLAN membership was dynamically created through GARP. The field value *Static* indicates the VLAN membership is user-defined.

- 3 Select the unit number.
- 4 Modify the fields as desired.
- 5 Click **Apply Changes**.

Defining Voice VLAN Port Settings Using CLI Commands

The following table summarizes the equivalent CLI command for defining **Voice VLAN port settings**.

Table 7-34. Voice VLAN Port Settings CLI Commands

CLI Command	Description
voice vlan secure	Use the voice vlan secure interface configuration command to configure the secure mode for the voice VLAN. Use the no form of this command to disable the secure mode.
no voice vlan secure	

Defining OUIs

The **Voice VLAN OUI** page lists the Organizationally Unique Identifiers (OUIs) associated with the Voice VLAN. The first three bytes of the MAC Address contain a manufacturer identifier. While the last three bytes contain a unique station ID. Using the OUI, network managers can add specific manufacturer's MAC addresses to the OUI table. Once the OUIs are added, all traffic received on the Voice VLAN ports from the specific IP phone with a listed OUI, is forwarded on the voice VLAN.

To open the **Voice VLAN OUI** page, click **Switch** → **Voice VLAN** → **OUI** in the tree view.

Figure 7-65. Voice VLAN OUI

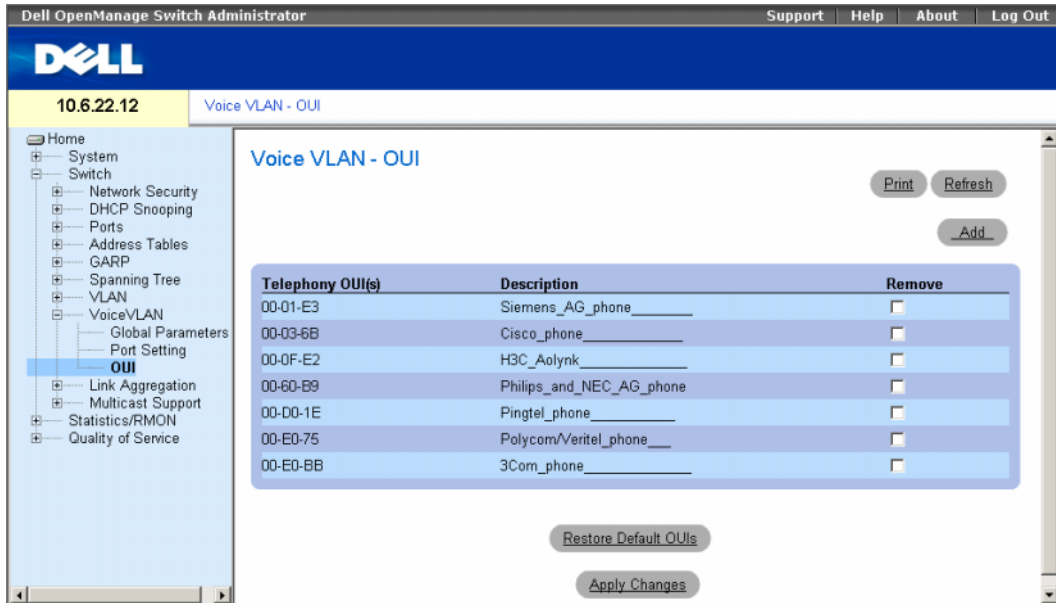

- **Telephony OUI(s)** — Lists the OUIs currently enabled on the Voice VLAN. The following OUIs are enabled by default.
 - 00-01-E3 — Siemens AG phone
 - 00-03-6B — Cisco phone
 - 00-0F-E2 — H3C Aolynk
 - 00-60-B9 — Philips and NEC AG phone
 - 00-D0-1E — Pingtel phone
 - 00-E0-75 — Polycom/Veritel phone
 - 00-E0-BB — 3COM phone
- **Description** — Provides an OUI description up to 32 characters.
- **Remove** — Removes OUI from the Telephony OUI List. The possible field values are:
 - **Checked** — Removes the selected OUI.
 - **Unchecked** — Maintains the current OUIs in the Telephony OUI List. This is the default value.
- **Restore Default OUIs** — Restores OUIs to the factory defaults.

Adding OUIs

- 1 Open the Voice VLAN OUI page.
- 2 Click Add. The Add OUI page opens.

Figure 7-66. Voice VLAN Add OUI Page

Port Setting Refresh

Unit No. 1

Interface	Voice VLAN Mode	Voice VLAN Security	Membership
1 1/1	None	Enable	Static

Interface	Voice VLAN Mode	Voice VLAN Security	Membership
1 LAG1	None	Enable	Dynamic

Apply Changes

- 3 Fill in the fields.
- 4 Click Apply Changes.
The OUIs is added.

Removing OUIs

- 1 Open the Voice VLAN OUI page.
- 2 Check the Remove checkbox next to each OUI to be removed.
- 3 Click Apply Changes.
The selected OUIs are removed.

Restoring Default OUIs

- 1 Open the Voice VLAN OUI page.
- 2 Click Restore Default OUIs.
The default OUIs are restored.

Defining Voice VLAN OUIs Using CLI Commands

The following table summarizes the equivalent CLI command for defining **Voice VLAN OUIs**.

Table 7-35. Voice VLAN OUIs CLI Commands

CLI Command	Description
<code>voice vlan oui-table {add <i>mac-address-prefix</i> [<i>description text</i>] remove <i>mac-address-prefix</i>}</code>	To configure the voice OUI table, use the voice vlan oui-table command in global configuration mode. To return to default, use the no form of this command.
<code>no voice vlan oui-table</code>	

Aggregating Ports

Link Aggregation optimizes port usage by linking a group of ports together to form a single LAG (aggregated group). Aggregating ports multiplies the bandwidth between the devices, increases port flexibility, and provides link redundancy.

The device supports both static LAGs and Link Aggregation Control Protocol (LACP) LAGs. LACP LAGs negotiate aggregating port's links with other LACP ports located on a different device. If the other device ports are also LACP ports, the devices establish a LAG between them.

Consider the following when aggregating ports:

- All ports within a LAG must be the same media type.
- A VLAN is not configured on the port.
- The port is not assigned to a different LAG.
- Auto-negotiation mode is not configured on the port.
- The port is in full-duplex mode.
- All ports in the LAG have the same ingress filtering and tagged modes.
- All ports in the LAG have the same back pressure and flow control modes.
- All ports in the LAG have the same priority.
- All ports in the LAG have the same transceiver type.
- The device supports up to eight LAGs, and eight ports in each LAG.
- Ports can be configured as LACP ports only if the ports are not part of a previously configured LAG.

Ports added to a LAG lose their individual port configuration. When ports are removed from the LAG, the original port configuration is applied to the ports.

The device uses a hash function to determine which packets are carried on which aggregated-link member. The hash function statistically load-balances the aggregated link members. The device considers an Aggregated Link a single logical port.

Aggregate ports can be linked into link-aggregation port-groups. Each group comprises ports with the same speed, set to full-duplex operations.

Ports in a Link Aggregated group (LAG) can contain different media types if the ports are operating at the same speed. Aggregated links can be manually or automatically configured by enabling Link Aggregation Control Protocol (LACP) on the relevant links.

This section contains the following topics:

- "Defining LACP Parameters" on page 383
- "Defining LAG Membership" on page 385

Defining LACP Parameters

The **LACP Parameters** page contains fields for configuring LACP LAGs. Aggregate ports can be linked into link-aggregation port-groups. Each group is comprised of ports with the same speed. Aggregated Links can be manually setup or automatically established by enabling Link Aggregation Control Protocol (LACP) on the relevant links.

To open the **LACP Parameters** page, click **Switch** → **Link Aggregation** → **LACP Parameters** in the tree view.

Figure 7-67. LACP Parameters

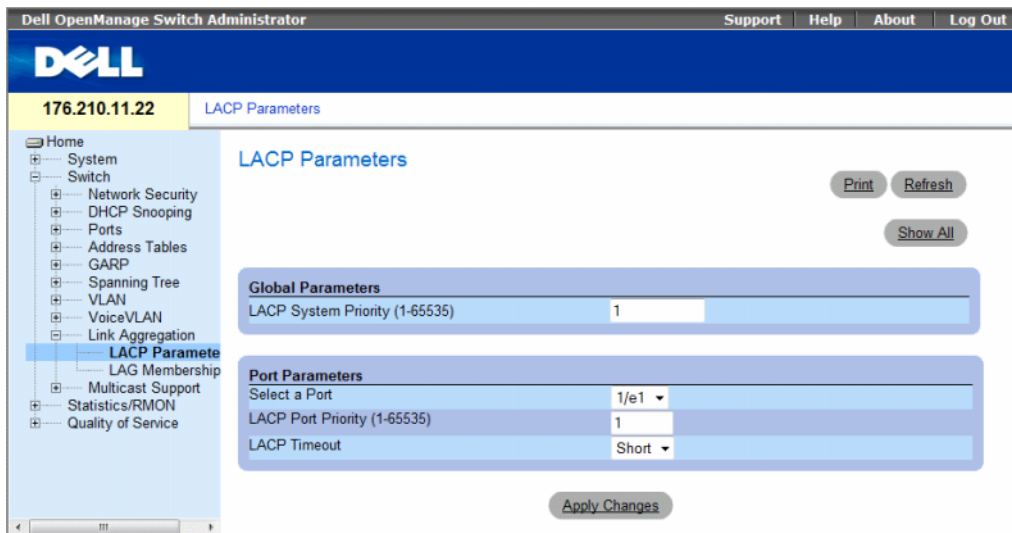

The **LACP Parameters** page contains the following fields:

- **LACP System Priority (1-65535)** — The LACP priority value for global settings. The possible range is 1- 65535. The default value is 1.
- **Select a Port** — The port number to which timeout and priority values are assigned.

- **LACP Port Priority (1-65535)** — LACP priority value for the port.
- **LACP Timeout** — Administrative LACP timeout. The possible field values are:
 - **Short** — Specifies a short timeout value.
 - **Long** — Specifies a long timeout value.

Defining Link Aggregation Global Parameters

- 1 Open the **LACP Parameters** page.
 - 2 Complete the **LACP System Priority** field.
 - 3 Click **Apply Changes**.
- The parameters are defined, and the device is updated.

Defining Link Aggregation Port Parameters

- 1 Open the **LACP Parameters** page.
 - 2 Complete the fields in the **Port Parameters** area.
 - 3 Click **Apply Changes**.
- The parameters are defined, and the device is updated.

Displaying the LACP Parameters Table

- 1 Open the **LACP Parameters** page.
 - 2 Click **Show All**.
- The **LACP Parameters Table** opens.

Figure 7-68. LACP Parameters Table

LACP Parameters Table Refresh

Unit No. 1 ▾

Port	Port-Priority	LACP Timeout
1		Short ▾

Apply Changes

Configuring LACP Parameters Using CLI Commands

The following table summarizes the equivalent CLI commands for configuring LACP parameters as displayed in the [LACP Parameters](#) page.

Table 7-36. LACP Parameters CLI Commands

CLI Command	Description
<code>lACP system-priority value</code>	Configures the system priority.
<code>lACP port-priority value</code>	Configures the priority value for physical ports.
<code>lACP timeout {long short}</code>	Assigns an administrative LACP timeout.
<code>show lACP ethernet interface [parameters statistics protocol-state]</code>	Displays LACP information for ethernet ports.

The following is an example of the CLI commands:

```
Console (config)# lACP system-priority 120
Console (config)# interface ethernet 1/e11
Console (config-if)# lACP port-priority 247
Console (config-if)# lACP timeout long
Console (config-if)# end
Console# show lACP ethernet 1/e11 statistics
Port 1/e11 LACP Statistics:
LACP PDUs sent:2
LACP PDUs received:2
```

Defining LAG Membership

The device supports fifteen LAGs per system, and eight ports per LAG, whether the device is a stand-alone device or in a stack.

When a port is added to a LAG, the port acquires the LAG's properties. If the port cannot be configured with the LAG's properties, it is not added to the LAG. An error message is generated. However, if the first port joining the LAG cannot be configured with the LAG settings, the port is added to the LAG, using the port default settings. An error message is generated. However, as this is the only port in the LAG, the entire LAG operates with the port's settings, instead of the LAG's defined settings.

Use the [LAG Membership](#) page to assign ports to LAGs.

To open the [LAG Membership](#) page, click **Switch** → **Link Aggregation** → **LAG Membership** in the tree view.

Figure 7-69. LAG Membership

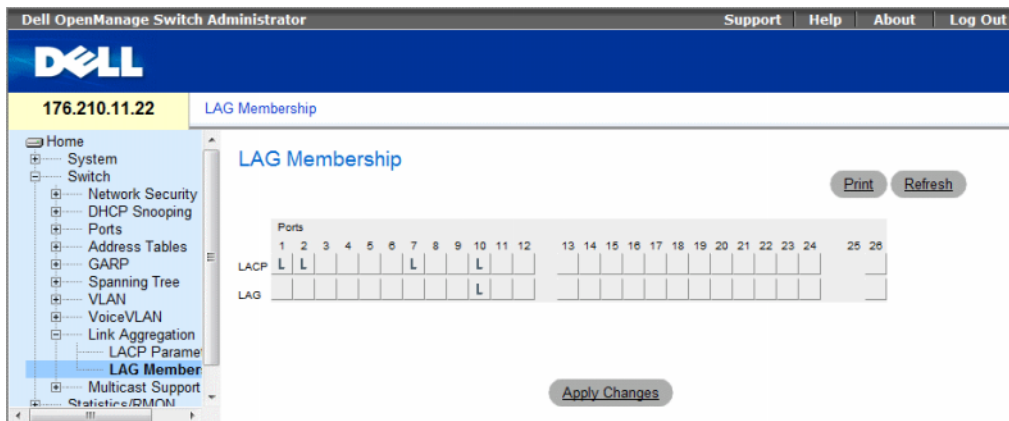

The LAG Membership page contains the following fields:

- **LACP** — Aggregates the port to a LAG, using LACP.
- **LAG** — Adds a port to a LAG, and indicates the specific LAG to which the port belongs.

Adding Ports to a LAG or LACP

- 1 Open the LAG Membership page.
- 2 In the LAG row (the second row), toggle the button to a specific number to aggregate or remove the port to that LAG number.
- 3 In the LACP row (the first row), toggle the button under the port number to assign either the LACP or the static LAG.
- 4 Click **Apply Changes**.

The port is added to the LAG or LACP, and the device is updated.

Adding Ports to LAGs Using CLI Commands

The following table summarizes the equivalent CLI commands for assigning ports to LAGs as displayed in the LAG Membership page.

Table 7-37. LAG Membership CLI Commands

CLI Command	Description
<code>channel-group port-channel-number mode {on auto}</code>	Associates a port with a port-channel. Use the no form of this command to remove the channel-group configuration from the interface.
<code>show interfaces port-channel [port-channel-number]</code>	Displays port-channel information.

The following is an example of the CLI commands:

```
console(config)# interface ethernet 1/e11
console(config-if)# channel-group 1 mode on
```

Multicast Forwarding Support

Multicast forwarding allows a single packet to be forwarded to multiple destinations. Layer 2 Multicast service is based on Layer 2 device receiving a single packet addressed to a specific Multicast address. Multicast forwarding creates copies of the packet, and transmits the packets to the relevant ports.

- **Registered Multicast traffic** — If traffic addressed to a registered multicast group is seen it is handled by an entry in the Multicast Filtering Database and forwarded only to the registered ports.
- **Unregistered Multicast traffic** — If traffic addressed to an unregistered Multicast group is seen, it is handled by a special entry in the Multicast Filtering Database. The default setting of this is to flood all such traffic (traffic in unregistered Multicast groups).

The device supports:

- **Forwarding L2 Multicast Packets** — Forwards Layer 2 Multicast packets. Layer 2 Multicast filtering is enabled by default, and not user-configurable.

The system supports Multicast filtering for 256 Multicast groups.

- **Filtering L2 Multicast Packets** — Forwards Layer 2 packets to interfaces. If Multicast filtering is disabled, Multicast packets are flooded to all relevant ports.

To open the **Multicast Support** page, click **Switch** → **Multicast Support** in the tree view.

This section contains the following topics:

- "Defining Multicast Global Parameters" on page 387
- "Adding Bridge Multicast Address Members" on page 389
- "Assigning Multicast Forward All Parameters" on page 394
- "IGMP Snooping" on page 396

Defining Multicast Global Parameters

Layer 2 switching forwards Multicast packets to all relevant VLAN ports by default, managing the packet as a single Multicast transmission. While Multicast traffic forwarding is effective, it is not optimal, as irrelevant ports also receive the Multicast packets. The excess packets cause increased network traffic. Multicast forwarding filters enable forwarding of Layer 2 packets to port subsets.

When IGMP Snooping is enabled globally, all IGMP packets are forwarded to the CPU. The CPU analyzes the incoming packets and determines:

- Which ports want to join which Multicast groups.
- Which ports have Multicast routers generating IGMP queries.
- What routing protocols are forwarding packets and Multicast traffic.

Ports requesting to join a specific Multicast group issue an IGMP report, specifying that Multicast group is accepting members. This results in the creation of the Multicast filtering database.

The **Global Parameters** page contains fields for enabling IGMP Snooping on the device.

To open the **Global Parameters** page, click **Switch** → **Multicast Support** → **Global Parameters** in the tree view.

Figure 7-70. Global Parameters

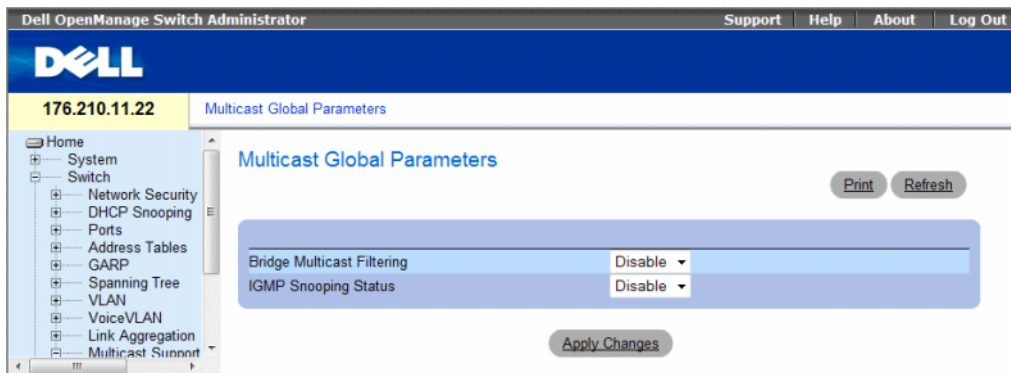

The **Global Parameters** page contains the following fields:

- **Bridge Multicast Filtering** — Enables or disables bridge Multicast filtering. Disabled is the default value.
 - **Enable** — Enables bridge multicast filtering on the device.
 - **Disable** — Disables bridge multicast filtering on the device.
- **IGMP Snooping Status** — Enables or disables IGMP Snooping on the device. Disabled is the default value. IGMP Snooping can be enabled only if **Global Parameters** is enabled.
 - **Enable** — Enables IGMP Snooping on the device.
 - **Disable** — Disables IGMP Snooping on the device.

Enabling Bridge Multicast Filtering on the device

- 1 Open the **Global Parameters** page.
- 2 Select **Enable** in the **Bridge Multicast Filtering** field.
- 3 Click **Apply Changes**.
Bridge Multicast Filtering is enabled on the device.

Enabling IGMP Snooping on the device

- 1 Open the Global Parameters page.
- 2 Select **Enable** in the IGMP Snooping Status field.
- 3 Click **Apply Changes**.

IGMP Snooping is enabled on the device.

Enabling Multicast Filtering and IGMP Snooping Using CLI Commands

The following table summarizes the equivalent CLI commands for enabling Multicast Filtering and IGMP Snooping as displayed on the **Global Parameters** page.

Table 7-38. Multicast Filtering and Snooping CLI Commands

CLI Command	Description
bridge multicast filtering	Enables filtering of Multicast addresses.
ip igmp snooping	Enables Internet Group Membership Protocol (IGMP) snooping.

The following is an example of the CLI commands:

```
console(config)# bridge multicast filtering
console(config)# ip igmp snooping
```

Adding Bridge Multicast Address Members

The **Bridge Multicast Group** page displays the ports and LAGs attached to the Multicast service group in the **Ports** and **LAGs** tables. The Port and LAG tables also reflect the manner in which the port or LAGs joined the Multicast group. Ports can be added either to existing groups or to new Multicast service groups. The **Bridge Multicast Group** page permits new Multicast service groups to be created. The **Bridge Multicast Group** page also assigns ports to a specific Multicast service address group.

To open the **Bridge Multicast Group** page, click **Switch** → **Multicast Support** → **Bridge Multicast Group** in the tree view.

Figure 7-71. Bridge Multicast Group

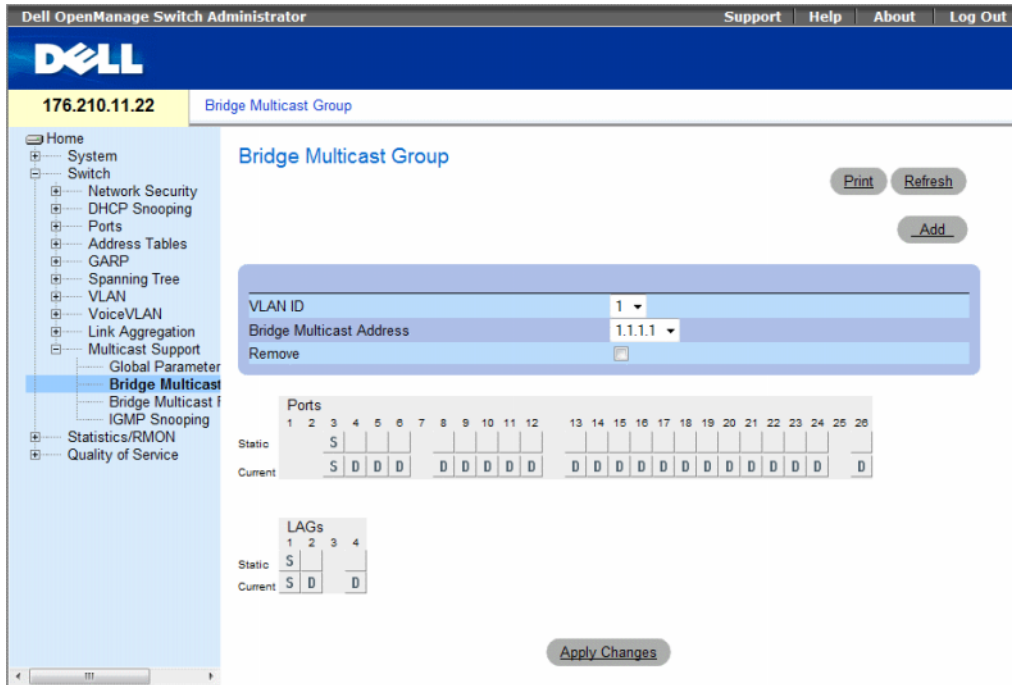

The **Bridge Multicast Group** page contains the following fields:

- **VLAN ID** — Identifies a VLAN and contains information about the Multicast group address.
- **Bridge Multicast Address** — Identifies the Multicast group MAC address/IP address.
- **Remove** — Indicates whether to remove a Bridge Multicast address.
 - **Checked** — Removes the selected Bridge Multicast address.
 - **Unchecked** — Maintains the selected Bridge Multicast address.
- **Ports** — Port that can be added to a Multicast service.
- **LAGs** — LAGs that can be added to a Multicast service.

The following table contains the IGMP port and LAG members management settings:

Table 7-39. IGMP Port/LAG Members Table Control Settings

Port Control	Definition
D	The port/LAG has joined the Multicast group dynamically in the Current Row.
S	Attaches the port to the Multicast group as static member in the Static Row. The port/LAG has joined the Multicast group statically in the Current Row.
F	Forbidden.
Blank	The port is not attached to a Multicast group.

Adding Bridge Multicast Addresses

- 1 Open the Bridge Multicast Group page.
- 2 Click Add.

The Add Bridge Multicast Group page opens.

Figure 7-72. Add Bridge Multicast Group

- 3 Define the VLAN ID and New Bridge Multicast Address fields.
- 4 Toggle a port to S to join the port to the selected Multicast group.
- 5 Toggle a port to F to forbid adding specific Multicast addresses to a specific port.
- 6 Click Apply Changes.

The bridge Multicast address is assigned to the Multicast group, and the device is updated.

Defining Ports to Receive Multicast Service

- 1 Open the **Bridge Multicast Group** page.
- 2 Define the **VLAN ID** and the **Bridge Multicast Address** fields.
- 3 Toggle a port to **S** to join the port to the selected Multicast group.
- 4 Toggle a port to **F** to forbid adding specific Multicast addresses to a specific port.
- 5 Click **Apply Changes**.

The port is assigned to the Multicast group, and the device is updated.

Assigning LAGs to Receive Multicast Service

- 1 Open the **Bridge Multicast Group** page.
- 2 Define the **VLAN ID** and the **Bridge Multicast Address** fields.
- 3 Toggle the LAG to **S** to join the LAG to the selected Multicast group.
- 4 Toggle the LAG to **F** to forbid adding specific Multicast addresses to a specific LAG.
- 5 Click **Apply Changes**.

The LAG is assigned to the Multicast group, and the device is updated.

Managing Multicast Service Members Using CLI Commands

The following table summarizes the equivalent CLI commands for managing Multicast service members as displayed in the **Bridge Multicast Group** page.

Table 7-40. Multicast Service Member CLI Commands

CLI Command	Description
<code>bridge multicast address {mac-multicast-address ip-multicast-address}</code>	Registers MAC-layer Multicast addresses to the bridge table, and adds static ports to the group.
<code>bridge multicast forbidden address {mac-multicast-address ip-multicast-address}[add remove] {ethernet interface-list port-channel port-channel-number-list}</code>	Forbids adding a specific Multicast address to specific ports. Use the no form of this command to return to default
<code>show bridge multicast address-table [vlan vlan-id] [address {mac-multicast-address ip-multicast-address}] [format ip mac]</code>	Displays Multicast MAC address table information.

The following is an example of the CLI commands:

```
Console(config-if)# bridge multicast address 0100.5e02.0203
add ethernet 1/e11,1/e12
console(config-if)# end
console # show bridge multicast address-table
```

Vlan	MAC Address	Type	Ports
----	-----	-----	-----
1	0100.5e02.0203	static	1/e11, 1/e12
19	0100.5e02.0208	static	1/e11-16
19	0100.5e02.0208	dynamic	1/e11-12

Forbidden ports for multicast addresses:

Vlan	MAC Address	Ports
----	-----	-----
1	0100.5e02.0203	1/e8
19	0100.5e02.0208	1/e8

```
console # show bridge multicast address-table format ip
```

Vlan	IP Address	Type	Ports
----	-----	-----	-----
1	224-239.130 2.2.3	static	1/e11, 1/e12
19	224-239.130 2.2.8	static	1/e11-16
19	224-239.130 2.2.8	dynamic	1/e11-12

Forbidden ports for multicast addresses:

Vlan	IP Address	Ports
1	224-239.130 2.2.3	1/e8
19	224-239.130 2.2.8	1/e8

Assigning Multicast Forward All Parameters

The Bridge Multicast Forward All page contains fields for attaching ports or LAGs to a device that is attached to a neighboring Multicast router/switch. Once IGMP Snooping is enabled, Multicast packets are forwarded to the appropriate port or VLAN.

To open the Bridge Multicast Forward All page, click Switch → Multicast Support → Bridge Multicast Forward All page in the tree view.

Figure 7-73. Bridge Multicast Forward All

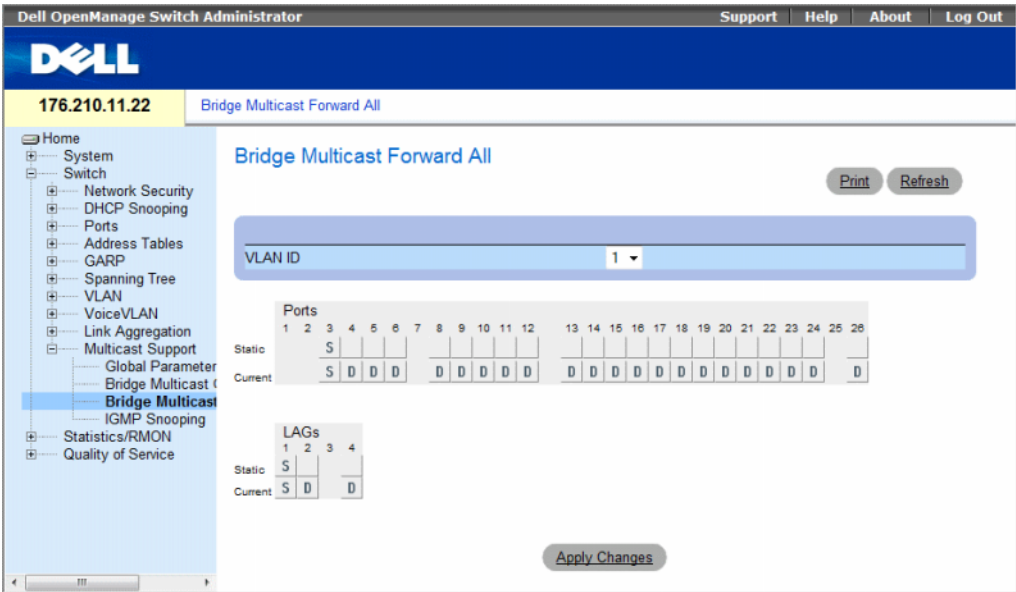

The Bridge Multicast Forward All page contains the following fields:

- **VLAN ID** — Identifies a VLAN.
- **Ports** — Ports that can be added to a Multicast service.
- **LAGs** — LAGs that can be added to a Multicast service.

The Bridge Multicast Forward All Switch/Port Control Settings Table contains the settings for managing router and port settings.

Managing Bridge Multicast Forward All Switch/Port Control Settings Table

The following table describes the controls used to set the port controls.

Table 7-41. Bridge Multicast Forward All Switch/Port Control Settings Table

Port Control	Definition
D	Attaches the port to the Multicast router or switch as a dynamic port.
S	Attaches the port to the Multicast router or switch as a static port.
F	Forbidden.
Blank	The port is not attached to a Multicast router or switch.

Attaching a Port to a Multicast Router or Switch

- 1 Open **Bridge Multicast Forward All** page.
- 2 Define the **VLAN ID** field.
- 3 Select a port in the **Ports** table, and assign the port a value.
- 4 Click **Apply Changes**.

The port is attached to the Multicast router or switch.

Attaching a LAG to a Multicast Router or Switch

- 1 Open **Bridge Multicast Forward All** page.
- 2 Define the **VLAN ID** field.
- 3 Select a port in the **LAGs** table, and assign the LAG a value.
- 4 Click **Apply Changes**.

The LAG is attached to the Multicast router or switch.

Managing LAGs and Ports Attached to Multicast Routers Using CLI Commands

The following table summarizes the equivalent CLI commands for managing LAGs and ports attached to Multicast routers as displayed on the **Bridge Multicast Forward All** page.

Table 7-42. CLI Commands for Managing LAGs and Ports Attached to Multicast Routers

CLI Command	Description
<code>show bridge multicast filtering <i>vlan-id</i></code>	Displays the Multicast filtering configuration.
<code>bridge multicast forward-all {add remove} {ethernet <i>interface-list</i> port-channel <i>port-channel-number-list</i>}</code>	Enables forwarding of all Multicast packets on a port. Use the no form of this command to return to default.

The following is an example of the CLI commands:

```
Console(config)# interface vlan 1
Console(config-if)# bridge multicast forward-all add ethernet
1/e3
Console(config-if)# end
Console# show bridge multicast filtering 1
Filtering: Enabled
VLAN:          Forward-All
Port           Static      Status
-----
1/e11          Forbidden  Filter
1/e12          Forward   Forward(s)
1/e13          -         Forward(d)
```

IGMP Snooping

The IGMP Snooping page contains fields for adding IGMP members. To open the IGMP Snooping page, click Switch→ Multicast Support→ IGMP Snooping in the tree view.

Figure 7-74. IGMP Snooping

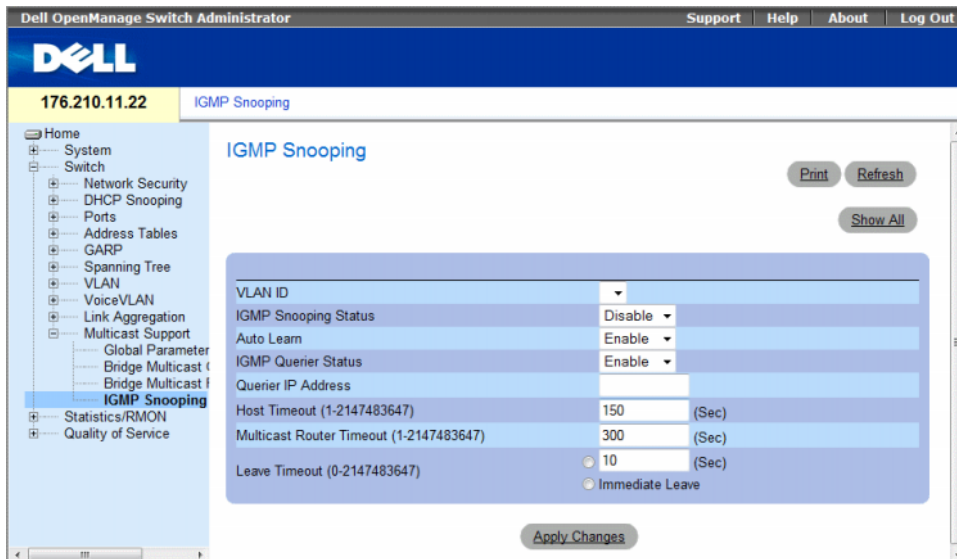

- **VLAN ID** — Specifies the VLAN ID.
- **IGMP Snooping Status** — Enables or disables IGMP snooping on the VLAN.
- **Auto Learn** — Enables or disables Auto Learn on the device.
- **IGMP Querier Status** — Enables or disables the IGMP Querier. The IGMP Querier simulates the behavior of a multicast router, allowing snooping of the layer 2 multicast domain even though there is no multicast router.
- **Querier IP Address** — IP address of the IGMP Querier. Use either use the VLAN's IP Interface address or define a unique IP address which will be used as a source address of Querier.
- **Host Timeout (1-2147483647)** — Time before an IGMP snooping entry is aged out. The default time is 260 seconds.
- **Multicast Router Timeout (1-2147483647)** — Time before aging out a Multicast router entry. The default value is 300 seconds.
- **Leave Timeout (0-2147483647)** — Time, in seconds, after a port leave message is received before the entry is aged out. **User-defined** enables a user-definable timeout period, and **Immediate Leave** specifies an immediate timeout period. The default timeout is 10 seconds.

Enabling IGMP Snooping on the Device

- 1 Open the **IGMP Snooping** page.
- 2 Select the VLAN ID for the device on which IGMP snooping needs to be enabled.
- 3 Select **Enable** in the **IGMP Snooping Status** field.
- 4 Complete the fields on the page.
- 5 Click **Apply Changes**.

IGMP snooping is enabled on the device.

Displaying the IGMP Snooping Table

- 1 Open the **IGMP Snooping**.
- 2 Click **Show All**.

The **IGMP Snooping Table** opens.

Figure 7-75. IGMP Snooping Table

IGMP Snooping Table Refresh

VLAN ID	IGMP Status	Auto Learn	IGMP Querier Status	Querier IP Address	IGMP Querier Address	Oper IP Address	Host Timeout	Multicast Router Timeout	Leave Timeout
1	Enable	Enable	Enable						

Apply Changes

Configuring IGMP Snooping with CLI Commands

The following table summarizes the equivalent CLI commands for configuring IGMP Snooping on the device:

Table 7-43. IGMP Snooping CLI Commands

CLI Command	Description
<code>ip igmp snooping</code>	Enables Internet Group Membership Protocol (IGMP) snooping.
<code>ip igmp snooping mrouter learn-pim-dvmrp</code>	Enables automatic learning of Multicast router ports in the context of a specific VLAN.
<code>ip igmp snooping host-time-out <i>time-out</i></code>	Configures the host-time-out.
<code>ip igmp snooping mrouter-time-out <i>time-out</i></code>	Configures the mrouter-time-out.
<code>ip igmp snooping leave-time-out { <i>time-out</i> <i>immediate-leave</i> }</code>	Configures the leave-time-out.
<code>ip igmp snooping querier enable</code> <code>no ip igmp snooping querier enable</code>	Enables Internet Group Management Protocol (IGMP) querier on a specific VLAN. Use the no form of this command to disable.
<code>ip igmp snooping querier address <i>ip-address</i></code> <code>no ip igmp snooping querier address</code>	Defines the source IP address that the IGMP Snooping querier would use. Use the no form of this command to return to default.
<code>show ip igmp snooping groups [vlan <i>vlan-id</i>] [address <i>ip-multicast-address</i>]</code>	Displays the Multicast groups learned by IGMP snooping.
<code>show ip igmp snooping interface <i>vlan-id</i></code>	Displays IGMP snooping configuration.
<code>show ip igmp snooping mrouter [interface <i>vlan-id</i>]</code>	Displays information about dynamically learned Multicast router interfaces.

The following is an example of the CLI commands:

```
Console> enable
Console# config
Console (config)# ip igmp snooping
Console (config)# interface vlan 1
Console (config-if)# ip igmp snooping mrouter learn-pim-dvmrp
Console (config-if)# ip igmp snooping host-time-out 300
Console (config-if)# ip igmp snooping mrouter-time-out 200
Console (config-if)# exit
Console (config)# interface vlan 1
Console (config-if)# ip igmp snooping leave-time-out 60
Console (config-if)# exit
Console (config)# exit
Console # show ip igmp snooping groups
```

Vlan	IP Address	Querier	Ports
-----	-----	-----	-----
1	224-239.130 2.2.3	Yes	g1, g2

```
Console # show ip igmp snooping interface 1000
IGMP Snooping is globally enabled
```

```
IGMP Snooping admin: Enabled
Hosts and routers IGMP version: 2
IGMP snooping oper mode: Enabled
IGMP snooping querier admin: Enabled
IGMP snooping querier oper: Enabled
IGMP snooping querier address admin:
IGMP snooping querier address oper: 172.16.1.1
IGMP snooping querier version admin: 3
IGMP snooping querier version oper: 2

IGMP host timeout is 300 sec
IGMP Immediate leave is disabled. IGMP leave timeout is 10 sec
IGMP mrouter timeout is 300 sec
Automatic learning of multicast router ports is enabled
```

```
Console # show ip igmp snooping mrouter
```

VLAN	Ports
----	-----
1	g1

Unregistered Multicast

Multicast frames are generally forwarded to all ports in the VLAN. If IGMP Snooping is enabled, the device learns about the existence of Multicast groups and monitors which ports have joined what Multicast group. Multicast groups can also be statically enabled. This enables the device to forward the Multicast frames (from a registered Multicast group) only to ports that are registered to that Multicast group.

The **Unregistered Multicast** Page contains fields to handle Multicast frames that belong to unregistered Multicast groups. Unregistered Multicast groups are the groups that are not known to the device. All unregistered Multicast frames are still forwarded to all ports on the VLAN. After a port has been set to Forwarding/Filtering, then this port's configuration is valid for any VLAN it is a member of (or will be a member of).

To open the **Unregistered Multicast** page, click **Switch**→**Multicast Support**→**Unregistered Multicast** in the tree view.

Figure 7-76. Unregistered Multicast

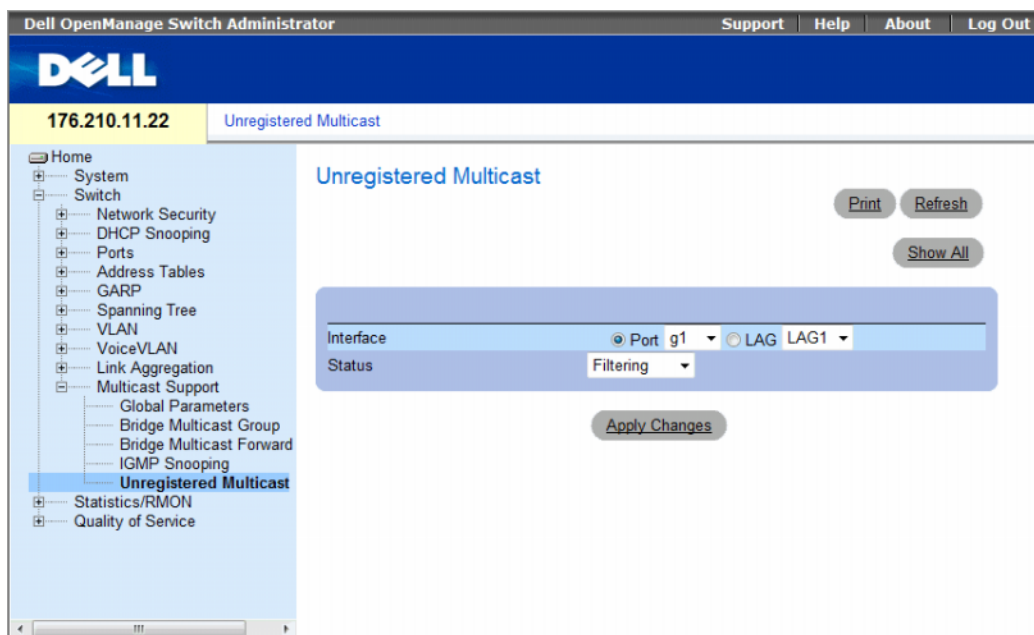

- **Interface** — Selects a port or LAG.
- **Status** — Indicates the forwarding status of the selected interface. The possible values are:
 - **Forwarding** — Enables forwarding of unregistered Multicast frames on the selected port or port-channel. This is the default value.
 - **Filtering** — Enables filtering of unregistered Multicast frames on the selected VLAN interface.

Setting the Unregistered Multicast Status of an Interface

- 1 Open the **Unregistered Multicast** page.
- 2 Select the interface for which Unregistered Multicast needs to be set.
- 3 Select a status in the **Status** field.
- 4 Click **Apply Changes**.

Unregistered Multicast status is set.

Displaying the Unregistered Multicast Table

- 1 Open the **Unregistered Multicast** page.
- 2 Click **Show All**.

The **Unregistered Multicast Table** opens.

Figure 7-77. Unregistered Multicast Table

Interface	Unregistered Multicast	Copy to Select All
1 1/e1	Filtering	<input type="checkbox"/>
2 1/e2	Forwarding	<input type="checkbox"/>

The **Unregistered Multicast Table** displays the following additional fields:

- **Unit No.** — Selects a stacking member.
- **Copy from** — Copies parameters from the selected item.

Copying Unregistered Multicast Settings Between Interfaces

- 1 Open the **Unregistered Multicast** page.
- 2 Click **Show All**. The **Unregistered Multicast Table** opens.
- 3 In the **Copy Parameters from** field, select the interface from which to copy.
- 4 For each interface to which you want to copy parameters, select the checkbox in the **Copy to** field. Alternatively, click **Select All** to automatically select all interfaces.
- 5 Click **Apply Changes**.

The Unregistered Multicast parameters are copied between the interfaces.

Configuring Unregistered Multicast with CLI Commands

The following table summarizes the equivalent CLI commands for configuring Unregistered Multicast on the device:

Table 7-44. Unregistered Multicast CLI Commands

CLI Command	Description
bridge multicast unregistered	Configures the forwarding state of unregistered multicast addresses.
show bridge multicast unregistered	Displays the unregistered multicast filtering configuration.

The following is an example of the CLI commands:

```
Console # show bridge multicast unregistered
```

```
Port Unregistered
```

```
-----
```

```
1/1 Forward
```

```
1/2 Filter
```

```
1/3 Filter
```

Viewing Statistics

The **Statistic** pages contains links to device information for interface, GVRP, etherlike, RMON, and device utilization. To open the **Statistics** page, click **Statistics** in the tree view.

CLI commands are not available for all the Statistics pages.

This section contains the following topics:

- "Viewing Tables" on page 405
- "Viewing RMON Statistics" on page 420
- "Viewing Charts" on page 435

Viewing Tables

The **Table Views** page contains links for displaying statistics in a table form. To open the page, click **Statistics** → **Table** in the tree view.

This section contains the following topics:

- "Viewing Utilization Summary" on page 405
- "Viewing Counter Summary" on page 407
- "Viewing Interface Statistics" on page 408
- "Viewing Etherlike Statistics" on page 411
- "Viewing GVRP Statistics" on page 414
- "Viewing EAP Statistics" on page 418
- "Viewing EAP Statistics Using the CLI Commands" on page 419

Viewing Utilization Summary

The **Utilization Summary** page contains statistics for interface utilization. This screen is refreshed periodically to minimize the impact on computers with lower memory. Display may be disrupted during this period.

To open the page, click **Statistics** → **Table Views** → **Utilization Summary** in the tree view.

Figure 8-1. Utilization Summary

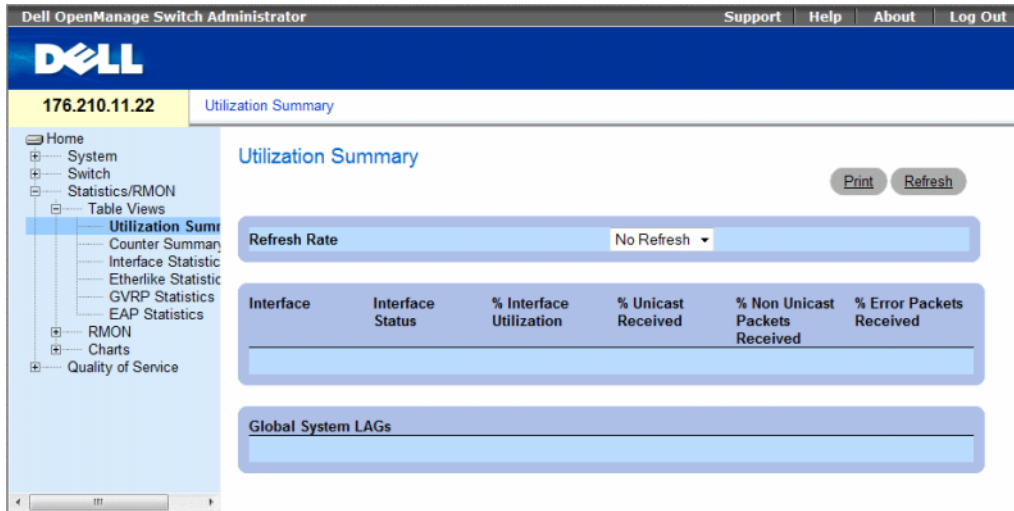

The Utilization Summary page contains the following fields:

- **Refresh Rate**—Indicates the amount of time that passes before the interface statistics are refreshed. The possible field values are:
 - **15 Sec** — Indicates that the interface statistics are refreshed every 15 seconds.
 - **30 Sec** — Indicates that the interface statistics are refreshed every 30 seconds.
 - **60 Sec** — Indicates that the interface statistics are refreshed every 60 seconds.
 - **No Refresh** — Indicates that the interface statistics are not refreshed automatically.
- **Interface** — The interface number.
- **Interface Status** — Status of the interface.
- **% Interface Utilization** — Network interface utilization percentage based on the duplex mode of the interface. The range of this reading is from 0 to 200%. The maximum reading of 200% for a full duplex connection indicates that 100% of bandwidth of incoming and outgoing connections is used by the traffic travelling through the interface. The maximum reading for a half duplex connection is 100%.
- **% Unicast Received** — Percentage of Unicast packets received on the interface.
- **% Non Unicast Packets Received** — Percentage of non-Unicast packets received on the interface.
- **% Error Packets Received** — Percentage of packets with errors received on the interface.
- **Global System LAGs** — Indicates the current global LAG utilization.

Viewing Counter Summary

The Counter Summary page contains statistics for port utilization in numeric sums as opposed to percentages.

To open the Counter Summary page, click **Statistics/RMON** → **Table Views** → **Counter Summary** in the tree view.

Figure 8-2. Counter Summary

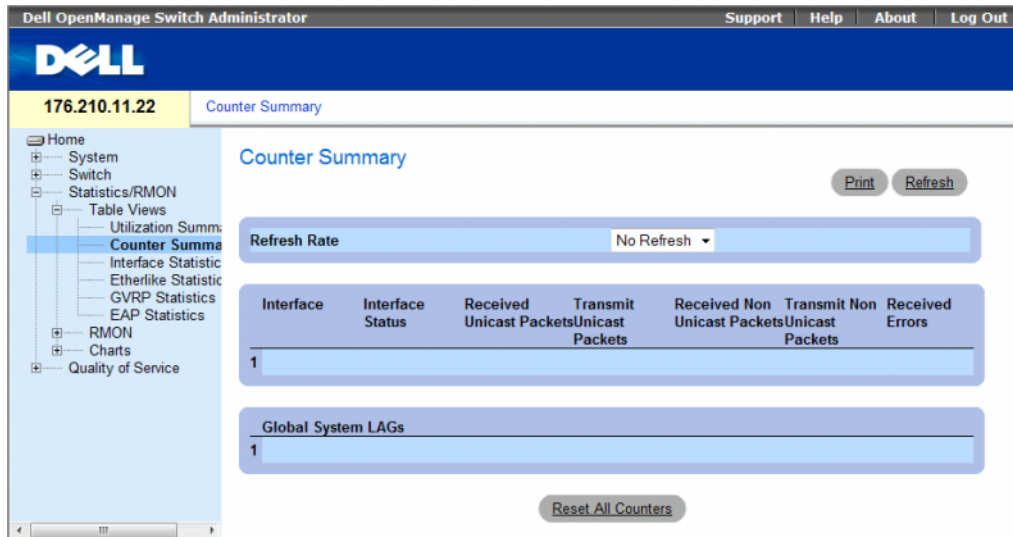

The Counter Summary page contains the following fields:

- **Refresh Rate** — Indicates the amount of time that passes before the interface statistics are refreshed. The possible field values are:
 - **15 Sec** — Indicates that the interface statistics are refreshed every 15 seconds.
 - **30 Sec** — Indicates that the interface statistics are refreshed every 30 seconds.
 - **60 Sec** — Indicates that the interface statistics are refreshed every 60 seconds.
 - **No Refresh** — Indicates that the interface statistics are not refreshed automatically.
- **Interface** — The interface number.
- **Interface Status** — Status of the interface.
- **Received Unicast Packets** — Number of received Unicast packets on the interface.
- **Transmit Unicast Packets** — Number of transmitted Unicast packets from the interface.

- **Received Non Unicast Packets** — Number of received non-Unicast packets on the interface.
- **Transmit Non Unicast Packets** — Number of transmitted non-Unicast packets from the interface.
- **Received Errors** — Number of received packets with errors on the interface.
- **Global System LAGs** — Provides a counter summary for global system LAGs.

Viewing Interface Statistics

The **Interface Statistics** page contains statistics for both received and transmitted packets. The fields for both received and transmitted packets are identical.

To open the **Interface Statistics** page, click **Statistics/RMON** → **Table Views** → **Interface Statistics** in the tree view.

Figure 8-3. Interface Statistics

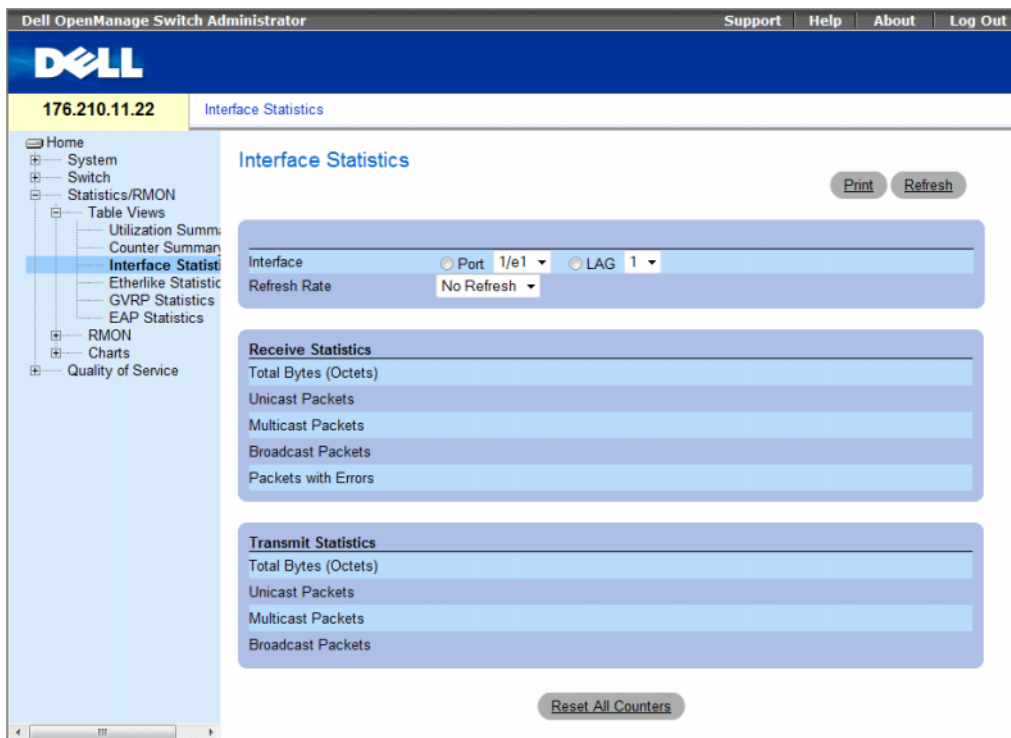

The **Interface Statistics** page contains the following fields:

- **Interface** — Specifies whether statistics are displayed for a port or LAG.
- **Refresh Rate** — Amount of time that passes before the interface statistics are refreshed. The possible field values are:
 - **15 Sec** — Indicates that the interface statistics are refreshed every 15 seconds.
 - **30 Sec** — Indicates that the interface statistics are refreshed every 30 seconds.
 - **60 Sec** — Indicates that the interface statistics are refreshed every 60 seconds.
 - **No Refresh** — Indicates that the interface statistics are not refreshed automatically.

Receive Statistics

- **Total Bytes (Octets)** — Amount of octets received on the selected interface.
- **Unicast Packets** — Amount of Unicast packets received on the selected interface.
- **Multicast Packets** — Amount of Multicast packets received on the selected interface.
- **Broadcast Packets** — Amount of Broadcast packets received on the selected interface.
- **Packets with Errors** — Number of errors packets received on the selected interface.

Transmit Statistics

- **Total Bytes (Octets)** — Amount of octets transmitted from the selected interface.
- **Unicast Packets** — Amount of Unicast packets transmitted from the selected interface.
- **Multicast Packets** — Amount of Multicast packets transmitted from the selected interface.
- **Broadcast Packets** — Amount of Broadcast packets transmitted from the selected interface.

Displaying Interface Statistics

- 1 Open the **Interface Statistics** page.
- 2 Select an interface in the **Interface** field.
The interface statistics for the selected interface are displayed.

Resetting Interface Statistics Counters

- 1 Open the **Interface Statistics** page.
- 2 Click **Reset All Counters**.
The interface statistics counters are reset.

Viewing Interface Statistics Using the CLI Commands

The following table contains the CLI commands for viewing interface statistics.

Table 8-1. Interface Statistics CLI Commands

CLI Command	Description
<code>show interfaces counters</code> [<code>ethernet interface</code> <code>port-channel port-channel-number</code>]	Displays traffic seen by the physical interface.

The following is an example of the CLI commands.

```
console> enable
console# show interfaces counters
Port InOctets InUcastPkts InMcastPkts InBcastPkts
-----
1/e1    0          0          0          0
1/e2    0          0          0          0
1/e3    0          0          0          0
1/e4    0          0          0          0
1/e5    0          0          0          0
1/e6    0          0          0          0
1/e7    0          0          0          0
1/e8    0          0          0          0
1/e9    0          0          0          0
1/e10   0          0          0          0
```

Viewing Etherlike Statistics

The Etherlike Statistics page contains interface errors statistics.

To open the Etherlike Statistics page, click **Statistics/RMON** → **Table Views** → **Etherlike Statistics** in the tree view.

Figure 8-4. Etherlike Statistics

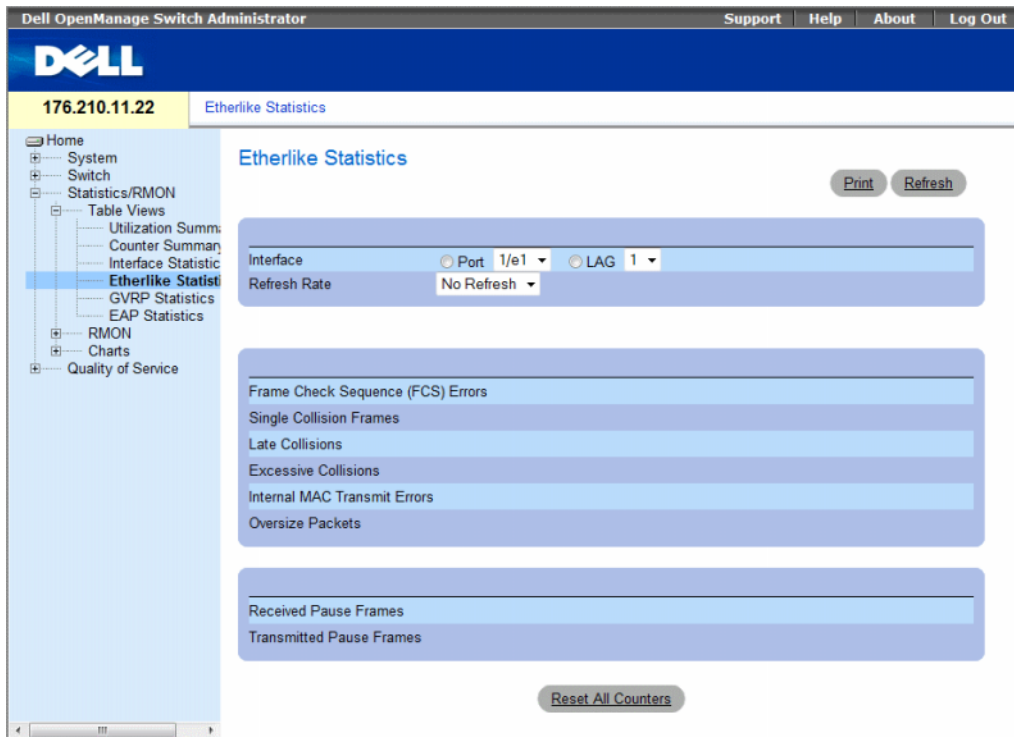

The Etherlike Statistics page contains the following fields:

- **Interface** — Specifies whether statistics are displayed for a port or LAG.
- **Refresh Rate** — Amount of time that passes before the interface statistics are refreshed. The possible field values are:
 - **15 Sec** — Indicates that the Etherlike statistics are refreshed every 15 seconds.
 - **30 Sec** — Indicates that the Etherlike statistics are refreshed every 30 seconds.
 - **60 Sec** — Indicates that the Etherlike statistics are refreshed every 60 seconds.
 - **No Refresh** — Indicates that the Etherlike statistics are not refreshed automatically.
- **Frame Check Sequence (FCS) Errors** — Number of FCS errors received on the selected interface.

- **Single Collision Frames** — Number of single collision frame errors received on the selected interface.
- **Late Collisions** — Number of late collisions received on the selected interface.
- **Internal MAC Transmit Errors** — Number of internal MAC transmit errors on the selected interface.
- **Oversize Packets** — Number of oversize packets on the selected interface.
- **Received Pause Frames** — Number of received paused errors on the selected interface.
- **Transmitted Pause Frames** — Number of transmitted paused errors on the selected interface.

Displaying Etherlike Statistics for an Interface

- 1 Open the Etherlike Statistics page.
- 2 Select an interface in the **Interface** field.

Resetting Etherlike Statistics

- 1 Open the Etherlike Statistics page.
- 2 Click **Reset All Counters**.
The Etherlike Statistics counters are reset.

Viewing Etherlike Statistics Using the CLI Commands

The following table contains the CLI commands for viewing etherlike statistics.

Table 8-2. Etherlike Statistics CLI Commands

CLI Command	Description
<code>show interfaces counters [ethernet interface port-channel port-channel-number]</code>	Displays traffic seen by the physical interface.

The following is an example of the CLI commands.

```
Console# show interfaces counters ethernet 1/e1

Port          IN Octets      InUcastPkts    InMcastPkts    InBcastPkts
-----
1/e1          183892         1289           987            8

Port          OUT Octets      OutUcastPkts    OutMcastPkts    OutBcastPkts
-----
1/e1          9188           9              8              0

FCS Errors: 8
Single Collision Frames: 0
Multiple Collision Frames: 0
SQE Test Errors: 0
Deferred Transmissions: 0
Late Collisions: 0
Excessive Collisions: 0
Internal MAC Tx Errors: 0
Carrier Sense Errors: 0
Oversize Packets: 0
Internal MAC Rx Errors: 0
Received Pause Frames: 0
Transmitted Pause Frames: 0
```

Viewing GVRP Statistics

The GVRP Statistics page contains device statistics for GVRP.

To open the page, click **Statistics/RMON** → **Table Views** → **GVRP Statistics** in the tree view.

Figure 8-5. GVRP Statistics

Dell OpenManage Switch Administrator

Support Help About Log Out

DELL

176.210.11.22 GVRP Statistics

Home
System
Switch
Statistics/RMON
Table Views
Utilization Summary
Counter Summary
Interface Statistics
Etherlike Statistics
GVRP Statistics
EAP Statistics
RMON
Charts
Quality of Service

GVRP Statistics Print Refresh

Interface Port 1/e1 LAG 1

Refresh Rate No Refresh

GVRP Statistics Table

Attribute (Counter)	Received	Transmitted
Join Empty		
Empty		
Leave Empty		
Join In		
Leave In		
Leave All		

GVRP Error Statistics

- Invalid Protocol ID
- Invalid Attribute Type
- Invalid Attribute Value
- Invalid Attribute Length
- Invalid Event

Reset All Counters

The GVRP Statistics page contains the following fields:

- **Interface** — Specifies whether statistics are displayed for a port or LAG.
- **Refresh Rate** — Amount of time that passes before the GVRP statistics are refreshed. The possible field values are:
 - **15 Sec** — Indicates that the GVRP statistics are refreshed every 15 seconds.
 - **30 Sec** — Indicates that the GVRP statistics are refreshed every 30 seconds.
 - **60 Sec** — Indicates that the GVRP statistics are refreshed every 60 seconds.
 - **No Refresh** — Indicates that the GVRP statistics are not refreshed automatically.

GVRP Statistics Table

- **Join Empty** — Device GVRP Join Empty statistics.
- **Empty** — Indicates the number of empty GVRP statistics.
- **Leave Empty** — Device GVRP Leave Empty statistics.
- **Join In** — Device GVRP Join In statistics.
- **Leave In** — Device GVRP Leave in statistics.
- **Leave All** — Device GVRP Leave all statistics.

GVRP Error Statistics

- **Invalid Protocol ID** — Device GVRP Invalid Protocol ID statistics.
- **Invalid Attribute Type** — Device GVRP Invalid Attribute ID statistics.
- **Invalid Attribute Value** — Device GVRP Invalid Attribute Value statistics.
- **Invalid Attribute Length** — Device GVRP Invalid Attribute Length statistics.
- **Invalid Event** — Device GVRP Invalid Events statistics.

Displaying GVRP Statistics for a Port

- 1 Open the **GVRP Statistics** page.
- 2 Select an interface in the **Interface** field.

The GVRP statistics for the selected interface are displayed.

Resetting GVRP Statistics

- 1 Open the **GVRP Statistics** page.
- 2 Click **Reset All Counters**.

The GVRP statistics counters are reset.

Viewing GVRP Statistics Using the CLI Commands

The following table contains the CLI commands for viewing GVRP statistics.

Table 8-3. GVRP Statistics CLI Commands

CLI Command	Description
<code>show gvrp statistics [ethernet <i>interface</i> port-channel <i>port-channel-number</i>]</code>	Displays GVRP statistics.
<code>show gvrp error-statistics [ethernet <i>interface</i> port-channel <i>port-channel-number</i>]</code>	Displays GVRP error statistics.

The following is an example of the CLI commands:

```
console# show gvrp statistics
GVRP statistics:
-----
Legend:
rJE : Join Empty Received
rJIn : Join In Received
rEmp : Empty Received
rLIn : Leave In Received
rLE : Leave Empty Received
rLA : Leave All Received
sJE : Join Empty Sent
sJIn : Join In Sent
sEmp : Empty Sent
sLIn : Leave In Sent
sLE : Leave Empty Sent
sLA : Leave All Sent
Port rJE rJIn rEmp rLIn rLE rLA sJE sJIn sEmp sLIn sLE sLA
-----
1/e1  0  0  0  0  0  0  0  0  0  0  0  0
1/e2  0  0  0  0  0  0  0  0  0  0  0  0
1/e3  0  0  0  0  0  0  0  0  0  0  00  0
```

```
Console# show gvrp error-statistics
```

```
GVRP error statistics:
```

```
-----
```

```
Legend:
```

```
INVPROT : Invalid Protocol Id
```

```
INVPLEN : Invalid PDU Length
```

```
INVATYP : Invalid Attribute Type
```

```
INVALEN : Invalid Attribute Length
```

```
INVAVAL : Invalid Attribute Value
```

```
INVEVENT : Invalid Event
```

```
Port INVPROT INVATYP INVAVAL INVPLEN INVALEN INVEVENT
```

```
-----
```

1/e1	0	0	0	0	0	0
1/e2	0	0	0	0	0	0
1/e3	0	0	0	0	0	0
1/e4	0	0	0	0	0	0

```
sLE : Leave Empty Sent
```

```
sLA : Leave All Sent
```

```
Port rJE rJIn rEmp rLIn rLE rLA sJE sJIn sEmp sLIn sLE sLA
```

```
-----
```

1/e1	0	0	0	0	0	0	0	0	0	0	0	0
1/e2	0	0	0	0	0	0	0	0	0	0	0	0
1/e3	0	0	0	0	0	0	0	0	0	0	0	0
1/e4	0	0	0	0	0	0	0	0	0	0	0	0
1/e5	0	0	0	0	0	0	0	0	0	0	0	0
1/e6	0	0	0	0	0	0	0	0	0	0	0	0
1/e7	0	0	0	0	0	0	0	0	0	0	0	0
1/e8	0	0	0	0	0	0	0	0	0	0	0	0

Viewing EAP Statistics

The **EAP Statistics** page contains information about EAP packets received on a specific port. For more information about EAP, see "**Port Based Authentication**".

To open the **EAP Statistics** page, click **Statistics/RMON** → **Table Views** → **EAP Statistics** in the tree view.

Figure 8-6. EAP Statistics

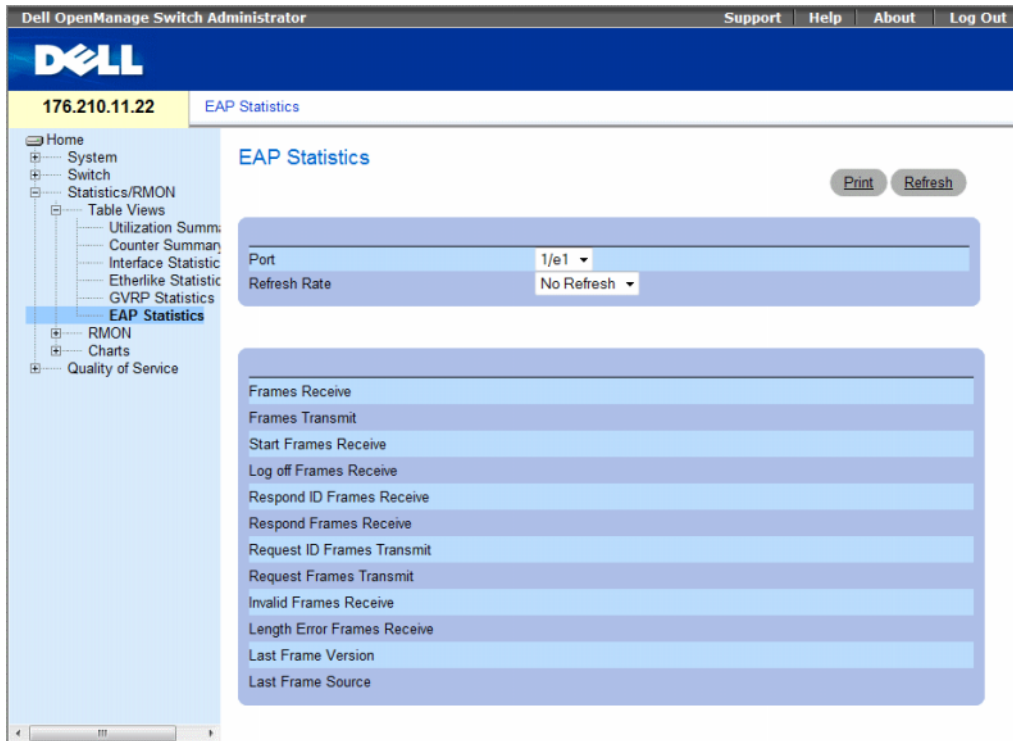

The **EAP Statistics** page contains the following fields:

- **Port** — Indicates the port which is polled for statistics.
- **Refresh Rate** — Amount of time that passes before the EAP statistics are refreshed. The possible field values are:
 - **15 Sec** — Indicates that the EAP statistics are refreshed every 15 seconds.
 - **30 Sec** — Indicates that the EAP statistics are refreshed every 30 seconds.
 - **60 Sec** — Indicates that the EAP statistics are refreshed every 60 seconds.
 - **No Refresh** — Indicates that the EAP statistics are not refreshed automatically.
- **Frames Receive** — Indicates the number of valid EAPOL frames received on the port.

- **Frames Transmit** — Indicates the number of EAPOL frames transmitted via the port.
- **Start Frames Receive** — Indicates the number of EAPOL Start frames received on the port.
- **Log off Frames Receive** — Indicates the number of EAPOL Logoff frames received on the port.
- **Respond ID Frames Receive** — Indicates the number of EAP Resp/Id frames received on the port.
- **Respond Frames Receive** — Indicates the number of valid EAP Response frames received on the port.
- **Request ID Frames Transmit** — Indicates the number of EAP Req/Id frames transmitted via the port.
- **Request Frames Transmit** — Indicates the number of EAP Request frames transmitted via the port.
- **Invalid Frames Receive** — Indicates the number of unrecognized EAPOL frames that have been received on this port.
- **Length Error Frames Receive** — Indicates the number of EAPOL frames with an invalid Packet Body Length received on this port.
- **Last Frame Version** — Indicates the protocol version number attached to the most recently received EAPOL frame.
- **Last Frame Source** — Indicates the source MAC address attached to the most recently received EAPOL frame.

Displaying EAP statistics for a port

- 1 Open the **EAP Statistics** page.
- 2 Select an interface in the **Interface** field.
The interface EAP statistics are displayed.

To reset the EAP Statistics

- 1 Open the **EAP Statistics** page.
- 2 Click **Reset All Counters**.
The EAP statistics counters are reset.

Viewing EAP Statistics Using the CLI Commands

The following table summarizes the CLI commands for viewing EAP statistics.

Table 8-4. EAP Statistics CLI Commands

CLI Command	Description
show dot1x statistics	Displays 802.1X statistics for the specified interface.

The following is an example of the CLI commands:

```
console# show dot1x statistics ethernet 1/e1
EapolFramesRx: 11
EapolFramesTx: 12
EapolStartFramesRx: 1
EapolLogoffFramesRx: 1
EapolRespIdFramesRx: 3
EapolRespFramesRx: 6
EapolReqIdFramesTx: 3
EapolReqFramesTx: 6
InvalidEapolFramesRx: 0
EapLengthErrorFramesRx: 0
LastEapolFrameVersion: 1
LastEapolFrameSource: 0008.3b79.8787
```

Viewing RMON Statistics

Remote Monitoring (RMON) allows network managers to view network information from a remote location. To open the **RMON** page, click a link below to access on-line help for the indicated screen.

lick **Statistics/RMON**→ **RMON** in the tree view.

This section contains the following topics:

- "Viewing RMON Statistics Group" on page 420
- "Viewing RMON History Control Statistics" on page 423
- "Viewing the RMON History Table" on page 425
- "Defining Device RMON Events" on page 428
- "Viewing the RMON Events Log" on page 430
- "Defining RMON Device Alarms" on page 431

Viewing RMON Statistics Group

Use the **RMON Statistics** page view information about device utilization and errors that occurred on the device. To open the **RMON Statistics** page, click **Statistics/RMON**→ **RMON**→ **Statistics** in the tree view.

Figure 8-7. RMON Statistics

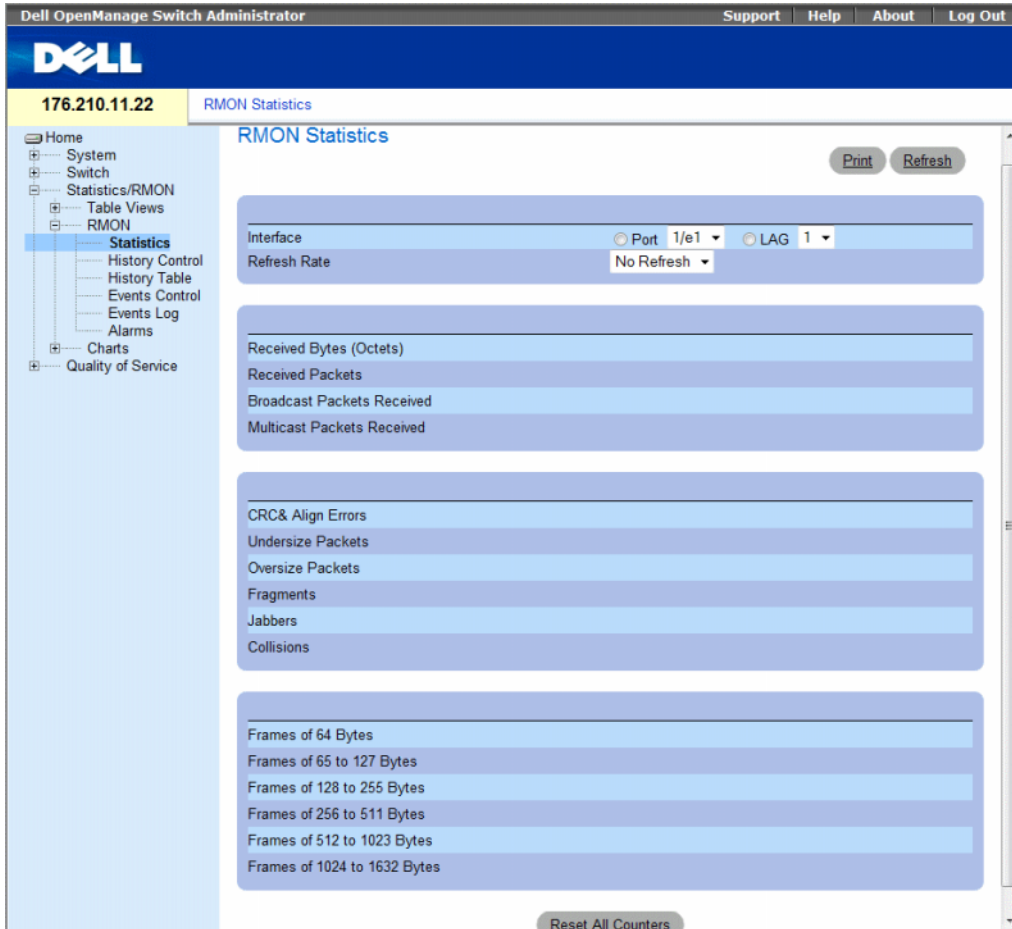

The RMON Statistics page contains the following fields:

- **Interface** — Specifies the port or LAG for which statistics are displayed.
- **Refresh Rate** — Amount of time that passes before the statistics are refreshed.
- **Received Bytes (Octets)** — Number of bytes received on the selected interface.
- **Received Packets** — Number of packets received on the selected interface.
- **Broadcast Packets Received** — Number of good Broadcast packets received on the interface since the device was last refreshed. This number does not include multicast packets.
- **Multicast Packets Received** — Number of good Multicast packets received on the interface since the device was last refreshed.

- **CRC & Align Errors** — Number of CRC and Align errors that have occurred on the interface since the device was last refreshed.
- **Undersize Packets** — Number of undersized packets (less than 64 octets) received on the interface since the device was last refreshed.
- **Oversize Packets** — Number of oversized packets (over 1632 octets) received on the interface since the device was last refreshed.
- **Fragments** — Number of fragments (packets with less than 64 octets, excluding framing bits, but including FCS octets) received on the interface since the device was last refreshed.
- **Jabbers** — Number of jabbers (packets longer than 1632 octets) received on the interface since the device was last refreshed.
- **Collisions** — Number of collisions received on the interface since the device was last refreshed.
- **Frames of *xx* Bytes** — Number of *xx*-byte frames transmitted and received on the interface since the device was last refreshed.

Viewing Interface Statistics

- 1 Open the **RMON Statistics** page.
- 2 Select an interface type and number in the **Interface** field.
The interface statistics are displayed.

Viewing RMON Statistics Using the CLI Commands

The following table contains the CLI commands for viewing RMON statistics.

Table 8-5. RMON Statistics CLI Commands

CLI Command	Description
<code>show rmon statistics {ethernet <i>interface</i> port-channel <i>port-channel-number</i>}</code>	Displays RMON Ethernet statistics.

The following is an example of the CLI commands:

```
console# show rmon statistics ethernet 1/e1
Port 1/e1
Dropped: 8
Octets: 878128 Packets: 978
Broadcast: 7 Multicast: 1
CRC Align Errors: 0 Collisions: 0
Undersize Pkts: 0 Oversize Pkts: 0
Fragments: 0 Jabbers: 0
64 Octets: 98 65 to 127 Octets: 0
128 to 255 Octets: 0 256 to 511 Octets: 0
512 to 1023 Octets: 491 1024 to 1632 Octets: 389
```

Viewing RMON History Control Statistics

The RMON History Control contains information about samples of data taken from ports. For example, the samples may include interface definitions or polling periods. To open the RMON History Control page, click **Statistics/RMON**→**RMON**→**History Control** in the tree view.

Figure 8-8. RMON History Control

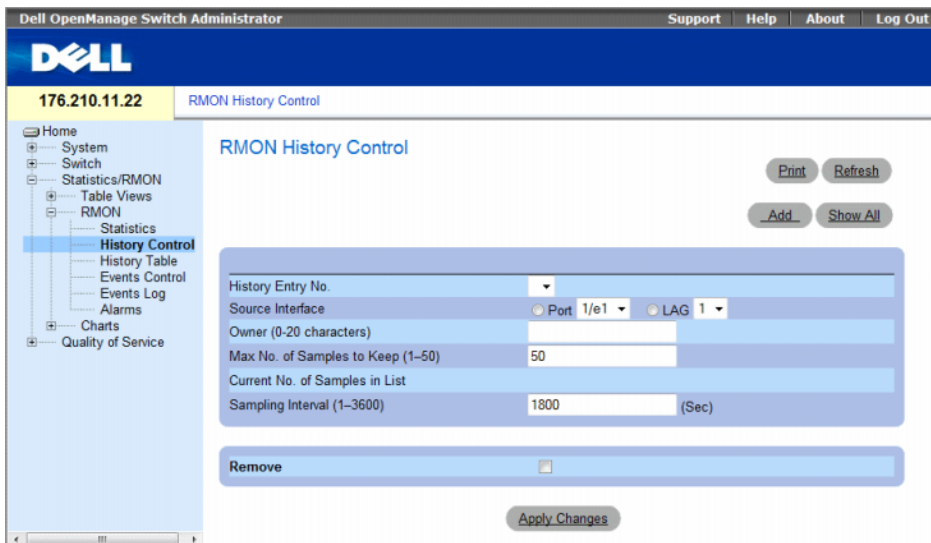

The **RMON History Control** page contains the following fields:

- **History Entry No.** — Entry number for the **History Control** page.
- **Source Interface** — Port or LAG from which the history samples were taken.
- **Owner (0-20 characters)** — RMON station or user that requested the RMON information.
- **Max No. of Samples to Keep (1-50)** — Number of samples to be saved. The default value is 50.
- **Current No. of Samples in List** — Indicates the current number of samples taken.
- **Sampling Interval (1-3600)** — Indicates the time interval in seconds, between what the samplings are taken from the ports. The possible values are 1-3600 seconds. The default is 1800 seconds (30 minutes).
- **Remove** — When checked, removes the **History Control Table** entry.

Adding a History Control Entry

- 1** Open the **RMON History Control** page.
- 2** Click **Add**.
- 3** Complete the fields in the dialog.
- 4** Click **Apply Changes**.

The **Add History Entry** page opens.

The entry is added to the **History Control Table**.

Modifying a History Control Table Entry

- 1** Open the **RMON History Control** page.
 - 2** Select an entry in the **History Entry No.** field.
 - 3** Modify the fields as desired
 - 4** Click **Apply Changes**.
- The table entry is modified, and the device is updated.

Deleting a History Control Table Entry

- 1** Open the **RMON History Control** page.
 - 2** Select an entry in the **History Entry No.** field.
 - 3** Click **Apply Changes**.
- The table entry is deleted, and the device is updated.

Viewing RMON History Control Using the CLI Commands

The following table contains the CLI commands for viewing RMON History Control.

Table 8-6. RMON History CLI Commands

CLI Command	Description
<code>rmon collection history <i>index</i> [owner <i>ownername</i> buckets <i>bucket-number</i>] [interval <i>seconds</i>]</code>	Enables and configures RMON on an interface.
<code>show rmon collection history [ethernet <i>interface</i> port-channel <i>port-channel-number</i>]</code>	Displays RMON collection history statistics.

The following is an example of the CLI commands:

```
console(config)# interface ethernet 1/e8
console(config-if)# rmon collection history 1 interval 2400
```

Viewing the RMON History Table

The RMON History Table contains interface specific statistical network samplings. Each table entry represents all counter values compiled during a single sample. To open the RMON History Table, click **Statistics/RMON**→ **RMON**→ **History Table** in the tree view.

Figure 8-9. RMON History Table

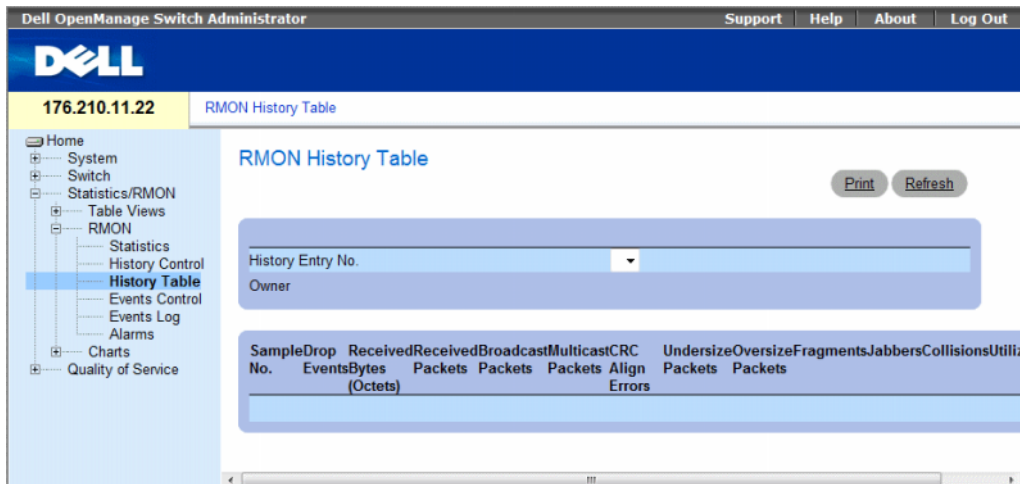

The **RMON History Table** page contains the following fields:

Not all fields are shown in the RMON History Table in the **RMON History Table** figure.

- **History Entry No.** — Specifies the entry number from the **History Control** page.
- **Owner** — Indicates the RMON station or user that requested the RMON information.
- **Sample No.** — Indicates the number of specific sample the information in the table reflects.
- **Drop Events** — The number of dropped packets due to lack of network resources during the sampling interval. This may not represent the exact number of dropped packets, but rather the number of times dropped packets were detected.
- **Received Bytes (Octets)**— The number of data octets, including bad packets, received on the network.
- **Received Packets** — The number of packets received during the sampling interval.
- **Broadcast Packets** — The number of good broadcast packets received during the sampling interval.
- **Multicast Packets** — The number of good multicast packets received during the sampling interval.
- **CRC Align Errors** — The number of packets received during the sampling session with a length 64-1632 octets. However, the packets has a bad packet Check Sequence (FCS) with an integral number of octets or a bad FCS with a non-integral number.
- **Undersize Packets** — The number of packets received less than 64 octets long during the sampling session.
- **Oversize Packets** — The number of packets received more than 1632 octets long during the sampling session.
- **Fragments** — The number of packets received less than 64 octets long and had a FCS during the sampling session.
- **Jabbers** — The number of packets received more than 1632 octets long and had a FCS during the sampling session.
- **Collisions** — Estimates the total number of packet collision that occurred during the sampling session. Collision are detected when repeater port detects two or more stations transmit simultaneously.
- **Utilization** — Estimates the main physical layer network usage on an interface during the session sampling. The value is reflected hundredths of percent.

Viewing Statistics for a Specific History Entry

- 1 Open the **RMON History Table**.
- 2 Select an entry in the **History Entry No.** field.

The entry statistics display in the RMON History Table.

Viewing RMON History Control Using the CLI Commands

The following table contains the CLI commands for viewing RMON history.

Table 8-7. RMON History Control CLI Commands

CLI Command	Description
<code>show rmon history <i>index</i> {throughput errors other} [period <i>seconds</i>]</code>	Displays RMON Ethernet statistics history.

The following is an example of the CLI commands for displaying RMON ethernet statistics for throughput on index 1:

```
console> enable
console# show rmon history 1 throughput
Sample Set: 50owner: cli
Interface: 24 interval: 10
Requested samples: 50 Granted samples: 50
Maximum table size: 270
Time                Octets PacketsBroadcast Multicast%
-----
09-Mar-2003 18:29:32 00      00          0
09-Mar-2003 18:29:42 00      00          0
09-Mar-2003 18:29:52 00      00          0
09-Mar-2003 18:30:02 00      00          0
09-Mar-2003 18:30:12 00      00          0
09-Mar-2003 18:30:22 00      00          0
```

Defining Device RMON Events

Use the RMON Events Control page to define RMON events. To open the RMON Events Control page, click Statistics/RMON→ RMON→ Events Control in the tree view.

Figure 8-10. RMON Events Control

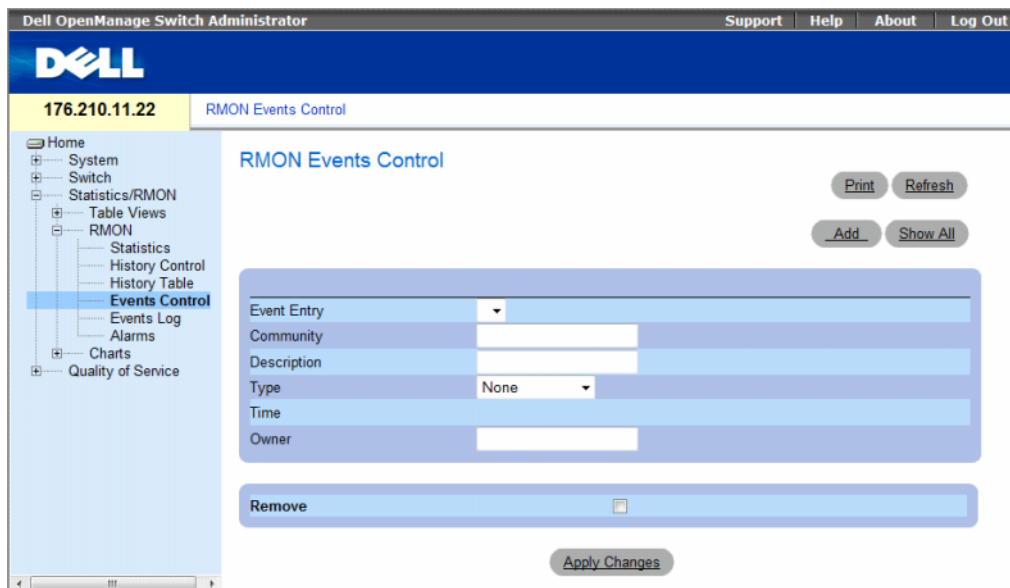

The RMON Events Control page contains the following fields:

- **Event Entry** — Indicates the event.
- **Community** — Community to which the event belongs.
- **Description** — User-defined event description.
- **Type** — Describes the event type. Possible values are:
 - **Log** — Event type is a log entry.
 - **Trap** — Event type is a trap.
 - **Log and Trap** — Event type is both a log entry and a trap.
 - **None** — There is no event.
- **Time** — Time when the event occurred.
- **Owner** — The device or user that defined the event.
- **Remove** — When checked, removes the event from the RMON Events Table.

Adding a RMON Event

- 1 Open the RMON Events Control page.
- 2 Click Add.
The Add an Event Entry page opens.
- 3 Complete the information in the dialog and click Apply Changes.
The Event Table entry is added, and the device is updated.

Modifying a RMON Event

- 1 Open the RMON Events Control page
- 2 Select an entry in the Event Table.
- 3 Modify the fields in the dialog and click Apply Changes.
The Event Table entry is modified, and the device is updated.

Deleting RMON Event Entries

A single event entry can be removed from the RMON Events Control page by checking the Remove check box on that page.

- 1 Open the RMON Events Control page.
- 2 Click Show All.
The RMON Events Table page opens.
- 3 Check the Remove checkbox for the event(s) that needs to be deleted and then click Apply Changes.
The table entry is deleted, and the device is updated.

Defining Device Events Using the CLI Commands

The following table contains the CLI commands for defining device events.

Table 8-8. Device Event Definition CLI Commands

CLI Command	Description
<code>rmon event <i>index type</i> [<i>community text</i>] [<i>description text</i>] [<i>owner name</i>]</code>	Configures RMON events.
<code>show rmon events</code>	Displays RMON event table.

The following is an example of the CLI commands:

```
console(config)# rmon event 1 log
console(config)# exit
console# show rmon events
```

Index	Description	Type	Community	Owner	Last Time Sent
1	Errors	Log		CLI	Jan 18 2002 23:58:17
2	High Broadcast	Log-Trap	router	Manager	Jan 18 2002 23:59:48

Viewing the RMON Events Log

The RMON Events Log page contains a list of RMON events. To open the RMON Events Log page, click **Statistics/RMON**→ **RMON**→ **Events Log** in the tree view.

Figure 8-11. RMON Events Log

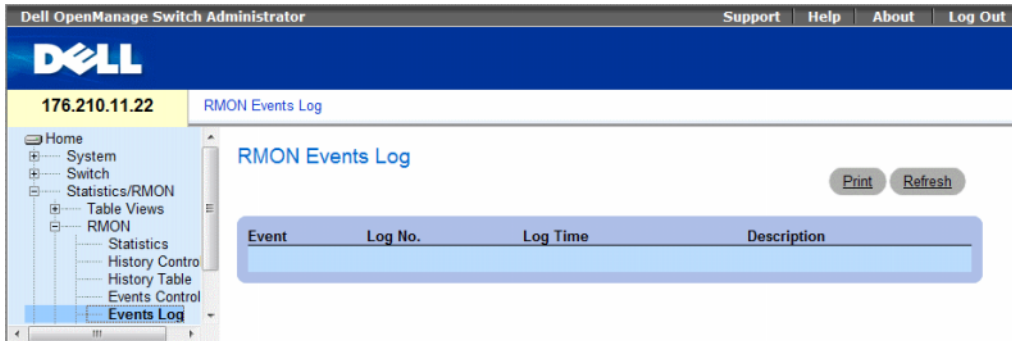

The RMON Events Log page contains the following fields:

- **Event** — The RMON Events Log entry number.
- **Log No.**— The log number.
- **Log Time** — Time when the log entry was entered.
- **Description** — Describes the log entry.

Defining Device Events Using the CLI Commands

The following table contains the CLI commands for defining device events.

Table 8-9. Device Event Definition CLI Commands

CLI Command	Description
<code>show rmon log [event]</code>	Displays the RMON logging table.

The following is an example of the CLI commands:

```
console(config)# rmon event 1 log
Console> show rmon log
Maximum table size: 500
Event Description      Time
-----
1      Errors           Jan 18 2002 23:58:17
2      High Broadcast      Jan 18 2002 23:59:48
```

Defining RMON Device Alarms

Use the **RMON Alarms** page to set network alarms. Network alarms occur when a network problem, or event, is detected. Rising and falling thresholds generate events. For more information about events, see "Viewing the RMON Events Log."

To open the **RMON Alarms** page, click **Statistics/RMON**→ **RMON**→ **Alarms** in the tree view.

Figure 8-12. RMON Alarms

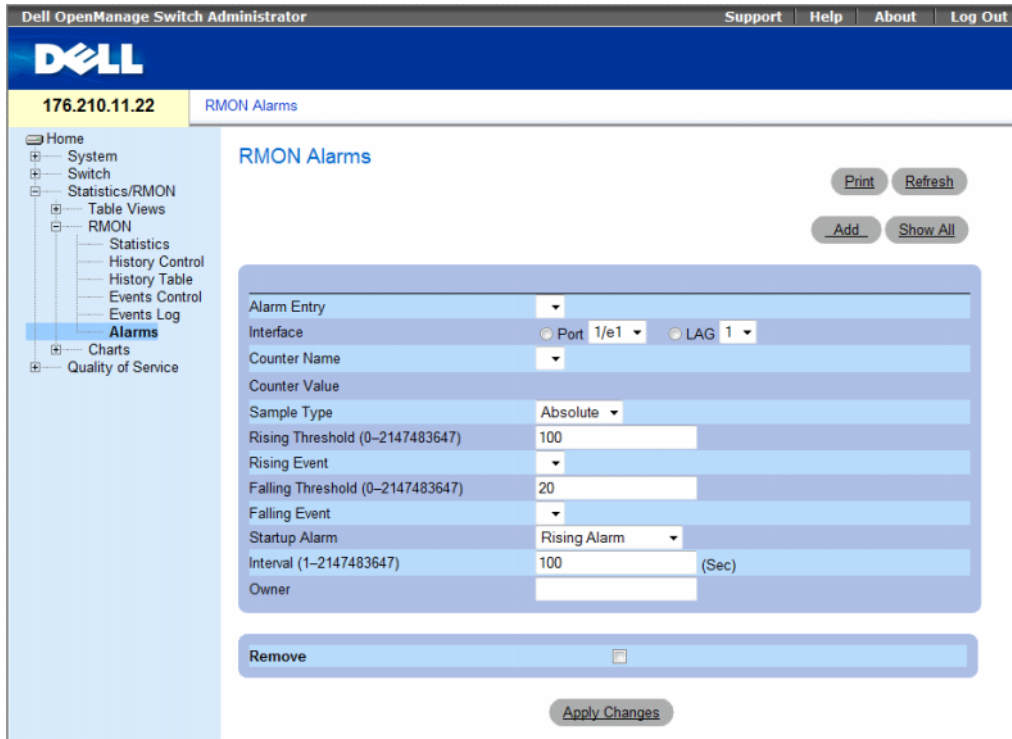

The RMON Alarms page contains the following fields:

- **Alarm Entry** — Indicates a specific alarm.
- **Interface** — Indicates the interface for which RMON statistics are displayed.
- **Counter Name** — Indicates the selected MIB variable.
- **Counter Value** — The value of the selected MIB variable.
- **Sample Type** — Specifies the sampling method for the selected variable and comparing the value against the thresholds. The possible field values are:
 - **Delta** — Subtracts the last sampled value from the current value. The difference in the values is compared to the threshold.
 - **Absolute** — Compares the values directly with the thresholds at the end of the sampling interval.
- **Rising Threshold (0-2147483647)** — The rising counter value that triggers the rising threshold alarm. The rising threshold is presented on top of the graph bars. Each monitored variable is designated a color. The field default is 100 seconds.

- **Rising Event** — The mechanism in which the alarms are reported including a log, a trap, or both. When a log is selected, there is no saving mechanism either in the device or in the management system. However, if the device is not being reset, it remains in the device Log table. If a trap is selected, an SNMP trap is generated and reported via the Trap mechanism. The trap can be saved using the same mechanism.
- **Falling Threshold (0–2147483647)** — The falling counter value that triggers the falling threshold alarm. The falling threshold is graphically presented on top of the graph bars. Each monitored variable is designated a color. The field default is 20.
- **Startup Alarm** — The trigger that activates the alarm generation. Rising is defined by crossing the threshold from a low-value threshold to a higher-value threshold.
- **Interval (1–2147483647) (sec)** — Alarm interval time. The field default is 100 seconds.
- **Owner** — Device or user that defined the alarm.
- **Remove** — When checked, removes an RMON Alarm.

Adding an Alarm Table Entry

- 1 Open the RMON Alarms page.
- 2 Click Add.

The Add an Alarm Entry page opens.

Figure 8-13. Add an Alarm Entry Page

- 3 Select an interface.
- 4 Complete the fields.
- 5 Click **Apply Changes**.

The RMON alarm is added, and the device is updated.

Modifying an Alarm Table Entry

- 1 Open the **RMON Alarms** page.
- 2 Select an entry in the **Alarm Entry** drop-down menu.
- 3 Modify the fields.
- 4 Click **Apply Changes**.

The entry is modified, and the device is updated.

Displaying the Alarm Table

- 1 Open the **RMON Alarms** page.
- 2 Click **Show All**.

The **Alarms Table** opens.

Deleting an Alarm Table Entry

- 1 Open the **RMON Alarms** page.
- 2 Select an entry in the **Alarm Entry** drop-down menu.
- 3 Check the **Remove** check box.
- 4 Click **Apply Changes**.

The entry is deleted, and the device is updated.

Defining Device Alarms Using the CLI Commands

The following table contains the CLI commands for defining device alarms.

Table 8-10. Device Alarm CLI Commands

CLI Command	Description
<code>rmon alarm index MIB_Object_ID interval rthreshold fthreshold revent fevent [type type] [startup direction] [owner name]</code>	Configures RMON alarm conditions.
<code>show rmon alarm-table</code>	Displays summary of the alarm table.
<code>show rmon alarm</code>	Displays the RMON alarm configuration.

The following is an example of the CLI commands:

```
console(config)# rmon alarm 1000 1.3.6.1.2.1.2.2.1.10.1 360000
1000000 1000000 10 20

Console# show rmon alarm-table

Index                                OID                                Owner
-----                                -
11.3.6.1.2.1.2.2.1.10.1             CLI
21.3.6.1.2.1.2.2.1.10.1             Manager
31.3.6.1.2.1.2.2.1.10.9             CLI
```

Viewing Charts

The **Chart** page contains links for displaying statistics in a chart form. To open the page, click **Statistics**→**Charts** in the tree view.

This section contains the following topics:

- "Viewing Port Statistics" on page 436
- "Viewing LAG Statistics" on page 437
- "Viewing the CPU Utilization" on page 439
- "Viewing CPU Utilization Using CLI Commands" on page 440

Viewing Port Statistics

Use the **Port Statistics** page to open statistics in a chart form for port elements. To open the **Port Statistics** page, click **Statistics/RMON**→ **Charts**→ **Port Statistics** in the tree view.

Figure 8-14. Port Statistics

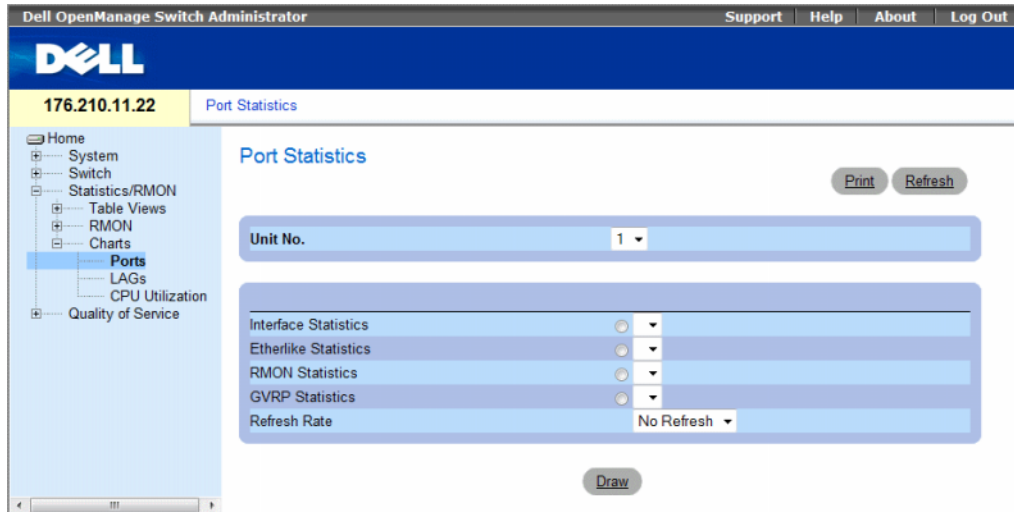

The **Port Statistics** page contains the following fields:

- **Unit No.** — Indicates the stacking unit for which the statistics are displayed.
- **Interface Statistics** — Selects the interface statistics to display.
- **Etherlike Statistics** — Selects the Etherlike statistics to display.
- **RMON Statistics** — Selects the RMON statistics to display.
- **GVRP Statistics** — Selects the GVRP statistics type to display.
- **Refresh Rate** — Amount of time that passes before the statistics are refreshed.

Displaying Port Statistics

- 1 Open the **Port Statistics** page.
- 2 Select the statistic type of to open.
- 3 Select the desired refresh rate from the **Refresh Rate** drop-down menu.
- 4 Click **Draw**.

The graph for the selected statistic is displayed.

Viewing Port Statistics Using the CLI Commands

The following table contains the CLI commands for viewing port statistics.

Table 8-11. Port Statistic CLI Commands

CLI Command	Description
<code>show interfaces counters [ethernet interface port-channel port-channel-number]</code>	Displays traffic seen by the physical interface.
<code>show rmon statistics { ethernet interface port-channel port-channel-number }</code>	Displays RMON Ethernet statistics.
<code>show gvrp statistics { ethernet interface port-channel port-channel-number }</code>	Displays GVRP statistics.
<code>show gvrp-error statistics { ethernet interface port-channel port-channel-number }</code>	Displays GVRP error statistics.

Viewing LAG Statistics

Use the LAG Statistics page to open statistics in a chart form for LAGs. To open the LAG Statistics page, click Statistics/RMON→ Charts→ LAG Statistics in the tree view.

Figure 8-15. LAG Statistics

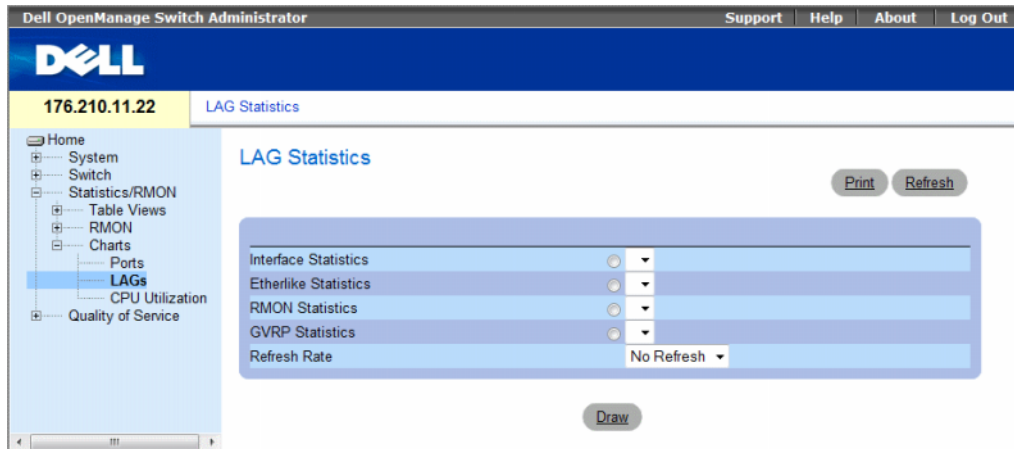

The **LAG Statistics** page contains the following fields:

- **Interface Statistics** — Selects the interface statistics to display.
- **Etherlike Statistics** — Selects the Etherlike statistics to display.
- **RMON Statistics** — Selects the RMON statistics to display.
- **GVRP Statistics** — Selects the GVRP statistics type to display.
- **Refresh Rate** — Amount of time that passes before the statistics are refreshed.

Displaying LAG Statistics

- 1 Open the **LAG Statistics** page.
- 2 Select the statistic type to open.
- 3 Select the desired refresh rate from the **Refresh Rate** drop-down menu.
- 4 Click **Draw**.

The graph for the selected statistic is displayed.

Viewing LAG Statistics Using the CLI Commands

The following table contains the CLI commands for viewing LAG statistics.

Table 8-12. LAG Statistic CLI Commands

CLI Command	Description
<code>show interfaces counters [ethernet interface port-channel port-channel-number]</code>	Displays traffic seen by the physical interface.
<code>show rmon statistics { ethernet interface port-channel port-channel-number }</code>	Displays RMON Ethernet statistics.
<code>show gvrp statistics { ethernet interface port-channel port-channel-number }</code>	Displays GVRP statistics.
<code>show gvrp-error statistics { ethernet interface port-channel port-channel-number }</code>	Displays GVRP error statistics.

Viewing the CPU Utilization

The CPU Utilization page contains information about the system's CPU utilization and percentage of CPU resources consumed by each stacking member. Each stacking member is assigned a color on the graph.

To open the CPU Utilization page, click **Statistics/RMON**→**Charts**→**CPU Utilization** in the tree view.

Figure 8-16. CPU Utilization

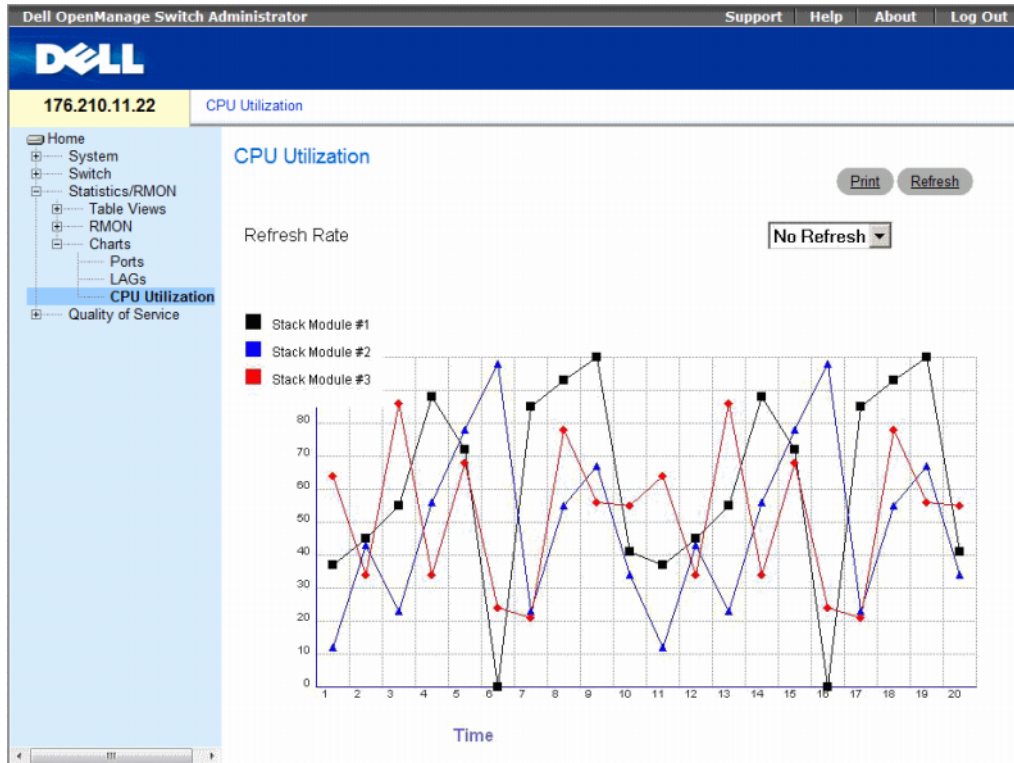

The CPU Utilization page contains the following information:

- **Refresh Rate** — Amount of time that passes before the statistics are refreshed.

Viewing CPU Utilization Using CLI Commands

The following table summarizes the equivalent CLI commands for viewing CPU utilization.

Figure 8-17. CPU Utilization CLI Commands

CLI Command	Description
<code>show cpu utilization</code>	To display the CPU utilization.

The following is an example of the CLI commands:

```
Console# show cpu utilization
CPU utilization service is on.

CPU utilization
-----
five seconds: 5%; one minute: 3%; five minutes: 3%
```

Configuring Quality of Service

This section provides information for defining and configuring Quality of Service (QoS) parameters. To open the **Quality of Service** page, click **Quality of Service** in the tree view.

This section contains the following topics:

- "Quality of Service (QoS) Overview" on page 441
- "Configuring QoS Global Settings" on page 443

Quality of Service (QoS) Overview

Quality of Service (QoS) provides the ability to implement QoS and priority queuing within a network. An implementation example that requires QoS includes certain types of traffic such as Voice, Video and real-time traffic, which can be assigned a high priority queue, while other traffic can be assigned a lower priority queue. The result is an improved traffic flow for traffic with high demand.

QoS is defined by:

- **Classification** — Specifies which packet fields are matched to specific values. All packets matching the user-defined specifications are classified together.
- **Action** — Defines traffic management where packets being forwarded are based on packet information, and packet field values such as VLAN priority tag (VPT) and DSCP (DiffServ Code Point).

VPT Classification Information

VLAN Priority Tags are used to classify the packets by mapping packets to one of the egress queues. VLAN Priority Tag to queue assignments are user-definable. The table below details the VPT to queue default settings:

Table 9-1. CoS to Queue Mapping Table Default values

CoS Value	Forwarding Queue Values
0	q2
1	q1 (Lowest Priority)
2	q1 (Lowest Priority)
3	q2
4	q3

Table 9-1. CoS to Queue Mapping Table Default values (continued)

CoS Value	Forwarding Queue Values
5	q3
6	q4
7	q4

Packets arriving untagged are assigned a default VPT value, which is set on a per port basis. The assigned VPT is used to map the packet to the egress queue.

DSCP values can be mapped to priority queues. The following table contains the default DSCP mapping to egress queue values:

Table 9-2. DSCP to Queue Mapping Table Default Values

DSCP Value	Forwarding Queue Values
0-15	q1 (Lowest Priority)
16-31	q2
32-47	q3
48-63	q4

DSCP mapping is enabled on a per-system basis.

This section contains the following topics:

- "CoS Services" on page 442

CoS Services

After packets are assigned to a specific egress queue, CoS services can be assigned to the queue(s). Egress queues are configured with a scheduling scheme by one of the following methods:

- **Strict Priority** — Ensures that time-sensitive applications are always forwarded. Strict Priority (SP) allows the prioritization of mission-critical, time-sensitive traffic over less time-sensitive applications. For example, under Strict Priority, voice over IP traffic can be prioritized so the IP traffic is forwarded before FTP or e-mail (SMTP) traffic.
- **Weighted Round Robin** — Ensures that a single application does not dominate the device forwarding capacity. Weighted Round Robin (WRR) forwards entire queues in a Round Robin order. All queues can be configured to WRR or SP queues. If WRR is selected, the following weights are assigned to the queues: 1, 2, 4, 8.

Configuring QoS Global Settings

Quality of Service (QoS) provides the ability to implement QoS and priority queuing within a network.

The **Global Settings** page contains a field for enabling or disabling QoS. It also contains a field for selecting the Trust mode. The Trust mode relies on predefined fields within the packet to determine the egress queue.

In addition, the **Global Settings** page enables defining queues as either Strict Priority (SP) or Weighted Round Robin (WRR).

To open the **Global Settings** page, click **Quality of Service** → **QoS Parameters** → **Global Settings** in the tree view.

Figure 9-1. Global Settings

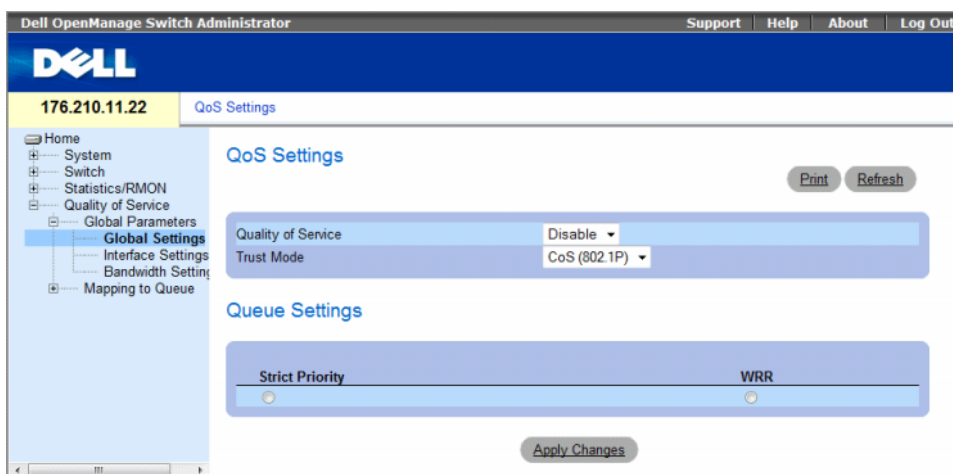

The **Global Settings** page contains the following sections:

- QoS Settings
- Queue Settings

QoS Settings

- **Quality of Service** — Enables or disables managing network traffic using Quality of Service.
- **Trust Mode** — Determines which packet fields are used to classify packets entering the device. When no rules are defined, the traffic containing the predefined CoS or DSCP packet field is mapped according to the selected trust mode. Traffic not containing a predefined packet field is mapped to the best effort queue (q2). The possible Trust Mode field values are:
 - **CoS (802.1p)** — The egress queue assignment is determined by the IEEE802.1p VLAN priority tag (VPT) or by the default VPT assigned to a port. The device default is the IEEE802.1p.
 - **DSCP** — The egress queue assignment is determined by the DSCP field.



NOTE: The interface Trust settings overrides the global Trust setting.

Queue Settings

- **Strict Priority** — Indicates the system queues are SP queues, when selected.
- **WRR** — Indicates the system queues are WRR queues, when selected.

Enabling Quality of Service:

- 1 Open the **Global Settings** page.
- 2 Select **Enable** in the **Quality of Service** field.
- 3 Click **Apply Changes**.
Class of Service is enabled on the device.

Enabling the Trust Mode:

- 1 Open the **Global Settings** page.
- 2 Define the **Trust Mode** field.
- 3 Click **Apply Changes**.
Trust mode is enabled on the device.

Enabling Trust Using the CLI Commands

The following table summarizes the equivalent CLI commands for configuring fields in the **Global Settings** page.

Table 9-3. QoS Settings CLI Commands

CLI Command	Description
<code>qos trust [cos dscp]</code>	Configures the system to trust mode.
<code>no qos trust</code>	Returns to the non-trusted state.

The following is an example of the CLI commands:

```
console(config)# qos trust dscp
```

This section contains the following topics:

- "Defining QoS Interface Settings" on page 445
- "Defining Bandwidth Settings" on page 446
- "Mapping CoS Values to Queues" on page 448
- "Mapping DSCP Values to Queues" on page 450

Defining QoS Interface Settings

The **Interface Settings** page contains fields for deactivating the Trust mode, and setting the default CoS value on incoming untagged packets. To open the **Interface Settings** page, click **Quality of Service** → **QoS Parameters** → **Interface Settings** in the tree view.

Figure 9-2. Interface Settings

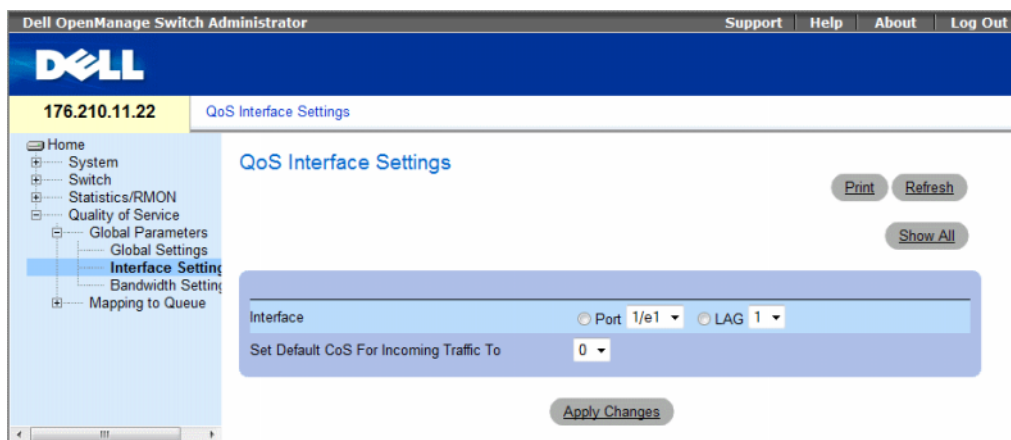

The **Interface Settings** page contains the following fields:

- **Interface** — The specific port or LAG to configure.
- **Disable "Trust" Mode on Interface** — Disables Trust mode on the specified interface. This setting overrides the Trust mode configured on the device globally.
- **Set Default CoS For Incoming Traffic To** — Sets the default CoS tag value for untagged packets. The CoS tag values are 0-7. The default value is 0.

Assigning QoS settings for an interface:

- 1 Open the **Interface Settings** page.
- 2 Select an interface in the **Interface** field.
- 3 Define the fields.
- 4 Click **Apply Changes**.
The CoS settings are assigned to the interface.

Displaying QoS/CoS settings:

- 1 Open the **Interface Settings** page.
- 2 Click **Show All**.
The Interface Table is displayed.

Assigning QoS Interfaces Using the CLI Commands

The following table summarizes the equivalent CLI commands for configuring fields in the **Interface Settings** page.

Table 9-4. QoS Interface CLI Commands

CLI Command	Description
qos trust	Enables the trust mode.
no qos trust	Disables Trust state on each port.

The following is an example of the CLI commands:

```
console(config)# interface ethernet 1/e15
console(config-if)# qos trust
```

Defining Bandwidth Settings

The **Bandwidth Settings** page contains fields for defining the bandwidth settings for a specified egress interface. Modifying queue scheduling affects the queue settings globally. Queue shaping can be based per queue and/or per interface. Shaping is determined by the lower specified value. The queue shaping type is selected in the Bandwidth Settings Page, click **Quality of Service** → **CoS Global Parameters** → **Bandwidth Settings** in the tree view.

Figure 9-3. Bandwidth Settings

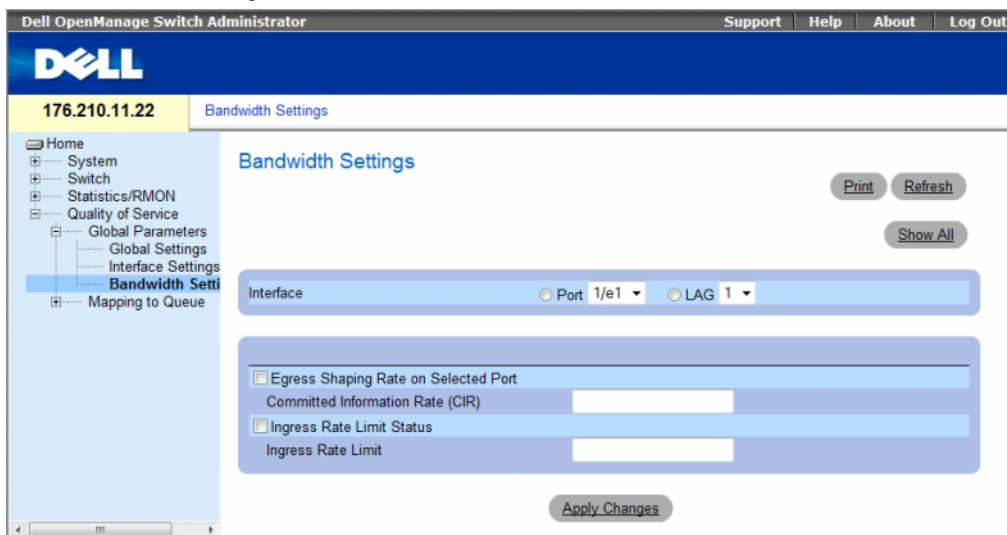

- **Interface** — Indicates the port or LAG that is being displayed.
- **Egress Shaping Rate on Selected Port** — Indicates the Egress traffic limit status for the interface.
 - *Checked* — The Egress traffic limit is enabled.
 - *Not Checked* — The Egress traffic limit is disabled.
- **Committed Information Rate (CIR)** — Defines the Egress CIR traffic limit for the interface.
- **Ingress Rate Limit Status** — Indicates the Ingress traffic limit status for the interface.
 - *Checked* — The Ingress traffic limit is enabled.
 - *Not Checked* — The Ingress traffic limit is disabled.
- **Ingress Rate Limit** — Defines the Ingress traffic limit for the interface.

Assigning bandwidth settings for an interface:

- 1 Open the **Bandwidth Settings** page.
- 2 Select an interface in the **Interface** field.
- 3 Define the fields.
- 4 Click **Apply Changes**.

The bandwidth settings are assigned to the interface.

Displaying the Bandwidth Settings Table:

- 1 Open the **Bandwidth Settings** page.
- 2 Click **Show All**.

The Bandwidth Settings Table opens.

Figure 9-4. Bandwidth Settings Table

Port Bandwidth Settings Table Refresh

Unit No. 1 ▾

Interface	Ingress Rate Limit Status	Rate Limit	Egress Shaping Rates Status	CIR
1	Enable	102400	Enable	64

Apply Changes

Assigning Bandwidth Settings Using the CLI Commands

The following table summarizes the equivalent CLI commands for configuring fields in the **Bandwidth Settings** page.

Table 9-5. Bandwidth Settings CLI Commands

CLI Command	Description
traffic-shape <i>committed-rate</i> [<i>committed-burst</i>]	Set shaper on egress port. Use no form in order to disable the shaper.
no traffic-shape	
rate-limit <i>rate</i>	Limit the rate of the incoming traffic. Use the no form to disable rate limit.
no rate-limit	

Mapping CoS Values to Queues

The CoS to Queue page contains fields for classifying CoS settings to traffic queues. To open the **CoS to Queue** page, click **Quality of Service**→**QoS Mapping**→**CoS to Queue** in the tree view.

Figure 9-5. CoS to Queue

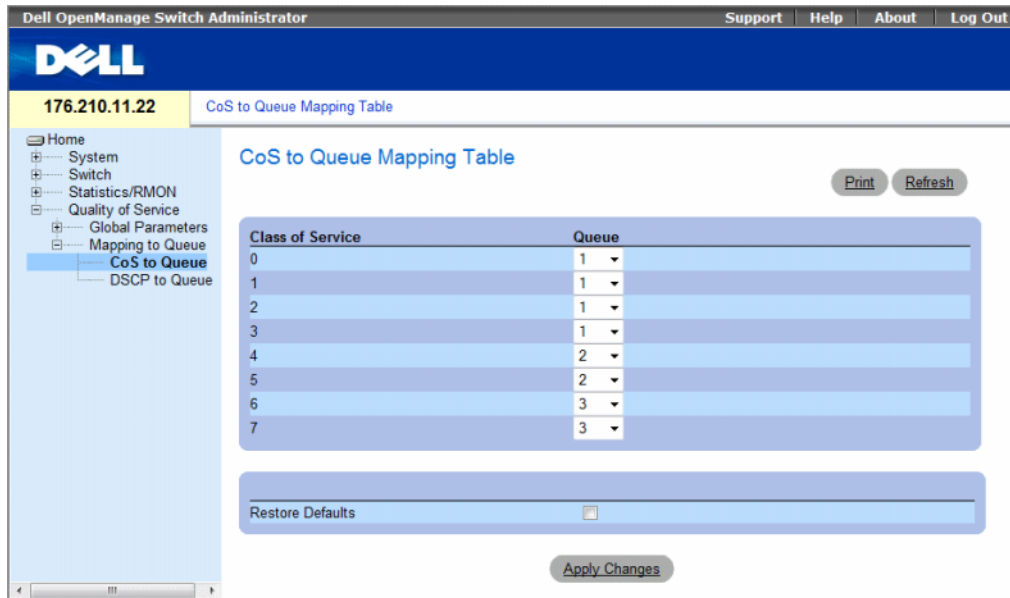

The CoS to **Queue** page contains the following fields:

- **Class of Service** — Specifies the CoS priority tag values, where zero is the lowest and 7 is the highest.
- **Queue** — The queue to which the CoS priority is mapped. Four traffic priority queues are supported.
- **Restore Defaults** — Restores the device factory defaults for mapping CoS values to an egress queue.

Mapping a CoS Value to a Queue

- 1 Open the CoS to **Queue** page.
- 2 Select a CoS entry.
- 3 Define the queue number in the **Queue** field.
- 4 Click **Apply Changes**.

The CoS value is mapped to an egress queue, and the device is updated.

Assigning CoS Values to Queues Using the CLI Commands

The following table summarizes the equivalent CLI commands for configuring fields in the CoS to **Queue** page.

Table 9-6. CoS to Queue Settings CLI Commands

CLI Command	Description
<code>wrr-queue cos-map <i>queue-id</i> <i>cos0.cos7</i></code>	Maps assigned CoS values to the egress queues.

The following is an example of the CLI commands:

```
console(config)# wrr-queue cos-map 4 7
```

Mapping DSCP Values to Queues

The DSCP to Queue page provides fields for defining egress queue to specific DSCP fields. To open the DSCP to Queue page, click **Quality of Service** → **QoS Mapping** → **DSCP to Queue** in the tree view.

Figure 9-6. DSCP to Queue

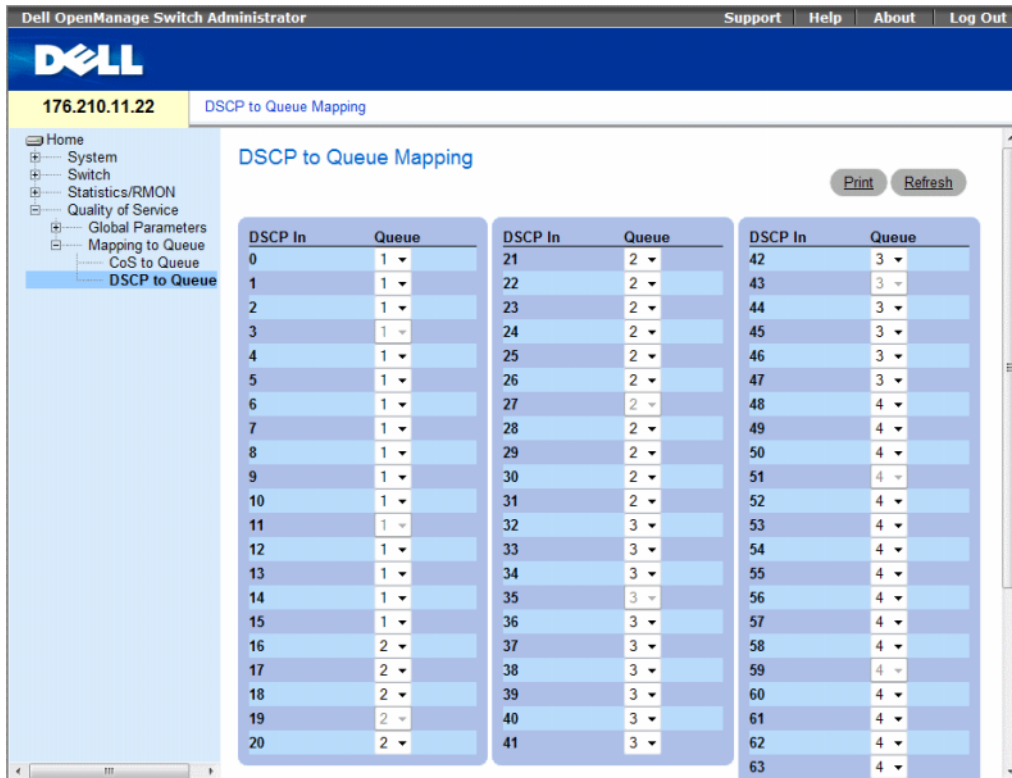

The DSCP to Queue page contains the following fields:

- **DSCP In** — The values of the DSCP field within the incoming packet.
- **Queue** — The queue to which packets with the specific DSCP value is assigned. The values are 1-4, where 1 is the lowest value and 4 is the highest.
- **Restore Defaults** — Restores the device factory defaults for mapping CoS values to an egress queue.

Mapping a DSCP Value and Assigning a Priority Queue

- 1 Open the DSCP to Queue page.
- 2 Select a value in the DSCP In column.
- 3 Define the Queue field.
- 4 Click Apply Changes.

The DSCP is overwritten, and the value is assigned an egress queue.

Assigning DSCP Values Using the CLI Commands

The following table summarizes the equivalent CLI commands for configuring fields in the DSCP to Queue page.

Table 9-7. DSCP Value to Queue CLI Commands

CLI Command	Description
<code>qos map dscp-queue <i>dscp-list</i> to <i>queue-id</i></code>	Modifies the DSCP to queue mapping.

The following is an example of the CLI commands:

```
console(config)# qos map dscp-queue 33 40 41 to 1
```

Glossary

This glossary contains key technical words of interest.

A B C D E F G H I L M N O P Q R S T U V W

A

Access Mode

Specifies the method by which user access is granted to the system.

Access Profiles

Allows network managers to define profiles and rules for accessing the switch module. Access to management functions can be limited to user groups, which are defined by the following criteria:

- Ingress interfaces
- Source IP address or Source IP subnets

ACL

Access Control List. Allow network managers to define classification actions and rules for specific ingress ports.

Aggregated VLAN

Groups several VLANs into a single aggregated VLAN. Aggregating VLANs enables routers to respond to ARP requests for nodes located on different sub-VLANs belonging to the same Super VLAN. Routers respond with their MAC address.

ARP

Address Resolution Protocol. A protocol that converts IP addresses into physical addresses.

ASIC

Application Specific Integrated Circuit. A custom chip designed for a specific application.

Asset Tag

Specifies the user-defined switch module reference.

Authentication Profiles

Sets of rules which that enables login to and authentication of users and applications.

Auto-negotiation

Allows 10/100 Mbps or 10/100/1000 Mbps Ethernet ports to establish for the following features:

- Duplex/ Half Duplex mode
- Flow Control
- Speed

B

Back Pressure

A mechanism used with Half Duplex mode that enables a port not to receive a message.

Backplane

The main BUS that carries information in the switch module.

Backup Configuration Files

Contains a backup copy of the switch module configuration. The Backup file changes when the Running Configuration file or the Startup configuration file is copied to the Backup file.

Bandwidth

Bandwidth specifies the amount of data that can be transmitted in a fixed amount of time. For digital switch modules, bandwidth is defined in Bits per Second (bps) or Bytes per Second.

Bandwidth Assignments

The amount of bandwidth assigned to a specific application, user, or interface.

Baud

The number of signaling elements transmitted each second.

Best Effort

Traffic is assigned to the lowest priority queue, and packet delivery is not guaranteed.

Boot Version

The boot version.

BootP

Bootstrap Protocol. Enables a workstation to discover its IP address, an IP address of a BootP server on a network, or a configuration file loaded into the boot of a switch module.

BPDU

Bridge Protocol Data Unit. Provide bridging information in a message format. BPDUs are sent across switch module information with in Spanning Tree configuration. BPDU packets contain information on ports, addresses, priorities, and forwarding costs.

Bridge

A device that connect two networks. Bridges are hardware specific, however they are protocol independent. Bridges operate at Layer 1 and Layer 2 levels.

Broadcast Domain

device sets that receive broadcast frames originating from any device within a designated set. Routers bind Broadcast domains, because routers do not forward broadcast frames.

Broadcasting

A method of transmitting packets to all ports on a network.

Broadcast Storm

An excessive amount of broadcast messages simultaneously transmitted across a network by a single port. Forwarded message responses are heaped onto the network, overloading network resources or causing the network to time out.

For more information about broadcast storms, see "Defining LAG Parameters" on page 304.

C

CDB

Configuration Data Base. A file containing a device's configuration information.

Class of Service

Class of Service (CoS). Class of Service is the 802.1p priority scheme. CoS provides a method for tagging packets with priority information. A CoS value between 0-7 is added to the Layer II header of packets, where zero is the lowest priority and seven is the highest.

A overlapping transmission of two or more packets that collide. The data transmitted cannot be used, and the session is restarted.

CLI

Command Line Interface. A set of line commands used to configure the system. For more information on using the CLI, see **Using the CLI**.

Communities

Specifies a group of users which retains the same system access rights.

CPU

Central Processing Unit. The part of a computer that processes information. CPUs are composed of a control unit and an ALU.

D

DHCP Client

A device using DHCP to obtain configuration parameters, such as a network address.

DHCP Snooping

DHCP Snooping expands network security by providing firewall security between untrusted interfaces and DHCP servers.

DSCP

DiffServe Code Point (DSCP). DSCP provides a method of tagging IP packets with QoS priority information.

Domain

A group of computers and devices on a network that are grouped with common rules and procedures.

DRAC/MC

DRAC/MC. Provides a single point of control for Dell Modular Server System components.

Duplex Mode

Permits simultaneous transmissions and reception of data. There are two different types of duplex mode:

- **Full Duplex Mode** — Permits for bisynchronous communication, for example, a telephone. Two parties can transmit information at the same time.
- **Half Duplex Mode** — Permits asynchronous communication, for example, a walkie-talkie. Only one party can transmit information at a time.

Dynamic VLAN Assignment (DVA)

- Allows automatic assignment of users to VLANs during the RADIUS server authentication. When a user is authenticated by the RADIUS server, the user is automatically joined to the VLAN configured on the RADIUS server.

E

Egress Ports

Ports from which network traffic is transmitted.

End System

An end user device on a network.

Ethernet

Ethernet is standardized as per IEEE 802.3. Ethernet is the most common implemented LAN standard. Supports data transfer rates of Mbps, where 10, 100 or 1000 Mbps is supported.

EWS

Embedded Web Server. Provides device management via a standard web browser. Embedded Web Servers are used in addition to or in place of a CLI or NMS.

F

FFT

Fast Forward Table. Provides information about forwarding routes. If a packet arrives to a device with a known route, the packet is forwarded via a route listed in the FFT. If there is not a known route, the CPU forwards the packet and updates the FFT.

FIFO

First In First Out. A queuing process where the first packet in the queue is the first packet out of the packet.

Flapping

Flapping occurs when an interfaces state is constantly changing. For example, an STP port constantly changes from listening to learning to forwarding. This may cause traffic loss.

Flow Control

Enables lower speed devices to communicate with higher speed devices, that is, that the higher speed device refrains from sending packets.

Fragment

Ethernet packets smaller than 576 bits.

Frame

Packets containing the header and trailer information required by the physical medium.

G

GARP

General Attributes Registration Protocol. Registers client stations into a Multicast domain.

Gigabit Ethernet

Gigabit Ethernet transmits at 1000 Mbps, and is compatible with existing 10/100 Mbps Ethernet standards.

GVRP

GARP VLAN Registration Protocol. Registers client stations into a VLANs.

H

HOL

Head of Line. Packets are queued. Packets at the head of the queue are forwarded before packets at the end of the line.

Host

A computer that acts as a source of information or services to other computers.

HTTP

HyperText Transport Protocol. Transmits HTML documents between servers and clients on the internet.

I

IC

Integrated Circuit. Integrated Circuits are small electronic devices composed from semiconductor material.

ICMP

Internet Control Message Protocol. Allows gateway or destination host to communicate with a source host, for example, to report a processing error.

IEEE

Institute of Electrical and Electronics Engineers. An Engineering organization that develops communications and networking standards.

IEEE 802.1d

Used in the Spanning Tree Protocol, IEEE 802.1d supports MAC bridging to avoid network loops.

IEEE 802.1p

Prioritizes network traffic at the data-link/MAC sublayer.

IEEE 802.1Q

Defines the operation of VLAN Bridges that permit the definition, operation, and administration of VLANs within Bridged LAN infrastructures.

IGMP Snooping

IGMP Snooping examines IGMP frame contents, when they are forwarded by the device from work stations to an upstream Multicast router. From the frame, the device identifies work stations configured for Multicast sessions, and which Multicast routers are sending Multicast frames.

Image File

System images are saved in two Flash sectors called images (Image 1 and Image 2). The active image stores the active copy; while the other image stores a second copy.

Ingress Port

Ports on which network traffic is received.

IP

Internet Protocol. Specifies the format of packets and their addressing method. IP addresses packets and forwards the packets to the correct port.

IP Address

Internet Protocol Address. A unique address assigned to a network device with two or more interconnected LANs or WANs.

IP Version 6 (IPv6)

A version of IP addressing with longer addresses than the traditional IPv4. IPv6 addresses are 128 bits long, whereas IPv4 addresses are 32 bits; allowing a much larger address space.

ISATAP

Intra-Site Automatic Tunnel Addressing Protocol .

ISATAP is an automatic overlay tunneling mechanism that uses the underlying IPv4 network as a non-broadcast/multicast access link layer for IPv6. ISATAP is designed for transporting IPv6 packets within a site where a native IPv6 infrastructure is not yet available.

L

LAG

Link Aggregated Group. Aggregates ports or VLANs into a single virtual port or VLAN.

For more information on LAGs, see **Defining LAG Membership**.

LAN

Local Area Networks. A network contained within a single room, building, campus or other limited geographical area.

Layer 2

Data Link Layer or MAC Layer. Contains the physical address of a client or server station. Layer 2 processing is faster than Layer 3 processing because there is less information to process.

Layer 4

Establishes a connections and ensures that all data arrives to their destination. Packets inspected at the Layer 4 level are analyzed and forwarding decisions based on their applications.

LLDP-MED

Link Layer Discovery Protocol - Media Endpoint Discovery. LLDP allows network managers to troubleshoot and enhance network management by discovering and maintaining network topologies over multi-vendor environments. MED increases network flexibility by allowing different IP systems to co-exist on a single network LLDP.

Load Balancing

Enables the even distribution of data or processing packets across available network resources. For example, load balancing may distribute the incoming packets evenly to all servers, or redirect the packets to the next available server.

M

MAC Address

Media Access Control Address. The MAC Address is a hardware specific address that identifies each network node.

MAC Address Learning

MAC Address Learning characterizes a learning bridge, in which the packet's source MAC address is recorded. Packets destined for that address are forwarded only to the bridge interface on which that address is located. Packets addressed to unknown addresses are forwarded to every bridge interface. MAC Address Learning minimizes traffic on the attached LANs.

MAC Layer

A sub-layer of the *Data Link Control* (DTL) layer.

Mask

A filter that includes or excludes certain values, for example parts of an IP address.

For example, Unit 2 is inserted in the first minute of a ten-minute cycle, and Unit 1 is inserted in fifth minute of the same cycle, the units are considered the same age.

MD5

Message Digest 5. An algorithm that produces a 128-bit hash. MD5 is a variation of MD4, and increases MD4 security. MD5 verifies the integrity of the communication, authenticates the origin of the communication.

MDI

Media Dependent Interface. A cable used for end stations.

MDIX

Media Dependent Interface with Crossover (MDIX). A cable used for hubs and switches.

MIB

Management Information Base. MIBs contain information describing specific aspects of network components.

Multicast

Transmits copies of a single packet to multiple ports.

N

NA

Neighbor Advertisement.

ND

Neighbor Discovery.

NS

Neighbor Solicitation.

NMS

Network Management System. An interface that provides a method of managing a system.

Node

A network connection endpoint or a common junction for multiple network lines. Nodes include:

- Processors
- Controllers
- Workstations

O

OID

Organizationally Unique Identifiers. Identifiers associated with a Voice VLAN.

OUI

Object Identifier. Used by SNMP to identify managed objects. In the SNMP Manager/ Agent network management paradigm, each managed object must have an OID to identify it.

P

Packets

Blocks of information for transmission in packet switched systems.

PDU

Protocol Data Unit. A data unit specified in a layer protocol consisting of protocol control information and layer user data.

PING

Packet Internet Groper. Verifies if a specific IP address is available. A packet is sent to another IP address and waits for a reply.

Port

Physical ports provide connecting components that allow microprocessors to communicate with peripheral equipment.

Port Mirroring

Monitors and mirrors network traffic by forwarding copies of incoming and outgoing packets from one port to a monitoring port.

For more information on port mirroring, see **Defining Port Mirroring Sessions**.

Port Speed

Indicates port speed of the port. Port speeds include:

- Ethernet 10 Mbps
- Fast Ethernet 100Mbps
- Gigabit Ethernet 1000 Mbps

Protocol

A set of rules that governs how devices exchange information across networks.

PVE

Protocol VLAN Edge. A port can be defined as a Private VLAN Edge (PVE) port of an uplink port, so that it will be isolated from other ports within the same VLAN.

Q

QoS

Quality of Service. QoS allows network managers to decide how and what network traffic is forwarded according to priorities, application types, and source and destination addresses.

Query

Extracts information from a database and presents the information for use.

R

RA

RADIUS Advertisement.

RD

RADIUS Discovery.

RS

Router Solicitation.

RADIUS

Remote Authentication Dial-In User Service. A method for authenticating system users, and tracking connection time.

RMON

Remote Monitoring. Provides network information to be collected from a single workstation.

Router

A device that connects to separate networks. Routers forward packets between two or more networks. Routers operate at a Layer 3 level.

RSTP

Rapid Spanning Tree Protocol. Detects and uses network topologies that allow a faster convergence of the spanning tree, without creating forwarding loops.

Running Configuration File

Contains all startup configuration file commands, as well as all commands entered during the current session. After the switch module is powered down or rebooted, all commands stored in the Running Configuration file are lost.

S

Segmentation

Divides LANs into separate LAN segments for bridging. Segmentation eliminates LAN bandwidth limitations.

Server

A central computer that provides services to other computers on a network. Services may include file storage and access to applications.

SNMP

Simple Network Management Protocol. Manages LANs. SNMP based software communicates with network devices with embedded SNMP agents. SNMP agents gather network activity and device status information, and send the information back to a workstation.

SNTP

Simple Network Time Protocol. SNTP assures accurate network switch clock time synchronization up to the millisecond.

SoC

System on a Chip. An ASIC that contains an entire system. For example, a telecom SoC application can contain a microprocessor, digital signal processor, RAM, and ROM.

Spanning Tree Protocol

Prevents loops in network traffic. The Spanning Tree Protocol (STP) provides tree topography for any arrangement of bridges. STP provides one path between end stations on a network, eliminating loops.

SSH

Secure Shell. Permits logging to another computer over a network, execute commands on a remote machine, and move files from one machine to another. Secure Shell provides strong authentication and secure communications methods over insecure channels.

Startup Configuration

Retains the exact switch module configuration when the switch module is powered down or rebooted.

Subnet

Sub-network. Subnets are portions of a network that share a common address component. On TCP/IP networks, devices that share a prefix are part of the same subnet. For example, all devices with a prefix of 157.100.100.100 are part of the same subnet.

Subnet Mask

Used to mask all or part of an IP address used in a subnet address.

Switch

Filters and forwards packets between LAN segments. Switches support any packet protocol type.

T**TCP/IP**

Transmissions Control Protocol. Enables two hosts to communicate and exchange data streams. TCP guarantees packet delivery, and guarantees packets are transmitted and received in the order their sent.

Telnet

Terminal Emulation Protocol. Enables system users to log in and use resources on remote networks.

TFTP

Trivial File Transfer Protocol. Uses User Data Protocol (UDP) without security features to transfer files.

Trap

A message sent by the SNMP that indicates that system event has occurred.

Trunking

Link Aggregation. Optimizes port usage by linking a group of ports together to form a single trunk (aggregated groups).

U**UDP**

User Data Protocol. Transmits packets but does not guarantee their delivery.

Unicast

A form of routing that transmits one packet to one user.

V**VLAN**

Virtual Local Area Networks. Logical subgroups with a Local Area Network (LAN) created via software rather than defining a hardware solution.

VoIP

Voice over IP.

W

WAN

Wide Area Networks. Networks that cover a large geographical area.

Wildcard Mask

Specifies which IP address bits are used, and which bits are ignored. A wild switch module mask of 255.255.255.255 indicates that no bit is important. A wildcard of 0.0.0.0 indicates that all the bits are important.

Device Feature Interaction Information

The following table contains information about feature interactions

Feature	Feature Notes
802.1x Unauthenticated VLAN	802.1x Unauthenticated VLANs have restricted functionality with: <ul style="list-style-type: none"> • 802.1X Guest VLAN • Special VLAN
802.1x Unauthenticated VLAN Port	802.1X Unauthenticated VLAN Ports have restricted functionality with: <ul style="list-style-type: none"> • MAC based VLAN ports • Ingress Filtering
ACL	ACL functionality is restricted with: <ul style="list-style-type: none"> • IP Based ACLs • MAC Based ACLs • Special VLANs
Auto-negotiation	No feature interaction restrictions or limitations.
Back Pressure Support	
Bridge Multicast Filtering	No feature interaction restrictions or limitations.
Cable Tests	No feature interaction restrictions or limitations.
Community ports	Community ports have restricted functionality with Locked Ports.
DHCP Snooping	No Restrictions or limitations.
DNS	No Restrictions or limitations.
Duplex Mode	
Flow Control	No feature interaction restrictions or limitations.
GARP	No feature interaction restrictions or limitations.
Guest VLANs	Guest VLANs cannot function with: <ul style="list-style-type: none"> • MAC Based VLANs • Special VLANs
GVRP	No feature interaction restrictions or limitations.
IGMP Snooping	No feature interaction restrictions or limitations.
Ingress Filtering	No feature interaction restrictions or limitations.
LAG Statistics	No feature interaction restrictions or limitations.

Feature	Feature Notes
Link Aggregation	No feature interaction restrictions or limitations. However, this feature has several guidelines for configuring Link Aggregation. For all the feature guidelines, see "Defining LAG Parameters".
LLDP-MED	No feature interaction restrictions or limitations.
Locked Ports	'Locked port functionality is restricted with: <ul style="list-style-type: none"> • MAC Based ACLs • Ingress Filtering
Logging	No feature interaction restrictions or limitations.
MAC Address Support	No feature interaction restrictions or limitations.
MDI/MDIX Deception	No feature interaction restrictions or limitations.
Multicast Filtering	No feature interaction restrictions or limitations.
Multiple Hosts	802.1X Standard (multiple hosts) cannot function with: <ul style="list-style-type: none"> • MAC Based VLAN Port
Multiple Spanning Tree	Multiple Spanning Tree cannot function with: <ul style="list-style-type: none"> • Ingress Filtering
Port Based Authentication	Port based authentication has limited or restricted functionality with: <ul style="list-style-type: none"> • 802.1 Single • Locked Ports • MAC Based VLANs • Ingress Ports
Port Mirroring	No feature interaction restrictions or limitations. However, this feature has several guidelines for configuring Storm Control. For all the feature guidelines, see "Defining Port Mirroring Sessions".
Port Statistics	No feature interaction restrictions or limitations
Private VLAN	Private VLANs cannot function with: <ul style="list-style-type: none"> • GVRP • IGMP Snooping • Special VLAN
Private VLAN	Private VLANs are limited or restricted functionality with: <ul style="list-style-type: none"> • GVRP • IGMP Snooping • Special VLAN
Quality of Service	No feature interaction restrictions or limitations.
RMON Statistics	No feature interaction restrictions or limitations.
SNMP Authentication Notifications	No feature interaction restrictions or limitations.
SNMP Notifications	No feature interaction restrictions or limitations.

Feature	Feature Notes
SNTP Authentication	No feature interaction restrictions or limitations.
Spanning Tree	No feature interaction restrictions or limitations.
Special VLAN	No feature interaction restrictions or limitations
Static MAC	No feature interaction restrictions or limitations
Storm Control	No feature interaction restrictions or limitations
System Logs	No feature interaction restrictions or limitations
System Time Synchronization	No feature interaction restrictions or limitations.
Voice VLAN	Voice VLAN has restricted functionality with: <ul style="list-style-type: none"> • GVRP

Index

Numerics

802.1d, 21
802.1Q, 21, 357, 360

A

AC unit, 35
Access mode, 235
Access profiles, 170
ACE, 453
ACL, 276
Address Resolution Protocol, 162, 453
Address tables, 315
AH, 453
Alert, 114, 116
Anycast, 101-102, 104
ARP, 162-164, 453
Asset, 78, 81, 210, 219
Authentication Profiles, 180-181
Authentication profiles, 177
Auto-Negotiation, 66

B

Back panels, 35
Backup master, 12

BootP, 454
BPDU, 327, 344, 454
Bridge Protocol Data Unit, 454
Broadcast, 102, 104
Buttons, 72

C

Cables, 165, 167
CBC, 219
CIDR, 455
Cipher Block-Chaining, 219
CLI, 12, 24
Command Line Interface, 12, 24
Command Mode Overview, 74
Communities, 234
Configuration file, 248
Console, 116
CoS, 445
Critical, 114, 116

D

Debug, 114, 116
Default Gateway, 129-130
Default Gateway, IPv6, 142

Default settings, 256
Defining device information, 78
Device installation, 40
Device representation, 71
Device view, 70
DHCP, 23
Dimensions, 30
DNS, 24, 154
Domain Name System, 24, 154
Downloading software, 246
DSCP, 441, 456
Dynamic Address Table, 320
Dynamic VLAN Assignment, 265

E

E-911, 206
EAP, 25, 262
Emergency, 114, 116
Emergency Call Service, 206
Enable, 178, 195
Error, 114, 116
Extensible Authentication Protocol, 25, 262

F

Failure, 12
Fans, 90
Fast link, 22, 332, 336
File Transfer Protocol, 457
Filtering, 358, 360, 387
Firmware, 248
Flow Control, 66
FTP, 457

G

GARP, 321-322, 324, 457
GARP VLAN Registration Protocol, 21, 457
Gateway, 129
GBIC, 457
Generic Attribute Registration Protocol, 321
Generic Attributes Registration Protocol, 457
GRE, 457
GVRP, 21, 351, 371, 414-415, 457
GVRP Parameters Page, 370

H

Hardware version, 98
Hash, 103
Head of Line, 18
Height, 30

HMAC-MD5, 231
HMAC-SHA-96, 231
HMP, 457
HOL, 18, 457
HTTP, 170
HTTPS, 170

I

ICMP, 458
IDRP, 458
IEEE, 458
IEEE 802.1d, 458
IEEE 802.1p, 458
IEEE 802.1Q, 458
IEEE 802.1Q-, 21
IGMP, 458
IGMP Snooping, 458
iles, 246
Image, 458
Image files, 253
Informational, 114, 116
Ingress, 458
IP, 458
IP addresses, 131
IP Version 6 (IPv6), 129
ISATAP Tunnel, 145

L

L2TP, 459
LACP, 383
LAGs, 336, 385, 394, 459
LCP, 341
LEDs, 30
Light Emitting Diodes, 30
Line, 178
Line Passwords, 192
Link aggregation, 383
Link Control Protocol, 341
Link/Duplex/Activity LEDs, 30
LLDP Media Endpoint Discovery, 25, 206
LLDP-MED, 25, 206
Local User Database, 189
Locked ports, 276, 282, 286, 288, 290, 292, 294, 296
Log, 114
Log file, 116
Logs, 113, 120-121
Loops, 325

M

MAC Addresses, 459-460
MAC addresses, 273
MAN, 460
Management Access Lists, 170

Management Access
 Methods, 181
Management Information
 Base, 219, 460
Management methods, 173
Management security, 170
Master Election/Topology
 Discovery Algorithm, 460
MD5, 102, 460
MDI, 18, 300, 460
MDI/MDIX, 66
MDIX, 18, 300, 460
MDU, 460
Media Endpoint
 Discovery, 211
Message, 103
Message digest 5, 103, 460
MIB, 219, 460
Multicast, 394

N

Network Control
 Protocols, 341
Network Management
 System., 461
Notice, 114, 116

O

Object ID, 220, 223
OID, 220, 223, 238
OUI, 379

P

Passwords, 69, 195
PDU, 461
PING, 461
PoE, 11, 17, 92
Port, 29
Port LEDs, 30
Port mirroring, 312
Ports, 71, 297, 437
Power over Ethernet, 11, 17,
 92
Power supplies, 35, 90
PPP, 462
Profiles, 170
Protocol, 365
Protocol VLAN Edge, 462
PVE, 462
PVID, 357, 360

Q

QinQ, 351
QoS, 441, 443-446, 462
Quality of Service, 441, 462

R

RADIUS, 178, 200, 202-203,
 212, 214, 217, 462
RAM logs, 116
Rapid Spanning Tree
 Protocol, 339, 463

Rapid STP, 342, 345, 349
Remote Authentication Dial
 In User Service, 25
Remote Authentication Dial-
 In User Service, 462
Remote Authorization Dial-In
 User Service, 200
Reset, 128
Reset button, 37
RMON, 420, 422-423, 425,
 462
RMON History Control
 Page, 423
RPS, 35
RSTP, 22, 339, 463
Rule, 175
Rules, 170
Running Configuration
 file, 246

S

Secure Shell, 182
Security, 170
SFP, 33
Simple Network Management
 Protocol, 23, 463
Simple Network Time
 Protocol, 24, 101
SNMP, 12, 23, 219, 463
SNMP management
 station, 12
SNTP, 24, 101

Software version, 98
Spanning Tree Protocol, 325
SPF LEDs, 30
SSH, 182, 463
Stack master, 12-13
Stacking, 12, 34, 36
Stacking discovering, 14
Stacking failover topology, 13
Startup file, 246
Static addresses, 318
Storm control, 308
STP, 21, 325-326, 331, 334,
340
SYSLOG RFC, 114

T

TACACS+, 178, 196
Telnet, 170, 182
Terminal Access Controller
Access Control
System, 196
TFTP, 464
Time Domain
Reflectometry, 165
Topology, 13
Traps, 240
Tree view, 69
Trivial File Transfer
Protocol, 464
Trust, 444-445
Tunnel, ISATAP, 145

U

UDP, 464
Understanding the
interface, 69
Unicast, 101-102, 104
Unit failure, 12
Unit IDs, 13
Uploading files, 250
User Data Protocol, 464
User Security Model, 219
USM, 219

V

Ventilation System, 37
Virtual Local Area
Networks, 464
VLAN, 351-352, 355, 357,
360, 394, 464
VLAN ID, 320
VLAN membership, 352
VLAN membership table, 353
VLAN Port Membership
Table, 354
VLAN priority, 441
VLAN tags, 351
Voice VLAN, 374
VoIP, 464

W

Warm standby, 14
Warning, 114, 116
Web management system
icons, 72
Width, 30