



## **User's Guide**

### **Fibre Channel Adapter**

QLE2740-DEL, QLE2740L-DEL,  
QLE2742-DEL, and QLE2742L-DEL

<b>Document Revision History</b>	
Revision A, March 21, 2016	
Revision B, April 19, 2016	
Revision C, February 1, 2017	
Revision D, August 24, 2017	
Revision E, December 19, 2017	
<b>Changes</b>	<b>Sections Affected</b>
<p>Added a description of the chapter contents.</p> <p>Added the following note stating a known issue with the firmware DUP:</p> <p>“If you update the firmware using the DUP with the Integrated Dell Remote Access Controller (iDRAC) or Lifecycle Controller (LC), it shows FFV as the QLogic Fibre Channel adapter MBI version. This issue occurs only the first time that you run the firmware DUP; following a reboot, FFV will be shown correctly on subsequent firmware updates with the DUP.”</p> <p>Added the following note stating a known issue with a Dell EMC switch:</p> <p>“The QLE2742 32Gbps FC HBA does not link up with the <b>Auto</b> setting when it is connected to a Dell EMC S4148U-ON switch.”</p> <p>Updated the descriptions of the QConvergeConsole Help system.</p>	<p><a href="#">“Introduction” on page ix</a></p> <p><a href="#">“Updating the Dell Firmware” on page 32</a></p> <p><a href="#">“Setting Fibre Channel Adapter Parameters” on page 41</a></p> <p><a href="#">“What Is in the QConvergeConsole Help System” on page 115</a></p>

# Table of Contents

## Introduction

Intended Audience . . . . .	ix
User's Guide Content . . . . .	x
Related Materials . . . . .	x
Documentation Conventions . . . . .	xi
Functionality and Features . . . . .	xiii
Functional Description . . . . .	xiii
Key Features . . . . .	xiii
Supported Operating Systems . . . . .	xiv
Windows . . . . .	xiv
Linux . . . . .	xiv
VMware . . . . .	xiv
Citrix XenServer . . . . .	xiv

## 1

### Hardware Installation

Hardware and Software Requirements . . . . .	1
Safety Precautions . . . . .	1
Pre-Installation Checklist . . . . .	2
PCIe Bus Slot Considerations . . . . .	2
Installing the Adapter . . . . .	3
Connecting to the SAN . . . . .	3

## 2

### Driver Installation and Configuration

Windows Driver Installation and Configuration . . . . .	4
Running the Dell Update Package in the GUI . . . . .	5
Running the Dell Update Package from the Command Line . . . . .	11
Examples . . . . .	11
Linux Driver Installation and Configuration . . . . .	11
Installation Overview . . . . .	12
Installing the Linux Fibre Channel Driver . . . . .	12
Building the Driver for RHEL 6.x and 7.x . . . . .	12
Building the Driver for SLES 11 . . . . .	14
Building the Driver for SLES 12 . . . . .	15

VMware Driver Installation and Configuration . . . . .	16
Installation Overview . . . . .	16
Installing the ESXi 6.5 and 6.0 U2 Fibre Channel Driver. . . . .	17
Updating an Existing Driver or Installing a New Driver for an Existing ESXi 6.5 or 6.0 U2/U3 Installation with esxcli. . . . .	17
Verifying the Version of the Installed Driver . . . . .	18
Installing QConvergeConsole VMware vCenter Server Plug-in . . . . .	18
Installation Package Contents . . . . .	19
Installing QConvergeConsole VMware vCenter Server Plug-in . . . . .	19
Plug-in Unregistration from a Manual Install. . . . .	24
Uninstalling the QConvergeConsole VMware vCenter Server Plug-in. . . . .	25
Installing the QLogic Adapter CIM Provider . . . . .	25
Uninstalling the QLogic Adapter CIM Provider . . . . .	28
Installing QConvergeConsole VMware vSphere Web Client Plug-in. . . . .	29
Uninstalling the QConvergeConsole VMware vCenter Server Plug-in. . . . .	30
<b>3 Fibre Channel Configuration</b>	
Updating the Dell Firmware . . . . .	32
Running the Firmware Update by Double-Clicking . . . . .	32
Running the Firmware Update from the Command Line. . . . .	34
Using <i>Fast!UTIL</i> for Custom Configuration. . . . .	35
Configuration Settings . . . . .	36
Adapter Settings . . . . .	36
Selectable Boot Settings . . . . .	38
Restore Default Settings. . . . .	39
Raw NVRAM Data . . . . .	39
Advanced Adapter Settings . . . . .	39
Scan Fibre Devices . . . . .	40
Fibre Disk Utility. . . . .	40
Loopback Data Test. . . . .	41
Select Adapter . . . . .	41
Exit <i>Fast!UTIL</i> . . . . .	41
Setting Fibre Channel Adapter Parameters . . . . .	41
Setting Fibre Channel Adapter Parameters with QConvergeConsole GUI . . . . .	42
Setting Fibre Channel Adapter Parameters with Interactive QConvergeConsole CLI . . . . .	42
Setting Fibre Channel Adapter Parameters with Noninteractive QConvergeConsole CLI . . . . .	42

Configuring Target Persistent Binding . . . . .	42
Configuring Persistent Binding with QConvergeConsole GUI. . . . .	43
Configuring Persistent Binding with Interactive QConvergeConsole CLI . . . . .	43
Configuring Persistent Binding with Noninteractive QConvergeConsole CLI . . . . .	44
Configuring Boot Devices. . . . .	44
Configuring Boot Devices with QConvergeConsole GUI. . . . .	44
Configuring Boot Devices with Interactive QConvergeConsole CLI. . . . .	44
Configuring Boot Devices with Noninteractive QConvergeConsole CLI . . . . .	45
Configuring Boot Devices with the BIOS. . . . .	45
Configuring Virtual Ports (NPIV). . . . .	45
Configuring NPIV with QConvergeConsole GUI. . . . .	46
Configuring NPIV with Interactive QConvergeConsole CLI. . . . .	46
Configuring NPIV with Noninteractive QConvergeConsole CLI . . . . .	46
Configuring NPIV Quality of Service . . . . .	47
Setting QoS by Bandwidth . . . . .	48
Setting QoS by Priority . . . . .	51
Configuring Fibre Channel Driver Parameters . . . . .	52
Configuring Fibre Channel Driver Parameters with QConvergeConsole GUI . . . . .	52
Configuring Fibre Channel Driver Parameters with Interactive QConvergeConsole CLI . . . . .	52
Configuring Fibre Channel Driver Parameters with Noninteractive QConvergeConsole CLI . . . . .	52
Configuring Fibre Channel Driver Parameters with QConvergeConsole VMware vCenter Server Plug-in. . . . .	53
Configuring Selective LUNs . . . . .	53
Configuring OoOFR . . . . .	53
Configuring OoOFR with QConvergeConsole GUI. . . . .	53
Configuring OoOFR with Interactive QConvergeConsole CLI. . . . .	54
Configuring OoOFR with Noninteractive QConvergeConsole CLI . . . . .	54
Configuring the UEFI Driver . . . . .	54
Setting an FA-PWWN . . . . .	61
Setting the FA-PWWN from the Adapter . . . . .	61
Setting FA-PWWN with QConvergeConsole GUI. . . . .	62
Setting FA-PWWN with QConvergeConsole CLI . . . . .	63
Setting FA-PWWN with QConvergeConsole VMware Plug-ins . . . . .	65

Setting an FA-WWN ( <i>continued</i> )	
Setting the FA-PWWN from the Brocade Switch . . . . .	66
Setting the FA-PWWN from the Switch . . . . .	66
Setting the Static FA-PWWN from the Switch . . . . .	66
Configuring and Verifying FA-BLD . . . . .	67
Configuring FA-BLD from the Adapter . . . . .	67
Enabling Host Bus Adapter Port BIOS and Fabric-assigned Boot LUN with QConvergeConsole GUI . . . . .	67
Configuring the Adapter and Boot Devices with QConvergeConsole CLI . . . . .	69
Configuring a Zone in a Brocade Switch . . . . .	70
Verifying that FA-BLD is Operational . . . . .	71
Adapter Side Restrictions . . . . .	72
Using a Fabric-Assigned Boot LUN . . . . .	73
Using a Fabric-Assigned Boot LUN in QConvergeConsole GUI . . . . .	73
Using a Fabric-Assigned Boot LUN in Interactive QConvergeConsole CLI . . . . .	73
Using a Fabric-Assigned Boot LUN with Noninteractive QConvergeConsole CLI . . . . .	73
Using a Fabric-Assigned Boot LUN with QConvergeConsole Plug-ins . . . . .	74
Running Diagnostics—Fibre Channel Ping and Trace Route . . . . .	75
Pinging and Viewing Trace of Routing Using Topology Map . . . . .	75
Running a Fibre Channel CT Ping Test . . . . .	76
Running a Fibre Channel CT Ping from QConvergeConsole GUI . . . . .	76
Running a Fibre Channel CT Ping from QConvergeConsole CLI . . . . .	77
Running a Fibre Channel CT Ping from QConvergeConsole VMware Plug-ins . . . . .	78
Fibre Channel Trace Route . . . . .	78
Configuring CS_CTL QoS . . . . .	80
CS_CTL QoS Features . . . . .	80
Enabling CS_CTL QoS Mode for the Initiator and Target Ports . . . . .	81
Verifying and Confirming CS_CTL Mode Setup for Each Port . . . . .	81
Creating a Virtual Port from the Adapter's Port in QConvergeConsole GUI . . . . .	81
Setting the QoS Priority Level for a Virtual Port in QConvergeConsole GUI . . . . .	83

Configuring End-to-End CS_CTL QoS . . . . .	83
Configuring CS_CTL QoS on the Switch . . . . .	84
Configuring CS_CTL QoS on the Storage Device . . . . .	85
Changing the QoS Priority Levels . . . . .	85
Changing the Priority Levels in Windows . . . . .	85
Changing the Priority Levels in VMware ESXi . . . . .	87
Configuring FDMI . . . . .	89
Brocade Switch FOS CLI . . . . .	90
Brocade Fabric Features . . . . .	91
FDMI Enhancements Support . . . . .	92
Enabling QLogic Forward Error Correction . . . . .	93
FEC Process Overview . . . . .	93
Enabling QLogic FEC . . . . .	94
Running Extended Link Service Commands . . . . .	95
Link Cable Beacon Extended Link Service Command . . . . .	95
Read Diagnostic Parameters Extended Link Service Command . . . . .	95

## **A Troubleshooting**

Fibre Channel Diagnostics . . . . .	98
Fibre Channel Diagnostics Using QConvergeConsole GUI . . . . .	98
Fibre Channel Diagnostics Using Interactive QConvergeConsole CLI . . . . .	100
Fibre Channel Diagnostics Using Noninteractive QConvergeConsole CLI . . . . .	100
Fibre Channel Troubleshooting Diagram . . . . .	101
Troubleshooting with a Diagnostic Port (D_Port) . . . . .	102
Configuring D_Port on a Brocade Fibre Channel 16G or 32G Switch . . . . .	103
Checking D_Port Results from a Brocade Fibre Channel 16G or 32G Switch . . . . .	104
Verifying D_Port Mode with QConvergeConsole GUI . . . . .	105
Verifying D_Port Mode with Interactive QConvergeConsole CLI . . . . .	106
Verifying D_Port Mode with Noninteractive QConvergeConsole CLI . . . . .	106
Verifying D_Port Mode with QConvergeConsole Plug-ins . . . . .	107

## **B Specifications**

Physical Characteristics . . . . .	108
Power Requirements . . . . .	108
Standards Specifications . . . . .	109
Interface Specifications . . . . .	109
Environmental Specifications . . . . .	109

<b>C</b>	<b>QConvergeConsole GUI</b>	
	Introduction to QConvergeConsole GUI . . . . .	110
	Downloading QConvergeConsole Documentation . . . . .	111
	Downloading and Installing Management Agents . . . . .	111
	Installing the Agents from the QLogic Web Site . . . . .	112
	Installing the Agents Using the Built-in Agent Installer . . . . .	112
	Installing QConvergeConsole GUI . . . . .	112
	Installing QConvergeConsole in a Windows Environment . . . . .	113
	Installing QConvergeConsole in a Linux Environment . . . . .	114
	Installing QConvergeConsole in Silent Mode . . . . .	115
	What Is in the QConvergeConsole Help System . . . . .	115
<b>D</b>	<b>Regulatory Information</b>	
	Warranty . . . . .	117
	Regulatory and Compliance Information . . . . .	117
	Laser Safety, FDA Notice . . . . .	117
	Agency Certification . . . . .	118
	EMI and EMC Requirements . . . . .	118
	Product Safety Compliance . . . . .	119



# Introduction

This introductory chapter provides a list of the covered models, describes the intended audience and contents of this guide, lists related documents and the document conventions, describes the product functionality and features, and lists the supported OSs.

This user's guide covers the following products:

- QLogic® QLE2740-DEL single-port, low profile adapter with a full-height bracket
- QLogic QLE2740L-DEL single-port, low profile adapter with a low profile bracket
- QLogic QLE2742-DEL dual-port, low profile adapter with a full-height bracket
- QLogic QLE2742L-DEL dual-port, low profile adapter with a low profile bracket

---

## NOTE

Throughout this document, the term *adapter* refers to any or all of these products.

---

This guide provides technical information about the adapters, including how to install and configure the adapter, as well as detailed descriptions of the adapter's various uses and functions.

## Intended Audience

This guide is intended for system administrators and other technical staff members responsible for configuring and managing adapters installed on Dell® PowerEdge® servers in Windows®, Linux®, or VMware® environments.

## User's Guide Content

This guide provides information in the following chapters and appendices:

- [Chapter 1 Hardware Installation](#) covers the hardware and software requirements, safety precautions, a pre-installation checklist, PCI Express® (PCIe®) slot considerations, and procedures for installing the adapter and connecting it to the network.
- [Chapter 2 Driver Installation and Configuration](#) covers the installation of the drivers included with the adapter on Windows, Linux, and VMware OSs.
- [Chapter 3 Fibre Channel Configuration](#) provides information about the multiboot image (Fibre Channel Adapter Function Configuration Utility) and instructions for setting Fibre Channel Adapter parameters; persistent binding; configuring the boot device, N\_Port ID virtualization (NPIV), and driver parameters; and reassembling out-of-order frames.
- [Appendix A Troubleshooting](#) provides information about Fibre Channel diagnostics and a Fibre Channel troubleshooting diagram.
- [Appendix B Specifications](#) defines the physical characteristics and power requirements and lists supported standards, interface, and environmental specifications.
- [Appendix C QConvergeConsole GUI](#) provides an overview of the QConvergeConsole Web management interface.
- [Appendix D Regulatory Information](#) provides warranty, regulatory, and compliance information.

## Related Materials

For additional information, refer to the following QLogic documents:

- *QConvergeConsole Help*, available through QConvergeConsole GUI, provides help topics on configuring and managing host servers and adapters using QConvergeConsole GUI.
- *Installation Guide—QConvergeConsole GUI* (part number SN0051105-00) contains instructions for installing and starting QConvergeConsole GUI.
- *User's Guide—QConvergeConsole CLI* (part number SN0054667-00) provides specific command line use in both interactive and noninteractive modes.
- *User's Guide—QConvergeConsole Plug-ins for VMware vSphere* (part number SN0054677-00) provides reference material on using the QConvergeConsole VMware vCenter Server Plug-in and the QConvergeConsole VMware vSphere Web Client Plug-in.

## NOTE

To access QLogic documents, go to [www.qlogic.com](http://www.qlogic.com) and click **Downloads**.

---

# Documentation Conventions

This guide uses the following documentation conventions:

- **NOTE** provides additional information.
- **CAUTION** without an alert symbol indicates the presence of a hazard that could cause damage to equipment or loss of data.
- Text in **blue** font indicates a hyperlink (jump) to a figure, table, or section in this guide, and links to Web sites are shown in underlined blue. For example:
  - [Table 9-2](#) lists problems related to the user interface and remote agent.
  - See “[Installation Checklist](#)” on page 3-6.
  - For more information, visit [www.qlogic.com](http://www.qlogic.com).
- Text in **bold** font indicates user interface elements such as a menu items, buttons, check boxes, or column headings. For example:
  - Click **Start**, point to **Programs**, point to **Accessories**, and then click **Command Prompt**.
  - Under **Notification Options**, select the **Warning Alarms** check box.
- Text in `Courier` font indicates a file name, directory path, or command line text. For example:
  - To return to the root directory from anywhere in the file structure, type `cd /root`, and then press the ENTER key.
  - Issue the following command: `# sh ./install.bin`
- Key names and key strokes are indicated with UPPERCASE:
  - Press the CTRL+P keys.
  - Press the UP ARROW key
- Text in *italics* indicates terms, emphasis, variables, or document titles. For example:
  - For a complete listing of license agreements, refer to the *QLogic Software End User License Agreement*.

- ❑ What are *shortcut keys*?
- ❑ To enter the date type *mm/dd/yyyy* (where *mm* is the month, *dd* is the day, and *yyyy* is the year).
- Topic titles between quotation marks identify related topics either within this manual or in the online help, which is also referred to as *QConvergeConsole Help* throughout this document.
- QConvergeConsole CLI non-interactive command syntax conventions include the following:
  - ❑ Plain text indicates items that you must type as shown. For example:
    - `qaucli -pr nic -ei`
  - ❑ `< >` (angle brackets) indicate a variable whose value you must specify. For example:
    - `<hba instance>`

---

#### NOTE

For CLI commands only, variable names are always indicated using angle brackets instead of *italics*.

---

- ❑ `[ ]` (square brackets) indicate an optional parameter. For example:
  - `[<file_name>]` means specify a file name, or omit it to select the default file name.
- ❑ `|` (vertical bar) indicates mutually exclusive options; select one option only. For example:
  - `on|off`
  - `1|2|3|4`
- ❑ `...` (ellipsis) indicates that the preceding item may be repeated. For example:
  - `x...` means *one* or more instances of `x`.
  - `[x...]` means *zero* or more instances of `x`.
- ❑ `( )` (parentheses) and `{ }` (braces) are used to avoid logical ambiguity. For example:
  - `a|b c` is ambiguous
  - `{(a|b) c}` means *a* or *b*, followed by *c*
  - `{a|(b c)}` means either *a*, or *b c*

## Functionality and Features

This section provides the following information:

- [Functional Description](#)
- [Key Features](#)
- [Supported Operating Systems](#)

### Functional Description

Functional descriptions for the adapters are as follows:

- **QLE2740-DEL:** A low profile, Gen 6 32Gb, single-port Fibre Channel PCIe adapter with a full-height bracket installed.
- **QLE2740L-DEL:** A low profile, Gen 6 32Gb, single-port Fibre Channel PCIe adapter with a low profile bracket installed.
- **QLE2742-DEL:** A low profile, Gen 6 32Gb, dual-port Fibre Channel PCIe adapter with a full-height bracket installed.
- **QLE2742L-DEL:** A low profile, Gen 6 32Gb, dual-port Fibre Channel PCIe adapter with a low profile bracket installed.

### Key Features

Key features of the adapters include:

- Centralized device management for SAN
- Connectivity to 32Gb/16Gb/8Gb Fibre Channel networks
- PCIe 3.0 x8
- Full hardware offload for the Fibre Channel protocol
- Message-signaled interrupts (MSI-X) and legacy interrupts (INT-X)
- NPIV
- Boot from SAN
- Several advanced management features for 2700 Series Adapters:
  - ❑ QConvergeConsole (GUI and CLI) is available if you are running Windows or Linux.
  - ❑ QConvergeConsole VMware vCenter Server Plug-in is available if you are running VMware ESXi.

## Supported Operating Systems

### NOTE

Because the *Dell Update Packages Version xx.xx.xxx User's Guide* is not updated in the same cycle as this Fibre Channel adapter user's guide, consider the operating systems listed in this section as the more current.

---

The adapter supports the following operating systems. To view the most complete and current list, refer to the product release notes.

### Windows

- Windows Server® 2016
- Windows Server 2012 R2
- Windows Server 2012

### Linux

- Red Hat® Enterprise Linux (RHEL®) 7.4
- RHEL 7.3
- RHEL 7.2
- RHEL 6.9
- RHEL 6.8
- SUSE® Linux Enterprise Server (SLES®) 12 SP2
- SLES 12 SP1
- SLES 11 SP4

### VMware

- vSphere®: VMware ESXi 6.5/6.5 U1
- vSphere: VMware ESXi 6.0 U2/U3

### Citrix XenServer

- Citrix® XenServer® 7.1
- Citrix XenServer 7.0
- Citrix XenServer 6.5

### NOTE

For the most current versions of the OS and drivers supported by the adapter, refer to the release notes file (`release.txt`).

---

# 1 Hardware Installation

This chapter provides the hardware and software requirements, safety precautions, a pre-installation checklist, PCIe slot considerations, and procedures for installing the adapter and connecting it to the network.

## Hardware and Software Requirements

Before you install the adapter, verify that the system meets the following hardware and software requirements.

- **Hardware:** For QLE274x-DEL Adapters port and slot assignments, refer to the “Expansion Cards” section of the *Hardware Owner’s Manual* for your Dell PowerEdge server.
- **Software:** For information on the supported operating systems, firmware versions, adapter drivers, and utilities, refer to the product release notes.

## Safety Precautions

---

**⚠ WARNING**

The adapter is being installed in a system that operates with voltages that can be lethal. Before you open the case of your system, observe the following precautions to protect yourself and to prevent damage to the system components.

---

For your safety, follow these precautions:

- Remove any metallic objects or jewelry from your hands and wrists.
- Make sure to use only insulated or nonconducting tools.
- Before you touch internal components, verify that the system is powered OFF and is unplugged.
- Install or remove adapters in a static-free environment. The use of a properly grounded wrist strap or other personal antistatic devices and an antistatic mat is strongly recommended.

## Pre-Installation Checklist

1. Verify that your system meets the hardware and software requirements listed in “[Hardware and Software Requirements](#)” on page 1.
2. Verify that your system is using the latest BIOS.

### NOTE

If you acquired the adapter software on a disk or from the Dell support Web site (<http://support.dell.com>), verify the path to the adapter driver files.

3. Check the adapter for visible signs of damage. Never attempt to install a damaged adapter.

## PCIe Bus Slot Considerations

The size of the PCIe bus slot in which you install the adapter will affect the speed throughput. [Table 1-1](#) lists the approximate speed throughput for each bus slot size.

**Table 1-1. Approximate Speed Throughput per Bus Slot Size**

Slot Size	PCIe Generation (Speed) Throughput		
	PCIe Gen1 (2.5 GT/s)	PCIe 2.0 (5 GT/s)	PCIe 3.0 (8 GT/s)
x8 slot	~20GFC (2.5 × 8)	~40GFC (5 × 8)	~64GFC (8 × 8)
x16 slot	~40GFC (2.5 × 16)	~80GFC (5 × 16)	~128GFC (8 × 16)
x32 slot	~80GFC (2.5 × 32)	~160GFC (5 × 32)	~256GFC (8 × 32)

[Table 1-2](#) lists the throughput needed to achieve line rates.

**Table 1-2. Throughput Requirements to Achieve Line Rate**

Number of 32G FC Ports	Model Number	PCIe Throughput Required to Achieve Line Rate	Minimum PCIe Gen and Slot Configurations
1	QLE2740-DEL, QLE2740L-DEL	32GFC (1 × 32GFC)	PCIe 2.0 x8 and higher PCIe 3.0 x8 and higher
2	QLE2742-DEL, QLE2742L-DEL	64GFC (2 × 32GFC)	PCIe 3.0 x8 and higher



## Installing the Adapter

### To install the QLE274x-DEL Adapters:

1. Power off the computer and all attached devices such as monitors, printers, and external components.
2. Disconnect the power cable.
3. Remove the computer cover and find an empty PCIe bus slot. For more information about selecting a bus slot, see [“PCIe Bus Slot Considerations” on page 2](#).
4. Pull out the slot cover (if any).
5. Grasp the adapter by the top edge and seat it firmly into the appropriate slot.
6. Refasten the adapter’s retaining bracket.
7. Close the computer cover.
8. Plug the Fibre Channel cable into the adapter.
9. Plug in the power cable and turn on the computer.

For more detailed information, refer to the *Hardware Owner’s Manual* for your Dell PowerEdge server.

## Connecting to the SAN

To connect the QLE274x-DEL Adapters to the SAN, refer to the *Hardware Owner’s Manual* for your Dell PowerEdge server.

# 2 Driver Installation and Configuration

---

## NOTE

If you need to update the Flash memory of multiple adapters simultaneously:

- For QConvergeConsole GUI, refer to the “Update the Flash Using the Flash Update Wizard” topic in the *QConvergeConsole Help*.
- For QConvergeConsole CLI, issue the `-flashsupport` command to update the Flash memory for all cards supported by the specified file. For example:

```
qacucli -pr nic -flashsupport -i ALL -a p3p11179.bin
```

---

This chapter provides the following information about the drivers included with the adapters:

- [“Windows Driver Installation and Configuration” on page 4](#)
- [“Linux Driver Installation and Configuration” on page 11](#)
- [“VMware Driver Installation and Configuration” on page 16](#)

---

## NOTE

When you disable the firmware (for example, during a firmware dump or during a firmware update) in Windows or Linux with a QConvergeConsole agent, multiple application messages are generated. These messages are generated because the application cannot communicate with the adapter while the firmware is disabled. After the firmware is re-enabled, the errors will go away.

---

## Windows Driver Installation and Configuration

You can run a software or driver Dell Update Package (DUP) in two ways:

- [Running the Dell Update Package in the GUI](#)
- [Running the Dell Update Package from the Command Line](#)

## Running the Dell Update Package in the GUI

Before you begin, refer to the *Dell Update Packages Version xx.xx.xxx User's Guide*, “Prerequisites and Features for Systems Running Windows” section.

### To run the DUP in the GUI:

1. Double-click the icon representing the DUP file.

---

**NOTE**

The actual file name of the DUP varies.

---

2. In the Dell Update Package window ([Figure 2-1](#)), click **Install**.



**Figure 2-1. Dell Update Package Window**

3. In the QLogic Super Installer—InstallShield® Wizard's Welcome window ([Figure 2-2](#)), click **Next**.

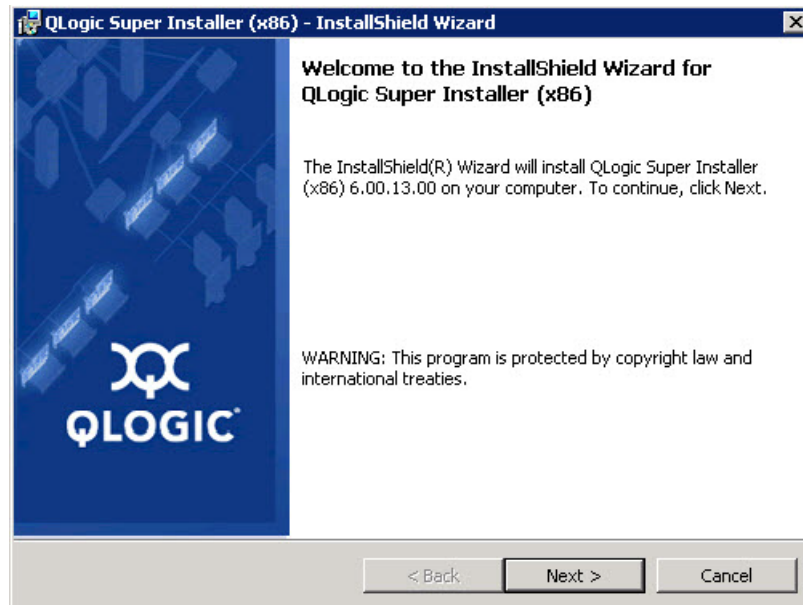

**Figure 2-2. QLogic InstallShield Wizard: Welcome Window**

4. In the wizard's License Agreement window ([Figure 2-3 on page 7](#)):
  - a. Read the QLogic End User Software License Agreement.
  - b. To continue, select **I accept the terms in the license agreement**.
  - c. Click **Next**.

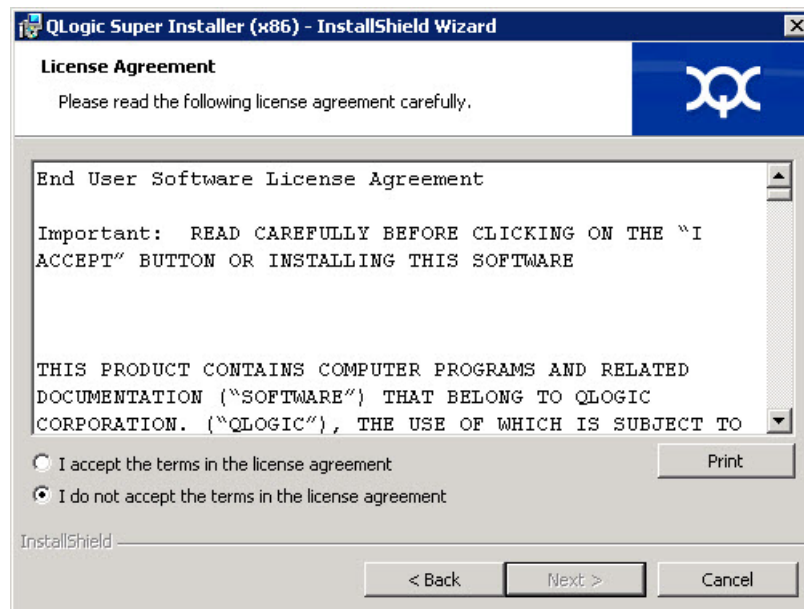

**Figure 2-3. QLogic InstallShield Wizard: License Agreement Window**

5. Complete the wizard's Setup Type window (Figure 2-4) as follows:
  - a. Select one of the following setup types:
    - Click **Complete** to install *all* program features.
    - Click **Custom** to manually select the features to be installed.
  - b. To continue, click **Next**.

If you selected **Complete**, proceed directly to [Step 6 b](#).

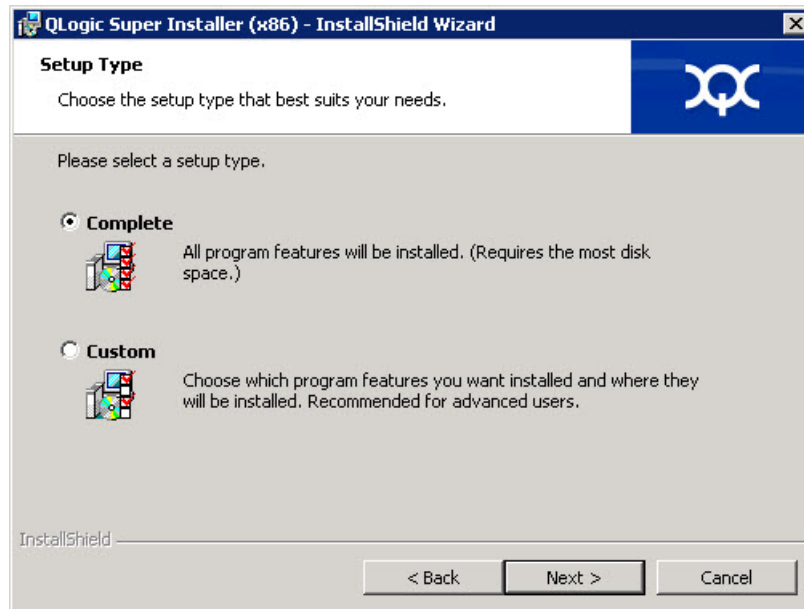

**Figure 2-4. InstallShield Wizard: Setup Type Window**

6. If you selected **Custom** in [Step 5](#), complete the Custom Setup window ([Figure 2-5 on page 9](#)) as follows:
  - a. Select the features to install. By default, all features are selected. To change a feature's install setting, click the icon next to it, and then select one of the following options:
    - **This feature will be installed on the local hard drive**—This setting marks the feature for installation without affecting any of its subfeatures.
    - **This feature, and all subfeatures, will be installed on the local hard drive**—This setting marks the feature and all of its subfeatures for installation.
    - **This feature will not be available**—This setting prevents the feature from being installed.
  - b. Click **Next** to continue.

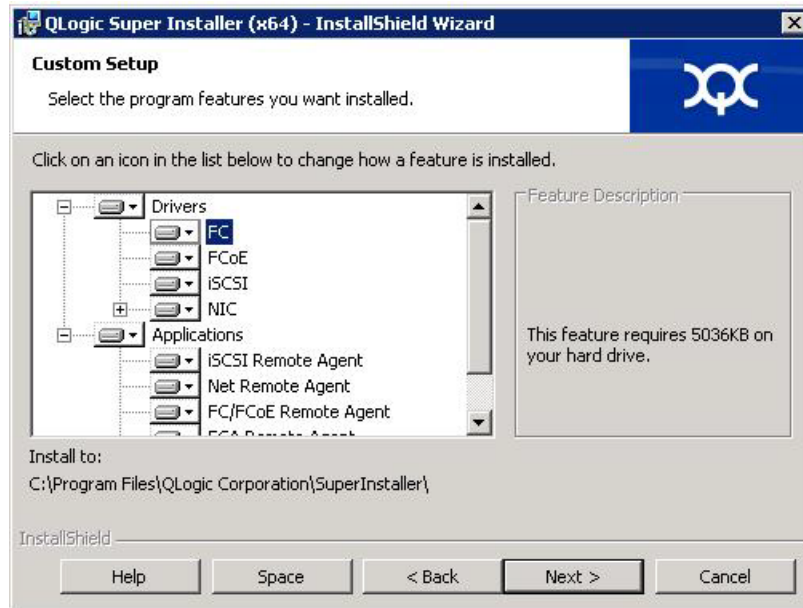

**Figure 2-5. InstallShield Wizard: Custom Setup Window**

7. In the InstallShield Wizard's Ready To Install window (Figure 2-6), click **Install**.

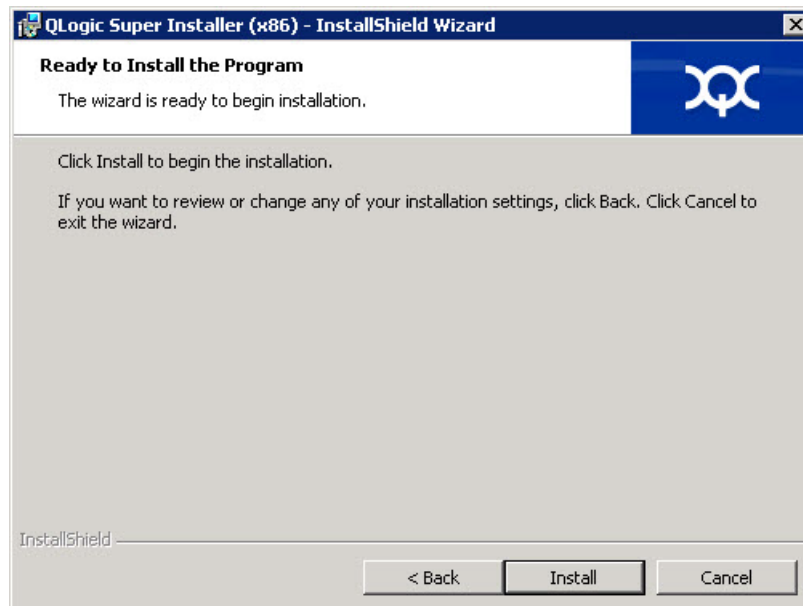

**Figure 2-6. InstallShield Wizard: Ready to Install the Program Window**

The InstallShield Wizard installs the QLogic Adapter drivers and Management Software Installer.

8. When the installation is complete, the InstallShield Wizard Completed window appears (Figure 2-7). Click **Finish** to dismiss the installer.

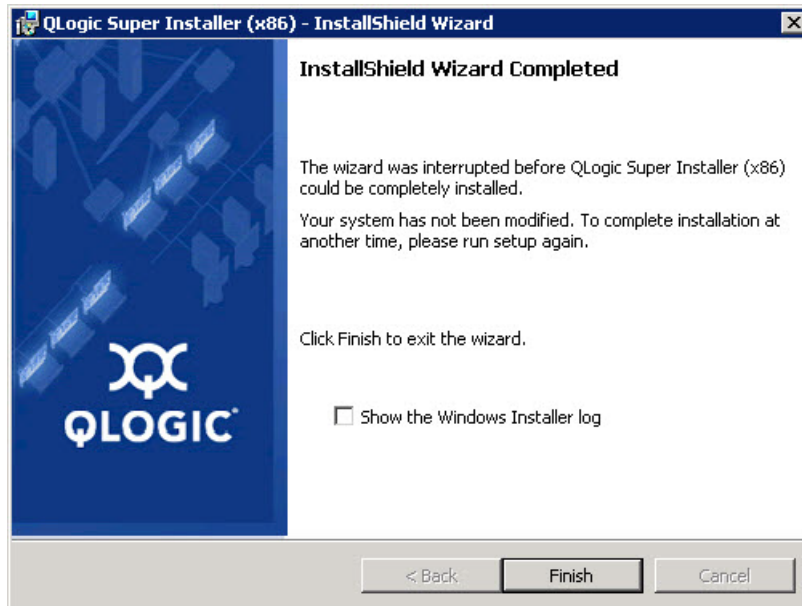

**Figure 2-7. InstallShield Wizard: Completed Window**

9. In the Dell Update Package (DUP) window (Figure 2-8 on page 10), “Complete” indicates successful installation.
  - ❑ (Optional) To open the log file, click **View Log**. The log file shows the progress of the DUP installation, any previous installed versions, any error messages, and other information about the installation.
  - ❑ To close the Update Package window, click **OK**.



**Figure 2-8. Dell Update Package Window**



## Running the Dell Update Package from the Command Line

For a list of the CLI options for systems running Windows, a description of each option, and the command syntax, refer to the *Dell Update Packages Version xx.xx.xxx User's Guide*, "Windows CLI Options" section.

Running the DUP from the command line, with no options specified, results in the same behavior as double-clicking the icon representing the DUP.

---

### NOTE

The actual file name of the DUP varies.

---

To run the DUP from the command line:

```
C:\><DUP_file_name>.EXE
```

The following shows the syntax for specifying options to customize the Dell update package installation behavior:

```
<DUP_file_name>.exe [/<option1>[=<value1>]] [/<option2>[=<value2>]]...
```

To display the GUI for guided installation, update, or extraction, use no options.

### Examples

To update the system silently:

```
<DUP_file_name>.exe /s
```

To extract the update contents to the C:\mydir\ directory:

```
<DUP_file_name>.exe /s /e=C:\mydir
```

To extract the driver components to the C:\mydir\ directory:

```
<DUP_file_name>.exe /s /drivers=C:\mydir
```

To install only the driver components:

```
<DUP_file_name>.exe /s /driveronly
```

To change from the default log location to C:\my path with spaces\log.txt:

```
<DUP_file_name>.exe /l="C:\my path with spaces\log.txt"
```

## Linux Driver Installation and Configuration

This section provides the following procedures for installing drivers on a Linux system:

- [Installation Overview](#)
- [Installing the Linux Fibre Channel Driver](#)

## Installation Overview

To install and configure the adapter drivers on a Linux system, refer to the driver release notes, readme, and installation instructions included in the package.

### NOTE

To install the Red Hat Package Manager (RPM), issue the following command as a root user:

```
# rpm -Uvh <rpm name>
```

For example:

```
# rpm -Uvh qla2xxx-kmp-default-  
<driver-version_kernel-version>-<release>.x86_64.rpm
```

To uninstall the RPM, issue the following command as a root user:

```
# rpm -e <rpm>
```

For example:

```
# rpm -e qla2xxx-kmp-default-  
<driver-version_kernel-version>-<release>
```

---

## Installing the Linux Fibre Channel Driver

This section provides procedures for installing the Linux Fibre Channel driver for the following operating systems:

- [Building the Driver for RHEL 6.x and 7.x](#)
- [Building the Driver for SLES 11](#)
- [Building the Driver for SLES 12](#)

### Building the Driver for RHEL 6.x and 7.x

1. From the directory that contains the source driver file, `qla2xxx-src-vx.xx.xx.xx.06.x-k.tar.gz`, issue the appropriate commands for your Linux version.

#### RHEL 6.x

```
# tar -xzvf qla2xxx-src-vx.xx.xx.xx.06.x-k.tar.gz  
# cd qla2xxx-src-vx.xx.xx.xx.06.x-k
```

#### RHEL 7.x

```
# tar -xzvf qla2xxx-src-vx.xx.xx.xx.07.x-k.tar.gz  
# cd qla2xxx-src-vx.xx.xx.xx.07.x-k
```

2. Build and install the driver modules from the source code by executing the `build.sh` script as follows:

```
# ./extras/build.sh install
```

The `build.sh` script does the following:

- Builds the driver `.ko` files.
- Copies the `.ko` files to the appropriate `/lib/modules/<kernel version>/extra/qlgc-qla2xxx` directory.
- Add the appropriate directive in the `modprobe.conf` (if applicable).

---

### NOTE

You can optionally complete either or both [Step 3](#) and [Step 4](#) of this procedure.

---

3. (Optional) To manually load the driver, issue the `insmod` or `modprobe` command:
  - To directly load the driver from the local build directory, issue the following `insmod` commands in order:

```
# modprobe scsi_tgt.ko (if not already loaded)
# modprobe scsi_transport_fc.ko
# insmod qla2xxx.ko
```
  - To load the driver using `modprobe`, issue the following command:

```
# modprobe -v qla2xxx
```
  - To unload the driver using `modprobe`, issue the following command:

```
# modprobe -r qla2xxx
```
4. (Optional) To automatically load the driver each time the system boots, rebuild the RAM disk to include the driver as follows:
  - a. Create a backup copy of the RAMDISK image by issuing the following commands:

```
# cd /boot
# cp initramfs-[kernel version].img initramfs-[kernel version].img.bak
```
  - b. Create the new RAMDISK by issuing the following command:

```
# dracut -f
```
  - c. To load the driver, reboot the host.

## Building the Driver for SLES 11

1. From the directory that contains the source driver file, `qla2xxx-src-vx.xx.xx.xx.11.x-k.tgz`, issue the following commands:

```
# tar -xvzf qla2xxx-src-vx.xx.xx.xx.11.x-k.tgz
# cd qla2xxx-x.xx.xx.xx.xx-k4
```

Where `x.xx.xx.xx.xx.xx` is the applicable version number.

2. Build and install the driver modules from the source code by executing the `build.sh` script as follows:

```
# ./extras/build.sh install
```

The `build.sh` script does the following:

- Builds the driver `.ko` files.
- Copies the `.ko` files to the appropriate `/lib/modules/3.x.../updates` directory.
- Adds the appropriate directive in the `modprobe.conf` file (if applicable).

---

### NOTE

You can optionally complete either or both [Step 3](#) and [Step 4](#) of this procedure.

---

3. (Optional) Manually load the driver for Linux.
  - Edit the `/etc/modprobe.d/unsupported_modules` file to make the following change:

```
allow_unsupported_modules 1 (replace 0 with 1)
```
  - To load the driver using `modprobe`, issue the following command:

```
# modprobe -v qla2xxx
```
  - To unload the driver using `modprobe`, issue the following command:

```
# modprobe -r qla2xxx
```

4. (Optional) Automatically load the driver by rebuilding the RAM disk to include the driver.

Create a copy of the current RAMDISK by issuing the following commands:

```
# cd /boot
# cp initrd-[kernel version].img initrd-[kernel
version].img.bak
# mkinitrd
```

---

**NOTE**

Depending on the server hardware, the RAMDISK file name may be different.

---

5. To load the driver, reboot the host.

### Building the Driver for SLES 12

1. From the directory that contains the source driver file, `qla2xxx-src-vx.xx.xx.xx.12.x-k.tgz`, issue the following commands:

```
# tar -xzvf qla2xxx-src-vx.xx.xx.xx.12.x-k.tgz
# cd qla2xxx-x.xx.xx.xx.xx-k4
```

Where `x.xx.xx.xx.xx.xx` is the applicable version number.

2. Build and install the driver modules from the source code by executing the `build.sh` script as follows:

```
# ./extras/build.sh install
```

The `build.sh` script does the following:

- Builds the driver `.ko` files.
- Copies the `.ko` files to the appropriate `/lib/modules/3.x.../updates` directory.
- Adds the appropriate directive in the `modprobe.conf` file (if applicable).

---

**NOTE**

You can optionally complete either or both [Step 3](#) and [Step 4](#) of this procedure.

---

3. (Optional) Manually load the driver for Linux.
  - ❑ Edit the `/etc/modprobe.d/unsupported_modules` file to make the following change:

```
allow_unsupported_modules 1 (replace 0 with 1)
```
  - ❑ To load the driver using `modprobe`, issue the following command:

```
# modprobe -v qla2xxx
```
  - ❑ To unload the driver using `modprobe`, issue the following command:

```
# modprobe -r qla2xxx
```
4. (Optional) To automatically load the driver each time the system boots, rebuild the RAM disk to include the driver as follows:
  - a. Create a backup copy of the RAMDISK image by issuing the following commands:

```
# cd /boot  
# cp initramfs-[kernel version].img initramfs-[kernel version].img.bak
```
  - b. Create the new RAMDISK by issuing the following command:

```
# dracut -f
```
5. To load the driver, reboot the host.

## VMware Driver Installation and Configuration

This section provides the following procedures for installing drivers on a VMware system:

- [Installation Overview](#)
- [Installing the ESXi 6.5 and 6.0 U2 Fibre Channel Driver](#)
- [Installing QConvergeConsole VMware vCenter Server Plug-in](#)
- [Installing QConvergeConsole VMware vSphere Web Client Plug-in](#)

### Installation Overview

To install and configure the adapter drivers on a VMware system, refer to the driver release notes and readme files included in the package.

## Installing the ESXi 6.5 and 6.0 U2 Fibre Channel Driver

The operating system manages and controls the driver installation process. To install the ESXi driver, follow the steps in this section.

### NOTE

This section provides the most common ways of installing and upgrading the driver. For other installation procedures, consult the operating system manuals and the driver readme file.

This section provides procedures for the following:

- [“Updating an Existing Driver or Installing a New Driver for an Existing ESXi 6.5 or 6.0 U2/U3 Installation with esxcli” on page 17](#)
- [“Verifying the Version of the Installed Driver” on page 18](#)

### Updating an Existing Driver or Installing a New Driver for an Existing ESXi 6.5 or 6.0 U2/U3 Installation with esxcli

#### To use the driver bundle <offline-bundle>.zip):

1. Copy the driver bundle (<offline-bundle>.zip) to this ESXi host.
2. Install the driver bundle (<offline-bundle>.zip) as follows:
  - a. To create a temporary directory, issue the following commands:

```
mkdir /install
cd /install
```
  - b. Unzip the driver bundle in the temporary directory:

```
/install : unzip <offline-bundle>.zip
```
  - c. Issue the following command:

```
esxcli software vib install -n qlnativefc -d /install
```

#### To use the driver VIB:

1. Copy the driver VIB to this ESXi host by issuing the following command:

```
qlnativefc-<driver-version>-1OEM.<esx-build>.x86_64.vib
```
2. Install the driver VIB using the following `esxcli` commands:
  - a. To make a temporary directory, issue the following commands:

```
mkdir /install
cd /install
```

- b. Issue the following command:

```
esxcli software vib install -v /install/<driver-vib>
```

### Verifying the Version of the Installed Driver

To verify the installed package in the system, issue the following command:

```
esxcli software vib list | grep qlnativefc
```

The driver version is embedded in the VIB version.

For example, the output looks like the following:

```
# esxcli software vib list | grep qlnativefc
qlnativefc                2.1.50.0-1OEM.600.0.0.2768847
QLogic VMwareCertified   2017-01-19
```

## Installing QConvergeConsole VMware vCenter Server Plug-in

To use QConvergeConsole VMware vCenter Server Plug-in, install the following software in this order:

1. **QConvergeConsole VMware vCenter Server Plug-in** on the vCenter Server
2. **QLogic Adapter CIM Provider** on the ESXi server

The following sections explain how to install and uninstall the required software:

- [“Installation Package Contents” on page 19](#)
- [“Installing QConvergeConsole VMware vCenter Server Plug-in” on page 19](#)
- [“Plug-in Unregistration from a Manual Install” on page 24](#)
- [“Uninstalling the QConvergeConsole VMware vCenter Server Plug-in” on page 25](#)
- [“Installing the QLogic Adapter CIM Provider” on page 25](#)
- [“Uninstalling the QLogic Adapter CIM Provider” on page 28](#)

For information on installing the Plug-in, refer to [“Installing QConvergeConsole VMware vCenter Server Plug-in” on page 19](#).



## Installation Package Contents

The latest version of the QLogic Adapter CIM Provider and QConvergeConsole VMware vCenter Server Plug-in package contains the files needed to install both the Plug-in and the CIM Provider. Required files include the following (where `x_x_x` is the version number):

- `QLogic_Adapter_VI_Plugin_x_x_x.exe`—This file is the QConvergeConsole VMware vCenter Server Plug-in installation package.
- `qlogic_adapter_provider_vmware_esx55_60-x.x.x`—This file contains the QLogic Adapter CIM Provider installation package for ESXi 6.0 U2/U3, where `x.x.x` is the version of the CIM Provider.
- `qlogic_adapter_provider_vmware_esx65-x.x.x`—This file contains the QLogic Adapter CIM Provider installation package for ESXi 6.5 and ESXi 6.5 U1, where `x.x.x` is the version of the CIM Provider.
- `readme.txt`—This file is the Read Me document that covers hardware and software requirements, operating system support, supported features, installation and removal instructions, known issues and workarounds, and support contact information.
- `release_notes.txt`—This file is the Release Notes document that lists changes, fixes, known issues, and release details.

For detailed information on installing the QConvergeConsole VMware vCenter Server Plug-in, refer to [“Installing QConvergeConsole VMware vCenter Server Plug-in” on page 19](#).

For detailed information on installing the CIM Provider, refer to [“Installing the QLogic Adapter CIM Provider” on page 25](#).

## Installing QConvergeConsole VMware vCenter Server Plug-in

### To install the QConvergeConsole VMware vCenter Server Plug-in:

1. Download the `QLogic_Adapter_VI_Plugin_x_x_x.exe` file (where `x_x_x` is the version number).
2. Start the installation either by double-clicking the `.exe` file, by typing the name of the `.exe` file in a Run window, or by clicking **Browse** and locating the `.exe` file.

The InstallAnywhere wizard opens, as shown in [Figure 2-9](#).

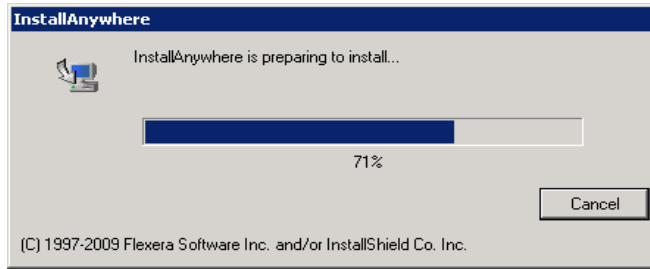

**Figure 2-9. InstallAnywhere Initial Window**

3. In the QLogic Adapter VI Plug-in wizard's Introduction window (see [Figure 2-10](#)), click **Next**.

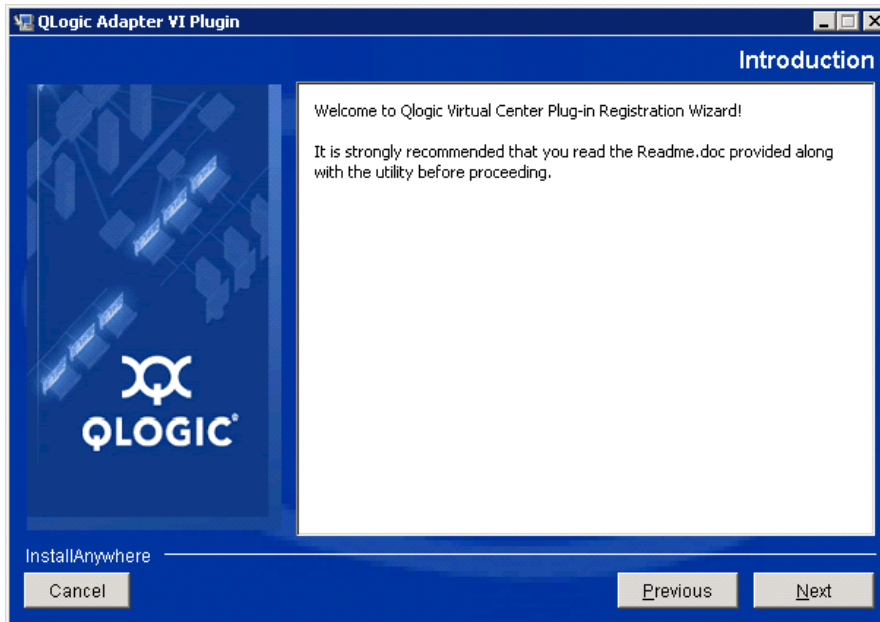

**Figure 2-10. QLogic Adapter VI Plug-in Wizard: Introduction**

Wait while the wizard configures the plug-in (see [Figure 2-11](#)).

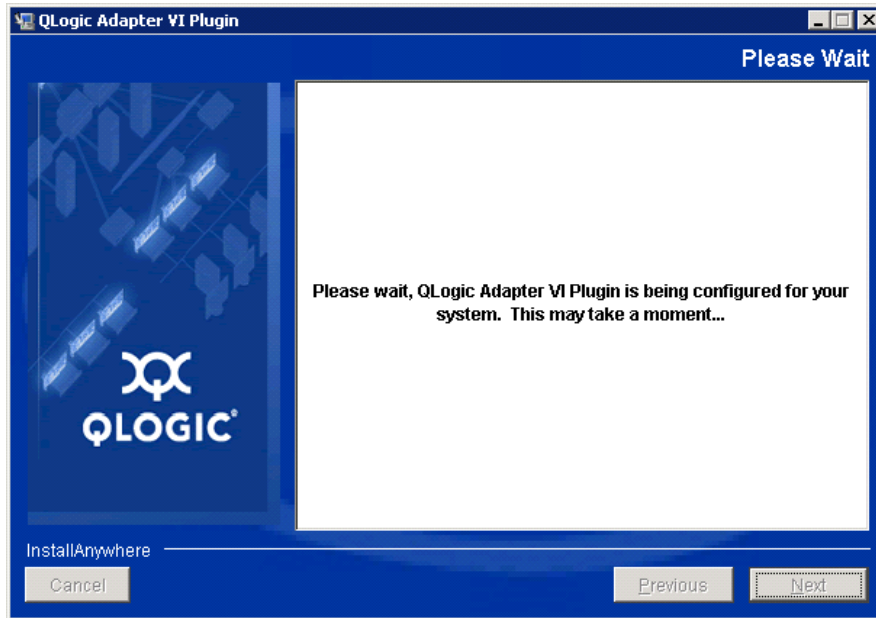

**Figure 2-11. QLogic Adapter VI Plug-in Wizard: Configuring the Plug-in**

4. Select the installation directory, and then click **Install** (see [Figure 2-12](#)).

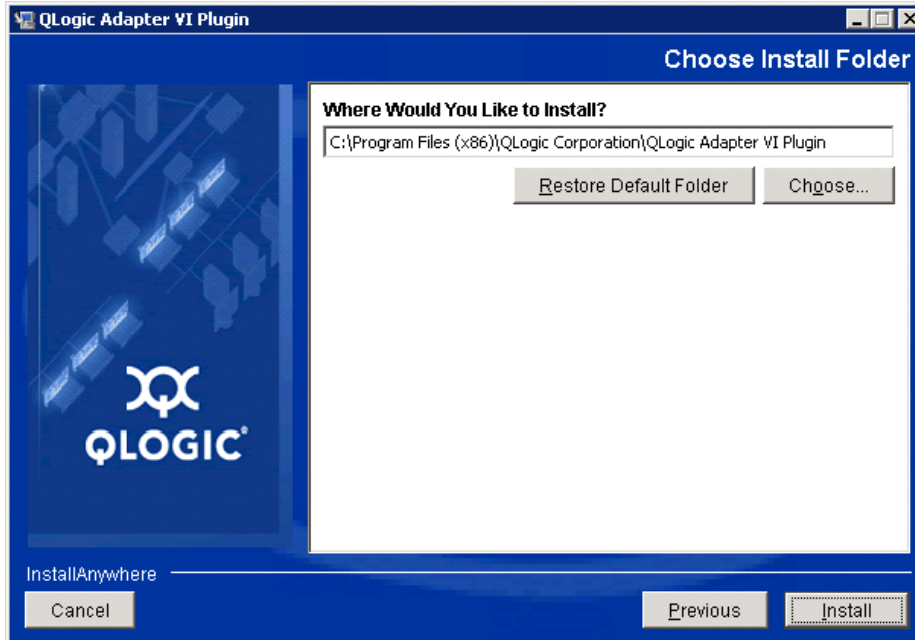

**Figure 2-12. QLogic Adapter VI Plug-in Wizard: Choose Install Folder**

Wait while the wizard performs the installation (see [Figure 2-13](#)).

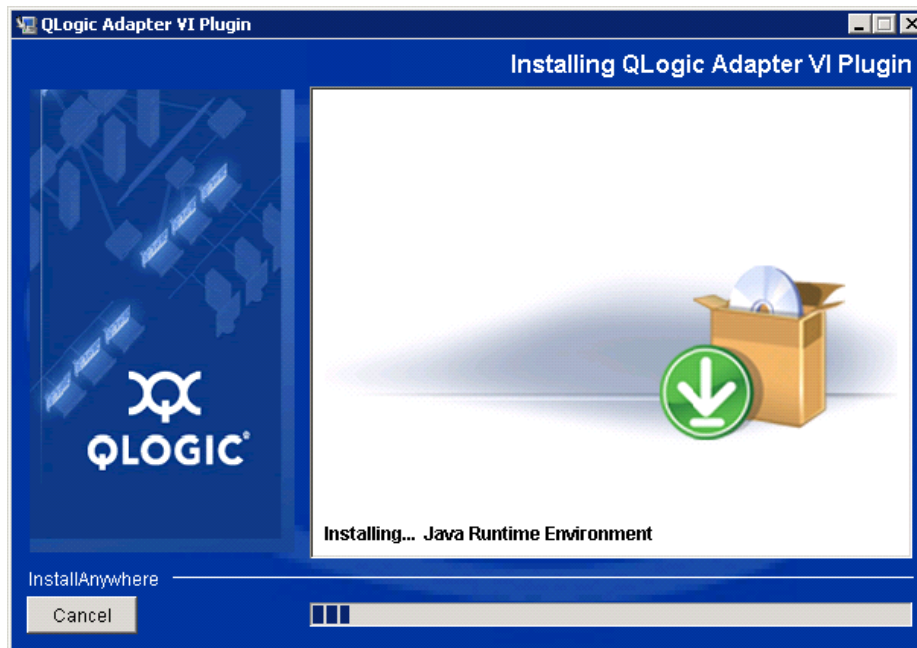

**Figure 2-13. QLogic Adapter VI Plug-in Wizard: Installing the Plug-In**

5. Type the requested information in the boxes, then click **Next** (see [Figure 2-14](#)).

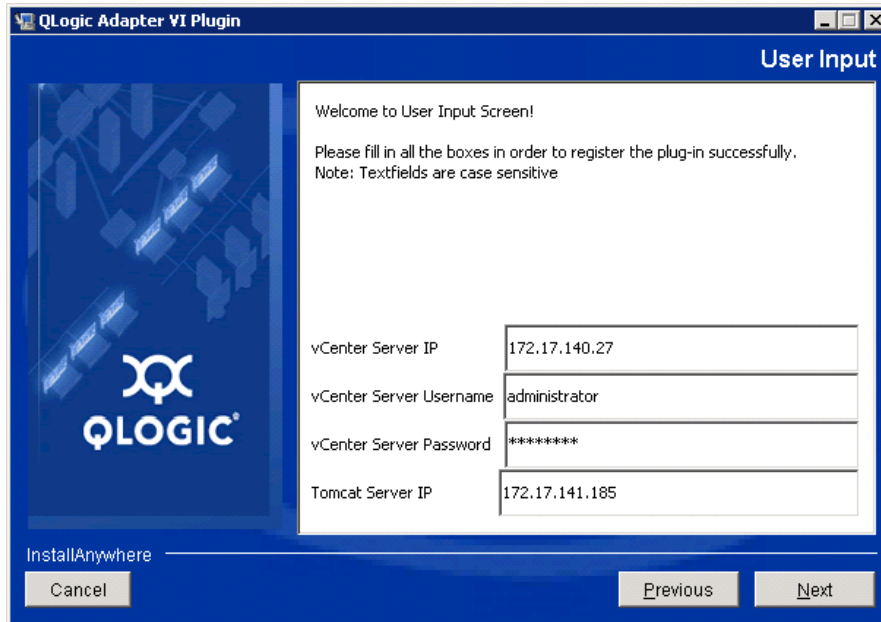

**Figure 2-14. QLogic Adapter VI Plug-in Wizard: User Input**

Wait while the wizard finishes configuring the plug-in (see [Figure 2-15](#)).

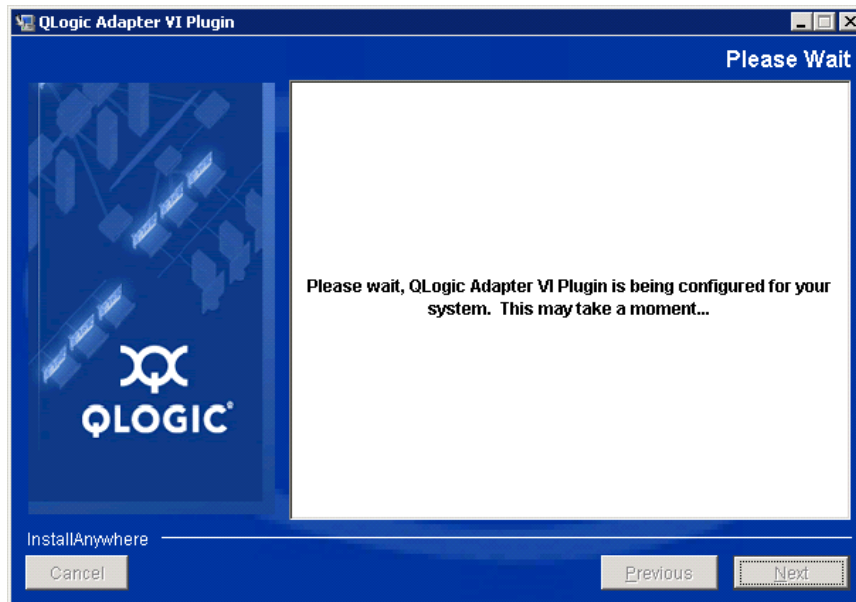

**Figure 2-15. QLogic Adapter VI Plug-in Wizard: Configuration in Progress**

6. When the Registration Result window (Figure 2-16) appears, click **Finish** to exit.

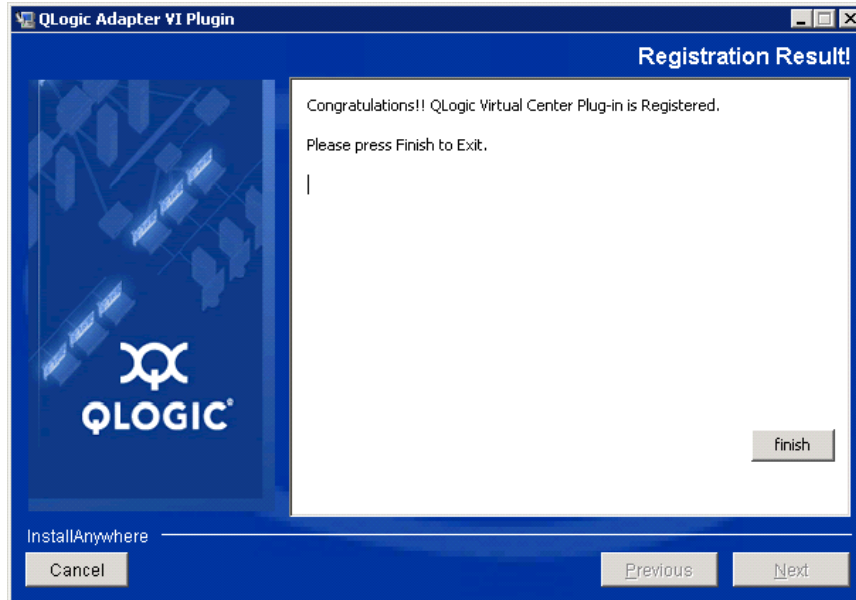

**Figure 2-16. QLogic Adapter VI Plug-in Wizard: Registration Result**

7. After the installation completes, restart the Tomcat™ service as follows:
  - If the plug-in is installed on the VMware vCenter Server, restart the VMware Virtual Center Management Web services.
  - If the plug-in is installed on a server other than the vCenter Server, restart the Apache Tomcat service.

### Plug-in Unregistration from a Manual Install

If you have performed a manual install of the QConvergeConsole VMware vCenter Server Plug-in, you must perform a manual uninstall before running the plug-in Installation Wizard.

VMware provides two type of scripts for plug-in registration (and unregistration):

- For PowerShell scripting:  
<http://communities.vmware.com/docs/DOC-4521>
- For Perl®:  
<http://communities.vmware.com/docs/DOC-4530>

Before you can use the script, you must download the appropriate VI SDK from VMware:

- For Perl VI SDK, download vSphere SDK for Perl:  
<http://www.vmware.com/support/developer/viperltoolkit/>
- For PowerShell, download vSphere PowerCLI:  
<http://communities.vmware.com/community/vmtn/vsphere/automationtools/powercli>

After downloading and installing the SDK and the registration script, follow the VMware instructions to unregister the plug-in. For example, the Perl unregister command is:

```
perl registerPlugin.pl --server="127.0.0.1"  
-username="administrator" --password="password"  
--key="com.qlogic.QLogicAdapterVIPlugIn" --action="remove"
```

To log into the vCenter Server, replace `administrator` and `password` with the correct information.

## Uninstalling the QConvergeConsole VMware vCenter Server Plug-in

**To remove the QConvergeConsole VMware vCenter Server Plug-in:**

1. In the Windows Control Panel, select **Programs and Features**.
2. In the Add or Remove Programs dialog box, select the QConvergeConsole VMware vCenter Server Plug-in, and then click **Change/Remove**.
3. To remove the plug-in, follow the instructions in the QConvergeConsole VMware vCenter Server Plug-in installer.

## Installing the QLogic Adapter CIM Provider

This section describes how to install, start, and remove the QLogic Adapter CIM Provider for VMware ESXi. Because there are multiple zip packages, ensure that you pick the zip package that matches your environment: ESXi 6.5 and ESXi 6.0 U2.

---

### NOTE

The QLogic Adapter CIM Provider for VMware ESXi was generated as a VIB file. A VIB contains the complete set of files and binaries required to install the provider on VMware ESXi. The file `offline-bundle.zip` contains the VIB and the necessary metadata to install the provider on VMware ESXi.

---

## Initial Installation Methods

Initial installation methods for the CIM Provider include the following:

- **Online.** Refer to “Installing the CIM Provider on an ESXi 6.5 or 6.0 U2/U3 Host” on page 26.
- **Offline.** Refer to “Existing ESXi Installation Using VMware Update Manager” on page 26.
- **Remote.** Refer to “Remote Installation of the CIM Provider on an ESXi Host” on page 27.

## Installing the CIM Provider on an ESXi 6.5 or 6.0 U2/U3 Host

1. Copy the following file to the root directory (/) of the ESXi 6.5 system:

```
QLGC-ESX-5.5.0-qlogic-adapter-provider-x.x.xx.xxxxxx-  
offline_bundle-xxxxxxx.zip
```

---

### NOTE

For an ESXi 6.0 U2/U3 host, select the .zip file for that version instead.

---

2. Issue the `esxcli` commands as follows:

```
# cd /  
# esxcli software acceptance set --level=CommunitySupported  
# esxcli software vib install -d  
file://<offline bundle>.zip --maintenance-mode
```

3. Reboot the system as required.

## Existing ESXi Installation Using VMware Update Manager

An existing ESXi host has asynchronous drivers installed using VMware Update Manager (VUM). For more information, see “Using vSphere ESXi Image Builder CLI” in the *vSphere Installation and Setup Guide* at:

<http://www.vmware.com/support/pubs/vsphere-esxi-vcenter-server-pubs.html>

### To install the asynchronous drivers:

1. Extract the contents of the asynchronous driver zip file.
2. Identify the `offline-bundle.zip` file or files.
3. From vCenter Server, go to **Home**, and then select **Update Manager**.
4. Click the **Patch Repository** tab.
5. Click the **Import Patches** link at the top right of the window.
6. Click **Finish**.



The asynchronous driver is now added to the patch repository.

7. Create a baseline and remediate the ESXi host. For more information, refer to *Installing and Administering VMware vSphere Update Manager*:

[http://www.vmware.com/support/pubs/vum\\_pubs.html](http://www.vmware.com/support/pubs/vum_pubs.html).

## Remote Installation of the CIM Provider on an ESXi Host

---

### NOTE

Before performing this procedure, ensure that the remote ESXi system is in Maintenance Mode. To do so using vSphere Client, select **Inventory**, select **Host**, and then select **Enter Maintenance Mode**.

---

1. Copy the `offline-bundle.zip` file to any location on the host where either the vSphere CLI package is installed or vSphere Management Assistant (vMA) is hosted.
2. Navigate to the location of the `offline-bundle.zip` file.
3. To install the offline bundle, issue the `vihostupdate` command as follows:

```
# vihostupdate.pl <conn_options> --install --bundle  
offline-bundle.zip --nosigcheck
```

4. Follow the on-screen instructions to complete the installation. You might need to reboot the ESXi system.

### NOTE

For more details on the `vihostupdate` command, see the *vSphere Command-Line Interface Installation and Reference Guide* at:

[http://www.vmware.com/pdf/vsphere4/r40/vsp\\_40\\_vcli.pdf](http://www.vmware.com/pdf/vsphere4/r40/vsp_40_vcli.pdf)

---

## Subsequent Update Installation

To update the QLogic Adapter CIM Provider after a prior VIB installation, follow the instructions in “[Uninstalling the QLogic Adapter CIM Provider](#)” on page 28 to remove the existing VIB. After completing the VIB removal, use the same steps in “[Initial Installation Methods](#)” on page 26 to install the new VIB.

## Starting the QLogic Adapter CIM Provider

After a system startup, the SFCB (Small-Footprint CIM Broker) CIMOM (CIM object manager) in the ESXi system should start automatically and load the QLogic Adapter CIM Provider, when necessary.

If the CIM Provider does not start automatically, you can manually stop, start, or restart the SFCB CIMOM by issuing the following commands.

- To stop the SFCB CIMOM and the QLogic Adapter CIM Provider:  

```
# /etc/init.d/sfcbd-watchdog stop
```
- To start the SFCB CIMOM and the QLogic Adapter CIM Provider:  

```
# /etc/init.d/sfcbd-watchdog start
```
- To restart the SFCB CIMOM and the QLogic Adapter CIM Provider:  

```
# /etc/init.d/sfcbd-watchdog restart
```

After starting the SFCB CIMOM, use a CIM client utility to query the QLogic Adapter CIM Provider for information.

### Uninstalling the QLogic Adapter CIM Provider

You can uninstall the QLogic Adapter CIM Provider for your version of VMware. For information about removing the QLogic Adapter CIM Provider through a remote host, see the *QLogic Adapter CIM Provider and vCenter Plug-in for VMware ESX/ESXi Readme* file.

#### To uninstall the CIM Provider from an ESXi 5.x host:

1. To view the VIB list, issue the following command:  

```
# esxcli software vib list
```
2. To remove the QLogic Adapter CIM Provider, issue the following command:  

```
# esxcli software vib remove --vibname qlogic-adapter-provider --maintenance-mode -f
```

#### To uninstall the CIM Provider from a remote host:

---

#### NOTE

Before performing this procedure, make sure that the ESXi system is in Maintenance Mode. To do so using the vSphere Client, select **Inventory**, select **Host**, and then select **Enter Maintenance Mode**.

---

1. From a console on the host where the vSphere CLI package is installed or vMA is hosted, query and find the Bulletin ID of the existing provider:  

```
# vihostupdate.pl <conn_options> --query
```
2. Remove the existing VIB by issuing the following command:  

```
# vihostupdate.pl <conn_options> --remove --bulletin <bulletinID>
```

## NOTE

For more details on `vihostupdate`, see the *vSphere Command-Line Interface Installation and Reference Guide*, located here:

[http://www.vmware.com/pdf/vsphere4/r40/vsp\\_40\\_vcli.pdf](http://www.vmware.com/pdf/vsphere4/r40/vsp_40_vcli.pdf)

---

## Installing QConvergeConsole VMware vSphere Web Client Plug-in

1. Gather the information necessary for the installation, including:
  - IP address of the vCenter Server
  - vCenter Server credentials (user name and password)
  - Where to host the QConvergeConsole VMware vSphere Web Client Plug-in (on vCenter Server or other server)

If you are hosting the QConvergeConsole VMware vSphere Web Client Plug-in on a non-vCenter Server, make sure the server has Tomcat running as a service and have the IP address of the Tomcat instance ready. Also, make sure the Tomcat `CATALINA_HOME` environment variable is set to the appropriate directory.

2. Run the installer on the server providing the Tomcat service. Provide the information requested by the installer.
  - On Windows, double-click the installer and follow the instructions on the GUI provided.
  - On Linux:
    - a. Make sure the user is the root user (or has root privileges).
    - b. Create the installer executable if one does not already exist. Choose the installer for your system (32-bit or 64-bit), and then issue the following command:

```
chmod +x <installer>
```

Where `<installer>` is the file name of the installer.
    - c. Run the installer by issuing the following command:

```
./<installer>
```

Where `<installer>` is the file name of the installer.
    - d. Follow the instructions provided by the installer.

3. Restart the Tomcat service.

If the QConvergeConsole VMware vCenter Server Plug-in is being hosted on the vCenter Server, you must restart the VMware Virtual Center Management Web services:

- ❑ In Windows, go to the **Administrative Tools** menu, select **Services**, and then restart VMware Virtual Center Management Web services.
- ❑ On the vCenter Server Appliance (Linux), issue the following command:

```
/etc/init.d/vmware-vpxd tomcat-restart
```

4. Restart any vSphere Web Client sessions.

If you are updating a previous version of the QConvergeConsole VMware vCenter Server Plug-in, restart the vSphere Web Client services as follows:

- ❑ In Windows, go to the **Administrative Tools** menu, select **Services**, and then restart VMware vSphere Web Client.
- ❑ On the vCenter Server Appliance (Linux), issue the following command:

```
/etc/init.d/vsphere-client restart
```

### Uninstalling the QConvergeConsole VMware vCenter Server Plug-in

To uninstall the QConvergeConsole VMware vCenter Server Plug-in, refer to the procedure for Windows or Linux:

- **Windows.** Uninstall the QConvergeConsole VMware vCenter Server Plug-in on Windows using the Windows Control Panel Uninstall Program window. Follow the uninstaller user interface to remove the plug-in.
- **Linux.** Uninstall the QConvergeConsole VMware vCenter Server Plug-in on Linux by issuing the following command at a command prompt:

```
/opt/qlogic/QLogic\ Adapter\ Web\ Client\  
Plugin/Uninstall_QLogic\ Adapter\ Web\ Client\  
Plugin/Uninstall\ QLogic\ Adapter\ Web\ Client\ Plugin
```

Follow the prompts (user interface or console commands) to uninstall the plug-in by the root user.

# 3

## Fibre Channel Configuration

This chapter provides the following information about configuring Fibre Channel:

- “Updating the Dell Firmware” on page 32
- “Using Fast!UTIL for Custom Configuration” on page 35
- “Setting Fibre Channel Adapter Parameters” on page 41
- “Configuring Target Persistent Binding” on page 42
- “Configuring Boot Devices” on page 44
- “Configuring Virtual Ports (NPIV)” on page 45
- “Configuring Fibre Channel Driver Parameters” on page 52
- “Configuring Selective LUNs” on page 53
- “Configuring OoOFR” on page 53
- “Configuring the UEFI Driver” on page 54
- “Setting an FA-PWWN” on page 61
- “Configuring and Verifying FA-BLD” on page 67
- “Using a Fabric-Assigned Boot LUN” on page 73
- “Running Diagnostics—Fibre Channel Ping and Trace Route” on page 75
- “Configuring CS\_CTL QoS” on page 80
- “Configuring End-to-End CS\_CTL QoS” on page 83
- “Configuring FDMI” on page 89
- “Enabling QLogic Forward Error Correction” on page 93
- “Running Extended Link Service Commands” on page 95

---

### NOTE

For information on configuring the Fibre Channel Adapter using VMware vCenter Server, refer to the *User’s Guide—QConvergeConsole Plug-ins for VMware vSphere* (part number SN0054677-00), available at:

<http://driverdownloads.qlogic.com>

---

## Updating the Dell Firmware

The firmware Dell Update Package (DUP) is a Flash update utility only; it is not used for adapter configuration. To run the firmware DUP, double-click the executable file. Alternatively, run the firmware DUP from the command line, which supports several command line options.

### NOTE

If you update the firmware using the DUP with the Integrated Dell Remote Access Controller (iDRAC) or Lifecycle Controller (LC), it shows FFV as the QLogic Fibre Channel adapter MBI version. This issue occurs only the first time that you run the firmware DUP; following a reboot, FFV will be shown correctly on subsequent firmware updates with the DUP.

---

## Running the Firmware Update by Double-Clicking

For additional information, refer to the *Dell Update Packages Version xx.xx.xxx User's Guide*, "Using Dell Update Packages" section.

**To run the firmware DUP by double-clicking the executable file:**

1. Double-click the icon representing the firmware DUP file. When the DUP splash screen appears (Figure 3-1), click **Install** to continue.

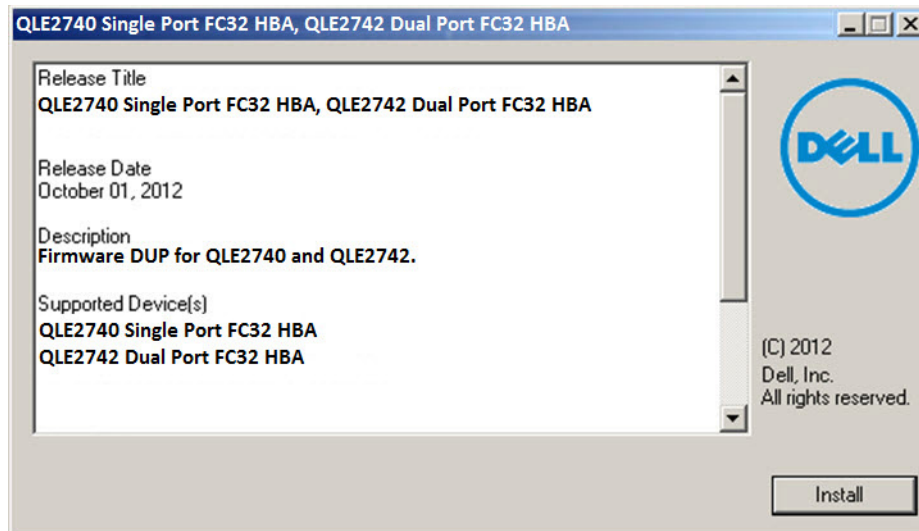

**Figure 3-1. Dell Update Package Splash Screen**

2. Follow the installer instructions. If a warning message appears (Figure 3-2), click **Yes** to continue the installation.

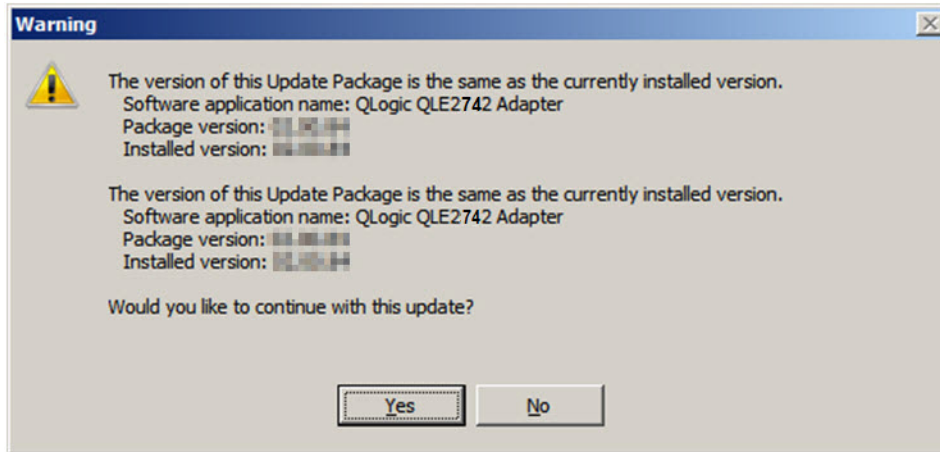

**Figure 3-2. Continue Dell Update Package Installation**

The installer indicates that it is loading the new firmware (Figure 3-3).

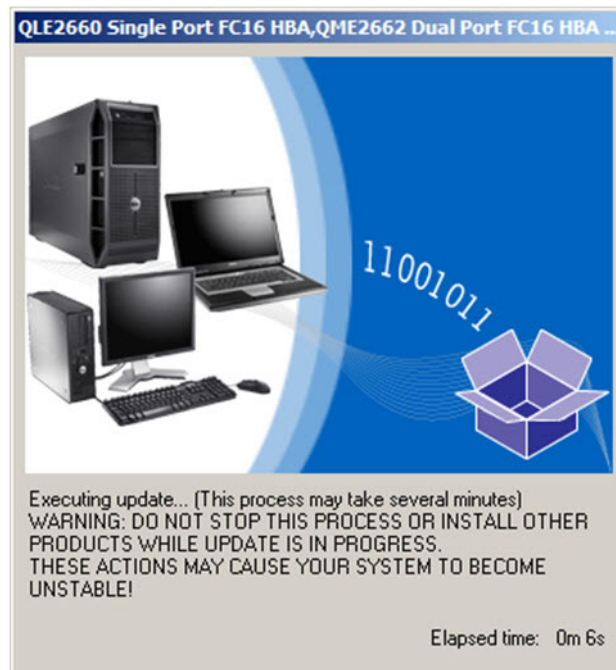

**Figure 3-3. Loading New Firmware**

3. When complete, the installer indicates the result of the installation (Figure 3-4). Click **Yes** to elect to reboot.

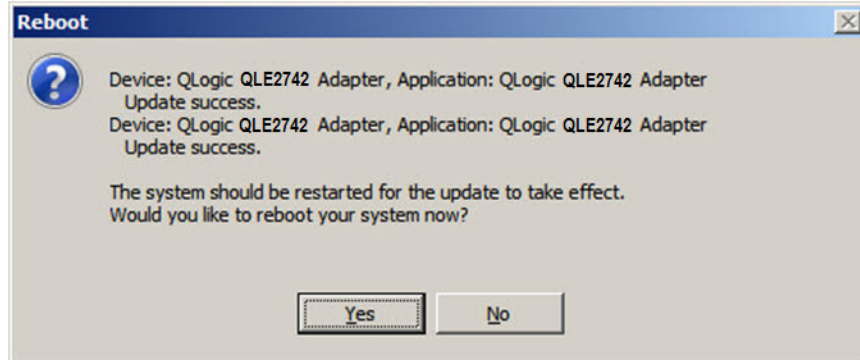

**Figure 3-4. Result of Installation**

4. To complete the installation, click **Finish** (Figure 3-5).

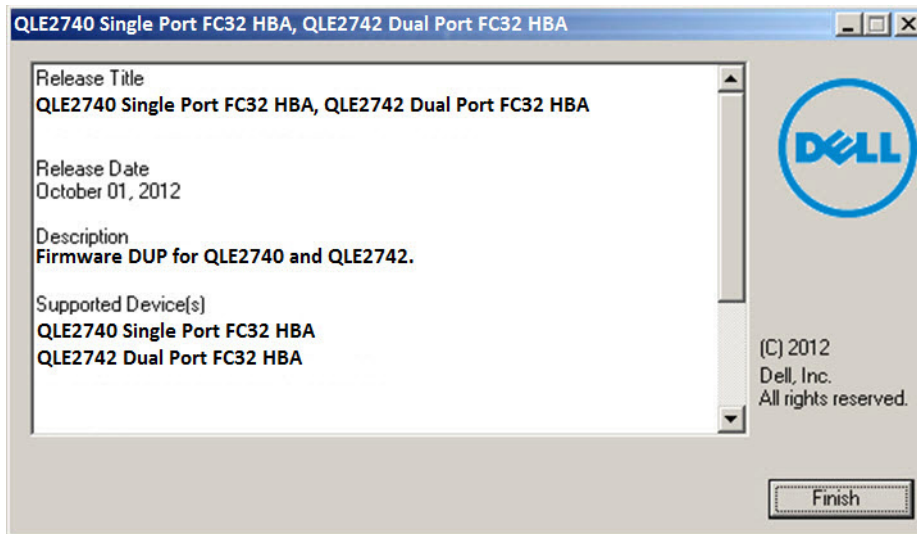

**Figure 3-5. Finish Installation**

## Running the Firmware Update from the Command Line

Running the firmware DUP from the command line, with no options specified, results in the same behavior as double-clicking the icon representing the DUP. Note that the actual file name of the DUP will vary.

```
C:\> Network_Firmware_2T12N_WN32_<version>_X16.EXE
```



Figure 3-6 shows the options you can use to customize the DUP installation behavior.

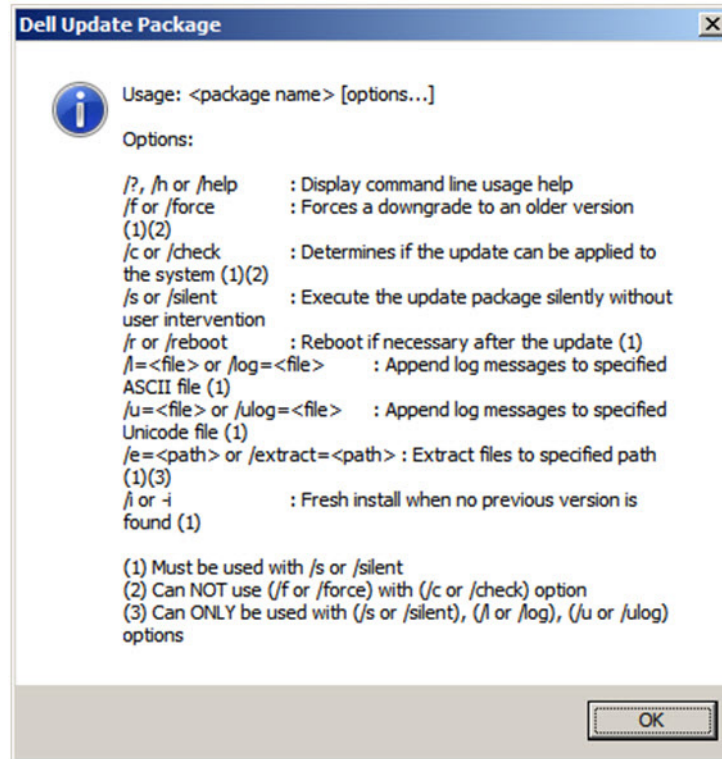

**Figure 3-6. Command Line Options**

## Using *Fast!UTIL* for Custom Configuration

This section provides detailed configuration information for advanced users who want to customize the configuration of the adapters and connected devices using *Fast!UTIL* (the QLogic Fibre Channel Adapter BIOS utility) in a pre-OS environment.

### To configure adapters using *Fast!UTIL*:

1. During the Host Bus Adapter BIOS initialization, press ALT+Q or CTRL+Q. It may take a few seconds for the *Fast!UTIL* menu to appear.
2. When the Select Host Adapter window appears, select the adapter type.
3. In the Adapter Settings window (see “[Adapter Settings](#)” on page 36), configure the adapter settings.
4. A message indicates that the configuration settings have been modified. Select **Save changes**.

5. To load the new parameters, reboot the system.

---

**CAUTION**

If the configuration settings are incorrect, your 2700 Series Adapter may not function properly.

---

The **Fast!UTIL Options** menu provides the following options:

- [Configuration Settings](#)
- [Scan Fibre Devices](#)
- [Fibre Disk Utility](#)
- [Loopback Data Test](#)
- [Select Adapter](#)
- [Exit Fast!UTIL](#)

## Configuration Settings

The following sections show and describe the 2700 Series Adapters **Configuration Settings** menu options in *Fast!UTIL*:

- [Adapter Settings](#)
- [Selectable Boot Settings](#)
- [Restore Default Settings](#)
- [Raw NVRAM Data](#)
- [Advanced Adapter Settings](#)

### Adapter Settings

[Table 3-1](#) describes the adapter settings.

**Table 3-1. Adapter Settings**

Setting	Values	Default	Description
Host Bus Adapter BIOS	Enabled, Disabled	Disabled	Disabling this setting disables the ROM BIOS on the 2700 Series Adapter, which frees space in upper memory. If you are booting from a Fibre Channel disk drive attached to the 2700 Series Adapter, you must enable this setting. See <a href="#">“Selectable Boot Settings” on page 38</a> for details on specifying the boot device.
Frame Size	512, 1024, 2048	2048	This setting specifies the maximum frame length supported by the 2700 Series Adapter.

**Table 3-1. Adapter Settings (Continued)**

Setting	Values	Default	Description
Loop Reset Delay	0–60 seconds	5 seconds	After resetting the loop, the firmware refrains from initiating any loop activity for the number of seconds specified in this setting.
Adapter Hard Loop ID	Enabled, Disabled	Disabled	If the Adapter Hard Loop ID setting is enabled, the adapter attempts to use the ID specified in the Hard Loop ID setting.
Hard Loop ID	0–125	0	If the Adapter Hard Loop ID setting is enabled, the adapter attempts to use the ID specified in this setting.
Connection Options	0, 1, 2	2	This setting defines the type of connection: <ul style="list-style-type: none"> <li>■ 0—loop only (for the 8Gb data rate)</li> <li>■ 1—point-to-point only (for the 8Gb, 16Gb, and 32Gb data rate)</li> <li>■ 2—loop preferred, then point-to-point (for the 8Gb and 16Gb data rate)</li> </ul>
Fibre Channel Tape Support	Enabled, Disabled	Enabled	This setting enables FCP-2 recovery.
Data Rate	2, 4, 5, 6	2	This setting determines the data rate: <ul style="list-style-type: none"> <li>■ 2—The adapter auto-negotiates and determines the data rate.</li> <li>■ 4—The adapter runs at 8GFC.</li> <li>■ 5—The adapter runs at 16GFC. Loop mode is not supported.</li> <li>■ 6—The adapter runs at 32GFC.</li> </ul>

## Selectable Boot Settings

The **Configuration Settings** menu provides access to the **Selectable Boot Settings** options. If you enable the Host Bus Adapter BIOS in the adapter settings, you can select the boot device, as shown in [Table 3-2](#).

**Table 3-2. Selectable Boot Settings**

Enable Selectable Boot	Boot WWPN/LUN	Device Boot
No	—	The BIOS configures the first disk drive it finds as the boot device.
Yes	None specified	The BIOS configures the first disk drive it finds that is also LUN 0 as the boot device.
Yes	Specified	The BIOS scans through the specified boot worldwide port name (WWPN) and LUN list until it finds a disk drive. This drive is configured as the boot device.

The **Selectable Boot Settings** option allows you to specify up to four WWPNs or LUNs as boot devices.

### To enable the Selectable Boot option and insert devices into boot device locations:

1. On the **Configuration Settings** menu, select **Host Adapter Settings**.
2. Enable the **Host Bus Adapter BIOS** and then press the ESC key to return to the **Configuration Settings** menu.
3. On the **Configuration Settings** menu, select **Selectable Boot Settings**.
4. To enable or disable (toggle) the **Selectable Boot** option, press the ENTER key. To move to the Primary location of the **Selectable Boot List** menu, press the DOWN ARROW key.
5. To see a list of accessible devices (in the Select Fibre Channel Device menu), press ENTER.
6. Select a drive by pressing the UP ARROW and DOWN ARROW keys or the PAGE UP and PAGE DOWN keys to scroll to the device that you want to put into your **Selectable Boot** menu list. Then press ENTER to select the requested device and load it into the **Selectable Boot** menu list.
7. To specify an alternate boot device on the 2700 Series Adapter, use the arrow keys to move to the next available alternate entry, press ENTER, select the disk drive you want, and press ENTER again. You can specify up to three alternate boot devices in this way.

## NOTE

System BIOS compatibility: To boot from a QLogic host 2700 Series Adapter in a computer system with a multiboot system BIOS, the 2700 Series Adapter must be included in the list of bootable devices in the system's **Boot** menu.

## Restore Default Settings

The **Restore Defaults** option restores the BIOS settings back to default.

## Raw NVRAM Data

The **Raw NVRAM Data** option displays the 2700 Series Adapter's NVRAM contents in hexadecimal format. This option is a QLogic troubleshooting tool; you cannot modify the raw NVRAM data.

## Advanced Adapter Settings

On the **Configuration Settings** menu in *Fast!UTIL*, select **Advanced Adapter Settings**. [Table 3-3](#) describes the default settings for the 2700 Series Adapters.

**Table 3-3. Advanced Adapter Settings**

Setting	Values	Default	Description
LUNs per Target	0, 8, 16, 32, 64, 128, 256	128	This setting specifies the number of LUNs supported per target if the target does not support the Report LUN command. Multiple LUN support is typically for redundant array of independent disks (RAID) boxes that use LUNs to map drives.
Enable LIP Reset <sup>1</sup>	Yes, No	No	This setting determines the type of loop initialization process (LIP) reset used when the OS initiates a bus reset routine as follows: <ul style="list-style-type: none"> <li>■ Yes = The driver initiates a global LIP reset to reset the target devices.</li> <li>■ No = The driver initiates a global LIP reset with full login.</li> </ul>
Enable LIP Full Login <sup>a</sup>	Yes, No	Yes	When this setting is Yes, the 2700 Series Adapter's reduced instruction set computer (RISC) controller log in to all ports after any LIP.
Enable Target Reset	Yes, No	Yes	When this setting is Yes, the drivers issue a Target Reset command to all devices on the loop when a SCSI Bus Reset command is issued.
Login Retry Count	0–255	8	This setting specifies the number of times the software tries to log in to a device.

**Table 3-3. Advanced Adapter Settings (Continued)**

Setting	Values	Default	Description
Port Down Retry Count	0–255 seconds	30 seconds	This setting specifies the number of seconds the software waits before resending a command to a port whose status indicates that the port is down.
Link Down Timeout	0–255 seconds	30 seconds	This setting specifies the number of seconds the software waits for a link that is down to come up.
Operation Mode	0, 5, 6	6	This setting specifies the reduced interrupt operation (RIO) modes if they are supported by the software driver. The RIO modes allow posting multiple command completions in a single interrupt. This setting supports the following modes: <ul style="list-style-type: none"> <li>■ 0—Interrupt for every I/O completion</li> <li>■ 5—Interrupt when the interrupt delay timer expires</li> <li>■ 6—Interrupt when the interrupt delay timer expires or no active I/Os</li> </ul>
Interrupt Delay Timer	0–255 (100µs units)	2 (200µs)	This setting contains the value used by a timer to set the wait time before generating an interrupt.
Enable Interrupt	Yes, No	No	This setting enables or disables the interrupt: <ul style="list-style-type: none"> <li>■ Yes—This setting enables the BIOS to use the interrupt request (IRQ) assigned to the 2700 Series Adapter.</li> <li>■ No—The BIOS polls for the 2700 Series Adapter's RISC controller mailbox command completion status.</li> </ul>

<sup>1</sup> Loop support is available only at port speeds up to 16GFC. At 32GFC, loop is not supported.

## Scan Fibre Devices

The **Scan Fibre Devices** option scans the Fibre Channel loop and lists all the connected devices by loop ID. It lists information about each device; for example, vendor name, product name, and revision. This information helps when configuring your 2700 Series Adapter and attached devices.

## Fibre Disk Utility

The **Fibre Disk Utility** option scans the Fibre Channel loop and lists all the connected devices by loop ID. You can select a Fibre Channel hard disk and do one of the following tasks:

- Perform a low-level format
- Verify the disk media
- Verify the disk data (Some targets do not support this feature.)

- Select a disk device

---

**CAUTION**

Performing a low-level format destroys all data on the disk.

---

## Loopback Data Test

The **Loopback Data Test** option allows you to perform the following loopback tests:

- External loopback data test
- Internal loopback data test

---

**NOTE**

When running an external loopback data test, make sure that the Fibre Channel link is up or a loopback plug is attached to the 2700 Series Adapter before starting the test.

---

## Select Adapter

If you have a multiport or multiple 2700 Series Adapters in the system, use the **Select Adapter** option to select and then configure or view the settings of a specific 2700 Series Adapter or one of its ports.

## Exit *Fast!UTIL*

The **Exit *Fast!UTIL*** option allows you to exit the utility and reboot the system. After making changes to the 2700 Series Adapter in *Fast!UTIL*, make sure you save the changes before you reboot the system.

## Setting Fibre Channel Adapter Parameters

Use QConvergeConsole to set Fibre Channel adapter parameters:

- [Setting Fibre Channel Adapter Parameters with QConvergeConsole GUI](#)
- [Setting Fibre Channel Adapter Parameters with Interactive QConvergeConsole CLI](#)
- [Setting Fibre Channel Adapter Parameters with Noninteractive QConvergeConsole CLI](#)

---

**NOTE**

The QLE2742 32Gbps FC HBA does not link up with the **Auto** setting when it is connected to a Dell EMC S4148U-ON switch.

---

## Setting Fibre Channel Adapter Parameters with QConvergeConsole GUI

For information about how to set Fibre Channel adapter parameters using QConvergeConsole GUI, refer to the topic about managing Fibre Channel and Fibre Channel over Ethernet (FCoE) adapter ports in the *QConvergeConsole Help*.

## Setting Fibre Channel Adapter Parameters with Interactive QConvergeConsole CLI

To set Fibre Channel adapter parameters with interactive QConvergeConsole CLI:

1. On the **Fibre Channel Adapter Configuration** menu, select **HBA Parameters**.
2. On the port menu, select a port to open the **HBA Parameters** menu.
3. On the **HBA Parameters** menu, select the **Configure HBA Parameters** option to open the **Configure Parameters** menu.

For more information, refer to the section about the Fibre Channel interactive commands in the *User's Guide—QConvergeConsole CLI* (part number SN0054667-00).

## Setting Fibre Channel Adapter Parameters with Noninteractive QConvergeConsole CLI

For information about how to set Fibre Channel adapter parameters using the noninteractive mode of QConvergeConsole CLI, refer to the section about the Fibre Channel noninteractive commands in the *User's Guide—QConvergeConsole CLI* (part number SN0054667-00).

## Configuring Target Persistent Binding

---

### NOTE

Target persistent binding is supported only on Windows.

---

Use QConvergeConsole to configure target persistent binding:

- [Configuring Persistent Binding with QConvergeConsole GUI](#)
- [Configuring Persistent Binding with Interactive QConvergeConsole CLI](#)
- [Configuring Persistent Binding with Noninteractive QConvergeConsole CLI](#)



## Configuring Persistent Binding with QConvergeConsole GUI

**To bind target devices attached to an adapter port using QConvergeConsole GUI:**

1. In the system tree, expand a Fibre Channel node.
2. In the system tree for a 2700 Series Adapter, select the physical port number.
3. Click the **Targets** tab, and then click the **Target Persistent Binding** tab.
4. Choose the binding options:
  - Select the **Bind All** check box to bind all the devices listed to adapter ports.
  - Select the **Bind** check box if you want to configure a specific port and bind it to the target ID that you have selected from the **Target ID** list. If you do not want to configure the port, clear the check box. If you clear the check box, the corresponding port is unconfigured.
5. To save the configuration changes, click **Save**.
6. If the Security Check dialog box appears, type the password in the **Enter Password** box, and then click **OK**.
7. The system overwrites any previously saved configuration for the current adapter and displays a message box. Click **OK** to close the message box.

For more information, refer to the topic about binding target devices in the *QConvergeConsole Help*.

## Configuring Persistent Binding with Interactive QConvergeConsole CLI

**To bind a target using interactive QConvergeConsole CLI:**

1. On the **Fibre Channel Adapter Configuration** menu, select **Target Persistent Bindings**.
2. On the port menu, select a port and then select **Bind Target(s)** to bind a target to a port.
3. Select a target and specify a target ID to open the **Target Persistent Binding – FC Port Configuration** menu with options to select more targets, save changes, or cancel the binding operation.

For more information, refer to the section about Fibre Channel interactive commands in the *User's Guide—QConvergeConsole CLI* (part number SN0054667-00).

## Configuring Persistent Binding with Noninteractive QConvergeConsole CLI

To bind a selected target to a specific adapter using the noninteractive mode of QConvergeConsole CLI, issue the following command:

```
# qacucli -pr fc -p (<hba instance> | <hba wwpn>) (<target wwnn>  
<target wwpn> <target port id> <target id>)
```

Where:

hba instance = Adapter number (use the `-g` command to find)  
hba wwnn = Worldwide node name of the adapter  
hba wwpn = Worldwide port name of the adapter  
target wwnn = Worldwide node name of the target  
target wwpn = Worldwide port name of the target  
target port id = Port ID of the target  
target id = ID to which the target is bound

For more information, refer to the section about Fibre Channel noninteractive commands in the *User's Guide—QConvergeConsole CLI* (part number SN0054667-00).

## Configuring Boot Devices

Use QConvergeConsole or *Fast!UTIL* to configure boot devices:

- [Configuring Boot Devices with QConvergeConsole GUI](#)
- [Configuring Boot Devices with Interactive QConvergeConsole CLI](#)
- [Configuring Boot Devices with Noninteractive QConvergeConsole CLI](#)
- [Configuring Boot Devices with the BIOS](#)

### Configuring Boot Devices with QConvergeConsole GUI

For information about configuring boot devices with QConvergeConsole GUI, refer to the topics about HBA parameters, viewing or modifying port parameters, and boot device selection in the *QConvergeConsole Help*.

### Configuring Boot Devices with Interactive QConvergeConsole CLI

On the **Fibre Channel Adapter Configuration** menu, select **Boot Devices Configuration** to open the **Boot Device Settings** menu with options to view and configure boot devices.

For information, refer to the section about the Fibre Channel interactive commands in the *User's Guide—QConvergeConsole CLI* (part number SN0054667-00).

## Configuring Boot Devices with Noninteractive QConvergeConsole CLI

To set a specific target as the boot device for a specific adapter, issue the following command:

```
# qaucli -pr fc -e (<hba instance> | <hba wwpn>) <target wwnn>  
<target wwpn> <target id> <lun id>
```

Where:

hba instance = Adapter number (use the `-g` command to find)

hba wwpn = Worldwide port name of the adapter

target wwnn = Worldwide node name of the target

target wwpn = Worldwide port name of the target

target id = ID to which the target is bound

lun id = ID of the LUN

For more information, refer to the “Fibre Channel Noninteractive Commands” section of the *User's Guide—QConvergeConsole CLI* (part number SN0054667-00).

## Configuring Boot Devices with the BIOS

For information about boot device configuration with the *Fast!UTIL* BIOS utility, refer to [“Using Fast!UTIL for Custom Configuration” on page 35](#) for information.

## Configuring Virtual Ports (NPIV)

Use QConvergeConsole to configure virtual ports for N\_Port ID virtualization and quality of service:

- [Configuring NPIV with QConvergeConsole GUI](#)
- [Configuring NPIV with Interactive QConvergeConsole CLI](#)
- [Configuring NPIV with Noninteractive QConvergeConsole CLI](#)
- [Configuring NPIV Quality of Service](#)

## Configuring NPIV with QConvergeConsole GUI

For information about using virtualization (NPIV) in QConvergeConsole GUI, refer to in the *QConvergeConsole Help*.

To access the *QConvergeConsole Help* system while the GUI utility is running,

point to the gear icon , point to **Help**, and then click then click **Browse Contents**. To install QConvergeConsole GUI, see “[Installing QConvergeConsole GUI](#)” on page 112.

## Configuring NPIV with Interactive QConvergeConsole CLI

For information about using virtualization (NPIV) in the interactive mode of QConvergeConsole CLI, refer to the *User’s Guide—QConvergeConsole CLI* (part number SN0054667-00). To download the guide, go to [www.qlogic.com](http://www.qlogic.com) and click **Downloads**.

## Configuring NPIV with Noninteractive QConvergeConsole CLI

To create a virtual port with an automatic WWPN using the noninteractive mode of QConvergeConsole CLI, issue the following command:

```
# qaucli -pr fc -vp (<hba instance> | <hba wwpn>) create auto
```

Where:

hba instance = Adapter number (use the `-g` command to find)

hba wwpn = Worldwide port name of the adapter

For more information, refer to the section about Fibre Channel noninteractive commands in the *User’s Guide—QConvergeConsole CLI* (part number SN0054667-00).

## Configuring NPIV Quality of Service

The QLogic 2700 Series Adapters solution provides for standards-based quality of service (QoS), ensuring high-quality performance for applications that require preferential delivery. The QLogic QoS solution is based on assigning QoS levels to virtual ports (NPIV ports). You can configure the QoS using the **priority method** or the **bandwidth method**, as shown in [Figure 3-7](#).

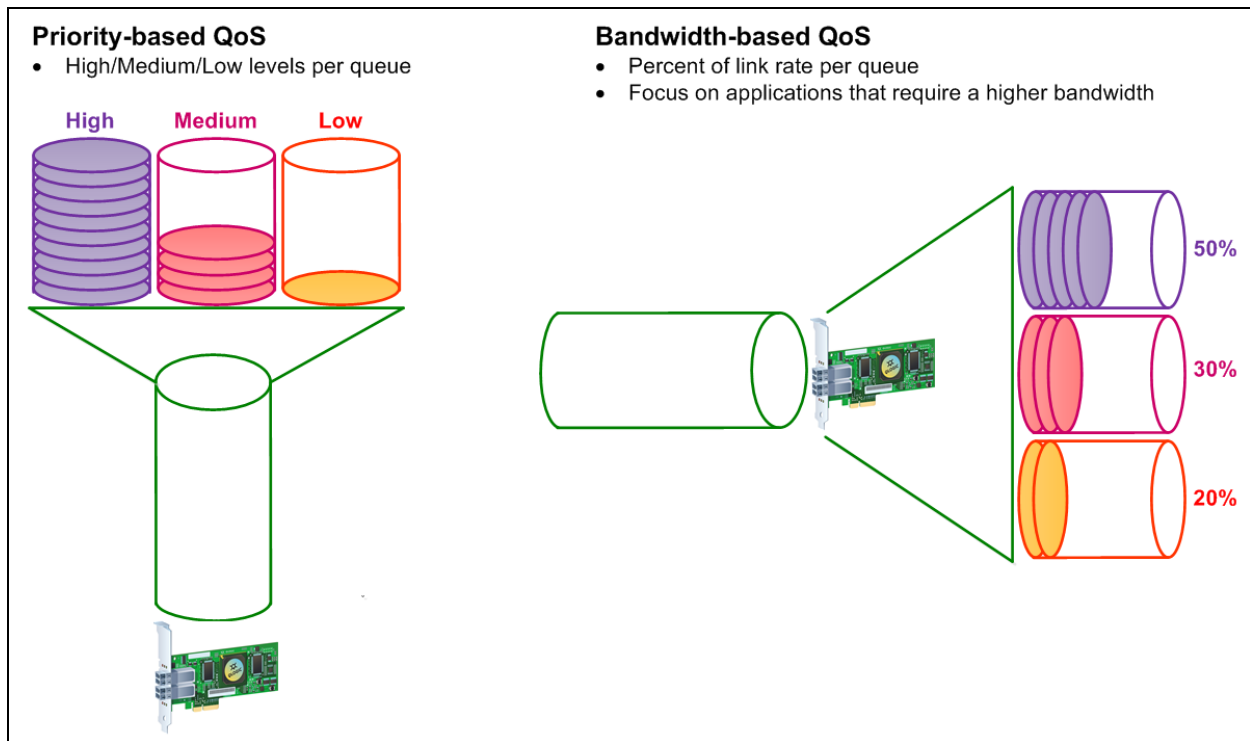

**Figure 3-7. Priority and Bandwidth-Based QoS**

On a single physical port, you can configure QoS using the priority method or the bandwidth method, but not both.

- The **priority method** assigns priority levels (low, medium, or high) to virtual ports based on the quality of service required for the applications or VMs using the virtual port. This method provides for various levels of latency requirements across virtual ports.
- The **bandwidth method** assigns a bandwidth percentage (0–100) or a bandwidth rate (for example, 6GFC) to applications or VMs that are using a virtual port. This method provides a minimum bandwidth guarantee. The bandwidth-based QoS configuration applies only when the total bandwidth requirement of the applications exceeds the available bandwidth. The bandwidth is not reserved for a specific virtual port, and unused bandwidth is shared among the other virtual ports.

The physical port or WWN always has high priority, independent of the bandwidth or priority scheme chosen for created virtual ports. You need not assign a QoS level to every virtual port that you create. If a QoS level is not assigned to a virtual port, the default is low priority (best effort), independent of the bandwidth or priority scheme. This flexibility allows you to focus on critical applications to ensure that the highest service level is provided. You can modify QoS levels for virtual ports using QConvergeConsole CLI.

To modify QoS levels, the configuration must meet the following hardware and software requirements:

- Server operating system: Microsoft® Windows Server 2012 or later
- Server support for MSI-X
- A QLogic 2700 Series Adapter
- Latest version of the QLogic STOR miniport driver, available from Dell:  
<http://support.dell.com>
- Fibre Channel switch that supports NPIV
- Physical port attached in a point-to-point connection

### Setting QoS by Bandwidth

Setting the QoS by bandwidth allocates up to 80 percent of the physical port's bandwidth to its virtual ports. The remaining 20 percent is reserved to handle non-QoS applications and virtual ports.

Setting QoS by bandwidth guarantees bandwidth for each virtual port and to the application or virtual machine (VM) associated with that virtual port. The proper QoS setting can prevent bottlenecks that occur when VMs contend for port bandwidth.

Consider how much bandwidth is required to maximize application or VM performance and set the QoS level to 105 percent of that value. For example, if a mission-critical application on a VM requires 1Gb of bandwidth to transmit its data over the fabric, QLogic recommends a 1.05Gb bandwidth for the virtual port.

Alternatively, you can set the virtual port QoS values as a percentage of the total available bandwidth.

---

#### NOTE

Setting QoS by bandwidth guarantees a minimum bandwidth to a virtual port, but not a maximum limit. If the application or virtual port requires more bandwidth than the QoS bandwidth value allows and the physical port has available bandwidth, the application receives the additional bandwidth. The port allocates additional bandwidth on demand up to the port capacity or until there is contention for bandwidth among the virtual ports.

---

When the physical port is partitioned into four virtual ports, the port bandwidth is divided between the virtual ports according to traffic demands.

QConvergeConsole lets you configure QoS for each virtual port by setting minimum and maximum percentages of the physical port's bandwidth for each virtual port. This feature lets you guarantee a transmission rate for each port that requires a specific bandwidth to run mission-critical applications for business continuity using virtual ports. The setting for a specific QoS can resolve bottlenecks that exist when VMs contend for port bandwidth.

**To set the QoS by bandwidth percentage with QConvergeConsole GUI:**

1. In the QConvergeConsole system tree pane on the left, expand a 2700 Series Adapter.
2. Select a virtual port.
3. In the content pane on the right, click the **QoS** tab.
4. In the **QoS Type** box, select **Bandwidth**.
5. In the **View By** box, select **Bandwidth Percentage**.
6. Move the slider to select a percentage between 1 percent to 100 percent. This selection indicates the bandwidth you want to guarantee for data transferred over the selected virtual port.

Figure 3-8 shows an example.

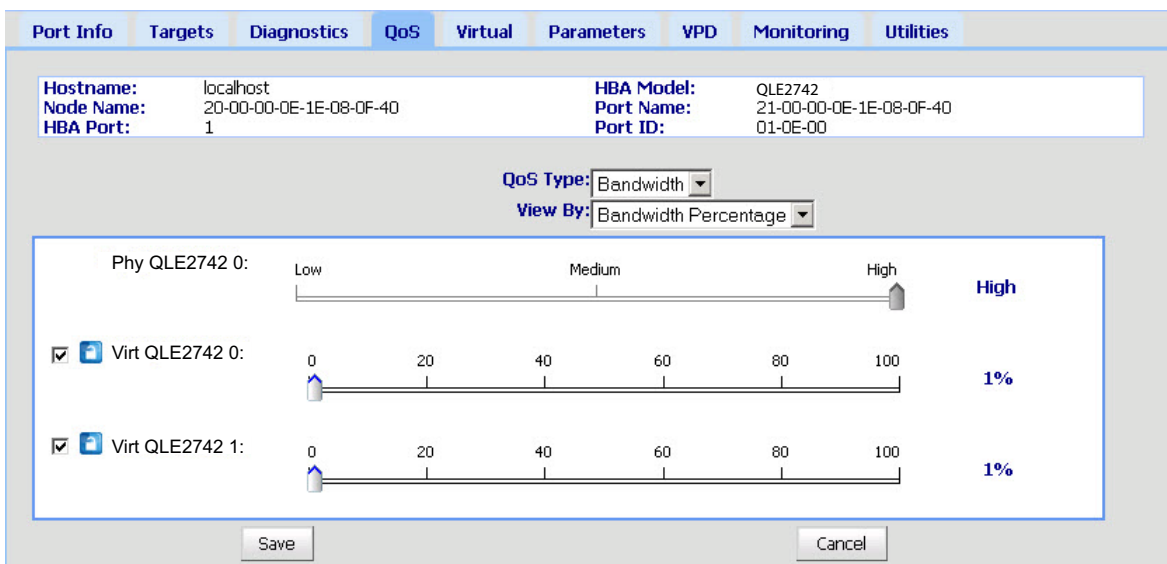
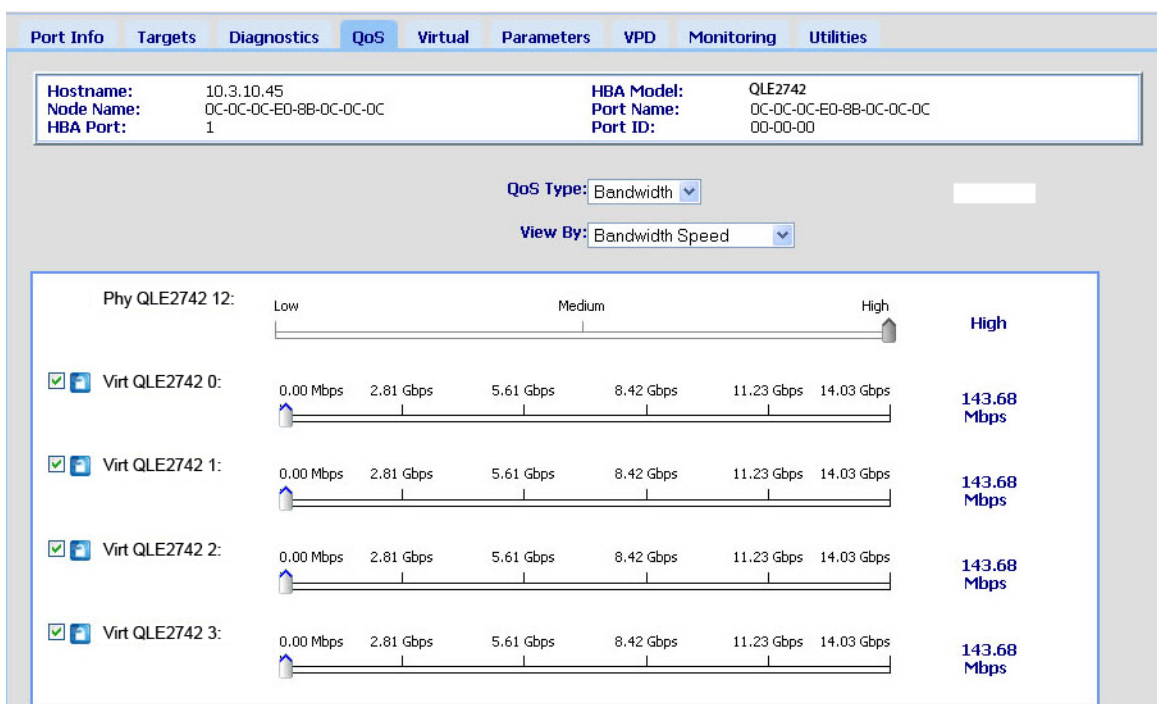

**Figure 3-8. Setting the QoS by Bandwidth Percentage**

7. Click **Save**.

**To set the QoS by bandwidth speed with QConvergeConsole GUI:**

1. In the QConvergeConsole tree pane on the left, expand a 2700 Series Adapter.
2. Select a virtual port.
3. In the content pane on the right, click the **QoS** tab.
4. In the **QoS Type** box, select **Bandwidth**.
5. In the **View By** box, select **Bandwidth Speed**.
6. Move the slider to select the bandwidth speed, as shown in [Figure 3-9](#).



**Figure 3-9. Setting the QoS by Bandwidth Speed**

7. Click **Save**.

**To set the QoS by bandwidth speed with interactive QConvergeConsole CLI:**

1. On the **Fibre Channel Adapter Configuration** menu, select the **QoS** option.
2. From the port menu, select a port to open the **QoS Type Menu**. Select **2: QoS Bandwidth** to set the bandwidth speed.



## Setting QoS by Priority

To set the QoS by priority with QConvergeConsole GUI:

1. In the QConvergeConsole tree pane on the left, expand a 2700 Series Adapter.
2. Select a virtual port.
3. In the content pane on the right, click the **QoS** tab.
4. In the **QoS Type** box, select **Priority**.
5. Move the slider to select a low, medium, or high priority, as shown in [Figure 3-10](#).

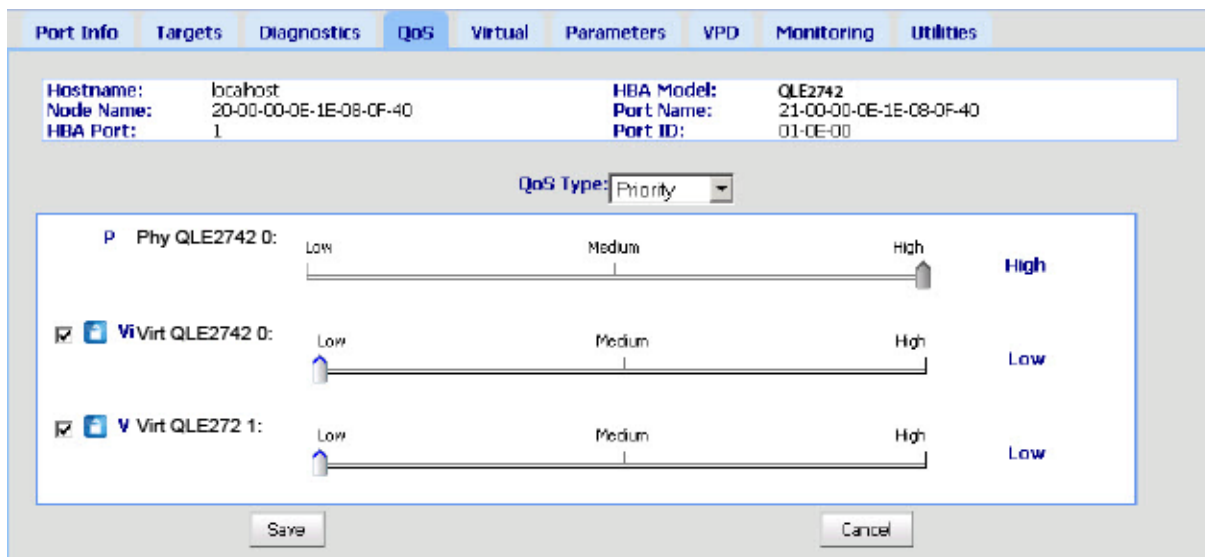

**Figure 3-10. Setting the QoS by Priority**

6. Click **Save**.

To set the QoS by priority with interactive QConvergeConsole CLI:

1. From the **Fibre Channel Adapter Configuration** menu, select the **QoS** option.
2. From the port menu, select a port to open the **QoS Type Menu**. Select **1: QoS Priority** to set the priority.

## Configuring Fibre Channel Driver Parameters

Use QConvergeConsole GUI, CLI, or VMware plug-in to configure Fibre Channel driver parameters:

- [Configuring Fibre Channel Driver Parameters with QConvergeConsole GUI](#)
- [Configuring Fibre Channel Driver Parameters with Interactive QConvergeConsole CLI](#)
- [Configuring Fibre Channel Driver Parameters with Noninteractive QConvergeConsole CLI](#)
- [Configuring Fibre Channel Driver Parameters with QConvergeConsole VMware vCenter Server Plug-in](#)

### Configuring Fibre Channel Driver Parameters with QConvergeConsole GUI

Refer to the topics about HBA parameters and viewing or modifying port parameters in the *QConvergeConsole Help* for information.

### Configuring Fibre Channel Driver Parameters with Interactive QConvergeConsole CLI

To configure Fibre Channel driver parameters using interactive QConvergeConsole CLI:

1. On the **Fibre Channel Adapter Configuration** menu, select **HBA Parameters**.
2. On the port menu, select a port to open the **HBA Parameters** menu.
3. On the **HBA Parameters** menu, select **Configure HBA Parameters** to open the **Configure Parameters** menu with options to configure connection options, data rate, frame size, hard loop ID, loop reset delay, BIOS, Fibre Channel tape support, operation mode, interrupt delay timer, login retry count, port down retry count, LIP full login, link down time-out, target reset, LUNS per target, and receive out-of-order frames.

For more information, refer to the section about the Fibre Channel interactive commands in the *User's Guide—QConvergeConsole CLI* (part number SN0054667-00).

### Configuring Fibre Channel Driver Parameters with Noninteractive QConvergeConsole CLI

To configure driver settings, issue the following command:

```
# qauccli -pr fc -fs (<hba instance> | <hba wwpn>) {(<param name> | <param alias>) <param value>}
```

Where:

`hba instance` = Adapter number (use the `-g` command to find)

`hba wwpn` = Worldwide port name of the adapter

`param name` = Name of the parameter

`param alias` = Alias of the parameter

`param value` = New value of the parameter

For more information, refer to the section about the Fibre Channel noninteractive commands in the *User's Guide—QConvergeConsole CLI* (part number SN0054667-00).

## Configuring Fibre Channel Driver Parameters with QConvergeConsole VMware vCenter Server Plug-in

For details on how to configure the Fibre Channel driver parameters using the QConvergeConsole plug-in, see the *User's Guide—QConvergeConsole Plug-ins for VMware vSphere* (part number SN0054677-00).

## Configuring Selective LUNs

The QConvergeConsole GUI cannot be used for configuring selective LUNs.

To configure selective LUNs with the interactive QConvergeConsole CLI, refer to the section about the Fibre Channel interactive commands in the *User's Guide—QConvergeConsole CLI* (part number SN0054667-00).

To configure selective LUNs with the noninteractive QConvergeConsole CLI, refer to the section about the Fibre Channel noninteractive commands in the *User's Guide—QConvergeConsole CLI* (part number SN0054667-00).

## Configuring OoOFR

Out-of-order frame reassembly (OoOFR) reassembles out-of-order frames as they are received, minimizing network congestion by eliminating the retransmission of frames and exchanges. To configure OoOFR, use either QConvergeConsole GUI or CLI.

### Configuring OoOFR with QConvergeConsole GUI

To enable OoOFR with QConvergeConsole GUI:

1. In the QConvergeConsole system tree pane on the left, select a Fibre Channel port.
2. In the content pane on the right, click **Parameters**.
3. Click the **Advanced HBA Parameters** tab.

4. Select the **Enable Receive Out of Order Frame** check box.

## Configuring OoOFR with Interactive QConvergeConsole CLI

To enable OoOFR with the interactive QConvergeConsole CLI:

1. On the **Fibre Channel Adapter Configuration** menu, select **HBA Parameters**.
2. On the port menu, select a port to open the HBA Parameters menu.
3. On the **HBA Parameters** menu, select **Configure HBA Parameters** to open the Configure Parameters menu.
4. Select **13: Enable Receive Out Of Order Frame**.

## Configuring OoOFR with Noninteractive QConvergeConsole CLI

To enable OoOFR in the noninteractive mode of QConvergeConsole CLI, issue one of the following commands:

```
# qaucli -n <hba instance>|<hba wwpn> EnableReceiveOutOfOrderFrame 1
# qaucli -n <hba instance>|<hba wwpn> EO 1
```

Where:

`hba instance` = Adapter number (use the `-g` command to find)

`hba wwpn` = Worldwide port name of the adapter

To disable OoOFR in the noninteractive mode of QConvergeConsole CLI, issue one of the following commands:

```
# qaucli -n <hba instance>|<hba wwpn> EnableReceiveOutOfOrderFrame 0
# qaucli -n <hba instance>|<hba wwpn> EO 0
```

## Configuring the UEFI Driver

This section provides information on configuring the unified extensible firmware interface (UEFI) driver contained in the multiboot image. UEFI 2.x systems use a human interface infrastructure (HII) to configure motherboard devices and plug-in adapters. QLogic Fibre Channel Adapters use an HII to configure adapter parameters and boot-from-SAN settings.

**To configure the UEFI driver for Dell:**

1. During system boot, press the key corresponding to your platform.
2. On the Dell System Setup window, select **Device Settings**, and then press the ENTER key.

The Device Settings window opens and lists the devices installed in the system. Each listed device supports the HII. QLogic devices have one device settings entry per port. Each entry contains the adapter name and WWPN of the port. [Figure 3-11](#) shows an example of the System Setup window for Device Settings.

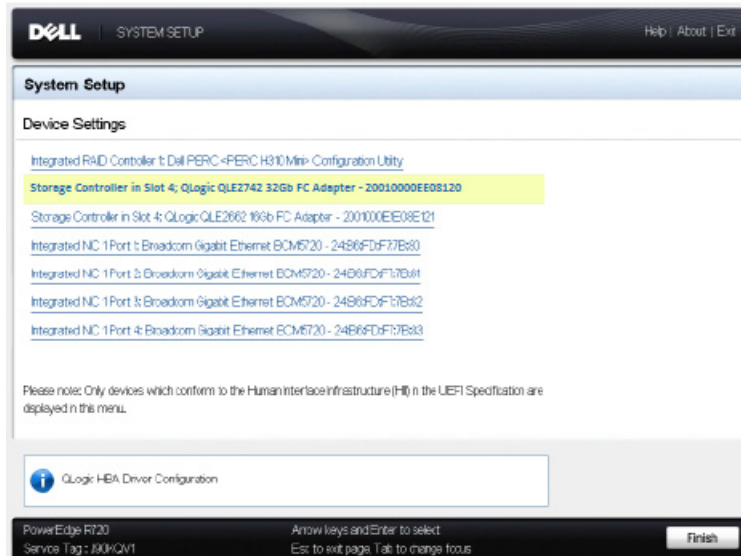

**Figure 3-11. Dell System Setup: Device Settings**

3. In the Device Settings window, select your device and then press ENTER. The Main Configuration Page for the selected device appears. The Main Configuration Page is the top-level menu of the adapter configuration pages. [Figure 3-12](#) shows an example of the Main Configuration Page.



**Figure 3-12. Dell System Setup: Main Configuration**

- On the Main Configuration Page, select **Port Configuration Page** and press ENTER.

The Port Configuration Page appears; [Figure 3-13](#) shows an example.



**Figure 3-13. Dell System Setup: Port Configuration**

- Use the Port Configuration Page to change adapter operational parameters, such as port speed. In most cases, use the default values. [Table 3-4](#) describes the configurable options on the Port Configuration Page.

**Table 3-4. Port Configuration Page Settings**

Setting	Description
<b>Device Name</b>	Indicates the name of the adapter.
<b>Port Number</b>	Indicates the index of the selected port (1 to N). <a href="#">Figure 3-13</a> shows port 1 in a two-port adapter.
<b>Port Speed</b>	Indicates the data rate of the Fibre Channel adapter port. This value can be automatic or specified in GFC. The adapters support 8GFC, 16GFC, and 32GFC.
<b>Port Connection Mode</b>	Indicates the connection mode of the Fibre Channel adapter port. The adapters support the following: <ul style="list-style-type: none"> <li>■ Loop Only<sup>1</sup></li> <li>■ Point to Point</li> <li>■ Loop Preferred, Otherwise Point To Point <sup>a</sup></li> </ul>
<b>World Wide Node Name</b>	Indicates the adapter port's unique worldwide node name (WWNN).

**Table 3-4. Port Configuration Page Settings (Continued)**

Setting	Description
<b>Virtual World Wide Node Name</b>	Indicates the adapter port's unique virtual WWNN.
<b>World Wide Port Name</b>	Indicates the adapter port's unique WWPN.
<b>Virtual World Wide Port Name</b>	Indicates the adapter port's unique virtual WWPN.

<sup>1</sup> Loop support is available only at port speeds up to and including 8GFC. At 16GFC and 32GFC, loop is not supported.

6. To return to the Main Configuration Page, click **Back**.
7. On the Main Configuration Page, select **Firmware and Device Information**, and then press ENTER.

The Firmware and Device Information page provides the adapter and firmware version information, and port address information. [Figure 3-14](#) shows an example.

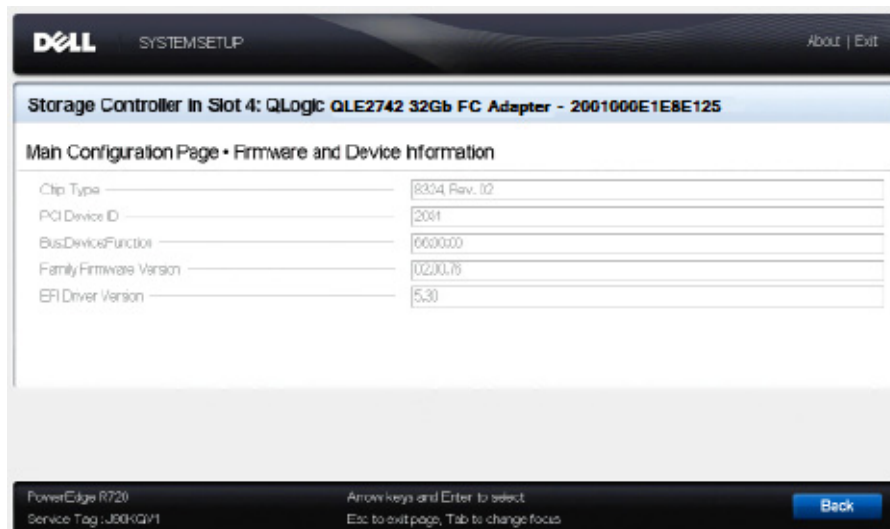

**Figure 3-14. Dell System Setup: Firmware and Device Information**

[Table 3-5](#) describes the Firmware and Device Information settings.

**Table 3-5. Firmware and Device Information Settings**

Setting	Description
<b>Chip Type</b>	Type of intelligent storage peripheral (ISP) controller used in the adapter.
<b>PCI Device ID</b>	Unique PCI device ID of the adapter.
<b>Bus:Device:Function</b>	PCI address of the adapter in the Bus:Device:Function (BDF) notation.
<b>Family Firmware Version</b>	Adapter firmware version information.
<b>EFI Driver Version</b>	Adapter extensible firmware interface (EFI) driver version information.

- To return to the Main Configuration Page, click **Back**.
- On the Main Configuration Page, select **Fibre Channel Target Configuration**, and then press ENTER.

The Fibre Channel Target Configuration page appears. [Figure 3-15](#) shows an example.



**Figure 3-15. Fibre Channel Target Configuration**



10. On the Fibre Channel Target Configuration page, select SAN storage devices for boot from SAN. With selective boot scan enabled, the target configuration determines which target LUNs to map. All other devices are ignored. [Table 3-6](#) describes the Fibre Channel Target Configuration settings.

**Table 3-6. Fibre Channel Target Configuration Settings**

Setting	Description
<b>Boot Scan Selection</b>	Specifies the adapter initiator behavior for booting the system from the specified Fibre Channel storage target(s) or fabric discovered target(s).
<b>First FC Target World Wide Port Name</b>	Specifies the WWPN of the first Fibre Channel storage target.
<b>First FC Target LUN</b>	Specifies the LUN of the first Fibre Channel storage target.
<b>Second FC Target World Wide Port Name</b>	Specifies the WWPN of the second Fibre Channel storage target.
<b>Second FC Target LUN</b>	Specifies the LUN of the second Fibre Channel storage target.

---

**NOTE**

System UEFI compatibility: To boot from a QLogic host 2700 Series Adapter in a computer system with a multiboot system UEFI, the 2700 Series Adapter must be included as the first device in the list of bootable devices in the system's **Boot** menu.

---

11. To return to the Main Configuration Page, click **Back**.
12. On the Main Configuration Page, select **HBA Configuration Page**, and then press ENTER.

The HBA Configuration Page appears; [Figure 3-16](#) shows an example.

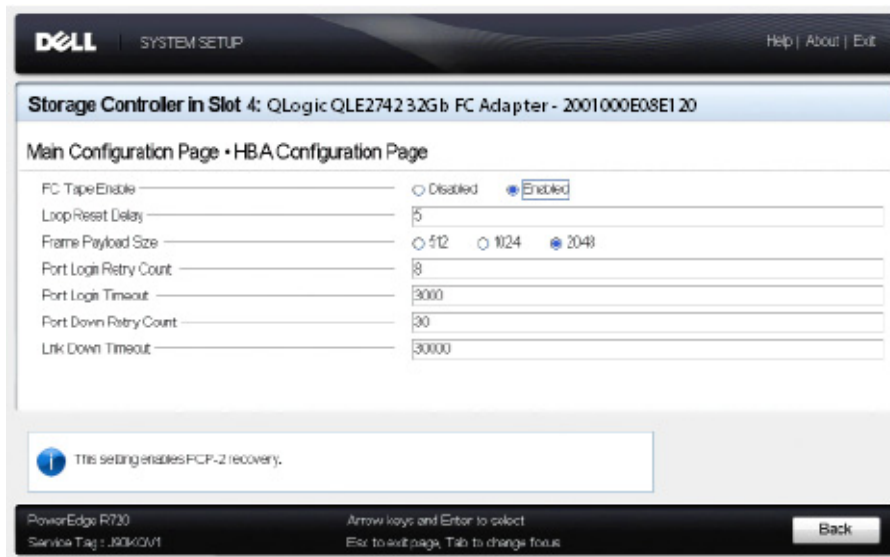

**Figure 3-16. Dell System Setup: HBA Configuration**

13. Use the HBA Configuration Page to configure adapter operational parameters. In most cases, use the default values.

[Table 3-7](#) describes the fields on the HBA Configuration Page.

**Table 3-7. HBA Configuration Page Settings**

Setting	Description
<b>FC Tape Enable</b>	Enables or disables Fibre Channel protocol (FCP-2) recovery.
<b>Loop Reset Delay</b>	Specifies the Fibre Channel arbitrated loop reset delay for the port. After resetting the loop, the adapter firmware refrains from initiating any loop activity for the number of seconds specified. The range is 0 to 60.
<b>Frame Payload Size</b>	Specifies the maximum Fibre Channel frame payload size.
<b>Port Login Retry Count</b>	Specifies the number of times the adapter firmware initiates to log in to a target device port. The range is 0 to 255.
<b>Port Login Timeout</b>	Specifies the time-out in milliseconds that the initiator uses when attempting to log in to the target device port. The range is 0 to 255000.

**Table 3-7. HBA Configuration Page Settings (Continued)**

Setting	Description
<b>Port Down Retry Count</b>	Specifies the number of seconds the software retries a command to a port returning port-down status. The range is 0 to 255.
<b>Link Down Timeout</b>	Specifies the number of milliseconds the Fibre Channel uplink port can be offline before the system is notified that the SAN fabric connectivity is lost and the uplink port is marked as being down. The range is 1 to 255000.

14. Click **Back** to return to the Main Configuration Page window.
15. Click **Finish** to save your changes and exit.

## Setting an FA-PWWN

This section provides the following information for fabric-assigned port world wide (FA-PWWN) name:

- [Setting the FA-PWWN from the Adapter](#)
- [Setting the FA-PWWN from the Brocade Switch](#)

### Setting the FA-PWWN from the Adapter

From the adapter side, you can set the FA-PWWN using the following utilities:

- [Setting FA-PWWN with QConvergeConsole GUI](#)
- [Setting FA-PWWN with QConvergeConsole CLI](#)
- [Setting FA-PWWN with QConvergeConsole VMware Plug-ins](#)

## Setting FA-PWWN with QConvergeConsole GUI

Before setting the FA-PWWN, the port name appears on the Port Info page as shown in the example in [Figure 3-17](#).

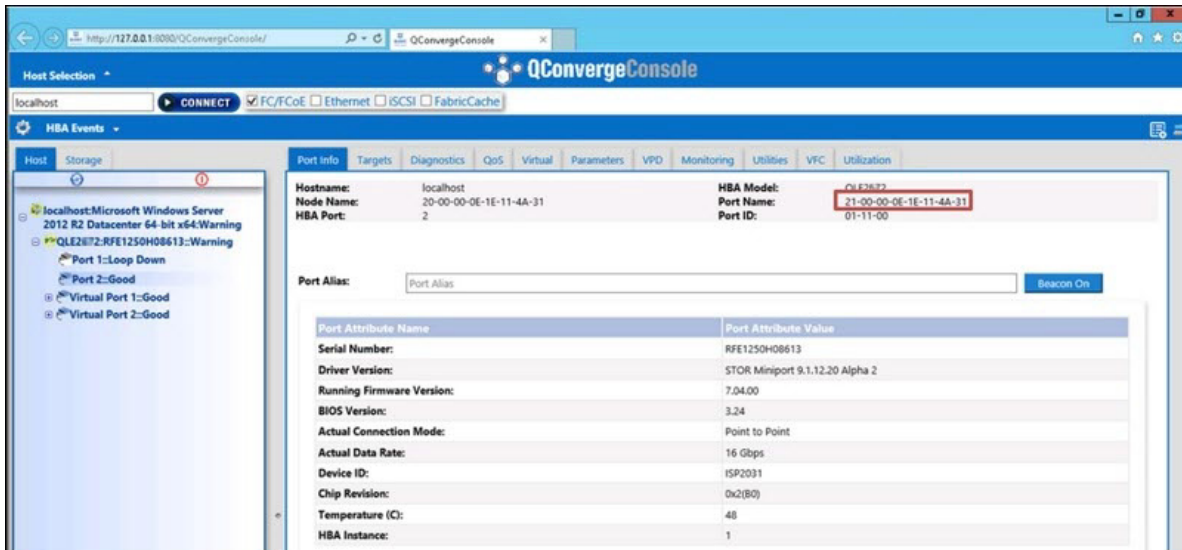
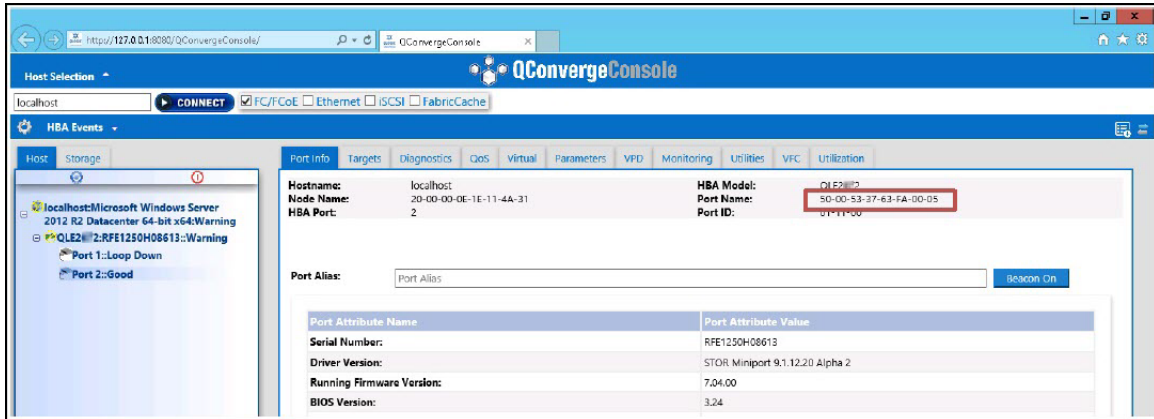

**Figure 3-17. Before Setting the FA-PWWN in the GUI**

To set the FA-PWWN from the adapter using QConvergeConsole GUI:

1. In the QConvergeConsole GUI tree pane on the left, select an adapter, expand the adapter node, and then select a port.
2. In the content pane on the right, click the **Parameters** tab.
3. On the Parameters page, click the **Advanced HBA Parameters** tab.
4. Under **Configure Port Advanced Parameters**, select the **Enable Fabric Assigned WWN** check box, and then click **Save**.

After refreshing the Brocade® switch, the Port Info page shows the **Port Name** as shown in [Figure 3-18](#).



**Figure 3-18. New FA-PWWN Port Name in GUI**

### Setting FA-PWWN with QConvergeConsole CLI

To set the FA-PWWN from the adapter using QConvergeConsole CLI:

1. In the interactive mode of QConvergeConsole CLI, select **Main Menu**, and then click **Adapter Configuration**.
2. Select **HBA Parameters**.
3. Select the appropriate port.
4. Select **Configuration HBA Parameters**.
5. Select **Enable Fabric Assign WWN**.
6. On the **Enable Fabric Assign WWN Menu**, select **1: Enable**.
7. Select the option to **Commit Changes**.

The following shows an example of setting the FA-PWWN:

```
HBA Desc.      : QLE2742 QLogic 2-port 32Gb Fibre Channel Adapter
FW Version     : 7.04.00
WWPN          : 21-00-00-OE-1E-11-4A-38
WWNN          : 21-00-00-OE-1E-11-4A-38
Link          : Online
```

=====

- 1: Connection Options
- 2: Data Rate
- 3: Frame Size
- 4: Enable HBA Hard Loop ID
- 5: Hard Loop ID
- 6: Loop Reset Delay (seconds)
- 7: Enable BIOS
- 8: Enable Fibre Channel Tape Support
- 9: Operation Mode
- 10: Interrupt Delay Timer (100 microseconds)
- 11: Execution Throttle
- 12: Login Retry Count
- 13: Port Down Retry Count
- 14: Enable LIP Full Login
- 15: Link Down Timeout (seconds)
- 16: Enable Target Reset
- 17: LUNs per Target
- 18: Enable Receive Out of Order Frame
- 19: Enable LR
- 20: Enable Fabric Assign WWN**
- 21: Commit Changes
- 22: Abort Changes

(p or 0: Previous Menu; m or 98: Main Menu; ex or 99: Quit)  
Please enter selection: **20**

QConvergeConsole  
Version 1.1.3 (Build 22)

Enable Fabric Assign WWN Menu

- 1: Enable
- 2: Disable (current)

```
(p or 0: Previous Menu; m or 98: Main Menu; ex or 99: Quit)
Please enter selection: 1
```

After refreshing the Brocade switch, the **Adapter Information** shows the port name as shown in the following example.

```
QConvergeConsole
CLI - Version 1.1.3 (Build 22)

FC Adapter Information

1: FC Adapter Information
2: FC Port Information
3: FC VPD Information
4: FC Target/LUN Information
5: FC VFC Information

(p or 0: Previous Menu; m or 98: Main Menu; ex or 99: Quit)
Please enter selection: 2

QConvergeConsole
CLI - Version 1.1.3 (Build 22)

Adapter Information
HBA Model QLE2742 SN: RFE12340H08416
1: Port 1: WWPN: 21-00-00-0F-1F-11-4A-30 Link Down
2: Port 2: WWPN: 50-00-53-37-63-FA-00-05 Online
```

### Setting FA-PWWN with QConvergeConsole VMware Plug-ins

For information about setting a FA-PWWN using the QConvergeConsole VMware vCenter Server Plug-in or QConvergeConsole VMware vSphere Web Client Plug-in, see the section “Managing a Fibre Channel Adapter Port” in the *User’s Guide—QConvergeConsole Plug-ins for VMware vSphere* (part number SN0054677-00).

## Setting the FA-PWWN from the Brocade Switch

From the Brocade switch, you can set a FA-PWWN and a static FA-PWWN. For the most current information, refer to the Brocade switch documentation.

### Setting the FA-PWWN from the Switch

Figure 3-19 shows the FA-PWWN setting from the Brocade switch.

```
portdisable 17
fapwn --enable -port 17
portenable 17
fapwn --show all
```

AG Port	port	Device Port WWN	Virtual Port WWN	PID	Enable	MapType
---	17	---	50:00:53:37:63:fa:00:05	--	Yes	Port/User

**Figure 3-19. Setting the FA-PWWN from the Brocade Switch**

After refreshing the Brocade switch, the **Device Port WWN** appears in Web Tools as shown in Figure 3-20.

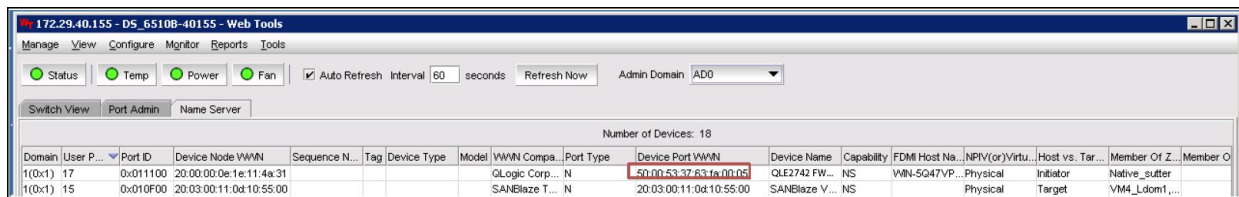

**Figure 3-20. Device Port WWN for Brocade Switch**

### Setting the Static FA-PWWN from the Switch

Figure 3-21 shows the static FA-PWWN setting from the Brocade switch.

```
portdisable 17
fapwn --assign -port 17 -v 51:00:53:37:63:fa:02:11
portenable 17
fapwn --show all
```

AG Port	port	Device Port WWN	Virtual Port WWN	PID	Enable	MapType
---	17	---	51:00:53:37:63:fa:02:11	--	Yes	Port/User
			50:00:53:37:63:fa:00:05			

**Figure 3-21. Setting the Static FA-PWWN from the Brocade Switch**

After refreshing the Brocade switch, the **Device Port WWN** appears in Web Tools as shown in Figure 3-22.



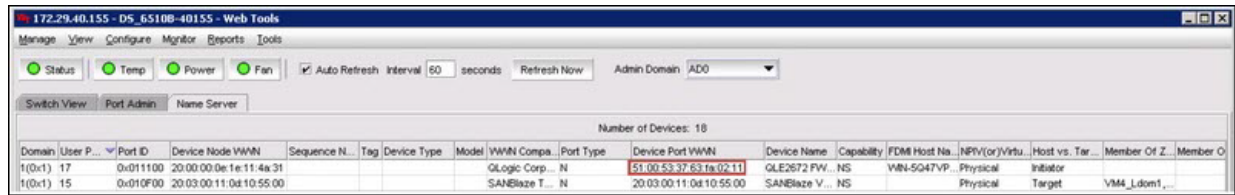

Domain	User P...	Port ID	Device Node	WWN	Sequence N.	Tag	Device Type	Model	WWN Compa.	Port Type	Device Port WWN	Device Name	Capability	FDM Host Na.	(NPV/(or)Virtu.)	Host vs. Tar...	Member Of Z.	Member O
1(0x1)	17	0x011100	20:00:00:0e:1e:11:4a:31					QLogic Corp...	N		51:00:53:37:63:fa:02:11	GLE2672 FW...	NS	WIN-5047VP...	Physical	Initiator		
1(0x1)	15	0x010F00	20:03:00:11:04:10:55:00					SANBlaze T...	N		20:03:00:11:04:10:55:00	SANBlaze V...	NS		Physical	Target	VM4_Ldon1...	

Figure 3-22. Device Port WWN (Static) for Brocade Switch

## Configuring and Verifying FA-BLD

This section provides the following information on fabric-assigned boot LUN discovery (FA-BLD):

- [Configuring FA-BLD from the Adapter](#)
- [Verifying that FA-BLD is Operational](#)
- [Adapter Side Restrictions](#)

### Configuring FA-BLD from the Adapter

On the adapter side, follow these procedures to configure fabric-assigned boot LUN discovery (FA-BLD) in the QConvergeConsole GUI and QConvergeConsole CLI.

#### Enabling Host Bus Adapter Port BIOS and Fabric-assigned Boot LUN with QConvergeConsole GUI

##### To enable the Host Bus Adapter Port BIOS:

1. In QConvergeConsole GUI, select the **Host** tab in the left pane.
2. In the system tree, expand the adapter node and then select a port node.
3. In the content pane on the right, click the **Parameters** tab.
4. On the Parameters page, click the **HBA Parameters** tab.
5. On the HBA Parameters page, select the **Enable HBA Port BIOS** check box.
6. Click **Save**.

Figure 3-23 shows an example.

The screenshot shows the QConvergeConsole GUI with the 'Parameters' tab selected. The 'Boot Device Selection' sub-tab is active. The main content area displays the following information:

<b>Hostname:</b>	localhost	<b>HBA Model:</b>	QLE2742
<b>Node Name:</b>	20-00-00-24-FF-8F-D7-F4	<b>Port Name:</b>	21-00-00-24-FF-8F-D7-F4
<b>HBA Port:</b>	1	<b>Port ID:</b>	00-00-00

Below this is a 'Configure Port General Parameters' section with the following settings:

- Connection Options:** 2 - Loop Preferred, Otherwise Point to Point
- Data Rate:** 32 Gbps
- Frame Size:** 2048
- Enable HBA Port Hard Loop ID
- Hard Loop ID:** 0
- Loop Reset Delay (seconds):** 5
- Enable HBA Port BIOS
- Enable Fibre Channel Tape Support

At the bottom of the form are two buttons: 'Save' and 'Restore Defaults'.

**Figure 3-23. Enabling Host Bus Adapter Port BIOS**

**To enable fabric-assigned boot LUN:**

1. In QConvergeConsole GUI, select the **Host** tab in the left pane.
2. In the system tree, expand the adapter node and then select a port node.
3. In the content pane on the right, click the **Parameters** tab.
4. On the Parameters page, click the **Boot Device Selection** tab.
5. On the Boot Device Selection page, select the **Enable Fabric Assigned Boot LUN** check box.
6. Click **Save**.

Figure 3-24 shows an example.

The screenshot shows the 'Boot Device Selection' configuration page in the QConvergeConsole CLI. The page is divided into several sections:

- Navigation Tabs:** Port Info, Targets, Diagnostics, QoS, Virtual, Parameters (selected), VPD, Monitoring, Utilities, VFC, Utilization.
- Sub-Tabs:** HBA Parameters, Advanced HBA Parameters, Boot Device Selection (selected).
- Host Information:**
  - Hostname: localhost
  - Node Name: 20-00-00-24-FF-8F-D7-F4
  - HBA Port: 1
  - HBA Model: QLE2742
  - Port Name: 21-00-00-24-FF-8F-D7-F4
  - Port ID: 00-00-00
- Configure Port Boot Parameters:**
  - Selectable Boot
  - Enable Fabric Assigned Boot LUN
  - (Primary) Boot Port Name: 00-00-00-00-00-00-00-00 LUN: 0
  - (Alternate 1) Boot Port Name: 00-00-00-00-00-00-00-00 LUN: 0
  - (Alternate 2) Boot Port Name: 00-00-00-00-00-00-00-00 LUN: 0
  - (Alternate 3) Boot Port Name: 00-00-00-00-00-00-00-00 LUN: 0
- Buttons:** Save, Restore Defaults

**Figure 3-24. Enabling Fabric-Assigned Boot LUN**

### Configuring the Adapter and Boot Devices with QConvergeConsole CLI

To configure adapter and boot devices:

1. In QConvergeConsole CLI, navigate to Adapter Configuration and then select **HBA Parameters**.
2. Enter the port number.
3. Select **Configure HBA Parameters**.
4. Select **Enable BIOS** and set it to **Enable**.
5. In the Adapter Configuration, select **Boot Device Configuration**.
6. Enter the port number.
7. Select **Configure Boot Device(s)**.
8. Set the **Enable Fabric Assign Boot LUN** to **Enable**.
9. Select **Commit Changes**.

Figure 3-25 shows an example of the adapter and boot device configuration.

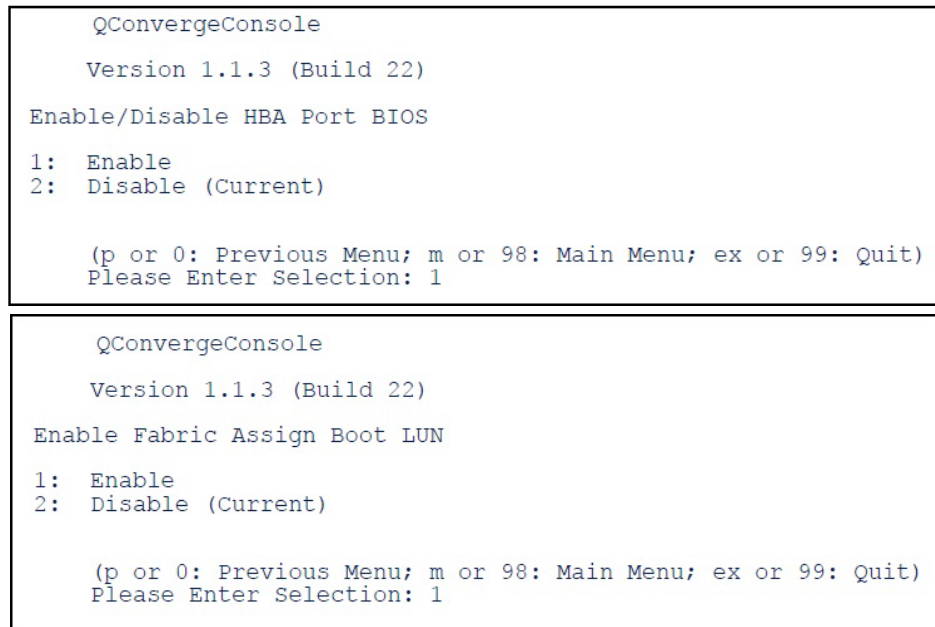

**Figure 3-25. Configuring Adapter and Boot Device**

## Configuring a Zone in a Brocade Switch

To configure a zone in a Brocade switch:

1. Create a boot LUN configuration as follows:  

```
bootluncfg --add 50:00:53:37:63:FA:00:05  
20:02:00:11:0d:51:5c:01 0000000000000000
```
2. Create a zone named with the following:
  - Device's PWWN
  - Specific information about the target WWN
  - LUN to be booted from
3. Add a zone to the zoneset configuration as follows:  

```
cfgadd config, "BFA_5000533763fa0005_BLUN"
```
4. To save the zoneset, issue the following command:  

```
cfigsave
```
5. Enable zoneset configuration to have it actively running:  

```
cfigenable config
```

Figure 3-26 shows an example of a configured zone in a Brocade switch.

```
Name of zone contains the PWWN: "BFA_5000533763fa0005_BLUN", and the 4 members of the zone are described as shown below:
1st member      00:00:00:00:                20:02:00:11 [Target's PWWN, first 4 octets]
2nd member      00:00:00:01:                0d:51:5c:01 [Target's PWWN, last 4 octets]
3rd member      00:00:00:02:                00:00:00:00 [Target's LUN, first 4 octets]
4th member      00:00:00:03:                00:00:00:00 [Target's LUN, last 4 octets]

zonecreate "BFA_5000533763fa0005_BLUN", "00:00:00:00:20:02:00:11; 00:00:00:01:0d:51:5c:01;
00:00:00:02:00:00:00:00; 00:00:00:03:00:00:00:00"
```

**Figure 3-26. Configuring a Zone in a Brocade Switch**

## Verifying that FA-BLD is Operational

To verify if the FA-BLD is operational, use either *Fast!UTIL* or the system.

Figure 3-27 shows *Fast!UTIL* displaying the boot LUN.

```
QLE2672 PCI3.0 Fibre Channel ROM BIOS Version 3.24
Copyright (C) QLogic Corporation 1993-2013. All rights reserved.
www.qlogic.com

Press <CTRL-Q> or <ALT-Q> for Fast!UTIL

BIOS for Adapter 0 is disabled
Firmware Version 7.04.00

<CTRL-Q> Detected, Initialization in progress, Please wait...

Device Device Adapter Port Lun Vendor Product Product
Number Type Number ID Number ID ID Revision
Disk 1 010B01 0 SANBlaze VLUN P2T1L0 U6.3
ROM BIOS Installed
```

**Figure 3-27. Verifying FA-BLD with Fast!UTIL**

Figure 3-28 shows using the system, with a LUN ready to install or OS booted from LUN.

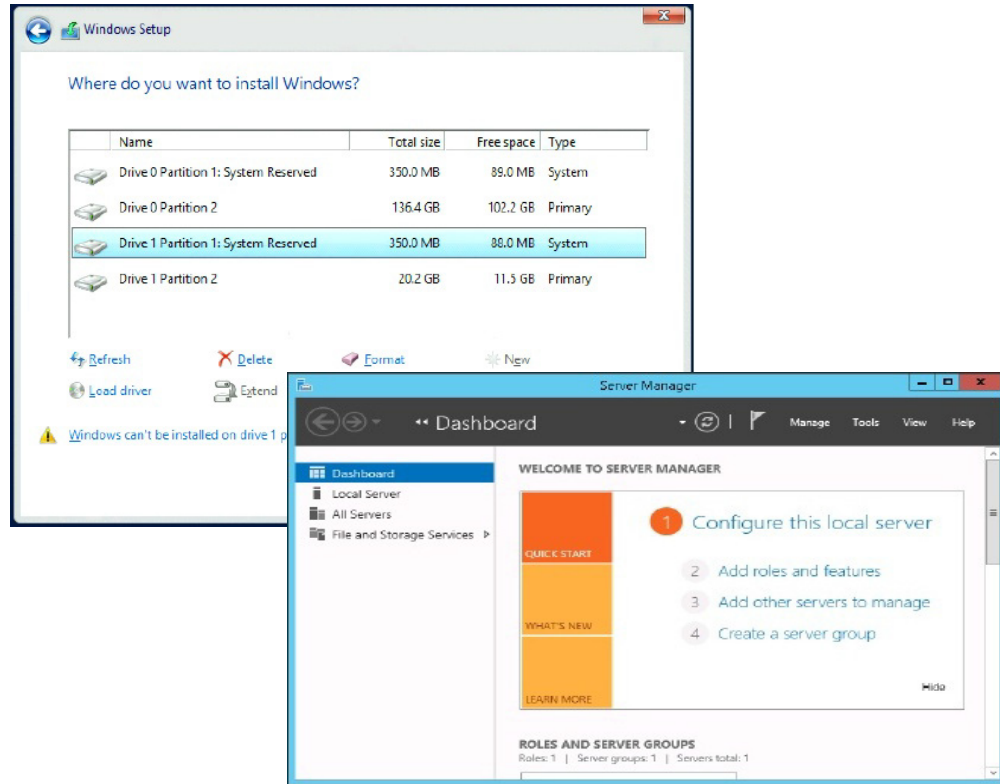

Figure 3-28. Verifying FA-BLD from the System

## Adapter Side Restrictions

The known fabric-assigned port world wide name (FA-PWNN) and FA-BLD restrictions include the following:

- Cannot be fully enabled from *Fast!UTIL*
- Do not use **Restore Defaults** from *Fast!UTIL*, QConvergeConsole GUI, or QConvergeConsole CLI. Doing so causes these capabilities to become disabled.

## Using a Fabric-Assigned Boot LUN

This section describes how to use a fabric-assigned boot LUN in the following utilities:

- [Using a Fabric-Assigned Boot LUN in QConvergeConsole GUI](#)
- [Using a Fabric-Assigned Boot LUN in Interactive QConvergeConsole CLI](#)
- [Using a Fabric-Assigned Boot LUN with Noninteractive QConvergeConsole CLI](#)
- [Using a Fabric-Assigned Boot LUN with QConvergeConsole Plug-ins](#)

### Using a Fabric-Assigned Boot LUN in QConvergeConsole GUI

For details about how to use a fabric-assigned LUN in QConvergeConsole GUI, refer to the “Fabric-Assigned Boot LUN” topic in the *QConvergeConsole Help*.

### Using a Fabric-Assigned Boot LUN in Interactive QConvergeConsole CLI

**To use a fabric-assigned boot LUN with interactive QConvergeConsole CLI:**

1. From the main menu, select the adapter type (**Fibre Channel Adapter**).
2. On the **Fibre Channel Adapter Configuration** menu, select **Boot Devices Configuration**.
3. On the **Boot Device Settings** menu, select **Configure Boot Device(s)**, and then press the ENTER key.
4. Select **Enable Fabric Assigned Boot LUN**, and then press ENTER.
5. On the **Enable Fabric Assign Boot LUN** menu, type **1** to enable this feature.

### Using a Fabric-Assigned Boot LUN with Noninteractive QConvergeConsole CLI

In noninteractive QConvergeConsole CLI, set a target as the fabric-assigned boot LUN for a specific adapter by issuing the following command:

```
# qaucli -pr fc -e <hba instance>|<hba wwpn> enable|disable  
FabricAssignBootLUN|fb
```

Where:

```
hba instance = Adapter number (use the -g command to find)  
hba wwpn = Worldwide port name of the adapter  
FabricAssignBootLUN or fb = Configure enable fabric-assigned boot LUN setting
```

## Using a Fabric-Assigned Boot LUN with QConvergeConsole Plug-ins

For information about using a fabric-assigned boot LUN for QConvergeConsole VMware vSphere Web Client Plug-in, see the section “Configure Fibre Channel Port Boot Parameters” in the *User’s Guide—QConvergeConsole Plug-ins for VMware vSphere* (part number SN0054677-00).

### To configure a 2700 Series Adapter boot device with QConvergeConsole VMware vCenter Server Plug-in:

1. In the QConvergeConsole VMware vCenter Server Plug-in, click the **QConvergeConsole** tab.
2. In the tree pane on the left, select a 2700 Series Adapter port.
3. Click the **Boot** tab.
4. On the Boot Device Selection page, select the **Enable Fabric Assigned Boot LUN** check box. [Figure 3-29](#) shows an example.

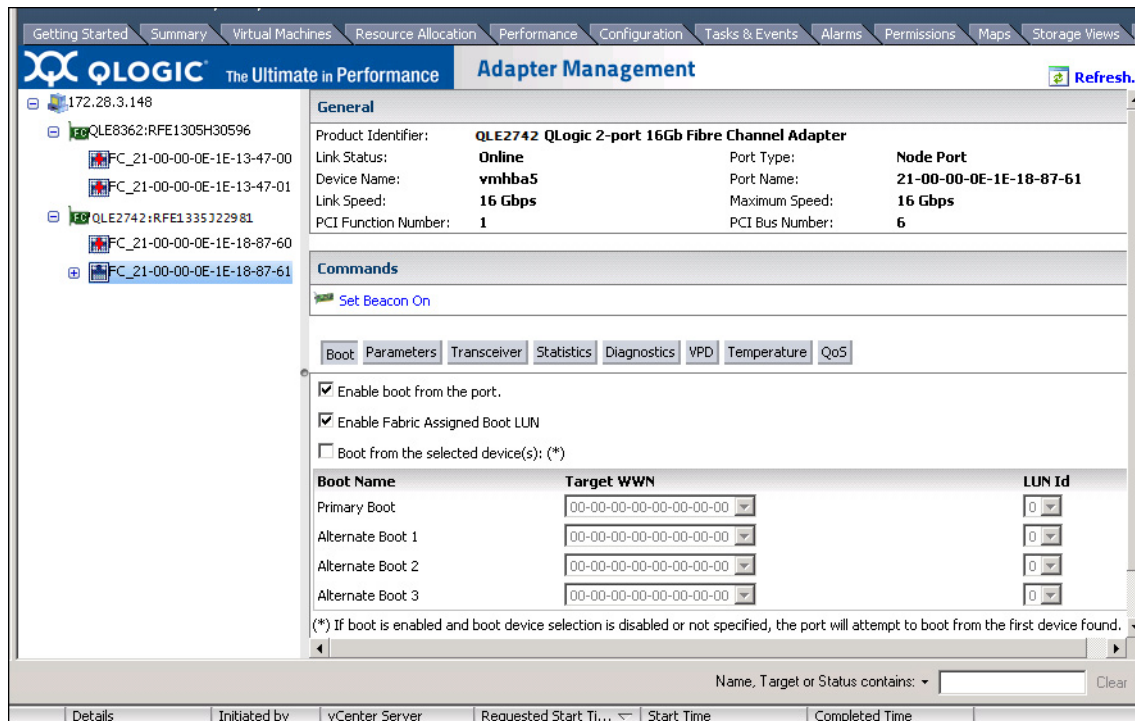

**Figure 3-29. Fabric-Assigned Boot LUN in QConvergeConsole VMware vCenter Server Plug-in**

For details, refer to the “Boot Device Selection” topic in *QConvergeConsole Help*.



5. Click **Save**. Any previously saved configuration for the current 2700 Series Adapters is overwritten.

## Running Diagnostics—Fibre Channel Ping and Trace Route

This section provides the following information on how to run Fibre Channel ping and trace route diagnostics:

- [Pinging and Viewing Trace of Routing Using Topology Map](#)
- [Running a Fibre Channel CT Ping Test](#)
- [Fibre Channel Trace Route](#)

### Pinging and Viewing Trace of Routing Using Topology Map

The QConvergeConsole GUI topology map uses the common transport (CT) layer to enable the adapter’s initiator port to ping or run a trace route that will navigate across the environment through multiple ports of the switch or switches and to the target.

[Table 3-8](#) compares the differences between the Ping Test, CT Ping Test, and the CT FTR Tests.

**Table 3-8. Ping Test, CT Ping Test, and CT FTR Test**

Ping Test	CT Ping Test	CT FTR Test
SCSI layer ping	CT or Fibre Channel ping	CT or Fibre Channel trace route
Uses SCSI inquiry command	Uses echo through an external link	Requires scan of physical topology
Can operate on any SCSI device	Can operate with all Fibre Channel devices that support CT or an external link	Can operate with all devices that are connected through a port that supports CT or an external link

Supported configurations for Fibre Channel ping and trace route include:

- QLogic 2700 Series Adapters
- Brocade Switches with Based Fabric OS® (FOS) v6.0.0a

## NOTE

The switch and the Fibre Channel end device must both support the Fibre Channel ping and trace route feature. See [Table 3-10 on page 92](#) for the supported Fibre Channel software version.

## Running a Fibre Channel CT Ping Test

You can run a Fibre Channel CT ping test from QConvergeConsole GUI, QConvergeConsole CLI, or the QConvergeConsole VMware plug-ins, as described in this section.

### Running a Fibre Channel CT Ping from QConvergeConsole GUI

To run a Fibre Channel CT ping test from QConvergeConsole GUI:

1. In the QConvergeConsole GUI left pane, click the **Host** tab.
2. On the Host page, expand the adapter node and then select a port.
3. In the content pane on the right, click the **Diagnostics** tab.
4. On the Diagnostics page, click the **General Diagnostics** tab.
5. On the General Diagnostics page (see [Figure 3-30](#)), complete the **Test Configuration** options, and then click **CT Ping Test** to start the test.

The screenshot shows the QConvergeConsole GUI with the 'Diagnostics' tab selected. Under 'General Diagnostics', the following information is displayed:

Hostname:	localhost	HBA Model:	QLE2742
Node Name:	20-00-00-24-FF-8F-D7-F4	Port Name:	21-00-00-24-FF-8F-D7-F4
HBA Port:	1	Port ID:	00-00-00

The 'Test Configuration' section includes:

- Data Pattern: Random
- Number of test(s) (1-65535): 1
- LB, 1-10000 R/W: 1
- Test Increment (1-65535): 1
- On Error: Ignore
- Test continuously:
- Data Size (Bytes): 8

At the bottom, the 'CT Ping Test' button is highlighted.

**Figure 3-30. Running the Fibre Channel CT Ping Test**

A caution message appears for the diagnostic CT ping test (Figure 3-31).

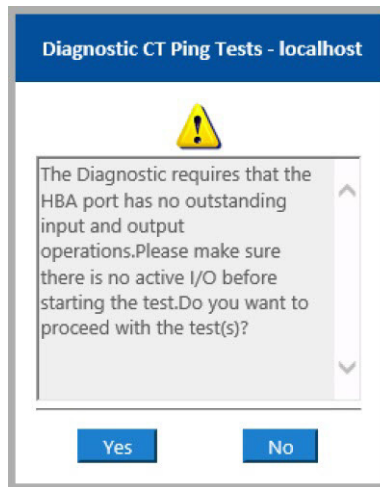

**Figure 3-31. CT Ping Test Caution**

6. Ensure that the port has no active I/O operations, and then either click **Yes** to proceed or **No** to cancel the test.

### Running a Fibre Channel CT Ping from QConvergeConsole CLI

**To run a Fibre Channel CT ping test from QConvergeConsole CLI:**

1. From the QConvergeConsole CLI **FC Diagnostics** menu, select **7: CT Ping Test**.
2. From the **HBA Model** list, select the port that you want to ping.
3. From the **CT Ping Test** menu, select **4: Start Diagnostic Test**.

The following shows example output from the CT ping test.

```
-----  
Diagnostics Test Configuration  
-----
```

```
Diagnostic Mode           : CT Ping  
Number of tests (1-10000) : 10  
Number of Pass           : 1  
Test Increment (1-10000) : 1  
Abort On Error           : Ignore  
Test Continuous          : OFF
```

```
-----  
ID      Data      Link      Sync      Signal      Invalid      Diagnostic  
Port/Loop Miscompare Failure Loss      Loss      CRC          Status  
-----
```

01-0B-01                    0                    0                    0                    0                    Success

---

**NOTE**

The default setting will repeat 10 times with output similar to the preceding for each pass of the test.

---

**Running a Fibre Channel CT Ping from QConvergeConsole VMware Plug-ins**

For information about running Fibre Channel CT ping from the QConvergeConsole VMware vCenter Server Plug-in or QConvergeConsole VMware vSphere Web Client Plug-in, see the section “Diagnostic Tests—Fibre Channel Port” in the *User’s Guide—QConvergeConsole Plug-ins for VMware vSphere* (part number SN0054677-00).

**Fibre Channel Trace Route**

**To run a Fibre Channel trace route from QConvergeConsole GUI:**

1. In the system tree pane on the left, click the **Host** tab.
2. In the content pane on the right, click the **Topology** tab.
3. Next to **Topology**, select the **Physical** option.
4. In the topology map, right-click the applicable adapter.
5. Select the **FC Trace Route** option.
6. In the Target Selection dialog box, select the target to run the trace route.
7. Click **Trace**.

Figure 3-32 shows an example.

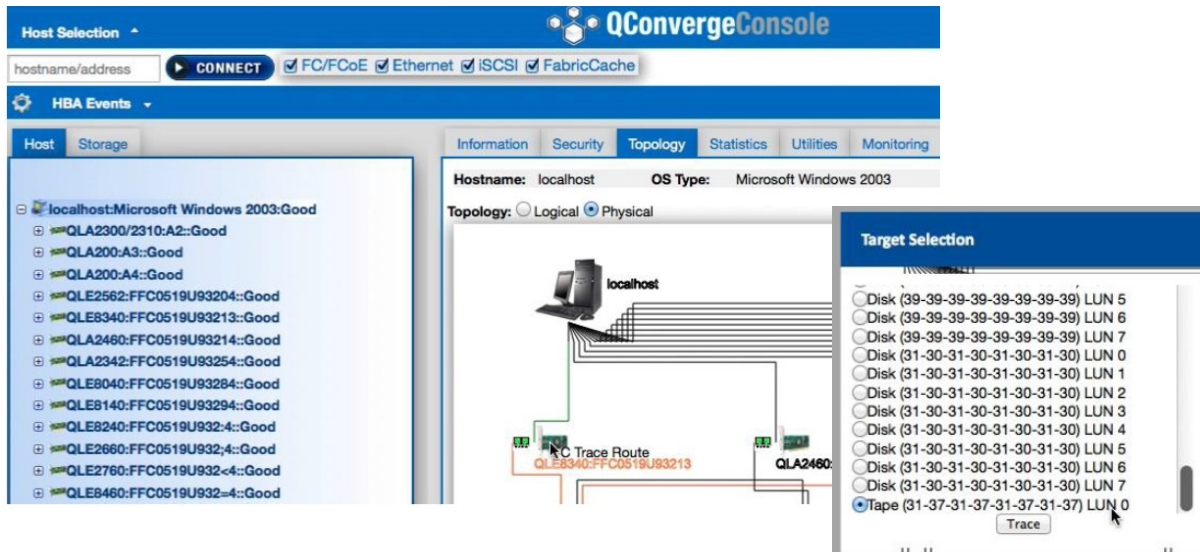

**Figure 3-32. Running Fibre Channel Trace Route from QConvergeConsole GUI**

The Fibre Channel trace route output from QConvergeConsole GUI shows a symbol of a red payload that starts from the host. The travel across the route is also highlighted in red. The payload enters and exits from the appropriate port on each switch as it traverses the path until it reaches the selected target.

The results appear as a success message output from the following:

- QConvergeConsole GUI
- QConvergeConsole CLI
- Diagnostics area

#### NOTE

You can also execute the CT FTR test.

For information about using Fibre Channel trace route in QConvergeConsole VMware vCenter Server Plug-in or QConvergeConsole VMware vSphere Web Client Plug-in, see the section “Diagnostic Tests—Fibre Channel Port” in the *User’s Guide—QConvergeConsole Plug-ins for VMware vSphere* (part number SN0054677-00).

## Configuring CS\_CTL QoS

### NOTE

For information about **end-to-end** CS\_CTL QoS, see [“Configuring End-to-End CS\\_CTL QoS” on page 83](#).

---

This section provides the following information on class-specific control (CS\_CTL) quality of service (QoS):

- [CS\\_CTL QoS Features](#)
- [Enabling CS\\_CTL QoS Mode for the Initiator and Target Ports](#)
- [Verifying and Confirming CS\\_CTL Mode Setup for Each Port](#)
- [Creating a Virtual Port from the Adapter’s Port in QConvergeConsole GUI](#)
- [Setting the QoS Priority Level for a Virtual Port in QConvergeConsole GUI](#)

### CS\_CTL QoS Features

The following highlights some of the features of the CS\_CTL QoS:

- Traffic priority classification for QLogic Gen 6 Fibre Channel SAN. QoS at the packet level is realized by using the CS\_CTL field, which is specified in the FC-FS-2 specification. QoS allows one to prioritize frames between a host and target, depending on the value of the CS\_CTL field in the FC Frame header.
- Extending QoS from the fabric to the host
- Enables QLogic Fibre Channel users to rapidly scale server virtualization without compromising service-level agreements
- Benefits for both physical and virtual server deployments
- Supported configuration:
  - QLogic 2700 Series Adapters
  - CS\_CTL-based QoS is end-to-end (requires target to support CS\_CTL)

## Enabling CS\_CTL QoS Mode for the Initiator and Target Ports

Figure 3-33 shows how to enable CS\_CTL QoS mode for the initiator and target ports.

```
portdisable 17
portcfgqos --enable 17 csctl_mode
Enabling CSCTL mode flows causes QoS zone flows to lose priority on such ports.
Do you want to proceed?(y/n):y
portenable 17

portdisable 0
portcfgqos --enable 0 csctl_mode
Enabling CSCTL mode flows causes QoS zone flows to lose priority on such ports.
Do you want to proceed?(y/n):y
portenable 0
```

Figure 3-33. Enabling CS\_CTL QoS Mode

## Verifying and Confirming CS\_CTL Mode Setup for Each Port

Figure 3-34 shows how to verify the CS\_CTL mode setup for each port.

```
portcfgshow
Ports of Slot 0      0  1  2  3  4  5  6  7  8  9 10 11 12 13 14 15
-----+-----+-----+-----+-----+-----+-----+-----+-----+-----+-----+-----+-----+-----+-----+-----+-----+
Octet Speed Combo  1  1  1  1  1  1  1  1  1  1  1  1  1  1  1  1
<ONLY PARTIAL OUTPUT SHOWN BELOW FOR THE APPROPRIATE AREA TO CHECK ON PORT 0 >

CSCTL mode          ON  ..  ..  ..  ..  ..  ..  ..  ..  ..  ..  ..  ..  ..  ..  ..
```

Figure 3-34. CS\_CTL Mode Setup for Each Port

## Creating a Virtual Port from the Adapter’s Port in QConvergeConsole GUI

To create a virtual port in QConvergeConsole GUI:

1. In the QConvergeConsole GUI content pane on the left, select the **Host** tab.
2. On the Host page, expand the adapter node, and then select a port.
3. In the content pane on the right, select the **Virtual** tab.
4. On the Virtual page under **Create New Virtual Port**, specify the **Number of vPort to create**, and then click **Update**.
5. Click **Create**.

Figure 3-35 shows how to create a virtual port from the adapter's port in QConvergeConsole GUI.

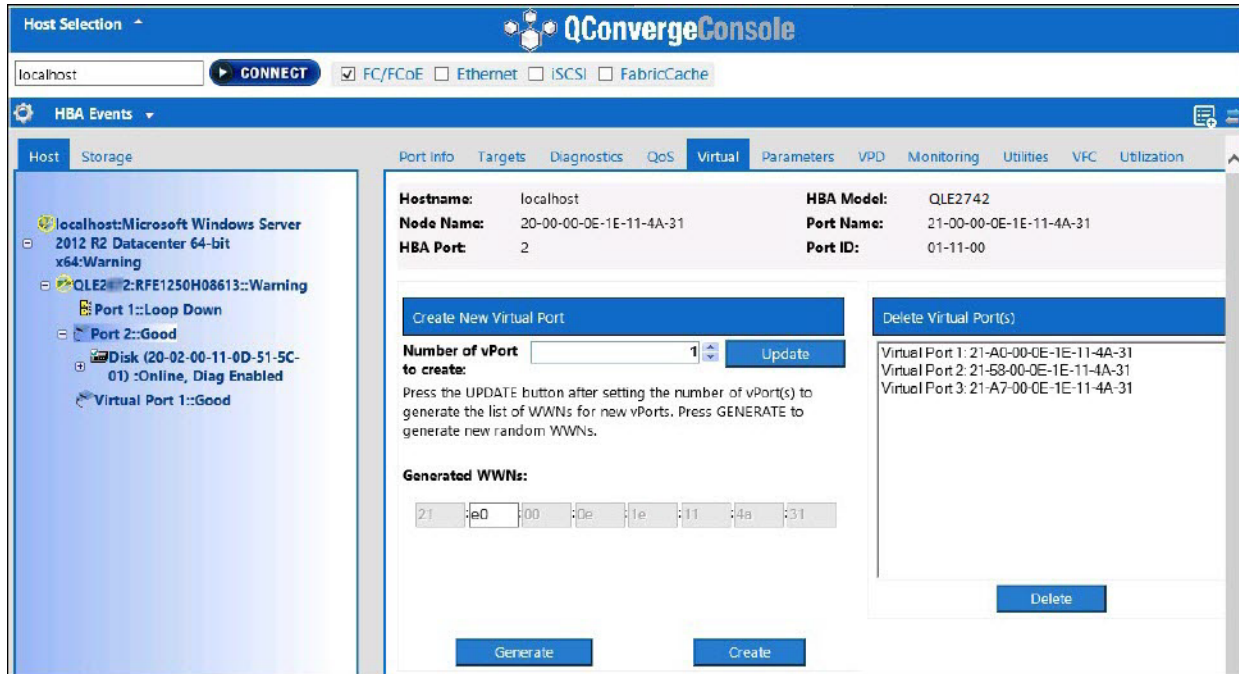

Figure 3-35. Creating a Virtual Port



## Setting the QoS Priority Level for a Virtual Port in QConvergeConsole GUI

Figure 3-36 shows how to set the QoS priority level for a virtual port in QConvergeConsole GUI.

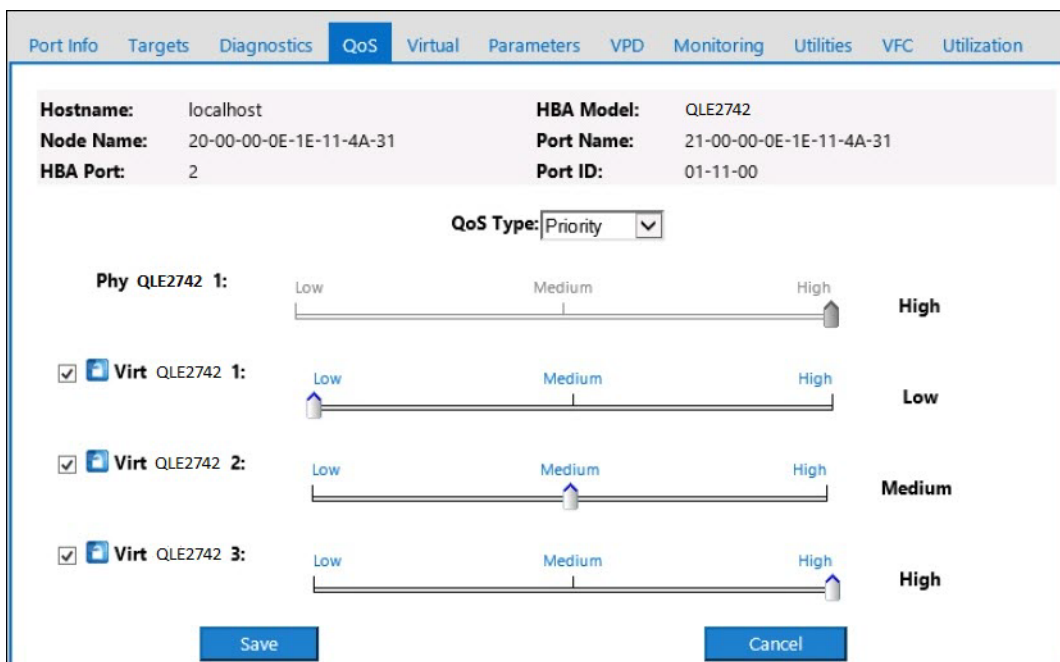

Figure 3-36. Setting the QoS Priority Level

### NOTE

By default, the QoS of the physical port is set to **High**, and the QoS of the virtual port is set to **Low**.

## Configuring End-to-End CS\_CTL QoS

### NOTE

For information about CS\_CTL QoS that is not end-to-end, see [“Configuring CS\\_CTL QoS” on page 80](#).

QLogic’s class specific control (CS\_CTL) QoS implementation is an end-to-end solution, encompassing the initiator (2700 Series Adapters), the switches, and the target (storage). The 2700 Series Adapter stamps the priority value (high, medium, low) in the CS\_CTL field of the Fibre Channel frame. All three entities (initiator, switch, and target) honor this priority value at their respective levels.

Therefore, when all three entities support QoS (and it is enabled on the switch and the target), a default priority value is populated in all FCP\_CMND, FCP\_DATA, FCP\_XFER\_RDY, FCP\_RSP, and FCP\_CONFIRM frames.

---

#### NOTE

QoS must be supported by both the switch and target devices.  
At the time of publication, CS\_CTL QoS has been tested only on the Brocade SW6510 switch with Fabric OS (FOS) version 7.3.0a.

---

The following sections describe how to configure end-to-end CS\_CTL QoS and change the default priority levels:

- [Configuring CS\\_CTL QoS on the Switch](#)
- [Configuring CS\\_CTL QoS on the Storage Device](#)
- [Changing the QoS Priority Levels](#)

## Configuring CS\_CTL QoS on the Switch

To enable CS\_CTL QoS on the Brocade SW6510 switch:

1. From the switch, issue the following command:

```
root> configurechassis  
Configure...
```

2. A list of attributes appear one at a time. After either accepting the default or entering a different value, the next attribute appears.

- Press ENTER to accept the default for `cfgload` attributes, Custom attributes, and system attributes.
- Type **y** for `fos` attributes.
- Type **1** for CSCTL QoS Mode.

For example:

```
cfgload attributes (yes, y, no, n): [no]  
Custom attributes (yes, y, no, n): [no]  
system attributes (yes, y, no, n): [no]  
fos attributes (yes, y, no, n): [no] y  
CSCTL QoS Mode (0 = default; 1 = auto mode): (0..1) [0] 1
```

3. Reboot the switch.
4. To verify that CS\_CTL QoS is enabled, issue the following command:

```
root> configshow -all | grep fos.csctlMode
```

This command should return the following response:

```
fos.csctlMode:1
```

5. To enable QoS on a switch-port basis, issue the following command:

```
portcfgqos --enable [slot/]port csctl_mode
```

## Configuring CS\_CTL QoS on the Storage Device

See your device's user guide for QoS configuration instructions.

## Changing the QoS Priority Levels

The QoS priority levels are set in the 2700 Series Adapters vPorts. The Windows and VMware adapter drivers assign default vPort priority levels. The following sections describe how to change the default vPort priority levels in Windows and VMware ESXi systems.

### Changing the Priority Levels in Windows

To change the vPort priority levels in Windows, you must first assign the vPorts, and then change the priority levels. Both procedures can be accomplished using either QConvergeConsole GUI or interactive QConvergeConsole CLI, as described in the following sections.

For more detailed information, see the *QConvergeConsole Help* and the *User's Guide—QConvergeConsole CLI* (part number SN0054667-00).

#### Creating a Vport

##### To create a vPort in QConvergeConsole GUI:

1. In the QConvergeConsole GUI left pane, connect to the host that has the 2700 Series Adapters where you want to create the vPorts.
2. Expand the host in the left pane by clicking the plus sign (+).
3. Locate and expand the 2700 Series Adapters where you want to create the vPorts.
4. In the right pane, click the **Virtual** tab.
5. Enter a valid value for the **Number of vPort to create** option, and then click **Update**.
6. To create the vPorts, click **Create**.

Figure 3-37 shows an example.

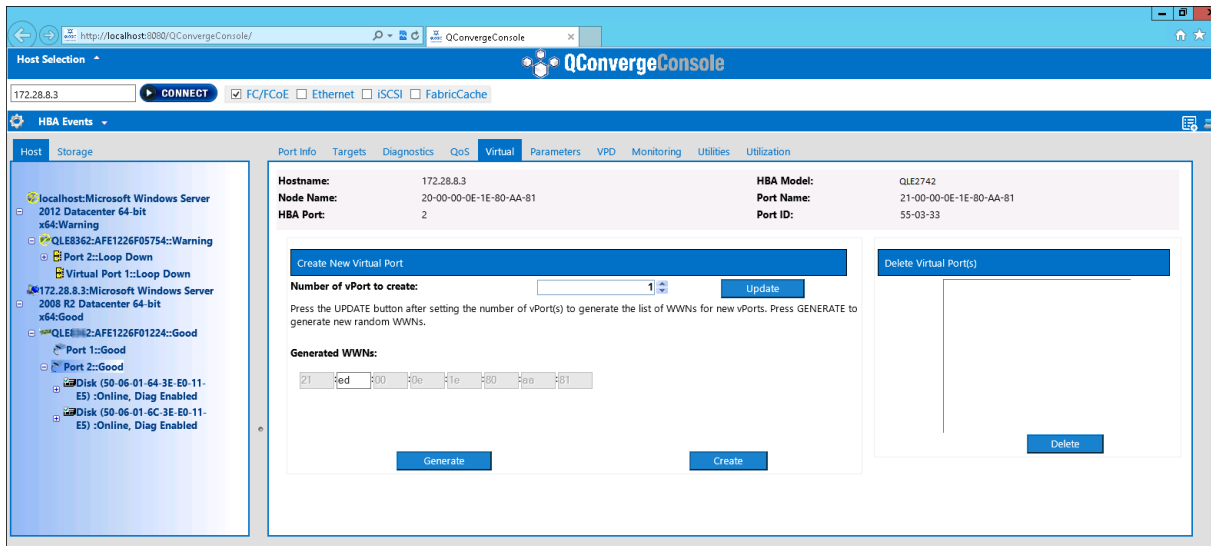

**Figure 3-37. Creating vPorts in QConvergeConsole GUI**

**To create a vPort in interactive QConvergeConsole CLI:**

1. On the **Main Menu**, select **Adapter Configuration**.
2. On the **Adapter Type Selection** menu, select **Virtual Ports (NPIV)**.
3. On the **Virtual Ports** menu, select **Adapter Port**.
4. On the **Adapter Port** menu, select **Create vPorts**.
5. On the **Create vPorts** menu, select **Generate**.
6. To create the vPorts, select **Commit**.

**Changing the vPort Priority Level**

**To change the vPort priority level using QConvergeConsole GUI:**

1. In the QConvergeConsole GUI left pane, connect to the host that contains the 2700 Series Adapter whose vPort levels you want to change.
2. Expand the host in the left pane by clicking the plus sign (+).
3. Locate and expand the 2700 Series Adapter whose vPort levels you want to change.
4. In the right pane, click the **QoS** tab.
5. In the **QoS Type** box, select **Priority**.
6. Ensure that the check box for the vPort you want to change is selected.
7. Set the QoS priority value for the vPort by moving the corresponding slider.

8. Repeat [Step 6](#) and [Step 7](#) for each vPort whose priority you want to change.
9. Click **Save**.

[Figure 3-38](#) shows an example.

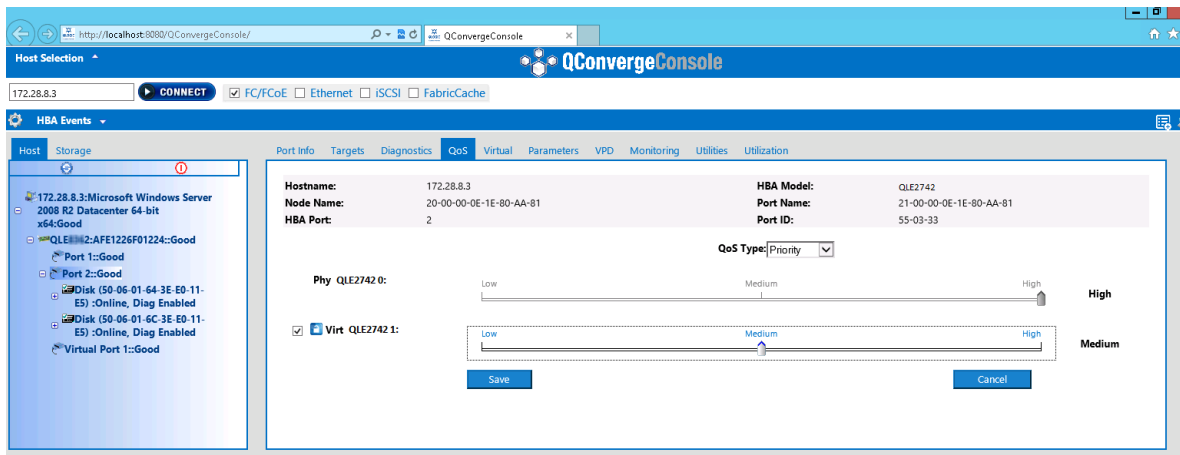

**Figure 3-38. Changing vPort Priority using QConvergeConsole GUI**

To change the vPort priority level using interactive QConvergeConsole CLI:

1. On the **Main Menu**, select **Adapter Configuration**.
2. On the **Adapter Type Selection** menu, select **QoS**.
3. On the **QoS** menu, select **Adapter Port**.
4. On the **Adapter Port** menu, select **QoS Priority**.
5. On the **QoS Priority** menu, select **Modify QoS Settings**.
6. Choose the priority value for the vPorts.
7. Select **Apply QoS**.

### Changing the Priority Levels in VMware ESXi

To change the priority levels using either QConvergeConsole VMware vCenter Server Plug-in or QConvergeConsole VMware vSphere Web Client Plug-in:

1. In the tree pane on the left, select a host.
2. Expand the host in the left pane by clicking the plus sign (+).
3. Locate and expand the 2700 Series Adapter whose priority levels you want to change.
4. Select a port in the 2700 Series Adapter.
5. On the content pane on the right, click **QoS**.

6. Set the vPort priority as follows:  
If the vPort is listed under **QoS**:
  - a. Select the vPort.
  - b. Set the QoS priority value for the vPort by moving the corresponding slider.
  - c. Click **Save**.

Figure 3-39 shows an example.

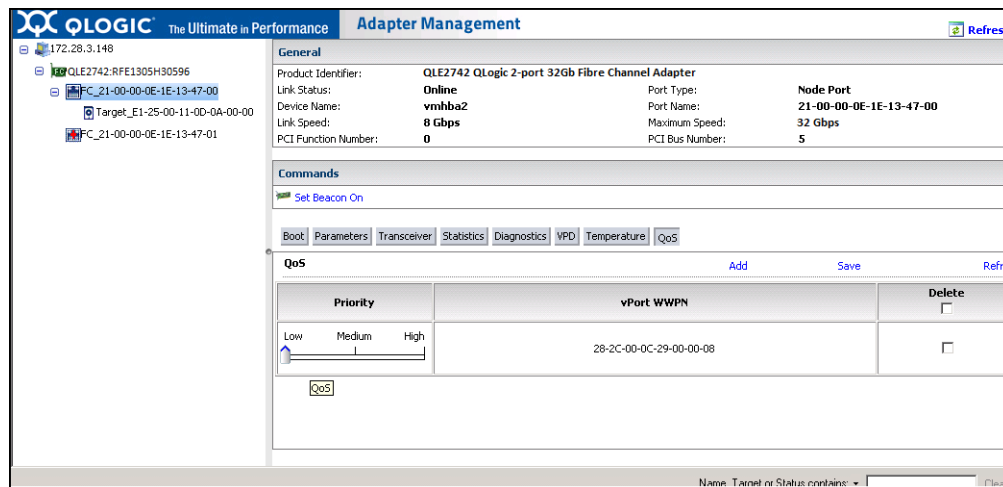

Figure 3-39. Changing vPort Priority Using QConvergeConsole Plug-ins

- If vPort is not listed under **QoS**:
- a. Under **QoS**, click **Add**.
  - b. Set the QoS priority value by moving the corresponding slider.
  - c. Enter the vPort WWPN.
  - d. Click **Save**.
7. Click **Refresh** to see the new QoS settings.

**To remove a vPort priority:**

1. Under **QoS**, locate the vPort whose priority you want to remove.
2. Do one of the following:
  - Select the **Delete** check box of the vPort you want to remove.
  - Select the **Delete** check box in the header to select or clear all of the vPorts.
3. Click **Save**.

## Configuring FDMI

The fabric device management interface (FDMI) enables the centralized management of devices such as host adapters. Supported configuration for FDMI:

- QLogic 2700 Series Adapters
- Brocade 16G and 32G switches with Fabric OS (FOS) v7.3 or higher

---

### NOTE

Results can be viewed from Switch CLI. If the Fibre Channel switch does not support FDMI-2, it falls back to FDMI-1 support.

---

This section provides the following information on the FDMI:

- [Brocade Switch FOS CLI](#)
- [Brocade Fabric Features](#)
- [FDMI Enhancements Support](#)





## Brocade Fabric Features

Table 3-9 shows the default configuration for Brocade Fibre Channel fabric features.

**Table 3-9. Brocade Fibre Channel Fabric Features—Default Configuration**

Feature	Description	Management Tools	Default Configuration
D_Port	Diagnostics port support	N/A	Diagnostic test; run from switch. Nothing to configure on adapter.
FA-PWWN	Fabric-assigned port world wide name	QConvergeConsole GUI QConvergeConsole CLI QConvergeConsole VMware vCenter Server Plug-in	Disabled by default on adapter. Must be enabled in NVRAM.
F-BLD	Fabric-based boot LUN discovery	QConvergeConsole GUI QConvergeConsole CLI QConvergeConsole VMware vCenter Server Plug-in	No default setting. Requires configuration on adapter.
FC Ping	Ping a Fibre Channel N_Port or end device	QConvergeConsole GUI QConvergeConsole CLI QConvergeConsole VMware vCenter Server Plug-in	Diagnostic test; nothing to configure.
FC Trace Route	Obtains the path information between two F_Ports from the Fabric Configuration Server	QConvergeConsole GUI QConvergeConsole CLI QConvergeConsole VMware vCenter Server Plug-in	Diagnostic test; nothing to configure.
QoS CS_CTL	Prioritize frames depending on the value of the CS_CTL field in the FC Frame header	QConvergeConsole GUI QConvergeConsole CLI QConvergeConsole VMware vCenter Server Plug-in	By default, QoS of the physical port is set to <b>High</b> .
FDMI Enhancements	FDMI attributes	N/A	Nothing to configure on adapter.



```
"Symbolic Name: QLE8362 FW:v7.04.00 DVR:v9.1.12.20 Alpha 2"  
"Number of Ports: 1"  
"Fabric Name: 10:00:00:05:33:8f:1a:43"  
"Bios Version: 3.26"  
"Vendor Identifier: QLOGIC"
```

## Enabling QLogic Forward Error Correction

QConvergeConsole supports the forward error correction (FEC) feature, which is a correction technique used for high-speed telecommunications devices to control errors in data transmission over unreliable or noisy communication channels.

FEC is mandatory when operating at 32Gb line rate. Gen 6 32Gb-capable adapters are required to support it, and FEC is automatically enabled when operating at 32G. If the 32G-capable adapter is operating at 16G, enabling FEC is optional, just as it is on QLE269x-DEL adapters.

---

### NOTE

The switch and the Fibre Channel end device must both support the FEC feature. See [Table 3-10 on page 92](#) for the supported Fibre Channel software version.

---

## FEC Process Overview

The following highlights how the FEC process works between the transmitting and receiving device:

1. Transmitter Device:
  - a. Takes the incoming data stream.
  - b. Inserts a redundant amount of parity bits of information on the data stream.
  - c. Sends the data stream.
2. Receiving Device:
  - a. Receives the data stream.
  - b. Checks for missing or corrupt data:
    - If there are no corrupt or missing bits of information, the receiving device proceeds with normal process.
    - If there are corrupt or missing bits of information, the receiving device reconstructs the original data by using pieces of the original data stream (that are still intact) and combining those with the parity bits of information.

## NOTE

Instead of having to request retransmission of the entire data frame, the receiving device can recreate or reconstruct the data stream itself. This process prevents multiple CRC errors from being triggered and causing application performance issues.

## Enabling QLogic FEC

To enable the QLogic FEC feature, contact [QLogic Support](#), or refer to the QLogic document, *Application Note: Enabling Forward Error Correction*, (part number 83830-514-03). In [Figure 3-41](#), the QConvergeConsole CLI interactive mode **Adapter Information** menu shows a port with an online FEC status.

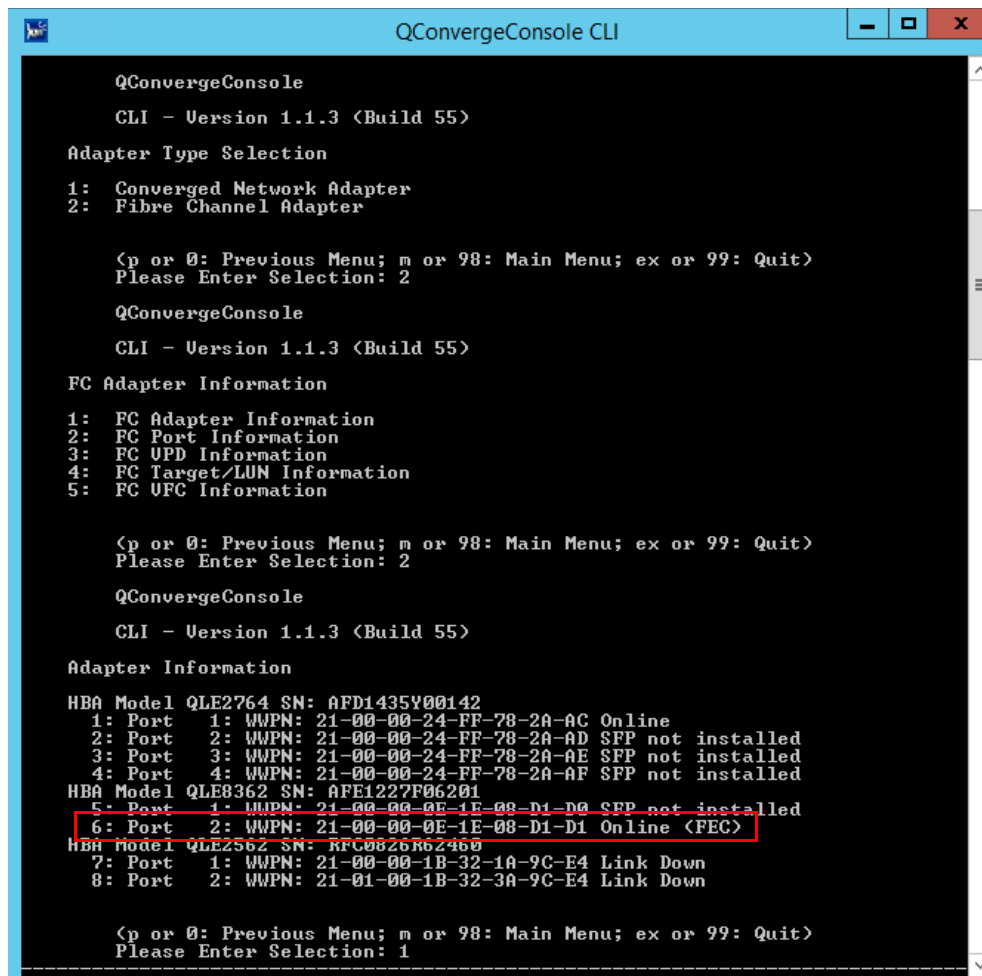

```
QConvergeConsole
CLI - Version 1.1.3 <Build 55>

Adapter Type Selection
1: Converged Network Adapter
2: Fibre Channel Adapter

<p or 0: Previous Menu; n or 98: Main Menu; ex or 99: Quit>
Please Enter Selection: 2

QConvergeConsole
CLI - Version 1.1.3 <Build 55>

FC Adapter Information
1: FC Adapter Information
2: FC Port Information
3: FC UPD Information
4: FC Target/LUN Information
5: FC UPC Information

<p or 0: Previous Menu; n or 98: Main Menu; ex or 99: Quit>
Please Enter Selection: 2

QConvergeConsole
CLI - Version 1.1.3 <Build 55>

Adapter Information
HBA Model QLE2764 SN: AFD1435Y00142
1: Port 1: WWPNN: 21-00-00-24-FF-78-2A-AC Online
2: Port 2: WWPNN: 21-00-00-24-FF-78-2A-AD SFP not installed
3: Port 3: WWPNN: 21-00-00-24-FF-78-2A-AE SFP not installed
4: Port 4: WWPNN: 21-00-00-24-FF-78-2A-AF SFP not installed
HBA Model QLE8362 SN: AFE1227F06201
5: Port 1: WWPNN: 21-00-00-0E-1E-08-D1-D0 SFP not installed
6: Port 2: WWPNN: 21-00-00-0E-1E-08-D1-D1 Online <FEC>
HBA Model QLE2562 SN: RFC0826R62460
7: Port 1: WWPNN: 21-00-00-1B-32-1A-9C-E4 Link Down
8: Port 2: WWPNN: 21-01-00-1B-32-3A-9C-E4 Link Down

<p or 0: Previous Menu; n or 98: Main Menu; ex or 99: Quit>
Please Enter Selection: 1
```

Figure 3-41. QConvergeConsole CLI Adapter Information Menu, FEC Status

## Running Extended Link Service Commands

Commands for extended link service on the switch include the following:

- [Link Cable Beacon Extended Link Service Command](#)
- [Read Diagnostic Parameters Extended Link Service Command](#)

### Link Cable Beacon Extended Link Service Command

---

**NOTE**

Run the LCB test only from a switch with FOS version 7.4.x or later.

---

The link cable beacon (LCB) extended link service command locates the corresponding ends of a cable by flashing the specific LEDs on the corresponding ports of a link. The LCB command can also be sent through a Brocade switch using the following commands, which show examples of enabling, disabling, or verifying the LCB:

```
SW6505:admin> portpeerbeacon --enable 12
SW6505:admin> portpeerbeacon --show -all
portPeerBeacon is enabled on port :12
SW6505:admin> portpeerbeacon --disable 12
```

### Read Diagnostic Parameters Extended Link Service Command

---

**NOTE**

You must run the RDP test from a switch with FOS version 7.4.x or later.

---

The following example shows the read diagnostic parameters extended link service (RDP ELS) command output for Port 13 on a Brocade 16G switch:

```
SW6505:admin> sfpshow 13 -link -force
Identifier: 3      SFP
Connector:  7     LC
Transceiver: 7004404000000000 8,16,32_Gbps M5 sw Short_dist
Encoding:    6     64B66B
Baud Rate:   140   (units 100 megabaud)
Length 9u:   0     (units km)
Length 9u:   0     (units 100 meters)
Length 50u (OM2): 3   (units 10 meters)
```

### 3-Fibre Channel Configuration

#### Running Extended Link Service Commands

---

Length 50u (OM3): 0 (units 10 meters)  
Length 62.5u:0 (units 10 meters)  
Length Cu: 0 (units 1 meter)  
Vendor Name: HP-F BROCADE  
Vendor OUI: 00:05:1e  
Vendor PN: QK724A  
Vendor Rev: A  
Wavelength: 850 (units nm)  
Options: 003a Loss\_of\_Sig,Tx\_Fault,Tx\_Disable  
BR Max: 0  
BR Min: 0  
Serial No: HAF314370000B7F  
Date Code: 140909  
DD Type: 0x68  
Enh Options: 0xfa  
Status/Ctrl: 0x30  
Pwr On Time: 0.30 years (2666 hours)  
E-Wrap Control: 0  
O-Wrap Control: 0  
Alarm flags[0,1] = 0x0, 0x0  
Warn Flags[0,1] = 0x0, 0x0

			Alarm		Warn	
			low	high	low	high
Temperature:	60	Centigrade	-5	85	0	75
Current:	8.430	mAmps	2.500	12.000	2.000	11.500
Voltage:	3322.2	mVolts	3000.0	3600.0	3100.0	3500.0
RX Power:	-3.1	dBm (495.3uW)	31.6 uW	1258.9 uW	31.6 uW	794.3 uW
TX Power:	-3.2	dBm (481.6 uW)	125.9 uW	1258.9 uW	251.2 uW	794.3 uW

State transitions: 5  
Port Speed Capabilities 8Gbps 16Gbps 32Gbps

PEER Port Gbic Info

Laser Type: Short Wave Laser  
SFP Type: Optical Port Type  
Connector Type: Other

Following SFP Parameters are Valid

Temperature: 35 Centigrade [Range -128 - +128 C]  
Current: 8.176 mAmps [Range 0 - 131 mAmps]

### 3-Fibre Channel Configuration

#### Running Extended Link Service Commands

---

Voltage: 3463.2 mVolts [Range 0 - 3600 mVolts]  
Rx Power: 460.4 uW [Range 0 - 6550 uW]  
Tx Power: 504.7 uW [Range 0 - 6550 uW]  
Signal Loss (Upstream) : -16.7 dBm (21.2 uW)  
Signal Loss (Downstream): -20.3 dBm (9.4 uW)  
Port Speed Capabilities 8Gbps 16Gbps 32Gbps  
Last poll time: 03-24-2015 UTC Tue 18:03:14

# A Troubleshooting

This appendix provides information about Fibre Channel diagnostics and a Fibre Channel troubleshooting diagram, including:

- [Fibre Channel Diagnostics](#)
- [“Fibre Channel Troubleshooting Diagram” on page 101](#)
- [“Troubleshooting with a Diagnostic Port \(D\\_Port\)” on page 102](#)

## Fibre Channel Diagnostics

Troubleshooting with Fibre Channel diagnostics include:

- [Fibre Channel Diagnostics Using QConvergeConsole GUI](#)
- [Fibre Channel Diagnostics Using Interactive QConvergeConsole CLI](#)
- [Fibre Channel Diagnostics Using Noninteractive QConvergeConsole CLI](#)

### Fibre Channel Diagnostics Using QConvergeConsole GUI

QConvergeConsole GUI supports the internal and external loopback, read/write buffer, and beacon on/off diagnostic tests for Fibre Channel ports.

**To set the loopback or read/write buffer test parameters:**

1. In the QConvergeConsole system tree, select the adapter port.
2. In the content pane on the right, click the **Diagnostics** tab, and then click the **General Diagnostics** tab.
3. From the **Data Pattern** list, do one of the following:
  - Select a data byte or compliant jitter pattern.
  - Click **Customized** to specify your own eight-byte pattern. Enter the data in hexadecimal format (0–FF) into the eight **Customized** boxes.
  - Click **Random** to randomly generate an eight-byte data pattern.

The data size sets the number of bytes transferred per test per iteration when the test is run.



4. From the **Data Size** list, click the number of bytes to transfer.  
Valid values are 8, 16, 32, 64, 128, 256, 512, 1024 and 2048. For Linux operating systems only, you can select data size values from 2048, 4096, 8192 up to 65535 (2K bytes to 64K bytes).
5. To set the test frequency, do one of the following:
  - In the **Number of Tests** box, type or select the number of tests you want to run. Testing stops when the passes complete. The valid range is between 1 and 65535 for loopback tests and between 1 and 10,000 for read/write buffer tests.
  - Select the **Test Continuously** check box. You determine when testing stops.
6. In the **On Error** box, click one of the following to determine how errors are handled. This selection applies whether you entered the **Number of Tests** or selected **Test Continuously**.
  - Ignore on Error**—Ignores errors and continues the test sequence.
  - Stop on Error**—Stops the test sequence once an error is encountered.
  - Loop on Error**—Uses the same data pattern and test until the failure is cleared.
7. In the **Test Increment** box, type or select the number of passes you want to run before the test stops.  
  
The valid range is between 1 and 10,000 and must be less than or equal to the value in the **Number of Tests** box (see [Step 5](#)). For example, if the **Number of Tests** box contains 100 and the **Test Increment** box contains 15, 100 tests are run in seven passes. The first six passes run 15 tests each; the seventh pass runs 10 tests:  $(6 \times 15) + 10 = 100$ .

**To run the loopback or read/write buffer test:**

1. Click the **Loopback Test** or **Read/Write Buffer Test** button.  
The diagnostic tests warning appears.
2. Click **Yes** if there are no I/Os active and you want to proceed with the test or click **No** to cancel the diagnostic test.
3. If you selected the loopback test, a dialog box allows you to select **Internal Loopback** or **External Loopback**. Click the appropriate test and then click **OK**.
4. If you selected **Yes** in [Step 2](#), a dialog box appears with the data pattern generated. Click **Stop** when you want to end the test.

**To run the beacon on/off test:**

1. In the QConvergeConsole GUI main window, click an adapter port in the system tree pane on the left.
2. In the content pane on the right, click the **Port Info** tab.
3. On the Port Info page, click **Beacon On** to run the test. To end the test, click **Beacon Off**.

For more information, refer to the topic about performing diagnostics in the *QConvergeConsole Help*.

## Fibre Channel Diagnostics Using Interactive QConvergeConsole CLI

**To run the loopback test, read/write buffer test, or beacon test:**

1. On the **Main Menu**, select **4: Adapter Diagnostics**.
2. On the **Fibre Channel Diagnostics** menu, select the test type to run:
  - 1: Loopback Test** to run the loopback test.
  - 2: Read Write Buffer Test** to run the read/write buffer test.
  - 3: Beacon Test** to run the beacon test.
  - 4: Transceiver Diagnostics Monitoring Interface (DMI)** to view the transceiver diagnostics information.

For more information, refer to the section about the Fibre Channel interactive commands in the *User's Guide—QConvergeConsole CLI* (part number SN0054667-00).

## Fibre Channel Diagnostics Using Noninteractive QConvergeConsole CLI

For information, refer to the section about the Fibre Channel noninteractive commands in the *User's Guide—QConvergeConsole CLI* (part number SN0054667-00).

# Fibre Channel Troubleshooting Diagram

Figure A-1 and Figure A-2 provide a two-part troubleshooting flowchart.

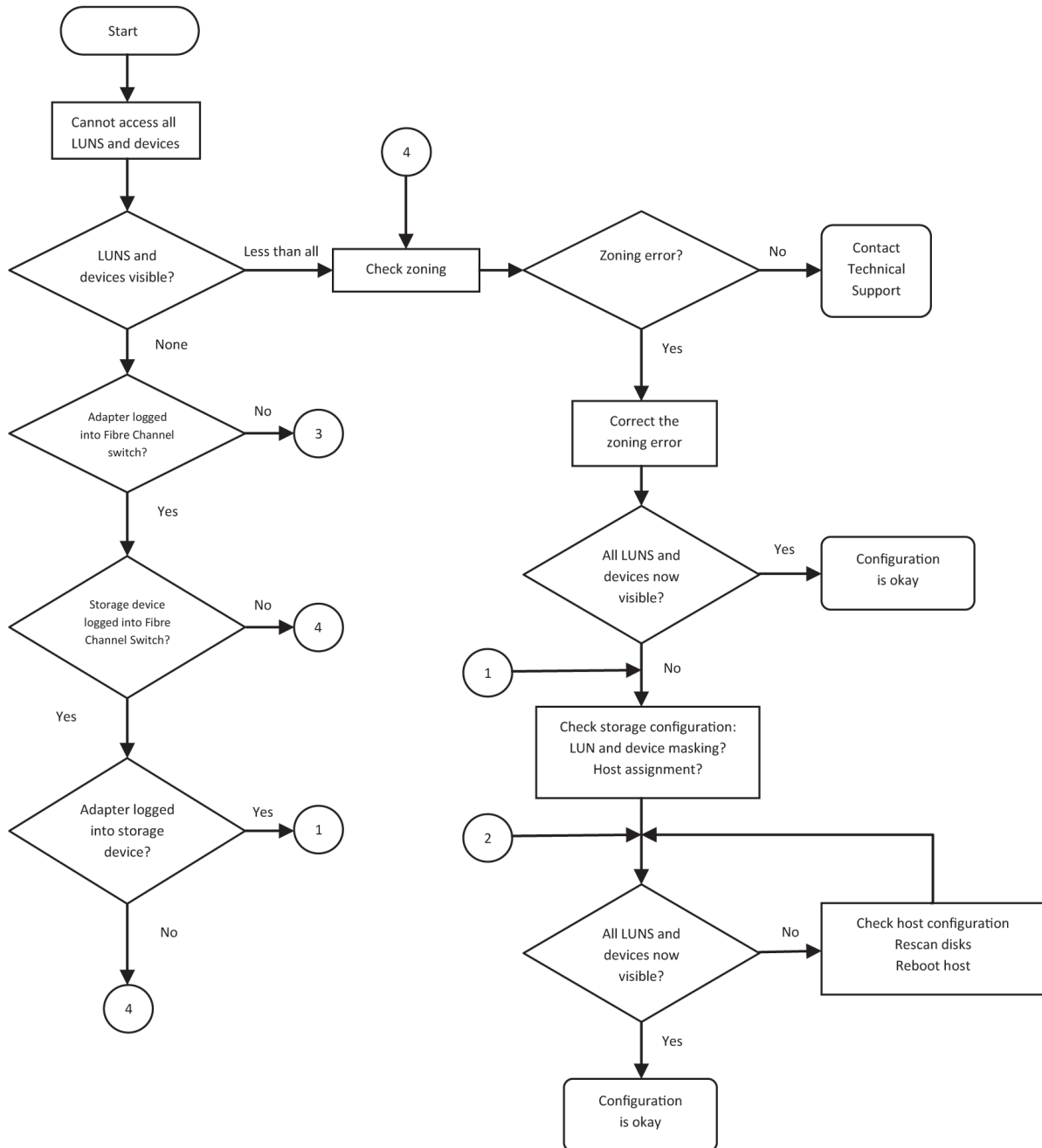
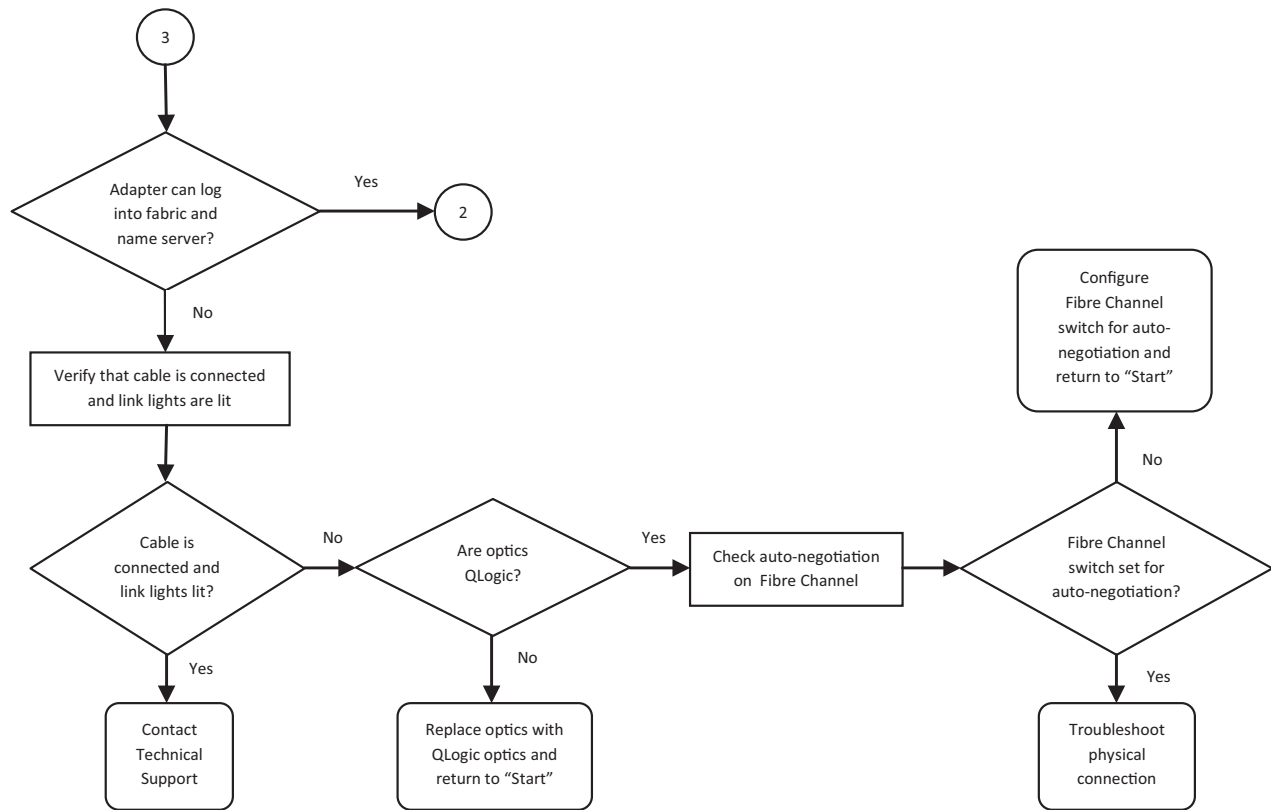

Figure A-1. Fibre Channel Troubleshooting Diagram (1 of 2)



**Figure A-2. Fibre Channel Troubleshooting Diagram (2 of 2)**

## Troubleshooting with a Diagnostic Port (D\_Port)

Use the D\_Port (diagnostic port) feature on the QLogic 2700 Series Adapters to identify and isolate link failures resulting from faulty modules (link, cable, or SFP) by running diagnostics over a Fibre Channel link.

- The D\_Port feature is supported on Windows, Linux, and ESXi.
- D\_Port can be run only in *dynamic* mode; it does not support *static* mode.
- D\_Port requires a Fibre Channel Adapter that is linked to a Brocade Fibre Channel 16G or 32G switch, the supported Brocade 16G or 32G Fibre Channel switch firmware, and a Brocade Fibre Channel switch feature license (Fabric Vision™).

Configure the diagnostic D\_Port on the Brocade switch to dynamically allow a port to enter D\_Port mode when a D\_Port is configured on the switch end, and then return to operational mode when the test is completed. Also configure the switch to start and stop the diagnostic test on the adapter port. See the Brocade switch documentation for details.

## NOTE

All QLogic-branded 32GFC SFP+ transceivers can run D\_Port tests. If you have a supported non-QLogic branded transceiver, ensure that it supports the optical wrap (OWrap) and electrical wrap (EWrap) capability that is required for D\_Port.

---

When a switch port is enabled as a D\_Port, the QLogic 2700 Series Adapter automatically runs the basic diagnostic test at both ends of the link. The Brocade switch then runs the following additional tests:

- Electric loopback test
- Optical loopback test

QLogic recommends running D\_Port tests on multipath configured boot from SAN/fabric-assigned boot LUN. Running D\_Port tests on single path boot from SAN/fabric-assigned boot LUN may cause issues with OS stability in true boot from SAN environments.

The following sections describe how to configure and run D\_Port mode from the Brocade Fibre Channel 16 switch, and how to verify D\_Port mode from the QConvergeConsole utilities:

- [Configuring D\\_Port on a Brocade Fibre Channel 16G or 32G Switch](#)
- [Checking D\\_Port Results from a Brocade Fibre Channel 16G or 32G Switch](#)
- [Verifying D\\_Port Mode with QConvergeConsole GUI](#)
- [Verifying D\\_Port Mode with Interactive QConvergeConsole CLI](#)
- [Verifying D\\_Port Mode with Noninteractive QConvergeConsole CLI](#)
- [Verifying D\\_Port Mode with QConvergeConsole Plug-ins](#)

## Configuring D\_Port on a Brocade Fibre Channel 16G or 32G Switch

**To enable D\_Port diagnostic mode:**

From the Brocade Fibre Channel 16G or 32G switch, issue the following commands:

```
# portdisable <port#>  
# portcfgdport --enable <port#>  
# portenable <port#>
```

The D\_Port test starts automatically.

**To disable D\_Port diagnostic mode:**

From the Brocade Fibre Channel 16G or 32G switch, issue the following commands:

```
# portdisable <port_num>
# portcfgdport --disable <port_num>
# portenable <port_num>
```

The D\_Port test stops.

## Checking D\_Port Results from a Brocade Fibre Channel 16G or 32G Switch

**To view the D\_Port test results from a Brocade Fibre Channel 16G or 32G switch:**

1. To get the port number, issue the `switchshow` command:

```
# switchshow
```

The following example output identifies port 17:

```
17 17 011100 id N16 Online FC D-Port Loopback->Port 17
```

2. Issue the `portdporttest` command as follows:

```
# portdporttest --show <port_num>
```

For example:

```
# portdporttest --show 17
```

Following is an example output for this command.

```
portdporttest --show 17
```

```
D-Port Information:
```

```
=====
```

```
Port: 17
Remote WWPN: 21:00:00:0e:1e:11:4a:31
Mode: Automatic
No. of test frames: 1 Million
Test frame size: 1024 Bytes
FEC (enabled/option/active): Yes/No/No
CR (enabled/option/active): Yes/No/No
Start time: Thu Aug 14 01:45:37 2014
End time: Thu Aug 14 01:47:40 2014
Status: PASSED
```

```
=====
```

Test	Start time	Result	EST (HH:MM:SS)	Comments
------	------------	--------	----------------	----------

```

=====
Electrical loopback      01:46:08      PASSED      -----  -----
Optical loopback       01:46:54      PASSED      -----  -----
Link traffic test      -----      SKIPPED     -----  -----
=====

Roundtrip link latency:      157 nano-seconds
Estimated cable distance:    3 meters
Buffers required:           1 (for 2112 byte frames at 16Gbps speed)
  
```

## Verifying D\_Port Mode with QConvergeConsole GUI

To verify D\_Port mode in QConvergeConsole GUI:

1. In the QConvergeConsole left pane, click the **Host** tab.
2. On the Host page, expand a 2700 Series Adapter to view its port nodes.

If a port is in D\_Port mode, the port node specifies **Loop Down, Diagnostic Mode**. [Figure A-3](#) shows an example.

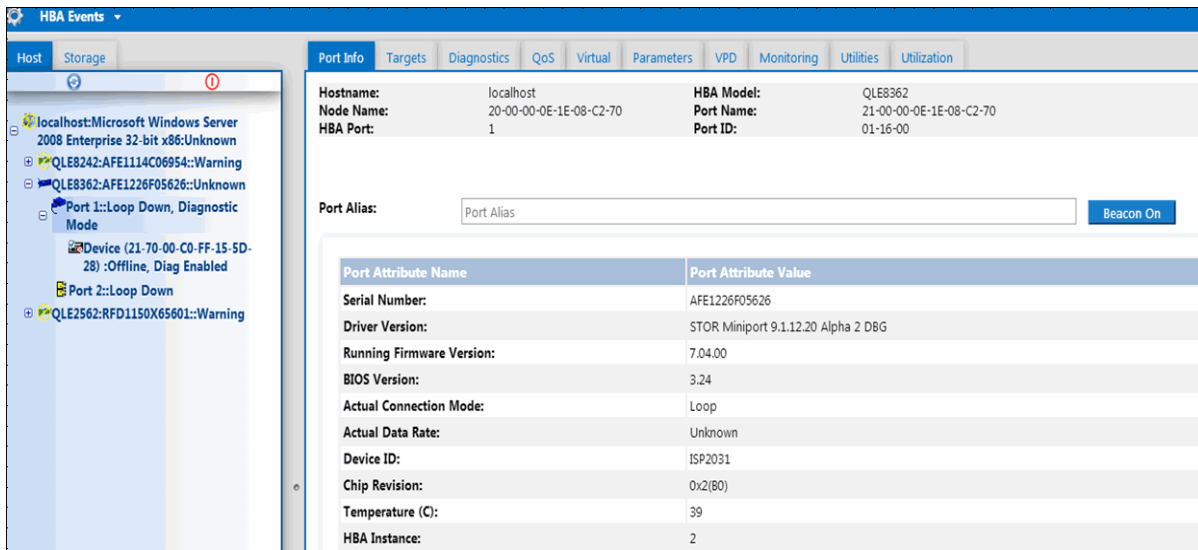

**Figure A-3. D\_Port Mode in QConvergeConsole GUI**

## Verifying D\_Port Mode with Interactive QConvergeConsole CLI

To verify D\_Port mode in interactive QConvergeConsole CLI:

1. From the main menu, select the **Adapter Information** option, and then select the adapter type (**Fibre Channel Adapter**).
2. From the **FC Adapter Information** menu, select **2 (FC Port Information)**.  
The Adapter Information menu shows the affected port with a status of **Loop Down, Diagnostic Mo**. [Figure A-4](#) shows an example.

```
QConvergeConsole
CLI - Version 1.1.3 <Build 23>

FC Adapter Information
1: FC Adapter Information
2: FC Port Information
3: FC UPD Information
4: FC Target/LUN Information

<p or 0: Previous Menu; n or 98: Main Menu; ex or 99: Quit>
Please Enter Selection: 2

QConvergeConsole
CLI - Version 1.1.3 <Build 23>

Adapter Information
HBA Model QLE8362 SN: AFE1226F05626
1: Port 1: WWPN: 21-00-00-0E-1E-08-C2-70 Loop Down, Diagnostic Mo
2: Port 2: WWPN: 21-00-00-0E-1E-08-C2-71 Link Down
HBA Model QLE2562 SN: RFD1150X65601
3: Port 1: WWPN: 21-00-00-24-FF-36-48-40 SFP not installed
4: Port 2: WWPN: 21-00-00-24-FF-36-48-41 SFP not installed

<p or 0: Previous Menu; n or 98: Main Menu; ex or 99: Quit>
Please Enter Selection: _
```

*Figure A-4. D\_Port Mode in Interactive QConvergeConsole CLI*

## Verifying D\_Port Mode with Noninteractive QConvergeConsole CLI

To verify D\_Port mode in noninteractive QConvergeConsole CLI, issue the following command:

```
quacli -pr fc -g
```



All the 2700 Series Adapters are listed. The affected port shows a status of **Loop Down, Diagnostic Mo**. [Figure A-5](#) shows an example.

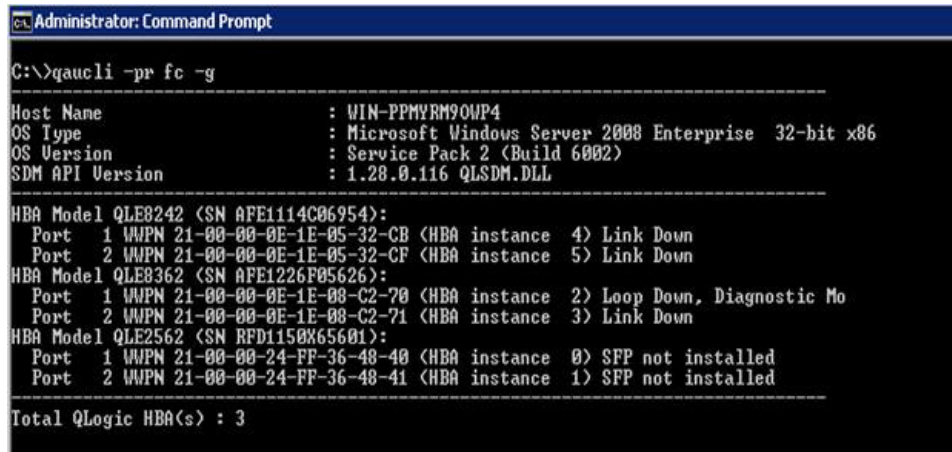

```
Administrator: Command Prompt
C:\>qacucli -pr fc -g
-----
Host Name           : WIN-PPMYRM90WP4
OS Type             : Microsoft Windows Server 2008 Enterprise 32-bit x86
OS Version          : Service Pack 2 (Build 6002)
SDM API Version     : 1.28.0.116 QLSDM.DLL
-----
HBA Model QLE8242 (SN AFE114C06954):
  Port 1 WWPN 21-00-00-0E-1E-05-32-CB (HBA instance 4) Link Down
  Port 2 WWPN 21-00-00-0E-1E-05-32-CF (HBA instance 5) Link Down
HBA Model QLE8362 (SN AFE1226F05626):
  Port 1 WWPN 21-00-00-0E-1E-08-C2-70 (HBA instance 2) Loop Down, Diagnostic Mo
  Port 2 WWPN 21-00-00-0E-1E-08-C2-71 (HBA instance 3) Link Down
HBA Model QLE2562 (SN RFD1150X65601):
  Port 1 WWPN 21-00-00-24-FF-36-48-40 (HBA instance 0) SFP not installed
  Port 2 WWPN 21-00-00-24-FF-36-48-41 (HBA instance 1) SFP not installed
-----
Total QLogic HBA(s) : 3
```

**Figure A-5. D\_Port Mode in Noninteractive QConvergeConsole CLI**

For more information, refer to the section about the Fibre Channel noninteractive commands in the *User's Guide—QConvergeConsole CLI* (part number SN0054667-00).

## Verifying D\_Port Mode with QConvergeConsole Plug-ins

For information about verifying D\_Port mode using QConvergeConsole VMware vCenter Server Plug-in and QConvergeConsole VMware vSphere Web Client Plug-in, see the “Managing Fibre Channel Adapters” section in the *User's Guide—QConvergeConsole Plug-ins for VMware vSphere* (part number SN0054677-00).

# B Specifications

This appendix provides specifications for the QLE274x-DEL Adapters.

## Physical Characteristics

Table B-1 lists the physical characteristics for the QLE274x-DEL Adapters.

**Table B-1. Physical Characteristics**

Adapter	Type	Bracket Installed	Length	Width
QLE2740-DEL	Low profile PCIe card	Full height	6.6 inches	2.731 inches
QLE2740L-DEL	Low profile PCIe card	Low profile	6.6 inches	2.731 inches
QLE2742-DEL	Low profile PCIe card	Full height	6.6 inches	2.731 inches
QLE2742L-DEL	Low profile PCIe card	Low profile	6.6 inches	2.731 inches

## Power Requirements

Table B-2 lists the power requirements for the QLE274x-DEL Adapters.

**Table B-2. Power Requirements**

Adapter	Nominal Power	Maximum Power
QLE2740-DEL	8.6W	10.65W
QLE2740L-DEL	8.6W	10.65W
QLE2742-DEL	9.3W	11.5W
QLE2742L-DEL	9.3W	11.5W

## Standards Specifications

Standards specifications for the QLE274x-DEL Adapters include the following:

- *PCI Express Base Specification, rev. 3.0*
- *PCI Express Card Electromechanical Specification, rev. 2.0*
- *PCI Bus Power Management Interface Specification, rev. 1.2*
- *SCSI-3 Fibre Channel Protocol (SCSI-FCP)*
- *Fibre Channel Tape (FC-TAPE) Profile*
- *SCSI Fibre Channel Protocol-2 (FCP-2)*
- *Second Generation FC Generic Services (FC-GS-2)*
- *Third Generation FC Generic Services (FC-GS-3)*

## Interface Specifications

Table B-3 list the interface specifications for the QLE274x-DEL Adapters.

**Table B-3. Interface Specifications**

Port Type	Media
32Gb SFP+	SFF-8431 Specification for SFP+, Revision 3.2

## Environmental Specifications

Table B-4 lists the environmental specifications for the QLE274x-DEL Adapters.

**Table B-4. Environmental Specifications**

Characteristic	Value
<b>Temperature</b>	
Operational: All models	0°C to 55°C (32°F to 131°F)
Storage: All models	–20°C to 70°C (–4°F to 158°F)
<b>Humidity</b>	
Relative (noncondensing)	10% to 90%
Storage	5% to 95%

# C QConvergeConsole GUI

This appendix provides the following information about QConvergeConsole GUI:

- [Introduction to QConvergeConsole GUI](#)
- [“Downloading QConvergeConsole Documentation” on page 111](#)
- [“Downloading and Installing Management Agents” on page 111](#)
- [“Installing QConvergeConsole GUI” on page 112](#)
- [“What Is in the QConvergeConsole Help System” on page 115](#)

---

## NOTE

For information on installing QConvergeConsole GUI, refer to the *Installation Guide—QConvergeConsole GUI* (part number SN0051105-00). All procedural information for the QConvergeConsole GUI utility is covered in the *QConvergeConsole Help*.

---

## Introduction to QConvergeConsole GUI

QConvergeConsole GUI is a Web-based client and server GUI management tool that provides centralized management and configuration of QLogic adapters within the entire network (LAN and SAN).

On the server side, QConvergeConsole GUI runs as an Apache Tomcat™ application server. After QConvergeConsole GUI is launched on the application server, you can connect to QConvergeConsole GUI through a browser, either locally on the server or remotely from another computer. Your browser window becomes the client used to connect to servers that host the QLogic adapters and connected storage devices within the network.

Use the QConvergeConsole GUI main window to connect to servers that host QLogic adapters. Each host server can include a combination of the following QLogic adapters:

- 4Gb and 8Gb Fibre Channel Adapters (QLx24xx and QLx25xx)
- 8Gb Fibre Channel-to-PCIe Mezzanine Card (QME2572)
- 16Gb Fibre Channel Adapters (QLE266x-DEL, QLE269x-DEL, QLE269xL-DEL)

- 16Gb Fibre Channel Mezzanine Card (QME2662-DEL)
- 10Gb Converged Network Adapters (QLE81xx, QLE82xx)
- 10Gb Converged Network Mezzanine Card (QME8242-k)
- 10GbE Blade Network Daughter Card (QMD8262-k)
- 10GbE Monolithic Server Standup Card (QLE8262)
- 10GbE Blade Mezzanine Card (QME8262-k)
- 32Gb Fibre Channel Adapters (QLE274x-DEL, QLE274xL-DEL)

Note the following:

- QConvergeConsole GUI works with the Windows Server 2016, Windows Server 2012, Red Hat Linux® Advanced Server and Enterprise Server, Novell® SUSE® Linux Enterprise Server (SLES®), and Oracle Linux—Unbreakable Enterprise Kernel (UEK). Multiple operating system support allows control of heterogeneous environments.
- QConvergeConsole GUI runs on the following Web browsers: Google Chrome™, Mozilla® Firefox®, Microsoft® Internet Explorer®, Opera®, Apple® Safari®. For details on browser versions, see the QConvergeConsole *Readme*, which you can download at <http://driverdownloads.qlogic.com>.

---

#### NOTE

Some auxiliary help features, such as the Search and Index tools, may not work properly in every Web browser.

---

## Downloading QConvergeConsole Documentation

To download the *Installation Guide—QConvergeConsole GUI* (part number SN0051105-00), go to [www.qlogic.com](http://www.qlogic.com) and click **Downloads**.

## Downloading and Installing Management Agents

To manage the adapters on a local or remote host, the *management agents* (also called *agents*) used by the host's adapters must already be installed on the host. The agent for Fibre Channel is `qlremote`.

To connect to a remote host, at least one management agent used by any of the host's adapters must be installed and running on the host. Only protocols whose agents are installed and running are shown under the host's system tree node.

Management agents are *not* automatically installed by the QConvergeConsole GUI installer and must be downloaded and installed separately. You can download the agents from the QLogic Web site Downloads page, or using the built-in Agent Installer.

## Installing the Agents from the QLogic Web Site

To obtain the agents from the QLogic Web site and install them (Windows and Linux, all versions):

1. Go to the QLogic Downloads page:  
<http://driverdownloads.qlogic.com>
2. Download the following for each adapter on the host server:
  - SuperInstaller
  - Readme* and *Release Notes*
3. Install the agents by running the SuperInstaller. For detailed information on running the SuperInstaller, refer to the *Readme* and *Release Notes*.

## Installing the Agents Using the Built-in Agent Installer

To access the QCC Agent Installer within QConvergeConsole GUI:

1. Point to the gear icon , point to **Help**, and then click **Download Agent Installers**.

The QCC Agent Installer Utility opens in a separate window and lists links for the platform that the utility has detected.

2. For each agent installer to download, click the link.
3. In the File Download dialog box, click **Save**.

---

### NOTE

For detailed installation instructions, refer to the *Installation Guide—QConvergeConsole GUI* (part number SN0051105-00).

---

## Installing QConvergeConsole GUI

Refer to the installation procedure for your operating system.

- [Installing QConvergeConsole in a Windows Environment](#)
- [Installing QConvergeConsole in a Linux Environment](#)
- [Installing QConvergeConsole in Silent Mode](#)

## Installing QConvergeConsole in a Windows Environment

The QConvergeConsole Installer for Windows is a self-extracting utility that installs QConvergeConsole and related files.

---

### NOTE

Before you begin, read the *QConvergeConsole Release Notes* and *Readme* documents for important, up-to-date product information.

---

### To install QConvergeConsole in a Windows environment:

1. Locate the directory where you downloaded the installation file, and then double-click the following file:  
`QConvergeConsole_Installer_Windows_<version>.exe`
2. If an Open File security dialog box appears, click **Run**.  
The InstallAnywhere utility prepares to install QConvergeConsole.
3. In the Tomcat Port Number Setup dialog box, enter a valid port number in the range 1025–65536, or accept the default port number, 8080. Then click **Next** to continue.
4. In the next dialog box, select **Yes** if you want a localhost-only installation. If you do not want a localhost-only installation, select **No**.

---

### NOTE

The localhost-only option installs QConvergeConsole locally so that you must run it locally (remote connection is not possible). To disable the option, you must uninstall QConvergeConsole and then reinstall it, selecting **No** in this step.

---

5. In the Pre-Installation Summary dialog box, verify that the information is correct, and then click **Install** to proceed.  
The installer displays the progress of the installation.  
A message box prompts you to confirm if you want to enable the SSL feature, which allows data to be encrypted within a secure layer before passing it to and from the server.
6. To enable the SSL feature, click **Yes**. Or to disable SSL, click **No**.
7. In the Install Complete dialog box, click **Done** to exit the installer.

You have installed QConvergeConsole on your server.

## Installing QConvergeConsole in a Linux Environment

You have the option of installing QConvergeConsole in a Linux environment using either a GUI or CLI method. To install from the CLI, see [“Installing QConvergeConsole in Silent Mode” on page 115](#).

You can graphically install QConvergeConsole on a Linux host by running a Virtual Network Computing (VNC®) program on a Windows host. The TightVNC Viewer, a VNC program, can remotely control QConvergeConsole installation on a Linux host.

### To install QConvergeConsole in a Linux environment:

1. Open the directory containing the installer file, which is one of the following:
  - QConvergeConsole\_Installer\_Linux\_i386\_<version>.bin
  - QConvergeConsole\_Installer\_Linux\_x64\_<version>.bin
2. In the terminal window, verify that the installer file has permission to execute by issuing the `ls -lt` command at the prompt.
3. To install QConvergeConsole, double-click the QConvergeConsole installer `.bin` file.

A prompt asks if you want to run or view the contents of the `.bin` file.

4. Click **Run in Terminal**.

The installer extracts the files and installs QConvergeConsole in the following directory:

```
/opt/QLogic_Corporation/QConvergeConsole
```

The InstallAnywhere window prepares to install QConvergeConsole.

5. In the installation Introduction dialog box, click **Next**.
6. In the Tomcat Port Number Setup dialog box, enter a valid port number in the range 1025–65536, or accept the default port number, 8080. Then click **Next** to continue.
7. In the next dialog box, select **Yes** if you want a localhost-only installation. If you do not want a localhost-only installation, select **No**.

---

### NOTE

The localhost-only option installs QConvergeConsole locally so that you must run it locally (remote connection is not possible). To disable the option, you must uninstall QConvergeConsole and then reinstall it, selecting **No** in this step.

---



8. In the Pre-Installation Summary dialog box, read the information, and then click **Install**. During the installation, the installer notifies you of the status.
9. In the Install Complete dialog box, click **Done** to exit the installer.

You have installed QConvergeConsole on your server.

## Installing QConvergeConsole in Silent Mode

You can install QConvergeConsole from a command prompt in silent mode.

To run the installer in silent mode, issue the following command:

```
<installer_file_name> -i silent -DUSER_INPUT_PORT_NUMBER=<A_NUMBER>
```

## What Is in the QConvergeConsole Help System

To access the *QConvergeConsole Help* system while the GUI utility is running, point to the gear icon , point to **Help**, and then click **Browse Contents**. The help system provides topics containing details of the following:

- **QConvergeConsole Overview** describes the application and lists the supported adapters.
- **Getting Started** shows how to start using QConvergeConsole and the help system. It also describes how to initiate automatic e-mail notifications and set security on adapters installed for a selected host.
- **Managing Host Connections** describes how to connect to a host, create and use a host group, view host information, and disconnect from one or more host servers.
- **Displaying Host Information** describes how to view general host information.
- **Displaying Adapter Information** describes how to view general adapter information.
- **Displaying Device Information** describes how to view information about a device (disk or tape).
- **Using Reports** describes the different types of reports and how to generate, view, and save them using QConvergeConsole's report facility.
- **Managing Fibre Channel and FCoE Adapters** describes how to do the following for a Fibre Channel Adapter (2400/2500/2600 Series) or Converged Network Adapter (8100/8200 Series):
  - Display and edit adapter-specific information for the selected adapter.
  - View and modify adapter configuration and settings.
  - Update the adapter's Flash memory or Fibre Channel/FCoE driver.

- **Managing Fibre Channel and FCoE Ports** describes how to do the following for a port on a Fibre Channel Adapter or a Converged Network Adapter:
  - View and modify the parameters and statistics for the selected port.
  - Use the advanced utilities, manage virtual ports, and run diagnostics.
- **Managing iSCSI Ports** shows and describes the parameters on the iSCSI port management pages for the 8200 Series Converged Network Adapters.
- **Managing Gigabit Ethernet Adapters** describes how to view NetXtreme gigabit adapter attributes and configure QLE84xx and FastLinQ Ethernet adapters.
- **Managing Ethernet (NIC) Ports** shows and describes the parameters and configuration options provided on the NIC port management pages for Series Intelligent Ethernet Adapters, as well as 8100/8200 Series Converged Network Adapters.
- **Using the Wizards** describes how to use QConvergeConsole wizards to update the following: Flash, drivers, NIC parameters, Fibre Channel and FCoE parameters, parameters files, passwords, and agents.
- **Troubleshooting** describes tools you can use to resolve the problems that can occur when installing and using the adapter. It also provides the procedures for tracing QConvergeConsole GUI and agent activity, if directed to do so by your authorized service provider.
- **Technical Support** explains how to obtain technical support, gives instructions for downloading software and documentation, and provides contact information.

# D Regulatory Information

This appendix provides warranty, regulatory, and compliance information for the Fibre Channel Adapters covered in this guide.

## Warranty

For information about your Dell warranty, see your system documentation.

## Regulatory and Compliance Information

### Laser Safety, FDA Notice

This product complies with DHHS Rules 21CFR Chapter I, Subchapter J. This product has been designed and manufactured according to IEC60825-1 on the safety label of laser product.

CLASS I LASER

Class 1 Laser Product	<b>Caution</b> —Class 1 laser radiation when open Do not view directly with optical instruments
Appareil laser de classe 1	<b>Attention</b> —Radiation laser de classe 1 Ne pas regarder directement avec des instruments optiques
Produkt der Laser Klasse 1	<b>Vorsicht</b> —Laserstrahlung der Klasse 1 bei geöffneter Abde- ckung Direktes Ansehen mit optischen Instrumenten vermeiden
Luokan 1 Laserlaite	<b>Varoitus</b> —Luokan 1 lasersäteilyä, kun laite on auki Älä katso suoraan laitteeseen käyttämällä optisia instrumenttejä

## Agency Certification

The following section contains a summary of EMI/EMC test specifications performed on model HD8310405 and CU0310421 to comply with radiated emission, radiated immunity, and product safety standards.

### EMI and EMC Requirements

#### **FCC Rules, CFR Title 47, Part 15, Subpart B: Class A**

FCC compliance information statement: This device complies with Part 15 of the FCC Rules. Operation is subject to the following two conditions: (1) this device may not cause harmful interference, and (2) this device must accept any interference received, including interference that may cause undesired operation.

#### **Industry Canada, ICES-003:2004: Class A**

This Class A digital apparatus complies with Canadian ICES-003.  
Cet appareil numérique de la classe A est conforme à la norme NMB-003 du Canada.

#### **CE Mark 2004/108/EC EMC Directive Compliance**

EN55022:2010/CISPR 22:2009+A1:2010: Class A  
EN55024:2010  
EN61000-3-2:2006 A1+A2:2009  
EN61000-3-3:2008  
  
EN61000-4-2: ESD  
EN61000-4-3: RF Electro Magnetic Field  
EN61000-4-4: Fast Transient/Burst  
EN61000-4-5: Fast Surge Common/Differential  
EN61000-4-6: RF Conducted Susceptibility  
EN61000-4-8: Power Frequency Magnetic Field  
EN61000-4-11: Voltage Dips and Interrupt

#### **VCCI: 20011-04; Class A**

#### **AS/NZS; CISPR 22:2009+A1:2010 Class A**

#### **Korea Certification**

KC-RRA KN22 KN24 (2011) Class A



Product Name/Model—2700 Series Adapter  
Certification Holder—QLogic Corporation  
Manufactured Date—Refer to date code listed on product  
Manufacturer/Country of Origin—QLogic Corporation/USA

A class equipment (Business purpose info/ telecommunications equipment)	As this equipment has undergone EMC registration for business purpose, the seller and/or the buyer is asked to beware of this point and in case a wrongful sale or purchase has been made, it is asked that a change to household use be made.
---	--

#### Korean Language Format—Class A

**A급 기기 (업무용 정보통신기기)**

이 기기는 업무용으로 전자파적합등록을 한 기기이오니 판매자 또는 사용자는 이 점을 주의하시기 바라며, 만약 잘못판매 또는 구입하였을 때에는 가정용으로 교환하시기 바랍니다.

## Product Safety Compliance

### UL, cUL Product Safety

UL60950-1 (2nd Edition), 2007

CSA C22.2 60950-1-07 (2nd Edition) 2007

Use only with listed ITE or equivalent.

Complies with 21 CFR 1040.10 and 1040.11.

Complies with 21 CFR 1040.10 and 1040.11.

For use with UL Listed Servers or equivalent.

Power off the computer and all attached devices such as monitors, printers, and external components before installing the accessory card or equivalent.

### 2006/95/EC Low Voltage Directive

TUV EN60950-1:2006+A11+A1+A12 2nd Edition

TUV IEC 60950-1:2005 2nd Edition Am 1:2009 CB



**Corporate Headquarters** Cavium, Inc. 2315 N. First Street San Jose, CA 95131 408-943-7100

**International Offices** UK | Ireland | Germany | France | India | Japan | China | Hong Kong | Singapore | Taiwan | Israel

---

Copyright © 2016, 2017 Cavium, Inc. All rights reserved worldwide. QLogic Corporation is a wholly owned subsidiary of Cavium, Inc. Cavium, the Cavium logo, QLogic, and QConvergeConsole are registered trademarks or trademarks of Cavium, Inc. All other brand and product names are trademarks or registered trademarks of their respective owners.

This document is provided for informational purposes only and may contain errors. Cavium reserves the right, without notice, to make changes to this document or in product design or specifications. Cavium disclaims any warranty of any kind, expressed or implied, and does not guarantee that any results or performance described in the document will be achieved by you. All statements regarding Cavium's future direction and intent are subject to change or withdrawal without notice and represent goals and objectives only.

