

OpenSwitch OPX Configuration Guide

Release 2.1.0

2017 - 7

Rev. A02

Contents

1 Network configuration.....	4
2 Interfaces.....	5
Physical ports.....	6
Fan-out interfaces.....	6
Port-channel/bond interfaces.....	7
VLAN interfaces.....	8
3 Layer 2 bridging.....	9
VLAN bridging.....	9
Link layer discovery protocol.....	11
Spanning-tree provisioning.....	11
4 Layer 3 routing.....	13
IPv4 routing.....	13
IPv6 routing.....	14
Neighbor table entries.....	14
Next-hop routing.....	15
L3 routing topology.....	15
Quagga routing.....	17
Routing using Quagga.....	19
5 Security.....	24
6 Monitoring.....	25
sFlow provisioning.....	25
Port statistics.....	26
7 Support resources.....	30

Network configuration

OpenSwitch OPX supports the ability to model and configure various networking features in the network processing unit (NPU) using two methods—Linux commands and CPS APIs. This information describes how to program networking features using Linux commands and open source applications.

See Programmability in the *OpenSwitch OPX Developers Guide* for a description of the CPS framework, and detailed information on using the CPS API for configuration.

OpenSwitch OPX network functionality is handled by the network adaptation service (NAS) which listens to netlink events for Layer 2 and Layer 3 configurations, and programs the NPU.

NOTE: Layer 2 LLDP configuration is not available when using the CPS API.

Linux command — open source application

- Interfaces — physical, link aggregation (LAG), VLAN
- Layer 2 bridging — LLDP, STP, VLAN
- Layer 3 routing — ECMP, IPv4, IPv6, unicast

CPS API configuration

- Interfaces — physical, link aggregation (LAG), VLAN, Fanout (script)
- Layer 2 bridging — MAC address table, STP, VLAN
- Layer 3 routing — ECMP, IPv4, IPv6, unicast
- Security — QoS and ACL
- Monitoring — port mirroring, sFlow, and port and VLAN statistics

Dell-provided commands

These features are not supported using standard Linux commands but can be configured using the Dell EMC-provided utilities.

- Fan-out (4x10G) interface configuration
- Layer 2 MAC address table configuration
- QoS and ACL configuration
- Port monitoring, sFlow configuration, and port and VLAN statistics

Interfaces

You can create and manage physical and virtual interfaces—physical port interfaces are ports on the NPU and do not include the Management port. Each physical port on the NPU maps to a data port on the front panel of the device.

Applications access physical and virtual ports using mapped Linux interfaces. The software allocates an `ifindex` for each Linux interface, and the value is used in CPS APIs to refer to a Linux interface.

Map ports to Linux interfaces

Each physical port is mapped to an internal Linux interface:

`eNSS-PPP-F.vvv`

- `e` — Ethernet port
- `N` — node ID (set to 1)
- `SS` — slot number (set to 01)
- `PPP` — port number (1 to 999)
- `F` — number of a 4x10G fan-out port (0 to 9)
- `vvv` — VLAN ID number (0 to 4095)

The `e101-031-0` interface refers to physical port 31 without a fan-out—`e101-005-4` identifies fanout port 4 on physical port 5, and `e101-001-2` identifies fanout port 2 on physical port 1.

Interfaces are created during system boot up and represent the physical ports on the NPU in a one-to-one mapping.

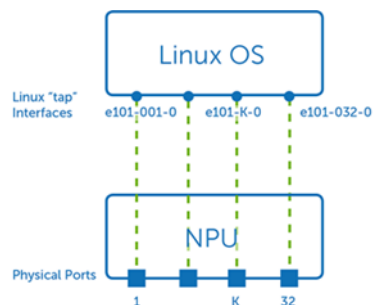

Internal interfaces allow applications to configure physical port parameters, such as MTU, port state, and link state. Interfaces also provide packet input/output functionality and support applications sending and receiving control plane packets.

Map CPU port to Linux interface

The software creates a dedicated interface (`npu0`) that maps to the CPU port. Configure control plane policy (CoPP) queue rates by specifying `npu0` as the port in the QoS CPS API.

Topics:

- [Physical ports](#)

- [Fan-out interfaces](#)
- [Port-channel/bond interfaces](#)
- [VLAN interfaces](#)

Physical ports

Physical ports are administratively down by default. Each interface has a reserved MAC hardware address derived from the system MAC address. Use standard Linux commands to configure physical interface parameters.

Set MTU

```
$ ip link set dev e101-002-0 mtu 1400
```

Show MTU

```
$ ip link show e101-002-0
```

```
17: e101-002-0: <BROADCAST,MULTICAST> mtu 1400 qdisc noop state DOWN mode DEFAULT group default qlen 500
    link/ether 90:b1:1c:f4:ab:f2 brd ff:ff:ff:ff:ff:ff
    alias NAS## 0 29
```

Configure L3 IPv4 address

```
$ ip addr add 10.1.1.1/24 dev e101-001-0
```

Configure L3 IPv6 address

```
$ ip -6 addr add 2000::1/64 dev e101-001-0
```

View interface parameters

```
$ ip addr show e101-001-0
```

```
16: e101-001-0: <BROADCAST,MULTICAST> mtu 1500 qdisc noop state DOWN group default qlen 500
    link/ether 90:b1:1c:f4:ab:ee brd ff:ff:ff:ff:ff:ff
    inet 10.1.1.1/24 scope global e101-001-0
        valid_lft forever preferred_lft forever
    inet6 2000::1/64 scope global tentative
        valid_lft forever preferred_lft forever
```

See Application examples in the *OpenSwitch OPX Developers Guide* for examples of how to program physical port configuration using the CPS API.

Fan-out interfaces

Using a breakout cable, you can split a 40GbE physical port into four (quad) 10GbE SFP+ ports (if supported by the NPU). Each 4x10G port is represented by a Linux interface with a fan-out field in the interface name that identifies the 4x10G port.

Use the `opx-config-fanout` script to configure fan-out interfaces. This script allows you to fan-out a 40GbE port or disable the fanned-out 4x10G configuration and return the physical port to 40G operation.

```
opx-config-fanout portID [true | false]
```

- `true` enables 4x10G fan-out on a 40GbE port
- `false` disables 4x10G fan-out on a 40GbE port

Configure fan-out interface

```
$ opx-config-fanout e101-005-0 true
Key: 1.20.1310766.1310754.1310755.1310756.1310757.
base-port/physical/unit-id = 0
base-port/physical/phy-media = 1
base-port/physical/front-panel-number = 0
```

```
base-port/physical/loopback = 0
base-port/physical/hardware-port-id = 45
base-port/physical/npu-id = 0
base-port/physical/fanout-mode = 4
base-port/physical/breakout-capabilities = 4,2
base-port/physical/port-id = 45
base-port/physical/slot-id = 0
Deleting.. e101-005-0
Completed...
```

```
Creating interface e101-005-1
Creating interface e101-005-2
Creating interface e101-005-3
Creating interface e101-005-4
Successfully created interfaces...
```

Port-channel/bond interfaces

A port-channel or link aggregation group (LAG) corresponds to a bond interface, which aggregates multiple physical interfaces into one virtual interface for load-balancing and link failovers. A LAG and a bond interface both refer to a link aggregation group. LAG refers to an NPU configuration, while `bond` interface refers to a Linux configuration.

NOTE: A Linux bond interface must be up before you can add member ports.

Create bond interface

```
$ ip link add bond1 type bond mode balance-rr miimon 50
```

Bring up bond interface

```
$ ip link set dev bond1 up
$ ip link show | grep bond1
50: bond1: <BROADCAST,MULTICAST,MASTER,UP,LOWER_UP> mtu 1500 qdisc noqueue state UNKNOWN mode
DEFAULT group default
```

Add port to bind interface

```
$ ip link set e101-010-0 master bond1
$ ip link show | grep bond1
12: e101-010-0: <BROADCAST,MULTICAST,SLAVE,UP,LOWER_UP> mtu 1500 qdisc mq master bond1 state UP
mode DEFAULT group default qlen 500
50: bond1: <BROADCAST,MULTICAST,MASTER,UP,LOWER_UP> mtu 1500 qdisc noqueue state UP mode
DEFAULT group default
```

Configure IP address on bond interface

```
$ ip addr add 20.1.1.1/24 dev bond1
$ ifconfig bond1
bond1    Link encap:Ethernet  HWaddr 90:b1:1c:f4:9d:60
         inet addr:20.1.1.1  Bcast:0.0.0.0  Mask:255.255.255.0
         inet6 addr: fe80::8480:fcff:fe2f:d93b/64 Scope:Link
         UP BROADCAST RUNNING MASTER MULTICAST  MTU:1500  Metric:1
         RX packets:66 errors:0 dropped:1 overruns:0 frame:0
         TX packets:77 errors:0 dropped:0 overruns:0 carrier:0
         collisions:0 txqueuelen:0
         RX bytes:4224 (4.1 KiB)  TX bytes:15648 (15.2 KiB)
```

Delete port from bond interface

```
$ ip link set e101-010-0 nomaster
$ ip link show | grep bond1
49: bond1: <NO-CARRIER,BROADCAST,MULTICAST,MASTER,UP> mtu 1500 qdisc noqueue state DOWN mode
DEFAULT group default
```

Delete bond interface

```
$ ip link delete bond1
$ ip link show | grep bond1
```

See www.kernel.org for more information about how to use bond interfaces, and see Application examples in the *OpenSwitch OPX Developers Guide* for more information on programming a bond interface using the CPS API.

VLAN interfaces

Virtual LANs (VLANs) define broadcast domains in a Layer 2 network, and an NPU VLAN entity is modeled as a separate Linux bridge instance.

NPU entities (VLANs) are mapped to Linux entities (bridges). An NPU VLAN entity uses the MAC address from the first port added as its member port. The bridge interface is operationally up when at least one of its member interfaces is up. You can assign IP addresses to multiple bridge interfaces to create an inter-VLAN routing domain.

Configure IP address on bridge interface

```
$ brctl show  
  
bridge name      bridge id          STP enabled      interfaces  
br100            8000.90b11cf49d3c no                e101-001-0.100  
  
$ ip addr add 100.1.1.1 dev br100  
$ ifconfig br100  
br100            Link encap:Ethernet HWaddr 90:b1:1c:f4:9d:3c  
                inet addr:100.1.1.1 Bcast:0.0.0.0 Mask:255.255.255.255  
                inet6 addr: fe80::92b1:1cff:fef4:9d3c/64 Scope:Link  
                UP BROADCAST RUNNING MULTICAST MTU:1500 Metric:1  
                RX packets:0 errors:0 dropped:0 overruns:0 frame:0  
                TX packets:7 errors:0 dropped:0 overruns:0 carrier:0  
                collisions:0 txqueuelen:0  
                RX bytes:0 (0.0 B) TX bytes:738 (738.0 B)
```

Layer 2 bridging

OpenSwitch OPX supports Layer 2 bridging and includes VLAN bridging, spanning-tree provisioning (STP), link layer discovery protocol (LLDP), and media access control (MAC) address forwarding. OpenSwitch OPX provides a CPS data model for configuring and managing the MAC address forwarding database using the CPS API.

You can configure Layer 2 MAC addresses and VLAN learning and forwarding properties in support of Layer 2 bridging. The device learns unicast MAC addresses to avoid flooding the packets to all the ports in a bridge domain. If the bridge receives a control protocol data unit (PDU) which does not have a corresponding protocol configured, the control PDU is considered as an unknown multicast data packet, and the packets are flooded across all ports that are part of the same bridge domain. If the bridge has the protocol corresponding to the PDU configured, the control PDU is considered as a control packet and is processed by the routing engine.

See the *OpenSwitch OPX Developers Guide* for more information on writing applications that access the CPS API to configure Layer 2, and using YANG models to configure the MAC address forwarding database.

Topics:

- [VLAN bridging](#)
- [Link layer discovery protocol](#)
- [Spanning-tree provisioning](#)

VLAN bridging

OpenSwitch OPX supports Layer 2 VLAN bridging by modeling each NPU VLAN entity as a separate Linux bridge instance. Each physical or LAG port that is a VLAN member is modeled by adding its corresponding Linux interface to the bridge instance. See Application examples in the *OpenSwitch OPX Developers Guide* for more information on creating a VLAN and assigning members.

To create a VLAN using the Linux bridge, create the bridge instance and then add a tagged member to the new bridge instance. OpenSwitch OPX determines the VLAN ID associated with each bridge instance using the VLAN ID of the first tagged member port assigned to the bridge instance. The VLAN is created only after you add the first tagged member to the bridge.

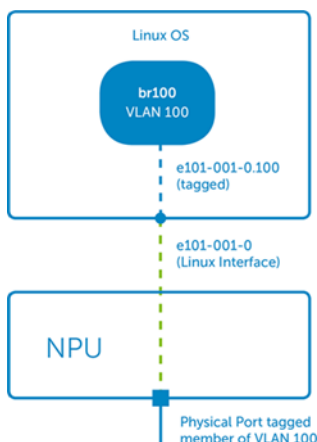

- 1 Create a bridge instance for the VLAN—`br100` is the name of the bridge instance used to model the VLAN, and OpenSwitch OPX does not derive the VLAN ID from the name.

```
$ brctl addbr br100
```

- 2 Add a tagged port to the VLAN to ensure that the Linux interface mapped to the port being added does not have an IP address.

```
$ ifconfig e101-001-0
e101-001-0 Link encap:Ethernet HWaddr 90:b1:1c:f4:9d:3c
   inet addr:1.1.1.1 Bcast:1.1.1.255 Mask:255.255.255.0
   BROADCAST MULTICAST MTU:1500 Metric:1
   RX packets:0 errors:0 dropped:0 overruns:0 frame:0
   TX packets:2221 errors:0 dropped:0 overruns:0 carrier:0
   collisions:0 txqueuelen:500
   RX bytes:0 (0.0 B) TX bytes:523446 (511.1 KiB)
```

If the interface already has an IP address, remove the IP address before continuing to the next step.

```
$ ip addr flush dev e101-001-0
```

- 3 Create a tagged virtual link—a Linux interface can only belong to a single bridge instance. To add the same interface to multiple VLAN domains, create a separate Linux virtual link for each VLAN in which the port is a member. Create a virtual tagged link for the `e101-001-0` Linux interface in VLAN 100—the `.100` suffix in the Linux interface name indicates that the interface is VLAN tagged.

```
$ ip link add link e101-001-0 name e101-001-0.100 type vlan id 100
```

- 4 Add the tagged virtual link to the VLAN to add the newly created virtual link to the Linux bridge instance created in Step 1. OpenSwitch OPX creates the VLAN and adds the physical port mapped to the `e101-001-0` Linux interface as a tagged member of the VLAN.

```
$ brctl addif br100 e101-001-0.100
```

- 5 Verify the VLAN configuration.

```
$ brctl show
bridge name      bridge id      STP enabled    interfaces
br100            8000.90b11cf49d3c  no             e101-001-0.100
```

Add untagged member to VLAN

You can add a Linux interface directly to a Linux bridge without creating a separate VLAN-specific virtual link. Note that in the example the interface does not have the `.100` suffix, which means the interface is an untagged VLAN member.

```
$ brctl addif br100 e101-002-0
```

A physical port can be an untagged member of only a single VLAN—a physical port can be added as a tagged member of multiple VLANs.

```
$ brctl show
bridge name      bridge id      STP enabled    interfaces
br100            8000.90b11cf49d3c  no             e101-001-0.100
                e101-002-0
```

Add port to multiple VLAN domains

To add the same port to a second VLAN, create another VLAN tagged virtual link on the `e101-001-0` interface, then add the new virtual link to the Linux bridge instance.

```
$ brctl addbr br200
$ ip link add link e101-001-0 name e101-001-0.200 type vlan id 200
$ brctl addif br200 e101-001-0.200
```

NOTE: All interfaces in a bridge instance must be either untagged or have the same tagged VLAN ID—you cannot configure `e101-001-0.100` and `e101-002-0.200` in the same Linux bridge instance.

```
$ brctl show
bridge name      bridge id      STP enabled    interfaces
br100            8000.90b11cf49d3c  no             e101-001-0.100
                e101-002-0
br200            8000.90b11cf49d3c  no             e101-001-0.200
```

Add Linux bond interface to VLAN domain

Add a Linux bond interface to a VLAN domain—`bond1` is a Linux interface that maps to a LAG port in the NPU. Use the command to add the LAG port to the VLAN associated with the bridge instance in the NPU.

```
$ ip link add link bond1 name bond1.200 type vlan id 200
$ brctl addif br200 bond1.200
```

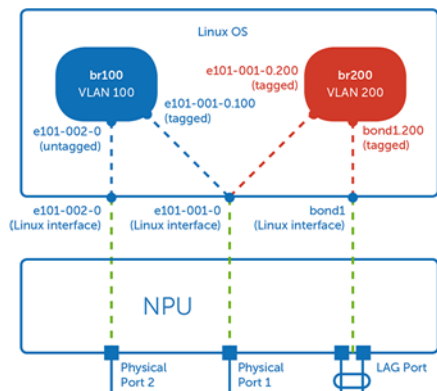

Remove VLAN member from VLAN

```
$ brctl delif br200 e101-001-0.100
```

Delete VLAN

```
$ brctl delbr br200
```

Link layer discovery protocol

OpenSwitch OPX supports the link layer discovery protocol (LLDP) daemon on Linux interfaces.

LLDP daemon

```
$ lldpcli show neighbors
```

LLDP neighbors:

```
Interface:      e101-003-0, via: LLDP, RID: 3, Time: 0 day, 01:17:18
Chassis:
  ChassisID:    mac 90:b1:1c:f4:9d:3b
  SysName:      OPEN
  Capability:    Repeater, on
  Capability:    Bridge, on
  Capability:    Router, on
  Port:
  PortID:       ifalias ethernet1/1/3
-----
```

Spanning-tree provisioning

OpenSwitch OPX supports spanning-tree provisioning (STP) using the CPS API including:

- Create a new spanning-tree group
- Add VLANs to a spanning-tree group
- Remove VLANs from a spanning-tree group
- Change the STP state of ports mapped to a spanning-tree group
- Delete a spanning-tree group

This enables OpenSwitch OPX to run any of the spanning-tree protocols such as STP, RSTP, PVST, and MSTP.

NOTE: OpenSwitch OPX does not support RSTP, MSTP, and RPVST in a Linux bridge due to a Linux kernel limitation. STP is not supported on a bridge which has multiple member interfaces with different VLAN IDs.

See YANG model reference in the *OpenSwitch OPX Developers Guide* for more information on the `dell-open-stp.yang` model for the supported STP parameters.

Linux STP does not support the concept of spanning-tree groups. In Linux, you can enable spanning tree independently in each bridge instance. OpenSwitch OPX treats STP enabled in a bridge instance as a separate spanning-tree group for each VLAN. If a Linux bridge contains only untagged ports, the software does not support STP on the bridge.

- 1 Create a VLAN in the Linux bridge (see [VLAN bridging](#)).
- 2 Enable STP on the bridge, then view the configuration.

```
$ brctl stp br100 on
$ brctl show br100
bridge name      bridge id      STP enabled    interfaces
br100            8000.90b11cf4a918  yes           e101-001-0.100

$ brctl showstp br100
br100
bridge id          8000.90b11cf4a918
designated root    8000.90b11cf4a918
root port         0              path cost      0
max age           20.00         bridge max age 20.00
hello time        2.00          bridge hello time 2.00
forward delay     15.00         bridge forward delay 15.00
ageing time       300.00
hello timer       0.00          tcn timer      0.00
topology change timer 0.00         gc timer       0.00
flags

e101-001-0.100 (1)
port id           8001          state          disabled
designated root    8000.90b11cf4a918 path cost      100
designated bridge  8000.90b11cf4a918 message age timer 0.00
designated port    8001          forward delay timer 0.00
designated cost    0             hold timer     0.00
flags
```

Disable STP on bridge

```
$ brctl stp br100 off
```

View bridge configuration

```
$ brctl show br100
bridge name      bridge id      STP enabled    interfaces
br100            8000.90b11cf4a918  no            e101-001-0.100
```

When you enable STP on a bridge which has tagged VLAN interfaces, OpenSwitch OPX creates a new spanning-tree group and associates the VLAN ID of the bridge with the newly created spanning-tree group. When you delete a bridge from the Linux kernel, the corresponding NPU spanning-tree group is deleted.

Layer 3 routing

OpenSwitch OPX supports unicast routing over Linux interfaces using routes in the Linux kernel routing table. Applications can also use the CPS API to configure routes. This information describes how to configure Layer 3 unicast routing to provision the NPU.

The OpenSwitch OPX routing subsystem manages the forwarding information base (FIB). The routing subsystem programs routes with resolved next hops using ARP/Neighbor table entries received from the Linux kernel.

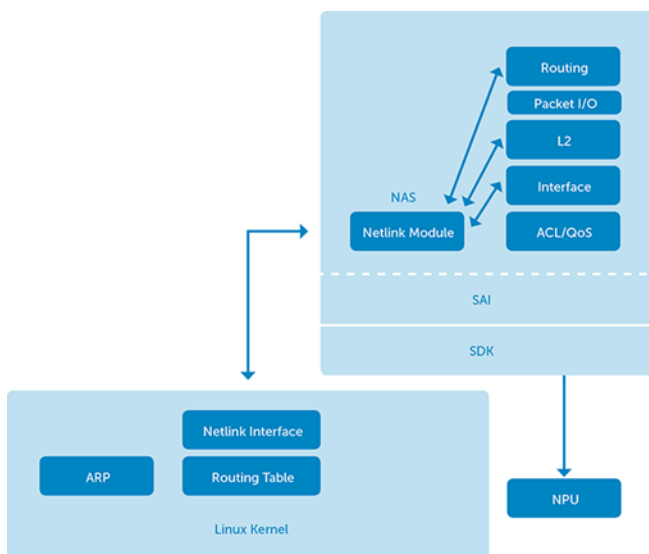

Topics:

- IPv4 routing
- IPv6 routing
- Neighbor table entries
- Next-hop routing
- L3 routing topology
- Quagga routing
- Routing using Quagga

IPv4 routing

Use the `iproute` command to create a route. A routing table entry consists of a destination IP address prefix and at least one next-hop address or a Linux interface.

Configure static route

```
$ ip route show
default dev eth0 scope link
3.3.3.0/24 dev e101-003-0 proto kernel scope link src 3.3.3.1
$ ip route add 11.10.10.0/24 dev e101-003-0
```

```
$ ip route show
default dev eth0 scope link
3.3.3.0/24 dev e101-003-0 proto kernel scope link src 3.3.3.1
11.10.10.0/24 dev e101-003-0 scope link
```

Configure static route with next-hop

```
$ ip route add 30.30.30.0/24 via 3.3.3.3
$ ip route show
default dev eth0 scope link
3.3.3.0/24 dev e101-003-0 proto kernel scope link src 3.3.3.1
30.30.30.0/24 via 3.3.3.3 dev e101-003-0
```

Delete static route

```
$ ip route delete 11.10.10.0/24
$ ip route show
default dev eth0 scope link
3.3.3.0/24 dev e101-003-0 proto kernel scope link src 3.3.3.1
```

To add a persistent static route that is saved after a reboot, configure the route in the `/etc/network/interfaces` configuration file.

See Application examples in the *OpenSwitch OPX Developers Guide* for more information on how to configure routing using the CPS API.

IPv6 routing

Add, delete, or modify IPv6 routes and next-hops in the routing table.

Add IPv4 route

```
$ ip -6 route add 5::5/64 via 3::3
```

View IPv6 route

```
$ ip -6 route show
3::/64 dev e101-003-0 proto kernel metric 256
5::/64 via 3::3 dev e101-003-0 metric 1024
```

Monitor IPv6 routing

```
$ ip monitor
30.30.30.0/24 via 3.3.3.3 dev e00-3
3::/64 via 3::3 dev e101-003-0 metric 1024
5::/64 via 3::3 dev e101-003-0 metric 1024
```

See Application examples in the *OpenSwitch OPX Developers Guide* for more information on how to configure routing using the CPS API.

Neighbor table entries

OpenSwitch OPX uses ARP and neighbor table entries to resolve adjacencies by using the host IP address-to-MAC address binding. The ARP table is used for IPv4 routing—the neighbor table is used for IPv6 routing.



View kernel ARP table entries

```
$ arp -n
Address HWtype HWaddress Flags Mask Iface 3.3.3.4 ether 90:b1:1c:f4:9d:44 C e101-003-0
```

View IPv6 neighbor table

```
$ ip -6 neighbor
```

Configure IPv6 address

```
$ ifconfig e101-003-0 inet6 add 3::1/64
$ ifconfig e101-003-0
e101-003-0 Link encap:Ethernet HWaddr 90:b1:1c:f4:a8:ea
inet addr:3.3.3.1 Bcast:3.3.3.255 Mask:255.255.255.0
inet6 addr: 3::1/64 Scope:Global
inet6 addr: fe80::92b1:1cff:fef4:a8ea/64 Scope:Link
UP BROADCAST RUNNING MULTICAST MTU:1500 Metric:1
RX packets:532 errors:0 dropped:0 overruns:0 frame:0
TX packets:173 errors:0 dropped:0 overruns:0 carrier:0
collisions:0 txqueuelen:500
RX bytes:46451 (45.3 KiB) TX bytes:25650 (25.0 KiB)
```

View IPv6 neighbor table

```
$ ip -6 neighbor show
3::3 dev e101-003-0 lladdr 90:b1:1c:f4:9d:44 router REACHABLE
```

Check connectivity to IPv6 neighbor

```
$ ping6 3::3
PING 3::3(3::3) 56 data bytes
64 bytes from 3::3: icmp_seq=1 ttl=64 time=1.74 ms
$ tcpdump -i e101-003-0
tcpdump: verbose output suppressed, use -v or -vv for full protocol decode
listening on e101-003-0, link-type EN10MB (Ethernet), capture size 262144 bytes
04:30:17.053115 IP6 3::1 > 3::3: ICMP6, echo request, seq 8, length 64
```

Next-hop routing

The Linux networking stack supports ECMP by adding multiple next-hops to a route, and the kernel provides limited support for IPv6 multipath routing.

Configure next-hop routing

```
$ ip route add 40.40.40.0/24 nexthop via 3.3.3.6 nexthop via 4.4.4.7
```

View ECMP configuration

```
$ ip route show
default dev eth0 scope link
3.3.3.0/24 dev e101-003-0 proto kernel scope link src 3.3.3.1
40.40.40.0/24
    nexthop via 3.3.3.6 dev e101-003-0 weight 1
    nexthop via 4.4.4.7 dev e101-004-0 weight 1
```

L3 routing topology

Use `ip addr add` or `ifconfig` to configure an interface.

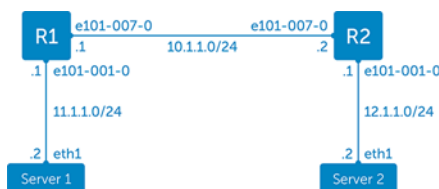

See Application examples in the *OpenSwitch OPX Developers Guide* for more information on how to configure routing using the CPS API.

Configure IP address on R1

```
$ ip addr add 10.1.1.1/24 dev e101-007-0
$ ip addr add 11.1.1.1/24 dev e101-001-0
```

Configure IP address on R2

```
$ ip addr add 10.1.1.2/24 dev e101-007-0
$ ip addr add 12.1.1.1/24 dev e101-001-0
```

Verify configuration on R1

```
$ ip addr show e101-007-0
16: e101-007-0: <BROADCAST,MULTICAST,UP,LOWER_UP> mtu 1500 qdisc mq state UP group default qlen
500
    link/ether 74:e6:e2:f6:af:87 brd ff:ff:ff:ff:ff:ff
    inet 10.1.1.1/24 scope global e101-007-0
        valid_lft forever preferred_lft forever
    inet6 fe80::76e6:e2ff:fef6:af87/64 scope link
        valid_lft forever preferred_lft forever
$ ip addr show e101-001-0
10: e101-001-0: <BROADCAST,MULTICAST,UP,LOWER_UP> mtu 1500 qdisc mq state UP group default qlen
500
    link/ether 74:e6:e2:f6:af:81 brd ff:ff:ff:ff:ff:ff
    inet 11.1.1.1/24 scope global e101-001-0
        valid_lft forever preferred_lft forever
    inet6 fe80::76e6:e2ff:fef6:af81/64 scope link
        valid_lft forever preferred_lft forever
```

Verify configuration on R2

```
$ ip addr show e101-007-0
16: e101-007-0: <BROADCAST,MULTICAST,UP,LOWER_UP> mtu 1500 qdisc mq state UP group default qlen
500
    link/ether 74:e6:e2:f6:ba:87 brd ff:ff:ff:ff:ff:ff
    inet 10.1.1.2/24 scope global e101-007-0
        valid_lft forever preferred_lft forever
    inet6 fe80::76e6:e2ff:fef6:ba87/64 scope link
        valid_lft forever preferred_lft forever
$ ip addr show e101-001-0
10: e101-001-0: <BROADCAST,MULTICAST,UP,LOWER_UP> mtu 1500 qdisc mq state UP group default qlen
500
    link/ether 74:e6:e2:f6:ba:81 brd ff:ff:ff:ff:ff:ff
    inet 12.1.1.1/24 scope global e101-001-0
        valid_lft forever preferred_lft forever
    inet6 fe80::76e6:e2ff:fef6:ba81/64 scope link
        valid_lft forever preferred_lft forever
```

Enable interfaces on R1 and R2

```
$ ip link set dev e101-007-0 up $ip link set dev e101-001-0 up
```

Configure static route to server on R1

```
$ ip route add 12.1.1.0/24 via 10.1.1.2
```

Configure static route to server on R2

```
$ ip route add 11.1.1.0/24 via 10.1.1.1
```

Check connectivity from server 2

```
$ ping 11.1.1.2
PING 11.1.1.2 (11.1.1.2) 56(84) bytes of data.
64 bytes from 11.1.1.2: icmp_seq=1 ttl=64 time=0.922 ms
^C
--- 11.1.1.2 ping statistics ---
1 packets transmitted, 1 received, 0% packet loss, time 0ms
rtt min/avg/max/mdev = 0.922/0.922/0.922/0.000 ms
$ping 10.1.1.2
PING 10.1.1.2 (10.1.1.2) 56(84) bytes of data.
64 bytes from 10.1.1.2: icmp_seq=1 ttl=64 time=0.709 ms
^C
--- 10.1.1.2 ping statistics ---
```



```
1 packets transmitted, 1 received, 0% packet loss, time 0ms
rtt min/avg/max/mdev = 0.709/0.709/0.709/0.000 ms
```

View ARP table on R1

```
$ arp -n
Address      HWtype  HWaddress      Flags Mask    Iface
11.1.1.2    ether   00:00:00:1d:9a:bd  C           e101-001-0
10.1.1.2    ether   74:e6:e2:f6:ba:87  C           e101-007-0
```

View ARP table on R2

```
$ arp -n
Address      HWtype  HWaddress      Flags Mask    Iface
10.1.1.1    ether   74:e6:e2:f6:af:87  C           e101-007-0
12.1.1.2    ether   00:00:00:1d:9a:be  C           e101-001-0
```

Quagga routing

Quagga is an open-source routing application that provides OSPFv2, OSPFv3, RIPv1 and v2, RIPvng, and BGP-4 functionality.

The Quagga architecture consists of a core daemon zebra, which acts as an abstraction layer to the underlying Linux kernel and presents a Zserv API over a Unix or TCP socket to Quagga clients. The Zserv clients implement a routing protocol and communicate routing updates to the zebra daemon. See github.com/opensourcerouting/quagga for complete information.

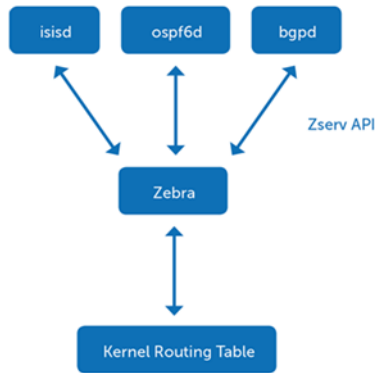

Install Quagga

```
$ apt-get install -y quagga
Reading package lists... Done
Building dependency tree
Reading state information... Done
The following NEW packages will be installed:
 quagga
0 upgraded, 1 newly installed, 0 to remove and 0 not upgraded.
Need to get 1217 kB of archives.
After this operation, 6323 kB of additional disk space will be used.
Get:1 http://10.11.56.31/debian/ jessie/main quagga amd64 0.99.23.1-1 [1217 kB]
Fetched 1217 kB in 0s (12.2 MB/s)
Preconfiguring packages ...
Selecting previously unselected package quagga.
(Reading database ... 46597 files and directories currently installed.)
Preparing to unpack .../quagga_0.99.23.1-1_amd64.deb ...
Unpacking quagga (0.99.23.1-1) ...
Processing triggers for systemd (215-17) ...
Processing triggers for man-db (2.7.0.2-5) ...
Setting up quagga (0.99.23.1-1) ...
Processing triggers for systemd (215-17) ...
Processing triggers for libc-bin (2.19-18) ...
```

Quagga daemons and the `debian.conf` file are stored in the `/etc/quagga` directory. All routing protocol daemons installed with Quagga are disabled by default. You must enable the zebra daemon to install the routes in the kernel routing table.

- 1 Open the `daemons` file for editing and change the daemon status to `yes`.

```
$ vim /etc/quagga/daemons
zebra=yes
bgpd=yes
ospfd=no
ospf6d=no
ripd=no
ripngd=no
isisd=no
babeld=no
```

- 2 Create the `vttysh.conf` and `Quagga.conf` configuration files.

```
$ cp /usr/share/doc/quagga/examples/vttysh.conf.sample /etc/quagga/vttysh.conf touch /etc/quagga/Quagga.conf
```

- 3 Restart the Quagga service.

```
$ /etc/quagga# service quagga restart
```

- 4 View the status of Quagga protocol daemons.

```
$ /etc/quagga# service quagga status
? quagga.service - LSB: start and stop the Quagga routing suite
Loaded: loaded (/etc/init.d/quagga)
Active: active (running) since Tue 2016-02-16 17:47:25 UTC; 4s ago
Process: 5078 ExecStop=/etc/init.d/quagga stop (code=exited, status=0/SUCCESS)
Process: 5097 ExecStart=/etc/init.d/quagga start (code=exited, status=0/SUCCESS)
CGroup: /system.slice/quagga.service
??5111 /usr/lib/quagga/zebra --daemon -A 127.0.0.1
??5115 /usr/lib/quagga/bgpd --daemon -A 127.0.0.1
??5121 /usr/lib/quagga/watchquagga --daemon zebra bgpd
```

```
Feb 16 17:47:25 OPX quagga[5097]: Loading capability module if not yet done.
Feb 16 17:47:25 OPX quagga[5097]: Starting Quagga daemons (prio:10): zebra...d.
Feb 16 17:47:25 OPX quagga[5097]: Starting Quagga monitor daemon: watchquagga.
Feb 16 17:47:25 OPX watchquagga[5121]: watchquagga 0.99.23.1 watching [zebr...]
Feb 16 17:47:25 OPX systemd[1]: Started LSB: start and stop the Quagga rou...e.
Feb 16 17:47:25 OPX watchquagga[5121]: bgpd state -> up : connect succeeded
Feb 16 17:47:25 OPX watchquagga[5121]: zebra state -> up : connect succeeded
Hint: Some lines were ellipsized, use -l to show in full
```

- 5 Remove the `!` character to the left of the `service integrated-vttysh-config` option in the `vttysh.conf` file.

```
$ /etc/quagga/vttysh.conf
!
! Sample
!
service integrated-vttysh-config
hostname quagga-router
username root nopassword
```

- 6 Enable paging in the `/etc/environment` file.

```
$ echo VTYSH_PAGER=more > /etc/environment
```

- 7 Source the environment file before you access the Quagga shell.

```
$ source /etc/environment
```

- 8 Access the Quagga shell.

```
$ vtysh
Hello, this is Quagga (version 0.99.23.1)
Copyright 1996-2005 Kunihiro Ishiguro, et al.
OPX#
```

- 9 Save the configuration changes.

```
$ write memory
Building Configuration...
Integrated configuration saved to /etc/quagga/Quagga.conf
[OK]
```

See github.com/opensourcerouting/quagga for complete information.

Routing using Quagga

This use case describes how to configure BGP using Quagga in a spine/leaf network. See github.com/opensourcerouting/quagga for complete information.

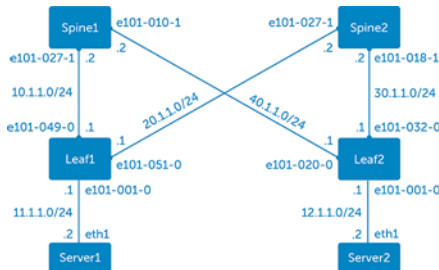

Link	Network	Link Nodes	BGP AS Number
Leaf1-to-Spine1	10.1.1.0/24	Leaf1	64501
		Spine1	64555
Leaf1-to-Spine2	20.1.1.0/24	Leaf1	64501
		Spine2	64555
Leaf2-to-Spine1	40.1.1.0/24	Leaf2	64502
		Spine1	64555
Leaf2-to-Spine2	30.1.1.0/24	Leaf2	64502
		Spine2	64555
Leaf1-to-Server1	11.1.1.0/24	Leaf1	64501
Leaf2-to-Server2	12.1.1.0/24	Leaf2	64502

- 1 Configure the IP addresses to Spine1, Spine2, and Server1 from Leaf1.

```
leaf1(config)# interface e101-049-0
leaf1(conf-if-e101-049-0)# ip address 10.1.1.1/24
leaf1(conf-if-e101-049-0)# no shutdown
leaf1(conf-if-e101-049-0)# exit

leaf1(config)# interface e101-051-0
leaf1(conf-if-e101-051-0)# ip address 20.1.1.1/24
leaf1(conf-if-e101-051-0)# no shutdown
leaf1(conf-if-e101-051-0)# exit

leaf1(config)# interface e101-001-0
leaf1(conf-if-e101-001-0)# ip address 11.1.1.1/24
leaf1(conf-if-e101-001-0)# no shutdown
```

- 2 Configure the IP addresses to Spine1, Spine2, and Server2 from Leaf2.

```
leaf2(config)# interface e101-032-0
leaf2(conf-if-e101-032-0)# ip address 30.1.1.1/24
leaf2(conf-if-e101-032-0)# no shutdown
leaf2(conf-if-e101-032-0)# exit

leaf2(config)# interface e101-020-0
leaf2(conf-if-e101-020-0)# ip address 40.1.1.1/24
leaf2(conf-if-e101-020-0)# no shutdown
leaf2(conf-if-e101-020-0)# exit

leaf2(config)# interface e101-001-0
```

```
leaf2(conf-if-e101-001-0)# ip address 12.1.1.1/24
leaf2(conf-if-e101-001-0)# no shutdown
```

3 Configure the IP addresses to Leaf1 and Leaf2 from Spine1.

```
spine1(config)# interface e101-027-1
spine1(conf-if-e101-027-1)# ip address 10.1.1.2/24
spine1(conf-if-e101-027-1)# no shutdown
spine1(conf-if-e101-027-1)# exit
```

```
spine1(config)# interface e101-010-1
spine1(conf-if-e101-010-1)# ip address 40.1.1.2/24
spine1(conf-if-e101-010-1)# no shutdown
```

4 Configure the IP addresses to Leaf1 and Leaf2 from Spine2.

```
spine2(config)# interface e101-027-1
spine2(conf-if-e101-027-1)# ip address 20.1.1.2/24
spine2(conf-if-e101-027-1)# no shutdown
spine2(conf-if-e101-027-1)# exit
```

```
spine2(config)# interface e101-018-1
spine2(conf-if-e101-018-1)# ip address 30.1.1.2/24
spine2(conf-if-e101-018-1)# no shutdown
spine2(conf-if-e101-018-1)# exit
```

5 Configure BGP to Spine1 and Spine2 from Leaf 1.

```
leaf1(config)# router bgp 64501
leaf1(conf-router-bgp-64501)# neighbor 10.1.1.2 remote-as 64555
leaf1(conf-router-bgp-64501)# neighbor 20.1.1.2 remote-as 64555
leaf1(conf-router-bgp-64501)# network 10.1.1.0/24
leaf1(conf-router-bgp-64501)# network 20.1.1.0/24
leaf1(conf-router-bgp-64501)# network 11.1.1.0/24
```

6 Configure BGP to Spine1 and Spine2 from Leaf 2.

```
leaf2(config)# router bgp 64502
leaf2(conf-router-bgp-64502)# neighbor 30.1.1.2 remote-as 64555
leaf2(conf-router-bgp-64502)# neighbor 40.1.1.2 remote-as 64555
leaf2(conf-router-bgp-64502)# network 12.1.1.0/24
leaf2(conf-router-bgp-64502)# network 30.1.1.0/24
leaf2(conf-router-bgp-64502)# network 40.1.1.0/24
```

7 Configure BGP to Leaf1 and Leaf2 from Spine1.

```
spine1(config)# router bgp 64555
spine1(conf-router-bgp-64555)# neighbor 10.1.1.1 remote-as 64501
spine1(conf-router-bgp-64555)# neighbor 40.1.1.1 remote-as 64502
spine1(conf-router-bgp-64555)# network 10.1.1.0/24
spine1(conf-router-bgp-64555)# network 40.1.1.0/24
```

8 Configure BGP to Leaf1 and Leaf2 from Spine 2.

```
spine2(config)# router bgp 64555
spine2(conf-router-bgp-64555)# neighbor 30.1.1.1 remote-as 64502
spine2(conf-router-bgp-64555)# neighbor 20.1.1.1 remote-as 64501
spine2(conf-router-bgp-64555)# network 30.1.1.0/24
spine2(conf-router-bgp-64555)# network 20.1.1.0/24
```

9 Configure ECMP from Leaf1 and Leaf2.

```
leaf1(config)# router bgp 64501
leaf1(conf-router-bgp-64501)# maximum-paths 16

leaf2(config)# router bgp 64502
leaf2(conf-router-bgp-64502)# maximum-paths 16
```

Verify spine/leaf configuration

1 Verify BGP neighbors from Leaf1 and Leaf2.

```
leaf1# show ip bgp sum
BGP router identifier 20.1.1.1, local AS number 64501
RIB entries 11, using 1232 bytes of memory
Peers 2, using 9136 bytes of memory

Neighbor  V AS MsgRcvd MsgSent  TblVer  InQ  OutQ  Up/Down  State/PfxRcd
10.1.1.2  4 64555  196   201   0  0  0 02:39:02  4
```

```
20.1.1.2 4 64555 195 206 0 0 0 02:38:57 4
```

```
Total number of neighbors 2
```

```
leaf2# show ip bgp sum  
BGP router identifier 40.1.1.1, local AS number 64502  
RIB entries 11, using 1232 bytes of memory  
Peers 2, using 9136 bytes of memory
```

Neighbor	V	AS	MsgRcvd	MsgSent	TblVer	InQ	OutQ	Up/Down	State/PfxRcd
30.1.1.2	4	64555	196	197	0 0 0	02:39:45	4		
40.1.1.2	4	64555	192	204	0 0 0	02:39:42	4		

```
Total number of neighbors 2
```

2 Verify BGP neighbors from Spine1 and Spine 2.

```
spine1# show ip bgp sum  
BGP router identifier 40.1.1.2, local AS number 64555  
RIB entries 11, using 1232 bytes of memory  
Peers 2, using 9136 bytes of memory
```

Neighbor	V	AS	MsgRcvd	MsgSent	TblVer	InQ	OutQ	Up/Down	State/PfxRcd
10.1.1.1	4	64501	199	201	0 0 0	02:40:55	3		
40.1.1.1	4	64502	202	198	0 0 0	02:41:01	3		

```
Total number of neighbors 2
```

```
spine2# show ip bgp sum  
BGP router identifier 30.1.1.2, local AS number 64555  
RIB entries 11, using 1232 bytes of memory  
Peers 2, using 9136 bytes of memory
```

Neighbor	V	AS	MsgRcvd	MsgSent	TblVer	InQ	OutQ	Up/Down	State/PfxRcd
20.1.1.1	4	64501	206	206	0 0 0	02:43:06	3		
30.1.1.1	4	64502	197	203	0 0 0	02:43:20	3		

```
Total number of neighbors 2
```

3 Verify BGP neighbors from Spine1 and Spine2.

```
spine1# show ip bgp sum  
BGP router identifier 40.1.1.2, local AS number 64555  
RIB entries 11, using 1232 bytes of memory  
Peers 2, using 9136 bytes of memory
```

Neighbor	V	AS	MsgRcvd	MsgSent	TblVer	InQ	OutQ	Up/Down	State/PfxRcd
10.1.1.1	4	64501	199	201	0 0 0	02:40:55	3		
40.1.1.1	4	64502	202	198	0 0 0	02:41:01	3		

```
Total number of neighbors 2
```

```
spine2# show ip bgp sum  
BGP router identifier 30.1.1.2, local AS number 64555  
RIB entries 11, using 1232 bytes of memory  
Peers 2, using 9136 bytes of memory
```

Neighbor	V	AS	MsgRcvd	MsgSent	TblVer	InQ	OutQ	Up/Down	State/PfxRcd
20.1.1.1	4	64501	206	206	0 0 0	02:43:06	3		
30.1.1.1	4	64502	197	203	0 0 0	02:43:20	3		

```
Total number of neighbors 2
```

4 Verify that the server route is ECMP in the routing table from Leaf1 and Leaf2.

```
leaf1# show ip route  
Codes: K - kernel route, C - connected, S - static, R - RIP,  
O - OSPF, I - IS-IS, B - BGP, A - Babel,  
> - selected route, * - FIB route
```

```
C>* 10.1.1.0/24 is directly connected, e101-049-0  
C>* 11.1.1.0/24 is directly connected, e101-001-0  
B>* 12.1.1.0/24 [20/0] via 10.1.1.2, e101-049-0, 02:44:45
```

```

*      via 20.1.1.2, e101-051-0, 02:44:45
C>* 13.1.1.0/24 is directly connected, e101-002-0
C>* 20.1.1.0/24 is directly connected, e101-051-0
B>* 30.1.1.0/24 [20/0] via 20.1.1.2, e101-051-0, 02:09:44
B>* 40.1.1.0/24 [20/0] via 10.1.1.2, e101-049-0, 02:11:50
C>* 127.0.0.0/8 is directly connected, lo

leaf2# show ip route
Codes: K - kernel route, C - connected, S - static, R - RIP,
       O - OSPF, I - IS-IS, B - BGP, A - Babel,
       > - selected route, * - FIB route

B>* 10.1.1.0/24 [20/0] via 40.1.1.2, e101-020-0, 02:12:43
B>* 11.1.1.0/24 [20/0] via 30.1.1.2, e101-032-0, 02:45:14
*      via 40.1.1.2, e101-020-0, 02:45:14
C>* 12.1.1.0/24 is directly connected, e101-001-0
B>* 20.1.1.0/24 [20/0] via 30.1.1.2, e101-032-0, 02:10:16
C>* 30.1.1.0/24 is directly connected, e101-032-0
C>* 40.1.1.0/24 is directly connected, e101-020-0
C>* 127.0.0.0/8 is directly connected, lo

```

- 5 Verify that the server route is ECMP in the Linux routing table from Leaf1 and Leaf2.

```

$ ip route show
10.1.1.0/24 dev e101-049-0 proto kernel scope link src 10.1.1.1
11.1.1.0/24 dev e101-001-0 proto kernel scope link src 11.1.1.1
12.1.1.0/24 proto zebra
    nexthop via 10.1.1.2 dev e101-049-0 weight 1
    nexthop via 20.1.1.2 dev e101-051-0 weight 1
13.1.1.0/24 dev e101-002-0 proto kernel scope link src 13.1.1.1
20.1.1.0/24 dev e101-051-0 proto kernel scope link src 20.1.1.1
30.1.1.0/24 via 20.1.1.2 dev e101-051-0 proto zebra
40.1.1.0/24 via 10.1.1.2 dev e101-049-0 proto zebra

$ ip route show
10.1.1.0/24 via 40.1.1.2 dev e101-020-0 proto zebra
11.1.1.0/24 proto zebra
    nexthop via 30.1.1.2 dev e101-032-0 weight 1
    nexthop via 40.1.1.2 dev e101-020-0 weight 1
12.1.1.0/24 dev e101-001-0 proto kernel scope link src 12.1.1.1
20.1.1.0/24 via 30.1.1.2 dev e101-032-0 proto zebra
30.1.1.0/24 dev e101-032-0 proto kernel scope link src 30.1.1.1
40.1.1.0/24 dev e101-020-0 proto kernel scope link src 40.1.1.1

```

- 6 Verify that the server route is ECMP in the NPU routing table from Leaf1 and Leaf2.

```

$ hshell -c 'l3 defip show'
Unit 0, Total Number of DEFIP entries: 16384
# VRF Net addr Next Hop Mac INTF MODID PORT PRIO CLASS HIT VLAN
4096 0 10.1.1.0/24 00:00:00:00:00:00 100002 0 0 0 0 y
4096 0 20.1.1.0/24 00:00:00:00:00:00 100002 0 0 0 0 y
4097 0 11.1.1.0/24 00:00:00:00:00:00 100002 0 0 0 0 y
4097 0 13.1.1.0/24 00:00:00:00:00:00 100002 0 0 0 0 n
4098 0 12.1.1.0/24 00:00:00:00:00:00 200000 0 0 0 0 n (ECMP)
4098 0 40.1.1.0/24 00:00:00:00:00:00 100004 0 0 0 0 n
4099 0 30.1.1.0/24 00:00:00:00:00:00 100005 0 0 0 0 n

$ hshell -c 'l3 multipath show'

Multipath Egress Object 200000
Interfaces: 100004 100005
Reference count: 1

$ hshell -c 'l3 defip show'

Unit 0, Total Number of DEFIP entries: 16384
# VRF Net addr Next Hop Mac INTF MODID PORT PRIO CLASS HIT VLAN
4096 0 30.1.1.0/24 00:00:00:00:00:00 100002 0 0 0 0 y
4096 0 40.1.1.0/24 00:00:00:00:00:00 100002 0 0 0 0 y
4097 0 12.1.1.0/24 00:00:00:00:00:00 100002 0 0 0 0 y
4097 0 11.1.1.0/24 00:00:00:00:00:00 200000 0 0 0 0 n (ECMP)

```

```
4098 0 10.1.1.0/24 00:00:00:00:00:00 100004 0 0 0 0 n
4098 0 20.1.1.0/24 00:00:00:00:00:00 100005 0 0 0 0 n
```

Security

OpenSwitch OPX secures your network using access control lists (ACLs) and quality of service (QoS).

ACLs

Access control lists are flexible, hardware-accelerated sets of rules that match packets using packet header criteria, and perform actions on selected packets. Configure an ACL on a physical port (NPU) only by using the CPS API.

- Ingress and egress ACL rules
- Match packet header fields, including MAC address, Ethertype, IP address, IP protocol, TCP/ UDP port numbers, and In Port
- Packet actions including drop, trap/forward to the CPU, redirect to port, change packet fields, and meter
- Group ACL rules to enable multiple rule match for a single packet

See Application examples in the *OpenSwitch OPX Developers Guide* for more information on how to configure ACLs using the CPS API.

QoS

Use the dell-base-qos.yang model to configure the software to provision quality of service parameters. QoS provisioning includes:

- Assign packet to traffic classes using packet 802.1p, DSCP, or more advanced ACL rules
- Mark packets
- Ingress rate policing using ACLs
- Map traffic classes to queues
- Egress queue rate shaping
- Weighted random early detection (WRED)
- Hierarchical scheduling
- Egress port-level shaping
- CoPP support for configuring CPU rate limits

See Programmability in the *OpenSwitch OPX Developers Guide* for more information on how to configure QoS using the CPS API.

Monitoring

OpenSwitch OPX supports network monitoring features such as port mirroring and sFlow which monitor and capture network traffic in the system. It also provides tools to collect port and VLAN statistics, and port media information.

Port mirroring

Mirroring copies packets from a source port to a destination port. OpenSwitch OPX supports local and remote porting mirroring using CPS and Dell EMC-specific commands—not standard Linux commands.

- In local port mirroring, packets are forwarded from a source port to a destination port on the same system

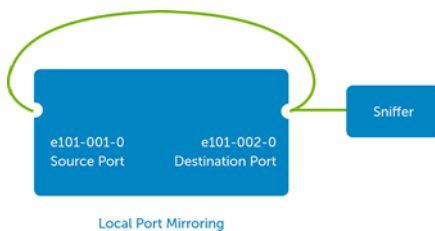

- In remote port mirroring, mirrored packets are forwarded using a dedicated L2 VLAN

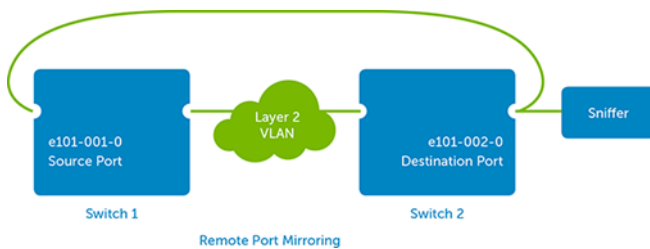

OpenSwitch OPX supports provisioning of mirroring capabilities using the CPS API:

- Create a mirroring session
- Update a mirroring session
- Delete a mirroring session

See Application examples in the *OpenSwitch OPX Developers Guide* for more information on how to configure port mirroring.

Topics:

- [sFlow provisioning](#)
- [Port statistics](#)

sFlow provisioning

sFlow monitors network traffic by sampling incoming and outgoing packets on physical ports. OpenSwitch OPX supports sFlow provisioning using the CPS API:

- Enable packet sampling on a physical port

- Disable packet sampling on a physical port
- Set the sampling interval rate
- Forward the sampled packet to an IP address/port

See Application examples in the *OpenSwitch OPX Developers Guide* for more information on how to configure sFlow using the CPS API.

Port statistics

OpenSwitch OPX provides scripts to view statistical information about ports, VLANs, and installed transceivers.

- Display port statistics for all or a specified Linux interface which maps to physical ports. Enter a *filter_list* value to display specified statistics.

```
$ opx-show-stats if_stat [iface_name] {filter_list}
```

- Display statistics and media information from a Linux interface which maps to a physical port. The output is a subset of the `opx-show-stats` output for the same physical port interface.

```
$ opx-ethtool [-v | -e | -s | -S]
```

- `-v` — Displays version information.
- `-e` — Displays media information from EEPROM.
- `-s` — Displays port speed, duplex, and auto-negotiation settings.
- `-S` — Displays port statistics.
- Display statistics from all or a specified VLAN. Enter a *filter_list* value to display specified statistics.

```
$ opx-show-stats vlan_stat [vlan_ifname] {filter_list}
```

- Delete port statistics for all or a specified Linux interface — command does not support deleting VLAN statistics.

```
$ opx-show-stats clear [iface_name]
```

Clear port statistics

```
$ opx-show-stats clear e101-001-0
Success
```

View e101-001-0 port statistics

```
$ opx-show-stats if_stat e101-001-0
Key:
base-stats/interface/ip/in-discards = 0
base-stats/interface/ether-octets = 13442942147
base-stats/interface/ether-out/pkts-64-octets = 0
base-stats/interface/ether-collisions = 0
base-stats/interface/ether-in/pkts-4096-to-9216-octets = 0
base-stats/interface/ether-in/pkts-1024-to-1518-octets = 0
base-stats/interface/ipv6-out-mcast-pkts = 0
base-stats/interface/if/in-octets = 0
base-stats/interface/ether-jabbers = 0
base-stats/interface/if-out-multicast-pkts = 36295
base-stats/interface/ether-out/pkts-256-to-511-octets = 0
base-stats/interface/if-out-errors = 0
base-stats/interface/ether-rx-no-errors = 0
base-stats/interface/ether/pkts-512-to-1023-octets = 0
base-stats/interface/ether/pkts-64-octets = 0
base-stats/interface/ether/pkts-1024-to-1518-octets = 13125220
base-stats/interface/ipv6/out-discards = 0
base-stats/interface/if/out-octets = 13442942147
base-stats/interface/ether-in/pkts-256-to-511-octets = 0
base-stats/interface/if/out-ucast-pkts = 13125220
base-stats/interface/ether-fragments = 0
base-stats/interface/ether-crc-align-errors = 0
base-stats/interface/ipv6-in-mcast-pkts = 0
base-stats/interface/ether-out/pkts-65-to-127-octets = 34014
base-stats/interface/if-out-broadcast-pkts = 0
base-stats/interface/ether-drop-events = 0
```

```

base-stats/interface/if/in-ucast-pkts = 0
base-stats/interface/ether-out/pkts-128-to-255-octets = 2281
base-stats/interface/ether-in/pkts-2048-to-4095-octets = 0
base-stats/interface/ether-tx-oversize-pkts = 0
base-stats/interface/ether/pkts-256-to-511-octets = 0
base-stats/interface/ether-multicast-pkts = 36295
base-stats/interface/ether-out/pkts-4096-to-9216-octets = 0
base-stats/interface/ether/pkts-128-to-255-octets = 2281
base-stats/interface/ether-in/pkts-128-to-255-octets = 0
base-stats/interface/time-stamp = 1455586392
base-stats/interface/ip-in-receives = 0
base-stats/interface/ether-rx-oversize-pkts = 0
base-stats/interface/ether-oversize-pkts = 0
base-stats/interface/ether-out/pkts-1024-to-1518-octets = 13125220
base-stats/interface/if-in-errors = 0
base-stats/interface/ether-out/pkts-512-to-1023-octets = 0
base-stats/interface/if/in-non-ucast-pkts = 0
base-stats/interface/ether-in/pkts-65-to-127-octets = 0
base-stats/interface/ether/pkts-65-to-127-octets = 34014
base-stats/interface/if/in-discards = 0
base-stats/interface/ipv6-in-receives = 0
base-stats/interface/if/out-non-ucast-pkts = 36295
base-stats/interface/ipv6/in-discards = 0
base-stats/interface/ether-tx-no-errors = 13161515
base-stats/interface/ether-broadcast-pkts = 0
base-stats/interface/if-in-broadcast-pkts = 0
base-stats/interface/if/out-discards = 0
base-stats/interface/ether-out/pkts-1519-to-2047-octets = 0
base-stats/interface/ether-out/pkts-2048-to-4095-octets = 0
base-stats/interface/ether-pkts = 13161515
base-stats/interface/ether-in/pkts-1519-to-2047-octets = 0
base-stats/interface/ether/pkts-4096-to-9216-octets = 0
base-stats/interface/ether-undersize-pkts = 0
base-stats/interface/if-in-unknown-protos = 0
base-stats/interface/if-out-qlen = 0
base-stats/interface/if-in-multicast-pkts = 0
base-stats/interface/ether-in/pkts-64-octets = 0
base-stats/interface/ether-in/pkts-512-to-1023-octets = 0

```

View VLAN statistics

```

$ opx-show-stats vlan_stat br1
Key:
base-stats/vlan/time-stamp: 1455586573
base-stats/vlan/in-octets: 16381983058
base-stats/vlan/in-pkts: 16101053
base-stats/vlan/out-octets: 55146334258
base-stats/vlan/out-pkts: 67419926

```

View port statistics

```

$ opx-ethtool -S e101-001-0
Statistics for interface e101-001-0
Ether statistics:
  rx_bytes: 9185614848
  rx_no_errors: 0
  tx_no_errors: 9003181
  tx_total_collision: 0
  rx_undersize_packets: 0
  rx_jabbers: 0
  rx_fragments: 0
  rx_align_errors: 0
  rx_discards: 0
  rx_mcast_packets: 35445
  rx_bcast_packets: 0
  rx_oversize_packets: 0
  tx_oversize_packets: 0
  rx_64_byte_packets: 0

```

```

rx_65_to_127_byte_packets: 0
rx_128_to_255_byte_packets: 0
rx_256_to_511_byte_packets: 0
rx_512_to_1023_byte_packets: 0
rx_1024_to_1518_byte_packets: 0
rx_1519_to_2047_byte_packets: 0
rx_2048_to_4095_byte_packets: 0
rx_4096_to_9216_byte_packets: 0
tx_64_byte_packets: 0
tx_65_to_127_byte_packets: 33217
tx_128_to_255_byte_packets: 2228
tx_256_to_511_byte_packets: 0
tx_512_to_1023_byte_packets: 0
tx_1024_to_1518_byte_packets: 8967736
tx_1519_to_2047_byte_packets: 0
tx_2048_to_4095_byte_packets: 0
tx_4096_to_9216_byte_packets: 0

```

View transceiver statistics

```

$ opx-ethtool -e e101-001-0
Show media info for e101-001-0
if_index is 17
Key: 2.19.1245389.1245248.1245249.1245250.
base-pas/media/rate-identifier = 0
base-pas/media/oper-status = 0
base-pas/media/category = 3
base-pas/media/voltage-state = 1
base-pas/media/bias-low-warning-threshold =
base-pas/media/vendor-pn = 568400002
base-pas/media/current-temperature = ??
base-pas/media/insertion-cnt = 0
base-pas/media/voltage-low-warning-threshold =
base-pas/media/cc_ext = 162
base-pas/media/length-om2 = 0
base-pas/media/length-om3 = 0
base-pas/media/rx-power-low-alarm-threshold =
base-pas/media/length-om1 = 0
base-pas/media/vendor-id = AP
base-pas/media/media-category/sfp-plus/br-max = 0
base-pas/media/connector = 33
base-pas/media/ext-transceiver = 0
base-pas/media/vendor-specific =
ffffffffffffffff000000000000000000000000000000000000000000000000000000
base-pas/media/media-category/sfp-plus/br-min = 0
base-pas/media/encoding = 0
base-pas/media/tx-power-high-warning-threshold =
base-pas/media/vendor-name = Amphenol
base-pas/media/rx-power-low-warning-threshold =
base-pas/media/slot = 1
base-pas/media/port = 1
base-pas/media/vendor-rev = 4700
base-pas/media/slot = 1
base-pas/media/port = 1
base-pas/media/tx-power-low-alarm-threshold =
base-pas/media/bias-low-alarm-threshold =
base-pas/media/capability = 6
base-pas/media/media-category/sfp-plus/sff-8472-compliance = 0
base-pas/media/diag-mon-type = 0
base-pas/media/temp-state = 1
base-pas/media/type = 43
base-pas/media/media-category/qsfp-plus/wavelength-tolerance = 0
base-pas/media/ext-identifier = 0
base-pas/media/temp-low-warning-threshold =
base-pas/media/voltage-high-warning-threshold =
base-pas/media/temp-high-alarm-threshold =
base-pas/media/length-sfm = 0
base-pas/media/rate-select-state = 0

```

```
base-pas/media/rx-power-measurement-type = 0
base-pas/media/wavelength = 0
base-pas/media/cc_base = 54
base-pas/media/temp-low-alarm-threshold =
base-pas/media/tx-power-low-warning-threshold =
base-pas/media/insertion-timestamp = 0
base-pas/media/current-voltage =
base-pas/media/bias-high-alarm-threshold =
base-pas/media/high-power-mode = 1
base-pas/media/br-nominal = 0
base-pas/media/options = 0
base-pas/media/rx-power-high-warning-threshold =
base-pas/media/date-code = 3131303632322000
base-pas/media/present = 1
base-pas/media/transceiver = 0000000000000000205c
base-pas/media/length-cable = 2
base-pas/media/voltage-high-alarm-threshold =
base-pas/media/identifier = 12
base-pas/media/voltage-low-alarm-threshold =
base-pas/media/dell-qualified = 0
base-pas/media/length-sfm-km = 0
base-pas/media/rx-power-high-alarm-threshold =
base-pas/media/admin-status = 0
base-pas/media/serial-number = APF11240020140
base-pas/media/tx-power-high-alarm-threshold =
base-pas/media/temp-high-warning-threshold =
base-pas/media/bias-high-warning-threshold =
base-pas/media/enhanced-options = 0
base-pas/media/media-category/qsfp-plus/max-case-temp = 70
```

Support resources

The Dell Networking Support site provides a range of documents and tools to assist you with effectively using Dell Networking devices. Through the support site you can obtain technical information regarding Dell Networking products, access software upgrades and patches, download available management software, and manage your open cases. The Dell Networking support site provides integrated, secure access to these services.

To access the Dell Networking Support site, go to www.dell.com/support/. To display information in your language, scroll down to the bottom of the page and select your country from the drop-down menu.

- To obtain product-specific information, enter the 7-character service tag or 11-digit express service code of your switch and click **Submit**.
To view the service tag or express service code, pull out the luggage tag on the chassis or enter the `show chassis` command from the CLI.
- To receive additional kinds of technical support, click **Contact Us**, then click **Technical Support**.

To access system documentation, see www.dell.com/manuals/.

To search for drivers and downloads, see www.dell.com/drivers/.

To participate in Dell community blogs and forums, see www.dell.com/community.