



S5000 Installation Guide
9.7.0.0 December 2017

Notes, Cautions, and Warnings

-  **NOTE:** A NOTE indicates important information that helps you make better use of your computer.
-  **CAUTION:** A CAUTION indicates either potential damage to hardware or loss of data and tells you how to avoid the problem.
-  **WARNING:** A WARNING indicates a potential for property damage, personal injury, or death.

Copyright © 2014 Dell Inc. All rights reserved. This product is protected by U.S. and international copyright and intellectual property laws. Dell™ and the Dell logo are trademarks of Dell Inc. in the United States and/or other jurisdictions. All other marks and names mentioned herein may be trademarks of their respective companies.

Contents

1 About this Guide.....	5
Related Publications.....	5
2 Introduction.....	6
Product Description.....	6
3 Unpacking the Switch.....	7
Important Points Before You Continue.....	7
Hardware Installation Overview.....	8
4 Hardware Overview.....	9
I/O Panel.....	9
Utility Panel.....	10
Power Supplies.....	10
Fans.....	10
Port Numbering Convention.....	11
System Status.....	11
5 Site Preparations.....	16
Site Selection.....	16
Cabinet Placement.....	16
Storing Components.....	17
6 Installation.....	18
Before You Begin.....	18
Installing the Rack or Cabinet.....	19
To install the S5000 system, Dell Networking recommends completing the installation procedures in the order presented here.....	19
Attaching the Mounting Brackets.....	19
Rack Mounting Safety Considerations.....	20
Installing the S5000 Chassis into a 4-Post Rack or Cabinet.....	20
Rack Grounding.....	21
Important Points to Remember for Installing an Ethernet Module.....	21
Installing an Ethernet Module.....	22
Replacing an Ethernet Module.....	23
Important Points to Remember for Installing a Unified Port Module.....	23
Installing a Unified Port Module.....	24
Replacing a Unified Port Module.....	25
Important Points to Remember for Installing an AC Power Supply.....	25
Installing an AC Power Supply.....	26
Important Points to Remember for Installing a DC Power Supply.....	27
Assembling and Connecting the Safety Ground Wire for DC Power Supply.....	28

Installing a DC Power Supply.....	29
Installing the Ferrite Bead for DC Power and Return Cables.....	30
Securing Power Cables.....	31
Replacing an AC or DC Power Supply.....	32
Important Points to Remember for Installing a Fan Module.....	32
Installing a Fan Module.....	32
Replacing a Fan Module.....	33
Installing the SFP+ and QSFP+ Optics.....	33
Splitting QSFP+ Ports to SFP+ Ports.....	33
Important Points to Remember.....	34
Connecting the Stacking Ports (Optional).....	34
Connecting Two S5000 Systems.....	35
Connecting Three S5000 Systems.....	36
Supplying Power and Powering Up the System.....	37
AC Power.....	37
DC Power.....	38
Hot-Swapping Units in a Stack.....	38

7 Technical Specifications..... 39

8 Agency Compliance..... 40

USA Federal Communications Commission (FCC) Statement.....	40
Canadian Department of Communication Statement.....	40
European Union EMC Directive Conformance Statement.....	40
European Community Contact.....	40
Japan: VCCI Compliance for Class A Equipment.....	41
Korean Certification of Compliance.....	41
Safety Standards and Compliance Agency Certifications.....	42
Electromagnetic Compatibility (EMC).....	42
Product Recycling and Disposal.....	42



9 Technical Support..... 44

Accessing Dell Networking Technical Support.....	44
--	----

About this Guide

This guide provides site preparation recommendations, and step-by-step procedures for rack mounting, installing and replacing pluggable modules, and connecting to a power source.

After you have completed the hardware installation and power-up of the S5000, for software configuration information, refer to the *Dell Networking OS Configuration Guide for the S5000 Switch* and for Command Line Interface (CLI) information, refer to the *Dell Networking OS Command Line Reference Guide for the S5000 Switch*.

-  **CAUTION:** To avoid electrostatic discharge (ESD) damage, wear grounding wrist straps when handling this equipment.
-  **WARNING:** Only trained and qualified personnel can install this equipment. Read this guide before you install and power up this equipment. This equipment contains two power cords. Disconnect both power cords before servicing.
-  **WARNING:** This equipment contains optical transceivers, which comply with the limits of Class 1 laser radiation.



-  **WARNING:** When no cable is connected, visible and invisible laser radiation may be emitted from the aperture of the optical transceiver ports. Avoid exposure to laser radiation and do not stare into open apertures.

Related Publications

For more information about the S5000, refer to the following documents:

- *Dell Networking OS Configuration Guide for the S5000 Switch*
- *Dell Networking OS Command Line Reference Guide for the S5000 Switch*
- *Dell Networking OS Release Notes for the S5000 Switch*

 **NOTE:** For the most recent documentation and software, visit Support : www.dell.com/support .

Introduction

This document provides basic information about installing the S5000 switch.

For information about how to configure and monitor switch features, refer to the *Dell Networking OS Configuration Guide for the S5000 Switch*, which is available on the Dell Support website at www.dell.com/support

This document contains the following sections:

- [Product Description](#)
- [Unpacking the Switch](#)
- [Hardware Overview](#)
- [Site Preparations](#)
- [Installation](#)
- [Technical Specifications](#)
- [Agency Compliance](#)
- [Technical Support](#)

Product Description

The S5000 is part of Dell Networking's S-Series switches for Data Center Top of Rack (ToR) switches.

The S5000 is purpose-built to provide architectural flexibility for unified and virtualized environments. It is a 10G ToR solution that enables converged local area networks (LAN) and storage area networks (SAN) in the same box. The S5000 delivers Fibre Channel over Ethernet (FCoE) and Fibre Channel (FC) capability in a one rack unit (RU) ToR switch form factor.

The S5000 supports Data Center Bridging (ETS/PFC/DCBX), FCoE Transit (FIP Snooping), NPIV Proxy Gateway (NPG), FC Fabric services (zoning, name server, login server, FSPF, and so on), and Internet small computer system interface (iSCSI) storage traffic. The S5000 also provides aggregation and convergence functionality using pluggable modules for flexible configuration.

Unpacking the Switch

The S5000 and its accessories are shipped in multiple boxes. Before unpacking the switch, inspect the container and immediately report any evidence of damage. Verify that you have received your ordered items. For example, if you order one S5000 switch, the following items are included.

 **WARNING: If any item is missing or damaged, contact your Dell Networking representative or reseller for instructions.**

 **WARNING: Electrostatic discharge (ESD) damage can occur if components are mishandled. Always wear an ESD-preventive wrist or heel ground strap when handling the S5000 and its components.**

- One S5000 switch
 - Two Fans
 - Two Power Supplies (either AC or DC)
 - One rail kit (#1 and #2 Phillips screwdrivers required)
 - Screws for rack installation
 - Zero to Four I/O Modules (according to order)
 - Zero to Four Blanks
 - One RJ-45 to DB-9 female cable
 - Two AC or DC power cords for AC or DC units (country/region specific)
 - *Getting Started Guide*
 - *Safety and Regulatory Information*
 - *Warranty and Support Information*
 - *Software License Agreement*
1. Place the container on a clean, flat surface and cut all straps securing the container.
 2. Open the container or remove the container top.
 3. Carefully remove all components from the container and place it on a secure and clean surface.
 4. Remove all packing material.
 5. Inspect the switch and accessories for damage.

Important Points Before You Continue

- Identify the I/O and Utility panel on the chassis. The I/O panel has four fixed 40GbE ports on the right side of the panel, refer to Figure 1. The Utility panel has the power supply slots, LEDs, and USB slots on the left side of the panel, refer to Figure 3.
- Identify slots 0, 1, 2, and 3 on the I/O panel, refer to Figure 2. You can insert a Unified Port module only in slot 0. You can install the Ethernet modules in slots 0, 1, 2, and 3.
- Identify slots 0, 1, 2, and 3 on the Utility panel, refer to Figure 3. You can insert Power supply units (PSUs) only in slots 0 and 3. You can insert the Fan modules in any of the slots.

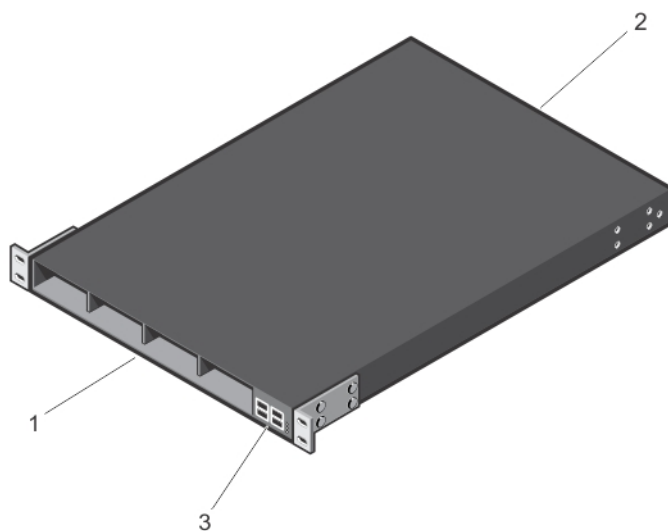

Figure 1. S5000 I/O and Utility Panels

1. I/O panel
2. Utility panel
3. Four 40GbE QSFP+ ports (each port ALSO supports 4 x 10GbE mode)

Hardware Installation Overview

To install the S5000, follow these steps:

1. Attach the mounting brackets.
2. Install the S5000 chassis into a 4-post rack or cabinet.
3. Ground the rack.
4. Install the Ethernet and/or Unified Port modules (Unified Port module must be installed only in slot 0).
5. Install the power supplies.
6. Secure the power cables.
7. Install the fan modules.
8. Install the SFP+ and QSFP+ optics.
9. Supply power and power up the system.

Hardware Overview

This section contains information about device characteristics and modular hardware configurations for the S5000.

The S5000 has the following physical dimensions:

- Height: 1.71 inches (43.5 mm)
- Width: 17.4 inches (441.9 mm)
- Depth: 28 inches (711.2 mm)

The S5000 has a chassis design with 640Gbps switching bandwidth.

The system also provides one DB9 RS-232 console port with YOST RJ-45 pinout and a dedicated Ethernet service port for out-of-band (OOB) management functions.

I/O Panel

All fixed data ports (4 × 40GbE quad small form-factor pluggable plus [QSFP+] ports) and the four slots for pluggable modules are on the I/O panel.

The I/O panel includes:

- Pluggable Modules
 - 12-Port Ethernet Module (100MbE/1GbE/10GbE speeds, RJ-45 connector)
 - 12-Port Ethernet Module (1GbE/10GbE speeds, SFP+ connector)
 - 12-Port Unified Port Module (10GbE or 2Gb/4Gb/8Gb speeds for Fibre Channel, SFP+ connector)
- 4 × 40GbE QSFP+ Ports and light emitting diodes (LEDs)

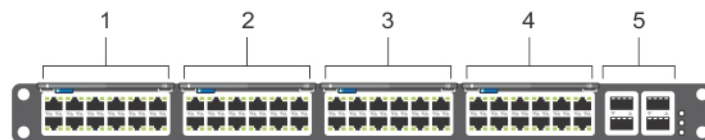

Figure 2. S5000 I/O Panel

- | | |
|--|--|
| 1. Slot 0 (supports Ethernet and Unified Port modules) | 2. Slot 1 (supports only Ethernet modules) |
| 3. Slot 2 (supports only Ethernet modules) | 4. Slot 3 (supports only Ethernet modules) |
| 5. Four 40GbE QSFP+ ports (each port ALSO supports 4 × 10GbE mode) | |

NOTE: The LED displays for the system status are on both sides of the chassis. The fan and power status LEDs are on the Utility panel.

Utility Panel

The Utility panel side of the platform contains the fan and power modules.

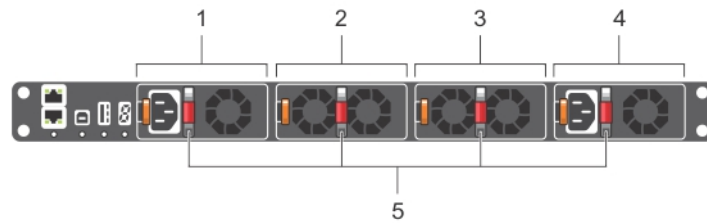

Figure 3. S5000 Power Supplies and Fan Modules

- | | |
|------------------------------|------------------------------|
| 1. Slot 0 (for PSU 0) | 2. Slot 1 (for Fan Module 0) |
| 3. Slot 2 (for Fan Module 1) | 4. Slot 3 (for PSU 1) |
| 5. Grab Handles | |

Power Supplies

The S5000 supports two hot-swappable PSUs.

The S5000 has SKUs that support the following configurations:

- AC PSU with fan airflow from I/O to Utility
- AC-R PSU with fan airflow from Utility to I/O
- DC PSU with fan airflow from I/O to Utility
- DC-R PSU with fan airflow from Utility to I/O

PSUs are field replaceable. To ensure power redundancy and adequate cooling, install two power supplies in the switch. When running with full redundancy (two PSUs installed and running), you can remove and replace one PSU while the other PSU is running without disrupting traffic.

NOTE: You can swap the fans and PSUs with fans/PSUs in the opposite airflow direction (from I/O to Utility or from Utility to I/O). However, do not mix directions in a single chassis. All the fans and PSUs must flow in the same direction. If you create a mixed airflow configuration, the software notifies you of the invalid configuration.

Fans

The S5000 supports two hot-swappable fan trays with airflow directions from I/O to Utility or Utility to I/O.

The S5000 has SKUs that support the following configurations:

- Fan with airflow from I/O to Utility
- Fan-R with airflow from Utility to I/O

NOTE: You can swap the fans and PSUs with fans/PSUs in the opposite airflow direction (from I/O to Utility or from Utility to I/O). However, do not mix directions in a single chassis. All the fans and PSUs must flow in the same direction. If you create a mixed airflow configuration, the software notifies you of the invalid configuration.

Port Numbering Convention

Even-numbered ports are at the bottom of the I/O panel and for modules odd-numbered ports are at the top of the I/O panel.

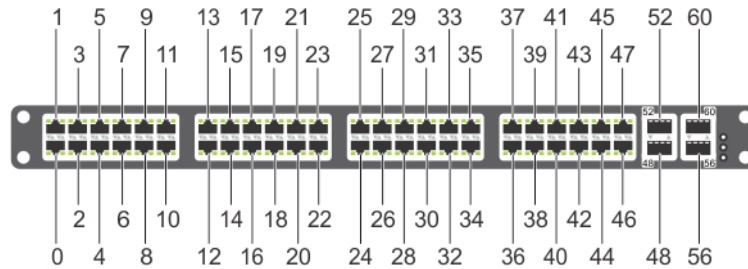

Figure 4. Port Numbering

The previous figure shows the fixed four 40GbE data ports (ports 48, 52, 56, and 60) and the four slots for pluggable modules on the S5000 I/O panel. You can also use the 40GbE ports in 4 × 10GbE mode.

The S5000 supports the following possible modules:

- 12-Port Ethernet Module (100MbE/1GbE/10GbE speeds, RJ-45 connector) (slot 0, 1, 2, or 3)
- 12-Port Ethernet Module (1GbE/10GbE speeds, SFP+ connector) (slot 0, 1, 2, or 3)
- 12-Port Unified Port Module (10GbE or 2Gb/4Gb/8Gb speeds for Fibre Channel, SFP+ connector) (slot 0)

The valid slot numbers are stack-unit numbers (from 0 to 11). The valid port numbers for each interface type are:

- 100MbE: Ports 0 to 47
- 1GbE: Ports 0 to 47
- 10GbE: Ports 0 to 63
- 40GbE: Ports 48, 52, 56, and 60
- Fibre Channel: Ports 0 to 11
- Management: Port 0

System Status

You can view S5000 status information in several ways, including LEDs and through the CLI `show` commands and with simple network management protocol (SNMP).

For more information about these options, refer to the *Dell Networking OS Command Line Reference Guide* and *Dell Networking OS Configuration Guide for the S5000 Switch*.

As shown in the following figure, the S5000 includes LED displays on the I/O and Utility side of the chassis. When the S5000 powers up or reloads, the status LED on the power supplies are solid green.

The following table lists the LED definitions for the S5000 system.

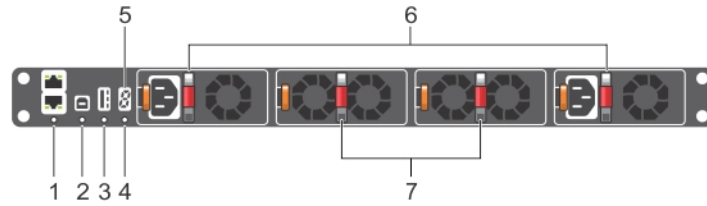

Figure 5. System LEDs (Utility Panel) (AC Power Supplies installed)

- | | |
|---|-------------------|
| 1. Locator beacon LED | 2. Alarm LED |
| 3. System status LED | 4. Master LED |
| 5. Seven-segment display to identify Stack ID | 6. PSU status LED |
| 7. Fan status LED | |

NOTE: For AC PSUs, an illuminated translucent handle indicates the power status.

NOTE: For DC PSUs, the power status LED is on the upper-left corner.

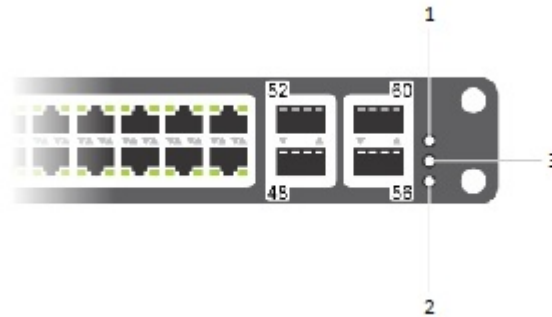





Figure 6. System LEDs (I/O Panel)

- | | |
|-----------------------|--------------|
| 1. Locator beacon LED | 2. Alarm LED |
| 3. System status LED | |

Table 1. System LED Displays (Utility and I/O Panel)

Label	LED Color/Display	Description
Locator beacon LED 	<ul style="list-style-type: none"> Off Blue 	<ul style="list-style-type: none"> No activity System beacon/locator
Alarm LED 	<ul style="list-style-type: none"> Off Amber solid Red solid 	<ul style="list-style-type: none"> No alarm Minor alarm Critical alarm
System status LED 	<ul style="list-style-type: none"> Off Green solid Green blinking Amber solid 	<ul style="list-style-type: none"> No power Normal operation System is booting System in card problem state
Master LED 	<ul style="list-style-type: none"> Green solid Green blinking 	<ul style="list-style-type: none"> Switch in Stacking Master mode OR Switch in Standalone mode Switch in Stacking Standby mode

Label	LED Color/Display	Description
	<ul style="list-style-type: none"> Off 	<ul style="list-style-type: none"> Switch in Stacking Member mode
PSU status LED	<ul style="list-style-type: none"> Green solid Off 	<ul style="list-style-type: none"> Normal operation Power not present
Fan status LED	<ul style="list-style-type: none"> Green solid Off 	<ul style="list-style-type: none"> Normal operation Power not present

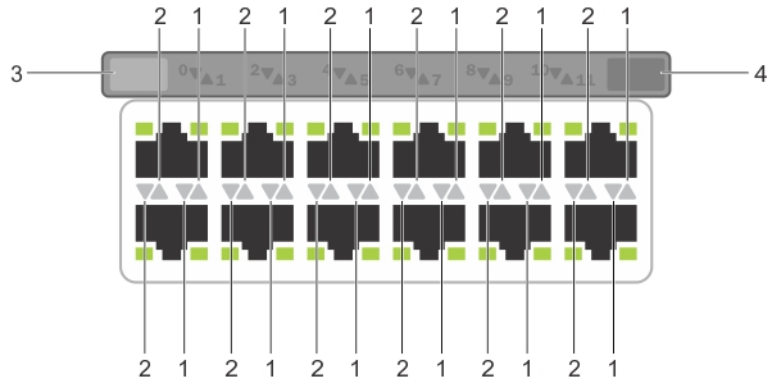

Figure 7. Module LEDs

- | | |
|------------------------------|---------------------------|
| 1. Port locator beacon LED | 2. Port link/activity LED |
| 3. Module locator beacon LED | 4. Module status LED |

NOTE: The downward and upward pointing triangles denote the lower and upper port LEDs respectively.

Table 2. Ethernet Port/Module LEDs

Label	LED Color/Display	Description
Port locator beacon LED	<ul style="list-style-type: none"> Off Blue 	<ul style="list-style-type: none"> No activity Port beacon/locator
Port link/activity LED	<ul style="list-style-type: none"> Off Green solid Green blinking 	<ul style="list-style-type: none"> No link or interface disabled Link present and interface enabled (Ethernet module) Port has activity
Module locator beacon LED	<ul style="list-style-type: none"> Off Blue 	<ul style="list-style-type: none"> No activity Module beacon/locator
Module status LED	<ul style="list-style-type: none"> Off Green solid Yellow 	<ul style="list-style-type: none"> Module is not powered up Module is powered up Problem detected with module

Table 3. Copper Module LEDs

Label	LED Color/Display	Description
Port locator/Port link/activity LED	<ul style="list-style-type: none"> Off Green solid Green blinking Amber solid Amber blinking Blue solid 	<ul style="list-style-type: none"> No link or interface disabled 10G link, interface enabled 10G link activity 1G/100M link, interface enabled 1G/100M link activity Port beacon/locator
Module status LED	<ul style="list-style-type: none"> Off Green solid Amber solid 	<ul style="list-style-type: none"> Module is not powered up Module is powered up and functioning normal Problem detected with module
Module locator beacon LED	<ul style="list-style-type: none"> Off Blue solid 	<ul style="list-style-type: none"> No activity Module beacon/locator

Table 4. Unified Port/Module LEDs

Label	LED Color/Display	Description
Port locator beacon LED	<ul style="list-style-type: none"> Off Blue Green 	<ul style="list-style-type: none"> No activity Port beacon/locator Fibre Channel mode enabled
Port link/activity LED	<ul style="list-style-type: none"> Off Green solid Green blinking 	<ul style="list-style-type: none"> No link or interface disabled Link present and interface enabled Port has activity
Module locator beacon LED	<ul style="list-style-type: none"> Off Green 	<ul style="list-style-type: none"> No activity Module beacon/locator
Module status LED	<ul style="list-style-type: none"> Off Green solid Yellow 	<ul style="list-style-type: none"> Module is not powered up Module is powered up Problem detected with module

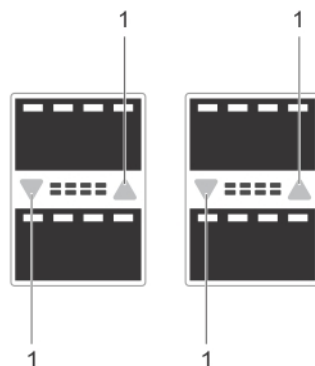

Figure 8. QSFP+ Port LEDs

1. Port link/activity LED

Table 5. 40GbE Port/Module LEDs

Label	LED Color/Display	Description
Port link/activity LED	<ul style="list-style-type: none">• Off• Green solid• Green blinking	<ul style="list-style-type: none">• No link or interface disabled• Link present and interface enabled• Port has activity

Site Preparations

The S5000 is suitable for installation as part of a Common Bond Network (CBN). It can be installed in:

- network telecommunication facilities
- data centers
- other locations where the National Electric Code (NEC) applies

This chapter contains the following sections:

- [Site Selection](#)
- [Cabinet Placement](#)
- [Storing Components](#)

Site Selection

Dell Networking equipment is intended for installation in restricted access areas. A restricted access area can only be accessed by service personnel by using a special tool, lock, key or other means of security and access is controlled by the authority responsible for the location.

Ensure that the area where you install your S5000 system meets the following safety requirements:

- Near an adequate power source. Connect the system to the appropriate branch circuit protection as defined by your local electrical codes.
- Environmental temperature between 32° to 104°F (0° to 40°C).
- Relative humidity that does not exceed 85 percent noncondensing.
- In a dry, clean, well-ventilated and temperature-controlled room, away from heat sources such as hot air vents or direct sunlight.
- Away from sources of severe electromagnetic noise.
- Positioned in a rack or cabinet, or on a desktop with adequate space in the front, rear, and sides of the S5000 for proper ventilation and access.

Cabinet Placement

Install the S5000 only in indoor cabinets designed for use in a controlled environment as described in [Site Selection](#).

The cabinet must meet the following criteria:

- Minimum cabinet size and airflow are according to the Electronic Industries Alliance (EIA) standard.

Storing Components

If you do not install your S5000 and components immediately, Dell Networking recommends properly storing the system and all optional components until you are ready to install them.



WARNING: ESD damage can occur when components are mishandled. Always wear an ESD-preventive wrist or heel ground strap when handling the S5000 and its accessories. After you remove the original packaging, place the S5000 and its components on an anti-static surface.

1. Storage temperature must remain constant ranging from -4° to 158° F (-20°C to 70° C).
2. Store on a dry surface or floor, away from direct sunlight, heat, and air conditioning ducts.
3. Store in a dust-free environment.

Installation

This document contains the following sections:

- [Before You Begin](#)
- [Install the S5000 Chassis in a Rack or Cabinet](#)
- [Attaching the Mounting Brackets](#)
- [Rack Mounting Safety Considerations](#)
- [Installing the S5000 Chassis into a 4-post rack or cabinet](#)
- [Rack Grounding](#)
- [Important Points to Remember for Installing an Ethernet Module](#)
- [Installing an Ethernet Module](#)
- [Replacing an Ethernet Module](#)
- [Important Points to Remember to Install a Fan Module](#)
- [Installing a Unified Port Module](#)
- [Replacing a Unified Port Module](#)
- [Important Points to Remember for Installing an AC Power Supply](#)
- [Installing an AC Power Supply](#)
- [Important Points to Remember for Installing a DC Power Supply](#)
- [Assembling and Connecting the Safety Ground Wire for DC Power Supply](#)
- [Installing a DC Power Supply](#)
- [Installing the Ferrite Bead for DC Power and Return Cables](#)
- [Securing The Power Cable\(s\)](#)
- [Replacing an AC or DC Power Supply](#)
- [Important Points to Remember for Installing a Fan Module](#)
- [Installing a Fan Module](#)
- [Replacing a Fan Module](#)
- [Installing the SFP+ and QSFP+ Optics](#)
- [Splitting QSFP+ Ports to SFP+ Ports](#)
- [Connecting the Stacking Ports \(Optional\)](#)
- [Connecting Two S5000 Systems](#)
- [Connecting Three S5000 Systems](#)
- [Supplying Power and Powering Up the System](#)
- [Hot-Swapping Units in a Stack](#)

Before You Begin

Before installing the switch, verify that you meet these guidelines:

- Enough clearance to the front of the switch so you can read the LEDs.
- AC/DC power cord reaches from the power outlet to the Utility-panel connector.
- Switch is rack-mounted before you install the power supply modules.

- Cabling is away from sources of electrical noise, such as radios, power lines, and fluorescent lighting. Make sure that the cabling is safely away from other devices that might damage the cables. If needed, allow one rack unit (RU) space between devices to provide room for cabling.
- Airflow around the switch and through the vents is unrestricted.
- Temperature around the unit does not exceed 104°F (40°C). If the switch is in a closed or multirack assembly, the temperature might be higher than normal room temperature.
- Humidity around the switch does not exceed 85 percent.
- Altitude at the installation site is below 6600 feet.
- Switch is installed in an environment as free as possible from dust and foreign conductive material (such as metal flakes from construction activities). Cooling mechanisms, such as fans and blowers in the switch, can draw dust and other particles causing contaminant buildup inside the chassis, which can result in system malfunction.

Installing the Rack or Cabinet

To install the S5000 system, Dell Networking recommends completing the installation procedures in the order presented here.

- **NOTE:** Always handle the system and its components with care. Avoid dropping the S5000 chassis or its field replaceable units.
- **NOTE:** For proper ventilation, position the S5000 chassis in an equipment rack (or cabinet) with a minimum of 5 inches (12.7 cm) of clearance around exhaust vents. The acceptable ambient temperature ranges are listed in the *Environmental Parameters* section.
- △ **CAUTION:** Always wear an ESD-preventive wrist or heel ground strap when handling the S5000 and its components. As with all electrical devices of this type, take all necessary safety precautions to prevent injury when installing this system. ESD damage can occur if components are mishandled.

Attaching the Mounting Brackets

The S5000 is shipped with mounting brackets (rack ears) and the required screws (eight screws) for rack or cabinet installation. The brackets are enclosed in a package with the chassis.

1. Take the brackets and screws out of their packaging.
2. Slide the mounting brackets, as shown in the following figure.

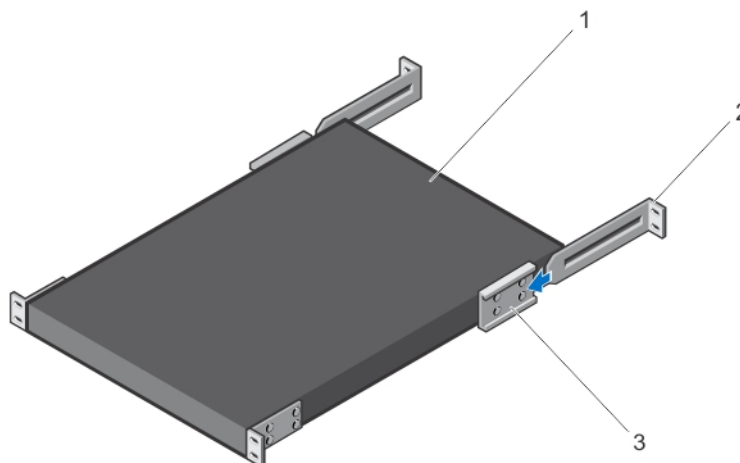

Figure 9. Slide the mounting brackets

1. Utility side of the chassis

2. Mounting Bracket

3. Holding Bracket (factory installed)

Rack Mounting Safety Considerations

You may either place the switch on the rack shelf or mount the switch directly into a 19" wide, EIA-310-E- compliant rack.

- Rack loading — Overloading or uneven loading of racks may result in shelf or rack failure, which may damage equipment and cause possible personal injury. Stabilize racks in a permanent location before loading begins. Mount the components beginning at the bottom of the rack, then work to the top. Do not exceed your rack load rating.
- Power considerations — Connect only to the power source specified on the unit. When multiple electrical components are installed in a rack, ensure that the total component power ratings do not exceed the circuit capabilities. Overloaded power sources and extension cords present fire and shock hazards.
- Elevated ambient temperature — If installed in a closed rack assembly, the operating temperature of the rack environment may be greater than the room ambient temperature. Use care not to exceed the 40°C maximum ambient temperature of the switch.
- Reduced air flow — Install the equipment in the rack so that the amount of airflow required for safe operation of the equipment is not compromised.
- Reverse air flow — Necessary clearance is required to ensure cool air intake and to avoid hot air blow out from I/O panel.
- Reliable earthing — Maintain reliable earthing of rack-mounted equipment. Pay particular attention to the supply connections other than the direct connections to the branch circuit; for example, use of power strips.
- Do not mount the equipment with the Utility panel facing in the downward position.

 **WARNING: These instructions are a condensed reference. Read the safety instructions in your Safety, Environmental, and Regulatory information booklet before you begin.**

 **NOTE: The illustrations in this document are not intended to represent a specific switch.**

Installing the S5000 Chassis into a 4-Post Rack or Cabinet

 **NOTE: Dell Networking recommends that one person hold the S5000 chassis in place while a second person attaches the brackets to the posts.**

Attach the bracket "ears" to the rack or cabinet posts, using two screws for each bracket. Ensure the screws are tightened firmly.

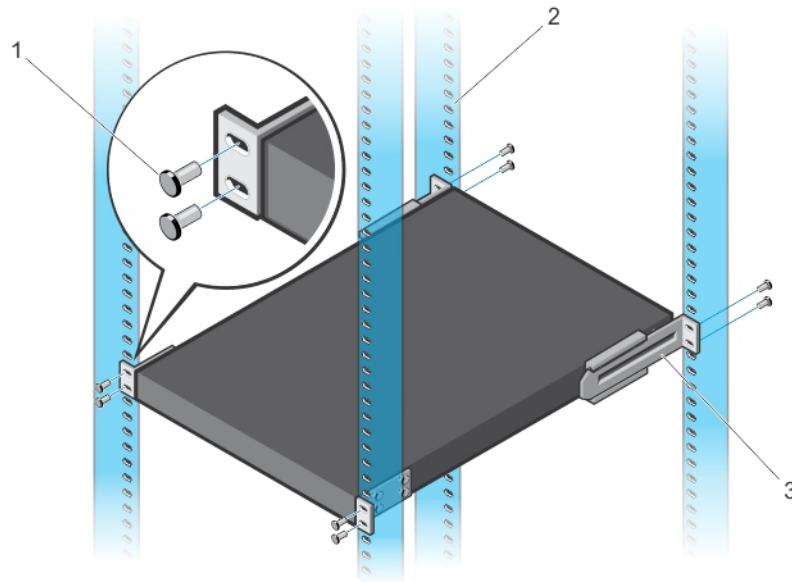

Figure 10. Front Rack Installation

1. Screws
2. 4-Post Rack or Cabinet
3. Mounting Bracket

Rack Grounding

When you prepare your equipment rack, ensure that the rack is earth ground. You must ground the equipment rack to the same ground point the power service uses in your area. The ground path must be permanent.

Important Points to Remember for Installing an Ethernet Module

- Installing and swapping of Ethernet modules must be done **BEFORE** power up. If you need to install or replace a module, power down the system before you install or replace it. If you install or replace a module when the system is powered up, the system does not recognize the module. Online insertion of modules can result in a catastrophic failure.
- Although the handle and port numbering may appear differently on an Ethernet module, there is no functional difference. A module may have:
 - A larger handle that covers the entire front of the module and has the part number written on top of the handle. Port numbering is written on the front of the handle.
 - A smaller handle that is half the size and does not cover the release button. The part number is written on the front of the handle. Port numbering is written on the lower part of the front of the module.

⚠ WARNING: Electrostatic discharge (ESD) damage can occur if components are mishandled. Always wear an ESD-preventive wrist or heel ground strap when handling the S5000 and its components.

📝 NOTE: For the Ethernet module, the part name and port number are inscribed on the handle, as shown in the following figure:

NOTE: A blue color release latch indicates that the Ethernet module does not support hot swapping during switch operations. Instead, you must power down the switch before removing and replacing an Ethernet module. A red color release latch indicates that the Ethernet module supports hot swapping during switch operations.

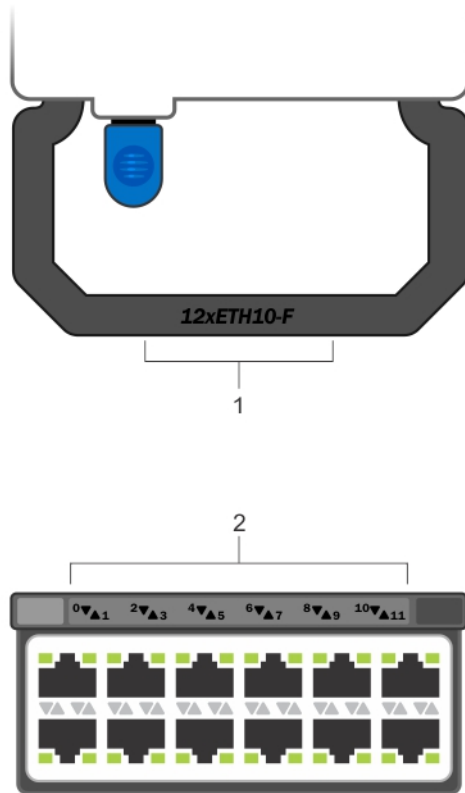

Figure 11. Part name and Port number on the Ethernet Module Handle

1 Part Name

2 Port Number

Installing an Ethernet Module

1. Use the grab handle on the Ethernet module to slide it into the switch module slot.
2. Connect any network interface cables to the attached module.

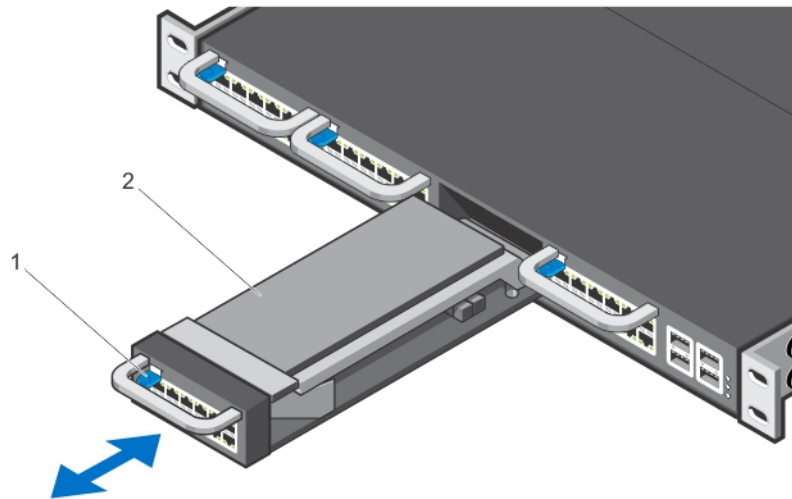

Figure 12. Installing an Ethernet Module

1. Release latch
2. Ethernet Module

Replacing an Ethernet Module

NOTE: S5000 does not support the hot swapping of an Ethernet pluggable module during switch operations. Instead, you must power down the switch before removing and replacing an expansion module.

1. Disconnect any network interface cables attached to the module.
2. Use the grab handle to slide the Ethernet module out of the switch module slot.
3. Use the grab handle on the replacement Ethernet module to slide it into the switch module slot.
4. Connect any network interface cables to the attached module.

Important Points to Remember for Installing a Unified Port Module

- You must insert the Unified Port module only in slot 0. If you use an FC module on an S5000 switch, the device cannot be stacked.
- If you want to use the FC module in passthrough Ethernet mode, use the `stack-unit unit-number port-group number portmode ethernet` command in Configuration mode.
- Installing and swapping of Unified Port modules must be done BEFORE power up. If you need to install or replace a module, power down the system before you install or replace it. If you install or replace a module when the system is powered up, the system does not recognize the module. Online insertion of modules can result in a catastrophic failure.
- The S5000 does not support the hot swapping of a Unified Port pluggable module during switch operations. Instead, you must power down the switch before removing and replacing a Unified Port module.
- Although the handle and port numbering may appear differently on a Unified Port module, there is no functional difference. A module may have:
 - A larger handle that covers the entire front of the module and has the part number written on top of the handle. Port numbering is written on the front of the handle.
 - A smaller handle that is half the size and does not cover the release button. The part number is written on the front of the handle. Port numbering is written on the lower part of the front of the module.

WARNING: Electrostatic discharge (ESD) damage can occur if components are mishandled. Always wear an ESD-preventive wrist or heel ground strap when handling the S5000 and its components.

 **NOTE:** The part name and port number of a Unified Port module are inscribed on the handle as shown below.

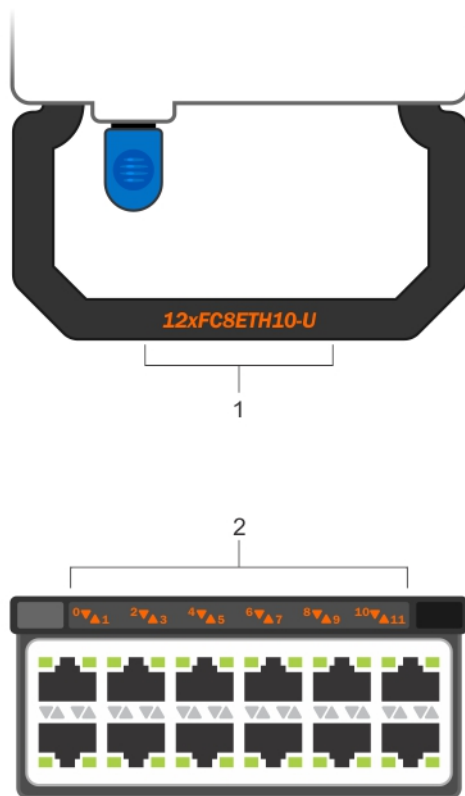

Figure 13. Part name and Port number on the Unified Port Module Handle

1 Part Name

2 Port Number

Installing a Unified Port Module

1. Use the grab handle on the Unified Port module to slide it into the switch module slot.
2. Connect any network interface cables to the attached module.

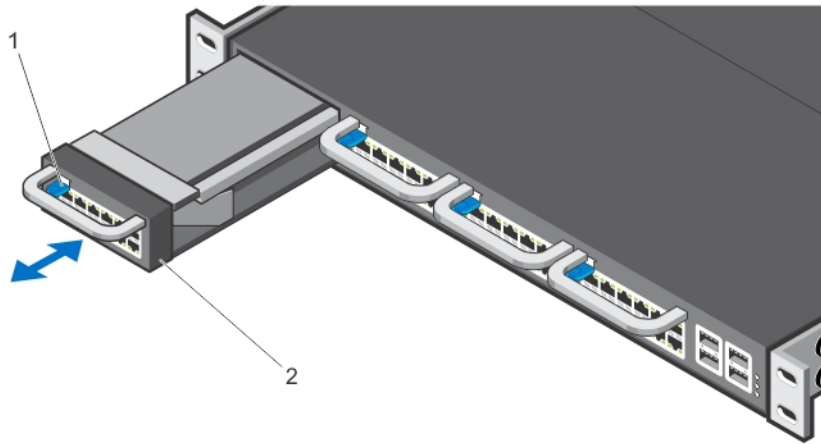

Figure 14. Installing a Unified Port Module

1. Release latch
2. Unified Port Module

Replacing a Unified Port Module

NOTE: S5000 does not support the hot swapping of a Unified Port pluggable module during switch operations. Instead, you must power down the switch before removing and replacing an expansion module.

1. Disconnect any network interface cables attached to the module.
2. Use the grab handle to slide the Unified Port module out of the switch module slot.
3. Use the grab handle on the replacement Unified Port module to slide it into the switch module slot.
4. Connect any network interface cables to the attached module.

Important Points to Remember for Installing an AC Power Supply

- The PSU slides into the slot smoothly. Do not force a PSU into a slot as this action may damage the PSU or the S5000 chassis.
- The S5000 supports AC and DC power supplies with two air-flow directions (I/O to Utility and Utility to I/O). The S5000 does not support mixing PSU types, that is, you cannot replace an AC PSU with a DC PSU and an AC-R PSU with a DC-R PSU. The fan airflow direction for both the PSUs must be the same.
- For AC PSUs, an illuminated translucent handle indicates the power status.
- To view the log messages, use the `show logging` command. For more information, refer to the System Logs chapters of the *Dell Networking OS Command Line Reference Guide for the S5000 Switch* and *Dell Networking OS Configuration Guide for the S5000 Switch*.

WARNING: Although the switch can run on one PSU, Dell Networking OS highly recommends using two PSUs for full redundancy and proper cooling. If the switch needs to run with only one PSU for a time, be sure to cover the second PSU slot opening with a blank plate to avoid overheating.

WARNING: The Utility panel consists of four slots numbered from 0 to 3. Insert PSUs in slots 0 and 3.

WARNING: The PCB edge connector is at the bottom. Avoid installing the switch upside down.

WARNING: Electrostatic discharge (ESD) damage can occur if components are mishandled. Always wear an ESD-preventive wrist or heel ground strap when handling the S5000 and its components.

CAUTION: DO NOT mix airflow directions. The airflow directions are color coded. A red label indicates that hot air is expelled from the PSU and a blue label indicates that hot air is expelled from the I/O. Both power supplies must use the same airflow direction (I/O to Utility or Utility to I/O). The power supplies and fans must have the same color strap. If you mismatch the airflows, the following error message appears and the system shuts down:

```
00:02:19: %S5000:0 %CHMGR-2-PSU_TYPE_AIRFLOW_MISMATCH: Mismatching PSU airflow detected. Unit 0 shall get shutdown in next 60 seconds if mismatch not rectified.  
00:02:19: %STKUNIT0-M:CP %CHMGR-1-PSU_AIRFLOW_COMBO_MISMATCH: Major alarm: Mismatching PSU airflow detected in unit 0
```

Installing an AC Power Supply

1. Remove the PSU from the electro-static bag.
2. Use the grab handle to slide the PSU into the switch PSU slot (install the PSU-exposed PCB edge connector first). The PSU slot is keyed so that the PSU can be fully inserted in only one way. When you install the PSU correctly, it snaps into place and is flush with the back of the switch.

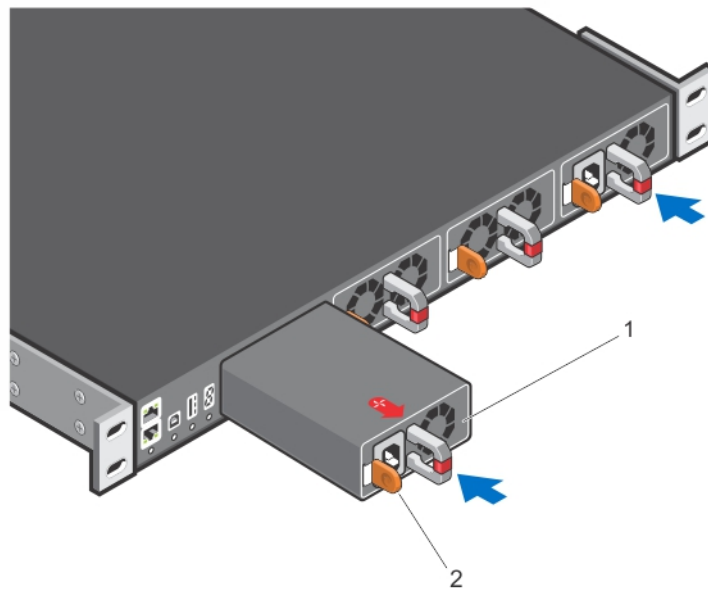

Figure 15. Installing an AC Power Supply

1. Slot 0 (for AC PSU 0)
2. Release latch
3. Plug in the AC3 prong cord from the switch PSU to the external power source (the AC wall outlet).

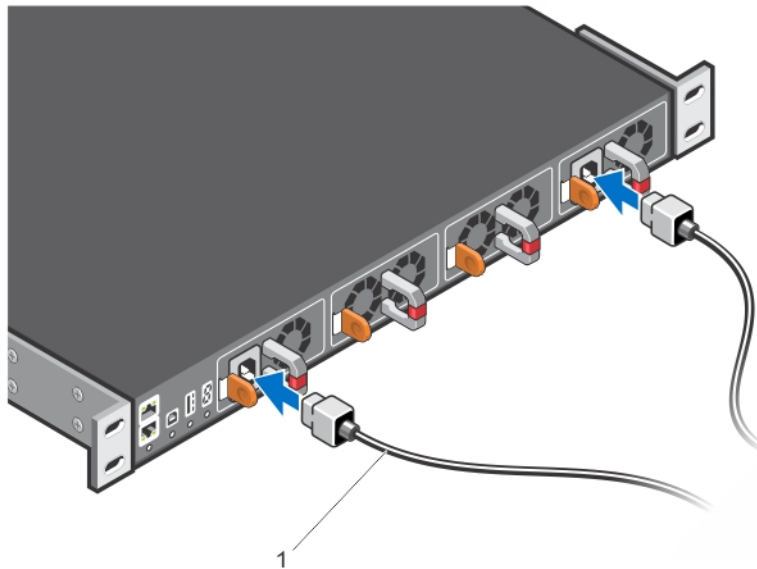

Figure 16. Connecting AC Power Supply Cords

1. AC3 Prong

NOTE: The system is powered-up as soon as you connect the power cord between the system and the power source.

CAUTION: Always disconnect the power cable before you service the power supply slots.

CAUTION: Use the power supply cord as the main disconnect device on the AC system. Ensure that the socket-outlet is located/installed near the equipment and is easily accessible.

4. Repeat steps 1 through 3 above using the second PSU.

NOTE: Ensure that the PSU is correctly installed. When you correctly install the PSU, the power connector is on the left side of the PSU.

Important Points to Remember for Installing a DC Power Supply

- When using DC power supply, peel off the DC electrical label and place it on the main regulatory label found on the bottom of the S5000 chassis. Position this label over the AC electrical ratings within the dashed outline.
- The PSU slides into the slot smoothly. Do not force a PSU into a slot as this action may damage the PSU or the S5000 chassis.
- The S5000 supports AC and DC power supplies with two air-flow directions (I/O to Utility and Utility to I/O). The S5000 does not support mixing PSU types, that is, you cannot replace an AC PSU with a DC PSU and an AC-R PSU with a DC-R PSU. The fan airflow direction for both the PSUs must be the same.
- For DC PSUs, the power status LED is on the upper-left corner.
- A DC PSU must be properly grounded. The system does not work when plugged into the wrong power source polarity.
- To view the log messages, use the `show logging` command. For more information, refer to the System Logs chapters of the *Dell Networking OS Command Line Reference Guide for the S5000 Switch* and *Dell Networking OS Configuration Guide for the S5000 Switch*.

WARNING: Although the switch can run on one PSU, Dell Networking highly recommends using two PSUs for full redundancy and proper cooling. If the switch needs to run with only one PSU for a time, be sure to cover the second PSU slot opening with a blank plate to avoid overheating.

WARNING: The Utility panel consists of four slots numbered from 0 to 3. Insert PSUs in slots 0 and 3.

WARNING: The PCB edge connector is at the bottom of the switch. Avoid installing the switch upside down.

WARNING: Electrostatic discharge (ESD) damage can occur if components are mishandled. Always wear an ESD-preventive wrist or heel ground strap when handling the S5000 and its components.

CAUTION: DO NOT mix airflow directions. The airflow directions are color coded. A red label indicates that hot air is expelled from the PSU and a blue label indicates that hot air is expelled from the I/O. Both fans must use the same airflow direction (I/O to Utility or Utility to I/O). The power supplies and fans must have the same color strap. If you mismatch the airflows, the following error message appears and the system shuts down:

```
00:02:19: %S5000:0 %CHMGR-2-PSU_TYPE_AIRFLOW_MISMATCH: Mismatching PSU airflow detected. Unit 0 shall get shutdown in next 60 seconds if mismatch not rectified.  
00:02:19: %STKUNIT0-M:CP %CHMGR-1-PSU_AIRFLOW_COMBO_MISMATCH: Major alarm: Mismatching PSU airflow detected in unit 0
```

Assembling and Connecting the Safety Ground Wire for DC Power Supply

WARNING: For equipment using $-(48-60)$ V DC power supplies, a qualified electrician must perform all connections to DC power and to safety grounds. Do not attempt connecting to DC power or installing grounds yourself. All electrical wiring must comply with applicable local or national codes and practices. Damage due to servicing that Dell Networking did not authorize is not covered by your warranty.

1. Strip the insulation from the end of the green/yellow wire, exposing approximately 4.5 mm (0.175 inch) of copper wire.
2. Using a hand-crimping tool (Tyco Electronics, 58433-3 or equivalent), crimp the ring-tongue terminal (Jeason Terminals Inc., R5-4SA or equivalent) to the green/yellow wire (safety ground wire).
3. Connect the safety ground wire to the grounding post on the back of the system using a #6-32 nut equipped with a locking washer.

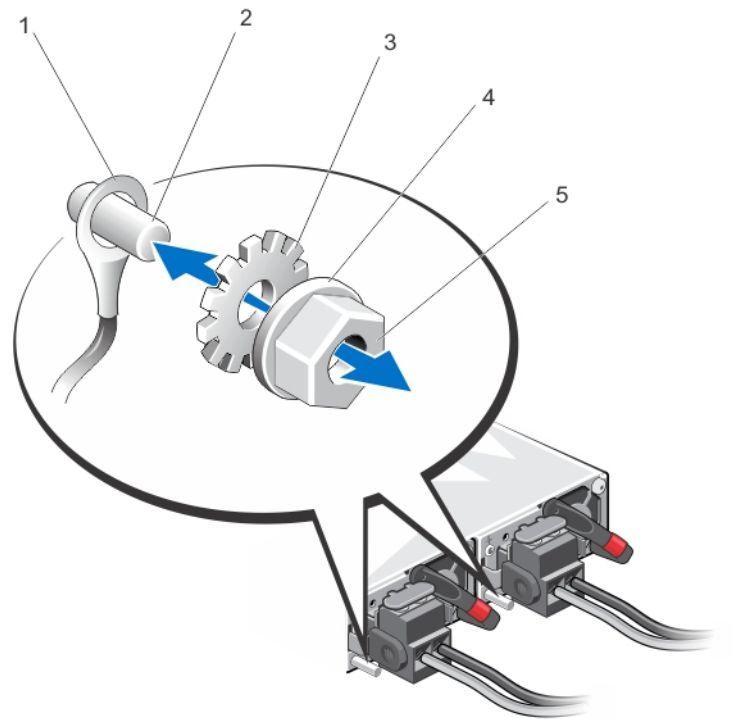

Figure 17. Assembling and Connecting the Safety Ground Wire For DC Power Supply

- | | |
|-----------------------|-------------------|
| 1. Safety ground wire | 2. Grounding post |
| 3. Locking washer | 4. Spring washer |
| 5. #6-32 nut | |

Installing a DC Power Supply

1. Remove the PSU from the electro-static bag.
2. Use the grab handle to slide the PSU into the switch PSU slot (install the PSU-exposed PCB edge connector first). The PSU slot is keyed so that the PSU can be fully inserted in only one way. When you correctly install the PSU, it snaps into place and is flush with the back of the switch.

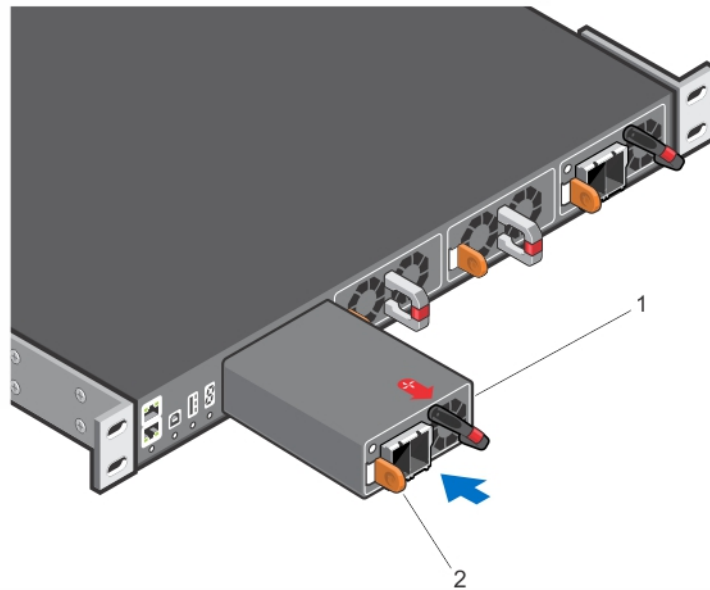

Figure 18. Installing a DC Power Supply

1. Slot 0 (for DC PSU 0)
 2. Release latch
3. Strip the insulation from the ends of the DC power wires, exposing approximately 13 mm (0.5 inch) of copper wire.
⚠ WARNING: Reversing polarity when connecting DC power wires can permanently damage the power supply or the system.
 4. Insert the copper ends into the mating connectors and tighten the captive screws at the top of the mating connector using a #2 Phillips screwdriver.
⚠ WARNING: To protect the power supply from electrostatic discharge, you must cover the captive screws with the rubber cap before inserting the mating connector into the power supply.
 5. Rotate the rubber cap clockwise to fix it over the captive screws.
 6. Insert the mating connector into the power supply.

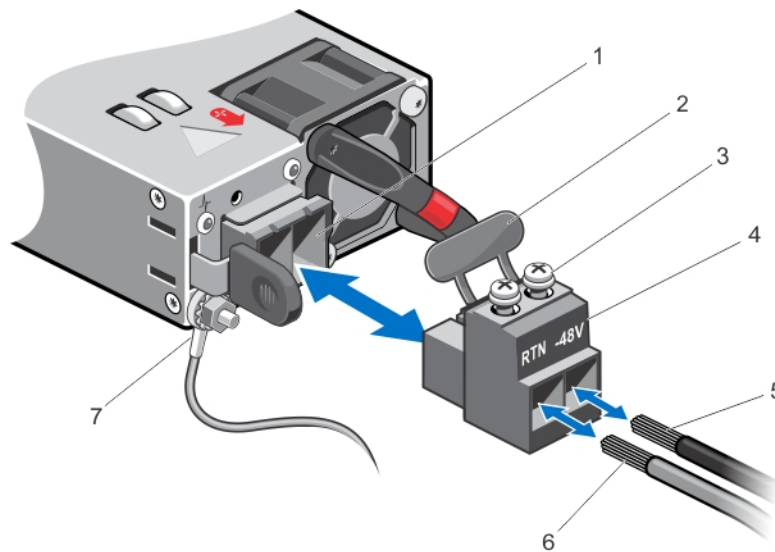

Figure 19. Assembling the DC Input Power Wires

- | | |
|-----------------------|-----------------------|
| 1. DC power socket | 2. Rubber cap |
| 3. Captive screws (2) | 4. DC power connector |
| 5. Wire (-48V) | 6. Wire RTN |
| 7. Grounding Wire | |

NOTE: The system is powered-up as soon as the power cord is connected between the system and the power source.

CAUTION: Always disconnect the power cable before you service the power supply slots.

CAUTION: Use the power supply cord as the main disconnect device on the AC or DC system. Ensure that the socket-outlet is located/installed near the equipment and is easily accessible.

7. Repeat steps 1 through 6 using the second PSU.

NOTE: Ensure that the PSU is correctly installed. When you correctly install the PSU, the power connector is on the left side of the PSU.

Installing the Ferrite Bead for DC Power and Return Cables

Add a ferrite bead to the DC power and return cables of the master module. Install the bead with a single loop.

1. Open ferrite bead with the depressions facing up.
2. Wrap the DC power and return cables around the ferrite bead twice if two turns of the cable fit inside the ferrite, otherwise simply clamp the ferrite onto both cables.

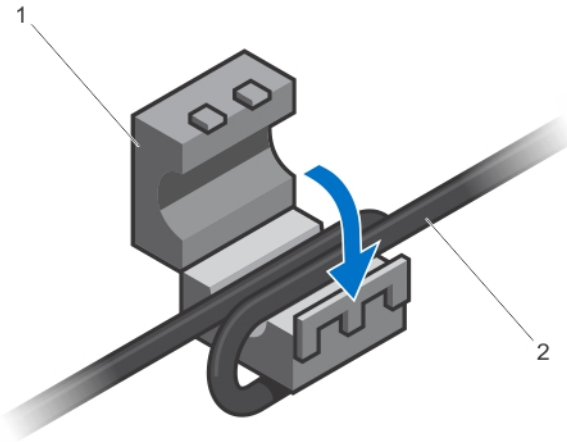

Figure 20. Installing the Ferrite Bead for DC Power and Return Cables

1. Ferrite Bead
2. DC Power and Return Cables
3. Leave approximately 4 to 5 inches of the DC power and return cables end protruding from the ferrite.
4. Snap the ferrite bead shut.

Securing Power Cables

1. Bend the system power cables, as shown in the following illustration, and attach to the cable clasp.

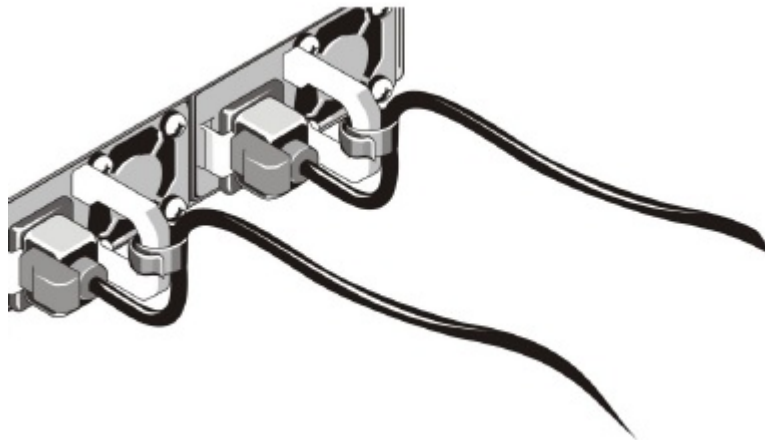

Figure 21. Securing Power Cables

2. Plug the other end of the power cables into a grounded electrical outlet or a separate power source such as an uninterruptible power supply (UPS) or a power distribution unit (PDU).

 **NOTE: For better performance, ensure that the system is connected to a stand-alone power source with stable power supply.**

Replacing an AC or DC Power Supply

To replace an AC or DC power supply, follow these steps:

 **NOTE: Although the switch can run on one PSU, Dell Networking highly recommends using two PSUs for full redundancy. If the switch needs to run with only one PSU for a time, be sure to cover the second PSU slot opening with a blank plate to avoid overheating.**

 **NOTE: If a PSU fails, you must completely replace it. There are no field serviceable components in the PSU.**

1. Disconnect the power cable from the PSU.
2. Use the grab handle to slide the PSU out of the switch PSU slot.
3. Use the grab handle on the replacement PSU to slide it into the switch PSU slot.
4. Attach the power cord to the replacement PSU.

Important Points to Remember for Installing a Fan Module

- The Utility panel consists of four slots numbered from 0 to 3. Insert the fan modules in slots 1 and 2.
- If a fan module fails, the system continues to operate without a significant degradation in cooling capacity for a six-hour duration.
- The cooling system is designed such that, during normal operation, the fans typically run at somewhere between 50 and 75 percent of their maximum speed at 26°C ambient temperature. This feature results in lower noise and higher average fan life. The switch increases the fan speed to maximum if the facility air condition fails or if a fan fails.
- The fan speed increases and decreases automatically based on the internal temperature. The switch never intentionally turns off the fans.
- For proper ventilation, position the S5000 in an equipment rack (or cabinet) with a minimum of 5 inches (12.7 cm) of clearance around the exhaust vents. When you install two S5000 systems near each other, position the two chassis at least 5 inches (12.7 cm) apart to permit proper airflow. The acceptable ambient temperature ranges are listed in [Technical Specifications](#).
- To view the log messages, use the `show logging` command. For more information, refer to the System Logs chapters of the *Dell Networking OS Command Line Reference Guide for the S5000 Switch* and *Dell Networking OS Configuration Guide for the S5000 Switch*.

 **CAUTION: DO NOT mix airflow directions. The airflow directions are color coded. A red label indicates that hot air is expelled from the PSU and a blue label indicates that hot air is expelled from the I/O. Both fans must use the same airflow direction (I/O to Utility or Utility to I/O). The power supplies and fans must have the same color strap. If you mismatch the airflows, the following error message appears and the system shuts down:**

```
00:00:53: %S5000:3 %CHMGR-2-PSU_TYPE_AIRFLOW_MISMATCH: Mismatching PSU and FAN airflow detected. Unit 0 shall get shutdown in next 60 seconds if mismatch not rectified.
00:00:53: %STKUNIT3-M:CP %CHMGR-1-PSU_AIRFLOW_COMBO_MISMATCH: Major alarm: Mismatching PSU and FAN airflow detected in unit 0
```

The fan modules are field replaceable. Module slot 1 is on the left side of the chassis; module slot 2 is on the right side of the chassis.

Installing a Fan Module

1. Take the fan module out of the shipping box.
2. Use the grab handle to slide the fan module into the switch fan slot, as shown below.

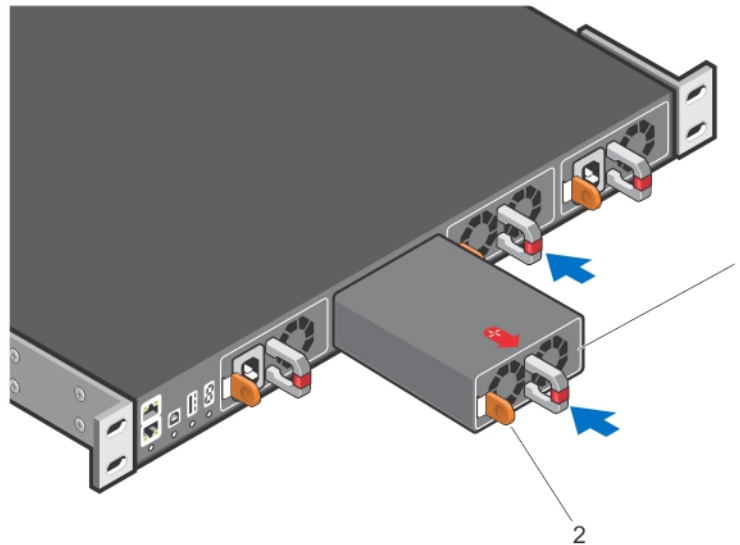

Figure 22. Installing a Fan Module

1. Fan module 0/Slot 1
2. Release latch

Replacing a Fan Module

1. Use the grab handle to slide the fan module out of the switch fan slot.
2. Use the grab handle on the replacement module to slide it into the switch fan slot.

CAUTION: You must complete steps 1 and 2 within one minute or the system powers down.

Installing the SFP+ and QSFP+ Optics

The S5000 has 48 small form-factor pluggable plus (SFP+) optical ports and four QSFP+ optical ports. For a list of supported optics, refer to the S5000 data sheet: <http://www.dell.com/us/enterprise/p/force10-s-series/pd>.

CAUTION: ESD damage can occur if the components are mishandled. Always wear an ESD-preventive wrist or heel ground strap when handling the S5000 and its components.

WARNING: When working with optical fibres, follow all the warning labels and always wear eye protection. Never look directly into the end of a terminated or unterminated fibre or connector as it may cause eye damage.

1. Position the optic so it is in the correct position. The optic has a key that prevents it from being inserted incorrectly.
2. Insert the optic into the port until it gently snaps into place.

NOTE: Both rows of QSFP+ ports require that you install the 40GbE optics with the tabs facing up.

NOTE: When you cable the ports, be sure not to interfere with the airflow from the small vent holes above and below the ports.

Splitting QSFP+ Ports to SFP+ Ports

The S5000 supports splitting a single 40GbE QSFP+ port into four 10GbE SFP+ ports using one of the supported breakout cables. For a list of supported optics, refer to the S5000 data sheet: <http://www.dell.com/us/enterprise/p/force10-s-series/pd>.

- Configure the system to recognize the port mode change.
CONFIGURATION mode
`stack-unit unit-number port number portmode quad`

- `stack-unit<unit-number>` - Enter the stack member unit identifier of the stack member to reset. The range is 0 to 11. The default is 0.
- `port <number>`- Enter the port number of the 40GbE port to be split. The range is 48 to 60.
- `portmode quad` - Configure a 40GbE port to operate in 4x10GbE mode.

Example of splitting a QSFP+ port to SFP+ ports





```
stack-unit 0 port 52 portmode quad
```

Important Points to Remember

- You cannot use split ports as a stack-link to stack an S5000 unit.
- The quad port must be in a default configuration before you can split it into four 10GbE SFP+ ports. When you split the port, the 40GbE port is lost in the running configuration. Be sure that the port is also removed from other L2/L3 feature configurations.
- For the split-port change to take effect, you must reload the system after issuing the CLI change commands.

Connecting the Stacking Ports (Optional)

Before you make your stacking port connections, rack-mount the systems or insert them into a cabinet. To connect the stacking ports, insert one end of the optical cable into a configured port and insert the other end of the optical cable into a similarly configured port of the adjacent system. There are no unique stacking ports; you can configure the SFP+ and QSFP+ ports to act as stacking ports. The SFP+ ports are labeled 0 to 47. The QSFP+ ports are labeled 48 and 56 for the lower ports and 52 and 60 for the upper ports.

-  **NOTE: You can connect up to six S5000 switches in a single stack.**
-  **NOTE: The S5000 system does not stack with other S-Series systems.**
-  **NOTE: Stacking is not supported on 40GbE ports operating in 4x10GbE (quad) mode.**
-  **NOTE: If you use three or more S5000 units in a stack, you can connect up to a maximum of eight 10GbE ports or two 40GbE ports in links between peer switches. If you use only two S5000 units in a stack, you can connect up to four 40GbE ports in links between the two switches.**

Important Points to Know

- Data ports are configured as stacking ports in predefined stacking groups of 40GbE (four 10GbE ports or one 40GbE port).
- Stacking ports are divided into 16 stack-groups (0 to 15). Each set of four 10GbE ports on an Ethernet module or each fixed 40GbE port on the front panel correspond to a stack group. Each stack group has 40GbE of bandwidth. When a stack-group number is assigned, the ports associated with that group are configured as stacking ports.
 - stack-group 0 = ports 0–3, stack-group 1 = ports 4–7, stack-group 2 = ports 8–11, and so on through stack-group 11 = ports 44–47.
 - stack-group 12 = port 48, stack-group 13 = port 52, stack-group 14 = port 56, stack-group 15 = port 60.
- All the ports in a stack-group are placed in stacking mode. You cannot use the unused ports in that group as data ports.

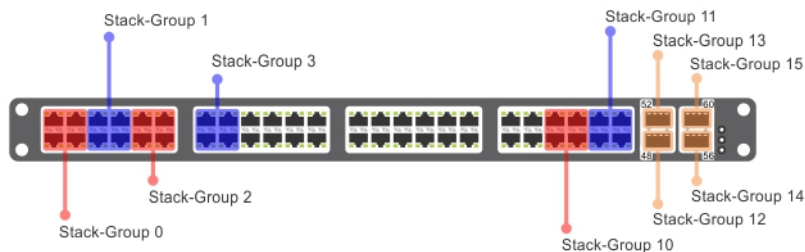

Figure 23. Stack-Group Assignments

You can connect the systems while they are powered down or up. Stacking ports are bidirectional. The S5000 supports stacking in either a ring or a daisy-chain topology. To provide redundant connectivity, Dell Networking recommends using the ring topology when stacking S5000 systems.

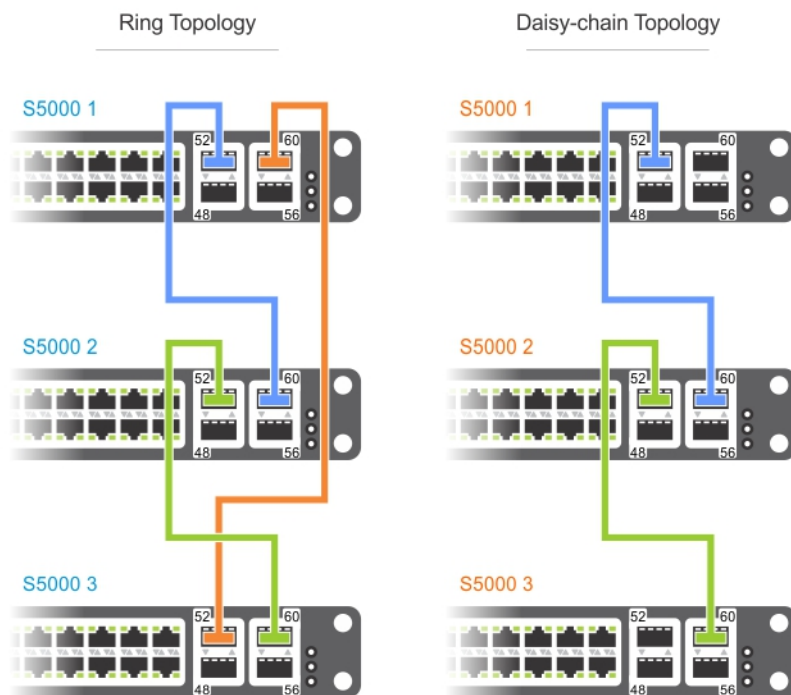

Figure 24. Stacking Topology

Connecting Two S5000 Systems

To provide backup connectivity and increased data transfer between the systems, Dell Networking recommends inserting an additional cable between the two units, in a second stacking port.

You can use any of the SFP+ or QSFP+ ports for stacking, provided it is configured as a stacking port.

CAUTION: The S5000 does not require special stacking cables. The cables used to connect 10GbE and 40GbE data ports are sufficient.

NOTE: The port numbers in the following procedure are examples only.

1. Insert one end of the first cable into stack port 60 in chassis 1 (bottom).
2. Insert the other end of the same cable into stack port 60 on chassis 2 (top).
3. Insert a second cable into stack port 56 on chassis 2 (top).
4. Insert the other end of the second cable into stack port 56 on chassis 1 (bottom).

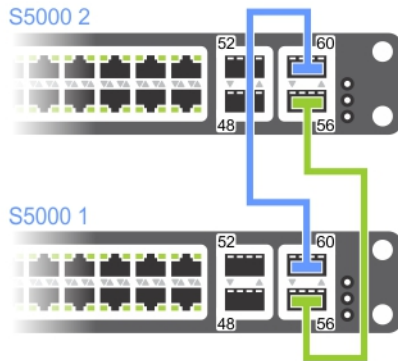

Figure 25. Two S5000 Systems Connected in a Ring

Connecting Three S5000 Systems

To provide backup connectivity and increased data transfer between the systems, Dell Networking recommends inserting an additional cable between the two units, in a second stacking port.

CAUTION: The S5000 does not require special stacking cables. The cables used to connect 10GbE and 40GbE data ports are sufficient.

NOTE: The port numbers in the following procedure are used as examples only.

1. Insert one end of the first cable into stack port 60 of chassis 1 (bottom).
2. Insert the other end of the cable into stack port 56 of chassis 2 (center).
3. Insert the second cable into stack port 60 of chassis 2 (center) and port 56 of chassis 3 (top).
4. Use the third cable to connect the top and bottom units by inserting one end of the cable into stack port 56 on chassis 1 (bottom) and the other end of the cable into stack port 60 on chassis 3 (top).

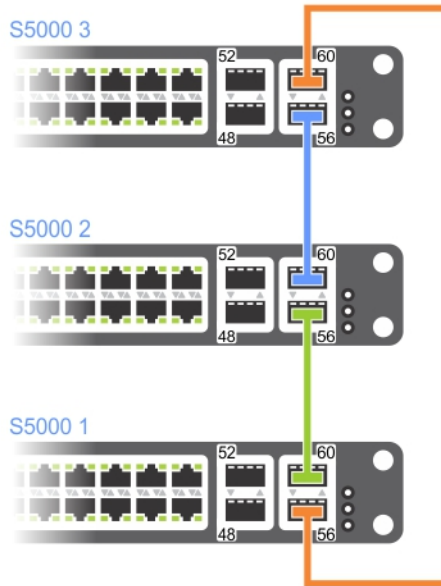

Figure 26. Three S5000s Connected in a Ring

Supplying Power and Powering Up the System

Supply power to the S5000 system after the chassis is mounted in a rack or cabinet.

WARNING: Installing and swapping of Unified Port or Ethernet modules must be done BEFORE power up. If you need to replace a module, power down the system before you replace it. If you replace a module when the system is powered up, the system does not recognize the module. Online insertion of modules can result in a catastrophic failure.

Dell Networking recommends reinspecting your system prior to powering up. Verify that:

- The equipment is properly secured to the rack.
- The equipment rack is properly mounted and grounded.
- The ambient temperature around the unit (which may be higher than the room temperature) is within the limits specified for the S5000.
- There is sufficient airflow around the chassis.
- The input circuits are correctly sized for the loads and that you use sufficient overcurrent protection devices.

NOTE: For powering up an AC PSU, an AC power cable is included in the shipping container. You must order all other power cables separately.

CAUTION: ESD damage can occur if the components are mishandled. Always wear an ESD-preventive wrist or heel ground strap when handling the S5000 and its components.

When the system powers up, the fans come on at high speed. The fan speed slows as the system boots up. The power status LED blinks until the boot-up sequence is complete. When the boot up is complete, the power status LED is steadily lit.

AC Power

CAUTION: Ensure that the PSU is installed correctly. The AC power connector must be on the left side of the PSU and the status LED at the top of the PSU.

Connect the plug to each AC power connector. Make sure that the power cord is secure.

As soon as the cable is connected between the S5000 and the power source, the chassis is powered-up; there is no on/off switch.

DC Power

Connect the plug to each DC receptacle. Make sure that the power cord is secure and the polarity is correct.

As soon as the cable is connected between the S5000 and the power source, the chassis is powered-up; there is no on/off switch.

Hot-Swapping Units in a Stack

You can add, remove, or swap S5000 units in an existing stack. The units in the stack and the new units can be already powered up or powered down. All units in a stack must run the same version of the operating system. The order in which the units come online or are added to or removed from the stack affects how the stack identifies them and how the units identify themselves. This order influences unit numbers, management addresses, and other elements of the configuration file.

Unit identification within the stack is determined by the identification algorithm you select. The default algorithm has the units self-identify as Unit 0 through Unit last based on the order in which they come online. So, when setting up a new set of switches in a stack, you should have no trouble forcing the identification of the management unit and unit IDs by methodically supplying power to the units in your preferred sequence.

Similarly, when you add a unit to the stack, the unit is gracefully added as Unit last (the lowest unused number) with the current configuration. Attaching a new unit may cause each unit in the stack to reload. The subsequent configuration file in each unit includes the awareness of the new unit.

If you have a preconfigured unit that you want to add to the stack, but you want to make sure that the configuration does not override the configuration of the stack, add the unit while it is powered down to avoid stack management conflicts.

For more information about removing a unit from a stack and other stacking commands, refer to the Stacking chapter in the *Dell Networking OS Configuration Guide for the S5000 Switch* and the Stacking Commands chapter in the *Dell Networking OS Command Line Reference Guide for the S5000 Switch*.

Technical Specifications

 **NOTE:** Operate the product at an ambient temperature not higher than 40°C.

 **CAUTION:** Lithium Battery Caution: There is a danger of explosion if the battery is incorrectly replaced.

 **NOTE:** Replace the battery only with same or equivalent type. Dispose of the batteries according to the manufacturer's instructions.

 **NOTE:** For RoHS information, see [Restricted Material Compliance](#).

Table 6. Chassis Physical Design

Parameter	Specifications
Height	1.71 inches (43.5 mm)
Width	17.4 inches (441 mm)
Depth	28 inches (711 mm)
Chassis weight with factory-installed components	34 pounds (approx.) (15.42 kg)
Rack clearance required	<ul style="list-style-type: none"> • Front: 5 inches (12.7 cm) • Rear: 5 inches (12.7 cm)

Table 7. Environmental Parameters

Parameter	Specifications
Operating temperature	32° to 104°F (0° to 40°C)
Operating humidity	10 to 85 percent (RH), noncondensing
Storage temperature	–40° to 158°F (–40° to 70°C)
Storage humidity	5 to 95 percent (RH), noncondensing
Relative humidity	10 to 85 percent, noncondensing
Maximum thermal output	2388 BTU/hr
Maximum Altitude	No performance degradation to 6600 ft

Table 8. Power Requirements

Parameter	Specifications
AC Power supply	100 VAC ~ 240 VAC 50/60 Hz
DC Power supply	–48V ~ –60V VDC
Maximum current draw per system	7 A @ 100 VAC 3.5 A @ 200 VAC
Maximum power consumption	700 Watts

Agency Compliance

USA Federal Communications Commission (FCC) Statement

This equipment has been tested and found to comply with the limits for a Class A digital device, under Part 15 of the FCC rules. These limits are designated to provide reasonable protection against harmful interference when the equipment is operated in a commercial environment. This equipment generates, uses, and can radiate radio frequency energy. If it is not installed and used in accordance to the instructions, it may cause harmful interference to radio communications. Operation of this equipment in a residential area is likely to cause harmful interference, in which case users will be required to take whatever measures necessary to correct the interference at their own expense. Properly shielded and grounded cables and connectors must be used in order to meet FCC emission limits. Dell Networking is not responsible for any radio or television interference caused by using other than recommended cables and connectors or by unauthorized changes or modifications in the equipment. Unauthorized changes or modification could void the user's authority to operate the equipment. This device complies with Part 15 of the FCC Rules. Operation is subject to the following two conditions:

- This device may not cause harmful interference
- This device must accept any interference received, including interference that may cause undesired operation

Canadian Department of Communication Statement

Industry Canada Class A emission compliance statement

This Class A digital apparatus complies with Canadian ICES-003.

Avis de conformité à la réglementation d'Industrie Canada

Cet appareil numérique de la classe A est conforme à la norme NMB-003 du Canada.

European Union EMC Directive Conformance Statement

This product is in conformity with the protection requirements of EU Council Directive 2004/108/EC on the approximation of the laws of the Member States relating to electromagnetic compatibility. Dell Networking cannot accept responsibility for any failure to satisfy the protection requirements resulting from a nonrecommended modification of this product, including the fitting of non-Dell option cards.

This product has been tested and found to comply with the limits for Class A Information Technology Equipment according to CISPR 22/European Standard EN 55022. The limits for Class A equipment were derived for commercial and industrial environments to provide reasonable protection against interference with licensed communication equipment.



WARNING: This is a Class A product. In a domestic environment, this device may cause radio interference, in which case, you may be required to take adequate measures.

European Community Contact

Dell Networking
 EMEA — Central Dahlenweg 19
 66265 Heusweiler
 Germany

Japan: VCCI Compliance for Class A Equipment

この装置は、情報処理装置等電波障害自主規制協議会（VCCI）の基準に基づくクラスA情報技術装置です。この装置を家庭環境で使用すると電波妨害を引き起こすことがあります。この場合には使用者が適切な対策を講ずるよう要求されることがあります。

 **WARNING: Use the AC power cords with Dell Networking equipment only. Do not use Dell Networking AC power cords with any unauthorized hardware.**

This is Class A product based on the standard of the Voluntary Control Council For Interference by Information Technology Equipment (VCCI). If this equipment is used in a domestic environment, radio disturbance may arise. When such trouble occurs, the user may be required to take corrective actions.

本製品に同梱いたしております電源コードセットは、本製品専用です。本電源コードセットは、本製品以外の製品ならびに他の用途でご使用いただくことは出来ません。製品本体には同梱された電源コードセットを使用し、他製品の電源コードセットを使用しないで下さい。

Korean Certification of Compliance

A급 기기 (업무용 방송통신기자재)	이 기기는 업무용(A급) 전자파적합기기로서 판매자 또는 사용자는 이 점을 주의하시기 바라며, 가정외의 지역에서 사용하는 것을 목적으로 합니다.
------------------------	---

Korean Package Label

	 [equipment type]
품명(Product Name)	Ethernet Switch
모델명(Model)	[model number]
신청인(Applicant)	Force10 Networks, Inc.
제조사(Manufacturer)	Delta Networks, (Dongguan) Ltd.
제조년월(Manufacturing Date)	[date]
제조국(Country of Origin)	China

Safety Standards and Compliance Agency Certifications

- CUS UL 60950-1, Second Edition
- CSA 60950-1-03, Second Edition
- EN 60950-1, Second Edition
- EN 60825-1, First Edition
- EN 60825-1 Safety of Laser Products — Part 1: Equipment Classification Requirements and User's Guide
- EN 60825-2 Safety of Laser Products — Part 2: Safety of Optical Fibre Communication Systems
- FDA Regulation 21CFR 1040.10 and 1040.11
- IEC 60950-1, Second Edition, including all National Deviations and Group Differences

Electromagnetic Compatibility (EMC)

Emissions

- International: CISPR 22: 2006, Class A
- Australia/New Zealand: AS/NZS CISPR 22:2009, Class A
- Canada: ICES-003, Issue-4, Class A
- Europe: EN55022 2006 (CISPR 22: 2006), Class A
- Japan: VCCI V-3/2011.04 Class A
- USA: FCC CFR47 Part 15, Subpart B, Class A

Immunity

- EN 300 386 v1.5.1:2010 EMC for Network Equipment
- EN55022 2006, Class A
- EN 55024 1998 + A1: 2001 + A2: 2003
- EN 61000-3-2 Harmonic Current Emissions
- EN 61000-3-3 Voltage Fluctuations and Flicker
- EN 61000-4-2 ESD
- EN 61000-4-3 Radiated Immunity
- EN 61000-4-4 EFT
- EN 61000-4-5 Surge
- EN 61000-4-6 Low Frequency Conducted Immunity

Product Recycling and Disposal

You must recycle or discard this system according to applicable local and national regulations. Dell Networking encourages owners of information technology (IT) equipment to responsibly recycle their equipment when it is no longer needed. Dell Networking offers various product return programs and services in several countries to assist equipment owners in recycling their IT products.

Waste Electrical and Electronic Equipment (WEEE) Directive for Recovery, Recycle and Reuse of IT and Telecommunications Products

Dell Networking switches are labeled in accordance with European Directive 2002/96/EC concerning waste electrical and electronic equipment (WEEE). The Directive determines the framework for the return and recycling of used appliances as applicable throughout the European Union. This label is applied to various products to indicate that the product is not to be thrown away, but rather reclaimed upon end of life per this Directive.



Figure 27. The European WEEE symbol

In accordance with the European WEEE Directive, electrical and electronic equipment (EEE) is to be collected separately and to be reused, recycled, or recovered at end of life. Users of EEE with the WEEE marking per Annex IV of the WEEE Directive, as shown above, must not dispose of end of life EEE as unsorted municipal waste, but use the collection framework available to customers for the return, Specifications | 47 recycling and recovery of WEEE. Customer participation is important to minimize any potential effects of EEE on the environment and human health due to the potential presence of hazardous substances in EEE.

Dell Networking products, which fall within the scope of the WEEE, are labeled with the crossed-out wheeled-bin symbol, as shown above, as required by WEEE.

For information on Dell Networking product recycling offerings, see the WEEE Recycling instructions on iSupport at: http://downloads.dell.com/Manuals/all-products/esuprt_electronics/esuprt_docking_stations/dell-superspeed-usb3-dock-stn_Reference%20Guide_en-us.pdf?c=us&l=en&cs=&s=gen

Technical Support

Dell Networking Technical Support provides a range of documents and tools to assist you with effectively using Dell Networking equipment and mitigating the impact of network outages.

Accessing Dell Networking Technical Support

The URL for Dell Networking Support is www.dell.com/support.

- On the Dell Networking Support page, enter your service tag if you have it. You can also access general support information from this page.
- <http://www.dell.com/support/contents/us/en/04/category/Contact-Information/Technical-Support>