

PS SERIES STORAGE ARRAYS HARDWARE MAINTENANCE

PS3000 SERIES



Copyright © 2007 EqualLogic, Inc.

May 2007

EqualLogic is a registered trademark of EqualLogic, Inc.

All trademarks and registered trademarks mentioned herein are the property of their respective owners.

Possession, use, or copying of the documentation or the software described in this publication is authorized only under the license agreement.

EqualLogic, Inc. will not be held liable for technical or editorial errors or omissions contained herein. Information in this document is subject to change.

Part Number: 110-0041-R3

Table of Contents

Preface	v
Audience	v
Organization	v
Conventions	vi
Documentation and Technical Support	vi
Warranty Information	vii
Restricted Access Requirement	vii
Regulatory Agency Notices	viii
1 Basic Array Information	1-1
Array Front and Back Panels.....	1-1
Interpreting Operations Panel LEDs	1-2
Using an Electrostatic Wrist Strap	1-4
Shutting Down and Restarting an Array	1-4
2 Maintaining Disks	2-1
Interpreting Disk LEDs	2-1
Disk Handling Requirements	2-2
Identifying Failed Disks	2-3
Removing Disks	2-3
Installing Disks.....	2-5
3 Maintaining Control Modules	3-1
Supported Control Modules	3-1
Interpreting Control Module LEDs	3-2
Control Module Handling Requirements	3-3
Identifying Control Module Failures.....	3-3
Understanding Failover Behavior	3-3
Maintaining Control Module Firmware	3-4
Connecting Network Cables.....	3-5
Removing a Control Module	3-7
Installing a Control Module	3-9
Replacing the Compact Flash Card	3-11
4 Maintaining Power Supply and Cooling Modules	4-1
Interpreting Power Supply and Cooling Module LEDs	4-1
Identifying Power Supply and Cooling Module Failures.....	4-2
Removing a Power Supply and Cooling Module	4-2

Installing a Power Supply and Cooling Module 4-4

A Environmental, Power, and Other Specifications.....A-1

Index.....Index-1

Preface

This manual describes how to maintain the hardware for PS3000 Series arrays from EqualLogic. Each array contains hot-swappable power supply and cooling modules, up to sixteen RAID-protected disks, and single or dual hot-swappable control modules.

With one or more PS Series arrays, you can create a PS Series group—a self-managing, iSCSI storage area network (SAN) that is affordable and easy to use, regardless of scale. To install hardware, see the PS3000 Series *QuickStart*.

Audience

This manual is designed for the administrators responsible for maintaining PS3000 Series hardware. Administrators are *not* required to have extensive network or storage system experience. However, it may be useful to understand:

- Basic networking concepts
- Current network environment
- User disk storage requirements
- RAID configurations
- Disk storage management

Note: Although this manual provides examples of using PS Series arrays in some common network configurations, detailed information about setting up a network is beyond its scope.

Organization



This manual is organized as follows:

- Chapter 1, *Basic Array Information*, describes the PS3000 Series array front and back panels, how to interpret LEDs, how to use an electrostatic wrist strap, and how to shut down and restart an array.
- Chapter 2, *Maintaining Disks*, describes how to install and remove disks.
- Chapter 3, *Maintaining Control Modules*, describes how to install and maintain control modules and replace the compact flash card. It also describes the best way to connect network cables to control modules for high performance and availability.

- Chapter 4, *Maintaining Power Supply and Cooling Modules*, describes how to install and remove one of the modules that provides both power and cooling.
- Appendix A, *Environmental, Power, and Other Specifications*, describes the specifications for a PS3000 Series array.

Conventions

Conventions used in the manual are shown in the following table.

Convention	Usage
	When displayed, indicates that you must attach an electrostatic wrist strap to your wrist and a grounded device to prevent electrostatic discharge.
	When displayed, indicates a potential personal injury hazard.

Documentation and Technical Support

For detailed information about PS Series storage arrays, groups, and volumes, see the following documentation:

- *Release Notes*. Provides the latest information about PS Series storage arrays.
- *QuickStart*. Describes how to set up the storage array hardware and create a PS Series group. Be sure to use the manual for your array model.
- *Group Administration*. Describes how to use the Group Manager graphical user interface (GUI) to manage a PS Series group. This manual provides comprehensive information about product concepts and procedures.
- *CLI Reference*. Describes how to use the Group Manager command line interface (CLI) to manage a PS Series group and individual arrays.
- *Hardware Maintenance*. Provides information about maintaining the storage array hardware. Be sure to use the manual for your array model.

- Online help. In the GUI, expand **TOOLS** in the far left panel and then click **Online Help** for help on both the GUI and the CLI. See *Obtaining Online Help* on page 2-16.

The *QuickStart* and *Hardware Maintenance* manuals are printed and shipped with the product. They are also located on the PS Series documentation CD-ROM that is shipped with the product, along with the *Group Administration* and *CLI Reference* manuals and the Group Manager online help.

In addition, the Host Integration Tools for Microsoft® Windows® systems are available on the Host Integration Tools CD-ROM that is shipped with the product.

Technical support on EqualLogic products is available for customers with arrays under warranty and customers with a valid support contract. To obtain support:

- Visit the EqualLogic Customer Support website to download the latest documentation and firmware. Go to www.equallogic.com and log in to your support account. If you do not have an account, register for an account.
- From the Customer Support website, you can submit a service request.
- In the United States, call toll-free 877-887-7337. Outside the United States, call +1 919-767-5729. If the issue is urgent, ask to speak with a member of the EqualLogic Customer Support team.

Warranty Information

The PS3000 Series array warranty is included in the shipping box. For information about registering a warranty, visit the EqualLogic website, www.equallogic.com.

Restricted Access Requirement

PS Series arrays must be installed in a restricted access location. A restricted access location is an area that is intended only for qualified or trained personnel.

Regulatory Agency Notices

PS Series arrays have been tested and found to comply with the limits for a Class A digital device, pursuant to part 15 of the FCC rules and other international standards. These limits are designed to provide reasonable protection against harmful interference when the equipment is operated in a commercial environment.

This equipment generates, uses, and can radiate radio frequency energy and, if not installed and used in accordance with the instruction manual, may cause harmful interference to radio communications. Operation of this equipment in a residential area is likely to cause harmful interference, which the user will be required to correct at his or her own expense.

Regulatory Agency Notes

Service Note	Disconnect all PS Series storage array power cables before servicing to avoid electric shock.
	There is a danger of explosion if a PS Series storage array control module cache battery is incorrectly replaced. Replace a battery only with the same or equivalent battery, as recommended by the manufacturer, and use the instructions in this document. Discard used batteries according to the manufacturer's instructions.

1 Basic Array Information

This chapter includes basic information about PS3000 Series arrays:

- *Array Front and Back Panels* on page 1-1
- *Interpreting Operations Panel LEDs* on page 1-2
- *Using an Electrostatic Wrist Strap* on page 1-4
- *Shutting Down and Restarting an Array* on page 1-4

Array Front and Back Panels

The front and back panels of a PS3000 Series array are shown below.

Figure 1-1: PS3000 Series Front Panel

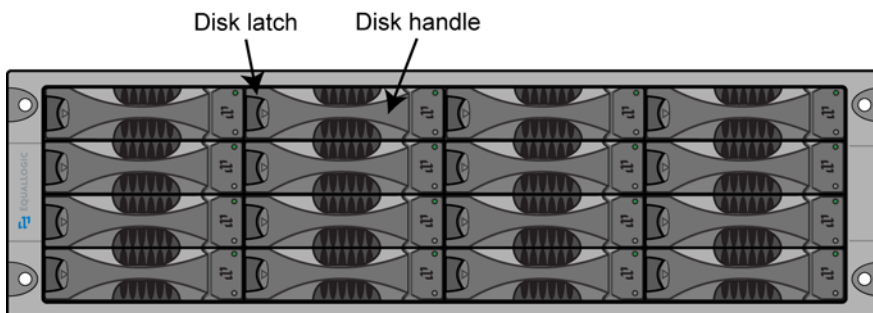
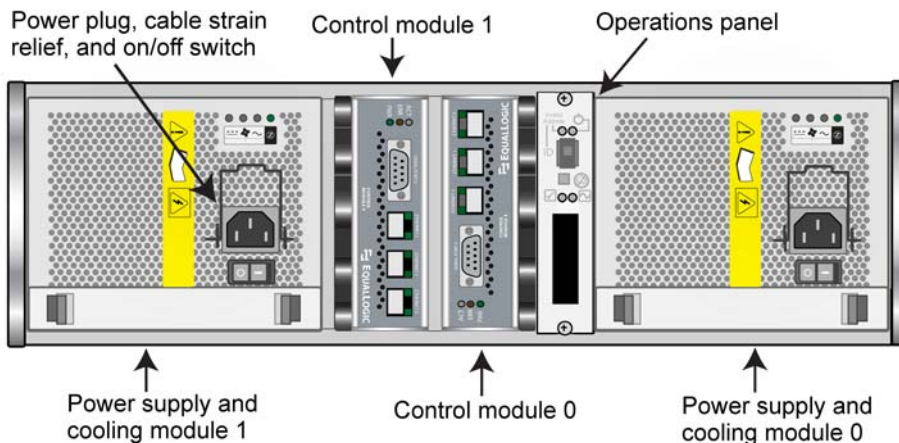

Figure 1-2: PS3000 Series Back Panel



Interpreting Operations Panel LEDs

The operations panel is used to monitor PS3000 Series hardware components. The panel is not redundant, but an array can continue to operate if it fails. See your PS Series array service provider for information about servicing the panel.

Figure 1-3 and Table 1-1 describe the LEDs on the PS3000 Series array operations panel, which can alert you to errors and conditions that require your attention. Serious problems should be reported to your PS Series service provider.

For information about other LEDs, see *Interpreting Disk LEDs* on page 2-1, *Interpreting Control Module LEDs* on page 3-2, and *Interpreting Power Supply and Cooling Module LEDs* on page 4-1.

Figure 1-3: Operations Panel LEDs

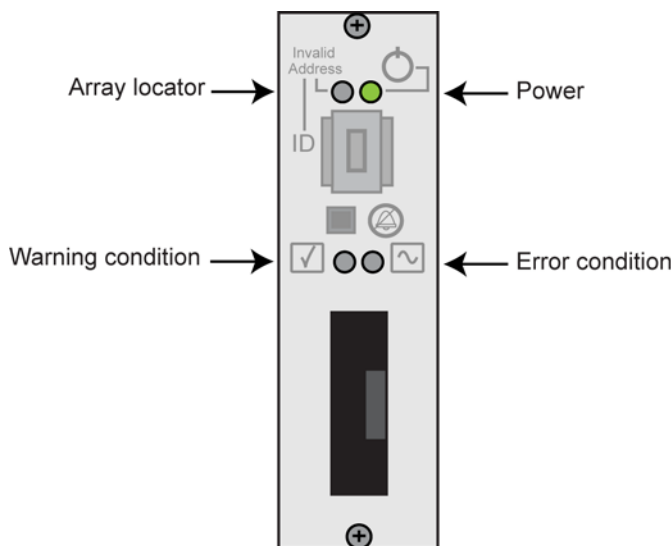

Table 1-1: Operations Panel LED Descriptions

Operations LED	Color	Description
Power (upper right)	Off	No power.
	Green	Power.
Array locator (upper left)	Off	No power or normal condition.
	Flashing orange	Administrator enabled the array locator function.

Table 1-1: Operations Panel LED Descriptions (Continued)

Operations LED	Color	Description
Warning condition (lower left)	Off	No power or normal condition.
	Flashing orange	One or more of the following has occurred: <ul style="list-style-type: none"> • RAID set is degraded but still functioning. • RAID set (volume level) has lost blocks. • Component temperature is near a limit. • Fan failed or fan RPMs exceed limit. • Power supply is not installed or has no power. • Only one control module installed or control module has failed over. • Control module has insufficient RAM. • Syncing active and secondary control modules. • No communication between control modules. • Installed spare disk does not have enough capacity to replace a disk in a RAID set. • A non-critical hardware component failed. • Real-time clock battery is low.
Error condition (lower right)	Off	No power or normal condition.
	Flashing orange	One or more of the following has occurred: <ul style="list-style-type: none"> • RAID is not functioning. • Lost block table is full. • Temperature exceeds upper or lower limit. • Control module cache has lost data. • A cooling module is not installed. • Both fans on a cooling module have failed. • Cache battery has less than 72 hours charge or temperature is too high to charge battery. • NVRAM coin cell battery failed. • Cache contains data that does not belong to any of the installed disks. • More than one valid RAID set exists in array. • Control modules are different models. • A critical hardware component has failed. • Operations panel failed or not installed. • Storage enclosure processor that monitors array components has experienced a failure.

Using an Electrostatic Wrist Strap

When handling the array chassis, disks, or control modules, you must use an electrostatic protection device to prevent electrostatic discharge.

An electrostatic wrist strap is included in the shipping box.

Figure 1-4: Using an Electrostatic Wrist Strap

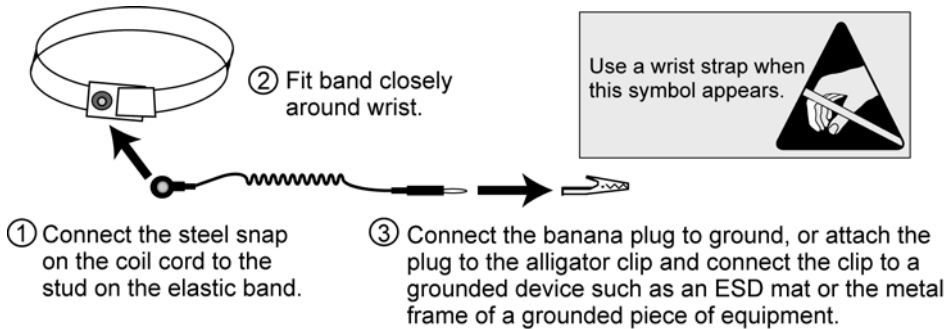

Shutting Down and Restarting an Array

A PS3000 Series array includes redundant, hot-swappable disks, power supplies, and control modules (if a dual control module array). You can remove a redundant component without affecting operation if a functioning component is available. Otherwise, it is recommended that you *cleanly* shut down the array and turn off power before removing a component.

Note: When an array is shut down, any volumes with data on the array will be set offline until the array is successfully restarted. This may affect initiators that are connected to the volumes.

To shut down an array, follow these steps:

1. Do one of the following:
 - Use telnet or SSH to connect to a functioning IP address assigned to a network interface on the array. Do *not* connect to the group IP address.
 - Use the null modem cable shipped with the array to connect Serial Port 0 on the active control module (ACT LED is green) to a console or a computer running a terminal emulator.

Serial line characteristics are as follows:

- 9600 baud
 - One STOP bit
 - No parity
 - 8 data bits
 - No hardware flow control
2. Log in to an account with read-write access, such as the `grpadmin` account.
 3. Enter the `shutdown` command, as shown next.

```
Login: grpadmin
Password: xxxxxxx
                Welcome to Group Manager
                Copyright 2001-2007 EqualLogic, Inc.
> shutdown
```

If you are using a serial connection to shut down an array, it is safe to turn off power when the “press any key” message appears. (Pressing any key will restart both control modules.)

If you are using a network connection, the session will be disconnected before the array is fully shut down. Confirm that the ACT LED on each control module is off (not lit) before turning off power to the array.

After performing array maintenance, you can turn on power to the array. When the array restart completes, the member and volumes will be set online.

2 Maintaining Disks

Each PS3000 Series array includes up to 16 hot-swappable disks. Disk maintenance topics include:

- *Interpreting Disk LEDs* on page 2-1
- *Disk Handling Requirements* on page 2-2
- *Identifying Failed Disks* on page 2-3
- *Removing Disks* on page 2-3
- *Installing Disks* on page 2-5

Interpreting Disk LEDs

Figure 2-1 shows how disks are numbered in a PS3000 Series array.

Figure 2-1: PS3000 Series Disk Numbering

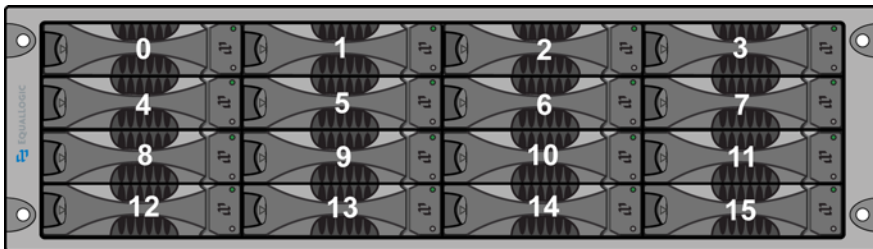

Figure 2-2 shows the disk LEDs. Table 2-1 describes the LEDs.

Figure 2-2: PS3000 Series Disk LEDs

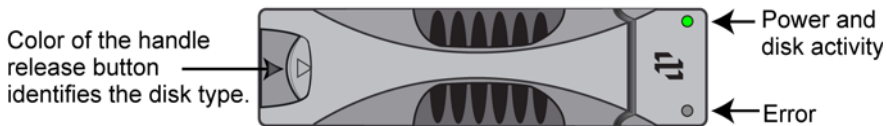

Table 2-1: PS3000 Series Disk LED Descriptions

Disk LEDs	Color	Description
Top	Off	No power or error condition.
	Green	Power.
	Flashing green	Disk activity.
Bottom	Off	No power or normal condition.
	Red	Error condition.

Disk Handling Requirements

You must adhere to the following disk handling requirements:

- **Store disks properly.** Store replacement disks in the packaging in which they were shipped. Do not stack disks or place anything on top of a disk.
- **Protect disks from electrostatic discharge.** Wear an electrostatic wrist strap when handling a disk, unless it is protected from electrostatic discharge.
- **Handle disks carefully.** Hold a disk only by the plastic part of the carrier or the handle. Do not drop or jolt a disk or force a disk into a disk slot.
- **Warm replacement disks to room temperature before installation.** For example, let a disk sit overnight before installing it in an array.
- **Do not leave disk slots empty.** Each disk slot in an array must contain a disk drive assembly or a blank carrier. Operating an array with an empty disk slot will void your warranty and support contract.
- **Do not remove a disk from its carrier.** This action will void your warranty and support contract.
- **Keep shipping material.** Return a failed disk to your PS Series array service provider in the packaging in which the replacement disk was shipped. Shipping disks in unauthorized packaging may void your warranty.

Identifying Failed Disks

Disks in a PS3000 Series array are numbered from 0 to 15 (from left to right, top row to bottom row). A disk failure is indicated by:

- The disk's error LED (bottom) is red, and the power LED (top) is off. See *Interpreting Disk LEDs* on page 2-1.
- A message on the console, in the event log, or in the Group Manager GUI Alarms panel describes a disk failure.
- The GUI Member Disks window or the CLI `member select show disks` command shows a disk failure.

Handling Failed Disks

How an array handles a disk failure depends on whether a spare disk is available and whether the RAIDset containing the failed disk is degraded. For example:

- If a spare disk is available, it replaces the failed disk. Performance is normal after reconstruction completes.
- If a spare disk is not available and the failed disk is in a RAIDset with no previous disk failure, the RAIDset becomes degraded. Performance may be impaired.
- If a spare disk is not available and the failed disk is in a RAIDset that is already degraded, data may be lost and must be recovered from a backup.

Removing Disks

Before removing a disk or blank carrier from an array, attach an electrostatic protection device, as described in *Using an Electrostatic Wrist Strap* on page 1-4.

Notes: Replace a failed disk as soon as possible to ensure the highest availability.

Do not remove a disk from a slot, unless you have another disk or a blank carrier to replace it. Each slot *must* contain a disk or blank carrier.

Do not remove a functioning disk from an array, unless the disk is a spare; otherwise, a RAIDset may become degraded. If you remove a spare, replace the disk as soon as possible.

Before completely removing a functioning disk from an array slot, wait 30 seconds to allow the disk to stop spinning and the heads to land.

Store replacement disks in the packaging in which they were shipped.

Figure 2-3 shows how to remove a disk from a PS3000 Series array. Instructions for removing a blank carrier are similar, except you do not have to wait 30 seconds.

Figure 2-3: Removing a Disk

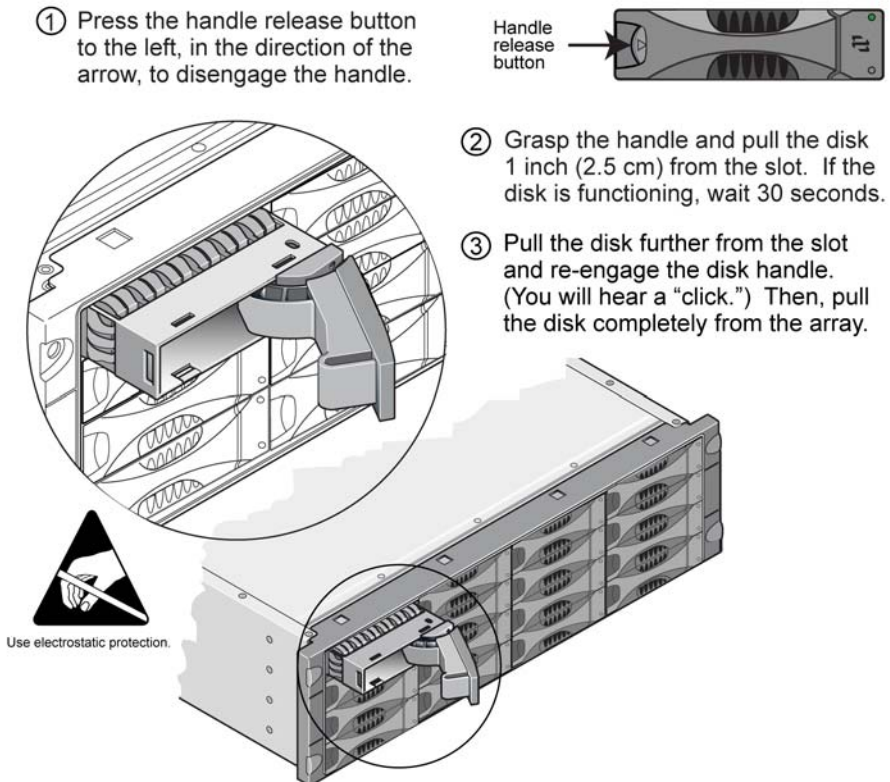

Installing Disks

Before installing a disk or blank carrier in an array, attach an electrostatic protection device, as described in *Using an Electrostatic Wrist Strap* on page 1-4.

Notes: Install only disks of the same type, speed, and spin rate in an array. The color of the handle release button indicates the disk type.

You can use disks with different sizes in an array. However, the smallest disk in the array will determine how much space can be used on each disk. For example, if the smallest disk is 400GB, only 400GB of space will be available for use on each disk.

Be sure to insert a disk fully in the chassis before pushing in the handle. When correctly installed, the disk carrier should *not* protrude from the chassis. After installation, make sure the disk power LED (top) is green or flashing green.

There is a two-minute delay between the time you insert a disk and the time the disk is automatically configured into a RAIDset. This time interval allows multiple disks to be simultaneously configured in an array, which is more efficient than installing a single disk, configuring it, and then repeating the process. For example, when you install a disk, the timer starts. If no other disks are installed, the disk is configured after a delay of two minutes. If you install another disk before two minutes have elapsed, the timer is restarted.

If you install a disk during RAID reconstruction or verification, the new disk will not be configured until the operation completes.

Figure 2-4 shows how to install a disk in an array. Use the same instructions for installing a blank carrier.

Notes: Make sure the disk is oriented in the position shown below, with the handle release button to the left.

When correctly installed, a disk will be level with the front of the array. If the disk is protruding from the array, reinstall the disk.

Figure 2-4: Installing a Disk

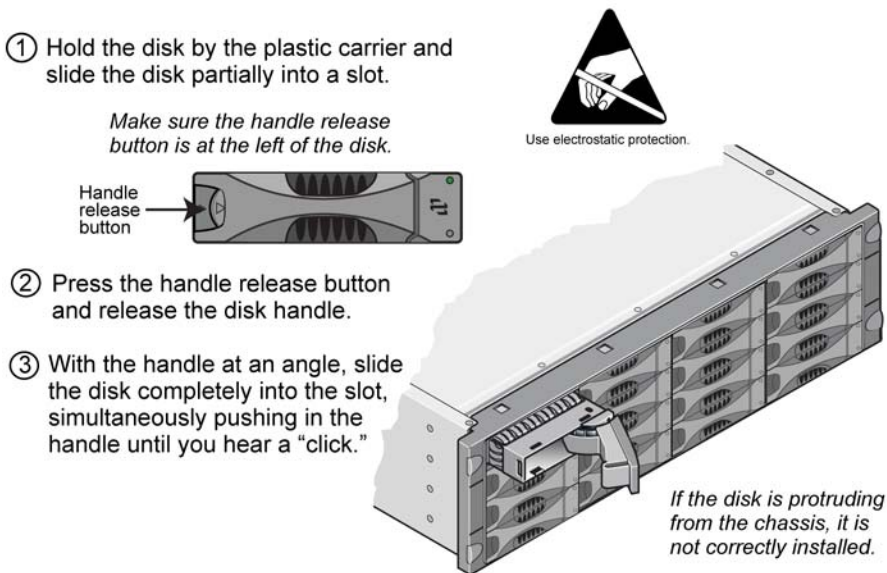

Verify that the new disk is operational by checking the LEDs on the front panel, as described in *Interpreting Disk LEDs* on page 2-1. The top LED should be green or flashing green, and the bottom LED should be off.

In addition, the GUI Member Disks window and the CLI `member select show disks` command output should show that the new disk is operational.

3 Maintaining Control Modules

A PS3000 Series array includes one or two hot-swappable control modules. Each control module includes a field-replaceable compact flash card (running PS Series firmware), in addition to cache and NVRAM batteries. For information about replacing a cache or NVRAM battery, contact your PS Series service provider.

Control module maintenance topics include:

- *Supported Control Modules* on page 3-1
- *Control Module Handling Requirements* on page 3-3
- *Identifying Control Module Failures* on page 3-3
- *Understanding Failover Behavior* on page 3-3
- *Maintaining Control Module Firmware* on page 3-4
- *Connecting Network Cables* on page 3-5
- *Removing a Control Module* on page 3-7
- *Installing a Control Module* on page 3-9
- *Replacing the Compact Flash Card* on page 3-11

Supported Control Modules

At the time of this release, PS3000 arrays support both Type 3 and Type 4 control modules, which are functionally equivalent and distinguished only by color. Always check the latest *Release Notes* for information about additional supported control modules.

This manual shows arrays with Type 4 control modules (gray), but the information also applies to arrays with Type 3 control modules (blue). However, *do not* mix control module types in an array.

Figure 3-1: Type 3 Control Module (Blue)

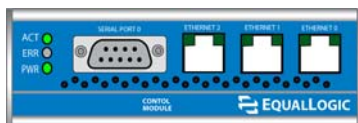
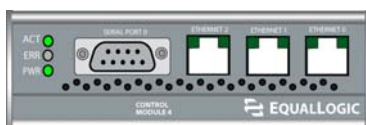

Figure 3-2: Type 4 Control Module (Gray)



Interpreting Control Module LEDs

Control modules have LEDs that enable you to determine the status of the control module (active or secondary) and identify problems. In addition, each network interface on a control module also has LEDs.

Figure 3-3: Control Module LEDs

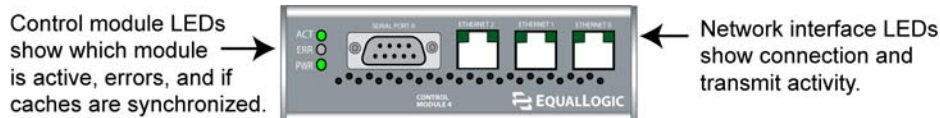

Note: Control modules are installed vertically in a PS3000 Series array, with the latch mechanism facing the power supply and cooling module.

Table 3-1: Control Module LED Descriptions

Control Module LEDs	Color	Description
ACT	Off	No power, secondary control module is not synchronized with active control module, or error condition.
	Green	Active control module (serving network I/O).
	Orange	Secondary control module; cache is synchronized with active control module.
ERR	Off	No power or no error condition.
	Red	Array is starting up or error condition.
PWR	Off	No power.
	Green	Power.

Table 3-2: Network Interface LED Descriptions

Network Interface LEDs	Color	Description
Left (as shown in Figure 3-3)	Off	No power or not connected to network.
	Green	Connected to network.
Right (as shown in Figure 3-3)	Off	No power or not transmitting.
	Green	Transmitting.

Control Module Handling Requirements

You must adhere to the following control module handling requirements:

- **Protect control modules from electrostatic discharge.** Always wear an electrostatic wrist strap when handling a control module, as described in *Using an Electrostatic Wrist Strap* on page 1-4. When not installed, store a control module in an antistatic bag or place it on a surface protected from electrostatic discharge.
- **Do not remove a control module from an array while the control modules are synchronizing.** When synchronization completes, a console message will appear. Also, the ACT LED on the secondary control module will be orange.
- **Do not leave a control module slot empty.** In an array with one control module, always attach a blank face plate to the empty control module slot.

Identifying Control Module Failures

A failure in a control module can be indicated by the following:

- A control module's ERR LED is red or the PWR LED is off but there is power to the array. See *Interpreting Control Module LEDs* on page 3-2.
- The ACT LED on one control module is green, but the ACT LED on the other control module is off instead of orange.
- A message on the console, in the event log, or in the Group Manager GUI Alarms panel describes a control module failure.
- The GUI Member Controllers window or CLI `member select show controllers` command shows the control module as not installed.

CM0 refers to the control module to the right, when viewing the array back panel. CM1 refers to the control module to the left.

Understanding Failover Behavior

A PS3000 Series array can have one to three active network connections. In a dual control module array, only one control module is active (serving network traffic) at one time. Each control module includes a battery-backed write cache for storing recently-used data. For redundancy, the cache on the secondary control module mirrors the data that is stored in the cache on the active control module.

Each control module has three ports: Ethernet 0, Ethernet 1, and Ethernet 2. The active control module can use a network interface only if there is a cable

connected to the port on the active control module. Therefore, you should connect a cable to the network interface port on each control module to ensure that both control modules can access an interface.

A PS3000 Series array provides two types of network failure protection:

- **Network connection failover.** If multiple network interfaces are configured and one network interface fails, iSCSI initiators that were connected to the failed interface can reconnect to the group IP address and be redirected to a functioning interface. For example, in a single control module array, if Ethernet 0 and Ethernet 1 are connected to a network, and Ethernet 0 fails, initiators that were connected to Ethernet 0 can be redirected to Ethernet 1.
- **Control module failover.** In a dual control module array, if the active control module fails, the secondary automatically takes over and becomes active. If a cable is connected to the port on the newly active control module, network I/O can continue through that interface. Control module failover is transparent to applications, but iSCSI initiators must reconnect to the group IP address.

Maintaining Control Module Firmware

A PS3000 Series array includes one or two control modules, each with a compact flash card running the array firmware. You should run the latest firmware version to take advantage of new product features and enhancements.

Caution: In a dual control module array, both control modules *must* be running the same firmware version; otherwise, only one control module will be functional. When you use the `update` command procedure, both control modules are updated to the same firmware version.

Group members should run the same firmware version; otherwise, only functionality common to all versions will be available in the group. See the PS Series *Release Notes* for information about mixed-firmware groups.

If you are upgrading to a dual control module array or replacing a failed compact flash card, be sure to order the correct firmware version from EqualLogic. If you are replacing a failed control module, remove the compact flash card from the failed control module and install it in the replacement control module. This will ensure that you retain the correct firmware.

A *new* compact flash card will show the firmware version on the label. To display the firmware version running on an array, examine the GUI Member Controllers window or use the CLI `member select show controllers` command. If the firmware on a compact flash card does not match the firmware running on an array, do not install it. Instead, contact your PS Series array service provider.

Connecting Network Cables

A PS3000 Series array must have at least one and can have up to three active network connections at one time. Multiple network connections are recommended for performance and availability.

Connect cables to network interfaces as follows:

- For copper-based networks, use Category 5E or Category 6 cables with RJ45 connectors. Use Category 5 cables if they meet the TIA/EIA TSB95 standard.
- Connect interfaces in this order: Ethernet 0, Ethernet 1, and Ethernet 2.
- Connect interfaces to different network switches.
- In a dual control module array, to ensure connectivity if a control module fails, connect a cable to the interface port on each control module. For example, connect a cable to Ethernet 0 on CM0 and Ethernet 0 on CM1.

See the PS Series *QuickStart* and the Technical Report on the EqualLogic Customer Support website for network requirements and recommendations.

For a single control module array, the minimum network configuration is one network connection to Ethernet 0. However, the single network connection is a potential point of failure. Therefore, it is recommended that you connect multiple network interfaces to different network switches.

For example, if you connect cables as shown in Figure 3-4, and Ethernet 0 fails, initiators can be redirected to another functioning interface. This configuration provides the maximum network bandwidth.

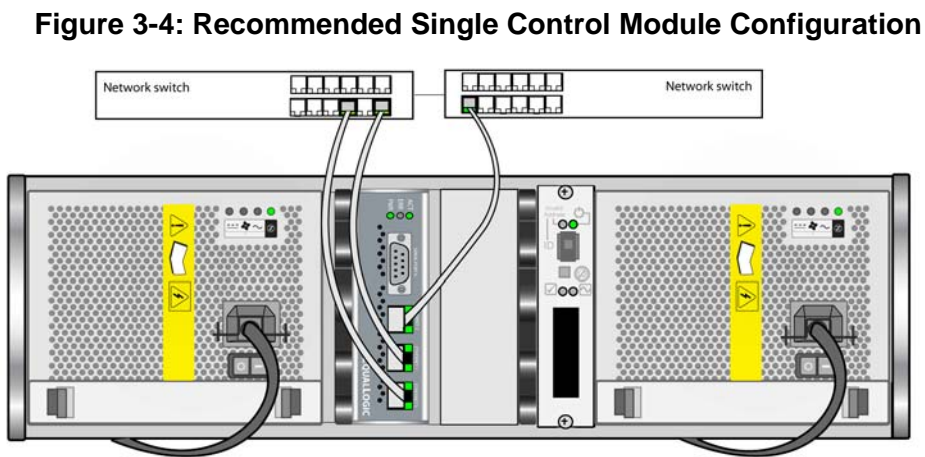

For a dual control module array, the minimum network configuration is a network connection to Ethernet 0 on *both* control modules. Although this configuration protects against control module failover, it is still a potential point of failure (for example, if the network cable connected to the active control module is disconnected). Therefore, it is recommended that you connect multiple network interfaces to different switches.

Figure 3-5 shows the minimum network configuration for a dual control module PS3000 Series array. Cables are connected to Ethernet 0 on both control modules.

Figure 3-5: Minimum Dual Control Module Configuration

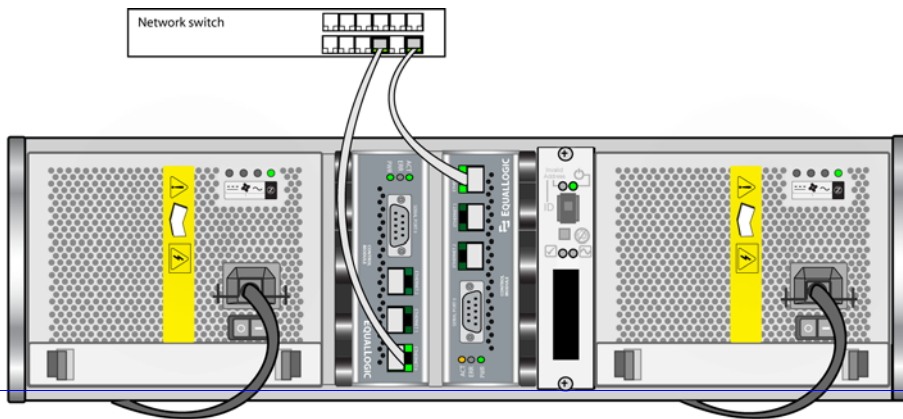
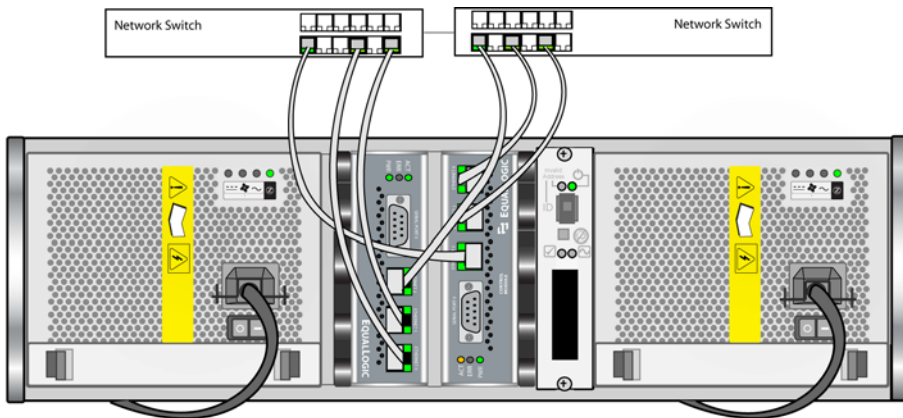

Figure 3-6 shows the recommended network configuration for a dual control module PS3000 Series array. This configuration provides the highest network availability and the maximum network bandwidth.

Figure 3-6: Recommended Dual Control Module Configuration

Removing a Control Module

If a control module fails, you should remove it and replace it with a functioning control module. You also may need to temporarily remove a control module to replace a compact flash card.

In a dual control module PS3000 Series array, you can remove a control module without shutting down the array, if the remaining control module has at least one connected and functioning network interface. However, if you remove the active control module (the LED labeled ACT will be green), there will be a short interruption as failover to the secondary control module occurs.

Caution: Do not remove a control module from an array while the control modules are still synchronizing. A message will appear on the console when synchronization completes. The ACT LED on the secondary control module will be orange when synchronization completes.

Before removing a control module:

- If you have a single control module array, if possible, cleanly shut down the array before removing the control module to protect against cache data loss. See *Shutting Down and Restarting an Array* on page 1-4.
- Disconnect any serial or network cables attached to the control module. If you have a dual control module array, you may want to re-attach the network cables to the functioning control module to ensure uninterrupted data access.
- Attach an electrostatic wrist strap, as described in *Using an Electrostatic Wrist Strap* on page 1-4.

To remove a control module, follow the instructions in Figure 3-7.

Note: If you are removing a failed control module, you must remove the compact flash card from the failed control module, as described in *Replacing the Compact Flash Card* on page 3-11. Then, install the card in the replacement control module. This will ensure that the new control module is running the correct firmware.

Figure 3-7: Removing a Control Module

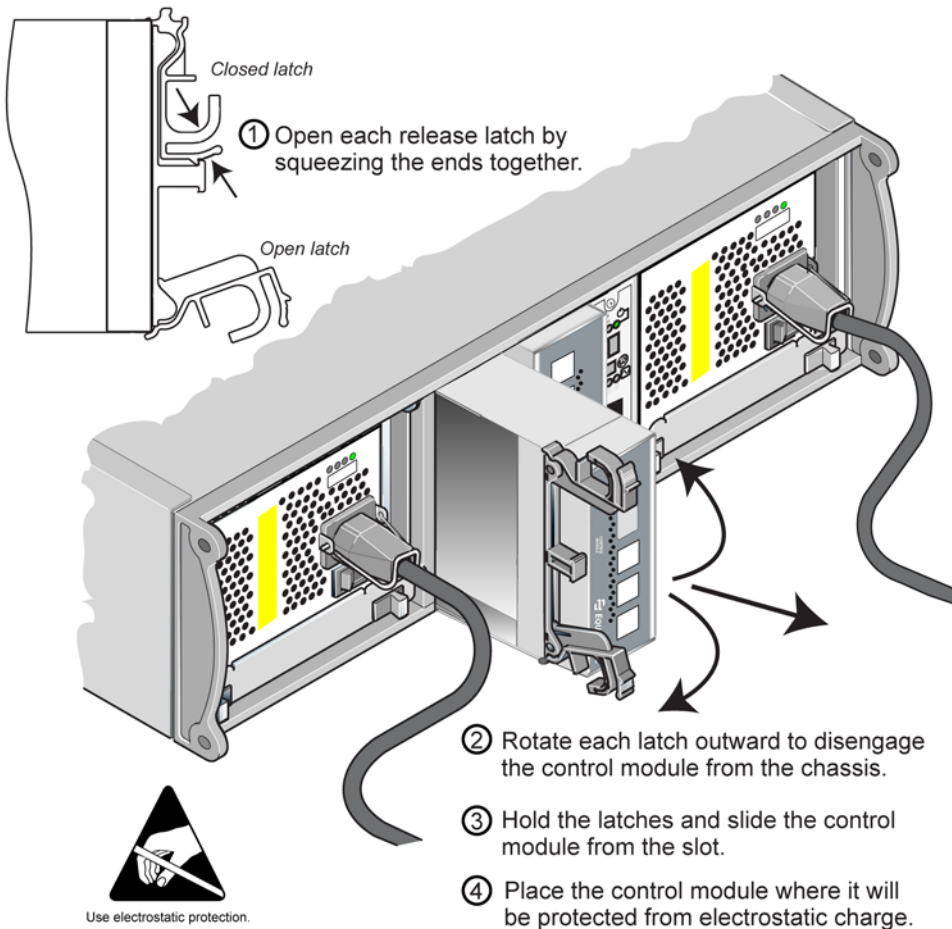

Once you remove a control module, place it on a surface that is protected from electrostatic charge.

If the array will permanently operate with only one control module, you *must* install a blank control module in the empty slot. You can order a blank from your PS Series array service provider. For proper cooling, do not leave a control module slot empty.

Installing a Control Module

You may need to install a control module as part of an upgrade from a single control module array to a dual control module array or for control module maintenance, such as replacing a failed control module.

Notes: You can upgrade to a dual control module array without shutting down the array.

Only install control modules of the same type in a PS3000 Series array.
Do not mix control module types in an array.

Before removing a control module:

- Make sure the firmware on the control module's compact flash card matches the firmware running on the already-installed control module. See *Maintaining Control Module Firmware* on page 3-4.

If you are replacing a failed control module, be sure to remove the compact flash card from the failed control module and install it in the replacement control module. This will ensure that the new control module is running the correct firmware.

- If you are upgrading to a dual control module array, remove the blank control module from the slot. See the instructions in Figure 3-7 for opening the latch.
- Attach an electrostatic wrist strap (see *Using an Electrostatic Wrist Strap* on page 1-4).

To install a control module, refer to the instructions in Figure 3-8.

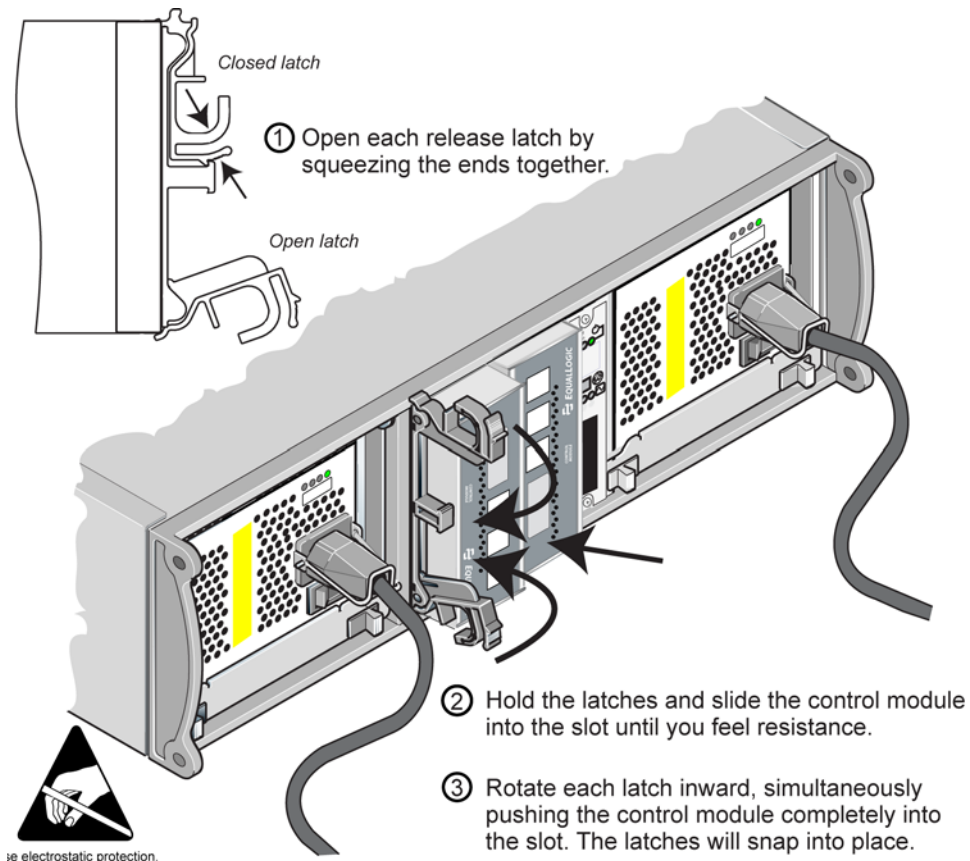
Figure 3-8: Installing a Control Module

After installing a control module, connect network cables to the control module, as described in *Connecting Network Cables* on page 3-5. Then, if the array was shut down, turn on power to the array.

Check the LEDs, as described in *Interpreting Control Module LEDs* on page 3-2. Also, check the GUI Member Controllers window or invoke the CLI `member select show controllers` command. The control module status will be either *active* (if there is only one control module) or *secondary*.

If two control modules are installed but only one appears in the GUI or CLI, the control module may not be properly installed. Re-seat the control module. If both control modules still do not appear in the GUI or CLI, they may not be running the same firmware, and you should contact your PS Series array service provider.

Note: Once connected, a control module cache battery may begin to charge. If you have a dual control module array and the low-battery-safe cache policy is enabled (the default), the array will operate in write-through mode until the cache battery is fully charged.

However, if you need optimal performance before the battery is fully charged, once the battery status is `good/charging`, you can *temporarily* disable the low-battery-safe policy and force the array to operate in write-back mode. Be sure to re-enable the low-battery-safe policy when the battery is fully charged. See the *Group Administration* manual for information about cache policies.

Replacing the Compact Flash Card

Each control module includes a compact flash card running the PS Series array firmware. There are two reasons why you may need to replace a compact flash card:

- The compact flash card fails on an otherwise functioning control module. Be sure to order a replacement card with the *same* firmware version as the failed card. See *Maintaining Control Module Firmware* on page 3-4 for information about identifying firmware.
- The control module fails, but the compact flash card is still functioning. If this occurs, remove the compact flash card from the failed control module and install the card in the replacement control module. This will ensure that the new control module is running the correct firmware.

To access the compact flash card, you can remove a control module in a dual control module array without shutting down the array, if the remaining control module has at least one connected and functioning network interface. If you remove the active control module (the LED labeled ACT will be green), there will be a short interruption as failover to the secondary control module occurs.

Before replacing a compact flash card:

- If you have a single control module array, if possible, cleanly shut down the array before removing the control module. See *Shutting Down and Restarting an Array* on page 1-4.
- Attach an electrostatic wrist strap, as described in *Using an Electrostatic Wrist Strap* on page 1-4.
- See *Removing a Control Module* on page 3-7 for instructions on removing a control module.

- You can access the compact flash card by sliding the control module *partially* from the slot. If you completely remove the control module, place it on a surface that is protected from electrostatic discharge.

Figure 3-9 on page 3-12 shows how to remove a compact flash card from a control module and also how to install a card.

After you replace the compact flash card, see *Installing a Control Module* on page 3-9 for instructions on installing a control module.

Figure 3-9: Removing and Installing a Compact Flash Card

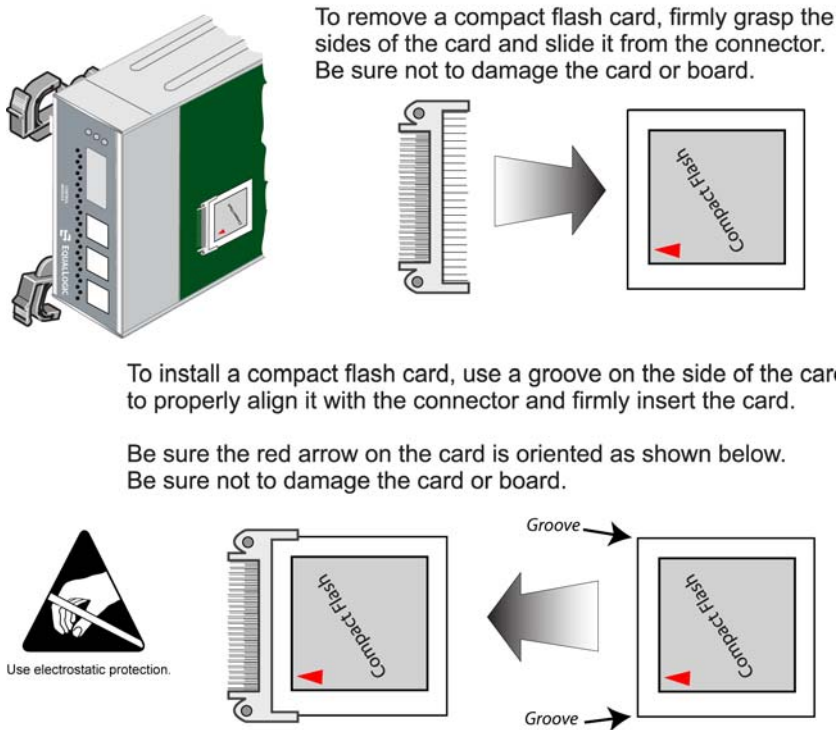

After installing the control module, if the array was shut down, turn on power.

To ensure that the control module is operational, check the LEDs, as described in *Interpreting Control Module LEDs* on page 3-2. Also, check the GUI Member Controllers window or invoke the CLI `member select show controllers` command. The control module status will be either `active` or `secondary`.

4 Maintaining Power Supply and Cooling Modules

A PS3000 Series array includes two hot-swappable, combination power supply and cooling modules.

Maintenance topics include:

- *Interpreting Power Supply and Cooling Module LEDs* on page 4-1
- *Identifying Power Supply and Cooling Module Failures* on page 4-2
- *Removing a Power Supply and Cooling Module* on page 4-2
- *Installing a Power Supply and Cooling Module* on page 4-4

Interpreting Power Supply and Cooling Module LEDs

Use the power supply and cooling module LEDs, shown in Figure 4-1 and described in Table 4-1, to determine the module status and identify problems.

Figure 4-1: Power Supply and Cooling Module LEDs

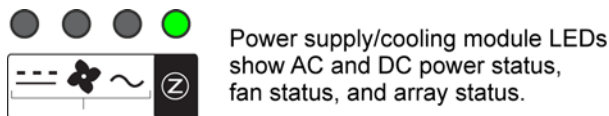

Table 4-1: Power Supply and Cooling Module LED Descriptions

Power Supply and Cooling Module LED	Color	Description
---	Off	No power or normal condition.
	Orange	DC power failure.
Fan icon	Off	No power or normal condition.
	Orange	Fan failure.
~	Off	No power or normal condition.
	Orange	AC power failure.
Z icon	Off	No power.
	Green	Normal array operation.

Identifying Power Supply and Cooling Module Failures

A failure on a power supply and cooling module can be indicated by the following:

- A power supply and cooling module LED is orange. See *Interpreting Power Supply and Cooling Module LEDs* on page 4-1.
- Message on the console, in the event log, or in the Group Manager GUI Alarms panel describes a power supply and cooling module failure.
- GUI Member Enclosure window or the CLI `member select show enclosure` command shows a power supply and cooling module failure.

Power supply and cooling module 0 refers to the module on the right side of the array back panel (when facing the back of the array). Power supply and cooling module 1 refers to the module on the left side. See Figure 1-2 on page 1-1 for details.

Removing a Power Supply and Cooling Module

If a power supply and cooling module fails, you must replace the module as soon as possible, although an array can operate with only one working module. To ensure proper cooling, do not remove a failed module until you are ready to replace it.

You can remove a power supply and cooling module from an array without affecting array operation if the second module is installed and functioning. Otherwise, if possible, cleanly shut down the array before removing the module, as described in *Shutting Down and Restarting an Array* on page 1-4.

Caution: After installing a power supply and cooling module, wait until the new module initializes before removing the other module. New module initialization can take from one to ten seconds. Completion is indicated by the green power LED and event log messages stating that fans have returned to their normal speed.

Figure 4-2 shows how to remove a power supply and cooling module from an array.

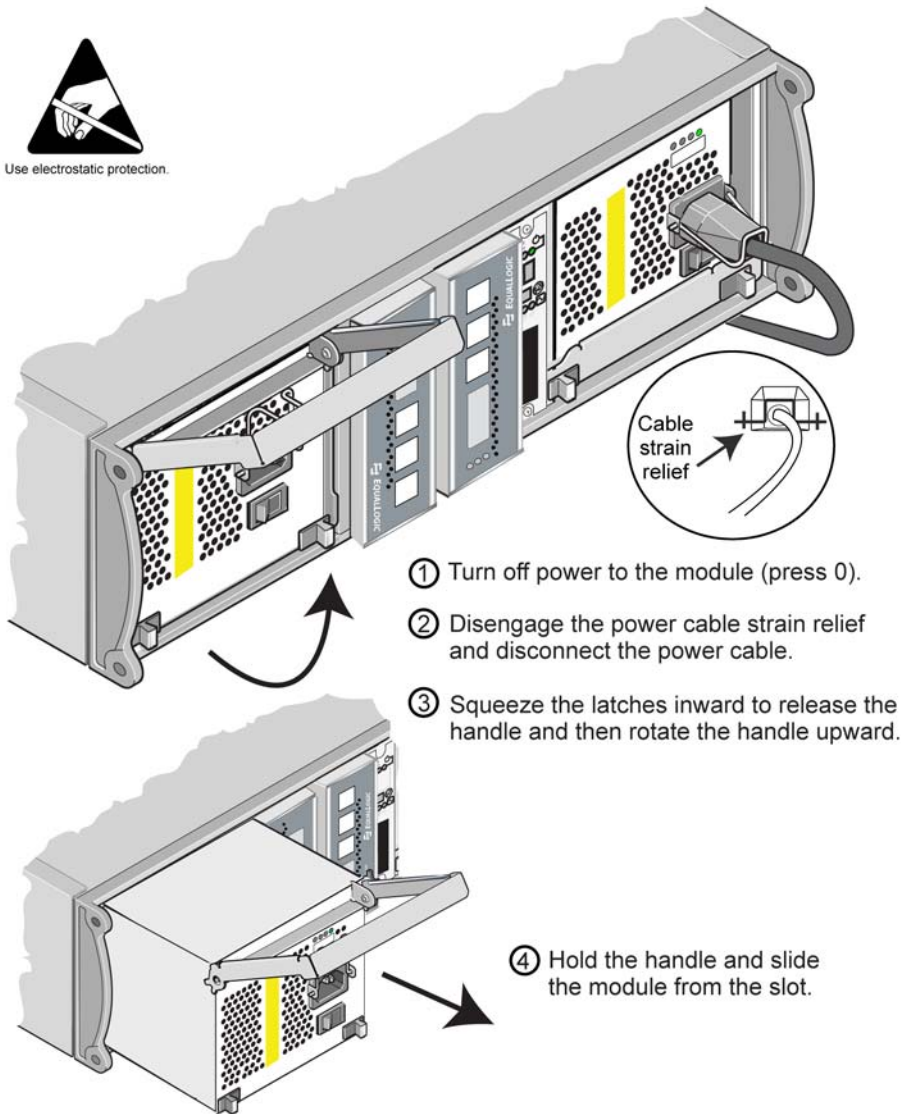
Figure 4-2: Removing a Power Supply and Cooling Module

Installing a Power Supply and Cooling Module

To install a power supply and cooling module in an array, refer to Figure 4-3.

Figure 4-3: Installing a Power Supply and Cooling Module

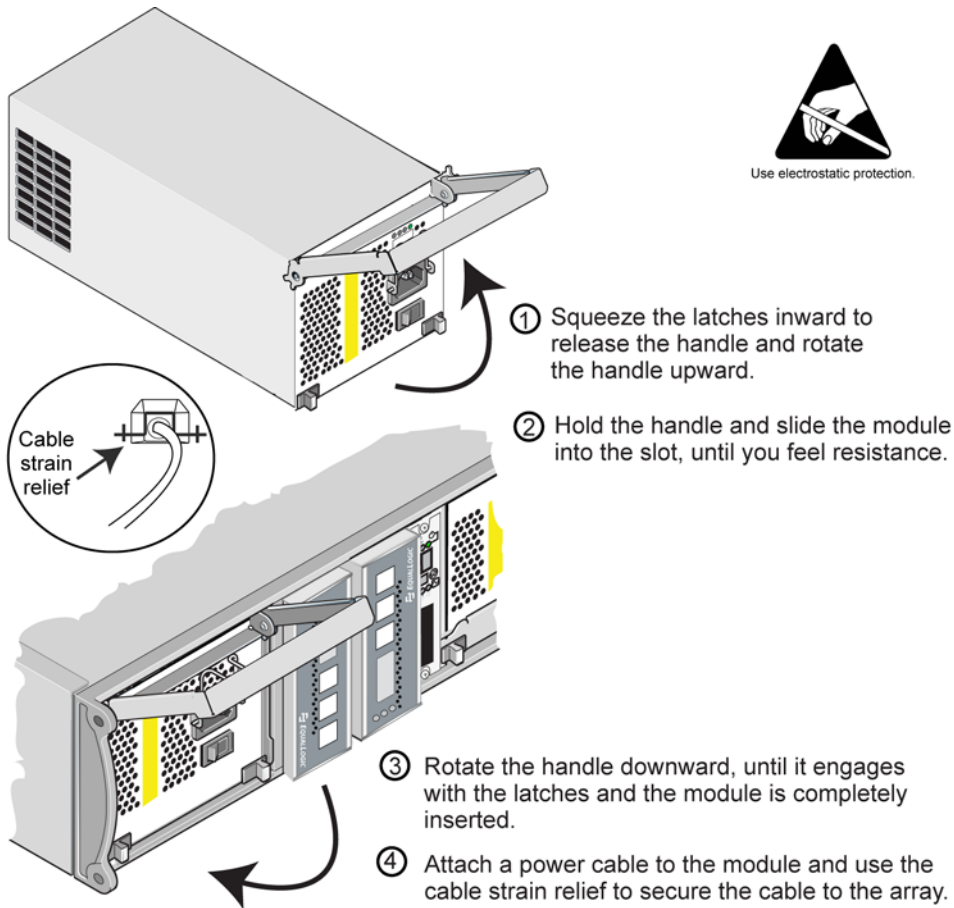

If your PS Series array was shipped with a power cable, use this cable to meet safety requirements.

Be sure to use the cable strain relief to secure the power cable to the array, as shown in Figure 4-4.

Figure 4-4: Using the Cable Strain Relief

If you need to reverse the cable strain relief wire for your power cable configuration, press the wire ends together to disengage the wire from the power plug socket. Reverse the wire and re-attach it to the socket.

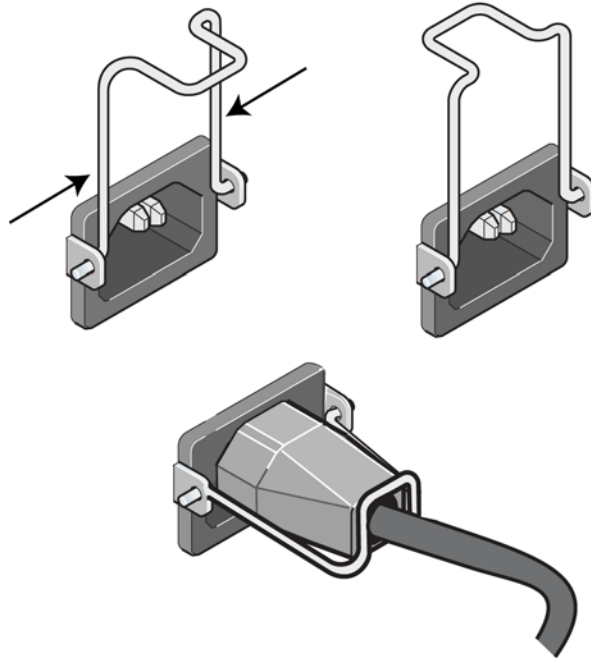

Turn on power to the power supply and cooling module (press $-$). Initialization generally can take from one to ten seconds. Completion is indicated by the green power LED and event log messages stating that fans have returned to their normal speed.

To ensure that the new module is operational, check that there are no red LEDs. Also, check the GUI Member Enclosure window or invoke the CLI `member select show enclosure` command.

A Environmental, Power, and Other Specifications

Table A-2 describes the environmental, power, and physical specifications for a PS3000 Series array.

Table A-2: PS3000 Series Array Specifications

Component	Requirement
Weight of fully-loaded array	77.6 pounds or 35 kilograms
Operating temperature	41 to 95 degrees F / 5 to 35 degrees C
Storage temperature	-22 to 140 degrees F / -30 to 60 degrees C
Maximum operating altitude	10,000 feet (3048 meters)
Operational relative humidity	20 to 80% non-condensing
Thermal output (fully-loaded array)	1700 BTU/hour
Operational shock	5 G for 10 ms 1/2 sin
Operational vibration	Random 0.21grms 5 - 500 Hz
Input voltage	100 to 240 VAC (auto-sensing)
Input frequency	48 - 62 Hz
System input power	530 VA (maximum)
Power supplies	Dual, 450 watts DC output Maximum input power: 0.7 KVA Input current: 7 – 3.5A
Height/Width/Depth	5.12" x 19" x 21.7" (13 x 48.26 x 55.1 cm)

Index

A

array

- back panel 1-1
- batteries 3-1
- control module restriction 3-9
- control modules 3-1
- cooling 4-1
- disks 2-1
- environmental requirements A-1
- failure indications 1-2
- fans 4-1
- firmware 3-4
- front panel 1-1
- LEDs 1-2, 2-1, 3-2, 4-1
- maximum network availability 3-6
- maximum network bandwidth 3-5, 3-6
- power supplies 4-1
- protecting from discharge 1-4
- shutdown procedure 1-4
- specifications A-1

B

batteries

- charging 3-11
- servicing 3-1

C

- cable strain relief, using 4-5
- cables (network), connecting 3-5
- cables (power), connecting 4-4
- cables (serial), connecting 1-4
- compact flash card
 - firmware requirements 3-4
 - identifying firmware 3-4
 - moving 3-8, 3-9, 3-11
 - replacing 3-4, 3-11
- control modules

batteries 3-1

- charging cache battery 3-11
- checking proper installation 3-10
- compact flash card moving 3-8, 3-9, 3-11
- compact flash card replacement 3-4, 3-11
- failover behavior 3-3
- failure indications 3-3
- firmware identification 3-4
- firmware requirements 3-4, 3-9, 3-11
- handling requirements 3-3
- installing in array 3-9
- LEDs 3-2
- locating 3-3
- removing from array 3-7
- restriction on mixing 3-9
- synchronizing 3-3
- types 3-9
- verifying operational status 3-10

cooling

- indications of failure 4-2
- initialization 4-2
- installing module in array 4-4
- LEDs 4-1
- locating modules 4-2
- removing module from array 4-2
- verifying operational status 4-5

D

disks

- failure behavior 2-3
- failure indications 2-3
- handling requirements 2-2
- installing in array 2-6
- LEDs 2-1
- locating 2-3
- protecting 2-2

- removing from array 2-3
- verifying operational status 2-6

E

- electrostatic protection, using 1-4
- environmental requirements A-1

F

failover

- control module 3-3, 3-4
- network connection 3-4
- port 3-4

failure indications

- array 1-2
- control modules 3-3
- cooling 4-2
- disks 2-3
- power 4-2

fans

- failure indications 4-2
- initialization 4-2
- installing module in array 4-4
- LEDs 4-1
- locating modules 4-2
- maintaining 4-1
- removing module from array 4-2
- verifying operational status 4-5

firmware

- identifying 3-4
- requirements 3-4, 3-11

L

LEDs

- control module 3-2
- cooling modules 4-1
- disks 2-1
- network interfaces 3-2
- operations panel 1-2
- power supplies 4-1

N

network

- cable connections 3-5
- configuration examples 3-5
- failure protection 3-4
- increasing availability 3-5
- increasing performance 3-5
- maximum availability 3-6
- maximum bandwidth 3-5, 3-6
- recommendations 3-5
- requirements 3-5

network interfaces, LEDs 3-2

O

operations panel

- LEDs 1-2
- servicing 1-2

P

physical requirements A-1

power cables

- restriction 4-4
- using strain relief 4-4

power supplies

- cable strain relief 4-5
- indications of failure 4-2
- initialization 4-2
- installing module in array 4-4
- LEDs 4-1
- locating modules 4-2
- maintaining 4-1
- removing module from array 4-2
- verifying operational status 4-5

R

requirements

- array handling 1-4
- control modules 3-3
- cooling 4-2
- disks 2-2
- environmental A-1
- firmware 3-4
- network 3-5
- physical A-1

power 4-2
power cables 4-4

S

serial connection, making 1-4
shutting down an array 1-4
specifications, array A-1

U

upgrading to dual control modules 3-4

110 Spitbrook Road, Nashua, NH 03062
Tel 603.579.9762 / Fax 603.579.6910 / www.equallogic.com



Copyright © EqualLogic, Inc. All rights reserved. EqualLogic, PeerStorage, and Simplifying Networked Storage are trademarks or registered trademarks of EqualLogic, Inc. All other brand or product names mentioned are trademarks or registered trademarks owned by their respective companies or organizations.