

Dell EMC XC Xpress Hyper-Converged Appliance Deployment Guide for ESXi

This document contains deployment information for the Dell EMC XC430 Xpress.

Dell EMC Engineering
September 2017

Revisions

Date	Description
June 2017	Initial release
September 2017	Update to Fabric Manager name and to limit document to XC Xpress.

The information in this publication is provided “as is.” Dell Inc. makes no representations or warranties of any kind with respect to the information in this publication, and specifically disclaims implied warranties of merchantability or fitness for a particular purpose.

Use, copying, and distribution of any software described in this publication requires an applicable software license.

Copyright © 2017 Dell Inc. or its subsidiaries. All Rights Reserved. Dell, EMC, and other trademarks are trademarks of Dell Inc. or its subsidiaries. Other trademarks may be the property of their respective owners. Published in the USA. [9/18/2017] [A02]

Dell EMC believes the information in this document is accurate as of its publication date. The information is subject to change without notice.

Table of contents

Revisions.....	2
1 Overview.....	5
1.1 Documentation resources.....	5
1.2 Introduction.....	5
1.3 About XC430 Xpress IT infrastructure.....	6
2 Installing hardware.....	7
2.1 Installation summary.....	7
2.2 Unpacking the appliances.....	7
2.3 Connecting to a network switch.....	7
2.3.1 Dell EMC XC430 Xpress with 1Gbe switch.....	8
2.3.2 Dell EMC XC430 Xpress with 10 Gbe switch.....	8
2.4 Connecting servers to electrical outlets.....	8
2.5 Turning on the appliances.....	8
3 Configuring iDRAC for remote network access (Recommended).....	10
3.1 Logging in to Dell iDRAC (Recommended).....	12
4 Getting ready for cluster setup.....	13
4.1 Downloading Java Runtime Environment.....	13
4.2 Downloading Google Chrome.....	14
4.3 Setting up Nutanix Support Portal.....	14
4.3.1 Registering your Service Tags with Nutanix.....	15
4.4 Downloading Foundation Applet.....	15
4.5 Downloading Fabric Manager.....	16
5 About Fabric Manager.....	17
6 About cluster creation.....	18
6.1 Discovering appliances with Nutanix Foundation Applet.....	18
6.2 Displaying discovered appliances.....	19
6.3 Defining the cluster.....	21
6.4 Setting up the appliance.....	22
6.5 Selecting images.....	22
6.6 Creating a cluster.....	25
6.6.1 Understanding PULSE.....	26
6.6.2 Dell Support Assist.....	26

7	Managing your cluster using Prism	27
7.1	Adding your Xpress cluster to vCenter	28
7.2	Running virtual machines on the default container	28
7.3	Prism monitoring software	29
8	Getting Help.....	30
8.1	Contacting Dell	30
8.2	Locating Service Tag.....	30
8.3	Quick Resource Locator	31
8.4	Documentation.....	31
A	Installation prerequisites.....	32
A.1	ESXi installation requirements.....	32
A.2	About Network Time Protocol (NTP)	32
A.2.1	Configuring NTP servers	32
A.3	Domain Name Server (DNS) requirements	33
A.4	Networking recommendations	33
A.4.1	Management network	34
A.4.2	Production network.....	34
A.5	Important information about SATADOM.....	35
A.6	Setting up the HTTP proxy in Prism	35
A.7	Setting up the name Server (DNS) in Prism.....	36
A.8	Creating bare metal recovery image	36
B	Introduction to troubleshooting.....	38
B.1	Foundation Applet issues	38
B.1.1	Unable to launch the Nutanix Foundation Applet from management workstation.	38
B.2	Desired appliances are not discovered in Foundation Launcher.	39
B.2.1	Ensure management workstation is connected on the same production network.	39
B.3	Cluster creation does not complete successfully	40
B.4	Unable to connect external networks/sites including websites, or PULSE	41
B.5	Why can't I discover my appliances?	41
C	Deployment checklist	42
C.1	Default / set up cluster credentials	42

1 Overview

The Dell EMC XC430 Xpress system is a hyper-converged appliance based on the Dell EMC XC430 paired with Nutanix software. The Dell EMC XC430 Xpress hardware platform supports two Intel Xeon v4 processors, up to 12 DIMMs, and one SSD and three HDDs. The XC Xpress solution includes the Dell EMC XC appliance and software from Nutanix (used as a virtual appliance), which simplifies virtualization by converging compute, storage, and network into a single appliance that is deployed in a clustered environment. For more information see, Dell.com/xcseriesmanuals. There is also a [QRL](#) that links you immediately to documentation and instructional videos on the QRL site.

1.1 Documentation resources

For a list of the associated documentation, see the *Dell EMC XC430 Xpress Hyper-Converged Appliance Support Matrix* found at Dell.com/xcseriesmanuals.

1.2 Introduction

The XC Xpress is a solution designed to bring the power of the Nutanix enterprise cloud platform to small and medium businesses (SMBs). The Dell EMC XC Xpress is designed to address the IT needs of smaller organizations through ease of deployment and management.

The Xpress features are limited to the features listed here:

Table 1 XC Xpress feature list

Available premium features	Feature limitations
Multi-hypervisor support	Max cluster size = 4 appliances
Virtualization management	2 clusters max (Primary/on site DR Cluster)
Single site disaster recovery (DR)	No heterogeneous clusters
Cloud connect	No multi-site DR
Metro availability	No availability domains
Prism starter and central	No resilience factor of 3 (RF3)
MapReduce compression and dedup	No Prism Pro
Supports 1 Gbe and 10 GbE networks	No erasure coding
	No encryption
	No all-flash drives (no all SSD configuration)

1.3 About XC430 Xpress IT infrastructure

The XC430 Xpress appliance is designed so that a small IT staff can install and manage the entire IT infrastructure. In this context, we have a management network and a production network.

Warning: Network communication between the Controller VM (CVM) and the host appliance leverages the 192.168.5.x IP subnet on a private virtual network. You cannot use the 192.168.5.x IP subnet for your production or iDRAC management networks.

Note: Management network (iDRAC) may be located on the same or different IP subnet as production network.

The following image is a physical diagram for an XC430 Xpress cluster. Three or four physical appliances function as a cluster as shown in Figure 1.

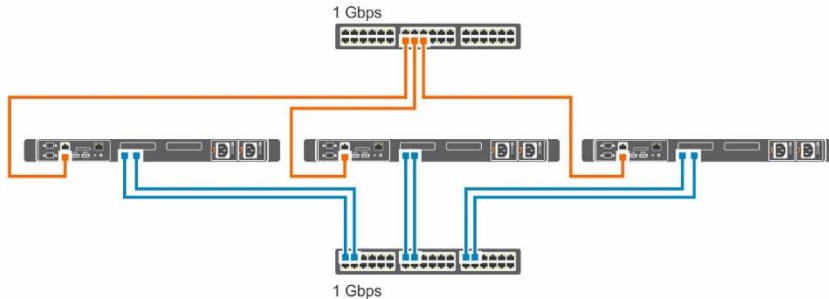

Figure 1 Physical diagram for an XC430 Xpress cluster

2 Installing hardware

You must have filled out the [Deployment Checklist](#), prior to any of the following tasks.

2.1 Installation summary

The following tasks outline the XC Xpress installation process and the details of each task follow below.

1. Unpack the Dell EMC XC430 appliances.
2. Install Dell EMC XC430 Xpress appliance into the rack. For more information about installing the server into the rack, see the rack documentation included with your solution.
3. Connect the network interface connections to the appropriate network switches.
4. Connect each of the servers to an electrical outlet.
5. Power the systems on by pressing the power button.

2.2 Unpacking the appliances

Before you begin unpacking the appliances, read through the following documentation. Documentation is found at Dell.com/xcseriesmanuals. The Support Matrix for this product contains the required software and firmware versions for successful deployment. This document is found on Dell.com/xcseriesmanuals. You can find a complete list of documentation for this product in the *Dell EMC XC Xpress Hyper-converged Appliance Support Matrix*.

- *Rack installation instructions shipped with your Dell solution.*
- *Xpress Getting Started Guide.*
- *Xpress Service and Installation Manual.*
- *Fabric Manager for XC Xpress User's Guide*
- *Deployment Checklist*
- *Xpress Support Matrix.*

2.3 Connecting to a network switch

Note: You must enable SSH on your switch prior to running Fabric Manager in a later step.

2.3.1 Dell EMC XC430 Xpress with 1Gbe switch

Use this for entry-level 1 Gbe only switch configurations.

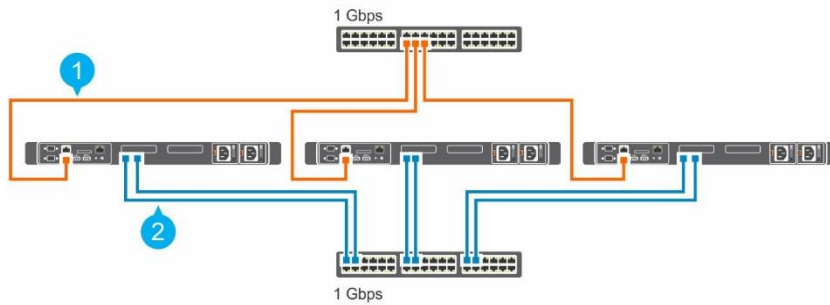

Figure 2 Connections for a Dell EMC XC430 Xpress with 1Gbe switch.

- 1. Management network (iDRAC network)
- 2. Production network

2.3.2 Dell EMC XC430 Xpress with 10 Gbe switch

Use this for 10 Gbe configurations.

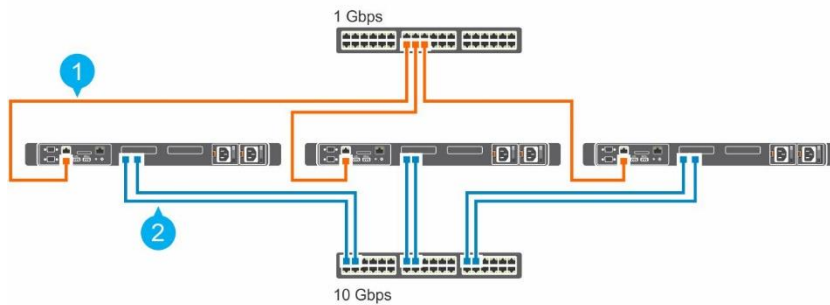

Figure 3 Connections for a Dell EMC XC430 Xpress with 10Gbe

- 1. Management network (iDRAC network)
- 2. Production network

2.4 Connecting servers to electrical outlets

To ensure each Dell EMC XC430 Xpress appliance has a redundant power source, plug the power cables from each physical server into separate power sources such as an uninterruptible power supply (UPS) or a power distribution unit (PDU).

2.5 Turning on the appliances

Press the power button on the appliances being configured. The buttons are located on the front of the Dell EMC XC430 Xpress appliance. The power LEDs illuminates when the appliances are turned on.

Refer to the *Dell EMC XC430 Xpress Hyper-Converged Appliance Service and Installation Manual* for a depiction of this model and other relevant information.

Go Dell.com/xcseriesmanuals and download the *Dell EMC XC430 Xpress Hyper-converged Appliance Deployment Checklist*. This is the same checklist included in this document, but it is easy to print out.

Note: Dell EMC recommends printing and filling out this Deployment checklist prior to deploying this solution.

3 Configuring iDRAC for remote network access (Recommended)

Use the following optional procedure to configure iDRAC network settings to enable remote access. This task assumes you have:

Note: After you have assigned an IP Address to the iDRAC, you can open a browser and browse to the IP assigned to the iDRAC.

- Monitor, keyboard and mouse temporarily connected to the Xpress appliance. Alternatively, connect using KVM over IP
 - IP Address, Subnet Mask, and Gateway: optionally, a DNS server IP address
1. Connect the physical keyboard, mouse, and monitor to the proper ports on the appliance.
 2. Turn on the appliance and press F2 to enter the **System Setup**.

```
F2 = System Setup
F10 = Lifecycle Controller
F11 = Boot Manager
F12 = PXE Boot

Initializing Intel(R) Boot Agent XE v2.3.08
PXE 2.1 Build 092 (WFM 2.0)

Initializing Intel(R) Boot Agent GE v1.4.03
PXE 2.1 Build 091 (WFM 2.0)

Initializing Serial ATA devices...
-
```

3. On the **System Setup** page, click **iDRAC Settings**.

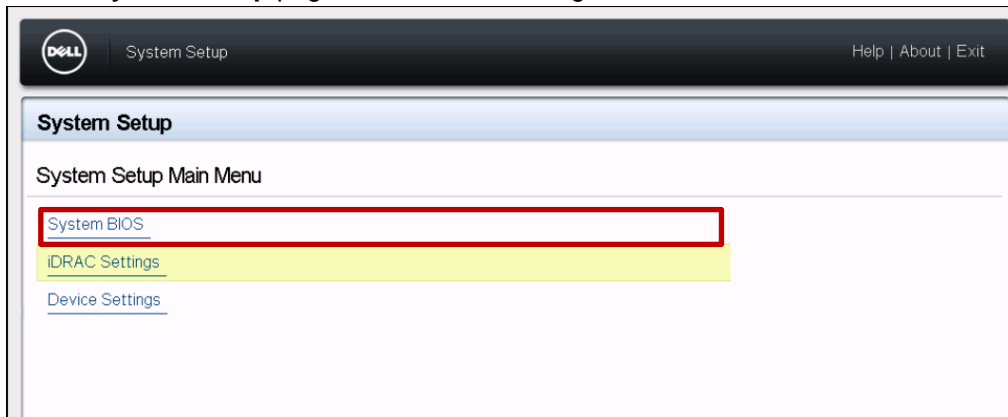

4. On the **iDRAC Settings** page, click **Network**.
5. Set the following items as described here:
 - a. Set **Enable NIC** to **Enabled**.
 - b. Set **NIC Selection** to **Dedicated**.

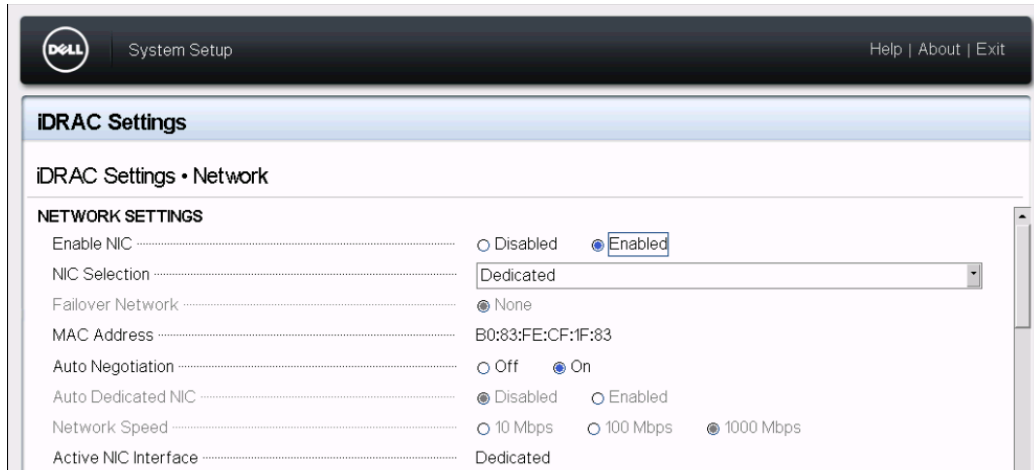

c. Set **Enable IPMI Over LAN** to **Enabled**.

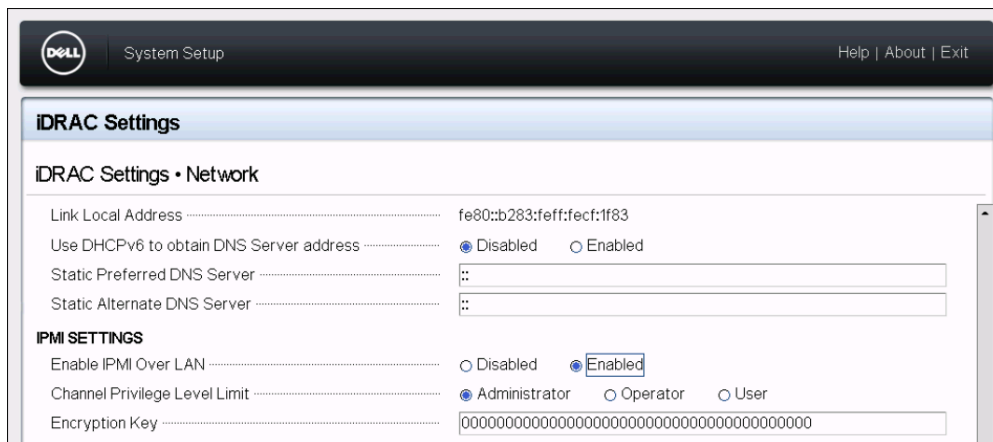

Note: It is not required to set the iDRAC IP information at this time. You can do it during cluster creation.

6. Scroll down the **iDRAC Settings** menu and configure the **IPv4 Settings**. This is where you can configure your iDRAC IP addresses.
7. To return to the **iDRAC Settings** page, click **Back**.
8. To return to the **System Setup** page, click **Finish**.
9. To save changes, click **Yes**.
10. After it reports that the settings were saved successfully, click **Yes**.

Note: The tasks below describe the configuration using a remote virtual console launched from the iDRAC WEB interface. In addition, you can use a directly attached monitor to configure each server and to start on a bootable USB device with an ISO file to install an operating system.

11. You may log out of **System Setup** menu at this time.
12. Go to [Logging in to Dell iDRAC](#).

3.1 Logging in to Dell iDRAC (Recommended)

Use the following procedure to launch a virtual console:

Note: This procedure may require Java Runtime Environment (JRE) is installed on the management workstation you are using to remotely manage the connected appliances. If the management workstation does not launch with default settings, select settings and select the Java option. You can use Java version 8 (1.8.0) or later.

1. To log in to iDRAC, open a web browser on a management workstation, and then type the iDRAC IP address in the address bar.
2. On the **iDRAC Log in** page, type the default login credentials:
 - a. In the **Username** box, type root.
 - b. In the **Password** box, type calvin.
3. On the **System Summary** page, in the **Properties** tab, under the **Virtual Console Preview** section, click **Launch**.

Note: Configure the Virtual Console *Plug-In Type* for native, Java, or HTML5. Depending on your IT settings, it may require additional steps to gain remote access. See the *Integrated Dell Remote Access Controller User's Guide* at dell.com/idracmanuals for additional help.

4 Getting ready for cluster setup

The next steps are done using a management workstation, not the appliance. Connect the management workstation for cluster set up to the same production network subnet where the XC Xpress appliance resides. Before you start this section, make sure you have completed the [Deployment checklist](#) and read the prerequisites sections in the [Appendix](#). If you have any issues, see the [Troubleshooting](#) sections prior to calling Technical Support.

The following tasks are described in more detail below in the following sections:

- [Download the Java Runtime Environment \(JRE\)](#)
- [Download Google Chrome \(Nutanix recommends\)](#)
- [Setting up the Nutanix Customer Portal](#)
- [Downloading Foundation Applet](#)
- [Downloading Fabric Manager](#)

4.1 Downloading Java Runtime Environment

A Java Runtime Environment (JRE) is required to launch the Nutanix Foundation Applet from your Windows based management station. The latest JRE is located at <https://www.java.com> and is a free download.

Note: Make sure all the appliances have run their first boot script before doing this task.

Note: Java version 8 (1.8.0) or later is required to use the Foundations Applet.

1. On the **Windows Control** panel, open the Java (32-bit) applet.
2. On the **Security** tab, click **High** and add an exception for the local applets by adding the following to the site list:

```
file:/
```

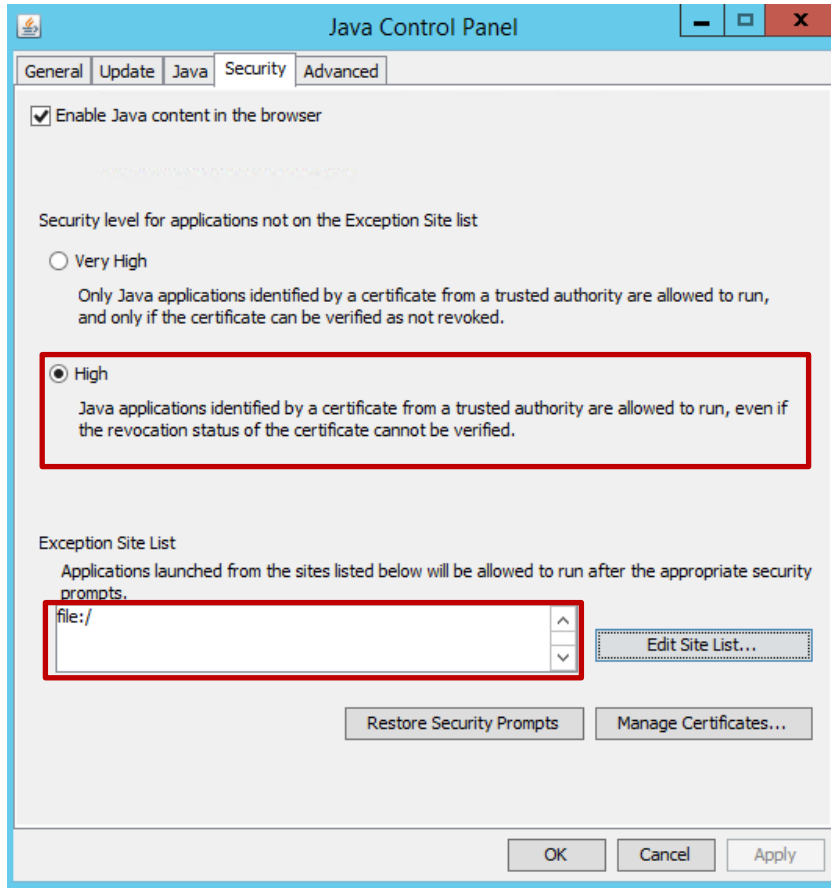

Figure 4 You must set Java to high, to lower security settings.

3. Click **OK**.

4.2 Downloading Google Chrome

Nutanix recommends using the Google Chrome web browser for downloading content from the Nutanix portal and managing your XC430 Xpress cluster.

Note: If your default browser is not set to Chrome, temporarily change your default browser to Chrome for the cluster set up.

4.3 Setting up Nutanix Support Portal

If you are new to Nutanix Support, create a personal profile on the Nutanix Support Portal. Creating a personal profile lets you manage licenses, user accounts, access KB articles, and access product documentation. Within the Nutanix Support Portal, you are prompted to add break-fix/admin contact information, linked to a cluster/asset. This account is where you manage the same list of users allowed to use Prism.

Note: The Nutanix Customer Portal is also required to access some of the advanced Nutanix documentation.

To set up your Nutanix Support Portal, complete the following tasks:

1. Go to the Nutanix Support Portal at <http://portal.nutanix.com> and click **Register Now**.
2. Register by typing data in appropriate boxes.
3. In the **Serial Number** box, type the **Service Tag number** of your Dell EMC XC430 Xpress.

Note: To find the Service Tag of your Dell EMC XC430 Xpress, see the [Locating The Service Tag](#) section in this document.

4. After the Customer Portal account is created, you can manage your licenses.

4.3.1 Registering your Service Tags with Nutanix

Your Nutanix license is auto-registered when you log in and register an appliance Service Tag with Nutanix.

1. On the **Nutanix Documentation** portal, see the *Web Console Guide* (for access details, see the Documentation matrix section in the *Support Matrix*).
2. In the *Nutanix Web Console Guide*, see the *License Management* section.
3. Perform the relevant licensing tasks for your system.

4.4 Downloading Foundation Applet

After you [created a Nutanix account](#), download the Foundation Applet by performing the following actions:

1. Sign into the Nutanix Portal: <https://portal.nutanix.com>.
2. From the toolbar, select **Downloads > Foundation**.

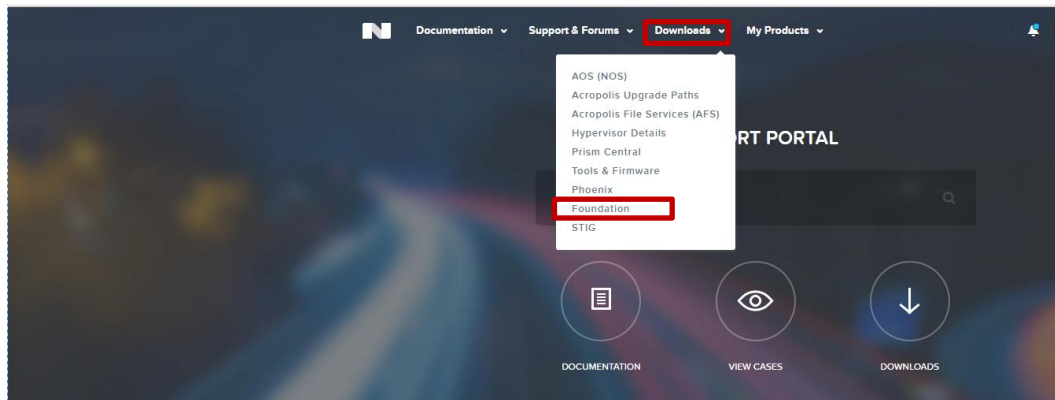

3. To download the Foundations Applet, on the **Foundation** page, click the **discovery applet** link.

Foundation

Getting started?
Download the [discovery applet](#) and run it in the same network as your new nodes.
You can also download the latest [iso_whitelist.json](#).

4. A file called **FoundationApplet-offline.zip** is downloaded locally to your system.
5. Save this download to a folder on your management workstation.

4.5 Downloading Fabric Manager

Fabric Manager is a network validation tool. To download:

1. Go to <https://dell.com/xcseriesmanuals>
2. From the dialog box, select the XC430 Xpress appliance.
3. On the left side, click **Drivers & downloads**.
4. Next to **View all available updates for Dell XC430 Xpress Hyper-converge Appliance**, click **Change OS**.
5. Click **Windows Server2012 R2**.
6. Scroll down and click **Applications**.
7. Download `DellPowerToolsFabricManager_X.X.X.XXXX-Win.zip`, save it to a location, and install the tool on your management workstation.

Note: The tool and dll must remain in the same directory.

For information on running Fabric Manager:

The *Fabric Manager for XC Xpress User's Guide* is found at <https://dell.com/xcseriesmanuals>.

1. Select your Xpress appliance.
2. On the left side, click **Manuals and Documents**.
3. Download *Fabric Manager for XC Xpress User's Guide*.

5 About Fabric Manager

Fabric Manager validates and report the requirements that verify network readiness and ensures a smooth deployment. Run the tool using the management workstation. This tool confirms if your network switch is a validated switch and validates network configuration settings are ready to begin deployment.

At this point, run Fabric Manager to validate your switch. For more information about Fabric Manager, see the *Fabric Manager for XC Xpress User's Guide* found at **Dell.com/xcseriesmanuals**.

6 About cluster creation

The following tasks outline the details of creating the cluster using Nutanix Foundation. For the sections below refer to the [Deployment Checklist](#) for required information.

6.1 Discovering appliances with Nutanix Foundation Applet

The Nutanix Foundations Applet provides a graphical user interface for discovering the XC430 Xpress appliances.

1. From the management workstation, navigate to the folder where you downloaded the Nutanix Foundation zip file.
2. Extract the all files to the same folder.
3. Double-click the `nutanix_foundation_applet.jnlp` file.

Note: It may take several minutes for all appliances to be discovered even after they have successfully booted for the first time.

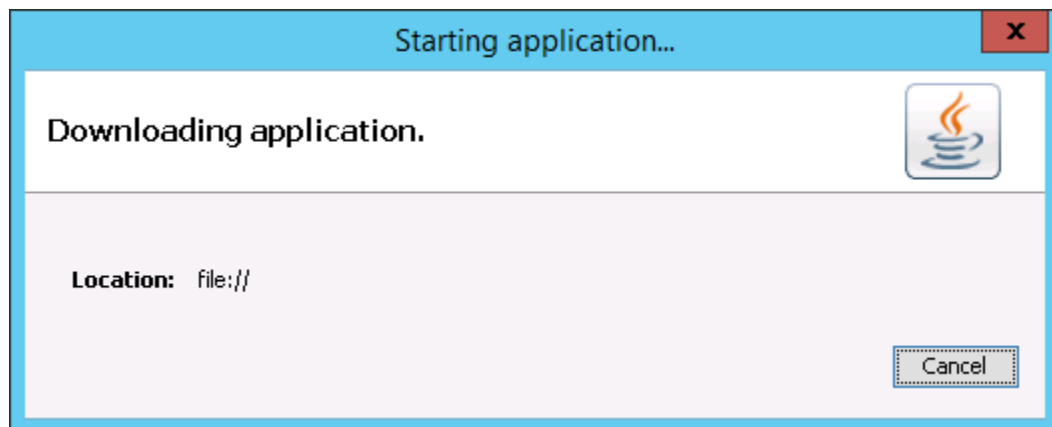

4. Verify that all XC Xpress appliances have been discovered by the Foundation applet by verifying the Service Tag (Serial Number) in the Foundation applet (Figure 5).

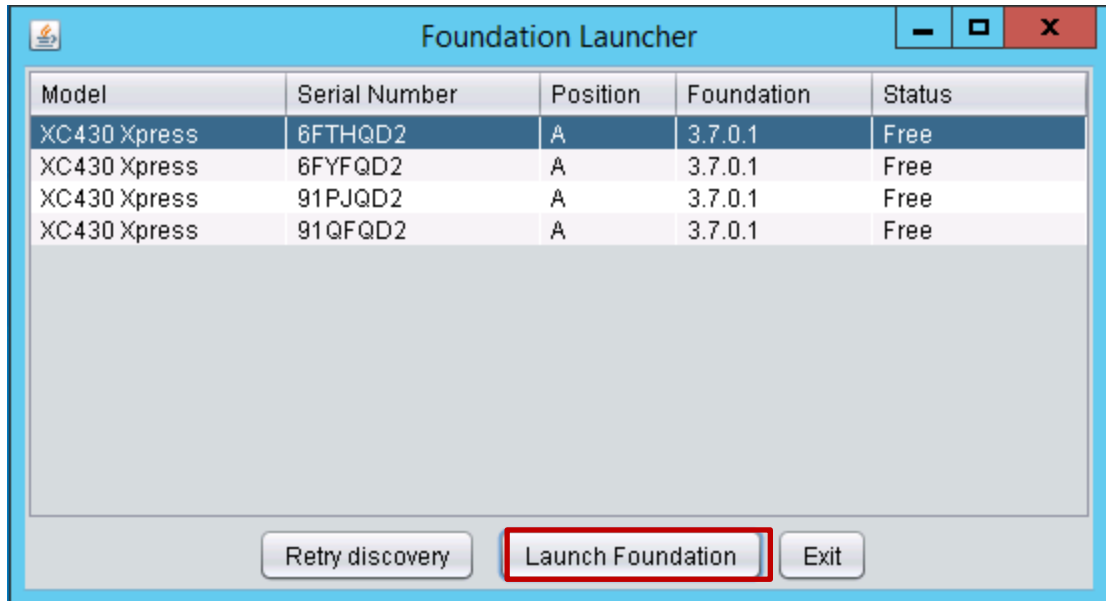

Figure 5 Nutanix Foundation Launcher dialog box showing Serial Numbers and Status.

5. Select a single XC Xpress appliance with the Status “Free” in the Foundation Applet, and click **Launch Foundation**.

6.2 Displaying discovered appliances

After you have discovered the XC Xpress appliances using the Foundation Applet, the browser displays all discovered XC appliances.

Note: XC and XC Xpress appliances cannot exist in the same cluster.

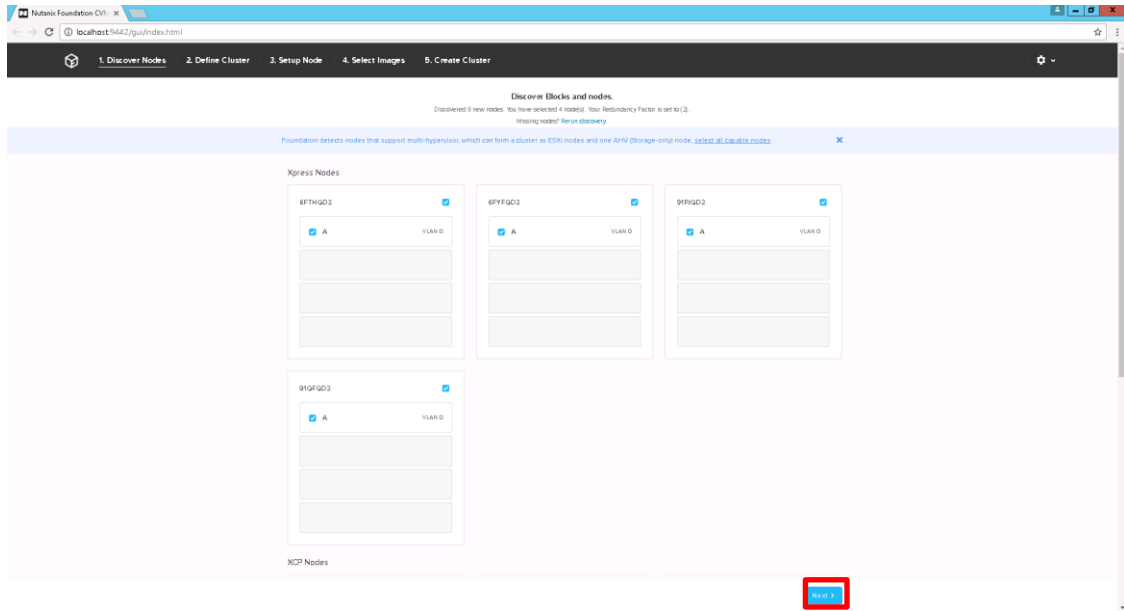

Figure 6 View all discovered XC Xpress appliance.

1. Select the check box next to the Service Tag for the Xpress appliance that you want to be a part of this cluster. The network interfaces are automatically checked.

Note: The maximum number of appliances for an XC430 Xpress cluster is four (4).

Note: The default redundancy factor is 2 and cannot be changed with XC Xpress configurations.

2. Click **Next**.

6.3 Defining the cluster

For the sections below refer to the [Deployment checklist](#) for required information.

The screenshot shows the 'New Cluster Setup' interface. At the top, a progress bar indicates the current step is '2. Define Cluster'. Below the progress bar, the title 'New Cluster Setup' is followed by the instruction 'Set up general information to create and connect your cluster to the network.' The main content area is divided into two sections: 'Cluster Information' and 'Network Information'. The 'Cluster Information' section includes fields for 'Cluster Name' (containing 'DellEMC_XC_Xpress'), 'IP Address (Optional)' (containing '1'), 'NTP Server Address (Optional)' (containing '10.10.10.10'), 'DNS Server IP (Optional)' (containing '10.10.10.10'), and a 'Time Zone (Optional)' dropdown menu. There is also an unchecked checkbox for 'Configure IPMI IP'. The 'Network Information' section includes fields for 'Network' (containing '295.295.252.0'), 'Gateway' (containing '10.10.10.10'), and 'CVM Memory (Optional)' (containing '12 - 64 GB'). There is also an unchecked checkbox for 'Enable Testing'.

Figure 7 New Cluster Setup screen.

1. On the **New Cluster Setup** screen, under **Cluster Information**, do the following:
 - a. In the **Cluster Name** box, type a name for the cluster.
 - b. In the **IP Address** box, type an IP address for the cluster.
 - c. Do not configure **IPMI**.
 - d. In the **NTP Server Address** box, type the NTP server address.
 - e. In the **DNS Server IP** box, type the DNS server IP address.
 - f. Select a time zone.
2. Under **Network Information**, do the following:
 - a. Under **CVM and Hypervisor**, do the following:
 - i. In the **Network** box, type the IP address for your network.
 - ii. In the **Gateway** box, type the IP address for your gateway.
 - iii. In the **CVM Memory** box, do not change the memory setting. Leave the default.

Important: Do not change the memory configuration for the CVMs at the default setting.

3. Under **Post Imaging Tests**, leave it cleared. **Do not select the Enable Testing** box.

Important: Under **Post Imaging Tests**, do not select **Enable Testing** (cleared by default) to bypass NCC check during cluster creation.

4. Click **Next**.

6.4 Setting up the appliance

Nutanix Foundation Ceph: X

localhost:5442/gui/index.html

1. Discover Nodes 2. Define Cluster 3. Setup Node 4. Select Images 5. Create Cluster

Node Setup
Set up the IP addresses of your nodes

Clear IPs and Hostnames

Hostnames and IP Range
Specify the IP Range for the Nodes.

Hypervisor Hostname
ENTER HOSTNAME
Set the hostname here

CVM IP
ENTER CIDR
Set IP range here

Hypervisor IP
ENTER CIDR
Set IP range here

Manual Input
Manually fill in the IP Range for the Nodes. [Reorder Blocks](#)

	HYPERVISOR HOSTNAME	CVM IP	HYPERVISOR IP
6FTHQDZ Node A	NodeA	XX.XX.XX.XX	XX.XX.XX.XX
6FYFQDZ Node B	NodeB	XX.XX.XX.XX	XX.XX.XX.XX
919JQDZ Node C	NodeC	XX.XX.XX.XX	XX.XX.XX.XX
91QFQDZ Node D	NodeD	XX.XX.XX.XX	XX.XX.XX.XX

< Prev

Validate Network

Figure 8 Node Setup screen.

1. On the **Node Setup** page, manually enter the IP addresses and hostnames for each appliance.
2. Click **Validate Network**.
3. If network validation fails, check to see if you have duplicate IP addresses. Correct any errors and click **Validate Network** again.

6.5 Selecting images

1. On the **Selecting Imaging Type** dialog box, click **Single Hypervisor**.

Note: The Multi Hypervisor option is not supported on Xpress.

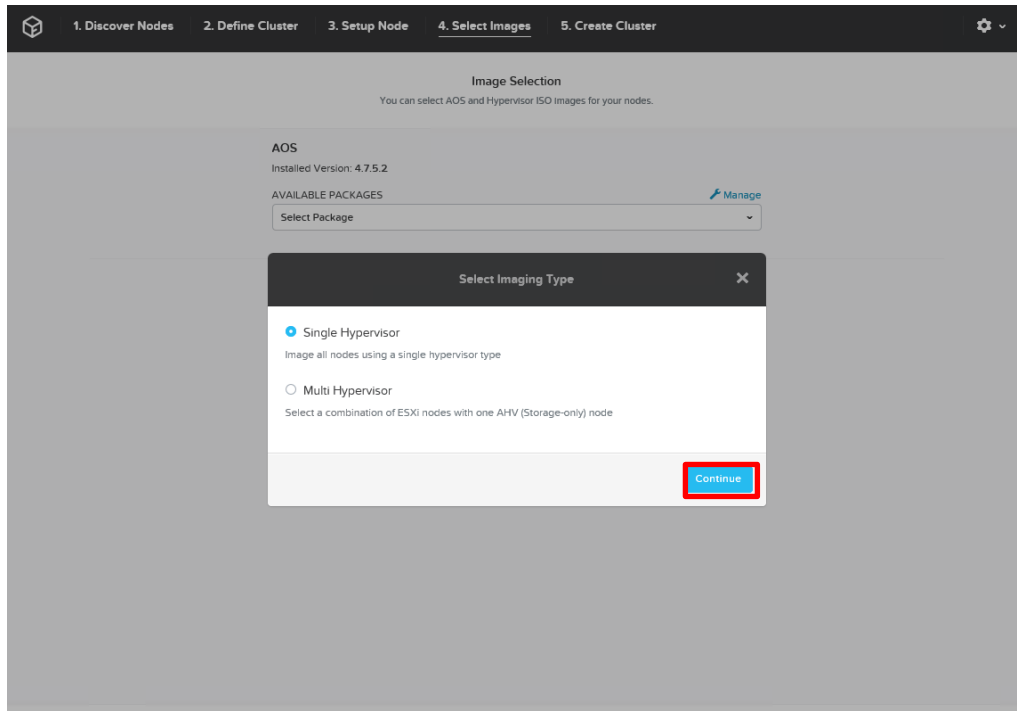

2. Click **Continue**.

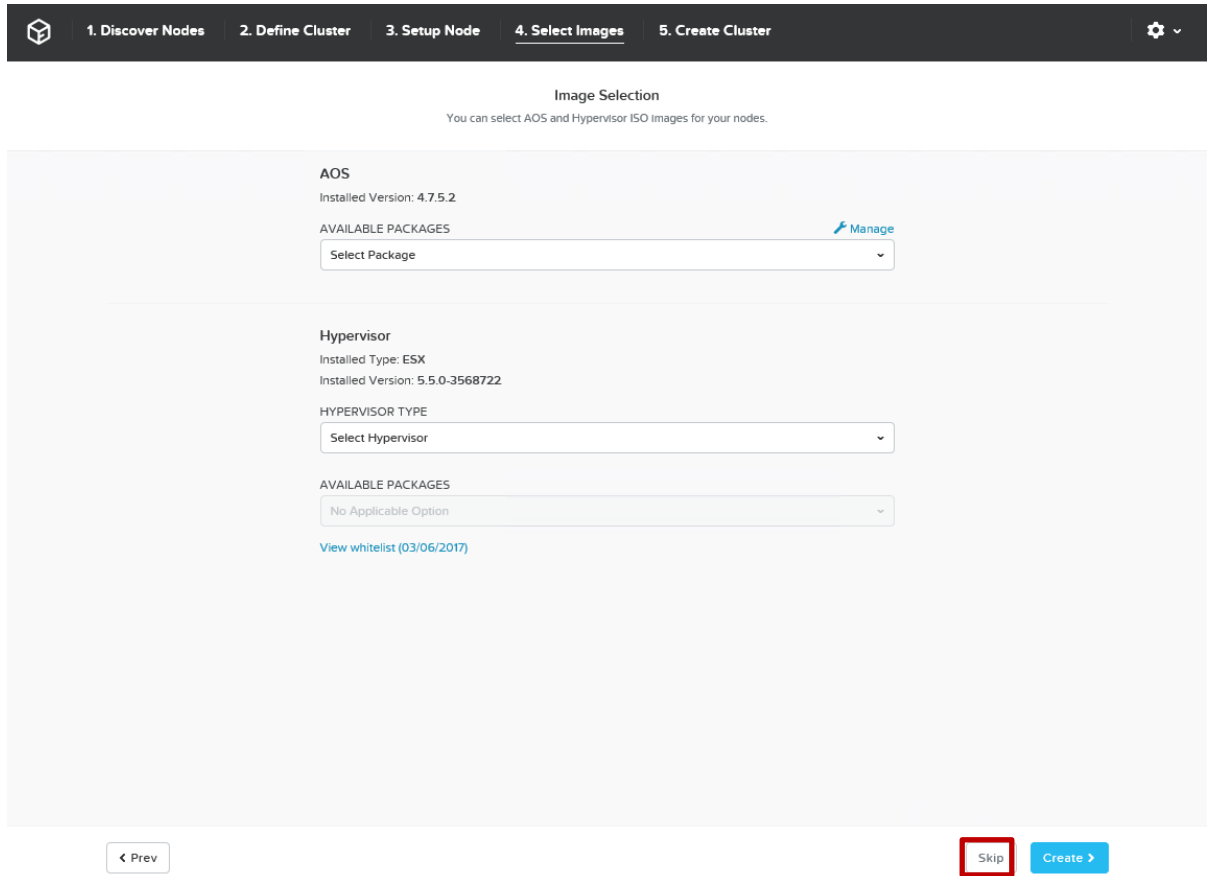

Figure 9 Image Selection screen.

3. On the **Image Selection** screen, click **Skip**.

Note: The Hypervisor is factory installed and should not be changed.

Important: Carefully proceed through the Select Image section. Your hypervisor preferences are factory installed and the image selection process should be skipped.

6.6 Creating a cluster

The imaging process is shown under **Cluster Creation Status** on the **Cluster Creation progress** screen.

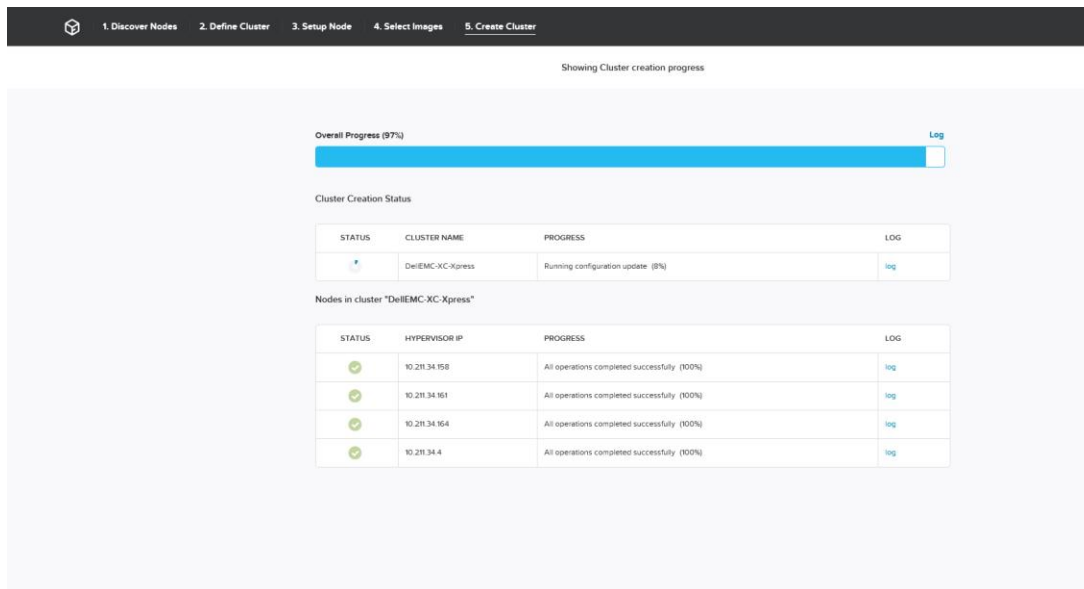

Figure 10 Observe the image process under Cluster Creation Status.

This process takes approximately 15 minutes depending on the configuration. Use the **log** link to monitor the cluster creation progress.

After completion, you are presented with the following screen:

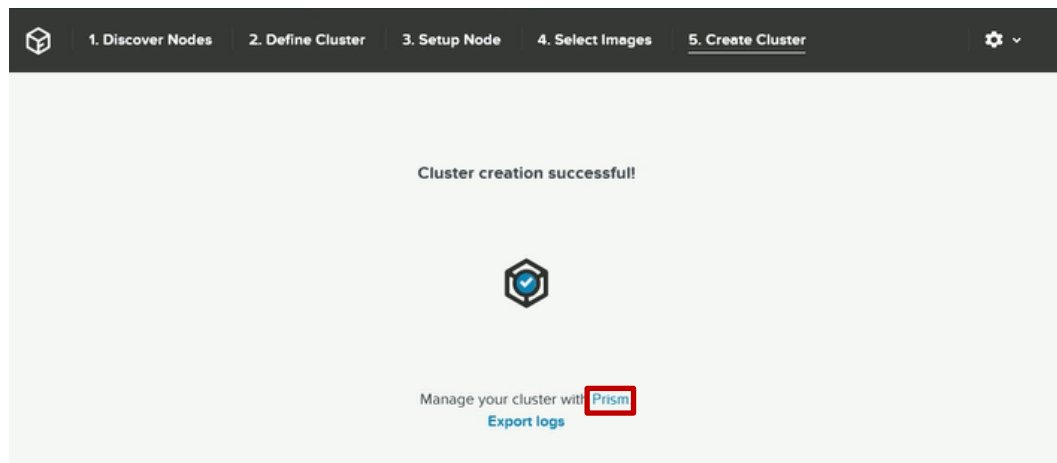

Figure 11 Cluster creation successful screen.

1. On the **Create Cluster** screen, click **Prism**, and a new web browser launches.
2. If cluster creations fails, see the [Troubleshooting](#) section prior to contacting Dell EMC support.

Note: If you enabled PULSE, your cluster must be able to connect to the external Pulse servers for automatic case creation. If applicable with your network layout, configure your [HTTP proxy settings](#) for external communication.

6.6.1 Understanding PULSE

This section assumes you have read the two Nutanix KB articles outlined in the [Deployment Checklist](#). See these KB articles to understand PULSE.

6.6.2 Dell Support Assist

For an enhanced Support Experience, Dell EMC recommends installing and configuring Dell SupportAssist. Dell SupportAssist is a software application that transparently collects information about your system and automatically creates support cases when issues are detected. Dell SupportAssist helps Dell to provide you an enhanced, personalized, and efficient support experience. Dell uses the data to solve common problem, designs and markets the products. For more information about installing and configuring Dell SupportAssist, see: <http://www.dell.com/enus/work/learn/supportassist-servers-storage-networking>

7 Managing your cluster using Prism

Important: Congratulations on creating your cluster. Dell EMC recommends that you log in to Prism and use 1-click update to install the latest recommended AOS version. Updating prior to putting your newly created cluster in production is strongly recommended. To see how to use Prism to update your AOS, see the *Acropolis Administrators Guide*.

Nutanix Prism is the one-click infrastructure management interface for XC clusters. Prism provides a simple and elegant way to manage your virtual environment.

1. Login with the default credentials:
 - Login: admin
 - Password: admin

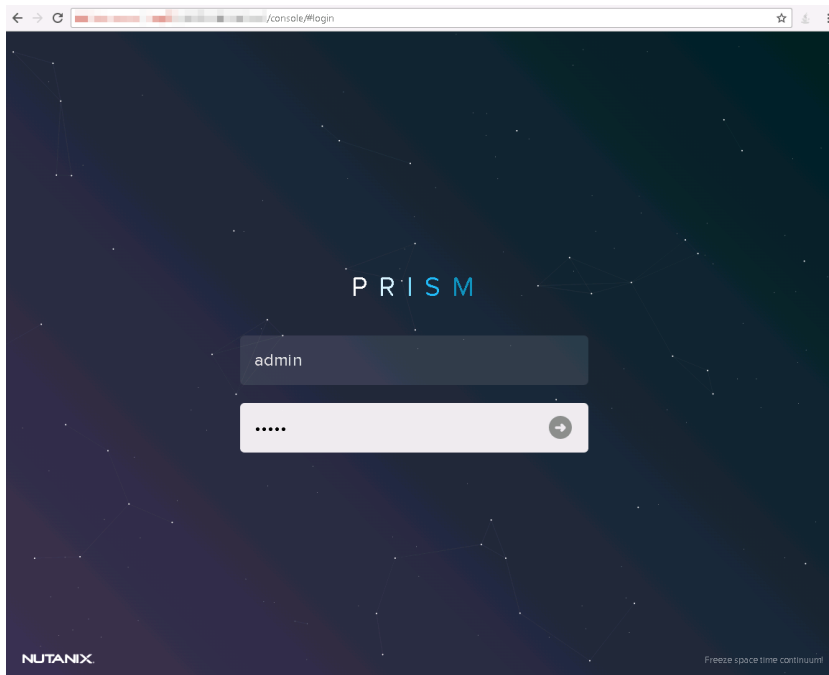

Figure 12 Nutanix Prism log in

You will immediately be prompted to change this password. The new password must be 8 to 255 characters. Follow the password requirements listed here.

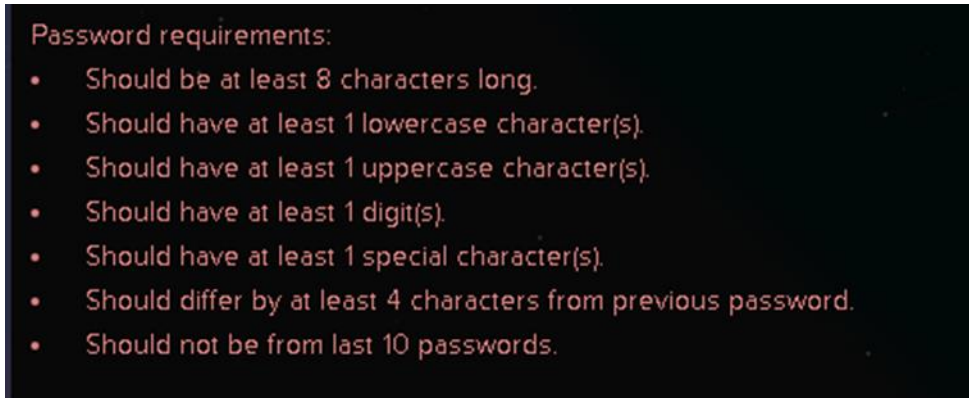

Figure 13 Password credentials

Follow your password security procedures to save your password. You cannot log in without the proper password.

7.1 Adding your Xpress cluster to vCenter

Go to the Nutanix Portal and download the *Nutanix vSphere Administration Guide for Acropolis (using vSphere Web Client)* to add your Xpress cluster to vCenter.

Note: The installable version of ESXi is installed in evaluation mode. Make sure that you license your hypervisor using your VMware documentation within the trial period.

7.2 Running virtual machines on the default container

Congratulations! You have now completed creating a cluster. A default storage pool is already created for you and presents the storage to all the hosts on the same subnet. You also have the option to create your own containers. See the *Nutanix Web Console Guide* for information on how to manage your cluster. To view your default storage pool and host presentation, do the following:

1. In **Nutanix Prism**, click **Home**.
2. In the drop-down menu, select **Storage**.

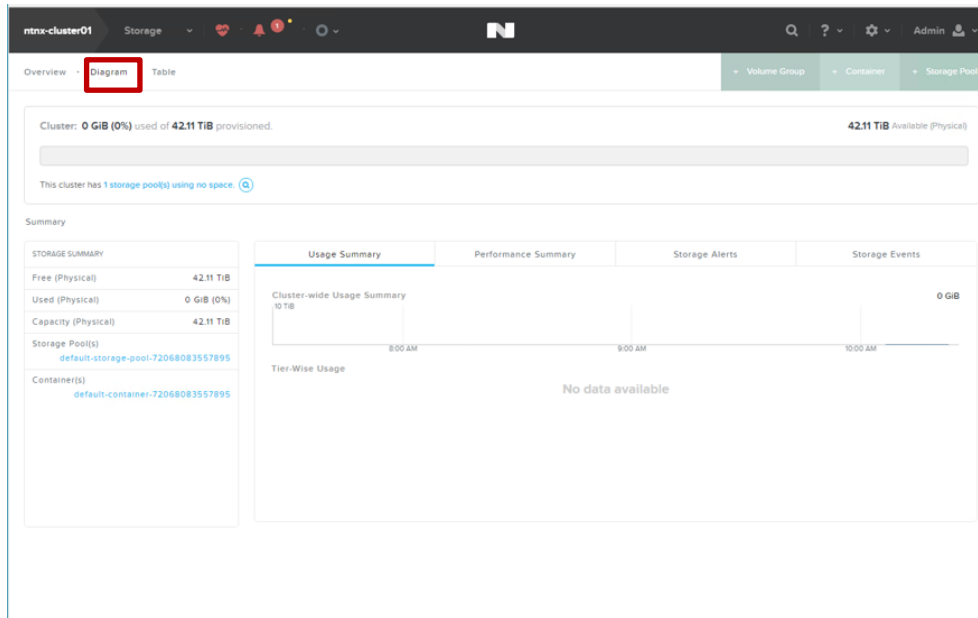

3. On the **Diagram** tab, under **Summary**, you can view your storage pools and created container.

Important: Run virtual machines on cluster containers only.

7.3 Prism monitoring software

To monitor the health of a cluster, VMs, performance, alerts, and events; the Nutanix web console provides a range of status-check features.

1. For more information about monitoring with the Nutanix web console, view the *Web Console Guide* document on the Nutanix documentation portal.
2. In the *Nutanix Web Console Guide* document, see the following sections:
 - Health Monitoring
 - Virtual Machine Monitoring
 - Performance Monitoring
 - Alert and Event Monitoring

You can find recommended documents in the Documentation section in the Support Matrix.

8 Getting Help

8.1 Contacting Dell

Dell provides several online and telephone-based support and service options. If you do not have an active internet connection, you can find contact information on your purchase invoice, packing slip, bill, or Dell product catalog. Availability varies by country and product, and some services may not be available in your area. To contact Dell for sales, technical assistance, or customer-service issues:

1. Go to **Dell.com/support**.
2. Select your country from the drop-down menu on the bottom right corner of the page.
3. For customized support:
 - a. Enter your system **Service Tag** in the **Enter your Service Tag** field.
 - b. Click Submit.

The support page that lists the various support categories is displayed.

For general support:

1. Select your **product category**.
2. Select your **product segment**.
3. Select your **product**.

The support page that lists the various support categories is displayed.

8.2 Locating Service Tag

Your system is identified by a unique Express Service Code and Service Tag number. This information is used by Dell to route support calls to the appropriate service provider.



Figure 14 Locating service tag

8.3 Quick Resource Locator

Use the Quick Resource Locator (QRL) to get immediate access to system information and how-to videos. This can be done by visiting Dell.com/QRL or by using your smartphone or tablet and a model-specific Quick Resource (QR) code located in your documentation. To try out the QR code, scan the following image.



Figure 15 Quick Resource Locator

8.4 Documentation

Documentation is found at Dell.com/xcseriesmanuals. The support matrix for this product contains the required software and firmware versions for successful deployment. You can find a complete list of documentation for this product in the *Dell EMC XC430 Xpress Series Hyper-converged Appliance Support Matrix*.

A Installation prerequisites

A.1 ESXi installation requirements

The Dell EMC Xpress solution requires the following. Detail of each are in the following sections.

- Network Time Protocol (NTP)
- Domain Name Server (DNS)
- vCenter (Required for configuring Xpress features.)

A.2 About Network Time Protocol (NTP)

Dell EMC recommends using accurate time on the hypervisor and the Controller VM (CVM) on all XC Xpress clusters, regardless of the hypervisor type (ESXi, KVM, or Hyper-V) being run. Dell EMC recommends syncing to three or five external [Stratum One time sources](#), the same as used by your Active Directory (AD) servers.

- Nutanix clusters must have accurate time relative to the AD domain, which is handling authentication. A Nutanix cluster cannot function if the time discrepancy is greater than 5 minutes.
- Accurate timestamps are also important for troubleshooting interactions with third-party software products, which may require synchronized time between the hypervisor and the Controller VM to determine which files to back up.
- Accurate time synchronization between Nutanix clusters paired in Disaster Recovery (DR) configurations is important so that snapshots do not expire too quickly or too late.
- Graphs in the Prism interface rely on the CVM time. Incorrect time skews graphs, especially in relation to other monitoring platforms, which rely on other clock sources.

A.2.1 Configuring NTP servers

To add (or delete) an NTP server entry, do the following:

1. In **Prism**, on the main page, click the **Gear** icon.
2. On the **Gear** menu (see Main Menu Options), select **NTP Servers**.

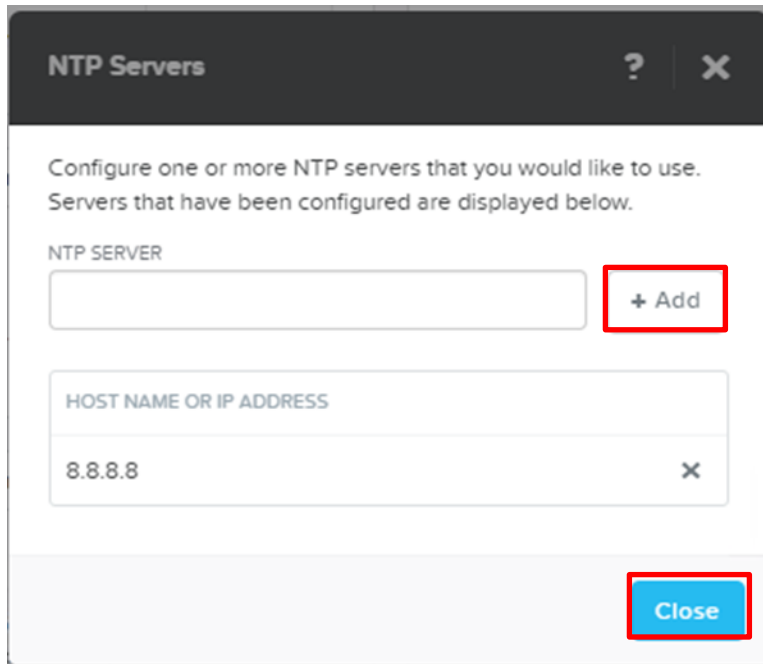

3. On the **NTP Servers** dialog box, do one of the following.
 - a. To add an NTP server, in the **NTP Server** box, type the server IP address or fully qualified host name and then click **Add**. The name or address is added to the **HOST NAME OR IP ADDRESS** list (below the NTP Server field).
 - b. To delete an NTP server entry, in the **Servers** list, click the delete (x) icon for that server.
 - c. In the dialog box that appears to verify the action; click **OK**. The server is removed from the list.
 - d. Click **Close**.

A.3 Domain Name Server (DNS) requirements

The following are the requirements for DNS:

- Each XC host must be assigned a name of 15 characters or less, which gets automatically added to the DNS server during domain joining.
- The XC storage cluster must be assigned a name of 15 characters or less, which must be added to the DNS server when the storage cluster is joined to the domain.

A.4 Networking recommendations

For network switch configuration information, see your documentation from your switch vendor. See the *Fabric Manager for XC Xpress User's Guide*. This describes what you must configure for your network to be functional for Dell EMC XC Xpress.

Important: If you have connectivity issues discovering appliances in the Foundation applet verify the following ports are open. For the Foundation applet to work properly, you must open the following ports for both IPv4 and IPv6 on the local system from which the Foundation applet is launched:

UDP on port 13000 (Nutanix discovery protocol)
TCP on ports 8000 (Foundation GUI)
TCP on 9442 (proxy)
TCP on 9443 (applet control)

Verify HTTP proxy is configured in Nutanix Prism. For more information on managing your HTTP proxy see section [Setting up the HTTP proxy in Prism](#).

A.4.1 Management network

The Dell EMC Xpress solution requires a compatible switch for the management network.

Note: The best practice setup is to connect the management port (iDRAC) across all three appliances to the same switch on the management network.

Note: The management (iDRAC) network may be a separate network from the Host network (Controller and Hypervisor).

A.4.2 Production network

Dell EMC recommends a redundant Top of Rack (TOR) switches for the production network. The selection depends on the Network Daughter Cards (NDCs) selected for the Dell EMC XC430 Xpress. For a list of recommendations for NDC and NIC cabling, see the *Dell EMC XC Xpress Series Hyper-converged Appliance Support Matrix*.

The following switch settings are required:

- Enable ipv6 link-local unicast and multicast.
- Disable Spanning Tree Protocol, refer to the corresponding *TOR switch documentation*. If Cisco TOR, enable portfast.
- Dell EMC recommends that all the switch ports enable default VLAN access for deployment. If default VLAN access is not permitted, refer to the *Nutanix Field Installation Guide* for assigning a VLAN tag during deployment.

Note: Configure all servers in a single domain.

A.5 Important information about SATADOM

The SATA Disk-On-Motherboard (SATADOM) shipped with XC Xpress Series appliances is intended as an appliance boot device.

Note: Write intensive activities and processes leveraged by XC Xpress appliances, are designed to take place on the SSDs and HDDs and not the boot device. The hypervisor boot device is not designed for application use.

Warning: Adding additional write intensive software to the SATADOM boot disk results in heavy wear on the device beyond design specifications resulting in premature hardware failure.

A.6 Setting up the HTTP proxy in Prism

The HTTP proxy is required for PULSE and it is also required for external connections.

1. Log in to **Prism**.
2. Click the **Gear** icon.
3. Select **HTTP Proxy**.
4. Select **New Proxy**. Fill out the required information.

Note: Username and password are only require if the proxy server requires it.

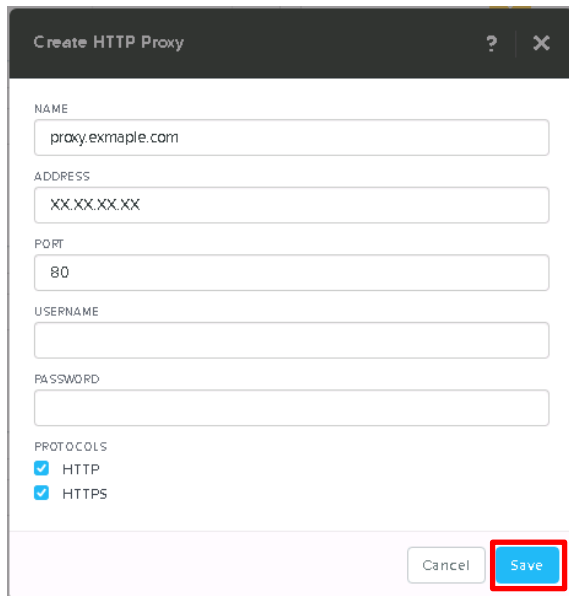

The screenshot shows a 'Create HTTP Proxy' dialog box with the following fields and options:

- NAME: proxy.exmaple.com
- ADDRESS: XX.XX.XX.XX
- PORT: 80
- USERNAME: (empty)
- PASSWORD: (empty)
- PROTOCOLS: HTTP, HTTPS
- Buttons: Cancel, Save (highlighted with a red box)

5. Click **Save**.

A.7 Setting up the name Server (DNS) in Prism

1. Log in to **Prism**.
2. Click the **Gear** icon.
3. Select **Name Servers**.
4. Specify the **Server Host name or IP Address** (DNS IP) address and then click **Add**.

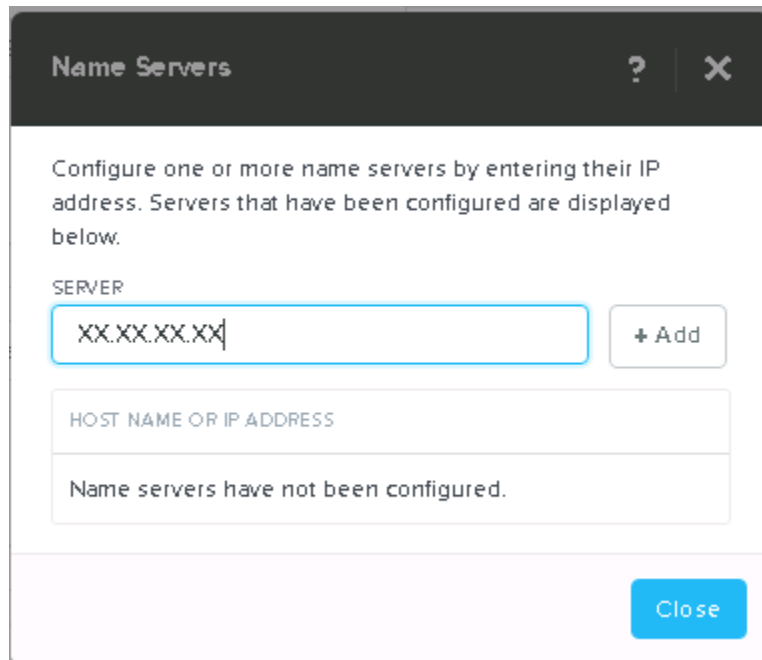

The screenshot shows a dialog box titled "Name Servers" with a question mark and a close button (X) in the top right corner. The main text reads: "Configure one or more name servers by entering their IP address. Servers that have been configured are displayed below." Below this text, there is a section labeled "SERVER" containing a text input field with the placeholder "XX.XX.XX.XX" and a "+ Add" button to its right. Below the input field is a label "HOST NAME OR IP ADDRESS" and a corresponding empty text input field. At the bottom of the dialog, there is a message "Name servers have not been configured." and a blue "Close" button.

5. Click **Close**.

A.8 Creating bare metal recovery image

To maintain a fast and efficient bare metal recovery option, Dell EMC recommends leveraging the Rapid Appliance System Recovery (RASR) tool. After deployment, use the following steps to create a RASR USB disk and safely store it as part of your disaster recovery planning.

Warning: Creating a RASR USB disk destroys all data on the USB disk.

Warning: Executing a Factory Restore on your appliance with the RASR USB backup disk destroys all data saved on that appliance.

To create a RASR USB disk:

1. Insert a USB disk device that is 16 GB or greater into one of the appliance's available USB slots.
2. In the **IDRAC** console, boot to SD Card.
3. Select **Local SD Card**.
This boots to RASR Recovery screen.
4. Select **Option 2 – creating USB key**.

Note: This process may take 20 minutes or more depending on the speed of the USB device.

B Introduction to troubleshooting

Use this troubleshooting section to resolve any issues you may encounter during deployment. Use these steps before you call [Dell EMC Customer Support](#).

B.1 Foundation Applet issues

B.1.1 Unable to launch the Nutanix Foundation Applet from management workstation.

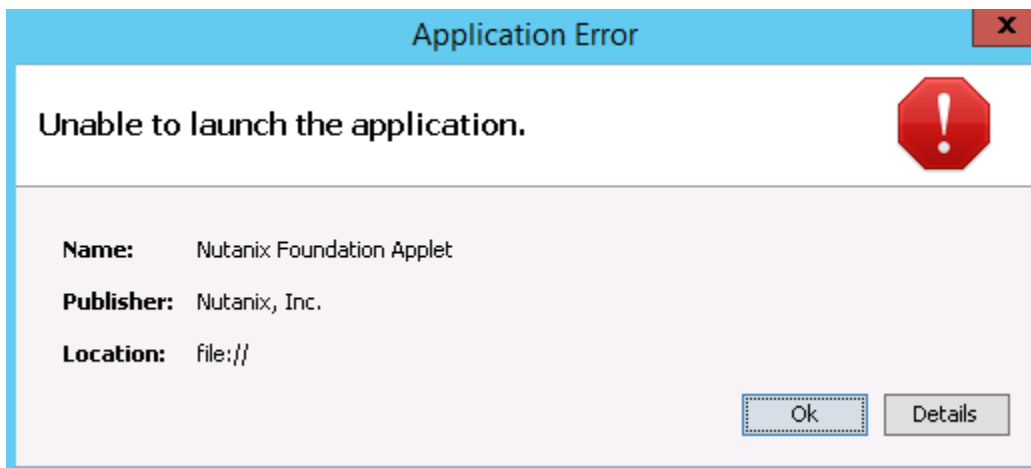

Figure 16 Error in launching the Nutanix Foundation Applet.

1. Ensure Nutanix recommended JRE is installed on management workstation. See [Downloading Java Runtime Environment](#).
2. Make sure to extract all content from `FoundationApplet-offline.zip`.
3. Re-launch the Nutanix Foundation applet to ensure it is now functioning.

B.2 Desired appliances are not discovered in Foundation Launcher.

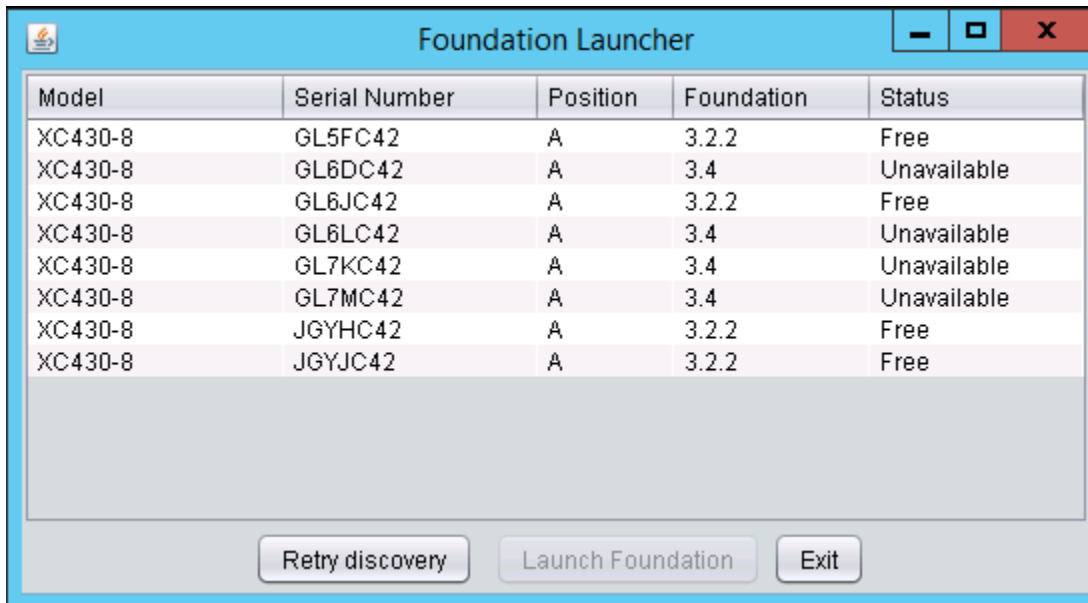

Figure 17 Appliances are not discovered using Foundation Launcher.

B.2.1 Ensure management workstation is connected on the same production network.

1. Ensure all network cables are connected. For more information, see [Installing hardware](#).
2. If using the 10 Gbe switch, ensure the correct Small Form factor Pluggable (SFP) is connected. For supported cabling, see *Dell EMC XC430 Xpress Series Support Matrix*.
3. Ping default gateway or any other system from management workstation. For information about making ping work see the section, "[Resolving ping issues](#)."
4. Make sure the TCUP and UDP ports are open.

IMPORTANT: If you have connectivity issues discovering appliances in the Foundation applet verify the following ports are open. For the Foundation applet to work properly, you must open the following ports for both IPv4 and IPv6 on the local system from which the applet is launched:

UDP on port 13000 (Nutanix discovery protocol)
TCP on ports 8000 (Foundation GUI)
TCP on 9442 (proxy)
TCP on 9443 (applet control)

5. Ensure all appliances are turned on and that both power supplies are plugged in properly and there is no Yellow flashing light on any of the power supplies.
6. Ensure First Time boot has completed successfully on each appliance.
 - a. Go to `C:\Program Files\Nutanix\Logs` and open `first_boot.log` file.
 - b. Verify the last line "Marking first boot script run as a success" is there.

7. After the First time Boot Script (FTBU) completes successfully wait five minutes before you launch the Nutanix Foundation Applet. You can find the Nutanix First Time Boot Script procedure in [section 4.1](#).

Note: The wait allows the CVM to complete boot up sequence on the appliance.

8. [Run Fabric Manager](#) on management workstation to identify any other potential network issues affecting discovery process.
9. If you have followed all the steps above and still cannot see your appliances, then call Dell EMC Customer Support.

B.3 Cluster creation does not complete successfully

If your clusters did not build successfully, you will see a screen like here in Figure 18.

Showing Cluster creation progress

Overall Progress (80%) There were errors in the installation. [Log](#)

Imaging Done. [Retry imaging failed nodes with last config](#)

Cluster Creation Status

STATUS	CLUSTER NAME	PROGRESS	LOG
	test	Starting (0%)	log

Node Status

STATUS	HYPERVISOR IP	PROGRESS	LOG
	10.10.10.10	Imaging completed (100%)	log
	10.10.10.11	Imaging completed (100%)	log
	10.10.10.12	Imaging completed (100%)	log
	10.10.10.13	Imaging completed (100%)	log

Figure 18 Cluster creation failed.

If your cluster creation does not complete successfully you may attempt the options below before contacting Dell EMC Technical Support:

1. Retry imaging failed appliances with last configuration.
2. If the imaging retry fails, collect the log files and contact Dell Customer Support.
 - a. In the **Cluster Creation Status** table, under **Log**, click the link to the specific log file.

```
11:17:05 INFO [0/3600s] Waiting for target cluster MESXAK to be created
20170228 11:17:06 DEBUG Failed to reach Genesis on the node 10.211.31.116
20170228 11:17:14 DEBUG Failed to reach a node where Genesis is up. Retrying...
20170228 11:17:15 DEBUG Failed to reach Genesis on the node 10.211.31.116
20170228 11:17:15 DEBUG Failed to reach a node where Genesis is up. Retrying...
20170228 11:17:16 DEBUG Failed to reach Genesis on the node 10.211.31.116
20170228 11:14:28 DEBUG Setting state of <ImagingStepHandoff(<NodeConfig(10.211.31.122) @7110->) @7f50> from PENDING to RUNNING
20170228 11:14:28 INFO Running <ImagingStepHandoff(<NodeConfig(10.211.31.122) @7110->) @7f50>
20170228 11:14:28 INFO foundation.imaging_step_handoff skipped
20170228 11:14:28 DEBUG Setting state of <ImagingStepHandoff(<NodeConfig(10.211.31.122) @7110->) @7f50> from RUNNING to FAILED
```

Figure 19 Example of a log showing when a cluster does not create successfully.

3. Call Dell EMC Technical Support.

Warning: This process should not be done on production systems. Any data on the appliance will be destroyed and is not recoverable. Factory reset resets the system to the state it was when it left the factory.

B.4 Unable to connect external networks/sites including websites, or PULSE

1. Verify HTTP proxy is configured in Prism. Prism is a Nutanix based software where you centrally manage your infrastructure. For more information on managing your HTTP proxy see section “Setting up the HTTP proxy in Prism” in the *Dell EMC XC430 Xpress Deployment Guide*.
2. Verify DNS (Name Server) is configured in Prism. For more information, see section, “Setting up the name Server (DNS) in Prism,” in the *Dell EMC XC430 Xpress Deployment Guide*.

B.5 Why can't I discover my appliances?

Reasons you cannot discover appliances include but not limited to the following:

- IPv6 not enabled on management station
- Firewall on management workstation blocking ports
- Switch is filtering the ports
- Management station on a different VLAN or subnet than appliances

Make sure you open the ports. Verify HTTP proxy is configured in Nutanix Prism. For more information on managing your HTTP proxy see section “[Setting up the HTTP proxy in Prism.](#)”

C Deployment checklist

Use this worksheet to collect your deployment data prior to installation.

For more information about Xpress documentation, including Acropolis guides, see the **Xpress Support Matrix** at www.dell.com/xcseriesmanuals and select your Xpress appliance.

C.1 Default / set up cluster credentials

The default cluster credentials for the system differ from those stated at the beginning of all Nutanix documentation. See Table 2 for default cluster credentials, which are specific to the system.

Table 2 Default / set up cluster credentials

Interface	Target	Username	Password
Web management console	iDRAC	root	calvin
Hyper-V appliance	Appliance	administrator	nutanix/4u
ESXi/AHV	Appliance	root	nutanix/4u
SSH client	Nutanix Controller VM	nutanix	nutanix/4u
Nutanix Web Console	PRISM Interface (after cluster configuration)	admin	admin

Follow your password security procedures to save your password. You cannot log in without the proper password. See the *Nutanix Web Console Guide* on the Nutanix web site.

Note: If your iDRAC management and production network have the same subnet mask and default gateway, they will share the same IP subnet mask and default gateway.

Table 3 Deployment worksheet

IP Addresses (Per appliance)				
	Appliance 1	Appliance 2	Appliance 3	Appliance 4 (if applicable*)
Service Tag				
CVM IP				
Hypervisor IP				
iDRAC IP				

*If applicable means if you have a four appliance configuration. Minimum requirement is for three appliances.

Network IP addresses (Per Cluster)		
WARNING: Network Communication between the Controller VM (CVM) and the host appliance leverages the 192.168.5.x IP subnet on a private virtual network. You cannot use the 192.168.5.0.x IP subnet for your production or iDRAC management networks.		
	iDRAC management	Production network
Subnet mask		
Default gateway		
Cluster name		
Cluster IP (primary external IP, PRISM IP)		
NTP IP		
DNS IP (Admin credentials required)		
Failover cluster name (Hyper-V only)		
Failover cluster IP (Hyper-V only)		
Active Directory domain name (Hyper-V only)		
Active Directory Domain Controller IP (Hyper-V only)		
vCenter IP address (ESXi only)		
Proxy settings (if needed)		

Downloads		
Nutanix Foundation Applet downloaded	<input type="checkbox"/>	
Download the Java Runtime Environment (JRE) 8 (1.8.0) or later	<input type="checkbox"/>	
Download Google Chrome (Optional)	<input type="checkbox"/>	
Download Fabric Manager for XC Xpress	<input type="checkbox"/>	
Credentials		
Use your corporate security policies to manage passwords. This is a list to show you what you need during the deployment process.		
	Username	Password
Default Nutanix Foundation login credentials		
Default Hyper-V login credentials (Hyper-V only)		
Default ESXi login credentials (ESXi only)		
Active Directory administrative credentials (Hyper-V only)		
vCenter admin credentials (ESXi only)		
Default AHV login credentials (AHV only)		

Nutanix management account users	
User name	
User name	
User name	
User name	
Registration and configuration options	
Nutanix Portal Registration	<input type="checkbox"/>
Configured iDRAC (all appliances)	<input type="checkbox"/>
Configured DNS	<input type="checkbox"/>
Configured NTP	<input type="checkbox"/>
Update Acropolis (1-click update)	<input type="checkbox"/> <div style="background-color: #f0f0f0; padding: 5px; margin-top: 10px;"> <p>Note: Dell EMC recommends updating the AOS version prior to putting your newly created cluster in production. To see how to use Prism to update your AOS, see the <i>Nutanix Acropolis Administrator's Guide</i>.</p> </div>
Configured Active Directory (Hyper-V)	<input type="checkbox"/>
KB articles to read before you attempt to deploy this solution	
000004093	What is in a Pulse submission to Nutanix?
000002595	Nutanix Support Services: Pulse, Pulse HD, and Alerts
000003005	NCC Health Check DNS_Server_check