

Dell PowerEdge Express Flash PCIe SSD User's Guide

Regulatory Model: Adapter UCEA-100 and UCEM-100



Notes, Cautions, and Warnings



NOTE: A NOTE indicates important information that helps you make better use of your computer.



CAUTION: A CAUTION indicates either potential damage to hardware or loss of data and tells you how to avoid the problem.



WARNING: A WARNING indicates a potential for property damage, personal injury, or death.

© 2013 Dell Inc. All Rights Reserved.

Trademarks used in this text: Dell™, the Dell logo, Dell Boomi™, Dell Precision™, OptiPlex™, Latitude™, PowerEdge™, PowerVault™, PowerConnect™, OpenManage™, EqualLogic™, Compellent™, KACE™, FlexAddress™, Force10™, Venue™ and Vostro™ are trademarks of Dell Inc. Intel®, Pentium®, Xeon®, Core® and Celeron® are registered trademarks of Intel Corporation in the U.S. and other countries. AMD® is a registered trademark and AMD Opteron™, AMD Phenom™ and AMD Sempron™ are trademarks of Advanced Micro Devices, Inc. Microsoft®, Windows®, Windows Server®, Internet Explorer®, MS-DOS®, Windows Vista® and Active Directory® are either trademarks or registered trademarks of Microsoft Corporation in the United States and/or other countries. Red Hat® and Red Hat® Enterprise Linux® are registered trademarks of Red Hat, Inc. in the United States and/or other countries. Novell® and SUSE® are registered trademarks of Novell Inc. in the United States and other countries. Oracle® is a registered trademark of Oracle Corporation and/or its affiliates. Citrix®, Xen®, XenServer® and XenMotion® are either registered trademarks or trademarks of Citrix Systems, Inc. in the United States and/or other countries. VMware®, vMotion®, vCenter®, vCenter SRM™ and vSphere® are registered trademarks or trademarks of VMware, Inc. in the United States or other countries. IBM® is a registered trademark of International Business Machines Corporation.

2013 - 12

Rev. A04

Contents

1 Overview	7
PCIe SSD Architecture	7
PCIe Interface	8
PCIe SSD Features	9
Performance	9
Hot Swap	9
Device Health	9
Self-Monitoring Analysis And Reporting Technology	10
Device Life Remaining	10
Device Write Status	10
Supported Operating Systems For PCIe SSD	10
2 Getting Started With PCIe SSD	11
Setting Up Your PCIe SSD For First Use	11
Configuring PCIe SSDs In Different Operating Systems	11
Servicing Your PCIe SSD	12
3 Replacing And Configuring Hardware	13
Removing A PCIe SSD From The System	13
Installing A PCIe SSD In The System	14
Removing The PCIe Extender Adapter Card	15
Installing The PCIe Extender Adapter Card	16
Removing The PCIe Extender Modular Card	17
Installing The PCIe Extender Modular Card	18
4 Driver Installation	19
Downloading PCIe SSD Drivers	19
Installing Or Upgrading The PCIe SSD Driver For Microsoft Windows Server 2008, Windows Server 2012, and Windows Server 2012 R2	19
Installing Or Upgrading The PCIe SSD Driver For Red Hat Enterprise Linux Or SUSE Linux Enterprise Server	20
Installing The PCIe SSD Driver On Systems Supporting VMware	21
5 Configuring And Managing Your PCIe SSD	23
Human Interface Infrastructure Configuration Utility	23
Entering The HII Configuration Utility	23
Viewing Physical Device Properties	23
Initializing Physical Devices	24
Setting LED Blinking	24

Exporting The Log.....	24
Exiting The HII Configuration Utility.....	25
Dell OpenManage Server Administrator.....	25
Launching Storage Management.....	25
Storage Information.....	25
Configuring And Managing PCIe SSDs.....	26
Running Physical Device Tasks.....	27
PCIe SSD Drop-Down Menu Tasks.....	27
Blink And Unblink Task For PCIe SSD.....	27
Preparing To Remove A PCIe SSD.....	27
Performing Full Initialization Task For PCIe SSD.....	28
Exporting The Log.....	28
6 Troubleshooting.....	29
Self-Monitoring Analysis And Reporting Technology Errors.....	29
PCIe SSD Carrier LED Indicators.....	29
Ungraceful System Shutdown Or Power Loss.....	30
Buffer I/O Error On PCIe SSD During Full Initialization.....	30
General Errors.....	31
PCIe SSD Is Not Listed In The Operating System.....	31
An Error Message Is Displayed When Running Full Initialization In HII.....	31
PCIe SSD Is Not Seen In Device Management In The Operating System.....	31
PCIe SSD Is Not Seen In Disk Management In The Operating System.....	32
Cannot Update The Firmware Using Dell Update Package (DUP).....	32
Linux Fails To Boot And Prompts For The Root Password.....	32
PCIe SSD Is Inserted In The System And Is Visible To The Operating System But The Status LED Is Off.....	32
Delay In System Boot While The PCIe SSD Activity LED Is Blinking.....	32
I/O Device Error On Write To PCIe SSD.....	33
PCIe SSD Performance Measurement Not Optimal.....	33
VMware ESXi Driver Fails To Install.....	34
PCIe SSD Is Listed In ESXi Host But Cannot Be Accessed In The Virtual Machine.....	34
VMware Reports A Missing Virtual Disk After A PCIe SSD Is Removed.....	34
VMware ESX 5.5 With Native Driver Version 3.3.4 Does Not Respond When The Host Operating System Is Booting.....	34
VMware ESX 5.5 With Native Driver Version 3.3.4 Is Unable To See Or Manage The PCIe SSD On The OpenManage Server Administrator.....	34
7 PCIe SSD Technical Specifications.....	37
SFF-8639 (PCIe SAS Combo-Connector).....	38
8 Getting Help.....	39
Locating Your System Service Tag.....	39

Related Documentation.....	39
Contacting Dell.....	39
Documentation Feedback.....	40

Overview

Dell PowerEdge Express Flash Peripheral Component Interconnect Express (PCIe) Solid State Device (SSD) is a high performance storage device designed for solutions requiring low latency, high input/output operations per second (IOPS), and enterprise class storage reliability and serviceability. The Dell PowerEdge Express Flash PCIe SSD is offered as a Single-Level Cell (SLC) and Multi-Level Cell (MLC) NAND flash technology with a high-speed PCIe 2.0 compliant interface. The high-speed PCIe 2.0 compliant interface helps improve performance for I/O bound solutions.

NOTE: Dell PowerEdge Express Flash PCIe SSD is not supported as a bootable device.

NOTE: Dell PowerEdge Express Flash Peripheral Component Interconnect Express Solid State Device is hereinafter referred to as PCIe SSD.

PCIe SSD Architecture

The PCIe SSD solution consists of a PCIe extender adapter card, which provides PCIe connectivity for up to four PCIe SSDs at the front of the chassis. The number of supported PCIe SSDs depends on the system.

PCIe SSDs from Dell are available in 175 GB and 350 GB (SLC) or 700 GB (MLC) capacities and are supported on Dell PowerEdge systems.

In Dell PowerEdge rack and tower systems, the PCIe extender adapter card connects to a PCIe SSD backplane, allowing connectivity for up to four PCIe SSDs. In PowerEdge modular systems, the PCIe extender modular card connects to the PCIe SSD backplane, allowing connectivity for up to two PCIe SSDs.

NOTE: To determine the maximum number of PCIe SSDs supported on your system, see the system-specific *Owner's Manual* at dell.com/support/manuals.

The following figures show different components of the PCIe SSD solution.

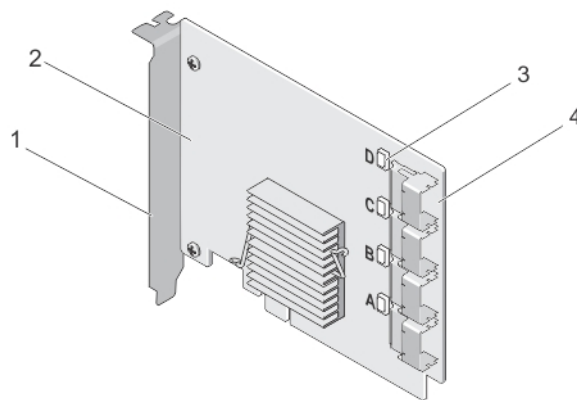

Figure 1. PCIe SSD Extender Adapter Card

1. filler bracket
2. PCIe extender adapter card
3. port link status LED (4)
4. adapter cable connectors (4)

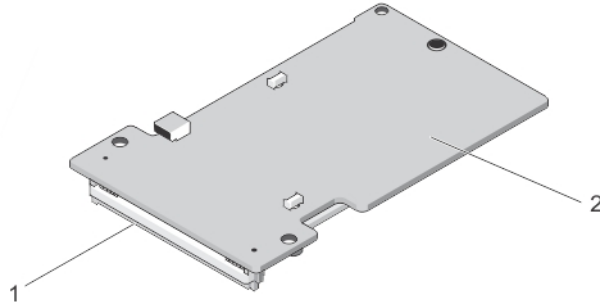

Figure 2. PCIe SSD Modular Extender Card

1. PCIe connector
2. PCIe modular extender card

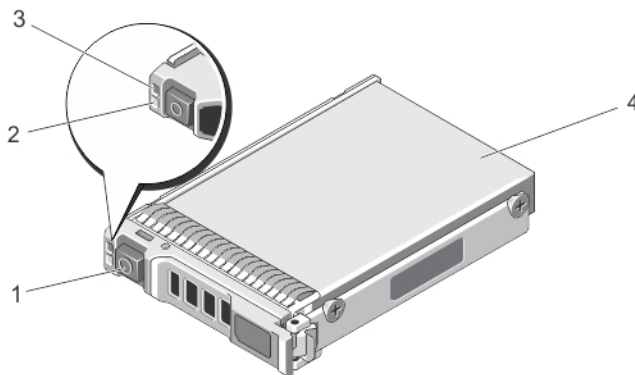



Figure 3. PCIe SSD

1. release button
2. activity indicator
3. status indicator
4. PCIe SSD

 **NOTE:** For more information on activity and status indicators, see [PCIe SSD Device Carrier LED Indicators](#).

PCIe Interface

The SSD controller used on the PCIe SSD has a PCIe Gen2 (5 Gbps) interface. The interface is available in a PCIe x4 lane width for a 16-channel flash memory controller. The PCIe interface is used to transmit or receive storage interface commands between the host and the PCIe SSD.

PCIe SSD Features

The following topics describe the different PCIe SSD features.

Performance

PCIe SSD is a high performance solid state storage device that enables IOPS performance of up to 350x more than conventional hard drives. A SLC PCIe SSD is designed to deliver sequential throughput on reads and writes at more than 1.5 Gbps speed.

 **NOTE:** MLC-based PCIe SSDs sustain equivalent sequential throughput on reads as SLC-based PCIe SSDs, but write performance is reduced because of larger memory of MLC-based PCIe SSDs.

Hot Swap

 **NOTE:** To check if your operating system supports PCIe SSD hot swap, see [Supported Operating Systems For PCIe SSD](#).

Dell PowerEdge Express Flash PCIe SSDs support orderly hot swap allowing you to add or remove a device without halting or restarting the system in which the devices are installed.

Dell-supported PCIe SSD hot swappable functions are defined below:

Orderly Insertion You insert a device into a running system where a similar device has not been previously inserted from the time it was last booted. Dell systems that support PCIe SSDs are configured to handle PCIe resource balancing in the event of a hot insertion. This preset system configuration makes this type of hot insertion an orderly operation.

Orderly Removal You remove a device from a running system. Prior to physically removing the device, you must notify the system that the device is about to be removed. This notification defines hot removal as an orderly operation.

Orderly Swap You remove a device from the system in an orderly fashion and replace it with a supported device. The device that is removed and the device that replaced it use the same device driver.

 **WARNING:** Do not remove the PCIe SSD without notifying the system first. For more information, see [Preparing To Remove A Physical Device Task For PCIe SSD](#).

 **NOTE:** Orderly hot swap is only supported when PCIe SSDs are installed in a supported Dell system running a supported operating system. To ensure that you have the correct hardware set up for your PCIe SSD, see the system specific *Owner's Manual* at dell.com/support/manuals.

 **NOTE:** Hot swapping PCIe devices is not supported in VMware ESXi 5.1.

 **NOTE:** Hot swapping PCIe devices is supported in VMware ESX 5.5, but the operating system has to be restarted to share the PCIe devices with the guest operating systems.

Device Health

PCIe SSD is designed, based on SLC and MLC NAND flash technology. NAND SSDs have a finite number of program or erase cycles and a finite number of spare blocks (replacements for other worn or faulty NAND blocks).

The program or erase cycles and spare blocks are continuously monitored for each Dell PowerEdge Express Flash PCIe SSD through Dell software management applications such as Human Interface Infrastructure (HII) and Dell OpenManage Server Administrator. For more information see, [Configuring and Managing Your PCIe SSD](#).

Self-Monitoring Analysis And Reporting Technology

The Self-Monitoring Analysis and Reporting Technology (SMART) feature-set minimizes unscheduled system downtimes by providing a method of early detection of device degradation or fault. By monitoring and storing critical performance and calibration parameters, the SMART feature-set attempts to predict degradation or fault conditions. The knowledge of a negative reliability condition allows the host system to warn you of an impending risk of device failure and advise on appropriate action.

 **NOTE:** The Dell OpenManage Server Administrator must be installed and running for SMART reporting.

Device Life Remaining

NAND SSDs have a finite number of program and erase cycles. Due to this, the Dell PowerEdge Express Flash PCIe SSD is warranted to a maximum amount of data written to the device in total bytes written. The Dell PowerEdge Express Flash PCIe SSD self monitors for these limits and Dell software management applications notify you when these limits are reached.

 **NOTE:** The Dell PowerEdge Express Flash PCIe SSD warranty expires when it reaches the threshold of total bytes written.

 **NOTE:** If you continue to write to the device after it reaches the threshold of total bytes written, the amount of time the Dell PowerEdge Express Flash PCIe SSD retains data while powered off decreases below device specifications. For more information see, [PCIe SSD Technical Specifications](#).

Device Write Status

NAND SSDs have a finite number of spare sectors and if the device exhausts the available spare sectors, the Dell PowerEdge Express Flash PCIe SSD enters the **Write Protect** mode (Read-Only). In the **Write Protect** mode, you can only perform read operations to the device. The Dell PowerEdge Express Flash PCIe SSD monitors for these limits and Dell software management applications notify you when these limits are reached.

Supported Operating Systems For PCIe SSD

Only the following operating systems support Dell PowerEdge Express Flash PCIe SSDs:

- Microsoft Windows Server 2012 (x64/EM64T)
- Microsoft Windows Server 2012 R2
- Microsoft Windows Server 2008 R2 (x64/EM64T) or later, including Hyper-V virtualization
- Red Hat Enterprise Linux 6.1 (x64/EM64T) or later
- SUSE Linux Enterprise Server 11 SP2 (x64/EM64T) or later
- SUSE Linux Enterprise Server 11 SP3
- VMware ESXi 5.1 or later

 **NOTE:** For all operating system documents, see dell.com/support/manuals, then, **Choose from a list of all Dell products** → **Software, Electronics & Peripherals** → **Software** → **Operating System** .

 **NOTE:** VMware ESX 5.5 version 3.3.4 only supports booting in the BIOS mode.

Getting Started With PCIe SSD

Dell PowerEdge Express Flash Peripheral Component Interconnect Express (PCIe) Solid State Devices (SSD)s are not bootable devices. Your system must have a supported operating system installed to access the PCIe SSD.

The PCIe SSDs you ordered with your system are preconfigured and ready for use. For more information, see [Configuring PCIe SSDs In Different Operating Systems](#) or see [Configuring and Managing Your PCIe SSD](#).

Setting Up Your PCIe SSD For First Use

If you are installing a new operating system, follow the steps below to set up your PCIe SSD for first use:

1. Set up your system and install the operating system software on a storage device other than the PCIe SSD.
To set up your system, see the system specific *Getting Started Guide*.
2. Install the PCIe SSD driver for your operating system.
For more information, see [Driver Installation](#).

 **NOTE:** For the latest list of supported operating systems and driver installation instructions go to dell.com/ossupport. For specific operating system service pack requirements, see the Drivers and Downloads section at dell.com/support.

Your PCIe SSD is now ready for use.

Configuring PCIe SSDs In Different Operating Systems

In Windows-based systems, Dell PowerEdge Express Flash PCIe SSDs have a controller entity and a device entity. The controller entity is displayed under the **Storage** controller menu in the **Device Manager**.

 **NOTE:** In driver versions 7.x and older, PCIe devices are displayed under **IDE ATA/ATAPI** controllers.

Use the controller entity when installing or updating the PCIe SSD driver. You can configure the PCIe SSD for use on Windows from, **Server Manager** → **Storage** → **Disk Management Tool**.

On Linux-based systems, you can configure the PCIe SSD from the partitioning tool by specifying or selecting the device name. The device name for PCIe SSDs is **/dev/rssdx**, where **x** is the letter corresponding to each PCIe SSD in the system (for example: **/dev/rssda**).

In VMware-based systems, you can configure the PCIe SSD as datastore or for a passthrough operation. You can use VMware vSphere Client to configure the PCIe SSD. Configuring PCIe devices as passthrough has the following limitations:

- You cannot take snapshots of the Virtual Machine (VM).
- Your VM cannot use failover features such as VMotion and Distributed Resources Scheduler (DRS).
- You cannot hot add any other device to the VM, such as a USB key. In order to install an additional device you must shut down the VM.

Use OpenManage Server Administrator for managing and performing PCIe SSD related tasks. For more information, see [Configuring and Managing Your PCIe SSD](#).

 **NOTE:** VMware ESX 5.5 version 3.3.4 only supports booting in the BIOS mode.

 **NOTE:** OpenManage Server Administrator is not supported on VMware ESX 5.5 version 3.3.4.

Servicing Your PCIe SSD

If you need to remove or replace your PCIe SSD, you can remove the PCIe SSD from a system that's operational, through an orderly removal process. This operation is supported in Windows and Linux. See [Supported Operating Systems For PCIe SSD](#).

 **CAUTION:** PCIe device hot swap is not supported in VMware ESXi 5.1. Hot swapping a PCIe SSD on a system running VMware ESXi 5.1 may lead to system instability.

To remove your PCIe SSD from a running system, use the **Prepare to Remove** task in OpenManage Server Administrator. You can safely remove the device from the system under the following conditions after you use the **Prepare to Remove** task:

- The PCIe SSD LED blinks in a pattern that indicates that the drive is preparing for removal.
- The PCIe SSD is no longer accessible by the system.

 **NOTE:** See the topic [Running Physical Device Tasks](#).

You can remove or replace your PCIe SSD while the system is offline.

 **NOTE:** To service your PCIe SSD on a system running the VMware ESXi 5.1 operating system, the system must be offline.

To service your PCIe SSD on a system running the VMware operating system:

1. Perform a graceful shutdown of the system.
2. Remove the PCIe SSD.

Replacing And Configuring Hardware

- △ **CAUTION:** All work must be performed at an electrostatic discharge (ESD)-safe workstation to meet the EIA-625-requirements for handling electrostatic discharge sensitive devices. All actions must be performed following the latest revisions of the IPC-A-610 ESD recommended practices.
- △ **CAUTION:** Many repairs may only be done by a certified service technician. You should only perform troubleshooting and simple repairs as authorized in your product documentation, or as directed by the online or telephone service and support team. Damage due to servicing that is not authorized by Dell is not covered by your warranty. Read and follow the safety instructions that came with the product.
- 🔧 **NOTE:** For complete information on U.S. Terms and Conditions of Sale, Limited Warranties and Returns, Export Regulations, Software License Agreement, safety, Environmental and Ergonomic Instructions, Regulatory Notices, and Recycling Information, see the *Safety, Environmental and Regulatory Information, End User License Agreement*, and *Warranty and Support Information* that shipped with your system.

All Dell PowerEdge Express Flash Peripheral Component Interconnect Express (PCIe) Solid State Devices (SSDs) connect to the system board through the PCIe SSD backplane. The PCIe SSD backplane is mounted on the front-chassis assembly of the system. PCIe SSDs are supplied in hot-swappable device carriers that are compatible with the PCIe SSD bays.

- △ **CAUTION:** Before attempting to remove or install a PCIe device from a system which is running, see [Preparing To Remove A Physical Device Task For PCIe SSD](#).
- 🔧 **NOTE:** For information on removing and installing the system components, see the system specific *Owner's Manual* at dell.com/support/manuals.

Removing A PCIe SSD From The System

If you are removing a PCIe SSD from a system, which is running, proceed to step 1. Otherwise, skip to step 2.

- △ **CAUTION:** To prevent data loss, it is mandatory that you prepare the PCIe SSD for removal before physically removing the PCIe SSD.

1. Use the **Prepare to Remove** task in OpenManage Server Administrator to safely remove a PCIe SSD from the system.

See [Preparing To Remove A Physical Device Task For PCIe SSD](#).

This task causes the status LEDs on the PCIe SSD to blink.

- △ **CAUTION:** The PCIe SSD LED blinks in a pattern that indicates that the drive is preparing for removal. When you initiate a prepare to remove operation, ensure that your PCIe SSD is no longer accessible by the system before you physically remove the PCIe SSD.

You can safely remove the PCIe SSD from the operating system under the following conditions after you use the **Prepare to Remove** task:

- The PCIe SSD is blinking the prepare for removal LED pattern. For more information, see the table PCIe SSD States and LED Indicator Codes.

- The PCIe SSD is no longer accessible by the operating system.
- 2. Press the release button and open the PCIe SSD carrier release handle to release the PCIe SSD. See figure Removing and Installing a PCIe SSD From/Into the System.
- 3. Slide out the PCIe SSD.

NOTE: To maintain proper system cooling, all empty PCIe SSD bays must have PCIe SSD blanks installed. For instructions on how to install a PCIe SSD bay, see the system specific *Owner's Manual* at dell.com/support/manuals.

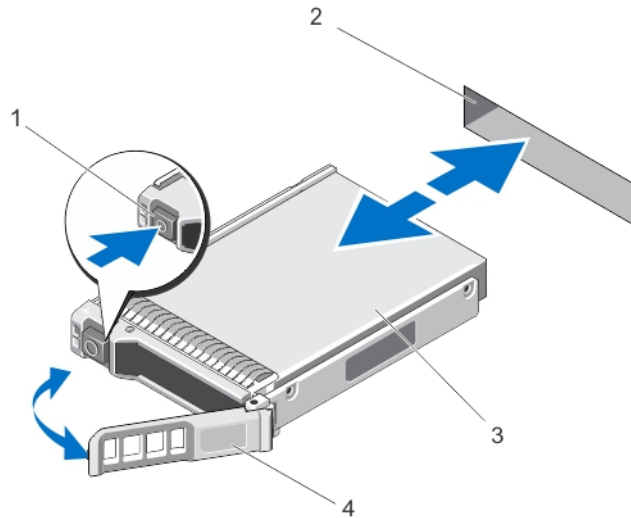

Figure 4. Removing and Installing a PCIe SSD From/Into the System

- 1. release button
- 2. PCIe SSD slot
- 3. PCIe SSD
- 4. PCIe SSD carrier handle

Installing A PCIe SSD In The System

WARNING: Inserting a PCIe SSD carrier and attempting to lock its lever next to a partially installed carrier can damage the partially installed carrier's shield spring, making it unusable.

When installing a PCIe SSD, ensure that the adjacent devices are installed.

- 1. Press the release button and open the handle.
- 2. Slide the PCIe SSD carrier into the PCIe SSD bay until the carrier contacts the backplane.
- 3. Close the PCIe SSD carrier handle to lock the device in place. See figure Removing and Installing a PCIe SSD From/Into the System.

Removing The PCIe Extender Adapter Card

Follow the steps below to remove the PCIe extender adapter card:

1. Perform a controlled shutdown of the system in which the PCIe extender adapter card is installed.
2. Disconnect the system from the electrical outlet and remove the system cover.

CAUTION: Running a system without the system cover installed may cause damage due to improper cooling.

3. Disconnect the data cables from the PCIe extender adapter card.
4. Remove any retention mechanism, such as a bracket screw that might be holding the PCIe extender adapter card in the system.
5. Lift the adapter card from the system's PCIe slot.

See figure Removing and Installing a PCIe Extender Adapter Card.

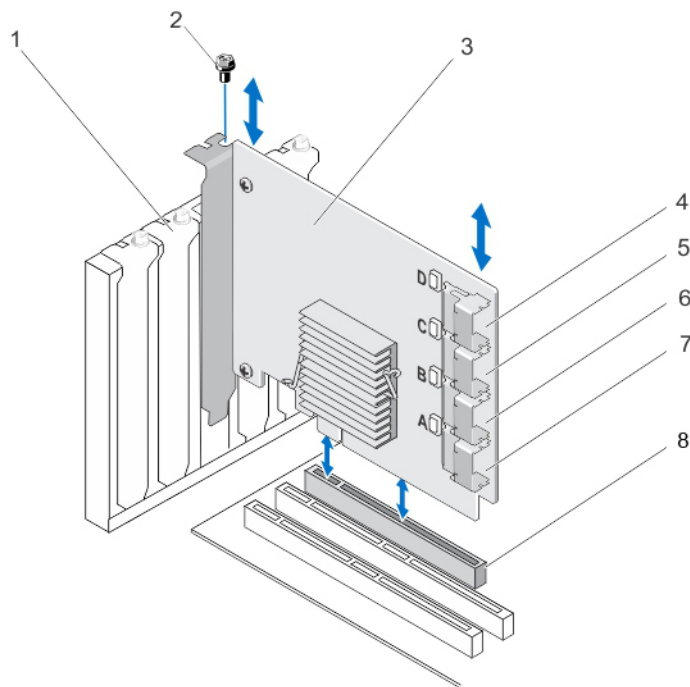



Figure 5. Removing and Installing a PCIe Extender Adapter Card

- | | |
|-------------------------------|-------------------|
| 1. blank-filler bracket slot | 6. adapter port B |
| 2. screw | 7. adapter port A |
| 3. PCIe extender adapter card | 8. PCIe slot |
| 4. adapter port D | |
| 5. adapter port C | |

Installing The PCIe Extender Adapter Card

 **NOTE:** Contact Dell technical support if the PCIe extender adapter card is damaged. See [Contacting Dell](#).

1. Unpack the PCIe extender adapter card.
2. Turn off the system and attached peripherals, and disconnect the system from the electrical outlet and peripherals.
3. Disconnect all attached devices and remove the system cover.
4. Select an empty PCIe x16 slot.

To determine the correct PCIe slot for your PCIe Extender Adapter card, see the system specific *Owner's Manual* at dell.com/support/manuals.

5. Remove the filler bracket on the back of the system aligned with the PCIe slot you have selected.
6. Align the PCIe extender adapter card with the PCIe slot you have selected.

 **CAUTION:** Never apply pressure to the extender adapter card while inserting it in the PCIe slot. Applying pressure may break the adapter module.

7. Insert the PCIe extender adapter card until the card is firmly seated in the PCIe slot.
8. Tighten the bracket screw (if any) or use the retention clips to secure the PCIe extender adapter card to the system chassis.
9. Connect the cables from the PCIe backplane to the PCIe extender adapter card.

For more information, see figure Removing and Installing a PCIe Extender Adapter Card.

 **NOTE:** The backplane connector cables are labeled as **PCIe BP A**, **PCIe BP B**, **PCIe BP C**, and **PCIe BP D** for connection to the backplane. The PCIe extender adapter card cable connectors are labeled as adapter port **A**, **B**, **C**, and **D** respectively for connection to the card. These cables must not be reversed. For more information, see figure Cabling a PCIe Extender Adapter Card.

10. Replace the system cover.
11. Reconnect the power cable and turn on the system.

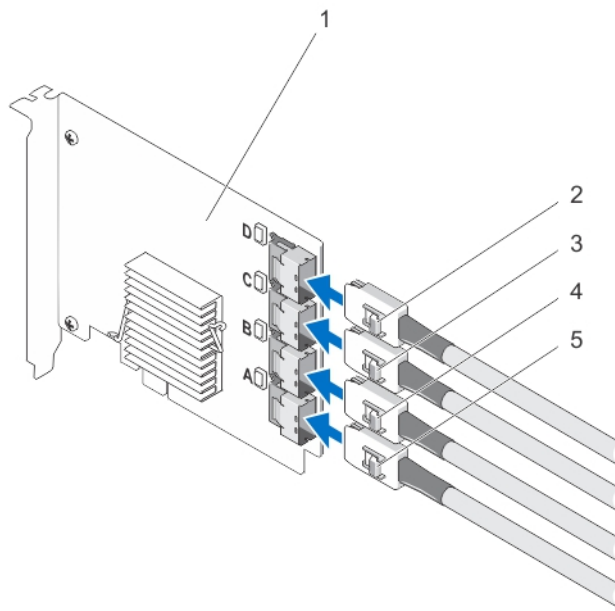

Figure 6. Cabling a PCIe Extender Adapter Card

- | | |
|-------------------------------|----------------|
| 1. PCIe extender adapter card | 4. Ctrl PCIe B |
| 2. Ctrl PCIe D | 5. Ctrl PCIe A |
| 3. Ctrl PCIe C | |

NOTE: Depending on the maximum number of PCIe SSDs supported on your system, fewer PCIe SSD cables may be required.

Removing The PCIe Extender Modular Card

Follow the steps below to remove the PCIe extender modular card:

1. Remove the modular system from the modular system chassis.
2. Remove the system cover.
3. Remove the system board and place it on a stable and flat surface.
4. Gently pull to disconnect the extender modular card connector from the system board connector.
For more information, see figure Removing and Installing a PCIe Extender Modular Card.
5. Lift the PCIe extender modular card from the system board.
For more information, see figure Removing and Installing a PCIe Extender Modular Card.
6. Reinstall the system board.
7. Replace the system cover.
8. Reinstall the modular system in the modular system chassis.
For the latest list of firmware and installation instructions, see the system documentation at dell.com/support/manuals.

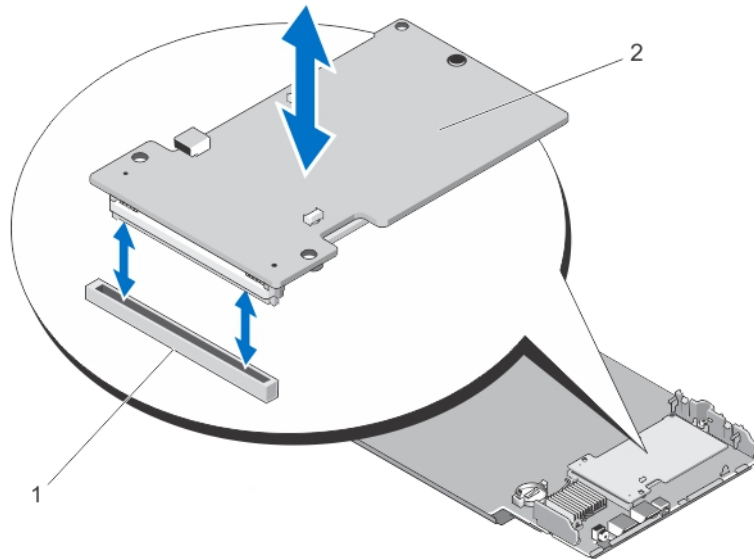



Figure 7. Removing and Installing a PCIe Extender Modular Card

1. PCIe slot
2. PCIe extender modular card

Installing The PCIe Extender Modular Card

 **NOTE:** Contact Dell technical support if the PCIe extender adapter card is damaged. See [Contacting Dell](#).

The PCIe extender modular card is located below the PCIe SSD bays of the Dell modular system.

1. Remove the modular system from the modular system chassis.
2. Remove the system cover.
3. Remove the system board and place it on a stable and flat surface.
4. Unpack the PCIe modular extender card.
5. Identify the PCIe extender connector.
6. Insert the PCIe modular extender card into the slot until it clicks into place.
7. Reinstall the system board.
8. Replace the system cover.
9. Reinstall the modular system in the modular system chassis.
10. Insert the PCIe SSD.

For more information, see the figure Removing and Installing a PCIe Extender Modular Card.

Driver Installation





For the current list of operating systems supported by Dell PowerEdge Express Flash Peripheral Component Interconnect Express (PCIe) Solid State Devices (SSDs), see [Supported Operating Systems For PCIe SSD](#).

Downloading PCIe SSD Drivers

To download PCIe SSD drivers:

1. Go to dell.com/support/drivers.
2. Enter **Service Tag or Express Service Code** or select **Choose from a list of all Dell products**.
3. Select **Servers, Storage & Networking**.
4. Select **PowerEdge**.
5. Select your system.
The drivers that are applicable to your selection are displayed.
6. Select **Solid State Storage**.
The PCIe SSD drivers that are applicable to your system are displayed.
From the available list, download the latest PCIe SSD drivers to a USB drive, CD, or DVD.

Installing Or Upgrading The PCIe SSD Driver For Microsoft Windows Server 2008, Windows Server 2012, and Windows Server 2012 R2



-  **NOTE:** For a complete list of supported operating systems, see [Supported Operating Systems For PCIe SSD](#).
-  **NOTE:** Use the procedures in this section to install or upgrade the driver for Windows. The driver is updated frequently. To ensure that you have the current version of the driver, download the updated Windows driver from dell.com/support. For more information, see [Downloading PCIe SSD Drivers](#).
-  **NOTE:** Close all applications on your system before you update the driver.
-  **NOTE:** Driver version 7.x is ATA port-based and driver version 8.x and later is a Storport-based driver. The functionality and features of both types of drivers are the same.

To install or upgrade the PCIe SSD driver for Windows server using Dell Update Package (DUP):



-  **NOTE:** Dell provides the DUP to update drivers on systems running Windows Server 2008 R2 SP1 and Windows Server 2012 operating systems. DUP is an executable application that updates drivers for specific devices. DUP supports command line interface and silent execution. For more information, see the DUP documentation at dell.com/support/esmanuals.

When DUPs are not used to upgrade the driver, follow the instructions below:

1. Insert the media containing the latest driver that you downloaded in [Downloading PCIe SSD Drivers](#).
2. Click **Start** → **Control Panel** → **System and Security**.

3. Select **Device Manager** under the **System** option.
The **Device Manager** screen is displayed.
4. Double-click the entry to expand **Storage** controllers. Alternatively, you can click on the plus symbol next to the **Storage** controllers.
The PCIe SSD device is displayed as `Dell Express Flash 175 GB (or 350 GB) P320h PCIe Controller` or `Dell Express Flash 700 GB P420m PCIe Controller`.
 **NOTE:** In driver versions 7.x and earlier, PCIe devices are displayed under **IDE ATA/ATAPI** controllers.
-  **NOTE:** If there is no PCIe SSD driver installed, the PCIe device may be listed under the **Other** devices option. In this case, the PCIe device is displayed as **Mass Storage Controller**.
5. Double-click the PCIe device for which you want to install or update the driver.
6. Click the **Driver** tab and click **Update Driver**.
The **Update Device Driver** screen is displayed.
7. Select **Browse my computer for driver software**.
8. Select **Let me pick from a list of device drivers on my computer**.
9. Click **Next**.
10. Select **Have Disk**.
11. Follow the steps in the wizard and browse to the location of the driver files.
12. Select the **INF** file from the driver media.
13. Click **OK** to exit the wizard.
14. Click **Next**.
15. Click **Install**.
 **NOTE:** If there is more than one PCIe SSD in the system, repeat steps 4–14 for all remaining devices in the system.
16. Restart the system for the changes to take effect.

Installing Or Upgrading The PCIe SSD Driver For Red Hat Enterprise Linux Or SUSE Linux Enterprise Server





-  **NOTE:** For a complete list of supported operating systems, see [Supported Operating Systems For PCIe SSD](#).
-  **NOTE:** Use the procedures in this section to install or upgrade the driver for Linux. The driver is updated frequently. To ensure that you have the current version of the driver, download the updated Linux driver from [dell.com/support](#). For more information, see [Downloading PCIe SSD Drivers](#).

SUSE Linux Enterprise Server 11 drivers are provided in the Kernel Module Package (KMP) format while Red Hat Enterprise Linux 6 drivers are provided in the Kernel Module Loader (KMOD) format. KMODs are normal Red Hat Packet Manager (RPM)s and are driver packaging methods that contain kernel modules, instituted to better handle kernel update situations. To install or update the PCIe SSD driver:

1. Uncompress the zipped tarball driver release package.
2. Install the driver package using the command: `rpm -ihv < driver rpm package name >.rpm`
 **NOTE:** Use `rpm -Uvh <package name>` when updating an existing package.
3. Restart the system for the driver update to take effect.
4. After the system restarts, verify the driver has been installed with the system command: `# modinfo mtip32xx`
The version shown in the output must match with the version of the package.

5. Verify that the driver has been loaded with the system command: `# lsmod` or `# cat /proc/modules`. These commands return `mtip32xx` in the list if the driver is loaded.
The PCIe SSDs are ready for use. See, [Configuring PCIe SSDs In Different Operating Systems](#).

Installing The PCIe SSD Driver On Systems Supporting VMware

-  **NOTE:** For a complete list of supported operating systems, see [Supported Operating Systems For PCIe SSD](#).
-  **NOTE:** Use the procedures in this section to install the driver for VMware ESXi 5.1. To ensure that you have the current version of the driver, download the updated VMware ESXi 5.1 driver from [dell.com/support](#). For more information, see [Downloading PCIe SSD Drivers](#).
-  **NOTE:** If you have previously installed a 1.x driver, uninstall the driver prior to installing a 2.x driver or later.
-  **NOTE:** VMware ESX 5.5 version 3.3.4 only supports booting in the BIOS mode.

VMware ESXi drivers are provided in an offline zip depot, which contains the driver VIB (vSphere Installation Bundle).

To install or update the PCIe SSD driver:

1. Transfer the PCIe SSD driver to the ESXi host.
You may use vSphere Client Browse Datastore or a SFTP/FTP Client to transfer the driver to the ESXi host.
2. To transfer the driver using the vSphere Client:
 - a) Navigate to the **Configuration** tab.
 - b) Select **Storage** from the hardware section.
 - c) Right-click **Datastore** and select **Browse**.
 - d) Upload the PCIe SSD driver to the datastore.To transfer the driver to the ESXi host using SFTP/FTP client, launch the SFTP/FTP program, and copy the PCIe SSD Driver **.zip** file to a local folder on the host.
3. Power off all virtual machines running inside the ESXi host operating system.
4. To enable ESXi shell service using vSphere, navigate to the **Configuration** tab of the Host IP.
 - a) Click **Security Profile** under **Software**.
 - b) Click **ESXi Shell** under **Services**.
 - c) Click **Properties**.
 - d) Start the ESXi shell service.
5. To enable ESXi shell service directly from the host settings:
 - a) Click **F2** to customize system settings.
 - b) Enter a user name and password.
 - c) Navigate to troubleshooting options.
 - d) Enable the **ESXi** shell.
 - e) Enable **SSH**.
6. To install the PCIe SSD driver on the ESXi host:
 - a) Navigate to datastore volume or file directory where the PCIe SSD driver is saved and run the following command: `esxcli software vib install -d / <complete_path_to_offline_zip_depot>`
 - b) Restart the ESXi host.
7. Check if the driver has been installed by running the following command: `esxcli software vib list | grep mtip32xx`
8. Using vSphere, put the ESXi host in maintenance mode and restart.
9. Once the host restarts and is running, take the host out of maintenance mode.

 **NOTE:** To remove the PCIe SSD VIB from host, run the following command: `esxcli software vib remove --vibName=mtip32xx-scsi`

Configuring And Managing Your PCIe SSD

Dell storage management applications enable you to manage and configure the Dell PowerEdge Express Flash Peripheral Component Interconnect Express (PCIe) Solid State Device (SSD) subsystem, control, and monitor multiple PCIe SSDs, and provide online maintenance.

The Dell PowerEdge Express Flash PCIe SSD solution supports Unified Extensible Firmware Interface (UEFI) and Human Interface Infrastructure (HII), for pre-operating system management and the Dell OpenManage Server Administrator application for operating system management.

Human Interface Infrastructure Configuration Utility

The HII Configuration utility is a standardized way of viewing and setting a device configuration. The HII Configuration utility provides pre-operating system functionality and management for PCIe SSDs including:

- Viewing physical device properties.
- Running physical device operations.
- Retrieving debug information.

 **CAUTION: Hot swapping PCIe SSDs is not supported in the HII Configuration utility. Hot swapping a PCIe SSD while in the HII Configuration utility may not be detected and handled properly.**

Entering The HII Configuration Utility

Follow the steps to enter the HII Configuration utility:

1. Turn on the system.
2. Press <F2> during system startup to enter the system setup.
3. Navigate to the **Device Settings** option.
The HII configuration is displayed for the various devices that support HII.
4. Select **Dell PCIe Solid State Devices**.

Viewing Physical Device Properties

Follow the steps to view physical device properties:

1. Navigate to **View Physical Device Properties** in the PCIe SSD HII Configuration utility.
2. Select a PCIe SSD to view the selected physical device properties.
3. Press <Esc> to return to the previous screen.
4. To exit the PCIe SSD HII Configuration utility, select the **Exit** button on the top right corner in the **System Setup** menu.

Initializing Physical Devices

 **CAUTION:** Performing a full initialization on a PCIe SSD overwrites all blocks and results in permanent loss of all data on the PCIe SSD.

 **NOTE:** During full initialization, the host cannot access the PCIe SSD.

 **NOTE:** If the system restarts or experiences a power loss during a full initialization, the operation is aborted. You must restart the system and restart the process.

Perform the following steps to initialize a PCIe SSD from the PCIe SSD HII Configuration utility:

1. Navigate to the **Select Physical Device Operations** menu of the PCIe SSD HII Configuration utility.
2. Select the PCIe SSD to be initialized.
3. Select **Full Initialization**.

The following warning message is displayed: "Performing full initialization will result in permanent loss of all data. Do you want to continue?"

If you select **Yes**, the full initialization operation starts. If you select **No**, the operation is not performed and returns you to the previous screen.

4. Press **<Esc>** to return to the previous screen.
5. To exit the PCIe SSD HII Configuration utility, click the **Exit** button at the top right corner in the **System Setup**.

 **NOTE:** Full initialization operation takes several minutes to complete. While this operation is in progress, you cannot navigate out of this page.

Setting LED Blinking

The **LED blink** option allows you to identify a physical device in the system. Perform the following steps to start or stop the option:

1. Navigate to the **Select Physical Device Operations** menu in the PCIe SSD HII Configuration utility.
2. Select a PCIe SSD.
3. Select the **Blink** option to begin activity LED blinking or the **Unblink** option to end LED blinking.
4. Press **<Esc>** to return to the previous screen.
5. To exit the PCIe SSD HII Configuration utility, select the **Exit** button on the top right corner in the **System Setup** menu.

Exporting The Log

The **Export Log** option exports the PCIe SSD log to a text file. The log contains debug information of the PCIe SSD, which helps while troubleshooting.

 **NOTE:** You need a writable media with a UEFI compatible filesystem attached to the system to save the log.

 **NOTE:** If there are no applicable devices inserted in the system when entering the Export Log HII page, the following message is displayed: "Log cannot be exported because no file systems were detected."

To export the log:

1. Navigate to the **Export Log** menu of the **PCIe SSD HII Configuration** utility.
2. Select the file system device where the log will be exported.

3. Select the directory where you want to save the log.
4. Confirm the export log path selected to save the PCIe SSD log.
5. Select the **Save Log** link.
 -  **NOTE:** The log file is saved as: **PCIeSSD_MDHMS.log**, where MD = *Month*, Date and HMS = *Hour, Min, Sec*.
6. Press **<Esc>** to return to the previous screen.
7. To exit the **PCIe SSD HII Configuration** utility, click the **Exit** button on the top right corner in the **System Setup** menu.

Exiting The HII Configuration Utility

To exit the PCIe SSD HII Configuration utility:

1. Click the **Exit** button on the top right corner in the **System Setup** menu of the HII Configuration utility.
2. Click **OK** and press **<Enter>**.

 **NOTE:** Clicking **Exit** in any PCIe SSD HII page takes you back to the main **System Setup** menu.

 **NOTE:** Press **<Esc>** from any PCIe SSD HII page to return to the previous page.

Dell OpenManage Server Administrator

The Dell OpenManage Server Administrator is a storage management application for Dell systems that provides features for managing components of the PCIe SSD solution. The Dell OpenManage Server Administrator application enables you to perform PCIe SSD functions from a single graphical or command-line interface.

 **NOTE:** The graphical user interface (GUI) is wizard driven with features for novice and advanced users, and a detailed online help. The command line interface, available on selected operating systems, enables you to perform PCIe SSD management tasks that are fully featured and scriptable. For more information, see the OpenManage Server Administrator online help accessible through the application.

Launching Storage Management

Storage Management is installed as a Dell OpenManage Server Administrator service. All storage management features for the PCIe SSD solution are accessible by selecting the **Storage** object, and then the **PCIe-SSD Subsystem** in the **Server Administrator** tree view.

Storage Information

To access Storage Information:

1. Expand the **Storage** tree object to display the storage component objects.
2. Select **PCIe SSD Subsystem**.
The **Storage Information** window is displayed under **Information/Configuration**.
3. Click **Properties**.

Storage properties may include the following:

ID	Displays the storage ID assigned to the component by storage management. Storage management enumerates the storage components attached to the system starting with zero.
Status	Displays the combined status for the PCIe SSD subsystem and its lower-level components.

Name	Displays the name of the extender.
State	Displays the current state of the PCIe SSD subsystem. Possible values are: <ul style="list-style-type: none"> – Ready: The component is functioning normally. – Degraded: The component has encountered a failure and is operating in a degraded state. – Failed: The component has encountered a failure and is no longer functioning.
Driver Version	Displays the version of the driver that is currently installed on the PCIe SSDs.
Number of Extenders	Displays the number of extenders in the PCIe SSD Subsystem.

Configuring And Managing PCIe SSDs

Use the **Physical Device Properties** screen to view information about PCIe SSDs and to run PCIe SSDs tasks.

To view the complete PCIe SSD properties, select **Full View** from the **Options** taskbar. Physical device properties are described below:

Name	Displays the name of the PCIe SSD. The name comprises the bay ID and the slot in which the PCIe SSD is installed.
State	Displays the current state of the PCIe SSD.
Bus Protocol	Displays the technology that the PCIe SSD is using.
Media	Displays the media type of the physical device.
Device Life Remaining	Displays the warranted wear out level of the PCIe SSD (in percentage).
Failure Predicted	Displays a status of the device on whether it has received a Self-Monitoring Analysis and Reporting Technology (SMART) alert and is therefore predicted to fail.
Revision	Displays the current running firmware version on the PCIe SSD.
Driver Version	Displays the current running driver version of the PCIe SSD.
Model Number	Displays the Piece Part Identification (PPID) of the PCIe SSD.
Capacity	Displays the full capacity of the device.
Vendor ID	Displays the hardware vendor of the device.
Product ID	Displays the product ID of the device.
Serial No.	Displays the serial number of the device.
Negotiated Speed	Displays the speed of data transfer that the device negotiated upon initial communication. This speed is dependent on the speed of the device, the capable speed of the PCIe extender card, and the current speed of the PCIe extender card on that connector.
Capable Speed	Displays the highest possible speed at which the device can transfer data.

 **NOTE:** For physical device properties status, see table PCIe SSD States and LED Indicator Codes.

Running Physical Device Tasks

1. Expand the **Storage** tree object to display the storage component objects.
2. Expand the **PCIe-SSD SubSystem** object.
3. Expand the **PCIe-SSD Extender** object.
4. Expand the **Enclosure (Backplane)** object.
5. Select the **Physical Devices** object.
6. Select a task from the **Available Tasks** drop-down menu.
7. Click **Execute**.

PCIe SSD Drop-Down Menu Tasks

The following are the PCIe SSD drop-down menu tasks:

- Blink
- Unblink
- Prepare to Remove
- Full Initialization
- Export Log

Blink And Unblink Task For PCIe SSD

The **Blink** task allows you to find a device within a system by blinking one of the LEDs on the device. You can use this task to locate a failed device. If you need to cancel the **Blink** task or if the physical device continues to blink indefinitely, use the **Unblink** task.

Preparing To Remove A PCIe SSD

 **CAUTION:** PCIe device hot swap is not supported on systems running VMware ESXi 5.1. Hot swapping a PCIe SSD while in ESXi 5.1 may cause system instability.

 **WARNING:** The identify LED pattern is the same LED pattern as prepare for removal. When you initiate a prepare to remove operation, ensure that your PCIe SSD is no longer accessible by the system before you physically remove the PCIe SSD.

 **CAUTION:** To prevent data loss, it is mandatory that you use the Prepare to Remove task before physically removing a device.

Use the **Prepare to Remove** task to safely remove a PCIe SSD from the system. This task causes the status LEDs on the device to blink. You can safely remove the device from the system under the following conditions after you use the **Prepare to Remove** task:

- The PCIe SSD LED blinks in a pattern that indicates that the drive is preparing for removal. See table PCIe SSD States and LED Indicator Codes.
- The PCIe SSD is no longer accessible by the system.

To perform the **Prepare to Remove** task:

1. Expand the **Storage** tree object to display the storage component objects.
2. Expand the **PCIe-SSD SubSystem** object.
3. Expand the **PCIe-SSD Extender** object.

4. Expand the **Enclosure (Backplane)** object.
5. Select the **Physical Devices** object.
6. Select **Prepare To Remove** task.
7. Click **Execute**.

The following warning message is displayed:

"Warning: Are you sure you want to prepare the physical device for removal?"

8. Select **Prepare to Remove Physical Device** to proceed or select **Go Back** to previous page to cancel the operation.

Performing Full Initialization Task For PCIe SSD

 **CAUTION:** Performing a full initialization on a PCIe SSD overwrites all blocks and will result in permanent loss of all data on the PCIe SSD.

 **NOTE:** During full initialization, the host is not able to access the PCIe SSD.

 **NOTE:** If the system restarts or experiences a power loss during a full initialization, the operation aborts. You must restart the system and restart the process.

1. Expand the **Storage** tree object to display the storage component objects.
2. Expand the **PCIe-SSD SubSystem** object.
3. Expand the **PCIe-SSD Extender** object.
4. Expand the **Enclosure (Backplane)** object.
5. Select the **Physical Devices** object.
6. Select **Full Initialization** task.
7. Click **Execute**.

The following caution message is displayed: "Caution: When you perform the Full Initialization operation, any data on the disk will be lost permanently. Are you sure you want to continue?"

8. Select **Full Initialization** to proceed or select **Go Back** to previous page to cancel the operation.

Exporting The Log

The log contains debug information of the PCIe SSD, which helps while troubleshooting. You can export the log through the **Physical Device Available Tasks** drop down menu.

To export the log:

1. Expand the **Storage** tree object to display the storage component objects.
2. Expand the **PCIe-SSD SubSystem** object.
3. Expand the **PCIe-SSD Extender** object.
4. Expand the **Enclosure (Backplane)** object.
5. Select the **Physical Devices** object.
6. Select **Export Log** task.
7. Click **Execute**.

The log file is saved to a pre-determined location on your system. This location is displayed on the page after you click **Execute**.

Troubleshooting

 **NOTE:** To get help for your Dell PowerEdge Express Flash PCIe SSD, see [Contacting Dell](#).

Self-Monitoring Analysis And Reporting Technology Errors

The PCIe SSD solution is always monitored for errors by its internal software. If an error occurs, it is detected and recorded in an internal log. Based on the criticality of the error, the software may inform the host server that further action is needed. It signifies that the error condition occurred a specific number of times and that the device health needs attention.

PCIe SSD Carrier LED Indicators

The LEDs on the PCIe SSD carrier indicate the state of each physical device. Each PCIe SSD carrier in your enclosure has an activity LED (green) and a status LED (bicolor, green/amber) as shown in the figure. The activity LED flashes whenever the device is accessed.

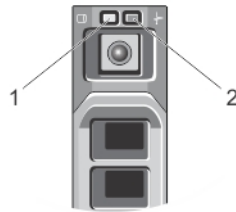



Figure 8. PCIe SSD Device Carrier LED Indicators

1. activity indicator
2. status indicator

While the operating system is running, the status indicator provides the current status of the device. The table below lists the device states along with the associated LED indicator codes.

Table 1. PCIe SSD States and LED Indicator Codes

State Name	Slot/Device State	Status LED (Green)	Status LED (Amber)
Device status off	OpenManage Server Administrator is not currently installed and running in the system.	Off	Off
Device online	The device is powered up and available for use by the host operating system.	On	Off

State Name	Slot/Device State	Status LED (Green)	Status LED (Amber)
	 NOTE: Device online state indicates the OpenManage Server Administrator is installed and running on the system.		
Device identify (blink)	The device is identifying the slot location or is indicating the device has received a Prepare for Removal command from the host operating system.	On for 250 msec Off for 250 msec	Off
Device failed	The host operating system no longer has access to the device because the device is not responding or has encountered a critical error condition.	Off	On for 250 msec Off for 250 msec

Ungraceful System Shutdown Or Power Loss

If the host system experiences a power loss, the PCIe SSD may not have time to perform its internal shut down procedure. In such an event, the device may enter a recovery mode which is indicated by the steady blinking of the activity LED (On for 200 msec, Off for 200 msec). See figure PCIe SSD Carrier LED Indicators.

This recovery process is also known as rebuilding. During rebuilding, there is very limited access from the host operating system. After the recovery procedure is complete, the steady blinking stops and the device is fully accessible.

 **CAUTION:** Removing a PCIe SSD from the system without preparing the device for removal first, causes the PCIe SSD to enter recovery mode the next time it is inserted in the system.

 **NOTE:** The operating system event log displays events during the time period the PCIe SSD is in recovery mode to indicate when the device enters the recovery mode and displays a progress indicator until the device exits the recovery mode.

 **NOTE:** It is recommended to use power backup solutions for all Dell systems.

Buffer I/O Error On PCIe SSD During Full Initialization

There may be I/O errors in a PCIe SSD during full initialization, while running in a Linux environment. The I/O error messages are displayed in the operating system event log.



 **WARNING:** To prevent data loss, do not send any I/Os to the device during full initialization.

If you are not sending any I/Os to the device, these error messages may still be displayed in the operating system event log. These I/O error messages do not indicate an issue with the device, and have no negative effects.

General Errors

The following section describes the general errors related to PCIe SSD.

PCIe SSD Is Not Listed In the Operating System

Cause	Hardware is not correctly installed.
Solution	<p>Check the following components:</p> <ul style="list-style-type: none">• Devices: Ensure that the PCIe SSDs are installed in a PCIe SSD backplane.  CAUTION: PCIe SSDs must be used with PCIe SSD backplanes. To ensure that you have the correct configuration for the PCIe SSD, see the platform-specific <i>Owner's Manual</i> at dell.com/support/manuals.• Backplane: Ensure that the cables for the PCIe SSD backplane are connected correctly.  NOTE: The backplane connector cables are labeled as PCIe BP A, PCIe BP B, PCIe BP C, and PCIe BP D for connecting to the backplane. The PCIe extender adapter card cable connectors are labeled as adapter port A, B, C, and D respectively for connecting to the card. These cables must not be reversed. Cables: PCIe cables are unique for the configuration. Ensure that the backplane cable connectors mate with the backplane and the extender card cable connectors mate with the extender card. See Replacing And Configuring Hardware.• Extender card: Ensure that the PCIe extender card is plugged into the correct supported slot. See the system specific <i>Owner's Manual</i> at dell.com/support/manuals.

An Error Message Is Displayed When Running Full Initialization In HII

Description	When you run a full initialization on Human Interface Infrastructure (HII), the following error message is displayed: "Full initialization failed, please contact your system vendor".
Cause	PCIe SSD is not accessible because it was hot swapped.
Solution	<p>Hot swap is not supported in pre-operating system environments. If a PCIe SSD is hot-removed or hot-inserted while in Unified Extensible Firmware Interface (UEFI) or HII, the device is not accessible until the host system has been power cycled. Perform the following steps to recover from this situation:</p> <ol style="list-style-type: none">1. Power off the system.2. Install your PCIe SSD.3. Power on the system.

PCIe SSD Is Not Seen In Device Management In The Operating System

Cause	The device driver is not installed.
Solution	See Driver Installation .

PCIe SSD Is Not Seen In Disk Management In The Operating System

Cause	The device is in recovery mode (rebuilding).
Solution	During the recovery period, the device does not respond to commands from the host operating system. You must wait until the recovery period completes, in order to access the PCIe SSD through the disk management. See Ungraceful System Shutdown Or Power Loss .

Cannot Update The Firmware Using Dell Update Package (DUP)

Cause	The device driver is not installed.
Solution	Before you update the device firmware using DUP, install the device driver. For more information, see Driver Installation .

Linux Fails To Boot And Prompts For The Root Password

Cause	A stale volume mount point is still present after a device removal or full initialization.
Solution	Perform the following steps to recover from this situation: <ol style="list-style-type: none">1. Enter the root password to enter maintenance mode.2. Remount the root filesystem as read-write using the following command: <code>mount -orw, remount</code>3. Manually edit /etc/fstab to remove the non-existent device entry.

PCIe SSD Is Inserted In The System And Is Visible To The Operating System But The Status LED Is Off

Cause	OpenManage Server Administrator is not installed or its services are not running.
Solution	Install a supported version of OpenManage Server Administrator and ensure its services are running. See Configuring and Managing Your PCIe SSD .
Cause	Latest Linux driver from Dell is not installed.
Description	Some Linux distributions come with a down-level PCIe SSD driver that is only partially functional.
Solution	Download and install the latest Linux driver from dell.com/support . See Installing Or Upgrading The PCIe SSD Driver For Red Hat Enterprise Linux Or SUSE Linux Enterprise .

Delay In System Boot While The PCIe SSD Activity LED Is Blinking

Cause	The device experienced an unexpected shutdown or power loss causing the device to enter in recovery mode.
Solution	When a device is in recovery mode, system boot pauses during initialization until the device exits the recovery mode period. A progress indicator displays the progress until the device exits the recovery mode condition.

I/O Device Error On Write To PCIe SSD

Cause	PCIe SSDs have a finite number of write cycles, when a PCIe SSD exhausts the number of writes it goes in to the Write Protect mode (Read Only).
Description	<p>Windows event log may report the following entries on the first write attempt to a PCIe SSD:</p> <ul style="list-style-type: none">• Event ID 11: The driver detected a controller error on \Device\Ide\IdePort#• Event ID 7: Device in Write-Protect Mode <p>Linux messages log may report the following entries on a write attempt to a PCIe SSD:</p> <ul style="list-style-type: none">• Taskfile error (40000000): attempting recovery...• restartPort: Issuing COM reset Write protect bit set• Fail: write w/tag 1 write protect• EH tags failed: [2 tags] <p>VMware kernel log may report the following entries:</p> <ul style="list-style-type: none">• scsiExecReadWriteCommand:Failure—drive has reached End of Life and has gone into Write Protect• scsiExecReadWriteCommand:IO Failed—drive is in write protect mode, EOL value=100
Solution	By using OpenManage Server Administrator, you may check the PCIe SSD state to confirm if the PCIe SSD is in Read-Only Mode . Alternatively, you can boot into the HII and do the same. For further instructions, contact a Dell Technical Service representative.

PCIe SSD Performance Measurement Not Optimal

Cause	PCIe SSD has not been pre-conditioned and/or BIOS settings are not optimal.
Description	There are a number of factors that may alter the performance of a PCIe SSD. It is recommended to take basic setup measures to ensure performance optimization of these devices.
Solution	<ul style="list-style-type: none">• Without pre-conditioning the PCIe SSD, performance measurements can be misleading as it may not reflect long term performance of the device. Pre-conditioning activates flash management, which stabilizes data throughput over a period of time. One way to pre-condition the PCIe SSD is to perform large block (64 KB or greater) sequential writes to the entire device's capacity.• Configure the server for low latency performance. To achieve maximum performance with Dell PowerEdge Express Flash PCIe SSDs, change the server performance profile in the BIOS settings to Maximum Performance.

VMware ESXi Driver Fails To Install

Cause	Full path to the offline zip depot or VIB (vSphere Installation Bundle) is not specified.
Description	When the full path to the zip depot or VIB is not specified, the following error message is displayed: [MetadataDownloadError] Could not download from depot at zip:/var/log/vmware/ <offline_zip_depot>? index.xml, skipping ('zip:/var/log/vmware/<offline_zip_depot?index.xml ', '', "Error extracting index.xml from /var/log/vmware/<offline_zip_depot>: [Errno2] No such file or directory: '/var/log/vmware/<offline_zip_depot>" ") url = zip:/var/log/vmware/ <offline_zip_depot>?index.xml
Solution	Specify the full path to the location of the offline zip depot. For example, if the file is located in /tmp/driver , then the command must be: <code>esxcli software vib install -d /tmp/driver/<offline_zip_depot></code>

PCIe SSD Is Listed In ESXi Host But Cannot Be Accessed In The Virtual Machine

Cause	The PCIe SSD is hot swapped.
Description	The virtual machine may become unresponsive and shut down.
Solution	Reboot the ESXi host and restart the virtual machine.

VMware Reports A Missing Virtual Disk After A PCIe SSD Is Removed

Cause	The PCIe SSD is either ungracefully removed from the system or it is properly removed but the virtual machine is not properly configured.
Description	VMware reports a missing virtual disk in the path <code>/vmfs/volumes/.../.../VD-name.vmdk</code> after a PCIe SSD is removed.
Solution	Dell PowerEdge Express Flash PCIe SSDs do not support hot swap in VMware ESXi. If the PCIe SSD is properly removed while the ESXi host system is shut down, ensure the virtual machine is reconfigured to reflect the removal.

VMware ESX 5.5 With Native Driver Version 3.3.4 Does Not Respond When The Host Operating System Is Booting

Cause	The host system is set to boot in the UEFI mode.
Description	VMware ESX 5.5 with native driver version 3.3.4 does not respond when the host operating system is booting.
Solution	Set the host to boot in the BIOS mode.

VMware ESX 5.5 With Native Driver Version 3.3.4 Is Unable To See Or Manage The PCIe SSD On The OpenManage Server Administrator

Cause	You are using native driver version 3.3.4
--------------	---

Description VMware ESX 5.5 with native driver version 3.3.4 is unable to see or manage the PCIe SSD.

Solution Download and install the latest available driver from dell.com/support.

PCIe SSD Technical Specifications

 **NOTE:** The specifications provided is for information purposes only and do not constitute an extension of Dell's warranty for this product.

Features	Description
NAND type	SLC: 175 GB and 350 GB MLC: 700 GB
Hot swappable	Yes
Embedded data protection enabled	Yes
Device write cache	No
Native Command Queuing (NCQ)	Yes
Bootable device	No
Self-monitoring enabled	Yes
Offline data retention	Up to one year after total bytes written reaches 100%

General

Model	PCIe SSD
System interface	PCIe
Standard	PCIe 2.0
Backplane interface	Combo-connector (SFF-8639)

 **NOTE:** For more information on the combo-connector, see [SFF-8639 \(PCIe SAS Combo-Connector\)](#).

Mechanical Dimensions

Height	66.80 mm
Width	14.9 mm
Minor Length	97.25 mm

Device Capacity

Unformatted capacity	175 GB, 350 GB, and 700 GB
User-addressable sectors	175 GB: 341884368 LBAs 350 GB: 683747568 LBAs 700 GB: 1367473968 LBAs
Bytes per sector	512 B

Device life (total bytes written) – SLC	175 GB: 12.5 petabyte (PB) 350 GB: 25 PB
---	---

Device life (total bytes written) – MLC	700 GB: 10 PB
---	---------------

Environment

Operating temperature	0 °C to 70 °C
-----------------------	---------------

Shock	1500 G/1.0ms
-------	--------------

Vibration	2 Hz–500 Hz at 3.1G
-----------	---------------------

Power Requirements

Active power	25 W (FW Limit)
--------------	-----------------

	30 W (HW Limit)
--	-----------------

Electrical characteristics

Voltage input	12 Volts
---------------	----------

SFF-8639 (PCIe SAS Combo-Connector)

The combo-connector, also known as a 6x unshielded connector, is a high-speed plug and receptacle connector pair. It is a common connector that supports both SAS and PCIe-based devices.

Systems utilizing the combo-connector can simultaneously support dual-port SAS or quad-lane PCIe device configurations in an isolated manner. Quad-port SAS devices may be supported by sharing two lanes between SAS and PCIe.







NOTE: The combo-connector can support both SAS drives and PCIe SSDs interchangeably. However, the Dell PowerEdge Express Flash PCIe SSD backplane with PCIe SAS combo-connector supports PCIe SSDs only.

Getting Help

Locating Your System Service Tag

Your system is identified by a unique Express Service Code and Service Tag number. The Express Service Code and Service Tag are found on the front of the system by pulling out the information tag. This information is used by Dell to route support calls to the appropriate personnel.

Related Documentation

-  **NOTE:** For all PowerEdge and PowerVault documentation, go to dell.com/support/manuals and enter the system Service Tag to get your system documentation.
-  **NOTE:** For all Dell OpenManage documents, go to dell.com/openmanagemanuals.
-  **NOTE:** For all operating system documents, go to dell.com/operatingsystemmanuals.
-  **NOTE:** For all storage controllers and PCIe SSD documents, go to dell.com/storagecontrollermanuals.

Your product documentation includes:

Getting Started Guide	Provides an overview of system features, setting up your system, and technical specifications. This document is also shipped with your system.
Owner's Manual	Provides information about system features and describes how to troubleshoot the system and install or replace system components.
Rack Installation Instructions	Describes how to install your system into a rack. This document is shipped with your rack solution.
Administrator's Guide	Provides information about configuring and managing the system.
Troubleshooting Guide	Provides information about troubleshooting the software and the system.
OpenManage Server Administrator User's Guide	Provides information about using Dell OpenManage Server Administrator to manage your system.
	NOTE: For any documentation related to Dell OpenManage Server Administrator, see dell.com/openmanage/manuals .

Contacting Dell

-  **NOTE:** Dell provides several online and telephone-based support and service options. If you do not have an active Internet connection, you can find contact information on your purchase invoice, packing slip, bill, or Dell product catalog. Availability varies by country and product, and some services may not be available in your area.

To contact Dell for sales, technical support, or customer-service issues:

1. Go to dell.com/contactdell.
2. Select your country or region from the drop-down menu in the top-left corner.
3. Select your business segment.
The main support page for the selected business segment is displayed.
4. Select the appropriate option depending on your requirement.

 **NOTE:** If you have purchased a Dell system, you may be asked for the Service Tag.

Documentation Feedback

If you have feedback for this document, write to documentation_feedback@dell.com. Alternatively, you can click on the **Feedback** link in any of the Dell documentation pages, fill up the form, and click **Submit** to send your feedback.