

Dell™ C7765dn
Color Multifunction Printer
Administrator Guide

Regulatory Model: C7765dn



Information in this document is subject to change without notice.

© 2013 Dell Inc. All rights reserved.

Reproduction of these materials in any manner whatsoever without the written permission of Dell Inc. is strictly forbidden.

Trademarks used in this text: *Dell* and the *DELL* logo are trademarks of Dell Inc.; *Microsoft*, *Windows*, *Windows NT*, *Windows Server*, *Windows Vista*, *Microsoft Network*, and *Internet Explorer* are either trademarks or registered trademarks of Microsoft Corporation in the United States and/or other countries; *NetWare* is a registered trademark of Novell, Inc. in the United States and other countries; *EtherTalk*, *Macintosh*, and *Mac OS* are trademarks of Apple Inc., registered in the U.S. and other countries. *Adobe*, *Acrobat*, and *PostScript* are either registered trademarks or trademarks of Adobe Systems Incorporated in the United States and/or other countries; *PCL*, *HP-GL*, and *HP-GL/2* are registered trademarks of Hewlett-Packard Corporation; *ThinPrint* is a registered trademark of ThinPrint GmbH in Germany and other countries; *RSA* and *BSAFE* are either registered trademarks or trademarks of EMC Corporation in the United States and/or other countries.

XML Paper Specification (XPS): This product may incorporate intellectual property owned by Microsoft Corporation. The terms and conditions upon which Microsoft is licensing such intellectual property may be found at <http://go.microsoft.com/fwlink/?LinkId=52369>; *DES*: This product includes software developed by Eric Young (eay@mincom.oz.au); *AES*: Copyright (c) 2003, Dr Brian Gladman, Worcester, UK. All rights reserved. This product uses published AES software provided by Dr Brian Gladman under BSD licensing terms; *TIFF (libtiff)*: Copyright (c) 1988-1997 Sam Leffler and Copyright (c) 1991-1997 Silicon Graphics, Inc.; *ICC Profile (Little cms)*: Copyright (c) 1998-2004 Marti Maria.

Nuance™ OCR © 1994-2013 Nuance Communications. All Rights Reserved.

Other trademarks and trade names may be used in this document to refer to either the entities claiming the marks and names or their products. Dell Inc. disclaims any proprietary interest in trademarks and trade names other than its own.

The printer software uses some of the codes defined by the Independent JPEG Group.

WSD stands for Web Services on Devices.



SD Logo is a trademark of SD-3C, LLC.

As for RSA BSAFE



This printer includes RSA® BSAFE® Cryptographic software from EMC Corporation.

UNITED STATES GOVERNMENT RESTRICTED RIGHTS

This software and documentation are provided with RESTRICTED RIGHTS. Use, duplication or disclosure by the Government is subject to restrictions as set forth in subparagraph (c)(1)(ii) of the Rights in Technical Data and Computer Software clause at DFARS 252.227-7013 and in applicable FAR provisions: Dell Inc., One Dell Way, Round Rock, Texas, 78682, USA.

August 2013 Rev. A00

Table of Contents

1	Before Using the Machine	13
	Preface.....	14
	Types of Manuals.....	15
	Using This Guide.....	16
	Organization of This Guide.....	16
	Conventions.....	17
	Interface Cables	19
	Using the USB Interface	19
	Using the Ethernet Interface	20
	Power Saver Mode	21
	Changing the Interval for Entering Power Saver Mode.....	22
	Completely Disabling the Wakeup Motion Sensor	23
	Customizing the Control Panel	25
	Changing the Default Screen.....	25
	Setting the Screen After Auto Clear	26
	Customizing the Button Layout.....	27
	Assigning Services to the Custom Buttons	31
	Adjusting the Screen Brightness	32
	Entering Text.....	34
2	Paper and Other Media	35
	Paper Types	36
	Loadable Quantity and Weight	36
	Supported Paper.....	36
	Loading Paper.....	47
	Loading Paper in Trays 1 to 4.....	47
	Loading Paper in Tray 5 (Bypass Tray).....	48
	Loading Paper in Tray 6 (HCF B1).....	49
	Changing the Paper Size	51
	Changing the Paper Size for Trays 1 to 4	51
	Changing the Paper Size for Tray 6 (HCF B1) (optional).....	52
	Changing the Paper Settings	54
3	Maintenance	57
	Replacing Consumables.....	58
	Replacing Toner Cartridges	58
	Replacing Waste Toner Container R5.....	60
	Replacing Drum Cartridges R1, R2, R3, or R4.....	63
	Replacing Staple Cartridge (for Finisher-B1)	66
	Replacing Booklet Staple Cartridge (for Booklet Maker Unit for Finisher-B1)	67
	Emptying the Hole Punch Waste Container (for Finisher-B1).....	68
	Cleaning the Machine.....	70
	Cleaning the Exterior.....	70
	Cleaning the Interior (LED Printheads)	70

	Cleaning the Touch Screen	72
	Cleaning Document Cover and Document Glass	72
	Cleaning Film and Constant Velocity Transport Glass	72
	Cleaning Document Feeder Rollers	73
	Executing Calibration	75
	Printing a Report/List	79
	Deleting a Private Charge Print Job with an Invalid User ID	80
	Setting Restore Tool.....	81
4	Machine Status	83
	Overview of Machine Status.....	84
	Machine Information	85
	General Information	85
	Paper Tray Status.....	86
	Print Reports	86
	Automatically Printed Reports/Lists	94
	Overwrite Hard Disk.....	95
	Print Mode.....	96
	Fax Receiving Mode	98
	Faults.....	99
	Supplies.....	100
	Billing Information	101
	Billing Information	101
	User Account Billing Information.....	102
5	Tools.....	105
	System Settings Procedure	106
	Step 1 Entering System Administration Mode	106
	Step 2 Entering the System Administrator User ID and Passcode	106
	Step 3 Selecting [Tools]	107
	Step 4 Selecting a Tab on the [Tools] Screen	107
	Step 5 Setting a Feature	109
	Step 6 Exiting System Administration Mode	109
	Tools Menu List.....	110
	Common Service Settings.....	124
	Machine Clock / Timers	124
	Power Saver Settings	127
	Audio Tones.....	127
	Screen / Button Settings	129
	Paper Tray Settings.....	131
	Image Quality Adjustment.....	136
	Reports.....	137
	Maintenance.....	139
	Watermark	140
	Force Annotation.....	141
	Print Universal Unique ID	143
	Notify Job Completion by E-mail	143

Plug-in Settings	144
Other Settings	144
Copy Service Settings	158
Copy Tab - Features Allocation	158
Preset Buttons	159
Copy Defaults	159
Copy Control	164
Original Size Defaults	166
Reduce / Enlarge Presets	167
Custom Colors	167
Annotations - Create Comments	167
Connectivity & Network Setup	168
Port Settings	168
Protocol Settings	173
Machine's E-mail Address / Host Name	176
Proxy Server Settings	177
Outgoing / Incoming E-mail Settings	178
Remote Authentication / Directory Service	179
Security Settings	184
Other Settings	188
Print Service Settings	190
Allocate Memory	190
Delete Form	192
Other Settings	192
Scan Service Settings	197
Screen Defaults	197
Scan Defaults	198
Scan to PC Defaults	200
Original Size Defaults	201
Output Size Defaults	201
Reduce / Enlarge Presets	201
Other Settings	201
Fax Service Settings	204
Screen Defaults	204
Fax Defaults	205
Fax Control	206
Fax Received Options	211
Reduce / Enlarge Presets	211
Original Size Defaults	212
Local Terminal Information	212
Internet Fax Control	213
E-mail / Internet Fax Service Settings	216
E-mail Control	216
Address Book Settings	219
Folder Service Settings	220
Job Flow Service Settings	221
Media Print Service Settings	222

Stored File Settings	223
Web Applications Service Setup	225
Server Certificate Verification Settings	225
Server Setup	227
Other Settings	228
Web Browser Setup	229
Setup	231
Create Folder	231
Stored Programming	233
Create Job Flow Sheet	233
Create Job Flow Sheet Keyword	241
Add Address Book Entry	241
Create Fax Group Recipients	248
Add Fax Comment	249
Paper Tray Attributes	250
Accounting	251
Create / View User Accounts	251
View Accounts	254
Reset User Accounts	254
System Administrator's Meter (Copy Jobs)	255
Accounting Type	255
Accounting Login Screen Settings	256
Fax Billing Data	257
Accounting / Billing Device Settings	258
Authentication / Security Settings	260
System Administrator Settings	260
Authentication	261
Allow User to Disable Active Settings	269
Job Status Default	269
Overwrite Hard Disk	269
6 Dell Printer Configuration Web Tool Settings	273
Installation of Dell Printer Configuration Web Tool	274
Preparations	274
Configuration on the Machine	275
Starting Dell Printer Configuration Web Tool	276
Configuring Machine Settings Using Dell Printer Configuration Web Tool	277
7 Printer Environment Settings	281
Print Overview	282
Installation When Using USB Port	285
Step 1 Preparations	285
Step 2 Configuration on the Machine	285
Step 3 Configuration on the Computer	286
Dell Printer Configuration Web Tool Setting Items	286
Installation When Using TCP/IP (LPD/Port 9100)	287
Step 1 Preparations	287

Step 2 Configuration on the Machine.....	287
Step 3 Configuration on the Computer	288
Dell Printer Configuration Web Tool Setting Items.....	288
Installation When Using NetWare	290
Step 1 Preparations	290
Step 2 Configuration on the Machine.....	290
Step 3 Configuration on the Computer	291
Dell Printer Configuration Web Tool Setting Items.....	291
Installation When Using Microsoft Network (SMB).....	293
Step 1 Preparations	293
Step 2 Configuration on the Machine.....	293
Step 3 Configuration on the Computer	294
Dell Printer Configuration Web Tool Setting Items.....	294
Installation When Using Internet Printing Protocol (IPP).....	295
Step 1 Preparations	295
Step 2 Configuration on the Machine.....	295
Step 3 Configuration on the Computer	296
Dell Printer Configuration Web Tool Setting Items.....	296
Installation When Using EtherTalk	297
Step 1 Preparations	297
Step 2 Configuration on the Machine	297
Step 3 Configuration on the Computer	298
Dell Printer Configuration Web Tool Setting Items.....	298
8 E-mail Environment Settings.....	299
E-mail Overview.....	300
Preparations	301
Installation Procedures	303
Step 1 Enabling Port and Setting up TCP/IP.....	303
Step 2 Configuring E-mail Environment.....	304
Dell Printer Configuration Web Tool Setting Items.....	305
9 Scanner Environment Settings	307
Scan Service Overview	308
Configuration of Store to Folder.....	310
Step 1 Enabling Port and Setting up TCP/IP.....	310
Step 2 Registering a Folder	311
Step 3 Configuring on the Computer.....	311
Configuration of Scan to PC.....	312
Step 1 Preparations	312
Step 2 Enabling Port and Setting up TCP/IP.....	313
Step 3 Configuration on the Computer	314
Configuration of Store to USB	315
Step 1 Available USB Memory Devices.....	315
Step 2 Dell Printer Configuration Web Tool Setting Items.....	315
Configuration of Job Flow Sheets	316
Step 1 Enabling Ports and Setting up TCP/IP.....	316

Step 2 Configuring the SNMP Port	317
Step 3 Configuration on the Computer	317
Configuration of Store & Send Link.....	318
Step 1 Configuring E-mail	318
Step 2 Enabling Authentication	318
Step 3 Other Settings	318
Step 4 Dell Printer Configuration Web Tool Setting Items	318
Configuration of Store to WSD.....	320
Step 1 Preparations	320
Step 2 Enabling Port.....	320
Step 3 Confirmation on the Computer	321
10 Using the Internet Fax Service.....	323
Internet Fax Overview	324
Preparations.....	324
System Requirements for the Machine	324
E-Mail Environment.....	324
Installation Procedures.....	326
Step 1 Enabling Port and Setting up TCP/IP	326
Step 2 Configuring E-mail Environment.....	327
Step 3 Testing the Internet Fax	328
11 Encryption and Digital Signature Settings.....	329
Encryption and Digital Signature Overview.....	330
Types of Certificate	330
Encryption Features for Communication	330
Encryption and Digital-Signature Features for Scan Files	331
Configuration of HTTP Communications Encryption	332
Installation Overview	332
Step1 Configuration on the Machine	332
Step2 Configuration on the Computer.....	333
Configuration of Encryption using IPSec	334
Installation Overview	334
Step1 Import and Configuration of a Certificate	334
Step2 Configuration on the Machine (Configuration of IPSec).....	335
Step3 Configuration on the Computer.....	336
Configuration of E-mail Encryption/Digital Signature.....	337
Installation Overview	337
Step1 Configuration on the Machine	337
Step2 Configuration on Sender and Recipient.....	339
Configuration of PDF/XPS Signature.....	341
Installation Overview	341
Step1 Configuration on the Machine	341
Step2 Configuration on the Computer.....	342
12 Authentication and Accounting Features	343
Overview of Authentication and Accounting Feature	344
Overview of Authentication Feature	344

Overview of Accounting Feature	345
Authentication	346
User Types Managed by Authentication Feature	346
User Roles and Authorization Groups	346
Types of Authentication	347
Types of Account Administration	348
Authentication and Accounting Relationship	350
Services Controlled by Authentication	351
Overview	351
Services Restricted by User ID Authentication	351
Services Restricted by the Combined Use of Smart Card Authentication and User ID Authentication	353
Authentication for Job Flow Sheets and Folders	356
Overview	356
When the Authentication Feature is Disabled	358
When the Authentication Feature is Enabled	361
Jobs Manageable by Account Administration	365
Configuration for Authentication	368
Installation Overview	368
Enabling Authentication	368
Changing the Default Authorization Group Settings	370
Creating an Authorization Group	371
Configuration for Account Administration	372
Step 1 Selecting an Accounting Type	372
Step 2 Registering User Information	372
User Authentication Operations	374
Authenticating Login Users	374
Changing Passcode	375
13 Problem Solving	377
Troubleshooting	378
Machine Trouble	379
Image Quality Trouble	384
Trouble during Copying	390
Unable to Copy	390
The Copy Result is Not What was Expected	391
Trouble during Printing	394
Unable to Print	394
The Print Result is Not What was Expected	395
Trouble during Faxing	397
Sending Problems	397
Receiving Problems	399
Trouble during Scanning	401
Unable to Scan with the Machine	401
Unable to Import Scanned Documents to the Computer	402
Unable to Send a Scanned Document over the Network (FTP/SMB)	403

Unable to Send E-mail	404
The Image is not What was Expected	404
Network-related Problems.....	406
When using SMB	406
When using NetWare	408
When using TCP/IP.....	412
When using EtherTalk	413
Dell Printer Configuration Web Tool Problems	414
E-mail Features Problems.....	415
Internet/Intranet Connection Problems.....	416
IPv4 and IPv6 Connection Problems	417
Media Print - Text Trouble.....	420
Media Print - Photos Trouble	421
Status Code.....	422
Other Errors.....	494
Paper Jams	495
Paper Jams in Upper Left Cover A.....	495
Paper Jams in Bottom Left Cover C	496
Paper Jams in Top Left Cover D	497
Paper Jams in Trays 1 to 4	498
Paper Jams in Tray 5 (Bypass Tray).....	498
Paper Jams in Tray 6 (HCF B1)	499
Paper Jams in Duplex Module B.....	501
Paper Jams in Finisher-B1.....	501
Document Jams	504
Duplex Automatic Document Feeder B1-C	504
Stapler Faults	506
Staple Jams in Staple Cartridge (for Finisher-B1)	506
14 Appendix	509
Specifications	510
Printable Area	519
Standard Printable Area.....	519
Extended Printable Area	519
Internal Fonts.....	520
Optional Components.....	522
Adjust Image Transfer	523
Adjusting the Transfer Output Value.....	523
ESC/P-K Emulation	526
Emulation.....	526
Fonts	527
Output Feature	527
ESC/P-K Emulation Print Features	527
ESC/P-K Emulation Settings	528
Magnification Table.....	534
Paper Size and Number of Printable Characters.....	539

PDF Direct Print	541
PDF Direct Print Settings	541
PCL Emulation	543
Emulation	543
Fonts	544
Output Feature	545
PCL Emulation Settings	545
HP-GL/2 Emulation	551
Emulation	551
Fonts	551
Output Feature	552
Factory Default Settings	552
HP-GL/2 Emulation Settings	553
Hard Clip Area	559
Printable Area	560
Auto Layout	562
Notes and Restrictions	569
Notes and Restrictions on the Use of the Machine	569
Notes and Restrictions on the Use of the Copy Feature	573
Notes and Restrictions on the Use of the Print Feature	574
Notes and Restrictions on the Use of the Scan Features	576
Notes and Restrictions on the Use of the Fax Feature	581
Notes and Restrictions on the Use of the E-mail/Internet Fax Feature	582
Notes and Restrictions when Connecting with Internet Service Provider	586
Notes and Restrictions on the Interrupt Mode	588
Notes and Restrictions on Folders	590
Notes and Restrictions when Connecting to Internet or Intranet	590
Notes and Restrictions when Operating from Computers	591
Notes and Restrictions on Job Flows	592
Notes and Restrictions on the Security Features	593
Notes and Restrictions on the Authentication and Accounting Features	593
Notes and Restrictions for Using SMB	593
Notes and Restrictions for Using TCP/IP	595
Notes and Restrictions for Using EtherTalk	596
Notes and Restrictions for Using Bonjour	597
Notes and Restrictions for IPv6 Connection	597
Notes and Restrictions for Print E-mail	599
Using the Telephone	600
Placing a Call	600
Activity Report	602
Index	605

1 Before Using the Machine

This chapter describes the organization of this guide and conventions used in this guide.

• Preface	14
• Types of Manuals	15
• Using This Guide	16
• Interface Cables	19
• Power Saver Mode	21
• Customizing the Control Panel	25
• Entering Text	34

Preface

Thank you for selecting the Dell C7765dn Color Multifunction Printer (hereafter referred to as "the machine").

This guide is intended for system administrators, and provides maintenance information such as how to replace consumables, how to configure network, and troubleshooting procedures.

The guide assumes that you are familiar with a personal computer and that are knowledgeable of computer networks. When you need additional information, refer to the manuals provided with the personal computer, operating system, and network products.

After reading this guide, be sure to keep it handy for quick reference. It will be useful in case you forget how to perform operations or if a problem occurs with the machine.

For more information on how to copy, print, scan, and fax, refer to the User Guide. For information about optional components for the Print feature, refer to the guide provided with each optional component.

Types of Manuals

The following guides are provided with the machine.

Accompanying Manuals

User's Guide (PDF)

The guide describes the basic operations of the machine, as well as daily management and maintenance. This guide is included in the Documentation CD-ROM.

PostScript User Guide (PDF)

The guide describes how to install the print driver and configure the functions in order to use the machine as a PostScript printer. This guide is included in the "PostScript Driver Library" CD-ROM.

Driver CD Kit Documentation (HTML)

The documentation describes installation and configuration procedures for print drivers and the printer environment. This documentation is included in the Driver CD Kit.

Print Driver Help

The help describes print features and operations.

Guides for Optional Components

Optional components are available for the machine. Some of them come with user guides. The guides for optional components describe all the necessary steps for using the optional components and installing the software.

Using This Guide

This guide is intended for system administrators, and provides maintenance information such as how to replace consumables, how to configure network, and troubleshooting procedures.

Organization of This Guide

This guide consists of the following chapters.

1 Before Using the Machine

Describes the organization of this guide and conventions.

2 Paper and Other Media

Describes the types of paper and other media that you can use on the machine and how to load media in a tray.

3 Maintenance

Describes how to replace consumables and to clean the machine.

4 Machine Status

Describes how to check the faults that occurred on the machine and to print various reports/lists.

5 Tools

Describes the procedures to set up the system.

6 Dell Printer Configuration Web Tool Settings

Describes how to use Dell Printer Configuration Web Tool.

7 Printer Environment Settings

Describes the settings to use the Print feature on the machine.

8 E-mail Environment Settings

Describes the settings to use various services via e-mail on the machine.

9 Scanner Environment Settings

Describes the settings to use the Scan services on the machine.

10 Using the Internet Fax Service

Describes the settings to use the services via the Internet Fax service on the machine.

11 Encryption and Digital Signature Settings

Describes how to configure the machine to use the Encryption and the Digital Signature features with your communications and documents.

12 Authentication and Accounting Features

The machine has the Authentication feature to restrict the availability of services for each feature and the Accounting feature to manage the use of each feature based on the Login Type selected.

13 Problem Solving

Describes troubleshooting procedures to solve the problems with the machine.

14 Appendix

Describes the specifications of the machine, optional accessories, and cautions/restrictions.

Conventions

- The screen shots and illustrations used in this guide vary depending on the machine configuration and optional components installed. Some of the items in the screen shots may not be displayed or available depending on your machine configuration.
- The procedures in this guide may vary depending on the driver and utility software being used due to the upgrades.
- In this guide, "Computer" refers to a personal computer or workstation.
- The following term is used in this guide:

Note : Additional information on operations or features.

- The following symbols are used in this guide:

" " : • A cross-reference included in this guide.

- Names of CD-ROM, features, and touch screen messages and input text.

[] : • Folders, files, applications, button or menu names displayed on the touch screen.
 • Names of menus, commands, windows, or dialog boxes displayed on the computer screen and their buttons and menu names.

< > button : Hardware buttons on the control panel.

< > key : Keys on the keyboard of the computer.

> : • Path to a certain item within a procedure on the control panel.
 For example: When you see the procedure "select [Tools] > [Setup] > [Create Folder]", this means that you need to select [Tools], select [Setup], and then select [Create Folder].

- Path to a certain item within a procedure on a computer.



For example: When you see the procedure "to search for files and folders, click [Start] > [Search] > [For Files or Folders]", this means that you need to click [Start], click [Search], and then click [For Files or Folders] to search for files and folders.

- Cross-reference

For example: "Refer to "5 Tools" > "Common Service Settings" > "Audio Tones" in the Administrator Guide."

The sentence above means that it is recommended to refer to the section "Audio Tones" in "Common Service Settings" in chapter 5 "Tools" of the Administrator Guide.

- Orientation of documents or paper is described in this guide as follows:

 , Long Edge Feed (LEF): Loading the document or paper in portrait orientation when viewed from the front of the machine.

☐, ☐, Short Edge Feed (SEF): Loading the document or paper in landscape orientation when viewed from the front of the machine.

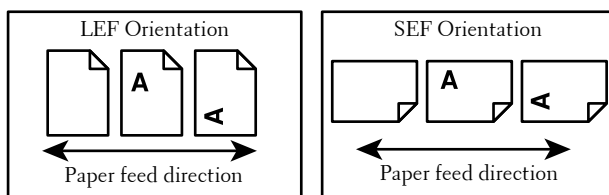

Interface Cables

When you connect the machine directly to your computer, use the USB interface. When you connect the machine to a network, use the Ethernet interface.

Using the USB Interface

The USB interface of the machine supports USB 2.0.

This section describes the installation procedures for the USB interface.

- 1 Press the power switch to the [⏻] position to switch off the power.
- 2 Make sure that the touch screen is blank and the <Power Saver> button is not lit.
- 3 Open the front cover.
- 4 Press the main power switch to the [○] position to switch off the main power.
- 5 Remove the rear right cover.

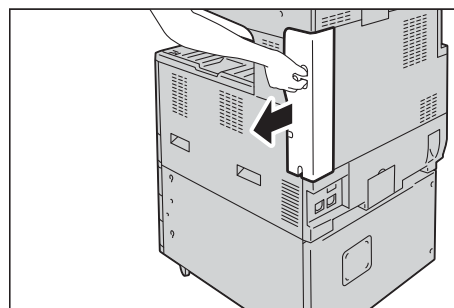

- 6 Connect the USB cable to the USB 2.0 interface connector.

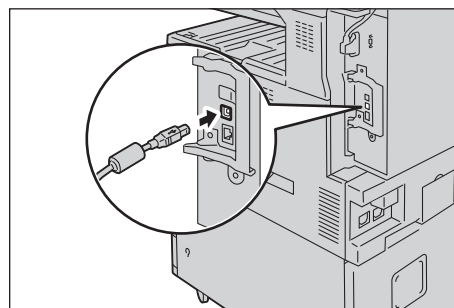

- 7 Return the rear right cover to its original position.

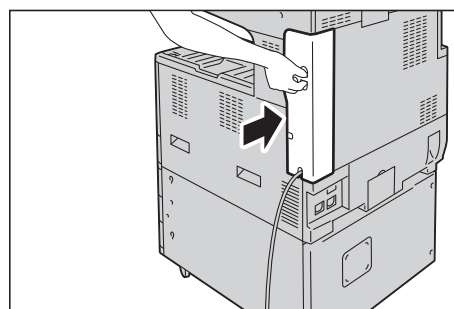

- 8 Connect the other end of the USB cable to the computer.
- 9 Press the main power switch to the [|] position to switch on the main power.
- 10 Close the front cover.
- 11 Press the power switch to the [|] position to switch on the power.
- 12 Restart the computer.

For more information on setting items, refer to "Printer Environment Settings" (P.281).

Using the Ethernet Interface

The Ethernet interface of the machine supports the following three types.

- 1000BASE-T
- 100BASE-TX
- 10BASE-T

This section describes the installation procedures for the Ethernet interface.

- 1 Press the power switch to the [⏻] position to switch off the power.
- 2 Make sure that the touch screen is blank and the <Power Saver> button is not lit.
- 3 Open the front cover.
- 4 Press the main power switch to the [○] position to switch off the main power.
- 5 Remove the rear right cover.

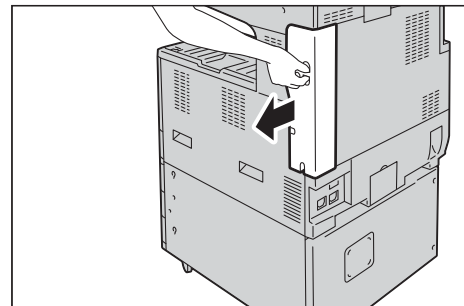

- 6 Connect the network cable to the Ethernet interface connector.

Note

- Always use the correct network cable with your network connection. When you replace the cable, contact Customer Support at dell.com/contactdell.

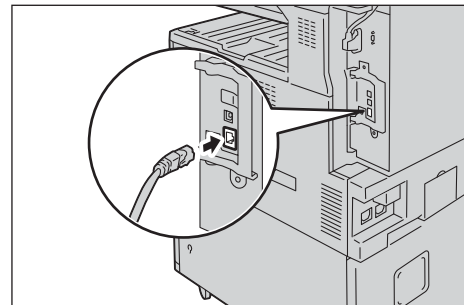

- 7 Return the rear right cover to its original position.

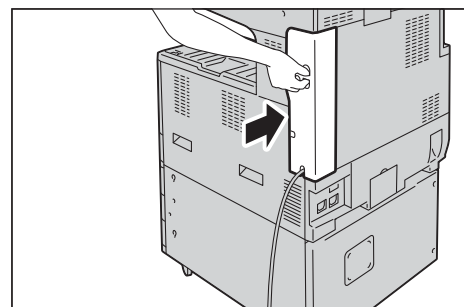

- 8 Press the main power switch to the [|] position to switch on the main power.
- 9 Close the front cover.
- 10 Press the power switch to the [|] position to switch on the power.

For more information on setting items, refer to "Printer Environment Settings" (P.281).

Power Saver Mode

The machine is equipped with the Power Saver mode that reduces the power consumption by saving the electricity to the machine when no copy or print data is received for a specified time.

There are two types of Power Saver modes: the Low Power mode and the Sleep mode.

When you press the <Power Saver> button or do not use the machine for a specified period of time, the machine enters the Low Power mode.

When time exceeds the time specified in the Low Power mode, the machine then enters the Sleep mode.

Press the <Power Saver> button on the control panel to make the machine enter the Power Saver mode.

Low Power Mode

The Low Power mode reduces the power to the control panel and the fusing unit.

This turns off the touch screen and turns on the <Power Saver> button on the control panel. To activate the machine, press the <Power Saver> button. Pressing the <Power Saver> button turns off the light and deactivates the Power Saver mode.

Note • While the machine is in the Low Power mode, the power supply to the fusing unit is also reduced.

Sleep Mode

The Sleep mode reduces the power to the machine even more than the Low Power mode.

This turns off the touch screen and turns on the <Power Saver> button on the control panel. To activate the machine, press the <Power Saver> button. Pressing the <Power Saver> button turns off the light and deactivates the Power Saver mode.

It takes longer time than the Low Power mode to deactivate the Sleep mode and enable to use the machine.

- Note**
- When you press the <Power Saver> button during the Power Saver mode, the touch screen lights up. At this point, the scanner and the output devices remain the Power Saver mode. Afterwards, by operations such as using the touch screen, opening or closing of the document cover, and loading paper in the document feeder, you can make the devices necessary to activate the machine exit the Power Saver mode and make the machine ready to start exiting the Power Saver mode.
 - When you make the machine exit the Power Saver mode by pressing the <Power Saver> button, the machine does not immediately identify the movements such as opening or closing of the front cover. To make the machine identify these operations, exit all Power Saver mode by operating the control panel (for example, pressing the <Machine Status> button) before opening the front cover.
 - If you replace toner cartridges or supply paper during the Power Saver mode, the machine does not identify these changes. Before performing these operations, exit Power Saver mode by pressing the <Power Saver> button and the <Machine Status> button on the control panel.
 - The Power Saver mode is not exited by the following operations:
 - Charge Print
 - Secure Print
 - Delayed Print
 - Private Charge Print
 - Faxes stored in folders
 - Direct Fax
 - Accessing a folder of the machine using Dell Printer Configuration Web Tool
 - The control panel remains lit off and only the output devices exit the Power Saver mode by the following operations:
 - Print
 - Sample Print
 - Print Fax

- When [Deactivate With wakeup motion sensor] is set to [Enabled] under [Tools] > [System Settings] > [Common Service Settings] > [Power Saver Settings], and human presence is detected, the machine automatically exits the Power Saver mode.
- When the following device is connected to the machine and a user performs the following operation, the Low Power mode can be deactivated without pressing the <Power Saver> button. If the machine is in the Sleep mode, however, the Sleep mode will not be deactivated by the operation. By setting longer time to elapse until the machine enters the Sleep mode, you can make the machine to exit the Power Saver mode without pressing the <Power Saver> button. For more information on how to change the time to elapse until the machine enters the Sleep mode, refer to "Changing the Interval for Entering Power Saver Mode" (P.22).
 - Placing a smart card on the smart card reader
- When the machine enters the Low Power mode during a user is authenticated, the machine exits the authentication mode.

Changing the Interval for Entering Power Saver Mode

This section describes the procedures for setting the Power Saver mode.

To activate the Power Saver, set the time to elapse until the machine enters the Low Power mode as well as the time to elapse until the machine enters the Sleep mode.

- Note**
- When the interval setting specified for the Sleep Mode is the same as that specified for the Low Power mode, the machine ignores the Low Power mode setting.

1 Press the <Log In/Out> button.

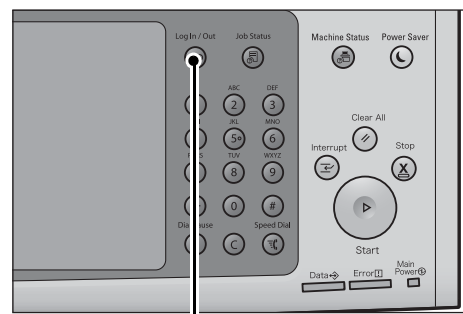

<Log In/Out> button

2 Enter the system administrator's user ID with the numeric keypad or the keyboard displayed on the screen, and select [Enter].

When a passcode is required, select [Next] and enter the system administrator's passcode, and select [Enter].

- Note**
- The default user ID is "admin".
 - The default passcode is "1111".

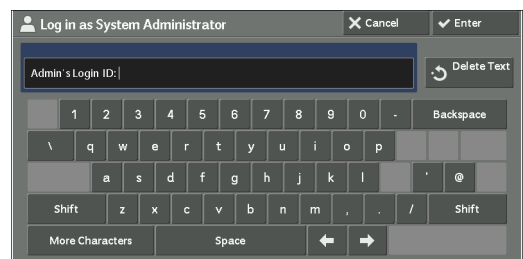

3 Select [Tools] on the [Home] screen.

- Note**
- When the [Home] screen is not displayed on the touch screen, press the <Home> button.

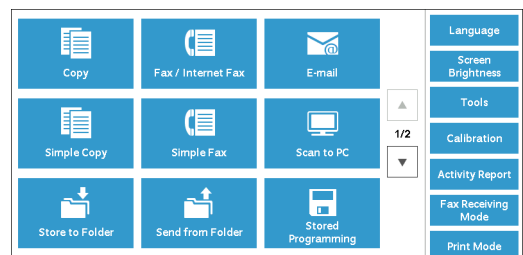

- 4 Select [System Settings] > [Common Service Settings] > [Power Saver Settings].

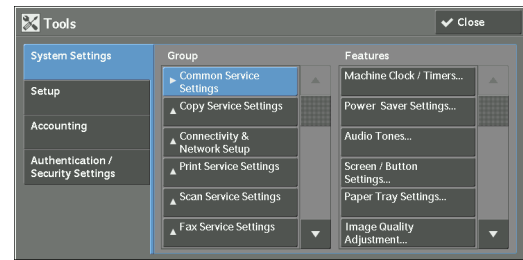

- 5 Select [Power Saver Timers], and then select [Change Settings].

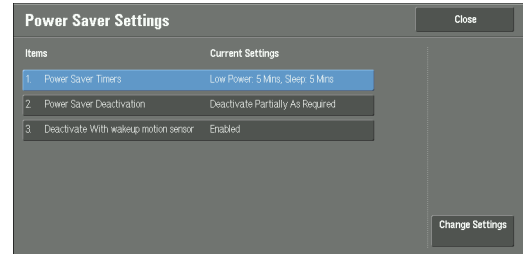

- 6 Using [▲] and [▼], set the time to elapse until entering the Power Saver mode, in 1 minute increments.

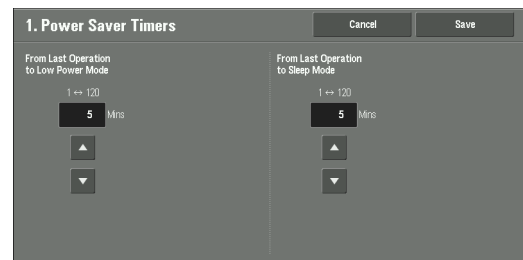

From Last Operation to Low Power Mode

Set the time to elapse from the last operation until the machine enters the Low Power mode.

- Note**
- The default value for [From Last Operation to Low Power Mode] is [1] minute. You cannot disable the Low Power mode.
 - The timer does not start counting until the operator leaves the detectable area of the wakeup motion sensor. The Access Lamp is lit while the machine detects human presence.

From Last Operation to Sleep Mode

Set the time to elapse from the last operation until the machine enters the Sleep mode.

- Note**
- The default value for [From Last Operation to Sleep Mode] is [1] minute. To make the machine enter the Low Power mode, set a longer period of time for [From Last Operation to Sleep Mode] than for [From Last Operation to Low Power Mode].
 - The timer does not start counting until the operator leaves the detectable area of the wakeup motion sensor. The Access Lamp is lit while the machine detects human presence.

- 7 Select [Save].
- 8 Select [Close] repeatedly until the [Tools] screen is displayed.
- 9 Select [Close].

Completely Disabling the Wakeup Motion Sensor

This section describes how to disable the wakeup motion sensor completely.

- 1 Press the power switch to the [⏻] position to switch off the power.
- 2 Make sure that the touch screen is blank and the <Power Saver> button is not lit.
- 3 Open the front cover.

4 Press the main power switch to the [○] position to switch off the main power.

5 Cover the wakeup motion sensor (pyroelectric sensor) with the sticker provided with the machine.

Note • Make sure that the sensor is covered with the sticker completely.

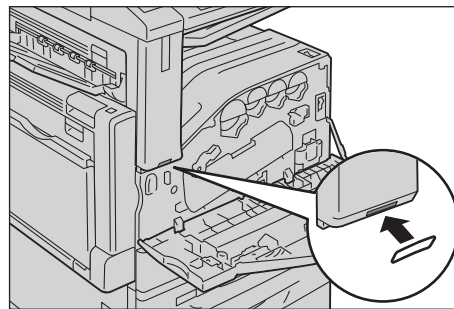

6 Press the main power switch to the [|] position to switch on the main power.

7 Close the front cover.

8 Press the power switch to the [|] position to switch on the power.

Customizing the Control Panel

You can change the services displayed on the touch screen or the features assigned to the buttons to make best use of the machine.

This section describes how to change the screen default, the services displayed after Auto Clear, the services displayed on the [Home] screen, and the services assigned to the custom buttons, and how to adjust the screen contrast.

For information on how to change the other settings of the control panel, refer to "Screen / Button Settings" (P.129).

Changing the Default Screen

You can specify what screen to display when the machine is turned on or the Power Saver mode is deactivated.

The [Home] screen is displayed by factory default.

- 1 Press the <Log In/Out> button.

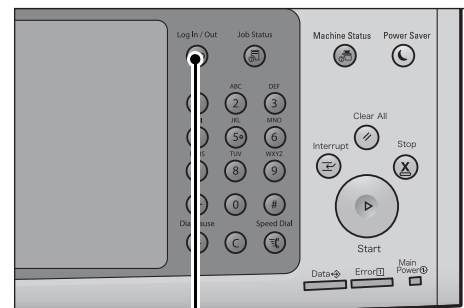

<Log In/Out> button

- 2 Enter the system administrator's user ID with the numeric keypad or the keyboard displayed on the screen, and select [Enter].

When a passcode is required, select [Next] and enter the system administrator's passcode, and select [Enter].

- Note**
- The default user ID is "admin".
 - The default passcode is "1111".

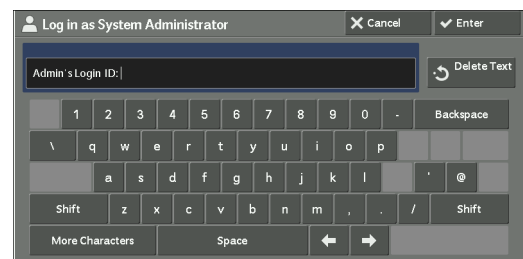

- 3 Select [Tools] on the [Home] screen.

- Note**
- When the [Home] screen is not displayed on the touch screen, press the <Home> button.

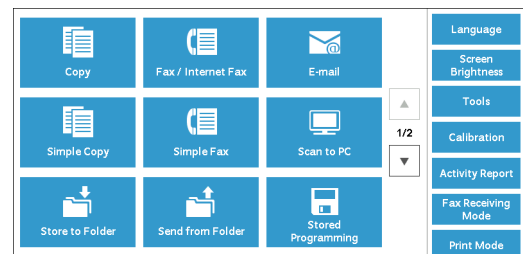

- 4 Select [System Settings] > [Common Service Settings] > [Screen/Button Settings].

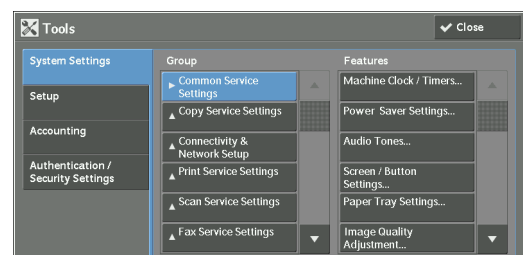

- 5 Select [Screen Default], and then select [Change Settings].

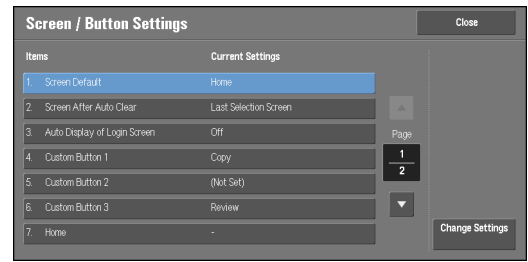

- 6 Select a service you want to display.

Note • Select [▲] to display the previous screen or [▼] to display the next screen.

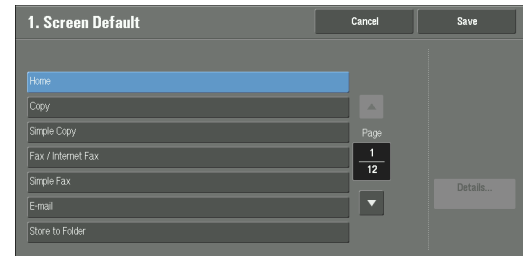

- 7 Select [Save].

Setting the Screen After Auto Clear

You can specify what screen to display when the settings are reset with Auto Clear. [Last Selection Screen] or [Home] can be selected.

For information on Auto Clear, refer to "Auto Clear" (P.125).

- 1 Press the <Log In/Out> button.

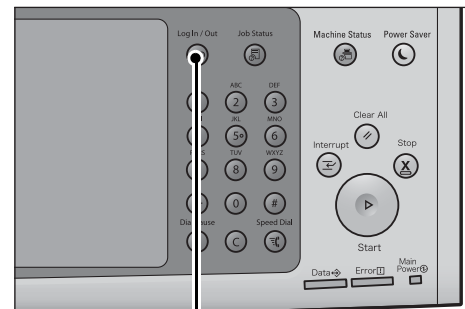

<Log In/Out> button

- 2 Enter the system administrator's user ID with the numeric keypad or the keyboard displayed on the screen, and select [Enter].

When a passcode is required, select [Next] and enter the system administrator's passcode, and select [Enter].

Note • The default user ID is "admin".
• The default passcode is "1111".

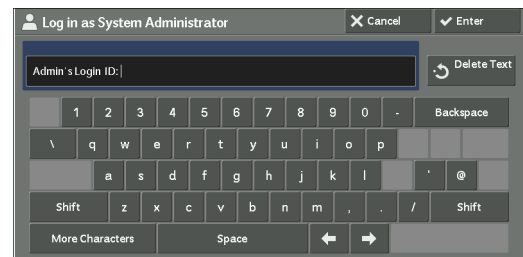

- 3 Select [Tools] on the [Home] screen.

Note • When the [Home] screen is not displayed on the touch screen, press the <Home> button.

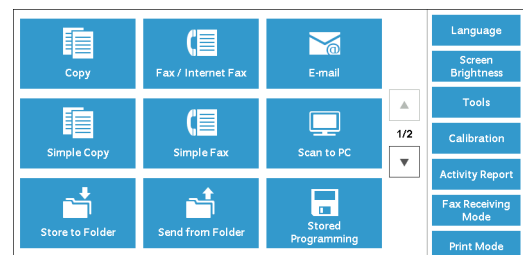

4 Select [System Settings] > [Common Service Settings] > [Screen/Button Settings].

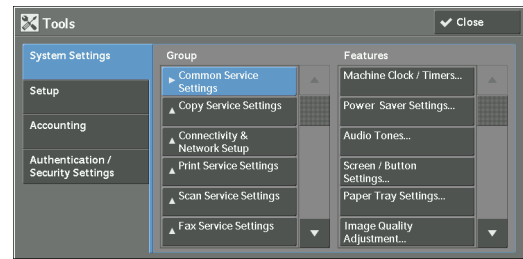

5 Select [Screen After Auto Clear], and then select [Change Settings].

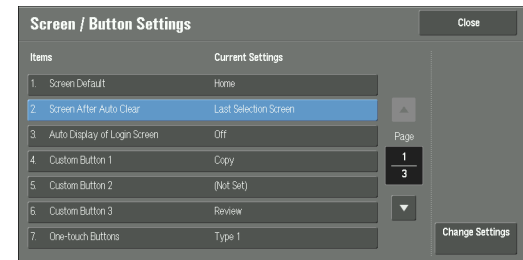

6 Select [Last Selection Screen] or [Home].

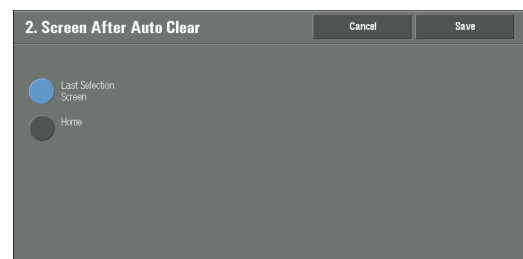

7 Select [Save].

Customizing the Button Layout

You can specify the button layout and what buttons to display on the [Home] screen, which can be displayed by pressing the <Home> button on the control panel.

Note • The feature unsupported by the machine will not be displayed, and the feature unavailable due to a failure will be grayed out.

- Copy
- Fax/Internet Fax
- E-mail
- Simple Copy
- Simple Fax
- Scan to PC
- Store to Folder
- Store to USB
- Send from Folder
- Stored Programming
- Store & Send Link

Note • This service is displayed when the User Authentication feature is used.

- Job Flow Sheets

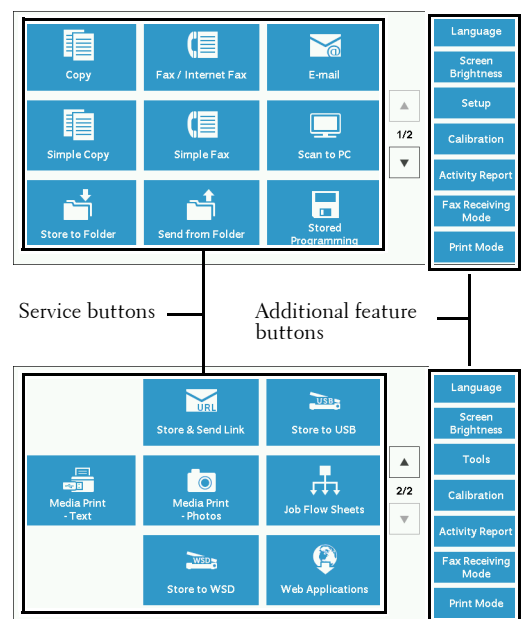

* WSD stands for Web Services on Devices.

- Web Applications
- Media Print - Text
- Media Print - Photos
- Secure Print
- Sample Set
- Delayed Print
- Charge Print
- Private Charge Print
- Store to WSD

Note • WSD stands for Web Services on Devices.

- Custom Services

Note • This service is for service representative use. For more information, contact Customer Support at dell.com/contactdell.

- Language
- Screen Brightness
- Setup
- Calibration
- Activity Report
- Fax Receiving Mode
- Print Mode
- Lockout Printer/Release Printer

Note • [Lockout Printer]/[Release Printer] is not displayed by default. To display this feature, select [Allow User to Lock Out] in [Printer Lockout] under [Tools] > [System Settings] > [Common Service Settings] > [Machine Clock/Timers], and then assign [Disable Auto Printing] to a button on the [Home - Additional Features] screen.

Home

You can select service buttons, which are displayed on the [Home] screen.

If you select [(Not Assigned)], the position of the selected button becomes blank.

- 1 Press the <Log In/Out> button.

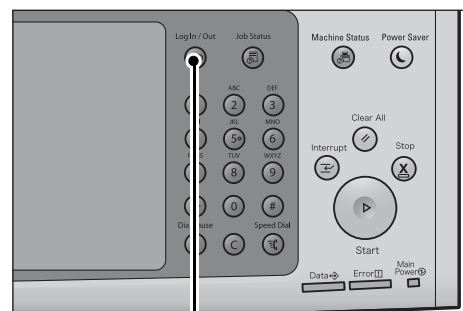

<Log In/Out> button

- Enter the system administrator's user ID with the numeric keypad or the keyboard displayed on the screen, and select [Enter].

When a passcode is required, select [Next] and enter the system administrator's passcode, and select [Enter].

- Note**
- The default user ID is "admin".
 - The default passcode is "1111".

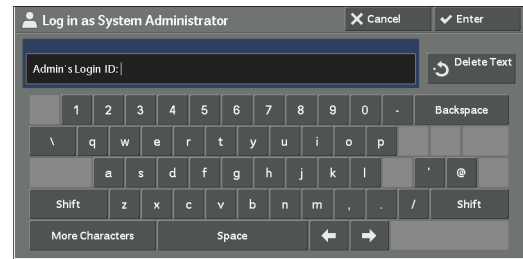

- Select [Tools] on the [Home] screen.

- Note**
- When the [Home] screen is not displayed on the touch screen, press the <Home> button.

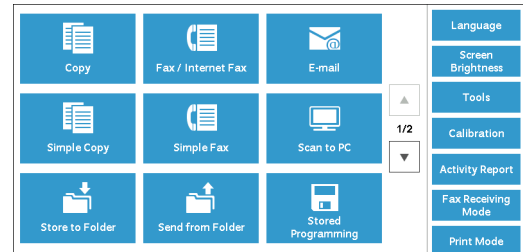

- Select [System Settings] > [Common Service Settings] > [Screen/Button Settings].

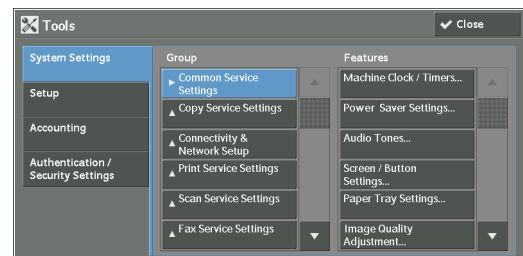

- Select [Home], and then select [Change Settings].

- Note**
- Select [▲] to display the previous screen or [▼] to display the next screen.

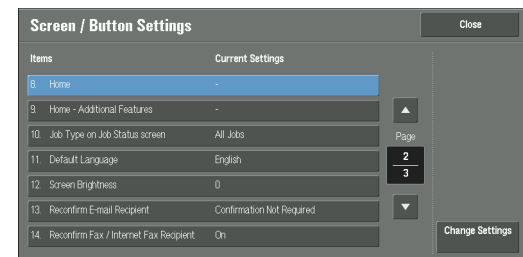

- Select the position where you want to assign a service.

- Note**
- Select [▲] to display the previous screen or [▼] to display the next screen.
 - The layout of the buttons in this screen corresponds to the layout of those on the [Home] screen.

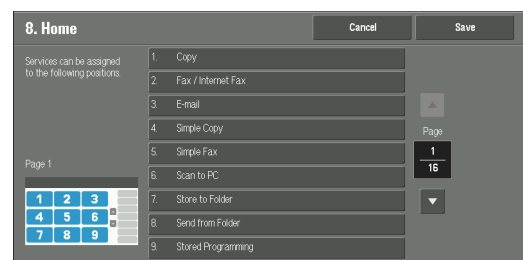

- Select the service to assign to the selected position.

- Note**
- Select [▲] to display the previous screen or [▼] to display the next screen.
 - You cannot assign the same feature to more than one button.

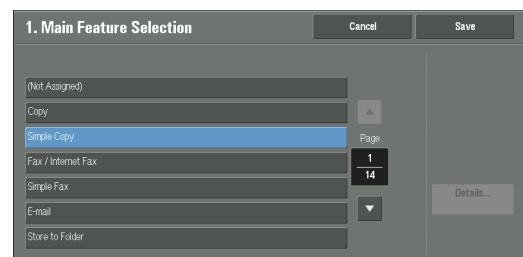

- Select [Save].

- Select [Save].

Home - Additional Features

You can select additional feature buttons, which are displayed on the [Home] screen.

If you select [(Not Assigned)], the position of the selected button becomes blank.

You cannot assign [Setup] to [(Not Assigned)]. If you do not want to display the [Setup] button, select the [Show this in Admin mode] check box.

- 1 Press the <Log In/Out> button.

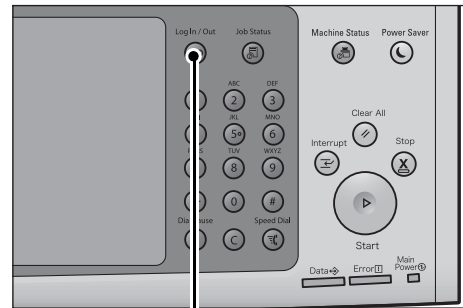

<Log In/Out> button

- 2 Enter the system administrator's user ID with the numeric keypad or the keyboard displayed on the screen, and select [Enter].

When a passcode is required, select [Next] and enter the system administrator's passcode, and select [Enter].

- Note**
- The default user ID is "admin".
 - The default passcode is "1111".

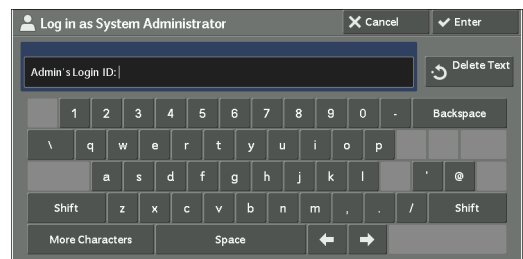

- 3 Select [Tools] on the [Home] screen.

- Note**
- When the [Home] screen is not displayed on the touch screen, press the <Home> button.

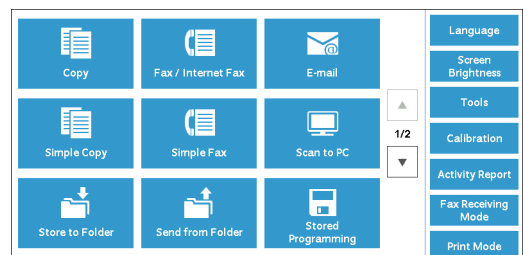

- 4 Select [System Settings] > [Common Service Settings] > [Screen/Button Settings].

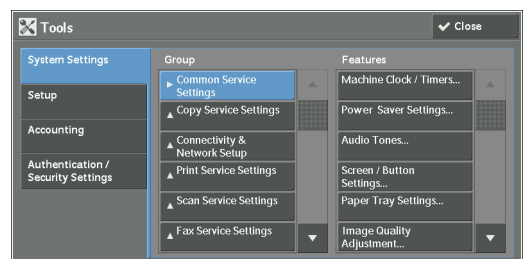

- 5 Select [Home - Additional Features], and then select [Change Settings].

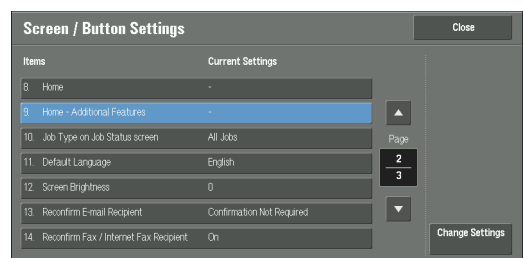

6 Select the position where you want to assign an additional feature.

Note • The layout of buttons in this screen is corresponding to the layout of those on the [Home] screen.

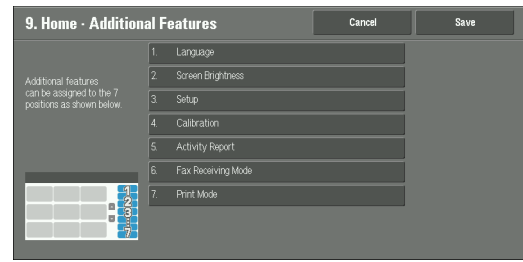

7 Select a service you want to display on the [Home] screen.

Note • Select [▲] to display the previous screen or [▼] to display the next screen.
• You cannot assign the same feature to more than one button.

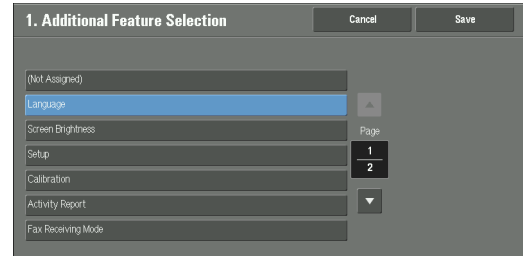

8 Select [Save].

9 Select [Save].

Assigning Services to the Custom Buttons

You can assign services to the <Copy>, <Shortcut 1>, and <Shortcut 2> buttons on the control panel.

Assigning a service to a custom button allows you to switch to this service without having to return to the [Home] screen. If you do not need to assign any service to a custom button, select [(Not Set)].

[Copy] is assigned to the <Copy> button and [Review] is assigned to the <Shortcut 2> button by factory default, while the <Shortcut 1> button has no assignment.

This section describes how to assign [Send from Folder] to the <Shortcut 1> button, as an example.

Note • After you change the assignment, apply the labels provided with the machine. When you assign a service for which no label is provided, use a blank label and write down the service name with a permanent marker. The labels include the services that are not supported by the machine.

1 Press the <Log In/Out> button.

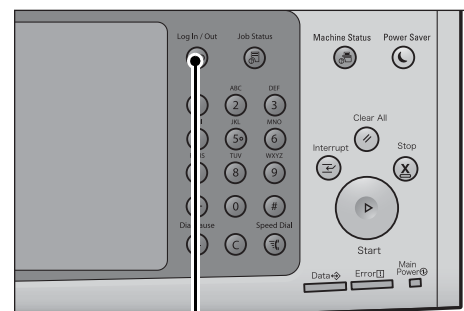

<Log In/Out> button

2 Enter the system administrator's user ID with the numeric keypad or the keyboard displayed on the screen, and select [Enter].

When a passcode is required, select [Next] and enter the system administrator's passcode, and select [Enter].

Note • The default user ID is "admin".

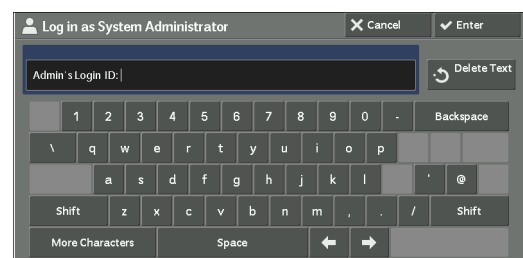

- The default passcode is "1111".

3 Select [Tools] on the [Home] screen.

Note • When the [Home] screen is not displayed on the touch screen, press the <Home> button.

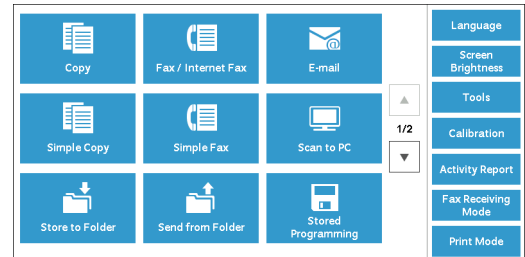

4 Select [System Settings] > [Common Service Settings] > [Screen/Button Settings].

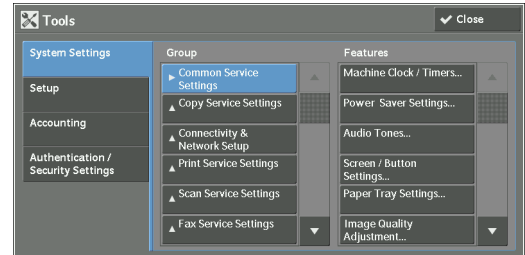

5 Select [Custom Button 2], and then select [Change Settings].

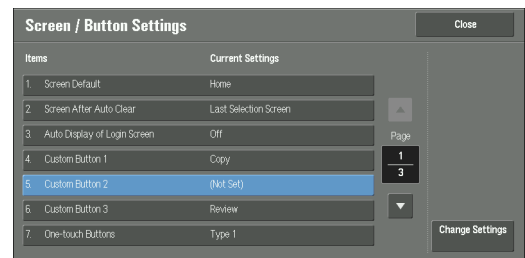

6 Select [Send from Folder].

Note • Select [▲] to display the previous screen or [▼] to display the next screen.



7 Select [Save].

Adjusting the Screen Brightness

You can adjust the screen brightness of the screen on the [Home] screen.

- 1 Select [Screen Brightness] on the [Home] screen.
- 2 Press [+] or [-] to adjust the screen brightness.

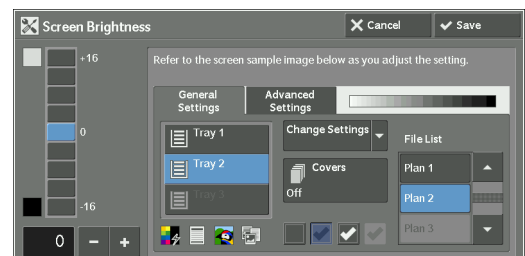

3 Select [Save].

To adjust the screen brightness from the [Tools] screen, refer to "Screen Brightness" (P.130).

Entering Text

During operations, a screen for entering text sometimes appears. The following describes how to enter text.

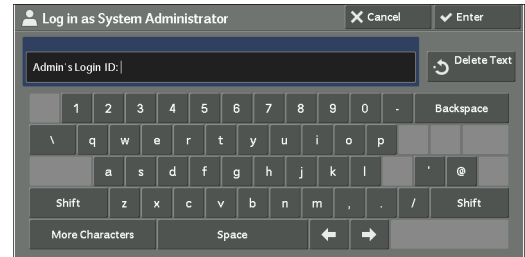

You can enter the following characters: numerals, alphabets, and symbols

Item	Description
Entering alphabets and numerals	To enter uppercase letters, select [Shift]. To return to the lowercase letters, select [Shift] again.
Entering symbols	Select [More Characters]. Note <ul style="list-style-type: none"> • Depending on the keyboard, you can select a symbol from the pull-up options displayed on the bottom left of the screen.
Entering a space	Select [Space].
Deleting characters	Select [Backspace] to delete one character at a time.

2 Paper and Other Media

This chapter describes the paper that can be used with the machine, precautions when handling paper, and how to load paper in trays.

- **Paper Types**36
- **Loading Paper**47
- **Changing the Paper Size**51
- **Changing the Paper Settings**.....54

Paper Types

This section describes the paper that can be used with this machine.

Use of unrecommended paper may result in paper jams, lower print quality, malfunctions, or damage to the machine. To achieve optimum performance of the machine, we recommend that you use only paper recommended by Dell.

If you desire to use paper other than the paper recommended by Dell, contact Customer Support at dell.com/contactdell.

Note • Moisture generated by water, rain, or vapor may cause the printed images to fade. For more information, contact Customer Support at dell.com/contactdell.

Loadable Quantity and Weight

Paper Tray	Loadable Paper	Loadable Quantity*
Trays 1 to 4	Basis Weight: 60 to 256 gsm Ream Weight: 51.6 - 220.1 kg	500 sheets
Tray 5 (bypass tray)	Basis Weight: 55 to 280 gsm Ream Weight: 47.3 - 240.7 kg	Up to 10 mm 90 sheets
Tray 6 (HCF B1) (optional)	Basis Weight: 55 to 216 gsm Ream Weight: 47.3 - 186 kg	2,030 sheets

*: When using 80 gsm paper

Note

- Printing on paper that differs from the paper type and size selected in the print driver, or printing from a tray that does not support the loaded paper may result in a paper jam. To ensure correct printing, select the correct paper size, paper type, and paper tray.
- Basis weight is the weight of 1 m² of a paper sheet.
- Ream weight is the weight of 1,000 sheets of duodecimo size (788 x 1,091 mm) paper.
- When copying on non-standard size paper from Tray 5, you must enter the paper size. Furthermore, if you frequently copy on non-standard size paper, you can preset the size on the machine. That size then appears under [Standard Size] on the [Tray 5] screen. For more information on the settings, refer to "Tray 5 - Paper Size Defaults" (P.133).
- Most ideal image quality with the paper can be obtained by setting the image quality for each type of paper. For more information on the settings, refer to "Image Quality" (P.134).

Supported Paper

Standard Paper

When printing or copying on commonly used paper (plain paper), use paper meeting the standards described below. To copy or print as clear as possible, we recommend the following standard paper.

Paper Name	Size	Basis Weight	Paper Type* ¹	Image Quality* ²	Notes / Countermeasure
Xerox Business 4200	8.5 x 11", 11 x 17"	75 gsm / 20 lb.	Plain	Plain E	
Xerox Color Xpressions Select	8.5 x 11", 11 x 17"	90 gsm / 24 lb.	Bond	Plain A	
Xerox Premier	A4, A3	80 gsm	Plain	Plain F	

Paper Name	Size	Basis Weight	Paper Type^{*1}	Image Quality^{*2}	Notes / Countermeasure
Xerox Colotech+ (Gold label)	A4, A3	90 gsm	Bond	Plain A	

*1 :Select the paper type setting for the paper loaded on a tray. For more information, refer to "Changing the Paper Settings" (P.54).

*2 :Most ideal image quality with the paper can be obtained by setting the image quality for each type of paper. For more information on the settings, refer to "Image Quality" (P.134).

Semi Standard Paper

In addition to the standard paper, the following paper can also be used.

Paper Name	Size	Basis Weight	Paper Type^{*1}	Image Quality^{*2}	Notes / Countermeasure
Xerox Business 4200	8.5 x 14"	75 gsm / 20 lb.	Plain	Plain E	
Xerox Color Xpressions Select	8.5 x 14"	90 gsm / 24 lb.	Bond	Plain A	
Xerox Business	A4, A3	80 gsm	Plain	Plain F	• Dog ear defect and wrinkles may occur under high humidity conditions.
Xerox Recycled Supreme	A4, A3	80 gsm	Recycled	Plain F	
Xerox Exclusive	A4, A3	80 gsm	Plain	Plain F	
Xerox Digital Colour Colotech+	A4, A3	90 gsm	Bond	Plain F	
	A4, A3	100 gsm	Bond	Plain F	

*1 :Select the paper type setting for the paper loaded on a tray. For more information, refer to "Changing the Paper Settings" (P.54).

*2 :Most ideal image quality with the paper can be obtained by setting the image quality for each type of paper. For more information on the settings, refer to "Image Quality" (P.134).

Usable Paper

In addition to the standard paper, the following paper can also be used.

Paper Name	Size	Basis Weight	Paper Type^{*1}	Image Quality^{*2}	Notes / Countermeasure
Xerox Business 4200 (3-hole)	8.5 x 11"	75 gsm / 20 lb.	Plain	Plain E	
Xerox Business Recycled Paper	8.5 x 11", 8.5 x 14", 11 x 17"	75 gsm / 20 lb.	Recycled	Plain E	
Xerox Business Recycled Paper (3-hole)	8.5 x 11"	75 gsm / 20 lb.	Recycled	Plain E	
Xerox Color Xpressions Select (3-hole)	8.5 x 11"	90 gsm / 24 lb.	Bond	Plain A	

Paper Name	Size	Basis Weight	Paper Type *1	Image Quality *2	Notes / Countermeasure
Xerox Color Xpressions Elite	8.5 x 11", 17 x 11", 18 x 12"	120 gsm / 32 lb.	Heavyweight	HW 1A	• Tray 1 does not support 18 x 12 paper.
	8.5 x 11", 17 x 11", 18 x 12"	163 gsm / 60 lb. cover	Heavyweight	HW 1A	• Tray 1 does not support 18 x 12 paper.
	8.5 x 11", 17 x 11", 18 x 12"	215 gsm / 80 lb. cover	Extra Heavyweight	HW 2A	• Tray 1 does not support 18 x 12 paper. • When you use Tray 5, automatic duplexing is not available.
	8.5 x 11", 17 x 11", 18 x 12"	270 gsm / 100 lb. cover	Extra Heavyweight Plus	HW 2A	• Load the paper into Tray 5. • Automatic duplexing is not available.
Xerox Color Xpressions Planet 20	8.5 x 11", 17 x 11", 18 x 12"	175 gsm / 65 lb. cover	Extra Heavyweight	HW 2A	• Tray 1 does not support 18 x 12 paper. • When you use Tray 5, automatic duplexing is not available.
	8.5 x 11", 17 x 11", 18 x 12"	270 gsm / 100 lb. cover	Extra Heavyweight Plus	HW 2A	• Load the paper into Tray 5. • Automatic duplexing is not available.
Xerox Business Index	8.5 x 11", 17 x 11"	163 gsm / 90 lb.	Heavyweight	Coated 1	• Manually feed one paper at a time, using Tray 5.
Xerox Premier	A4	60 gsm	Plain	Plain F	
	A4, A3	90 gsm	Bond	Plain F	
	A4	120 gsm	Heavyweight	HW 1A	
Xerox Exclusive (4-hole)	A4	80 gsm	Plain	Plain F	
Xerox Exclusive	A4, A3	90 gsm	Bond	Plain A	
Xerox Colour Impressions	A4, A3	80 gsm	Plain	Plain F	
	A4	90 gsm	Bond	Plain F	
	A3, SRA3	120 gsm	Heavyweight	HW 1A	• Tray 1 does not support SRA3.
Xerox Colour Impressions	A3, SRA3	250 gsm	Extra Heavyweight	HW 2A	• Tray 1 does not support SRA3. • Duplexing is supported by Tray 5 only. Automatic duplexing is not available.

Paper Name	Size	Basis Weight	Paper Type *1	Image Quality *2	Notes / Countermeasure
Xerox Digital Colour Colotech+	A3+, SRA3	90 gsm	Bond	Plain F	<ul style="list-style-type: none"> • Load the paper into paper trays other than Tray 1.
	A3+, SRA3	100 gsm	Bond	Plain F	<ul style="list-style-type: none"> • Load the paper into paper trays other than Tray 1.
	A4, A3, A3+, SRA3	120 gsm	Heavyweight	HW 1A	<ul style="list-style-type: none"> • Tray 1 does not support A3+ and SRA3.
	A4, A3, A3+, SRA3	160 gsm	Heavyweight	HW 1A	<ul style="list-style-type: none"> • Tray 1 does not support A3+ and SRA3.
	A4, A3, A3+, SRA3	200 gsm	Extra Heavyweight	HW 2A	<ul style="list-style-type: none"> • Tray 1 does not support A3+ and SRA3. • When you use Tray 5, automatic duplexing is not available.
	A4, A3, A3+, SRA3	220 gsm	Extra Heavyweight	HW 2A	<ul style="list-style-type: none"> • Tray 1 does not support A3+ and SRA3. • When you use Tray 5, automatic duplexing is not available.
	A4, A3, SRA3	250 gsm	Extra Heavyweight	HW 2A	<ul style="list-style-type: none"> • Tray 1 does not support SRA3. • Duplexing is supported by Tray 5 only. Automatic duplexing is not available.
Xerox Colotech+ (Gold label)	A4, A3, SRA3	250 gsm	Extra Heavyweight	HW 2A	<ul style="list-style-type: none"> • Tray 1 does not support SRA3. • Duplexing is supported by Tray 5 only. Automatic duplexing is not available.
	SRA3	90 gsm	Bond	Plain A	<ul style="list-style-type: none"> • Load the paper into paper trays other than Tray 1.
	A4, A3, SRA3	100 gsm	Bond	Plain A	<ul style="list-style-type: none"> • Tray 1 does not support SRA3.
	A4, A3, SRA3	120 gsm	Heavyweight	HW 1A	<ul style="list-style-type: none"> • Tray 1 does not support SRA3.
	A4, A3, SRA3	160 gsm	Heavyweight	HW 1A	<ul style="list-style-type: none"> • Tray 1 does not support SRA3.
	A4, A3, SRA3	200 gsm	Extra Heavyweight	HW 2A	<ul style="list-style-type: none"> • Tray 1 does not support SRA3. • When you use Tray 5, automatic duplexing is not available.
	A4, A3, SRA3	220 gsm	Extra Heavyweight	HW 2A	<ul style="list-style-type: none"> • Tray 1 does not support SRA3. • When you use Tray 5, automatic duplexing is not available.

Paper Name	Size	Basis Weight	Paper Type *1	Image Quality *2	Notes / Countermeasure
XeroxColotech+ Natural White	A4, A3, A3+, SRA3	100 gsm	Bond	Plain A	• Tray 1 does not support A3+ and SRA3.
	A4, A3, A3+, SRA3	160 gsm	Heavyweight	HW 1A	• Tray 1 does not support A3+ and SRA3.
	A4, A3, A3+, SRA3	200 gsm	Extra Heavyweight	HW 2A	• Tray 1 does not support A3+ and SRA3. • When you use Tray 5, automatic duplexing is not available.

*1 : Select the paper type setting for the paper loaded on a tray. For more information, refer to "Changing the Paper Settings" (P.54).

*2 : Most ideal image quality with the paper can be obtained by setting the image quality for each type of paper. For more information on the settings, refer to "Image Quality" (P.134).

Special Media

You can use the following special media such as postcards and envelopes:

Paper Name	Size	Basis Weight	Paper Type *1	Image Quality *2	Notes / Countermeasure
Xerox Transparency - Removable Stripe	8.5 x 11"	-	Transparency	Transparency	<ul style="list-style-type: none"> • Load the paper with the paper stripe at the trail edge. • It is not recommended to output more than 20 transparencies at a time. • Duplexing is not available. • Place plain paper underneath the transparency sheet if misfeeds occur.
Envelopes	4.1 x 9.5"	75 - 90 gsm	No. 10 Envelope (4.1 x 9.5")	Envelope	<ul style="list-style-type: none"> • Load the paper into Tray 5. • Duplexing is not available.
	3.9 x 7.5"	75 - 90 gsm	Monarch Envelope (3.9 x 7.5")	Envelope	<ul style="list-style-type: none"> • Load the paper into Tray 5. • Duplexing is not available.
Xerox Colour Laser Labels	A4	-	Label	HW 2A	<ul style="list-style-type: none"> • Load the paper into Tray 1 or Tray 5. • Duplexing is not available.
XeroxHighSpeed Laser Removable Labels	A4	-	Labels	HW 2A	<ul style="list-style-type: none"> • Load the paper into Tray 1 or Tray 5. • Duplexing is not available.
XeroxHighSpeed Laser Labels	A4	-	Labels	HW 2A	<ul style="list-style-type: none"> • Load the paper into Tray 1 or Tray 5. • Duplexing is not available.

Paper Name	Size	Basis Weight	Paper Type* ¹	Image Quality* ²	Notes / Countermeasure
Xerox Plain Transparency for Colour	A4	-	Transparency	-	<ul style="list-style-type: none"> • Duplexing is not available. • It is not recommended to output more than 20 transparencies at a time. • Place plain paper underneath the transparency sheet if misfeeds occur.

*1 :Select the paper type setting for the paper loaded on a tray. For more information, refer to "Changing the Paper Settings" (P.54).

*2 :Most ideal image quality with the paper can be obtained by setting the image quality for each type of paper. For more information on the settings, refer to "Image Quality" (P.134).

Note • For more information on special paper such as other heavyweight paper, contact Customer Support at dell.com/contactdell.

Limited Paper

You can use the following paper with limitations:

Paper Name	Size	Basis Weight	Paper Type* ¹	Image Quality* ²	Notes / Countermeasure
Xerox Color Xpressions Elite	8.5 x 11", 17 x 11"	105 gsm / 28 lb.	Bond	Plain A	
Xerox Color Xpressions Elite (3-hole)	8.5 x 11"	105 gsm / 28 lb.	Bond	Plain A	
Xerox Color Xpressions Planet 20	8.5 x 11", 17 x 11", 18 x 12"	105 gsm / 28 lb.	Bond	Plain A	<ul style="list-style-type: none"> • If misregistration occurs when output sheets are delivered to Finisher-B1, invert the paper in the paper tray.
	8.5 x 11", 17 x 11", 18 x 12"	215 gsm / 80 lb. cover	Extra Heavyweight	HW 2A	<ul style="list-style-type: none"> • Tray 1 does not support 18 x 12 paper. • When you use Tray 5, automatic duplexing is not available.
Xerox Digital Color Elite Silk Text and Cover (C2S)	8.5 x 11", 17 x 11", 18 x 12"	120 gsm / 80 lb. text	Gloss	Coated 1	<ul style="list-style-type: none"> • Manually feed one sheet at a time, using Tray 5.
	8.5 x 11", 17 x 11", 18 x 12"	140 gsm / 100 lb. text	Gloss	Coated 1	<ul style="list-style-type: none"> • Manually feed one sheet at a time, using Tray 5.
	8.5 x 11", 17 x 11", 18 x 12"	210 gsm / 80 lb. cover	Heavyweight Gloss	Coated 2	<ul style="list-style-type: none"> • Manually feed one sheet at a time, using Tray 5. • Automatic duplexing is not available.

Paper Name	Size	Basis Weight	Paper Type*¹	Image Quality*²	Notes / Countermeasure
Xerox Digital Color Elite Gloss Text and Cover (C2S)	8.5 x 11", 17 x 11", 18 x 12"	120 gsm / 80 lb. text	Gloss	Coated 1	• Manually feed one sheet at a time, using Tray 5.
	8.5 x 11", 17 x 11", 18 x 12"	140 gsm / 100 lb. text	Gloss	Coated 1	• Manually feed one sheet at a time, using Tray 5.
	8.5 x 11", 17 x 11", 18 x 12"	210 gsm / 80 lb. cover	Heavyweight Gloss	Coated 2	• Manually feed one sheet at a time, using Tray 5. • Automatic duplexing is not available.
	8.5 x 11", 17 x 11", 18 x 12"	280 gsm / 100 lb. cover	Extra Heavyweight Gloss	Coated 2	• Manually feed one sheet at a time, using Tray 5. • Automatic duplexing is not available.
Xerox Digital Color Select Gloss Text and Cover (C2S)	17 x 11", 18 x 12"	120 gsm / 80 lb. text	Gloss	Coated 1	• Manually feed one sheet at a time, using Tray 5.
	17 x 11", 18 x 12"	210 gsm / 80 lb. cover	Heavyweight Gloss	Coated 2	• Manually feed one sheet at a time, using Tray 5. • Automatic duplexing is not available.
Xerox Digital Color Supreme Gloss FSC (C1S)	8.5 x 11", 17 x 11", 18 x 12"	8 pt / 160 gsm	Gloss	Coated 1	• Manually feed one sheet at a time, using Tray 5. • Set the output destination to other than [Center Tray - Upper] ([Center Tray] when a finisher is installed).
	8.5 x 11", 17 x 11", 18 x 12"	12 pt / 247 gsm	Heavyweight Gloss	Coated 2	• Manually feed one sheet at a time, using Tray 5. • Automatic duplexing is not available. • Set the output destination to other than [Center Tray - Upper] ([Center Tray] when a finisher is installed).
Xerox Business Index	8.5 x 11"	199 gsm / 110 lb.	Extra Heavyweight	Coated 2	• Manually feed one sheet at a time, using Tray 5. • Automatic duplexing is not available.
Xerox Digital Color Select Gloss Labels	8.5 x 11"	-	Labels	HW 2A	• Manually feed one sheet at a time, using Tray 5. • Duplexing is not available.
Xerox Matte Coated Labels	8.5 x 11"	-	Labels	HW 2A	• Manually feed one sheet at a time, using Tray 5. • Duplexing is not available.

Paper Name	Size	Basis Weight	Paper Type*¹	Image Quality*²	Notes / Countermeasure
Xerox Phase Professional Transparency	8.5 x 11"	-	Transparency	Transparency	<ul style="list-style-type: none"> • It is not recommended to output more than 20 transparencies at a time. • Duplexing is not available. • Place plain paper underneath the transparency sheet if misfeeds occur.
Xerox Digital EA Color Transfer Paper	8.5 x 11", 17 x 11"	-	Heavyweight	HW 1A	<ul style="list-style-type: none"> • Load the paper into Tray 5. • Duplexing is not available.
Xerox Colour Impressions	A3, SRA3	90 gsm	Bond	Plain F	
	A4, A3, SRA3	100 gsm	Bond	Plain F	
XeroxColotech+ Gloss Coated	A4, A3, SRA3	120 gsm	Gloss	Coated 1	<ul style="list-style-type: none"> • Manually feed one sheet at a time, using Tray 5. • Blisters may occur on a printed page under high temperature and humidity conditions.
	A4, A3, SRA3	140 gsm	Gloss	Coated 1	<ul style="list-style-type: none"> • Manually feed one sheet at a time, using Tray 5.
	A4, A3, SRA3	170 gsm	Heavyweight Gloss	Coated 2	<ul style="list-style-type: none"> • Manually feed one sheet at a time, using Tray 5. • Automatic duplexing is not available.
	A4, A3, SRA3	210 gsm	Heavyweight Gloss	Coated 2	<ul style="list-style-type: none"> • Manually feed one sheet at a time, using Tray 5. • Automatic duplexing is not available.
	A4, A3, SRA3	250 gsm	Heavyweight Gloss	Coated 2	<ul style="list-style-type: none"> • Manually feed one sheet at a time, using Tray 5. • Automatic duplexing is not available.
XeroxColotech+ Silk Coated	A4, A3, SRA3	120 gsm	Gloss	Coated 1	<ul style="list-style-type: none"> • Manually feed one sheet at a time, using Tray 5.
	A4, A3, SRA3	140 gsm	Gloss	Coated 1	<ul style="list-style-type: none"> • Manually feed one sheet at a time, using Tray 5.
	A4, A3, SRA3	170 gsm	Heavyweight Gloss	Coated 2	<ul style="list-style-type: none"> • Manually feed one sheet at a time, using Tray 5. • Automatic duplexing is not available.
	A4, A3, SRA3	210 gsm	Heavyweight Gloss	Coated 2	<ul style="list-style-type: none"> • Manually feed one sheet at a time, using Tray 5. • Automatic duplexing is not available.
	A4, A3, SRA3	250 gsm	Heavyweight Gloss	Coated 2	<ul style="list-style-type: none"> • Manually feed one sheet at a time, using Tray 5. • Automatic duplexing is not available.

Paper Name	Size	Basis Weight	Paper Type*¹	Image Quality*²	Notes / Countermeasure
XeroxColotech+ Supergloss	A4	135 gsm	Gloss	Coated 1	<ul style="list-style-type: none"> Manually feed one sheet at a time, using Tray 5. Set the output destination to other than [Center Tray - Upper] ([Center Tray] when a finisher is installed).
	A4, A3	160 gsm	Gloss	Coated 1	<ul style="list-style-type: none"> Manually feed one sheet at a time, using Tray 5. Set the output destination to other than [Center Tray - Upper] ([Center Tray] when a finisher is installed).
	A4, A3, SRA3	210 gsm	Heavyweight Gloss	Coated 2	<ul style="list-style-type: none"> Manually feed one sheet at a time, using Tray 5. Automatic duplexing is not available. Set the output destination to other than [Center Tray - Upper] ([Center Tray] when a finisher is installed).
Xerox Dura Paper Labels	A4	-	Label	HW 2A	<ul style="list-style-type: none"> Load the paper into Tray 1 or Tray 5. Duplexing is not available.
XeroxColotech Supergloss Labels	A4, SRA3	-	Heavyweight Gloss	Coated 2	<ul style="list-style-type: none"> Manually feed one sheet at a time, using Tray 5. Duplexing is not available. Set the output destination to other than [Center Tray - Upper] ([Center Tray] when a finisher is installed).
Xerox Colotech Super Gloss CD Labels	A4	-	Heavyweight Gloss	Coated 2	<ul style="list-style-type: none"> Manually feed one sheet at a time, using Tray 5. Duplexing is not available. Set the output destination to other than [Center Tray - Upper] ([Center Tray] when a finisher is installed).
Xerox Colour Laser Matte CD Labels, Combi Box	A4	-	Heavyweight	-	<ul style="list-style-type: none"> Manually feed one sheet at a time, using Tray 5. Duplexing is not available.
Xerox DocuPac Folders High Gloss White	A4+	210 gsm	Heavyweight Gloss	-	<ul style="list-style-type: none"> Manually feed one sheet at a time, using Tray 5. Duplexing is not available.
Xerox DocuPac Folders Matte White	A4+	180 gsm	Extra Heavyweight	-	<ul style="list-style-type: none"> Manually feed one sheet at a time, using Tray 5. Duplexing is not available.
Xerox Digital EA Color Transfer paper	A4, A3	-	Heavyweight	-	<ul style="list-style-type: none"> Load the paper into Tray 5. Duplexing is not available.

Paper Name	Size	Basis Weight	Paper Type *1	Image Quality *2	Notes / Countermeasure
Envelopes	9 x 6.4", 8.7 x 4.3"	75 - 90 gsm	Envelope	-	<ul style="list-style-type: none"> • Load the paper into Tray 5. • Duplexing is not available. • Wrinkles with certain brands and types are possible. If wrinkles are encountered, try a different brand or type.

*1 :Select the paper type setting for the paper loaded on a tray. For more information, refer to "Changing the Paper Settings" (P.54).

*2 :Most ideal image quality with the paper can be obtained by setting the image quality for each type of paper. For more information on the settings, refer to "Image Quality" (P.134).

Note • "High temperature and humidity conditions" in the above table means an environment with temperature of 28 °C and humidity of 85%, and "low temperature and humidity conditions" means an environment with temperature of 10 °C and humidity of 15%.

Unusable Paper

Using paper and transparencies not recommended by Dell may cause a paper jam or machine malfunction. Use paper and transparencies recommended by Dell.

- Transparencies
- Damp or wet paper
- Paper pre-printed with another printer or copying machine
- Wrinkled, creased, or ripped paper
- Envelopes that are not flat, or that have clasps
- Color paper with surface treatments
- Paper with rough surface, such as pulp paper or fibrous paper
- Symphony (Pastel Pink etc.) A4 80 gsm

Storing and Handling Paper

Please keep the following points in mind when storing paper

- Store paper inside a cabinet or other dry place. Paper that has absorbed moisture can result in paper jams and lower image quality.
- After opening a package of paper, wrap and store any remaining paper. We recommend that you store remaining paper in moisture prevention packets.
- Store paper on a flat surface to prevent bends or warping.

Please adhere to the following points when loading paper in a tray

- Align the stack of paper neatly before setting it in a tray.
- Do not use paper that is creased or wrinkled.
- Do not use warped or curled paper.
- Do not load paper of mixed sizes together into a tray.
- Carefully fan transparencies and labels before use. Otherwise, the paper may stick together, resulting in paper jams, or multiple sheets being fed to the machine simultaneously.
- When continuously outputting on transparencies, transparency sheets may stick together. After printing 20 or more sheets, remove them from the output tray and fan them to cool them down.

Loading Paper

This section describes how to load paper.

Types of paper loaded in trays

The machine automatically detects the size and orientation of loaded paper in a tray, but not a paper type. Normally, each tray is set to plain paper. When loading paper other than plain paper, you must change the paper type setting. You can name paper types and can set up to five paper types as user-defined paper.

For information on changing the paper type settings, refer to "Changing the Paper Settings" (P.54).

Automatic Tray Selection

If you set paper source on the [Paper/Output] tab to [Paper Tray] in the PCL print driver's screen when printing, the machine automatically selects the paper tray according to the size and orientation of the document to be printed. This is called the Automatic Tray Selection.

When copying, selecting [Auto Select] for [Paper Supply] enables automatic tray selection. If the machine detects two or more corresponding trays for the automatic tray selection, the machine selects the tray with the highest priority specified in [Paper Type Priority] among the trays set under [Paper Type]. Trays whose [Paper Type Priority] setting is set to [Auto Paper Off] are ignored in automatic tray selection. Also, if the [Paper Type Priority] settings are identical, the tray priority is determined by [Paper Tray Priority].

- Note**
- Some trays may not be selected in automatic tray selection depending on the setting of that tray for [Auto Paper Select]. For more information, refer to "Change Settings" (P.132).
 - Tray 5 cannot be selected in automatic tray selection.
 - When the paper runs out during copying or printing, select a tray containing the same sized paper and orientation, and the machine continues copying or printing (Auto Tray Switching feature). The machine cannot switch to a tray containing a paper type for which [Paper Type Priority] is set to [Auto Paper Off].

For information about [Paper Type], [Paper Type Priority], and [Paper Tray Priority] settings, and the paper substitute feature, refer to "Paper Tray Settings" (P.131). You can also set these settings from Dell Printer Configuration Web Tool.

Adding paper

When the machine runs out of paper during copying or printing, a message appears on the touch screen. Add paper according to the message instructions. Copying or printing automatically resumes when paper is added.

- Note**
- Carefully fan the paper before loading it in a tray. Otherwise, the paper may stick together, resulting in paper jams, or multiple sheets being fed to the machine simultaneously.

Loading Paper in Trays 1 to 4

The following describes the procedures to load paper in Trays 1 to 4.

When the machine runs out of paper during copying or printing, a message appears on the touch screen. Add paper according to the message instructions. Copying or printing automatically resumes when paper is added.

- Note**
- Carefully fan the paper before loading it in a tray. Otherwise, the paper may stick together, resulting in paper jams.

For information on changing the paper size and orientation, refer to "Changing the Paper Size for Trays 1 to 4" (P.51).

1 Pull out the tray until it stops.

- Note**
- While the machine is processing a job, do not pull out the tray that is being used for the job.
 - To prevent paper jams or erroneous detection of loaded paper in a tray by the machine, do not add paper on top of any remaining paper in the tray. Remove any remaining paper in the tray, and then load that paper on top of the newly loaded paper.

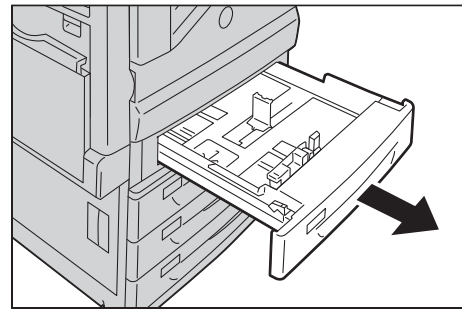

- Do not pull out all the trays at the same time. Otherwise, the machine gets inclined and turns over, which may cause injuries.

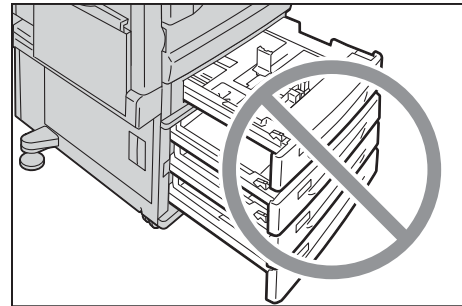

2 Load and align the edge of the paper against the left edge of the tray, with the side to be copied or printed on facing up.

- Note**
- Do not load paper above the maximum fill line ("MAX" in the right figure). It may cause paper jams or machine malfunction.
 - Do not place any paper or objects in the empty space on the right side of Trays 1 to 4. It may cause paper jams or machine malfunction.

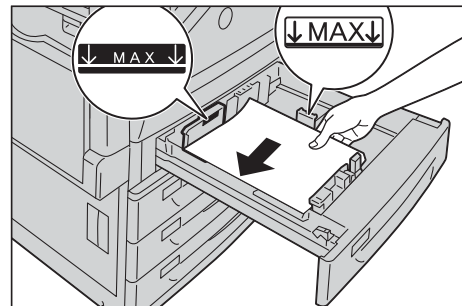

3 Push the tray in gently until it stops.

- Note**
- When inserting the tray, push it gently. Forcibly pushing the tray in may cause machine malfunction.

Loading Paper in Tray 5 (Bypass Tray)

When printing or copying on a size or type of paper that cannot be set in Trays 1 to 4, use Tray 5 (bypass tray). The following describes the procedures to load paper in Tray 5. To use Tray 5 when printing, select Tray 5 and specify the paper type on the [Paper/Output] tab of the print driver.

- Note**
- To prevent paper jams and erroneous detection of paper loaded in the tray by the machine, do not take out paper of a package until the tray runs out of paper.
 - Carefully fan the paper before loading it in a tray. Otherwise, the paper may stick together, resulting in paper jams, or multiple sheets being fed to the machine simultaneously.

1 Open Tray 5.

- Note**
- If necessary, pull out the extension tray. The extension tray can be extended in two stages. Pull out the extension tray gently.

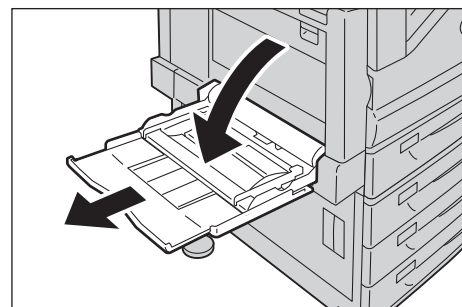

- 2 Load paper with the side to be copied or printed on facing down, inserting the paper until its edge lightly touches against the paper feed entrance.

- Note**
- Do not load mixed paper types into the tray.
 - Do not load paper above the maximum fill line. It may cause paper jams or machine malfunction.
 - Depending on the type of the heavyweight paper, paper may not be fed to the machine or image quality may deteriorate.

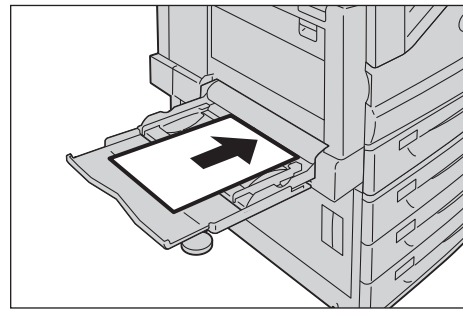

- 3 Adjust the paper guides to align the edges of the paper loaded.

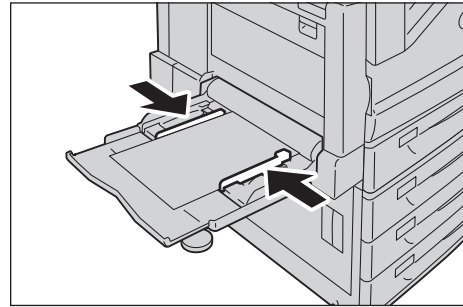

- 4 Instruct a copy or print job.

Loading Paper in Tray 6 (HCF B1)

The following describes the procedure for loading paper into Tray 6 (HCF B1).

When the machine runs out of paper during copying or printing, a message is displayed on the touch screen. Add paper according to the displayed instructions. Copying or printing is automatically resumed when paper is added.

- Note**
- Carefully fan the paper before loading it in a tray. Otherwise, the paper may stick together, resulting in paper jams.

For information on changing the paper size and orientation, refer to "Changing the Paper Size" (P.51).

- 1 Pull out Tray 6 until it stops.

- Note**
- While the machine is processing a job, do not pull out the tray that is being used for the job.
 - To prevent paper jams or erroneous detection of loaded paper in a tray by the machine, do not add paper on top of any remaining paper in the tray.

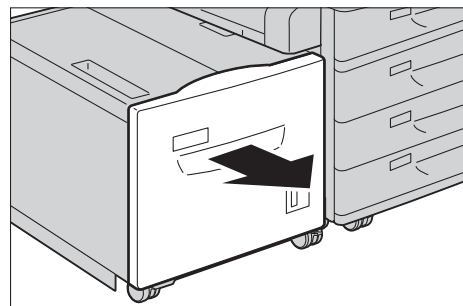

- 2 Load and align the edge of the paper against the right edge of the tray with the side to be copied or printed on facing down.

- Note**
- Do not load paper above the maximum fill line ("MAX" in the right figure). It may cause paper jams or machine malfunction.

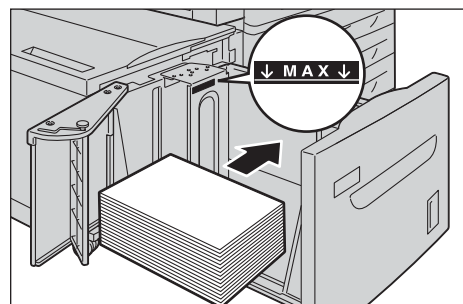

3 Push the tray in gently until it stops.

Changing the Paper Size

This section describes how to change the paper size in Trays 1 to 4, and 6.

- Note**
- The types of paper in Trays 1 to 4, and 6 are preset. Normally, Trays 1 to 4 are set to plain paper. When changing to a different paper type, change the paper quality settings to match the type of paper to be loaded so that you can maintain high quality printing.
For more information on paper type settings, refer to "Changing the Paper Settings" (P.54).
 - Non-standard size paper can be loaded in Trays 1 to 4. When loading non-standard size paper, you must register the paper size. For information on registering paper sizes, refer to "Paper Size" (P.132).

For more information on corresponding paper sizes, refer to "Paper Size Settings" (P.145).

For more information on how to copy on non-standard size paper, refer to "3 Copy" > "Copy" > "Paper Supply (Selecting the Paper for Copying)" in the User Guide. For more information on how to print on non-standard size paper, refer to the help of the print driver.

- Note**
- Do not load paper of mixed sizes together into a tray.

Changing the Paper Size for Trays 1 to 4

The following describes how to change paper size in Trays 1 to 4.

- Note**
- The types of paper in Trays 1 to 4 are preset. There are 16 paper types: Plain paper, Bond paper, Recycled paper, Transparency, Heavyweight paper, Gloss, Labels, Punched, Letterhead, Pre-Print, Other, and Custom paper 1 to 5, and normally, plain paper is set. When changing to a different paper type, change the paper quality settings to match the type of paper to be loaded so that you can maintain high quality printing.
For more information on paper type settings, refer to "Changing the Paper Settings" (P.54).
 - When loading non-standard size paper, you must register the paper size. For information on registering paper sizes, refer to "Paper Tray Attributes" (P.132).

For more information on how to copy on non-standard size paper, refer to "3 Copy" > "Copy" > "Paper Supply (Selecting the Paper for Copying)" in the User Guide. For more information on how to print on non-standard size paper, refer to the help of the print driver.

- 1 Pull out the Tray until it stops.

- Note**
- While the machine is processing a job, do not pull out the tray that is being used for the job.
 - To prevent paper jams or erroneous detection of loaded paper in a tray by the machine, do not add paper on top of any remaining paper in the tray.

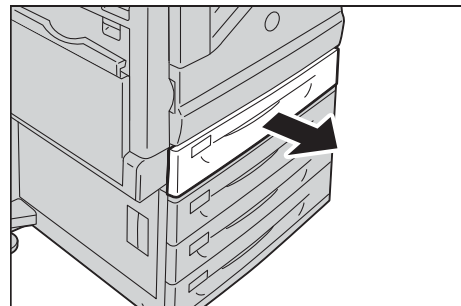

- 2 Remove any paper loaded in the tray.

- 3 While pinching the two paper guides, move them to the edges of the paper.

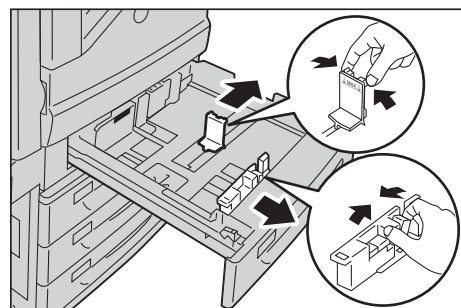

- 4 Load and align the edge of the paper against the left side of the tray, with the side to be copied or printed on facing up.

Note

- Do not load paper above the maximum fill line ("MAX" in the right figure).

- 5 Push the tray in gently until it stops.

Note

- When inserting the tray, push it gently. Forcibly pushing the tray in may cause machine malfunction.
- Affix the paper size label to the front of the paper tray.

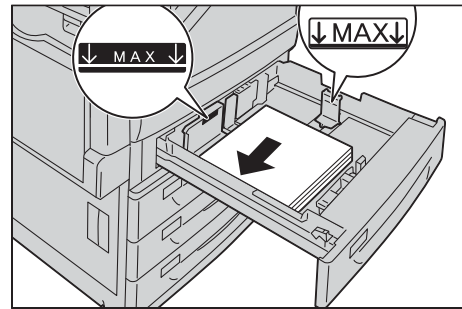

For more information on paper type settings, refer to "Changing the Paper Settings" (P.54).

Changing the Paper Size for Tray 6 (HCF B1) (optional)

The following describes how to change paper size in Tray 6 (HCF B1) (optional).

- 1 Pull out the Tray 6 until it stops.

Note

- While the machine is processing a job, do not pull out the tray that is being used for the job.
- To prevent paper jams or erroneous detection of loaded paper in a tray by the machine, do not add paper on top of any remaining paper in the tray.

- 2 Remove any paper loaded in the tray.

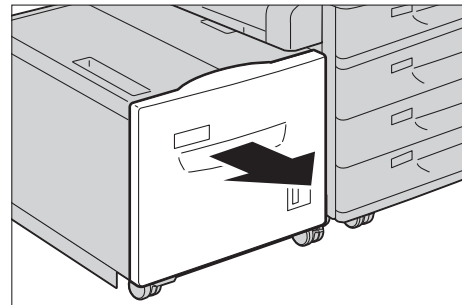

- 3 Open the end guide (1) and unscrew the screw (2). And then remove the guide from the tray.

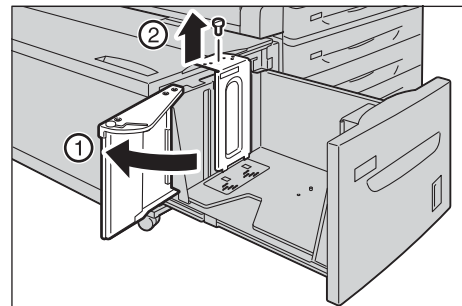

- 4 Insert the small protrusions at the bottom of the guide into the holes corresponding to the paper size (1). Insert the protrusion on the tray into a hole corresponding to the paper size on the top of the guide, and tighten up the screw (2).

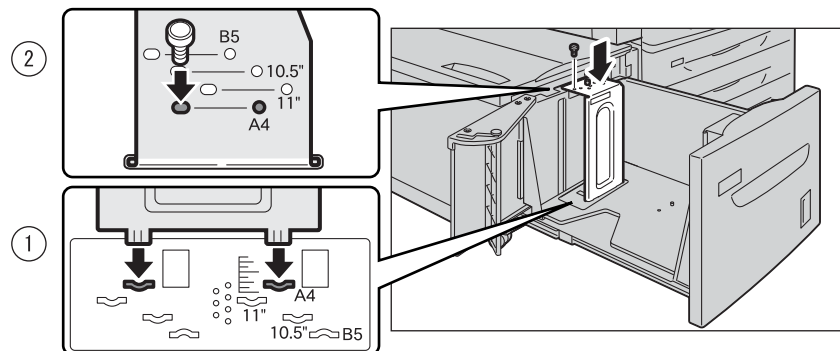

- 5 Unscrew the screw of the front guide and remove the guide from the tray.

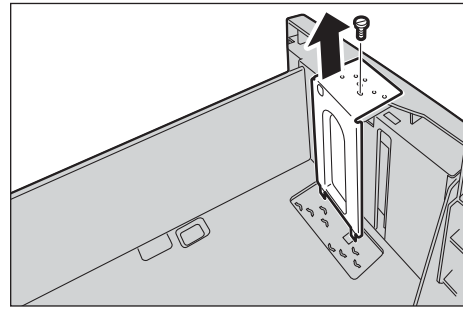

- 6 Insert the small protrusions at the bottom of the guide into the holes corresponding to the paper size (1). Insert the protrusion on the tray into a hole corresponding to the paper size on the top of the guide, and tighten up the screw (2).

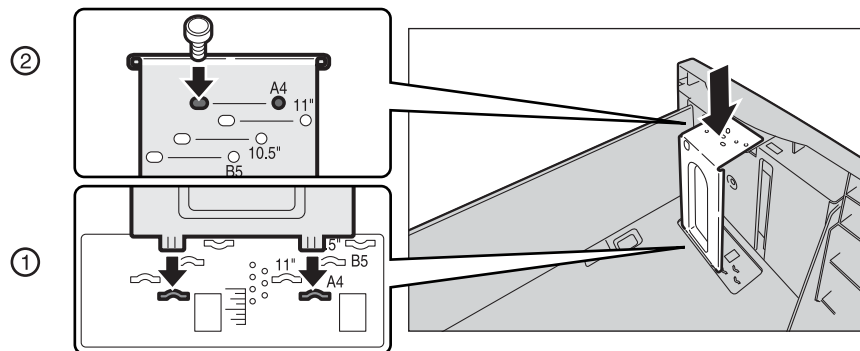

- 7 Pull up the lever of the end guide (1). Move the lever along the slot, and set it at the position corresponding to the paper size (2). And then press the lever down (3).

- Note**
- Adjust the end guide correctly to the size of the paper. If the end guide is not adjusted correctly, the machine cannot feed the paper properly, resulting in paper jams.
 - The slot to the left of 8.5" is not used.

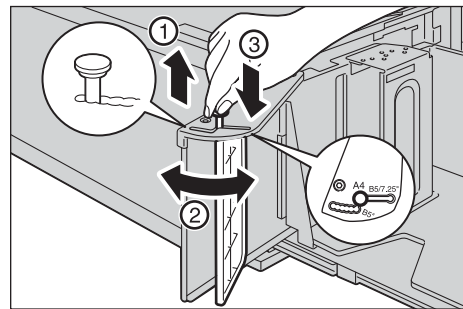

- 8 Open the end guide (1), and load and align the edge of the paper against the right edge of the tray with the side to be copied or printed on facing down (2).

- Note**
- Do not load paper above the maximum fill line ("MAX" in the right figure). It may cause paper jams or machine malfunction.

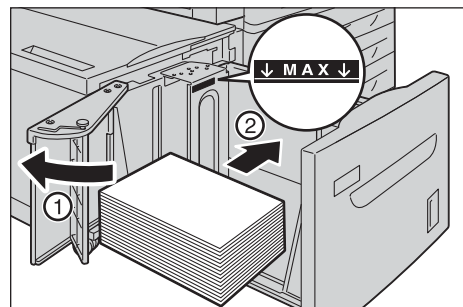

- 9 Close the end guide securely.

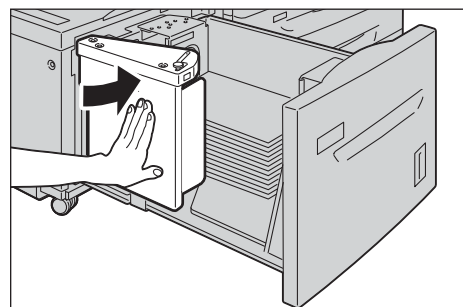

- 10 Push the tray in gently until it stops.

Changing the Paper Settings

This section describes how to change the paper type for Trays and how to set image quality processing by the individual paper type.

After loading paper in a tray, specify the type of paper loaded and select image quality for the paper type. Setting image quality for each paper type enables you to print with the most suitable image quality for the paper type.

For information on image quality processing for each paper type, refer to "Image Quality" (P.134).

- Note**
- Users can name Custom 1 to Custom 5 displayed in the paper type settings. For information on how to set names to Custom 1 to Custom 5, refer to "Custom Paper Name / Color" (P.132).
 - You can change the paper type setting without entering to the System Administration mode on the [Setup] screen, which is displayed by selecting [Setup] in the [Home] screen if you configure the settings in advance. For more information, refer to "Customize Paper Supply Screen" (P.132).

- 1 Press the <Log In/Out> button.

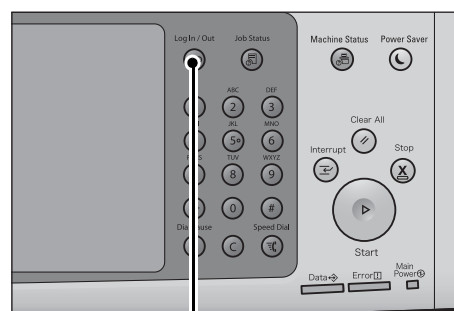

<Log In/Out> button

- 2 Enter the system administrator's user ID with the numeric keypad or the keyboard displayed on the screen, and select [Enter].

When a passcode is required, select [Next] and enter the system administrator's passcode, and select [Enter].

- Note**
- The default user ID is "admin".
 - The default passcode is "1111".

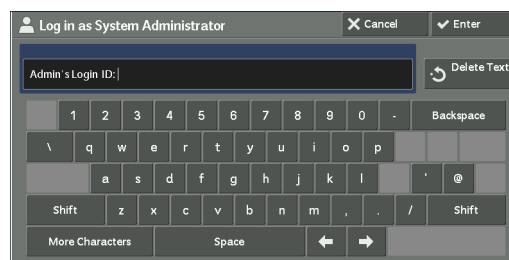

- 3 Select [Tools] on the [Home] screen.

- Note**
- When the [Home] screen is not displayed on the touch screen, press the <Home> button.

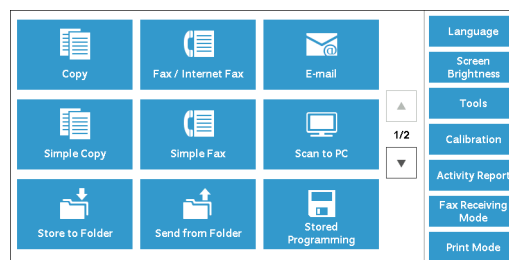

- 4 Select [System Settings] > [Common Service Settings] > [Paper Tray Settings].

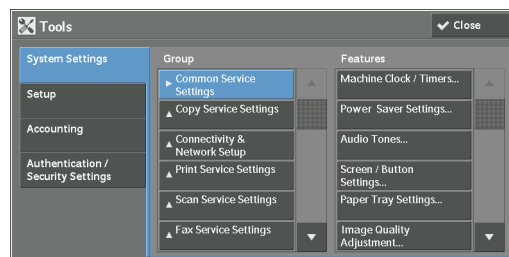

5 Select [Paper Tray Attributes].

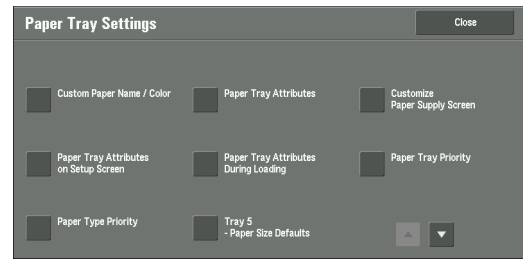

6 Select a paper tray for changing the paper type setting under [Items].

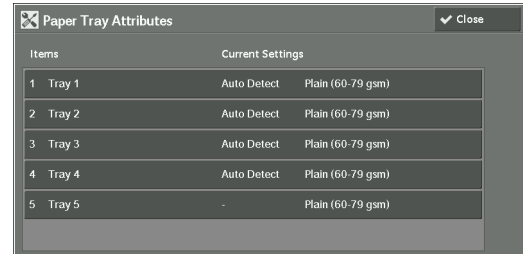

7 Select [Change Settings].

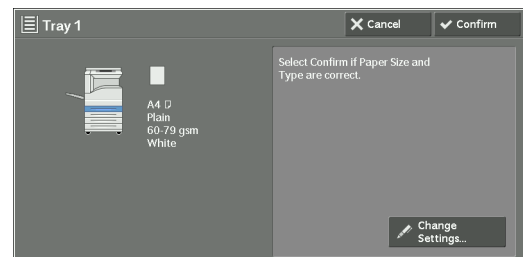

8 Select the [Paper Type], [Paper Size], [Paper Color], and [Auto Paper Select] respectively.

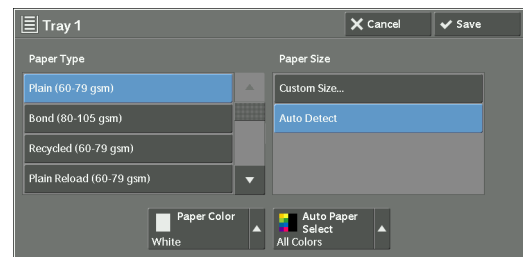

9 Select [Save], [Confirm], or [Close] repeatedly until the [Paper Tray Settings] screen is displayed.

10 Select [Image Quality].

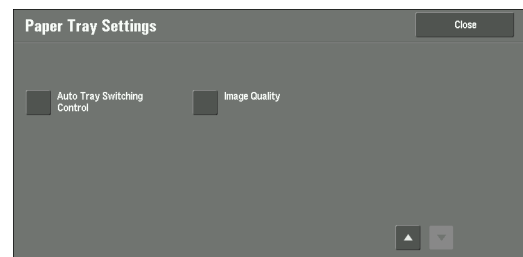

11 Select the paper type for changing the image quality settings under [Items], and then select [Change Settings].

Note • Select [▲] to display the previous screen or [▼] to display the next screen.

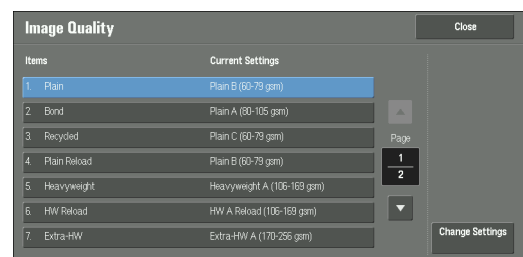

- 12** Select the image quality, and then select [Save].

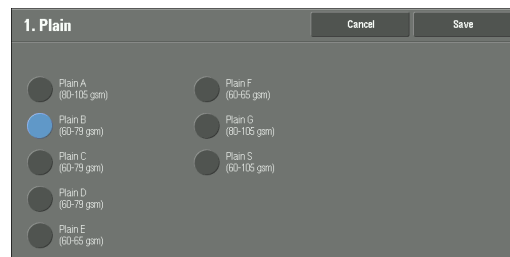

- 13** Make sure that the paper type you selected is displayed under [Current Settings] of [Items], and then select [Close].
- 14** Select [Close] repeatedly until the [Tools] screen is displayed.
- 15** Select [Close].

3 Maintenance

This chapter describes how to replace consumables, clean the machine, calibrate colors, print a report/list, and delete a print job with an invalid User ID.

- **Replacing Consumables.....58**
- **Cleaning the Machine70**
- **Executing Calibration.....75**
- **Printing a Report/List.....79**
- **Deleting a Private Charge Print Job with an Invalid User ID80**
- **Setting Restore Tool.....81**

Replacing Consumables

Use the supplies recommended by Dell. Visit the Dell Printer Supplies website at dell.com/supplies, or order Dell Printer Supplies by phone.

Handling consumables/periodic replacement parts

- Do not store boxes of consumables/periodic replacement parts upright.
- Do not unpack consumables/periodic replacement parts before use. Avoid storing consumables/periodic replacement parts in the following locations:
 - In high temperature and humid locations
 - Near heat-generating devices
 - Areas exposed to direct sunlight
 - Dusty areas
- When using consumables/periodic replacement parts, carefully read precautions for use. Precautions for use are instructed on their bodies or packages, or a precaution sheet is included in their packages.
- We recommend always keeping spare consumables/periodic replacement parts in stock.
- When calling customer support to order consumables/periodical replacement parts, have your Dell printer Service Tag available.
- The use of consumables/periodic replacement parts not recommended by Dell could impair machine quality and performance. Use only consumables/periodic replacement parts recommended by Dell.

Checking the status of consumables

You can check the status of consumables on the [Supplies] screen.
For information on consumables, refer to "Supplies" (P.100).

The following shows the reference section for each procedure.

Replacing Toner Cartridges.....	58
Replacing Waste Toner Container R5.....	60
Replacing Drum Cartridges R1, R2, R3, or R4	63
Replacing Staple Cartridge (for Finisher-B1)	66
Replacing Booklet Staple Cartridge (for Booklet Maker Unit for Finisher-B1).....	67
Emptying the Hole Punch Waste Container (for Finisher-B1)	68

Replacing Toner Cartridges

The following messages are displayed on the touch screen depending on the amount of toner remaining. Replace the toner cartridge according to the message.

Message*1	Remaining Page Yield*2	Solution
Please order a Yellow Toner [Y] Cartridge.	Black: Approx. 3,500 pages Other than Black: Approx. 2,500 pages	You do not need to replace the Toner Cartridge immediately. Order the Toner Cartridge displayed on the screen.
Yellow Toner [Y] Cartridge needs to be replaced soon.	Approx. 40 pages	Replace the toner cartridge with a new one.

Message*1	Remaining Page Yield*2	Solution
Yellow Toner [Y] Cartridge needs to be replaced.	-	The machine will stop. Replace the toner cartridge with a new one.

*1 :The messages in the above table apply to Yellow Toner. "Yellow Toner [Y]" shown in the messages varies depending on the color and number of the applicable toner.

*2 :The remaining page yield for copy/print jobs is applicable when A4 paper LEF () is used. The value is an estimate and varies depending on the conditions such as the content printed, dot coverage (area coverage), paper size, paper type, copy/print density, output image type, and the machine operating environment.

- Note**
- When replacing a toner cartridge, toner may spill and soil the floor. We recommend laying paper on the floor beforehand.
 - The use of toner cartridges not recommended by Dell may degrade image quality and performance. Use only toner cartridges recommended by Dell.
 - When the remaining amount of toner is low, the machine may stop printing and display a message. If this occurs, replace the toner cartridge to resume copying or printing.
 - Replace toner cartridges while the machine is on.
 - Copy or print density may decrease slightly after the message "Please order a XXX Toner Cartridge" appears on the touch screen.
 - If you replace a toner cartridge with a partially used toner cartridge, the number of pages that you can copy or print after the message "Please order a XXX Toner Cartridge" is displayed may differ significantly from the values described in the above table.

1 Make sure that the machine is not operating, and open the front cover.

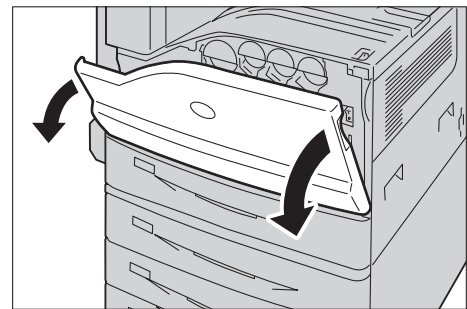

2 Put your hand under the dent of the toner cartridge indicated in the message, and slightly lift up the cartridge.

- Note**
- "Y", "M", "C", or "K" indicates Yellow, Magenta, Cyan, and Black, respectively.

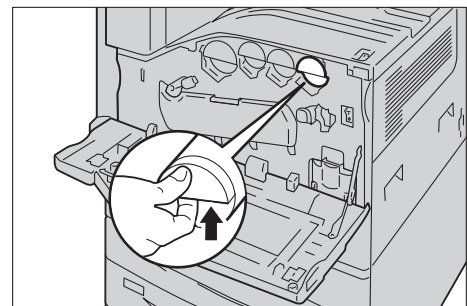

3 Pull out the toner cartridge slowly, and slide it out.

- Note**
- Slide out the toner cartridge gently. Otherwise, toner may spill from the cartridge.

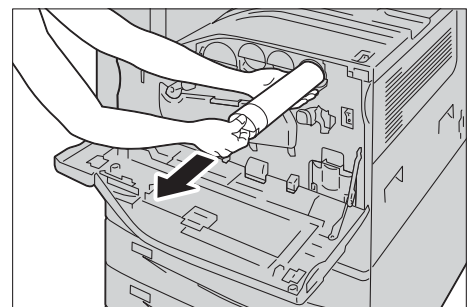

- 4 Take the new toner cartridge of the same color out of the box, and shake the cartridge up and down and left and right for ten times.

Note • Do not touch the shutter part.

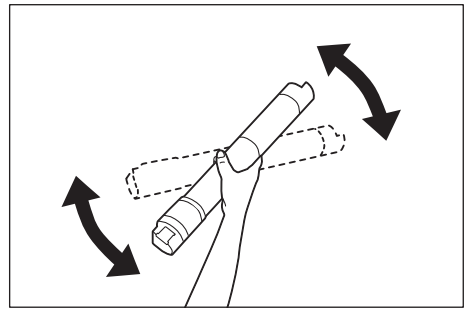

- 5 Hold the cartridge with the arrow facing up, and push the cartridge in slowly until it stops.

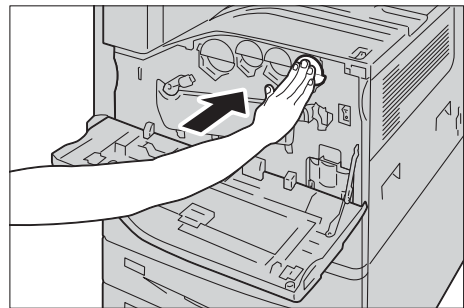
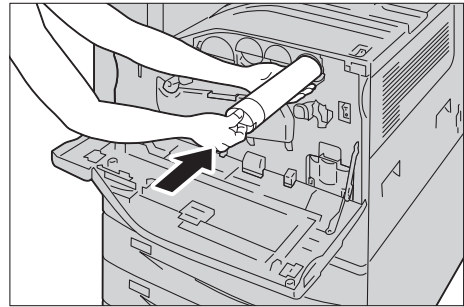

- 6 Close the front cover.

Note • If the front cover is not closed completely, a message appears and the machine will remain paused.

Replacing Waste Toner Container R5

The waste toner container holds used toner. The following messages are displayed on the touch screen according to the status of the waste toner container. Follow the messages as necessary.

Message	Remaining Page Yield*	Solution
Please order a Waste Toner Container.	Approx. 1,200 pages	Order the waste toner container.
The Waste Toner Container needs to be replaced.	-	The machine will stop. Replace the waste toner container with a new one.

*: The remaining page yield for copy/print jobs is applicable when A4 paper LEF (☐) is used. The value is an estimate and varies depending on the conditions such as the content printed, dot coverage (area coverage), paper size, paper type, copy/print density, output image type, and machine operating environment.

When replacing the waste toner container, clean the LED printhead with the supplied cleaning bar to prevent inconsistencies in density or color in copies and prints.

Note

- Do not touch the five gray-colored sponge parts on the back side of the waste toner container. Otherwise, your hands may get dirty with toner.
- When replacing the waste toner container, toner may spill and soil the floor. We recommend laying paper on the floor beforehand.

- The proper disposal of used waste toner containers is required.
- The use of waste toner containers not recommended by Dell may degrade image quality and performance. Use only waste toner containers recommended by Dell.

1 Make sure that the machine is not operating, and open the front cover.

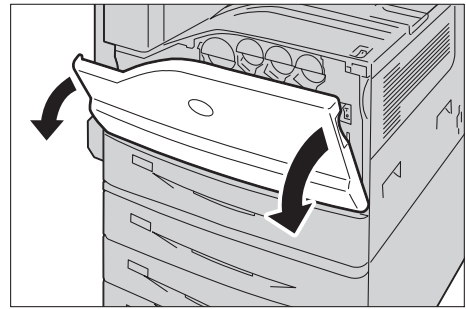

2 Pull out the waste toner container slowly while holding its left side with one hand.

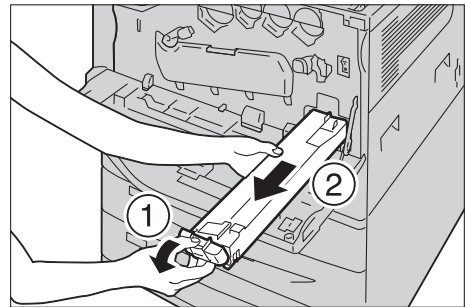

3 Prepare a new waste toner container out of a box.

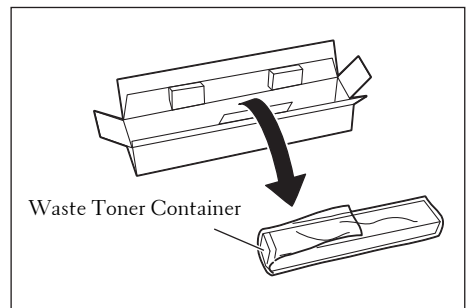

4 While holding the left side of the waste toner container, push the container in until it clicks.

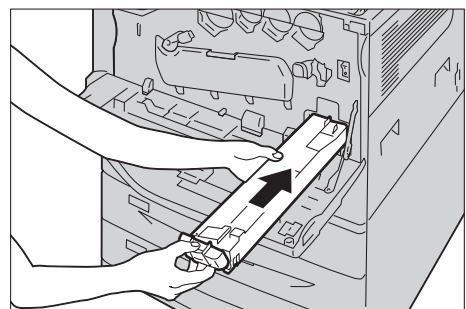

5 Insert the used waste toner container into the supplied plastic bag and then seal it firmly with the zipper.

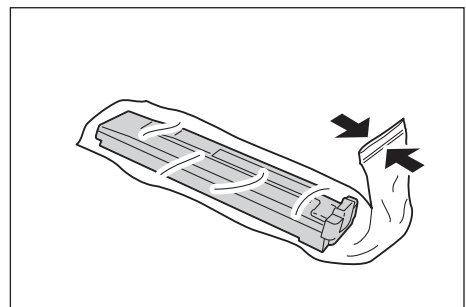

- 6 Carefully place the old waste toner container into the empty box with both hands.

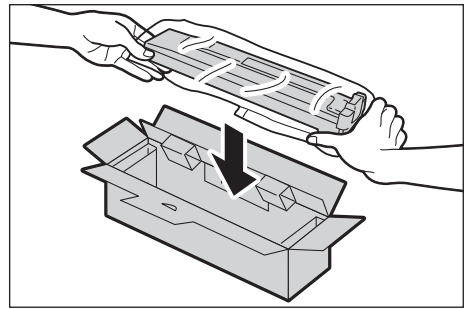

- 7 Rotate the release lever of the drum cartridge cover counterclockwise.

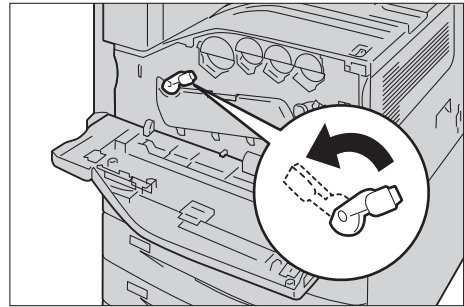

- 8 Lower the cover.

Note • You can now see the drum cartridge.

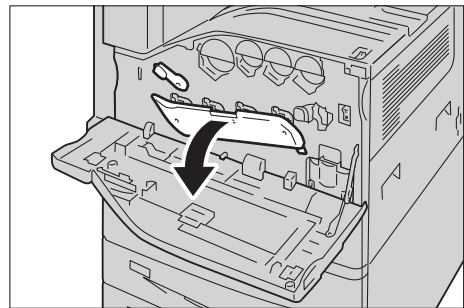

- 9 Slowly slide out the cleaning bar housed within the LED printhead until it stops. The cleaning bars are located in the cleaning connection just under the drum cartridges R1, R2, R3, and R4.

Note • Slide out the cleaning bar until you see "●●●".
• Do not remove the cleaning bar from the housing.

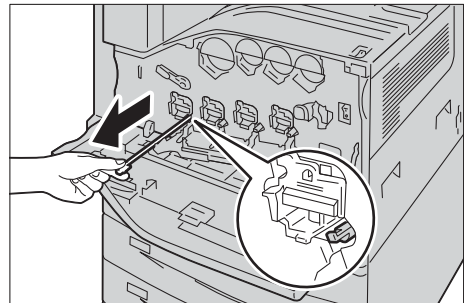

- 10 Slowly slide the cleaning bar back into place.

Note • Clean the four LED printheads R1 to R4 by sliding the cleaning bar back and forth for two or three times respectively.

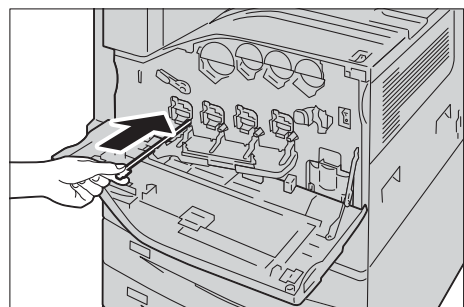

11 Return the cover to the original position.

Note • Push the cover until it clicks into place.

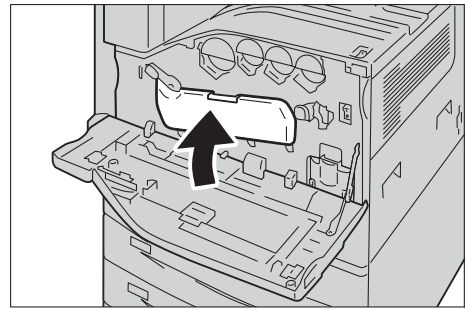

12 Rotate the release lever clockwise to lock the cover.

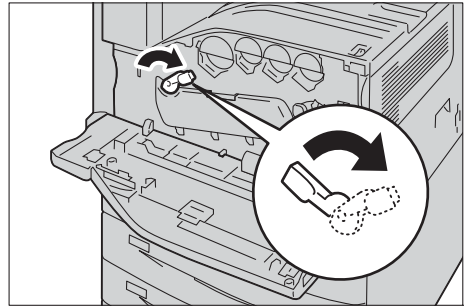

13 Close the front cover.

Note • If the front cover is not closed completely, a message appears and the machine will remain paused.

Replacing Drum Cartridges R1, R2, R3, or R4

The machine displays the following messages when a drum cartridge R1, R2, R3 or R4 needs to be replaced. When the message is displayed, contact Customer Support at dell.com/contactdell.

If you continue to copy or print without replacing the drum cartridge after the message is displayed on the touch screen, the machine will stop after copying or printing the number of pages shown in the following table.

Message	Remaining Page yield	Solution
Please order a Drum Cartridge RX.	Black: Approx. 3,000 pages Other than Black: Approx. 3,000 pages	You do not need to replace the Drum Cartridge immediately. Order the Drum Cartridge displayed on the screen.
Drum Cartridge needs to be replaced.	-	Replace the drum cartridge with a new one.

- Note**
- The use of drum cartridges not recommended by Dell may degrade image quality and performance. Use only drum cartridges recommended by Dell.
 - Do not expose drum cartridges to direct sunlight or strong light from indoor fluorescent lighting. Do not touch or scratch the surface of the drum. Doing so may result in unsatisfactory printing.
 - The remaining page yield is applicable when A4 paper LEF () is used. The value is an estimate and varies depending on the conditions such as the paper size, the paper orientation, the number of pages continuously print, and the machine operating environment.
 - Images output from the machine may get dirty after the message "Please order a Drum Cartridge XXX RX" appears on the touch screen.

- 1 Make sure that the machine is not operating, and open the front cover.

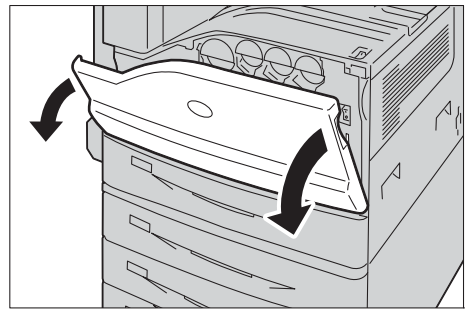

- 2 Rotate the release lever of the drum cartridge cover counterclockwise.

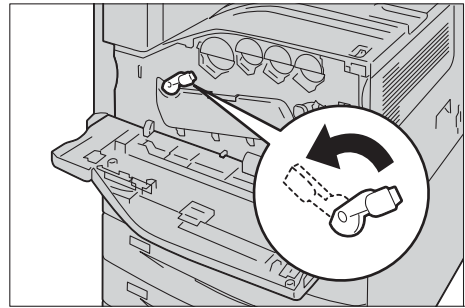

- 3 Lower the cover.

Note • The drum cartridge is unlocked.

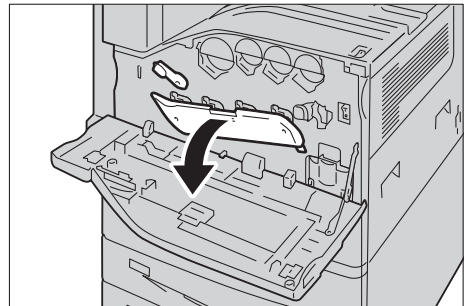

- 4 Grasp the handle of the drum cartridge R1, R2, R3, or R4 indicated in the message and gently slide out the cartridge.

Note • When removing the drum cartridge, be careful not to drop it on the floor.
• The illustrations in this section explain how to replace the drum cartridge R1, as an example.

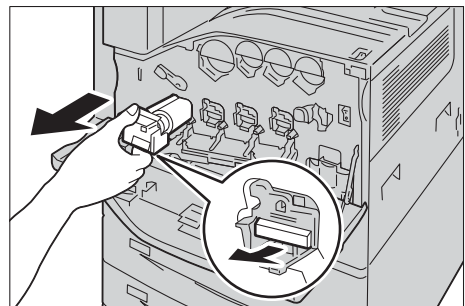

- 5 Hold the bottom of the drum cartridge as shown in the illustration, and pull it out from the machine.

Note • Be careful not to touch the toner attached to the cartridge.

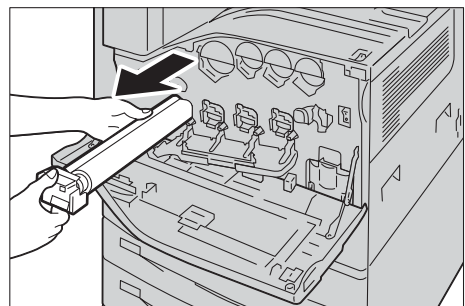

- 6 Take the new drum cartridge out of the box, and insert the used drum cartridge into the supplied plastic bag and place it into the box.

Note • Do not place the new drum cartridge in an upright position.

- 7 Insert the front two points of the new drum cartridge with protective cover in the holes on the machine.

Note • Insert the two points as shown in the illustration on the right.

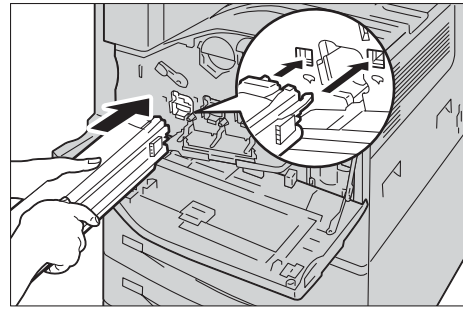

- 8 Pull out the black paper while holding the protective cover with one hand. While doing so, keep the two points inserted in the holes.

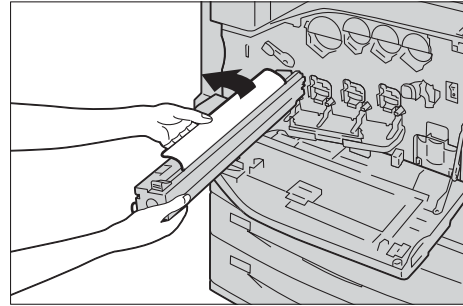

- 9 Grasp the tab on top of the cartridge and slide it toward the machine while holding the protective cover with one hand.

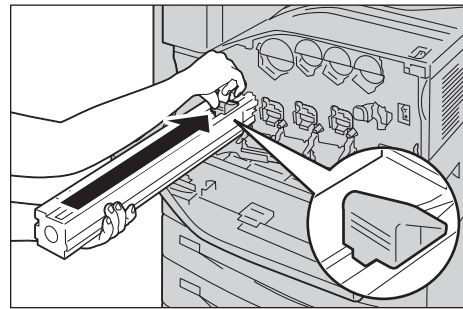

- 10 Slide the tab until it stops.

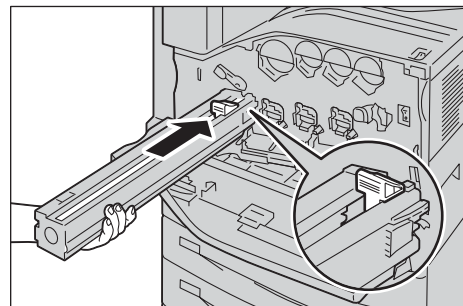

- 11 Carefully remove the protective cover.

- 12 Push the drum cartridge straight in the housing until it stops.

Note • Place the protective cover into the box.

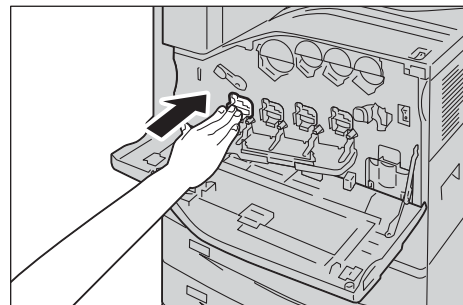

13 Return the cover to the original position.

Note • Push the cover until it clicks into place.

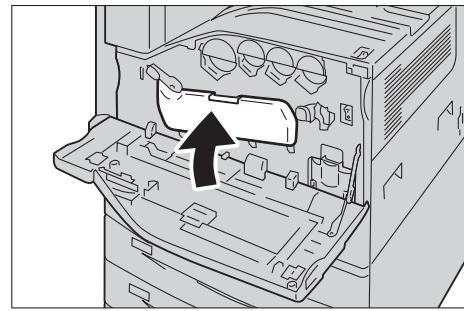

14 Rotate the release lever clockwise to lock the cover.

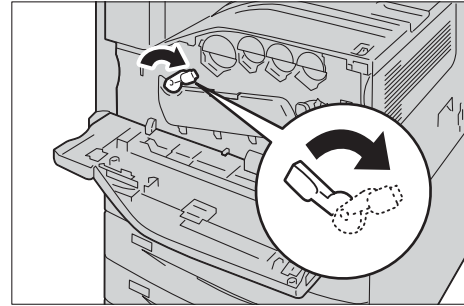

15 Close the front cover.

Note • If the front cover is not closed completely, a message appears and the machine will remain paused.

Replacing Staple Cartridge (for Finisher-B1)

When the optional Finisher-B1 is installed and the staple cartridge needs to be replaced, a message appears on the touch screen. When the message appears, load a new staple case into the staple cartridge.

Note • The use of staple cartridges not recommended by Dell may degrade quality and performance. Use only staple cartridges recommended by Dell.

1 Make sure that the machine is not operating, and open the finisher front cover.

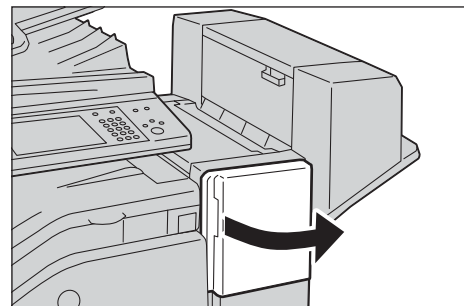

2 Grasp the handle and pull out the staple cartridge holder to the right, towards you.



- 3 Take the staple cartridge out of the finisher.

Note • The staple cartridge is firmly inserted. A slight force is required to pull the cartridge out of the finisher.

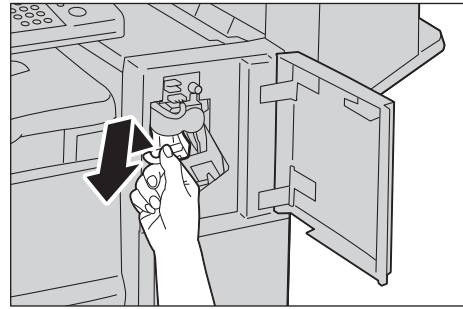

- 4 Pinch both sides of the empty staple case with your fingers (1), and remove the staple case from the cartridge (2).

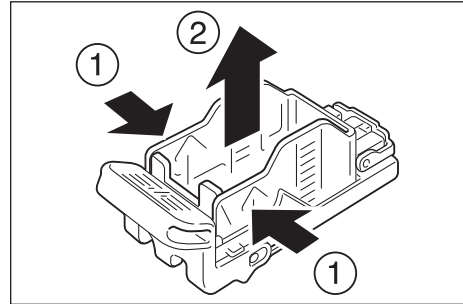

- 5 Insert the front side of the new staple case into the staple cartridge (1), and then push the rear side into the cartridge (2).

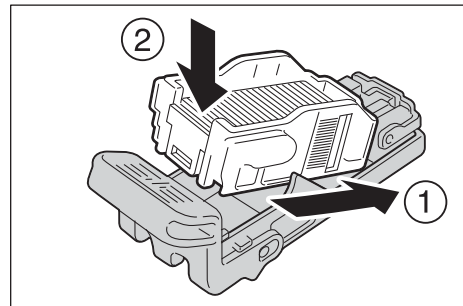

- 6 Push the staple cartridge into the finisher until it clicks into place.

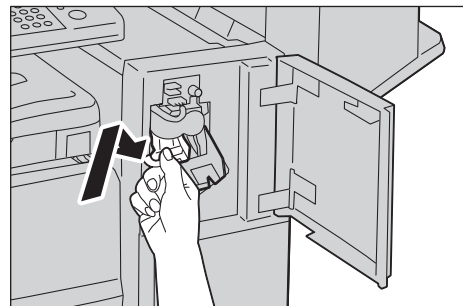

- 7 Close the finisher front cover.

Note • If the front cover is not closed completely, a message appears and the machine will remain paused.

Replacing Booklet Staple Cartridge (for Booklet Maker Unit for Finisher-B1)

When the optional Booklet Maker Unit for Finisher-B1 is installed and the booklet staple cartridges need to be replaced, a message appears on the touch screen. When the message appears, replace the booklet staple cartridges with new ones.

Note • The use of booklet staple cartridges not recommended by Dell may degrade quality and performance. Use only booklet staple cartridges recommended by Dell.

- 1 Make sure that the machine is not operating, and open the finisher side cover.

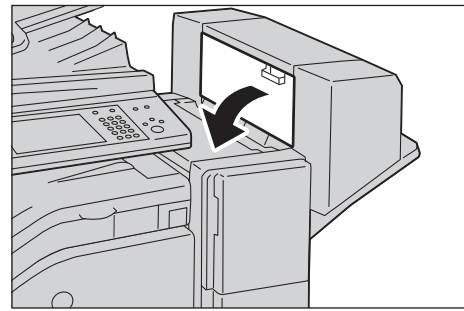

- 2 Hold the tabs on both sides of the booklet staple cartridge and pull it out.

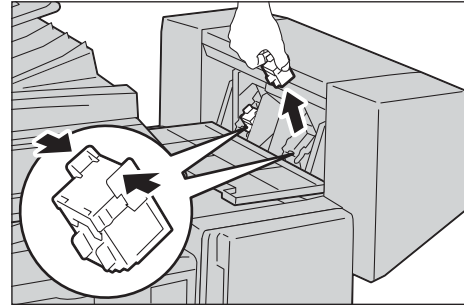

- 3 Hold the tabs on both sides of a new booklet staple cartridge, and insert it into the finisher until it clicks.

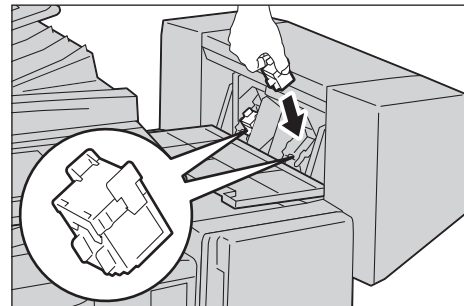

- 4 Do the same for the booklet staple cartridge on the other side.
- 5 Close the finisher side cover.

Note • If the cover is not closed completely, a message appears and the machine will remain paused.

Emptying the Hole Punch Waste Container (for Finisher-B1)

When the optional Finisher-B1 is installed and the hole punch waste container becomes full, a message appears on the touch screen. When the message appears, empty the hole punch waste container as instructed.

Make sure to discard all paper chads when emptying the hole punch waste container. Not doing so will cause the container to fill up before the message telling you to empty the container appears again, and this can cause machine malfunction.

Note • Empty the hole punch waste container when the machine is on. If you empty the container while the machine is off, the machine does not recognize that the container has been emptied.

- 1 Make sure that the machine is not operating, lift the top transport cover, and then open the front transport cover of the finisher.

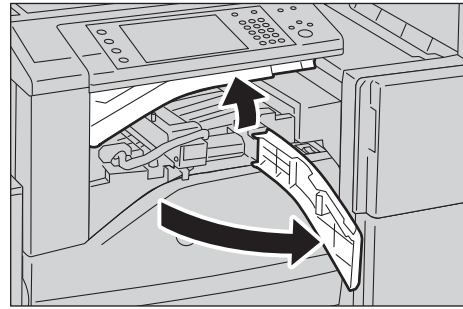

- 2 Pull out the hole punch waste container.

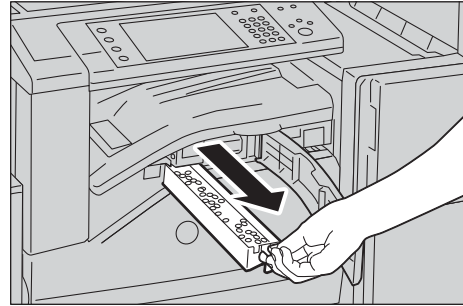

- 3 Empty the container.

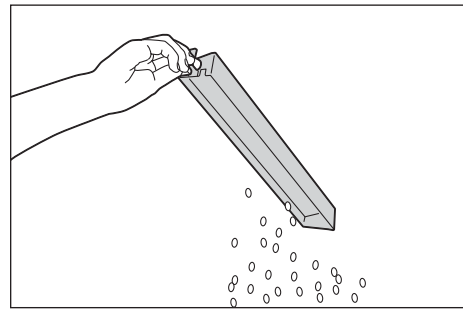

- 4 Insert the emptied hole punch waste container into the finisher until it stops.

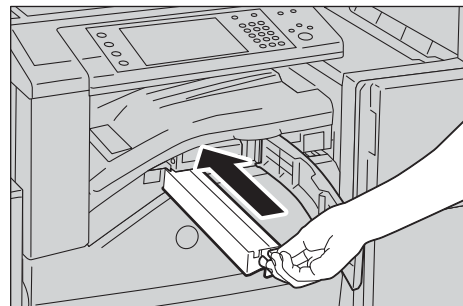

- 5 Close the front transport cover, and then close the top transport cover of the finisher.

Note • If the cover is not completely closed, a message will appear and the machine remain paused.

Cleaning the Machine

This section describes how to clean the machine such as the machine exterior, document cover, document feeder, and document glass.

Cleaning the Exterior

The following describes how to clean the exterior of the machine.

- Note**
- Do not use benzene, paint thinner, or other volatile liquids or spray insect repellent on the machine as they might discolor, deform, or crack covers.
 - Cleaning the machine with an excessive amount of water may cause the machine to malfunction or damage documents during copying.

- 1 Wipe the exterior with a firmly wrung soft cloth moistened with water.

- Note**
- Do not use cleaning agents other than water or neutral detergent.
 - If you cannot remove the dirt easily, gently wipe the machine with a soft cloth moistened with a small amount of neutral detergent.

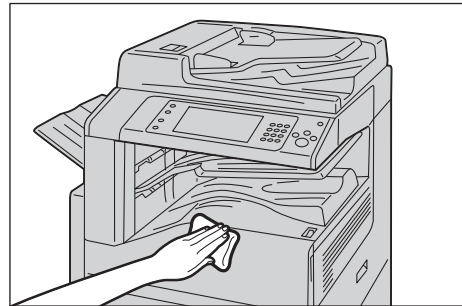

- 2 Wipe off any excess water with a soft cloth.

Cleaning the Interior (LED Printheads)

The following describes how to clean the interior (LED printheads) of the machine.

Normally, clean the LED printheads when you replace the waste toner container. However, if you have image quality problems such as white or colored stripes appear on copied or printed outputs, clean the LED printheads.

- Note**
- Clean the LED printheads periodically when you replace the waste toner container.

- 1 Make sure that the machine is not operating, and open the front cover.

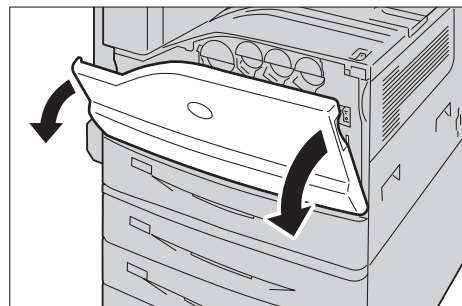

- 2 Rotate the release lever of the drum cartridge cover counterclockwise.

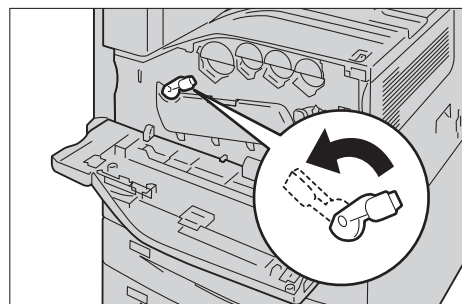

3 Lower the cover.

Note • You can now see the drum cartridge.

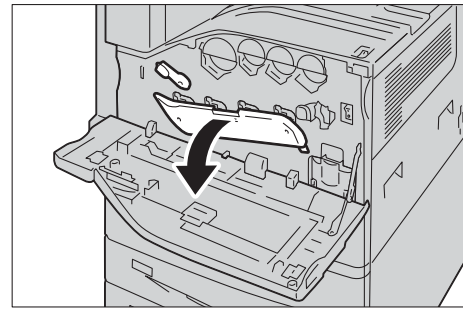

4 Slowly slide out the cleaning bar housed within the LED printhead until it stops. The cleaning bars are located in the cleaning connection just under the drum cartridges R1, R2, R3, and R4.

Note

- Slide out the cleaning bar until you see "●●●".
- Do not remove the cleaning bar from the housing.

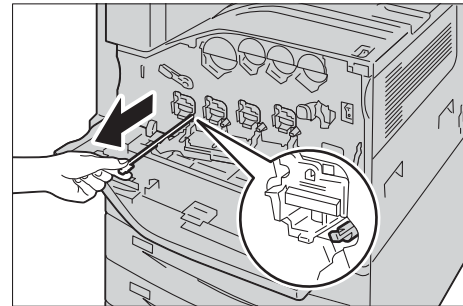

5 Slowly slide the cleaning bar back into place.

Note

- Clean the four LED printheads R1 to R4 by sliding the cleaning bar back and forth for two or three times respectively.

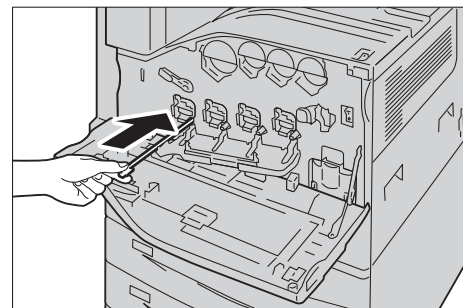

6 Return the cover to the original position.

Note • Push the cover until it clicks into place.

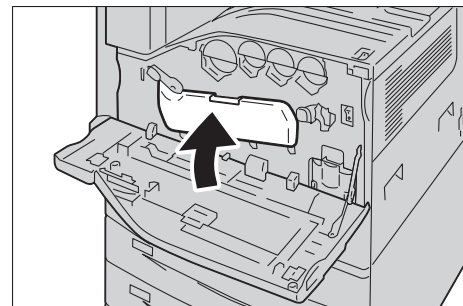

7 Rotate the release lever clockwise to lock the cover.

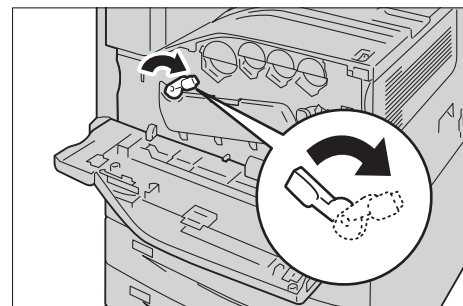

8 Close the front cover.

Note • If the front cover is not closed completely, a message appears and the machine will remain paused.

Cleaning the Touch Screen

This section describes how to clean the touch screen of the machine.

- 1 Wipe the LCD only with a soft cloth moistened with neutral detergent or alcohol.

- Note**
- Do not apply too much neutral detergent or alcohol. Squeeze out excess moisture before you wipe the LCD if the fluid drips.
 - Do not use volatile solvent such as benzene and paint thinner or insect killer. Doing so might cause discolored, deformed, or cracked parts.
 - Wipe the panel softly, otherwise, the parts might be damaged.

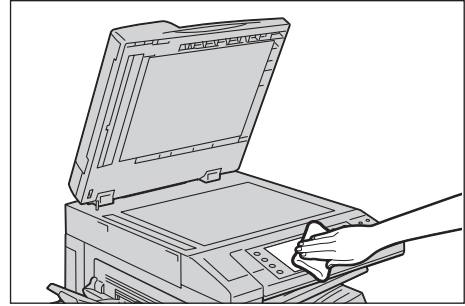

Cleaning Document Cover and Document Glass

If the document cover and document glass become soiled, smudges may appear on copies, faxes, or scanned documents and the machine may not properly detect document sizes.

To ensure clear copies at all times, clean the document cover and the document glass once a month.

- Note**
- Do not use benzene, paint thinner, or other organic solvents. Doing so might damage paint or coating on plastic parts.
 - Cleaning the machine with an excessive amount of water may cause the machine to malfunction or damage documents during copying, faxing, or scanning.

- 1 Wipe the document cover with a soft cloth moistened with water to remove any dirt, and then wipe it with a soft, dry cloth.

- Note**
- Do not use cleaning agents other than water or neutral detergent.
 - If you cannot remove dirt easily, gently wipe the document cover with a soft cloth moistened with a small amount of neutral detergent.

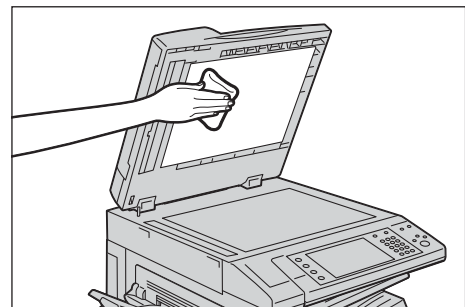

- 2 Wipe the document glass with a soft cloth moistened with water to remove any dirt, and then wipe it with a soft, dry cloth.

- Note**
- Do not use cleaning agents other than water or neutral detergent.
 - If you cannot remove dirt easily, gently wipe the document glass with a soft cloth moistened with a small amount of neutral detergent.

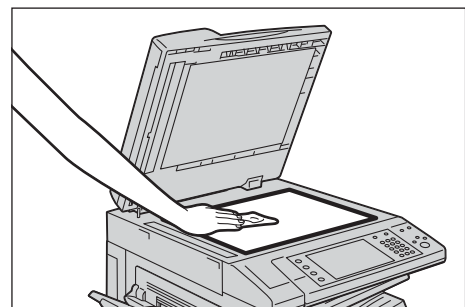

Cleaning Film and Constant Velocity Transport Glass

If the film or constant velocity transport glass become soiled, smudges may appear on copies, faxes, or scanned documents and the machine may not properly detect document sizes.

To ensure clear copies at all times, clean the film and the constant velocity transport glass once a month.

- Note**
- Do not use benzene, paint thinner, or other organic solvents. Doing so might damage paint or coating on plastic parts.
 - Cleaning the machine with an excessive amount of water may cause the machine to malfunction or damage documents during copying, faxing, or scanning.

- 1 Wipe the film with a soft cloth moistened with water to remove any dirt, and then wipe it with a soft, dry cloth.

- Note**
- Do not press the film with an excessive force as it can be easily damaged.
 - Do not use cleaning agents other than water or neutral detergent.
 - If you cannot remove dirt easily, gently wipe the film with a soft cloth moistened with a small amount of neutral detergent.

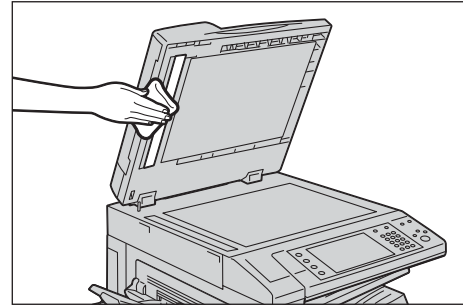

- 2 Wipe the constant velocity transport glass with a soft cloth moistened with water to remove any dirt, and then wipe it with a soft dry cloth.

- Note**
- Do not use cleaning agents other than water or neutral detergent.
 - If you cannot remove dirt easily, gently wipe the glass with a soft cloth moistened with a small amount of neutral detergent.

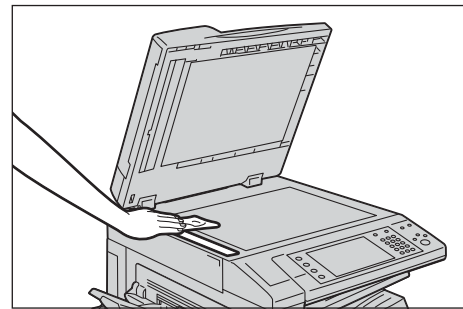

Cleaning Document Feeder Rollers

If the document feeder rollers become soiled, smudges may appear on copies, faxes, or scanned documents and paper jams may occur.

To ensure clean copies at all times, clean the document feeder roller about once a month.

- Note**
- Do not use benzene, paint thinner, or other organic solvents. Doing so might damage paint or coating on plastic parts.
 - Cleaning the machine with an excessive amount of water may cause the machine to malfunction or damage documents during copying, faxing, scanning, or printing.

- 1 Pull up the knob on the left cover of the document feeder, and open the cover completely.

- Note**
- When you fully open the cover, it enters a fixed position. Open the cover gently.

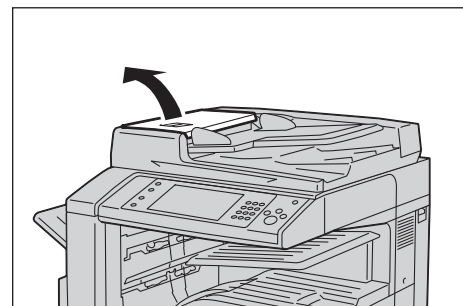

- 2 While turning the rollers, wipe them with a soft cloth moistened with water.

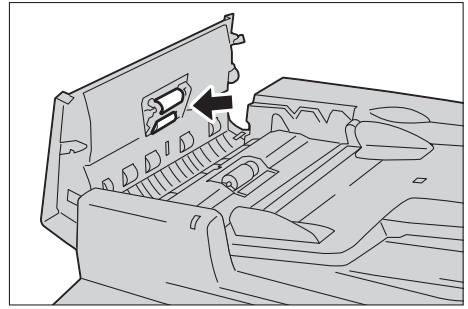

Note

- Do not use cleaning agents other than water or neutral detergent.
- Use a cloth firmly wrung to prevent water drops from falling into the machine. If water gets into the machine, it may cause the machine to malfunction.
- If you cannot remove dirt easily, gently wipe the rollers with a soft cloth moistened with a small amount of neutral detergent.

- 3 Close the document feeder left cover until it clicks into place, and confirm that there is no space between the near or far side of the cover and the document feeder.

Executing Calibration

Calibrate the machine regularly to correct and ensure consistency of printing colors over time, environment and devices.

Select a screen type on the [Calibration] screen and execute calibration, and calibration data for that screen type will be saved. The saved calibration data will be applied to the job when that type of screen is to be used for the job. Which type of screen is to be used for the job will be determined by the job settings.

The following four screen types can be selected on the [Calibration] screen.

- Copy Job 1

The calibration data for [Copy Job 1] will be applied when [Text], [Photo & Text], or [Map] is selected for [Original Type].

- Copy Job 2

The calibration data for [Copy Job 2] will be applied when [Photo] is selected for [Original Type].

- Print Job 1

For PCL print drivers

- The calibration data for [Print Job 1] will be applied when the screen for [Image Quality], [Image Adjustment Mode], and [Image Types], which can be specified on the [Color Options] tab, is to be used.
- The calibration data for [Print Job 1] will be applied when [Auto Screening], [Fineness], or [Standard] is selected for [Screen] on the [Advanced] tab.

For PostScript print drivers

- The calibration data for [Print Job 1] will be applied when [High Quality] or [High Resolution] is selected for [Image Quality] and [Auto Screening], [Fineness], or [Standard] is selected for [Screen] on the [Color Options] tab.
- The calibration data for [Print Job 1] will be applied when [High Speed] is selected for [Image Quality] and [Fineness] or [Standard] is selected for [Screen] on the [Color Options] tab.

- Print Job 2

For PCL print drivers

- The calibration data for [Print Job 2] will be applied when [Gradation] is selected for [Screen] on the [Advanced] tab unless [High Resolution] is selected for [Image Quality].
- The calibration data for [Print Job 2] will be applied when [Print Page Mode] is selected on the [Advanced] tab unless [High Resolution] is specified for [Image Quality].

For PostScript print drivers

- The calibration data for [Print Job 2] will be applied when [High Speed] is selected for [Image Quality] and [Auto Screening] or [Fineness] is selected for [Screen] on the [Color Options] tab.

Note

- It is recommended to execute calibration for each of the four screen types. After calibration for the first screening type, select the next screen type and repeat the procedure.
- When the printed colors do not seem to have been corrected properly despite regular calibration, contact Customer Support at dell.com/contactdell.
- Make sure that the following settings are specified under [Tools] > [System Settings] > [Copy Service Settings] > [Copy Defaults] in the System Administration mode before calibration.
 - Lighten/Darken: Normal
 - Contrast: Normal
 - Sharpness: Normal

- Saturation: Normal
- Color Balance: 0, 0, 0
- Color Shift: Normal

- You can change the above [Copy Defaults] settings after calibration.
- For information on [Copy Defaults], refer to "Copy Defaults" (P.159).
- During calibration, the machine cannot receive print jobs or faxes.

The following describes how to calibrate the machine.

1) Select [Calibration] on the [Home] screen.

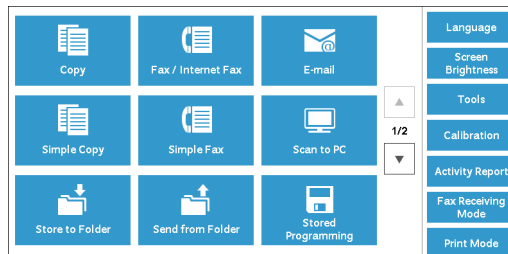

When [Calibration] is not displayed, follow the procedure below.

1) Press the <Log In/Out> button.

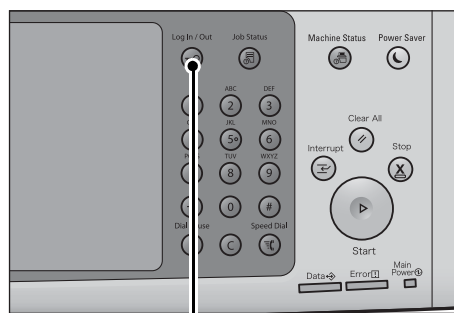

<Log In/Out> button

2) Enter the System Administrator's user ID with the numeric keypad or the keyboard displayed on the screen, and select [Enter].

When a passcode is required, select [Next] and enter the System Administrator's passcode, and select [Enter].

- Note**
- The default user ID is "admin".
 - The default passcode is "1111".

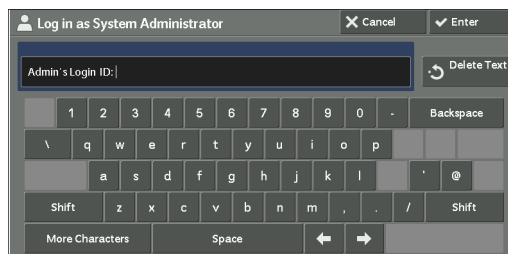

3) Select [Tools] on the [Home] screen.

- Note**
- When the [Home] screen is not displayed on the touch screen, press the <Home> button.

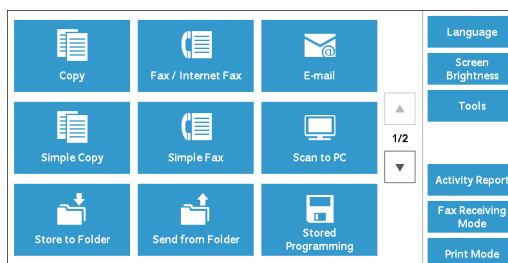

4) Select [System Settings] > [Common Service Settings] > [Image Quality Adjustment].

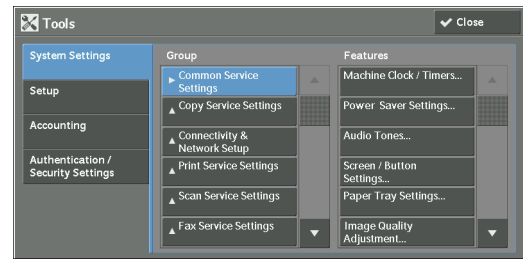

5) Select [Calibration].



2 Set [Screen Type] and [Paper Supply].

- Note**
- [Copy Job 1] is selected here as an example.
 - Make sure that [Target] is set to [Copy & Print Jobs]. If not, calibration will not be effective for jobs outside the selected range.

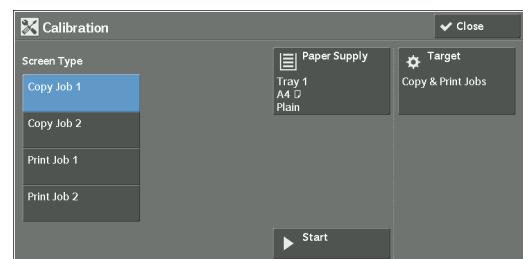

3 Select [Start].

- Note**
- A message saying "Outputting the Calibration Chart... - Copy Job 1" appears, and the machine prints the Calibration Chart.



4 Place the Calibration Chart face down on the document glass with the magenta marks on corners on your left hand side.

- Note**
- Place the Calibration Chart on the document glass.

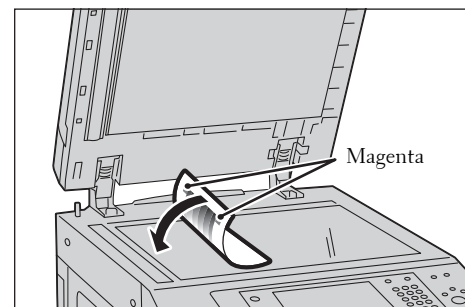

5 Place at least five sheets of white paper on the Calibration Chart to cover the Chart and close the document cover.

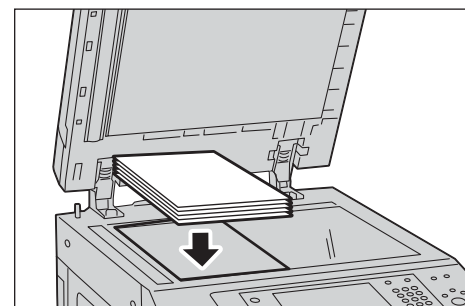

6 Select [Start].

The machine starts calibration. It takes about 10 seconds to complete the calibration.
The calibration result will be shown on the screen.

7 Select [Confirm].

8 To execute calibration for another screen type, repeat steps 2 to 7.

9 Select [Close] repeatedly until the [Tools] screen is displayed.

10 Select [Close].

11 Copy to confirm the image quality.

Note • During calibration, the machine cannot receive print jobs or faxes.

12 Select [Close].

Printing a Report/List

You can print a report/list to check the settings and communication status.

This section describes how to print a report/ list.

For information on the types of report/list, refer to "Print Reports" (P.86).

Note • When the <Data> indicator is not lit, you cannot print the Stored File List.

1 Press the <Machine Status> button.

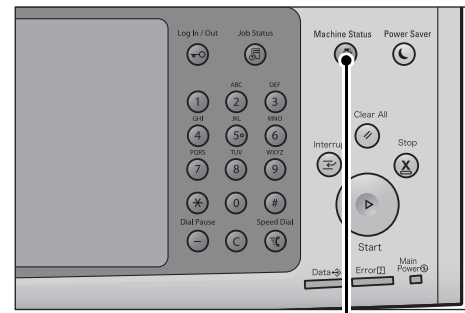

<Machine Status> button

2 Select [Print Reports].

Note • If [Print Reports Button] under [Reports] is set to [Disabled], the [Print Reports] button appears only when the [Tools] button is displayed on the [Home] screen. For more information on [Reports], refer to "Reports" (P.137).

• If you want to print [Billing Data List] or [Auditron Report (Fax Jobs)], insert a card to the machine before instructing print.

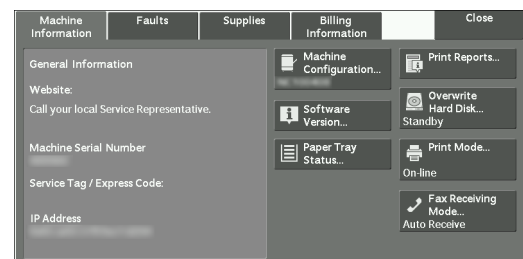

3 Select a report or list to print, and then press the <Start> button.

Note • The reports and the lists to be displayed on the screen depend on the configuration of your machine.

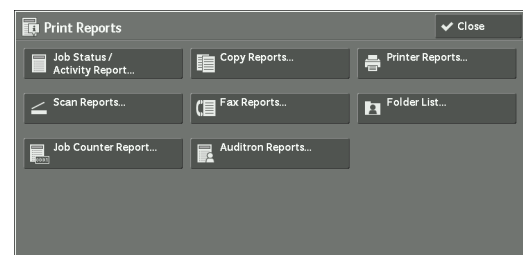

Deleting a Private Charge Print Job with an Invalid User ID

When the Private Charge Print feature is used, all the print jobs with a User ID, regardless of its validity, are stored with the Private Charge Print feature. The system administrator can set the expiration date and can set up the machine to delete the expired jobs automatically, or manually delete them.

This section describes how to delete documents with an invalid User ID stored with the Private Charge Print feature.

For more information on the Private Charge Print feature, refer to "11 Job Status" > "Printing and Deleting Stored Jobs", and "12 Computer Operations" > "Print" in the User Guide.

For more information on how to set the period of time save jobs, refer to "Stored File Settings" (P.223).

- 1 Press the <Log In/Out> button.
- 2 Enter the system administrator's user ID with the numeric keypad or the keyboard displayed on the screen, and select [Enter].

When a passcode is required, select [Next] and enter the system administrator's passcode, and select [Enter].

- Note**
- The default user ID is "admin".
 - The default passcode is "1111".

- 3 Press the <Job Status> button.
- 4 Select the [Secure Print Jobs & More] tab.

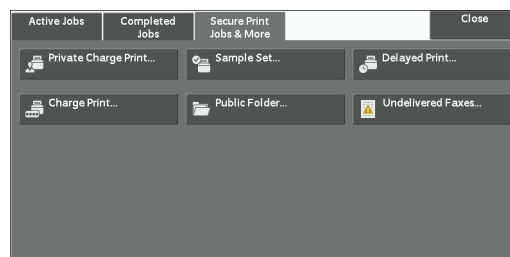
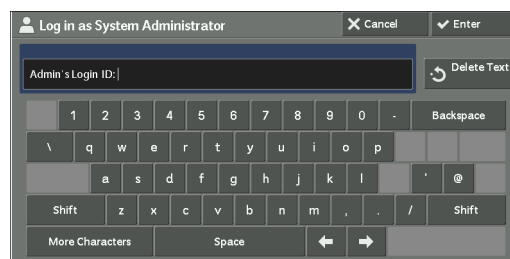

- 5 Select [Private Charge Print].
- 6 Select the User ID of the job to delete, and then select [Job List...].
- 7 Select the job to delete, and then select [Delete].

Setting Restore Tool

Setting Restore Tool backs up the settings data of the machine to a network-connected computer to prevent the loss of data resulting from the malfunction of the machine's hard disk.

The feature is designed to restore data to the machine after the hard disk is replaced.

For more information on Setting Restore Tool, contact Customer Support at dell.com/contactdell.

The following data can be backed up on the computer:

- Address Book
- Folder (except for document files)
- User account list
- Job Flow
- Stored Programming
- Job log
- Error log
- Auditron log
- Other information such as user setting data

Users cannot replace the hard disk by themselves. When replacing the hard disk, contact Customer Support at dell.com/contactdell.

4 Machine Status

This chapter describes the features for checking the machine status.

- **Overview of Machine Status**.....84
- **Machine Information**85
- **Faults**.....99
- **Supplies**.....100
- **Billing Information**101

Overview of Machine Status

You can check machine status and the number of printed pages on the screen. You can also print various reports/lists to check the job history, settings and registered information.

- 1 Press the <Machine Status> button.

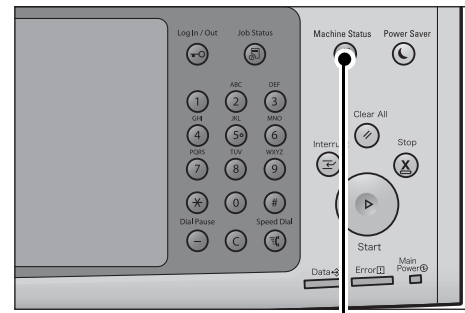

<Machine Status> button

You can check the following information on the [Machine Status] screen:

Machine Information

You can check the machine configuration, paper tray status, and hard disk overwriting status. You can also change or set print modes, and check the number of pages printed per meter or per user. You can also print various reports/lists to check the job history, settings and registered information.

For more information, refer to "Machine Information" (P.85).

Faults

You can check the information on errors that occurred on the machine.

For more information, refer to "Faults" (P.99).

Supplies

You can check the status of consumables.

For more information, refer to "Supplies" (P.100).

Billing Information

You can check the number of pages printed by meter.

For more information, refer to "Billing Information" (P.101).

Machine Information

On the [Machine Information] screen, you can check the machine configuration and paper tray status, print various reports/lists, and change and set print mode settings.

The following shows the reference section for each item.

General Information.....	85
Paper Tray Status	86
Print Reports.....	86
Automatically Printed Reports/Lists	94
Overwrite Hard Disk	95
Print Mode.....	96
Fax Receiving Mode.....	98

- 1 Press the <Machine Status> button.
- 2 On the [Machine Information] screen displayed, you can check the machine status.

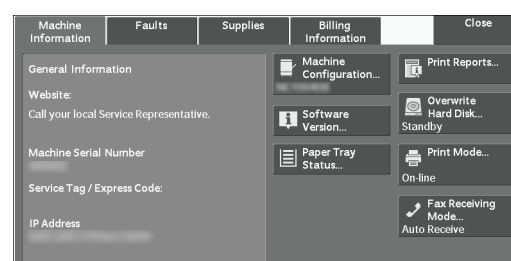

General Information

In the [General Information] area, you can check the serial number of the machine, machine configuration, and software version.

- 1 Check the general information.

Website:

Tells you whom to contact when making inquiries about maintenance and operation.

Machine Serial Number:

Indicates the serial number of the machine.

Service Tag / Express Code:

Displays the Service Tag and the Express Code of the machine.

IP Address

Indicates the IP address of the machine.

Machine Configuration

Displays the [Machine Configuration] screen.

For more information, refer to "[Machine Configuration] Screen" (P.86).

Software Version

Displays the [Software Version] screen.

For more information, refer to "[Software Version] Screen" (P.86).

[Machine Configuration] Screen

You can check the machine configuration.

- 1 Select [Machine Configuration].
- 2 Check the machine configuration on the screen displayed.

Note • Select [▲] to display the previous screen or [▼] to display the next screen.

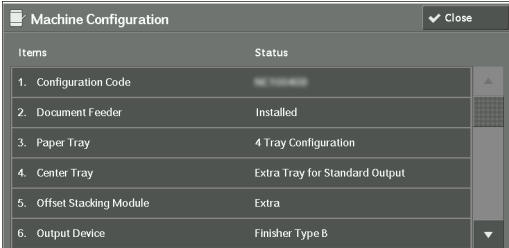

Items	Status
1. Configuration Code	00000000
2. Document Feeder	Installed
3. Paper Tray	4 Tray Configuration
4. Center Tray	Extra Tray for Standard Output
5. Offset Stacking Module	Extra
6. Output Device	Finisher Type B

[Software Version] Screen

You can check the software version.

- 1 Select [Software Version].
- 2 Check the software versions.

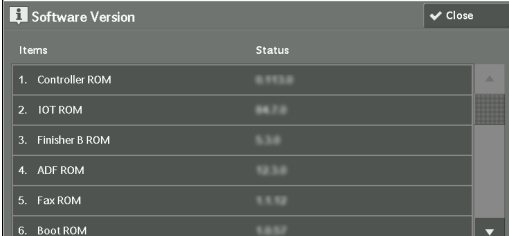

Items	Status
1. Controller ROM	6.113.0
2. IOT ROM	04.7.0
3. Finisher B ROM	1.3.0
4. ADF ROM	12.3.0
5. Fax ROM	1.1.02
6. Boot ROM	1.0.07

Paper Tray Status

You can check the paper trays set on the machine. On the screen, you can check the following items:

- Status
- % Full (Amount of paper remaining)
- Paper Size
- Paper Type

- 1 Select [Paper Tray Status].
- 2 Check the status of the paper trays.

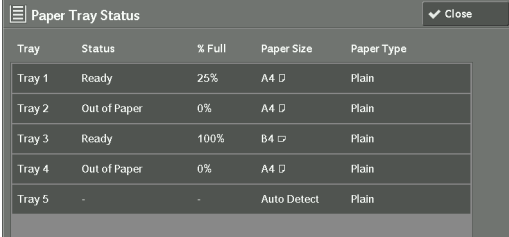

Tray	Status	% Full	Paper Size	Paper Type
Tray 1	Ready	25%	A4 D	Plain
Tray 2	Out of Paper	0%	A4 D	Plain
Tray 3	Ready	100%	B4 D	Plain
Tray 4	Out of Paper	0%	A4 D	Plain
Tray 5	-	-	Auto Detect	Plain

Print Reports

The following describes how to print a report and a list.

Note • The items displayed vary depending on the optional features installed.

- 1 Select [Print Reports].
- 2 Select the type of a report or a list to print.

Note • The screen on the right appears when the [Tools] button is displayed on the [Home] screen.

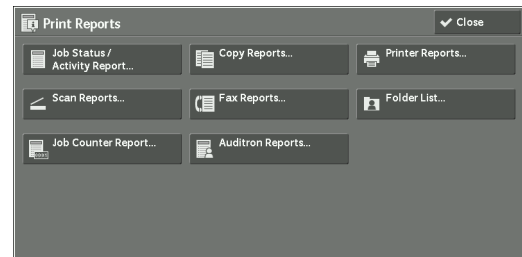

Job Status / Activity Report

- 1 Select [Job Status / Activity Report].

Note • To display the [Job Status / Activity Report] screen, press the <Machine Status> button, and then select [Machine Information] > [Print Reports] > [Job Status / Activity Report].

- 2 Select a report or a list to print.

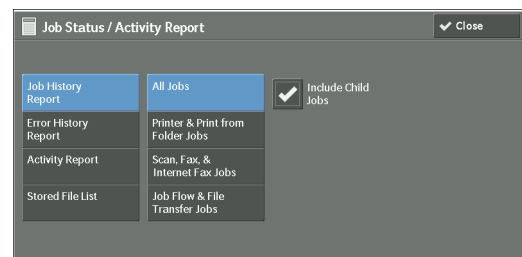

- 3 Press the <Start> button.

Job History Report

You can check the status or result of each job. Up to 200 latest jobs can be printed. Select a report to print from [All Jobs], [Printer & Print from Folder Jobs], [Scan, Fax, & Internet Fax Jobs], [File Transfer Jobs], or [Job Flow & File Transfer Jobs].

Selecting [Include Child Jobs] check box prints each related job on each line. Deselecting this check box prints the multiple related jobs (such as job flow jobs) on one line.

You can also set up the machine to automatically print a [Job History Report] every 50 jobs. For information on the auto print of a job history report, refer to "Reports" (P.137). When you set the machine to print a job history report automatically, the machine prints the results of all jobs.

Error History Report

You can print information on errors occurred in the machine. The latest 50 errors are printed.

Activity Report

You can check whether transmissions completed successfully or not. The remote terminal name and the result and status are recorded by sorting into incoming or outgoing fax.

The following information is not included in the Activity Report.

- Redialed transmissions and pollings.
- When the power is shut off, or when a system error occurs during an activity.
- Deleted documents that were waiting to be transmitted.

You can also set up the machine to automatically print the [Activity Report] every 100 activities.

For information on the settings, refer to "Reports" (P.137).

For more information about the Activity Report, refer to "Activity Report" (P.602).

Stored File List

You can print a list of uncompleted jobs (uncompleted transmissions/receptions or those stored for polling) stored in folders.

Copy Reports

1 Select [Copy Reports].

Note • To display the [Copy Reports] screen, press the <Machine Status> button, and then select [Machine Information] > [Print Reports] > [Copy Reports].

2 Select [Configuration Report].

3 Press the <Start> button.



Configuration Report

You can check the hardware configuration, network information, and print and copy settings of the machine.

Note • The contents of [Configuration Report] are identical whether it is printed from [Copy Reports], [Printer Reports], [Scan Reports], or [Fax Reports].

Printer Reports

1 Select [Printer Reports].

Note • To display the [Printer Reports] screen, press the <Machine Status> button, and then select [Machine Information] > [Print Reports] > [Printer Reports].

2 Select a list to print.

Note • The items displayed vary depending on the options installed.

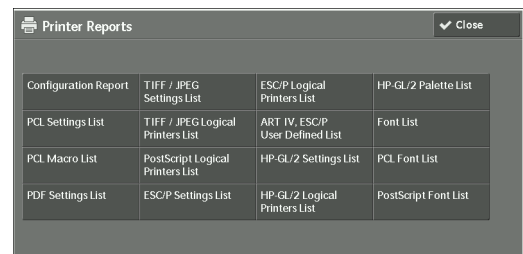

3 Press the <Start> button.

Configuration Report

You can check the hardware configuration, network information, and print and copy settings of the machine with the report.

Note • The contents of [Configuration Report] are identical whether it is printed from [Copy Reports], [Printer Reports], [Scan Reports], or [Fax Reports].

PCL Settings List

Prints the settings for the PCL printer.

PCL Macro List

Prints the list of forms registered for PCL.

PDF Settings List

Prints the settings configured in the PDF printer mode.

TIFF / JPEG Settings List

Prints the settings configured in the TIFF and JPEG printer mode.

TIFF / JPEG Logical Printers List

Prints the list of logical printers created in the TIFF and JPEG printer mode.

Note • You can configure the setting for TIFF and JPEG logical printers using Dell Printer Configuration Web Tool.

PostScript Logical Printers List

Prints the list of logical printers created in PostScript.

Note • You can configure the setting for PostScript logical printers using Dell Printer Configuration Web Tool.

ESC/P Settings List

Prints the settings configured in the ESC/P-K emulation mode.

ESC/P Logical Printers List

Prints the programming settings configured in the ESC/P-K emulation mode.

HP-GL/2 Settings List

Prints the settings for the HP-GL[®], HP-GL/2[®] and HP-RTL emulation modes.

HP-GL/2 Logical Printers List

Prints the stored programming settings for the HP-GL, HP-GL/2, and HP-RTL emulation modes.

HP-GL/2 Palette List

Prints the sample list in 256 colors that can be set with the pen attribute on HP-GL and HP-GL/2 emulation modes.

Font List

Prints the list of fonts available on the machine.

Note • Information printed varies depending on the options installed.

PCL Font List

Prints the fonts available in PCL.

PostScript Font List

Prints the fonts available in PostScript.

Scan Reports

1 Select [Scan Reports].

Note • To display the [Scan Reports] screen, press the <Machine Status> button, and then select [Machine Information] > [Print Reports] > [Scan Reports].

- 2 Select a list to print.
- 3 Press the <Start> button.

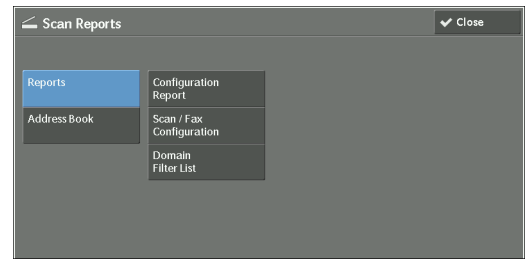

Reports

You can print the Configuration Report, Scan/Fax Configuration Report, and Domain Filter List. Select a list to print, and then press the <Start> button.

- Configuration Report

You can check the hardware configuration, network information, and print and copy settings of the machine.

- Note**
- The contents of [Configuration Report] are identical whether it is printed from [Copy Reports], [Printer Reports], [Scan Reports], or [Fax Reports].

- Scan / Fax Configuration

You can check the settings configured for the Scan feature and the Fax feature.

- Domain Filter List

You can check the settings configured for the domain which filters data transmissions.

Address Book

You can check the settings for the address numbers. When you specify a range of address numbers, the list of settings for the specified address numbers is printed. Each page contains the settings information on 50 address numbers.

- 1 Select [Address Book].
- 2 Specify a range of address numbers to print.
- 3 Press the <Start> button.

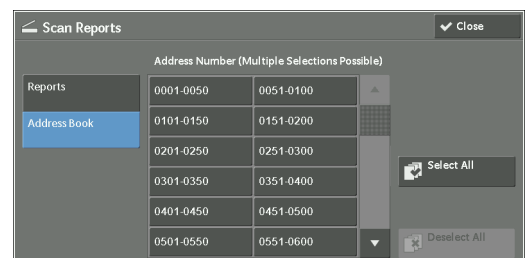

Fax Reports

- 1 Select [Fax Reports].

- Note**
- To display the [Fax Reports] screen, press the <Machine Status> button, and then select [Machine Information] > [Print Reports] > [Fax Reports].

- 2 Select a list to print.
- 3 Press the <Start> button.

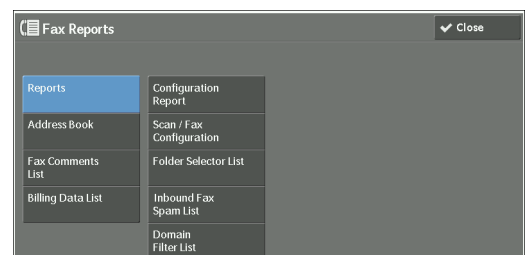

Reports

You can print the Configuration Report, Scan/Fax Configuration Report, Folder Selector List, Inbound Fax Spam List, Domain Filter List and VoIP Gateway List. Select a list to print, and then press the <Start> button.

- Configuration Report

You can check the hardware configuration, network information, and print and copy settings of the machine.

Note • The contents of [Configuration Report] are identical whether it is printed from [Copy Reports], [Printer Reports], [Scan Reports], or [Fax Reports].

- Scan / Fax Configuration

You can check the settings configured for the Fax feature and the Scan feature.

Note • The contents of [Configuration Report] are identical whether it is printed from [Copy Reports], [Printer Reports], [Scan Reports], or [Fax Reports].

- Folder Selector List

You can check the settings for the Folder Sorting feature.

- Inbound Fax Spam List

You can check the settings for the G3-ID (telephone numbers) for which fax reception is restricted.

- Domain Filter List

You can check the settings configured for the domain which filters data transmissions.

- VoIP Gateway List

You can check the registration for VoIP gateways.

Address Book

You can check the settings for the address numbers (speed dial), fax group recipients, and relay stations.

When you specify a range of address numbers, the lists of settings for the specified address numbers and relay stations are printed. Each page contains the settings information on 50 address numbers.

For information on how to register speed dial and fax group recipients, refer to "Add Address Book Entry" (P.241) and "Create Fax Group Recipients" (P.248).

Selecting [Address Book] displays the screen for specifying a range of address numbers. Select a range of numbers, and then press the <Start> button.

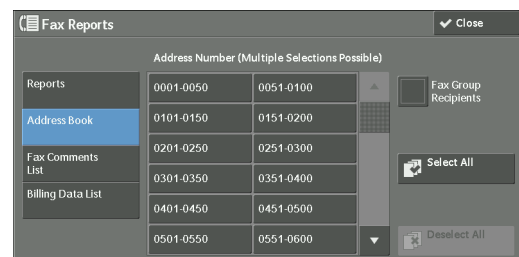

- Fax Group Recipients

You can print the list of settings for Fax Group Recipients.

- Select All

You can print the lists of settings for all address numbers, fax group recipients, and relay stations.

Fax Comments List

You can check the registered comments to use on fax cover sheets.

Billing Data List

You can check the registration status of the billing data.

Note • [Billing Data List] is displayed when [Fax / Internet Fax Service] is set to [Enable Accounting] under [Accounting] > [Accounting Type] > [Local Accounting] > [Auditron Mode].

Selecting [Billing Data List] displays the screen for specifying a range of address numbers. Select a range of numbers, and then press the <Start> button.

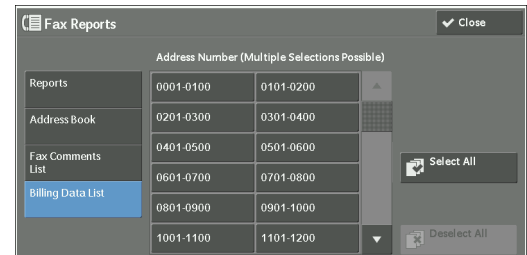

- Select All

You can print the list of all billing data.

Folder List

Prints the list of folder settings and the procedure for saving files to folders.

Note • [Folder List] appears when the [Tools] button is displayed on the [Home] screen.

For information on how to create a folder, refer to "Create Folder" (P.231).

1 Select [Folder List].

Note • To display the [Folder List] screen, press the <Machine Status> button, and then select [Machine Information] > [Print Reports] > [Folder List].

2 Select a range of folder numbers to print.

3 Press the <Start> button.

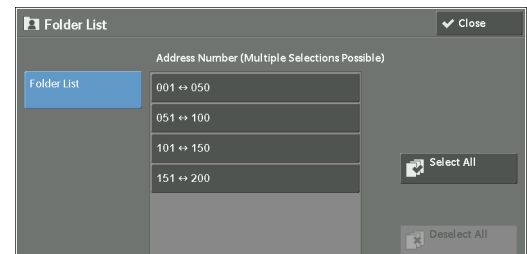

Job Counter Report

Prints the counter report for each job. You can check the breakdown of the number of actual use of the machine by feature (such as the number of pages printed and the number of times used) and cumulative time when the machine is used (such as runtime, standby time, Low Power mode, Sleep mode, and power-off time) by minutes on the Job Counter Report.

Note • [Job Counter Report] appears when the [Tools] button is displayed on the [Home] screen.

1 Select [Job Counter Report].

Note • To display the [Job Counter Report] screen, press the <Machine Status> button, and then select [Machine Information] > [Print Reports] > [Job Counter Report].

- 2 Select [Job Counter Report].
- 3 Press the <Start> button.

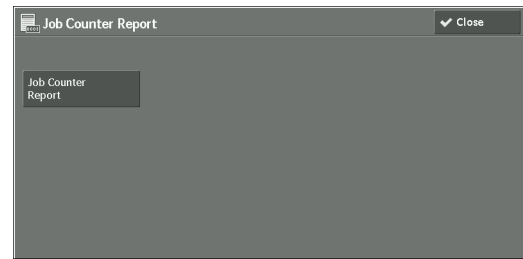

Auditron Reports

You can print an auditron report by each user. Note that the content on the screen differs depending on whether the Auditron mode for services is enabled or not.

- Note**
- [Auditron Reports] appears when the [Tools] button is displayed on the [Home] screen.
 - You cannot output the report to a file.

When [Accounting Type] is set to other than [Local Accounting]

When [Accounting Type] of each service is set to other than [Local Accounting], the following screen appears, allowing you to print a Meter Report (Print Jobs).

- 1 Select [Auditron Reports].
- Note**
- To display the [Auditron Reports] screen, press the <Machine Status> button, and then select [Machine Information] > [Print Reports] > [Auditron Reports].
- 2 Select [Meter Report (Print Jobs)].
 - 3 Press the <Start> button.



Meter Report (Print Jobs)

You can check the total number of printed pages and sheets of paper used for each client (job owner). [Meter Report (Print Jobs)] counts pages from the time at which the data is initialized.

When [Accounting Type] is set to [Local Accounting]

When [Accounting Type] is set to [Local Accounting], the [Auditron Reports] screen appears. You can print the auditron report per user for the services of which the Auditron mode is set to [Enable Accounting].

For information on enabling the Auditron feature for each service, refer to "Accounting" (P.251).

- 1 Select [Auditron Reports].
- Note**
- To display the [Auditron Reports] screen, press the <Machine Status> button, and then select [Machine Information] > [Print Reports] > [Auditron Reports].

2 Select an auditor report to print.

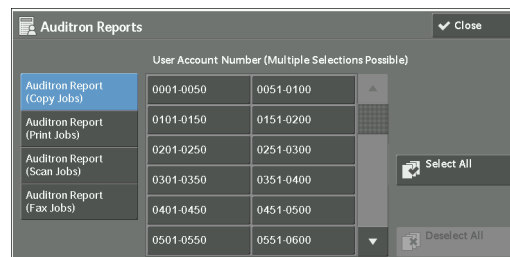

3 Select a range of user numbers to print.

Note • Selecting [Select All] selects all users.

4 Press the <Start> button.

Auditor Report (Copy Jobs)

You can check the total number of pages copied and printed on the machine. If the limit is set for the number of pages or colors that can be scanned, you can also check the limit value. [Auditor Report (Copy Jobs)] counts pages from the time at which the data is initialized.

Note • The number of pages copied or printed to be displayed on the report is the User Account Number assigned when a user is registered under [Accounting] or [Authentication / Security Settings].

Auditor Report (Print Jobs)

You can check the total number of pages printed and sheets of paper used for each client (job owner). [Auditor Report (Print Jobs)] counts pages from the time at which the data is initialized.

Note • When [Print Service] is set to [Disable Accounting] in [Auditor Mode] under [Accounting Type], [Meter Report (Print Jobs)] is displayed instead of [Auditor Report (Print Jobs)]. For more information on [Meter Report (Print Jobs)], refer to "Meter Report (Print Jobs)" (P.93).
• The number of pages printed to be displayed on the report is the User Account Number assigned when a user is registered under [Accounting] or [Authentication / Security Settings].

Auditor Report (Scan Jobs)

You can check the total number of pages scanned with the machine. If the limit is set for the number of pages that can be scanned, you can also check the limit value. [Auditor Report (Scan Jobs)] counts pages from the time at which the data is initialized.

Note • The number of pages scanned to be displayed on the report is the User Account Number assigned when a user is registered under [Accounting] or [Authentication / Security Settings].

Auditor Report (Fax Jobs)

You can check the total number of fax transmissions/receptions and the total number of pages transmitted for each user.

Note • The number of pages faxed to be displayed on the report is the User Account Number assigned when a user is registered under [Accounting] or [Authentication / Security Settings].

Automatically Printed Reports/Lists

Some reports/lists related to the Fax and Scan services can be printed only automatically. The following describes reports/lists that can be printed automatically.

Transmission Report - Job Undelivered

The report is automatically printed when a transmission of scanned data to a computer on a network or a transmission of scanned data by e-mail fails. When a fax or the Internet Fax transmission fails, this report is also printed. You can check a thumbnail of the scanned data and its transmission result.

You can set not to print out the Transmission Report - Undelivered automatically.

For information on setting whether to print the report for e-mails automatically, refer to "Scan File Transfer Report" (P.138).

For information on setting whether to print the report for faxes automatically, refer to "Transmission Report - Job Undelivered" (P.138).

Transmission Report

The report is automatically printed when a transmission of scanned data to a computer on a network or a transmission of scanned data by e-mail succeeds. When a fax or the Internet Fax transmission succeeds, this report is also printed. You can check a thumbnail of the scanned data and its transmission result.

You can set not to print out the Transmission Report - Undelivered automatically.

For information on setting whether to print the report for e-mails automatically, refer to "Scan File Transfer Report" (P.138).

For information on setting whether to print the report for faxes automatically, refer to "Transmission Report - Job Undelivered" (P.138).

Folder Report

You can confirm that a document is stored in a folder.

For information on setting whether to print the report automatically, refer to "Folder Report" (P.138).

Broadcast Report

You can check the result of a broadcast transmission. The recipients and transmission result/status are recorded.

If you set to print this report automatically, it is printed each time a broadcast transmission is completed.

For information on setting whether to print the report automatically, refer to "Broadcast / Multi-Poll Report" (P.138).

Multi-Poll Report

You can check the result of a multi-poll communication (polling from multiple recipients). The remote terminal name and transmission result/status are recorded.

If you set to print this report automatically, it is printed each time a multi-poll transmission is completed.

For information on setting whether to print the report automatically, refer to "Broadcast / Multi-Poll Report" (P.138).

Job Flow Error Report

This report notifies job flow errors. The date and time of the status occurred and the status codes are printed.

You can set not to print out the Job Flow Error Report automatically.

For information on setting whether to print the report automatically, refer to "Job Flow Error Report" (P.138).

Overwrite Hard Disk

You can check the overwriting status of the hard disk. "Overwriting" indicates that the overwriting is in progress. "Standby" indicates that the overwriting is completed.

Note • [Overwrite Hard Disk] appears when [Overwrite Hard Disk] is enabled under [Authentication / Security Settings]. For more information, refer to "Overwrite Hard Disk" (P.269).

- 1 Select [Overwrite Hard Disk].

- 2 Check the overwriting status of the hard disk.



Print Mode

You can print the programming settings configured in the ESC/P-K emulation mode and retrieve the programming.

Note • The items displayed vary depending on the options installed.

- 1 Select [Print Mode].
- 2 Select [Off-line] or [On-line].

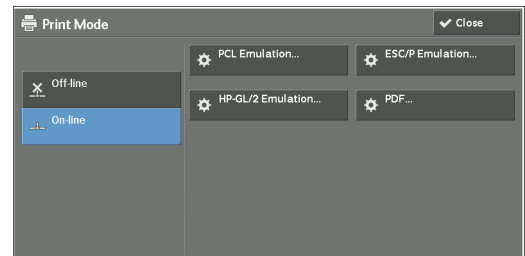

Off-line

The machine does not accept data from a computer. Any data being sent is cancelled and not printed.

On-line

The machine accepts data from a computer.

- 3 Select a printer language to set a print mode.
- 4 Set each item.

Note • The items displayed vary depending on the printer language.

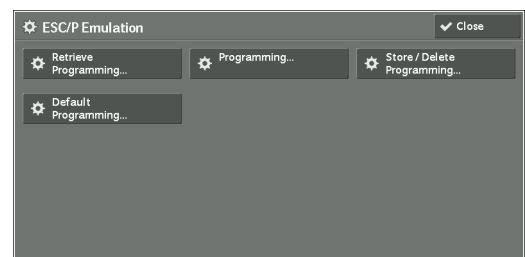

Retrieve Programming

You can retrieve and use settings registered in memory.

- 1 Select [Retrieve Programming].

- 2 Select the memory number to use.

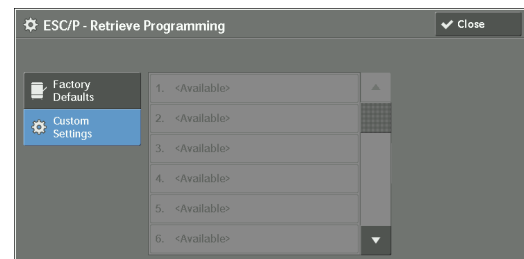

Factory Defaults

You can use the factory default settings.

Custom Settings

Displays the numbers stored in the memory.

Programming

You can check or change the value set for the print mode item number.

For the item numbers that can be configured in each mode menu, refer to "ESC/P-K Emulation Settings" (P.528), "PDF Direct Print Settings" (P.541), "PCL Emulation Settings" (P.545), and "HP-GL/2 Emulation Settings" (P.553).

- 1 Select [Programming].
- 2 Enter the item number of the feature to set in [Item Number] with the numeric keypad.
- 3 Select [Confirm].
- 4 Select [Change Value].
- 5 Enter [New Value] with the numeric keypad.
- 6 Select [Save].

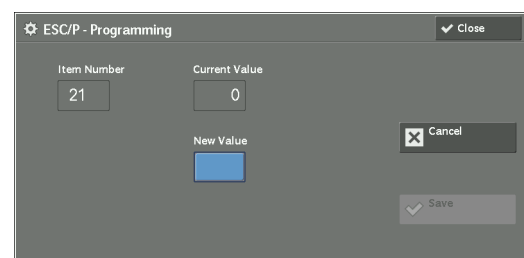

Store / Delete Programming

For ESC/P-K and HP-GL/2 emulations, you can register settings in memory. You can register up to 20 print modes for ESC/P-K and HP-GL/2 emulations.

- 1 Select [Store / Delete Programming].
- 2 Select [Store Current Selections] or [Delete].

Store Current Selections

Stores the current selections. If you select a number already used, its settings will be overwritten with the new settings. The overwritten settings cannot be restored.

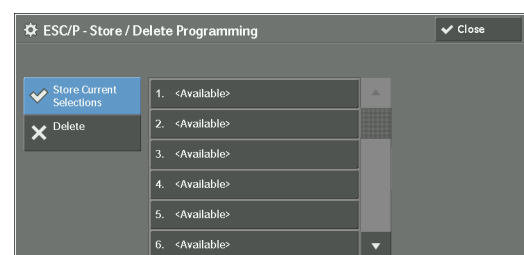

Delete

Select this to delete a programming.

Note • Deleted settings cannot be restored.

- 3 Select the memory number to store or to delete.

Default Programming

You can start the machine using the settings stored in memory as default settings.

- 1 Select [Default Programming].
- 2 Select [Factory Defaults] or [Custom Settings].

Factory Defaults

You can use the factory default settings.

Custom Settings

Displays the numbers stored in memory.

- 3 When you select [Custom Settings], select a memory number to use.
- 4 Select [Save].

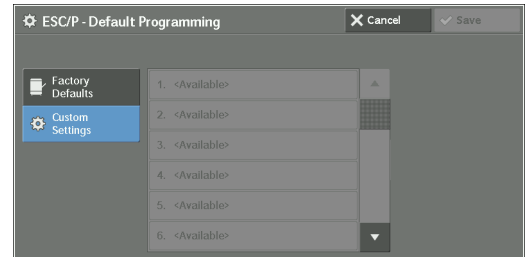
**Password**

For PDF Direct Print, if a password is set for files, set the password here in advance. PDF files can be printed only when the passwords assigned and entered are the same.

You can use up to 32 characters for the password.

- 1 Select [Password].
- 2 Enter a password of up to 32 single-byte characters with the keyboard displayed, and select [Save].

Fax Receiving Mode

You can set a mode for receiving faxes.

For information on auto receive and manual receive, refer to "4 Fax" > "Receiving Faxes" in the User Guide.

- 1 Select [Fax Receiving Mode].
- 2 Select a fax receiving mode.

Manual Receive

The machine manually receives faxes from a remote machine. This mode is convenient to confirm the sender or use an external telephone before receiving faxes.

Auto Receive

The machine automatically receives faxes.

- 3 Select [Save].

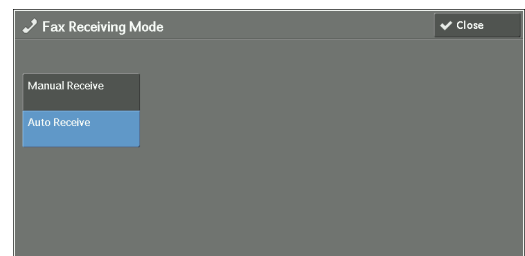

Faults

This section describes how to check the information on errors that occurred on the machine. The error history report shows the list of the latest 50 errors. The items printed include the date and time, status code, and error category.

The following describes how to print the error history report.

- 1 Press the <Machine Status> button.
- 2 Select the [Faults] tab.
- 3 Select [Error History Report].
- 4 Press the <Start> button.

- Note**
- You can also access [Error History Report] under [Machine Information] > [Print Reports] > [Job Status / Activity Report].
 - If [Print Reports Button] under [Reports] is set to [Disabled], the [Error History Report] button does not appear on the screen. For more information on [Reports], refer to "Reports" (P.137).



Supplies

You can check the status of consumables on the [Supplies] screen. The status of consumables is shown as "OK", "Replace Soon (Order Now)", or "Replace Now".

The following describes the procedure to check the status of consumables.

For information on replacing consumables, refer to "Maintenance" (P.57).

- 1 Press the <Machine Status> button.
- 2 Select the [Supplies] tab and confirm the status of the toners.

Note • Pressing a supply name displays a screen about the status of the supply.

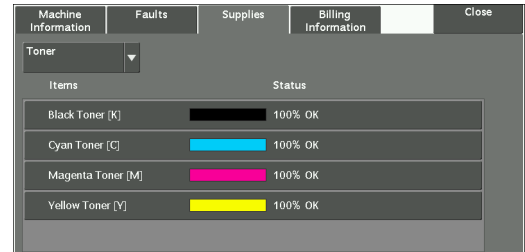

- 3 Select [Toner] from the drop-down list box, and then select [Other Consumables] and confirm the status of the consumables.

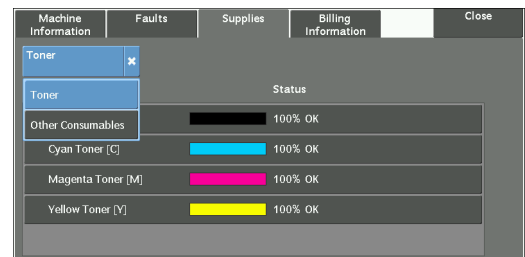

On the [Supplies] screen, you can check the following items:

- Black Toner [K]
- Cyan Toner [C]
- Magenta Toner [M]
- Yellow Toner [Y]
- Drum Cartridge [R1]
- Drum Cartridge [R2]
- Drum Cartridge [R3]
- Drum Cartridge [R4]
- Waste Toner Container [R5]
- Staple Cartridge [R1]
- Booklet Staple Cartridge [R2]
- Booklet Staple Cartridge [R3]
- Hole Punch Waste Container [R4]

Note

- If you replace a toner cartridge with a partially used toner cartridge (such as a toner cartridge removed from another Dell C7765dn Color Multifunction Printer), the status displayed may differ from the actual remaining amount. When replacing toner cartridges, we recommend that you use new ones.
- Pressing a supply name displays a screen about the status of the supply.
- The items displayed vary depending on the options installed.

Billing Information

On the [Billing Information] screen, you can check the number of pages printed per meter or user.

The following shows the reference section for each item.

Billing Information	101
User Account Billing Information	102

- 1 Press the <Machine Status> button.
- 2 Select the [Billing Information] tab.

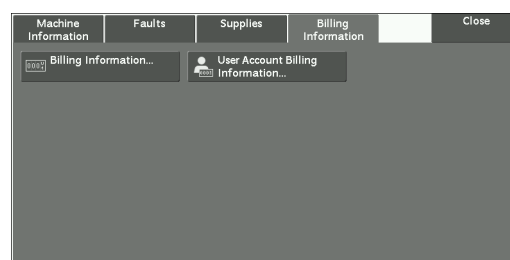

Billing Information

You can check the total number of copies and pages printed by individual meters.

- 1 Select [Billing Information].
- 2 On the screen, check each meter.

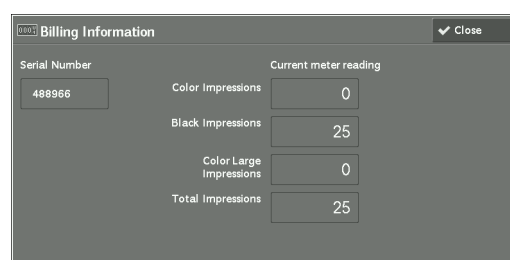

Serial Number

Displays the serial number of the machine.

Color Impressions

Displays the total number of pages copied or printed in full color.

Black Impressions

Displays the total number of pages copied or printed in black and white, and pages faxed ^{*1}.

Color Large Impressions

Displays the total number of pages printed in large-size full color ^{*2}.

Total Impressions

Displays the total number of Color Impressions and Black Impressions.

- Note**
- When print data resulting from color conversion using an ICC profile, for example, on the application is printed at Auto (Color/B/W), even documents that appear in black-and-white on the monitor are printed in color. In this case, Color Impressions is used for counting the number of prints.

- *1 is applied on machines equipped with the Fax features. Only B/W and not color is supported for Faxes.
- For *2, large-size full color is counted as a print at either of number of full color copies or number of full color prints in Color Impressions if a copy or print is made on paper of 279 mm x 400 mm or larger (279 mm or more in the primary scanning direction and 400 mm or more in the secondary scanning direction) when the user has selected color (4-color or 3-color) for copying or printing or a color document has been recognized during document scanning on the scanner.

User Account Billing Information

You can check the number of pages printed by user.

When the Auditron mode is enabled, you can check the billing meters for the currently authenticated user ID.

Note • [User Account Billing Information] is displayed when the [Accounting Type] is set to [Local Accounting].

For more information on the Auditron mode, refer to "Accounting" (P.251).

1 Press the <Log In/Out> button.

To check the billing meter of a currently authenticated user ID

- 1) Enter the user ID with the numeric keypad or the keyboard displayed on the screen, and select [Enter].

When a password is required, select [Next] and enter the user's passcode, and select [Enter].

- 2) Press the <Machine Status> button.

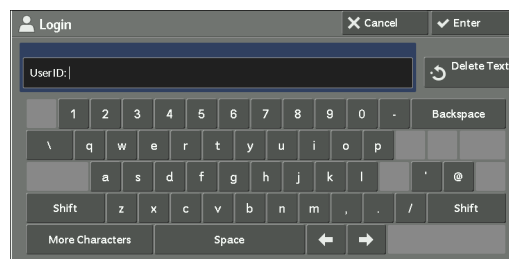

To check the system administrator meter

- 1) Enter the system administrator's user ID with the numeric keypad or the keyboard displayed on the screen, and select [Enter].

When a passcode is required, select [Next] and enter the system administrator's passcode, and select [Enter].

Note • The default user ID is "admin".
• The default passcode is "1111".

- 2) Press the <Machine Status> button.

2 Select the [Billing Information] tab.

3 Select [User Account Billing Information].

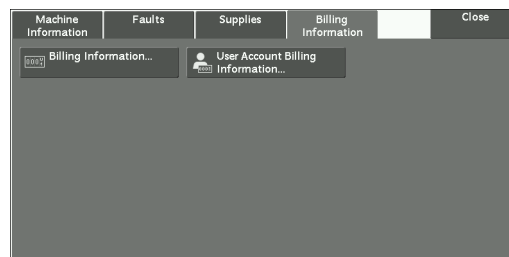

4 Select a meter to check.

- Note**
- The meters are displayed only for the features set to [Enable Accounting] in the Auditor mode.

	Color	Black & White
This Session	0	0
Total	0	0
Account Limit	9999999	9999999
Available Balance	9999999	9999999

Meter (Copy Jobs)

Displays the number of pages copied.

Meter (Scan Jobs)

Displays the number of pages scanned.

Meter (Print Jobs)

Displays the number of pages printed.

- Note**
- [Meter (Print Jobs)] is not displayed for the system administrator.

5 Tools

Each feature of the machine is set to the factory default (initial) settings, but you can customize these settings in accordance with your environment. To change or customize these settings, enter the System Administration mode and make changes in the [Tools] screen.

This chapter describes the features that can be changed and the procedures to change the settings.

• System Settings Procedure	106
• Tools Menu List	110
• Common Service Settings	124
• Copy Service Settings	158
• Connectivity & Network Setup	168
• Print Service Settings	190
• Scan Service Settings	197
• Fax Service Settings	204
• E-mail / Internet Fax Service Settings	216
• Address Book Settings	219
• Folder Service Settings	220
• Job Flow Service Settings	221
• Media Print Service Settings	222
• Stored File Settings	223
• Web Applications Service Setup	225
• Web Browser Setup	229
• Setup	231
• Accounting	251
• Authentication / Security Settings	260

System Settings Procedure

To change or customize the system settings, enter the System Administration mode.

This section describes the basic procedures for system settings. The following shows the reference section for each procedure.

Step 1 Entering System Administration Mode	106
Step 2 Entering the System Administrator User ID and Passcode	106
Step 3 Selecting [Tools]	107
Step 4 Selecting a Tab on the [Tools] Screen	107
Step 5 Setting a Feature	109
Step 6 Exiting System Administration Mode.....	109

Step 1 Entering System Administration Mode

- 1 Press the <Log In/Out> button or the login information field on the touch screen.

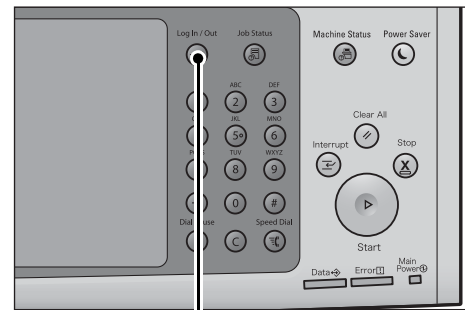

<Log In/Out> button

Step 2 Entering the System Administrator User ID and Passcode

To enter the System Administration mode, enter the System Administrator's User ID. If [Passcode Entry for Control Panel Login] is set to [On] under [Tools] > [Authentication / Security Settings] > [Authentication] > [Passcode Policy], you need to enter the passcode.

We recommend that you change the System Administrator's User ID and passcode immediately after installing the machine.

For more information on how to change the passcode, refer to "System Administrator Settings" (P.260).

- 1 Enter the system administrator's user ID with the numeric keypad or the keyboard displayed on the screen, and select [Enter].

When a passcode is required, select [Next] and enter the system administrator's passcode, then select [Enter].

Note

- The default user ID is "admin".
- The default passcode is "1111".
- The screen may differ depending on the settings of the machine.
- The <Log In/Out> button is lit when the machine enters the System Administration mode.

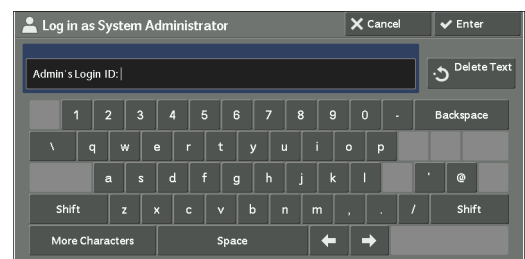

Step 3 Selecting [Tools]

- 1 Select [Tools] on the [Home] screen.

Note • When the [Home] screen is not displayed on the touch screen, press the <Home> button.



Step 4 Selecting a Tab on the [Tools] Screen

On the [Tools] screen, select a tab to set.

For the settings that can be selected on the [Tools] screen, refer to "Tools Menu List" (P.110).

- 1 Select a tab.

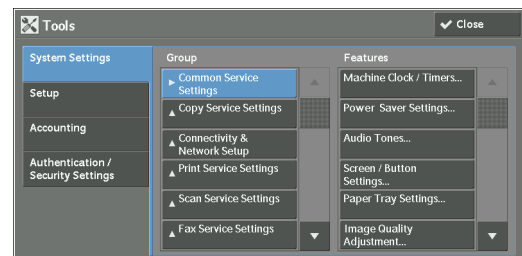

System Settings

You can set or change the default values of each service.

Common Service Settings

Allows you to configure the general settings of the machine.

For more information, refer to "Common Service Settings" (P.124).

Copy Service Settings

Allows you to configure the copy service settings such as copy feature defaults, copy operation control, and button indications.

For more information, refer to "Copy Service Settings" (P.158).

Connectivity & Network Setup

Allows you to configure the network related settings such as ports and protocols.

For more information, refer to "Connectivity & Network Setup" (P.168).

Print Service Settings

Allows you to configure the print service settings such as memory settings and print operation control.

For more information, refer to "Print Service Settings" (P.190).

Scan Service Settings

Allows you to configure the scan service settings such as scanner defaults and button indications.

For more information, refer to "Scan Service Settings" (P.197).

Fax Service Settings

Allows you to configure the fax service settings such as setting defaults, fax control and button settings.

For more information, refer to "Fax Service Settings" (P.204).

E-mail / Internet Fax Service Settings

Allows you to configure the e-mail and Internet fax transmission specifications settings.

For more information, refer to "E-mail / Internet Fax Service Settings" (P.216).

Address Book Settings

Allows you to configure the Address Book settings.

For more information, refer to "Address Book Settings" (P.219).

Folder Service Settings

Allows you to configure the settings relating to folders.

For more information, refer to "Folder Service Settings" (P.220).

Job Flow Service Settings

Allows you to configure the settings relating to Job Flow.

Job Flow is a function to execute a series of registered operations.

For more information, refer to "Job Flow Service Settings" (P.221).

Media Print Service Settings

Allows you to configure the settings relating to Media Print (Text and Photo).

For more information, refer to "Media Print Service Settings" (P.222).

Stored File Settings

Allows you to set how to delete files in a folder and print documents stored in the machine.

For more information, refer to "Stored File Settings" (P.223).

Web Applications Service Setup

Allows you to configure a remote access destination server.

For more information, refer to "Web Applications Service Setup" (P.225).

Web Browser Setup

Allows you to configure the settings relating to the web browser when accessing a remote destination server.

For more information, refer to "Web Browser Setup" (P.229).

Setup

You can create and change folders, job flow sheets, and the Address Book (speed dial numbers).

For more information, refer to "Setup" (P.231).

Accounting

You can register users and configure the settings for account administration.

For more information, refer to "Accounting" (P.251).

Authentication / Security Settings

You can configure the authentication and security settings.

For more information, refer to "Authentication / Security Settings" (P.260).

Step 5 Setting a Feature

1 Select any feature.

- Note**
- Select a submenu from the [Group] list, and then select a feature from the [Features] list.
 - Select [▲] or [▼] as required.

2 Select an item to set.

3 After setting the feature, select [Save].

4 Select [Close] repeatedly until the [Home] screen is displayed.

- Note**
- If rebooting the machine is required to enable the new settings, when you select [Close] in the [Tools] screen, a message may be displayed. Follow the message and reboot the machine. After the machine reboots, it exits from the System Administration mode, and the <Log In/Out> button is unlit.

Step 6 Exiting System Administration Mode

1 Press the <Log In/Out> button.

- Note**
- You can also log out by pressing the login information field on the touch screen, and then selecting [Logout].
 - The <Log In/Out> button is unlit when the machine exits from the System Administration mode.

Tools Menu List

The following tables list the items that can be set on the [Tools] screen. Note that the some items may not appear depending on the configuration of the machine.

System Settings

Common Service Settings

"Machine Clock / Timers" (P.124)	<ul style="list-style-type: none"> • "Date" (P.124) • "Time" (P.124) • "NTP Time Synchronization" (P.125) • "Connection Interval" (P.125) • "Time Server Address" (P.125) • "Auto Clear" (P.125) • "Auto Job Release" (P.125) • "Auto Print" (P.125) • "Printer Lockout" (P.126) • "Time Zone" (P.126) • "Daylight Savings" (P.126) • "Print-On-Demand Duration" (P.126)
"Power Saver Settings" (P.127)	<ul style="list-style-type: none"> • "Power Saver Timers" (P.127) • "Power Saver Deactivation" (P.127) • "Deactivate With wakeup motion sensor" (P.127)
"Audio Tones" (P.127)	<ul style="list-style-type: none"> • "Control Panel Select Tone" (P.128) • "Control Panel Alert Tone" (P.128) • "Base Tone" (P.128) • "Machine Ready Tone" (P.128) • "Job Complete Tone 1, 2" (P.128) • "Fault Tone" (P.128) • "Auto Clear Alert Tone" (P.128) • "Alert Tone" (P.128) • "Out of Paper Warning Tone" (P.128) • "Low Toner Alert Tone" (P.128) • "Stored Programming Tone" (P.129) • "Stored Programming Complete Tone" (P.129) • "Line Monitor Volume" (P.129) • "Ring Volume" (P.129)
"Screen / Button Settings" (P.129)	<ul style="list-style-type: none"> • "Screen Default" (P.129) • "Screen After Auto Clear" (P.129) • "Auto Display of Login Screen" (P.129) • "Custom Buttons 1 to 3" (P.129) • "One-touch Buttons" (P.129) • "Home" (P.130) • "Home - Additional Features" (P.130) • "Job Type on Job Status screen" (P.130) • "Default Language" (P.130) • "Screen Brightness" (P.130) • "Reconfirm E-mail Recipient" (P.130) • "Reconfirm Fax / Internet Fax Recipient" (P.131) • "Reconfirm E-mail Recipient Button" (P.131) • "Reconfirm Fax / Internet Fax Button" (P.131) • "Screen After Inserting USB" (P.131)

"Paper Tray Settings" (P.131)	<ul style="list-style-type: none"> • "Custom Paper Name / Color" (P.132) • "Paper Tray Attributes" (P.132) • "Customize Paper Supply Screen" (P.132) • "Paper Tray Attributes on Setup Screen" (P.133) • "Paper Tray Attributes During Loading" (P.133) • "Paper Tray Priority" (P.133) • "Paper Type Priority" (P.133) • "Tray 5 - Paper Size Defaults" (P.133) • "Auto Tray Switching Control" (P.134) • "Image Quality" (P.134)
"Image Quality Adjustment" (P.136)	<ul style="list-style-type: none"> • "Image Quality" (P.136) • "Calibration" (P.137)
"Reports" (P.137)	<ul style="list-style-type: none"> • "Print Reports Button" (P.137) • "Job History Report" (P.138) • "Activity Report" (P.138) • "Transmission Report - Job Undelivered" (P.138) • "Transmission Report - Job Deleted" (P.138) • "Folder Report" (P.138) • "Broadcast / Multi-Poll Report" (P.138) • "Scan File Transfer Report" (P.138) • "2 Sided Report" (P.138) • "Activity Report - Recipient" (P.138) • "Job Flow Error Report" (P.138)
"Maintenance" (P.139)	<ul style="list-style-type: none"> • "Initialize Hard Disk" (P.139) • "Delete All Data" (P.139) • "Software Options" (P.139) • "Power on Self Test" (P.139) • "Finisher Adjustment" (P.139) • "Adjust Image Transfer" (P.139) • "Adjust Paper Registration" (P.140) • "Delete All Certificates / Initialize Settings" (P.140) • "Quick Setup Home" (P.140)
"Watermark" (P.140)	<ul style="list-style-type: none"> • "Date Format" (P.140) • "Default Watermark" (P.140) • "Font Size" (P.140) • "Background Pattern" (P.140) • "Font Color" (P.140) • "Density" (P.141) • "Watermark / Background Contrast" (P.141) • "Force Watermark - Copy" (P.141) • "Force Watermark - Client Print" (P.141) • "Force Watermark - Print Stored File" (P.141) • "Force Watermark - Media Print" (P.141) • "Custom Watermark 1 to 3" (P.141) • "Print this Sample List" (P.141)
"Force Annotation" (P.141)	<ul style="list-style-type: none"> • "Apply Layout Template to Copy/Print Jobs" (P.142) • "Delete Layout Template" (P.142) • "Create Text String" (P.143)
"Print Universal Unique ID" (P.143)	<ul style="list-style-type: none"> • "Print Universal Unique ID" (P.143) • "Print Position" (P.143) • "Print Position Adjustment" (P.143) • "Print Position (Side 2)" (P.143)
"Notify Job Completion by E-mail" (P.143)	<ul style="list-style-type: none"> • "Targeted Jobs" (P.143) • "E-mail Addresses 1 to 5" (P.143) • "E-mail Message" (P.144)

"Plug-in Settings" (P.144)	<ul style="list-style-type: none">• "Embedded Plug-ins" (P.144)• "List of Embedded Plug-ins" (P.144)
"Other Settings" (P.144)	<ul style="list-style-type: none">• "Offset Stacking (Center Tray)" (P.144)• "Offset Stacking (Center Tray - Upper)" (P.144)• "Offset Stacking (Center Tray - Lower)" (P.144)• "Offset Stacking (Right Middle Tray)" (P.144)• "Booklet Offset" (P.145)• "Auto Job Promotion" (P.145)• "Default Print Paper Size" (P.145)• "Odd Page 2 Sided" (P.145)• "Paper Size Settings" (P.145)• "Millimeters / Inches" (P.154)• "Keyboard Input Restriction" (P.154)• "Operation of Up / Down Buttons" (P.154)• "Display Consumables Screen" (P.154)• "Data Encryption" (P.154)• "Encryption Key for Confidential Data" (P.156)• "Service Rep. Restricted Operation" (P.156)• "Software Download" (P.157)• "Drum Cartridge Conservation Mode" (P.157)• "Restrict Recipient Selection Method" (P.157)• "Restrict User to Edit Address Book" (P.157)• "Auto Validation of Speed Dial Entry" (P.157)• "Data Indicator" (P.157)

Copy Service Settings

"Copy Tab - Features Allocation" (P.158)	-
"Preset Buttons" (P.159)	<ul style="list-style-type: none">• "Paper Supply - Button 2 - 5" (P.159)• "Reduce/Enlarge - Button 3 - 4" (P.159)• "Front Cover Tray - Button 1 - 3" (P.159)• "Back Cover Tray - Button 1 - 3" (P.159)• "Transparency Tray - Button 1 - 3" (P.159)• "Separator & Handout Tray - Button 1 - 3" (P.159)

 "Copy Defaults" (P.159)

- "Paper Supply" (P.159)
 - "Reduce / Enlarge" (P.159)
 - "Output Color" (P.160)
 - "Output Color (Simple Copy)" (P.160)
 - "Single Color" (P.160)
 - "Dual Color - Source Color" (P.160)
 - "Dual Color - Target Area Color" (P.160)
 - "Dual Color - Non-target Area Color" (P.160)
 - "Original Type" (P.160)
 - "Original Type - Auto (Non-Black & White)" (P.160)
 - "Original Type - Auto (Black & White)" (P.160)
 - "Lighten / Darken" (P.160)
 - "Contrast" (P.161)
 - "Sharpness" (P.161)
 - "Saturation" (P.161)
 - "Background Suppression" (P.161)
 - "Color Balance - Yellow / Color Balance - Magenta / Color Balance - Cyan / Color Balance - Black" (P.161)
 - "Color Shift" (P.161)
 - "2 Sided Copying" (P.161)
 - "Mixed Size Originals" (P.161)
 - "Edge Erase - Top Edge" (P.161)
 - "Edge Erase - Bottom Edge" (P.161)
 - "Edge Erase - Left Edge" (P.162)
 - "Edge Erase - Right Edge" (P.162)
 - "Center Erase / Binding Edge Erase" (P.162)
 - "Edge Erase - 2 Sided Original - Side 2" (P.162)
 - "Image Shift - Side 1" (P.162)
 - "Image Shift - Side 2" (P.162)
 - "Image Rotation" (P.162)
 - "Image Rotation - Rotation Direction" (P.162)
 - "Original Orientation" (P.162)
 - "Pages per Side" (P.162)
 - "Copy Output" (P.162)
 - "Uncollated - Default Separator Tray" (P.162)
 - "Output Destination" (P.163)
 - "Output Destination (Simple Copy)" (P.163)
 - "Sample Job" (P.163)
 - "Annotations - Stored Comment" (P.163)
 - "Annotations - Comment on Side 1 and Side 2" (P.163)
 - "Annotations - Comment - Font Size" (P.163)
 - "Annotations - Comment - Font Color" (P.163)
 - "Date - Position on Side 1 and Side 2" (P.163)
 - "Date - Font Size" (P.163)
 - "Page Numbers - Style" (P.163)
 - "Page Numbers - Position on Side 1 and Side 2" (P.163)
 - "Page Numbers - Font Size" (P.164)
 - "Bates Stamp - Number of Digits" (P.164)
 - "Bates Stamp - Position on Side 1 and Side 2" (P.164)
 - "Bates Stamp - Font Size" (P.164)
 - "Booklet Creation - Default Cover Tray" (P.164)
 - "Covers - Default Front Cover Tray, Default Back Cover Tray" (P.164)
 - "Separators - Default Separator Tray" (P.164)
-

"Copy Control" (P.164)	<ul style="list-style-type: none"> • "Memory Full Procedure" (P.164) • "Maximum Stored Pages" (P.164) • "Auto Paper Off" (P.165) • "Mixed Size Originals - 2 Sided Copy" (P.165) • "Fine-tune 100%" (P.165) • "ID Card Copy - Reduce / Enlarge" (P.165) • "Background Suppression (Photo & Text)" (P.165) • "Background Suppression Level (Text)" (P.165) • "Photo & Text /Printed Original" (P.165) • "Original Type - See-Through Paper" (P.166) • "Annotations - Comment Density" (P.166) • "Comment Position - Top Left, - Top Center, - Top Right, - Left Center, - Center, - Right Center, - Bottom Left, - Bottom Center, and - Bottom Right" (P.166) • "Date Position - Top Left, - Top Center, - Top Right, - Bottom Left, - Bottom Center, and - Bottom Right" (P.166) • "Page Number Position - Top Left, - Top Center, - Top Right, - Bottom Left, - Bottom Center, and - Bottom Right" (P.166) • "Bates Stamp - Top Left, - Top Center, - Top Right, - Bottom Left, - Bottom Center, and - Bottom Right" (P.166) • "Quantity Display" (P.166) • "Maximum Number of Sets" (P.166)
"Original Size Defaults" (P.166)	-
"Reduce / Enlarge Presets" (P.167)	-
"Custom Colors" (P.167)	-
"Annotations - Create Comments" (P.167)	-

Connectivity & Network Setup

"Port Settings" (P.168)	<ul style="list-style-type: none"> • "USB" (P.168) • "LPD" (P.169) • "NetWare" (P.169) • "SMB" (P.169) • "IPP" (P.170) • "EtherTalk" (P.170) • "Bonjour" (P.170) • "Port 9100" (P.170) • "SNMP" (P.170) • "FTP Client" (P.170) • "Receive E-mail" (P.171) • "Send E-mail" (P.171) • "E-mail Notification Service" (P.171) • "UPnP Discovery" (P.171) • "WSD" (P.171) ^{*1} • "Internet Services (HTTP)" (P.172) • "SOAP" (P.172) • "WebDAV" (P.172) • "ThinPrint" (P.173)
-------------------------	--

"Protocol Settings" (P.173)	<ul style="list-style-type: none"> • "Ethernet Rated Speed" (P.173) • "TCP/IP - IP Mode" (P.173) • "IPv4 - IP Address Resolution" (P.174) • "IPv4 - IP Address" (P.174) • "IPv4 - Subnet Mask" (P.174) • "IPv4 - Gateway Address" (P.174) • "IPv4 - DNS Server Setup" (P.175) • "IPv4 - IP Filter" (P.175) • "IPv6 Address Manual Configuration" (P.175) • "Manually Configured IPv6 Address" (P.175) • "Manually Configured IPv6 Address Prefix" (P.175) • "Manually Configured IPv6 Gateway" (P.175) • "IPv6 - DNS Server Setup" (P.175) • "Automatically Configured IPv6 Address" (P.176) • "IPv6 - IP Filter" (P.176)
"Machine's E-mail Address / Host Name" (P.176)	<ul style="list-style-type: none"> • "E-mail Address" (P.176) • "Machine Name" (P.176) • "Host Name" (P.176) • "Domain Name" (P.177)
"Proxy Server Settings" (P.177)	<ul style="list-style-type: none"> • "Use Proxy Server" (P.177) • "Proxy Server Setup" (P.177) • "Addresses to Bypass Proxy Server" (P.177) • "HTTP Proxy Server Name" (P.177) • "HTTP Proxy Server Port Number" (P.177) • "HTTP Proxy Server Authentication" (P.177) • "HTTP Proxy Server Login Name" (P.177) • "HTTP Proxy Server Password" (P.177) • "HTTPS Proxy Server Name" (P.177) • "HTTPS Proxy Server Port Number" (P.177) • "HTTPS Proxy Server Authentication" (P.177) • "HTTPS Proxy Server Login Name" (P.178) • "HTTPS Proxy Server Password" (P.178)
"Outgoing / Incoming E-mail Settings" (P.178)	<ul style="list-style-type: none"> • "POP3 Server Settings" (P.178) • "SMTP Server Settings" (P.178)
"Remote Authentication / Directory Service" (P.179)	<ul style="list-style-type: none"> • "Authentication System Setup" (P.179) • "Kerberos Server Settings" (P.179) • "LDAP Server / Directory Service Settings" (P.180) • "SMB Server Settings" (P.184)
"Security Settings" (P.184)	<ul style="list-style-type: none"> • "SSL / TLS Settings" (P.184) • "S/MIME Settings" (P.185) • "PDF / XPS Signature Settings" (P.186) *2 • "IPSec Settings" (P.186) • "IEEE 802.1x Settings" (P.187) • "Certificate Revocation Retrieval Settings" (P.188)
"Other Settings" (P.188)	<ul style="list-style-type: none"> • "Protocol to Receive E-mail" (P.189) • "Add Domain Name to User Name" (P.189) • "Output Destination for E-mail" (P.189) • "Domain Filtering" (P.189)

*1 :WSD stands for Web Services on Devices.

*2 :XPS stands for XML Paper Specification.

Print Service Settings

"Allocate Memory" (P.190)	<ul style="list-style-type: none"> • "PostScript Memory" (P.190) • "ART IV, ESC/P, 201H Form Memory" (P.190) • "HP-GL/2 Auto Layout Memory" (P.190) • "Job Ticket Memory" (P.190) • "Receiving Buffer - USB" (P.191) • "Receiving Buffer - LPD" (P.191) • "Receiving Buffer - NetWare" (P.191) • "Receiving Buffer - SMB" (P.191) • "Receiving Buffer - IPP" (P.191) • "Receiving Buffer - EtherTalk" (P.192) • "Receiving Buffer - Port 9100" (P.192)
"Delete Form" (P.192)	-
"Other Settings" (P.192)	<ul style="list-style-type: none"> • "Print Area" (P.192) • "Substitute Tray" (P.192) • "Paper Type Mismatch" (P.193) • "Unregistered Forms" (P.193) • "Resume Job After Print Error" (P.193) • "When Paper Jam Occurs" (P.194) • "Print User ID" (P.194) • "Banner Sheet" (P.194) • "Banner Sheet Offset" (P.195) • "Banner Sheet Tray" (P.195) • "PostScript Default Color" (P.195) • "PostScript Paper Supply" (P.195) • "PostScript Font Absence" (P.195) • "PostScript Font Substitution" (P.195) • "XPS Print Ticket Processing" (P.195)* • "LPD Print Queue" (P.195) • "OCR Font Glyphs (0 x 5C)" (P.196)

* :XPS stands for XML Paper Specification.

Scan Service Settings

"Screen Defaults" (P.197)	<ul style="list-style-type: none"> • "Email Screen Default" (P.197) • "Scan to PC Screen Default" (P.197) • "1st Tab - Features Allocation" (P.197) • "Reduce/Enlarge - Buttons 2 to 5" (P.198)
---------------------------	---

"Scan Defaults" (P.198)	<ul style="list-style-type: none"> • "Color Scanning" (P.198) • "Original Type" (P.198) • "File Format" (P.198) • "Optimize PDF For Quick Web View" (P.198) • "Thumbnail - Outgoing E-mail" (P.198) • "Thumbnail - Scan to PC" (P.198) • "Lighten / Darken" (P.198) • "Contrast" (P.198) • "Sharpness" (P.198) • "Background Suppression" (P.199) • "Shadow Suppression" (P.199) • "Color Space" (P.199) • "Original Orientation" (P.199) • "Resolution" (P.199) • "Mixed Size Originals" (P.199) • "Edge Erase" (P.199) • "Edge Erase - Top & Bottom Edges" (P.199) • "Edge Erase - Left & Right Edges" (P.199) • "Center Erase / Binding Edge Erase" (P.199) • "Quality / File Size" (P.199) • "E-mail Subject" (P.199) • "Store & Send Link - E-mail Subject" (P.200) • "E-mail Encryption" (P.200) • "Searchable Text" (P.200) • "Language of the Original" (P.200) • "Searchable - Text Compression" (P.200)
"Scan to PC Defaults" (P.200)	<ul style="list-style-type: none"> • "Transfer Protocol" (P.200) • "Login Credential to Access Destination" (P.200) • "User Name for FTP Scan" (P.200)
"Original Size Defaults" (P.201)	-
"Output Size Defaults" (P.201)	-
"Reduce / Enlarge Presets" (P.201)	-
"Other Settings" (P.201)	<ul style="list-style-type: none"> • "Memory Full Procedure" (P.202) • "Maximum Stored Pages" (P.202) • "Saturation" (P.202) • "Background Suppression Level" (P.202) • "Shadow Suppression Level" (P.202) • "Color Space" (P.202) • "TIFF Format" (P.202) • "Image Transfer Screen" (P.202) • "Searchable - Page Orientation" (P.203) • "URL File Expiration" (P.203) • "Generation of URL Link" (P.203) • "Store & Send Link - Maximum File Size" (P.203) • "Print Login Name on PDF Files" (P.203)

Fax Service Settings

"Screen Defaults" (P.204)	<ul style="list-style-type: none"> • "Fax Screen Default" (P.204) • "1st Tab - Features Allocation" (P.204) • "Reduce / Enlarge - Button 3 - 5" (P.204) • "Transmission Screen" (P.204)
---------------------------	---

"Fax Defaults" (P.205)	<ul style="list-style-type: none"> • "Resolution" (P.205) • "Original Type" (P.205) • "Lighten / Darken" (P.205) • "Mixed Size Originals" (P.205) • "Skip Blank Pages" (P.205) • "Starting Rate" (P.205) • "Delay Start - Specific Time" (P.205) • "Transmission Header Text" (P.205) • "Confirmation Options" (P.205) • "Delivery Receipts / Read Receipts" (P.205) • "Internet Fax Profile" (P.205) • "Internet Fax Subject" (P.206) • "Internet Fax Encryption" (P.206)
"Fax Control" (P.206)	<ul style="list-style-type: none"> • "Re-enter Recipients" (P.206) • "Re-enter Broadcast Recipients" (P.206) • "Re-enter Speed Dial Recipients" (P.206) • "Re-enter Group Recipients" (P.206) • "Broadcast Checkbox on 1st Tab" (P.207) • "Chain Dial" (P.207) • "Manual Redial List - Saved Entries" (P.207) • "Manual Redial List - Dial Mode" (P.207) • "Transmission Header Text - Polling" (P.207) • "Polled Files - Auto Delete" (P.207) • "Rotate 90 degrees" (P.207) • "G3 Sender ID - Fax" (P.207) • "Save Undelivered Faxes" (P.207) • "Save Deleted Faxes" (P.207) • "Saved Faxes - Auto Delete" (P.208) • "Transmission Interval" (P.208) • "Batch Send" (P.208) • "Manual Send / Receive Default" (P.208) • "Fax Receiving Mode" (P.208) • "Border Limit" (P.208) • "Auto Reduce On Receipt" (P.208) • "Receiving Paper Size" (P.208) • "2 Pages Up On Receipt" (P.209) • "2 Sided Printing" (P.209) • "Edge Erase - Top & Bottom Edges" (P.209) • "Edge Erase - Left & Right Edges" (P.209) • "Reduce 8.5 x 11" Original to A4" (P.209) • "Pseudo-Photo Gradation Mode" (P.209) • "Folder Selector Setup" (P.209) • "Memory Full Procedure" (P.209) • "Maximum Stored Pages" (P.210) • "Mixed Size Originals Scan Mode" (P.210) • "Skip Blank Pages" (P.210) • "Fax Data in Folder Priority 1 to 3" (P.210) • "Direct Fax" (P.210) • "Block Inbound Faxes" (P.210) • "Block Unknown Fax Numbers" (P.210)
"Fax Received Options" (P.211)	<ul style="list-style-type: none"> • "Folder Selector Setup" (P.211) • "Output Destination Setup" (P.211)
"Reduce / Enlarge Presets" (P.211)	-
"Original Size Defaults" (P.212)	-

"Local Terminal Information" (P.212)	<ul style="list-style-type: none"> • "Local Name" (P.212) • "Company Logo" (P.212) • "Machine Password" (P.212) • "Line 1 - Company Logo" (P.212) • "G3 Line 1 - Fax ID" (P.212) • "G3 Line 1 - Dial Type" (P.213) • "G3 Line 1 - Line Type" (P.213)
"Internet Fax Control" (P.213)	<ul style="list-style-type: none"> • "Internet Fax Path" (P.213) • "Profile for Broadcast Job" (P.213) • "Broadcast Starting Rate" (P.214) • "Delivery Confirmation Method" (P.214) • "Incoming Internet Fax Print Options" (P.214) • "Internet Fax Output Destination" (P.214) • "Fax Transfer from Address Book" (P.215) • "Transmission Header Text - Fax Transfer" (P.215) • "Fax Transfer Maximum Data Size" (P.215)

E-mail / Internet Fax Service Settings

"E-mail Control" (P.216)	<ul style="list-style-type: none"> • "Maximum Address Entries" (P.216) • "Incoming E-mail Print Options" (P.216) • "Print Error Notification E-mail" (P.216) • "Response to Read Receipts" (P.216) • "Read Receipts" (P.217) • "Print Delivery Confirmation Mail" (P.217) • "Split Send Method" (P.217) • "Maximum Data Size per E-mail" (P.217) • "Maximum Total Data Size" (P.217) • "Maximum Split Count" (P.217) • "Allow Casual Users to Edit From Field" (P.218) • "Allow Guest Users to Edit From Field" (P.218) • "Allow to edit From if Search Found" (P.218) • "Allow to edit From if Search Failed" (P.218) • "E-mail Sending When Search Failed" (P.218) • "Add Me to "To" Field" (P.218) • "Add Me to "Cc" Field" (P.218) • "Edit E-mail Recipients" (P.218)
--------------------------	---

Address Book Settings

"Address Book Settings" (P.219)	<ul style="list-style-type: none"> • "Address Book Type" (P.219) • "Directory Service" (P.219) • "Address Book Default - Scan" (P.219) • "Address Book Default - Fax" (P.219) • "Search Display Default" (P.219) • "Fax Speed Dial Default" (P.219)
---------------------------------	---

Folder Service Settings

"Folder Service Settings" (P.220)	<ul style="list-style-type: none"> • "Files Retrieved By Client" (P.220) • "File Display Default" (P.220) • "Print & Delete Confirmation Screen" (P.220) • "Convert Custom Size to Standard Size" (P.220) • "Standard Size Threshold Value" (P.220) • "Internet Fax to Internet Fax" (P.220) • "Internet Fax to E-mail" (P.220) • "Quality / File Size for Retrieval" (P.220)
-----------------------------------	---

Job Flow Service Settings

"Job Flow Service Settings" (P.221)	<ul style="list-style-type: none"> • "Pool Server" (P.221) • "Pool Server Login Method" (P.221) • "Job Flow Sheet List Default" (P.221) • "Fax Transfer Resolution" (P.221)
-------------------------------------	---

Media Print Service Settings

"Media Print Service Settings" (P.222)	<ul style="list-style-type: none"> • "Text - Paper Supply - Button 2 to 5" (P.222) • "Photos - Paper Supply - Button 1 to 5" (P.222)
--	--

Stored File Settings

"Stored File Settings" (P.223)	<ul style="list-style-type: none"> • "Expiration Date for Files in Folder" (P.223) • "Stored Job Expiration Date" (P.223) • "Display Details of Stored Print Job List" (P.224) • "Print Job Confirmation Screen" (P.224) • "Minimum Passcode Length for Stored Jobs" (P.224) • "Print Order for All Selected Files" (P.224)
--------------------------------	---

Web Applications Service Setup

"Server Setup" (P.227)	<ul style="list-style-type: none"> • "URL" (P.227) • "Server Name" (P.227) • "Description" (P.227) • "Use User ID" (P.228) • "User ID" (P.228) • "Password" (P.228) • "Machine / Authentication Notification" (P.228) • "Notify User Authorization Information" (P.228) • "Delete All Settings" (P.228)
"Other Settings" (P.228)	<ul style="list-style-type: none"> • "When Sending User Details" (P.228)

Web Browser Setup

"Web Browser Setup" (P.229)	<ul style="list-style-type: none"> • "Web Applications Version" (P.229) • "Delete Persistent Cookie Upon Closing" (P.229) • "Clear Cache Upon Closing" (P.229) • "Use Cache" (P.229) • "Accept Cookies" (P.229) • "Use TLS1.0" (P.229) • "Use SSL3.0" (P.229) • "When SSL Certificate Verification Fails" (P.229) • "Enable File Printing" (P.230)
-----------------------------	---

Setup

"Create Folder" (P.231)	<ul style="list-style-type: none"> • "Folder Name" (P.232) • "Check Folder Passcode" (P.232) • "Delete Files After Retrieval" (P.232) • "Delete Expired Files" (P.232) • "Link Job Flow Sheet to Folder" (P.233) • "When the [Delete Folder] Button is Selected" (P.233)
-------------------------	--

"Stored Programming" (P.233)	-
"Create Job Flow Sheet" (P.233)	<ul style="list-style-type: none"> • "Restrictions on Using Job Flow" (P.234) • "Create New Job Flow Sheet" (P.235) • "Name" (P.236) • "Description" (P.236) • "Keyword" (P.236) • "Send as Fax" (P.236) • "Send as Internet Fax" (P.236) • "Send as E-mail" (P.237) • "Transfer via FTP (1), Transfer via FTP (2)" (P.238) • "Transfer via SMB (1), Transfer via SMB (2)" (P.239) • "Print" (P.240) • "E-mail Notification" (P.240) • "Edit / Delete" (P.241)
"Create Job Flow Sheet Keyword" (P.241)	-
"Add Address Book Entry" (P.241)	<ul style="list-style-type: none"> • "Address Type" (P.243) • "Fax Number" (P.246) • "E-mail Address" (P.243) • "Name" (P.244) • "Surname" (P.244) • "Given Name" (P.244) • "Custom Item 1" (P.244) • "Custom Item 2" (P.244) • "Custom Item 3" (P.244) • "S/MIME Certificate" (P.244) • "Transfer Protocol" (P.245) • "Server Name / IP Address" (P.245) • "Shared Name (SMB Only)" (P.245) • "Save in" (P.245) • "User Name" (P.245) • "Password" (P.245) • "Port Number" (P.245) • "Fax Number" (P.246) • "Index" (P.246) • "Starting Rate" (P.246) • "Resolution" (P.246) • "Cover Page" (P.246) • "Maximum Image Size" (P.246) • "Delay Start" (P.247) • "Remote Folder" (P.247) • "F Code" (P.247) • "Relay Broadcast" (P.247) • "Billing - Day Time, Billing - Night Time, Billing - Midnight" (P.248) • "Internet Fax Profile" (P.248)
"Create Fax Group Recipients" (P.248)	-
"Add Fax Comment" (P.249)	-
"Paper Tray Attributes" (P.250)	-

Accounting

"Create / View User Accounts" (P.251)	<ul style="list-style-type: none"> • "User ID" (P.252) • "User Name" (P.252) • "Passcode" (P.252) • "E-mail Address" (P.252) • "Device Access" (P.252) • "Service Access" (P.252) • "User Role" (P.253) • "Reset Account" (P.253) • "Reset Total Impressions" (P.254)
"Reset User Accounts" (P.254)	-
"System Administrator's Meter (Copy Jobs)" (P.255)	-
"Accounting Type" (P.255)	<ul style="list-style-type: none"> • "Accounting Disabled" (P.255) • "Local Accounting" (P.255) • "Network Accounting" (P.255) • "ColorTrack" (P.256) • "Auditron Mode" (P.256) • "Verify User Details" (P.256) • "Customize User Prompts" (P.256)
"Accounting Login Screen Settings" (P.256)	<ul style="list-style-type: none"> • "Alternative Name for User ID" (P.256) • "Mask User ID (***)" (P.256) • "Alternative Name for Account ID" (P.257) • "Mask Account ID (***)" (P.257) • "Display Billing Information Upon Login" (P.257) • "Store User Details" (P.257)
"Fax Billing Data" (P.257)	-
"Accounting / Billing Device Settings" (P.258)	<ul style="list-style-type: none"> • "Connect with Account / Billing Device" (P.258) • "Accounting / Billing Device" (P.258) • "Track Print Jobs" (P.258) • "Track Scan / Fax Jobs" (P.258) • "Interrupt Mode" (P.258) • "Job with Insufficient Credit" (P.259) • "Charge Print Jobs" (P.259) • "Track with Cumulative Device" (P.259) • "Scan Ahead for Copy Job" (P.259)

Authentication / Security Settings

"System Administrator Settings" (P.260)	<ul style="list-style-type: none"> • "System Administrator's Login ID" (P.260) • "System Administrator's Passcode" (P.260)
"Authentication" (P.261)	<ul style="list-style-type: none"> • "Login Type" (P.261) • "Access Control" (P.261) • "Create / View User Accounts" (P.263) • "Reset User Accounts" (P.263) • "Create Authorization Groups" (P.263) • "User Details Setup" (P.264) • "Maximum Login Attempts by System Administrator" (P.266) • "Passcode Policy" (P.266) • "Charge / Private Print Settings" (P.266) • "Receive Control" (P.267)
"Allow User to Disable Active Settings" (P.269)	-

"Job Status Default" (P.269)	<ul style="list-style-type: none">• "Active Jobs View" (P.269)• "Completed Jobs View" (P.269)
"Overwrite Hard Disk" (P.269)	<ul style="list-style-type: none">• "Number of Overwrites" (P.270)

Common Service Settings

In [Common Service Settings], you can make settings relating to the machine's common features. The following shows the reference section for each item.

Machine Clock / Timers	124
Power Saver Settings.....	127
Audio Tones	127
Screen / Button Settings	129
Paper Tray Settings	131
Image Quality Adjustment	136
Reports.....	137
Maintenance.....	139
Watermark	140
Force Annotation	141
Print Universal Unique ID.....	143
Notify Job Completion by E-mail	143
Other Settings	144

- 1 On the [Tools] screen, select [System Settings] > [Common Service Settings].
For information on how to display the [Tools] screen, refer to "System Settings Procedure" (P.106).
- 2 Select an item to set or change.

Machine Clock / Timers

You can set the machine clock or the time intervals of the machine to reset settings.

Date

Set the date in the system clock of the machine. The date set here will be printed on all lists and reports.

- 1 Select [Date], and then select [Change Settings].
- 2 Select a date format.
- 3 Specify [Year], [Month], and [Day].
- 4 Select [Save].

Time

Set the time in the system clock of the machine, using 12-hour or 24-hour format. The time set here will be printed on all lists and reports.

- 1 Select [Time], and then select [Change Settings].

- 2 Select the time format.
- 3 When you select [12 Hour Clock], set [AM] or [PM].
- 4 Specify [Hours] and [Minutes].
- 5 Select [Save].

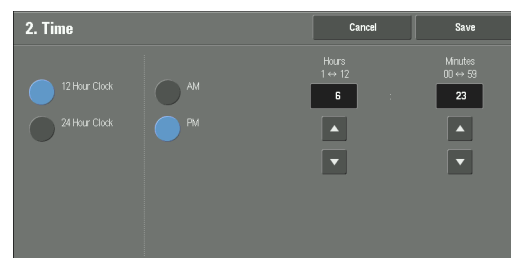

NTP Time Synchronization

You can synchronize the machine clock with a time server (NTP: Network Time Protocol), receiving time information from the server.

To connect to a time server, select [On] for [NTP Time Synchronization], and set the IP address of the time server in [Time Server Address].

Connection Interval

Select the time interval to connect to the time server.

You can select from 1 to 500 hours in 1 hour increments.

Time Server Address

Set the server name or IP address of the time server.

- Note**
- For IPv4, enter the IP address in xxx.xxx.xxx.xxx format, where "xxx" is a value between 0 and 255.
 - For IPv6, enter the IP address in xxxx:xxxx:xxxx:xxxx:xxxx:xxxx:xxxx:xxxx format, where "xxxx" is a hexadecimal number.

Auto Clear

Specify the time lapsed without any operation until the machine resets the settings automatically.

When you select [On], specify a value between 10 and 900 seconds in 1 second increments. To disable this feature, select [Off].

- Note**
- When [Off] is selected, the machine will cancel the standby status and begin processing a document after one minute has elapsed in anticipation of a job command.
 - The timer does not start counting until the operator leaves the detectable area of the wakeup motion sensor.

Auto Job Release

Specify the time lapsed until the machine cancels the active job and starts the next job if an error such as document or paper jams and running out of paper occurs during copying or scanning. In that case, only those jobs not affected by the error can be processed.

When you select [On], specify a value in 1 minute increments. To disable this feature, select [Off].

Auto Print

Set the time period to start the next print job after the operation of the control panel (except for the <Start> and <Clear All> buttons) after the end time of the Printer Lockout Duration passed.

When you select [On], specify a value between 1 and 240 seconds in 1 second increments. When you select [Off], printing starts immediately after the machine is ready.

Printer Lockout

You can set the machine to disable printing during the specified time period or to temporarily disable printing.

Selecting [On] allows you to set [Set Lockout Duration] and/or [Allow User to Lock Out]. When [Allow User to Lock Out] is selected, the [Lock Out Printer] button needs to be displayed on the right side of the [Home] screen.

For information on how to display the [Lock Out Printer] button on the [Home] screen, refer to "Customizing the Button Layout" (P.27).

Set Lockout Duration

Set the time period to disable printing. Specify the start and end time to disable printing in 1 minute increments.

Allow User to Lock Out

Selecting [Lock Out Printer] on the [Home] screen temporarily disables printing. [Release Printer] is displayed during the printer lockout duration. Selecting [Release Printer] enables printing.

- Note**
- A job started before the start time will be printed continuously even after elapsing the start time. The job will be printed continuously even if you select [Lock Out Printer] while printing. After the job is completed, the machine enters the printer lockout status.
 - When both [Set Lockout Duration] and [Allow User to Lock Out] are set and the start time comes while the [Release Printer] button is displayed, the machine automatically enters the printer lockout status.
 - When you select [Release Printer] during the printer lockout duration, printing is enabled, and when you then select [Lock Out Printer], the machine resumes the printer lockout status.
 - The printer lockout status is not released automatically even after the end time elapsed. To release the printer lockout status, the control panel operation is required.
 - The printer lockout duration will not be released even when you switch the power off and then on again, or even when you press the <Power Saver> button while the machine is in the Power Saver mode (Low Power mode or Sleep mode).
 - The machine starts printing in accordance with the setting in [Auto Print] when [Release Printer] is selected. Thus the printing may not start just after [Release Printer] is selected.
 - You can also print during the printer lockout duration by selecting a job in [Active Jobs] on the [Job Status] screen and then selecting [Promote Job].
 - When the [Allow User to Lock Out] check box is deselected, [Disable Auto Printing] in [Home - Additional Features] is displayed as [(Not Assigned)].

Time Zone

Set the time difference from GMT between -12 and +12 hours.

- Note**
- GMT stands for Greenwich Mean Time.

Daylight Savings

You can set daylight saving time. During daylight saving time period, the machine moves the clock forward by one hour.

Select from [Adjust Off], [Adjust by Day, Month & Time], or [Adjust by Month, Week, Day of Week & Time].

If you select [Adjust by Day, Month & Time], specify the month, day, and time for [Start Date] and [End Date].

If you select [Adjust by Month, Week, Day of Week & Time], specify the month, week, day of week, and time for [Start Date] and [End Date].

Print-On-Demand Duration

Specify the duration for the machine to receive a print job from web applications. Unless the machine receives full data of the print job within the specified period of time, the machine does not process the print job.

Specify the time duration between 0 and 255 minutes in 1 minute increments. If you specify [0], it means that there is no time limit set on the machine for receiving data.

- Note**
- When you send a print job that contains a large amount of data or a print job whose contents take a while to be processed, transmission may be timed out before the machine receives the last page of the print job. If transmission is timed out, the print job will be canceled. Therefore, you should consider the machine usage when you set the time duration.

Power Saver Settings

You can configure the following settings of the Power Saver mode.

Power Saver Timers

The Power Saver mode has two modes: the Low Power and Sleep modes. When a specified period of time has elapsed, the machine switches to these modes in the following order to reduce power consumption.

Last operation on the machine → Low Power mode → Sleep mode

For more information on the setting procedure, refer to "Power Saver Mode" (P.21).

- Note**
- You cannot configure the machine not to switch to the Low Power mode or the Sleep mode.

From Last Operation to Low Power Mode

Specify a time period between 1 and 120 minutes in 1 minute increments to enter the Low Power mode after the last operation.

- Note**
- The timer does not start counting until the operator leaves the detectable area of the wakeup motion sensor. The Access Lamp will be lit while the machine detects human presence.

From Last Operation to Sleep Mode

Specify a time period between 1 to 120 minutes in 1 minute increments to enter the Sleep mode after the last operation.

- Note**
- Configure the [From Last Operation to Sleep Mode] time to be longer than the [From Last Operation to Low Power Mode] time.
 - The timer does not start counting until the operator leaves the detectable area of the wakeup motion sensor. The Access Lamp will be lit while the machine detects human presence.

Power Saver Deactivation

Select whether to disable the Power Saver mode fully or partially when exiting the mode.

Deactivate All

All devices of the machine exit the Power Saver mode.

Deactivate Partially As Required

Only the devices necessary for the operation exit the Power Saver mode.

You can select from [Always On] or [When Printing / Job Auto Processing].

- Note**
- This is not effective when [EtherTalk Compatible - Port Status] is set to [Enabled]. For more information on the port setting, refer to "Port Settings" (P.168).

Deactivate With wakeup motion sensor

Set whether or not to allow the wakeup motion sensor to deactivate the Power Saver mode.

Audio Tones

Select whether to sound an alarm when a job ends or a fault occurs.

Control Panel Select Tone

Set the volume to be sounded when a button displayed on the screen is correctly selected. You can select from [Soft], [Normal], or [Loud]. To disable the sound, select [Off].

Control Panel Alert Tone

Set the volume to be sounded when a button that cannot be selected is selected, or an error occurs.

You can select from [Soft], [Normal], or [Loud]. To disable the sound, select [Off].

Base Tone

Set the volume for the base tone of the toggle button, which changes setting each time it is pressed. The machine plays this sound when it exits the Interrupt mode.

You can select from [Soft], [Normal], or [Loud]. To disable the sound, select [Off].

Machine Ready Tone

Set the volume to be sounded when the machine is ready to copy or print, or powered on.

You can select from [Soft], [Normal], or [Loud]. To disable the sound, select [Off].

Job Complete Tone 1, 2

Set the volume to be sounded when a job is completed normally.

You can select from [Soft], [Normal], or [Loud]. To disable the sound, select [Off].

You can select the target jobs to play the sound.

Fault Tone

Set the volume to be sounded when a job fails.

You can select from [Soft], [Normal], or [Loud]. To disable the sound, select [Off].

You can select the target jobs to play the sound.

Auto Clear Alert Tone

Set the volume to be sounded at five seconds before automatically returning to the initial screen when [Auto Clear] is set to [On].

You can select from [Soft], [Normal], or [Loud]. To disable the sound, select [Off].

For more information, refer to "Auto Clear" (P.125).

Alert Tone

Set the volume to be sounded when a fault such as a paper jam occurs, and the job remains in failure state.

You can select from [Soft], [Normal], or [Loud]. To disable the sound, select [Off].

Out of Paper Warning Tone

Set the volume to be sounded when a job is suspended because there is no paper in a tray.

You can select from [Soft], [Normal], or [Loud]. To disable the sound, select [Off].

Low Toner Alert Tone

Set the volume to be sounded when the toner cartridge needs replacing.

You can select from [Soft], [Normal], or [Loud]. To disable the sound, select [Off].

Stored Programming Tone

Set the volume to be sounded while a stored program is being registered.

You can select from [Soft], [Normal], or [Off].

This tone cannot be disabled.

Stored Programming Complete Tone

Set the volume to be sounded when the call of a stored programming registered is completed.

You can select from [Soft], [Normal], or [Loud]. To disable the sound, select [Off].

Line Monitor Volume

You can relay the sound on the telephone line until the connection is made through the speakers on the machine. This is convenient for Fax Information Services without using the telephone receiver.

You can select a volume level from [Soft], [Normal], or [Loud]. To disable the sound, select [Off].

Ringing Volume

Set the volume to be sounded when the machine receives a fax.

You can select from [Soft], [Normal], or [Loud]. To disable the sound, select [Off].

Screen / Button Settings

Set screens and buttons.

Screen Default

Set the screen displayed after powering on the machine or canceling the Power Saver mode.

For more information on the setting procedure, refer to "Customizing the Control Panel" (P.25).

Screen After Auto Clear

Set the screen displayed after Auto Clear.

For more information on the setting procedure, refer to "Setting the Screen After Auto Clear" (P.26).

Auto Display of Login Screen

When the Authentication feature is enabled on the machine, set whether or not to automatically display the login screen after turning on the machine or canceling the Power Saver mode.

Custom Buttons 1 to 3

You can assign services such as Copy and Send from Folder to the custom buttons on the control panel: Custom Button 1 to Custom Button 3.

To leave a feature unassigned, select [(Not Set)].

Note • Copy service is assigned to [Custom Button 1] and Review is assigned to [Custom Button 3] by factory default.

For more information, refer to "Assigning Services to the Custom Buttons" (P.31).

One-touch Buttons

Set the number of address numbers that are assigned to the one touch buttons.

Type 1

Assigns the one touch buttons 1 to 70 to the address numbers 0001 to 0070, and buttons M01 and M02 to the stored programming jobs 1 and 2.

Type 2

Assigns the one touch buttons 1 to 60 to the address numbers 0001 to 0060, and buttons 61 to 72, and M01 and M02 to the stored programming jobs 1 and 12.

Note • [Type 1] is selected by factory default.

Home

Set the layout of service buttons that appear on the [Home] screen.

For more information on how to set the buttons, refer to "Customizing the Button Layout" (P.27).

Home - Additional Features

Set the layout of additional feature buttons that appear on the [Home] screen.

Note • If you do not want to display [Setup] as an additional feature button, select the [Show this in Admin mode] check box. You can set or change settings with the machine only when it is in the System Administration mode.

For more information on how to set the buttons, refer to "Customizing the Button Layout" (P.27).

Job Type on Job Status screen

Select the job types to be shown on the [Completed Jobs] screen under the [Job Status] screen that is displayed when the <Job Status> button on the control panel is pressed.

Select from [All Jobs], [Printer & Print from Folder Jobs], [Scan, Fax, & Internet Fax Jobs], or [Job Flow & File Transfer Jobs].

Default Language

You can select the language displayed on the machine.

There are two ways of selecting the language: set in the System Administration mode and set by local users.

- Setting in the System Administration mode

The language set here is the standard language that is retained even when the machine is powered off and on.

- Setting by in the Local User mode

The language setting in [Language] in the [Home] screen is lost when the machine is powered off.

Note • When [English] is selected, only ASCII characters can be used.
• When you set [Language] to [English] on the [Home] screen and an address book entry or contents of [Details] of Job Flow Sheets is entered in other than ASCII characters, the characters may not be displayed properly. When you use Dell Printer Configuration Web Tool to import a CSV file* that includes the characters other than those used for the language selected in [Language], the characters in the file may be garbled or the import may fail.

* : CSV (Comma Separated Values) is a file format that is often used for saving data by spreadsheets and database programs.

Screen Brightness

You can adjust the screen brightness of the control panel between -16 and +16.

Reconfirm E-mail Recipient

Select whether or not to display the screen to confirm e-mail recipients when sending e-mails.

Select from [Confirmation Not Required], [Always Reconfirm Recipient], or [Reconfirm If Multiple Recipients].

Reconfirm Fax / Internet Fax Recipient

Set whether or not to display a screen to confirm fax/Internet fax recipients when sending faxes / Internet faxes.

First Tab - Reconfirm Recipients

Select from [Off], [Always Reconfirm Recipient], and [Reconfirm If Multiple Recipients].

Start Job at Other Tabs

Select from [Disabled] and [Enabled].

Note • When you select [Disabled], you cannot confirm the e-mail recipients in other tabs.

Reconfirm Recipient at Other Tabs

Select from [Off], [Always Reconfirm Recipient], and [Reconfirm If Multiple Recipients].

Note • This item is not displayed when you select [Disabled] for [Start Job at Other Tabs].
• [Off] cannot be selected when you select [Reconfirm If Multiple Recipients] for [First Tab - Reconfirm Recipients]. And [Off] and [Reconfirm If Multiple Recipients] cannot be selected when you select [Always Reconfirm Recipient] for [First Tab - Reconfirm Recipients].

Reconfirm E-mail Recipient Button

Set whether or not to display a screen to check available memory when sending e-mails. Select from [Disabled (Show Memory)] and [Enabled].

Reconfirm Fax / Internet Fax Button

Set whether or not to display a screen to check available memory when sending faxes / Internet faxes.

Select from [Disabled (Show Memory)] and [Enabled].

Screen After Inserting USB

Select whether or not to display the screen when the machine detects USB memory device insertion, and also select the screen type at the time.

Select from [Off], [Store to USB], [Media Print - Text], [Media Print - Photos], and [Service Selection Screen].

Note • If you select [Service Selection Screen], the [USB Device Detected] screen is displayed when a USB memory device is inserted. You can select [Store to USB], [Media Print - Text], or [Media Print - Photos].
• If a USB memory device is inserted when the machine is switched off, and then you switch on, the [Home] screen is displayed.
• When a USB memory device is inserted into the USB memory slot during the Power Saver mode, the touch screen does not light up. After exiting the Power Saver mode by pressing the <Power Saver> button, insert the USB memory device again or select the feature to be used on the [Home] screen.
• If a commercially available Memory Card Reader is used and it is left inserted all the time, the screen is not switched to the selected screen even when a medium is inserted into the slot of the Memory Card Reader.

Paper Tray Settings

You can name the Custom Paper Type 1-5, which can be specified for [Paper Type], and the Custom Paper Color 1-5, which can be specified for [Paper Color] under [Paper Tray Attributes].

Custom Paper Name / Color

You can name Custom Paper Types 1 to 5 which you can select in [Paper Type] and Custom Paper Colors 1 to 5 which you can select in [Paper Color] of [Paper Tray Attributes].

You can use letters, numerals, and symbols of up to 24 characters for each name and color.

For example, you can use a name showing its usage, such as "Color" for colored paper, and "Covers" for bond paper.

For information about how to enter characters, refer to "Entering Text" (P.34).

Paper Tray Attributes

You can set the size and type of paper loaded in trays.

For more information, refer to "Changing the Paper Settings" (P.54).

Change Settings

Select this button, if you change the paper size for the tray or the setting of auto paper selection.

When you load non-standard size paper in a tray, select [Custom Size], and specify the width and length. When you load standard size paper in a tray, select [Auto Detect].

Note • Align the paper guides against the paper to prevent paper jams or errors. If the machine cannot detect a tray, use Tray 5.

- Paper Type

Select the type of paper to load in the trays.

For information about paper types available on the machine, refer to "Loadable Quantity and Weight" (P.36).

- Paper Size

When using Trays 1 to 4, you can load both standard size paper and non-standard size paper. When you load non-standard size paper, select [Custom Size], and then set the size in the X (width) direction and in the Y (length) direction. For Tray 1, set the size in X (width) direction between 182 and 432 mm and the Y (length) direction between 140 and 297 mm in 1 mm increments. For Trays 2 to 4, set the X (width) direction between 182 to 457 mm and the Y (length) direction between 140 to 320 mm in 1 mm increments. When you load standard size paper, select [Auto Detect].

For Tray 6 (optional HCF B1), select [Auto Detect] because only standard size paper can be loaded.

- Paper Color

Set the color of paper. The paper color selected here is displayed as the paper color on the [Paper Supply] screen.

- Auto Paper Select

Set the condition for Auto Paper selection. When the color mode selected is used, Auto Paper selection is enabled. Select from [All Colors], [Color], and [Black & White].

Automatic tray selection means that a tray containing the appropriate paper is automatically selected by the machine for copying or printing.

Customize Paper Supply Screen

Select whether the setting items specified in [Paper Size] or [Auto Paper Select] under [Paper Tray Attributes] are to be displayed on the [Paper Supply] screen.

Disabled

Does not display the items specified in [Paper Size].

Size Detection

Displays the setting in [Paper Size].

Usage (Auto Paper Select)

Displays the setting in [Auto Paper Select].

Paper Tray Attributes on Setup Screen

Select whether or not to display [Paper Tray Attributes] in the [Setup] screen or not.

This setting allows you to select the size and type of paper without entering the System Administration mode.

Paper Tray Attributes During Loading

Select whether or not to display the [Paper Tray Attributes] screen after the tray is pulled out or inserted in.

This setting applies to Trays 1 to 4, 6 (optional). You cannot set this setting to Tray 5.

Paper Tray Priority

Set the priority of the trays to use when paper of the same size and the same orientation is set in the multiple trays or print data does not include the paper tray information.

Auto Paper selection means that a tray containing the appropriate paper is automatically selected by the machine for copying or printing.

This setting applies to Trays 1 to 4, 6 (optional). You cannot set this setting to Tray 5.

Note • When a logical printer is used and if you specify the paper tray with the print driver, this setting will be ignored.

Paper Type Priority

Set the priority of the trays to use when paper of the same size and the same orientation is set in the multiple trays.

Auto Paper selection means that a tray containing the appropriate paper is automatically selected by the machine for copying or printing.

You can set Bond paper, Plain paper, Recycled paper, Plain Reload paper, Heavyweight (HW) paper, Gloss paper, Heavyweight (HW) A paper, Heavyweight (HW) B paper, Heavyweight (HW) C paper, Heavyweight (HW) S paper, and Custom Paper 1 to 5.

The paper type setting is prioritized over the paper tray priority settings.

If, however, different paper types appear in the same priority sequence, the paper is determined by paper tray priority sequence. The tray containing paper type set to [Auto Paper Off] is not selected by automatic tray selection.

For more information about the tray priority sequence, refer to "Paper Tray Priority" (P.133).

Tray 5 - Paper Size Defaults

Select the paper sizes displayed in the [Tray 5] screen in [Paper Supply] when copying with Tray 5.

You can assign the paper size selected here to the buttons for [Standard Size] in the [Tray 5] screen.

If you frequently use non-standard size paper for copying, assigning the paper sizes to the buttons will save your time to specify the size each time. For your convenience, set the commonly used paper sizes in the upper level.

A/B Series Size

You can select from sizes of A and B series.

Inch Size

You can select from sizes of inch series.

Others

You can select from other sizes.

Custom Size

You can enter any size. Set the X width between 98 and 483 mm, and the Y length between 89 and 320 mm in 1 mm increments.

Note • For envelopes, enter the size with the flap size excluded.

Auto Tray Switching Control

Set the alternative tray or paper when running out of paper loaded in the tray selected.

Auto Tray Switching

You can select from [Always Enable], [Enable during Auto Select], or [Enable for Same Paper Type / Color].

When [Enable during Auto Select] is selected, the machine switches the tray when [Auto Select] is selected in the [Copy] screen or [Paper Select] of the print driver.

Note • The machine does not switch the tray automatically in the following cases:

- Tray 5 is selected.
- The tray containing paper that is set as [Auto Paper Off] in [Paper Type Priority] is selected.

Targeted Paper Type (Copy Jobs)

You can select paper types.

When [According to Priority Assigned] is selected, the paper type is determined according to the settings in [Paper Type Priority]. When selecting [Selected Paper Type Only], you can specify the paper type.

Targeted Paper Color (Copy Jobs)

You can target all paper colors or only one paper color.

Image Quality

You can specify the image quality processing method for each of bond paper, plain paper, recycled paper, plain reload paper, heavyweight paper, heavyweight reload paper, extra heavyweight paper, extra heavyweight reload paper, and custom paper 1 to 5.

When copying or printing a document, the machine controls the image quality according to the type of paper set in [Image Quality] and the image quality processing method specified for that type of paper.

The following table shows available settings.

For information about paper characteristics and notes, refer to "Loadable Quantity and Weight" (P.36).

Setting values	Meaning
Plain A (80-105 gsm)	Default setting for bond paper. The image quality is suitable for color printing. Paper having ream weight of 80 - 105 gsm.
Plain B (60-79 gsm)	Paper having ream weight of 60 - 79 gsm.
Plain C (60-79 gsm)	Default setting for recycled paper. The image quality is suitable for the recycled paper that contains 70% or more recycled pulp. Paper having ream weight of 60 - 79 gsm.
Plain D (60-79 gsm)	Normally, do not select this value.

Setting values	Meaning
Plain E (60-79 gsm)	Default setting for plain paper (North American model). This image quality is suitable for general office use. Paper having ream weight of 60 - 79 gsm.
Plain F (60-79 gsm)	Default setting for plain paper (European model). This image quality is suitable for general office use. Paper having ream weight of 60 - 79 gsm.
Plain G (80-105 gsm)	Normally, do not select this value.
Plain S (60-105 gsm)	This is for custom settings.
Heavyweight (HW) A (106-169 gsm)	Default setting for heavyweight 1 paper. The image quality is suitable for the bond paper and eco-friendly paper that is made of 100% of farmed trees. Paper having ream weight of 106 - 169 gsm.
Heavyweight (HW) B (106-169 gsm)	This is for custom settings.
Heavyweight (HW) C (106-169 gsm)	This is for custom settings.
Heavyweight (HW) S (106-169 gsm)	Normally, do not select this value.
Heavyweight A Reload (106-169 gsm)	Default setting for Heavyweight Reload paper. The image quality is suitable for side 2 of the Heavyweight A paper.
Heavyweight B Reload (106-169 gsm)	The image quality is suitable for side 2 of the Heavyweight B paper.
Heavyweight C Reload (106-169 gsm)	The image quality is suitable for side 2 of the Heavyweight C paper.
Heavyweight S Reload (106-169 gsm)	Normally, do not select this value.
Extra Heavyweight (X-HW) A (170-256 gsm)	Default setting for Extra Heavyweight paper. The image quality is suitable for the bond paper, eco-friendly paper which is made of 100% of farmed trees, postcards, and envelopes. Paper having ream weight of 170 - 256 gsm.
Extra Heavyweight (X-HW) B (170-256 gsm)	This is for custom settings.
Extra Heavyweight (X-HW) C (170-256 gsm)	This is for custom settings.
Extra Heavyweight (X-HW) D (170-256 gsm)	This is for custom settings.
Extra Heavyweight (X-HW) S (170-256 gsm)	Normally, do not select this value.
Extra Heavyweight (X-HW) A Reload (170-256 gsm)	Default setting for Extra Heavyweight Reload paper. The image quality is suitable for side 2 of the Extra Heavyweight A paper.
Extra Heavyweight (X-HW) B Reload (170-256 gsm)	The image quality is suitable for side 2 of the Extra Heavyweight B paper.
Extra Heavyweight (X-HW) C Reload (170-256 gsm)	The image quality is suitable for side 2 of the Extra Heavyweight C paper.
Extra Heavyweight (X-HW) D Reload (170-256 gsm)	The image quality is suitable for side 2 of the Extra Heavyweight D paper.
Extra Heavyweight (X-HW) S Reload (170-256 gsm)	Normally, do not select this value.

Image Quality Adjustment

You can set the image quality and calibration settings.

Image Quality

You can select the image quality processing method when the machine scans a document.

Photo & Text Recognition

Allows you to change a level with which the machine determines a document as text or photos. This setting is used when you select [Photo & Text] for [Original Type] on the [Image Quality] screen.

Selecting [More Text] enables the machine to easily recognize very fine print as text.

Selecting [More Photo] enables the machine to easily recognize halftone images from newspapers and advertisements as photos.

Output Color Recognition

Allows you to change a level from the five levels with which the machine determines a document as monochrome or color. This setting is used when you select [Auto Detect] for [Output Color] on the [Copy] screen.

Selecting [More Black & White] enables the machine to easily recognize monochrome documents.

Selecting [More Color] enables the machine to easily recognize color documents.

Photo Reproduction Level

When copying with [Original Type] in the [Image Quality] screen set to [Photo & Text], you can adjust the color reproduction level in the areas determined by the machine as photos.

Selecting [More Text] yields a bold copy effect, emphasizing the dense parts of an image.

Selecting [More Photo] softens the image gradation of the photo aspects of an image, enhancing the reproducibility of subtle colors.

Photo Image Quality

[Photo Image Quality] is valid when [Photo] is selected for [Original Type] on the [Image Quality] screen.

Selecting [High Speed] copies a document without reducing the processing speed. Selecting [High Quality] creates a near-quality reproduction of the document.

Note • Selecting [High Quality] may reduce the copy speed.

Background Suppression (Color Copy)

Set the method of background suppression to be used when making color copies.

Background suppression is the function to detect the density of colors and suppress the scan of background colors when a document has background colors on colored paper.

Select [High Speed] to sample a section of the document and detect the background color.

Select [High Quality] to conduct a pre-scan, and sample the whole document to detect the background color.

Note • When you select [High Quality], and [Corner Shift] is selected in [Image Shift] with a ratio of 60% or less is specified in [Reduce / Enlarge], a part of the image may not be printed or blank paper may be output.

Background Suppression (Black Copy)

Set the method of background suppression to be used when making monochrome copies.

Background suppression is the function to detect the density of colors and suppress the scan of background colors when a document has background colors on colored paper.

Select [High Speed] to sample a section of the document and detect the background color.

Select [High Quality] to conduct a pre-scan, and sample the whole document to detect the background color.

Note • When you select [High Quality], and [Corner Shift] is selected in [Image Shift] with a ratio of 60% or less is specified in [Reduce / Enlarge], a part of the image may not be printed or blank paper may be output.

Background Suppression (Scan Jobs)

Set the method of background suppression to be used for scan operations.

Set how the machine detects density and deletes the background color.

Select [High Speed] to sample a section of the document and detect the background color.

Select [High Quality] to conduct a pre-scan, and sample the whole document to detect the background color.

Image Enhancement

Allows you to select whether to carry out image enhancement. If you select [On], the machine gives the image a smoother appearance when printed.

Calibration

Calibrate the machine regularly to correct and ensure consistency of printing colors over time, environment and devices.

For more information, refer to "Executing Calibration" (P.75).

When the printed colors do not seem to have been corrected properly despite regular calibration, contact Customer Support at dell.com/contactdell.

Screen Type

Select from [Copy Job 1], [Copy Job 2], [Print Job 1], and [Print Job 2].

For more information about screen type, refer to "Executing Calibration" (P.75).

Paper Supply

Select a paper tray.

Target

Select from [Copy & Print Jobs], [Copy Jobs Only], [Print Jobs Only], and [None].

Reports

You can configure settings related to printing reports.

Print Reports Button

Set the display method of [Print Reports] under the [Machine Information] screen and [Error History Report] under the [Faults] screen displayed by pressing the <Machine Status> button.

If you select [Disabled], the [Print Reports] button under [Machine Status] > [Machine Information] and the [Error History Report] button under [Faults] are displayed only in the System Administration mode.

For information on Print Reports, refer to "Print Reports" (P.86).

For information on Error History Report, refer to "Faults" (P.99).

Job History Report

Select whether or not to automatically print a Job History Report when a total of 50 jobs have been processed. All jobs are automatically listed on the printed report.

For information on how to print a Job History Report manually, refer to "Print Reports" (P.86).

Activity Report

Select whether or not to automatically print an Activity Report when a total of 100 communication results have been accumulated.

For information on an Activity Report, refer to "Activity Report" (P.602).

For information on how to print an Activity Report manually, refer to "Job Status / Activity Report" (P.87).

Transmission Report - Job Undelivered

Select whether or not to automatically print a Transmission Report - Job Undelivered.

Transmission Report - Job Deleted

Select whether or not to automatically print a Transmission Report - Job Deleted for a cancelled document.

Folder Report

Select whether or not to automatically print a Folder Report.

Broadcast / Multi-Poll Report

Select whether or not to automatically print a Broadcast Report and a Multi-Poll Report.

Scan File Transfer Report

Select whether or not to print the report for data transmission results when the scanned data is transferred to the computer on the network or is sent via e-mail.

Off

Does not print a report regardless of the data transmission result.

On

Automatically prints a Transmission Report when data is sent successfully and a Transmission Report - Job Undelivered when data transmission failed.

Print when delivery fails

Prints a Transmission Report - Job Undelivered when the data transmission failed.

2 Sided Report

Select whether or not to print a report on one side of the paper or both sides when printing a report/list.

Activity Report - Recipient

Select how the information on recipients is shown when printing an Activity Report: the first 40 characters or the last 40 characters.

Job Flow Error Report

Select whether or not to automatically print a Job Flow Error Report.

Maintenance

You can initialize or delete data from the hard disk of the machine.

Initialize Hard Disk

Initializes the hard disk.

Note • The secure print documents and logs are not erased.

Data deleted by initialization includes supplementary fonts and ESC/P forms.

Delete All Data

This feature is designed to prevent the leakage of confidential information of a customer when the machine is returned to Dell. By executing [Start], all data registered on the machine is deleted.

Note • It takes several minutes to several hours to delete all data. (The time taken depends on the machine configuration or the hard disk capacity.)

Software Options

This feature is for service representative use. For more information, contact Customer Support at dell.com/contactdell.

Power on Self Test

Set whether or not to perform self test when the machine is turned on and started up.

If any abnormal condition such as intentional program modification is found during the program diagnosis, the machine stops starting up and records the information in the audit log.

Note • The information may not be recorded in the audit log depending on the status of program malfunction.
• If the machine does not start, contact Customer Support at dell.com/contactdell.

Check Smart Card Details

When you select [Check Smart Card Details] and touch your smart card to the smart card reader, the information of the smart card appears on the touch screen.

Note • You can register the authentication information using Dell Printer Configuration Web Tool.

Finisher Adjustment

This feature is displayed only when the Finisher-B1 (optional), the Booklet Maker Unit for Finisher-B1 (optional), or the Hole Punch Unit (optional) is installed.

Hole Punch Tool

Specify either 2/4 Hole Punch or 2/3 Hole Punch (US Specification).

Adjust Punch Position / Booklet Fold Position

Set the punch position and booklet fold position for paper smaller than B4 or larger than or equal to B4.

Adjust Image Transfer

You can specify the transfer output value for each paper type. This is useful when the toner image does not transfer to the paper properly.

For more information, refer to "Adjust Image Transfer" (P.523).

Adjust Paper Registration

Allows you to adjust the print image position vertically and horizontally. Enter values from -2.0 to +2.0, and select [Adjust].

When you enter the [Number of Sheets] value and select [Sample Printout], the machine prints a sample with the image position adjusted.

Delete All Certificates / Initialize Settings

Deletes all certificates stored in the machine and initializes the security settings associated with certificates. This feature is designed to use when you cannot use a certificate data in the machine because of an abnormality of certificate file even when the certificate is set to enabled for [SSL / TLS Settings] under [Connectivity & Network Setup] > [Security Settings].

Quick Setup Home

Starts the installation wizard for the machine.

You can configure the Screen/Button Setup, the Network Setup, and the Fax Setup.

For more information on the setting items, refer to "Screen / Button Settings" (P.129), "Connectivity & Network Setup" (P.168), and "Fax Service Settings" (P.204).

Watermark

You can print watermark text or pattern as the background of the main document to protect the document from unauthorized copying.

The following Watermark settings can be specified.

Date Format

Specify the format of the date to print as watermark. The format specified here will also be used for Annotation and Force Annotation.

The following three formats are available: "YYYY/MM/DD", "MM/DD/YYYY", and "DD/MM/YYYY".

Default Watermark

Specify the text to print as watermark.

You can select the text from [Copy Prohibited], [Copy], [Duplicate], and the text specified for Custom Watermark 1 to 3.

For more information about custom text, refer to "Custom Watermark 1 to 3" (P.141).

Font Size

Specify the font size of watermark.

You can set the font size from 24 to 80 points in 1 point increments.

Background Pattern

Specify the background pattern to print as watermark.

The following eight patterns are available: [Wave], [Circle], [Stripe], [Chain], [Beam], [Rhombic], [Sunflower], and [Fan].

Font Color

Specify the color of watermark.

You can select from [Black], [Magenta], and [Cyan].

- Note**
- The Watermark will be printed in black on faxes regardless of this setting.

Density

Specify the density of watermark.

You can select from [Lighten], [Normal], and [Darken].

Watermark / Background Contrast

Specify the contrast level of watermark text and pattern.

You can select a level from 1 to 9. To print samples, select [Print this Sample List].

Force Watermark - Copy

Specify whether to force printing watermark on every copied document. When [On] is selected, the [Watermark] setting on the [Output Format] screen will be fixed to [On] and unchangeable. The user ID, the machine ID, and the date and time will be printed as watermark.

- Note**
- You can authorize a user to temporarily cancel the Force Watermark settings. For more information, refer to "User Roles and Authorization Groups" (P.346).

Force Watermark - Client Print

Specify whether to force printing watermark on every document printed from a computer. To apply the Watermark settings of the machine, select [Allow Device Settings to Override]. To apply the settings specified from an application such as TrustMarkingBasic (sold separately) or a print server, select [Allow Client Settings to Override]. When [Allow Device Settings to Override] is selected, the user ID, the machine ID, and the date and time will be printed as watermark.

Force Watermark - Print Stored File

Specify whether to force printing watermark on every document printed from a folder on the machine. The user ID, the machine ID, and the date and time will be printed as watermark.

- Note**
- You can authorize a user to temporarily cancel the Force Watermark settings. For more information, refer to "User Roles and Authorization Groups" (P.346).

Force Watermark - Media Print

Specify whether to force printing watermark on a Media Print job.

The user ID, the machine ID, and the date and time will be printed as watermark.

- Note**
- You can authorize a user to temporarily cancel the Force Watermark settings. For more information, refer to "User Roles and Authorization Groups" (P.346).

Custom Watermark 1 to 3

You can register 3 custom watermarks of up to 32 single-byte characters. The registered custom watermarks will be specifiable for [Default Watermark].

For information about how to enter characters, refer to "Entering Text" (P.34).

Print this Sample List

Prints samples of watermarks with different background contrasts, which is useful for selecting the contrast level for [Watermark / Background Contrast].

Force Annotation

The string such as a user name and a date (Annotation) is forcibly printed out according to the layout template associated with each job type.

- Note**
- When a watermark or Universal Unique ID is to be printed on the copies, it may overlap the text printed by the Force Annotation feature.

The layout templates, Preset 1 to Preset 4, are provided with the machine. The printed items with the templates as follows:

- Preset 1 and Preset 2

The string registered on [Create Text String 1] is printed faintly at an angle in the center of paper.

The following items are printed at the bottom right for Preset 1 or bottom left for Preset 2 of paper.

- first line: file name and the IP address of the computer that send a print job
- second line: user name, user ID, card ID, and date and time

- Preset 3 and Preset 4

The string registered on [Create Text String 1] is printed faintly at an angle in the center of paper.

The following items are printed at the bottom right for Preset 3 or bottom left for Preset 4 of paper.

- user ID and date and time

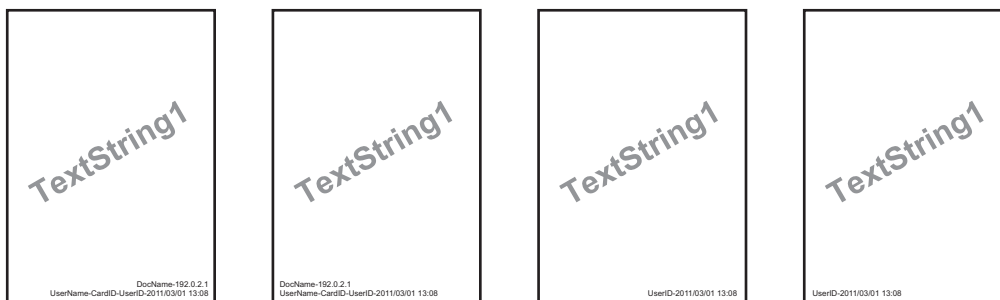

- Note**
- Some items may not be printed depending on the job type and performance conditions.
 - Force annotation is not printed on a blank paper generated by the machine.
 - When the Force Annotation is enabled, you cannot select [Auto Detect] for [Tray 5].
 - A time printed faintly using the Force Annotation feature may differ from the time the print job is submitted depending on the status and settings of the machine and the contents of the print job. In this case, the print job start time is printed as a watermark.

For information about how to enter characters, refer to "Entering Text" (P.34).

Apply Layout Template to Copy/Print Jobs

Set the association with layout templates. You can associate layout templates with the following types of jobs.

- Copy
- Client Print
- Print Stored File
- Media Print
- Print Fax
- Print E-mail
- Report

- Note**
- You can associate a layout template with Client Print when a print job is sent from a computer.
 - You can associate a layout template with Print Stored File when printing a file in a folder.

Delete Layout Template

Deletes a layout template.

- Note**
- The provided layout templates, Preset 1 to Preset 4, cannot be deleted.

Create Text String

Register text strings for the Force Annotation feature. You can register up to eight types of strings in [Create Text String 1] to [Create Text String 8]. You can enter up to 64 single-byte characters.

- Note**
- The available text for the provided layout templates, Preset 1 to Preset 4, is the text strings registered in [Create Text String 1].

Print Universal Unique ID

You can print Universal Unique IDs (UUIDs) for each print job to identify each job.

- Note**
- You can authorize a user to temporarily cancel force watermark printing. For more information, refer to "User Roles and Authorization Groups" (P.346).
 - If a layout template is specified in [Apply Layout Template to Copy/Print Jobs] under [Force Annotation], UUIDs are overlapped with the text on the layout template.

For details on Force Annotation, refer to "Force Annotation" (P.141).

Print Universal Unique ID

Select whether or not to print Universal Unique IDs.

- Note**
- If [Print Universal Unique ID] is set to [Yes], you cannot select [Auto Detect] for [Tray 5].

Print Position

Select a print position from six positions: [Top Left], [Bottom Left], [Top Center], [Bottom Center], [Top Right], or [Bottom Right].

Print Position Adjustment

Adjust print positions vertically and horizontally from 0 to 100 mm and from 0 to 200 mm respectively, in 0.5 mm increments.

- Note**
- 0 mm is at the edge of paper. Increasing the value moves the print position toward the center of the paper. However, for [Top Center] or [Bottom Center], the horizontal value for the center of paper is set to 100 mm. Therefore, when you select [Top Center] or [Bottom Center], set the value to 100 mm and then specify desired value.

Print Position (Side 2)

Select the position to print the UUID on Side 2 from [Same as Side 1] or [Mirror Side 1] when making 2 sided copies.

Notify Job Completion by E-mail

You can receive the results of jobs performed by an e-mail notification.

Targeted Jobs

Select the service whose job result you want to receive by an e-mail notification. When the target job is already selected, [Selected] is displayed.

You can select more than one target job from [Copy], [Fax], [Scan], [Print], or [Report].

Select the notification timing from [Notify at the End of Job] or [Notify when Error Only].

E-mail Addresses 1 to 5

Specify the e-mail addresses to notify the result of the jobs.

- Note**
- When you select [Save] to exit this screen without specifying an e-mail address, the setting of [Targeted Jobs] or [E-mail Message] is deleted.

E-mail Message

Enter a comment attached to the e-mail.

Plug-in Settings

When you use custom services, you can set whether to enable embedded plug-ins and display the list of the plug-ins.

Embedded Plug-ins

Set whether to enable embedded plug-ins.

List of Embedded Plug-ins

Displays the names and status of the embedded plug-ins.

Other Settings

You can configure other settings related to the machine.

Offset Stacking (Center Tray)

Offsetting means that each set of copies is delivered to the center tray and shifted slightly to separate it from the previous job. When a set of copies is delivered to the front of the tray, the next set is delivered to the rear of the tray. Set the offset function for the Center Tray. Select from [No Offset], [Offset per Set], and [Offset per Job]. When [Offset per Set] or [Offset per Job] is selected, the machine slightly shifts the output position per set or per job (print job) respectively.

Offset Stacking (Center Tray - Upper)

Offsetting means that each set of copies is delivered to the center tray and shifted slightly to separate it from the previous job. When a set of copies is delivered to the front of the tray, the next set is delivered to the rear of the tray. Set the offset function for the Center Tray - Upper. Select from [No Offset], [Offset per Set], and [Offset per Job]. When [Offset per Set] or [Offset per Job] is selected, the machine slightly shifts the output position per set or per job (print job) respectively.

Offset Stacking (Center Tray - Lower)

Offsetting means that each set of copies is delivered to the center tray and shifted slightly to separate it from the previous job. When a set of copies is delivered to the front of the tray, the next set is delivered to the rear of the tray. Set the offset function for the Center Tray - Lower. Select from [No Offset], [Offset per Set], and [Offset per Job]. When [Offset per Set] or [Offset per Job] is selected, the machine slightly shifts the output position per set or per job (print job) respectively.

Offset Stacking (Right Middle Tray)

Offsetting means that each set of copies is delivered to the center tray and shifted slightly to separate it from the previous job. When a set of copies is delivered to the front of the tray, the next set is delivered to the rear of the tray. Set the offset function for the Right Middle Tray. Select from [No Offset], [Offset per Set], and [Offset per Job]. When [Offset per Set] or [Offset per Job] is selected, the machine slightly shifts the output position per set or per job (print job) respectively.

- Note**
- An optional component is required to use this feature. For more information, contact Customer Support at dell.com/contactdell.

Booklet Offset

When [Offset Stacking (Center Tray)] or [Offset Stacking (Right Middle Tray)] is set to [Offset per Set], the paper is output to the tray by being slightly displaced by set. If, however, [Fold & Staple] is selected for booklet settings, the paper is not output by set.

- Note**
- An optional component is required to use this feature. For more information, contact Customer Support at dell.com/contactdell.

Auto Job Promotion

You can select whether or not to allow another job to automatically bypass the current job when the machine is unable to start an operation for any reason, (for example, running out of paper in a tray when starting copying or printing).

- Note**
- Stored documents such as Secure Print and Sample Set documents cannot be used with the Auto Job Promotion feature.
 - When [Enabled] is selected and there is a job bypassed because of paper out, a message stating the reason of the job promotion appears. The job bypassed can be processed after you take proper measures by following the instruction of the message. Or, you can cancel the job by pressing the <Clear All> button. When multiple jobs are bypassed, a screen that lists the bypassed jobs appears. This screen allows you to display the details screen and to delete the jobs.

Default Print Paper Size

You can set the most commonly-used paper size, A4 or 8.5 x 11", to print reports and/or lists.

Odd Page 2 Sided



























You can specify whether or not to add a blank page when a document containing an odd number of pages is printed in 2-sided.



















Paper Size Settings



You can specify the size of paper to be automatically detected when you use standard sizes of a document or the machine is set to detect sizes of a document.

You can select from the following tables: [A/B Series (8 x 13")], [A/B Series], [A/B Series (8K / 16K)], [A/B Series (8 x 13" / 8 x 14")], and [Inch Series].

Refer to the following tables for a combination of sizes that can be detected automatically.



























Paper size group	AB series (8 × 13")						AB series					
	Document glass	Document feeder	Tray 1	Trays 2 to 4	Tray 5	Tray 6 (HCF B1)	Document glass	Document feeder	Tray 1	Trays 2 to 4	Tray 5	Tray 6 (HCF B1)
A6 	O	X	X	X	X	X	O	X	X	X	X	X
A5 	O	O	O	O	O	X	O	O	O	O	O	X
A5 	O	X	X	X	X	X	O	O	X	X	O	X
A4 	O	O	O	O	X	X	O	O	O	O	O	X
A4 	O	O	O	O	X	O	O	O	O	O	O	O
A3 	O	O	O	O	X	X	O	O	O	O	O	X
B6 	O	X	X	X	O	X	O	X	X	X	X	X
B6 	X	X	X	X	X	X	X	X	X	X	O	X
B5 	O	X	O	O	O	X	O	O	O	O	O	X
B5 	O	O	X	X	X	X	O	O	O	O	O	O
B4 	O	O	O	O	X	X	O	O	O	O	O	X
5.5 × 8.5" 	X	X	X	X	X	X	X	X	X	X	X	X
5.5 × 8.5" 	O	O	X	X	O	X	X	X	X	X	X	X
7.25 × 10.5" 	X	O	O	O	X	O	X	X	X	X	X	X
8 × 10" 	X	X	X	X	X	X	X	X	X	X	X	X
8 × 10" 	X	X	X	X	X	X	X	X	X	X	X	X
8.5 × 11" 	O	O	O	O	O	X	X	O	O	O	X	X
8.5 × 11" 	O	O	O	O	O	O	X	O	O	O	X	O
8.5 × 13" 	X	O	O	O	O	X	X	X	O	O	X	X
8.5 × 14" 	X	X	O	O	O	X	X	X	O	O	X	X
11 × 17" 	O	O	O	O	O	X	X	O	O	O	X	X
12 × 18" 	X	X	X	X	X	X	X	X	X	X	X	X
SRA3 	X	X	X	O	X	X	X	X	X	O	X	X
16 K  (Taiwan)	X	X	X	X	X	X	X	X	X	X	X	X
16 K  (Taiwan)	X	X	X	X	X	X	X	O	O	O	X	X
8 K  (Taiwan)	X	X	X	X	X	X	X	O	O	O	X	X



















Paper size group	AB series (8 × 13")						AB series					
	Document glass	Document feeder	Tray 1	Trays 2 to 4	Tray 5	Tray 6 (HCF B1)	Document glass	Document feeder	Tray 1	Trays 2 to 4	Tray 5	Tray 6 (HCF B1)
16 K  (mainland China)	X	X	X	X	X	X	X	X	X	X	X	X
16 K  (mainland China)	X	X	X	X	X	X	X	O	O	O	X	X
8 K  (mainland China)	X	X	X	X	X	X	X	O	O	O	X	X
Postcard 	X	X	X	X	X	X	X	X	X	X	O	X
Envelope (120 x 235 mm) 	X	X	X	X	X	X	X	X	X	X	O	X
Envelope (90 x 205 mm) 	X	X	X	X	X	X	X	X	X	X	O	X
Envelope (240 x 332 mm) 	X	X	X	X	X	X	X	X	X	X	O	X
Envelope (162 x 229 mm) 	X	X	X	X	X	X	X	X	X	X	O	X
Envelope (229 x 324 mm) 	X	X	X	X	X	X	X	X	X	X	O	X
Envelope (235 x 120 mm) 	X	X	X	X	X	X	X	X	X	X	O	X
Envelope (114 x 162 mm) 	X	X	X	X	X	X	X	X	X	X	O	X
Envelope (98 x 148 mm) 	X	X	X	X	X	X	X	X	X	X	O	X
Envelope (105 x 235 mm) 	X	X	X	X	X	X	X	X	X	X	O	X
Commercial #10 envelopes 	X	X	X	X	O	X	X	X	X	X	X	X
Monarch 7.3/4 envelopes 	X	X	X	X	X	X	X	X	X	X	X	X
DL envelopes 	X	X	X	X	X	X	X	X	X	X	X	X
C4 envelopes 	X	X	X	X	X	X	X	X	X	X	X	X
C5 envelopes 	X	X	X	X	X	X	X	X	X	X	X	X
Postcard (4 × 6") 	X	X	X	X	X	X	X	X	X	X	X	X



Paper size group	AB series (8 × 13")						AB series					
	Document glass	Document feeder	Tray 1	Trays 2 to 4	Tray 5	Tray 6 (HCF B1)	Document glass	Document feeder	Tray 1	Trays 2 to 4	Tray 5	Tray 6 (HCF B1)
Photograph 2L (5 × 7") 	X	X	X	X	X	X	X	X	X	X	X	X
Postcard (6 × 9") 	X	X	X	X	X	X	X	X	X	X	X	X

O :Available

X :Not available



























Paper size group	AB series (8 K / 16 K)						AB series (8 × 13" / 8 × 14")					
	Document glass	Document feeder	Tray 1	Trays 2 to 4	Tray 5	Tray 6 (HCF B1)	Document glass	Document feeder	Tray 1	Trays 2 to 4	Tray 5	Tray 6 (HCF B1)
A6 	O	X	X	X	X	X	O	X	X	X	X	X
A5 	O	O	O	O	O	X	O	O	O	O	O	X
A5 	O	O	X	X	O	X	O	X	X	X	X	X
A4 	O	O	O	O	O	X	O	O	O	O	X	X
A4 	O	O	O	O	O	O	O	O	O	O	X	O
A3 	O	O	O	O	O	X	O	O	O	O	X	X
B6 	O	X	X	X	X	X	O	X	X	X	O	X
B6 	X	X	X	X	O	X	X	X	X	X	X	X
B5 	O	O	O	O	O	X	O	X	O	O	O	X
B5 	O	O	O	O	O	O	O	O	X	X	X	X
B4 	O	O	O	O	O	X	O	O	O	O	X	X
5.5 × 8.5" 	X	X	X	X	X	X	X	X	X	X	X	X
5.5 × 8.5" 	X	X	X	X	X	X	O	O	X	X	O	X
7.25 × 10.5" 	X	X	X	X	X	X	X	O	O	O	X	O
8 × 10" 	X	X	X	X	X	X	X	X	X	X	X	X
8 × 10" 	X	X	X	X	X	X	X	X	X	X	X	X
8.5 × 11" 	X	O	O	O	X	X	O	O	O	O	O	X
8.5 × 11" 	O	O	O	O	X	O	O	O	O	O	O	O
8.5 × 13" 	X	X	O	O	X	X	X	O	O	O	O	X
8.5 × 14" 	X	X	O	O	X	X	X	X	O	O	O	X
11 × 17" 	O	O	O	O	X	X	O	O	O	O	O	X
12 × 18" 	X	X	X	X	X	X	X	X	X	X	X	X
SRA3 	X	X	X	O	X	X	X	X	X	O	X	X
16 K 	O	X	X	X	X	X	X	X	X	X	X	X
16 K 	O	O	O	O	X	X	X	X	X	X	X	X
8 K 	O	O	O	O	X	X	X	X	X	X	X	X





















Paper size group	AB series (8 K / 16 K)						AB series (8 × 13" / 8 × 14")					
	Document glass	Document feeder	Tray 1	Trays 2 to 4	Tray 5	Tray 6 (HCF B1)	Document glass	Document feeder	Tray 1	Trays 2 to 4	Tray 5	Tray 6 (HCF B1)
16 K  (mainland China)	O	X	X	X	X	X	X	X	X	X	X	X
16 K  (mainland China)	O	O	O	O	X	X	X	X	X	X	X	X
8 K  (mainland China)	O	O	O	O	X	X	X	X	X	X	X	X
Postcard 	X	X	X	X	O	X	X	X	X	X	X	X
Envelope (120 x 235 mm) 	X	X	X	X	O	X	X	X	X	X	X	X
Envelope (90 x 205 mm) 	X	X	X	X	O	X	X	X	X	X	X	X
Envelope (240 x 332 mm) 	X	X	X	X	O	X	X	X	X	X	X	X
Envelope (162 x 229 mm) 	X	X	X	X	O	X	X	X	X	X	X	X
Envelope (229 x 324 mm) 	X	X	X	X	O	X	X	X	X	X	X	X
Envelope (235 x 120 mm) 	X	X	X	X	O	X	X	X	X	X	X	X
Envelope (114 x 162 mm) 	X	X	X	X	O	X	X	X	X	X	X	X
Envelope (98 x 148 mm) 	X	X	X	X	O	X	X	X	X	X	X	X
Envelope (105 x 235 mm) 	X	X	X	X	O	X	X	X	X	X	X	X
Commercial #10 envelopes 	X	X	X	X	X	X	X	X	X	X	O	X
Monarch 7.3/4 envelopes 	X	X	X	X	X	X	X	X	X	X	X	X
DL envelopes 	X	X	X	X	X	X	X	X	X	X	X	X
C4 envelopes 	X	X	X	X	X	X	X	X	X	X	X	X
C5 envelopes 	X	X	X	X	X	X	X	X	X	X	X	X
Postcard (4 × 6") 	X	X	X	X	X	X	X	X	X	X	X	X

Paper size group	AB series (8 K / 16 K)						AB series (8 × 13" / 8 × 14")					
	Document glass	Document feeder	Tray 1	Trays 2 to 4	Tray 5	Tray 6 (HCF B1)	Document glass	Document feeder	Tray 1	Trays 2 to 4	Tray 5	Tray 6 (HCF B1)
Photo 2L (5 × 7") 	X	X	X	X	X	X	X	X	X	X	X	X
Postcard (6 × 9") 	X	X	X	X	X	X	X	X	X	X	X	X

O :Available

X :Not available

Paper size group	Inch series					
	Document glass	Document feeder	Tray 1	Trays 2 to 4	Tray 5	Tray 6 (HCF B1)
Loading Position						
Size / Orientation						
A6 	O	X	X	X	X	X
A5 	O	X	X	X	X	X
A5 	O	X	X	X	X	X
A4 	O	O	O	O	X	X
A4 	O	O	O	O	X	X
A3 	O	O	O	O	X	X
B6 	O	X	X	X	X	X
B6 	X	X	X	X	X	X
B5 	O	X	O	O	X	X
B5 	O	O	X	X	X	X
B4 	O	O	O	O	X	X
5.5 × 8.5" 	X	O	O	O	X	X
5.5 × 8.5" 	O	O	X	X	O	X
7.25 × 10.5" 	X	O	O	O	X	O
8 × 10" 	X	X	X	X	X	X
8 × 10" 	X	X	X	X	X	X
8.5 × 11" 	O	O	O	O	O	X
8.5 × 11" 	O	O	O	O	O	O
8.5 × 13" 	X	X	O	O	O	X
8.5 × 14" 	X	O	O	O	O	X
11 × 17" 	O	O	O	O	O	X
12 × 18" 	X	X	X	O	X	X
SRA3 	X	X	X	X	X	X
16 K  (Taiwan)	X	X	X	X	X	X
16 K  (Taiwan)	X	X	X	X	X	X
8 K  (Taiwan)	X	X	X	X	X	X

Paper size group	Inch series					
	Document glass	Document feeder	Tray 1	Trays 2 to 4	Tray 5	Tray 6 (HCF B1)
16 K  (mainland China)	X	X	X	X	X	X
16 K  (mainland China)	X	X	X	X	X	X
8 K  (mainland China)	X	X	X	X	X	X
Postcard 	X	X	X	X	X	X
Envelope (120 x 235 mm) 	X	X	X	X	X	X
Envelope (90 x 205 mm) 	X	X	X	X	X	X
Envelope (240 x 332 mm) 	X	X	X	X	X	X
Envelope (162 x 229 mm) 	X	X	X	X	X	X
Envelope (229 x 324 mm) 	X	X	X	X	X	X
Envelope (235 x 120 mm) 	X	X	X	X	X	X
Envelope (114 x 162 mm) 	X	X	X	X	X	X
Envelope (98 x 148 mm) 	X	X	X	X	X	X
Envelope (105 x 235 mm) 	X	X	X	X	X	X
Commercial #10 envelopes 	X	X	X	X	O	X
Monarch 7.3/4 envelopes 	X	X	X	X	O	X
DL envelopes 	X	X	X	X	O	X
C4 envelopes 	X	X	X	X	O	X
C5 envelopes 	X	X	X	X	O	X
Postcard (4 × 6") 	X	X	X	X	O	X
Photo 2L (5 × 7") 	X	X	X	X	O	X

2 Select [On].



3 Select [New Encryption Key], and enter an encryption key of 1 to 12 single-byte characters, and then select [Save].

4 Select [Re-enter Encryption Key].

5 Enter the same encryption key, and then select [Save].

6 Select [Save].

Data Restoration

The encrypted data cannot be restored in the following cases:

- When a problem occurs with the hard disk.
- When you have forgotten the encryption key.
- When you have forgotten the system administrator's user ID and a passcode when [On] is selected in [Service Rep. Restricted Operation].

Starting the Data Encryption and Changing Settings

When you change the Data Encryption setting or the encryption key, you must restart the machine. When the machine reboots, the machine initializes part of the disk area. The previous data is not secured.

The disk area stores the following data.

- Spooled print data
- Print data including Secure Print and Sample Set
- Forms for the Form Overlay feature
- Folder and job flow sheet settings (folder name, passcode, etc.)
- Files in folders
- Address book data

- Note**
- Be sure to save all necessary settings and files before using data encryption or changing any settings.
 - Make sure that the hard disk and encryption settings match. Otherwise, an error will occur. For information on error messages and their remedies, refer to "Other Errors" (P.494).
 - The following procedure is recommended for changing the encryption settings while a large amount of data (100 jobs or more) is stored in a folder, and [Number of Overwrites] is set to [1 Overwrite] or [3 Overwrites] under [Overwrite Hard Disk].
 1. Select [Tools] > [Setup] > [Create Folder] to display the [Create Folder] screen.
 2. Select the folder, then select [Delete Folder].
 3. Select [Close].
 4. Press the <Machine Status> button, and confirm that [Standby] in [Overwrite Hard Disk] is displayed.
 5. Enter the System Administration mode, and change the data encryption settings. For information on how to enter the System Administration mode, refer to "System Settings Procedure" (P.106).
 - Our service representative cannot restore the encryption key.
 - When our service representative replaces the electrical circuit board, the encryption key is initialized. Do not lose the encrypted information.

Encryption Key for Confidential Data

Allows you to set an encryption key to encrypt confidential information such as the passcode of the system administrator and a folder. Encrypting confidential information prevents a network hacking and an unauthorized access to the information.

Enter an encryption key of 4 to 12 single-byte characters using alphanumeric characters.

- Note**
- If you change the existing encryption key, you may not restore confidential information from a backup.
 - The factory default encryption key is "admin".

- 1 Select [Encryption Key for Confidential Data], and then [Change Settings].
- 2 Select [New Encryption Key], and enter an encryption key of 4 to 12 digits, and then select [Save].
- 3 Select [Re-enter Encryption Key].
- 4 Enter the same encryption key, and then select [Save].
- 5 Select [Save] to display a confirmation screen. Select [Yes] on the screen to save the setting.

Service Rep. Restricted Operation

Allows you to select whether or not to restrict the operation by our service representative to protect the security settings from being altered by someone impersonating our service representative.

Off

The operation by our service representative is not restricted.

On

Our service representative cannot change the following settings:

- "Delete All Data" (P.139)
- "Print Universal Unique ID" (P.143)
- "Data Encryption" (P.154)
- "Encryption Key for Confidential Data" (P.156)
- "Service Rep. Restricted Operation" (P.156)
- "SSL/TLS Settings" (P.184)
- "S/MIME Settings" (P.185)
- "IPSec Settings" (P.186)
- "System Administrator Settings" (P.260)
- "Maximum Login Attempts by System Administrator" (P.266)
- "Overwrite Hard Disk" (P.269)
- Creating/Changing Users with System Administrator Rights
- Changing SNMP v3 Setting

When [On] is set, you can set a maintenance passcode of 4 to 12 digits in the [Maintenance Passcode] screen.

Entering the passcode is required when our service representative performs maintenance.

- Note**
- When [On] is set, note the followings:
 - If you lose the System Administrator's user ID and passcode, the items restricted to the service representative cannot be changed.

- If you lose the passcode, our service representative cannot perform maintenance in the case when an error occurs in the machine.

- To change the restricted items or perform maintenance, the electric circuit board of the machine must be replaced.

You will be charged for the electrical circuit board and handling cost.

Be sure not to lose the System Administrator's user ID and passcode.

For information on the system administrator permissions, refer to "User Roles" (P.347).

Software Download

You can select whether or not to permit software downloading. This feature is for service representative use. For more information, contact Customer Support at dell.com/contactdell.

Drum Cartridge Conservation Mode

Specifies the operation when [Auto Detect] is selected for [Output Color]. Select either [On] or [Off].

If the machine is set to automatically switch the type of a document (color/monochrome), select [On], If not, select [Off]. Selecting [Off] outputs in color.

Restrict Recipient Selection Method

Allows you to select whether or not to restrict a fax/Internet fax or an e-mail transmissions to addresses not registered on the Address Book.

Selecting [Only From Address Book] disables address entry using the keyboard or numeric keypad, and permits only transmission to addresses registered on the Address Book.

- Note**
- You can also give users authority to deactivate [Restrict Recipient Selection Method]. For more information, refer to "User Roles and Authorization Groups" (P.346).

Restrict User to Edit Address Book

Specify whether or not to permit Local Users to add and edit recipients in the Address Book.

When you select [Yes], Local Users cannot add or edit the Address Book.

- Note**
- You can also give users authority to deactivate [Restrict User to Edit Address Book]. For more information, refer to "User Roles and Authorization Groups" (P.346).

Auto Validation of Speed Dial Entry

Allows you to select whether the machine automatically validate the number when you use speed dial. When you select [Validate entry after a fixed time], you can select the time to auto-validation from [Shorter], [Default], or [Longer].

- Note**
- An optional component is required to use this feature.

Data Indicator

Allows you to set the lighting pattern of the <Data> indicator.

Pattern 1

Lights up when a document is stored in the hard disk of the machine.

Pattern 2

Lights up when a fax document is in a print queue or a fax received with the Store Fax - Local Folder feature is stored in the folder.

Pattern 3

Lights up for 30 seconds after a job in the print queue is printed.

Copy Service Settings

In [Copy Service Settings], you can configure settings related to the Copy feature. The following shows the reference section for each procedure.

Copy Tab - Features Allocation	158
Preset Buttons	159
Copy Defaults	159
Copy Control.....	164
Original Size Defaults.....	166
Reduce / Enlarge Presets.....	167
Custom Colors	167
Annotations - Create Comments.....	167

- 1 On the [Tools] screen, select [System Settings] > [Copy Service Settings].
For the method of displaying the [Tools] screen, refer to "System Settings Procedure" (P.106).
- 2 Select an item to set or change.

Copy Tab - Features Allocation

You can customize the features displayed on the [Copy] screen. Setting the most frequently used features enables you to avoid extra operations such as selecting tabs.

- 1 Select the number of features displayed on the [Copy] screen.

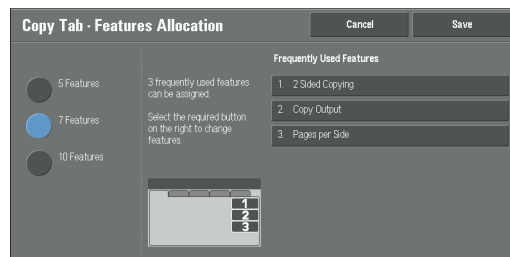

5 Features

The following features are shown on the screen: [Output Color], [Reduce / Enlarge], [Paper Supply], [2 Sided Copying], and [Copy Output]. Features and positions displayed cannot be changed.

7 Features

Allows you to set features appearing in the fourth column from the left of the [Copy] screen.

Note • [Output Color], [Reduce / Enlarge] and [Paper Supply] cannot be specified.

10 Features

Allows you to set features appearing in the third and fourth columns from the left of the [Copy] screen.

Note • [Output Color], [Reduce / Enlarge] and [Paper Supply] cannot be specified.

- 2 From [Frequently Used Features] on the right of the screen, select a button and the position of the button where you want to allocate a feature.

Note • The position of each button on the right side corresponds to the position on the [Copy] screen.

3 Select a feature to display, and select [Save].

Note • Select [▲] to display the previous screen or [▼] to display the next screen.

4 Repeat steps 2 and 3 as required, and then select [Save].

Preset Buttons

Paper Supply - Button 2 - 5

You can select the paper tray displayed in the second to fifth buttons in [Paper Supply] on the [Copy] screen.

Reduce/Enlarge - Button 3 - 4

You can select the magnification ratio displayed in the third and fourth buttons in [Reduce / Enlarge] on the [Copy] screen.

Select the ratio from the Reduce/Enlarge Preset buttons registered.

Front Cover Tray - Button 1 - 3

Set the default value of the tray displayed in [Paper Supply] when an option that printed on Front Cover is selected for [Front Cover] under [Output Format] > [Covers].

Back Cover Tray - Button 1 - 3

Set the default value of the tray displayed in [Paper Supply] when an option that printed on Back Cover is selected for [Back Cover] under [Output Format] > [Covers].

Transparency Tray - Button 1 - 3

Set the default value of the transparency tray displayed in [Transparency Options] on the [Output Format] screen.

Separator & Handout Tray - Button 1 - 3

Set the default value of the separator & handout tray displayed in [Transparency Options] on the [Output Format] screen.

Copy Defaults

You can set the default settings of the Copy feature. When the machine is turned on, or the machine exits the Power Saver mode, or when the <Clear All> button is pressed, the machine resets to the default values set here. Setting frequently used features and values as the defaults can avoid extra operations required during the use of the machine.

For more information on each setting item, refer to "3 Copy" in the User Guide.

Paper Supply

Set the default value for [Paper Supply] in the [Copy] screen.

When the default value of [Reduce / Enlarge] is set to [Auto %], [Auto Select] cannot be selected for [Paper Supply].

Reduce / Enlarge

Set the default value for [Reduce / Enlarge] in the [Copy] screen.

Select the ratio from [100%], [Auto %], and the buttons registered as Reduce/Enlarge Preset buttons.

When the default value of [Paper Supply] is set to [Auto Select], [Auto %] cannot be selected for [Reduce / Enlarge].

For information on the Reduce/Enlarge Preset buttons, refer to "Reduce / Enlarge Presets" (P.167).

Output Color

Set the default value for [Output Color] in the [Copy] screen.

When [No Default] is selected, select the output color in the [Copy] screen before making copies.

Output Color (Simple Copy)

Set the default value for [Output Color] in the [Simple Copy] screen. You can select from [Auto Detect], [Color], and [Black & White].

Single Color

Set the default value for [Single Color] in [More] of [Output Color] in the [Copy] screen. You can select from six preset colors and six custom colors.

For information about custom colors, refer to "Custom Colors" (P.167).

Dual Color - Source Color

Set the default value for [Source Color] that appears when [Dual Color] is selected for [More] of [Output Color] in the [Copy] screen.

Selecting [Color] enables you to select from six colors.

Dual Color - Target Area Color

Set the default value for [Target Area Color] that appears when [Dual Color] is selected for [More] of [Output Color] in the [Copy] screen. You can select from seven preset colors and six custom colors.

For information about custom colors, refer to "Custom Colors" (P.167).

Dual Color - Non-target Area Color

Set the default value for [Non-target Area Color] that appears when [Dual Color] is selected for [More] of [Output Color] in the [Copy] screen. You can select from seven preset colors and six custom colors.

For information about custom colors, refer to "Custom Colors" (P.167).

Original Type

Set the default value for [Original Type] on the [Image Quality] screen.

Original Type - Auto (Non-Black & White)

Set the default value for [Original Type] on the [Image Quality] screen.

This is valid when a color other than [Black & White] is selected for [Output Color] in the [Copy] screen.

Original Type - Auto (Black & White)

Set the default value for [Original Type] in the [Image Quality] screen.

This is valid when [Black & White] is selected for [Output Color] in the [Copy] screen.

Lighten / Darken

Set the default value for [Lighten / Darken] of [Image Options] in the [Image Quality] screen.

Contrast

Set the default value for [Contrast] of [Image Enhancement] in the [Image Quality] screen.

Sharpness

Set the default value for [Sharpness] of [Image Options] in the [Image Quality] screen.

Saturation

Set the default value for [Saturation] of [Image Options] in the [Image Quality] screen.

Background Suppression

Set the default value for [Suppress Background] of [Image Enhancement] in the [Image Quality] screen.

[Background Suppression] is valid when [Original Type] is set to [Photo & Text], [Text], or [Map].

Color Balance - Yellow / Color Balance - Magenta / Color Balance - Cyan / Color Balance - Black

Set the default density levels for the [Color Balance] in the [Image Quality] screen.

You can set density levels of each color for each of the [Highlights], [Midtones], and [Shadows].

- Note**
- Depending on the density level settings, [Color Balance] in the [Image Quality] screen is set as follows:
 - When the density levels of all colors are set to [0, 0, 0], [Color Balance] in the [Image Quality] screen is set to [Normal].
 - When the same value is set to all levels for each color (for example: [0, 0, 0] or [1, 1, 1]), [Color Balance] in the [Image Quality] screen is set to [Basic Color].
 - When the settings other than the ones described above are applied, [Color Balance] in the [Image Quality] screen is set to [Advanced Color].

Color Shift

Set the default value for [Color Shift] in the [Image Quality] screen.

2 Sided Copying

Set the default value for [2 Sided Copying] in the [Copy] screen, [Layout Adjustment] screen, and [Output Format] screen.

Mixed Size Originals

Set the default value for [Mixed Size Originals] in the [Layout Adjustment] screen.

Edge Erase - Top Edge

Set the default value for the amount of edge erased from the original in the top directions in [Edge Erase] in the [Layout Adjustment] screen. Set the value from 0 to 50 mm in 1 mm increments.

- Note**
- You cannot copy the whole area even if you set [0] to [Edge Erase - Top Edge]. For the printable area, refer to "Printable Area" (P.519).

Edge Erase - Bottom Edge

Set the default value for the amount of edge erased from the original in the bottom directions in [Edge Erase] in the [Layout Adjustment] screen. Set the value from 0 to 50 mm in 1 mm increments.

- Note**
- You cannot copy the whole area even if you set [0] to [Edge Erase - Bottom Edge]. For the printable area, refer to "Printable Area" (P.519).

Edge Erase - Left Edge

Set the default value for the amount of edge erased from the original in the left directions in [Edge Erase] in the [Layout Adjustment] screen. Set the value from 0 to 50 mm in 1 mm increments.

Note • You cannot copy the whole area even if you set [0] to [Edge Erase - Left Edge]. For the printable area, refer to "Printable Area" (P.519).

Edge Erase - Right Edge

Set the default value for the amount of edge erased from the original in the right directions in [Edge Erase] in the [Layout Adjustment] screen. Set the value from 0 to 50 mm in 1 mm increments.

Note • You cannot copy the whole area even if you set [0] to [Edge Erase - Right Edge]. For the printable area, refer to "Printable Area" (P.519).

Center Erase / Binding Edge Erase

Set the default value for [Center] in [Edge Erase] in the [Layout Adjustment] screen. Set the value from 0 to 50 mm in 1 mm increments.

Note • You cannot copy the whole area even if you set [0] to [Center Erase / Binding Edge Erase]. For the printable area, refer to "Printable Area" (P.519).

Edge Erase - 2 Sided Original - Side 2

Set the default value for [2 Sided Original-Side 2] of [Edge Erase] in the [Layout Adjustment] screen.

Image Shift - Side 1

Set the default value for [Side 1] of [Image Shift] in the [Layout Adjustment] screen.

Image Shift - Side 2

Set the default value for [Side 2] of [Image Shift] in the [Layout Adjustment] screen.

Image Rotation

Set the default value for [Image Rotation] in the [Layout Adjustment] screen.

Image Rotation - Rotation Direction

Set the default value for [Image Rotation - Rotation Direction] of [Image Rotation] in the [Layout Adjustment] screen.

Original Orientation

Set the default value for [Original Orientation] in the [Layout Adjustment] screen.

Pages per Side

Set the default value for [Pages per Side] in the [Copy] and [Output Format] screens.

Copy Output

Set the default value for [Copy Output] in the [Copy] and [Output Format] screens.

Note • To use the [Collated] feature, an optional component is required. If the optional component is not installed, the machine behaves as [Uncollated] is selected.

Uncollated - Default Separator Tray

Set the default value for [Separator Tray] under [Copy Output] > [Uncollated with Separators] in the [Copy] and [Output Format] screens.

Output Destination

Set the default value for [Output Destination / Offset] under [Copy Output] in the [Copy] and [Output Format] screens.

- Note**
- An optional component is required to use this feature. For more information, contact Customer Support at dell.com/contactdell.

Output Destination (Simple Copy)

Set the output destination when you start copying from the [Simple Copy] screen.

- Note**
- If paper cannot be output to the tray you set, the destination may be changed automatically.
 - When the [Simple Copy] screen is displayed, you can confirm the output destination on the [Review] screen, which can be displayed by pressing the <Shortcut 2> button. For information on the <Shortcut 2> button, refer to "2 Product Overview" > "Control Panel" in the User Guide.

Sample Job

Set the default value for [Sample Job] in the [Job Assembly] screen.

Annotations - Stored Comment

Set the default value for [Stored Comments] displayed when [Comment] is selected for [Annotations] in the [Output Format] screen.

You can select a comment type from eight preset types and custom text registered.

For information about how to set custom text, refer to "Annotations - Create Comments" (P.167).

Annotations - Comment on Side 1 and Side 2

Set the default value for [Position] displayed when [Comment] is selected for [Annotations] in the [Output Format] screen.

Annotations - Comment - Font Size

Set the default value for [Font Size] under [Format & Style] displayed when [Comment] is selected for [Annotations] in the [Output Format] screen.

Annotations - Comment - Font Color

Set the default value for [Font Color] under [Format & Style] displayed when [Comment] is selected for [Annotations] in the [Output Format] screen.

Date - Position on Side 1 and Side 2

Set the default value for [Position] displayed when [Date] is selected for [Annotations] in the [Output Format] screen.

Date - Font Size

Set the default value for [Font Size] under [Font Size] displayed when [Date] is selected for [Annotations] in the [Output Format] screen.

Page Numbers - Style

Set the default value for [Style] displayed when [Page Numbers] is selected for [Annotations] in the [Output Format] screen.

Page Numbers - Position on Side 1 and Side 2

Set the default value for [Position] displayed when [Page Numbers] is selected for [Annotations] in the [Output Format] screen.

Page Numbers - Font Size

Set the default value for [Font Size] under [Font Size] displayed when [Page Numbers] is selected for [Annotations] in the [Output Format] screen.

Bates Stamp - Number of Digits

Set the default value for [Number of Digits] displayed when [Bates Stamp] is selected for [Annotations] in the [Output Format] screen.

Bates Stamp - Position on Side 1 and Side 2

Set the default value for [Position] displayed when [Bates Stamp] is selected for [Annotations] in the [Output Format] screen.

Bates Stamp - Font Size

Set the default value for [Font Size] under [Font Size] displayed when [Bates Stamp] is selected for [Annotations] in the [Output Format] screen.

Booklet Creation - Default Cover Tray

Set the default value for [Covers] which is displayed when you select a Cover page option in the [Booklet Creation] screen.

Covers - Default Front Cover Tray, Default Back Cover Tray

Set the default value for [Front Cover] and [Back Cover] which are displayed when you select a Front Cover and Back Cover option in the [Covers] screen.

Separators - Default Separator Tray

Set the default value for [Segment Separator Tray] under [Segment Separators] which is displayed when you set [Build Job] to [On] in the [Job Assembly] screen.

Copy Control

You can configure settings related to copy operation control.

Memory Full Procedure

If there is insufficient hard disk memory while scanning a document, a screen appears asking you how you want to handle the partially stored data.

Set the process you want the machine to perform for the partially stored data after a certain time has elapsed in the confirmation screen.

You can set the time until the memory full procedure is carried out. For more information, refer to "Auto Job Release" (P.125).

Delete Job

Deletes the data partially stored.

Run Job

Treats the read-in data as valid, and start copying the document partially stored.

Maximum Stored Pages

Set the maximum number of pages stored for a copy document. You can set from 1 to 999 pages.

Auto Paper Off

Select the tray used when [Auto Select] of [Paper Supply] in the [Copy] screen is cancelled. [Auto Select] of [Paper Supply] is cancelled when [Auto %], [Auto X - Y%] for [Independent X - Y%], or [Slight Reduction (Improves Fit)] is selected.

Mixed Size Originals - 2 Sided Copy

Specify paper to copy side 2 of a document: in 2 sided copying, if the size of side 1 and side 2 of a document is different, and the machine detects different paper size for sides 1 and 2.

Note • When the side 1 and side 2 are different sizes and if the side 2 is copied on the sheet on which the side 1 has been printed, a part of the image may be missing.

Copy to new sheet

Side 2 is copied as side 1 on a new sheet of paper.

Copy to Side 2

Side 2 is copied on the reverse side of side 1 without changing paper size.

Fine-tune 100%

You can fine-tune magnification when copying at 100% (actual size). The set value is applied to [100%] in the [Copy] screen is set to 100%.

Set the value in the X/Y direction between 98 and 102% in 0.1% increments.

Note • This feature is applied only when a copy is made using the document glass. This setting is not reflected in the magnification (100%) under [Independent X - Y%] or [Calculator %].
• A magnification displays [100%] even if [Fine-tune 100%] is selected.

ID Card Copy - Reduce / Enlarge

Set the copy magnification ratio when to copy ID cards. Selecting [Allow to Change] allows you to specify the ratio between 25 to 400 % in 1 % increments.

Note • The machine may copy an ID card in a different orientation from the original orientation depending on the magnification ratio you specified.

Background Suppression (Photo & Text)

Set the background suppression level for color copying. This setting is valid when [Photo & Text] is selected for [Original Type] in the [Image Quality] screen.

The larger the value the stronger the effect of removing background noise is.

Background Suppression Level (Text)

Set the background suppression level for color copying. This setting is valid when [Text] is selected for [Original Type] in the [Image Quality] screen.

The larger the value the stronger the effect of removing background noise is.

Photo & Text /Printed Original

Set the type of document when [Printed Original] of [Photo & Text] is selected for [Original Type] in the [Image Quality] screen.

Normal

Copies with standard image quality.

Inkjet Originals

Select [Inkjet Originals] when copying a document printed with an inkjet printer. This improves the recognition of inkjet colors.

Highlighted Originals

Select [Highlighted Originals] when copying an original marked with a highlight pen. This improves the recognition of the colors of highlight pen.

Original Type - See-Through Paper

When [Text] is selected for [Original Type] in the [Image Quality] screen, set whether to display [Text on See-Through Paper].

Annotations - Comment Density

Set the translucency of the comment printed as annotation.

You can select from three translucency values: Darken, Normal, and Lighten. Darken represents no translucency.

Note • If a stamp set to [Darken] density is printed over text, the text may be unreadable.

Comment Position - Top Left, - Top Center, - Top Right, - Left Center, - Center, - Right Center, - Bottom Left, - Bottom Center, and - Bottom Right

You can adjust the position to print a comment finely.

Date Position - Top Left, - Top Center, - Top Right, - Bottom Left, - Bottom Center, and - Bottom Right

You can adjust the position to print a date stamp finely.

Page Number Position - Top Left, - Top Center, - Top Right, - Bottom Left, - Bottom Center, and - Bottom Right

You can adjust the position to print a page number finely.

Bates Stamp - Top Left, - Top Center, - Top Right, - Bottom Left, - Bottom Center, and - Bottom Right

You can adjust the position to print a bates stamp finely.

Quantity Display

You can select how you want to display the counter in the Copy service.

Select from [Quantity], [Quantity and Memory], and [Quantity and Original Count].

Maximum Number of Sets

Set the maximum number of allowed sets to copy between 1 and 999. Users will not be able to specify a larger number of sets to copy than the value set here.

Original Size Defaults

Set the original sizes displayed in [Original Size] in the [Layout Adjustment] screen.

You can assign original sizes to the buttons other than [Auto Detect].

If you frequently make copies of non-standard size document, setting non-standard size as the default can avoid extra operations required during the use of the machine.

A/B Series Size

You can select from A and B series sizes.

Inch Size

You can select from inch series sizes.

Others

You can select from other sizes.

Custom Size

You can enter any size. Set the width (X) from 15 to 432 mm, and the height (Y) from 15 to 297 mm in 1 mm increments.

Reduce / Enlarge Presets

Set the magnifications displayed as [Preset %] which are displayed when [Proportional %] is selected under [Reduce / Enlarge] in the [Copy] screen.

You can assign any magnification to the Reduce/Enlarge Preset buttons other than [100%] and [Auto %].

Custom Colors

Set the custom colors used for [Single Color] and [Dual Color] in the [Output Color] screen.

You can assign custom colors with yellow (0 to 100%), magenta (0 to 100%), and cyan (0 to 100%) to each custom color buttons 1 to 6.

Note • Adjust so that the total of yellow, magenta, and cyan does not exceed 240%.

Annotations - Create Comments

Register text to print with [Comment] under [Annotations]. You can enter up to 64 single-byte characters.

For information about how to enter characters, refer to "Entering Text" (P.34).

Connectivity & Network Setup

In [Connectivity & Network Setup], you can configure settings related to the Connectivity & Network feature.

For information on Connectivity and Network Settings, refer to "Printer Environment Settings" (P.281) or "E-mail Environment Settings" (P.299).

If you use Dell Printer Configuration Web Tool, more detailed settings are possible. For more information, refer to "Dell Printer Configuration Web Tool Settings" (P.273).

The following shows the reference section for each setting.

Port Settings	168
Protocol Settings	173
Machine's E-mail Address / Host Name	176
Proxy Server Settings	177
Outgoing / Incoming E-mail Settings	178
Remote Authentication / Directory Service	179
Security Settings	184
Other Settings	188

- 1 On the [Tools] screen, select [System Settings] > [Connectivity & Network Setup].
For the method of displaying the [Tools] screen, refer to "System Settings Procedure" (P.106).
- 2 Select an item to set or change.

Port Settings

Set the interface of the machine connected to a client. In [Port Settings], you can configure the following settings.

- Note**
- For LPD, Port 9100, and HTTP-SSL/TLS, do not use a number that is the same as a port number of another port.
For a port that uses HTTP (IPP, Internet Service (HTTP), UPnP Discovery, SOAP, WebDAV, and Web Services on Devices (WSD)), do not use a number that is the same as a port number of LPD, Port9100, and HTTP-SSL/TLS.
Furthermore, if any of the above are set to one of the port numbers indicated below, operation may no longer be performed properly depending on the setting conditions of the port:
25, 139, 427, 445, 631, 15000

For information on HTTP-SSL/TLS port, refer to "HTTP - SSL / TLS Port Number" (P.184).

USB

Port Status

Select [Enabled] to use a USB interface.

Print Mode

Select the printer language use on the machine. Selecting [Auto] enables the machine to automatically determine and use the most suitable language to print data received from the host device.

PJL

PJL (Printer Job Language) is a job control language and a PJL command is data prepended to the top of the print jobs. Usually select [Enabled].

Auto Eject Time

Configure the time that the data so far received by the machine will automatically be printed since data is no longer sent to the printer.

You can enter a time between 5 and 1275 seconds in 5 seconds increments.

Adobe Communication Protocol

- Standard

Select this when the output protocol of the print driver is in the ASCII format.

- Binary

Select this when the output protocol of the print driver is in the BCP format.

- TBCP

Select this when the output protocol of the print driver is in the TBCP format.

- RAW

Select this when the output protocol of the print driver is in the ASCII or binary format.

The data is printed without being controlled by the Adobe communication protocol.

PostScript Wait Timeout

The machine automatically terminates a connection when the machine does not receive data for a certain period of time. When data is being printed with [RAW] is selected for [Adobe Communication Protocol], select [Disabled] if you want to use the time period set in [Auto Eject Time] or select [Enabled] if you want to use the timeout period of PostScript.

LPD**Port Status**

Select [Enabled] to use LPD.

Port Number

Enter a port number for LPD from 1 to 65535.

The default value is 515.

Note • Do not use the numbers assigned to the other ports.

Maximum Number of Sessions

Enter the maximum number of client sessions using LPD. You can enter a number from 1 to 10 in 1 session increments.

The default value is 5.

NetWare**Port Status**

Select [Enabled] to use NetWare®.

SMB**Port Status**

Select [Enabled] to use SMB when you use the Scan to PC (SMB) service or share the machine on the network.

IPP

Port Status

Select [Enabled] to use IPP.

Set this when you want to use IPP (Internet Printing Protocol) to print via the Internet.

Added Port Number

Select [Disabled] when you want to set the machine does not accept IPP from other than the standard port number, or select [Enabled] when accepts all port numbers.

Enter a port number for IPP other than the standard port number from 1 to 65535.

The default value is 80.

- Note**
- Do not use a number that is the same as a port number of another port. However, you can use the same port number for a port that uses HTTP (IPP, Internet Services (HTTP), UPnP Discovery, SOAP, WebDAV, and Web Services on Devices (WSD)).
 - [Added Port Number] cannot be configured if [Port Status] is set to [Disabled]. To configure [Added Port Number], enable port status and reboot the machine, and then configure [Added Port Number].

EtherTalk

Port Status

Select [Enabled] to use EtherTalk.

Bonjour

Port Status

Select [Enabled] to use Bonjour.

- Note**
- To print from a printer detected by [Bonjour], the LPD port must be activated in advance.

Port 9100

Port Status

Select [Enabled] to use Port 9100.

Select this option when the communication protocol is in RAW format for Windows[®] Standard TCP/IP port monitor.

Port Number

Enter a port number for Port 9100 from 1 to 65535.

The default value is 9100.

- Note**
- Do not use the numbers assigned to the other ports.

SNMP

Port Status

Select [Enabled] to use SNMP, when you use any web applications to control the machine on the network.

FTP Client

Port Status

Select [Enabled] when you use the Scan to PC service with FTP transmission.

- Note**
- Select a communication mode to send data scanned via FTP from [Passive Mode] and [Active Mode]. [Passive Mode] is selected by factory default. You can change the setting from Dell Printer Configuration Web Tool.

Receive E-mail

Port Status

Select [Enabled] when you receive e-mails or Internet faxes.

Send E-mail

Port Status

Select [Enabled] when you send e-mails or Internet faxes.

E-mail Notification Service

Port Status

Select [Enabled] when you use the E-mail Notification Service. The E-mail Notification Service notifies you of the machine status or the completion of a print job and a direct fax job by e-mail.

- Note**
- [Consumables Status], [Parts Status], [Paper Tray Status], [Output Tray Status], [Jam Status], [Interlock Status], and [Fault Notice] are notified as the machine status.
 - You can configure the E-mail Notification Service in Dell Printer Configuration Web Tool.

UPnP Discovery

Port Status

Select [Enabled] to use UPnP.

Port Number

Enter a port number for UPnP communication from 1 to 65535.

The default value is 80.

- Note**
- Do not use a number that is the same as a port number of another port. However, you can use the same port number for a port that uses HTTP (IPP, Internet Services (HTTP), UPnP Discovery, SOAP, WebDAV, and Web Services on Devices (WSD)).

WSD

- Note**
- WSD stands for Web Services on Devices.

WSD Print - Port Status

Select [Enabled] to use WSD Print.

Set this when you search a device on a network from Windows Vista[®], Windows 7, and Windows 8.

WSD Scan - Port Status

Select [Enabled] to use WSD Scan.

Set this when you search a device on a network from Windows Vista, Windows 7, and Windows 8.

Port Number

Enter a port number from 1 to 65535.

The default value is 80.

- Note**
- Do not use a number that is the same as a port number of another port. However, you can use the same port number for a port that uses HTTP (IPP, Internet Services (HTTP), UPnP Discovery, SOAP, WebDAV, and Web Services on Devices (WSD)).

Internet Services (HTTP)

Port Status

Select [Enabled] to use Dell Printer Configuration Web Tool.

For more information about Dell Printer Configuration Web Tool, refer to "Dell Printer Configuration Web Tool Settings" (P.273).

Port Number

Enter a port number for the Internet Services from 1 to 65535.

The default value is 80.

- Note**
- Do not use a number that is the same as a port number of another port. However, you can use the same port number for a port that uses HTTP (IPP, Internet Services (HTTP), UPnP Discovery, SOAP, WebDAV, and Web Services on Devices (WSD)).
 - You cannot select [Port Number], if HTTP port is disabled.
To configure [Port Number], enable port status and reboot the machine, and then configure [Port Number].

SOAP

Port Status

Select [Enabled] when you use an application program.

Port Number

Enter a port number for SOAP from 1 to 65535.

The default value is 80.

- Note**
- Do not use a number that is the same as a port number of another port. However, you can use the same port number for a port that uses HTTP (IPP, Internet Services (HTTP), UPnP Discovery, SOAP, WebDAV, and Web Services on Devices (WSD)).

WebDAV

Port Status

Select [Enabled] when you use an application program such as Network Scanner Utility 3 to access folders in the machine.

- Note**
- You cannot select [Port Number] and [Operation Time-Out], if WebDAV port is disabled.
To configure [Port Number] and [Operation Time-Out], enable port status and reboot the machine, and then configure [Port Number] and [Operation Time-Out].

Port Number

Enter a port number for WebDAV from 1 to 65535.

The default value is 80.

- Note**
- Do not use a number that is the same as a port number of another port. However, you can use the same port number for a port that uses HTTP (IPP, Internet Services (HTTP), UPnP Discovery, SOAP, WebDAV, and Web Services on Devices (WSD)).

Operation Time-Out

You can enter an operation time-out period between 1 and 65535 seconds in 1 second increments.

ThinPrint

Port Status

You can use the machine for print in the ThinPrint environment. The machine decompresses and prints the compressed print data sent from the server.

Select [Enabled] when you use ThinPrint®.

Port Number

Enter a port number for ThinPrint from 1 to 65535.

The default value is 4000.

- Note**
- Do not use any numbers assigned to the other ports.
 - ThinPrint is available when the communication protocol uses IPv4.
 - The maximum of three connections are possible at a time.

Protocol Settings

Set the parameters required for communications. In [Protocol Settings], you can set the following items.

Ethernet Rated Speed

Set the communication speed for the Ethernet interface.

Auto (Up to 100 Mbps)

Select this to detect the Ethernet transmission rate up to 100 Mbps automatically.

100 Mbps Full-Duplex

Select this to set 100BASE-TX (Full Duplex) as the default value.

100 Mbps Half-Duplex

Select this to set 100BASE-TX (Half Duplex) as the default value.

10 Mbps Full-Duplex

Select this to set 10BASE-T (Full Duplex) as the default value.

10 Mbps Half-Duplex

Select this to set 10BASE-T (Half Duplex) as the default value.

Auto (Up to 1 Gbps)

Select this to detect the Ethernet transmission rate up to 1 Gbps automatically.

1000 Mbps

Select this to set 1000BASE-T as the default value.

TCP/IP - IP Mode

Allows you to select the TCP/IP operation mode.

IPv4 Mode

Select this option for IPv4.

IPv6 Mode

Select this option for IPv6.

Dual Stack

Select this option for an environment using both IPv4 and IPv6.

IPv4 - IP Address Resolution

Allows you to select a method for obtaining the IP address, subnet mask, and gateway address.

DHCP

The address, subnet mask, and gateway address will automatically be set via DHCP.

BOOTP

The address, subnet mask, and gateway address will automatically be set via BOOTP.

RARP

The address, subnet mask, and gateway address will automatically be set via RARP.

DHCP / Autonet

The address, subnet mask, and gateway address will automatically be set via DHCP/Autonet. If the machine fails to communicate with the DHCP server, the AutoIP function is automatically enabled and the machine is assigned an IP address (169.254.xxx.xxx). When communication between the machine and the DHCP server recovers, the machine is re-assigned an IP address, a subnet mask, and a gateway address by the DHCP server.

STATIC

Allows you to manually specify an IP address, a subnet mask, and a gateway address.

Note • To configure a subnet mask and a gateway address, an IP Address must be set first.

IPv4 - IP Address

Enter the IP address using the keyboard displayed or the numeric keypad when selecting [STATIC] at [IPv4 - IP Address Resolution].

Note

- Enter the address in the format "xxx.xxx.xxx.xxx", where "xxx" is a numeric value from 0 to 255.
- Specify an IP address using numbers (0 to 9) and periods (.). If you mistyped a character on the screen, select [Backspace] to delete the character.

IPv4 - Subnet Mask

Enter the subnet mask using the keyboard displayed or the numeric keypad when selecting [STATIC] at [IPv4 - IP Address Resolution].

Note

- Enter the address in the format "xxx.xxx.xxx.xxx", where "xxx" is a numeric value from 0 to 255.
- Specify a subnet mask using numbers (0 to 9) and periods (.). If you mistyped a character on the screen, select [Backspace] to delete the character.

IPv4 - Gateway Address

Enter the gateway address using the keyboard displayed or the numeric keypad when selecting [STATIC] at [IPv4 - IP Address Resolution].

Note

- Enter the address in the format "xxx.xxx.xxx.xxx", where "xxx" is a numeric value from 0 to 255.
- Specify a gateway address using numbers (0 to 9) and periods (.). If you mistyped a character on the screen, select [Backspace] to delete the character.

IPv4 - DNS Server Setup

Set the DNS server.

Get IP Address from DHCP

Set whether or not to automatically obtain the address of the DNS server from the DHCP server.

DNS Server IP Address

When [Get IP Address from DHCP] is set to [Disabled], manually set the DNS server address.

IPv4 - IP Filter

Select whether or not to limit IPv4 addresses that can access the machine.

- Note**
- [IPv4 - IP Filter] applies to all features using TCP/IP, such as Print, and Store to Folder.
 - To set the IPv4 IP addresses that the machine accepts connection from, use [IP Filtering] in Dell Printer Configuration Web Tool. For more information, refer to "Dell Printer Configuration Web Tool Settings" (P.273).
 - When [IP Filtering] is enabled, make sure to switch the FTP transfer mode to [Active Mode] to transfer the scanned image from the machine via FTP. You can switch the FTP transfer mode from Dell Printer Configuration Web Tool.

IPv6 Address Manual Configuration

Allows you to select whether or not to configure the IPv6-address settings manually.

Manually Configured IPv6 Address

This setting is configurable when [IPv6 Address Manual Configuration] is set to [Enabled]. Specify an IPv6 address.

- Note**
- Enter the address in the format "xxxx:xxxx:xxxx:xxxx:xxxx:xxxx:xxxx:xxxx", where "xxxx" is a hexadecimal value.
 - Specify an address using alphanumeric characters (0 to 9, and A to F) and colons (:). If you mistyped a character on the screen, select [Backspace] to delete the character.

Manually Configured IPv6 Address Prefix

This setting is configurable when [Manually Configured IPv6 Address] is set. Specify a prefix length from 0 to 128.

Manually Configured IPv6 Gateway

This setting is configurable when [Manually Configured IPv6 Address] is set. Specify a gateway address.

- Note**
- Enter the address in the format "xxxx:xxxx:xxxx:xxxx:xxxx:xxxx:xxxx:xxxx", where "xxxx" is a hexadecimal value.

IPv6 - DNS Server Setup

Set the DNS server for IPv6.

Get IP Address from DHCP

Set whether or not to automatically obtain the address of the DNS server from the DHCP server.

DNS Server IP Address

When [Get IP Address from DHCP] is set to [Disabled], manually set the DNS server address.

Automatically Configured IPv6 Address

Displays the following addresses automatically assigned.

- Link-local Address
- Auto Stateless Address 1 and Prefix Length
- Auto Stateless Address 2 and Prefix Length
- Auto Stateless Address 3 and Prefix Length
- Auto Gateway Address

IPv6 - IP Filter

Select whether or not to limit IPv6 addresses that can access the machine.

- Note**
- [IPv6 - IP Filter] applies to all features using TCP/IP, such as the Print, Store to Folder, Web Applications services, and Dell Printer Configuration Web Tool.
 - To set the IPv6 addresses that the machine accepts connection from, use [IP Filtering] in Dell Printer Configuration Web Tool. For more information, refer to "Dell Printer Configuration Web Tool Settings" (P.273).
 - When [IP Filtering] is enabled, make sure to switch the FTP transfer mode to [Active Mode] to transfer the scanned image from the machine via FTP. You can switch the FTP transfer mode from Dell Printer Configuration Web Tool.

Machine's E-mail Address / Host Name

Set the e-mail address, host name, and domain name of the machine.

E-mail Address

Enter the E-mail address of the machine with up to 128 single-byte characters.

When receiving E-mail via SMTP

You can set any name for the account (on the left side of @). Set the address section (on the right side of @), with the combination of the host name and domain name. An alias cannot be set.

For Example: mymail@myhost.example.com

- Account name: mymail
- Host name: myhost
- Domain Name: example.com

When receiving E-mails via POP3

Enter the POP user name (on the left side of @) and incoming POP3 mail server name in the address section (on the right side of @). You can set an alias, such as mymail@example.com.

For Example: mymail@myhost.example.com

- Account name: mymail

Machine Name

Enter the machine name with up to 32 single-byte characters.

Host Name

Enter the host name with up to 32 single-byte characters.

- Note**
- For SMB, only the first 15 single-byte characters will be used as the Host Name.

Domain Name

Enter the domain name with up to 64 single-byte characters.

Proxy Server Settings

Configure the settings for a proxy server.
Configure a proxy server when using inbound/outbound access.

Note • Do not set this item unless you use services requiring proxy server settings.

Use Proxy Server

Select whether or not to use a proxy server.

Proxy Server Setup

Select the proxy server specification from [Same Proxy for All Protocols] or [Different Proxy for Each Protocol].

Addresses to Bypass Proxy Server

Enter addresses not using the proxy server. You can specify the addresses by IPv4 address, IPv6 address, and FQDN. You can use wildcards "*" for specifying the addresses.

HTTP Proxy Server Name

Enter the server name or IP address of the HTTP proxy server. Up to 255 characters are allowed. You can specify the addresses by IPv4 address, IPv6 address, and FQDN.

HTTP Proxy Server Port Number

Set the HTTP proxy server port number from 1 to 65535.

The default value is 8080.

Note • Do not use the numbers assigned to the other ports.

HTTP Proxy Server Authentication

Select [Enabled] when authentication is required to connect to the HTTP proxy server.

HTTP Proxy Server Login Name

Enter a login name of the HTTP proxy server. Up to 31 characters are allowed.

HTTP Proxy Server Password

Enter a password of the HTTP proxy server. Up to 31 characters are allowed.

HTTPS Proxy Server Name

Enter the HTTPS proxy server name or the IP address. Up to 255 characters are allowed. You can specify the addresses by IPv4 address, IPv6 address, and FQDN.

HTTPS Proxy Server Port Number

Set the HTTPS proxy server port number from 1 to 65535.

The default value is 8080.

Note • Do not use the numbers assigned to the other ports.

HTTPS Proxy Server Authentication

Select [Enabled] when authentication is required to connect to the HTTPS proxy server.

HTTPS Proxy Server Login Name

Enter a login name of the HTTPS proxy server. Up to 31 characters are allowed.

HTTPS Proxy Server Password

Enter a password of the HTTPS proxy server. Up to 31 characters are allowed.

Outgoing / Incoming E-mail Settings

Set e-mail transmission and reception settings.

POP3 Server Settings

Set the POP3 server. In [POP3 Server Settings], you can set the following items:

- Note**
- For IPv4, enter the address in the format "xxx.xxx.xxx.xxx", where "xxx" is a numeric value from 0 to 255.
 - For IPv6, enter the address in the format "xxxx:xxxx:xxxx:xxxx:xxxx:xxxx:xxxx:xxxx", where "xxxx" is a hexadecimal value.
 - When you make an entry mistake, press the <C> (Clear) button and enter again.

Server Name / IP Address

Enter a server name or IP address with up to 128 characters, and then select [Save].

Port Number

Enter a port number from 1 to 65535.

The default value is 110.

- Note**
- Do not use the numbers assigned to the other ports.

Polling Interval

Set the interval for checking the e-mail on the POP3 server from 1 to 120 minutes in 1 minute increments.

Login Name

Enter the name to login to the POP3 server with up to 64 characters.

Password

Enter a password for the POP3 server with up to 64 characters.

Enter the same password in [New Password] and [Retype Password] using the numeric keypad displayed by selecting [Keyboard]. If you do not set the password, leave the text boxes blank and select [Save].

POP Password Encryption

Select [On (APOP)] to encrypt the password.

SMTP Server Settings

Set the SMTP server. In [SMTP Server Settings], you can set the following items:

- Note**
- For IPv4, enter the address in the format "xxx.xxx.xxx.xxx", where "xxx" is a numeric value from 0 to 255.
 - For IPv6, enter the address in the format "xxxx:xxxx:xxxx:xxxx:xxxx:xxxx:xxxx:xxxx", where "xxxx" is a hexadecimal value.
 - When you make an entry mistake, press the <C> (Clear) button and enter again.

SMTP Server Name / IP Address

Enter a server name or IP address, and then select [Save]. Up to 128 characters are allowed.

SMTP Server Port Number

Enter a port number in the range from 1 to 65535.

The default value is 25.

Note • Do not use the numbers assigned to the other ports.

E-mail Send Authentication

Select one from [Off], [POP before SMTP], or [SMTP AUTH].

Note • If [POP before SMTP] is selected, the POP3 settings must be set.
• AUTH GSSAPI (only for Kerberos), AUTH NTLMv2, AUTH NTLMv1, AUTH PLAIN, AUTH-LOGIN, or AUTH CRAM-MD5 can be used as an authentication method.

Login Credentials for E-mail Send

Select the login user name when sending e-mails from [Remotely Authenticated User] and [System]. When [Remotely Authenticated User] is selected and if the machine tries authenticating the remote server before a job startup, the machine performs verification at the time of transmission with the remotely authenticated user name and password. You can also select the post-failure behavior of the machine from [Cancel E-mail Send] and [Relogin using System Data]. If you do not set remote authentication, the machine uses the user ID and passcode of the machine for authentication.

SMTP AUTH Login Name

Enter the user name for verification purposes at the SMTP server with up to 64 characters.

SMTP AUTH Password

Enter the password for verification purposes at the SMTP server. Up to 64 single-byte characters are allowed.

Note • If you do not set the password, leave the text boxes blank and select [Save].

Remote Authentication / Directory Service

You can make the settings for the remote authentication server and directory service.

Authentication System Setup**Authentication System**

Allows you to select the authentication system from [Kerberos (Windows 2000)], [Kerberos (Solaris)], [LDAP], [SMB], and [Authentication Agent].

After you change the authentication system, personal folders and personal sheets used with the previous authentication system are not deleted automatically. If these folders or job flow sheets are no longer needed, delete them from the machine. If the same user IDs are also used on the new authentication system, personal folders and personal job flow sheets can be used by the same users.

Server Response Time-Out

Set the server time-out response between 1 and 75 seconds in 1 second increments.

Search Time-Out

Set the user information search time-out between 1 and 120 seconds in 1 second increments.

Kerberos Server Settings

Configure the Kerberos Servers 1 to 5.

The settings in [Kerberos Server 1 (Default)] will be the default settings for authentication.

Primary Server Name / Address

Enter the primary server name or IP address.

- Note**
- For IPv4, enter the address in the format "xxx.xxx.xxx.xxx", where "xxx" is a numeric value from 0 to 255.
 - For IPv6, enter the address in the format "xxxx:xxxx:xxxx:xxxx:xxxx:xxxx:xxxx:xxxx", where "xxxx" is a hexadecimal value.

Primary Server - Port Number

Set the primary server port number from 1 to 65535.

The default value is 88.

- Note**
- Do not use the numbers assigned to the other ports.

Secondary Server Name / Address

Enter the secondary server name or IP address.

- Note**
- For IPv4, enter the address in the format "xxx.xxx.xxx.xxx", where "xxx" is a numeric value from 0 to 255.
 - For IPv6, enter the address in the format "xxxx:xxxx:xxxx:xxxx:xxxx:xxxx:xxxx:xxxx", where "xxxx" is a hexadecimal value.

Secondary Server - Port Number

Set the secondary server port number in the range from 1 to 65535.

The default value is 88.

- Note**
- Do not use the numbers assigned to the other ports.

Domain Name

When you use Active Directory of Windows Server[®] 2003, Windows Server 2008, or Windows Server 2012 as server, specify the domain name of Active Directory in [Domain Name]. Up to 64 characters are allowed.

- Note**
- Enter a realm name in uppercase characters. Otherwise, an authentication error occurs.

LDAP Server / Directory Service Settings

Configure the directory server, authentication method, and search attributes and ranges for LDAP authentication and the Address Book search by LDAP.

Primary Server Name / Address

Enter the primary server name or IP address.

- Note**
- For IPv4, enter the address in the format "xxx.xxx.xxx.xxx", where "xxx" is a numeric value from 0 to 255.
 - For IPv6, enter the address in the format "xxxx:xxxx:xxxx:xxxx:xxxx:xxxx:xxxx:xxxx", where "xxxx" is a hexadecimal value.

Primary Server - Port Number

Set the Primary server port number from 1 to 65535.

The default value is 389.

- Note**
- Do not use the numbers assigned to the other ports.

Secondary Server Name / Address

Enter the secondary server name or IP address.

- Note**
- For IPv4, enter the address in the format "xxx.xxx.xxx.xxx", where "xxx" is a numeric value 0 to 255.
 - For IPv6, enter the address in the format "xxxx:xxxx:xxxx:xxxx:xxxx:xxxx:xxxx:xxxx", where "xxxx" is a hexadecimal value.

Secondary Server - Port Number

Set the secondary server port number from 1 to 65535.

The default value is 389.

Note • Do not use the numbers assigned to the other ports.

Authentication Method

Select a method to perform LDAP authentication from [Direct Authentication] and [Authentication of User Attributes].

- Direct Authentication
User ID and password entered by a user are used for LDAP authentication.
- Authentication of User Attributes
The user ID entered is used as an attribute specified in [Attribute of Typed User Name] to perform a search on the LDAP server. [Attribute of Login User Name] of a user found through the search is used as the user ID of a job and the owner of a job flow sheet and a folder.

Attribute of Typed User Name

When [Authentication of User Attributes] is used for LDAP authentication, set the attribute of the user ID entered. Up to 32 characters are allowed.

Set the attribute of the User Attribute information registered on the LDAP server that corresponds to the value to be entered as the user name from the control panel. For example, when you want a user to enter the mail address, set "mail."

Attribute of Login User Name

Enter an attribute to be used for LDAP authentication using User Attribute information registered on the LDAP server. Up to 32 characters are allowed.

Use Added Text String

Select whether or not to automatically add text strings in [Text String Added to User Name] when you enter the authentication information from the control panel.

Text String Added to User Name

Enter text strings for [Text String Added to User Name] when you use additional text strings. Up to 64 characters are allowed.

When [Use Added Text String] is set to [Enabled], enter the corresponding fixed text string.

For Example:

When "mail" is set for [Attribute of Typed User Name] and the information registered for the target user is "mail@myhost.example.com," you will need to enter "mail@myhost.example.com".

However, if [Use Added Text String] is set to [Enabled] and "@myhost.example.com" is specified for [Text String Added to User Name], you will only need to enter "mail" from the control panel because the machine adds "@myhost.example.com" to the end of the string.

Attribute of Smart Card

When a smart card is used for LDAP authentication, set the attribute of the card ID to perform a search on the LDAP server to authenticate the user who has the card. Up to 32 characters are allowed.

Note • This item is displayed when [Passcode Entry for Smart Card Login] under [Tools] > [Authentication / Security Settings] > [Authentication] > [Passcode Policy] is set to [Off].

Network User ID Attribute

When a smart card is used for LDAP authentication, set the attribute of the user name to be used for a smart card ID search. The user name is given to the remote service as the authentication information. Up to 32 characters are allowed.

- Note**
- This item is displayed when [Passcode Entry for Smart Card Login] under [Tools] > [Authentication / Security Settings] > [Authentication] > [Passcode Policy] is set to [Off].

Login Credentials to Search Entries

Select which users are allowed to search the Address Book.

You can select from [Remotely Authenticated User] or [System].

Login Name

Set a user name for the Address Book search and access to the directory server using [Authentication of User Attributes] method for LDAP authentication. Set this item only when authentication is required for the search for the directory service. Up to 255 characters are allowed.

Password

Set a login password for the user specified in [Login Name]. Up to 32 characters are allowed.

Search Directory Root

Enter a search root character string with up to 255 characters.

Scope of Search from Root Entry

Select the search range from the root entry.

- Root entry only
 - Searches the root level only.
- One level below root entry only
 - Searches from the root level to one level below the root level.
- All levels below root entry
 - Searches from the root level to all lower levels below the root level.

Object Class of Search Target

Enter the object class to search with up to 32 characters.

LDAP Referrals

Specify whether or not to re-establish connection to another LDAP server if a currently connected LDAP server requests to do so.

LDAP Referral Hop Limit

When using the Referral feature, specify how many times that a user is allowed to hop servers within 1 to 5 times.

LDAP Server

Select the software used by the directory server from [Microsoft Active Directory], [Microsoft Exchange], [Novell NetWare], [IBM Lotus Domino 6.*], and [Other Applications].

Search Entries by Common Name

Set whether or not to use [Attribute Type of Name] as a search entry when a name is used as a search key.

Search Entries by Surname

Set whether or not to use [Attribute Type of Surname] when a name is used as a search key.

Search Entries by Given Name

Set whether or not to use [Attribute Type of Given Name] when a name is used as a search key.

Attribute Type of Name

Set the recipient name attribute type. Enter a field attribute name to be used as a recipient name from user information registered on the LDAP server. Up to 32 characters are allowed. For Windows, enter "cn" for an attribute name used as a recipient name.

Attribute Type of Surname

Set the sender's family name attribute type. Up to 32 characters are allowed.

Attribute Type of Given Name

Set the sender's first name attribute type. Up to 32 characters are allowed.

Attribute Type of E-mail Address

Set the e-mail address attribute type. Enter a field attribute name to be used as e-mail information from the user information registered on the LDAP server. Up to 32 characters are allowed. For Windows, enter "mail" for an attribute name used as e-mail information.

Attribute Type of Fax Number

Set the fax number attribute type. Up to 32 characters are allowed.

Attribute Type of E-mail (Internet Fax)

Set the Internet fax address attribute type. Up to 32 characters are allowed.

Attribute Type of Custom Items 1, 2, and 3

Set the LDAP attribute type of custom items 1 to 3. In addition to [Attribute Type of Name] and [Attribute Type of E-mail Address], you can assign user attributes registered on the LDAP server for a search. Up to 32 characters are allowed.

Attribute Name of Custom Items 1, 2, and 3

Set the attribute names assigned to custom items 1 to 3. Up to 16 single-byte characters are allowed.

Attribute Type of Certificate

Set the certificate attribute type. Select and enter the field name to use as a certificate from among the user information registered on the LDAP server. Up to 32 characters are allowed.

For Windows, enter "userCertificate;binary" for an attribute name used as certificate information. The information is used as an S/MIME certificate when you specify an address using the directory service to encrypt e-mail transmission by S/MIME.

Note • To encrypt communications using this feature, a trusted root certificate authority and all intermediate certificate authorities that are registered in the path of a certificate to use must be registered.

Maximum Number of Search Results

Set a maximum number of address to display from search results from 5 to 100. If the search results exceed the maximum, the search stops at the maximum number set. The default value is 50.

Search Time-Out

Select whether or not to set a search time-out. Set the value from 5 to 120 seconds in 1 second increments.

SMB Server Settings

SMB Server Setup

Select the server specification method from [By Domain Name] and [By Domain & Server Names / IP Address].

According to the option you selected here, set [Domain Name] and [Server Name / IP Address] for SMB servers 1 to 5 respectively. The setting for SMB server 1 is used as the default setting for authentication.

Domain Name

Enter the domain name of the server. Up to 64 characters are allowed.

This setting is mandatory regardless of the SMB server specification method selected for [SMB Server Setup].

Note • Use the NetBIOS or Active Directory domain name for the domain name.

Server Name / IP Address

Enter the server name or IP address.

This setting is valid when [SMB Server Setup] is set to [By Domain & Server Names / IP Address].

Note • Use the NetBIOS computer name or full computer name with DNS suffix for the server name.
• For IPv4, enter the address in the format "xxx.xxx.xxx.xxx", where "xxx" is a numeric value from 0 to 255.

Security Settings

Set the security settings.

SSL / TLS Settings

Configure the SSL/TLS settings.

Device Certificate - Server

Select a certificate for HTTP SSL/TLS communications.

HTTP - SSL / TLS Communication

Select whether or not to enable HTTP SSL/TLS communications.

HTTP - SSL / TLS Port Number

Set the port number used for HTTP SSL/TLS communication from 1 to 65535.

The default value is 443.

Note • Do not use the numbers assigned to the other ports.

LDAP - SSL / TLS Communication

Set whether or not to enable the SSL/TLS communications for authentication and searches.

If you enable the LDAP SSL/TLS communications, you must set [Primary Server - Port Number] and [Secondary Server - Port Number] under [LDAP Server / Directory Service Settings].

The port number for SSL/TLS communications of the LDAP directory server is normally set to 636.

SMTP - SSL / TLS Communication

Configure the SSL/TLS communications.

- Disabled
The machine does not communicate in SSL/TLS.
- STARTTLS (If Available)
The machine verifies the certificate and communicates in SSL/TLS. If the verification fails, the machine does not communicate in SSL/TLS.
- STARTTLS
The machine verifies the certificate and communicates in SSL/TLS. If the verification fails, the machine cannot perform communication.
- SSL / TLS
The machine communicates in SSL/TLS.

Note • The Internet Fax Direct (P2P) feature does not support SMTP-SSL/TLS communication.

ThinPrint - SSL / TLS Communication

Select whether or not to enable the SSL/TLS communications.

Device Certificate - Client

Select a certificate for HTTP SSL/TLS communications.

Verify Remote Server Certificate

When the machine is operated as an SSL client, select whether or not to verify the certificate of the remote server.

S/MIME Settings

Configure S/MIME settings.

Device Certificate - S/MIME

Select a certificate for S/MIME communications.

For more information on the certificate, refer to "Encryption and Digital Signature Settings" (P.329).

S/MIME Communication

Select whether or not to enable S/MIME communications.

Receive Untrusted E-mail

If you select [No], the machine does not receive the following e-mail:

- E-mails other than e-mail sent by S/MIME when [S/MIME Communication] is set to [Enabled].
- E-mails that fail to attach a signature or verification.
- E-mails that are attached with an expired certificate.

Receive Untrusted Internet Fax

If you select [No], the machine does not receive the following Internet fax:

- Internet faxes other than the Internet fax sent by S/MIME when [S/MIME Communication] is set to [Enabled].
- Internet faxes that fail to attach a signature or verification.
- Internet faxes that are attached with an expired certificate.

Message Digest Algorithm

Select a message digest algorithm. Select from [SHA-1], [MD5] and [SHA-256].

Message Encryption Method

Set the encryption method for mail contents. Select from [3DES], [RC2-40], [RC2-64], [RC2-128], [AES-128], [AES-192], and [AES-256].

Split Encrypted E-mail

Select whether or not to split an outgoing encrypted e-mail for each recipient.

Split Encrypted Internet Fax

Select whether or not to split an outgoing encrypted Internet fax for each recipient.

Digital Signature - Outgoing E-mail

Select whether or not to always add a digital signature to outgoing e-mails. You can also select the setting in which the machine asks to add a digital signature to the e-mail whenever you send.

Signing Certificate for E-mail Attachment

Select the certificate to use for attaching a signature to e-mails.

Digital Signature - Outgoing Internet Fax

Select whether or not to always add a digital signature to outgoing Internet faxes. You can also select the setting in which the machine asks to add a digital signature to the Internet fax whenever you send.

Certificate Auto Store

Select whether or not to automatically store an S/MIME certificate attached with the e-mail when receiving e-mail from an address registered on the Address Book.

PDF / XPS Signature Settings

Configure signature settings of PDF/XPS documents.

Note • XPS stands for XML Paper Specification.

Device Certificate

Select a certificate to use for the signature.

For more information on the certificate, refer to "Encryption and Digital Signature Settings" (P.329).

PDF Signature

Select the setting for PDF Signature from [Do not add signature], [Always add visible signature], [Always add invisible signature], or [Select during send].

PDF Signature Hash Algorithm

Select the setting for PDF Signature Hash Algorithm from [SHA-1] or [SHA-256].

XPS Signature

Select the setting for XPS Signature from [Do not add signature], [Always add invisible signature], or [Select during send].

IPSec Settings

Configure the IPSec settings.

Note • For [IKE Authentication Method], [Preshared Key], [DH Group], and [PFS Settings], consult your network administrator.

IKE Authentication Method

Set the IKE authentication method. Select from [Authenticate by Preshared Key] or [Authenticate by Digital Signature].

Preshared Key

Enter a preshared key. This setting is valid when [IKE Authentication Method] is set to [Authenticate by Preshared Key].

Device Certificate

Select a certificate for IPSec communications.

Select a certificate when [IKE Authentication Method] is set to [Authenticate by Digital Signature]. A self-signed certificate created by Dell Printer Configuration Web Tool cannot be used.

For more information on a certificate, refer to "Types of Certificate" (P.330).

IPSec Communication

Select whether or not to enable IPSec communications.

IKE SA Life Time

Specify IKE SA lifetime from 5 to 28800 minutes in 1 minute increments.

Note • The value must be greater than the value set in [IPSec SA Life Time].

IPSec SA Life Time

Specify IPSec SA lifetime from 300 to 172800 seconds in 1 second increments.

Note • The value must be smaller than the value set in [IKE SA Life Time].

DH Group

Set DH group. Select from [G1] or [G2].

PFS Settings

Select whether or not to enable PFS.

Destination IPv4 Address

Set the IPv4 address of the destination.

When entering an IP address, enter the address in the format "xxx.xxx.xxx.xxx", where "xxx" is a numeric value from 0 to 255.

Destination IPv6 Address

Set the IPv6 address of the destination.

When entering an IP address, enter the address in the format "xxxx:xxxx:xxxx:xxxx:xxxx:xxxx:xxxx:xxxx", where "xxxx" is a hexadecimal value.

Communicate with Non-IPSec Devices

Select whether or not to communicate with non-IPSec devices.

IEEE 802.1x Settings

Configure the IEEE 802.1x settings.

IEEE 802.1x

Set whether or not to use IEEE 802.1x authentication.

Authentication Method

Select from [EAP-MD5], [EAP-MS-CHAPv2], [PEAP / MS-CHAPv2], or [EAP-TLS].

Login User Name

Enter the login user name with up to 128 characters.

Login Password

Enter the login password with up to 128 characters.

Server Certificate Verification

Select whether or not to verify a server certificate when [PEAP / MS-CHAPv2] is selected in [Authentication Method].

Certificate Revocation Retrieval Settings

Configure the settings for certificate revocation retrieval.

Level of Certificate Verification

Select a level of certificate verification from [Low], [Medium], or [High].

Selecting [Low] does not verify the validity of certificates.

Selecting [Medium] verifies the validity of certificates. If a certificate cannot be verified because of a network error or any other problems, the certificate is determined as valid.

Selecting [High] verifies the validity of certificates, and determines only certificates that have not been revoked as valid.

Retrieval of Certificate Status

Select the method to verify the validity of certificates. Select [By Retrieving CRL] if the machine retrieves a CRL (Certificate Revocation List) from the validation authority to verify the revocation status of the certificate. Select [By OCSP] if the machine uses OSCP (Online Certificate Status Protocol), which can verify the validity revocation status of the certificate, to have the certificate authority or validation authority check the revocation status.

Auto Retrieval of CRL

Select whether or not to automatically retrieve a CRL.

CRL Retrieval Time-Out

Specify a time-out value to retrieve a CRL from 5 to 60 seconds in 1 second increments.

Send Query to OCSP Responder With

Select how to access an OCSP responder from [URL as Specified in Certificate] or [URL as Specified by Administrator].

URL of OCSP Responder

Enter the URL of an OCSP responder when [URL as Specified by Administrator] has been selected for [Send Query to OCSP Responder With]. Up to 255 characters are allowed.

OCSP Communication Time-Out

Specify a time-out value for OCSP communication from 5 to 60 seconds in 1 second increments.

Other Settings

You can set the following network related items:

Protocol to Receive E-mail

Select from [SMTP] or [POP3] depending on your environment.

Add Domain Name to User Name

Select whether or not to add domain names to user names.

Output Destination for E-mail

Specify an output destination for e-mail print. Selecting [Auto] enables the machine to select the output destination, which is set as the default output destination.

Domain Filtering

Set the domain filtering settings for the E-mail and Internet Fax features.

Domain Filtering

When [Allow Domains] is selected, you can specify domains to permit transmissions. When [Block Domains] is selected, you can specify domains to prohibit transmissions.

Domains 1 to 50

When [Domain Filtering] is set to [Allow Domains] or [Block Domains], you can specify up to 50 domains to allow or block transmissions.

Selecting [Change Settings] allows you to enter the domain name using a keyboard displayed with up to 64 characters.

Print Service Settings

In [Print Service Settings], you can configure settings related to the Print feature. Using Dell Printer Configuration Web Tool, you can make more detailed settings. For more information, refer to "Dell Printer Configuration Web Tool Settings" (P.273).

The following shows the reference section for each setting.

Allocate Memory	190
Delete Form	192
Other Settings	192

- 1 On the [Tools] screen, select [System Settings] > [Print Service Settings].
For the method of displaying the [Tools] screen, refer to "System Settings Procedure" (P.106).
- 2 Select an item to set or change.

Allocate Memory

For each interface, set the memory capacity of the receiving buffer (temporary storage for data sent from the client).

You can change the receiving buffer capacity according to its use and purpose. Increasing the receiving buffer capacity may allow a client to be released sooner from an interface.

- Note**
- If you change the capacity memory, the memory is reset, thus all data stored in memory area is erased.
 - You cannot allocate more memory beyond its memory capacity. When you turn the machine on, and the size set exceeds the total memory size, the system automatically adjusts the memory size.
 - When a port is set to [Disabled], the corresponding items to the port do not appear.
 - Depending on the amount of data sent from the client, increasing the memory capacity may not change the time taken to release the client.

PostScript Memory

Specify a value for the PostScript memory capacity from 70.00 to 128.00 MB in 0.25 MB increments.

- Note**
- The maximum amount of memory you can allocate varies according to the amount of free space available in memory.

ART IV, ESC/P, 201H Form Memory

Displays where to save forms for use with ESC/P-K.

HP-GL/2 Auto Layout Memory

The working memory area for the HP-GL/2 auto layout feature is fixed to the hard disk.

Job Ticket Memory

Specify the amount of memory to use for job tickets from 0.25 to 8.00 MB in 0.25 MB increments.

- Note**
- The maximum amount of memory you can allocate varies according to the amount of free space available in memory.

Receiving Buffer - USB

Set the receiving buffer for USB.

You can specify a value from 64 to 1024 KB in 32 KB increments.

Receiving Buffer - LPD

Note • You may not be able to change the [Receiving Buffer - LPD] setting because of the setting of [LPD Print Queue].

For more information on [LPD Print Queue], refer to "LPD Print Queue" (P.195).

No Spooling

Does not use spooling. While LPD printing is performed for one client, data cannot be received over the same interface from another client.

Specify a value for the dedicated LPD receiving buffer memory capacity from 1024 to 2048 KB in 32 KB increments.

Spool to Memory

Carries out spooling. The receiving buffer for spooling uses memory. When this setting is selected, specify the memory capacity of a receiving buffer for spooling from 0.50 MB to 32.00 MB in 0.25 MB increments.

Note that print data exceeding the memory capacity set is not accepted. In such cases, select [Spool to Hard Disk] or [No Spooling].

Spool to Hard Disk

Carries out spooling. The receiving buffer for spooling uses the hard disk.

Receiving Buffer - NetWare

Set the NetWare receiving buffer.

Specify a value from 64 to 1024 KB in 32 KB increments.

Receiving Buffer - SMB

No Spooling

Does not use spooling. While SMB printing is performed for one client, data cannot be received over the same interface from another client.

Specify a value for the dedicated SMB receiving buffer memory capacity from 64 to 1024 KB in 32 KB increments.

Note • If you select [No Spooling], job names are displayed as "unknown document name".

Spool to Memory

Carries out spooling. The receiving buffer for spooling uses memory. When this setting is selected, specify the memory capacity of a receiving buffer for spooling from 0.50 MB to 32.00 MB in 0.25 MB increments.

Note that print data exceeding the memory capacity set is not accepted. In such cases, select [Spool to Hard Disk] or [No Spooling].

Spool to Hard Disk

Carries out spooling. The receiving buffer for spooling uses the hard disk.

Receiving Buffer - IPP

No Spooling

Does not use spooling. While IPP printing is performed for one client, data cannot be received over the same interface from another client.

Specify a value for the dedicated IPP receiving buffer memory capacity from 64 to 1024 KB in 32 KB increments.

Spool to Hard Disk

Carries out spooling. The receiving buffer for spooling uses the hard disk.

Receiving Buffer - EtherTalk

Set the EtherTalk receiving buffer.

Specify a value from 1024 to 2048 KB in 32 KB increments.

Receiving Buffer - Port 9100

Set the Port 9100 receiving buffer.

Specify a value from 64 to 1024 KB in 32 KB increments.

Delete Form

You can delete registered ESC/P-K forms.

- 1 Select [Delete Form].
- 2 Select the print mode to delete forms.
- 3 Enter the form number with the numeric keypad, and select [Confirm].

ESC/P

Deletes ESC/P-K emulation forms.

Form Number

When you select an item to delete, you can enter the form number.

Form Name

After you enter the form number and select [Confirm], the form name matching the form number entered appears.

- 4 Check the form name, and then select [Delete Data].



Other Settings

You can configure other settings related to the paper used in the printer.

Print Area

Set whether or not to expand the print area.

For more information about the printable area, refer to "Printable Area" (P.519).

For more information on the extended printable area, refer to "Extended Printable Area" (P.519).

Substitute Tray

When there is no tray containing the paper size selected by the Auto Paper selection, select whether or not to print with paper loaded in another paper tray. In the event of using a

substitute tray, select the paper size from [Use Larger Size], [Use Closest Size], or [Select Tray 5].

- Note**
- When documents are printed using emulation such as ESC/P-K and HP-GL/2, the substitute tray setting is not valid and a message prompting you to load paper displayed on the screen.

Display Message

Does not use a substitute tray, but displays a paper loading message.

Use Larger Size

Switches to the next larger size of paper than previously selected and prints at the same magnification.

Use Closest Size

Switches to the closest size of paper to previously selected and prints. If necessary, the image is automatically reduced in size on the paper.

- Note**
- If there is a client specification, the client specification is prioritized.

Select Tray 5

Prints using the paper loaded in Tray 5.

Paper Type Mismatch

Set an action to take when the paper type loaded in the paper tray does not match the paper type specified.

Print

Prints using the paper loaded in the tray.

Display Confirmation Screen

A confirmation screen appears to ask whether or not to print the job.

If a paper type mismatch occurs during printing, the machine ignores the paper type specified in the print driver and prints the job on another type of paper loaded in the machine.

For more information, refer to "Automatic Tray Selection" (P.47).

Display Paper Supply Screen

The [Paper Supply] screen appears, prompting you to load another type of paper in the selected tray. The job can be printed if you follow the instructions displayed on the screen.

- Note**
- The machine keeps the changed paper type setting after the printing.
 - Even if you select the [Start] button without loading another type of paper in the selected tray, the machine considers the paper type has been changed and prints the job. Consequently, the print quality cannot be guaranteed because the paper type loaded in the paper tray does not match the paper type specified.

Unregistered Forms

Set whether or not to print a job if a form specified for printing in a form data file (overlay printing) is not registered on the machine. If you specify [Print], only the data is printed because the specified form is not present.

Resume Job After Print Error

Set whether or not to automatically cancel a print job when the print job was suspended because of an error.

- Note**
- The machine will enter the off-line state to restrict subsequent print jobs.

Job Resumes Automatically

Automatically cancels the print job to print subsequent jobs.

Resume by User

Displays a confirmation screen before cancelling the print job. After the confirmation, the machine cancels the print job to print the subsequent jobs.

Note • When [Resume by User] is selected, the machine will not temporarily stop printing even when the <Interrupt> button is pressed.

When Paper Jam Occurs

Specify how the machine handles print jobs after a paper jam is cleared.

Resume Job after Jam Clearance

When a paper jam is cleared, the machine automatically resumes printing from the next page of the page which was output correctly.

Delete Job

The machine cancels printing and removes the print job.

Note • For print files stored in a folder such as Charge Print, Private Charge Print, Secure Print, and Sample Set, the machine resumes printing after the paper jam is cleared.

Print User ID

When printing using a print driver, specify whether or not to print user ID set in the print driver on paper. The first 64 letters of the user ID are printed.

Select a position to print from [Top Left], [Top Right], [Bottom Left], and [Bottom Right].

Note • To use the Print User ID feature, the user ID must be set in the print driver beforehand. For more information, refer to the help of the print driver.
• When user ID set in the print driver is not available, "Unknown User" is printed.

Banner Sheet

You can output a banner sheet to separate different jobs by users not to be mixed the outputs. The machine outputs the banner sheet before or after the job.

A date, time, user name, and file name are printed on the banner sheet.

Note • Even if stapling is selected, banner sheets are not stapled.
• When a document is printed from a Macintosh, the document name is not printed on the banner sheet.
• When printed, banner sheets are counted by meter.

Off

Does not print banner sheets.

Start Sheet

Prints a banner sheet before a print job.

End Sheet

Prints a banner sheet after a print job.

Start Sheet & End Sheet

Prints a banner sheet before and after a print job.

Allow Print Driver to Override

Select the check box to print a banner sheet according to the banner sheet print settings of the print driver.

Banner Sheet Offset

Set whether or not to offset when banner sheets are output.

Banner Sheet Tray

Select a paper tray used for banner sheets.

This setting applies to Trays 1 to 4 and 6 (optional). You cannot apply this setting to Tray 5.

PostScript Default Color

Set the default value for Post Script output color.

PostScript Paper Supply

Select whether the PostScript Deferred Media Selection feature is enabled or disabled when the paper tray is selected. Select [Auto Select] to enable the PostScript Deferred Media Selection feature, or [Select Paper Tray] to disable the feature.

When PostScript data generated by other than the print driver is printed, the tray is not selected as intended depending on the description method of the PostScript data. In this case, select [Select Paper Tray].

Note • Even when you select [Auto Select], the setting is automatically changed to [Select Paper Tray] when [Use Larger Size] or [Use Closest Size] is selected for [Substitute Tray] and print PostScript data.

PostScript Font Absence

Set an action to take when a PostScript font specified in a job is not present.

Cancel Printing

Cancels printing.

Substitute Font and Print

Prints using a substitute font. Courier is used as the substitute font.

PostScript Font Substitution

Set whether or not to use ATCx as a substitute if a PostScript font specified in a job is not present.

XPS Print Ticket Processing

Set how the machine processes the print tickets written in XPS documents.

Note • XPS stands for XML Paper Specification.

Off

Does not process print tickets.

Standard Mode

Uses the standard mode to process print tickets.

Compatible Mode

Uses the Microsoft®-compliant mode to process print tickets.

LPD Print Queue

Set the LPD print sequence.

Note • If you change the [LPD Print Queue] setting, the [Receiving Buffer - LPD] setting may automatically be changed. For more information on Receiving Buffer - LPD Spool, refer to "Receiving Buffer - LPD" (P.191).

Data Processing Order

Prints jobs in the order of becoming print-ready status after receiving the jobs.

When you print jobs of multiple documents continuously, the machine may preferentially print the next job in the middle of processing depending on the processing time.

Job Submission Order

Prints jobs in the order of lpr print submission.

Note • This setting is valid only when [Receiving Buffer - LPD] is set to [Spool to Hard Disk]. When any other setting, printing is performed in [Data Processing Order].

OCR Font Glyphs (0 x 5C)

Allows you to select [Backslash] or [Japanese Yen Sign] to print 0x5C character when the OCR fonts are used.

Scan Service Settings

You can configure settings related to the Scan services.

Note • When [Scan to Fax Server] is selected in the System Settings, [Scan Service Settings] is replaced with [Scan / Fax Service Settings].

For information on scanner environment settings, refer to "Scanner Environment Settings" (P.307).

The following shows the reference section for each setting.

Screen Defaults	197
Scan Defaults.....	198
Scan to PC Defaults.....	200
Original Size Defaults	201
Output Size Defaults	201
Reduce / Enlarge Presets	201
Other Settings	201

1 On the [Tools] screen, select [System Settings] > [Scan Service Settings].

For the method of displaying the [Tools] screen, refer to "System Settings Procedure" (P.106).

2 Select an item to set or change.

Screen Defaults

You can set the items that appear in the First Tab screen. The First Tab means the screen displayed when you select the following tabs in the [E-mail], [Store to Folder], [Scan to PC], [Store & Send Link], and [Store to USB] screens.

- The [E-mail] tab of the E-mail service
- The [Store to Folder] tab of the Store to Folder service
- The [Scan to PC] tab of the Scan to PC service
- The [Store & Send Link] tab of the Store & Send Link service
- The [Store to USB] tab of the Store to USB service

Email Screen Default

Set the default screen that appears when [E-mail] on the [Home] screen is selected. Select from [First Tab] and [Address Book].

Scan to PC Screen Default

Set the default screen that appears when [Scan to PC] on the [Home] screen is selected. Select from [First Tab] and [Address Book].

1st Tab - Features Allocation

You can set the features that appear in the second to the fourth column of the lower part in the First Tab screen.

Select a column by choosing from [Feature in 1st Column] to [Feature in 4th Column]. And set the item to be displayed from [Not Selected], [Color Scanning], [2 Sided Scanning], [Original Type], [File Format], [Resolution], [Lighten / Darken], [Reduce / Enlarge], [Mixed Size Originals], and [Original Orientation].

Reduce/Enlarge - Buttons 2 to 5

This item can be set when [Reduce / Enlarge] is selected for one of the features that appear in the second to the fourth column in [1st Tab - Features Allocation].

Select the magnification ratio displayed in [Reduce / Enlarge] from the Reduce/Enlarge Presets registered.

For information about the Reduce/Enlarge Preset buttons, refer to "Reduce / Enlarge Presets" (P.201).

Scan Defaults

You can set the default settings of the Scan services. When the machine is turned on, or the machine exits the Power Saver mode, or when the <Clear All> button is pressed, the machine resets to the default values set here. Setting frequently used features and values as the defaults can avoid extra operations required during the use of the machine.

The values set here become valid after the machine turned off and then on.

For more information on each setting item, refer to "5 Scan" in the User Guide.

Color Scanning

Set the default value for [Color Scanning] in the First Tab.

Original Type

Set the default value for [Original Type] in the First Tab.

File Format

Set the default value for [File Format] in the First Tab.

Optimize PDF For Quick Web View

Set the default value for [Optimize For Quick Web View] of [File Format] in the First Tab.

Thumbnail - Outgoing E-mail

For the E-mail feature, set the default value for [Add Thumbnail] when [XPS] is selected for [File Format] in the First Tab.

Note • XPS stands for XML Paper Specification.

Thumbnail - Scan to PC

For the Scan to PC feature, set the default value for [Add Thumbnail] when [XPS] is selected for [File Format] in the First Tab.

Note • XPS stands for XML Paper Specification.

Lighten / Darken

Set the default value for [Lighten / Darken] of [Image Options] in the [Advanced Settings] screen.

Contrast

Set the default value for [Contrast] of [Image Enhancement] in the [Advanced Settings] screen. The contrast setting is valid when [Color Scanning] is set to [Color] or [Grayscale].

Sharpness

Set the default value for [Sharpness] of [Image Options] in the [Advanced Settings] screen.

Background Suppression

Set the default value for [Background Suppression] of [Image Enhancement] in the [Advanced Settings] screen.

Shadow Suppression

Set the default value for [Shadow Suppression] in the [Advanced Settings] screen.

Color Space

Set the default value for [Color Space] in the [Advanced Settings] screen.

Note • When [Device Color Space] is selected as default and [Color Space] under [Other Settings] is set to [Disabled], [Auto Detect] of [Color Scanning] in the First Tab, and [MRC High Compression] and [Specific Color] under [File Format] do not appear.

Original Orientation

Set the default value for [Original Orientation] in the [Layout Adjustment] screen.

Resolution

Set the default value for [Resolution] in the [Layout Adjustment] screen.

You can select from [200 dpi], [300 dpi], [400 dpi], or [600 dpi].

Mixed Size Originals

Set the default value for [Mixed Size Originals] in the [Layout Adjustment] screen.

Edge Erase

Set the default value for [Edge Erase] in the [Layout Adjustment] screen. You can select from [All Edges] or [Parallel Edges].

Edge Erase - Top & Bottom Edges

Set the default value for [Top & Bottom] in [Edge Erase] in the [Layout Adjustment] screen. Specify a value from 0 to 50 mm in 1 mm increments.

Edge Erase - Left & Right Edges

Set the default value for [Left & Right] in [Edge Erase] in the [Layout Adjustment] screen. Specify a value from 0 to 50 mm in 1 mm increments.

Center Erase / Binding Edge Erase

Set the default value for [Center] in [Edge Erase] in the [Layout Adjustment] screen. Specify a value from 0 to 50 mm in 1 mm increments.

Quality / File Size

Set the default value for [Quality / File Size] in the [Filing Options] screen. Select from [Quality: Normal / File Size: Small], [Quality: Higher +1 / File Size: Larger +1], [Quality: Higher +2 / File Size: Larger +2], [Quality: Higher +3 / File Size: Larger +3], or [Quality: Maximum / File Size: Largest].

E-mail Subject

Set the default value for the e-mail subject. Up to 128 characters can be entered for the subject.

Store & Send Link - E-mail Subject

Set the default value for the subject used for the Store & Send Link feature. Up to 128 characters can be entered for the subject.

For more information on the Store & Send Link feature, refer to "5 Scan" > "Scanning Procedure" > "Step 2 Selecting the Features" in the User Guide.

E-mail Encryption

Set the default value for [Encryption] in the [E-mail Options] in the [E-mail] screen.

Note • This feature appears only when the root certificate for a remote authentication server is set.

Searchable Text

Set the default value for [Searchable Text] in the [File Format] screen under the First Tab.

Language of the Original

Set the default language to identify the text on a document.

Searchable - Text Compression

Set whether or not to compress searchable text when using the OCR feature.

Scan to PC Defaults

Transfer Protocol

Set the default value for the transfer protocol used for transfer from [FTP], [SMB], or [SMB (UNC Format)].

Login Credential to Access Destination

Set whether or not to use a user authenticated by the remote server when the user logs in to the destination computer for the Scan to PC service. This setting is effective for remote authentication.

None

Does not use the remotely authenticated user.

Remotely Authenticated User

Uses the user name and the password of the remotely authenticated user for login.

User Name for FTP Scan

When the remotely authenticated user name is used as a login user name for FTP transfers for the Scan to PC service, specify whether or not to include the domain part of the credentials.

User Name Only

Uses only the user name part (before "@") of the login credential for the login name. The domain part is not used.

Add Domain Name

Uses the full login credential name, including the domain name (after "@"), for the user name.

Original Size Defaults

Set the document size displayed in [Original Size] in the [Layout Adjustment] screen. You can assign a document size to each of the 17 buttons other than [Auto Detect].

If you frequently use non-standard size paper for scanning, assigning the paper sizes to the buttons will save your time to specify the size each time.

A/B Series Size

You can select from sizes of A and B series such as A4 and B5.

Inch Size

You can select from size of Inch series such as 8.5 x 11" and 11 x 17".

Others

You can select from sizes of other than the above series such as photo and postcard sizes.

Custom Size

You can enter any size. Set the width (X) from 15 to 432 mm, and the height (Y) from 15 to 297 mm in 1 mm increments.

Output Size Defaults

Set the sizes to display in [Output Size] when selecting [Enter Output Size] for scanning documents at [Reduce / Enlarge] in the [Layout Adjustment] screen.

You can assign any output size to output size buttons. Assigning the output sizes to the buttons will save your time to specify the size each time.

A/B Series Size

You can select from sizes of A and B series such as A4 and B5.

Inch Size

You can select from size of Inch series such as 8.5 x 11" and 11 x 17".

Others

You can select from sizes of other than the above series such as photo and postcard sizes.

Reduce / Enlarge Presets

Set the magnifications displayed as [Preset %] which are displayed when [Proportional %] is selected under [Reduce / Enlarge] in the [Layout Adjustment] screen.

You can assign any magnification to the Reduce/Enlarge Preset buttons other than [100%].

Preset %

Select from standard magnification ratios.

Variable %

You can specify a magnification from 25 to 400% in 1% increments.

Other Settings

You can configure other settings related to the Scan services specifications.

Memory Full Procedure

If there is insufficient hard disk memory while scanning a document, a screen appears asking you how you want to handle the partially stored data.

Set the process you want the machine to perform for the partially stored data after a certain time has elapsed in the confirmation screen.

You can set the time until the memory full procedure is carried out. For more information, refer to "Auto Job Release" (P.125).

Delete Job

Deletes the data partially stored.

Run Job

Treats the read-in data as valid, and starts sending the document partially stored.

Maximum Stored Pages

Set the maximum number of pages stored for a scan document. You can specify from 1 to 999 pages.

Saturation

Set the saturation when scanning a full color document. When a document is scanned, saturation is automatically adjusted according to the value set here.

Background Suppression Level

Set the background suppression level. This is valid when [Background Suppression] is set to [Auto Suppression].

The larger the value the stronger the effect of removing background noise is.

Shadow Suppression Level

Set the shadow suppression level. This is valid when [Shadow Suppression] is set to [Auto Suppression].

Color Space

Set whether or not to display the Color Space feature.

When you select [Enabled], the [Color Space] button is displayed on the [Advanced Settings] screen for the [E-mail], [Store to Folder], and [Scan to PC].

Note • When [Disabled] is selected as default and [Color Space] under [Scan Defaults] is set to [Device Color Space], [Auto Detect] of [Color Scanning] in the First Tab ([E-mail]/[Store to Folder]/[Scan to PC]), and [MRC High Compression] and [Specific Color] under [File Format] do not appear. For more information on Color Space, refer to "Color Space" (P.199).

TIFF Format

Set the TIFF format for scanned data. You can select either [TIFF V6] or [TTN2].

Image Transfer Screen

Select whether or not to display a message when the scan of a document completes.

Disabled

Does not display a scan completion message.

Display Message at End of Scanning

Displays a scan completion message.

Display Scan & Transfer Screens

Displays the transfer screen after scan completion. The scan completion message is not displayed.

Display Message at End of Transfer

Displays a transfer completion message.

Searchable - Page Orientation

Set whether or not to handle the character orientation to be upright when the machine scans a document with OCR (Optical Character Recognition).

Auto Upright Orientation

Handles the character orientation upright regardless of the document orientation.

According to Original Orientation

Handles the character orientation depending on the document orientation.

URL File Expiration

Set the retention period for files stored with the Store & Send Link feature. You can specify a value from 1 to 168 hours in 1 hour increments. The default value is 3 hours.

Generation of URL Link

Set the format of URLs generated with the Store & Send Link feature. Select either [Use IP Address] or [Use FQDN].

The following are examples of URLs:

If [Use IP Address] is selected:

`http://192.0.2.1/scanUrl/doc1/get.htm`

If [Use FQDN] is selected:

`http://pc1.mycompany.co.jp/scanUrl/doc1/get.htm`

Store & Send Link - Maximum File Size

Set the maximum data size of files that can be stored for the Store & Send Link feature. You can specify the value from 1 to 200 MB in 1 MB increments. The default value is 200 MB.

Print Login Name on PDF Files

If scanning a document in PDF format when local machine authentication or remote authentication is enabled, you can set whether to add an authentication user name as the Author in the document properties of the PDF document.

Fax Service Settings

In [Fax Service Settings], you can configure settings related to the Fax service.

- Note**
- An optional component is required to use this feature. For more information, contact Customer Support at dell.com/contactdell.
 - You can register new address book entries in [Add Address Book Entry] under [Setup]. For more information, refer to "Add Address Book Entry" (P.241).

The following shows the reference section for each setting.

Screen Defaults	204
Fax Defaults	205
Fax Control	206
Fax Received Options	211
Reduce / Enlarge Presets.....	211
Original Size Defaults.....	212
Local Terminal Information.....	212
Internet Fax Control.....	213

- 1 On the [Tools] screen, select [System Settings] > [Fax Service Settings].
For the method of displaying the [Tools] screen, refer to "System Settings Procedure" (P.106).
- 2 Select an item to set or change.

Screen Defaults

You can set items displayed on the [Fax / Internet Fax] screen.

Fax Screen Default

Set the default screen that appears when the [Fax / Internet Fax] screen is selected in the [Home] screen.
Select from [Fax Tab] or [Address Book].

1st Tab - Features Allocation

Set the features that appear on the [Fax / Internet Fax] screen.

Feature in 2nd to 4th Column

You can set the features that appear in the second to the fourth column of the lower part on the [Fax / Internet Fax] screen.

Select the item to be displayed from [Not Selected], [2 Sided Faxing], [Original Type], [Resolution], [Confirmation Options], [Starting Rate], [Transmission Header], [Mixed Size Originals], and [Reduce / Enlarge].

Reduce / Enlarge - Button 3 - 5

This item can be set when [Reduce / Enlarge] is selected in [Feature in 2nd to 4th Column].
You can set the magnifications displayed as [Preset %] which are displayed under [Reduce / Enlarge] in the [Layout Adjustment] screen. You can assign any magnification to the Reduce / Enlarge - Button 3 - 5.

Transmission Screen

Set whether or not to display transmission status during transmission.

Fax Defaults

You can set the default settings of the Fax services. When the machine is turned on, or the machine exits from the Power Saver mode, or when the <Clear All> button is pressed, the machine resets to the default values specified under this menu. By setting frequently used features and values as the defaults, you can simplify operations.

For more information on each setting item, refer to "4 Fax" in the User Guide.

Resolution

Set the default value for [Resolution] in the [Fax / Internet Fax] screen.

Original Type

Set the default value for [Original Type] in the [Fax / Internet Fax] screen.

Lighten / Darken

Set the default value for [Lighten / Darken] in the [Fax / Internet Fax] screen.

Mixed Size Originals

Set the default value for [Mixed Size Originals] in the [Layout Adjustment] screen.

Skip Blank Pages

Set the default value for [2 Sided Scanning] in the [Fax / Internet Fax] and [Layout Adjustment] screens to [2 Sided (First Page 1 Sided)].

Note • This feature is for service representative use. For more information, contact Customer Support at dell.com/contactdell.

Starting Rate

Set the default value for [Starting Rate] in the [Fax / Internet Fax Options] screen.

Delay Start - Specific Time

Set the default value for [Specific Time] of [Priority Send / Delay Start] in the [Fax / Internet Fax Options] screen when [Specific Time] is selected for [Delay Start].

Transmission Header Text

Set the default value for [Transmission Header Text] in the [Fax / Internet Fax Options] screen.

Confirmation Options

Set the default value for [Confirmation Options] of [Acknowledgement Report] in the [Fax / Internet Fax Options] screen.

Note • You can select Delivery Receipts or Read Receipts in [Delivery Confirmation Method]. For more information on the delivery confirmation method, refer to "Delivery Confirmation Method" (P.214).

Delivery Receipts / Read Receipts

Set the default value for [Read Receipts] or [Delivery Receipts] of [Acknowledgement Report] in the [Fax / Internet Fax Options] screen.

Note • You can select Delivery Receipts or Read Receipts in [Delivery Confirmation Method]. For more information on the delivery confirmation method, refer to "Delivery Confirmation Method" (P.214).

Internet Fax Profile

Set the default value for [Internet Fax Profile] in the [Fax / Internet Fax Options] screen.

Internet Fax Subject

Set the default value for [Internet Fax Subject] in the [Fax / Internet Fax Options] screen. Up to 128 single-byte characters can be entered for the subject.

Internet Fax Encryption

Set the default value for [Encryption] in the [Fax / Internet Fax Options] screen.

Note • This feature appears only when the root certificate for a remote server for remote authentication is set.

Fax Control

You can configure the settings related to fax control.

Re-enter Recipients

Set whether to re-enter the recipient after once specifying the recipient, to reduce the risk of sending a fax or an Internet fax to the wrong address. When Re-enter Recipients is set to [Enter Twice], if you specify the recipient by entering the phone number, or by selecting from the Address Book, the screen prompting you to re-enter the recipient appears. If the same recipient has been entered, the transmission process will start.

Re-enter Broadcast Recipients

This setting is required when you selected [Enter Twice] for [Re-enter Recipients]. Set whether or not to allow the Broadcast Send.

- Enter Once Only
Allows the Broadcast Send. No need to re-enter the recipient.
- Enter Twice
Allows the Broadcast Send. Re-entering the recipient is required.
- Broadcast Disabled
No Broadcast Send is allowed.

Re-enter Speed Dial Recipients

This setting is required when you selected [Enter Twice] for [Re-enter Recipients]. Select how to re-enter a recipient after the first entry.

- Enter Once Only
No need to re-enter the recipient.
- Enter Twice
Use the Speed Dial feature to re-enter the recipient.
- Re-enter Fax Number or E-mail
You cannot enter the speed dial when you re-enter the number or address. Use the fax number, phone number, or e-mail address to enter the recipient.

Re-enter Group Recipients

Specifies whether you need to re-enter group addresses after entering a group address.

- Group Send Disabled
No group recipient is allowed.
- Enter Once Only

No need to re-enter the group recipient.

- Enter Twice

Re-entering the group recipient is required.

Broadcast Checkbox on 1st Tab

Specify whether or not to show the [Enable Broadcast] checkbox in the [Fax / Internet Fax] screen to explicitly express broadcast directions.

Chain Dial

Allows you to combine the fax numbers registered in one touch button, speed dial, and address book respectively and the numbers entered using the numeric keypad to specify as one recipient. You can select from [No] or [Yes].

Note • This item is available when [Type 1] is set for [Address Book Type] under [Tools] > [System Settings] > [Address Book Settings].

Manual Redial List - Saved Entries

Specify the number of redial destinations saved.

Manual Redial List - Dial Mode

Specify the destination type saved as a redial destination number.
When you deselect all the check boxes, the Redial feature becomes disabled.

Transmission Header Text - Polling

Set whether or not to attach a transmission header to a polling file.

A "polling file" means that a document is stored in the machine's public folder for polling, and can then be sent by an operation from the other party.

Polled Files - Auto Delete

Set whether or not to automatically delete a polling file after transmission.

Rotate 90 degrees

Set whether or not to automatically rotate a document if its image must be reduced in size unless it is rotated.

Note • If an arbitrary magnification is specified in [Reduce / Enlarge], the Rotate 90 Degrees feature does not function.

G3 Sender ID - Fax

When using G3 communications, you can select whether to notify G3-ID to recipients for fax.

Save Undelivered Faxes

Set whether or not to save a fax document if a fax transmission fails. When [Yes] is selected, the [Undelivered Faxes] button appears on the [Secure Print Jobs & More] tab of the [Job Status] screen. Select this button to send the fax document again.

For details on Undelivered Faxes, refer to "11 Job Status" > "Printing and Deleting Stored Jobs" > "Undelivered Faxes" in the User Guide.

Save Deleted Faxes

When [Yes] is selected for [Save Undelivered Faxes], set whether or not to save cancelled faxes.

Saved Faxes - Auto Delete

When [Yes] is selected for [Save Undelivered Faxes], set whether or not to automatically delete saved faxes in 24 hours.

Transmission Interval

Specify a value for the interval between the end of one transmission and the beginning of the next, from 3 to 255 seconds in 1 second increments.

A longer transmission interval increases the total time to send a broadcast transmission, but allows calls to be received during the standby time.

Batch Send

When the machine stores multiple faxes addressed to a destination, enabling the Batch Send feature allows you to send them all at the same time in a single fax transmission. By using this feature, you can reduce your communication costs.

Select whether or not to enable the Batch Send feature.

Note that a batch send is not available for manual transmissions, broadcasts, relay broadcasts, remote folder, and delayed start transmission with a specified time before the specified time. When a redial, resend, delayed start transmission job, or the Authentication feature is used and different users send to the same address, a batch send is not possible.

Manual Send / Receive Default

When on-hook or off-hook is used when sending a fax, select either [Manual Receive] or [Manual Send].

Fax Receiving Mode

Set the default value for [Fax Receiving Mode] in the [Machine Information] screen displayed by pressing the <Machine Status> button. Select whether or not to receive a fax automatically or manually.

Border Limit

Set the length to make a page break that will be applied when the length of a received fax document is longer than the paper length. You can specify a value from 0 to 127 mm in 1 mm increments.

This setting can conveniently be used together with the following Auto Reduce On Receipt feature.

Auto Reduce On Receipt

When the length of a received fax document exceeds the paper length but is within the page break threshold value, select whether or not to automatically reduce the image to fit the page.

This setting can conveniently be used together with the Border Limit feature. If you select [No], the part of the image beyond the paper length is ignored.

Receiving Paper Size

Set the method of notifying the paper size on which the received fax document will be printed, from the receiver to the sender.

Tray Mode

Specify the paper tray for printing the received fax document. Only the specified paper tray will be used for printing the received document. Multiple paper trays can be specified except for Tray 5. If the fax document cannot be printed on the paper loaded in the specified paper trays, the machine displays a message stating that it will be printed on the paper loaded in

Tray 5. Load paper in Tray 5 and press the <Start> button to print the document. To cancel printing, press the <Clear All> button.

User Mode

Specify the paper sizes to use for printing received fax documents. Regardless of whether the paper is loaded in the trays, only the specified size paper is used for printing. When you select [User Mode], select paper sizes from [A3☐], [A4☐], [A4☐], [A5☐], [B4☐], [B5☐], [8.5 x 11"☐], and [Select All]. You can select one or more paper sizes.

2 Pages Up On Receipt

Set whether or not to print two pages of a fax document on one side of a sheet. This is convenient for saving paper.

For example, when two A5 pages are received, they are printed on a single A4 sheet. However, if paper of the same paper size as the received document is specified in [Receiving Paper Size], it is printed on the specified size of paper. Depending on the sizes of the received document, multiple-up printing may not be possible.

2 Sided Printing

Set whether or not to print received fax documents (including the Internet fax received documents) as 2 sided. This is convenient for saving paper.

Note • Even if you select [On], depending on the data, 2 sided printing may not always be possible.

Edge Erase - Top & Bottom Edges

Specify the amount of edges erased from the document in the top and bottom directions. Specify a value from 0 to 20 mm in 1 mm increments.

Edge Erase - Left & Right Edges

Specify the amount of edges erased from the document in the left and right directions. Specify a value from 0 to 20 mm in 1 mm increments.

Reduce 8.5 x 11" ☐ Original to A4 ☐

When [Reduce / Enlarge] in the [Layout Adjustment] screen is set to [Auto %], you can set whether or not to reduce 8.5 x 11"☐ size document to A4☐, while scanning the document.

Pseudo-Photo Gradation Mode

You can select a gradation expression mode. Selecting this mode enables the machine to change the processing method for gray part (halftone) to achieve near-photo quality. Select either [Error Diffusion] or [Dither].

Changing this setting also changes the photo gradation mode for Color Scanning (Black & White).

Folder Selector Setup

Select whether or not to use the Folder Selector Setup feature.

The Folder Selector Setup feature allows you to classify received faxes by line type and store them in folders specified.

Memory Full Procedure

If there is insufficient hard disk memory while scanning a document, a screen appears asking you how you want to handle the partially stored data.

Set the process you want the machine to perform for the partially stored data after a certain time has elapsed in the confirmation screen.

You can set the time until the memory full procedure is carried out. For more information, refer to "Auto Job Release" (P.125).

Delete Job

Deletes the data partially stored.

Run Job

Treats the read-in data as valid, and start scanning the document partially stored.

Maximum Stored Pages

Set the maximum number of pages stored for a fax document. You can specify from 1 to 999 pages.

Mixed Size Originals Scan Mode

Set the scan mode when the machine scans documents of various sizes simultaneously with the document feeder. If only documents of standard sizes are to be scanned, we recommend that you select [Standard Size Mode].

- Note**
- When [Standard Size Mode] is selected, image loss may occur if the following types of documents are scanned:
 - Non-standard size documents
 - B4 size documents with the inch series setting in [Paper Size Settings].

Skip Blank Pages

Set whether or not to detect blank pages while scanning 2 sided documents and transmits only pages that are not blank.

- Note**
- This feature is for service representative use. For more information, contact Customer Support at dell.com/contactdell.

Fax Data in Folder Priority 1 to 3

Set the priority to display the fax information received using folders. For instance, when using Network Scanner Utility 3, the fax information is displayed in the [Recipient] section of the file list screen.

There are priority levels from 1 to 3. All priority can be set, however, if you want to display only one priority level, make the settings of all priority levels the same.

Direct Fax

Set whether or not to receive a fax, which is instructed using a fax driver from a computer. When you select [Disabled], the Direct Fax feature becomes unavailable.

Block Inbound Faxes

Set a G3-ID (fax number) from which you want to reject a fax reception. You can specify up to 50 G3-IDs.

You can find the G3-ID of the sender that you want to reject in "Remote Station" column of an Activity Report or "Input Source" column of a Job History Report.

Block Unknown Fax Numbers

Set whether or not to receive faxes from unknown G3-ID fax numbers. When [Yes] is selected, the machine does not receive faxes from unknown fax numbers.

Fax Received Options

Fax Received Options allows you to specify a method for classifying received fax documents into specified folders.

Folder Selector Setup

If you set the classification by line type, the machine classifies the received documents by line type and store them in the folders specified.

- 1 Select [Folder Selector Setup].
- 2 Select the line to register, and then select [Change Settings].

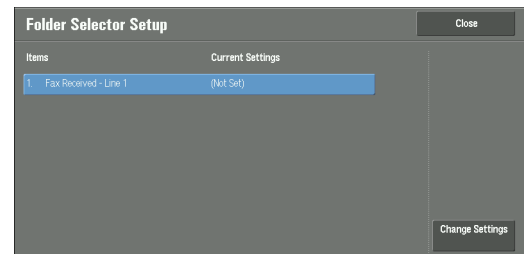

- 3 Select [On].



- 4 Enter the folder number (three-digits) where you want to store the faxes with the numeric keypad.
- 5 Select [Save].

Output Destination Setup

In [Output Destination Setup], you can set the output destination.

Fax Received - Line 1

Specify output tray for line 1.

Public Folder Printed Files

Specifies output tray for public folder for polling.

Reduce / Enlarge Presets

You can set the magnifications displayed as [Preset %] which are displayed under [Reduce / Enlarge] in the [Layout Adjustment] screen. You can assign any magnification to the Reduce/Enlarge Preset buttons other than [100%] and [Auto %].

Preset %

You can select from preset ratios.

Variable %

You can specify a magnification from 50 to 400% in 1% increments.

Original Size Defaults

You can set the original sizes displayed in [Original Size] in the [Layout Adjustment] screen. You can assign original sizes to the buttons other than [Auto Detect]. If you frequently use non-standard size paper for scanning, setting non-standard size as the default will save your time to specify the size each time.

A/B Series Size

You can select from sizes of A and B series such as A4 and B5.

Inch Size

You can select from size of Inch series such as 8.5 x 11" and 11 x 17".

Others

You can select from sizes of other than the above series such as photo and postcard sizes.

Local Terminal Information

You can set the local terminal information, including a local name and company logo.

- Note**
- The displayed items may vary depending on the options installed.
 - For each line, you can set a company logo, G3 ID (fax number), G3 dial type, and G3 line type.

For information about how to enter characters, refer to "Entering Text" (P.34).

Local Name

Register the name of the local terminal as the local name. The local name is shown in the recipient's touch screen or Activity Report. Depending on the recipient's device, however, it may not be displayed. Specify a local name with up to 20 single-byte characters using the keyboard displayed or the numeric keypad.

Company Logo

Register the sender name (company logo). The company logo is printed in the Transmission Header Text or Cover Page. Specify a company log with up to 60 single-byte characters using the keyboard displayed or the numeric keypad.

- Note**
- If [Line 1 - Company Logo] is not registered, the company logo is used.

Machine Password

Set the machine password when you want to limit the other parties that can send faxes.

When the machine password is set, only a party that sends the correct machine password by F code is allowed to send or poll. Note that this means that faxes cannot be accepted from a fax without the F Code feature.

Line 1 - Company Logo

Register the sender name for line 1. The sender name is printed in the Transmission Header Text or Cover Page. Enter up to 60 single-byte characters using the keyboard displayed or the numeric keypad.

G3 Line 1 - Fax ID

When using G3 communications, register the G3 ID. The G3 ID is normally set to the local terminal fax number.

Specify a G3 ID with up to 20 digits using the keyboard displayed or the numeric keypad.

- Note**
- A G3 ID (fax number) can consist of not more than 20 digits, including 0 to 9, +, and space.

G3 Line 1 - Dial Type

Set the dial type.

Tone

Tone dialing line.

10pps

Pulse dialing line.

G3 Line 1 - Line Type

Set the line type.

PSTN

Subscriber telephone line.

PBX

Private branch exchange.

Internet Fax Control

You can configure the settings related to the Internet fax control.

Internet Fax Path

Set the Internet fax communication path.

Via E-mail Server

Sends e-mail via an SMTP server.

Direct (P2P)

Directly sends to the machine with the Internet Fax feature, without going through an SMTP server.

You can specify the following two types of e-mail address for the Internet Fax feature:

- Specifying a host name
@ must be followed by FQDN.
Example: local-part@device.domain.jp
- Specifying an IP address
@ must be followed by an IP address with brackets.
Example: local-part@[192.0.2.1]

Profile for Broadcast Job

Set the default value for an Internet fax profile when performing an Internet fax broadcast send.

A profile is specified to restrict attribute information such as image resolution and paper size for transmissions between Internet Fax-enabled machines.

- Note**
- The supported TIFF-file profiles vary depending on the destination Internet Fax-enabled machine. Before specifying a profile, check the profile that the destination machine supports.

TIFF-S

The Internet fax standard profile. For documents larger than A4, the size is automatically reduced to A4 when transmission.

TIFF-F

Select this profile when you specify [Superfine (400 dpi)] or [Superfine (600 dpi)] for [Resolution] or when you send A3 or B4 documents.

TIFF-J

Select this profile for sending documents in JBIG.

Broadcast Starting Rate

Set the default value for the communications mode for the broadcasting for the Internet fax.

Delivery Confirmation Method

Set the default value for the method of confirming that an Internet fax sent has arrived or not.

To print a transmission result, set [Print Delivery Confirmation Mail] to [On] under [E-mail / Internet Fax Service Settings] > [E-mail Control].

Note • You can select [Delivery Receipts] when the destination machine supports the DSN feature. You can use [Read Receipts] when the destination machine supports the MDN feature.

Delivery Receipts

You can confirm whether the Internet fax you sent is delivered to the recipient's folder successfully.

Read Receipts

You can confirm whether the Internet fax including attachments you sent is processed properly at the recipient.

Incoming Internet Fax Print Options

When an e-mail sent from an Internet fax compatible machine to the e-mail address of the machine is received, you can select the print operation.

Print Attachment Only

Only prints the attached documents.

Attachment, Full Headers & Message

Prints the e-mail header and body of e-mails.

Attachment, Basic Headers & Message

Prints the part of headers (From/To/Subject/Date) and the contents of e-mails.

When you select [Do not print if no message], the machine prints only e-mail that has contents.

Internet Fax Output Destination

Set the output tray to use for printed Internet fax documents.

Note • An optional component is required to use this feature. For more information, contact Customer Support at dell.com/contactdell.

Fax Transfer from Address Book

Set whether to permit forwarding of Internet fax data received by e-mail via SMTP when the forwarding destination is not registered on the Address Book.

Off

Permits forwarding.

On

Checks whether the forwarding fax number is listed in the Address Book, and if not, rejects receiving the e-mail and deletes it.

Transmission Header Text - Fax Transfer

When forwarding received e-mail from Internet fax to fax, select whether or not to add a Transmission Header Text (start time, company logo, recipient name, G3 ID, and number of pages).

Fax Transfer Maximum Data Size

When forwarding a received e-mail from Internet fax to fax, set the maximum data size.

No Limit

No limit on data size.

Limit Size

Specify a value from 1 to 65535 KB in 1 KB increments. If a data size exceeds the specified value, the data is deleted.

E-mail / Internet Fax Service Settings

In [E-mail / Internet Fax Service Settings], you can configure settings related to the e-mail and the Internet Fax service.

- 1 On the [Tools] screen, select [System Settings] > [E-mail / Internet Fax Service Settings].
For the method of displaying the [Tools] screen, refer to "System Settings Procedure" (P.106).
- 2 Select an item to set or change.

E-mail Control

You can configure the settings for e-mail and Internet fax transmissions.

Maximum Address Entries

Set the maximum number of addresses that can be specified when sending an e-mail. The number of addresses is the total number of To:/Cc:/Bcc:.

You can set the maximum number of addresses from 1 to 100. If the maximum number of addresses exceeds, the e-mail transmission is aborted.

Note • This option is not applicable to the Internet Fax service.

Incoming E-mail Print Options

When an e-mail sent to the e-mail address of the machine is received, you can select the print operation.

Print Attachment Only

Only prints the attached documents.

Attachment, Full Headers & Message

Prints the e-mail headers and body of e-mails.

When you select [Attachment, Full Headers & Message (with S/MIME Info)], S/MIME Information is also printed.

Attachment, Basic Headers & Message

Prints the part of headers (From/To/Subject/Date) and the contents of e-mails.

When you select [Do not print if no message], the machine prints only e-mail that has contents.

Print Error Notification E-mail

Select whether the error e-mail because of an incorrect address or transmission error should be automatically printed.

Note • The job for printing error e-mail is displayed as an error on the [Job Status] screen and a Job History Report even when the job has been complete successfully.

Response to Read Receipts

Set whether or not to respond when a read receipt (MDN) is requested.

Off

Does not respond.

On

Automatically notifies the sender that the e-mail has been processed.

Read Receipts

When an e-mail is sent from the machine, select whether or not to use the Read Receipts feature.

Off

The Read Receipts feature is disabled.

On

Uses the Read Receipts feature.

Note • For the Internet fax read receipts setting, select either [Delivery Receipts] or [Read Receipts] in [Delivery Confirmation Method] under [Tools] > [System Settings] > [Fax Service Settings] > [Internet Fax Control].

Print Delivery Confirmation Mail

Select whether or not to automatically print transmission result e-mails (DSN response/MDN response).

Off

Does not print transmission result e-mails.

On

Transmission result e-mails are automatically printed regardless of success or failure of the transmission.

Print when delivery fails

Prints only when the transmission failed.

Split Send Method

Set the default value for the mail split method.

Split into Pages

Splits into pages.

Split by Data Size

Splits by the data size set in [Maximum Data Size per E-mail].

Maximum Data Size per E-mail

Set the upper limit of the data size for splitting mail.

Specify a value from 512 to 20480 KB in 1 KB increments. The default value is 10240 KB.

Maximum Total Data Size

Set the upper limit of the data size of mail.

Specify a value from 512 to 200000 KB in 1 KB increments. The default value is 200000 KB.

Maximum Split Count

Set the split upper limit for when splitting mail.

Specify not to split mail or a value from 2 to 500.

Allow Casual Users to Edit From Field

Set whether or not to protect e-mail addresses from being changed by unregistered users under [From] on the [E-mail] tab.

Allow Guest Users to Edit From Field

Set whether or not to protect e-mail addresses from being changed by guest users under [From] on the [E-mail] tab.

Allow to edit From if Search Found

Set whether or not to protect e-mail addresses from being changed under [From] on the [E-mail] tab when a login user retrieves an e-mail address.

Allow to edit From if Search Failed

Set whether to protect e-mail addresses from being changed under [From] on the [E-mail] tab when a login user fails to retrieve an e-mail address.

E-mail Sending When Search Failed

Set whether or not to disable the [E-mail] service when a login user fails to retrieve an e-mail address.

Add Me to "To" Field

Set whether or not to automatically add the sender's address to the To field.

Add Me to "Cc" Field

Set whether or not to automatically add the sender's address to the CC field.

Edit E-mail Recipients

Set whether or not to permit to edit e-mail recipients (To, CC, BCC). Selecting [No] prevents e-mails from being sent to unintended destinations.

Note • If you set [Edit E-mail Recipients] to [No], set [Add Me to "To" Field] to [Yes].

Address Book Settings

In [Address Book Settings], you can configure settings related to the e-mail and the address book.

- 1 On the [Tools] screen, select [System Settings] > [Address Book Settings].
For the method of displaying the [Tools] screen, refer to "System Settings Procedure" (P.106).
- 2 Select an item to set or change.

Address Book Type

Select the type of the Address Book from [Type 1] or [Type 2].

Directory Service

Select whether or not to use an address book stored on the directory server.

Even when [Enabled] is selected, the address book of the directory server will not be started unless the following conditions are satisfied.

- The IP address of the machine must be set.
- The IP address or Internet address of the directory server (primary) must be set.
- The port numbers used for LDAP communication must be set on the directory server and the machine.

Address Book Default - Scan

Select from [Public Entries] or [Network Entries].

Address Book Default - Fax

Select from [Public Entries] or [Network Entries].

Search Display Default

Select from [Advanced Search] or [Simple Search].

- Note** • This item can be set when [Address Book Type] is set to [Type 1].

Fax Speed Dial Default

Specify the default speed dial to display at the top of the [Fax Address Book] screen.

Set the number from 1 to 2000.

- Note** • Available numbers to assign to speed dials depend on the configuration of your machine. For more information, contact Customer Support at dell.com/contactdell.

Folder Service Settings

In [Folder Service Settings], you can configure settings to handle files stored in folders.

- 1 On the [Tools] screen, select [System Settings] > [Folder Service Settings].
For the method of displaying the [Tools] screen, refer to "System Settings Procedure" (P.106).
- 2 Select an item to set or change.

Files Retrieved By Client

Set whether or not to delete a file stored in a folder when a client retrieves it.

Delete according to Folder settings

Operates following the settings for individual folder.

For more information about setting folders, refer to "Delete Files After Retrieval" (P.232).

Force Delete

Ignores the settings for individual folder, and when a file is retrieved by a client, the retrieved file is forcibly deleted.

File Display Default

Set the display method of the file list screen. Select from [List] or [Thumbnail].

Print & Delete Confirmation Screen

Set whether or not to display a confirmation screen for automatically deleting files after printing the files stored in a folder.

Convert Custom Size to Standard Size

Set whether or not to convert custom size to standard size when transferring a fax/Internet fax received or a file for Secure Polling in the folder.

Standard Size Threshold Value

Specify a threshold value for converting custom size to standard size when [Convert Custom Size to Standard Size] is set to [Yes (Fax & Internet Fax files only)].

Specify the value from 0 to 10 mm in 1 mm increments.

Internet Fax to Internet Fax

Select whether or not to permit Internet fax forwarding of files received in a folder.

Internet Fax to E-mail

Select whether or not to permit e-mail forwarding of files received in a folder.

Quality / File Size for Retrieval

Select a quality and size for files highly compressed and retrieved from folders. Select from [Quality: Normal / File Size: Small], [Quality: Higher / File Size: Larger], or [Quality: Maximum / File Size: Largest].

Job Flow Service Settings

In [Job Flow Service Settings], you can configure the settings related to the Job Flow. The Job Flow is a function to perform a series of jobs registered.

Also, in [Job Flow Service Settings], you can configure a pool server. As for [Pool Server], [Pool Server Login Method], and [Job Flow Sheet List Default], however, leave the default settings unchanged because a pool server is not available for the machine.

You can select a resolution in [Fax Transfer Resolution] when you transfer a scanned document as a fax.

Pool Server

Leave the default setting unchanged.

Pool Server Login Method

Leave the default setting unchanged.

Job Flow Sheet List Default

Set the default values for [Save in], [Owner], and [Target] of Job flow sheets which are displayed when you select [Job Flow Sheets] on the [Home] screen.

Save in

Leave the default setting unchanged.

Owner

Select the owner of job flow sheets from Administrator and Non-System Administrator to filter.

Note • When the machine is in the Authentication mode, select the owner from Shared or Personal.

Target

Select the target of job flow sheets from Scan Jobs, External Application, and Copy to filter.

Fax Transfer Resolution

Select the resolution setting when you send a color document as a fax using the Job Flow feature.

Same Resolution (High Quality)

Converts color images to black and white images on a document with the same resolution when the document is transferred as a fax. Conversion of high resolution color images will take longer.

200 dpi (High Speed)

Converts color images to black and white images of 200 dpi on a document when the document is transferred as a fax.

Reduces the time when converting color images of 300 dpi or higher to black and white images. 200 dpi is equivalent to [Fine (200 dpi)] in fax transmission.

Media Print Service Settings

In [Media Print Service Settings], you can select the paper trays displayed for [Paper Supply] in the [Media Print - Text] and [Media Print - Photos] screens.

You can import and print image data (DCF1.0 (Exif 2.0 - 2.2 compliant JPEG/TIFF files)) from a digital camera and document files (PDF, TIFF, XML Paper Specification (XPS), or JPEG (JFIF)). This feature is called the Media Print feature.

- 1 On the [Tools] screen, select [System Settings] > [Media Print Service Settings].
For the method of displaying the [Tools] screen, refer to "System Settings Procedure" (P.106).
- 2 Select an item to set or change.

Text - Paper Supply - Button 2 to 5

Select the paper tray displayed in the second to fifth columns for [Paper Supply] on the [Media Print - Text] screen.

Photos - Paper Supply - Button 1 to 5

Select the paper tray displayed in the first to fifth columns for [Paper Supply] on the [Media Print - Photos] screen.

Stored File Settings

In [Stored File Settings], you can select whether to automatically delete files stored to the folders of the machine. Set the expiration date and the time of deletion.

You can also specify the types of the files to delete.

- 1 On the [Tools] screen, select [System Settings] > [Stored File Settings].
For the method of displaying the [Tools] screen, refer to "System Settings Procedure" (P.106).
- 2 Select an item to set or change.

Expiration Date for Files in Folder

You can set expiration date for the file in a folder. To delete stored files automatically, specify an expiration date and deletion time. The settings apply to all stored files.

Off

Does not automatically delete the print files stored in the machine.

On

Allows you to set the file retention period and the expiration date. The stored files will be deleted after the time specified in [Files deleted at:] passed.

Files kept for:

Set the file retention period from 1 to 14 days.

Files deleted at:

Set the deletion time for the expired files from 1 to 12 hours for AM or PM and 0 to 59 minutes.

Note • When you select [24 Hour Clock] for [Time] under [Tools] > [System Settings] > [Common Service Settings] > [Machine Clock / Timers], set the deletion time from 0 to 23 hours and 00 to 59 minutes.

To automatically delete files at the time specified here, you need to set [Delete Expired Files] to [Yes]. For more information, refer to "Delete Expired Files" (P.232).

Stored Job Expiration Date

You can set whether or not to automatically delete print files (Charge Print, Private Charge Print, Secure Print, or Sample Print) stored in the machine.

Options

Set the retention period for stored jobs.

Select from [Off], [On], and [Same Date as Files in Folder]. When [On] is selected, set the value for [Files kept for:] from 1 to 23 hours in 1 hour increments. When the time elapses, print files stored in the machine will be deleted. When [Same Date as Files in Folder] is selected, print files stored in the machine will be deleted in accordance with the setting in [Expiration Date for Files in Folder].

Power Off Deletes Jobs

Allows you to set whether or not to delete stored jobs when the machine is turned off and then on. When [Yes] is selected, all the stored jobs will be deleted. When [No] is selected, only the expired jobs will be deleted.

Note • When [Yes] is selected, all the stored jobs will be deleted regardless of the [Files kept for:] settings.

Display Details of Stored Print Job List

Set whether or not to display detailed information such as output color and 2 sided in the stored job list of print files (Charge Print, Secure Print, Sample Print, or Delayed Print). When you select [On], detailed information is displayed in the list. When you select [Off], you can see more jobs at a time since detailed information is not displayed.

Print Job Confirmation Screen

Set whether or not to display a print confirmation screen for deletion of the print files stored in the machine after printing. When [Enabled] is selected, the confirmation message appears. You can change the number of print sets when the print settings are allowed to be changed. When [Disabled] is selected, print files stored in the machine are automatically deleted after printing.

Minimum Passcode Length for Stored Jobs

Set the minimum number of allowed passcode digits between 0 and 12 digits. A passcode is required when Secure Print or Private Charge Print files are to be stored or printed.

A passcode must be a string consisting of the number of digits that is equal to or larger than the value specified here.

Note • Specify "0" if you do not set passcodes or the minimum number of digits.

Print Order for All Selected Files

Specify the printing order when you select to print all print files stored.

Date & Time: Oldest First

Prints files in chronological order.

Date & Time: Newest First

Prints files in reverse chronological order.

File Name: Ascending

Prints files in ascending order by file name.

File Name: Descending

Prints files in descending order by file name.

Web Applications Service Setup

In [Web Applications Service Setup], you can specify the remote access destination.

Remote access allows you to view web application services, which are compatible with the machine, directly on the touch screen, to upload a document that has been scanned on the machine to the web applications, and to directly select and print a document that is stored in the remote server. It also allows you to directly upload and print a file without going through another computer.

Note • To use this feature, any web application (purchased separately) is required.

- 1 On the [Tools] screen, select [System Settings] > [Web Applications Service Setup].
For the method of displaying the [Tools] screen, refer to "System Settings Procedure" (P.106).
- 2 Select an item to set or change.

Server Certificate Verification Settings

When the machine is connected to a remote server (ASP) that is located in the Internet zone, server certificate verification is available to prevent phishing attempts as with a Windows web browser. Configure the following settings.

Preparations

Download a root certificate (CA certificate) of the root certification authority, which issues the server certificate for the remote server to be connected, to a computer connected to Dell Printer Configuration Web Tool.

The CA certificate formats that can be used are as follows:

- DER encoded binary X.509 (.CER)
- Base 64 encoded X.509 (.CER)
- Cryptographic Message Syntax Standard - PKCS #7 Certificates (.P7B)

Setting Procedure

- 1 Start Dell Printer Configuration Web Tool.
For information on how to start Dell Printer Configuration Web Tool, refer to "Starting Dell Printer Configuration Web Tool" (P.276).
- 2 Generate a certificate.
If you use an approved device certificate, proceed to step 3.
 - 1) Click the [Properties] tab.
 - 2) Click [Security] to display the items in the folder.
 - 3) Click [Machine Digital Certificate Management].
 - 4) Click the [Create New Self Signed Certificate] button.
 - 5) Set [Public Key Size] and [Issuer], and then click [Apply].
After a short while, [Settings have been changed.] is displayed.
- 3 Enable SSL/TLS communication.
 - 1) Click [SSL / TLS Settings].
 - 2) Select the [Enabled] check box for [HTTP - SSL / TLS Communication].

- 3) Select the [Enabled] check box for [Verify Remote Server Certificate].
- 4) Click [Apply].
- 5) When the right frame on the web browser will change to the machine reboot display, click [Reboot Machine]. The machine reboots and the setting values are enabled.

4 Import the root certificate of the remote server.

- 1) Refresh the web browser to reload Dell Printer Configuration Web Tool.

Note • An address beginning with "https" instead of "http" is displayed in the address box in the web browser.

- 2) Click the [Properties] tab.
- 3) Click [Security] to display the items in the folder.
- 4) Click [Machine Digital Certificate Management].
- 5) Click [Upload Signed Certificate].
- 6) Enter a file name you want to import, or select a file to be imported from a dialog box displayed by clicking the [Browse] button.
- 7) Click the [Import] button.
After a short while, [Settings have been changed.] is displayed.
- 8) Refresh the web browser to reload Dell Printer Configuration Web Tool.

5 Confirm that the certificate has been imported.

Otherwise, proceed to step 6.

- 1) Click [Certificate Management].
- 2) Select [Trusted Certificate Authorities] for [Category], and then click the [Display the list] button.
- 3) Select the check box next to the certificate you want to confirm.
- 4) Click the [Certificate Details] button.

6 Configure connection settings for the remote server.

- 1) Click the [Properties] tab.
- 2) Click [General Setup] to display the items in the folder.
- 3) Click [Dell Printer Configuration Web Tool Settings].
- 4) Configure connection settings for the remote server.
- 5) Click [Edit].
Configure connection settings for the remote server again.

Note • Enter an address beginning with "https" instead of "http" into the address box in the web browser.

- 6) Click [Apply].
After a short while, [Settings have been changed.] is displayed.

Server Setup

This section describes how to register a server on access web applications.

Note • If there are one or more servers to register, it is helpful to assign the servers to the buttons displayed on the [Home] screen. For information on changing the buttons on the [Home] screen, refer to "Customizing the Control Panel" (P.25).

- 1 Select [Server Setup].
- 2 Select an access destination you want to register, and then select [Change Settings].
- 3 Enter the URL of the access destination, if you register an access destination in a new entry.

URL

Enter the URL of the access destination with up to 256 single-byte characters, and select [Save]. URL must begin with the type of the protocol used.

Use the version of a web application that is set [Web Applications Version] in "Web Browser Setup" (P.229).

For example:

- http://www.example.com
- http://192.0.2.1 (IPv4)
- http://[2001:DB8::1234] (IPv6)
- https://www.example.com
- https://192.0.2.1 (IPv4)
- https://[2001:DB8::1234] (IPv6)
- When specified with V2 (old version)
 - http-v2://www.example.com
 - http-v2://192.0.2.1 (IPv4)
 - http-v2://[2001:DB8::1234] (IPv6)
- When specified with V3
 - http-v3://www.example.com
 - http-v3://192.0.2.1 (IPv4)
 - http-v3://[2001:DB8::1234] (IPv6)
- When specified with V4 (new version)
 - http-v4://www.example.com
 - http-v4://192.0.2.1 (IPv4)
 - http-v4://[2001:DB8::1234] (IPv6)

Note • When the URL is specified with V3, V4 (new version) is used for connection.
• Begin with "https" for a protocol with an encryption feature.

- 4 Configure other settings as necessary.

Server Name

Enter the access destination name with up to 32 single-byte characters.

Description

Enter the description of the access destination with up to 128 single-byte characters.

Use User ID

- No
 - When [Login Type] is set to [Login to Remote Accounts]:
The machine accesses the remote service using the user information authenticated on the machine.
 - When [Login Type] is set to [No Login Required] or [Login to Local Accounts]:
The machine prompts the user to input User ID and password to access Web applications.
- Yes
Allows you to enter a user ID and password into [User ID] and [Password] respectively, which are used when the machine accesses the remote service.

User ID

Enter the User ID to access the remote service with up to 128 characters.

- Note**
- Depending on the settings on the remote service, the entry for [User ID] may be invalid. Check the settings on the remote service.
 - Along with [User ID], set also [Password]. [User ID] will be invalid unless [Password] is set.
 - All the specified settings are ignored if the remote service to be connected requires other than a user ID and its password for authentication.

Password

Enter the password for the User ID with up to 128 characters.

Machine / Authentication Notification

Set whether or not to notify the remote server of machine information and user authentication information every time the machine connects to the remote service.

- Note**
- The remote service determines whether to use the information. No need to configure settings on the control panel.

Notify User Authorization Information

Set whether or not to notify the remote service of user authorization information every time the machine connects to the remote service.

Delete All Settings

Deletes all settings registered.

Other Settings

When Sending User Details

Set whether or not to display a confirmation screen when the machine send user authorization information (authorized User ID, password, e-mail address, and the services restricted) to the remote server.

- Note**
- Even when you select [No Confirmation Required], if there is a flaw in the authentication information, a confirmation screen is displayed.

Web Browser Setup

In [Web Browser Setup], you can configure the settings for the web browser to be used when the machine accesses a web application using the Web Applications feature.

Remote access allows you to view web application services, which are compatible with the machine, directly on the touch screen, to upload a document that has been scanned on the machine to the web applications, and to directly select and print a document that is stored in the remote server. It also allows you to directly upload and print a file without going through another computer.

Note • To use this feature, any web application (purchased separately) is required.

1 On the [Tools] screen, select [System Settings] > [Web Browser Setup].

For the method of displaying the [Tools] screen, refer to "System Settings Procedure" (P.106).

2 Select an item to set or change.

Web Applications Version

Select a version of the Web applications service from [V2 (Old Version)] and [V4 (New Version)].

Note

- If [V2 (Old Version)] is selected, the following settings become invalid: [Delete Persistent Cookie Upon Closing], [Clear Cache Upon Closing], [Use Cache], [Accept Cookies], [Use TLS1.0], [Use SSL3.0], [When SSL Certificate Verification Fails], and [Enable File Printing].
- When you use V3 of the web application version, select [V4 (New Version)].

Delete Persistent Cookie Upon Closing

Specify whether to delete persistent cookie when connection to a Web application ends.

Clear Cache Upon Closing

Specify whether to delete cache when connection to a Web application ends.

Use Cache

Specify whether to use cache.

Accept Cookies

Specify whether to accept cookies.

Select from [No], [Yes], and [Warn user when cookie is offered].

When you select [Warn user when cookie is offered], the machine behaves as when you select [Yes].

Use TLS1.0

Specify whether to use TLS 1.0.

Use SSL3.0

Specify whether to use SSL 3.0.

When SSL Certificate Verification Fails

Specify whether to stop accessing the site or to display a confirmation screen for access if SSL certificate verification fails.

Enable File Printing

Specify whether to use the File Printing feature.

The File Printing feature allows you to directly print the printable files obtained from the remote Web server.

Setup

In [Setup], you can create or update folders, job flows, and the Address Book.

The following shows the reference section for each setting.

Create Folder.....	231
Stored Programming.....	233
Create Job Flow Sheet.....	233
Create Job Flow Sheet Keyword.....	241
Add Address Book Entry.....	241
Create Fax Group Recipients.....	248
Add Fax Comment.....	249
Paper Tray Attributes.....	250

- 1 On the [Tools] screen, select [Setup].
For the method of displaying the [Tools] screen, refer to "System Settings Procedure" (P.106).
- 2 Select an item to set or change.

Create Folder

Using the Folder function enables you to store scanned documents using the machine, fax received documents, or print documents sent from a computer in the machine.

You can also send a file stored in a folder via e-mail or retrieve a file stored in a computer on a network.

You can create a private folder and a public folder in the machine and use them separately depending on your purpose.

You can create up to 200 folders.

You can check the current folders in a Folder List. For more information, refer to "Folder List" (P.92).

- 1 Select [Create Folder].
- 2 Select the folder to create.
 - Note**
 - Select [▲] to display the previous screen or [▼] to display the next screen.
 - Entering a 3-digit folder number with the numeric keypad displays the specified folder at the top of the column.

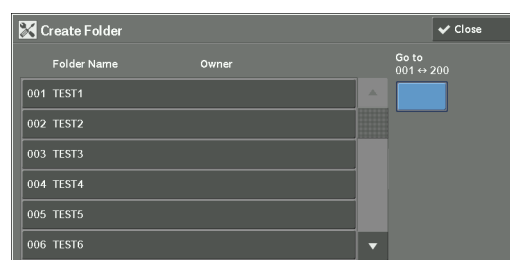

- 3 When you create a folder, the [New Folder - Passcode] screen appears. Select items, and then select [Save].
 - Note**
 - When you select a folder already created, the [Folder - Create / Delete] screen appears.

For more information on assigning a passcode, refer to "Check Folder Passcode" (P.232).

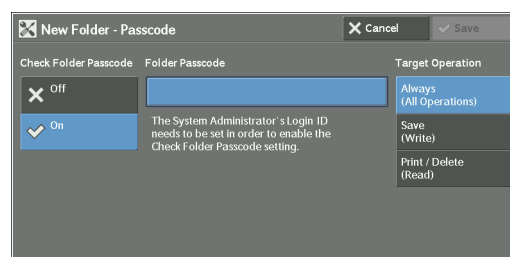

- 4 Select items and set the required settings.
- 5 When you finish required settings, select [Save].

Folder Name

Set the folder name. Enter up to 20 single-byte characters using the keyboard displayed or the numeric keypad.

For information about how to enter characters, refer to "Entering Text" (P.34).

Check Folder Passcode

Set an access restriction to permit operations for specified users only.

Check Folder Passcode

Set whether or not to set a passcode.

- Off

Does not set an access restriction.

- On

Set a passcode for access restriction.

Folder Passcode

To use the Check Folder Passcode feature, enter a passcode. You can enter a passcode of up to 20 numeric digits (0 to 9).

Target Operation

Set the operations to be restricted.

- Always (All Operations)

A passcode entry is required when a folder is selected or a file in a folder is printed or deleted.

- Save (Write)

A passcode entry is required when a folder is selected.

- Print / Delete (Read)

A passcode entry is required when printing or deleting the file in the folder.

Delete Files After Retrieval

When a file stored in a folder is printed or is retrieved from a remote server, set whether the file should be deleted.

No

The file is left stored.

Yes

After the file is printed, or is retrieved by an external source, it is automatically deleted.

Note • If you select [Yes], a file is not deleted when retrieved from Dell Printer Configuration Web Tool.

Delete Expired Files

Specify whether or not to enable the operation to delete files stored in a folder at a specified time after a retention period has elapsed.

No

Even when the retention period has elapsed, files are not deleted.

Yes

Deletes expired files at the specified time. If, however, the expiration date has not been specified, files are not deleted even when [Yes] is selected.

Note • When the machine is off at the deletion time of an expired file, the file is deleted next time the deletion time comes after the machine is turned on.

For information on setting the file retention period, refer to "Expiration Date for Files in Folder" (P.223).

Link Job Flow Sheet to Folder

You can link a job flow sheet to a folder. Linking a job flow in which a series of actions is recorded to a folder enables you to set the processing method for files stored in a folder.

For information on how to register a job flow, refer to "Create Job Flow Sheet" (P.233).

Cut Link

Cancels the link between a folder and a linked job flow sheet.

Create / Change Link

A screen to link a job flow sheet appears. You can select the existing job flow sheets or create a new job flow sheet.

For more information about the operation, refer to "Create Job Flow Sheet" (P.233).

Auto Start

If you select the [Auto Start] check box, when a file is stored in a folder, the procedures registered on the job flow linked automatically starts.

When the [Delete Folder] Button is Selected

Selecting this button deletes the selected folder. Any files stored in the folder are also deleted.

If [Login Type] is set to [No Login Required], all the job flow sheets, including a Local User created on the [Create Folder] screen or job flow sheets created on the [Send from Folder] screen, are deleted as well.

Note • Once files or job flow sheets are deleted, they cannot be restored.

Stored Programming

The Stored Programming feature enables you to register frequently used settings and record a series of operations.

For more information on operation, refer to "8 Stored Programming" > "Registering/Deleting/Renaming Stored Programs" in the User Guide.

Create Job Flow Sheet

Job flow is a feature to execute a series of registered actions. Up to 1000 job flow sheets can be created.

The target of a job flow is files stored in a folder. A job flow can be executed by using one of the following three methods:

- by automatically starting a job flow when a file is stored in a folder
- by selecting a file stored in a folder to manually execute the associated job flow
- by selecting a file stored in a folder to select a job flow and execute manually

To start a job flow automatically, you must link the job flow to a folder. When a file is stored in the folder, it is automatically processed in accordance with the job flow sheet linked.

Note • To link a folder with a job flow sheet created with [Create Job Flow Sheet], start from [Send from Folder] or [Create Folder]. For more information, refer to "6 Send from Folder" in the User Guide and "Create Folder" (P.231).

Features that can be registered are listed below.

- Forward to (FTP, SMB, e-mail, fax, and Internet fax)
- Print

Depending on the method of storing in the folder, there are restrictions on the combination of features.

Output Input	Print	Fax	Internet Fax *1	Mail	FTP	SMB
Fax Documents for Secure Polling	○	○	○	○	○	○
Scanning	○	○	○	○	○	○
Fax to Folder	○*2	○	○	○	○	○
Internet Fax Received	○	○	△	△	○	○
Print Stored	X	X	X	X	X	X

○ :Available

X :Not available

△ :Available depending on the System Administration mode settings

*1 :Load an A4 document in landscape orientation when TIFF-S has been selected for the Internet fax forwarding profile. Loading the document in portrait orientation will reduce the size of the Internet fax image.

*2 :If the fax USB cable is disconnected while a received fax file in a folder is being printed, the file is not deleted after printing, even if the delete after printing setting is enabled in the folder settings.

Restrictions on Using Job Flow

A job flow can be used by single or multiple users, or can be used by linking to a specific folder. The Authentication feature restricts the use of the job flows.

For information on the available Job Flow features and restrictions on use, refer to "Authentication for Job Flow Sheets and Folders" (P.356).

- 1 Select [Create Job Flow Sheet].
- 2 Carry out the job flow operation in accordance with your purpose.

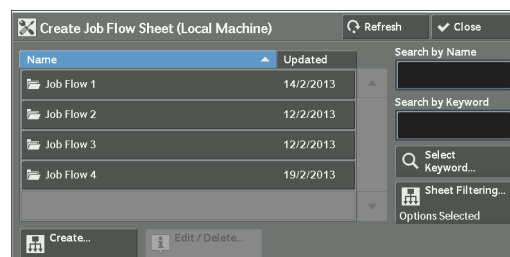

Sheet Filtering

You can filter the job flow sheets to display.

Select the filtering conditions, and then select [Save].

- Note**
- The screen displayed varies depending on the Login Type selected.

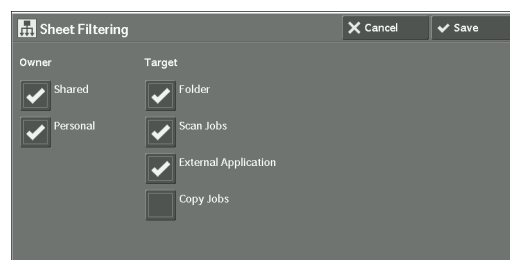

- Owner
Filters job flow sheets by owner type.
- Target
Filters job flow sheets by target, such as scan jobs and folders.

Create

Displays the [Create New Job Flow Sheet] screen.

Refer to "Create New Job Flow Sheet" (P.235).

Edit / Delete

Displays the [Details] screen.

Refer to "Edit / Delete" (P.241).

Search by Name

Searches for job flows that partially match the entry. The machine searches through job flow names that were registered upon each job flow creation. You can enter up to 128 single-byte characters.

For information about how to enter characters, refer to "Entering Text" (P.34).

Search by Keyword

Searches for job flows that fully match the entry. The machine searches through keywords that were registered upon each job flow creation.

For information about how to enter characters, refer to "Entering Text" (P.34).

Select Keyword...

Displays the [Select Keyword] screen. Select a keyword registered in the System Settings to search for job flows. Job flows that fully match the entry are searched. The machine searches through keywords that were registered upon each job flow creation.

For information on the keyword registry, refer to "Create Job Flow Sheet Keyword" (P.241).

Create New Job Flow Sheet

Create a new job flow.

- 1 Select an item to set, and then select [Edit].

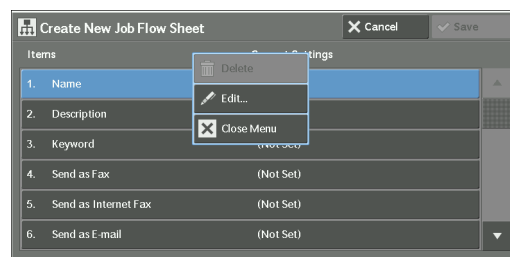

Delete

Deletes all setting values of the selected item.

Edit

Confirm or change the settings of the selected item.

Close Menu

Deselect the selected item.

Name

Set the name for the job flow sheet with up to 128 single-byte characters.

Description

Set the description of the job flow sheet with up to 256 single-byte characters.

Keyword

Enter a keyword with up to 12 single-byte characters for job flow search. You can also use the keywords that are registered for [Create Job Flow Sheet Keyword].

For information on the job flow keyword search, refer to "Create Job Flow Sheet Keyword" (P.241).

Send as Fax

Specify destinations for fax transmission. You can specify a total of 100 destinations, either by selecting from the Address Book or by direct input.

Note • You cannot use wildcards or group dial numbers.

Speed Dial

Specify an address with a speed dial. Enter the speed dial with the numeric keypad, and select [Save]. The address specified appears in [Name / Fax Number] in the [Send as Fax] screen.

New Recipient

Specify a new address. The address specified appears in [Name / Fax Number] in the [Send as Fax] screen.

Name / Fax Number

Displays the recipient name or fax number specified.

Remove

Deletes all information for the selected recipient.

Edit

Displays the [Edit Recipient] screen, which allows you to check or change the recipient selected.

For more information on the [Edit Recipient] screen, refer to "5 Scan" in the User Guide.

Cancel

Deselect the selected item.

Send as Internet Fax

Specify destinations for fax transmission. You can specify a total of 100 destinations, either by selecting from the Address Book or by direct input.

Note • You cannot use wildcards or group dial numbers.

Speed Dial

Specify an address with a speed dial. Enter the speed dial with the numeric keypad, and select [Save]. The address specified appears in [Name / E-mail Address] in the [Send as Internet Fax] screen.

New Recipient

Specify a new address. The address specified appears in [Name / E-mail Address] in the [Send as Internet Fax] screen.

Name / E-mail Address

Displays the recipient name or address specified.

Remove

Deletes all information for the selected recipient.

Edit

Displays the [Edit Recipient] screen, which allows you to check or change the recipient selected.

For more information on the [Edit Recipient] screen, refer to "5 Scan" in the User Guide.

Close Menu

Deselect the selected item.

Message

Enter body message of an Internet fax with the keyboard displayed.

Internet Fax Profile

Select an Internet fax profile.

A profile is specified to restrict attribute information such as image resolution and paper size for transmissions between Internet Fax-enabled machines.

Resend Attempts

Set whether or not to try sending again if a transmission fails. If you select [On], set the number of resend attempts and interval.

- Resend Attempts
Set the transmission retry count from 1 to 5.
- Resend Interval
Set the transmission retry interval from 30 to 300 seconds.

Transmission Header Text

Set whether or not to add a Transmission Header Text to an Internet fax.

Send as E-mail

Specify the recipients for e-mail transmission.

You can specify a total of 100 addresses, either by selecting from the Address Book or by direct input.

If [Encryption] is set to [On], you cannot specify a recipient by selecting [New Recipient].

Address Book

You can specify the recipients from the Address Book. The address specified appears in [Name / E-mail Address] in the [Send as E-mail] screen.

New Recipient

Specify a new address. The address specified appears in [Name / E-mail Address] in the [Send as E-mail] screen.

Name / E-mail Address

Displays the recipient name or e-mail address specified.

Subject

Enter a subject using the keyboard displayed.

Remove

Deletes all information for the selected recipient information.

Edit

Displays the [Edit Recipient] screen, which allows you to check or change the recipient selected.

For more information on the [Edit Recipient] screen, refer to "5 Scan" in the User Guide.

File Format

Select an output file format.

For more information on the [File Format] screen, refer to "5 Scan" in the User Guide.

Resend Attempts

Set whether or not to try sending again if a transmission fails. If you select [On], set the number of resend attempts and interval.

- Resend Attempts
Set the transmission retry count from 1 to 5.
- Resend Interval
Set the transmission retry interval from 30 to 300 seconds.

Encryption

Set whether or not to encrypt the e-mail transmission.

- Note**
- To encrypt e-mail transmission, the configuration of S/MIME is required.
 - To encrypt e-mail transmission, a certificate is required.
 - To enable encryption, select [On] before specifying an address. [On] will be disabled after an address is specified.

Digital Signature

Select whether or not to add digital signature.

- Note**
- To add digital signature, the configuration of S/MIME is required.
 - To add digital signature, a certificate is required.

Transfer via FTP (1), Transfer via FTP (2)

[Transfer via FTP (2)] will be displayed when [Transfer via FTP (1)] is configured.

Specify where FTP forwarding is to be stored.

Address Book

When the server address is registered on the Address Book, you can specify the address from the Address Book. The specified address appears in the [Transfer via FTP (1)] or [Transfer via FTP (2)] screen.

For more information on the Address Book, refer to "Add Address Book Entry" (P.241).

File Format

Specify an output file format.

For more information on the [File Format] screen, refer to "5 Scan" in the User Guide.

Resend Attempts

Set whether or not to try sending again if a transmission fails. If you select [On], set the number of resend attempts and interval.

- Resend Attempts

Set the transmission retry count from 1 to 5.

- Resend Interval

Set the transmission retry interval from 30 to 300 seconds.

Name, Server, Save in, User Name, and Password

Select [Name], [Server], [Save in], [User Name], or [Password] to display an input screen.

The numbers of characters you can input are as follows:

- Name: Up to 18 single-byte characters
- Server: Up to 64 single-byte characters
- Save in: Up to 128 single-byte characters
- User Name: Up to 97 single-byte characters
- Password: Up to 32 single-byte characters

Transfer via SMB (1), Transfer via SMB (2)

Specify where SMB forwarding is to be stored.

[Transfer via SMB (2)] will be displayed when [Transfer via SMB (1)] is configured.

Address Book

When the server address is registered on the Address Book, you can specify the address from the Address Book. The specified address appears in the [Transfer via SMB (1)] or [Transfer via SMB (2)] screen.

For more information on the Address Book, refer to "Add Address Book Entry" (P.241).

File Format

Specify an output file format.

For more information on the [File Format] screen, refer to "5 Scan" in the User Guide.

Resend Attempts

Set whether or not to try sending again if a transmission fails. If you select [On], set the number of resend attempts and interval.

- Resend Attempts

Set the transmission retry count from 1 to 5.

- Resend Interval

Set the transmission retry interval from 30 to 300 seconds.

Name, Server, Shared Name, Save in, User Name, and Password

Select [Name], [Server], [Shared Name], [Save in], [User Name], or [Password] to display an input screen.

The numbers of characters you can input are as follows:

- Name: Up to 18 single-byte characters
- Server: Up to 64 single-byte characters
- Shared Name: Up to 64 single-byte characters
- Save in: Up to 128 single-byte characters
- User Name:
For domain users: up to 97 characters with the format of "user name@domain name" or "domain name\user name"
(user name and domain name must be up to 32 and 64 single-byte characters, respectively)
For local users: up to 32 single-byte characters
- Password: Up to 32 single-byte characters

Print

Configure print settings. When [On] is selected, you can configure the settings for the Print feature.

Print Quantity

Set the number of copy sets from 1 to 999 in 1 set increments.

Paper Supply

Select a paper tray for printing. When [Auto Select] is selected, the same paper size as the document size is used.

- Auto Select
A suitable paper tray is automatically selected.
- Trays 1 to 4 and 6 (optional)
Select paper from five trays.
- Bypass
Prints on paper loaded in Tray 5.

2 Sided Printing

Set the 2 sided printing option.

Output

Configure the stapling, hole punch, and output destination settings.

- Staple
Set the position for stapling.
- Hole Punch
Set the position for punching.
- Output Destination
Set the output destination.

E-mail Notification

You can receive an e-mail notification when a file is saved in a folder or a job flow ends.

Name / E-mail Address

Set the recipient of the e-mail notification.

Message

Enter a message that is displayed in the e-mail message body.

When to Notify

Select the e-mail notification timing from [When file is stored] and [At the end of Job Flow].

Delete Recipient

Deletes all information for the selected recipient.

Edit

Allows you to check or change the recipient selected.

For more information on the [Edit Recipient] screen, refer to "5 Scan" in the User Guide.

Close Menu

Deselects the selected item.

Edit / Delete

You can check the content of a job flow sheet, and edit, copy, or delete it.

Note • Some operations may be restricted according to types of job flow owners, authentication settings, and user types. For more information, refer to "Authentication for Job Flow Sheets and Folders" (P.356).

Delete

Deletes the selected job flow sheet.

Copy

Creates a duplicate of the selected job flow sheet. You can create a new job flow sheet based on the duplicate.

The procedure of creation is the same as creation of a new job flow sheet. For more information, refer to "Create New Job Flow Sheet" (P.235).

Edit

You can edit the selected job flow sheet.

The procedure of change is the same as creation of a new job flow sheet. For more information, refer to "Create New Job Flow Sheet" (P.235).

Create Job Flow Sheet Keyword

You can register job flow search keywords. The registered keywords will be displayed under [Select Keyword] and can be used for searching job flow sheets. The keywords are also available from a list under [Keyword] that is displayed when you create a new job flow sheet. Up to 12 single-byte characters are allowed for a job flow search keyword.

Add Address Book Entry

You can register frequently used addresses on the Address Book. Select an address type from Fax, Internet Fax, E-mail, and Server (FTP/SMB).

When an address is registered, you can search for it with [Address Book] on the [Fax], [Internet Fax], and [E-mail] screens.

You can store a total of 2000 addresses for Fax, Internet Fax, E-mail, and Server (FTP/SMB).

- Note**
- The following address types can be selected when you add an address to Address Book: Fax, Internet Fax, E-mail, and Server (FTP/SMB)
When you register an address on the Address Book, select an address type in accordance with the service. The address book entry registered with the wrong address type cannot be selected from the original service.
 - The address numbers correspond to the one touch buttons. The one touch buttons are available for fax and Internet Fax. For more information on the relationship between the address numbers and the one touch buttons, refer to "One-touch Buttons" (P.129).
 - To specify an e-mail or server (FTP/SMB) address (for insertion in the Address Book), it is not possible to use a speed dial specified with the numeric keypad, one-touch dialing, or a group dial number.
 - To specify an e-mail address or a server address for the Scan services, use the Address Book. The speed dial with the numeric keypad, the one touch buttons, and the group address created using the Group Recipients feature cannot be used to specify such addresses.
 - You can register, edit, delete, or view the Address Book from Dell Printer Configuration Web Tool.

1 Select [Add Address Book Entry].

- Note**
- To display the [Add Address Book Entry] screen, press the <Log In/Out> button and enter the system administrator's user ID, and then select [Tools] > [Setup] > [Add Address Book Entry]. If [Setup] is displayed on the [Home] screen, select [Setup] > [Add Address Book Entry].

2 Press a speed dial to register.

- Note**
- Select [▲] to display the previous screen or [▼] to display the next screen.
 - Entering a speed dial number with the numeric keypad displays the specified number at the top of the column.

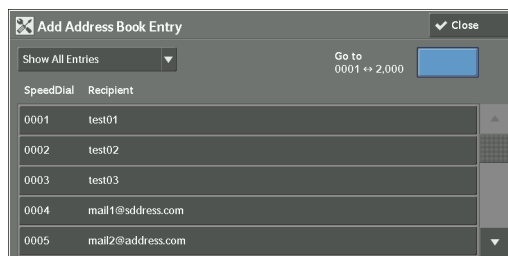

3 Select [Address Type].

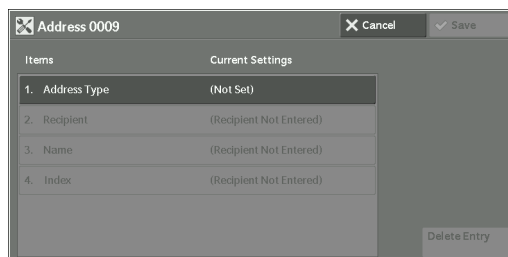

4 Select the address type, and then select [Save].

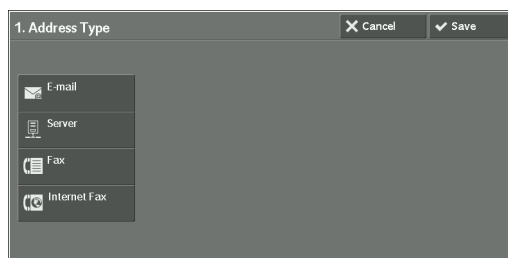

5 Select an item to set and set.

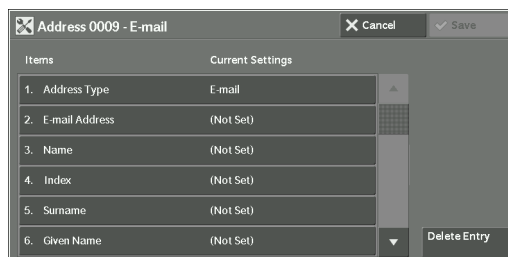

6 When the settings are completed, select [Save].

When selecting [E-mail] as the address type

The following items appear:

- Address Type
- E-mail Address
- Name
- Index
- Surname
- Given Name
- Custom Item 1 (Telephone Number*)
- Custom Item 2 (Office*)
- Custom Item 3 (Department*)
- S/MIME Certificate

* : Factory default setting

When selecting [Server] as the address type

The following items appear:

- Address Type
- Name
- Index
- Transfer Protocol
- Server Name / IP Address
- Save in
- User Name
- Password
- Port Number
- Shared Name (SMB Only)

When selecting [Fax] as the address type

The following items appear:

- Address Type
- Fax Number
- Name
- Index
- Starting Rate
- Resolution
- Cover Page
- Maximum Image Size
- Delay Start
- Remote Folder
- F Code
- Relay Broadcast
- Billing - Day Time
- Billing - Night Time
- Billing - Midnight

When selecting [Internet Fax] as the address type

The following items appear:

- Address Type
- E-mail Address
- Name
- Index
- S/MIME Certificate
- Starting Rate
- Resolution
- Maximum Image Size
- Internet Fax Profile

Address Type

Allows you to change an address type.

E-mail Address

Enter an e-mail address with up to 128 single-byte characters.

For information about how to enter characters, refer to "Entering Text" (P.34).

Name

Enter a recipient name with up to 18 single-byte characters.
For information about how to enter characters, refer to "Entering Text" (P.34).

Index

You can register a single alphanumeric index character so that you can use it as a search keyword when the registered recipients are listed in alphabetical order.
For information about how to enter characters, refer to "Entering Text" (P.34).

Surname

Enter a recipient surname with up to 32 single-byte characters.
For information about how to enter characters, refer to "Entering Text" (P.34).

Given Name

Enter a recipient given name with up to 32 single-byte characters.
For information about how to enter characters, refer to "Entering Text" (P.34).

Custom Item 1

The attribute name set as [Attribute Name of Custom Item 1] is shown as the item name.
You can input any information as an auxiliary item. Up to 20 single-byte characters are allowed. This item is suitable for information represented by a shorter character string, such as telephone number and employee number.
For more information on the attribute name, refer to "Attribute Name of Custom Items 1, 2, and 3" (P.183).

Custom Item 2

The attribute name set as [Attribute Name of Custom Item 2] is shown as the item name.
You can input any information as an auxiliary item. Up to 40 single-byte characters can be used. This item is suitable for information represented by a longer character string, such as company name and department name.
For more information on the attribute name, refer to "Attribute Name of Custom Items 1, 2, and 3" (P.183).

Custom Item 3

The attribute name set as [Attribute Name of Custom Item 3] is shown as the item name.
You can input any information as an auxiliary item. Up to 60 single-byte characters can be used. This item is suitable for information represented by a much longer character string, such as company division name and company address.
For more information on the attribute name, refer to "Attribute Name of Custom Items 1, 2, and 3" (P.183).

S/MIME Certificate

Allows you to link an S/MIME certificate. The S/MIME certificate must be registered in advance.

To link a certificate, select [Attach/Change Certificate] and select a certificate in a screen displayed. To remove a link, select [Remove Certificate].

- Note**
- If a certificate linked to an S/MIME certificate in the Address Book is deleted by some reasons such as hard disk initialization and the deletion of the certificate, the certificate linked to the S/MIME certificate will be invalid. Even if you re-register the S/MIME certificate, you have to manually link it again.
 - If many certificates are registered on the machine, it may take a long time to link a certificate.

For more information on the certificate, refer to "Encryption and Digital Signature Settings" (P.329).

Transfer Protocol

Set the transfer protocol. You can select either [FTP] or [SMB].

Server Name / IP Address

Enter a name or an IP address of a forwarding destination server.

Shared Name (SMB Only)

Enter the shared name set for the SMB folder.

- Note**
- If the "/" mark is used at the top of a shared name, a job flow cannot read the shared name correctly. Do not use the "/" mark at the top of a shared name.

Save in

Enter the directory for storing files. When SMB is selected, use a UNC format.

- Transferring via FTP
For example: aaa/bbb
When you save files in the bbb directory under the aaa directory in the root directory.
- Transferring via SMB
For example: aaa\bbb
When you save files in the bbb directory under the aaa directory in a specified volume.

User Name

Set the user name when a user name is required to be input by the forwarding destination server.

When [FTP] is selected for [Transfer Protocol], up to 97 characters are allowed.

When [SMB] is selected for [Transfer Protocol], use one of the following formats:

- For Active Directory:
User name@Domain name (User name: up to 32 characters / Domain name: up to 64 characters)
For example: abc@example.com ("abc" is a user name and "example.com" is a domain name)
- For Windows NT[®] domains:
Domain name\User name (Domain name: up to 64 characters / User name: up to 32 characters)
For example: example\abc ("example" is a domain name and "abc" is a user name)
- For workgroups:
Local User (up to 32 characters)
For example: ABC

Password

Set a password when the forwarding destination server prompts a password entry. You can enter up to 32 single-byte characters for a password.

Port Number

Set the forwarding destination port number. Specify a number from 1 to 65535.

Fax Number

Enter a fax number with up to 128 digits.

For information about how to enter characters, refer to "Entering Text" (P.34).

Index

You can register a single alphanumeric index character for use as a keyword to search with the Address Book.

For information about how to enter characters, refer to "Entering Text" (P.34).

Starting Rate

Set a communications mode. You can select either [G3 Auto] or [Forced 4800 bps].

When the destination is specified by a speed dial number with the communications mode set, you cannot change the communications mode in the [Fax / Internet Fax] screen.

Resolution

Set image quality for transmission.

Select from [Panel] (image quality selected on the control panel), [Standard (200 x 100 dpi)], [Fine (200 dpi)], [Superfine (400 dpi)], or [Superfine (600 dpi)].

Cover Page

Select whether or not to attach a cover page to a fax or an internet fax. On the cover page, you can print a Recipient's Comment and a Sender's Comment.

Comments must be registered in advance.

For information on comment registration, refer to "Add Fax Comment" (P.249).

- 1 Select [Print Cover Page].
- 2 Select [Comments].
- 3 Select any comment from the list of comments displayed under [Recipient's Comment] and [Sender's Comment].

Note • Select [▲] to display the previous screen or [▼] to display the next screen.

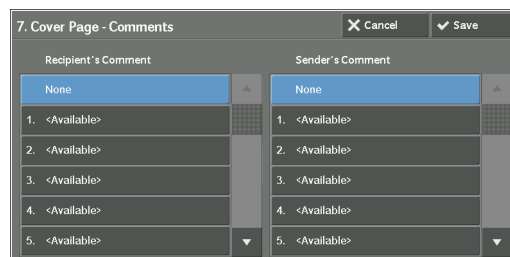
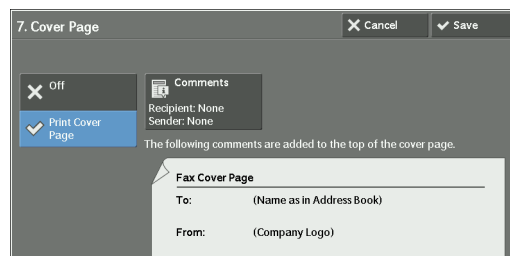

- 4 Select [Save]. The image of the Fax Cover Page is displayed.
- 5 Select [Save].

Maximum Image Size

Select the maximum image size from [A3], [B4], or [A4] to match the recipient's paper size or available profile.

Delay Start

Set whether or not to use a delayed start transmission.

If the machine's system clock is set to the 24-hour display, [AM] and [PM] do not appear. For information on the system clock, refer to "Time" (P.124).

Remote Folder

Select whether or not to send a fax or an Internet fax to a recipient's folder. To use folder communications, you must obtain the recipient's folder number and passcode in advance.

- 1 Select [On].
- 2 Enter a recipient's folder number with the numeric keypad.
- 3 If a passcode is set, enter the passcode with the numeric keypad.

Note • If no passcode is set, leave the text boxes blank and select [Save].

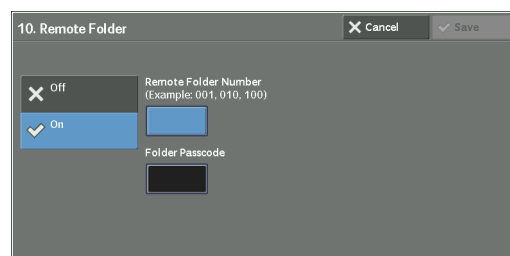

F Code

Select whether or not to use F code communications.

F Code is the transmission procedure set by the Communications and Information Network Association of Japan and is the T.30 (communication protocol) method for using sub-addresses that are standardized by the ITU-T.

For F code (sub address) and password, you can use up to 20 digits 0 to 9, *, and #.

- 1 Select [On].
- 2 Enter the F code with the numeric keypad.
- 3 Enter the password as required with the numeric keypad, and then select [Save].

Note • You can enter up to 20 digits for the password.

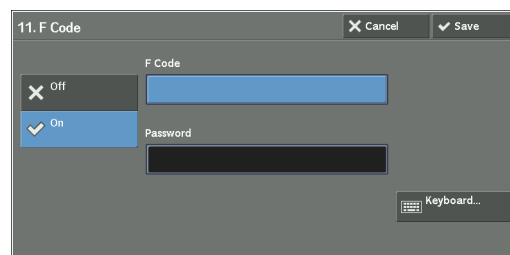

Relay Broadcast

Set the instruction given to a relay station, which is used when the machine is a base station and the registered speed dial is a relay station for relay broadcast.

When selecting [On], set [Relay Station ID], [Print at Relay Station], and [Broadcast Recipients].

- 1 Select [On].
- 2 Enter a 2-digit relay station ID with the numeric keypad.
- 3 Select [Speed Dial 001 <-> 099].
- 4 Enter a speed dial number of broadcast destination (001 to 099) or group number (#01 to #09) registered on the relay station with the numeric keypad, and then select [Add].

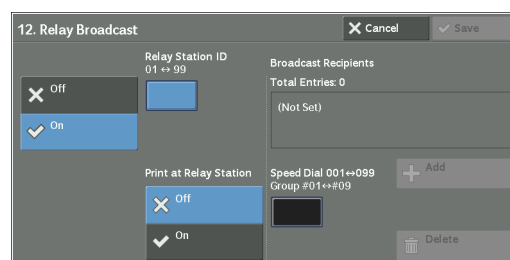

Note • If there are more than one broadcast destinations, repeat step 4.

- 5 To print a document also at the relay station, under select [On] for [Print at Relay Station].
- 6 Select [Save].

Billing - Day Time, Billing - Night Time, Billing - Midnight

Set the connection time for one unit charge in each of the time bands (daytime/night/midnight).

You can set a value from 0.1 to 255.9 seconds in 0.1 second increments.

This item is displayed when [Accounting] > [Accounting Type] is set to [Local Accounting] and [Fax / Internet Fax Service] is set to [Enable Accounting] under [Auditron Mode]. For information on how to enable the feature, refer to "Auditron Mode" (P.256).

The information registered can be confirmed by printing a Billing Data List. For information about how to print, refer to "Billing Data List" (P.92).

- 1 Select one of [Billing - Day Time], [Billing - Night Time], and [Billing - Midnight].
- 2 Select [Billing].
- 3 Enter the time for one unit charge from 0.1 to 255.9 seconds in 0.1 second increments with the numeric keypad.
- 4 Select [Save].

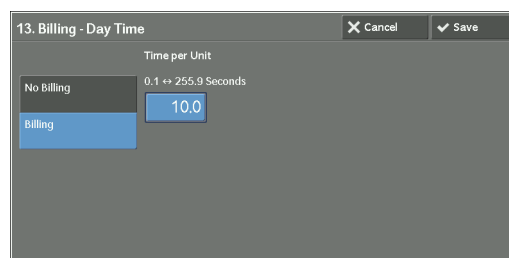

Internet Fax Profile

Set the format of the Internet fax profile.

A profile is specified to restrict attribute information such as image resolution and paper size for transmissions between Internet Fax-enabled machines.

TIFF-S

The Internet fax standard profile. For documents larger than A4, the size is automatically reduced to A4 when transmission.

TIFF-F

Select this profile when you specify [Superfine (400 dpi)] or [Superfine (600 dpi)] for [Resolution] or when you send A3 or B4 documents.

TIFF-J

Select this profile for sending documents in JBIG.

When the [Delete Entry] Button is Selected

Selecting this button deletes all the information registered for the address selected. To delete all information registered, select [Delete].

Note • Deleted information cannot be restored.

Create Fax Group Recipients

You can register addresses for broadcast transmission as a group. Each group can include up to 20 address numbers. The maximum number of groups that can be registered is 50.

Note that recipients to be added to a group must be registered in the speed dials on the Address Book.

- Note**
- Even when the speed dial number of fax recipients (address book entries) are included in a group, the machine does not send faxes to the recipients if their address types are set to [E-mail] or [Server].
 - You cannot include a group in another group.
 - You can use wildcards for specifying the numbers in the last one or two digits as shown in the following example:
 - 001*:Specifies the 10 addresses with address numbers 0010 to 0019.
 - *****.Specifies all address numbers.

1 Select [Create Fax Group Recipients].

2 Select a group number to register.

- Note**
- Select [▲] to display the previous screen or [▼] to display the next screen.

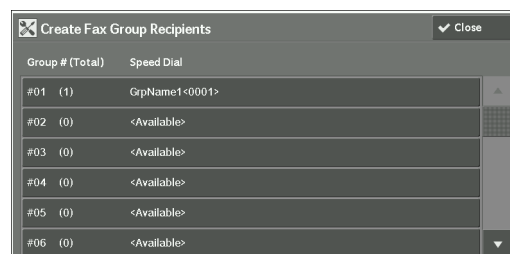

3 Select [Group Name] and enter a group name to register, and then select [Save].

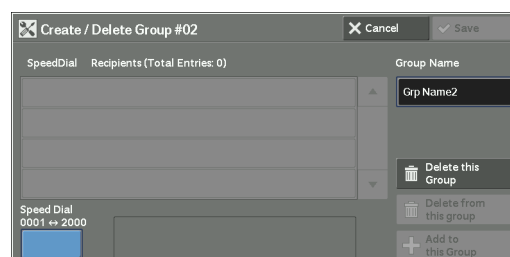

4 Enter a speed dial number (four digits) to register with the numeric keypad, and then select [Add to this Group].

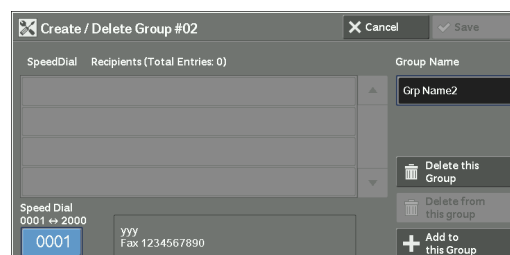

5 Repeat step 4 to register the address numbers.

6 Select [Save].

Delete this Group

Deletes all information registered on a group.

Delete from this group

Deletes a registered address. Select the speed dial or enter the speed dial number to delete with the numeric keypad, and then select [Delete from this group].

Add Fax Comment

You can register comments to be printed on cover sheets. A maximum of 50 comments can be registered, each of which can be up to 36 single-byte characters.

For information about how to enter characters, refer to "Entering Text" (P.34).

Paper Tray Attributes

Set a paper size and a paper type load in each tray.
Refer to "Paper Tray Attributes" (P.132).

Accounting

In [Accounting], you can register the users that will use the machine, and set the operation settings of the Accounting feature.

For more information about this feature, refer to "Authentication and Accounting Features" (P.343).

The following shows the reference section for each setting.

Create / View User Accounts	251
View Accounts	254
Reset User Accounts.....	254
System Administrator's Meter (Copy Jobs)	255
Accounting Type	255
Accounting Login Screen Settings	256
Fax Billing Data.....	257
Accounting / Billing Device Settings	258

1 On the [Tools] screen, select [Accounting].

For the method of displaying the [Tools] screen, refer to "System Settings Procedure" (P.106).

2 Select an item to set or change.

Create / View User Accounts

To enable the Accounting feature, register user IDs and user names to authenticate registered users.

You can set a limit on the number of pages for each user of the machine. You can also check the cumulative number of pages for each user registered. Up to 1,000 user data can be registered. The settings described here are identical with [Create / View User Accounts] under [Authentication] of [Authentication / Security Settings].

Note

- Before registering users, refer to "Accounting Type" (P.255) and set the Accounting Type you use.
- This item does not appear when [Network Accounting] is selected in "Accounting Type" (P.255).

1 Select [Create / View User Accounts].

2 Select a User ID to register, and then select [Create / Delete].

Note

- A 4-digit number displayed on the left of the User ID is the User Account Number.
- Selecting [<Available>] displays the screen to enter the User ID. Enter the User ID, and then select [Save].
- Select [▲] to display the previous screen or [▼] to display the next screen.
- Entering a 4-digit User ID number with the numeric keypad displays the specified number at the top of the column.

3 Specify the settings.

- 4 Select [Close].

User ID

Enter a user ID to use the machine. Up to 32 single-byte characters are allowed.

User Name

Set a user name. Up to 32 single-byte characters are allowed.

For information about how to enter characters, refer to "Entering Text" (P.34).

Passcode

Set a passcode. Setting a passcode is strongly recommended for security. Set a passcode from 4 to 12 digits.

Note • When [Passcode Entry for Control Panel Login] is set to [On], a passcode entry is required upon user authentication.

For information on how to change your passcode later, refer to "Changing Passcode" (P.375).

E-mail Address

Enter an e-mail address with up to 128 characters. The address set here will be set as [From] under [E-mail].

For information about how to enter characters, refer to "Entering Text" (P.34).

Device Access

Set whether to allow the machine use.

Enabled

Allows the machine use. When the smart card reader is connected, you can select the settings for each Login Type.

Disabled

Prohibits the machine use.

Service Access

You can place restrictions on the use and the maximum number of allowed pages for each of the Copy, Fax, Scan, and Print features.

- 1 Select [Service Access].
- 2 Select a feature to restrict.

- 3 To set account limits, select [Change Account Limit], and then enter the maximum number of pages with the numeric keypad.

Feature Access

Set access restrictions on features.

- Free Access

The feature is not restricted.

- No Access to Copy/Fax/Scan/Print Service
Allows you to restrict the use of the Copy, Fax, Scan, or Print service.

Account Limit

Set the maximum number of pages for copying, scanning, or printing.

You can specify a number from 1 to 9,999,999 (7 digits) pages in 1 page increments.

- The following limits can be placed on the Copy service for each user:
Permission to use: [Free Access], [Black & White Only], [Color Only], or [No Access to Copy Service]
Maximum number of color pages allowed: 1 to 9,999,999
Maximum number of black-and-white pages allowed: 1 to 9,999,999
- The following limits can be placed on the Fax service for each user:
Permission to use: [Free Access] or [No Access to Fax Service]
- The following limits can be placed on the Scan service for each user:
Permission to use: [Free Access], [Black & White Only], [Color Only], or [No Access to Scan Service]
Maximum number of color pages allowed: 1 to 9,999,999
Maximum number of black-and-white pages allowed: 1 to 9,999,999
- The following limits can be placed on the Print service for each user:
Permission to use: [Free Access], [Black & White Only], or [No Access to Print Service]
Maximum number of color pages allowed: 1 to 9,999,999
Maximum number of black-and-white pages allowed: 1 to 9,999,999

User Role

User Role

Allows you to select a user role for a user.

- User
No special authority is given to this user role.
- System Administrator
The same authority as a system administrator is given except for the following operation:
 - Operate folders
 - Operate job flow sheets
 - Change the passcode of the system administrator
- Account Administrator
The following authorities are given:
 - Create, delete, change (except for passcode), and view (unavailable depending on some settings) user information
 - Create, delete, change, and view accounting
 - Change an Alternative Name for Account ID or Mask Account ID
 - Print an Auditron Report for each user

Add This User To Authorization Group

Allows you to select an authorization group for a user.

Reset Account

Deletes all registered information for a selected user.

Reset

Deletes the registered user data. Once deleted, the data cannot be restored.

- Note**
- All job flow sheets, folders, and files within folders belonging to the user are deleted. If the user is owner of a large amount of material (when a large quantity of files is left remaining within a folder for example), the deletion will take a considerable time.

Cancel

Cancels the deletion of the user data.

Reset Total Impressions

Resets the current cumulative number of pages for a selected user, returning it to zero.

Reset

Resets the current cumulative number of pages for users. Once reset, the previous count cannot be restored.

Cancel

Cancels resetting the cumulative number of pages.

View Accounts

Selecting [ColorTrack] on the [Accounting Type] screen allows you to check the following for each registered user or group: (1) the maximum number of times that the account can be used for each service, and (2) how many times the account has been used for each service.

- 1 Click [View Accounts].
- 2 Select [User Account] or [Group Account]. If you select [User Account], select also the User ID to check.
- 3 Click [Account Details].

Reset User Accounts

You can delete all registered information for all registered users in a single operation, or reset the auditron data. It is also available to print contents for confirmation before resetting. The settings described here are identical with [Reset User Accounts] under [Authentication] of [Authentication / Security Settings].

- Note**
- This item does not appear when [Network Accounting] or [ColorTrack] is selected in [Accounting Type].

All User Accounts

Deletes all information registered for each user. It also deletes all data including the maximum number of pages, cumulative number of pages, and printer auditron data.

- Note**
- All job flow sheets, folders, and documents within folders belonging to the user are deleted. If the user is owner of a large amount of material (when a large quantity of files is left remaining within a folder for example), the deletion will take a considerable time.

All Feature Access Settings

Resets the feature access limit for all users.

All Account Limits

Resets the maximum number of pages for all users to the default (9,999,999 pages).

Total Impressions

Resets all accounting data for all users including the system administrator. The number of pages is also reset to 0.

All Authorization Groups

Delinks users from authorization groups, and links those users to the default authorization group.

Meter (Print Jobs)

Resets all printer auditron, and deletes automatically registered job owner names. The number of pages printed is also reset to 0.

Note • [Meter (Print Jobs)] is displayed when [Disable Accounting] is selected for [Print Service] in the [Auditron Mode] screen under [Accounting Type].

Print the Meter Report

Prints a meter report, which is helpful when you check counters before you reset or delete them.

Note • [Meter (Print Jobs)] is displayed when [Disable Accounting] is selected for [Print Service] in the [Auditron Mode] screen under [Accounting Type].

Print the Auditron Report

Prints a report including contents registered information to reset or a report including contents administration data to reset.

The report is available for confirmation before resetting.

Reset

Deletes or resets the data for the selected item.

System Administrator's Meter (Copy Jobs)

You can check or reset the total impression copied using the System Administration mode on the screen.

The total impressions are counted up to 9,999,999 pages.

Note • This item does not appear when [Network Accounting] is selected in [Accounting Type].

Accounting Type

You can select whether or not to use the Accounting feature.

Accounting Disabled

Does not perform accounting.

Local Accounting

Performs accounting.

Network Accounting

Performs accounting based on the user information managed on a remote service. User information is registered on the remote service.

Note • When [Network Accounting] is selected, users are prompted to enter their Account ID on the [Login] screen that is displayed when attempting to use services required for accounting.

For more information on Network Accounting, refer to "Types of Account Administration" (P.348).

ColorTrack

Accounting is carried out based on the user information and account information pre-registered on the machine.

Auditron Mode

Allows you to set whether or not to enable the Auditron feature for the following services:

- Copy
- E-mail
- Store & Send Link
- Media Print - Photos
- Fax / Internet Fax
- Scan to PC
- Store to WSD
- Print
- Store to Folder
- Store to USB
- Media Print - Text

Note

- WSD stands for Web Services on Devices.
- The services displayed on the screen vary depending on the machine configuration.
- When [Enable Accounting] is selected for a service, [] is displayed on the button of the applicable service on the [Home] screen. Also, [: Requires Login] is displayed at the lower left of the [Home] screen. [] and [: Requires Login] are not displayed after authentication.
- Print jobs may be canceled depending on the settings in "Receive Control" (P.267).

Verify User Details

Allows you to set whether or not to verify user information.
Selecting [Yes] also allows you to select [For Printer / Direct Fax Jobs].

Customize User Prompts

Allows you to set the type of user information used for authentication.

Note

- Account ID is used for accounting.
- Display User ID & Account ID Prompts
Prompts users to enter both their user ID and Account ID.
- Display User ID Prompt Only
Prompts users to enter their user ID only.
- Display Account ID Prompt Only
Prompts users to enter their Account ID only.
- Display No Prompts
Does not prompt users to enter their user ID or Account ID.

Accounting Login Screen Settings

You can configure Accounting settings.

Alternative Name for User ID

If required, you can change the indication "Account ID" on the [Login] screen that appears when the <Log In/Out> button on the control panel or the login information area on the touch screen is pressed to another name such as "Account Name" or "Number". The alias can be set to 1 to 15 single-byte characters.

Note

- The name changed is also printed in a report or a list.

Mask User ID (***)

You can set how an entered user ID is shown on the screen. Use this feature to enhance security as required.

Show

As you enter the user ID, the characters are echoed on the screen in the normal way.

Hide

As you enter the user ID, the character string is hidden as a row of asterisks (*****).

Alternative Name for Account ID

If required, you can change the indication "Account ID" on the [Login] screen that appears when the <Log In/Out> button on the control panel or the login information field on the touch screen is pressed to another name such as "Account Name" or "Number". The alias can be set to 1 to 15 single-byte characters.

- Note**
- This item is displayed when [Network Accounting] is selected in [Accounting Type].
 - The name changed is also printed in a report or a list.

Mask Account ID (*)**

You can set how an entered Account ID is shown on the screen. Use this feature to enhance security as required.

- Note**
- This item is displayed when [Network Accounting] is selected in [Accounting Type].

Show

As you enter the Account ID, the characters are echoed on the screen in the normal way.

Hide

As you enter the Account ID, the character string is hidden as a row of asterisks (*****).

Display Billing Information Upon Login

Select whether or not to display the billing information of the user upon logging in. When [Enabled] is selected, [Impressions], [Account Limit] and [Balance] of Copy, Print and Scan will be displayed.

- Note**
- This item is displayed when [Login to Local Accounts] is selected in [Login Type] and [Local Accounting] is selected in [Accounting Type].
 - The restricted items will not be displayed.
 - This is ineffective in the System Administration mode.

Store User Details

You can set the destination to save authentication information. Select [NVM] or [Hard Disk].

- Note**
- This item is displayed when [Network Accounting] is selected in [Accounting Type].
 - NVM stands for nonvolatile memory and the data on it is stable after the machine is turned off.

Fax Billing Data

You can configure fax billing settings.

- Note**
- To register the billing data, enable the Auditron feature for fax/Internet fax under Accounting in advance. For details on how to enable the Auditron feature, refer to "Auditron Mode" (P.256).
 - Set the connection time for one unit charge in each of the time bands (daytime/night/midnight) in [Billing]. For more information on how to set [Billing], refer to "Billing - Day Time, Billing - Night Time, Billing - Midnight" (P.248).
 - The registered details can be confirmed by printing the Billing Data List. For information on how to print, refer to "Billing Data List" (P.92).

1 Select [Fax Billing Data].

- 2 Select [Charge Rate per Unit].

Charge Rate per Unit

This is a communication charge per unit. You can set a value from 0.1 to 255.9 seconds in 0.1 second increments.

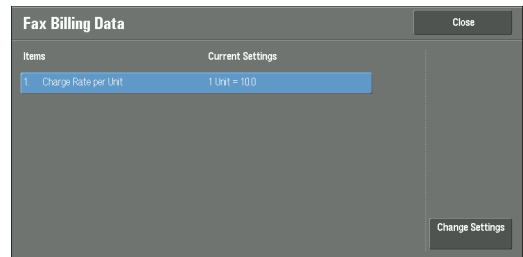

- 3 Select [Change Settings].
- 4 Enter an amount with the keyboard displayed on the screen or the numeric keypad.
- 5 Select [Save].

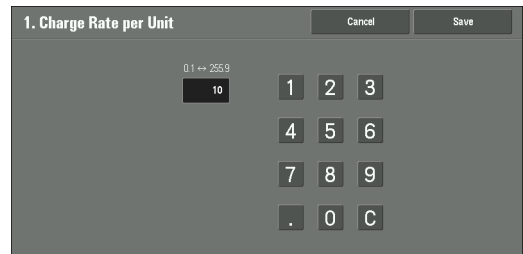

Accounting / Billing Device Settings

You can configure the accounting or billing device settings.

- Note**
- When an accounting or a billing device is connected to the machine, be sure to set a password and that users other than the system administrator do not disconnect the device by mistake.
 - Optional components or related products are required to use the features. For more information, contact Customer Support at dell.com/contactdell.

Connect with Account / Billing Device

Allows you to select whether or not to use the connected accounting or billing device from [None] or [Connected].

- Note**
- While a device for maintenance is connected, you cannot change the setting.

Accounting / Billing Device

Select the type of the accounting/billing device connected to the machine.

- Note**
- If a device connected does not match the device selected in [Accounting / Billing Device], an error occurs. Jobs related to the accounting/billing device cannot be performed until the error is resolved. For information on how to resolve the error, refer to "Status Code" (P.422).

Track Print Jobs

The feature is effective for the Print service.

Select whether or not to track billing information for the print jobs. Select from [No Tracking] and [Track with Accounting / Billing Device].

This feature is available for all accounting/billing devices.

Track Scan / Fax Jobs

The feature is effective for the Scan, Fax, and Internet Fax services.

Select whether or not to track billing information for the scan, fax, and Internet fax jobs. Select from [No Tracking] and [Track with Accounting / Billing Device].

Interrupt Mode

The feature is effective for the Copy service.

Select whether or not to enable the Interrupt mode. Select from [Disabled] and [Enabled].
This feature is available for accounting/billing devices other than Card Activated - Cumulative and Smart Card Reader.

Job with Insufficient Credit

The feature is effective for the Copy, Print, and Scan services.

Select the operation of the machine when the amount remaining in the accounting/billing device becomes insufficient. Select from [Delete Job Immediately] and [Hold Job].

This feature is available for accounting/billing devices other than Card Activated - Cumulative and Smart Card Reader.

Charge Print Jobs

The feature is effective for the Print service.

Select how the print job performed is charged. Select from [Charge by Card Number] and [Do not Charge by Card Number].

This feature is available for Card Activated - Cumulative and Card Activated - Subtractive.

Track with Cumulative Device

The feature is effective for the Copy and Print services.

Select the timing that the amount for copy or print job is charged. Select from [Track with Accounting Device] and [High Speed Printing].

This feature is available for Card Activated - Cumulative.

Scan Ahead for Copy Job

The feature is effective for the Copy service.

Select whether or not to enable the Scan Ahead feature for copy jobs. Select from [Disabled] and [Enabled].

This feature is available for Card Activated - Cumulative, Card Activated - Subtractive, and Smart Card Reader.

Note • Some of the products listed above may not be available for this feature depending on the types and settings.

Authentication / Security Settings

In [Authentication / Security Settings], you can configure the authentication and security settings.

For more information about the feature, refer to "Authentication and Accounting Features" (P.343).

The following shows the reference section for each setting.

System Administrator Settings.....	260
Authentication	261
Allow User to Disable Active Settings.....	269
Job Status Default.....	269
Overwrite Hard Disk.....	269

- 1 On the [Tools] screen, select [Authentication / Security Settings].

For the method of displaying the [Tools] screen, refer to "System Settings Procedure" (P.106).

- 2 Select an item to set or change.

System Administrator Settings

In [System Administrator Settings], you can set the system administrator ID and passcode.

We recommend setting the system administrator ID and passcode to prevent unauthorized setting changes and ensure security.

System Administrator's Login ID

Set the system administrator's user ID. Enter the ID from 1 to 32 single-byte characters.

Note • The default of the system administrator's user ID is "admin".

- 1 Select [System Administrator's Login ID].
- 2 Select [On].
- 3 Select [Keyboard].
- 4 Enter the system administrator's ID with up to 32 characters, and then select [Save].
- 5 Repeat steps 3 and 4 to re-enter the same system administrator's ID in [Re-enter System Administrator's Login ID].
- 6 Select [Save].
- 7 A confirmation window appears. Select [Yes] to confirm your entry.



System Administrator's Passcode

Set the passcode for the System Administration mode.

Setting a passcode is strongly recommended to enhance security.

Note • The default of the system administrator's passcode is "1111".

The system administrator's passcode set here is used when [Passcode Entry for Control Panel Login] is set to [On] under [Authentication / Security Settings] > [Passcode Policy].

Set the passcode after setting the system administrator's user ID. You can set the passcode from 4 to 12 numeric digits.

For more information about [Passcode Entry for Control Panel Login], refer to "Passcode Policy" (P.266).

- 1 Select [System Administrator's Passcode].
- 2 Select [New Passcode].
- 3 Enter a new passcode (4 to 12 digits) using the keyboard displayed, and then select [Save].

Note • If no passcode is set, leave the text boxes blank and select [Save].

- 4 Select [Retype Passcode], enter the same passcode, and then select [Save].
- 5 Select [Save].
- 6 A confirmation window appears. Select [Yes] to confirm your entry.

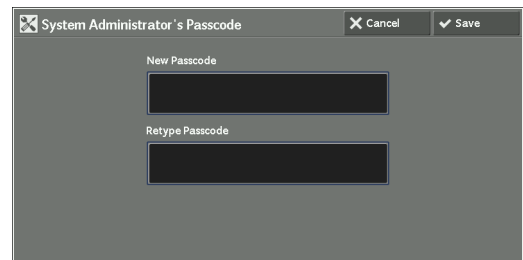

Authentication

In [Authentication], you can set the following items.

The following shows the reference section for each setting.

Login Type.....	261
Access Control.....	261
Create / View User Accounts	263
Reset User Accounts.....	263
Create Authorization Groups	263
User Details Setup.....	264
Maximum Login Attempts by System Administrator	266
Passcode Policy	266
Charge / Private Print Settings	266
Receive Control	267

Login Type

Allows you to select a type of authentication.

No Login Required

Does not use the Authentication feature.

Login to Local Accounts

Authenticates users based on the user information registered on the machine.

Note • When [Login to Local Accounts] is selected, the machine enters the Login mode and [Login] is displayed at the lower left of the [Home] screen.

Login to Remote Accounts

Authenticates users based on the user information registered on a remote authentication server.

Note • The machine enters the Login mode, and [Login] is displayed at the lower left of the [Home] screen.

Access Control

Allows you to restrict access to the machine or each service. Once the access control is enabled, user authentication is required to use the machine or the services.

- Note**
- When a user is authenticated by a remote authentication server, the authenticated user can access the services through the control panel based on the permission information obtained from the remote server.
 - When a guest user is permitted to use the machine, access restriction for each service cannot be specified for the guest user. If you want to restrict a guest user to use the machine, refer to "Guest User" (P.265).

Device Access

Allows you to restrict buttons operation on the control panel of the machine.

Select [Unlocked] or [Locked].

Service Access

Allows you to restrict access to each of the following services.

- Note**
- When [Locked (Show Icon)] is selected for a service, [🔒] is displayed on the button of the applicable service on the [Home] screen. Also, [🔒 : Requires Login] is displayed at the lower left of the [Home] screen. [🔒] and [🔒 : Requires Login] are not displayed after authentication.
 - When [Locked (Hide Icon)] is selected for a service, the applicable service is not displayed on the [Home] screen. It will be displayed after authentication.

For more information on [Login Type], refer to "Login Type" (P.261).

- Copy

Restricts access to the Copy service on the machine.

If a stored programming contains steps to use the Copy service, the use of the store programming is also restricted.

- Fax / Internet Fax

Restricts access to the Fax / Internet Fax / Direct Fax service on the machine.

If a stored programming contains steps to use the Fax / Internet Fax service, the use of the store programming is also restricted.

- Scan

Restricts access to the E-mail, Store to Folder, Scan to PC, Store to USB, Store & Send Link, and Store to WSD services and features on the machine.

If a stored programming contains steps to use the Scan services, the use of the store programming is also restricted.

- Note**
- WSD stands for Web Services on Devices.

- Media Print - Text

Restricts access to the Media Print - Text service on the machine.

- Media Print - Photos

Restricts access to the Media Print - Photos service on the machine.

- Send from Folder

Restricts access to the Send from Folder service on the machine.

- Stored Programming

Restricts access to the Stored Programming service on the machine.

- Job Flow Sheets

Restricts access to the Job Flow Sheets service on the machine.

- Web Applications

Restricts access to the Web Applications service.

- Custom Services

Restricts access to custom services on the machine.

Note • This feature is for service representative use. For more information, contact Customer Support at dell.com/contactdell.

- Print

Restricts users to print jobs stored on the machine, such as the Secure Print and Sample Set jobs.

This feature also restricts the submission of print jobs from a computer via a network.

To use the Authentication feature, authentication information such as a user ID and passcode needs to be entered in a print driver.

If authentication fails, the print data sent to the machine is saved in the machine or deleted according to the Charge Print settings.

Feature Access

Set [Color Copying], [Print Files from Folder], and [Retrieve Files from Folder].

Create / View User Accounts

To enable the Accounting feature, register user IDs and user names to authenticate registered users.

You can set a limit on the number of pages for each user of the machine. You can also check the cumulative number of pages for each user registered. Up to 1,000 user data can be registered. The settings described here are identical with [Create / View User Accounts] under [Accounting].

Refer to "Create / View User Accounts" (P.251).

Reset User Accounts

You can delete all registered information for all registered users in a single operation, or reset the auditor data. It is also available to print contents for confirmation before resetting. The settings described here are identical with [Reset User Accounts] under [Accounting].

Refer to "Reset User Accounts" (P.254).

Create Authorization Groups

System administrators can give login users authority to use some features that are restricted for login users. The login users can be divided into different authorization groups.

Note • Up to 20 groups can be registered.

- 1 Select [Create Authorization Groups].
- 2 Select a registration number, and then select [Create / Delete].
- 3 Select and set any item.

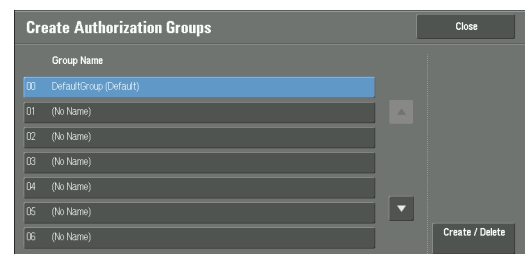

Group Name

Enter a group name with up to 32 single-byte characters.

Restrict Recipient Selection Method

Select whether or not to remove restriction when a transmission to a recipient who is not registered on the Address Book is restricted for the Fax / Internet Fax or Scan feature.

Restrict User to Edit Address Book

Select whether or not to remove restriction when the edit of the Address Book is restricted.

Allow User to Disable Active Settings

Select whether or not to permit the group members to temporarily disable the forcible printing features, such as the Force Watermark, Print Universal Unique ID, and Force Annotation features, and to allow the machine to process a job.

User Details Setup

Set the information required when carrying out authentication.

Alternative Name for User ID

If required, you can change the indication "UserID" on the [Login] screen that appears when the <Log In/Out> button on the control panel is pressed to another name such as "User Name" or "Number". The alias can be set to 1 to 15 single-byte characters.

Note • The name changed is also printed in a report or a list.

Mask User ID (*)**

You can set how an entered user ID is shown on the screen. Use this feature to enhance security as required.

When you select [Show], the characters you enter are echoed on the screen in the normal way as you enter the user ID. When you select [Hide], the characters you enter is hidden as a row of asterisks (*****) as you enter the user ID.

Failed Access Log

Set the failure count to detect unauthorized access. An error is logged if authentication fails the number of times specified here within a predetermined time (10 minutes).

Logout Confirmation Screen

Set whether or not to display a logout confirmation screen every time a user session ends.

User ID for Login

Set whether or not to make the user ID entry field on the user login screen case-sensitive.

When you select [Case Sensitive], authentication is performed using the User ID as registered (including upper and lower cases). When you select [Non-Case Sensitive], authentication is performed with case ignored even if the User ID has both upper and lower cases.

Note

- Do not change the setting while a file is stored for the Private Charge Print. Otherwise, you may encounter problems, such as being unable to print. Change the setting after the machine prints all the files stored.
- Do not select [Case Sensitive] when the machine stores User IDs such as "ABC" and "abc" which are regarded as the same ID under the setting. If you select [Case Sensitive], it may cause the problem and those IDs may not be displayed. Before you select the setting, correct those User IDs to distinguish them.

When Smart Card Reader is Connected

Set whether or not to enable the user ID authentication when the smart card reader is connected. When [Smart Card Login] is selected, the user ID authentication cannot be used. When [Smart Card or Control Panel Login] is selected, both smart card authentication and user ID authentication can be used.

Account Auto Setup for Card Login

Set whether or not to register new user information when an unregistered user holds a card over the smart card reader.

When [Disabled] is selected, the machine does not register the user. When [Enabled] is selected, the machine registers the user automatically.

- Note**
- When [Auto Assign] is selected, [User Name], [Service Access], and [Add User To Authorization Group] will be displayed.
 - Set the user name by selecting [User Name].
 - When [Service Access] is selected, [Copy], [Fax], [Scan], and [Print] will be displayed. You can set [Feature Access] and [Change Account Limit] for each item.
 - When [Add User To Authorization Group] is selected, you can select a user role and an authorization group for the user.
 - When [Passcode Entry for Smart Card Loginn] under [Tools] > [Authentication / Security Settings] > [Authentication] > [Passcode Policy] is set to [On], you need to enter the passcode twice for the auto assign.

Guest User

Set whether or not to permit a guest user when [Login to Remote Accounts] is selected. Set the guest user passcode from 4 to 12 digits.

- Note**
- Access restriction for each service cannot be specified for the guest user.

Use of Smart Card

Set whether or not to use smart card authentication.

Smart Card Link Mode

Set whether or not to require a passcode for smart card authentication when [Login to Remote Accounts] is selected.

Smart Card Certificate Verification

Set whether or not to verify the smart cart certificate when a user uses the smart card.

When [Enabled] is selected, the owner of the smart card is verified not only by PIN code verification but by certification verification of the smart card and private key match. In this case, the upper level CA certificate of the smart card certification must be registered on the machine.

When [Disabled] is selected, the owner of the smart card is verified by PIN code verification.

Smart Card Logout Timing

Select the logout method for smart card authentication when a contactless smart card is used for authentication.

When [Log Out when Card is Removed] is selected, you can logout from the machine by removing the smart card from the smart card reader. When [Log Out from Control Panel] is selected, you can logout by operating the touch screen or control panel.

Save remote accounts in this machine

Select whether or not to save the user information used for remote authentication. While the user information is saved in the machine, the machine can authenticate the user using the information saved in the machine even when the remote server is off.

- Note**
- This setting applies only to a user who is authenticated by smart cards.

Delete Remote Accounts

Select whether or not to delete the user information saved in the machine for remote authentication. Select from [Do Not Delete], [Weekly], and [Monthly].

For [Weekly], you can set the day and time. For [Monthly], set the date and time.

- Note**
- This setting applies only to a user who is authenticated by smart cards.

Maximum Login Attempts by System Administrator

This feature protects the settings from being changed by someone impersonating your system administrator. If authentication for a system administrator's ID fails more than specified times continuously, access is denied.

You can specify a login attempt count from 1 to 10.

- Note**
- The failure count is reset when the machine is restarted.
 - To cancel the access rejection state, restart the machine by switching off and on the power.

Passcode Policy

Passcode Entry for Control Panel Login

You can set whether a passcode is required when the system administrator or a user uses the machine. Selecting [On] enables [System Administrator's Passcode] setting and [Passcode] setting for [Create / View User Accounts].

Selecting [Off] does not require the passcode, even if a passcode is set in the above settings.

- Note**
- The setting of [Passcode Entry for Control Panel Login] is used for authentication on the machine. A passcode must always be entered when accessing from remote devices using Dell Printer Configuration Web Tool or the like, regardless of the use of passcode setting. Depending on authentication procedures, a passcode may be required for other processes as well.
 - The system administrator's passcode is also required when you change settings from Dell Printer Configuration Web Tool.

Passcode Entry for Smart Card Login

You can set whether to require the passcode when the system administrator or a user uses the machine.

Minimum Passcode Length

Set this item when you specify the minimum number of digits allowed for a passcode.

Set a value from 4 to 12 in 1 digit increments.

- Note**
- This is only applicable to login users (not applicable to the system administrator and guests).
 - Registered users can be authenticated with a passcode less than the minimum number of digits.

Charge / Private Print Settings

You can set how received print jobs should be handled.

You can directly print jobs and temporarily store print jobs to Charge Print or Private Charge Print for stored files.

The Charge Print feature prints the print jobs of authenticated users. But, using this feature, you can also temporarily store print jobs and print them later by operating the machine. If [Save as Charge Print Job] is selected, print jobs received are saved by a user ID for storage set in a print driver.

The Private Charge Print feature stores jobs to the machine, using the login User ID or Sub User ID at print instruction. You can print the jobs later by operating the machine. Only the files of the login user and sub users linked are displayed on the touch screen, therefore, it can help ensure privacy protection as well as prevent output from being left in the tray.

- Note**
- For more information on the sub user, refer to "Sub User" (P.346).
 - For more information on the Charge Print and Private Charge Print features, refer to "11 Job Status" > "Printing and Deleting Stored Jobs" and "12 Computer Operations" > "Print" in the User Guide.

To use Charge Print or Private Charge Print, [Receive Control] must be set. For more information, refer to "Receive Control" (P.267).

Receive Control

You can set how received print jobs should be handled.

For information about printing from a print driver, refer to "12 Computer Operations" in the User Guide.

For information about printing or deleting the print job saved, refer to "11 Job Status" > "Printing and Deleting Stored Jobs" > "Private Charge Print" in the User Guide, and about deleting a Private Charge Print job with an invalid User ID, refer to "Deleting a Private Charge Print Job with an Invalid User ID" (P.80).

- 1 Select [Receive Control], and then select [Change Settings].
- 2 Select any item.
- 3 According to the selected item, set the processing to apply to jobs.

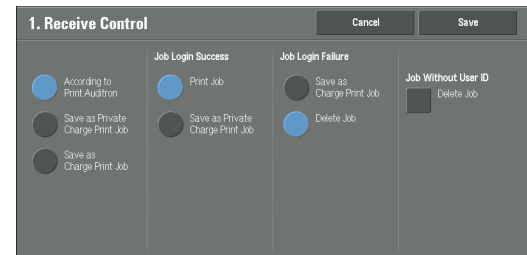

- 4 Select [Save] after the setting is completed.

According to Print Auditor

Specifies how print jobs should be handled when the Authentication and Accounting features are enabled and [Print] under [Service Access] is set to [Locked].

Note • When the Authentication and Accounting features are disabled and [Print] under [Service Access] is set to [Unlocked], the settings specified in the print driver are applied.

When [According to Print Auditor] is selected, [Job Login Success], [Job Login Failure], and [Job Without User ID] are displayed.

- Job Login Success

Set the processing to apply to successfully authenticated jobs.

- To print jobs, select [Print Job].
- To save jobs as Private Charge Print, select [Save as Private Charge Print Job].

Note • When [Save as Private Charge Print Job] is selected, the Secure Print, Sample Set, Store in Remote Folder, and Delayed Print settings specified in the print driver will be ignored.

- Job Login Failure

Set the processing to apply to jobs authentication failed (whose information such as the user ID and passcode has been incorrectly registered on the print driver).

- To save jobs as Private Charge Print, select [Save as Charge Print Job].
- To delete jobs, select [Delete Job].

- Job Without User ID

Set the processing to apply to jobs with no authentication user ID attached (such as print jobs sent from Dell Printer Configuration Web Tool or e-mail print).

- To print jobs, select [Print Job].
- To save jobs as Charge Print, select [Save as Charge Print Job].
- To delete jobs, select [Delete Job].

- Note**
- [Job Without User ID] is automatically changed to [Print Job] on the machine when you select as follows on Dell Printer Configuration Web Tool: [Properties] > [Security] > [Authentication Configuration] > [Non-account Print]. When [Job Without User ID] is set to [Save as Charge Print Job] or [Delete Job], the [Non-account Print] check box on Dell Printer Configuration Web Tool is deselected automatically.

Save as Private Charge Print Job

Regardless of whether the Authentication feature is being used or not, all jobs that have a user ID are saved as Private Charge Print. You can also specify how to handle the job that does not have a User ID or a PjL command.

- Note**
- When [Save as Private Charge Print Job] is selected, all the print jobs that have User IDs are saved regardless of whether or not being successfully authenticated. To minimize the unnecessary print jobs, specify an expiration date, so that they can be automatically deleted after a specified period of time. Or the system administrator can manually delete them. For details on how to specify an expiration date, refer to "Stored File Settings" (P.223). For details on how to delete the print jobs manually, refer to "Deleting a Private Charge Print Job with an Invalid User ID" (P.80).
 - When [Save as Private Charge Print Job] is selected, the Secure Print, Sample Set, Store in Remote Folder, and Delayed Print settings specified in the print driver will be ignored.

When [Save as Private Charge Print Job] is selected, [Job Without User ID] and [Non-PjL Command Job(s)] are displayed.

- Job Without User ID

Set how to process jobs with no user ID attached.

- To print jobs, select [Print Job].
- To save jobs as Charge Print job, select [Save as Charge Print Job].
- To delete jobs, select [Delete Job].

- Note**
- [Job Without User ID] is automatically changed to [Print Job] on the machine when you select as follows on Dell Printer Configuration Web Tool: [Properties] > [Security] > [Authentication Configuration] > [Non-account Print]. When [Job Without User ID] is set to [Save as Charge Print Job] or [Delete Job], the [Non-account Print] check box on Dell Printer Configuration Web Tool is deselected automatically.

- Non-PjL Command Job(s)

Set how to handle the job that does not have a PjL command. The job will be distinguished by the existence of the User ID, and will be handled according to the following settings.

- Select [Do Not Use At All] to apply the [Non-PjL Command Job(s)] setting regardless of whether the job has a User ID.
- Select [Use When Available] to specify how to handle the job that has a User ID.
 - To print jobs, select [Print Job].
 - To save jobs as Charge Print, select [Save as Charge Print Job].
 - To save jobs as Private Charge Print, select [Save as Private Charge Print Job].
 - To delete jobs, select [Delete Job].

Save as Charge Print Job

Regardless of whether the Authentication feature is being used or not, all received jobs are saved as Charge Print.

- Note**
- When using [Save as Charge Print Job], all the print jobs are saved regardless of whether or not being successfully authenticated. To minimize the unnecessary print jobs, specify an expiration date, so that they can be automatically deleted after a specified period of time. Or the system administrator can manually delete them. For details on how to specify an expiration date, refer to "Stored File Settings" (P.223). For details on how to delete the print jobs manually, refer to "11 Job Status" > "Printing and Deleting Stored Jobs" > "Charge Print" in the User Guide.
 - When [Save as Charge Print Job] is selected, the Secure Print, Sample Set, Store in Remote Folder, and Delayed Print settings specified in the print driver will be ignored.

Allow User to Disable Active Settings

Use this feature when you want use active settings for most jobs but not for specific jobs.

You can temporarily disable active settings such as Force Watermark, Print Universal Unique ID and Force Annotation features that have been enabled.

This feature is applicable to Copy, Print from Folder, Print Stored File, Media Print - Text, and Media Print - Photos jobs when [Enable Active Settings] is selected (for jobs such as Fax, Client Print, and Report, you cannot disable active settings).

This option is displayed when [Enable Active Settings] is selected for [Allow User to Disable Active Settings] for the authorization group where the login user belongs.

- Note**
- If this setting is set to [Enable Active Settings] while a job is in progress, the setting is not effective for the job.
 - You can disable active settings even when you select a file in a folder using the Job Flow feature and manually execute a job.
 - Users with system administrator role can configure this feature regardless of authorization group.

For more information about Force Watermark, refer to "Watermark" (P.140).

For more information about Print Universal Unique ID, refer to "Print Universal Unique ID" (P.143).

For settings of authorization group, refer to "Authentication and Accounting Features" (P.343).

Job Status Default

You can hide active jobs, completed jobs, and job logs from unauthenticated users or non-job owners, to protect privacy and prevent leakage of confidential information.

- Note**
- If you set to hide job details, you cannot stop or delete jobs you instructed. Therefore, you cannot cancel jobs in the case of operational error of copies or wrong transmission of faxes.

Active Jobs View

Select whether or not to hide active jobs from local users.

Completed Jobs View

Select from [Allow Job Viewing at All Times], [Require Login to View Jobs], or [No Job Viewing].

Access To:

This feature is displayed when [Require Login to View Jobs] is selected.

Select either [All Jobs] or [Jobs Run By Login User Only].

Hide Job Details

This feature is displayed when [Allow Job Viewing at All Times] or [Require Login to View Jobs] is selected.

Select either [No] or [Yes].

Overwrite Hard Disk

Select whether or not to conduct hard disk overwriting. If you overwrite the hard disk, you can select whether to overwrite once or three times.

When copy, fax, scan, or print processing is completed, the data is deleted from the hard disk and the area on which the deleted data was stored is automatically overwritten with blank data. This feature prevents unauthorized retrieval or restoration of the data recorded on the hard disk. It also applies to copy document and other information stored temporarily by the system.

The following option can be configured.

Number of Overwrites

You can select the number of overwrites either once or three times.

- Note**
- If the machine is turned off during the overwriting, unfinished files may remain on the hard disk. The overwriting will resume if you turn the machine on again with the unfinished files remaining on the hard disk.
 - Overwriting once erases the data, but overwriting three times makes it even more definite that the data cannot be restored. It does, however, take longer.
 - During overwriting, normal operations may be slowed down.

For more information on how to check the status during overwriting, refer to "Overwrite Hard Disk" (P.95).

Prerequisite for Using Data Security Feature

The system administrator must follow the instructions below:

- To protect the data deleted from or stored on the hard disk, the following settings are required:
 - Number of Overwrites: [1 Overwrite] or [3 Overwrites]
 - Data Encryption: [On]: an encryption key of 12 digits
 - Service Representative Restricted Operation: [Yes]
- Change the system administrator's factory default passcode (1111). Register a new passcode of 7 characters or more (maximum 12 characters). Be careful not to register a passcode that can be easily assumed and not to store the registered passcode on a location that is easily accessible to other persons.

- Note**
- If the system administrator's user ID and passcode are forgotten, the machine configuration will not be able to recover in case of malfunction.

- Set [Passcode Entry for Control Panel Login] to [On].
- Set [Maximum Login Attempts by System Administrator] to 5 times.
- Note that the hard disk security will not be warranted if you do not correctly follow the above setting instructions.

For more information on how to set data encryption, refer to "Data Encryption" (P.154).

For more information on how to set service representative restricted operation, refer to "Service Rep. Restricted Operation" (P.156).

For more information on how to set [Passcode Entry for Control Panel Login], refer to "Passcode Policy" (P.266).

For more information on how to set the system administrator's user ID, refer to "System Administrator's Login ID" (P.260).

The manager (of the organization that this machine is used for) must follow the instructions below:

- Assign an appropriate person as a system administrator and manage and train he/she properly.
- When turning off the machine, make sure no operation is running. Train the users to turn off the machine after an active operation completes, if any.
- Note that this feature is used to protect deleted document data from being recovered; it does not protect files stored in folders in the hard disk.
- Install an anti-bugging device on the internal network that the machine is located on, and perform the network settings properly to protect the machine from interceptions.
- To block unauthorized access, install a firewall device between the external network and the internal network that the machine is located on.

- Set the passcode and encryption key according to the following rules:
 - Do not use easily assured character string
 - Use both characters and numerics

For more information on encryption key, refer to "Encryption Key for Confidential Data" (P.156).

6 Dell Printer Configuration Web Tool Settings

This chapter describes how to set up Dell Printer Configuration Web Tool.

- **Installation of Dell Printer Configuration Web Tool274**
- **Starting Dell Printer Configuration Web Tool.....276**
- **Configuring Machine Settings Using Dell Printer Configuration Web Tool277**

Installation of Dell Printer Configuration Web Tool

Dell Printer Configuration Web Tool provides services such as displaying the status of the machine and jobs, and altering configurations using a web browser in a TCP/IP environment.

Preparations

Prepare a computer supporting the TCP/IP protocol to use Dell Printer Configuration Web Tool.

Dell Printer Configuration Web Tool supports the following browsers:

For Windows 8

- Microsoft® Internet Explorer® 10.0

For Windows 7

- Microsoft Internet Explorer 8.0

For Windows Vista

- Microsoft Internet Explorer 7.0

For Windows XP

- Mozilla® Firefox® 3.0
- Microsoft Internet Explorer 6.0 Service Pack 3

For OS X 10.8

- Safari 5

For Mac OS X 10.7

- Safari 5

For Mac OS X 10.6

- Safari 5
- Mozilla Firefox 3.0

For Mac OS X 10.5

- Mozilla Firefox 3.0

For Mac OS X 10.4

- Mozilla Firefox 3.0
- Safari 3

For Mac OS X 10.3.9

- Safari 1.3

For more information, refer to "Dell Printer Configuration Web Tool Problems" (P.414).

Configuration on the Machine

The following describes the configuration procedure for using Dell Printer Configuration Web Tool on the machine.

1 Display the [Tools] screen.

- 1) Press the <Log In/Out> button.
- 2) Enter the system administrator's user ID with the numeric keypad or the keyboard displayed on the screen, and select [Enter].

When a passcode is required, select [Next] and enter the system administrator's passcode, then select [Enter].

- Note**
- The default user ID is "admin".
 - The default passcode is "1111".

- 3) Select [Tools] on the [Home] screen.
- 4) Select [System Settings].

2 Enable the Internet Services (HTTP) port on the machine.

- 1) Select [Connectivity & Network Setup].
- 2) Select [Port Settings].
- 3) Select [Internet Services (HTTP)], and then select [Change Settings].
- 4) Select [Port Status], and then select [Change Settings].
- 5) Select [Enabled], and then select [Save].
- 6) Select [Close] repeatedly until the [Tools] screen is displayed.

3 Set an IP address.

If an IP address is already set, you can skip this step. For an environment with DHCP or BOOTP, configure the method for obtaining the address. If an IP address cannot be obtained automatically or manual configuration is preferred, confirm the settings of an IP address, a subnet mask, and a gateway address.

For information on how to set an IP address, refer to "Protocol Settings" (P.173).

4 Select [Close] repeatedly until the [Tools] screen appears.

5 Select [Close].

- Note**
- Rebooting the machine may be required depending on the settings. When a message displayed on the screen, follow the message and reboot the machine.

6 After the machine reboots, you can print out a configuration report to confirm that the port for Dell Printer Configuration Web Tool is enabled and TCP/IP is set up correctly.

For information on how to print a configuration report, refer to "Print Reports" (P.86).

7 Start Dell Printer Configuration Web Tool to confirm whether the service is available or not.

For information on how to start Dell Printer Configuration Web Tool, refer to "Starting Dell Printer Configuration Web Tool" (P.276).

Starting Dell Printer Configuration Web Tool

To use Dell Printer Configuration Web Tool, perform the following procedure on your computer.

When Login Type is selected on the machine, authentication is required to access the machine via a web browser.

- 1 Start a web browser.
- 2 Enter the machine's IP address or the Internet address in the address box on the web browser, and press the <Enter> key.

- Example of the IP address entry

http://192.0.2.1/ (IPv4)

http://[2001:DB8::1234] (IPv6)

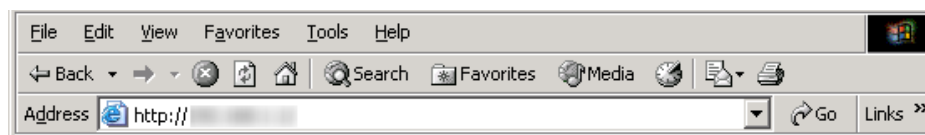

- Example of the Internet address entry (when the machine's Internet address is myhost.example.com)

http://myhost.example.com/

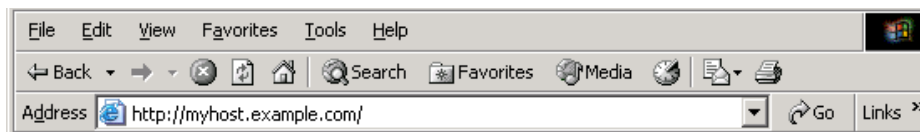

Note

- If your network uses DNS (Domain Name System) and the machine's host name is registered on the domain name server, you can access the machine using the Internet address combining the host name and the domain name. For example, if the host name is "myhost", and the domain name is "example.com" then the Internet address is "myhost.example.com".
- When specifying a port number, add ":" and the port number after the Internet address.
- If using the Authentication feature on the machine, enter a user ID and passcode in the [User Name] and [Password] fields. If you are not sure about the user ID and passcode, consult your system administrator.
The features you can operate vary depending on the system administrator's authority that was given to a user.
- If communications are encrypted; when the [Enabled] check box is selected under [Security] > [SSL / TLS Settings] > [HTTP - SSL / TLS Communication] on the [Properties] tab, you must specify an address that starts with "https" instead of "http" to access Dell Printer Configuration Web Tool.
Example of the IP address entry
https://192.0.2.1/ (IPv4)
https://[2001:DB8::1234] (IPv6)
Example of the Internet address entry
https://myhost.example.com/

If Dell Printer Configuration Web Tool is not displayed, refer to "Dell Printer Configuration Web Tool Problems" (P.414).

Configuring Machine Settings Using Dell Printer Configuration Web Tool

Dell Printer Configuration Web Tool enables you to change various settings on the machine from a computer.

- Note**
- Confirm that the port in use is enabled in [Properties] tab > [Connectivity] > [Port Settings] of Dell Printer Configuration Web Tool when an item that you want to set is not displayed.
 - You cannot change settings from Dell Printer Configuration Web Tool while the wakeup motion sensor is detecting human presence or the control panel is being used. You can change settings after the machine resets the settings automatically (Auto Clear). For information about Auto Clear, refer to "Auto Clear" (P.125).
 - You may be prompted to enter your user name and passcode when you attempt to change settings on Dell Printer Configuration Web Tool. In that case, enter the system administrator's user ID and passcode into the [User Name] and [Password] fields. The default user ID is "admin" and passcode is "1111".

You can configure the following settings with Dell Printer Configuration Web Tool:

Item	How to Select	Overview/Reference
Usage Counters	Select from [Status] tab > [Counters]	Displays the total number of pages printed for each service.
Total Runtime	Select from [Status] tab	Displays the cumulative time of runtime (printing or scanning), standby time, Sleep mode time, warm-up time, and power-off time of the machine by minutes.
Folder	Select from [Scan] tab	Refer to "Create Folder" (P.231).
Job Flow Sheets		Refer to "Create Job Flow Sheet" (P.233).
Add New User	Select from [Address Book] tab	Refer to "Add Address Book Entry" (P.241).
Job Management	Select from [Properties] tab > [General Setup]	Allows you to configure the delete method of jobs.
Paper Tray Attributes		Refer to "Changing the Paper Settings" (P.54).
Paper Settings		Refer to "Changing the Paper Settings" (P.54).
Energy Saver Settings		Allows you to configure the settings for the Power Saver feature. Refer to "Changing the Interval for Entering Power Saver Mode" (P.22).
Stored Job Settings		Refer to "Stored File Settings" (P.223).
Memory Settings		Refer to "Allocate Memory" (P.190).
Web Browser Setup		Refer to "Web Browser Setup" (P.229).
Dell Printer Configuration Web Tool Settings		Allows you to configure the auto refresh interval and the display language of the Dell Printer Configuration Web Tool settings.
Pool Server Settings		Leave the default settings unchanged because a pool server is not available for the machine. Refer to "Job Flow Service Settings" (P.221).
Web Applications Service Setup		Refer to "Web Applications Service Setup" (P.225).

Item	How to Select	Overview/Reference
Cloning		Allows you to save the settings of the machine in a file, and copy the file to the other machine of the same model but not to the other models.
Notify Job Completion by E-mail	Select from [Properties] tab > [General Setup] > [Alert Notification]	Refer to "Notify Job Completion by E-mail" (P.143).
E-mail Notification for Machine Status		Allows you to configure the recipient of the notification and a status of which to be notified.
Port Settings	Select from [Properties] tab > [Connectivity]	Refer to "Port Settings" (P.168).
Physical Connections		Refer to "Port Settings" (P.168).
Protocols		Refer to "Protocol Settings" (P.173).
Language Emulations	Select from [Properties] tab > [Services] > [Printing]	Refer to "Print Mode" (P.96).
E-mail	Select from [Properties] tab > [Services]	Refer to "E-mail / Internet Fax Service Settings" (P.216).
Internet Fax		Refer to "E-mail / Internet Fax Service Settings" (P.216).
Fax		Refer to "Fax Service Settings" (P.204).
Scan to PC		Refer to "Configuration of Scan to PC" (P.312).
Store & Send Link		Refer to "Configuration of Store & Send Link" (P.318).
Store to USB		Refer to "Store to USB" (P.308).
Media Print		Allows you to enable and disable the Media Print - Text and Media Print - Photos services.
USB		Allows you to enable and disable Store to USB, Media Print - Text, and Media Print - Photos settings.
Accounting		Select from [Properties] tab
Authentication Configuration	Select from [Properties] tab > [Security]	Refer to "Authentication" (P.261).
User Details Setup		Refer to "User Details Setup" (P.264).
Create Authorization Groups		Refer to "Create Authorization Groups" (P.263).
Remote Authentication Servers		Refer to "Remote Authentication / Directory Service" (P.179).
IP Filtering		Allows you to configure the IPs to permit access, for IPv4 and IPv6 respectively.
Unbounded Port		Allows you to set unbounded port numbers.

Item	How to Select	Overview/Reference
Audit Log	Select from [Properties] tab > [Security]	Allows you to enable the Audit Log feature that logs the operation on the machine, and retrieve the audit log.
Machine Digital Certificate Management		Allows you to create a self-signed certificate and import a certificate to the machine.
IPSec		Refer to "Configuration of Encryption using IPSec" (P.334).
Certificate Management		Displays the certificates registered on the machine. Also allows you to select, delete, and export of the certificate.
Certificate Revocation Retrieval Settings		Refer to "Certificate Revocation Retrieval Settings" (P.188).
IEEE 802.1x		Refer to "IEEE 802.1x Settings" (P.187).
SSL / TLS Settings		Refer to "SSL / TLS Settings" (P.184).
S/MIME Settings		Refer to "S/MIME Settings" (P.185).
PDF / XPS Signature Settings [*]		Refer to "PDF / XPS Signature Settings" (P.186).
Watermark		Refer to "Watermark" (P.140)
Force Annotation		Refer to "Force Annotation" (P.141).
Job Status Default		Allows you to configure the display/hide settings for completed and active jobs.
Plug-in Settings		Allows you to configure the settings for plug-ins.
Service Representative Restricted Operation		Allows you to restrict the operation of service representatives. Prevents the machine from being altered by someone impersonating our service representative.
System Administrator Settings		Refer to "System Administrator Settings" (P.260).
Smart Card Settings	Allows you to configure the smart card settings and backup the settings.	

* :XPS stands for XML Paper Specification.

7 Printer Environment Settings

This chapter describes the settings to use the Print feature on the machine.

- **Print Overview**282
- **Installation When Using USB Port**.....285
- **Installation When Using TCP/IP (LPD/Port 9100)**.....287
- **Installation When Using NetWare**290
- **Installation When Using Microsoft Network (SMB)**293
- **Installation When Using Internet Printing Protocol (IPP)**295
- **Installation When Using EtherTalk**297

Print Overview

This machine can be set up as a local printer by directly connecting the machine to a computer using a USB interface cable. Similarly, it can be set up as a network printer by connecting the machine to a network.

Enable the necessary port using the control panel or Dell Printer Configuration Web Tool.

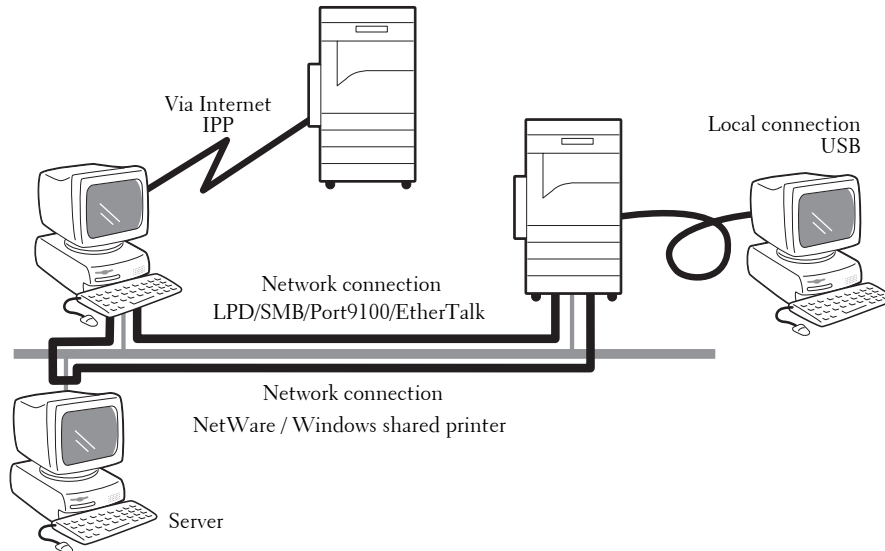

- Note**
- The print drivers are contained in the Driver CD Kit. For information on the driver installation procedures, refer to the manual contained in the Driver CD Kit.
 - You can download the latest print driver from our web site.

Using the Machine as a Local Printer

USB

Use a USB interface cable to directly connect the machine to a computer.

For more information on how to set up the machine using USB connection, refer to "Installation When Using USB Port" (P.285).

Using the Machine as a Network Printer

To set up the machine as a network printer, the following protocols are available to connect the machine.

LPD

Use LPD when direct communication between the machine and a computer via TCP/IP is available.

For more information on how to set up the machine using LPD, refer to "Installation When Using TCP/IP (LPD/Port 9100)" (P.287).

NetWare

The machine supports the PServer mode using Netware directory service and bindery service. The PServer mode enables the machine to function as a printer server, and to retrieve print jobs in the print queue to output. The printer created for the machine consumes one user license of the file server.

- Note**
- The machine does not support Remote Printer (RPrinter) mode.
 - You can use the machine as a printer in a NDPS environment by using a Novell® NDPS Gateway. To use the machine as a printer in a NDPS environment, you need to have the machine operating in a NetWare print environment beforehand, or enable LPD in advance and set it as a gateway destination

in a Novell NDPS Gateway setup. Attributes, however, that can be set or obtained by NDPS are not supported.

- Supported interfaces
 - 1000BASE-T
 - 100BASE-TX
 - 10BASE-T
- Supported frame types
 - Ethernet II specification
 - IEEE802.3 specification
 - IEEE802.3 / IEEE802.2 specification
 - IEEE802.3 / IEEE802.2 / SNAP specification

- Note**
- The machine sends out packets of each frame type on the network, and will initialize for the same frame type as that of the first reply packet received. The frame type can also be fixed. If, however, there are multiple protocols running on the same network, use Ethernet II specification.
 - Some network equipment, such as hubs, may not be compatible with the automatic frame type detection. If a data link indicator corresponding to the port of the network equipment connected with the machine is not lit up, change the frame type settings of the machine accordingly with that of the file server. Use Dell Printer Configuration Web Tool to change these settings.

For more information on how to set up the machine using NetWare, refer to "Installation When Using NetWare" (P.290).

SMB

Use SMB to print using Microsoft Networks.

For more information on how to set up the machine using SMB, refer to "Installation When Using Microsoft Network (SMB)" (P.293).

IPP

Use IPP to print via the Internet.

For more information on how to set up the machine using IPP, refer to "Installation When Using Internet Printing Protocol (IPP)" (P.295).

Port 9100

Use Port 9100 when the machine uses Port 9100.

For more information on how to set up the machine using Port 9100, refer to "Installation When Using TCP/IP (LPD/Port 9100)" (P.287).

EtherTalk

Use EtherTalk when you print from a Macintosh computer.

For more information on how to set up the machine using EtherTalk, refer to "Installation When Using EtherTalk" (P.297).

Supported Operating Systems

Connection method		Local connection	Network connection										
Port		USB 2.0*1	LPD	NetWare			SMB		IPP	Port 9100	WSD*2	Ether Talk	Bonjour
Protocol		-	TCP/IP	TCP/IP	IPX/SPX	Net BEUI	TCP/IP	TCP/IP	TCP/IP	WSD*2	Apple Talk	Bonjour	
OS	Windows 2000	○	○	○	○	○	○	○	○				
	Windows XP	○	○	○	○		○	○	○				
	Windows Server 2003	○	○	○	○		○	○	○				
	Windows Server 2008	○	○	○	○		○	○	○				
	Windows Vista	○	○	○	○		○	○	○	○			
	Windows 7	○	○				○	○	○	○			
	Windows 8	○	○				○	○	○	○			
	Windows Server 2012	○	○				○	○	○	○			
	Mac OS	○*3	○*3							○*3		○*4	○*3

○ : Available

Blank : Not available

*1 : A USB 2.0 port is required on a computer to connect.

*2 : WSD stands for Web Services on Devices.

*3 : Supports Mac OS X 10.5/10.6/10.7/10.8.

*4 : The machine does not support Mac OS X 10.7 Lion.

For information on network environments, refer to the manual contained in the Driver CD Kit.

Installation When Using USB Port

This section describes how to install the machine using a USB interface.

The following shows the reference section for each procedure.

Step 1 Preparations.....	285
Step 2 Configuration on the Machine	285
Step 3 Configuration on the Computer.....	286
Dell Printer Configuration Web Tool Setting Items	286

Step 1 Preparations

The following items are required to connect the machine to a computer via a USB interface.

- USB cable
- The Driver CD Kit (provided with the machine)

Step 2 Configuration on the Machine

The following describes the configuration procedures to use a USB interface on the machine.

- Note**
- To print binary data using a USB interface, set [Adobe Communication Protocol] to [RAW]. For more information, refer to "USB" (P.168).
 - You can configure the settings using Dell Printer Configuration Web Tool. For items that can be configured using Dell Printer Configuration Web Tool, refer to "Dell Printer Configuration Web Tool Setting Items" (P.286).

1 Display the [Tools] screen.

- 1) Press the <Log In/Out> button.
- 2) Enter the system administrator's user ID with the numeric keypad or the keyboard displayed on the screen, and select [Enter].

When a passcode is required, select [Next] and enter the system administrator's passcode, and select [Enter].

- Note**
- The default user ID is "admin".
 - The default passcode is "1111".

- 3) Select [Tools] on the [Home] screen.

2 Enable the USB port on the machine.

- 1) Select [Port Settings].
- 2) Select [Connectivity & Network Setup].
- 3) Select [USB], and then select [Change Settings].
- 4) Select [Port Status], and then select [Change Settings].
- 5) Select [Enabled], and then select [Save].

3 Configure [Print Mode] or [Auto Eject Time] as necessary.

For information on the setting items, refer to "USB" (P.168)

4 Select [Close] repeatedly until the [Tools] screen is displayed.

5 Select [Close].

- Note** • Rebooting the machine may be required depending on the settings. When a message displayed on the screen, follow the message and reboot the machine.

6 Print a configuration report to confirm that the USB port is enabled.

For information on how to print a configuration report, refer to "Printer Reports" (P.88).

Step 3 Configuration on the Computer

To print a document from your computer, you need to install a print driver on your computer.

For information on the supported operating systems, refer to "Supported Operating Systems" (P.284).

For information on the driver installation procedures, refer to the manual contained in the Driver CD Kit.

Dell Printer Configuration Web Tool Setting Items

You can configure the following setting items using Dell Printer Configuration Web Tool:
For information on how to start Dell Printer Configuration Web Tool, refer to "Starting Dell Printer Configuration Web Tool" (P.276).

- Receiving buffer size for the USB interface
([Properties] > [General Setup] > [Memory Settings] > [USB])
- Port Settings
- Bi-directional Communication
- Auto Eject Time
- Adobe Communication Protocol
- PostScript Wait Timeout (RAW Mode)

Installation When Using TCP/IP (LPD/Port 9100)

This section describes how to install the machine using TCP/IP.

The following shows the reference section for each procedure.

Step 1 Preparations.....	287
Step 2 Configuration on the Machine	287
Step 3 Configuration on the Computer.....	288
Dell Printer Configuration Web Tool Setting Items	288

Step 1 Preparations

The following items are required to use the machine via TCP/IP (LPD/Port 9100).

- TCP/IP network environment
- The Driver CD Kit (provided with the machine)

Step 2 Configuration on the Machine

The following describes the configuration procedures to use TCP/IP (LPD/Port 9100) on the machine. Enable the LPD port or the Port 9100 port, and then configure TCP/IP settings.

Note • You can configure the settings using Dell Printer Configuration Web Tool.

For the items that can be configured using Dell Printer Configuration Web Tool, refer to "Dell Printer Configuration Web Tool Setting Items" (P.288).

- 1 Display the [Tools] screen.
 - 1) Press the <Log In/Out> button.
 - 2) Enter the system administrator's user ID with the numeric keypad or the keyboard displayed on the screen, and select [Enter].

When a passcode is required, select [Next] and enter the system administrator's passcode, and select [Enter].

Note • The default user ID is "admin".
• The default passcode is "1111".

 - 3) Select [Tools] on the [Home] screen.
- 2 Enable the LPD port or Port 9100 port as appropriate.
In this example, the LPD port is enabled.
 - 1) Select [Connectivity & Network Setup].
 - 2) Select [Port Settings].
 - 3) Select [LPD], and then select [Change Settings].
 - 4) Select [Port Status], and then select [Change Settings].
 - 5) Select [Enabled], and then select [Save].
 - 6) Select [Close] repeatedly until the [Tools] screen is displayed.
- 3 Set an IP address and the other addresses.
Skip this step if an IP address is already set.
If DHCP or BOOTP is available in your environment, configure the method for obtaining the address. The configuration of an IP address, a subnet mask, and a gateway address is not required.
For information on how to set an IP address, refer to "Protocol Settings" (P.173).

- 4 If the operating system on the client is Mac OS X 10.5 or later, enable the Bonjour port, and the Discovery feature that automatically detects printers on the IP network can be enabled.
Note • To print from a printer detected by Bonjour, the LPD port must be enabled in advance.
 - 1) Select [Connectivity & Network Setup].
 - 2) Select [Port Settings].
 - 3) Select [Bonjour], and then select [Change Settings].
 - 4) Select [Port Status], and then select [Change Settings].
 - 5) Select [Enabled], and then select [Save].
- 5 Select [Close] repeatedly until the [Tools] screen is displayed.
- 6 Select [Close].
Note • Rebooting the machine may be required depending on the settings. When a message displayed on the screen, follow the message and reboot the machine.
- 7 Print a configuration report to confirm that the LPD port is enabled and that TCP/IP is set up correctly.
For information on how to print a configuration report, refer to "Print Reports" (P.86).
- 8 Configure other LPD or Port 9100 settings as necessary.
For information on how to set up the LPD port or Port 9100, refer to "Dell Printer Configuration Web Tool Setting Items" (P.288).

Step 3 Configuration on the Computer

To print from the machine, you need to install a print driver on your computer.

For information on the supported operating systems, refer to "Supported Operating Systems" (P.284).

For information on the driver installation procedures, refer to the manual contained in the Driver CD Kit.

You can print via TCP/IP (LPD) from a Macintosh computer for Mac OS X 10.5/10.6/10.7/10.8. For information on the installation procedures of the print driver for Mac OS X, refer to the manual contained in the CD-ROM provided with the driver.

Dell Printer Configuration Web Tool Setting Items

You can configure the following setting items using Dell Printer Configuration Web Tool:

For information on how to start Dell Printer Configuration Web Tool, refer to "Starting Dell Printer Configuration Web Tool" (P.276).

- Spool Destination for Jobs
([Properties] > [General Setup] > [Memory Settings] > [LPD])
- Note** • The spool destination can be configured when the LPD port is enabled.
- Receiving buffer size for Port 9100
([Properties] > [General Setup] > [Memory Settings] > [Port 9100])
- Port Settings
- IP Mode
- Host Name
- IPv4
 - IP Address Resolution
 - Port Settings
 - IP Address

- Subnet Mask
- Gateway Address
- IPv6
 - Enable Manual Address
 - IP Address
 - Link-Local Address
 - Gateway Address
- Domain Name
- DNS Configuration
 - IPv4
 - IPv6
- DHCP / DDNS
- WINS Server
- Port Number
- TBCP Filter
- Connection Time-Out
- Maximum Number of Sessions

Note • The Maximum Number of Sessions can be configured when the LPD port is enabled.

- TCP-MSS Mode
- IPv4 Subnet Mask when TCP-MSS Mode is enabled
- IP Filtering
 - IPv4 Filtering
 - IPv6 Filtering

Installation When Using NetWare

This section describes how to install the machine using Netware.

The following shows the reference section for each procedure.

Step 1 Preparations	290
Step 2 Configuration on the Machine	290
Step 3 Configuration on the Computer	291
Dell Printer Configuration Web Tool Setting Items.....	291

Step 1 Preparations

The following items are required to set up the machine to use NetWare.

- NetWare server
- TCP/IP or IPX/SPX network environment
- The Driver CD Kit (provided with the machine)

Step 2 Configuration on the Machine

The following describes the configuration procedures to use NetWare on the machine.

Note • You can configure the settings using Dell Printer Configuration Web Tool.

For the items that can be configured using Dell Printer Configuration Web Tool, refer to "Dell Printer Configuration Web Tool Setting Items" (P.291).

Using IPX/SPX

- 1 Display the [Tools] screen.
 - 1) Press the <Log In/Out> button.
 - 2) Enter the system administrator's user ID with the numeric keypad or the keyboard displayed on the screen, and select [Enter].

When a passcode is required, select [Next] and enter the system administrator's passcode, and select [Enter].
- 2 Enable the NetWare port.
 - 1) Select [Connectivity & Network Setup].
 - 2) Select [Port Settings].
 - 3) Select [NetWare], and then select [Change Settings].
 - 4) Select [Port Status], and then select [Change Settings].
 - 5) Select [Enabled], and then select [Save].
- 3 Select [Close] repeatedly until the [Tools] screen is displayed.
- 4 Select [Close].

Note • Rebooting the machine may be required depending on the settings. When a message displayed on the screen, follow the message and reboot the machine.

- 5 Print a configuration report to confirm that the NetWare port is enabled, and confirm the NetWare device name and the network address.

For information on how to print a configuration report, refer to "Print Reports" (P.86).

Using an LPD Port in NDPS

- 1 Display the [Tools] screen.
- 1) Press the <Log In/Out> button.
 - 2) Enter the system administrator's user ID with the numeric keypad or the keyboard displayed on the screen, and select [Enter].
- Note**
- The default user ID is "admin".
 - The default passcode is "1111".
- 3) Select [Tools] on the [Home] screen.
- 2 Enable the LPD port.
- 1) Select [Connectivity & Network Setup].
 - 2) Select [Port Settings].
 - 3) Select [LPD], and then select [Change Settings].
 - 4) Select [Port Status], and then select [Change Settings].
 - 5) Select [Enabled], and then select [Save].
 - 6) Select [Close] repeatedly until the [Tools] screen is displayed.
- 3 Set an IP address and the other addresses.
- Skip this step if an IP address is already set.
- If DHCP or BOOTP is available in your environment, configure the method for obtaining the address. The configuration of an IP address, a subnet mask, and a gateway address is not required.
- For information on how to set an IP address, refer to "Protocol Settings" (P.173).
- 4 Select [Close] repeatedly until the [Tools] screen is displayed.
- 5 Select [Close].
- Note**
- Rebooting the machine may be required depending on the settings. When a message displayed on the screen, follow the message and reboot the machine.
- 6 Print a configuration report to confirm that the LPD port is enabled and that TCP/IP is set up correctly.
- For information on how to print a configuration report, refer to "Print Reports" (P.86).
- Configure other LPD settings as necessary. For information on the LPD settings, refer to "Installation When Using TCP/IP (LPD/Port 9100)" (P.287).

Step 3 Configuration on the Computer

To print from the machine, you need to install a print driver on your computer.

For information on the supported operating systems, refer to "Supported Operating Systems" (P.284).

For information on the driver installation procedures, refer to the manual contained in the Driver CD Kit.

Dell Printer Configuration Web Tool Setting Items

You can configure the following setting items using Dell Printer Configuration Web Tool:

For information on how to start Dell Printer Configuration Web Tool, refer to "Starting Dell Printer Configuration Web Tool" (P.276).

- Receiving buffer size for the NetWare interface
([Properties] > [General Setup] > [Memory Settings] > [NetWare])
- Port Settings
- Transport Protocol (IPX/SPX) Frame Type
- Queue Poll Interval
- Print Server Name
- Password
- Active Mode
- Number of Searches
- TBCP Filter
- File Server Name

Note • The File Server Name can be configured when the operation mode is in Bindery Service.

- NDS Tree / NDS Context

Note • The DNS Tree/NDS Context can be configured only when the operation mode is in Bindery Service.

- SLP Active Discovery
 - Version
 - Active Discovery
 - Use SLP for Name Resolution
 - Scope
 - SLP Server

Installation When Using Microsoft Network (SMB)

This section describes how to install the machine using Microsoft Network (SMB).

The following shows the reference section for each procedure.

Step 1 Preparations.....	293
Step 2 Configuration on the Machine	293
Step 3 Configuration on the Computer.....	294
Dell Printer Configuration Web Tool Setting Items	294

Step 1 Preparations

The following items are required to set up the machine to use Microsoft Network (SMB).

- NetWare server
- TCP/IP or NetBEUI network environment
- The Driver CD Kit (provided with the machine)

Step 2 Configuration on the Machine

The following describes the configuration procedures to use Microsoft Networks (SMB) on the machine. Enable the LPD Port, and then configure TCP/IP settings.

Note • You can configure the settings using Dell Printer Configuration Web Tool.

For the items that can be configured using Dell Printer Configuration Web Tool, refer to "Dell Printer Configuration Web Tool Setting Items" (P.294).

1 Display the [Tools] screen.

- 1) Press the <Log In/Out> button.
- 2) Enter the system administrator's user ID with the numeric keypad or the keyboard displayed on the screen, and select [Enter].

When a passcode is required, select [Next] and enter the system administrator's passcode, and select [Enter].

Note • The default user ID is "admin".
• The default passcode is "1111".

- 3) Select [Tools].

2 Enable the SMB port.

- 1) Select [Connectivity & Network Setup].
- 2) Select [Port Settings].
- 3) Select [SMB], and then select [Change Settings].
- 4) Select [Port Status], and then select [Change Settings].
- 5) Select [Enabled], and then select [Save].
- 6) Select [Close] repeatedly until the [Tools] screen is displayed.

3 Set an IP address and the other addresses.

Skip this step if an IP address is already set.

If DHCP or BOOTP is available in your environment, configure the method for obtaining the address. The configuration of an IP address, a subnet mask, and a gateway address is not required.

For information on how to set an IP address, refer to "Protocol Settings" (P.173).

4 Select [Close] repeatedly until the [Tools] screen is displayed.

5 Select [Close].

Note • Rebooting the machine may be required depending on the settings. When a message displayed on the screen, follow the message and reboot the machine.

6 Print a configuration report to confirm that the SMB port is enabled and that TCP/IP is set up correctly.

For information on how to print a configuration report, refer to "Print Reports" (P.86).

Note • If NetBEUI protocol is used as the transport protocol, select [NetBEUI] on the [Port Settings] screen for SMB in Dell Printer Configuration Web Tool.

7 Configure the other SMB settings as necessary.

For information on the SMB settings, refer to "Dell Printer Configuration Web Tool Setting Items" (P.294).

Step 3 Configuration on the Computer

To print from the machine, you need to install a print driver on your computer.

For information on the supported operating systems, refer to "Supported Operating Systems" (P.284).

For information on the driver installation procedures, refer to the manual contained in the Driver CD Kit.

Dell Printer Configuration Web Tool Setting Items

You can configure the following setting items using Dell Printer Configuration Web Tool:

For information on how to start Dell Printer Configuration Web Tool, refer to "Starting Dell Printer Configuration Web Tool" (P.276).

- Spool Destination for Jobs
([Properties] > [General Setup] > [Memory Settings] > [SMB])
- Port Settings
- Transport Protocol
- Maximum Connections per Port
- Workgroup
- Server Name
- TBCP Filter
- Unicode Support
- Auto Master Mode
- Password Encryption
- Obtain WINS Server Address Automatically
- Primary Server IP Address & Primary Server Port Number
- Secondary Server IP Address & Secondary Server Port Number

Installation When Using Internet Printing Protocol (IPP)

This section describes how to install the machine using Internet Printing Protocol (IPP).

The following shows the reference section for each procedure.

Step 1 Preparations.....	295
Step 2 Configuration on the Machine	295
Step 3 Configuration on the Computer.....	296
Dell Printer Configuration Web Tool Setting Items	296

Note • If the size of print data sent via IPP is larger than the value set in the proxy server, the machine cannot receive the data. In this case, set a larger value in the proxy server or change your browser setting not to use the proxy server.

Step 1 Preparations

The following items are required to set up the machine to use Internet Printing Protocol (IPP).

- TCP/IP network environment
- The Driver CD Kit (provided with the machine)

Step 2 Configuration on the Machine

The following describes the configuration procedures to use Internet Printing Protocol (IPP) on the machine. Enable the IPP port, and then configure TCP/IP settings.

Note • You can configure the settings using Dell Printer Configuration Web Tool.

For the items that can be configured using Dell Printer Configuration Web Tool, refer to "Dell Printer Configuration Web Tool Setting Items" (P.296).

1 Display the [Tools] screen.

- 1) Press the <Log In/Out> button.
- 2) Enter the system administrator's user ID with the numeric keypad or the keyboard displayed on the screen, and select [Enter].

When a passcode is required, select [Next] and enter the system administrator's passcode, and select [Enter].

Note • The default user ID is "admin".

• The default passcode is "1111".

- 3) Select [Tools] on the [Home] screen.

2 Enable the IPP port.

- 1) Select [Connectivity & Network Setup].
- 2) Select [Port Settings].
- 3) Select [IPP], and then select [Change Settings].
- 4) Select [Port Status], and then select [Change Settings].
- 5) Select [Enabled], and then select [Save].
- 6) Select [Close] repeatedly until the [Tools] screen is displayed.

3 Set an IP address and the other addresses.

Skip this step if an IP address is already set.

If DHCP or BOOTP is available in your environment, configure the method for obtaining

the address. The configuration of an IP address, a subnet mask, and a gateway address is not required.

For information on how to set an IP address, refer to "Protocol Settings" (P.173).

4 Select [Close] repeatedly until the [Tools] screen is displayed.

5 Select [Close].

Note • Rebooting the machine may be required depending on the settings. When a message displayed on the screen, follow the message and reboot the machine.

6 Print a configuration report to confirm that the IPP port is enabled and that TCP/IP is set up correctly.

For information on how to print a configuration report, refer to "Print Reports" (P.86).

7 Configure other IPP settings as necessary.

Refer to "Dell Printer Configuration Web Tool Setting Items" (P.296).

Step 3 Configuration on the Computer

To print from the machine, you need to install a print driver on your computer.

For information on the supported operating systems, refer to "Supported Operating Systems" (P.284).

For information on the driver installation procedures, refer to the manual contained in the Driver CD Kit.

Dell Printer Configuration Web Tool Setting Items

You can configure the following setting items using Dell Printer Configuration Web Tool:

For information on how to start Dell Printer Configuration Web Tool, refer to "Starting Dell Printer Configuration Web Tool" (P.276).

- Spool Destination for Jobs
([Properties] > [General Setup] > [Memory Settings] > [IPP])
- Port Settings
- Add Port Number
- TBCP Filter
- Administrator Mode
- DNS
- Connection Time-Out

Installation When Using EtherTalk

This section describes how to install the machine using EtherTalk.

The following shows the reference section for each procedure.

Step 1 Preparations.....	297
Step 2 Configuration on the Machine	297
Step 3 Configuration on the Computer.....	298
Dell Printer Configuration Web Tool Setting Items	298

Step 1 Preparations

The following items are required to set up the machine to use the EtherTalk interface.

- EtherTalk network environment

Step 2 Configuration on the Machine

The following describes the configuration procedures to use EtherTalk on the machine.

Note • You can configure the settings using Dell Printer Configuration Web Tool. For the items that can be configured using Dell Printer Configuration Web Tool, refer to "Dell Printer Configuration Web Tool Setting Items" (P.298).

1 Display the [Tools] screen.

- 1) Press the <Log In/Out> button.
- 2) Enter the system administrator's user ID with the numeric keypad or the keyboard displayed on the screen, and select [Enter].

When a passcode is required, select [Next] and enter the system administrator's passcode, and select [Enter].

Note • The default user ID is "admin".
• The default passcode is "1111".

- 3) Select [Tools] on the [Home] screen.

2 Enable the EtherTalk port.

- 1) Select [Connectivity & Network Setup].
- 2) Select [Port Settings].
- 3) Select [EtherTalk], and then select [Change Settings].
- 4) Select [Port Status], and then select [Change Settings].
- 5) Select [Enabled], and then select [Save].

3 Select [Close] repeatedly until the [Tools] screen is displayed.

4 Select [Close].

Note • Rebooting the machine may be required depending on the settings. When a message displayed on the screen, follow the message and reboot the machine.

5 Print a configuration report to confirm that the EtherTalk port is enabled.

For information on how to print a configuration report, refer to "Print Reports" (P.86).

6 Configure other EtherTalk settings as necessary.

For information on the EtherTalk settings, refer to "Dell Printer Configuration Web Tool Setting Items" (P.298).

Step 3 Configuration on the Computer

To print from the machine, you need to install a print driver on your computer.
For information on the supported operating systems, refer to "Supported Operating Systems" (P.284).

Dell Printer Configuration Web Tool Setting Items

You can configure the following setting items using Dell Printer Configuration Web Tool:
For information on how to start Dell Printer Configuration Web Tool, refer to "Starting Dell Printer Configuration Web Tool" (P.276).

- Receiving buffer size for the AppleTalk interface
([Properties] > [General Setup] > [Memory Settings] > [EtherTalk])
- Port Settings
- Printer Name
- Zone Name

8 E-mail Environment Settings

This chapter describes the settings to use various services via e-mail on the machine.

- **E-mail Overview**300
- **Preparations**301
- **Installation Procedures**.....303

E-mail Overview

The machine can send and receive e-mails.

The following services and features are available using e-mail:

- E-mail
- Store & Send Link
- Internet Fax Service
- Print E-mail
- E-mail Notification (Consumables Status)
- Job Completion Notice

E-mail

Scanned documents can be converted into electronic form and transmitted via e-mail.

Store & Send Link

The machine can convert a document scanned by a user authenticated by the machine into electronic form, store it in the hard disk, and send a URL that indicates the location of the document.

Internet Fax Service

Unlike the normal fax transmissions via telephone lines, faxed data is transmitted via a corporate intranet or the Internet as an e-mail attachment.

The message body of e-mail is processed according to the settings in [Incoming Internet Fax Print Options] of Dell Printer Configuration Web Tool.

Print E-mail

You can send and transfer e-mails with files attached from computers. File formats that can be attached to the e-mails are TIFF, PDF, JPEG (JFIF), and XPS.

The message body of e-mail is processed according to the settings in [Incoming E-mail Print Options] of Dell Printer Configuration Web Tool.

Note • XPS stands for XML Paper Specification.

E-mail Notification (Consumables Status)

The machine can notify the status information such as consumable status, parts status, and paper tray status that is set in [E-mail Notification for Machine Status] of Dell Printer Configuration Web Tool to a specified recipient. By receiving the statuses of consumables periodically or when they need to be replaced soon, you can properly determine when to replace the toner and drum cartridges.

It is recommended that you register the address of the system administrator or a shared address as the recipient of the e-mail.

Job Completion Notice

The following methods can be used to notify the completion of the jobs. Register the address of the network administrator or a shared address as necessary.

- Notify the Completion of Jobs by E-mail

When a computer submitted a print job or a Direct Fax job to the machine, its completion can be notified by e-mail. For more information, refer to the help of the print driver.

- Notify Job Completion by E-mail

You can receive the result of the jobs performed by e-mail. For more information, refer to "Notify Job Completion by E-mail" (P.143).

- E-mail Notification

You can receive an e-mail notification when a file is saved in a folder or a job flow ends. For more information, refer to "E-mail Notification" (P.240).

Preparations

The following items must be set to use the E-mail feature.

For more information on the preparations to use the Internet Fax feature, refer to "Preparations" (P.324).

Configuration on the Machine

Item	Description	E-mail	Store & Send Link	Print E-mail		E-mail Notification	Job Completion Notice
				via SMTP	via POP3		
TCP/IP address	The TCP/IP address for the machine. E-mails are sent via TCP/IP.	○	○	○	○	○	○
Subnet mask	Required when the network is divided into subnets.	△	△	△	△	△	△
Gateway address	Required when multiple networks are connected by gateways.	△	△	△	△	△	△
Machine e-mail address	Set the E-mail address of the machine.	○	○	○	○	○	○
DNS server address	Required when the addresses for a POP3 server and an SMTP server are set with a domain name format instead of their IP addresses. You can also acquire this from DHCP.	△	△	△	△	△	△
SMTP server address	The machine uses an SMTP server to send e-mails. The SMTP server can also be used for receiving e-mails.	○	○	○	△	○	○
SMTP AUTH login name and password	If an SMTP server requires authentication, specify an authentication user name. Also specify a password as required.	△	△	△	△	△	△

Item	Description	E-mail	Store & Send Link	Print E-mail		E-mail Notification	Job Completion Notice
				via SMTP	via POP3		
POP3 server	Set the POP3 server address.	Δ	Δ	-	○	Δ	Δ
POP login name and password	Set the POP receiving user name. Also specify a password as required.	Δ	Δ	-	○	Δ	Δ
S/MIME settings	Set the S/MIME information.	Δ	X	Δ	Δ	X	X

○ :Required to be set
 Δ :Set as required
 - :Not required to be set
 X :Not supported

Note • To transmit e-mails encrypted by S/MIME or with digital signatures attached, a certificate must be ready in advance. For more information on a certificate, refer to "Configuration of E-mail Encryption/ Digital Signature" (P.337).

Configuration on the Server

Note • Information on server settings, contact your System Administrator.

Item	Description	E-mail	Store & Send Link	Print E-mail		E-mail Notification	Job Completion Notice
				via SMTP	via POP3		
Machine e-mail address	When using the E-mail feature on the machine, an e-mail account of the machine must be registered on a mail server in advance.	○	○	○	○	○	○
Host name	Set the host name and domain name of the machine along with the TCP/IP address for the machine on the DNS server.	Δ	Δ	Δ	Δ	Δ	Δ
Domain name		Δ	Δ	Δ	Δ	Δ	Δ

○ :Required to be set
 Δ :Set as required

Installation Procedures

This section describes how to configure the machine to use the E-mail service.

The following shows the reference section for each procedure.

Step 1 Enabling Port and Setting up TCP/IP	303
Step 2 Configuring E-mail Environment	304
Dell Printer Configuration Web Tool Setting Items	305

Step 1 Enabling Port and Setting up TCP/IP

Enable the E-mail port, and set the IP address.

Note • You can configure the settings using Dell Printer Configuration Web Tool. For information on how to use Dell Printer Configuration Web Tool, refer to "Dell Printer Configuration Web Tool Settings" (P.273).

- 1 Display the [Tools] screen.
 - 1) Press the <Log In/Out> button.
 - 2) Enter the system administrator's user ID with the numeric keypad or the keyboard displayed on the screen, and select [Enter].

When a passcode is required, select [Next] and enter the system administrator's passcode, and select [Enter].

Note • The default user ID is "admin".
• The default passcode is "1111".
 - 3) Select [Tools] on the [Home] screen.
- 2 Enable ports to use for the E-mail feature.
 - 1) Select [Connectivity & Network Setup].
 - 2) Select [Port Settings].
 - 3) Select [Send E-mail], and then select [Change Settings].
 - 4) Select [Port Status], and then select [Change Settings].
 - 5) Select [Enabled], and then select [Save].
 - 6) Select [Close].
 - 7) Select [Enabled] on the [Receive E-mail - Port Status] screen under [Receive E-mail] as described above to use the Print E-mail feature.
 - 8) Select [Enabled] on the [E-mail Notification - Port Status] screen under [E-mail Notification Service] as described above to use the E-mail Notification or the Job Completion Notification feature.
 - 9) Select [Close] repeatedly until the [Tools] screen is displayed.
- 3 Set an IP address and the other addresses.

Skip this step if an IP address is already set.

If DHCP or BOOTP is available in your environment, configure the method for obtaining the address. If an IP address cannot be obtained automatically or manual configuration is preferred, confirm the settings of an IP address, a subnet mask, and a gateway address.

For information on how to set an IP address, refer to "Protocol Settings" (P.173).
- 4 Select [Close] repeatedly until the [Tools] screen is displayed.
- 5 Select [Close].

Note • Rebooting the machine may be required depending on the settings. When a message displayed on the screen, follow the message and reboot the machine.

- 6 Print a configuration report to confirm that the ports are enabled and that TCP/IP is set up correctly.

For information on how to print a configuration report, refer to "Print Reports" (P.86).

Step 2 Configuring E-mail Environment

The following describes the configuration procedures to use the E-mail features.

You can configure the settings using Dell Printer Configuration Web Tool. For the items that can be configured using Dell Printer Configuration Web Tool, refer to "Dell Printer Configuration Web Tool Setting Items" (P.305).

For information on how to start Dell Printer Configuration Web Tool, refer to "Starting Dell Printer Configuration Web Tool" (P.276).

- 1 Display the [Tools] screen.

- 1) Press the <Log In/Out> button.
- 2) Enter the system administrator's user ID with the numeric keypad or the keyboard displayed on the screen, and select [Enter].

When a passcode is required, select [Next] and enter the system administrator's passcode, and select [Enter].

Note • The default user ID is "admin".
• The default passcode is "1111".

- 3) Select [Tools] on the [Home] screen.

- 2 Set up the e-mail address of the machine.

- 1) Select [Connectivity & Network Setup].
- 2) Select [Machine's E-mail Address / Host Name], and then configure items.

For information on how to set an e-mail address, refer to "Machine's E-mail Address / Host Name" (P.176).

- 3) Select [Close] repeatedly until the [Tools] screen is displayed.

- 3 Set up the protocol to receive e-mails.

- 1) Select [Connectivity & Network Setup].
- 2) Select [Other Settings].
- 3) Select [Protocol to Receive E-mail], and then select [Change Settings].
- 4) Select either [SMTP] or [POP3] as appropriate for your environment.
- 5) Select [Save].
- 6) Select [Close] repeatedly until the [Tools] screen is displayed.

- 4 Configure the server settings for receiving e-mails.

- 1) Select [Connectivity & Network Setup].
- 2) Select [Outgoing / Incoming E-mail Settings].

When [SMTP] is selected for [Protocol to Receive E-mail]

Configure the SMTP server.

For information on how to configure the SMTP server, refer to "SMTP Server Settings" (P.178).

For information on how to set the machine's e-mail address when you receive e-mails via SMTP, refer to "Machine's E-mail Address / Host Name" (P.176).

For information on how to set the machine's e-mail address when you receive e-mails via SMTP, refer to "Machine's E-mail Address / Host Name" (P.176)

When [POP3] is selected for [Protocol to Receive E-mail]

Configure the POP3 server.

For information on how to configure the POP3 server, refer to "POP3 Server Settings" (P.178).

For information on how to set the machine's e-mail address when you receive e-mails via POP3, refer to "Machine's E-mail Address / Host Name" (P.176)

5 Configure the server settings for sending e-mails.

Note • To send e-mails, SMTP server settings are required. When [POP3] is selected in [Protocol to Receive E-mail], configure the SMTP server in [Outgoing / Incoming E-mail Settings].

For information on how to configure the e-mail transmission, refer to "SMTP Server Settings" (P.178).

6 Select [Close] repeatedly until the [Tools] screen is displayed.

7 Configure the domain filtering for receiving e-mails as necessary.

For information on how to configure the domain filtering, refer to "Domain Filtering" (P.189).

8 Set up the S/MIME information.

1) Select [Connectivity & Network Setup].

2) Select [Security Settings].

3) Select [S/MIME Settings], and then set the items.

For more information on how to configure S/MIME, refer to "S/MIME Settings" (P.185).

9 Select [Close] repeatedly until the [Tools] screen is displayed.

10 Select [Close].

Note • Rebooting the machine may be required depending on the settings. When a message displayed on the screen, follow the message and reboot the machine.

11 Print a configuration report to confirm that the settings of each item.

For information on how to print a configuration report, refer to "Print Reports" (P.86).

Dell Printer Configuration Web Tool Setting Items

You can configure the following setting items using Dell Printer Configuration Web Tool:

For information on how to start Dell Printer Configuration Web Tool, refer to "Starting Dell Printer Configuration Web Tool" (P.276).

- Machine's E-mail Address
- Setup E-mail Notification (Billing Meter Read Alerts)
- Port Settings
- SMTP Server Settings
- POP3 Server Settings
- Receiving Protocol
- Domain Filtering

- S/MIME Settings

9 Scanner Environment Settings

This chapter describes the settings to use the Scan services on the machine.

- **Scan Service Overview**308
- **Configuration of Store to Folder**310
- **Configuration of Scan to PC**312
- **Configuration of Store to USB**315
- **Configuration of Job Flow Sheets**316
- **Configuration of Store & Send Link**318

Scan Service Overview

The machine is equipped with scanning capabilities.

The following scan services are available on the machine:

- E-mail
- Store to Folder
- Scan to PC
- Store to USB
- Job Flow Scanning
- Store & Send Link
- Store to WSD

Note • WSD stands for Web Services on Devices.

E-mail

Scanned documents can be converted into electronic data and sent via e-mail.

For information on e-mail environment settings, refer to "E-mail Environment Settings" (P.299).

Store to Folder

You can scan a document you want to retrieve as electronic data, and store it in a folder. The document can be accessed later from any computers on the network.

For information on the Store to Folder service, refer to "Configuration of Store to Folder" (P.310).

Scan to PC

When the machine is connected to a network, you can store the scanned data on network computers using the FTP or SMB protocol.

You can scan a document you want to retrieve as electronic data, and store it on a computer connected to a network.

For information on the Scan to PC service, refer to "Configuration of Scan to PC" (P.312).

Store to USB

You can store the scanned data to a USB memory device when you insert the USB 2.0 memory device into the USB memory slot of the control panel of the machine. You can also select data stored in the USB memory device and print the data directly.

For information on the Store to USB service settings, refer to "Configuration of Store to USB" (P.315).

Job Flow Scanning

You can scan a document with a job flow process from a computer on a network.

For information on how to configure job flow scanning, refer to "Configuration of Job Flow Sheets" (P.316).

Store & Send Link

The machine can convert a scanned document into electronic form, store it in the hard disk, and send a URL that indicates the location of the document.

Note • To use the Store & Send Link feature, you need to configure the authentication settings.

For information on the Store & Send Link service, refer to "Configuration of Store & Send Link" (P.318).

Store to WSD

You can scan and store the document by operation from a computer on the network. To specify the destination computer, use the control panel of the machine.

Note • WSD stands for Web Services on Devices.

For more information on the Store to WSD service, refer to "Configuration of Store to WSD" (P.320).

Configuration of Store to Folder

This section describes configuration procedures to use the Store to Folder service on the machine.

The following shows the reference section for each procedure.

Step 1 Enabling Port and Setting up TCP/IP.....	310
Step 2 Registering a Folder.....	311
Step 3 Configuring on the Computer.....	311

Step 1 Enabling Port and Setting up TCP/IP

To use Network Scanner Utility 3 (Scan Driver and Stored File Manager 3), which supports WebDAV protocol, enable the WebDAV, SNMP, and SOAP ports and set up an IP address.

Note • You can configure the settings using Dell Printer Configuration Web Tool. For information on how to use Dell Printer Configuration Web Tool, refer to "Configuring Machine Settings Using Dell Printer Configuration Web Tool" (P.277).

1 Display the [Tools] screen.

- 1) Press the <Log In/Out> button.
- 2) Enter the system administrator's user ID with the numeric keypad or the keyboard displayed on the screen, and select [Enter].

When a passcode is required, select [Next] and enter the system administrator's passcode, and select [Enter].

Note • The default user ID is "admin".
• The default passcode is "1111".

- 3) Select [Tools] on the [Home] screen.

2 Enable the ports.

- 1) Select [Connectivity & Network Setup].
- 2) Select [Port Settings].
- 3) Select [SNMP], and then select [Change Settings].
- 4) Select [Port Status], and then select [Change Settings].
- 5) Select [Enabled], and then select [Save].
- 6) Select [Close].
- 7) Select [SOAP], and then select [Change Settings].
- 8) Select [Port Status], and then select [Change Settings].
- 9) Select [Enabled], and then select [Save].
- 10) Select [Close].
- 11) Select [WebDAV], and then select [Change Settings].
- 12) Select [Port Status], and then select [Change Settings].
- 13) Select [Enabled], and then select [Save].
- 14) Select [Close] repeatedly until the [Tools] screen is displayed.

3 Set an IP address and the other addresses.

Skip this step if an IP address is already set.

If DHCP or BOOTP is available in your environment, configure the method for obtaining

the address. If an IP address cannot be obtained automatically or manual configuration is preferred, confirm the settings of an IP address, a subnet mask, and a gateway address.

For information on how to set an IP address, refer to "Protocol Settings" (P.173).

4 Select [Close] repeatedly until the [Tools] screen is displayed.

5 Select [Close].

Note • Rebooting the machine may be required depending on the settings. When a message displayed on the screen, follow the message and reboot the machine.

6 Print a configuration report to confirm that the WebDAV port is enabled and that TCP/IP is set up correctly.

For information on how to print a configuration report, refer to "Print Reports" (P.86).

Step 2 Registering a Folder

Register a folder to store scanned data.

For information on registering a folder, refer to "Create Folder" (P.231).

Step 3 Configuring on the Computer

To use Network Scanner Utility 3, install Network Scanner Utility 3 on a computer.

Network Scanner Utility 3 is included in the Driver CD Kit provided with the machine. For information on how to install the Network Scanner Utility 3, refer to the manual contained in the Driver CD Kit.

For information on the usage of the Network Scanner Utility 3, refer to "12 Computer Operations" in the User Guide.

Configuration of Scan to PC

This section describes how to configure the machine to use the Scan to PC service.

The following shows the reference section for each procedure.

Step 1 Preparations	312
Step 2 Enabling Port and Setting up TCP/IP	313
Step 3 Configuration on the Computer	314

Step 1 Preparations

The following items are required to use the Scan to PC feature.

Using FTP

To transfer data via FTP, one of the following FTP servers and an account to the FTP server (login name and password) are required.

- Microsoft Windows Server 2003, Microsoft Windows Server 2008, Microsoft Windows Server 2008 R2, Microsoft Windows Vista, or Microsoft Windows 7.
FTP service of Microsoft Internet Information Server 6.0
- Microsoft Windows 2000 Server, Microsoft Windows 2000 Professional, or Microsoft Windows XP
FTP service of Microsoft Internet Information Server 3.0 or later
- Mac OS X
FTP service of Mac OS X 10.2.X/10.3.8/10.3.9/10.4.2/10.4.4/10.4.8/10.4.9/10.4.10/10.4.11/10.5/10.6
- Novell NetWare
FTP service of NetWare 5.11 or 5.12

For information on how to configure the FTP service, refer to the manual provided with the software.

For information on how to configure the settings on Mac OS X v10.7 Lion, refer to the official website of Apple Inc.

Using SMB

To transfer data via SMB, your computer must run on one of the following operating systems that includes folder sharing.

For Mac OS X, a shared user account is required on the Mac OS X.

- Microsoft Windows 2000
- Microsoft Windows Server 2003
- Microsoft Windows Server 2008
- Microsoft Windows Server 2008 R2
- Microsoft Windows XP
- Microsoft Windows Vista
- Microsoft Windows 7
- Mac OS X 10.2.x/10.3.x/10.4.x/10.5/10.6

Step 2 Enabling Port and Setting up TCP/IP

To use Scan to PC service, enable the port (SMB or FTP client) and set the IP address. The following describes the configuration procedures on the machine.

Note

- You can configure the settings using Dell Printer Configuration Web Tool. For information on how to use Dell Printer Configuration Web Tool, refer to "Configuring Machine Settings Using Dell Printer Configuration Web Tool" (P.277).

1 Display the [Tools] screen.

1) Press the <Log In/Out> button.

2) Enter the system administrator's user ID with the numeric keypad or the keyboard displayed on the screen, and select [Enter].

When a passcode is required, select [Next] and enter the system administrator's passcode, and select [Enter].

Note

- The default user ID is "admin".
- The default passcode is "1111".

3) Select [Tools] on the [Home] screen.

2 Enable the port.

Using SMB

Enable the SMB port.

1) Select [Connectivity & Network Setup].

2) Select [Port Settings].

3) Select [SMB], and then select [Change Settings].

4) Select [Port Status], and then select [Change Settings].

5) Select [Enabled], and then select [Save].

6) Select [Close] repeatedly until the [Tools] screen is displayed.

Using FTP

Enable the FTP port.

1) Select [Connectivity & Network Setup].

2) Select [Port Settings].

3) Select [FTP Client], and then select [Change Settings].

4) Select [Port Status], and then select [Change Settings].

5) Select [Enabled], and then select [Save].

6) Select [Close] repeatedly until the [Tools] screen is displayed.

3 Set the IP address of the machine and the other addresses.

Skip this step if an IP address is already set.

If DHCP or BOOTP is available in your environment, configure the method for obtaining the address. If an IP address cannot be obtained automatically or manual configuration is preferred, confirm the settings of an IP address, a subnet mask, and a gateway address.

For information on how to set an IP address, refer to "Protocol Settings" (P.173).

4 Select [Close] repeatedly until the [Tools] screen is displayed.

5 Select [Close].

Note

- Rebooting the machine may be required depending on the settings. When a message displayed on the screen, follow the message and reboot the machine.

- 6 Print a configuration report to confirm that the SMB port or FTP client is enabled and that TCP/IP is set up correctly.

For information on how to print a configuration report, refer to "Print Reports" (P.86).

Step 3 Configuration on the Computer

Create a destination folder on your computer.

- Using FTP

Create a destination folder on the server where you login and set write rights on the folder.

- Using SMB

Create a shared folder on your computer and set the write rights on the shared folder.

Note • To use SMB on Mac OS X, set [Windows Sharing] to [On] in the [Service] tab of [Sharing] under [System Preferences].

Configuration of Store to USB

This section describes how to configure the machine to use the Store to USB service.

The following shows the reference section for each procedure.

Step 1 Available USB Memory Devices.....	315
Step 2 Dell Printer Configuration Web Tool Setting Items.....	315

Step 1 Available USB Memory Devices

The Store to USB service allows you to directly save the scanned data to a USB 2.0 memory device which is inserted into the USB memory slot on the control panel of the machine.

- USB 2.0 memory devices
- USB memory devices with the capacity of up to 128 GB
- USB memory devices that support FAT12, FAT16, FAT32, or VFAT (long name)

Note • USB memory devices that are encrypted with software cannot be used with the machine.

Step 2 Dell Printer Configuration Web Tool Setting Items

You can enable/disable the Store to USB service using Dell Printer Configuration Web Tool. When you disable the service, the Store to USB button is not displayed on the [Home] screen, and you cannot use the service.

The Store to USB service is set to enabled by the factory default.

For information on how to start Dell Printer Configuration Web Tool, refer to "Starting Dell Printer Configuration Web Tool" (P.276).

Configuration of Job Flow Sheets

This section describes how to configure the machine to use the Job Flow Sheets service.

The following shows the reference section for each procedure.

Step 1 Enabling Ports and Setting up TCP/IP	316
Step 2 Configuring the SNMP Port	317
Step 3 Configuration on the Computer	317

Step 1 Enabling Ports and Setting up TCP/IP

To use the Job Flow Sheets service, enable the SOAP, SNMP, and Internet Services (HTTP) ports, and set an IP address and other addresses. The following describes the configuration procedures on the machine.

Note • You can configure the settings using Dell Printer Configuration Web Tool. For information on how to use Dell Printer Configuration Web Tool, refer to "Dell Printer Configuration Web Tool Settings" (P.273).

1 Display the [Tools] screen.

- 1) Press the <Log In/Out> button.
- 2) Enter the system administrator's user ID with the numeric keypad or the keyboard displayed on the screen, and select [Enter].

When a passcode is required, select [Next] and enter the system administrator's passcode, and select [Enter].

Note • The default user ID is "admin".
• The default passcode is "1111".

- 3) Select [Tools] on the [Home] screen.

2 Enable the SOAP port.

- 1) Select [Connectivity & Network Setup].
- 2) Select [Port Settings].
- 3) Select [SOAP], and then select [Change Settings].
- 4) Select [Port Status], and then select [Change Settings].
- 5) Select [Enabled], and then select [Save].
- 6) Select [Close] repeatedly until the [Port Settings] screen is displayed.

3 Enable the SNMP port.

- 1) Select [SNMP], and then select [Change Settings].
- 2) Select [Port Status], and select [Change Settings].
- 3) Select [Enabled], and then select [Save].
- 4) Select [Close] repeatedly until the [Port Settings] screen is displayed.
- 5) Enable the Internet Services (HTTP) port as described above.
- 6) Select [Close] repeatedly until the [Tools] screen is displayed.

4 Set an IP address and the other addresses.

Skip this step if an IP address is already set.

If DHCP or BOOTP is available in your environment, configure the method for obtaining the addresses. If an IP address cannot be obtained automatically or manual configuration is preferred, confirm the settings of an IP address, a subnet mask, and a gateway address.

For information on how to set an IP address, refer to "Protocol Settings" (P.173).

- 5 Select [Close] repeatedly until the [Tools] screen is displayed.
- 6 Select [Close].

Note • Rebooting the machine may be required depending on the settings. When a message displayed on the screen, follow the message and reboot the machine.

- 7 Print a configuration report to confirm that the SOAP, SNMP, and Internet Services (HTTP) ports are enabled and that TCP/IP is set up correctly.

For information on how to print a configuration report, refer to "Print Reports" (P.86).

Step 2 Configuring the SNMP Port

Configure the transport protocol for the SNMP port using Dell Printer Configuration Web Tool.

- 1 Start Dell Printer Configuration Web Tool.

For information on how to start Dell Printer Configuration Web Tool, refer to "Starting Dell Printer Configuration Web Tool" (P.276).

- 2 Configure the transport protocol for the SNMP port.
 - 1) Click the [Properties] tab.
 - 2) Click [Connectivity].
 - 3) Click [Port Settings].
 - 4) Select the [UDP] check box under [SNMP].
 - 5) Click [Apply].
 - 6) The right frame of the web browser changes to the machine reboot display.
 - 7) Click [Reboot Machine]. The machine reboots and the settings are enabled.

Step 3 Configuration on the Computer

Create job flows using Job Flow Editor to use for scanned documents.

Note • Job Flow Editor is included in the Driver CD Kit.

Configuration of Store & Send Link

This section describes how to configure the machine to use the Store & Send Link service.

- Note**
- When a user is notified by e-mail of a URL location to retrieve scanned data, the e-mail message is not encrypted, which enables the user to retrieve the data without password authentication. Thus, in case the URL information is leaked on the e-mail transmission path due to any attempts, other parties to whom the information is leaked cannot be tracked. To prevent others from viewing scanned data, select [PDF] in [File Format] and set a password in [PDF Security] before scanning a document.
 - To use the Store & Send Link service, the configuration for authentication is required.

The following shows the reference section for each procedure.

Step 1 Configuring E-mail.....	318
Step 2 Enabling Authentication.....	318
Step 3 Other Settings.....	318
Step 4 Dell Printer Configuration Web Tool Setting Items	318

Step 1 Configuring E-mail

Configure the e-mail settings on the machine.

For information on how to configure e-mail settings, refer to "E-mail Environment Settings" (P.299).

Step 2 Enabling Authentication

Configure the authentication settings on the machine.

For information on how to configure e-mail settings, refer to "Configuration for Authentication" (P.368).

Step 3 Other Settings

Configure the following items if necessary.

- URL File Expiration
- Generation of URL Link
- Store & Send Link - Maximum File Size
- Print Login Name on PDF Files

For information about URL File Expiration, refer to "URL File Expiration" (P.203).

For information about Generation of URL Link , refer to "Generation of URL Link" (P.203).

For information about Store & Send Link - Maximum File Size , refer to "Store & Send Link - Maximum File Size" (P.203).

For information about Print Login Name on PDF Files, refer to "Print Login Name on PDF Files" (P.203).

Step 4 Dell Printer Configuration Web Tool Setting Items

You can configure the following items using Dell Printer Configuration Web Tool:

- URL File Expiration
- Generation of URL Link
- Maximum File Size

- Subject
- Message
- Attachment
- Device Information
- Signature

For information on how to start Dell Printer Configuration Web Tool, refer to "Starting Dell Printer Configuration Web Tool" (P.276).

Configuration of Store to WSD

This section describes how to configure the machine to use the Store to WSD service.

Note • WSD stands for Web Services on Devices.

The following shows the reference section for each procedure.

Step 1 Preparations	320
Step 2 Enabling Port	320
Step 3 Confirmation on the Computer	321

Step 1 Preparations

The following environment is required to use the Store to WSD feature on the machine.

- The following operation system must be installed on a destination computer.
 - Microsoft Windows 8
 - Microsoft Windows 7
 - Microsoft Windows Vista Service Pack 2

Note • WSD stands for Web Services on Devices.

Step 2 Enabling Port

To use the Store to WSD service, enable the WSD scan port. The following describes the configuration procedures on the machine.

Note • WSD stands for Web Services on Devices.

- You can configure the settings using Dell Printer Configuration Web Tool. For information on how to use Dell Printer Configuration Web Tool, refer to "Configuring Machine Settings Using Dell Printer Configuration Web Tool" (P.277).

1 Display the [Tools] screen.

- 1) Press the <Log In/Out> button.
- 2) Enter the system administrator's user ID with the numeric keypad or the keyboard displayed on the screen, and select [Enter]. When a passcode is required, select [Next] and enter the system administrator's passcode, and select [Enter].

Note • The default user ID is "admin".

- The default passcode is "1111".

3) Select [Tools] on the [Home] screen.

2 Enable the port.

- 1) Select [Connectivity & Network Setup].
- 2) Select [Port Settings].
- 3) Select [WSD], and then select [Change Settings].
- 4) Select [WSD Scan - Port Status], and then select [Change Settings].
- 5) Select [Enabled], and then select [Save].
- 6) Select [Close] repeatedly until the [Tools] screen is displayed.

3 Select [Close].

Note • Rebooting the machine may be required depending on the settings. When a message displayed on the screen, follow the message and reboot the machine.

4 Print a configuration report to confirm that the WSD port is set up correctly.

For information on how to print a configuration report, refer to "Print Reports" (P.86).

Step 3 Confirmation on the Computer

Confirm that the machine name is displayed on the computer as a network device.

On Windows Vista, select [Control Panel] > [Hardware and Sound] > [Scanners and Cameras] (On Windows 7, select [Control Panel] > [Devices and Printers]), and confirm the machine name on the screen.

It is convenient to configure the settings such as the color format, file type, and resolution in [Scan Profiles] and save them in advance.

For more information, refer to Windows Help.

- Note**
- On Windows Vista Home Basic or Home Premium, scanning with [Windows Fax and Scan] is not supported. Use other features such as [From scanner or camera] in [Microsoft Paint] for scanning.

10 Using the Internet Fax Service

This chapter describes the settings to use services via the Internet Fax on the machine.

Note • An optional component is required to use this feature. For more information, contact Customer Support at dell.com/contactdell.

• Internet Fax Overview	324
• Preparations	324
• Installation Procedures	326

Internet Fax Overview

When the Fax feature is available, the machine can transmit scanned data as an e-mail attachment using a corporate intranet or the Internet, unlike conventional fax machines which use public phone lines. Also, the machine can receive e-mails transmitted from the Internet Fax-enabled machines.

For details of the Internet Fax, refer to "4 Fax" > "About Internet Fax" in the User Guide.

Preparations

This section describes the prerequisites to use the Internet Fax on the machine.

System Requirements for the Machine

- The machine is connected to a network via TCP/IP.
- The environment is prepared for e-mail transmissions.

E-Mail Environment

To use the Internet Fax feature, configure the following settings for your e-mail environment.

Item	Description	Internet Fax		Internet Fax Direct*
		via SMTP	via POP3	via SMTP
TCP/IP address	TCP/IP address of the machine. TCP/IP protocol is used for e-mail transmissions.	○	○	○
Subnet mask	The subnet mask is required when a network is divided into subnetworks.	△	△	△
Gateway address	The gateway address is required when multiple networks are used via gateways.	△	△	△
The machine's e-mail address	Set the machine's e-mail address.	○	○	○
DNS server address	The address is required when the address of POP3 or SMTP server is set not using an IP address but a domain name. The address can be obtained by DHCP.	△	△	△
SMTP server address	SMTP server is used for sending e-mails from the machine. The SMTP server can also be used for receiving e-mails.	○	○	X
SMTP AUTH login name, password	When a certification-required SMTP server is used, configure a user name for authentication. Set the password as necessary.	△	△	△
POP3 server	Set the POP3 server address.	X	○	X
POP user name	Configure the user name for POP receiving. Set the password as necessary.	X	○	X

Item	Description	Internet Fax		Internet Fax Direct*
		via SMTP	via POP3	via SMTP
S/MIME settings*	Configure S/MIME.	Δ	Δ	Δ

○ :Required

Δ :Set as required

X :Not supported

* :When you use the Internet Fax Direct feature, set [Tools] > [System Settings] > [Fax Service Settings] > [Internet Fax Control] > [Internet Fax Path] to [Direct (P2P)].

Note

- To transmit e-mails encrypted by S/MIME or with digital signatures attached, a certificate must be ready in advance. For more information on a certificate, refer to "Configuration of E-mail Encryption/Digital Signature" (P.337).

Installation Procedures

This section describes the configuration procedures to use the Internet Fax feature on the machine.

The following shows the reference section for each procedure.

Step 1 Enabling Port and Setting up TCP/IP.....	326
Step 2 Configuring E-mail Environment.....	327
Step 3 Testing the Internet Fax	328

Step 1 Enabling Port and Setting up TCP/IP

To use the Internet Fax feature on the machine, enable the ports for the E-mail feature, and set the IP address. The following shows the configuration procedures on the machine.

Note • You can configure the settings using Dell Printer Configuration Web Tool.

For information on how to use Dell Printer Configuration Web Tool, refer to "Configuring Machine Settings Using Dell Printer Configuration Web Tool" (P.277).

1 Display the [Tools] screen.

- 1) Press the <Log In/Out> button.
- 2) Enter the system administrator's user ID with the numeric keypad or the keyboard displayed on the screen, and select [Enter].

When a passcode is required, select [Next] and enter the system administrator's passcode, and select [Enter].

Note • The default user ID is "admin".
• The default passcode is "1111".

- 3) Select [Tools] on the [Home] screen.

2 Enable ports to use for the E-mail feature.

- 1) Select [Connectivity & Network Setup].
- 2) Select [Port Settings].
- 3) Select [Receive E-mail], and then select [Change Settings].
- 4) Select [Port Status], and then select [Change Settings].
- 5) Select [Enabled], and then select [Save].
- 6) Select [Close].
- 7) Select [Enabled] for [Send E-mail - Port Status] on the [Send E-mail] screen as described above.
- 8) Select [Close] repeatedly until the [Tools] screen is displayed.

3 Set an IP address and the other addresses.

Skip this step if an IP address is already set.

If DHCP or BOOTP is available in your environment, configure the method for obtaining the address. If an IP address cannot be obtained automatically, or if manual configuration is preferred, confirm the settings of an IP address, a subnet mask, and a gateway address.

For information on how to set an IP address, refer to "Protocol Settings" (P.173).

4 Select [Close] repeatedly until the [Tools] screen is displayed.

5 Select [Close].

Note • Rebooting the machine may be required depending on the settings. When a message displayed on the screen, follow the message and reboot the machine.

- 6 Print a Configuration Report to confirm that the ports are enabled and that TCP/IP is set up correctly.

For information on how to print a Configuration Report, refer to "Print Reports" (P.86).

Step 2 Configuring E-mail Environment

The following describes the configuration procedures to use the E-mail features.

You can configure the settings using Dell Printer Configuration Web Tool. For the items that can be configured using Dell Printer Configuration Web Tool, refer to "Dell Printer Configuration Web Tool Setting Items" (P.305).

For information on how to start Dell Printer Configuration Web Tool, refer to "Starting Dell Printer Configuration Web Tool" (P.276).

- 1 Display the [Tools] screen.

- 1) Press the <Log In/Out> button.

- 2) Enter the system administrator's user ID with the numeric keypad or the keyboard displayed on the screen, and select [Enter].

When a passcode is required, select [Next] and enter the system administrator's passcode, and select [Enter].

Note • The default user ID is "admin".
• The default passcode is "1111".

- 3) Select [Tools] on the [Home] screen.

- 2 Set up the e-mail address of the machine.

- 1) Select [Connectivity & Network Setup].

- 2) Select [Machine's E-mail Address / Host Name], and then set the items.

For information on how to set an e-mail address, refer to "Machine's E-mail Address / Host Name" (P.176).

- 3) Select [Close] repeatedly until the [Tools] screen is displayed.

- 3 Set up the protocol to receive e-mails.

- 1) Select [Connectivity & Network Setup].

- 2) Select [Other Settings].

- 3) Select [Protocol to Receive E-mail], and then select [Change Settings].

- 4) Select either [SMTP] or [POP3] as appropriate for your environment.

- 5) Select [Save].

- 6) Select [Close] repeatedly until the [Tools] screen is displayed.

- 4 Configure the server settings for receiving e-mails.

- 1) Select [Connectivity & Network Setup].

- 2) Select [Outgoing / Incoming E-mail Settings].

When [SMTP] is selected for [Protocol to Receive E-mail]

Configure the SMTP server.

For information on how to configure the SMTP server, refer to "SMTP Server Settings" (P.178).

For information on how to set the machine's e-mail address when you receive e-mails via SMTP, refer to "Machine's E-mail Address / Host Name" (P.176).

When [POP3] is selected for [Protocol to Receive E-mail]

Configure the POP3 server.

For information on how to configure the POP3 server, refer to "POP3 Server Settings" (P.178).

For information on how to set the machine's e-mail address when you receive e-mails via POP3, refer to "Machine's E-mail Address / Host Name" (P.176).

1) Select [Close].

5 Configure the server settings for sending e-mails.

Note • To send e-mails, SMTP server settings are required. When [POP3] is selected in [Protocol to Receive E-mail], configure the SMTP server in [Outgoing / Incoming E-mail Settings].

For information on how to configure the e-mail transmission, refer to "SMTP Server Settings" (P.178).

6 Configure the domain filtering for sending and receiving e-mails as necessary.

For information on how to configure the domain filtering, refer to "Domain Filtering" (P.189).

7 Set up the S/MIME information.

1) Select [Connectivity & Network Setup].

2) Select [Security Settings].

3) Select [S/MIME Settings], and then set the items.

For more information on how to configure S/MIME settings, refer to "S/MIME Settings" (P.185).

8 Select [Close] repeatedly until the [Tools] screen is displayed.

9 Select [Close].

Note • Rebooting the machine may be required depending on the settings. When a message displayed on the screen, follow the message and reboot the machine.

10 After the machine reboots, you can print a Configuration Report to confirm that the settings of each item.

For information on how to print a Configuration Report, refer to "Print Reports" (P.86).

Step 3 Testing the Internet Fax

Test the Internet fax transmission from the machine.

1 Select [Fax / Internet Fax] on the [Home] screen to display the [Fax / Internet Fax] screen.

2 Select [Internet Fax] from the drop-down menu.

3 Enter a destination address.

4 Press the <Start> button to transmit.

5 Check whether the computer received the e-mail.

If the computer cannot receive the e-mail, refer to "Problem Solving" (P.377).

11 Encryption and Digital Signature Settings

This chapter describes the settings to use the Encryption feature and the Digital Signature feature on the machine.

- **Encryption and Digital Signature Overview**330
- **Configuration of HTTP Communications Encryption**332
- **Configuration of Encryption using IPSec**334
- **Configuration of E-mail Encryption/Digital Signature**.....337
- **Configuration of PDF/XPS Signature**341

Encryption and Digital Signature Overview

Types of Certificate

To use the Encryption feature and the Signature feature on the machine, a certificate is required.

The following two types of device certificate can be used on the machine:

- A self-signed certificate created by Dell Printer Configuration Web Tool (The valid period can be specified from 1 to 9,999 days.)
- A certificate issued by another CA

When you use a certificate issued by another CA, import the certificate using Dell Printer Configuration Web Tool.

Types of Certificate / Types of Encryption	Self-Signed Certificate	Certificate Issued by Another CA
Encrypting HTTP communications from a client to the machine (SSL/TLS server)	○	○
Encrypting HTTP communications from the machine to a remote server (SSL/TLS client)	X	○
Encryption using IPsec	X	Δ ^{*1}
E-mail encryption/digital signature	X	○
PDF signature/XPS ^{*2} signature	○	○

○ :Available

Δ :Set as necessary

X :Not available

*1 :Available when [IKE Authentication Method] is set to [Authenticate by Digital Signature].

*2 :XPS stands for XML Paper Specification.

Encryption Features for Communication

The data sent between the machine and computers on a network can be encrypted.

Encrypting HTTP Communications from a Client to the Machine (SSL/TLS Server)

The SOAP, Internet Services (HTTP), IPP, and WebDAV ports use the HTTP server of the machine.

The SSL/TLS protocol is used to encrypt the HTTP communications between a client and the machine.

To encrypt communications, either one of the device certificate is required: a self-signed certificate or a certificate issued by another CA.

Note • By encrypting HTTP communications, communications data can be encrypted at the time of printing using IPP (SSL encrypted communications).

Encrypting HTTP Communications from the Machine to a Remote Server (SSL/TLS Client)

The SSL/TLS protocol is used to encrypt the HTTP communications between a remote server and the machine.

No certificate is required in general. However, if a remote server is set to require an SSL client certificate, you can use a certificate issued by another CA.

When verification of server certificates is enabled to verify the SSL/TLS certificate of a remote server, import a certificate issued by another CA using Dell Printer Configuration Web Tool to the machine.

Encryption using IPSec

IPSec enables IP-level (not application-level) encrypted communications with remote devices.

If you select [Authenticate by Digital Signature] for [IKE Authentication Method], a certificate issued by another CA is required.

If you select [Authenticate by Preshared Key], no device certificate is required.

Note • If the certificate for IPSec contains the V3 extension (keyUsage), "digitalSignature" bit must be asserted.

For information on IKE authentication methods, refer to "IKE Authentication Method" (P.187).

To verify the certificate of the remote device, you must register a root certificate created by a CA of the remote device on the machine.

Note • To use certificates that have already been created, import them with Dell Printer Configuration Web Tool.

E-mail Encryption/Digital Signature

S/MIME is used for E-mail Encryption/Digital Signature. To use S/MIME on the machine, S/MIME certificates are used.

For an S/MIME certificate, you can use a certificate issued by another CA.

The personal certificates or the device certificates of destinations are required for encrypted communications.

Note • If the certificate for S/MIME contains an "email Address" or a V3 extension (keyUsage), "digitalSignature" and "keyEncipherment" must be asserted. If the certificate contains v3 extension (extendedKeyUsage), "emailProtection" must be set.

Encryption and Digital-Signature Features for Scan Files

Encrypting PDF Documents

PDF documents can be encrypted and protected by a password.

For information on how to encrypt PDF documents, refer to "5 Scan" > "E-mail" > "File Format (Selecting a File Format for Output Data)" in the User Guide.

Encryption/Digital Signature of PDF/XPS Documents

Digital signatures are available for PDF and XPS documents.

To use the digital signature, a device certificate is required.

For a device certificate, you can use any registered certificates.

Note • XPS stands for XML Paper Specification.

Configuration of HTTP Communications Encryption

This section describes the settings to encrypt HTTP communications.

The following shows the reference section for each procedure.

Installation Overview	332
Step1 Configuration on the Machine	332
Step2 Configuration on the Computer	333

Installation Overview

To encrypt HTTP communications, configure the machine and your computer as follows:

Configuration on the Machine

Configure a certificate on the machine. No certificate is registered on the machine by factory default. Configure certificates for an SSL server as needed.

- Configuring certificates by Dell Printer Configuration Web Tool

The following two methods are available depending on types of certificates.

- Create a self-signed certificate on the machine, and then enable HTTPS.
- Enable HTTPS, and then import a certificate issued by another CA to the machine.

Configuration on the Computer

To encrypt communications between a web browser and the machine, enter an address beginning with "https" instead of "http" into the address box of the web browser.

Step1 Configuration on the Machine

Configure a certificate on the machine. No certificate is registered to the machine by factory default. Configure certificates for an SSL server as needed.

The following describes the procedures to set up a certificate by Dell Printer Configuration Web Tool.

Setting up a Certificate using Dell Printer Configuration Web Tool

To set up a certificate using Dell Printer Configuration Web Tool, you can have the machine create a self-signed certificate for SSL server or can import any registered certificate (issued by another CA) to the machine.

- Note**
- When performing SSL communications using a self-signed certificate created on the machine, or a certificate with which the character code is encoded with UTF-8, you will not be able to connect with SSL if Internet Explorer is used with Mac OS X v10.2 or later. This is because the operating system cannot recognize the character code (UTF-8) of the certificate. Use Netscape 7 in the above-mentioned OS environments.
 - You cannot import a certificate that has been already registered in [Local Device] or [Others]. Delete the registered certificate before importing.

1 Start Dell Printer Configuration Web Tool.

For more information on how to start Dell Printer Configuration Web Tool, refer to "Starting Dell Printer Configuration Web Tool" (P.276).

2 Create a certificate.

- 1) Click the [Properties] tab.
- 2) Click [Security] to display the items in the folder.

- 3) Click [Machine Digital Certificate Management].
 - 4) Click the [Create New Self Signed Certificate] button.
 - 5) Set [Digital Signature Algorithm] as necessary.
 - 6) Set [Public Key Size] as necessary.
 - 7) Set [Issuer] as necessary.
 - 8) Set [Days of Validity] as necessary.
 - 9) Click [Apply].
 - 10) Refresh the web browser.
- 3** Set up the SSL/TLS information.
- 1) Click [Security] to display the items in the folder.
 - 2) Click [SSL / TLS Settings].
 - 3) Select the [Enabled] check box for [HTTP - SSL / TLS Communication].
 - 4) Set up [HTTP - SSL / TLS Communication Port Number].
- Note** • Do not use the numbers of any other ports.
- 5) Click [Apply].
 - 6) When the right frame of the web browser changes to the machine reboot display, click [Reboot Machine]. The machine reboots and the settings are enabled.

Step2 Configuration on the Computer

To encrypt communications between a web browser and the machine, enter an address beginning with "https" instead of "http" in the address box of the web browser.

- Example of IP address entry:
https://192.0.2.1/ (IPv4)
https://[2001:DB8::1234]/ (IPv6)
- Example of Internet address entry:
https://myhost.example.com/

When encrypting IPP communications (Internet printing) and adding a printer from [Add Printer], enter an address beginning with "https" instead of "http" as the URL of the printer. For information on the settings, refer to the manual contained in the Driver CD Kit.

Configuration of Encryption using IPsec

This section describes how to encrypt communications using IPsec.

When the IKE authentication method is set to [Authenticate by Preshared Key], skip step 1 "Import and Configuration of a Certificate" and go to step 2 "Configuration on the Machine (Configuration of IPsec)".

For IKE authentication methods, refer to "IKE Authentication Method" (P.187).

Step1 Import and Configuration of a Certificate.....	334
Step2 Configuration on the Machine (Configuration of IPsec).....	335
Step3 Configuration on the Computer	336

Installation Overview

To encrypt communications using IPsec, configure the machine and your computer as follows:

Configuration on the Machine

When [IKE Authentication Method] is set to [Authenticate by Digital Signature], configure a certificate on the machine. No certificate is registered on the machine by factory default. After importing a certificate, configure IPsec.

Configure the following setting to set up a certificate on the machine.

- Configuring certificates by Dell Printer Configuration Web Tool
 - Enable HTTPS, and then import a certificate issued by another CA to the machine.

Note • If a certificate to be imported as an IPsec certificate contains V3 extension "KeyUsage", "digitalSignature" bit must be asserted.

Configuration on the Computer

Configure the following settings to encrypt communications between a computer and the machine.

- Create an IP security policy
- Assign the IP security policy

Step1 Import and Configuration of a Certificate

The following describes configuration procedures to set up a certificate with Dell Printer Configuration Web Tool.

To configure a certificate using Dell Printer Configuration Web Tool, configure the encryption settings for HTTP communications, and then import a certificate issued by another CA to use it for the IPsec certificate.

Note • You cannot use a self-signed certificate created with Dell Printer Configuration Web Tool for IPsec.
• The machine supports the capability to import the RSA® public key (up to 4096 bits).

For details on how to configure the encryption settings for HTTP communication, refer to "Configuration of HTTP Communications Encryption" (P.332).

1 Start Dell Printer Configuration Web Tool.

For more information on how to start Dell Printer Configuration Web Tool, refer to "Starting Dell Printer Configuration Web Tool" (P.276).

2 Import a certificate.

- Note**
- You cannot import a certificate that has been already registered in [Local Device] or [Others]. Delete the registered certificate before importing.
 - If the certificate to be imported contains the V3 extension "keyUsage", "digitalSignature" must be asserted.

- 1) Click the [Properties] tab.
 - 2) Click [Security] to display the items in the folder.
 - 3) Click [Machine Digital Certificate Management].
 - 4) Click [Upload Signed Certificate].
 - 5) Enter [Password].
 - 6) Enter [Retype Password].
 - 7) Enter a file name you want to import or select a file to import from a dialog box displayed by clicking the [Browse] button, and then select [Save].
 - 8) Click the [Import] button.
 - 9) Refresh the web browser.
- 3** Configure the certificate.
- 1) Click [Security].
 - 2) Click [Certificate Management].
 - 3) Select [Local Device] for [Category] and [IPSec] for [Certificate Purpose], and then click the [Display the list] button.
 - 4) Select the check box next to the certificate to set.
 - 5) Click the [Certificate Details] button.
 - 6) Click the [Use this certificate] button.
 - 7) Click [Reboot Machine]. The machine reboots and the settings are enabled.

Step2 Configuration on the Machine (Configuration of IPSec)

The following describes configuration procedures to set up IPSec on the machine.

- 1** Press the <Log In/Out> button.
 - 2** Enter the system administrator's user ID with the numeric keypad or the keyboard displayed on the screen, and select [Enter].
When a passcode is required, select [Next] and enter the system administrator's passcode, and select [Enter].
- Note**
- The default user ID is "admin".
 - The default passcode is "1111".
- 3** Select [Tools] on the [Home] screen.
 - 4** Select [Connectivity & Network Setup].
 - 5** Select [Security Settings].
 - 6** Select [IPSec Settings].
 - 7** Configure the required settings.
For details on the settings, refer to "IPSec Settings" (P.186).
 - 8** Select [Close].

Step3 Configuration on the Computer

The following describes the configuration procedures on the computer.

Configure the following settings on the computer.

- Create an IP security policy
- Assign the IP security policy

For details on the settings, refer to the help of the computer.

Configuration of E-mail Encryption/Digital Signature

This section describes how to encrypt e-mails and how to attach a digital signature to e-mails.

The following shows the reference section for each procedure.

Step1 Configuration on the Machine	337
Step2 Configuration on Sender and Recipient.....	339

Installation Overview

To encrypt e-mails and attach a digital signature, configure the machine and your computer as follows:

- Note**
- To encrypt e-mails and attach a digital signature to e-mails between the machine and a computer, a personal or device certificate for S/MIME of a recipient and the device certificate of the machine must be set on the computer. Configure the following settings to the certificates:
 - "e-mail address"
 - If the certificate contains V3 extension "keyUsage", "digitalSignature" and "keyEncipherment" must be asserted.
 - If the certificate contains V3 extension "extendedKeyUsage", "emailProtection" must be set.
 - Up to 100 addresses can be encrypted with S/MIME.

Configuration on the Machine

Configure a certificate on the machine. No certificate is registered on the machine by factory default.

Configure the following settings to set up a certificate on the machine.

- Configuring certificates by Dell Printer Configuration Web Tool
 - Set up HTTPS communications encryption settings, and then configure a certificate on the machine.

Configuration on Sender and Recipient

To transmit e-mails encrypted by S/MIME and with digital signatures attached, register the required certificate on equipment of a sender and a recipient.

Step1 Configuration on the Machine

This section describes configuration procedures to set up a certificate with Dell Printer Configuration Web Tool.

- Note**
- You cannot use a self-signed certificate created with Dell Printer Configuration Web Tool for S/MIME.
 - The machine supports the capability to import the RSA public key (up to 4096 bits).

Setting up a Certificate using Dell Printer Configuration Web Tool

To configure a certificate using Dell Printer Configuration Web Tool, configure the encryption settings for HTTP communications, and then import a certificate issued by another CA to enable S/MIME.

For details on how to configure the encryption settings for HTTP communication, refer to "Configuration of HTTP Communications Encryption" (P.332).

1 Start Dell Printer Configuration Web Tool.

For more information on how to start Dell Printer Configuration Web Tool, refer to "Starting Dell Printer Configuration Web Tool" (P.276).

2 Import a certificate.

- Note**
- You cannot import a certificate that has been already registered in [Local Device] or [Others]. Delete the registered certificate before importing.

- 1) Click the [Properties] tab.
 - 2) Confirm that [Machine's E-mail Address] of [Description] is entered.
 - 3) Click [Security] to display the items in the folder.
 - 4) Click [Machine Digital Certificate Management].
 - 5) Click [Upload Signed Certificate].
 - 6) Enter [Password].
 - 7) Enter [Retype Password].
 - 8) Enter a file name you want to import or select a file to import from a dialog box displayed by clicking the [Browse] button, and then select [Save].
 - 9) Click the [Import] button.
 - 10) Refresh the web browser.
- 3** Configure the certificate.
- 1) Click [Security] to display the items in the folder.
 - 2) Click [Certificate Management].
 - 3) Select [Local Device] for [Category] and [S/MIME] for [Certificate Purpose], and then click the [Display the list] button.
 - 4) Select the check box next to the certificate to set.
 - 5) Click the [Certificate Details] button.
 - 6) Click the [Use this certificate] button.
 - 7) Click [Reboot Machine]. The machine reboots and the settings are enabled.
 - 8) Refresh the web browser.
- 4** Enable [S/MIME Communication].
- 1) Click [Security] to display the items in the folder.
 - 2) Click [SSL/TLS Settings].
 - 3) Select the [Enabled] check box for [S/MIME Communication].
 - 4) Click [Apply].
 - 5) When the right frame on the web browser changes to the machine reboot display, click [Reboot Machine]. The machine reboots and the settings are enabled.
- 5** Configure the settings for S/MIME.
- 1) Refresh the web browser.
 - 2) Click [Security] to display the items in the folder.
 - 3) Click [S/MIME Settings] and configure the following settings.
 - Message Digest Algorithm
Select a message digest algorithm from [SHA-1], [MD5] or [SHA-256].
 - Message Encryption Method
Select an encryption method for the e-mail message body from [3DES], [RC2-40], [RC2-64], [RC2-128], [AES-128], [AES-192], or [AES-256] when you send an e-mail from the machine.

- **Certificate Auto Store**
Select whether to automatically store the certificate when receiving an e-mail with an S/MIME certificate attached from an address registered in the Address Book.
 - **Receive Untrusted E-mail**
Set whether or not to receive untrusted e-mails such as an e-mail with expired certificate attached or no certificate attached.
 - **Digital Signature - Outgoing E-mail**
Set whether to always attach a digital signature to an outgoing e-mail or to select a digital signature when sending e-mail from the machine.
 - **Receive Untrusted Internet Fax**
Set whether or not to receive untrusted Internet faxes such as an e-mail with expired certificate attached or with no certificate attached.
 - **Digital Signature - Outgoing Internet Fax**
Set whether to always attach a digital signature to an outgoing Internet fax or to select a digital signature when sending Internet fax from the machine.
- 4) Click [Apply].

Step2 Configuration on Sender and Recipient

To transmit e-mails encrypted or with digital signature attached, a device certificate and a personal certificate must be registered with each machine.

This section describes certificates required for destination and source, and registration procedures.

- Note**
- Required certificates include a trusted root certificate authority and all intermediate certificate authorities that are registered in the path of a certificate to use.

When source is the machine and destination is a computer

The personal certificate of a computer must be registered on the machine. And the device certificate of the machine must be registered on a computer.

To register the computer's personal certificate, use Dell Printer Configuration Web Tool.

There are two methods to register the machine's device certificate to a computer:

- Send an e-mail with S/MIME digital signature to a computer from the machine and register it to the certificate store of an e-mail application in the computer.
To send an e-mail with S/MIME digital signature, select [Always add signature] or [Select during send] for [Digital Signature - Outgoing E-mail] under [Tools] > [System Settings] > [Connectivity & Network Setup] > [Security Settings] > [S/MIME Settings] in advance.
- Export the certificate of the machine to a computer using Dell Printer Configuration Web Tool, and register it to the certificate store of an e-mail application in the computer.

For information on how to import and export a certificate using Dell Printer Configuration Web Tool, refer to "Importing/exporting a certificate using Dell Printer Configuration Web Tool" (P.340).

For information on how to register a certificate to the certificate store of an e-mail application, refer to the manual of your e-mail software.

When source is the machine and destination is another multifunctional machine

The device certificate of another multifunctional machine must be registered on the machine. And the device certificate of the machine must be registered on another multifunctional machine.

To register the device certificate of another multifunctional machine, start Dell Printer Configuration Web Tool of another multifunctional machine from a computer and export the certificate to the computer. And then, start Dell Printer Configuration Web Tool of the machine and import the certificate.

To register the device certificate of the machine, perform the same procedure as described above.

For information on how to import and export a certificate using Dell Printer Configuration Web Tool, refer to "Importing/exporting a certificate using Dell Printer Configuration Web Tool" (P.340).

When source is a computer and destination is the machine

The device certificate of the machine must be registered on a computer. The registration of the personal certificate of a computer to the machine is not required.

There are two methods to register the machine's device certificate to a computer:

- Send an e-mail with S/MIME digital signature to a computer from the machine (or another multifunctional machine) and register it to the certificate store of an e-mail application in the computer.

To send an e-mail with S/MIME digital signature, select [Always add signature] or [Select during send] for [Digital Signature - Outgoing E-mail] under [Tools] > [System Settings] > [Connectivity & Network Setup] > [Security Settings] > [S/MIME Settings] in advance.

- Export the certificate of the machine to a computer using Dell Printer Configuration Web Tool, and register it to the certificate store of an e-mail application in the computer.

For information on how to import and export a certificate using Dell Printer Configuration Web Tool, refer to "Importing/exporting a certificate using Dell Printer Configuration Web Tool" (P.340).

For information on how to register a certificate to the certificate store of e-mail software, refer to the manual of your e-mail application.

The following e-mail applications can transmit e-mails between the machine and a computer:

- Windows XP: Microsoft® Outlook® Express 6
- Windows Vista, Windows 7: Microsoft® Outlook® 2007, Microsoft® Outlook® 2010
- Mac OS X: Mail 2.1.1

Importing/exporting a certificate using Dell Printer Configuration Web Tool

To import a certificate, select the [Properties] tab > [Security] > [Machine Digital Certificate Management] > [Upload Signed Certificate].

To export a certificate, select the [Properties] tab > [Security] > [Certificate Management] and select a certificate to export, and then click the [Export this certificate] button.

Configuration of PDF/XPS Signature

This section describes the settings to send scanned documents in PDF or XPS format with a digital signature (PDF or XPS) attached.

Note • XPS stands for XML Paper Specification.

The following shows the reference section for each procedure.

Installation Overview	341
Step1 Configuration on the Machine	341
Step2 Configuration on the Computer	342

Installation Overview

To attach a signature (PDF signature/XPS signature) to a scanned document to send as a PDF or XPS document, configure the machine and your computer as follows:

Note • XPS stands for XML Paper Specification.

Configuration on the Machine

Configure a certificate on the machine. No certificate is registered on the machine by factory default.

Configure the following setting to set up a certificate on the machine.

- Configuring certificates by Dell Printer Configuration Web Tool

Set up HTTPS communications encryption settings, and then configure a certificate on the machine.

Configuration on the Computer

- Sending a PDF or XPS signature file from the machine to a computer

Make sure that the root certificate of the certificate to be used for the scan file signature of the machine is registered on the recipient's computer.

Step1 Configuration on the Machine

This section describes configuration procedures to set up a certificate with Dell Printer Configuration Web Tool.

Setting up a Certificate using Dell Printer Configuration Web Tool

To configure a certificate using Dell Printer Configuration Web Tool, configure the encryption settings for HTTP communications, and then import a certificate issued by another CA to enable S/MIME.

For details on how to configure the encryption settings for HTTP communication, refer to "Configuration of HTTP Communications Encryption" (P.332).

1 Start Dell Printer Configuration Web Tool.

For more information on how to start Dell Printer Configuration Web Tool, refer to "Starting Dell Printer Configuration Web Tool" (P.276).

2 Import a certificate.

Note • You cannot import a certificate that has been already registered in [Local Device] or [Others]. Delete the registered certificate before importing.

1) Click the [Properties] tab.

- 2) Click [Security] to display the items in the folder.
 - 3) Click [Machine Digital Certificate Management].
 - 4) Click [Upload Signed Certificate].
 - 5) Enter [Password].
 - 6) Enter [Retype Password].
 - 7) Enter a file name you want to import or select a file to import from a dialog box displayed by clicking the [Browse] button, and then select [Save].
 - 8) Click the [Import] button.
 - 9) Refresh the web browser.
- 3** Configure the certificate.
- 1) Click [Security].
 - 2) Click [Certificate Management].
 - 3) Select [Local Device] for [Category] and [Scan File] for [Certificate Purpose], and then click the [Display the list] button.
 - 4) Select the check box next to the certificate to set.
 - 5) Click the [Certificate Details] button.
 - 6) Click the [Use this certificate] button.
 - 7) Click [Reboot Machine]. The machine reboots and the settings are enabled.
- 4** Configure the settings for PDF Signature/ XPS Signature.
- Note** • XPS stands for XML Paper Specification.
- 1) Refresh the web browser.
 - 2) Click [Security] to display the items in the folder.
 - 3) Click [PDF / XPS Signature Settings] and configure the following settings.
 - PDF Signature
Select the setting for PDF signature from [Do not add signature], [Always add visible signature], [Always add invisible signature], or [Select during send].
 - PDF Signature Hash Algorithm
Select the setting for PDF Signature Hash Algorithm from [SHA-1] or [SHA-256].
 - XPS Signature
Select the setting for XPS signature from [Do not add signature], [Always add signature], or [Select during send].
 - 4) Click [Apply].

Step2 Configuration on the Computer

- Sending a PDF or XPS signature file from the machine to a computer
Make sure that the root certificate of the certificate to be used for the scan file signature of the machine is registered on the recipient's computer.

Note • XPS stands for XML Paper Specification.

12 Authentication and Accounting Features

The machine provides the Authentication feature to restrict the availability of services for each feature and the Accounting feature to manage the use of each feature based on the Login Type selected.

This chapter describes the settings to restrict the availability of services and to manage account usage on the machine.

- **Overview of Authentication and Accounting Feature344**
- **Authentication.....346**
- **Services Controlled by Authentication351**
- **Authentication for Job Flow Sheets and Folders356**
- **Jobs Manageable by Account Administration365**
- **Configuration for Authentication.....368**
- **Configuration for Account Administration372**
- **User Authentication Operations374**

Overview of Authentication and Accounting Feature

This section overviews the Authentication feature and the Accounting feature.

The following shows the reference section for each feature.

Overview of Authentication Feature.....	344
Overview of Accounting Feature.....	345

Overview of Authentication Feature

Types of Users

The users include the System Administrator, Login User, Unregistered User, and Local User. For more information about the feature, refer to "User Types Managed by Authentication Feature" (P.346).

User Role/Authorization Group

Allows you to assign a user role and an authorization group to each user.

When you assign [System Administrator] in [User Role] to a user, for example, the user has almost the same privileges as the System Administrator.

For more information about the feature, refer to "User Roles and Authorization Groups" (P.346).

Types of Authentication

The machine supports two authentication types: [Login to Local Accounts] that authenticates users based on the user information registered on the machine, and [Login to Remote Accounts] that authenticates users based on the user information registered on a remote server.

For more information about the feature, refer to "Types of Authentication" (P.347).

Note • The available remote servers are LDAP, Kerberos, and SMB servers.

Access Control

Allows you to prohibit the operation of the control panel buttons.

For more information, refer to "Device Access" (P.262).

Allows you to configure whether to restrict the availability per service such as Copy, Fax, and Scan.

For more information about the feature, refer to "Service Access" (P.262).

Allows you to restrict users from making color copies, or from printing or retrieving files stored in folders per user.

For more information about the feature, refer to "Feature Access" (P.263).

Account Limit for Each User

- Allows you to restrict access to each service and to set the maximum number of pages allowed for the service per user.

For more information about the feature, refer to "Services Controlled by Authentication" (P.351).

- Allows you restrict creating/editing/using job flow sheets and folders per user.

For more information about the feature, refer to "Authentication for Job Flow Sheets and Folders" (P.356).

Overview of Accounting Feature

Accounting Type

The machine supports the following types of account administration: Local Accounting, Network Accounting, and ColorTrack.

For more information, refer to "Types of Account Administration" (P.348).

Available Combinations of Login and Accounting Types

You can select the Login and Accounting Types individually, but some combinations are not available.

For more information, refer to "Authentication and Accounting Relationship" (P.350).

Authentication

This section describes the Authentication feature used with the machine.

User Types Managed by Authentication Feature.....	346
User Roles and Authorization Groups	346
Types of Authentication	347
Types of Account Administration	348
Authentication and Accounting Relationship.....	350

User Types Managed by Authentication Feature

The following describes the types of users that can be managed with the Authentication feature.

User information can be registered on the machine.

Types of User

Users are classified into the following four types. The Authentication feature restricts operations according to the user type.

System Administrator

The System Administrator can register and change system settings to adapt to the environment to be used.

A system administrator uses a specific user ID called a system administrator's user ID.

To login as the system administrator, enter the system administrator's user ID in the user ID entry field on the screen.

Login User

A Login User is a user registered on the machine or a remote server.

To use restricted services, enter the user ID and passcode on the screen.

Note • Users who are assigned as [System Administrator] in [User Role] have almost the same privileges as the system administrator. For more information, refer to "User Roles and Authorization Groups" (P.346).

Unregistered User

Unregistered User is a user not registered on the machine.

An unregistered user cannot use restricted services.

Local User

A user who does not login to the machine is called a Local User.

Sub User

You can associate sub users with a user ID of a login user in accordance with the intended use. Up to 10 Sub User IDs can be associated with a User ID.

User Roles and Authorization Groups

You can select a user role and an authorization group for each user when registering a user on the machine.

Note • When the Login Type is [Login to Local Accounts] and the Accounting Type is [Network Accounting], an authorization group cannot be assigned to a user. Therefore, the features configured for the authorization group, such as the feature to temporarily disable forcible printing, are not available.

User Roles

The following three user roles are available:

User

No special authority is given to this user role.

System Administrator

The same authority as a system administrator is given except for the following operations:

- Operate folders
- Operate job flows sheets
- Change the passcode of the system administrator

Account Administrator

The following authorities are given:

- Create, delete, change (except for passcode), and view (unavailable depending on some settings) user information
- Create, delete, change, and view accounting
- Change Alternative Name for Account ID or Mask Account ID
- Print an Auditron Report for each user

Authorization Groups

The following three settings can be configured for each authorization group.

For details on authorization groups, refer to "Create Authorization Groups" (P.263).

Restrict Recipient Selection Method

Allows you to set whether or not to permit the group members to specify recipients when [Restrict Recipient Selection Method] is set to [Only From Address Book].

For details on the Restrict Recipient Selection Method setting, refer to "Restrict Recipient Selection Method" (P.157).

Restrict User to Edit Address Book

Allows you to set whether or not to permit the group members to edit the Address Book in the machine when editing the Address Book is prohibited.

For details on the Restrict User to Edit Address Book setting, refer to "Restrict User to Edit Address Book" (P.157).

Allow User to Disable Active Settings

Allows you to set whether or not to permit the group members to disable active settings, such as Force Watermark or Print Universal Unique ID, and perform a job. This setting enables users belonging to an authorization group to disable active settings from [Tools] on the [Home] screen.

For details on the Watermark and UUID settings, refer to "Watermark" (P.140) and "Print Universal Unique ID" (P.143).

For information on how to temporarily disable active settings, refer to "Allow User to Disable Active Settings" (P.269).

Types of Authentication

The following describes the types of authentication (Login Type) available on the machine.

The following authentication methods are available.

User ID Authentication

The machine requires users to enter their user IDs and passcodes with the numeric keypad or the touch screen of the machine.

Authentication is performed using user information registered on the machine or user information registered on a remote server.

The following two types of authentication methods are available according to the registration condition of user information.

Login to Local Accounts

Login to Local Accounts uses the user information registered on the machine to manage authentication.

A print job directly sent to the machine from a computer can be received on the machine after being authenticated through cross-checking process whereby the authentication information configured on the client's driver with the information registered on the machine.

For information on driver settings, refer to the help of the driver.

Login to Remote Accounts

Authentication is performed for a remote server. User information is not registered on the machine.

Login to Remote Accounts uses the user information registered on a remote authentication server (LDAP, Kerberos, or SMB) to perform authentication.

- Note**
- When a user is authenticated by a remote authentication server, the authenticated user can access the services through the control panel based on the permission information obtained from the remote server.
 - When you change Login Type to or from [Login to Remote Accounts], user information, private folders, and Personal Sheets registered on the machine will be deleted.
 - When you register user information on a remote authentication server, use up to 32 single-byte characters for a user ID and up to 128 single-byte characters for a password. Note, however, that up to 32 single-byte characters are allowed for an SMB authentication password.

Smart Card Authentication

Authentication is performed using the IC Card Reader.

- Note**
- Set whether or not to enable user ID authentication when the smart card reader is connected. For more information, refer to "When Smart Card Reader is Connected" (P.264).

Combined Use of Smart Card Authentication and User ID Authentication

Authentication is performed using the user ID of the card pre-registered on the machine or the remote server.

- Note**
- When remote authentication is used, the registration of the user ID on the machine is not required.

Types of Account Administration

The following describes the types of account administration (Accounting Type) available on the machine.

- Note**
- Some Accounting Types may be grayed out and not selectable depending on the Login Type selected. For more information, refer to "Authentication and Accounting Relationship" (P.350).

The Account Administration feature is classified into the following types:

Local Accounting

Local Accounting performs account administration on the machine.

In Local Accounting, account administration is performed using the login users' information registered on the machine. Also, accounting information is counted using various counters automatically created for each user. To print auditron reports for each user, you must be authenticated as the system administrator, a user with the System Administrator user role, or a user with the Account Administrator user role.

For information on the types of jobs that can be monitored with account administration, refer to "Jobs Manageable by Account Administration" (P.365).

For information on how to print reports, refer to "Print Reports" (P.86).

Network Accounting

Network Accounting performs account administration using user information managed by a remote service.

In Network Accounting, the remote server collects job data stored on the machine and counts up the numbers of pages processed for each user.

User information managed by the remote service is sent to be registered on the machine. When the user information on the remote service is updated, the updated information must be sent from the remote service to the machine.

Accounting using Authentication Server

Account administration is performed using a remote authentication server.

In this accounting, the remote server collects job data stored on the machine and counts up the numbers of pages processed for each user.

The authentication server manages the user's authorization information and obtains accounting information from a remote server.

ColorTrack

Account administration is performed using the user information and account information registered on the machine. Also, accounting information is counted using various counters automatically created for each user. Auditron reports are created in CSV format using Dell Printer Configuration Web Tool.

For information on driver settings, refer to the help of the driver.

Note • When setting the user information or account information for another machine, we recommend that you use the Cloning feature of Dell Printer Configuration Web Tool.

Authentication and Accounting Relationship

You can individually select Login and Accounting Types, and can combine them as described in the following table.

		Accounting Types				
		Accounting Disabled	Local Accounting	Network Accounting	Authentication on Server	ColorTrack
Login Types	No Login Required	O ^{*1}	X	O	X	O
	Login to Local Accounts	X	O ^{*1}	O	X	O
	Login to Remote Accounts	O ^{*2}	X	X	O ^{*3}	X

O :Available

X :Not available

*1 :Default

*2 :When [Login Type] is [Login to Remote Accounts] and [Authentication System] is not set to [Authentication Agent], [Accounting Type] will automatically be set to [Accounting Disabled].

*3 :When [Login Type] is [Login to Remote Accounts] and [Authentication System] is set to [Authentication Agent], [Accounting Type] will automatically be set to [Authentication Server].

Services Controlled by Authentication

This section describes the features that are controlled by the Authentication feature.

The restricted features vary depending on how the machine is used.

For information on the folder and job flow sheet restrictions when the Authentication feature is enabled, refer to "Authentication for Job Flow Sheets and Folders" (P.356).

Overview	351
Services Restricted by User ID Authentication	351
Services Restricted by the Combined Use of Smart Card Authentication and User ID Authentication.....	353

Overview

The services can be controlled as follows.

Some restrictions can be set for each user, and other restrictions can be set for the machine as a whole.

For information on the restrictions that can be set for each user, refer to "Service Access" (P.252), and for information on the restrictions that can be set for the machine as a whole, refer to "Service Access" (P.262).

Services Restricted by User ID Authentication

For User ID Authentication, the services restricted by authentication and account administration differ depending on the combination of the Authentication and Accounting modes.

When [Login Type] is [Login to Local Accounts] and [Accounting Type] is [Local Accounting]

The following services are controlled.

Services	Authentication *1	Restrictions per user		Per-user Usage Count
	User ID	Feature restrictions *2	Account Limit *3	
Copy	○	○	○	○
Print	○	○	○	○
Charge Print, Private Charge Print	○	○	○	○
Scan	○	○	○	○
Fax, Internet Fax	○	○	-	○
Direct Fax	○	○	-	○
Report/List	-	-	-	-

○ :Available

- :Not available

*1 :This column shows whether authentication is required for each service. "O" indicates that authentication is required.

*2 :You can select features available for each user. For more information, refer to "Service Access" (P.252).

*3 :This feature stops machine operation when the number of pages specified in the account limit is processed. For more information, refer to "Service Access" (P.252).

When [Login Type] is [Login to Local Accounts] and [Accounting Type] is [Network Accounting]

The following services are controlled.

Services	Authentication *1	Restrictions per user		Per-user Usage Count
	User ID	Feature restrictions *2	Account Limit *3	
Copy	O	O	-	-
Print	O	O	-	-
Charge Print, Private Charge Print	O	O	-	-
Scan	O	O	-	-
Fax, Internet Fax	O	O	O	-
Direct Fax	O	O	-	-
Report/List	-	-	-	-

O :Available

- :Not available

*1 :This column shows whether authentication is required for each service. "O" indicates that authentication is required.

*2 :You can select features available for each user. The settings can be configured with the remote service.

*3 :This feature stops machine operation when the number of pages specified in the account limit is processed. The settings can be configured with the remote service.

When [Login Type] is [Login to Remote Accounts]

The following services are controlled.

Services	Authentication *1	Restrictions per user		Per-user Usage Count
	User ID	Feature restrictions	Account Limit	
Copy	O	O	-	-
Print	O*2	O	-	-
Charge Print, Private Charge Print	O	O	-	-
Scan	O	O	-	-
Fax, Internet Fax	O	O	-	-
Direct Fax	-*3	-	-	-
Report/List	-	-	-	-

O :Available

- :Not available

*1 :This column shows whether authentication is required for each service. "O" indicates that authentication is required.

*2 :When [Login Type] is set to [Login to Remote Accounts], the Print feature cannot be restricted. To restrict print operations, use the Charge Print or Private Charge Print feature.

*3 :When [Login Type] is [Login to Remote Accounts], the Direct Fax feature cannot be restricted. To disable the Direct Fax feature, refer to "Direct Fax" (P.210).

When [Login Type] is [Login to Local Accounts] and [Accounting Type] is [ColorTrack]

The following services are controlled.

Services	Authentication *1		Restrictions per user		Per-user Usage Count
	User ID		Feature restrictions	Account Limit *2	
Copy	O		O	O	O
Print	O		O	O	O
Charge Print, Private Charge Print	O		O	O	O
Scan	O		O	O	O
Fax, Internet Fax	O		O	O	O
Direct Fax	O		O	O	O
Report/List	-		-	-	-

O :Available
 - :Not available

*1 :This column shows whether authentication is required for each service. "O" indicates that authentication is required.

*2 :This feature stops machine operation when the number of pages specified in the account limit is processed.

Services Restricted by the Combined Use of Smart Card Authentication and User ID Authentication

For the combined use of Smart Card Authentication and User ID Authentication, the services restricted by authentication and account administration differ depending on the combination of the Authentication (local machine authentication or remote authentication) and Accounting modes.

When [Login Type] is [Login to Local Accounts] and [Accounting Type] is [Local Accounting]

The following services are controlled.

Services	Authentication *1		Restrictions per user		Per-user Usage Count
	User ID	Card *2	Feature restrictions *3	Account Limit *4	
Copy	- *5	O	O	O	O
Print*4	O	- *5	O	O	O
Charge Print, Private Charge Print	- *5	O	O	O	O
Scan	- *5	O	O	O	O
Fax, Internet Fax	-	O	O	-	O

Services	Authentication *1		Restrictions per user		Per-user Usage Count
	User ID	Card *2	Feature restrictions *3	Account Limit *4	
Direct Fax	O	-	O	-	O
Report/List	-	O*6	-	-	-

O :Available
 - :Not available

*1 :This column shows whether authentication is required for each service. "O" indicates that authentication is required.

*2 :The user ID of the card is checked against the user ID registered on the machine when IC Card Reader is used.

*3 :You can select features available for each user. For more information, refer to "Service Access" (P.252).

*4 :This feature stops machine operation when the number of pages specified in the account limit is processed. For more information, refer to "Service Access" (P.252).

*5 :When you set [When Smart Card Reader is Connected] under [Tools] > [Authentication / Security Settings] > [Authentication] > [User Details Setup] to [Smart Card or Control Panel Login], authentication is required. For more information, refer to "When Smart Card Reader is Connected" (P.264).

*6 :Report and List can be printed using a smart card not registered on the machine.

When [Login Type] is [Login to Local Accounts] and [Accounting Type] is [Network Accounting]

The following services are controlled.

Services	Authentication *1		Restrictions per user		Per-user Usage Count
	User ID	Card *2	Feature restrictions *3	Account Limit *4	
Copy	-*5	O	O	-	-
Print	O	-*5	O	-	-
Charge Print, Private Charge Print	-*5	O	O	-	-
Scan	-*5	O	O	-	-
Fax, Internet Fax	-	O	O	-	-
Direct Fax	O	-	O	-	-
Report/List	-	O*6	-	-	-

O :Available
 - :Not available

*1 :This column shows whether authentication is required for each service. "O" indicates that authentication is required.

*2 :The user ID of the card is checked against the user ID registered on the machine when IC Card Reader is used.

*3 :You can select features available for each user. The settings can be configured with the remote service.

*4 :This feature stops machine operation when the number of pages specified in the account limit is processed. The settings can be configured with the remote service.

*5 :When you set [When Smart Card Reader is Connected] under [Tools] > [Authentication / Security Settings] > [Authentication] > [User Details Setup] to [Smart Card or Control Panel Login], authentication is required. For more information, refer to "When Smart Card Reader is Connected" (P.264).

*6 :Report and List can be printed using a smart card not registered on the machine.

For more information on Network Accounting, refer to "Network Accounting" (P.349).

When [Login Type] is [Login to Remote Accounts]

When IC Card Reader is used, authentication in combination with remote authentication is available.

The following services are controlled.

Note • Only IC Card Reader can be connected as an authentication device for remote authentication. Remote authentication cannot be performed with other devices than IC Card Reader.

Services	Authentication *1		Restrictions per user		Per-user Usage Count
	User ID	Card	Feature restrictions	Account Limit	
Copy	O	O	O	-	-
Print	- *2	O *3	O	-	-
Charge Print, Private Charge Print	O	O *4	O	-	-
Scan	O	O	O	-	-
Fax, Internet Fax	-	O	O	-	-
Direct Fax	- *5	-	-	-	-
Report/List	-	O	-	-	-

O :Available

- :Not available

*1 :This column shows whether authentication is required for each service. "O" indicates that authentication is required.

*2 :When [Login Type] is set to [Login to Remote Accounts], the Print feature cannot be restricted. To restrict print operations, use the Charge Print or Private Charge Print feature.

*3 :When you hold your card over IC Card Reader, the machine automatically prints the print job being paused. We recommend that you use Charge Print or Private Charge Print to avoid unintended printing.

*4 :The user ID of the card is checked against the user ID registered on the machine.

*5 :When [Login Type] is [Login to Remote Accounts], the Direct Fax feature cannot be restricted. To disable the Direct Fax feature, refer to "Direct Fax" (P.210).

Note • Authentication is not performed when [Verify User Details] is set to [No] under [Tools] > [Accounting] > [Accounting Type] > [Network Accounting].

Authentication for Job Flow Sheets and Folders

This section describes the restrictions of job flows, folders, and job flow sheets and folder links when the Authentication feature is enabled.

Overview	356
When the Authentication Feature is Disabled	358
When the Authentication Feature is Enabled	361

Overview

Job Flow Sheet Types and Overview

Job flow sheets that you can create on the machine targets the documents stored in folders. You can create job flow sheets that can handle documents in folders and scanned documents using Job Flow Editor from a computer on the network.

Note • For information on job flow sheets that you can create on the machine, refer to "6 Send from Folder" > "Configuring/Starting Job Flow" in the User Guide. Job Flow Editor is included in the Driver CD Kit.

You can create job flow sheets for folder operations on the machine. Job flow sheets for scanner operations can be created using software on a computer connected to a network.

The job flow sheets created on the computer cannot be edited or copied on the machine.

The following four types of job flow sheets are available for the machine:

General Shared Job Flow Sheets

This is a job flow sheet created on the [Create Job Flow Sheet] screen by a Local User when the Authentication feature is disabled.

When the Authentication feature is disabled, this type of job flow sheet can be shared and its settings can be changed by any machine user.

When the Authentication feature is enabled, this type of job flow sheet can be operated only by the system administrator.

Folder Job Flow Sheets

This is a job flow sheet created by a Local User or the System Administrator on the [Create Folder] or [Send from Folder] screen when the Authentication feature is disabled.

The owner of the job flow sheet is the "folder" from which it was created. For example, the owner of a job flow sheet created in Folder 001 will be "Folder 001", and the job flow sheet can be used only in Folder 001.

Any users who have access to the folder upon the job flow sheet creation can use the job flow and change its settings.

This job flow sheet can be used by any machine user when the Authentication feature is disabled. When the Authentication feature is enabled, this job flow sheet can be operated only by the system administrator.

Personal Job Flow Sheets

This is a job flow sheet created by a login user when the Authentication feature is enabled.

When the Authentication feature is enabled, this type of job flow sheet is available for the login user who created the job flow sheet and for the system administrator.

Administrator Shared Job Flow Sheets

This is a job flow sheet created by the system administrator.

When the Authentication feature is disabled, any machine user can use this type of job flow sheet.

When the Authentication feature is enabled, any login user can use the job flow sheet.

Only the system administrator, however, can change its settings.

To create administrator shared job flow sheets, you must press the <Log In/Out> button and operate the machine as the system administrator.

The available operations for job flow sheets vary depending on whether the Authentication feature is enabled or disabled.

Job Flow Sheet Types	When Authentication is Disabled			When Authentication is Enabled		
	Create	Edit/Delete	Use *	Create	Edit/Delete	Use *
General Shared Job Flow Sheet	O	O	O	X	X	Δ
Folder Job Flow Sheet						
Personal Job Flow Sheet	X	X	Δ	O	O	O
Administrator Shared Job Flow Sheet	Δ	Δ	O	Δ	Δ	O

O :Available

X :Not available

Δ :Available to the System Administrator only

* :Viewing, copying, selecting, and executing job flow sheets

Types of Folders and Overview

The following three types of folders can be used with the machine:

General Shared Folder

This is a folder created by a Local User when the Authentication feature is not enabled.

When the Authentication feature is not enabled, this folder is shared and its settings can be changed by any user.

When the Authentication feature is enabled, this folder can be operated only by the system administrator.

Personal Folder

This is a folder created by a login user when the Authentication feature is enabled.

The login user who created it and the system administrator can use it.

When the Authentication feature is not enabled, this folder can be operated only by the system administrator.

The methods you can use folders differ depending on whether the Authentication feature is enabled.

Administrator Shared Folder

This is a folder created by the system administrator.

When the Authentication feature is not enabled, this folder can be shared by all users. When the Authentication feature is enabled, this folder can be shared by all login users.

Only the system administrator, however, can change the settings.

To create an administrator shared folder, you must press the <Log In/Out> button and operate the machine as the system administrator.

The available operations for folders vary depending on whether the Authentication feature is enabled or disabled.

Types of Folders	When Authentication is Disabled			When Authentication is Enabled		
	Create	Edit/Delete	Use *	Create	Edit/Delete	Use *
General Shared Folder	O	O	O	X	Δ	Δ
Personal Folder	X	X	Δ	O	O	O
Administrator Shared Folder	Δ	Δ	O	Δ	Δ	O

O :Available

X :Not available

Δ :Available to the System Administrator only

* : Viewing folders, viewing, deleting, registering, and outputting files, and viewing and starting job flow sheets

Linking Job Flow Sheets to Folders

The methods to link job flow sheets to folders vary depending on whether the Authentication feature is enabled.

The types of job flow sheets and folders to be linked vary depending on whether the Authentication feature is enabled or disabled.

Folder / Job Flow	When Authentication is Disabled			When Authentication is Enabled		
	General shared	Personal	Admin shared	General shared	Personal	Admin shared
Folder	O	Δ	Δ	Δ	Δ	Δ
General shared	O	Δ	Δ	Δ	Δ	Δ
Personal	Δ	Δ	Δ	Δ	O	Δ
Admin shared	Δ	Δ	Δ	Δ	O	Δ

O :Available

Δ :Available to the System Administrator only

When the Authentication Feature is Disabled

Available Job Flow Sheet Operations

If you change the authentication setting from "enabled" to "disabled", delete all existing personal job flow sheets, and create general shared and folder job flow sheets.

When the Authentication feature is disabled, the relationships between users and job flows are as follows.

The available job flow sheet operations differ between the job flow sheets created on the [Create Folder] under [Setup] or [Send from Folder] screens and those created on the [Create Job Flow Sheet] screen under [Setup].

[Create Folder] screen / [Send from Folder] screen

The following table describes the operations that can be performed on the [Create Folder] screen under [Setup] or on the [Send from Folder] screen.

Job Flow operation	General Users				System Administrators			
	General shared	Folder	Admin shared	Personal	General shared	Folder	Admin shared	Personal
Create/Register	-	○	-	-	-	-	○	-
Display	○	○	○	-	○	○	○	○
Edit	○	○	-	-	○	○	○	○
Copy *	○	○	○	-	○	○	○	○
Delete	○	○	-	-	○	○	○	○
Select/Run	○	○	○	-	○	○	○	○
Link to folder	○	○	○	-	○	○	○	○

○ :Available
 - :Not available

* :The owner of a copied job flow sheet is the user who copied the document.

- Note**
- A job flow sheet created on the [Create Folder] screen under [Setup] or on the [Send from Folder] screen can be edited, copied, deleted, or selected/run only from the folder where the job flow sheet was created. The applicable users are all users who can use the folders.
 - If job flow sheets, which are no longer available for use as a result of a change in the Login Type, are linked to folders, they cannot be edited or copied, but still can be used. If you cancel the links, however, the job flow sheets will no longer be displayed and will be unavailable.

[Create Job Flow Sheet] under [Setup]

The following table describes the operations that can be performed on the [Create Job Flow Sheet] screen under [Setup].

Job Flow operation	General Users				System Administrators			
	General shared	Folder	Admin shared	Personal	General shared	Folder	Admin shared	Personal
Create/Register	○	-	-	-	-	-	○	-
Display	○	-	○	-	○	○	○	○
Edit	○	-	-	-	○	○	○	○
Copy *	○	-	○	-	○	○	○	○
Delete	○	-	-	-	○	○	○	○
Select/Run	○	-	○	-	○	○	○	○

○ :Available
 - :Not available

* :The owner of a copied job flow sheet is the user who copied the document.

Available Folder Operations

If you change the Authentication feature from "enabled" to "disabled", delete all existing personal folders, and create general shared folders.

When the Authentication feature is disabled, the relationships between users and folders are as follows.

Folder operation		General Users			System Administrators		
		General shared	Admin shared	Personal	General shared	Admin shared	Personal
Create/Register		O	-	-	-	O	-
Display		O	O	-	O	O	O
Delete		O	-	-	O	O	O
Change Settings		O	-	-	O	O	O
Display File		O	O	-	O	O	O
Delete File		O	O	-	O	O	O
Register File *		O	O	-	O	O	O
Output File *		O	O	-	O	O	O
Job Flow Sheet	Display	O	O	-	O	O	O
	Link	O	-	-	O	O	O
	Auto Start	O	O	-	O	O	O
	Manual Run	O	O	-	O	O	O

O :Available
 - :Not available

* : The following operations are not authenticated:
 - Document retrieval using Network Scanner Utility 3.

Note • If job flow sheets, which are no longer available for use as a result of a change in the Login Type, are linked to folders, they cannot be edited or copied, but still can be used. If you cancel the links, however, the job flow sheets will no longer be displayed and will be unavailable.

Linking Job Flow Sheets and Folders

If job flow sheets, which are no longer available for use as a result of a change in the Login Type, are linked to folders, they cannot be edited or copied, but still can be used. If you cancel the links, however, the job flow sheets will no longer be displayed and will be unavailable.

When the Authentication feature is disabled, the relationships between users and folders are as follows.

Folder / Job Flow	General Users			System Administrators		
	General shared	Admin shared	Personal	General shared	Admin shared	Personal
Folder	O	-	-	O	O	O
General shared	O	-	-	O	O	O
Admin shared	O	-	-	O	O	O
Personal	-	-	-	O	O	O

O :Available
 - :Not available

When the Authentication Feature is Enabled

Available Job Flow Sheet Operations

If you change the authentication setting from "disabled" to "enabled", delete all existing general shared and folder job flow sheets, and create personal job flow sheets.

When the Authentication feature is enabled, the relationships between users and job flows are as follows.

The same operations can be used on [Create Folder] under the [Setup] and [Create Job Flow Sheet] screens.

For information on the Authentication feature, refer to "Overview of Authentication Feature" (P.344).

When [Login to Local Accounts] is selected, when [Verify User Details] is set to [Yes] in [Network Accounting] and [Customize User Prompts] is set to [Display User ID & Account ID Prompts] or [Display User ID Prompt Only], or when authenticated as a user other than a guest user in [Login to Remote Accounts]

- Note**
- If authenticated as a guest user in [Login to Remote Accounts], you are treated as an unregistered user (local user) and cannot operate job flow sheets.

Job flow operation	Unregistered Users (Local Users)				Local Users					System Administrators			
	General shared	Folder	Admin shared	Personal	General shared	Folder	Admin shared	Personal (owner)	Personal (Non-owner)	General shared	Folder	Admin shared	Personal
Create/ Register	-	-	-	-	-	-	-	○	-	-	-	○	-
Display	-	-	-	-	-	-	○	○	-	○	○	○	○
Edit	-	-	-	-	-	-	-	○	-	○	○	○	○
Copy *	-	-	-	-	-	-	○	○	-	○	○	○	○
Delete	-	-	-	-	-	-	-	○	-	○	○	○	○
Select/Run	-	-	-	-	-	-	○	○	-	○	○	○	○
Link to Folder	-	-	-	-	-	-	○	○	-	○	○	○	○

○ :Available

- :Not available

* :The owner of a copied job flow sheet is the user who copied the document.

Available Folder Operations

If you change the authentication setting from "disabled" to "enabled", delete all existing general shared shared folders, and create personal folders.

When the Authentication feature is enabled, the relationships between users and job flows are as follows.

For information on the Authentication feature, refer to "Overview of Authentication Feature" (P.344).

When [Login to Local Accounts] is selected, when [Verify User Details] is set to [Yes] in [Network Accounting] and [Customize User Prompts] is set to [Display User ID & Account ID Prompts] or [Display User ID Prompt Only], or when authenticated as a user other than a guest user in [Login to Remote Accounts]

- Note** • If authenticated as a guest user in [Login to Remote Accounts], you are treated as an unregistered user (local user) and cannot operate folders.

Folder operation		Unregistered Users (Local Users)			Login Users				System Administrators		
		General shared	Admin shared	Personal	General shared	Admin shared	Personal (owner)	Personal (Non-owner)	General shared	Admin shared	Personal
Create/Register		-	-	-	-	-	○	-	-	○	-
Display		-	○ ^{*1}	-	-	○	○	-	○	○	○
Delete		-	-	-	-	-	○	-	○	○	○
Change Settings		-	-	-	-	-	○	-	○	○	○
Display File		-	○ ^{*1}	-	-	○	○	-	○	○	○
Delete File		-	○ ^{*1}	-	-	○	○	-	○	○	○
Register File		-	○ ^{*1}	-	-	○	○	-	○	○	○
Output File		-	○ ^{*1}	-	-	○	○	-	○	○	○
Job Flow Sheet	Display	-	- ^{*2}	-	-	○	○	-	○	○	○
	Link	-	-	-	-	-	○	-	○	○	○
	Auto Start	-	- ^{*2}	-	-	○	○	-	○	○	○
	Manual Run	-	- ^{*2}	-	-	○	○	-	○	○	○

○ :Available

- :Not available

*1 :Available only when the folder operations are permitted in the Authentication feature settings of the System Administration mode.

*2 :You can perform display, auto run and manual run operations for job flow sheets linked to folders.

- Note** • If job flow sheets, which are no longer available for use as a result of a change in the Login Type, are linked to folders, they cannot be edited or copied, but still can be used. If you cancel the links, however, the job flow sheets will no longer be displayed and will be unavailable.

Linking Job Flow Sheets and Folders

When the Authentication feature is enabled, the relationships between users and folders are as follows.

For information on the Authentication feature, refer to "Overview of Authentication Feature" (P.344).

When [Login to Local Accounts] is selected, when [Verify User Details] is set to [Yes] in [Network Accounting] and [Customize User Prompts] is set to [Display User ID & Account ID Prompts] or [Display User ID Prompt Only], or when authenticated as a user other than a guest user in [Login to Remote Accounts]

Note • If authenticated as a guest user in [Login to Remote Accounts], you are treated as an unregistered user (local user) and cannot operate job flow sheets or folders.

Folder / Job Flow	Unregistered Users (Local Users)			Login Users				System Administrators		
	General shared	Admin shared	Personal	General shared	Admin shared	Personal (owner)	Personal (Non- owner)	General shared	Admin shared	Personal
General shared	-	-	-	-	-	-	-	○	○	○
Admin shared	-	-	-	-	-	○	-	○	○	○
Personal (Owner)	-	-	-	-	-	○	-	○	○	○
Personal (Non-owner)	-	-	-	-	-	-	-	○	○	○

○ :Available

- :Not available

Jobs Manageable by Account Administration

This section describes the information that can be managed for the jobs for each service.

Print

You can manage the following print job information using the Accounting feature:

Services (Jobs)		Authentication	Target User	Managed Items
Normal Print	Machine's print driver	Required	Login user	Pages/sheets
	Other than machine's print driver	_ *1	Unregistered user	Pages/sheets
Secure Print	Store Files	Required	-	-
	Print Files	Not required*2	Login user	Pages/sheets
Sample Set	Store Files, Print first set	Required	Login user	Pages/sheets
	Print remaining sets	Not required*2	Login user	Pages/sheets
Print Stored File	Store Files	Required	-	-
	Print Files	Required/ Not required*3	Login user	Pages/sheets
Delayed Print	Store Files	Required	-	-
	Print Files	Not required*3	Login user	Pages/sheets
Charge Print	Store Files	Not required	-	-
	Print Files	Required	Login user	Pages/sheets
Private Charge Print	Store Files	Required/ Not required*4	-	-
	Print Files	Required	Login user	Pages/sheets
Print E-mail		_ *1	Unregistered user	Pages/sheets

*1 :Printing is available only when [Non-account Print] is set to [Enabled] in Dell Printer Configuration Web Tool.

*2 :Authentication is not required for printing because each print job has been authenticated when received by the machine.

*3 :Depends on the [Send from Folder] setting under "Feature Access" (P.263) in the System Administration mode.

*4 :Depends on the "Receive Control" (P.267) setting in the System Administration mode.

Scan

You can manage the following scan job information using the Accounting feature:

Corresponding Service	Authentication	Target User	Managed Items
E-mail	Required	Login user	Scanned pages, mail transmission pages
Store to Folder	Required	Login user	Scanned pages
Scan to PC	Required	Login user	Scanned pages, file transfer pages
Store & Send Link	Required	Login user	Scanned pages
Store to USB	Required	Login user	Scanned pages

Fax

You can manage the following fax job information using the Accounting feature:

Services (Jobs)		Authentic ation	Target User	Managed Items
Send as Fax	Automatic Send	Required	Login user	Transmissions/pages, charging units
	Manual Send (Call-in, Call-out)	Required	Login user	Transmissions/pages, charging units
Receive Fax/Print Fax	Automatic Reception/Print	Not required	Fax reception	Receptions/pages, charging units, printed pages/number of sheets
	Manual Reception/Print (Call-in, Call-out)	Required	Fax reception	Receptions/pages, charging units, printed pages/number of sheets
Store Fax - Local Folder	Automatic Reception to Folder	Not required	Fax reception	Receptions/pages, charging units
	Print Folder-received Fax	Required*	Login user	Printed pages/number of sheets
Fax Polling	Storing for Polling (Folders, Polling Folders)	Required*	-	-
	Automatic Send (to Folder)	Not required	Unregistered user	Transmissions/pages
	Automatic Reception/Print	Required	Login user	Polls/pages, charging units, printed pages/number of sheets
	Polling File Sample Printout (Folders, Polling Folders)	Required*	Login user	Pages/number of sheets
Fax Relay Broadcast	Relay Broadcasting, Printing	Not required	Relay Broadcast	Transmissions/pages, charging units, printed pages/number of sheets
Direct Fax transmission		Required	Login user	Transmissions/pages, charging units
Send as Internet Fax		Required	Login user	Transmissions/pages
Receive Internet Fax/Print Internet Fax	Automatic Reception/Print	Not required	Internet Fax Received	Receptions/pages, printed pages/number of sheets
	Automatic Reception to Folder	Not required	Internet Fax Received	Receptions/pages
	Print Folder-received Fax	Required*	Login user	Pages/number of sheets
Receive Internet Fax/Internet Fax Transfer	Automatic Transmission (Transfer)	Not required	Internet Fax reception/fax forwarding	Transmissions/pages, charging units

* : When you select [Unlocked] for [Print Files from Folder] under [Tools] > [Authentication / Security Settings] > [Authentication] > [Access Control] > [Feature Access], authentication is not required to access folders shared by system administrators, and the machine prints jobs as unregistered user.

Restriction on Using the Accounting feature on Fax Jobs:

Note the following conditions when you use the Accounting feature on fax jobs.

- Sending files from different user accounts to the same destination is not counted as a batch send.

- The number of charging units is calculated using the machine's built-in timer. Therefore, the communications charges calculated from the number of charging units may slightly differ from the charges invoiced by the telecommunications company.
- When fax-received pages are split for printing, the number of pages counted will be those received, not those printed.
- The number of charging units is not counted for the following communications:
 - When dialing a fax number using the numeric keypad or the On-hook/Off-hook feature.
 - When using an address number in which the billing data is not registered.
 - When a phone conversation took place, including the one before a transmission.

Billing for Fax Jobs

Fax jobs are not billed for the following communications:

- When dialing a fax number using the numeric keypad or the On-hook/Off-hook feature.
- When using an address number in which the billing data is not registered.
- Manual Receive, Manual Send, or Manual Polling is used.
- When a phone conversation took place, including the one before a transmission.

Configuration for Authentication

This section describes the settings to use the Authentication feature on the machine.

The following shows the reference section for each procedure.

Enabling Authentication	368
Changing the Default Authorization Group Settings.....	370
Creating an Authorization Group.....	371

Installation Overview

To use the Authentication feature, configure the following settings.

Note • If job flow sheets, which are no longer available for use because of a change in the Login Type, are linked to folders, they cannot be edited or copied, but still can be used. If you cancel the links, however, the job flow sheets will no longer be displayed and will be unavailable.

Login to Local Accounts

Specify the Login Type and access control, and then create a user.

Login to Remote Accounts

Specify the Login Type, access control, and remote authentication server.

Change the default authorization group settings and add an authorization group, as necessary.

Enabling Authentication

This section describes the procedures for [Login to Local Accounts] and [Login to Remote Accounts] respectively.

When [Login to Local Accounts] is Selected

Perform the following procedures to use local authentication.

- 1 Press the <Log In/Out> button.
 - 2 Enter the system administrator's user ID with the numeric keypad or the keyboard displayed on the screen, and select [Enter].
When a passcode is required, select [Next] and enter the system administrator's passcode, and select [Enter].
- Note** • The default user ID is "admin".
 • The default passcode is "1111".
- 3 Select [Tools] on the [Home] screen.
 - 4 Select [Authentication / Security Settings].
 - 5 Select [Authentication].
 - 6 Select [Login Type].
 - 7 Select [Login to Local Accounts], and then select [Save].
For more information, refer to "Login Type" (P.261).
 - 8 Select [Access Control].

- 9 Select [Service Access].
- 10 Select [Unlocked] for the required services to permit users unlimited access, and then select [Save].
- 11 After you finish settings for each feature, select [Close].
- 12 To disable button operations on the control panel, select [Device Access] and select [Locked], and then select [Save] and then [Close].
- 13 Select [Passcode Entry for Control Panel Login] under [Passcode Policy].
Select [On] to prompt users to enter their passcode, or select [Off] if the passcode entry is not required, and then select [Save] and then [Close].
- 14 Select [Create / View User Accounts].
- 15 Select a user displayed as [<Available>], and then select [Create / Delete].
- 16 Enter a User ID and select [Save].
- 17 Select [Account Limit].
- 18 Configure the [Account Limit] and [Feature Access] settings for each service, and then select [Close].
- 19 If necessary, select a user role and an authorization group for the user under [User Role] and [Add This User To Authorization Group] respectively, and then select [Save].
- 20 Select [Close] repeatedly until the [Tools] screen is displayed.
- 21 Select [Close].

- Note**
- Rebooting the machine may be required depending on the settings. When a message displayed on the screen, follow the message and reboot the machine.
 - The machine enters the Login mode, and [Login] is displayed at the lower left of the [Home] screen.
 - When [Locked (Show Icon)] is selected for a service under [Service Access], [] is displayed on the button of the applicable service on the [Home] screen. Also, [: Requires Login] is displayed at the lower left of the [Home] screen. [] and [: Requires Login] are not displayed after authentication.
 - When [Locked (Hide Icon)] is selected for a service under [Service Access] the applicable service is not displayed on the [Home] screen. The services is displayed after authentication.

When [Login to Remote Accounts] is Selected

Perform the following procedures to use remote authentication.

- 1 Press the <Log In/Out> button.
 - 2 Enter the system administrator's user ID with the numeric keypad or the keyboard displayed on the screen, and select [Enter].
When a passcode is required, select [Next] and enter the system administrator's passcode, and select [Enter].
- Note**
- The default user ID is "admin".
 - The default passcode is "1111".
- 3 Select [Tools] on the [Home] screen.
 - 4 Select [Authentication / Security Settings].
 - 5 Select [Authentication].
 - 6 Select [Login Type].
 - 7 Select [Login to Remote Accounts], and then select [Save].
For more information, refer to "Login Type" (P.261).

- 8 Select [Yes].
- 9 Select [Access Control].
- 10 Select [Service Access].
- 11 Select [Unlocked] for the required services to permit users unlimited access, and then select [Save].
- 12 Select [Close] repeatedly until the [Tools] screen is displayed.
- 13 Select [System Settings].
- 14 Select [Connectivity & Network Setup].
- 15 Select [Remote Authentication / Directory Service].
- 16 Select [Authentication System Setup] > [Authentication System], and then select a remote authentication server.

For more information, refer to "Remote Authentication / Directory Service" (P.179).

Note • The available options are [Kerberos (Windows 2000)], [Kerberos (Solaris)], [LDAP], [SMB], and [Authentication Agent].

- 17 Configure the settings for the remote authentication server.

For more information on the Authentication feature, refer to "Kerberos Server Settings" (P.179), "LDAP Server / Directory Service Settings" (P.180), and "SMB Server Settings" (P.184).

- 18 Select [Close] repeatedly until the [Tools] screen is displayed.
- 19 Select [Close].

Note

- Rebooting the machine may be required depending on the settings. When a message displayed on the screen, follow the message and reboot the machine.
- The machine enters the Login mode, and [Login] is displayed at the lower left of the [Home] screen.
- When [Locked (Show Icon)] is selected for a service under [Service Access], [] is displayed on the button of the applicable service on the [Home] screen. Also, [: Requires Login] is displayed at the lower left of the [Home] screen. [] and [: Requires Login] are not displayed after authentication.
- When [Locked (Hide Icon)] is selected for a service under [Service Access] the applicable service is not displayed on the [Home] screen. The services is displayed after authentication.

When an LDAP server is used as a remote authentication server

Set the user authorization on the LDAP server using the following steps.

- 1 Start Dell Printer Configuration Web Tool.
- 2 Click the [Properties] tab.
- 3 Click [Connectivity] > [Protocols] > [LDAP] > [LDAP Authorization Access].
- 4 Set attributes in [System Administrator Access] and [Accounting Administrator Access].

Setting example:

System Administrator Access: CN=SA,CN=Users,DC=secEQ,DC=local

Accounting Administrator Access: CN=AA,CN=Users,DC=secEQ,DC=local

- 5 Click [Apply].

Changing the Default Authorization Group Settings

Perform the following procedures to change the settings of the default authentication group.

The settings changed here will be used as the default value of the authorization group for a created user.

- 1 Press the <Log In/Out> button.
- 2 Enter the system administrator's user ID with the numeric keypad or the keyboard displayed on the screen, and select [Enter].
When a passcode is required, select [Next] and enter the system administrator's passcode, and select [Enter].
Note
 - The default user ID is "admin".
 - The default passcode is "1111".
- 3 Select [Tools] on the [Home] screen.
- 4 Select [Authentication / Security Settings].
- 5 Select [Authentication].
- 6 Select [Create Authorization Groups].
- 7 Select the group displayed as [DefaultGroup (Default)], and then select [Create / Delete].
- 8 Set each item.
For more information, refer to "Create Authorization Groups" (P.263).
- 9 Select [Close] repeatedly until the [Tools] screen is displayed.
- 10 Select [Close].

Creating an Authorization Group

Perform the following procedures to add authorization groups, if necessary.

- 1 Press the <Log In/Out> button.
- 2 Enter the system administrator's user ID with the numeric keypad or the keyboard displayed on the screen, and select [Enter].
When a passcode is required, select [Next] and enter the system administrator's passcode, and select [Enter].
Note
 - The default user ID is "admin".
 - The default passcode is "1111".
- 3 Select [Tools] on the [Home] screen.
- 4 Select [Authentication / Security Settings].
- 5 Select [Authentication].
- 6 Select [Create Authorization Groups].
- 7 Select a group displayed as [(No Name)], and then select [Create / Delete].
- 8 Enter a group name into [Group Name].
- 9 Set the other items.
For more information, refer to "Create Authorization Groups" (P.263).
- 10 Select [Close] repeatedly until the [Tools] screen is displayed.
- 11 Select [Close].

Configuration for Account Administration

This section describes the settings to use the Accounting feature on the machine.

The following shows the reference section for each procedure.

Step 1 Selecting an Accounting Type	372
Step 2 Registering User Information.....	372

Step 1 Selecting an Accounting Type

The following describes the configuration procedures to use the Accounting feature.

Note • For information on relationships between the Authentication and Accounting modes, refer to "Authentication and Accounting Relationship" (P.350).

- 1 Press the <Log In/Out> button.
- 2 Enter the system administrator's user ID with the numeric keypad or the keyboard displayed on the screen, and select [Enter].
When a passcode is required, select [Next] and enter the system administrator's passcode, and select [Enter].
Note • The default user ID is "admin".
• The default passcode is "1111".
- 3 Select [Tools] on the [Home] screen.
- 4 Select [Accounting].
- 5 Select [Accounting Type].
- 6 Select an accounting type, and then select [Save].
Note • You can select the accounting type from [Local Accounting] and [ColorTrack].
For information on accounting types, refer to "Accounting Type" (P.255).
- 7 Select [Close] repeatedly until the [Tools] screen is displayed.
- 8 Select [Close].

Step 2 Registering User Information

- 1 Press the <Log In/Out> button.
- 2 Enter the system administrator's user ID with the numeric keypad or the keyboard displayed on the screen, and select [Enter].
When a passcode is required, select [Next] and enter the system administrator's passcode, and select [Enter].
Note • The default user ID is "admin".
• The default passcode is "1111".
- 3 Select [Tools] on the [Home] screen.
- 4 Select [Accounting].
- 5 Select [Create / View User Accounts].

- 6** Select [**<Available>**], and then select [**Create / Delete**].
- 7** Enter a User ID and select [**Save**].
- 8** Select [**Service Access**].
- 9** Configure the [**Service Access**] and [**Feature Access**] settings for each service, and then select [**Save**].

For more information, refer to "Service Access" (P.252).

- 10** If necessary, select a user role and an authorization group for the user under [**User Role**], and then select [**Save**].

Note • [**User Role**] is displayed only when [**Login Type**] is set to [**Login to Local Accounts**].

For more information, refer to "User Role" (P.253).

- 11** Select [**Close**] repeatedly until the [**Tools**] screen is displayed.
- 12** Select [**Close**].

User Authentication Operations

The machine has the Authentication feature to restrict the services available.

This section describes the authentication method to use the restricted services.

The following shows the reference section for each procedure.

Authenticating Login Users.....	374
Changing Passcode	375

Authenticating Login Users

There are two methods to authenticate login users: using the control panel of the machine and touching the smart card to the IC Card Reader.

To authenticate the login users using the operator panel, the user must enter the user ID. In addition, the passcode entry is also required when [Passcode Entry for Control Panel Login] is set to [On] under [Authentication / Security Settings] > [Authentication] > [Passcode Policy].

For more information on the passcode policy, refer to "Passcode Policy" (P.266).

For more information on user registration from the touch screen, refer to "Create / View User Accounts" (P.263).

Note • An optional component is required to use this feature. For more information, contact Customer Support at dell.com/contactdell.

Log In/Log Out from the Operator Panel

User Authentication

- 1 Press the <Log In/Out> button or the login information field on the touch screen.
- 2 Enter the user ID with the numeric keypad or the keyboard displayed on the screen, and select [Enter].

When a passcode is required, select [Next] and enter the passcode, and select [Enter].

Note

- Finish user authentication before you cancel the Interrupt mode.
- When you select the service restricted, the [Login] screen may appear. Enter the user ID and/or the passcode to use the service.
- When the user is authenticated, the <Log In/Out> button is lit.

Logging Out of User Authentication

- 1 Press the <Log In/Out> button.

Note

- You can also log out by pressing the login information field on the touch screen, and then select [Logout].
- When the user is logged out, the <Log In/Out> button light goes out.

Log In/Log Out by Touching the IC Card Reader

User Authentication

- 1 Touch the smart card to the IC Card Reader.

Note

- A passcode may be required depending on the settings. To re-enter the passcode after entering a wrong one, press the <Log In/Out> button to exit the Authentication mode, and then hold your smart card over the IC Card Reader again.

Logging Out of User Authentication

The logging out method vary depending on the Smart Card Logout Timing setting. For more information, refer to "Smart Card Logout Timing" (P.265).

- When you select [Log Out when Card is Removed], the user is authenticated while the smart card is being touched to the IC Card Reader.
- When you select [Log Out from Control Panel], the user can log out by using the same log out method as using the control panel.

Changing Passcode

You can change the passcode to use for user authentication. Change the passcode by following the steps in this section.

Changing Passcode by User

When a user is authenticated, the user can change his/her own passcode.

- 1 Select [Setup] on the [Home] screen.
- 2 Select [User Details Setup].
- 3 Select [Change Passcode].
- 4 Enter the current passcode, and then select [Next].
- 5 Select [New Passcode] and enter a new passcode, and then select [Save].
- 6 Select [Retype Passcode] and re-enter the new passcode, and then select [Save].
- 7 Select [Close].

Setting or Changing Passcode by System Administrator

The system administrator can set or change passcodes using Dell Printer Configuration Web Tool.

For more information on setting or changing passcodes from the touch screen, refer to "Create / View User Accounts" (P.263).

- 1 Start Dell Printer Configuration Web Tool.
For information on how to start Dell Printer Configuration Web Tool, refer to "Starting Dell Printer Configuration Web Tool" (P.276).
- 2 Click the [Properties] tab.
- 3 Click [Security], and then click [Authentication Configuration].
- 4 Click [Next].
- 5 Enter the account number of the user to set or change in [Account Number], and then click [Edit].
- 6 Enter a new passcode in [Password].
- 7 Re-enter the new passcode in [Retype Password].
- 8 Click [Apply].

13 Problem Solving

This chapter describes solutions to various problems you may have with the machine.

• Troubleshooting	378
• Machine Trouble	379
• Image Quality Trouble	384
• Trouble during Copying	390
• Trouble during Printing	394
• Trouble during Faxing	397
• Trouble during Scanning	401
• Network-related Problems	406
• Media Print - Text Trouble	420
• Media Print - Photos Trouble	421
• Status Code	422
• Paper Jams	495
• Document Jams	504
• Stapler Faults	506

Troubleshooting

This section describes troubles that may occur with the machine and their solutions. Follow the troubleshooting procedure below to solve the problems.



If the error is not resolved even after following the above procedure, contact Customer Support at dell.com/contactdell.

Machine Trouble

Before you conclude that the machine is defective, check the machine status again.

Symptom	Cause	Remedy
The machine is not powered on.	Is the main power and power switched on?	Switch the main power and power on. Refer to "2 Product Overview" in the User Guide.
	Is the power cord plugged into the power outlet?	Switch the main power and power off, and then firmly plug the power cord into the connector of the machine and power outlet. Then switch the main power and power on. Refer to "2 Product Overview" in the User Guide.
	Is the power cord disconnected from the machine?	
	Does the AC outlet supply power properly?	Connect another appliance to the outlet to verify the power supply. Refer to "1 Before Using the Machine" in the User Guide.
The <Error> indicator is blinking.	The system of the machine or the components installed may have a trouble.	Switch the main power and power off and then on. If the error still is not resolved, contact Customer Support at dell.com/contactdell .
The <Error> indicator is lit.	Is paper or a document jammed?	Remove the jammed paper or document. If paper is jammed, refer to "Paper Jams" (P.495), and a document is jammed, refer to "Document Jams" (P.504).
	Is the front cover or top cover open?	Solve the problem by following the message displayed.
	Is a message displayed on the touch screen prompting you to replace the consumables?	Replace the consumables indicated in the message. Refer to "Replacing Consumables" (P.58).
	Is a message displayed in the upper part of the touch screen?	Check the message and solve the problem. If a status code such as "016-450" is displayed, check the status code list and solve the problem. Refer to "Status Code" (P.422).
The touch screen is too dark.	Is the <Power Saver> button lit?	The machine is in the Power Saver mode. Press the <Power Saver> button on the control panel to exit the Power Saver mode. Refer to "2 Product Overview" in the User Guide.
	Is the screen brightness too low?	Adjust the screen brightness on the [Screen Brightness] screen. Refer to "Adjusting the Screen Brightness" (P.32).

Symptom	Cause	Remedy
Unable to print, or unable to copy.	Is a message displayed on the touch screen?	Follow the instructions displayed to resolve the problem.
	Is the memory capacity insufficient?	Perform one of the following: <ul style="list-style-type: none"> • Set [Image Quality] to [Standard] in the print driver, or try printing again by setting [Print Page Mode] to [On]. • Set the status of the unused ports to [Disabled].
	Is the print mode [Off-line]?	Press the <Machine Status> button to check the [Print Mode] on the [Machine Status] screen. If [Print Mode] is set to [Off-line], select [On-line].
	Is the power cord disconnected from the machine?	Switch the main power and power off, and then firmly plug the power cord into the connector of the machine and power outlet. Then switch the main power and power on. Refer to "2 Product Overview" > "Power Source" in the User Guide.
The <Data> indicator does not light even though you instructed the machine to print.	Is the interface cable connected?	Check the interface cable connection. Refer to "Interface Cables" (P.19).
	Is the computer's environment correctly set?	Check the computer environment such as print driver settings.
	Is the required port status set to [Enabled]?	Check the status of the port to use, and then set the port status to [Enabled]. Refer to "Port Settings" (P.168).
Paper is not fed from Tray 5.	Is the specified size paper loaded in the tray?	Follow the instructions displayed to load paper of correct size, and then try again. Refer to "Loading Paper in Tray 5 (Bypass Tray)" (P.48).
Unsatisfactory print quality.	A probable cause is an image defect.	Resolve the problem by referring to "Image Quality Trouble". Refer to "Image Quality Trouble" (P.384).
Unable to print text correctly. (Text is garbled.)	Non-standard fonts are used for printing.	Check the application or print driver settings. If PostScript is being used, download the required fonts.
Unable to insert or remove a paper tray.	Did you open a cover or turn the machine off during printing?	Do not forcibly insert or remove the paper tray. Switch off the power. In a few seconds, switch on the power. When the machine is ready to receive data, insert or remove the paper tray.

Symptom	Cause	Remedy
Unable to copy with the specified size.	Is the document glass or the document cover dirty?	Clean the document glass and the document cover. Refer to "Cleaning Document Cover and Document Glass" (P.72).
	Is the document a transparent type such as a transparency film?	Place the document on the document glass, and place a white sheet on top of the document when copying.
	Is the document in the correct position?	Load the document correctly. Refer to "3 Copy" > "Copying Procedure" in the User Guide.
	Is the document loaded correctly?	
	Are the document guides on the document feeder set in the correct positions?	Adjust the document guide positions. Refer to "3 Copy" > "Copying Procedure" in the User Guide.
	Is the document folded?	Unfold and correctly load the document. Refer to "3 Copy" > "Copying Procedure" in the User Guide.
	Is the document a non-standard size?	Specify the document size. Refer to "3 Copy" > "Copying Procedure" in the User Guide.

Symptom	Cause	Remedy
Paper is often jammed or wrinkled.	Is the paper loaded correctly in the tray?	Load the paper correctly. Refer to "Loading Paper" (P.47).
	Is the paper tray inserted correctly?	Firmly push in the paper tray until it stops to insert it correctly. Refer to "Loading Paper" (P.47).
	Is the paper damp?	Replace the paper with new one. Refer to "Loading Paper" (P.47).
	Is the paper curled?	Turn over the paper in the tray, or replace the paper with new one. Refer to "Loading Paper" (P.47).
	Are the paper and paper tray settings correct?	Correctly set the paper and paper trays to correspond to the paper. Refer to "Changing the Paper Settings" (P.54).
	Are any torn pieces of paper remaining or is there a foreign object in the machine?	Open the cover of the machine or slide out the paper tray to remove the torn pieces or the foreign object. Refer to "Paper Jams" (P.495) or "Loading Paper" (P.47).
	Is non-standard paper loaded in the tray?	Replace with paper that meets machine specifications. Refer to "Paper Types" (P.36) or "Loading Paper" (P.47).
	Is paper exceeding the maximum fill line in the tray?	Load paper in the paper tray so that it does not exceed the maximum fill line. Refer to "Loading Paper" (P.47).
	Are the paper guides set correctly?	Load the paper correctly, and align the paper guides to the paper. Refer to "Loading Paper" (P.47) or "Changing the Paper Size" (P.51).
	Is the image nearly the same size as the paper?	Increase the edge erase widths. For more information, refer to "3 Copy" in the User Guide when you copying, or to the help of the print driver when printing.
	Is the paper finely cut out?	Some types of paper may not be cut out finely. Load the paper after fanning it well.
A document is not fed into the document feeder.	Is the document small?	The minimum size of the document that can be loaded on the document feeder is 125 x 85 mm (Standard size: A5, A5 ). Refer to "3 Copy" > "Copying Procedure" in the User Guide.
An error message appears after paper is loaded in Tray 5 and the <Start> button is pressed.	Check the positions of the paper guides of Tray 5.	Adjust the paper guides to the correct positions. Refer to "Loading Paper in Tray 5 (Bypass Tray)" (P.48).

Symptom	Cause	Remedy
Documents are often jammed.	Are suitable types of documents being used?	Correctly load documents suitable for the document feeder.
	Are you trying to use irregular shaped documents, business cards, transparencies, or thin documents?	Refer to "3 Copy" > "Copying Procedure" in the User Guide.
	Are you trying to use documents with sticky tags, paper clips or adhesive tape?	Remove sticky tags, paper clips or adhesive tape from the document before copying.
	Are the document guides set in the correct positions?	Adjust the document guide positions. Refer to "3 Copy" > "Copying Procedure" in the User Guide.
	Is a piece of torn paper remaining in the document feeder?	Open the document feeder cover and check inside. Refer to "Document Jams" (P.504).
	Is the [Mixed Size Originals] setting set to [Off] when you copy originals of different sizes?	Set [Mixed Size Originals] to [On]. Refer to "3 Copy" > "Layout Adjustment" > "Mixed Size Originals (Scanning Different Size Documents Simultaneously)" in the User Guide.
	Is an A5 document loaded in landscape orientation (☐) on the document feeder when [Mixed Size Originals] is set to [On]?	Load the A5 document in portrait orientation (☐).
An edge of the document is folded.	Is the document curled?	Flatten the curl and load the document again.
Cannot copy in color.	Is [Output Color] set to [Black & White]?	Set [Output Color] to [Color]. Refer to "3 Copy" > "Copy" > "Output Color (Selecting the Color for Copying)" in the User Guide.
	Is a message displayed on the touch screen prompting you to replace the toner cartridge?	Replace the toner cartridge of the color indicated in the message. Refer to "Replacing Toner Cartridges" (P.58).
	Is a message displayed on the touch screen prompting you to replace the drum cartridge?	Replace the drum cartridge indicated in the message. Refer to "Replacing Drum Cartridges R1, R2, R3, or R4" (P.63).
Cannot staple properly	Is staple jam occurred in the staple cartridge?	Remove the staple jammed in the cartridge. Refer to "Stapler Faults" (P.506).
	Is the print driver set correctly?	Check the [Staple] setting in [Print Setup] in the print driver when you send a print job from the computer.



Image Quality Trouble



If the image quality of printed documents is poor, identify the symptom in the following table to perform the remedy.



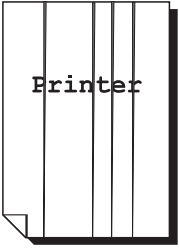
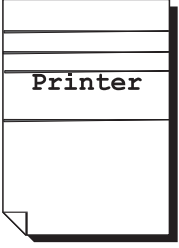
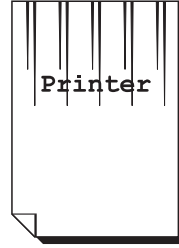

If image quality does not improve even after the remedy, contact Customer Support at dell.com/contactdell.

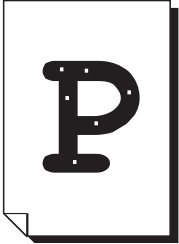

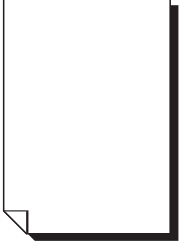
Symptom	Cause	Remedy
The copy is dirty.	Is the document glass or the document cover dirty?	Clean the document glass and the document cover. Refer to "Cleaning Document Cover and Document Glass" (P.72).
	Is the document a transparent type such as a transparency film?	If the document is transparent, dirt on the document cover will be copied. Place a white sheet of paper on top of the document when copying.
	Is the document colored, rough, or a blueprint?	Adjust the copy density or image quality. Refer to "3 Copy" > "Image Quality" in the User Guide.
	Is the document glossy printing paper?	Glossy printing paper easily sticks to the document glass, and shadows are sometimes copied, soiling the image. Place a transparency film under the document when copying.
The copy has black lines.	Is the constant velocity transport glass on the document feeder dirty?	Clean the constant velocity transport document glass. Refer to "Cleaning Film and Constant Velocity Transport Glass" (P.72).
The copy is too dark.	Is the copy density set to [Darken]?	Adjust the copy density. Refer to "3 Copy" > "Image Quality" in the User Guide.
The copy is too light.	Is the document faint? Is the copy density set to [Lighten]?	
The copy is slightly misaligned.	Are the paper edges aligned and the leading edge adjusted to the tray corners?	Align the paper edges, adjust them to the tray's top corners, and reload the paper. Refer to "Loading Paper" (P.47).

Symptom	Cause	Remedy
The copy is misaligned or skewed.	Is the document loaded correctly?	Load the document correctly. Refer to "3 Copy" > "Copying Procedure" in the User Guide.
	Is the paper loaded correctly in the tray?	Load the paper correctly. Refer to "Loading Paper" (P.47).
	Are the paper guides of Tray 5 correctly aligned to the paper?	Load the paper correctly and align the document guides to the document edges. Refer to "Loading Paper in Tray 5 (Bypass Tray)" (P.48).
	Are the document guides on the document feeder set in the correct positions?	Load the document correctly, and align the document guides to the document edges. Refer to "3 Copy" > "Copying Procedure" in the User Guide.
	Is the paper tray inserted correctly?	Firmly push in the tray until it stops to insert it properly. Refer to "Loading Paper" (P.47).
Part of the image is missing on the copy.	Is the paper damp?	If the paper is damp, the copy image may be partially missing or unclear. Replace the paper with new one. Refer to "Loading Paper" (P.47).
	Is folded or wrinkled paper included in the tray?	Remove the unsuitable paper or replace all of the paper with new one. Refer to "Loading Paper" (P.47).
	Is the document pasted or folded?	The pasted or folded section may not be laying flat on the document glass. Place a stack of white sheets on top of the document to flatten the document against the document glass.
The copy has a stripe pattern.	Is the enlargement ratio too large?	Vertical stripes may be printed on the copies depending on the ratio. Adjust the ratio to eliminate the stripes. Refer to "3 Copy" > "Copy" > "Reduce/Enlarge (Making Enlarged/Reduced Copies)" in the User Guide.
Color shift of color copies is poor, resulting in unsatisfactory image quality.	Is the color calibration incorrect?	Execute auto calibration. Refer to "Executing Calibration" (P.75).
	Is the machine set where it is exposed to direct sunlight?	If the document glass is exposed to strong light when you turn the machine on or cancel the Power Saver mode, color shift may occur. Close the document cover and turn the machine on, and when the machine becomes ready to copy or print, turn the machine off and then on one more time.

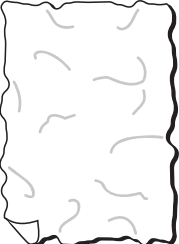
Symptom	Cause	Remedy
<p>Printing is faint. (smudged, unclear)</p> 	<p>The paper is damp.</p> <p>The drum cartridge has deteriorated or is damaged.</p> <p>There is no toner left in the toner cartridge.</p>	<p>Replace the paper with new one. Refer to "Loading Paper" (P.47).</p> <p>Replace the drum cartridge with a new one. Refer to "Replacing Drum Cartridges R1, R2, R3, or R4" (P.63).</p> <p>Replace the toner cartridge with a new one. Refer to "Replacing Toner Cartridges" (P.58).</p>
<p>Black dots are printed.</p> 	<p>The drum cartridge has deteriorated or is damaged.</p>	<p>Replace the drum cartridge with a new one. Refer to "Replacing Drum Cartridges R1, R2, R3, or R4" (P.63).</p>
<p>Black or colored lines are printed.</p>  	<p>The drum cartridge has deteriorated or is damaged.</p> <p>The machine interior (LED printhead) is dirty.</p> <p>The constant velocity transport glass on the document feeder is dirty.</p>	<p>Replace the drum cartridge with a new one. Refer to "Replacing Drum Cartridges R1, R2, R3, or R4" (P.63).</p> <p>Clean the machine interior. Refer to "Cleaning the Interior (LED Printheads)" (P.70).</p> <p>Clean the constant velocity transport glass. Refer to "Cleaning Film and Constant Velocity Transport Glass" (P.72).</p>
<p>Dirt appears at equal intervals.</p>  <p>Paper feed direction</p>	<p>The paper path is dirty.</p> <p>The drum cartridge has deteriorated or is damaged.</p>	<p>Print a few pages to remove the dirt.</p> <p>Replace the drum cartridge with a new one. Refer to "Replacing Drum Cartridges R1, R2, R3, or R4" (P.63).</p>

Symptom	Cause	Remedy
<p>White dots appear in black filled areas.</p> 	<p>The paper is unsuitable.</p>	<p>Load suitable paper. Refer to "Loading Paper" (P.47).</p>
	<p>The drum cartridge has deteriorated or is damaged.</p>	<p>Replace the drum cartridge with a new one. Refer to "Replacing Drum Cartridges R1, R2, R3, or R4" (P.63).</p>
<p>Printed toner smudges when rubbed with your finger. Toner is not fused. The paper is soiled with toner.</p> 	<p>The paper is damp.</p>	<p>Replace the paper with new one. Refer to "Loading Paper" (P.47).</p>
	<p>The paper is unsuitable.</p>	<p>Load suitable paper. Refer to "Loading Paper" (P.47).</p>
<p>The entire paper area is printed black.</p> 	<p>The drum cartridge has deteriorated or is damaged.</p>	<p>Replace the drum cartridge with a new one. Refer to "Replacing Drum Cartridges R1, R2, R3, or R4" (P.63).</p>
	<p>High-voltage power supply may have malfunctioned.</p>	<p>Contact Customer Support at dell.com/contactdell.</p>
<p>Nothing is printed.</p> 	<p>Two or more sheets of paper are being fed simultaneously (double-feed).</p>	<p>Fan the paper well and load it again. Refer to "Loading Paper" (P.47).</p>
	<p>No toner remains in the toner cartridge.</p>	<p>Replace the toner cartridge with a new one. Refer to "Replacing Toner Cartridges" (P.58).</p>
	<p>Power supply or high-voltage power supply may have malfunctioned.</p>	<p>Contact Customer Support at dell.com/contactdell.</p>

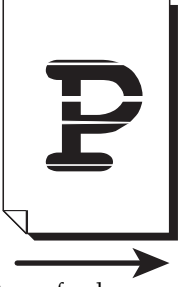
Symptom	Cause	Remedy
<p>White areas or white or colored stripes appear.</p> 	<p>The machine interior (LED printheads) may be soiled.</p>	<p>Clean the interior. Refer to "Cleaning the Interior (LED Printheads)" (P.70).</p>
	<p>The paper is damp.</p>	<p>Replace the paper with new one. Refer to "Loading Paper" (P.47).</p>
	<p>The paper is unsuitable.</p>	<p>Load suitable paper. Refer to "Loading Paper" (P.47).</p>
<p>The entire output is faint.</p> 	<p>When Tray 5 is used, the size and type of the loaded paper are different from the settings on the print driver.</p>	<p>Load paper of the correct type and size into Tray 5. Refer to "Loading Paper in Tray 5 (Bypass Tray)" (P.48).</p>
	<p>Two or more sheets may be fed simultaneously.</p>	<p>Fan the paper well and load it again. Refer to "Loading Paper" (P.47).</p>
<p>Paper becomes wrinkled.</p> 	<p>The paper is unsuitable.</p>	<p>Replace the paper with new one.</p>
	<p>Paper has been added to the paper loaded.</p>	<p>Refer to "Loading Paper" (P.47).</p>
	<p>The paper is damp.</p>	
<p>Text is blurred.</p> 	<p>The paper is unsuitable.</p>	<p>Replace the paper with new one.</p>
	<p>Paper has been added to the paper loaded.</p>	<p>Refer to "Loading Paper" (P.47).</p>
	<p>The paper is damp.</p>	

Symptom	Cause	Remedy
<p>White or color patches appear vertically.</p>  <p>Paper feed direction</p>	<p>The drum cartridge has deteriorated or is damaged.</p> <p>No toner remains in the toner cartridge.</p> <p>The machine interior (LED printheads) may be soiled.</p>	<p>Replace the drum cartridge with a new one. Refer to "Replacing Drum Cartridges R1, R2, R3, or R4" (P.63).</p> <p>Replace the toner cartridge with a new one. Refer to "Replacing Toner Cartridges" (P.58).</p> <p>Clean the interior. Refer to "Cleaning the Interior (LED Printheads)" (P.70).</p>
<p>Text or images are printed at an angle.</p> 	<p>The paper guides in the paper tray are not set in the correct positions.</p>	<p>Adjust the horizontal and vertical paper guides to the correct positions. Refer to "Loading Paper" (P.47).</p>

Trouble during Copying

This section describes how to resolve copy problems.

Unable to Copy

If you cannot copy a document, identify the symptom in the following table to perform the remedy.

Symptom	Cause	Remedy
The document is not correctly fed from the document feeder.	The document is too small.	The minimum size of document that can be loaded on the document feeder is 125 x 85 mm (A5, A5 ). Refer to "3 Copy" > "Copying Procedure" in the User Guide.
	The document type is unsuitable.	The document feeder does not feed irregular sized documents, business cards, transparencies, or thin documents. In addition, the document feeder does not feed documents with sticky tags, paper clips, or adhesive tape. Refer to "3 Copy" > "Copying Procedure" in the User Guide.
	The document guides are set in incorrect positions.	Adjust the document guides to the document. Refer to "3 Copy" > "Copying Procedure" in the User Guide.
	A piece of torn paper remains in the document feeder.	Open the document feeder cover, and remove the piece. Refer to "Document Jams" (P.504).
	Documents of mixed sizes are loaded.	When loading documents of mixed sizes, be sure to set [Mixed Size Originals] to [On]. Otherwise, a paper jam will occur. Refer to "3 Copy" > "Layout Adjustment" > "Mixed Size Originals (Scanning Different Size Documents Simultaneously)" in the User Guide.

The Copy Result is Not What was Expected

If the copy result is not what was expected, identify the symptom in the following table to perform the remedy.

Symptom	Cause	Remedy
The copy is dirty.	The document glass or the document cover is soiled.	Clean the document glass or the document cover. Refer to "Cleaning Document Cover and Document Glass" (P.72).
	The document is a transparent type such as a transparency film.	If the document is transparent, dirt on the document cover may be copied. Place a white sheet of paper on top of the document when copying.
	The document is colored, rough, or a blueprint.	The paper's background color is copied. Adjust the copy density or image quality, or specify [Suppress Background].
	The document is glossy printing paper.	Glossy printing paper easily sticks to the document glass, and shadows are sometimes copied, soiling the image. Place a transparency film under the document when copying.
The copy is too dark or light.	The copy density is set to [Darken] or [Lighten].	Adjust the copy density. Refer to "3 Copy" > "Image Quality" in the User Guide.
	The document density is too light.	Adjust the copy density. Refer to "3 Copy" in the User Guide.
	The setting for [Original Type] is inappropriate for the document.	Copy black text. If the printout is too light, select [Text] for [Original Type]. Refer to "3 Copy"> "Image Quality" in the User Guide.
The color of the document and of the copy differ.	Is the color calibration incorrect?	Execute auto calibration. Refer to "Executing Calibration" (P.75).
	The document type selected is not suitable.	Set the suitable value for [Original Type]. Refer to "3 Copy"> "Image Quality" > "Original Type (Selecting the Document Type)" in the User Guide.
	The image quality selected is unsuitable for the document.	Copy black text. If the printout is too light, select [Text] for [Original Type]. Refer to "3 Copy"> "Image Quality" in the User Guide.
The copy is slightly misaligned.	Paper is misaligned in the tray.	Align the paper edges, and adjust them to the tray's top corners to reload the paper. Refer to "Loading Paper" (P.47).

Symptom	Cause	Remedy
Part of the image is missing on the copy.	The paper is damp.	If the paper is damp, the copy image may be partially missing or unclear. Replace the paper with new one. Refer to "Loading Paper" (P.47).
	Folded or wrinkled paper is included in the tray.	Remove the unsuitable paper or replace all of the paper with new one. Refer to "Loading Paper" (P.47).
	The document is pasted or folded.	The pasted or folded section may not be laying flat on the document glass. Place a stack of white sheets on top of the document to flatten the document against the document glass.
The copy has a stripe pattern.	The document enlargement ratio is too large.	Vertical stripes may be printed on the copies depending on the ratio. Adjust the ratio to eliminate the stripes. Refer to "3 Copy" > "Copy" > "Reduce/Enlarge (Making Enlarged/Reduced Copies)" in the User Guide.
The copy is misaligned or skewed.	The document is not loaded correctly.	Load the document correctly. Refer to "3 Copy" > "Copying Procedure" in the User Guide.
	The document guides on the document feeder are not set in the correct positions.	Load the document correctly, and align the document guides to the document. Refer to "3 Copy" > "Copying Procedure" in the User Guide.
	The paper tray is not inserted correctly.	Firmly push in the tray until it stops to set it properly. Refer to "Loading Paper" (P.47).
	The paper guides in Tray 5 are not set in the correct positions.	Load the paper correctly, and align the paper guides to the paper edges. Refer to "Loading Paper in Tray 5 (Bypass Tray)" (P.48).

Symptom	Cause	Remedy
Unable to copy with the specified size.	The document glass or the document cover is dirty.	Clean the document glass or the document cover. Refer to "Cleaning Document Cover and Document Glass" (P.72).
	The document is a transparent type such as a transparency film.	Place a white sheet of paper on top of the document when copying.
	The document is misaligned.	Load the document correctly. Refer to "3 Copy" > "Copying Procedure" in the User Guide.
	The document guides on the document feeder are not set in the correct positions.	Load the document correctly, and align the document guides to the document. Refer to "3 Copy" > "Copying Procedure" in the User Guide.
	The document is a non-standard size.	Specify the document size, and then copy. Refer to "3 Copy" > "Copying Procedure" in the User Guide.
	The document is folded.	Flatten the curl and load the document again. Refer to "3 Copy" > "Copying Procedure" in the User Guide.
Unable to copy in color.	[Output Color] is set to [Black & White].	Set [Output Color] to [Auto Detect] or [Color]. Refer to "3 Copy" > "Copy" > "Output Color (Selecting the Color for Copying)" in the User Guide.
The document edges are missing on the copy.	The document is larger than the printable area.	Adjust [Reduce / Enlarge] to copy the document smaller.
Outputs are not stapled.	The Finisher is not attached.	The Finisher is required to staple. Install the Finisher, or change the print option settings to cancel stapling.
	The number of pages to be stapled exceeds the maximum number for stapling.	You cannot staple more than 50 pages. Reduce the number of pages to 50 or fewer.

Trouble during Printing

This section describes how to resolve print problems.

Unable to Print

If you cannot print a document, identify the symptom in the following table to perform the remedy.

Symptom	Cause	Remedy
Data remains in the printer icon.	The machine is not powered on.	Switch the main power and power on.
	The network cable is disconnected from the computer.	Connect the network cable to the computer.
	The network cable is disconnected from the machine.	Connect the network cable to the machine. Refer to "Interface Cables" (P.19).
	The print mode is [Off-line] on the machine.	Press the <Machine Status> button to check the [Print Mode] on the [Machine Status] screen. If [Print Mode] is set to [Off-line], select [On-line].
	An error occurred in the machine.	Check the error details and take an appropriate action.
	The IP address or SMB network path is not correctly set.	Set the correct IP address or SMB network path. Refer to "Printer Environment Settings" (P.281).
	The network between the computer and machine is abnormal.	Check with your network administrator.
	The port is not enabled.	Enable the port. Refer to "Port Settings" (P.168).
	The hard disk space of the machine is insufficient.	Delete unnecessary data such as stored documents (Charge Print, Private Charge Print, and Secure Print) in folders to increase free space.
	The machine is connected to multiple computers.	Wait for a while, and then try printing again.
The data has been sent to the machine.	The machine is out of paper.	Load paper in the machine.
	No paper is loaded for the specified paper size.	Load paper of the size specified. Refer to "Loading Paper" (P.47).
	Printing is interrupted by a copy operation.	Cancel the interrupting operation.
	An error occurred in the machine.	Check the error details and take an appropriate action.

The Print Result is Not What was Expected

If the print result is not what was expected, identify the symptom in the following table to perform the remedy.

Symptom	Cause	Remedy
Cannot print in color.	[Output Color] is set to [Black & White].	Set [Output Color] to [Auto Detect] or [Color].
Outputs are not stapled.	The Finisher is not installed.	The Finisher is required to staple. Install the Finisher, or change the print option settings to cancel stapling.
	The number of pages to be stapled exceeds the maximum number for stapling.	You cannot staple more than 50 pages. Reduce the number of pages to 50 or fewer.
The document is printed on a different paper size than specified.	The document size is different from the paper size loaded in the specified tray.	Change the size of paper in the tray, or change the print option to specify a tray that contains the correct sized paper.
The image on the document edges is missing on the output.	The image is larger than the printable area.	Expand the printable area of the machine, or reduce the image size on the printout.
The printed font differs from the font specified on the computer.	Font replacement is set on the print driver.	Check the font replacement table.
The printout is not offset.	The machine does not offer the Offset feature.	To output offset, the Offset Stacking Module or the Finisher is required.
Printing is slow.	[High Resolution] is selected for [Image Quality].	When image data, such as photos, is printed with the high resolution, the print speed becomes slow. Select [Standard] for [Image Quality].
The specified print options are not enabled.	The print driver for another model is used.	Install the print driver for the model.
	The required optional kit is not installed on the machine.	Check the optional components installed on the machine, and set [Installable Options] under [Configuration] in the print driver again.
The document edges are missing on the printout.	The image is larger than the printable area.	Expand the printable area of the machine, or reduce the image size on the printout.
The output color differs between Secure Print and Print Stored File.	This is because the print path is different. The output color of Print Stored File is reproduced by the presence or absence of dots, as with copying or faxing. On the other hand, the output color of Secure Print is reproduced using density by default, as with printing.	To closer match the color of Secure Print and files in folder, select [On] in [Image Options] > [Print Page Mode] on the [Advanced] tab of the print driver settings.

Symptom	Cause	Remedy
The print color differs from before.	The color calibration is incorrect.	Execute auto calibration. Refer to "Executing Calibration" (P.75).
Black lines are printed.	The job is output from a print driver for another machine.	Output the job from a print driver for the machine to be used for printing.

Trouble during Faxing

This section describes how to resolve fax problems.

- Note**
- For troubles during Internet faxing, refer to "E-mail Features Problems" (P.415).
 - An optional component is required to use the Fax features. For more information, contact Customer Support at dell.com/contactdell.

Sending Problems

If you cannot send a fax, identify the symptom in the following table to perform the remedy.

Symptom	Cause	Remedy
A Transmission Report - Job Undelivered is output.	The fax was not sent because of an error.	Check the Transmission Results in the Transmission Report - Job Undelivered. If a status code is displayed, refer to "Status Code" (P.422).
Unable to communicate (general fax)	The phone line is not connected correctly.	The machine is equipped with connectors to which to connect phone lines. Communication is enabled only when the phone line is connected to the correct connector. When the cable connection is correct, the On-hook feature allows you to call via general lines.
	The phone dialing method is not available.	Specify the same dialing method as the one (Tone/10pps) subscribed for the machine.
	An error occurred with the phone line.	Use a telephone near the machine to check whether you can make a phone call. If the phone call is disabled, the problem is in the phone line, not in the machine.
	The destination machine is abnormal.	The data cannot be sent if the machine of the recipient is turned off, is set to "manual" receiving mode, or does not support G3 reception. Call the recipient to confirm the machine condition.
	An incorrect fax number is used.	Check the fax number and try sending again.
	The number is not for fax number.	If no peep sound is heard from the receiver when you call the number, the number is not for a fax number.
	You forgot the external access number.	When calling from an extension line, the external access number is required. When dialing, dial the external access number such as "0", and then dial the fax number. When the switchboard is changed and you cannot send faxes, try the external access number "0*" instead of "0".

Symptom	Cause	Remedy
Unable to communicate (general fax)	When calling from an abbreviated telephone number, an external access number is appended.	When calling from an abbreviated telephone number to an external line, an external access number such as "0" may be registered for the abbreviated telephone number. Confirm the telephone number of the receiver on the Transmission Report - Job Undelivered.
	You are using a feature such as the Polling feature that is not supported by the destination fax.	Confirm whether the destination fax supports the feature.
	The Authentication/Accounting feature is being used and the fax is being sent directly from the computer.	When the Authentication/Accounting feature is used and you send a fax directly from the computer, you must set the user ID and passcode registered on the machine to the fax driver. For details on the Authentication/Accounting feature, refer to "Authentication and Accounting Features" (P.343). For details on how to directly send a fax from the computer, refer to "12 Computer Operations" > "Sending Fax" in the User Guide.
The image quality is poor.	The document glass is dirty.	Clean the document glass. Refer to "Cleaning Film and Constant Velocity Transport Glass" (P.72).
	The fax density is inappropriate.	Adjust the fax density. Refer to "4 Fax" > "Fax/Internet Fax" in the User Guide.
	The sender's machine has a problem.	Confirm with the sender. Note • Image quality may be affected by a problem of the sender's machine, not just by a problem of the machine.

Receiving Problems

If you cannot receive a fax, identify the symptom in the following table to perform the remedy.

Symptom	Cause	Remedy
Unable to communicate (general fax)	The phone line is not connected correctly.	The machine is equipped with connectors to which to connect phone lines. Communication is enabled only when the phone line is connected to the correct connector. When the cable connection is correct, the On-hook feature allows you to call via general lines.
	An error occurred with the phone line.	Use a telephone near the machine to check whether you can make a phone call. If the phone call is disabled, the problem is in the phone line, not in the machine.
	The machine is turned off.	The machine cannot receive a fax when turned off. Switch the main power and power on.
	No paper is set.	Load paper in the machine to receive faxes.
	Paper is jammed.	Follow the instructions displayed on the control panel to remove the jammed paper. Refer to "Paper Jams" (P.495).
	The machine is in the System Administration mode.	The machine cannot receive a fax in the System Administration mode. Exit the System Administration mode.
	A machine password has been set.	When a machine password has been set, the machine accepts only data or polling fax sent with the correct machine password in F code.
	The machine is in manual receive mode.	Receive the fax manually, or set [Fax Receiving Mode] to [Auto Receive]. Refer to "Fax Receiving Mode" (P.98).
	The machine is in manual send mode.	To use Fax information service, set the reception mode to [Manual Send] on the on-hook screen, enter an information code, and press the <Start> button.
The document is not correctly loaded on the sender's machine.	Check with the sender. Note • Image quality may be affected by a problem of the sender's machine, not just by a problem of the machine.	

Symptom	Cause	Remedy									
<p>The image quality is poor.</p>	<p>The drum cartridge is damaged.</p>	<p>Copy a document. If the image quality is poor, replace the drum cartridge with a new one. Refer to "Replacing Drum Cartridges R1, R2, R3, or R4" (P.63).</p>									
	<p>The document glass of the sender's machine is dirty.</p>	<p>Check with the sender. Note • Image quality may be affected by a problem of the sender's machine, not just by a problem of the machine.</p>									
	<p>The resolution setting on the sender's machine is too low.</p>	<p>Check with the sender. Note • Image quality may be affected by a problem of the sender's machine, not just by a problem of the machine.</p>									
<p>The one-page document is received split into multiple pages.</p>	<p>When scanned on the sender's machine, the document was enlarged for some reason.</p>	<p>You can set the machine to process such a document by using the Auto Reduce on Receipt feature and a border limit value for page splitting. According to the setting combination specified, the received document is printed as follows:</p> <table border="1" data-bbox="938 931 1430 1391"> <thead> <tr> <th data-bbox="938 931 1099 1088">Auto Reduce on Receipt / Page Split Border Limit</th> <th data-bbox="1099 931 1262 1088">Auto Reduce on Receipt ON</th> <th data-bbox="1262 931 1430 1088">Auto Reduce on Receipt OFF</th> </tr> </thead> <tbody> <tr> <td data-bbox="938 1088 1099 1283">Within border limit</td> <td data-bbox="1099 1088 1262 1283">Automatically reduces image size and prints it on one page.</td> <td data-bbox="1262 1088 1430 1283">Trims the portion exceeding standard size and then prints.</td> </tr> <tr> <td data-bbox="938 1283 1099 1391">Exceeding border limit</td> <td data-bbox="1099 1283 1262 1391">Splits data at equal ratio and prints.</td> <td data-bbox="1262 1283 1430 1391">-</td> </tr> </tbody> </table> <p>Refer to "Border Limit" (P.208), or "Auto Reduce On Receipt" (P.208).</p>	Auto Reduce on Receipt / Page Split Border Limit	Auto Reduce on Receipt ON	Auto Reduce on Receipt OFF	Within border limit	Automatically reduces image size and prints it on one page.	Trims the portion exceeding standard size and then prints.	Exceeding border limit	Splits data at equal ratio and prints.	-
Auto Reduce on Receipt / Page Split Border Limit	Auto Reduce on Receipt ON	Auto Reduce on Receipt OFF									
Within border limit	Automatically reduces image size and prints it on one page.	Trims the portion exceeding standard size and then prints.									
Exceeding border limit	Splits data at equal ratio and prints.	-									
<p>Although the Folder Selector feature is set, however, the received document is printed, and cannot be stored in the folder.</p>	<p>An unregistered folder is specified on the Folder Selector feature.</p>	<p>When using the Folder Selector feature, specify a registered folder. If an unregistered folder is selected, the received document cannot be stored in the folder, and will be automatically printed. For information on how to register the folder, refer to "Create Folder" (P.231). For information on the setting of the Folder Selector, refer to "Fax Received Options" (P.211).</p>									

Trouble during Scanning

This section describes how to resolve scan problems.

Unable to Scan with the Machine

If you cannot scan with the machine, identify the symptom in the following table to perform the remedy.

Symptom	Cause	Remedy
The document is not correctly fed from the document feeder.	The document is too small.	The minimum size of the document that can be loaded on the document feeder is 125 x 85 mm (Standard size: A5, A5 ). Refer to "5 Scan" > "Scanning Procedure" in the User Guide.
	The document type is unsuitable.	The document feeder does not feed irregular sized documents, business cards, transparencies, or thin documents. In addition, the document feeder does not feed documents with sticky tags, paper clips, or adhesive tape. Refer to "5 Scan" > "Scanning Procedure" in the User Guide.
	The document guides are set in incorrect positions.	Adjust the document guides to the document. Refer to "5 Scan" > "Scanning Procedure" in the User Guide.
	A piece of torn paper remains in the document feeder.	Open the document feeder cover, and remove the piece. Refer to "Document Jams" (P.504).
	Documents of mixed sizes are loaded.	When loading documents of mixed sizes, be sure to set [Mixed Size Originals] to [On]. Otherwise, a paper jam will occur. Refer to "5 Scan" > "Layout Adjustment" in the User Guide.

Unable to Import Scanned Documents to the Computer

If you cannot import scanned documents to the computer, identify the symptom in the following table to perform the remedy.

Symptom	Cause	Remedy
Unable to find the scanner.	The machine is not turned on.	Switch the main power and power on.
	The network cable is disconnected from the computer.	Connect the network cable to the computer.
	The network cable is disconnected from the machine.	Connect the network cable to the machine. Refer to "Interface Cables" (P.19).
	The network between the computer and machine is abnormal.	Check with your network administrator.
Unable to open a folder.	The folder is unregistered.	Register the folder. Refer to "Create Folder" (P.231).
	The folder passcode has been forgotten.	The passcode cannot be retrieved. Set the passcode to [Off], and then set the passcode again. Refer to "Create Folder" (P.231).
Unable to import data from the scanner because of a TWAIN transmission error.	The scan driver is not installed.	Install the scan driver.
Operation terminates during scanning.	The file size is too large.	Lower the resolution, and import again. Refer to "5 Scan" > "Layout Adjustment" in the User Guide.

Unable to Send a Scanned Document over the Network (FTP/SMB)

If you cannot send a scanned document over the network, identify the symptom in the following table to perform the remedy.

Symptom	Cause	Remedy
A Transmission Report - Job Undelivered is output.	Unable to transmit because of the error.	Check the Transmission Results in the Transmission Report - Job Undelivered. If a status code is displayed, refer to "Status Code" (P.422).
Unable to send data over the network.	The server is not correctly specified.	Correctly specify the server.
	The save destination is not correctly specified.	Correctly specify the save destination.
	When SMB is selected, the shared name is not correctly specified.	Correctly specify the shared name.
	When SMB (UNC Format) is selected, the save destination is not correctly specified.	Correctly specify the save destination.
	The login name is not entered correctly.	Correctly enter the login name.
	The password is not correctly entered.	Correctly enter the password.
	The time set on the machine does not agree with that of Windows, when SMB transmission is performed to Windows Server 2003 or Windows Server 2008.	Synchronize the time settings of the machine and Windows.
	On Windows Server 2003, Windows Server 2008, or Windows XP, users who do not set a password cannot use SMB transmission.	Follow the steps below to change the settings of network access: <ol style="list-style-type: none"> 1. Start Windows, and select [Control Panel] > [Administrative Tools] > [Local Security Policy]. 2. Select [Security Settings] > [Local Policies] > [Security Options]. 3. Change [Account: Limit local account use of blank passwords to console logon only] to [Disabled].
	Is the root of the DFS name space (\\Domain name\Shared name) specified with more than three characters.	Specify a DFS name space with a root comprised of less than four characters.

Unable to Send E-mail

If you cannot send a scanned document using the E-mail feature, identify the symptom in the following table to perform the remedy.

Symptom	Cause	Remedy
A Transmission Report - Job Undelivered is output.	Unable to transmit because of an error.	Check the Transmission Results in the Transmission Report - Job Undelivered. If the status code is displayed, refer to "Status Code" (P.422).
Unable to send e-mail.	The mail address is incorrect.	Enter the correct mail address.
	The data size exceeded the maximum e-mail size.	Change the maximum e-mail size, or lower the resolution. Refer to "Maximum Total Data Size" (P.217), or "5 Scan" > "Layout Adjustment" in the User Guide.

The Image is not What was Expected

If the image is not what was expected, identify the symptom in the following table to perform the remedy.

Symptom	Cause	Remedy
The image is dirty.	The document glass or the document cover is soiled.	Clean the document glass or the document cover. Refer to "Cleaning Document Cover and Document Glass" (P.72).
	The document is a transparent type such as a transparency film.	If the document is transparent, dirt on the document cover may be copied on the image. Place a white sheet of paper on top of the document when scanning.
	The document is colored, rough, or a blueprint.	Adjust the copy density or image quality when scanning.
	The document is glossy printing paper.	Glossy printing paper easily sticks to the document glass, and shadows are sometimes scanned, soiling the image. Place a transparency film under the document when scanning.
The image is too dark, or too light.	The scan density is set to [Darken] or [Lighten].	Adjust the scan density. Refer to "5 Scan" > "Advanced Settings" in the User Guide.
	The setting for [Original Type] is inappropriate for the document.	Select an image quality appropriate for the document. Refer to "5 Scan" > "Advanced Settings" in the User Guide.
Part of the image is missing.	The document is pasted or folded.	The pasted or folded section may not be laying flat on the document glass. Place a stack of white sheets on top of the document to flatten the document against the document glass.

Symptom	Cause	Remedy
The image is not the desired size.	The document glass or the document cover is dirty.	Clean the document glass or the document cover. Refer to "Cleaning Document Cover and Document Glass" (P.72).
	The document is a transparent type such as a transparency film.	Place a white sheet of paper on top of the document when scanning.
	The document is misaligned.	Load the document correctly. Refer to "5 Scan" > "Scanning Procedure" in the User Guide.
	The document guides on the document feeder are not set in the correct positions.	Load the document correctly, and align the document guides to the document. Refer to "5 Scan" > "Scanning Procedure" in the User Guide.
	The document is a non-standard size.	Specify the document size. Refer to "5 Scan" > "Scanning Procedure" in the User Guide.
	The document is folded.	Flatten the curl and load the document again. Refer to "5 Scan" > "Scanning Procedure" in the User Guide.
The image is not scanned in color.	[Color Scanning] is set to [Black & White], or [Grayscale].	Set [Color Scanning] to [Color]. Refer to "5 Scan" > "E-mail" in the User Guide.
The image is coarse.	The resolution is too low.	Set the resolution higher. Refer to "5 Scan" > "Layout Adjustment" in the User Guide.
	Image is saved with high compression.	Select a lower compression ratio in [Quality / File Size]. Refer to "5 Scan" > "E-mail Options/Filing Options" in the User Guide.
Black-and-white gradation is not reproduced properly.	[Black & White] is selected for [Color Scanning].	Set [Color Scanning] to [Grayscale]. Refer to "5 Scan" > "E-mail" in the User Guide.

Network-related Problems

This section describes how to resolve network related problems.

When using SMB

When SMB is used, identify the symptom in the following table to perform the remedy.

When you cannot communicate with the machine

Cause	Check point	Remedy
The computer and the machine are using different protocols.	Although [Search for Other Computers] under [Start] > [Search] > [Other Computers] on the computer is displaying the machine, [Network Computer] does not display the machine.	Configure the machine and each computer to use the same SMB operational protocol.
The machine belongs to different network (subnet).	Although [Search for Other Computers] under [Start] > [Search] > [Other Computers] on the computer is displaying the machine, [Network Computer] does not display the machine.	If the machine and the computers are set to different networks, consult your network administrator.
The host name specified for the machine is already in use.	Print out Configuration Report to confirm whether "Repetitive Host Name" is printed in the SMB status information.	Use Dell Printer Configuration Web Tool to change the host name to a unique name, or restore the machine settings to the default settings.

When you cannot communicate with the machine or other SMB machines

Cause	Check point	Remedy
If [Auto Master Mode] of SMB is set to [On], the number of machines whose information can be stored is limited. The number depends on the network environment.	The machine or other SMB machines cannot be searched from the Network Computers icon.	Confirm the setting of [Auto Master Mode] of SMB. If the setting is enabled, change it to [Off].

When you cannot print

Cause	Check point	Remedy
The machine is processing a print job from a different computer. (When [SMB (Spool)] is set to [Off])	Confirm whether the machine is processing a print job. (A write error dialog is displayed to indicate that there is no room to store your print job.)	Wait until the machine completes processing the print job, or change the machine setting to the [Spool] mode.
The connections to the machine exceeded the maximum number allowed.	Confirm whether the machine is processing simultaneous requests (print requests, status queries, etc.) from multiple computers. (A write error dialog is displayed to indicate that no more remote computers can be connected.)	Wait for a while and try printing again.

When you cannot delete documents from the [Print] window

Cause	Check point	Remedy
You are trying to delete all print data displayed in the [Print] window. (Only the system administrator is allowed to delete all data.)	Confirm whether you are trying to delete the print data from the [Print] menu. ([Cancel All Documents] menu.)	Select the print data to delete, and delete from the [Document] menu in the [Print] window. (Select [Cancel].)
The print data has a different owner.	Confirm whether the name displayed as the owner for the selected print data and the user's login name to Windows are the same.	Login to Windows using the name displayed as the owner of the print data, and then delete the print data.

Others

Symptom	Remedy
The message "Unknown document name" is displayed for the job name in the job history instead of the correct job name.	Change the setting of the SMB receiving buffer to [Hard Disk Spool] or [Memory Spool].

When using NetWare

The possible causes, check points, and remedies for problems when using NetWare are as follows:

When you cannot print

Cause	Check point	Remedy
Network equipment, such as hubs, does not support automatic frame type detection.	Confirm whether the data link indicator of the network equipment port to which the machine is connected is lit. Confirm whether the frame types used by the file servers on the network are standardized.	Specify the frame type set on the connected file server as the frame type for the machine.
A problem occurred on the network between the computer and the machine.	Use NWADMIN on the computer to confirm whether the machine object can be browsed.*	Replace the faulty network cable connected between the computer and the machine.
Job sender (user or group name) is not specified in [User] for the print queue.	Use NWADMIN from a computer to confirm whether the print queue object's [User] information lists the job sender (user or group name).*	Re-send the print data to the print queue for which the job sender (user or group name) is registered as the [User].
		Use NWADMIN from a computer to register job sender (user or group name) to [User] of [Print Queue].*
Job transmission to the print queue is prohibited.	Use PCONSOLE to confirm whether [User can register to the queue] is set to [Yes] under [Current Queue Status] of [Print Queue].	Use PCONSOLE to set the item to [Yes].
	Use NWADMIN on the computer to confirm whether the operator flag is being confirmed with [Recognition] of the print queue.*	Use NWADMIN on a computer to confirm whether each item of the operator flag is being confirmed with [Recognition] of the print queue.*
Job sender (user or group name) is not specified in the user setting for the print server.	Use NWADMIN from a computer to confirm that the print server's [User] information lists the job sender (user or group name).*	Re-send the print data to the print queue whose [User] of [Print Server Information] includes the job sender (user or group name).
		Use NWADMIN from a computer to register job sender (user or group name) to [User] information of the print server.*
The print queue where the user has transmitted the print data, is not assigned to the machine.	Use NWADMIN from a computer to check the print queue's [Assignment] whether the machine is assigned in the printer list serviced by the print queue.*	Re-send the print data to the print queue which is assigned to the machine.*
		Use NWADMIN from a computer to add the print queue to the machine.*

Cause	Check point	Remedy
Print data format and the print environment settings on the computer do not match.	-	If the computer is running on Windows, set it not to output Ctrl-D.
The number of print queues set for the machine exceeds the maximum number allowed.	Use NWADMIN from a computer to check on the print queue list of [Assignment] for the machine whether the desired print queue is assigned.*	Re-send the print data to the print queue which is assigned to the machine.*
The slave file server is not configured. ([Bindery Service] mode)	Use PCONSOLE from a computer to confirm whether the slave file server is registered to [Service NetWare Server] on the print server indicated by [Print Server Information].*	Use PCONSOLE from computer to register the slave file server and reflect the configured settings.*
The slave file server configuration is mismatched. ([Bindery Service] mode)	Use PCONSOLE from a computer to confirm whether the printer type is set to [Defined Elsewhere] under [Print Server Information] > [Printer] > [Printer xxx Environment Settings].*	If the printer type is not set to [Defined Elsewhere], change it to [Defined Elsewhere], and then reflect the configured settings.*
The form number on the print data and the form number set to the printer do not match.	Use NWADMIN on a computer to select the machine and confirm whether the start number of the form in the environment settings matches the number in the print data.*	Use NWADMIN from a computer to match the [Start Form] number in the machine's environment settings to the number in the print data.*
The level settings for the IPX checksum do not match.	Use the set command from the console screen on the file server to confirm whether the IPX checksum is set to level 2.	Enter the following command from the console screen on the file server to set the IPX checksum to either level 0 or level 1. set Enable IPX Checksum=x (x = 0 or 1)
The level settings for the NCP packet signature do not match.	Use the set command from the console screen on the file server to confirm whether the NCP packet signature is set to level 3.	Enter the following command from the console screen on the file server to set the NCP packet signature to either level 0, 1, or 2, and restart the file server. set NCP Packet Signature Option=x (x = 0, 1, or 2)
The default device name is incorrect.	Print the Configuration Report to confirm the last 6 digits (3 bytes) of the Ethernet address.	Set the device name using the correct Ethernet address.
		Set a device name differing from the default name.
The directory tree name is not configured.	Print Configuration Report to confirm whether the tree name is specified.	Set the tree name.

Cause	Check point	Remedy
The context is not set.	Print Configuration Report to confirm whether the context is specified.	Set the context.
Connected to a different printer object.	Use NWADMIN from a computer to confirm, on the layout information of the print server, whether the correct object is assigned.*	Use the Driver CD Kit from a computer to correctly set the file server name/tree name/context/active mode.
		Use Dell Printer Configuration Web Tool from a computer to correctly set the file server name/tree name/context/active mode.
The NetWare port on the machine is not activated.	Print Configuration Report to confirm whether the NetWare port is activated.	Select the [Enabled] check box of [NetWare] to activate the port.
The file server is down.	Search for the file server on [Network Neighborhood].	Start the file server.
There is another device on the network with an identical device name.	Turn off the machine and use NWADMIN from a computer to confirm whether the status of the relevant printer object is "Standby".	Use the Driver CD Kit from a computer to set a different device name.
The NetWare port is not activated.	Print Configuration Report to confirm whether the network number is "0000000" (NetWare server is down), if using IPX/SPX. If using TCP/IP, confirm whether the IP address is "0.0.0.0" (static address unspecified, or the DHCP server is down).	In the case of IPX/SPX, start the NetWare server. In the case of TCP/IP, either set a static IP address or start the DHCP server.

* :For more information on configuration and operations, refer to NetWare Online Documentation.

When "Switch the machine off" is displayed

Cause	Check point	Remedy
A NetWare problem occurred.	-	Restart the machine. Wait until the screen completely goes out to switch on the machine power.

When print result is not what was expected

Cause	Check point	Remedy
The printer language of the print data and the printer language configured on the machine are different.	Confirm the printer language on the machine.	Match the printer language of the print data and the printer language configured on the machine.

When no notification is received

The possible causes, check points, and remedies when a computer that instructed a print job does not receive notification are as follows:

When the printing problems are not notified

Cause	Check point	Remedy
The user is not listed on the print server notification recipient list.	Use PCONSOLE on the computer to confirm whether the job user or user's group is registered under [Print Server Information] > [Printer] > [Printer xxx Environment Settings] > [Notify].	Add the name of the job user or the name of the user's group to [Notify].

When the completion of the job is not notified

Cause	Check point	Remedy
The [Notify] option was not specified when the computer transmitted the print data.	Confirm whether the [Notify] option is specified when transmitting the print data.	Specify the [Notify] option when transmitting the print data.
Netware command [CASTOFF] has been executed on the computer.	-	Execute the NetWare command [CASTON] on the computer.

When using TCP/IP

The possible causes, check points, and remedies when using TCP/IP (LPD) are as follows.

Windows XP, Windows Vista, Windows 7, Windows 8, Windows Server 2003, Windows Server 2008, Windows Server 2008 R2, or Windows Server 2012

When you cannot print

Cause	Check point	Remedy
The IP address is incorrect.	Request your network administrator to check the machine's IP address.	Set a correct IP address on the machine.
The volume of the print data sent in an instruction from a computer exceeded the maximum receivable volume when the LPD spool is set to memory spool.	Confirm the memory amount for the LPD spool and the volume of the print data transmitted by an instruction.	If the one file of print data exceeds the memory amount, divide the file not to exceed the amount.
		If the print data is divided into multiple files and exceeds the memory amount, decrease the number of files not to exceed the amount.
An unrecoverable error occurred during the printing process.	Confirm whether any error messages are displayed on the control panel.	Restart the machine. Wait until the screen completely goes out to switch on the machine power.
The machine is not set to the transport protocol corresponding to the computer.	Confirm the transport protocol selected on the machine.	Select the transport protocol corresponding to the computer.
The machine is trying to process a data format that does not match the data format of the print data transmitted from a computer.	-	Set not to output Ctrl-D.

When print result is not what was expected

Cause	Check point	Remedy
Selected printer language on the machine does not match the printer language of the print data.	Confirm the selected printer language on the machine and the printer language of the print data.	Select the printer language on the machine to match the print data.
The computer is not using the print driver supplied with the machine (is using another company's print driver).	Confirm whether the print driver on the computer is the one supplied with the machine.	On the computer, select the print driver supplied with the machine. If the print driver is not listed for selection, install the print driver and then select it. Operation is not guaranteed if another company's print driver is used.

Mac OS X 10.5/10.6/10.7/10.8**When you cannot print**

Cause	Check point	Remedy
The LPD port is not activated.	Confirm whether the LPD port is activated.	When printing with a printer detected by using Bonjour, select the [Enabled] check box of [LPD] to activate the port.

When using EtherTalk

The possible symptoms, causes, and remedies for problems when using EtherTalk are as follows:

Cause	Check point	Remedy
Documents are printed by another machine.	If a machine assigned the same printer name already existed on the network, the printer names is automatically changed when starting the machine. Therefore, depending on the timing of starting the printer, the machine may be started with a different name, and documents are printed by another machine.	A machine that is assigned the same printer name may exist on the network. Confirm the printer name, and change the name if it is duplicated.
The printer cannot be browsed from clients.	If the machine is turned on before it is connected to a network, clients may not be able to identify the printer name and therefore cannot browse the printer.	Turn the machine on after connecting to the network. If the machine is turned on while disconnected from the network, turn the machine off, connect it to the network, and then turn the machine on again.

Dell Printer Configuration Web Tool Problems

The possible symptoms and remedies for problems when using Dell Printer Configuration Web Tool are as follows:

Symptom	Remedy
Cannot connect to Dell Printer Configuration Web Tool.	Is the machine working properly? Check whether the machine is turned on.
	Is Internet Services (HTTP) port activated? Print Configuration Report to confirm.
	Is the Internet address correctly entered? Confirm the Internet address again. If the problem persists, enter an IP address to connect to Dell Printer Configuration Web Tool.
	Is a proxy server being used? Depending on the proxy server, connections may not be possible. Set the browser to [Not using proxy server] or set that particular address to [Not using a proxy server].
The [Please wait] message is continuously displayed.	Wait for a while as instructed. If the status does not change, click the [Refresh] button. If this does not impart any effect, confirm whether the machine is operating correctly.
The [Refresh] button is not functioning.	Are you using a specified browser? Refer to "Installation of Dell Printer Configuration Web Tool" (P.274) to confirm whether your browser is supported.
Selecting the menu on the left frame does not update the right frame contents.	
The screen display is distorted.	Change the window size for the browser.
The latest information is not displayed.	Click the [Refresh] button.
Characters are not correctly displayed.	Use Western European language command.
Pressing [Apply] does not apply the new settings.	Are the entered values correct? If a value outside of the permitted range is entered, the update will automatically be made within the range.
	This may occur when the control panel is being operated or the operation has just been completed. When the automatic reset function is set, any setting configure with Dell Printer Configuration Web Tool is not applied until setting the time set for automatic reset. Wait until then.
When you click [Apply], a message such as "The server has returned ineffective or unrecognizable response" or "No data" is displayed on the browser.	Is the password correct? The entries for Password and Confirm Password do not match. Enter the correct password.
	Restart the machine.
Cannot delete jobs.	Wait for a while, and click [Refresh].

E-mail Features Problems

The possible symptoms and remedies for problems when using E-mail Notification Service, the Print E-mail feature, the E-mail service, and Internet Fax service as follows:

Symptom	Remedy
Cannot receive e-mail (Print E-mail, and Internet Fax).	Is the e-mail address for the machine configured?
	Is [Receive E-mail] set to [Enabled]?
	Are settings such as the IP addresses for the SMTP server and POP3 server (if POP3 is selected as the incoming mail protocol) configured correctly?
	Are the POP3 user name and password entered correctly?
	Is [Domain Filtering] set? Confirm whether your own domain is set to [Allow Domains], on Dell Printer Configuration Web Tool.
	Are the SMTP server and/or POP server operating properly? Consult your network administrator.
Cannot transmit e-mail (E-mail Notification Service, Internet Fax, and E-mail).	Is the E-mail address for the machine configured?
	Is [E-mail Notification Service] set to [Enabled]? (For E-mail Notification Service).
	Is [Send E-mail] set to [Enabled]?
	Is the IP address for the SMTP server configured correctly?
	Are the settings for notification of transmission configured correctly? (for E-mail Notification Service) Confirm the settings on the [Properties] tab of Dell Printer Configuration Web Tool.
	Is the destination address entered correctly?
	Is the SMTP server operating properly? Consult your network administrator.

Internet/Intranet Connection Problems

The possible causes and remedies for problems when connecting to the Internet or intranet are as follows:

When connection to the Internet/Intranet fails

Cause	Remedy
The Authentication feature used on the remote server is not supported by the machine.	Only Basic Authentication is supported by the machine. The machine does not support NTLM/digest. For security purposes, change to the Authentication feature using SSL.
The remote linkage services used does not support the model or accessories of the machine.	Purchase products/models/accessories supported by the remote linkage services.
The IP address is incorrect.	Confirm the IP address. If the IP address is incorrect, either set a static IP address or resolve the IP address using DHCP or Autonet.
The IP gateway address is incorrect.	Set the correct IP gateway address when connecting to the proxy server, or to a Web server via the IP gateway.
The subnet mask is incorrect.	Set the correct subnet mask corresponding to your environment.
The DNS server address is incorrect.	Confirm the DNS server address.
The DNS server selected cannot resolve the address.	Select a DNS server that can resolve the address. <ul style="list-style-type: none"> • When connecting via the proxy server Set the IP address of a DNS server that can resolve the address of the proxy server. • When not connecting via the proxy server Set the IP address of a DNS server that can resolve the destination address.
The address that does not use a proxy server is incorrect.	Confirm whether only addresses that do not use a proxy server are set. Even if addresses not through a proxy server are specified using the FQDN, if a server is directly accessed using its IP address, the registered server is not excluded. Set the address not to use a proxy server. Likewise, even if you directly specify an address that does not use a proxy server, if a server is accessed with the FQDN, the registered server is not excluded. Set an IP address with the FQDN not to use a proxy server.
The desired server, or the proxy server is down.	Confirm whether the desired server or the proxy server is operating correctly.
The network cable is not connected, or broken.	Confirm whether the network cable is correctly connected. We recommend using a spanning-tree configuration, with which network disconnection rarely occurs.
Cannot communicate because of overloading of the server application.	Wait for a while and try accessing again.
An error that is not displayed on the control panel occurs.	Even though an error occurs during background processing, no message appears on the control panel. Display the [Job Status] screen or print the Job History Report to confirm the result.

Cause	Remedy
Cannot access the proxy server, firewall, or Web server as a result of access control.	<p>The following types of access control are used. Confirm the configured access control.</p> <ul style="list-style-type: none"> • Address (port) restriction • SSL restriction • User access restriction (including access right levels) • Content block • Scheme restriction (cannot use HTTP etc.) • Transfer data size restriction • Method restriction (cannot use POST etc.) • HTTP header restriction (only accepting specified browsers etc.) • Time restriction (only available during a specific period of time etc.)

When connection to a desired Web server fails

Cause	Remedy
The setting to use the proxy server is not configured.	In the environment using the proxy server, you must configure the machine to use the proxy server to connect to a desired Web server. Make sure that you configure the settings to use the proxy server.
The setting to use a proxy server is configured even though the environment does not use a proxy server.	In an environment that does not use a proxy server, such as when connecting to an intranet, do not make the settings to use the proxy server.
The proxy server address is incorrect.	When the settings to use a proxy server are configured, you cannot connect to a desired Web server if the IP address of the proxy server is wrong. Set the correct IP address of the proxy server.
When the proxy server access requires authentication, you cannot connect to the server because the user name or password is incorrect.	Set the user name and password on the machine that allow connection to the proxy server.

IPv4 and IPv6 Connection Problems

The possible causes and remedies for problems when using an IPv4 or IPv6 address are as follows:

Unable to connect using an IPv4 address

Symptom	Remedy
When 0 (zero) is prepended to the head of a value for the IPv4 address (for example: 192.0.2.010), connection fails.	Do not prepend 0 (zero) to each value of an IPv4 address.

Unable to connect using an IPv6 address

Symptom	Remedy
You cannot connect to the machine with the link-local address.	When you specify the machine's link-local address, a scope ID must be appended to the address. For example, when you use Internet Explorer 7 on Windows Vista to access the address "fe80::203:baff:fe48:9010", you must append the Ethernet adapter local area connection number (for example, 8) for Windows Vista to the address as follows: fe80::203:baff:fe48:9010%8
The machine cannot connect to a computer running Windows OS that supports IPv6.	Assign a static IPv6 address to the computer running Windows OS that supports IPv6. Then, register the IPv6 address on the machine as host address to allow communication.
A device outside the router cannot be searched.	When searching for a device outside the router via SMB, directly specify the address. Multicasting is supported only within a local link (FF02::1).
When SSL is enabled on Dell Printer Configuration Web Tool, even if you specify "http://[IPv6 address]", you are not redirected to "https://[IPv6 address]".	When SSL is enabled, directly specify "https://[IPv6 address]".

Unable to print using an IPv6 address

Symptom	Remedy
On an IPv6 network without a DNS server, a computer running Windows OS that supports IPv6 cannot be connected to a Windows shared printer.	Register the computer name of the machine on the "hosts" file stored on the computer running Windows OS that supports IPv6. For example, register in the following file: C:\Windows\system32\driver\etc\hosts
IPv6 communication cannot be established with NetWare.	NetWare does not support IPv6 communication. Use IPv4 for NetWare.

Unable to scan using an IPv6 address

Symptom	Remedy
When the machine is configured with only a link-local address, file transfer fails.	Assign a global address to the machine.
When you specify the computer name on a storage destination server of the Scan to PC (SMB) service in an IPv6 environment without a DNS server, scan data cannot be transferred.	Scan data cannot be transferred with SMB if a destination server is specified using the computer name. Use the IPv6 format to specify the server.
The machine does not operate correctly if the Internet Fax direct destination is specified in IPv6 address literal format. Example: csw@[ipv6:2001:db8::1]	In an IPv6 environment, use a DNS server and specify a destination using a fully qualified domain name (FQDN).
The machine does not operate correctly if the mail address for the E-mail service is specified in IPv6 address literal format. Example: csw@[ipv6:2001:db8::1]	In an IPv6 environment, use a DNS server and specify an e-mail address using the FQDN.

Other problems on IPv6 addresses

Symptom	Remedy
Unable to search devices with IPv6 addresses in UPnP.	In an IPv6 environment, use Function Discovery of Web Services on Devices (WSD).
In an IPv6 network with no DNS server installed, authentication fails if an SMB authentication server is specified using the computer name.	Directly specify the IPv6 address to specify the computer name of an authentication server.
When the Web Applications service is used, you cannot correctly specify the destination URL using the IPv6 address. Example: http://[ipv6:2001:db8::1]	In an IPv6 environment, use a DNS server and specify a remote service's destination URL using the FQDN.
IPv6 addresses are not correctly recorded on output job logs.	Use an IPv4 network for correct logging.

Media Print - Text Trouble

The possible symptoms, causes, and remedies for problems when using Media Print - Text are as follows.

Symptom	Cause	Remedy
[Media Print - Text] is not displayed on the [Home] screen.	[Media Print] in Dell Printer Configuration Web Tool is not checked.	Check [Media Print] in Dell Printer Configuration Web Tool to enable the service.

Media Print - Photos Trouble

The possible symptoms, causes, and remedies for problems when using Media Print - Photos are as follows:

Symptom	Cause	Remedy
A blank sheet of paper is output.	Files that cannot be printed (image files in other than DCF1.0 format) are included among the files specified for printing.	Files that cannot be printed (image files in other than DCF1.0 format) are not printed with index printing. Specify printing again, excluding the images not displayed for index printing. Note • Note that editing or saving DCF1.0-format image files on a computer makes those files' format other than DCF1.0.

Status Code

This section describes status codes.

An error message and status code (***) are displayed if printing terminated abnormally because of an error, or a malfunction occurred in the machine.

For faxing, a status code is also displayed on an Activity Report and a Transmission Report - Job Undelivered.

Refer to the status codes in the following table to resolve problems.

Note • If a status code is displayed, any print data remaining in the machine and information stored in the machine's memory is not secured.

If a status code is displayed that is not listed in the following table, or if you cannot resolve an error despite following the instructions described in the table, contact Customer Support at dell.com/contactdell.

Status Code	Cause and Remedy
002-500	<p>[Cause] An error occurred during the scan job.</p> <p>[Remedy] Execute the operation again. Also, check whether or not the account limit for the Scan service is set when the accounting type is ColorTrack. If the error still is not resolved, contact Customer Support at dell.com/contactdell.</p>

Status Code	Cause and Remedy
003-311 003-318 003-319 003-320 003-321 003-322 003-323 003-324 003-325 003-326 003-327 003-328 003-329 003-330 003-331 003-332 003-333 003-334 003-335 003-336 003-337 003-338 003-339 003-340 003-341 003-342 003-343 003-344 003-345 003-346	<p>[Cause] An error occurred.</p> <p>[Remedy] Switch off the machine power, make sure that the touch screen is blank, and then switch on the machine power. If the same message is displayed again, contact Customer Support at dell.com/contactdell.</p>
003-700	<p>[Cause] Too many documents are set in the document feeder after clearing the paper jam.</p> <p>[Remedy] Check the output, and then replace the documents that have not been copied yet.</p>
003-702	<p>[Cause] You tried to copy sides 1 and 2 of a document simultaneously specifying different Reduce/Enlarge ratio for each side.</p> <p>[Remedy] Specify the same Reduce/Enlarge ratio for both sides.</p>
003-703	<p>[Cause] The Calibration Chart is not detected correctly.</p> <p>[Remedy] Place the Calibration Chart properly.</p>
003-704	<p>[Cause] An error is found in the calibration pattern read, and the machine may be out of order.</p> <p>[Remedy] Execute the calibration again. If the error is not still resolved, contact Customer Support at dell.com/contactdell.</p>
003-705	<p>[Cause] Copying is started before the machine exits the Power Saver mode and detects the change for the tray size, when the paper size set in the tray that has been changed during the Power Saver mode.</p> <p>[Remedy] Cancel copying, and perform the operation for copying again.</p>
003-750	<p>[Cause] Unable to store any documents using the 2 Sided Book Copying feature.</p> <p>[Remedy] Check the 2 Sided Book Copying settings. Refer to "3 Copy" > "Layout Adjustment" in the User Guide.</p>

Status Code	Cause and Remedy
003-751	<p>[Cause] Unable to process the document because the specified scan area is too small.</p> <p>[Remedy] Increase the resolution or scan area.</p>
003-752	<p>[Cause] A mix sized document was to be scanned at 600 dpi in Color/2 sided.</p> <p>[Remedy] Set [Resolution] to [400 dpi] or lower, and try scanning again.</p>
003-753	<p>[Cause] A mix sized document was to be scanned at high resolution, 2 sided.</p> <p>[Remedy] Set [Resolution] to [200 dpi], and scan the document again.</p>
003-754 003-755	<p>[Cause] An error occurred in the document feeder.</p> <p>[Remedy] Execute the job again.</p>
003-756	<p>[Cause] The faxed document is completely blank.</p> <p>[Remedy] Check whether the document is blank or whether the side of the document to be faxed is loaded correctly.</p>
003-757	<p>[Cause] A mix sized document was to be scanned at high resolution, 2 sided.</p> <p>[Remedy] Set [Resolution] to [300 dpi] or lower, and scan the document again.</p>
003-760	<p>[Cause] An incompatible combination of feature is specified for document scan conditions.</p> <p>[Remedy] Confirm the selected options.</p>
003-761	<p>[Cause] The paper size of the tray selected for auto tray differs from the paper size of the tray selected for Auto Paper selection.</p> <p>[Remedy] Change the paper size for the tray, or change the [Paper Type Priority] settings.</p>
003-763	<p>[Cause] An error occurred when reading the Calibration Chart.</p> <p>[Remedy] Place the Calibration Chart correctly on the document glass. Refer to "Executing Calibration" (P.75).</p>
003-780	<p>[Cause] Failed to compress the scanned document.</p> <p>[Remedy] Reduce the resolution or the ratio for [Reduce / Enlarge] to decrease the data size, or split the data to send it separately.</p>
003-795	<p>[Cause] When enlarging/reducing a scanned document to the paper size specified, the reduction/enlargement ratio exceeds the allowed range.</p> <p>[Remedy] Take one of the following measures:</p> <ul style="list-style-type: none"> • Manually enter a reduction/enlargement ratio. • Change the paper size.
005-275 005-280	<p>[Cause] An error occurred in the document feeder.</p> <p>[Remedy] Switch off the machine power, make sure that the touch screen is blank, and then switch on the machine power. If the error still is not resolved, contact Customer Support at dell.com/contactdell.</p>
010-330	<p>[Cause] An error occurred in the machine.</p> <p>[Remedy] Switch off the machine power, make sure that the touch screen is blank, and then switch on the machine power. If the error still is not resolved, contact Customer Support at dell.com/contactdell.</p>

Status Code	Cause and Remedy
010-371 010-372 010-373 010-374 010-375 010-376 010-377 010-378 010-379 010-380 010-381 010-382 010-398	<p>[Cause] An error occurred in the machine.</p> <p>[Remedy] Switch off the machine power, make sure that the touch screen is blank, and then switch on the machine power. If the same message is displayed again, contact Customer Support at dell.com/contactdell.</p>
012-210 012-211 012-212 012-213 012-221 012-223 012-224 012-225 012-226 012-227 012-228 012-229 012-230 012-231 012-232 012-233 012-234 012-241 012-243	<p>[Cause] Finisher malfunction</p> <p>[Remedy] Switch off the machine power, make sure that the touch screen is blank, and then switch on the machine power. If the error still is not resolved, contact Customer Support at dell.com/contactdell.</p>
012-246	<p>[Cause] The Booklet Maker is not fully inserted completely into the Finisher.</p> <p>[Remedy] Completely insert the Booklet Maker into the Finisher, and turn the machine off and then on.</p>
012-247 012-249	<p>[Cause] Finisher malfunction</p> <p>[Remedy] Switch off the machine power, make sure that the touch screen is blank, and then switch on the machine power. If the error still is not resolved, contact Customer Support at dell.com/contactdell.</p>
012-255	<p>[Cause] Finisher Tray malfunction</p> <p>[Remedy] Switch off the machine power, make sure that the touch screen is blank, and then switch on the machine power. If the error still is not resolved, contact Customer Support at dell.com/contactdell.</p>

Status Code	Cause and Remedy
012-259 012-260 012-261 012-263 012-264 012-265 012-266 012-268 012-269 012-280 012-282 012-283 012-284 012-286 012-287 012-291 012-295 012-296	<p>[Cause] Finisher malfunction</p> <p>[Remedy] Switch off the machine power, make sure that the touch screen is blank, and then switch on the machine power. If the error still is not resolved, contact Customer Support at dell.com/contactdell.</p>
012-334	<p>[Cause] An error occurred.</p> <p>[Remedy] Switch off the machine power, make sure that the touch screen is blank, and then switch on the machine power. If the same message is displayed again, contact Customer Support at dell.com/contactdell.</p>
012-402	<p>[Cause] The hole punch waste container of the finisher is not installed.</p> <p>[Remedy] Install the hole punch waste container. When the same message is displayed even after you install the hole punch waste container, remove the container, and then install it again.</p>
012-500	<p>[Cause] An error occurred in the finisher.</p> <p>[Remedy] Switch off the machine power, make sure that the touch screen is blank, and then switch on the machine power. If the same message is displayed again, contact Customer Support at dell.com/contactdell.</p>
013-210 013-211 013-212 013-213 013-220	<p>[Cause] An error occurred in the Booklet Unit.</p> <p>[Remedy] Switch off the machine power, make sure that the touch screen is blank, and then switch on the machine power. If the error still is not resolved, contact Customer Support at dell.com/contactdell.</p>
016-210 016-211 016-212 016-213 016-214 016-215 016-216 016-217 016-218 016-219	<p>[Cause] An error occurred in the software.</p> <p>[Remedy] Switch off the machine power, make sure that the touch screen is blank, and then switch on the machine power. If the error still is not resolved, contact Customer Support at dell.com/contactdell.</p>

Status Code	Cause and Remedy
016-220 016-221 016-222 016-223 016-224 016-225 016-226 016-227 016-228	<p>[Cause] An error occurred in the document feeder.</p> <p>[Remedy] Switch off the machine power, make sure that the touch screen is blank, and then switch on the machine power. If the error still is not resolved, contact Customer Support at dell.com/contactdell.</p>
016-229 016-230	<p>[Cause] An error occurred in the software</p> <p>[Remedy] Switch off the machine power, make sure that the touch screen is blank, and then switch on the machine power. If the error still is not resolved, contact Customer Support at dell.com/contactdell.</p>
016-232	<p>[Cause] An error occurred during initialization of the high compression board.</p> <p>[Remedy] Switch off the machine power, make sure that the touch screen is blank, and then switch on the machine power. If the error still is not resolved, contact Customer Support at dell.com/contactdell.</p>
016-233	<p>[Cause] An error occurred in the software.</p> <p>[Remedy] Switch off the machine power, make sure that the touch screen is blank, and then switch on the machine power. If the error still is not resolved, contact Customer Support at dell.com/contactdell.</p>
016-234 016-235 016-236 016-237 016-238 016-239	<p>[Cause] An error occurred in the Authentication feature of the machine.</p> <p>[Remedy] Switch off the machine power, make sure that the touch screen is blank, and then switch on the machine power. If the error still is not resolved, contact Customer Support at dell.com/contactdell.</p>
016-240	<p>[Cause] An error occurred in the document feeder.</p> <p>[Remedy] Switch off the machine power, make sure that the touch screen is blank, and then switch on the machine power. If the error still is not resolved, contact Customer Support at dell.com/contactdell.</p>
016-242	<p>[Cause] An error occurred in the machine.</p> <p>[Remedy] Switch off the machine power, make sure that the touch screen is blank, and then switch on the machine power. If the error still is not resolved, contact Customer Support at dell.com/contactdell.</p>

Status Code	Cause and Remedy
016-310 016-311 016-312 016-313 016-314 016-315 016-316 016-317 016-318 016-319 016-320 016-321 016-322 016-323 016-324 016-325 016-326 016-327	<p>[Cause] An error occurred.</p> <p>[Remedy] Switch off the machine power, make sure that the touch screen is blank, and then switch on the machine power. If the same message is displayed again, contact Customer Support at dell.com/contactdell.</p>
016-330 016-331 016-332	<p>[Cause] An error occurred in the machine.</p> <p>[Remedy] Switch off the machine power, make sure that the touch screen is blank, and then switch on the machine power. If the same message is displayed again, contact Customer Support at dell.com/contactdell.</p>
016-335 016-336 016-337 016-338 016-339 016-340 016-341 016-342	<p>[Cause] An error occurred.</p> <p>[Remedy] Switch off the machine power, make sure that the touch screen is blank, and then switch on the machine power. If the same message is displayed again, contact Customer Support at dell.com/contactdell.</p>
016-345 016-347 016-348 016-350 016-351 016-360 016-362 016-363 016-364 016-365 016-366 016-367 016-368 016-369 016-370 016-371	<p>[Cause] An error occurred.</p> <p>[Remedy] Switch off the machine power, make sure that the touch screen is blank, and then switch on the machine power. If the same message is displayed again, contact Customer Support at dell.com/contactdell.</p>

Status Code	Cause and Remedy
016-372 016-373 016-374 016-375 016-376 016-377 016-378 016-379 016-380 016-381 016-382	<p>[Cause] An error occurred.</p> <p>[Remedy] Switch off the machine power, make sure that the touch screen is blank, and then switch on the machine power. If the same message is displayed again, contact Customer Support at dell.com/contactdell.</p>
016-400	<p>[Cause] The user name or password for 802.1x authentication does not match.</p> <p>[Remedy] Confirm and correctly enter the user name or password. If the error still is not resolved, check whether the network environment is set correctly.</p>
016-401	<p>[Cause] The 802.1x authentication method cannot be processed.</p> <p>[Remedy] Set the authentication method of the machine to the same method as set for the authentication server.</p>
016-402	<p>[Cause] The authentication connection timed out.</p> <p>[Remedy] Confirm the network connection and switch setting of the authentication device physically connected to the machine via a network, and check whether it is connected to the machine correctly.</p>
016-403	<p>[Cause] The root certificate did not match.</p> <p>[Remedy] Confirm the authentication server and store the root certificate of the server certificate of the authentication server into the machine. If you cannot acquire the root certificate of the server certificate, set [Server Certificate Verification] of [IEEE 802.1x Settings] to [Disabled] on the touch screen.</p>
016-404	<p>[Cause] An internal error occurred.</p> <p>[Remedy] Execute the operation again. If the error still is not resolved, contact Customer Support at dell.com/contactdell.</p>
016-405	<p>[Cause] An error occurred in the certificate stored in the machine.</p> <p>[Remedy] Initialize the certificate. For more information on initializing certificates, refer to "Delete All Certificates / Initialize Settings" (P.140).</p>
016-406	<p>[Cause] An error occurred in the SSL client certificate.</p> <p>[Remedy] Take one of the following measures: 1)Store an SSL client certificate in the machine, and set it as the SSL client certificate. 2)If an SSL client certificate cannot be set on the machine, select an option other than [EAP-TLS] in [Authentication Method].</p>
016-407 016-408 016-409 016-410 016-411 016-412	<p>[Cause] After automatically obtained the IP address, the machine failed to retrieve proxy server settings from the DHCP server.</p> <p>[Remedy] Modify the customized program and install it again.</p>

Status Code	Cause and Remedy
016-450	<p>[Cause] The SMB host name already exists.</p> <p>[Remedy] Change the host name. Refer to "Host Name" (P.176).</p>
016-453	<p>[Cause] Updating of the IPv6 address and host name for the DNS server failed.</p> <p>[Remedy] Check whether the IP address of the DNS server is set correctly.</p>
016-454	<p>[Cause] Unable to retrieve the IP address from DNS.</p> <p>[Remedy] Confirm the DNS configuration and IP address retrieve setting. Refer to "Protocol Settings" (P.173).</p>
016-455	<p>[Cause] Connection to the SNTP server timed out.</p> <p>[Remedy] Confirm the network cable connection and the IP address of the SNTP server are correct. Refer to "Machine Clock / Timers" (P.124).</p>
016-456	<p>[Cause] Received a message from the SNTP server stating that the server is not synchronized with the standard time source.</p> <p>[Remedy] Confirm the SNTP server settings. Refer to "Machine Clock / Timers" (P.124).</p>
016-500 016-501 016-502	<p>[Cause] An error occurred.</p> <p>[Remedy] Switch off the machine power, make sure that the touch screen is blank, and then switch on the machine power. If the same message is displayed again, contact Customer Support at dell.com/contactdell.</p>
016-503	<p>[Cause] Unable to resolve the SMTP server name when sending e-mail.</p> <p>[Remedy] Check on Dell Printer Configuration Web Tool whether the SMTP server settings are correct. Also, confirm whether the DNS server settings are correct.</p>
016-504	<p>[Cause] Unable to resolve the POP3 server name when sending e-mail.</p> <p>[Remedy] Check on Dell Printer Configuration Web Tool whether the POP3 server settings are correct. Also, confirm whether the DNS server settings are correct.</p>
016-505	<p>[Cause] Unable to log into the POP3 server when sending e-mail.</p> <p>[Remedy] Check on Dell Printer Configuration Web Tool whether the user name and password used on the POP3 server are correct.</p>
016-513	<p>[Cause] An error occurred in connecting to the SMTP server. Probable causes are as follows: 1)The SMTP server or network may be overloaded. 2)The source port number for SMTP is incorrect.</p> <p>[Remedy] For 1), wait for a while, and then execute the operation again. For 2), confirm whether the source port number for SMTP is correct.</p>
016-514	<p>[Cause] An error occurred during processing of an XPS document.</p> <p>[Remedy] If an error occurred while printing from a driver which supports XPS, print from the application using another print driver (PCL, etc.). If an error occurred while direct printing an XPS document (such as E-mail and Media Print - Text), print using the print driver (PCL, etc.) from XPS Document Viewer.</p> <p>Note • XPS stands for XML Paper Specification.</p>

Status Code	Cause and Remedy
016-515	<p>[Cause] There was insufficient memory during processing of an XPS document.</p> <p>[Remedy] Take one of the following measures:</p> <ul style="list-style-type: none"> • Set [Image Quality] to [Standard] • Print using the print driver (PCL, etc.) from XPS Document Viewer. <p>Note • XPS stands for XML Paper Specification.</p> <p>For more information on [Image Options], refer to the help of the print driver.</p>
016-516	<p>[Cause] The Print Ticket included in the XPS document includes an invalid description or a print setting not supported by the machine.</p> <p>[Remedy] Check whether there is a problem with the method of using the application that sent the print job, or with the content of the print instruction. If your application usage and print instruction are correct, check with the application manufacturer that sent the print job for operations of the application, not with Dell. If the error still is not resolved, contact Customer Support at dell.com/contactdell.</p> <p>Note • XPS stands for XML Paper Specification.</p>
016-517	<p>[Cause] There is an error in the content described in the PostScript file.</p> <p>[Remedy] Print with the PostScript driver. Furthermore, modify ProcessColorModel described in the PostScript file so that the color mode does not change.</p>
016-518	<p>[Cause] With the PostScript driver, booklet and Watermark/UUID were specified at the same time.</p> <p>[Remedy] With the PostScript driver, specifying a combination of booklet and Watermark/UUID is not possible. Cancel one of them.</p>
016-519	<p>[Cause] The number of pages reached the maximum number of pages specified, and the print job is terminated.</p> <p>[Remedy] Have your system administrator change the maximum limit of printable pages.</p>
016-520	<p>[Cause] An error occurred in the high compression hardware.</p> <p>[Remedy] Execute the operation again. Also change the output file format and color mode. If the problem is not resolved, switch off the machine power, make sure that the touch screen is blank, and then switch on the machine power. And then perform the above operation again. If the error still is not resolved, contact Customer Support at dell.com/contactdell.</p>
016-521	<p>[Cause] The smart card reader is disconnected from the machine while scanning the data with digital signature.</p> <p>[Remedy] Switch off the machine power and connect the smart card reader, and then switch on the machine power.</p>
016-522	<p>[Cause] LDAP server SSL authentication error. Unable to acquire an SSL client certificate.</p> <p>[Remedy] The LDAP server is requesting an SSL client certificate. Set an SSL client certificate on the machine.</p>
016-523	<p>[Cause] LDAP server SSL authentication error. The server certificate data is incorrect.</p> <p>[Remedy] The machine cannot trust the SSL certificate of the LDAP server. Register the root certificate for the LDAP server's SSL certificate to the machine.</p>
016-524	<p>[Cause] LDAP server SSL authentication error. The server certificate will expire soon.</p> <p>[Remedy] Change the SSL certificate of the LDAP server to a valid one. You can clear this error by selecting [Disabled] for [LDAP - SSL / TLS Communication] under [SSL / TLS Settings] on the machine; however, note that selecting this option does not ensure the validity of the LDAP server.</p>

Status Code	Cause and Remedy
016-525	<p>[Cause] LDAP server SSL authentication error. The server certificate has expired.</p> <p>[Remedy] Change the SSL certificate of the LDAP server to a valid one. You can clear this error by selecting [Disabled] for [LDAP - SSL / TLS Communication] under [SSL / TLS Settings] on the machine; however, note that selecting this option does not ensure the validity of the LDAP server.</p>
016-526	<p>[Cause] LDAP server SSL authentication error. The server name does not match the certificate.</p> <p>[Remedy] Set the same LDAP server address to the machine and to the SSL certificate of the LDAP server. You can clear this error by selecting [Disabled] for [LDAP - SSL / TLS Communication] under [SSL / TLS Settings] on the machine; however, note that selecting this option does not ensure the validity of the LDAP server.</p>
016-527	<p>[Cause] LDAP server SSL authentication error. This is an SSL authentication internal error.</p> <p>[Remedy] An error occurred in the software. Contact Customer Support at dell.com/contactdell.</p>
016-528	<p>[Cause] You are logged out of the smart card authentication mode while scanning the data with a digital signature.</p> <p>[Remedy] Log in to the machine with the smart card, and then execute the operation again.</p>
016-529	<p>[Cause] An error occurred when connecting to the Remote Download server. There was no response from the server within the specified time (45 seconds).</p> <p>[Remedy] Confirm the network connection. Check whether the Remote Download server is correctly set on the network.</p>
016-533	<p>[Cause] Kerberos server authentication protocol error</p> <p>[Remedy] The time difference between the machine and the Kerberos server exceeded the clock skew limit value set on the Kerberos server. Check whether the clocks on the machine and Kerberos server are correctly set. Also check whether the summer time and the time zone are correctly set on the machine and Kerberos server.</p>
016-534	<p>[Cause] Kerberos server authentication protocol error</p> <p>[Remedy] The domain set on the machine does not exist on the Kerberos server, or the Kerberos server address set on the machine is invalid for connection. Check whether the domain name and the server address have been correctly set on the machine. For connection to Windows 2003 Server, specify the domain name in uppercase.</p>
016-535	<p>[Cause] The specified file does not exist on the Remote Download server.</p> <p>[Remedy] Confirm the file.</p>
016-536	<p>[Cause] An error occurred when accessing the DNS prior to connecting to the Remote Download server.</p> <p>[Remedy] Confirm the connection with the DNS. Also check whether the Remote Download server name is registered to the DNS.</p>
016-537	<p>[Cause] Could not connect to the Remote Download server. The port of the destination Remote Download server is not open.</p> <p>[Remedy] Confirm the port in the network settings.</p>
016-538	<p>[Cause] An error occurred when writing the remote download file to the hard disk. The file obtained from the Remote Download server could not be written to the hard disk.</p> <p>[Remedy] Confirm the amount of available space, and delete files that are no longer required. Alternatively, replace the hard disk.</p>
016-539	<p>[Cause] Kerberos server authentication protocol error</p> <p>[Remedy] An error occurred in the software. Contact Customer Support at dell.com/contactdell.</p>
016-546	<p>[Cause] A Local User tried to obtain the information of another user.</p> <p>[Remedy] Contact Customer Support at dell.com/contactdell.</p>

Status Code	Cause and Remedy
016-559	<p>[Cause] A remote download parameter error occurred. An invalid value is set for essential system data.</p> <p>[Remedy] Confirm the settings for essential system data.</p>
016-562	<p>[Cause] Multiple entries containing the same smart card information were found in the guest database of Active Directory.</p> <p>[Remedy] Correct the guest database entries of Active Directory so that they do not contain the same smart card information.</p>
016-564	<p>[Cause] Failed to authenticate the Remote Download server.</p> <p>[Remedy] Confirm the login name and password to access the Remote Download server. If the error still is not resolved, contact Customer Support at dell.com/contactdell.</p>
016-569	<p>[Cause] Authentication Agent error</p> <p>[Remedy] Contact Customer Support at dell.com/contactdell.</p>
016-574	<p>[Cause] The machine failed to transfer data using FTP of the Scan to PC service because the host or server name of the FTP server could not be resolved when accessing the DNS server.</p> <p>[Remedy] Confirm the connection to the DNS server. Check whether the FTP server name is registered correctly on the DNS server.</p>
016-575	<p>[Cause] The machine failed to transfer data using FTP of the Scan to PC service because the DNS server address was not registered on the machine.</p> <p>[Remedy] Specify the correct DNS server address. Or, specify the destination FTP server by using its IP address.</p>
016-576	<p>[Cause] The machine failed to transfer data using FTP of the Scan to PC service because it could not connect to the FTP server.</p> <p>[Remedy] Ensure that both the destination FTP server and the machine are available for network communications, by checking the following conditions:</p> <ul style="list-style-type: none"> • The IP address of the server is set correctly. • The network cables are plugged in securely.
016-577	<p>[Cause] Unable to connect to the FTP service of the destination server.</p> <p>[Remedy] Take one of the following measures:</p> <ul style="list-style-type: none"> • Check whether the FTP service of the server is activated. • Check whether the FTP port number of the server is correctly registered on the machine.
016-578	<p>[Cause] The machine failed to transfer data using FTP of the Scan to PC service because of unsuccessful login to the FTP server.</p> <p>[Remedy] Check whether the login name (user name) and password are correct.</p>
016-579	<p>[Cause] The machine failed to transfer data using FTP of the Scan to PC service because the scanned image could not be saved in the FTP server after connection.</p> <p>[Remedy] Check whether the FTP server's save location is correct.</p>
016-580	<p>[Cause] The machine failed to transfer data using FTP of the Scan to PC service because the file or folder name on the FTP server could not be retrieved after connection.</p> <p>[Remedy] Confirm the access privilege for the FTP server.</p>
016-581	<p>[Cause] The machine failed to transfer data using FTP of the Scan to PC service because the suffix of the name of the file or folder exceeded the limit value when the machine was connected to the server and the name of a file or folder on the server was determined.</p> <p>[Remedy] Change the file name or forwarding destination folder of the scan server. Also try moving or deleting the files within the forwarding destination folder.</p>

Status Code	Cause and Remedy
016-582	<p>[Cause] The machine failed to transfer data using FTP of the Scan to PC service because files could not be created on the FTP server after connection.</p> <p>[Remedy] Take one of the following measures:</p> <ul style="list-style-type: none"> • Check whether the specified file name can be used in the save location. • Check whether enough space is available in the save location.
016-583	<p>[Cause] Failed to create the lock directory in the FTP server while transferring data using FTP of the Scan to PC service.</p> <p>[Remedy] Take one of the following measures:</p> <ul style="list-style-type: none"> • If the lock directory (*.LCK) exists in the destination, delete it manually, and then execute the operation again. • Check whether the specified name is available in the save location. • Confirm that the specified name is not duplicated in the save location. • Check whether enough space is available in the save location.
016-584	<p>[Cause] The machine failed to transfer data using FTP of the Scan to PC service because folders could not be created on the FTP server after connection.</p> <p>[Remedy] Take one of the following measures:</p> <ul style="list-style-type: none"> • Check whether the specified folder name can be used in the save location. • Check whether the same folder name exists in the save location. • Check whether enough space is available in the save location.
016-585	<p>[Cause] The machine failed to transfer data using FTP of the Scan to PC service because files could not be deleted on the FTP server after connection.</p> <p>[Remedy] Confirm the access privilege for the FTP server.</p>
016-586	<p>[Cause] The machine failed to delete the lock directory while transferring data using FTP of the Scan to PC service.</p> <p>[Remedy] Take one of the following measures:</p> <ul style="list-style-type: none"> • Confirm the access privilege for the server. • If the lock directory (*.LCK) exists in the destination, delete it manually, and then execute the operation again.
016-587	<p>[Cause] The machine failed to transfer data using FTP of the Scan to PC service because folders could not be deleted on the FTP server after connection.</p> <p>[Remedy] Confirm the access privilege for the FTP server.</p>
016-588	<p>[Cause] The machine failed to transfer data using FTP of the Scan to PC service because the data could not be written on the FTP server after connection.</p> <p>[Remedy] Check whether enough space is available in the save location.</p>
016-589	<p>[Cause] The machine failed to transfer data using FTP of the Scan to PC service because the data could not be read from the FTP server after connection.</p> <p>[Remedy] Confirm the access privilege for the FTP server.</p>
016-590	<p>[Cause] The machine failed to transfer data using FTP of the Scan to PC service because there are duplicate file names.</p> <p>[Remedy] Set [Do Not Save] for the action for file name conflict.</p>
016-591	<p>[Cause] The machine failed to perform the additional processing for the file name conflict using FTP of the Scan to PC service.</p> <p>[Remedy] If [Add to Existing Folder] is set for the additional processing for file name conflict, confirm that the file format is not multi-page.</p>

Status Code	Cause and Remedy
016-592	<p>[Cause] The machine failed to access the NEXTNAME.DAT file using FTP of the Scan to PC service.</p> <p>[Remedy] When [Add to Existing Folder] is set as the process to be executed in case of a file name duplication, check the NEXTNAME.DAT file is correct.</p>
016-593	<p>[Cause] The machine failed to transfer data using FTP of the Scan to PC service because an internal error occurred after connection to the FTP server.</p> <p>[Remedy] Execute the operation again. If the error still is not resolved, contact Customer Support at dell.com/contactdell.</p>
016-594 016-595	<p>[Cause] The machine failed to transfer data using FTP of the Scan to PC service because a network error occurred.</p> <p>[Remedy] Execute the operation again. If the error still is not resolved, contact Customer Support at dell.com/contactdell.</p>
016-596	<p>[Cause] The machine failed to transfer data using FTP of the Scan to PC service because a network error occurred.</p> <p>[Remedy] Execute the operation again. If the error still is not resolved, contact Customer Support at dell.com/contactdell.</p>
016-597	<p>[Cause] The machine failed to transfer data using FTP of the Scan to PC service because a network error occurred.</p> <p>[Remedy] Stop all accesses from the other devices, and then execute the operation again. If the error still is not resolved, contact Customer Support at dell.com/contactdell.</p>
016-598 016-599	<p>[Cause] The size of an e-mail page exceeds the maximum message size because of page splitting.</p> <p>[Remedy] Take one of the following measures:</p> <ul style="list-style-type: none"> • Reduce the file size for [Quality / File Size]. • Increase the value for [Maximum Split Count]. <p>For more information on [Quality / File Size], refer to "5 Scan" > "E-mail Options/Filing Options" > "Quality/File Size (Specifying an Image Compression Ratio When Scanning)" in the User Guide.</p> <p>For more information on [Maximum Split Count], refer to "Maximum Split Count" (P.217).</p>
016-700	<p>[Cause] The job was suspended because the number of the digits for the Secure Print or Charge Print passcode set on the print driver was less than the value specified in [Minimum Passcode Length for Stored Jobs] on the machine.</p> <p>[Remedy] On the print driver, set the passcode string equal to or longer than the value specified in [Minimum Passcode Length for Stored Jobs].</p>
016-702	<p>[Cause] Unable to process print data because of insufficient print page buffer.</p> <p>[Remedy] Take one of the following measures:</p> <ul style="list-style-type: none"> • Set [Image Quality] to [Standard]. • Increase the print page buffer size. <p>For more information on the [Image Quality], refer to the help of the print driver. For more information about memory, refer to "Allocate Memory" (P.190).</p>

Status Code	Cause and Remedy
016-703	<p>[Cause] The machine received an e-mail specified with an invalid folder number.</p> <p>[Remedy] For errors occurring during fax or Internet fax transmission: Contact Customer Support at dell.com/contactdell.</p> <p>For errors occurring during e-mail/fax/Internet fax reception: Take one of the following measures:</p> <ul style="list-style-type: none"> • Register the specified folder number, and request the sender to send the e-mail/fax/Internet fax again. • Request the sender to send to an available folder. <p>If the error still is not resolved, contact Customer Support at dell.com/contactdell.</p>
016-704	<p>[Cause] The folder is full, and hard disk capacity is insufficient.</p> <p>[Remedy] Delete unnecessary files from the folder, and save the file. Refer to "6 Send from Folder" > "Checking/Operating Files in a Folder" in the User Guide.</p>
016-705	<p>[Cause] You have not used the print driver for the machine.</p> <p>[Remedy] Use the print driver appropriate for the machine.</p> <p>If the error still is not resolved, contact Customer Support at dell.com/contactdell.</p>
016-706	<p>[Cause] The hard disk space is insufficient because the number of Secure Print users exceeded the maximum limit.</p> <p>[Remedy] Delete unnecessary files from the machine, and delete unnecessary Secure Print users. For more information on deleting users for Secure Print files, refer to "11 Job Status" > "Printing and Deleting Stored Jobs", and on folders, refer to "6 Send from Folder" > "Checking/Operating Files in a Folder" in the User Guide.</p>
016-708	<p>[Cause] Unable to annotate because of insufficient hard disk space.</p> <p>[Remedy] Delete unnecessary data from the hard disk to free up disk space.</p>
016-709	<p>[Cause] An error occurred during print processing.</p> <p>[Remedy] Contact Customer Support at dell.com/contactdell.</p>
016-711	<p>[Cause] The upper limit for the e-mail size has been exceeded.</p> <p>[Remedy] Take one of the following measures, and then try sending the mail again.</p> <ul style="list-style-type: none"> • Reduce the number of pages of the document. • Lower the resolution with [Resolution]. • Reduce the magnification with [Reduce / Enlarge]. • Ask your system administrator to increase the value set for [Maximum Total Data Size]. • For color scanning, set [MRC High Compression] to [On] under [File Format].
016-712	<p>[Cause] Unable to process the document because the specified scan area is too small.</p> <p>[Remedy] Increase the resolution or scan area.</p>
016-713	<p>[Cause] The passcode entered does not match the passcode set on the folder.</p> <p>[Remedy] Enter the correct passcode.</p>
016-714	<p>[Cause] The specified folder does not exist.</p> <p>[Remedy] Create a new folder or specify an existing folder.</p>
016-715	<p>[Cause] The machine failed to access the ESCP form because the password of the ESCP form does not match.</p> <p>[Remedy] Enter the correct password of the ESCP form.</p>

Status Code	Cause and Remedy
016-716	<p>[Cause] Unable to spool TIFF file because of insufficient hard disk space.</p> <p>[Remedy] Delete unnecessary files and users from the hard disk. Refer to "11 Job Status" > "Printing and Deleting Stored Jobs" in the User Guide.</p>
016-717	<p>[Cause] Unable to create a Transmission Report - Job Undelivered or a Transmission Report because the transmission result information required for creating the report is not stored in the machine's memory.</p> <p>[Remedy] Take one of the following measures:</p> <ul style="list-style-type: none"> • Execute the jobs for large size Internet fax documents (about 2GB) by splitting each document to minimize memory or HDD usage. • If many scan or Internet fax documents are being processed, wait until the jobs are completed to execute a new job. • After completing the job that you want to confirm in a report, do not execute 200 or more jobs before printing the report.
016-718	<p>[Cause] Unable to process the PCL print data because of insufficient memory.</p> <p>[Remedy] Reduce the resolution, or cancel 2 sided printing or N up feature, and then print again.</p>
016-719	<p>[Cause] Unable to process the PCL print data because of insufficient print page buffer.</p> <p>[Remedy] Increase the size of the print page buffer.</p>
016-720	<p>[Cause] An invalid command is included in PCL print data.</p> <p>[Remedy] Confirm the print data and try printing again.</p>
016-721	<p>[Cause] An error occurred during print processing. Probable causes are as follows:</p> <ol style="list-style-type: none"> 1) Printing was instructed by the Auto Paper selection when [Paper Type Priority] is set to [Auto Paper Off] for all paper in the [Common Service Settings]. 2) ESC/P-K command error occurred. <p>[Remedy] For 1), when printing by the Auto Paper selection, set one of the paper types to other than [Auto Paper Off] in [Paper Type Priority].</p> <p>For 2), confirm the print data.</p> <p>Refer to "Paper Type Priority" (P.133).</p>
016-722	<p>[Cause] The specified staple position is not supported by the machine, or the paper size specified is not supported by the finisher.</p> <p>[Remedy] Confirm the staple position and the paper size, and try printing again.</p>
016-723	<p>[Cause] The specified punch position is not supported by the machine, or the paper size specified is not supported by the finisher.</p> <p>[Remedy] Confirm the punch position and the paper size, and try printing again.</p>
016-724	<p>[Cause] The specified staple and punch position combination is unsupported.</p> <p>[Remedy] Specify the staple and punch positions on the same side, and try printing again.</p>
016-725	<p>[Cause] A scanned document stored in a folder was to be sent by fax using the Job Flow feature, but the file in the folder could not be converted to fax data.</p> <p>[Remedy] Do not use the Job Flow feature. Simply scan the document from the machine's [Fax] screen to send it by fax.</p>
016-727	<p>[Cause] A print job was cancelled without storing a file into a folder because the file was determined as not containing any pages.</p> <p>[Remedy] The file could not be stored into the folder because the machine determined the print file as not containing any pages. Disable [Skip Blank Pages] on the [Advanced] tab on the print driver, or add text to the file if the file is blank.</p>

Status Code	Cause and Remedy
016-728	<p>[Cause] An unsupported tag is included in the TIFF file.</p> <p>[Remedy] Confirm the print data.</p>
016-729	<p>[Cause] Unable to print because the number of colors or the resolution of the TIFF file exceeds the allowed range.</p> <p>[Remedy] Change the number of colors or resolution for the TIFF file, and execute the operation again.</p>
016-731	<p>[Cause] Unable to print TIFF data because it was interrupted.</p> <p>[Remedy] Retry printing.</p>
016-732	<p>[Cause] The form specified by emulation has not been registered at the host side.</p> <p>[Remedy] Resend the form data.</p>
016-733	<p>[Cause] Probable causes are as follows:</p> <ol style="list-style-type: none"> 1) Unable to obtain the IP address (the string after "@" in the destination e-mail address) when e-mail is sent. 2) DNS server was unable to resolve the Internet address (the string after "@") by the DNS server when e-mail is sent. <p>[Remedy] For 1), confirm the e-mail address. For 2), confirm the DNS server address.</p>
016-738	<p>[Cause] Unsupported paper size was specified when specifying booklet creation with PostScript.</p> <p>[Remedy] Specify a paper size supported for booklet creation, and try printing again.</p>
016-739	<p>[Cause] Used an unsupported combination of document size and paper size when specifying booklet creation with PostScript.</p> <p>[Remedy] Specify a combination of document size and paper size supported for booklet creation, and try printing again.</p>
016-740	<p>[Cause] Used an unsupported paper tray when specifying booklet creation with PostScript.</p> <p>[Remedy] Specify a paper tray supported for booklet creation, and try printing again.</p>
016-741 016-742 016-743 016-744 016-745	<p>[Cause] An error occurred during the update process of the machine.</p> <p>[Remedy] Switch off the machine power, make sure that the touch screen is blank, and then switch on the machine power. If the error still is not resolved, contact Customer Support at dell.com/contactdell.</p>
016-746	<p>[Cause] An unsupported feature is included in the received PDF.</p> <p>[Remedy] Print using a print driver.</p>
016-747	<p>[Cause] The memory became insufficient when using the Repeat Image feature and the Annotations features simultaneously.</p> <p>[Remedy] Take one of the following measures:</p> <ul style="list-style-type: none"> • Increase the annotation image size. • Reduce the usage of Repeat Image.
016-748	<p>[Cause] Unable to print because of insufficient hard disk space.</p> <p>[Remedy] Reduce the number of print pages by dividing the print data or by printing one copy at a time when printing multiple copies.</p>

Status Code	Cause and Remedy
016-749	<p>[Cause] Probable causes are as follows:</p> <p>For a print job:</p> <p>1) The printer language received from the print driver is unsupported by this machine.</p> <p>For printing of a document received by Internet Fax:</p> <p>2) The printer language of the document received from the remote machine is unsupported by this machine.</p> <p>[Remedy] For 1), use the machine's print driver for printing. If the error still is not resolved, contact Customer Support at dell.com/contactdell.</p> <p>For 2), request the sender to send Internet fax documents using a printer language supported by the machine.</p> <p>Note • An optional component must be installed for some printer languages such as PostScript. For more information, contact Customer Support at dell.com/contactdell.</p>
016-750	<p>[Cause] The machine received a printing job ticket with a PDF or XPS from an application that allows direct transmissions of files, but the printing job ticket data had a grammar or print instruction unsupported by the machine.</p> <p>[Remedy] Check whether you are correctly using the application and whether the print instruction was correct.</p> <p>If your application usage and print instruction are correct, check with the application manufacturer that sent the print job for operations of the application.</p> <p>If the error still is not resolved, have the Configuration Report, the Job History Report, and the print data with the printing job ticket ready, and contact Customer Support at dell.com/contactdell.</p> <p>Note • XPS stands for XML Paper Specification.</p>
016-751	<p>[Cause] Probable causes are as follows:</p> <p>1) During the PDF Bridge processing, a syntax or parameter error occurred, an undefined command was used, and a PDF file was damaged.</p> <p>2) When [Print Processing Mode([408])] for the PDF Direct Print feature has been set to [PS([1])], memory is insufficient.</p> <p>3) When [Print Processing Mode([408])] for the PDF Direct Print feature has been set to [PS([1])], a PDF file including OpenType fonts is processed.</p> <p>[Remedy] For 1), use the print driver to print the document.</p> <p>For 2), take one of the following measures:</p> <ul style="list-style-type: none"> • Use the print driver to print the document. • Increase PostScript memory. <p>For 3), create a PDF file in which OpenType fonts are not included.</p> <p>For more information on the memory, refer to "Allocate Memory" (P.190).</p>
016-752	<p>[Cause] Unable to process for PDF Bridge because of insufficient memory space.</p> <p>[Remedy] Change the [Image Quality] setting from [High Resolution] to [High Quality], or from [High Quality] to [Standard].</p>
016-755	<p>[Cause] Attempted to process a print-protected PDF file.</p> <p>[Remedy] Cancel the print protection using Adobe Reader, and try printing again.</p>
016-756	<p>[Cause] Do not have permission to use the service.</p> <p>[Remedy] Consult your system administrator.</p>
016-757	<p>[Cause] The passcode is incorrect.</p> <p>[Remedy] Enter the correct passcode.</p>

Status Code	Cause and Remedy
016-758	<p>[Cause] The division does not have permission to use the service.</p> <p>[Remedy] Consult your system administrator.</p>
016-759	<p>[Cause] The number of pages reached the maximum number of pages for this service.</p> <p>[Remedy] Consult your system administrator.</p>
016-760	<p>[Cause] An error occurred during PostScript processing.</p> <p>[Remedy] Take one of the following measures:</p> <ul style="list-style-type: none"> • Set [Image Quality] to [High Speed]. • Increase PostScript memory. <p>For more information on [Image Quality], refer to the help of the print driver. For more information on memory, refer to "Allocate Memory" (P.190).</p>
016-761	<p>[Cause] An error occurred during image processing.</p> <p>[Remedy] Set [Image Quality] to [Standard] and execute the operation again. If the error still is not resolved, set [Print Page Mode] to [On].</p>
016-762	<p>[Cause] The specified printer language is not installed on the machine.</p> <p>[Remedy] For [USB] in [Print Mode] under [Port Settings], specify correct printer language.</p>
016-763	<p>[Cause] Unable to connect to the POP server.</p> <p>[Remedy] Confirm the POP server IP address set on the machine.</p>
016-764	<p>[Cause] Unable to connect to the SMTP server.</p> <p>[Remedy] Consult the SMTP server administrator.</p>
016-765	<p>[Cause] Unable to send the e-mail because the hard disk on the SMTP server is full.</p> <p>[Remedy] Consult the SMTP server administrator.</p>
016-766	<p>[Cause] An error occurred on the SMTP server.</p> <p>[Remedy] Consult the SMTP server administrator.</p>
016-767	<p>[Cause] Unable to send the e-mail because the address is not correct.</p> <p>[Remedy] Confirm the address, and try sending again.</p>
016-768	<p>[Cause] Unable to connect to the SMTP server because the machine's mail address is incorrect.</p> <p>[Remedy] Confirm the machine's mail address.</p>
016-769	<p>[Cause] The SMTP server does not support delivery receipts (DSN).</p> <p>[Remedy] Send e-mail without setting delivery receipts (DSN).</p>
016-770	<p>[Cause] Direct Fax is restricted.</p> <p>[Remedy] Consult your system administrator whether Direct Fax is available. If it is available, contact Customer Support at dell.com/contactdell.</p>
016-772	<p>[Cause] The DNS server address is not set.</p> <p>[Remedy] Set the DNS server address.</p>
016-774	<p>[Cause] Unable to process compression conversion because of insufficient hard disk space.</p> <p>[Remedy] Delete unnecessary data from the hard disk to free up disk space.</p>
016-775	<p>[Cause] Unable to process image conversion because of insufficient hard disk space.</p> <p>[Remedy] Delete unnecessary data from the hard disk to free up disk space.</p>

Status Code	Cause and Remedy
016-776	<p>[Cause] An error occurred during image conversion processing.</p> <p>[Remedy] For errors occurring when forwarding with Store to Folder or Internet Fax: The image conversion processing for the part of the data may be completed. Retrieve each converted page from the folder using Dell Printer Configuration Web Tool.</p> <p>For more information, refer to "Configuring Machine Settings Using Dell Printer Configuration Web Tool" (P.277).</p> <p>For errors occurring after instructing encryption or signature using a certificate: Take one of the following measures:</p> <ul style="list-style-type: none"> • Check whether the certificate is valid. • Set the correct date and time on the machine.
016-777	<p>[Cause] A hard disk error occurred during image processing.</p> <p>[Remedy] The hard disk may be defective. To replace the hard disk, contact Customer Support at dell.com/contactdell.</p>
016-778	<p>[Cause] The conversion processing of the scanned image was interrupted because of insufficient disk space.</p> <p>[Remedy] Delete unnecessary data from the hard disk to free up disk space.</p>
016-779	<p>[Cause] An error occurred during scanned image conversion processing.</p> <p>[Remedy] Retry scanning. If using large-size paper such as A3 with [Resolution] set to [600 dpi], specify [Resolution] to [400 dpi] or lower in [Layout Adjustment]. If the error still is not resolved, contact Customer Support at dell.com/contactdell.</p>
016-780	<p>[Cause] A hard disk error occurred during scanned image conversion processing.</p> <p>[Remedy] The hard disk may be defective. To replace the hard disk, contact Customer Support at dell.com/contactdell.</p>
016-781	<p>[Cause] Probable causes are as follows:</p> <ol style="list-style-type: none"> 1)The mail server cannot be found during e-mail sending (TCP/IP session establishment failed). 2)The machine received an SMTP server error from the mail server during e-mail sending. <p>[Remedy] 1)Take one of the following measures:</p> <ul style="list-style-type: none"> - Check whether the network cables are plugged in securely. - Check whether the IP address of the SMTP server is correct when an IP address is used for server specification. <p>2)Enter the host name of the machine using ASCII characters. Available ASCII characters are follows:</p> <ul style="list-style-type: none"> - alphabets - numerals <p>Check whether or not ASCII characters are used in [Tools] > [System Settings] > [Connectivity & Network Setup] > [Machine's E-mail Address / Host Name].</p>
016-786	<p>[Cause] When using the Scan feature, the machine could not write the file to the hard disk.</p> <p>[Remedy] Take one of the following measures:</p> <ul style="list-style-type: none"> • Switch off the machine power, make sure that the touch screen is blank, and then switch on the machine power. • Load paper on the paper tray as necessary. • If the error occurs when sending an e-mail, take one of the following measures: <ul style="list-style-type: none"> - Lower the resolution. - Reduce the size. - Reduce the number of pages, and divide the job into several e-mails to send. - Send the job by setting [Color Scanning] to [Black & White].

Status Code	Cause and Remedy
016-788	<p>[Cause] Failed to retrieve a file from the Web browser.</p> <p>[Remedy] Take one of the following measures, and then execute the operation again:</p> <ul style="list-style-type: none"> • Reload the browser page. • Restart the browser. • Switch off the machine power, make sure that the touch screen is blank, and then switch on the machine power.
016-790	<p>[Cause] Unable to send an e-mail with Split Send because of exceeding the maximum number of splits allowed.</p> <p>[Remedy] Take one of the following measures:</p> <ul style="list-style-type: none"> • Reduce the file size for [Quality / File Size]. • Increase the value for [Maximum Split Count]. <p>For more information on [Quality / File Size], refer to "5 Scan" > "E-mail Options/Filing Options" > "Quality/File Size (Specifying an Image Compression Ratio When Scanning)" in the User Guide. For more information on [Maximum Split Count], refer to "Maximum Split Count" (P.217).</p>
016-792	<p>[Cause] Failed to acquire the specified job history when printing a Job Report.</p> <p>[Remedy] The specified job history does not exist.</p>
016-794	<p>[Cause] Media is not inserted correctly.</p> <p>[Remedy] Check whether the media is inserted correctly.</p>
016-795 016-796 016-797	<p>[Cause] An error occurred when reading the data on the media.</p> <p>[Remedy] On a computer, confirm the content recorded on the media.</p>
016-799	<p>[Cause] An invalid print parameter is included in the print data of the application, or the print data and the Print Setup settings may not match.</p> <p>[Remedy] Check the print data of the application and the Print Setup settings, and try printing again.</p>
017-700	<p>[Cause] ThinPrint.Engine connection timed out.</p> <p>[Remedy] Confirm the connection to the ThinPrint.Engine.</p>
017-701	<p>[Cause] An error occurred while connecting to ThinPrint.Engine.</p> <p>[Remedy] Confirm the connection to the ThinPrint.Engine.</p>
017-702	<p>[Cause] The data sent to ThinPrint.Engine is invalid.</p> <p>[Remedy] Confirm the connection to the ThinPrint.Engine.</p>
017-703	<p>[Cause] The print data sent from ThinPrint.Engine exceeded the maximum size of the machine.</p> <p>[Remedy] Split the job, and try printing again.</p>
017-704	<p>[Cause] An internal error occurred.</p> <p>[Remedy] Switch off the machine power, make sure that the touch screen is blank, and then switch on the machine power. Send the job again.</p>
017-705 017-706 017-707 017-708	<p>[Cause] ThinPrint.Engine SSL authentication error.</p> <p>[Remedy] Check the server certificate information (expiry date and address) that is registered to ThinPrint.Engine.</p>
017-709	<p>[Cause] An SSL communication error occurred between ThinPrint.Engine and the machine.</p> <p>[Remedy] Check the settings of the machine.</p>

Status Code	Cause and Remedy
017-713	<p>[Cause] The SMTP server does not support STARTTLS.</p> <p>[Remedy] Change SSL/TLS communication setting to other than [STARTTLS].</p>
017-714	<p>[Cause] SSL connection to the SMTP server failed.</p> <p>[Remedy] Confirm whether the SMTP server supports SSL connection. If the server supports it, check the port number of the SMTP server. If the error still is not resolved, contact Customer Support at dell.com/contactdell.</p>
017-715	<p>[Cause] SMTP server SSL authentication error. The server certificate is invalid.</p> <p>[Remedy] Use the valid SSL server certificate of the SMTP server. You can avoid this error by setting [SMTP - SSL / TLS Communication] in [SSL / TLS Settings] to [Disabled], however the validity of the server cannot be warranted.</p>
017-716	<p>[Cause] SMTP server SSL authentication error. It is before the valid period of the server certificate.</p> <p>[Remedy] Use the valid SSL server certificate of the SMTP server. You can avoid this error by setting [SMTP - SSL / TLS Communication] in [SSL / TLS Settings] to [Disabled], however the validity of the server cannot be warranted.</p>
017-717	<p>[Cause] SMTP server SSL authentication error. The server certificate expired.</p> <p>[Remedy] Use the valid SSL server certificate of the SMTP server. You can avoid this error by setting [SMTP - SSL / TLS Communication] under [SSL / TLS Settings] to [Disabled], however the validity of the server cannot be warranted.</p>
017-718	<p>[Cause] SMTP server SSL authentication error. The server name and certificate do not match.</p> <p>[Remedy] Use the valid SSL server certificate of the SMTP server. You can avoid this error by setting [SMTP - SSL / TLS Communication] in [SSL / TLS Settings] to [Disabled], however the validity of the server cannot be warranted.</p>
017-719	<p>[Cause] SMTP server SSL authentication error. SSL authentication internal error.</p> <p>[Remedy] Execute the operation again. If the error still is not resolved, contact Customer Support at dell.com/contactdell.</p>
017-725	<p>[Cause] An error occurred while receiving a print job when the Force Annotation is enabled.</p> <p>[Remedy] Incorrect name is set for the template of the Force Annotation. Confirm the name of the template registered in the machine.</p>
017-729	<p>[Cause] When the machine is used as a print job storage device, print job sending was stopped temporarily because the number of jobs in the machine exceeded the maximum receivable volume or the space for spool data was insufficient.</p> <p>[Remedy] Take one of the following measures:</p> <ul style="list-style-type: none"> • Set to spool data to the hard disk from the setting of the storage destination machine. • Set [IPP] under [Properties] > [General Setup] > [Memory Settings] to [Spool to Hard Disk] by Dell Printer Configuration Web Tool. • Wait for a while and send the job again.
017-730	<p>[Cause] When the machine is used as a print job storage device, the computer failed to send a job to the machine because a network error occurred.</p> <p>[Remedy] Confirm the followings:</p> <ul style="list-style-type: none"> • The network cable is connected properly. • The storage destination machine is powered on. • The IPP port of the storage destination machine is enabled. <p>If the error still is not resolved, contact Customer Support at dell.com/contactdell.</p>

Status Code	Cause and Remedy
017-731	<p>[Cause] Unable to connect to the POP server.</p> <p>[Remedy] Confirm the followings:</p> <ul style="list-style-type: none"> • The IP address of the POP server is set on the machine. • The network cable is connected properly.
017-732	<p>[Cause] When the machine is used as a print job storage device, the computer failed to send a job because the machine is off-line.</p> <p>[Remedy] Press the <Machine Status> button of the storage destination machine, and set [Print Mode] to [On-line] on the [Machine Information] screen. If the error still is not resolved, contact Customer Support at dell.com/contactdell.</p>
017-733	<p>[Cause] When the machine is used as a print job storage device, an internal error in the software is occurred while the job sending to the machine.</p> <p>[Remedy] Execute the operation again. If the error still is not resolved, contact Customer Support at dell.com/contactdell.</p>
017-734	<p>[Cause] An internal error occurred.</p> <p>[Remedy] Execute the print job again using a print driver other than AirPrint or a software. If the error still is not resolved, contact Customer Support at dell.com/contactdell.</p>
018-400	<p>[Cause] Although IPsec is enabled, the IPsec settings are inconsistent.</p> <ul style="list-style-type: none"> • Although [Authenticate by Preshared Key] is set in [IKE Authentication Method], a passcode is not set. • Although [Authenticate by Digital Signature] is set in [IKE Authentication Method], an IPsec certificate is not set. <p>[Remedy] Remove the inconsistency of the IPsec settings, and enable IPsec again.</p> <ul style="list-style-type: none"> • When [Authenticate by Preshared Key] is set in [IKE Authentication Method], set the passcode. • When [Authenticate by Digital Signature] is set in [IKE Authentication Method], set an IPsec certificate.
018-405	<p>[Cause] An error occurred during LDAP authentication.</p> <p>[Remedy] The account is disabled in the active directory of the authentication server, or the access is set to disabled. Consult your network administrator.</p>
018-500	<p>[Cause] The certificate does not exist in the authentication server.</p> <p>[Remedy] Configure the server certificate. Or, cancel authentication.</p>
018-501	<p>[Cause] Communications with the CA server set in the machine failed.</p> <p>[Remedy] Check the network connection and the address of the CA server.</p>
018-502	<p>[Cause] The machine failed to transfer data using SMB of the Scan to PC service because computers allowed to login are restricted.</p> <p>[Remedy] Confirm the property information for the specified user, and check whether the computers allowed to login to the server are restricted.</p>
018-503 018-504	<p>[Cause] Communications with the CA server set in the machine failed.</p> <p>[Remedy] Execute the authentication operation again.</p>

Status Code	Cause and Remedy
018-505	<p>[Cause] Failed to log into the destination computer while transferring data using SMB of the Scan to PC service.</p> <p>[Remedy] Check whether the user name and password of the SMTP server registered in the machine is correct.</p> <p>Note</p> <ul style="list-style-type: none"> • The password cannot be confirmed. If you have forgotten the password, reset the password. Consult your system administrator for the password reset procedure. • When using Windows Server 2003, be sure to match the time set on the SMB server and the machine. • When the destination computer is Macintosh, you need to change the account settings of the shared folder so that file sharing with Windows users becomes available. For information about necessary accounting settings, consult your system administrator. The following is an example of a procedure for Mac OS X 10.6. It is recommended that users create a dedicated account for data transfer. You can create and set the account on the dialog box that appears by choosing Apple menu > [System Preferences] and then clicking [Accounts] icon. <ol style="list-style-type: none"> 1. From Apple menu, choose [System Preferences], and then click [Sharing]. 2. Make sure that [File Sharing] check box is selected, and then click [Options]. 3. Select [Share files and folders using SMB]. 4. Select the user accounts to enable for file sharing. Enter the user's password, then click [OK]. 5. Click [Done]. <p>For information on how to change the account settings on other version of Mac OS, consult your system administrator or the official website of Apple Inc.</p>
018-506	<p>[Cause] Communications with the CA server set in the machine failed.</p> <p>[Remedy] Execute the authentication operation again.</p>
018-507	<p>[Cause] The authentication failed because the user name or password entered is not correct.</p> <p>[Remedy] Enter the correct user name or password.</p>
018-508	<p>[Cause] A server error occurred during authentication.</p> <p>[Remedy] Check the status of the authentication server.</p>

Status Code	Cause and Remedy
018-543	<p>[Cause] Probable causes are as follows:</p> <ol style="list-style-type: none"> 1)The machine failed to transfer data using SMB of the Scan to PC service because the specified shared name does not exist. 2)The machine failed to transfer data using SMB of the Scan to PC service because Invalid characters are used in the specified shared name. 3)The machine failed to transfer data using SMB of the Scan to PC service because access privilege does not set on the specified shared name when the server is Macintosh. <p>[Remedy] 1)Confirm that the specified shared name exists in the destination PC. 2)Take one of the following measures:</p> <ul style="list-style-type: none"> - Check whether the following invalid characters are included in the shared name set in the machine: " / : < > ; , * ? \ [] + = - Check whether a space character is included at the top or end of the shared name set in the machine. - Check whether the shared name set in the machine is specified only by a period. <p>3)When the destination computer is Macintosh, you need to change the access privileges for the user for shared folder. For information about necessary accounting settings, consult your system administrator. The following is an example of a procedure for Mac OS X 10.6.</p> <p>Note</p> <ul style="list-style-type: none"> • It is recommended to create a dedicated account for data transfer. You can create and set the account on the dialog box that appears by choosing Apple menu > [System Preferences] and then clicking [Accounts] icon. <ol style="list-style-type: none"> 1. From Apple menu, choose [System Preferences], and then click [Sharing]. 2. Make sure that [File Sharing] check box is selected. 3. Select the folder being shared from folders listed in the [Shared Folders] field. 4. Choose [Read & Write] as privilege option for the user listed in the [Users] field. <p>For information on how to change the access privilege settings on other version of Mac OS, consult your system administrator or the official website of Apple Inc.</p>
018-547	<p>[Cause] The machine failed to transfer data using SMB of the Scan to PC service because the number of users logging into the SMB server exceeded the limit when logging in to the SMB server.</p> <p>[Remedy] Take one of the following measures:</p> <ul style="list-style-type: none"> • Confirm how many users can access the shared folder. • Check whether the number of login users have exceeded the limit.
018-556	<p>[Cause] Received an error detection code from the HTTP server.</p> <p>[Remedy] 1)Check whether the specified drive and directory is available on the destination HTTP server for the scanned document. 2)Perform the same operation again. If the problem persists, contact Customer Support at dell.com/contactdell.</p>
018-557	<p>[Cause] The specified file name contains invalid characters.</p> <p>[Remedy] Modify the file name. Make sure that invalid characters are not contained in the destination file name for the scanned document.</p>
018-558	<p>[Cause] Received an error code from HTTP server.</p> <p>[Remedy] 1)Check whether the specified directory exists on the destination HTTP server for the scanned document. 2)Check whether the specified file exists on the HTTP server.</p>
018-559	<p>[Cause] The same file name already exists. [Do Not Save] is selected when duplicate file name exists.</p> <p>[Remedy] Select any option other than [Do Not Save] in [File Name Conflict].</p>

Status Code	Cause and Remedy
018-560	<p>[Cause] A user authentication error occurred. (Received HTTP Status 401).</p> <p>[Remedy] Check the followings:</p> <ul style="list-style-type: none"> • The destination HTTP server for the scanned document is accessible by PC. • Login name • Login password • The HTTP server name • The HTTP server path name
018-561	<p>[Cause] The hostname or the script storage location is not correct. (Received HTTP Status 404).</p> <p>[Remedy] Check the followings:</p> <ul style="list-style-type: none"> • The destination HTTP server for the scanned document is accessible by PC. • The HTTP server name • The HTTP server path name
018-562	<p>[Cause] A client-side error occurred. (Received HTTP Status 4xx other than 401 and 404).</p> <p>[Remedy] Check the followings:</p> <ul style="list-style-type: none"> • The destination HTTP server for the scanned document is accessible by PC. • The server settings
018-563	<p>[Cause] A server-side error occurred. (Received HTTP Status 5xx).</p> <p>[Remedy] Check the followings:</p> <ul style="list-style-type: none"> • The destination HTTP server for the scanned document is accessible by PC. • The server settings
018-564	<p>[Cause] DNS resolution for the specified hostname failed.</p> <p>[Remedy] Check the followings:</p> <ul style="list-style-type: none"> • The destination HTTP server for the scanned document is registered on the DNS server. • The machine is connected to the DNS server. • The address of the DNS server is set on the machine.
018-565	<p>[Cause] DNS resolution for the proxy server name set on the machine failed.</p> <p>[Remedy] Check the followings:</p> <ul style="list-style-type: none"> • The proxy server name set on the machine is registered on the DNS server. • The machine is connected to the DNS server. • The address of the DNS server is set on the machine.
018-566	<p>[Cause] Unable to connect to the HTTP server.</p> <p>[Remedy] Check the followings:</p> <ul style="list-style-type: none"> • The network cable connection on the machine • The destination HTTP server for the scanned document is accessible by PC.
018-567	<p>[Cause] The followings may be the cause:</p> <ul style="list-style-type: none"> • The communication is disconnected while reading or writing due to some reason. • Close process of the file failed due to some reason <p>[Remedy] Check whether the destination HTTP server for the scanned document is accessible by PC.</p>

Status Code	Cause and Remedy
018-568	<p>[Cause] An SSL/TLS connection error occurred.</p> <p>[Remedy] Check the followings:</p> <ul style="list-style-type: none"> • The destination HTTP server for the scanned document is accessible by PC. • SSL settings for the HTTP server is correct. • The HTTP server name • The HTTP server path name
018-569	<p>[Cause] The SSL server certificate may have a problem.</p> <p>[Remedy] 1)Check whether the destination HTTP server for the scanned document is accessible by PC. 2)Check whether the SSL server certificate is registered on the HTTP server. 3)Check whether the SSL server certificate is valid. Check the followings:</p> <ul style="list-style-type: none"> - the certificate is unexpired - the time set on the machine is correct - the certificate is not on the discard list <p>4)Check the certificate path to the SSL server certificate, and import the required CA certificate. 5)If the SSL server certificated is not registered on the HTTP server, disable the [Verify Remote Server Certificate] setting.</p>
018-570	<p>[Cause] A client certificate authentication error occurred on the HTTP server.</p> <p>[Remedy] Check the followings:</p> <ul style="list-style-type: none"> • The destination HTTP server for the scanned document is accessible by PC. • The SSL client certificate is registered on the machine. • The device certificate is correctly registered on the HTTP server.
018-571	<p>[Cause] An internal error occurred.</p> <p>[Remedy] Perform the same operation again. If the problem persists, contact Customer Support at dell.com/contactdell.</p>
018-572	<p>[Cause] The specified context name contains invalid characters.</p> <p>[Remedy] Check whether the specified context name is correct.</p>
018-573	<p>[Cause] The specified connection name contains invalid characters.</p> <p>[Remedy] Check whether the specified connection name is correct.</p>
018-574	<p>[Cause] The specified volume name contains invalid characters.</p> <p>[Remedy] Check whether the specified volume name is correct.</p>
018-575	<p>[Cause] The specified user name or password contains invalid characters.</p> <p>[Remedy] Check whether the specified user name or password is correct.</p>
018-576	<p>[Cause] The specified path name contains invalid characters.</p> <p>[Remedy] Check whether the specified path name is correct.</p>
018-577	<p>[Cause] The specified file name contains invalid characters.</p> <p>[Remedy] Check whether the specified file name is correct.</p>
018-578	<p>[Cause] The specified server or tree name does not exist.</p> <p>[Remedy] Check the followings:</p> <ul style="list-style-type: none"> • The network cable connection on the machine • The NetWare server is accessible by PC • The NetWare server or tree name <p>Run DSREPAIR at the server console on the NetWare server.</p>

Status Code	Cause and Remedy
018-579	<p>[Cause] The hard disk on the NetWare server may be full.</p> <p>[Remedy] Check the followings:</p> <ul style="list-style-type: none"> • The NetWare server is accessible by PC • The free space of the server to store data <p>Run DSREPAIR at the server console on the NetWare server.</p>
018-580	<p>[Cause] The specified volume name does not exist on the NetWare server.</p> <p>[Remedy] Check the followings:</p> <ul style="list-style-type: none"> • The NetWare server is accessible by PC • The volume name <p>Run DSREPAIR at the server console on the NetWare server.</p>
018-581	<p>[Cause] The specified directory path does not exist on the NetWare server.</p> <p>[Remedy] Check the followings:</p> <ul style="list-style-type: none"> • The NetWare server is accessible by PC • The directory path name <p>Run DSREPAIR at the server console on the NetWare server.</p>
018-582	<p>[Cause] The followings may be the cause:</p> <ul style="list-style-type: none"> • The login user does not have Open rights to the file. • The login user does not have Create rights to create a file. • The login user does not have Access rights to the directory. • The login user does not have Read rights to the file. • The login user does not have Write rights to the file. • The login user does not have Delete rights of the directory or file. • Made a delete request to the directories or files but all of them are read-only. • Made a delete request to the directories or files but some of them are read-only. <p>[Remedy] 1) Check whether the NetWare server is accessible by PC. 2) Check the user has the following rights.</p> <ul style="list-style-type: none"> - Open rights to the file - Create rights to a file - Access rights to the directory - Read rights to the file - Write rights to the file - Delete rights to the directory or file <p>3) Run DSREPAIR at the server console on the NetWare server.</p>
018-583	<p>[Cause] A hard disk error occurred on the NetWare server.</p> <p>[Remedy] 1) Check the status of the HDD on the NetWare server. 2) Check whether the NetWare server is accessible by PC. 3) Run DSREPAIR at the server console on the NetWare server.</p>
018-584	<p>[Cause] The followings may be the cause:</p> <ul style="list-style-type: none"> • The communication is disconnected while reading or writing due to some reason • Close process of the file failed due to some reason <p>[Remedy] 1) Check whether the NetWare server is accessible by PC. 2) Run DSREPAIR at the server console on the NetWare server.</p>

Status Code	Cause and Remedy
018-585	<p>[Cause] The followings may be the cause:</p> <ul style="list-style-type: none"> • The specified folder or file is in use by another user • Made a delete request to the directories or files though some of them are in use by another user • Made a delete request to the directories or files though all of them are in use by another user <p>[Remedy] 1)Check whether the NetWare server is accessible by PC. 2)Check the status of use of the other users. 3)Run DSREPAIR at the server console on the NetWare server.</p>
018-586	<p>[Cause] Login to the NetWare server was denied.</p> <p>[Remedy] Check the followings:</p> <ul style="list-style-type: none"> • The NetWare server is accessible by PC • Login user name • Login password • Volume name • Server or tree name • Context name <p>Run DSREPAIR at the server console on the NetWare server.</p>
018-587	<p>[Cause] There are duplicate file names. [Do Not Save] is set as a handling method when names are duplicated for scanned files.</p> <p>[Remedy] Set the process to be executed in case of a file name duplication to other than [Do Not Save].</p>
018-588	<p>[Cause] Detected an incorrect filing policy (when add was selected) after connecting to the server.</p> <p>[Remedy] When [Rename New File] is set as the process to be executed in case of a file name duplication, confirm that the file format is not multi-page.</p>
018-589	<p>[Cause] Failed to access the NEXTNAME.DAT file.</p> <p>[Remedy] When [Rename New File] is set as the process to be executed in case of a file name duplication, check the NEXTNAME.DAT file is correct.</p>
018-590	<p>[Cause] A file or folder of the same name was detected on the server.</p> <p>[Remedy] Take one of the following measures:</p> <ol style="list-style-type: none"> 1)Execute the operation again by not accessing the same folder or the same server from multiple machines. 2)If the error still is not resolved, contact Customer Support at dell.com/contactdell.
018-591	<p>[Cause] When the machine was connected to the server and the name of a file or folder on the server was determined, the suffix of the name of the file or folder exceeded the limit value.</p> <p>[Remedy] Change the file name or forwarding destination folder of the scan server. Also try moving or deleting the files within the forwarding destination folder.</p>
018-592	<p>[Cause] Failed to delete a scan lock folder.</p> <p>[Remedy] Take one of the following measures:</p> <ol style="list-style-type: none"> 1)If an existing lock directory (*.LCK) remains in the forwarding destination, delete it manually, and then execute the job again. 2)Confirm that there is a folder with the name specified.
018-593	<p>[Cause] Failed to create the scan lock folder.</p> <p>[Remedy] If an existing lock directory (*.LCK) remains in the forwarding destination, delete it manually, and then execute the job again.</p>

Status Code	Cause and Remedy
018-595	<p>[Cause] Multiple entries containing the same smart card information were detected in the database of the LDAP server.</p> <p>[Remedy] Correct the temporary user entries of the LDAP server so that they do not contain the same smart card information.</p>
018-596	<p>[Cause] An error occurred during LDAP server authentication.</p> <p>[Remedy] Execute the operation again. If the error still is not resolved, contact Customer Support at dell.com/contactdell.</p>
018-700	<p>[Cause] The network for Web Applications is being initialized.</p> <p>[Remedy] Wait for a while, and then execute the operation again.</p>
018-701	<p>[Cause] An LDAP server protocol error occurred as a result of the Address Book operation. The server returned RFC2251 Result Message No "1" (operations error) for Address Book query.</p> <p>[Remedy] Check whether [LDAP Server / Directory Service Settings] under [Remote Authentication / Directory Service] has been set correctly. Or, the server may have a problem. Consult your network administrator.</p>
018-702	<p>[Cause] An LDAP server protocol error occurred as a result of the Address Book operation. The server returned RFC2251 Result Message No "2" (protocol error) for Address Book query.</p> <p>[Remedy] Have your network administrator confirm the LDAP server settings, and execute the operation again.</p>
018-703	<p>[Cause] An LDAP server protocol error occurred as a result of the Address Book operation. The server returned RFC2251 Result Message No "3" (time limit exceeded) for Address Book query.</p> <p>[Remedy] Change the search conditions/start position to narrow the search range, and execute the operation again. If the error still is not resolved, consult your network administrator.</p>
018-704	<p>[Cause] An LDAP server protocol error occurred as a result of the Address Book operation. The server returned RFC2251 Result Message No "4" (size limit exceeded) for Address Book query.</p> <p>[Remedy] Change the search conditions/start position to narrow the search range, and execute the operation again. If the error still is not resolved, consult your network administrator.</p>
018-705	<p>[Cause] An LDAP server protocol error occurred as a result of the Address Book operation. The server returned RFC2251 Result Message No "5" (compare false) for Address Book query.</p> <p>[Remedy] The result may differ from the specified content. Have your network administrator confirm the LDAP server status.</p>
018-706	<p>[Cause] An LDAP server protocol error occurred as a result of the Address Book operation. The server returned RFC2251 Result Message No "6" (compare true) for Address Book query.</p> <p>[Remedy] The desired result has been achieved. No problem occurred.</p>
018-707	<p>[Cause] An LDAP server protocol error occurred as a result of the Address Book operation. The server returned RFC2251 Result Message No "7" (specified authentication method not supported) for Address Book query.</p> <p>[Remedy] The LDAP server does not support the specified authentication method. Change the authentication method. Consult your system administrator for another method.</p>
018-708	<p>[Cause] An LDAP server protocol error occurred as a result of the Address Book operation. The server returned RFC2251 Result Message No "8" (strong authentication required) for Address Book query.</p> <p>[Remedy] Check whether the authentication settings are correct. Consult your system administrator about the authentication, and execute the operation again.</p>

Status Code	Cause and Remedy
018-709	<p>[Cause] An error occurred for external access (Web Applications).</p> <p>[Remedy] Take one of the following measures depending on the setting:</p> <p>For IPv4 environment</p> <ul style="list-style-type: none"> • Check the IPv4 address of the machine. • Confirm whether the network cable is connected correctly. • Check the address of the DHCP server. <p>For IPv6 environment</p> <ul style="list-style-type: none"> • Confirm whether the global address distributed from an IPv6 router is assigned to the IPv6 address of the machine. • Confirm whether the network cable is connected correctly. • Confirm whether the IPv6 router is set correctly.
018-710	<p>[Cause] An LDAP server protocol error occurred as a result of the Address Book operation. The server returned RFC2251 Result Message No "10" (referral) for Address Book query.</p> <p>[Remedy] No registered items were found in the specified retrieval range. Have your network administrator confirm the authentication settings.</p>
018-711	<p>[Cause] An LDAP server protocol error occurred as a result of the Address Book operation. The server returned RFC2251 Result Message No "11" (admin limit exceeded) for Address Book query.</p> <p>[Remedy] Have your network administrator confirm the operational status of the server.</p>
018-712	<p>[Cause] An LDAP server protocol error occurred as a result of the Address Book operation. The server returned RFC2251 Result Message No "12" (unavailable extension) for Address Book query.</p> <p>[Remedy] Have your network administrator confirm the operational status of the server.</p>
018-713	<p>[Cause] An LDAP server protocol error occurred as a result of the Address Book operation. The server returned RFC2251 Result Message No "13" (confidentiality required) for Address Book query.</p> <p>[Remedy] Have your network administrator confirm the operational status of the server.</p>
018-714	<p>[Cause] An LDAP server protocol error occurred as a result of the Address Book operation. The server returned RFC2251 Result Message No "14" (SASL bind in progress) for Address Book query.</p> <p>[Remedy] Retry after waiting for a while. If the error still is not resolved, consult your network administrator.</p>
018-715	<p>[Cause] Kerberos server authentication protocol error. There is no authentication method which supports both the machine authentication and Kerberos server authentication.</p> <p>[Remedy] Take one of the following measures:</p> <ul style="list-style-type: none"> • Set the appropriate authentication method in the Kerberos server. • Disable the FIPS140 validation mode of the machine. <p>If the error still is not resolved, contact Customer Support at dell.com/contactdell.</p>
018-716	<p>[Cause] An LDAP server protocol error occurred as a result of the Address Book operation. The server returned RFC2251 Result Message No "16" (no such attribute) for Address Book query.</p> <p>[Remedy] The LDAP server has an attribute problem. Have your network administrator confirm the LDAP server status.</p>

Status Code	Cause and Remedy
018-717	<p>[Cause] An LDAP server protocol error occurred as a result of the Address Book operation. The server returned RFC2251 Result Message No "17" (undefined type) for Address Book query.</p> <p>[Remedy] The LDAP server has an attribute problem. Have your network administrator confirm the LDAP server status.</p>
018-718	<p>[Cause] An LDAP server protocol error occurred as a result of the Address Book operation. The server returned RFC2251 Result Message No "18" (inappropriate matching) for Address Book query.</p> <p>[Remedy] The LDAP server has an attribute problem. Have your network administrator confirm the LDAP server status.</p>
018-719	<p>[Cause] An LDAP server protocol error occurred as a result of the Address Book operation. The server returned RFC2251 Result Message No "19" (constraint violation) for Address Book query.</p> <p>[Remedy] The LDAP server has an attribute problem. Have your network administrator confirm the LDAP server status.</p>
018-720	<p>[Cause] An LDAP server protocol error occurred as a result of the Address Book operation. The server returned RFC2251 Result Message No "20" (attribute exists) for Address Book query.</p> <p>[Remedy] The LDAP server has an attribute problem. Have your network administrator confirm the LDAP server status.</p>
018-721	<p>[Cause] An LDAP server protocol error occurred as a result of the Address Book operation. The server returned RFC2251 Result Message No "21" (invalid syntax) for Address Book query.</p> <p>[Remedy] The LDAP server has an attribute problem. Have your network administrator confirm the LDAP server status.</p>
018-725	<p>[Cause] The user password set in the Kerberos server expired.</p> <p>[Remedy] Extend the expiration date of the password.</p>
018-726	<p>[Cause] The root (or intermediate) CA certificate on the smart card is not registered on the machine.</p> <p>[Remedy] Register the root (or intermediate) CA certificate on the smart card on the machine.</p>
018-728	<p>[Cause] Authentication by the Kerberos server failed.</p> <p>[Remedy] Take one of the following measures:</p> <ul style="list-style-type: none"> • When the root CA certificate of the KDC certificate is not registered, register the root CA certificate. • When the KDC certificate is revoked, update the KDC certificate of the server. • Confirm that the address of the Kerberos server set in the machine and the address on the KDC certificate of the server match.
018-732	<p>[Cause] An LDAP server protocol error occurred as a result of the Address Book operation. The server returned RFC2251 Result Message No "32" (no such object) for Address Book query.</p> <p>[Remedy] The specified e-mail address does not exist. Confirm the e-mail address you entered or the e-mail address registered on the LDAP server.</p>
018-733	<p>[Cause] An LDAP server protocol error occurred as a result of the Address Book operation. The server returned RFC2251 Result Message No "33" (incorrect alias) for Address Book query.</p> <p>[Remedy] The LDAP server has a name problem. Have your network administrator confirm the LDAP server status.</p>

Status Code	Cause and Remedy
018-734	<p>[Cause] An LDAP server protocol error occurred as a result of the Address Book operation. The server returned RFC2251 Result Message No "34" (invalid DN syntax) for Address Book query.</p> <p>[Remedy] The LDAP server has a name problem. Confirm the user name and password to cancel an incorrect password. If the error still is not resolved, have your network administrator confirm the authentication settings and status of the LDAP server.</p>
018-735	<p>[Cause] An LDAP server protocol error occurred as a result of the Address Book operation. The server returned RFC2251 Result Message No "35" (object is leaf) for Address Book query.</p> <p>[Remedy] The LDAP server has a name problem. Have your network administrator confirm the LDAP server status.</p>
018-736	<p>[Cause] An LDAP server protocol error occurred as a result of the Address Book operation. The server returned RFC2251 Result Message No "36" (alias differencing problem) for Address Book query.</p> <p>[Remedy] The LDAP server has a name problem. Have your network administrator confirm the LDAP server status.</p>
018-748	<p>[Cause] An LDAP server protocol error occurred as a result of the Address Book operation. The server returned RFC2251 Result Message No "48" (inappropriate authentication) for Address Book query.</p> <p>[Remedy] The LDAP server has a security problem. Have your network administrator confirm the authentication settings on the LDAP server.</p>
018-749	<p>[Cause] An LDAP server protocol error occurred as a result of the Address Book operation. The server returned RFC2251 Result Message No "49" (invalid credentials) for Address Book query. The address search was performed with an incorrect authentication user name and password.</p> <p>[Remedy] The LDAP server has a security problem. Confirm your authentication user name and password to cancel an incorrect login name. If the error still is not resolved, have your network administrator confirm the authentication settings on the LDAP server.</p>
018-750	<p>[Cause] An LDAP server protocol error occurred as a result of the Address Book operation. The server returned RFC2251 Result Message No "50" (insufficient access) for Address Book query.</p> <p>[Remedy] The LDAP server has a security problem. Have your network administrator confirm the access rights for the LDAP server.</p>
018-751	<p>[Cause] An LDAP server protocol error occurred as a result of the Address Book operation. The server returned RFC2251 Result Message No "51" (busy) for Address Book query.</p> <p>[Remedy] The service has a problem. Retry after waiting for a while. If the error still is not resolved, consult your network administrator.</p>
018-752	<p>[Cause] An LDAP server protocol error occurred as a result of the Address Book operation. The server returned RFC2251 Result Message No "52" (unavailable) for Address Book query.</p> <p>[Remedy] The LDAP server has a service problem. Retry after waiting for a while. If the error still is not resolved, consult your network administrator.</p>
018-753	<p>[Cause] An LDAP server protocol error occurred as a result of the Address Book operation. The server returned RFC2251 Result Message No "53" (unwilling to perform) for Address Book query.</p> <p>[Remedy] The LDAP server has a service problem. Retry after waiting for a while. If the error still is not resolved, consult your network administrator.</p>

Status Code	Cause and Remedy
018-754	<p>[Cause] An LDAP server protocol error occurred as a result of the Address Book operation. The server returned RFC2251 Result Message No "54" (loop detected) for Address Book query.</p> <p>[Remedy] The LDAP server has a service problem. Have your network administrator confirm the operational status of the service on the LDAP server.</p>
018-764	<p>[Cause] An LDAP server protocol error occurred as a result of the Address Book operation. The server returned RFC2251 Result Message No "64" (naming violation) for Address Book query.</p> <p>[Remedy] The LDAP server has an update problem. Have your network administrator confirm the LDAP server status.</p>
018-765	<p>[Cause] An LDAP server protocol error occurred as a result of the Address Book operation. The server returned RFC2251 Result Message No "65" (object class violation) for Address Book query.</p> <p>[Remedy] The LDAP server has an update problem. Have your network administrator confirm the LDAP server status.</p>
018-766	<p>[Cause] An LDAP server protocol error occurred as a result of the Address Book operation. The server returned RFC2251 Result Message No "66" (not allowed on nonleaf) for Address Book query.</p> <p>[Remedy] The LDAP server has an update problem. Have your network administrator confirm the LDAP server status.</p>
018-767	<p>[Cause] An LDAP server protocol error occurred as a result of the Address Book operation. The server returned RFC2251 Result Message No "67" (not allowed on RDN) for Address Book query.</p> <p>[Remedy] The LDAP server has an update problem. Have your network administrator confirm the LDAP server status.</p>
018-768	<p>[Cause] An LDAP server protocol error occurred as a result of the Address Book operation. The server returned RFC2251 Result Message No "68" (already exists) for Address Book query.</p> <p>[Remedy] The LDAP server has an update problem. Have your network administrator confirm the LDAP server status.</p>
018-769	<p>[Cause] An LDAP server protocol error occurred as a result of the Address Book operation. The server returned RFC2251 Result Message No "69" (no object class modifications) for Address Book query.</p> <p>[Remedy] The LDAP server has an update problem. Have your network administrator confirm the LDAP server status.</p>
018-770	<p>[Cause] An LDAP server protocol error occurred as a result of the Address Book operation. The server returned RFC2251 Result Message No "70" (results too large) for Address Book query.</p> <p>[Remedy] Change the search conditions/start position to narrow the search range, and execute the operation again. If the error still is not resolved, consult your network administrator.</p>
018-771	<p>[Cause] An LDAP server protocol error occurred as a result of the Address Book operation. The server returned RFC2251 Result Message No "71" (affecting multiple DSAs) for Address Book query.</p> <p>[Remedy] Have your network administrator confirm the LDAP server status.</p>
018-780	<p>[Cause] An LDAP server protocol error occurred as a result of the Address Book operation. The server returned RFC2251 Result Message No "80" (unknown error) for Address Book query.</p> <p>[Remedy] Have your network administrator confirm the LDAP server status.</p>

Status Code	Cause and Remedy
018-781	<p>[Cause] An LDAP server protocol error occurred as a result of the Address Book operation. Connection to the server cannot be established for the Address Book query.</p> <p>[Remedy] Take one of the following measures:</p> <ul style="list-style-type: none"> • Confirm the network cable connection. • If the network cable connection has no problem, confirm the active status of the target server. • Check whether the server name has been correctly set for [LDAP Server / Directory Service Settings] under [Remote Authentication / Directory Service].
018-782	<p>[Cause] An LDAP server protocol error occurred as a result of the Address Book operation. The server returned RFC2251 Result Message No "82" (program error or SASL authentication error) for Address Book query.</p> <p>[Remedy] Have your network administrator confirm the LDAP server status.</p>
018-783	<p>[Cause] An LDAP server protocol error occurred as a result of the Address Book operation. The server returned RFC2251 Result Message No "83" (encoding error) for Address Book query.</p> <p>[Remedy] Have your network administrator confirm the LDAP server status.</p>
018-784	<p>[Cause] An LDAP server protocol error occurred as a result of the Address Book operation. The server returned RFC2251 Result Message No "84" (decoding error) for Address Book query.</p> <p>[Remedy] Have your network administrator confirm the LDAP server status.</p>
018-785	<p>[Cause] An LDAP server protocol error occurred as a result of the Address Book operation. The server returned RFC2251 Result Message No "85" (timeout) for Address Book query.</p> <p>[Remedy] Change the search conditions/start position to narrow the search range, and execute the operation again. If the error still is not resolved, consult your network administrator.</p>
018-786	<p>[Cause] An LDAP server protocol error occurred as a result of the Address Book operation. The server returned RFC2251 Result Message No "86" (unknown authentication method) for Address Book query.</p> <p>[Remedy] Have your network administrator confirm the LDAP server status.</p>
018-787	<p>[Cause] An LDAP server protocol error occurred as a result of the Address Book operation. The server returned RFC2251 Result Message No "87" (search filter error) for Address Book query.</p> <p>[Remedy] Confirm the search conditions set on Address Book. If the error still is not resolved, consult your network administrator.</p>
018-788	<p>[Cause] An LDAP server protocol error occurred as a result of the Address Book operation. The server returned RFC2251 Result Message No "88" (user cancelled operation) for Address Book query.</p> <p>[Remedy] Have your network administrator confirm the LDAP server status.</p>
018-789	<p>[Cause] An LDAP server protocol error occurred as a result of the Address Book operation. The server returned RFC2251 Result Message No "89" (incorrect parameter) for Address Book query.</p> <p>[Remedy] Have your network administrator confirm the LDAP server status.</p>
018-790	<p>[Cause] An LDAP server protocol error occurred as a result of the Address Book operation. The server returned RFC2251 Result Message No "90" (no memory) for Address Book query.</p> <p>[Remedy] Have your network administrator confirm the LDAP server status.</p>

Status Code	Cause and Remedy
018-791	<p>[Cause] An LDAP server protocol error occurred as a result of the Address Book operation. The server returned RFC2251 Result Message No "91" (server connection error) for Address Book query.</p> <p>[Remedy] Have your network administrator confirm the LDAP server status.</p>
018-792	<p>[Cause] An LDAP server protocol error occurred as a result of the Address Book operation. The server returned RFC2251 Result Message No "92" (unsupported feature) for Address Book query.</p> <p>[Remedy] Have your network administrator confirm the LDAP server status.</p>
018-793	<p>[Cause] An LDAP server protocol error occurred as a result of the Address Book operation. The server returned RFC2251 Result Message No "93" (no results returned) for Address Book query.</p> <p>[Remedy] Have your network administrator confirm the LDAP server status.</p>
018-794	<p>[Cause] An LDAP server protocol error occurred as a result of the Address Book operation. The server returned RFC2251 Result Message No "94" (no more results) for Address Book query.</p> <p>[Remedy] Have your network administrator confirm the LDAP server status.</p>
018-795	<p>[Cause] An LDAP server protocol error occurred as a result of the Address Book operation. The server returned RFC2251 Result Message No "95" (results remaining) for Address Book query.</p> <p>[Remedy] Have your network administrator confirm the LDAP server status.</p>
018-796	<p>[Cause] An LDAP server protocol error occurred as a result of the Address Book operation. The server returned RFC2251 Result Message No "96" (client loop detected) for Address Book query.</p> <p>[Remedy] Have your network administrator confirm the LDAP server status.</p>
018-797	<p>[Cause] An LDAP server protocol error occurred as a result of the Address Book operation. The server returned RFC2251 Result Message No "97" (referral limit exceeded) for Address Book query.</p> <p>[Remedy] Have your network administrator confirm the LDAP server status.</p>
021-210 021-211 021-212	<p>[Cause] An error occurred in the smart card reader.</p> <p>[Remedy] Check the connection between the smart card reader and the machine. Switch off the machine power, make sure that the touch screen is blank, and then switch on the machine power. If the error still is not resolved, the smart card reader may be defective. Connect an unbroken smart card reader and execute the operation again.</p>
021-214	<p>[Cause] An error occurred during encrypted communication between the machine and the USB memory device.</p> <p>[Remedy] Switch off the machine power, make sure that the touch screen is blank, and then switch on the machine power. Execute the operation again. If the error still is not resolved, contact Customer Support at dell.com/contactdell.</p>
021-215	<p>[Cause] The accounting/billing device connected does not match the device set on the machine.</p> <p>[Remedy] Change the setting on the machine or connect the correct accounting/billing device, and switch off the machine power, make sure that the touch screen is blank, and then switch on the machine power.</p>
021-360 021-361	<p>[Cause] An error occurred.</p> <p>[Remedy] Switch off the machine power, make sure that the touch screen is blank, and then switch on the machine power. If the same message is displayed again, contact Customer Support at dell.com/contactdell.</p>

Status Code	Cause and Remedy
021-401	<p>[Cause] The number of authentication devices such as a smart card reader connected exceeds the setting value.</p> <p>[Remedy] Disconnect the authentication device connected.</p>
021-500	<p>[Cause] The following operation is performed when the Auditron mode for the Fax service is enabled.</p> <ul style="list-style-type: none"> • While a Send Fax job is processing, another job that the Auditron mode is enabled starts. • While another job that the Auditron mode is enabled is processing, a Send Fax job starts. <p>[Remedy] Wait for the active job finishes, and start the next job.</p>
021-731	<p>[Cause] While the EP system is available, you attempted to make color copies when the use of color is restricted.</p> <p>[Remedy] Contact Customer Support at dell.com/contactdell.</p>
021-732	<p>[Cause] The EP system is not available.</p> <p>[Remedy] Contact Customer Support at dell.com/contactdell.</p>
021-733	<p>[Cause] The EP system is not available because the use of color is restricted or the number of color pages reached the maximum.</p> <p>[Remedy] Contact Customer Support at dell.com/contactdell.</p>

Status Code	Cause and Remedy
024-340 024-341 024-342 024-343 024-345 024-346 024-347 024-348 024-349 024-350 024-351 024-352 024-353 024-354 024-355 024-356 024-357 024-358 024-359 024-360 024-361 024-362 024-363 024-364 024-365 024-366 024-367 024-368 024-370 024-371 024-372 024-373 024-375 024-376	<p>[Cause] An error occurred in the machine.</p> <p>[Remedy] Switch off the machine power, make sure that the touch screen is blank, and then switch on the machine power. If the same message is displayed again, contact Customer Support at dell.com/contactdell.</p>
024-701	<p>[Cause] The specified paper type is not compatible with the Face Up/Down Output setting selected.</p> <p>[Remedy] Specify a paper type that is compatible with the Face Up/Down setting.</p>
024-702	<p>[Cause] Paper jam occurred while [When Paper Jam Occurs] is set to [Delete Job] in [Print Service Settings].</p> <p>[Remedy] Remove the jammed paper, and then try printing again.</p>
024-703	<p>[Cause] Unable to print because the number of booklet pages exceeds the maximum number allowed.</p> <p>[Remedy] Use paper of less weight. Or, cancel the booklet creation.</p>
024-705	<p>[Cause] The template of the specified force annotation was not found in the machine.</p> <p>[Remedy] Delete the document in the folder of the machine, and then select [Store to Folder] again from the print driver to store the document.</p>

Status Code	Cause and Remedy
024-742	<p>[Cause] Booklet printing was specified for printer properties, but the number of print pages for the job exceeded the maximum number allowed for booklet creation.</p> <p>[Remedy] Change the printer properties setting to split the pages appropriately to create separate volumes, or to cancel the booklet creation setting.</p>
024-746	<p>[Cause] The specified paper type is not compatible with the specified paper size, paper tray, output tray, or 2 sided printing.</p> <p>[Remedy] Confirm the print data.</p>
024-747	<p>[Cause] Incompatible print parameters are used. The combination of the specified features such as Document Size, Paper Size, Paper Tray, 2 sided printing, and Output Tray is incompatible.</p> <p>[Remedy] Confirm the print data, and try printing again.</p>
024-748	<p>[Cause] The number of digits specified in [Bates Stamp - Number of Digits] screen does not match the value specified in [Starting Number].</p> <p>[Remedy] Set [Bates Stamp - Number of Digits] to the value specified in [Starting Number] or to [Auto Assign].</p>
024-775	<p>[Cause] Booklet printing was specified for printer properties, but the number of print pages for the job exceeded the maximum number allowed for booklet creation.</p> <p>[Remedy] Change the printer properties setting to split the pages appropriately to create separate volumes, or to cancel the booklet creation setting.</p>
025-596 025-597	<p>[Cause] An error occurred with the hard disk.</p> <p>[Remedy] Replace the hard disk.</p>
026-400	<p>[Cause] More than two devices are connected to the USB host port.</p> <p>[Remedy] Disconnect the third or more devices so that the number of connected devices becomes two. If the error still is not resolved, switch off the machine power, make sure that the touch screen is blank, and then switch on the machine power.</p>
026-700	<p>[Cause] By Address Book operation, the machine received an unsupported protocol from the LDAP server.</p> <p>[Remedy] Execute the operation again. If the error still is not resolved, contact Customer Support at dell.com/contactdell.</p>
026-701	<p>[Cause] The number of queries submitted to the Address Book exceeded the machine's processing capability.</p> <p>[Remedy] Wait for a while and execute the operation again. If the only one query is being submitted to the Address Book, the machine's software may be defective. Contact Customer Support at dell.com/contactdell.</p>
026-702	<p>[Cause] The number of accesses from the LDAP server to the machine by Address Book operation exceeded the machine's processing capability.</p> <p>[Remedy] Wait for a while and execute the operation again. If the error still is not resolved, contact Customer Support at dell.com/contactdell.</p>
026-703	<p>[Cause] Authentication is canceled when adding documents during faxing or scanning.</p> <p>[Remedy] Authenticate when adding documents.</p>

Status Code	Cause and Remedy
026-708	<p>[Cause] Exceeded the maximum limit for the scan data size that can be stored for one job with Store & Send Link.</p> <p>[Remedy] Take one of the following measures:</p> <ol style="list-style-type: none"> 1) Reduce the resolution (scan quality) of the scan parameters and execute the operation again. 2) Reduce the image with magnification of the scan parameters (such as A3 > A4) and then execute the operation again. 3) If [Store & Send Link - Maximum File Size] is set to a small value, increase the value.
026-709	<p>[Cause] The capacity of the hard disk that can be used to store scan data with Store & Send Link is insufficient.</p> <p>[Remedy] Wait around one day, and when capacity becomes available as a result of the automatic deletion of files, execute the operation again.</p>
026-710	<p>[Cause] The machine has received an e-mail encrypted by S/MIME, but does not support the encryption method.</p> <p>[Remedy] Take one of the following measures:</p> <ul style="list-style-type: none"> • Ask the sender to send the e-mail encrypted by 3DES. • Disable the FIPS140 validation mode of the machine.
026-711	<p>[Cause] Exceeded the maximum size allowed for a multi-page file when scanning.</p> <p>[Remedy] Take one of the following measures:</p> <ol style="list-style-type: none"> 1) Reduce the resolution (scan quality) of the scan parameters and execute the operation again. 2) Reduce the number of document pages and then execute the operation again. <p>The maximum size is 2 GB for TIFF, XPS, and PDF.</p> <p>Note • XPS stands for XML Paper Specification.</p>
026-712	<p>[Cause] An error occurred while operating from Dell Printer Configuration Web Tool.</p> <p>[Remedy] Retry after waiting for a while.</p>
026-718	<p>[Cause] Incompatible print parameters are used. The combination of the specified features such as Document Size, Paper Size, Paper Tray, 2 sided printing, and Output Tray is incompatible.</p> <p>[Remedy] Confirm the print data, and try printing again.</p>
026-719	<p>[Cause] An error occurred while operating the Store to USB service.</p> <p>[Remedy] Wait for a while and execute the operation again. If the error still is not resolved, contact Customer Support at dell.com/contactdell.</p>
026-720	<p>[Cause] The capacity of the USB memory device of the recipient is insufficient while performing the Store to USB service.</p> <p>[Remedy] Confirm the amount of available space.</p>
026-721	<p>[Cause] An error occurred while operating the Store to USB service.</p> <p>[Remedy] Check the following conditions:</p> <ul style="list-style-type: none"> • The USB memory device is inserted into the USB memory slot. • The USB memory device is accessible from your computer. • The unencrypted USB memory device is used.

Status Code	Cause and Remedy
026-722	<p>[Cause] The USB memory device is not initialized.</p> <p>[Remedy] Initialize the USB memory device on a computer with the following file format, and then execute the operation again.</p> <ul style="list-style-type: none"> • Supported file formats: FAT12, FAT16 (FAT), FAT32 <p>Note</p> <ul style="list-style-type: none"> • NTFS is not supported. • A software-encrypted USB memory device is not supported. <p>If the error still is not resolved, contact Customer Support at dell.com/contactdell.</p>
026-723	<p>[Cause] The machine failed to access to the medium.</p> <p>[Remedy] 1)Check that the medium is not inserted or removed, or the other medium is not inserted, while the machine is referencing the medium. 2)Check that the file in the medium can be accessed via a computer.</p>
026-726	<p>[Cause] The machine configuration information at a print job specification does not match the actual machine configuration.</p> <p>[Remedy] Modify the machine configuration information in the print driver screen to match the actual machine configuration.</p>
026-727	<p>[Cause] Probable causes are as follows:</p> <ol style="list-style-type: none"> 1)Unusable characters are included in the path name of the file location. 2)The length of the path name of the file location (including extension) exceeds the number of characters available. <p>[Remedy] Take one of the following measures:</p> <ol style="list-style-type: none"> 1)Change the path name of the file location. 2)Set the path in the range of 1 to 255 bytes.
026-730	<p>[Cause] The size of paper loaded in the specified tray is unknown.</p> <p>[Remedy] Check whether the paper guides are correctly positioned in the tray, and then try again.</p>
026-736	<p>[Cause] An internal error occurred while sending the scanned document to the HTTP server.</p> <p>[Remedy] Execute the operation again. If the error still is not resolved, contact Customer Support at dell.com/contactdell.</p>
026-737	<p>[Cause] Unable to send the scanned document to the HTTP server because a network error occurred.</p> <p>[Remedy] Consult your network administrator whether the network or the server have any problem.</p>
026-738	<p>[Cause] The machine failed to send scanned document data to the HTTP server because Web application is closed during it.</p> <p>[Remedy] Execute the operation again.</p>
027-400	<p>[Cause] Communications with the machine failed.</p> <p>[Remedy] If other messages are displayed, confirm their content. If the control panel is being operated, terminate the operation. If remote access is being executed, wait until it completes. If the error still is not resolved, switch off the machine power, make sure that the touch screen is blank, and then switch on the machine power. If the problem persists, contact Customer Support at dell.com/contactdell.</p>
027-442	<p>[Cause] The IP address of IPv6 already exists.</p> <p>[Remedy] Change the [Auto Stateless Address 1] for IPv6 on the machine, or the IP address of IPv6 on the network device, to remove the duplication of addresses.</p>
027-443	<p>[Cause] The IP address of IPv6 already exists.</p> <p>[Remedy] Change the [Auto Stateless Address 2] for IPv6 on the machine, or the IP address of IPv6 on the network device, to remove the duplication of addresses.</p>

Status Code	Cause and Remedy
027-444	<p>[Cause] The IP address of IPv6 already exists.</p> <p>[Remedy] Change the [Auto Stateless Address 3] for IPv6 on the machine, or the IP address of IPv6 on the network device, to remove the duplication of addresses.</p>
027-445	<p>[Cause] IP address for IPv6 set manually is incorrect.</p> <p>[Remedy] Set the IP address correctly.</p>
027-446	<p>[Cause] The IP address of IPv6 set manually already exists.</p> <p>[Remedy] Change the [Manually Configured IPv6 Address] on the machine, or the IP address of IPv6 on the network device, to remove the duplication of addresses.</p>
027-447	<p>[Cause] The IP address of IPv6 already exists.</p> <p>[Remedy] Change the [Link-local Address] for IPv6 on the machine, or the IP address of IPv6 on the network device, to remove the duplication of addresses.</p>
027-452	<p>[Cause] IP address of IPv4 already exists.</p> <p>[Remedy] Change the IP address of IPv4 set on the machine or the IP address of IPv4 on the network device.</p>
027-500	<p>[Cause] Unable to connect to the SMTP server.</p> <p>[Remedy] Specify the SMTP server name correctly or specify the server by using its IP address.</p>
027-501	<p>[Cause] A POP server error occurred.</p> <p>[Remedy] Execute the operation again. If the error still is not resolved, contact Customer Support at dell.com/contactdell.</p>
027-502	<p>[Cause] Failed to log into the POP3 server when using the POP3 protocol.</p> <p>[Remedy] Confirm whether the user name and password used in the POP3 server are correct on Dell Printer Configuration Web Tool.</p>
027-503	<p>[Cause] A POP server error occurred.</p> <p>[Remedy] Execute the operation again. If the error still is not resolved, contact Customer Support at dell.com/contactdell.</p>
027-504	<p>[Cause] An SMTP server error occurred.</p> <p>[Remedy] Execute the operation again. If the error still is not resolved, contact Customer Support at dell.com/contactdell.</p>
027-513	<p>[Cause] The machine failed to transfer data using SMB of the Scan to PC service because access to the SMB server was not permitted.</p> <p>When the server is Macintosh, a folder with the same name as the specified file name may exist on the server.</p> <p>[Remedy] Consult your system administrator for settings.</p>
027-514	<p>[Cause] The machine failed to transfer data using SMB of the Scan to PC service because an error has been occurred between the SMB server and the DNS server.</p> <p>[Remedy] Check the following conditions:</p> <ul style="list-style-type: none"> • The SMB server is connected to the DNS server. • The SMB server name is registered on the DNS server.
027-515	<p>[Cause] The machine failed to transfer data using SMB of the Scan to PC service because an error has been occurred.</p> <p>[Remedy] Take the following measures:</p> <ul style="list-style-type: none"> • Set the DNS server address. • Set the target SMB server address using IP address.

Status Code	Cause and Remedy
027-516	<p>[Cause] Probable causes are as follows:</p> <ol style="list-style-type: none"> 1)The SMB server of the destination computer cannot be found while transferring data using SMB of the Scan to PC service (TCP/IP session establishment failed). 2)The SMB server specified as the destination does not respond to the machine while transferring data using SMB of the Scan to PC service. 3)Failed to name resolution of the SMB server specified as destination to transfer data using SMB of the Scan to PC service. <p>[Remedy] Take one of the following measures:</p> <ol style="list-style-type: none"> 1)Confirm the connection of the network cable. <ul style="list-style-type: none"> - For communications over subnet, confirm the WINS server settings, and check whether the server address can be resolved correctly. - File Sharing service (communicating via port 137 (UDP), port 138 (UDP), and port 139 (TCP)) is authorized for the Firewall settings of the destination SMB server. 2)Check whether the file sharing service is enabled on the destination SMB server. <ul style="list-style-type: none"> - File Sharing service for Microsoft Network is activated. <p>If the error still is not resolved, check the following setting.</p> <ul style="list-style-type: none"> - NetBIOS over TCP/IP for TCP/IP is activated. 3)Take one of the following measures: <ul style="list-style-type: none"> - When the destination SMB server name is specified using the FQDN (example: mypc01.abc0.co.jp), confirm that the DNS server address is set correctly in the Connectivity & Network Setup of the machine. - If the connection with the DNS server has any problem, check whether the destination server name set in the machine is registered on the DNS server.
027-518	<p>[Cause] The machine failed to transfer data using SMB of the Scan to PC service because the specified password was incorrect.</p> <p>When the server is Macintosh, the specified user may not have been registered as a user who is permitted to use Windows Sharing.</p> <p>[Remedy] Confirm the password for the shared folder.</p> <p>When the server is Macintosh, specify a user who is permitted to use Windows Sharing.</p>
027-519	<p>[Cause] The machine failed to transfer data using SMB of the Scan to PC service because the save location or file name specified for the scanned image had a problem.</p> <ul style="list-style-type: none"> • The save location or the file name has a problem. • The specified save location does not exist on the server. • Invalid characters are used in the save location or the file name. • Because the specified save location has the Distributed File System (DFS) settings, it is linked to another shared folder. <p>[Remedy] Take one of the following measures:</p> <ul style="list-style-type: none"> • Check whether the save location is correct • Check whether the specified file name can be used on the SMB server. • Confirm the Distributed File System (DFS) settings with your system administrator. To confirm the settings, execute the following procedures: <ol style="list-style-type: none"> 1)Select [Start] > [Programs] > [Administrative Tools] > [Distributed File System] on the SMB server. 2)Select the specified save location from the left side frame of the [Distributed File System] window, and then confirm the target information displayed on the right side frame of the window. 3)Specify the SMB server, shared name, and save location based on the information you confirmed in step 2.

Status Code	Cause and Remedy
027-520	<p>[Cause] The machine failed to transfer data using SMB of the Scan to PC service because the file name or folder name could not be retrieved.</p> <p>[Remedy] Confirm the access privilege to the SMB server.</p>
027-521	<p>[Cause] The machine failed to transfer data using SMB of the Scan to PC service because the suffix of the name of the file or folder exceeded the limit value.</p> <p>[Remedy] Change the file name or forwarding destination folder of the scan server. Or, try moving or deleting the files within the forwarding destination folder.</p>
027-522	<p>[Cause] During forwarding using SMB of the Scan to PC service, the scanned image file could not be created on the SMB server because of one of the following reasons:</p> <ul style="list-style-type: none"> • The specified file name already exists. • The specified file name has already been used. • The specified file name exists as a directory. • Invalid characters are used in the file name. <p>[Remedy] Take one of the following measures:</p> <ul style="list-style-type: none"> • Check whether the specified file name can be used in the save location. • Check whether the specified file name has been used by another user. • Check whether the specified file name has been used for another file or folder.
027-523	<p>[Cause] The machine failed to transfer data using SMB of the Scan to PC service because a folder could not be created on the SMB server. The specified folder already exists.</p> <p>[Remedy] Check whether the specified name is being used for another file or folder on the SMB server.</p>
027-524	<p>[Cause] The machine failed to transfer data using SMB of the Scan to PC service because a folder could not be created on the SMB server. The specified folder already exists.</p> <p>[Remedy] Check whether the specified name is being used for another file or folder on the SMB server.</p>
027-525	<p>[Cause] During forwarding using SMB of the Scan to PC service, a file could not be deleted from the SMB server because of one of the following reasons:</p> <ul style="list-style-type: none"> • The file does not exist. • The file is opened. • The specified file name is being used as a directory. <p>[Remedy] Check whether the file is not being used by another user at the specified save location.</p>
027-526	<p>[Cause] The machine failed to delete the lock directory on the SMB server while transferring data using SMB of the Scan to PC service.</p> <p>[Remedy] If the lock directory (*.LCK) exists in the destination, delete it manually, and then execute the operation again.</p>
027-527	<p>[Cause] During forwarding using SMB of the Scan to PC service, a folder could not be deleted from the SMB server because of one of the following reasons:</p> <ul style="list-style-type: none"> • The file does not exist. • The directory is not empty. • The specified directory name does not exist. <p>[Remedy] Check whether the file is not being used by another user at the specified save location.</p>
027-528	<p>[Cause] The machine failed to transfer data using SMB of the Scan to PC service because no space is available at the save location on the SMB server.</p> <p>[Remedy] Check whether the save location has free space.</p>

Status Code	Cause and Remedy
027-529	<p>[Cause] The machine failed to transfer data using SMB of the Scan to PC service because an unexpected error has been received from the SMB server, or an unexpected internal error has occurred on the machine.</p> <p>[Remedy] Log into the server from another computer using the same user name, to confirm whether a file can be written into the same save location on the server. If the error still is not resolved, it may be an internal error. Contact Customer Support at dell.com/contactdell.</p>
027-530	<p>[Cause] There are duplicate file names. [Do Not Save] is set as a handling method when names are duplicated for scanned files.</p> <p>[Remedy] Set the process to be executed in case of a file name duplication to other than [Do Not Save].</p>
027-531	<p>[Cause] Detected an incorrect filing policy (when add was selected) after connecting to the server.</p> <p>[Remedy] When [Rename New File] is set as the process to be executed in case of a file name duplication, confirm that the file format is not multi-page.</p>
027-532	<p>[Cause] Failed to access the NEXTNAME.DAT file.</p> <p>[Remedy] When [Rename New File] is set as the process to be executed in case of a file name duplication, check the NEXTNAME.DAT file is correct.</p>
027-533	<p>[Cause] An internal error occurred.</p> <p>[Remedy] Execute the operation again. If the error still is not resolved, contact Customer Support at dell.com/contactdell.</p>
027-543	<p>[Cause] The SMB server (NetBIOS) name is invalid.</p> <p>[Remedy] Check whether the server name of the SMB server is correct.</p>
027-547	<p>[Cause] SMB protocol error. An invalid character was detected in the specified domain name.</p> <p>[Remedy] If the error occurred during SMB authentication:</p> <p>Consult your network administrator for the domain name, and then set it correctly.</p> <p>Also, check whether the domain name set on the machine is correct.</p> <p>To confirm the settings, execute the following procedures:</p> <ol style="list-style-type: none"> 1) Enter the System Administration mode, and select [Tools] > [System Settings] > [Connectivity & Network Setup] > [Remote Authentication / Directory Service] > [SMB Server Settings]. 2) Select the SMB server to confirm the domain name. <p>If the error occurred during transferring using SMB of the Scan to PC service:</p> <p>Consult your network administrator whether the domain name specified when entering login name is correct.</p> <p>To confirm the domain name on the server, execute the following procedures:</p> <ol style="list-style-type: none"> 1) Select [Start] > [Programs] > [Administrative Tools] > [Active Directory Domains and Trusts] on the Active Directory domain controller. 2) From the left side frame of the [Active Directory Domains and Trusts] window, select [Active Directory Domains and Trusts] > [Domains]. Right-click [Domains] to select [Properties]. 3) Select [General] tab in the domain properties window, and confirm the domain name (prior to Windows 2000).

Status Code	Cause and Remedy
027-548	<p>[Cause] SMB protocol error. An invalid character has been detected in the specified user name.</p> <p>[Remedy] Ask your network administrator to set the user name with valid characters.</p> <p>To confirm the user name on the server, execute the following procedures:</p> <ol style="list-style-type: none"> 1) Select [Start] > [Programs] > [Administrative Tools] > [Active Directory Users and Computers] on the Active Directory domain controller where the user information is set. 2) Select [Active Directory Users and Computers] > [Server] > [Domains] > [Users] from the left side frame of the [Active Directory Users and Computers] window, to display the user information. 3) Right-click the target user from the right side frame of the [Active Directory Domains and Trusts] window to select [Properties]. 4) Select the [Account] tab in the [User Properties] window, and confirm the user name of [User Log On Name (Prior to Windows 2000)].
027-549	<p>[Cause] SMB protocol error</p> <p>[Remedy] Execute the operation again. If the error still is not resolved, contact Customer Support at dell.com/contactdell.</p>
027-564	<p>[Cause] SMB protocol error. The SMB server was not found.</p> <p>[Remedy] Check whether the connection between the authentication server and the machine has been established via a network.</p> <p>For example, confirm the following conditions:</p> <ul style="list-style-type: none"> • Network cable connection • TCP/IP settings • Connection via Port 137 (UDP), Port 138 (UDP), and Port 139 (TCP)
027-565	<p>[Cause] SMB protocol error</p> <p>[Remedy] Execute the operation again. If the error still is not resolved, contact Customer Support at dell.com/contactdell.</p>
027-566	<p>[Cause] SMB protocol error. SMB (TCP/IP) is not active.</p> <p>[Remedy] Confirm that SMB (TCP/IP) is active on the [Port Settings] screen of the [Properties] tab on Dell Printer Configuration Web Tool.</p>
027-569	<p>[Cause] The SMB (TCP/IP) port is not activated.</p> <p>[Remedy] Confirm that SMB (TCP/IP) is active on the [Port Settings] screen of the [Properties] tab on Dell Printer Configuration Web Tool.</p>
027-572 027-573 027-574 027-576 027-578	<p>[Cause] SMB protocol error</p> <p>[Remedy] Execute the operation again. If the error still is not resolved, contact Customer Support at dell.com/contactdell.</p>
027-584	<p>[Cause] SMB protocol error. The SMB server is in shared security mode.</p> <p>[Remedy] The SMB server may be set on Windows 95, Windows 98, or Windows Me OS. Set the SMB server on an OS other than Windows 95, Windows 98, or Windows Me OS.</p>
027-585	<p>[Cause] SMB protocol error. Login is disabled at this time.</p> <p>[Remedy] Confirm the period login permitted with your system administrator.</p>
027-586	<p>[Cause] SMB protocol error. The password has expired.</p> <p>[Remedy] Obtain a valid password from your system administrator.</p>

Status Code	Cause and Remedy
027-587	<p>[Cause] SMB protocol error. The password must be changed.</p> <p>[Remedy] Log into Windows, and change the password. Ask your system administrator to change the setting so that you do not need to change the login password next time.</p>
027-588	<p>[Cause] SMB protocol error. The user is invalid.</p> <p>[Remedy] Ask your system administrator to validate the user.</p>
027-589	<p>[Cause] SMB protocol error. The user was locked out.</p> <p>[Remedy] Ask your system administrator to cancel the lockout status.</p>
027-590	<p>[Cause] SMB protocol error. The user account has expired.</p> <p>[Remedy] Obtain a valid user account from your system administrator. Or, ask your system administrator to extend the account expiration date.</p>
027-591	<p>[Cause] SMB protocol error. Users are restricted. A blank password is invalid.</p> <p>[Remedy] Set the password for the user.</p>
027-700	<p>[Cause] The domain section of the recipient's e-mail address is a prohibited domain.</p> <p>[Remedy] Specify a domain that is not prohibited for the domain section of the recipient's e-mail address.</p>
027-701	<p>[Cause] The network cable is disconnected from the machine.</p> <p>[Remedy] Connect the network cable securely if the cable is disconnected.</p>
027-702	<p>[Cause] The specified recipient's certificate does not exist.</p> <p>[Remedy] Register the certificate for the recipient on the machine.</p>
027-703	<p>[Cause] The specified recipient's certificate has expired.</p> <p>[Remedy] Register a valid certificate for the recipient on the machine.</p>
027-704	<p>[Cause] The CA certificate of the specified recipient's certificate does not exist.</p> <p>[Remedy] Confirm the path to the recipient's certificate, and register the required CA certificate on the machine.</p>
027-705	<p>[Cause] The specified recipient's certificate has been revoked.</p> <p>[Remedy] Specify a valid certificate for the recipient.</p>
027-706	<p>[Cause] Unable to find the S/MIME certificate associated with the machine's e-mail address when sending e-mail.</p> <p>[Remedy] Import the S/MIME certificate corresponding to the mail address to the machine.</p>
027-707	<p>[Cause] The S/MIME certificate associated with the machine's e-mail address has expired when sending e-mail.</p> <p>[Remedy] Ask the sender to issue a new S/MIME certificate, and then import the certificate to the machine.</p>
027-708	<p>[Cause] The S/MIME certificate associated with the machine's e-mail address is not reliable when sending e-mail.</p> <p>[Remedy] Import a reliable S/MIME certificate to the machine.</p>
027-709	<p>[Cause] The S/MIME certificate associated with the machine's e-mail address has been discarded when sending e-mail.</p> <p>[Remedy] Import a new S/MIME certificate to the machine.</p>
027-710	<p>[Cause] No S/MIME certificate is attached to the received e-mail.</p> <p>[Remedy] Ask the sender to send the e-mail with an S/MIME certificate attached.</p>

Status Code	Cause and Remedy
027-711	<p>[Cause] No S/MIME certificate can be obtained from the received e-mail.</p> <p>[Remedy] Import the sender's S/MIME certificate to the machine, or ask the sender to send S/MIME signature mail with an S/MIME certificate attached.</p>
027-712	<p>[Cause] The received S/MIME certificate has expired, or is an unreliable certificate.</p> <p>[Remedy] Ask the sender to send the e-mail with a valid S/MIME certificate attached.</p>
027-713	<p>[Cause] The received e-mail has been discarded because it may have been altered on its transmission route.</p> <p>[Remedy] Inform this error to the sender, and ask the sender to send the e-mail again.</p>
027-714	<p>[Cause] The received e-mail has been discarded because the address in its From field is different from the mail address in the S/MIME signature mail.</p> <p>[Remedy] Inform the sender that the mail addresses differ, and ask the sender to send the e-mail again.</p>
027-715	<p>[Cause] The received S/MIME certificate has not been registered on the machine, or has not been set for use on the machine.</p> <p>[Remedy] Import the sender's S/MIME certificate to the machine, or change settings to use the S/MIME certificate on the machine if the S/MIME certificate has already been registered.</p>
027-716	<p>[Cause] The received S/MIME certificate has been discarded because the certificate was unreliable.</p> <p>[Remedy] Ask the sender to send the e-mail with a reliable S/MIME certificate attached.</p>
027-717	<p>[Cause] Unable to obtain SMTP server address for e-mail transmissions from the DNS server.</p> <p>[Remedy] Check whether the DNS server is set correctly.</p>
027-722	<p>[Cause] The jobs timed out during connection with an application interface destination.</p> <p>[Remedy] Try processing the job flow again.</p>
027-727	<p>[Cause] A parameter is illegal during an application interface.</p> <p>[Remedy] Try processing the job flow again.</p>
027-728	<p>[Cause] The number of files that are to be sent to external services exceeded the maximum number.</p> <p>[Remedy] Reduce the number of files, and send them again.</p>
027-730	<p>[Cause] The number of the document pages attached to the SMTP mail exceeds the maximum number of pages allowed for the Split Send feature.</p> <p>[Remedy] Increase the number of pages allowed for the Split Send feature, or reduce the number of the document pages.</p>
027-735	<p>[Cause] The data transfer using SSL is specified, but the SSL setting of the machine is disabled.</p> <p>[Remedy] Enable the SSL setting, or specify HTTP for the transfer protocol.</p>
027-736	<p>[Cause] The server certificate verification feature of the machine is disabled when the server certificate verification is required.</p> <p>[Remedy] Enable the server certificate validation. Or, disable the server certificate validation for data transfer.</p>
027-750	<p>[Cause] Attempted to execute a fax, a print, or an Internet fax transmission to the scanned document.</p> <p>[Remedy] The Fax, Print, or Internet Fax features are unavailable for scanned documents. Set the job flow correctly.</p>
027-751	<p>[Cause] An error occurred during job flow processing.</p> <p>[Remedy] Confirm the settings of the job flow.</p>

Status Code	Cause and Remedy
027-752	<p>[Cause] A mandatory entry field is blank in the job flow.</p> <p>[Remedy] Take one of the following measures:</p> <ul style="list-style-type: none"> • Do not link folders to job flows that have mandatory entry fields. • Set the default values to the mandatory fields of the job flow.
027-753	<p>[Cause] 1) Attempted to execute the service while the port necessary for the job flow is either deactivated or disabled. 2) Attempted to execute a job flow to send e-mail using the Encryption or Digital Signature feature while S/MIME communication is disabled.</p> <p>[Remedy] For 1), have your system administrator confirm the port status. For 2), enable S/MIME communication, or modify the job flow so that e-mail is sent by not using the Encryption or Digital Signature feature.</p>
027-754	<p>[Cause] [PDF Signature] is set inconsistency in the job flow.</p> <p>[Remedy] Check the PDF signatures for both the system data settings (machine's current settings) and the executed job flow settings. If these settings differ, coordinate them.</p>
027-761	<p>[Cause] An on-demand print job was sent to the machine using the Web Applications feature, but the time interval from receiving the print job until starting the print processing exceeded the time limit specified on the machine.</p> <p>[Remedy] When multiple documents are to be printed, reduce the number of documents, and then execute the operation again. If the error still is not resolved, enter the System Administration mode, and then select [System Settings] > [Common Service Settings] > [Machine Clock/Timers] > [Print-On-Demand Duration], and specify a larger value or "0".</p> <p>When on-demand printing is executed using the Web Application feature, the print processing time is limited. Consequently if many documents are to be printed or if print processing takes time, a timeout may occur before all the data are received. To resolve this problem, change the time limit value according to the document volume and type. If the error still is not resolved, contact Customer Support at dell.com/contactdell.</p>
027-762	<p>[Cause] An on-demand print job is sent to the machine using the Web Applications feature, however, the specified job ticket is invalid because of one of the following causes:</p> <ul style="list-style-type: none"> • Abnormal change to the job ticket because of the machine software failure • Abnormal change to the job ticket because of a bug on the sender's remote server • Abnormal change to the job ticket because of network trouble • Intentional alteration to the job ticket <p>[Remedy] Execute the print job again. If the error still is not resolved, contact Customer Support at dell.com/contactdell.</p>
027-763	<p>[Cause] The machine failed to verify the user information against the remote accounting server.</p> <p>[Remedy] Take one of the following measures:</p> <ul style="list-style-type: none"> • Check whether the remote accounting server is operating properly. • Check whether there is no network failure. • Connect the network cable securely. • Confirm the settings on the machine.
027-770	<p>[Cause] The print job has a problem.</p> <p>[Remedy] Submit the print job again.</p>
027-771	<p>[Cause] The hard disk of the server connected to the machine is full.</p> <p>[Remedy] Delete unnecessary data from the server.</p>

Status Code	Cause and Remedy
027-772	<p>[Cause] An error occurred during communication with the SMTP server.</p> <p>[Remedy] Use ASCII characters to modify the host name that has been specified under [Tools] > [System Settings] > [Connectivity & Network Setup] > [Machine's E-mail Address / Host Name]. If the error still is not resolved, confirm with your network administrator whether the SMTP server supports the HELO command.</p>
027-773	<p>[Cause] An error occurred during communication with the SMTP server.</p> <p>[Remedy] Wait for a while, and then execute the operation again.</p>
027-774	<p>[Cause] The specified e-mail address contains unsupported characters.</p> <p>[Remedy] Specify the e-mail address using only ASCII characters.</p>
027-775	<p>[Cause] Too many destination addresses have been specified.</p> <p>[Remedy] Reduce the number of destination addresses. If the error still is not resolved, confirm with your network administrator whether the SMTP server supports the EHLO command.</p>
027-776	<p>[Cause] An error occurred during communication with the SMTP server.</p> <p>[Remedy] Use ASCII characters to modify the host name that has been specified under [Tools] > [System Settings] > [Connectivity & Network Setup] > [Machine's E-mail Address / Host Name]. If the error still is not resolved, confirm with your network administrator whether the SMTP server supports the EHLO command.</p>
027-777	<p>[Cause] The destination SMTP server does not support SMTP-AUTH.</p> <p>[Remedy] Set [E-mail Send Authentication] to [Off] under [Tools] > [System Settings] > [Connectivity & Network Setup] > [Outgoing / Incoming E-mail Settings] > [SMTP Server Settings].</p>
027-778	<p>[Cause] The destination SMTP server does not support the SMTP-AUTH system set on the machine.</p> <p>[Remedy] Confirm the authentication type supported by the SMTP server with your network administrator. The machine supports the following authentication types: AUTH GSSAPI (only for Kerberos), AUTH NTLMv2, AUTH NTLMv1, AUTH PLAIN, AUTH LOGIN, AUTH CRAM-MD5.</p>
027-779	<p>[Cause] Failed to authenticate the SMTP server.</p> <p>[Remedy] Confirm the login name and password set to SMTP-AUTH.</p>
027-796	<p>[Cause] The received e-mail was discarded because no documents were attached to it. (The machine is set to print attached documents only.)</p> <p>[Remedy] To print the mail body or header information also, change settings in the [Properties] screen of Dell Printer Configuration Web Tool.</p> <p>Refer to "12 Computer Operations" > "E-mail Printing" in the User Guide.</p>
027-797	<p>[Cause] The output destination of the received e-mail is invalid.</p> <p>[Remedy] Specify a correct output destination, and send the e-mail again.</p>

Status Code	Cause and Remedy
033-310 033-311 033-312 033-313 033-314 033-315 033-316 033-317 033-318 033-319 033-320 033-321 033-322 033-323 033-324 033-325 033-326 033-327 033-328 033-329 033-330 033-331 033-332 033-333 033-334 033-335 033-336 033-338 033-339	<p>[Cause] An error occurred.</p> <p>[Remedy] Switch off the machine power, make sure that the touch screen is blank, and then switch on the machine power. If the same message is displayed again, contact Customer Support at dell.com/contactdell.</p>
033-500 033-501	<p>[Cause] An error occurred during fax transmission.</p> <p>[Remedy] Confirm the recipient, and then execute the operation again. If receiving, ask the sender to send again.</p>
033-502	<p>[Cause] A response is not received for the fax.</p> <p>[Remedy] Confirm the recipient, and then execute the operation again. Also, confirm the recipient's machine (memory is full, machine is being maintained, or other conditions), and execute the operation again.</p>
033-505	<p>[Cause] An error occurred during fax transmission.</p> <p>[Remedy] Confirm the recipient, and then execute the operation again. If receiving, ask the sender to send again.</p>
033-506	<p>[Cause] Communication was terminated at the recipient's machine.</p> <p>[Remedy] The job may have been canceled at the recipient. If the job was not canceled, check whether the other machine has a problem, and execute the operation again.</p>
033-507	<p>[Cause] The recipient's machine cannot receive.</p> <p>[Remedy] Confirm the recipient's machine (memory is full, machine is being maintained, or other conditions), and execute the operation again.</p>
033-508	<p>[Cause] No spooling documents exist at the other machine.</p> <p>[Remedy] Ask the other party to prepare polling documents, and execute the operation again.</p>

Status Code	Cause and Remedy
033-509	<p>[Cause] An error occurred during fax transmission.</p> <p>[Remedy] Execute the operation again. If the error still is not resolved, confirm the condition of the other machine.</p>
033-510	<p>[Cause] An error occurred during fax transmission.</p> <p>[Remedy] Confirm the condition of the line and the other machine, and execute the operation again.</p>
033-511	<p>[Cause] An error occurred during fax transmission.</p> <p>[Remedy] Confirm the following conditions:</p> <ul style="list-style-type: none"> • Whether a polling document exists at the other machine • Whether a document is jammed at the other machine • Whether the passwords match
033-512	<p>[Cause] The other party cannot execute Relay Broadcast.</p> <p>[Remedy] Confirm whether the other party can execute Relay Broadcast.</p>
033-513	<p>[Cause] The other machine does not have the Folder feature.</p> <p>[Remedy] Confirm whether the other machine has the Folder feature.</p>
033-514	<p>[Cause] An error occurred during fax transmission.</p> <p>[Remedy] Ask the sender to send again.</p>
033-516	<p>[Cause] An error occurred during fax transmission.</p> <p>[Remedy] Confirm the recipient, and then execute the operation again. If receiving, ask the sender to send again.</p>
033-517	<p>[Cause] An error occurred during fax transmission.</p> <p>[Remedy] Execute the operation again. If the error still is not resolved, confirm the condition of the other machine.</p>
033-518	<p>[Cause] The other machine cannot correspond to reception of SUB.</p> <p>[Remedy] Check whether the other machine can correspond to reception of SUB, and execute the operation again.</p>
033-519	<p>[Cause] The other machine cannot correspond to reception of SEP.</p> <p>[Remedy] Check whether the other machine can correspond to reception of SEP, and execute the operation again.</p>
033-520	<p>[Cause] The other machine cannot correspond to reception of PWD/SID.</p> <p>[Remedy] Check whether the other machine can correspond to reception of PWD/SID, and execute the operation again.</p>
033-521	<p>[Cause] An error occurred during fax transmission.</p> <p>[Remedy] Confirm the condition of the machine (memory is full, paper has run out, or other conditions), and execute the operation again.</p>
033-522	<p>[Cause] An error occurred during fax transmission.</p> <p>[Remedy] Ask the sender to execute the operation again.</p>
033-526	<p>[Cause] An error occurred during fax transmission.</p> <p>[Remedy] Confirm the model of the sender's machine, and then execute the operation again. If receiving, ask the sender to send again.</p>
033-527	<p>[Cause] An error occurred during fax transmission.</p> <p>[Remedy] Confirm the other machine has a problem, and then execute the operation again.</p>

Status Code	Cause and Remedy
033-528	[Cause] An error occurred during fax transmission. [Remedy] Ask the sender to send again.
033-529	[Cause] An error occurred during fax transmission. [Remedy] Confirm the other machine has a problem, and then execute the operation again.
033-530	[Cause] Received a procedure disabled signal. [Remedy] Execute the operation again. If the error still is not resolved, contact Customer Support at dell.com/contactdell .
033-531	[Cause] Received a command rejection signal. [Remedy] Confirm the condition of the other machine (memory is full, paper has run out, or other conditions), and execute the operation again.
033-532 033-533	[Cause] An error occurred during fax transmission. [Remedy] Execute the operation again. If receiving, ask the sender to send again.
033-534	[Cause] The other machine does not offer a feature to print the number of document sets sent. [Remedy] Do not specify multiple sets.
033-535	[Cause] An error occurred during fax transmission. [Remedy] Confirm information such as the recipient and folder information, and execute the operation again.
033-536 033-537	[Cause] An error occurred during fax transmission. [Remedy] Execute the operation again.
033-538 033-539 033-540	[Cause] An error occurred during fax transmission. [Remedy] Execute the operation again. If the error still is not resolved, contact Customer Support at dell.com/contactdell .
033-541	[Cause] The recipient is not specified. [Remedy] Specify the recipient correctly.
033-543	[Cause] The recipient (fax number) is incorrect. [Remedy] Enter a correct fax number, and execute the operation again.
033-544	[Cause] The recipient's line is busy. [Remedy] Wait for a while, and then execute the operation again.
033-546	[Cause] A dial tone was not detected. [Remedy] Check whether the line is connected correctly.
033-547	[Cause] Communication was terminated by a cause such as pressing the <Stop> button. [Remedy] No measure is required.
033-548	[Cause] Cannot transmit manually because a line is unavailable. [Remedy] Establish communication such as by telephone, and execute the operation again.
033-549	[Cause] Cannot use the Fax service because of causes such as memory is insufficient. [Remedy] Wait for a while, and execute the operation again.
033-550	[Cause] Cannot execute another job because fax communication is in progress. [Remedy] Wait until the job being communicated completes, and then execute the operation again.

Status Code	Cause and Remedy
033-551	<p>[Cause] You attempted to change a job immediately before fax or telephone communication completed.</p> <p>[Remedy] Wait for a while, and execute the operation again.</p>
033-552	<p>[Cause] The total quantity of error lines detected with G3 exceeded the set value.</p> <p>[Remedy] Confirm the model of the other machine, and execute the operation again. If receiving, ask the sender to send again.</p>
033-553	<p>[Cause] This machine does not have confidential or relay function. The F-code sent from the other machine contains an instruction for a function not supported by the machine.</p> <p>[Remedy] If necessary, check whether the sender entered an invalid F-code.</p>
033-554	<p>[Cause] The password was omitted or did not match in fax communication.</p> <p>[Remedy] No measure is required.</p>
033-555	<p>[Cause] The password received from the other machine did not match the password for receiving faxes on the machine.</p> <p>[Remedy] Check whether the sender specified an incorrect machine password.</p>
033-556	<p>[Cause] The password sent to the other machine did not match the password for receiving faxes on the other machine.</p> <p>[Remedy] If necessary, check whether the correct machine password has been instructed to the other machine.</p>
033-557	<p>[Cause] The number of services or of recipients exceeds the maximum limit.</p> <p>[Remedy] Wait until the number of jobs awaiting transmission decreases, or reduce the number of recipients, and then send again.</p>
033-558	<p>[Cause] The machine is set to reject faxes without a remote ID, and a remote ID was not sent from the other machine.</p> <p>[Remedy] Ask the sender to set a remote ID. If necessary, set the machine to receive even when a remote ID is not sent.</p>
033-563	<p>[Cause] Paper that can print faxed documents is not loaded in a tray.</p> <p>[Remedy] Take one of the following measures:</p> <ul style="list-style-type: none"> • Specify the paper size. • Confirm whether the paper tray is set correctly.
033-564	<p>[Cause] The machine was turned off during communication.</p> <p>[Remedy] Wait for a while, confirm the fax service settings and the fax number, and then send again if sending. If the error still is not resolved, contact Customer Support at dell.com/contactdell.</p>
033-565	<p>[Cause] Cannot send because too many recipients are specified.</p> <p>[Remedy] Wait until the number of jobs awaiting transmission decreases, or reduce the number of recipients, and then send again.</p>
033-566	<p>[Cause] Cannot send because the recipient (fax number) is not specified.</p> <p>[Remedy] Correctly specify the recipient's fax number.</p>
033-567	<p>[Cause] The recipient (fax number) is incorrect.</p> <p>[Remedy] Correctly enter the recipient's fax number, and execute the operation again.</p>
033-568	<p>[Cause] An error occurred during fax transmission.</p> <p>[Remedy] Execute the operation again. If receiving, ask the sender to send again. If the error still is not resolved, contact Customer Support at dell.com/contactdell.</p>

Status Code	Cause and Remedy
033-569	<p>[Cause] Paper in the tray is not loaded in the direction that the received fax data can be printed.</p> <p>[Remedy] Load paper in Tray 5 according to the direction displayed on the screen.</p>
033-570	<p>[Cause] The machine was turned off during communication.</p> <p>[Remedy] Wait for a while, confirm the Fax service settings and the fax number, and then send again if sending. If the error still is not resolved, contact Customer Support at dell.com/contactdell.</p>
033-571	<p>[Cause] The Fax service is not available from a reason such as insufficient memory.</p> <p>[Remedy] Cancel the fax data in the queue, or wait for a while, and execute the operation again.</p>
033-572	<p>[Cause] The data received is not printed.</p> <p>[Remedy] No measure is required. The data will be printed after a while.</p>
033-574	<p>[Cause] An unavailable line is specified.</p> <p>[Remedy] Specify an available line.</p>
033-575	<p>[Cause] An error occurred during fax transmission.</p> <p>[Remedy] Execute the operation again.</p>
033-576	<p>[Cause] The recipient (fax number) is incorrect.</p> <p>[Remedy] Enter a correct fax number, and execute the operation again.</p>
033-577	<p>[Cause] An error occurred during fax transmission.</p> <p>[Remedy] Execute the operation again.</p>
033-578	<p>[Cause] An error occurred during fax receiving.</p> <p>[Remedy] Confirm the status of the line and the recipient machine, and then ask the sender to send again.</p>
033-710	<p>[Cause] The document to be sent by polling was deleted.</p> <p>[Remedy] Store the document again.</p>
033-712	<p>[Cause] Unable to process because of insufficient memory.</p> <p>[Remedy] Delete unnecessary data.</p>
033-713	<p>[Cause] An error occurred during fax transmission.</p> <p>[Remedy] Contact Customer Support at dell.com/contactdell.</p>
033-716	<p>[Cause] The folder specified from the sender's machine does not exist.</p> <p>[Remedy] Register the folder. Refer to "Create Folder" (P.231).</p>
033-717	<p>[Cause] The folder passcode specified from the sender's machine is incorrect. Or, the machine passcode for reception is incorrect.</p> <p>[Remedy] Inform the correct information to the sender's machine.</p>
033-718	<p>[Cause] Fax or polling documents do not exist in the folder specified from the sender's machine.</p> <p>[Remedy] Store fax or polling documents into the folder as necessary.</p>
033-719	<p>[Cause] The document may be deleted by turning the machine off and then on.</p> <p>[Remedy] Retry sending.</p>
033-721	<p>[Cause] An error occurred during fax transmission.</p> <p>[Remedy] Switch off the machine power, make sure that the touch screen is blank, and then switch on the machine power. If the error still is not resolved, contact Customer Support at dell.com/contactdell.</p>

Status Code	Cause and Remedy
033-725	<p>[Cause] The hard disk is full.</p> <p>[Remedy] Delete unnecessary data from the hard disk to free up disk space.</p>
033-726	<p>[Cause] The received document was printed with 1 sided printing, because 2 sided printing is not available for mixed sized documents.</p> <p>[Remedy] No measure is required.</p>
033-727	<p>[Cause] The received page was printed without being rotated, because its data volume was too large to change the orientation automatically.</p> <p>[Remedy] No measure is required.</p>
033-728	<p>[Cause] The auto print formatting of the received fax document was interrupted by a manual print operation.</p> <p>[Remedy] No measure is required. The machine will automatically start the auto print job after manual printing completes.</p>
033-731	<p>[Cause] The printing of the received fax document was interrupted.</p> <p>[Remedy] The auto print processing of the received fax document was interrupted by a manual print operation. No measure is required.</p>
033-733	<p>[Cause] An error occurred during fax transmission.</p> <p>[Remedy] Switch off the machine power, make sure that the touch screen is blank, and then switch on the machine power. If the error still is not resolved, contact Customer Support at dell.com/contactdell.</p>
033-734	<p>[Cause] Because a report job was instructed while preparing to print a received fax, the printing of the received fax is temporarily suspended.</p> <p>[Remedy] No measure is required.</p>
033-735	<p>[Cause] An error occurred during fax transmission.</p> <p>[Remedy] Switch off the machine power, make sure that the touch screen is blank, and then switch on the machine power. If the error still is not resolved, contact Customer Support at dell.com/contactdell.</p>
033-736	<p>[Cause] The forwarding job was interrupted because the data volume exceeded the upper limit.</p> <p>[Remedy] No measure is required.</p>
033-737	<p>[Cause] An error occurred during fax transmission.</p> <p>[Remedy] Execute the operation again. If the error still is not resolved, contact Customer Support at dell.com/contactdell.</p>
033-738	<p>[Cause] Received abnormal JBIG data.</p> <p>[Remedy] No measure is required.</p>
033-740	<p>[Cause] The printing of the received fax document was interrupted.</p> <p>[Remedy] No measure is required.</p>
033-741	<p>[Cause] An error occurred during fax transmission.</p> <p>[Remedy] Execute the operation again. If the error still is not resolved, contact Customer Support at dell.com/contactdell.</p>
033-742	<p>[Cause] An error occurred during fax transmission. This error may occur if the remaining capacity of the machine's memory is 10% or less and Manual Send is used.</p> <p>[Remedy] If this error was caused when using Manual Send, connect the line after storing the document, and then send. If the error still is not resolved, delete unnecessary data from the hard disk to free up disk space, and execute the operation again. If the error persists, contact Customer Support at dell.com/contactdell.</p>

Status Code	Cause and Remedy
033-743 033-744 033-745 033-746	[Cause] An error occurred during fax transmission. [Remedy] Switch off the machine power, make sure that the touch screen is blank, and then switch on the machine power. Try again. If the error still is not resolved, contact Customer Support at dell.com/contactdell .
033-747	[Cause] The job is temporarily suspended. [Remedy] No measure is required.
033-749	[Cause] The machine will automatically recover and print the document. [Remedy] No measure is required.
033-750	[Cause] An error occurred during fax transmission. [Remedy] Switch off the machine power, make sure that the touch screen is blank, and then switch on the machine power. Try again. If the error still is not resolved, contact Customer Support at dell.com/contactdell .
033-751	[Cause] An activity report output occurred during the printer lockout duration. Outputting the activity report was suspended because the machine was in the Sleep mode. [Remedy] No measure is required because the machine will output the report after exiting the Sleep mode.
041-310	[Cause] An error occurred. [Remedy] Switch off the machine power, make sure that the touch screen is blank, and then switch on the machine power. If the same message is displayed again, contact Customer Support at dell.com/contactdell .
041-316 041-317	[Cause] An error occurred. [Remedy] Switch off the machine power, make sure that the touch screen is blank, and then switch on the machine power. If the same message is displayed again, contact Customer Support at dell.com/contactdell .
041-340 041-341 041-351	[Cause] An error occurred. [Remedy] Switch off the machine power, make sure that the touch screen is blank, and then switch on the machine power. If the same message is displayed again, contact Customer Support at dell.com/contactdell .
041-368 041-369	[Cause] An error occurred. [Remedy] Switch off the machine power, make sure that the touch screen is blank, and then switch on the machine power. If the same message is displayed again, contact Customer Support at dell.com/contactdell .
041-388	[Cause] An error occurred in the machine. [Remedy] Switch off the machine power, make sure that the touch screen is blank, and then switch on the machine power. If the same message is displayed again, contact Customer Support at dell.com/contactdell .
041-393 041-394 041-395 041-396 041-397 041-398 041-399	[Cause] An error occurred in the machine. [Remedy] Switch off the machine power, make sure that the touch screen is blank, and then switch on the machine power. If the same message is displayed again, contact Customer Support at dell.com/contactdell .

Status Code	Cause and Remedy
042-316 042-320 042-323 042-324 042-325 042-330 042-332 042-334 042-335 042-336 042-337 042-338 042-340 042-341 042-342 042-343 042-344	<p>[Cause] An error occurred in the machine.</p> <p>[Remedy] Switch off the machine power, make sure that the touch screen is blank, and then switch on the machine power. If the same message is displayed again, contact Customer Support at dell.com/contactdell.</p>
045-310 045-311 045-312	<p>[Cause] An error occurred.</p> <p>[Remedy] Switch off the machine power, make sure that the touch screen is blank, and then switch on the machine power. If the same message is displayed again, contact Customer Support at dell.com/contactdell.</p>
045-319 045-320 045-343	<p>[Cause] An error occurred in the machine.</p> <p>[Remedy] Switch off the machine power, make sure that the touch screen is blank, and then switch on the machine power. If the same message is displayed again, contact Customer Support at dell.com/contactdell.</p>
045-370 045-371 045-372 045-373 045-374 045-375 045-376	<p>[Cause] An error occurred.</p> <p>[Remedy] Switch off the machine power, make sure that the touch screen is blank, and then switch on the machine power. If the same message is displayed again, contact Customer Support at dell.com/contactdell.</p>
047-211 047-212	<p>[Cause] An error occurred in the Offset Stacking Unit.</p> <p>[Remedy] Switch off the machine power, make sure that the touch screen is blank, and then switch on the machine power. If the same message is displayed again, contact Customer Support at dell.com/contactdell.</p>
047-213	<p>[Cause] Detected the installation of a finisher of a different type than expected.</p> <p>[Remedy] Switch off the machine power, make sure that the touch screen is blank, and then switch on the machine power. If the same message is displayed again, contact Customer Support at dell.com/contactdell.</p>
047-216	<p>[Cause] An error occurred while detecting the finisher.</p> <p>[Remedy] Switch off the machine power, make sure that the touch screen is blank, and then switch on the machine power. If the same message is displayed again, contact Customer Support at dell.com/contactdell.</p>
047-217	<p>[Cause] An error occurred while detecting Tray 6 (HCF B1).</p> <p>[Remedy] Switch off the machine power, make sure that the touch screen is blank, and then switch on the machine power. If the same message is displayed again, contact Customer Support at dell.com/contactdell.</p>

Status Code	Cause and Remedy
047-320	<p>[Cause] An error occurred.</p> <p>[Remedy] Switch off the machine power, make sure that the touch screen is blank, and then switch on the machine power. If the same message is displayed again, contact Customer Support at dell.com/contactdell.</p>
061-350 061-351 061-352 061-353 061-354 061-355 061-356 061-357 061-358 061-359 061-360 061-361 061-362 061-363 061-364 061-365 061-366 061-367 061-368 061-369 061-370 061-371 061-372 061-373 061-374 061-375 061-376 061-377 061-378 061-379	<p>[Cause] An error occurred.</p> <p>[Remedy] Switch off the machine power, make sure that the touch screen is blank, and then switch on the machine power. If the same message is displayed again, contact Customer Support at dell.com/contactdell.</p>

Status Code	Cause and Remedy
061-384 061-385 061-386 061-387 061-388 061-389 061-390 061-391 061-392 061-393 061-394 061-395 061-396 061-397 061-398 061-399	[Cause] An error occurred. [Remedy] Switch off the machine power, make sure that the touch screen is blank, and then switch on the machine power. If the same message is displayed again, contact Customer Support at dell.com/contactdell .
062-277	[Cause] A communication error occurred between the document scanning unit and the document feeder. [Remedy] Contact Customer Support at dell.com/contactdell .
062-311	[Cause] An error occurred. [Remedy] Switch off the machine power, make sure that the touch screen is blank, and then switch on the machine power. If the same message is displayed again, contact Customer Support at dell.com/contactdell .
062-328 062-329	[Cause] An error occurred. [Remedy] Switch off the machine power, make sure that the touch screen is blank, and then switch on the machine power. If the same message is displayed again, contact Customer Support at dell.com/contactdell .
062-330 062-345 062-360 062-362 062-371 062-380 062-386 062-389 062-393 062-395 062-396 062-397 062-398	[Cause] An error occurred. [Remedy] Switch off the machine power, make sure that the touch screen is blank, and then switch on the machine power. If the same message is displayed again, contact Customer Support at dell.com/contactdell .
062-399	[Cause] An error occurred in the document feeder. [Remedy] Switch off the machine power, make sure that the touch screen is blank, and then switch on the machine power. If the same message is displayed again, contact Customer Support at dell.com/contactdell .
062-790	[Cause] Copying of the scanned document is prohibited. [Remedy] Refer to "I Before Using the Machine" > "Legal Notice" in the User Guide.

Status Code	Cause and Remedy
063-210	<p>[Cause] An error occurred in the document feeder.</p> <p>[Remedy] Contact Customer Support at dell.com/contactdell.</p>
065-210 065-221 065-222 065-223 065-224 065-225	<p>[Cause] An error occurred in the machine.</p> <p>[Remedy] Contact Customer Support at dell.com/contactdell.</p>
071-210	<p>[Cause] Tray 1 malfunction</p> <p>[Remedy] Confirm the paper loading condition for the Tray, and then switch off the machine power, make sure that the touch screen is blank, and then switch on the machine power. If the error still is not resolved, contact Customer Support at dell.com/contactdell. You can use a tray other than Tray 1.</p>
071-212	<p>[Cause] Tray 1 malfunction</p> <p>[Remedy] Execute the operation again.</p>
072-210	<p>[Cause] Tray 2 malfunction</p> <p>[Remedy] Confirm the paper loading condition for the Tray 2, and then switch off the machine power, make sure that the touch screen is blank, and then switch on the machine power. If the error still is not resolved, contact Customer Support at dell.com/contactdell. You can use a tray other than Tray 2.</p>
072-212	<p>[Cause] Tray 2 malfunctioned</p> <p>[Remedy] Contact Customer Support at dell.com/contactdell. You can use a tray other than Tray 2.</p>
073-210	<p>[Cause] Tray 3 malfunction</p> <p>[Remedy] Confirm the paper loading condition for the Tray, and then switch off the machine power, make sure that the touch screen is blank, and then switch on the machine power. If the error still is not resolved, contact Customer Support at dell.com/contactdell. You can use a tray other than Tray 3.</p>
073-212	<p>[Cause] Tray 3 malfunction</p> <p>[Remedy] Contact Customer Support at dell.com/contactdell. You can use a tray other than Tray 3.</p>
074-210	<p>[Cause] Tray 4 malfunction</p> <p>[Remedy] Confirm the paper loading condition for the Tray, and then switch off the machine power, make sure that the touch screen is blank, and then switch on the machine power. If the error still is not resolved, contact Customer Support at dell.com/contactdell. You can use a tray other than Tray 4.</p>
074-212	<p>[Cause] Tray 4 malfunction</p> <p>[Remedy] Contact Customer Support at dell.com/contactdell. You can use a tray other than Tray 4.</p>
075-212	<p>[Cause] Tray 5 malfunction</p> <p>[Remedy] Contact Customer Support at dell.com/contactdell. You can use a tray other than Tray 5.</p>
077-211 077-212	<p>[Cause] Detected the installation of a tray of a different type than expected.</p> <p>[Remedy] Contact Customer Support at dell.com/contactdell.</p>

Status Code	Cause and Remedy
077-214 077-215	[Cause] Detected the installation of a tray of a different type than expected. [Remedy] Contact Customer Support at dell.com/contactdell .
077-314 077-320	[Cause] An error occurred. [Remedy] Switch off the machine power, make sure that the touch screen is blank, and then switch on the machine power. If the same message is displayed again, contact Customer Support at dell.com/contactdell .
078-210 078-211	[Cause] Tray 6 (HCF B1) malfunction [Remedy] Contact Customer Support at dell.com/contactdell .
078-216 078-219 078-250	[Cause] An error occurred in Tray 6 (HCF B1). [Remedy] Switch off the machine power, make sure that the touch screen is blank, and then switch on the machine power. If the error still is not resolved, contact Customer Support at dell.com/contactdell .
078-500	[Cause] An error occurred. [Remedy] Switch off the machine power, make sure that the touch screen is blank, and then switch on the machine power. If the same message is displayed again, contact Customer Support at dell.com/contactdell .
091-313	[Cause] An error occurred. [Remedy] Switch off the machine power, make sure that the touch screen is blank, and then switch on the machine power. If the same message is displayed again, contact Customer Support at dell.com/contactdell .
091-407	[Cause] An error occurred in the drum cartridge [R1]. [Remedy] Pull out the drum cartridge [R1], and then insert the cartridge again.
091-417	[Cause] An error occurred in the drum cartridge [R4]. [Remedy] Pull out the drum cartridge [R4], and then insert the cartridge again.
091-427	[Cause] An error occurred in the drum cartridge [R3]. [Remedy] Pull out the drum cartridge [R3], and then insert the cartridge again.
091-437	[Cause] An error occurred in the drum cartridge [R2]. [Remedy] Pull out the drum cartridge [R2], and then insert the cartridge again.
092-312 092-313 092-314 092-315	[Cause] An error occurred. [Remedy] Switch off the machine power, make sure that the touch screen is blank, and then switch on the machine power. If the same message is displayed again, contact Customer Support at dell.com/contactdell .
093-314 093-315 093-316 093-317	[Cause] An error occurred. [Remedy] Switch off the machine power, make sure that the touch screen is blank, and then switch on the machine power. If the same message is displayed again, contact Customer Support at dell.com/contactdell .
093-401	[Cause] The toner cartridge [Y] (yellow) is not installed. [Remedy] Install the toner cartridge [Y] (yellow).
093-403	[Cause] The toner cartridge [M] (magenta) is not installed. [Remedy] Install the toner cartridge [M] (magenta).
093-404	[Cause] The toner cartridge [C] (cyan) is not installed. [Remedy] Install the toner cartridge [C] (cyan).

Status Code	Cause and Remedy
093-426	<p>[Cause] An error occurred in the toner cartridge [K] (black).</p> <p>[Remedy] Pull out the toner cartridge [K] (black), and then insert the cartridge again.</p>
093-427	<p>[Cause] An error occurred in the toner cartridge [Y] (yellow).</p> <p>[Remedy] Pull out the toner cartridge [Y] (yellow), and then insert the cartridge again.</p>
093-428	<p>[Cause] An error occurred in the toner cartridge [M] (magenta).</p> <p>[Remedy] Pull out the toner cartridge [M] (magenta), and then insert the cartridge again.</p>
093-429	<p>[Cause] An error occurred in the toner cartridge [C] (cyan).</p> <p>[Remedy] Pull out the toner cartridge [C] (cyan), and then insert the cartridge again.</p>
093-430	<p>[Cause] The toner cartridge [K] (black) is not installed.</p> <p>[Remedy] Install the toner cartridge [K] (black).</p>
094-320	<p>[Cause] An error occurred.</p> <p>[Remedy] Switch off the machine power, make sure that the touch screen is blank, and then switch on the machine power. If the same message is displayed again, contact Customer Support at dell.com/contactdell.</p>
102-356	<p>[Cause] An error occurred.</p> <p>[Remedy] Switch off the machine power, make sure that the touch screen is blank, and then switch on the machine power. If the same message is displayed again, contact Customer Support at dell.com/contactdell.</p>
103-310 103-311 103-312 103-313	<p>[Cause] An error occurred.</p> <p>[Remedy] Switch off the machine power, make sure that the touch screen is blank, and then switch on the machine power. If the same message is displayed again, contact Customer Support at dell.com/contactdell.</p>
116-210 116-211 116-212	<p>[Cause] An error occurred in the USB memory device.</p> <p>[Remedy] Switch off the machine power, make sure that the touch screen is blank, and then switch on the machine power. If the error still is not resolved, contact Customer Support at dell.com/contactdell.</p>
116-220	<p>[Cause] Failed to enter the Download mode.</p> <p>[Remedy] Contact Customer Support at dell.com/contactdell.</p>

Status Code	Cause and Remedy
116-310 116-311 116-312 116-313 116-314 116-315 116-316 116-317 116-318 116-319 116-321 116-322 116-323 116-324 116-325 116-328 116-329 116-330 116-331 116-332 116-333 116-334 116-336 116-337 116-338 116-340 116-341	<p>[Cause] An error occurred.</p> <p>[Remedy] Switch off the machine power, make sure that the touch screen is blank, and then switch on the machine power. If the same message is displayed again, contact Customer Support at dell.com/contactdell.</p>
116-324	<p>[Cause] An error occurred in the machine.</p> <p>[Remedy] If an error occurred while printing, turn off the machine once, then turn the machine on holding down both the <Start> and <Stop> buttons simultaneously for six seconds. This deletes the print data that caused the error. If the error was caused by another reason, switch off the machine power, make sure that the touch screen is blank, and then switch on the machine power. If the error still is not resolved, contact Customer Support at dell.com/contactdell.</p>
116-342	<p>[Cause] An error occurred.</p> <p>[Remedy] Contact Customer Support at dell.com/contactdell.</p>

Status Code	Cause and Remedy
116-343 116-345 116-346 116-347 116-348 116-349 116-350 116-351 116-352 116-353 116-354 116-355 116-356 116-357 116-358 116-359 116-360 116-361 116-362 116-363 116-364 116-365 116-366 116-367 116-368 116-370 116-371 116-372 116-373 116-374 116-375 116-376 116-377 116-378 116-379 116-380 116-381 116-382 116-383 116-384 116-385	<p>[Cause] An error occurred.</p> <p>[Remedy] Switch off the machine power, make sure that the touch screen is blank, and then switch on the machine power. If the same message is displayed again, contact Customer Support at dell.com/contactdell.</p>
116-386	<p>[Cause] The fax cable is not connected correctly.</p> <p>[Remedy] Connect the cable securely, and then switch off the machine power, make sure that the touch screen is blank, and then switch on the machine power. If the error still is not resolved, contact Customer Support at dell.com/contactdell.</p>
116-387	<p>[Cause] An error occurred in the machine.</p> <p>[Remedy] Switch off the machine power, make sure that the touch screen is blank, and then switch on the machine power. If the same message is displayed again, contact Customer Support at dell.com/contactdell.</p>

Status Code	Cause and Remedy
116-390	<p>[Cause] An error occurred in the machine.</p> <p>[Remedy] Follow the message displayed on the touch screen and initialize the memory of the machine.</p>
116-391 116-392 116-393 116-394 116-395 116-396 116-397 116-399	<p>[Cause] An error occurred in the machine.</p> <p>[Remedy] Switch off the machine power, make sure that the touch screen is blank, and then switch on the machine power. If the same message is displayed again, contact Customer Support at dell.com/contactdell.</p>
116-702	<p>[Cause] A print job was processed using a substitute font.</p> <p>[Remedy] Check the print data.</p>
116-703	<p>[Cause] Probable causes are as follows: 1)An error occurred during PostScript processing. 2)An error occurred because of insufficient memory for PostScript processing.</p> <p>[Remedy] For 1), check the print data. For 2), increase the value for [PostScript Memory].</p>
116-704	<p>[Cause] An error occurred when reading data on the media.</p> <p>[Remedy] Check whether the media is inserted correctly.</p>
116-705 116-706 116-707 116-708 116-709	<p>[Cause] An error occurred when reading data on the media.</p> <p>[Remedy] Use a computer to confirm the content recorded on the media.</p>
116-710	<p>[Cause] The correct document size could not be judged because the receive data exceeded the HP-GL/2 spool size.</p> <p>[Remedy] Increase the size assigned to HP-GL/2 auto layout memory.</p>
116-713	<p>[Cause] The data has been divided into a number of jobs because of insufficient disk space.</p> <p>[Remedy] Delete unnecessary data from the hard disk to free up disk space.</p>
116-714	<p>[Cause] An HP-GL/2 command error occurred.</p> <p>[Remedy] Check the print data.</p>
116-716 116-717	<p>[Cause] An error occurred when reading the data on the media.</p> <p>[Remedy] On a computer, confirm the content recorded on the media.</p>
116-720	<p>[Cause] An error occurred during print processing because of insufficient memory.</p> <p>[Remedy] Stop unnecessary ports or delete unnecessary data to free up disk space.</p>
116-738	<p>[Cause] The size and orientation of the form specified are not matched with the paper to be printed.</p> <p>[Remedy] Match the size and orientation of the paper with the form specified, and print again.</p>
116-739	<p>[Cause] The form or logo data cannot be registered because memory for the form and logo data or memory capacity for the hard disk is insufficient.</p> <p>[Remedy] Delete unnecessary data, or free up the space for the form memory.</p>

Status Code	Cause and Remedy
116-740	<p>[Cause] A numerical value operation error occurred because a value exceeding the value limit of the machine was used in the print data.</p> <p>[Remedy] Check the print data.</p>
116-741	<p>[Cause] The form cannot be registered because the number of the form registration exceeds the maximum number allowed.</p> <p>[Remedy] Delete unnecessary form. The maximum number allowed is 2048.</p>
116-742	<p>[Cause] The logo data cannot be registered because the number of the logo data registration exceeds the maximum number allowed.</p> <p>[Remedy] Delete unnecessary logo data.</p>
116-743	<p>[Cause] The logo data or form cannot be registered because the memory for the form and logo data is insufficient.</p> <p>[Remedy] Increase memory.</p>
116-746	<p>[Cause] The form specified is not registered.</p> <p>[Remedy] Use the form registered, or register the form.</p>
116-747	<p>[Cause] The paper margin value is too large for the HP-GL/2 active coordinates area.</p> <p>[Remedy] Decrease the paper margin value, and then execute the operation again.</p>
116-748	<p>[Cause] There is no plot data in the HP-GL/2 print data.</p> <p>[Remedy] Check the print data.</p>
116-749	<p>[Cause] The job was cancelled because the specified font does not exist.</p> <p>[Remedy] Install the font, or set the print driver to replace the font.</p>
116-750	<p>[Cause] Banner sheet tray malfunction</p> <p>[Remedy] Restore the tray to normal condition or change the Banner sheet tray.</p>
116-751	<p>[Cause] The process has been canceled because the hard disk is full.</p> <p>[Remedy] Delete stored data in the hard disk. If the error still is not resolved, split the file and send the job again.</p>
116-752	<p>[Cause] The descriptions of the PDF or XPS printing job ticket have a problem.</p> <p>[Remedy] Execute the operation again. If the error still is not resolved, contact Customer Support at dell.com/contactdell.</p> <p>Note • XPS stands for XML Paper Specification.</p>
116-771 116-772 116-773 116-774 116-775 116-776 116-777 116-778	<p>[Cause] The data was automatically modified because it included an invalid parameter.</p> <p>[Remedy] The printed image may be incomplete. Confirm with the sender whether the image has a problem, or ask the sender to send the data again. When using the Internet Fax Forwarding feature, confirm its condition with the e-mail recipient.</p>
116-780	<p>[Cause] There is a problem with the document attached to the received e-mail.</p> <p>[Remedy] Check the attached document.</p>

Status Code	Cause and Remedy
116-790	<p>[Cause] Probable causes are as follows:</p> <p>1)If the operator cancelled printing a document that was received using the Store Fax - Local Folder or Store Internet Fax - Local Folder feature: The first set of the document is not stapled.</p> <p>2)For causes other than 1) No set of the document is stapled.</p> <p>[Remedy] For 1), manually staple the first set of the document. Or, do not cancel printing of a document that is received using the Store Fax - Local Folder or Store Internet Fax - Local Folder feature.</p> <p>For 2), check whether the staple position has been correctly specified, and try printing again.</p>
117-312	<p>[Cause] An error occurred in the machine.</p> <p>[Remedy] Contact Customer Support at dell.com/contactdell.</p>
117-326	<p>[Cause] An error occurred in the machine.</p> <p>[Remedy] Switch off the machine power, make sure that the touch screen is blank, and then switch on the machine power. If the same message is displayed again, contact Customer Support at dell.com/contactdell.</p>
117-331 117-332 117-333	<p>[Cause] An error occurred in the machine.</p> <p>[Remedy] Switch off the machine power, make sure that the touch screen is blank, and then switch on the machine power. If the same message is displayed again, contact Customer Support at dell.com/contactdell.</p>
118-310	<p>[Cause] An error occurred in the machine.</p> <p>[Remedy] Switch off the machine power, make sure that the touch screen is blank, and then switch on the machine power. If the same message is displayed again, contact Customer Support at dell.com/contactdell.</p>
118-311	<p>[Cause] An error occurred during software processing.</p> <p>[Remedy] Switch off the machine power, make sure that the touch screen is blank, and then switch on the machine power. If the same message is displayed again, contact Customer Support at dell.com/contactdell.</p>
121-311	<p>[Cause] An error occurred between the machine and the device connected.</p> <p>[Remedy] Once a smart card reader is connected to the machine, the machine automatically changes the [Passcode Entry for Smart Card Login] setting to [On] under [Tools] > [Authentication / Security Settings] > [Authentication] > [Passcode Policy]. Change the setting as required.</p>
121-314 121-316 121-318 121-319 121-320 121-321 121-322 121-323 121-324	<p>[Cause] An error occurred between the machine and the device connected.</p> <p>[Remedy] Switch off the machine power, make sure that the touch screen is blank, and then switch on the machine power. If the same message is displayed again, contact Customer Support at dell.com/contactdell.</p>
121-333	<p>[Cause] An error occurred between the machine and the device connected.</p> <p>[Remedy] Confirm that the device is switched on, and then switch off the machine power, make sure that the touch screen is blank, and switch on the machine power. If the error still is not resolved, contact Customer Support at dell.com/contactdell.</p>

Status Code	Cause and Remedy
121-334 121-335 121-336 121-337 121-338	[Cause] An error occurred between the machine and the device connected. [Remedy] Switch off the machine power, make sure that the touch screen is blank, and then switch on the machine power. If the same message is displayed again, contact Customer Support at dell.com/contactdell .
121-340 121-350 121-370	[Cause] An error occurred between the machine and the device connected. [Remedy] Switch off the machine power, make sure that the touch screen is blank, and then switch on the machine power. If the same message is displayed again, contact Customer Support at dell.com/contactdell .
123-310 123-311 123-312 123-325 123-326 123-333 123-343 123-344 123-350 123-352 123-353 123-354 123-355 123-356 123-357 123-358 123-362 123-368 123-369 123-371 123-374 123-377 123-379 123-380 123-381 123-382 123-383 123-384 123-389 123-390 123-392 123-393 123-395 123-396 123-397 123-398 123-399	[Cause] An error occurred in the machine. [Remedy] Switch off the machine power, make sure that the touch screen is blank, and then switch on the machine power. If the same message is displayed again, contact Customer Support at dell.com/contactdell .

Status Code	Cause and Remedy
124-310	[Cause] An error occurred in the machine.
124-311	[Remedy] Switch off the machine power, make sure that the touch screen is blank, and then switch
124-312	on the machine power. If the same message is displayed again, contact Customer
124-313	Support at dell.com/contactdell .
124-314	
124-315	
124-316	
124-317	
124-318	
124-319	
124-320	
124-321	
124-322	
124-323	
124-324	
124-325	
124-326	
124-327	
124-328	
124-331	
124-332	
124-333	
124-334	
124-335	
124-336	
124-337	
124-338	
124-339	
124-340	
124-341	
124-342	
124-343	
124-344	
124-345	
124-346	
124-347	
124-348	
124-349	
124-350	
124-351	
124-352	
124-353	
124-360	
124-361	
124-362	
124-363	
124-372	
124-373	
124-374	
124-380	

Status Code	Cause and Remedy
124-381 124-382 124-383 124-390 124-391 124-392 124-393	<p>[Cause] An error occurred in the machine.</p> <p>[Remedy] Switch off the machine power, make sure that the touch screen is blank, and then switch on the machine power. If the same message is displayed again, contact Customer Support at dell.com/contactdell.</p>
124-701	<p>[Cause] The output destination was changed because of the malfunction of the specified output tray (Side Tray).</p> <p>[Remedy] Contact Customer Support at dell.com/contactdell. You can use any output trays other than the defective output tray.</p>
124-702	<p>[Cause] The output destination was changed because of the malfunction of the specified output tray (Finisher Tray).</p> <p>[Remedy] Contact Customer Support at dell.com/contactdell. You can use any output trays other than the defective output tray.</p>
124-705	<p>[Cause] The punch setting was cancelled.</p> <p>[Remedy] Confirm the punch position, and then execute the operation again.</p>
124-706	<p>[Cause] The folding setting was cancelled.</p> <p>[Remedy] Confirm the folding setting, and then execute the operation again.</p>
124-708	<p>[Cause] The output destination has been changed to the Center Tray or the Finisher Tray. The probable causes are as follows:</p> <ol style="list-style-type: none"> 1) Paper of a different size from the specified is loaded for 2 sided copying. 2) The Punching feature of the Finisher has malfunctioned. <p>[Remedy] For 1), check whether the specified size paper is loaded in the tray.</p> <p>For 2), confirm whether the status code 012-231, 012-232, 012-233, or 012-234 is displayed on the touch screen, and contact Customer Support at dell.com/contactdell.</p>
124-709	<p>[Cause] The document exceeded the maximum number of pages that can be stapled.</p> <p>[Remedy] Reduce the number of pages, or cancel the stapling setting, then try printing again.</p>
124-710	<p>[Cause] The machine cannot output to the output destination specified. A paper size or a paper type that cannot be output is specified or something is wrong with the output destination.</p> <p>[Remedy] The machine automatically selects the available output destination. If the paper is not still output from the specified output destination even after the correct paper size and type is selected, contact Customer Support at dell.com/contactdell.</p>
125-311	<p>[Cause] An error occurred in the machine.</p> <p>[Remedy] Switch off the machine power, make sure that the touch screen is blank, and then switch on the machine power. If the same message is displayed again, contact Customer Support at dell.com/contactdell.</p>
127-210 127-211 127-212	<p>[Cause] A communication error occurred between the machine and the Print Server.</p> <p>[Remedy] Disconnect the print server cable, and then securely insert the cable into the connector. Switch off the machine power, make sure that the touch screen is blank, and then switch on the machine power.</p>
127-213	<p>[Cause] A communication error occurred between the machine and the Print Server.</p> <p>[Remedy] Update the machine and the Print Server software to the latest versions.</p>

Status Code	Cause and Remedy
127-220 127-221	<p>[Cause] A communication error occurred between the machine and the Print Server.</p> <p>[Remedy] Disconnect the print server cable, and then securely insert the cable into the connector. Switch off the machine power, make sure that the touch screen is blank, and then switch on the machine power.</p>
127-310 127-311 127-312 127-313 127-314 127-315 127-320 127-337 127-342 127-353 127-354 127-396 127-398 127-399	<p>[Cause] An error occurred in the machine.</p> <p>[Remedy] Switch off the machine power, make sure that the touch screen is blank, and then switch on the machine power. If the same message is displayed again, contact Customer Support at dell.com/contactdell.</p>
133-210 133-211 133-212 133-213 133-214 133-215 133-216 133-217 133-218 133-219 133-220 133-221 133-222 133-223 133-224	<p>[Cause] An error occurred during fax transmission.</p> <p>[Remedy] Switch off the machine power, make sure that the touch screen is blank, and then switch on the machine power. If the error still is not resolved, contact Customer Support at dell.com/contactdell.</p>
133-226	<p>[Cause] A country/region code not supported by the machine was specified.</p> <p>[Remedy] Contact Customer Support at dell.com/contactdell.</p>
133-280 133-281 133-282 133-283	<p>[Cause] An error occurred during fax transmission.</p> <p>[Remedy] Switch off the machine power, make sure that the touch screen is blank, and then switch on the machine power. If the error still is not resolved, contact Customer Support at dell.com/contactdell.</p>
133-700	<p>[Cause] The staple/hole punch setting was cancelled.</p> <p>[Remedy] Check whether the staple/hole punch position is correct, and then execute the operation again.</p>

Status Code	Cause and Remedy
133-710	<p>[Cause] When printing the received fax document, the paper loaded on the bypass tray was used for printing because the specified tray could not be used.</p> <p>[Remedy] Take one of the following measures:</p> <ul style="list-style-type: none"> • Load paper available for printing the received fax document: A3 SEF☐, A4 LEF☐, B4 SEF☐, B5 LEF☐, A4 SEF☐, A5 SEF☐, B5 SEF☐, 8.5 x 11" SEF☐, 8.5 x 13" SEF☐, 8.5 x 14" SEF☐, 11 x 17" SEF☐, 8.5 x 11" LEF☐, 5.5 x 8.5" SEF☐. • Use a paper type available for printing the received fax document: plain paper, bond paper, recycled paper, side 2 paper, user-defined custom paper. • Confirm the settings by selecting [Tools] > [System Settings] > [Fax Service Settings] > [Fax Control] > [Receiving Paper Size]. <p>1) Select [Receiving Paper Size] > [Tray Mode] to add a tray to be used for printing the received fax documents.</p> <p>2) Set up paper so that the tray specified for [Tray Mode] can be used for printing the received fax documents.</p> <p>If the error still is not resolved, contact Customer Support at dell.com/contactdell.</p>
149-310	<p>[Cause] The machine was turned off during the downloading.</p> <p>[Remedy] Switch off the machine power, make sure that the touch screen is blank, and then switch on the machine power. If the same message is displayed again, contact Customer Support at dell.com/contactdell.</p>
149-700	<p>[Cause] The output destination was changed to the Finisher Output Tray although you selected the High Capacity Stacker.</p> <p>[Remedy] Check whether the specified paper is supported by the machine.</p>

Note • If you cannot resolve an error despite following the instructions described in the table, contact Customer Support at dell.com/contactdell.

Other Errors

This section describes the remedies when the following messages are displayed.

Error Message	Cause and Remedy
A fault has occurred. Switch off the machine. (xxx-yyy)	<p>[Cause] An error occurred.</p> <p>[Remedy] Switch off the machine power, make sure that the touch screen is blank, and then switch the machine power on again. If the message persists, record the content displayed for [(xxx-yyy)]. Then immediately switch the main power and power off, make sure that the touch screen is blank, and then contact Customer Support at dell.com/contactdell.</p>
Completed with an error. (xxx-yyy)	<p>[Cause] An error occurred, and the operation terminated abnormally.</p> <p>[Remedy] Execute the operation again.</p>
A fault has occurred. The machine has rebooted. Select [Close]. If the problem persists, call for service. (xxx-yyy)	<p>[Cause] An auto-recoverable internal error occurred, and the machine restarted automatically.</p> <p>[Remedy] Select [Close] to use the machine normally. If the error still is not resolved, contact Customer Support at dell.com/contactdell.</p>

Paper Jams

When a paper jam occurred, the machine stops and an alarm beeps. A message is also displayed on the touch screen. Follow the instructions displayed to remove the jammed paper.

Gently remove the paper to avoid it to be torn. If the paper is torn, remove all the torn pieces, making sure that none remain inside the machine.

If a paper jam message appears again after you have cleared the paper jam, another paper jam may be occurred in some other parts of the machine. Clear this by following the message.

When the paper jam is cleared, printing is automatically resumed from the point when the paper jam occurred.

If you were during copying, press the <Start> button to resume the copying from the point when the paper jam occurred.

This section describes how to clear a paper jam occurring in the following locations.

The following shows the reference section for the procedures to clear a paper jam in each location.

Paper Jams in Upper Left Cover A	495
Paper Jams in Bottom Left Cover C.....	496
Paper Jams in Top Left Cover D	497
Paper Jams in Trays 1 to 4.....	498
Paper Jams in Tray 5 (Bypass Tray)	498
Paper Jams in Tray 6 (HCF B1)	499
Paper Jams in Duplex Module B.....	501
Paper Jams in Finisher-B1	501

- Note**
- When a paper jam occurred, if you pull out a paper tray without checking the paper jam location, the jammed paper may be torn and the pieces may remain inside the machine. This may cause machine malfunctions; therefore, always check where the paper jam occurred first.
 - If any piece of jammed paper remains inside the machine, the paper jam message will not disappear from the touch screen.
 - Clear the paper jams while the machine is powered on. If you turn off the machine, all data stored on the memory of the machine will be erased.
 - Do not touch components inside the machine. This may cause print defects.

Paper Jams in Upper Left Cover A

The following describes how to clear paper jams occurring in the upper left cover.

- Note**
- Do not touch the black film like Transfer Belt inside the upper left cover when you remove the jammed paper because images might be shifted on the Transfer Belt. If you touch the belt, the image quality might be deteriorated or the belt may be damaged and need replacement.

- 1 Remove paper from the Side Tray.

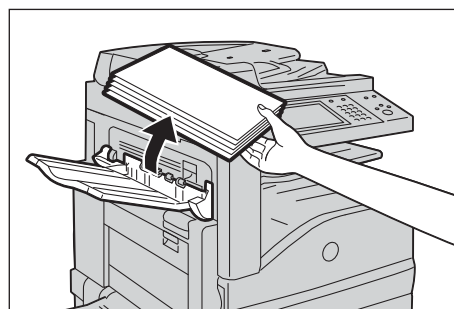

- 2 Open Tray 5 (1), and then while lifting up the release lever (2) gently open the upper left cover (3).

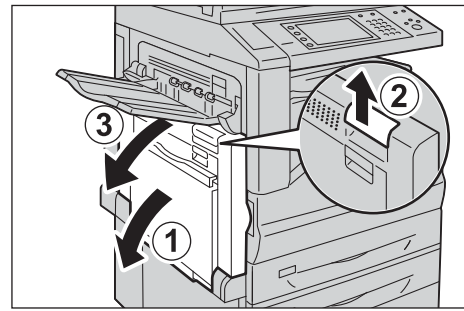

- 3 If you can see the edge of the jammed paper on the output tray, pull the paper straight from the exit area.

Note • Toner may adhere on the transfer roller, but the image quality will not be affected.

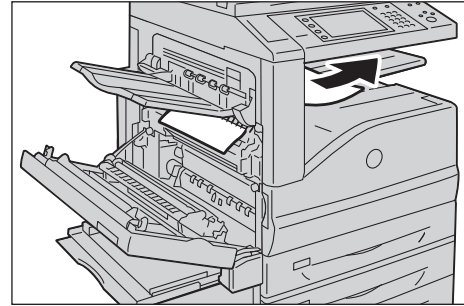

- 4 Remove the jammed paper.

Note • If the paper is torn, make sure no piece of paper remains inside the machine.

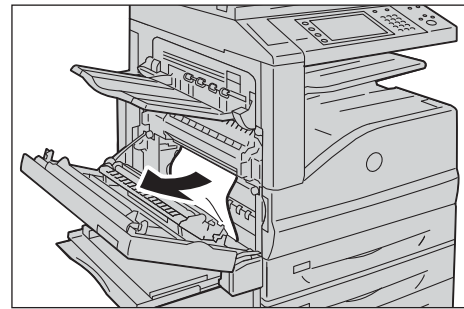

- 5 If paper is jammed in the Fusing Unit, gently remove the paper to avoid it to be torn.

Note • The Fusing Unit is extremely hot. Do not touch the Fusing Unit as it may result in burn injury.

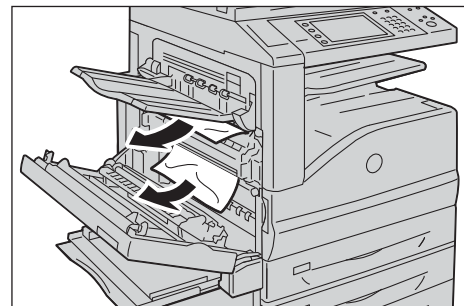

- 6 Push the center of the upper left cover and close the cover gently, and then close Tray 5.

Paper Jams in Bottom Left Cover C

The following describes how to clear paper jams occurring in the bottom left cover.

- 1 Gently open the bottom left cover while pulling the release lever.

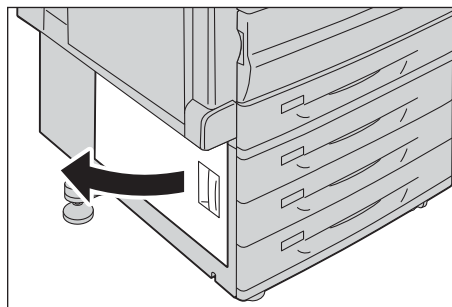

- 2 Remove the jammed paper.

Note

- Paper may be jammed in the hidden area on the upper position. Check inside thoroughly.
- If the paper is torn, make sure no piece of paper remains inside the machine.

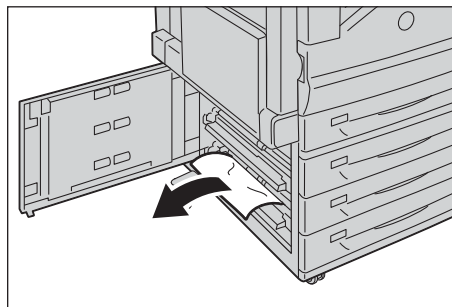

- 3 Close the bottom left cover gently.

Paper Jams in Top Left Cover D

The following describes how to clear paper jams occurring in the top left cover.

Note

- Do not touch the black film like Transfer Belt inside the top left cover when you remove the jammed paper because images might be shifted on the Transfer Belt. If you touch the belt, the image quality might be deteriorated or the belt may be damaged and need replacement.

- 1 Remove paper from the Side Tray.

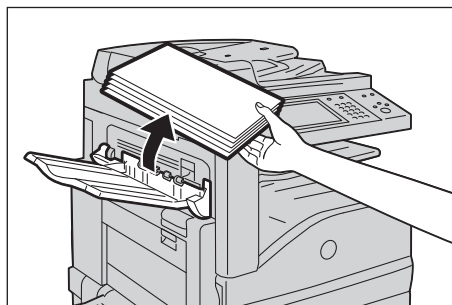

- 2 Open Tray 5 (1), and then while lifting up the release lever (2) gently open the upper left cover (3).

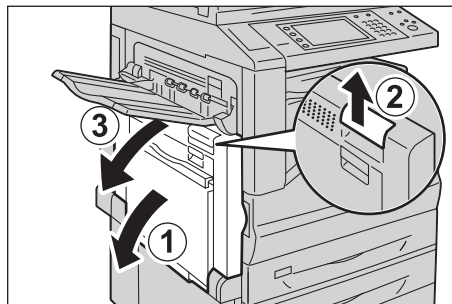

- 3 Lift up the lever to open the top left cover.

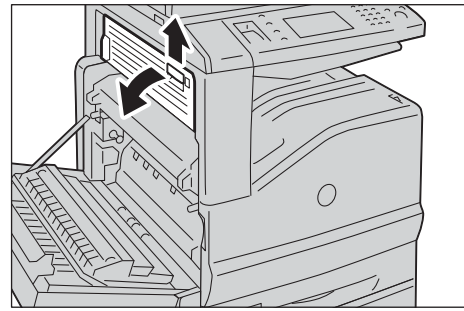

- 4 Remove the jammed paper.

Note • If the paper is torn, make sure no piece of paper remains inside the machine.

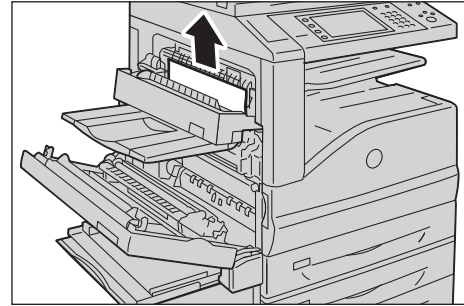

- 5 Close the top left cover gently.

- 6 Push the center of the upper left cover and close the cover gently, and then close Tray 5.

Paper Jams in Trays 1 to 4

The following describes how to clear paper jams occurring in Trays 1 to 4.

- 1 Pull out the tray where the paper jam occurred.

Note • If you pull out a paper tray without checking the paper jam location, the jammed paper may be torn and the pieces may remain inside the machine. This may cause machine malfunctions; therefore, always check where the paper jam occurred first.

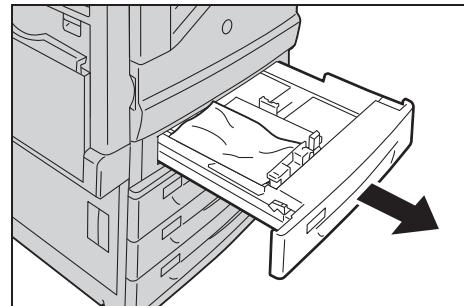

- 2 Remove the jammed paper.

Note • If the paper is torn, make sure no piece of paper remains inside the machine.

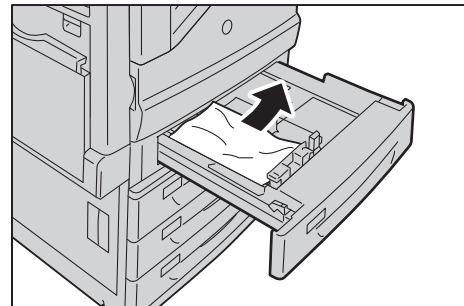

- 3 Push the tray in gently until it stops.

Paper Jams in Tray 5 (Bypass Tray)

The following describes how to clear paper jams occurring in Tray 5.

- 1 Check the back of Tray 5 (around the paper feed entrance) and remove the jammed paper.

- Note**
- When two or more sheets of paper are loaded, remove all of the sheets from the tray.
 - If the paper is torn, make sure no piece of paper remains inside the machine.

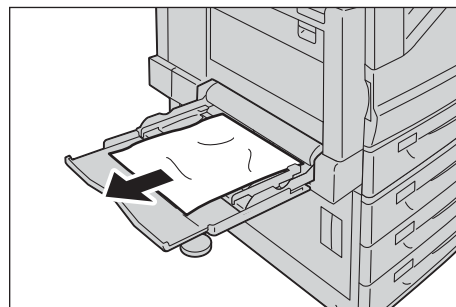

- 2 When two or more sheets of paper were loaded, jog the paper you removed making sure that all four corners are neatly aligned.
- 3 Insert the paper into the tray with the printing side facing down until its edge lightly touches against the paper feed entrance.

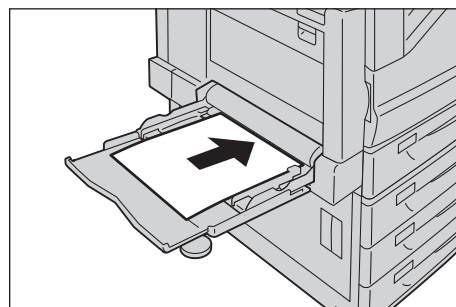

Paper Jams in Tray 6 (HCF B1)

This section describes how to clear paper jams occurring in Tray 6 (HCF B1).

- Note**
- Remedy differs depending on where the paper jam occurs. Follow the instructions displayed and remove the jammed paper.

Paper Jams in Tray 6 Exit

- 1 Gently move Tray 6 to the left until it stops by gripping the handle on the top left side of Tray 6.

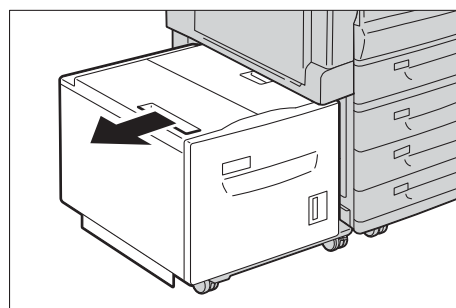

- 2 Remove the jammed paper.

- Note**
- If the paper is torn, make sure no pieces of paper remain inside Tray 6.

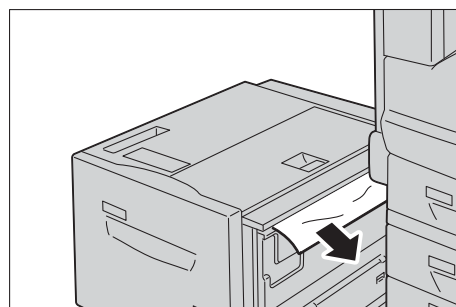

- 3 Gently put Tray 6 back into position.

Paper Jams in Tray 6 Top Cover

- 1 Gently move Tray 6 to the left until it stops by gripping the handle on the top left side of Tray 6.

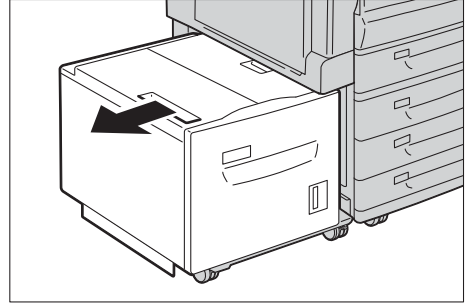

- 2 Open the Tray 6 top cover.

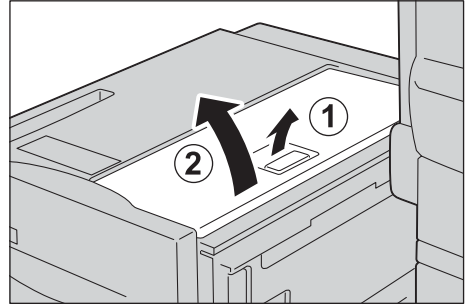

- 3 Remove the jammed paper.

Note • If the paper is torn, make sure no pieces of paper remain inside Tray 6.

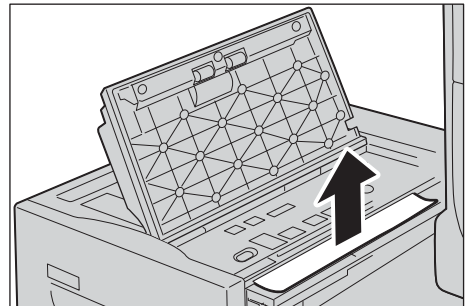

- 4 Close the top cover.
- 5 Gently put Tray 6 back into position.

Paper Jams in Tray 6

- 1 Pull out Tray 6 until it stops.

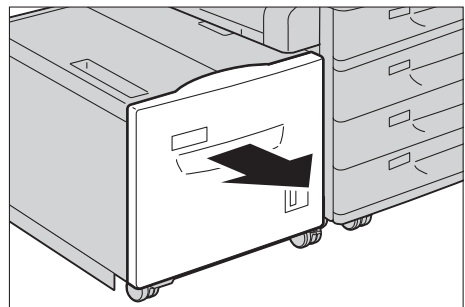

- 2 Remove the jammed paper.

Note • If the paper is torn, make sure no pieces of paper remain inside Tray 6.

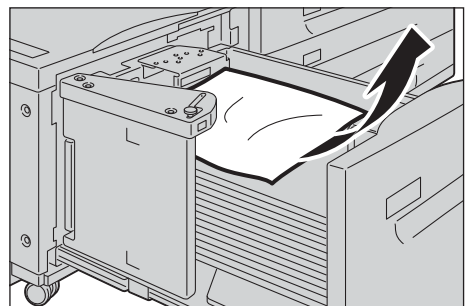

- 3 Push Tray 6 in gently until it stops.

Paper Jams in Duplex Module B

The following describes how to clear paper jams occurring in the Duplex Module B if the machine supports the 2 Sided Printing feature.

- 1 Open Tray 5 (1), lift up the release lever (2), and then gently open the cover of the Duplex Module B (3).

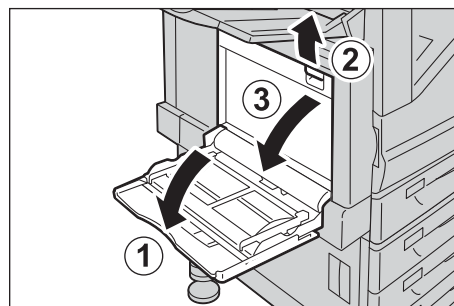

- 2 Remove the jammed paper.

Note • If the paper is torn, make sure no piece of paper remains inside the machine.

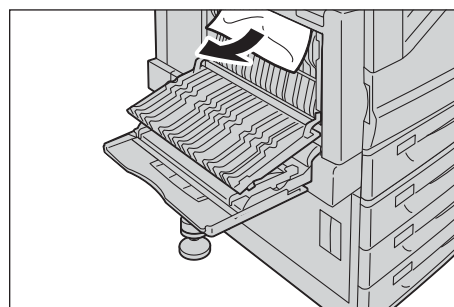

- 3 Close the cover (1), and then close Tray 5 (2).

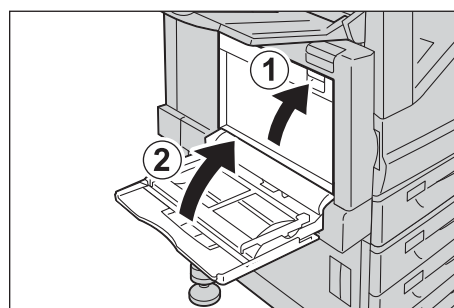

Paper Jams in Finisher-B1

The following describes how to clear paper jams occurring in the Finisher-B1 (optional).

Paper Jams under the Finisher Top Cover

1 Push up the lever on the finisher top cover.

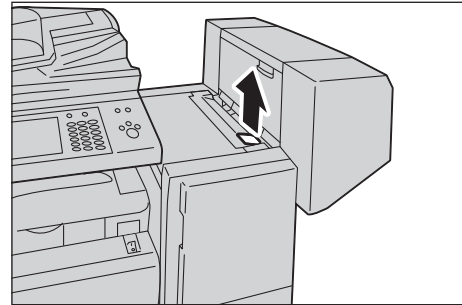

2 The finisher top cover opens.

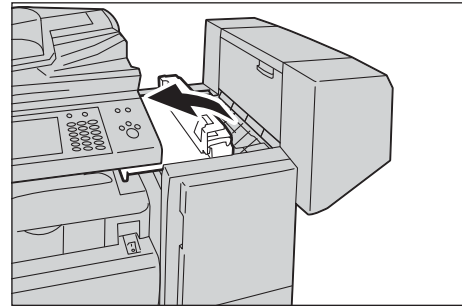

3 Remove the jammed paper.

Note • If the paper is torn, make sure no piece of paper remains inside the machine.

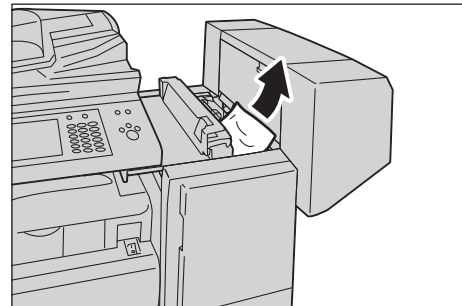

4 Close the finisher top cover.

Paper Jams in the Center Unit

1 Lift the top cover and open.

Note • The top cover cannot be detached from the machine.

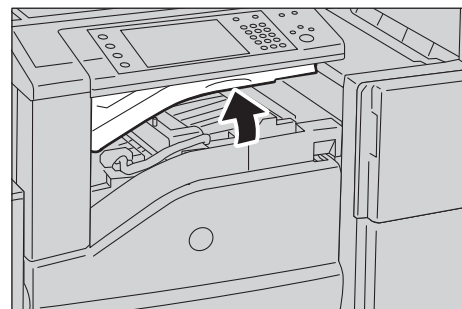

2 Remove the jammed paper.

Note • If the paper is torn, make sure no piece of paper remains inside the machine.



3 Close the cover.

Document Jams

When a document jam occurred in the document feeder, the machine stops and a message is displayed on the touch screen. Follow the instructions displayed to clear the document jam and then load the document in the document feeder again.

Duplex Automatic Document Feeder B1-C

- 1 Pull up the handle of the top cover of the document feeder, and then open the top cover until it stops.

Note • When you fully open the cover, it enters a fixed position. Open the cover gently.

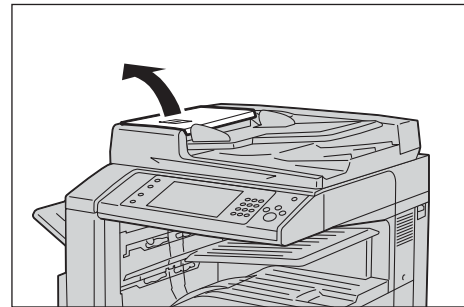

- 2 If the document is not caught in the entry of the document feeder, pull out the document.

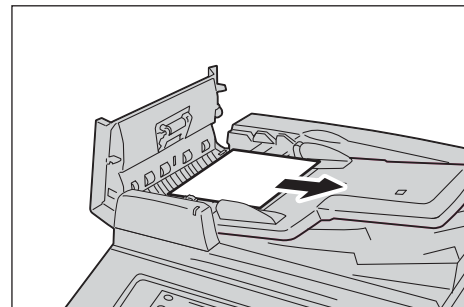

- 3 If the message on the screen instructs you to turn the knob, turn the knob to eject the document upward.

Note • If the document is caught, do not pull it out forcibly. The document could be damaged.

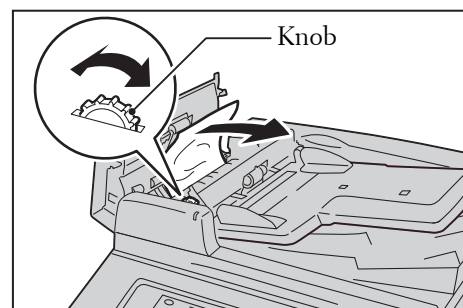

- 4 If the message on the display instructs you to open the inner cover, lift up the handle, and open the inner cover.

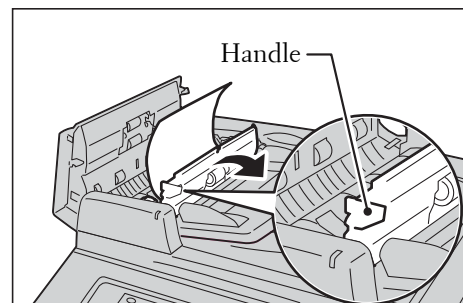

- 5 Turn the knob to eject the document upward to remove.

Note • If the document is caught, do not pull it out forcibly. The document could be damaged.

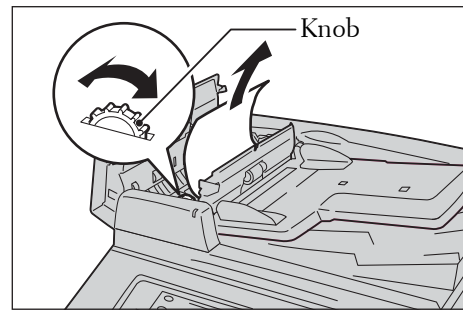

- 6 Close the inner cover of the document feeder.
- 7 Close the left cover of the document feeder until it clicks into place, and confirm that there is no space between the near or far side of the cover and the document feeder.
- 8 If you cannot find the document, lift the document feeder gently, and remove the document if it is there, and then close the document feeder.
- 9 If you still cannot find the document in step 8, lift the document feeder tray and remove the document.

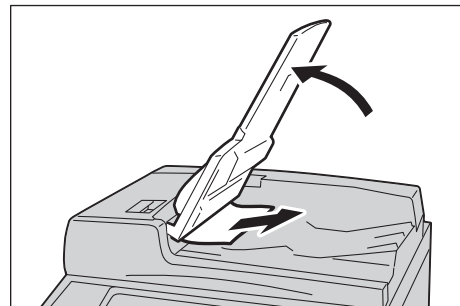

- 10 Return the document feeder tray gently.
- 11 Make sure that the document is not torn, wrinkled or folded, and then load the document again following the instructions displayed on the touch screen.
- Note**
- After removing the jammed document, reload the entire document including the pages already scanned. The machine will automatically skip the scanned pages and start scanning unscanned pages.
 - Torn, wrinkled or folded documents may cause document jams and damage. To scan such documents, directly place the document on the document glass to make copies.

Stapler Faults

This section describes how to clear stapler troubles when the optional finisher is installed. Perform the procedures on the following pages when copies are not stapled or staples are bent. Contact Customer Support at dell.com/contactdell if the problem persists after you have tried the following solutions.

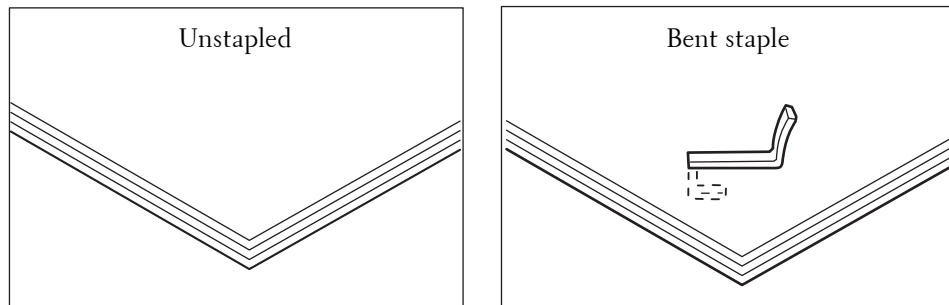

If copies are stapled as shown in the figures below, contact Customer Support at dell.com/contactdell.

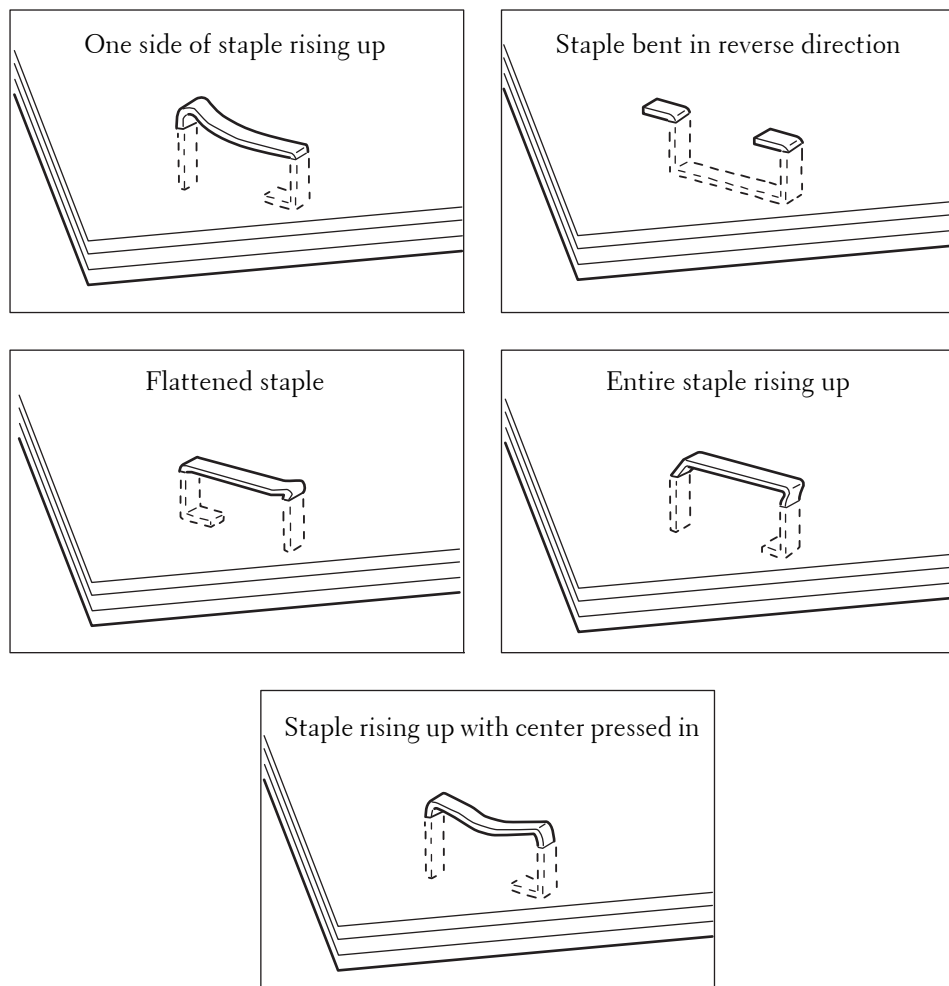

Staple Jams in Staple Cartridge (for Finisher-B1)

This section describes how to clear staple jam occurred in the staple cartridge of the Finisher-B1 (optional).

- 1 Make sure that the machine is not operating, and open the finisher front cover.

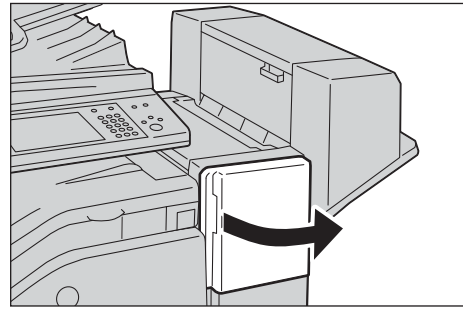

- 2 Grasp the handle as shown in the illustration to pull out the staple cartridge to the right, towards you.



- 3 Move up the staple cartridge, and then take it out of the machine.

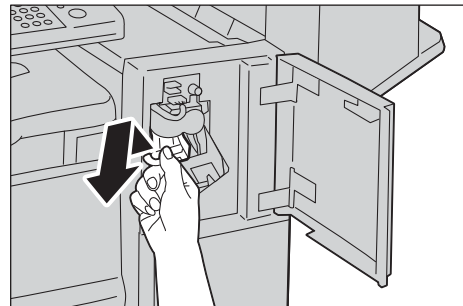

- 4 After you take out the staple cartridge, check inside of the finisher for any remaining staples.

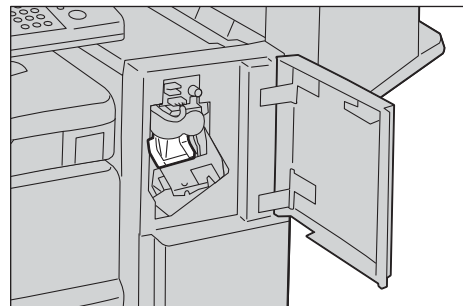

- 5 Pull up the metal part of the staple cartridge as shown in the illustration.

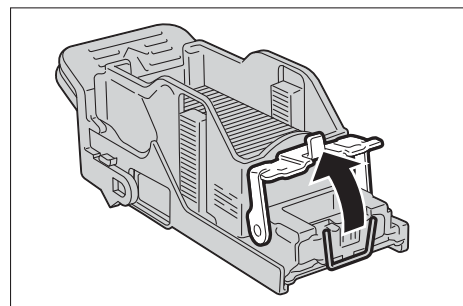

- 6 Remove the jammed staples (1), and then return the metal part pulled up in step 5 to the original position (2).

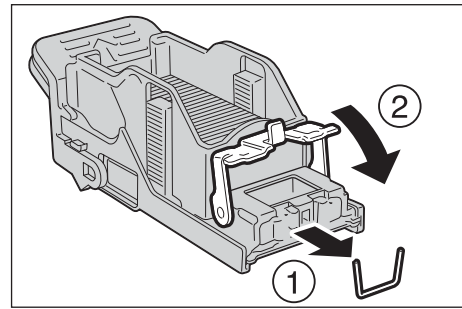

- 7 Push the staple cartridge into the machine until it clicks into place.

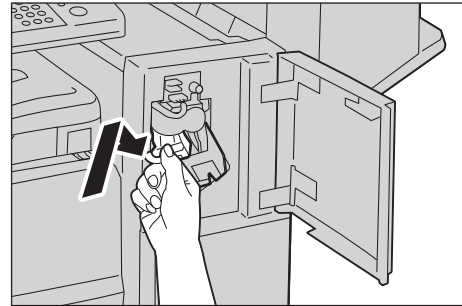

- 8 Close the finisher front cover.

Note • If the finisher front cover is not completely closed, a message will appear and the machine remains paused.

14 Appendix

This chapter describes the machine specifications, notes and restrictions, optional components, and printer emulation languages.

• Specifications	510
• Printable Area	519
• Internal Fonts	520
• Optional Components	522
• Adjust Image Transfer	523
• ESC/P-K Emulation	526
• PDF Direct Print	541
• PCL Emulation	543
• HP-GL/2 Emulation	551
• Notes and Restrictions	569
• Using the Telephone	600
• Activity Report	602

Specifications

This section lists the main specifications of the machine. Note that the specifications and the appearance of the product may change without prior notice.

Basic Specifications / Copy Function

Type	Console
Memory	2 GB
HDD	160 GB Note • Not all the HDD space described above can be used.
Color Capability	Full color
Scanning Resolution	600 x 600 dpi
Printing Resolution	1,200 x 2,400 dpi (multicolored photo), 600 x 600 dpi (text/text-photo/photo/map)
Halftone/Printable Colors	256 halftones for each color (16,700,000 colors)
Warm-up Time	40 seconds or less (at 20 °C room temperature) When the main power is switched on: 35 seconds or less
Original Paper Size	The maximum size is 297 x 432 mm (A3, 11 x 17") for both sheets and books.
Output Paper Size	[Paper Trays 1 to 4] Maximum : SRA3 12.6 x 17.7" (320 x 449.6 mm), : 12 x 18" (304.8 x 457.2 mm) Minimum : A5 (148 x 210 mm) [Paper Tray 5] Maximum : 12 x 19" (304.8 x 482.6 mm) Minimum : Postcard (100 x 148 mm), : Envelope (120 x 235 mm) Image loss width: Top edge, 4 mm or less; bottom edge, 2 mm or less; left and right edges, 2 mm or less Note • If the X direction of non-standard size paper is less than 140 mm, copying may not be performed correctly.
Output Paper Weight	Paper Trays 1 to 4 : 60 - 256 gsm Paper Tray 5 (bypass tray) : 55 - 280 gsm Paper Tray 6 (HCF B1) : 55 - 216 gsm Note • Use paper recommended by Dell. Copying may not be performed correctly depending on the conditions.

<p>First Copy Output Time</p> <p>Note</p> <ul style="list-style-type: none"> The values may vary depending on the machine configuration. 	<p><When the document glass is used></p> <p>For A4□/monochrome priority mode (the default for the [Output Color] is [Black & White] or [No Default])</p> <p>Monochrome : 5.2 seconds Color : 8.5 seconds</p> <p>For A4□/color priority mode (the default for the [Output Color] is [Color], [Auto Detect], [Dual Color] or [Single Color])</p> <p>Monochrome : 6.4 seconds Color : 7.2 seconds</p> <p>*Same magnification/Paper Tray 1/1-sided/Center Tray</p> <p><When the document feeder is used></p> <p>For A4□/monochrome priority mode (the default for the [Output Color] is [Black & White] or [No Default])</p> <p>Monochrome : 7.5 seconds Color : 8.9 seconds</p> <p>For A4□/color priority mode (the default for the [Output Color] is [Color], [Auto Detect], [Dual Color] or [Single Color])</p> <p>Monochrome : 7.3 seconds Color : 9.0 seconds</p> <p>*Same magnification/Paper Tray 1/1-sided/Center Tray</p>																																																												
<p>Reduction/Enlargement</p>	<p>Size-for-Size: 1 ± 0.7%</p> <p>Preset % 1:0.50, 1:0.70, 1:0.81, 1:0.86, 1:1.15, 1:1.22, 1:1.41, 1:2.00</p> <p>Variable % 1:0.25-1:4.00 (1% increments)</p>																																																												
<p>Continuous Copy Speed</p> <p>Note</p> <ul style="list-style-type: none"> The speed may be reduced due to image quality adjustment. The performance may be reduced depending on the paper type and/or the paper tray. When paper in width narrower than B5, such as postcards, is output continuously, temperature on the fusing becomes high. As a result, the machine may suspend the output, appearing a message "Please wait", and resumes in 1 minute. Also, for paper A5 or smaller, even after 1 sheet of paper is output, the machine may suspend with a "Please wait" message and may resume in 30 seconds. 	<ul style="list-style-type: none"> Paper Trays 1 - 4, 6 : Continuous 1 sided copy/same magnification <table border="0"> <tr> <td></td> <td>[Monochrome]</td> <td>[Color]</td> </tr> <tr> <td>B5□, A4□</td> <td>: 35 sheets/minute</td> <td>35 sheets/minute</td> </tr> <tr> <td>A4, B5</td> <td>: 27 sheets/minute</td> <td>27 sheets/minute</td> </tr> <tr> <td>B4</td> <td>: 23 sheets/minute</td> <td>23 sheets/minute</td> </tr> <tr> <td>A3</td> <td>: 20 sheets/minute</td> <td>20 sheets/minute</td> </tr> </table> <ul style="list-style-type: none"> Paper Trays 1 - 4, 6 : Continuous 2 sided copy/same magnification <table border="0"> <tr> <td></td> <td>[Monochrome]</td> <td>[Color]</td> </tr> <tr> <td>B5□, A4□</td> <td>: 35 pages/minute</td> <td>35 pages/minute</td> </tr> <tr> <td>A4, B5</td> <td>: 27 pages/minute</td> <td>27 pages/minute</td> </tr> <tr> <td>B4</td> <td>: 14 pages/minute</td> <td>14 pages/minute</td> </tr> <tr> <td>A3</td> <td>: 13 pages/minute</td> <td>13 pages/minute</td> </tr> </table> <ul style="list-style-type: none"> Paper Tray 5 : Continuous 1 sided copy/same magnification <table border="0"> <tr> <td></td> <td>[Monochrome]</td> <td>[Color]</td> </tr> <tr> <td>B5□, A4□</td> <td>: 30 sheets/minute</td> <td>30 sheets/minute</td> </tr> <tr> <td>A4, B5</td> <td>: 24 sheets/minute</td> <td>24 sheets/minute</td> </tr> <tr> <td>B4</td> <td>: 21 sheets/minute</td> <td>21 sheets/minute</td> </tr> <tr> <td>A3</td> <td>: 18 sheets/minute</td> <td>18 sheets/minute</td> </tr> </table> <ul style="list-style-type: none"> Paper Tray 5 : Continuous 2 sided copy/same magnification <table border="0"> <tr> <td></td> <td>[Monochrome]</td> <td>[Color]</td> </tr> <tr> <td>B5□, A4□</td> <td>: 32 pages/minute</td> <td>32 pages/minute</td> </tr> <tr> <td>A4, B5</td> <td>: 25 pages/minute</td> <td>25 pages/minute</td> </tr> <tr> <td>B4</td> <td>: 13 pages/minute</td> <td>13 pages/minute</td> </tr> <tr> <td>A3</td> <td>: 12 pages/minute</td> <td>12 pages/minute</td> </tr> </table> <p>Note</p> <ul style="list-style-type: none"> When paper is fed from Tray 5 and the paper size is set to [Auto Detect], the printing speed for the first page will be slower. 		[Monochrome]	[Color]	B5□, A4□	: 35 sheets/minute	35 sheets/minute	A4, B5	: 27 sheets/minute	27 sheets/minute	B4	: 23 sheets/minute	23 sheets/minute	A3	: 20 sheets/minute	20 sheets/minute		[Monochrome]	[Color]	B5□, A4□	: 35 pages/minute	35 pages/minute	A4, B5	: 27 pages/minute	27 pages/minute	B4	: 14 pages/minute	14 pages/minute	A3	: 13 pages/minute	13 pages/minute		[Monochrome]	[Color]	B5□, A4□	: 30 sheets/minute	30 sheets/minute	A4, B5	: 24 sheets/minute	24 sheets/minute	B4	: 21 sheets/minute	21 sheets/minute	A3	: 18 sheets/minute	18 sheets/minute		[Monochrome]	[Color]	B5□, A4□	: 32 pages/minute	32 pages/minute	A4, B5	: 25 pages/minute	25 pages/minute	B4	: 13 pages/minute	13 pages/minute	A3	: 12 pages/minute	12 pages/minute
	[Monochrome]	[Color]																																																											
B5□, A4□	: 35 sheets/minute	35 sheets/minute																																																											
A4, B5	: 27 sheets/minute	27 sheets/minute																																																											
B4	: 23 sheets/minute	23 sheets/minute																																																											
A3	: 20 sheets/minute	20 sheets/minute																																																											
	[Monochrome]	[Color]																																																											
B5□, A4□	: 35 pages/minute	35 pages/minute																																																											
A4, B5	: 27 pages/minute	27 pages/minute																																																											
B4	: 14 pages/minute	14 pages/minute																																																											
A3	: 13 pages/minute	13 pages/minute																																																											
	[Monochrome]	[Color]																																																											
B5□, A4□	: 30 sheets/minute	30 sheets/minute																																																											
A4, B5	: 24 sheets/minute	24 sheets/minute																																																											
B4	: 21 sheets/minute	21 sheets/minute																																																											
A3	: 18 sheets/minute	18 sheets/minute																																																											
	[Monochrome]	[Color]																																																											
B5□, A4□	: 32 pages/minute	32 pages/minute																																																											
A4, B5	: 25 pages/minute	25 pages/minute																																																											
B4	: 13 pages/minute	13 pages/minute																																																											
A3	: 12 pages/minute	12 pages/minute																																																											

Operating System	<p>PCL6</p> <p>Microsoft® Windows® 2000, Microsoft® Windows® XP, Microsoft® Windows® XP x64, Microsoft® Windows Server® 2003, Microsoft® Windows Server® 2003 x64, Microsoft® Windows Server® 2008, Microsoft® Windows Server® 2008 x64, Microsoft® Windows Server® 2008 R2, Microsoft® Windows Vista®, Microsoft® Windows Vista® x64, Microsoft® Windows® 7, Microsoft® Windows® 7 x64, Microsoft® Windows® 8, Microsoft® Windows® 8 x64, Microsoft® Windows Server® 2012 x64</p> <p>PostScript</p> <p>Microsoft® Windows® 2000, Microsoft® Windows® XP, Microsoft® Windows® XP x64, Microsoft® Windows Server® 2003, Microsoft® Windows Server® 2003 x64, Microsoft® Windows Server® 2008, Microsoft® Windows Server® 2008 x64, Microsoft® Windows Server® 2008 R2, Microsoft® Windows Vista®, Microsoft® Windows Vista® x64, Microsoft® Windows® 7, Microsoft® Windows® 7 x64, Microsoft® Windows® 8, Microsoft® Windows® 8 x64, Microsoft® Windows Server® 2012 x64, Mac OS® X 10.5/10.6/10.7/10.8</p> <p>Note • For information about the latest supported OS, contact Customer Support at dell.com/contactdell.</p>
Fonts	<p>PCL :</p> <p>European 82 type faces, symbol 43 sets, Korean font 6 type faces, Chinese font 1 type face</p> <p>PostScript :</p> <p>European 136 type faces</p>
Emulation	ESC/P-K (LQ1900K II), HP-GL (HP7586B), HP-GL/2 /RTL (HP Design Jet 750C Plus), PCL5/PCL6 (HP Color Laser Jet 5500)
Connectivity	Ethernet (1000BASE-T/100BASE-TX/10BASE-T), USB 2.0

Scan Function

Type	Color scanner
Maximum Document Size	Same as the Copy Function
Scanning Resolution	600 x 600 dpi, 400 x 400 dpi, 300 x 300 dpi, 200 x 200 dpi

Scanning Halftone	10-bit input / 8-bit output for each RGB color
Scanning Speed	<p>Monochrome : 70 sheets/min. Color : 70 sheets/min. (For ITU-T No.1 Chart A4 200 dpi, Store to Folder)</p> <p>Note • The scanning speed varies depending on documents.</p>
Connectivity	Ethernet 1000BASE-T/100BASE-TX/10BASE-T
Store to Folder	<p>Protocol : TCP/IP (WebDAV, HTTP) File Format:</p> <p>Monochrome binary : TIFF, PDF*, XPS* Gray scale : TIFF, JPEG, PDF*, XPS* Full color : TIFF, JPEG, PDF*, XPS*, high-compressed PDF, high-compressed XPS</p> <p>* :Supported only when documents are received using Dell Printer Configuration Web Tool.</p> <p>Note • XPS stands for XML Paper Specification.</p> <p>Driver:TWAIN Operating System:</p> <p>Microsoft® Windows® 2000, Microsoft® Windows® XP, Microsoft® Windows Server® 2003, Microsoft® Windows Server® 2008, Microsoft® Windows Vista®, Microsoft® Windows® 7, Microsoft® Windows® XP Professional x64, Microsoft® Windows Server® 2003 x64, Microsoft® Windows Server® 2008 x64, Microsoft® Windows Vista® x64, Microsoft® Windows Server® 2008 R2 x64, Microsoft® Windows® 7 x64, Microsoft® Windows® 8 x64</p> <p>Note • For information about the latest supported OS, contact Customer Support at dell.com/contactdell.</p>

Scan to PC	<p>Protocol : TCP/IP (SMB, FTP)</p> <p>Operating System :</p> <p>Microsoft® Windows® 2000, Microsoft® Windows® XP, Microsoft® Windows Vista®, Microsoft® Windows Server® 2003, Microsoft® Windows Server® 2008, Microsoft® Windows® XP x64, Microsoft® Windows Vista® x64, Microsoft® Windows Server® 2003 x64, Microsoft® Windows Server® 2008 x64, Microsoft® Windows Server® 2008 R2 x64, Microsoft® Windows® 7 x64, Mac OS X 10.2.x/10.3.8/10.3.9/10.4.2/10.4.4/10.4.8/10.4.9/ 10.4.10/10.4.11/10.5.0/10.5.1/10.5.2/10.5.3/10.5.4/10.6/10.7*, NetWare® 5.11/5.12*</p> <p>* : Supports FTP protocol only.</p> <p>Note • For information about the latest supported OS, contact Customer Support at dell.com/contactdell.</p> <p>File Format:</p> <p>Monochrome binary : TIFF (Compression type: MH, MMR), PDF (Compression type: MH, MMR, JBIG2), XPS (Compression type: MH, MMR)</p> <p>Gray scale/Full color: TIFF (Compression type: JPEG), JPEG, PDF (Compression type: JPEG, Flate), XPS (Compression type: JPEG)</p> <p>Note • XPS stands for XML Paper Specification.</p>
Scan to E-mail	<p>Protocol : TCP/IP (SMTP)</p> <p>File Format :</p> <p>Monochrome binary: TIFF (Compression type: MH, MMR), PDF (Compression type: MH, MMR, JBIG2), XPS (Compression type: MH, MMR)</p> <p>Gray scale/full color: TIFF (Compression type: JPEG), JPEG, PDF (Compression type: JPEG, Flate), XPS (Compression type: JPEG)</p> <p>Note • XPS stands for XML Paper Specification.</p>

Fax Function

Send Document Size	Maximum : A3, 11 x 17", Long document (Maximum: 600 mm)
Recording Paper Size	Maximum : A3, 11 x 17" Minimum : A5
Transmission Time	2 seconds or more but below 3 seconds Note • When transmitting an A4 size 700-character document in the standard quality (8 x 3.85 lines/mm) and high speed mode (28.8 kbps or above: JBIG). This is only the transmission speed for image information and does not include the controlling time for the communication. Note that the actual transmission time depends on the content of documents, the machine that the recipient uses, and the status of the communication line.

Transmission Mode	ITU-T G3
Scanning Resolution	Standard : 8 x 3.85 lines/mm 200 x 100 dpi (7.9 x 3.9 dots/mm) Fine : 8 x 7.70 lines/mm 200 x 200 dpi (7.9 x 7.9 dots/mm) Superfine (400 dpi) : 400 x 400 dpi (15.7 x 15.7 dots/mm) Superfine (600 dpi) : 600 x 600 dpi (23.6 x 23.6 dots/mm)
Coding Method	MH / MR / MMR / JBIG
Transmission Speed	G3 : 33.6/31.2/28.8/26.4/24.0/21.6/19.2/16.8/14.4/12.0/9.6/7.2/4.8/2.4 kbps
No. of Fax Lines	PSTN, PBX (G3 line x 1)



Direct Fax Function

Fax Resolution	Standard : 200 x 100 dpi (7.9 x 3.9 dots/mm) Fine : 200 x 200 dpi (7.9 x 7.9 dots/mm) Superfine : 400 x 400 dpi (15.7 x 15.7 dots/mm) 600 x 600 dpi (23.6 x 23.6 dots/mm)
Document Size	A3, B4, A4
Transmission Speed	Same as the Fax function
Applicable Lines	Same as the Fax function
Operating System	Microsoft® Windows® 2000, Microsoft® Windows® XP, Microsoft® Windows Server® 2003, Microsoft® Windows Vista®, Microsoft® Windows Server® 2008, Microsoft® Windows® 7, Microsoft® Windows® 8, Microsoft® Windows® XP x64, Microsoft® Windows Server® 2003 x64, Microsoft® Windows Vista® x64 Microsoft® Windows Server® 2008 x64, Microsoft® Windows Server® 2008 R2 x64, Microsoft® Windows® 7 x64, Microsoft® Windows® 8 x64, Mac OS X 10.5/10.6/10.7 Note • For information about the latest supported OS, contact Customer Support at dell.com/contactdell .

Internet Fax Function

Document Size	A3, B4, A4, Long document (Maximum: 600 mm)
Scanning Resolution	Same as the Fax function
Output Format	Format : TIFF-FX Compression method : MH, MMR, JBIG
Profile	TIFF-S, TIFF-F, TIFF-J
Protocol	Transmission : SMTP, Reception: SMTP, POP3
Connectivity	Ethernet 1000BASE-T/100BASE-TX/10BASE-T

Duplex Automatic Document Feeder B1-C

Type	Duplex Automatic Document Feeder
Original Paper Size	Maximum : A3, 11 x 17" (279 x 432 mm) Minimum : A5*, 38 - 128 gsm (2 sided: 50 - 128 gsm) * : For non-standard size paper: 125 x 85 mm
Capacity	110 sheets (A4  1 sided) Note • When using 80 gsm paper
Feeding Speed	A4  1 sided: Monochrome : 36 sheets/minute Color : 36 sheets/minute A4  2 sided: Monochrome : 31 sheets/minute Color : 31 sheets/minute Note • The number of sheets may vary depending on the scanning speed.
Dimensions/Weight	Width 560 x Depth 492 x Height 105 mm, 7.5 kg

Duplex Output Unit

Paper Size	Maximum : SRA3, 12.6 x 17.7" (320 x 449.6mm), 12 x 18" (304.8 x 457.2mm), A3 Minimum : A5
Paper Weight	60 - 220 gsm

Finisher-B1 (optional)

Type	Finisher tray x 1 : Sorting (Offset available) Stacking (Offset available)
Paper Size/Paper Weight	Maximum : A3, 11 x 17" Minimum : B5 55 - 220 gsm
Stacker Capacity	Unstapled sheets A4 : 2,000 sheets B4 or larger : 1,000 sheets Mixed size*1 : 300 sheets Unstapled sheets A4 : 100 sets or 1,000 sheets B4 or larger : 75 sets or 750 sheets Creased + Stapled*2 : 50 sets or 600 sheets Creased*2 : 500 sheets Note • When using 80 gsm paper
Staple	Capability : 50 sheets (90 gsm or less) Paper size : Maximum: A3, 11 x 17", Minimum: B5  Position : 1 position (front: angled, back: straight) 2 positions (parallel) Note • When using 80 gsm paper

Punch*3	Paper size : A3, 11 x 17", B4, A4, A4☐, 8.5 x 11", 8.5 x 11"☐, B5☐ Paper Weight : 55 - 200 gsm Number of Holes : 2/4 holes, US 2/3 holes Note • When using 80 gsm paper
Booklet Creation *2	Sheets per Subset : 2-15 sheets (Crease + Staple), 1-5 sheets (Crease) Paper Size : Maximum: A3, 11 x 17", Minimum: A4, 8.5 x 11" Paper Weight : 64 - 80 gsm (Crease + Staple) 64 - 105 gsm (Crease) Note • When using 80 gsm paper
Dimensions/Weight	Width 620 x Depth 552 x Height 987 mm, 28 kg Width 620 x Depth 597 x Height 1,057 mm, 37 kg (with the Booklet Maker Unit)
Space Requirement (with the main unit)	Width 1,666 x Depth 699 mm (Main unit + Finisher-B1, when the extension tray and the bypass tray are fully extended) Width 1,666 x Depth 699 mm (Main unit + Finisher-B1 + Booklet Maker Unit, when the extension tray and the bypass tray are fully extended)

*1 : With paper of a larger size delivered on paper of a smaller size.

*2 : For Crease + Staple, the Booklet Maker Unit for Finisher-B1 (optional) is required. Note that the next job will not be output until the creased and stapled booklet is removed from the finisher tray, and that the creased and stapled booklet will not be output when the output paper remaining on the finisher tray is of a smaller size.

*3 : For punching, 2/4 Hole Punch Kit for Finisher-B1 (optional) or US 2/3 Hole Punch Kit for Finisher-B1 (optional) is required.

Side Tray

Paper Size	Same as the Copy Function
Capacity	100 sheets Note • When using 80 gsm paper
Dimensions/Weight	Width 274 x Depth 469 x Height 128 mm, 1 kg
Space Requirement (when connected to the main unit)	Width 1,064 x Depth 699 mm* * : When the bypass tray is fully extended and the stopper of the document output tray is pulled out

HCF B1 (optional)

Paper Size	A4☐, 8.5 x 11"☐, B5☐
Paper Weight	55 - 216 gsm
Capacity	2,030 sheets Note • When using 80 gsm paper
Dimensions/Weight	Width 389 x Depth 610 x Height 380 mm, 29 kg
Space Requirement (with the main unit)	Width 1,064 x Depth 699 mm* * : When the bypass tray is fully extended and the stopper of the document output tray is pulled out

Printable Area

This section describes the area on paper that can be printed.

Standard Printable Area

The standard printable area is the area of a sheet of paper excluding the 4.0 mm margins on all four edges of paper. For SRA3 paper (width of 320 mm), the printable area of the paper is the area excluding the 11.5 mm left and right margins. The actual printable area, however, may vary depending on the printer (plotter) control language.

Extended Printable Area

When you select the extended printable area setting for printing, you can expand the width and length of the printable area to 305.0 x 476.6 mm and the print assured area to 297.0 x 476.6 mm. For copying, the printable area and the print assured area can be extended up to 297.0 x 432.0 mm. The area of paper you can print to, however, may vary depending on the size of paper.

Note • To extend the printable area, change the PCL print driver setting, or the [Print Area] setting on the touch screen.

For more information on the setting method on the print driver, refer to the help provided for the print driver. For more information on the setting on the control panel, refer to "Print Area" (P.192).

	When the paper width is less than 12 inches (A3)	When the paper width is 12 inches (12 x 19")	When the paper width is 12.6 inches (SRA3 (320 mm width))
Print			
Copy			

Internal Fonts

This section lists the fonts pre-installed on the machine.

For more information on the PostScript fonts, refer to the PostScript User Guide. For more information on the optional HP-GL/2 and PCL fonts, refer to "PCL Emulation" (P.543) and "HP-GL/2 Emulation" (P.551).

Stroke fonts (for PCL5 and HP-GL/2)			• European Stroke fonts	
Outline fonts	Euro- pean	ESC/P-K	Roman	Sans Serif
		PDF	Arial Arial Italic Arial Bold Arial Bold Italic Courier Courier Italic Courier Bold Courier Bold Italic	Symbol Times New Roman Times New Roman Bold Times New Roman Italic Times New Roman Bold Italic ITC Zapf Dingbats GoldSEMM GoldSMMM

Outline fonts	Euro-pean	PCL	CG Times CG Times Italic CG Times Bold CG Times Bold Italic Univers Medium Univers Medium Italic Univers Bold Univers Bold Italic Univers Medium Condensed Univers Medium Condensed Italic Univers Bold Condensed Univers Bold Condensed Italic Antique Olive Antique Olive Italic Antique Olive Bold CG Omega CG Omega Italic CG Omega Bold CG Omega Bold Italic Garamond Antiqua Garamond Kursiv Garamond Halbfett Garamond Kursiv Halbfett (Default): Courier Courier Italic Courier Bold Courier Bold Italic Letter Gothic Letter Gothic Italic Letter Gothic Bold Albertus Medium Albertus Extra Bold Clarendon Condensed Coronet Marigold Arial Arial Italic Arial Bold Arial Bold Italic Times New Times New Italic	Times New Bold Times New Bold Italic Symbol Wingdings Line Printer Times Roman Times Italic Times Bold Times Bold Italic Helvetica Helvetica Oblique Helvetica Bold Helvetica Bold Oblique CourierPS CourierPS Oblique CourierPS Bold CourierPS Bold Oblique SymbolPS Palatino Roman Palatino Italic Palatino Bold Palatino Bold Italic ITC Bookman Light ITC Bookman Light Italic ITC Bookman Demi ITC Bookman Demi Italic Helvetica Narrow Helvetica Narrow Oblique Helvetica Narrow Bold Helvetica Narrow Bold Oblique New Century Schoolbook Roman New Century Schoolbook Italic New Century Schoolbook Bold New Century Schoolbook Bold Italic ITC Avant Garde Book ITC Avant Garde Book Oblique ITC Avant Garde Demi ITC Avant Garde Demi Oblique ITC Zapf Chancery Medium Italic ITC Zapf Dingbats OCR-B
	KO	PCL5	Myungio Gothic R- Gothic	Graphic Kungso Saemmul
	TC	PCL5	ShuSong	
	SC	PCL5 ESC/P-K	ShuSong	

Note • The fonts provided will vary depending on the region of use.

Optional Components

The following table shows the optional components available. To purchase these options, contact Customer Support at dell.com/contactdell.

Product Name	Description
Finisher-B1	Staples output sheets.
Booklet Maker Unit for Finisher-B1	Staples output sheets. Also folds output sheets in half or staples them.
2/4 Hole Punch Kit for Finisher-B1	2/4 hole-punches output sheets.
US 2/3 Hole Punch Kit for Finisher-B1	2/3 hole-punches output sheets.
HCF B1	A tray that can load 2,030 sheets of paper (When using 80 gsm paper).
Wing Table	A kit to load related products such as a smart card reader, or to secure work space. The table can be placed either right or left side of the document cover.
USB Hub	Adds a USB port to equip the Memory Card Reader to the machine.
Fax Kit 2	Adds the Fax and Internet Fax feature to the machine.

- Note**
- The optional components are subject to change without notice.
 - For the latest information, contact Customer Support at dell.com/contactdell.

Adjust Image Transfer

This section describes how to adjust the transfer output value.

You can specify the transfer output value. This is useful when the toner image does not transfer to the paper properly.

Adjusting the Transfer Output Value

You can specify the transfer output value for each paper type.

- 1 Press the <Log In/Out> button.

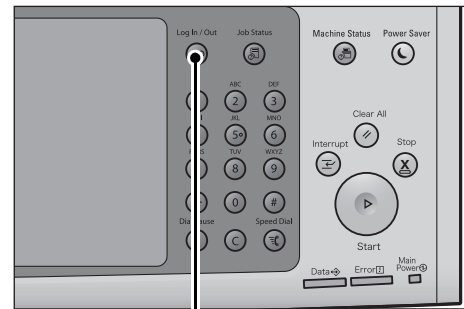

<Log In/Out> button

- 2 Enter the system administrator's user ID with the numeric keypad or the keyboard displayed on the screen, and select [Enter].

When a passcode is required, select [Next] and enter the system administrator's passcode, and select [Enter].

- Note**
- The default user ID is "admin".
 - The default passcode is "1111".

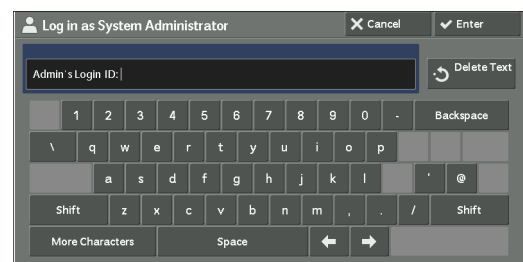

- 3 Select [Tools] on the [Home] screen.

- Note**
- When the [Home] screen is not displayed on the touch screen, press the <Home> button.

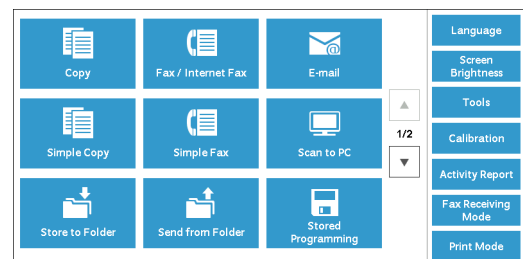

- 4 Select [System Settings] > [Common Service Settings] > [Maintenance].

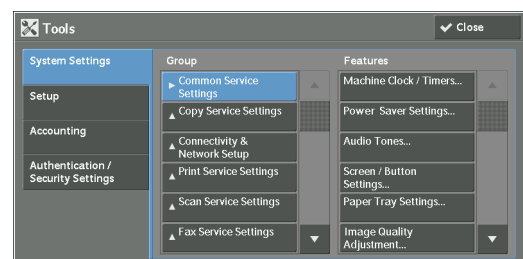

5 Select [Adjust Image Transfer].

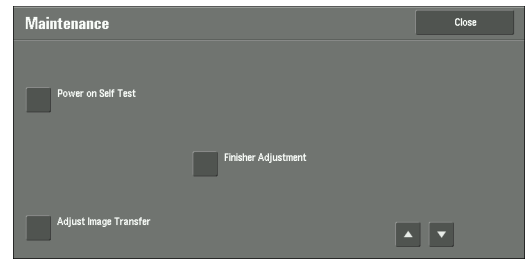

6 Select [Paper Type].

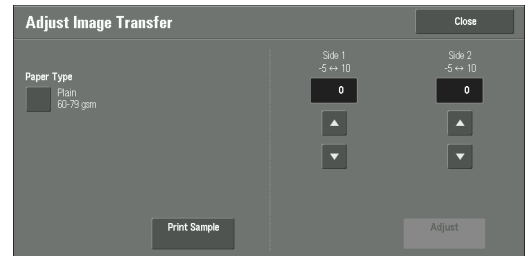

7 Select the paper type, and then select [Close].

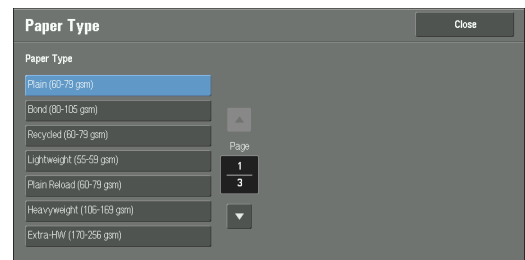

8 Select [Print Sample].

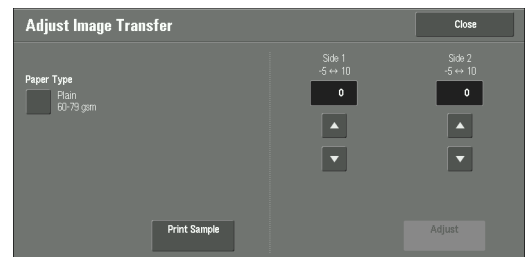

9 Select the paper size, load paper of that size in Tray 5 (Bypass), and then select [1 Sided] or [2 Sided].

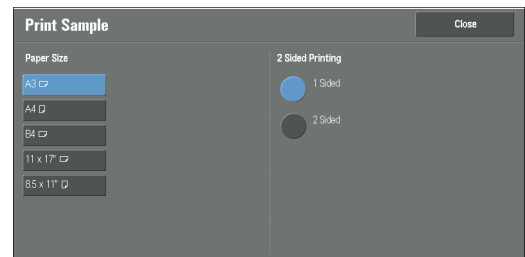

10 Press the <Start> button.

The print sample will be printed.

- Note**
- “Side 1” will be printed on the top right of the Side 1 sample, and “Side 2” will be printed on the top right of the Side 2 sample.
 - When the paper size is A4, B4, or 8.5 × 11”, the sample will be printed on two sheets.

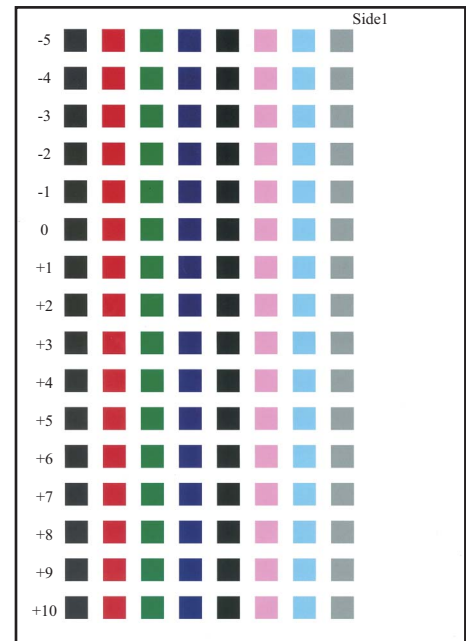

11 Check the print sample, and take a note of the value (-5 to +10) printed on the left side of the most-successfully printed row.

- Note**
- When [2 Sided] is selected, do the same for both the Side 1 sample and the Side 2 sample.

12 Enter the [Side 1] and the [Side 2] values you selected in step 11.

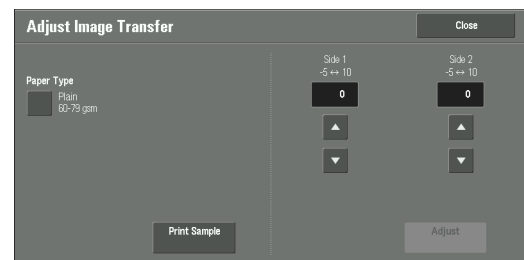

13 Select [Adjust].

The specified transfer output values will be applied when the paper type of the job is the same as the paper type selected in step 7.

14 Select [Close].

ESC/P-K Emulation

This section describes how to use ESC/P-K emulation.

Emulation

This section describes the printer language emulations available on the machine.

Print data conforms to certain rules (grammars). These rules (grammars) are called printer languages.

The machine supports two types of printer languages: a page description language, which is used to create images on a page-by-page basis, and an emulation, which is used to achieve the print results similar to those of other printers. To "emulate" means to imitate the print results of other printers.

Emulation Mode

When printing data written in a language other than a page description language supported by the machine, switch the machine to the emulation mode. The relationships between the emulation mode and the printer to be emulated are as follows:

Emulation Mode	Printer to be Emulated
ESC/P-K emulation mode (ESC/P-K mode)	LQ1900K II+

Host Interfaces and Emulation

Different host interfaces support different printer languages. The host interfaces that support printer languages are as follows:

- USB port
- NetWare port
- lpd port
- SMB port
- IPP port
- Port 9100 port
- WSD port

Note • WSD stands for Web Services on Devices.

Switching between Printer Languages

The machine provides the Multi-emulation feature that allows switching between different printer languages.

The methods of switching between printer languages are as follows:

Switching by Commands

Commands for switching between printer languages are provided. Upon receipt of a command, the machine switches to the relevant printer language.

Automatic Switching

The machine analyzes the data received by a host interface, and automatically identifies the printer language to be used. It then switches to the identified printer language.

Interface-dependent

You can set a printer language for each host interface by using Dell Printer Configuration Web Tool. The machine switches to a printer language corresponding to the host interface that received data.

Fonts

This section explains the fonts used for emulation.

Available fonts

The following fonts can be used for ESC/P-K emulation:

ESC/P-K Emulation

Available outline fonts are as follows:

- Roman
- Sans serif
- ShuSong
- OCR-B

User-defined Characters

On the machine, you can use user-defined characters.

The total capacity of memory for storing user-defined characters and other user-defined data can be set on the control panel. This value is retained after the machine is turned off.

User-defined characters are registered as bitmap fonts, and cannot be shared among different printer languages.

Font Caching

To ensure hi-speed printing, outline fonts of up to a certain size are cached. Outline fonts are converted into bitmap data temporarily and then printed. To minimize this processing time, the processed bitmap data is saved in the memory. This process is called font caching.

The saved bitmap data is deleted when you turn the machine off or reset it.

Output Feature

This section describes the machine's output feature.

Outputting a Pending Print Job

The printing of jobs already received by the machine can be prioritized over other jobs.

For information on prioritizing the printing of jobs already received by the machine, refer to "11 Job Status" > "Printing Pending Jobs" in the User Guide.

ESC/P-K Emulation Print Features

Multiple-Up

The Multiple-Up feature reduces the size of multiple-sheet documents and prints them on a single sheet of paper.

The Multiple-Up feature can be used in the ESC/P-K emulation mode. In the ESC/P-K mode, 2 Up can be used.

Form Overlay

In the ESC/P-K mode, you can register an original form on the machine, and overprint the form on a printout.

The form to be used for overlaying can be specified on the control panel.

For more information on registering forms, contact Customer Support at dell.com/contactdell.

Barcodes

In the ESC/P-K mode, you can use barcodes. The barcodes that can be used are as follows:

- EAN-13
- EAN-8
- Interleaved 2 of 5
- UPC-A
- UPC-E
- CODE39
- CODE128
- POSTNET

Forms

You can use ESC/P-K to register forms on the machine. Up to 64 forms can be registered.

For more information on registering forms, contact Customer Support at dell.com/contactdell.

ESC/P-K Emulation Settings

The following tables show the basic and extended settings that can be configured on the ESC/P-K emulation mode menu.

Basic Settings

Setting Item	Item Number	Value
Output color	5	Sets the output color. [0] (Default) : Color [1] : Monochrome

Setting Item	Item Number	Value
Paper tray	3	<p>Sets the paper tray to be used for printing.</p> <p>[0] : Auto [1] (Default) : Tray 1 [2] : Tray 2 [3] : Tray 3 [4] : Tray 4 [5] : Tray 5 [6] : Tray 6 (HCF B1)</p> <p>If printing from Tray 5, instruct printing and then operate the machine to start printing. To cancel the setting, change the setting for "Tray 5 Confirmation".</p> <p>Note</p> <ul style="list-style-type: none"> • When Trays 1 to 4 and 6 is selected, the paper size is determined by the size of paper loaded in the tray, and thus [Paper Size] cannot be set. • When [Auto] is selected and paper of the same size in the same orientation in multiple trays is loaded, paper will be fed in the order of Tray 1 → Tray 2 → Tray 3 → Tray 4 → Tray 6. If paper of the same size is loaded in multiple trays but in different orientations, feeding of the paper loaded in the landscape orientation is prioritized.
Document size	1	<p>Sets the client-created document size.</p> <p>[99] (Default) : Paper [100] : Continuous form paper (10 x 12) [101] : Continuous form paper (10 x 11) [102] : Continuous form paper (15 x 12) [103] : Continuous form paper (15 x 11) [3] : A3 [4] : A4 [5] : A5 [14] : B4 [15] : B5 [21] : 8.5 x 14 [22] : 8.5 x 13 [23] : 8.5 x 11 [24] : 11 x 17 [0] : Postcard</p> <p>The number of characters printed is: 80 characters/72 rows for continuous form paper (10 x 12), 80 characters/66 rows for continuous form paper (10 x 11), 136 characters/72 rows for continuous form paper (15 x 12), and 136 characters/66 rows for continuous form paper (15 x 11).</p> <p>Note</p> <ul style="list-style-type: none"> • When a continuous form paper is selected for [Original Size], [Paper Position] cannot be set. • When [Preset%] or [Fit to Cut Sheet] is selected for [Reduce/Enlarge], the machine automatically calculates the magnification based on a combination of [Original Size] and [Paper Size]. If the ratio, however, is outside the range of 45-210%, the document will not be reduced/enlarged, and will be printed at a scale of 100%. When [2 Up] is selected, the machine automatically calculates the magnification based on a combination of [Original Size] and 1/2 of [Paper Size]. • The orientation set here is that of the document. It is not affected by the orientation of paper loaded in the paper trays.
Orientation	19	<p>Sets the orientation of paper.</p> <p>[0] (Default) : Portrait [1] : Landscape</p>

Setting Item	Item Number	Value
Paper size	2	<p>Sets the size of paper to be printed. This setting can be made only when [Paper Tray] is set to [Auto] or [Tray 5]. This setting can be configured only for cut sheets.</p> <p>[3] : A3 [4] : A4 [5] : A5 [14] : B4 [15] : B5 [21] : 8.5 x 14 [22] : 8.5 x 13 [23] : 8.5 x 11 [24] : 11 x 17 [0] : Postcard</p> <p>Note</p> <ul style="list-style-type: none"> • If [Paper Tray] is set to Trays 1 to 4 or Tray 6, [Paper Size] cannot be set. • When [Preset%] or [Fit to Cut Sheet] is selected for [Reduce/Enlarge], the machine automatically calculates the magnification based on a combination of [Original Size] and [Paper Size]. If the magnification, however, is outside the range of 45-210%, the document will not be reduced/enlarged, and will be printed at a scale of 100%. When [2 Up] is selected, the machine automatically calculates the magnification based on a combination of [Original Size] and 1/2 of [Paper Size].

Extended Settings

Setting Item	Item Number	Value
Paper position	20	<p>Sets the paper position.</p> <p>[0] (Default) : Without cut sheet feeder (left) [1] : With cut sheet feeder (center)</p> <p>Note</p> <ul style="list-style-type: none"> • When [Without cut sheet feeder (left)] is specified and FF (line feed command) is received, the machine skips the number of lines specified in VFU. When [With cut sheet feeder (center)] is specified, the machine inserts a page break. • When a continuous form paper is selected for [Original Size], [Paper Position] cannot be set.
Output quantity	8	<p>Sets the number of copies to be printed.</p> <p>[1 to 250] (Default: 1): 1-250 copies</p> <p>Note</p> <ul style="list-style-type: none"> • When the output quantity is specified by a client, that number of copies is printed. After printing, the number set on the control panel is overwritten with the number newly specified. However, the number of copies specified from the NetWare or lpd port will not overwrite the number set on the control panel.

Setting Item	Item Number	Value
Reduce/Enlarge	54 (Reduce/ Enlarge mode)	<p>Sets the print magnification.</p> <p>[0] (Default) : Preset % [1] : Variable % [2] : Fit to Cut Sheet</p> <p>[Preset %] is a magnification automatically calculated based on [Original Size] and [Paper Size], and reduces/enlarges the printable area of the document to fit in the printable area of the output paper. Therefore, when the size of the document and the output paper are the same, the ratio will be 100%. Also, if [2 Up] is selected, the document will be reduced to the size at which two pages fit onto one sheet of paper.</p> <p>[Variable %] is a magnification set in [Variable %] under [Reduce/Enlarge]. A reference point for scaling (reducing/enlarging) is the upper left corner of the printable area. This reference point applies to all text, images, and graphics.</p> <p>[Fit to Cut Sheet] prints the entire cut sheet area onto the printable area of the output paper. It is a magnification automatically calculated based on [Original Size] and [Paper Size], and reduces/enlarges the entire document (including the area outside of the printable area) to fit onto the printable area of the output paper.</p>
	17 (Variable %/ vertical magnification)	<p>Sets the magnification for the vertical or horizontal direction.</p> <p>[45 to 210] (Default:100): 45-210%</p> <p>Note • When a continuous form paper is selected for [Original Size], print result is identical for [Preset %] and [Fit to Cut Sheet].</p>
	18 (Variable %/ horizontal magnification)	
2 Up mode	21	<p>Sets whether to print with the 2 Up or page by page. 2 Up is a feature that prints two pages onto one sheet of paper. Depending on the paper orientation, the two pages are printed side by side, or one above the other.</p> <p>[0] (Default) : Off [1] : Forward [2] : Reverse</p> <p>Note • When [Landscape] is selected for [Original Size], print result is identical for [Forward] and [Reverse].</p>
Output destination	9	<p>Sets the output tray for the printouts.</p> <p>[0] (Default) : Right Top Tray [1] : Left Top Tray [80] : Right Middle Tray or Center Tray</p>
Tray 5 confirmation	67	<p>Prints from Tray 5, after you instruct to print and then operate the machine to start printing.</p> <p>[0] (Default) : Off [1] : On</p>
Grid lines	22	<p>Sets the method for printing double-byte grid lines. The options are as follows.</p> <p>[0] (Default) : Image [1] : Font</p>
2 Sided printing	12	<p>Sets the 2 sided printing.</p> <p>[0] (Default) : Off [1] : Head to Head [2] : Head to Toe</p> <p>Note • When [Postcard] is selected for [Paper Size], [Head to Head] and [Head to Toe] cannot be selected.</p>

Setting Item	Item Number	Value
Font	14 (Alphanumeric fonts)	Sets the font for single-byte characters. [0] (Default) : Roman [1] : Sanserif Note <ul style="list-style-type: none"> • Since this feature selects the default value, its setting will not be affected when an extended command is received.
Print control	51 (Blank sheet output)	Sets whether to print blank pages if included in the document. [0] (Default) : Off [1] : On Note <ul style="list-style-type: none"> • Even when [Off] is selected, blank pages are printed if they are spaces created with user-defined characters or images in white color. • When [Off] is selected for this feature and 2 Up or 2 sided printing is specified, blank pages are not printed.
	52 (Character print area)	Extends the position of the right margin. [0] (Default) : Standard [1] : Extended Note <ul style="list-style-type: none"> • Changing the character print area from [Extended] to [Standard] restores the left and right margins to the default values. • When the position of the right margin is set here, that position becomes the right edge of the character print area.
	53 (Image enhancement)	Sets whether or not to enable the Image Enhancement feature. Image Enhancement smoothens the border between black and white, reducing rough edges, and thus seemingly increasing the resolution. [0] : Off [1] (Default) : On
ESCP switch	55 (Text quality)	Sets the Text Quality mode to high quality or draft. [0] (Default) : High Quality [1] : Draft Note <ul style="list-style-type: none"> • Since the default value is selected for the [Text Quality], [Reduced Characters], [Character Code Table], [Page Length], and [1-inch Perforation Skip] features, their settings will not be affected when an extended command is received. • Changing settings does not change actual printing quality. • This setting affect the Text Quality selection commands. For more information on the Text Quality selection commands, contact Customer Support at dell.com/contactdell.
	56 (Reduced characters)	Reduces the size of single-byte alphanumeric characters when printing. Sets whether to reduce their sizes or to print them at a scale of 100%. [0] (Default) : Off [1] : On
	58 (Page length)	Sets the length of a page (printable area) to 11 inches or 12 inches. [0] (Default) : 11 inches [1] : 12 inches
	59 (1-Inch perforation skip)	Sets whether or not to leave a 1-inch space between pages. [0] (Default) : Off [1] : On Note <ul style="list-style-type: none"> • This is effective only when CSF under [Paper Position] is set to [Off].
	60 (Paper feed position)	Sets the position to start printing at 8.5 mm or 22 mm below the top edge of paper. [0] (Default) : 8.5 mm [1] : 22 mm

Setting Item	Item Number	Value
ESCP switch	61 (CR feature)	Sets the action to be executed when a CR command is received. [0] (Default) : Carriage return [1] : Carriage return and linefeed
Position adjustment	15 (Vertical position adjustment)	Adjusts the printing position vertically or horizontally, and changes the positions of the margins. [0] (Default) : Off [1-500] : -250 to +250 mm
	16 (Horizontal position adjustment)	Note <ul style="list-style-type: none"> • Data outside the printable area is not printed regardless of the adjustment of the print position. In addition, data moved outside the printable area as a result of adjusting the print position is not printed.
Escape sequence	62 (Escape sequence)	A normal extended command is specified starting with hexadecimal 1BH ESC as the escape sequence identifying the command, followed by ; (3BH). When you cannot use a semicolon or ESC code with the host computer, you can use a special string instead as an escape sequence. This setting specifies whether or not to enable the escape sequence replacement feature. When enabling, specify the escape sequence with item 63. [0] (Default) : Disabled [1] : Enabled For more information on extended commands, contact Customer Support at dell.com/contactdell .
	63 (Escape sequence character)	To control an extended command with a text code, you must specify an escape sequence (the first two bytes) of the extended command. Enter two characters using the keyboard displayed on the screen. [&%] (Default) : 0x21 - 0x7e
Form overlay	64	Constantly performs Form Overlay by selecting a form name (No. 01-64) registered on the machine. [0] (Default) : Off [1-64] : No. 1 - No. 64 Note <ul style="list-style-type: none"> • Since the default value is selected for this feature, this setting is not affected when an extended command is received. • Once a form name is selected, it continues to be displayed even if the form is deleted. When a form name is selected using the up and down arrow keys, it is not displayed. In this case, the setting is set to "Off".
Stapling	66	Sets the stapling position. [0] (Default) : Off [1] : Top left [2] : Top Double [3] : Top Right [4] : Left Double [5] : Right Double [6] : Bottom Left [7] : Bottom Double [8] : Bottom Right
Bypass Tray - Wait User	67	Sets whether to suspend the print processing when feeding paper from the bypass tray. Processing is resumed by a user operation on the machine. [0] : Off [1] (Default) : On
Form Type	68	Sets the form type. [0] (Default) : ESC/P-K

Setting Item	Item Number	Value
Punching	69	Select the position for punching holes. [0] (Default) : Off [1] : Top [2] : Bottom [3] : Left [4] : Right
Number of holes	70	Select the number of punch holes. [0] (Default) : 2 holes [1] : 3 holes [2] : 4 holes
Binary character strings	72	Sets the character strings to be specified when entering commands in hexadecimal format. [0] (Default) : Off [1] : &\$\$%\$ [2] : \$?!#
0 Style	73	Sets the typeface for "0". [0] (Default) : 0 [1] : ∅
Number of sets	74	Sets the method of specifying the number of print sets. [0] : Protocol [1] : Panel [2] (Default) : Command

Magnification Table

Preset %

Document Size	Paper Size	A3	A4	A5	B4	B5	11 x 17"	8.5 x 14"	8.5 x 13"	8.5 x 11"	Postcard
A3	Long edge	100	70	49	86	60	103	84	78	66	100
	Short edge	100	70	48	86	60	94	72	72	72	100
A4	Long edge	143	100	70	123	86	147	120	112	94	48
	Short edge	143	100	69	123	86	135	103	103	103	45
A5	Long edge	204	143	100	177	123	210	172	160	135	69
	Short edge	207	145	100	178	124	195	149	149	149	65
B4	Long edge	116	81	57	100	70	119	98	90	76	100
	Short edge	116	81	56	100	70	109	83	83	83	100
B5	Long edge	164	116	81	143	100	171	140	130	109	56
	Short edge	164	116	81	143	100	156	120	120	120	53
11 x 17"	Long edge	97	68	48	84	59	100	82	76	64	100
	Short edge	106	74	51	92	64	100	77	77	77	100
8.5 x 14"	Long edge	119	83	58	102	72	122	100	93	78	100
	Short edge	139	97	67	120	84	131	100	100	100	100
8.5 x 13"	Long edge	128	90	63	111	77	132	108	100	84	100
	Short edge	139	97	67	120	84	131	100	100	100	100

8.5 x 11"	Long edge	152	106	74	131	92	156	128	119	100	100
	Short edge	139	97	67	120	84	131	100	100	100	100
Postcard	Long edge	100	100	145	100	178	100	100	100	100	100
	Short edge	100	100	153	100	190	100	100	100	100	100
15 x 11"	Long edge	119	83	58	103	72	122	100	93	78	100
	Short edge	103	72	50	89	62	97	74	74	74	100
15 x 12"	Long edge	119	83	58	103	72	122	100	93	78	100
	Short edge	95	66	46	81	57	89	68	68	68	100
10 x 11"	Long edge	147	103	72	127	89	151	124	115	97	50
	Short edge	142	99	68	122	85	133	102	102	102	45
10 x 12"	Long edge	135	95	66	117	81	139	114	105	89	46
	Short edge	142	99	68	122	85	133	102	102	102	45

Unit: %

Note

- If the magnification for either the long edge or short edge is outside the range of 45 - 210%, the magnifications for both the long edge and short edge becomes 100%.

Preset % (2-Up Printing)

Document Size	Paper Size	A3/2	A4/2	A5/2	B4/2	B5/2	11 x 17" /2	8.5 x 14" /2	8.5 x 13" /2	8.5 x 11" /2	Postcard /2
A3	Long edge	70	49	100	60	100	66	50	50	50	100
	Short edge	70	48	100	60	100	72	59	54	45	100
A4	Long edge	100	70	48	86	60	94	72	72	72	100
	Short edge	100	69	48	86	59	103	84	78	65	100
A5	Long edge	143	100	69	123	86	135	103	103	103	45
	Short edge	145	100	69	124	86	149	121	112	94	47
B4	Long edge	81	57	100	70	49	76	58	58	58	100
	Short edge	81	56	100	70	48	83	68	63	53	100
B5	Long edge	116	81	56	100	70	109	83	83	83	100
	Short edge	116	80	55	100	69	120	98	90	76	100
11 x 17"	Long edge	68	48	100	59	100	64	49	49	49	100
	Short edge	74	51	100	64	100	77	62	58	48	100
8.5 x 14"	Long edge	83	58	100	72	50	78	60	60	60	100
	Short edge	97	67	100	84	57	100	82	75	63	100
8.5 x 13"	Long edge	90	63	100	77	54	84	64	64	64	100
	Short edge	97	67	100	84	57	100	82	75	63	100
8.5 x 11"	Long edge	106	74	51	92	64	100	77	77	77	100
	Short edge	97	67	46	84	57	100	82	75	63	100
Postcard	Long edge	100	145	100	178	124	100	149	149	149	65
	Short edge	100	153	105	190	131	100	185	172	144	71
15 x 11"	Long edge	83	58	100	72	100	78	60	60	60	100
	Short edge	72	50	100	62	100	74	60	56	47	100
15 x 12"	Long edge	83	58	100	72	100	78	60	60	100	100
	Short edge	66	46	100	57	100	68	55	51	100	100
10 x 11"	Long edge	103	72	50	89	62	97	74	74	74	100
	Short edge	99	68	47	85	59	102	83	77	64	100
10 x 12"	Long edge	95	66	46	81	57	89	68	68	68	100
	Short edge	99	68	47	85	59	102	83	77	64	100

Unit: %

- Note** • If the magnification for either the long edge or short edge is outside the range of 45 - 210%, the magnifications for both the long edge and short edge becomes 100%.

Fit to Cut Sheet

Document Size	Paper Size	A3	A4	A5	B4	B5	11 x 17"	8.5 x 14"	8.5 x 13"	8.5 x 11"	Postcard
A3	Long edge	98	69	48	85	59	101	83	77	64	100
	Short edge	97	68	47	84	58	91	70	70	70	100
A4	Long edge	138	97	68	120	84	142	117	108	91	100
	Short edge	137	96	66	118	82	129	99	99	99	100
A5	Long edge	196	137	96	169	118	201	165	153	129	66
	Short edge	195	136	94	168	117	183	140	140	140	62
B4	Long edge	113	79	55	98	68	116	95	88	74	100
	Short edge	112	78	54	97	67	105	81	81	81	100
B5	Long edge	160	112	78	138	97	165	135	125	105	54
	Short edge	158	110	76	136	95	149	114	114	114	50
11 x 17"	Long edge	95	67	47	82	57	98	80	74	63	100
	Short edge	103	72	50	89	62	97	74	74	74	100
8.5 x 14"	Long edge	116	81	57	100	70	119	98	90	76	100
	Short edge	133	93	64	115	80	125	96	96	96	100
8.5 x 13"	Long edge	125	87	61	108	75	128	105	97	82	100
	Short edge	133	93	64	115	80	125	96	96	96	100
8.5 x 11"	Long edge	147	103	72	127	89	151	124	115	97	100
	Short edge	133	93	64	115	80	125	96	96	96	100
Postcard	Long edge	100	195	136	100	168	100	100	100	183	94
	Short edge	100	201	139	100	173	100	100	100	207	91
15 x 11"	Long edge	135	95	66	117	81	139	105	114	89	46
	Short edge	142	99	68	122	85	133	102	102	102	45
15 x 12"	Long edge	135	95	66	117	81	139	105	114	89	46
	Short edge	142	99	68	122	85	133	102	102	102	45
10 x 11"	Long edge	147	103	72	127	89	151	115	124	97	50
	Short edge	142	99	68	122	85	133	102	102	102	45
10 x 12"	Long edge	147	103	72	127	89	151	124	115	97	50
	Short edge	142	99	68	122	85	133	102	102	102	45

Unit: %

- Note**
- If the magnification for either the long edge or short edge is outside the range of 45 - 210%, the magnifications for both the long edge and short edge becomes 100%.

Fit to Cut Sheet (When 2 Up is specified)

Document Size	Paper Size	A3/2	A4/2	A5/2	B4/2	B5/2	11 x 17" /2	8.5 x 14" /2	8.5 x 13" /2	8.5 x 11" /2	Postcard/ 2
A3	Long edge	69	48	100	59	100	64	49	49	100	100
	Short edge	68	47	100	58	100	70	57	53	100	100
A4	Long edge	97	68	47	84	58	91	70	70	70	100
	Short edge	96	66	46	82	57	99	80	74	62	100
A5	Long edge	137	96	66	118	82	129	99	99	99	100
	Short edge	136	84	65	117	80	140	114	106	88	100
B4	Long edge	79	55	100	68	48	74	57	57	57	100
	Short edge	78	54	100	67	46	81	66	61	51	100
B5	Long edge	112	78	54	97	67	105	81	81	81	100
	Short edge	110	76	53	95	65	114	93	86	72	100
11 x 17"	Long edge	67	47	100	57	100	63	48	48	48	100
	Short edge	72	50	100	62	100	74	60	56	47	100
8.5 x 14"	Long edge	81	47	100	70	49	76	58	58	58	100
	Short edge	93	50	100	80	55	96	78	72	61	100
8.5 x 13"	Long edge	87	61	100	75	52	82	63	63	63	100
	Short edge	93	64	100	80	55	96	78	72	61	100
8.5 x 11"	Long edge	103	89	100	89	72	97	74	74	74	100
	Short edge	93	80	100	80	55	96	78	72	61	100
Postcard	Long edge	195	136	94	168	117	183	140	140	140	62
	Short edge	201	139	96	173	119	207	169	156	131	65
15 x 11"	Long edge	95	66	46	81	57	89	68	68	68	100
	Short edge	99	68	47	85	59	102	83	77	64	100
15 x 12"	Long edge	95	66	46	81	57	89	68	68	68	100
	Short edge	99	68	47	85	59	102	83	77	64	100
10 x 11"	Long edge	103	72	50	89	62	97	74	74	74	100
	Short edge	99	68	47	85	59	102	83	77	64	100
10 x 12"	Long edge	103	72	50	89	62	97	74	74	74	100
	Short edge	99	68	47	85	59	102	83	77	64	100

Unit: %

- Note**
- If the magnification for either the long edge or short edge is outside the range of 45 - 210%, the magnifications for both the long edge and short edge becomes 100%.

Paper Size and Number of Printable Characters

When the paper feed position is 22 mm

Paper Size	Portrait		Landscape	
	Characters	Lines	Characters	Lines
A3	113	92	161	63
B4	97	78	139	53
A4	79	63	113	42
B5	68	53	97	35
A5	54	42	79	27
Postcard	35	30	54	19
11 x 17"	106	94	166	58
8.5 x 14"	81	76	136	43
8.5 x 13"	81	70	126	43
8.5 x 11"	81	58	106	43

When the paper feed position is 8.5 mm

Paper Size	Portrait		Landscape	
	Characters	Lines	Characters	Lines
A3	113	95	161	66
B4	97	82	139	56
A4	79	66	113	45
B5	68	56	97	39
A5	54	45	79	31
Postcard	35	30	54	19
11 x 17"	106	98	166	62
8.5 x 14"	81	80	136	47
8.5 x 13"	81	74	126	47
8.5 x 11"	81	62	106	47

- Note**
- The values are based on 10-cpi character pitch and 6-lpi line pitch.
 - The magnification for both the long edge and short edge is 100%.
 - Some paper sizes may not be available depending on your hardware configuration.

Fit to Cut Sheet

Paper Size	Portrait		Landscape	
	Characters	Lines	Characters	Lines
A3	116	99	165	70
B4	101	85	143	60
A4	82	70	116	49
B5	71	60	101	42
A5	58	49	82	34
Postcard	39	34	58	23
11 x 17"	110	102	170	66
8.5 x 14"	85	84	140	51
8.5 x 13"	85	78	130	51
8.5 x 11"	85	66	110	51

- Note**
- The values are based on 10-cpi character pitch and 6-lpi line pitch.
 - Some paper sizes may not be available depending on your hardware configuration.

15-inch Continuous Form Mode (When Aligned at Left in Landscape Orientation)

Paper Size	Portrait		Landscape	
	Characters	Lines	Characters	Lines
All supported paper sizes	136	66	136	72

- Note**
- The values are based on 10-cpi character pitch and 6-lpi line pitch.

10-inch Continuous Form Mode

Paper Size	Portrait		Landscape	
	Characters	Lines	Characters	Lines
All supported paper sizes	80	66	80	72

PDF Direct Print

PDF Direct Print is a feature that prints PDF files by directly using the lpr command instead of a print driver. When this feature is used, the following items will be printed based on the settings of [PDF] under [Print Mode].

- Output Quantity
- 2 Sided Printing
- Print Mode
- Collate
- Layout
- Paper Size
- Output Color
- Print Processing Mode

Note • Before you print PDF file using the lpr command, the LPD protocol of the machine must be started with the control panel or Dell Printer Configuration Web Tool.

PDF Direct Print Settings

This section describes the available settings with the PDF Direct Print feature.

Setting Item	Item Number	Value
Output quantity	401	Sets the number of copies to be printed. [1-999] (Default: 1): 1-999 sheets
2 sided printing	402	Sets the 2 sided printing option. [0] (Default) : 1 Sided [1] : 2 Sided, Flip on Long Edge [2] : 2 Sided, Flip on Short Edge [2 Sided Print, Flip on Long Edge] prints 2 sided in the orientation so that pages can be bound along the long edge. [2 Sided Print, Flip on Short Edge] prints 2 sided in the orientation so that pages can be bound along the short edge.
Print mode	403	Selects which you prioritize: image quality or print speed. [0] (Default) : Standard [1] : High Speed [2] : Fine The [Standard] setting prints in a standard speed and quality. The [High Speed] setting prioritize the print speed. The [Fine] quality setting prints in high quality but in a slower speed.
Collate	404	Selects whether to print multiple-sheet documents as collated sets (1, 2, 3...1, 2, 3...). [0] (Default) : Off [1] : On

Setting Item	Item Number	Value
Layout	405	<p>Sets the layout for printing. [0] (Default) : Auto % [1] : Booklet [2] : 2-up [3] : 4-up [4] : 100% (size-by-size)</p> <p>The [Auto %] setting automatically calculates the largest magnification possible to fit to the output paper size. The [Booklet] setting prints the images side by side, on both sides of each page, in the correct order to make a booklet based on the layout of the original PDF file. Some documents may not be printed in a booklet fashion depending on the structure of their pages. In this case, they will be printed with the [Auto %] setting.</p> <p>Note</p> <ul style="list-style-type: none"> • When [A4] is selected for [Paper Size], documents will be printed on A4 size paper. • When [Paper Size] is set to [Auto], documents will be printed on A3 or A4 size paper. <p>The [2-up] setting prints two pages onto one sheet of paper. When [2-Up] is selected, the paper size is fixed at A4. The [4-up] setting prints four pages on each sheet of paper. When [4-Up] is selected, the paper size is fixed at A4.</p>
Paper size	406	<p>Sets the size of the paper to be printed. [0] (Default) : Auto [1] : A4</p> <p>The [Auto] setting automatically determines the paper size, based on the size and settings of a PDF file to be printed.</p>
Output color	407	<p>Sets whether to print in color or monochrome. [0] (Default) : Auto [1] : Black</p> <p>The [Auto] setting automatically determines the output color: color or monochrome for each page. If colors other than black and white are used on the original, the machine prints the document in color, and if only black and white are used on the original, the machine prints in monochrome.</p>
Print processing mode	408	<p>Sets the print processing mode when you use the PDF Direct Print feature. [0] (Default) : PDF Bridge [1] : PS</p> <p>[PDF Bridge] processes PDF files using the PDF Direct Print feature. [PS] processes PDF files using the PostScript feature provided by Adobe.</p> <p>Note</p> <ul style="list-style-type: none"> • The print results may differ between the [PDF Bridge] and [PS] selections. • When [PS] is selected, the [Layout] setting becomes invalid.

PCL Emulation

Emulation

This section describes the printer language emulations available on the machine.

Print data conforms to certain rules (grammars). These rules (grammars) are called printer languages.

The machine supports two types of printer languages: a page description language, which is used to create images on a page-by-page basis, and an emulation, which is used to achieve the print results similar to those of other printers. To "emulate" means to imitate the print results of other printers.

Emulation Mode

When printing data written in a language other than a page description language supported by the machine, switch the machine to the emulation mode. The relationships between the emulation mode and the printer to be emulated are as follows:

Emulation Mode	Printer to be Emulated
PCL emulation mode (PCL mode)	CJL5500

Switching between Printer Languages

The machine provides the Multi-emulation feature that allows switching between different printer languages.

The methods of switching between printer languages are as follows:

Switching by Commands

Commands for switching between printer languages are provided. Upon receipt of a command, the machine switches to the relevant printer language.

Automatic Switching

The machine analyzes the data received by a host interface, and automatically identifies the printer language to be used. It then switches to the identified printer language.

Interface-dependent

You can set a printer language for each host interface by using Dell Printer Configuration Web Tool. The machine switches to a printer language corresponding to the host interface that received data.

Fonts

Available fonts

The following fonts can be used for PCL emulation:

Alphanumeric fonts

- CG Times
- CG Times Italic
- CG Times Bold
- CG Times Italic Bold
- Univers Medium
- Univers Medium Italic
- Univers Bold
- Univers Italic Bold
- Univers Medium Condensed
- Univers Medium Condensed Italic
- Garamond Kursiv
- Garamond Halbfett
- Garamond Kursiv Halbfett
- Courier
- Courier Italic
- Courier Bold
- Courier Bold Italic
- Letter Gothic
- Letter Gothic Italic
- Letter Gothic Bold
- Albertus Medium
- Albertus Extra Bold
- Clarendon Condensed
- Coronet
- Marigold
- Arial
- Arial Italic
- Arial Bold
- Arial Bold Italic
- Times New
- Times New Italic
- Times New Bold
- Times New Bold Italic
- Symbol
- Wingdings
- Univers Bold Condensed
- Univers Bold Condensed Italic
- Antique Olive
- Antique Olive Italic
- Antique Olive Bold
- CG Omega
- CG Omega Italic
- CG Omega Bold
- CG Omega Bold Italic
- Garamond Antiqua
- Helvetica Oblique
- Helvetica Bold
- Helvetica Bold Oblique
- CourierPS
- CourierPS Oblique
- CourierPS Bold
- CourierPS Bold Oblique
- SymbolPS
- Palatino Roman
- Palatino Italic
- Palatino Bold
- Palatino Bold Italic
- ITC Bookman Light
- ITC Bookman Light Italic
- ITC Bookman Demi
- ITC Bookman Demi Italic
- Helvetica Narrow
- Helvetica Narrow Oblique
- Helvetica Narrow Bold
- Helvetica Narrow Bold Oblique
- New Century Schoolbook Roman
- New Century Schoolbook Italic
- New Century Schoolbook Bold
- New Century Schoolbook Bold Italic
- ITC Avant Garde Book

- Line Printer
- Times Roman
- Times Italic
- Times Bold
- Times Bold Italic
- Helvetica
- ITC Avant Garde Book Oblique
- ITC Avant Garde Demi
- ITC Avant Garde Demi Oblique
- ITC Zapf Chancery Medium Italic
- ITC Zapf Dingbats
- OCR-B

Font Caching

To ensure hi-speed printing, outline fonts of up to a certain size are cached. Outline fonts are converted into bitmap data temporarily and then printed. To minimize this processing time, the processed bitmap data is saved in the memory. This process is called font caching.

The saved bitmap data is deleted when you turn the machine off or reset it. For the PCL emulation mode, data other than that being processed is not saved.

Output Feature

This section describes the machine's output features. The following two output features are available:

- Outputting a Pending Print Job
- Forcible Output in Emulation Mode

Outputting a Pending Print Job

The printing of jobs already received by the machine can be prioritized over other jobs.

For information on prioritizing the printing of jobs already received by the machine, refer to "11 Job Status" > "Printing Pending Jobs" in the User Guide.

Forcible Output in Emulation Mode

In emulation mode, data is not output until one complete page of data is prepared or the page break command is received. For a USB interface, if printing ends in the middle of a page, the next data set waits until the time set with [Auto Eject Time] elapses.

In this case, the Forcible Printing feature does not wait for the auto eject time; however, forcibly prints the data within the machine.

For more information on forcible printing, refer to "11 Job Status" in the User Guide.

For more information on the auto eject time, refer to "Auto Eject Time" (P.169).

PCL Emulation Settings

The following table shows the emulation parameters and their values for PCL emulation.

PCL Settings List

The following table describes the parameters that can be set with the mode menu.

Parameter	Item No.	Value
Paper tray	201	<p>Sets the paper tray to be used for printing.</p> <p>[0] (Default) : Auto [1] : Tray 1 [2] : Tray 2 [3] : Tray 3 [4] : Tray 4 [5] : Tray 5 [6] : Tray 6 (HCF B1)</p> <p>Note</p> <ul style="list-style-type: none"> • When Trays 1 to 4, Tray 6 is selected, the paper size is determined by the size of paper loaded in the tray, and thus [Paper Size] cannot be set. • When [Auto] is selected and paper of the same size in the same orientation in multiple trays is loaded, paper will be fed in the order of Tray 1 → Tray 2 → Tray 3 → Tray 4 → Tray 6. If paper of the same size is loaded in multiple trays but in different orientations, feeding of the paper loaded in the landscape orientation is prioritized.
Auto size	202	<p>Sets the default paper size. Only available when [Paper Tray] is set to [Auto]. Only cut sheet can be set.</p> <p>[3] : A3 [4] (Default) : A4 [5] : A5 [14] : B4 [15] : B5 [21] : 8.5 × 14" [22] : 8.5 × 13" [23] (Default) : 8.5 × 11" [24] : 11 × 17" [25] : Custom Size [30] : 8K</p> <p>Note</p> <ul style="list-style-type: none"> • When Trays 1 to 4, Tray 6 is selected, [Paper Size] cannot be set. The paper size loaded in the specified tray is displayed. • When Trays 1 to 4, Tray 6 is selected, the paper size is determined by the size of paper loaded in the tray, and thus [Paper Size] cannot be set. • Depending on the combination of [Original Size] and [Paper Size], [?] may be displayed for the magnification. In this case, the document is printed at a scale of 100%.
Bypass size	203	<p>Sets the default paper size. Only available when [Paper Tray] is set to [Auto]. Only cut sheet can be set.</p> <p>[3] : A3 [4] (Default) : A4 [5] : A5 [14] : B4 [15] : B5 [21] : 8.5 × 14" [22] : 8.5 × 13" [23] (Default) : 8.5 × 11" [24] : 11 × 17" [25] : Custom Size</p>
Output destination	204	<p>Sets the output tray for the printouts.</p> <p>[0] (Default) : Right Top Tray [1] : Left Top Tray [80] : Right Middle Tray or Center Tray</p>
Orientation	205	<p>Set the orientation of paper.</p> <p>[0] (Default) : Portrait [1] : Landscape</p>

Parameter	Item No.	Value
2 Sided printing	206	Sets the 2 sided printing. [0] (Default) : Off [1] : On

Parameter	Item No.	Value
Default font	207	[0] : CG Times [43] : Symbol
		[1] : CG Times Italic [44] : Wingdings
		[2] : CG Times Bold [45] : Line Printer
		[3] : CG Times Bold [46] : Times Roman
		[3] : CG Times Bold [46] : Times Roman
		[3] : CG Times Bold Italic [47] : Times Italic
		[4] : Univers Medium [48] : Times Bold
		[5] : Univers Medium [49] : Times Bold Italic
		[5] : Univers Medium Italic [50] : Helvetica
		[6] : Univers Bold [51] : Helvetica Oblique
		[7] : Univers Bold Italic [52] : Helvetica Bold
		[8] : Univers Medium [53] : Helvetica Bold
		[8] : Univers Medium Condensed [53] : Helvetica Bold Oblique
		[9] : Univers Medium [54] : CourierPS
		[9] : Univers Medium Condensed Italic [55] : CourierPS Oblique
		[10] : Univers Bold [56] : CourierPS Bold
		[10] : Univers Bold Condensed [57] : CourierPS Bold
		[11] : Univers Bold [57] : CourierPS Bold
		[11] : Univers Bold Condensed Italic [58] : CourierPS Bold Oblique
		[12] : Antique Olive [59] : SymbolPS
		[13] : Antique Olive Italic [60] : Palatino Roman
		[14] : Antique Olive Bold [61] : Palatino Italic
		[15] : CG Omega [62] : Palatino Bold
		[16] : CG Omega Italic [63] : Palatino Bold Italic
		[17] : CG Omega Bold [64] : ITC Bookman
		[18] : CG Omega Bold [64] : ITC Bookman
		[18] : CG Omega Bold Italic [64] : ITC Bookman Light
		[19] : Garamond Antiqua [65] : ITC Bookman Light Italic
		[20] : Garamond Kursiv [65] : ITC Bookman Demi
		[21] : Garamond Halbfett [66] : ITC Bookman Demi Italic
		[22] : Garamond Kursiv Halbfett [67] : Helvetica Narrow
		[23] (Default) : Courier [68] : Helvetica Narrow
		[24] : Courier Italic [68] : Helvetica Narrow Oblique
		[25] : Courier Bold [69] : Helvetica Narrow Bold
		[26] : Courier Bold Italic [69] : Helvetica Narrow Bold
		[27] : Letter Gothic [70] : Helvetica Narrow Bold Oblique
		[28] : Letter Gothic Italic [70] : Helvetica Narrow Bold Oblique
		[29] : Letter Gothic Bold [71] : New Century
		[30] : Albertus Medium [71] : New Century Schoolbook Roman
		[31] : Albertus Extra Bold [72] : New Century Schoolbook Italic
		[32] : Clarendon [72] : New Century Schoolbook Italic
		[32] : Clarendon Condensed [73] : New Century Schoolbook Bold
		[33] : Coronet [73] : New Century Schoolbook Bold
		[34] : Marigold [74] : New Century Schoolbook Bold
		[35] : Arial [74] : New Century Schoolbook Bold
		[36] : Arial Italic [75] : ITC Avant Garde
		[37] : Arial Bold [75] : ITC Avant Garde Book
		[38] : Arial Bold Italic [75] : ITC Avant Garde Book
		[39] : Times New [76] : ITC Avant Garde Book Oblique
		[40] : Times New Italic [76] : ITC Avant Garde Book Oblique
		[41] : Times New Bold [77] : ITC Avant Garde Demi
		[42] : Times New Bold [77] : ITC Avant Garde Demi
		[42] : Times New Bold Italic [78] : ITC Avant Garde Demi Oblique
		[79] : ITC Zapf Chancery Medium Italic
		[80] : ITC Zapf Dingbats

Parameter	Item No.	Value
Binding	217	Sets binding when printing 2 sided. You can select [LEF] or [SEF] for 2 sided printing. Select according to the edge to be bound. Unifies the leading direction of the image on the front and rear sides of the paper at the long edge of the paper for LEF and at the short edge of the paper for SEF. [0] (Default) : LEF [1] : SEF
Line termination	218	Sets line termination processing. [0] (Default) : Off [1] : Add-LF (Appends an LF to CR) [2] : Add-CR (Appends a CR to LF and FF) [3] : CR-XX (Appends a CR to LF and FF, and LF to CR)
Default custom paper size	219 (Short edge)	Specifies the default custom paper size. [2100] (Default short-edge value) : 210.0 mm [2970] (Default long-edge value) : 297.0 mm [0] - [9999] : 0 to 999.9 mm
	220 (Long edge)	
Print Quantity Setup	221	Sets the method for specifying the number of copies to print. [0] : Protocol [1] : Panel [2] (Default) : Command

HP-GL/2 Emulation

Emulation

This section describes the printer language emulations available on the machine.

Print data conforms to certain rules (grammars). These rules (grammars) are called printer languages.

The machine supports two types of printer languages: a page description language, which is used to create images on a page-by-page basis, and an emulation, which is used to achieve the print results similar to those of other printers. To "emulate" means to imitate the print results of other printers.

Emulation Mode

When printing data written in a language other than a page description language supported by the machine, switch the machine to the emulation mode. The relationships between the emulation mode and the printer to be emulated are as follows:

Emulation Mode	Printer to be Emulated
HP-GL/2 emulation mode (HP-GL/2 mode)	DJ750C Plus

Switching between Printer Languages

The machine provides the Multi-emulation feature that allows switching between different printer languages.

The methods of switching between printer languages are as follows:

Switching by Commands

Commands for switching between printer languages are provided. Upon receipt of a command, the machine switches to the relevant printer language.

Automatic Switching

The machine analyzes the data received by a host interface, and automatically identifies the printer language to be used. It then switches to the identified printer language.

Interface-dependent

You can set a printer language for each host interface by using Dell Printer Configuration Web Tool. The machine switches to a printer language corresponding to the host interface that received data.

Fonts

Available fonts

The following fonts can be used for HP-GL/2 emulation:

Alphanumeric fonts

Roman

Sans serif

Font Caching

To ensure hi-speed printing, outline fonts of up to a certain size are cached. Outline fonts are converted into bitmap data temporarily and then printed. To minimize this processing time, the processed bitmap data is saved in the memory. This process is called font caching.

The saved bitmap data is deleted when you turn the machine off or reset it. For the PCL emulation mode, data other than that being processed is not saved.

Output Feature

This section describes the machine's output feature. The following two output features are available:

- Outputting a Pending Print Job
- Forcible Output in Emulation Mode

Outputting a Pending Print Job

The printing of jobs already received by the machine can be prioritized over other jobs.

For information on prioritizing the printing of jobs already received by the machine, refer to "11 Job Status" > "Printing Pending Jobs" in the User Guide.

Forcible Output in Emulation Mode

In emulation mode, data is not output until one complete page of data is prepared or the page break command is received. For a USB interface, if printing ends in the middle of a page, the next data set waits until the time set with [Auto Eject Time] elapses.

In this case, the Forcible Printing feature does not wait for the auto eject time; however, forcibly prints the data within the machine.

For more information on forcible printing, refer to "11 Job Status" in the User Guide.

For more information on the auto eject time, refer to "Auto Eject Time" (P.169).

Factory Default Settings

In HP-GL or HP-GL/2 emulation mode factory default setting, the document is reduced or enlarged to print according to the paper size (Auto Layout).

Document: Auto, Coordinate Origin: 0 degrees, Scaling Mode: Paper Size, Scaling: On

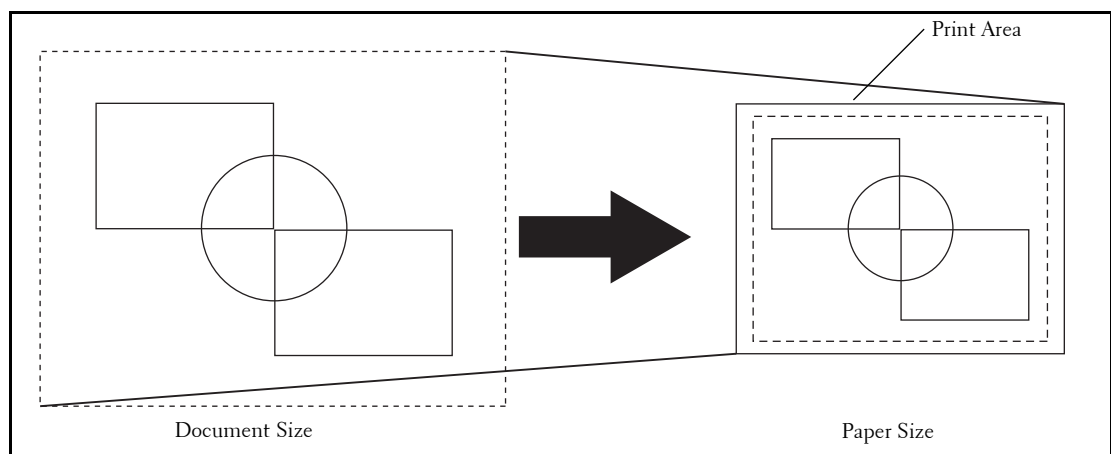

Note • Change the factory default setting if required. For more information on changing procedures, refer to "HP-GL/2 Emulation" (P.551).

Paper Margin

[Paper size] is set to [A Size] by factory default. If the print data is larger than the active coordinates area, the machine prints the data on the next larger A series paper (for example, the next larger size of A4 is A3).

When you set the paper margins, however, the active coordinates area is determined by subtracting the area set in paper margins from the active coordinates area obtained in the area determination mode. Therefore, set the paper margins if the data is printed on larger paper than specified. Set the range from 0 to 99 mm. The default value is 0 mm.

HP-GL/2 Emulation Settings

The following table shows the emulation parameters and their values for HP-GL/2 emulation.

HP-GL Settings List

Items that can be set using the HP-GL mode menu are explained in two groups: basic settings and extended settings.

Basic Settings

Parameter	Item No.	Value
Document size	101	<p>Sets the document size created by a computer.</p> <p>[0] : A0 [1] : A1 [2] : A2 [3] : A3 [4] : A4 [5] : A5 [10] : B0 [11] : B1 [12] : B2 [13] : B3 [14] : B4 [15] : B5 [99] (Default) : Auto [100] : Paper</p> <p>When [Auto] is selected, the settings of the Scaling mode, the Area Determination mode, and the Paper Margin settings of Print Control become enabled.</p> <p>Note</p> <ul style="list-style-type: none"> • If the document size other than [Auto] is selected, the settings under [Auto layout] become [ON]. • Depending on the combination of [Document size] and [Paper size], the document is printed at a scale of 100%.

Parameter	Item No.	Value
Paper size	102	<p>Sets the default paper size. Only available when [Paper tray] is set to [Auto] or [Tray 5]. Only cut sheet can be set.</p> <p>[3] : A3 [4] (Default) : A4 [5] : A5 [14] : B4 [15] : B5 [99] : Auto [101] (Default) : A Size</p> <p>Note</p> <ul style="list-style-type: none"> • When Trays 1 to 4, Tray 6 is selected, [Paper size] cannot be set. The paper size loaded in the specified tray is displayed. • If [A Size] or [Auto] is selected, the settings become as follows: <ul style="list-style-type: none"> - When [Document size] is set to other than [Auto], [Paper size] is set to [A3]. - When Trays 1 to 4, Tray 6 is selected, the paper size is determined by the size of paper loaded in the tray, and thus [Paper size] cannot be set. - Depending on the combination of [Document size] and [Paper size], [?] may be displayed for the magnification. In this case, the document is printed at a scale of 100%.
Paper tray	103	<p>Sets the paper tray to be used for printing.</p> <p>[0] (Default) : Auto [1] : Tray 1 [2] : Tray 2 [3] : Tray 3 [4] : Tray 4 [5] : Tray 5 [6] : Tray 6 (HCF B1)</p> <p>Note</p> <ul style="list-style-type: none"> • When Trays 1 to 4, Tray 6 is selected, the paper size is determined by the size of paper loaded in the tray, and thus [Paper size] cannot be set. • When [Auto] is selected and paper of the same size in the same orientation in multiple trays is loaded, paper will be fed in the order of Tray 1 → Tray 2 → Tray 3 → Tray 4 → Tray 6. If paper of the same size is loaded in multiple trays but in different orientations, feeding of the paper loaded in the landscape orientation is prioritized.
Coordinate rotation	104	<p>Sets the paper orientation for printing.</p> <p>[0] (Default) : 0 degree [1] : 90 degree</p>
Color mode	105	<p>Sets the color mode.</p> <p>[0] (Default) : Color [1] : Grayscale [2] : Black pen</p>



Extended Settings





Parameter	Item No.	Value
Auto layout	106	<p>Selects whether to perform auto layout of the document or not.</p> <p>[0] (Default) : ON [1] : OFF</p>
Active palette	107	<p>Selects whether to use a pen specified by command or set on the panel.</p> <p>[0] (Default) : Command [1] : Panel</p>
No. of prints	108	<p>Sets the number of copy to be printed.</p> <p>[1] - [250] (Default: 1) : 1 - 250</p>

Parameter	Item No.	Value
Output destination	109	Sets the output tray for the printouts. [0] (Default) : Right Top Tray [1] : Left Top Tray [80] : Right Middle Tray or Center Tray
2 sided printing	110	Sets 2 sided printing. [0] (Default) : None [1] : Head to head [2] : Head to toe
Alphanumeric fonts	112	Sets the font for single-byte characters. For more information on fonts, refer to "Internal Fonts" (P.520). [0] (Default) : Stroke [1] : Roman [2] : Sans serif
Position adjustment	113 (Vertical position adjustment)	Adjusts the hard clip area vertically or horizontally. You can set from -250 mm to +250 mm in 1 mm increments. [0] (Default) : Does not move the hard clip area. [1] - [250] : -250 to -1 mm [251] - [500] : +1 to +250 mm Note • Data outside the printable area is not printed regardless of the adjustment of the print position. In addition, data moved outside the printable area as a result of adjusting the print position is not printed.
	114 (Horizontal position adjustment)	
Number of sets	115	Sets the method for specifying the print sets. [0] (Default) : Protocol [1] : Panel [2] : Command

Parameter	Item No.	Value
Print control	150 (HP-GL mode)	Selects a graphics language. This setting affects to IW, OW, and UC of HP-GL/2 commands. [0] (Default) : HP-GL [1] : HP-GL/2 Note • To print HP-GL/2 command that does not include BP command, select [HP-GL/2].
	151 (Hard clip)	Sets the size of hard clip area. In HP-GL mode, the plottable area is determined in line with the paper size, apart from the printable area. This area is called the "hard clip area", and determines the maximum range of pen movement. Accordingly, images cannot be drawn outside the boundary of the hard clip area. [0] : Standard [2] (Default) : Paper For more information on hard clip area, refer to "Hard Clip Area" (P.559).
	152 (Eject command SP)	Sets the command that indicates the end of plotting. When the command specified here is received, plotting is terminated and the paper is output. [0] (Default) : OFF [1] : ON The default value is [ON] for SPO, and [OFF] for the others. Note • If multiple commands are specified, when one of the commands is received, plotting is terminated and the paper is output.
	153 (Eject command SPO)	
	154 (Eject command NR)	
	155 (Eject command FR)	
	156 (Eject command PG)	
	157 (Eject command AF)	
158 (Eject command AH)		

Parameter	Item No.	Value
Print control	159 (Scaling)	Sets whether the original size is enlarged or reduced so that the document size fits the paper size. [0] : OFF [1] (Default) : ON
	160 (Scaling mode)	Selects the document size for auto scaling: A series paper (A0, A1, A2, A3, A4, and A6) or the active coordinate area which is determined accordance with the setting selected in [Area Determination Mode]. [0] (Default) : Paper Size [1] : Active Coordinate Area Note <ul style="list-style-type: none"> • [Active Coordinate Area] can be selected only when [Auto layout] is set to [ON]. When [OFF] is selected, [Scaling mode] becomes [Paper Size]. • The setting of the scaling mode is valid when [Document size] is set to [Auto].
	161 (Active area determination command)	Sets the method to obtain the active coordinate area when auto scaling is being used. [0] (Default) : Auto [1] : PS [2] : IW [3] : IP [4] : Adapted Note <ul style="list-style-type: none"> • The setting of the active area determination command is valid when [Document size] is set to [Auto].
	162 (Paper margin)	Sets the paper margin when auto scaling is being used. [0] - [99] (Default: 0) : 0 to 99 mm Note <ul style="list-style-type: none"> • The setting of the paper margin is valid when [Document size] is set to [Auto].
	163 (Image enhancement)	Sets whether to perform image enhancement, which artificially increases the resolution of an image and smooth its edges. [0] : OFF [1] (Default) : ON
Stapling	164	Sets the stapling position. [0] (Default) : None [1] : Top Left [2] : Top Double [3] : Top Right [4] : Left Double [5] : Right Double [6] : Bottom Left [7] : Bottom Double [8] : Bottom Right [9] : Center
Manual feed tray check indicator	165	[0] : None [1] (Default) : Yes
Punching	166	Select the position for punching holes. [0] (Default) : None [1] : Top [2] : Bottom [3] : Left [4] : Right
Number of holes	167	Select the number of punch holes. [0] (Default) : 2 holes [1] : 3 holes [2] : 4 holes

Parameter	Item No.	Value
180 degree rotation	168	Specify whether or not to rotate landscape documents in 180 degrees. [0] (Default) : Off [3] : On
Pen attributes	800-815 (Pen width) (No. 0-No.15)	Set the width (thickness of the line) of the 16 pens (No. 00 to 15). You can set the width from 0.0 to 25.5 mm in 0.1 mm increments. No. 00 denotes Item No. 800. [0] - [255] (Default: 3) : 0 to 25.5 mm Note <ul style="list-style-type: none"> • If the image is reduced by concern with the relationship between [Document size] and [Paper size] settings, the pen width is reduced accordingly to 0.1 mm at the smallest. • The width of the line gets thick symmetrically with respect to the center of the line. • If the width is set to 0.0 mm, nothing is plotted.
	850-865 (Line end shape)(No. 0-No.15)	Set the line end shape of the 16 pens (No. 00 to 15). No. 00 denotes Item No. 850. [0] (Default) : Cut [1] : Round [2] : Rectangular [Cut]  • : specified coordinate [Round]  • : specified coordinate [Rectangular]  • : specified coordinate

Parameter	Item No.	Value														
Pen attributes	900-915 (Pen intersects) (No. 0-No.15)	<p>Set the process for when pens' lines intersect for 16 pens (No. 00 to 15). No. 00 denotes Item No. 900.</p> <p>[0] (Default) : None [1] : Intersect [2] : Round [3] : Cut</p> <p>[None] </p> <p>[Intersect] </p> <p>[Round] </p> <p>[Cut] </p> <p>Note</p> <ul style="list-style-type: none"> • [None] is suitable for drafts because it takes shortest processing time. • If a symbol is set by symbol command, the link process is not executed. The symbol command is an HP-GL/2 command for specifying a symbol. 														
	950-965 (Pen density) (No. 0-No.15)	<p>Sets the density of the 16 pens (No. 00 to 15). You can set the density from 0 to 250% in 1% increments. The default value is [0] for No. 0, and [100] for the others. No. 00 denotes Item No. 950.</p> <p>[0] - [255] : 0 to 250 (density)</p> <p>Note</p> <ul style="list-style-type: none"> • The relationship between the pen attributes and fonts are as follows: <table border="1" data-bbox="758 1254 1212 1646"> <thead> <tr> <th>Fonts / Pen attributes</th> <th>Stroke</th> <th>Roman, Sans-Serif</th> </tr> </thead> <tbody> <tr> <td>Pen width</td> <td>Valid</td> <td>Invalid</td> </tr> <tr> <td>Line end shape</td> <td>Valid</td> <td>Invalid</td> </tr> <tr> <td>Link process</td> <td>Invalid</td> <td>Invalid</td> </tr> <tr> <td>Pen density</td> <td>Valid</td> <td>Valid</td> </tr> </tbody> </table>	Fonts / Pen attributes	Stroke	Roman, Sans-Serif	Pen width	Valid	Invalid	Line end shape	Valid	Invalid	Link process	Invalid	Invalid	Pen density	Valid
Fonts / Pen attributes	Stroke	Roman, Sans-Serif														
Pen width	Valid	Invalid														
Line end shape	Valid	Invalid														
Link process	Invalid	Invalid														
Pen density	Valid	Valid														

Hard Clip Area

In the HP-GL mode, the plottable area is determined in line with the paper size, apart from the printable area. This area is called the "hard clip area", and determines the maximum range of pen movement. Accordingly, images cannot be drawn outside the boundary of the hard clip area. This machine allows you to select a hard clip area from the following:

Standard

Defines the printable area of the machine as the hard clip area.

Paper

Defines a size same as the paper size as the hard clip area. However, the area that allows actual printing is within the printable area.

The hard clip area can be set either with HP-GL emulation mode settings or by the specified hard clip command "&I".

The following coordinate values present an example of when the origin is set at the lower left (Auto Layout in HP-GL/2) of A3 sheet.

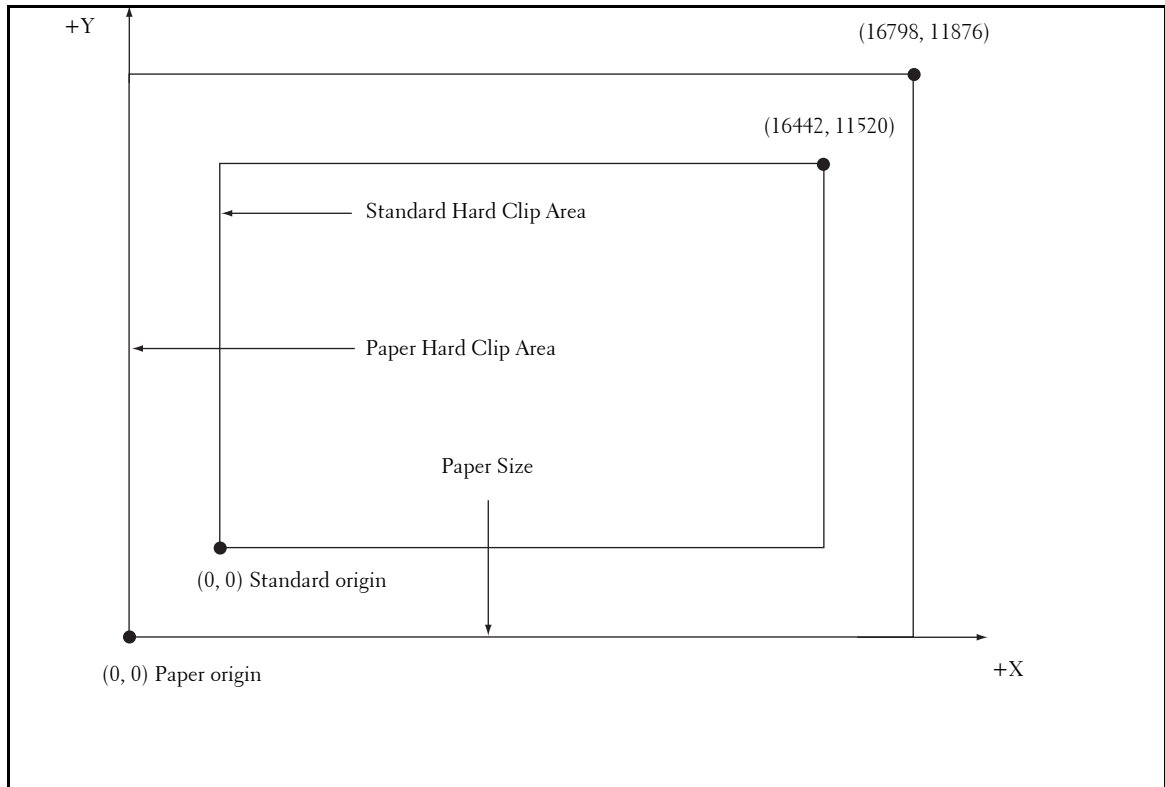

Printable Area

The printable area in the HP-GL mode is as follows:

Paper Size and Printable Area

Paper size	Paper Length (1/7200 inch)		Coordinate Value (1/7200 inch)							
	X Axis	Y Axis	Margin		Printable Area		Top-right Edge		Margin	
	Width	Height	Bottom-left X	Bottom-left Y	Long Side	Short Side	Top-right X	Top-right Y	XR	YU
A3	119052	84168	1260	1260	116532	81648	117792	82908	1260	1260
A4	84168	59508	1260	1260	81648	56988	82908	58248	1260	1260
A5	59508	41940	1260	1260	56988	39420	58248	40680	1260	1260
B4	103176	72828	1260	1260	100656	70308	101916	71568	1260	1260
B5	72828	51588	1260	1260	70308	49068	71568	50328	1260	1260

Note • The HP-GL emulation supports five paper sizes: A3, A5, A4, B4, and B5.

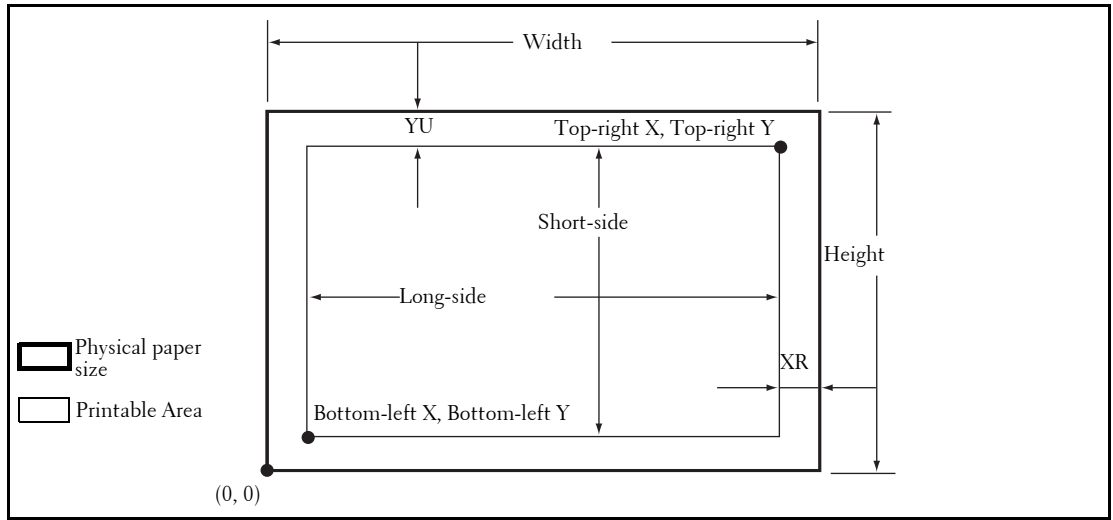

Paper size	Paper Length (1/7200 inch)		Coordinate Value (1/7200 inch)							
	X Axis	Y Axis	Margin		Printable Area		Top-right Edge		Margin	
	Width	Height	Bottom - left X	Bottom - left Y	Long Side	Short Side	Top-right X	Top-right Y	XR	YU
A3	84168	119052	1260	1260	81648	116532	82908	117792	1260	1260
A4	59508	84168	1260	1260	56988	81648	58248	82908	1260	1260
A5	41940	59508	1260	1260	39420	56988	40680	58248	1260	1260
B4	72828	103176	1260	1260	70308	100656	71568	101916	1260	1260
B5	51588	72828	1260	1260	49068	70308	50328	71568	1260	1260

Note • The HP-GL emulation supports five paper sizes: A3, A5, A4, B4, and B5.

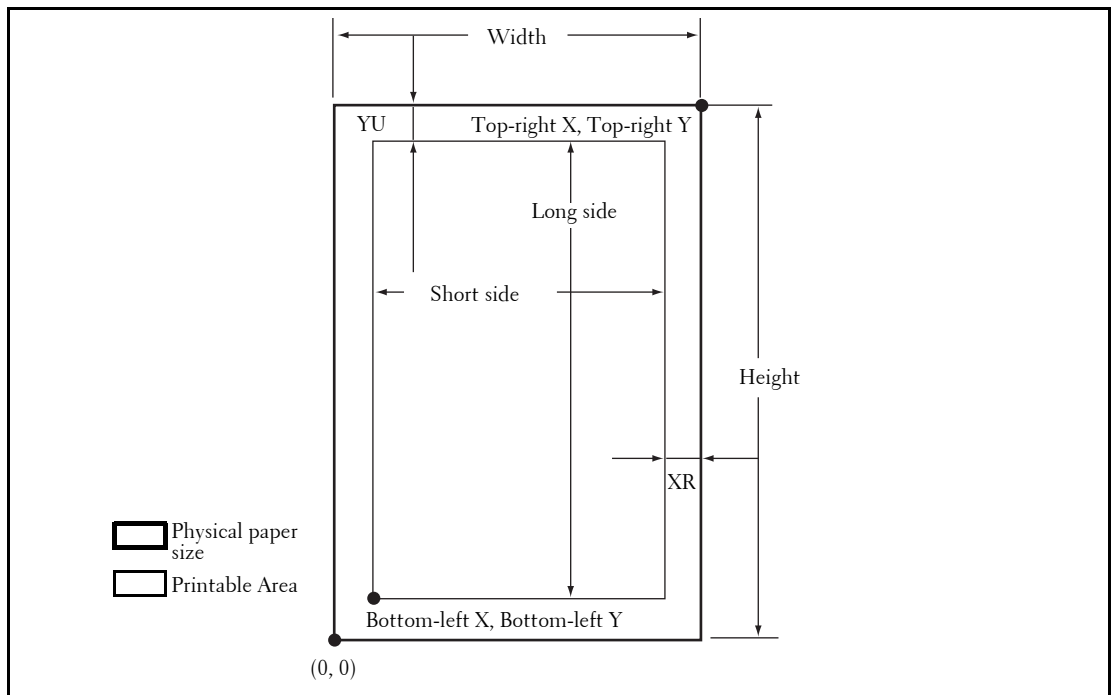

Auto Layout

This section explains Auto Layout.

What is Auto Layout?

Auto Layout is a function that evaluates document size using the HP-GL data entered from a host system and enlarges or reduces the document size corresponding to the paper size so that data plotted is placed in the center of the paper. Using the Auto Scaling/Auto Layout function enables you to print a document in the HP-GL mode without concern for document size and origin position.

All Auto Layout settings can be made in the [HP-GL/2 - Programming] screen (Press the <Machine Status> button > [Print Mode] > [HP-GL/2 Emulation] > [Programming]). The settings cannot be made with advanced commands.

Enabling Auto Layout

To enable Auto Layout, enter Item Numbers and Values on the [HP-GL/2 - Programming] screen as follows:

- Set [Document size ([101])] to [Auto ([99])]. The default value is [Auto ([99])].
- Set [Auto layout ([106])] to [ON ([0])] to set the origin position. The default value is [ON ([0])].
- Set [Scaling ([159])] to [ON ([1])]. The default value is [ON ([1])].
- Select a method for obtaining the active coordinate area using the area determination mode. The default value is [Auto ([0])].
- Set the paper margin using [Paper margin ([162])]. The default value is 0 mm ([0]).
- Set the scaling mode. The default value is [Paper Size ([0])].

Setting Item Details

The following describes the details for each setting. You can change the settings on the [HP-GL/2 - Programming] screen.

Document Size

To set Document size to Auto, enter [101] to the [Item Number] box and select [Change Value], and then enter [99] to the [New Value] box and select [Save]. Once you set Document size to Auto, you can set Auto layout to ON.

Auto Layout

To set Auto layout to ON, enter [106] to the [Item Number] box and select [Change Value], and then enter [0] to the [New Value] box and select [Save]. Enabling Auto layout activates the settings for scaling, area determination mode, paper margins, and scaling mode.

Scaling

Set whether the original size is enlarged or reduced so that the document size fits the paper size.

Area Determination Mode

The following methods are available to obtain an active coordinates area using HP-GL data.

- Auto
Automatically selects the method of determining the active coordinates area from PS, IW, IP, and Adapted in that order of priority.

- IW

The area specified by the last IW command in the data becomes the active coordinates area.

If there are no IW commands in the data, the active coordinates area is determined by Adapted.
- IP

The coordinates encompassing all areas specified by IP commands in the data becomes the active coordinates area.

If there are no IP commands in the data, the active coordinates area is determined by Adapted.
- Adapted

The active coordinates area is determined by the following conditions:

 - Minimum/Maximum position coordinates plotted by drawing commands
 - Maximum font size specified within the page
 - Maximum line width
- PS

The coordinates encompassing all areas specified by PS commands in the data becomes the active coordinates area.

If there are no PS commands in the data, the active coordinate area is determined by Adapted.

Paper Margin

Set the range from 0 to 99 mm. The default value is 0 mm. To get the active coordinates area, subtract the area set in paper margins from the active coordinates area obtained in the area determination mode.

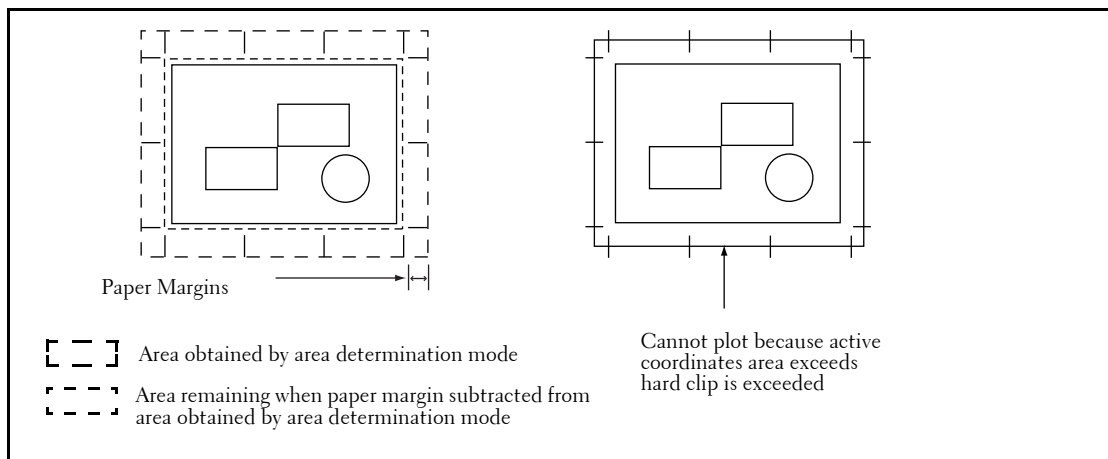

Scaling Mode

Select the mode for determining the document size from the obtained active coordinates area. Use active coordinates area to determine whether the paper orientation will be portrait or landscape.

- If it is an Active Coordinates Area

To obtain the document size, subtract the area specified in paper margins from the active coordinates area obtained in the area determination mode.

- If it is a Paper Size
Set the document size from the obtained active coordinates area and the origin point setting. The document size can be selected from six sizes of A series paper (A0, A1, A2, A3, A4, or A5).

How to Determine Document Size

The document size is determined by comparing with the hard clip area of each paper size based on the active coordinates area obtained in the scaling mode, paper margin, and area determination mode.

If the Scaling Mode is a Paper Size

- 1) Obtain the coordinate area to be active from the HP-GL data entered, in accordance with the area determination mode.
- 2) As a margin, add the larger value of either the font size specified in the page, the default size or one half the specified pen width, to the active coordinates area obtained in step 1.
- 3) Subtract the value set in paper margins from the active coordinates area obtained in step 2.
- 4) The minimum size that includes the active coordinates area obtained in step 3 will be the document size.

If the Scaling Mode is the ACA

- 1) Obtain the coordinate area to be active from the HP-GL data entered, in accord with the area determination mode.
- 2) As a margin, add the larger value of either the font size specified in the page, the default size or one half the specified pen width, to the active coordinates area obtained in step 1.
- 3) Subtract the value set in paper margins from the active coordinates area obtained in step 2.
- 4) The ACA obtained in the process up to step 3 will be the document size.

- For Example:

If the following data is entered when the scaling mode is paper size, origin position is Auto, paper margin is 10mm, and area determination mode is IP:

All pen width settings are 0.1 mm.

The following data does not contain a character size specification command and the A3 physical size of the area specified by IP/IW.

IN;

IP-8399,-5938, 8399, 5938;

IW-8399,-5938, 8399, 5938;

PU;

SP1;

:

:

SP0;

- 1) As the area determination mode is IP, the active coordinates area is specified as the area -8399,-5938,8399,5938 by an IP command.
- 2) Because there are no font size specification commands and all pen widths are 0.1 mm in the above example, add the height/2 of the default font size for A3 size paper (75 plotter units) to the active coordinates area obtained in step 1.

The active coordinates area obtained in step 2 is -8474,-6013,8474,6013.

- 3) The value set in paper margins (10 mm = 400 plotter units) is subtracted from the active coordinates area obtained in step 2.

The active coordinates area obtained in step 3 is -8074,-5613,8074,5613.

- 4) As the active coordinates area obtained in step 3 exceeds the A4 size and is A3 size, the document size is determined to be A3.

In addition, when the paper margin setting is 0 mm and the active coordinates area is 8474,-6013,8474,6013, and this exceeds A3, but is A2 or smaller, the document size is determined to be A2.

How to Determine Paper Size

If the operation panel settings are as follows, the paper size is determined as below.

Document size: Auto

Paper Tray: Auto

The method for determining the paper size differs according to the paper size and scaling mode settings on the operation panel.

If the Paper Size Setting is A Sizes

The paper sizes among the three sizes (A3, A4, and A5) that are actually loaded in the trays become the possible paper size.

If A series paper (A3, A4, A5) is not loaded in the trays, all three sizes, A3, A4, and A5 become possible sizes; a message is displayed on the touch screen prompting the user to load A series paper.

If the Paper Size Setting is Auto

The paper sizes among the five sizes (A3, B4, A4, B5, and A5) that are actually loaded in the trays become the possible paper size.

If A3, B4, A4, B5, or A5 paper is not loaded in the trays, all five sizes become possible sizes; a message is displayed on the touch screen prompting the user to load paper.

If the Scaling Mode Setting is Paper Size

If the paper size and the document size are the same, select paper that is the same size as the document.

If the document size is larger than any possible paper sizes, select the largest paper.

If the document size is smaller than any possible paper sizes, select the smallest paper.

If the Scaling Mode Setting is ACA

Select the smallest paper size that can contain the ACA.

If the active coordinates area is larger than any possible paper sizes, select the largest paper.

If the active coordinates area is smaller than any possible paper sizes, select the smallest paper.

- Note**
- If the document size is set to anything other than Auto, the paper size is the one set on the control panel.
 - If the paper tray is set to Auto, the paper size is the one loaded in each tray. However, if paper whose size is not supported is loaded, an error message will be displayed prompting the user to load a supported paper.

How to Determine the Scaling Ratio

When auto scaling is being used, although the scaling ratio is determined by document size and paper size, it differs according to the scale mode setting.

- Note**
- To activate scaling, set the scaling to ON on the [HP-GL/2 - Programming] screen. If it is set to OFF, it is plotted at the same scale (100%).

If the Document Size is Auto and the Scaling Mode is Paper Size

The hard clip setting is inactive. The hard clip area is always the paper's hard clip area.

- If the document size = paper size, it plots at the same scale (100%).
- If the document size > paper size, it plots at a reduced scale.
- If the document size < paper size, it plots at the same scale (100%).

Document Size	Paper Size				
	A3	A4	A5	B4	B5
A0	35	25	100	31	100
A1	50	35	25	43	31
A2	71	50	35	61	43
A3	100	71	50	87	61
A4	100	100	71	100	87
A5	100	100	100	100	100

Unit: Percent (%)

If the origin position of the plotting position is Layout, the document is placed and drawn in the center. If the origin position is bottom left or center, the origin of the document and the paper are aligned and drawn.

If the Document Size is Auto and the Scaling Mode is ACA

The hard clip setting is inactive. The hard clip area is always the advanced hard clip area.

The scaling factor is determined according to the ACA and the paper size. The range for the ACA for each paper size is as follows:

Paper Size	0 Degrees				90 Degrees			
	Min Value		Max Value		Min Value		Max Value	
	P2x - P1x	P2y - P1y	P2x - P1x	P2y - P1y	P2x - P1x	P2y - P1y	P2x - P1x	P2y - P1y
A3	7829	5485	73075	51200	5485	7829	51200	73075
A4	5485	3828	51200	35733	3828	5485	35733	51200
A5	3828	2648	35733	24720	2648	3828	44088	35733
B4	6762	4723	63120	44088	4723	6762	44088	63120
B5	4723	3297	44088	30773	3297	4723	30773	44088

Unit: Plotter Unit

The maximum scaling factor is 210% of the advanced hard clip area for each paper size and the minimum scaling factor is 22.5%.

Examples of Combinations of Each Function

The following are examples showing the print results that can be achieved by combining various functions.

Document: Auto, Coordinate Origin: 0 Degrees, Scaling Mode: Paper Size, Scaling: ON

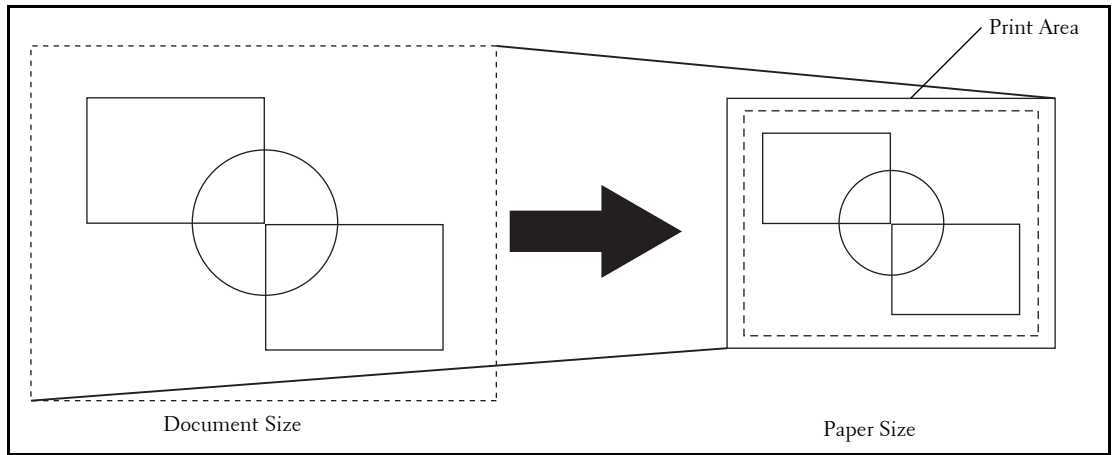

Document: Auto, Coordinate Origin: 0 Degrees, Scaling Mode: Paper Size, Scaling: OFF

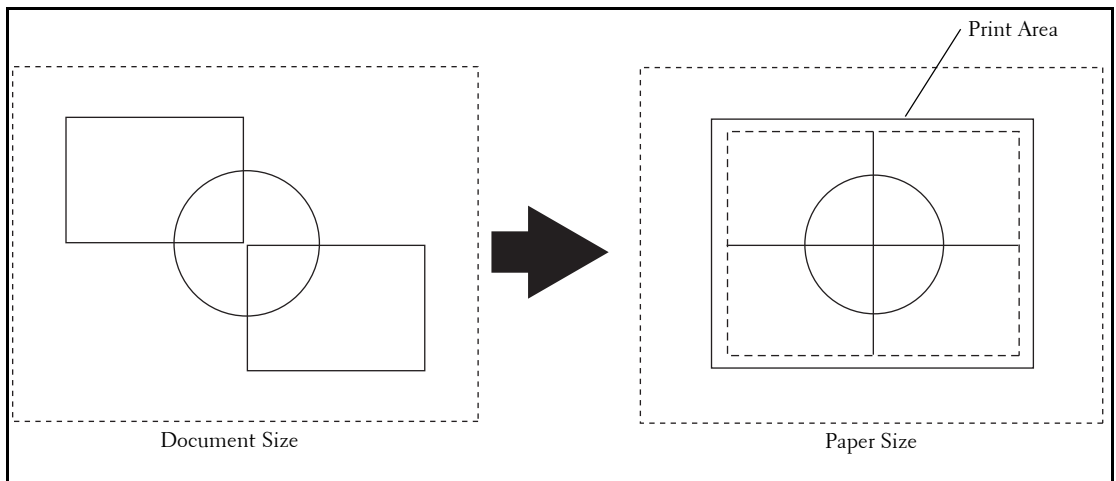

Document: Auto, Coordinate Origin: 0 Degrees, Scaling Mode: Active Coordinate Area, Scaling: ON

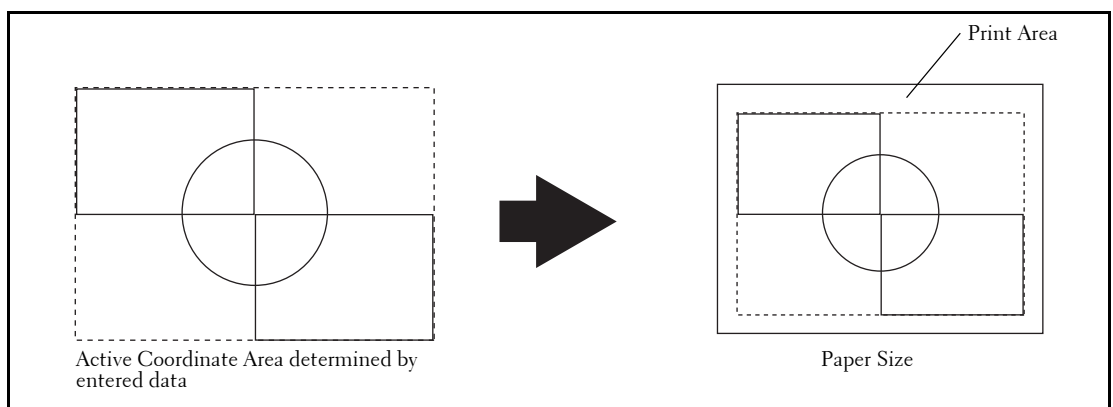

Document: Auto, Coordinate Origin: 0 Degrees, Scaling Mode: Active Coordinate Area, Scaling: OFF

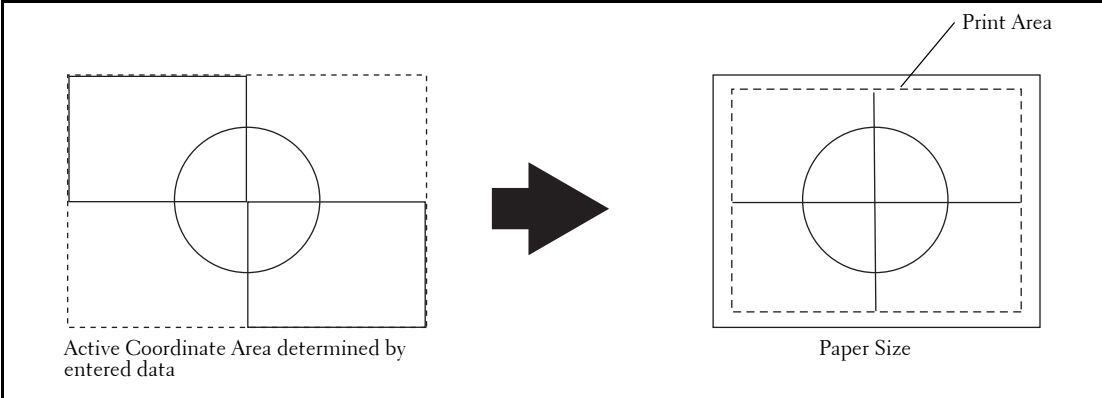

Notes and Restrictions

This section describes the notes and restrictions to observe when using the machine.

Notes and Restrictions on the Use of the Machine

Notes on Switching Off the Main Power and Power

Power off processing is performed internally on the machine for a while after the power is switched off. Therefore, do not switch the main power off immediately after switching the power off. Do not switch the main power off while the touch screen displays a screen or the <Power Saver> button blinks. Switching off the main power may damage the hard disk and the memory or cause a machine malfunction. In addition, the machine will not be activated soon if you switch on the power before the touch screen gets blank. Confirm that the touch screen is blank before switching on the power.

Hard Disk

- You can specify the hard disk as a storage location of print data sent by lpd, SMB, and IPP. The storage location of an HP-GL/2 auto-layout memory is fixed to the hard disk, and you cannot change the location.
- Initializing a hard disk erases additional fonts and the forms of ESC/P-K. Secure Print files and logs are not deleted.

Installing and Moving the Machine

- When moving the machine to another location, contact Customer Support at dell.com/contactdell.
- When the machine is operating, do not subject it to shock.
- When closing the document cover, be careful not to pinch your fingers.
- Do not place any objects near the ventilation openings of the machine's exhaust fan.

Character Code

In data transmission from a computer or read processing of data in a medium such as a USB memory device, if characters that the machine does not support are included in folder and file names, these characters may not be displayed correctly.

When the Media Print - Photos service is used, only ASCII characters can be used.

Output Destination

When you change the finisher to install, reconfigure the output destination under [Tools] > [System Settings] > [Copy Service Settings] > [Copy Defaults] > [Output Destination].

You can also change the output destination for Print E-mail, Private Folder Printed Files, and Fax Received as required.

Selecting [Auto Detect] for [Output Color]

When [Auto Detect] is selected for [Output Color] for the Copy jobs or [Color] is selected for [Output Color] for the Print jobs, the drums or toners of Yellow, Magenta, or Cyan may be consumed even for the black and white documents.

If you select [Off] for [Drum Cartridge Conservation Mode] under [System Settings] > [Common Service Settings] > [Other Settings], the drums or toners of Yellow, Magenta, or Cyan are consumed because the drums or toners of those colors are always used even for black and white documents.

Restrictions on Method of Recipient Specification

- The [New Recipients] and [Redial List] buttons may not be displayed when you specify a recipient for fax/Internet fax/e-mail transmission if the method of recipient specification is restricted in the System Administration mode. In this case, you cannot use the numeric keypad either. Consequently, the recipients you can specify are limited to those who are registered on the Address Book.

You must add an address book entry using Dell Printer Configuration Web Tool or Job Flow Editor. The system administrator, however, can register new recipients from the control panel of the machine even when the method of recipient specification is limited.

- The users who belong to an authorization group for which [Restrict Recipient Selection Method] is set to [No Restriction] can directly specify a recipient for fax/Internet fax or an e-mail transmission.

One Touch Buttons

The one touch buttons (only for fax models) are used to specify an address when sending faxes, Internet faxes, Scan to PC, or E-mail. The buttons cannot be used when you specify an e-mail address, a shared folder of SMB/FTP, or a server address.

The following two methods are available to assign the address numbers to the one touch buttons.

- [Type 1]: Assigns the one touch buttons 1 to 70 to the address numbers 0001 to 0070, and buttons M01 and M02 to the stored programming jobs 1 and 2.
- [Type 2]: Assigns the one touch buttons 1 to 60 to the address numbers 0001 to 0060, and buttons 61 to 70, M01, and M02 to the stored programming jobs 1 and 12.

Note • [Type 1] is selected by factory default.

For more information on how to change the number of address numbers assigned, refer to "One-touch Buttons" (P.129).

Assigning to the One Touch Buttons

You can change the way to assign address numbers and stored programs to the one touch buttons. When you have changed the assignment, some one touch buttons that were used for address numbers before may be used for stored programs while other one touch buttons that were used for stored programs before may be used for address numbers. Be sure that you perform the correct operation.

USB Memory Slot on the Control Panel

- Insert a USB memory device directly into the USB memory slot on the control panel. If you connect a USB memory device via a USB cable, the operation is not guaranteed.
- To connect a USB memory device via a USB cable, use the USB 2.0 interface connector on the rear of the left side of the machine.

Printed Time in Force Annotation

The time you specified to print a job, the time at which the print job is started inside the machine, and the time at which the job is actually printed may not be coincident with one another depending on the machine status and settings or the content of the print job. The time printed in Force Annotation is the time at which the print job is started inside the machine.

Stored Programming

- The following features and operations cannot be registered on a stored program.
 - Registration and call of a stored program
 - System settings

- The [Media Print -Text] and [Media Print - Photos] buttons on the [Home] screen
 - The [Store to USB] button on the [Home] screen
 - The [Job Flow Sheets] and [Web Applications] buttons on the [Home] screen
 - A custom button to which the Job Flow feature is assigned
 - Address Book for the Fax/Internet Fax, E-mail, and Scan to PC services
 - Buttons that cannot be selected
 - The [Language] button on the [Home] screen
 - The [Screen Brightness] button on the [Home] screen
 - The use of a scrolling bar when you select an item
 - The [Browse] button of the Scan to PC service
 - Address editing operation of the E-mail service ([Remove], [Edit], and [Close Menu] on the pop-up menu)
 - the <Power Saver> button
- After registering a program, you may not be able to retrieve the stored program correctly if you execute the following operations:
 - If a Watermark is registered on the program, and you change the default value of the Watermark after registering the program
 - If a passcode of a folder that is subject to operation by a stored program is changed after the program is registered
 - If the settings of the control panel are changed
 - If the features registered on the custom buttons are changed
 - If the setting is changed with [Tools] > [System Settings] > [Copy Service Settings] > [Preset Buttons]
 - If the program is selected from a list of a job flow or the Address Book
 - If a button no longer functions as a result of a change of optional components such as a finisher
 - If the measurement unit such as mm or inch is changed
 - If a file is selected from a file list with Job Status

Software Option

When you buy the Software Option, we provide you with the documentation including "LICENSE AGREEMENT". Set the software key (passcode) specified on the documentation for [Tools] > [System Settings] > [Common Service Settings] > [Maintenance] > [Software Options] on the machine to use the feature.

- The individual Software Option is required for each machine. (You cannot install one Software Option on multiple machines.) You can install multiple Software Options on a machine.
- For some Software Options, a device must be installed with the software key.

Power Source

- The machine has the power switch and the main power switch. While the power switch is off, the machine does not operate.
- While the power switch is off, the machine does not receive faxes.

Restrictions on the Interrupt Mode

While the machine is processing a copy job in the Interrupt mode, it does not accept print jobs instructed from a computer or print jobs of received faxes, internet faxes, or e-mails.

Output Color

When you select [Auto Detect] in [Output Color] for a copy job or select [Color] in [Output Color] for a print job, the machine may consume yellow, magenta, and cyan toner cartridges and drum cartridges even when your document is black and white.

In addition, when [Background Suppression (Color Copy)] is set to [High Speed] under [System Settings] > [Common Service Settings] > [Image Quality Adjustment], yellow, magenta, and cyan toner cartridges and drum cartridges are always used. Thus these color toner cartridges and drum cartridges are consumed even when your document is black and white.

Operations during the Power Saver mode

- It takes a few seconds before you can operate the system settings under [Tools] after the machine exits the Sleep mode.
- The <Power Saver> button still lights up when you perform the operations which do not light up the touch screen such as printing command from a computer.
- A message does not appear on the touch screen if you open and close the top cover of the document feeder when the document feeder is deactivated (such as when the service to use a scanner is not selected). However, the confirmation message appears on the touch screen and the <Error> indicator lights up when the document feeder is activated (exits the Power Saver mode) while the top cover is open.
- The confirmation indicator does not light up if the document is loaded while the document feeder is in the Power Saver mode (such as when the service to use a scanner is not selected). However, the confirmation indicator lights up and the document is detected when you load the document and then make the machine exit the Power Saver mode.
- The machine exits the Power Saver mode when you open the document cover to copy or scan.
- After the machine exits the Power Saver mode, the document feeder and scanner device are activated after the document cover is opened while the scanner device is deactivated. However, to make the document detected on the document glass, make sure that the scanner device in the document glass moves to the detect position for the document size, and then close the document cover.
- After the machine is activated from the Power Saver mode, a message does not appear on the touch screen if you perform the following operations while the service to be used for the output device, such as copying and secure printing, is not selected.
 - Opening and closing the top cover of the document feeder
 - Opening and closing the front cover
 - Opening and closing the bottom left cover
 - Opening the paper tray
 - All the operations including opening and closing the front cover of the finisher, and pressing the buttons

However, the confirmation message appears and the <Error> indicator lights up when the machine is activated (exits the Power Saver mode) while each cover or a paper tray is open.

- After the machine exits the Power Saver mode, the value detected before the machine enters the Power Saver mode is displayed or informed as paper tray status and the information on the consumables such as the toner remaining amount, status of the drum cartridge, and paper, if the service used for the output device is not activated.
- After the machine exits the Power Saver mode, be careful for the following if you use the copy feature before you activate the service used for the output device.

The information displayed such as a paper size specified for the paper tray or the remaining amount is detected before the Power Saver mode. If you change the paper size or remaining amount during the Power Saver mode, it takes a few seconds for the change to be updated on the screen.

- Exiting the Power Saver mode activates the entire machine when Copy, Simple Copy, or Stored Programming is set as the default screen on the touch screen.
- Exiting the Power Saver mode activates the entire machine when [Paper Tray Attributes During Loading] is set to [On].
- The entire machine exits the Power Saver mode when you press the <Machine Status> button, enter the System Administration mode, or select the Stored Programming service.
- When [Tools] > [System Settings] > [Connectivity & Network Setup] > [Port Settings] > [EtherTalk] > Change Settings > [Port Status] > Change Settings > [EtherTalk Compatible - Port Status] is set to [Enabled], or [USB] > [USB - Print Mode] is set to any option other than [Auto], exiting the Power Saver mode activates the entire machine.

Opening and Closing of the Document Cover during the Power Saver Mode

If you open the document cover during the Power Saver mode, and then start scanning a document immediately after the machine exits the mode, the detection error of a document size may occur. In this case, enter the document size manually. It takes a few seconds before the machine can detect a document size automatically. This detection error will not occur if you load a document, close the document cover, and wait for a few seconds before start scanning a document.

Notes and Restrictions on the Use of the Copy Feature

Copy Feature

The machine does not offer the Improves Fit feature.

Meter Count for Dual Color and Single Color Copies

Dual color and single color copies are counted as color copies.

Color Effect for Dual Color Copy

To extract colors for dual color copy, adjusting the colors of the document is required in advance.

Our service representative performs the adjustment. Contact Customer Support at dell.com/contactdell.

Auto Contrast

The machine does not offer the [Auto Contrast] feature for [Color Effects].

Pages per Side for Black & White and Color Mixed Documents and Meter Count

If you copy a document that contains black & white and color pages by specifying [Pages per Side], an output sheet that has both black & white and color pages will be counted as a color page.

Copy and Simple Copy

You cannot switch the screen between the Copy and Simple Copy services. Return to the [Home] screen, and then select a service. In that case, the settings specified in either service are cleared.

ID Card Copy

- The machine does not shift the ID card image to the center of the output in any magnification ratio and image size you specified.
- When the reduced size is specified to copy an ID card, the machine may copy the ID card in a different orientation from the original orientation depending on the magnification ratio specified.

Notes and Restrictions on the Use of the Print Feature

Output of Long Feed Documents

The output of long feed documents is not supported.

PostScript Driver

Some options such as Poster (Photo Enlargement) are not supported by the PostScript driver. With the Pages per Sheet (N-Up) feature, you can specify 2, 4, 6, 9, or 16 pages up, and with or without frame borders.

Printing from Macintosh via USB Connection

When you send a print job from the PostScript driver of Macintosh connected via USB and the job includes application data with graphic data (EPS file including binary data) pasted, the machine may misidentify the binary data as protocol data; therefore, the output of text data may extend for multiple pages.

In this case, select [RAW] for [Adobe Communication Protocol] under [Tools] > [System Settings] > [Connectivity & Network Setup] > [Port Settings] > [USB] to properly print data which includes EPS files with binary data.

Text and Photos for Media Print

You can use a commercially available single-slot memory card reader, but the operation is not guaranteed.

When you use a multi-slot memory card reader, only one of those slots can be recognized. The slot to be used differs depending on the card readers. Some of the media and slots of memory card readers may not be used on the machine, and the operation is not guaranteed.

Thumbnail for Media Print

The Media Print - Photos feature supports Thumbnail view but not Preview. The Media Print - Text feature supports neither Thumbnail view nor Preview.

Print Jobs while the Control Panel is being Operated

The processing and output speeds of print jobs may slow in the following conditions:

- The control panel is being operated while the machine processes a print job.
- The status of a print job is being viewed in the [Job Status] screen.

When Printing from the Bypass Tray

When you load A5  in Tray 5 and specify 2 sided printing, all data is printed on one side.

When the Print Results Differ from the Settings

As in the following cases, insufficient memory for the print page buffer may cause print result in not printing as specified. In this case, we recommend that you increase the memory.

- Printed only on 1 side when 2 sided printing is specified.

- A job was terminated (If data cannot be written to the print page buffer, the job including that page is terminated).

Printing from a USB Memory Device

- You can use a USB host adapter to print from your USB memory device or via your USB cable (as necessary), but the operation is not guaranteed.
- Use USB 2.0 compliant memory devices only.
The following USB memory devices are not supported:
 - A USB memory device with multiple media partitions that require other utilities to access to the contents therein.
 - A USB memory device connected via an external hub.
- Multiple USB memory devices cannot be used simultaneously.
- The machine does not display a menu to prevent you from removing a USB memory device while it is being accessed.

Meter Counts for 2 Sided Printing

When printing 2 sided, depending on the application being used, blank sheets can be inserted automatically to adjust pages. These blank sheets inserted by the application will also be counted by the meter.

Meter Count for Watermark

When a document is printed using the Watermark feature (such as Annotation and Force Annotation), the meters count with the following method:

- Color documents are counted as color copies regardless of whether the Watermark feature is used or not.
- Black & white documents are counted as color copies if [Font Color] is set to other than [Black], or counted as black & white if [Font Color] is set to [Black].

PDF Direct Print

PDF Direct Print supports Adobe PDF 1.6. However, note the followings:

- It may take long to output a PDF file, for the rendering processing is complicated.
- This feature does not support the "Embed OpenType Fonts" setting of Adobe Acrobat 7 (PDF 1.6).
- This feature supports the features of PDF 1.6 created by Adobe Acrobat 7 or later. However, it does not support the features of PDF 1.7 (Adobe Acrobat 8 and 9).
- PDF Bridge of the machine supports the features of PDF 1.6 such as transparent object.
- Set the PostScript Memory to its maximum value (128MB) to print PDF files properly.

IPP Printing

If the size of print data sent via IPP is larger than the value set in the proxy server, the machine cannot receive the data. In this case, set a larger value in the proxy server or change your browser setting not to use the proxy server.

XPS-compliant Driver

An XPS-compliant driver is a print driver to print a document from application software developed for Windows Vista.

With this driver, a document may not be printed correctly from application software developed for operating systems earlier than Windows Vista, including 2007 Microsoft Office system, due to compatibility problems.

When you use an XPS-compliant driver, make sure in advance that the machine as the output destination supports XPS printing. When you use an XPS-compliant driver on machines that do not support XPS printing, the print result may be not what was expected.

Note • XPS stands for XML Paper Specification.

ThinPrint

- To install "ThinPrint .print" to Windows Server 2003 or Windows Server 2008, a ".print Application Server Engine" license is required.
- ThinPrint can operate in an IPv4 environment, but not in an IPv6 environment.
- Up to three can be connected simultaneously. The fourth or above connection requests are stored in the queue. Up to 10 connection requests can be stored in the queue. If exceeding 10, another connection request is no longer received. After preceding connections are terminated, the connection requests in the queue will be processed subsequently when the total number of the connections becomes less than four.
- Functions to control jobs, such as canceling or suspending jobs, are not provided. Instead, you can cancel a job on the [Job Status] screen from the control panel, or from Dell Printer Configuration Web Tool.
- The machine prints jobs in the order in which they are spooled. The jobs may not be printed in the order in which the job requests are received by the machine.
- If the power is switched off, this feature can store the order of jobs spooled and their data. If the power switched off while a job is being received, the job is deleted.

Direct Fax Driver

The direct fax driver does not support Envelope (90 x 205 mm), Envelope (162 × 229 mm), Envelope (229 × 324 mm), and Envelope (235 × 120 mm).

Notes and Restrictions on the Use of the Scan Features

This section describes notes and restrictions to observe when using the Scan features.

For the notes and restrictions on Network Scan Driver and Stored File Manager 3, refer to the Readme contained in the Driver CD Kit.

Retrieving Files from Folder

- When [Delete Files After Retrieval] is set to [No], the same file can be accessed by multiple clients.
When [Delete Files After Retrieval] is set to [Yes], only one client can access any given file. The file that is being imported by a client cannot be seen by other clients.
- When files are retrieved from Dell Printer Configuration Web Tool, the files are not deleted regardless of the setting of [Delete Files After Retrieval].

Using Network Scan Driver and Stored File Manager 3 Simultaneously

You cannot use both the Network Scan Driver and Stored File Manager 3 on a single computer to connect to the machine.

A maximum of three computers using either the Network Scan Driver or Stored File Manager 3 may retrieve files simultaneously from one machine.

Using TIFF Files

The TIFF files created by Stored File Manager 3 are compressed into the MMR, MH, JBIG, or JPEG format. To open a TIFF file, use application software that supports the format.

Restriction on Scanning Capacity

The maximum scanning capacity for one page is 297 x 432 mm. For standard sizes, A3 or 11 x 17 inches.

Number of Sheets for Scanning (for Folder)

A maximum of 999 pages can be scanned for folders at one time. The number of pages may differ depending on the file size and resolution.

Store to USB

- You cannot use this service on job flows (whose Target is Scan Jobs or Folder).
- The USB 2.0 compliant memory device is supported.
- Neither file nor directory names in a USB memory device are displayed on the touch screen.
- You cannot delete the files or folders in a USB memory device using the machine.
- To prevent you from removing a USB memory device while it is being accessed, an icon showing that the removal of a USB memory device is prohibited appears on the touch screen. Be sure to remove a USB memory device from the machine after the message "Data has been transferred." is displayed on the touch screen.
- When the data size exceeds the capacity of the USB memory device while the machine is performing the Store to USB service, the job in progress is cancelled.
- Neither the Media Print - Text nor Media Print - Photos feature can be used while the Store to USB service is in progress. The Store to USB service cannot be used as well while the Media Print - Text or Media Print - Photos feature is in progress.
- You can enable or disable the Store to USB service from Dell Printer Configuration Web Tool in the System Administration mode. You cannot set it from the touch screen. (The default setting is [Enabled].)
- You can set not to display the [Store to USB] service on the [Home] screen from the touch screen.
- The machine may not be able to recognize a USB memory device that was formatted by a digital camera or a tool other than the Windows standard format tool.

Screen Switching After Inserting a USB Memory Device

- If a USB memory device is inserted when the machine is switched off, and then you switch on, the [Home] screen is displayed.
- When a USB memory device is inserted into the USB memory slot during the Power Saver mode, the touch screen does not light up. After exiting the Power Saver mode by pressing the <Power Saver> button, insert the USB memory device again or select the feature to be used on the [Home] screen.
- The screen does not switch when removing a USB memory device.
- The screen switches even when a USB memory device whose format is not supported is inserted. However, an error occurs when selecting the menu.
- If no medium is in the Memory Card Reader (commercially available), the screen switches when you insert the Reader.
- If the Memory Card Reader (commercially available) is used and it is left inserted all the time, the screen does not switch even when a medium is inserted into the slot of the Reader.

Network Reference on SMB Environment

- If you configure more than 256 shared resources other than shared folders (such as shared printers) when using Windows 2000, Windows XP, Windows Server 2003, Windows Vista, or Windows 7, shared resources other than shared folders may be displayed in the shared folder list.
- Names such as workgroup names, server names, and shared names on the network may not be displayed alphabetically on the list.

Scan High Compression Feature

- You can select 200 dpi or 300 dpi for the resolution.
- You can open High-compression PDF files with Adobe Acrobat 4.0 (PDF 1.3) or later.
- The Image Compression feature may not be able to scan the colors of the documents precisely due to the image processing to improve the compression ratio.

PKI Encryption and PKI Signature of Scan Files

- Acrobat Approval is not supported.

PKI Encryption and PKI Signature of PDF Documents

- PKI (Public Key Infrastructure) encryption of PDF is not available. A certificate is not used for password encryption.
- If a message stating that a certificate revocation could not be checked is displayed and a signature verification error occurs in the viewer of PDF, confirm the certificate revocation setting in the viewer.

Digital Signature of PDF

- The security handler (DL.MFP.PPKMS) is not provided.
- When a PDF document signed by the machine is displayed with Adobe Acrobat (Reader), a message stating that no handler was found for signature confirmation may be displayed. In this case, select [Windows Digital Certificate] or [Adobe Default Security].
- A certificate to be used for PDF digital signature must meet the conditions described in "S/MIME" section.

S/MIME Communication

The E-mail and Internet Fax services support S/MIME.

Searchable PDF

- We recommend that you set [300 dpi] for [Resolution] when you use the optical character recognition (OCR) feature.
- For Store to Folder, you cannot select [Searchable] for [Searchable Text].
- When you use Dell Printer Configuration Web Tool to retrieve a file from a folder, you can set [Searchable Text] if all scanned images of the file in the folder are set as follows:
 - Image Size: 15 x 15 mm to 309 x 432 mm
 - Color Scanning: Auto Detect, Color, Grayscale, Black & White
 - Original Type: Photo & Text, Text (for faxes, all types)
 - Color Space: sRGB
 - Resolution: 200dpi, 300dpi (for faxes, all resolutions)
 - Reduce/Enlarge: 100% (for faxes, all ratios)

Compression Format of Scanned Images

- You cannot retrieve grayscale or color images in uncompressed (Raw) format.
- JBIG2 compression of PDF is supported.

Preview of Scan File

- If [MRC High Compression] is set to [On] under [File Format], preview cannot be displayed.
- If you select [Specific Color] for [File Format], preview cannot be displayed.
- If a preview image is not what you expected, cancel the job, configure the settings, and then scan the document again.
- If you cancel the scanning of a document by pressing the <Stop> button on the control panel or the [Delete] button in the touch screen, selecting [Preview] may not display all the scanned files.

Scanning Documents with a Small Number of Colors (the Specific Color Feature)

- Specific Color (for PDF) and MRC High Compression (for PDF) cannot be used simultaneously.
- You cannot use this feature when retrieving data via Network Scanner Utility 3.
- Select [Color] for [Color Scanning].
- This feature is available when [Color Scanning] is set to [Color], when [Resolution] is set to [200 dpi] or [300 dpi], and when [File Format] is set to [PDF].
- You cannot change the number of colors. (The maximum is 16 colors.)
- You can attach thumbnails to files when [Specific Color] is selected, but the thumbnails are displayed in full color.
- Monochrome images scanned with the Specific Color feature may be different from the ordinary monochrome images in the image quality.
- The Specific Color feature is not suitable for documents with graphs and photographs, or with multiple colors. For those documents, use MRC High Compression.

Obtaining Addresses from LDAP Server

- Recipients' addresses that can be obtained from the LDAP server for the E-mail service are e-mail addresses, Internet fax addresses, and fax numbers.
- The Address Book that can be used for the E-mail service in Job Flows is the Address Book stored in the machine.

Restrictions on Internet Explorer

- When you access a URL that is sent by e-mail using Internet Explorer, a File Download pop-up window is displayed. Start the download within three minutes after the pop-up window appears, otherwise an incomplete file will be left in your computer.
- When you use the Store & Send Link service by selecting [Single File for Each Page] for [File Format], you may not properly obtain files from the destination URL if [Automatic prompting for file downloads] is set to [Disable] under [Tools] > [System Settings] > [Internet Options] > [Security] > [Custom Level] > [Automatic prompting for file downloads] with your Internet Explorer.
- When you use Internet Explorer, even if you click "To delete file, click here." in the [Document Acquisition] screen of the Store & Send Link service, file deletion may not be performed. In this case, use another browser than Internet Explorer to delete the file.

Split Files

You cannot select [Single File for Each Page] when using the Store to Folder or Job Flow feature.

Thumbnail View

Files in a folder may not be displayed in thumbnail view in the following cases. In those cases, display them in list view.

- Some file is not displayed in thumbnail view even though it is stored in the folder.
- Characters and images are not correctly displayed because they are scaled down from the actual sizes.
- The orientation of an image displayed in thumbnail view depends on which orientation the document was stored in.
- If the power is cut off immediately after a scanned file is stored in a folder, or if the hard disk space is insufficient to display thumbnails, files in the folder may not be displayed in thumbnail view. In that case, display them in list view.

2 Sided Simultaneous Scan

When [Color Scanning] is set to [Color] and [Color Space] is set to [Device ColorSpace], 2 sided simultaneous scan is not available.

FTP Transmission for Scan to PC

- By factory default, [Passive Mode] is selected as a transfer mode for sending scanned data via FTP from the machine.
- You can switch the FTP transfer mode using Dell Printer Configuration Web Tool, but cannot switch the mode per job or per destination FTP server.
- Depending on your network environment, operations may not be performed properly unless the FTP transfer mode is switched from [Passive Mode] to [Active Mode].
- When [IP Filtering] is enabled, make sure to switch the FTP transfer mode to [Active Mode].

In [Passive Mode], the server allows the client to connect to the port for transferring data, and the client starts the connection. [Passive Mode] is commonly used and also has lower security risk than [Active Mode].

In [Active Mode], the client notifies the server of the port number for transferring data, and the server starts the connection. [Active Mode] may incur a security risk such as impersonation by third parties. In addition, the proper connection may not be available in the firewall environment. In such a case, select [Passive Mode].

Store to WSD

Note • WSD stands for Web Services on Devices.

- When the WSD scan port is not activated, the [Store to WSD] button is not displayed in the [Home] screen. Enable the WSD scan port to use the Store to WSD service on the machine.
- The Store to WSD feature requires the default scanner driver of Windows Vista Service Pack 2 or later. When an appropriate operation system is installed, you can operate scan using [Windows Fax and Scan] or [From scanner or camera] in [Microsoft Paint].
- [Next Original] is not displayed when using the WSD scan feature.
- You cannot execute multiple jobs simultaneously. If you execute a job during the scan job, the latter job is not accepted.
- When using WSD scan, you cannot change layout settings by the machine. Configure the settings on the computer using the scanner driver included as standard in Windows.

- The Store to WSD feature requires the default scanner driver of Windows Vista or later. Setting items are different from those for the dedicated scanner driver.

Notes and Restrictions on the Use of the Fax Feature

Settings on Manual Fax Transmissions

Manual fax transmissions are performed in accordance with the settings in [Fax Defaults]. If you change settings on the fax screen before the calling screen appears, the settings become effective.

Relay Broadcast

The machine has the function of an initiating station but does not have the function of a relay station.

The machine does not support G4 communications, but if a relay station supports G4 communications, the machine can select a G4 communication function that a relay station performs as an instruction for relay broadcast.

Features Supported by F Code Communication

F Code communication supports the following features: the Send Fax - Remote Folder, Secure Polling, Store File - Local Folder, Relay Broadcast, and Remote Relay Broadcast features.

Fax Immediate Reception

If the machine's memory capacity becomes insufficient to receive fax data, the machine automatically switches into immediate reception mode. In this mode, the machine outputs received documents on a page-by-page basis; each document page is output immediately after the machine finishes receiving it. However, if the machine receives large data, such as an A3 size photo with many halftone levels, the machine may not print it even after the machine finishes receiving it. In that case, press the <Stop> button, or turn the machine off and then on again, to have the machine print the document.

Skip Blank Pages Feature

The accuracy of detecting blank pages depends on the status of the page. For example, if a blank page has background shadows, the machine may not determine the page as a blank page.

Address Type Settings When Registering on the Address Book

The following address types can be selected when you add an address to Address Book:

Fax, Internet Fax, E-mail, and Server (FTP/SMB)

When you register an address on the Address Book, select an address type in accordance with the service. The address book entry registered with the wrong address type cannot be selected from the original service.

Fax Blocking Feature

To use the fax blocking feature, set a G3-ID of the sender for [Block Inbound Faxes].

You can find the G3-ID of the sender that you want to reject in "Remote Station" column of an Activity Report or "Input Source" column of a Job History Report.

Simple Fax

- While you are making the settings for [Fax/Internet Fax], you cannot switch to the [Simple Fax] screen. To switch to the [Simple Fax] screen, you must return to the [Home] screen. Once you return to the [Home] screen, the settings you have made will be cleared.

- You can re-enter a recipient after entering the recipient to prevent sending a fax to a wrong address.
- You cannot use address numbers to specify recipients for Broadcast Send, group dial numbers, the Address Book, and wildcards.

Printer Lockout

If the power is switched off when both [Set Lockout Duration] and [Allow User to Lock Out] are selected in [Printer Lockout], the manually configured [Lock Out Printer] setting is cleared. If the power is switched on again, [Set Lockout Duration] will be effective regardless of the [Lock Out Printer] setting.

Prevention of Wrong Transmissions for Direct Fax

- After specifying a recipient using an address number (Speed Dial) or the Address Book, the [Settings of Reentering Fax Address] dialog box will not be displayed even when [Settings of Reentering Fax Address:] is set to [On] on the [Configuration] tab on the [Properties] screen.
- You cannot enter a fax number when [Restriction of Specifying Fax Address] is set to [Speed Dial Only] or [Phonebook Only] on the [Configuration] tab on the [Properties] screen. Specify a recipient using an address number (Speed Dial) or the Address Book under this setting.
- You cannot specify multiple recipients when [On] is set for [Restrict Multi-Address Fax Transmission:] to prevent faxes from being sent to undesired destinations.

Direct Fax

When sending a fax using the Direct Fax feature, the recipient name is printed on the Activity Report, Confirmation Options, Transmission Report - Job Undelivered, Broadcast Report, and Job History Report. If you want to print the telephone number instead, leave the text box of [Name] on the print driver screen blank. Note that the column of [To] on the Fax Cover Page is also left blank under this setting.

Notes and Restrictions on the Use of the E-mail/Internet Fax Feature

Notes on E-mail Transmissions

"The job has been sent." that is displayed on the confirmation screen, Activity Report, or Confirmation Options indicates that an e-mail has been sent to the SMTP server configured on the machine for transmitting e-mail. The e-mail, however, may not reach its destination for some problem on the transmission path of the Internet. In this case, the machine is not notified of such transmission error. After sending an important e-mail, we recommend that you confirm its reception, such as by calling the recipient.

Feature Combinations when Transmitting an Internet Fax

- [Resolution] on the [Fax/Internet Fax] screen

When [TIFF-S] is selected for [Internet Fax Profile] on the [Fax/Internet Fax Options] screen, [Superfine (400 dpi)] or [Superfine (600 dpi)] cannot be selected.

For information on Internet fax profiles, refer to "4 Fax > "Fax/Internet Fax Options" > "Internet Fax Profile (Specifying Internet Fax Profiles)" in the User Guide.

- [Starting Rate] on the [Fax/Internet Fax Options] screen

The communication mode can be specified only when sending e-mail using the Fax Gateway feature. For other cases, e-mail is sent via G3 Auto.

For more information on the Fax Gateway feature, refer to "4 Fax" > "About Internet Fax" > "Useful Features" > "Sending Internet Fax to regular fax machines via a relay station" in the User Guide.

- [Original Size] on the [Layout Adjustment] screen

When [TIFF-S] is selected for [Internet Fax Profile] on the [Fax/Internet Fax Options] screen, an Internet fax is sent in A4 even if a size larger than A4 is specified.

For information on Internet fax profiles, refer to "4 Fax > "Fax/Internet Fax Options" > "Internet Fax Profile (Specifying Internet Fax Profiles)" in the User Guide.

Internet Fax and Direct Internet Fax

- You can switch between the Internet Fax and Internet Fax Direct features in the System Administration mode, however, you cannot use both features simultaneously. For switching between the features, contact your System Administrator.
- Both the Internet Fax and E-mail services can be used at the same time. The Internet Fax Direct and E-mail services can also be used simultaneously.
- Peer-to-peer communication of the Internet Fax Direct feature can be established only between Dell C7765dn Color Multifunction Printers installed with the Fax Kit 2.
- When [Resend Attempts] is set to [On] and the status of the Internet Fax Direct feature enters Resend Required, the subsequent jobs will not be executed until the jobs in Standby status finish.
- Transmission results of Internet faxes cannot be listed on Transmission Report - Job Undelivered or Transmission Report by recipients. Transmission results of Internet Direct faxes can be listed on the reports.

Internet Fax Profiles

- When specifying an Internet fax profile

The Internet fax profile that can be processed varies depending on the machine that the recipient uses. When specifying an Internet fax profile, confirm whether it can be processed by the recipient's machine.

- When an Internet fax profile not supported by the recipient's machine is specified

If the Internet fax profile you specified is not supported by the recipient's machine, the image you sent cannot be displayed or printed on the recipient's machine. Before using an Internet fax profile, confirm if it can be processed by both your machine and the recipient's machine.

- TIFF files and Internet fax profiles that can be processed upon Internet fax reception
 - TIFF file format: TIFF-FX (RFC2301)
 - Internet fax profile: TIFF-S, TIFF-F, TIFF-J

If receiving a TIFF-C profile, an error occurs and the machine cannot print the file. If receiving another unsupported Internet fax profile, the machine may not be able to print the files.

Note • Communications and Information network Association of Japan (CIAJ) confirms the use of image-tiff-fx.

- Transmission conditions for broadcast transmission
 - When sending a document via a broadcast transmission, it can be sent to both Internet fax and regular fax addresses at the same time. To Internet fax addresses, the document will be sent by e-mail, and to regular fax addresses, the document will be sent by fax.

- When the transmission conditions are different for each address, set all addresses to the following settings.
 - Internet fax profile: TIFF-S
 - Transmission mode:G3 Auto
 - Read/delivery receipt:None

E-mail Forwarding

If the fax you received is a JBIG-compressed image, and if the Internet fax profile of the forwarding destination is set to TIFF-F, the machine converts the image into MH format when forwarding. When the Internet fax profile is TIFF-S, the data is forwarded with its size and resolution unchanged.

S/MIME Communication for Internet Fax

S/MIME Encryption cannot be used for the features that use special e-mail addresses, such as the reception of Internet fax with a folder specified and a fax transfer for e-mails received by Internet Fax.

S/MIME Untrusted E-mail Reception Settings

When [Receive Untrusted E-mail] or [Receive Untrusted Internet Fax] under [Connectivity & Network Setup] > [Security Settings] > [S/MIME Settings] is set to [No] in the System Administration mode, you cannot receive the confirmation result even if [Read Receipts] is set to [On].

Fax Gateway Feature

This feature can only be used when the e-mail receiving protocol is SMTP on the Internet Fax-enabled machine that faxes are sent to.

If an e-mail was sent by converting it into fax, and if it was not delivered successfully to the recipient, the e-mail that was received originally will be deleted.

For more information on the Fax Gateway feature, refer to "4 Fax" > "About Internet Fax" > "Useful Features" > "Sending Internet Fax to regular fax machines via a relay station" in the User Guide.

Restrictions on Paper Selections upon Internet Fax Reception

The machine determines whether a TIFF file attached to an e-mail complies with the content type defined in RFC2301 and RFC3250. If the content type is compliant with RFC2301 and RFC3250, the machine selects appropriate paper to render the file image as a fax-received image.

Even when the file was received via Internet Fax, if its content type is not compliant with RFC2301 or RFC3250, the machine will not properly select paper for it. For example, an incoming fax that is A4 size may be printed on B4 paper instead.

Such problems may improve depending on the usage. Contact Customer Support at dell.com/contactdell for further information.

Restrictions on the E-mail Server

Depending on the system environment (such as the restrictions on your e-mail server), large e-mail may not be delivered successfully. When sending a large e-mail by splitting it, check the capacity of your system environment and of the recipient's environment.

If the data size is still too large to send, reduce their size by lowering the image resolution or transmission resolution.

Network Security

We do not guarantee the security of any information disclosed over the network.

Setting the System Environment for E-mail Service

To send or receive e-mail, the system environment of the machine must be set for the E-mail service. Set up the system environment such as SMTP, POP3, and DNS servers, as required.

Notes on Security

E-mail uses the Internet, which is a network connecting computers worldwide, as its transmission path. Thus, since other signals also are sent over the Internet, you must pay attention to security to prevent third parties from reading or tampering of your e-mail.

Consequently, to transmit important information, we recommend that you use other transmission methods that guarantee security. In addition, to avoid the reception of unwanted e-mail, we recommend that you not disclose your e-mail address to third parties unless necessary.

Preventing Receipt of Unwanted E-mail

The machine provides a feature that prevents the reception of unwanted e-mail sent from third parties.

By specifying the domains from which e-mail can be received, you automatically can reject e-mail sent from other addresses.

For information on restricting domains from which e-mail can be received, refer to "Domain Filtering" (P.189).

Notes on E-mail Receptions

A large volume of e-mail may not be printed if the memory capacity is insufficient. In this case, increase the memory size or ask the sender to lower the resolution.

Notes on E-mail Reception when [Split by Data Size] is specified

When [Split by Data Size] is specified as the e-mail splitting method, even if you receive the split e-mail, you cannot reconstruct and print it.

Notes on E-mail Transmission when [Split by Data Size] is specified

When [Split by Data Size] is specified as the e-mail splitting method, split the data so as to enable e-mail reception with e-mail software corresponding to the Message/Partial content type.

Job Counter Report

If you specify multiple different [Pages per Side] settings using the Build Job feature, the numbers of pages displayed for [2 Pages] and [Greater than 2 Pages Up] displayed on the Job Counter Report are calculated according to the latest N-up setting you specify.

Example 1:

When you select [2 Pages] for Document 1 (4 pages) and [Off] for Document 2 (2 pages), both Documents 1 and 2 are set to [Off] and the number of printed pages is calculated as follows:

- Total pages: 4
- 2 up: 0

Example 2:

When you select [Off] for Document 1 (4 pages) and [2 Pages] for Document 2 (2 pages), both Documents 1 and 2 are set to [2 Pages] and the number of printed pages is calculated as follows:

- Total pages: 5
- 2 up: 5

The meter on the [Billing Information] screen calculates the number of printed pages correctly regardless of the [Pages per Side] setting.

Folder Passcode

- Communications and Information network Association of Japan (CIAJ) confirms the use of image-/tiff-fx.

Notes and Restrictions when Connecting with Internet Service Provider

This section describes notes and restrictions to observe when using features that transmit e-mails or Internet faxes using an Internet service provider (ISP).

The features related to e-mail are as follows:

- E-mail
- E-mail Notification Service
- Print E-mail
- Internet Fax

Notes and Restrictions on Accessing ISP

Observe the following notes and restrictions when connecting the machine to ISP:

- Dial-up connection is not supported. Continuous connection is required.
- Connect the machine in an environment using IP masquerade. Assigning a global IP address to the machine is not supported.
- Be sure to assign an exclusive e-mail account to the machine for POP reception. Sharing an e-mail account with other users may cause troubles.
- Be sure to set size limitation for sending e-mail. Although the applicable e-mail size may vary depending on the ISP used, we recommend that you set a small value.
- Although continuous connection other than ADSL or cable connection is also supported, the reception of image data significantly burdens the machine.
- SMTP reception is not supported. This machine supports only POP reception.
- When installing the machine in an environment that is operating a mail transfer agent (MTA) in a private segment, set the machine to adapt to the operation system being used.
- For information about supported ISPs, contact Customer Support at dell.com/contactdell.
- When received via POP, the fax cannot be sent using the Fax Gateway feature. This is because POP receiving does not forward an Internet fax document received by e-mail to the fax machine.

Feature Specifications

Details of the features related to e-mail are as follows:

- Transmission specifications

Supported protocol	: SMTP
Port number	: 25 (default)

- Authentication for transmission

SMTP authentication	: AUTH GSSAPI (only for Kerberos), AUTH NTLMv2, AUTH NTLMv1, AUTH PLAIN, AUTH LOGIN, and AUTH CRAM-MD5
---------------------	--

POP before SMTP	: Plain and APOP
Waiting time for POP authentication	: cannot be changed
Encryption communication (SSL)	: supported
• Receiving specifications	
Supported protocol	: POP3
POP3 port number	: 110 (default)
Authentication method for POP3	: Plain and APOP
E-mail processing after POP3 reception	: deletes e-mail received from a server after reception. Settings to store e-mail on the server is not supported.
Encryption communication (SSL)	: not supported

Note • IMAP4 is not supported.

IP Address Settings

The machine does not support a global IP address. Be sure to use the machine in an environment using IP masquerade.

- Operating with fixed address

Register the machine's IP address on a router or a server managing IP addresses for domain control servers.

- Operating with DHCP

Setting is not required. Depending on settings of the router and the DHCP server, registration may be required. Confirm operation rules for the router and DHCP server you are using. When access is restricted by MAC address, registration on the DHCP server may be required.

Settings from the Control Panel

Before you use the E-mail service, set the maximum data size for sending e-mail on the control panel. For more information on the maximum limit, refer to the ISP guidelines. The recommended value is 1 to 2 MB.

In the System Administration mode, select [Tools] > [System Settings] > [E-mail/Internet Fax Service Settings] > [E-mail Control] > [Maximum Total Data Size] to configure the setting.

For more information on setting, refer to "Maximum Total Data Size" (P.217).

Suitable image sizes are as follows:

- A4 full-color 200 dpi with standard compression : around 700 KB
- A4 full-color 200 dpi with high compression : around 400 KB
- A4 black and white 200 dpi (text document) : around 25 KB
- A4 black and white 200 dpi (text & photo document) : around 200 KB

Note • The sizes described above are applicable when sending e-mail. The actual size may be different.

Settings from Dell Printer Configuration Web Tool

Set [Polling Interval] to at least 10 minutes when connecting to ISP.

Notes and Restrictions on the Interrupt Mode

If you press the <Interrupt> button while printing, the machine temporarily stops printing and enters the Interrupt mode.

- Note**
- When [Resume by User] in "Resume Job After Print Error" (P.193) is selected, the machine will not temporarily stop printing even when the <Interrupt> button is pressed.
 - However, if the machine is scanning a document while printing, the print job cannot be interrupted.

Jobs can/cannot be executed during interruption are as follows:

Job		Job Instruction from the Control Panel*¹	Job Execution
Copy		Required	O
Print	Printing of a document* ² instructed from a client computer	Required* ³	O
	Printing of a document* ⁴ instructed from the <Job Status> button > [Secure Print Jobs & More]	Required	O
Fax	Fax transmission, Broadcast Send	Required	O
	Store for Poling	Required	O
	Incoming Fax Print	Required* ³	O
	Printing of a document in the Public Folder ([Job Status] > [Secure Print Jobs & More] on the control panel)	Required	O
Direct Fax	Direct Fax transmission	Not required	Δ
Internet Fax	Internet fax Transmission	Required	O
	Internet fax reception/printing	Required* ³	O
	Internet fax reception/Store Internet fax - Local Folder	Not required	Δ
	Forwarding an incoming Internet fax to a regular fax machine	Not required	Δ
	Forwarding an incoming fax to an Internet fax	Not required	X
Scan	Store to Folder, Scan to PC, E-mail, Store & Send Link, and Store to USB	Required	O
Report/List	Automatic printing of a report/list other than a Job History Report	Not required	X
	Automatic printing of a Job History Report	Not required	O
	Printing of a report/list instructed from the <Machine Status> button > [Machine Information] > [Print Reports]	Required	O
Folder	Automatic forwarding of a stored file, automatic fax/Internet fax transmission	Not required	X
	Printing of a stored file (Fax for Secure Polling/Store Fax - Local Folder/Store Internet Fax - Local Folder) instructed from the control panel	Required	O
	Printing of a stored file (scanned file/print file) instructed from the control panel	Required	X
	Automatic printing of a stored file	Required* ³	O
Job Flow Sheet	Execution of a job flow sheet instructed in [Send from Folder] or [Job Flow Sheets] on the touch screen	Required	O

- O :The job can be executed during the Interrupt mode.
- X :The job cannot be executed during the Interrupt mode.
- Δ :The job can be accepted from a client or another machine, but the job cannot be executed during the Interrupt mode.
- *1 :The job instruction from the control panel is required/not required to execute the job.
- *2 :Normal printing, first set of Sample Set, Delayed Print (auto print)
- *3 :During interruption, any document displayed as a pending job on the [Job Status] screen can be printed by selecting [Promote Job]. When priority printing is instructed during interruption, the next priority printing is disabled until the instructed print job is completed.
- *4 :Secure Print, Private Charge Print, Sample Set, Delayed Print, or Charge Print

- Note**
- The following types of jobs will be executed even in the Interrupt mode.
 - Automatic fax transmission (Send Fax - Remote Folder)
 - Fax reception

Notes and Restrictions on Folders

Printing Scan Files

When you print files in a folder such as the following, it may take long to output the first page:

- Files with multiple pages
- Files with colors or saved in high resolution

Retrieving Files in Folder from Dell Printer Configuration Web Tool

- Files in a folder can be retrieved in PDF format from Dell Printer Configuration Web Tool, but PDF files that are encrypted or with signature attached cannot be retrieved from Dell Printer Configuration Web Tool.
- When you retrieve a file in PDF format from Dell Printer Configuration Web Tool, the PDF file cannot be optimized for Web view.

Notes and Restrictions when Connecting to Internet or Intranet

Internet/Intranet Connection

Depending on the web server, server application, proxy server, and firewall, you may not be able to connect to the Internet or intranet.

To connect to the Internet or intranet using a third party server application, proxy, or firewall, the following requirements must be met:

- Support Windows 2000, Windows XP, Windows Server 2003, Windows Server 2008, Windows Server 2008 R2, Windows Vista, or Windows 7
- Comply with the following conditions:
 - RFC2616: Hypertext Transfer Protocol HTTP/1.1 (Standard connection/SSL connection/Proxy authentication)
 - RFC2617: HTTP Authentication: Basic and Digest Access Authentication (only Basic authentication is supported, the other authentications are not supported)
 - RFC2817: Upgrading to TLS Within HTTP/1.1
 - RFC2818: HTTP Over TLS
- Supporting the HTTP/HTTPS schemata
- Supporting the GET/CONNECT/POST methods

Notes and Restrictions when Operating from Computers

Restrictions on Macintosh (standard)

- In Macintosh environment, the Scan features using the Direct Fax feature and a TWAIN scanner driver cannot be used.
- The print driver for Mac OS X adopts the Plugin driver, which enables you to make the settings for the authentication information and to use the Secure Print feature.
- In Macintosh environment, the Scan features using a TWAIN scanner driver cannot be used.

Print Driver for Mac OS X

- Mac OS X 10.5/10.6/10.7/10.8 is supported.
- The Direct Fax feature cannot be used.

Direct Fax for Mac OS

- Multi-size documents are not supported.
- When sending a document of different orientations using this feature, the machine may divide the document into multiple jobs in each size. (It depends on the application you use.)
- This feature does not support documents with covers.
- If you attach covers to a document on Mac OS, only the cover page will be sent to the recipient. Even if you set to output multiple sets, the setting will be changed to 1 set automatically.
- The Collate feature is not available.

Dell Printer Configuration Web Tool

- When [CSRF Protection] feature is enabled, Dell Printer Configuration Web Tool may become inaccessible depending on your browser type, web browser usage situation, and the network environment. In such a case, try to access Dell Printer Configuration Web Tool from other computer. Be sure to consult your System Administrator before disabling the feature. If you have no other computer that can access Dell Printer Configuration Web Tool, contact Customer Support at dell.com/contactdell.

CSRF is a type of attack that forces a user to execute unwanted action on a web site in which the user is currently authenticated, via the malicious web site. The [CSRF Protection] feature prevents unwanted actions from being executed on Dell Printer Configuration Web Tool and changing the machine settings in case the user unknowingly accesses a malicious website.

- Do not edit or change the CSV file (address book data) exported by Dell Printer Configuration Web Tool using software such as Microsoft[®] Excel[®]. The machine may not display any warning message when registering the altered data. Since the altered data may be damaged, fax may be sent to undesired recipients.
- The recipient data is added to the Address Book in the machine without deleting registered recipients when you import the data from [Data Import] on [Address Book] tab of Dell Printer Configuration Web Tool. If you want to change the setting to overwrite mode, contact Customer Support at dell.com/contactdell.
- Only the Address Book data exported from [Data Export] on the [Address Book] tab of Dell Printer Configuration Web Tool is available for importing with [Data Import] on [Address Book] tab.

Notes and Restrictions on Job Flows

Job Flows

- If you transfer fax or Internet fax documents via SMB, FTP, or E-mail, the documents will be converted into the standard size (such as A4 and A3) and printed.
- If a Job Flow is performed with the following settings, an interference pattern may be created:
 - Original Type: [Photo & Text] or [Photo]
 - Resolution: [400 dpi] or [600 dpi]
 - Internet fax profile for sending Internet faxes: [TIFF-S]
- If an interference pattern is created, change the settings as follows:
 - Resolution: [200 dpi] or [300 dpi]
 - Internet fax profile for sending Internet faxes: [TIFF-F] or [TIFF-J]

Web Application feature

- The following conditions and restrictions are applied when you print files stored in a remote server.
 - [Output Destination] can be specified, but the staple and hole punch cannot be specified.
 - The [Pages per Side] feature can be specified only when you print PDF files.
 - When [Port Settings] is set to [NetWare] or [SMB], set the transport protocol to [TCP/IP].
 - HTTP or HTTPS can be used for the communications between the machine and a remote server.
 - Printable file formats are [TIFF], [PDF], and [XPS].
 - Print data is spooled to the hard disk of the machine, and then printed as a job. Therefore, the print data is recognized as a job while the data is being spooled to the hard disk.
 - The Secure Print feature cannot be used.
 - Printing is available even when [Auto Print] is set to [On] under [Machine Clock / Timers].
 - "Web Applications - Print" is displayed on the [Job Status] screen.
 - The <Online> indicator is unlit while the print data is being spooled to the hard disk.

Note • XPS stands for XML Paper Specification.

Job Flow Settings for High Compression Format

When [MRC High Compression] is set to [On] under [File Format] for the Scan features, select one of the alternatives for each setting item:

- Color Scanning: [Auto Detect], [Color], or [Grayscale]
- Resolution: [200 dpi] or [300 dpi]
- Reduce / Enlarge: [100%]
- File Format (without thumbnail specification): [PDF] or [XPS]
- File Format (with thumbnail specification): [XPS]

Note • If settings other than the above are used, you can register a Job Flow sheet on the machine, but an error occurs when the machine executes the Job Flow and the Job Flow cannot be carried out.
• XPS stands for XML Paper Specification.

Addresses Registered on Job Flows

If you specify a speed dial or an address registered on the Address Book when creating a job flow on the machine, any subsequent change of the number or address on the Address Book

is not reflected on the job flow created. To transmit to the changed address, you must directly correct the address registered on the job flow.

Notes and Restrictions on the Security Features

Encrypted Communication

Encrypting HTTP communication enables you to encrypt communication data for IPP printing (SSL encrypted communication). The data is encrypted only on the network, but send data itself is not encrypted.

Allow User to Disable Active Settings (for Forcible Printing Features)

This feature cannot be applied to the ordinary print jobs. This feature is applicable to the jobs stored in the machine and then printed by the instruction from the touch screen, such as Copy, Secure Print, Private Charge Print, Store in Remote Folder, Media Print - Text, and Media Print - Photos jobs.

Private Charge Print

User ID for Private Charge Print must be specified not more than 24 bytes (24 characters). If the User ID set to the print driver exceeds 24 bytes, the job will not be stored. Also, when the User ID with more than 24 bytes is used for authentication, the user cannot instruct Private Charge Print.

Notes and Restrictions on the Authentication and Accounting Features

Login to Remote Accounts

- Only the services that can be instructed from the touch screen (Copy, Scan, Fax, Internet Fax, Charge Print, and Private Charge Print) are restricted by the Login to Remote Accounts feature. You cannot restrict the output color or the number of pages.
- In this feature, neither Print nor Direct Fax can be restricted. To restrict print operations, use the Charge Print or Private Charge Print feature. If there is a security problem, prohibit Direct Fax. To prohibit Direct Fax, contact Customer Support at dell.com/contactdell.
- When you change Login Type to or from [Login to Remote Accounts], user information, private folders, and Personal Sheets registered on the machine will be deleted.

Remote Authentication using the Smart Card

- Remote Authentication can be performed in an environment where Active Directory is used.
- Change the default realm name only when you want to use a different realm name.

Notes and Restrictions for Using SMB

This section describes notes and restrictions to observe when using SMB.

Configuration on the Machine

- IP addresses are managed for the entire system. Configure the settings only after consulting your network administrator.

- The setting of subnet mask and gateway addresses may be required depending on the network environment. Consult your network administrator and configure the required settings.
- When the port status is set to [Enabled], it may automatically switch to [Disabled] if the machine has insufficient memory. In this case, either set an unused port to [Disabled] or adjust the assigned memory size.
- Adjust the receiving buffer size for SMB in [Receiving Buffer - SMB] according to usage. If the receiving buffer size is smaller than the transmitted data, the machine may not be able to receive the data.

Configuration on the Computer

- IP addresses are managed for the entire system. Configure the settings only after consulting your network administrator.
- When setting the network such as IP addresses with a host used under the Network Information Service (NIS), consult your NIS administrator.

Turning Off the Machine

Check the following points when turning off the machine:

- When [Receiving Buffer - SMB] is set to [Spool to Memory]
All print data spooled within the machine memory, including the data which is being printed, is erased. The print data does not remain when the machine is turned on again.
However, if the machine was turned off immediately after a computer instructed a print job, the job may remain on the computer. In this case, when the machine is turned on, the data stored on the computer is printed before any jobs instructed subsequently.
- When [Receiving Buffer - SMB] is set to [Spool to Hard Disk]
All print data spooled in the machine hard disk, including the data which is being printed, is saved. In this case, when the machine is turned on, the data stored on the machine hard disk is printed before any jobs instructed subsequently.
- When [Receiving Buffer - SMB] is set to [No Spooling]
All print data spooled in the machine receiving buffer, including the data which is being printed, is erased. The print data does not remain when the machine is turned on again.
However, if the machine was turned off immediately after a computer instructed a print job, the job may remain on the computer. In this case, when the machine is turned on, the data stored on the computer is printed before any jobs instructed subsequently.

While Printing

- When [Receiving Buffer - SMB] is set to either [Spool to Hard Disk] or [Spool to Memory]
If the transmitted print data size exceeds the available capacity of either the hard disk or memory, the print data is not received.

Note • When the print data exceeds the receivable size, some computers may immediately re-transmit the print data. In this case, the computer appears to be not operating. Remedy this problem by canceling the print data transmission from the computer.

- When [Receiving Buffer - SMB] is set to [No Spooling]
When the machine receives a print request from a computer, the machine cannot accept print requests from any other computers.
- When a computer's IP address or a computer name is changed

When you change a computer's IP address or a computer name, queries and cancel processes submitted from the machine are no longer executed correctly. Thus, turn the machine off and on when there is no print data in the receiving buffer.

Note • From the control panel on the machine, you can cancel print jobs or force the machine to print the jobs remaining in the receiving buffer. For more information on the operation, refer to "11 Job Status" in the User Guide.

- When the machine is off-line

If a computer instructs a print job while the machine is off-line, the machine does not receive the data, and a write error dialog box is displayed on the computer.

Environment for Printing via SMB

- When using Windows 2000, Windows XP, Windows Server 2003, Windows Server 2008, Windows Server 2008 R2, Windows Vista, or Windows 7 and the [Enabled] check box is selected for [Unicode Support], you cannot print with the SMB environment.
- When printing via the SMB port on Windows XP, the user name may not be displayed correctly.

SMB Authentication

When an IP address or a host name is used to designate the authentication server for SMB authentication, even if the domain name is incorrect, the authentication succeeds if the correct user name and passcode are entered.

Notes and Restrictions for Using TCP/IP

This section describes notes and restrictions to observe when using TCP/IP (LPD).

Configuration on the Machine

- IP addresses are managed for the entire system. Configure the settings only after consulting your network administrator.
- The setting of subnet mask and gateway addresses may be required depending on the network environment. Consult your network administrator and configure the required settings.
- When the port status is set to [Enabled], it may automatically switch to [Disabled] if the machine has insufficient memory. In this case, either set an unused port to [Disabled] or adjust the assigned memory size.
- Adjust the receiving buffer size for LPD in [Receiving Buffer - LPD] according to usage. If the receiving buffer size is smaller than the transmitted data, the machine may not be able to receive the data.

Configuration on the Computer

- IP addresses are managed for the entire system. Configure the settings only after consulting your network administrator.
- When setting the network such as IP addresses with a host used under the Network Information Service (NIS), consult your NIS administrator.

Turning Off the Machine

Check the following points when turning off the machine:

- When [Receiving Buffer - LPD] is set to [Spool to Memory]

All print data spooled within the machine memory, including the data which is being printed, is erased. The print data does not remain when the machine is turned on again.

However, if the machine was turned off immediately after a computer instructed a print job, the job may remain on the computer. In this case, when the machine is turned on, the data stored on the computer is printed before any jobs instructed subsequently.

- When [Receiving Buffer - LPD] is set to [Spool to Hard Disk]

All print data spooled in the machine hard disk, including the data which is being printed, is saved. In this case, when the machine is turned on, the data stored on the machine hard disk is printed before any jobs instructed subsequently.

- When [Receiving Buffer - LPD] is set to [No Spooling]

All print data spooled in the machine receiving buffer, including the data which is being printed, is erased. The print data does not remain when the machine is turned on again.

However, if the machine was turned off immediately after a computer instructed a print job, the job may remain on the computer. In this case, when the machine is turned on, the data stored on the computer is printed before any jobs instructed subsequently.

While Printing

- When [Receiving Buffer - LPD] is set to either [Spool to Hard Disk] or [Spool to Memory]

If the transmitted print data size exceeds the available capacity of either hard disk or memory, the print data is not received.

Note • When the print data exceeds the receivable size, some computers may immediately re-transmit the print data. In this case, the computer appears to be not operating. Remedy this problem by canceling the print data transmission from the computer.

- When [Receiving Buffer - LPD] is set to [No Spooling]

When the machine receives a print request from a computer, the machine cannot accept print requests from any other computers.

- When a computer's IP address or a computer name is changed

When you change a computer's IP address or a computer name, queries and cancel processes submitted from the machine are no longer executed correctly. Thus, turn the machine off and on when there is no print data in the receiving buffer.

Note • From the control panel on the machine, you can cancel print jobs or force the machine to print the jobs remaining in the receiving buffer. For more information on the operation, refer to "11 Job Status" in the User Guide.

Notes and Restrictions for Using EtherTalk

This section describes notes and restrictions to observe when using EtherTalk.

Printer Name

The system is set so that printer names used for identification by clients are not duplicated on the network. When assigning a new printer name, if the same printer name already exists on the network, the system automatically changes the printer name when the machine is started.

<Rules for changing printer name>

Printer names are changed according to the following rules:

- Names of 31 characters or less

Adds a number to the end of the printer name. If the same printer name with the number added already exists on the network, increases the added number by one.

- Names of 32 characters

Changes the last character of the printer name to a number. If the same printer name with the last character changed already exists on the network, increases the changed number by one.

If the printer name is changed, the previous printer name set before the change is displayed when browsing [Protocols] on the [Properties] tab of Dell Printer Configuration Web Tool. However, since the changed printer name is registered on the network, clients can browse the machine by using the changed printer name. Turning the machine off and then on after changing the printer name activates the machine with the changed printer name. If the same printer name already exists on the network, the printer name is changed according to the rules described above when the machine is started.

Assign a printer name so as not to duplicate other printer names on the network.

Zone Name

Zone names can be set in [Protocols] on the [Properties] tab of Dell Printer Configuration Web Tool. However, if the zone name set does not exist on the network to which the machine is connected, the zone name is automatically changed to the default name. To set a zone name, use the zone name that already exists on the network to which the machine is connected.

Notes and Restrictions for Using Bonjour

This section describes notes and restrictions to observe when using Bonjour.

Supported Environment for Bonjour

Bonjour is available on Printer Setup Tool (Print Center, Printer Setup Utility) of Mac OS X 10.5, 10.6, 10.7, or 10.8 or Macintosh computers that use Safari. The Discovery feature of Bonjour is available only within the same subnet.

Printer Name

- If you change a printer name or a host name that is already assigned, documents may be printed by a printer that is not selected.
- If a printer name or a host name is duplicated on the same network, one of the duplicated names is automatically changed by adding a number to avoid duplication.
- If you change a printer name or a host name, because of the limitation on the number or type of characters used, a name differing from the designated name may be assigned. We recommend that you not change printer names or host names.

Notes and Restrictions for IPv6 Connection

This section describes notes and restrictions to observe when using IPv6 connection.

- Printing via IPv6 supports the following versions of the operating systems.
 - Windows Vista
 - Windows 7
 - Windows 8
 - Windows Server 2008
 - Windows Server 2008 R2
- IPv6 does not support the following protocols:
 - NetWare IP
 - UPnP Discovery

- Bonjour

- Some features of SMB are not supported (If you attempt to use services with a NetBIOS name, communication may not be available in some environment).
- IPv6-in-IPv4-tunneling in the machine itself is not supported.

Note • If [IP Mode] is set to [IPv6 Mode], the IPv6-inIPv4-tunneling cannot be performed.

- If more than one router exist in the same subnet, a communication error may occur.
- In a dual stack environment, some services may cause performance problems depending on the network settings (for example, when you attempt to set the machine to prioritize IPv6 in an environment where the Web server is started with IPv4).
- In a multi-prefix environment (where multiple IPv6 global addresses are used), data transmission from the machine to a device installed on another network may fail.
- In a multi-prefix environment (where multiple IPv6 global addresses are used), an address that is not assigned to the machine may be used for communication.
- The machine may be assigned an unavailable address, such as site local addresses (fec0::) or the documentation prefix (2001:db8::/32), as an autoconfigured IPv6 address or as an IPv6 DNS server address.
- The machine may use the DNS information for IPv4 rather than that for IPv6 if: the machine is in Dual Stack mode, the DNS information for both IPv4 and IPv6 is configured, the machine is to be communicate with a device that is specified using the FQDN, and the machine has just been turned on.
- The machine may display an incorrect machine address.
Example:
Either the IPv4 or IPv6 address is not displayed in Dual Stack mode.
A different IPv6 address is displayed.
- A time synchronization server cannot be specified in IPv6 format. Use the IPv4 format to specify a time synchronization server directly.
- WINS does not support IPv6 communication.
- When a self-signed certificate is used for SSL communication, observe the following restrictions when specifying the printer URL:
 - When specifying the machine by using the domain name (for IPv4 or IPv6):
Set the host name and domain name for the machine before creating a self-signed certificate.
Example:
When the FQDN is "csw.ipv6.domain.local", specify csw for the host name, and ipv6.domain.local for the domain name.
 - When specifying the machine by using the IPv4 address:
Import a self-signed certificate that is created in IPv4 or Dual-Stack mode.
 - When specifying the machine by using the IPv6 address:
Secure IPP (IPP-S) communication is not available.
- When IPv6 is enabled and IPv4 is disabled on the machine, you cannot specify a storage location for the Browse function of the Scan to PC (SMB) service.
- When the Scan to PC (FTP) service is used, only ASCII characters can be used for file names.
- In the following cases, since the addresses may not be recognized as those of the same machine, the lpq command (for status check) and the lprm command (for canceling) may not be available for LPD print jobs.
 - When simultaneously operating IPv4 and IPv6 addresses with the same host
 - When simultaneously operating multiple IPv6 addresses with the same host

- IPv6 addresses may not be correctly recorded on job logs. Use an IPv4 network for correct logging.
- When searching a device outside the router via SMB, directly specify the address. Multicasting is supported only within a local link (FF02::1).
- In an IPv6 environment without a DNS server, if a computer name is specified in the SMB server settings for SMB authentication, the authentication fails. Specify the IPv6 address directly for a computer name of the authentication server.
- If you specify an IPv6 address as a destination URL using a remote access service, the address does not operate correctly. In an IPv6 environment, use a DNS server and specify a remote service's destination URL by using the FQDN.

Notes and Restrictions for Print E-mail

Print E-mail

The machine cancels receiving e-mails but does not display status codes when disk space is insufficient.

Using the Telephone

This section describes how to use an external telephone connected to the machine with the Fax feature.

Placing a Call

The following describes how to place a call using the external telephone.

To place a call, the following two methods can be used:

- Dialing with the receiver lifted (off-hook dialing)
- Dialing with the receiver resting in the cradle (on-hook dialing)

Off-hook Dialing

The following describes how to place a call with off-hook dialing.

- 1 Pick up the receiver of the external telephone.

Note

- While the machine is in the Power Saver mode, you cannot place a call using the external telephone. To place a call, press the <Power Saver> button to exit the Power Saver mode.



- 2 Specify the call destination.

- The call destination can be specified using the numeric keypad, address numbers, or one-touch buttons. The Address Book cannot be used.
- The call destination can be specified also with the keyboard displayed on the screen.

Note

- To disconnect the call, select [Close].
- If your telephone line is set to touch-tone, [Tone (:)] does not appear.
- If you want to send tones (or to use the touch-tone services) while using a pulse line, select [Tone (:)].
- Some touch-tone services may not be available even if you set your telephone to send tones.



- 3 When the call is connected, start speaking.
- 4 When the call is finished, place the receiver back in the cradle.

Note

- Be sure that the receiver is placed properly in the cradle. Otherwise, the line remains "busy".

- 5 Select [Close].

On-hook Dialing

The following describes how to place a call with on-hook dialing. When placing a call, we recommend that you turn the line monitor volume to "Loud".

The volume of the line monitor can be changed in the System Administration mode. For more information on how to change the volume, refer to "Line Monitor Volume" (P.129). By factory default, the volume is set to [Normal].

- 1 On the [Home] screen, select [Fax/Internet Fax].

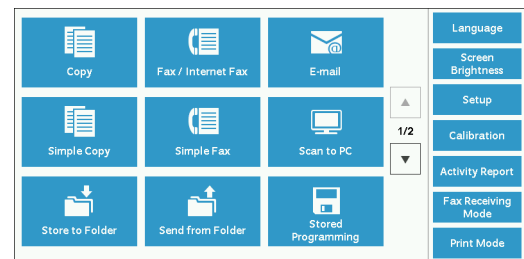

- 2 Select [On-hook (Manual Send/Receive)] on the [More Options] screen.

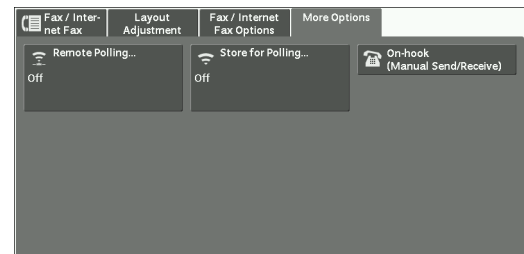

- 3 Specify the call destination.

- The call destination can be specified using the numeric keypad, address numbers, or one-touch buttons. The Address Book cannot be used.
- The call destination can be specified also with the keyboard displayed on the screen.

Note

- To disconnect the call, select [Line Cut].
- If your telephone line is set to touch-tone, [Tone (:)] does not appear.
- If you want to send tones (or to use the touch-tone services) while using a pulse line, select [Tone (:)].
- Some touch-tone services may not be available even if you set your telephone to send tones.

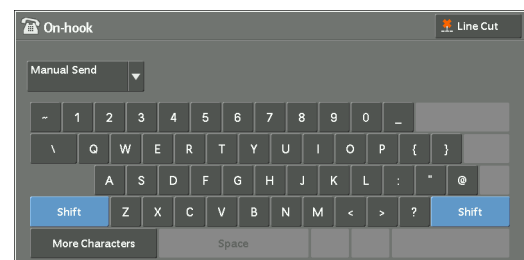

- 4 When the call is connected, lift the receiver and start speaking.

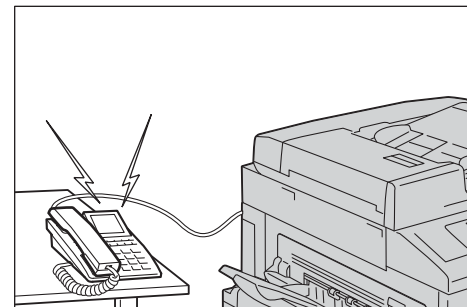

- 5 After the call is finished, place the receiver back in the cradle.

Note

- Make sure that the receiver is placed properly in the cradle. Otherwise, the line remains "busy".

Activity Report

You can print activity reports to check whether a transmission is successfully completed or not. In the report, a remote terminal name and a result or a status of each operation are recorded by outgoing and incoming transmission.

For information on how to print the activity report, refer to "Print Reports" (P.86).

Item	Description
No.	The serial numbers for transmissions is shown.
Doc.	Job numbers that the machine automatically assigned to documents when the documents were received.
Remote Station	<p>Information on recipient to which transmission is made is recorded in the following order of priority.</p> <p>Transmitting (speed dialing)</p> <ol style="list-style-type: none"> 1. Recipient 2. Remote terminal name 3. G3 ID (including spaces) 4. Tel. No. 5. Communication mode EC (or G3, SG3) <p>Transmitting (when all digits are dialed)</p> <ol style="list-style-type: none"> 1. Remote terminal name 2. G3 ID (including spaces) 3. Tel. No. 4. Communication mode EC (or G3, SG3) <p>Receiving</p> <ol style="list-style-type: none"> 1. Remote terminal name 2. G3 ID (including spaces) 3. Communication mode EC (or G3, SG3) <p>Note • You can set the number of character digits displayed for the recipient whether the first 40 digits or the last 40 digits. For details on setting up, see "Activity Report - Recipient" (P.138). The factory default displays the first 40 digits.</p>
Start Time	The date and time that the communication began are shown. In Batch Send, the start time of the transmission for each document is recorded.
Duration	The duration of the transmission is displayed. In Batch Send, it is the length of time taken to transmit each document is recorded.

Item	Description
Pages	<p>"-" is shown when the number of pages is 0.</p> <p>Transmitting</p> <p>The number printed on the left side of the slash "/" indicates the number of pages that were successfully transmitted. The number printed on the right side of the slash "/" indicates the number of total pages. In Batch Send, the number of total pages is not shown.</p> <p>Receiving/Polling</p> <p>The number of pages that the machine successfully received is shown.</p> <p>Note • Depending on the transmission status on the recipient's machine or the setting of the machine, the value in [Pages] may differ from the actual number of pages printed.</p>
Mode	<p>The mode used for the communication is shown.</p> <p>There are three modes: G3, EC, and SG3 (Super G3). (This field is blank if a mode other than above these was used.)</p>
Contents	<p>The information about the communication is indicated. See the Note field at the bottom of the report for a list of abbreviations and their definitions.</p> <p>Transmitting</p> <ol style="list-style-type: none"> 1. Remote service 2. Redial 3. Folder XXX 4. Broadcast/Multi-Poll 5. Polling 6. Relay Broadcast Assignment 7. Fax forwarding box XXX <p>Receiving</p> <ol style="list-style-type: none"> 1. Folder XXX 2. Polling 3. Receiving line box XXX <p>Note • XXX indicates the Folder number.</p>

Item	Description
Status	<p>The result of the operation is indicated.</p> <p>Completed : The operation ended normally.</p> <p>Busy : The recipient is busy or did not answer.</p> <p>Auto Send : The document is being re-sent and the set re-send times has not been exceeded.</p> <p>Canceled : The communication was terminated.</p> <p>Check Remote Station : An error caused by the recipient or the line during communication.</p> <p>Send Again : The document must be re-sent because the re-send times have reached the maximum due to a transmission error.</p> <p>Receive Again : A polling request must be re-sent due to a polling reception error. Or, you must ask a sender to resend the document due to a reception error.</p> <p>Disconnected : Check that the line is properly connected.</p> <p>XXX-XXX : Status code</p> <p>For more information on lines, refer to "2 Product Overview > "Machine Components" > "Telephone line connectors" in the User Guide and for more information on XXX-XXX (status code), refer to "Status Code" (P.422).</p> <p>For more information on how to connect network cables, refer to "Using the Ethernet Interface" (P.20).</p>
Total	All pages received or sent are recorded.

Index

Numerics

1000BASE-T	283
100BASE-TX	283
10BASE-T	283
2 Pages Up On Receipt	209
2 Sided Copying (default value)	161
2 Sided Printing	209
2 Sided Report	138

A

Access Control	261
According to Print Auditron	267
Account Administration	372
Account Details	254
Account Limit	252, 253
Accounting	251
Accounting Login Screen Settings	256
Accounting Type	255
Accounting/Billing Device	258
Accounting/Billing Device Settings	258
Activity Report	87, 138, 602
Add Address Book Entry	241
Add Domain Name to User Name	189
Add Fax Comment	249
Add Me to "CC" Field	218
Add Me to "To" Field	218
Address Book	90, 91, 219
Address Type	243
Adjust Image Transfer	139, 523
Adjust Paper Registration	140
Administrator Shared Folder	357
Administrator Shared Job Flow Sheet	356
Alert Tone	128
Allocate Memory	190
Allow Casual Users to Edit From Field	218
Allow Guest Users to Edit From Field	218
Allow to edit From if Search Failed	218
Allow to edit From if Search Found	218
Allow User to Disable Active Settings	269
Alternative Name for Account ID	257
Alternative Name for User ID	256, 264

Annotations	163
Annotations - Comment Density	166
Annotations - Create Comments	167
applicable lines	516
ART IV, ESC/P, 201H Form Memory	190
Audio Tones	127
Auditron Mode	256
Auditron Reports	93
authenticated user	346
Authentication	106, 261, 368, 593
Authentication System Setup	179
Authentication/Security Settings	260
Authorization Groups	347
Auto Clear	26, 125
Auto Clear Alert Tone	128
Auto Display of Login Screen	129
Auto Job Promotion	145
Auto Job Release	125
Auto Paper Off	165
Auto Paper Select	132
Auto Print	125
Auto Receive	98
Auto Reduce On Receipt	208
Auto Select	47
Auto Tray Switching	134
Auto Validation of Speed Dial Entry	157
Automatically Configured IPv6 Address	176
automatically printed reports/lists	94

B

Background Pattern (Watermark)	140
Background Suppression	136, 165
Background Suppression (default value)	161, 199
Background Suppression Level	202
Banner Sheet	194
Banner Sheet Offset	195
Banner Sheet Tray	195
Base Tone	128
Batch Send	208
Bates Stamp	164
Billing	248
Billing Data List	92

Billing Information.....	101
Block Inbound Faxes.....	210
Block Unknown Fax Numbers.....	210
Bonjour	170, 284
booklet finishing.....	518
Booklet Maker Unit for Finisher-B1.....	67
Border Limit	208
Bottom Left Cover.....	496
Broadcast Checkbox on 1st Tab.....	207
Broadcast Report	95
Broadcast Starting Rate	214
Broadcast/Multi-Poll Report.....	138
Bypass Proxy Server.....	177
bypass tray	498

C

Calibration	137
capacity.....	517, 518
Center Erase/Binding Edge Erase	162
Center Unit	502
Certificate Revocation Retrieval Settings.....	188
Chain Dial	207
changing the paper size	51
changing the paper type.....	54
Charge Print Jobs	259
Charge Rate Per Unit.....	258
Charge/Private Print Settings	266
Check Folder Passcode	232
Check Smart Card Details.....	139
cleaning the machine.....	70
coding method	516
Color Balance	161
color capability	510
Color Scanning.....	198
Color Shift	161
Color Space	199, 202
ColorTrack.....	256
Comment Position.....	166
Common Service Settings	124
Company Logo.....	212
Configuration Report	88, 90, 91
configuring the SNMP port	317
Confirmation Options	205
Connect with Accounting/Billing Device	258
Connection Interval.....	125

connectivity.....	513
Constant Velocity Transport Glass.....	72
consumables.....	58, 154
consumables status notice (by e-mail)	300
continuous copy	512
continuous copy speed	511
continuous print speed.....	512
Contrast.....	161, 198
Control Panel.....	25
Control Panel Alert Tone.....	128
Control Panel Select Tone	128
Convert Custom Size to Standard Size.....	220
Copy	158
Copy Control	164
Copy Defaults	159
Copy Output.....	162
Copy Reports	88
Copy Service Settings.....	158
copying a job flow sheet	241
Cover Page	246
Cover Tray.....	164
Covers.....	164
Create Authorization Groups	263
Create Folder.....	231
Create Job Flow Sheet.....	233
Create Job Flow Sheet Keyword	241
Create Text String.....	143
Create/View User Accounts.....	251
creating a new job flow	235
Creating Fax Group Recipients	248
Custom Button	31, 129
Custom Colors.....	167
Custom Watermark (Watermark)	141
Customize User Prompts	256

D

Data Encryption	154
Data Indicator	157
Date Stamp	163
Daylight Savings	126
Deactivate With wakeup motion sensor	127
Default Language	130
Default Print Paper Size.....	145
Default Programming.....	98
Default Watermark (Watermark)	140

-
- | | | | |
|--|--------------------|--|--------------------|
| Delay Start..... | 247 | E-mail Control..... | 216 |
| Delay Start - Specific Time | 205 | E-mail Encryption | 337 |
| Delete All Certificates/Initialize Settings..... | 140 | E-mail notification | 300 |
| Delete All Data | 139 | E-mail Notification Service..... | 171 |
| Delete Expired Files | 232 | E-mail Printing | 300 |
| Delete Files After Retrieval | 232 | E-mail Sending When Search Failed | 218 |
| Delete Folder | 233 | E-mail Subject | 199 |
| Delete Form | 192 | E-mail/Internet Fax Service Settings..... | 216 |
| Delete Remote Accounts..... | 265 | emulation | 513, 526, 543, 551 |
| deleting a job flow sheet | 241 | Encryption..... | 330 |
| Delivery Confirmation Method | 214 | Encryption Key for Confidential Data | 156 |
| Delivery Receipts/Read Receipts..... | 205 | entering text..... | 34 |
| Dell Printer Configuration Web Tool..... | 274, 286, 305, 591 | Error History Report | 87, 99 |
| Device Access | 262 | ESC/P Logical Printers List..... | 89 |
| Digital Signature | 330, 337 | ESC/P Settings List | 89 |
| dimensions | 512 | Ethernet | 20 |
| dimensions/weight | 517, 518 | Ethernet II..... | 283 |
| Direct Fax..... | 210 | Ethernet Rated Speed | 173 |
| DNS..... | 301 | EtherTalk | 170, 297 |
| document cover..... | 72 | Expiration Date for Files in Folder..... | 223 |
| document feeder | 504 | Express Code | 85 |
| Document Feeder Rollers..... | 73 | extension tray..... | 48 |
| document glass..... | 72 | | |
| document jams..... | 504 | F | |
| document size | 516 | | |
| Domain Filter List | 90, 91 | F Code..... | 247 |
| Domain Filtering | 189 | Failed Access Log | 264 |
| Domain Name..... | 177 | Fault Tone | 128 |
| Drum Cartridge Conservation Mode | 157 | Fax Billing Data | 257 |
| Dual Color - Non-target Area Color | 160 | Fax Comments List..... | 92 |
| Dual Color - Source Color..... | 160 | Fax Control..... | 206 |
| Dual Color - Target Area Color | 160 | Fax Data in Folder Priority | 210 |
| Duplex Automatic Document Feeder..... | 517 | Fax Defaults..... | 205 |
| duplex module | 501 | Fax Number | 246 |
| Duplex Output Unit..... | 517 | Fax Received Options | 211 |
| | | Fax Receiving Mode | 98, 208 |
| E | | Fax Reports | 90 |
| | | Fax Screen Default | 204 |
| Edge Erase | 161 | Fax Service Settings..... | 204 |
| Edge Erase - Left & Right Edges | 209 | Fax Transfer from Address Book..... | 215 |
| Edge Erase - Top & Bottom Edges | 209 | Fax Transfer Maximum Data Size | 215 |
| Edge Erase (default value) | 199 | Feature Access | 252 |
| Edit E-mail Recipients..... | 218 | feeding speed | 517 |
| editing a job flow sheet..... | 241 | File Format | 198 |
| E-mail | 300, 308 | Files Retrieved By Client..... | 220 |
| E-mail Address | 243, 252 | Fine-tune 100%..... | 165 |
-

Finisher Adjustment	139
Finisher Top Cover	502
Finisher-B1	66, 68, 501, 506
first copy output time	511
First Tab - Scan	197
Folder List	92
Folder Name	232
Folder Report	138
Folder Selector List	91
Folder Selector Setup	209, 211
Folder Service Settings	220
Font Color (Watermark)	140
Font List	89
Font Size (Watermark)	140
fonts	513
Force Annotation	141
Force Watermark - Client Print	141
Force Watermark - Copy	141
Force Watermark - Media Print	141
Force Watermark - Print Stored File	141
FTP	170, 312
FTP client port	313

G

G3	212
G3 Line - Dial Type	213
G3 Line - Fax ID	212
G3 Line - Line Type	213
General Shared Folder	357
Generation of URL Link	203
Given Name	244
Guest User	265

H

halftone/printable colors	510
handling paper	46
hard clip area	559
HCF	499, 518
HDD	510
hole punch waste container	68
Host Name	176
HP-GL/2 Auto Layout Memory	190
HP-GL/2 Logical Printers List	89

HP-GL/2 Palette List	89
HP-GL/2 Settings List	89
HTTP	275
HTTP Proxy Server	177
HTTPS	332
HTTPS Proxy Server	177

I

ID Card Copy	165
IEEE 802.1x Settings	187
IEEE802.3	283
Image Enhancement	137
image quality	134
image quality trouble	384
Image Rotation	162
Image Shift	162
Image Transfer Screen	202
Incoming E-mail Print Options	216
Incoming Internet Fax Print Options	214
Index	246
Initialize Hard Disk	139
internal fonts	520
Internet Fax Control	213
Internet Fax Output Destination	214
Internet Fax Path	213
Internet Fax Profile	205, 248
Internet Fax Subject	206
Internet Fax to E-mail	220
Internet Fax to Internet Fax	220
Internet Printing Protocol	295
Internet Services	172, 316
Interrupt Mode	258
IP Address	85
IPP	170, 295
IPSec Settings	186
IPv4 - DNS Server Setup	175
IPv4 - IP Address Resolution	174
IPv4 Address	174
IPv4 Gateway Address	174
IPv4 IP Filter	175
IPv4 Subnet Mask	174
IPv6 Address Manual Configuration	175
IPv6 IP Filter	176

J

Job Complete Tone	128
Job Completion Notice.....	300
Job Counter Report	92
Job Flow Error Report.....	95, 138
Job Flow Scanning	308
Job Flow Service Settings	221
job flow sheet shared by local users.....	356
job flow sheet types.....	356
Job Flow Sheets.....	316
Job Flows	592
Job History Report	87, 138
Job Status Default.....	269
Job Status/Activity Report	87
Job Ticket Memory	190
Job with Insufficient Credit	259
jobs manageable by Account Administration.....	365

K

Kerberos Server Settings	179
Keyboard Input Restriction	154

L

Language	130
Language of the Original.....	200
layout template	142
LDAP Server/Directory Service	180
LED printhead.....	70
Lighten/Darken	160, 205
Lighten/Darken (default value)	198
limited paper	41
Line 1 - Company Logo.....	212
Line Monitor Volume	129
Link Job Flow Sheet to Folder	233
linking job flow sheets to folders.....	358
loading paper.....	47
local access.....	262
Local Accounting	255, 349
Local machine authentication	368
Local Name	212
Local Terminal Information.....	212
local user.....	346
login	106

Login Credential to Access Destination.....	200
Login to Local Accounts	348
Login to Remote Accounts	348
Login Type	261
Logout Confirmation Screen	264
Low Power Mode	21
Low Toner Alert Tone	128
LPD	169, 287, 291
LPD Print Queue.....	195

M

Machine Clock/Timers	124
machine configuration	86, 277
machine information.....	85
Machine Name	176
Machine Password	212
Machine Ready Tone.....	128
Machine Status	84
machine trouble.....	379
machine's E-mail address.....	176, 304, 327
Manual Receive.....	98
Manual Redial List - Dial Mode	207
Manual Redial List - Saved Entries	207
Manual Send.....	208
Manual Send/Receive Default	208
Manually Configured IPv6 Address	175
Manually Configured IPv6 Address Prefix	175
Manually Configured IPv6 Gateway.....	175
Mask Account ID (***).....	257
Mask User ID (***)	256, 264
Maximum Address Entries.....	216
Maximum Data Size per E-mail	217
maximum fill line	48, 49, 53
Maximum Image Size	246
Maximum Login Attempts	266
Maximum Number of Sets.....	166
Maximum Passcode Length for Stored Jobs	224
Maximum Split Count	217
Maximum Stored Pages	164, 202, 203, 210
Maximum Total Data Size.....	217
Media Print Service Settings.....	222
media print trouble.....	420, 421
memory	510
Memory Full Procedure.....	164, 202, 209
messages	422

Microsoft Network	293
Minimum Passcode Length.....	266
Mixed Size Originals.....	161, 199, 205
Mixed Size Originals - 2 Sided Copy.....	165
Mixed Size Originals Scan Mode.....	210
Multi-poll Report.....	95

N

NetWare.....	169, 290
network.....	282
Network Accounting.....	255, 349
notes and restrictions.....	569
NTP Time Synchronization.....	125
number of fax lines.....	516

O

Odd Page 2 Sided.....	145
off-hook dialing.....	600
Offset Stacking.....	144
one touch button.....	129
on-hook dialing.....	600
operating system.....	513, 516
Operation of Up/Down Buttons.....	154
Optimize PDF For Quick Web View.....	198
optional components.....	522
Original Orientation.....	162, 199
original paper size.....	510, 513, 517
Original Size Defaults.....	166, 201, 212
Original Type.....	160, 198, 205
Original Type - Auto (Black & White).....	160
Original Type - Auto (Non-Black & White).....	160
Original Type - See-Through Paper.....	166
Out of Paper Warning Tone.....	128
outgoing/incoming E-mail settings.....	178
Output Color.....	160
Output Color (Simple Copy).....	160
Output Destination.....	163
Output Destination for E-mail.....	189
output paper size.....	510, 512
output paper weight.....	510
Output Size Defaults.....	201
output tray capacity.....	512
Overwrite Hard Disk.....	95, 269

P

Pages per Side.....	162
paper color.....	132
paper guides.....	49, 51
paper jams.....	495
paper size.....	132, 518
Paper Size Settings.....	145
paper size/paper weight.....	517
Paper Supply.....	132, 159
Paper Tray Attributes.....	132
paper tray capacity.....	512
Paper Tray Priority.....	133
Paper Tray Status.....	86
paper type.....	132
Paper Type Mismatch.....	193
Paper Type Priority.....	133
paper types.....	36
Paper Weight.....	517, 518
Passcode.....	106
Passcode Entry from Control Panel.....	266
Passcode Policy.....	266
Password.....	245
PCL Font List.....	89
PCL Macro List.....	88
PCL Settings List.....	88
PDF Direct Print.....	541
PDF Settings List.....	89
PDF signature.....	341
PDF/XPS Signature Settings.....	186
PDL.....	512
Personal Folder.....	357
Personal Job Flow Sheet.....	356
Photo & Text/Printed Original.....	165
Photos - Paper Supply.....	222
Polled Documents - Auto Delete.....	207
POP3.....	304, 327
POP3 Server Settings.....	178
Port 9100.....	170, 287
Port Number.....	245
Port Settings.....	168
PostScript Default Color.....	195
PostScript Font Absence.....	195
PostScript Font List.....	89
PostScript Font Substitution.....	195
PostScript Logical Printers List.....	89

-
- PostScript Memory 190
- PostScript Paper Supply 195
- power consumption 512
- Power on Self Test 139
- Power Saver Mode..... 21, 127
- Power Saver Timers 127
- power supply..... 512
- Print & Delete Confirmation Screen..... 220
- Print Area 192
- Print Delivery Confirmation Mail..... 217
- Print Error Notification E-mail 216
- Print Job Confirmation Screen 224
- Print Login Name on PDF Files 203
- Print Mode 96
- Print Order for All Selected Files 224
- Print Reports 86, 137
- Print Service Settings..... 190
- Print this Sample List (Watermark) 141
- Print User ID..... 194
- printable area..... 519, 560
- Printer Lockout 126
- Printer Reports 88
- printing a report/list 79
- printing resolution 510, 512
- Print-On-Demand Duration 126
- Private Charge Print 80
- problem solving..... 377
- Profile for Broadcast Job 213
- Protocol Settings 173
- Protocol to Receive E-mail 189
- proxy server..... 177
- Pseudo-Photo Gradation Mode 209
- punch..... 518
- Q**
- Quality/File Size..... 199
- Quality/File Size for Retrieval 220
- Quantity Display 166
- R**
- Read Receipts 217
- Receive Control..... 267
- Receive E-mail 171, 326
- Receiving Buffer - EtherTalk 192
- Receiving Buffer - IPP 191
- Receiving Buffer - LPD 191
- Receiving Buffer - NetWare 191
- Receiving Buffer - Port 9100 192
- Receiving Buffer - SMB 191
- Receiving Buffer - USB..... 191
- Receiving Paper Size..... 208
- receiving protocol 304, 327
- Reconfirm E-mail Recipient 130
- Reconfirm Fax/Internet Fax Recipient..... 131
- recording paper size 515
- Reduce 8.5 x 11" Original to A4..... 209
- Reduce/Enlarge 159
- Reduce/Enlarge Presets 167, 201, 211
- Re-enter Broadcast Recipients 206
- Re-enter Group Recipients 206
- Re-enter Recipients 206
- Re-enter Speed Dial Recipients 206
- registering a server to setup..... 227
- Relay Broadcast 247
- remote accounting..... 349
- remote authentication..... 368
- Remote Folder 247
- Reset Account 253
- Reset Total Impressions 254
- Reset User Accounts 254
- Resolution 199, 205, 246
- Response to Read Receipts 216
- Restore Tool..... 81
- Restrict Recipient Selection Method 157
- Restrict User to Edit Address Book 157
- Resume Job After Print Error..... 193
- Retrieve Programming..... 96
- Ringing Volume 129
- Rotate 90 degrees..... 207
- RSA BSAFE..... 2
- S**
- S/MIME..... 305, 328
- S/MIME certificate 244
- S/MIME Settings 185
- Sample Job 163
- Saturation..... 161, 202
- Save Deleted Faxes..... 207
- Save in Charge Print 268
-

Save in Private Charge Print.....	268	Skip Blank Pages	205, 210
Save Undelivered Faxes	207	Sleep Mode	21
Saved Faxes - Auto Delete.....	208	smart card.....	264, 266
Scan Ahead for Copy Job.....	259	Smart Card Certificate Verification	265
Scan Defaults	198	Smart Card Link Mode	265
Scan File Transfer Report.....	138	SMB.....	169, 293, 312
Scan Reports.....	89	SMB port	313
Scan Service Settings	197	SMB Server Settings	184
Scan to e-mail.....	515	SMTP	304, 327
Scan to PC.....	308, 312, 515	SMTP Server Settings	178
scanning halftone	513	SNMP	170
scanning resolution	510, 513, 516	SNMP port	316
scanning speed	513	SOAP	172, 173
Screen After Auto Clear.....	129	SOAP port	316
Screen Brightness	32, 130	Software Download.....	157
Screen Default.....	129	Software Options	139
Screen Type.....	137	Software Version	86
Screen/Button Settings.....	129	space requirement	512, 518
Searchable - Page Orientation.....	203	special media.....	40
Searchable Text.....	200	Split Send Method.....	217
Searchable Text Compression.....	200	SSL/TLS Communication	184
Security Settings	184	SSL/TLS Settings.....	184
semi standard paper	37	stacker capacity	517
send document size.....	515	standard paper.....	36
Send E-mail.....	171, 326	Standard Size Threshold Value.....	220
Separator Tray.....	162	staple	517
Separators	164	Staple Cartridge	66, 67, 506
Serial Number	85	staple faults	506
Server Certificate Verification Settings	225	Starting Rate	205, 246
Server Name/IP address	245	STATIC.....	174
Service Access.....	262	status code.....	422
Service Rep. Restricted Operation	156	Store & Send Link	308, 318
Service Tag.....	85	Store & Send Link - Maximum File Size	203
setting via BOOTP.....	174	Store & Send Link - Subject	200
setting via DHCP.....	174	Store to Folder	308, 514
setting via DHCP/Autonet	174	Store to USB	308, 315
setting via RARP	174	Store to WSD	320
Setup.....	231	Store User Details.....	257
Shadow Suppression	199	Stored File List	88
Shadow Suppression Level	202	Stored File Settings	223
Shared Name (SMB Only)	245	Stored Job Expiration Date.....	223
Sharpness.....	161	Stored Programming Tone.....	129
Sharpness (default value)	198	Subnet mask.....	301
Sheet Filtering.....	235	Substitute Tray	192
Side Tray.....	518	Supplies	100
Single Color.....	160	supported frame types	283

supported interfaces.....	283
supported operating systems	284
System Administration mode.....	106, 109
System Administrator Login ID.....	260
System Administrator Meter (Copy Jobs)	255
System Administrator Passcode	260
System Administrator Settings	260

T

TCP/IP.....	287
TCP/IP - IP Mode	173
Text - Paper Supply	222
Thumbnail - Outgoing E-mail	198
Thumbnail - Scan to PC.....	198
TIFF / JPEG Logical Printers List.....	89
TIFF / JPEG Settings List	89
TIFF Format	202
Time Server Address	125
Time Zone.....	126
toner cartridge.....	58
Tools menu	110
Top left cover	497
touch screen	72
Track Print Jobs.....	258
Track Scan/Fax Jobs.....	258
Track with Cumulative Device	259
Transfer Protocol	200, 245
Transmission Header Text	205
Transmission Header Text - Fax Transfer.....	215
Transmission Header Text - Polling	207
Transmission Interval	208
transmission mode	516
Transmission Report.....	95
Transmission Report - Job Deleted.....	138
Transmission Report - Job Undelivered.....	94, 138
Transmission Screen.....	204
transmission speed.....	516
transmission time.....	515
tray capacity	517
trouble during copying.....	390
trouble during printing.....	394
trouble during scanning.....	401
troubleshooting.....	378
types of authentication.....	347

U

unable to copy.....	390
unable to print	394
unable to receive a fax	399
unable to send a fax	397
unauthenticated user.....	346
Uncollated with Separators	162
unit (millimeters/inches).....	154
UNITED STATES GOVERNMENT	
RESTRICTED RIGHTS.....	2
Universal Unique ID	143
Unregistered Forms	193
unusable paper.....	46
UPnP Discovery	171
Upper Left Cover.....	495
URL File Expiration	203
usable paper	37
USB.....	19, 285
USB memory device	131
Use of Smart Card	265
User Account Billing Information.....	102
User Authentication	374
User Details Setup.....	264
User ID.....	106
User ID for Login.....	264
User Name	245, 252
User Name for FTP Scan	200
User Role.....	253

V

Verify User Details.....	256
verifying server certificates	225

W

warm-up time.....	510
Watermark/Background Contrast (Watermark)	141
Web Applications - Enable File Printing	230
Web Applications Service Setup	225
Web Applications Version	229
Web Browser Setup.....	229
WebDAV	172
weight	512
WSD	171, 284

X

XPS Print Ticket Processing..... 195

www.dell.com | dell.com/support

KE3023EN0-1