

Dell EMC Networking N-Series  
N1100-ON, N1500, N2000,  
N2100-ON, N2200-ON, N3000E-  
ON, N3100-ON and N3200-ON  
Switches

User's Configuration  
Guide  
Version 6.7.0



Regulatory Models: E04W, E05W, E06W,  
E07W, E15W, E16W, E17W, E18W, E30W,  
E31W, E32W, E41W

# Notes and Cautions



**NOTE:** A NOTE indicates important information that helps you make better use of your computer.



**CAUTION:** A CAUTION indicates potential damage to hardware or loss of data if instructions are not followed.

---

**Information in this publication is subject to change without notice.**

**Copyright © 2021 Dell EMC Inc. All rights reserved.**

Reproduction of these materials in any manner whatsoever without the written permission of Dell Inc. is strictly forbidden.

This product is protected by U.S. and international copyright and intellectual property laws. Dell EMC™ and the Dell EMC logo are trademarks of Dell EMC Inc. in the United States and/or other jurisdictions. All other marks and names mentioned herein may be trademarks of their respective companies.

**Marketing Models: N1108T-ON, N1108P-ON, N1108EP-ON, N1124T-ON, N1124P-ON, N1148T-ON, N1148P-ON, N1524, N1524P, N1548, N1548P, N2024, N2024P, N2048, N2048P, N2128PX-ON, N2224X-ON, N2224PX-ON, N2248X-ON, N2248PX-ON, N3000E-ON, N3132PX-ON, N3208PX-ON, N3224T-ON, N3224F-ON, N3248X-ON, N3248TE-ON, N3224PX-ON, N3224P-ON, N3248P-ON, N3248PX-ON**

**Regulatory Models: E04W, E05W, E06W, E07W, E15W, E16W, E17W, E18W, E30W, E31W, E32W, E41W**

# Contents

1	Introduction . . . . .	53
	<b>About This Document</b> . . . . .	<b>53</b>
	<b>Audience</b> . . . . .	<b>54</b>
	<b>Document Conventions</b> . . . . .	<b>54</b>
	<b>Additional Documentation</b> . . . . .	<b>55</b>
2	Switch Feature Overview . . . . .	57
	<b>System Management Features</b> . . . . .	<b>58</b>
	Multiple Management Options . . . . .	58
	System Time Management . . . . .	58
	Log Messages . . . . .	59
	System Reset . . . . .	59
	Integrated DHCP Server . . . . .	59
	Management of Basic Network Information . . . . .	60
	IPv6 Management Features . . . . .	60
	Dual Software Images . . . . .	60
	File Management . . . . .	61
	Switch Database Management Templates . . . . .	61
	Automatic Installation of Firmware and Configuration	61
	sFlow . . . . .	62
	SNMP Alarms and Trap Logs . . . . .	62
	CDP Interoperability Through ISDP . . . . .	63
	Remote Monitoring (RMON) . . . . .	63
	<b>Stacking Features</b> . . . . .	<b>63</b>
	Mixed and Single Series Stacking . . . . .	63

Single IP Management . . . . .	65
Primary Failover with Transparent Transition . . . . .	65
Nonstop Forwarding on the Stack . . . . .	65
Hot Add/Delete and Firmware Synchronization . . . . .	65
<b>Security Features . . . . .</b>	<b>67</b>
Configurable Access and Authentication Profiles . . . . .	67
Password-Protected Management Access . . . . .	67
Strong Password Enforcement . . . . .	67
TACACS+ Client . . . . .	67
RADIUS Support . . . . .	68
SSH/SSL . . . . .	68
Inbound Telnet Control . . . . .	68
Denial of Service . . . . .	68
Port Protection . . . . .	69
Captive Portal . . . . .	70
802.1X Authentication (IEEE 802.1X) . . . . .	70
MAC-Based 802.1X Authentication . . . . .	71
802.1X Monitor Mode . . . . .	71
Port Security . . . . .	72
Access Control Lists (ACLs) . . . . .	72
Time-Based ACLs . . . . .	72
IP Source Guard (IPSG) . . . . .	73
DHCP Snooping . . . . .	73
Dynamic ARP Inspection . . . . .	73
Protected Ports (Private VLAN Edge) . . . . .	73
<b>Green Technology Features . . . . .</b>	<b>74</b>
Energy Detect Mode . . . . .	74
Energy Efficient Ethernet . . . . .	74
Power Utilization Reporting . . . . .	75
<b>Power over Ethernet (PoE) Features . . . . .</b>	<b>75</b>
PD Detection . . . . .	75

Legacy (Reduced Capacitor) Detection . . . . .	75
Classification . . . . .	76
Port Start Up . . . . .	76
Overload Detection and Port Shutdown . . . . .	76
Disconnect Detection . . . . .	76
IC Thermal Monitoring . . . . .	76
Over-Temperature Protection . . . . .	77
4-Pair Ports . . . . .	77
IEEE 802.3bt Capability . . . . .	78
PoE Port Capabilities and Power Limits . . . . .	79
Key PoE Plus Features . . . . .	81
Power Over Ethernet (PoE) Support . . . . .	82
PoE Plus Support . . . . .	82
PoE 60W Support . . . . .	82
Powered Device Detection . . . . .	83
PoE Power Management Modes . . . . .	83
Power Management in Guard Band . . . . .	85
PoE Plus Default Settings . . . . .	87
<b>Switching Features . . . . .</b>	<b>88</b>
Flow Control Support (IEEE 802.3x) . . . . .	88
Head of Line Blocking Prevention . . . . .	88
Jumbo Frames Support . . . . .	88
Auto-MDI/MDIX Support . . . . .	88
VLAN-Aware MAC-based Switching . . . . .	88
Back Pressure Support . . . . .	89
Auto-negotiation . . . . .	89
Storm Control . . . . .	89
Port Mirroring . . . . .	90
Static and Dynamic MAC Address Tables . . . . .	90
Link Layer Discovery Protocol (LLDP) . . . . .	90
Link Layer Discovery Protocol (LLDP) for Media Endpoint Devices . . . . .	91
Connectivity Fault Management (IEEE 802.1ag) . . . . .	92

Cisco Protocol Filtering . . . . .	92
DHCP Layer-2 Relay . . . . .	92
<b>Virtual Local Area Network Supported Features . . . . .</b>	<b>93</b>
VLAN Support . . . . .	93
Port-Based VLANs . . . . .	93
IP Subnet-based VLAN . . . . .	93
MAC-based VLAN . . . . .	93
IEEE 802.1v Protocol-Based VLANs. . . . .	93
Voice VLAN . . . . .	94
GARP and GVRP Support . . . . .	94
Guest VLAN . . . . .	94
Unauthorized VLAN . . . . .	94
Double VLANs. . . . .	94
<b>Spanning Tree Protocol Features . . . . .</b>	<b>95</b>
Spanning Tree Protocol (STP) . . . . .	95
Spanning Tree Port Settings . . . . .	95
Rapid Spanning Tree . . . . .	95
Multiple Spanning Tree . . . . .	95
Bridge Protocol Data Unit (BPDU) Guard. . . . .	96
BPDU Filtering . . . . .	96
RSTP-PV and STP-PV. . . . .	96
<b>Link Aggregation Features. . . . .</b>	<b>97</b>
Link Aggregation . . . . .	97
Link Aggregate Control Protocol (LACP) . . . . .	98
Multi-Switch LAG (MLAG) . . . . .	98
<b>Routing Features . . . . .</b>	<b>99</b>
Address Resolution Protocol (ARP) Table Management	99
VLAN Routing . . . . .	99
IP Configuration. . . . .	99
Open Shortest Path First (OSPF) . . . . .	100
Border Gateway Protocol (BGP) . . . . .	100

Virtual Routing and Forwarding . . . . .	100
BOOTP/DHCP Relay Agent . . . . .	101
IP Helper and DHCP Relay . . . . .	101
Routing Information Protocol. . . . .	101
Router Discovery . . . . .	101
Routing Table . . . . .	101
Virtual Router Redundancy Protocol (VRRP). . . . .	102
Tunnel and Loopback Interfaces. . . . .	102
<b>IPv6 Routing Features . . . . .</b>	<b>103</b>
IPv6 Configuration . . . . .	103
IPv6 Routes . . . . .	103
OSPFv3 . . . . .	103
DHCPv6 . . . . .	103
<b>Quality of Service (QoS) Features . . . . .</b>	<b>104</b>
Differentiated Services (DiffServ) . . . . .	104
Class Of Service (CoS) . . . . .	104
Auto Voice over IP (VoIP). . . . .	104
Internet Small Computer System Interface (iSCSI) Optimization. . . . .	105
<b>Layer-2 Multicast Features . . . . .</b>	<b>105</b>
MAC Multicast Support. . . . .	105
IGMP Snooping. . . . .	105
IGMP Snooping Querier . . . . .	106
MLD Snooping . . . . .	106
Multicast VLAN Registration . . . . .	106
<b>Layer-3 Multicast Features . . . . .</b>	<b>107</b>
Distance Vector Multicast Routing Protocol. . . . .	107
Internet Group Management Protocol . . . . .	107
IGMP Proxy . . . . .	107
Protocol Independent Multicast—Dense Mode . . . . .	107
Protocol Independent Multicast—Sparse Mode . . . . .	108

	Protocol Independent Multicast—Source Specific Multicast	
	108	
	Protocol Independent Multicast IPv6 Support . . . . .	108
	MLD/MLDv2 (RFC2710/RFC3810) . . . . .	108
<b>3</b>	<b>Hardware Overview . . . . .</b>	<b>109</b>
	<b>Dell EMC Networking N1100-ON Series Switch Hardware 109</b>	
	N1100-ON Series Front Panel . . . . .	109
	N1100-ON Series Power Supply . . . . .	112
	N1100-ON Series Ventilation System . . . . .	112
	N1100-ON Series Thermal Shutdown . . . . .	112
	N1100-ON Series LED Definitions . . . . .	112
	Power Consumption for N1100-ON Series PoE Switches	116
	N1100-ON Series Wall Installation . . . . .	117
	<b>Dell EMC Networking N1500 Series Switch Hardware 119</b>	
	N1500 Series Front Panel . . . . .	119
	N1500 Series Back Panel . . . . .	123
	N1500 Series LED Definitions . . . . .	124
	Power Consumption for N1500 Series PoE Switches	127
	<b>Dell EMC Networking N2000 Series Switch Hardware 128</b>	
	N2000 Series Front Panel . . . . .	128
	N2000 Series Back Panel . . . . .	132
	N2000 Series LED Definitions . . . . .	134
	Power Consumption for N2000 Series PoE Switches	137
	<b>Dell EMC Networking N2100-ON Series Switch Hardware 139</b>	
	N2100-ON Series Front Panel . . . . .	139
	N2100-ON Series Back Panel . . . . .	141
	N2100-ON Series LED Definitions . . . . .	141
	Power Consumption for N2100-ON Series PoE Switches	145
	<b>Dell EMC Networking N2200-ON Series Switch Hardware 148</b>	



N2200-ON Series Front Panel . . . . .	148
N2200-ON Series Rear Panel. . . . .	148
N2200X-ON Series Switch Ports . . . . .	149
N2200-ON Series Console Port. . . . .	150
N2200-ON Series USB Port. . . . .	151
N2200-ON Series Reset Button. . . . .	151
N2200-ON Series Port and System LEDs. . . . .	151
N2200-ON Series LED of Management Unit in Stack and Stack Number Display . . . . .	151
N2200-ON Series Power Supplies . . . . .	152
N2200-ON Series LED Definitions . . . . .	153
<b>Dell EMC Networking N3000E-ON Series Switch Hardware</b>	<b>157</b>
Front Panel . . . . .	157
Back Panel . . . . .	163
LED Definitions . . . . .	165
Power Consumption for PoE Switches. . . . .	170
<b>Dell EMC Networking N3100-ON Series Switch Hardware</b>	<b>172</b>
N3100-ON Series Front Panel . . . . .	172
N3100-ON Series Back Panel . . . . .	174
N3100-ON Series LED Definitions . . . . .	174
Power Consumption for N3100-ON Series PoE Switches	179
<b>Dell EMC Networking N3200-ON Series Switch Hardware</b>	<b>183</b>
N3200-ON Series Front Panel . . . . .	183
N3200-ON Series Rear Panel. . . . .	183
N3200-ON Series Switch Ports. . . . .	184
N3200-ON Series Console Port. . . . .	185
N3200-ON Series USB Port. . . . .	186
N3200-ON Series Reset Button. . . . .	186
N3200-ON Series Port and System LEDs. . . . .	187
N3200-ON Series LED of Management Unit in Stack and Stack Number Display . . . . .	187

	N3200-ON Series Power Supplies . . . . .	187
	N3200-ON Series LED Definitions. . . . .	188
	<b>Switch MAC Addresses . . . . .</b>	<b>201</b>
	<b>Cables and Optics . . . . .</b>	<b>203</b>
<b>4</b>	<b>Using Dell EMC OpenManage Switch Administrator . . . . .</b>	<b>207</b>
	<b>About Dell EMC OpenManage Switch Administrator. . . . .</b>	<b>207</b>
	<b>Starting the Application . . . . .</b>	<b>208</b>
	<b>Understanding the Interface. . . . .</b>	<b>209</b>
	<b>Using the Switch Administrator Buttons and Links. . . . .</b>	<b>211</b>
	<b>Defining Fields . . . . .</b>	<b>212</b>
	<b>Understanding the Device View. . . . .</b>	<b>212</b>
	Using the Device View Port Features. . . . .	212
	Using the Device View Switch Locator Feature . . . . .	213
<b>5</b>	<b>Using the Command-Line Interface. . . . .</b>	<b>215</b>
	<b>Accessing the Switch Through the CLI . . . . .</b>	<b>215</b>
	Console Connection. . . . .	215
	Telnet Connection. . . . .	216
	<b>Understanding Command Modes . . . . .</b>	<b>217</b>
	<b>Entering CLI Commands . . . . .</b>	<b>219</b>
	Using the Question Mark to Get Help. . . . .	219
	Using Command Completion . . . . .	220
	Entering Abbreviated Commands. . . . .	220

	Negating Commands . . . . .	220
	Command Output Paging . . . . .	220
	Understanding Error Messages . . . . .	221
	Recalling Commands from the History Buffer . . . . .	221
<b>6</b>	<b>Default Settings</b> . . . . .	<b>223</b>
<b>7</b>	<b>Setting the IP Address and Other Basic Network Information</b> . . . . .	<b>227</b>
	<b>IP Address and Network Information Overview</b> . . . . .	<b>227</b>
	What Is the Basic Network Information? . . . . .	227
	Why Is Basic Network Information Needed? . . . . .	228
	How Is Basic Network Information Configured? . . . . .	229
	What Is Out-of-Band Management and In-Band Management? . . . . .	229
	<b>Default Network Information</b> . . . . .	<b>232</b>
	<b>Configuring Basic Network Information (Web)</b> . . . . .	<b>233</b>
	Out-of-Band Interface . . . . .	233
	IP Interface Configuration (Default VLAN IP Address) . . . . .	234
	Route Entry Configuration (Switch Default Gateway) . . . . .	236
	Domain Name Server . . . . .	238
	Default Domain Name . . . . .	239
	Host Name Mapping . . . . .	240
	Dynamic Host Name Mapping . . . . .	241
	<b>Configuring Basic Network Information (CLI)</b> . . . . .	<b>242</b>
	Enabling the DHCP Client on the OOB Port . . . . .	242
	Enabling the DHCP Client on the Default VLAN . . . . .	242
	Managing DHCP Leases . . . . .	243
	Configuring Static Network Information on the OOB Port . . . . .	244

Configuring Static Network Information on the Default VLAN	245
Configuring and Viewing Additional Network Information	246

**Basic Network Information Configuration Examples . . . . . 248**

Configuring Network Information Using the OOB Port	248
Configuring Network Information Using the Serial Interface	250

**8 Stacking . . . . . 253**

**Stacking Overview . . . . . 253**

Dell EMC Networking Stacking Compatibility . . . . .	257
How is the Management Unit in the Stack Selected?	258
Adding a Switch to the Stack . . . . .	259
Removing a Switch from the Stack . . . . .	260
How is the Firmware Updated on the Stack? . . . . .	261
What is Stacking Standby? . . . . .	261
What is Nonstop Forwarding? . . . . .	262
Switch Stack MAC Addressing and Stack Design Considerations . . . . .	265
NSF Network Design Considerations . . . . .	266
Why is Stacking Needed? . . . . .	266

**Default Stacking Values . . . . . 266**

**Managing and Monitoring the Stack (Web) . . . . . 268**

Unit Configuration . . . . .	268
Stack Summary . . . . .	269
Stack Firmware Synchronization . . . . .	270
Supported Switches . . . . .	271
Stack Port Summary . . . . .	272
Stack Port Counters . . . . .	273
Stack Port Diagnostics . . . . .	273
NSF Summary . . . . .	274
Checkpoint Statistics . . . . .	275

<b>Managing the Stack (CLI)</b> . . . . .	<b>276</b>
Configuring Stack Member, Stack Port, SFS and NSF Settings . . . . .	276
Viewing and Clearing Stacking and NSF Information	278
Connecting to the Management Console from a Stack Member . . . . .	279
<b>Stacking and NSF Usage Scenarios.</b> . . . . .	<b>279</b>
Basic Failover. . . . .	279
Preconfiguring a Stack Member . . . . .	281
NSF in the Data Center . . . . .	283
NSF and VoIP . . . . .	284
NSF and DHCP Snooping . . . . .	285
NSF and the Storage Access Network. . . . .	286
NSF and Routed Access . . . . .	288
<b>9 Authentication, Authorization, and Accounting</b>	<b>291</b>
<b>AAA Introduction</b> . . . . .	<b>291</b>
Methods . . . . .	292
Method Lists . . . . .	293
Access Lines . . . . .	294
Enabling SSH Access. . . . .	295
Access Lines (AAA) . . . . .	295
Access Lines (Non-AAA) . . . . .	296
<b>Authentication</b> . . . . .	<b>297</b>
Authentication Access Types . . . . .	297
Authentication Manager . . . . .	298
Using RADIUS . . . . .	307
Using TACACS+ . . . . .	312
Dynamic ACL Overview. . . . .	314
Authentication Examples. . . . .	321

Public Key SSH Authentication Example . . . . .	329
Associating a User With an SSH Key. . . . .	338
<b>Authorization . . . . .</b>	<b>340</b>
Exec Authorization Capabilities. . . . .	340
Authorization Examples. . . . .	342
RADIUS Change of Authorization. . . . .	344
TACACS Authorization . . . . .	348
<b>Accounting . . . . .</b>	<b>352</b>
RADIUS Accounting . . . . .	352
<b>IEEE 802.1X . . . . .</b>	<b>355</b>
What is IEEE 802.1X? . . . . .	355
What are the 802.1X Port Authentication Modes? . . . . .	356
What are Authentication Host Modes . . . . .	357
What is MAC Authentication Bypass? . . . . .	358
What is the Role of 802.1X in VLAN Assignment? . . . . .	360
What is Monitor Mode?. . . . .	364
How Does the Authentication Server Assign DiffServ Policy or ACLs? . . . . .	366
What is the Internal Authentication Server? . . . . .	366
Default 802.1X Values. . . . .	367
Configuring IEEE 802.1X (Web) . . . . .	368
<b>Captive Portal . . . . .</b>	<b>392</b>
Captive Portal Overview . . . . .	392
Default Captive Portal Behavior and Settings . . . . .	400
Configuring Captive Portal (Web). . . . .	402
Configuring Captive Portal (CLI) . . . . .	418
Captive Portal Configuration Example . . . . .	424
In Case Of Problems in Captive Portal Deployment . . . . .	428
<b>Network Access Control. . . . .</b>	<b>429</b>
Pre-enrollment State . . . . .	429

Walled Garden . . . . .	429
-------------------------	-----

<b>Media Access Control Security . . . . .</b>	<b>431</b>
--	------------

## 10 Monitoring and Logging System Information 433

<b>System Monitoring Overview . . . . .</b>	<b>433</b>
---	------------

What System Information Is Monitored?. . . . .	433
--	-----

Why Is System Information Needed? . . . . .	434
---	-----

Where Are Log Messages Sent?. . . . .	434
---------------------------------------	-----

What Are the Severity Levels? . . . . .	435
---	-----

What Are the System Startup and Operation Logs? . . . . .	435
---	-----

What Is the Log Message Format?. . . . .	436
--	-----

What Factors Should Be Considered When	
--	--

Configuring Logging? . . . . .	438
--------------------------------	-----

<b>Default Log Settings . . . . .</b>	<b>439</b>
---------------------------------------	------------

<b>Monitoring System Information and Configuring Logging (Web) 440</b>	
--	--

Device Information . . . . .	440
------------------------------	-----

System Health . . . . .	442
-------------------------	-----

System Resources . . . . .	443
----------------------------	-----

Unit Power Usage History . . . . .	444
------------------------------------	-----

Integrated Cable Test for Copper Cables. . . . .	445
--	-----

Optical Transceiver Diagnostics . . . . .	446
---	-----

Log Global Settings . . . . .	447
-------------------------------	-----

RAM Log . . . . .	448
-------------------	-----

Log File . . . . .	450
--------------------	-----

SYSLOG Server . . . . .	450
-------------------------	-----

Email Alert Global Configuration . . . . .	453
--	-----

Email Alert Mail Server Configuration . . . . .	453
---	-----

Email Alert Subject Configuration . . . . .	455
---	-----

Email Alert To Address Configuration . . . . .	456
--	-----

Email Alert Statistics . . . . .	456
----------------------------------	-----

<b>Monitoring System Information and Configuring Logging (CLI)</b>	<b>458</b>
Viewing System Information and Enabling the Locator LED	458
Running Cable Diagnostics . . . . .	458
Configuring Local Logging . . . . .	460
Configuring Remote Logging . . . . .	461
Configuring Mail Server Settings . . . . .	462
Configuring Email Alerts for Log Messages . . . . .	463
<b>Logging Configuration Examples . . . . .</b>	<b>465</b>
Configuring Local and Remote Logging . . . . .	465
Configuring Email Alerting . . . . .	468

## 11 Managing General System Settings . . . 471

<b>System Settings Overview . . . . .</b>	<b>471</b>
Why Does System Information Need to Be Configured?	472
What Are SDM Templates? . . . . .	473
Why is the System Time Needed? . . . . .	476
How Does SNTP Work? . . . . .	476
What Configuration Is Required for Plug-In Modules?	477
<b>Default General System Information . . . . .</b>	<b>477</b>
<b>Configuring General System Settings (Web) . . . . .</b>	<b>478</b>
System Information . . . . .	478
CLI Banner . . . . .	481
SDM Template Preference . . . . .	482
Clock . . . . .	483
SNTP Global Settings . . . . .	484
SNTP Authentication . . . . .	485
SNTP Server . . . . .	487
Summer Time Configuration . . . . .	490
Time Zone Configuration . . . . .	491
Card Configuration . . . . .	492
Slot Summary . . . . .	493



Supported Cards . . . . .	494
Power Over Ethernet Global Configuration. . . . .	495
Power Over Ethernet Unit Configuration . . . . .	496
Power Over Ethernet Interface Configuration . . . . .	497
<b>Configuring System Settings (CLI). . . . .</b>	<b>499</b>
Configuring System Information . . . . .	499
Configuring the Banner. . . . .	500
Managing the SDM Template . . . . .	501
Configuring SNMP Authentication and an SNMP Server	501
Setting the System Time and Date Manually. . . . .	503
Configuring the Expansion Slots . . . . .	504
Viewing Slot Information . . . . .	505
Configuring PoE Settings . . . . .	505
<b>General System Settings Configuration Examples . . . . .</b>	<b>507</b>
Configuring System and Banner Information . . . . .	507
Configuring SNMP. . . . .	510
Configuring the Time Manually. . . . .	512
<b>12 SNMP. . . . .</b>	<b>513</b>
<b>SNMP Overview . . . . .</b>	<b>513</b>
What Is SNMP?. . . . .	513
What Are SNMP Traps? . . . . .	514
Why Is SNMP Needed? . . . . .	515
<b>Default SNMP Values . . . . .</b>	<b>515</b>
<b>Configuring SNMP (Web) . . . . .</b>	<b>517</b>
SNMP Global Parameters . . . . .	517
SNMP View Settings . . . . .	518
Access Control Group . . . . .	520
SNMPv3 User Security Model (USM) . . . . .	522
Communities . . . . .	525

Notification Filter . . . . .	527
Notification Recipients . . . . .	528
Trap Flags . . . . .	530
OSPFv2 Trap Flags . . . . .	531
OSPFv3 Trap Flags . . . . .	532
Trap Log . . . . .	533
<b>Configuring SNMP (CLI) . . . . .</b>	<b>535</b>
Configuring the SNMPv3 Engine ID. . . . .	535
Configuring SNMP Views, Groups, and Users . . . . .	536
Configuring Communities . . . . .	539
Configuring SNMP Notifications (Traps and Informs) . . . . .	541
<b>SNMP Configuration Examples . . . . .</b>	<b>544</b>
Configuring SNMPv1 and SNMPv2. . . . .	544
Configuring SNMP Management Station Access . . . . .	545
Configuring SNMPv3 . . . . .	546
<b>13 Images and File Management . . . . .</b>	<b>551</b>
<b>Image and File Management Overview . . . . .</b>	<b>551</b>
What Files Can Be Managed? . . . . .	551
Why Is File Management Needed?. . . . .	553
What Methods Are Supported for File Management? . . . . .	556
What Factors Should Be Considered When Managing Files? . . . . .	557
How Is the Running Configuration Saved? . . . . .	560
<b>Managing Images and Files (Web) . . . . .</b>	<b>561</b>
File System . . . . .	561
Active Images. . . . .	562
USB Flash Drive. . . . .	563
File Download . . . . .	564
File Upload . . . . .	566
Copy Files . . . . .	568

<b>Managing Images and Files (CLI)</b> . . . . .	<b>569</b>
Downloading and Activating a New Image (TFTP).	570
Managing Files in Internal Flash . . . . .	571
Managing Files on a USB Flash Device . . . . .	572
Uploading a Configuration File (SCP).	573
Managing Configuration Scripts (SFTP) . . . . .	574
SCP Server . . . . .	575
<b>File and Image Management Configuration Examples</b> . . . . .	<b>576</b>
Upgrading the Firmware . . . . .	576
Managing Configuration Scripts . . . . .	579
Managing Files by Using the USB Flash Drive . . . . .	581
<b>14 DHCP and USB Auto-Configuration</b> . . . . .	<b>583</b>
<b>Auto Configuration Overview</b> . . . . .	<b>583</b>
What Is USB Auto Configuration? . . . . .	584
What Files Does USB Auto Configuration Use? . . . . .	584
How Does USB Auto Configuration Use the Files on the USB Device? . . . . .	585
What Is the Setup File Format? . . . . .	587
What Is the DHCP Auto Configuration Process? . . . . .	588
Monitoring and Completing the DHCP Auto Configuration Process . . . . .	594
What Are the Dependencies for DHCP Auto Configuration?	595
<b>Default Auto Configuration Values</b> . . . . .	<b>596</b>
<b>Managing Auto Configuration (Web)</b> . . . . .	<b>597</b>
Auto-Install Configuration . . . . .	597
<b>Managing Auto Configuration (CLI)</b> . . . . .	<b>598</b>
Managing Auto Configuration . . . . .	598
<b>Auto Configuration Example</b> . . . . .	<b>599</b>

Enabling USB Auto Configuration and Auto Image Download	599
Enabling DHCP Auto Configuration and Auto Image Download . . . . .	600
Easy Firmware Upgrade/Downgrade via USB . . . . .	602

## 15 Monitoring Switch Traffic . . . . . 603

### **Traffic Monitoring Overview. . . . . 603**

What is sFlow Technology?. . . . .	603
What is RMON?. . . . .	606
What is Port Mirroring?. . . . .	607
Port Mirroring Behaviors . . . . .	609
RSPAN . . . . .	611
Remote Capture. . . . .	612
Why is Traffic Monitoring Needed? . . . . .	613

### **Default Traffic Monitoring Values. . . . . 613**

### **Monitoring Switch Traffic (Web) . . . . . 614**

sFlow Agent Summary . . . . .	614
sFlow Receiver Configuration . . . . .	615
sFlow Sampler Configuration . . . . .	616
sFlow Poll Configuration . . . . .	617
Interface Statistics . . . . .	618
Etherlike Statistics . . . . .	619
GVRP Statistics . . . . .	620
EAP Statistics . . . . .	621
Utilization Summary. . . . .	622
Counter Summary. . . . .	623
Switchport Statistics . . . . .	624
RMON Statistics . . . . .	625
RMON History Control Statistics . . . . .	625
RMON History Table . . . . .	628
RMON Event Control . . . . .	629
RMON Event Log . . . . .	631

RMON Alarms . . . . .	632
Port Statistics. . . . .	634
LAG Statistics. . . . .	635
Port Mirroring. . . . .	636
<b>Monitoring Switch Traffic (CLI) . . . . .</b>	<b>638</b>
Configuring sFlow. . . . .	638
Configuring RMON . . . . .	640
Viewing Statistics. . . . .	642
Configuring Port Mirroring . . . . .	643
Configuring RSPAN. . . . .	644
<b>Traffic Monitoring Examples . . . . .</b>	<b>648</b>
Showing Interface Traffic . . . . .	648
Configuring sFlow. . . . .	649
Configuring RMON . . . . .	651
Configuring Remote Capture . . . . .	652
Configuring RSPAN. . . . .	657
<b>Encapsulated Remote Port Analyzer . . . . .</b>	<b>660</b>
<b>16 iSCSI Optimization. . . . .</b>	<b>663</b>
<b>iSCSI Optimization Overview . . . . .</b>	<b>663</b>
What Does iSCSI Optimization Do?. . . . .	663
What Occurs When iSCSI Optimization Is Enabled or Disabled? . . . . .	664
How Does the Switch Detect iSCSI Traffic Flows? . . . . .	664
How Is Quality of Service Applied to iSCSI Traffic Flows? . . . . .	664
How Does iSCSI Optimization Use ACLs? . . . . .	665
What Information Does the Switch Track in iSCSI Traffic Flows?. . . . .	665
How Does iSCSI Optimization Interact With Dell EqualLogic and Compellent Arrays? . . . . .	666

How Does iSCSI Optimization Interact with Other SAN Arrays? . . . . .	666
<b>Default iSCSI Optimization Values . . . . .</b>	<b>667</b>
<b>Configuring iSCSI Optimization (Web). . . . .</b>	<b>668</b>
iSCSI Global Configuration . . . . .	668
<b>Configuring iSCSI Optimization (CLI) . . . . .</b>	<b>669</b>
<b>iSCSI Optimization Configuration Examples . . . . .</b>	<b>670</b>
Configuring iSCSI Optimization Between Servers and a Disk Array . . . . .	670
<b>17 Port Characteristics . . . . .</b>	<b>673</b>
<b>Port Overview . . . . .</b>	<b>673</b>
What Physical Port Characteristics Can Be Configured? . . . . .	673
Auto-Negotiation . . . . .	675
Maximum Transmission Unit . . . . .	675
What is Link Dependency? . . . . .	676
What Interface Types are Supported? . . . . .	678
What is Interface Configuration Mode? . . . . .	678
What Are the Green Ethernet Features? . . . . .	680
Switchport Modes . . . . .	681
<b>Default Port Values . . . . .</b>	<b>682</b>
<b>Configuring Port Characteristics (Web). . . . .</b>	<b>684</b>
Port Configuration. . . . .	684
Link Dependency Configuration . . . . .	687
Link Dependency Summary. . . . .	689
Port Green Ethernet Configuration . . . . .	690
Port Green Ethernet Statistics . . . . .	691
Port Green Ethernet LPI History . . . . .	693

<b>Configuring Port Characteristics (CLI)</b> . . . . .	<b>694</b>
Configuring Port Settings . . . . .	694
Configuring Link Dependencies . . . . .	696
Configuring Green Features . . . . .	697
<b>Port Configuration Examples</b> . . . . .	<b>698</b>
Configuring Port Settings . . . . .	698
Configuring a Link Dependency Groups . . . . .	699
Configuring a Port in Access Mode . . . . .	699
Configuring a Port in Trunk Mode . . . . .	700
Configuring a Port in General Mode . . . . .	703
<b>18 Port and System Security</b> . . . . .	<b>705</b>
<b>Port Security</b> . . . . .	<b>705</b>
<b>Denial of Service</b> . . . . .	<b>712</b>
<b>19 Access Control Lists</b> . . . . .	<b>713</b>
<b>ACL Overview</b> . . . . .	<b>713</b>
ACL Counters . . . . .	715
What Are MAC ACLs? . . . . .	715
What Are IP ACLs? . . . . .	716
ACL Actions . . . . .	716
What Is the ACL Redirect Function? . . . . .	717
What Is the ACL Mirror Function? . . . . .	718
What Is ACL Logging . . . . .	718
What Are Time-Based ACLs? . . . . .	718
ACL Limitations . . . . .	719
<b>ACL Configuration Details</b> . . . . .	<b>724</b>
How Are ACLs Configured? . . . . .	724
Editing Access Lists . . . . .	724

Preventing False ACL Matches . . . . .	724
Using IP and MAC Address Masks . . . . .	726
<b>Policy-Based Routing . . . . .</b>	<b>727</b>
Packet Classification . . . . .	727
Route-Map Processing . . . . .	728
Route-Map Actions . . . . .	729
ACLs and Policy Interaction . . . . .	731
Limitations. . . . .	732
<b>Configuring ACLs (Web) . . . . .</b>	<b>735</b>
IP ACL Configuration . . . . .	735
IP ACL Rule Configuration . . . . .	738
MAC ACL Configuration. . . . .	740
MAC ACL Rule Configuration . . . . .	742
IPv6 ACL Configuration . . . . .	743
IPv6 ACL Rule Configuration . . . . .	744
ACL Binding Configuration . . . . .	746
Time Range Configuration . . . . .	747
<b>Configuring ACLs (CLI) . . . . .</b>	<b>749</b>
Configuring an IPv4 ACL . . . . .	749
Configuring a MAC ACL. . . . .	755
Configuring an IPv6 ACL . . . . .	759
Configuring a Time Range . . . . .	762
<b>ACL Configuration Examples. . . . .</b>	<b>764</b>
Basic Rules . . . . .	764
Internal System ACLs. . . . .	765
Complete ACL Example . . . . .	766
Advanced Examples . . . . .	770
Policy-Based Routing Examples . . . . .	782



20 VLANs . . . . .	787
<b>VLAN Overview . . . . .</b>	<b>787</b>
VLAN Tagging . . . . .	790
GVRP . . . . .	791
Double-VLAN Tagging . . . . .	792
Voice VLAN . . . . .	793
Private VLANs . . . . .	799
Additional VLAN Features . . . . .	805
<b>Default VLAN Behavior . . . . .</b>	<b>806</b>
<b>Configuring VLANs (Web) . . . . .</b>	<b>808</b>
VLAN Membership . . . . .	808
VLAN Port Settings . . . . .	813
VLAN LAG Settings . . . . .	814
Bind MAC to VLAN . . . . .	816
Bind IP Subnet to VLAN . . . . .	816
GVRP Parameters. . . . .	818
Protocol Group . . . . .	820
Adding a Protocol Group . . . . .	821
Double VLAN Global Configuration. . . . .	823
Double VLAN Interface Configuration . . . . .	824
Voice VLAN . . . . .	826
<b>Configuring VLANs (CLI) . . . . .</b>	<b>827</b>
Creating a VLAN . . . . .	827
Configuring VLAN Settings for a LAG . . . . .	828
Configuring Double VLAN Tagging. . . . .	829
Configuring MAC-Based VLANs . . . . .	832
Configuring IP-Based VLANs. . . . .	834
Configuring a Protocol-Based VLAN. . . . .	836
Configuring GVRP. . . . .	839
Configuring Voice VLANs. . . . .	841
Configuring a Voice VLAN (Extended Example) . . . . .	843

Enterprise Voice VLAN Configuration With QoS . . . . .	844
MLAG with RPVST and Voice VLAN . . . . .	847
Assigning an 802.1p Priority to VLAN Traffic . . . . .	854
Configuring a Private VLAN . . . . .	855
Configuring Inter-Switch Private VLANs . . . . .	857
<b>VLAN Configuration Examples . . . . .</b>	<b>858</b>
Configuring VLANs Using the Dell EMC OpenManage Switch Administrator . . . . .	858
Configuring VLANs Using the CLI . . . . .	866
<b>21 Spanning Tree Protocol . . . . .</b>	<b>871</b>
<b>STP Overview . . . . .</b>	<b>871</b>
What Are Classic STP, Multiple STP, and Rapid STP? . . . . .	871
How Does STP Work? . . . . .	872
How Does MSTP Operate in the Network? . . . . .	873
MSTP with Multiple Forwarding Paths . . . . .	877
MSTP and VLAN IDs . . . . .	878
What are the Optional STP Features? . . . . .	878
<b>RSTP-PV . . . . .</b>	<b>880</b>
DirectLink Rapid Convergence . . . . .	882
IndirectLink Rapid Convergence Feature . . . . .	884
Interoperability Between STP-PV and RSTP-PV Modes . . . . .	886
Interoperability With IEEE Spanning Tree Protocols . . . . .	886
Configuration Examples . . . . .	891
<b>Default STP Values . . . . .</b>	<b>892</b>
<b>Configuring Spanning Tree (Web) . . . . .</b>	<b>893</b>
STP Global Settings . . . . .	893
STP Port Settings . . . . .	895
STP LAG Settings . . . . .	897
Rapid Spanning Tree . . . . .	898

MSTP Settings . . . . .	900
MSTP Interface Settings . . . . .	902
PVST/RPVST Global Configuration . . . . .	903
PVST/RPVST VLAN Configuration . . . . .	904
PVST/RPVST Interface Configuration . . . . .	906
PVST/RPVST Statistics . . . . .	907
<b>Configuring Spanning Tree (CLI) . . . . .</b>	<b>908</b>
Configuring Global STP Bridge Settings . . . . .	908
Configuring Optional STP Features. . . . .	909
Configuring STP Interface Settings . . . . .	910
Configuring MSTP Switch Settings. . . . .	911
Configuring MSTP Interface Settings . . . . .	912
<b>STP Configuration Examples . . . . .</b>	<b>913</b>
STP Configuration Example. . . . .	913
MSTP Configuration Example . . . . .	915
RSTP-PV Access Switch Configuration Example . . . . .	918
<b>22 Discovering Network Devices. . . . .</b>	<b>923</b>
<b>Device Discovery Overview . . . . .</b>	<b>923</b>
What Is ISDP? . . . . .	923
What is IPDT?. . . . .	923
What is LLDP? . . . . .	924
What is LLDP-MED? . . . . .	924
Why are Device Discovery Protocols Needed? . . . . .	924
<b>Default IDSP and LLDP Values . . . . .</b>	<b>925</b>
<b>Default IPDT Values . . . . .</b>	<b>926</b>
<b>Configuring ISDP and LLDP (Web) . . . . .</b>	<b>927</b>
ISDP Global Configuration . . . . .	927
ISDP Neighbor Table . . . . .	929

ISDP Interface Configuration . . . . .	930
ISDP Statistics . . . . .	931
LLDP Configuration . . . . .	932
LLDP Statistics . . . . .	934
LLDP Connections. . . . .	935
LLDP-MED Global Configuration . . . . .	936
LLDP-MED Interface Configuration. . . . .	937
LLDP-MED Local Device Information. . . . .	938
LLDP-MED Remote Device Information . . . . .	938
<b>Configuring ISDP and LLDP (CLI) . . . . .</b>	<b>939</b>
Configuring Global ISDP Settings. . . . .	939
Enabling ISDP on a Port . . . . .	940
Viewing and Clearing ISDP Information . . . . .	940
Configuring Global LLDP Settings. . . . .	941
Configuring Port-based LLDP Settings . . . . .	941
Viewing and Clearing LLDP Information . . . . .	942
Configuring LLDP-MED Settings . . . . .	943
Viewing LLDP-MED Information . . . . .	944
<b>Device Discovery Configuration Examples . . . . .</b>	<b>944</b>
Configuring ISDP . . . . .	944
Configuring LLDP . . . . .	945
Configuring IPDT . . . . .	947
<b>23 Port-Based Traffic Control . . . . .</b>	<b>949</b>
<b>Port-Based Traffic Control Overview . . . . .</b>	<b>949</b>
What is Flow Control?. . . . .	950
What is Storm Control?. . . . .	950
What are Protected Ports?. . . . .	951
What is Error Recovery? . . . . .	951
What is Link Local Protocol Filtering? . . . . .	951
What is Loop Protection?. . . . .	953

<b>Default Port-Based Traffic Control Values . . . . .</b>	<b>954</b>
<b>Configuring Port-Based Traffic Control (Web) . . . . .</b>	<b>955</b>
Flow Control (Global Port Parameters). . . . .	955
Storm Control . . . . .	956
Protected Port Configuration. . . . .	958
LLPF Configuration . . . . .	960
<b>Configuring Port-Based Traffic Control (CLI) . . . . .</b>	<b>961</b>
Configuring Flow Control and Storm Control. . . . .	961
Configuring Protected Ports . . . . .	962
Configuring LLPF . . . . .	963
<b>Port-Based Traffic Control Configuration Example . . . . .</b>	<b>964</b>
<b>24 Layer-2 Multicast Features . . . . .</b>	<b>967</b>
<b>L2 Multicast Overview. . . . .</b>	<b>967</b>
Multicast Flooding and Forwarding . . . . .	967
What Are the Multicast Bridging Features? . . . . .	968
What Is L2 Multicast Traffic?. . . . .	969
What Is IGMP Snooping?. . . . .	969
What Is MLD Snooping? . . . . .	971
What Is Multicast VLAN Registration?. . . . .	973
When Are Layer-3 Multicast Features Required? . . . . .	974
What Are GARP and GMRP? . . . . .	974
<b>Snooping Switch Restrictions. . . . .</b>	<b>976</b>
MAC Address-Based Multicast Group. . . . .	976
Topologies Where the Multicast Source Is Not Directly Connected to the Querier. . . . .	976
Using Static Multicast MAC Configuration. . . . .	976
IGMP Snooping and GMRP. . . . .	976
<b>Default L2 Multicast Values . . . . .</b>	<b>977</b>

<b>Configuring L2 Multicast Features (Web)</b> . . . . .	<b>979</b>
Multicast Global Parameters . . . . .	979
Bridge Multicast Group . . . . .	980
MFDB Summary . . . . .	983
MRouter Status . . . . .	984
General IGMP Snooping . . . . .	985
Global Querier Configuration . . . . .	988
VLAN Querier . . . . .	989
VLAN Querier Status . . . . .	991
MFDB IGMP Snooping Table . . . . .	992
MLD Snooping General . . . . .	993
MLD Snooping Global Querier Configuration . . . . .	995
MLD Snooping VLAN Querier . . . . .	996
MLD Snooping VLAN Querier Status . . . . .	998
MFDB MLD Snooping Table . . . . .	999
MVR Global Configuration . . . . .	1000
MVR Members . . . . .	1001
MVR Interface Configuration . . . . .	1001
MVR Statistics . . . . .	1004
GARP Timers . . . . .	1005
GMRP Parameters . . . . .	1007
MFDB GMRP Table . . . . .	1009
<b>Configuring L2 Multicast Features (CLI)</b> . . . . .	<b>1010</b>
Configuring Layer-2 Multicasting . . . . .	1010
Configuring IGMP Snooping on VLANs . . . . .	1011
Configuring IGMP Snooping Querier . . . . .	1012
Configuring MLD Snooping on VLANs . . . . .	1013
Configuring MLD Snooping Querier . . . . .	1014
Configuring MVR . . . . .	1015
Configuring GARP Timers and GMRP . . . . .	1017
<b>Case Study on a Real-World Network Topology</b> . . . . .	<b>1018</b>
Multicast Snooping Case Study . . . . .	1018

25	Connectivity Fault Management . . . . .	1023
	<b>Dot1ag Overview.</b> . . . . .	<b>1023</b>
	How Does Dot1ag Work Across a Carrier Network?	1024
	What Entities Make Up a Maintenance Domain?	1025
	What is the Administrator's Role? . . . . .	1027
	<b>Default Dot1ag Values.</b> . . . . .	<b>1028</b>
	<b>Configuring Dot1ag (Web).</b> . . . . .	<b>1029</b>
	Dot1ag Global Configuration . . . . .	1029
	Dot1ag MD Configuration. . . . .	1029
	Dot1ag MA Configuration. . . . .	1030
	Dot1ag MEP Configuration . . . . .	1031
	Dot1ag MIP Configuration . . . . .	1032
	Dot1ag RMEP Summary . . . . .	1033
	Dot1ag L2 Ping . . . . .	1034
	Dot1ag L2 Traceroute. . . . .	1034
	Dot1ag L2 Traceroute Cache . . . . .	1035
	Dot1ag Statistics . . . . .	1035
	<b>Configuring Dot1ag (CLI).</b> . . . . .	<b>1037</b>
	Configuring Dot1ag Global Settings and Creating	
	Domains. . . . .	1037
	Configuring MEP Information. . . . .	1038
	Dot1ag Ping and Traceroute . . . . .	1039
	<b>Dot1ag Configuration Example</b> . . . . .	<b>1040</b>
26	Ethernet Ring Protection . . . . .	1043
	<b>Ethernet Ring Protection Switching Port Role</b> . . . . .	<b>1045</b>
	RPL Owner Port. . . . .	1045
	RPL Neighbor Port . . . . .	1045
	Normal Port. . . . .	1045

<b>R-APS Channel</b> . . . . .	<b>1045</b>
<b>Traffic Channel</b> . . . . .	<b>1046</b>
<b>Ring Scope</b> . . . . .	<b>1046</b>
<b>Ethernet Ring Protection Port Status</b> . . . . .	<b>1046</b>
<b>Ethernet Ring Protection Timers</b> . . . . .	<b>1047</b>
Hold-off . . . . .	1047
Wait-to-Restore . . . . .	1047
Guard Timer . . . . .	1047
Wait-to-Block . . . . .	1047
<b>Revertive and Non-Revertive Operation Modes</b> . . . . .	<b>1048</b>
Revertive . . . . .	1048
Non-Revertive . . . . .	1048
<b>ERPS Subrings</b> . . . . .	<b>1048</b>
Without R-APS Virtual Channel . . . . .	1049
With R-APS Virtual Channel . . . . .	1049
<b>Topology Change Notification</b> . . . . .	<b>1049</b>
<b>Protection Switching Triggers</b> . . . . .	<b>1049</b>
<b>Ring Failure Detection</b> . . . . .	<b>1050</b>
<b>Ring Protection Example</b> . . . . .	<b>1050</b>

## 27 Snooping and Inspecting Traffic . . . . . 1053

<b>Traffic Snooping and Inspection Overview</b> . . . . .	<b>1053</b>
What Is DHCP Snooping? . . . . .	1054
How Is the DHCP Snooping Bindings Database Populated? . . . . .	1055
What Is IP Source Guard? . . . . .	1058
What is Dynamic ARP Inspection? . . . . .	1059



Why Is Traffic Snooping and Inspection Necessary?	1060
<b>Default Traffic Snooping and Inspection Values</b>	<b>1060</b>
<b>Configuring Traffic Snooping and Inspection (Web)</b>	<b>1062</b>
DHCP Snooping Configuration	1062
DHCP Snooping Interface Configuration	1063
DHCP Snooping VLAN Configuration	1065
DHCP Snooping Persistent Configuration	1066
DHCP Snooping Static Bindings Configuration	1067
DHCP Snooping Dynamic Bindings Summary	1068
DHCP Snooping Statistics	1069
IPSG Interface Configuration	1070
IPSG Binding Configuration	1070
IPSG Binding Summary	1071
DAI Global Configuration	1072
DAI Interface Configuration	1073
DAI VLAN Configuration	1075
DAI ACL Configuration	1076
DAI ACL Rule Configuration	1076
DAI Statistics	1077
<b>Configuring Traffic Snooping and Inspection (CLI)</b>	<b>1079</b>
Configuring DHCP Snooping	1079
Configuring IP Source Guard	1081
Configuring Dynamic ARP Inspection	1082
<b>Traffic Snooping and Inspection Configuration Examples</b>	<b>1085</b>
Configuring DHCP Snooping	1085
Configuring IPSG	1087
28 Link Aggregation	1089
<b>Link Aggregation</b>	<b>1089</b>
Overview	1089

Default Link Aggregation Values . . . . .	1093
<b>Configuring Link Aggregation (Web) . . . . .</b>	<b>1094</b>
<b>Configuring Link Aggregation (CLI) . . . . .</b>	<b>1100</b>
Link Aggregation Configuration Examples . . . . .	1104
<b>Multi-Switch LAG (MLAG) . . . . .</b>	<b>1107</b>
Overview . . . . .	1107
Deployment Scenarios . . . . .	1108
Definitions . . . . .	1110
Configuration Consistency . . . . .	1111
Operation in the Network . . . . .	1114
Layer-2 Configuration Steps . . . . .	1118
Switch Firmware Upgrade Procedure . . . . .	1121
Static Routing on MLAG Interfaces. . . . .	1122
Caveats and Limitations. . . . .	1129
Basic Configuration Example . . . . .	1135
A Complete MLAG Example. . . . .	1143
<b>29 MAC Addressing and Forwarding . . . . .</b>	<b>1161</b>
<b>MAC Address Table Overview. . . . .</b>	<b>1161</b>
How Is the Address Table Populated? . . . . .	1161
What Information Is in the MAC Address Table? . . . . .	1162
How Is the MAC Address Table Maintained	
Across a Stack?. . . . .	1162
<b>Default MAC Address Table Values . . . . .</b>	<b>1162</b>
<b>Managing the MAC Address Table (Web). . . . .</b>	<b>1163</b>
Static Address Table . . . . .	1163
Global Address Table. . . . .	1165
<b>Managing the MAC Address Table (CLI) . . . . .</b>	<b>1166</b>

Managing the MAC Address Table. . . . .	1166
<b>MAC Notification</b> . . . . .	<b>1168</b>
<b>30 DHCP Server Settings</b> . . . . .	<b>1169</b>
<b>DHCP Overview</b> . . . . .	<b>1169</b>
How Does DHCP Work? . . . . .	1170
What are DHCP Options? . . . . .	1171
What Additional DHCP Features Does the Switch Support? . . . . .	1171
<b>Default DHCP Server Values.</b> . . . . .	<b>1172</b>
<b>Configuring the DHCP Server (Web)</b> . . . . .	<b>1173</b>
DHCP Server Network Properties . . . . .	1173
Address Pool . . . . .	1175
Address Pool Options. . . . .	1179
DHCP Bindings . . . . .	1181
DHCP Server Reset Configuration . . . . .	1181
DHCP Server Conflicts Information. . . . .	1182
DHCP Server Statistics . . . . .	1183
<b>Configuring the DHCP Server (CLI)</b> . . . . .	<b>1184</b>
Configuring Global DHCP Server Settings . . . . .	1184
Configuring a Dynamic Address Pool . . . . .	1185
Configuring a Static Address Pool . . . . .	1186
Monitoring DHCP Server Information . . . . .	1187
<b>DHCP Server Configuration Examples</b> . . . . .	<b>1188</b>
Configuring a Dynamic Address Pool . . . . .	1188
Configuring a Static Address Pool . . . . .	1190

<b>31 IP Routing</b> . . . . .	<b>1193</b>
<b>IP Routing Overview</b> . . . . .	<b>1193</b>
<b>Default IP Routing Values</b> . . . . .	<b>1195</b>
<b>IP Path MTU and Path MTU Discovery</b> . . . . .	<b>1196</b>
<b>ARP Table</b> . . . . .	<b>1197</b>
<b>Configuring IP Routing Features (Web)</b> . . . . .	<b>1198</b>
IP Configuration. . . . .	1198
IP Statistics . . . . .	1199
ARP Create . . . . .	1200
ARP Table Configuration . . . . .	1201
Router Discovery Configuration . . . . .	1202
Router Discovery Status . . . . .	1203
Route Table . . . . .	1204
Best Routes Table. . . . .	1205
Route Entry Configuration. . . . .	1206
Configured Routes . . . . .	1208
Route Preferences Configuration. . . . .	1209
<b>Configuring IP Routing Features (CLI)</b> . . . . .	<b>1210</b>
Configuring Global IP Routing Settings. . . . .	1210
Configuring ARP Settings. . . . .	1211
Configuring Router Discovery (IRDP). . . . .	1212
Configuring Route Table Entries and Route Preferences	1213
<b>IP Routing Configuration Example.</b> . . . . .	<b>1215</b>
Configuring Dell EMC Networking N-Series Switch A	1216
Configuring Dell EMC Networking N-Series Switch B	1217
<b>Wake-on-LAN</b> . . . . .	<b>1218</b>

## 32 Routing Interfaces . . . . . 1219

### **Routing Interface Overview . . . . . 1219**

What Are VLAN Routing Interfaces? . . . . . 1219

What Are Loopback Interfaces? . . . . . 1220

What Are Tunnel Interfaces? . . . . . 1221

Why Are Routing Interfaces Needed? . . . . . 1222

### **Default Routing Interface Values . . . . . 1224**

### **Configuring Routing Interfaces (Web). . . . . 1225**

IP Interface Configuration . . . . . 1225

DHCP Lease Parameters . . . . . 1226

VLAN Routing Summary . . . . . 1226

Tunnel Configuration . . . . . 1227

Tunnels Summary. . . . . 1228

Loopbacks Configuration . . . . . 1229

Loopbacks Summary . . . . . 1230

### **Configuring Routing Interfaces (CLI) . . . . . 1231**

Configuring VLAN Routing Interfaces (IPv4) . . . . . 1231

Configuring Loopback Interfaces. . . . . 1233

Configuring Tunnels . . . . . 1234

## 33 Layer-2 and Layer-3 Relay Features . . . . . 1235

### **L2 and L3 Relay Overview . . . . . 1235**

What Is L2 DHCP Relay? . . . . . 1235

What Is L3 DHCP Relay? . . . . . 1239

What Is the IP Helper Feature? . . . . . 1240

### **Default L2/L3 Relay Values . . . . . 1244**

### **Configuring L2 and L3 Relay Features (Web) . . . . . 1245**

L2 DHCP Relay Global Configuration . . . . . 1245

L2 DHCP Relay Interface Configuration . . . . .	1246
L2 DHCP Relay Interface Statistics . . . . .	1248
L2 DHCP Relay VLAN Configuration . . . . .	1249
DHCP Relay Agent Configuration . . . . .	1249
IP Helper (L3 DHCP Relay) Global Configuration .	1251
IP Helper (L3 DHCP Relay) Interface Configuration	1253
IP Helper Statistics . . . . .	1255
<b>Configuring L2 and L3 Relay Features (CLI)</b> . . . . .	<b>1256</b>
Configuring L2 DHCP Relay . . . . .	1256
Configuring L3 Relay (IP Helper) Settings . . . . .	1258
<b>Relay Agent Configuration Example</b> . . . . .	<b>1260</b>
<b>34 OSPF and OSPFv3</b> . . . . .	<b>1263</b>
<b>OSPF Overview</b> . . . . .	<b>1264</b>
What Are OSPF Areas and Other OSPF Topology	
Features? . . . . .	1264
What Are OSPF Routers and LSAs? . . . . .	1265
How Are Routes Selected? . . . . .	1265
How Are OSPF and OSPFv3 Different? . . . . .	1265
<b>OSPF Feature Details</b> . . . . .	<b>1266</b>
Stub Router . . . . .	1266
Static Area Range Cost . . . . .	1268
LSA Pacing . . . . .	1269
Flood Blocking . . . . .	1270
MTU . . . . .	1271
<b>OSPFv3 MIB Support</b> . . . . .	<b>1271</b>
<b>Default OSPF Values</b> . . . . .	<b>1272</b>
<b>Configuring OSPF Features (Web)</b> . . . . .	<b>1275</b>
OSPF Configuration . . . . .	1275

OSPF Area Configuration . . . . .	1276
OSPF Stub Area Summary . . . . .	1279
OSPF Area Range Configuration . . . . .	1280
OSPF Interface Statistics. . . . .	1281
OSPF Interface Configuration . . . . .	1282
OSPF Neighbor Table. . . . .	1283
OSPF Neighbor Configuration . . . . .	1284
OSPF Link State Database . . . . .	1285
OSPF Virtual Link Configuration . . . . .	1285
OSPF Virtual Link Summary. . . . .	1287
OSPF Route Redistribution Configuration . . . . .	1288
OSPF Route Redistribution Summary. . . . .	1289
NSF OSPF Configuration . . . . .	1290
<b>Configuring OSPFv3 Features (Web) . . . . .</b>	<b>1291</b>
OSPFv3 Configuration . . . . .	1291
OSPFv3 Area Configuration. . . . .	1291
OSPFv3 Stub Area Summary . . . . .	1295
OSPFv3 Area Range Configuration. . . . .	1296
OSPFv3 Interface Configuration . . . . .	1297
OSPFv3 Interface Statistics . . . . .	1298
OSPFv3 Neighbors . . . . .	1299
OSPFv3 Neighbor Table . . . . .	1300
OSPFv3 Link State Database . . . . .	1301
OSPFv3 Virtual Link Configuration . . . . .	1302
OSPFv3 Virtual Link Summary . . . . .	1304
OSPFv3 Route Redistribution Configuration . . . . .	1305
OSPFv3 Route Redistribution Summary . . . . .	1306
NSF OSPFv3 Configuration . . . . .	1307
<b>Configuring OSPF Features (CLI) . . . . .</b>	<b>1308</b>
Configuring Global OSPF Settings . . . . .	1308
Configuring OSPF Interface Settings. . . . .	1311
Configuring Stub Areas and NSSAs . . . . .	1313
Configuring Virtual Links . . . . .	1315
Configuring OSPF Area Range Settings . . . . .	1317

Configuring NSF Settings for OSPF . . . . .	1319
<b>Configuring OSPFv3 Features (CLI) . . . . .</b>	<b>1320</b>
Configuring Global OSPFv3 Settings . . . . .	1320
Configuring OSPFv3 Interface Settings. . . . .	1322
Configuring Stub Areas and NSSAs . . . . .	1324
Configuring Virtual Links . . . . .	1326
Configuring an OSPFv3 Area Range . . . . .	1327
Configuring OSPFv3 Route Redistribution Settings	1328
Configuring NSF Settings for OSPFv3. . . . .	1329
<b>OSPF Configuration Examples . . . . .</b>	<b>1330</b>
Configuring an OSPF Border Router and Setting	
Interface Costs . . . . .	1330
Configuring Stub and NSSA Areas for OSPF and OSPFv3	1333
Configuring a Virtual Link for OSPF and OSPFv3 .	1336
Interconnecting an IPv4 Backbone and Local IPv6	
Network . . . . .	1339
Configuring the Static Area Range Cost . . . . .	1342
Configuring Flood Blocking . . . . .	1347
<b>Configuring OSPF VRFs . . . . .</b>	<b>1352</b>
<b>35 VRF . . . . .</b>	<b>1355</b>
<b>Sample Configuration . . . . .</b>	<b>1356</b>
<b>VRF Resource Sharing . . . . .</b>	<b>1356</b>
VRF ARP Entries. . . . .	1356
VRF Route Entries. . . . .	1357
<b>36 RIP . . . . .</b>	<b>1361</b>
<b>RIP Overview . . . . .</b>	<b>1361</b>



How Does RIP Determine Route Information? . . .	1361
What Is Split Horizon? . . . . .	1362
What RIP Versions Are Supported? . . . . .	1362
<b>Default RIP Values . . . . .</b>	<b>1363</b>
<b>Configuring RIP Features (Web) . . . . .</b>	<b>1364</b>
RIP Configuration . . . . .	1364
RIP Interface Configuration . . . . .	1365
RIP Interface Summary . . . . .	1366
RIP Route Redistribution Configuration . . . . .	1367
RIP Route Redistribution Summary . . . . .	1368
<b>Configuring RIP Features (CLI) . . . . .</b>	<b>1369</b>
Configuring Global RIP Settings . . . . .	1369
Configuring RIP Interface Settings . . . . .	1370
Configuring Route Redistribution Settings . . . . .	1371
<b>RIP Configuration Example . . . . .</b>	<b>1373</b>
<b>37 VRRP . . . . .</b>	<b>1377</b>
<b>VRRP Overview . . . . .</b>	<b>1377</b>
How Does VRRP Work? . . . . .	1377
What Is the VRRP Router Priority? . . . . .	1378
What Is VRRP Preemption? . . . . .	1378
What Is VRRP Accept Mode? . . . . .	1379
What Are VRRP Route and Interface Tracking? . . . . .	1379
VRRP and OSPF Interoperability . . . . .	1380
<b>Default VRRP Values . . . . .</b>	<b>1381</b>
<b>Configuring VRRP Features (Web) . . . . .</b>	<b>1382</b>
VRRP Configuration . . . . .	1382
VRRP Virtual Router Status . . . . .	1383

VRRP Virtual Router Statistics . . . . .	1384
VRRP Router Configuration . . . . .	1385
VRRP Route Tracking Configuration . . . . .	1386
VRRP Interface Tracking Configuration . . . . .	1388
<b>Configuring VRRP Features (CLI)</b> . . . . .	<b>1390</b>
Configuring VRRP Settings . . . . .	1390
<b>VRRP Configuration Example</b> . . . . .	<b>1392</b>
VRRP with Load Sharing . . . . .	1392
Troubleshooting VRRP . . . . .	1395
VRRP with Route and Interface Tracking . . . . .	1396
Configuring VRRP in a VRF . . . . .	1399
<b>38 BGP</b> . . . . .	<b>1403</b>
<b>Overview</b> . . . . .	<b>1404</b>
Autonomous Systems . . . . .	1406
Graceful Restart . . . . .	1406
<b>BGP Operations</b> . . . . .	<b>1406</b>
Decision Process Overview . . . . .	1406
Path Attributes . . . . .	1408
BGP Finite State Machine (FSM) . . . . .	1411
Detecting Loss of Adjacency . . . . .	1413
Authentication . . . . .	1414
Outbound Update Groups . . . . .	1414
Removing Private AS Numbers . . . . .	1415
Templates . . . . .	1415
Resolving Interface Routes . . . . .	1417
Originating BGP Routes . . . . .	1417
Equal Cost Multipath (ECMP) . . . . .	1418
BGP Next-Hop Resolution . . . . .	1419
Address Aggregation . . . . .	1421

Routing Policy . . . . .	1423
Inbound Policy . . . . .	1424
Outbound Policy . . . . .	1424
Routing Policy Changes . . . . .	1425
BGP Timers . . . . .	1426
Communities . . . . .	1427
Routing Table Overflow. . . . .	1427
Route Reflection . . . . .	1428
VRF Support. . . . .	1429
BGP Neighbor Configuration . . . . .	1429
Extended Communities . . . . .	1429
VPNv4/VRF Route Distribution via MP-BGP . . . .	1432
IPv6 . . . . .	1435
<b>BGP Limitations . . . . .</b>	<b>1441</b>
<b>BGP Configuration Examples . . . . .</b>	<b>1443</b>
Enabling BGP . . . . .	1443
BGP Example . . . . .	1444
Network Example. . . . .	1445
BGP Redistribution of OSPF Example . . . . .	1446
Configuring the Multi-Exit Discriminator in BGP Advertised Routes . . . . .	1447
Configuring Communities in BGP. . . . .	1448
Configuring a Route Reflector . . . . .	1449
Campus Network MP-BGP and OSPF Configuration	1451
Configuring MP-eBGP and Extended Communities	1467
<b>39 Bidirectional Forwarding Detection . . . . .</b>	<b>1475</b>
<b>Overview . . . . .</b>	<b>1475</b>
<b>BFD Operational Modes . . . . .</b>	<b>1476</b>
Asynchronous Mode . . . . .	1476

Demand Mode . . . . .	1476
Echo Function . . . . .	1477
<b>Limitations . . . . .</b>	<b>1477</b>
<b>BFD Example . . . . .</b>	<b>1478</b>
40 Unicast Reverse Path Forwarding . . . . .	1481
<b>Limitations . . . . .</b>	<b>1482</b>
41 IPv6 Routing . . . . .	1483
<b>IPv6 Routing Overview . . . . .</b>	<b>1483</b>
How Does IPv6 Compare with IPv4? . . . . .	1484
How Are IPv6 Interfaces Configured? . . . . .	1484
<b>Default IPv6 Routing Values . . . . .</b>	<b>1486</b>
<b>Configuring IPv6 Routing Features (Web) . . . . .</b>	<b>1488</b>
Global Configuration . . . . .	1488
Interface Configuration . . . . .	1489
Interface Summary . . . . .	1490
IPv6 Statistics . . . . .	1491
IPv6 Neighbor Table . . . . .	1492
DHCPv6 Client Parameters . . . . .	1493
DHCPv6 Client Statistics . . . . .	1494
IPv6 Router Entry Configuration . . . . .	1495
IPv6 Route Table . . . . .	1496
IPv6 Route Preferences . . . . .	1497
Configured IPv6 Routes . . . . .	1498
<b>Configuring IPv6 Routing Features (CLI) . . . . .</b>	<b>1499</b>
Configuring Global IP Routing Settings . . . . .	1499
Configuring IPv6 Interface Settings . . . . .	1500

Configuring IPv6 Neighbor Discovery . . . . .	1501
Configuring IPv6 Route Table Entries and Route Preferences. . . . .	1503
IPv6 Show Commands . . . . .	1505
<b>IPv6 Static Reject and Discard Routes . . . . .</b>	<b>1506</b>
<b>IPv6 Router Advertisement Guard . . . . .</b>	<b>1507</b>
<b>42 DHCPv6 Server Settings . . . . .</b>	<b>1511</b>
<b>DHCPv6 Overview . . . . .</b>	<b>1511</b>
What Is a DHCPv6 Pool? . . . . .	1512
What Is a Stateless Server? . . . . .	1512
What Is the DHCPv6 Relay Agent Information Option? . . . . .	1512
What Is a Prefix Delegation? . . . . .	1512
<b>Default DHCPv6 Server and Relay Values. . . . .</b>	<b>1513</b>
<b>Configuring the DHCPv6 Server and Relay (Web). . . . .</b>	<b>1514</b>
DHCPv6 Global Configuration . . . . .	1514
DHCPv6 Pool Configuration. . . . .	1515
Prefix Delegation Configuration . . . . .	1517
DHCPv6 Pool Summary. . . . .	1518
DHCPv6 Interface Configuration . . . . .	1519
DHCPv6 Server Bindings Summary . . . . .	1521
DHCPv6 Statistics. . . . .	1522
<b>Configuring the DHCPv6 Server and Relay (CLI) . . . . .</b>	<b>1523</b>
Configuring Global DHCP Server and Relay Agent Settings . . . . .	1523
Configuring a DHCPv6 Pool for Stateless Server Support . . . . .	1523
Configuring a DHCPv6 Pool for Specific Hosts. . . . .	1524
Configuring DHCPv6 Interface Information . . . . .	1525
Monitoring DHCPv6 Information . . . . .	1526
<b>DHCPv6 Configuration Examples . . . . .</b>	<b>1528</b>

Configuring a DHCPv6 Stateless Server . . . . .	1528
Configuring the DHCPv6 Server for Prefix Delegation	1529
Configuring an Interface as a DHCPv6 Relay Agent	1529

## 43 Differentiated Services . . . . . 1531

<b>DiffServ Overview . . . . .</b>	<b>1531</b>
How Does DiffServ Functionality Vary Based on the Role of the Switch? . . . . .	1532
What Are the Elements of DiffServ Configuration?	1532
Class-Map Processing . . . . .	1533
<b>Default DiffServ Values . . . . .</b>	<b>1534</b>
<b>Configuring DiffServ (Web) . . . . .</b>	<b>1535</b>
DiffServ Configuration . . . . .	1535
Class Configuration . . . . .	1536
Class Criteria . . . . .	1537
Policy Configuration . . . . .	1539
Policy Class Definition . . . . .	1541
Service Configuration. . . . .	1544
Service Detailed Statistics . . . . .	1545
Flow-Based Mirroring . . . . .	1546
<b>Configuring DiffServ (CLI) . . . . .</b>	<b>1547</b>
DiffServ Configuration (Global) . . . . .	1547
DiffServ Class Configuration for IPv4. . . . .	1548
DiffServ Class Configuration for IPv6. . . . .	1549
DiffServ Protocol Matching. . . . .	1551
DiffServ Policy Creation. . . . .	1552
Simple DiffServ Policy Attributes Configuration .	1552
DiffServ Service Configuration . . . . .	1555
<b>DiffServ Configuration Examples . . . . .</b>	<b>1556</b>
Providing Subnets Equal Access to External Network	1556

Configuring DiffServ Policy Using ACLs . . . . .	1558
DiffServ for VoIP . . . . .	1560
<b>WRED . . . . .</b>	<b>1563</b>
WRED Processing . . . . .	1563
WRED Drop Probabilities . . . . .	1563
Exponential Weighting Constant . . . . .	1564
WRED Color-Aware Processing . . . . .	1564
Simple Meter Implementation . . . . .	1565
Single Rate Meter Implementation. . . . .	1565
Two-Rate Meter Implementation. . . . .	1566
<b>44 Class-of-Service . . . . .</b>	<b>1567</b>
<b>CoS Overview . . . . .</b>	<b>1567</b>
What Are Trusted and Untrusted Port Modes? . . . . .	1568
How Is Traffic Shaping Used on Egress Traffic? . . . . .	1568
How Are Traffic Queues Configured? . . . . .	1569
Which Queue Management Methods Are Supported? . . . . .	1570
CoS Queue Usage . . . . .	1571
<b>Default CoS Values . . . . .</b>	<b>1571</b>
<b>Configuring CoS (Web) . . . . .</b>	<b>1573</b>
Mapping Table Configuration . . . . .	1573
Interface Configuration. . . . .	1575
Interface Queue Configuration . . . . .	1576
Interface Queue Drop Precedence Configuration . . . . .	1577
<b>Configuring CoS (CLI) . . . . .</b>	<b>1579</b>
Mapping Table Configuration . . . . .	1579
CoS Interface Configuration Commands . . . . .	1580
Interface Queue Configuration . . . . .	1580
Configuring Interface Queue Drop Probability . . . . .	1582

<b>CoS Configuration Example</b> . . . . .	<b>1583</b>
<b>Explicit Congestion Notification</b> . . . . .	<b>1586</b>
Enabling ECN in Microsoft Windows . . . . .	1587
Example 1: SLA Configuration . . . . .	1588
Example 2: Long-Lived Congestion . . . . .	1592
Example 3: Data Center TCP (DCTCP) Configuration . . . . .	1592
<b>45 Auto VoIP</b> . . . . .	<b>1595</b>
<b>Auto VoIP Overview</b> . . . . .	<b>1595</b>
How Does Auto VoIP Use ACLs? . . . . .	1596
<b>Default Auto VoIP Values</b> . . . . .	<b>1596</b>
<b>Configuring Auto VoIP (Web)</b> . . . . .	<b>1597</b>
Auto VoIP Global Configuration . . . . .	1597
Auto VoIP Interface Configuration . . . . .	1597
<b>Configuring Auto VoIP (CLI)</b> . . . . .	<b>1599</b>
<b>46 IPv4 and IPv6 Multicast</b> . . . . .	<b>1601</b>
<b>L3 Multicast Overview</b> . . . . .	<b>1601</b>
What Is IP Multicast Traffic? . . . . .	1602
Multicast Addressing . . . . .	1602
What Multicast Protocols Does the Switch Support? . . . . .	1603
What Are the Multicast Protocol Roles? . . . . .	1604
When Is L3 Multicast Required on the Switch? . . . . .	1604
What Is the Multicast Routing Table? . . . . .	1605
What Is IGMP? . . . . .	1606
What Is MLD? . . . . .	1607
What Is PIM? . . . . .	1607
What Is DVMRP? . . . . .	1618



<b>Default L3 Multicast Values . . . . .</b>	<b>1621</b>
<b>Configuring General IPv4 Multicast Features (Web) . . . . .</b>	<b>1623</b>
Multicast Global Configuration . . . . .	1623
Multicast Interface Configuration . . . . .	1624
Multicast Route Table . . . . .	1625
Multicast Admin Boundary Configuration . . . . .	1626
Multicast Admin Boundary Summary . . . . .	1627
Multicast Static MRoute Configuration . . . . .	1627
Multicast Static MRoute Summary. . . . .	1628
<b>Configuring IPv6 Multicast Features (Web). . . . .</b>	<b>1629</b>
IPv6 Multicast Route Table. . . . .	1629
<b>Configuring IGMP and IGMP Proxy (Web) . . . . .</b>	<b>1630</b>
IGMP Global Configuration . . . . .	1630
IGMP Interface Configuration . . . . .	1631
IGMP Interface Summary . . . . .	1632
IGMP Cache Information . . . . .	1632
IGMP Interface Source List Information . . . . .	1633
IGMP Proxy Interface Configuration . . . . .	1634
IGMP Proxy Configuration Summary. . . . .	1635
IGMP Proxy Interface Membership Info . . . . .	1636
Detailed IGMP Proxy Interface Membership Information	1637
<b>Configuring MLD and MLD Proxy (Web) . . . . .</b>	<b>1638</b>
MLD Global Configuration . . . . .	1638
MLD Routing Interface Configuration . . . . .	1639
MLD Routing Interface Summary. . . . .	1640
MLD Routing Interface Cache Information. . . . .	1640
MLD Routing Interface Source List Information . . . . .	1641
MLD Traffic . . . . .	1642
MLD Proxy Configuration. . . . .	1643
MLD Proxy Configuration Summary . . . . .	1644
MLD Proxy Interface Membership Information . . . . .	1645
Detailed MLD Proxy Interface Membership Information	1646

<b>Configuring PIM for IPv4 and IPv6 (Web)</b> . . . . .	<b>1647</b>
PIM Global Configuration . . . . .	1647
PIM Global Status. . . . .	1649
PIM Interface Configuration . . . . .	1650
PIM Interface Summary . . . . .	1651
Candidate RP Configuration . . . . .	1652
Static RP Configuration . . . . .	1654
SSM Range Configuration . . . . .	1656
BSR Candidate Configuration. . . . .	1658
BSR Candidate Summary . . . . .	1659
<b>Configuring DVMRP (Web).</b> . . . . .	<b>1660</b>
DVMRP Global Configuration . . . . .	1660
DVMRP Interface Configuration . . . . .	1661
DVMRP Configuration Summary . . . . .	1662
DVMRP Next Hop Summary . . . . .	1663
DVMRP Prune Summary . . . . .	1664
DVMRP Route Summary . . . . .	1664
<b>Configuring L3 Multicast Features (CLI).</b> . . . . .	<b>1665</b>
Configuring and Viewing IPv4 Multicast Information	1665
Configuring and Viewing IPv6 Multicast Route Information	1667
Configuring and Viewing IGMP . . . . .	1668
Configuring and Viewing IGMP Proxy . . . . .	1670
Configuring and Viewing MLD . . . . .	1671
Configuring and Viewing MLD Proxy . . . . .	1672
Configuring and Viewing PIM-DM for IPv4 Multicast Routing . . . . .	1673
Configuring and Viewing PIM-DM for IPv6 Multicast Routing . . . . .	1674
Configuring and Viewing PIM-SM for IPv4 Multicast Routing . . . . .	1675
Configuring and Viewing PIM-SM for IPv6 Multicast Routing . . . . .	1677
Configuring and Viewing DVMRP Information . . . . .	1680

<b>L3 Multicast Configuration Examples</b> . . . . .	<b>1681</b>
Configuring Multicast VLAN Routing With IGMP and PIM-SM . . . . .	1681
Configuring DVMRP . . . . .	1685
<b>47 Multiple Registration Protocol</b> . . . . .	<b>1687</b>
<b>Overview</b> . . . . .	<b>1687</b>
<b>MVRP</b> . . . . .	<b>1688</b>
<b>MMRP</b> . . . . .	<b>1689</b>
<b>MRP Configuration Example</b> . . . . .	<b>1690</b>
<b>48 OpenFlow</b> . . . . .	<b>1693</b>
<b>Dell EMC Networking OpenFlow Hybrid Overview</b> . . . . .	<b>1693</b>
Enable Dell EMC Networking OpenFlow Hybrid . . . . .	1694
Interaction with OpenFlow Controllers . . . . .	1696
Deploy OpenFlow Controller Flows . . . . .	1726
Collect Port and Queue Status and Statistics . . . . .	1731
Usage Scenarios . . . . .	1731
Eligible Interfaces . . . . .	1731
<b>OpenFlow Hybrid</b> . . . . .	<b>1732</b>
<b>Example Configuration</b> . . . . .	<b>1732</b>
<b>Interaction with Other Switch Functions</b> . . . . .	<b>1733</b>
OpenSSL . . . . .	1733
IP Stack . . . . .	1733
VLANs . . . . .	1733
LAGs . . . . .	1734
Ports . . . . .	1734

Network Interface ARP Table . . . . .	1734
Routing Interface ARP Table . . . . .	1734
QoS . . . . .	1734
IP Routing, IP Multicast, and Layer-2 Multicast . . . . .	1735
LLDP and Voice VLAN . . . . .	1735
<b>Limitations, Restrictions, and Assumptions. . . . .</b>	<b>1736</b>
List of OpenFlow—Dell EMC Networking Component Interferences . . . . .	1736
<b>OpenFlow Configuration Example. . . . .</b>	<b>1737</b>
49 Dell EMC Networking Python Support.	1739
A Appendix . . . . .	1747
<b>Feature Limits and Platform Constants . . . . .</b>	<b>1747</b>
<b>System Process Definitions . . . . .</b>	<b>1762</b>
<b>SupportAssist . . . . .</b>	<b>1769</b>
Index . . . . .	1773

# Introduction

The switches in the N-Series are stackable Layer-2 and Layer-3 switches. These switches include the following features:

- 1U form factor, rack-mountable chassis design.
- Support for all data-communication requirements for a multi-layer switch, including Layer-2 switching, IPv4 routing, IPv6 routing, IP multicast, quality of service, security, and system management features.
- High availability with automatic failover and checkpointing of dynamic state.

The Dell EMC Networking N-Series includes the following switch models: N1108T-ON, N1108P-ON, N1108EP-ON, N1124T-ON, N1124P-ON, N1148T-ON, N1148P-ON, N1524, N1524P, N1548, N1548P, N2024, N2024P, N2048, N2048P, N2128PX-ON, N2224-ON, N2224PX-ON, N2248-ON, N2248PX-ON, N3132PX-ON, N3208PX-ON, N3224T-ON, N3224F-ON, N3248X-ON, N3248TE-ON, N3224PX-ON, N3224P-ON, N3248P-ON, N3248PXE-ON



**NOTE:** Switch administrators are strongly advised to maintain Dell EMC Networking N-Series switches on the latest version of the Dell EMC Networking Operating System. Dell EMC Networking continually improves the features and functions based on feedback from you, the customer. For critical infrastructure, prestaging of a new release into a non-critical portion of the network is recommended to verify network configuration and operation with any new version of Dell EMC Networking N-Series switch firmware.

## About This Document

This guide discusses and provides examples on how to configure, monitor, and maintain Dell EMC Networking N-Series switches by using web-based Dell EMC OpenManage Switch Administrator utility or the command-line interface (CLI).

Examples given in this guide may not include complete CLI syntax as the preference is to present CLI syntax relevant to the configuration task. Refer to the *Dell EMC Networking N1100-ON, N1500, N2000, N2100-ON, N2200-ON, N3000E-ON, N3100-ON, and N3200-ON Series Switches CLI Reference Guide* for definitive syntax for any particular command. The parameter ranges listed in the examples or text may vary from the allowed range on any particular switch due to product limitations. Refer to the Feature Limits and Platform Constants section located in the Appendix of this document for range limits relevant to a particular switch model.

## Audience

This guide is for network administrators in charge of managing one or more Dell EMC Networking N-Series switches. To obtain the greatest benefit from this guide, you should have a basic understanding of Ethernet networks and local area network (LAN) concepts.

## Document Conventions

Table 1-1 describes the typographical conventions this document uses.

**Table 1-1. Document Conventions**

Convention	Description
<b>Bold</b>	Page names, field names, menu options, button names, and CLI commands and keywords.
<code>courier font</code>	Command-line text (CLI output) and file names
[ ]	In a command line, square brackets indicate an optional entry.
{ }	In a command line, inclusive brackets indicate a selection of compulsory parameters separated by the   character. One option must be selected. For example: <b>spanning-tree mode {stp rstp mstp}</b> means that for the <b>spanning-tree mode</b> command, <b>stp</b> , <b>rstp</b> , or <b>mstp</b> must be entered.
<i>Italic</i>	In a command line, indicates a variable.
<Enter>	Any individual key on the keyboard.

**Table 1-1. Document Conventions**

<b>Convention</b>	<b>Description</b>
CTRL + Z	A keyboard combination that involves pressing the Z key while holding the CTRL key.

## Additional Documentation

The following documents for the Dell EMC Networking N-Series switches are available at [www.dell.com/support](http://www.dell.com/support):

- *Getting Started Guide*—provides information about the switch models in the series, including front and back panel features. It also describes the installation and initial configuration procedures.
- *CLI Reference Guide*—provides information about the command-line interface (CLI) commands used to configure and manage the switch. The document provides in-depth CLI descriptions, syntax, default values, and usage guidelines.





# Switch Feature Overview

This section describes the switch user-configurable software features.



**NOTE:** Before proceeding, read the release notes for this product. The release notes are part of the firmware download.

The topics covered in this section include:

- System Management Features
- Stacking Features
- Security Features
- Green Technology Features
- Power over Ethernet (PoE) Features
- Switching Features
- Virtual Local Area Network Supported Features
- Spanning Tree Protocol Features
- Link Aggregation Features
- Routing Features
- IPv6 Routing Features
- Quality of Service (QoS) Features
- Layer-2 Multicast Features
- Layer-3 Multicast Features

# System Management Features

## Multiple Management Options

Any of the following methods can be used to manage the switch:

- Use a web browser to access the Dell EMC OpenManage Switch Administrator interface. The switch contains an embedded Web server that serves HTML pages. Dell EMC Networking N-Series switches support HTTP and HTTPS over IPv4 or IPv6.
- Use a Telnet client, SSH client, or a direct console connection to access the CLI. The CLI syntax and semantics conform as much as possible to common industry practice. Dell EMC Networking N-Series switches support Telnet and SSH access over IPv4 or IPv6.
- Use a network management system (NMS), like the Dell EMC OpenManage Network Manager, to manage and monitor the system through SNMP. The switch supports SNMP v1/v2c/v3 over the UDP/IP transport protocol.

Nearly all switch features support a pre-configuration capability, even when the feature is not enabled or the required hardware is not present. Pre-configured capabilities become active only when enabled (typically via an admin mode control) or when the required hardware is present (or both). For example, a port can be preconfigured with both trunk and access mode information. The trunk mode information is applied only when the port is placed into trunk mode and the access mode information is only applied when the port is placed into access mode. Likewise, OSPF routing can be configured in the switch without being enabled on any port. This capability is present in all of the switch management options.

## System Time Management

The switch can be configured to obtain the system time and date through a remote Simple Network Time Protocol (SNTP) server, or the time and date can be set locally on the switch. The time zone and information about time shifts that might occur during summer months can also be configured. When SNTP is used to obtain the time, communications between the switch and the SNTP server can be encrypted.

The Dell EMC Networking SNTP client supports connection to SNTP servers over IPv4 or IPv6.

For information about configuring system time settings, see "Managing General System Settings" on page 471.

## Log Messages

The switch maintains in-memory log messages as well as persistent logs. Remote logging can be configured so that the switch sends log messages to a remote syslog server. The switch can also be configured to email log messages to a configured SMTP server. This allows the administrator to receive the log message in a specified e-mail account. Switch auditing messages, CLI command logging, Web logging, and SNMP logging can be enabled or disabled.

Dell EMC Networking N-Series switches support logging to syslog servers over IPv4 or IPv6.

For information about configuring system logging, see "Monitoring and Logging System Information" on page 433.

## System Reset

When the switch is reset, it logs the reason in the persistent log, which is displayed in the log on startup. The possible reasons for a switch reset are:

- Switch was reset due to operator intervention.
- Switch was reset due to a software exception.
- Switch was reset due to a watchdog expiration.
- Switch was reset due to a Stack Manager conflict.
- Switch was reset due to software-initiated exit.
- Switch was reset due to power disruption or unexpected restart (error[0x0]).

The last reason code is the default if none of the other conditions are detected.

## Integrated DHCP Server



**NOTE:** This feature is not supported on the Dell EMC Networking N1100-ON/N1500 Series switches.

Dell EMC Networking N-Series switches include an integrated DHCP server that can deliver host-specific configuration information to hosts on the network. The switch DHCP server allows the configuration of IPv4 address pools (scopes), and when a host's DHCP client requests an address, the switch DHCP server automatically assigns the host an address from the pool. For information about configuring the DHCP server settings, see "DHCP Server Settings" on page 1169.

## **Management of Basic Network Information**

The DHCP client on the switch allows the switch to acquire information such as the IPv4 or IPv6 address and default gateway from a network DHCP server. The DHCP client can also be disabled and static network information can be configured instead. Other configurable network information includes a Domain Name Server (DNS), hostname to IP address mapping, and a default domain name.

If the switch detects an IP address conflict on the management interface, it generates a trap and sends a log message.

For information about configuring basic network information, see "Setting the IP Address and Other Basic Network Information" on page 227.

## **IPv6 Management Features**

Dell EMC Networking N-Series switches provide IPv6 support for many standard management features including HTTP, HTTPS/SSL, Telnet, SSH, syslog, SNMP, TFTP, and traceroute on both the in-band and out-of-band management ports.

## **Dual Software Images**

Dell EMC Networking N-Series switches can store up to two software images. The dual image feature enables upgrading the switch without deleting the older software image. One image is designated as the active image and the other image as the backup image.

For information about managing the switch image, see "Images and File Management" on page 551.

## File Management

Files, such as configuration files and system images, can be uploaded and downloaded using HTTP (web only), TFTP, Secure FTP (SFTP), or Secure Copy (SCP). Configuration file uploads from the switch to a server are a good way to back up the switch configuration. A configuration file can also be downloaded from a server to the switch to restore the switch to the configuration in the downloaded file.

Files can be copied to and from a USB Flash drive that is plugged into the USB port on the front panel of the switch. Or, the switch can be automatically upgraded by booting it with a newer firmware image on a USB drive plugged into the switch. Dell EMC Networking N-Series switches support file copy protocols to both IPv4 and IPv6 servers.

For information about uploading, downloading, and copying files, see "Images and File Management" on page 551.

## Switch Database Management Templates

Switch Database Management (SDM) templates enable reallocating system resources to support a different mix of features based on network requirements. Dell EMC Networking N-Series switches support the following three templates:

- Dual IPv4 and IPv6 (default)
- IPv4 Routing
- IPv4 Data Center

For information about setting the SDM template, see "Managing General System Settings" on page 471.

## Automatic Installation of Firmware and Configuration

The Auto Install feature allows the switch to upgrade or downgrade to a newer software image and update the configuration file automatically during device initialization with limited administrative configuration on the device. If a USB device is connected to the switch and contains a firmware image and/or configuration file, the Auto Install feature installs the image or configuration file from USB device. Otherwise, the switch can obtain the necessary information from a DHCP server on the network.



**NOTE:** Automatic migration of the startup configuration to the next version of firmware from the current and previous versions of firmware is supported; the syntax is automatically updated when it is read into the running-config. Check the release notes to determine if any parts of the configuration cannot be migrated. Save the running-config to maintain the updated syntax. Migration of configuration is not assured on a firmware downgrade. When upgrading or downgrading firmware, check the configuration to ensure that it implements the desired configuration. Meta-configuration data (stack-port and slot configuration) is always reset to the defaults on a downgrade on each stack unit. As an example, Ethernet ports configured as stacking ports default back to Ethernet mode on a downgrade.

Migration of configuration information is never assured when errors are shown while the system is booting. Although the errored lines are displayed, commands that enter a sub-configuration mode followed by an exit command cause the CLI to exit Global Configuration mode, and subsequent configuration commands are ignored. Always hand-edit the startup-config if errors are shown on the screen during bootup.

For information about Auto Install, see "DHCP and USB Auto-Configuration" on page 583.

## **sFlow**

sFlow is the standard for monitoring high-speed switched and routed networks. sFlow technology is built into network equipment and gives complete visibility into network activity, enabling effective management and control of network resources. The Dell EMC Networking N-Series switches support sFlow version 5.

For information about configuring managing sFlow settings, see "Monitoring Switch Traffic" on page 603.

## **SNMP Alarms and Trap Logs**

The system logs events with severity codes and timestamps. The events are sent as SNMP traps to a trap recipient list.

For information about configuring SNMP traps and alarms, see "SNMP" on page 513.

## **CDP Interoperability Through ISDP**

Industry Standard Discovery Protocol (ISDP) allows the Dell EMC Networking N-Series switch to interoperate with Cisco devices running the Cisco Discovery Protocol (CDP). ISDP is a proprietary Layer-2 network protocol which inter-operates with Cisco network equipment and is used to share information between neighboring devices (routers, bridges, access servers, and switches).

For information about configuring ISDP settings, see "Discovering Network Devices" on page 923.

## **Remote Monitoring (RMON)**

RMON is a standard Management Information Base (MIB) that defines current and historical MAC-layer statistics and control objects, allowing real-time information to be captured across the entire network.

For information about configuring managing RMON settings, see "Monitoring Switch Traffic" on page 603.

## **Stacking Features**

For information about creating and maintaining a stack of switches, see "Stacking" on page 253.

### **Mixed and Single Series Stacking**

The Dell EMC Networking N2000, N2100-ON, N3000E-ON, N3100-ON, and N3200-ON Series switches include a stacking feature that allows multiple switches of the same or different series to operate as a single unit as listed below.

Dell EMC Networking N1100-ON Series switches stack with other Dell EMC N1100-ON Series switches and Dell EMC Networking N1500 Series switches stack with other Dell EMC N1500 Series switches.

The Dell EMC Networking N1124T-ON/N1124P-ON/N1148P-ON/N1148T-ON switches stack up to four units using 10G Ethernet ports configured for stacking. The Dell EMC Networking N1500 Series switches stack up to four units using 10GB Ethernet links configured as stacking.

The Dell EMC Networking N2000 and N2100-ON Series switches have two fixed mini-SAS stacking connectors at the rear. Any unit may be the stack primary unit.

Dell EMC Networking N2000 Series switches stack with other Dell EMC Networking N2000 Series switches and with Dell EMC Networking N2100-ON Series switches stack in a stack of up to eight units. The mixed stacking image name is N2000N2100Stdv6.5.1.X.itb.

Dell EMC Networking N2200-ON Series switches stack with other Dell EMC Networking N2200-ON Series switches in a stack of up to 12 units. The image name is N2200E-ONv6.6.X.Y.stk.

Dell EMC Networking N2100-ON and N2000 switch series firmware is also available without mixed stacking capabilities. These images are named as follows:

N2100Stdv6.5.1.X.stk                    - N2100 only stack

N2000Stdv6.5.1.X.stk                    - N2000 only stack

Dell EMC Networking N3100-ON Series switches stack with the Dell EMC Networking N3000E-ON switches in a stack of up to 12 units. The image name is N3000N3100Advv6.5.1.x.itb. Any unit may be the stack primary. N3024/N3024P/N3034F/N3048/N3048P units will be recognized if stacked with this image. However, the front panel interfaces will remain detached and inoperable.

Dell EMC Networking N3100-ON and N3000E-ON switch series firmware is also available without mixed stacking capabilities. These images are named as follows:

N3100Advv6.5.1.X.stk                    - N3100 only stack

N3000E-ONAdvv6.5.1.X.stk               - N3000E-ON only stack

Dell EMC Networking N3200-ON Series switches stack with other Dell EMC Networking N3200-ON Series switches in a stack of up to 12 units using the 2x50G stacking ports. The image name is N3200-ONv6.6.X.Y.stk.



## Single IP Management

When multiple switches are connected together through the stack ports, they operate as a single unit with a larger port count. The stack operates and is managed as a single entity. One switch acts as the primary, and the entire stack is managed through the management interface (Web, CLI, or SNMP) of the stack primary.

## Primary Failover with Transparent Transition

The stacking feature supports a *standby* or backup unit that assumes the stack primary role if the stack primary fails. As soon as a stack primary failure is detected, the standby unit initializes the control plane and enables all other stack units with the current configuration. The standby unit maintains a synchronized copy of the running configuration for the stack.

## Nonstop Forwarding on the Stack

The Nonstop Forwarding (NSF) feature allows the forwarding plane of stack units to continue to forward packets while the control and management planes restart as a result of a power failure, hardware failure, or software fault on the stack primary and allows the standby switch to quickly takeover as the primary.

## Hot Add/Delete and Firmware Synchronization

Units can be added to and deleted from the stack without cycling the power on the stack. Units to be added to the stack must be powered off prior to cabling into the stack to avoid election of a new primary unit and a possible downgrade of the stack. When the newly added unit is powered on, the Stack Firmware Synchronization feature, if enabled, automatically synchronizes the firmware version with the version running on the stack primary. The synchronization operation may result in either an upgrade or a downgrade of firmware on the mismatched stack member. Once the firmware is synchronized on a member unit, the running-config on the member is updated to match the primary switch. The startup-config on the standby and member switches is not updated to match the primary switch due to configuration changes on the primary switch. Saving the startup config on the primary switch also saves it to the startup config on all the other stack

members. The hardware configuration of every switch is updated to match the primary switch (unit number, slot configuration, stack member number, etc.).



**NOTE:** ALWAYS POWER OFF a unit to be added to a stack prior to cabling it into the stack. Newly added units must be powered on one-at-a-time beginning with the unit directly connected to an already powered on stack member.

# Security Features

## Configurable Access and Authentication Profiles

Rules can be configured to limit access to the switch management interface based on criteria such as access type and source IP address of the management host. The user can also be required to be authenticated locally or by an external server, such as a RADIUS server.

For information about configuring access and authentication profiles, see "Authentication, Authorization, and Accounting" on page 291.

## Password-Protected Management Access

Access to the Web, CLI, and SNMP management interfaces is password protected, and there are no default users on the system.

For information about configuring local user accounts, see "Authentication, Authorization, and Accounting" on page 291.

## Strong Password Enforcement

The Strong Password feature enforces a baseline password strength for all locally administered users. Password strength is a measure of the effectiveness of a password in resisting guessing and brute-force attacks. The strength of a password is a function of length, complexity and randomness. Using strong passwords lowers overall risk of a security breach.

For information about configuring password settings, see "Authentication, Authorization, and Accounting" on page 291.

## TACACS+ Client

The switch has a TACACS+ client. TACACS+ provides centralized security for validation of users accessing the switch. TACACS+ provides a centralized user management system while still retaining consistency with RADIUS and other authentication processes.

For information about configuring TACACS+ client settings, see "Authentication, Authorization, and Accounting" on page 291.

## **RADIUS Support**

The switch has a Remote Authentication Dial In User Service (RADIUS) client and can support up to 32 named authentication and accounting RADIUS servers. The switch also supports configuration of multiple RADIUS Attributes and accepts RADIUS COA requests. The switch can also be configured to accept RADIUS-assigned VLANs, ACLs and DiffServ Policies.

For information about configuring RADIUS client settings, see "Authentication, Authorization, and Accounting" on page 291.

## **SSH/SSL**

The switch supports Secure Shell (SSH) for secure, remote connections to the CLI and Secure Sockets Layer (SSL) to increase security when accessing the web-based management interface. The SSH server can be enabled using the **ip ssh server** command or disabled using the **no ip ssh server** command.

For information about configuring SSH and SSL settings, see "Authentication, Authorization, and Accounting" on page 291.

## **Inbound Telnet Control**

By default, the switch allows access over Telnet. The administrator can enable or disable the Telnet server using the **ip telnet server** command. Additionally, the Telnet port number is configurable using the same command.

For information about configuring inbound Telnet settings, see "Authentication, Authorization, and Accounting" on page 291.

## **Denial of Service**

The switch supports configurable Denial of Service (DoS) attack protection for eight different types of attacks.

For information about configuring DoS settings, see "Port and System Security" on page 705.

## Port Protection

A port may be put into the error-disabled state for any of the following reasons:

- **BPDU Storm:** By default, if Spanning Tree Protocol (STP) bridge protocol data units (BPDUs) are received at a rate of 15 pps or greater for three consecutive seconds on a port, the port will be error-disabled. The threshold is not configurable.
- **Broadcast, Multicast, Unicast Storm:** If broadcast, unknown multicast, or unknown unicast packets are received at a rate greater than the configured limit and the configured action is to disable the port, the port will be error-disabled. Storm control is not enabled by default. See the **storm-control** commands for further information. A trap is issued for ports disabled by Storm Control.
- **DHCP Rate Limit:** If DHCP packets are received on a port at a rate that exceeds 15 pps, the port will be error-disabled. The threshold is configurable up to 300 pps for up to 15s long using the **ip dhcp snooping limit** command. DHCP snooping is disabled by default. The default protection limit is 15 pps. A trap is issued for interfaces disabled by DHCP Snooping.
- **DoS:** Interfaces on which a denial of service attack is detected are error-disabled. Refer to the **dos-control** command for configuration options.
- **ARP Inspection:** By default, if Dynamic ARP Inspection packets are received on a port at a rate that exceeds 15 pps for 1 second, the port will be error-disabled. The threshold is configurable up to 300 pps and the burst is configurable up to 15s long using the **ip arp inspection limit** command. A trap is issued for interfaces disabled by Dynamic ARP Inspection.
- **SFP Mismatch:** Insertion of an unsupported SFP transceiver will error-disable the interface. This behavior can be suppressed using the **service unsupported-transceiver** command.
- **SFP+ transceivers:** SFP+ transceivers are not compatible with SFP slots (N3024F front-panel ports). To avoid damage to SFP+ transceivers mistakenly inserted into SFP ports, the SFP port is error-disabled when an SFP+ transceiver is detected.
- **UDLD:** Interfaces on which unidirectional packet flow is detected are error-disabled.

- ICMP storms: Ports on which ICMP storms are detected are error-disabled. The rate limit and burst sizes are configurable separately for IPv4 and IPv6.
- PML: Interfaces on which the port security violation is configured to shut down the interface are error-disabled when a violation occurs.
- Loop Protect: Loop protection diagnostically disables ports on which a loop is detected. A log message may be issued when a port is disabled by Loop Protection.
- BPDU Guard: An interface that receives a BPDU with BPDU guard enabled is error-disabled. Use the `spanning-tree bpduguard` command to enable BPDU guard.

A port that is error-disabled may be returned to service using the `no shutdown` command. Alternatively, the operator may configure the auto recovery service to return the error disabled ports to service after a configurable period of time. Refer to the `errdisable recovery` command for more information.

## Captive Portal

The Captive Portal feature blocks clients from accessing the network until user verification has been established. When a user attempts to connect to the network through the switch, the user is presented with a customized Web page that might contain username and password fields or the acceptable use policy. Users can be required to be authenticated by a local or remote RADIUS database before access is granted.

For information about configuring the Captive Portal features, see "Captive Portal" on page 392.

## 802.1X Authentication (IEEE 802.1X)

802.1X authentication enables the authentication of network clients through a local internal server or an external server. Only authenticated and approved network clients can transmit and receive frames over the port. Clients are authenticated using the Extensible Authentication Protocol (EAP). EAP-MD5 authentication with no privacy protocol is supported for switch-initiated (server-side) authentication to remote authentication servers. Local (IAS) authentication supports EAP-MD5 only. MAB supports EAP, PAP, and CHAP. Encrypted communication with authentication servers is not

supported; however, the switch will transport encrypted packets, such as PEAP or EAP-TLS packets, between the supplicant and authentication server in support of mutual authentication and privacy.

For information about configuring IEEE 802.1X settings, see "IEEE 802.1X" on page 355.

### **MAC-Based 802.1X Authentication**

MAC-based authentication allows multiple supplicants connected to the same port to each authenticate individually. The switch uses the device's MAC address to restrict access to the port to only the devices that have authenticated. For example, a system attached to the port might be required to authenticate in order to gain access to the network, while a VoIP phone might not need to authenticate in order to send voice traffic through the port.

For information about configuring MAC-based 802.1X authentication, see "IEEE 802.1X" on page 355.

### **802.1X Monitor Mode**

Monitor mode is intended to provide network administrators with a way of validating authentication access in a test environment. Because monitor mode always allows network access whenever possible, it should never be used in a production network with real users except on a limited temporary basis. Use monitor mode with test users or in a non-production environment to troubleshoot 802.1X configurations.

Monitor mode can be enabled in conjunction with 802.1X authentication to allow network access even when the user fails to authenticate. The switch logs the results of the authentication process for diagnostic purposes. The only purpose of this mode is to help troubleshoot the configuration of 802.1X authentication on the switch without affecting the network access to the users of the switch.

For information about enabling the 802.1X Monitor mode, see "IEEE 802.1X" on page 355.

## Port Security

The port security feature limits access on a port to users with specific MAC addresses. These addresses are manually defined or learned on that port. When a frame is seen on a locked port, and the frame source MAC address is not tied to that port, the protection mechanism is invoked.

For information about configuring port security, see "Port and System Security" on page 705.

## Access Control Lists (ACLs)

Access Control Lists (ACLs) can help to ensure network availability for legitimate users while blocking attempts to access the network by unauthorized users or to restrict legitimate users from accessing the network. ACLs may be used to provide traffic flow control, restrict contents of routing updates, decide which types of traffic are forwarded or blocked, and above all, provide some level of security for the network. The switch supports the following ACL types:

- IPv4 ACLs
- IPv6 ACLs
- MAC ACLs

For all ACL types, the ACL rule can be configured to filter traffic when a packet enters or exits the Ethernet port, LAG, or VLAN interface. ACLs work only on switched ports. They do not operate on the out-of-band port.

ACLs can be used to implement policy-based routing (PBR) to implement packet routing according to specific organizational policies.

For information about configuring ACLs and PBR, see "Access Control Lists" on page 713.

## Time-Based ACLs

With the Time-based ACL feature, the administrator can define when an ACL is in effect and the amount of time it is in effect.

For information about configuring time-based ACLs, see "Access Control Lists" on page 713.



## **IP Source Guard (IPSG)**

IP source guard (IPSG) is a security feature that filters IP packets based on the source ID. The source ID may either be source IP address or a source IP address source MAC address pair as found in the local DHCP snooping database. IPSG depends on DHCP Snooping to associate IP address with MAC addresses.

For information about configuring IPSG, see "Snooping and Inspecting Traffic" on page 1053.

## **DHCP Snooping**

DHCP Snooping is a security feature that monitors DHCP messages between a DHCP client and DHCP server. It filters harmful DHCP messages and builds a bindings database of (MAC address, IP address, VLAN ID, port) tuples that are specified as authorized. DHCP snooping can be enabled globally and on specific VLANs. Ports within the VLAN can be configured to be trusted or untrusted. DHCP servers must be reached through trusted ports.

For information about configuring DHCP Snooping, see "Snooping and Inspecting Traffic" on page 1053.

## **Dynamic ARP Inspection**

Dynamic ARP Inspection (DAI) is a security feature that rejects invalid and malicious ARP packets. The feature prevents a class of man-in-the-middle attacks, where an unfriendly station intercepts traffic for other stations by poisoning the ARP caches of its unsuspecting neighbors. The malicious station sends ARP requests or responses mapping another station's IP address to its own MAC address.

Dynamic ARP Inspection relies on DHCP Snooping.

For information about configuring DAI, see "Snooping and Inspecting Traffic" on page 1053.

## **Protected Ports (Private VLAN Edge)**

Private VLAN Edge (PVE) ports are a Layer-2 security feature that provides port-based security between ports that are members of the same VLAN. It is an extension of the common VLAN. Traffic from protected ports is sent only to the uplink ports and cannot be sent to other ports within the VLAN.

For information about configuring IPSC, see "Port-Based Traffic Control" on page 949.

## Green Technology Features

For information about configuring Green Technology features, see "Port Characteristics" on page 673.

### Energy Detect Mode

When the Energy Detect mode is enabled and the port link is down, the PHY automatically goes down for short period of time and then wakes up periodically to check link pulses. This mode reduces power consumption on the port when no link partner is present. Energy Detect is proprietary and operates independently from EEE.

### Energy Efficient Ethernet

Dell EMC Networking switches support IEEE 802.3az Energy Efficient Ethernet (EEE) Lower Power Idle Mode on front panel copper ports, which enables both the send and receive sides of the link to disable some functionality for power savings when the link is lightly loaded. EEE is standardized by the IEEE and operates independently of Energy Detect. EEE requires auto-negotiation to be enabled. Setting a port to a forced speed disables EEE.

EEE and Energy Detect are supported on the Dell EMC Networking N1100-ON, N2000, N2100-ON, N3000E-ON, N3100-ON, and N3200-ON Series 1G copper ports. EEE is supported on Gigabit Ethernet ports 1-8 on the N1108 Series switches, on Gigabit Ethernet ports 5-20 on the N1124 Series switches, and Gigabit Ethernet ports 9-24 and 29-44 on the N1148 Series switches. EEE is supported on Gigabit Ethernet ports 1-17 on the N1524 and Gigabit Ethernet ports 9-41 on the N1548. Energy detect is supported on all Gigabit Ethernet ports on the N1100 and N1500 Series switches.

EEE and Energy Detect are enabled by default on the N-Series copper ports. Neither Energy Detect nor EEE are supported on out-of-band, 2.5G or 5G NBASE-T ports.

## Power Utilization Reporting

The switch displays the current power consumption of the power supply (or power supplies). This information is available from the management interface.

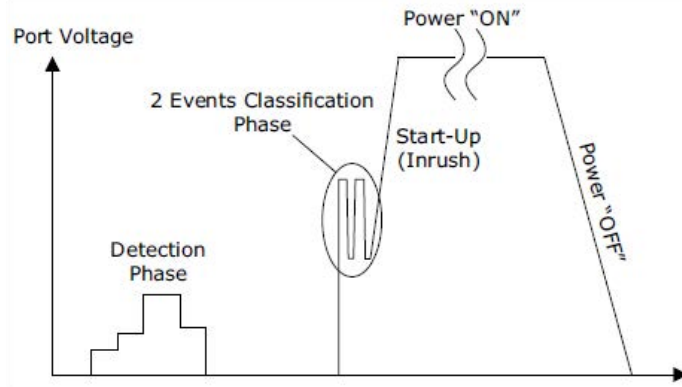
## Power over Ethernet (PoE) Features

Dell EMC Networking PoE switches implement IEEE 802.3af and IEEE 802.3at functionality as well as legacy (capacitor) and pre-standard PDs detection. IEEE 802.3bt capability is also supported on the N2200 and N3200 model. Moreover, additional protections, such as short circuit and dV/dT protection upon startup, are supported.

### PD Detection

The PD detection feature detects a valid AF or AT load, as specified in the AF/AT standard. PD detection is based on four different voltage levels generated to the PD (the load), as illustrated in the following figure.

**Figure 2-1. PD Detection**



### Legacy (Reduced Capacitor) Detection

In cases where legacy detection is enabled, the PD Detection mechanism detects and powers up legacy PDs as well as AF/AT-compliant PDs. This mechanism is designed to detect and power up pre-standard legacy PDs.

## Classification

The classification process takes place immediately after PD detection has successfully completed. The goal of the classification process is to detect the PD class, as specified in IEEE802.3AF and AT standards.

- In AF mode, the classification mechanism is based on a single event, and the device is classified as a Type 1 PD.
- In AT mode, the classification mechanism is based on two events as defined in IEEE802.3AT-2009, and the device is classified as a Type 1 or a Type 2 PD.

## Port Start Up

Upon a successful detection and classification process, power is applied to the load using a controlled Start Up mechanism. During this period, inrush current is limited to 425 milliamperes (mA) for a typical duration of 65 milliseconds (ms), which allows PD load to charge to a steady state power condition.

## Overload Detection and Port Shutdown

After power up, the switch automatically initializes its internal protection mechanisms. These are utilized to monitor and disconnect power from the PD in the cases where extreme conditions occur, as specified in the IEEE802.3AF/AT standard. These conditions include over-current or short ports terminals scenarios.

## Disconnect Detection

The PoE switches support a DC Disconnect Function, per the IEEE802.3AF/AT standard. This mechanism continuously monitors load current and disconnects power in cases where the load current is below 7.5mA (typical) for more than 324 ms.

## IC Thermal Monitoring

The PoE IC contains a thermal sensor that is sampled every 20ms so the die temperature is monitored at all times. In case the die exceeds the 150°C, the system ports will be disconnected to protect the ICs.

## Over-Temperature Protection

In addition to the die thermal sensor, there are thermal sensors on each MOSFET that continuously monitor per port main MOSFET's junction temperature and will shut down the port load power in cases where the temperature exceeds 200°C.

## 4-Pair Ports

In order to have the ability to deliver more than 30w to the PD, 4-pair powering is used. 4-pair powering utilizes all eight Registered Jack-45 (RJ-45) wires for delivering the power. It is implemented by utilizing two separate front-ends, each capable of delivering maximum AT power, enabling delivery of 60W over four pairs. The two front ends drive separate pairs and connect together inside the PD.

The combined front ends follow certain rules:

### 1 Line detection:

- In case one pair fails pre-detection, the port will turn on as a 2-pair port.
- In case both pairs pass pre-detection and fail line detection, the port will not power on.

### 2 Classification:

- PD must have a mechanism that counts the number of class events and determines the PSE type.
  - 2 class events —PSE is two pairs AT.
  - 4 class events —PSE is four pairs AT/UPoE.
- When one of the classes (or both) is *class error*, both pairs will not turn on.
- When the ports have different class levels, the switch will not turn on any of the pairs.

### 3 Startup:

- Startup of the ports is done simultaneously with maximum gap of 10ms.

### 4 Port disconnection:

- In case one of the pairs disconnects due to fault (OVL, UDL, OVT, SC, TLIM), the second pair will immediately follow and also disconnect.

## IEEE 802.3bt Capability

The Dell Networking N2224PX-ON/N2248PX-ON switches implement 802.3bt Type 3 power sourcing equipment capability. The N3208P/N3224P/N3248P switches implement 802.3bt Type 2 power sourcing equipment capability. The N3224PX/N3248PX switches implement 802.3bt Type 4 power sourcing equipment capability. These switches are capable of negotiating the capabilities with the powered device via LLDP. IEEE 802.3bt support allows 2 pair class 0-4, 4 pair, class 0-4, and 2, 3, or 4 pair class 5-6 power. The N3224PX-ON and N3248PX-ON models also support IEEE 802.3bt 4-pair class 7-8 power.

There are two modes of operation as determined by the **power inline detection** configuration. The 802.3bt-capable switches do not allow static management of the power limit. The **power inline limit** and **power inline management static** commands are deprecated on these models.

Configuring the switch with **power inline detection dot3bt** implements a strictly compliant IEEE 802.3bt classification.

Configuring the switch with **power inline detection dot3bt+legacy** implements the IEEE 802.3bt classification with the following differences for 4-pairs matrix (60W) operation. This mode is a special Type 3 802.3bt compliant classification up to 60W, with the exception that Class 4 single-signature PD will be treated as Class 6 to support Class 4 60W (4 class events will be generated). The maximum logical power is 60W. A legacy-detected PD will be treated as a single signature PD. The special Class 4 single-signature PD will not be power demoted, that is, if power is not available the port will not power up. Classes 7 and 8 are power demoted to Class 6 under an insufficient power condition. Other classes will be power demoted when power is not available, based on IEEE 802.3bt behavior. For example, Classes 5 and 6 will be demoted to Class 4 30W under an insufficient power condition. Any classification error will not be powered up. Class 0 PDs are treated as 802.3bt Class 3.

## PoE Port Capabilities and Power Limits

Table 2-1 identifies the PoE capabilities of each switch.

**NOTE:** These power limits are measured at the PSE (switch). Due to insertion losses, the power received by the PD may be less than the requested power feed. For example, a class 8 device requesting 90W power over a Cat5e/6 cable will receive between 72W and 95W depending on the insertion loss.

**Table 2-1. Switch PoE Capabilities**

<b>Technology</b>	<b>Maximum Power (at PSE)</b>
PoE 802.3af	15.4W
PoE+ 802.3at	30W
PoE 60W four-pair	60W
802.3bt Type 3	60W
802.3bt Type 4	90W

**Table 2-2. Models and Ports/Technology**

<b>Model</b>	<b>Ports/Technology</b>
N1124P-ON	12xPoE or 6xPoE+
N1148P-ON	24xPoE or 12xPoE+
N1524P	24xPoE+
N1548P	48xPoE+
N2024P	12x30W PoE+ & 12x60W PoE 60W
N2048P	36x30W PoE+ & 12x60W PoE 60W
N2128PX-ON	24x30W PoE+ & 4x60W PoE 60W
N2224PX-ON	12x30W PoE+ & 12x60W PoE 60W
N2248PX-ON	24x30W PoE+ & 24x60W PoE 60W
N3024EP-ON	12x30W PoE+ & 12x60W PoE 60W
N3048EP-ON	36x30W PoE+ & 12x60W PoE 60W
N3132PX-ON	24x30W PoE & 8x60W PoE 60W
N3208PX-ON	8x90W PoE++
N3224P-ON	24x30W PoE+
N3248P-ON	48x30W PoE+
N3224PX-ON	24x90W PoE++
N3248PXE-ON	48x90W PoE++

**Table 2-3. IEEE 802.3bt Class Power Limits and Margin**

<b>Class</b>	<b>Limit</b>	<b>Margin</b>
<b>0</b>	<b>15.4W</b>	<b>+15%</b>
<b>1</b>	<b>4W</b>	<b>+15%</b>
<b>2</b>	<b>7W</b>	<b>+15%</b>
<b>3</b>	<b>15.4W</b>	<b>+6%</b>
<b>4</b>	<b>30W</b>	<b>+6%</b>
<b>5</b>	<b>45W</b>	<b>+6%</b>
<b>6</b>	<b>60W</b>	<b>+6%</b>



**Table 2-3. IEEE 802.3bt Class Power Limits and Margin (Continued)**

Class	Limit	Margin
7	75W	+6%
8	90W	+6%

**Table 2-4. IEEE 802.3at Class Power Limits and Margin**

Class	Limit	Margin
0	16.4W	+5%
1	5W	+5%
2	8W	+5%
3	16.4W	+5%
4	32W	+5%
4-pair class 4 AT	64W	+5%

For information about configuring PoE Plus features, see ["Managing General System Settings" on page 471](#).

## Key PoE Plus Features

Table 2-5 describes some of the key PoE Plus features.

**Table 2-5. PoE Plus Key Features**

Feature	Description
Global Usage Threshold	Provides the ability to specify a power limit as a percentage of the maximum power available to PoE ports. Setting a limit prevents the PoE switch from reaching an overload condition.
Per-Port Power Prioritization	Provides the ability to assign a priority to each PoE port. When the power budget of the PoE switch has been exhausted, the higher-priority ports are given preference over the lower-priority ports. Lower priority ports are automatically stopped from supplying power in order to provide power to higher-priority ports.
Per-Port Power Limit	Configurable power limit for each PoE-Plus port.

**Table 2-5. PoE Plus Key Features (Continued)**

<b>Feature</b>	<b>Description</b>
Power Management Modes	Supports three power-management modes: <ul style="list-style-type: none"><li>• Static—Reserves a configurable amount of power for a PoE port.</li><li>• Dynamic—Power is not reserved for the port at any point of time. Power is supplied based upon the detected powered device (PD) signature.</li><li>• Class-based—Reserves a classed-based amount of power for a PoE port. The final power delivered is determined via LLDP-MED negotiation, which allows for refinement of the power limit.</li></ul>
Power Detection Mode	Sets the mode to 802.3at or 802.3at+legacy detection.

## **Power Over Ethernet (PoE) Support**

PoE switches implement the PoE specification (IEEE 802.3af) and support configuration for power threshold, power priority, SNMP traps, and PoE legacy device support. Power can be limited on a per-port basis.

## **PoE Plus Support**

PoE Plus-capable switches implement the PoE Plus specification (IEEE 802.3at), in addition to the IEEE 802.3af specification. This allows power to be supplied to Class 4 PD devices that require power greater than 15.4 Watts. Each port is capable of delivering up to 30W of power. Real-time power supply status is also available on the switch as part of the PoE Plus implementation.

## **PoE 60W Support**

PoE 60W allows power to be supplied to Class 4 powered devices that require power up to 60 watts. PoE 60W power must be configured manually for 802.3AT switches.

Class D or better cabling is required for feeds in excess of 30 watts. Normally, CAT 5E cabling does meet this requirement.

PoE-capable switches that are connected to another PSE supplying power will stop supplying power on the affected ports. PSE capability should be disabled when connecting Dell EMC PoE enabled ports to other PSE equipment.

## Powered Device Detection

The switch is capable, based upon configuration, of detecting legacy, AF, AT or BT devices in two-pair or four-pair modes. BT/AT detection is initiated first, followed by AF detection, and if configured, legacy detection. The switch supplies limited power to the port during power up and prior to performing detection. Only 802.3BT-capable switches are capable of BT detection.

## PoE Power Management Modes

PoE-capable switches can be configured to manage powered devices (PD) using a dynamic, static, or class-based management. The power management mode is configured using the **power inline management** command. Static mode is not available on 802.3BT-capable switches.

### Static Power Management

In this mode, the power reserved for the port is the configured limit regardless of whether the port is powered or not. The device may draw up to the configured limit. This mode is useful for devices that do not support LLDP-MED.

Available Power = Power Limit of the Sources – Total Configured Power

The total configured power is calculated as the sum of the configured power allocation for each port. Static mode reserves maximum power for the port, for example, 30W for two-pair mode and 60W for four-pair mode, unless a lower limit is configured by the administrator. Power is not reserved until a PD is connected to the port. The powered device may draw up to the configured limit. LLDP-MED packets requesting power are ignored in static mode. Do not configure the powered device to use LLDP-MED to request power in this mode.

### Dynamic Power Management

In this mode, power is allocated based upon the detected PD class signature.

Available Power = Power Limit of the Sources – Total Allocated Power

The total allocated power is calculated as the sum of the power consumed by each port. Dynamic mode does not reserve power for the port (the port power limit is 0). Dynamic power management ignores LLDP-MED packets sent by the powered device. Do not configure the powered device to send LLDP-MED packets in this mode. The powered device may draw up to the detected class limit plus 5%.

### **Class-Based Power Management**

Class-based power management allocates power based on the class selected by the detected powered device signature and LLDP-MED. The detection method must be configured as dot3at+legacy (dot3bt+legacy) for pre-AF signature devices to be detected.

Available Power = Power Limit of the Sources – Total Class Configured Power

The total class configured power is calculated as the sum of the class-based power allocation for each port. Note that class-based power management mode allocates the class limit for the port. The powered device may draw up to the class maximum based upon the detected powered device signature. The powered device need not draw all of the requested power. The Consumed Power display from the **show power inline** command takes into account the class reserved power. Configure the powered device to send LLDP-MED packets in this mode. It may take up to 60 seconds to fully power up a device in class-based management mode because LLDP-MED packets need to be exchanged in order to configure the desired power.

Power is supplied to the device in class mode per Table 2-6.

**Table 2-6. Class-based Power Management**

Class	Usage	AF/AT Device (Watts)	BT Device (Watts)	PD Type
0	Default	15.4	4	1 802.3af
1	Optional	4	4	1 802.3af
2	Optional	7	7	1 802.3af
3	Optional	15.4	15.4	1 802.3af
4	802.3at or 802.3bt	30	30	2 802.3at
5	802.3bt	NA	45	3 802.3bt
6	802.3bt	NA	60	3 802.3bt
7	802.3bt	NA	90	4 802.3bt
8	802.3bt	NA	90	4 802.3bt

In four-pair mode, for classes 0-4, twice the power listed in Table 2-6 above is delivered. Classes 5 and 6 may be two, three, or four-pair power. Classes 7 and 8 are four-pair power. For information about the available system power, see the Hardware Overview chapter.

### Power Management in Guard Band

All Dell EMC Networking PoE-capable switches support a dynamic guard band, which means that the guard band used varies depending upon the following factors:

- Power management mode
- Class of the device being powered up.

Prior to a device being powered up, the switch calculates the following:

$$\text{threshold power} - \text{guard band} - (\text{current power consumption} + \text{computed power draw of the new device})$$

If this value is less than zero (which means powering up the new PD device will put the total power draw into the guard band or above the switch power capacity), then the switch does not power up the new device. A device being

powered up in class or dynamic mode is always supplied with 15.4 watts at startup. Once the device class or power draw is determined, power to the device may be reduced or increased.

The power management mode is configured using the **power inline management** command. The guard band is calculated by the switch as shown below. The user- defined threshold power limit can be found with the **show power inline detailed** command, and is configured with the **power inline usage-threshold** command. Threshold Power is reduced by the guard band when powering up a port.

If the remaining available power (threshold power - guard band - current power consumption) is less than the computed power draw of the new device, the device is not powered up.

Ports may have a PoE priority assigned. If a device is plugged into a higher priority port, lower priority ports will be de-powered to power the higher priority port. Among ports with the same priority, lower numbered ports have priority over higher numbered ports.

Regardless of the power management mode, the guard band is configured according to the device class.

### **Dynamic or Static Power Management Mode Guard Band**

In these modes, the guard band for the port being powered up is 32 watts.

### **Class-Based Power Management Mode Guard Band**

In this mode, the dynamic guard band for the port being powered up is:

- For Class 0 device: 16.4 watts
- For Class 1 device: 5 watts
- For Class 2 device: 8 watts
- For Class 3 device: 16.4 watts
- For Class 4 device: 32 watts
- For Class 5 device: 47.5 watts
- For Class 6 device: 63 watts
- For Class 7 device: 95 watts
- For Class 8 device: 95 watts

## PoE Plus Default Settings

Table 2-7 shows the default PoE settings for the Dell EMC Networking PoE-capable switches.

**Table 2-7. PoE Key Features**

<b>Feature</b>	<b>Description</b>
Global Usage Threshold	90%
Per-Port Admin Status	Auto
Per-Port Power Prioritization	Enabled (globally, per-port priority is Low)
Per-Port Power Limit	None
Power Management Mode	Dynamic
Power Detection Mode	802.3at+legacy (802.3bt+legacy for capable devices)
Power Pairs	alternative-a

# Switching Features

## Flow Control Support (IEEE 802.3x)

Flow control enables lower speed switches to communicate with higher speed switches by requesting that the higher speed switch refrain from sending packets for a limited period of time. Transmissions are temporarily halted to prevent buffer overflows.

For information about configuring flow control, see "Port-Based Traffic Control" on page 949.

## Head of Line Blocking Prevention

Head of Line (HOL) blocking prevention prevents traffic delays and frame loss caused by traffic competing for the same egress port resources. HOL blocking queues packets, and the packets at the head of the queue are forwarded before packets at the end of the queue.

## Jumbo Frames Support

Jumbo frames enable transporting data in fewer frames to ensure less overhead, lower processing time, and fewer interrupts.

For information about configuring the switch MTU, see "Port Characteristics" on page 673.

## Auto-MDI/MDIX Support

The switch supports auto-detection between crossed and straight-through cables. Media-Dependent Interface (MDI) is the standard wiring for end stations, and the standard wiring for hubs and switches is known as Media-Dependent Interface with Crossover (MDIX). Auto-negotiation must be enabled for the switch to detect the wiring configuration. NBASE-T ports (2.5G and 5G) do not support auto-detection. Use the correct crossover or straight-through cable on 2.5/5G NBASE-T interfaces.

## VLAN-Aware MAC-based Switching

Packets arriving from an unknown source address are sent to the CPU and added to the Hardware Table. Future packets addressed to or from this address are more efficiently forwarded.



## Back Pressure Support

On half-duplex links, a receiver may prevent buffer overflows by jamming the link so that it is unavailable for additional traffic. On full-duplex links, a receiver may send a PAUSE frame indicating that the transmitter should cease transmission of frames for a specified period.



**NOTE:** Dell EMC Networking N2000/N2100-ON/N3000E-ON/N3100-ON Series switches do not support half-duplex operation.

When flow control is enabled, the Dell EMC Networking N-Series switches will observe received PAUSE frames or jamming signals, but will not issue them when congested.

## Auto-negotiation

Auto-negotiation allows the switch to advertise modes of operation. The auto-negotiation function provides the means to exchange information between two switches that share a point-to-point link segment and to automatically configure both switches to take maximum advantage of their transmission capabilities.

Dell EMC Networking N-Series switches enhance auto-negotiation by providing configuration of port advertisement. Port advertisement allows the system administrator to configure the port speeds that are advertised.

For information about configuring auto-negotiation, see "Port Characteristics" on page 673.

## Storm Control

When Layer-2 frames are processed, broadcast, unknown unicast, and multicast frames are flooded to all ports on the relevant virtual local area network (VLAN). The flooding occupies bandwidth and loads all nodes connected on all ports. Storm control limits the amount of broadcast, unknown unicast, and multicast frames accepted and forwarded by the switch.

For information about configuring Broadcast Storm Control settings, see "Port-Based Traffic Control" on page 949.

## Port Mirroring

Port mirroring mirrors network traffic by forwarding copies of incoming and outgoing packets from multiple source ports to a monitoring port. Source ports may be VLANs, Ethernet interfaces, port-channels, or the CPU port. The switch also supports flow-based mirroring, which allows copying certain types of traffic to a single destination port using an ACL. This provides flexibility—instead of mirroring all ingress or egress traffic on a port the switch can mirror a subset of that traffic. The switch can be configured to mirror flows based on certain kinds of Layer-2, Layer-3, and Layer-4 information.

Destination (probe) ports must be connected to a passive monitoring device. Traffic sent from the probe into the switch probe port is dropped. Mirrored traffic sent to the probe device will contain control plane traffic such as spanning-tree, LLDP, DHCP, etc.

Dell EMC Networking N-Series switches support RSPAN destinations where traffic can be tunneled across the operational network. Mirrored traffic is flooded in the RSPAN VLAN from the source(s) to the destination(s) across any intermediate switches. This allows the administrator flexibility in connecting destination (probe) ports to the RSPAN. RSPAN does not support configuration of the CPU port as a source.

For information about configuring port mirroring, see "Monitoring Switch Traffic" on page 603.

## Static and Dynamic MAC Address Tables

Static entries can be added to the switch's MAC address table and the aging time can be configured for entries in the dynamic MAC address table. Entries can also be searched in the dynamic table based on several different criteria.

For information about viewing and managing the MAC address table, see "MAC Addressing and Forwarding" on page 1161.

## Link Layer Discovery Protocol (LLDP)

The IEEE 802.1AB defined standard, Link Layer Discovery Protocol (LLDP), allows the switch to advertise major capabilities and physical descriptions. This information can be used to help identify system topology and detect bad configurations on the LAN.

For information about configuring LLDP, settings see "Discovering Network Devices" on page 923.

### **Link Layer Discovery Protocol (LLDP) for Media Endpoint Devices**

The Link Layer Discovery Protocol for Media Endpoint Devices (LLDP-MED) provides an extension to the LLDP standard for network configuration and policy, device location, and Power over Ethernet.

For information about configuring LLDP-MED, settings see "Discovering Network Devices" on page 923.

## Connectivity Fault Management (IEEE 802.1ag)



**NOTE:** This feature is available on the Dell EMC Networking N1500/N2200 Switches Series switches only.

The Connectivity Fault Management (CFM) feature, also known as Dot1ag, supports Service Level Operations, Administration, and Management (OAM). CFM is the OAM Protocol provision for end-to-end service layer instance in carrier networks. The CFM feature provides mechanisms to help perform connectivity checks, fault detection, fault verification and isolation, and fault notification per service in a network domain.

For information about configuring IEEE 802.1ag settings, see "Connectivity Fault Management" on page 1023.

## Cisco Protocol Filtering

The Cisco Protocol Filtering feature (also known as Link Local Protocol Filtering) filters Cisco protocols that should not normally be relayed by a bridge. The group addresses of these Cisco protocols do not fall within the IEEE defined range of the 802.1D MAC Bridge Filtered MAC Group Addresses (01-80-C2-00-00-00 to 01-80-C2-00-00-0F).

For information about configuring LLPF, settings see "Port-Based Traffic Control" on page 949.

## DHCP Layer-2 Relay

This feature permits Layer-3 relay agent functionality in Layer-2 switched networks. The switch supports Layer-2 DHCP relay configuration on individual ports, link aggregation groups (LAGs) and VLANs.

For information about configuring Layer-2 DHCP relay settings see "Layer-2 and Layer-3 Relay Features" on page 1235.

# Virtual Local Area Network Supported Features

For information about configuring VLAN features see "VLANs" on page 787.

## VLAN Support

VLANs are collections of switching ports that comprise a single broadcast domain. Incoming packets are classified as belonging to a VLAN based on either the VLAN tag or a combination of the ingress port and packet contents. Transmitted packets are forwarded tagged or untagged based upon the configuration of the egress port. The Dell EMC Networking N-Series switches are in full compliance with IEEE 802.1Q VLAN tagging.

## Port-Based VLANs

Port-based VLANs classify incoming packets to VLANs based on their ingress port configuration and the VLAN tag, if present. When a port uses 802.1X port authentication, packets can be assigned to a VLAN based on the result of the 802.1X authentication a client uses when it accesses the switch. This feature is useful for assigning traffic to Guest VLANs or Voice VLANs.

## IP Subnet-based VLAN

This feature allows incoming untagged packets to be assigned to a VLAN and traffic class based on the source IP address of the packet.

## MAC-based VLAN

This feature allows incoming untagged packets to be assigned to a VLAN and traffic class based on the source MAC address of the packet.

## IEEE 802.1v Protocol-Based VLANs

VLAN classification rules are defined on data-link layer (Layer-2) protocol identification. Protocol-based VLANs are used for isolating Layer-2 traffic.

## **Voice VLAN**

The Voice VLAN feature enables switch ports to carry voice traffic with a configured QoS and to optionally authenticate phones on the network. This allows preferential treatment of voice traffic over data traffic transiting the switch. Voice VLAN is the preferred solution for enterprises wishing to deploy VoIP services in their network.

## **GARP and GVRP Support**

The switch supports the Generic Attribute Registration Protocol (GARP). GARP VLAN Registration Protocol (GVRP) relies on the services provided by GARP to provide IEEE 802.1Q-compliant VLAN pruning and dynamic VLAN creation on 802.1Q trunk ports. When GVRP is enabled, the switch registers and propagates VLAN membership on all ports that are part of the active spanning tree protocol topology.

For information about configuring GARP timers see "Layer-2 Multicast Features" on page 967.

## **Guest VLAN**

The Guest VLAN feature allows the administrator to provide service to unauthenticated users, i.e., users that are unable to support 802.1X authentication.

For information about configuring the Guest VLAN see "Guest VLAN" on page 363.

## **Unauthorized VLAN**

The Unauthorized VLAN feature allows the administrator to configure a VLAN for 802.1X-aware hosts that attempt authentication and fail.

## **Double VLANs**

The Double VLAN feature (IEEE 802.1QinQ) allows the use of a second tag on network traffic. The additional tag helps differentiate between customers in the Metropolitan Area Networks (MAN) while preserving individual customer's VLAN identification when they enter their own 802.1Q domain.

# Spanning Tree Protocol Features

For information about configuring Spanning Tree Protocol features, see "Spanning Tree Protocol" on page 871.

## Spanning Tree Protocol (STP)

Spanning Tree Protocol (IEEE 802.1D) is a standard requirement of Layer-2 switches that allows bridges to automatically prevent and resolve Layer-2 forwarding loops.

## Spanning Tree Port Settings

The STP feature supports a variety of per-port settings including path cost, priority settings, Port Fast mode, STP Root Guard, Loop Guard, TCN Guard, and Auto Edge. These settings are also configurable per-LAG.

## Rapid Spanning Tree

Rapid Spanning Tree Protocol (RSTP) detects and uses network topologies to enable faster spanning tree convergence after a topology change, without creating forwarding loops. The port settings supported by STP are also supported by RSTP.

## Multiple Spanning Tree

Multiple Spanning Tree (MSTP) operation maps VLANs to spanning tree instances. Packets assigned to various VLANs are transmitted along different paths within MSTP Regions (MST Regions). Regions are one or more interconnected MSTP bridges with identical MSTP settings. The MSTP standard lets administrators assign VLAN traffic to unique paths.

The switch supports IEEE 802.1Q-2005, which corrects problems associated with the previous version, provides for faster transition-to-forwarding, and incorporates new features for a port (restricted role and restricted TCN).

## **Bridge Protocol Data Unit (BPDU) Guard**

Spanning Tree BPDU Guard is used to disable the port in case a new device tries to enter the already existing topology of STP. Thus devices, which were originally not a part of STP, are not allowed to influence the STP topology.

## **BPDU Filtering**

When spanning tree is disabled on a port, the BPDU Filtering feature allows BPDU packets received on that port to be dropped. Additionally, the BPDU Filtering feature prevents a port in Port Fast mode from sending and receiving BPDUs. A port in Port Fast mode is automatically placed in the forwarding state when the link is up to increase convergence time.

## **RSTP-PV and STP-PV**

Dell EMC Networking N-Series switches support both Rapid Spanning Tree Per VLAN (RSTP-PV) and Spanning Tree Per VLAN (STP-PV). RSTP-PV is the IEEE 802.1w (RSTP) standard implemented per VLAN. A single instance of rapid spanning tree (RSTP) runs on each configured VLAN. Each RSTP instance on a VLAN has a root switch. STP-PV is the IEEE 802.1s (STP) standard implemented per VLAN.



# Link Aggregation Features

For information about configuring link aggregation (port-channel) features, see "Link Aggregation" on page 1089.

## Link Aggregation

Up to eight ports can combine to form a single Link Aggregation Group (LAG). This enables fault tolerance protection from physical link disruption, higher bandwidth connections and improved bandwidth granularity. LAGs are formed from similarly configured physical links; i.e., the speed, duplex, auto-negotiation, PFC configuration, DCBX configuration, etc., must be compatible on all member links.

Per IEEE 802.1AX, only links with the identical operational characteristics, such as speed and duplex setting, may be aggregated. Dell EMC Networking N-Series switches aggregate links only if they have the same operational speed and duplex setting, as opposed to the configured speed and duplex setting. This allows operators to aggregate links that use auto-negotiation to set values for speed and duplex or to aggregate ports with SFP+ technology operating at a lower speed, e.g., 1G. Dissimilar ports will not become active in the LAG if their operational settings do not match those of the first member of the LAG.

In practice, some ports in a LAG may auto-negotiate a different operational speed than other ports depending on the far-end settings and any link impairments. Per the above, these ports will not become active members of the LAG. On a reboot or on flapping the LAG links, a lower-speed port may be the first port selected to be aggregated into the LAG. In this case, the higher-speed ports are not aggregated. Use the **lacp port-priority** command to select one or more primary links to lead the formation of the aggregation group.

While it is a requirement of a port-channel that the link members operate at the same duplex and speed settings, administrators should be aware that copper ports have larger latencies than fiber ports. If fiber and copper ports are aggregated together, packets sent over the fiber ports would arrive significantly sooner at the destination than packets sent over the copper ports. This can cause significant issues in the receiving host (e.g., a TCP receiver) as it would be required to buffer a potentially large number of out-

of-order frames. Devices unable to buffer the requisite number of frames will show excessive frame discard. Configuring copper and fiber ports together in an aggregation group is not recommended.

Logically, port channels are distinct from the member ports. This means that configuration of the port channel affects the operational characteristics of the member ports, not the configured characteristics. For example, shutting down a port channel will operationally disable the port channel members without altering the member port configuration.

### **Link Aggregate Control Protocol (LACP)**

Link Aggregate Control Protocol (LACP) uses peer exchanges across links to determine, on an ongoing basis, the aggregation capability of various links, and continuously provides the maximum level of aggregation capability achievable between a given pair of systems. LACP automatically determines, configures, binds, and monitors the binding of ports to aggregators within the system.

### **Multi-Switch LAG (MLAG)**

Dell EMC Networking N-Series switches support the MLAG feature to extend the LAG bandwidth advantage across multiple Dell EMC Networking N-Series switches connected to a LAG partner device. The LAG partner device is unaware that it is connected to two peer Dell EMC Networking N-Series switches; instead, the two switches appear as a single switch to the partner. When using MLAG, all links can carry data traffic across a physically diverse topology and, in the case of a link or switch failure, traffic can continue to flow with minimal disruption.

# Routing Features



**NOTE:** The N1100-ON Series switches do not support routing.

## Address Resolution Protocol (ARP) Table Management

Static ARP entries can be created, and many settings for the dynamic ARP table can be managed, such as age time for entries, retries, and cache size. The ARP table supports routing by caching MAC addresses corresponding to the IP addresses of attached stations.

For information about managing the ARP table, see "IP Routing" on page 1193.

## VLAN Routing

Dell EMC Networking N-Series switches support VLAN routing. A VLAN-routed packet is routed based on a longest prefix match lookup of the destination IP address in the routing table and is forwarded on a different VLAN by rewriting the destination MAC address obtained from the ARP table, decrementing the TTL, recalculating the frame CRC, and transmitting the frame on the VLAN.

For information about configuring VLAN routing interfaces, see "Routing Interfaces" on page 1219.

## IP Configuration

The switch IP configuration settings allow the configuration of network information for VLAN routing interfaces, such as the IP address and subnet mask. Global IP configuration settings for the switch allow enabling or disabling the generation of several types of ICMP messages, setting a default gateway, and enabling or disabling inter-VLAN routing of packets.

For information about managing global IP settings, see "IP Routing" on page 1193.

## Open Shortest Path First (OSPF)



**NOTE:** This feature is not available on Dell EMC Networking N1100-ON or N1500 Series switches.

Open Shortest Path First (OSPF) is a dynamic routing protocol commonly used within medium-to-large enterprise networks. OSPF is an interior gateway protocol (IGP) that operates within a single autonomous system. For information about configuring OSPF, see "OSPF and OSPFv3" on page 1263.

## Border Gateway Protocol (BGP)



**NOTE:** This feature is not available on Dell EMC Networking N1100-ON, N1500, N2000, and N2100-ON Series switches.

BGP is a protocol used for exchanging reachability information between autonomous systems. BGP uses a standardized decision process, which, when used in conjunction with network policies configured by the administrator, support a robust set of capabilities for managing the distribution of routing information.

Dell EMC Networking supports BGP4 configured as an IGP or an EGP. As an IGP, configuration as a source or client route reflector is supported. Both IPv6 and IPv4 peering sessions are supported.

For more information about configuring BGP, see "BGP" on page 1403.

## Virtual Routing and Forwarding



**NOTE:** This feature is not available on Dell EMC Networking N1100-ON, N1500, N2000, and N2100-ON switches.

The virtual routing feature is available for both IPv4 and IPv6.

Virtual Routing and Forwarding (VRF) allows multiple independent instances of the forwarding plane to exist simultaneously. This allows segmenting the network without incurring the costs of multiple routers. Each VRF instance operates as an independent VPN. The IPv4/IPv6 addresses assigned to each VPN may overlap. Static route leaking to and from the global instance is supported. VLANs associated with a VRF may not overlap with other VRF instances.

For more information about configuring VRFs, see "VRF" on page 1355.

### **BOOTP/DHCP Relay Agent**

The switch BootP/DHCP Relay Agent feature relays BootP and DHCP messages between DHCP clients and DHCP servers that are located in different IP subnets.

For information about configuring the BootP/DHCP Relay agent, see "Layer-2 and Layer-3 Relay Features" on page 1235.

### **IP Helper and DHCP Relay**

The IP Helper and DHCP Relay features provide the ability to relay various protocols to servers on a different subnet.

For information about configuring the IP helper and DHCP relay features, see "Layer-2 and Layer-3 Relay Features" on page 1235.

### **Routing Information Protocol**

Routing Information Protocol (RIP), like OSPF, is an IGP used within an autonomous Internet system. RIP is an IGP that is designed to work with moderate-size networks.

For information about configuring RIP, see "RIP" on page 1361.

### **Router Discovery**

For each interface, the Router Discovery Protocol (RDP) can be configured to transmit router advertisements. These advertisements inform hosts on the local network about the presence of the router.

For information about configuring router discovery, see "IP Routing" on page 1193.

### **Routing Table**

The routing table displays information about the routes that have been dynamically learned. Static and default routes and route preferences can be configured. A separate table shows the routes that have been manually configured.

For information about viewing the routing table, see "IP Routing" on page 1193.

## Virtual Router Redundancy Protocol (VRRP)

VRRP provides hosts with redundant routers in the network topology without any need for the hosts to reconfigure or know that there are multiple routers. If the primary router fails, a secondary router assumes control and continues to use the virtual router IP (VRIP) address.

VRRP Route Interface Tracking extends the capability of VRRP to allow tracking of specific route/interface IP states within the router that can alter the priority level of a virtual router for a VRRP group.

For information about configuring VRRP settings, see "VRRP" on page 1377.

## Tunnel and Loopback Interfaces



**NOTE:** This feature is not available on Dell EMC Networking N1100-ON or N1500 Series switches.

Dell EMC Networking N-Series switches support the creation, deletion, and management of tunnel and loopback interfaces. Tunnel interfaces facilitate the transition of IPv4 networks to IPv6 networks. A loopback interface is always expected to be up, so a stable IP address can be configured to enable other network devices to contact or identify the switch.

For information about configuring tunnel and loopback interfaces, see "Routing Interfaces" on page 1219.

# IPv6 Routing Features



**NOTE:** This feature is not available on Dell EMC Networking N1100-ON, N1500, N2000, and N2100-ON Series switches.

## IPv6 Configuration

The switch supports IPv6, the next generation of the Internet Protocol. IPv6 can be globally enabled on the switch and settings such as the IPv6 hop limit and ICMPv6 rate limit error interval can be configured. The administrator can also control whether IPv6 is enabled on a specific interface. The switch supports the configuration of many per-interface IPv6 settings including the IPv6 prefix and prefix length.

For information about configuring general IPv6 routing settings, see "IPv6 Routing" on page 1483.

## IPv6 Routes

Because IPv4 and IPv6 can coexist on a network, the router on such a network needs to forward both traffic types. Given this coexistence, each switch maintains a separate routing table for IPv6 routes. The switch can forward IPv4 and IPv6 traffic over the same set of interfaces.

For information about configuring IPv6 routes, see "IPv6 Routing" on page 1483.

## OSPFv3

OSPFv3 provides a routing protocol for IPv6 networking. OSPFv3 is a new routing component based on the OSPF version 2 component. In dual-stack IPv6, both OSPF and OSPFv3 components can be configured and used.

For information about configuring OSPFv3, see "OSPF and OSPFv3" on page 1263.

## DHCPv6

DHCPv6 incorporates the notion of the “stateless” server, where DHCPv6 is not used for IP address assignment to a client, rather it only provides other networking information such as DNS, Network Time Protocol (NTP), and/or Session Initiation Protocol (SIP) information.

For information about configuring DHCPv6 settings, see "DHCPv6 Server Settings" on page 1511.

## Quality of Service (QoS) Features



**NOTE:** Some features that can affect QoS, such as ACLs and Voice VLAN, are described in other sections within this chapter.

### Differentiated Services (DiffServ)

The QoS Differentiated Services (DiffServ) feature allows traffic to be classified into streams and given certain QoS treatment in accordance with defined per-hop behaviors. Dell EMC Networking N-Series switches support both IPv4 and IPv6 packet classification.

For information about configuring DiffServ, see "Differentiated Services" on page 1531.

### Class Of Service (CoS)

The Class Of Service (CoS) queuing feature enables directly configuring certain aspects of switch queuing. This provides the desired QoS behavior for different types of network traffic when the complexities of DiffServ are not required. CoS queue characteristics, such as minimum guaranteed bandwidth and transmission rate shaping, are configurable at the queue (or port) level.

For information about configuring CoS, see "Class-of-Service" on page 1567.

### Auto Voice over IP (VoIP)

This feature provides ease of use for the user in setting up VoIP for IP phones on a switch. This is accomplished by enabling a VoIP profile that a user can select on a per port basis.

For information about configuring Auto VoIP, see "Auto VoIP" on page 1595.

This capability is not available on the N3000E-ON Series switches when running the AGGRAGATION ROUTER image.



## **Internet Small Computer System Interface (iSCSI) Optimization**

The iSCSI Optimization feature helps network administrators track iSCSI traffic between iSCSI initiator and target systems. This is accomplished by monitoring, or snooping traffic to detect packets used by iSCSI stations in establishing iSCSI sessions and connections. Data from these exchanges may optionally be used to create classification rules to assign the traffic between the stations to a configured traffic class. This affects how the packets in the flow are queued and scheduled for egress on the destination port.

For information about configuring iSCSI settings, see "iSCSI Optimization" on page 663.

## **Layer-2 Multicast Features**

For information about configuring Layer-2 multicast features, see "Layer-2 Multicast Features" on page 967.

### **MAC Multicast Support**

Multicast service is a limited broadcast service that supports one-to-many and many-to-many forwarding behavior. In the Layer-2 multicast service, a single frame addressed to a specific multicast address is received and copies of the frame to be transmitted on each relevant port are forwarded.

### **IGMP Snooping**

Internet Group Management Protocol (IGMP) Snooping is a feature that allows a switch to forward multicast traffic intelligently on the switch.

Multicast traffic is traffic that is destined to a host group. Host groups are identified by the destination MAC address, i.e. the range 01:00:5e:00:00:00 to 01:00:5e:7f:ff:ff:ff for IPv4 multicast traffic or 33:33:xx:xx:xx:xx for IPv6 multicast traffic. Based on the IGMP query and report messages, the switch forwards traffic only to the ports that request the multicast traffic. This prevents the switch from broadcasting the traffic to all ports and possibly affecting network performance.

## **IGMP Snooping Querier**

When Protocol Independent Multicast (PIM) and IGMP are enabled in a network with IP multicast routing, an IP multicast router acts as the IGMP querier. However, if it is desirable to keep the multicast network Layer-2 switched only, the IGMP Snooping Querier can perform the query functions of a Layer-3 multicast router.

## **MLD Snooping**

In IPv4, Layer-2 switches can use IGMP Snooping to limit the flooding of multicast traffic by dynamically configuring Layer-2 interfaces so that multicast traffic is forwarded to only those interfaces associated with IP multicast address.

In IPv6, MLD snooping performs a similar function. With MLD snooping, IPv6 multicast data is selectively forwarded to a list of ports intended to receive the data (instead of being flooded to all of the ports in a VLAN). This list is constructed by snooping IPv6 multicast control packets.

## **Multicast VLAN Registration**

The Multicast VLAN Registration (MVR) protocol, like IGMP Snooping, allows a Layer-2 switch to listen to IGMP frames and forward the multicast traffic only to the receivers that request it. Unlike IGMP Snooping, MVR allows the switch to forward multicast frames across different VLANs. MVR uses a dedicated VLAN, which is called the multicast VLAN, to forward multicast traffic over the Layer-2 network to the various VLANs that have multicast receivers as members.

## Layer-3 Multicast Features

For information about configuring Layer-3 (L3) multicast features, see "IPv4 and IPv6 Multicast" on page 1601.



**NOTE:** This feature is not available on Dell EMC Networking N1100-ON, N1500, N2000, and N2100-ON Series switches.

### Distance Vector Multicast Routing Protocol

Distance Vector Multicast Routing Protocol (DVMRP) exchanges probe packets with all DVMRP-enabled routers, establishing two way neighboring relationships and building a neighbor table. It exchanges report packets and creates a unicast topology table, which is used to build the multicast routing table. This multicast route table is then used to route the multicast packets.

### Internet Group Management Protocol

The Internet Group Management Protocol (IGMP) is used by IPv4 systems (hosts and routers) to report their IP multicast group memberships to any neighboring multicast routers. Dell EMC Networking N-Series switches perform the “multicast router part” of the IGMP protocol, which means it collects the membership information needed by the active multicast router.

### IGMP Proxy

The IGMP Proxy feature allows the switch to act as a proxy for hosts by sending IGMP host messages on behalf of the hosts that the switch discovered through standard IGMP router interfaces.

### Protocol Independent Multicast—Dense Mode

Protocol Independent Multicast (PIM) is a standard multicast routing protocol that provides scalable inter-domain multicast routing across the Internet, independent of the mechanisms provided by any particular unicast routing protocol. The Protocol Independent Multicast-Dense Mode (PIM-DM) protocol uses an existing Unicast routing table and a Join/Prune/Graft mechanism to build a tree. PIM-DM creates source-based shortest-path distribution trees, making use of reverse path forwarding (RPF).

## **Protocol Independent Multicast—Sparse Mode**

Protocol Independent Multicast-Sparse Mode (PIM-SM) is used to efficiently route multicast traffic to multicast groups that may span wide area networks, and where bandwidth is a constraint. PIM-SM uses shared trees by default and implements source-based trees for efficiency. This data threshold rate is used to toggle between trees.

## **Protocol Independent Multicast—Source Specific Multicast**

Protocol Independent Multicast—Source Specific Multicast (PIM-SSM) is a subset of PIM-SM and is used for one-to-many multicast routing applications, such as audio or video broadcasts. PIM-SSM does not use shared trees.

## **Protocol Independent Multicast IPv6 Support**

PIM-DM and PIM-SM support IPv6 routes.

## **MLD/MLDv2 (RFC2710/RFC3810)**

MLD is used by IPv6 systems (listeners and routers) to report their IP multicast addresses memberships to any neighboring multicast routers. The implementation of MLD v2 is backward compatible with MLD v1.

MLD protocol enables the IPv6 router to discover the presence of multicast listeners, the nodes that want to receive the multicast data packets, on its directly attached interfaces. The protocol specifically discovers which multicast addresses are of interest to its neighboring nodes and provides this information to the multicast routing protocol that make the decision on the flow of the multicast data packets.

# Hardware Overview

This section provides an overview of the switch hardware. It is organized by product type:

- Dell EMC Networking N1100-ON Series Switch Hardware
- Dell EMC Networking N1500 Series Switch Hardware
- Dell EMC Networking N2000 Series Switch Hardware
- Dell EMC Networking N2100-ON Series Switch Hardware
- Dell EMC Networking N2200-ON Series Switch Hardware
- Dell EMC Networking N3000E-ON Series Switch Hardware
- Dell EMC Networking N3100-ON Series Switch Hardware
- Dell EMC Networking N3200-ON Series Switch Hardware
- Switch MAC Addresses

## Dell EMC Networking N1100-ON Series Switch Hardware

This section contains information about device characteristics and modular hardware configurations for the Dell EMC Networking N1100-ON switch.

### N1100-ON Series Front Panel

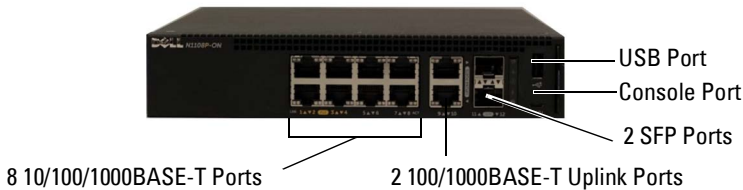
The N1108-ON models are half-width, 1U, rack-mountable switches. To rack-mount the N1108-ON switches, either the Dell EMC Rack Mount Kit or the Dell EMC Tandem Tray Kit is required. The N1124-ON and N1148-ON models are full-width, 1U, rack mountable switches.

The Dell EMC Networking N1108-ON front panel provides eight 10/100/1000BASE-T Ethernet RJ-45 ports, capable of full-duplex or half-duplex operation, two 100/1000BASE-T RJ-45 uplink ports capable of full-duplex operation only, and two SFP ports. The SFP ports are capable of 1G full-duplex operation only. The N1108P-ON supports two PoE+ or four PoE ports on Gigabit Ethernet ports 1-4. Dell-qualified SFP transceivers are sold separately.

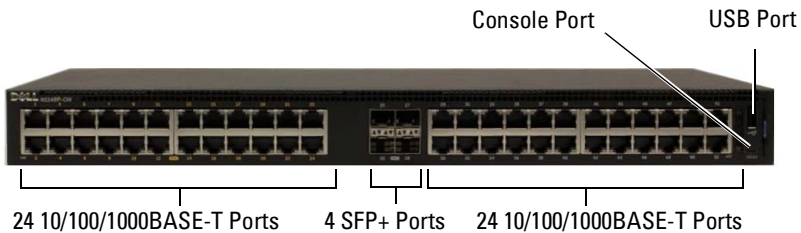
The Dell EMC Networking N1124-ON front panel provides 24 10/100/1000BASE-T Ethernet RJ-45 ports capable of full-duplex and half-duplex operation, and four SFP+ ports. The N1124P-ON supports six PoE+ or 12 PoE ports on Gigabit Ethernet ports 5-16. Dell EMC-qualified SFP+ transceivers are sold separately.

The Dell EMC Networking N1148-ON front panel provides 48 10/100/1000BASE-T Ethernet RJ-45 ports capable of full-duplex and half-duplex operation, and four SFP+ ports. The N1148P-ON supports 12 PoE+ or 24 PoE ports on Gigabit Ethernet ports 1-24. Dell EMC-qualified SFP+ transceivers are sold separately.

**Figure 3-1. Dell EMC Networking N1108P-ON Switch (Front Panel)**



**Figure 3-2. Dell EMC Networking N1148P-ON Switch (Front Panel)**



### Console Port

The console port provides serial communication capabilities, which allows communication using RS-232 protocol. The micro-USB port provides a direct connection to the switch and allows access to the CLI from a console terminal connected to the port through the provided USB cable (with a male USB micro B to male USB type A connector).

The console port is separately configurable and can be run as an asynchronous link from 1200 baud to 115,200 baud. The Dell EMC CLI supports changing only the speed of the console port. The defaults are 115,200 baud, 8 data bits, no parity, 1 stop bit, and no flow control.

### **USB Port**

The Type-A, female USB port supports a USB 2.0-compliant flash memory drive. The Dell EMC Networking N-Series switch can read or write to a flash drive with a single partition formatted as FAT-32. Use a USB flash drive to copy switch configuration files and images between the USB flash drive and the switch. The USB flash drive may be used to move and copy configuration files and images from one switch to other switches in the network. The system does not support the deletion of files on USB flash drives.

The USB port does not support any other type of USB device.

### **Port and System LEDs**

The front panel contains light emitting diodes (LEDs) that indicate the status of port links, power supplies, fans, stacking, and the overall system status. See "N1100-ON Series LED Definitions" on page 112 for more information.

### **LED of Management Unit in Stack**

When a switch within a stack is the primary unit, the LED of the management unit in the stack is solid green. If the LED of the management unit in the stack is off, the stack member is not the primary unit. If a switch is not part of a stack (in other words, it is a stack of one switch), the LED of the management unit is illuminated.

### **Information Tag**

The front panel includes a slide-out label panel that contains system information, such as the Service Tag, MAC address, and so on.

## **N1100-ON Series Power Supply**

The internal power supply wattage for the Dell EMC Networking N1100-ON switches is as follows:

- N1108T-ON: 24W
- N1108P-ON: 80W
- N1124T-ON: 40W
- N1124P-ON: 250W
- N1148T-ON: 60W
- N1148P-ON: 500W

For information about power consumption for the N1100-ON PoE switches, see "Power Consumption for N1100-ON Series PoE Switches" on page 116.

## **N1100-ON Series Ventilation System**

The N1108T-ON, N1124T-ON, and N1148T-ON switches are fanless. The N1108P-ON has one internal fan, and the N1124P-ON and N1148P-ON each have two internal fans.

## **N1100-ON Series Thermal Shutdown**

Upon reaching critical temperature, the switch will shut down for 5 minutes and then automatically power on again. This cycle will repeat for as long as the switch is at or above critical temperature. During shutdown, the fans of switches so equipped will remain operational.

## **N1100-ON Series LED Definitions**

This section describes the LEDs on the front panel of the switch.

### **Port LEDs**

Each port on a Dell EMC Networking N1100-ON Series switch includes two LEDs. One LED is on the left side of the port, and the second LED is on the right side of the port. This section describes the LEDs on the switch ports.

Each 100/1000/10000BASE-T port has two LEDs. Figure 3-16 illustrates the 100/1000/10000BASE-T port LEDs.



**Figure 3-3. 100/1000/10000BASE-T Port LEDs**

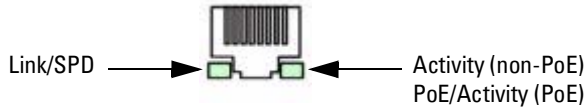


Table 3-19 shows the 100/1000/10000BASE-T port LED definitions.

**Table 3-1. 100/1000/10000BASE-T Port LED Definitions**

LED	Color	Definition
Link/SPD LED	Off	There is no link.
	Solid amber	The port is operating at 10/100 Mbps.
	Solid green	The port is operating at 1000 Mbps.
Activity LED (on non-PoE switches)	Off	There is no current transmit/receive activity.
	Blinking green	The port is actively transmitting/receiving.
Activity/PoE LED (on PoE switches)	Off	There is no current transmit/receive activity and PoE power is off.
	Blinking green	The port is actively transmitting/receiving and PoE power is off.
	Blinking amber	The port is actively transmitting/receiving and PoE power is on.
	Solid amber	There is no current transmit/receive activity and PoE power is on.

**Table 3-2. SFP Port LED Definitions (N1108-ON Only)**

<b>LED</b>	<b>Color</b>	<b>Definition</b>
Link/SPD LED (Left LED)	Off	There is no link.
	Solid green	The port is operating at 1 Gbps.
Activity LED (Right LED)	Off	There is no current transmit/receive activity.
	Blinking green	The port is actively transmitting/receiving.

**Table 3-3. SFP+ Port LED Definitions (N1124-ON and N1148-ON Only)**

<b>LED</b>	<b>Color</b>	<b>Definition</b>
Link/SPD LED (Left bi-color LED)	Off	There is no link.
	Solid green	The port is operating at 10 Gbps.
	Solid amber	The port is operating at 1 Gbps.
Activity LED (Right single-color LED)	Off	There is no current transmit/receive activity.
	Blinking green	The port is actively transmitting/receiving.

**Stacking Port LEDs****Table 3-4. Stacking Port LED Definitions**

<b>LED</b>	<b>Color</b>	<b>Definition</b>
Link LED	Off	There is no link.
	Solid green	The port is actively transmitting/receiving.
Activity LED	Off	There is no current transmit/receive activity.
	Blinking green	The port is actively transmitting/receiving.

## System LEDs

The system LEDs, located on the front panel, provide information about the power supplies, thermal conditions, and diagnostics.

Table 3-25 shows the System LED definitions for the Dell EMC Networking N1100-ON switches.

**Table 3-5. System LED Definitions**

LED	Color	Definition
Status	Solid green	Normal operation.
	Blinking green	The switch is booting
	Solid amber	A critical system error has occurred.
	Blinking amber	A noncritical system error occurred (fan or power supply failure).
Power	Off	There is no power or the switch has experienced a power failure.
	Solid green	Power to the switch is on.
	Solid green	POST is in progress.
Primary	Off	The switch is not in primary mode.
	Solid green	The switch is primary for the stack.
Temp	Solid green	The switch is operating below the threshold temperature.
	Solid red	The switch temperature exceeds the threshold limit, or there is a fan failure (if fan-equipped).
System Locator LED	Blinking blue	The locator LED has been activated to locate the physical switch.
	Off	The beacon LED is idle.

## Power Consumption for N1100-ON Series PoE Switches

Table 3-6 describes the power consumption for N3132P-ON PoE switches. The PoE power budget is 60W for the N1108P-ON, 185W for the N1124P-ON, and 370W for the N1148P-ON.

**Table 3-6. Power Consumption for N3132P-ON PoE Switches**

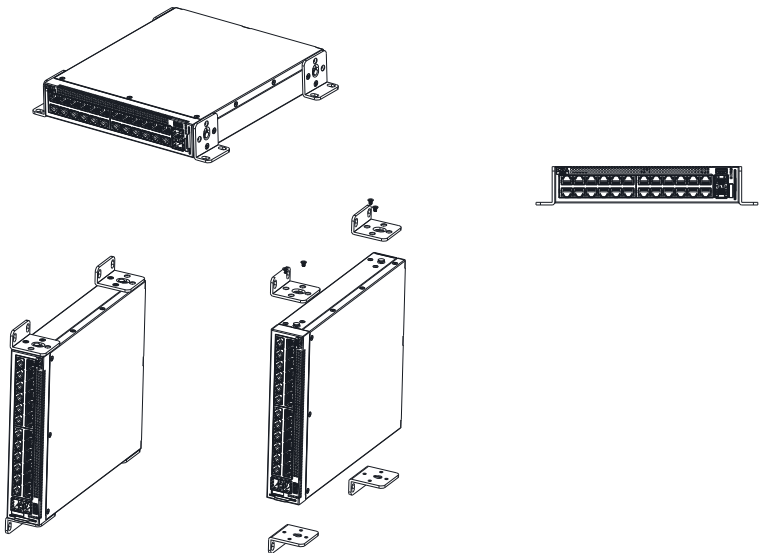
Model	Input Voltage	Power Supply Configuration	Maximum Steady Current Consumption (A)	Maximum Steady Power (W)
N1108P-ON	100V/60Hz	Main PSU	0.95A	88.64W
	110V/60Hz	Main PSU	0.87A	88.43W
	120V/60Hz	Main PSU	0.80A	88.22W
	220V/50Hz	Main PSU	0.49A	89.28W
	240V/50Hz	Main PSU	0.45A	89.70W
N1124P-ON	100V/60Hz	Main PSU	2.66A	260.66W
	110V/60Hz	Main PSU	2.38A	257.95W
	120V/60Hz	Main PSU	2.16A	256.27W
	220V/50Hz	Main PSU	1.18A	250.52W
	240V/50Hz	Main PSU	1.10A	251.25W
N1148P-ON	100V/60Hz	Main PSU	4.78A	476.03W
	110V/60Hz	Main PSU	4.32A	472.64W
	120V/60Hz	Main PSU	3.95A	470.58W
	220V/50Hz	Main PSU	2.14A	459.37W
	240V/50Hz	Main PSU	1.97A	459.06W

## N1100-ON Series Wall Installation

To mount the switch on a wall:

- 1 Make sure that the mounting location meets the following requirements:
  - The surface of the wall must be capable of supporting the switch.
  - Allow at least two inches (5.1 cm) space on the sides for proper ventilation and five inches (12.7 cm) at the back for power cable clearance.
  - The location must be ventilated to prevent heat buildup.
- 2 Place the supplied wall-mounting bracket on one side of the switch, verifying that the mounting holes on the switch line up to the mounting holes on the wall-mounting bracket.

**Figure 3-4. Bracket Installation for Wall Mounting**



- 3 Insert the supplied screws into the wall-mounting bracket holes and tighten with a screwdriver.
- 4 Repeat the process for the wall-mounting bracket on the other side of the switch.

- 5** Place the switch on the wall in the location where the switch is being installed.
- 6** On the wall, mark the locations where the screws to hold the switch must be prepared.
- 7** On the marked locations, drill the holes and place all plugs (not provided) in the holes.
- 8** Secure the switch to the wall with screws (not provided). Make sure that the ventilation holes are not obstructed.

# Dell EMC Networking N1500 Series Switch Hardware

This section contains information about device characteristics and modular hardware configurations for the Dell EMC Networking N1500 Series switches.

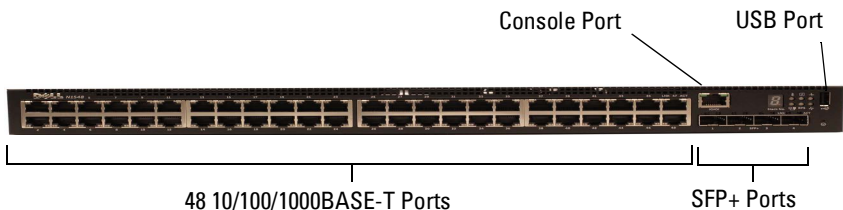
## N1500 Series Front Panel

The Dell EMC Networking N1500 Series front panel includes the following features:

- Switch Ports
- Console Port
- USB Port
- Reset Button
- SFP+ Ports
- Port and System LEDs
- LED of the management unit in the stack and Stack Number Display

The following images show the front panels of the switch models in the Dell EMC Networking N1500 Series.

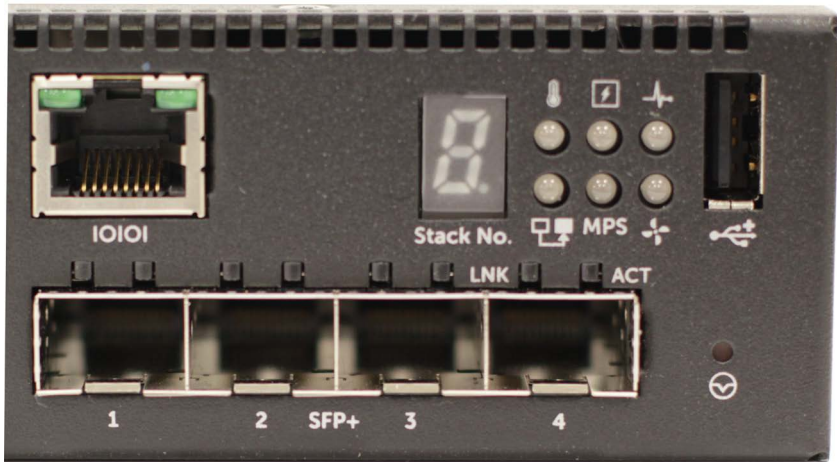
**Figure 3-5. Dell EMC Networking N1548 Front-Panel Switch with 48 10/100/1000BASE-T Ports (Front Panel)**



In addition to the switch ports, the front panel of each model in the Dell EMC Networking N1500 Series includes the following ports:

- RJ-45 Console port
- USB port for storage

**Figure 3-6. Dell EMC Networking N1524P Close-up**



The Dell EMC Networking 1524 front panel has status LEDs for over-temperature alarm (left), internal power (middle), and status (right) on the top row. The bottom row of status LEDs displays, from left to right, the management unit in the stack, redundant power supply (RPS) status, and fan alarm status.

The Dell EMC Networking 1524P front panel, shown in Figure 3-6, has status LEDs for over-temperature alarm, internal power, and status on the top row. The bottom row of status LEDs displays the management unit in the stack, modular power supply (MPS) status, and fan alarm status.

### **Switch Ports**

The Dell EMC Networking N1524/N1524P front panel provides 24 Gigabit Ethernet (10/100/1000BASE-T) RJ-45 ports that support auto-negotiation for speed, flow control, and duplex. The Dell EMC Networking N1500 Series front-panel ports operate in full-duplex or half-duplex mode. The Dell EMC Networking N1524/N1524P models support four SFP+ 10G ports. Dell EMC-qualified SFP+ transceivers are sold separately.

The Dell EMC Networking N1548/N1548P front panel provides 48 Gigabit Ethernet (10BASE-T, 100BASE-TX, 1000BASE-T) RJ-45 ports that support auto-negotiation for speed, flow control, and duplex. The Dell EMC



Networking N1500 Series front-panel ports operate in full-duplex or half-duplex mode. The Dell EMC Networking N1548/N1548P supports four SFP+ 10G ports. Dell EMC-qualified SFP+ transceivers are sold separately.

The front-panel switch ports have the following characteristics:

- The switch automatically detects the difference between crossed and straight-through cables on RJ-45 ports and automatically chooses the MDI or MDIX configuration to match the other end.
- SFP+ ports support Dell EMC-qualified transceivers utilizing 10GBASE-SR, 10GBASE-LR, 10GBASE-CR, or 1000BASE-X technologies. The default behavior is to log a message and generate an SNMP trap on insertion or removal of an optic that is not qualified by Dell EMC. The message and trap can be suppressed by using the **service unsupported-transceiver** command.
- RJ-45 front-panel ports support full-duplex or half-duplex mode 10/100/1000 Mbps speeds on standard Category 5 UTP cable. 1000BASE-X and 1000BASE-T operation requires the use of auto-negotiation.
- SFP+ ports support SFP+ transceivers and SFP+ copper twin-ax technology operating at 10G or 1G speeds in full-duplex mode. SFP transceivers are supported in SFP+ ports and operate at 1G full-duplex. SFP transceivers require auto-negotiation to be enabled.

SFP+ ports may be configured to support 16 GB stacking over Ethernet cables. These ports may be configured to support stacking in pairs, e.g., Te1/0/1 and Te1/0/2 may be configured to support stacking, or Te1/0/3 and Te1/0/4 may be configured to support stacking, or all four ports may be configured to support stacking.

- The Dell EMC Networking N1524P/N1548P front-panel ports support PoE (15.4W) and PoE+ (34.2W) as well as legacy capacitive detection for pre-standard powered devices (PDs).

### **Console Port**

The console port provides serial communication capabilities, which allows communication using the RS-232 protocol. The serial port provides a direct connection to the switch and allows access to the CLI from a console terminal connected to the port through the provided serial cable (with RJ-45 YOST to female DB-9 connectors).

The console port is separately configurable and can be run as an asynchronous link from 1200 baud to 115,200 baud. The Dell CLI supports changing the speed only. The defaults are 9600 baud, 8 data bits, no parity, 1 stop bit, and no flow control.

### **USB Port**

The Type-A, female USB port supports a USB 2.0-compliant flash memory drive. The Dell EMC Networking N-Series switch can read or write to a flash drive with a single partition formatted as FAT-32. Use a USB flash drive to copy switch configuration files and images between the USB flash drive and the switch. The USB flash drive may be used to move and copy configuration files and images from one switch to other switches in the network. The system does not support the deletion of files on USB flash drives.

The USB port does not support any other type of USB device.

### **Reset Button**

The reset button is accessed through the pinhole and enables performing a hard reset on the switch. To use the reset button, insert an unbent paper clip or similar tool into the pinhole. When the switch completes the boot process after the reset, it resumes operation with the most recently saved configuration. Any changes made to the running configuration that were not saved to the startup configuration prior to the reset are lost.

### **Port and System LEDs**

The front panel contains light emitting diodes (LEDs) that indicate the status of port links, power supplies, fans, stacking, and the overall system status. See "N1500 Series LED Definitions" on page 124 for more information.

### **LED of Management Unit in Stack and Stack Number Display**

When a switch within a stack is the primary unit, the LED of the management unit in the stack is solid green. If the LED of the management unit in the stack is off, the stack member is not the primary unit. The Stack No. panel displays the unit number for the stack member. If a switch is not part of a stack (in other words, it is a stack of one switch), the LED of the management unit in the stack is illuminated, and the unit number is displayed.

## N1500 Series Back Panel

The following image shows the back panels of the Dell EMC Networking N1500 Series switches.

**Figure 3-7. Dell EMC Networking N1500 Series Back Panel**



## Power Supplies

### *Dell EMC Networking N1524 and N1548*

The Dell EMC Networking N1524 and N1548 Series switches have an internal 100-watt power supply. The additional redundant power supply (Dell EMC Networking RPS720) provides 180 watts of power and gives full redundancy for the switch.

### *Dell EMC Networking N1524P and N1548P*

The Dell EMC Networking N1524P and N1548P switches have an internal 600-watt power supply feeding up to 24 PoE devices at full PoE+ power (500W). An additional modular power supply (MPS1000) provides 1000 watts and gives full power coverage for all 48 PoE devices (1500W).



**NOTE:** PoE power is dynamically allocated. Not all ports will require the full PoE+ power.



**CAUTION:** Remove the power cable from the power supplies prior to removing the power supply module itself. Power must not be connected prior to insertion in the chassis.

## Ventilation System

Two internal fans cool the Dell EMC Networking N1500 Series switches.

### Information Tag

The back panel includes a slide-out label panel that contains system information, such as the Service Tag, MAC address, and so on.

### N1500 Series LED Definitions

This section describes the LEDs on the front and back panels of the switch.

#### Port LEDs

Each port on a Dell EMC Networking N1500 Series switch includes two LEDs. One LED is on the left side of the port, and the second LED is on the right side of the port. This section describes the LEDs on the switch ports.

#### 100/1000/10000BASE-T Port LEDs

Each 100/1000/10000BASE-T port has two LEDs. Figure 3-8 illustrates the 100/1000/10000BASE-T port LEDs.

**Figure 3-8. 100/1000/10000BASE-T Port LEDs**

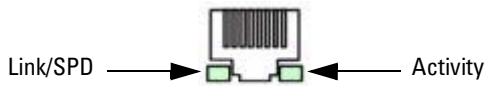


Table 3-7 shows the 100/1000/10000BASE-T port LED definitions.

**Table 3-7. 100/1000/10000BASE-T Port Definitions**

LED	Color	Definition
Link/SPD LED	Off	There is no link.
	Solid yellow	The port is operating at 10/100 Mbps.
	Solid green	The port is operating at 1000 Mbps.
Activity/PoE LED (on PoE switches)	Off	There is no current transmit/receive activity and PoE power is off.
	Blinking green	The port is actively transmitting/receiving and PoE power is off.
	Blinking yellow	The port is actively transmitting/receiving and PoE power is on.
	Solid yellow	There is no current transmit/receive activity and PoE power is on.

### Stacking Port LEDs

**Table 3-8. Stacking Port LED Definitions**

LED	Color	Definition
Link LED	Off	There is no link.
	Solid green	The port is actively transmitting/receiving.
Activity LED	Off	There is no current transmit/receive activity.
	Blinking green	The port is actively transmitting/receiving.

### Console Port LEDs

**Table 3-9. Console Port LED Definitions**

LED	Color	Definition
Link/SPD LED	Off	There is no link.
	Solid green	A link is present.

## System LEDs

The system LEDs, located on the front panel, provide information about the power supplies, thermal conditions, and diagnostics.

Table 3-10 shows the System LED definitions for the Dell EMC Networking N1500 Series switches.

**Table 3-10. System LED Definitions**

LED	Color	Definition
Status	Solid green	Normal operation.
	Blinking green	The switch is booting
	Solid red	A critical system error has occurred.
	Blinking red	A noncritical system error occurred (fan or power supply failure).
Power	Off	There is no power or the switch has experienced a power failure.
	Solid green	Power to the switch is on.
	Blinking green	The switch locator function is enabled.
RPS (on non-PoE switches)	Off	There is no redundant power supply (RPS).
	Solid green	Power to the RPS is on.
	Solid red	An RPS is detected but it is not receiving power.
EPS (on PoE switches)	Off	There is no external power supply (EPS).
	Solid green	Power to the EPS is on.
	Solid red	An EPS is detected but it is not receiving power.
Fan	Solid green	The fan is powered and is operating at the expected RPM.
	Solid red	A fan failure has occurred.
Management Unit in Stack	Off	The switch is not the management unit in the stack.
	Solid green	The switch is primary for the stack.

**Table 3-10. System LED Definitions (Continued)**

LED	Color	Definition
Temp	Solid green	The switch is operating below the threshold temperature.
	Solid red	The switch temperature exceeds the threshold of 75°C.
Stack No.	–	Switch ID within the stack.

### Power Consumption for N1500 Series PoE Switches

Table 3-11 shows power consumption data for the PoE-enabled switches.

**Table 3-11. Power Consumption**

Model	Input Voltage	Power Supply Configuration	Max Steady Current Consumption (A)	Max Steady Power (W)
Dell EMC Networking N1524P	100V	Main PSU+EPS PSU	8.8	876.0
	110V	Main PSU+EPS PSU	7.9	871.0
	120V	Main PSU+EPS PSU	7.2	865.0
	220V	Main PSU+EPS PSU	3.8	844.0
	240V	Main PSU+EPS PSU	3.5	840.0
Dell EMC Networking N1548P	100V	Main PSU+EPS PSU	17.1	1719.0
	110V	Main PSU+EPS PSU	15.5	1704.0
	120V	Main PSU+EPS PSU	14.1	1690.0
	220V	Main PSU+EPS PSU	7.5	1642.4
	240V	Main PSU+EPS PSU	6.9	1647.0

The PoE power budget for each interface is controlled by the switch firmware. The administrator can limit the power supplied on a port or prioritize power to some ports over others. Table 3-12 shows power budget data.

**Table 3-12. Dell EMC Networking N1500 Series PoE Power Budget Limit**

Model Name	Internal Only PSU		MPS Only		Two PSUs	
	Max. PSU Output Ability	PoE+ Power Turn-on Limitation	Max. PSU Output Ability	PoE+ Power Turn-on Limitation	Max. PSUs Output Ability	PoE+ Power Turn-on Limitation
Dell EMC Networking N1524P	600W	Power budget is 500W: The total PoE supplied power must not exceed 500W.	1000W	Power budget is 900W: The total PoE supplied power must not exceed 900W.	1600W	Power budget is 1350W: All PoE+ ports can supply maximum power.
Dell EMC Networking N1548P	600W	Power budget is 500W: The total PoE supplied power must not exceed 500W.	1000W	Power budget is 900W: The total PoE supplied power must not exceed 900W.	1600W	Power budget is 1350W: The total PoE supplied power must not exceed 1350W.

## Dell EMC Networking N2000 Series Switch Hardware

This section contains information about device characteristics and modular hardware configurations for the Dell EMC Networking N2000 Series switches.

### N2000 Series Front Panel

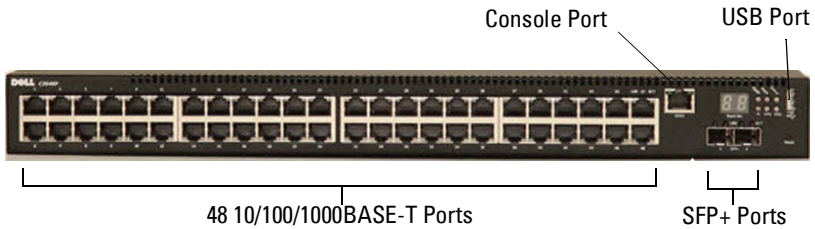
The Dell EMC Networking N2000 Series front panel includes the following features:

- Switch Ports
- Console Port
- USB Port
- Reset Button
- SFP+ Ports
- Port and System LEDs
- LED of the management unit in the stack and Stack Number Display

The following images show the front panels of the switch models in the Dell EMC Networking N2000 Series.



**Figure 3-9. Dell EMC Networking N2048 Switch with 48 10/100/1000BASE-T Ports (Front Panel)**



In addition to the switch ports, the front panel of each model in the Dell EMC Networking N2000 Series includes the following ports:

- RJ-45 Console port
- USB port for storage

**Figure 3-10. Dell EMC Networking N2024/N2048 Close-up**



The Dell EMC Networking N2024/N2048 front panel, shown in Figure 3-10, has status LEDs for over-temperature alarm (left), internal power (middle), and status (right) on the top row. The bottom row of status LEDs displays, from left to right, the management unit in the stack, redundant power supply (RPS) status, and fan alarm status.

The Dell EMC Networking N2024P/N2048P front panel has status LEDs for over-temperature alarm, internal power and status on the top row. The bottom row of status LEDs displays the management unit in the stack, modular power supply (MPS), status and fan alarm status.

## Switch Ports

The Dell EMC Networking N2024/N2024P front panel provides 24 Gigabit Ethernet (10/100/1000BASE-T) RJ-45 ports that support auto-negotiation for speed, flow control, and duplex. The Dell EMC Networking N2024/N2024P models support two SFP+ 10G ports. Dell EMC-qualified SFP+ transceivers are sold separately. Dell EMC Networking N2000 Series switches operate in full-duplex mode only.

The Dell EMC Networking N2048/N2048P front panel provides 48 Gigabit Ethernet (10BASE-T, 100BASE-TX, 1000BASE-T) RJ-45 ports that support auto-negotiation for speed, flow control, and duplex. The Dell EMC Networking N2048/N2048P supports two SFP+ 10G ports. Dell EMC-qualified SFP+ transceivers are sold separately.

The front-panel switch ports have the following characteristics:

- The switch automatically detects the difference between crossed and straight-through cables on RJ-45 ports and automatically chooses the MDI or MDIX configuration to match the other end.
- SFP+ ports support Dell EMC-qualified transceivers. The default behavior is to log a message and generate an SNMP trap on insertion or removal of an optic that is not qualified by Dell. The message and trap can be suppressed by using the **service unsupported-transceiver** command.
- RJ-45 ports support full-duplex mode 10/100/1000 Mbps speeds on standard Category 5 UTP cable. 1000BASE-T operation requires the use of auto-negotiation.
- SFP+ ports support SFP+ transceivers and SFP+ copper twin-ax technology operating at 10G or 1G speeds in full-duplex mode. SFP transceivers are supported in SFP+ ports and operate at 1G full-duplex. SFP transceivers require auto-negotiation to be enabled.
- The Dell EMC Networking N2024P/N2048P front-panel ports support PoE (15.4W) and PoE+ (34.2W) as well as legacy capacitive detection for pre-standard powered devices (PDs).

## **Console Port**

The console port provides serial communication capabilities, which allows communication using RS-232 protocol. The serial port provides a direct connection to the switch and allows access to the CLI from a console terminal connected to the port through the provided serial cable (with RJ-45 YOST to female DB-9 connectors).

The console port is separately configurable and can be run as an asynchronous link from 1200 baud to 115,200 baud. The Dell CLI supports changing only the speed of the console port. The defaults are 9600 baud, 8 data bits, no parity, 1 stop bit, and no flow control. It is recommended that the serial port be configured to run at 115,200.

## **USB Port**

The Type-A, female USB port supports a USB 2.0-compliant flash memory drive. The Dell EMC Networking N-Series switch can read or write to a flash drive with a single partition formatted as FAT-32. Use a USB flash drive to copy switch configuration files and images between the USB flash drive and the switch. The USB flash drive may be used to move and copy configuration files and images from one switch to other switches in the network. The system does not support the deletion of files on USB flash drives.

The USB port does not support any other type of USB device.

## **Reset Button**

The reset button is accessed through the pinhole and enables performing a hard reset on the switch. To use the reset button, insert an unbent paper clip or similar tool into the pinhole. When the switch completes the boot process after the reset, it resumes operation with the most recently saved configuration. Any changes made to the running configuration that were not saved to the startup configuration prior to the reset are lost.

## **Port and System LEDs**

The front panel contains light emitting diodes (LEDs) that indicate the status of port links, power supplies, fans, stacking, and the overall system status. See "N2000 Series LED Definitions" on page 134 for more information.

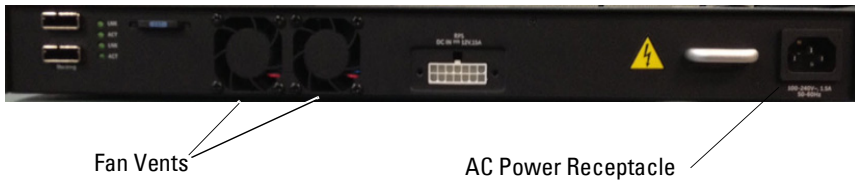
### LED of Management Unit in Stack and Stack Number Display

When a switch within a stack is the primary unit, the LED of the management unit in the stack is solid green. If the LED of the management unit in the stack is off, the stack member is not the primary unit. The Stack No. panel displays the unit number for the stack member. If a switch is not part of a stack (in other words, it is a stack of one switch), the LED of the management unit in the stack is illuminated, and the unit number is displayed.

### N2000 Series Back Panel

The following images show the back panels of the Dell EMC Networking N2000 Series switches.

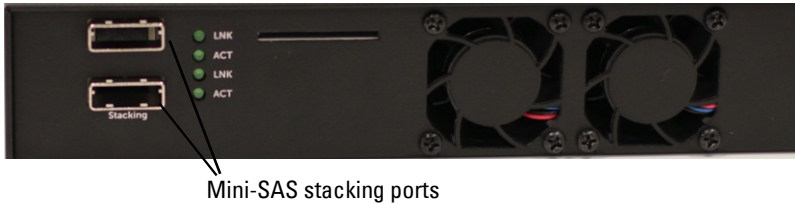
**Figure 3-11. Dell EMC Networking N2000 Series Back Panel**



**Figure 3-12. Dell EMC Networking N2024P/N2048P Back Panel**

The term mini-SAS refers to the stacking port cable connections shown in Figure 3-13. See "Stacking" on page 253 for information on using the mini-SAS ports to connect switches.

**Figure 3-13. Dell EMC Networking N2048 Mini-SAS Stacking Ports and Fans**



Mini-SAS stacking ports

## Power Supplies

### ***Dell EMC Networking N2024 and N2048***

The Dell EMC Networking N2024 and N2048 Series switches have an internal 100-watt power supply. The additional redundant power supply (Dell EMC Networking RPS720) provides 180 watts of power and gives full redundancy for the switch.

### ***Dell EMC Networking N2024P and N2048P***

The Dell EMC Networking N2024P and N2048P switches have an internal 1000-watt power supply feeding up to 24 PoE devices at full PoE+ power (850W). An additional modular power supply (MPS1000) provides 1000 watts and gives full power coverage for all 48 PoE devices (1800W).



**NOTE:** PoE power is dynamically allocated. Not all ports will require the full PoE+ power.



**CAUTION:** Remove the power cable from the power supplies prior to removing the power supply module itself. Power must not be connected prior to insertion in the chassis.

## Ventilation System

Two internal fans cool the Dell EMC Networking N2000 Series switches.

## Information Tag

The back panel includes a slide-out label panel that contains system information, such as the Service Tag, MAC address, and so on.

## N2000 Series LED Definitions

This section describes the LEDs on the front and back panels of the switch.

### Port LEDs

Each port on a Dell EMC Networking N2000 Series switch includes two LEDs. One LED is on the left side of the port, and the second LED is on the right side of the port. This section describes the LEDs on the switch ports.

### 100/1000/10000BASE-T Port LEDs

Each 100/1000/10000BASE-T port has two LEDs. Figure 3-14 illustrates the 100/1000/10000BASE-T port LEDs.

**Figure 3-14. 100/1000/10000BASE-T Port LEDs**

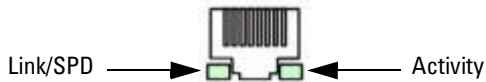


Table 3-13 shows the 100/1000/10000BASE-T port LED definitions.

**Table 3-13. 100/1000/10000BASE-T Port Definitions**

<b>LED</b>	<b>Color</b>	<b>Definition</b>
Link/SPD LED	Off	There is no link.
	Solid yellow	The port is operating at 10/100 Mbps.
	Solid green	The port is operating at 1000 Mbps.
Activity LED (on non-PoE switches)	Off	There is no current transmit/receive activity.
	Blinking green	The port is actively transmitting/receiving.
Activity/PoE LED (on PoE switches)	Off	There is no current transmit/receive activity and PoE power is off.
	Blinking green	The port is actively transmitting/receiving and PoE power is off.
	Blinking yellow	The port is actively transmitting/receiving and PoE power is on.
	Solid yellow	There is no current transmit/receive activity and PoE power is on.

### Stacking Port LEDs

**Table 3-14. Stacking Port LED Definitions**

<b>LED</b>	<b>Color</b>	<b>Definition</b>
Link LED	Off	There is no link.
	Solid green	The port is actively transmitting/receiving.
Activity LED	Off	There is no current transmit/receive activity.
	Blinking green	The port is actively transmitting/receiving.

## Console Port LEDs

**Table 3-15. Console Port LED Definitions**

LED	Color	Definition
Link/SPD LED	Off	There is no link.
	Solid green	A link is present.

## System LEDs

The system LEDs, located on the front panel, provide information about the power supplies, thermal conditions, and diagnostics.

Table 3-16 shows the System LED definitions for the Dell EMC Networking N2000 Series switches.

**Table 3-16. System LED Definitions**

LED	Color	Definition
Status	Solid green	Normal operation.
	Blinking green	The switch is booting
	Solid red	A critical system error has occurred.
	Blinking red	A noncritical system error occurred (fan or power supply failure).
Power	Off	There is no power or the switch has experienced a power failure.
	Solid green	Power to the switch is on.
	Blinking green	The switch locator function is enabled.
RPS (on non-PoE switches)	Off	There is no redundant power supply (RPS).
	Solid green	Power to the RPS is on.
	Solid red	An RPS is detected but it is not receiving power.
EPS (on PoE switches)	Off	There is no external power supply (EPS).
	Solid green	Power to the EPS is on.
	Solid red	An EPS is detected but it is not receiving power.



**Table 3-16. System LED Definitions (Continued)**

LED	Color	Definition
Fan	Solid green	The fan is powered and is operating at the expected RPM.
	Solid red	A fan failure has occurred.
Management Unit in Stack	Off	The switch is not the management unit in the stack.
	Solid green	The switch is primary for the stack.
Temp	Solid green	The switch is operating below the threshold temperature.
	Solid red	The switch temperature exceeds the threshold of 75°C.
Stack No.	–	Switch ID within the stack.

### Power Consumption for N2000 Series PoE Switches

Table 3-17 shows power consumption data for the PoE-enabled switches.

**Table 3-17. Power Consumption**

Model	Input Voltage	Power Supply Configuration	Max Steady Current Consumption (A)	Max Steady Power (W)
Dell EMC Networking N2024P	100V	Main PSU+EPS PSU	8.9	890.0
	110V	Main PSU+EPS PSU	8.3	913.0
	120V	Main PSU+EPS PSU	7.6	912.0
	220V	Main PSU+EPS PSU	4.0	880.0
	240V	Main PSU+EPS PSU	3.6	873.6
Dell EMC Networking N2048P	100V	Main PSU+EPS PSU	17.8	1780.0
	110V	Main PSU+EPS PSU	15.8	1740.2
	120V	Main PSU+EPS PSU	14.5	1740.0
	220V	Main PSU+EPS PSU	7.7	1687.4
	240V	Main PSU+EPS PSU	7.1	1704.0

The PoE power budget for each interface is controlled by the switch firmware. The administrator can limit the power supplied on a port or prioritize power to some ports over others. Table 3-18 shows power budget data.

**Table 3-18. Dell EMC Networking N2000 Series PoE Power Budget Limit**

Model Name	One PSU		Two PSUs	
	Max. PSU Output Ability	PoE+ Power Turn-on Limitation	Max. PSUs Output Ability	PoE+ Power Turn-on Limitation
Dell EMC Networking N2024P	1000W	Power budget is 850W: The total PoE supplied power must not exceed 850W.	2000W	Power budget is 1700W: All PoE+ ports can supply maximum power.
Dell EMC Networking N2048P	1000W	Power budget is 850W: The total PoE supplied power must not exceed 850W.	2000W	Power budget is 1700W: All PoE+ ports can supply maximum power.

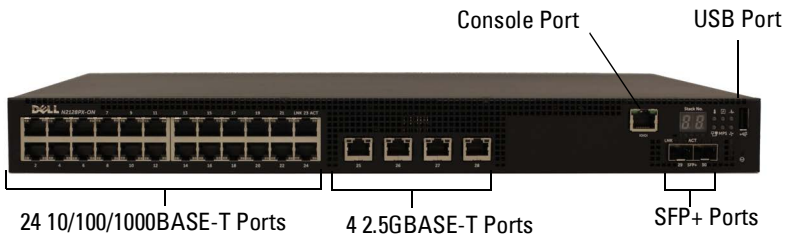
# Dell EMC Networking N2100-ON Series Switch Hardware

This section contains information about device characteristics and modular hardware configurations for the Dell EMC Networking N2128PX-ON switch.

## N2100-ON Series Front Panel

All N2128PX-ON PoE models are 1U, rack-mountable switches. The Dell EMC Networking N2128PX-ON front panel provides 24 10/100/1000BASE-T Ethernet RJ-45 ports and four 2.5G NBASE-T Ethernet RJ-45 ports that support auto-negotiation for speed, flow control, and duplex. NBASE-T interfaces require auto-negotiation to be enabled. They will not operate correctly in fixed speed mode. The 2.5G NBASE-T ports support PoE 60W capability. The N2128PX switch front panel ports operate in full-duplex mode only. The N2128PX models support two SFP+ 10G ports. The N2128PX-ON provides one RJ-45 console port for local management and a Type-A USB port for storage.

**Figure 3-15. Dell EMC Networking N2128PX-ON Switch (Front Panel)**



The Dell N2128PX-ON switch is capable of loading an OS via the ONIE boot loader, therefore the port numbering on the front panel labels is consecutive, per the ONIE requirements, regardless of port type.

For the N2128PX-ON switch, ports 1-24 are 1G interfaces, ports 25-28 are 2.5GBASE-T interfaces, ports 29-30 are 10G interfaces, and rear panel ports 31-32 are HiGig stacking interfaces. NBASE-T interfaces require auto-negotiation to be enabled. NBASE-T interfaces require auto-negotiation and will not operate correctly in fixed speed mode.

To remain consistent with prior N-Series devices, CLI and GUI port references will be non-consecutive when the port type changes. Ports labeled 1-28 on the front panel will be referred to in the UI as Gi1/0/X (where X = 1 to 28), ports labeled 29-30 on the front panel will be referred to in the UI as Te1/0/Y (where Y= 1 to 2) and ports labeled 31-32 on the rear panel will be referred to as Tw1/1/W (where W=1 to 2).

### **Console Port**

The console port provides serial communication capabilities, which allows communication using RS-232 protocol. The serial port provides a direct connection to the switch and allows access to the CLI from a console terminal connected to the port through the provided serial cable (with RJ-45 YOST to female DB-9 connectors).

The console port is separately configurable and can be run as an asynchronous link from 1200 baud to 115,200 baud. The Dell EMC CLI supports changing only the speed of the console port. The defaults are 115,200 baud, 8 data bits, no parity, 1 stop bit, and no flow control.

### **USB Port**

The Type-A, female USB port supports a USB 2.0-compliant flash memory drive. The Dell EMC Networking N-Series switch can read or write to a flash drive with a single partition formatted as FAT-32. Use a USB flash drive to copy switch configuration files and images between the USB flash drive and the switch. The USB flash drive may be used to move and copy configuration files and images from one switch to other switches in the network. The system does not support the deletion of files on USB flash drives.

The USB port does not support any other type of USB device.

### **Reset Button**

The reset button is accessed through the pinhole and enables performing a hard reset on the switch. To use the reset button, insert an unbent paper clip or similar tool into the pinhole. When the switch completes the boot process after the reset, it resumes operation with the most recently saved configuration. Any changes made to the running configuration that were not saved to the startup configuration prior to the reset are lost.

## **Port and System LEDs**

The front panel contains light emitting diodes (LEDs) that indicate the status of port links, power supplies, fans, stacking, and the overall system status. See "N2100-ON Series LED Definitions" on page 141 for more information.

## **LED of Management Unit in Stack and Stack Number Display**

When a switch within a stack is the primary unit, the LED of the management unit in the stack is solid green. If the LED of the management unit in the stack is off, the stack member is not the primary unit. The Stack No. panel displays the unit number for the stack member. If a switch is not part of a stack (in other words, it is a stack of one switch), the LED of the management unit in the stack is illuminated, and the unit number is displayed.

## **N2100-ON Series Back Panel**

The N2128PX-ON has two 21G stacking ports in the rear that accept mini-SAS connectors. It also has a 16-pin connection for a modular power supply (Dell MPS1000) supporting an additional 1000W of power.

## **Power Supply**

The Dell EMC Networking N2128PX-ON switch has an internal 715-watt power supply feeding up to 16 PoE devices at full PoE+ power (500W).

## **Ventilation System**

Two internal fans cool the Dell EMC Networking N2128PX-ON Series switches.

## **Information Tag**

The back panel includes a slide-out label panel that contains system information, such as the Service Tag, MAC address, and so on.

## **N2100-ON Series LED Definitions**

This section describes the LEDs on the front and back panels of the switch.

## Port LEDs

Each port on a Dell EMC Networking N2100-ON Series switch includes two LEDs. One LED is on the left side of the port, and the second LED is on the right side of the port. This section describes the LEDs on the switch ports.

Each 100/1000/10000BASE-T port has two LEDs. Figure 3-16 illustrates the 100/1000/10000BASE-T port LEDs.

**Figure 3-16. 100/1000/10000BASE-T Port LEDs**

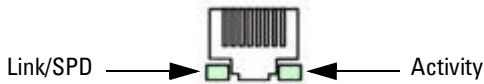


Table 3-19 shows the 100/1000/10000BASE-T port LED definitions.

**Table 3-19. 100/1000/10000BASE-T Port LED Definitions**

LED	Color	Definition
Link/SPD LED	Off	There is no link.
	Solid yellow	The port is operating at 10/100 Mbps.
	Solid green	The port is operating at 1000 Mbps.
Activity/PoE LED (on PoE switches)	Off	There is no current transmit/receive activity and PoE power is off.
	Blinking green	The port is actively transmitting/receiving and PoE power is off.
	Blinking yellow	The port is actively transmitting/receiving and PoE power is on.
	Solid yellow	There is no current transmit/receive activity and PoE power is on.

**Table 3-20. 2500BASE-T Port LED Definitions**

<b>LED</b>	<b>Color</b>	<b>Definition</b>
Link/SPD LED (Left bi-color LED)	Off	There is no link.
	Solid green	The port is operating at 2.5 Gbps.
	Solid amber	The port is operating at 100 Mbps or 1 Gbps.
Activity/PoE LED (Right bi-color LED)	Off	There is no current transmit/receive activity, and PoE power is off.
	Blinking green	The port is actively transmitting/receiving, and PoE power is off.
	Blinking yellow	The port is actively transmitting/receiving, and PoE power is on.
	Solid yellow	There is no current transmit/receive activity, and PoE power is on.

**Table 3-21. SFP+ Port LED Definitions**

<b>LED</b>	<b>Color</b>	<b>Definition</b>
Link/SPD LED (Left bi-color LED)	Off	There is no link.
	Solid green	The port is operating at 10 Gbps.
	Solid amber	The port is operating at 1 Gbps.
Activity LED (Right single-color LED)	Off	There is no current transmit/receive activity.
	Blinking green	The port is actively transmitting/receiving.

**Table 3-22. QSFP Port LED Definitions**

<b>LED</b>	<b>Color</b>	<b>Definition</b>
Link/SPD LED (Left single-color LED)	Off	There is no link.
	Solid green	The port is operating at 40 Gbps.
Activity LED (Right single-color LED)	Off	There is no current transmit/receive activity.
	Blinking green	The port is actively transmitting/receiving.

## Stacking Port LEDs

**Table 3-23. Stacking Port LED Definitions**

LED	Color	Definition
Link LED	Off	There is no link.
	Solid green	The port is actively transmitting/receiving.
Activity LED	Off	There is no current transmit/receive activity.
	Blinking green	The port is actively transmitting/receiving.

## Console Port LEDs

**Table 3-24. Console Port LED Definitions**

LED	Color	Definition
Link/SPD LED	Off	There is no link.
	Solid green	A link is present.

## System LEDs

The system LEDs, located on the front panel, provide information about the power supplies, thermal conditions, and diagnostics.

Table 3-25 shows the System LED definitions for the Dell EMC Networking N2128PX-ON switches.

**Table 3-25. System LED Definitions**

LED	Color	Definition
Status	Solid green	Normal operation.
	Blinking green	The switch is booting
	Solid red	A critical system error has occurred.
	Blinking red	A noncritical system error occurred (fan or power supply failure).
Power	Off	There is no power or the switch has experienced a power failure.
	Solid green	Power to the switch is on.
	Blinking green	The switch locator function is enabled.



**Table 3-25. System LED Definitions (Continued)**

LED	Color	Definition
EPS (on PoE switches)	Off	There is no external power supply (EPS).
	Solid green	Power to the EPS is on.
	Solid red	An EPS is detected but it is not receiving power.
Fan	Solid green	The fan is powered and is operating at the expected RPM.
	Solid red	A fan failure has occurred.
Management Unit in Stack	Off	The switch is not the management unit in the stack.
	Solid green	The switch is primary for the stack.
Temp	Solid green	The switch is operating below the threshold temperature.
	Solid red	The switch temperature exceeds the threshold of 75°C.
Stack No.	–	Switch ID within the stack.

### Power Consumption for N2100-ON Series PoE Switches

Table 3-26 shows power consumption data for the PoE-enabled N2128PX-ON switch when the power budget is 800W for the main power supply.

**Table 3-26. Power Consumption**

Model	Input Voltage	Power Supply Configuration	Maximum Steady Current Consumption (A)	Max Steady Power (W)
Dell EMC Networking N2128PX-ON	100V/60Hz	Main PSU	9.73A	965.5W
	110V/60Hz	Main PSU	8.75A	960.4W
	120V/60Hz	Main PSU	8.03A	958.3
	220V/50Hz	Main PSU	4.33A	931W
	240V/50Hz	Main PSU	3.97A	928.7W

Table 3-27 shows power consumption data for the PoE-enabled N2128PX-ON switch when the power budget is 800W for the MPS.

**Table 3-27. Power Consumption**

<b>Model</b>	<b>Input Voltage</b>	<b>Power Supply Configuration</b>	<b>Maximum Steady Current Consumption (A)</b>	<b>Max Steady Power (W)</b>
Dell EMC	100V/60Hz	MPS	9.92A	986.5W
Networking N2128PX-ON	110V/60Hz	MPS	8.93A	975.7W
	120V/60Hz	MPS	8.01A	955.4W
	220V/50Hz	MPS	4.44A	945.4W
	240V/50Hz	MPS	4.08A	951.4W

Table 3-28 shows power consumption data for the PoE-enabled N2128PX-ON switch when the power budget is 1600W for the main power supply and the MPS.

**Table 3-28. Power Consumption**

<b>Model</b>	<b>Input Voltage</b>	<b>Power Supply Configuration</b>	<b>Maximum Steady Current Consumption (A)</b>	<b>Max Steady Power (W)</b>
Dell EMC	100V/60Hz	Main PSU + MPS	11.83A	1175W
Networking N2128PX-ON	110V/60Hz	Main PSU + MPS	10.71A	1169W
	120V/60Hz	Main PSU + MPS	9.84A	1168.9W
	220V/50Hz	Main PSU + MPS	5.4A	1138.4W
	240V/50Hz	Main PSU + MPS	5.93A	1141W

The PoE power budget for each interface is controlled by the switch firmware. The administrator can limit the power supplied on a port or prioritize power to some ports over others. Table 3-29 shows power budget data.

**Table 3-29. Dell EMC Networking N2100-ON Series PoE Power Budget Limit**

Model Name	One PSU		Two PSUs	
	Max. PSU Output Ability	PoE+ Power Turn-on Limitation	Max. PSUs Output Ability	PoE+ Power Turn-on Limitation
Dell EMC Networking N2128PX-ON	1000W	Power budget is 800W: The total PoE supplied power must not exceed 800W.	2000W	Power budget is 1600W: All PoE+ ports can supply maximum power.

# Dell EMC Networking N2200-ON Series Switch Hardware

This section contains information about device characteristics and modular hardware configurations for the Dell EMC Networking N2200 Series switches.

## N2200-ON Series Front Panel

The Dell EMC Networking N2224X-ON/N2124PX-ON/N2248X-ON/N2248PX-ON switch front panels include the following features:

- 24 or 48 RJ-45 10/100/1000/2500BASE-T ports
- Four SFP28 10G/25GBASE-X ports
- Two QSFP 40G stacking ports
- RJ-45 and Type-B micro USB 3.0 console ports
- Reset button
- Port and system LEDs
- LED of the management unit in the stack and Stack Number Display
- Type-A USB 3.0 port for storage
- Out-of-band Ethernet interface

The following images show a representative front panel of the Dell EMC Networking switch.

**Figure 3-17. Dell EMC Networking N2248PX Switch (Front Panel)**



## N2200-ON Series Rear Panel

The Dell EMC Networking N2200 Series back panel has two 40G QSFP stacking ports in the rear. Each of these ports support  $4 \times 10\text{G}$  or  $1 \times 40\text{G}$  lane configuration. Changing the stacking mode to Ethernet mode or, conversely, requires a reboot of the switch.

The back panel also has two slots for power supplies, and two (N2224X-ON/N2224PX-ON) or three (N2248X-ON/N2248PX-ON) hot-swap fan trays.

**Figure 3-18. Dell EMC Networking N2248PX Switch (Rear Panel)**



## **N2200X-ON Series Switch Ports**

The Dell EMC Networking N2200X-ON Series front panel provides 24 or 48 10/100/1000/2500BASE-T Ethernet RJ-45 ports that support auto-negotiation for speed, flow control, and duplex. Dell EMC Networking N2200X-ON Series switch front panel 2.5G ports operate in full-duplex at all speeds or half-duplex at 10/100 Mbps speeds. The Dell EMC Networking N2200X-ON Series switch models support four 10G/25G SFP28 ports and two 40G QSFP stacking ports. Dell-qualified transceivers are sold separately.

The front-panel switch ports have the following characteristics:

- The switch automatically detects the difference between crossed and straight-through cables on RJ-45 ports and automatically chooses the MDI or MDIX configuration to match the other end.
- The 10/100/1000/2500BASE-T Ethernet RJ-45 ports support full-duplex mode 10/100/1000/2500 Mbps speeds or half-duplex 10/100 Mbps speeds on standard Category 5 UTP cable. 2500BASE-T operation requires the use of auto-negotiation.
- SFP28 ports support Dell-qualified transceivers utilizing 25GBASE-SR, 25GBASE-LR, 25GBASE-CR, 25GBASE-CR-S or 25GBASE-ER technologies. SFP28 ports support SFP+ fiber transceivers and SFP+ copper twin-ax or DAC technology operating at 10G speeds in full-duplex mode. All SFP28 ports must be configured to operate at the same speed. 25GBASE-CR and 10G-BASE-CR modes (copper twin-ax or DAC cables) require the use of auto-negotiation.
- The default behavior is to log a message and generate an SNMP trap on insertion or removal of a transceiver that is not qualified by Dell. The message and trap can be suppressed by using the **service unsupported-transceiver** command.

On the N2224X-ON/N2224PX-ON switches, ports 1-12 may be configured to support 10M/100M half-duplex.

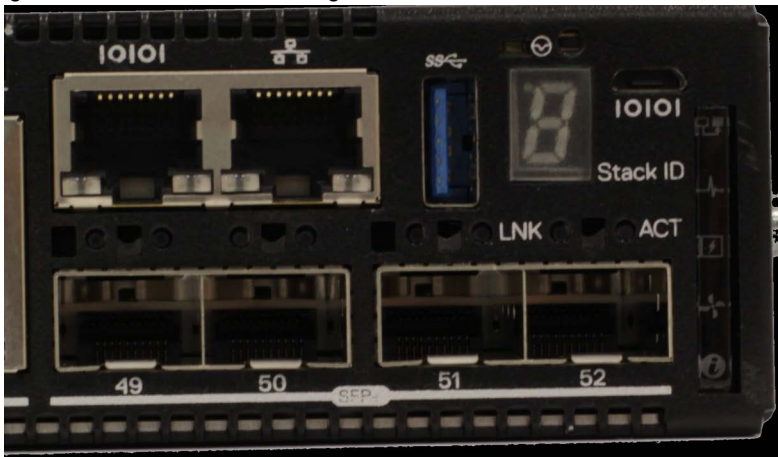
On the N2248X-ON switches, ports 5-36 may be configured to support 10M/100M half-duplex.

N2200-ON SFP28 ports may be configured to operate using SFP+ transceivers using the `speed 10000` command for fiber media or the `speed auto 10000` command for copper media. All four SFP28 ports must be configured to operate at the same speed. A mix of SFP+ and SFP28 transceivers or speeds is not supported. The switch UI does not enforce this restriction.

### N2200-ON Series Console Port

The console port provides serial communication capabilities, which allows communication using RS-232 protocol. The serial port provides a direct connection to the switch and allows access to the CLI from a console terminal connected to the port through the provided serial cable (with RJ-45 YOST to female DB-9 connectors). The console port is separately configurable and can be run as an asynchronous link from 1200 baud to 115,200 baud. The Dell CLI only supports changing the speed. The defaults are 115,200 baud rate, 8 data bits, no parity, 1 stop bit, no flow control.

**Figure 3-19. Dell EMC Networking N2248 Console Port**



A separate USB micro type B port is also available for console access to the CPU CLI. RS-232 emulation over USB is supported on this port. A driver may need to be installed to support the RS-232 emulation. Only one of the console ports may be used at a time.

## **N2200-ON Series USB Port**

The Type-A, female USB port supports a USB 3.0-compliant flash memory drive. The Dell EMC Networking N-Series switch can read or write to a flash drive with a single partition formatted as FAT-32. Use a USB flash drive to copy switch configuration files and images between the USB flash drive and the switch. The USB flash drive may be used to move and copy configuration files and images to other switches in the network. The system does not support the deletion of files on USB flash drives. The USB port does not support any other type of USB device.

## **N2200-ON Series Reset Button**

The reset button is accessed through the pinhole and enables performing a hard reset on the switch. To reset the switch, insert an unbent paper clip or similar tool into the pinhole for four seconds. When the switch completes the boot process after the reset, it resumes operation with the most recently saved configuration. Any changes made to the running configuration that were not saved to the startup configuration prior to the reset are lost.

To clear the configuration and reset the switch, press the reset button for at least eight seconds. The saved configuration is cleared and the switch reboots. The switch will then start the auto-configuration process.

## **N2200-ON Series Port and System LEDs**

The front panel contains light emitting diodes (LEDs) that indicate the status of system temperature, port links, power supplies, fans, stacking, and the overall system status. A locator beacon capability is also present on the system LEDs. See "N2000 Series LED Definitions" on page 134 for more information.

## **N2200-ON Series LED of Management Unit in Stack and Stack Number Display**

When a switch within a stack is the primary unit, the LED of the management unit in the stack is solid green. If the LED of the management unit in the stack is off, the stack member is not the primary unit. The stack number LCD displays the unit number for the stack member. If a switch is not part of a stack (in other words, it is a stack of one switch), the LED of the management unit in the stack is illuminated, and the unit number is displayed.

## **N2200-ON Series Power Supplies**

The Dell EMC Networking N2224X-ON/N2248X-ON switches have a field-replaceable 550W power supply (DS-550 AC). An additional field-replaceable power supply may be added to support redundancy.

The Dell EMC Networking N2224PX-ON switches have a field-replaceable 1050-watt power supply (DPS-1050 AC) feeding up to 16x30W PoE and 2x60W devices at full power (712W). The Dell EMC Networking N2248PX-ON switches have an internal 1050W power supply (DPS-1050 AC) feeding up to 16x30W PoE devices and 1Xx60W at full power (624W).

In both PoE models, additional field replaceable 1050W, 1600W, or 2000W power supplies are available to support redundancy or to supply full front panel demand. The N2224PX-ON and N2248PX-ON models also support an EPS external power supply in the rear for redundant or shared power operation. The EPS should not be configured as the primary power supply. Rebooting the switch or powering up the switch when the EPS is the only power supply is not supported. Ensure that an internal power supply is present and powered prior to performing switch maintenance. When using the EPS, always connect the power to the **A** (left) connector. EPS power is not available to the switch if the only EPS power connection is to the **B** connector.



Table 3-30 shows power budget data.

**Table 3-30. Dell EMC Networking N2200PX-ON Series PoE Power Budget Limit**

Model Name	One PSU		Two PSUs	
	PoE Power Budget	Power Turn-on Limitation	PoE Power Budget	Power Turn-on Limitation
Dell EMC Networking N2224PX-ON	712W	The switch can power all 16x30W and 3x60W ports.	1080W	The switch can power all 16x30W and 8x60W ports at full power.
1050W@110V	712W		1080W	
1050W@2200V	812W		1757W	
Dell EMC Networking N2248PX-ON	624W	The switch can power 19x30W or 9x60W ports.	1479W	The switch can power 32x30W and 7x60W ports at full power.
1600W@110V	624W		1479W	
1600W@220V	1274W		2714W	

## N2200-ON Series LED Definitions

This section describes the LEDs on the front and back panels of the switch.

### Port LEDs

Each port on a Dell EMC Networking N2200-ON Series switch includes two LEDs. One LED is on the left side of the port, and the second LED is on the right side of the port. This section describes the LEDs on the switch ports.

Figure 3-20 illustrates the 2500BASE-T port LEDs.

**Figure 3-20. 2500BASE-T Port LEDs**



**Table 3-31. 2500BASE-T Port LED Definitions**

<b>LED</b>	<b>Color</b>	<b>Definition</b>
Link/SPD LED (Left bi-color LED)	Off	There is no link.
	Solid green	The port is operating at 2.5 Gbps.
	Solid amber	The port is operating at 100 Mbps or 1 Gbps.
Activity/PoE LED (Right bi-color LED)	Off	There is no current transmit/receive activity, and PoE power is off.
	Blinking green	The port is actively transmitting/receiving, and PoE power is off.
	Blinking yellow	The port is actively transmitting/receiving, and PoE power is on.
	Solid yellow	There is no current transmit/receive activity, and PoE power is on.

**Table 3-32. SFP+ Port LED Definitions**

<b>LED</b>	<b>Color</b>	<b>Definition</b>
Link/SPD LED (Left bi-color LED)	Off	There is no link.
	Solid green	The port is operating at 10 Gbps.
	Solid amber	The port is operating at 1 Gbps.
Activity LED (Right single-color LED)	Off	There is no current transmit/receive activity.
	Blinking green	The port is actively transmitting/receiving.

**Table 3-33. QSFP Port LED Definitions**

LED	Color	Definition
Link/SPD LED (Left single-color LED)	Off	There is no link.
	Solid green	The port is operating at full speed.
	Solid amber	The port is operating at lower than 25GE speed
Activity LED (Right single-color LED)	Off	There is no current transmit/receive activity.
	Blinking green	The port is actively transmitting/receiving.

**Stacking Port LEDs****Table 3-34. Stacking Port LED Definitions**

LED	Color	Definition
Link LED	Off	There is no link.
	Solid green	The port is actively transmitting/receiving.
Activity LED	Off	There is no current transmit/receive activity.
	Blinking green	The port is actively transmitting/receiving.

**Console Port LEDs****Table 3-35. Console Port LED Definitions**

LED	Color	Definition
Link/SPD LED	Off	There is no link.
	Solid green	A link is present.

**System LEDs**

The system LEDs, located on the front panel, provide information about the power supplies, thermal conditions, and diagnostics.

Table 3-36 shows the System LED definitions for the Dell EMC Networking N2200 switches.

**Table 3-36. N2200-ON Series System LED Definitions**

LED	Color	Definition
Status	Solid green	Normal operation.
	Blinking green	The switch is booting
	Solid red	A critical system error has occurred.
	Blinking red	A noncritical system error occurred (fan or power supply failure).
Power	Off	There is no power or the switch has experienced a power failure.
	Solid green	Power to the switch is on.
	Blinking green	The switch locator function is enabled.
EPS (on PoE switches)	Off	There is no external power supply (EPS).
	Solid green	Power to the EPS is on.
	Solid red	An EPS is detected but it is not receiving power.
Fan	Solid green	The fan is powered and is operating at the expected RPM.
	Solid red	A fan failure has occurred.
Management Unit in Stack	Off	The switch is not the management unit in the stack.
	Solid green	The switch is primary for the stack.
System Beacon (Bi-color LED)	Off	Idle
	Flashing blue with 1 second on and 1 second off	SID
Temp	Solid green	The switch is operating below the threshold temperature.
	Solid red	The switch temperature exceeds the threshold of 75°C.
Stack No.	–	Switch ID within the stack.

# Dell EMC Networking N3000E-ON Series Switch Hardware

This section contains information about device characteristics and modular hardware configurations for the Dell EMC Networking N3000E-ON Series switches.

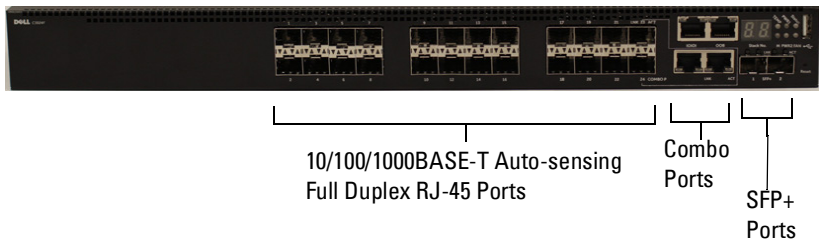
## Front Panel

The Dell EMC Networking N3000E-ON Series front panel includes the following features:

- Switch Ports
- Console Port
- Out-of-Band Management Port
- USB Port
- SFP+ Ports
- Reset Button
- Port and System LEDs
- LED of the management unit in the stack and Stack Number Display

The following images show the front panels of the switch models in the Dell EMC Networking N3000E-ON Series.

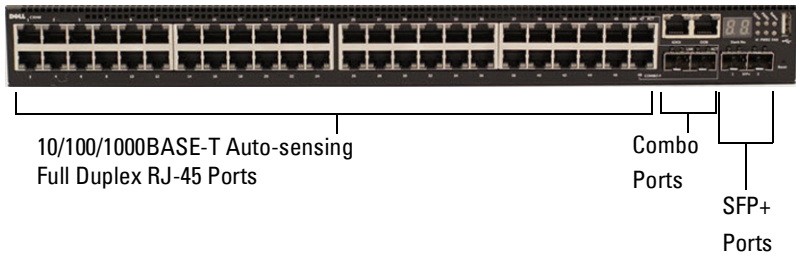
**Figure 3-21. Dell EMC Networking N3024EF-ON with 24 10/100/1000BASE-T Ports (Front Panel)**



The Dell EMC Networking N3000E-ON Series switch includes two combo ports. The combo ports are SFP on the Dell EMC Networking N3000E-ON Series and 1000BASE-T on the Dell EMC Networking N3024EF-ON switch. The combo ports are set to prefer fiber. A fiber combo port may flap once

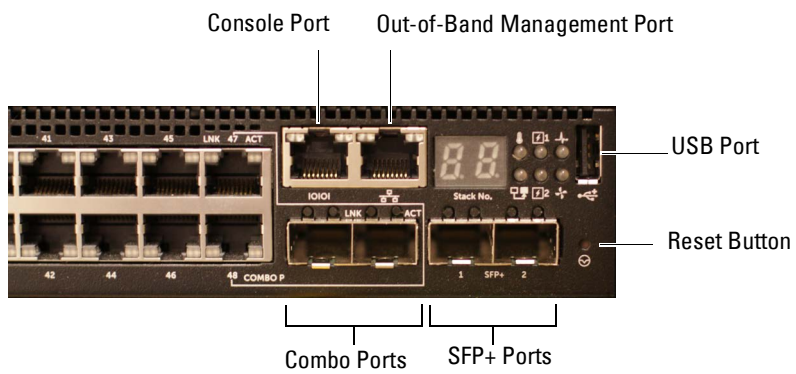
after powering up the transceiver and detecting that a change in the interface mode is required. If using the 1000BASE-T port, remove any transceivers from the SFP port. The combo ports and the N3024F front panel ports support 100BASE-FX transceivers.

**Figure 3-22. Dell EMC Networking N3048ET-ON with 48 10/100/1000BASE-T Ports (Front Panel)**



The additional ports are on the right side of the front panel, as shown in Figure 3-22 and Figure 3-23.

**Figure 3-23. Additional Dell EMC Networking N3000E-ON Series Ports**



The Dell EMC Networking N3000E-ON Series front panel above also contains a reset button (pinhole) and several status LEDs. See Figure 3-23.

The Dell EMC Networking N3000E-ON Series front panel displays, from left to right, status LEDs for over-temperature alarm, internal power supply 1, and switch status on the top row. The bottom row of status LEDs displays, from left to right, the management unit in the stack, internal power supply 2, and fan alarm status.

## Switch Ports

The Dell EMC Networking N3024ET-ON/N3024EP-ON front panel provides 24 Gigabit Ethernet (10/100/1000BASE-T) RJ-45 ports that support auto-negotiation for speed, flow control, and duplex. The Dell EMC Networking N3024P models support two SFP+ 10G ports. Dell EMC-qualified SFP+ transceivers are sold separately. The Dell EMC Networking N3000E-ON Series switches operate in full-duplex mode only.

The Dell EMC Networking N3024EF-ON front panel provides 24 Gigabit Ethernet 100BASE-FX/1000BASE-X SFP ports plus two 1000BASE-T combo ports. The combo ports are set to prefer fiber. A fiber combo port may flap once after powering up the transceiver and detecting that a change in the interface mode is required. If using the 1000BASE-T port, remove any transceivers from the SFP port. Dell EMC-qualified SFP transceivers are sold separately. 1000BASE-X and 1000BASE-T operation requires the use of auto-negotiation.

The Dell EMC Networking N3048ET-ON/N3000 front panel provides 48 Gigabit Ethernet (10BASE-T, 100BASE-TX, 1000BASE-T) RJ-45 ports that support auto-negotiation for speed, flow control, and duplex. The Dell EMC Networking N3048ET-ON/N3048P-ON support two SFP+ 10G ports. Dell EMC-qualified SFP+ transceivers are sold separately.

The front-panel switch ports have the following characteristics:

- The switch automatically detects the difference between crossed and straight-through cables on RJ-45 ports and automatically chooses the MDI or MDIX configuration to match the other end.
- SFP+ ports support Dell EMC-qualified transceivers. The default behavior is to log a message and generate an SNMP trap on insertion or removal of an optic that is not qualified by Dell. The message and trap can be suppressed by using the **service unsupported-transceiver** command.
- RJ-45 ports support full-duplex mode 10/100/1000 Mbps speeds on standard Category 5 UTP cable.

- SFP ports support 1000BASE-X and 100BASE-X (100BASE-FX/100BASE-LX/100BASE-SX) transceivers. SFP ports with 1000BASE-X transceivers require auto-negotiation to be enabled but also allow configuration of forced speeds with auto-negotiation disabled. However, the SFP ports do not support auto-negotiation for 100BASE-X transceivers. When the switch detects a 100BASE-X transceiver, it resets the port to use 4B/5B NRZI line coding from the default 8B/10B NRZ coding. This causes the link to flap momentarily. The flap may be observed at the link partner upon insertion of an SFP transceiver and on switch reboot. Administrators should ensure that the link partner is set to accept a single link flap on 100BASE-X interfaces.
- SFP+ ports support SFP+ transceivers and SFP+ copper twin-ax technology operating at 10G/1G speeds in full-duplex mode. SFP transceivers are supported in SFP+ ports and operate at 1G full-duplex. SFP transceivers in an SFP+ port require auto-negotiation to be enabled per the IEEE 802.3 standard but may be configured to use a forced speed with auto-negotiation disabled.
- The Dell EMC Networking N3024P/N3048P/N3048ET-ON/N3000 front-panel ports support PoE (15.4W) and PoE+ (34.2W) as well as legacy capacitive detection for pre-standard PDs.
- Additionally, ports 1–12 support PoE 60W power when configured in high-power mode.

### **Combo Ports**

Combo ports automatically select the active media and always choose fiber (SFP) media if both copper and fiber are active. Copper combo ports do not support 10 Mbps forced mode. Auto-negotiation is not supported for 100BASE-X (FX/SX/LX) transceivers. If using the 1000BASE-T port, remove any transceivers from the SFP port.

### **Console Port**

The console port provides serial communication capabilities, which allows communication using RS-232 protocol. The serial port provides a direct connection to the switch and allows access to the CLI from a console terminal connected to the port through the provided serial cable (with RJ45 YOST to female DB-9 connectors).



The console port is separately configurable and can be run as an asynchronous link from 1200 BAUD to 115,200 BAUD.

The Dell CLI only supports changing the speed.

The defaults are 115,200 BAUD, 8 data bits, no parity, 1 stop bit, and no flow control.

### **Out-of-Band Management Port**

The Out-of-Band (OOB) management port is a 10/100/1000BASE-T Ethernet port connected directly to the switch CPU and dedicated to switch management. Traffic on this port is separated from operational network traffic on the switch ports and cannot be switched or routed to or from the operational network. In addition, ACLs (including management ACLS), do not operate on the out-of-band port. Connect the out-of-band port only to a physically secure network.

### **USB Port**

The Type-A, female USB port supports a USB 2.0-compliant flash memory drive. The Dell EMC Networking N-Series switch can read or write to a flash drive with a single partition formatted as FAT-32. Use a USB flash drive to copy switch configuration files and images between the USB flash drive and the switch. It is also possible to use the USB flash drive to move and copy configuration files and images from one switch to other switches in the network. The system does not support the deletion of files on attached USB flash drives.

The USB port does not support any other type of USB device.

### **Reset Button**

The reset button is accessed through the pinhole and enables performing a hard reset on the switch. To use the reset button, insert an unbent paper clip or similar tool into the pinhole. When the switch completes the boot process after the reset, it resumes operation with the most recently saved configuration. Any changes made to the running configuration that were not saved to the startup configuration prior to the reset are lost.

## **Port and System LEDs**

The front panel contains light emitting diodes (LEDs) that indicate the status of port links, power supplies, fans, stacking, and the overall system status.

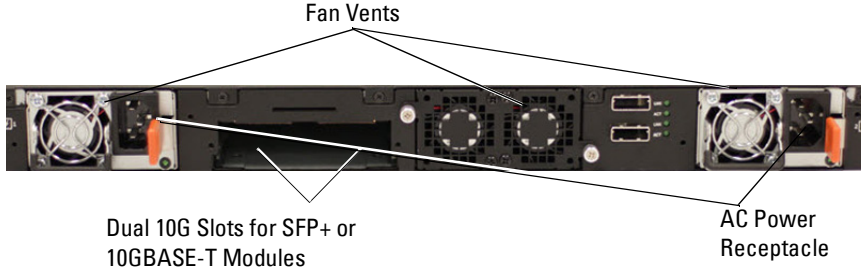
## **LED of Management Unit in Stack and Stack Number Display**

When a switch within a stack is the primary unit, the LED of the management unit in the stack is solid green. If the LED of the management unit in the stack is off, the stack member is not the primary unit. The Stack No. panel displays the unit number for the stack member. If a switch is not part of a stack (in other words, it is a stack of one switch), the LED of the management unit in the stack is illuminated and the unit number is displayed.

## Back Panel

The following images show the back panels of the Dell EMC Networking N3000E-ON Series switches.

**Figure 3-24. Dell EMC Networking N3000E-ON Series Back Panel**



**Figure 3-25. Dell EMC Networking N3024EP-ON/N3000 Back Panel**



**Figure 3-26. Dell EMC Networking N3048ET-ON Mini-SAS Stacking Ports Close-up**



The term mini-SAS refers to the stacking port cable connections shown in Figure 3-26. See "Stacking" on page 253 for information on using the mini-SAS ports to connect switches.

## Expansion Slots for Plug-in Modules

One expansion slot is located on the back of the Dell EMC Networking N3000E-ON Series models and can support the following modules:

- 10GBASE-T module
- SFP+ module

Each plug-in module has two ports. The plug-in modules include hot-swap support, so a switch reboot is not needed after a new module is installed. Issue a **no slot** command after removing the original module and prior to inserting a new type of module. If the module is not recognized, issue the **no slot** command, then remove and re-insert the module.

## Power Supplies

### ***Dell EMC Networking N3024ET-ON, N3024EF-ON, and N3048ET-ON***

Dell EMC Networking N3024ET-ON, N3024EF-ON and N3000 switches support two 200-watt Field Replaceable Unit (FRU) power supplies which give full power redundancy for the switch. The Dell EMC Networking N3024ET-ON, N3024EF-ON, and N3048ET-ON switches offer the V-lock feature for users desiring the need to eliminate accidental power disconnection. The V-lock receptacle on the Power Supply Unit (PSU) allows for the use of a power cord that has the V-lock feature to create an integral secure locking connection.

### ***Dell EMC Networking N3024EP-ON and N3000***

Dell EMC Networking N3024EP-ON and N3000 switches support one or two 1100-watt FRU power supplies. The Dell EMC Networking N3024EP-ON switch is supplied with a single 715-watt power supply (the default configuration) and supports an additional 1100-watt supply. For the Dell EMC Networking N3000 switches, a single 1100-watt power supply is supplied and another 1100 watt power supply can be added.

A single 1100-watt power supply can feed up to 24 PoE devices at full PoE+ power (950W). Dual-equipped switches will feed up to 48 PoE devices at full PoE+ power (1800W), as well as provide power supply redundancy.



**NOTE:** PoE power is dynamically allocated by default. Not all ports will require the full PoE+ power.

**CAUTION:** Remove the power cable from the power supplies prior to removing the power supply module itself. Power must not be connected prior to insertion in the chassis.

## Ventilation System

Two fans cool the Dell EMC Networking N3000E-ON Series switches. The Dell EMC Networking N3000E-ON Series switches additionally have a fan in each internal power supply. The Dell EMC Networking N3000E-ON Series fan is field-replaceable.

## Information Tag

The back panel includes a slide-out label panel that contains system information, such as the Service Tag, MAC address, and other information.

## LED Definitions

This section describes the LEDs on the front and back panels of the switch.

### Port LEDs

Each port on a Dell EMC Networking N3000E-ON Series switch includes two LEDs. One LED is on the left side of the port, and the second LED is on the right side of the port. This section describes the LEDs on the switch ports.

#### 100/1000/10000BASE-T Port LEDs

Each 100/1000/10000BASE-T port has two LEDs. Figure 3-27 illustrates the 100/1000/10000BASE-T port LEDs.

**Figure 3-27. 100/1000/10000BASE-T Port LEDs**



Table 3-37 shows the 100/1000/10000BASE-T port LED definitions.

**Table 3-37. 100/1000/10000BASE-T Port Definitions**

<b>LED</b>	<b>Color</b>	<b>Definition</b>
Link/SPD LED	Off	There is no link.
	Solid yellow	The port is operating at 10/100 Mbps.
	Solid green	The port is operating at 1000 Mbps.
Activity LED (on non-PoE switches)	Off	There is no current transmit/receive activity.
	Blinking green	The port is actively transmitting/receiving.
Activity/PoE LED (on PoE switches)	Off	There is no current transmit/receive activity and PoE power is off.
	Blinking green	The port is actively transmitting/receiving and PoE power is off.
	Blinking yellow	The port is actively transmitting/receiving and PoE power is on.
	Solid yellow	There is no current transmit/receive activity and PoE power is on.

### Module Bay LEDs

The following tables describe the purpose of each of the module bay LEDs when SFP+ and 10GBASE-T modules are used.

**Table 3-38. SFP+ Module LED Definitions**

<b>LED</b>	<b>Color</b>	<b>Definition</b>
Link/SPD LED	Off	There is no link.
	Solid green	The port is operating at 10 Gbps.
	Solid amber	The port is operating at 1000 Mbps.
Activity LED	Off	There is no current transmit/receive activity.
	Blinking green	The port is actively transmitting/receiving.

**Table 3-39. 10GBASE-T Module LED Definitions**

<b>LED</b>	<b>Color</b>	<b>Definition</b>
Link/SPD LED	Off	There is no link.
	Solid green	The port is operating at 10 Gbps.
	Solid amber	The port is operating at 100/1000 Mbps.
Activity LED	Off	There is no current transmit/receive activity.
	Blinking green	The port is actively transmitting/receiving.

**Stacking Port LEDs****Table 3-40. Stacking Port LED Definitions**

<b>LED</b>	<b>Color</b>	<b>Definition</b>
Link LED	Off	There is no link.
	Solid green	The port is actively transmitting/receiving.
Activity LED	Off	There is no current transmit/receive activity.
	Blinking green	The port is actively transmitting/receiving.

**Out-of-Band Port LEDs****Table 3-41. OOB Port LED Definitions**

<b>LED</b>	<b>Color</b>	<b>Definition</b>
Link/SPD LED	Off	There is no link.
	Solid green	The port is actively transmitting/receiving at 1000 Mbps.
	Solid amber	The port is actively transmitting/receiving at 10/100 Mbps.
Activity LED	Off	There is no current transmit/receive activity.
	Blinking green	The port is actively transmitting/receiving.

## Console Port LEDs

**Table 3-42. Console Port LED Definitions**

LED	Color	Definition
Link/SPD LED	Off	There is no link.
	Solid green	A link is present.

## System LEDs

The system LEDs, located on the front panel, provide information about the power supplies, thermal conditions, and diagnostics.

Table 3-43 shows the System LED definitions for the Dell EMC Networking N3000E-ON Series switches.

**Table 3-43. System LED Definitions**

LED	Color	Definition
Status	Solid green	Normal operation.
	Blinking green	The switch is booting
	Solid red	A critical system error has occurred.
	Blinking red	A noncritical system error occurred (fan or power supply failure).



**Table 3-43. System LED Definitions**

<b>LED</b>	<b>Color</b>	<b>Definition</b>
Power 1, Power 2	Off	There is no power or the switch has experienced a power failure.
	Solid green	Power to the switch is on.
	Blinking green	The switch locator function is enabled.
Fan	Solid green	The fan is powered and is operating at the expected RPM.
	Solid red	A fan failure has occurred.
Managem ent Unit in Stack	Off	The switch is in stand-alone mode.
	Solid green	The switch is primary for the stack.
Temp	Solid green	The switch is operating below the threshold temperature.
	Solid red	The switch temperature exceeds the threshold of 75°C.
Stack No.	–	Switch ID within the stack.

## Power Consumption for PoE Switches

Table 3-44 shows power consumption data for the PoE-enabled switches.

**Table 3-44. Dell EMC Networking N3000E-ON Series Power Consumption**

Model	Input Voltage	Power Supply Configuration	Max Steady Current Consumption (A)	Max Steady Power (W)
Dell EMC Networking N3024EP-ON	100V	PSU1+PSU2	13.1	1310.0
	110V	PSU1+PSU2	11.7	1287.0
	120V	PSU1+PSU2	10.6	1272.0
	220V	PSU1+PSU2	5.6	1232.0
	240V	PSU1+PSU2	5.2	1240.8
Dell EMC Networking N3000	100V	PSU1+PSU2	21.8	2180.0
	110V	PSU1+PSU2	19.5	2145.0
	120V	PSU1+PSU2	17.8	2136.0
	220V	PSU1+PSU2	9.31	2048.2
	240V	PSU1+PSU2	8.6	2064.0

The PoE power budget for each interface is controlled by the switch firmware. The administrator can limit the power supplied on a port or prioritize power to some ports over others. Table 3-45 shows the power budget data.

**Table 3-45. Dell EMC Networking N3000E-ON Series PoE Power Budget Limit**

<b>Model Name</b>	<b>One PSU</b>		<b>Two PSUs</b>	
	<b>Max. PSU Output Ability</b>	<b>PoE+ Power Turn-on Limitation</b>	<b>Max. PSUs Output Ability</b>	<b>PoE+ Power Turn-on Limitation</b>
Dell EMC Networking N3024EP-ON	715W	Power budget is 550W: The total PoE supplied power must not exceed 550W.	715W	Power budget is 1100W: All PoE+ ports can supply maximum power.
Dell EMC Networking N3048EP-ON	1100W	Power budget is 950W: The total PoE supplied power must not exceed 950W.	2200W	Power budget is 1900W: All PoE+ ports can supply maximum power.

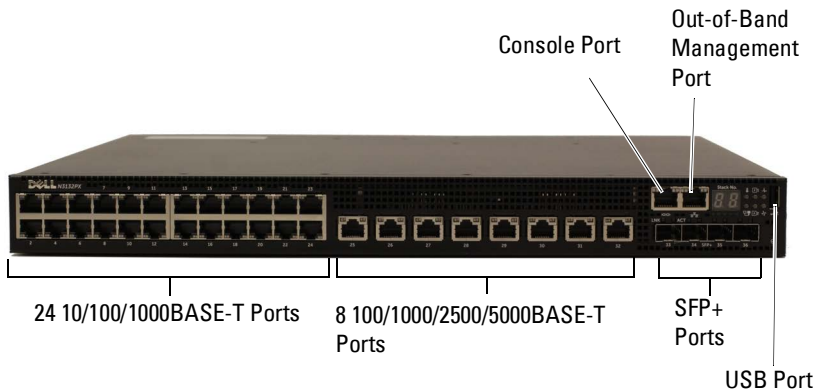
# Dell EMC Networking N3100-ON Series Switch Hardware

## N3100-ON Series Front Panel

All N3132PX-ON models are 1U, rack-mountable switches. The N3132PX-ON front panel provides twenty-four 10/100/1000BASE-T Ethernet RJ-45 ports and eight 5G NBASE-T Ethernet RJ-45 ports that support auto-negotiation for speed, flow control, and duplex. NBASE-T interfaces require auto-negotiation to be enabled. They will not operate correctly in fixed speed mode. The N3132PX-ON switch front panel ports operate in full-duplex mode only. N3132PX-ON front panel copper ports support PoE 60W capability. The N3132PX-ON models support four SFP+ 10G ports. The SFP+ 10G ports support SFP+ transceivers or SFP transceivers, but not both types simultaneously. Use either all SFP+ transceivers or all SFP transceivers. One RJ-45 console port provides serial communication capabilities, which allows communication using RS-232 protocol. The front panel has a Type-A USB port for storage.

The following image shows the front panel of the Dell EMC Networking N3132PX-ON switch.

**Figure 3-28. Dell EMC Networking N3132PX-ON with 24 10/100/1000BASE-T Ports (Front Panel)**



## **Console Port**

The console port provides serial communication capabilities, which allows communication using RS-232 protocol. The serial port provides a direct connection to the switch and allows access to the CLI from a console terminal connected to the port through the provided serial cable (with RJ-45 YOST to female DB-9 connectors).

The console port is separately configurable and can be run as an asynchronous link from 1200 baud to 115,200 baud. The Dell EMC CLI only supports changing the speed. The defaults are 115,200 baud, 8 data bits, no parity, 1 stop bit, and no flow control.

## **USB Port**

The Type-A female USB port supports a USB 2.0-compliant flash memory drive. The Dell EMC Networking N-Series switch can read or write to a flash drive with a single partition formatted as FAT-32. Use a USB flash drive to copy switch configuration files and images between the USB flash drive and the switch. The USB flash drive may be used to move and copy configuration files and images from one switch to other switches in the network. The system does not support the deletion of files on USB flash drives.

The USB port does not support any other type of USB device.

## **Reset Button**

The reset button is accessed through the pinhole and enables performing a hard reset on the switch. To use the reset button, insert an unbent paper clip or similar tool into the pinhole. When the switch completes the boot process after the reset, it resumes operation with the most recently saved configuration. Any changes made to the running configuration that were not saved to the startup configuration prior to the reset are lost.

## **Port and System LEDs**

The front panel contains light emitting diodes (LEDs) that indicate the status of port links, power supplies, fans, stacking, and the overall system status. See "N3100-ON Series LED Definitions" on page 174 for more information.

### **LED of Management Unit in Stack and Stack Number Display**

When a switch within a stack is the primary unit, the LED of the management unit in the stack is solid green. If the LED of the management unit in the stack is off, the stack member is not the primary unit. The Stack No. panel displays the unit number for the stack member. If a switch is not part of a stack (in other words, it is a stack of one switch), the LED of the management unit in the stack is illuminated, and the unit number is displayed.

### **N3100-ON Series Back Panel**

The N3132PX-ON rear panel has an expansion slot which accepts a 2 x 40G QSFP+ module or a 2 x 21G stacking module. The QSFP+ module supports SR4, LR4, and copper CR4 technologies in 40G mode only.

### **Power Supply**

The N3132PX-ON rear panel has one 715W field-replaceable power supply. A redundant power supply may be added in the available slot. Optional 715W and 1100W power supplies are available.



**CAUTION: Remove the power cable from the power supplies prior to removing the power supply module itself. Power must not be connected prior to insertion in the chassis.**

### **Ventilation System**

Two internal fans in a single field replaceable unit (FRU) cool the Dell EMC Networking N3132PX-ON Series switches.

### **Information Tag**

The back panel includes a slide-out label panel that contains system information, such as the Service Tag, MAC address, and so on.

### **N3100-ON Series LED Definitions**

Each port on a N3132PX-ON Series switch includes two LEDs. One LED is on the left side of the port, and the second LED is on the right side of the port. This section describes the LEDs on the switch ports.

## Port LEDs

Each 100/1000/10000BASE-T port has two LEDs. Figure 3-29 illustrates the 100/1000/10000BASE-T port LEDs.

**Figure 3-29. 100/1000/10000BASE-T Port LEDs**

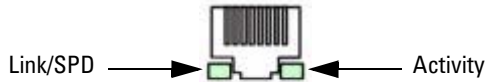


Table 3-46, Table 3-47, and Table 3-48 show the port LED definitions.

**Table 3-46. 100/1000/10000BASE-T Port LED Definitions**

LED	Color	Definition
Link/SPD LED	Off	There is no link.
	Solid yellow	The port is operating at 10/100 Mbps.
	Solid green	The port is operating at 1000 Mbps.
Activity LED (on non-PoE switches)	Off	There is no current transmit/receive activity.
	Blinking green	The port is actively transmitting/receiving.
Activity/PoE LED (on PoE switches)	Off	There is no current transmit/receive activity and PoE power is off.
	Blinking green	The port is actively transmitting/receiving and PoE power is off.
	Blinking yellow	The port is actively transmitting/receiving and PoE power is on.
	Solid yellow	There is no current transmit/receive activity and PoE power is on.

**Table 3-47. 5000BASE-T Port LED Definitions**

<b>LED</b>	<b>Color</b>	<b>Definition</b>
Link/SPD LED (Left bi-color LED)	Off	There is no link.
	Solid green	The port is operating at 2.5/5 Gbps.
	Solid amber	The port is operating at 100 Mbps or 1 Gbps.
Activity/PoE LED (Right bi-color LED)	Off	There is no current transmit/receive activity and PoE power is off.
	Blinking green	The port is actively transmitting/receiving and PoE power is off.
	Blinking yellow	The port is actively transmitting/receiving and PoE power is on.
	Solid yellow	There is no current transmit/receive activity and PoE power is on.

**Table 3-48. SFP+ Port LED Definitions**

<b>LED</b>	<b>Color</b>	<b>Definition</b>
Link/SPD LED (Left bi-color LED)	Off	There is no link.
	Solid green	The port is operating at 10 Gbps.
	Solid amber	The port is operating at 1 Gbps.
Activity LED (Right single-color LED)	Off	There is no current transmit/receive activity.
	Blinking green	The port is actively transmitting/receiving.



## Module Bay LEDs

The following tables describe the purpose of each of the module bay LEDs when a QSFP or a Stacking module is installed.

**Table 3-49. QSFP Module LED Definitions**

LED	Color	Definition
Link/SPD LED	Off	There is no link.
	Solid green	The port is operating at 40 Gbps.
Activity LED	Off	There is no current transmit/receive activity.
	Blinking green	The port is actively transmitting/receiving.

**Table 3-50. Stacking Module Port LED Definitions**

LED	Color	Definition
Link LED	Off	There is no link.
	Solid green	The port detects a link.
Activity LED	Off	There is no current transmit/receive activity.
	Blinking green	The port is actively transmitting/receiving.

## Out-of-Band Port and Console Port LEDs

Table 3-51 shows the OOB port LED definitions, and Table 3-52 shows the console port LED definitions.

**Table 3-51. OOB Port LED Definitions**

LED	Color	Definition
Link/SPD LED	Off	There is no link.
	Solid green	The port is actively transmitting/receiving at 1000 Mbps.
	Solid amber	The port is actively transmitting/receiving at 10/100 Mbps.
Activity LED	Off	There is no current transmit/receive activity.
	Blinking green	The port is actively transmitting/receiving.

**Table 3-52. Console Port LED Definitions**

<b>LED</b>	<b>Color</b>	<b>Definition</b>
Link/SPD LED	Off	There is no link.
	Solid green	A link is present.

**System LEDs**

The system LEDs, located on the front panel, provide information about the power supplies, thermal conditions, and diagnostics.

Table 3-53 shows the System LED definitions for the Dell EMC Networking N3132PX-ON Series switches.

**Table 3-53. System LED Definitions**

<b>LED</b>	<b>Color</b>	<b>Definition</b>
Status	Solid green	Normal operation.
	Blinking green	The switch is booting
	Solid red	A critical system error has occurred.
	Blinking red	A noncritical system error occurred (fan or power supply failure).

**Table 3-53. System LED Definitions**

LED	Color	Definition
Power 1, Power 2	Off	There is no power or the switch has experienced a power failure.
	Solid green	Power to the switch is on.
	Blinking green	The switch locator function is enabled.
Fan	Solid green	The fan is powered and is operating at the expected RPM.
	Solid red	A fan failure has occurred.
Management Unit in Stack	Off	The switch is in stand-alone mode.
	Solid green	The switch is primary for the stack.
Temp	Solid green	The switch is operating below the threshold temperature.
	Solid red	The switch temperature exceeds the threshold of 75°C.
Stack No.	–	Switch ID within the stack.

### Power Consumption for N3100-ON Series PoE Switches

Table 3-54 shows power consumption data for the PoE-enabled N3132PX-ON switch when the power budget is 500W for one 715W power supply.

**Table 3-54. Power Consumption**

Model	Input Voltage	Power Supply Configuration	Maximum Steady Current Consumption (A)	Max Steady Power (W)
Dell EMC Networking N3132PX-ON	100V/60Hz	One 715W	6.47A	647.3W
	110V/60Hz	One 715W	5.79A	636.1W
	120V/60Hz	One 715W	5.12A	611.9W
	220V/50Hz	One 715W	2.85A	621.7W
	240V/50Hz	One 715W	2.62A	618.7W

Table 3-55 shows power consumption data for the PoE-enabled N3132PX-ON switch when the power budget is 1200W for two 715W power supplies.

**Table 3-55. Power Consumption**

<b>Model</b>	<b>Input Voltage</b>	<b>Power Supply Configuration</b>	<b>Maximum Steady Current Consumption (A)</b>	<b>Max Steady Power (W)</b>
Dell EMC Networking N3132PX-ON	100V/60Hz	Two 715W	14.37A	1429.8W
	110V/60Hz	Two 715W	12.95A	1417.6W
	120V/60Hz	Two 715W	11.78A	1409.1W
	220V/50Hz	Two 715W	6.35A	1374.8W
	240V/50Hz	Two 715W	5.84A	1372.5W

Table 3-56 shows power consumption data for the PoE-enabled N3132PX-ON switch when the power budget is 750W for one 1100W power supply.

**Table 3-56. Power Consumption**

<b>Model</b>	<b>Input Voltage</b>	<b>Power Supply Configuration</b>	<b>Maximum Steady Current Consumption (A)</b>	<b>Max Steady Power (W)</b>
Dell EMC Networking N3132PX-ON	100V/60Hz	One 1100W	9.41A	937.1W
	110V/60Hz	One 1100W	8.48A	929.7W
	120V/60Hz	One 1100W	7.69A	918.3W
	220V/50Hz	One 1100W	4.16A	904.3W
	240V/50Hz	One 1100W	3.81A	902.3W

Table 3-57 shows power consumption data for the PoE-enabled N3132PX-ON switch when the power budget is 1700W for two 1100W power supplies.

**Table 3-57. Power Consumption**

<b>Model</b>	<b>Input Voltage</b>	<b>Power Supply Configuration</b>	<b>Maximum Steady Current Consumption (A)</b>	<b>Max Steady Power (W)</b>
Dell EMC Networking N3132PX-ON	100V/60Hz	Two 1100W	19.16A	1911.2W
	110V/60Hz	Two 1100W	17.24A	1892W
	120V/60Hz	Two 1100W	15.68A	1873W
	220V/50Hz	Two 1100W	8.37A	1819W
	240V/50Hz	Two 1100W	7.7A	1819.2W

Table 3-58 shows power consumption data for the PoE-enabled N3132PX-ON switch when the power budget is 1440W for one 1100W power supply + one 715W power supply.

**Table 3-58. Power Consumption**

<b>Model</b>	<b>Input Voltage</b>	<b>Power Supply Configuration</b>	<b>Maximum Steady Current Consumption (A)</b>	<b>Max Steady Power (W)</b>
Dell EMC Networking N3132PX-ON	100V/60Hz	1100W + 715W	17.51A	1748W
	110V/60Hz	1100W + 715W	15.7A	1722.3W
	120V/60Hz	1100W + 715W	14.36A	1704.2W
	220V/50Hz	1100W + 715W	7.63A	1663.1W
	240V/50Hz	1100W + 715W	6.99A	1656.3W

### PoE Power Budget Limit

The PoE power budget for each interface is controlled by the switch firmware. The administrator can limit the power supplied on a port or prioritize power to some ports over others. Table 3-59 shows the power budget data.

**Table 3-59. Dell EMC Networking N3132PX-ON PoE Power Budget Limit**

<b>Model Name</b>	<b>One PSU</b>		<b>Two PSUs</b>	
	<b>Max. PSU Output Ability</b>	<b>PoE+ Power Turn-on Limitation</b>	<b>Max. PSUs Output Ability</b>	<b>PoE+ Power Turn-on Limitation</b>
Dell EMC Networking N3132PX-ON	715W	Power budget is 500W: The total PoE supplied power must not exceed 500W.	715W	Power budget is 1200W: All PoE+ ports can supply maximum power.

# Dell EMC Networking N3200-ON Series Switch Hardware

This section contains information about device characteristics and modular hardware configurations for the Dell EMC Networking N3200-ON Series switches.

## N3200-ON Series Front Panel

All N3200-ON models, except the N3208PX-ON, are 1U rack-mountable switches. A kit to rack mount the N3208PX-ON is available separately. All N3200-ON switch models support:

- RJ-45 and Type-B micro USB 3.0 console ports (115200–8–N–1)
- Reset button
- Port and system LEDs
- LED of the management unit in the stack and Stack Number Display (not present on N3208PX-ON)
- Type-A USB 3.0 port for storage
- Out-of-band Ethernet interface

**Figure 3-30. Dell EMC Networking N3248 Switch (Front Panel)**



## N3200-ON Series Rear Panel

On all N3200-ON models, except the N3208PX-ON, there are two QSFP28 ports in the rear. These ports do not support QSFP transceivers. Inserting a QSFP transceiver may damage the switch. Each of these ports support configuring in  $4 \times 25\text{G}$ ,  $2 \times 50\text{G}$ , or  $1 \times 100\text{G}$  lane configuration. When configured in  $2 \times 50\text{G}$  mode, these ports may be configured in Ethernet mode or stacking mode. Ports, when configured in  $1 \times 100\text{G}$  or  $4 \times 25\text{G}$ , support only Ethernet mode. Auto-negotiation is not supported when configured for  $2 \times 50\text{G}$  Ethernet mode. Each lane is mapped to a suitably-named Ethernet interface. Unmapped interfaces show their status as detached. A suitable breakout cable may be required.

**Figure 3-31. Dell EMC Networking N3248 Switch (Rear Panel)**



### **N3200-ON Series Switch Ports**

The N3248PXE-ON and N3248X-ON front panels support 48x10G 10GBASE-T ports plus 4x25G SFP28 ports. The SFP28 ports support SFP28 25G or SFP+ 10G transceivers. The 10GBASE-T ports can also operate at 10/100/1000Base-T full duplex or 2.5/5GBase-T speeds.

The N3248PXE-ON supports 802.3bt Type-4 90W PoE on the front panel 10G ports.

The N3224PX-ON front panel supports 24x10G Cu ports with 4x25G SFP28 ports. The SFP28 ports support SFP28 25G or SFP+ 10G transceivers. The 10GBASE-T ports also support at 100/100/1000Base-T full duplex operation.

The N3224PX-ON supports 802.3bt Type-4 90W PoE on the front panel 10G ports.

The N3248P-ON and N3248TE-ON front panels support 48x1G 1000Base-T ports plus 4x10G SFP+ ports. The 1G ports support 10/100/1000BASE-T full duplex operation and support half duplex operation at 10M/100M speeds.

The N3248P-ON supports 802.3at Type-2 30W PoE on the 1G ports.

The N3224P-ON and N3224T-ON front panels support 24x1G 1000BASE-T ports plus 4x10G SFP+ ports. The 1G ports support 10/100/1000BASE-T full duplex operation and support half duplex operation at 10M/100M speeds.

The SFP+ ports support SFP+ or SFP transceivers. The N3224P-ON supports 802.3at Type-2 30W PoE on the 1G ports.

The N3224F-ON front panels support 24x1G SFP ports plus 4x10G SFP+ ports. The SFP+ ports support SFP+ or SFP transceivers.

The N3208PX-ON supports 4x1G 1000BASE-T ports plus 4x5GBASE-T ports and 2x10G SFP+ ports. The SFP+ ports support SFP+ or SFP transceivers. The N3208PX-ON does not support stacking. Dell-qualified transceivers are sold separately.



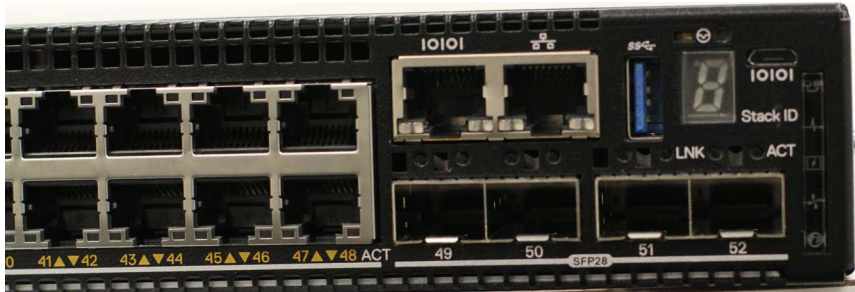
The front-panel switch ports have the following characteristics:

- The switch automatically detects the difference between crossed and straight-through cables on RJ-45 ports and automatically chooses the MDI or MDIX configuration to match the other end.
- The 1000/2500/5000 BASE-T Ethernet RJ-45 ports support full-duplex mode 1000/2500/5000 Mbps speeds on standard Category 5 UTP cable. 2500BASE-T and 5000BASE-T operation requires the use of auto-negotiation.
- SFP28 ports support Dell-qualified transceivers utilizing 25GBASE-SR, 25GBASE-LR, 25GBASE-CR, 25GBASE-CR-S or 25GBASE-ER technologies. Dell-qualified DAC and AOC cables are supported. SFP28 ports support SFP+ fiber transceivers and SFP+ copper twin-ax or DAC technology operating at 10G speeds in full-duplex mode. All SFP28 ports must be configured to operate at the same speed. 25GBASE-CR and 10GBASE-CR modes (copper twin-ax or DAC cables) require the use of auto-negotiation.
- The default behavior is to log a message and generate an SNMP trap on insertion or removal of a transceiver that is not qualified by Dell. The message and trap can be suppressed by using the service unsupported transceiver command. N3200-ON SFP28 ports may be configured to operate using SFP+ transceivers using the speed 10000 command for fiber media or the speed auto 10000 command for copper media. All four SFP28 ports must be configured to operate at the same speed. A mix of SFP+ and SFP28 transceivers or speeds is not supported. The switch UI does not enforce this restriction.

### **N3200-ON Series Console Port**

The console port provides serial communication capabilities, which allows communication using RS-232 protocol. The serial port provides a direct connection to the switch and allows access to the CLI from a console terminal connected to the port through the provided serial cable (with RJ-45 YOST to female DB-9 connectors). The console port is separately configurable and can be run as an asynchronous link from 1200 baud to 115,200 baud. The Dell CLI only supports changing the speed. The defaults are 115,200 baud rate, 8 data bits, no parity, 1 stop bit, no flow control.

**Figure 3-32. Dell EMC Networking N3248 System Panel**



A separate USB micro type B port is also available for console access to the CPU CLI. RS-232 emulation over USB is supported on this port. A driver may need to be installed to support the RS-232 emulation. Only one of the console ports may be used at a time.

### **N3200-ON Series USB Port**

The Type-A, female USB port supports a USB 3.0-compliant flash memory drive. The Dell EMC Networking N-Series switch can read or write to a flash drive with a single partition formatted as FAT-32. Use a USB flash drive to copy switch configuration files and images between the USB flash drive and the switch. The USB flash drive may be used to move and copy configuration files and images to other switches in the network. The system does not support the deletion of files on USB flash drives. The USB port does not support any other type of USB device.

### **N3200-ON Series Reset Button**

The reset button is accessed through the pinhole and enables performing a hard or soft reset on the switch. To use the reset button, insert an unbent paper clip or similar tool into the pinhole for four seconds and then release the button. When the switch completes the boot process after the reset, it resumes operation with the most recently saved configuration. Any changes made to the running configuration that were not saved to the startup configuration prior to the reset are lost.

To clear the configuration and reboot, press the reset button for at least eight seconds and then release it. The saved configuration is cleared and the switch reboots. The switch will then start the auto-configuration process.

## **N3200-ON Series Port and System LEDs**

The front panel contains light emitting diodes (LEDs) that indicate the status of system temperature, port links, power supplies, fans, stacking, and the overall system status. A locator beacon capability is also present on the system LEDs. See N3200-ON Series LED Definitions for more information.

## **N3200-ON Series LED of Management Unit in Stack and Stack Number Display**

When a switch within a stack is the primary unit, the LED of the management unit in the stack is solid green. If the LED of the management unit in the stack is off, the stack member is not the primary unit. The stack number LCD displays the unit number for the stack member. Units 10, 11, and 12 display a dot in the lower left corner of the LCD and the second digit of the unit number. If a switch is not part of a stack (in other words, it is a stack of one switch), the LED of the management unit in the stack is illuminated, and the unit number is displayed.

## **N3200-ON Series Power Supplies**

All N3200-ON PoE switches, except the N3208PX-ON, support field replaceable unit (FRU) power supplies on the rear panel. All N3200PX-ON models, except the N3208PX-ON, have one 715W field-replaceable power supply accessible on the rear panel. The N3224PX-ON and N3248PX-ON models also support an EPS external power supply in the rear for redundant or shared power operation. The EPS should not be configured as the primary power supply. Rebooting the switch or powering up the switch when the EPS is the only power supply is not supported. Ensure that an internal power supply is present and powered prior to performing switch maintenance. When using the EPS, always connect the power to the **A** (left) connector. EPS power is not available to the switch if the only EPS power connection is to the **B** connector.

The N3208PX-ON is supplied with an internal DPS-320AP power supply and also supports the ADP-320 external power supply with a connector located on the back panel.

Table 3-30 shows power budget data.

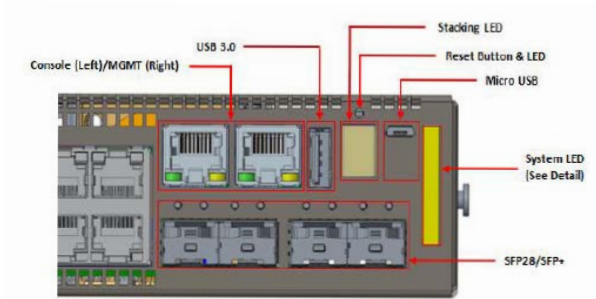
**Table 3-60. Dell EMC Networking N3200-ON Series PoE Power Budget Limit**

Model Name	One PSU		Additional PSUs	
	PoE Power Budget	Power Turn-on Limitation	PoE Power Budget	Power Turn-on Limitation
Dell EMC Networking N3208PX-ON	193W	The switch can power two ports with 802.3bt Type 4 90W power.	793W	The switch can power seven ports with 802.3bt Type 4 90W power using 3 x 320W power supplies.
Dell EMC Networking N3224P-ON	720W	The switch can power 24 ports with 802.3bt Type 2 30W power.	720W	The switch can power 24 ports with 802.3at Type 2 30W power using redundant 1050W power supplies.
Dell EMC Networking N3224PX-ON	610W	The switch can power 6 ports with 802.3bt Type 4 90W power.	1465W	The switch can power 14 ports with 802.3bt Type 4 90W power using 2 x 1600W power supplies.
Dell EMC Networking N3248P-ON	713W	The switch can power 23 ports with 802.3bt Type 2 30W power.	1440W	The switch can power 48 ports with 802.3at Type 2 30W power using 2 x 1050W power supplies and the EPS (SB-04AA).
Dell EMC Networking N3248PXE-ON	406W	The switch can power 4 ports with 802.3bt Type 4 90W power.	1878W	The switch can power 18 ports with 802.3bt Type 4 90W power using 2x 1600W power supplies and the EPS(SB-04AA)

### N3200-ON Series LED Definitions

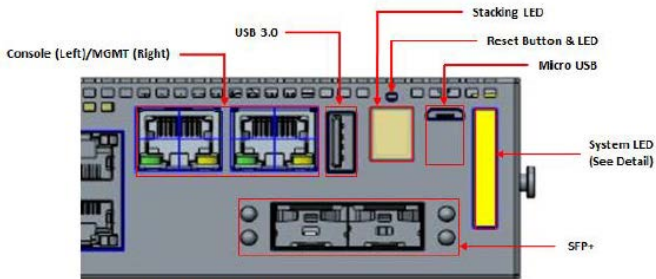
This section describes the LEDs on the front and back panels of the switch.

**Figure 3-33. N3200 System LED Definition**



**NOTE:** Figure 3-33 is for N3200 models, except for N3208PX-ON.

**Figure 3-34. System LED Definition for N3208PX-ON Only**



### Reset LEDs

Table 3-61 shows the Reset LED definitions for the N3200-ON switches.

**Table 3-61. Reset LED Definitions**

<b>Feature</b>	<b>Description</b>
Reset LED	<p>One Green/Amber Reset LED indicates the following statuses based on reset button press:</p> <ul style="list-style-type: none"><li>• Reset (press in for 4 seconds and switch resets, maintain current config/settings)</li></ul> <p>After reset button is pressed in for 4 seconds, the Reset LED starts Flashing Green with 2 seconds on and 1 second off. Then the user can release the reset button.</p> <ul style="list-style-type: none"><li>• Complete clearing of settings (press in for 8 seconds and switch resets and clears the startup configuration.)</li></ul> <p>After the reset button is pressed in for 8 seconds, the Reset LED turns amber, then the user can release the reset button. Once the CPU receives this NMI event, the operating system turns off this reset LED and clears the startup configuration.</p>

### **System LEDs**

The system LEDs, located on the front panel, provide information about stacking, system, power supplies, fan, and beacon status.

Table 3-36 shows the System LED definitions for the N3200-ON switches.

**Table 3-62. N3200-ON Series System LED Definitions**

<b>LED</b>	<b>Color</b>	<b>Definition</b>
Platform Stacking (Bi-color LED)	Off Solid green	System is a secondary of the stack System is as primary of the stack or standalone unit

**Table 3-62. N3200-ON Series System LED Definitions (Continued)**

<b>LED</b>	<b>Color</b>	<b>Definition</b>
System Status (Bi-color LED)	Solid green	All functions are normal
	Flashing green with 2 seconds on and 1 second off	The switch is booting
	Solid amber	A major fault has occurred
	Flashing amber with 2 seconds on and 1 second off	A minor fault has occurred
Power Status (Bi- color LED)	Solid green	Normal
	Solid amber	POST in progress
	Flashing amber with 2 seconds on and 1 second off	PSU fault
	Off	No power
Fan (Bi-color LED)	Solid green	The fan is powered and is operating at the expected RPM.
	Flashing amber with 2 seconds on and 1 second off	A fan tray fault
System Beacon (Bi-color LED)	Off	Idle
	Flashing blue with 1 second on and 1 second off	SID
7-digit Stacking	–	Indicates the stacking ID number

**N3200 Per Port LED Definitions**

This section describes the LEDs on the switch ports.

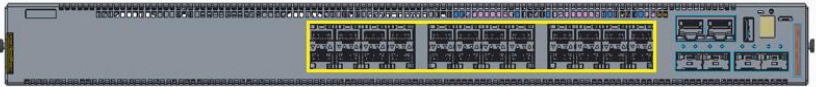
**Figure 3-35. N3248X-ON, N3248TE-ON, N3248P-ON, N3248PXE-ON**



**Figure 3-36. N3224T-ON, N3224P-ON**



**Figure 3-37. N3224F-ON**



**Figure 3-38. N3208PX-ON**

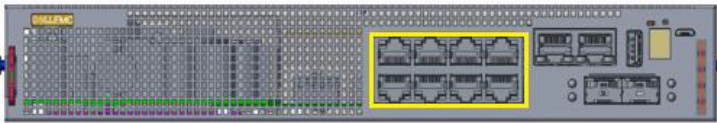




Table 3-63 shows the 1000BASE-T copper Ethernet port LED definitions.

**Table 3-63. 1000BASE-T Copper Ethernet Port LED Definitions**

LED	Color	Definition
Link/SPD LED (Left bi-color LED)	Off	There is no link
	Solid amber	The port is operating at 10/100MBASE-T
	Solid green	The port is operating at 1000BASE-T (Max)
Activity/PoE LED (on PoE switches) (Right bi-color LED)	Off	There is no current transmit/receive activity and PoE power is off
	Solid amber	There is no current transmit/receive activity and PoE power is on
	Blinking amber (~30ms)	The port is actively transmitting/receiving and PoE power is on
	Blinking green (~30ms)	The port is actively transmitting/receiving and PoE power is off (activity for non-P)

**Table 3-64. 2.5G/5GBASE-T Copper Ethernet Port LED Definitions**

LED	Color	Definition
Link/SPD LED (Left bi-color LED)	Off	There is no link.
	Solid amber	The port is operating at 1000BASE-T or 2.5GBASE-T
	Solid green	The port is operating at 5GBASE-T (Max)
Activity/PoE LED (Right bi-color LED)	Off	There is no current transmit/receive activity, and PoE power is off.
	Solid amber	There is no current transmit/receive activity, and PoE power is on.
	Blinking amber (~30ms)	The port is actively transmitting/receiving, and PoE power is on.
	Blinking green (~30ms)	The port is actively transmitting/receiving, and PoE power is off.

**Table 3-65. 2.5G/5G/10GBASE-T Copper Ethernet Port LED Definitions**

<b>LED</b>	<b>Color</b>	<b>Definition</b>
Link/SPD LED (Left bi-color LED)	Off	There is no link.
	Solid amber	The port is operating at 1000BASE-T or 2.5/5GBASE-T
	Solid green	The port is operating at 10GBASE-T (Max)
Activity/PoE LED (Right bi-color LED)	Off	There is no current transmit/receive activity.
	Solid amber	There is no current transmit/receive activity, and PoE power is on
	Blinking amber (~30ms)	The port is actively transmitting/receiving, and PoE power is on
	Blinking green (~30ms)	The port is actively transmitting/receiving, and PoE power is off (Activity for Non-P)

**Table 3-66. 1000BASE-X SFP Port LED Definitions**

<b>LED</b>	<b>Color</b>	<b>Definition</b>
Link/SPD LED (Left bi-color LED)	Off	There is no link.
	Solid green	The port is operating at 1GE speed
	Solid amber	The port is operating at lower than 1GE speed
Activity LED (Right bi-color LED)	Off	There is no current transmit/receive activity
	Blinking green (~30ms)	The port is actively transmitting/receiving

**Table 3-67. 10GBASE-X SFP+ Port LED Definitions**

LED	Color	Definition
Link/SPD LED (Left bi-color LED)	Off	There is no link.
	Solid green	The port is operating at 10GE speed
	Solid amber	The port is operating at lower than 10GE speed
Activity LED (Right bi-color LED)	Off	There is no current transmit/receive activity
	Blinking green (~30ms)	The port is actively transmitting/receiving

**Table 3-68. 25GBASE-X SFP28 Port LED Definitions**

LED	Color	Definition
Link/SPD LED (Left bi-color LED)	Off	There is no link.
	Solid green	The port is operating at 25GE speed
	Solid amber	The port is operating at lower than 25GE speed
Activity LED (Right bi-color LED)	Off	There is no current transmit/receive activity
	Blinking green (~30ms)	The port is actively transmitting/receiving

## Stacking Port LEDs

**Table 3-69. QSFP28 Stacking Port LED Definitions**

LED	Color	Definition
Link/Activity LED (Bi-color LED)	1st LED: Green/Amber	
	Solid green	Port linked operating at max port speed, for example, running 100GbE on QSFP28 port. Green (Luminance at 1.5ft = 45+5 cd/m <sup>2</sup> )
	Blinking green (~30ms)	The port is actively transmitting/receiving at max port speed, for example, running 100GbE on QSFP28 port. Green (Luminance at 1.5ft = 45+5 cd/m <sup>2</sup> )
	Solid amber	The port is actively transmitting/receiving at lower speed, for example, running 50GbE or 25GbE or 10GbE on QSFP28 port. Amber (Luminance at 1.5ft = 45+5 cd/m <sup>2</sup> )
	Blinking amber (~30ms)	The port is actively transmitting/receiving at lower speed, for example, running 50GbE or 25GbE or 10GbE on QSFP28 port. Amber (Luminance at 1.5ft = 45+5 cd/m <sup>2</sup> )
	Off	There is no link.
	Blinking amber with 1 second on and 1 second off	.Port Beacon. Amber (Luminance at 1.5ft = 180+10 cd/m <sup>2</sup> )

**Table 3-69. QSFP28 Stacking Port LED Definitions (Continued)**

<b>LED</b>	<b>Color</b>	<b>Definition</b>
Link/Activity LED (Bi-color LED)		All four LEDs are used when 4x25GbE mode or 4x10GbE mode is running on QSFP28 port.
	Solid green	4x25GbE Link on QSFP28 port. Green (Luminance at 1.5ft = 45+5 cd/m <sup>2</sup> )
	Solid amber	4x10GbE Link on QSFP28 port. Amber (Luminance at 1.5ft = 45+5 cd/m <sup>2</sup> )
	Blinking green (~30ms)	4x25GbE Activity on QSFP28 port. Green (Luminance at 1.5ft = 45+5 cd/m <sup>2</sup> )
	Blinking amber (~30ms)	4x10GbE Activity on QSFP28 port. Amber (Luminance at 1.5ft = 45+5cd/m <sup>2</sup> )
	Off	There is no link
	Blinking amber with 1 second on and 1 second off	Port Beacon. Amber (Luminance at 1.5ft = 180+10 cd/m <sup>2</sup> )
Link/Activity LED (Bi-color LED)		1st and 3rd LEDs are used when 2x50GbE mode is running on QSFP28 port.
	Solid Green	2x50GbE Link on QSFP28 port. Green (Luminance at 1.5ft = 45+5 cd/m <sup>2</sup> )
	Blinking green (~30ms)	2x50GbE Activity on QSFP28 port. Green (Luminance at 1.5ft = 45+5 cd/m <sup>2</sup> )
	Off	There is no link
	Blinking amber with 1 second on and 1 second off	Port Beacon. Amber (Luminance at 1.5ft = 180+10 cd/m <sup>2</sup> )

## OOB Ethernet Port LEDs

**Table 3-70. OOB Ethernet Port LED Definitions**

LED	Color	Definition
Link/SPD LED (Left bi-color LED)	Off	There is no link
	Solid green	The port is operating at 1000BASE-T
	Solid amber	The port is operating at 10/100MBASE-T
Activity LED (Right single color LED)	Off	There is no link
	Blinking green (~30ms)	The port is actively transmitting/receiving

## Console Port LEDs

**Table 3-71. Console Port LED Definitions**

LED	Color	Definition
Link/SPD LED (Left bi-color LED)	Off	There is no link.
	Solid green	A link is present.

## N3200 Pluggable PSU LED Definition

Figure 3-39. PSU Status LEDs

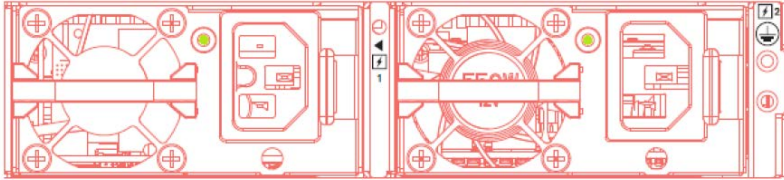
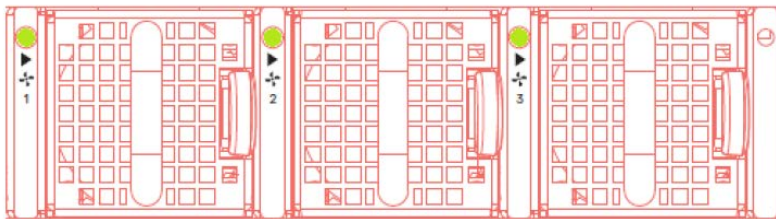


Table 3-72. PSU Status LED Definitions

LED	Color	Definition
Only for Pluggable PSUs	Off	Off
	Solid green	INOUT_OK
	Blinking amber	Fault
	Blinking green at 4Hz with 5 times and Off	Mismatch
	Blinking green	Firmware update

## N3200 Pluggable Fan LED Definition

Figure 3-40. Fan Status LEDs



**Table 3-73. Fan Status LED Definitions**

LED	Color	Definition
Only for Pluggable Fans	Off	Input power loss
	Solid green	Normal operating
	Blinking amber with 2 seconds on and 1 second off	Fan tray fault
	Fault Condition:	<ul style="list-style-type: none"><li>• Missing one more fan tray in the N+1 redundancy system</li><li>• Fan tray not functioning properly</li><li>• Fan tray airflow direction mismatch, and so on</li></ul>

There are two 6.7.0 image variants for the N3200 Series platform; one is with the MACsec feature disabled (6.7.0.1) which is downloadable from the [www.dell.com/support](http://www.dell.com/support) (Drivers & Downloads page), and another image variant is with MACsec feature-enabled (6.7.0.31) which is not generally available for download due to export compliance restrictions. If a customer wants to download the MACsec feature-enabled image:

- 1 Raise a \$0 purchase order
- 2 Order the MACsec-enabled image SKU: 529-BBFW
- 3 Post where the user can download the MACsec-enabled image from the Dell Digital Locker (DDL) with the valid credentials.

Only the N3248PXE platform supports the MACsec feature, while other variants of the N3200 Series switching platform do not support MACsec feature.

All variants of the N3200 Series switching platform, including N3248PXE can be stacked together.

Both MACsec-enabled and MACsec-disabled images can be installed on the N3200 Series switching platforms. However, MACsec features, and the related CLI commands to configure them, are available only on the MACsec-enabled image. Any attempt to configure and apply MACsec on an interface other than on the N3248PXE variant, gives an error and is not applied.



# Switch MAC Addresses

The switch allocates MAC addresses from the Vital Product Data information stored locally in flash. MAC addresses are used as follows:

**Table 3-74. MAC Address Use**

---

Base	Switch address, Layer 2
Base + 1	Out-of-band port (not available on Dell EMC Networking N1100-ON/N1500/N2000/N2100-ON Series switches)
Base + 3	Layer 3

---

Shown below are three commands that display the MAC addresses used by the switch:

```
console#show system
```

```
System Description: Dell Ethernet Switch
System Up Time: 0 days, 00h:05m:11s
System Contact:
System Name:
System Location:
Burned In MAC Address: 001E.C9F0.004D
System Object ID: 1.3.6.1.4.1.674.10895.3042
System Model ID: N4032
Machine Type: N4032
Temperature Sensors:
```

Unit	Description	Temperature (Celsius)	Status
----	-----	-----	-----
1	MAC	32	Good
1	CPU	31	Good
1	PHY (left side)	26	Good
1	PHY (right side)	29	Good

```
Fans:
```

Unit	Description	Status
----	-----	-----
1	Fan 1	OK
1	Fan 2	OK
1	Fan 3	OK
1	Fan 4	OK
1	Fan 5	OK
1	Fan 6	No Power

Power Supplies:

Unit	Description	Status	Average Power (Watts)	Current Power (Watts)	Since Date/Time
1	System	OK	42.0	43.4	
1	Main	OK	N/A	N/A	04/06/2001 16:36:16
1	Secondary	No Power	N/A	N/A	01/01/1970 00:00:00

USB Port Power Status:

-----  
Device Not Present

console#show ip interface out-of-band

IP Address..... 10.27.21.29  
Subnet Mask..... 255.255.252.0  
Default Gateway..... 10.27.20.1  
Configured IPv4 Protocol..... DHCP  
Burned In MAC Address..... 001E.C9F0.004E

console#show ip interface vlan 1

Routing Interface Status..... Down  
Primary IP Address..... 1.1.1.2/255.255.255.0  
Method..... Manual  
Routing Mode..... Enable  
Administrative Mode..... Enable  
Forward Net Directed Broadcasts..... Disable  
Proxy ARP..... Enable  
Local Proxy ARP..... Disable  
Active State..... Inactive  
MAC Address..... 001E.C9F0.0050  
Encapsulation Type..... Ethernet  
IP MTU..... 1500  
Bandwidth..... 10000 kbps  
Destination Unreachables..... Enabled  
ICMP Redirects..... Enabled

## Cables and Optics

The N2200/N3200 Dell EMC Networking switches recognize and comply with Multi-Service Agreement (MSA) SFF-8024 R4.7 for supported technologies. If FEC is enabled on the interface in inherit mode, the appropriate medium and FEC will be configured by reading the transceiver properties. If auto-negotiation is enabled, the appropriate medium and FEC capability are advertised and the interface is set to the negotiated result. It is the operator's responsibility to configure auto-negotiation properly. Table 3-75 identifies the SFF-8024 capabilities recognized and the recommended auto-negotiation setting.

**Table 3-75. SFF-8024 Capabilities**

<b>SFF-8024 Code</b>	<b>Description of Module</b>	<b>Inherit Mode FEC Setting</b>	<b>Compatible Interface</b>	<b>AN Setting (by Operator)</b>	<b>Note</b>
01h	100G AOC (Active Optical Cable) 25GAUI C2M AOC	CL91 RS-FEC CL74 BASE-R FEC	CAUI4 25GAUI	Disabled	CL108 optional for 25G
02h	100GBASE-SR4, 100GBASE-ESR4, 25GBASE-SR	CL91 RS-FEC CL74 BASE-R FEC	CAUI4 25GAUI	Disabled	
03h	100GBASE-LR4, 25GBASE-LR	None	CAUI4 25GAUI	Disabled	
04h	100GBASE-ER4-LITE	None	CAUI4	Disabled	
06h	100G CWDM4	CL91 RS-FEC	CAUI4	Disabled	
07h	100G PSM4 Parallel SMF	CL91 RS-FEC	CAUI4	Disabled	
08h	100G ACC (Active Copper Cable) 25GAUI C2M ACC	CL91 RS-FEC CL74 BASE-R FEC	CAUI4 25GAUI	Disabled	CL108 optional for 25G
10h	40GBASE-ER4	None	XLAUI	Disabled	CL108 optional for 25G
0Bh	100GBASE-CR4 25GBASE-CR CA-25G-L	CL91 RS-FEC CL74 BASE-R FEC	100GBASE-CR4 25GBASE-CR	Enabled	CL108 optional for 25G
0Ch	25GBASE-CR CA-25G-S	CL74 BASE-R FEC	25GBASE-CR	Enabled	
0Dh	25GBASE-CR CA-25G-N	None	25GBASE-CR	Enabled	
10h	40GBASE-ER4	None	CAUI4	Disabled	

<b>SFF-8024 Code</b>	<b>Description of Module</b>	<b>Inherit Mode FEC Setting</b>	<b>Compatible Interface</b>	<b>AN Setting (by Operator)</b>	<b>Note</b>
17h	100G CLR4	None	CAUI4	Disabled	CL-91 RS-FEC optional. Use forced mode to enable.
1Ah	100G DWDM2	None	CAUI4	Disabled	
1Fh	40G SWDM4	None	XLAUI	Disabled	
20h	100G SWDM4	CL91 RS-FEC	CAUI4	Disabled	
21h	100GBASE-BIDI	None	CAUI4	Disabled	
22h	4WDM-10 MSA (10km version of 100G CWDM4)	CL91 RS-FEC	CAUI4	Disabled	
23h	4WDM-20 MSA (20km version of 100GBASE-LR)	CL91 RS-FEC	CAUI4	Disabled	
24h	4WDM-40 MSA (40km reach with APD receiver)	CL91 RS-FEC	CAUI4	Disabled	
25h	100GBASE-DR	None	CAUI4	Disabled	
26h	100GBASE-FR	None	CAUI4	Disabled	
27h	100GBASE-LR	None	CAUI4	Disabled	



# Using Dell EMC OpenManage Switch Administrator

## Dell EMC Networking N-Series Switches

This section describes how to use the Dell EMC OpenManage Switch Administrator application. The topics covered in this section include:

- About Dell EMC OpenManage Switch Administrator
- Starting the Application
- Understanding the Interface
- Using the Switch Administrator Buttons and Links
- Defining Fields

## About Dell EMC OpenManage Switch Administrator

Dell EMC OpenManage Switch Administrator is a web-based tool for managing and monitoring Dell EMC Networking N-Series switches. Table 4-1 lists the web browsers that are compatible with Dell EMC OpenManage Switch Administrator. The browsers have been tested on a PC running the Microsoft Windows operating system.

**Table 4-1. Compatible Browsers**

<b>Browser</b>	<b>Version</b>
Internet Explorer	v9
Mozilla Firefox	v14
Safari	v5.0
Chrome	v21



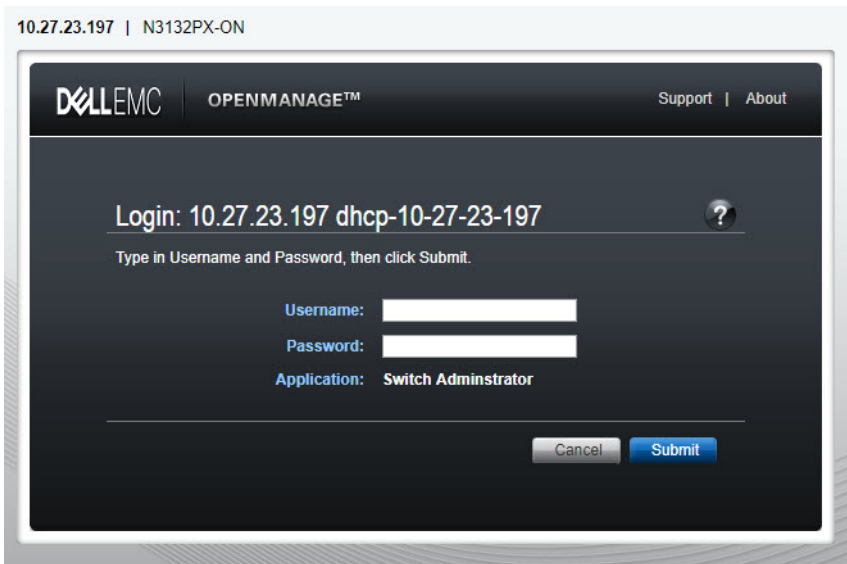
**NOTE:** Additional operating systems and browsers might be compatible but have not been explicitly tested with Dell EMC OpenManage Switch Administrator.


# Starting the Application

To access the Dell EMC OpenManage Switch Administrator and log on to the switch:

- 1 Open a web browser.
- 2 Enter the IP address of the switch in the address bar and press <Enter>. For information about assigning an IP address to a switch, see "Setting the IP Address and Other Basic Network Information" on page 227.
- 3 When the **Login** window displays, enter a username and password. Passwords and usernames are both case sensitive and alpha-numeric.

**Figure 4-1. Login Screen**



 **NOTE:** The switch is not configured with a default user name or password. The administrator must connect to the CLI by using the console port to configure the initial user name and password. For information about connecting to the console, see "Console Connection" on page 215. For information about creating a user and password, see "Authentication, Authorization, and Accounting" on page 291.



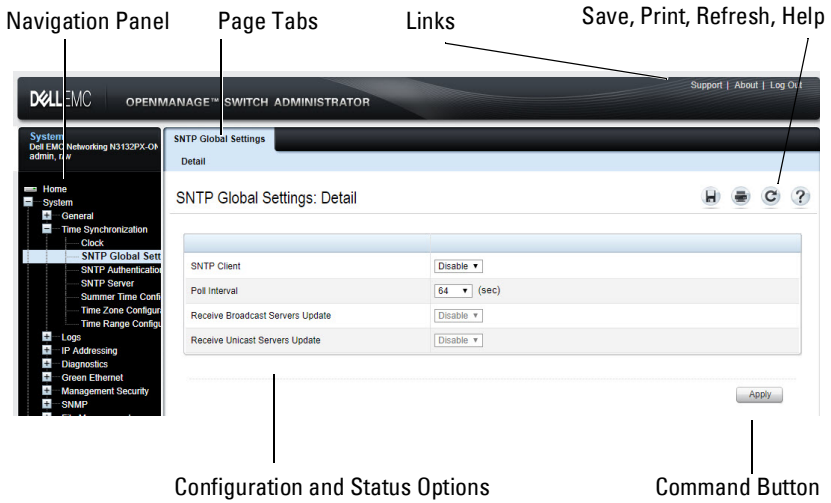
- 4 Click **Submit**.
- 5 The **Dell EMC OpenManage Switch Administrator** home page displays.  
The home page is the **Device Information** page, which contains a graphical representation of the front panel of the switch. For more information about the home page, see "Device Information" on page 440.

## Understanding the Interface

The Dell EMC OpenManage Switch Administrator interface contains the following components:

- **Navigation panel** — Located on the left side of the page, the navigation pane provides an expandable view of features and their components.
- **Configuration and status options** — The main panel contains the fields used to configure and monitor the switch.
- **Page tabs** — Some pages contain tabs that allow the administrator to access additional pages related to the feature.
- **Command buttons** — Command buttons are located at the bottom of the page. Use the command buttons to submit changes, perform queries, or clear lists.
- **Save, Print, Refresh, and Help buttons** — These buttons appear on the top-right side of the main panel and are on every page.
- **Support, About, and Logout links** — These links appear at the top of every page.

**Figure 4-2. Switch Administrator Components**



# Using the Switch Administrator Buttons and Links

Table 4-2 describes the buttons and links available from the Dell EMC OpenManage Switch Administrator interface.

**Table 4-2. Button and Link Descriptions**

Button or Link	Description
Support	Opens the Dell Support page at <a href="http://www.dell.com/support">www.dell.com/support</a> .
About	Contains the version and build number and Dell copyright information.
Log Out	Logs out of the application and returns to the login screen.
Save	Saves the running configuration to the startup configuration. When a user clicks <b>Apply</b> , changes are saved to the running configuration. When the system boots, it loads the startup configuration. Any changes to the running configuration that were not saved to the startup configuration are lost across a power cycle.
Print	Opens the printer dialog box that enables printing the current page. Only the main panel prints.
Refresh	Refreshes the screen with the current information.
Help	Online help that contains information to assist in configuring and managing the switch. The online help pages are context sensitive. For example, if the <b>IP Addressing</b> page is open, the help topic for that page displays if the user clicks <b>Help</b> .
Apply	Updates the running configuration on the switch with the changes. Configuration changes take effect immediately.
Clear	Resets statistic counters and log files to the default configuration.
Query	Queries tables.
Left arrow and Right arrow	Moves information between lists.



**NOTE:** A few pages contain a button that occurs only on that page. Page-specific buttons are described in the sections that pertain to those pages.

## Defining Fields

User-defined fields can contain 1–159 characters, unless otherwise noted on the Dell EMC OpenManage Switch Administrator web page.

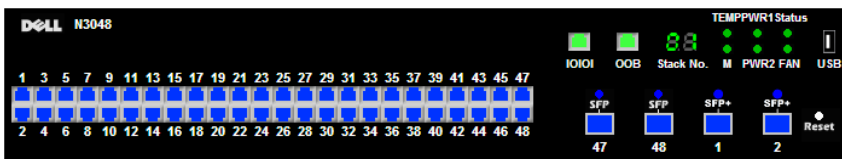
All characters may be used except for the following:

- \
- /
- :
- \*
- ?
- <
- >
- |

## Understanding the Device View

The Device View shows various information about switch. This graphic appears on the Dell EMC OpenManage Switch Administrator **Home** page, which is the page that displays after a successful login. The graphic provides information about switch ports and system health.

**Figure 4-3. Dell EMC Networking N3048 Device View**



### Using the Device View Port Features

The switching-port coloring indicates if a port is currently active. Green indicates that the port has a link, red indicates that an error has occurred on the port, and blue indicates that the link is down. Ethernet ports configured for stacking show as gray. Each port image is a hyperlink to the **Port Configuration** page for the specific port.

## Using the Device View Switch Locator Feature

The Device View graphic includes a **Locate** button and a drop-down menu of timer settings. When the user clicks **Locate**, the switch locator LED blinks for the number of seconds selected from the timer menu. The blinking LED can help the administrator or a technician near the switch identify the physical location of the switch within a room or rack full of switches. After the user clicks the **Locate** button, it turns green on the screen and remains green while the LED is blinking. For information about the locator LED on a specific switch, including color and physical placement, see the hardware description for the switch model in "Hardware Overview" on page 109.



**NOTE:** The `locate` command in the CLI can be used to enable the locator LED.



# Using the Command-Line Interface

## Dell EMC Networking N-Series Switches

This section describes how to use the Command-Line Interface (CLI) on Dell EMC Networking N-Series switches.

The topics covered in this section include:

- Accessing the Switch Through the CLI
- Understanding Command Modes
- Entering CLI Commands

## Accessing the Switch Through the CLI

The CLI provides a text-based way to manage and monitor the Dell EMC Networking N-Series switches. The CLI can be accessed using a direct connection to the console port or by using a Telnet or SSH client.

To access the switch by using Telnet or Secure Shell (SSH), the switch must have an IP address, and the management station used to access the device must be able to ping the switch IP address.

For information about assigning an IP address to a switch, see "Setting the IP Address and Other Basic Network Information" on page 227.

### Console Connection

Use the following procedures to connect to the CLI by connecting to the console port. For more information about creating a serial connection, see the *Getting Started Guide* available at [www.dell.com/support](http://www.dell.com/support).

- 1 Connect the DB-9 connector of the supplied serial cable to a management station, and connect the RJ-45 connector to the switch console port. The N1100-ON switches utilize a USB cable to access the console.

On Dell EMC Networking N1500, N2000, N2100-ON, N2200-ON, N3000E-ON, N3100-ON, and N3200-ON Series switches, the console port is located on the right side of the front panel and is labeled with the |O|O| symbol. On the N1100-ON Series switches, the USB console port is located in the bottom right corner of the front panel.



**NOTE:** For a stack of switches, be sure to connect to the console port on the primary switch. The primary switch LED is illuminated on the stack primary. Alternatively, use the **connect** command to access the console session.

- 2 Start the terminal emulator, such as Microsoft HyperTerminal, and select the appropriate serial port (for example, COM 1) to connect to the console.
- 3 Configure the management station serial port with the following settings:
  - Data rate — 9600 baud (115,200 for the N1100-ON, N2128PX-ON, N2200-ON, N3100E-ON, and N3200E-ON switches).
  - Data format — 8 data bits
  - Parity — None
  - Stop bits — 1
  - Flow control — None
- 4 Power on the switch (or stack).

After the boot process completes, the `console>` prompt displays, and CLI commands can be entered.



**NOTE:** By default, no authentication is required for console access. However, if an authentication method has been configured for console port access, the `User: login` prompt displays.

## Telnet Connection

Telnet is a terminal emulation TCP/IP protocol. ASCII terminals can be virtually connected to the local device through a TCP/IP protocol network.

Telnet connections are enabled by default, and the Telnet port number is 23. All CLI commands can be used over a Telnet session. Use the **terminal monitor** command to receive asynchronous notification of system events in the telnet session.



**NOTE:** SSH, which is more secure than Telnet, is disabled by default.



To connect to the switch using Telnet, the switch must have an IP address, and the switch and management station must have network connectivity. Any Telnet client on the management station can be used to connect to the switch.

A Telnet session can also be initiated from the Dell EMC OpenManage Switch Administrator. For more information, see "Initiating a Telnet Session from the Web Interface" on page 479.

## Understanding Command Modes

The CLI groups commands into modes according to the command function. Each of the command modes supports specific software commands. The commands in one mode are not available until the user switches to that particular mode, with the exception of the User Exec mode commands. The User Exec mode commands can be executed in the Privileged Exec mode.

To display the commands available in the current mode, enter a question mark (?) at the command prompt. In each mode, a specific command is used to navigate from one command mode to another.

The main command modes include the following:

- User Exec (0) — Commands in this mode permit connecting to remote devices, changing terminal settings on a temporary basis, performing basic tests, and listing limited system information.
- Privileged Exec (1) — Commands in this mode enable viewing all switch settings and entering Global Configuration mode.
- Global Configuration (15) — Commands in this mode manage the device configuration on a global level and apply to system features, rather than to a specific protocol or interface.
- Interface Configuration (15) — Commands in this mode configure the settings for a specific interface or range of interfaces.
- VLAN Configuration (15) — Commands in this mode create and remove VLANs and configure IGMP/MLD Snooping parameters for VLANs.

The CLI includes many additional command modes. For more information about the CLI command modes, including details about all modes, see the *CLI Reference Guide*.

Table 5-1 describes how to navigate between CLI Command Mode and lists the prompt that displays in each mode.

**Table 5-1. Command Mode Overview**

<b>Command Mode</b>	<b>Access Method</b>	<b>Command Prompt</b>	<b>Exit or Access Previous Mode</b>
User Exec	The user is automatically in User Exec mode unless the user is defined as a privileged user.	console>	logout
Privileged Exec	From User Exec mode, enter the <b>enable</b> command	console#	Use the <b>exit</b> command, or press Ctrl-Z to return to User Exec mode.
Global Configuration	From Privileged Exec mode, use the <b>configure</b> command.	console (config) #	Use the <b>exit</b> command, or press Ctrl-Z to return to Privileged Exec mode.
Interface Configuration	From Global Configuration mode, use the <b>interface</b> command and specify the interface type and ID.	console (config-if) #	To exit to Global Configuration mode, use the <b>exit</b> command, or press Ctrl-Z to return to Privileged Exec mode.

# Entering CLI Commands

The switch CLI provides several techniques to help users enter commands.

## Using the Question Mark to Get Help

Enter a question mark (?) at the command prompt to display the commands available in the current mode.

```
console(config-vlan)#?
```

```
exit           To exit from the mode.
help           Display help for various special keys.
ip             Configure IP parameters.
ipv6           Configure IPv6 parameters.
protocol       Configure the Protocols associated with
               particular Group Ids.
vlan           Create a new VLAN or delete an existing
               VLAN.
```

Enter a question mark (?) after entering each word to display available command keywords or parameters.

```
console(config)#vlan ?
```

```
<vlan-list>   <1-4093> - separate non-consecutive IDs with ',' and
               no spaces; Use '-' for range.
makestatic     Change the VLAN type from 'Dynamic' to 'Static'.
protocol       Configure the protocol based VLAN settings.
```

If there are no additional command keywords or parameters, or if additional parameters are optional, the following message appears in the output:

```
<cr>          Press enter to execute the command.
```

Typing a question mark (?) after one or more characters of a word shows the available command or parameters that begin with the characters, as shown in the following example:

```
console#show po?
```

```
policy-map           port           ports
```

## Using Command Completion

The CLI can complete partially entered commands when the <Tab> or <Space> key are pressed.

```
console#show run<Tab>  
console#show running-config
```

If the characters entered are not enough for the switch to identify a single matching command, continue entering characters until the switch can uniquely identify the command. Use the question mark (?) to display the available commands matching the characters already entered.

## Entering Abbreviated Commands

To execute a command, enter enough characters so that the switch can uniquely identify a command. For example, to enter Global Configuration mode from Privileged Exec mode, enter **conf** instead of **configure**.

```
console#conf  
  
console(config)#
```

## Negating Commands

For many commands, the prefix keyword **no** is entered to cancel the effect of a command or reset the configuration to the default value. Many configuration commands have this capability.

## Command Output Paging

Lines are printed on the screen up to the configured terminal length limit (default 24). Use the space bar to show the next page of output or the carriage return to show the next line of output. Setting the terminal length to zero disables paging. Command output displays until no more output is available.

## Understanding Error Messages

If a command is entered and the system is unable to execute it, an error message appears. Table 5-2 describes the most common CLI error messages.

**Table 5-2. CLI Error Messages**

Message Text	Description
% Invalid input detected at '^' marker.	Indicates that an incorrect or unavailable command was entered. The carat (^) shows where the invalid text is detected. This message also appears if any of the parameters or values are not recognized.
Command not found / Incomplete command. Use ? to list commands.	Indicates that the required keywords or values were not entered.
Ambiguous command	Indicates that not enter enough letters were entered to uniquely identify the command.

If you attempt to execute a command and receive an error message, use the question mark (?) to help determine the possible keywords or parameters that are available.

## Recalling Commands from the History Buffer

Every time a command is entered in the CLI, it is recorded in an internally managed Command History buffer. By default, the history buffer is enabled and stores the last 10 commands entered. These commands can be recalled, reviewed, modified, and reissued. This buffer is not preserved after switch resets.

**Table 5-3. History Buffer Navigation**

Keyword	Source or Destination
Up-arrow key or <Ctrl>+<P>	Recalls commands in the history buffer, beginning with the most recent command. Repeats the key sequence to recall successively older commands.
Down-arrow key or <Ctrl>+<N>	Returns to more recent commands in the history buffer after recalling commands with the up-arrow key. Repeating the key sequence recalls more recent commands in succession.



## Default Settings

This section describes the default settings for many of the software features on the Dell EMC Networking N-Series switches.

**Table 6-1. Default Settings**

Feature	Default
IP address	DHCP on OOB interface, if equipped. DHCP on VLAN1 if no OOB interface
Subnet mask	None
Default gateway	None
DHCP client	Enabled on out-of-band (OOB) interface or VLAN 1 if no OOB interface.
VLAN 1 Members	All switch ports
SDM template	Dual IPv4 and IPv6 routing
Users	None
Minimum password length	8 characters
IPv6 management mode	Enabled
SNTP client	Disabled
Global logging	Enabled
Switch auditing	Enabled
CLI command logging	Disabled
Web logging	Disabled
SNMP logging	Disabled
Console logging	Enabled (Severity level: warnings and above)
Monitor logging:	Disabled
Buffer (In-memory) logging	Enabled (Severity level: informational and above)
Persistent (flash) logging	Enabled (Severity level: emergencies and above)

**Table 6-1. Default Settings (Continued)**

<b>Feature</b>	<b>Default</b>
DNS	Enabled (No servers configured)
SNMP	Enabled (SNMPv1)
SNMP Traps	Enabled
Auto Configuration	Enabled
Auto Save	Disabled
Stacking	Enabled
Nonstop Forwarding on the Stack	Enabled
sFlow	Disabled
ISDP	Enabled (Versions 1 and 2)
RMON	Enabled
TACACS+	Not configured
RADIUS	Not configured
SSH/SSL	Disabled
Telnet	Enabled
Denial of Service Protection	Disabled
Captive Portal	Disabled
IEEE 802.1X Authentication	Disabled
Access Control Lists (ACL)	None configured
IP Source Guard (IPSG)	Disabled
DHCP Snooping	Disabled
Dynamic ARP Inspection	Disabled
Protected Ports (Private VLAN Edge)	None
Energy Detect Mode	Enabled
EEE Lower Power Mode	Enabled
PoE Plus (POE switches)	Auto
Flow Control Support (IEEE 802.3x)	Enabled
Maximum Frame Size	1518 bytes



**Table 6-1. Default Settings (Continued)**

<b>Feature</b>	<b>Default</b>
Auto-MDI/MDIX Support	Enabled
Auto-negotiation	Enabled
Advertised Port Speed	Maximum Capacity
Broadcast Storm Control	Disabled
Port Mirroring	Disabled
LLDP	Enabled
LLDP-MED	Disabled
Loop Protection	Disabled
MAC Table Address Aging	300 seconds (Dynamic Addresses)
Cisco Protocol Filtering (LLPF)	No protocols are blocked
DHCP Layer-2 Relay	Disabled
Default VLAN ID	1
Default VLAN Name	Default
GVRP	Disabled
GARP Timers	Leave: 60 centiseconds Leave All: 1000 centiseconds Join: 20 centiseconds
Interface Auto-Recovery (err-disable)	Disabled for all causes
Voice VLAN	Disabled
Guest VLAN	Disabled
RADIUS-assigned VLANs	Disabled
Double VLANs	Disabled
Spanning Tree Protocol (STP)	Enabled
STP Operation Mode	IEEE 802.1w Rapid Spanning Tree
Optional STP Features	Disabled
STP Bridge Priority	32768
Multiple Spanning Tree	Disabled

**Table 6-1. Default Settings (Continued)**

<b>Feature</b>	<b>Default</b>
Link Aggregation	No LAGs configured
LACP System Priority	1
Routing Mode	Disabled
OSPF Admin Mode	Disabled
OSPF Router ID	0.0.0.0
IP Helper and UDP Relay	Disabled
RIP	Disabled
VRRP	Disabled
Tunnel and Loopback Interfaces	None
IPv6 Routing	Disabled
DHCPv6	Disabled
OSPFv3	Disabled
DiffServ	Enabled
Auto VoIP	Disabled
Auto VoIP Traffic Class	6
iSCSI	Enabled
MLD Snooping	Enabled
IGMP Snooping	Enabled
IGMP Snooping Querier	Disabled
GMRP	Disabled
IPv4 Multicast	Disabled
IPv6 Multicast	Disabled
OpenFlow	Disabled

# Setting the IP Address and Other Basic Network Information

## Dell EMC Networking N-Series Switches

This chapter describes how to configure basic network information for the switch, such as the IP address, subnet mask, and default gateway. The topics in this chapter include:

- IP Address and Network Information Overview
- Default Network Information
- Configuring Basic Network Information (Web)
- Configuring Basic Network Information (CLI)
- Basic Network Information Configuration Examples

## IP Address and Network Information Overview

### What Is the Basic Network Information?

The basic network information includes settings that define the Dell EMC Networking N-Series switches in relation to the network. Table 7-1 provides an overview of the settings this chapter describes.

**Table 7-1. Basic Network Information**

Feature	Description
IP Address	On an IPv4 network, the a 32-bit number that uniquely identifies a host on the network. The address is expressed in dotted-decimal format, for example 192.168.10.1.
Subnet Mask	Determines which bits in the IP address identify the network, and which bits identify the host. Subnet masks are also expressed in dotted-decimal format, for example 255.255.255.0.

**Table 7-1. Basic Network Information (Continued)**

<b>Feature</b>	<b>Description</b>
Default Gateway	Typically a router interface that is directly connected to the switch and is in the same subnet. The switch sends IP packets to the default gateway when it does not recognize the destination IP address in a packet.
DHCP Client	Requests network information from a DHCP server on the network.
Domain Name System (DNS) Server	Translates hostnames into IP addresses. The server maintains a domain name databases and their corresponding IP addresses.
Default Domain Name	Identifies your network, such as dell.com. If a hostname is entered without the domain name information, the default domain name is automatically appended to the hostname.
Host Name Mapping	Allows statically mapping an IP address to a hostname.

Additionally, this chapter describes how to view host name-to-IP address mappings that have been dynamically learned by the system.

### **Why Is Basic Network Information Needed?**

Dell EMC Networking N-Series switches are Layer-2/3 managed switches. To manage the switch remotely by using a web browser or Telnet client, the switch must have an IP address, subnet mask, and default gateway. A username and password is required to be able to log into the switch from a remote host. For information about configuring users, see "Authentication, Authorization, and Accounting" on page 291. If managing the switch by using the console connection only, configuring an IP address and user is not required. In this case, disabling the Telnet server using the **no ip telnet** command is recommended.



**NOTE:** The configuration example in this chapter includes commands to create an administrative user with read/write access.

Configuring the DNS information, default domain name, and host name mapping help the switch identify and locate other devices on the network and on the Internet. For example, to upgrade the switch software by using a TFTP

server on the network, the TFTP server must be identified. If configuring the switch to use a DNS server to resolve hostnames into IP addresses, it is possible to enter the hostname of the TFTP server instead of the IP address. It is often easier to remember a hostname than an IP address, and if the IP address is dynamically assigned, it might change from time-to-time.

## How Is Basic Network Information Configured?

A console-port connection is required to perform the initial switch configuration. When booting the switch for the first time, if there is no startup configuration file, the Dell Easy Setup Wizard starts. The Dell Easy Setup Wizard is a CLI-based tool to help the administrator perform the initial switch configuration. If no response to the Dell Easy Setup Wizard prompt is received within 60 seconds, the `console>` prompt appears, and the switch enters User Configuration mode.

For more information about performing the initial switch configuration by using the wizard, see the *Getting Started Guide* at [www.dell.com/support](http://www.dell.com/support).

If the wizard is not used to supply the initial configuration information, the administrator can manually enable the DHCP client on the switch to obtain network information from a DHCP server via the in-band ports or the out-of-band port. Alternatively, the network configuration can be statically configured.

After configuring the switch with an IP address and creating a user account, continue to use the console connection to configure basic network information, or log on to the switch by using a Telnet client or a web browser. It is possible at this point to change the IP address information and configure additional network information from the remote system.

## What Is Out-of-Band Management and In-Band Management?

The Dell EMC Networking N2200-ON, N3000E-ON, N3100-ON, and N3200-ON Series switches have an external port intended solely for management of the switch. This port is the out-of-band (OOB) management port. Traffic received on the OOB port is never switched or routed to any in-band port and is not rate limited. Likewise, traffic received on any in-band port is never forwarded or routed over the OOB port. The only applications available on the OOB port are protocols required to manage the switch, for example Telnet, SSH, DHCP client, and TFTP. If using the out-of-band

management port, it is strongly recommended that the port be connected only to a physically isolated secure management network. The OOB port is a Layer-3 interface that uses an internal non-user-configurable VLAN.

The out-of-band port is a logical management interface. The IP stack's routing table contains both IPv4/IPv6 routes associated with these management interfaces and IPv4/IPv6 routes associated with routing interfaces. If routes to the same destination (such as a default route) are learned or configured on both the OOB interface and a routing interface, the routing interface route is preferred. If a directly connected subnet is configured on an out-of-band interface, it cannot also be configured on an in-band interface. If a default gateway is configured on routing interfaces (front-panel ports), then IP addresses not in the OOB port subnet will not be reachable via the OOB port. It is never recommended that the switch default gateway be configured on the out-of-band port subnet.

Dell recommends that, if used, the OOB port be used for remote management on a physically independent management network and be assigned an IP address from the non-routable private IP address space. The following list highlights some advantages of using OOB management instead of in-band management:

- Traffic on the OOB port is passed directly to the switch CPU, bypassing the switching silicon. The OOB port is implemented as an independent NIC, which allows direct access to the switch CPU from the management network.
- If the production network is experiencing problems, administrators can still access the switch management interface and troubleshoot issues.
- Because the OOB port is intended to be physically isolated from the production network or deployed behind a firewall, configuration options are limited to just those protocols needed to manage the switch. Limiting the configuration options makes it difficult to accidentally cut off management access to the switch.

Alternatively, network administrators may choose to manage their network via the production network. This is in-band management. Because in-band management traffic is mixed in with production network traffic, it is subject to all of the filtering rules usually applied on a switched/routed port, such as ACLs and VLAN tagging, and may be rate limited to protect against DoS attacks.

The administrator can assign an IPv4 address or an IPv6 address to the OOB management port and to any VLAN. By default, all ports (other than the OOB port) are members of VLAN 1. If an IP address is assigned to VLAN 1, it is possible to connect to the switch management interface by using any of the front-panel switch ports. Assignment of an IP address to a VLAN associated to a front panel interface is required to manage the Dell EMC Networking, N1100-ON, N1500, N2000, and N2100-ON Series switches. The use of VLAN 1 for switch administration presents some security risks. Alternatively, a management VLAN can be assigned as the native VLAN for a limited set of front-panel ports and an IP address can be assigned to that VLAN. The use of ACLs to restrict access to switch management is strongly recommended.

DHCP can be enabled on the OOB interface and VLAN interfaces simultaneously, or they can be configured with static information. To configure static address information on the default VLAN (or the management VLAN), set the IP address and subnet mask on the VLAN interface and configure a global default gateway for the switch to use front panel interfaces (not the OOB interface). If a default gateway is configured on routing interfaces (front-panel ports), then IP addresses not in the OOB port subnet will not be reachable via the OOB port. The switch sends the Vendor Class Identifier (Option 60) in the DHCP discover messages to assist DHCP server administrators in distinguishing Dell EMC switches from other devices in the network. This is a text string of the form `DellEMC;<switch model>;<firmware version>;<serial number>` where the switch model number is the specific switch model.

### **Adjusting the Management Interface MTU**

When logging into the Dell EMC Networking N-Series switch using TCP, the switch negotiates the TCP Maximum Segment Size (MSS) using the minimum of the requested MSS or the MTU setting of the port. TCP packets are transmitted from the switch with the DF (Don't Fragment) bit set in order to receive notification of fragmentation from any transit routers. Upon receiving an ICMP *Destination Unreachable, Fragmentation needed but DF set* notification, the switch will reduce the MSS. However, many firewalls block ICMP Destination Unreachable messages, which causes the destination to request the packet again until the connection times out.

To resolve this issue, reduce the TCP MSS setting to a more appropriate value on the local host or alternatively, set the system MTU to a smaller value.

## Default Network Information




**NOTE:** Dell EMC Networking N1100-ON, N1500, N2000, and N2100-ON Series switches do not have an out-of-band interface.

By default, no network information is configured. The DHCP client is enabled on the OOB interface by default on Dell EMC Networking N2200-ON, N3000E-ON, N3100-ON, and N3200-ON Series switches. The DHCP client is enabled on VLAN 1 by default on the Dell EMC Networking N1100-ON, N1500, N2000, and N2100-ON Series switches. DNS is enabled, but no DNS servers are configured. VLAN 1 does not have an IP address, subnet mask, or default gateway configured on Dell EMC Networking N2200-ON, N3200E-ON, N3100-ON, and N3200-ON Series switches.



## Configuring Basic Network Information (Web)

This section provides information about the OpenManage Switch Administrator pages for configuring and monitoring basic network information on the Dell EMC Networking N-Series switches. For details about the fields on a page, click  at the top of the Dell EMC OpenManage Switch Administrator web page.

### Out-of-Band Interface



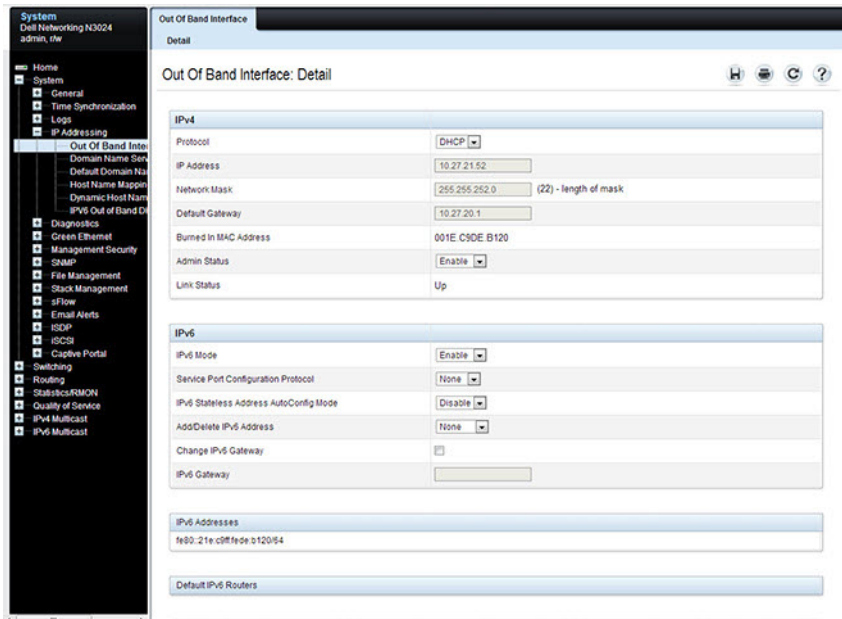
**NOTE:** Dell EMC Networking, N1100-ON, N1500, N2000, and N2100-ON Series switches do not have an out-of-band interface.

Use the **Out of Band Interface** page to assign the out-of-band interface IP address and subnet mask or to enable/disable the DHCP client for address information assignment. DHCP is enabled by default on the OOB interface. The OOB interface must be configured on a subnet separate from the front-panel port routing interfaces. The system default gateway must not share an address range/subnet with the OOB interface.

The out-of-band interface may also be assigned an IPv6 address, either statically or via DHCP. In addition, the out-of-band port may be assigned an IPv6 address via the IPv6 auto-configuration process.

To display the **Out of Band Interface** page, click **System** → **IP Addressing** → **Out of Band Interface** in the navigation panel.

Figure 7-1. Out of Band Interface



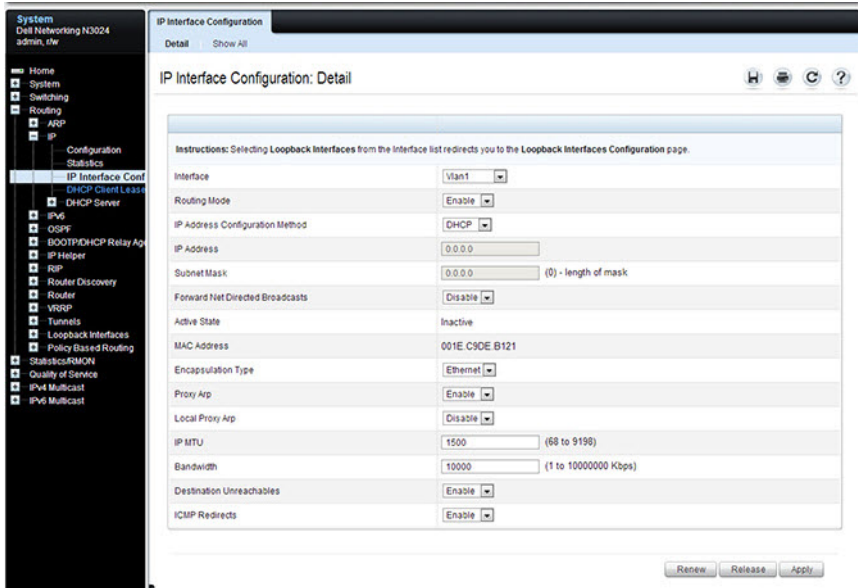
To enable the DHCP client and allow a DHCP server on your network to automatically assign the network information to the OOB interface, select DHCP from the **Protocol** menu. If the network information is statically assigned, ensure that the **Protocol** menu is set to None.

### IP Interface Configuration (Default VLAN IP Address)

Use the **IP Interface Configuration** page to assign the default VLAN IP address and subnet mask, the default gateway IP address, and to assign the boot protocol.

To display the **IP Interface Configuration** page, click **Routing** → **IP** → **IP Interface Configuration** in the navigation panel.

**Figure 7-2. IP Interface Configuration (Default VLAN)**



### Assigning Network Information to the Default VLAN

To assign an IP Address and subnet mask to the default VLAN:

- 1 From the **Interface** menu, select VLAN 1.
- 2 From the **Routing Mode** field, select **Enable**.
- 3 From the **IP Address Configuration Method** field specify whether to assign a static IP address (Manual) or use DHCP for automatic address assignment.
- 4 If **Manual** is selected for the configuration method, then the **IP Address** and **Subnet Mask** can be entered in the appropriate fields.
- 5 Click **Apply**.



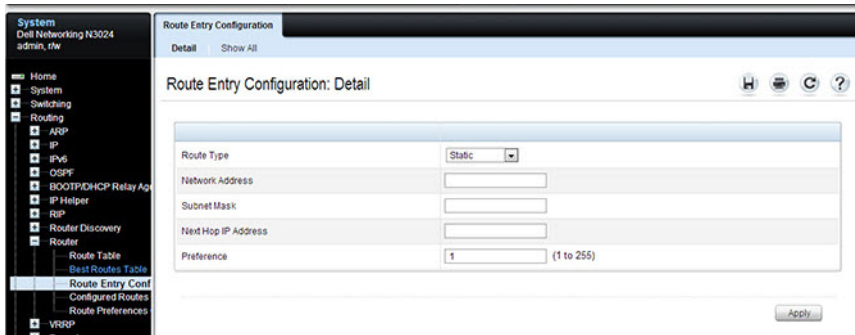
**NOTE:** No additional fields on the page must be configured. For information about VLAN routing interfaces, see "Routing Interfaces" on page 1219.

## Route Entry Configuration (Switch Default Gateway)

Use the **Route Entry Configuration** page to configure the default gateway for the switch. The default VLAN uses the switch default gateway as its default gateway. The switch default gateway must not be on the same subnet as the OOB management port, as the OOB management port cannot route packets received on the front-panel ports.

To display the **Route Entry Configuration** page, click **Routing** → **Router** → **Route Entry Configuration** in the navigation panel.

**Figure 7-3. Route Configuration (Default VLAN)**

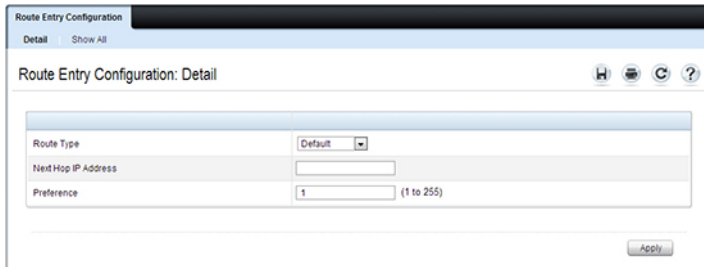


### Configuring a Default Gateway for the Switch:

To configure the switch default gateway:

- 1 Open the **Route Entry Configuration** page.
- 2 From the **Route Type** field, select **Default**.

**Figure 7-4. Default Route Configuration (Default VLAN)**



- 3 In the **Next Hop IP Address** field, enter the IP address of the default gateway.
- 4 Click **Apply**.

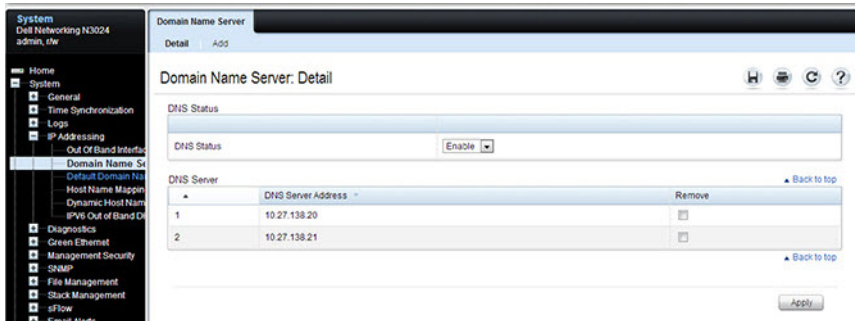
For more information about configuring routes, see "IP Routing" on page 1193.

## Domain Name Server

Use the **Domain Name Server** page to configure the IP address of the DNS server. The switch uses the DNS server to translate hostnames into IP addresses.

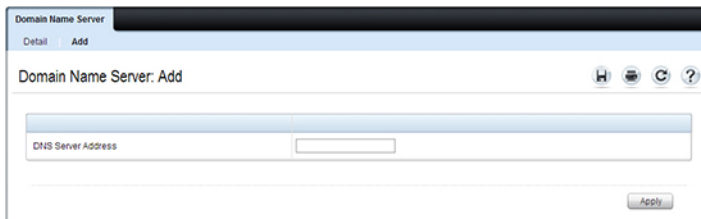
To display the **Domain Name Server** page, click **System** → **IP Addressing** → **Domain Name Server** in the navigation panel.

**Figure 7-5. DNS Server**



To configure DNS server information, click the **Add** link and enter the IP address of the DNS server in the available field.

**Figure 7-6. Add DNS Server**

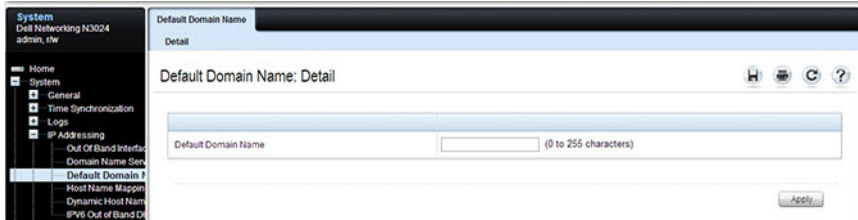


## Default Domain Name

Use the **Default Domain Name** page to configure the domain name the switch adds to a local (unqualified) hostname.

To display the **Default Domain Name** page, click **System** → **IP Addressing** → **Default Domain Name** in the navigation panel.

**Figure 7-7. Default Domain Name**

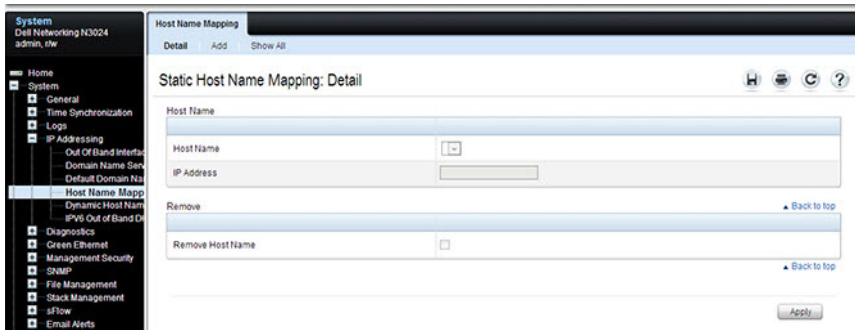


## Host Name Mapping

Use the **Host Name Mapping** page to assign an IP address to a static host name. The **Host Name Mapping** page provides one IP address per host.

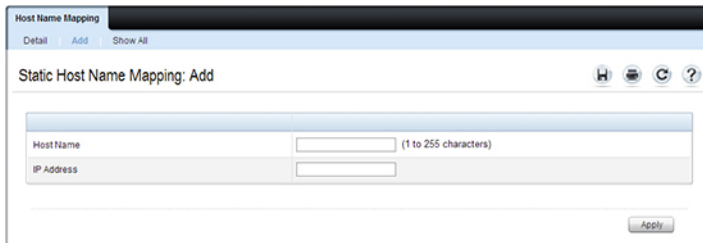
To display the **Host Name Mapping** page, click **System** → **IP Addressing** → **Host Name Mapping**.

**Figure 7-8. Host Name Mapping**



To map a host name to an IP address, click the **Add** link, type the name of the host and its IP address in the appropriate fields, and then click **Apply**.

**Figure 7-9. Add Static Host Name Mapping**



Use the **Show All** link to view all configured host name-to-IP address mappings.

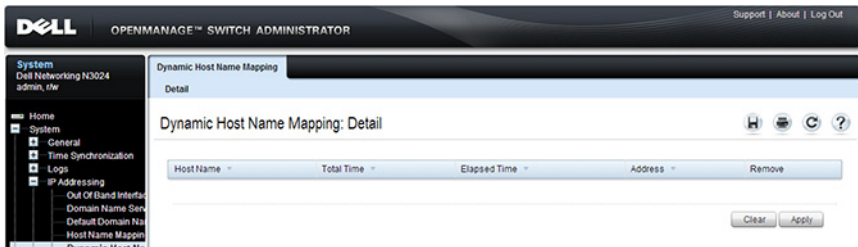


## Dynamic Host Name Mapping

Use the **Dynamic Host Name Mapping** page to view dynamic host entries the switch has learned. The switch learns hosts dynamically by using the configured DNS server to resolve a hostname. For example, if you ping `www.dell.com` from the CLI, the switch uses the DNS server to lookup the IP address of `dell.com` and adds the entry to the Dynamic Host Name Mapping table.

To display the **Dynamic Host Name Mapping** page, click **System** → **IP Addressing** → **Dynamic Host Name Mapping** in the navigation panel.


**Figure 7-10. View Dynamic Host Name Mapping**



# Configuring Basic Network Information (CLI)

This section provides information about the commands used for configuring basic network information on the Dell EMC Networking N-Series switches. For more information about these commands, see the *Dell EMC Networking N1100-ON, N1500, N2000, N2100-ON, N2200-ON, N3000E-ON, N3100-ON, and N3200-ON Series Switches CLI Reference Guide* at [www.dell.com/support](http://www.dell.com/support).

## Enabling the DHCP Client on the OOB Port

 **NOTE:** Dell EMC Networking N1100-ON, N1500, N2000, and N2100-ON Series switches do not have an out-of-band interface.

Use the following commands to enable the DHCP client on the OOB port.

Command	Purpose
<code>configure</code>	Enter Global Configuration mode.
<code>interface out-of-band</code>	Enter Interface Configuration mode for the OOB port.
<code>ip address dhcp</code>	Enable the DHCP client.
<code>CTRL + Z</code>	Exit to Privileged Exec mode.
<code>show ip interface out-of-band</code>	Display network information for the OOB port.

## Enabling the DHCP Client on the Default VLAN

Use the following commands to enable the DHCP client on the default VLAN, which is VLAN 1. As a best practice, it is recommended that a separate VLAN other than one used for client traffic be used for in-band management of the switch. In general, using VLAN 1, or any other VLAN carrying client traffic, for in-band management introduces a security vulnerability.

Command	Purpose
<code>configure</code>	Enter Global Configuration mode.
<code>interface vlan 1</code>	Enter Interface Configuration mode for VLAN 1.

<b>Command</b>	<b>Purpose</b>
<code>ip address dhcp</code>	Enable the DHCP client.
<code>ipv6 address dhcp</code>	Enable the DHCPv6 client.
<code>CTRL + Z</code>	Exit to Privileged Exec mode.
<code>show ip interface vlan 1</code>	Display network information for VLAN 1.

## Managing DHCP Leases

Use the following commands to manage and troubleshoot DHCP leases on the switch.

<b>Command</b>	<b>Purpose</b>
<code>show dhcp lease interface [interface]</code>	Display IPv4 addresses leased from a DHCP server.
<code>show ipv6 dhcp interface vlan [interface]</code>	Display information about the IPv6 DHCP information for all interfaces or for the specified interface.
<code>debug dhcp packet</code>	Display debug information about DHCPv4 client activities and to trace DHCPv4 packets to and from the local DHCPv4 client.
<code>debug ipv6 dhcp</code>	Display debug information about DHCPv6 client activities and to trace DHCPv6 packets to and from the local DHCPv6 client.
<code>ipv6 address { [prefix/prefixlen]   autoconfig   dhcp }</code>	Set the IPv6 address of the management interface or enables auto-configuration or DHCP.
<code>ip default-gateway ipv4-address</code>	Configure a global default gateway. Only one IPv4 gateway may be configured per switch.
<code>ipv6 gateway ipv6-address</code>	Set the global IPv6 default gateway address. Only one IPv6 gateway may be configured per switch.
<code>ipv6 enable</code>	Enable IPv6 functionality on the interface.
<code>show ipv6 interface out-of-band</code>	Show settings for the interface.

## Configuring Static Network Information on the OOB Port



**NOTE:** Dell EMC Networking N1100-ON, N1500, N2000, and N2100-ON Series switches do not have an out-of-band interface.

Use the following commands to configure a static IP address, subnet mask, and default gateway on the OOB port. If no default gateway is configured, then the zero subnet (0.0.0.0) is used. In this configuration, the OOB port can reach hosts in the local subnet only, because the OOB port will not be able to issue ARP requests to the default gateway. Configuring a default gateway address on the OOB port allows the OOB port to issue ARPs and address traffic to hosts on other subnets; however, if routing is enabled, routing will use the gateway on the OOB port for front-panel ARP requests and as a route of last resort. Since the OOB interface does not route packets, this is not a recommended configuration. The OOB port subnet may not overlap with any in-band VLAN subnet.

Command	Purpose
<code>configure</code>	Enter Global Configuration mode.
<code>interface out-of-band</code>	Enter Interface Configuration mode for the OOB port.
<code>ip address ip_address subnet_mask [gateway_ip]</code>	Configure a static IP address and subnet mask. Optionally, a default gateway can also be configured (not recommended).
<code>ipv6 address prefix/prefix- length</code>	Configure an IPv6 prefix for the OOB port
<code>ipv6 address enable</code>	Enable IPv6 addressing on the OOB port
<code>ipv6 address autoconfig</code>	Enable IPv6 auto-configuration for the OOB port
<code>ipv6 address dhcp</code>	Enable DHCP address assignment for the OOB port.
<code>CTRL + Z</code>	Exit to Privileged Exec mode.
<code>show ip interface out-of-band</code>	Verify the network information for the OOB port.
<code>show ipv6 interface out-of- band</code>	Verify the IPv6 network information for the OOB port.



**NOTE:** The out-of-band port also supports IPv6 address assignment, including IPv6 auto-configuration and an IPv6 DHCP client.

## Configuring Static Network Information on the Default VLAN

Use the following commands to configure a static IP address, subnet mask, and default gateway on the default VLAN. Alternatively, a DHCP server may be used to obtain a network address. The switch also supports IPv6 address auto-configuration.

IP subnets on in-band ports (configured on switch VLANs) may not overlap with the OOB port subnet. If configuring management access on the front-panel ports, it is recommended that:

- A VLAN other than the default VLAN be used to avoid attack vectors enabled by incorrect cabling.
- Both ACLs and Management ACLs be utilized on front-panel ports to reduce the possibility of DoS attacks or intruders gaining access to the switch management console. Management ACLs provide software filtering with deep inspection of packets, whereas ACLs provide hardware filtering with a more limited set of capabilities.

Command	Purpose
<code>configure</code>	Enter Global Configuration mode.
<code>vlan 10</code>	Create a management VLAN and enter VLAN Configuration mode.
<code>exit</code>	Exit VLAN Configuration mode
<code>interface vlan 10</code>	Enter Interface Configuration mode for VLAN 10. VLAN 10 is the management VLAN.
<code>ip address <i>ip_address</i> <i>subnet_mask</i></code>	Enter the IP address and subnet mask.
<code>ipv6 address <i>prefix/prefix-length</i> [<i>eui64</i>]</code>	Enter the IPv6 address and prefix.
<code>ipv6 enable</code>	Enable IPv6 on the interface.
<code>exit</code>	Exit to Global Configuration mode

<b>Command</b>	<b>Purpose</b>
<code>ip default-gateway <i>ip_address</i></code>	Configure the IPv4 default gateway. Only one IPv4 gateway may be configured per switch.
<code>ipv6 gateway <i>ip_address</i></code>	Configure the default gateway for IPv6. Only one IPv6 gateway may be configured per switch.
<code>exit</code>	Exit to Privileged Exec mode.
<code>show ip interface vlan 10</code>	Verify the network information for VLAN 10.
<code>show ipv6 interface vlan 10</code>	Verify IPv6 network information for VLAN 10.
<code>interface Gi1/0/24</code>	Enter physical Interface Configuration mode for the specified interface.
<code>switchport access vlan 10</code>	Allow access to the management VLAN over this port.
<code>exit</code>	Exit Interface Configuration mode.

## Configuring and Viewing Additional Network Information

Use the following commands to configure a DNS server, the default domain name, and a static host name-to-address entry. Use the **show** commands to verify configured information and to view dynamic host name mappings. Remember to assign VLANs to interfaces.

<b>Command</b>	<b>Purpose</b>
<code>configure</code>	Enter Global Configuration mode.
<code>ip domain-lookup</code>	Enable IP DNS-based host name-to-address translation.
<code>ip name-server <i>ip_address</i></code>	Enter the IP address of an available name server to use to resolve host names and IP addresses. Up to eight DNS servers may be configured.
<code>ip domain-name <i>name</i></code>	Define a default domain name to complete unqualified host names.
<code>ip host <i>name ip_address</i></code>	Use to configure static host name-to-address mapping in the host cache.
<code>ip address-conflict-detect run</code>	Trigger the switch to run active address conflict detection by sending gratuitous ARP packets for IPv4 addresses on the switch.

---

<b>Command</b>	<b>Purpose</b>
CTRL + Z	Exit to Privileged Exec mode.
show ip interface vlan 1	Verify the network information for VLAN 1.
show ipv6 interface vlan 1	Verify the network information for VLAN 1.
show hosts	Verify the configured network information and view the dynamic host mappings.
show ip address-conflict	View the status information corresponding to the last detected address conflict.
clear ip address-conflict-detect	Clear the address conflict detection status in the switch.

---

# Basic Network Information Configuration Examples

## Configuring Network Information Using the OOB Port

In this example, an administrator at a Dell office in California decides not to use the Dell Easy Setup Wizard to perform the initial switch configuration. The administrator configures Dell EMC Networking N2200-ON, N3000E-ON, N3100-ON and N3200-ON Series switches to obtain information from a DHCP server on the management network and creates the administrative user with read/write access. The administrator also configures the following information:

- Primary DNS server: 10.27.138.20
- Secondary DNS server: 10.27.138.21
- Default domain name: sunny.dell.com

The administrator also maps the administrative laptop host name to its IP address. The administrator uses the OOB port to manage the switch.

To configure the switch:



**NOTE:** Dell EMC Networking N1100-ON, N1500, N2000, and N2100-ON Series switches do not have an out-of-band interface.

- 1 Connect the OOB port to the management network. DHCP is enabled by default on the switch OOB interface by default on Dell EMC Networking N3000E-ON, N3100-ON, and N3200-ON Series switches. DHCP is enabled on VLAN 1 on the Dell EMC Networking N1100-ON/N1500/N2000/N2100-ON Series switches as they do not support an OOB interface. If the DHCP client on the switch has been disabled, use the following commands to enable the DHCP client on the OOB port.

```
console#configure
console(config)#interface out-of-band
console(config-if)#ip address dhcp
console(config-if)#exit
```

- 2 Configure the administrative user.

```
console(config)#username admin password secret123 privilege 15
```



- 3 Configure the DNS servers, default domain name, and static host mapping.

```
console(config)#ip name-server 10.27.138.20 10.27.138.21
console(config)#ip domain-name sunny.dell.com
console(config)#ip host admin-laptop 10.27.65.103
console(config)#exit
```

- 4 View the network information that the DHCP server on the network dynamically assigned to the switch.

```
console#show ip interface out-of-band

IP Address..... 10.27.22.153
Subnet Mask..... 255.255.255.0
Default Gateway..... 10.27.22.1
Protocol Current..... DHCP
Burned In MAC Address..... 001E.C9AA.AA08
```

- 5 View additional network information.

```
console#show hosts

Host name:
Default domain: sunny.dell.com dell.com
Name/address lookup is enabled
Name servers (Preference order): 10.27.138.20, 10.27.138.21
Configured host name-to-address mapping:
Host                Addresses
-----
admin-laptop        10.27.65.103

cache: TTL (Hours)
```

```
Host                Total    Elapsed Type          Addresses
-----
No hostname is mapped to an IP address
```

- 6 Verify that the static hostname is correctly mapped.

```
console#ping admin-laptop
Pinging admin-laptop with 0 bytes of data:

Reply From 10.27.65.103: icmp_seq = 0. time <10 msec.
Reply From 10.27.65.103: icmp_seq = 1. time <10 msec.
```

## Configuring Network Information Using the Serial Interface

In this example, the administrator configures a Dell EMC Networking N1100-ON/N1500/N2000/N2100-ON Series switch via the serial interface while using the same DHCP server and address configuration as given in the previous example.

- 1 Connect a front-panel port (e.g., `gi1/0/24`) to the management network. Use the following commands to create a management VLAN, disable DHCP on VLAN 1, and disable L3 addressing on VLAN 1, and enable the DHCP client on the management VLAN.

```
console#configure
console(config)#vlan 4093
console(config-vlan4093)#interface vlan 1
console(config-if-vlan1)#no ip address
console(config-if-vlan1)#exit
console(config)#no interface vlan 1
console(config-)#interface vlan 4093
console(config-if-vlan4093)#ip address dhcp
```

- 2 Assign the management VLAN to an interface connected to the management network.

```
console(config-if-vlan4093)#interface gi1/0/24
console(config-if-Gil/0/24)#switchport access vlan 4093
console(config-if-Gil/0/24)#exit
```

- 3 Configure the administrative user.

```
console(config)#username admin password secret123 privilege 15
```

- 4 Configure the DNS servers, default domain name, and static host mapping.

```
console(config)#ip name-server 10.27.138.20 10.27.138.21
console(config)#ip domain-name sunny.dell.com
console(config)#ip host admin-laptop 10.27.65.103
console(config)#exit
```

- 5 View the network information that the DHCP server on the network dynamically assigned to the switch.

```
console#show ip interface vlan 4093
```

```
Routing interface status..... Up
Primary IP Address..... 10.27.22.150/255.255.252.0
Method..... DHCP
Routing Mode..... Enable
Administrative Mode..... Enable
```

```
Forward Net Directed Broadcasts..... Disable
Proxy ARP..... Enable
Local Proxy ARP..... Disable
Active State..... Active
MAC Address..... 001E.C9DE.B77A
Encapsulation Type..... Ethernet
IP MTU..... 1500
Bandwidth..... 10000 kbps
Destination Unreachables..... Enabled
ICMP Redirects..... Enabled
```

Refer to the Access Control Lists section for information on restricting access to the switch management interface.



# Stacking

## Dell EMC Networking N-Series Switches

This chapter describes how to configure and manage a stack of switches.

The topics covered in this chapter include:

- Stacking Overview
- Default Stacking Values
- Managing and Monitoring the Stack (Web)
- Managing the Stack (CLI)
- Stacking and NSF Usage Scenarios

## Stacking Overview

The Dell EMC Networking N2100-ON, N2200-ON, N3100-ON, and N3200-ON Series switches include a stacking feature that allows up to eight switches to operate as a single unit. The Dell EMC Networking N2000 Series switches stack up to eight units. The Dell EMC Networking N1124T-ON/N1148T-ON/N1124P-ON/N1148P-ON, and N1500 Series switches stack up to four units using 10GB Ethernet links configured as stacking. Dell EMC Networking N2000 and N2100-ON Series switches have two fixed mini-SAS connectors at the rear for stacking. Dell EMC Networking N3100-ON Series switches have an optional 2x21G or 2x40G stacking module. The Dell EMC Networking N2200-ON supports a QSFP stacking port in the rear.

Dell EMC Networking N1124T-ON/N1148T-ON/N1124P-ON/N1148P-ON Series switches only stack with other Dell EMC Networking N1124T-ON/N1148T-ON/N1124P-ON/N1148P-ON Series switches. Dell EMC Networking N1108P-ON/N1108T-ON/N3208PX-ON Series switches do not stack.

Dell EMC Networking N3000E-ON Series switches stack with other Dell EMC Networking N3000E-ON Series switches and Dell EMC Networking N3100-ON Series switches, using the optional stacking module. Beginning with the 6.5.1 release, any stack containing any N3000E-ON Series switch (other than the N3000E-ON) is limited to a maximum of eight units.

Dell EMC Networking N1500 Series switches stack with other N1500 Series switches using the 10G SFP+ front-panel ports.

Dell EMC Networking N1124T-ON/N1148T-ON/N1124P-ON/N1148P-ON switches and N1500 Series switches support high-performance stacking over the 10G front-panel ports, allowing increased capacity to be added as needed, without affecting network performance and providing a single point of management. Up to four Dell EMC Networking N1124T-ON/N1148T-ON/N1124P-ON/N1148P-ON switches and N1500 Series switches can be stacked using any 10G port as long as the link bandwidth for parallel stacking links is the same. Note that configuring a 10G port for stacking also configures the adjacent partner 10G port for stacking.

A stack of four Dell EMC Networking N1124T-ON/N1148T-ON/N1124P-ON/N1148P-ON switches and N1500 Series switches has an aggregate throughput capacity of 192 Gbps. Dell EMC Networking N1124T-ON/N1148T-ON/N1124P-ON/N1148P-ON and N1500 Series stacking links operate at 10 Gbps or 5.2% of total aggregate throughput capacity of a full stack; therefore, it is recommended that operators provision large stacking topologies such that it is unlikely that a significant portion of the stack capacity will transit stacking links. One technique for achieving this is to distribute uplinks evenly across the stack vs. connecting all uplinks to a single stack unit or to adjacent stacking units.

A stack of 12 48-port Dell EMC Networking N2000, N2100-ON, N3000E-ON, or N3100-ON Series switches has an aggregate throughput capacity of 576 Gbps. Dell EMC Networking N2000/N2100-ON/N3000E-ON/N3100-ON Series stacking links operate at 21 Gbps or 3.6% of total aggregate throughput capacity of a 12 high stack; N2100-ON/N3100-ON stack links can operate at 21 Gbps/40 Gbps; therefore, it is recommended that operators provision large stacking topologies such that it is unlikely that a significant portion of the stack capacity will transit stacking links. One technique for achieving this is to distribute uplinks evenly across the stack vs. connecting all uplinks to a single stack unit or to adjacent stacking units.

Additional stacking connections can be made between adjacent switch units to increase the stacking bandwidth provided that all redundant stacking links have the same port speed. It is strongly recommended that the stacking bandwidth be kept equal across all stacking connections; that is, avoid mixing single and double stacking connections within a stack.

It is recommended that operators provision large stacking topologies such that it is unlikely that a significant portion of the stack capacity will transit stacking links. One technique for achieving this is to distribute downlinks and transit links evenly across the stack vs. connecting all downlinks/transit links to a single stack unit or to adjacent stacking units.

A single switch in the stack manages all the units in the stack (the management unit in the stack), and the stack is managed by using a single IP address. The IP address of the stack does not change, even if the the management unit in the stack changes.

A stack is created by daisy-chaining stacking links on adjacent units. If available, up to eight links per stack unit can be used for stacking (four in each direction). A stack of units is manageable as a single entity when the units are connected together. If a unit cannot detect a stacking partner on any port enabled for stacking, the unit automatically operates as a standalone unit. If a stacking partner is detected, the switch always operates in stacking mode. One unit in the stack is designated as the management unit in the stack. The primary manages all the units in the stack. The management unit in the stack runs the user interface and switch software, and propagates changes to the member units. To manage a stack using the serial interface, the administrator must connect to the management unit in the stack via the **connect** command or by physically connecting the cable to the management unit in the stack.

A second switch is designated as the standby unit, which becomes the primary if the management unit in the stack is unavailable. The unit to be selected as the standby can be manually configured, or the system can select the standby automatically.

When units are in a stack, the following activities occur:

- All units are checked for software version consistency.
- The switch Control Plane is active only on the primary. The Control Plane is a software layer that manages system and hardware configuration and runs the network control protocols to set system configuration and state.
- The switch Data Plane is active on all units in the stack, including the primary. The Data Plane is the set of hardware components that forward data packets without intervention from a control CPU.

- The running configuration is propagated to all units and the application state is synchronized between the primary and standby during normal stacking operation. The startup configuration and backup configuration on the stack members are not overwritten with the primary switch configuration.

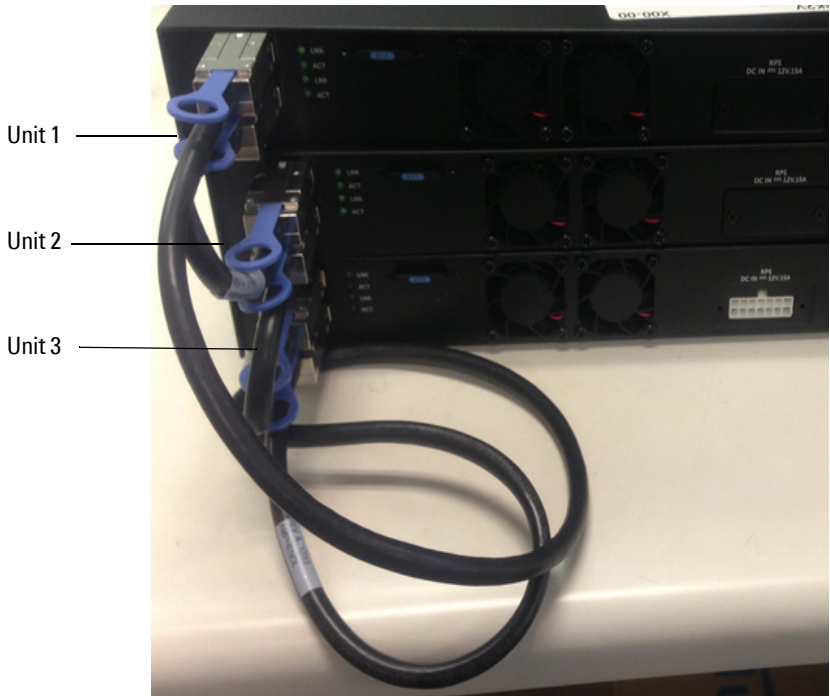
Dell strongly recommends connecting the stack in a ring topology so that each switch is connected to two other switches. Connecting switches in a ring topology allows the stack to utilize the redundant communication path to each switch. If a switch in a ring topology fails, the stack can automatically establish a new communications path to the other switches. Switches not stacked in a ring topology may split into multiple independent stacks upon the failure of a single switch or stacking link.

Additional stacking connections can be made between adjacent switch units to increase the stacking bandwidth, provided that all redundant stacking links have the same bandwidth. It is strongly recommended that the stacking bandwidth be kept equal across of all stacking connections; that is, avoid mixing single and double stacking connections within a stack. Up to eight redundant stacking links can be configured on a stacking unit (four in each direction).

Figure 8-1 shows a stack with three switches as stack members connected in a ring topology.



**Figure 8-1. Connecting a Stack of Switches**



The stack in Figure 8-1 has the following physical connections between the switches:

- The lower stacking port on Unit 1 is connected to the upper stacking port on Unit 2.
- The lower stacking port on Unit 2 is connected to the upper stacking port on Unit 3.
- The lower stacking port on Unit 3 is connected to the upper stacking port on Unit 1.

## **Dell EMC Networking Stacking Compatibility**

Dell EMC Networking N1100-ON and N1500 Series switches do not stack with different Dell EMC Networking Series switches or other Dell EMC Networking switches. Dell EMC Networking N1124T-ON/N1148T-ON/N1124P-ON/N1148P-ON Series switches only stack with other Dell EMC Networking N1124T-ON/N1148T-ON/N1124P-ON/N1148P-ON Series switches. Dell EMC Networking N1108T-ON/N1108P-ON switches do not stack. Dell EMC Networking N1500 Series switches only stack with other Dell EMC Networking N1500 Series switches.

Dell EMC Networking N3100-ON Series switches stack with Dell EMC Networking N3000E-ON switches up to 12 units. Dell EMC Networking N2200-ON switches stack with other N2200-ON switches. Dell EMC Networking N3200-ON switches stack with other stacking-capable N3200-ON switches up to 12 units.

### **How is the Management Unit in the Stack Selected?**

A management unit in the stack is elected or re-elected based on the following considerations, in order:

- 1** The switch is currently the management unit in the stack.
- 2** The switch has the higher MAC address.
- 3** A unit is selected as standby by the administrator, and a fail over action is manually initiated or occurs due to the failure of the management unit in the stack.

In most cases, a switch that is added to an existing stack will become a stack member, and not the management unit in the stack. When a switch is added to the stack, one of the following scenarios takes place regarding the management status of the new switch:

- If the switch has the management unit in the stack function enabled but another management unit in the stack is already active, then the switch changes its configured management unit in the stack value to disabled.
- If the management unit in the stack function is unassigned and there is another management unit in the stack in the system then the switch changes its configured management unit in the stack value to disabled.
- If the management unit in the stack function is enabled or unassigned and there is no other management unit in the stack in the system, then the switch becomes stack primary.

- If the management unit in the stack function is disabled, the unit remains a non-management unit in the stack.

If the entire stack is powered OFF and ON again, the unit that was the management unit in the stack before the reboot will remain the management unit in the stack after the stack resumes operation.

The unit number for the switch can be manually configured. To avoid unit-number conflicts, one of the following scenarios takes place when a new member is added to the stack:

- If the switch has a unit number that is already in use, then the unit that is added to the stack changes its configured unit number to the lowest unassigned unit number.
- If the added switch does not have an assigned unit number, then the switch sets its configured unit number to the lowest unassigned unit number.
- If the unit number is configured and there are no other devices using the unit number, then the switch starts using the configured unit number.
- If the switch detects that the maximum number of units already exist in the stack making it unable to assign a unit number, then the switch sets its unit number to *unassigned* and does not participate in the stack.

## **Adding a Switch to the Stack**

When adding a new member to a stack, make sure that only the stack cables, and no network cables, are connected before powering up the new unit. Stack port configuration is stored on the member units. If stacking over Ethernet ports (Dell EMC Networking N1100-ON and N1500 Series only), configure the ports on the unit to be added to the stack as stacking ports and power the unit off prior to connecting the stacking cables. Make sure the links are not already connected to any ports of that unit. This is important because if STP is enabled and any links are UP, the STP reconvergence will take place as soon as the link is detected.

After the stack cables on the new member are connected to the stack, the units can be powered up, beginning with the unit directly attached to the currently powered-up unit. Always power up new stack units closest to an existing powered unit first. Do not connect a new member to the stack after it is powered up. Never connect two functional, powered-up stacks together. Hot insertion of units into a stack is not supported.

If a new switch is added to a stack of switches that are powered and running and already have an elected management unit in the stack, the newly added switch becomes a stack member rather than the management unit in the stack. Use the **boot auto-copy-sw** command on the management unit in the stack to enable automatic firmware upgrade of newly added switches. If a firmware mismatch is detected, the newly added switch does not fully join the stack and holds until it is upgraded to the same firmware version as the management unit in the stack. After firmware synchronization finishes, the running configuration of the newly added unit is overwritten with the configuration of the management unit in the stack. Stack port configuration is always stored on the local unit and may be updated with preconfiguration information from the management unit in the stack when the unit joins the stack.

Information about a stack member and its ports can be preconfigured before the unit is added to the stack. The preconfiguration takes place on the management unit in the stack. If there is saved configuration information on the management unit in the stack for the newly added unit, the management unit in the stack applies the configuration to the new unit; otherwise, the management unit in the stack applies the default configuration to the new unit.

## **Removing a Switch from the Stack**

Prior to removing a member from a stack, check that other members of the stack will not become isolated from the stack due to the removal. Check the stack-port error counters to ensure that a stack configured in a ring topology can establish a communication path around the member to be removed.

The main point to remember when removing a unit from the stack is to disconnect all the links on the stack member to be removed. Also, be sure to take the following actions:

- Remove all the STP participating ports and wait to stabilize the STP.
- Remove all the member ports of any Port-Channels (LAGs) so there will not be any control traffic destined to those ports connected to this member.
- Statically re-route any traffic going through this unit.

When a unit in the stack fails, the management unit in the stack removes the failed unit from the stack. The failed unit reboots with its original running-config. If the stack is configured in a ring topology, then the stack

automatically routes around the failed unit. If the stack is not configured in a ring topology, then the stack may split, and the isolated members will reboot and re-elect a new management unit in the stack. No changes or configuration are applied to the other stack members; however, the dynamic protocols will try to reconverge as the topology could change because of the failed unit.

If you remove a unit and plan to renumber the stack, issue a **no member unit** command in Stack Configuration mode to delete the removed switch from the configured stack member information.

### **How is the Firmware Updated on the Stack?**

When adding a new switch to a stack, the Stack Firmware Synchronization feature, if enabled, automatically synchronizes the firmware version with the version running on the management unit in the stack per the configuration on the primary switch. The synchronization operation may result in either upgrade or downgrade of firmware on the mismatched stack member. Use the **boot auto-copy-sw** command to enable stack firmware synchronization (SFS).

Upgrading the firmware on a stack of switches is the same as upgrading the firmware on a single switch. After downloading a new image by using the File Download page or **copy** command, the downloaded image is distributed to all the connected units of the stack. For more information about downloading and installing images, see "Images and File Management" on page 551. When copying firmware onto the switch in a stacked configuration, use the **show sfs** and **show version** commands to check the status of stack firmware synchronization prior to a reboot.

### **What is Stacking Standby?**

The standby unit may be preconfigured or automatically selected. If the current management unit in the stack fails, the standby unit becomes the management unit in the stack. If no switch is preconfigured as the standby unit, the software automatically selects a standby unit from among the existing stack units.

When the failed primary resumes normal operation, it joins the stack as a member (not as the primary) if the new management unit in the stack has already been elected.

The management unit in the stack copies its running configuration to the standby unit whenever it changes (subject to some restrictions to reduce overhead). This enables the standby unit to take over the stack operation with minimal interruption if the management unit in the stack becomes unavailable.

Operational state synchronization also occurs:

- when the running configuration is saved to the startup configuration on the management unit in the stack.
- when the standby unit changes.

## **What is Nonstop Forwarding?**

Networking devices, such as the Dell EMC Networking N-Series switches, are often described in terms of three semi-independent functions called the forwarding plane, the control plane, and the management plane. The forwarding plane forwards data packets and is implemented in hardware. The control plane is the set of protocols that determine how the forwarding plane should forward packets, deciding which data packets are allowed to be forwarded and where they should go. Application software on the management unit in the stack acts as the control plane. The management plane is application software running on the management unit in the stack that provides interfaces allowing a network administrator to configure the device.

The Nonstop Forwarding (NSF) feature allows the forwarding plane of stack units to continue to forward packets while the control and management planes restart as a result of a power failure, hardware failure, or software fault on the management unit in the stack. This type of operation is called nonstop forwarding (NSF). When the management unit in the stack fails, only the switch ASICs and processor on the management unit in the stack need to be restarted.

To prevent adjacent networking devices from rerouting traffic around the restarting device, the NSF feature uses the following three techniques:

- 1** A protocol can distribute a part of its control plane across stack units so that the protocol can give the appearance that it is still functional during the restart.
- 2** A protocol may enlist the cooperation of its neighbors through a technique known as graceful restart.

- 3 A protocol may simply restart after the failover if neighbors react slowly enough that they will not normally detect the outage.

The NSF feature enables the management unit in the stack unit to synchronize the running-config within 60 seconds after a configuration change has been made. However, if a lot of configuration changes happen concurrently, NSF uses a back-off mechanism to reduce the load on the switch. In this case, the management unit in the stack will attempt resynchronization no more often than once every 120 seconds.

The **show nsf** command output includes information about when the next running-config synchronization will occur.

### Initiating a Failover

The NSF feature allows the administrator to initiate a failover using the **initiate failover** command. This method is preferred over the **reload unit** command as it ensures synchronization of the management unit in the stack and standby unit.

Initiating a failover reloads the management unit in the stack, triggering the standby unit to take over. Before the failover, the management unit in the stack pushes application data and other important information to the standby unit. Although the handoff is controlled and causes minimal network disruption, some ephemeral application state is lost, such as pending timers and other pending internal events. Use the **show nsf** command to view the stack checkpoint status prior to reloading a stack member. Do not reload while a checkpoint operation is in progress.

Always check the stack health before failing over to the standby unit. Use the **show switch stack-ports counters** command to verify that the stack ports are up and no errors are present. Resolve any error conditions prior to failing over a management unit in the stack. Use the **show switch stack-ports stack-path** command to verify the reachability of all stack units. If any units are not reachable, the stack may split during a failover.

### Checkpointing

Switch applications (features) that build up a list of data such as neighbors or clients can significantly improve their restart behavior by remembering this data across a warm restart. This data can either be stored persistently, as in

the case of configuration data, or the management unit in the stack can checkpoint this data directly to the standby unit active processes, as in the case of operational data.

Use the `show nsf` command to view the stack checkpoint status prior to reloading a stack member. Do not reload while a checkpoint operation is in progress.

The NSF checkpoint service allows the management unit in the stack to communicate startup configuration data to the standby unit in the stack. When the stack selects a standby unit, the checkpoint service notifies applications to start a complete checkpoint. After the initial checkpoint is done, applications checkpoint changes to their data every 120 seconds.


 **NOTE:** The switch cannot guarantee that a standby unit has exactly the same data that the management unit in the stack has when it fails. For example, the management unit in the stack might fail before the checkpoint service gets data to the standby if an event occurs shortly before a failover.

Table 8-1 lists the applications on the switch that checkpoint data and describes the type of data that is checkpointed.

**Table 8-1. Applications that Checkpoint Data**

<b>Application</b>	<b>Checkpointed Data</b>
ARP	Dynamic ARP entries
Auto VOIP	Calls in progress
Captive Portal	Authenticated clients
DHCP server	Address bindings (persistent)
DHCP snooping	DHCP bindings database
DOT1Q	Internal VLAN assignments
DOT1S	Spanning tree port roles, port states, root bridge, etc.
802.1X	Authenticated clients
DOT3ad	Port states
IGMP/MLD Snooping	Multicast groups, list of router ports, last query data for each VLAN
IPv6 NDP	Neighbor cache entries



**Table 8-1. Applications that Checkpoint Data**

<b>Application</b>	<b>Checkpointed Data</b>
iSCSI	Connections
LLDP	List of interfaces with MED devices attached
OSPFv2	Neighbors and designated routers
OSPFv3	Neighbors and designated routers
Route Table Manager	IPv4 and IPv6 dynamic routes
SIM	The system's MAC addresses. System up time. IP address, network mask, default gateway on each management interface, DHCPv6 acquired IPv6 address.
Voice VLAN	VoIP phones identified by CDP or DHCP (not LLDP)

## Switch Stack MAC Addressing and Stack Design Considerations

The switch stack uses the MAC addresses assigned to the management unit in the stack.



**NOTE:** Each switch is assigned four consecutive MAC addresses. A stack of switches uses the MAC addresses assigned to the management unit in the stack.

If the backup unit assumes control due to a management unit in the stack failure or warm restart, the backup unit continues to use the MAC addresses of the original management unit in the stack. This reduces the amount of disruption to the network because ARP and other Layer-2 entries in neighbor tables remain valid after the failover to the backup unit.

Stack units should always be connected with a ring topology (or other redundant topology), so that the loss of a single stack link does not divide the stack into multiple stacks. If a stack is partitioned such that some units lose all connectivity to other units, then both parts of the stack start using the same MAC addresses. This can cause severe problems in the network.

If removing the management unit in the stack from a stack for use in a different place in the network, make sure to power down the whole stack before redeploying the management unit in the stack so that the stack members do not continue to use the MAC address of the redeployed primary switch.

## NSF Network Design Considerations

A network can be designed to take maximum advantage of NSF. For example, by distributing a LAG's member ports across multiple units, the stack can quickly switch traffic from a port on a failed unit to a port on a surviving unit. When a unit fails, the forwarding plane of surviving units removes LAG members on the failed unit so that it only forwards traffic onto LAG members that remain up. If a LAG is left with no active members, the LAG goes down. To prevent a LAG from going down, configure LAGs with members on multiple units within the stack, when possible. If a stack unit fails, the system can continue to forward on the remaining members of the stack.

If the switch stack performs VLAN routing, another way to take advantage of NSF is to configure multiple “best paths” to the same destination on different stack members. If a unit fails, the forwarding plane removes Equal Cost Multipath (ECMP) next hops on the failed unit from all unicast forwarding table entries. If the cleanup leaves a route without any next hops, the route is deleted. The forwarding plane only selects ECMP next hops on surviving units. For this reason, try to distribute links providing ECMP paths across multiple stack units.

## Why is Stacking Needed?

Stacking increases port count without requiring additional configuration. If you have multiple Dell EMC Networking N-Series switches, stacking them helps make management of the switches easier because you configure the stack as a single unit and do not need to configure individual switches.

## Default Stacking Values

Stacking is always enabled on Dell EMC Networking N-Series switches.

On the Dell EMC Networking N1100-ON/N1500 Series switches, by default, the 10G SFP+ ports are in Ethernet mode and must be configured to be used as stacking ports. Ports that are configured in stacking mode show as “detached” in the output of the **show interfaces status** command.





**NOTE:** N1124T-ON/N1148T-ON/N1124P-ON/N1148P-ON/N1500 10G SFP+ ports may only be configured as stacking in adjacent pairs, e.g. Te1/0/1 and Te1/0/2. If configuring all four ports as stacking, the pairs of stacking links must be connected to the same unit, i.e. both Te1/0/1-2 must connect to a single adjacent stack unit.

Configuring an Ethernet port as a stacking port changes the default configuration of the port. To determine the stacking configuration of a port, use the `show switch stack-ports` command. On the Dell EMC Networking N2000/N2100-ON/N3000E-ON Series switches, there are two fixed stacking ports in the rear of the switch. The N3100-ON supports a pluggable stacking module in the rear. Stacking on Ethernet ports is not supported. The fixed stacking ports show as `TwentyGigabitStacking` and are abbreviated `Tw`.

NSF is enabled by default. NSF can be disabled to redirect the CPU resources consumed by data checkpointing; however, this is ill-advised, as checkpointing consumes almost no switch resources. Checkpointing only occurs when a backup unit is elected, so there is no need to disable the NSF feature on a standalone switch. When a new unit is added to the stack, the new unit is given the configuration of the stack, including the NSF setting. OSPF implements a separate graceful restart control that enables NSF for OSPF. OSPF graceful restart is not enabled by default.

# Managing and Monitoring the Stack (Web)

This section provides information about the OpenManage Switch Administrator pages for configuring and monitoring stacking on Dell EMC Networking N1100-ON, N1500, N2000, N2100-ON, N3000E-ON, N3100-ON, and N3200-ON Series switches. For details about the fields on a page, click  at the top of the Dell EMC OpenManage Switch Administrator web page.

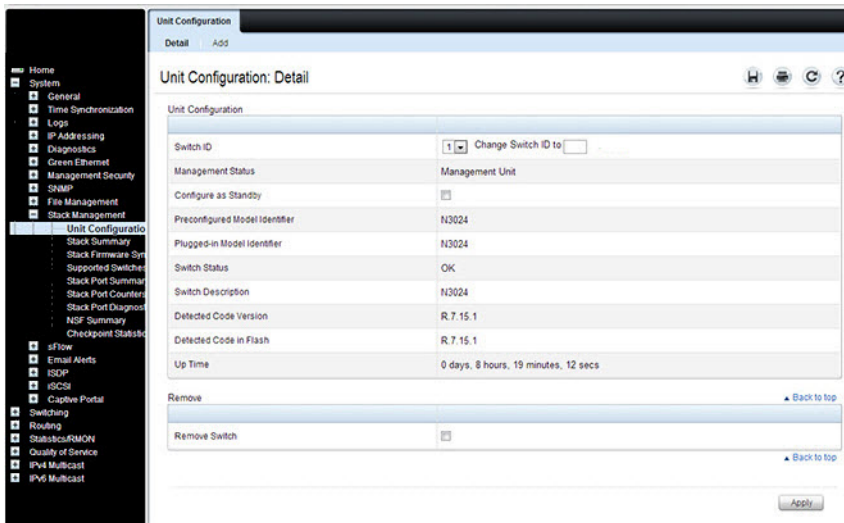
 **NOTE:** Changes made on the Stacking configuration pages take effect only after the device is reset.

## Unit Configuration

Use the **Unit Configuration** page to change the unit number and unit type (Management, Member, or Standby).

To display the **Unit Configuration** page, click **System** → **Stack Management** → **Unit Configuration** in the navigation panel. For the N30xx series switches, stack size is limited to 8.

**Figure 8-2. Stack Unit Configuration**



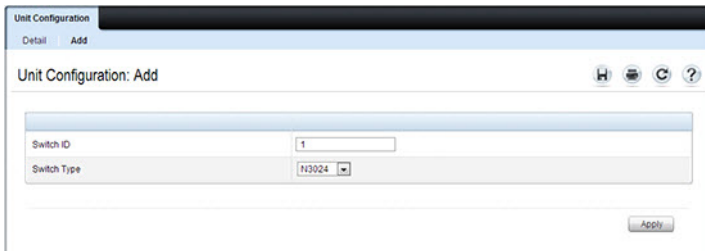
## Changing the ID or Switch Type for a Stack Member

To change the switch ID or type:

- 1 Open the **Unit Configuration** page.
- 2 Click **Add** to display the **Add Unit** page.

For the N30xx series switches, stack size is limited to 8.

**Figure 8-3. Add Remote Log Server Settings**



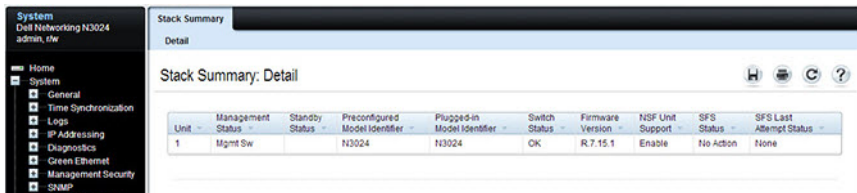
- 3 Specify the switch ID, and select the model number of the switch.
- 4 Click **Apply**.

## Stack Summary

Use the **Stack Summary** page to view a summary of switches participating in the stack.

To display the **Stack Summary** page, click **System** → **Stack Management** → **Stack Summary** in the navigation panel.

**Figure 8-4. Stack Summary**

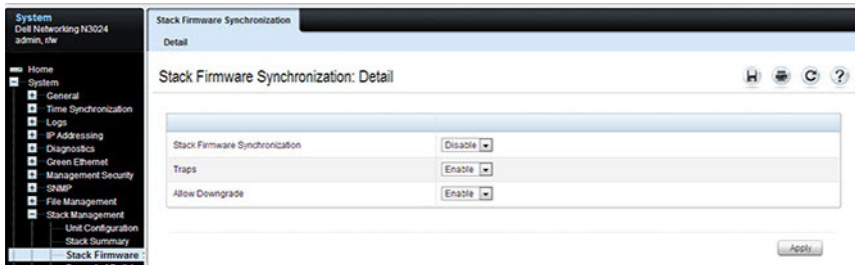


## Stack Firmware Synchronization

Use the **Stack Firmware Synchronization** page to control whether the firmware image on a new stack member can be automatically upgraded or downgraded to match the firmware image of the management unit in the stack.

To display the **Stack Firmware Synchronization** page, click **System** → **Stack Management** → **Stack Firmware Synchronization** in the navigation panel.

**Figure 8-5. Stack Firmware Synchronization**

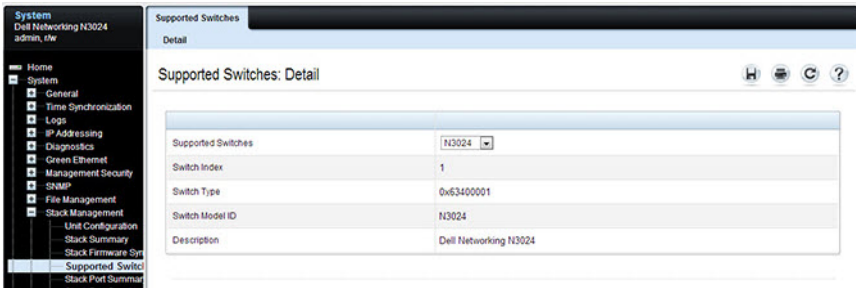


## Supported Switches

Use the **Supported Switches** page to view information regarding each type of supported switch for stacking, and information regarding the supported switches.

To display the **Supported Switches** page, click **System** → **Stack Management** → **Supported Switches** in the navigation panel.

**Figure 8-6. Supported Switches**



## Stack Port Summary

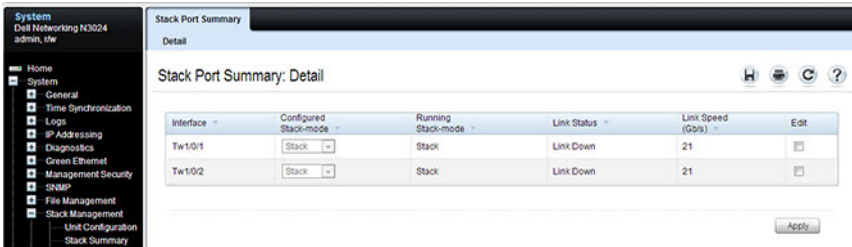
Use the **Stack Port Summary** page to configure the stack-port mode and to view information about the stackable ports. This screen displays the unit, the stackable interface, the configured mode of the interface, the running mode as well as the link status and link speed of the stackable port.



**NOTE:** By default the ports are configured to operate as Ethernet ports. To configure a port as a stack port on the N1124-ON/N1148-ON, or N1500 Series switches, the Configured Stack Mode setting must be changed from Ethernet to Stack.

To display the **Stack Port Summary** page, click **System** → **Stack Management** → **Stack Port Summary** in the navigation panel.

**Figure 8-7. Stack Port Summary**



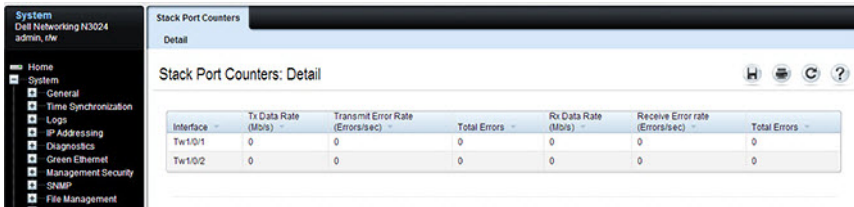


## Stack Port Counters

Use the **Stack Port Counters** page to view the transmitted and received statistics, including data rate and error rate.

To display the **Stack Port Counters** page, click **System** → **Stack Management** → **Stack Port Counters** in the navigation panel.

**Figure 8-8. Stack Port Counters**



The screenshot displays the 'Stack Port Counters: Detail' page. On the left is a navigation menu with options like Home, System, General, Time Synchronization, Logs, IP Addressing, Diagnostics, Green Ethernet, Management Security, SNMP, and File Management. The main content area shows a table with the following data:


Interface	Tx Data Rate (Mbps)	Transmit Error Rate (Errors/sec)	Total Errors	Rx Data Rate (Mbps)	Receive Error rate (Errors/sec)	Total Errors
Tw1/0/1	0	0	0	0	0	0
Tw1/0/2	0	0	0	0	0	0

## Stack Port Diagnostics

The **Stack Port Diagnostics** page is intended for Field Application Engineers (FAEs) only.

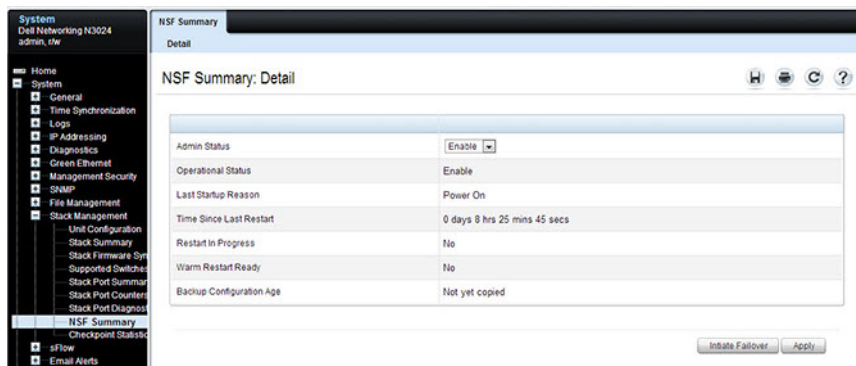
## NSF Summary

Use the **NSF Summary** page to change the administrative status of the NSF feature and to view NSF information.

 **NOTE:** The OSPF feature uses NSF to enable the hardware to continue forwarding IPv4 packets using OSPF routes while a backup unit takes over the management unit in the stack responsibility. To configure NSF on a stack that uses OSPF or OSPFv3, see "NSF OSPF Configuration" on page 1290 and "NSF OSPFv3 Configuration" on page 1307.

To display the NSF Summary page, click **System** → **Stack Management** → **NSF Summary** in the navigation panel.

**Figure 8-9. NSF Summary**



To cause the master unit to failover to the standby unit, click **Initiate Failover**. The failover results in a warm restart of the management unit in the stack. Initiating a failover reloads the management unit in the stack, triggering the backup unit to take over.

## Checkpoint Statistics

Use the Checkpoint Statistics page to view information about checkpoint messages generated by the management unit in the stack.

To display the Checkpoint Statistics page, click **System** → **Stack Management** → **Checkpoint Statistics** in the navigation panel.

**Figure 8-10. Checkpoint Statistics**

The screenshot displays the 'Checkpoint Statistics: Detail' page. The left sidebar shows the navigation menu with 'System' expanded and 'Checkpoint Statistics' selected. The main content area contains a table with the following data:

Messages Checkpointed	0
Bytes Checkpointed	0
Time Since Counters Cleared	0 days 8 hrs 26 mins 29 secs
Checkpoint Message Rate	0.000 msg/sec
Last 10-second Message Rate	0.0 msg/sec
Highest 10-second Message Rate	0.0 msg/sec

A 'Clear' button is located at the bottom right of the table area.

# Managing the Stack (CLI)


This section provides information about the commands for managing the stack and viewing information about the switch stack. For more information about these commands, see the *Dell EMC Networking N1100-ON, N1500, N2000, N2100-ON, N2200-ON, N3000E-ON, N3100-ON, and N3200-ON Series Switches CLI Reference Guide* at [www.dell.com/support](http://www.dell.com/support).

## Configuring Stack Member, Stack Port, SFS and NSF Settings

Use the following commands to configure stacking and SFS settings.

Command	Purpose
<code>configure</code>	Enter Global Configuration mode.
<code>switch <i>current_ID</i></code> <code>renumber <i>new_ID</i></code>	Change the switch ID number. Changing the ID number causes all switches in the stack to be reset to perform management unit in the stack renumbering. The running configuration is cleared when the units reset.
<code>stack</code>	Enter Global Stack Configuration mode.
<code>initiate failover</code>	Move the management switch functionality from the primary switch to the standby switch.
<code>standby <i>unit</i></code>	Specify the stack member that will come up as the primary if a stack failover occurs.
<code>set description <i>unit</i></code> <code>&lt;<i>text</i>&gt;</code>	Configure a description for the specified stack member.

Command	Purpose
<code>member unit SID</code>	<p>Add a switch to the stack and specify the model of the new stack member.</p> <ul style="list-style-type: none"> <li>• <i>unit</i> - The switch unit ID</li> <li>• <i>SID</i> - The index into the database of the supported switch types, indicating the type of the switch being preconfigured.</li> </ul> <p><b>Note:</b> Member configuration displayed in the running config may be learned from the physical stack. Member configuration is not automatically saved in the startup configuration. Save the configuration to retain the current member settings.</p> <p>To view the SID associated with the supported switch types, use the <b>show supported switchtype</b> command in Privileged Exec mode.</p>
<code>stack-port {tengigabitethernet   twentygigabitethernet} unit/slot/port {ethernet   stack   shutdown} [speed {40g   21g}]</code>	<p>Set the mode of the port to either Ethernet or stacking (Dell EMC Networking N1124-ON/N1148-ON, and N1500 Series only). The speed option is only available on the N2100/N3100 Series switches.</p>
<code>nsf</code>	<p>Enable nonstop forwarding on the stack. (Enabled by default.)</p>
<code>exit</code>	<p>Exit to Global Config mode.</p>
<code>boot auto-copy-sw</code>	<p>Enable the Stack Firmware Synchronization feature.</p>
<code>boot auto-copy-sw allow-downgrade</code>	<p>Allow the firmware version on the newly added stack member to be downgraded if the firmware version on manager is older. Config migration is not assured for firmware downgrade.</p>
<code>exit</code>	<p>Exit to Privileged Exec mode.</p>
<code>show auto-copy-sw</code>	<p>View the Stack Firmware Synchronization settings for the stack.</p>
<code>reload unit</code>	<p>If necessary, reload the specified stack member.</p>

 **NOTE:** The OSPF feature uses NSF to enable the hardware to continue forwarding IPv4 packets using OSPF routes while a backup unit takes over responsibility as management unit in the stack. Additional NSF commands are available in OSPF and OSPFv3 command modes. For more information, see "NSF OSPF Configuration" on page 1290 and "NSF OSPFv3 Configuration" on page 1307

## Viewing and Clearing Stacking and NSF Information

Use the following commands to view stacking information and to clear NSF statistics.

Command	Purpose
<code>show switch [<i>stack-member-number</i>]</code>	View information about all stack members or the specified member.
<code>show switch stack-standby</code>	View the ID of the switch that will assume the role of the management unit in the stack if it goes down.
<code>show switch stack-ports</code>	View information about the stacking ports.
<code>show switch stack-ports counters</code>	View the statistics about the data the stacking ports have transmitted and received.
<code>show switch stack-ports stack-path {&lt;unit&gt;   all}</code>	View the path that packets take from one stack member to another.
<code>show supported switchtype [&lt;switchindex&gt;]</code>	View the Dell EMC Networking models that are supported in the stack and the switch index (SID) associated with each model. The information may vary, depending on the loaded firmware (Adv/AdvLite).
<code>show nsf</code>	View summary information about the NSF state of the primary and standby switches.
<code>show checkpoint statistics</code>	View information about checkpoint messages generated by the management unit in the stack.
<code>clear checkpoint statistics</code>	Reset the checkpoint statistics counters to zero.

## Connecting to the Management Console from a Stack Member

From the CLI Unavailable prompt, use the following command to connect the console session to the local unit.

Command	Purpose
<code>connect [unit]</code>	Connect the console on the remote unit to the local unit

## Stacking and NSF Usage Scenarios

Only a few settings are available to control the stacking configuration, such as the designation of the standby unit or enabling/disabling NSF. The examples in this section describe how the stacking and NSF feature act in various environments.

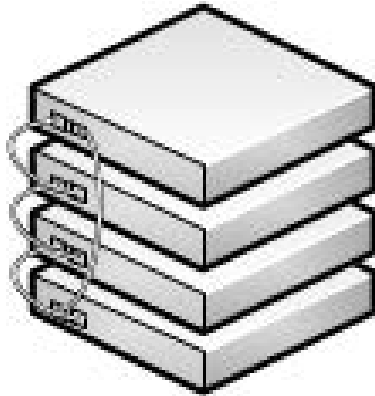
This section contains the following examples:

- Basic Failover
- Preconfiguring a Stack Member
- NSF in the Data Center
- NSF and VoIP
- NSF and DHCP Snooping
- NSF and the Storage Access Network
- NSF and Routed Access

### Basic Failover

In this example, the stack has four members that are connected in a ring topology, as Figure 8-11 shows.

**Figure 8-11. Basic Stack Failover**



When all four units are up and running, the `show switch` CLI command gives the following output:

```
console#show switch
```

SW	Management Status	Standby Status	Preconfig Model ID	Plugged-in Model ID	Switch Status	Code Version
1	Stack Member	Opr Stby	N3048	N3048	OK	6.0.0.0
2	Stack Member		N3048	N3048	OK	6.0.0.0
3	Mgmt Switch		N3048	N3048	OK	6.0.0.0
4	Stack Member		N3048	N3048	OK	6.0.0.0

At this point, if Unit 2 is powered off or rebooted due to an unexpected failure, `show switch` gives the following output:

```
console#show switch
```

SW	Management Status	Standby Status	Preconfig Model ID	Plugged-in Model ID	Switch Status	Code Version
1	Stack Member	Opr Stby	N3048	N3048	OK	6.0.0.0
2	Unassigned		N3048		Not Present	0.0.0.0
3	Mgmt Switch		N3048	N3048	OK	6.0.0.0
4	Stack Member		N3048	N3048	OK	6.0.0.0



When the failed unit resumes normal operation, the previous configuration that exists for that unit is reapplied by the management unit in the stack.

To permanently remove the unit from the stack, enter into Stack Config Mode and use the member command, as the following example shows.

```
console#configure
console(config)#stack
console(config-stack)#no member 2
console(config-stack)#exit
console(config)#exit
console#show switch
```

SW	Management Status	Standby Status	Preconfig Model ID	Plugged-in Switch Model ID	Switch Status	Code Version
1	Mgmt Sw		N2128PX	N2128PX	OK	6.3.6.4
3	Stack Mbr		N2128PX	N2128PX	OK	6.3.6.4
4	Stack Mbr		N2128PX	N2128PX	OK	6.3.6.4

## Preconfiguring a Stack Member

To preconfigure a stack member before connecting the physical unit to the stack, use the **show supported switchtype** command to obtain the switch model ID (SID) of the unit to be added.

The example in this section demonstrates pre-configuring a stand-alone Dell EMC Networking N-Series switch.

To configure the switch:

- 1 View the list of SIDs to determine which SID identifies the switch to preconfigure. The following is the output on the switches. The supported switch types vary by switch series and loaded image.

```
console#show supported switchtype
```

```
SID          Switch Model ID
-----
1    N3024
2    N3024F
3    N3024P
4    N3048
5    N3048P
6    N3048EP-ON
7    N3132PX-ON
```

The following is the output on Dell EMC Networking N1500 Series switches:

```
console#show supported switchtype
```

```
SID Switch Model ID
---
1 N1524
2 N1524P
3 N1548
4 N1548P
```

- 2 Preconfigure the switch (SID = 2) as member number 2 in the stack.

```
console#configure
console(config)#stack
console(config-stack)#member 2 2
console(config-stack)#exit
console(config)#exit
```

- 3 Confirm the stack configuration. Some of the fields have been omitted from the following output due to space limitations.

```
console#show switch
```

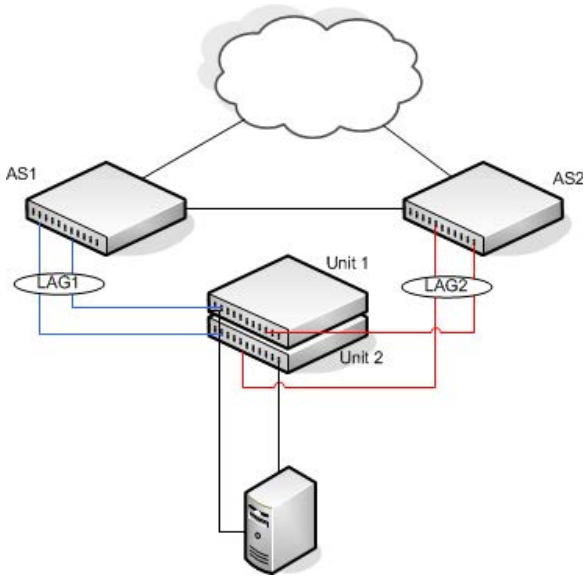
Management SW Status	Standby Status	Preconfig Model ID	Plugged-in Model ID	Switch Status	Code Version
---	---	-----	-----	-----	-----
1 Mgmt Sw		N3048	N3048	OK	6.0.0.0

Preconfigured switches may be removed from the configuration using the **no member** command. Only switches that are not active members of the stack may be removed.

## NSF in the Data Center

Figure 8-12 illustrates a data center scenario, where the stack of two Dell EMC Networking N-Series switches acts as an access switch. The access switch is connected to two aggregation switches, AS1 and AS2. The stack has a link from two different units to each aggregation switch, with each pair of links grouped together in a LAG. The two LAGs and link between AS1 and AS2 are members of the same VLAN. Spanning tree is enabled on the VLAN. Assume spanning tree selects AS1 as the root bridge. Assume the LAG to AS1 is the root port on the stack and the LAG to AS2 is discarding. Unit 1 is the management unit in the stack. If unit 1 fails, the stack removes the Unit 1 link to AS1 from its LAG. The stack forwards outgoing packets through the Unit 2 link to AS1 during the failover. During the failover, the stack continues to send BPDUs and LAG PDUs on its links on Unit 2. The LAGs stay up (with one remaining link in each), and spanning tree on the aggregation switches does not see a topology change.

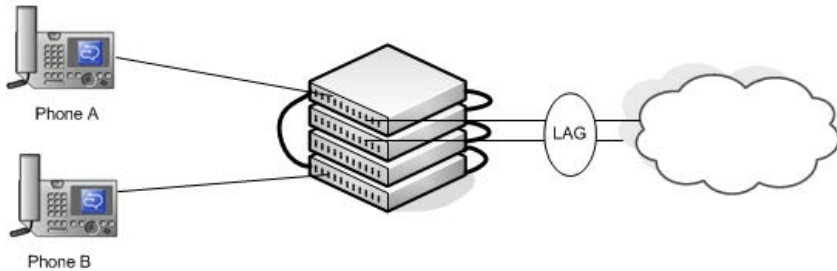
**Figure 8-12. Data Center Stack Topology**



## NSF and VoIP

Figure 8-13 shows how NSF maintains existing voice calls during a failure of the management unit in the stack. Assume the top unit is the management unit in the stack. When the management unit in the stack fails, the call from phone A is immediately disconnected. The call from phone B continues. On the uplink, the forwarding plane removes the failed LAG member and continues using the remaining LAG member. If phone B has learned VLAN or priority parameters through LLDP-MED, it continues to use those parameters. The stack resumes sending LLDPDUs with MED TLVs once the control plane restarts. Phone B may miss an LLDPDU from the stack, but should not miss enough PDUs to revert its VLAN or priority, assuming the administrator has not reduced the LLDPDU interval or hold count. If phone B is receiving quality of service from policies installed in the hardware, those policies are retained across a restart of the management unit in the stack.

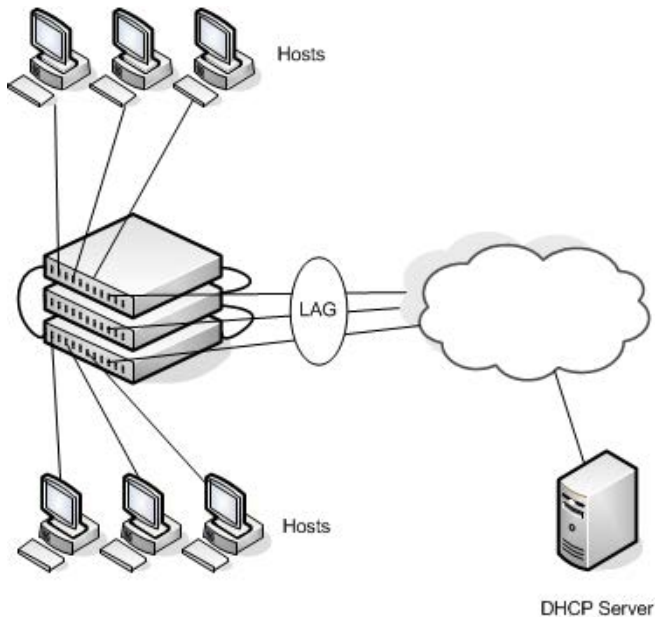
**Figure 8-13. NSF and VoIP**



## NSF and DHCP Snooping

Figure 8-14 illustrates a Layer-2 access switch running DHCP snooping. DHCP snooping only accepts DHCP server messages on ports configured as *trusted* ports. DHCP snooping listens to DHCP messages to build a bindings database that lists the IP address the DHCP server has assigned to each host. IP Source Guard (IPSG) uses the bindings database to filter data traffic in hardware based on source IP address and source MAC address. Dynamic ARP Inspection (DAI) uses the bindings database to verify that ARP messages contain a valid sender IP address and sender MAC address. DHCP snooping checkpoints its bindings database.

**Figure 8-14. NSF and DHCP Snooping**



If the management unit in the stack fails, all hosts connected to that unit lose network access until that unit reboots. The hardware on surviving units continues to enforce source filters IPSG installed prior to the failover. Valid hosts continue to communicate normally. During the failover, the hardware continues to drop data packets from unauthorized hosts so that security is not compromised.

If a host is in the middle of an exchange with the DHCP server when the failover occurs, the exchange is interrupted while the control plane restarts. When DHCP snooping is enabled, the hardware traps all DHCP packets to the CPU. The control plane drops these packets during the restart. The DHCP client and server retransmit their DHCP messages until the control plane has resumed operation and messages get through. Thus, DHCP snooping does not miss any new bindings during a failover.

As DHCP snooping applies its checkpointed DHCP bindings, IPSG confirms the existence of the bindings with the hardware by reinstalling its source IP address filters.

If Dynamic ARP Inspection is enabled on the access switch, the hardware traps ARP packets to the CPU on untrusted ports. During a restart, the control plane drops ARP packets. Thus, new traffic sessions may be briefly delayed until after the control plane restarts.

If IPSG is enabled and a DHCP binding is not checkpointed to the backup unit before the failover, that host will not be able to send data packets until it renews its IP address lease with the DHCP server.

## **NSF and the Storage Access Network**

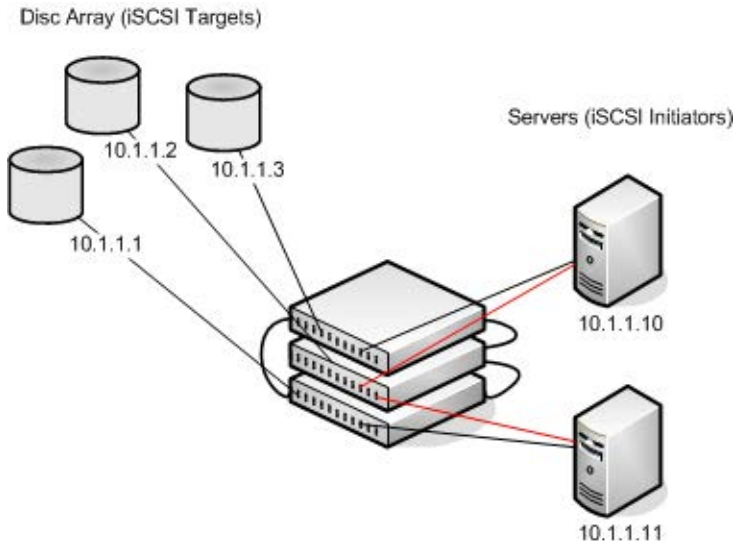
Figure 8-15 illustrates a stack of three Dell EMC Networking N-Series switches connecting two servers (iSCSI initiators) to a disk array (iSCSI targets). There are two iSCSI connections as follows:

Session A: 10.1.1.10 to 10.1.1.3

Session B: 10.1.1.11 to 10.1.1.1

An iSCSI application running on the management unit in the stack (the top unit in the diagram) has installed priority filters to ensure that iSCSI traffic that is part of these two sessions receives priority treatment when forwarded in hardware.

**Figure 8-15. NSF and a Storage Area Network**

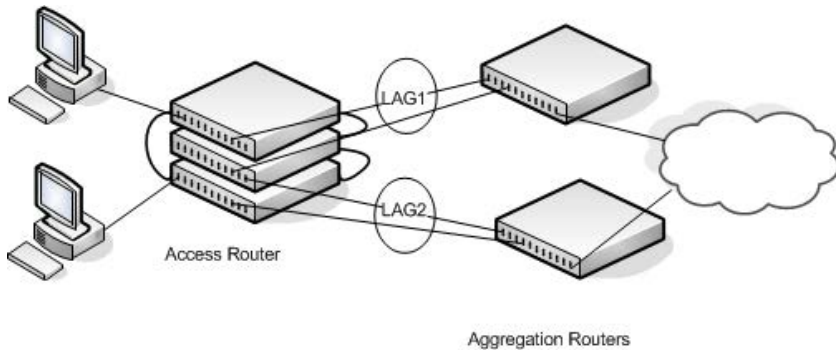


When the management unit in the stack fails, session A drops. The initiator at 10.1.1.10 detects a link down on its primary NIC and attempts to reestablish the session on its backup NIC to a different IP address on the disk array. The hardware forwards the packets to establish this new session, but assuming the session is established before the control plane is restarted on the backup unit, the new session receives no priority treatment in the hardware. Session B remains established and fully functional throughout the restart and continues to receive priority treatment in the hardware.


## NSF and Routed Access

Figure 8-16 shows a stack of three units serving as an access router for a set of hosts. Two LAGs connect the stack to two aggregation routers. Each LAG is a member of a VLAN routing interface. The stack has OSPF and PIM adjacencies with each of the aggregation routers. The top unit in the stack is the management unit.

**Figure 8-16. NSF and Routed Access**



If the management unit in the stack fails, its link to the aggregation router is removed from the LAG. When the control plane restarts, both routing interfaces come back up by virtue of the LAGs coming up. OSPF sends grace LSAs to inform its OSPF neighbors (the aggregation routers) that it is going through a graceful restart.

 **NOTE:** The graceful restart feature for OSPF is disabled by default. For information about the web pages and commands to configure NSF for OSPF or OSPFv3, see "OSPF and OSPFv3" on page 1263.

The grace LSAs reach the neighbors before they drop their adjacencies with the access router. PIM starts sending hello messages to its neighbors on the aggregation routers using a new generation ID to prompt the neighbors to quickly resend multicast routing information. PIM neighbors recognize the new generation ID and immediately relay the group state back to the restarting router. IGMP sends queries to relearn the hosts' interest in multicast groups. IGMP tells PIM the group membership, and PIM sends



JOIN messages upstream. The control plane updates the driver with checkpointed unicast routes. The forwarding plane reconciles Layer-3 hardware tables.

The OSPF graceful restart finishes, and the control plane deletes any stale unicast routes not relearned at this point. The forwarding plane reconciles Layer-3 multicast hardware tables. Throughout the process, the hosts continue to receive their multicast streams, possibly with a short interruption as the top aggregation router learns that one of its LAG members is down. The hosts see no more than a 50 ms interruption in unicast connectivity.



# Authentication, Authorization, and Accounting

## Dell EMC Networking N-Series Switches

This chapter describes how to control access to the switch management interface using authentication and authorization. These services can also be used to restrict or allow network access when used in conjunction with IEEE 802.1x. It also describes how to record this access using accounting. Together the three services are referred to by the acronym AAA.

The topics covered in this chapter include:

- AAA Introduction
- Authentication
- Authorization
- Accounting
- IEEE 802.1X
- Captive Portal

## AAA Introduction

AAA is a framework for configuring management security in a consistent way. Three services make up AAA:

- Authentication—Validates the user identity. Authentication takes place before the user is allowed access to switch services.
- Authorization—Determines which services the user is allowed to access. Examples of services are access to the switch management console and access to network services.
- Accounting—Collects and sends security information about switch management console users and switch management commands

Each service is configured using method lists. Method lists define how each service is to be performed by specifying the methods available to perform the service. The first method in a list is tried first. If the first method returns an

error, the next method in the list is tried. This continues until all methods in the list have been attempted. If no method can perform the service, then the service fails. A method may return an error due to lack of network access, misconfiguration of a server, and other reasons. If there is no error, the method returns success if the user is allowed access to the service and failure if the user is not.

AAA gives the user flexibility in configuration by allowing different method lists to be assigned to different access lines. In this way, it is possible to configure different security requirements for the serial console than for Telnet, for example.

## Methods

A method performs authentication or authorization for the configured service. Not every method is available for every service. Some methods require a username and password and other methods only require a password.

Table 9-1 summarizes the various methods:

**Table 9-1. AAA Methods**

<b>Method</b>	<b>Username?</b>	<b>Password?</b>	<b>Can Return an Error?</b>
enable	no	yes	yes
ias	yes	yes	no
line	no	yes	yes
local	yes	yes	yes
none	no	no	no
radius	yes	yes	yes
tacacs	yes	yes	yes

Methods that never return an error cannot be followed by any other methods in a method list.

- The **enable** method uses the enable password. If there is no enable password defined, then the enable method will return an error.
- The **ias** method is a special method that is only used for 802.1X. It uses an internal database (separate from the local user database) that acts like an 802.1X authentication server. This method never returns an error. It will always authenticate or deny a user.
- The **line** method uses the password for the access line on which the user is accessing the switch. If there is no line password defined for the access line, then the line method will return an error.
- The **local** method uses the local user database. If the user password does not match, then access is denied. This method returns an error if the user name is not present in the local user database.
- The **none** method does not perform any service, but instead always returns a result as if the service had succeeded. This method never returns an error. If none is configured as a method, the user will always be authenticated and allowed to access the switch.
- The **radius** and **tacacs** methods communicate with servers running the RADIUS and TACACS+ protocols, respectively. These methods can return an error if the switch is unable to contact the server.

## Method Lists

The method lists shown in Table 9-2 are defined by default. They cannot be deleted, but they can be modified. Using the “no” command on these lists will return them to their default configuration.

**Table 9-2. Default Method Lists**

AAA Service (type)	List Name	List Methods
Authentication (login)	defaultList	none
Authentication (login)	networkList	local
Authentication (enable)	enableList	enable none
Authentication (enable)	enableNetList	enable
Authorization (exec)	dfltExecAuthList	none

**Table 9-2. Default Method Lists (Continued)**

<b>AAA Service (type)</b>	<b>List Name</b>	<b>List Methods</b>
Authorization (commands)	dfltCmdAuthList	none
Accounting (exec)	dfltExecList	tacacs (start-stop)
Accounting (commands)	dfltCmdList	tacacs (stop-only)

## **Access Lines**

There are five access lines: console, Telnet, SSH, HTTP, and HTTPS. HTTP and HTTPS are not configured using AAA method lists. Instead, the authentication list for HTTP and HTTPS is configured directly (authorization and accounting are not supported). The default method lists for both the HTTP and HTTPS access lines consist of only the local method. Each of the other access lines may be assigned method lists independently for the AAA services.

The SSH line has built-in authentication beyond that configured by the administrator.

In the SSH protocol itself, there are multiple methods for authentication. These are not the authentication methods configured in AAA, but are internal to SSH itself. When an SSH connection is attempted, the challenge-response method is specified in the connection request.

The methods available for authentication using SSH are: host-based authentication, public key authentication, challenge-response authentication, and password authentication. Authentication methods are tried in the order specified above, although SSH-2 has a configuration option to change the default order.

Host-based SSH authentication is not supported by Dell EMC Networking N-Series switches. Use the Management ACL capability to perform the equivalent function.

Public key SSH authentication operates as follows:

The administrator first generates a pair of encryption keys, the “public” key and the “private” key. Messages encrypted with the private key can be decrypted only by the public key, and vice-versa. The administrator keeps the private key on his/her local machine, and loads the public key on to the switch. When the administrator attempts to log into the switch, the protocol sends a brief message, encrypted with the public key. If the switch can decrypt

the message (and can send back some proof that it has done so) then the response proves that switch must possess the public key, and user is authenticated without giving a username/password.

The public key method is implemented in the Dell EMC Networking N-Series switch as opposed to an external server. If the user does not present a certificate, it is not considered an error and authentication will continue with challenge-response authentication.

Challenge-response SSH authentication works as follows:

The switch sends an arbitrary “challenge” text and prompts for a response. SSH-2 allows multiple challenges and responses; SSH-1 is restricted to one challenge/response only. Examples of challenge-response authentication include BSD Authentication.

Finally, if all other authentication methods fail, SSH prompts the user for a password.

## Enabling SSH Access

The following example enables the switch to be accessed using SSH. If RSA or DSA keys exist, the switch will prompt to overwrite the keys as shown below. The RSA and DSA keys are used to negotiate the symmetric encryption algorithm used for the SSH session.

```
console(config)#crypto key generate rsa
Do you want to overwrite the existing RSA keys? (y/n):y
RSA key generation started, this may take a few minutes...
RSA key generation complete.
console(config)#crypto key generate dsa
Do you want to overwrite the existing DSA keys? (y/n):y
DSA key generation started, this may take a few minutes...
DSA key generation complete.
console(config)#ip ssh server
```

## Access Lines (AAA)

Table 9-3 shows the method lists assigned to the various access lines by default.

**Table 9-3. Default AAA Methods**

<b>AAA Service (type)</b>	<b>Console</b>	<b>Telnet</b>	<b>SSH</b>
Authentication (login)	defaultList	networkList	networkList
Authentication (enable)	enableList	enableList	enableList
Authorization (exec)	dfltExecAuthList	dfltExecAuthList	dfltExecAuthList
Authorization (commands)	dfltCmdAuthList	dfltCmdAuthList	dfltCmdAuthList
Accounting (exec)	none	none	none
Accounting (commands)	none	none	none

**Access Lines (Non-AAA)**

Table 9-4 shows the default configuration of the access lines that do not use method lists.

**Table 9-4. Default Configuration for Non-AAA Access Lines**

<b>Access Line</b>	<b>Authentication</b>	<b>Authorization</b>
HTTP	local	n/a
HTTPS	local	n/a
802.1X	none	none



# Authentication

Authentication is the process of validating a user's identity. During the authentication process, only identity validation is done. There is no determination made of which switch services the user is allowed to access. This is true even when RADIUS is used for authentication; RADIUS cannot perform separate transactions for authentication and authorization. However, the RADIUS server can provide attributes during the authentication process that are used in the authorization process.

## Authentication Access Types

There are three types of authentication access:

- **login**— Login authentication grants access to the switch if the user credentials are validated. Access is granted only at privilege level one.
- **enable**— Enable authentication grants access to a higher privilege level if the user credentials are validated for the higher privilege level. When RADIUS is used for enable authentication, the username for this request is always \$enab15\$. The username used to log into the switch is not used for RADIUS enable authentication.
- **dot1X**— 802.1X authentication is used to grant an 802.1X supplicant access to the network. For more information about 802.1X, see "Port and System Security" on page 705.

Table 9-5 shows the valid methods for each type of authentication:

**Table 9-5. Valid Methods for Authentication Access Types**

<b>Method</b>	<b>Login</b>	<b>Enable</b>	<b>802.1x</b>
enable	yes	yes	no
ias	no	no	yes
line	yes	yes	no
local	yes	no	no
none	yes	yes	yes
radius	yes	yes	yes
tacacs	yes	yes	no

# Authentication Manager

## Overview

The Authentication Manager supports the hierarchical configuration of host authentication methods on an interface. Use of the Authentication Manager is optional, but it is recommended when using multiple types of authentication on an interface, e.g., Captive Portal in conjunction with MAB or IEEE 802.1X. Dell switches support the following host authentication methods:

- IEEE 802.1x
- MAC Authentication Bypass (MAB)
- Captive portal

Using the Authentication Manager, the administrator can configure a list of authentication methods on a per-port basis. Authentication can be enabled or disabled. If authentication is disabled, then no authentication method is applied and the port is provided with open access. The default behavior is that authentication is disabled for all ports.

The configured authentication methods are attempted in list order. If an authentication method times out (an error), then the next configured method is attempted. If an authentication method fails, such as, an incorrect password was entered, then the next method is not attempted and authentication begins again from the first method. If all the methods return an error, then the Authentication Manager starts a timer for reauthentication. The value of the timer is equal to the re-authentication restart timer. Failure in this context means that host authentication was attempted and the host was unable to successfully authenticate. At the expiry of the timer, the Authentication Manager starts the authentication process again from the first method in the list.

The Authentication Manager supports configuring a priority for each authentication method on a port. The authentication priority allows a higher priority method (not currently running) to interrupt an authentication in progress with a lower-priority method. If a client is already authenticated, an interrupt from a higher-priority method can cause a client previously authenticated using a lower priority method to reauthenticate.

By default, Dell switches are configured with a method list that contains the methods (in order) 802.1x, MAB as the default methods for all the ports. Dell switches restrict the configuration such that no method is allowed to follow the Captive Portal method, if configured.

The authentication manager controls only the order in which the authentication methods are executed. The switch administrator is responsible for implementing the required configuration for the respective methods to authenticate successfully.

### **Authentication Restart**

Authentication restarts from the first configured method on any of the following events:

- Link flap
- Authentication fails for all configured methods
- Authentication priority (802.1X packet received when a lower priority method is active)

### **802.1X Interaction**

By default, 802.1X drops all traffic (other than LLDP/CDP/DHCP/BOOTP) prior to successful 802.1X (or MAB) authentication. If Captive Portal is configured as a method, authentication allows certain traffic types, such as DHCP or DNS, access to the network during the Captive Portal method invocation.

### **Authentication Priority**

The default authentication priority of a method is equivalent to its position in the authentication list. If authentication method priorities are configured, then methods with the same priority are processed in list order.

Authentication priority allows a higher-priority method (not currently running) to interrupt an in-progress authentication of a lower-priority method. Alternatively, if the client is already authenticated, an interrupt from a higher-priority method can cause a client, which was previously authenticated using a lower-priority method, to reauthenticate.

For example, if a client is already authenticated using a method other than 802.1X (MAB or Captive Portal) and 802.1X has higher priority than the authenticated method, and if an 802.1X frame is received, then the existing

authenticated client is removed and the authentication process begins again from the first method in the order. If 802.1X has a lower priority than the authenticated method, then the client is not removed and the 802.1X frames are ignored.

If the administrator changes the priority of the methods, then all the users who are authenticated using a lower-priority method are forced to reauthenticate. If an authentication session is in progress and the administrator changes the order of the authentication methods, then the configuration will take effect for the next session onwards.

### **Authentication Host Modes**

The switch supports multiple modes of authenticating hosts and allowing access to the network. Access may be restricted to a single data or voice client, multiple data clients with a single authentication or multiple authentications with or without voice VLAN access. The host mode is configurable on a per port basis.

#### ***Single-Host Mode***

Single-Host mode allows a single device access to the network. The device may authenticate to either the data or voice VLAN (if configured). The switch will drop packets from MAC addresses other than the authenticated device. Additional authentications are rejected.

Single-Host mode does not support RADIUS VLAN assignment in switchport access mode.

Single-Host mode is supported for interfaces configured in switchport access and switchport general modes.

MAB is supported for Single-Host mode hosts.

#### ***Multi-Auth Mode***

Multi-Auth mode supports authentication of multiple data hosts. Once authentication succeeds for a host, network access is allowed for packets from the authenticated host. Packets from un-authenticated hosts are dropped. The number of authenticated hosts may be limited via configuration.

A typical use case is a wireless access point which is connected to an access-controlled port of a NAS. Once the access point is authenticated by the NAS, the wireless clients connected to the access point also authenticate using the switch resources. The access point must be configured to transparently pass EAPOL traffic.

Voice VLAN access is supported in Multi-Auth mode.

MAB access is supported in Multi-Auth mode.

Multi-Auth mode does not support RADIUS VLAN assignment in switchport access mode.

### ***Multi-Host Mode***

Multi-Host mode supports authentication of a single host. Once the host authenticates, network access is allowed for any other hosts connected to the port.

A typical use case is a wireless access point which is connected to an access controlled port of a NAS. Once the access point is authenticated by the NAS, the wireless clients connected to the access point authenticate using the access point resources.

MAB is supported in Multi-Host mode.

Voice VLAN access is not supported in Multi-Host mode.

Multi-Host mode supports RADIUS VLAN assignment.

### ***Multi-Domain-Multi-Host Mode***

Multi-Domain-Multi-Host mode supports authentication of a multiple data hosts and multiple voice hosts. Each host that successfully authenticates is allowed network access. Once the host limit is reached, additional host authentications are rejected.

A typical use case is a wireless access point which is connected to an access controlled port of a NAS. Once the access point is authenticated by the NAS, the wireless clients connected to the access point also authenticate using the switch resources. The access point must be configured to transparently pass EAPOL traffic.

Voice VLAN access is supported in Multi-Domain-Multi-Host mode.

Multi-Domain-Multi-Host mode supports RADIUS VLAN assignment.

MAB is not supported for Multi-Domain-Multi-Host mode. The switch does not enforce this restriction.

### **Multi-Domain Mode**

Multi-Domain mode supports authentication of a single data host and a single voice device. Each host that successfully authenticates is allowed network access. Once the host limit is reached, additional host authentications are rejected.

A typical use case is an IP phone connected to a NAS port and a laptop connected to the hub port of the IP phone. Both devices need to be authenticated to access the network services behind the NAS. The voice and data domains are separated by VLAN.

MAB is supported in Multi-Domain mode.

Voice VLAN access is supported in Multi-Domain mode.

Multi-Domain mode supports RADIUS VLAN assignment.

### **Configuration Example—802.1X and MAB**

In this scenario, the authentication manager selects the first authentication method, 802.1X. If authentication using 802.1X is successful, then the client is allowed network access. If authentication using 802.1X errors out, then authentication manager selects the next authentication method: MAB. If authentication using MAB returns an error, then the port is unauthorized. The authentication manager will start a timer to re-authenticate the host. At the expiry of the timer, the authentication manager restarts authentication by selecting the 802.1X method.

- 1 Enter global configuration mode and define the RADIUS server.

```
console#configure
console (config) #aaa new-model
console (config) #dot1x system-auth-control
console (config) #radius server auth 10.10.10.10
console (config-auth-radius) #name BigRadius
console (config-auth-radius) #primary
console (config-auth-radius) #usage 802.1x
console (config-auth-radius) #exit
```

- 2 Define the global RADIUS server key.

```
console (config) #radius server key thatsyoursecret-keepit-keepit
```

- 3 Enable authentication and globally enable 802.lx client authentication via RADIUS:

```
console (config) #authentication enable
console (config) #aaa authentication dot1x default radius
console (config) #dot1x system-auth-control
```

- 4 On the interface, set the port to access mode, assign a PVID, enable Multi-Domain mode, enable MAB, and set the order of authentication to 802.IX followed by MAC authentication. Configure the switch to send CHAP attributes to the RADIUS server. Set the format of the User-Name sent to the RADIUS server to XXXX.XXXX.XXXX. Also enable periodic re-authentication.

```
console (config) #mab request format attribute 1 groupsize 4
separator . uppercase
console (config) #vlan 2
console (config-vlan2) #interface gil/0/4
console (config-if-Gil/0/4) #switchport mode access
console (config-if-Gil/0/4) #switchport access vlan 2
console (config-if-Gil/0/4) #authentication host-mode multi-
domain
console (config-if-Gil/0/4) #dot1x pae authenticator
console (config-if-Gil/0/4) #mab
console (config-if-Gil/0/4) #mab auth-type chap
console (config-if-Gil/0/4) #authentication order dot1x mab
console (config-if-Gil/0/4) #authentication periodic
console (config-if-Gil/0/4) #exit
```

### Configuration Example—802.1X Critical VLANs

In this example, both a critical data and critical voice VLAN are configured. A test user ID is configured for determining the RADIUS server liveness. The test user must NOT be an actual login on the RADIUS server.

- 1 Enter global configuration mode, enable 802.IX authentication and configure the RADIUS server.

```
console#configure
console (config) #aaa new-model
console (config) #dot1x system-auth-control
console (config) #radius server auth 10.10.10.10
console (config-auth-radius) #name BigRadius
console (config-auth-radius) #key thatsyoursecret-keepit-keepit
console (config-auth-radius) #automate-tester username tst
idle-time 1
console (config-auth-radius) #deadtime 1
```

```
console(config-auth-radius) #usage 802.1x
console(config-auth-radius) #exit
```

- 2 Create the VLANs. VLAN 2 is the secure data VLAN; VLAN 202 is the critical data VLAN; VLAN 10 is the voice VLAN.

```
console(config) #vlan 2,202,10
console(config-vlan2,202,10) #exit
```

- 3 Enable authentication and globally enable 802.1x client authentication via RADIUS. Globally enable Voice VLAN.

```
console(config) #authentication enable
console(config) #aaa authentication dot1x default radius
console(config) #dot1x system-auth-control
console(config) #switchport voice vlan
```

- 4 On the interface, set the port to access mode, assign a PVID, enable Multi-Domain mode and set the order of authentication to 802.1X. Configure the voice VLAN on the interface. Also enable periodic re-authentication and configure the critical voice VLAN and the critical data VLAN.

```
console(config) #interface gil/0/4
console(config-if-Gil/0/4) #switchport mode access
console(config-if-Gil/0/4) #switchport access vlan 2
console(config-if-Gil/0/4) #authentication host-mode multi-
domain
console(config-if-Gil/0/4) #dot1x pae authenticator
console(config-if-Gil/0/4) #authentication order dot1x
console(config-if-Gil/0/4) #authentication periodic
console(config-if-Gil/0/4) #voice vlan 202
console(config-if-Gil/0/4) #authentication event server dead
action authorize voice
console(config-if-Gil/0/4) #authentication event server dead
action authorize vlan 11
console(config-if-Gil/0/4) #exit
```

Some host devices may require access to network resources prior to authenticating. Examples include IP phones that must connect to a call manager to obtain firmware updates and configuration information. If it is desired that hosts be able to access network resources prior to authentication, the following configuration can be used in conjunction with the above example.

```
console(config-Gil/0/4) #authentication open
```



## Configuration Example—MAB Client

This example shows how to configure a MAB client on interface Gi1/0/2 using the IAS database for authentication.

- 1 Enter global configuration mode and create VLAN 3.

```
console#configure
console (config) #configure
console (config) #vlan 3
console (config-vlan3) #exit
```

- 2 Enable the authentication manager and globally enable 802.1x.

```
console (config) #authentication enable
console (config) #dot1x system-auth-control
```

- 3 Set IEEE 802.1x to use the local IAS user database.

```
console (config) #aaa authentication dot1x default ias
```

- 4 Configure the IAS database with the client MAC address as the user name and password. The password MUST be entered in upper case or the authentication will fail with an MD5 Validation Failure, as the MD5 password hashes would not match.

```
console (config) #aaa ias-user username F8B1562BA1D9
console (config-ias-user) #password F8B1562BA1D9
console (config-ias-user) #exit
```

- 5 Configure interface gi1/0/2 to use VLAN 3 in access mode.

```
console (config) #interface Gi1/0/2
console (config-if-Gi1/0/2) #switchport mode access
console (config-if-Gi1/0/2) #switchport access vlan 3
```

- 6 On the interface, configure the port to use Single-Host authentication mode and enable MAB. The authentication manager is configured to only use MAB and the priority is set to MAB.

```
console (config-if-Gi1/0/2) #authentication host-mode single-host
console (config-if-Gi1/0/2) #mab
console (config-if-Gi1/0/2) #authentication order mab
console (config-if-Gi1/0/2) #authentication priority mab
console (config-if-Gi1/0/2) #exit
```

If it is possible that an 802.1x aware client may be connected, it is advisable to configure a re-authentication timer on the port using the **authentication timer reauthenticate** command.

The following command shows the 802.1x configuration on the interface:

```

console#show authentication interface gigabitethernet 1/0/1

Authentication Manager Status..... Enabled

Interface..... Gi1/0/1
Port Control Mode..... auto
Host Mode..... multi-auth
Open Authentication..... Disabled
Authentication Restart timer..... 30
Configured method order..... mab undefined
undefined
Enabled method order..... mab undefined
undefined
Configured method priority..... mab undefined
undefined
Enabled method priority..... mab undefined
undefined
Reauthentication Period (secs)..... 300
Reauthentication Enabled..... TRUE
Reauthentication Session timeout from server .. FALSE
Maximum Users..... 32
Guest VLAN ID..... 0
Authentication retry attempts..... 1
Unauthenticated VLAN ID..... 0
Critical Vlan Id..... 0
Authentication Violation Mode..... Restrict
Authentication Server Dead action..... None
Authentication Server Dead action for Voice... None
Authentication Server Alive action..... Reinitialize

```

```

console#show authentication clients gigabitethernet 1/0/1

Interface..... Gi1/0/10
Mac Address..... 0E:87:CC:D3:00:00
User Name..... testUser
VLAN Assigned Reason..... RADIUS Assigned
VLAN (193)
Host Mode..... multi-auth
Method..... 802.1X
Control Mode..... auto
Session time..... 139
Session timeout ..... 0
Session Termination Action..... Default
Filter ID.....
RADIUS Framed IPv4/IPv6 address.....

```

```
DACL..... IP-DACL-IN-
00000018
Redirect ACL.....
Redirect URL.....
Acct SessionId..... testUser:a00000018
Linksec policy..... should-secure
```

## Using RADIUS

The RADIUS client on the switch supports multiple RADIUS servers. When multiple authentication servers are configured, they can help provide redundancy. One server can be designated as the primary and the other(s) will function as backup server(s). The switch attempts to use the primary server first. If the primary server does not respond, the switch attempts to use the backup servers. A priority value can be configured to determine the order in which the backup servers are contacted.

### How Does RADIUS Control Management Access?

Many networks use a RADIUS server to maintain a centralized user database that contains per-user authentication information. RADIUS servers provide a centralized authentication method for:

- Network Access (IEEE 802.1X)
- User Manager (Management access)
- Captive Portal

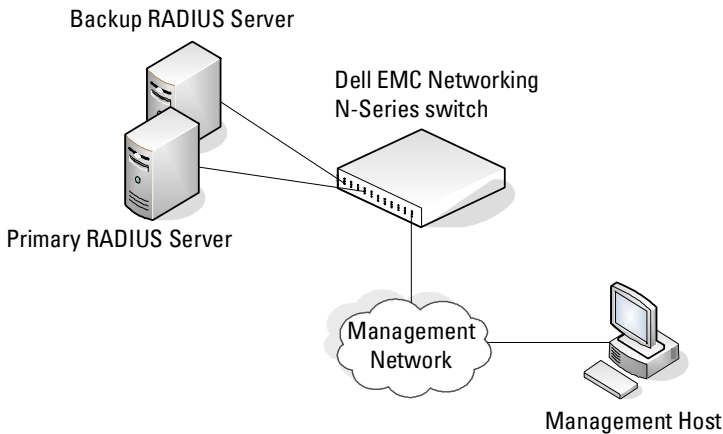
Like TACACS+, RADIUS access control utilizes a database of user information on a remote server. Making use of a single database of accessible information—as in an Authentication Server—can greatly simplify the authentication and management of users in a large network. One such type of Authentication Server supports the Remote Authentication Dial In User Service (RADIUS) protocol as defined by RFC 2865.

For authenticating users, the RADIUS standard has become the protocol of choice by administrators of large networks. To accomplish the authentication in a secure manner, the RADIUS client and RADIUS server must both be configured with the same shared password or “secret”. This “secret” is used to generate one-way encrypted authenticators that are present in all RADIUS packets. The “secret” is never transmitted over the network.

RADIUS conforms to a secure communications client/server model using UDP as a transport protocol. It is extremely flexible, supporting a variety of methods to authenticate and statistically track users. RADIUS is also extensible, allowing for new methods of authentication to be added without disrupting existing functionality.

As a user attempts to connect to the switch management interface, the switch first detects the contact and prompts the user for a name and password. The switch encrypts the supplied information, and a RADIUS client transports the request to a preconfigured RADIUS server.

**Figure 9-1. RADIUS Topology**



The server can authenticate the user itself or make use of a back-end device to ascertain authenticity. In either case a response may or may not be forthcoming to the client. If the server accepts the user, it returns a positive result with attributes containing configuration information. If the server rejects the user, it returns a negative result. If the server rejects the client or the shared secrets differ, the server returns no result. If the server requires additional verification from the user, it returns a challenge, and the request process begins again.

If using a RADIUS server to authenticate users, the RADIUS administrator must configure user attributes in the user database on the RADIUS server. The user attributes include the user name, password, and privilege level.



**NOTE:** To set the user privilege level at login, it is required that the Service-Type attribute be used for RADIUS instead of the vendor proprietary (vendor ID 9, sub-type 1) AV pair priv-lvl attribute. The Cisco AV priv-lvl is supported only for TACACS authorization.

### Which RADIUS Attributes Does the Switch Support?

Table 9-6 lists the RADIUS attributes that the switch supports and indicates whether the 802.1X feature, User Manager feature, or Captive Portal feature supports the attribute. The RADIUS administrator must configure these attributes on the RADIUS server(s) when utilizing the switch RADIUS service and may also need to enable processing of the specific attribute on the switch. Only one of the NAS-IP-Address or the NAS-Identifier may be sent in an Access-Request message. The switch relies on IP Device Tracking (IPDT) to populate the RADIUS Framed-IP-Address attribute and to modify the IP source address in received Dynamic ACLs. Enable DHCP Snooping and IPDT to support transmission of the Framed-IP-Address in RADIUS Access-Request packets and the update of Dynamic ACLs.

**Table 9-6. Supported RADIUS Attributes**

Type	RADIUS Attribute Name	802.1X	User Manager	Captive Portal
1	User-Name	Yes	Yes	No
2	User-Password	Yes	Yes	No
3	CHAP-Password	Yes	No	No
4	NAS-IP-Address	Yes	Yes	No
5	NAS-Port	Yes	No	No
6	Service-Type	Yes	Yes	No
8	Framed-IP-Address	Auth. only	Yes	No
11	Filter-ID	Yes	No	No
12	Framed-MTU	Yes	No	No
15	Login-Service	No	Yes	No
18	Reply-Message	Auth. only	Yes	No
24	State	Yes	Yes	No

**Table 9-6. Supported RADIUS Attributes (Continued)**

Type	RADIUS Attribute Name	802.1X	User Manager	Captive Portal
25	Class	Yes	Yes	No
26	Vendor-Specific	Yes	Yes	Yes
27	Session-Timeout	Yes	No	Yes
28	Idle-Timeout	No	No	Yes
29	Termination-Action	Yes	No	No
30	Called-Station-ID	Yes	No	No
31	Calling-Station-ID	Yes	No	Yes
32	NAS-Identifier	Yes	Yes	No
40	Acct-Status-Type	Acct. only	Yes	No
41	Acct-Delay-Time	Acct. only	No	No
42	Acct-Input-Octets	Yes	No	No
43	Acct-Output-Octets	Yes	No	No
44	Acct-Session-ID	Acct. only	Yes	No
46	Acct-Session-Time	Yes	Yes	No
49	Acct-Terminate-Cause	Yes	No	No
52	Acct-Input-Gigawords	Yes	No	No
53	Acct-Output-Gigawords	Yes	No	No
61	NAS-Port-Type	Yes	No	Yes
64	Tunnel-Type	Yes	No	No
65	Tunnel-Medium-Type	Yes	No	No
79	EAP-Message	Yes	No	No
80	Message-Authenticator	Auth. only	Yes	No
81	Tunnel-Private-Group-ID	Yes	No	No
168	Framed-IPv6-Address	Acct. only	No	No

**How Are RADIUS Attributes Processed on the Switch?**

The following attributes are processed in the RADIUS Access-Accept message received from a RADIUS server:

- **REPLY-MESSAGE**  
Trigger to respond to the Access-Accept message with an EAP notification.
- **STATE**  
RADIUS server state. Transmitted in Access-Request messages.
- **SERVICE-TYPE**  
The Service-Type attribute may be validated in the Access-Accept packet received from the RADIUS server. Only the Login-User(1), Administrative-User(6), and Call-Check(10) values are considered valid for Service-Type in the Access-Accept message returned from the RADIUS server.
- **SESSION-TIMEOUT**  
Session time-out value for the session (in seconds). Used by both 802.1x and Captive Portal.
- **TERMINATION-ACTION**  
Indication as to the action taken when the service is completed.
- **EAP-MESSAGE**  
Contains an EAP message to be sent to the user. This is typically used for MAB clients.
- **VENDOR-SPECIFIC**  
The following vendor proprietary (vendor ID 9, sub-type 1) AV Pairs are supported:
  - shell:priv-lvl
  - shell:roles
  - ip:inacl={standard-access-control-list-name | extended-access-control-list-name}
  - ipv6:inacl={standard-access-control-list-name | extended-access-control-list-name}
  - ip:inacl[#number]={extended-access-control-list}
  - ipv6:inacl[#number]={extended-access-control-list}
  - ip:traffic-class = {pre-configured ACL name}

- device-traffic-class=switch
  - subscriber:command=reauthenticate (COA only)
  - subscriber:command=bounce-host-port (COA only)
  - subscriber:command=disable-host-port (COA only)
  - url-redirect-acl={extended-access-control-list}
  - url-redirect={redirect URL}
  - ACS:CiscoSecure-Defined-ACL=#ACSACL#<<ACL-Name>>
- FILTER-ID  
Name of an existing ACL or DiffServ policy for this user. Names ending with an ".in" suffix are ACLs.
  - FRAMED-IP-ADDRESS  
The IP address assigned to the host accessing the network. Cached and transmitted in accounting packets.
  - FRAMED-IPv6-ADDRESS  
The IPv6 address assigned to the host accessing the network. Cached and transmitted in accounting packets.
  - TUNNEL-TYPE  
Used to indicate that a VLAN is to be assigned to the host session when set to tunnel type VLAN (13).
  - TUNNEL-MEDIUM-TYPE  
Used to indicate the tunnel medium type. Must be set to medium type 802 (6) to enable VLAN assignment.
  - TUNNEL-PRIVATE-GROUP-ID  
Used to indicate the VLAN to be assigned to the host session. May be a string which matches a preconfigured VLAN name or a VLAN ID. If a VLAN ID is given, the string must contain only decimal digits.

## Using TACACS+

TACACS+ (Terminal Access Controller Access Control System) provides access control for networked devices via one or more centralized servers. TACACS+ simplifies authentication by making use of a single database that

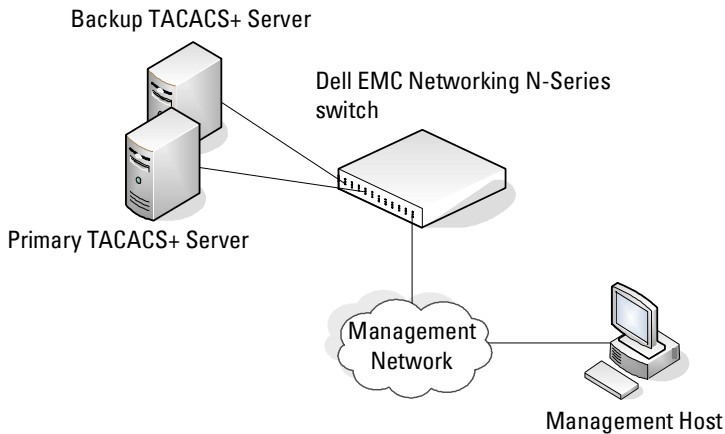


can be shared by many clients on a large network. TACACS+ uses TCP to ensure reliable delivery and a shared key configured on the client and daemon server to encrypt all messages.

If TACACS+ is configured as the authentication method for user login and a user attempts to access the user interface on the switch, the switch prompts for the user login credentials and requests services from the TACACS+ client. The client then uses the configured list of servers for authentication, and provides results back to the switch.

Figure 9-2 shows an example of access management using TACACS+.

**Figure 9-2. Basic TACACS+ Topology**



The TACACS+ server list can be configured with one or more hosts defined via their network IP addresses. Each can be assigned a priority to determine the order in which the TACACS+ client will contact the servers. TACACS+ contacts the server when a connection attempt fails or times out for a higher priority server.

Each server host can be configured with a specific connection type, port, timeout, and shared key, or the server hosts can be globally configured with the key and timeout.

The TACACS+ server can do the authentication itself, or redirect the request to another back-end device. All sensitive information is encrypted and the shared secret is never passed over the network; it is used only to encrypt the data.

**Which TACACS+ Attributes Does the Switch Support?**

Table 9-7 lists the TACACS+ attributes that the switch supports and indicates whether the authorization or accounting service supports sending or receiving the attribute. The authentication service does not use attributes. The following attributes can be configured on the TACACS+ server(s) when utilizing the switch TACACS+ service.

**Table 9-7. Supported TACACS+ Attributes**

Attribute Name	Exec Authorization	Command Authorization	Accounting
cmd	both (optional)	sent	sent
cmd-arg		sent	
elapsed-time			sent
priv-lvl	received		
protocol			sent
roles	both (optional)		
service=shell	both	sent	sent
start-time			sent
stop-time			sent

**Dynamic ACL Overview**

**NOTE:** This feature is only supported in 802.1X-enabled configurations.

Dynamic ACLs allow operators to administer bespoke network access policies from a central location (the RADIUS server). Access policies are enforced via the use of ACLs or DiffServ policy installed for the duration of the user session. Unique policies can be assigned based upon the user credentials/location/time of day and other information presented to the RADIUS server during the authentication process. The benefit to the end user is that the policy can *follow* the user around the network, regardless of

where the network is accessed. The benefit to the network administrator is that policy can be configured once for the user and does not need to be configured on multiple devices.

IEEE 802.1X port-control auto mode ports may be configured to accept 802.1X authentication for both the data VLAN and voice VLAN using host modes multi-domain or multi-domain multi-host. In this case, both authentications may contain DACL references or definitions. The DACLs are applied and removed for each authentication session independently of the other sessions, however, the DACLs scope is at the port level and are capable of filtering any matching ingress traffic, regardless of which authentication session actually instantiated the DACL. Do not apply both DACLs and DiffServ policies on a port at the same time.

**NOTE:** 802.1X port-control auto mode ports are restricted to a single data device and a single voice device by default (host mode multi-domain multi-host). This restriction is enforced by implicitly filtering incoming traffic based upon the MAC address of the authenticating client.

DACLs contained in an 802.1X re-authentication Access-Accept replace the DACLs instantiated in the existing session. DACLs are never applied to hosts authenticated into the Guest or Unauthenticated VLAN. DACLs are compatible with RADIUS VLAN assignment.

### Filter-ID Support

The switch supports the association of preconfigured access-lists to an 802.1X authenticated port as presented in the IETF Filter-ID (11) RADIUS attribute (RFC 2865) in an Access-Accept message if configured to accept same. Other RADIUS attributes (for example, Tunnel-Medium-Type, Tunnel-Type, Tunnel-Private-Group-ID, and so on) are processed in the normal manner. The named ACL must exist on the switch and can be of any ACL type (MAC, IPv4, or IPv6).

When the identified ACL is applied, all statically-configured ACLs on the port are removed and the new ACL is configured prior to 802.1X authorizing the port. When the 802.1X session terminates, the dynamic ACL is removed and the pre-existing ACLs are restored to the port.

If no Access list exists matching the Filter-ID, the Access-Accept is treated as an Access-Reject and the port is not authorized. A log message indicating same is issued (Interface X/X/X not authorized. Filter-ID XXXX selected by server x.y.z.x is not present on

switch) . No Acct-Start packet is sent and an EAP-Failure is sent to the 802.1X client. Note that the *name* in a Filter-ID may be a number of an ACL in the form of <ACL#.in>, such as 100.in. If both a Filter-ID and a vendor proprietary AV-Pair (26) ip:inacl or ipv6:inacl attribute are present in the Access-Accept, the Access-Accept is treated as an Access-Reject and the port is not authorized. A log message indicating same is issued (Interface X/X/X not authorized. RADIUS Access-Accept/COA-Request contains both Filter-ID(11) and AV-Pair (26) attributes) . No Acct-Start packet is sent and an EAP-Failure is sent to the 802.1X client.

Dynamic ACLs using the Filter-ID syntax are always enabled.

Filter-ID syntax:

Named ACL - printable character string of the form <ACLNAME> .  
<Direction>, for example, Filter-id="test\_static.in"

Filter-ID example:

Named\_ACL - printable character string of the form Filter-id=  
"test\_static.in".

### Preconfigured or Dynamic ACLs

The switch also supports the application of preconfigured ACLs or the configuration and application of dynamically-created Access Lists to an 802.1X authenticated port as presented in a series of vendor proprietary VSA (009/001) AV-pair (26) attributes in a RADIUS Access-Accept. If dynamic ACL capability is not enabled, VSA 26 attributes are ignored as if they are not present in the message and authentication proceeds in the normal manner. Other RADIUS attributes (for example, Tunnel-Medium-Type, Tunnel-Type, Tunnel-Private-Group-ID, and so on) are processed in the normal manner.

Dynamic ACLs using the VSA AV-Pair syntax may be enabled by configuring the **radius server vsa send authentication** command.

The switch will configure the rules in IPv4 or IPv6 Extended Access Lists named IP-DACL-IN-<session-id># where <session-id> is the user presentable 802.1X session suffix. The corresponding IPv6 naming convention is IPV6-DACL-IN-<session-id>. Note that the # sign is not an acceptable character for an ACL name which prevents the DACL from being edited or removed via the UI. The original ACL, if any, is restored to the port after the 802.1X session terminates. Only ingress ACLs are supported.

If there is an error applying the ACL to the port, a WARN log message indicating same is issued (Interface X/X/X not authorized. Application of downloaded ACL XXX did not complete due to resource exhaustion) and the Access-Accept is treated as an Access-Reject. The port is not authorized. Any previously configured ACLs are added back to the port. If Accounting is enabled, the Acct-Start packet is not sent and an EAP-Failure packet is sent to the 802.1X client.

The VSA av-pair is coded as follows: Attribute 26, Vendor ID 9, Vendor sub-type 9.

### **Predefined ACL Selection**

Send the vendor proprietary VSA (009/001) AV-pair (26) attribute syntax from the RADIUS server in the Access-Accept message to select an ACL that is already configured on the switch, but is not necessarily associated to the authenticating interface. The ACL must be preconfigured on the switch. The extended-access-control-list-name is the name or number of an existing ACL. The standard-access-control-list-name is the number of an existing ACL. The ACL need not be statically preconfigured on the port prior to RADIUS configuring the ACL when authorizing the port. All statically-configured ACLs on a port are disassociated from the port prior to configuring the dynamic ACL and authorizing the port. The ACL applied is considered state, not configuration and is not shown in the running-config.

### **Syntax**

```
ip:inacl={standard-access-control-list-name | extended-access-control-list-name }
```

```
ipv6:inacl={standard-access-control-list-name | extended-access-control-list-name }
```

- The ip token before the colon indicates an existing IPv4 ACL name or number follows the equals sign.
- The ipv6 token before the colon indicates an IPv6 ACL name or number follows the equals sign.
- The token standard-access-control-list-name means a Dell EMC Standard ACL identified by the decimal number after the equals sign.

- The token `extended-access-control-list-name` means a Dell EMC IP/IPv6 Extended ACL identified by the decimal number or the name of a preconfigured ACL. The range numbers are not restricted to ranges as in other vendor implementations.
- The tokens `ip:inacl` and `ipv6:inacl` are in lower case and are followed by an equals sign with no intervening white space.

### **Predefined ACL Examples**

```
ip:inacl=Named_ACL
ipv6:inacl=Named_IPv6_ACL
```

### **Dynamic ACL Creation**

Send the vendor proprietary VSA (009/001) AV-pair (26) attribute syntax from the RADIUS server in the Access-Accept message to create an ACL that does not exist on the switch. The ACL need not be statically preconfigured on the switch prior to RADIUS creating the ACL, associating the ACL to the port, and authorizing the port. All statically configured ACLs on a port are disassociated from the port prior to configuring the dynamic ACL. The ACL applied is considered state, not configuration and is not shown in the `running-config`.

### **Syntax**

```
ip:inacl[#number]={extended-access-control-list}
ipv6:inacl[#number]={ extended-access-control-list}
```

- where `ip` indicates an IPv4 ACL definition follows the equals sign and `ipv6` indicates an IPv6 ACL definition follows the equals sign.
- `#number` is the ACL sequence number in decimal format. Range 1-2147483647.
- The tokens `ip:inacl` and `ipv6:inacl` are in lower case and are followed by an equals sign with no intervening white space.
- The token `extended-access-control-list` means a Dell EMC IPv4/IPv6 Extended ACL CLI rule definition beginning with the `{permit|deny}` tokens followed by the protocol `{ eigrp | gre | icmp | igmp | ip | ipinip | ospf | pim | tcp | udp | 0-55 }` et. seq., as described in the *CLI Reference Guide* for the `permit/deny` commands.

Dynamic ACL Example (Extended syntax, for example, `ip access-list extended ...`):

```
ip:inacl#100=permit ip any 209.165.0.0 0.0.255.255
ip:inacl#110=permit ip any 209.166.0.0 0.0.255.255
ip:inacl=permit ip any 209.167.0.0 0.0.255.255
```

## Restrictions and Caveats

Only ingress ACLs are supported. Dynamic ACLs are supported only for ports in General or Access mode.

The processing of dynamic ACLs VSAs is controlled by the [no] radius server vsa send authentication syntax. The default is disabled. No other VSAs (such as voice VLAN) are affected by this configuration.

Either traffic-class av-pairs or multiple ip:inacl/ipv6:inacl av-pairs may be present in the RADIUS message, but not both. If both are present, or there are syntax errors in the received ACLs (other than duplicate rules), the ACL rules are not applied, the RADIUS Access-Accept is treated as an Access-Reject, and a WARN log message or Interface X/X/X not authorized. Application of downloaded ACL did not complete due to invalid syntax XXXXX is issued indicating that a received RADIUS rule is misconfigured with invalid syntax or configured with both ip:traffic-class and in acl rules, and identifying the RADIUS server and the affected interface. If Accounting is enabled, the Acct-Start packet is not sent. An EAP-Failure is sent to the 802.1X client.

The VSAs may appear in any order in the RADIUS message. A mixture of in/out and IPv4/IPv6 rules may be present in the RADIUS message to be parsed into the four two Access-Groups. Rules are separated by newlines (either CR or CR/LF). Upper and lower case shall be accepted. The strings ip:traffic-class, ip:inacl, ... are always in lower case. The optional digits following the # symbol indicate the ACL number in the access list.

The rules are applied in the order they appear in the RADIUS packet (the ACL numbers indicate the relative internal priority). Duplicate entries (identical number) in the Access-Accept message follow the same behavior as exists in the UI today (overwrite the previous entry). Conflicting rules are handled in the same manner as if configured via the CLI.

RADIUS-supplied dynamic ACLS are applied at the access-group level after removing all statically configured access groups/traffic filters on the port and before any policies specified in Filter-ID. The following order is observed for application of the access-groups: IPv6-DACL-IN, IP-DACL-IN, IPv6-V

DACL-IN, IP-V DACL-IN. Empty rules sets are not applied to the port. The words *statically configured access-groups* do not include denial of service or storm control configurations as they use different internal hardware.

The dynamic ACLs exist only for the duration of the 802.1X session. They are removed when the 802.1X session is terminated (including for COA bounce-host-port or COA termination requests) or when the port goes down (unplugged or shut down). Any static ACLs previously removed from the port are restored when the last 802.1X session ends. Note that the port is unauthorized when the session ends, so the static rules are not actually written into hardware. They are available for application if the RADIUS server does not send an ACL or the port otherwise becomes authorized. The administrator can override the port configuration and add a manually configured ACL. If the administrator adds an ACL, only the DACL is removed when the session ends.

The switch alters a dynamic ACL IP address filter configured with the *any* keyword for the source IP address. IP source addresses in the DACL are rewritten to use the supplicant IP address if available. If the IP address is not available in the IPDT table at the time the ACL is applied and it subsequently becomes available, the ACL is then rewritten with the source IP address of the host.

Dynamic ACLs are supported for 802.1X enabled (authentication port-control auto mode) ports configured in switchport access or general mode. Only one dynamic IPv4 ACL and one dynamic IPv6 ACL may be associated with an 802.1X session (for a total of two access-groups per 802.1X session). Only two named ACLs (one IPv4 and one IPv6) are supported (for a total of two access groups per 802.1X session) per received Access-Accept.

Dynamic ACLs are supported for ports configured in 802.1X Monitor Mode. Syntax errors are logged in the Monitor Mode log. Monitor mode behavior is not altered, for example, if sufficient information to allow access the host to the port is present, the host is allowed access to the port.

Dynamic ACLs are subject to the same hardware scale limitations as static ACLs. If the ACL cannot be applied (resource limitation), then the Access-Accept is treated as an Access-Reject and the port is not authorized. A log message indicating same is issued (`Interface X/X/X not authorized. ACL received from RADIUS server exceeds available resources`). No Acct-Start packet is sent and an EAP-Failure is sent to the 802.1X client.



Dynamic ACLs may not exceed the size of a single RADIUS Access-Accept packet. There is no support for multiple packet ACLs. (Max dynamic ACL is 4000 ASCII characters). There is no support for *Downloadable ACLs* where the NAS sends a second Access-Request to the RADIUS server to retrieve an ACL.

## Authentication Examples

It is important to understand that during authentication, all that happens is that the device is validated. If any attributes are returned from the RADIUS server, they are not processed during the authentication phase. The attributes are processed after authentication if the device is authorized on the port. In the examples below, it is assumed that the default configuration of authorization—that is, no authorization—is used.

### Local Authentication Example

Use the following configuration to require local authentication when logging in over a Telnet connection:

- 1 Create a login authentication list called “loc” that contains the method local:

```
console#config
console (config) #aaa authentication login "loc" local
```

- 2 Enter the configuration mode for the Telnet line:

```
console (config) #line telnet
```

- 3 Assign the loc login authentication list to be used for users accessing the switch via Telnet:

```
console (config-telnet) #login authentication loc
console (config-telnet) #exit
```

- 4 Allow Telnet and SSH users access to Privileged Exec mode. It is required that an enable password be configured to allow local access users to elevate to privileged exec level:

```
console (config) #enable password PaSSW0rd
```

- 5 Create a user with the name “guest” and password “password”. A simple password can be configured here, since strength-checking has not yet been enabled:

```
console (config) #username guest password password
```

- 6 Set the minimum number of numeric characters required when password strength checking is enabled. This parameter is enabled only if the **passwords strength minimum character-classes** parameter is set to something greater than its default value of 0:

```
console(config)#passwords strength minimum numeric-characters 2
```

- 7 Set the minimum number of character classes that must be present in the password. The possible character classes are: upper-case, lower-case, numeric and special:

```
console(config)#passwords strength minimum character-classes 4
```

- 8 Enable password strength checking:

```
console(config)#passwords strength-check
```

- 9 Create a user with the name “admin” and password “paSS1&word2”. This user is enabled for privilege level 15. Note that, because password strength checking was enabled, the password was required to have at least two numeric characters, one uppercase character, one lowercase character, and one special character:

```
console(config)#username admin password paSS1&word2 privilege 15
```

- 10 Configure the switch to lock out a local user after three failed login attempts:

```
console(config)#passwords lock-out 3
```

This configuration allows either user to log into the switch. Both users will have privilege level 1. If no enable password was configured, neither user would be able to successfully execute the **enable** command, which grants access to Privileged Exec mode, because there is no enable password set by default (the default method list for Telnet enable authentication is only the “enable” method).



**NOTE:** It is recommend that the password strength checking and password lockout features be enabled when configuring local users.

## RADIUS Authentication Example

Use the following configuration to require RADIUS authentication to support administrator login over a Telnet connection:

- 1 Create a login authentication list called “rad” that contains the method radius. If this method returns an error, the user will fail to login:

```
console#config
console (config) #aaa authentication login "rad" radius
```

- 2 Create an enable authentication list called “raden” that contains the method radius. If this method fails, then the user will be unable to execute the enable command:

```
console (config) #aaa authentication enable "raden" radius
```

- 3 The following command is the first step in defining a RADIUS authentication server at IP address 1.2.3.4. The `automate-tester username` parameter is a dummy User ID that is NOT configured on the RADIUS server, and is used to verify server liveness. The result of this command is to place the user in radius server configuration mode to allow further configuration of the server:

```
console (config) #radius server auth 1.2.3.4
console (config-auth-radius) #name Radius-Server
console (config-auth-radius) #automate-tester username
DummyLogin idle-time 30
```

- 4 Define the shared secret. This must be the same as the shared secret defined on the RADIUS server:

```
console (config-auth-radius) #key "secret"
console (config-auth-radius) #exit
```

- 5 Enter the configuration mode for the Telnet line:

```
console (config) #line telnet
```

- 6 Assign the rad login authentication method list to be used for users accessing the switch via Telnet:

```
console (config-telnet) #login authentication rad
```

- 7 Assign the raden enable authentication method list to be used for users executing the enable command when accessing the switch via Telnet:

```
console (config-telnet) #enable authentication raden
console (config) #exit
```

## ACL Using Authentication Manager to Configure MAB with RADIUS Server

The following is a relatively complex example of using an ACL to control access to Gi1/0/1, using the Authentication Manager to configure MAB in conjunction with a RADIUS server.

- 1 Create VLAN 60 which will be used for management access via Gi1/0/1:

```
console#config
console(config)#vlan 60
console(config-vlan60)#exit
```

- 2 Enable the authentication manager:

```
console(config)#authentication enable
```

- 3 Create an access list limiting IP communication exclusively to host 172.25.129.299. All other IP addresses are excluded. This address is in the Bogons address space:

```
console(config)#ip access-list RADIUSCAP
console(config-ip-acl)#permit ip any 172.25.129.229 0.0.0.0
console(config-ip-acl)#permit ip 172.25.129.229 0.0.0.0 any
console(config-ip-acl)#deny ip any any
console(config-ip-acl)#permit every
console(config-ip-acl)#exit
```

- 4 Set a default gateway for the switch:

```
console(config)#ip default-gateway 172.25.128.254
```

- 5 Set a default route with administrative distance 253:

```
console(config)#ip route 0.0.0.0 0.0.0.0 172.25.128.254 253
```

- 6 Assign an IP address to the management VLAN:

```
console(config)#interface vlan 60
console(config-vlan60)#ip address 172.25.128.214 255.255.0.0
console(config-vlan60)#exit
```

- 7 Enable 802.1x client authentication via RADIUS and allow VLAN assignment to 802.1x clients:

```
console(config)#dot1x system-auth-control
console(config)#aaa authentication dot1x default radius
console(config)#aaa authorization network default radius
```

- 8 Allow 802.1x client VLANs to be dynamically created via RADIUS:

```
console(config)#authentication dynamic-vlan enable
```

- 9 Configure the primary RADIUS sever and set it to authenticate both 802.1X and MAB authentication:

```

console (config) #radius server auth 172.25.129.229
console (config-auth-radius) #name Default-Radius-Server
console (config-auth-radius) #primary
console (config-auth-radius) #usage authmgr
console (config-auth-radius) #key "dellSecret"
console (config) #exit

```

- 10 Configure the management interface and bypass 802.1x authentication for the connected management host:

```

console (config) #interface Gi1/0/1
console (config-if-Gi1/0/1) #switchport access vlan 60
console (config-if-Gi1/0/1) #authentication port-control force-authorized
console (config-if-Gi1/0/1) #ip access-group RADIUSCAP in 1
console (config) #exit

```

- 11 Configure a dedicated printer port. This ports is enabled for MAB only. The VLAN is assigned by the RADIUS server:

```

console (config) #interface Gi1/0/21
console (config-if-Gi1/0/21) #switchport mode access
console (config-if-Gi1/0/21) #authentication port-control auto
console (config-if-Gi1/0/21) #authentication host-mode single-host
console (config-if-Gi1/0/21) #dot1x pae authenticator
console (config-if-Gi1/0/21) #mab
console (config-if-Gi1/0/21) #authentication order mab
console (config-if-Gi1/0/21) #authentication priority mab
console (config-if-Gi1/0/21) #exit

```

- 12 Configure a port for authentication using MAB or 802.1X. The timers are configured to quickly authenticate:

```

console (config) #interface Gi1/0/22
console (config-if-Gi1/0/22) #switchport mode access
console (config-if-Gi1/0/22) #authentication port-control auto
console (config-if-Gi1/0/22) #authentication periodic
console (config-if-Gi1/0/22) #authentication timer
reauthenticate 7200
console (config-if-Gi1/0/22) #authentication timer restart 60
console (config-if-Gi1/0/22) #dot1x timeout server-timeout 10
console (config-if-Gi1/0/22) #dot1x timeout quiet-period 10
console (config-if-Gi1/0/22) #dot1x timeout supp-timeout 2
console (config-if-Gi1/0/22) #dot1x max-req 2
console (config-if-Gi1/0/22) #dot1x timeout tx-period 3
console (config-if-Gi1/0/22) #authentication host-mode multi-domain
console (config-if-Gi1/0/22) #mab

```

```
console(config-if-Gil/0/22) #authentication order dot1x mab
console(config-if-Gil/0/22) #exit
```

### Combined RADIUS, CoA, MAB and 802.1x Example

The following example configures RADIUS in conjunction with IEEE 802.1X to provide network access to switch clients.

- 1 Enable 802.1x:

```
console#config
console(config) #dot1x system-auth-control
console(config) #authentication enable
```

- 2 Configure 802.1x clients to use RADIUS services:

```
console(config) #aaa authentication dot1x default radius
```

- 3 Enable CoA for RADIUS:

```
console(config) #aaa server radius dynamic-author
```

- 4 Configure the remote RADIUS server for COA requests at 10.130.191.89 with “shared secret” as the key:

```
console(config-radius-da) #client 10.130.191.89 server-key
"shared secret"
```

- 5 Specify that any CoA request with a matching key identifies a client:

```
console(config-radius-da) #auth-type any
console(config-radius-da) #exit
```

- 6 Configure a group of RADIUS clients (switches) to appear as a single large RADIUS client (by using the same NAS-IP-Address):

```
console(config) #radius server attribute 4 10.130.65.4
```

- 7 Specify that the RADIUS server for host authentication/network access is located at 10.130.191.89:

```
console(config) #radius server auth 10.130.191.89
console(config-auth-radius) #name Default-RADIUS-Server
```

- 8 Configure the RADIUS shared secret as “shared secret”:

```
console(config-auth-radius) #key "shared secret"
console(config-auth-radius) #exit
```

- 9 Configure Gi1/0/7 to use multi-auth host authentication. This allows multiple hosts sharing the same network port to be individually allowed or denied access to network resources. CoA requests to terminate a host

session can be issued by the RADIUS server. This means that if the RADIUS server terminates the host session and subsequently refuses to authorize the host, the host is denied access to the network:

```
console (config) #interface Gi1/0/7
console (config-if-Gi1/0/7) #authentication host-mode multi-auth
console (config-if-Gi1/0/7) #authentication order dot1x
console (config-if-Gi1/0/7) #exit
```

- 10 Configure Gi1/0/6 to allow connected hosts access to network resources, regardless of RADIUS configuration. RADIUS CoA disconnect requests are ignored for clients on this port:

```
console (config) #interface Gi1/0/6
console (config-if-Gi1/0/6) #authentication port-control force-authorized
console (config-if-Gi1/0/6) #exit
```

- 11 Configure Gi1/0/5 to use standard 802.1x port-based authentication. A single authentication allows all hosts access to network resources.

```
console (config) #interface Gi1/0/5
console (config-if-Gi1/0/5) #authentication port-control auto
console (config-if-Gi1/0/5) #exit
```

## Configure RADIUS Server Load Balancing

The following example configures multiple RADIUS servers in a load balancing configuration.

- 1 Enable 802.1x:

```
console#config
console (config) #dot1x system-auth-control
console (config) #authentication enable
```

- 2 Configure 802.1x clients to use RADIUS services:

```
console (config) #aaa authentication dot1x default radius
```

- 3 Configure the first RADIUS server for host authentication/network access located at 10.130.191.89 with a shared secret. The name command is optional in this configuration as it uses the default RADIUS group. This server will be the primary RADIUS server:

```
console (config) #radius server auth 10.130.191.89
console (config-auth-radius) #name Default-RADIUS-Server
console (config-auth-radius) #primary
console (config-auth-radius) #key "shared secret"
console (config-auth-radius) #exit
```

- 4 Configure the second RADIUS server for host authentication/network access is located at 10.130.191.90 with a shared secret. This server will be a secondary RADIUS server:

```
console(config)#radius server auth 10.130.191.90
console(config-auth-radius)#name Default-RADIUS-Server
console(config-auth-radius)#key "shared secret"
console(config-auth-radius)#exit
```

- 5 Configure the third RADIUS server for host authentication/network access is located at 10.130.191.91 with a shared secret. This server will also be a secondary RADIUS server. It will be load balanced in lexical order, meaning the secondary server configured above will be used once the number of outstanding requests exceeds the batch size for the primary server. Only when the number of outstanding requests exceeds the batch size for both the primary and secondary server above will the third RADIUS server be utilized:

```
console(config)#radius server auth 10.130.191.91
console(config-auth-radius)#name Default-RADIUS-Server
console(config-auth-radius)#key "shared secret"
console(config-auth-radius)#exit
```

- 6 Configure the load sharing parameters. Decrease the batch size to send up to 3 requests at once to the primary RADIUS server before load sharing to the secondary servers:

```
console(config)#radius server load-balance name Default-
RADIUS-Server method least-outstanding batch-size 3
```

## TACACS+ Authentication Example

Use the following configuration to require TACACS+ authentication when logging in over a Telnet connection:

- 1 Create a login authentication list called "tacplus" that contains the method tacacs. If this method returns an error, the user will fail to login:

```
console#config
console(config)#aaa authentication login "tacplus" tacacs
```

- 2 Create an enable authentication list called "tacp" that contains the method tacacs. If this method fails, then the user will fail to execute the enable command:

```
console(config)#aaa authentication enable "tacp" tacacs
```



- 3 The following command is the first step in defining a TACACS+ server at IP address 1.2.3.4. The result of this command is to place the user in tacacs-server mode to allow further configuration of the server:

```
console (config) #tacacs-server host 1.2.3.4
```

- 4 Define the shared secret. This must be the same as the shared secret defined on the TACACS+ server:

```
console (config-tacacs) #key "secret"  
console (config-tacacs) #exit
```

- 5 Enter the configuration mode for the Telnet line.

```
console (config) #line telnet
```

- 6 Assign the tacplus login authentication method list to be used for users accessing the switch via Telnet:

```
console (config-telnet) #login authentication tacplus
```

- 7 Assign the tacp enable authentication method list to be used for users executing the enable command when accessing the switch via Telnet:

```
console (config-telnet) #enable authentication tacp  
console (config-telnet) #exit
```



**NOTE:** A user logging in with this configuration would be placed in User Exec mode with privilege level 1. To access Privileged Exec mode with privilege level 15, use the enable command.



**NOTE:** Dell EMC Networking TACACS supports setting the maximum user privilege level in the authorization response. Configure the TACACS server to send priv-lvl=X, where X is either 1 (Non-privileged mode), or 15 (Privileged mode).

## Public Key SSH Authentication Example

The following is an example of a public key configuration for SSH login. Using a tool such as putty and a private/public key infrastructure, one can enable secure login to the Dell EMC Networking N-Series switch without a password. Instead, a public key is used with a private key kept locally on the administrator's computer. The public key can be placed on multiple devices, allowing the administrator secure access without needing to remember multiple passwords. It is strongly recommended that the private key be protected with a password.

This configuration requires entering a public key, which can be generated by a tool such as PuTTYgen. Be sure to generate the correct type of key. In this case, we use an RSA key with the SSH-2 version of the protocol.

## Switch Configuration

- 1 Create a switch administrator:

```
console#config  
console(config)#username "admin" password  
f4d77eb781360c5711ecf3700a7af623 privilege 15 encrypted
```

- 2 Set the login and enable methods for line to NOAUTH.

```
console(config)#aaa authentication login "NOAUTH" line  
console(config)#aaa authentication enable "NOAUTH" line
```

- 3 Generate an internal RSA key. This step is not required if an internal RSA key has been generated before on this switch:

```
console(config)#crypto key generate rsa
```

- 4 Set SSH to use a public key for the specified administrator login. The user login is specified by the `username` command, not the `ias-user` command:

```
console(config)#crypto key pubkey-chain ssh user-key "admin"  
rsa
```

- 5 Enter the public key obtained from a key authority or from a tool such as PuTTYGen. This command is entered as a single line, not as multiple lines as it appears in the following text.

```
console(config-pubkey-key)#key-string row  
AAAAB3NzaC1yc2EAAAABJQAAAIBoR6DPjYDpSy8Qcji68xrS/4Lf8c9Jq4xXKI  
Z5Pvv20AkRFE0ifVI9EH4jyZagR3wzH5X19dyjA6bTuqMgN15C1xJC1159FU88  
JaY7ywGdRppmoaJrNRPM7RZtQPdDVIunzm3eMr9PywWQ0umsHWGNexUrDYHFWR  
IAmJp689AAxw==  
console(config)#exit
```

- 6 Set the line method to SSH:

```
console(config)#line ssh
```

- 7 Configure the authentication method to the `networkList`. The `networkList` contains a single method — `local` — which is equivalent to password authentication. Since the authentication is provided by the public key, a second layer of authentication is not required:

```
console(config-ssh)#login authentication networkList  
console(config-ssh)#exit
```

- 8** The following three lines enable the SSH server, configure it to use public key authentication, and specify use of the SSH-2 protocol.

```
console (config) #ip ssh server
console (config) #ip ssh pubkey-auth
```

The following command shows the configured authentication methods:

```
console (config) #show authentication methods
```

```
Login Authentication Method Lists
```

```
-----
defaultList      : none
networkList      : local
NOAUTH           : line
```

```
Enable Authentication Method Lists
```

```
-----
enableList       : enable  none
enableNetList    : enable
NOAUTH           : line
```

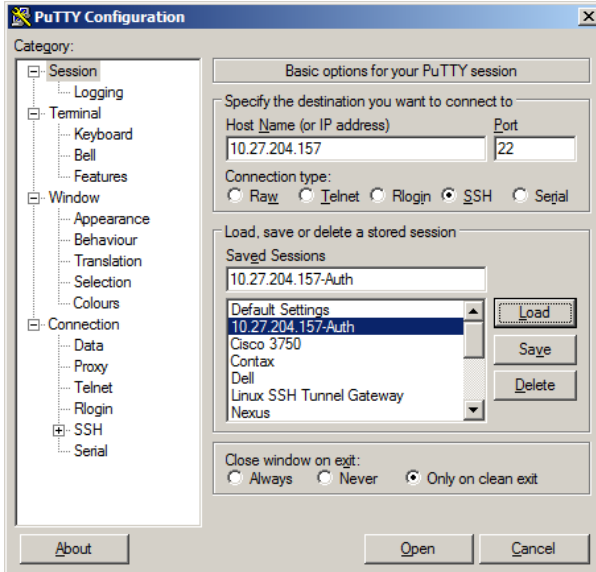
```
Line      Login Method List      Enable Method List
-----
Console   defaultList                    enableList
Telnet    networkList                    enableList
SSH       defaultList                    enableList

HTTPS     :local
HTTP      :local
DOT1X     :
```

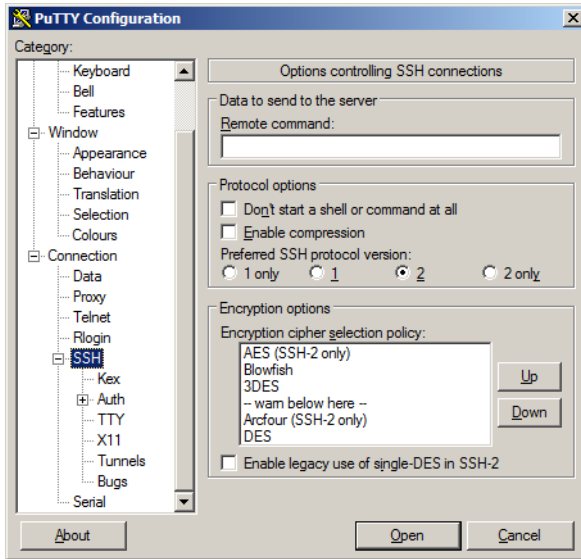
## PUTTY Configuration

### Main Screen

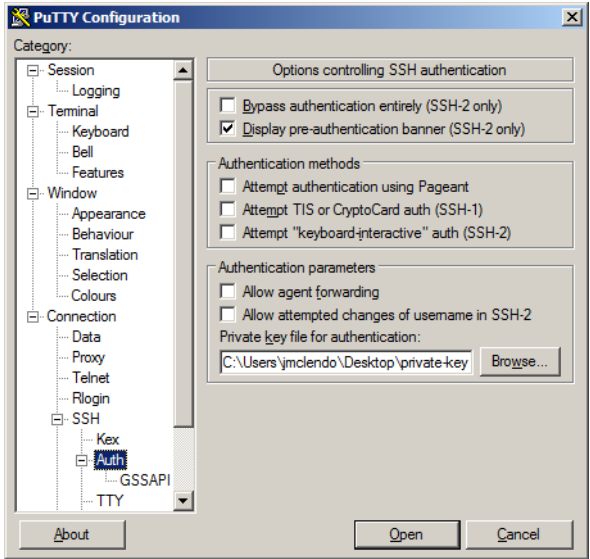
On the following screen, the IP address of the switch is configured and SSH is selected as the secure login protocol.



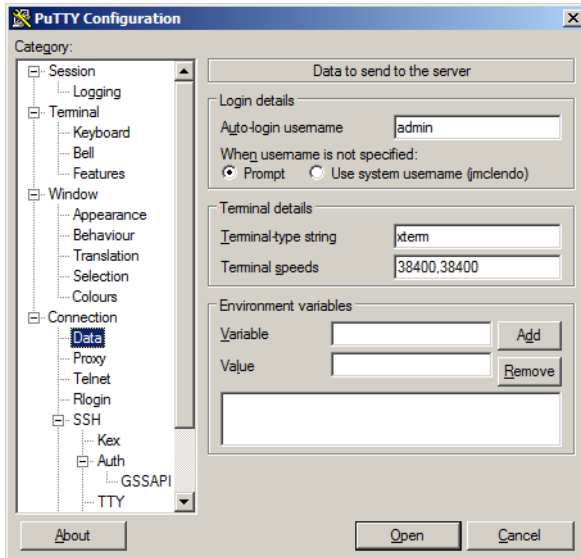
On the next screen, PUTTY is configured to use SSH-2 only. This is an optional step that accelerates the login process.



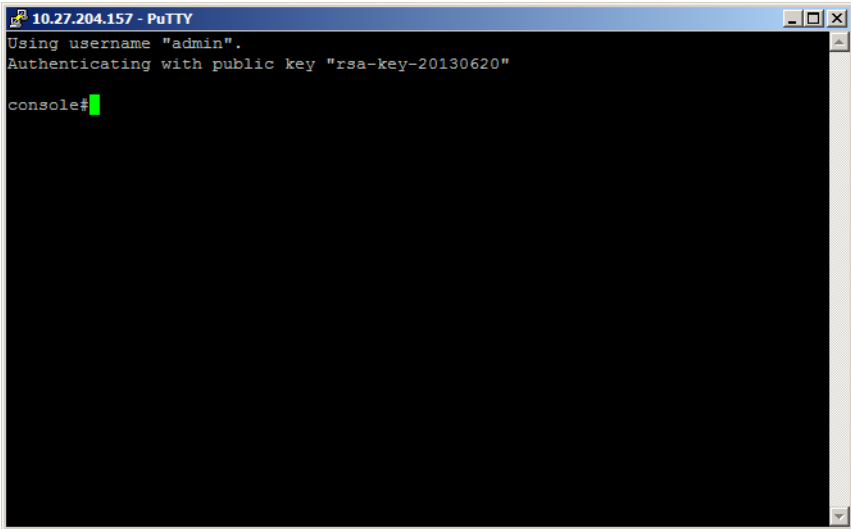
The following screen is the key to the configuration. It is set to display the authentication banner, disable authentication with Pageant, disable keyboard-interactive authentication (unless desired), disable attempted changes of user name, and select the private key file used to authenticate with the switch.



The following screen configures the user name to be sent to the switch. A user name is always required. Alternatively, leave Auto-login name blank and the system will prompt for a user name.



After configuring Putty, be sure to save the configuration. The following screen shows the result of the login process. The user name is entered automatically and the switch confirms that public key authentication occurs.



### Authenticating with a Public Key from Linux

The following example configures the switch to allow administrative access without a password for Linux users with correctly configured SSH clients. Dell EMC Networking SSH is configured to require a password on administrator accounts. This example shows how to generate a public/private key pair on Linux, configure Linux SSH, and configure the switch to authenticate SSH connections.

- 1 Log in to your Linux account and generate the RSA key pair. DSA keys are considered weak.

```
ssh-keygen -t rsa
```

- 2 In the `~/.ssh` subdirectory in your Linux account, create an SSH configuration file "ssh\_config" with the following contents:

```
User admin  
PubkeyAuthentication yes  
IdentityFile /home/jmclendo/.ssh/id_rsa
```



Substitute the login ID of the switch administrator for the User admin parameter above, and set the correct path to your account for the IdentityFile parameter.

- 3 On the switch, generate the ephemeral encryption keys to enable the SSH server to run, create the admin user, and configure the SSH server and the authentication key as shown below, making the appropriate substitutions for the login ID:

```
console(config)#crypto key generate rsa
Do you want to overwrite the existing RSA keys? (y/n):y
RSA key generation started, this may take a few minutes...
RSA key generation complete.
console(config)#crypto key generate dsa
Do you want to overwrite the existing DSA keys? (y/n):y
DSA key generation started, this may take a few minutes...
DSA key generation complete.
console(config)#username "admin" password
5f4dcc3b5aa765d61d8327deb882cf99
privilege 15 encrypted
console(config)#ip ssh server
console(config)#ip ssh pubkey-auth
console(config)#line ssh
console(config-ssh)#login authentication networkList
console(config-ssh)#exit
console(config)#crypto key pubkey-chain ssh user-key admin rsa
console(config-pubkey-key)#Key-String "ssh-rsa
AAAAAB3NzaC1yc2EAAAABIwAAAQEAvcChaxFl4sMoWMZAawtx/pcVbljY6moer3C
T231M47dgZDPFJ
1qf7/fuDwmES72FmIJAqq8cTUfT55BrI0r3vk05QJu0nnhcNjW6c98mNL9wxfx
7TWybySs3zJJpS
NhcZ9JM+OJ104n4oS4izYZ7NSSNa+LQgg5j0mw9jdITY8SicImenLCjluILrp
i6YA9WtC9RHGpi
xLzIRFQ/Kmf5SWcXiSRft4gUJP7Xp69SF3VAAuoUFQove5RMr6paLXUiZfwzDk
HA8F4WHaDyHCtx
ESLXnZuQQjCiow1l8Q2Nq5YXnu/ZEUJTyof1Uc8S13aP2rr+6Ndzbn6khBmSSg
QnVw==
jsmith@xl-rtp-02"
console(config-pubkey-key)#exit
```

The Key-String above is the contents of the ~/.ssh/id\_rsa.pub file enclosed in quotes. This file was generated by the ssh-keygen command as shown above.

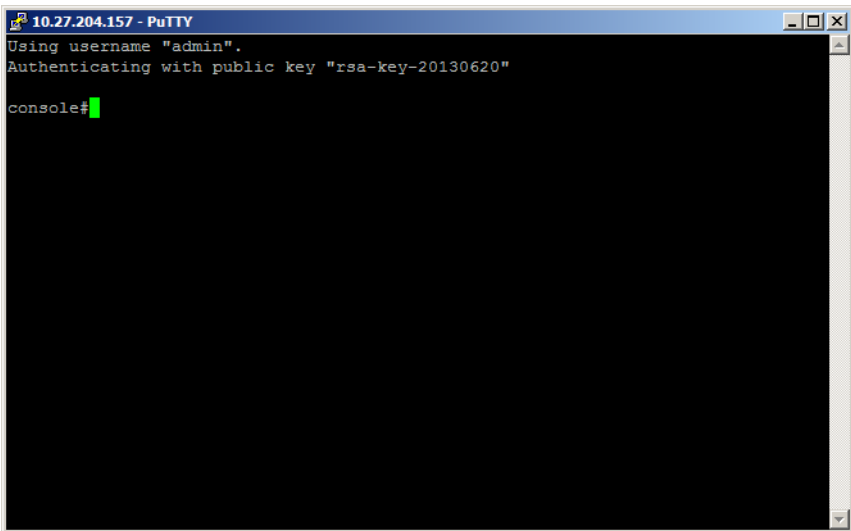
Also, ensure that the private key `~/.ssh/id_rsa` is not readable by others by executing the `chmod 0600 ~/.ssh/id_rsa` command in Linux. Authentication will fail if the file is readable by others.

The command string to log into the switch (substituting the correct IP address) from a Linux account is:

```
ssh -2 -i ~/.ssh/id_rsa -F ~/.ssh/ssh_config 10.27.21.70
```

### Authenticating Without a Public Key

When authenticating without the public key, the switch prompts for the user name and password. This is an SSH function, not a switch function. If the user knows the administrator login and password, then they are able to authenticate in this manner.



### Associating a User With an SSH Key

The following example shows how to associate a user with an externally generated SSH key. SSH, RSA, or DSA keys can be generated by using the `ssh-keygen` command on a Unix system or with other publicly available utilities.

- 1 Create the local user:

```
console#config
console (config) #username mylogin password XXXXXXXX privilege
15
```

- 2 Enter the externally generated key:

```
console (config) #crypto key pubkey-chain ssh
```

- 3 Associate the key with the newly added user login:

```
console (config-pubkey-chain) #user-key mylogin dsa
```

- 4 Add the externally generated key. All of the key information is entered between double quotes.

```
console (config-pubkey-key) #key-string "ssh-dss
AAAAAB3NzaC1kc3MAAACBAJRwUAD3AuRACp1MOBeh1AgyZb18wf9Btdip+t+1C
bAqiQNEh4lBiew184DSKk0T6SnSSXuCN+bJnQPXJeiQt+OFnmjiYhnHcvI04Q5
KnQhloZcEFgSsmQ7zJnReWtLvUQI0QvBIStanzedmQVGHvDrQ5X2R729ToSH0i
bBrnYtAAAAFQDNord7S9EJvUkKKxVBpWE6/skCmQAAAIBMjMO+BPP5KXzNwfZh
qAhxBSobvif/z6pzi9xWLLy99A03zmRYCpcGIoLWiRHsR7NVpxFqwqbqvez8KS
0CDJ5aoKKLrpBlpg5ETkYEew/utZ14lQQRBrzPwGBfxvTXKCWiI2j5KFa/WKLS
nmWJX0/98qpXW/LMXoXsA9iK4pnMKwAAAIb4Jrt6jmoLybpzqOPOI0DsJ7jQwW
acinD0jliz8k+qzCpanhd2wH+DEdj/xO2sFRfnYlME3hmXoB+7NByVUtheVjuQ
2CWhcGFIKm9tbuPC6DtXh1xxT0NJ7rspvLgb0s6y/0tk+94ZP5RCoAtLZ7wirs
hy3/KJ4RE0y2SFZjIVjQ=="
```

```
console (config-pubkey-key) #exit
console (config-pubkey-chain) #exit
console (config) #exit
```

- 5 Use the following command to show the user and SSH association:

```
console#show crypto key pubkey-chain ssh username mylogin
Username : mylogin
ssh-dss
AAAAAB3NzaC1kc3MAAACBAJRwUAD3AuRACp1MOBeh1AgyZb18wf9Btdip+t+1C
bAqiQNEh4lBiew184DSKk0T6SnSSXuCN+bJnQPXJeiQt+OFnmjiYhnHcvI04Q5
KnQhloZcEFgSsmQ7zJnReWtLvUQI0QvBIStanzedmQVGHvDrQ5X2R729ToSH0i
bBrnYtAAAAFQDNord7S9EJvUkKKxVBpWE6/skCmQAAAIBMjMO+BPP5KXzNwfZh
qAhxBSobvif/z6pzi9xWLLy99A03zmRYCpcGIoLWiRHsR7NVpxFqwqbqvez8KS
0CDJ5aoKKLrpBlpg5ETkYEew/utZ14lQQRBrzPwGBfxvTXKCWiI2j5KFa/WKLS
nmWJX0/98qpXW/LMXoXsA9iK4pnMKwAAAIb4Jrt6jmoLybpzqOPOI0DsJ7jQwW
acinD0jliz8k+qzCpanhd2wH+DEdj/xO2sFRfnYlME3hmXoB+7NByVUtheVjuQ
2CWhcGFIKm9tbuPC6DtXh1xxT0NJ7rspvLgb0s6y/0tk+94ZP5RCoAtLZ7wirs
hy3/KJ4RE0y2SFZjIVjQ==
Fingerprint : d9:d1:21:ad:26:41:ba:43:b1:dc:5c:6c:b9:57:07:6c
```

# Authorization

Authorization is used to determine which services the user is allowed to access. For example, the authorization process may assign a user's privilege level, which determines the set of commands the user can execute. There are three kinds of authorization: commands, exec, and network.

- **Commands:** Command authorization determines which CLI commands the user is authorized to execute.
- **Exec:** Exec authorization determines what the user is authorized to do on the switch; that is, the user's privilege level and an administrative profile.
- **Network:** Network authorization enables a RADIUS server to assign a particular 802.1X supplicant to a VLAN. For more information about 802.1X, see "Port and System Security" on page 705.

Table 9-8 shows the valid methods for each type of authorization:

**Table 9-8. Authorization Methods**

Method	Commands	Exec	Network
local	no	yes	no
none	yes	yes	no
radius	no	yes	yes
tacacs	yes	yes	no

## Exec Authorization Capabilities

Dell EMC Networking N-Series switches support two types of service configuration with exec authorization: privilege level and administrative profiles.

### Privilege Level

By setting the privilege level during exec authorization, a user can be placed directly into Privileged Exec mode when they log into the command line interface.

## Administrative Profiles

The Administrative Profiles feature allows the network administrator to define a list of rules that control the CLI commands available to a user. These rules are collected in a “profile.” The rules in a profile can define the set of commands, or a command mode, to which a user is permitted or denied access.

Within a profile, rule numbers determine the order in which the rules are applied. When a user enters a CLI command, rules within the first profile assigned to the user are applied in descending order until there is a rule that matches the input. If no rule permitting the command is found, then the other profiles assigned to the user (if any) are searched for rules permitting the command. Rules may use regular expressions for command matching. All profiles have an implicit “deny all” rule, such that any command that does not match any rule in the profile is considered to have been denied by that profile.

A user can be assigned to more than one profile. If there are conflicting rules in profiles, the “permit” rule always takes precedence over the “deny” rule. That is, if any profile assigned to a user permits a command, then the user is permitted access to that command. A user may be assigned up to 16 profiles.

A number of profiles are provided by default. These profiles cannot be altered by the switch administrator. See "Administrative Profiles" on page 341 for the list of default profiles.

If the successful authorization method does not provide an administrative profile for a user, then the user is permitted access based upon the user's privilege level. This means that, if a user successfully passes enable authentication or if exec authorization assigns a privilege level, the user is permitted access to all commands. This is also true if none of the administrative profiles provided are configured on the switch. If some, but not all, of the profiles provided in the authentication are configured on the switch, then the user is assigned the profiles that exist, and a message is logged that indicates which profiles could not be assigned.

The administrative profiles shown in Table 9-9 are system-defined and may not be deleted or altered. To see the rules in a profile, use the **show admin-profiles name *profile name*** command.

**Table 9-9. Default Administrative Profiles**

<b>Name</b>	<b>Description</b>
network-admin	Allows access to all commands.
network-security	Allows access to network security features such as 802.1X, Voice VLAN, Dynamic ARP Inspection and IP Source Guard.
router-admin	Allows access to Layer 3 features such as IPv4 Routing, IPv6 Routing, OSPF, RIP, etc.
multicast-admin	Allows access to multicast features at all layers, this includes L2, IPv4 and IPv6 multicast, IGMP, IGMP Snooping, etc.
dhcp-admin	Allows access to DHCP related features such as DHCP Server and DHCP Snooping.
CP-admin	Allows access to the Captive Portal feature.
network-operator	Allows access to all User Exec mode commands and show commands.

### **Authorization Examples**

Authorization allows the administrator to control which services a user is allowed to access. Some of the things that can be controlled with authorization include the user's initial privilege level and which commands the user is allowed to execute. When authorization fails, the user is denied access to the switch, even though the user has passed authentication.

The following examples assume that the configuration used in the previous examples has already been applied.

#### **Local Authorization Example—Direct Login to Privileged Exec Mode**

Apply the following configuration to use the local user database for authorization, such that a user can enter Privileged Exec mode directly:

```
aaa authorization exec "locex" local
line telnet
authorization exec locex
exit
```

With the users that were previously configured, the guest user will still log into user Exec mode, since the guest user only has privilege level 1 (the default). The admin user will be able to login directly to Privileged Exec mode since his privilege level was configured as 15.

### **RADIUS Authorization Example—Direct Login to Privileged Exec Mode**

Apply the following configuration to use RADIUS for authorization, such that a user can enter Privileged Exec mode directly:

```
aaa authorization exec "rad" radius
line telnet
authorization exec rad
exit
```

Configure the RADIUS server so that the RADIUS attribute Service Type (6) is sent with value Administrative. Any value other than Administrative is interpreted as privilege level 1.

The following describes each line in the above configuration:

- The `aaa authorization exec "rad" radius` command creates an exec authorization method list called "rad" that contains the method radius.
- The `authorization exec rad` command assigns the rad exec authorization method list to be used for users accessing the switch via Telnet.



#### **NOTES:**

- If the privilege level is zero (that is, blocked), then authorization will fail and the user will be denied access to the switch.
- If the privilege level is higher than one, the user will be placed directly in Privileged Exec mode. Note that all commands in Privileged Exec mode require privilege level 15, so assigning a user a lower privilege level will be of no value.
- A privilege level greater than 15 is invalid and treated as if privilege level zero had been supplied.

### **RADIUS Authorization Example—Administrative Profiles**

The switch should use the same configuration as in the previous authorization example.

The RADIUS server should be configured such that it will send the Cisco AV Pair attribute with the “roles” value. For example:

```
shell:roles=router-admin
```

The above example attribute gives the user access to the commands permitted by the router-admin profile.

## **RADIUS Change of Authorization**

Dell EMC Networking N-Series switches support the Change of Authorization Disconnect-Request and COA-Request per RFC 5176. The Dell EMC Networking N-Series switch listens for the Disconnect-Request/COA-Request on UDP port 3799. The Disconnect-Request/COA-Request identifies the user session to be terminated using any or all of the following attributes:

- User-Name (IETF attribute #1)
- NAS-Port (IETF attribute #5)
- Framed-IP-Address (IETF attribute #8)
- Acct-Session-Id (IETF attribute #44)
- Calling-Station-Id (IETF attribute #31, which contains the host MAC address)

For CLI-based sessions (Console, Telnet and SSH), the supported Session Identification Attributes are User-Name and Framed-IP-Address.

The Calling-Station-ID must be a string of upper or lower case hexadecimal digits in one of the following formats:

- Raw notation, for example, AbCD01234567 - length 12
- Dotted quad notation, for example, BADC.1010.1234 - length 14
- Colon separated hex digits, for example, AB:cd:01:23:45:67 - length 17
- Dash separated hex digits: 01-23-45-67-89-Ab - length 17

A RADIUS Disconnect message may also contain the Acct-Terminate-Cause attribute (IETF #49).

The following messages from RFC 3576 are supported:

40 – Disconnect-Request

41 – Disconnect-ACK



## 42 – Disconnect-NAK

A CoA Disconnect-Request terminates the session without disabling the switch port. Instead, a CoA Disconnect-Request termination causes reinitialization of the authenticator state machine for the specified host.

A CoA bounce host port request disables the port for 10 seconds. The bounce host port is requested using the proprietary AVPair *subscriber:command=bounce-host-port*. The switch may be configured to ignore bounce host port requests using the **authentication** command **bounce-port ignore** command.

A CoA disable host port request disables the port. The operator must re-enable the port via the UI or configure `errdisable recovery` for the `authmgr` cause. The disable host port is requested using the proprietary AVPair *subscriber:command=disable-host-port*. The switch may be configured to ignore disable host port requests using the **authentication** command **disable-port ignore** command.

The CoA re-authenticate request re-authenticates the identified session. If the session is unable to successfully authenticate, it is terminated. The re-authenticate session action is requested using the proprietary AVPair *subscriber:command=reauthenticate*.

Any authentication host mode can be configured for 802.1X sessions in conjunction with CoA. If the session cannot be located, the device returns a Disconnect-NAK message with the *Session Context Not Found* error-cause attribute. If the session is located, the device performs the requested action on the interface or 802.1X session. After the action has been performed, the device returns a Disconnect-ACK message. The attributes returned within a CoA ACK can vary based on the CoA Request.

The administrator can configure whether all or any of the session attributes are used to identify a client session. If all is configured, all session identification attributes included in the CoA-Request/Disconnect-Request must match a session or the device returns a Disconnect-NAK or CoA-NAK with the *Invalid Attribute Value* error-code attribute. All attributes in the CoA-Request/Disconnect-Request are treated as mandatory attributes, except `Acct-Terminate-Cause`. Unsupported attributes generate a Disconnect-NAK with error-cause `Unsupported Service`.

Dell EMC Networking N-Series switches support the following attributes in responses:

- User-Name (IETF attribute #1)

- NAS-Port (IETF attribute #5)
- Framed-IP-Address (IETF attribute #8)
- Calling-Station-ID (IETF attribute #31)
- Acct-Session-ID (IETF attribute #44)
- Message-Authenticator (IETF attribute #80)
- Error-Cause (IETF attribute #101)

A CoA NAK message is not sent for all CoA requests with a key mismatch. The message is sent only for the first three requests for a client. After that, all the packets from that client are dropped. When there is a key mismatch, the response authenticator sent with the CoA NAK message is calculated from a dummy key value.

The Dell EMC Networking N-Series switch will start listening to the 802.1X client again based on the re-authentication timer.

### RADIUS COA Example

The following example configures the Dell EMC Networking N-Series switch to listen for and respond to RADIUS COA messages. This example does not configure any ports to use 802.1X or enable 802.1X. See "IEEE 802.1X" on page 355 for information on configuring 802.1X on interfaces.

- 1 Configure the switch to use the new model CLI command set. Dell EMC Networking N-Series switches do not support old model commands:

```
console#config
console(config)#aaa new-model
```

- 2 Configure the switch to listen to RADIUS CoA requests.

```
console(config)#aaa server radius dynamic-author
```

- 3 Configure a local RADIUS client connection to RADIUS server 10.11.12.13 using the shared secret "secret sauce". The default port number is used.

```
console(config-radius-da)#client 10.11.12.13 server-key
"secret sauce"
```

- 4 Disconnect-request client identification must match on all keys present in the request.

```
console(config-radius-da)#auth-type all
console(config-radius-da)#exit
```

## RADIUS COA Example with Telnet and SSH

The following example configures telnet and SSH clients in conjunction with RADIUS CoA.

- 1 Configure a login list named “login-list” that uses RADIUS as the only method:

```
console#config
console (config) #aaa authentication login "login-list" radius
```

- 2 Enable RADIUS COA:

```
console (config) #aaa server radius dynamic-author
```

- 3 Enable the switch RADIUS client connecting to the RADIUS server at 10.130.191.89:

```
console (config-radius-da) #client 10.130.191.89 server-key
"shared secret"
```

- 4 Allow matching of the client session on any of the key values present in the RADIUS disconnect:

```
console (config-radius-da) #auth-type any
console (config-radius-da) #exit
```

- 5 Configure the RADIUS server attribute 4 (NAS-IP-Address). This attribute is sent in the RADIUS message to the RADIUS server but does not change the source IP address sent in the RADIUS messages. It allows a group of NASs to simulate a large RADIUS NAS:

```
console (config) #radius server attribute 4 10.130.65.4
```

- 6 Configure the remote RADIUS server address with name Default-RADIUS-Server and key “shared secret”:

```
console (config) #radius server auth 10.130.191.89
console (config-auth-radius) #name Default-RADIUS-Server
console (config-auth-radius) #key "shared secret"
console (config-auth-radius) #exit
```

- 7 Configure telnet sessions to the switch to use RADIUS authentication (the only login-list method):

```
console (config) #line telnet
console (config-telnet) #login authentication login-list
console (config-telnet) #exit
```

- 8 Configure SSH sessions to the switch to use RADIUS authentication:

```
console (config) #line ssh
console (config-ssh) #login authentication login-list
```

```
console(config-ssh) #exit
```

- 9 Enable the SSH server (the telnet server is enabled by default):

```
console(config) #ip ssh server
```

## TACACS Authorization

### TACACS+ Authorization Example—Direct Login to Privileged Exec Mode

Apply the following configuration to use TACACS+ for authorization, such that a user can enter Privileged Exec mode directly:

- 1 Create an exec authorization method list called “tacex” which contains the method tacacs.

```
console#config
console(config) #aaa authorization exec "tacex" tacacs
```

- 2 Assign the tacex exec authorization method list to be used for users accessing the switch via Telnet.

```
console(config) #line telnet
console(config-telnet) #authorization exec tacex
console(config-telnet) #exit
```

- 3 Configure the TACACS+ server so that the shell service is enabled and the priv-lvl attribute is sent when user authorization is performed. For example:

```
shell:priv-lvl=15
```

### NOTES:

- If the privilege level is zero (that is, blocked), then authorization will fail and the user will be denied access to the switch.
- If the privilege level is higher than one, the user will be placed directly in Privileged Exec mode. Note that all commands in Privileged Exec mode require privilege level 15, so assigning a user a lower privilege level will be of no value.
- A privilege level greater than 15 is invalid and treated as if privilege level zero had been supplied.
- The shell service must be enabled on the TACACS+ server. If this service is not enabled, authorization will fail and the user will be denied access to the switch.

## TACACS+ Authorization Example—Administrative Profiles

The switch should use the same configuration as for the previous authorization example.

The TACACS+ server should be configured such that it will send the “roles” attribute. For example:

```
shell:roles=router-admin
```

The above example attribute will give the user access to the commands permitted by the router-admin profile.



**NOTE:** If the priv-lvl attribute is also supplied, the user can also be placed directly into Privileged Exec mode.

## TACACS+ Authorization Example—Custom Administrative Profile

This example creates a custom profile that allows the user to control user access to the switch by configuring a administrative profile that only allows access to AAA related commands. Use the following commands to create the administrative profile:

- 1 Create an administrative profile called “aaa” and place the user in admin-profile-config mode.

```
console#config  
console (config) #admin-profile aaa
```

- 2 Enter rule *number* **permit** *command* *regex* commands to allows any command that matches the regular expression.

The command rules use regular expressions as implemented by Henry Spencer's regex library (the POSIX 1003.2 compliant version). In the regular expressions used in this example, the caret (^) matches the null string at the beginning of a line, the period (.) matches any single character, and the asterisk (\*) repeats the previous match zero or more times.

```
console (config) #rule 99 permit command ^show aaa .*  
console (admin-profile) #rule 98 permit command ^show authentication .*  
console (admin-profile) #rule 97 permit command ^show authorization .*  
console (admin-profile) #rule 96 permit command ^show accounting .*
```

```

console(admin-profile)#rule 95 permit command "^show tacacs
.*"
console(admin-profile)#rule 94 permit command "^aaa .*"
console(admin-profile)#rule 93 permit command "^line .*"
console(admin-profile)#rule 92 permit command "^login .*"
console(admin-profile)#rule 91 permit command "^authorization
.*"
console(admin-profile)#rule 90 permit command "^accounting .*"
console(admin-profile)#rule 89 permit command "^configure .*"
console(admin-profile)#rule 88 permit command "^password .*"
console(admin-profile)#rule 87 permit command "^username .*"
console(admin-profile)#rule 86 permit command "^show user.*"
console(admin-profile)#rule 85 permit command "^radius server
.*"
console(admin-profile)#rule 84 permit command "^tacacs-server
.*"

```

- 3 Enter rule *number* permit mode *mode-name* commands to allow all commands in the named mode.

```

console(admin-profile)#rule 83 permit mode radius-auth-config
console(admin-profile)#rule 82 permit mode radius-acct-config
console(admin-profile)#rule 81 permit mode tacacs-config
console(admin-profile)#exit

```

- 4 Assign this profile to a user by configuring the TACACS+ server so that it sends the following “roles” attribute for the user:

```
shell:roles=aaa
```

If it is desired to also permit the user access to network-operator commands (basically, all the command in User Exec mode), then the “roles” attribute would be configured as follows:

```
shell:roles=aaa,network-operator
```

## **TACACS+ Authorization Example—Per-command Authorization**

An alternative method for command authorization is to use the TACACS+ feature of per-command authorization. With this feature, every time the user enters a command, a request is sent to the TACACS+ server to ask if the user is permitted to execute that command. Exec authorization does not need to be configured to use per-command authorization.

Apply the following configuration to use TACACS+ to authorize commands:

- 1 Creates a command authorization method list called “taccmd” that includes the method tacacs.

```
console#config
console (config) #aaa authorization commands "taccmd" tacacs
```

- Assigns the taccmd command authorization method list to be used for users accessing the switch via Telnet.

```
console (config) #line telnet
console (config-telnet) #authorization commands taccmd
console (config-telnet) #exit
```

The TACACS+ server must be configured with the commands that the user is allowed to execute. If the server is configured for command authorization as “None”, then no commands will be authorized. If both administrative profiles and per-command authorization are configured for a user, any command must be permitted by both the administrative profiles and by per-command authorization.

## **TACACS Authorization—Privilege Level**

Dell EMC Networking TACACS supports setting the maximum user privilege level in the TACACS authorization response. Configure the TACACS server to send `priv-lvl=X`, where X is either 1 (Non-privileged mode), or 15 (Privileged Exec mode).

# Accounting

Accounting is used to record security events, such as a user logging in or executing a command. Accounting records may be sent upon completion of an event (stop-only) or at both the beginning and end of an event (start-stop). There are three types of accounting: commands, Dot1x, and exec.

- **Commands**—Sends accounting records for command execution.
- **Dot1x**—Sends accounting records for network access.
- **Exec**—Sends accounting records for management access (logins).

For more information about the data sent in accounting records, see "Which RADIUS Attributes Does the Switch Support?" on page 309 and "Using TACACS+" on page 312.

Table 9-10 shows the valid methods for each type of accounting:

**Table 9-10. Accounting Methods**

Method	Commands	Dot1x	Exec
radius	no	yes	yes
tacaacs	yes	no	yes

## RADIUS Accounting

Dell EMC Networking N-Series switches support RADIUS accounting. The supported accounting types are start-only or start-stop.

The following attributes may be sent in the Accounting Stop record that is sent to the RADIUS server when the switch is configured for 802.1X accounting:

- User-Name (1)
- NAS-IP-Address (4)
- Framed-IP-Address (8)
- Called-Station-Id (30)
- Calling-Station-Id (31)
- NAS-Identifier (33)
- NAS-Port-Type (61)



- Acct-Terminate-Cause(49)
- Class (25)
- Acct-Authentic (45)
- Acct-Session Time(46)
- Acct-Input-Octets (42)
- Acct-Output-Octets (43)
- Acct-Input-Gigawords(52)
- Acct-Output-Gigawords (53)
- Framed-IPv6-Address (168)
- Acct-Delay-Time (41)
- Acct-Session-Id (44)
- NAS-Port-Id (87)

Certain of the attributes above may be sent only if received from the RADIUS server during the Access Request process, for example, Class. Only one of the NAS-IP-Address or the NAS-Identifier may be sent in an Accounting Stop record.

The following attributes are sent in the Accounting Start record sent to the RADIUS server when the switch is configured for 802.1x accounting:

- User-Name (1)
- NAS-IP-Address (4)
- Framed-IP-Address (8)
- Class (25)
- Called-Station-Id (30)
- Calling-Station-Id (31)
- NAS-Identifier (33)
- Acct-Authentic (45)
- NAS-Port-Type (61)
- Tunnel-Private-Group-Id (81) - VLAN ID
- Framed-IPv6-Address (168)
- Acct-Session-Id (44)

- NAS-Port-Id (87)

The Framed-IP-Address or Framed-IPv6-Address are only sent if available. Only one of the NAS-IP-Address or the NAS-Identifier may be sent in an Accounting Start record.

# IEEE 802.1X

## What is IEEE 802.1X?

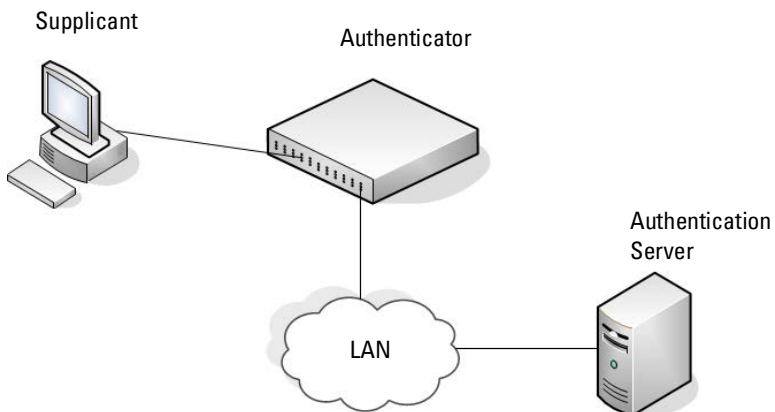
The IEEE 802.1X standard provides a means of preventing unauthorized access by supplicants (clients) to the services the switch offers, such as access to the LAN.

The 802.1X network has three components:

- **Supplicant** — The client connected to the authenticated port that requests access to the network.
- **Authenticator** — The network device that prevents network access prior to authentication.
- **Authentication Server** — The network server (such as a RADIUS server) that performs the authentication on behalf of the authenticator, and indicates whether the user is authorized to access system services. Dell EMC Networking supports interoperability with a variety of external authentication servers. Refer to "Authentication, Authorization, and Accounting" on page 291 for more information.

Figure 9-3 shows the 802.1X network components.

**Figure 9-3. IEEE 802.1X Network**



As shown in Figure 9-3, the Dell EMC Networking switch is the authenticator and ensures that the supplicant (a PC) that is attached to an 802.1X-controlled port is authenticated by an authentication server (a RADIUS server). The result of the authentication process determines whether the supplicant is authorized to access network services on that controlled port. Dell EMC Networking N-Series switches support 802.1X authentication using remote RADIUS or using a local authentication service (IAS).

Supported security methods for supplicant communication with remote authentication servers include MD5, PEAP, EAP-TTL, EAP-TTLS, and EAP-TLS. Only EAP-MD5 is supported when using the local authentication server (IAS) for communication with the supplicant.

For a list of RADIUS attributes that the switch supports, see "Using RADIUS" on page 307.

### **What are the 802.1X Port Authentication Modes?**

The 802.1X port authentication mode determines whether to allow or prevent network traffic on the port. A port can be configured to be in one of the following 802.1X authentication modes:

- Auto (default)
- Force-authorized
- Force-unauthorized

These modes control the behavior of the port. The port state is either Authorized or Unauthorized. 802.1X auto mode may be configured on ports in general or access mode. 802.1X is not supported on trunk mode ports.

If the port is in the force-authorized mode, the port state is Authorized and the port sends and receives normal traffic without client port-based authentication. When a port is in a forced-unauthorized mode, the port state is Unauthorized and the port ignores supplicant authentication attempts and does not provide authentication services. By default, when 802.1X is globally enabled on the switch, all ports are in auto authentication mode, which means the port will be unauthorized until a successful authentication exchange has taken place.

The port security feature can be utilized if it is desired to limit access on auto mode configured ports. To limit access to a phone and laptop configuration using Voice VLAN, the port security limit should be set to 3 as many IP phones also utilize the data VLAN during power up. For more information on port security, see "Port and System Security" on page 705.



**NOTE:** Only Auto mode uses 802.1X and RADIUS to authenticate. Force-authorized and Force-unauthorized modes are manual overrides.

## What are Authentication Host Modes

Authentication host modes configure the allowed authentication modes on a port. The authentication modes restrict the number of simultaneously authenticated clients and VLAN assignments.

### Single-Host Mode

In a single-host mode, only one data or one voice client can be authenticated and granted access to the port. Access is allowed only for this client and no other. Only when this client is unauthenticated can another client get authenticated and authorized on the port. A single voice VLAN device is supported in single-host mode if no other device has authenticated.

### Multi-Host Mode

In multi-host mode, only one data client can be authenticated on a port. However, once authentication succeeds, access is granted to all hosts connected to the port. A typical use case is a wireless access point which is connected to an access-controlled port of a NAS. Once the access point is authenticated by the NAS, the port is authorized for traffic from, not just the access point, but also from all the wireless clients connected to the access point.

### Multi-Domain Mode

In multi-domain mode, only one data client and one voice client can be authenticated on a port. A typical use case is an IP phone connected to a NAS port and a laptop connected to the hub port of the IP phone. Both the devices need to be authenticated to access the network. The voice and data domains

are separated into separate VLANs. The RADIUS server attribute vendor proprietary AVPair *device-traffic-class=voice* is used to identify the voice client.

### **Multi-Domain-Multi-Host Mode**

In multi-domain-multi-host mode, one voice device and one data device may authenticate on a port. However, once the data device is authenticated, access is authorized on the data VLAN to any connected device.

The typical use case is an IP phone connected to a NAS port and a Virtual Machine Controller connected to the data port of the IP phone. The Virtual Machine Controller hosts multiple Virtual Machines. Both the VM Controller and the IP phone authenticate to access the network services behind the NAS. The voice and data domains are separated. Once the VM Controller is authenticated, it allows traffic from all the VMs hosted by the VM Controller.

### **Multi-Auth Mode**

In multi-auth mode, one voice client and multiple data hosts can be authenticated on a port. Each host must authenticate individually. A typical use case for multi-auth mode is a network of laptops and an IP phone connected to the NAS port via a hub.

### **What is MAC Authentication Bypass?**

The option to use MAC Authentication Bypass (MAB) is available in all authentication host modes. MAB is a supplemental authentication mechanism that allows 802.1X-unaware clients—such as printers, fax machines, and some IP phones—to authenticate to the network using the client MAC address as an identifier.

The known and allowable MAC address and corresponding access rights of the client must be pre-populated in the authentication server. Both MAB authentication and any of the authentication host modes are supported on a port simultaneously.

When a port configured for MAB receives traffic from an unauthenticated client, the switch (Network Authentication Server or NAS):

- Sends a EAP Request packet to the unauthenticated client
- Waits a pre-determined period of time for a response

- Retries – resends the EAP Request packet up to three times
- Considers the client to be 802.1X unaware client (if it does not receive an EAP response packet from that client)

The NAS sends a request to the authentication server with the MAC address of the client in a hexadecimal format as the username and the MD5 hash of the MAC address as the password. The authentication server checks its database for the authorized MAC addresses and returns an Access-Accept or an Access-Reject response, depending on whether the MAC address is found in the database. If an Access-Accept is received by the NAS, an internal ACL is applied to the port using the MAC address of the authenticated device allowing it to access the network. Any other devices wishing to access the network must authenticate individually. MAB also allows 802.1X-unaware clients to be placed in a RADIUS-assigned VLAN or to apply a specific Filter ID to the client traffic.

The following information is sent to the RADIUS authenticator for MAB clients using EAP-MD5 authentication:

- 1 - User-Name—MAC address of MAB device (AA:BB:CC:DD:EE:FF)
- Attribute 2 is not sent if Auth type is EAP-MD5.
- 4 - NAS-IP-Address—IP address of the switch
- 5 - NAS-Port—switch internal port number (ifIndex)
- 6 - Service Type 10 (Call-Check)
- 12 - Framed-MTU - port/switch MTU - header length (e.g. 1500)
- 30 - Called Station ID —MAC address of device (xx:xx:xx:xx:xx:xx format)
- 31 - Calling Station ID—Switch MAC address
- 61 - NAS-Port-Type (Ethernet 15)
- 80 - Message Authenticator
- 87- NAS-Port-Id (such as Gigabitethernet 1/0/15)
- 79-EAP-Message

The format of the Calling-Station-ID for MAB clients may be altered using the **attribute 31** command. The format of the User-Name attribute for MAB clients may be altered using the **attribute 1** command.

By default, MAB clients are authenticated to the authentication server using EAP-MD5. MAB clients may optionally be configured to use CHAP or PAP to authenticate the MAB device. For CHAP or PAP, the following attributes are sent to the RADIUS server:

- 1 - User-Name—MAC address of MAB device
- 2 - User Password (PAP only)
- 3 - CHAP-Password - = Encrypted MAC address (CHAP) only or unencrypted (PAP) User Name
- 4 - NAS-IP-Address—IP address of the switch
- 5 - NAS-Port—switch internal port number (ifIndex)
- 6 - Service Type is set to 10 for MAB (Call-Check)
- 12 - Framed-MTU - port/switch MTU - header length (e.g. 1500)
- 30 - Called Station ID—MAC address of device (in xx:xx:xx:xx:xx:xx format)
- 31 - Calling Station ID—Switch MAC address
- 60 - CHAP Challenge (CHAP only)
- 61 - NAS-Port-Type (Ethernet 15)
- 80 - Message Authenticator
- 87 - NAS-Port-ID



**NOTE:** MAB initiates only after the dot1x guest VLAN period times out. If the client responds to any of the EAPOL identity requests, MAB does not initiate for that client.

### **What is the Role of 802.1X in VLAN Assignment?**

Dell EMC Networking N-Series switches allow a port to be placed into a particular VLAN based on the result of the authentication. The authentication server can provide information to the switch about which VLAN to assign the supplicant or the administrator can configure the level of access provided when authentication fails or is never attempted.

When a host connects to a switch that uses an authentication server to authenticate, the host authentication will have one of three outcomes:

- The host is authenticated.



- The host attempts to authenticate but fails because it lacks certain security credentials.
- The host does not try to authenticate at all (802.1X unaware).

Three separate VLANs can be configured on the switch to handle a host depending on whether the host authenticates, fails the authentication, or does not attempt authentication. The RADIUS server informs the switch of the selected VLAN as part of the authentication.

### **RADIUS VLAN Assignment**

Hosts that authenticate normally are assigned to a VLAN that includes access to network resources. In some cases, the administrator may use a default VLAN that restricts network access. In these cases, the VLAN may be assigned by the RADIUS server for ports configured in multi-host or multi-domain-multi-host modes. Hosts that fail authentication may be denied access to the network or placed into an unauthenticated VLAN, if configured. Hosts that do not attempt authentication may be placed into a guest VLAN, if configured. The network administrator can configure the type of access provided to the authenticated, guest, and unauthenticated VLANs.

Much of the configuration to assign authenticated hosts to a particular VLAN takes place on the 802.1X authenticator server (for example, a RADIUS server). If an external RADIUS server is used to manage VLANs, configure the server to use Tunnel attributes in Access-Accept messages in order to inform the switch about the selected VLAN. These attributes are defined in RFC 2868 and their use for dynamic VLAN is specified in RFC 3580.

The VLAN attributes defined in RFC3580 and required for VLAN assignment via RADIUS are as follows:

- Tunnel-Type (64) = VLAN (13)
- Tunnel-Medium-Type (65) = 802 (6)
- Tunnel-Private-Group-ID (81) = VLANID

The tag value for the Tunnel-Private-Group-ID is parsed as the length of the VLAN ID. The VLAN ID may consist of a VLAN name (not to exceed 32 characters) or a numeric value in ASCII (no alphabetic characters are allowed) in the range 1–4093.

## **Dynamic VLAN Creation**

If RADIUS-assigned VLANs are enabled through the Authorization Network RADIUS configuration option, the RADIUS server is expected to include the VLAN ID in the 802.1X tunnel attributes of its response message to the switch. If dynamic VLAN creation is enabled on the switch and the RADIUS-assigned VLAN does not exist, then the assigned VLAN is dynamically created and the port PVID or native VLAN is set to the RADIUS-assigned VLAN ID. Trunk mode ports are also made members of the created VLAN.

If the VLAN is already created on the switch, the port PVID or native VLAN is set to the VLAN ID. This implies that the client can connect from any port and be assigned to the appropriate VLAN based on the RADIUS server configuration. This gives flexibility for clients to move around the network without much additional configuration required on the switches in the network. Dynamic VLAN assignment requires that the port be configured in general or access mode.

## **Unauthenticated VLAN**

The network administrator may choose to configure an unauthenticated VLAN. Hosts that attempt authentication and fail are placed in the unauthenticated VLAN, if configured.

The 802.1X state machine implements the Held timer (per IEEE 802.1X-2010) and will not place the host in the unauthenticated VLAN until the timer expires.

Once in the unauthenticated VLAN, authentication is not reattempted until:

- the re-authentication timer expires
- the supplicant disconnects from the port
- the port is shut down and re-enabled

The number of re-authentication failures required to place a supplicant in the unauthenticated VLAN is not configurable.

The network administrator can configure the unauthenticated VLAN to provide the desired level of network access, i.e., a black hole or a guest VLAN type of access.

## Guest VLAN

The Guest VLAN feature provides a mechanism to allow hosts access to a guest VLAN. For example, the administrator might provide a guest VLAN to visitors and contractors to permit network access that allows visitors to connect to external network resources, such as the Internet, with no ability to access information on the internal LAN.

As an example, on a port configured in auto authentication mode (**authentication port-control auto**) and connected to a host that does not support 802.1X, the host does not respond to the 802.1X requests from the switch. The port remains in the unauthorized state and the client is not granted access to the network. If a guest VLAN is configured for that port, the host is placed in the configured guest VLAN and moved to the authorized state, allowing access to the client over the guest VLAN.



**NOTE:** MAB and the guest VLAN feature are mutually exclusive on a port. If MAB is enabled on a port concurrently with guest VLAN, the port will not move to the authorized state.

When the guest VLAN capability is disabled, hosts authorized by the guest VLAN are removed from the VLAN and denied network access.

Authentication is periodically re-attempted for hosts placed into the guest VLAN. The re-authentication period is calculated as follows:

$$\text{Re-authentication period} = (\text{max-reauth-req} + 1) \times \text{tx-period}$$

The max-reauth-req and tx-period are configured using the following commands:

- `dot1x max-reauth-req`
- `dot1x timeout tx-period`

## RADIUS Trunk Mode Assignment

Some network administrators may choose to use a default configuration on all ports in the network and administer bespoke network policies via RADIUS. Dell EMC switches support configuration of switchport trunk mode on ports

via RADIUS. In an 802.1X Access-Accept message, the Cisco VSA device-traffic-class=switch indicates that the connected device is capable of forwarding traffic from multiple stations using tagged and untagged traffic. When an Access-Accept message is received that contains the VSA device-traffic-class=switch, the switch operationally sets the port to trunk mode and utilizes the RADIUS-assigned VLAN to set the operational native VLAN. If not present, the port PVID is used to set the operational trunk port native VLAN. Spanning-tree portfast is operationally disabled on the port. Any trunk mode configuration on the port is respected.

Additional hosts may authenticate on a switchport trunk (or general) mode port configured in authentication host-mode multi-auth and contain a VLAN assignment. If the Access-Accept contains a VLAN assignment, the VLAN assignment is honored for the client. Client packets must be tagged with the assigned VLAN to be forwarded.

### What is Monitor Mode?

The monitor mode is a special mode that can be enabled in conjunction with 802.1X authentication. Monitor mode provides a way for network administrators to identify possible issues with the 802.1X configuration on the switch without affecting the network access to the users of the switch. It allows network access even in case where there is a failure to authenticate but logs the results of the authentication process for diagnostic purposes.

The monitor mode can be configured globally on a switch. If the switch fails to authenticate a user for any reason (for example, RADIUS access reject from RADIUS server, RADIUS timeout, or the client itself is dot1x-unaware), the client is authenticated and is undisturbed by the failure condition(s). The reasons for failure are logged for tracking purposes.

Table 9-11 provides a summary of the 802.1X Monitor Mode behavior.

**Table 9-11. IEEE 802.1X Monitor Mode Behavior**

Case	Sub-case	Regular 802.1X	802.1X Monitor Mode
RADIUS/IAS Success	Success	Port State: Permit VLAN: Assigned Filter: Assigned	Port State: Permit VLAN: Assigned Filter: Assigned
	Incorrect NAS Port	Port State: Deny	Port State: Permit VLAN: Assigned

**Table 9-11. IEEE 802.1X Monitor Mode Behavior (Continued)**

<b>Case</b>	<b>Sub-case</b>	<b>Regular 802.1X</b>	<b>802.1X Monitor Mode</b>
	Invalid VLAN Assignment	Port State: Deny	Port State: Permit VLAN: Default PVID of the port
	Invalid Filter-ID	Port State: Deny	Port State: Permit VLAN: Assigned
	Invalid DACL	Port State: Deny	Port State: Permit DACL: Not Assigned VLAN: Assigned
	Bad RADIUS packet	Port State: Deny	Port State: Permit VLAN: Default PVID of the port
RADIUS/IAS Failure	Default behavior	Port State: Deny	Port State: Permit VLAN: Default PVID of the port
	Unauth VLAN enabled	Port State: Permit VLAN: Unauth	Port State: Permit VLAN: Unauth
RADIUS Timeout	Default behavior	Port State: Deny	Port State: Permit VLAN: Default PVID of the port
	Unauth VLAN enabled	Port State: Deny	Port State: Permit VLAN: Unauth
Critical Voice VLAN	Default behavior	Port State: Deny	Port State: Permit VLAN: Critical Voice VLAN
EAPOL Timeout	Default behavior	Port State: Deny	Port State: Permit
3 × EAPOL Timeout (Guest VLAN timer expiry or MAB timer expiry)	Guest VLAN enabled	Port State: Permit VLAN: Guest	Port State: Permit VLAN: Guest

**Table 9-11. IEEE 802.1X Monitor Mode Behavior (Continued)**

Case	Sub-case	Regular 802.1X	802.1X Monitor Mode
	MAB Success Case	Port State: Permit VLAN: Assigned Filter: Assigned	Port State: Permit VLAN: Assigned Filter: Assigned
	MAB Fail Case	Port State: Deny	Port State: Permit VLAN: Default PVID of the port
Supplicant Timeout		Port State: Deny	Port State: Deny
Port/Client Authenticated on Guest VLAN	Delete Guest VLANID through Dot1Q	Port State: Deny	Port State: Permit VLAN: Default PVID of the port

### **How Does the Authentication Server Assign DiffServ Policy or ACLs?**

The Dell EMC Networking N-Series switches allow the external 802.1X Authenticator or RADIUS server to assign ACL or DiffServ policies to users that authenticate to the switch. When a host (supplicant) attempts to connect to the network through a port, the switch contacts the 802.1X authenticator or RADIUS server, which then provides information to the switch about which ACL or DiffServ policy to assign the host (supplicant). The application of the policy is applied to the host after the authentication process has completed. The ACL or DiffServ policy is always applied for the “in” direction of the interface and applies to the interface as a whole. Do not configure both ACLs and DiffServ policies to an interface at the same time. For additional guidelines about using an authentication server to assign DiffServ policies, see "Configuring Authentication Server Dynamic ACL or DiffServ Policy Assignments" on page 389.

### **What is the Internal Authentication Server?**

The Internal Authentication Server (IAS) is a dedicated local database for authentication of users for network access through 802.1X. In this database, the switch maintains a list of username and password combinations to use for 802.1X authentication. Entries can be created in the database manually, or the IAS information can be uploaded to the switch.

If the authentication method for 802.1X is IAS, the switch uses the locally stored list of username and passwords to provide port-based authentication to users instead of using an external authentication server. Authentication using the IAS supports the EAP-MD5 method only.



**NOTE:** The IAS database does not support VLAN assignments or DiffServ policy/ACL assignments.

## Default 802.1X Values

Table 9-12 lists the default values for the 802.1X features.


**Table 9-12. Default Port-Based Security Values**

Feature	Description
Global 802.1X status	Disabled
802.1X authentication method	None
Per-port 802.1X status	Disabled
Port authentication mode	Auto mode
Port authentication state	Unauthorized
Periodic reauthentication	Disabled
Seconds between reauthentication attempts	3600
Authentication server timeout	30 seconds
Resending EAP identity Request	30 seconds
Quiet period	60 seconds
Supplicant timeout	30 seconds
Max EAP request	2 times
Maximum number of supplicants per port	64 (32 for N1100-ON and N1500 Series switches)
Guest VLAN	Disabled
Unauthenticated VLAN	Disabled
Dynamic VLAN creation	Disabled

**Table 9-12. Default Port-Based Security Values**

<b>Feature</b>	<b>Description</b>
RADIUS-assigned VLANs	Disabled
IAS users	none configured
Port security	Unlocked
Port security traps	Enabled
Maximum learned MAC addresses	100 (when locked)
Monitor mode	Disabled

### **Configuring IEEE 802.1X (Web)**

This section provides information about the OpenManage Switch Administrator pages for configuring and monitoring the IEEE 802.1X features and Port Security on Dell EMC Networking switches. For details about the fields on a page, click  at the top of the Dell EMC OpenManage Switch Administrator web page.

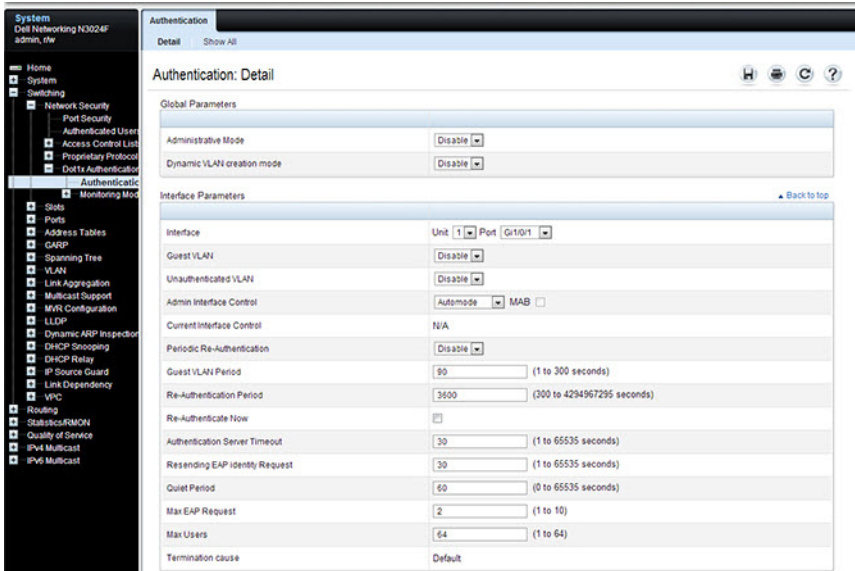
#### **Dot1x Authentication**

Use the **Dot1x Authentication** page to configure the 802.1X administrative mode on the switch and to configure general 802.1X parameters for a port.

To display the **Dot1x Authentication** page, click **Switching** → **Network Security** → **Dot1x Authentication** → **Authentication** in the navigation panel.



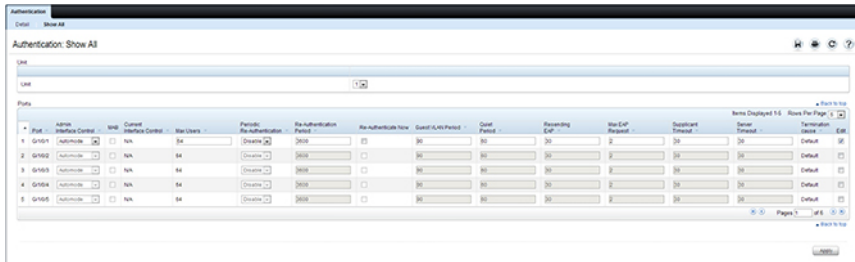
**Figure 9-4. Dot1x Authentication**



To configure 802.1X authentication on multiple ports:

- 1 Open the **Dot1x Authentication** page.
- 2 Click **Show All** to display the **Dot1x Authentication Table** page.
- 3 In the Ports list, select the check box in the **Edit** column for the port to configure.
- 4 Select the desired settings to change for all ports that are selected for editing.

**Figure 9-5. Configure Dot1x Settings**



**5 Click Apply.**

To reauthenticate a port:

- 1** Open the **Dot1x Authentication** page.
- 2** Click **Show All**.

The **Dot1x Authentication Table** displays.

- 3** Check **Edit** to select the Unit/Port to re-authenticate.
- 4** Check **Re-authenticate Now**.
- 5** Click **Apply**.

The authentication process is restarted on the specified port.

To reauthenticate multiple ports:

- 1** Open the **Dot1x Authentication** page.
  - 2** Click **Show All**.
- The **Dot1x Authentication Table** displays.
- 3** Check **Edit** to select the Units/Ports to re-authenticate.
  - 4** To re-authenticate on a periodic basis, set **Periodic Re-Authentication** to **Enable**, and specify a **Re-Authentication Period** for all desired ports.
  - 5** To re-authenticate immediately, check **Re-authenticate Now** for all ports to be re-authenticated.
  - 6** Click **Apply**.

The authentication process is restarted on the specified ports (either immediately or periodically).

To change the administrative port control:

- 1 Open the **Dot1x Authentication** page.
- 2 Click **Show All**.

The **Dot1x Authentication Table** displays.

- 3 Scroll to the right side of the table and select the **Edit** check box for each port to configure. Change **Admin Interface Control** to **Authorized**, **Unauthorized**, or **Automode** as needed for chosen ports. Only **Automode** actually uses 802.1X to authenticate. **Authorized** and **Unauthorized** are manual overrides.
- 4 Click **Apply**.

Admin Port Control is updated for the specified ports, and the device is updated.

### **Authenticated Users**

The **Authenticated Users** page is used to display lists of ports that have authenticated users.


To display the **Authenticated Users** page, click **Switching** → **Network Security** → **Authenticated Users** in the navigation panel.

**Figure 9-6. Network Security Authenticated Users**



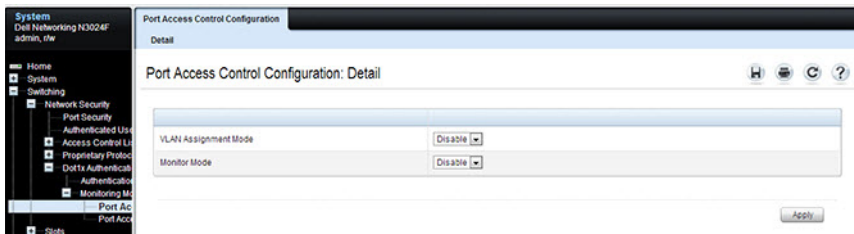
### **Port Access Control Configuration**

Use the **Port Access Control Configuration** page to globally enable or disable RADIUS-assigned VLANs and to enable Monitor Mode to help troubleshoot 802.1X configuration issues.

 **NOTE:** The VLAN Assignment Mode field is the same as the Admin Mode field on the **System** → **Management Security** → **Authorization Network RADIUS** page.

To display the **Port Access Control Configuration** page, click **Switching** → **Network Security** → **Dot1x Authentication** → **Monitor Mode** → **Port Access Control Configuration** in the navigation panel.

**Figure 9-7. Port Access Control Configuration**

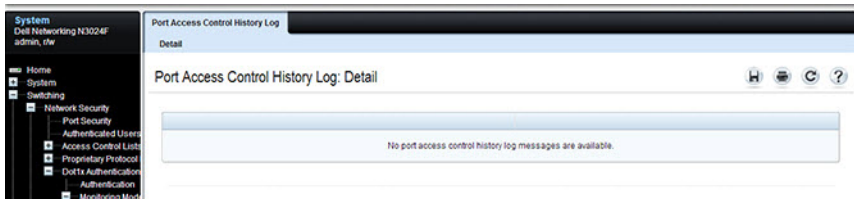


### ***Port Access Control History Log***

Use the **Port Access Control History Log** page to view log messages about 802.1X client authentication attempts. The information on this page can help you troubleshoot 802.1X configuration issues.

To display the **Port Access Control History Log Summary** page, click **Port Access Control Configuration** page, click **Switching** → **Network Security** → **Dot1x Authentication** → **Monitor Mode** → **Port Access Control History Log Summary** in the navigation panel.

**Figure 9-8. Port Access Control History Log**

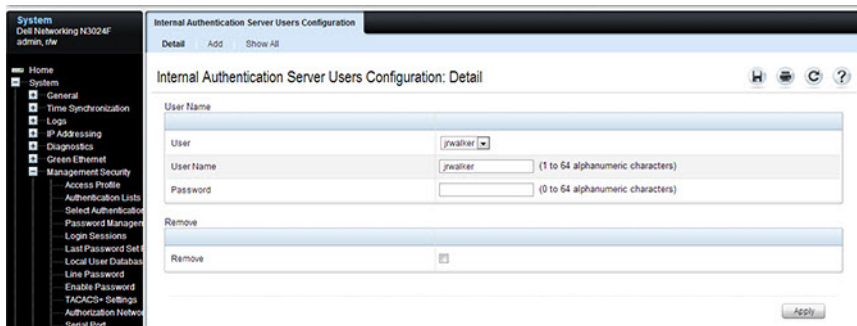


## Internal Authentication Server Users Configuration

Use the **Internal Authentication Server Users Configuration** page to add users to the local IAS database and to view the database entries.

To display the **Internal Authentication Server Users Configuration** page, click **System** → **Management Security** → **Internal Authentication Server Users Configuration** in the navigation panel.

**Figure 9-9. Internal Authentication Server Users Configuration**



**NOTE:** If no users exist in the IAS database, the IAS Users Configuration Page does not display the fields shown in the image.

To add IAS users:

- 1 Open the **Internal Authentication Server Users Configuration** page.
- 2 Click **Add** to display the **Internal Authentication Server Users Add** page.
- 3 Specify a username and password in the appropriate fields.

**Figure 9-10. Adding an IAS User**



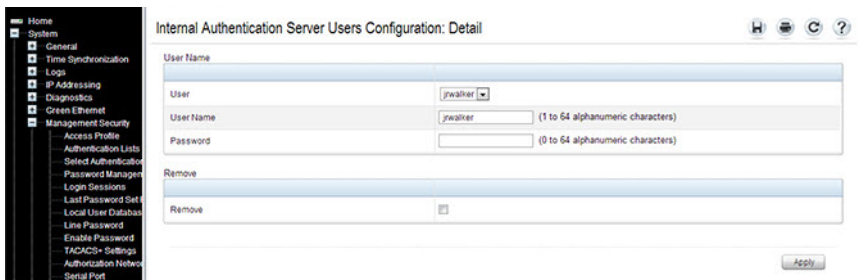
4 Click Apply.

To view the Internal Authentication Server Users Table page, click **Show All**.

To delete an IAS user:

- 1 Open the **Internal Authentication Server Users Configuration** page.
- 2 From the User menu, select the user to remove, select the user to remove.
- 3 Select the **Remove** check box.

**Figure 9-11. Removing an IAS User**



4 Click Apply.

### Configuring IEEE 802.1X (CLI)

This section provides information about commands you use to configure 802.1X and Port Security settings. For additional information about the commands in this section, see the *Dell EMC Networking N1100-ON, N1500, N2000, N2100-ON, N2200-ON, N3000E-ON, N3100-ON, and N3200-ON Series Switches CLI Reference Guide* at [www.dell.com/support](http://www.dell.com/support).


#### Configuring Basic 802.1X Authentication Settings

Use the following commands to enable and configure 802.1X authentication on the switch.

Command	Purpose
configure	Enter Global Configuration mode.

Command	Purpose
aaa authentication dot1x default <i>method1</i>	Specify the authentication method to use to authenticate 802.1X clients that connect to the switch.  <i>method1</i> —The method keyword can be <b>radius</b> , <b>none</b> , or <b>ias</b> .
authentication monitor interface <i>interface</i>	Globally enable 802.1X authentication on the switch.  Enter interface configuration mode for the specified interface. The <i>interface</i> variable includes the interface type and number, for example <b>tengigabitethernet 1/0/3</b> .  A range of interfaces can be specified using the <b>interface range</b> command. For example, <b>interface range tengigabitethernet 1/0/8-12</b> configures interfaces 8, 9, 10, 11, and 12.
authentication port-control {force-authorized   force-unauthorized   auto}	Specify the authentication mode for the port.  <b>NOTE:</b> For standard 802.1X implementations in which one client is connected to one port, use the <b>authentication port-control auto</b> command to enable 802.1X authentication on the port.  <ul style="list-style-type: none"> <li>• <b>auto</b> — Enables 802.1X authentication on the interface and causes the port to transition to the authorized or unauthorized state based on the 802.1X authentication exchange between the switch and the client. Once the port is authenticated by any host, additional hosts on the port will have access to network resources using the port PVID.</li> <li>• <b>force-authorized</b> — Disables 802.1X authentication on the interface and causes the port to transition to the authorized state without any authentication exchange required. The port sends and receives normal traffic without 802.1X-based authentication of the client.</li> <li>• <b>force-unauthorized</b> — Denies all access through this interface by forcing the port to transition to the unauthorized state, ignoring all attempts by the client to authenticate. The switch cannot provide authentication services to the client through the interface.</li> </ul>
mab [auth-type {pap eap-md5 chap}]	This command can be used to enable MAB on the interface and select the authentication type.

Command	Purpose
CTRL + Z	Exit to Privileged Exec mode.
show dot1x	View the current 802.1X status.
show authentication clients {all   <i>interface</i> }	View information about 802.1X clients that have successfully authenticated and are connected to the switch. The <i>interface</i> variable includes the interface type and number.
show dot1x users [username <i>username</i> ]	View the 802.1X authenticated users for the switch.

 **NOTE:** To enable 802.1X Monitor Mode to help troubleshoot authentication issues, use the **authentication monitor** command in Global Configuration mode. To view 802.1X authentication events and information, use the **show authentication authentication-history {*interface* | all} [failed-auth-only] [detail]** command. To clear the history, use the **clear authentication authentication-history** command in Privileged Exec mode.

### Configuring Additional 802.1X Interface Settings

Use the following commands to configure 802.1X interface settings such as the reauthentication period and switch-to-client retransmission time.

Command	Purpose
configure	Enter Global Configuration mode.
interface <i>interface</i>	Enter interface configuration mode for the specified interface. The <i>interface</i> variable includes the interface type and number, for example <b>tengigabitethernet 1/0/3</b> .  A range of interfaces can be specified using the <b>interface range</b> command. For example, <b>interface range tengigabitethernet 1/0/8-12</b> configures interfaces 8, 9, 10, 11, and 12.
authentication periodic	Enable periodic re-authentication of the client.
authentication timer reauthenticate <i>seconds</i>	Set the number of seconds between re-authentication attempts.



<b>Command</b>	<b>Purpose</b>
<code>dot1x timeout server-timeout <i>seconds</i></code>	Set the time that the switch waits for a response from the authentication server.
<code>dot1x timeout tx-period <i>seconds</i></code>	Set the number of seconds that the switch waits for a response to an Extensible Authentication Protocol (EAP)-request/identity frame from the client before resending the request.
<code>dot1x timeout quiet-period <i>seconds</i></code>	Set the number of seconds that the switch remains in the quiet state following a failed authentication exchange (for example, the client provided an invalid password).
<code>dot1x timeout supp-timeout <i>seconds</i></code>	Set the time that the switch waits for a response before retransmitting an Extensible Authentication Protocol (EAP)-request frame to the client.
<code>dot1x max-req <i>count</i></code>	Set the maximum number of times that the switch sends an Extensible Authentication Protocol (EAP)-request frame (assuming that no response is received) other than Request-Identity to the client before restarting the authentication process.
<code>dot1x max-reauth-req <i>count</i></code>	Set the maximum number of times that the switch sends an Extensible Authentication Protocol (EAP)-Request Identify frame to client with no response before restarting the authentication process.
<code>authentication max-users <i>users</i></code>	Set the maximum number of clients supported on the port when 802.1X authentication is enabled on the port.
CTRL + Z	Exit to Privileged Exec mode.
<code>clear authentication sessions [<i>interface</i>]</code>	Start the initialization sequence on all ports or on the specified port. <b>NOTE:</b> This command is valid only if the port-control mode for the specified port is auto.
<code>show authentication [<i>interface interface</i>]</code>	View the authentication settings for the switch or for the specified interface.
<code>show dot1x statistics interface-id</code>	View 802.1X statistics for the specified interface.

### Configuring 802.1X Settings for RADIUS-Assigned VLANs

Use the following commands to configure 802.1X settings that affect the RADIUS-assigned VLAN.

Command	Purpose
<code>configure</code>	Enter Global Configuration mode.
<code>aaa authorization network default radius</code>	Allow the RADIUS server to assign VLAN IDs to clients.
<code>authentication dynamic-vlan enable</code>	If the RADIUS assigned VLAN does not exist on the switch, allow the switch to dynamically create the assigned VLAN.
<code>interface interface</code>	Enter interface configuration mode for the specified interface. The <i>interface</i> variable includes the interface type and number, for example <code>tengigabitethernet 1/0/3</code> .  A range of interfaces can be specified using the <code>interface range</code> command. For example, <code>interface range tengigabitethernet 1/0/8-12</code> configures interfaces 8, 9, 10, 11, and 12.
<code>authentication event no-response action authorize vlan-id</code>	Specify the guest VLAN.
<code>dot1x unauth-vlan vlan-id</code>	Specify the unauthenticated VLAN.
<code>CTRL + Z</code>	Exit to Privileged Exec mode.
<code>show authentication</code>	View the current authentication configuration.



**NOTE:** When dynamically creating VLANs, the uplink port should be in trunk mode so that it will automatically participate in all dynamically-created VLANs. Otherwise, the supplicant may be placed in a VLAN that does not extend beyond the switch because no other ports are participating.

## Configuring Internal Authentication Server Users

Use the following commands to add users to the IAS database and to use the database for 802.1X authentication.

Command	Purpose
<code>configure</code>	Enter Global Configuration mode.
<code>aaa ias-user username user</code>	Add a user to the IAS user database. This command also changes the mode to the IAS User Config mode.
<code>password password [encrypted]</code>	Configure the password associated with the user.
<code>CTRL + Z</code>	Exit to Privileged Exec mode.
<code>show aaa ias-users</code>	View all configured IAS users.
<code>clear aaa ias-users</code>	Delete all IAS users from the database.

## IEEE 802.1X Configuration Examples

This section contains the following examples:

- Configuring 802.1X Authentication
- Controlling Authentication-Based VLAN Assignment
- Allowing Dynamic Creation of RADIUS-Assigned VLANs
- Configuring Authentication Server Dynamic ACL or DiffServ Policy Assignments

### Configuring 802.1X Authentication

The network in this example requires clients to use 802.1X authentication to access the network through the switch ports. The administrator must configure the following settings on systems other than the switch before configuring the switch:

- 1 Add the users to the client database on the Authentication Server, such as a RADIUS server with Cisco<sup>®</sup> Secure Access Control Server (ACS) software.
- 2 Configure the settings on the client, such as a PC running Microsoft<sup>®</sup> Windows, to require 802.1X authentication.

The switch uses an authentication server with an IP address of 10.10.10.10 to authenticate clients. Port 7 is connected to a printer in the unsecured area. The printer is an 802.1X unaware client, so Port 7 is configured to authenticate with MAB.

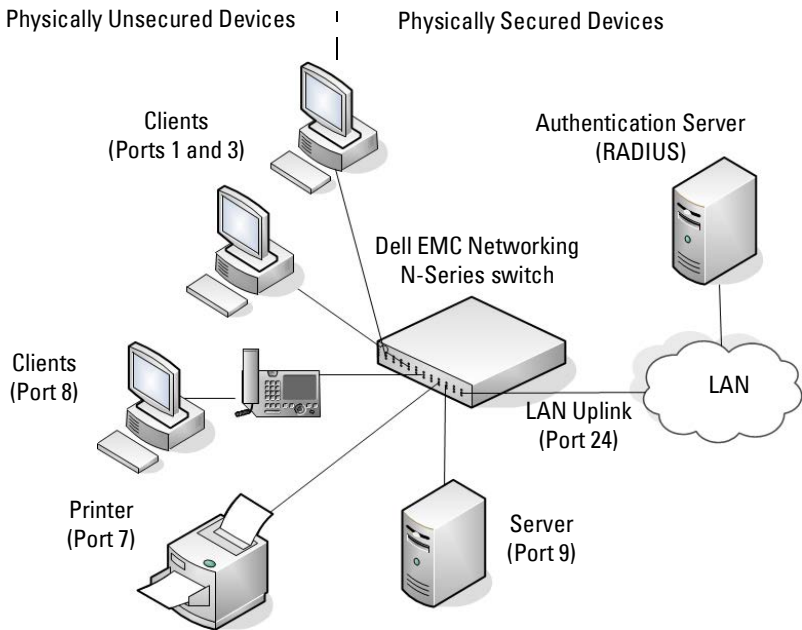


**NOTE:** The printer requires an entry in the client database that uses the printer MAC address as the username.

An IP phone is directly connected to Port 8, and a PC is connected to the IP phone. Both devices are authenticated with multi-domain host mode, which allows a data and voice device to authenticate on a single port. The hosts authenticate separately with the RADIUS server.

Port 9 is connected to a server in a part of the network that has secure physical access (i.e. the doors to the wiring closet and data center are locked), so this port is set to the Authorized state, meaning that the device connected to this port does not need to authenticate using 802.1X. Port 24 is the uplink to a router and is also in the Authorized state.

**Figure 9-12. 802.1X Example**



The following example shows how to configure the example shown in Figure 9-12.

- 1 Configure the RADIUS server IP address and a global shared secret (*secret*).

```
console#configure
console (config) #radius server auth 10.10.10.10
console (config-auth-radius) #name Default-RADIUS-Server
console (config-auth-radius) #exit
console (config) #radius server key secret
console (config) #exit
```

- 2 Enable 802.1X port-based access control on the switch and configure and enable voice VLAN.

```
console (config) #dot1x system-auth-control
console (config) #vlan 11
console (config-vlan11) #exit
console (config) #switchport voice vlan
```

- 3 Configure ports 9 and 24 to be in the Authorized state, which allows the devices to connect to these ports to access the switch services without authentication.

```
console(config)#interface range Gi1/0/9,Gi1/0/24
console(config-if)#authentication port-control force-authorized
console(config-if)#exit
```

- 4 Configure Port 7 to allow a single device with 802.IX or MAB. By default, EAP-MD5 authentication is used.

```
console(config)#interface gi1/0/7
console(config-if-Gi1/0/7)#authentication host mode single-host
console(config-if-Gi1/0/7)#authentication order mab dot1x
console(config-if-Gi1/0/7)#authentication port-control auto
console(config-if-Gi1/0/7)#mab
```

- 5 Configure the port in access mode. Access or general mode is required for MAB.

```
console(config-if-Gi1/0/7)#switchport mode access
console(config-if-Gi1/0/7)#exit
```

- 6 Enable multi-domain host mode on port 8. This limits the number of devices that can authenticate on that port to 2.

```
console(config)#interface gi1/0/8
console(config-if-Gi1/0/8)#authentication host-mode multi-domain
console(config-if-Gi1/0/8)#authentication order dot1x
console(config-if-Gi1/0/8)#authentication port-control auto
console(config-if-Gi1/0/8)#switchport voice vlan 11
```

- 7 Configure the port in access mode.

```
console(config-if-Gi1/0/8)#switchport mode access
console(config-if-Gi1/0/8)#exit
console(config)#exit
```

- 8 View the client connection status.

When the clients on Ports 1, 3, and 7 (supplicants), attempt to communicate via the switch, the switch challenges the supplicants for 802.IX credentials. The switch encrypts the provided information and

transmits it to the RADIUS server. If the RADIUS server grants access, the system sets the 802.1X port state of the interface to authorized and the supplicants are able to access network resources.

```
console#show authentication clients all
```

Interface VLAN	MAC-Address Assigned Reason	Method	Host Mode	Control Mode
Gi2/0/24 Voice VLAN 172)	04:EB:40:B9:D1:57	none	multi-domain	auto
Te3/0/1 RADIUS Assigned VLAN (193)	0E:96:B0:CD:00:00	802.1X	multi-auth	auto
Te3/0/1 RADIUS Assigned VLAN (130)	72:75:6F:9C:00:00	802.1X	multi-auth	auto
Tel1/0/1 Default VLAN (193)	5E:A6:AC:6A:00:00	none	multi-auth	auto
Gi12/0/21 auto Voice VLAN (182)	A0:93:51:0F:DF:CF	mab	multi-domain-multi-host	

## 9 View a summary of the port status.

```
console#show authentication
```

```
Authentication Manager Status..... Disabled
Dynamic VLAN Creation Mode..... Disabled
VLAN Assignment Mode..... Disabled
Authentication Monitor Mode..... Disabled
Critical Recovery Max ReAuth..... 10
Number of Authenticated clients..... 0
Number of clients in Monitor Mode.... 0
```

Port	Admin Mode	Oper Mode	Reauth Control	Reauth Period
Gi1/0/1	auto	Authorized	FALSE	3600
Gi1/0/2	auto	N/A	FALSE	3600
Gi1/0/3	auto	Authorized	FALSE	3600
Gi1/0/4	auto	N/A	FALSE	3600
Gi1/0/5	auto	N/A	FALSE	3600
Gi1/0/6	auto	N/A	FALSE	3600
Gi1/0/7	auto	Authorized	FALSE	3600
Gi1/0/8	auto	N/A	FALSE	3600
Gi1/0/9	force-authorized	Authorized	FALSE	3600
Gi1/0/10	force-authorized	Authorized	FALSE	3600
Gi1/0/11	auto	N/A	FALSE	3600

## 10 View 802.IX information about Port 8.

```
console#show authentication interface gigabitethernet 1/0/8

Authentication Manager Status..... Enabled

Interface..... Gil/0/8
Port Control Mode..... auto
Host Mode..... multi-domain
Open Authentication..... Disabled
Authentication Restart timer..... 30
Configured method order..... dot1x mab
captive-portal
Enabled method order..... undefined
undefined undefined
Configured method priority..... dot1x mab
captive-portal
Enabled method priority..... undefined
undefined undefined
Reauthentication Period (secs)..... 300
Reauthentication Enabled..... TRUE
Reauthentication Session timeout from server .. FALSE
Maximum Users..... 32
Guest VLAN ID..... 0
Authentication retry attempts..... 1
Unauthenticated VLAN ID..... 0
Critical Vlan Id..... 0
Authentication Violation Mode..... Restrict
Authentication Server Dead action..... None
Authentication Server Dead action for Voice.... None
Authentication Server Alive action..... Reinitialize
```

### ***Controlling Authentication-Based VLAN Assignment***

The network in this example uses three VLANs to control access to network resources. When a client connects to the network, it is assigned to a particular VLAN based on one of the following events:

- It attempts to contact the 802.IX server and is authenticated.
- It attempts to contact the 802.IX server and fails to authenticate.
- It does not attempt to contact the 802.IX server.

The following table describes the three VLANs:



VLAN ID	VLAN Name	VLAN Purpose
100	Authorized	Data from authorized clients
200	Unauthorized	Data traffic from clients that fail the authentication with the RADIUS server
300	Guest	Data traffic from clients that do not attempt to authenticate with the RADIUS server



**NOTE:** Dynamic VLAN creation applies only to authorized ports. The VLANs for unauthorized and guest users must be configured on the switch and cannot be dynamically created based on RADIUS-based VLAN assignment.



**NOTE:** RADIUS VLAN assignment is supported for all port modes other than trunk mode.

The commands in this example show how to configure the switch to control VLAN assignment for the example network. This example also contains commands to configure the uplink, or trunk, port (a port connected to a router or the internal network), and to configure the downlink, or access, ports (ports connected to one or more hosts). Ports 1–23 are downstream ports. Port 24 is an uplink port. An external RADIUS server handles the VLAN assignment.



**NOTE:** The configuration to control the VLAN assignment for authorized users is done on the external RADIUS server.

To configure the switch:

- 1 Create the VLANs and configure the VLAN names.

```
console(config)#vlan 100  
console(config-vlan100)#name Authorized  
console(config-vlan100)#exit
```

```
console(config)#vlan 200  
console(config-vlan200)#name Unauthorized  
console(config-vlan200)#exit
```

```
console(config)#vlan 300  
console(config-vlan300)#name Guest  
console(config-vlan300)#exit
```

- 2 Configure information about the external RADIUS server the switch uses to authenticate clients. The RADIUS server IP address is 10.10.10.10, and the global shared secret is qwerty123. The RADIUS server is configured into the default group.

```
console(config)#radius server key qwerty123  
console(config)#radius server auth 10.10.10.10  
console(config-auth-radius)#exit
```

- 3 Enable 802.1X on the switch.

```
console(config)#dot1x system-auth-control
```

- 4 Create a default authentication login list and use the RADIUS server for port-based authentication for connected clients.

```
console(config)#aaa authentication dot1x default radius
```

- 5 Allow the switch to accept VLAN assignments by the RADIUS server.

```
console(config)#aaa authorization network default radius
```

- 6 Enter interface configuration mode for the downlink ports.

```
console(config)#interface range Gi1/0/1-23
```

- 7 Set the downlink ports to the access mode because each downlink port connects to a device that belongs to a single VLAN. Other devices (such as, WAP clients) may authenticate with the switch after the directly connected device authenticates, therefore the host mode is set to multi-auth. Set the port control mode to auto (default) to allow VLAN assignment from the RADIUS server.

```
console(config-if)#switchport mode access  
console(config-if)#authentication port-control auto
```

```
console (config-if) #authentication host-mode multi-auth
```

- 8 Enable periodic reauthentication of the client on the ports and set the number of seconds to wait between reauthentication attempts to 300 seconds. Reauthentication is enabled to increase security by verifying that another device is not spoofing the MAC address of the indirectly connected devices.

```
console (config-if) #authentication periodic  
console (config-if) #authentication timer reauthenticate 300
```

- 9 Set the unauthenticated VLAN on the ports to VLAN 200 so that any client that connects to one of the ports and fails the 802.1X authentication is placed in VLAN 200.

```
console (config-if) #event fail authorize vlan 200
```

- 10 Set the guest VLAN on the ports to VLAN 300. This command automatically enables the Guest VLAN Mode on the downlink ports. Any client that connects to the port and does not attempt to authenticate is placed into the guest VLAN.

```
console (config-if) #authentication event no-response action  
authorize 300  
console (config-if) #exit
```

- 11 Enter Interface Configuration mode for port 24, the uplink (trunk) port.

```
console (config) #interface Gi1/0/24
```

- 12 Disable 802.1X authentication on the interface. This causes the port to transition to the authorized state without any authentication exchange required. This port does not connect to any end-users, so there is no need for 802.1X-based authentication.

```
console (config-if-Gi1/0/24) #authentication port-control force-  
authorized
```

- 13 Set the uplink port to trunk mode so that it accepts tagged traffic and transmits it to the connected device (another switch or router).

```
console (config-if-Gi1/0/24) #switchport mode trunk
```

### ***Allowing Dynamic Creation of RADIUS-Assigned VLANs***

The network in this example uses a RADIUS server to provide VLAN assignments to host that connect to the switch. In this example, the VLANs are not configured on the switch. Instead, the switch is configured to allow the dynamic creation of VLANs when a RADIUS-assigned VLAN does not already exist on the switch.

In this example, Ports 1–23 are configured as downlink, or access, ports, and Port 24 is the trunk port. As a trunk port, Port 24 is automatically added as a member to all VLANs that are statically or dynamically configured on the switch. However, the network administrator in this example has determined that traffic in VLANs 1000–2000 should not be forwarded on the trunk port, even if the RADIUS server assigns a connected host to a VLAN in this range, and the switch dynamically creates the VLAN.



**NOTE:** The configuration to control the VLAN assignment for hosts is done on the external RADIUS server.

To configure the switch:

- 1 Configure information about the external RADIUS server the switch uses to authenticate clients. The RADIUS server IP address is 10.10.10.10, and the global shared secret is qwerty123.

```
console(config)#radius server key qwerty123
console(config)#radius server 10.10.10.10
console(config-auth-radius)#name MyRadius
console(config-auth-radius)#exit
```

- 2 Enable 802.1X on the switch.

```
console(config)#dot1x system-auth-control
```

- 3 Create a default authentication login list and use the RADIUS server for port-based authentication for connected clients.

```
console(config)#aaa authentication dot1x default radius
```

- 4 Allow the switch to accept VLAN assignments by the RADIUS server.

```
console(config)#aaa authorization network default radius
```

- 5 Allow the switch to dynamically create VLANs when a RADIUS-assigned VLAN does not exist on the switch.

```
console(config)#authentication dynamic-vlan enable
```

- 6 Enter interface configuration mode for the downlink ports.

```
console (config) #interface range Gi1/0/1-23
```

- 7 Set the downlink ports to the access mode because each downlink port connects to a single host that belongs to a single VLAN. Set the port-control mode to auto (the default) to allow assignment of the dynamically created VLANs to the host connected port. Allow a single host to authenticate on each port.

```
console (config-if) #switchport mode access  
console (config-if) #authentication port-control auto  
console (config-if) #authentication host-mode single-host  
console (config-if) #exit
```

- 8 Enter Interface Configuration mode for port 24, the uplink (trunk) port.

```
console (config) #interface Gi1/0/24
```

- 9 Disable 802.1X authentication on the interface. This causes the port to transition to the authorized state without any authentication exchange required. This port does not connect to any end-users, so there is no need for 802.1X-based authentication.

```
console (config-if-Gi1/0/24) #authentication port-control force-authorized
```

- 10 Set the uplink port to trunk mode so that it accepts tagged traffic and transmits it to the connected device (another switch or router). The trunk port will automatically become a member of any dynamically created VLANs unless configured to exclude them.

```
console (config-if-Gi1/0/24) #switchport mode trunk
```

- 11 Forbid the trunk from forwarding traffic that has VLAN tags for any VLAN from 1000–2000, inclusive.

```
console (config-if-Gi1/0/24) #switchport trunk allowed vlan  
remove 1000-2000  
console (config-if-Gi1/0/24) #exit
```

### ***Configuring Authentication Server Dynamic ACL or DiffServ Policy Assignments***

To enable Dynamic ACL or DiffServ policy assignment by an external server, the following conditions must be true:

- The RADIUS or 802.1X server must specify the name of the ACL or policy to assign.

For example, if the DiffServ policy to assign is named `internet_access`, include the following attribute in the RADIUS server configuration:

Filter-id (11) = "internet\_access"

If it is desired that an existing ACL be configured, include the following attribute in the RADIUS server configuration:

Filter-ID(11) = "Existing\_ACL.in"

- The ACL or DiffServ policy specified in the attribute must already be configured on the switch, and the ACL names must be identical to the one sent by the RADIUS server with an ".in" suffix.

For information about configuring a DiffServ policy, see "DiffServ Configuration Examples" on page 1556. For information about configuring a Dynamic ACL, see "Dynamic ACL Overview" on page 314. The example "Providing Subnets Equal Access to External Network" on page 1556, describes how to configure a policy named `internet_access`.

If you use an authentication server to assign ACLs or DiffServ policies to an authenticated user, note the following guidelines:

- If the policy or ACL specified within the server Filter-ID attribute does not exist on the switch, authentication will fail.
- Do not delete policies or ACLs used as the Filter-ID by the RADIUS server while 802.1X is enabled.
- Do not use the DiffServ `service-policy` command to apply the filter to an interface if you configure the RADIUS server or 802.1X authenticator to assign the DiffServ filter.

In the following example, Company XYZ uses IEEE 802.1X to authenticate all users. Contractors and temporary employees at Company XYZ are not permitted to have access to SSH ports, and data rates for Web traffic is limited. When a contractor is authenticated by the RADIUS server, the server assigns a DiffServ policy to control the traffic restrictions.

The network administrator configures two DiffServ classes: `cl-ssh` and `cl-http`. The class `cl-ssh` matches all incoming SSH packets. The class `cl-http` matches all incoming HTTP packets. Then, the administrator configures a traffic policy called `con-pol` and adds the `cl-ssh` and `cl-http`. The policy is configured so that SSH packets are to be dropped, and HTTP data rates are limited to 1 MB with a burst size of 64 Kbps. HTTP traffic that exceeds the limit is dropped. The host ports, ports 1–23, are configured to use single-host mode. Finally, the administrator configures the RADIUS server with the attribute Filter-id (11) = "con-pol" (steps not shown).

To configure the switch:

- 1 Configure the DiffServ traffic class that matches SSH traffic.

```
console#configure
console (config) #class-map match-all cl-ssh
console (config-classmap) #match dst14port 22
console (config-classmap) #exit
```

- 2 Configure the DiffServ traffic class that matches HTTP traffic.

```
console (config) #class-map match-all cl-http
console (config-classmap) #match dst14port 80
console (config-classmap) #exit
```

- 3 Configure the DiffServ policy.

```
console (config) #policy-map con-pol in
console (config-policy-map) #class cl-ssh
console (config-policy-classmap) #drop
console (config-policy-classmap) #exit
console (config-policy-map) #class cl-http
console (config-policy-classmap) #police-simple 1000000 64
console (config-policy-classmap) #police-action transmit violate-action drop
console (config-policy-classmap) #exit
console (config-policy-map) #exit
```

- 4 Enable DiffServ on the switch. (Optional as DiffServ is enabled by default.)

```
console (config) #diffserv
```

- 5 Configure information about the external RADIUS server the switch uses to authenticate clients. The RADIUS server IP address is 10.10.10.10, and the global shared secret is qwerty123.

```
console (config) #radius server key qwerty123
console (config) #radius server 10.10.10.10
console (config-auth-radius) #name MyRadius
console (config-auth-radius) #exit
```

- 6 Enable 802.1X on the switch.

```
console (config) #dot1x system-auth-control
```

- 7 Create a default authentication login list and use the RADIUS server for port-based authentication for connected clients.

```
console (config) #aaa authentication dot1x default radius
```

- 8 Enter Interface Configuration mode for ports 1–23 and configure the ports in single-host mode.

```
console(config)#interface range Gi1/0/1-23  
console(config-if)#authentication host-mode single-host
```

- 9 Set the ports to access mode (default VLAN 1). Enable the policy on the ports.

```
console(config-if)#switchport mode access  
console(config-if)#service-policy in con-pol  
console(config-if)#exit  
console(config)#exit
```

## Captive Portal

This section describes how to configure the Captive Portal feature.

The topics covered in this section include:

- Captive Portal Overview
- Default Captive Portal Behavior and Settings
- Configuring Captive Portal (Web)
- Configuring Captive Portal (CLI)
- IEEE 802.1X Configuration Examples

### Captive Portal Overview

A Captive Portal (CP) helps manage or restrict network access. CPs are often used in locations that provide wired Internet access to customers, such as business centers and hotels. For example, a hotel might provide an Ethernet port in each room so that guests can connect to the Internet during their stay. The hotel might charge for Internet use, or the hotel might allow guests to connect only after they indicate that they have read and agree to the acceptable use policy.

#### What Does Captive Portal Do?

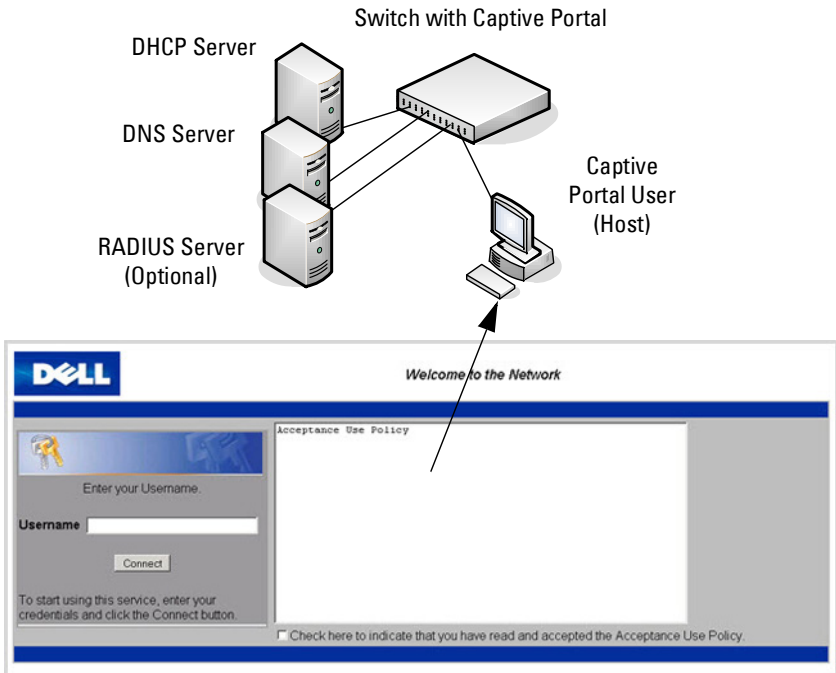
The CP feature allows you to require a user to enter login information on a custom web page before gaining access to the network. When the user connects to the port and opens a browser, the user is presented with a welcome screen. To gain network access, the user must enter a username (for guest access) or a username and password (for authenticated access) and



accept the terms of use. The network administrator can also configure the CP feature to redirect the user to another web page after successful authentication, for example a company home page.

CP is supported in IPv4 networks only.

**Figure 9-13. Connecting to the Captive Portal**



Default Captive Portal Welcome Screen (Displays in Captive Portal User's Browser)

The CP feature blocks hosts connected to the switch from most network access until user verification has been established. Access to 802.1X, DHCP, ARP, NetBIOS, and DNS services is allowed. The network administrator can configure CP verification to allow access for both guest and authenticated users. Authenticated users must be validated against a database of authorized CP users before access is granted. The database can be stored locally on the switch or on a RADIUS server.

### **Is Captive Portal Dependent on Any Other Feature?**

If security procedures require RADIUS authentication, the administrator must configure the RADIUS server information on the switch (see "Using RADIUS" on page 307). The RADIUS administrator must also configure the RADIUS attributes for CP users on the RADIUS server. For information about the RADIUS attributes to configure, see Table 9-15.

For a list of RADIUS attributes that the switch supports, see "Which RADIUS Attributes Does the Switch Support?" on page 309.

To support redirection of user entered URLs from a web browser, a DNS server must be configured in the network. If routing is enabled on the switch, IP helper should be enabled to allow hosts to obtain an IP address via DHCP. A DHCP server must be available if it is expected that hosts will obtain IP addresses dynamically. In addition, if routing is enabled, DHCP relay must be configured.

The only type of interface where CP can be enabled is a physical port. CP is not supported on multi-access VLANs or on LAGs.

A physical port's VLAN membership does not affect CP. A physical port enabled for CP can be a member of any VLAN or multiple VLANs, which can be switching or routing VLANs.

A port enabled for CP may be directly connected to a single client (e.g., an access switch), or the port may serve many clients (e.g., a port on an aggregation switch).

Port security and CP cannot both be enabled on the same interface.

If a physical port configured with CP is made a member of a LAG, CP is disabled on the port.

Dell EMC Networking does not support configuring spanning tree on a CP port. BPDUs received on a port enabled for CP will not receive their normal prioritization.

CP can coexist on an interface with DHCP snooping and Dynamic ARP Inspection (DAI).

The administrator can configure the switch to send SNMP trap messages to any enabled SNMP Trap Receivers for several CP events, such as when a CP user has an authentication failure or when a CP user successfully connects to

the network. If traps are enabled, the switch also writes a message to the trap log when the event occurs. To enable the CP traps, see "Configuring SNMP Notifications (Traps and Informs)" on page 541.

### **What Factors Should Be Considered When Designing and Configuring a Captive Portal?**

Before enabling the CP feature, decide what type (or types) of authentication will be supported. Since Dell EMC Networking N-Series switches support up to 10 different CP instances, it is possible to configure one CP that requires a username and password and another that only requires the username. For each CP, the administrator can customize the welcome screen, including the colors and logo.

If network policy requires authentication, consider the number of users that must exist in the user database. The local user database supports up to 128 users. If there is a need to support more than 128 authenticated users, use a remote RADIUS server for authentication.

The administrator can specify whether the CP uses HTTP or HTTPS as the protocol during the user verification process. HTTP does not use encryption during verification, and HTTPS uses the Secure Sockets Layer (SSL), which requires a certificate to provide encryption. The certificate is presented to the user at connection time.

If the authenticating user requires DNS or DHCP services, these will need to be configured in the network and the switch will need to relay DHCP packets.

The initial Web page that a user sees when he or she connects to the CP can be customized. The logo, color schemes, welcome messages, and all text on the page can be customized, including the field and button labels. The welcome page the user sees after a successful verification or authentication can also be customized.

**Figure 9-14. Customized Captive Portal Welcome Screen**



### How Does Captive Portal Work?

When a port is enabled for CP, all the traffic coming onto the port from the unverified clients is dropped except for the ARP, DHCP, NetBIOS, and DNS packets. These packets are forwarded by the switch so that the unverified clients can get an IP address and are able to resolve host or domain names. If an unverified client opens a web browser and tries to connect to the network, CP redirects all the HTTP/HTTPS traffic from the unverified client to the authenticating server on the switch. If the network administrator has configured an additional web server port, packets with this destination TCP port number are also forwarded to the authenticating server. A CP web page is sent back to the unverified client. If the verification mode for the CP associated with the port is Guest, the client can be verified without providing authentication information. If the verification mode is Local or RADIUS, the client must provide credentials that are compared against the information in the Local or RADIUS client database. After the user successfully provides the required information, the CP feature grants access to the network.

### What Captive Portal Pages Can Be Customized?

The following three CP pages can be customized:

- Authentication Page — This page displays when a client attempts to connect to the network. The images, text, and colors that display on this page can be customized.

- **Logout Page** — If the user logout mode is enabled, this page displays in a pop-up window after the user successfully authenticates. This window contains the logout button.
- **Logout Success Page** — If the user logout mode is enabled, this page displays after a user clicks the logout button and successfully deauthenticates.

### ***Understanding User Logout Mode***

The User Logout Mode feature allows a user who successfully authenticates to the network through the CP to explicitly deauthenticate from the network. When User Logout Mode is disabled or the user does not specifically request logout, the connection status will remain authenticated until the CP deauthenticates the user based on the configured session timeout value. In order for the user logout feature to function properly, the client browser must have JavaScript enabled and must allow pop-up windows.

### ***Localizing Captive Portal Pages***

The CP localization feature allows you to create up to three language-specific web pages for each CP as long as all pages use the same verification type; either guest or authorized user web pages. This allows you to create pages in a variety of languages to accommodate a diverse group of users.

To customize the pages that the user sees, click the language tab. By default, the English tab is available. The settings for the **Authentication Page** display.

### **Captive Portal IP Address Selection**

CP automatically associates with one of the IP addresses assigned to the switch. The automatic IP address selection algorithm is outlined below:

- 1 On switching-only devices or when routing is disabled, CP uses the out-of-band interface IP address, if available.
- 2 If routing is enabled, CP uses a loopback interface if one is defined, and a routing interface as the second choice.
- 3 If routing is enabled and no active routing interface is available, the CP goes down.
- 4 If the CP IP address changes due to administrator action or due to an interface going down, then the CP is automatically disabled and re-enabled. All active sessions are dropped.

## Captive Portal and DNS

CP allows unauthenticated users access to DNS services on TCP and UDP destination port 53. CP inspects all DNS traffic to ensure that it conforms with the DNS protocol (RFC 1035/1996). CP checks the format of DNS messages and discards packets that do not conform to the minimum standards. Specifically, CP performs the following checks on a DNS packet:

- The packet must have a full-size header and at least one question field
- The packet must have a valid DNS response code
- The first question field must not exceed 63 octets in length, nor must the length field be greater than 63
- The first question class field must be valid.

## Captive Portal Troubleshooting

The following table explains the status values for CP authentication sessions and the resulting actions taken, if any. CP global status, interface status, and session status are available in the user interfaces.

**Table 9-13. Captive Portal Status Values**

Status Value	Description	Browser Action
Default	Initial request from the client.	Used to detect initial request.
Serve	Default serve.	Used when serving the initial connection page.
Validate	Actual validation request.	Indicates that the user has submitted credentials and requests authentication.
WIP	Indicates that validation is in progress.	The validation page begins to poll the server until the status flag changes. The actual poll request is the same http(s) request used to “validate” as described above. While waiting between polls, the browser displays an “authorization in process” message.

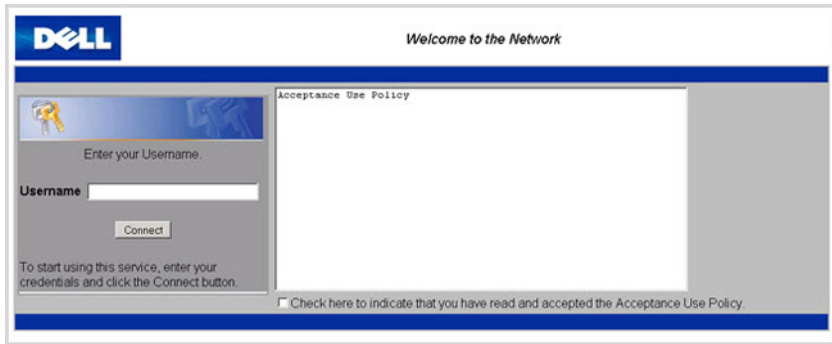
**Table 9-13. Captive Portal Status Values (Continued)**

<b>Status Value</b>	<b>Description</b>	<b>Browser Action</b>
RADIUS_WIP	Indicates that RADIUS validation is in progress.	The browser action is the same as for the WIP status.
Success	Indicates that authentication is a success.	Displays either the customized welcome page or an external URL.
Denied	Indicates that the user has failed to enter credentials that match the expected configuration.	The default serve page is resubmitted and includes the appropriate failure message.
Resource	Indicates that the system has rejected authentication due to system resource limitations or session timeout.	The default serve page is resubmitted and includes the appropriate failure message.
No Accept	Indicates that the user did not accept the acceptance use policy.	The default serve page is resubmitted and includes the appropriate failure message.
Timeout	Indicates that the authentication transaction took too long. This could be due to user input time, or a timeout due to the overall transaction.	The default serve page is resubmitted and includes the appropriate failure message.

## Default Captive Portal Behavior and Settings

CP is disabled by default. If you enable CP, no interfaces are associated with the default CP. After you associate an interface with the CP and globally enable the CP feature, a user who connects to the switch through that interface is presented with the CP Welcome screen shown in Figure 9-15.

**Figure 9-15. Default Captive Portal Welcome Screen**



The user types a name in the Username field, selects the Acceptance Use Policy check box, and clicks **Connect** to gain network access. By default, the user does not need to be defined in a database or enter a password to access the network because the default verification mode is Guest. Note that duplicate Username entries can exist in this mode because the client IP and MAC addresses are obtained for identification.

Table 9-14 shows the default values for the CP feature.

**Table 9-14. Default Captive Portal Values**


Feature	Value
Global Captive Portal Operational Status	Disabled
Additional HTTP or HTTPS Ports	Disabled CP can be configured to use an additional HTTP and/or HTTPS port (in support of Proxy networks).
Authentication Timeout	300 seconds



**Table 9-14. Default Captive Portal Values**

<b>Feature</b>	<b>Value</b>
Configured Captive Portals	1
Captive Portal Name	Default
Protocol Mode	HTTP
Verification Mode	Guest
URL Redirect Mode	Off
User Group	1-Default
Session Timeout	86400 seconds
Local Users	None configured
Interface associations	None
Interface status	Not blocked  If the CP is blocked, users cannot gain access to the network through the CP. Use this function to temporarily protect the network during unexpected events, such as denial of service attacks.
Supported Captive Portal users	1024
Supported local users	128
Supported Captive Portals	10

## Configuring Captive Portal (Web)

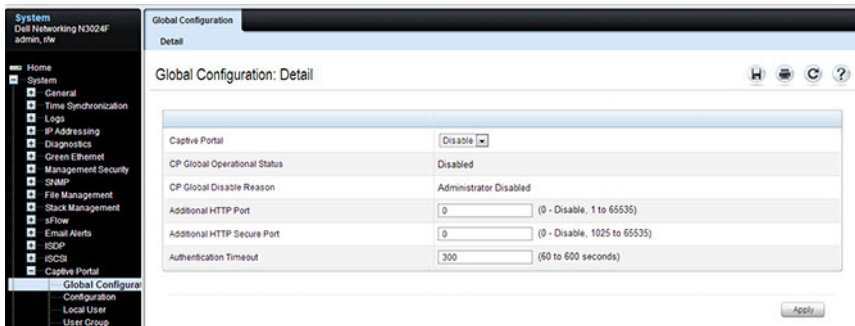
This section provides information about the OpenManage Switch Administrator pages for configuring and monitoring CP settings on Dell EMC Networking switches. For details about the fields on a page, click  at the top of the Dell EMC OpenManage Switch Administrator web page.

### Captive Portal Global Configuration

Use the **Captive Portal Global Configuration** page to control the administrative state of the CP feature and configure global settings that affect all CPs configured on the switch.

To display the **Captive Portal Global Configuration** page, click **System** → **Captive Portal** → **Global Configuration**.

**Figure 9-16. Captive Portal Global Configuration**



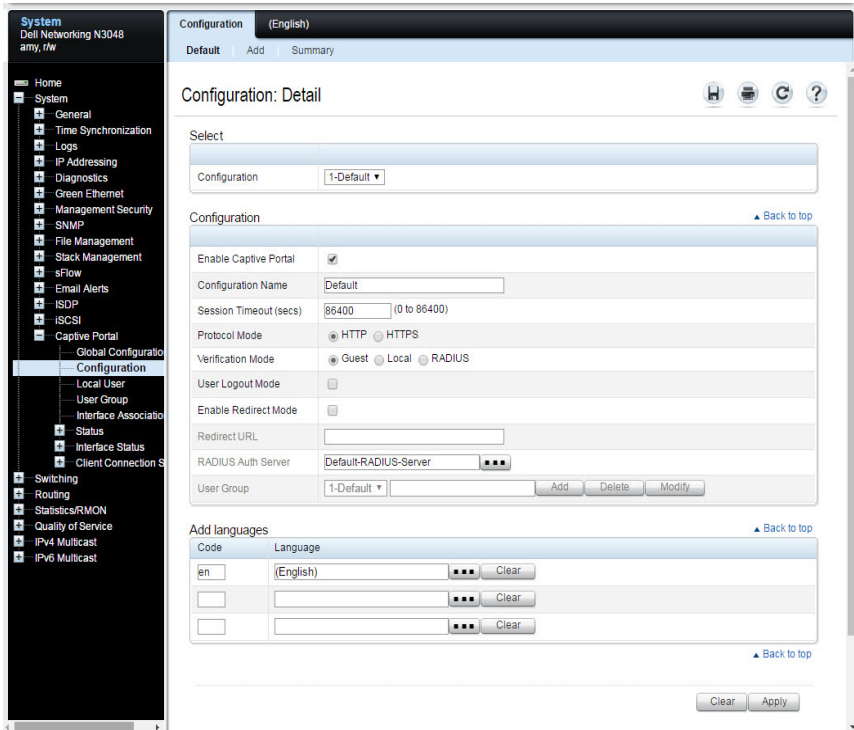
### Captive Portal Configuration

Use the **Captive Portal Configuration** page to view summary information about CPs on the system, add a CP, and configure existing CPs.

The switch supports 10 CP configurations. CP configuration 1 is created by default and cannot be deleted. Each CP configuration can have unique guest or group access modes and a customized acceptance use policy that displays when the client connects.

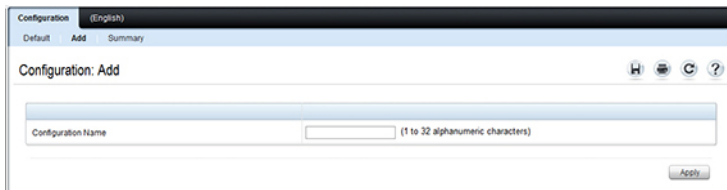
To display the **Captive Portal Configuration** page, click **System** → **Captive Portal** → **Configuration**.

**Figure 9-17. Captive Portal Configuration**



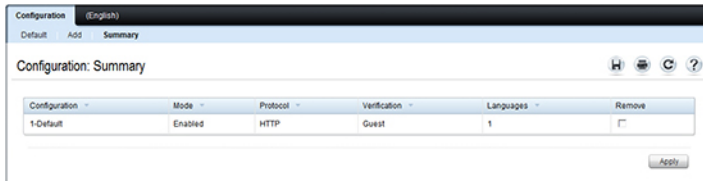
From the Captive Portal Configuration page, click **Add** to create a new CP instance.

**Figure 9-18. Add Captive Portal Configuration**



From the Captive Portal Configuration page, click **Summary** to view summary information about the CP instances configured on the switch.

**Figure 9-19. Captive Portal Summary**




### **Customizing a Captive Portal**

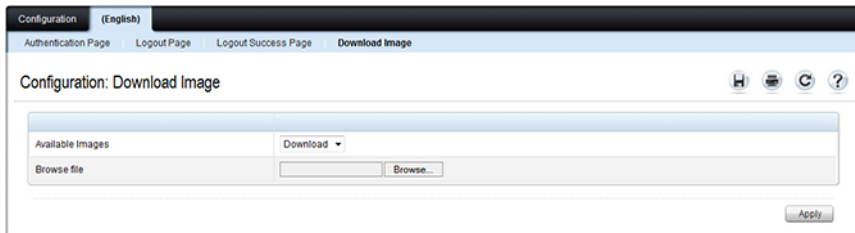
The procedures in this section customize the pages that the user sees when he or she attempts to connect to (and log off of) a network through the CP. These procedures configure the English version of the Default Captive Portal.

To configure the switch:

- 1 From the **Captive Portal Configuration** page click the **(English)** tab. The settings for the **Authentication Page** display, and the links to the CP customization appear.
- 2 Click **Download Image** to download one or more custom images to the switch. A downloaded custom image can be used for the branding logo (default: Dell logo) on the Authentication Page and Logout Success page, for the account image (default: blue banner with keys) on the Authentication Page, and for the background image (default: blank) on the Logout Success Page.

 **NOTE:** The image to download must be accessible from your local system. The image should be 5 KB max, 200x200 pixels, GIF or JPG format.

**Figure 9-20. Captive Portal Download Image Page**



- 3** Make sure **Download** is selected in the **Available Images** menu, and click **Browse**.
- 4** Browse to the directory where the image to be downloaded is located and select the image.
- 5** Click **Apply** to download the selected file to the switch.
- 6** To customize the **Authentication Page**, which is the page that a user sees upon attempting to connect to the network, click the **Authentication Page** link.

**Figure 9-21. Captive Portal Authentication Page**

The screenshot shows a web-based configuration interface for a Captive Portal Authentication Page. The interface is organized into three main sections: 'Greeting and Resources', 'Textual Content', and 'Messages'. Each section contains various configuration fields with labels, values, and character limits.

**Greeting and Resources**

- Captive Portal ID: Default
- Branding Image: del\_logo.gif
- Fonts: Arial, sans-serif (0-512 characters)
- Browser Title: Captive Portal (0-128 characters)
- Page Title: Welcome to the Network (0-128 characters)
- Separator Color: #003366
- Foreground Color: #999999
- Background Color: #BFBFBF

**Textual Content**

- Account Image: login\_key.jpg
- Account Title: Enter your Username (0-64 characters)
- User Label: Username (0-32 characters)
- Password Label: Password (0-32 characters)
- Button Label: Connect (1-32 characters)
- Acceptance Use Policy: Acceptance Use Policy (0-8192 characters)
- Acceptance Message: Check here to indicate that you have read and accepted the (0-128 characters)


**Messages**

- Instructional Text: To start using this service, enter your credentials and click the Connect button. (0-256 characters)
- Denied Message: Error: Invalid Credentials, please try again! (1-128 characters)
- Resource Message: Error: Limited Resources, please reconnect and try again later! (1-128 characters)
- Timeout Message: Error: Timed Out, please reconnect and try again! (1-128 characters)
- Busy Message: Connecting, please be patient (1-128 characters)
- No Accept Message: Error: You must acknowledge the Acceptance Use Policy before connecting! (0-128 characters)
- Welcome Title: Congratulations! (0-128 characters)
- Welcome Text: You are now authorized and connected to the network. (0-256 characters)

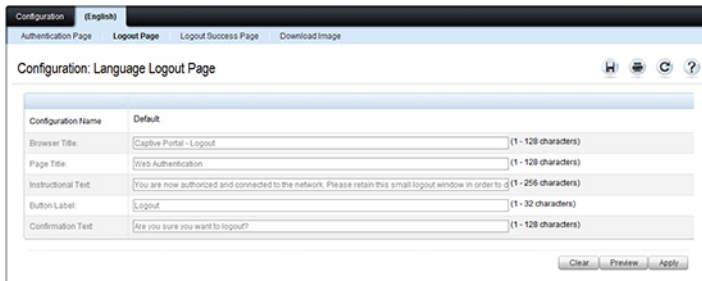
At the bottom of the page, there are three buttons: 'Clear', 'Preview', and 'Apply'.

- 7 Select the branding image to use and customize other page components such as the font for all text the page displays, the page title, and the acceptance use policy.
- 8 Click **Apply** to save the settings to the running configuration or click **Preview** to view what the user will see. To return to the default views, click **Clear**.

- Click the **Logout Page** link to configure the page that contains the logout window.

 **NOTE:** The Logout Page settings can be configured only if the User Logout Mode is selected on the **Configuration** page. The User Logout Mode allows an authenticated client to deauthenticate from the network.

**Figure 9-22. Captive Portal Logout Page**



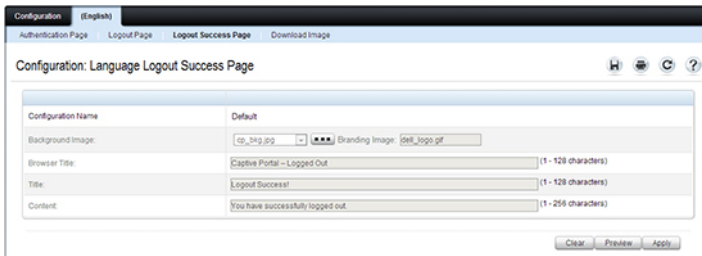
The screenshot shows the configuration page for the Language Logout Page. The configuration table is as follows:

Configuration Name	Default
Browser Title	Captive Portal - Logout (1 - 128 characters)
Page Title	Web Authentication (1 - 128 characters)
Instructional Text	You are now authorized and connected to the network. Please retain this small logout window in order to (1 - 256 characters)
Button Label	Logout (1 - 32 characters)
Confirmation Text	Are you sure you want to logout? (1 - 128 characters)

Buttons: Clear, Preview, Apply

- Customize the look and feel of the Logout Page, such as the page title and logout instructions.
- Click **Apply** to save the settings to the running configuration or click **Preview** to view what the user will see. To return to the default views, click **Clear**.
- Click the **Logout Success Page** link to configure the page that contains the logout window. A user is required to logout only if the User Logout Mode is selected on the **Configuration** page.

**Figure 9-23. Captive Portal Logout Success Page**



The screenshot shows the configuration page for the Language Logout Success Page. The configuration table is as follows:

Configuration Name	Default
Background Image	cp_250.jpg   Branding Image: 59E_logo.gif
Browser Title	Captive Portal - Logged Out (1 - 128 characters)
Title	Logout Successful (1 - 128 characters)
Content	You have successfully logged out. (1 - 256 characters)

Buttons: Clear, Preview, Apply

- 13 Customize the look and feel of the Logout Page, such as the background image and successful logout message.
- 14 Click **Apply** to save the settings to the running configuration or click **Preview** to view what the user will see. To return to the default views, click **Clear**.

## Local User

A portal can be configured to accommodate guest users and authorized users. Guest users do not have assigned user names and passwords. Authorized users provide a valid user name and password that must first be validated against a local database or RADIUS server. Authorized users can gain network access once the switch confirms the user's credentials.

By default, each CP instance contains the default group. The default group can be renamed, or a different group can be created and assigned to each CP instance. A CP instance can be associated to one user group only. A user, however, can be assigned to multiple groups.

The **Local User** page allows you to add authorized users to the local database, which can contain up to 128 user entries. Users can be added to and deleted from the local database using the **Local User** page.

To display the **Local User** page, click **System** → **Captive Portal** → **Local User**.

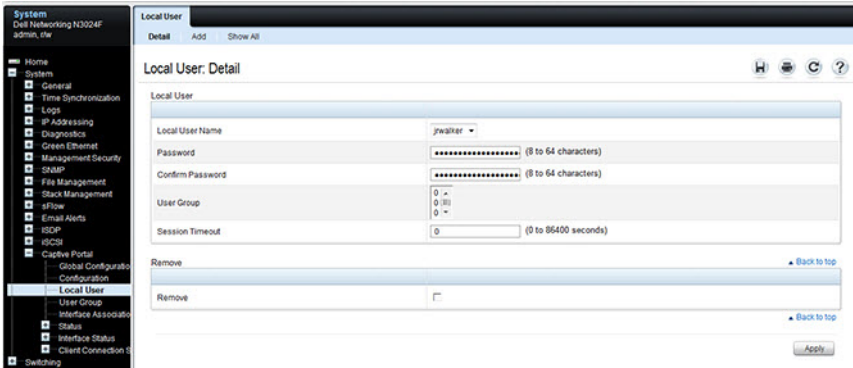
Figure 9-24 shows the **Local User** page after a user has been added. If no users have been added to the switch, many of the fields do not display on the screen.



**NOTE:** Multiple user groups can be selected by holding the CTRL key down while clicking the desired groups.

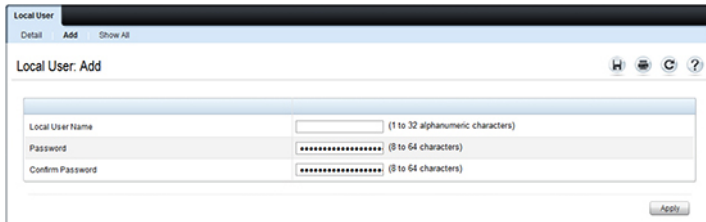


**Figure 9-24. Local User Configuration**



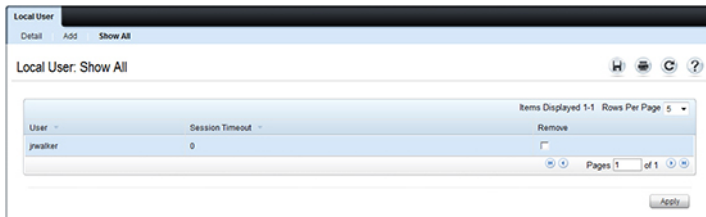
From the **Local User** page, click **Add** to add a new user to the local database.

**Figure 9-25. Add Local User**



From the **Local User** page, click **Show All** to view summary information about the local users configured in the local database.

**Figure 9-26. Captive Portal Local User Summary**



To delete a configured user from the database, select the Remove check box associated with the user and click **Apply**.

**Configuring Users in a Remote RADIUS Server**

A remote RADIUS server client authorization can be used. All users must be added to the RADIUS server. The local database does not share any information with the remote RADIUS database.

Table 9-15 indicates the RADIUS attributes you use to configure authorized CP clients. The table indicates both RADIUS attributes and vendor-specific attributes (VSA). VSAs are denoted in the Attribute column and are comma delimited (vendor ID, attribute ID).

**Table 9-15. Captive Portal User RADIUS Attributes**

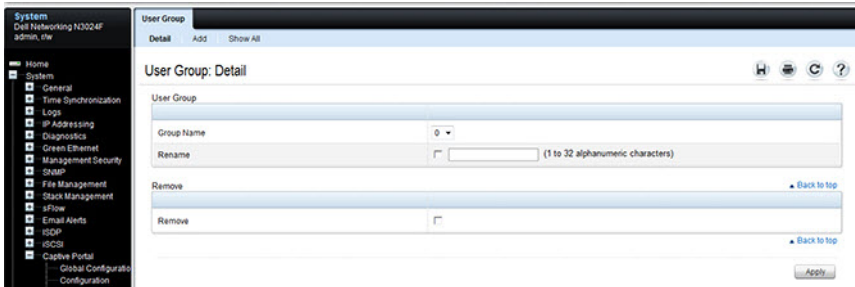
Attribute	Number	Description	Range	Usage	Default
User-Name	1	User name to be authorized	1-32 characters	Required	None
User-Password	2	User password	8-64 characters	Required	None
Session-Timeout	27	Logout once session timeout is reached (seconds). If the attribute is 0 or not present then use the value configured for the CP.	Integer (seconds)	Optional	0
Dell-Captive-Portal-Groups	6231, 127	A comma-delimited list of group names that correspond to the configured CP instance configurations.	String	Optional	None. The default group is used if not defined here

## User Group

Local Users can be assigned to User Groups. If the Verification Mode is Local or RADIUS, a User Group is assigned to a CP Configuration. All users who belong to the group are permitted to access the network through this portal. The User Group list is the same for all CP configurations on the switch.

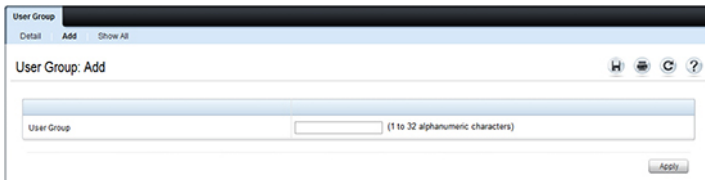
To display the User Group page, click **System** → **Captive Portal** → **User Group**.

**Figure 9-27. User Group**



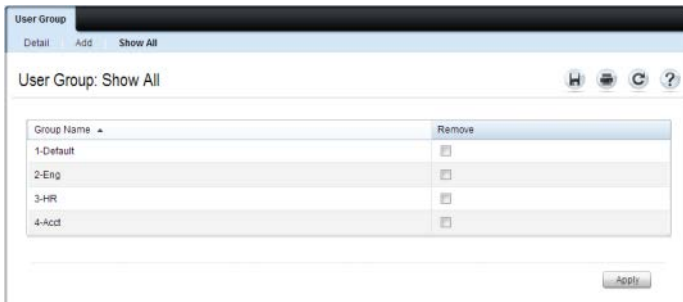
From the User Group page, click **Add** to configure a new user group.

**Figure 9-28. Add User Group**



From the User Group page, click **Show All** to view summary information about the user groups configured on the switch.

**Figure 9-29. Captive Portal User Group Summary**



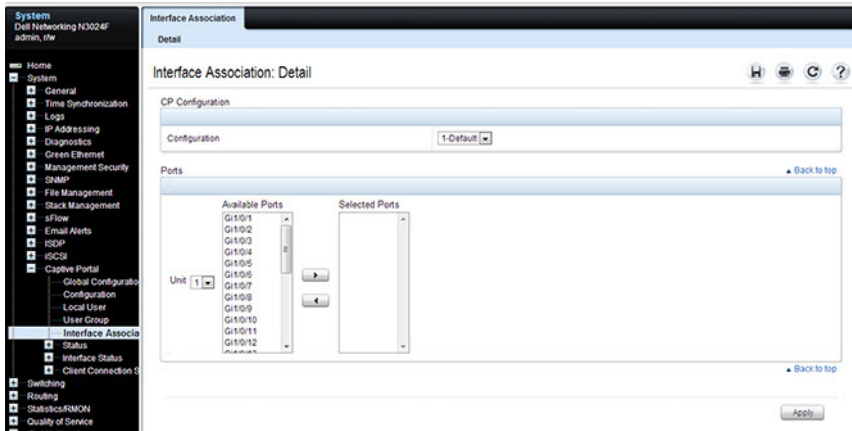
To delete a configured group, select the Remove check box associated with the group and click **Apply**.

### Interface Association

Using the **Interface Association** page, a configured CP can be associated with specific interfaces. The CP feature only runs on the interfaces that you specify. A CP can have multiple interfaces associated with it, but an interface can be associated to only one CP at a time.

To display the **Interface Association** page, click **System** → **Captive Portal** → **Interface Association**.

**Figure 9-30. Captive Portal Interface Association**





**NOTE:** When you associate an interface with a CP, the interface is disabled in the Interface List. Each interface can be associated with only one CP at a time.

## Captive Portal Global Status

The **Captive Portal Global Status** page contains a variety of information about the CP feature, including information about the CP activity and interfaces.

To display the **Global Status** page, click **System** → **Captive Portal** → **Status** → **Global Status**.

**Figure 9-31. Captive Portal Global Status**

The screenshot shows the 'Global Status' page in a network management interface. The left sidebar contains a navigation tree with 'System' expanded to 'Captive Portal' and 'Global Status' selected. The main content area displays the 'Global Status: Detail' page with a table of metrics.

Global Status: Detail	
CP Global Operational Status	Disabled
CP Global Disable Reason	Administrator Disabled
Authenticated Users	0
System Supported Users	1024
Supported Local Users	128
Configured Local Users	0
CP IP Address	0.0.0.0
Configured Captive Portals	1
Supported Captive Portals	10
Active Captive Portals	0

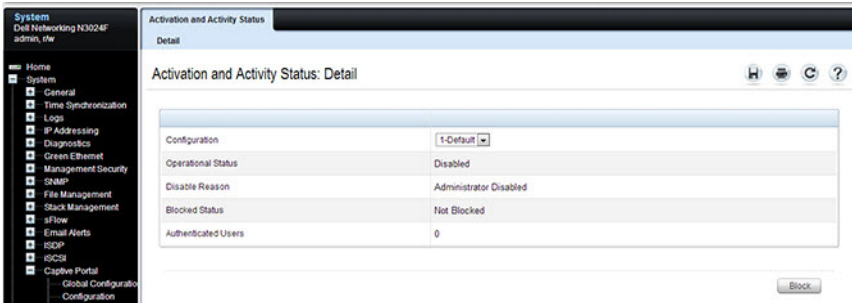
## Captive Portal Activation and Activity Status

The **Captive Portal Activation and Activity Status** page provides information about each CP configured on the switch.

The **Captive Portal Activation and Activity Status** page has a drop-down menu that contains all CPs configured on the switch. When you select a CP, the activation and activity status for that portal displays.

To display the **Activation and Activity Status** page, click **System** → **Captive Portal** → **Status** → **Activation and Activity Status**.

**Figure 9-32. Captive Portal Activation and Activity Status**



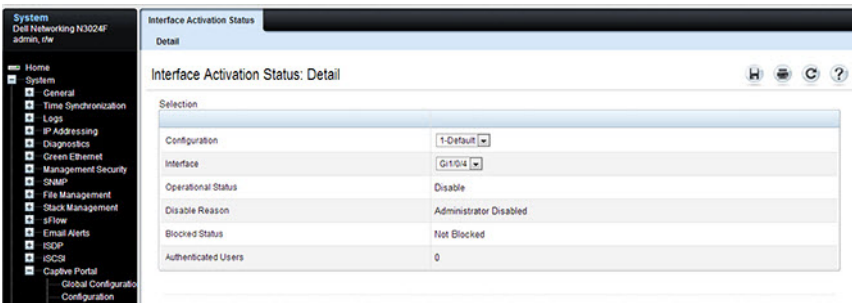
**NOTE:** Use the Block and Unblock buttons to control the blocked status. If the CP is blocked, users cannot gain access to the network through the CP. Use this function to temporarily protect the network during unexpected events, such as denial of service attacks.

### Interface Activation Status

The **Interface Activation Status** page shows information for every interface assigned to a CP instance.

To display the **Interface Activation Status** page, click **System** → **Captive Portal** → **Interface Status** → **Interface Activation Status**.

**Figure 9-33. Interface Activation Status**

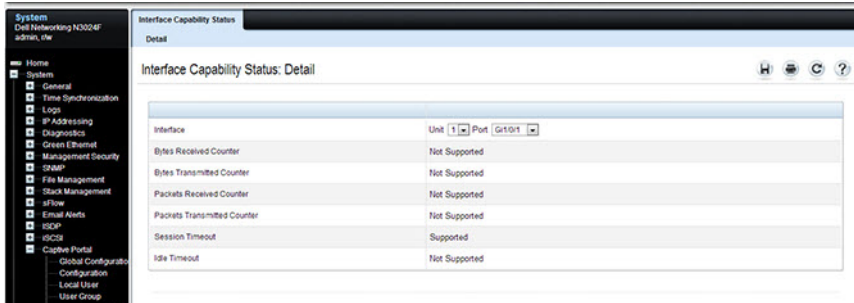


## Interface Capability Status

The **Interface Capability Status** page contains information about interfaces that can have CPs associated with them. The page also contains status information for various capabilities. Specifically, this page indicates what services are provided through the CP to clients connected on this interface. The list of services is determined by the interface capabilities.

To display the **Interface Capability Status** page, click **System** → **Captive Portal** → **Interface Status** → **Interface Capability Status**.

**Figure 9-34. Interface Capability Status**



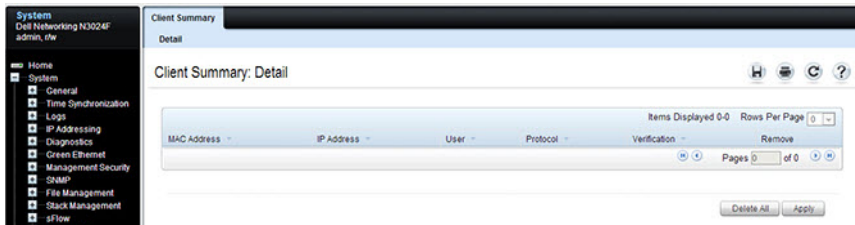
Interface	Unit	Port	Actions
Bytes Received Counter			Not Supported
Bytes Transmitted Counter			Not Supported
Packets Received Counter			Not Supported
Packets Transmitted Counter			Not Supported
Session Timeout			Supported
Idle Timeout			Not Supported

## Client Summary

Use the **Client Summary** page to view summary information about all authenticated clients that are connected through the CP. From this page, the CP can be manually forced to disconnect one or more authenticated clients. The list of clients is sorted by client MAC address.

To display the **Client Summary** page, click **System** → **Captive Portal** → **Client Connection Status** → **Client Summary**.

**Figure 9-35. Client Summary**



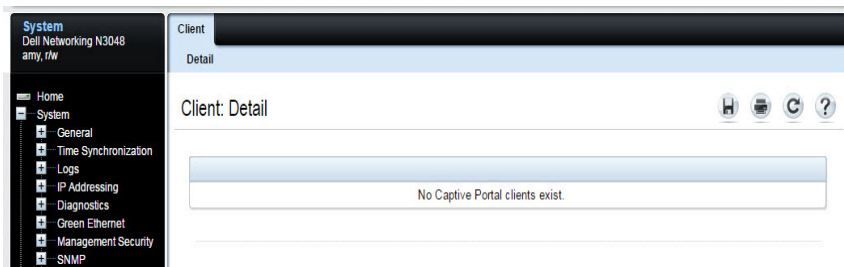
To force the CP to disconnect an authenticated client, select the **Remove** check box next to the client MAC address and click **Apply**. To disconnect all clients from all CPs, click **Delete All**.

### Client Detail

The **Client** page shows detailed information about each client connected to the network through a CP.

To display the **Client** page, click **System** → **Captive Portal** → **Client Connection Status** → **Client**.

**Figure 9-36. Client**



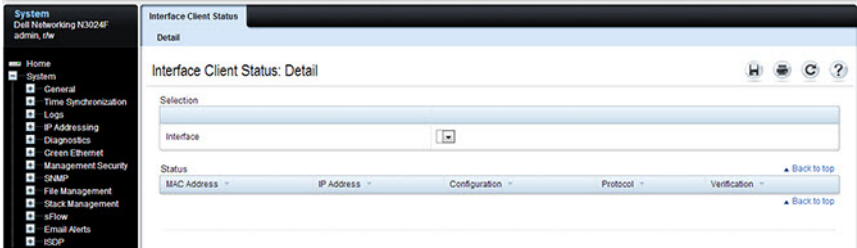
### Captive Portal Interface Client Status

Use the **Interface Client Status** page to view clients that are authenticated to a specific interface.

To display the **Interface Client Status** page, click **System** → **Captive Portal** → **Client Connection Status** → **Interface Client Status**.



**Figure 9-37. Interface - Client Status**

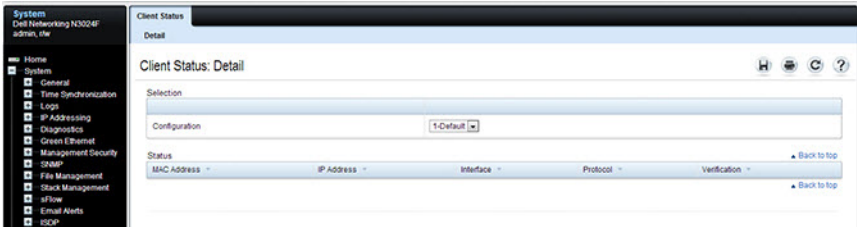


### Captive Portal Client Status

Use the Client Status page to view clients that are authenticated to a specific CP configuration.

To display the Client Status page, click System → Captive Portal → Client Connection Status → Client Status.

**Figure 9-38. Captive Portal - Client Status**



## Configuring Captive Portal (CLI)

This section provides information about the commands you use to create and configure Captive Portal (CP) settings. For more information about the commands, see the *Dell EMC Networking N1100-ON, N1500, N2000, N2100-ON, N2200-ON, N3000E-ON, N3100-ON, and N3200-ON Series Switches CLI Reference Guide* at [www.dell.com/support](http://www.dell.com/support).

### Configuring Global Captive Portal Settings

Use the following commands to configure global CP settings.

Command	Purpose
<code>configure</code>	Enter global configuration mode.
<code>captive-portal</code>	Enter Captive Portal mode.
<code>http port <i>port-num</i></code>	(Optional) Configure an additional HTTP port for CP to monitor. Use this command on networks that use an HTTP proxy server.  <i>port-num</i> — The port number to monitor (Range: 1–65535, excluding ports 80, 443, and the configured switch management port).
<code>https port <i>port-num</i></code>	(Optional) Configure an additional HTTPS port for CP to monitor. Use this command on networks that use an HTTPS proxy server.  <i>port-num</i> — The port number to monitor Range: 1–65535, excluding ports 80, 443, and the configured switch management port).
<code>authentication timeout <i>timeout</i></code>	(Optional) Configure the number of seconds the user has to enter valid credentials into the verification page. If the user exceeds the configured timeout, the verification page needs to be served again in order for the client to gain access to the network.  <i>timeout</i> — The authentication timeout (Range: 60–600 seconds).
<code>enable</code>	Globally enable the CP feature.

<b>Command</b>	<b>Purpose</b>
CTRL + Z	Exit to Privileged Exec mode.
show captive-portal [status]	View the CP administrative and operational status. Use the <b>status</b> keyword to view additional global CP information and summary information about all configured CP instances.

## Creating and Configuring a Captive Portal

Use the following commands to create a CP instance and configure its settings.

<b>Command</b>	<b>Purpose</b>
configure	Enter global configuration mode.
captive-portal	Enter Captive Portal mode.
configuration <i>cp-id</i>	Enter the CP instance mode <i>cp-id</i> — The CP instance (Range: 1–10). The CP configuration identified by CP ID 1 is the default CP configuration.
name <i>string</i>	Add a name to the CP instance. <i>string</i> — CP configuration name (Range: 1–32 characters).
protocol {http   https}	Specify whether to use HTTP or HTTPS during the CP user verification process.
verification {guest   local   radius}	Specify how to process user credentials the user enters on the verification page. <ul style="list-style-type: none"> <li>• guest — Allows access for unauthenticated users (users that do not have assigned user names and passwords).</li> <li>• local — Authenticates users against a local user database.</li> <li>• radius — Authenticates users against a remote RADIUS database.</li> </ul>
radius-auth-server <i>name</i>	(Optional) Specify the name of the RADIUS server to use for RADIUS verification. Use the commands described in "Using RADIUS" on page 307 to configure RADIUS server settings for the switch. This command is not required if <b>local</b> or <b>guest</b> verification is configured.

Command	Purpose
<code>user-logout</code>	(Optional) Enable user logout mode to allow an authenticated client to deauthenticate from the network. If this option is clear or the user does not specifically request logout, the client connection status remains authenticated until the CP deauthenticates the user, for example by reaching the idle timeout or session timeout values.
<code>redirect</code>	(Optional) Enable the redirect mode for a CP configuration so that the user is redirected to a specific Web page after the verification or authentication process. When the redirect mode is not enabled, the user sees the CP welcome page after the verification or authentication process.
<code>redirect-url <i>url</i></code>	(Optional) Specify the web page that the users sees after successful verification or authentication through the CP. <i>url</i> — The URL for redirection (Range: 1–512 characters).
<code>group <i>group-number</i></code>	(For Local and RADIUS verification) Configure the group number associated with this CP configuration. By default, only the default group exists. To assign a different user group to the CP instance, you must first configure the group. <i>group-number</i> — The number of the group to associate with this configuration (Range: 1–10)
<code>session-timeout <i>timeout</i></code>	(Optional) Enter the number of seconds to wait before terminating a session. A user is logged out once the session timeout is reached. The session timeout can be set for each user if the CP requires authentication. <i>timeout</i> — Session timeout. 0 indicates timeout not enforced (Range: 0–86400 seconds)
<code>interface <i>interface</i></code>	Associate an interface with this CP. (The <i>interface</i> variable includes the interface type and number, for example <code>tengigabitethernet 1/0/3</code> .)
<code>enable</code>	Enable the CP instance.

Command	Purpose
block	(Optional) Block all traffic for a CP configuration. If the CP is blocked, users cannot gain access to the network through the CP. Use this function to temporarily protect the network during unexpected events, such as denial of service attacks.
CTRL + Z	Exit to Privileged Exec mode.
show captive-portal configuration <i>cp-id</i> [status   interface]	View summary information about a CP instance. <ul style="list-style-type: none"> <li>• <i>cp-id</i> — The CP instance (Range: 1–10).</li> <li>• <b>status</b> — View additional information about the CP instance.</li> <li>• <b>interface</b> — View information about the interface(s) associated with the specified CP.</li> </ul>
show captive-portal interface configuration <i>cp-id</i> status	View information about the interfaces associated with the specified CP instance. <i>cp-id</i> — The CP instance (Range: 1–10).



**NOTE:** To return the default CP instance to its default values, use the **clear** command in the Captive Portal Instance mode. You must also use the **no interface *interface*** command to remove any associated interfaces from the instance.

### Configuring Captive Portal Groups and Users

Use the following commands to create a CP group. The default group can be used, or a new group can be created.

Command	Purpose
configure	Enter global configuration mode.
captive-portal	Enter Captive Portal mode.

<b>Command</b>	<b>Purpose</b>
<b>user group</b> <i>group-id</i> [ <i>name name</i> ]	Configure a group. Each CP that requires authentication has a group associated with it. Only the users who are members of that group can be authenticated if they connect to the CP. <ul style="list-style-type: none"> <li>• <i>group-id</i>— Group ID (Range: 1–10).</li> <li>• <i>name</i>— Group name (Range: 1–32 characters).</li> </ul>
<b>user</b> <i>user-id name name</i>	Create a new user for the local user authentication database. <ul style="list-style-type: none"> <li>• <i>user-id</i>—User ID (Range: 1–128).</li> <li>• <i>name</i>—user name (Range: 1–32 characters).</li> </ul>
<b>user</b> <i>user-id password password</i>	Configure the password for the specified user. <ul style="list-style-type: none"> <li>• <i>user-id</i>—User ID (Range: 1–128).</li> <li>• <i>password</i>—User password (Range: 8–64 characters).</li> </ul>
<b>user</b> <i>user-id group group-id</i>	Associate a group with a CP user. A user can be associated with more than one group. <ul style="list-style-type: none"> <li>• <i>user-id</i>— User ID (Range: 1–128).</li> <li>• <i>group-id</i>— Group ID (Range: 1–10).</li> </ul>
<b>user</b> <i>user-id session-timeout timeout</i>	Enter the number of seconds to wait before terminating a session for the specified user. The user is logged out once the session timeout is reached. <ul style="list-style-type: none"> <li>• <i>user-id</i>— User ID (Range: 1–128).</li> <li>• <i>timeout</i>— Session timeout. 0 indicates timeout not enforced (Range: 0–86400 seconds)</li> </ul>
<b>user group</b> <i>group-id moveusers new-group-id</i>	(Optional) Move all of the users in a group to a different group. This command removes the users from the group specified by <i>group-id</i> . <ul style="list-style-type: none"> <li>• <i>group-id</i>— Group ID (Range: 1–10).</li> <li>• <i>new-group-id</i>— Group ID (Range: 1–10).</li> </ul>
CTRL + Z	Exit to Privileged Exec mode.
<b>show captive-portal user</b> [ <i>user-id</i> ]	View summary information about all users configured in the local database. Specify the user ID to view additional information about a user.  <i>user-id</i> — User ID (Range: 1–128).

<b>Command</b>	<b>Purpose</b>
clear captive portal users	(Optional) Delete all CP user entries from the local database.

### Managing Captive Portal Clients

Use the following commands to view and manage clients that are connected to a CP.

<b>Command</b>	<b>Purpose</b>
show captive-portal configuration [ <i>cp-id</i> ] client status	Display information about the clients authenticated to all CP configurations or a to specific configuration. <i>cp-id</i> — The CP instance (Range: 1–10).
show captive-portal interface <i>interface</i> client status	Display information about clients authenticated on all interfaces or no a specific interface. <i>interface</i> — Specific Ethernet interface, such as <i>gi1/0/8</i> .
show captive-portal client [ <i>macaddr</i> ] status	Display client connection details or a connection summary for connected CP users. <i>macaddr</i> — The MAC address of the client.
captive-portal client deauthenticate <i>macaddr</i>	Deauthenticate a specific CP client. <i>macaddr</i> — The MAC address of the client.

## Captive Portal Configuration Example

The manager of a resort and conference center needs to provide wired Internet access to each guest room at the resort and in each conference room. Due to legal reasons, visitors and guests must agree to the resort's acceptable use policy to gain network access. Additionally, network access from the conference rooms must be authenticated. The person who rents the conference room space receives a list username and password combinations upon arrival. Hotel employees have their own CP.

The network administrator for the resort and conference center decides to configure the three CPs Table 9-16 describes.

**Table 9-16. Captive Portal Instances**

CP Name	Description
Guest	Free Internet access is provided in each guest room, but guests must enter a name and agree to the acceptable use policy before they can gain access. The manager wants guests to be redirected to the resort's home web page upon successful verification. No logout is required.
Conference	Because physical access to the conference rooms is less secure than access to each guest room, the manager wants to ensure that people who connect to the network through a port in a conference room are authenticated. The Conference CP uses the local database for authentication.
Employee	To gain network access, resort employees must enter a username and password that is stored on a RADIUS server.

### Configuration Overview

The following steps provide an overview of the process you use to configure the CP feature. In addition to the following steps, IP Helper/DHCP relay should be configured (not shown) if routing is enabled so that clients can obtain an IP address from a DHCP server. Ensure that a DNS server is configured in the network to resolve domain names in user-entered URLs to IP addresses. Refer to "Layer-2 and Layer-3 Relay Features" on page 1235 for further information.

To configure the switch:



1. If a RADIUS server is selected for authentication, configure the RADIUS server settings on the switch.
2. If authentication is required, configure the user groups to associate with each CP.
3. Create (add) the CPs.
4. Configure the CP settings for each CP, such as the verification mode.
5. Associate interfaces with the CP instances.
6. Download the branding images, such as the company logo, to the switch. The images you download must be accessible from the switch, either on the system you use to manage the switch or on a server that is on the same network as the switch.



**NOTE:** You must use the web interface to download images.

7. Customize the authentication, logout, and logout success web pages that a CP user will see.  
Dell recommends the use of the Dell OpenManage Administrator to customize the CP authentication, logout, and logout success pages. A **Preview** button is available to allow a preview of the pages that a CP user will see.
8. If the local database for user authentication is selected, configure the users on the switch.
9. If a RADIUS server for authentication is selected, add the users to the database on the RADIUS server. If the Captive Portal clients use DNS or DHCP services, configure access to the appropriate services using IP Helper (routed networks) or Layer-2 relay (switched networks).
10. Associate interfaces with the CP instances.
11. Test and verify end-user access over the Captive Portal ports and, if satisfied all services are available and working correctly, globally enable CP.

## Detailed Configuration Procedures

Use the following steps to perform the CP configuration:

1. Configure the RADIUS server information on the switch.

In this example, the RADIUS server IP address is 192.168.2.188, and the RADIUS server group name is `luxury-radius`.

```
console#configure
console(config)#radius server 192.168.12.182
console(config-auth-radius)#name luxury-radius
console(config-auth-radius)#exit
```

2. Configure the CP groups.

```
console(config)#captive-portal
console(config-CP)#user group 2 name Conference
console(config-CP)#user group 3 name Employee
console(config-CP)#exit
```

3. Configure the Guest CP.

```
console(config)#captive-portal
console(config-CP)#configuration 2
console(config-CP 2)#name Guest
console(config-CP 2)#redirect
console(config-CP 2)#redirect-url
http://www.luxuryresorturl.com
console(config-CP 2)#interface tel1/0/1
console(config-CP 2)#interface tel1/0/2
...
console(config-CP 2)#interface tel1/0/4
console(config-CP 2)#exit
```

4. Configure the Conference CP.

```
console(config-CP)#configuration 3
console(config-CP 3)#name Conference
console(config-CP 3)#verification local
console(config-CP 3)#group 2
console(config-CP 4)#interface tel1/0/8
...
console(config-CP 4)#interface tel1/0/15
console(config-CP 3)#exit
```

5. Configure the Employee CP.

```
console(config-CP)#configuration 4
console(config-CP 4)#name Employee
console(config-CP 4)#verification radius
console(config-CP 4)#group 3
```

```
console (config-CP 4) #interface tel/0/18
...
console (config-CP 4) #interface tel/0/40
console (config-CP 4) #exit
```

6. Use the web interface to customize the CP pages that are presented to users when they attempt to connect to the network.



**NOTE:** CP page customization is supported only through the web interface. For information about customizing the CP pages, see "Customizing a Captive Portal" on page 404.

7. Add the Conference users to the local database.

```
console (config-CP) #user 1 name EaglesNest1
console (config-CP) #user 1 password
Enter password (8 to 64 characters): *****
Re-enter password: *****
console (config-CP) #user 1 group 2
```

Continue entering username and password combinations to populate the local database.

8. Add the User-Name, User-Password, Session-Timeout, and Dell-Captive-Portal-Groups attributes for each employee to the database on the RADIUS server.
9. Globally enable CP.

```
console (config-CP) #enable
```



**NOTE:** Other items that may need to be configured to obtain a working configuration are:

- DNS servers
- DHCP servers
- DHCP Relay or DHCP L2 Relay
- Default gateway (if routing is enabled)

## **In Case Of Problems in Captive Portal Deployment**

When configuring captive portal, many administrators will find that the web browsers or hosts are not able to reach the captive portal web page. This is most often due to network issues as opposed to issues with the captive portal service.

When deploying captive portal, first ensure that web clients on the internal network can reach the external network by disabling captive portal entirely and verifying connectivity. It may be required to configure DHCP relay or DHCP snooping, add one or more default gateways in routed networks, and ensure access to one or more DNS servers. After outside network connectivity is verified by bringing up web pages from the external network on an internal host on the captive portal disabled port, re-enable captive portal.

# Network Access Control

## Pre-enrollment State

In the pre-enrollment state, 802.1X/MAB clients authenticate directly with the Network Authentication Server (NAS) as they have already completed the enrollment process and obtained the appropriate security credentials needed to be recognized by the Network Access Controller (NAC)/RADIUS server. As part of the 802.1X/MAB authentication process, clients may be assigned to a secure network or a guest network. Network security policies may be enforced through VLANs or ACLs or a combination of both. In this context, VLANs are used to enforce the security policy. The Dell EMC Networking switches also support enforcement using DACLs.

For clients that are not enrolled or registered in the MAB database, the client is authenticated into a walled garden where enrollment can be performed. The NAC uses MAB to send an Access-Request to the RADIUS server/NAC. The NAC must send an Access-Accept placing the unenrolled host into the walled garden VLAN. In conjunction with placement into the walled garden, a redirect URL and redirect ACL is included in the Access Accept to enable enrollment via HTTP/HTTPS.

## Walled Garden

The walled garden is a limited access in-band network where the client can perform any required enrollment steps, complete posture assessment and authenticate into the appropriate network (secure network or guest network). A redirect-acl configuration on the NAS allows limited access to the enrollment server along with access to a DHCP server (the client needs an IP address) at a minimum. Other services such as NTP and DNS may also be accessible. The NAS is configured with a redirect-url and redirect-acl to intercept HTTP/HTTPS traffic from the client and redirect the client to the enrollment server. Typically, a walled garden may be configured in the default VLAN or a different VLAN and a successful authentication assigns the client to a new (secure) VLAN. The result of a successful authentication on the enrollment server may be any one of the following:

- The enrollment server supplies 802.1X credentials to the client as part of enrollment and the client authenticates immediately into the secure or guest VLAN using those credentials. Alternatively, the client may temporarily reset the interface prior to authenticating. This places the port back into the pre-enrollment state.
- The enrollment server enrolls the client MAC address and returns a RADIUS Access-Accept with the guest or secure VLAN in response to the MAB Access-Request. Alternatively, the client may temporarily reset the interface prior to authenticating. This places the port back into the pre-enrollment state.
- The enrollment server sends a COA request to the NAS, placing the client into the secure or guest VLAN, and may apply a DACL or named ACL to further enable or restrict access. The request may be a simple COA request with a VLAN or a bounce port request with a new VLAN. (Supported post version 6.7)

Clients failing the enrollment process may also be placed into an unauthenticated or guest VLAN via configuration on the switch (802.1x/MAB timeout) or left in the walled garden.

# Media Access Control Security

**NOTE:** Only the Dell EMC Networking N32xx supports the Media Access Control Security feature.

The Media Access Control Security (MACsec) feature provides secure communications between stations that are attached to the same LAN. It uses symmetric key cryptography so that communication cannot be monitored or altered on the wire. Traffic traversing the link is MACsec-secured through the use of data integrity checks and encryption.

MACsec is standardized in IEEE 802.1AE, which specifies the forwarding plane for MACsec. The key management and its integration with 802.1x is standardized in IEEE 802.1X-2010.

The data integrity checks verify the integrity of the data. MACsec appends an 8-byte header called Sectag and a 16-byte tail called ICV to all secured Ethernet frames. These are checked by the receiving interface to ensure that the data was not compromised while traversing the link.

MACsec can also be used to encrypt all traffic on the Ethernet link. The encryption used by MACsec ensures that the data in the Ethernet frame cannot be viewed by anyone monitoring traffic on the link. MACsec encryption is optional and user-configurable—you can enable MACsec to ensure the data integrity checks are performed while still sending unencrypted data in the clear over the MACsec-secured link, if desired.

Dell MACsec supports confidentiality through encryption, integrity, and replay protection.

For information about the CLI commands you use to configure MACsec features, refer to Switch Management Commands in the *Dell EMC Networking CLI Reference Guide* at [www.dell.com/support](http://www.dell.com/support).





# Monitoring and Logging System Information

## Dell EMC Networking N-Series Switches

This chapter provides information about the features used for monitoring the switch, including logging, cable tests, and email alerting. The topics covered in this chapter include:

- System Monitoring Overview
- Default Log Settings
- Monitoring System Information and Configuring Logging (Web)
- Monitoring System Information and Configuring Logging (CLI)
- Logging Configuration Examples

## System Monitoring Overview

### What System Information Is Monitored?

The CLI and web-based interfaces provide information about physical aspects of the switch, such as system health and cable diagnostics, as well as information about system events, such as management login history. The switch also reports system resource usage.

The system logging utility can monitor a variety of events, including the following:

- System events — System state changes and errors that range in severity from Emergency to Debug
- Audit events — Attempts to login or logout from the switch and attempts to perform any operations with files on the flash drive
- CLI commands — Commands executed from the CLI
- Web page visits — Pages viewed by using OpenManage Switch Administrator
- SNMP events — SNMP set operations

## Why Is System Information Needed?

The information the switch provides can help the switch administrator troubleshoot issues that might be affecting system performance. The cable diagnostics test help the administrator troubleshoot problems with the physical connections to the switch. Auditing access to the switch and the activities an administrator performed while managing the switch can help provide security and accountability.

## Where Are Log Messages Sent?

The messages the switch generates in response to events, faults, errors, and configuration changes can be recorded in several locations. By default, these messages are stored locally on the switch in the RAM (cache). This collection of log files is called the RAM log or buffered log. When the RAM log file reaches the configured maximum size, the oldest message is deleted from the RAM when a new message is added. If the system restarts, all messages are cleared.

In addition to the RAM log, log files can be sent to the following sources:

- Console — If the administrator is connected to the switch CLI through the console port, messages display to the screen as they are generated. Use the **terminal monitor** command to control logging of messages to the console when connected via Telnet or SSH.
- Log file — Messages sent to the log file are saved in the flash memory and are not cleared when the system restarts.
- Remote server — Messages can be sent to a remote log server for viewing and storage.
- Email — Messages can be sent to one or more email addresses. Information about the network Simple Mail Transport Protocol (SMTP) server must be configured for email to be successfully sent from the switch.

## What Are the Severity Levels?

The severity of the messages to be logged for each local or remote log file can be specified. Each severity level is identified by a name and a number. Table 10-1 provides information about the severity levels.

**Table 10-1. Log Message Severity**

Severity Keyword	Severity Level	Description
emergencies	0	The switch is unusable.
alerts	1	Action must be taken immediately.
critical	2	The switch is experiencing critical conditions.
errors	3	The switch is experiencing error conditions.
warnings	4	The switch is experiencing warning conditions.
notification	5	The switch is experiencing normal but significant conditions.
informational	6	The switch is providing non-critical information.
debugging	7	The switch is providing debug-level information.

When the severity level is specified, messages with that severity level and higher are sent to the log file. For example, if the severity level is specified as critical, messages with a severity level of alert and emergency are also logged. When the severity level is specified in a CLI command, the keyword or the numerical level can be used.

## What Are the System Startup and Operation Logs?

Two types of log files exist in flash (persistent) memory:

- The first log type is the system startup log. The system startup log stores the first 32 messages received after system reboot. The log file stops when it is full.
- The second log type is the system operation log. The system operation log stores the last 1000 messages received during system operation. The oldest messages are overwritten when the file is full.

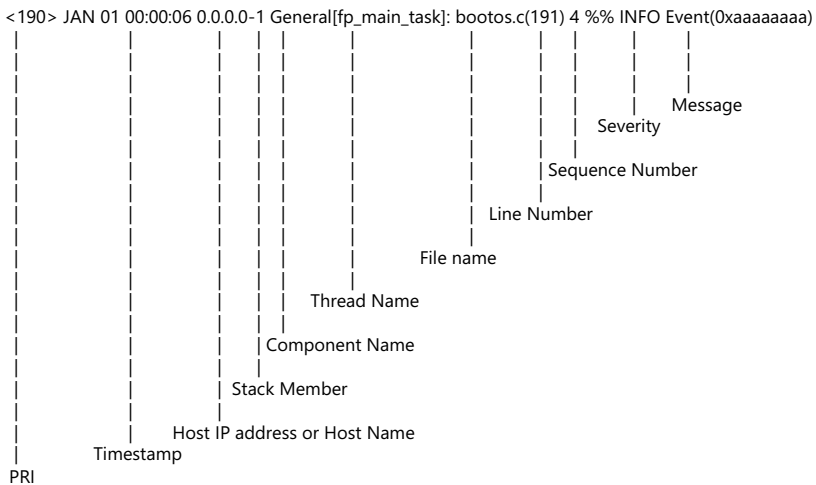
A message is only logged in one file. On system startup, if the Log file is enabled, the startup log stores messages up to its limit. Then the operation log begins to store the messages.

To view the log messages in the system startup and operational log files, the log files must be download to an administrative host. The startup log files are named slogX.txt and the operation log files are named ologX.txt. When enabled, the system stores the startup and operation log files for the last three switch boots. The current log files have a zero (0) in the file name (replacing the X in the name as shown above), the prior log files contain a one (1) in the name, and the oldest log files contain a two (2) in the name. For more information about downloading files, see "Images and File Management" on page 551.

### What Is the Log Message Format?

The first part of the log message up to the first left bracket is fixed by the SYSLOG standard (RFC 3164). The second part up to the two percent signs is standardized for all Dell EMC Networking logs. The variable text of the log message follows. The log message is limited to 96 bytes.

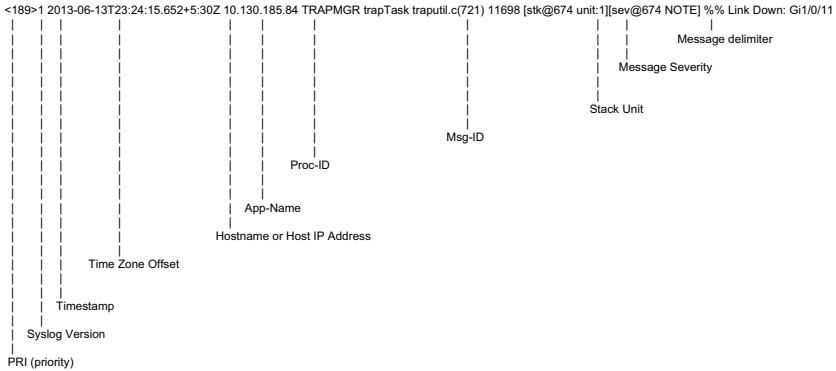
Each log message uses the following format:



- PRI—This consists of the facility code (see RFC 3164) multiplied by 8 and added to the severity. The log messages use the local7 facility code (23). This implies that a message of severity 0 will have a priority of 184 and a message of severity 7 will have a priority of 191.

- **Timestamp**—This is the system up time. For systems that use SNTP, this is UTC. When time zones are enabled, local time will be used.
- **Host IP address or Host Name**—This is the IP address of the local system, if known.
- **Stack Member**—This is the assigned stack member number which originated the message. For the Dell EMC Networking switches, the stack ID number may range from 1 to 12. The number 1 is used for systems without stacking ability. The management unit in the stack is used to collect messages for the stack members.
- **Component name**—The component name for the logging component. Component “General” is substituted for components that do not identify themselves to the logging component.
- **Thread ID**—The thread ID of the logging component.
- **File name** —The name of the file issuing the message.
- **Line number** —The line number identifying the location issuing the message.
- **Sequence number** —The message sequence number for this stack component. Sequence numbers may be skipped because of filtering but are always monotonically increasing on a per-stack member basis.
- **Severity** —The printed severity of the message. One of the following strings: EMER, ALRT, CRIT, ERR, WARN, NOTE, INFO, DBG

- Message — Contains the text of the log message. While RFC 5424 is enabled, the logging output will appear as follows. RFC 5424 may be enabled using the **logging protocol** command.



## What Factors Should Be Considered When Configuring Logging?

Dell recommends that network administrators deploy a SYSLOG server in their network and configure all switches to log messages to the SYSLOG server. Switch administrators should also consider enabling persistent logging on the switch.

When managing logs on a stack of switches, the RAM log and persistent log files exist only on the top of stack platform. Other platforms in the stack forward their messages to the top of stack log.

Logging of debug level messages is intended for use by support personnel. The output is voluminous and cryptic and, because of the large number of messages generated, can adversely affect switch operations. Set the logging level to debug only under the direction of support personnel.


## Default Log Settings

System logging is enabled, and messages are sent to the console (severity level: warning and above) and RAM log (severity level: informational and above). Switch auditing is enabled. CLI command logging, Web logging, and SNMP logging are disabled. By default, no messages are sent to the log file that is stored in flash, and no remote log servers are defined.

Email alerting is disabled, and no recipient email address is configured. Additionally, no mail server is defined. If a mail server is added, by default, no authentication or security protocols are configured, and the switch uses TCP port 25 for SMTP.

After email alerting is enabled and the mail server and recipient email address are configured, log messages with a severity level of emergency and alert are sent immediately with each log message in a separate mail. The email subject is “Urgent Log Messages.” Log messages with a severity level of critical, error, and warning are sent periodically in a single email. The email subject is “Non Urgent Log Messages.” Messages with a severity level of notice and below are not sent in an email.

# Monitoring System Information and Configuring Logging (Web)

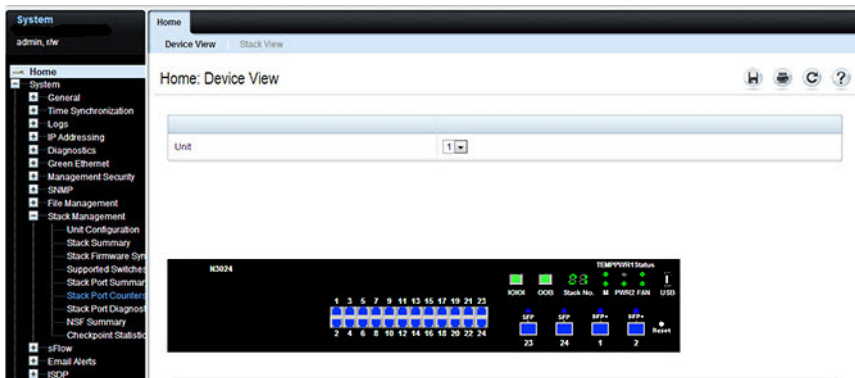
This section provides information about the OpenManage Switch Administrator pages to use to monitor system information and configure logging on the Dell EMC Networking Series switches. For details about the fields on a page, click  at the top of the Dell EMC OpenManage Switch Administrator web page.

## Device Information

The **Device Information** page displays after you successfully log on to the switch by using the Dell EMC OpenManage Switch Administrator. This page is a virtual representation of the switch front panel. Use the **Device Information** page to view information about the port status, or system status, and the switch stack. Click on a port to access the **Port Configuration** page for the selected port.

To display the **Device Information** page, click **Home** in the navigation panel.

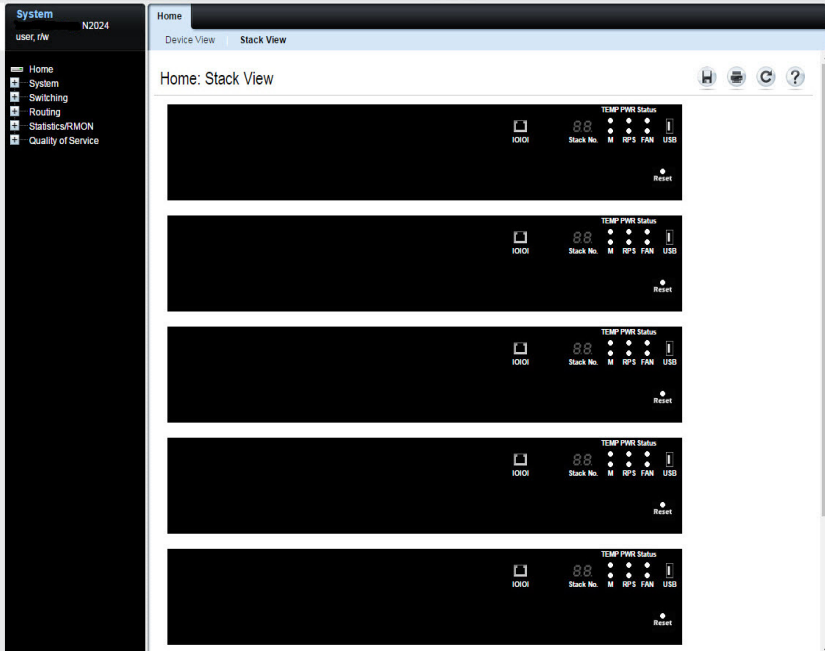
**Figure 10-1. Device Information**



Click the **Stack View** link to view front panel representations for all units in the stack.



**Figure 10-2. Stack View**



For more information about the device view features, see "Understanding the Device View" on page 212.

## System Health

Use the **Health** page to view status information about the switch power and ventilation sources.

To display the **Health** page, click **System** → **General** → **Health** in the navigation panel.

**Figure 10-3. Health**

The screenshot displays the 'Health: Detail' page for a Dell Networking N3024 switch. The left sidebar shows the navigation menu with 'System' > 'General' > 'Health' selected. The main content area is divided into several sections:

- Power:** A table showing power usage for the system and two power supplies (PS-1 and PS-2).
- Fans:** A table showing the status of two fans (Fan 1 and Fan 2).
- Temperature Sensors:** A table showing the temperature of two sensors (MAC and PHY).
- Unit Temperature State:** A table showing the overall temperature state of the unit.

Unit No.	Description	Status	Average Power (Watts)	Current Power (Watts)	Since Date/Time
1	System	✓	29.5	28.9	
1	PS-1	✓	N/A	N/A	01/01/1970 00:00:00
1	PS-2	✓	N/A	N/A	01/01/1970 00:00:47

Unit No.	Fan Description	Fan Status
1	Fan 1	✓
1	Fan 2	✓

Unit No.	Sensor Description	Temperature (°C)
1	MAC	31
1	PHY	33

Unit	Temperature (°C)	State
1	33	Good

## System Resources

Use the System Resources page to view information about memory usage and task utilization.

To display the System Resources page, click System → General → System Resources in the navigation panel.

Figure 10-4. System Resources

The screenshot displays the 'System Resources' page in a network management interface. The page is titled 'System Resources: Detail' and shows the following information:

- Memory Usage:**

Total Memory	1032452 KBytes
Available Memory	194004 KBytes
- Task Usage:**

Task Name	5 Seconds	1 Minute	5 Minutes
(ksoftirqd/0)	0.19%	0.05%	
(ksoftirqd/1)	0.00%	0.01%	
(procmgr)	0.09%	0.06%	
osapiTimer	0.00%	0.01%	
portMonTask	0.09%	0.02%	
- CPU Usage:**

Total CPU Utilization	5 Secs ( 7.3930%) 60 Secs ( 8.3521%)
-----------------------	--------------------------------------

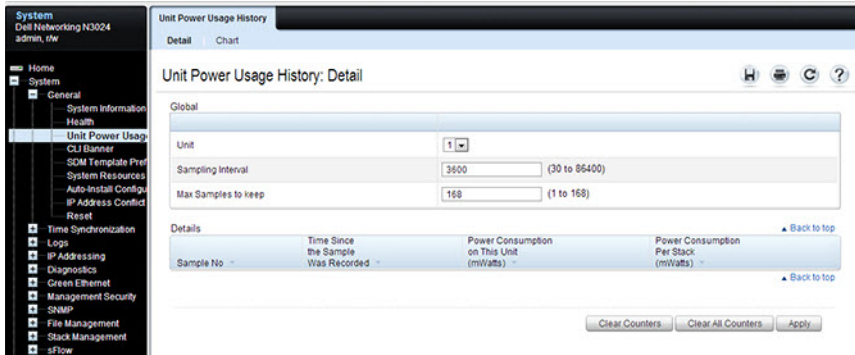
The interface includes a navigation sidebar on the left with the following menu items: Home, System, General (System Information, Global Configuration, Health, Unit Power Usage, CLI Banner, SDM Template Prof, System Resource), Auto-Install Config, IP Address Conflict, Reset, Time Synchronization, Logs, IP Addressing, Diagnostics, Green Ethernet, Management Security, SNMP, File Management, Stack Management, sFlow, Email Alerts, RDP, iSCSI, Captive Portal, Switching, and Routing.

## Unit Power Usage History

Use the Unit Power Usage History page to view information about switch power consumption.

To display the Unit Power Usage History page, click System → General → Unit Power Usage History in the navigation panel.

Figure 10-5. Unit Power Usage History



## Integrated Cable Test for Copper Cables

Use the **Integrated Cable Test for Copper Cables** page to perform tests on copper cables. Cable testing provides information about where errors occurred in the cable, the last time a cable test was performed, and the type of cable error which occurred. The tests use Time Domain Reflectometry (TDR) technology to test the quality and characteristics of a copper cable attached to a port. Cables up to 120 meters long can be tested. Cables are tested when the ports are in the down state, with the exception of the Approximated Cable Length test. SFP, SFP+, and QSFP cables with passive copper assemblies are not capable of performing TDR tests.



**NOTE:** Cable diagnostics may give misleading results if any green Ethernet modes are enabled on the port. Disable EEE and energy-detect mode prior to running any cable diagnostics.

To display the **Integrated Cable Test for Copper Cables** page, click **System** → **Diagnostics** → **Integrated Cable Test** in the navigation panel.

**Figure 10-6. Integrated Cable Test for Copper Cables**

The screenshot displays the 'Integrated Cable Test' interface. On the left is a navigation tree with 'System' expanded to 'Diagnostics' and 'Integrated Cable Test' selected. The main window has a header 'Integrated Cable Test' with 'Detail' and 'Results' tabs. Below the header is a sub-header 'Integrated Cable Test: Detail'. The main content area contains two tables. The first table, 'Cable Test', has columns for 'Interface', 'Unit', and 'Port'. The 'Interface' row shows 'Unit [T] Port [Gi1/0/5]'. The 'Test Result' row shows 'Test has not been performed'. The 'Cable Fault Distance' row shows '0 (m)'. The 'Last Update' row shows 'Jan 1 00:00:00 1970'. The second table, 'Cable Length', has a single row 'Cable Length' with the value 'Unknown (m)'. A 'Run Test' button is located at the bottom right of the page.

To view a summary of all integrated cable tests performed, click the **Results** link.

**Figure 10-7. Integrated Cable Test Results**

Integrated Cable Test: Results

Unit: 1

Interface	Test Result	Cable Fault Distance (m)	Last Update	Cable Length (m)
Gi1/0/1	No Cable	0	Nov 1 02:29:38 2016	Unknown
Gi1/0/2	No Cable	0	Nov 1 02:31:20 2016	Unknown
Gi1/0/3	Test has not been performed	0	Jan 1 00:00:00 1970	Unknown
Gi1/0/4	Test has not been performed	0	Jan 1 00:00:00 1970	Unknown
Gi1/0/5	Test has not been performed	0	Jan 1 00:00:00 1970	Unknown

Pages 1 of 10

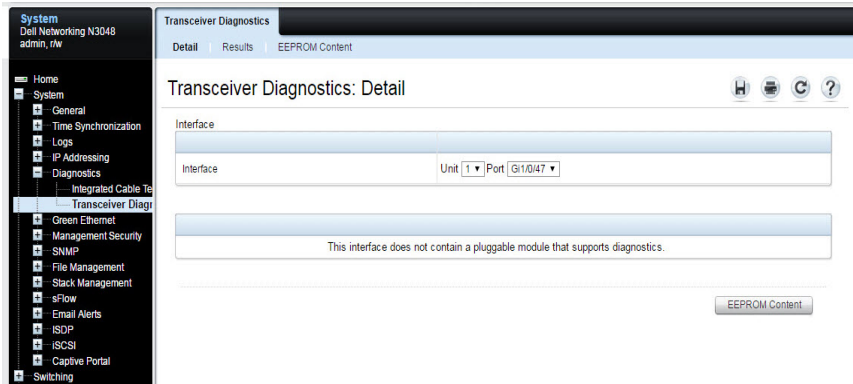
## Optical Transceiver Diagnostics

Use the **Transceiver Diagnostics** page to perform tests on Fiber Optic cables. To display the **Transceiver Diagnostics** page, click **System** → **Diagnostics** → **Transceiver Diagnostics** in the navigation panel.



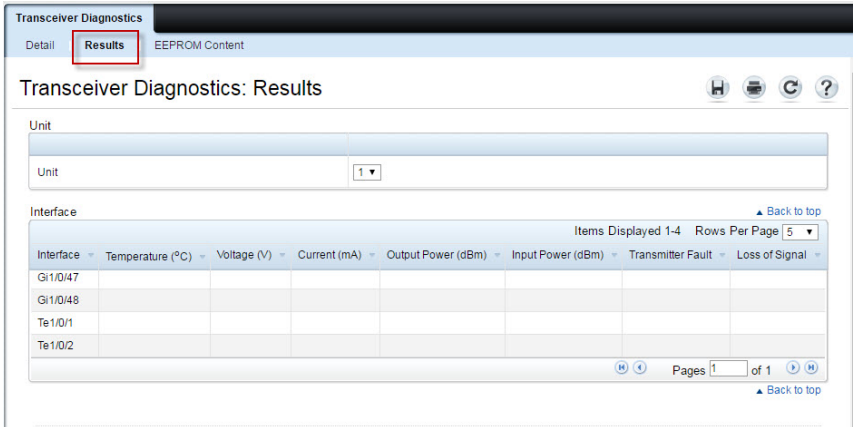
**NOTE:** Optical transceiver diagnostics can be performed only when the link is present.

**Figure 10-8. Transceiver Diagnostics**



To view a summary of all optical transceiver diagnostics tests performed, click the **Results** link.

**Figure 10-9. Transceiver Diagnostics Results**



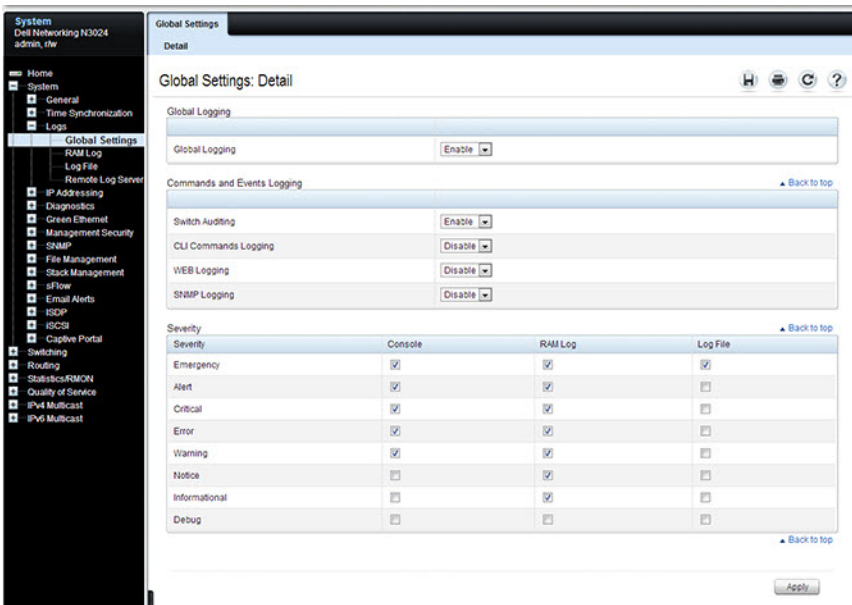
## Log Global Settings

Use the **Global Settings** page to enable logging globally, to enable other types of logging. The severity of messages that are logged to the console, RAM log, and flash-based log file can also be specified.

The **Severity** table lists log messages from the highest severity (Emergency) to the lowest (Debug). When a severity level is selected, all higher levels are automatically selected. To prevent log messages from being sent to the console, RAM log, or flash log file, clear all check boxes in the **Severity** column.

To display the **Global Settings** page, click **System** → **Logs** → **Global Settings** in the navigation panel.

**Figure 10-10. Global Settings**



## RAM Log

Use the **RAM Log** page to view information about specific RAM (cache) log entries, including the time the log was entered, the log severity, and a description of the log.

To display the **RAM Log**, click **System** → **Logs** → **RAM Log** in the navigation panel.



Figure 10-11. RAM Log Table

The screenshot shows a web-based network management interface. On the left is a dark sidebar menu with categories like 'System', 'Home', and 'System'. The 'System' menu is expanded to show 'Logs', which is further expanded to 'RAM Log'. The main content area is titled 'RAM Log' and 'Detail'. It features a table with columns for 'Severity', 'Log Time', 'Component', and 'Description'. The table contains five rows of log entries. Below the table is a pagination control showing 'Pages 1 of 80' and a 'Clear' button.

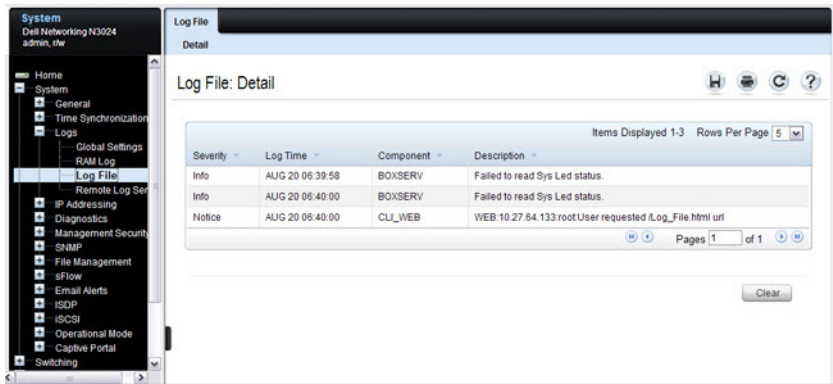
Severity	Log Time	Component	Description
Info	Jan 1 08:53:58	CLI_WEB	[WEB admin.10.12.17.134] User has successfully logged in
Info	Jan 1 08:53:50	CLI_WEB	[WEB admin.10.12.17.134] Disconnected due to Idle Timeout
Info	Jan 1 08:45:45	CLI_WEB	[WEB admin.10.12.17.134] User has successfully logged in
Info	Jan 1 07:53:49	CLI_WEB	[WEB admin.10.12.17.134] User has successfully logged in
Info	Jan 1 07:52:57	CLI_WEB	[WEB admin.10.12.17.134] Disconnected due to Idle Timeout

## Log File

The **Log File** contains information about specific log entries, including the time the log was entered, the log severity, and a description of the log.

To display the **Log File**, click **System** → **Logs** → **Log File** in the navigation panel.

**Figure 10-12. Log File**

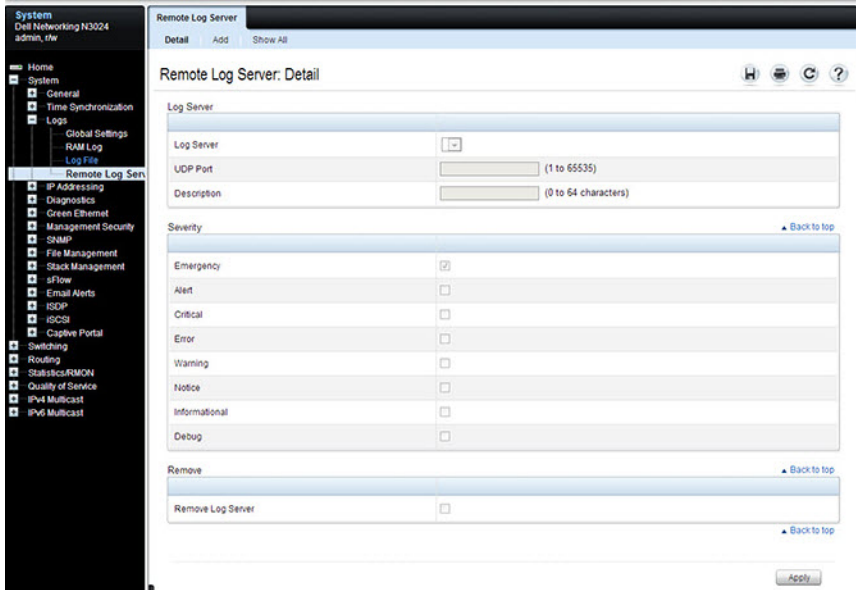


## SYSLOG Server

Use the **Remote Log Server** page to view and configure the available SYSLOG servers, to define new SYSLOG servers, and to set the severity of the log events sent to the SYSLOG server.

To display the **Remote Log Server** page, click **System** → **Logs** → **Remote Log Server**.

**Figure 10-13. Remote Log Server**

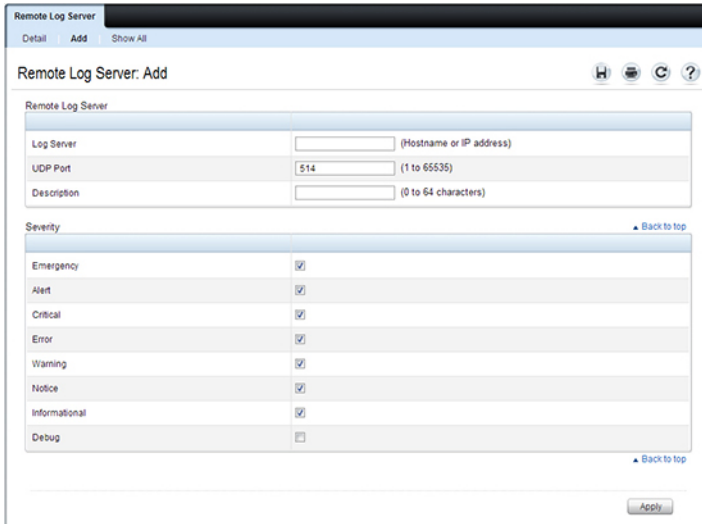


### Adding a New Remote Log Server

To add a SYSLOG server:

- 1 Open the **Remote Log Server** page.
- 2 Click **Add** to display the **Add Remote Log Server** page.
- 3 Specify the IP address or hostname of the remote server.
- 4 Define the **UDP Port** and **Description** fields.

**Figure 10-14. Add Remote Log Server**



5 Select the severity of the messages to send to the remote server.

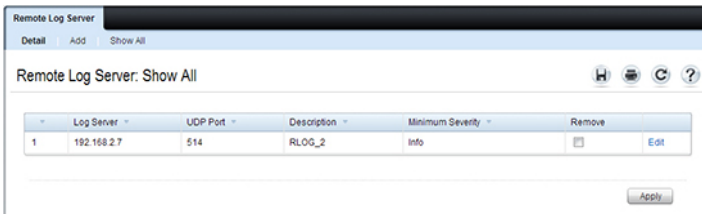


**NOTE:** When a severity level is selected, all higher (numerically lower) severity levels are automatically selected.

6 Click **Apply**.

Click the **Show All** link to view or remove remote log servers configured on the system.

**Figure 10-15. Show All Log Servers**

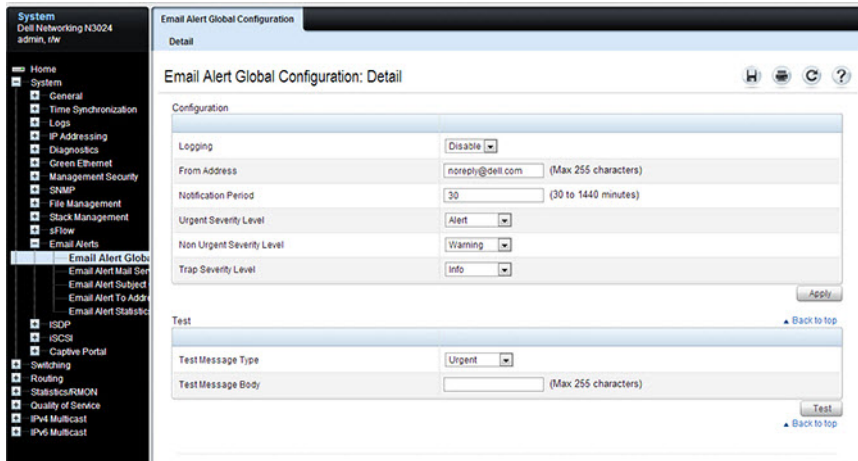


## Email Alert Global Configuration

Use the **Email Alert Global Configuration** page to enable the email alerting feature and configure global settings so that system log messages can be sent to from the switch to one or more email accounts.

To display the **Email Alert Global Configuration** page, click **System** → **Email Alerts** → **Email Alert Global Configuration** in the navigation panel.

**Figure 10-16. Email Alert Global Configuration**



The screenshot shows the 'Email Alert Global Configuration: Detail' page. The left sidebar contains a navigation tree with 'Email Alert Global Configuration' selected. The main content area is divided into two sections: 'Configuration' and 'Test'.

**Configuration Section:**

Logging	<input type="button" value="Disable"/>
From Address	<input type="text" value="noreply@del.com"/> (Max 255 characters)
Notification Period	<input type="text" value="30"/> (30 to 1440 minutes)
Urgent Severity Level	<input type="button" value="Alert"/>
Non Urgent Severity Level	<input type="button" value="Warning"/>
Trap Severity Level	<input type="button" value="Info"/>

**Test Section:**

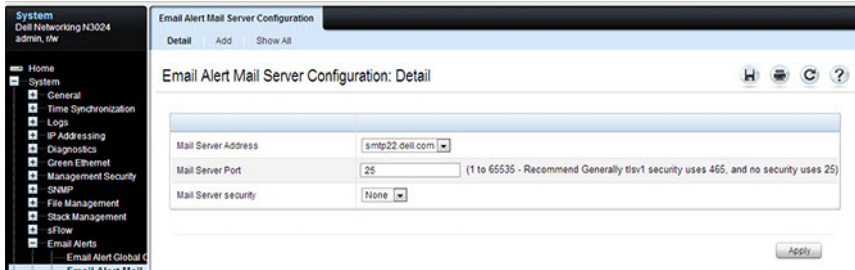
Test Message Type	<input type="button" value="Urgent"/>
Test Message Body	<input type="text"/> (Max 255 characters)

## Email Alert Mail Server Configuration

Use the **Email Alert Mail Server Configuration** page to configure information about the mail server the switch uses for sending email alert messages.

To display the **Email Alert Mail Server Configuration** page, click **System** → **Email Alerts** → **Email Alert Mail Server Configuration** in the navigation panel.

**Figure 10-17. Email Alert Mail Server Configuration**

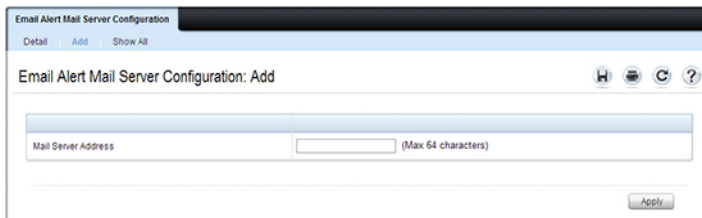


### Adding a Mail Server

To add a mail server:

- 1 Open the **Email Alert Mail Server Configuration** page.
- 2 Click **Add** to display the **Email Alert Mail Server Add** page.
- 3 Specify the hostname of the mail server.

**Figure 10-18. Add Mail Server**



- 4 Click **Apply**.
- 5 If desired, click **Configuration** to return to the **Email Alert Mail Server Configuration** page to specify port and security settings for the mail server.

Click the **Show All** link to view or remove mail servers configured on the switch.

**Figure 10-19. Show All Mail Servers**

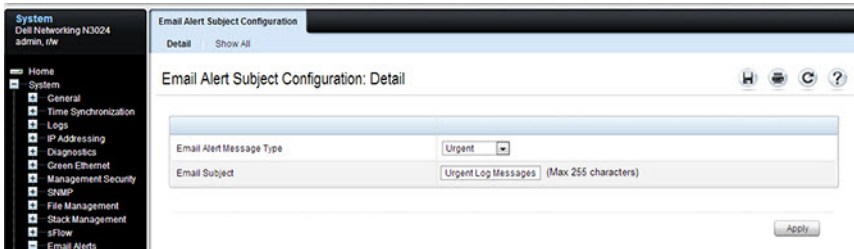


## Email Alert Subject Configuration

Use the **Email Alert Subject Configuration** page to configure the subject line for email alerts that are sent by the switch. The subject for the message severity and entry status can customize be customized.

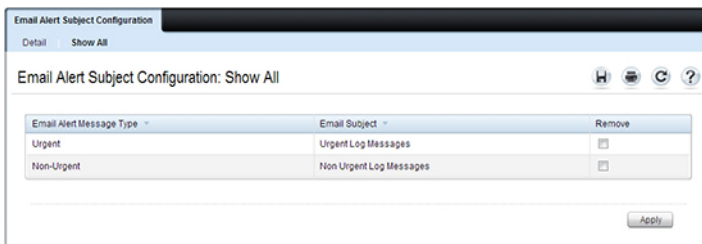
To display the **Email Alert Subject Configuration** page, click **System** → **Email Alerts** → **Email Alert Subject Configuration** in the navigation panel.

**Figure 10-20. Email Alert Subject Configuration**



To view all configured email alert subjects, click the **Show All** link.

**Figure 10-21. View Email Alert Subjects**

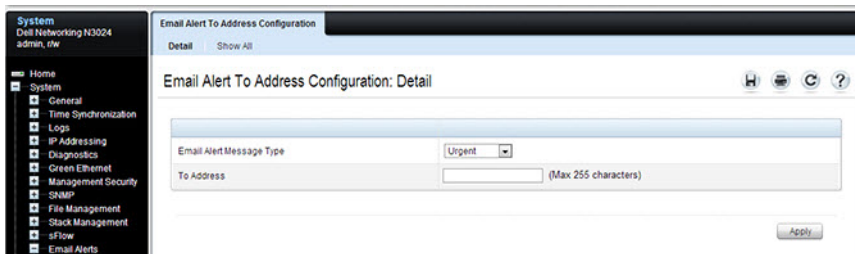


## Email Alert To Address Configuration

Use the **Email Alert To Address Configuration** page to specify where the email alerts are sent. Multiple recipients can be configured and different message severity levels can be associated with different recipient addresses.

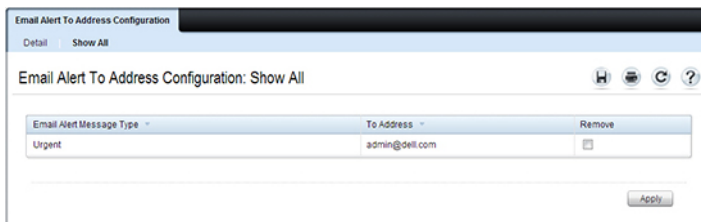
To display the **Email Alert To Address Configuration** page, click **System** → **Email Alerts** → **Email Alert To Address Configuration** in the navigation panel.

**Figure 10-22. Email Alert To Address Configuration**



To view configured recipients, click the **Show All** link.

**Figure 10-23. View Email Alert To Address Configuration**



## Email Alert Statistics

Use the **Email Alert Statistics** page to view the number of emails that were successfully and unsuccessfully sent, and when emails were sent.

To display the **Email Alert Statistics** page, click **System** → **Email Alerts** → **Email Alert Statistics** in the navigation panel.



**Figure 10-24. Email Alert Statistics**

The screenshot shows a web-based interface for a network device. On the left is a dark sidebar with a navigation menu. The main content area is titled "Email Alert Statistics" and "Detail". It contains a table with three rows of statistics. A "Clear" button is located at the bottom right of the table area.

Email Alert Statistics: Detail	
No Of Emails Sent	0
No Of Emails Failed	0
Time since last email Sent	0 days, 0 hours, 0 mins 0 secs

# Monitoring System Information and Configuring Logging (CLI)

This section provides information about the commands used for configuring features for monitoring on the Dell EMC Networking Series switches. For more information about these commands, see the *Dell EMC Networking N1100-ON, N1500, N2000, N2100-ON, N2200-ON, N3000E-ON, N3100-ON, and N3200-ON Series Switches CLI Reference Guide* at [www.dell.com/support](http://www.dell.com/support).

## Viewing System Information and Enabling the Locator LED

Use the following commands to view system health and resource information and to enable the switch locator LED.

Command	Purpose
show system	Display various system information.
show system power	Display the power supply status.
show system temperature	Display the system temperature and fan status.
show memory cpu	Display the total and available RAM space on the switch.
show process cpu	Display the CPU utilization for each process currently running on the switch.
locate [switch <i>unit</i> ] [time <i>time</i> ]	Enable the switch locator LED located on the switch. Optionally, the unit to identify within a switch stack and the length of time that the LED blinks can be specified.

## Running Cable Diagnostics

Use the following commands to run the cable diagnostic tests.



**NOTE:** Cable diagnostics may give misleading results if green mode is enabled on the port. Disable green mode prior to running any cable diagnostics.

Command	Purpose
test copper-port tdr <i>interface</i>	<p>Perform the Time Domain Reflectometry (TDR) test to diagnose the quality and characteristics of a copper cable attached to the specified port. SFP, SFP+, and QSFP cables with passive copper assemblies are not capable of performing TDR tests.</p> <p><b>⚠ CAUTION: Issuing the test copper-port tdr command will bring the interface down.</b></p> <p><b>NOTE:</b> To ensure accurate measurements, disable all Green Ethernet modes (EEE and energy-detect mode) on the port before running the test.</p> <p>The interface is specified in unit/slot/port format. For example 1/0/3 is GbE interface 3 on unit 1 of the stack.</p>
show copper-ports tdr <i>[interface]</i>	<p>Display the diagnostic information collected by the test copper-port tdr command for all copper interfaces or a specific interface.</p>
show fiber-ports optical-transceiver <i>[interface]</i>	<p>Display the optical transceiver diagnostics for all fiber ports. Include the <i>interface</i> option to show information for the specified port.</p>

## Configuring Local Logging

Use the following commands to configure the type of messages that are logged and where the messages are logged locally.

Command	Purpose
<code>configure</code>	Enter Global Configuration mode.
<code>logging on</code>	Globally enables logging.
<code>logging audit</code>	Enable switch auditing.
<code>logging cli-command</code>	Enable CLI command logging
<code>logging monitor</code>	Enable logging to stations other than the console.
<code>logging web-session</code>	Enable logging of the switch management Web page visits.
<code>logging snmp</code>	Enable logging of SNMP <code>set</code> commands.
<code>terminal monitor</code>	Enable display of system messages on the console for Telnet/SSH sessions.
<code>logging {buffered console file monitor} [severity]</code>	<p>Enable logging to the specified file. Optionally, a logging discriminator can be defined to help filter log messages and set the severity of the messages to log.</p> <ul style="list-style-type: none"><li>• <b>buffered</b> — Enables logging to the RAM file (cache). If the switch resets, the buffered logs are cleared.</li><li>• <b>console</b> — Enables logging to the screen when the administrator is connected to the CLI through the console port.</li><li>• <b>file</b> — Enables logging to the startup and operational log files on the flash.</li><li>• <b>monitor</b> — Enable logging to remote administrator sessions connected via telnet/SSH.</li><li>• <b>severity</b> — (Optional) Enter the number or name of the desired severity level. For information about severity levels, see Table 10-1.</li></ul>
<code>logging facility facility-type</code>	Set the facility for logging messages. Permitted <i>facility-type</i> values are local0, local1, local2, local3, local4, local5, local 6, local7
<code>logging protocol [0 1]</code>	Configure the format of log messages (0-RFC 3164, 1-RFC5424)

<b>Command</b>	<b>Purpose</b>
CTRL + Z	Exit to Privileged Exec mode.
show logging	Displays the state of logging and the SYSLOG messages stored in the internal buffer.
show logging file	View information about the flash (persistent) log file.
clear logging	Use to clear messages from the logging buffer.

## Configuring Remote Logging

Use the following commands to define a remote server to which the switch sends log messages.

<b>Command</b>	<b>Purpose</b>
configure	Enter Global Configuration mode.
logging { <i>ip-address</i>   <i>hostname</i> }	Define a remote log server and enter the configuration mode for the specified log server.
description <i>description</i>	Describe the log server. Use up to 64 characters. If the description includes spaces, surround it with quotation marks.
level <i>severity</i>	Specify the severity level of the logs that should be sent to the remote log server. For information about severity levels, see Table 10-1.
port <i>udp-port</i>	Specify the UDP port to use for sending log messages. The range is 1 to 65535, and the default is 514.
CTRL + Z	Exit to Privileged Exec mode.
show syslog-servers	Verify the remote log server configuration.

## Configuring Mail Server Settings

Use the following commands to configure information about the mail server (SMTP host) on the network that will initially receive the email alerts from the switch and relay them to the correct recipient.

Command	Purpose
<code>configure</code>	Enter Global Configuration mode.
<code>mail-server <i>ip-address</i></code>	Specify the IP address of the SMTP server on the network and enter the configuration mode for the mail server.
<code>security {<i>tls</i> <i>none</i>}</code>	(Optional) Specify the security protocol to use with the mail server.
<code>port {<i>25</i> <i>465</i>}</code>	Configure the TCP port to use for SMTP, which can be 25 (SMTP) or 465 (SMTP over SSL).
<code>username <i>username</i></code>	If the SMTP server requires authentication, specify the username to use for the switch.  The same username and password settings must be configured on the SMTP host.
<code>password <i>password</i></code>	If the SMTP server requires authentication from clients, specify the password to associate with the switch username.
<code>CTRL + Z</code>	Exit to Privileged Exec mode.
<code>show mail-server all</code>	View mail server configuration information for all configured mail servers.

## Configuring Email Alerts for Log Messages

Use the following commands to configure email alerts so that log messages are sent to the specified address.

Command	Purpose
<code>configure</code>	Enter Global Configuration mode.
<code>logging email [severity]</code>	Enable email alerting and determine which non-critical log messages should be emailed. Use <b>logging email</b> with no parameter to enable email logging. Including the <i>severity</i> value sets the lowest severity for which log messages are emailed. These messages are collected and sent in a single email at the configured log duration.  <i>severity</i> — (Optional) Enter the number or name of the severity level for non-critical messages. Log messages at or above this severity level are emailed. For information about severity levels, see Table 10-1. Log messages below the specified level are not emailed.
<code>logging email urgent {severity   none}</code>	Determine which log messages are critical and should be sent in a single email as soon as they are generated.  <i>severity</i> — (Optional) Enter the number or name of the severity level for critical messages. For information about severity levels, see Table 10-1.
<code>logging email logtime minutes</code>	Specify how often to send the non-critical email alerts that have been collected. . The valid range is 30 - 1440 minutes.
<code>logging email message-type {urgent   non-urgent   both} to-addr email-address</code>	Specify the email address of the recipient for log messages.
<code>logging email from-addr email-address</code>	Specify the email address of the sender, which is the switch.
<code>logging email message-type {urgent   non-urgent   both} subject subject</code>	Specify the text that will appear in the subject line of email alerts sent by the switch.

---

<b>Command</b>	<b>Purpose</b>
logging email test message-type {urgent   non-urgent   both} message-body <i>body</i>	Send a test email to the configured recipient to verify that the feature is properly configured.
CTRL + Z	Exit to Privileged Exec mode.
show logging email config	View the configured settings for email alerts.
show logging email statistics	View information about the number of emails sent and the time they were sent.
clear logging email statistics	Clear the email alerting statistics.

---



# Logging Configuration Examples

This section contains the following examples:

- Configuring Local and Remote Logging
- Configuring Email Alerting

## Configuring Local and Remote Logging

This example shows how to enable switch auditing and CLI command logging. Log messages with a severity level of Notification (level 5) and above are sent to the RAM (buffered) log. Emergency, Critical, and Alert (level 2) log messages are written to the log file on the flash drive. All log messages are displayed on the console and sent to a remote SYSLOG server.

By default, logging uses protocol version 0 (RFC 3164). Administrators may wish to configure protocol version 1 format (RFC 5424) messages.

By default, the log messages appear in reverse order, i.e. the newest message is shown first.

To configure the switch:

- 1 Enable switch auditing and CLI command logging.

```
console#configure
console (config) #logging audit
console (config) #logging cli-command
```

- 2 Specify where the logs are sent locally and what severity level of message is to be logged. The severity can be specified as the level number, as shown in the first two commands, or as the keyword, as shown in the third command.

```
console (config) #logging buffered 5
console (config) #logging file 2
console (config) #logging console debugging
```

- 3 Define the remote log server.

```
console (config) #logging 192.168.2.10
console (Config-logging) #description "Syslog Server"
console (Config-logging) #level debug
console (Config-logging) #exit
console (config) #exit
```

#### 4 Verify the remote log server configuration.

```
console#show syslog-servers
```

```
IP/IPv6 Address/Hostname Port Severity Description
-----
192.168.2.10 514 debugging Syslog Server
```

```
Transport Type Authentication Certificate Index
-----
UDP
```

#### 5 Verify the local logging configuration and view the log messages stored in the buffer (RAM log).

```
console#show logging
```

```
Logging is enabled
Logging protocol version: 0
Source Interface..... Default
Console Logging: Level warnings. Messages : 4 logged, 379
ignored
Monitor Logging: disabled
Buffer Logging: Level informational. Messages : 139 logged, 244
ignored
File Logging: Level emergencies. Messages : 0 logged, 383
ignored
Switch Auditing : enabled
CLI Command Logging: disabled
Web Session Logging : disabled
SNMP Set Command Logging : disabled
Logging facility level : local7
Logging source interface : V117
```

```
Syslog Server Details:
```

```
192.168.2.10 : Level informational. Messages : 0 dropped
0 Messages dropped due to lack of resources
Buffer Log:
<190> Oct 18 07:09:12 0.0.0.0-0 VR_AGENT[Cnfr_Thread ]:
vr_agent_api.c(72) 15 %% INFO initialized the clnt
addr:/tmp/fpcvragent.00,family:1
<190> Oct 18 07:09:12 0.0.0.0-1 UNITMGR[Cnfr_Thread ]:
unitmgr_status.c(150) 13 %% INFO Unit Manager status sampling
initialization done
<185> Oct 18 07:09:12 0.0.0.0-1 SIM[Cnfr_Thread ]:
sim_util.c(3890) 12 %% ALRT Switch was reset due to operator
intervention.
```

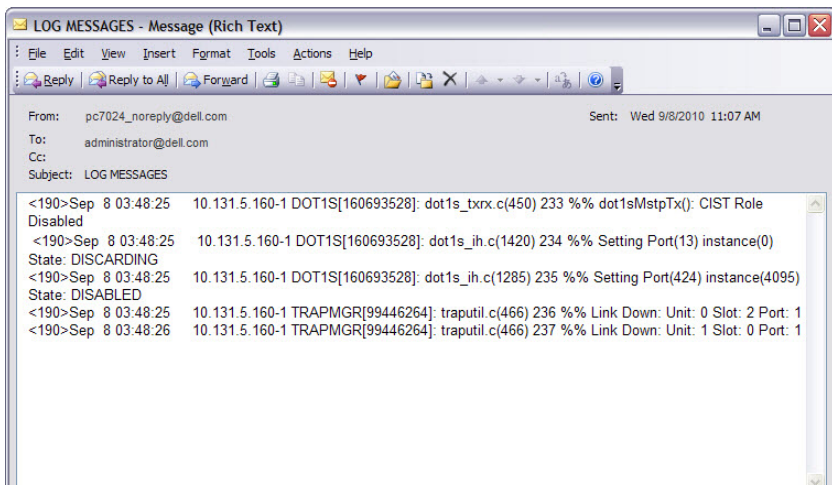
```
<189> Oct 18 07:09:12 0.0.0.0-1 OSAPI[fp_main_task]:
osapi_netlink.c(551) 11 %% NOTE Unable to add the entry to
/etc/iproute2/rt_protos.
<186> Oct 18 07:09:12 0.0.0.0-1 General[fp_main_task]:
bootos.c(191) 10 %% CRIT Event(0xaaaaaaaa)
<189> Oct 18 07:09:12 0.0.0.0-1 BSP[fp_main_task]:
bootos.c(175) 9 %% NOTE BSP initialization complete, starting
switch firmware.
<190> Oct 18 07:09:12 0.0.0.0-1 OSAPI[fp_main_task]:
osapi_crash.c(1297) 8 %% INFO Oldest crashlog (5) will be
deleted if another crash happens.
<190> Oct 18 07:09:12 0.0.0.0-1 OSAPI[fp_main_task]:
osapi_crash.c(1292) 7 %% INFO 5 Crashlogs found.
<190> Oct 18 07:09:11 0.0.0.0-1 DRIVER[fp_main_task]:
broad_hpc_stacking.c(1236) 6 %% INFO Configuring CPUTRANS RX
<190> Oct 18 07:09:11 0.0.0.0-1 DRIVER[fp_main_task]:
broad_hpc_stacking.c(1224) 5 %% INFO Configuring CPUTRANS TX
<190> Oct 18 07:09:11 0.0.0.0-1 DRIVER[fp_main_task]:
broad_hpc_stacking.c(1193) 4 %% INFO Adding BCM transport
pointers
<189> Oct 18 07:09:06 0.0.0.0-1 General[fp_main_task]:
sdm_template_mgr.c(488) 3 %% NOTE Booting with default SDM
template Data Center - IPv4 and IPv6.
<190> Oct 18 07:09:05 0.0.0.0-1 General[procLOG]:
procmgr.c(3685) 2 %% INFO Application Terminated (user.start,
ID = 7, PID = 1349)
<185> Oct 18 07:09:05 0.0.0.0-0 General[fp_main_task]:
unitmgr.c(6612) 1 %% ALRT Reboot 1 (0x1)
```

## Configuring Email Alerting

The commands in this example define the SMTP server to use for sending email alerts. The mail server does not require authentication and uses the standard TCP port for SMTP, port 25, which are the default values. Only Emergency messages (severity level 0) will be sent immediately as individual emails, and messages with a severity of alert, critical, and error (levels 1-3) will be sent in a single email every 120 minutes. Warning, notice, info, and debug messages are not sent in an email.

The email the administrator will in the inbox has a format similar to the following:

**Figure 10-25. Email Alert Message Format**



For emergency-level messages, the subject is LOG MESSAGE - EMERGENCY. For messages with a severity level of alert, critical, and error, the subject is LOG MESSAGE.

To configure the switch:

- 1 Specify the mail server to use for sending messages.

```
console#configure
console(config)#mail-server 192.168.2.34
```

- 2 Configure the username and password that the switch must use to authenticate with the mail server.

```
console (Mail-Server) #username switchN3048
console (Mail-Server) #password passwordN3048
console (Mail-Server) #exit
```

- 3 Configure emergencies and alerts to be sent immediately, and all other messages to be sent in a single email every 120 minutes.

```
console (config) #logging email error
console (config) #logging email urgent emergency
console (config) #logging email logtime 120
```

- 4 Specify the email address of the sender (the switch).

```
console (config) #logging email from-addr N3048_noreply@dell.com
```

- 5 Specify the address where email alerts should be sent.

```
console (config) #logging email message-type both to-addr
administrator@dell.com
```

- 6 Specify the text that will appear in the email alert Subject line.

```
console (config) #logging email message-type urgent subject "LOG
MESSAGES - EMERGENCY"
console (config) #logging email message-type non-urgent subject
"LOG MESSAGES"
```

- 7 Enable email logging and verify the configuration.

```
console (config) #logging email
console (config) #show mail-server all
```

Mail Servers Configuration:

```
No of mail servers configured..... 1

Email Alert Mail Server Address..... 192.168.2.34
Email Alert Mail Server Port..... 25
Email Alert SecurityProtocol..... none
Email Alert Username..... switchN3048
Email Alert Password..... passwordN3048
```

```
console (config) #show logging email config
```

```
Email Alert Logging..... enabled
Email Alert From Address.....
N3048_noreply@dell.com
Email Alert Urgent Severity Level..... 0
```

Email Alert Non Urgent Severity Level..... 3  
Email Alert Trap Severity Level..... 6  
Email Alert Notification Period..... 120 min

Email Alert To Address Table:

For Msg Type.....1

Address1.....administrator@dell.com

For Msg Type.....2

Address1.....administrator@dell.com

Email Alert Subject Table :

For Msg Type 1, subject is.....LOG MESSAGES - EMERGENCY

For Msg Type 2, subject is.....LOG MESSAGE

# Managing General System Settings

## Dell EMC Networking N-Series Switches

This chapter describes how to set system information, such as the hostname, and time settings, and how to select the Switch Database Management (SDM) template to use on the switch.

For PoE-capable switches (a P appears in the model name), this chapter also describes how to configure the Power over Ethernet (PoE) settings. For the Dell EMC Networking N3000E-ON, N3100-ON, and N3200-ON Series switches, this chapter also describes how to view back-panel expansion slot information.

The topics covered in this chapter include:

- System Settings Overview
- Default General System Information
- Configuring General System Settings (Web)
- Configuring System Settings (CLI)
- General System Settings Configuration Examples

## System Settings Overview

The system settings include the information described in Table 11-1. This information helps identify the switch.

**Table 11-1. System Information**

Feature	Description
System Name	The switch name (host name). If the system name is changed, the CLI prompt changes from <code>console</code> to the system name.
System contact	Identifies the person to contact for information regarding the switch.
System location	Identifies the physical location of the switch.
Asset tag	Uniquely identifies the switch. Some organizations use asset tags to identify, control, and track each piece of equipment.

**Table 11-1. System Information (Continued)**

<b>Feature</b>	<b>Description</b>
CLI Banner	Displays a message upon connecting to the switch or logging on to the switch by using the CLI.
SDM Template	Determines the maximum resources a switch or router can use for various features. For more information, see "What Are SDM Templates?" on page 473

The switch can obtain the time from a Simple Network Time Protocol (SNTP) server, or the time can be set manually. Table 11-2 describes the settings that help the switch keep track of time.

**Table 11-2. Time Settings**

<b>Feature</b>	<b>Description</b>
SNTP	Controls whether the switch obtains its system time from an SNTP server and whether communication with the SNTP server requires authentication and encryption. Information for up to eight SNTP servers can be configured. The SNTP client on the switch can accept updates from both IPv4 and IPv6 SNTP servers.
Real time clock (RTC)	If SNTP is disabled, the system time and date can be entered manually.
Time Zone	Specifies the offset from Coordinated Universal Time (UTC), which is also known as Greenwich Mean Time (GMT).
Summer Time	In some regions, the time shifts by one hour in the fall and spring. In the United States, this is called daylight saving time.

### **Why Does System Information Need to Be Configured?**

Configuring system information is optional. However, it can be helpful in providing administrative information about the switch. For example, if an administrator manages several standalone Dell EMC Networking N-Series switches and has Telnet sessions open with several different switches, the system name can help quickly identify the switch because the host name replaces `console` as the CLI command prompt.



The Banner can provide information about the switch status. For example, if multiple users connect to the switch, the message of the day (MOTD) banner might alert everyone who connects to the switch about a scheduled switch image upgrade.

## What Are SDM Templates?

An SDM template is a description of the maximum resources a switch or router can use for various features. Different SDM templates allow different combinations of scaling factors, enabling different allocations of resources depending on how the device is used. In other words, SDM templates enable reallocating system resources to support a different mix of features based on network requirements.

Dell EMC Networking N-Series switches support the following three templates:

- Dual IPv4 and IPv6 (default)
- IPv4 Routing
- IPv4 Data Center

Table 11-3 describes the parameters that are scaled for each template and the per-template maximum value of the parameter. The N1100-ON Series switches do not support routing. The N3000EP-ON scales identically to the other N3000-ON Series switches, depending on the selected firmware.

**Table 11-3. SDM Template Parameters and Values**

Parameter	Dual IPv4/IPv6	Dual IPv4/IPv6 Data Center	IPv4 Only	IPv4 Data Center
ARP entries				
N1500	4096	4096	1024	0
N2000/N2100-ON/N2200-ON	4096	4096	4096	6144
N3000-ON/N3100-ON/N3200-ON	4096	4096	6144	4096

**Table 11-3. SDM Template Parameters and Values (Continued)**

<b>Parameter</b>	<b>Dual IPv4/IPv6</b>	<b>Dual IPv4/IPv6 Data Center</b>	<b>IPv4 Only</b>	<b>IPv4 Data Center</b>
IPv4 unicast routes				
N1500	512	512	1024	0
N2000/N2100- ON/N2200-ON	512	512	1024	0
N3000-ON/N3100- ON/N3200-ON	8160	8160	12288	8160
IPv6 Neighbor Discovery Protocol (NDP) entries				
N1500	512	512	0	0
N2000/N2100- ON/N2200-ON	512	512	0	0
N3000-ON/N3100- ON/N3200-ON	2560	2560	0	0
IPv6 unicast routes				
N1500	64	64	0	0
N2000/N2100- ON/N2200-ON	256	256	0	0
N3000-ON/N3100- ON/N3200-ON	4096	4096	0	0
ECMP next hops				
N1500	1	1	1	1
N2000/N2100- ON/N2200X-ON	1	1	1	1
N3000-ON/N3100- ON/N3200-ON	4	16	16	16

**Table 11-3. SDM Template Parameters and Values (Continued)**

<b>Parameter</b>	<b>Dual IPv4/IPv6</b>	<b>Dual IPv4/IPv6 Data Center</b>	<b>IPv4 Only</b>	<b>IPv4 Data Center</b>
IPv4 multicast routes				
N1500	0	0	0	0
N2000/N2100- ON/N2200X-ON	0	0	0	0
N3000E- ON/N3100- ON/N3200-ON	1536	1536	2048	2048
IPv6 multicast routes				
N1500	0	0	0	0
N2000/N2100- ON/N2200X-ON	0	0	0	0
N3000-ON/N3100- ON/N3200-ON	512	512	0	0

## SDM Template Configuration Guidelines

When the switch is configured to use an SDM template that is not currently in use, the switch must be reloaded for the configuration to take effect.



**NOTE:** If a unit is attached to a stack and its template does not match the stack's template, then the new unit will automatically reboot using the template used by the management unit. To avoid the automatic reboot, you may first set the template to the template used by the management unit. Then power off the new unit, attach it to the stack, and power it on.

If the IPv4 Routing or IPv4 Data Center template is currently in use and the administrator attempts to configure IPv6 routing features without first selecting the Dual IPv4-IPv6 Routing template, the IPv6 commands do not take effect. IPv6 features are not available when an IPv4-only template is active.

## Why is the System Time Needed?

The switch uses the system clock to provide time stamps on log messages. Additionally, some **show** commands include the time in the command output. For example, the **show users login-history** command includes a Login Time field. The system clock provides the information for the Login Time field.

## How Does SNTP Work?

SNTP assures accurate switch clock time synchronization. Time synchronization is performed by a network SNTP server.

Time sources are established by Stratums. Stratums define the accuracy of the reference clock. The higher the stratum (where zero is the highest), the more accurate the clock. The switch is at a stratum that is one lower than its time source. For example, if the SNTP server in an internal network is a Stratum 3 device, the switch is a Stratum 4 device.

The switch can be configured to request the time from an SNTP server on the network or it can receive SNTP broadcasts.

Requesting the time from a unicast SNTP server is more secure. Use this method if you know the IP address of the SNTP server on your network. If you allow the switch to receive SNTP broadcasts, any clock synchronization information is accepted, even if it has not been requested by the device. This method is less secure than polling a specified SNTP server.

To increase security, authentication can be required between the configured SNTP server and the SNTP client on the switch. Authentication is provided by Message Digest 5 (MD5). MD5 verifies the integrity of the communication and authenticates the origin of the communication.

### **What Configuration Is Required for Plug-In Modules?**

The Dell EMC Networking N3000E-ON/N3100-ON Series switches support several different plug-in modules (also known as cards) for the expansion slots located on the back of the switch. For information about the slots and the supported modules, see "Hardware Overview" on page 109. The card type can be preconfigured prior to inserting it into the switch.

Hot-swap is supported on the Dell EMC Networking N3000E-ON and N3100-ON Series switch modules.


Before inserting a new module into the expansion slot that was previously occupied by a different type of module, issue a **no slot** command from the CLI so that the switch can recognize the new module. If the **no slot** command is issued after the new type of module is inserted, it may be necessary to remove and re-insert the module.

Once a module has been recognized by the switch, its configuration is stored locally on the switch as the switch default. The module configuration appears in the running-config for informational purposes.

## **Default General System Information**


By default, no system information or time information is configured, and the SNTP client is disabled. The default SDM Template applied to the switch is the Dual IPv4-IPv6 template.

# Configuring General System Settings (Web)

This section provides information about the OpenManage Switch Administrator pages for configuring and monitoring general system settings on the Dell EMC Networking Series switches. For details about the fields on a page, click  at the top of the Dell EMC OpenManage Switch Administrator web page.

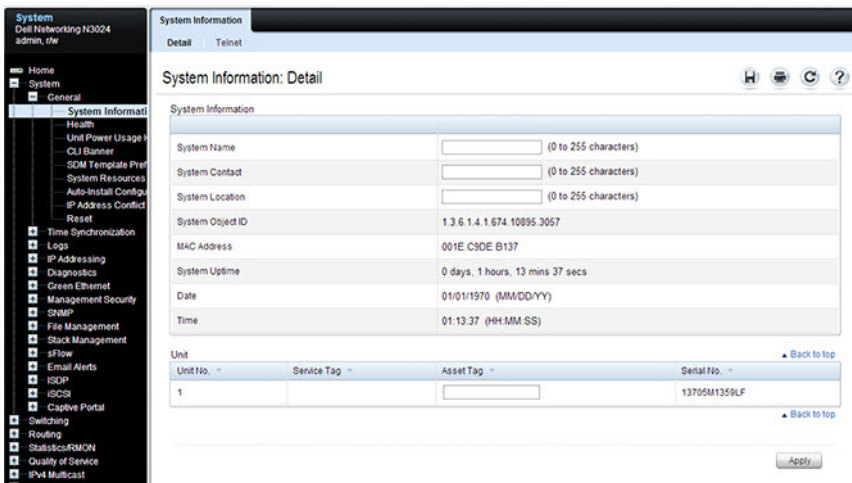
## System Information

Use the **System Information** page to configure the system name, contact name, location, and asset tag.

 **NOTE:** A Telnet session to the switch can also be initiated from the **System Information** page.

To display the **System Information** page, click **System** → **General** → **System Information** in the navigation panel.

**Figure 11-1. System Information**



## Initiating a Telnet Session from the Web Interface

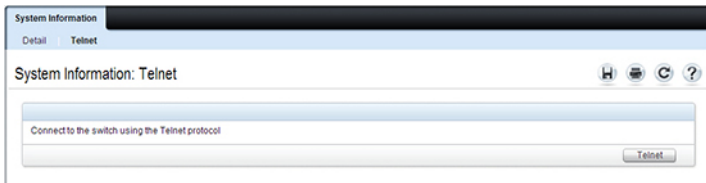


**NOTE:** The Telnet client feature does not work with Microsoft Windows Internet Explorer 7 and later versions. Initiating this feature from any browser running on a Linux operating system is not supported.

To launch a Telnet session:

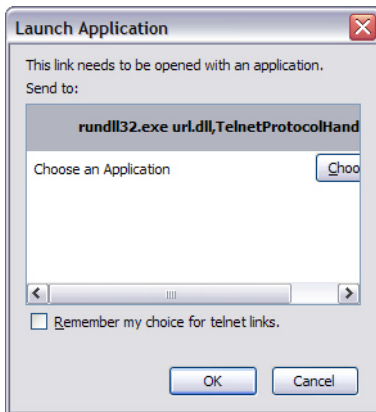
- 1 From the **System** → **General** → **System Information** page, click the Telnet link.
- 2 Click the **Telnet** button.

**Figure 11-2. Telnet**



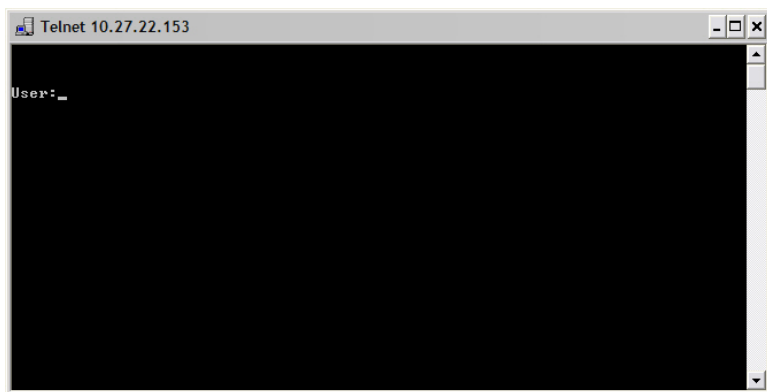
- 3 Select the Telnet client, and click **OK**.

**Figure 11-3. Select Telnet Client**



The selected Telnet client launches and connects to the switch CLI.

**Figure 11-4. Telnet Session**





## CLI Banner

Use the **CLI Banner** page to configure a message for the switch to display when a user connects to the switch by using the CLI. Different banners can be configured for various CLI modes and access methods.

To display the **CLI Banner** page, click **System** → **General** → **CLI Banner** in the navigation panel.

**Figure 11-5. CLI Banner**

The screenshot shows the CLI Banner configuration page in a network management interface. The left sidebar contains a navigation tree with the following items: Home, System, General (System Information, Health, Unit Power Usage), CLI Banner (selected), SDM Template Pref, System Resources, Auto-Install Configu, IP Address Confid, Reset, Time Synchronization, Logs, IP Addressing, Diagnostics, Green Ethernet, Management Security, File Management, Stack Management, sFlow, Email Alerts, ISDP, iSCSI, Captive Portal, Switching, Routing, Statistics/MON, Quality of Service, IPv4 Multicast, and IPv6 Multicast.

The main content area is titled "CLI Banner" and is divided into three configuration sections:

- Detail:** Contains three rows for "Line Console", "Line SSH", and "Line Telnet", each with a dropdown menu set to "Enable". Below these is a large text area for the "Banner" (0 - 2000 characters).
- Login Configuration:** Contains three rows for "Line Console", "Line SSH", and "Line Telnet", each with a dropdown menu set to "Enable". Below these is a large text area for the "Banner" (0 - 2000 characters). A "Back to top" link is present.
- Message of the Day Configuration:** Contains an "Acknowledgment Configuration" dropdown set to "Disable", and three rows for "Line Console", "Line SSH", and "Line Telnet", each with a dropdown menu set to "Enable". Below these is a large text area for the "Banner" (0 - 2000 characters). A "Back to top" link is present.

An "Apply" button is located at the bottom right of the page.

## SDM Template Preference

Use the **SDM Template Preference** page to view information about template resource settings and to select the template that the switch uses. If a new SDM template is selected for the switch to use, the switch must be rebooted before the template is applied.

To display the **SDM Template Preference** page, click **System** → **General** → **SDM Template Preference** in the navigation panel.

**Figure 11-6. SDM Template Preference**

The screenshot shows the 'SDM Template Preference: Detail' page. It includes a navigation sidebar on the left with 'SDM Template Preference' selected. The main content area displays the current and next template IDs, both set to 'Dual IPv4 and IPv6 Default'. Below this is a summary table of various SDM templates and their resource usage.

SDM Template ID	ARP Entries	IPv4 Unicast Routes	IPv6 NDP Entries	IPv6 Unicast Routes	ECMP Next Hops	IPv4 Multicast Routes	IPv6 Multicast Routes
Dual IPv4 and IPv6 Default	4096	8160	2560	4096	4	1536	512
IPv4 Routing Default	6144	12288	0	0	4	2048	0
IPv4 Routing Data Center	4096	8160	0	0	16	2048	0
IPv4 Data Center Plus	6144	12288	0	0	16	2048	0
Dual IPv4 and IPv6 Data Center	4096	8160	2560	4096	16	1536	512

## Clock

If the switch is not configured to obtain the system time from an SNTP server, the date and time can be manually set on the switch using the **Clock** page. The **Clock** page also displays information about the time settings configured on the switch.

To display the **Clock** page, click **System** → **Time Synchronization** → **Clock** in the navigation panel.

**Figure 11-7. Clock**

The screenshot shows the 'Clock: Detail' configuration page. The left navigation pane is expanded to 'System' > 'Time Synchronization' > 'Clock'. The main content area is titled 'Clock: Detail' and contains several sections:

- Current Time**: A table with fields for Time (01:25:40), Zone (UTC + 0:0), Date (01/01/1970), and Time Source (Time Source is Local).
- Time Zone**: A section with a 'Back to top' link, containing fields for Zone (Acronym not configured) and Offset (UTC + 0:0).
- Summertime**: A section with a 'Back to top' link, containing a field for Summertime (Disabled).

An 'Apply' button is located at the bottom right of the configuration area.



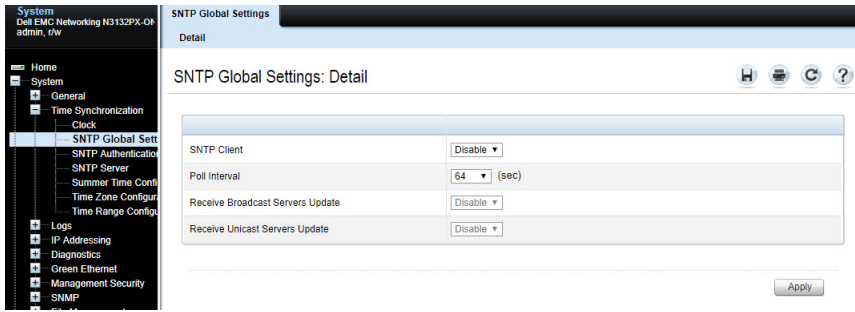
**NOTE:** The system time cannot be set manually if the SNTP client is enabled. Use the **SNTP Global Settings** page to enable or disable the SNTP client.

## SNTP Global Settings

Use the **SNTP Global Settings** page to enable or disable the SNTP client, configure whether and how often the client sends SNTP requests, and determine whether the switch can receive SNTP broadcasts.

To display the SNTP Global Settings page, click **System** → **Time Synchronization** → **SNTP Global Settings** in the navigation panel.

**Figure 11-8. SNTP Global Settings**



## SNTP Authentication

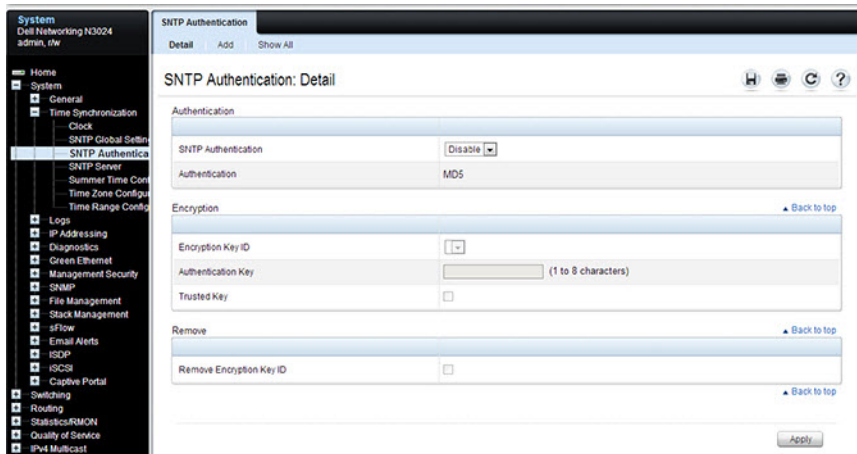
Use the **SNTP Authentication** page to enable or disable SNTP authentication, to modify the authentication key for a selected encryption key ID, to designate the selected authentication key as a trusted key, and to remove the selected encryption key ID.



**NOTE:** The SNTP server must be configured with the same authentication information to allow time synchronization to take place between the two devices.

Click **System** → **Time Synchronization** → **SNTP Authentication** in the navigation panel to display the **SNTP Authentication** page.

**Figure 11-9. SNTP Authentication**



### Adding an SNTP Authentication Key

To configure SNTP authentication:

- 1 Open the **SNTP Authentication** page.
- 2 Click the **Add** link.

The **Add Authentication Key** page displays:

**Figure 11-10. Add Authentication Key**

SNTP Authentication: Add

Encryption Key ID  (1 to 4294967295)

Authentication Key  (1 to 8 characters)

Trusted Key

Apply

- 3 Enter a numerical encryption key ID and an authentication key in the appropriate fields.
- 4 If the key is to be used to authenticate a unicast SNTP server, select the **Trusted Key** check box. If the check box is clear, the key is untrusted and cannot be used for authentication.
- 5 Click **Apply**.

The SNTP authentication key is added, and the device is updated.

To view all configured authentication keys, click the **Show All** link. The **Authentication Key Table** displays. The **Authentication Key Table** can also be used to remove or edit existing keys.

**Figure 11-11. Authentication Key Table**

SNTP Authentication: Show All

Encryption Key ID	Authentication Key	Trusted Key	Remove
2345654345	authkey1	TRUE	<input type="checkbox"/> Edit

Items Displayed 1-1 Rows Per Page 5

Pages 1 of 1

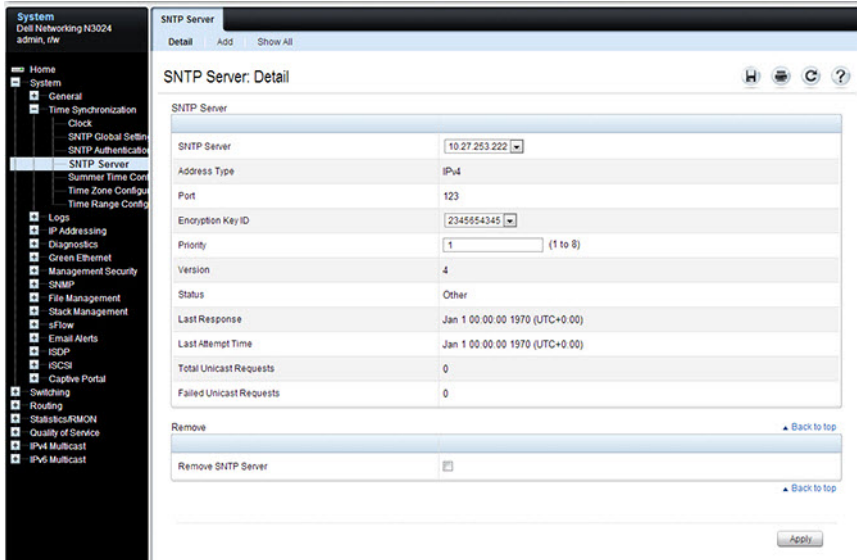
Apply

## SNTP Server

Use the SNTP Server page to view and modify information about SNTP servers, and to add new SNTP servers that the switch can use for time synchronization. The switch can accept time information from both IPv4 and IPv6 SNTP servers.

To display the SNTP Server page, click **System** → **Time Synchronization** → **SNTP Server** in the navigation panel. If no servers have been configured, the fields in the following image are not displayed.

**Figure 11-12. SNTP Servers**



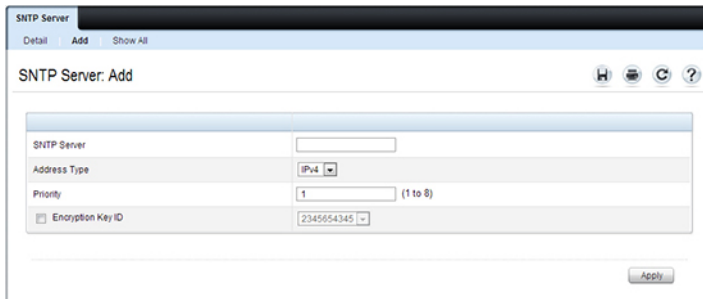
### Defining a New SNTP Server

To add an SNTP server:

- 1 Open the SNTP Servers page.
- 2 Click Add.

The Add SNTP Server page displays.

**Figure 11-13. Add SNTP Server**



- 3** In the **SNTP Server** field, enter the IP address or host name for the new SNTP server.
- 4** Specify whether the information entered in the **SNTP Server** field is an IPv4 address, IPv6 address, or a hostname (DNS).
- 5** If authentication is required between the SNTP client on the switch and the SNTP server, select the Encryption Key ID check box, and then select the key ID to use.

To define a new encryption key, see "Adding an SNTP Authentication Key" on page 485.

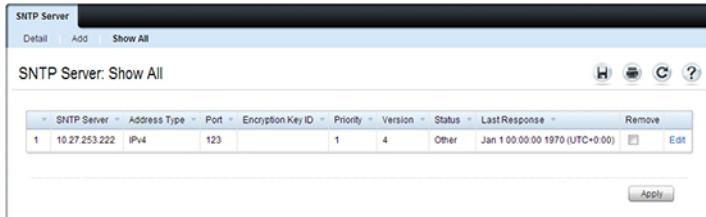


**NOTE:** The SNTP server must be configured with the same authentication information to allow time synchronization to take place between the two devices.



To view all configured SNTP servers, click the **Show All** link. The **SNTP Server Table** displays. The **SNTP Server Table** page can also be used to remove or edit existing SNTP servers.

**Figure 11-14. SNTP Servers Table**



The screenshot shows a web interface for managing SNTP servers. At the top, there is a navigation bar with 'Detail', 'Add', and 'Show All' links. Below this, the page title is 'SNTP Server: Show All'. A table displays the configuration for one SNTP server. The table has columns for SNTP Server, Address Type, Port, Encryption Key ID, Priority, Version, Status, Last Response, and Remove. The first row contains the following data: 1, 10.27.253.222, IPv4, 123, 1, 4, Other, Jan 1 00:00:00 1970 (UTC+0:00), and a checkbox for 'Remove' with an 'Edit' link.

SNTP Server	Address Type	Port	Encryption Key ID	Priority	Version	Status	Last Response	Remove
1	10.27.253.222	IPv4	123	1	4	Other	Jan 1 00:00:00 1970 (UTC+0:00)	<input type="checkbox"/> Edit

Apply

## Summer Time Configuration

Use the **Summer Time Configuration** page to configure summer time (daylight saving time) settings.

To display the **Summer Time Configuration** page, click **System** → **Time Synchronization** → **Summer Time Configuration** in the navigation panel.

**Figure 11-15. Summer Time Configuration**

The screenshot shows the 'Summer Time Configuration: Detail' page. The left sidebar contains a navigation tree with 'System' expanded and 'Summer Time Configuration' selected. The main content area is titled 'Summer Time Configuration: Detail' and includes the following sections:

- Summer Time:** A 'Summertime' dropdown menu set to 'Disable'.
- Recurring and Non Recurring:** A 'Recurring' checkbox, which is currently unchecked. A 'Back to top' link is visible.
- Time:** Fields for configuring the time zone and DST settings. A 'Back to top' link is visible.

The 'Time' section fields are as follows:

Field	Value
Start Month	Jan
Start Date	1
Start Year	2000
Start Time	0 : Minutes 0
End Month	Jan
End Date	1
End Year	2000
End Time	0 : Minutes 0
Offset	(1 - 1440 minutes)
Zone	(0 - 4 characters)

An 'Apply' button is located at the bottom right of the configuration area.



**NOTE:** The fields on the **Summer Time Configuration** page change when the **Recurring** check box is selected or cleared.

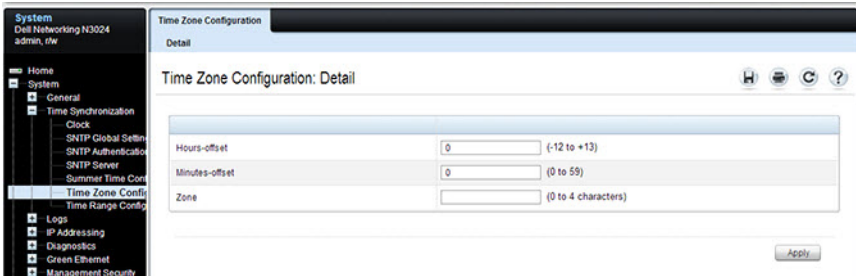
To use the preconfigured summer time settings for the United States or European Union, select the **Recurring** check box and specify USA or EU from the Location menu.

## Time Zone Configuration

Use the **Time Zone Configuration** to configure time zone information, including the amount time the local time is offset from UTC and the acronym that represents the local time zone.

To display the **Time Zone Configuration** page, click **System** → **Time Synchronization** → **Time Zone Configuration** in the navigation panel.

**Figure 11-16. Time Zone Configuration**

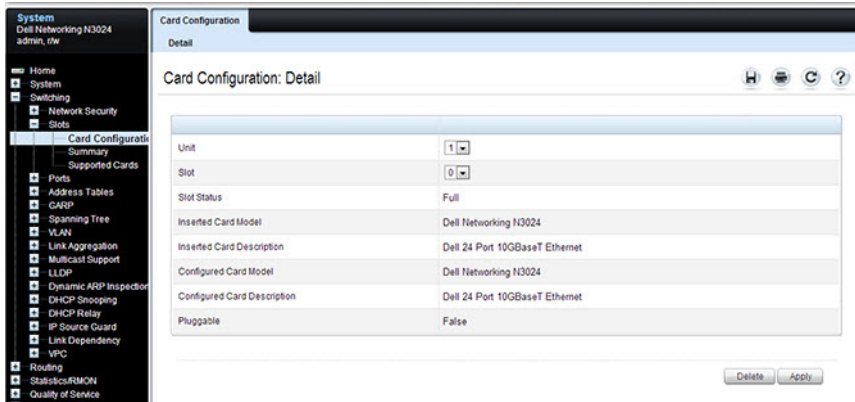


## Card Configuration

Use the **Card Configuration** page to control the administrative status of the rear-panel expansion slots (Slot 1 or Slot 2), if present, and to configure the plug-in module to use in the slot.

To display the **Card Configuration** page, click **Switching** → **Slots** → **Card Configuration** in the navigation panel.

**Figure 11-17. Card Configuration**

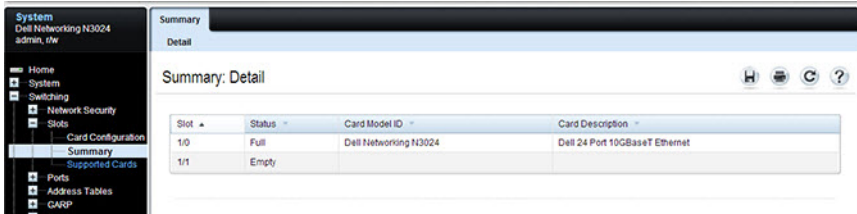


## Slot Summary

Use the **Slot Summary** page to view information about the expansion slot status.

To display the **Slot Summary** page, click **Switching** → **Slots** → **Summary** in the navigation panel.

**Figure 11-18. Slot Summary**



The screenshot shows the 'Slot Summary' page in a network management interface. The left navigation panel is visible, showing the path: System → Switching → Slots → Summary. The main content area displays a table titled 'Summary: Detail' with the following data:

Slot	Status	Card Model ID	Card Description
1/0	Full	Dell Networking N3024	Dell 24 Port 10GBaseT Ethernet
1/1	Empty		

## Supported Cards

Use the **Supported Cards** page to view information about the supported plug-in modules for the switch.

To display the **Supported Cards** page, click **Switching** → **Slots** → **Supported Cards** in the navigation panel.

**Figure 11-19. Supported Cards**

The screenshot displays the 'Supported Cards' page in a network management interface. The left navigation panel shows the path: **Switching** → **Slots** → **Supported Cards**. The main content area is titled 'Supported Cards: Detail' and contains a table with the following data:

Supported Card	Card Model	Card Description
Dell 10GBase-T Card	Dell 10GBase-T Card	Dell 2 Port 10GBase-T Expansion Card
Dell Networking N2024	Dell Networking N2024	Dell 24 Port 10GBaseT Ethernet
Dell Networking N2024	Dell Networking N2024	Dell 24 Port 10GBaseT Ethernet
Dell Networking N2048	Dell Networking N2048	Dell 48 Port 10GBaseT Ethernet
Dell Networking N2048	Dell Networking N2048	Dell 48 Port 10GBaseT Ethernet
Dell Networking N3024	Dell Networking N3024	Dell 24 Port 10GBaseT Ethernet
Dell Networking N3024	Dell Networking N3024	Dell 24 Port 10GBaseT Ethernet
Dell Networking N3024F	Dell Networking N3024F	Dell 24 Port 10G Fiber
Dell Networking N3048	Dell Networking N3048	Dell 48 Port 10GBaseT Ethernet
Dell Networking N3048	Dell Networking N3048	Dell 48 Port 10GBaseT Ethernet
Dell SFP+ Card	Dell SFP+ Card	Dell 2 Port SFP+ Expansion Card

## Power Over Ethernet Global Configuration

(Dell EMC Networking N1108P-ON/N1124P-ON/N1148P-ON, N1524P/N1548P, N2024P/N2048P/N2128PX-ON, N2224PX-ON, N2248PX-ON, and N3024P/N3048P/N3132PX-ON Only)

Use the PoE Global Configuration page to configure the PoE settings for the switch.

To display the PoE Global Configuration page, click **System** → **General** → **Power over Ethernet** → **Global Configuration** in the navigation panel.

**Figure 11-20. PoE Global Configuration**

The screenshot shows the 'Global Configuration' page for PoE. On the left is a navigation tree with 'System' expanded to 'General' and 'Power over Ethernet' selected. The main content area is titled 'Global Configuration: Detail' and contains a table of configuration parameters and a 'System Usage' section.

Unit	Power Status	Total Power (W)	Threshold Power(W)	Consumed Power (W)	Firmware Version	Power Management Mode	Usage Threshold	Power Detection Type
1	On	850.0	765.0	0.0	265_1	Dynamic	90	Dot3at-Legacy

**System Usage**

System Usage Threshold:  (1 to 99 percent)

Power Management Mode:

Detection Type:

[Apply](#)

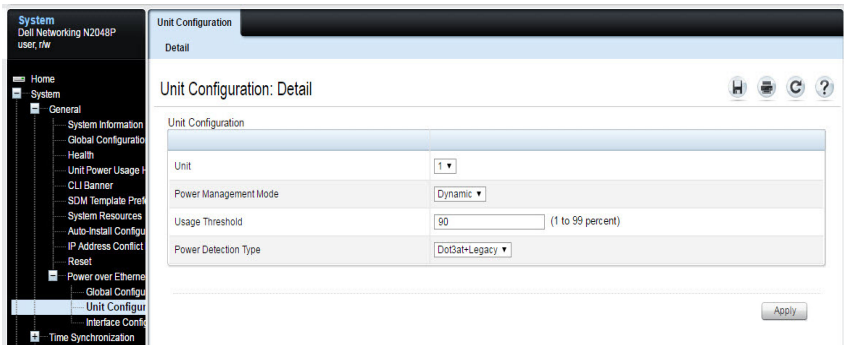
## Power Over Ethernet Unit Configuration

(Dell EMC Networking N1124P-ON/N1148P-ON, N1524P/N1548P, N2024P/N2048P/N2128PX-ON, N2224PX-ON/N2248PX-ON, and N3024P/N3048P/N3132PX-ON Only)

Use the PoE Unit Configuration page to configure the PoE settings for switch stack members. This page is not available on the N1108P-ON switch because it does not support stacking.

To display the PoE Unit Configuration page, click **System** → **General** → **Power over Ethernet** → **Unit Configuration** in the navigation panel.

**Figure 11-21. PoE Unit Configuration**





## Power Over Ethernet Interface Configuration

(Dell EMC Networking N1108P-ON/N1124P-ON/N1148P-ON, N1524P/N1548P, N2024P/N2048P/N2128PX-ON, N2224PX-ON/N2248PX-ON, and N3024P/N3048P/N3132PX-ON Only)

Use the PoE **Interface Configuration** page to configure the per-port PoE settings. This page also provides access to the PoE Counters table and PoE Port Table. The PoE Port table allows viewing and configuring PoE settings for multiple ports on the same page.

To display the PoE **Interface Configuration** page, click **System** → **General** → **Power over Ethernet** → **Interface Configuration** in the navigation panel.

**Figure 11-22. PoE Interface Configuration**

The screenshot shows the PoE Interface Configuration page for a Dell EMC Networking N2048P switch. The left navigation panel is open to the 'Power over Ethernet' section, with 'Interface Configuration' selected. The main content area displays the 'Interface Configuration: Detail' page for port Gi1/0/1. The configuration table includes the following settings:

Configuration Item	Value
Port	1 Port Gi1/0/1
Admin Status	Auto
Power Priority Level	Low
High Power Mode	Enable
Limit Type	Default
Limit	32000
Power Classification	Unknown
Powered Device	(0 to 20 characters)
Overload Counter	0
Short Counter	0
Denied Counter	0
Absent Counter	0
Invalid Signature Counter	0
Output Volts	53 (Volts)
Output Current	0 (mA)
Consumed Power	0 (mW)
Temperature	43 (°C)
Operational Status	Searching
Fault Status	No Error
Port Reset	<input type="checkbox"/>

An 'Apply' button is located at the bottom right of the configuration area.

To view PoE statistics for each port, click **Counters**.

**Figure 11-23. PoE Counters Table**

The screenshot shows the 'Interface Configuration: Counters' page. At the top, there are tabs for 'Detail', 'Counters', and 'Show All'. Below the tabs is a 'Unit' dropdown menu set to '1'. The main content is a table with the following data:

Port	Consumed Power (mW)	Overload Counter	Short Counter	Denied Counter	Absent Counter	Invalid Signature Counter	Output Volts (Volts)	Output Current (mA)	Temperature (C)
1 Gi1/0/1	0	0	0	0	0	0	53	0	47
2 Gi1/0/2	0	0	0	0	0	0	53	0	47
3 Gi1/0/3	0	0	0	0	0	0	53	0	47
4 Gi1/0/4	0	0	0	0	0	0	53	0	47
5 Gi1/0/5	0	0	0	0	0	0	53	0	47

At the bottom of the table, there are navigation controls: 'Items Displayed 1-5', 'Rows Per Page 5', and 'Pages 1 of 10'. There are also 'Back to top' and 'Apply' buttons.

To view the PoE Port Table, click **Show All**.

**Figure 11-24. PoE Port Table**

The screenshot shows the 'Power over Ethernet Table: Show All' page. At the top, there are tabs for 'Detail', 'Counters', and 'Show All'. Below the tabs is a 'Unit' dropdown menu set to '1'. The main content is a table with the following data:

Port	Admin Status	Power Priority Level	High Power Mode	Limit Type	Limit	Power Classification	Powered Device	Operational Status	Fault Status
1 Gi1/0/1	Auto	Low	Enable	Default	32000	Unknown		Searching	No Error
2 Gi1/0/2	Auto	Low	Enable	Default	32000	Unknown		Searching	No Error
3 Gi1/0/3	Auto	Low	Enable	Default	32000	Unknown		Searching	No Error
4 Gi1/0/4	Auto	Low	Enable	Default	32000	Unknown		Searching	No Error
5 Gi1/0/5	Auto	Low	Enable	Default	32000	Unknown		Searching	No Error

At the bottom of the table, there are navigation controls: 'Items Displayed 1-5', 'Rows Per Page 5', and 'Pages 1 of 10'. There are also 'Back to top' and 'Apply' buttons.

If you change any settings for one or more ports on the **PoE Port Table** page, click **Apply** to update the switch with the new settings.

# Configuring System Settings (CLI)

This section provides information about the commands used for configuring system information and time settings on the Dell EMC Networking Series Switches. For more information about these commands, see the *Dell EMC Networking N1100-ON, N1500, N2000, N2100-ON, N2200-ON, N3000E-ON, N3100-ON, and N3200-ON Series Switches CLI Reference Guide* at [www.dell.com/support](http://www.dell.com/support).

## Configuring System Information

Use the following commands to configure system information.

Command	Purpose
<code>configure</code>	Enter Global Configuration mode.
<code>hostname <i>name</i></code>	Configure the system name. The CLI prompt changes to the host name after you execute the command. The hostname is advertised in the LLDP system-name TLV.
<code>snmp-server contact <i>name</i></code>	Configure the name of the switch administrator. If the name contains a space, use quotation marks around the name.
<code>snmp-server location <i>location</i></code>	Configure the switch location.
<code>asset-tag [unit <i>unit_id</i>] <i>tag</i></code>	Configure the asset tag for the switch. Use the <b>unit</b> keyword to configure the asset tag for each unit in a stack of switches.
<code>CTRL + Z</code>	Exit to Privileged Exec mode.
<code>show system [id]</code>	Display system information. Include the <b>id</b> keyword to display additional system information.

## Configuring the Banner

Use the following commands to configure the MOTD, login, or User Exec banner. The switch supports the following banner messages:

- MOTD—Displays when a user connects to the switch.
- Login—Displays after the MOTD banner and before the login prompt.
- Exec—Displays immediately after the user logs on to the switch.

Command	Purpose
configure	Enter Global Configuration mode.
banner {motd login exec} <i>text</i>	Configure the banner message that displays when you connect to the switch (motd and login) or enter User Exec mode (exec).  Use quotation marks around a message if it includes spaces.
line {telnet ssh console}	Enter the terminal line configuration mode for Telnet, SSH, or the console.
motd-banner	Specify that the configured MOTD banner displays. To prevent the banner from displaying, enter <b>no motd-banner</b> .
exec-banner	Specify that the configured exec banner displays. To prevent the banner from displaying, enter <b>no exec-banner</b> .
login-banner	Specify that the configured login banner displays. To prevent the banner from displaying, enter <b>no login-banner</b> .
CTRL + Z	Exit to Privileged Exec mode.
show banner	Display the banner status on all line terminals.

## Managing the SDM Template

Use the following commands to set the SDM template preference and to view information about the available SDM templates.

Command	Purpose
configure	Enter Global Configuration mode.
sdm prefer {dual-ipv4-and-ipv6 default   ipv4-routing {data-center   default}}	Select the SDM template to apply to the switch after the next boot.
CTRL + Z	Exit to Privileged Exec mode.
show sdm prefer [template]	View information about the SDM template the switch is currently using. Use the <i>template</i> variable to view the parameters for the specified template.

## Configuring SNTP Authentication and an SNTP Server

Use the following commands to require the SNTP client to use authentication when communicating with the SNTP server. The commands also show how to configure an SNTP server.

Requiring authentication is optional. However, if you configure authentication on the switch SNTP client, the SNTP server must be configured with the same authentication information to allow time synchronization to take place between the two devices.

Command	Purpose
configure	Enter Global Configuration mode.
sntp authentication-key key_id md5 key_word	Define an authentication key for SNTP. The variables are: <ul style="list-style-type: none"><li>• <i>key_id</i>—The encryption key ID, which is a number from 1–4294967295.</li><li>• <i>key_word</i>—The authentication key, which is a string of up to eight characters.</li></ul>

<b>Command</b>	<b>Purpose</b>
<code>sntp trusted-key <i>key_id</i></code>	Specify the authentication key the SNTP server must include in SNTP packets that it sends to the switch. The <i>key_id</i> number must be an encryption key ID defined in the previous step.
<code>sntp authenticate</code>	Require authentication for communication with the SNTP server. A trusted key must be configured before this command is executed.
<code>sntp server {<i>ip_address</i>   <i>hostname</i>} [<i>priority</i> <i>priority</i>] [<i>key key_id</i>] [<i>poll</i>]</code>	Define the SNTP server. <ul style="list-style-type: none"> <li><i>ip_address</i>—The IP address (or host name) of the SNTP server to poll. The IP address can be an IPv4 or IPv6 address.</li> <li><i>priority</i>—(Optional) If multiple SNTP servers are defined, this number determines which server the switch polls first. The priority is 1–8, where 1 is the highest priority. The default priority is 1. Servers of the same priority are polled in the order entered.</li> <li><i>key_id</i>—(Optional) Enter an authentication key to use. The key must be previously defined by the <code>sntp authentication-key</code> command.</li> <li><i>poll</i>—(Optional) Enable polling of this server.</li> </ul>
<code>sntp {unicast   broadcast} client enable</code>	This command enables the SNTP client and allows the switch to poll configured unicast SNTP servers for updates or receive broadcasts from any SNTP server.
<code>sntp client poll timer <i>seconds</i></code>	Specify how often the SNTP client requests SNTP packets from the configured server(s). <i>seconds</i> —The poll interval can be 64, 128, 256, 512, or 1024 seconds.
CTRL + Z	Exit to Privileged Exec mode.
<code>show sntp configuration</code>	Verify the SNTP configuration.
<code>show sntp status</code>	View information about the SNTP updates.

## Setting the System Time and Date Manually

Use the following commands to configure the time and date, time zone, and summer time settings.

Command	Purpose
<code>clock set {hh:mm:ss}   {mm/dd/yyyy}</code>	Configure the time and date. Enter the time first and then the date, or the date and then the time. <ul style="list-style-type: none"><li><i>hh:mm:ss</i> — Time in hours (24-hour format, from 01-24), minutes (00-59), and seconds (00-59).</li><li><i>mm/dd/yyyy</i> — Two digit month (1-12), two-digit date of the month (01-31), and four-digit year.</li></ul>
<code>clock timezone hours-offset [minutes minutes-offset] [zone acronym]</code>	Configure the time zone settings. <ul style="list-style-type: none"><li><i>hours-offset</i> — Hours difference from UTC. (Range: -12 to +13)</li><li><i>minutes-offset</i> — Minutes difference from UTC. (Range: 0-59)</li><li><i>acronym</i> — The acronym for the time zone. (Range: Up to four characters)</li></ul>
<code>clock summer-time recurring {usa   eu   {week day month hh:mm week day month hh:mm}} [offset offset] [zone acronym]</code>	Use this command if the summer time starts and ends every year based on a set pattern. For switches located in the United States or European Union, use the <b>usa</b> or <b>eu</b> keywords to use the preconfigured values. Otherwise, configure the start and end times by using the following values: <ul style="list-style-type: none"><li><i>week</i> — Week of the month. (Range: 1-5, first, last)</li><li><i>day</i> — Day of the week. (The first three letters by name)</li><li><i>month</i> — Month. (The first three letters by name; jan, for example.)</li><li><i>hh:mm</i> — Time in 24-hour format in hours and minutes. (Range: hh: 0-23, mm: 0-59)</li><li><i>offset</i> — Number of minutes to add during the summertime. (Range: 1-1440)</li><li><i>acronym</i> — The acronym for the time zone to be displayed when summertime is in effect. (Up to four characters)</li></ul>

Command	Purpose
<b>clock summer-time</b> <b>date</b> { <i>date month</i>   <i>month date</i> } <i>year</i> <i>hh:mm</i> { <i>date month</i>   <i>month date</i> } <i>year</i> <i>hh:mm</i> [ <b>offset</b> <i>offset</i> ] [ <b>zone</b> <i>acronym</i> ]	Use this command if the summer time does not start and end every year according to a recurring pattern. Enter the month and then the date, or the date and then the month. <ul style="list-style-type: none"> <li>• <i>date</i>— Day of the month. (Range: 1-31.)</li> <li>• <i>month</i>— Month. (Range: The first three letters by name)</li> <li>• <i>hh:mm</i>— Time in 24-hour format in hours and minutes. (Range: hh: 0–23, mm: 0–59)</li> <li>• <i>offset</i>— Number of minutes to add during the summertime. (Range: 1–1440)</li> <li>• <i>acronym</i>— The acronym for the time zone to be displayed when summertime is in effect. (Range: Up to four characters)</li> </ul>
CTRL + Z	Exit to Privileged Exec mode.
<b>show clock</b> [ <b>detail</b> ]	View information about the time. Include the <b>detail</b> keyword to view information about the time zone and summer time.

## Configuring the Expansion Slots

This section applies to Dell EMC Networking N3000E-ON/N3100-ON Series Only.

Use the following commands to configure and view information about the expansion slots and plug-in modules (cards).

Command	Purpose
<b>configure</b>	Enter Global Configuration mode.
<b>slot</b> <i>unit/slot cardindex</i>	Configured the specified slot (1–2) to use the plug-in module identified by the <i>cardindex</i> number (CID). To view the CID associated with each plug-in module, use the <b>show supported cardtype</b> command.
CTRL + Z	Exit to Privileged Exec mode.
<b>show slot</b>	Display status information about the expansion slots.
<b>show supported cardtype</b>	Display information about the plug-in modules the switch supports.



## Viewing Slot Information

Use the following commands to view information about Slot 0 and its support.

Command	Purpose
<code>show slot</code>	Display status information about the expansion slots.
<code>show supported cardtype</code>	Display information about the modules the switch supports.

## Configuring PoE Settings

This section applies to (Dell EMC Networking N1108P-ON/ N1124P-ON/ N1148P-ON, N1524P/N1548P, N2024P/N2048P/N2128PX-ON, N2224PX-ON/N2248PX-ON, N3024EP-ON/N3000/N3132PX-ON Only)

Use the following commands to configure PoE information.

Command	Purpose
<code>configure</code>	Enter Global Configuration mode.
<code>power inline usage-threshold <i>threshold</i> [unit <i>unit-id</i>]</code>	Specify the maximum usage for PoE power on the switch or the specified stack unit. The <i>threshold</i> variable (range: 1–99%) is a percentage of total system power.
<code>power inline management [unit <i>unit-id</i>] {class   static   dynamic}</code>	Set the power-management mode for the switch or the specified stack unit. Static power management is not available on the N2200PX-ON switch.

Command	Purpose
<code>power inline detection [unit <i>unit-id</i>] {dot3at   dot3at+legacy-only   dot3bt   dot3bt+legacy}</code>	<p>Set the power-management mode for the switch or the specified stack unit.</p> <ul style="list-style-type: none"> <li>• <b>dot3at</b>—IEEE 802.3at detection scheme is used.</li> <li>• <b>dot3at+legacy-only</b>—IEEE 802.3at 4point detection scheme is used and when it fails to detect a connected PD, legacy capacitive detection is used.</li> <li>• <b>dot3bt</b>—IEEE 802.3bt detection scheme is used. N2200PX-ON switch only.</li> <li>• <b>dot3bt+legacy</b>—A modified IEEE 802.3bt detection scheme is used. N2200PX-ON switch only.</li> </ul>
<code>interface <i>interface</i></code>	Enter interface configuration mode for the specified port. The <i>interface</i> variable includes the interface type and number, for example <b>gigabitethernet 1/0/3</b> .
<code>power inline {auto   never}</code>	<p>Set the PoE device discovery admin mode.</p> <ul style="list-style-type: none"> <li>• <b>auto</b> — Enables the device discovery protocol and, if found, supplies power to the device.</li> <li>• <b>never</b> — Disables the device discovery protocol and stops supplying power to the device.</li> </ul>
<code>power inline priority {critical   high   low}</code>	Configures the port priority level for the delivery of power to an attached device.
<code>power inline four-pair forced</code>	Enable power feed on all pairs.
<code>power inline powered-device <i>type</i></code>	Provide a description to represent the type of device connected to the port.
<code>power inline reset</code>	(Optional) Reset the port. You might use this command if the port is stuck in an Error state.
<code>CTRL + Z</code>	Exit to Privileged Exec mode.
<code>show power inline</code>	Display PoE information for the switch.
<code>show power inline <i>interface</i></code>	Display PoE information for the specified interface.

# General System Settings Configuration Examples

This section contains the following examples:

- Configuring System and Banner Information
- Configuring SNMP
- Configuring the Time Manually

## Configuring System and Banner Information

In this example, an administrator configures the following system information:

- System name: N2048
- System contact: Jane Doe
- System location: RTP100
- Asset tag: 006429

The administrator then configures the MOTD banner to alert other switch administrators of the connected topology.

To configure the switch:

- 1 Configure the hosts name.

```
console#configure
console (config) #hostname N2048
```

- 2 Configure the contact, location, and asset tag. Notice that the prompt changed to the host name.

```
N2048 (config) #snmp-server contact "Jane Doe"
N2048 (config) #snmp-server location RTP100
N2048 (config) #asset-tag 006429
```

- 3 Configure the message that displays when a user connects to the switch.

```
N2048 (config) #banner motd "This switch connects users in
cubicles C121-C139."
N2048 (config) #exit
```

- 4 View system information to verify the configuration.

```
N2048#show system
System Description: Dell Ethernet Switch
System Up Time: 0 days, 19h:36m:36s
System Contact: Jane Doe
System Name: N2048
```

System Location: RTP100  
Burned In MAC Address: 001E.C9AA.AA07  
System Object ID: 1.3.6.1.4.1.674.10895.3035  
System Model ID: N2048  
Machine Type: Dell EMC Networking N2048  
Temperature Sensors:

Unit	Temperature (Celsius)	Status
1	43	OK

Power Supplies:

Unit	Description	Status	Source
1	Main	OK	AC
1	Secondary	Error	DC

**5** View additional information about the system.

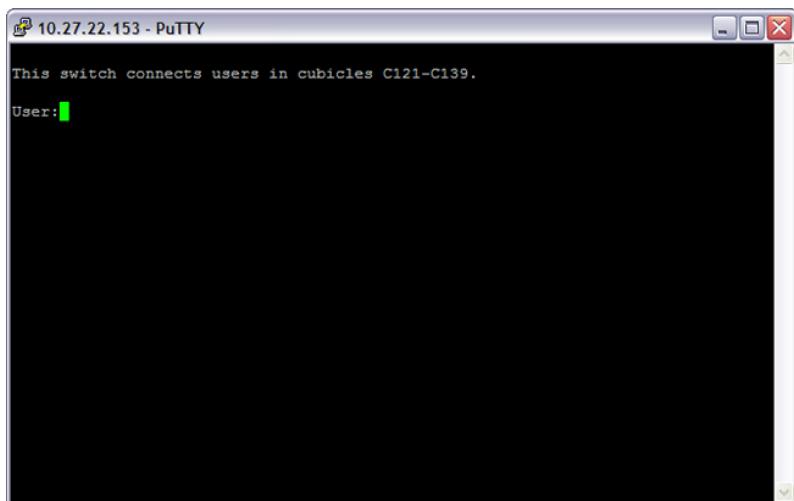
N2048#**show system id**

Service Tag:at-c2048p-01  
Serial Number: 7048NX1011  
Asset Tag: 006429

Unit	Service tag	Serial number	Asset tag
1	at-c2048p-01	70498NX1011	006429

**6** Initiate a new Telnet session to verify the MOTD.

**Figure 11-25. Verify MOTD**



## Configuring SNTP

The commands in this example configure the switch to poll an SNTP server to synchronize the time. Additionally, the SNTP sessions between the client and server must be authenticated.

To configure the switch:

- 1 Configure the authentication information. The SNTP server must be configured with the same authentication key and ID.

```
console#configure
console(config)#sntp authentication-key 23456465 md5 sntpkey
console(config)#sntp trusted-key 23456465
console(config)#sntp authenticate
```

- 2 Specify the IP address of the SNTP server to poll and include the authentication key. This command automatically enables polling and sets the priority to 1.

```
console(config)#sntp server 192.168.10.30 key 23456465
console(config)#sntp unicast client enable
```

- 3 Verify the configuration.

```
console#show sntp configuration
```

```
Polling interval: 64 seconds
MD5 Authentication keys:
Authentication is not required for synchronization.
Trusted keys:
No trusted keys.
Unicast clients: Disable
```

```
Unicast servers:
Server Key   Polling     Priority    Source      Interface
-----
-----
```

#### 4 View the SNTP status on the switch.

```
console#show sntp status
```

```
Client Mode:          Unicast
Last Update Time:    MAR 01 09:12:43 2010
```

```
Unicast servers:
```

Server	Status	Last response
-----	-----	-----
192.168.10.30	Other	09:12:43 Mar 1 2011

## Configuring the Time Manually

The commands in this example manually set the system time and date. The time zone is set to Eastern Standard Time (EST), which has an offset of -5 hours. Summer time is enabled and uses the preconfigured United States settings.

To configure the switch:

- 1 Configure the time zone offset and acronym.

```
console#configure
console(config)#clock timezone -5 zone EST
```

- 2 Configure the summer time (daylight saving time) to use the preconfigured settings for the United States.

```
console(config)#clock summer-time recurring us
```

- 3 Set the local time and date.

```
console(config)#clock set 16:13:06
console(config)#clock set 03/01/2017
```

- 4 Verify the time settings.

```
console#show clock detail
```

```
16:13:19 EST(UTC-5:00) Mar 3 2017
No time source
```

```
Time zone:
Acronym is EST
Offset is UTC-5:00
```

```
Summertime:
Acronym not configured
Recurring every year (USA)
Begins on second Sunday of Mar at 02:00
Ends on first Sunday of Nov at 02:00
Offset is +60 minutes
```



# SNMP

## Dell EMC Networking N-Series Switches

The topics covered in this chapter include:

- SNMP Overview
- Default SNMP Values
- Configuring SNMP (Web)
- Configuring SNMP (CLI)
- SNMP Configuration Examples

## SNMP Overview

Simple Network Management Protocol (SNMP) provides a method for managing network devices. The Dell EMC Networking N-Series switches support SNMP version 1, SNMP version 2, and SNMP version 3. Dell EMC Networking switches support SNMP over both IPv4 and IPv6.

### What Is SNMP?

SNMP is a standard protocol that enables remote monitoring and management of a device through communication between an SNMP manager and an SNMP agent on the remote device. The SNMP manager is typically part of a Network Management System (NMS) that runs on an administrative host. The switch software includes Management Information Base (MIB) objects that the SNMP agent queries and modifies. The switch uses standard public MIBs and private MIBs.

A MIB acts as a structured road map for managed objects. A managed object is any feature or setting that can be configured or monitored on the switch. An Object Identifier (OID) is the unique number assigned to an object defined in a MIB. An OID is written as a sequence of subidentifiers in decimal notation.

The SNMP agent maintains a list of variables that are used to manage the switch. The variables are defined in the MIB. The MIB presents the variables controlled by the agent. The SNMP agent defines the MIB specification format, as well as the format used to access the information over the network. Access rights to the SNMP agent are controlled by access strings.

SNMP v3 also applies access control and a new traps mechanism to SNMPv1 and SNMPv2 PDUs. In addition, the User Security Model (USM) is defined for SNMPv3 and includes:

- Authentication — Provides data integrity and data origin authentication. Both MD5 and SHA authentication methods are supported.
- Privacy — Protects against disclosure of message content. DES is used for encryption. Either authentication is enabled on an SNMP message, or both authentication and privacy are enabled on an SNMP message. However privacy cannot be enabled without authentication.
- Timeliness — Protects against message delay or message redundancy. The SNMP agent compares incoming message to the message time information.
- Key Management — Defines key generation, key updates, and key use.

Authentication or Privacy Keys are modified in the SNMPv3 User Security Model (USM).

## **What Are SNMP Traps?**

SNMP is frequently used to monitor systems for fault conditions such as temperature violations, link failures, and so on. Management applications can monitor for these conditions by polling the appropriate OIDs with the `get` command and analyzing the returned data. This method has its drawbacks. If it is done frequently, significant amounts of network bandwidth can be consumed. If it is done infrequently, the response to the fault condition may not occur in a timely fashion. SNMP traps avoid these limitations of the polling method.

An SNMP trap is an asynchronous event indicating that something significant has occurred. This is analogous to a pager receiving an important message, except that the SNMP trap frequently contains all the information needed to diagnose a fault.

Various features can be configured on the switch to generate SNMP traps that inform the NMS about events or problems that occur on the switch. Traps generated by the switch can also be viewed locally by using the web-based interface or CLI.

## Why Is SNMP Needed?

Some network administrators prefer to use SNMP as the switch management interface. Settings that you view and configure by using the web-based Dell EMC OpenManage Switch Administrator and the CLI are also available by using SNMP.

If you do not use NMS software to manage or monitor other devices on your network, it might not be necessary to configure SNMP on the switch.

## Default SNMP Values

By default, SNMPv2 is automatically enabled on the device. SNMPv1 and SNMPv3 are disabled. To enable SNMPv3, you must define a local engine ID for the device. The local engineID is by default set to the switch MAC address, however when the switch operates in a stacking mode, it is important to manually configure the local engineID for the stack. This local engineID must be defined so that it is unique within the network. It is important to do this because the default engineID in a stack is the MAC address of the primary unit, which may change if the primary unit fails and another unit takes over the stack.

Table 12-1 summarizes the default values for SNMP.

**Table 12-1. SNMP Defaults**

Parameter	Default Value
SNMPv1	Disabled
SNMPv2	Enabled
SNMPv3	Disabled
SNMP traps	Enabled
SNMP trap receiver	None configured
Switch traps	Enabled

**Table 12-1. SNMP Defaults**

Parameter	Default Value
QoS traps	Enabled
Multicast traps	Disabled
Captive Portal traps	Disabled
OSPF traps	Disabled

Table 12-2 describes the two views that are defined by default.

**Table 12-2. SNMP Default Views**


View Name	OID Subtree	View Type
Default	iso	Included
	snmpVacmMIB	Excluded
	usmUser	Excluded
	snmpCommunityTable	Excluded
DefaultSuper	iso	Included


By default, three groups are defined. Table 12-3 describes the groups. The Read, Write, and Notify values define the preconfigured views that are associated with the groups.

**Table 12-3. SNMP Default Groups**

Group Name	Security Level	Read	Write	Notify
DefaultRead	No Auth No Priv	Default	–	Default
DefaultWrite	No Auth No Priv	Default	Default	Default
DefaultSuper	No Auth No Priv	DefaultSuper	DefaultSuper	DefaultSuper

# Configuring SNMP (Web)

This section provides information about the OpenManage Switch Administrator pages for configuring and monitoring the SNMP agent on Dell EMC Networking Series switches. For details about the fields on a page, click  at the top of the Dell EMC OpenManage Switch Administrator web page.

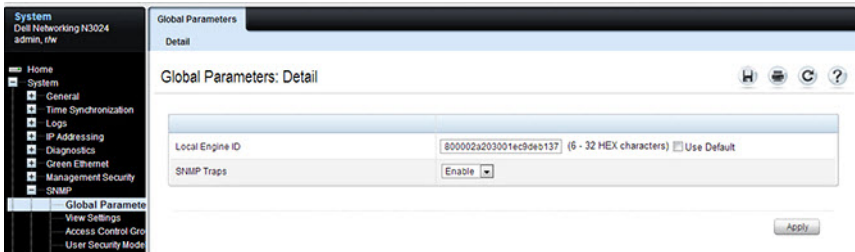
 **NOTE:** For some features, the control to enable or disable traps is available from a configuration page for that feature and not from the **Trap Manager** pages that this chapter describes.

## SNMP Global Parameters

Use the **Global Parameters** page to enable SNMP and Authentication notifications.

To display the **Global Parameters** page, click **System** → **SNMP** → **Global Parameters** in the navigation panel.

**Figure 12-1. SNMP Global Parameters**

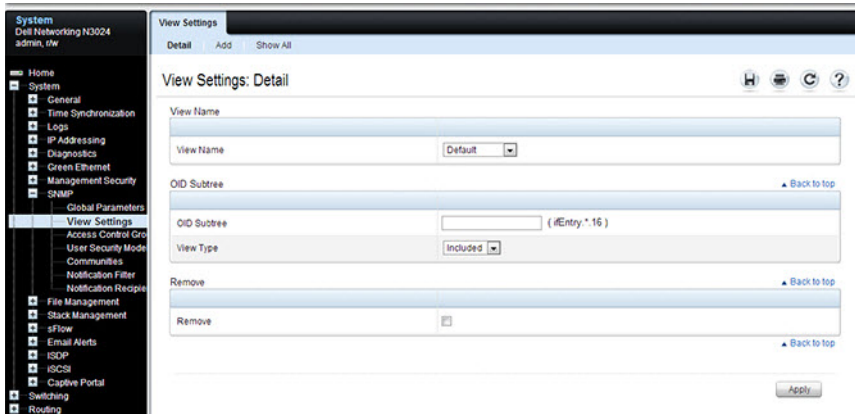


## SNMP View Settings

Use the SNMP View Settings page to create views that define which features of the device are accessible and which are blocked. A view can be created that includes or excludes OIDs corresponding to interfaces.

To display the View Settings page, click System → SNMP → View Settings in the navigation panel.

**Figure 12-2. SNMP View Settings**



### Adding an SNMP View

To add a view:

- 1 Open the View Settings page.
- 2 Click Add.

The Add View page displays:

**Figure 12-3. Add View**

View Settings

Detail Add Show All

View Settings: Add

View Name	<input type="text"/>	(1-30 characters)
OID Subtree	<input type="text"/>	(Entry * 16)
View Type	<input type="text" value="Included"/>	

Apply

- 3** Specify a name for the view and a valid SNMP OID string.
- 4** Select the view type.
- 5** Click **Apply**.

The SNMP view is added, and the device is updated.

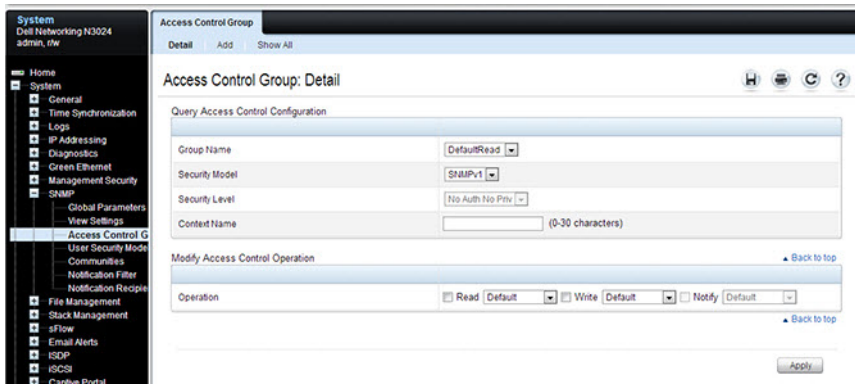
Click **Show All** to view information about configured SNMP Views.

## Access Control Group

Use the **Access Control Group** page to view information for creating SNMP groups, and to assign SNMP access privileges. Groups allow network managers to assign access rights to specific device features or features aspects.

To display the **Access Control Group** page, click **System** → **SNMP** → **Access Control** in the navigation panel.

**Figure 12-4. SNMP Access Control Group**



### Adding an SNMP Group

To add a group:

- 1 Open the **Access Control Configuration** page.
- 2 Click **Add**.

The **Add an Access Control Configuration** page displays:



**Figure 12-5. Add Access Control Group**

Access Control Group: Add

Group Name	<input type="text"/>	(1-30 characters)
Security Model	SNMPv1	
Security Level	No Auth No Priv	
Context Prefix	<input type="text"/>	(0-30 characters)
Operation	<input checked="" type="checkbox"/> Read (Default)	<input type="checkbox"/> Write (Default) <input type="checkbox"/> Notify (Default)


Apply

- 3** Specify a name for the group.
- 4** Select a security model and level
- 5** Define the context prefix and the operation.
- 6** Click **Apply** to update the switch.

Click **Show All** to view information about existing access control configurations.

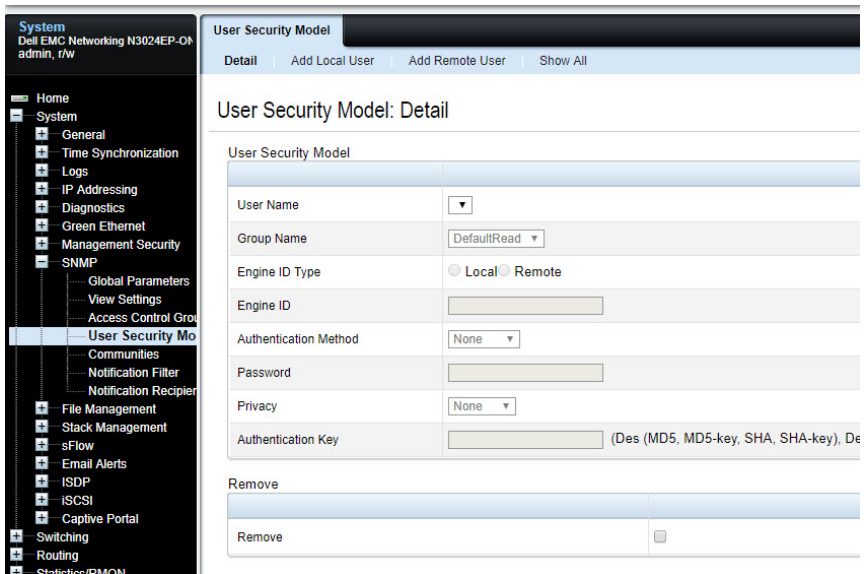
## SNMPv3 User Security Model (USM)

Use the User Security Model page to assign system users to SNMP groups and to define the user authentication method.

 **NOTE:** The Local User Database page under **Management Security** can also be used for configuring SNMPv3 settings for users. For more information, see "Authentication, Authorization, and Accounting" on page 291.

To display the User Security Model page, click **System** → **SNMP** → **User Security Model** in the navigation panel.

**Figure 12-6. SNMPv3 User Security Model**



### Adding Local SNMPv3 Users to a USM

To add local users:

- 1 Open the User Security Model page.
- 2 Click Add Local User.

The Add Local User page displays:

**Figure 12-7. Add Local Users**

User Security Model	
Detail	Add Local User
Add Remote User	Show All
User Security Model: Add Local User	
Local Engine ID	800002a203f48e38417455
User Name	<input type="text"/> (1 to 32 characters)
Group Name	DefaultRead ▼
Authentication Method	None ▼
Password	<input type="text"/> (MD5 - 32; MD5-key - 32; SHA - 32; SHA-key - 40)
Privacy	None ▼
Authentication Key	<input type="text"/> (Des (MD5, MD5-key, SHA, SHA-key), Des-key (M))

- 3 Define the relevant fields.
- 4 Click **Apply** to update the switch.

Click **Show All** to view the User Security Model Table, which contains information about configured Local and Remote Users.

### **Adding Remote SNMPv3 Users to a USM**

To add remote users:

- 1 Open the **SNMPv3 User Security Model** page.
- 2 Click **Add Remote User**.

The **Add Remote User** page displays:

**Figure 12-8. Add Remote Users**

User Security Model [Redacted]

Detail | Add Local User | **Add Remote User** | Show All

---

User Security Model: Add Remote User

---

Remote Engine ID	<input type="text"/>	(6 - 32 HEX characters)
User Name	<input type="text"/>	(1 to 32 characters)
Group Name	<input type="text" value="DefaultRead"/>	
Authentication Method	<input type="text" value="None"/>	
Password	<input type="text"/>	(MD5 - 32; MD5-key - 32; SHA - 32; SHA-key - 40)
Privacy	<input type="text" value="None"/>	
Authentication Key	<input type="text"/>	(Des (MD5, MD5-key, SHA, SHA-key), Des-key (M

- 3** Define the relevant fields.
- 4** Click **Apply** to update the switch.

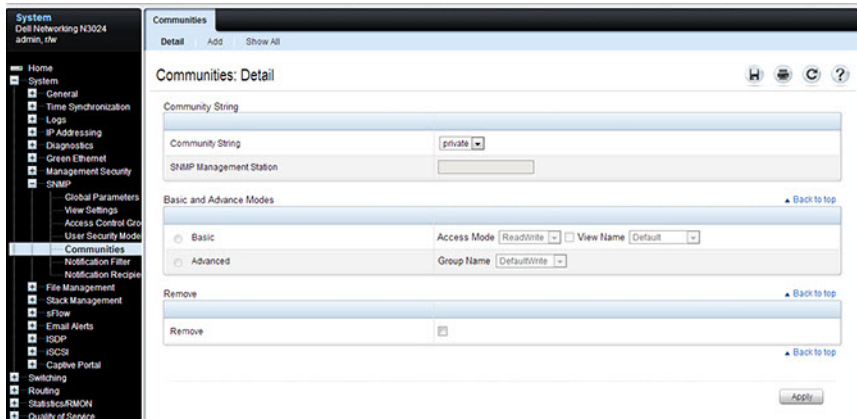
Click **Show All** to view the User Security Model Table, which contains information about configured Local and Remote Users.

## Communities

Access rights for SNMPv1 and SNMPv2 are managed by defining communities **Communities** page. When the community names are changed, access rights are also changed. SNMP Communities are defined only for SNMP v1 and SNMP v2.

To display the **Communities** page, click **System** → **SNMP** → **Communities** in the navigation panel.

**Figure 12-9. SNMP Communities**



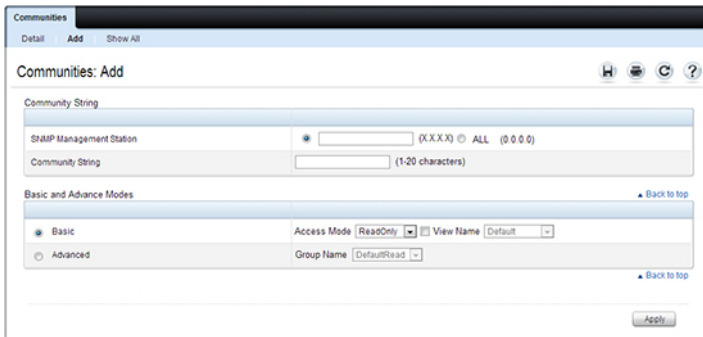
### Adding SNMP Communities

To add a community:

- 1 Open the **Communities** page.
- 2 Click **Add**.

The **Add SNMPv1,2 Community** page displays:

**Figure 12-10. Add SNMPv1,2 Community**



- 3** Specify the IP address of an SNMP management station and the community string to act as a password that will authenticate the management station to the SNMP agent on the switch.
- 4** Select the access mode.
- 5** Click **Apply** to update the switch.

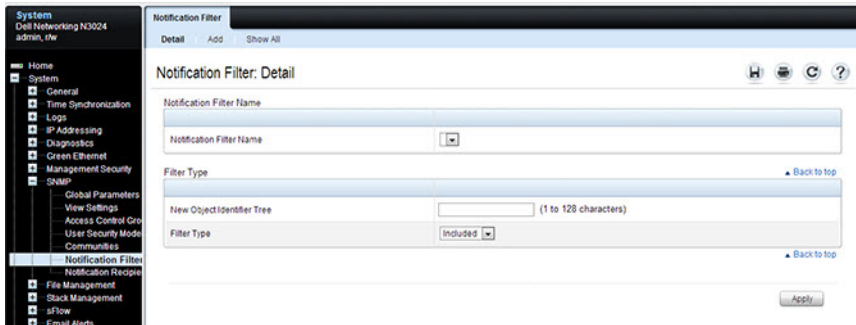
Click **Show All** to view the communities that have already been configured.

## Notification Filter

Use the **Notification Filter** page to set filtering traps based on OIDs. Each OID is linked to a device feature or a feature aspect. The **Notification Filter** page also allows you to filter notifications.

To display the **Notification Filter** page, click **System** → **SNMP** → **Notification Filters** in the navigation panel.

**Figure 12-11. SNMP Notification Filter**



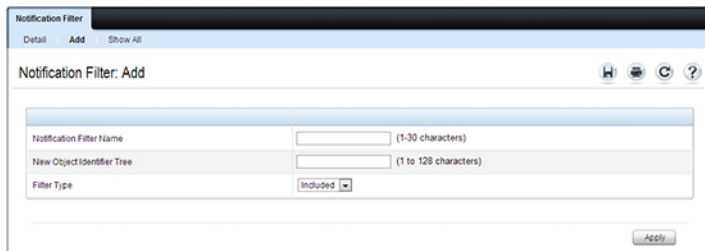
## Adding a Notification Filter

To add a filter:

- 1 Open the **Notification Filter** page.
- 2 Click **Add**.

The **Add Filter** page displays:

**Figure 12-12. Add Notification Filter**



- 3 Specify the name of the filter, the OID for the filter.
- 4 Choose whether to send (include) traps or informs to the trap recipient or prevent the switch from sending (exclude) the traps or informs.
- 5 Click **Apply** to update the switch.

Click **Show All** to view information about the filters that have already been configured.

## **Notification Recipients**

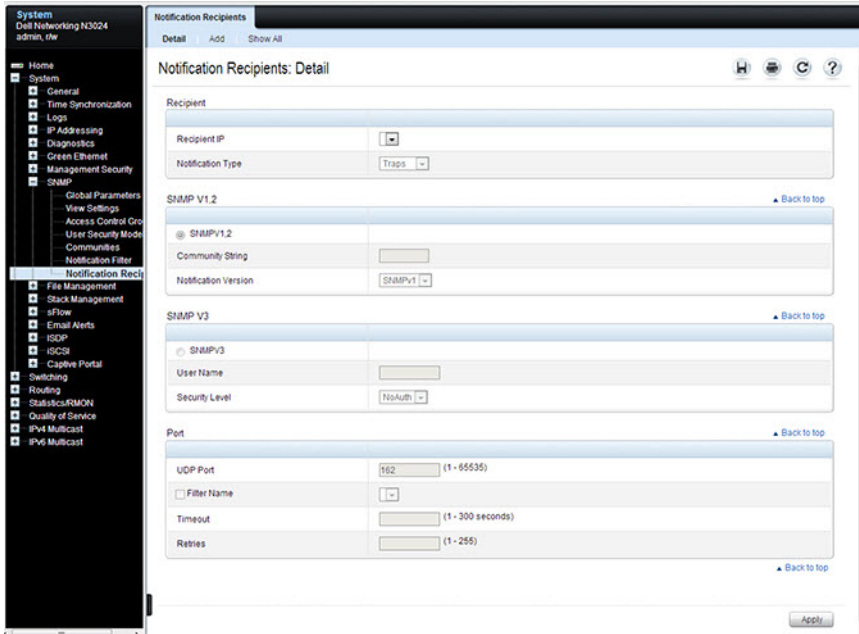
Use the **Notification Recipients** page to view information for defining filters that determine whether traps are sent to specific users, and the trap type sent. SNMP notification filters provide the following services:

- Identifying Management Trap Targets
- Trap Filtering
- Selecting Trap Generation Parameters
- Providing Access Control Checks

To display the **Notification Recipients** page, click **System** → **SNMP** → **Notification Recipient** in the navigation panel.



**Figure 12-13. SNMP Notification Recipient**



## Adding a Notification Recipient

To add a recipient:

- 1 Open the **Notification Recipient** page.
- 2 Click **Add**.

The **Add Recipient** page displays:

**Figure 12-14. Add Notification Recipient**

The screenshot shows a web interface for adding a notification recipient. It is divided into several sections, each with a 'Back to top' link:

- Recipient:** Includes a text input for 'Recipient IP' and a dropdown menu for 'Notification Type' currently set to 'Traps'.
- SNMP V1.2:** Includes a text input for 'Community String' (with a '(1-20 characters)' hint) and a dropdown menu for 'Notification Version' set to 'SNMPv1'.
- SNMP V3:** Includes a text input for 'User Name' (with a '(1-30 characters)' hint) and a dropdown menu for 'Security Level' set to 'NoAuth'.
- Port:** Includes a text input for 'UDP Port' set to '162' (with a '(1-65535)' hint), a dropdown for 'Filter Name', a text input for 'Timeout' set to '15' (with a '(1-300 seconds)' hint), and a text input for 'Retries' set to '3' (with a '(1-255)' hint).

An 'Apply' button is located at the bottom right of the form.

- 3 Specify the IP address or hostname of the host to receive notifications.
- 4 Select whether to send traps or informs to the specified recipient
- 5 Define the relevant fields for the SNMP version you use.
- 6 Configure information about the port on the recipient.
- 7 Click **Apply** to update the switch.

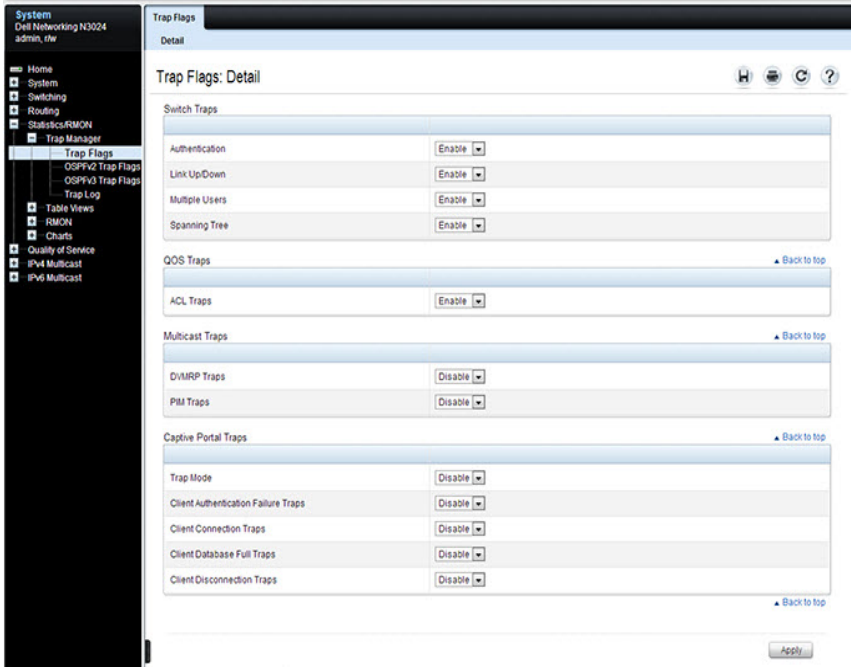
Click **Show All** to view information about the recipients that have already been configured.

## Trap Flags

The **Trap Flags** page is used to specify which traps you want to enable or disable. When the condition identified by an active trap is encountered by the switch, a trap message is sent to any enabled SNMP Trap Receivers, and a message is written to the trap log.

To access the **Trap Flags** page, click **Statistics/RMON** → **Trap Manager** → **Trap Flags** in the navigation panel.

**Figure 12-15. Trap Flags**

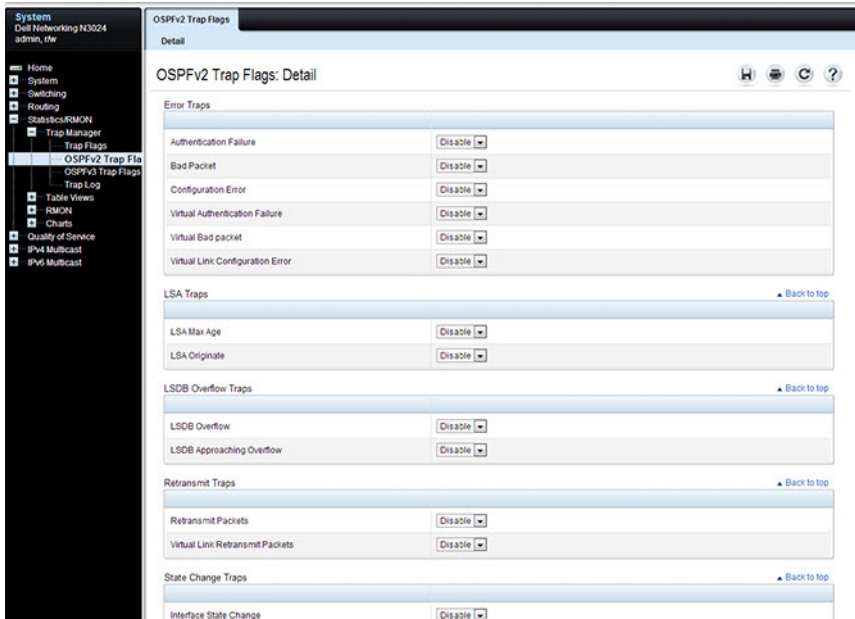


## OSPFv2 Trap Flags

The OSPFv2 **Trap Flags** page is used to specify which OSPFv2 traps you want to enable or disable. When the condition identified by an active trap is encountered by the switch, a trap message is sent to any enabled SNMP Trap Receivers, and a message is written to the trap log.

To access the **OSPFv2 Trap Flags** page, click **Statistics/RMON** → **Trap Manager** → **OSPFv2 Trap Flags** in the navigation panel.

**Figure 12-16. OSPFv2 Trap Flags**

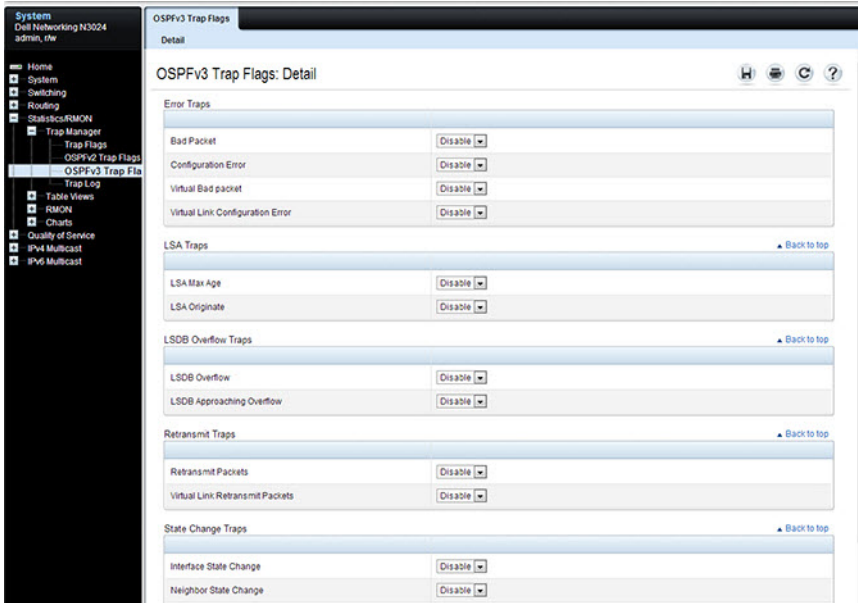


### OSPFv3 Trap Flags

The OSPFv3 Trap Flags page is used to specify which OSPFv3 traps you want to enable or disable. When the condition identified by an active trap is encountered by the switch, a trap message is sent to any enabled SNMP Trap Receivers, and a message is written to the trap log.

To access the OSPFv3 Trap Flags page, click **Statistics/RMON** → **Trap Manager** → **OSPFv3 Trap Flags** in the navigation panel.

**Figure 12-17. OSPFv3 Trap Flags**



## Trap Log

The **Trap Log** page is used to view entries that have been written to the trap log.

To access the **Trap Log** page, click **Statistics/RMON** → **Trap Manager** → **Trap Log** in the navigation panel.

Figure 12-18. Trap Logs

The screenshot shows a network management interface with a sidebar on the left and a main content area on the right. The sidebar contains a tree view with the following items: System, Home, System, Switching, Routing, Statistics/RMON, Trap Manager, Trap Flags, OSPFv2 Trap Flags, OSPFv3 Trap Flags, Trap Log, Table Views, RMON, Charts, Quality of Service, IPv6 Multicast, and IPv6 Multicast. The main content area is titled 'Trap Log' and has a 'Detail' tab selected. Below the title bar, there are icons for Home, Refresh, and Help. The 'Trap Log: Detail' section contains a table with the following data:

Trap Log	
Number of Traps Since Last Reset	7
Trap Log Capacity	256
Number of Traps Since Log Last Viewed	7

Below this table is a 'Log' section with a 'Back to top' link. It contains a table with the following data:

	System Up Time	Trap
0	Jan 1 00:02:01 1970	Entity Database: Configuration Changed
1	Jan 1 00:01:57 1970	Power On Start has completed on unit 1.
2	Jan 1 00:01:55 1970	Link on V11 is failed
3	Jan 1 00:01:55 1970	Link Down: V11
4	Jan 1 00:01:48 1970	Entity Database: Configuration Changed

At the bottom of the log table, there are navigation controls: 'Items Displayed 1-5', 'Rows Per Page 5', and 'Pages 1 of 2'. A 'Clear' button is located at the bottom right of the interface.

Click Clear to delete all entries from the trap log.

## Configuring SNMP (CLI)

This section provides information about the commands you use to manage and view SNMP features on the switch. For more information about these commands, see the *Dell EMC Networking N1100-ON, N1500, N2000, N2100-ON, N2200-ON, N3000E-ON, N3100-ON, and N3200-ON Series Switches CLI Reference Guide* at [www.dell.com/support](http://www.dell.com/support).

### Configuring the SNMPv3 Engine ID

To use SNMPv3, the switch must have an engine ID configured. The default string that is generated using the MAC address of the switch can be used, or another value can be specified. If the SNMPv3 engine ID is deleted, or if the configuration file is erased, then SNMPv3 cannot be used. Since the EngineID should be unique within an administrative domain, Dell recommends that you use the default keyword to configure the Engine ID for stand-alone switches.

The following guidelines are recommended:

- For standalone switches use the default keyword to configure the Engine ID.
- For a stack of switches, configure your own EngineID, and verify that is unique within your administrative domain.

Changing the value of SNMP EngineID has important side-effects. A user's password (entered on the command line) is converted to an MD5 or SHA security digest. This digest is based on both the password and the local engine ID. The command line password is then destroyed, as required by RFC 2274. Because of this deletion, if the local value of engineID changes, the security digests of SNMPv3 users will be invalid, and the users will have to be reconfigured.

Use the following commands to configure an engine ID for SNMP.

Command	Purpose
configure	Enter Global Configuration mode

Command	Purpose
snmp-server engineID local { <i>engineid-string</i>   default}	Configure the SNMPv3 Engine ID. <ul style="list-style-type: none"> <li>engineid-string — The character string that identifies the engine ID. The engine ID is a concatenated hexadecimal string. Each byte in the character string consists of two hexadecimal digits. Each byte can be separated by a period or colon. (Range: 6-32 characters)</li> <li>default — The engineID is created automatically, based on the device MAC address.</li> </ul>
exit	Exit to Privileged Exec mode.
show snmp engineid	View the local SNMP engine ID.

## Configuring SNMP Views, Groups, and Users

Use the following commands to define SNMP views, and SNMP groups, and local and remote SNMPv3 users.

Command	Purpose
configure	Enter Global Configuration mode
snmp-server view <i>view-name</i> <i>oid-tree</i> {included   excluded}	Configure the SNMP view. When configuring groups, users, and communities, a view can be associated with the group, user, or community <ul style="list-style-type: none"> <li><i>view-name</i> — Specifies the name of the view. (Range: 1-30 characters.)</li> <li><i>oid-tree</i> — Specifies the object identifier of the ASN.1 subtree to be included or excluded from the view. To identify the subtree, specify a text string consisting of numbers, such as 1.3.6.2.4, or a word, such as <code>system</code>. Replace a single subidentifier with the asterisk (*) wildcard to specify a subtree family; for example 1.3.*.4.</li> <li><b>included</b> — Indicates that the view type is included.</li> <li><b>excluded</b> — Indicates that the view type is excluded.</li> </ul>



Command	Purpose
<pre>snmp-server group   groupname {v1   v2   v3}   {noauth   auth   priv}   [notify view-name]   [context view-name]   [read view-name] [write   view-name]</pre>	<p>Specify the identity string of the receiver and set the receiver timeout value.</p> <ul style="list-style-type: none"> <li>• <i>groupname</i> — Specifies the name of the group. (Range: 1-30 characters.)</li> <li>• <i>v1</i> — Indicates the SNMP Version 1 security model.</li> <li>• <i>v2</i> — Indicates the SNMP Version 2 security model.</li> <li>• <i>v3</i> — Indicates the SNMP Version 3 security model.</li> <li>• <i>noauth</i> — Indicates no authentication of a packet. Applicable only to the SNMP Version 3 security model.</li> <li>• <i>auth</i> — Indicates authentication of a packet without encrypting it. Applicable only to the SNMP Version 3 security model.</li> <li>• <i>priv</i> — Indicates authentication of a packet with encryption. Applicable only to the SNMP Version 3 security model.</li> <li>• <i>view-name</i> — Specifies the view (defined in the previous step) to use for the context, notification, read, and write privileges for the group.</li> <li>• <i>read</i> — Enables the agent to view the SNMP MIB contents.</li> <li>• <i>write</i> — Enables the agent to configure the switch MIBs.</li> </ul>

Command	Purpose
<pre>snmp-server user username groupname [remote engineid-string] [ { authmd5 password   auth-sha password   auth-md5- key md5-key   auth-sha- key sha-key } [priv-des password   priv-des-key des-key]</pre>	<p>Configure a new SNMPv3 user.</p> <ul style="list-style-type: none"> <li>• <i>username</i> — Specifies the name of the user on the host that connects to the agent. (Range: 1-32 characters.)</li> <li>• <i>groupname</i> — Specifies the name of the group to which the user belongs. (Range: 1-32 characters.)</li> <li>• <i>engineid-string</i> — Specifies the engine ID of the remote SNMP entity to which the user belongs. The engine ID is a concatenated hexadecimal string. Each byte in the hexadecimal character string is two hexadecimal digits. The remote engine id designates the remote management station, and should be defined to enable the device to receive acknowledgements to “informs.” (Range: 5-32 characters.)</li> <li>• <i>auth-md5</i> — The HMAC-MD5-96 authentication level.</li> <li>• <i>auth-sha</i> — The HMAC-SHA-96 authentication level.</li> <li>• <i>password</i> — A password. (Range: 1 to 32 characters.)</li> <li>• <i>auth-md5-key</i> — The HMAC-MD5-96 authentication level. Enter a pregenerated MD5 key.</li> <li>• <i>auth-sha-key</i> — The HMAC-SHA-96 authentication level. Enter a pregenerated SHA key.</li> <li>• <i>md5-key</i> — Character string—length 32 hex characters.</li> <li>• <i>sha-key</i> — Character string—length 40 characters.</li> <li>• <i>priv-des</i> — The CBC-DES Symmetric Encryption privacy level. Enter a password.</li> <li>• <i>priv-des-key</i> — The CBC-DES Symmetric Encryption privacy level. The user must enter a pregenerated MD5 or SHA key depending on the authentication level selected.</li> <li>• <i>des-key</i> — A pregenerated DES encryption key. Length is determined by authentication method selected: 32 hex characters if MD5 Authentication is selected, 40 hex characters if SHA Authentication is selected.</li> </ul>
(continued)	
exit	Exit to Privileged Exec mode.
show snmp views	View SNMP view configuration information.

Command	Purpose
<code>show snmp group</code> [ <i>group_name</i> ]	View SNMP group configuration information.
<code>show snmp user</code> [ <i>user_name</i> ]	View SNMP user configuration information.

## Configuring Communities

Use the following commands to configure access rights for SNMPv1 and SNMPv2.

Command	Purpose
<code>configure</code>	Enter Global Configuration mode
<code>snmp-server community</code> <i>string</i> [ <b>ro</b>   <b>rw</b>   <b>su</b> ] [ <b>view</b> <i>view-name</i>   <b>ipaddress</b> <i>ip_address</i> <b>ipmask</b> ]	<p>Configure the community string and specify access criteria for the community.</p> <ul style="list-style-type: none"> <li>• <i>community-string</i> — Acts as a password and is used to authenticate the SNMP management station to the switch. The string must also be defined on the NMS in order for the NMS to access the SNMP agent on the switch (Range: 1-20 characters). Any printable character is allowed other than the @ \ ? characters.</li> <li>• <b>ro</b> — Indicates read-only access</li> <li>• <b>rw</b> — Indicates read-write access.</li> <li>• <i>view-name</i> — Specifies the name of a previously defined MIB view.</li> <li>• <i>ip_address</i> — Specifies the IPv4/IPv6 address or subnet of the allowed management stations. If no IP address or an all-zeros IP address is specified, all management stations are permitted. The IP address may be an IPv4 or IPv6 address or an address and subnet mask in /length or dotted quad notation.</li> </ul>

Command	Purpose
<b>snmp-server community-</b> <b>group</b> <i>community-string</i> <i>group-name</i> [ <b>ipaddress</b> <i>ip-address</i> <b>ipmask</b> ]	Map the internal security name for SNMP v1 and SNMP v2 security models to the group name. <ul style="list-style-type: none"> <li>• <i>community-string</i> — Community string that acts like a password and permits access to the SNMP protocol. (Range: 1-20 characters)</li> <li>• <i>group-name</i> — Name of a previously defined group. The group defines the objects available to the community. (Range: 1-30 characters)</li> <li>• <i>ip-address</i> — Management station IPv4/IPv6 address and optional netmask. Default is all IP addresses are allowed access.</li> </ul>
<b>exit</b>	Exit to Privileged Exec mode.
<b>show snmp</b>	View SNMP settings and verify the configuration

## Configuring SNMP Notifications (Traps and Informs)

Use the following commands to allow the switch to send SNMP traps and to configure which traps are sent.

Command	Purpose
<code>configure</code>	Enter Global Configuration mode
<code>snmp-server enable traps [acl   all   auto-copy-sw   bgp state-changes limited   buffers   captive-portal cp-type   cpu   dot1q   dvrmp   link   portsecurity [trap-rate]   multiple-users   [vrf vrf-name] ospf ospftype   ospfv3 ospfv3type   pim   poe   snmp authentication   spanning-tree   vrrp]</code>	Specify the traps to enable. The captive portal, OSPF and OSPFv3 traps include several different traps that can be enabled. For more information, use the CLI command <code>help</code> or see the CLI Command Reference.
<code>snmp-server filter filter-name oid-tree {included   excluded}</code>	<p>Configure a filter for SNMP traps and informs based on OIDs. Each OID is linked to a device feature or a feature aspect.</p> <ul style="list-style-type: none"><li>• <i>filter-name</i> — Specifies the label for the filter record that is being updated or created. The name is used to reference the record. (Range: 1-30 characters.)</li><li>• <i>oid-tree</i> — Specifies the object identifier of the ASN.1 subtree to be included or excluded from the view. To identify the subtree, specify a text string consisting of numbers, such as 1.3.6.2.4, or a word, such as <code>system</code>. Replace a single subidentifier with the asterisk (*) wildcard to specify a subtree family; for example, 1.3.*.4.</li><li>• <b>included</b> — Indicates that the filter type is included.</li><li>• <b>excluded</b> — Indicates that the filter type is excluded.</li></ul>

Command	Purpose
<b>snmp-server host</b> <i>host-addr</i> [ <b>informs</b> [ <b>timeout</b> <i>seconds</i> ] [ <b>retries</b> <i>retries</i> ]   <b>traps</b> <b>version</b> { <b>1</b>   <b>2</b> }] <i>community-string</i> [ <i>udp-port</i> ] [ <b>filter</b> <i>filtername</i> ]	<p>For SNMPv1 and SNMPv2, identify the system to receive SNMP traps or informs.</p> <ul style="list-style-type: none"> <li>• <i>host-addr</i>— Specifies the IP address of the host (targeted recipient) or the name of the host. (Range:1-158 characters).</li> <li>• <b>informs</b> — Indicates that SNMPv2 informs are sent to this host</li> <li>• <b>timeout</b> <i>seconds</i> — Number of seconds to wait for an acknowledgment before resending informs. The default is 15 seconds. (Range: 1-300 characters.)</li> <li>• <i>retries</i> — Maximum number of times to resend an inform request. The default is 3 attempts.</li> <li>• <b>traps</b> — Indicates that SNMP traps are sent to this host             <ul style="list-style-type: none"> <li>– <b>version 1</b> — Indicates that SNMPv1 traps will be used</li> <li>– <b>version 2</b> — Indicates that SNMPv2 traps will be used</li> </ul> </li> <li>• <i>community-string</i> — Specifies a password-like community string sent with the notification operation. (Range: 1-20 characters)</li> <li>• <i>udp-port</i> — UDP port of the host to use. The default is 162. (Range: 1-65535 characters.)</li> <li>• <i>filtername</i> — A string that is the name of the filter that defines the filter for this host. If unspecified, does not filter anything (Range: 1-30 characters.)</li> </ul>

Command	Purpose
<pre>snmp-server v3-host {ip- address   hostname} username {traps   informs} [noauth   auth   priv] [timeout seconds] [retries retries] [udpport port] [filter filtername]</pre>	<p>For SNMPv3, identify the system to receive SNMP traps or informs.</p> <ul style="list-style-type: none"> <li>• <i>ip-address</i> — Specifies the IP address of the host (targeted recipient).</li> <li>• <i>hostname</i> — Specifies the name of the host. (Range: 1-158 characters.)</li> <li>• <i>username</i> — Specifies user name used to generate the notification. (Range: 1-25 characters.)</li> <li>• <b>traps</b> — Indicates that SNMP traps are sent to this host.</li> <li>• <b>informs</b> — Indicates that SNMPv2 informs are sent to this host.</li> <li>• <b>noauth</b> — Specifies sending of a packet without authentication.</li> <li>• <b>auth</b> — Specifies authentication of a packet without encrypting it</li> <li>• <b>priv</b> — Specifies authentication and encryption of a packet.</li> <li>• <i>seconds</i> — Number of seconds to wait for an acknowledgment before resending informs. This is not allowed for hosts configured to send traps. The default is 15 seconds. (Range: 1-300 seconds.)</li> <li>• <i>retries</i> — Maximum number of times to resend an inform request. This is not allowed for hosts configured to send traps. The default is 3 attempts. (Range: 0-255 retries.)</li> <li>• <i>port</i> — UDP port of the host to use. The default is 162. (Range: 1-65535.)</li> <li>• <i>filter-name</i> — Specifies the optional filter (defined with the <b>snmp-server filter</b> command) to use for the host. (Range: 1-30 characters.)</li> </ul>
<b>exit</b>	Exit to Privileged Exec mode.
<b>show trapflags</b>	View the status of the configurable SNMP traps.

# SNMP Configuration Examples

This section contains the following examples:

- Configuring SNMPv1 and SNMPv2
- Configuring SNMPv3

## Configuring SNMPv1 and SNMPv2

This example shows how to complete a basic SNMPv1/v2 configuration. The commands enable read-only access from any host to all objects on the switch using the community string *public*, and enable read-write access from any host to all objects on the switch using the community string *private*.

**NOTE:** For additional obfuscation, SNMP community strings may be configured using any printable character other than a backslash, an at sign, or a question mark.

This example also shows how to allow the switch to generate traps for all features that produce traps. The traps are sent to the host with an IP address of 192.168.3.65 using the community string *public*.

To configure the switch:

- 1 Configure the public community string.

```
console#configure
console(config)#snmp-server community public ro
```

- 2 Configure the private community string.

```
console(config)#snmp-server community private rw
```

- 3 Enable all traps and specify the IP address of the host where the traps should be sent.

```
console(config)#snmp-server enable traps all
console(config)#snmp-server host 192.168.3.65 public
console(config)#exit
```

- 4 View the current SNMP configuration on the switch.

```
console#show snmp
```

Community String	Community Access	View Name	IP Address	IP Mask
private	Read/Write	Default	All	All
public	Read Only	Default	1.1.1.1	255.255.255.254



Community-String	Group Name	IP Address	IP Mask
private	DefaultWrite	All	All
public	DefaultRead	All	All

Traps are enabled.  
 Authentication trap is enabled.

Version 1,2 notifications

Target Address	Type	Community	Version	UDP Port	Filter Name	TO	Sec	Retries
-----	-----	-----	-----	-----	-----	-----	-----	-----

Version 3 notifications

Target Address	Type	Username	Security Level	UDP Port	Filter Name	TO	Sec	Retries
-----	-----	-----	-----	-----	-----	-----	-----	-----
								-

System Contact:  
 System Location:  
 Source Interface:  
 SNMP trap Client Source Interface..... Default

## Configuring SNMP Management Station Access

SNMP supports the ability to restrict SNMP MIB access to a single station or a subnet of management stations. Access can be restricted to a specific protocol version and to specific parts of the MIB for read or read-write access. The example below restricts SNMP access to specific parts of the MIB for SNMP requests originating from subnet 10.85.234.0/24 and using SNMP version v2c only. An irregular community name is configured, read-only and

read-write MIB access privileges are configured individually, and are then combined into a community-group which is configured for subnet 10.85.234.0/24.

**NOTE:** The community name may need to be escaped if attempting to use it in a shell environment with tools like `snmpstatus` or `snmpwalk`.

- 1 Create a view with write access to the private MIB.

```
console#configure
console(config)#snmp-server view MyWriteView private included
```

- 2 Create a view with read access to the entire SNMP MIB except the community table.

```
console(config)#snmp-server view "MyReadView"
snmpCommunityTable excluded
console(config)#snmp-server view "MyReadView" iso included
```

- 3 Configure a community group to allow both read and write access to different MIB trees. SNMP v2c protocol is required.

```
console(config)#snmp-server group "MyGroup" v2 read
"MyReadView" write "MyWriteView"
```

- 4 Allow station 10.85.234.2 read-only and read/write access to specific MIB groups.

```
console(config)#snmp-server community-group "%g77&&g!~"
MyGroup ipaddress 10.85.234.0 255.255.255.0
```

### Configuring SNMPv3

This example shows how to complete a basic SNMPv3 configuration. The commands create a view that includes objects from the *internet* MIB subtree (OID 1.3.6.1), which includes all objects on the switch.

The user named *admin* has read-write privileges to all objects within the view (in other words, all objects on the switch) after supplying the appropriate authentication credentials (secretkey).

To configure the switch:

- 1 Configure the view. *view\_snmpv3* and specify the objects to include.

```
console#configure
console(config)#snmp-server view view_snmpv3 internet included
```

- 2 Create the group *group\_snmpv3* and allow read-write access to the view configured in the previous step.

```
console (config) #snmp-server group group_snmpv3 v3 auth read
view_snmpv3 write view_snmpv3
```

- 3 Create the user *admin*, assign the user to the group, and specify the authentication credentials.

```
console (config) #snmp-server user admin group_snmpv3 auth-md5
secretkey
```

- 4 Specify the IP address of the host where traps are to be sent. Packet authentication using MD5-SHA is enabled for the traps.

```
console (config) #snmp-server v3-host 192.168.3.35 admin traps
auth
console (config) #exit
```

- 5 View the current SNMP configuration on the switch. The output includes the SNMPv1/2 configuration in the previous example.

```
console#show snmp
```

Community-String	Community-Access	View Name	IP Address	IP Mask
private		DefaultWrite	All	
public		DefaultRead	All	

Community-String	Community-Access	View Name	IP Address
private	Read/Write	Default	All
public	Read Only	Default	All

Community-String	Group Name	IP Address
private	DefaultWrite	All
public	DefaultRead	All

Traps are enabled.

Authentication trap is enabled.

Version 1,2 notifications

Target	Addr.	Type	Community	Version	UDP Port	Filter Name	TO Sec	Retries
192.168.3.65		Trap	public	1	162			

```

Version 3 notifications
Target Addr. Type Username Security UDP Filter TO Retries
Level Port Name Sec
-----
192.168.3.35 Trap admin Auth-NoP 162 15 3

```

```

System Contact:
System Location:
Source Interface:
SNMP trap Client Source Interface..... Default

```

```

console#show snmp views
Name          OID Tree          Type
-----
Default       iso               Included
Default       snmpVacmMIB      Excluded
Default       usmUser           Excluded
Default       snmpCommunityTable Excluded
view_snmpv3   internet         Included
DefaultSuper  iso               Included

```

```

console#show snmp group
Name          Context Model Security Read Views Notify
Prefix          Level
-----
DefaultRead  ""      V1    NoAuth- Default ""      Default
           NoPriv
DefaultRead  ""      V2    NoAuth- Default ""      Default
           NoPriv
DefaultSuper ""      V1    NoAuth- DefaultSuDefault Default
           NoPriv per Super Super
DefaultSuper ""      V2    NoAuth- DefaultSuDefault Default
           NoPriv per Super Super
DefaultWrite ""      V1    NoAuth- Default Default Default
           NoPriv
DefaultWrite ""      V2    NoAuth- Default Default Default
           NoPriv
group_snmpv3 ""      V3    Auth- view_snmpview_sn ""
           NoPriv v3 mpv3

```

```

console#show snmp user

```

Name	Group Name	Auth Meth	Priv Meth	Remote Engine ID
-----	-----	-----	-----	-----
admin	group_snmpv3	MD5		800002a203001ec9aaaa07



# Images and File Management

## Dell EMC Networking N-Series Switches

This chapter describes how to upload, download, and copy files, such as firmware images and configuration files, on the switch. The topics covered in this chapter include:

- Image and File Management Overview
- Managing Images and Files (Web)
- Managing Images and Files (CLI)
- SCP Server



**NOTE:** For information about the Auto Configuration feature that enables the switch to automatically upgrade the image or load a new configuration file during the boot process, see DHCP and USB Auto-Configuration.

## Image and File Management Overview

### What Files Can Be Managed?

Dell EMC Networking N-Series switches maintain multiple types of files on the flash file system. Keywords are used in the CLI to differentiate among the file types. Table 13-1 describes the files that can be managed. The table also lists the type of action that can be taken on the file, which is one or more of the following:

- Download the file to the switch from a remote system (or USB flash drive).
- Upload the file from the switch to a remote system (or USB flash drive).
- Copy the file from one location on the file system to another location.

**Table 13-1. Files to Manage**

<b>File</b>	<b>Action</b>	<b>Description</b>
image	Download Upload Copy	Firmware for the switch. The switch can maintain two images: the active image and the backup image.
startup-config	Download Upload Copy	Contains the software configuration that loads during the boot process.
running-config	Download Upload Copy	Contains the current switch configuration. This file may be loaded by the stack standby unit during primary failover.
backup-config	Download Upload Copy	An additional configuration file that serves as a backup.
Configuration script	Download Upload	Text file with CLI commands. When you activate a script on the switch, the commands are executed and added to the running-config. Scripts use the .scr filename extension.
Log files	Upload	Provides various information about events that occur on the switch. For more information, see Monitoring and Logging System Information.
SSH key files	Download	Contains information to authenticate SSH sessions. The switch supports the following private and public key files for SSH: <ul style="list-style-type: none"><li>• SSH-1 RSA Key File [ssh_host_rsa_key and ssh_host_key.pub]</li><li>• SSH-2 RSA Key File (PEM Encoded) [ssh_host_rsa_key and ssh_host_rsa_key.pub]</li><li>• SSH-2 Digital Signature Algorithm (DSA) Key File (PEM Encoded) ssh_host_dsa_key and ssh_host_dsa_key.pub]</li></ul>



**Table 13-1. Files to Manage**

<b>File</b>	<b>Action</b>	<b>Description</b>
SSH certificate files (Not supported on Dell EMC Networking N1500 switches)	Download	<p>Contains information to encrypt, authenticate, and validate HTTPS sessions. The switch supports the following files for SSL:</p> <ul style="list-style-type: none"> <li>• SSL Trusted Root (or Intermediary) Certificate File (PEM Encoded) [CA.pem]</li> <li>• SSH Server Certificate File (PEM Encoded) [ssl_cert.pem]</li> <li>• SSH Diffie-Hellman Weak Encryption Key File (PEM Encoded) [ssl_key.pem]</li> <li>• SSH Diffie-Hellman Strong Encryption Key File (PEM Encoded)</li> </ul>
IAS Users	Download	List of Internal Authentication Server (IAS) users for IEEE 802.1X authentication. For more information, see "What is the Internal Authentication Server?" on page 366

## Why Is File Management Needed?

This section provides some reasons why you might choose to manage various files.

### Image Files

The switch can store two firmware images, but only one is active. The other image file is a backup image. By default, the switch has only one image. You might copy an image or download an image to the switch for the following reasons:

- To create a backup image
- To upgrade the firmware as new images become available

The Dell EMC Networking N-Series firmware releases for single series stacking environments are named as follows:

```
<switch name>v<version number>.stk
```

```
<switch name>Stdv<version number>.stk
```

<switch name>Advvv<version number>.stk

<switch name>AdvLitev<version number>.stk

The Dell EMC Networking N-Series firmware releases for mixed stacking environments are named as follows:

N2000N2100Stdv<version number>.itb - N2000/N2100 mixed stack firmware

N3000E-ONN3100Advv<version number>.itb - N3000E-ON/N3100-ON mixed stack firmware

Where the switch name is:

N3200—Dell EMC Networking N3200-ON Series switch firmware for N3208PX-ON, N3224T-ON, N3224F-ON, N3248X-ON, N3248TE-ON, N3224PX-ON, N3224P-ON, N3248P-ON, N3248PXE-ON.

N3100 — Dell EMC Networking N3100-ON Series switch firmware for N3132PX-ON.

N3000E — Dell EMC Networking N3000E-ON Series switch firmware for N3024EP-ON, N3024ET-ON, N3024EF-ON, N3048ET-ON, N3000.

N2200-ON — Dell EMC Networking N2200X-ON Series switch firmware for N2224X-ON, N2224PX-ON, N2248X-ON, N2248PX-ON.

N2100 — Dell EMC Networking N2100-ON Series switch firmware for N2128PX-ON.

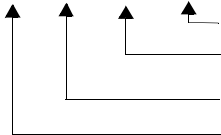
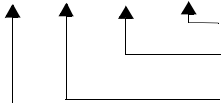
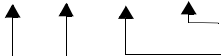
N2000 — Dell EMC Networking N2000 Series switch firmware for N2024, N2048, N2024P, N2048P.

N1500 — Dell EMC Networking N1500 Series switch firmware for N1524, N1524P, N1548, N1548P.

N1100 — Dell EMC Networking N1100-ON Series switch firmware for N1108T-ON, N1108P-ON, N1124T-ON, N1124P-ON, N1148T-ON, N1148P-ON.

And the version number convention is:

Version number	Description
6 6 0 1	Four part version number

Version number	Description
	Denotes the build number.
	Denotes a scheduled maintenance release of the firmware.
	Denotes a minor release of the firmware.
	Denotes a major release of the firmware.

- Major release numbers start at 6.
- Minor release numbers start at 0.
- Maintenance release numbers start at 0.
- Web release build numbers start at 1. A build number of 0 indicates a factory build, which should be upgraded using a web release build from [www.dell.com/support](http://www.dell.com/support).

#### **Examples:**

- N1500v6.2.5.0.stk — Dell EMC Networking N1500 Series switch firmware release 6.2.5.0. This is the factory build for the fifth maintenance release of the second minor release of the 6.X major release family.
- N3000E-ONv6.0.1.3.stk — Dell EMC Networking N3000E-ON Series switch firmware version 6.0.1.3. This is the third build for the first maintenance release for the 6.0 major release.
- N3000E-ONv6.1.0.1.stk — Dell EMC Networking N3000E-ON Series switch firmware version 6.1.0.1. This is the first build for the first minor release after the 6.0 major release, i.e., release 6.1.

#### **Configuration Files**

Configuration files contain the CLI commands that change the switch from its default configuration. The switch can maintain three separate configuration files: startup-config, running-config, and backup-config. The switch loads the startup-config file when the switch boots. Any configuration changes that take place after the boot process completes are written to the running-config file. The backup-config file does not exist until you explicitly create one by copying an existing configuration file to the backup-config file or downloading a backup-config file to the switch.

Configuration scripts, which are text files that contains CLI commands, can also be created.



**NOTE:** You must use the CLI to manage configuration scripts. The configuration scripting feature is not available from the web interface.

When you apply (run) a configuration script on the switch, the commands in the script are executed in the order in which they are written as if you were typing them into the CLI. The commands that are executed in the configuration script are added to the running-config file.

You might upload a configuration file from the switch to a remote server for the following reasons:

- To create a backup copy
- To use the configuration file on another switch
- To manually edit the file

You might download a configuration file from a remote server to the switch for the following reasons:

- To restore a previous configuration
- To load the configuration copied from another switch
- To load the same configuration file on multiple switches

Use a text editor to open a configuration file and view or change its contents.

### **SSH/SSL Keys and Certificates**

If you use OpenManage Switch Administrator to manage the switch over an HTTPS connection, you must import the appropriate certificate files to the switch (**crypto key import**). If you use the CLI to manage the switch over an SSH connection, you must import the appropriate key files to the switch or use the **crypto key** command to generate the key files locally. Regenerating the RSA/DSA keys will invalidate any existing certificates.

### **What Methods Are Supported for File Management?**

Any of the following protocols can be used to download files from a remote system to the switch or to upload files from the switch to a remote system:

- TFTP

- SFTP
- SCP
- FTP
- HTTP (Web only)
- HTTPS (Web only)

Files can also be copied between the file system on the internal flash and a USB flash drive that is connected to the external USB port.



**NOTE:** The use of SFTP, SCP or HTTPS may require RSA/DSA keys to be generated prior to use.

## What Factors Should Be Considered When Managing Files?

### Uploading and Downloading Files

To use TFTP, SFTP, SCP, or FTP for file management, you must provide the IP address of the remote system that is running the appropriate server (TFTP, SFTP, SCP or FTP). Make sure there is a route from the switch to the remote system. The **ping** command in the CLI can be used to verify that a route exists between the switch and the remote system.

If you are downloading a file from the remote system to the switch, be sure to provide the correct path to the file and the correct file name.

### Managing Images

When you download a new image to the switch, it overwrites the backup image, if it exists. To use the new image, it must be activated and reloaded on the switch. The image that was previously the active image becomes the backup image after the switch reloads. If the switch is upgraded to a newer image and the image is found to be incompatible with the network, the switch can revert to the original image.

If a new image is activated and reloaded on the switch, and the switch is unable to complete the boot process due to a corrupt image or other problem, the boot menu can be used to activate the backup image. The administrator must connect to the switch through the console port to access the boot menu. The image files may contain firmware for the PHY processors on the

switch. The PHY firmware may be updated to the firmware version supported by the switch firmware during the boot process or, in the case of switches that support the hot swap of cards, when the card is inserted into the switch.

### **Editing and Downloading Configuration Files**

Each configuration file contains a list of executable CLI commands. The commands must be complete and in a logical order, as if you were entering them by using the switch CLI.

When you download a startup-config or backup-config file to the switch, the new file replaces the previous version. To change the running-config file, you execute CLI commands either by typing them into the CLI or by applying a configuration script with the **script apply** command. The startup-config and backup-config files can also be applied to the running-config by using the **script apply** command.

### **Creating and Applying Configuration Scripts**

When you use configuration scripting, keep the following considerations and rules in mind:

- The application of scripts is partial if the script fails. For example, if the script executes four of ten commands and the script fails, the script stops at four, and the final six commands are not executed.
- Scripts cannot be modified or deleted while being applied.
- Validation of scripts checks for syntax errors only. It does not validate that the script will execute properly when applied.
- The file extension must be `.scr`.
- A maximum of ten scripts are allowed on the switch.
- Only configuration commands are accepted. Session-specific commands such as **show** are elided from the script during syntax checking.
- The combined size of all script files on the switch cannot exceed 2 MB.
- The maximum number of configuration file command lines in a script is 2000.

Single-line annotations in the configuration file can be used to improve script readability. The exclamation point (!) character flags the beginning of a comment. The comment flag character can begin anywhere within a single

line, and all input following this character to the end of the line is ignored. Any line in the file that begins with the “!” character is recognized as a comment line and ignored by the parser.

The following example shows annotations within a file (commands are bold):

```
! Script file for displaying management access
show telnet !Displays the information about remote connections
! Display information about direct connections
show serial
! End of the script file
```

## Managing Files on a Stack

Image files downloaded to the primary unit of a stack are automatically downloaded to all stack members. If you activate the backup image on the primary, it is activated on all units as well so that when you reload the stack, all units use the same image.

The running-config, startup-config, and backup-config files, as well as all keys and certificates are synchronized across the stack when the running-config file is saved to the startup-config file.


Configuration scripts are not distributed across the stack and only exist on the unit that is the primary unit at the time of the file download.

## Uploading Configuration Files by Using SNMP

When you use SNMP to upload a configuration file to a TFTP server, the agentTransferUploadFileName object must be set to the local filename, which is either startup-config or backup-config.


## How Is the Running Configuration Saved?

Changes you make to the switch configuration while the switch is operating are written to the running-config. These changes are not automatically written to the startup-config. When you reload the switch, the startup-config file is loaded. If you reload the switch (or if the switch resets unexpectedly), any settings in the running-config that were not explicitly saved to the startup-config are lost. You must save the running-config to the startup-config to ensure that the settings you configure on the switch are saved across a switch reset.

To save the running-config to the startup-config by using the web-based interface, click  (the save icon), which is available at the top of each page. To save the running-config to the startup-config from the CLI, use the **write** command.



# Managing Images and Files (Web)

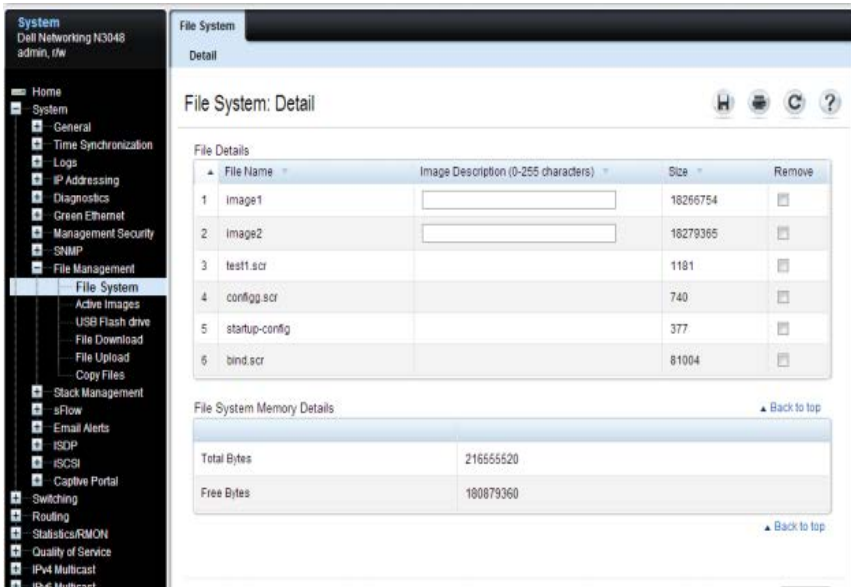
This section provides information about the OpenManage Switch Administrator pages to use to manage images and files on Dell EMC Networking Series switches. For details about the fields on a page, click  at the top of the Dell EMC OpenManage Switch Administrator web page.

## File System

Use the **File System** page to view a list of the files on the device and to modify the image file descriptions.

To display the **File System** page, click **System** → **File Management** → **File System** in the navigation panel.

**Figure 13-1. File System**



The screenshot displays the 'File System' page in the OpenManage Switch Administrator. The left navigation panel shows the 'File System' menu item selected. The main content area is titled 'File System: Detail' and contains a table of file details and a section for 'File System Memory Details'.

File Name	Image Description (0-255 characters)	Size	Remove
1 image1	<input type="text"/>	18266754	<input type="checkbox"/>
2 image2	<input type="text"/>	18279365	<input type="checkbox"/>
3 test1.scr		1181	<input type="checkbox"/>
4 configg.scr		740	<input type="checkbox"/>
5 startup-config		377	<input type="checkbox"/>
6 bind.scr		81004	<input type="checkbox"/>

File System Memory Details		<a href="#">Back to top</a>
Total Bytes	216555520	
Free Bytes	180879360	<a href="#">Back to top</a>

## Active Images

Use the **Active Images** page to set the firmware image to use when the switch boots. If you change the boot image, it does not become the active image until you reset the switch.

On the Dell EMC Networking N-Series switches, the images are named *active* and *backup*.

To display the **Active Images** page, click **System** → **File Management** → **Active Images** in the navigation panel.

**Figure 13-2. Active Images**



## USB Flash Drive

Use the **USB Flash Drive** page to view information about a USB flash drive connected to the USB port on the front panel of the switch. The page also displays information about the files stored on the USB flash drive.

A USB flash drive must be un-mounted by the operator before removing it from the switch. If a new USB flash drive is installed without un-mounting the previous drive, the new flash drive may not be recognized. If a USB flash drive is removed without un-mounting it, un-mount the flash drive (i.e., use the command **unmount usb**) and remove and reinstall the USB flash drive in the switch.

To display the **USB Flash Drive** page, click **System** → **File Management** → **USB Flash Drive** in the navigation panel.

**Figure 13-3. USB Flash Drive**

The screenshot shows the 'USB Flash Drive' page in a network switch management interface. The left sidebar contains a navigation menu with 'USB Flash drive' selected. The main content area is titled 'USB Flash Drive' and 'Detail USB Flash Drive Unmount'. It displays 'USB Device Information: Detail' with a table of device details and 'USB Directory Details' with a table of directory statistics. At the bottom, there is a 'USB Memory statistics' section with a table of file information and 'Back to top' links.

USB Device Details	
Device Status	
Manufacturer	
Product Name	
Serial Number	
USB Version Compliance	
Class Code	
Subclass Code	
Protocol	
Vendor ID	
Product ID	

USB Directory Details	
Total Size	
Bytes Used	
Bytes Free	

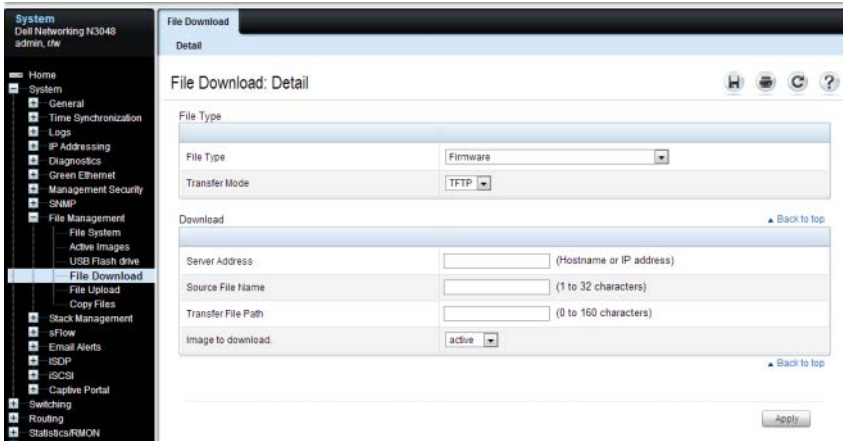
USB Memory statistics			Back to top
Filename	Filesize	Modification Time	
			Back to top

## File Download

Use the **File Download** page to download image (binary) files, SSH and SSL certificates, IAS User files, and configuration (ASCII) files from a remote server to the switch.

To display the **File Download** page, click **System** → **File Management** → **File Download** in the navigation panel.

**Figure 13-4. File Download**



### Downloading Files

To download a file to the switch:


- 1 Open the **File Download** page.
- 2 Select the type of file to download to the switch.
- 3 Select the transfer mode.

If you select a transfer mode that requires authentication, additional fields appear in the **Download** section. If you select **HTTP** as the download method, some of the fields are hidden.

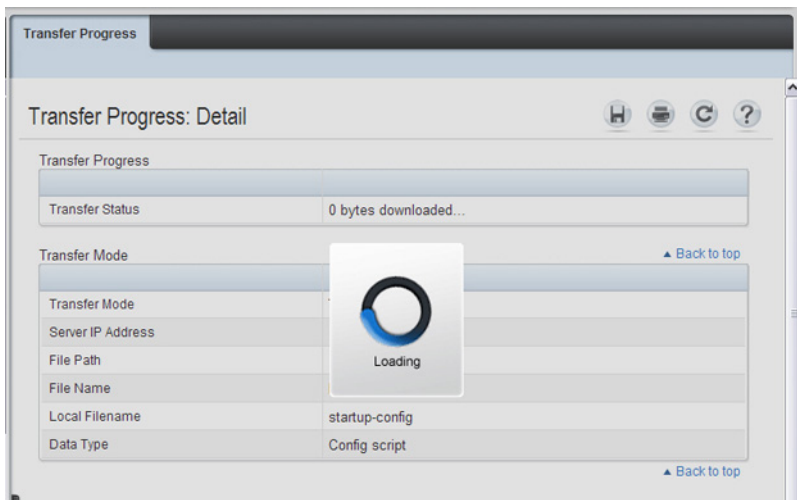


**NOTE:** If you are using **HTTPS** to manage the switch, the download method will be **HTTPS**.

- 4 To download using HTTP, click **Choose Files** and select the file to download, then click **Apply**.
- 5 To download using any method other than HTTP, enter the IP address of the server that contains the file to download, the name of the file and the path on the server where it is located. For SFTP and SCP, provide the user name and password.
- 6 Click **Apply** to begin the download.

 **NOTE:** After you start a file download, the page refreshes and a transfer status field appears to indicate the number of bytes transferred. The web interface is blocked until the file download is complete.

**Figure 13-5. File Download in Progress**



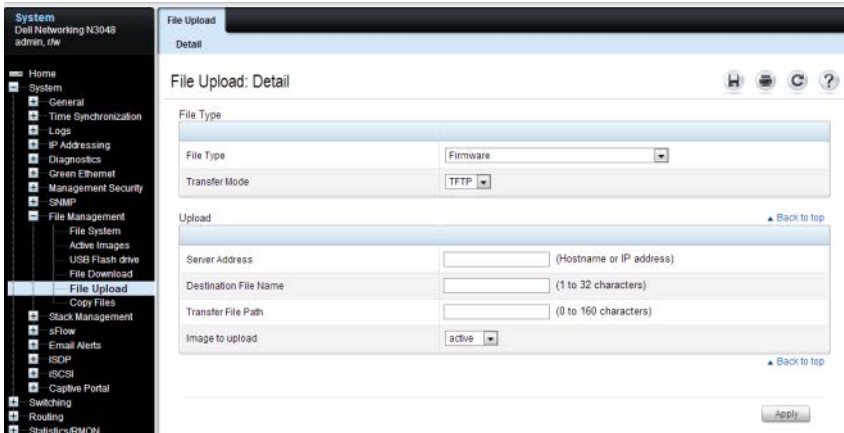
- 7 The file is downloaded to the switch.

## File Upload

Use the **File Upload: Detail** page to upload configuration (ASCII), image (binary), IAS user, operational log, and startup log files from the switch to a remote server.

To display the **File Upload: Detail** page, click **System** → **File Management** → **File Upload** in the navigation panel.

**Figure 13-6. File Upload**



### Uploading Files

To upload a file from the switch to a remote system:

- 1 Open the **File Upload** page.
- 2 Select the type of file to download to the remote server.
- 3 Select the transfer mode.

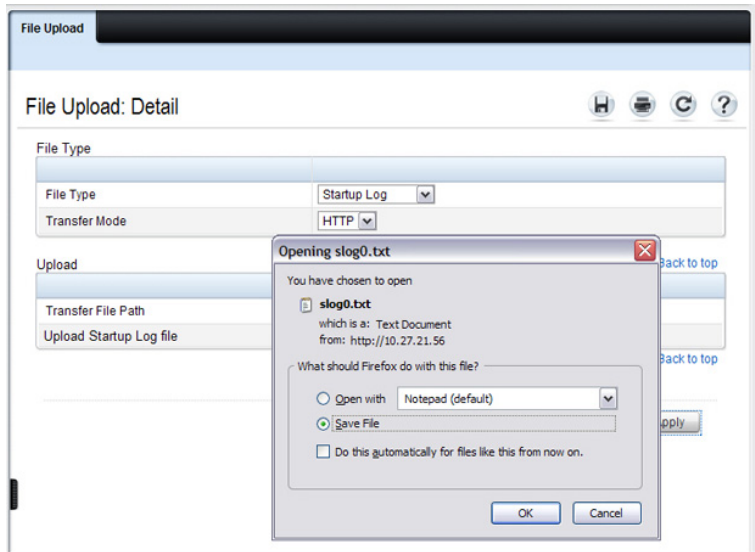
If you select a transfer mode that requires authentication, additional fields appear in the Upload section. If you select HTTP as the upload method, some of the fields are hidden.



**NOTE:** If you are using HTTPS to manage the switch, the download method will be HTTPS.

- To upload by using HTTP, click **Apply**. A dialog box opens to allow you to open or save the file.

**Figure 13-7. File Upload**



- To upload by using any method other than HTTP, enter the IP address of the server and specify a name for the file. For SFTP and SCP, provide the user name and password.

- Click **Apply** to begin the upload.



**NOTE:** For some file uploads and methods, the page refreshes and a transfer status field appears to indicate the number of bytes transferred. The web interface is blocked until the file upload is complete.

- The file is uploaded to the specified location on the remote server.

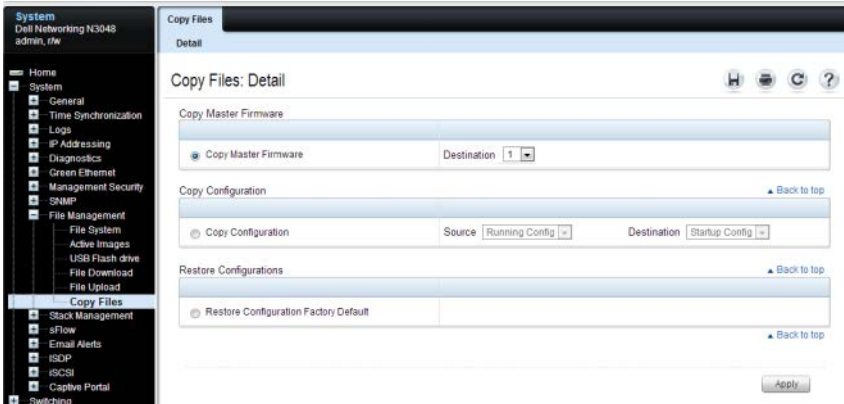
## Copy Files

Use the Copy Files page to:

- Copy the active firmware image to one or all members of a stack.
- Copy the running, startup, or backup configuration file to the startup or backup configuration file.
- Restore the running configuration to the factory default settings.

To display the Copy Files page, click **System** → **File Management** → **Copy Files** in the navigation panel.

**Figure 13-8. Copy Files**





## Managing Images and Files (CLI)

This section provides information about the commands you use to upload, download, and copy files to and from the Dell EMC Networking N-Series switches. For more information about these commands, see the *Dell EMC Networking N1100-ON, N1500, N2000, N2100-ON, N2200-ON, N3000E-ON, N3100-ON, and N3200-ON Series Switches CLI Reference Guide* at [www.dell.com/support](http://www.dell.com/support). It also describes the commands that control the Auto Configuration feature.



**NOTE:** Upload, download, and copy functions use the **copy** command to send and receive files from remote systems. The basic syntax for the command is **copy source destination**.

The examples in this section give some specific examples of source URLs for copying remote files to the switch. The complete source URL syntax is:

```
url          flash://filename |
             tftp://{ipaddress|hostname}/filepath/filename
             ftp://user@{ipaddress|hostname}/path/filename |
             scp://user@{ipaddress|hostname}/path/filename |
             sftp://user@{ipaddress|hostname}/path/filename |
             usb://filepath/filename
```

The complete destination URL syntax for copying files from the switch to a remote system is:

```
url          flash://filename |
             tftp://{ipaddress|hostname}/filepath/filename
             ftp://user@{ipaddress|hostname}/path/filename |
             scp://user@{ipaddress|hostname}/path/filename |
             sftp://user@{ipaddress|hostname}/path/filename |
             usb://filepath/filename
```



**NOTE:** The flash syntax identifies a file on the switch.

Not all combinations are available. For example, **copy tftp:1.2.3.4/asd scp:4.3.2.1/asd** is a nonsensical command and is not allowed.

## Downloading and Activating a New Image (TFTP)

Use the following commands to download a new firmware image to the switch and to make it the active image. This example shows how to use TFTP to download the image.

Command	Purpose
<code>copy tftp://{ip-address hostname}/path/file-name {active   backup}</code>	Use TFTP to download the firmware image at the specified source to the non-active image. If the image file is in the TFTP file system root (download path), you do not need to specify the path in the command.
<code>show version [unit]</code>	View information about the currently active image on the management unit in the stack or on the specified unit.
<code>filedescr {active   backup} description</code>	Add a description to the image files.
<code>boot system {active   backup}</code>	Set the image to use as the boot (active) image after the switch resets.
<code>reload</code>	Reboot the switch to make the new image the active image. You are prompted to verify that you want to continue.

## Managing Files in Internal Flash

Use the following commands to copy, rename, delete and list the files in the internal flash.

Command	Purpose
<code>dir [filepath]</code>	List the files in the flash file system.
<code>copy flash://filename usb://filename</code>	Copy a file from the internal flash to a USB flash drive. Use the <code>dir</code> command to see a list of the files that can be copied from the internal flash. Make sure a flash drive has been inserted in the USB port on the front panel before executing the command.
<code>rename current_name new_name</code>	Rename a file in flash.
<code>delete filename</code>	Remove the specified file.
<code>erase {startup-config   backup-image   backup- config   application filename}</code>	Erase the startup configuration, the backup configuration, the backup image, or an application.
<code>copy startup-config backup-config</code>	Save the startup configuration to the backup configuration file.
<code>copy running-config startup-config</code>	Copy the current configuration to the startup configuration. This saves the current configuration to NVRAM.
<code>show startup-config</code>	View the contents of the startup-config file
<code>show running-config</code>	View the contents of the running-config file

## Managing Files on a USB Flash Device

Use the following commands to manage files that are on a USB device that is plugged into the USB flash port on the front panel of the switch.

Command	Purpose
<code>show usb device</code>	Display USB flash device details
<code>dir usb</code>	Display USB device contents and memory statistics
<code>copy usb://filename { url   active   application [filename]   backup   backup-config   ca-root [1-8]   client-key [1-8]   client-sll-cert [1-8]   ias-users   openflow-ssl-ca-cert   openflow-ssl-cert   openflow-ssl-priv-key   running-config   script destfilename   startup-config }</code>	Copy the specified file from the USB flash device to the specified file in internal flash. The <i>url</i> parameter may be one of the following: <ul style="list-style-type: none"><li>• <code>flash://filename</code></li><li>• <code>tftp://{ipaddress hostname} /filepath/filename</code></li><li>• <code>ftp://user@{ipaddress hostname}/path/filename</code></li><li>• <code>scp://user@{ipaddress hostname}/path/filename</code></li><li>• <code>sftp://{ipaddress hostname}/path/filename</code></li><li>• <code>usb://filepath/filename</code></li></ul>
<code>unmount usb</code>	Make the USB flash device inactive. The device must be removed and re-inserted to become active again.

## Uploading a Configuration File (SCP)

Use the following commands to upload a configuration file from the switch to a remote system by using SCP.

Command	Purpose
<code>copy file scp://user@{ip-address hostname}/path/file-name</code>	<p>Copy a file from the switch using SCP.</p> <p>The file can be one of the following files:</p> <ul style="list-style-type: none"><li>• application [<i>filename</i>]</li><li>• backup-config</li><li>• active or backup image</li><li>• operational-log</li><li>• core-dump <i>filename</i></li><li>• log-files</li><li>• crashlog {0-4   data   kernel}</li><li>• running-config</li><li>• script <i>filename</i></li><li>• startup-config</li><li>• startup-log</li></ul>
Password entry	After you enter the <code>copy</code> command, the CLI prompts you for the password associated with the username.

## Managing Configuration Scripts (SFTP)

Use the following commands to download a configuration script from a remote system to the switch, validate the script, and activate it.



**NOTE:** The startup-config and backup-config files are essentially configuration scripts and can be validated and applied by using the commands in this section.

Command	Purpose
<code>copy sftp://user@{ip-address hostname}/path/file-name script dest-name</code>	Downloads the specified script from the remote server to the switch.
Password entry	After you enter the <code>copy</code> command, the CLI prompts you for the password associated with the username.
<code>script validate script-name</code>	Checks the specified script for syntax errors. The script is automatically validated when you download it to the switch. This command can be used to validate it again.
<code>script list</code>	View the list of available scripts.
<code>script activate script-name</code>	Executes the commands within the script in order. The configuration changes in the script are applied to the running configuration.
<code>script show script-name</code>	View the contents of the specified script.

## SCP Server

The switch supports an SCP server that allows file transfers to be initiated remotely. The SCP server is capable of accepting *pushed* files from an external host over the in-band or out-of-band interface.

The SCP server shares the key and certificate configuration with the SSH server. To configure security/passwords for the SCP server, follow the same steps as for configuring security/passwords the SSH server and additionally enable the SCP server. Up to five simultaneous SSH/SCP sessions are supported.

During SCP file transfer operations, switch management operations are blocked.

Command	Purpose
<code>ip scp server enable</code>	Enable the SCP server.

# File and Image Management Configuration Examples

This section contains the following examples:

- Upgrading the Firmware
- Managing Configuration Scripts

## Upgrading the Firmware

This example shows how to download a firmware image to the switch and activate it. The TFTP server in this example is PumpKIN, an open source TFTP server running on a Windows system.

- TFTP server IP address: 10.27.65.103
- File path: \image
- File name: dell\_0308.stk

Use the following steps to prepare the download, and then download and upgrade the switch image.

- 1 Check the connectivity between the switch and the TFTP server.

```
console#ping 10.27.65.103
Pinging 10.27.65.103 with 0 bytes of data:

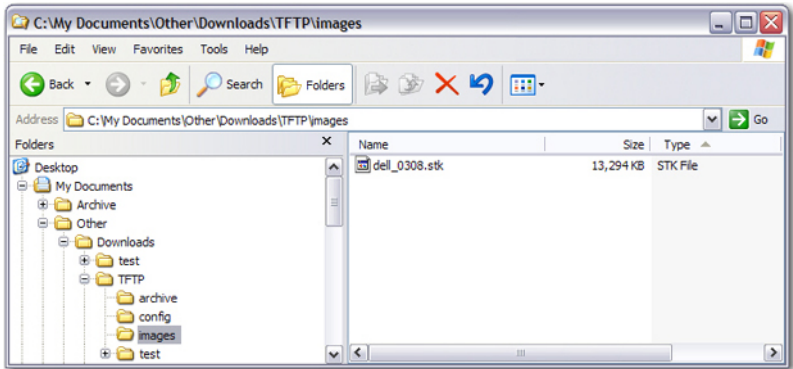
Reply From 10.27.65.103: icmp_seq = 0. time <10 msec.
Reply From 10.27.65.103: icmp_seq = 1. time <10 msec.
Reply From 10.27.65.103: icmp_seq = 2. time <10 msec.
Reply From 10.27.65.103: icmp_seq = 3. time <10 msec.

----10.27.65.103 PING statistics----
4 packets transmitted, 4 packets received, 0% packet loss
round-trip (msec) min/avg/max = <10/<10/<10
```

- 2 Copy the image file to the appropriate directory on the TFTP server. In this example, the TFTP root directory is C:\My Documents\Other\Downloads\TFTP, so the file path is images .



**Figure 13-9. Image Path**



- 3 View information about the current image.

```
console#show version
```

```
Machine Description..... Dell Networking Switch
System Model ID..... N2128PX
Machine Type..... Dell EMC Networking N2128PX-ON
Serial Number.....
Manufacturer..... 0xbc00
Burned In MAC Address..... 1418.770C.9DD8
System Object ID..... 1.3.6.1.4.1.674.10895.3077
SOC Version..... BCM56547_A0
HW Version..... 2
CPLD Version..... 5
Boot Version..... v1.0.21
Image File..... N2100v6.2.0.1
Software Capability..... Stack Limit = 12, VLAN Limit = 4093
```

unit	active	backup	current-active	next-active
1	6.5.0.2	6.4.0.1	6.2.5.1	6.2.5.1
2	6.5.0.2	6.4.0.1	6.2.5.1	6.2.5.1

- 4 Download the image to the switch. After you execute the copy command, you must verify that you want to start the download.

Use either the **active** or **backup** keyword to select the specified image to replace (which takes effect only after a reboot). In the following example, the active image is replaced.

```
console#copy tftp://10.27.65.103/images/N2100v6.5.0.2.stk
active
Transfer Mode..... TFTP
Server IP Address..... 10.27.65.103
Source File Path..... images/
Source Filename..... N2100v6.5.0.2.stk
Data Type..... Code
Destination Filename..... active
Management access will be blocked for the duration of the
transfer
Are you sure you want to start? (y/n)
```

- 5 Activate the new image (backup) so that it becomes the active image after the switch resets. This step is not necessary if downloading to the active image.

Use either the **active** or **backup** keyword, depending on which image you selected for replacement in step 4. It is possible to activate the backup image and subsequently reactivate the original active image prior to a reboot.

```
console#boot system backup
Activating image backup..
```

- 6 View information about the current image.

```
console#show bootvar
Image Descriptions
```

```
active :
backup :
```

Images currently available on Flash

unit	active	backup	current-active	next-active
1	6.5.0.2	6.2.5.0	6.2.5.1	6.5.0.2

- 7 Copy the running configuration to the startup configuration to save the current configuration to NVRAM.

```
console#copy running-config startup-config
```

This operation may take a few minutes.  
Management interfaces will not be available during this time.

Are you sure you want to save? (y/n)**y**

Configuration Saved!

- 8 Reset the switch to boot the system with the new image.

```
console#reload
```

Are you sure you want to continue? (y/n)**y**

Reloading all switches...

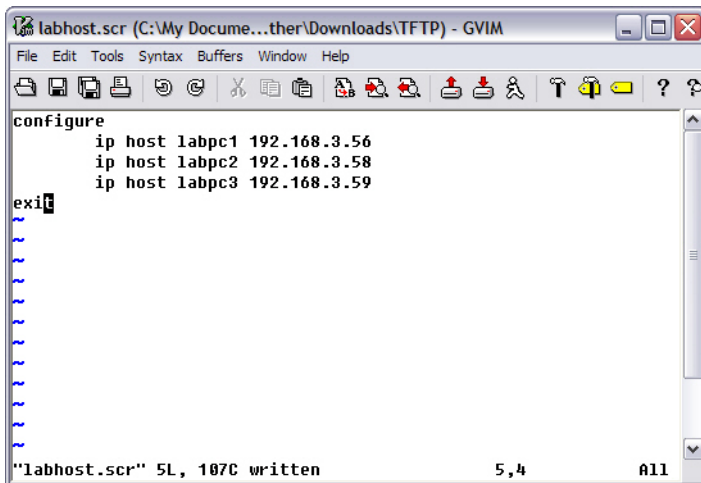
## Managing Configuration Scripts

This example shows how to create a configuration script that adds three hostname-to-IP address mappings to the host table.

To configure the switch:

- 1 Open a text editor on an administrative computer and type the commands as if you were entering them by using the CLI.

**Figure 13-10. Create Config Script**



2 Save the file with an \*.scr extension and copy it to the appropriate directory on your TFTP server.

3 Download the file from the TFTP server to the switch.

```
console#copy tftp://10.27.65.103/labhost.scr script
labhost.scr
Transfer Mode..... TFTP
Server IP Address..... 10.27.65.103
Source File Path..... ./
Source Filename..... labhost.scr
Data Type..... Config Script
Destination Filename..... labhost.scr
Management access will be blocked for the duration of the
transfer
Are you sure you want to start? (y/n)
```

4 After you confirm the download information and the script successfully downloads, it is automatically validated for correct syntax.

```
Are you sure you want to start? (y/n) y

135 bytes transferred

Validating configuration script...
configure
exit
configure
ip host labpc1 192.168.3.56

ip host labpc2 192.168.3.58

ip host labpc3 192.168.3.59

Configuration script validated.
File transfer operation completed successfully.
```

5 Run the script to execute the commands.

```
console#script apply labhost.scr

Are you sure you want to apply the configuration script? (y/n)y

configure
exit
configure
ip host labpc1 192.168.3.56
```

```
ip host labpc2 192.168.3.58

ip host labpc3 192.168.3.59

Configuration script 'labhost.scr' applied.
```

## 6 Verify that the script was successfully applied.

```
console#show hosts
Host name: jmclendon
Default domain: rtp.dell.com
Name/address lookup is enabled
DNS source interface :Default
Name servers (Preference order): 192.168.3.20, 192.168.3.21
Configured host name-to-address mapping:
Host                               Addresses
-----
labpc1                             192.168.3.56
labpc2                             192.168.3.58
labpc3                             192.168.3.59
cache: TTL (Hours)
Host      Total      Elapsed Type      Addresses
-----
No hostname is mapped to an IP address
```

## Managing Files by Using the USB Flash Drive

In this example, the administrator copies the backup image to a USB flash drive before overwriting the backup image on the switch with a new image. The administrator also makes a backup copy of the running-config by copying it to a USB flash drive. After the backups are performed, the administrator copies a new image from the USB flash drive to the switch to prepare for the upgrade.

This example assumes the new image is named `new_img.stk` and has already been copied from an administrative host onto the USB flash drive.

To configure the switch:

- 1 Insert the USB flash drive into the USB port on the front panel of the switch. The USB flash drive is automatically mounted.
- 2 Copy the backup image from the switch to the USB flash drive.

```
console#copy backup usb://img_backup.stk
```

```
Mode..... Binary
Data Type..... Code
```

Management access will be blocked for the duration of the transfer

Are you sure you want to start? (y/n) **y**

- 3 Copy the running-config to the USB flash drive.

```
console#copy running-config usb://rc_backup.scr
```

```
Mode..... Binary
Data Type..... Config Script
Source Filename..... temp-config.scr
```

Management access will be blocked for the duration of the transfer

Are you sure you want to start? (y/n) **y**

- 4 Download the new image from the USB flash drive to the switch. The image overwrites the backup image.

```
console#copy usb://new_image.stk backup
```

```
Mode..... Binary
Data Type..... Code
Destination Filename..... backup
```

Management access will be blocked for the duration of the transfer

Are you sure you want to start? (y/n) **y**

- 5 To activate the new image after it has been successfully downloaded to the switch, follow the procedures described in Upgrading the Firmware, starting with [step 5](#).

# DHCP and USB Auto-Configuration

## Dell EMC Networking N-Series Switches

The topics covered in this chapter include:

- Auto Configuration Overview
- What Are the Dependencies for DHCP Auto Configuration?
- Default Auto Configuration Values
- Managing Auto Configuration (Web)
- Managing Auto Configuration (CLI)
- Auto Configuration Example

## Auto Configuration Overview

The Auto Configuration feature can automatically update the firmware image and obtain configuration information when the switch boots. Auto Configuration begins the automatic download and installation process when the switch or management unit in the stack is initialized and no configuration file (startup-config) is found, or when the switch boots and loads a saved configuration that has Auto Configuration enabled. Auto Configuration is enabled by default. Allow downgrade is also enabled by default.

The Auto Configuration feature includes two components:

- USB Auto Configuration
- DHCP Auto Install

If no saved startup configuration file is found on the switch and the Auto Configuration feature is enabled (which it is by default), the Auto Configuration process begins. If a USB device is connected to the Dell EMC Networking N-Series switch USB port and contains the appropriate file(s), the switch uses the USB Auto Configuration feature to update the configuration or image. If the USB Auto Configuration fails - either because it is disabled, no USB storage device is present, or no configuration or images files are present on the USB storage device, the switch uses the DHCP Auto Install process.



**NOTE:** Neither USB Configuration nor Auto Install is invoked if a saved startup configuration file is on the switch.

## What Is USB Auto Configuration?

The USB Auto Configuration feature can be used to configure or upgrade one or more switches that have not been previously configured, such as when new switches are deployed, and it is desirable to record the IP/MAC address pairs along with the configuration and firmware version on a USB key for recovery purposes. Before deploying the switch, the following steps must be performed to install pre-deployment configuration and firmware to specific switches:

- 1 Create a text file that contains IP addresses and netmasks (and optionally, MAC addresses) and file names that are parsed and used to configure the switch. The optional MAC address used to identify the switch is the MAC address of the base MAC address of the switch, although the feature will accept any of the switch MAC addresses (see "Dell EMC Networking N3200-ON Series Switch Hardware" on page 183 for further information). The IP address and netmask are the minimum required fields in the configuration file. Refer to the example below for an explanation of the file format.
- 2 Copy the file onto a USB device, along with any desired switch firmware and configuration files.
- 3 Insert the USB device into the front-panel USB port on the Dell EMC Networking N-Series switch.

When the Auto Configuration process starts and no saved startup-config file is present on the switch, the feature automatically searches a plugged-in USB device for configuration information and firmware images. Note that only .stk files are recognized by USB Auto-Configuration. Mixed stack .itb images are not recognized by USB Auto-Configuration.

## What Files Does USB Auto Configuration Use?

The USB Auto Configuration feature uses the following file types:

- \*.setup file for initial switch configuration
- \*.text file for configuration information
- \*.stk file for software image installation



- \*.itb images are not recognized

The Auto Configuration feature first searches the USB device for a file with a \*.setup extension. If only one .setup file is present, the switch uses the file.

When multiple \*.setup files are present, the switch uses only the dellswitch.setup file. If no dellswitch.setup file is available, the switch checks for a file with a \*.text configuration file and a \*.stk image file. If multiple .text files exist, the switch uses the dellswitch.text file. If only a \*.stk file is present, the switch checks the .stk file version and loads it into the backup image if the version is later than the current active image. If multiple \*.stk files are present, the switch checks the image with the highest (most recent) version. Finally, if no \*.setup, \*.text, or \*.stk files are found, the switch proceeds to the DHCP Auto Configuration process.

## **How Does USB Auto Configuration Use the Files on the USB Device?**

The \*.setup file can include the following information:

- MAC address of the switch (optional)
- IP address and netmask (mandatory)
- Config file (optional)
- Firmware Image file (optional)

### **MAC Address Lookup**

The switch MAC address should be on the same line as the IP address and configuration file and/or image file name to allow a specific switch (identified by its MAC address) to be associated with a specific config file or image. The IP address on the line is assigned as the switch management IP address.

### **IP Address Lookup**

If the switch MAC address is not found within the .setup file, the first line that contains an IP address and no MAC address and is not marked in-use will be used by the switch to assign the management IP address/netmask. This method allows a group of IP addresses to be handed out without regard to the specific switch identified by the MAC address. A switch will mark a line as invalid if it is read and failed to properly parse if, for example, it contains an invalid configuration, a duplicate IP address or an image file name that is not

available. Once a switch selects an IP address from the file, it adds its MAC address to the line, marks the line as in-use, and updates the file on the USB device.

If the \*.setup file configuration line contains an IP address but no configuration or image file names, the management IP address will be assigned, and then the feature will search the USB device for files with the .text and .stk extensions, which indicates that all switches will be using the same configuration file and/or image on the USB device. This method allows different IP addresses to be assigned, but the same configuration file or image is downloaded to multiple switches. Alternatively, the line may contain a specific configuration or image file name, or both.

After the current switch has been configured and/or upgraded and the completion message is displayed on the switch, the current line in the \*.setup text file will be marked as used. This allows using the \*.setup file for additional switches without manually changing the file. The USB device can then be removed and inserted into the next switch to begin the process again. Also, the switch MAC address of a switch that has been automatically configured is added to the beginning of the line (if no MAC address was specified in the file) for lines using the IP address lookup method so that the MAC and IP address combinations are recorded within the \*.setup file for future use bindings.

At the start of the next USB auto download, if all lines in the \*.setup file are marked as already “in-use” or “invalid,” and there is no MAC address match for a switch, the process will halt, and a message similar to the following is displayed on the console:

```
<###> APR 22 08:32:43 Error: Auto Configuration has terminated
due to there being no more lines available for use within the
USB file "XXXXX.setup".
```

## Configuration File

The \*.text configuration file identified in the \*.setup file contains the running-config to be loaded on to the switch. The configuration file may be specified on a line in the .setup file to assign specific configuration to specific switches, or, if it is desired to assign a single configuration to all switches, the configuration file need not be specified in the .setup file as long as it is present on the USB device. The configuration file specified in the \*.setup file

should exist on the USB device. It must have a .text file name extension. No other file name extension is allowed. For information about the format and contents of the \*.text file, see Editing and Downloading Configuration Files.

## Image File

If the Auto Configuration process includes a switch image upgrade, the name of the image file may optionally be included in the \*.setup file. If it is desired to assign a specific image to a specific set of switches. If it is desired to use a single image for all switches being upgraded, it is not necessary to include the image file name in the .setup file as long as it is present on the USB device. The specified image file should exist on the USB device.

## What Is the Setup File Format?

The setup file must have a \*.setup extension or this part of the Auto Configuration process will never begin. If there are multiple .setup files located on the USB device, the dellswitch.setup file will be utilized. If no dellswitch.setup file is present and there are multiple .setup files present, the Auto Configuration process does not start.

The general format of the configuration file lines is as follows. The IP address and subnet mask are always required on each line of the .setup file. The MAC address, configuration file, and image file name entries are optional.

```
MAC_address  IP_Address  Subnet_Mask  Config_File  Image_File
```

The following example shows a \*.setup example for two switches:

```
2180.c200.0010 192.168.0.10 255.255.255.0 switch-A.text N2000v6.0.1.3.stk  
3380.c200.0011 192.168.0.11 255.255.255.0 switch-B.text N2000v6.0.1.3.stk
```

After a line has been read and implemented by the Auto Configuration feature, it automatically adds “in-use” to the end of the line to ensure that the information is not utilized for the next switch. To replicate the entire USB auto configuration process, the “in-use” statements from the .setup file need to be removed while leaving the inserted MAC address information. Then, if the process is restarted, the MAC address/IP address combinations will be ensured for any switch that has previously attempted upgrade and all other switch upgrades can take place as if for the first time.

## What Is the DHCP Auto Configuration Process?

If the USB Auto Configuration fails or is not used, the switch can use a DHCP server to obtain configuration information from a TFTP server. DHCP Auto Configuration is initiated every time the switch receives an address lease via DHCP.

DHCP Auto Configuration is accomplished in three phases:

- 1 Assignment or configuration of an IP address for the switch
- 2 Assignment of a TFTP server
- 3 Obtaining image, network and host configuration files for the switch from a TFTP server

Auto Configuration is successful when an image or configuration file is downloaded to the switch or management unit in the stack from a TFTP server and processed.



**NOTE:** The downloaded configuration file is not automatically saved to startup-config. You must explicitly issue a save request (**copy running-config startup-config**) in order to save the configuration. If the downloaded configuration is not saved to the startup-config, DHCP auto configuration will be done every time the DHCP lease expires.

## What Files Does DHCP Auto-Configuration Use?

DHCP Auto-Configuration uses three types of files:

- Image Configuration File: This file contains a single line of ASCII text with the path and filename of the switch firmware image located on the TFTP server.
- Network Configuration File: This file contains one or more lines of ASCII text with the command **ip host** followed by a switch IP address and a host name on each line.
- Host Configuration File: This file contains one or more lines of ASCII CLI configuration that are executed in Privileged Exec mode on the switch. Each line contains a single command.

## Obtaining IP Address Information

DHCP is enabled by default on the Out-of-Band (OOB) interface on Dell EMC Networking N2200X-ON, N3000E-ON, N3100-ON, and N3200-ON Series switches. DHCP is enabled by default on VLAN 1 on the Dell EMC Networking N1100-ON, N1500, N2000, and N2100-ON Series switches. If an IP address has not been assigned, the switch issues requests for an IP address assignment.

A network reachable DHCP server may return the following information:

- IP address and subnet mask to be assigned to the switch
- IP address of a default gateway, if needed for IP communication

After an IP address is assigned to the switch, if a hostname is not already assigned, Auto Configuration issues a DNS request for the corresponding hostname. This hostname is also displayed as the CLI prompt (as in response to the **hostname** command).

## Obtaining Other Dynamic Information

The following information is also processed and if returned by a BOOTP or DHCP server:

- Name of a host configuration file (boot-file-name) to be downloaded from the TFTP server.  
The DHCP option 67 boot-file-name field can contain both a relative path and file name.
- Name of an image configuration file (DHCP Option 125, sub-option 5).
- Identification of the TFTP server storing the file. The TFTP server can be identified by name or by IP address as follows:
  - hostname: DHCP option 66 or the *sname* field in the DHCP header)
  - IP address: DHCP option 150 or the *siaddr* field in the DHCP header
- Domain Name Server - Option 6
- SYSLOG Server - Option 7
- Client Host Name - Option 12
- Domain Name - Option 15
- NTP Server - Option 42

When a DHCP OFFER identifies the TFTP server in multiple options, the DHCP client selects from the options in the following order: *sname*, option 66, option 150, *siaddr*. If the TFTP server is identified by hostname, a reachable DNS server is required to translate the name to an IP address.

### Obtaining the Switch Firmware Image

Auto Configuration attempts to download an image configuration file from a TFTP server only if no startup configuration file was found in the internal flash or a USB drive. A saved configuration with Auto Configuration enabled will not cause Auto Configuration to run.

The network DHCP server may return a DHCP OFFER message with option 125 sub-option 5. When configuring the network DHCP server for image downloads, include Option 125 and specify the Dell Enterprise Number, 674. Within the Dell section of option 125, sub-option 5 must specify the path and name of an image configuration file on the TFTP server. This file is not the image file itself, but rather a text file that contains the relative path and name of the image file on the TFTP server. Upon receipt of option 125 with sub-option 5, the switch downloads the image configuration file from the TFTP server, reads the path and name of the image file and downloads the image file from the TFTP server.

For example, one might enter the following information:

- A2-02-00-00 — Dell Enterprise number 674. It should be written from right to left. The number 674 in hexadecimal notation is 02 a2 00 00.
- 0c — Data Length (12 decimal)
- 05 — Sub-option code 5
- 0a — Sub-option length (10 decimal)
- Conversion of the file name from ACSII to hexadecimal:  
"Config.txt" – 43-6F-6E-66-69-67-2E-74-78-74

The Config.txt file should contain the full name of the image file on the TFTP server, including the relative path name, e.g.,

N3000E-ON\_N2000v6.3.0.1.stk

or

mytftpserverpath/N3000E-ON\_N2000v6.3.0.1.stk

After the switch successfully downloads and installs the new image, it automatically reboots. On reboot, Auto Configuration will run again if no saved configuration is present on the switch and no USB configuration is present.

The download or installation might fail for one of the following reasons:

- The path or filename of the image on the TFTP server does not match the information specified in the file identified in DHCP option 125 sub option 5.
- The downloaded image is the same as the current image.
- The validation checks, such as valid CRC Checksum, fails.

If the download or installation was unsuccessful, a message is logged.



**NOTE:** In stack of switches, the downloaded image is pushed to all members attached to the stack at the time of download. For members who join the stack after the download, the Stack Firmware Synchronization feature, if enabled, will push the downloaded image to all members.

### Obtaining Configuration Files

If the DHCP OFFER identifies a host-specific configuration path/file, in DHCP option 67, the switch attempts to download and process the host configuration file. The DHCP option 67 field may contain both a relative path and file name component in the form directory/subdirectory/././filename up to 128 characters in length.

Host configuration files consist of a series of CLI configuration commands, one per line. The host configuration file is processed in Privileged Exec mode. Only commands that will appear in the running-config are processed. Action commands such as **locate** will cause an error and the remainder of the configuration script will not be processed.



**NOTE:** The configuration file is required to have a file name that matches the following pattern: "\*.cfg"

The TFTP client makes three unicast requests if the TFTP server is reachable. A TFTP server is not reachable if it does not respond to ARP, if its DNS name (DHCP option 66) does not resolve, or if the TFTP server does

not respond to TFTP Read Requests. If the unicast attempts fail, or if the DHCP OFFER did not specify a TFTP server address, the auto-configuration download fails.

If the DHCP server does not specify a host configuration file in DHCP option 67 or download of the host-specific configuration file fails, the Auto Configuration process makes three attempts to download a network configuration file with the name `dell-net.cfg`. The switch unicasts or broadcasts TFTP requests for a network configuration file in the same manner as it attempts to download a host-specific configuration file.

The network configuration file consists of a set of IP address-to-hostname mappings, using the command `ip host hostname address`. The switch finds its own IP address, as learned from the DHCP server, in the configuration file and extracts its hostname from the matching command. If the default network configuration file does not contain the switch's IP address, the switch attempts a reverse DNS lookup to resolve its hostname.

A sample `dell-net.cfg` file might appear as follows:

```
config
...
ip host switch1 192.168.1.10
ip host switch2 192.168.1.11
... <other hostname definitions>
exit
```

If a hostname has been identified in the network configuration file or in the DHCP offer, the switch issues up to three TFTP requests for a host configuration file named `hostname.cfg`, where `hostname` is the first thirty-two characters of the switch's hostname.

If the switch is unable to map its IP address to a hostname, or no prior host configuration file has been downloaded, Auto Configuration sends up to three TFTP requests for the generic host configuration file `host.cfg`.



Table 14-1 summarizes the config files that may be downloaded and the order in which they are sought. A Yes in the Final File Sought column means that a successful download terminates the Auto Configuration process.

**Table 14-1. Configuration File Possibilities**

Order Sought	File Name	Description	Final File Sought
1	<bootfile>.cfg	Host-specific config file from DHCP option 67, ending in a *.cfg file extension	Yes
2	dell-net.cfg	Default network config file	No
3	<hostname>.cfg	Host-specific config file, associated with hostname.	Yes
4	host.cfg	Default config file	Yes

Table 14-2 displays the determining factors for issuing unicast or broadcast TFTP requests.

**Table 14-2. TFTP Request Types**

TFTP Server Address Available	Host-specific Switch Config Filename Available	TFTP Request Method
Yes	Yes	Issue a unicast request for the host-specific router config file to the TFTP server
Yes	No	Issue a unicast request for a default network or router config file to the TFTP server
No	Yes	Issue a broadcast request for the host-specific router config file to any available TFTP server
No	No	Issue a broadcast request for the default network or router config file to any available TFTP server

## Monitoring and Completing the DHCP Auto Configuration Process

When the switch boots and triggers an Auto Configuration, a message displays on the console screen to indicate that the process is starting. After the process completes, the Auto Configuration process writes a log message. When Auto Configuration has successfully completed, the **show running-config** command can be used to validate the contents of configuration.

### Saving a Configuration

The Auto Configuration feature includes an AutoSave capability that allows the downloaded configuration to be automatically saved; however, AutoSave is disabled by default. If AutoSave has not been enabled, you must explicitly save the downloaded configuration in nonvolatile memory on the management unit in the stack. This makes the configuration available for the next reboot. In the CLI, this is performed by issuing a **write** command or **copy running-config startup-config** command and should be done after validating the contents of saved configuration.

If the downloaded configuration is not saved to the startup-config, the configuration will be reloaded by the switch every time the DHCP lease expires.

### Stopping and Restarting the Auto Configuration Process

The Auto Configuration process can be terminated at any time before the image or configuration file is downloaded. This is useful when the switch is disconnected from the network. Termination of the Auto Configuration process ends further periodic requests for a host-specific configuration file.

The Auto Configuration process automatically starts after a reboot if the startup-config file is not found on the switch. The configuration file will not be found if it has never been saved on the switch, or if you issue a command to erase the configuration file (**erase startup-config**).

### Managing Downloaded Config Files

The configuration files downloaded by Auto Configuration are stored in the nonvolatile memory as .scr files. The files may be managed (viewed or deleted) along with files downloaded by the configuration scripting utility. The script files may not contain commands that are not capable of being saved in the running configuration, for example, **locate**.

A file is not automatically deleted after it is downloaded. The file does not take effect upon a reboot unless you explicitly save the configuration (the saved configuration takes effect upon reboot). If you do not save the configuration downloaded by the Auto Configuration feature, the Auto Configuration process occurs again on a subsequent reboot or when the DHCP lease expires. This may result in one of the previously downloaded files being overwritten.

### **What Are the Dependencies for DHCP Auto Configuration?**

The Auto Configuration process from TFTP servers depends upon the following network services:

- A DHCP server must be configured on the network with appropriate services.
- An image file and a text file containing the image file name for the switch must be available from a TFTP server if a firmware update is desired.
- A configuration file (a default file such as `host.cfg` or a specific path/file name using DHCP option 67 `boot-file-name`) for the switch must be available from a TFTP server if a configuration update is desired from a specific file on the TFTP server. DHCP option 67 may contain a path name in addition to the file name.
- The switch must be connected to the network and have a Layer-3 interface that is in an UP state.
- A DNS server must contain an IP address to hostname mapping for the TFTP server if the DHCP server response identifies the TFTP server by name.
- A DNS server must contain an IP address to hostname mapping for the switch if a `<hostname>.cfg` file is to be downloaded.
- If a default gateway is needed to forward TFTP requests, an IP helper address for TFTP needs to be configured on the default gateway.


# Default Auto Configuration Values

Table 14-3 describes the Auto Configuration defaults.

**Table 14-3. Auto Configuration Defaults**

Feature	Default	Description
Auto Install Mode	Enabled	When the switch boots and no saved configuration is found, Auto Configuration automatically begins.
Retry Count	3	When the DHCP or BootP server returns information about the TFTP server and a DHCP option 67 boot-file-name, the switch makes three unicast TFTP requests for the specified file. If the unicast attempts fail or if a TFTP server address was not provided, the switch makes three broadcast requests to any available TFTP server for the specified file.
AutoSave	Disabled	If the switch is successfully auto-configured, the running configuration is not saved to the startup configuration after applying the DHCP option 67 configuration.
AutoReboot	Enabled	After an image is successfully downloaded during the Auto Configuration process, the switch automatically reboots and makes the downloaded image the active image.

# Managing Auto Configuration (Web)

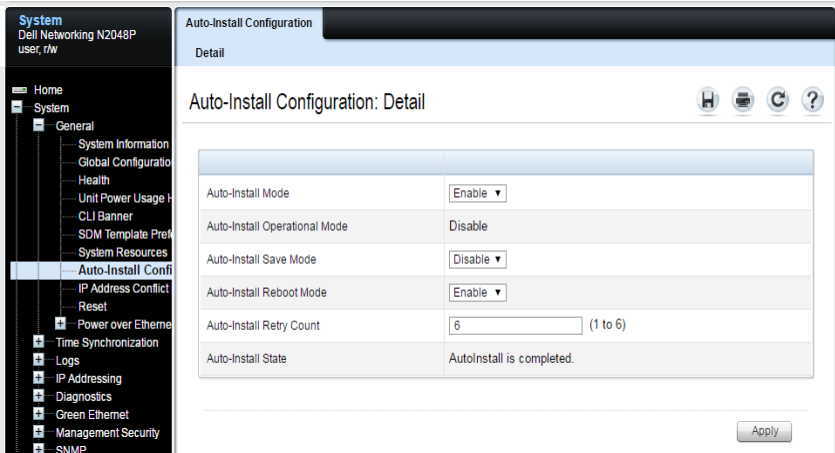
This section provides information about the OpenManage Switch Administrator pages to use to manage images and files on Dell EMC Networking Series Switches. For details about the fields on a page, click  at the top of the Dell EMC OpenManage Switch Administrator web page.

## Auto-Install Configuration

Use the **Auto-Install Configuration** page to allow the switch to obtain network information (such as the IP address and subnet mask) and automatically download a host-specific or network configuration file during the boot process if no startup-config file is found.

To display the **Auto Configuration** page, click **System** → **General** → **Auto-Install Configuration** in the navigation panel.

**Figure 14-1. Auto-Install Configuration**



# Managing Auto Configuration (CLI)

This section provides information about the commands you manage the Auto-Install Configuration feature on the switch. For more information about these commands, see the *Dell EMC Networking N1100-ON, N1500, N2000, N2100-ON, N2200-ON, N3000E-ON, N3100-ON, and N3200-ON Series Switches CLI Reference Guide* at [www.dell.com/support](http://www.dell.com/support).

## Managing Auto Configuration

Use the following commands to manually activate the Auto Configuration process and download a configuration script from a remote system to the switch, validate the script, and activate it.



**NOTE:** The Auto Configuration feature begins automatically when the switch is booted and no startup-config file is found or if the system boots and finds the **boot host dhcp** command in the startup-config file.

Command	Purpose
<code>configure</code>	Enter Global Configuration mode.
<code>boot host dhcp</code>	Enable Auto Configuration for the next reboot cycle. The command does not change the current behavior of Auto Configuration, but it does save the command to NVRAM.
<code>boot host auto-save</code>	Allow the switch to automatically save the configuration file downloaded to the switch by the Auto Configuration feature.
<code>boot host retry-count retries</code>	Specify the number of attempts to download the file (by sending unicast TFTP requests, and if unsuccessful, broadcast TFTP requests) specified in the response from the DHCP server.
<code>boot host auto-reboot</code>	Allow the switch to automatically reboot when the image is successfully downloaded through the Auto Configuration feature.
<code>exit</code>	Exit to Privileged Exec mode.
<code>show boot</code>	Displays the current status of the Auto Configuration process.

# Auto Configuration Example

A network administrator is deploying three Dell EMC Networking N-Series switches and wants to quickly and automatically install a specific version of switch firmware and a common configuration file that configures basic settings such as VLAN creation and membership, RADIUS server settings, and 802.1X information. The configuration file also contains the command **boot host auto-save** so that the downloaded configuration is automatically saved to the startup config.

This section describes two ways to enable automatic configuration file download:

- Enabling USB Auto Configuration and Auto Image Download
- Enabling DHCP Auto Configuration and Auto Image Download

## Enabling USB Auto Configuration and Auto Image Download

This example describes how to deploy three switches and automatically install a custom configuration file on the switch and install a specific version of switch firmware by using the USB Auto Configuration feature. The switches have the following MAC addresses:

- Switch A: 001E.C9AA.AC17
- Switch B: 001E.C9AA.AC20
- Switch C: 001E.C9AA.AC33

To configure each switch with a pre-assigned IP address, include the switch MAC address in the .setup file on the line containing the corresponding IP address/netmask. An IP address and netmask are the minimum mandatory elements of each configuration line in the configuration file.

To use USB auto configuration:

- 1** Create a default config file for each switch (or one configuration file for all switches). For example, the configuration files may be named `switchA.txt`, `switchB.txt`, and `switchC.txt`. For information about creating configuration files, see *Images and File Management*.
- 2** Copy the configuration files to a USB device.
- 3** Copy the image file(s) to the USB device. In this example, the firmware file that each switch will download is named `N2000v6.1.0.1.stk` or `N2000v6.2.0.1.stk`.

- 4 Create a setup file named `dellswitch.setup`. The setup file contains the following lines:

```
192.168.0.1 255.255.255.0 switchA.txt N2000v6.1.0.1.stk
192.168.0.2 255.255.255.0 switchB.txt N2000v6.2.0.1.stk
192.168.0.3 255.255.255.0 switchC.txt N2000v6.2.0.1.stk
```

- 5 Copy the `dellswitch.setup` file to the USB device.
- 6 Connect the USB device to Switch A.
- 7 Insert the USB device into the USB port on the front panel of Switch A.
- 8 Power on Switch A. If no startup-config file is found, the Easy Startup wizard will begin. Press N to skip the Easy Startup wizard and the USB Auto Configuration process will begin. If necessary, delete the startup-config file and reboot the switch.

The configuration in `switchA.txt` file is downloaded to the switch, and the management interface acquires network information. After the process completes, a message displays to indicate the status. The `dellswitch.setup` file is updated to add the term `in-use` to the end of the line. The `N2000v6.1.0.1.stk` firmware is also downloaded to the switch and activated.

- 9 Remove the USB device from Switch A and insert it into Switch B.
- 10 Repeat the process to connect a port to the network. Power on the switch to begin the USB Auto Configuration process on Switch B.
- 11 Remove the USB device from Switch B after the process completes, and repeat the steps to perform the USB Auto Configuration process on Switch C. Note that switch A will use the 6.1.0.1 firmware and switches B and C will be loaded with 6.2.0.1 firmware.

## Enabling DHCP Auto Configuration and Auto Image Download

If no USB device is connected to the USB port on the Dell EMC Networking N-Series switch and no configuration file is found during the boot process, the Auto Configuration feature uses the DHCP Auto Configuration process to download the configuration file to the switch. This example describes the procedures to complete the configuration.

To use DHCP auto configuration:



- 1** Create a default config file for the switches named `host.cfg`. The `host.cfg` file contains the path and name of the image file on the TFTP server (option 125, sub-option 5). For information about creating configuration files, see Images and File Management.
- 2** Upload the `host.cfg` file to the TFTP server.
- 3** Upload the image file to the TFTP server.
- 4** Configure an address pool on the DHCP server to contain the following information:
  - a** The IP address (*yiaddr*) and subnet mask (option 1) to be assigned to the interface
  - b** The IP address of a default gateway (option 3)
  - c** DNS server address (option 6)
  - d** Name of config file for each host
  - e** Identification of the TFTP server by hostname (DHCP option 66 or the *sname* field in the DHCP header) or IP address (DHCP option 150 or the *siaddr* field in the DHCP header)
  - f** Name of the text file (option 125, the V-I vendor-specific Information option) that contains the image file name and path.

For example, one might enter the following information:

- 00-00-02-A2 — Enterprise number 674. The number 674 in hexadecimal notation is 00 00 02 A2.
  - 0a — Data Length (10 decimal)
  - 05 — Sub option code 5
  - 08 — Sub option length (8 decimal)
  - Conversion of the file name from ACSII to hexadecimal  
"host.cfg" - 68-6F-73-74-46-63-66-67
- 5** Connect a port (OOB port for out-of-band management or any switch port that is a member of VLAN 1 for in-band management) on each switch to the network.
  - 6** Boot the switches.

## Easy Firmware Upgrade/Downgrade via USB

If a USB device is detected during bootup and there is switch firmware on the USB device (and no .setup files and no .text files), and the switch has no saved startup config file, then the latest version of firmware on the USB device is checked against the active firmware version on the switch. If a newer<sup>1</sup> image version is found on the USB device, the image is copied to the switch backup and the switch reloads using the new firmware version.

- 1 Copy the startup-config file to the backup-config; e.g., **copy startup-config backup-config**.
- 2 Delete the startup-config file; e.g., **del startup-config**.
- 3 Put the new image on a cleanly formatted USB stick and insert the USB stick into the management unit in the stack.
- 4 Reboot the management unit in the stack and skip the Easy Startup configuration wizard by pressing N when prompted.
- 5 After the upgrade completes, copy the backup-config to the startup-config, remove the USB stick, and reload the stack. The startup configuration is migrated to the new syntax when loaded into the running-config. Check the running-config, make any necessary adjustments and then save the running-config into the startup-config.

If the latest firmware version on the USB drive is the same version as the backup firmware on the switch, the backup firmware is made active. If the latest firmware version on the USB drive is the same version as the active firmware, no action is taken. Otherwise, the switch copies the latest firmware version on the USB drive to the switch backup and makes the backup firmware active for the next reload.

The USB drive may contain multiple versions of firmware. Only firmware versions that are compatible with the switch hardware are considered in the upgrade/downgrade process. Only the latest version of firmware on the USB drive is selected for the image upgrade/downgrade process unless a specific version of firmware is identified in the .setup file.

1. If an older version of firmware is found on the USB and the **boot auto-copy-sw allow-downgrade** option is selected (default setting), the switch will be downgraded.

# Monitoring Switch Traffic

## Dell EMC Networking N-Series Switches

This chapter describes sFlow features, Remote Monitoring (RMON), and Port Mirroring features.

The topics covered in this chapter include:

- Traffic Monitoring Overview
- Default Traffic Monitoring Values
- Monitoring Switch Traffic (Web)
- Monitoring Switch Traffic (CLI)
- Traffic Monitoring Examples
- Encapsulated Remote Port Analyzer

## Traffic Monitoring Overview

The switch maintains statistics about network traffic that it handles. It also has embedded technology that collects and sends information about traffic to other devices. Dell EMC Networking N-Series switches include support for flow-based monitoring through sFlow and Remote Network Monitoring (RMON) agents.

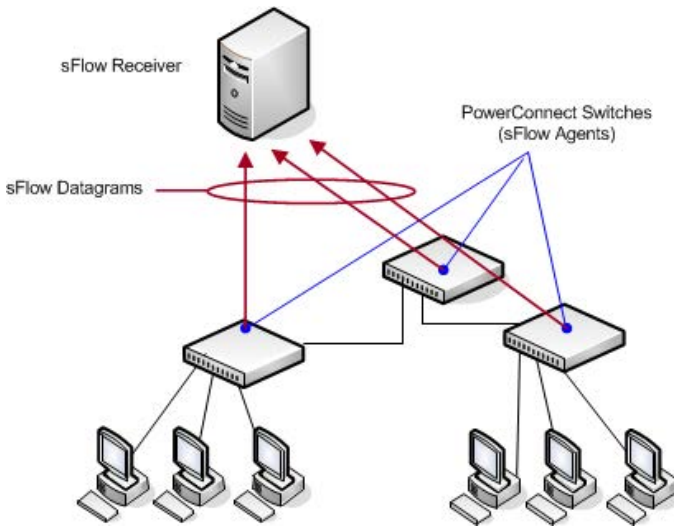
### What is sFlow Technology?

sFlow is an industry standard technology for monitoring high-speed switched and routed networks. Dell EMC Networking N-Series switch software has a built-in sFlow agent that can monitor network traffic on each port and generate sFlow data to an sFlow receiver (also known as a collector). sFlow helps to provide visibility into network activity, which enables effective management and control of network resources. sFlow is an alternative to the NetFlow network protocol, which was developed by Cisco Systems. The switch supports sFlow version 5.

As illustrated in Figure 15-1, the sFlow monitoring system consists of sFlow Agents (such as Dell EMC Networking N-Series switches) and a central sFlow receiver. sFlow Agents use sampling technology to capture traffic statistics

from monitored devices. sFlow datagrams forward sampled traffic statistics to the sFlow Collector for analysis. Up to eight different sFlow receivers can be specified to which the switch sends sFlow datagrams.

**Figure 15-1. sFlow Architecture**



The advantages of using sFlow are:

- It is possible to monitor all ports of the switch continuously, with no impact on the distributed switching performance.
- Minimal memory/CPU is required. Samples are not aggregated into a flow-table on the switch; they are forwarded immediately over the network to the sFlow receiver.
- The sFlow system is tolerant to packet loss in the network because statistical modeling means the loss is equivalent to a slight change in the sampling rate.
- sFlow receiver can receive data from multiple switches, providing a real-time synchronized view of the whole network.
- The receiver can analyze traffic patterns based on protocols found in the headers (e.g., TCP/IP, IPX, Ethernet, AppleTalk...). This alleviates the need for a Layer-2 switch to decode and understand all protocols.

## **sFlow Sampling**

The sFlow Agent in the Dell EMC Networking software uses two forms of sampling:

- Statistical packet-based sampling of switched or routed Packet Flows
- Time-based sampling of counters

Packet Flow Sampling and Counter Sampling are performed by sFlow Instances associated with individual Data Sources within an sFlow Agent. Both types of samples are combined in sFlow datagrams. Packet Flow Sampling creates a steady, but random, stream of sFlow datagrams that are sent to the sFlow Collector. Counter samples may be taken opportunistically to fill these datagrams.

To perform Packet Flow Sampling, an sFlow Sampler Instance is configured with a Sampling Rate. Packet Flow sampling results in the generation of Packet Flow Records. To perform Counter Sampling, an sFlow Poller Instance is configured with a Polling Interval. Counter Sampling results in the generation of Counter Records. sFlow Agents collect Counter Records and Packet Flow Records and send them as sFlow datagrams to sFlow Collectors.

### ***Packet Flow Sampling***

Packet Flow Sampling, carried out by each sFlow instance, ensures that any packet observed at a Data Source has an equal chance of being sampled, irrespective of the Packet Flow(s) to which it belongs.

Packet Flow Sampling is accomplished as follows:

- A packet arrives on an interface.
- The Network Device makes a filtering decision to determine whether the packet should be dropped.
- If the packet is not filtered (dropped) a destination interface is assigned by the switching/routing function.
- A decision is made on whether or not to sample the packet.

The mechanism involves a counter that is decremented with each packet. When the counter reaches zero a sample is taken.

- When a sample is taken, the counter indicating how many packets to skip before taking the next sample is reset. The value of the counter is set to a random integer where the sequence of random integers used over time is the Sampling Rate.

### ***Counter Sampling***

The primary objective of Counter Sampling is to efficiently, periodically export counters associated with Data Sources. A maximum Sampling Interval is assigned to each sFlow instance associated with a Data Source.

Counter Sampling is accomplished as follows:

- sFlow Agents keep a list of counter sources being sampled.
- When a Packet Flow Sample is generated the sFlow Agent examines the list and adds counters to the sample datagram, least recently sampled first. Counters are only added to the datagram if the sources are within a short period, 5 seconds say, of failing to meet the required Sampling Interval.
- Periodically, say every second, the sFlow Agent examines the list of counter sources and sends any counters that must be sent to meet the sampling interval requirement.

The set of counters is a fixed set.

### **What is RMON?**

Like sFlow, RMON is a technology that enables the collection and analysis of a variety of data about network traffic. Dell EMC Networking N-Series switch software includes an RMON probe (also known as an RMON agent) that collect information and analyze packets. The data that is collected is defined in the RMON MIB, RFC 2819.

RMON is defined in an Internet Engineering Task Force (IETF) specification and is an extension of the SNMP MIB. The RMON information can be viewed locally on the switch or by using a generic RMON console on a network management station (NMS). SNMP does not need to be configured on the switch to view the RMON data locally. However, if you use a management station to view the RMON data that the switch collects and analyzes, you must configure the following SNMP settings:

- Set up the SNMP community string to be used by the SNMP manager at a given IP address.

- Specify the network management system IP address or permit management access from all IP addresses.

For more information about configuring SNMP, see "SNMP" on page 513.

The RMON agent in the switch supports the following groups:

- Group 1—Statistics. Contains cumulative traffic and error statistics.
- Group 2—History. Generates reports from periodic traffic sampling that are useful for analyzing trends.
- Group 3 —Alarm. Enables the definition and setting of thresholds for various counters. Thresholds can be passed in either a rising or falling direction on existing MIB objects, primarily those in the Statistics group. An alarm is triggered when a threshold is crossed and the alarm is passed to the Event group. The Alarm requires the Event Group.
- Group 9 —Event. Controls the actions that are taken when an event occurs. RMON events occur when:
  - A threshold (alarm) is exceeded
  - There is a match on certain filters.



**NOTE:** The switch supports RMON1.

## What is Port Mirroring?

Port mirroring is used to monitor the network traffic that a port sends and receives. The Port Mirroring feature creates a copy of the traffic that the source port handles and sends it to a destination port. The source port is the port that is being monitored. The destination port is where a network protocol analyzer (probe) is connected. Dell EMC Networking N-Series switches also support RSPAN destinations where traffic can be tunneled across the operational network over a VLAN.

A port monitoring session includes one or more source ports that mirror traffic to a single destination port (also known as a probe port). Sources can include VLANs, physical interfaces, port-channels, the internal CPU port, and IP or MAC ACL flows. Certain sources are not supported; i.e., physical members of a port-channel, VLANs that contain a LAG member, etc. Up to four monitoring sessions, each with a unique destination port, may be configured. Destination (probe) ports, once configured, no longer participate

in spanning tree, IGMP/MLD snooping, or GVRP; do not learn MAC addresses (learned MAC addresses are purged); do not participate in routing (route entries are purged); and do not utilize any static filter configuration. Incoming packets are dropped. Probe ports “lose” their VLAN membership, i.e. they do not forward/flood packets based on VLAN membership. Changing VLAN membership does not affect a probe port until the port is removed from probe status. Traffic transmitted into a probe port from the connected station is dropped. The original configuration of a destination port is restored when the port is no longer configured as a destination port. A probe port should be connected to a network analyzer or intrusion detection system and should never be connected to a network as control plane traffic from the mirrored sources is transmitted to the probe.

On ingress, the port mirroring logic stage is after the VLAN tag processing stage in the hardware. This means that mirrored packets may not appear the same as they do on the wire if VLAN tag processing occurs. Examples of VLAN tag processing are DVLAN tunneling (QinQ) or VLAN rewriting.

Likewise, on egress, the port mirroring logic stage is before the VLAN tag processing stage. This means that, on egress, packets may not appear as they do on the wire if processing such as VLAN or CoS value rewriting is programmed.

Each source port can be configured whether to mirror ingress traffic (traffic the port receives, or RX), egress traffic (traffic the port sends, or TX), or both ingress and egress traffic.

An ACL can be configured to filter traffic and attached to a port-mirroring session. This is often useful to reduce the amount of traffic transmitted to the probe port. The ACL filter is configured on the source switch. An ACL filter is internally re-configured as an egress ACL on the destination interface/reflector port. All criteria in the ACL are marked with the *mirror* attribute (and the RSPAN VLAN) to match the mirrored traffic (including the implicit deny-all). If configuring an egress ACL on the destination port, care must be taken with the ACL numbering to ensure the mirrored traffic is properly processed.



**NOTE:** A DiffServ policy class definition or an ACL can be created that mirrors specific types of traffic to a destination port. For more information, see “Differentiated Services” on page 1531 or “Access Control Lists” on page 713.



The packet that is mirrored to the destination port is normally in the same format as the original packet on the wire, except as noted in the following section: Port Mirroring Behaviors. This means that the mirrored packet is VLAN tagged or untagged as it was received/transmitted on the source port. Destinations include physical interfaces and RSPAN VLANs.

Mirrored traffic is subject to the same QoS constraints as normal traffic. Oversubscribed traffic (both mirrored and un-mirrored) will be dropped in accordance with the configured or default policy. The operator may assign CoS or DiffServ policies to the mirrored traffic in the same manner as for normal traffic. RSPAN traffic is transmitted with a PCP of 0.

After configuring the port mirroring session, enable or disable the administrative mode of the session to start or stop the probe port from receiving mirrored traffic.

## Port Mirroring Behaviors

The following behaviors are applicable to port mirroring:

- The following source port types may be configured in more than one session in support of M:N mirroring:
  - Physical ports
  - LAGs
  - CPU

VLANs and RSPAN may not be configured as mirroring sources in more than a single session. VLAN mirroring is not recommended for RSPAN if sources on multiple switches are members of the VLAN. This is because as stations communicate with each other over the mirrored VLAN, duplicate packets will be sent to the probe: once for the source port, and once for each switch over which the packet is received in the source VLAN.

- Only one destination (probe) is supported for a session. Logical and CPU ports cannot be configured as a probe port. The destination (probe) port loses its VLAN configuration when port mirroring is enabled. The VLAN configuration is restored when the port is no longer configured for a monitor session. Traffic transmitted by the connected station into a probe port is dropped. The mirrored source and the transit ports retain their VLAN configuration. VLAN-based mirroring is applicable only for ingress traffic.

- When port mirroring is enabled, all MAC address entries associated with destination ports are purged. This prevents transmitting packets out of the port that are not seen on the mirrored port. If spanning tree is enabled, this is treated as a topology change.
- The spanning tree protocol is disabled on destination ports such that frames are always received from or transmitted out of the port as soon as the port is up (spanning tree status is forwarding and role is disabled). This is analogous to always setting the spanning tree state of the port to forwarding. When a port is no longer configured to be the destination port, spanning tree is re-enabled for that port, if configured. Note that the disabling of spanning tree on a destination port means that administrators must only connect the destination port to directly attached probes to avoid the possibility of a network loop.
- GVRP is disabled on destination ports such that GVRP PDUs are never received from or transmitted to the port. Dynamic registrations are not allowed on a destination port. The GVRP configuration at the port is maintained and is reapplied when the port is no longer part of the SPAN.
- All static filters, both ingress and egress, are disabled on destination ports.
- If routing is enabled on a destination port or an RSPAN VLAN, all route entries associated with that port are purged. From a routing perspective, the interface is marked as down.
- Generally, the configuration of the source port is undisturbed so that its behavior remains the same as if it was not mirrored.
- Packets locally generated by the switch and transmitted over a source port are not mirrored in an RSPAN VLAN mirroring session.
- The internal CPU port is allowed as a source port for local monitoring sessions only (not allowed for RSPAN). If the internal CPU port is mirrored, packets received and generated by the CPU for all ports are mirrored.
- On ingress, the port mirroring logic stage is after the VLAN tag processing stage in the hardware. This means that mirrored packets may not appear the same as they do on the wire if VLAN tag processing occurs. Examples of VLAN tag processing are DVLAN tunneling (QinQ) or VLAN rewriting. Likewise, on egress, the port mirroring logic stage is before the VLAN tag

processing stage. This means that on egress, packets may not appear as they do on the wire if processing such as VLAN or CoS value rewriting is programmed.

## **RSPAN**

Administrators should consider reserving a few VLANs across the network for the exclusive use of RSPAN. The RSPAN VLANs should only be configured on the reflector interfaces (generally the uplink/transit/downlink interface). Each RSPAN session must use a unique reflector port, destination port, and RSPAN VLAN. Reflector ports (source/transit/destination) should be configured in trunk or general mode and should be members of the RSPAN VLAN. Do not assign other ports to the RSPAN VLANs.

Mirrored traffic is encapsulated in the RSPAN VLAN on the reflector port on the source switch. On a source switch, when both an RSPAN VLAN and reflector port are configured on a trunk or general mode port with other VLANs, the interface can also carry normal traffic on the other VLANs. For example, an uplink interface (trunk port) can carry both the RSPAN traffic and other traffic. Do not configure the RSPAN VLAN as a native VLAN on interfaces other than the uplink/transit/downlink interfaces. Be sure to remove the RSPAN VLAN from ports on which mirrored traffic should not be encapsulated and transported (e.g. trunk ports).

For RSPAN, the original tag is not retained for tagged traffic received/transmitted at the source port(s).

When configuring VLAN mirroring, the source VLAN cannot be the same as the RSPAN VLAN. The source VLAN and the destination RSPAN VLAN cannot be configured on the same port. A source VLAN is mirrored in the ingress direction only. Careful consideration to placement of VLAN source mirroring sessions will allow bidirectional traffic to be mirrored using VLAN mirroring. An alternative is to use port mirroring and a VLAN ACL filter if duplicate packets are received on the probe device.

Bidirectional mirroring of multiple ports in a network may result in duplicate packets transmitted on the probe port (one copy for the receive side and another copy for the transmit side). Configuring the mirroring as RX only may help to reduce this issue.

The reflector port must be configured as the only member of the RSPAN VLAN on the source switch. The source interface must be configured as the only member of the RSPAN VLAN on the destination switch. Configuring a source that mirrors to the RSPAN VLAN on the destination switch is not supported.

RSPAN intermediate switches may also be configured with multiple source ports feeding into an existing RSPAN VLAN. The source configuration requires an interface parameter so traffic mirrored on the intermediate switch is not flooded across the entire RSPAN VLAN. Place probe ports upstream of the intermediate switch in this case.

Configuring a second session on a source switch that mirrors RSPAN traffic from the reflector port is not supported. Configuring a second session on a source switch that mirrors an RSPAN source port to a local probe port is supported.

If an ACL filter is specified, the ACL must be created prior to its use in an RSPAN configuration. The ACL filter is configured on the source switch. ACL filters are internally configured as an egress ACL on the destination interface/reflector port. All the criteria in the ACL are marked with the *mirror* attribute (and the RSPAN VLAN) to match the mirrored traffic (including the implicit deny-all). If configuring an egress ACL on the destination port, care must be taken with the ACL numbering to ensure the mirrored traffic is properly processed.

RSPAN VLANs must be configured with the **remote-span** command prior to configuration in an RSPAN session.

VLAN mirroring is not recommended for RSPAN if sources on multiple switches are members of the VLAN. This is because, as stations communicate with each other over the mirrored VLAN, duplicate packets will be sent to the probe: once for the source port, and once for each switch over which the packet is received in the source VLAN.

## Remote Capture

The Remote Capture feature enables mirroring packets transmitted and received by the switch CPU to a remote client for packet analysis using the Wireshark tool. This feature can be used to help diagnose switch behavior or monitor traffic sent to the switch CPU. The capture feature can also be configured to capture to a local file or to an in-memory buffer.

## Why is Traffic Monitoring Needed?

Monitoring the traffic that the switch handles, as well as monitoring all traffic in the network, can help provide information about network performance and utilization. This information can be useful in network planning and resource allocation. Information about traffic flows can also help troubleshoot problems in the network.

## Default Traffic Monitoring Values

The sFlow agent is enabled by default, but sampling and polling are disabled on all ports. Additionally, no sFlow receivers (collectors) are configured. Table 15-1 contains additional default values for the sFlow feature.


**Table 15-1. sFlow Defaults**

Parameter	Default Value
Receiver timeout for sampling	0
Receiver port	6343
Receiver Maximum Datagram Size	1400 bytes
Maximum header size	128 bytes

RMON is enabled by default, but no RMON alarms, events, or history statistic groups are configured.

Port mirroring is disabled, and no ports are configured as source or destination ports. After you configure a port mirroring session, the administrative mode is disabled until you explicitly enable it.

# Monitoring Switch Traffic (Web)

This section provides information about the OpenManage Switch Administrator pages to use to monitor network traffic on Dell EMC Networking N1100-ON, N1500, N2000, N2100-ON, N2200-ON, N3000E-ON, N3100-ON, and N3200-ON Series switches. For details about the fields on a page, click  at the top of the Dell EMC OpenManage Switch Administrator web page.

## sFlow Agent Summary

Use the sFlow Agent Summary page to view information about sFlow MIB and the sFlow Agent IP address.

To display the Agent Summary page, click **System** → **sFlow** → **Agent Summary** in the navigation panel.

**Figure 15-2. sFlow Agent Summary**

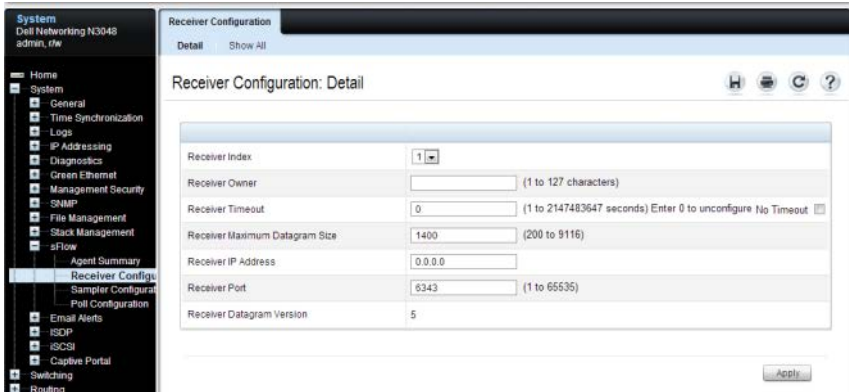


## sFlow Receiver Configuration

Use the sFlow Receiver Configuration page to configure settings for the sFlow receiver to which the switch sends sFlow datagrams. Up to eight sFlow receivers can be configured to receive datagrams.

To display the Receiver Configuration page, click **System** → **sFlow** → **Receiver Configuration** in the navigation panel.

**Figure 15-3. sFlow Receiver Configuration**



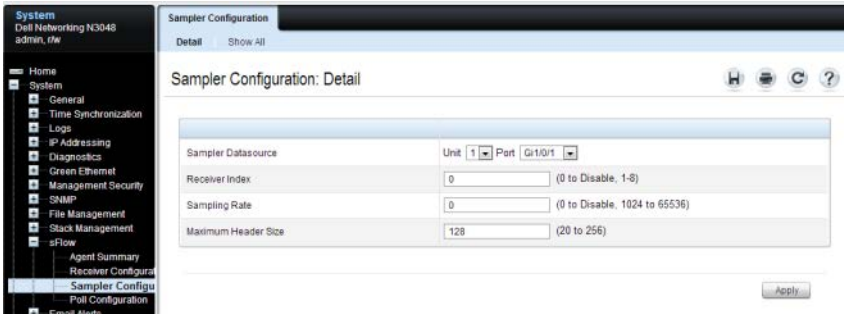
Click **Show All** to view information about configured sFlow receivers.

## sFlow Sampler Configuration

Use the sFlow Sampler Configuration page to configure the sFlow sampling settings for switch ports.

To display the Sampler Configuration page, click **System** → **sFlow** → **Sampler Configuration** in the navigation panel.

**Figure 15-4. sFlow Sampler Configuration**



Click **Show All** to view information about configured sampler data sources.



## sFlow Poll Configuration

Use the sFlow **Poll Configuration** page to configure how often a port should collect counter samples.

To display the **Poll Configuration** page, click **System** → **sFlow** → **Poll Configuration** in the navigation panel.

**Figure 15-5. sFlow Poll Configuration**



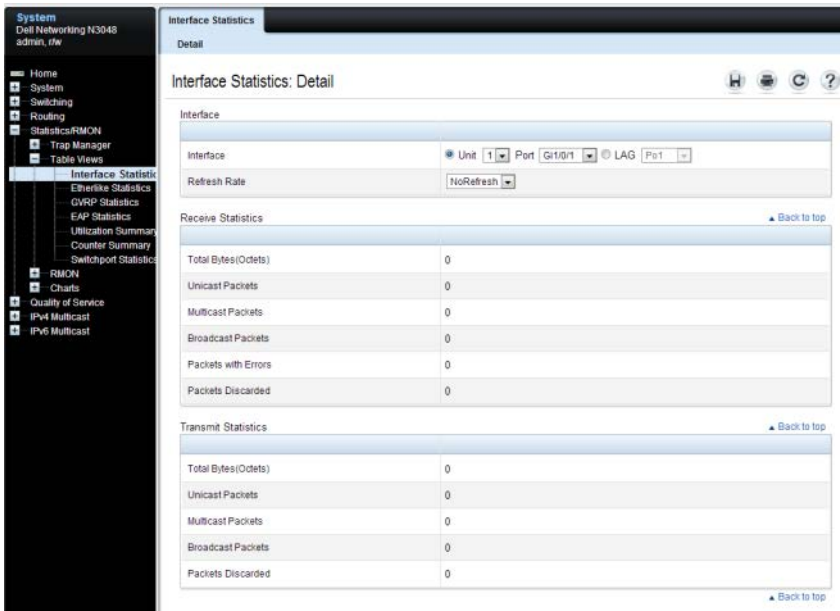
Click **Show All** to view information about the ports configured to collect counter samples.

## Interface Statistics

Use the **Interface Statistics** page to display statistics for both received and transmitted packets. The fields for both received and transmitted packets are identical.

To display the page, click **Statistics/RMON** → **Table Views** → **Interface Statistics** in the navigation panel.

**Figure 15-6. Interface Statistics**



## Etherlike Statistics

Use the Etherlike Statistics page to display interface statistics.

To display the page, click **Statistics/RMON** → **Table Views** → **Etherlike Statistics** in the navigation panel.

**Figure 15-7. Etherlike Statistics**

The screenshot shows the 'Etherlike Statistics: Detail' page. The left navigation pane is expanded to 'Etherlike Statistics'. The main content area displays the following:

- Interface:** Unit 1, Port Gi1/0/1, LAG, Po1
- Refresh Rate:** NoRefresh
- Frame Errors:** A table with 6 rows, all showing 0 errors.
- Pause Frames:** A table with 2 rows, both showing 0 frames.
- Clear** button at the bottom right.

Frame Errors	
Frame Check Sequence(FCS)Errors	0
Single Collision Frames	0
Late Collisions	0
Excessive Collisions	0
Internal MAC Transmit Errors	0
Oversize Packets	0
Internal MAC Receive Errors	0

Pause Frames	
Received Pause Frames	0
Transmitted Pause Frames	0

## GVRP Statistics

Use the GVRP Statistics page to display switch statistics for GVRP.

To display the page, click **Statistics/RMON** → **Table Views** → **GVRP Statistics** in the navigation panel.

**Figure 15-8. GVRP Statistics**

The screenshot shows the GVRP Statistics page in a network management system. The left sidebar contains a navigation menu with the following items: Home, System, Switching, Routing, Statistics/RMON, Trap Manager, Table Views, Interface Statistics, Etherlike Statistics, **GVRP Statistics**, EAP Statistics, Utilization Summary, Counter Summary, Switchport Statistics, RMON, Charts, Quality of Service, IPv6 Multicast, and IPv6 Multicast.

The main content area is titled "GVRP Statistics: Detail" and includes the following sections:

- Interface:** A configuration area with fields for "Interface" (Unit: 1, Port: Gi1/0/1, LAG: Po1), "Refresh Rate" (NoRefresh), and a "Detail" tab.
- GVRP Statistics Table:** A table showing statistics for various GVRP states. The table has three columns: "Attribute", "Received", and "Transmitted".
- Error Statistics:** A table showing error statistics for GVRP. The table has two columns: "Error Statistics" and "Received".

Attribute	Received	Transmitted
Join Empty	0	0
Empty	0	0
Leave Empty	0	0
Join In	0	0
Leave In	0	0
Leave All	0	0

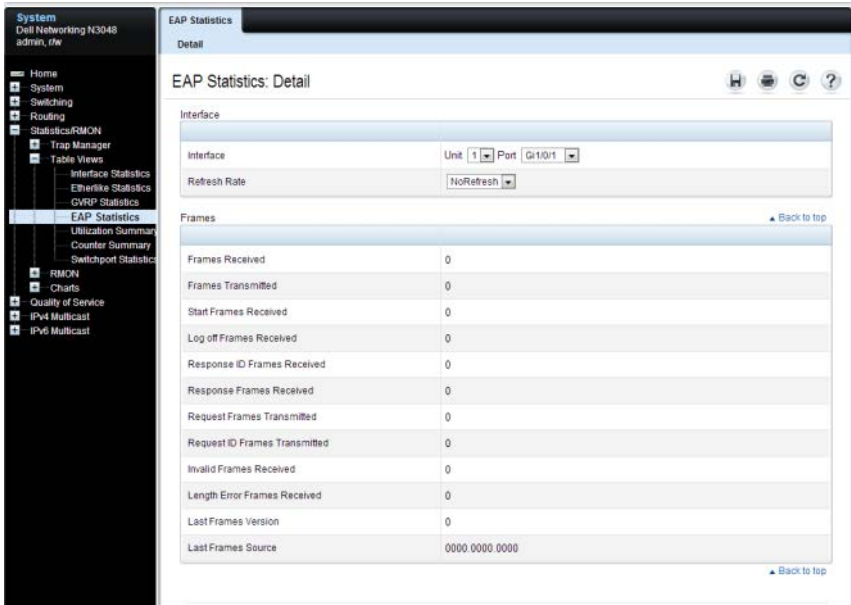
Error Statistics	Received
Invalid Protocol ID	0
Invalid Attribute Type	0
Invalid Attribute Value	0
Invalid Attribute Length	0
Invalid Event	0

## EAP Statistics

Use the **EAP Statistics** page to display information about EAP packets received on a specific port. For more information about EAP, see "Port and System Security" on page 705.

To display the **EAP Statistics** page, click **Statistics/RMON** → **Table Views** → **EAP Statistics** in the navigation panel.

**Figure 15-9. EAP Statistics**



## Utilization Summary

Use the Utilization Summary page to display interface utilization statistics.

To display the page, click **Statistics/RMON** → **Table Views** → **Utilization Summary** in the navigation panel.

**Figure 15-10. Utilization Summary**

The screenshot shows the 'Utilization Summary' page in a network management system. The left sidebar contains a navigation menu with the following items: System, Home, System, Switching, Routing, Statistics/RMON, Trap Manager, Table Views, Interface Statistics, Ethernet Statistics, OSPF Statistics, EAP Statistics, Utilization Summary (highlighted), Counter Summary, Switchport Statistics, RMON, Charts, Quality of Service, IPv4 Multicast, and IPv6 Multicast.

The main content area is titled 'Utilization Summary: Detail' and includes the following sections:

- Unit:** A dropdown menu showing '1'.
- Refresh Rate:** A dropdown menu showing 'NoRefresh'.
- Interfaces:** A table with columns: Interface, Interface Status, Unicast Packets Received(%), Non Unicast Packets Received(%), and Error Packets Received(%). The table shows five interfaces (Gi1/0/1 to Gi1/0/5) all with a status of 'Down' and 0% utilization.
- LAGs:** A table with columns: LAGs, Interface status, Unicast Packets Received(%), Non Unicast Packets Received(%), and Error Packets Received(%). The table shows five LAGs (Po1 to Po5) all with a status of 'Down' and 0% utilization.

## Counter Summary

Use the Counter Summary page to display interface utilization statistics in numeric sums as opposed to percentages.

To display the page, click **Statistics/RMON** → **Table Views** → **Counter Summary** in the navigation panel.

**Figure 15-11. Counter Summary**

The screenshot shows the Counter Summary page for a Dell Networking N3048 switch. The navigation menu on the left includes System, Home, System, Switching, Routing, Statistics/RMON, Trap Manager, Table Views, Interface Statistics, Etherlike Statistics, GVRP Statistics, EAP Statistics, Utilization Summary, Counter Summary, Switchport Statistics, RMON, Charts, Quality of Service, IPv4 Multicast, and IPv6 Multicast. The main content area is titled 'Counter Summary: Detail' and includes the following sections:

- Unit:** A form with 'Unit No.' set to 1.
- Refresh Rate:** A dropdown menu set to 'NoRefresh'.
- Interfaces:** A table showing statistics for interfaces Gi1/0/1 through Gi1/0/5. All interfaces are in a 'Down' status.
- LAGs:** A table showing statistics for LAGs Po1 through Po5. All LAGs are in a 'Down' status.

Interface	Interface Status	Received Unicast Packets	Transmit Unicast Packets	Received Non Unicast Packets	Transmit Non Unicast Packets	Received Errors	Transmit Errors	Received Discards	Transmit Discards
Gi1/0/1	Down	0	0	0	0	0	0	0	0
Gi1/0/2	Down	0	0	0	0	0	0	0	0
Gi1/0/3	Down	0	0	0	0	0	0	0	0
Gi1/0/4	Down	0	0	0	0	0	0	0	0
Gi1/0/5	Down	0	0	0	0	0	0	0	0

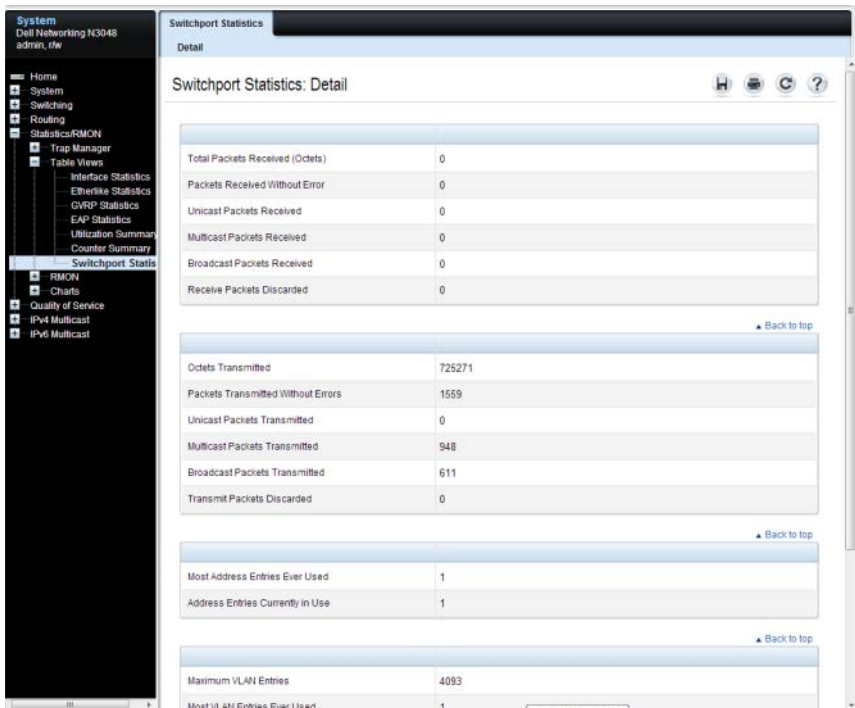
LAGs	Interface Status	Received Unicast Packets	Transmit Unicast Packets	Received Non Unicast Packets	Transmit Non Unicast Packets	Received Errors	Transmit Errors	Received Discards	Transmit Discards
Po1	Down	0	0	0	0	0	0	0	0
Po2	Down	0	0	0	0	0	0	0	0
Po3	Down	0	0	0	0	0	0	0	0
Po4	Down	0	0	0	0	0	0	0	0
Po5	Down	0	0	0	0	0	0	0	0

## Switchport Statistics

Use the **Switchport Statistics** page to display statistical summary information about switch traffic, address tables, and VLANs.

To display the page, click **Statistics/RMON** → **Table Views** → **Switchport Statistics** in the navigation panel.

**Figure 15-12. Switchport Statistics**



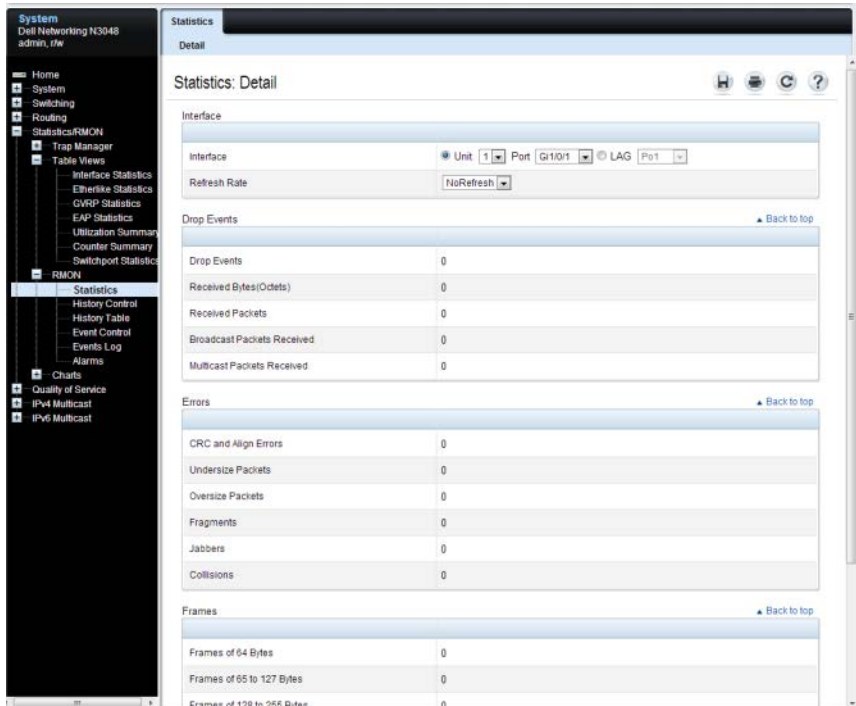


## RMON Statistics

Use the **RMON Statistics** page to display details about switch use such as packet processing statistics and errors that have occurred on the switch.

To display the page, click **Statistics/RMON** → **RMON** → **Statistics** in the navigation panel.

**Figure 15-13. RMON Statistics**

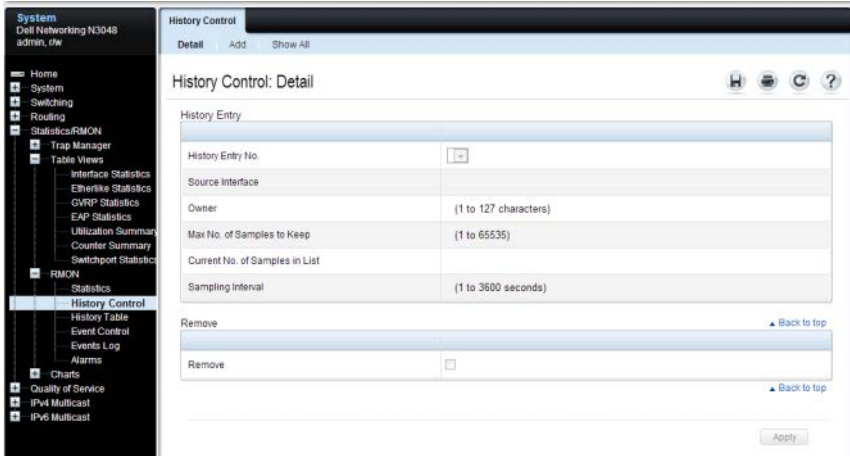


## RMON History Control Statistics

Use the **RMON History Control** page to maintain a history of statistics on each port. For each interface (either a physical port or a port-channel), the number of buckets and the time interval between each bucket snapshot can be configured.

To display the page, click **Statistics/RMON** → **RMON** → **History Control** in the navigation panel.

**Figure 15-14. RMON History Control**



### Adding a History Control Entry

To add an entry:

- 1 Open the **RMON History Control** page.
- 2 Click **Add**.

The **Add History Entry** page displays.

**Figure 15-15. Add History Entry**

New History Entry	1
Source Interface	<input checked="" type="radio"/> Unit <input type="radio"/> Port <input type="radio"/> LAG <input type="radio"/> Po1 Unit: 1 Port: G11/0/1
Owner	<input type="text"/> (1 to 127 characters)
Max No. of Samples to Keep	50 (1 to 65535)
Sampling Interval	1800 (1 to 3600 seconds)

Apply

- 3 Select the port or LAG on which you want to maintain a history of statistics.
- 4 Specify an owner, the number of historical buckets to keep, and the sampling interval.
- 5 Click **Apply** to add the entry to the **RMON History Control Table**.

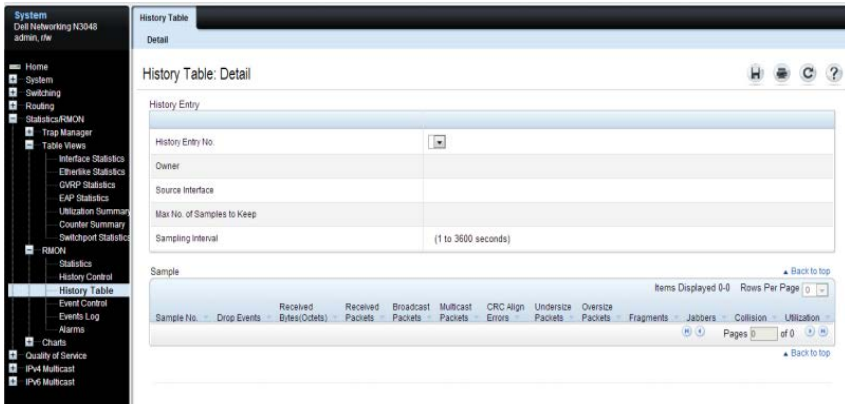
To view configured history entries, click the **Show All** tab. The **RMON History Control Table** displays. Configured history entries can be removed using this page.

## RMON History Table

Use the RMON History Table page to display interface-specific statistical network samplings. Each table entry represents all counter values compiled during a single sample.

To display the **RMON History Table** page, click **Statistics/RMON** → **RMON** → **History Table** in the navigation panel.

**Figure 15-16. RMON History Table**

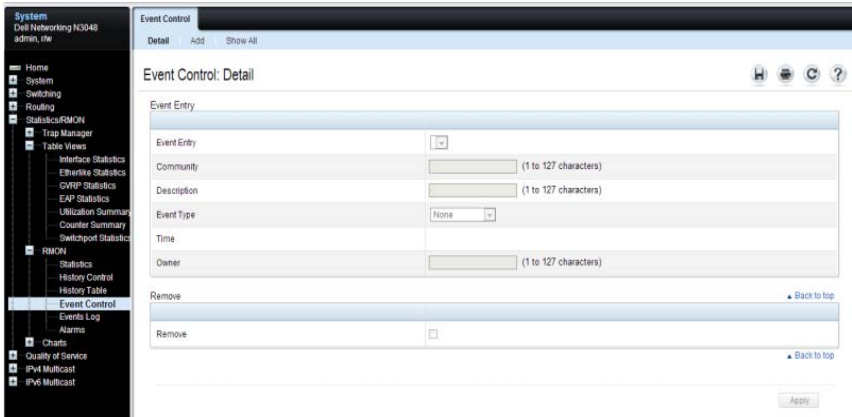


## RMON Event Control

Use the **RMON Events Control** page to define RMON events. Events are used by RMON alarms to force some action when a threshold is crossed for a particular RMON counter. The event information can be stored in a log and/or sent as a trap to a trap receiver.

To display the page, click **Statistics/RMON → RMON → Event Control** in the navigation panel.

**Figure 15-17. RMON Event Control**



### Adding an RMON Event

To add an event:

- 1 Open the **RMON Event Control** page.
- 2 Click **Add**.

The **Add an Event Entry** page displays.

**Figure 15-18. Add an Event Entry**

Event Entry	1
Community	<input type="text"/> (1 to 127 characters)
Description	<input type="text"/> (1 to 127 characters)
Event Type	None
Owner	<input type="text"/> (1 to 127 characters)

- 3 If the event sends an SNMP trap, specify the SNMP community to receive the trap.
- 4 Optionally, provide a description of the event and the name of the event owner.
- 5 Select an event type.
- 6 Click **Apply**.  
The event is added to the **RMON Event Table**, and the device is updated.

### **Viewing, Modifying, or Removing an RMON Event**

To manage an event:

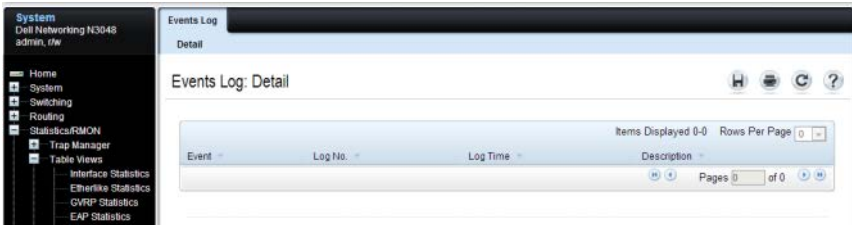
- 1 Open the **RMON Event Control** page.
- 2 Click **Show All** to display the **Event Control Table** page.
- 3 To edit an entry:
  - a Select the **Edit** check box in for the event entry to change.
  - b Modify the fields on the page as needed.
- 4 To remove an entry, select the **Remove** check box in for the event entry to remove.
- 5 Click **Apply**.

## RMON Event Log

Use the **RMON Event Log** page to display a list of RMON events.

To display the page, click **Statistics/RMON → RMON → Events Log** in the navigation panel.

**Figure 15-19. RMON Event Log**

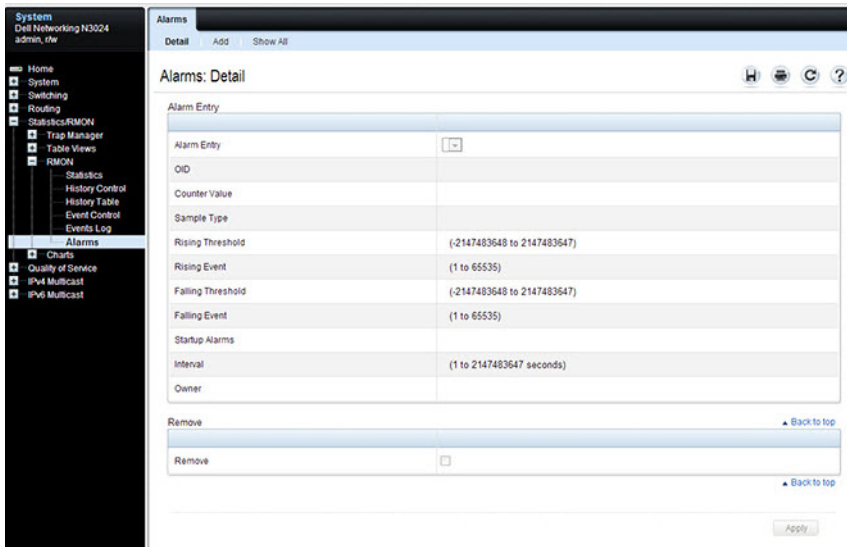


## RMON Alarms

Use the **RMON Alarms** page to set network alarms. Alarms occur when certain thresholds are crossed for the configured RMON counters. The alarm triggers an event to occur. The events can be configured as part of the RMON Events group. For more information about events, see "RMON Event Log" on page 631.

To display the page, click **Statistics/RMON → RMON → Alarms** in the navigation panel.

**Figure 15-20. RMON Alarms**





## Adding an Alarm Table Entry

To add an alarm:

1. Open the RMON Alarms page.
2. Click Add.

The Add an Alarm Entry page displays.

**Figure 15-21. Add an Alarm Entry**

Alarm Entry	1
OID	<input type="text"/>
Sample Type	Absolute
Rising Threshold	<input type="text"/> (-2147483648 to 2147483647)
Rising Event	<input type="text"/> (1 to 65535)
Falling Threshold	<input type="text"/> (-2147483648 to 2147483647)
Falling Event	<input type="text"/> (1 to 65535)
Startup Alarms	Rising
Interval	3600 (1 to 2147483647 seconds)
Owner	<input type="text"/> (1 to 127 characters)

Apply

3. Complete the fields on this page as needed. Use the help menu to learn more information about the data required for each field.
4. Click Apply.

The RMON alarm is added, and the device is updated.

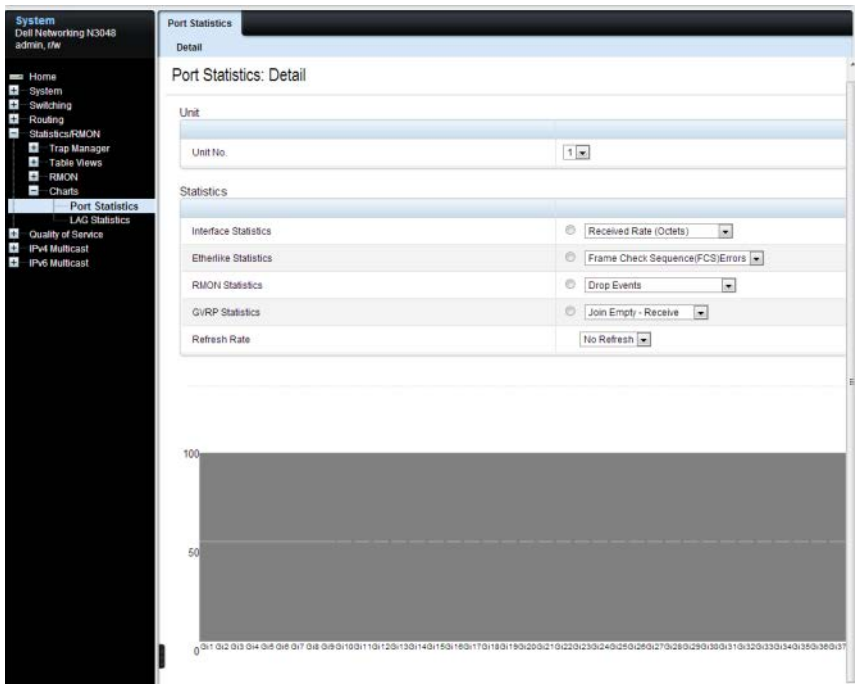
To view configured alarm entries, click the **Show All** tab. The **Alarms Table** displays. Configured alarms can be removed using this page.

## Port Statistics

Use the **Port Statistics** page to chart port-related statistics on a graph.

To display the page, click **Statistics/RMON** → **Charts** → **Port Statistics** in the navigation panel.

**Figure 15-22. Ports Statistics**

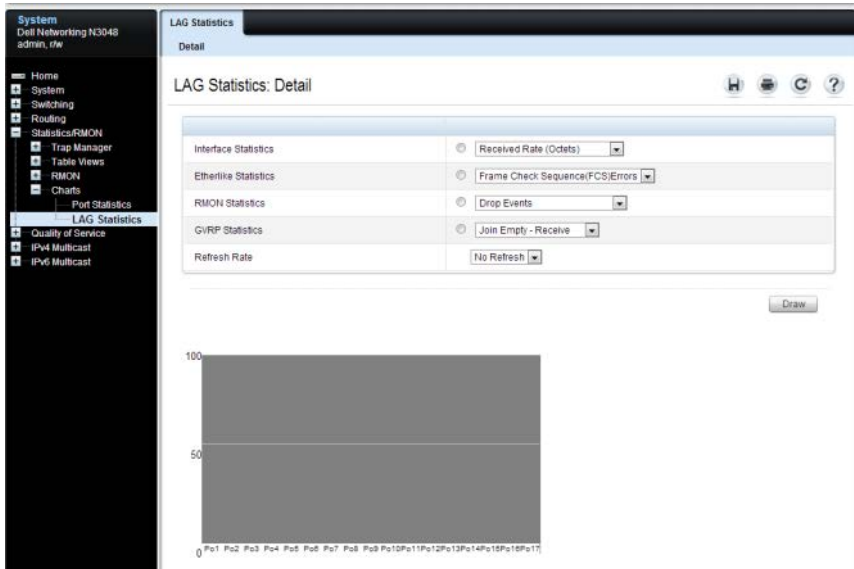


To chart port statistics, select the type of statistics to chart and (if desired) the refresh rate, then click **Draw**.

## LAG Statistics

Use the **LAG Statistics** page to chart LAG-related statistics on a graph. To display the page, click **Statistics/RMON** → **Charts** → **LAG Statistics** in the navigation panel.

**Figure 15-23. LAG Statistics**



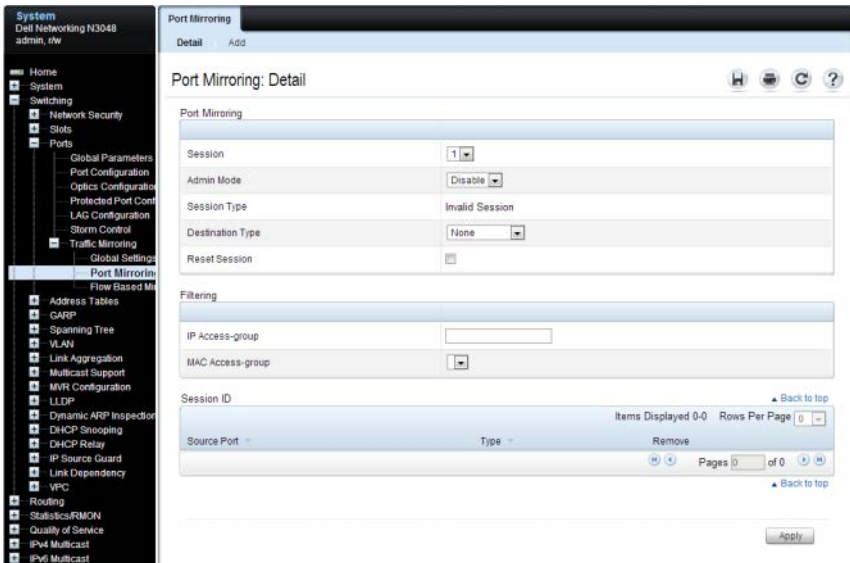
To chart LAG statistics, select the type of statistics to chart and (if desired) the refresh rate, then click **Draw**.

## Port Mirroring

Use the **Port Mirroring** page to create a mirroring session in which all traffic that is sent or received (or both) on one or more source ports is mirrored to a destination port.

To display the **Port Mirroring** page, click **Switching** → **Ports** → **Traffic Mirroring** → **Port Mirroring** in the navigation panel.

**Figure 15-24. Port Mirroring**



## Configuring a Port Mirror Session

To configure port mirroring:

- 1 Open the **Port Mirroring** page.
- 2 Click **Add**.  
The **Add Source Port** page displays.
- 3 Select the port to be mirrored.
- 4 Select the traffic to be mirrored.

**Figure 15-25. Add Source Port**

Port Mirroring: Add

Session: 1

Source Type: Port

Source Port: Unit 1 | Port Gi1/0/1 | LAG Po1

Type: Tx and Rx

Apply

- 5 Click Apply.
- 6 Repeat the previous steps to add additional source ports.
- 7 Click Port Mirroring to return to the Port Mirroring page.
- 8 Enable the administrative mode and specify the destination port.

**Figure 15-26. Configure Additional Port Mirroring Settings**

Port Mirroring: Detail

Port Mirroring

Session: 1

Admin Mode: Disable

Session Type: Invalid Session

Destination Type: None

Reset Session:

Filtering

IP Access-group:

MAC Access-group:

Session ID

Source Port	Type	Remove
Gi1/0/9	Tx and Rx	<input type="checkbox"/>
Gi1/0/10	Tx and Rx	<input type="checkbox"/>

Items Displayed 1-2 Rows Per Page 5

Pages 1 of 1

Apply

- 9 Click Apply.

# Monitoring Switch Traffic (CLI)

This section provides information about the commands you use to manage traffic monitoring features on the switch and to view information about switch traffic. For more information about these commands, see the *Dell EMC Networking N1100-ON, N1500, N2000, N2100-ON, N2200-ON, N3000E-ON, N3100-ON, and N3200-ON Series Switches CLI Reference Guide* at [www.dell.com/support](http://www.dell.com/support).

## Configuring sFlow

Use the following commands to configure the sFlow receiver and to configure the sampling and polling on switch interfaces.

Command	Purpose
<code>configure</code>	Enter Global Configuration mode
<code>sflow rcvr_index destination ip-address [port]</code>	Configure the address of the sFlow receiver and (optionally) the destination UDP port for sFlow datagrams. <ul style="list-style-type: none"><li>• <code>rcvr_index</code>—The index of this sFlow receiver (Range: 1–8).</li><li>• <code>ip-address</code>—The sFlow receiver IP address.</li><li>• <code>port</code>—The destination Layer-3 UDP port for sFlow datagrams. (Range: 1–65535).</li></ul>
<code>sflow rcvr_index destination owner owner_string timeout timeout</code>	Specify the identity string of the receiver and set the receiver timeout value.  <code>timeout</code> —The number of seconds the configuration will be valid before it is automatically cleared. A value of 0 essentially means the receiver is not configured.
<code>sflow rcvr_index destination maxdatagram size</code>	Specify the maximum number of data bytes that can be sent in a single sample datagram.  The receiver should also be set to this value to avoid fragmentation of the sFlow datagrams. (Range: 200–9116 bytes).

Command	Purpose
<code>sflow rcvr-index polling</code> <code>if_type if_number poll-</code> <code>interval</code>	<p>Enable a new sFlow poller instance on an interface range.</p> <ul style="list-style-type: none"> <li>• <i>rcvr-index</i> — The sFlow Receiver associated with the poller (Range: 1–8).</li> <li>• <i>if_type if_number</i> — The list of interfaces to poll. The interface type can be Gigabitethernet (gi) or Tengigabitethernet (te), for example <code>te1/0/3-5</code> enables polling on ports 3, 4, and 5.</li> <li>• <i>poll-interval</i> — The sFlow instance polling interval. A value of <i>n</i> means once in <i>n</i> seconds a counter sample is generated. (Range: 0–86400).</li> </ul>
<code>sflow rcvr-index</code> <code>sampling if_type</code> <code>if_number sampling-rate</code> <code>[size]</code>	<p>Enable a new sflow sampler instance for the specified interface range.</p> <ul style="list-style-type: none"> <li>• <i>rcvr-index</i> — The sFlow Receiver for this sFlow sampler to which flow samples are to be sent.</li> <li>• <i>if_type if_number</i> — The list of interfaces to sample. The interface type can be Gigabitethernet (gi) or Tengigabitethernet (te), for example <code>te1/0/3-5</code> enables polling on ports 3, 4, and 5.</li> <li>• <i>sampling-rate</i> — The statistical sampling rate for packet sampling from this source. A sampling rate of 1 counts all packets. A value of <i>n</i> means that out of <i>n</i> incoming packets, 1 packet will be sampled. (Range: 1024 - 65536).</li> <li>• <i>size</i> — The maximum number of bytes that should be copied from the sampler packet (Range: 20 - 256 bytes).</li> </ul>
<code>interface interface</code>	<p>Enter interface configuration mode for the specified interface. The <i>interface</i> variable includes the interface type and number, for example <code>tengigabitethernet 1/0/3</code> or <code>te1/0/3</code>.</p> <p>A range of interfaces can be specified using the <code>interface range</code> command. For example, <code>interface range tengigabitethernet 1/0/8-12</code> configures 10G Ethernet interfaces 8, 9, 10, 11, and 12.</p>
<code>sflow rcvr-index polling</code> <code>poll-interval</code>	<p>Enable a new sFlow poller instance for the interface.</p>

Command	Purpose
<code>sflow rcvr-index sampling</code> <i>sampling-rate</i> [size]	Enable a new sflow sampler instance for the interface.
<code>show sflow agent</code>	View information about the switch sFlow agent.
<code>show sflow index destination</code>	View information about a configured sFlow receivers.
<code>show sflow index polling</code>	View information about the configured sFlow poller instances for the specified receiver.
<code>show sflow index sampling</code>	View information about the configured sFlow sampler instances for the specified receiver.

## Configuring RMON

Use the following commands to configure RMON alarms, collection history, and events. The table also lists the commands you use to view information collected by the RMON probe.

Command	Purpose
<code>configure</code>	Enter Global Configuration mode
<code>rmon event number</code> [log] [trap community] [description string] [owner string]	Configure an RMON event. <ul style="list-style-type: none"> <li>• <i>number</i> — The event index. (Range: 1–65535)</li> <li>• <i>log</i> — Specify that an entry is made in the log table for each event.</li> <li>• <i>trap community</i> — If the event is an SNMP trap to be sent, it is sent to the SNMP community specified by this octet string. (Range: 0-127 characters)</li> <li>• <i>description string</i> — A comment describing this event. (Range 0-127 characters)</li> <li>• <i>owner string</i> — Enter a name that specifies who configured this event. If unspecified, the name is an empty string.</li> </ul>



Command	Purpose
<b>rmon alarm</b> <i>number</i> <i>variable interval</i> {absolute   delta} <b>rising-</b> <b>threshold</b> <i>value</i> [ <i>event-</i> <i>number</i> ] <b>rising-</b> <b>threshold</b> <i>value</i> [ <i>event-</i> <i>number</i> ] [ <b>startup</b> <i>direction</i> ] [ <b>owner</b> <i>string</i> ]	Add an alarm entry <ul style="list-style-type: none"> <li>• <i>number</i> — The alarm index. (Range: 1–65535)</li> <li>• <i>variable</i> — A fully qualified SNMP object identifier that resolves to a particular instance of an MIB object.</li> <li>• <i>interval</i> — The interval in seconds over which the data is sampled and compared with the rising and falling thresholds. (Range: 1–4294967295)</li> <li>• <b>rising-threshold</b> <i>value</i> — Rising threshold value. (Range: 0–4294967295)</li> <li>• <b>rising-threshold</b> <i>value</i> — Falling threshold value. (Range: 0–4294967295)</li> <li>• <i>event-number</i> — The index of the event that is used when a rising or falling threshold is crossed. (Range: 1–65535)</li> <li>• <b>delta</b> — The sampling method for the selected variable and calculating the value to be compared against the thresholds. If the method is delta, the selected variable value at the last sample is subtracted from the current value, and the difference compared with the thresholds.</li> <li>• <b>absolute</b> — The sampling method for the selected variable and calculating the value to be compared against the thresholds. If the method is absolute, the value of the selected variable is compared directly with the thresholds at the end of the sampling interval.</li> <li>• <b>startup</b> <i>direction</i> — The type of startup alarm, which can be <b>rising</b>, <b>falling</b>, or <b>rising-falling</b>.</li> <li>• <b>owner</b> <i>string</i> — Enter a name that specifies who configured this alarm.</li> </ul>
<b>interface</b> <i>interface</i>	Enter Interface Configuration mode for the specified port or LAG.

Command	Purpose
<code>rmon collection history</code> <code>index</code> [owner <code>ownername</code> ] [buckets <code>bucket-number</code> ] [interval <code>seconds</code> ]	Enable an RMON MIB history statistics group on the interface.  <b>NOTE:</b> You must configure RMON alarms and events before RMON collection history is able to display. <ul style="list-style-type: none"> <li><code>index</code>— The requested statistics index group. (Range: 1–65535)</li> <li><code>ownername</code>— Records the RMON statistics group owner name. If unspecified, the name is an empty string.</li> <li><code>bucket-number</code>— A value associated with the number of buckets specified for the RMON collection history group of statistics. If unspecified, defaults to 50. (Range: 1 - 65535)</li> <li><code>seconds</code>— The number of seconds in each polling cycle. If unspecified, defaults to 1800. (Range: 1–3600)</li> </ul>
CTRL + Z	Exit to Privileged Exec mode.
<code>show rmon</code> {alarms   collection history   events   history   log   statistics}	View information collected by the RMON probe.

## Viewing Statistics

Use the following commands in Privileged Exec mode to view statistics about the traffic handled by the switch.

Command	Purpose
<code>show interfaces counters</code> [errors] [{ <code>interface</code>   <code>port-channel</code> }]	Display the error counters or number of octets and packets handled by all interfaces or the specified interface.
<code>show statistics</code> { <code>switchport</code>   <code>interface</code> }	Display detailed statistics for a specific port or LAG, or for the entire switch. The <code>interface</code> variable includes the interface type and number.
<code>show interfaces</code> <code>utilization</code> [ <code>interface-id</code> ]	Display the TX and RX link utilization (frame rate and bits per second).

<b>Command</b>	<b>Purpose</b>
<code>show interfaces traffic</code> <code>[interface-id]</code>	Display the current TX and RX queue congestion and congestion discards.

## Configuring Port Mirroring

Use the following commands in Privileged Exec mode to configure a port mirroring session.

<b>Command</b>	<b>Purpose</b>
<code>configure</code>	Enter Global Configuration mode
<code>monitor session</code> <code>session_number source</code> <code>interface {interface-id}</code> <code>[rx   tx   both]</code>	<p>Configure a source (monitored) port or CPU interface for a monitor session.</p> <ul style="list-style-type: none"> <li><code>session_number</code>—The monitoring session ID, which ranges from 1 to 4. The Dell EMC Networking N1500 supports a single session.</li> <li><code>interface-id</code>—The interface to be monitored.</li> <li><code>rx   tx</code>—Monitor ingress (rx) or egress (tx) traffic. If no parameter is given, both ingress and egress traffic are monitored.</li> </ul>
<code>monitor session</code> <code>session_number</code> <code>destination interface</code> <code>interface-id</code>	<p>Configure a destination (probe) port for a monitor session.</p> <ul style="list-style-type: none"> <li><code>session_number</code>—The monitoring session ID, which ranges from 1 to 4. The Dell EMC Networking N1500 supports a single session.</li> <li><code>interface</code>—The Ethernet interface to which the monitored source traffic is copied.</li> </ul>
<code>monitor session</code> <code>session_number mode</code>	Enable the administrative mode for the configured port mirroring session to start sending the traffic from the source port to the destination (probe) port.
<code>exit</code>	Exit to Privileged Exec mode.
<code>show monitor session</code> <code>session_number</code>	View information about the configured port mirroring session.

## Configuring RSPAN

RSPAN is an extension of port mirroring that operates across multiple switches. Mirrored traffic is tagged with the RSPAN VLAN and is flooded in the RSPAN VLAN. This allows considerable flexibility in the placement of probe ports. Use the following commands in Privileged Exec mode to configure RSPAN. Remember to assign VLANs to physical interfaces (steps not shown).

### Configuring RSPAN (Source Switch)

Command	Purpose
<code>configure</code>	Enter Global Configuration mode.
<code>vlan <i>vlan-id</i></code>	Configure an RSPAN VLAN.
<code>remote-span</code>	Configure the VLAN as a spanning VLAN.
<code>exit</code>	Exit to Global Configuration mode.
<code>interface tel/0/1</code>	Enter interface configuration mode.
<code>switchport mode trunk</code>	Set the egress span interface to trunk mode.
<code>switchport trunk allowed vlan <i>vlan-id</i></code>	Restrict the trunk to the spanning VLAN (optional).
<code>exit</code>	Exit to Global Configuration mode.
<code>monitor session <i>session- number</i> source {interface <i>interface-id</i>   vlan <i>vlan-id</i>   remote vlan <i>rspan-vlan-id</i>} [rx   tx]</code>	Configure a source (monitored) port for a monitor session. Source ports should not be members of the RSPAN VLAN. <ul style="list-style-type: none"><li><i>session_number</i>—The monitoring session ID, which ranges from 1 to 4. The Dell EMC Networking N1500 supports a single session.</li><li><i>interface-id</i>—The interface to be monitored. The internal CPU port may not be configured as an RSPAN source.</li><li><b>rx</b>   <b>tx</b>—Monitor ingress (rx) or egress (tx) traffic. If no parameter is given, both ingress and egress traffic are monitored. Using the RX option helps eliminate duplicate packets when monitoring multiple stations engaged in peer-to-peer communication.</li></ul>

<b>Command</b>	<b>Purpose</b>
<code>monitor session <i>session-number</i> destination {interface <i>interface-id</i>   remote vlan <i>rspan-vlan-id</i> reflector-port <i>interface-id</i>}</code>	Configure a local RSPAN reflector port on the source switch. The reflector port should be configured as a trunk port.
<code>monitor session <i>session_number</i> mode</code>	Enable the administrative mode for the configured port mirroring session to start sending the traffic from the source port to the destination (probe) port.
<code>exit</code>	Exit to Privileged Exec mode.

### Configuring RSPAN (Transit Switch)

<b>Command</b>	<b>Purpose</b>
<code>configure</code>	Enter Global Configuration mode.
<code>vlan <i>vlan-id</i></code>	Create an RSPAN VLAN.
<code>remote-span</code>	Configure the VLAN as a spanning VLAN.
<code>exit</code>	Exit to Global Configuration mode.
<code>interface range <i>te1/0/1-2</i></code>	Configure the span interfaces.
<code>switchport mode trunk</code>	Configure the interface to be in trunking mode.
<code>switchport trunk allowed vlan <i>vlan-id</i></code>	Restrict the trunk to the RSPAN VLAN (optional).
<code>exit</code>	Exit to Global Configuration mode.

### Configuring RSPAN (Destination Switch)

<b>Command</b>	<b>Purpose</b>
<code>configure</code>	Enter Global Configuration mode.
<code>vlan <i>vlan-id</i></code>	Create a VLAN.
<code>remote-span</code>	Configure the VLAN as an RSPAN VLAN.
<code>exit</code>	Exit to Global Configuration mode

<b>Command</b>	<b>Purpose</b>
<code>monitor session <i>session_id</i> source remote vlan <i>vlan_id</i></code>	Configure a source RSPAN VLAN on the destination switch.
<code>monitor session <i>session_id</i> destination interface <i>interface</i></code>	Configure the destination port on the RSPAN destination switch.
<code>monitor session <i>session_id</i> mode</code>	Enable the monitor session.

### Configuring RSPAN (Filtering Traffic)

<b>Command</b>	<b>Purpose</b>
<code>configure</code>	Enter Global Configuration mode.
<code>vlan <i>vlan-id</i></code>	Create a VLAN.
<code>remote-span</code>	Configure the VLAN as an RSPAN VLAN.
<code>exit</code>	Exit to Global Configuration mode.
<code>mac access-list extended <i>testQinQ</i></code>	Create a MAC access-list named <i>testQinQ</i> .
<code>permit any any secondary-vlan eq <i>vlan-id</i></code>	Match on the inner VLAN of the RSPAN tagged packets. An optional sequence number may be added to the ACL.
<code>exit</code>	Exit to Global Configuration mode.
<code>monitor session <i>session-id</i> destination remote vlan <i>vlan-id</i> reflector-port Te1/0/24</code>	Set Te1/0/24 as the RSPAN reflector.
<code>monitor session <i>session-id</i> source interface Te1/0/1</code>	Set Te1/0/1 as the source interface
<code>monitor session <i>session-id</i> filter mac access-group <i>testQinQ</i></code>	Apply the VLAN filter to monitored traffic. Mirrored traffic other than VLAN is dropped on egress.
<code>monitor session <i>session-id</i> mode</code>	Enable mirroring for the session

<b>Command</b>	<b>Purpose</b>
<code>interface Te1/0/1</code>	Enter Interface Configuration mode for interface Te1/0/1 (the source interface).
<code>switchport mode trunk</code>	Configure the source as a trunk port (multiple VLANs).
<code>switchport trunk allowed vlan remove <i>vlan-id</i></code>	Remove the RSPAN VLAN from the source port.
<code>exit</code>	Exit to Global Configuration mode.
<code>interface Te1/0/24</code>	Enter Interface Configuration mode for interface Te1/0/24 (the RSPAN reflector port).
<code>switchport mode trunk</code>	Configure the uplink port as a trunk port
<code>exit</code>	Exit to Global Configuration mode.

### ***RSPAN VLAN Restrictions***

MAC learning is disabled on the RSPAN VLAN. RSPAN traffic is tagged with the RSPAN VLAN. Traffic in the RSPAN VLAN is flooded to all ports in the RSPAN VLAN and is never sent to the CPU on the source, transit, and destination switches. Because RSPAN VLAN traffic is flooded, it is advisable for the administrator to consider setting the monitored ports as RX only. This may help avoid duplicate packets when mirroring ports connected to stations are engaged in direct connections. The administrator should also consider using an ACL filter on a port-mirrored interface to limit uplink utilization. The RSPAN VLAN should be configured only on the uplink/transit/downlink interfaces. A monitored interface should never be configured as a member of the RSPAN VLAN. The switch will not allow configuration of a monitored source VLAN as an RSPAN VLAN.

# Traffic Monitoring Examples

This section contains the following examples:

- Showing Interface Traffic
- Configuring sFlow
- Configuring RMON
- Configuring Remote Capture
- Configuring RSPAN

## Showing Interface Traffic

Use the `show interfaces utilization` and `show interfaces traffic` commands to display information about interface traffic and internal packet buffer usage. The following are examples of the output of these commands. Refer to the *Dell EMC Networking N1100-ON, N1500, N2000, N2100-ON, N2200-ON, N3000E-ON, N3100-ON, and N3200-ON Series Switches CLI Reference Guide* for more details about the output. The N1100-ON Series switches do not support accounting for color drops. The counters remain fixed at 0.

This example shows Gi1/0/1 is suffering from congestion (Tx Queue high) and is dropping packets, either due to WRED drops or due to exceeding the internal buffer limits.

```
console#show interfaces traffic
```

Intf Name	Congestion Drops (Pkts)	Tx Queue (Cells)	Rx Queue (Cells)	Color Yellow	Drops Red (Pkts)	Tx Queue (Pkts)
Gi1/0/1	18981	132	0	0	0	13
Gi1/0/2	0	0	0	0	0	0
Gi1/0/3	0	0	0	0	0	0

The following example shows a classical incast situation on interface Gi1/0/2 where the port is fully utilized or nearly fully utilized, buffering many frames (with increased latency) and beginning to drop frames as the internal thresholds for buffering on the port are reached. A conscientious network operator might want to examine why the devices attached to Gi1/0/5 and Gi1/0/6 are sending so much traffic to Gi1/0/2 attached devices and redistribute the devices, rate-limit traffic egressing the devices attached to Gi1/0/5 and Gi1/0/6, or increase the number of links available for the device attached to Gi1/0/2.



```
console#show interfaces utilization
```

Port	Load Interval	Oper. Speed	Rx Util	Tx Util	Rx PPS	Tx PPS	Buffer Size	Drop Count
Gi1/0/1	300	10M	1	0	296	0	0	0
Gi1/0/2	300	1G	0	99	0	674500	938098	1102
Gi1/0/3	300	1G	0	15	0	112428	7	0
Gi1/0/4	300	0	0	0	0	1	0	0
Gi1/0/5	300	1G	37	0	249565	1	0	1
Gi1/0/6	300	1G	88	1	593560	3	0	0
Gi1/0/7	300	0	0	0	0	0	0	0
Gi1/0/8	300	0	0	0	0	1	0	0

## Configuring sFlow

This example shows how to configure the switch so that ports 10-15 and port 23 send sFlow datagrams to an sFlow receiver at the IP address 192.168.20.34. The receiver owner is receiver1, and the timeout is 100000 seconds. A counter sample is generated on the ports every 60 seconds (polling interval), and 1 out of every 8192 packets is sampled. Note that sFlow monitoring is not enabled until a receiver owner string is configured.

To configure the switch:

- 1 Configure information about the sFlow receiver.

```
console#configure
console(config)#sflow 1 destination 192.168.30.34
console(config)#sflow 1 destination owner receiver1 timeout
100000
```

- 2 Configure the polling and sampling information for Tengegabit Ethernet ports 10-20.

```
console(config)#sflow 1 polling te1/0/10-15 60
console(config)#sflow 1 sampling te1/0/10-15 8192
```

- 3 Configure the polling and sampling information for Tengegabit Ethernet port 23.

```
console(config)#interface te1/0/23
console(config-if-Te1/0/23)#sflow 1 polling 60
console(config-if-Te1/0/23)#sflow 1 sampling 8192
```

- 4 Verify the configured information.

```
console#show sflow 1 destination
```

```

Receiver Index..... 1
Owner String..... receiver1
Time out..... 99994
IP Address:..... 192.168.30.34
Address Type..... 1
Port..... 6343
Datagram Version..... 5
Maximum Datagram Size..... 1400

```

```
console#show sflow 1 polling
```

Poller Data Source	Receiver Index	Poller Interval
-----	-----	-----
Tel/0/10	1	60
Tel/0/11	1	60
Tel/0/12	1	60
Tel/0/13	1	60
Tel/0/14	1	60
Tel/0/15	1	60
Tel/0/23	1	60

```
console#show sflow 1 sampling
```

Sampler Data Source	Receiver Index	Packet Sampling Rate	Max Header Size
-----	-----	-----	-----
Tel/0/10	1	8192	128
Tel/0/11	1	8192	128
Tel/0/12	1	8192	128
Tel/0/13	1	8192	128
Tel/0/14	1	8192	128
Tel/0/15	1	8192	128
Tel/0/23	1	8192	128

## Configuring RMON

This example generates a trap and creates a log entry when the number of inbound packets are undeliverable due to errors increases by 20 or more.

First, an RMON event is created. Then, the alarm is created. The event (event 1) generates a trap and creates a log entry. The alarm is configured for the MIB object ifInErrors (OID: 1.3.6.1.2.1.2.2.1.14.1). The OID is the variable. The alarm checks the variable every 30 seconds to compare the MIB counter to the configured rising and falling thresholds. If the rise is equal to or greater than 20, event 1 goes into effect.

To configure the switch:

- 1 Create the event. The trap is sent to the private SNMP community.

```
console#configure
console(config)#rmon event 1 description "emergency event" log
trap private
```

- 2 Create the alarm.

```
console(config)#rmon alarm 1 1.3.6.1.2.1.2.2.1.14.1 30 delta
rising-threshold 20 1 falling-threshold 1
```

- 3 Verify the configuration.

```
console#show rmon events
```

Index	Description	Type	Community	Owner	Last time sent
1	emergency event	log-trap	private		0 days 0h:0m:0s

```
console#show rmon alarms
```

Index	OID	Owner
1	1.3.6.1.2.1.2.2.1.14.1	

## Configuring Remote Capture

This example configures the switch to mirror packets transmitted and received by the switch CPU to a Wireshark client. This is useful to diagnose switch behavior and to determine if an attached device is sending properly formatted packets with correct information to the switch, or just to monitor traffic sent to the switch CPU. The capture feature can also be configured to capture to a local file in pcap format or to capture to an in-memory buffer (text format).

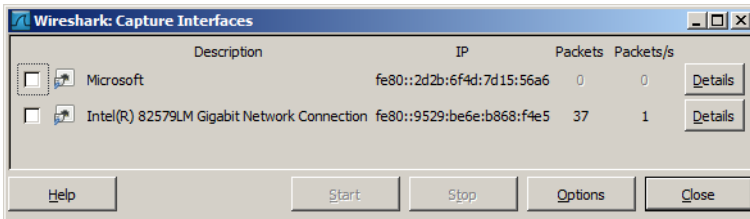
- 1 Configure capture for Wireshark remote access on port 2002.

```
console(config)#monitor capture mode remote
console(config)#exit
```

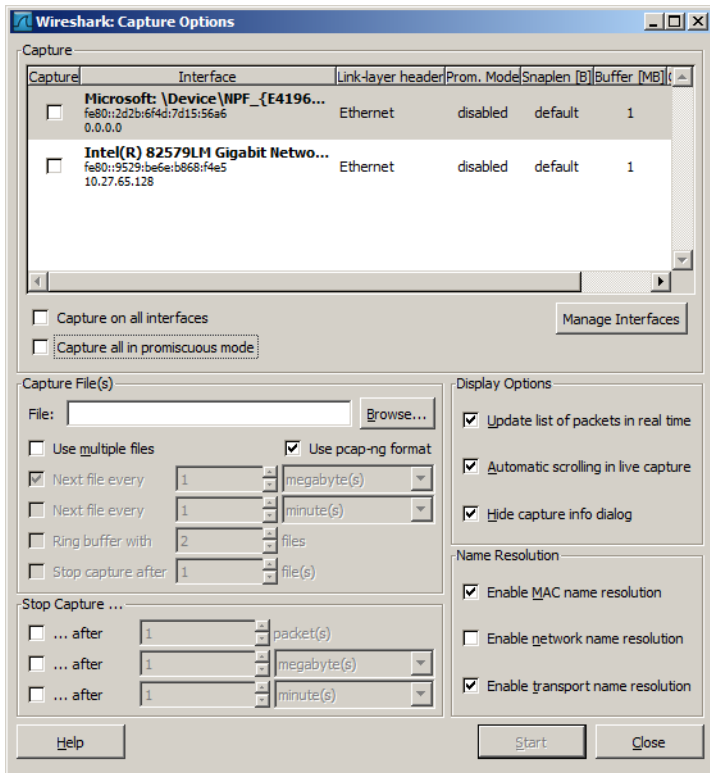
- 2 Start the capture enabling capture of both transmitted and received packets.

```
console#monitor capture start all
```

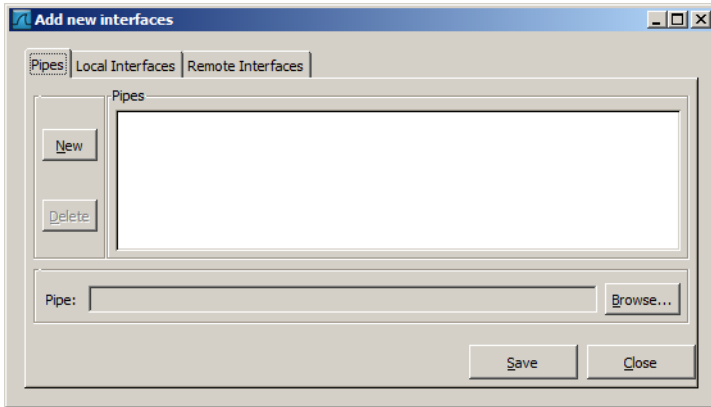
- 3 Configure Wireshark for remote capture by selecting **Capture** → **Interfaces** from the top tab. (The screens shown in this example are from Wireshark 1.10.1.)



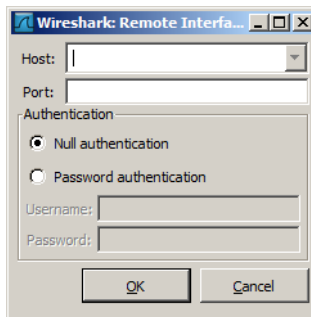
- 4 On the Capture Interfaces dialog, click **Options**.



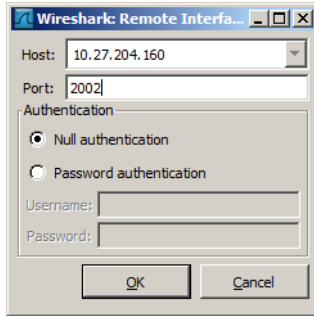
- 5 On the Capture Options dialog, click **Manage Interfaces**.



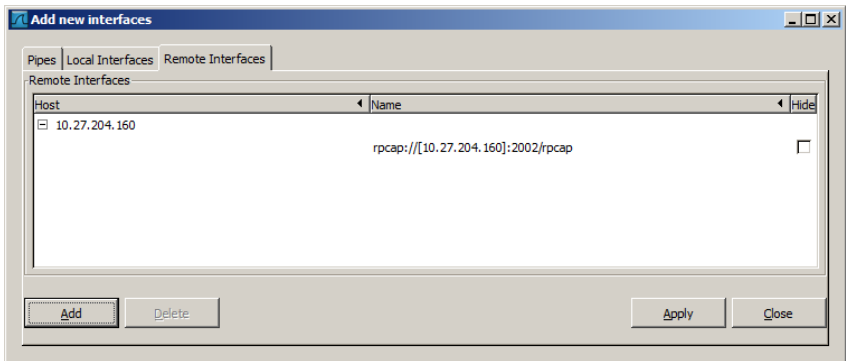
- 6 Add a new interface by giving the switch IP address and the default remote port (2002). First, select the **Remote Interfaces** tab and click **Add**.



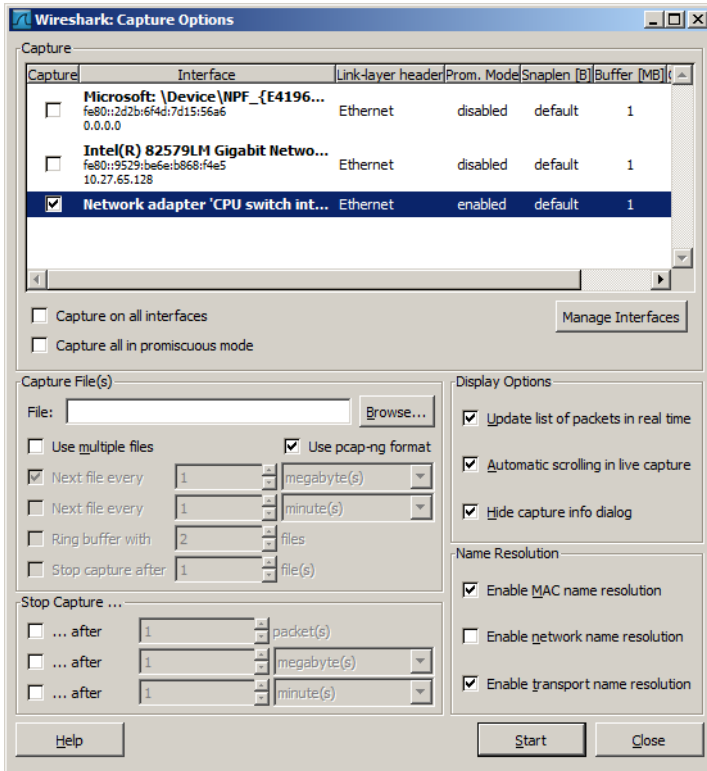
- 7 Enter the switch IP address and port (2002). Choose **Null authentication** (default).



8 Click **OK** to accept the entry.



9 On the Add new interfaces dialog, click **Apply** and then click **Close**.



- From the Wireshark:Capture Options dialog, select the remote switch and click **Start**.

### Remote Capture Caveats

Remote capture over an in-band port captures the capture packets transmitted to the Wireshark client. Therefore, when using remote capture over an in-band port, it is best to configure remote capture to capture only received packets, to configure remote capture to operate over the out-of-band port, or to configure local capture to capture to the in-memory buffer or a local pcap file.



## Configuring RSPAN

RSPAN supports the transport of mirrored packets across the network to a remote switch. Ports may be configured as source ports, intermediate ports, or destination ports.

### RSPAN Source Switch

This example mirrors interface `gi1/0/3` to VLAN 723. VLAN 723 is the selected transit VLAN. Administrators should reserve a VLAN as the RSPAN VLAN when designing their network. The source switch requires a reflector port to carry packets to the transit switch. The reflector port must be configured as trunk port. Untagged packets on the source port are transmitted on the RSPAN VLAN tagged with the RSPAN VLAN. Tagged packets on the source port are transmitted over the RSPAN VLAN double-tagged with the outer tag containing the RSPAN VLAN.

Note that neither the source port nor the destination (probe) port are members of the RSPAN VLAN. Both ports are configured as access (untagged) ports.

The last line in this configuration enables the monitor session. It is recommended that configuration proceed with the destination switch first, followed by the intermediate switches, and then by the source switch.

- 1 Configure RSPAN on VLAN 723:

```
console#configure
console (config) #vlan 723
console (config-vlan723) #remote-span
console (config-vlan723) #exit
```

- 2 Configure interface `tel1/0/1` as the reflector port in trunk mode:

```
console (config) #interface tel1/0/1
console (config-if-Tel1/0/1) #switchport mode trunk
console (config-if-Tel1/0/1) #switchport trunk allowed vlan 723
console (config-if-Tel1/0/1) #exit
```

- 3 Configure a mirroring session with a source port `gi1/0/3`, the destination VLAN 723, and reflector port `tel1/0/1`:

```
console (config) #monitor session 1 source interface gi1/0/3
console (config) #monitor session 1 destination remote vlan 723
reflector-port tel1/0/1
```

- 4 Enable the monitor session:

```
console (config) #monitor session 1 mode
```

RSPAN cannot use the CPU as a mirror source. Instead, configure remote capture to view packets sent to or from the switch CPU.

### RSPAN Transit Switch

The following is an example of an RSPAN transit switch configuration. The RSPAN VLAN should be configured as a remote-span in order to disable MAC learning on the VLAN. In this case, the transit switch ports are configured as trunk ports (members of all VLANs) and may be used by other traffic. Packets on the transit switch (in this example) are received and transmitted tagged.

- 1 Configure remote span on a VLAN:

```
console#configure
console(config)#vlan 723
console(config-vlan723)#remote-span
console(config-vlan723)#exit
```

- 2 Configure the transit switch ports in trunk mode:

```
console(config)#interface te1/0/1
console(config-if-Te1/0/1)#switchport mode trunk
console(config-if-Te1/0/1)#interface te1/0/2
console(config-if-Te1/0/2)#switchport mode trunk
```

### RSPAN Destination Switch

The following example shows the configuration of the RSPAN destination switch. The RSPAN mirrored packets are transmitted over the destination port untagged. The destination port should be configured in access mode and should not be a member of the RSPAN VLAN.

- 1 Configure remote span on VLAN 723:

```
console#configure
console(config)#vlan 723
console(config-vlan723)#remote-span
console(config-vlan723)#exit
```

- 2 Configure interface gi1/0/1 as the destination port. This port should not be a member of the RSPAN VLAN.

```
console(config)#interface gi1/0/1
console(config-if-Gi1/0/1)#switchport mode access
console(config-if-Gi1/0/1)#exit
```

- 3 Configure a mirroring session with the remote VLAN 723 as the source and interface `gi1/0/1` as the destination port:

```
console (config) #monitor session 1 source remote vlan 723
console (config) #monitor session 1 destination interface
gi1/0/1
```

- 4 Enable the mirroring session:

```
console (config) #monitor session 1 mode
```

# Encapsulated Remote Port Analyzer

The Encapsulated Remote Port Analyzer (ERSPAN) allows mirroring collection points to be located anywhere across a routed network. This is achieved by encapsulating L2 mirrored packets using GRE with IP delivery. After a packet has been encapsulated, it can be forwarded throughout the L3-routed network.

ERSPAN uses a GRE tunnel to carry traffic between switches. ERSPAN consists of an ERSPAN source session, an ERSPAN destination session, and routable ERSPAN GRE-encapsulated traffic.

All participating switches must be connected at Layer 3 and the network path must support the size of the ERSPAN traffic for egress mirroring session.

Dell platforms do not terminate the ERSPAN mirrored packets, that is, the IP/GRE tunnel added on top of the mirrored packet is not removed. The probe port of an ERSPAN destination session should be connected to a sniffer PC running Wireshark. The capture filter needs to be configured in the Wireshark application, to filter the packets with the IP protocol number 47, which is GRE.

At the source switch, the following parameters are configured:

- Source ports (that is, the traffic on this port is mirrored)
- ERSPAN destination IPv4 address
- ERSPAN origin IPv4 address
- ERSPAN session ID
- Tx/Rx
- IP/MAC ACLs (optional)
  - IP/MAC ACLs can be configured with rate limit

At the destination switch, the following parameters are configured:

- ERSPAN destination IPv4 address (as source)
- ERSPAN session ID
- Probe port

The following are limitations:

- Only IPv4 is supported as an ERSPAN delivery method; IPv6 is not supported due to a hardware limitation.

- The ERSPAN feature does not support packet fragmentation. The *do not fragment* bit is set in the IP header of ERSPAN packets.
- ERSPAN cannot quite operate at the wire-speed due to the additional packet overhead.
- Because there is no standard, the interop is not guaranteed.
- As the packets are encapsulated, applying MAC ACL filters to ERSPAN sessions cannot be supported.
- The ERSPAN feature currently does not support configuring VLAN as source for mirroring the traffic.



# iSCSI Optimization

## Dell EMC Networking N2000, N2100-ON, N3000E-ON, N3100-ON, and N3200-ON Series Switches



**NOTE:** This feature is not available on the Dell EMC Networking N1100-ON or N1500 Series switches.

This chapter describes how to configure Internet Small Computer System Interface (iSCSI) optimization, which enables special quality of service (QoS) treatment for iSCSI traffic.

The topics covered in this chapter include:

- iSCSI Optimization Overview
- Default iSCSI Optimization Values
- Configuring iSCSI Optimization (Web)
- Configuring iSCSI Optimization (CLI)
- iSCSI Optimization Configuration Examples

## iSCSI Optimization Overview

iSCSI optimization provides a means of configuring ports automatically when connecting to Compellent or EqualLogic storage devices.

### What Does iSCSI Optimization Do?

In networks containing iSCSI initiators and targets, iSCSI Optimization helps to monitor iSCSI sessions or give iSCSI traffic preferential QoS treatment. Dynamically-generated classifier rules generated by snooping iSCSI traffic are used to direct iSCSI data traffic to queues that can be given the desired preference characteristics over other data traveling through the switch. This may help to avoid session interruptions during times of congestion that would otherwise cause iSCSI packets to be dropped. However, in systems where a large proportion of traffic is iSCSI, it may also interfere with other network control-plane traffic, such as ARP or LACP.

The preferential treatment of iSCSI traffic needs to be balanced against the needs of other critical data in the network.

### **What Occurs When iSCSI Optimization Is Enabled or Disabled?**

The iSCSI feature is enabled on all ports by default. When iSCSI is enabled on the switch, the following actions occur:

- Flow control is globally enabled, if it is not already enabled.
- iSCSI LLDP monitoring starts to automatically detect Dell EqualLogic arrays.

If the iSCSI feature is disabled on the switch, iSCSI resources are released and the detection of Dell EqualLogic arrays by using LLDP is disabled. Disabling iSCSI does not remove the MTU, flow control, portfast or storm control configuration applied as a result of enabling iSCSI. iSCSI Optimization is enabled by default.

### **How Does the Switch Detect iSCSI Traffic Flows?**

The switch snoops iSCSI session establishment (target login) and termination (target logout) packets by installing classifier rules that trap iSCSI protocol packets to the CPU for examination. Devices that initiate iSCSI sessions generally use well-known TCP ports 3260 or 860 to contact targets. When iSCSI optimization is enabled, by default the switch identifies IP packets to or from these ports as iSCSI session traffic. In addition, the switch separately tracks connections associated with a login session (ISID) (dynamically allocated source/destination TCP port numbers). The switch can be configured to monitor traffic for additional port numbers or port number-target IP address combinations, and the well-known port numbers can be removed from monitoring. A target name can also be associated with a configured target TCP port entry. The maximum number of iSCSI sessions is 1024.

### **How Is Quality of Service Applied to iSCSI Traffic Flows?**

The iSCSI CoS mode is configurable and controls whether CoS queue assignment and/or packet marking is performed on iSCSI traffic. When the iSCSI CoS mode is enabled, the CoS policy is applied to packets in detected iSCSI sessions.



When iSCSI CoS mode is enabled, iSCSI login sessions up to the switch limits are tracked, and data packets for those sessions are given the configured CoS treatment. iSCSI sessions in excess of the switch limits are not given the configured CoS treatment; therefore, it is not advisable to exceed the iSCSI session limit. Multiple connections within a session are counted against the session limit, even though they show in the session table as a single session.

Whether the iSCSI optimization feature uses the VLAN priority or IP DSCP mapping to determine the traffic class queue is configurable. By default, iSCSI flows are assigned to the highest VLAN priority tag or DSCP value mapped to the highest queue not used for stack management or voice VLAN. Use the `classofservice dotIp-mapping` command or the **Quality of Service → Class of Service → Mapping Table Configuration** page to configure the relevant Class of Service parameters for the queue in order to complete the setting.

Whether iSCSI frames are remarked to contain the configured VLAN priority tag or the IP DSCP value when forwarded through the switch is configurable.

### **How Does iSCSI Optimization Use ACLs?**

iSCSI Optimization borrows ACL lists from the global system pool. ACL lists allocated by iSCSI Optimization reduce the total number of ACLs available for use by the network operator. Enabling iSCSI Optimization uses one ACL list to monitor for iSCSI sessions. Each monitored iSCSI session utilizes two rules from additional ACL lists up to a maximum of two ACL lists. This means that the maximum number of ACL lists allocated by iSCSI is three.

### **What Information Does the Switch Track in iSCSI Traffic Flows?**

Packets are examined to find the following data, which is used in tracking the session and creating the classifier entries that enable QoS treatment:

- Initiator's IP Address
- Target's IP Address
- ISID (Initiator defined session identifier)
- Initiator's IQN (iSCSI Qualified Name)
- Target's IQN
- Initiator's TCP Port
- Target's TCP Port

If no iSCSI traffic is detected for a session for a configurable aging period, the session data is cleared.

## **How Does iSCSI Optimization Interact With Dell EqualLogic and Compellent Arrays?**

The iSCSI feature includes auto-provisioning support with the ability to detect directly connected Dell EqualLogic (EQL) or Compellent SAN storage arrays and automatically reconfigure the switch to enhance storage traffic flows.

The Dell EMC Networking N-Series switches use LLDP, a vendor-neutral protocol, to discover Dell SAN devices on the network. LLDP is enabled by default. For more information about LLDP, see "Discovering Network Devices" on page 923.

When the switch detects a Dell SAN array, the following actions occur:

- An MTU of 9216 is enabled on the system, if it is not already enabled.
- Spanning tree portfast is enabled on the SAN-connected interface identified by LLDP.
- Unicast storm control is disabled on the SAN-connected interface identified by LLDP.

It is advisable to enable spanning tree portfast and disable unicast storm control on ports connected to the initiators as well.

If the iSCSI CoS policy feature is enabled on the switch and an EQL array is detected, the switch applies additional iSCSI CoS policies to the EQL inter-array traffic on TCP ports 9876 and 25555. If the iSCSI CoS policy is disabled and EQL arrays are present, the additional CoS policy is removed globally.

## **How Does iSCSI Optimization Interact with Other SAN Arrays?**

Dell EMC Networking N-Series switches support a macro that may be used to configure a port connected to a SAN storage array. The name of the macro is *profile-compellent-nas*. The macro takes a single argument: the interface identifier to which the SAN array is connected. The macro disables unicast storm control and sets the spanning tree configuration on the port to portfast. For an example of how to execute the macro, see "Configuring iSCSI Optimization Between Servers and a Disk Array" on page 670.


# Default iSCSI Optimization Values

Table 16-1 shows the default values for the iSCSI optimization feature.

**Table 16-1. iSCSI Optimization Defaults**

<b>Parameter</b>	<b>Default Value</b>
iSCSI optimization global status	Enabled
iSCSI CoS mode	Disabled
Jumbo frames	Disabled
Spanning tree portfast	Disabled
Unicast storm control	Disabled
Classification	iSCSI packets are classified by VLAN instead of by DSCP values.
VLAN priority tag	iSCSI flows are assigned by default the highest 802.1p VLAN priority tag mapped to the highest queue not used for stack management or the voice VLAN.
DSCP	When DSCP is selected as the classification, iSCSI flows are assigned by default the highest DSCP tag mapped to the highest queue not used for stack management or the voice VLAN.
Remark	Not enabled

# Configuring iSCSI Optimization (Web)

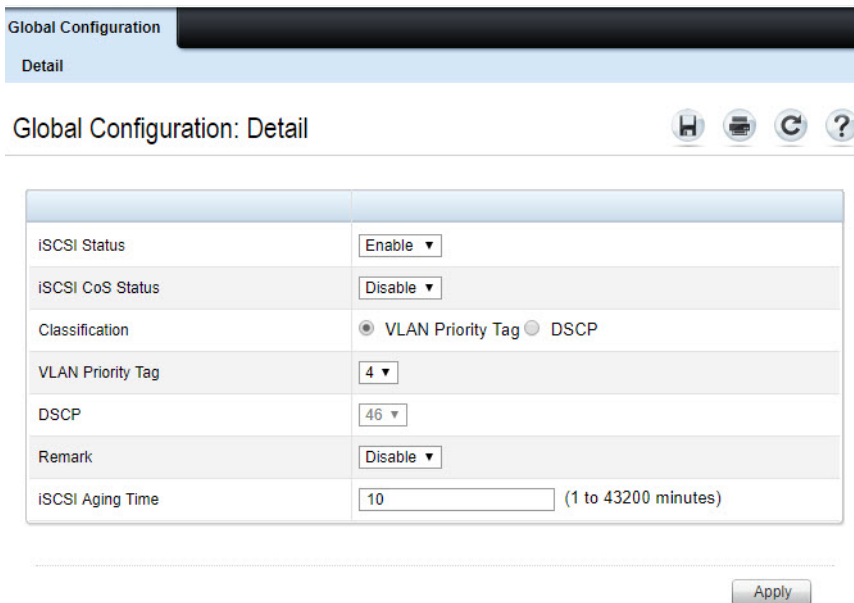
This section provides information about the OpenManage Switch Administrator pages to use to the iSCSI features on Dell EMC Networking N2000, N2100-ON, N3000E-ON, N3100-ON, and N3200-ON Series switches. For details about the fields on a page, click  at the top of the Dell EMC OpenManage Switch Administrator web page.





## iSCSI Global Configuration

Use the **Global Configuration** page to configure QoS treatment for packets where the iSCSI protocol is detected.

To access the **iSCSI Global Configuration** page, click **System** → **iSCSI Global Configuration** in the navigation panel.

**Figure 16-1. iSCSI Global Configuration**



Global Configuration	
Detail	
Global Configuration: Detail    	
iSCSI Status	Enable ▾
iSCSI CoS Status	Disable ▾
Classification	<input checked="" type="radio"/> VLAN Priority Tag <input type="radio"/> DSCP
VLAN Priority Tag	4 ▾
DSCP	46 ▾
Remark	Disable ▾
iSCSI Aging Time	10 (1 to 43200 minutes)
<input type="button" value="Apply"/>	

## Configuring iSCSI Optimization (CLI)

This section provides information about the commands used for configuring iSCSI settings on the switch. For more information about the commands, see the *Dell EMC Networking N1100-ON, N1500, N2000, N2100-ON, N2200-ON, N3000E-ON, N3100-ON, and N3200-ON Series Switches CLI Reference Guide* at [www.dell.com/support](http://www.dell.com/support).

Command	Purpose
<code>configure</code>	Enter Global Configuration mode. iSCSI optimization is enabled by default.
<code>iscsi cos {enable   disable   vtp vtp   dscp dscp [remark]}</code>	Optionally set the quality of service profile that will be applied to iSCSI flows. <ul style="list-style-type: none"><li>• <b>enable</b>—Enables application of preferential QoS treatment to iSCSI frames. On switches that support DCBX, this also enables the generation of the Application Priority TLV for iSCSI.</li><li>• <b>disable</b>—Disables application of preferential QoS treatment to iSCSI frames.</li><li>• <b>vtp/dscp</b>—The VLAN Priority Tag or DSCP value to assign received iSCSI session packets.</li><li>• <b>remark</b>—Mark the iSCSI frames with the configured DSCP value when egressing the switch.</li></ul>
<code>exit</code>	Exit to Privilege Exec mode.
<code>show iscsi</code>	Display iSCSI settings.

# iSCSI Optimization Configuration Examples

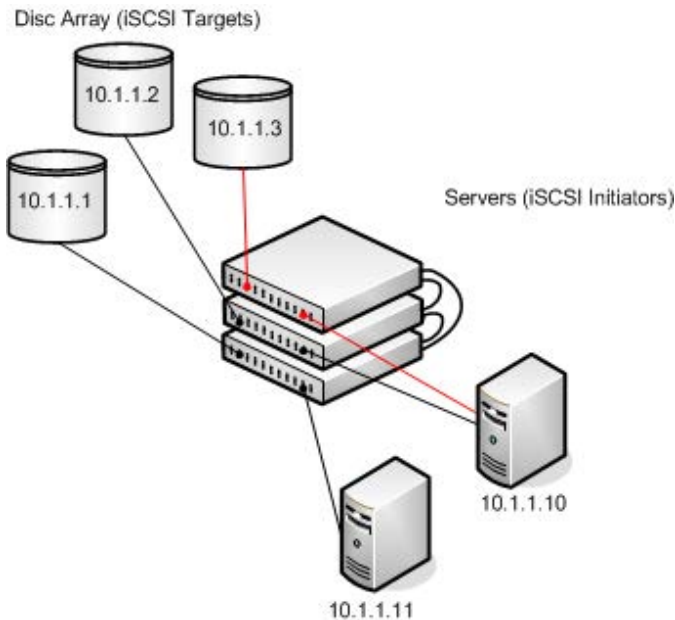
iSCSI optimization is enabled by default. The following procedure illustrates the configuration steps required if configuring iSCSI manually.

## Configuring iSCSI Optimization Between Servers and a Disk Array

Figure 16-2 illustrates a stack of three Dell EMC Networking N-Series switches connecting two servers (iSCSI initiators) to a disk array (iSCSI targets).

An iSCSI application running on the management unit (the top unit in the diagram) has installed priority filters to ensure that iSCSI traffic that is part of these two sessions receives priority treatment when forwarded in hardware.

**Figure 16-2. iSCSI Optimization**



The following commands show how to configure the iSCSI example depicted in Figure 16-2. Remember that iSCSI optimization is enabled by default.

- 1 Set the system MTU to 9216 to enable the use of jumbo frames.

```
console#config  
console (config) #system jumbo mtu 9216
```

- 2 Optionally configure the switch to associate CoS queue 5 with detected iSCSI session traffic.

```
console (config) #iscsi cos enable  
console (config) #exit
```

The default target port and IP address criteria is used to determine which packets are snooped for iSCSI session data (ports 860 and 3260; any IP address).

- 3 If the array is a Compellent storage array, execute the Compellent macro on the ports attached to the array:

```
console#config  
console (config) #macro global apply profile-compellent-nas  
$interface_name tel/0/21  
console (config) #macro global apply profile-compellent-nas  
$interface_name tel/0/22  
console (config) #macro global apply profile-compellent-nas  
$interface_name tel/0/23
```





# Port Characteristics

## Dell EMC Networking N-Series Switches

This chapter describes how to configure physical switch port characteristics, including settings such as administrative status and maximum frame size. This chapter also describes the link dependency feature.

The topics covered in this chapter include:

- Port Overview
- Default Port Values
- Configuring Port Characteristics (Web)
- Configuring Port Characteristics (CLI)
- Port Configuration Examples

## Port Overview

A port is a physical interface. Cables physically connect ports on devices such as PCs or servers to ports on the switch to provide access to the network. The number and type of physical ports available on your Dell EMC Networking N-Series switch depends on the model.

### What Physical Port Characteristics Can Be Configured?

Table 17-1 provides a summary of the physical characteristics that can be configured on the switch ports.

**Table 17-1. Port Characteristics**

Feature	Description
Administrative status	Controls whether the port is administratively enabled or disabled.
Description	Provides a text-based description of the port.
Auto-negotiation	Enables a port to advertise its transmission rate, duplex mode and flow control abilities to its partner.

**Table 17-1. Port Characteristics**

<b>Feature</b>	<b>Description</b>
Speed	Specifies the transmission rate for frames.
Duplex mode	Specifies whether the interface supports transmission between the switch and the connected client in one direction at a time (half) or both directions simultaneously (both).
Maximum frame size	Indicates the maximum frame size that can be handled by the port.
Green Ethernet features	Green Ethernet features include: <ul style="list-style-type: none"><li>• Energy Detect mode</li><li>• Energy Efficient Ethernet (EEE), which enables the low-power idle mode</li></ul>
Flow control	This is a global setting that affects all ports. For more information about this feature, see "Port-Based Traffic Control" on page 949.
Storm control	For more information about this feature, see "Port-Based Traffic Control" on page 949.
Port security	For more information about this feature, see "Port and System Security" on page 705.
Protected port	For more information about this feature, see "Port-Based Traffic Control" on page 949.

## Auto-Negotiation

Dell EMC Networking N-Series switches implement IEEE 802.3 auto-negotiation for 1000BASE-T, 1000BASE-X, NBASE-T and 10GBASE-T based copper interfaces. 1000BASE-X fiber interfaces also implement auto-negotiation. Auto-negotiation is required to be present and enabled for 1000BASE-T, NBASE-T, and 10GBASE-T copper interfaces in order for a clock primary to be selected.

The administrator can configure the advertised capabilities, including the acceptable link speeds, or may disable auto-negotiation altogether. Auto-negotiation must be disabled and full-duplex must be enabled on certain fiber interfaces. However, 1000BASE-X fiber interfaces require auto-negotiation to be enabled. Disabling auto-negotiation on copper interfaces is not recommended as it can lead to a configuration mismatch, where one or both interfaces may appear to come up but, in fact, they have not agreed on the speed, duplex, or clock primary. This may occur when the devices are connected as follows:

- One end is set manually to half-duplex and the other is manually set to full-duplex
- One end is set to auto-negotiation and the other is manually set to full-duplex
- Both sides are manually set to full-duplex, with one side set to auto-negotiate with the link partner and the other side configured with auto-negotiation disabled.

## Maximum Transmission Unit

Dell EMC Networking N-Series switches allow the operator to configure the maximum transmission unit for the switch to a value larger than the IEEE 802.3 standard allows. This jumbo frames technology is employed in certain situations to reduce the task load on a server CPU and to transmit large amounts of data efficiently. The need for jumbo frames predominantly appears where certain applications would benefit from using a larger frame size (for example, Network File System (NFS)). The larger frame size reduces the number of headers transmitted per unit of data, leading to greater throughput. The Dell EMC Networking jumbo frames feature extends the standard Ethernet MTU (Max Frame Size) from 1518 bytes (1522 bytes with

a VLAN header) to 9216 bytes. Dell EMC Networking N-Series switches assumes that all packets are in Ethernet format. Any device connecting to the same broadcast domain must support the same MTU.

Dell EMC Networking N-Series switches do not fragment L2 or L3 forwarded traffic. Received frames larger than the system MTU are discarded. The switch will not transmit a frame larger than the system MTU.

Packets originated by the switch are fragmented based upon path MTU discovery. IPv4 packets forwarded in software are dropped if they exceed the IPv4 MTU of the outgoing interface, whether or not the Do Not Fragment bit is set in the IP header. An ICMP Fragmentation Needed message is returned to the sender. Dell EMC Networking IPv4 software forwarding does not fragment packets.

An IPv4 packet originated on the switch is fragmented in the IP stack if it is larger than the IPv4 path MTU to the packet's destination. For each IPv4 route in the IP stack's routing table, the default IPv4 path MTU is the IPv4 MTU of the outgoing interface. The IP stack updates the path MTU for each route when it receives Fragmentation Needed ICMP messages.

An IPv6 packet originated on the switch is fragmented in the IP stack if it is larger than the IPv6 path MTU to the packet's destination. IPv6 does not allow forwarded packets to be fragmented. If a forwarded IPv6 packet is larger than the path MTU to its destination, the packet is dropped and an ICMPv6 Packet Too Big message is returned.

## **What is Link Dependency?**

The link dependency feature provides the ability to enable or disable one or more ports based on the link state of one or more different ports. With link dependency enabled on a port, the link state of that port is dependent on the link state of another port. For example, if port A is dependent on port B and the switch detects a link loss on port B, the switch automatically brings down the link on port A. When the link is restored to port B, the switch automatically restores the link to port A.

A maximum of 72 dependency groups can be created. The ports participating in the Link Dependency can be across all the Stack Units (Manager/Member unit).

## Link Action

The link action specifies the action that the group members will take when the dependent port is down. The group members can transition to the same state as the dependant port, or they can transition to the opposite state. In other words, if the link action is **down** and the dependent port goes down, the members ports will go down as well. Conversely, when the link action is **up** and the dependant link goes down, the group member ports are enabled (brought up).

Creating a link dependency group with the **up** link action essentially creates a backup link for the dependent link and alleviates the need to implement STP to handle the fail-over.

## Link Dependency Scenarios

The Link Dependency feature supports the scenarios in the following list.



**NOTE:** Whether the member ports or LAGs are brought *up* or *down* depends on the link action.

- Port dependent on port — If a port loses the link, the switch brings up/down the link on another port.
- Port dependent on LAG — If all ports in a channel-group lose the link, the switch brings up/down the link on another port.
- LAG dependent on port — If a port loses the link, the switch brings up/down all links in a channel-group.
- Multiple port command — If a group of ports lose their link, the switch brings up/down the link on another group of ports.
- Overlapping ports — Overlapping ports on different groups will be brought up/down only if both dependent ports lose the link.

## What Interface Types are Supported?

The physical ports on the switch include the out-of-band (OOB) interface (Dell EMC Networking N2200-ON, N3000-ON, N3100-ON, and N3200-ON Series only) and Ethernet switch ports. The OOB interface supports a limited set of features and is for switch management only. The Ethernet switch ports support many logical features that are often supported by logical interfaces. The switch supports the following types of logical interfaces:

- Port-based VLANs — For more information, see "VLANs" on page 787.
- VLAN routing interfaces — For more information, see "Routing Interfaces" on page 1219.
- Link Aggregation Groups (LAGs), which are also called port-channels) — For more information, see "Link Aggregation" on page 1089.
- Tunnels — For more information, see "Routing Interfaces" on page 1219.
- Loopback interfaces — For more information, see "Routing Interfaces" on page 1219.

The Dell EMC Networking N-Series switches includes the following Power over Ethernet (PoE) models: N1108PX-ON, N1524P, N1548P, N2024P, N2048P, N2128PX-ON, N2224PX-ON, N2248PX-ON, N3024P, N3048P, N3000, and N3132PX-ON. For information about configuring PoE features for the ports, see "Managing General System Settings" on page 471.

Dell EMC Networking N3000-ON and N3100-ON Series switches have a single expansion slot and can support the following module types:

- 10GBaseT module (Dell EMC Networking N3000-ON)
- SFP+ module (Dell EMC Networking N3000-ON)
- QSFP+ module (Dell EMC Networking N3100-ON Series only)
- Stacking module (Dell EMC Networking N3100-ON Series only)

## What is Interface Configuration Mode?

When you use the CLI to configure physical or logical characteristics for an interface, you must enter Interface Configuration Mode for that interface. To enter the mode, type the keyword **interface** followed by the interface type and additional information to identify the interface, such as the interface number.

To enter Interface Configuration mode for a physical switch port, the following information is required:

- **Type** — For physical switch ports, the type is Gigabit Ethernet (`gigabitEthernet` or `gi`) for 10/100/1000 Mbps Ethernet ports or 10-Gigabit Ethernet (`tengigabitEthernet` or `te`) for 10,000 Mbps Ethernet ports.
- **Stack member number**— The unit number within the stack. The range is 1–12. The default unit number for a switch that has not been in a stack is 1. To view the member number assigned to each switch in a stack, use the `show switch` command.
- **Module (slot) number**—For the Dell EMC Networking N3100-ON Series, the slot number is always 0. The expansion module slot number is 1 for a module inserted in the left slot or 2 when it is in the right slot (when viewing the back panel of the switch). For front-panel ports, the slot number is 0.
- **Port number**—The number assigned to the port. For front-panel ports the port number is written above or below each port. Odd-numbered ports are on the top row, and even-numbered ports are on the bottom row. The port numbers increase from left to right. For ports on the optional modules, the port number is shown on the module and increments beginning with 1.

For example, to enter Interface Configuration mode for Gigabit Ethernet port 10 on a switch that is not part of a stack, use the following command:

```
console (config) #interface gigabitEthernet 1/0/10
```

For example, to enter Interface Configuration mode for 10-Gigabit Ethernet port 10, use the following command:

```
console (config) #interface tengigabitEthernet 1/0/10
```



**NOTE:** When you enter Interface Configuration mode, the command prompt changes and identifies the interface. In the previous example, the command prompt becomes `console (config-if-Tel/0/10) #`.

To enter Interface Configuration mode for Gigabit Ethernet port 6 on stack member 3, use the following command:

```
console (config) #interface gigabitEthernet 3/0/6
```

To enter Interface Configuration mode for port 1 on a 10-Gigabit Ethernet module in the left slot, use the following command:

```
console (config) #interface tengigabitEthernet 1/1/1
```

For many features, a range of interfaces can be specified. When you enter Interface Configuration mode for multiple interfaces, the commands you execute apply to all interfaces specified in the range.

To enter Interface Configuration mode for a range of interfaces, include the keyword **range** and specify the interfaces to configure. For example, to apply the same configuration to 10G Ethernet interfaces 1-10 on a standalone switch, use the following command:

```
console (config) #interface range tengigabitEthernet 1/0/1-10
```

To enter Interface Configuration mode for 10G Ethernet interfaces 3, 4, 5, 12, and 14 on a standalone switch, use the following command:

```
console (config) #interface range tengigabitEthernet 1/0/3-5,1/0/12,1/0/14
```



**NOTE:** To switch to another interface or range of interfaces, enter the interface command while in Interface Configuration mode. It is not necessary to exit Interface Configuration mode to select a different interface.

## What Are the Green Ethernet Features?

The Green Ethernet feature supports two per-port power-saving modes:

- Energy-detect Mode
- EEE

All integrated 1G and module-based 10G copper ports on Dell EMC Networking N-Series switches are capable of utilizing the Energy Detect and EEE modes for reduced power consumption.

When the Energy Detect mode is enabled and the port link is down, the PHY automatically goes down for short period of time and then wakes up to check link pulses. This mode reduces power consumption on the port when no link partner is present.

EEE enables ports to enter a low-power mode to reduce power consumption during periods of low link utilization. EEE is defined by IEEE 802.3az. EEE enables both the send and receive sides of the link to disable some functionality for power savings when the link is lightly loaded. EEE requires auto-negotiation to be enabled on the port.





**NOTE:** Cable diagnostics may give misleading results if green mode is enabled on the port. Disable green mode prior to running any cable diagnostics.

## Switchport Modes

Each port on the Dell EMC Networking N-Series switches can be configured to be in one of the following modes:

- **Access**—Access ports are intended to connect end-stations to the system, especially when the end-stations are incapable of generating VLAN tags. Access ports support a single VLAN (the PVID). Packets received untagged are processed as if they are tagged with the access port PVID. Packets received that are tagged with the PVID are also processed. Packets received that are tagged with a VLAN other than the PVID are dropped. If the VLAN associated with an access port is deleted, the PVID of the access port is set to VLAN 1. VLAN 1 may not be deleted from the switch.

Access mode port VLAN membership may be reconfigured dynamically by protocols such as 802.1X or Voice VLAN. Reconfiguration can change the PVID (802.1X RADIUS assignment) or allow an additional VLAN (Voice VLAN) to pass traffic.

- **Trunk**—Trunk-mode ports are intended for switch-to-switch links. Trunk ports can receive both tagged and untagged packets. Tagged packets received on a trunk port are forwarded on the VLAN contained in the tag if the trunk port is a member of the VLAN. Untagged packets received on a trunk port are forwarded on the native VLAN. Packets received on another interface belonging to the native VLAN are transmitted untagged on a trunk port.

Trunk mode ports are members of all VLANs by default. Administrators can restrict the VLAN membership of trunk mode ports and may configure VLANs that do not exist on the switch. Trunk mode port VLAN membership is generally not reconfigured by protocols beyond adding newly created VLANs to the port, as allowed by trunk port membership configuration.

- **General**—General ports can act like access or trunk ports or a hybrid of both. General mode port VLAN membership may be reconfigured dynamically by protocols such as 802.1X, GVRP, MVRP, or Voice VLAN. Reconfiguration can change the PVID (802.1X RADIUS assignment), or

allow additional VLANs (Voice VLAN, MVRP, GVRP) to pass traffic. Administrators can restrict the VLAN membership of general mode ports, and may configure VLANs that do not exist on the switch.

General mode ports may be configured to accept only tagged traffic, or only untagged traffic, or both. When ingress filtering is enabled, the frame is dropped if the port is not a member of the VLAN identified by the VLAN ID in the tag. If ingress filtering is disabled, all tagged frames are forwarded.

VLAN membership rules that apply to a port are based on the switchport mode configured for the port. Table 17-2 shows the behavior of the three switchport modes.

**Table 17-2. Default Switchport Mode Behavior**

Mode	VLAN Membership	Frames Accepted	Frames Sent	Ingress Filtering
Access	One VLAN <sup>a</sup>	Untagged/ Tagged <sup>a</sup>	Untagged/ Tagged <sup>a</sup>	Always On
Trunk	All VLANs that exist in the system (default)	Untagged/ Tagged	Tagged and Untagged	Always On
General	As many as desired	Tagged or Untagged	Tagged or Untagged	On or Off

a. Access mode ports may be configured to support Voice VLAN in addition to the data VLAN.

## Default Port Values

Table 17-3 lists the default values for the port characteristics that this chapter describes.

**Table 17-3. Default Port Values**

Feature	Description
Administrative status	All ports are enabled
Description	None defined
Auto-negotiation	Enabled for copper ports, disabled for fiber ports
Speed	Max port speed

**Table 17-3. Default Port Values**

<b>Feature</b>	<b>Description</b>
Duplex mode	Full-duplex
Flow control	Enabled (RX only)
Maximum frame size	1518
Energy Detect mode	Enabled
EEE mode	Enabled
Link Dependency	None configured
Switchport mode	Access


The settings in Table 17-4 show recommended port settings by port type.

**Table 17-4. Recommended Port Settings**

<b>Port</b>	<b>Settings</b>
1000M Copper	Auto-Neg (100,1000), Full-duplex
2.5G Copper	Auto-Neg (100,1000,2500), Full-duplex
5G Copper	Auto-Neg (100,1000,5000), Full-duplex
SFP	Auto-Neg (100,1000), Full-duplex
SFP DAC	Auto-Neg (100,1000), Full-duplex
SFP+	10000, Full-duplex
SFP+ DAC	Auto-Neg (1000,10000), Full-duplex
QSFP	40G (or 4x10G), Full-duplex
QSFP DAC	Auto-Neg (40G or 4x10G), Full-duplex

Auto-negotiation is recommended for DAC cables when the link partner is also capable of performing auto-negotiation. If the link partner cannot perform auto-negotiation, then a fixed speed must be utilized. In all cases, the link partners need identical settings, e.g. both sides must be set to use auto-negotiation or a fixed speed. In the case of a fixed speed link, both sides must be set to the same speed.

# Configuring Port Characteristics (Web)

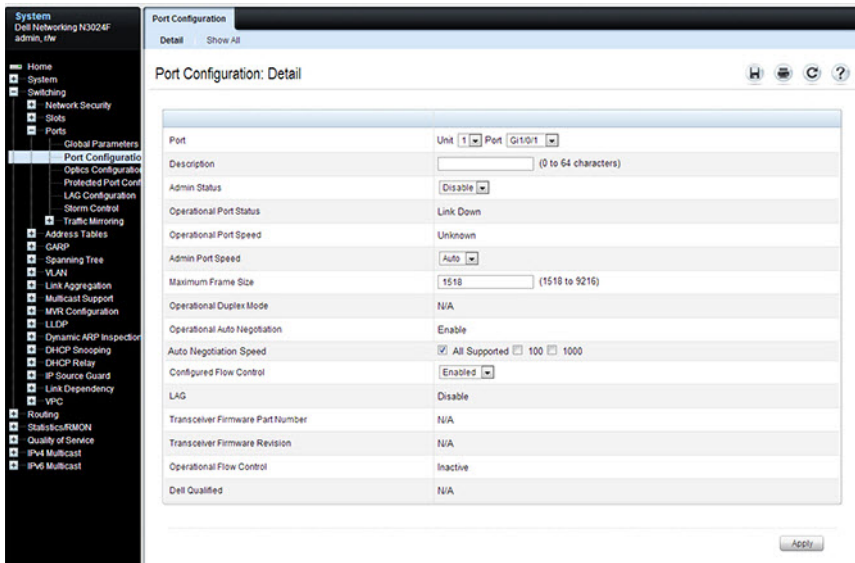
This section provides information about the OpenManage Switch Administrator pages for configuring and monitoring port characteristics on Dell EMC Networking Series switches. For details about the fields on a page, click  at the top of the Dell EMC OpenManage Switch Administrator web page.

## Port Configuration

Use the **Port Configuration** page to define port parameters.

To display the **Port Configuration** page, click **Switching** → **Ports** → **Port Configuration** in the navigation panel.

**Figure 17-1. Port Configuration**

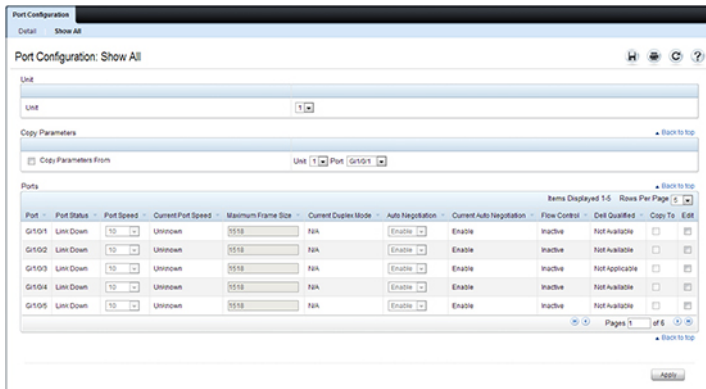


## Configuring Multiple Ports

To configure port settings on multiple ports:

- 1 Open the **Port Configuration** page.
- 2 Click **Show All** to display the **Port Configuration Table** page.
- 3 In the **Ports** list, select the check box in the **Edit** column for the port to configure.
- 4 Select the desired settings.
- 5 Click **Apply**.

**Figure 17-2. Configure Port Settings**



- 6 Select the **Copy Parameters From** check box, and select the port with the settings to apply to other ports.
- 7 In the **Ports** list, select the check box(es) in the **Copy To** column that will have the same settings as the port selected in the **Copy Parameters From** field.

In the following example, Ports 3, 4, and 5 will be updated with the settings that are applied to Port 1.

**Figure 17-3. Copy Port Settings**

The screenshot shows a web-based configuration interface for a network switch. The main heading is "Port Configuration: Show All". Below this, there are sections for "Unit" (set to 1), "Copy Parameters" (checked, from Unit 1 Port Gt10/1), and a "Ports" table. The table lists five ports (Gt10/1 to Gt10/5), all with a status of "Link Down". The table includes columns for Port, Port Status, Port Speed, Current Port Speed, Maximum Frame Size, Current Duplex Mode, Auto Negotiation, Current Auto Negotiation, Flow Control, Dell Qualified, and Copy To. At the bottom right of the table, there is a "Pages 1 of 6" indicator.

Port	Port Status	Port Speed	Current Port Speed	Maximum Frame Size	Current Duplex Mode	Auto Negotiation	Current Auto Negotiation	Flow Control	Dell Qualified	Copy To	Edit
Gt10/1	Link Down	10	Unknown	1518	N/A	Enable	Enable	Inactive	Not Available	<input checked="" type="checkbox"/>	<input type="checkbox"/>
Gt10/2	Link Down	10	Unknown	1518	N/A	Enable	Enable	Inactive	Not Available	<input type="checkbox"/>	<input type="checkbox"/>
Gt10/3	Link Down	10	Unknown	1518	N/A	Enable	Enable	Inactive	Not Applicable	<input checked="" type="checkbox"/>	<input type="checkbox"/>
Gt10/4	Link Down	10	Unknown	1518	N/A	Enable	Enable	Inactive	Not Available	<input checked="" type="checkbox"/>	<input type="checkbox"/>
Gt10/5	Link Down	10	Unknown	1518	N/A	Enable	Enable	Inactive	Not Available	<input checked="" type="checkbox"/>	<input type="checkbox"/>

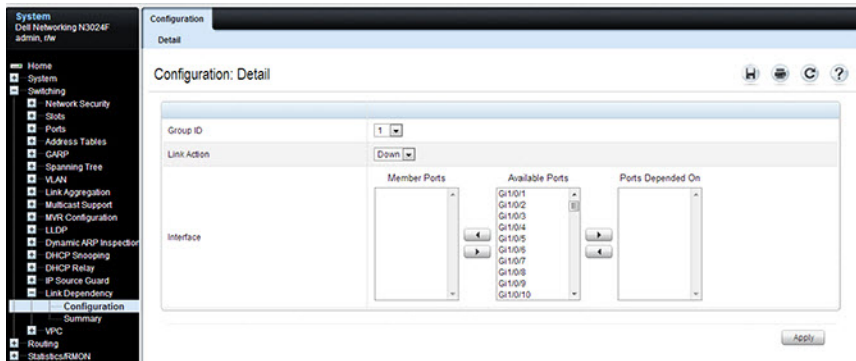
**8** Click Apply.

## Link Dependency Configuration

Use the **Link Dependency Configuration** page to create link dependency groups. The page displays the groups whether they have been configured or not.

To display the **Link Dependency Configuration** page, click **Switching** → **Link Dependency** → **Configuration** in the navigation panel.

**Figure 17-4. Link Dependency Configuration**



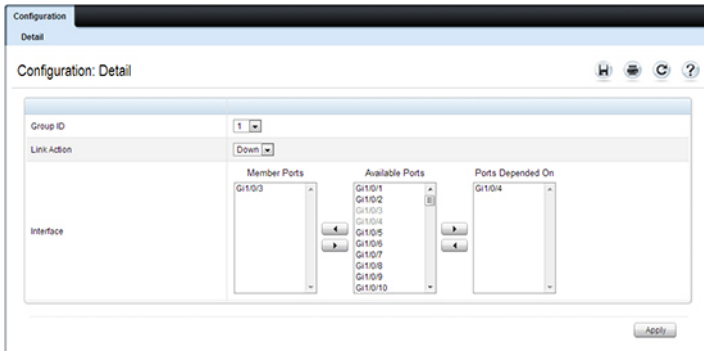
### Creating a Link Dependency Group

To create link dependencies:

- 1 Open the **Link Dependency Configuration** page.
- 2 In the **Group ID** field, select the ID of the group to configure.
- 3 Specify the link action.
- 4 To add a port to the **Member Ports** column, click the port in the **Available Ports** column, and then click the < button to the left of the **Available Ports** column. Ctrl + click to select multiple ports.
- 5 To add a port to the **Ports Depended On** column, click the port in the **Available Ports** column, and then click the > button to the right of the **Available Ports** column.

In the following example, Group 1 is configured so that Port 3 is dependent on Port 4.

**Figure 17-5. Link Dependency Group Configuration**



**6** Click **Apply**.

The Link Dependency settings for the group are modified, and the device is updated.



## Link Dependency Summary

Use the **Link Dependency Summary** page to view all link dependencies on the system and to access the **Link Dependency Configuration** page. The page displays the groups whether they have been configured or not.

To display the **Link Dependency Summary** page, click **Switching** → **Link Dependency** → **Link Dependency Summary** in the navigation panel.

**Figure 17-6. Link Dependency Summary**

Group ID	Member Ports	Ports Depended On	Link Action	Remove	Modify
1	Not configured.	Not configured.	Link Down	<input type="checkbox"/>	Modify
2	Not configured.	Not configured.	Link Down	<input type="checkbox"/>	Modify
3	Not configured.	Not configured.	Link Down	<input type="checkbox"/>	Modify
4	Not configured.	Not configured.	Link Down	<input type="checkbox"/>	Modify
5	Not configured.	Not configured.	Link Down	<input type="checkbox"/>	Modify
6	Not configured.	Not configured.	Link Down	<input type="checkbox"/>	Modify
7	Not configured.	Not configured.	Link Down	<input type="checkbox"/>	Modify
8	Not configured.	Not configured.	Link Down	<input type="checkbox"/>	Modify
9	Not configured.	Not configured.	Link Down	<input type="checkbox"/>	Modify
10	Not configured.	Not configured.	Link Down	<input type="checkbox"/>	Modify
11	Not configured.	Not configured.	Link Down	<input type="checkbox"/>	Modify
12	Not configured.	Not configured.	Link Down	<input type="checkbox"/>	Modify
13	Not configured.	Not configured.	Link Down	<input type="checkbox"/>	Modify
14	Not configured.	Not configured.	Link Down	<input type="checkbox"/>	Modify
15	Not configured.	Not configured.	Link Down	<input type="checkbox"/>	Modify
16	Not configured.	Not configured.	Link Down	<input type="checkbox"/>	Modify

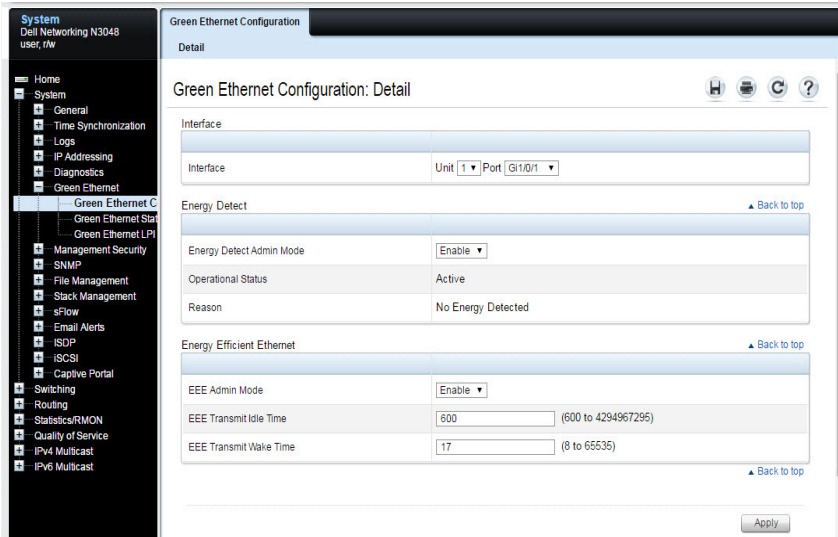
To configure a group, click the **Modify** link associated with the ID of the group to configure. Clicking the **Modify** link takes you to the **Link Dependency Configuration** page. The Group ID is automatically selected based on the link that was clicked.

## Port Green Ethernet Configuration

Use the **Green Ethernet Configuration** page to enable or disable energy-saving modes on each port.

To display the **Green Ethernet Configuration** page, click **System** → **Green Ethernet** → **Green Ethernet Configuration** in the navigation panel.

**Figure 17-7. Green Ethernet Configuration**



## Port Green Ethernet Statistics

Use the Green Ethernet Statistics page to view information about per-port energy savings.

To display the Green Ethernet Statistics page, click **System** → **Green Ethernet** → **Green Ethernet Statistics** in the navigation panel.

**Figure 17-8. Green Ethernet Statistics**

The screenshot displays the 'Green Ethernet Statistics: Detail' page. The left sidebar shows the navigation menu with 'Green Ethernet Statistics' selected. The main content area is split into two sections:

### Local Device Information

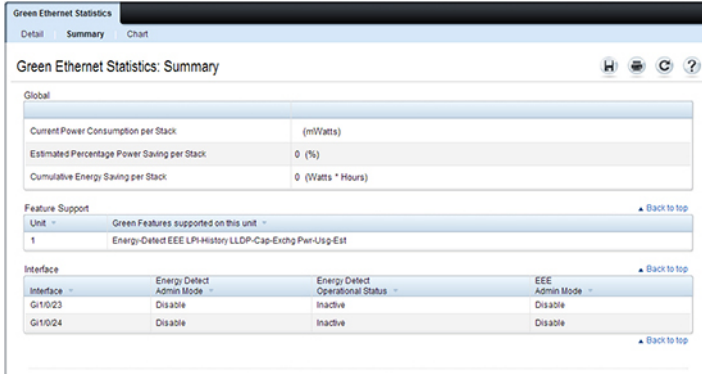
Interface	Unit	Port
Cumulative Energy Saved on this port due to Green Modes(s)		
Rx Low Power Idle Event Count	6710863	
Rx Low Power Idle Duration	167772160	(uSec)
Tx Low Power Idle Event Count	23	
Tx Low Power Idle Duration	927560	(uSec)
Tw_sys_tx	17	(uSec)
Tw_sys_tx Echo	17	(uSec)
Tw_sys_rx	17	(uSec)
Tw_sys_rx Echo	17	(uSec)
Fallback Tw_sys	17	(uSec)
Tx_ql_enable	No	
Tx_ql_ready	No	
Rx_ql_enable	No	
Rx_ql_ready	No	
Time Since Counters Last Cleared	0 day 4 hr 42 min 37 sec	

### Remote Device Information

Interface
No LLDP data has been received on this interface

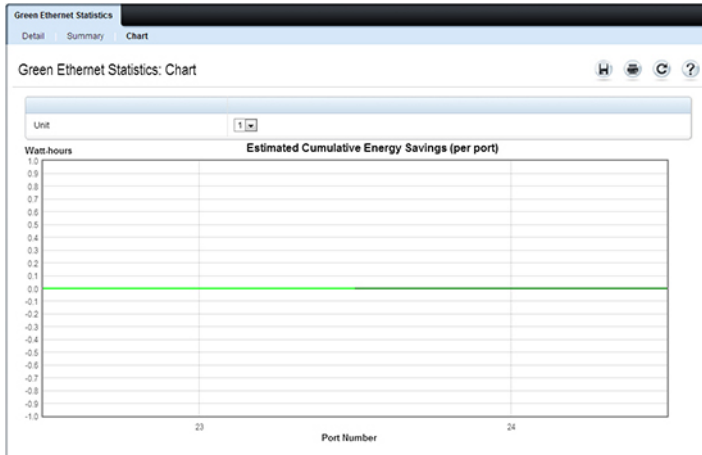
To view a summary of energy savings for the switch and all ports, click **Summary**.

**Figure 17-9. Green Ethernet Statistics Summary**



To view a chart that shows the estimated per-port energy savings, click **Chart**.

**Figure 17-10. Green Ethernet Statistics Chart**

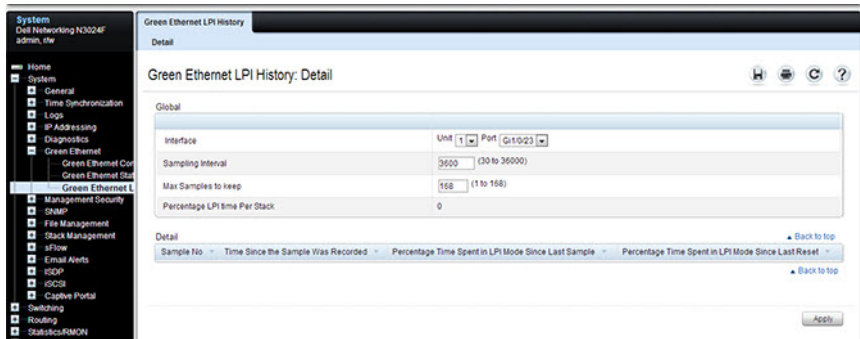


## Port Green Ethernet LPI History

Use the **Green Ethernet LPI History** page to view data about the amount of time the switch has spent in low-power idle (LPI) mode.

To display the **Green Ethernet LPI History** page, click **System** → **Green Ethernet** → **Green Ethernet LPI History** in the navigation panel.

**Figure 17-11. Green Ethernet LPI History**



## Configuring Port Characteristics (CLI)

This section provides information about the commands used for configuring port characteristics. For more information about the commands, see the *Dell EMC Networking N1100-ON, N1500, N2000, N2100-ON, N2200-ON, N3000E-ON, N3100-ON, and N3200-ON Series Switches CLI Reference Guide* at [www.dell.com/support](http://www.dell.com/support).

### Configuring Port Settings

Use the following commands to configure various port settings.

Command	Purpose
<code>configure</code>	Enter Global Configuration mode.
<code>interface <i>interface</i></code>	Enter interface configuration mode for the specified interface. The <i>interface</i> variable includes the interface type and number, for example <code>tengigabitethernet 1/0/3</code> .  A range of interfaces can be specified using the <code>interface range</code> command. For example, <code>interface range tengigabitethernet 1/0/8-12</code> configures interfaces 8, 9, 10, 11, and 12.
<code>description <i>string</i></code>	Add a description to the port. The text string can be from 1-64 characters.
<code>shutdown</code>	Administratively disable the interface.

<b>Command</b>	<b>Purpose</b>
<pre>speed {10   100   1000   10000   auto [100   1000   2500   5000   10000 ]}</pre>	<p>Configure the speed of a given Ethernet interface or allow the interface to automatically detect the speed.</p> <p>If you use the 100, 1000, 2500, 5000, 10000 keywords with the auto keyword, the port auto-negotiates only at the specified speeds. Setting the speed without the auto keyword forces the speed to the single selected value and disables auto-negotiation. It is possible to configure a fiber port for a speed not supported by the transceiver. In this case, the port may or may not link up.</p> <p>Auto-negotiation should always be used for copper ports (including SFP and SFP+ DAC cables) as well as 1000BASE-X fiber ports. Auto-negotiation internally selects the appropriate medium for both ends of the link and will perform link training (adjusting the pre-emphasis values) and enables DFE to ensure the highest signal integrity on copper media.</p> <p>On combo ports, it is possible to configure auto-negotiation even if only the fiber interface is active. The auto-negotiation settings will be utilized when the copper port is active or a 1000BASE-X transceiver is inserted. Fiber ports always operate in full-duplex mode.</p>
<code>system jumbo mtu <i>size</i></code>	Enable jumbo frames on the switch by adjusting the maximum size of a packet.
<code>CTRL + Z</code>	Exit to Privileged Exec mode.
<code>show interfaces status</code>	Show summary information about all interfaces.
<code>show interfaces configuration</code>	View a summary of the configuration for all ports.
<code>show interfaces advertise</code>	View a summary of the speeds that are advertised on each port.
<code>show interfaces description</code>	View configured descriptions for all ports.
<code>show interfaces detail <i>interface</i></code>	View detailed information about the specified port.

## Configuring Link Dependencies

Use the following commands to configure ports that are dependent on the state of other ports.

Command	Purpose
<code>configure</code>	Enter Global Configuration mode.
<code>link-dependency group <i>group_id</i></code>	Enter the link-dependency mode to configure a link-dependency group.
<code>add <i>interface</i></code>	<p>Add member ports to the group.</p> <p>The <i>interface</i> variable includes the interface type and number, for example <code>tengigabitethernet 1/0/3</code>. Port-channels (LAGs) can also be added as members by using the keyword <code>port-channel</code> followed by an ID.</p> <p>A range of interfaces can also be specified. For example, <code>interface tengigabitethernet 1/0/8-10,1/0/20</code> configures interfaces 8, 9, 10 and 20.</p>
<code>depends-on <i>interface</i></code>	Specify the port(s) upon which the member ports are dependent. For information about the <i>interface</i> variable, see the previous command description.
<code>action {down up}</code>	<p>Specifies the action the member ports take when the dependent link goes down.</p> <ul style="list-style-type: none"><li>• <b>down</b>—When the dependent link is down, the group members are down (the members are up otherwise).</li><li>• <b>up</b>—When the dependent link goes down, the group members are brought up (the members are down otherwise)</li></ul>
<code>CTRL + Z</code>	Exit to Privileged Exec mode.
<code>show link-dependency [<i>group group_id</i>]</code>	View link dependency settings for all groups or for the specified group, along with the group state.



## Configuring Green Features

Use the following commands to configure and monitor energy-saving features for the ports and the switch. EEE capability requires auto-negotiation to be enabled.

Command	Purpose
<code>configure</code>	Enter Global Configuration mode.
<code>interface <i>interface</i></code>	Enter interface configuration mode for the specified interface. The <i>interface</i> variable includes the interface type and number, for example <code>gigabitethernet 1/0/3</code> .  A range of interfaces can be specified using the <code>interface range</code> command. For example, <code>interface range gigabitethernet 1/0/8-12</code> configures interfaces 8, 9, 10, 11, and 12.
<code>green-mode energy-detect</code>	Enable energy-detect mode on the interface.
<code>green-mode eee</code>	Enable EEE low power idle mode on the interface.
<code>exit</code>	Exit to global configuration mode.
<code>green-mode eee-lpi-history {sampling-interval <i>seconds</i>   max-samples <i>max</i>}</code>	Configure the global EEE LPI history collection interval and buffer size.
<code>exit</code>	Exit to Privileged Exec mode.
<code>show green-mode <i>interface</i></code>	View green mode settings for the specified port.
<code>show green-mode eee-lpi-history <i>interface interface</i></code>	View the EEE LPI history statistics for the specified port.

# Port Configuration Examples

This section contains the following examples:

- Configuring Port Settings
- Configuring a Link Dependency Groups

## Configuring Port Settings

The commands in this example specify the speed for port 1 (GigabitEthernet 1/0/1) and change the system MTU size.

To configure the switch:

- 1 Enter Interface Configuration mode for port 1.

```
console#configure
console(config)#interface gigabitEthernet 1/0/1
```

- 2 Change the speed settings for the port.

```
console(config-if-Gi1/0/1)#speed 100
console(config-if-Gi1/0/1)#exit
```

- 3 Enable jumbo frame support on the interfaces.

```
console(config)#system jumbo mtu 9216
console(config)#CTRL + Z
```

- 4 View summary information about the ports

```
console#show interfaces configuration
```

Port	Type	Duplex	Speed	Neg	Admin St.
Gi1/0/1	Gigabit - Level	Full	100	Off	Up
Gi1/0/2	Gigabit - Level	N/A	Unknown	Auto	Up
Gi1/0/3	Gigabit - Level	N/A	Unknown	Auto	Up
Gi1/0/4	Gigabit - Level	N/A	Unknown	Auto	Up
Gi1/0/5	Gigabit - Level	N/A	Unknown	Auto	Up

## Configuring a Link Dependency Groups

The commands in this example create two link dependency groups. Group 1 has port 3 as a member port that is dependent on port 4. The group uses the default link action, which is down. This means that if port 4 goes down, port 3 goes down. When port 4 returns to the up state, port 3 is brought back up. In Group 2, port 6 dependent on port-channel (LAG) 1, and the link action is up. If port-channel 1 goes down, port 6 is brought up. This also means that when port-channel 1 is up, port 6 is down.

To configure the switch:

- 1 Enter the configuration mode for Group 1.

```
console#configure
console (config) #link-dependency group 1
```

- 2 Configure the member and dependency information for the group.

```
console (config-linkDep-group-1) #add tengigabitethernet 1/0/3
console (config-linkDep-group-1) #depends-on tengigabitethernet
1/0/4
console (config-linkDep-group-1) #exit
```

- 3 Enter the configuration mode for Group 2

```
console (config) #link-dependency group 2
console (config-linkDep-group-2) #add tengigabitethernet 1/0/6
console (config-linkDep-group-2) #depends-on port-channel 1
console (config-linkDep-group-2) #action up
console (config-linkDep-group-2) #CTRL + Z
```

- 4 View the configured link dependency groups.

```
console#show link-dependency
```

GroupId	Member Ports	Ports Depended On	Link Action
1	Te1/0/3	te/0/4	Link Down
2	te/0/6	chl	Link Up

## Configuring a Port in Access Mode

Use the following commands to configure an access mode VLAN interface and, optionally, assign the interface to a VLAN. When a port is in access mode, it can only be a member of one data VLAN and will accept tagged packets with the access VLAN ID or untagged packets. Untagged packets are treated as belonging to the access VLAN. Packets received with a VLAN ID other than the access VLAN ID are discarded, except for voice packets tagged

with the voice VLAN on ports configured for voice VLAN. When configuring an interface as an access mode port, the interface is automatically made a member of VLAN 1 by default and removed from all other VLAN memberships. Each interface can be configured separately, or a range of interfaces can be configured with the same settings.

Command	Purpose
<code>configure</code>	Enter global configuration mode.
<code>interface <i>interface</i></code>	Enter interface configuration mode for the specified interface. The <i>interface</i> variable includes the interface type and number, for example <code>tengigabitethernet 1/0/3</code> .  A range of interfaces can be specified using the <code>interface range</code> command. For example, <code>interface range tengigabitethernet 1/0/8-12</code> configures interfaces 8, 9, 10, 11, and 12.
<code>switchport mode access</code>	Configure the interface as an access mode VLAN interface. Access mode VLANs accept tagged or untagged packets for the access VLAN only.
<code>switchport access vlan <i>vlan-id</i></code>	Configure the interface as a member of the specified VLAN. By default, access mode ports are members of VLAN 1.  <i>vlan-id</i> — A valid VLAN ID of the VLAN to which the port is configured. (Range: 1–4093)
CTRL + Z	Exit to Privileged Exec mode.
<code>show interfaces</code> <code>switchport <i>interface</i></code>	Display information about the VLAN settings configured for the specified interface.

### Configuring a Port in Trunk Mode

Use the following commands to configure an interface as a Layer-2 trunking interface, which connects two switches. Trunk mode ports support traffic tagged with different VLAN IDs and are most often configured as uplinks. Untagged received traffic is switched in the native VLAN. A trunk port is automatically configured as a member of all VLANs, including any newly

created VLANs. Trunk ports can be removed from membership in specific VLANs, including VLANs that are not yet configured on the switch. By default, the native VLAN for a trunk port is VLAN 1.

<b>Command</b>	<b>Purpose</b>
<code>configure</code>	Enter global configuration mode.
<code>interface <i>interface</i></code>	Enter interface configuration mode for the specified interface. The <i>interface</i> variable includes the interface type and number, for example <code>tengigabitethernet 1/0/3</code> .  A range of interfaces can be specified using the <b>interface range</b> command; For example, <b>interface range tengigabitethernet 1/0/8-12</b> configures interfaces 8, 9, 10, 11, and 12.
<code>switchport mode trunk</code>	Configure the interface as a tagged Layer-2 VLAN interface.

Command	Purpose
<pre>switchport trunk {allowed vlan <i>vlan-</i> <i>list</i> native vlan <i>vlan-id</i>}</pre>	<p>Set the list of allowed VLANs that can receive and send traffic on this interface in tagged format when in trunking mode.</p> <ul style="list-style-type: none"> <li>• <b>allowed <i>vlan-list</i></b>— Set the list of allowed VLANs that can receive and send traffic on this interface in tagged format when in trunking mode. Separate non-consecutive VLAN IDs with a comma and no spaces. Use a hyphen to designate a range of IDs.</li> </ul> <p>The <i>vlan-list</i> format is <b>all</b>   [<b>add</b>   <b>remove</b>   <b>except</b>] <i>vlan-atom</i> [<i>vlan-atom</i>...] where:</p> <ul style="list-style-type: none"> <li>• <b>all</b>—Specifies all VLANs from 1 to 4093. This keyword is not allowed on commands that do not permit all VLANs in the list to be set at the same time.</li> <li>• <b>add</b>—Adds the list of VLANs to the allowed set.</li> <li>• <b>remove</b>—Removes the list of VLANs from the allowed set. Removing the native VLAN from a trunk port forces the port to allow tagged packets only.</li> <li>• <b>except</b>—Allows all VLANs other than those in the list.</li> <li>• <i>vlan-atom</i>—Either a single VLAN number from 1 to 4093 or a continuous range of VLANs described by two VLAN numbers, the lesser one first, separated by a hyphen.</li> <li>• <b>native <i>vlan-id</i></b>— The untagged VLAN. Untagged packets received on this interface are switched in the native VLAN. Transmitted packets in this VLAN are sent untagged.</li> </ul>
CTRL + Z	Exit to Privileged Exec mode.
<pre>show interfaces switchport <i>interface</i></pre>	Display information about the VLAN settings configured for the specified interface. The <i>interface</i> variable includes the interface type and number.

## Configuring a Port in General Mode

Use the following commands to configure an interface with full 802.1q support and configure the VLAN membership information for the interface. General mode allows the configuration of the full range of VLAN tagging, including configuring a port with no default or native VLAN. In general, it is recommended that operators use either trunk or access mode as their default behaviors better match operator expectations.

Command	Purpose
<code>configure</code>	Enter global configuration mode.
<code>interface <i>interface</i></code>	Enter interface configuration mode for the specified interface. The <i>interface</i> variable includes the interface type and number, for example <code>tengigabitethernet 1/0/3</code> .  A range of interfaces can be specified using the <code>interface range</code> command. For example, <code>interface range tengigabitethernet 1/0/8-12</code> configures interfaces 8, 9, 10, 11, and 12.
<code>switchport mode general</code>	Configure the interface as a tagged and untagged Layer-2 VLAN interface.
<code>switchport general allowed vlan [add remove] <i>vlan-list</i> {tagged untagged}</code>	Configure the VLAN membership for the port. This command can also be used to change the egress tagging for packets without changing the VLAN assignment. <ul style="list-style-type: none"><li>• <code>add <i>vlan-list</i></code> — List of VLAN IDs to add. Separate nonconsecutive VLAN IDs with a comma and no spaces. Use a hyphen to designate a range of IDs. (Range: 1–4093)</li><li>• <code>remove <i>vlan-list</i></code> — List of VLAN IDs to remove. Separate nonconsecutive VLAN IDs with a comma and no spaces. Use a hyphen to designate a range of IDs.</li><li>• <code>tagged</code> — Sets the port to transmit tagged packets for the VLANs. If the port is added to a VLAN without specifying tagged or untagged, the default is untagged.</li><li>• <code>untagged</code> — Sets the port to transmit untagged packets for the VLANs.</li></ul>

<b>Command</b>	<b>Purpose</b>
<code>switchport general pvid <i>vlan-id</i></code>	(Optional) Set the port VLAN ID. Untagged traffic that enters the switch through this port is tagged with the PVID.  <i>vlan-id</i> — PVID. The selected PVID assignment must be to an existing VLAN. (Range: 1–4093). Entering a PVID value does not remove the previous PVID value from the list of allowed VLANs.
<code>switchport general acceptable-frame-type tagged-only</code>	(Optional) Specifies that the port will only accept tagged frames. Untagged frames are dropped at ingress.
<code>switchport general ingress-filtering disable</code>	(Optional) Turn off ingress filtering so that all received tagged frames are forwarded whether or not the port is a member of the VLAN in the tag.
CTRL + Z	Exit to Privileged Exec mode.
<code>show interfaces</code> <code>switchport <i>interface</i></code>	Display information about the VLAN settings configured for the specified interface. The <i>interface</i> variable includes the interface type and number.



# Port and System Security

## Dell EMC Networking N-Series Switches

This chapter describes how to configure port-based and system security features, which control access to the network through the switch ports, and the denial of service (DoS) feature.

The topics covered in this chapter include:

- Port Security
- Denial of Service

## Port Security

Port Security is used to enable security on a per-port basis. When a port is enabled for Port Security, only packets with allowable source MAC addresses are forwarded. All other packets are discarded. Port Security allows a configurable limit to the number of source MAC addresses that can be learned on a port.



**NOTE:** Port-based security can also be accomplished by using Access Control Lists (ACLs). For information about configuring ACLs, see "Access Control Lists" on page 713.

The Port Security feature allows the administrator to limit the number of source MAC addresses that can be learned on a port. If a port reaches the configured limit, any additional addresses beyond that limit are not learned, and the frames received from unlearned stations are discarded. Frames with a source MAC address that has already been learned will be forwarded.

The purpose of this feature, which is also known as Port-MAC locking, is to help secure the network by preventing unknown devices from forwarding packets into the network. For example, to ensure that only a single device can be active on a port, set the number of allowable dynamic addresses to one. After the MAC address of the first device is learned, no other devices will be allowed to forward frames into the network.

Two methods are used to implement Port Security: dynamic locking and static locking. Static locking further has an optional sticky mode. Dynamic locking implements a *first arrival* mechanism for MAC locking.

The administrator specifies how many dynamic addresses may be learned on the locked port. If the limit has not been reached, then a packet with an unknown source MAC address is learned and forwarded normally. If the MAC address limit has been reached, the packet is discarded. The administrator can disable dynamic locking (learning) by setting the number of allowable dynamic entries to zero.

When a Port Security-enabled link goes down, all of the dynamically locked addresses are *freed*. When the link is restored, that port can once again learn MAC addresses up to the administrator specified limit.

A dynamically locked MAC address is eligible to be aged out if another packet with that MAC address is not seen within the age-out time. Dynamically locked MAC addresses are also eligible to be relearned on another port if station movement occurs. Statically locked MAC addresses are not eligible for aging. If a packet arrives on a port with a source MAC address that is statically locked on another port, then the packet is discarded.

Static locking allows the administrator to specify a list of host MAC addresses that are allowed on a port. The behavior of packets is the same as for dynamic locking: only packets received with a known source MAC address can be forwarded.

Any packets with source MAC addresses that are not configured are discarded. The switch treats this as violation and supports the ability to send an SNMP port security trap.

If the specific MAC address (or addresses) that will be connected to a particular port are known, the administrator can specify those addresses as static entries. By setting the number of allowable dynamic entries to zero, only packets with a source MAC address matching a MAC address in the static list are forwarded.

Sticky mode configuration converts all the existing dynamically learned MAC addresses on an interface to sticky. This means that they will not age out and will appear in the running-config. In addition, new addresses learned on the interface will also become sticky. Note that sticky is not the same as static —

the difference is that all sticky addresses for an interface are removed from the running-config when the interface is taken out of sticky mode. Static addresses must be removed from the running-config individually.

Sticky MAC addresses appear in the running-config in the following form:

```
switchport port-security mac-address sticky
0011.2233.4455 vlan 33
```

Statically locked MAC addresses appear in the running-config in the following form:

```
switchport port-security mac-address
0011.2233.4455 vlan 33
```


### Default Port Security Values

Table 18-1 lists the default values for the Port Security feature.

**Table 18-1. Default Port Security Values**

Feature	Description
Port security	Unlocked
Port security traps	Enabled
Maximum learned MAC addresses	600 (when locked)
Maximum static MAC addresses	100
Monitor mode	Disabled

### Configuring Port Security Configuration (Web)


This section provides information about the OpenManage Switch Administrator pages for configuring and monitoring the IEEE 802.1X features and Port Security on Dell EMC Networking Series switches. For details about the fields on a page, click  at the top of the Dell EMC OpenManage Switch Administrator web page.

#### Port Security

Use the **Port Security** page to enable MAC locking on a per-port basis. When a port is locked, a limit can be specified for the number of source MAC addresses that are allowed to transmit traffic on the port.

To display the **Port Security** page, click **Switching** → **Network Security** → **Port Security** in the navigation panel.

**Figure 18-1. Network Security Port Security**

Port Security: Detail 

---

Global Settings

Admin Mode	Disable ▾
------------	-----------

---

Per Interface Settings

Interface	<input checked="" type="radio"/> Unit 1 ▾ Port Gi1/0/1 ▾ <input type="radio"/> LAG Po1 ▾
Set Port	Unlocked ▾
Traps	Enable ▾
Trap Frequency	30 (1 to 1000000)
Max Learned Addresses	600 (0 to 600)
Sticky Mode	Disable ▾

**Configuring Port Security Settings on Multiple Ports**

To configure port security on multiple ports:

- 1 Open the **Port Security** page.
- 2 Click **Show All** to display the **Port Security Table** page.
- 3 In the Ports list, select the check box in the **Edit** column for the port to configure.
- 4 Select the desired settings for all ports that are selected for editing.

**Figure 18-2. Configure Port Security Settings**

System  
Dell Networking N3024F  
admin, lhw

Home  
System  
Switching  
Network Security  
Port Security  
Authenticated Users  
Access Control Lists  
Proprietary Protocol  
Ports Authentication  
Slots  
Ports  
Address Tables  
GARP  
Spanning Tree  
VLAN  
Link Aggregation  
Multicast Support  
MVR Configuration  
LLDP  
Dynamic ARP Inspection  
DHCP Snooping  
DHCP Relay  
IP Source Guard  
Link Dependency  
VPC  
Routing  
Statistics/RMON  
Quality of Service  
IPv6 Multicast  
IPv6 Multicast

Port Security  
Detail Show All

Port Security: Show All

Unit  
Unit

Port Settings [Back to top](#)  
Items Displayed 1-5 Rows Per Page

Port	Set Port	Trap	Trap Frequency	Edit
1 Gi1/0/1	Unlocked	Disable	<input type="text" value="30"/>	<input type="checkbox"/>
2 Gi1/0/2	Unlocked	Disable	<input type="text" value="30"/>	<input type="checkbox"/>
3 Gi1/0/3	Unlocked	Disable	<input type="text" value="30"/>	<input type="checkbox"/>
4 Gi1/0/4	Unlocked	Disable	<input type="text" value="30"/>	<input type="checkbox"/>
5 Gi1/0/5	Unlocked	Disable	<input type="text" value="30"/>	<input type="checkbox"/>

Pages 1 of 6

LAG Settings [Back to top](#)  
Items Displayed 1-5 Rows Per Page

Port	Set Port	Trap	Trap Frequency	Edit
1 Po1	Unlocked	Disable	<input type="text" value="30"/>	<input type="checkbox"/>
2 Po2	Unlocked	Disable	<input type="text" value="30"/>	<input type="checkbox"/>
3 Po3	Unlocked	Disable	<input type="text" value="30"/>	<input type="checkbox"/>
4 Po4	Unlocked	Disable	<input type="text" value="30"/>	<input type="checkbox"/>
5 Po5	Unlocked	Disable	<input type="text" value="30"/>	<input type="checkbox"/>

Pages 1 of 26

**5** Click Apply.

## Configuring Port Security (CLI)

Use the following commands to enable port security on an interface to limit the number of source MAC addresses that can be learned.

Command	Purpose
<code>configure</code>	Enter Global Configuration mode.
<code>switchport port-security</code>	Enable port-security administrative mode. Port security must be enabled globally in order to operate on any interfaces.
<code>interface <i>interface</i></code>	Enter interface configuration mode for the specified interface. The <i>interface</i> variable includes the interface type and number, for example <code>tengigabitethernet 1/0/3</code> .  A range of interfaces can be specified using the <code>interface range</code> command. For example, <code>interface range tengigabitethernet 1/0/8-12</code> configures interfaces 8, 9, 10, 11, and 12.
<code>switchport port-security [mac-address {sticky   [sticky] <i>mac-address</i> vlan {<i>vlan-id</i>}}]   dynamic <i>value</i>   maximum <i>value</i>]   violation {protect   shutdown}</code>	Enable port security on the port. This prevents the switch from learning new addresses on this port after the maximum number of addresses has been learned. <ul style="list-style-type: none"><li>• <b>mac-address</b> — Configure a static MAC address on the interface and VLAN. This command performs the same function as the <code>mac address-table static</code> command. Use the optional <code>sticky</code> keyword to configure a sticky MAC address.</li><li>• <b>dynamic</b> — Set the maximum number of dynamic MAC addresses that may be learned on the interface.</li><li>• <b>maximum</b> — Set the maximum number of static MAC addresses that may be configured on the interface. This limit applies regardless of the port security administrative setting.</li><li>• <b>sticky</b> — Convert dynamic addresses learned on the interface to sticky</li><li>• <b>violation</b> — Configure the interface behavior on a port security violation</li></ul>
<code>CTRL + Z</code>	Exit to Privileged Exec mode.

---

<b>Command</b>	<b>Purpose</b>
<code>show port-security</code> <code>[<i>interface-id</i>   <b>all</b>  </code> <code><b>dynamic</b> <i>interface-id</i>  </code> <code><b>static</b> <i>interface-id</i>  </code> <code><b>violation</b> <i>interface-id</i>]</code>	View port security settings on all interfaces or the specified interface. Use the <b>dynamic</b> keyword to display learned MAC addresses and the <b>static</b> keyword to display configured MAC addresses.

---

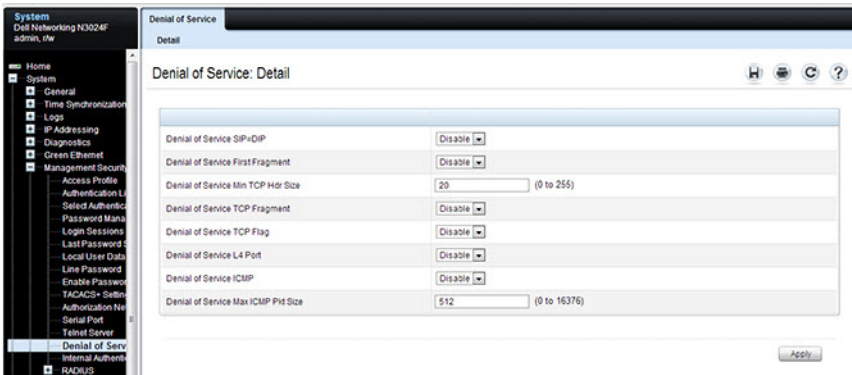
# Denial of Service

Denial of Service (DoS) refers to the exploitation of a variety of vulnerabilities which would interrupt the service of a host or make a network unstable. Use the Denial of Service page to configure settings to help prevent DoS attacks.

DoS protection is disabled by default.

To display the Denial of Service page, click System → Management Security → Denial of Service in the navigation panel.

**Figure 18-3. Denial of Service**





# Access Control Lists

## Dell EMC Networking N-Series Switches

This chapter describes how to configure Access Control Lists (ACLs), including IPv4, IPv6, and MAC ACLs. This chapter also describes how to configure time ranges that can be applied to any of the ACL types.

The topics covered in this chapter include:

- ACL Overview
- ACL Configuration Details
- Policy-Based Routing
- Configuring ACLs (Web)
- Configuring ACLs (CLI)
- ACL Configuration Examples. Dynamic ACLs are covered in the Authentication, Authorization, and Accounting section of this manual.

## ACL Overview

Access Control Lists (ACLs) are a collection of rules that provide security by blocking selected packets from ingressing the switch. ACLs are implemented in hardware and processed at line rate for the front-panel ports. A reduced functionality set of ACLs is implemented in firmware for the OOB port.

ACLs can also provide ingress traffic rate limiting and decide which types of traffic are forwarded or blocked. Egress ACLs support traffic shaping. ACLs support deployment as a firewall router, a router connecting two internal networks, or a Layer-3 router implementing routing policies.

To harden the switch against external threats, it is possible to create an ACL that limits access to the management interfaces based on the connection method (for example, Telnet or HTTP) and/or the source IP address.

The Dell EMC Networking N-Series switches support ACL configuration in both the ingress and egress direction. Egress ACLs provide the capability to implement security rules on the egress flows (traffic leaving a port) rather than the ingress flows (traffic entering a port). Ingress and egress ACLs can be applied to any physical port, port-channel (LAG), or VLAN routing port.

Depending on whether an ingress or egress ACL is applied to a port, when the traffic enters (ingress) or leaves (egress) a port, the ACL compares the criteria configured in its rules, in list order, to the fields in a packet or frame to check for matching conditions. The ACL processes the traffic based on the actions contained in the rules.

ACLs are organized into access groups. Access groups are numbered in priority (lowest number has highest priority). Multiple access groups can be configured on an interface, in which the lowest numbered access group is processed first, followed by the next lowest numbered access group, etc.



**NOTE:** Conceptually, ACL processing proceeds by attempting to match each of the ACLs listed in the first match term or clause in the first access group in order. If an ACL does not match, processing moves to the next ACL in order until an ACL matches or the ACL group is exhausted. If there are more access groups configured, processing proceeds with the next access group.

In reality, all interface ACL matches are attempted in parallel at once, and the priority of the ACL is used to determine the action. Then, all VLAN ACL matches are attempted in parallel at once, and the priority of the ACL is used to determine the action. This implies that a packet that matches both a physical interface ACL and a VLAN ACL will always take the physical interface action.

Within an access group, ACL rules are processed in sequence, from the first (lowest numbered) rule to the last (highest numbered) rule in the access group. If a matching rule is found, the rule action is taken and no subsequent rules are processed for that packet. Frequently matched rules should be placed near or at the front of the list. At least one access list within the access groups configured on an interface must contain at least one permit rule or all traffic is denied (dropped). ACL entries may be numbered by the administrator when configured or automatically numbered by the system. Additionally, remarks may be entered for an ACL entry.

Packets generated by the switch are sent regardless of any egress ACL deny rules.



**NOTE:** The last access group configured on an interface is terminated by an implicit **deny all** rule, which drops any packet not matching a preceding **permit** rule. The implicit **deny all** rule is not configured if Policy-Based Routing is configured on the interface.

ACLs may be used to control traffic at Layer 2, Layer 3, or Layer 4. MAC ACLs contain packet match criteria based on Layer-2 fields in Ethernet frames. IP ACLs contain packet match criteria based on Layer-3 and Layer-4 fields in the packet. Dell EMC Networking N-Series switches support both IPv4 and IPv6 ACLs and supports ACLs applied to up to 24 VLAN interfaces.

## ACL Counters

Matching rules in an ACL are counted. The counts may be displayed using the `show ip access-list` or `show mac access-list` commands. For ACL counters, if an ACL rule is configured without a rate-limit, the counter value is the count of the permitted or denied packets. (Example: If a burst of 100 matching packets is received, the counter value is 100.)

If an ACL rule is configured with a rate limit, the counter value will be the matched packet count. If the received traffic rate exceeds the configured limit, the counters still display matched packet count despite the packets which exceed the configured limit since match criteria is met. For example, if the rate limit is set to 10 Kbps and ‘matching’ traffic is received at 100 Kbps, the counters reflect the 100 Kbps value. If the received traffic rate is less than the configured limit, the counters display only the matched packet count. ACL counters do not interact with DiffServ policies.

## What Are MAC ACLs?

MAC ACLs are Layer-2 ACLs. MAC ACLs can filter on the following fields of a packet:

- Source MAC address
- Source MAC mask
- Destination MAC address
- Destination MAC mask
- VLAN ID
- Class of Service (CoS) (802.1p)
- EtherType

MAC access list actions include CoS queue assignment, logging, mirroring, redirection to another port, and logging, as well as the usual permit and deny actions. It is possible to configure MAC access groups in conjunction with IP access groups on the same interface. MAC ACLs can be configured on a VLAN interface as well as a physical interface or port channel.

## What Are IP ACLs?

IP ACLs contain filters for layers 3 and 4 on IPv4 or IPv6 traffic.

Each IP ACL is a set of up to the maximum supported rules applied to inbound or outbound traffic. See Table 19-2. IP ACLs support logging, redirect, mirroring, and drop. The following fields may be specified in the permit or deny rules.

- Destination IP with wildcard mask
- Every protocol or a specific protocol
- IP DSCP
- IP precedence
- IP TOS
- TCP flags
- Source IP with wildcard mask
- Source Layer-4 port, with eq, ne, gt, and lt operators and ranges (IP/TCP/UDP packets only)
- Destination Layer-4 port, with eq, ne, gt, and lt operators and ranges (TCP/UDP packets only)

IP access lists may be configured on physical interfaces and port channels as well as VLANs.

## ACL Actions

The following actions are available for ingress ACLs. Not all actions are available for all types of ACLs. Refer to "ACL Limitations" on page 719 for more details.

- CoS queue assignment—assign the matching packet to the specific CoS queue. This action does not rewrite any fields in the packet.

- Log—perform the logging action on the matching packet as described below.
- Mirror—forward a copy of the matching packet to the designated interface. The original packet continues to be forwarded to its original destination.
- Redirect—forward the matching packet to the designated interface. The original destination of the packet is ignored.
- Rate limit—forward matching packets that do not exceed the rate limit. Drop packets exceeding the rate limit. Refer to the DiffServ section for more sophisticated ingress rate limiting.

The following actions are available for egress ACLs. Not all actions are available for all types of ACLs. Refer to "ACL Limitations" on page 719 for more details.

- CoS queue assignment—rewrite the matching packet CoS value. This action does not affect processing of the packet within the switch.
- Log—perform the logging action on the matching packet as described below.
- Mirror—forward a copy of the matching packet to the designated interface. The original packet continues to be forwarded to its original destination.
- Redirect—forward the matching packet to the designated interface. The original destination of the packet is ignored.
- Rate limit—forward matching packets that do not exceed the rate limit. Drop packets exceeding the rate limit. Refer to "Differentiated Services" on page 1531 for more sophisticated ingress rate limiting.

## **What Is the ACL Redirect Function?**

The redirect function allows traffic that matches a permit rule to be redirected to a specific physical port or LAG instead of processed on the original port. A packet that is redirected does not go through the normal forwarding process. It is sent to the redirect target port. The redirect function and mirror function are mutually exclusive. In other words, a given ACL rule cannot be configured with both mirror and redirect attributes.

## What Is the ACL Mirror Function?

ACL mirroring provides the ability to send a copy of traffic that matches a permit rule to a specific physical port or LAG. Using ACLs to mirror traffic is called flow-based mirroring, since the traffic flow is defined by the ACL classification rules. This is in contrast to port mirroring, where all traffic encountered on a specific interface is replicated out of another interface.

Mirroring is similar to the redirect function, except that in flow-based mirroring a copy of the permitted traffic is delivered to the mirror interface while the packet itself is forwarded normally through the device. A given ACL rule cannot be configured with both mirror and redirect attributes.

## What Is ACL Logging

ACL Logging provides a means for counting the number of “hits” against an ACL rule. To configure ACL Logging, augment the ACL permit or deny rule specification with a “log” parameter that enables hardware hit count collection and reporting. The switch uses a fixed five minute logging interval, at which time trap log entries are written for each ACL logging rule that accumulated a non-zero hit count during that interval. The hit count is the number of times the rule has been invoked since the expiry of the last logging interval. It is not possible to configure the logging interval.

## What Are Time-Based ACLs?

The time-based ACL feature allows the switch to dynamically apply an explicit ACL rule within an ACL for a predefined time interval by specifying a time range on a per-rule basis within an ACL, so that the time restrictions are imposed on the ACL rule.

With a time-based ACL, one can define when and for how long an individual rule of an ACL is in effect. To apply a time to an ACL, first define a specific time interval and then apply it to an individual ACL rule so that it is operational only during the specified time range, for example, during a specified time period or on specified days of the week.

A time range can be absolute (specific time) or periodic (recurring). If an absolute and periodic time range entry are defined within the same time range, the periodic timer is active only when the absolute timer is active.



**NOTE:** Adding a conflicting periodic time range to an absolute time range will cause the time range to become inactive. For example, consider an absolute time range from 8:00 AM Tuesday March 1st 2011 to 10 PM Tuesday March 1st 2011. Adding a periodic entry using the 'weekend' keyword will cause the time-range to become inactive because Tuesdays are not on the weekend.

A named time range can contain up to 10 configured time ranges. Only one absolute time range can be configured per time range. During the ACL configuration, a configured time range can be associated with the ACL to provide additional control over permitting or denying a user access to network resources.

Benefits of using time-based ACLs include:

- Providing more control over permitting or denying a user access to resources, such as an application (identified by an IP address/mask pair and a port number).
- Providing control of logging messages. Individual ACL rules defined within an ACL can be set to log traffic only at certain times of the day so access can simply be denied without the need to analyze many logs generated during peak hours.

## ACL Limitations

There are two hardware matching engines visible to the Dell switch administrator: the ingress processor and the egress processor. Each of these processors has different limits and actions. The ingress matching engine processes packets on ingress to the switch and can apply actions such as applying CoS processing, diverting to a different port, etc. The egress matching engine processes packets after they are switched and queued for egress and supports policies such as rewriting the DSCP or CoS values, as well as the normal permit (forward) and deny (drop) actions.

ACLs operate by matching on specific fields within packets. Various match conditions (operators) are supported (e.g., equal, less than, not equal, etc.), along with masks that support selection of all or a portion of a field. Each field to be matched is assigned to a matching engine (a slice). A slice is defined by an offset into the packet that is compared against a set of matching values and masks along with an associated action (ACEs). Each Dell EMC Networking N-Series switch supports a fixed number of slices and each slice

supports a fixed number of matching criteria (values and masks). Slices operate in parallel to perform the configured matching operations. An ACL with a different offset requires the use of a new hardware slice but multiple matching values can be specified for a single slice (e.g., an IPv4 destination address with a 32-bit mask is 192.168.21.1 or 192.168.12.3). Slices can also be joined together to match widths larger than 32 bits or they can be concatenated to provide a larger number of matching values with a single offset. In general, ACLs that match on less than 32 bits will be expanded internally to match on 32 bits with a variable mask. This allows other ACLs using the same offset to utilize the same slice with potentially different masks and match values.

The user interface limits for ACLs are 1023 rules per access list and 100 access lists. The switch automatically combines slices to operate in parallel over greater field widths (e.g., IPv6 source address) or combines slices to supply more match conditions (IPv4 destination address equal to multiple ranges of addresses). In the case of a match condition specifying a match wider than 32 bits (e.g., a 128-bit IPv6 address), additional slices are assigned to operate in parallel on the additional match fields. This reduces the overall number of slices available to match on other key fields. The switch attempts to assign slices to match conditions in an optimal manner; however, combinations of match conditions can reduce the maximum number of ACLs that can be configured to fewer than the published limits. As an example, the smallest IPv6 QoS match will utilize six slices in the switch hardware.

If encountering a situation where the hardware limit is exceeded when configuring an ingress ACL, consider disabling features that use ACLs internally, such as iSCSI or CFM.

The hardware limits are shown in Table 19-1:



**Table 19-1. ACL Hardware Limits**

Limitation	Dell EMC Networking N1100 Series	Dell EMC Networking N1500 Series	Dell EMC Networking N2000/N2100-ON/N2200-ON Series	Dell EMC Networking N3000E-ON/N3100-ON/N3200-ON Series
Maximum number of ingress rules	1023	1023	1023	1023
Maximum number of egress rules	511	511	511	1023
Total number of rules	1534	3072	3914	3914
Ingress slices	6	6	14	14
Egress slices	4	4	4	4
Ingress slice rule depth	256	256	256	256
Egress slice rule depth	128	128	256	256

The software limits are shown in Table 19-2:

**Table 19-2. ACL Software Limits**

Limitation	Dell EMC Networking N1100 Series	Dell EMC Networking N1500 Series	Dell EMC Networking N2000/N2100-ON/N2200-ON Series	Dell EMC Networking N3000E-ON/N3100-ON/N3200-ON Series
Maximum number of ACLs (any type)	100	100	100	100

**Table 19-2. ACL Software Limits (Continued)**

Limitation	Dell EMC Networking N1100 Series	Dell EMC Networking N1500 Series	Dell EMC Networking N2000/N2100-ON/N2200-ON Series	Dell EMC Networking N3000E-ON/N3100-ON/N3200-ON Series
Maximum number of configurable rules per list.	1023	1023	1023	1023
Maximum ACL Rules per Interface and Direction (IPv4/L2)	1023 ing., 511 egr.	1023 ing., 1023 egr.	1023 ing., 1023 egr.	1023 ing., 511 egr.
Maximum ACL Rules per Interface and Direction (IPv6)	1021 ing., 253 egr.	378 ing., 253 egr.	1023 ing., 509 egr.	1021 ing., 509 egr.
Maximum ACL Rules (system-wide)		2030	3914	3914
Maximum VLAN interfaces with ACLs applied		24	24	24
Maximum ACL Logging Rules (system-wide)		128	128	128

Note the following additional limitations on ingress and egress ACLs:

- Port ranges are not supported for egress ACLs for either IPv4 or IPv6 ACLs.
- It is possible to configure mirror or redirect attributes for a given ACL rule, but not both.
- The Dell EMC Networking N-Series switches support a limited number of counter resources, so it may not be possible to log every ACL rule. It is possible to define an ACL with any number of logging rules, but the rules that are actually logged cannot be determined until the ACL is configured in the interface hardware. Furthermore, hardware counters that become

available after an ACL is applied are not retroactively assigned to rules that were unable to be logged (the ACL must be disassociated from the interface and then re-associated). Rules that are unable to be logged are still active in the ACL for purposes of permitting or denying a matching packet. If console logging is enabled and the severity is set to a numerically equal or lower severity than the console severity setting, a log entry may appear on the screen.

- The order of the rules is important: when a packet matches multiple rules, the first rule takes precedence. Once a packet has matched a rule, the corresponding action is taken and no further attempts to match the packet are made. Also, once an access group is configured on an interface, all traffic not specifically permitted by an ACL is dropped by the implicit deny all the system supplies at the end of the last configured access group.
- Egress (out) ACLs only affect switched/routed traffic. They have no effect on packets generated locally by the switch, e.g., LACPDU or spanning tree BPDUs.
- Ingress ACLs filter packets before they are processed by the switching fabric. Egress ACLs filter packets after they have been processed by the switching fabric.
- User-defined ingress ACLs are prioritized before system ACLs. User-defined ingress ACLs that match control plane packets such as BPDUs may interfere with switch operation.
- The **fragments** and **routing** keywords are not supported for egress IPv6 ACLs. The **fragments** keyword is not supported on IPv4 egress ACLs.
- On the Dell EMC Networking N2000 and N3000E-ON Series switches, the IPv6 ACL **fragment** keyword matches only on the first IPv6 extension header (next header code 44). If the fragment header appears in the second or subsequent header, it is not matched.
- The IPv6 ACL **routing** keyword matches only on the first IPv6 extension header (next header code 43). If the fragment header appears in the second or subsequent header, it is not matched.



**NOTE:** The actual number of ACLs and rules supported depends on the resources consumed by other processes and configured features running on the switch. If the switch does not allow a rule to be configured, consider disabling features that consume user ACL space such as iSCSI, CFM, or IPv6 RA Guard.

# ACL Configuration Details

## How Are ACLs Configured?

To configure ACLs, follow these steps:

- 1 Create a IP or MAC ACL by specifying a name.
- 2 Add new rules to the ACL.
- 3 Configure the match criteria for the rules.
- 4 Apply the ACL to one or more interfaces.

## Editing Access Lists

When editing access lists, entries are added in the order specified by the rule sequence number. It is recommended that rule sequence number indices be separated by a fixed offset (e.g., 10). The ACL sequence number can range from 1 to 2147483647.

If no sequence number is specified, new entries are added to the end of the list. There is an implicit deny all statement at the end of the last access-group that is not shown and is not editable. To insert a rule in the middle of an ACL, enter a sequence number less than the following rule and greater than the preceding rule. Use the **no [sequence-number]** command in ACL Configuration mode to remove rules from an ACL.



**NOTE:** When configuring access lists, complete checks are made only when the access list is applied to an active interface. It is recommended that you configure and test an access list on an active (up) interface prior to deploying it on links in the production network. If an ACL is configured on an interface that is not up, error messages regarding ACL resource allocation may be logged when the interface is brought up.

## Preventing False ACL Matches

Be sure to specify ACL access-list, permit, and deny rule criteria as fully as possible to avoid false matches. This is especially important in networks with protocols that have different frame or EtherType values. For example, Layer-3 ACL rules that specify a TCP or UDP port value should also specify the TCP or UDP protocol. MAC ACL rules that specify an EtherType value for the

frame should also specify a source or destination MAC address wherever possible. Likewise, MAC ACLs that specify a source MAC address should specify an EtherType to avoid interfering with control-plane traffic.

In general, any rule that specifies matching on an upper-layer protocol field should also include matching constraints for as many of the lower-layer as where possible. For example, a rule to match packets directed to the well-known UDP port number 22 (SSH) should also include matching constraints on the IP protocol field (protocol=0x11 or UDP) and the source or destination IP address. Table 19-3 lists commonly-used EtherTypes numbers:

**Table 19-3. Common EtherType Numbers**

<b>EtherType</b>	<b>Protocol</b>
0x0800	Internet Protocol version 4 (IPv4)
0x0806	Address Resolution Protocol (ARP)
0x0842	Wake-on LAN Packet
0x8035	Reverse Address Resolution Protocol (RARP)
0x8100	VLAN tagged frame (IEEE 802.1Q)
0x86DD	Internet Protocol version 6 (IPv6)
0x8808	MAC Control
0x8809	Slow Protocols (IEEE 802.3)
0x8870	Jumbo frames
0x888E	EAP over LAN (EAPOL – 802.1x)
0x88CC	Link Layer Discovery Protocol
0x8906	Fibre Channel over Ethernet
0x9100	Q in Q

Table 19-4 lists commonly-used IP protocol numbers:

**Table 19-4. Common IP Protocol Numbers**

<b>IP Protocol Number</b>	<b>Protocol</b>
0x00	IPv6 Hop-by-hop option
0x01	ICMP

**Table 19-4. Common IP Protocol Numbers (Continued)**

IP Protocol Number	Protocol
0x02	IGMP
0x06	TCP
0x08	EGP
0x09	IGP
0x11	UDP

### Using IP and MAC Address Masks

Masks are used with IP and MAC addresses to specify what should be considered in the address for a match. Masks are expanded internally into a bit mask and are applied bit-wise in the hardware even though they are entered in decimal or hexadecimal format. Masks need not have contiguous 0 or 1 bits. A 0 bit value in the mask indicates that the address field in the packet being compared must match the address bit exactly. A 1 value in the mask indicates a wildcard or don't care value, i.e. the access bits are not compared and match any possible value. For example, an IP address of 3.3.3.3 with a mask of 0.0.0.0 indicates that the ACL matches on all four bytes of the IP address. Likewise, a MAC address of 68:94:23:AD:F3:18 with a mask of 00:00:00:00:00:ff indicates that the first five bytes must match (e.g., 68:94:23:AD:F3) and the last byte may take on any value from 0x00 to 0xff (0–255) and still be considered a match.

The following ACL equivalents are noted:

Address	Mask	Equivalent Address
0.0.0.0	255.255.255.255	any
x.x.x.x	host	x.x.x.x
00:00:00:00:00:00	ff:ff:ff:ff:ff:ff	any

## Policy-Based Routing

In contemporary inter-networks, network administrators often need to implement packet forwarding/routing according to specific organizational policies. Policy-Based Routing (PBR) exactly fits this purpose. Policy-Based Routing provides a flexible mechanism to implement solutions where organizational constraints dictate that traffic be routed through specific network paths. PBR does not affect route redistribution that occurs via routing protocols.

PBR is a true routing policy solution. The packet TTL is decremented in PBR-routed packets. The destination MAC is rewritten in PBR-routed packets. ARP lookups are sent when required for unresolved next-hop addresses.

Configuring PBR consists of installing a route-map with **match** and **set** commands and then applying the corresponding route-map to the routing VLAN interface. IP routing must be enabled on the interfaces by assigning IP addresses to the VLAN interfaces, assigning the VLANs to physical interfaces, and enabling IP routing globally.

### Packet Classification

Route-maps may specify multiple packet attributes in match statements. These attributes can be matched through a “match” clause based on length of the packet or a “match” clause linked with up to 16 ACLs.

The match attributes listed below for each ACL type indicate the criteria used to classify Layer-3 routed traffic for PBR. At least one of the listed attributes must be present in the ACL of the given type:

- VLAN tag (implicitly added)
- MAC access list (**match mac-list**)
  - Source MAC address
  - 802.1p priority
- IP access list (**match ip address**)
  - Source or destination IP address
- Protocol ID field in the IP header
- L3 packet length in the IP header (**match length**)

Additional match criteria may be configured by the administrator if desired. Since a route-map is configured in the context of a routing VLAN, a VLAN tag is automatically added to the match criteria without the need for the administrator to specify the VLAN ID.

## Route-Map Processing

An incoming packet is matched against the criteria in the 'match' terms specified in each route-map in the policy. The 'match' terms (clauses) must refer to one or more MAC or IPv4 access-groups or a packet length. Multiple MAC, IPv4, or IPv6 access-group match terms are allowed in a route-map, each access-group consisting of a list of ACLs.

Conceptually, access-group processing proceeds by attempting to match each of the access-groups listed in the first match clause, in order. If an access-group does not match, processing moves to the next access-group, in order, until an access-group matches or the access-group list is exhausted. If there are more match terms in the route-map, processing proceeds with the next match term, in order. In reality, all access-group matches within an access-group are attempted in parallel at once, and the priority of the access-group is used to implement the conceptual match process.

An access-group that is used in a 'match' term itself has one or more permit and/or deny rules. The incoming packet is matched sequentially against the permit rules in each ACL in the access-group, in order, and a permit/deny decision is reached. If a permit rule in an access-group in the list matches, the match term criteria is met and no further match processing takes place in the route-map. If none of the permit rules in an access-group matches, the packet match is attempted against the next access-group in the route-map match list. Deny rules are optimized out of both permit and deny route-maps and are not processed.

Once a match has occurred:

- For a permit route-map, if the decision reached in the above step is permit, then PBR executes the action specified in the set term(s) of the route-map statement. The counter for the route-map is incremented for each matching packet.



- For a permit route-map, if the decision reached in the above step is deny, then PBR does not apply any action that is specified in **set** term(s) in the route-map statement. In this situation, the counter for this match statement is not incremented. The processing logic terminates, and the packet goes through the standard destination-based routing logic.
- For a deny route-map, if the decision reached in the above step is permit, then PBR processing logic terminates and the packet goes through standard destination-based routing logic. The counter is incremented for each matching packet.
- For a deny route-map, if the decision reached in the above step is deny, the counter for this match statement is not incremented. The processing logic terminates, and the packet goes through the standard destination-based routing logic.

PBR counters increment when a packet matches the corresponding ACL. They do not indicate the outcome of the processing logic; i.e., PBR counters do not count packets that are policy-routed vs. not policy-routed. ACL packet matching occurs in parallel across all ACLs. If a policy ACL matches a packet, and an interface or VLAN ACL also matches the packet, the PBR counter may be incremented even though the interface or VLAN ACL caused the packet to be dropped.

If no match occurs, then the packet goes through the standard destination-based routing logic.

## Route-Map Actions

Policy-Based Routing overrides the normal routing decisions taken by the router and attempts to route the packet using the criteria in the set clause:

- List of next-hop IP addresses—The **set ip next-hop command** checks for the next-hop address in the routing table and, if the next-hop address is present and active in the routing table, then the policy routes the ACL matching packets to the next hop. If the next hop is not present in the routing table, the command uses the normal routing table to route the packet. Non-matching packets are routed using the normal routing table. The IP address must specify an adjacent next-hop router in the path toward the destination to which the packets should be routed. The first available IP address associated with a currently active routing entry is used to route the packets. This type of rule takes priority over all entries in the routing table.

- List of default next-hop IP addresses—The **set ip default next-hop** command checks the list of destination IP addresses in the routing table and, if there is no explicit route for the packet's destination address in the routing table, the next-hop destinations are evaluated, and packets are routed to the first-available next hop. Packets that do not match are routed using the routing table. A default route in the routing table is not considered an explicit route for an unknown destination address. This type of rule takes priority over default entries in the routing table.
- IP precedence—Packets matching the ACL criteria have their IP precedence rewritten. The IP precedence value is the 4 ToS bits in the IP packet header.

The following table summarizes the actions taken by the routing policy depending on the combination of ACL and route-map permit and deny rules:

<b>ACL</b>	<b>Match</b>	<b>Route-Map</b>	<b>Outcome</b>	<b>Action</b>	<b>Optimized</b>
Permit	Yes	Permit	Permit	Set	No
Permit	No	Permit	Deny	Next	No
Permit	Yes	Deny	Permit	Route	No
Permit	No	Deny	Deny	Next	No
Deny	Yes	Permit	Deny	Next	Yes
Deny	No	Permit	Deny	Next	Yes
Deny	Yes	Deny	Deny	Next	Yes
Deny	No	Deny	Deny	Next	Yes

In the table, the Action column indicates the disposition of the packet:

- *Next* means fall through to next route-map, and if there are no further route-maps to be processed, route the packet using the default routing table.
- *Set* means route the packet per the action in the set clause.
- *Route* means route the packet with the default routing table.

In the last column of the table (Optimized), a Yes entry means the rule is never processed in hardware because the action, if any, is to fall through to the next match criteria. The system optimizes out deny ACL match clauses and never processes them in the system hardware. Counters for these match clauses will always show 0.

## ACLs and Policy Interaction

Within this paragraph, the word policy refers to both DiffServ Policy and Policy Based Routing. A more specific term may be use when the statement only applies to one of the policy types.

PBR can be configured only on VLAN routing interfaces. However, ACLs can be configured on all types of interfaces, including physical interfaces, port-channels, and VLANs. DiffServ policies can be defined on Ethernet interfaces and port channels (with or without VLAN match criteria). When processing packets on which both policy and ACLs are configured, policy matching is performed only after the application of all VLAN and interface ACLs matches, including the implicit deny all match at the end of ACL processing.

Only packets that match a user-defined ingress permit ACL rule configured on an incoming interface are eligible for processing by policy. This is due to the implicit deny all rule that takes effect at the end of ACL processing and prior to PBR and DiffServ Policy processing. Interface ACLs have a higher precedence than VLAN ACLs or PBR ACLs. In the case of conflicting actions, the interface ACL takes precedence. Specifically, if an interface ACL drops a packet (explicit or implicit deny), policy is not applied to the packet. Likewise, if a VLAN interface ACL drops a packet, policy is not applied to the packet.

In many cases, the switch is capable of taking multiple actions on a packet, irrespective of whether the action is configured in a policy or in an ACL configured on a port. For example, the system can both rate limit packets on ingress with an interface ACL and set the ip precedence on packets that do not exceed the rate limit with a PBR ACL or DiffServ Policy.

The following table describes the action resolution mechanism when a packet matches both the policy rules configured on a VLAN routing interface and a permit ACL rule configured on a physical interface (the deny ACL action is included for emphasis):

<b>Policy Action (VLAN)</b>	<b>ACL Action (Interface)</b>	<b>Result</b>
set ip precedence	deny	deny
	mirror	both
	redirect	both (see Note 1)
	rate limit	both
set interface null0	deny	deny (see Note 2)
	mirror	mirror
	redirect	redirect
	rate limit	deny
set ip next-hop (default)	deny	deny
	mirror	both
	redirect	both (see Note 1)
	rate limit	both

1. In the case of redirect ACL action, both the redirect and policy actions are honored, if possible. This implies the policy routed packet is redirected to the configured physical port and the redirected port is participating in the egress VLAN to which the packet is being routed. In other words, the system will select the interface specified by the ACL which is a member of the egress VLAN. If the physical interface is not a member of the egress VLAN, the behavior is undefined.

2. In case of the PBR **set interface Null0** action, the PBR routed packet is dropped only if no conflicting port ACL is configured. Configuring ACL deny statements that also match packets with a PBR **set interface Null0** action is redundant and wastes system resources.

---

## Limitations

### Internally Generated Packets

Packets that are generated internally by the router are never policy routed.

### Set Clause Required

Route-map deny/permit statements without “set” clauses are ignored except in the case where a deny route-map refers to an ACL with a permit statement.

### **No Implicit “deny all” Rule**

When an access-group is configured on an interface, an implicit rule of “deny all” is applied to the last access-group on the interface. Since PBR processing occurs after normal ACL processing, when a “permit” route-map associated ACL is applied to an interface, the implicit “deny all” rule is not applied.

When match rules in an ACL associated with a route-map are successful, packets are considered as candidates for routing according to rules specified in route-map. If none of the match rules are successful, then packet is routed by the standard L3 routing process. The implicit “deny all” rule is not applicable to interfaces on which a routing policy is configured. Configuring an explicit deny all ACL that not associated with a route-map will drop packets prior to them being processed by PBR.

### **Black Holes Possible**

If the next hop specified by a policy-based rule is not reachable, packets matching the ACL are routed using the routing table. If the routing table does not supply a route to the destination, then the packets are lost. If a set interface null0 statement is present in the policy map, the packets are dropped. The set interface null0 statement can also be used to drop undesirable or unwanted traffic, i.e. create a black hole route.

### **Counter Support for Route-map ACL**

A counter is associated with each ACL rule associated with a route-map in order to indicate how many packets have been policy routed. There is no provision to non-destructively clear these counters from the UI. Counters associated with route-map statement are cleared when the route-map is removed from the VLAN. The hardware does not support both a counter and a rate-limit. Therefore, the system does not support configuring ACLs with a rate-limit being used for PBR. In this case, a separate interface or VLAN ACL with a rate-limit can be used at the cost of consuming additional resources.

Packets matching PBR-associated ACLs that contain deny statements are not counted. Deny ACLs in PBR rules are optimized out of the system as they always fall through to the next PBR statement.

## **PBR Associated ACLs and DiffServ Policies Processed After User-defined ACLs**

Each ACL in an access-group is associated with a sequence number indicating the order in which the ACL is processed by the hardware. Likewise, a route-map may have multiple statements with different sequence numbers associated with each ACL entry. These statements are processed in sequential order after the implicit deny all at the end of the user-defined ACL and beginning with the lowest numbered rule, but only after all user configured ACLs that are not associated with any route-map.

Likewise, a DiffServ policy may have multiple statements, including match criteria referring to an ACL. As a DiffServ policy may be configured on an interface with an ACL, and vice-versa, the ACL statements are processed first, then the ACL implicit deny all is processed, and then the DiffServ policy match statements (including permit/deny statements in a referred ACL) and actions are processed.

Implicitly, any packet that does not match a permit clause in an ACL is dropped. Packets that do not match the match clauses in a PBR or DiffServ Policy are processed in the normal manner and packets that match the PBR or DiffServ Policy are processed per the policy.

## **ACL Resource Usage**

When a route-map defines a “match” rule associated with an ACL, except for the implicit routing behavior mentioned above, the resource consumption is the same as if a normal ACL is applied on an interface. Rules consumed by an ACL corresponding to route-map “match” clause share hardware resources with the ACL component. Some resources cannot be shared. For example, it is not permitted to utilize the rate-limit clause in a PBR ACL, as the hardware cannot support both a counter (allocated by every PBR route-map) and a rate limit.

ACLs associated with a route-map and general ACLs share the same hardware resources. If PBR consumes the maximum number of hardware resources on an interface/system wide, general purpose ACLs can't be configured later and vice versa. Hardware allocation is performed on a first-come first-serve basis when the interface becomes active.

## ACL Resource Sharing

An ACL rule contains match and action attributes. For example, an ACL rule may have a match clause on source IP address and action attributes independent of PBR such as queue assignment as shown below:


```
console#config
console(config)#ip access-list example-1
console(config-ip-acl)#permit ip 1.1.1.1 0.0.0.255 any assign-queue
2
console(config-ip-acl)#permit every
console(config-ip-acl)#exit
```

Actions specified in the “set” clauses of a route-map utilize the hardware entries of the corresponding ACL. This sharing does not consume additional hardware resources as Dell EMC Networking supports multiple actions in an ACL rule. However, if conflicting actions are specified, an error is thrown when the switch attempts to configure the conflicting actions in the hardware.

## Locally Generated Packets

Policy-Based Routing does not affect locally generated packets, i.e. packets generated by protocols running on the switch.

## Configuring ACLs (Web)

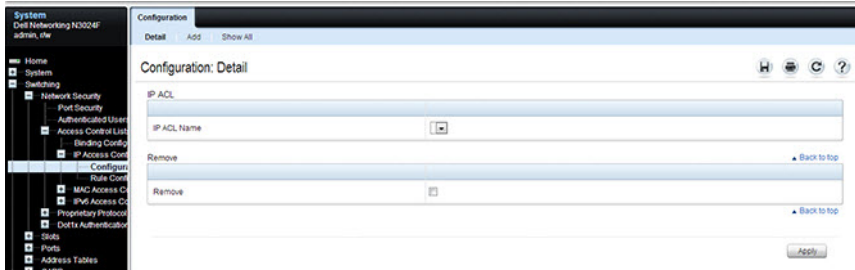
This section provides information about the OpenManage Switch Administrator pages for configuring and monitoring ACLs on Dell EMC Networking N1100-ON, N1500, N2000, N2100-ON, N2200-ON, and N3100-ON Series switches. For details about the fields on a page, click  at the top of the Dell EMC OpenManage Switch Administrator web page.

## IP ACL Configuration

Use the **IP ACL Configuration** page to add or remove IP-based ACLs.

To display the **IP ACL Configuration** page, click **Switching** → **Network Security** → **Access Control Lists** → **IP Access Control Lists** → **Configuration** in the navigation panel.

**Figure 19-1. IP ACL Configuration**

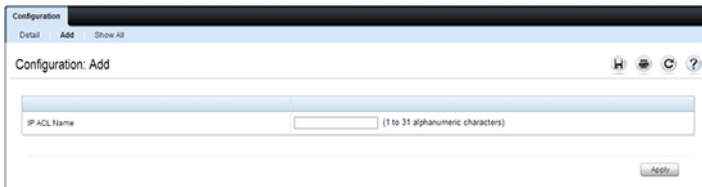


### Adding an IPv4 ACL

To add an IPv4 ACL:

- 1 Open the **IP ACL Configuration** page.
- 2 Click **Add** to display the **Add IP ACL** page.
- 3 Specify an ACL name.

**Figure 19-2. Add IP ACL**



- 4 Click **Apply**.

### Removing IPv4 ACLs

To delete an IPv4 ACL:

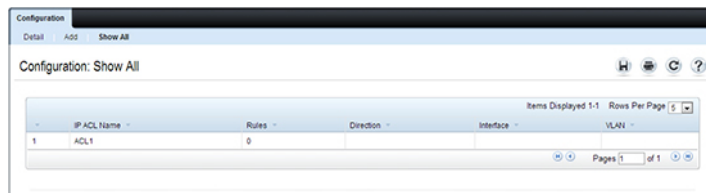
- 1 From the **IP ACL Name** menu on the **IP ACL Configuration** page, select the ACL to remove.
- 2 Select the **Remove** checkbox.
- 3 Click **Apply**.



## Viewing IPv4 ACLs

To view configured ACLs, click **Show All** from the **IP ACL Configuration** page.

**Figure 19-3. View IPv4 ACLs**



The screenshot shows a web interface for configuring IPv4 ACLs. At the top, there are tabs for 'Detail', 'Add', and 'Show All'. Below the tabs, the text 'Configuration: Show All' is displayed. A table lists the configured ACLs. The table has columns for 'IP ACL Name', 'Rules', 'Direction', 'Interface', and 'VLAN'. There is one row with the following data: '1', 'ACL1', '0', and 'VLAN'. The table also includes a 'Rows Per Page' dropdown set to '5' and a 'Pages 1 of 1' indicator.

	IP ACL Name	Rules	Direction	Interface	VLAN
1	ACL1	0			

## IP ACL Rule Configuration

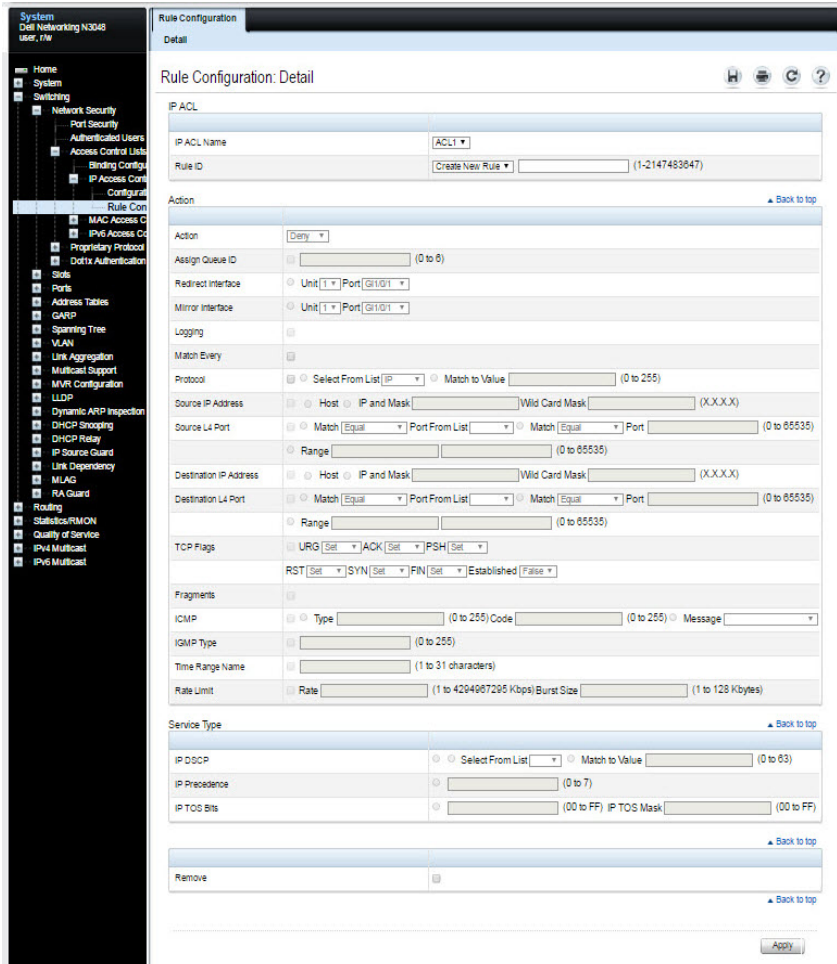
Use the **IP ACL Rule Configuration** page to define rules for IP-based ACLs. The access list definition includes rules that specify whether traffic matching the criteria is forwarded normally or discarded. Additionally, rules can be used to assign traffic to a particular queue, filter on some traffic, change a VLAN tag, and/or redirect the traffic to a particular port.



**NOTE:** There is an implicit **deny all** rule at the end of an ACL list. This means that if an ACL is applied to a packet and if none of the explicit rules match, then the final implicit “deny all” rule applies and the packet is dropped.

To display the **IP ACL Rule Configuration** page, click **Switching** → **Network Security** → **Access Control Lists** → **IP Access Control Lists** → **Rule Configuration** in the navigation panel.

**Figure 19-4. IP ACL - Rule Configuration**



### Removing an IP ACL Rule

To delete an IP ACL rule:

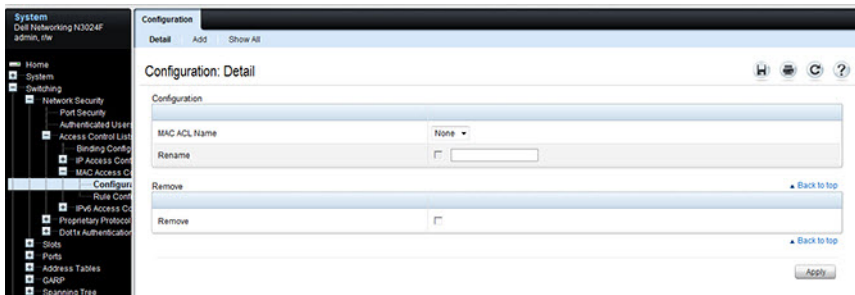
- 1 From the **Rule ID** menu, select the ID of the rule to delete.
- 2 Select the **Remove** option near the bottom of the page.
- 3 Click **Apply** to remove the selected rule.

## MAC ACL Configuration

Use the MAC ACL Configuration page to define a MAC-based ACL.

To display the MAC ACL Configuration page, click **Switching** → **Network Security** → **Access Control Lists** → **MAC Access Control Lists** → **Configuration** in the navigation panel.

**Figure 19-5. MAC ACL Configuration**

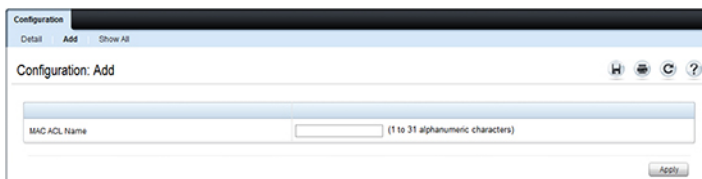


### Adding a MAC ACL

To add a MAC ACL:

- 1 Open the **MAC ACL Configuration** page.
- 2 Click **Add** to display the **Add MAC ACL** page.
- 3 Specify an ACL name.

**Figure 19-6. Add MAC ACL**



- 4 Click **Apply**.

### Renaming or Removing MAC ACLs

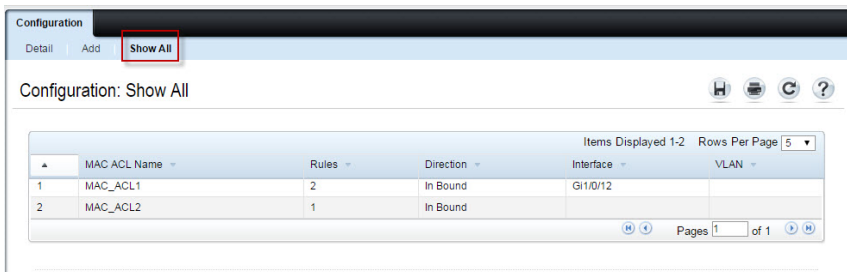
To rename or delete a MAC ACL:

- 1 From the **MAC ACL Name** menu on the **MAC ACL Configuration** page, select the ACL to rename or remove.
- 2 To rename the ACL, select the **Rename** checkbox and enter a new name in the associated field.
- 3 To remove the ACL, select the **Remove** checkbox.
- 4 Click **Apply**.

### Viewing MAC ACLs

To view configured ACLs, click **Show All** from the **MAC ACL Configuration** page.

**Figure 19-7. Show All MAC ACLs**



The screenshot shows the 'Configuration' page for MAC ACLs. At the top, there are tabs for 'Detail', 'Add', and 'Show All', with 'Show All' selected and highlighted with a red box. Below the tabs, the text 'Configuration: Show All' is displayed. To the right of this text are icons for home, print, refresh, and help. Below this is a table with columns for MAC ACL Name, Rules, Direction, Interface, and VLAN. The table contains two rows of data. At the bottom right of the table, there are navigation arrows and a page indicator 'Pages 1 of 1'.

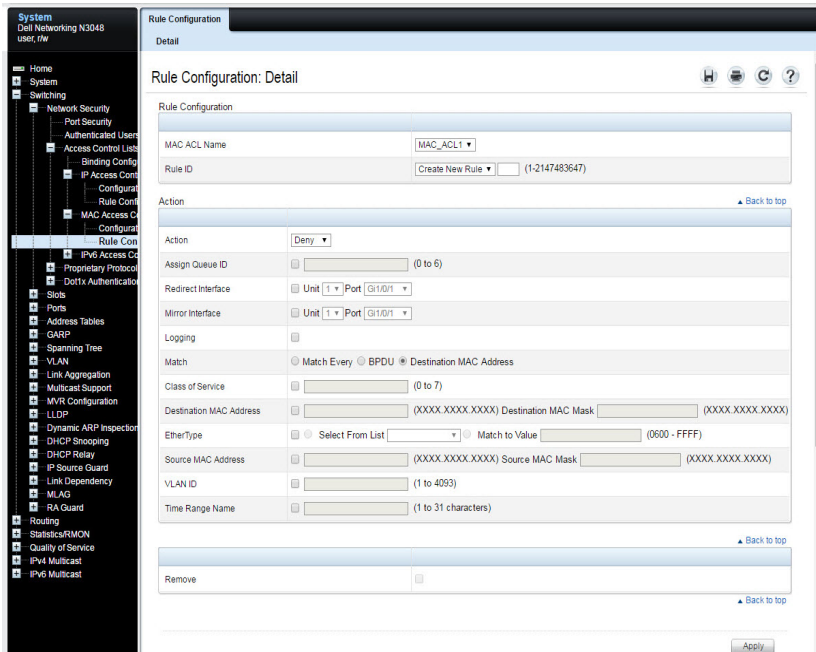
	MAC ACL Name	Rules	Direction	Interface	VLAN
1	MAC_ACL1	2	In Bound	Gi1/0/12	
2	MAC_ACL2	1	In Bound		

## MAC ACL Rule Configuration

Use the **MAC ACL Rule Configuration** page to define rules for MAC-based ACLs. The access list definition includes rules that specify whether traffic matching the criteria is forwarded normally or discarded. A default **deny all** rule is the last rule of every list.

To display the **MAC ACL Rule Configuration** page, click **Switching** → **Network Security** → **Access Control Lists** → **MAC Access Control Lists** → **Rule Configuration** in the navigation panel.

**Figure 19-8. MAC ACL Rule Configuration**



### Removing a MAC ACL Rule

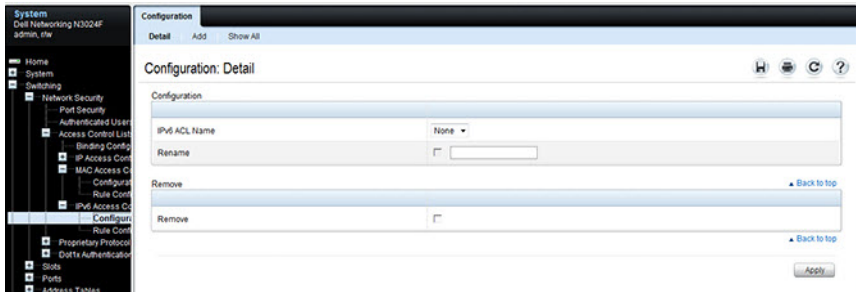
To delete a MAC ACL rule:

- 1 From the **Rule ID** menu, select the ID of the rule to delete.
- 2 Select the **Remove** option near the bottom of the page.
- 3 Click **Apply** to remove the selected rule.

## IPv6 ACL Configuration

Use the **IPv6 ACL Configuration** page to add or remove IP-based ACLs. To display the IP ACL Configuration page, click **Switching** → **Network Security** → **Access Control Lists** → **IPv6 Access Control Lists** → **IPv6 ACL Configuration** in the navigation panel.

**Figure 19-9. IPv6 ACL Configuration**

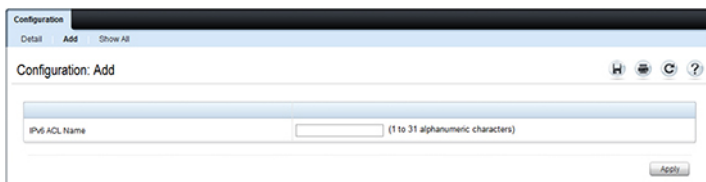


### Adding an IPv6 ACL

To add an IPv6 ACL:

- 1 Open the **IPv6 ACL Configuration** page.
- 2 Click **Add** to display the **Add IPv6 ACL** page.
- 3 Specify an ACL name.

**Figure 19-10. Add IPv6 ACL**



- 4 Click **Apply**.

### Renaming or Removing IPv6 ACLs

To rename or delete an IPv6 ACL:

- 1 From the **IPv6 ACL Name** menu on the **IPv6 ACL Configuration** page, select the ACL to rename or remove.
  - a To rename the ACL, select the **Rename** checkbox and enter a new name in the associated field
  - b To delete the ACL, select the **Remove** checkbox.
- 2 Click **Apply**.

## Viewing IPv6 ACLs

To view configured ACLs, click **Show All** from the **IPv6 ACL Configuration** page. The **IPv6 ACL Table** page displays.

**Figure 19-11. Show IPv6 ACL**

The screenshot shows the 'Configuration: Show All' page. At the top, there are tabs for 'Detail', 'Add', and 'Show All' (which is highlighted with a red box). Below the tabs, there are icons for home, print, refresh, and help. The main content is a table with the following data:

▲	IPv6 ACL Name	Rules	Direction	Interface	VLAN
1	TestNet	2	In Bound	Gi1/0/9	
2	LocalACL	1	In Bound	Gi1/0/25	

At the bottom of the table, there are navigation controls: 'Items Displayed 1-2', 'Rows Per Page 5', and 'Pages 1 of 1'.

## IPv6 ACL Rule Configuration

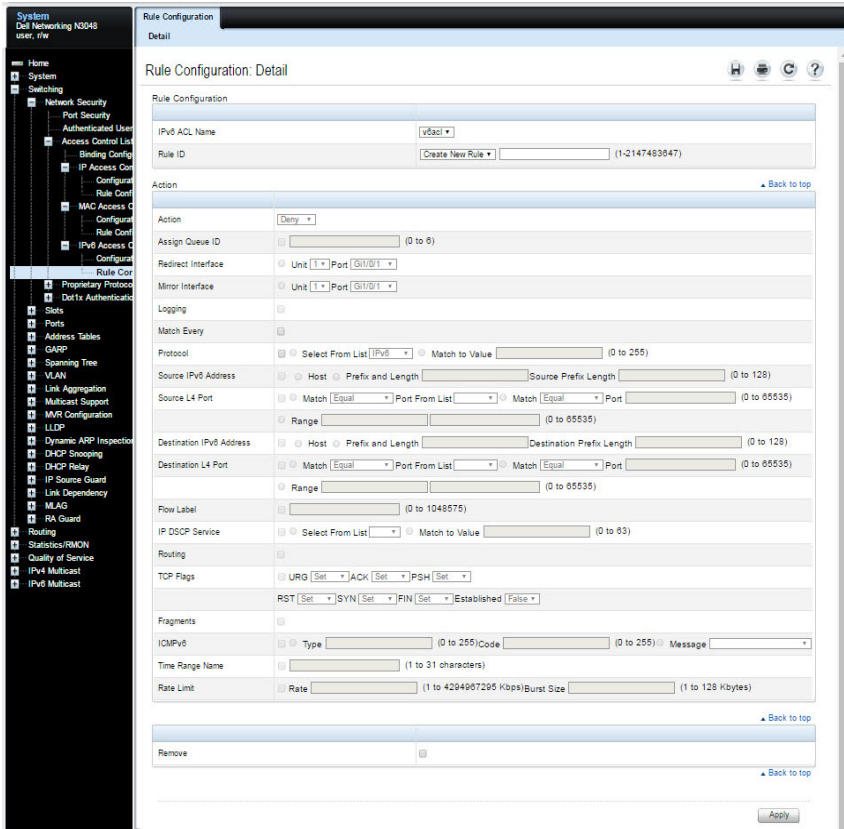
Use the IPv6 ACL Rule Configuration page to define rules for IPv6-based ACLs. The access list definition includes rules that specify whether traffic matching the criteria is forwarded normally or discarded. Additionally, rules can specify to assign traffic to a particular queue, filter on some traffic, change VLAN tag, and/or redirect the traffic to a particular port. By default, no specific value is in effect for any of the IPv6 ACL rules.

There is an implicit **deny all** rule at the end of an ACL list. This means that if an ACL is applied to a packet and if none of the explicit rules match, then the final implicit **deny all** rule applies and the packet is dropped.

To display the IPv6 ACL Rule Configuration page, click **Switching** → **Network Security** → **Access Control Lists** → **IPv6 Access Control Lists** → **Rule Configuration** in the navigation menu.



**Figure 19-12. IPv6 ACL - Rule Configuration**



## Removing an IPv6 ACL Rule

To delete an IPv6 ACL rule:

- 1 From the **Rule ID** menu, select the ID of the rule to delete.
- 2 Select the **Remove** option near the bottom of the page.
- 3 Click **Apply** to remove the selected rule.

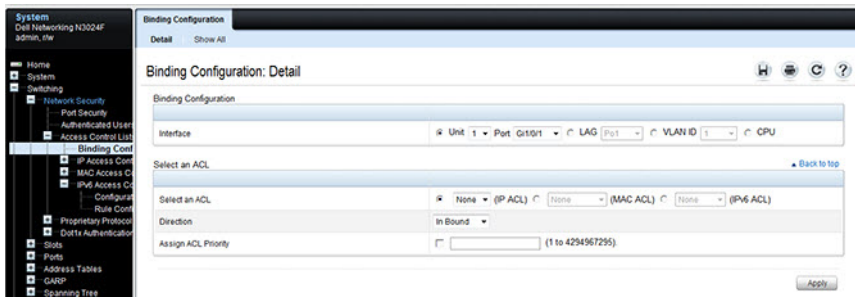
## ACL Binding Configuration

When an ACL is bound to an interface, all the rules that have been defined are applied to the selected interface. Use the **ACL Binding Configuration** page to assign ACL lists to ACL Priorities and Interfaces.

From the web interface, the ACLs rules can be configured in the ingress or egress direction so that they implement security rules for packets entering or exiting the port. ACLs can be applied to any physical (including 10 Gb) interface, LAG, or routing port.

To display the **ACL Binding Configuration** page, click **Switching** → **Network Security** → **Access Control Lists** → **Binding Configuration** in the navigation panel.

**Figure 19-13. ACL Binding Configuration**



## Time Range Configuration

Use the **Time Range Configuration** page to define time ranges to associate with ACL rules.

To display the **Time Range Configuration** page, click **System** → **Time Synchronization** → **Time Range Configuration** in the navigation panel. The following image shows the page after at least one time range has been added. Otherwise, the page indicates that no time ranges are configured, and the time range configuration fields are not displayed.

**Figure 19-14. Time Range Configuration**

The screenshot shows the 'Time Range Configuration: Detail' page. The configuration form is as follows:

Time Range Name	wktend
Time Range Entry	Create New Time Range Entry
Time Range Entry ID	(1-10)
Time Range Entry Type	Periodic
Applicable Days	<input type="radio"/> Daily <input checked="" type="radio"/> Weekdays <input type="radio"/> Weekend <input type="radio"/> Days of week
Periodic Start Day and Time	
Start Day	Sunday
Start Time	(hh:mm)
Periodic End Day and Time	
End Day	Sunday
End Time	(hh:mm)



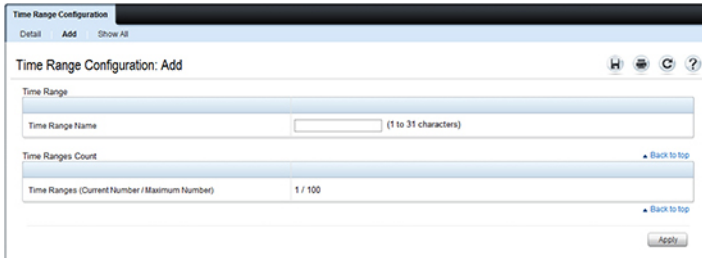
**NOTE:** A time-range parameter in an ACL that is referred to by a route-map statement is active only during the time range specified. When the ACL is not active (outside the time range), the route-map simply treats the ACL as a “no match”.

### Adding a Time Range

To configure a time range:

- 1 From the **Time Range Configuration** page, click **Add**.
- 2 Specify a name to identify the time range.

**Figure 19-15. Add a Time Range**



- 3 Click **Apply**.
- 4 Click **Detail** to return to the **Time Range Configuration** page.
- 5 In the **Time Range Name** field, select the name of the time range to configure.
- 6 Specify an ID for the time range. Up to 10 different time range entries can be configured to include in the named range. However, only one absolute time entry is allowed per time range.
- 7 Configure the values for the time range entry.
- 8 Click **Apply**.
- 9 To add additional entries to the named time range, repeat [step 5](#) through [step 8](#).

## Configuring ACLs (CLI)

This section provides guidelines for the commands you use to create and configure ACLs. For a complete description of the commands, see the *Dell EMC Networking N1100-ON, N1500, N2000, N2100-ON, N2200-ON, N3000E-ON, N3100-ON, and N3200-ON Series Switches CLI Reference Guide* at [www.dell.com/support](http://www.dell.com/support).

### Configuring an IPv4 ACL

Use the following commands to create an IPv4 ACL, configure rules for the ACL, and bind the ACL to an interface.



**NOTE:** The `ip access-group` command can be issued in Global Configuration mode or Interface configuration mode. If it is applied in Global Configuration mode, the ACL binding is applied to all interfaces. If it is applied in Interface Configuration mode, it is applied only to the specified interfaces within the mode.

Command	Purpose
<code>configure</code>	Enter global configuration mode.
<code>ip access-list name</code>	Create an extended ACL and enter IPv4 access-list configuration mode.

Command	Purpose
<pre>[sequence-number] {deny   permit} {{ipv4- protocol   0-255   every} {srcip srcmask   any   host srcip} [{range {portkey   startport} {portkey   endport}   {eq   neq   lt   gt} {portkey   0-65535}] {dstip dstmask   any   host dstip} [{range {portkey   startport} {portkey   endport}   {eq   neq   lt   gt} {portkey   0-65535}] [flag [+fin   -fin] [+syn   -syn] [+rst   -rst] [+psh   -psh] [+ack   - ack] [+urg   -urg] [established]] [icmp- type icmp-type [icmp- code icmp-code]   icmp- message icmp-message] [igmp-type igmp-type] [fragments] [precedence precedence   tos tos [tosmask]   dscp dscp]}] [time-range time-range-name] [log] [assign-queue queue-id] [{mirror   redirect} interface] [rate-limit rate burst-size]</pre>	<p>Enter the permit and deny conditions for the extended ACL.</p> <ul style="list-style-type: none"> <li>• <i>sequence-number</i>— Identifies the order of application of the permit/deny statement. If no sequence number is assigned, permit/deny statements are assigned a sequence number beginning at 1000 and incrementing by 10. Statements are applied in hardware beginning with the lowest sequence number. Sequence numbers apply only within an access group; i.e., the ordering applies within the access-group scope. The range for sequence numbers is 1–2147483647.</li> <li>• <b>{deny   permit}</b> — Specifies whether the IP ACL rule permits or denies the matching traffic.</li> <li>• <b>{ipv4-protocol   number   every}</b> — Specifies the protocol to match for the IP ACL rule. <ul style="list-style-type: none"> <li>– IPv4 protocols: <b>eigrp, gre, icmp, igmp, ip, ipinip, ospf, sctp, tcp, udp, pim, arp, sctp</b></li> <li>– <i>number</i>: a protocol number in decimal, e.g. 8 for EGP</li> <li>– <i>every</i>: Match any protocol (don't care)</li> </ul> </li> <li>• <i>srcip srcmask   any   host srcip</i> — Specifies a source IP address and netmask to match for the IP ACL rule. <ul style="list-style-type: none"> <li>– Specifying “any” implies specifying <i>srcip</i> as “0.0.0.0” and <i>srcmask</i> as “255.255.255.255” for IPv4.</li> <li>– Specifying “host A.B.C.D” implies <i>srcip</i> as “A.B.C.D” and <i>srcmask</i> as “0.0.0.0”.</li> </ul> </li> <li>• <b>{[{eq   neq   lt   gt} {portkey   number}   range startport endport]}</b> — Specifies the Layer-4 source or destination port match condition for the TCP or UDP ACL rule. A port number, which ranges from 0-65535, can be entered, or a <i>portkey</i>, which can be one of the following keywords: <b>domain, echo, ftp, ftp-data, http, smtp, snmp, telnet, tftp, www, bgp, pop2, pop3, ntp, rip, time, and who</b>. Each of these keywords translates into its equivalent port number. A port match is only valid for the TCP and UDP protocols.</li> </ul>

Command	Purpose
<i>continued</i>	<ul style="list-style-type: none"> <li data-bbox="445 225 1002 496">– When <b>range</b> is specified, TCP or UDP ACL rule matches only if the Layer-4 port number falls within the specified port range. The <i>startport</i> and <i>endport</i> parameters identify the first and last ports that are part of the port range. They have values from 0 to 65535. The ending port must have a value equal or greater than the starting port. The starting port, ending port, and all ports in between will be part of the Layer-4 port range.</li> <li data-bbox="445 496 1002 592">– When <b>eq</b> is specified, the IP ACL rule matches only if the Layer-4 port number is equal to the specified port number or portkey.</li> <li data-bbox="445 592 1002 735">– When <b>lt</b> is specified, the IP ACL rule matches if the Layer-4 source or destination port number is less than the specified port number or portkey. It is equivalent to specifying the range as 0 to &lt;specified port number – 1&gt;.</li> <li data-bbox="445 735 1002 895">– When <b>gt</b> is specified, the IP ACL rule matches if the Layer-4 source or destination port number is greater than the specified port number or portkey. It is equivalent to specifying the range as &lt;specified port number + 1&gt; to 65535.</li> <li data-bbox="445 895 1002 991">– When <b>neq</b> is specified, the IP ACL rule matches only if the Layer-4 source or destination port number is not equal to the specified port number or portkey.</li> <li data-bbox="445 991 1002 1086">– IPv4 TCP/UDP port names: <b>domain</b>, <b>echo</b>, <b>ftp</b>, <b>ftp-data</b>, <b>http</b>, <b>smtp</b>, <b>snmp</b>, <b>telnet</b>, <b>tftp</b>, <b>www</b>, <b>bgp</b>, <b>pop2</b>, <b>pop3</b>, <b>ntp</b>, <b>rip</b>, <b>time</b>, and <b>who</b>.</li> <li data-bbox="445 1086 1002 1310">• <b><i>dstip dstmask</i>   any   host dstip</b>—Specifies a destination IP address and netmask for match condition of the IP ACL rule. <ul style="list-style-type: none"> <li data-bbox="445 1182 1002 1246">– Specifying <b>any</b> implies specifying <i>dstip</i> as “0.0.0.0” and <i>dstmask</i> as “255.255.255.255”.</li> <li data-bbox="445 1246 1002 1310">– Specifying <b>host A.B.C.D</b> implies <i>dstip</i> as “A.B.C.D” and <i>dstmask</i> as “0.0.0.0”.</li> </ul> </li> <li data-bbox="445 1310 1002 1444">• <b>[precedence precedence   tos tos [tosmask]   dscp dscp]</b>—Specifies the TOS for an IP/TCP/UDP ACL rule depending on a match of precedence or DSCP values using the parameters <b>dscp</b>, <b>precedence</b>, or <b>tos tosmask</b>.</li> </ul>

Command	Purpose
<i>continued</i>	<ul style="list-style-type: none"> <li data-bbox="387 236 958 847"> <p>• <b>flag</b> [<b>+fin</b>   <b>-fin</b>] [<b>+syn</b>   <b>-syn</b>] [<b>+rst</b>   <b>-rst</b>] [<b>+psh</b>   <b>-psh</b>] [<b>+ack</b>   <b>-ack</b>] [<b>+urg</b>   <b>-urg</b>] [<b>established</b>]            Specifies that the IP/TCP/UDP ACL rule matches on the TCP flags.</p> <ul style="list-style-type: none"> <li data-bbox="407 363 698 387">– <b>Ack</b> – Acknowledgement bit</li> <li data-bbox="407 395 602 419">– <b>Fin</b> – Finished bit</li> <li data-bbox="407 427 564 451">– <b>Psh</b> – push bit</li> <li data-bbox="407 459 564 483">– <b>Rst</b> – reset bit</li> <li data-bbox="407 491 639 515">– <b>Syn</b> – Synchronize bit</li> <li data-bbox="407 523 586 547">– <b>Urg</b> – Urgent bit</li> <li data-bbox="407 571 958 651">– When “+&lt;tcpflagname&gt;” is specified, a match occurs if specified &lt;tcpflagname&gt; flag is set in the TCP header.</li> <li data-bbox="407 659 958 738">– When “-&lt;tcpflagname&gt;” is specified, a match occurs if specified &lt;tcpflagname&gt; flag is *NOT* set in the TCP header.</li> <li data-bbox="407 746 958 810">– When <b>established</b> is specified, a match occurs if either the RST or ACK bits are set in the TCP header.</li> <li data-bbox="407 818 844 842">– This option is visible only if protocol is <b>tcp</b>.</li> </ul> </li> <li data-bbox="387 855 958 1430"> <p>• [<b>icmp-type</b> <i>icmp-type</i> [<b>icmp-code</b> <i>icmp-code</i>]   <b>icmp-message</b> <i>icmp-message</i>] —Specifies a match condition for ICMP packets.</p> <ul style="list-style-type: none"> <li data-bbox="407 951 958 1031">– When <b>icmp-type</b> is specified, IP ACL rule matches on the specified ICMP message type, a number from 0 to 255.</li> <li data-bbox="407 1038 958 1118">– When <b>icmp-code</b> is specified, IP ACL rule matches on the specified ICMP message code, a number from 0 to 255.</li> <li data-bbox="407 1126 958 1190">– Specifying <b>icmp-message</b> implies both <b>icmp-type</b> and <b>icmp-code</b> are specified.</li> <li data-bbox="407 1198 958 1278">– <b>icmp-message</b> is decoded into corresponding ICMP type and ICMP code within that ICMP type. This option is visible only if the protocol is <b>icmp</b>.</li> <li data-bbox="407 1286 958 1430">– IPv4 ICMP message types: echo, echo-reply, host-redirect, mobile-redirect, net-redirect, net-unreachable, redirect, packet-too-big, port-unreachable, source-quench, router-solicitation, router-advertisement, time-exceeded, ttl-exceeded, unreachable.</li> </ul> </li> </ul>



Command	Purpose
<i>continued</i>	<ul style="list-style-type: none"> <li data-bbox="423 236 1002 327">• <b>igmp-type</b> <i>igmp-type</i>—When <b>igmp-type</b> is specified, the IP ACL rule matches on the specified IGMP message type (i.e., a number from 0 to 255).</li> <li data-bbox="423 336 1002 512">• <b>fragments</b>—Specifies the rule matches packets that are non-initial fragments (fragment bit asserted). Not valid for rules that match L4 information such as TCP port number since that information is carried in the initial packet. This keyword is also not valid for IPv6 packets since they should never be fragmented.</li> <li data-bbox="423 521 866 549">• <b>log</b>—Specifies that this rule is to be logged.</li> <li data-bbox="423 558 1002 911">• <b>time-range</b> <i>time-range-name</i>—Allows imposing time limitation on the ACL rule as defined by the parameter <i>time-range-name</i>. If a time range with the specified name does not exist and the ACL containing this ACL rule is applied to an interface or bound to a VLAN, then the ACL rule is applied immediately. If a time range with specified name exists and the ACL containing this ACL rule is applied to an interface or bound to a VLAN, then the ACL rule is applied when the time-range with specified name becomes active. The ACL rule is removed when the time-range with specified name becomes inactive.</li> <li data-bbox="423 920 1002 1011">• <b>assign-queue</b> <i>queue-id</i>—Specifies the assign-queue, which is the queue identifier to which packets matching this rule are assigned.</li> <li data-bbox="423 1021 1002 1139">• <b>{mirror   redirect}</b> <i>interface</i>—Specifies the mirror or redirect interface which is the interface ID to which packets matching this rule are copied or forwarded, respectively.</li> <li data-bbox="423 1149 1002 1310">• <b>rate-limit</b> <i>rate burst-size</i>—Specifies the allowed rate of traffic as per the configured rate in kbps, and burst-size in kbytes. <ul style="list-style-type: none"> <li data-bbox="445 1246 934 1273">– <b>Rate</b> – the committed rate in kilobits per second</li> <li data-bbox="445 1283 956 1310">– <b>Burst-size</b> – the committed burst size in Kilobytes.</li> </ul> </li> <li data-bbox="423 1319 852 1347">• <b>routing</b> - indicates a packet that is routed.</li> </ul>

Command	Purpose
<code>interface interface</code>	<p>(Optional) Enter interface configuration mode for the specified interface. The <i>interface</i> variable includes the interface type and number, for example <code>tengigabitethernet 1/0/3</code>.</p> <p>A range of interfaces can be specified using the <code>interface range</code> command. For example, <code>interface range tengigabitethernet 1/0/8-12</code> configures interfaces 8, 9, 10, 11, and 12.</p>
<code>ip access-group name direction seqnum</code>	<p>Bind the specified ACL to an interface.</p> <p><b>NOTE:</b> To apply this ACL to all interfaces, issue the command in Global Configuration mode.</p> <ul style="list-style-type: none"> <li>• <i>name</i> — Access list name. (Range: Valid IP access-list name up to 31 characters in length)</li> <li>• <i>direction</i> — Direction of the ACL. (Range: In or out. Default is <i>in</i>.)</li> <li>• <i>seqnum</i> — Precedence for this interface and direction. A lower sequence number has higher precedence. Range: 1 – 4294967295. Default is 1.</li> </ul>
<code>CTRL + Z</code>	Exit to Privileged Exec mode.
<code>show ip access-lists [name]</code>	Display all IPv4 access lists and all of the rules that are defined for the IPv4 ACL. Use the optional <i>name</i> parameter to identify a specific IPv4 ACL to display.

## Configuring a MAC ACL

Use the following commands to create an MAC ACL, configure rules for the ACL, and bind the ACL to an interface.

Command	Purpose
<code>configure</code>	Enter global configuration mode.
<code>mac access-list extended</code> <i>name</i>	Create a named MAC ACL. This command also enters MAC Access List Configuration mode. If a MAC ACL with this name already exists, this command enters the mode to update the existing ACL.

Command	Purpose
<pre>[sequence-number] {deny   permit} {srcmac srcmacmask   any} {dstmac dstmacmask   any   bpd} [ethertypekey   0x0600- 0xFFFF] [vlan eq 0- 4095] [cos 0-7] [secondary-vlan eq 0- 4095] [log] [time-range time-range-name] [assign-queue queue-id] [{mirror   redirect} interface] [rate-limit rate burst-size]</pre>	<p>Specify the rules (match conditions) for the MAC access list.</p> <ul style="list-style-type: none"> <li>• <i>sequence-number</i> — Identifies the order of application of the permit/deny statement. If no sequence number is assigned, permit/deny statements are assigned a sequence number beginning at 1000 and incrementing by 10. Statements are applied in hardware beginning with the lowest sequence number. Sequence numbers are applicable only within an access group; i.e., the ordering applies within the access-group scope. The range for sequence numbers is 1–2147483647.</li> <li>• <i>srcmac</i> — Valid source MAC address.</li> <li>• <i>srcmacmask</i> — Valid MAC address bitmask for the source MAC address.</li> <li>• <i>any</i> — Packets sent to or received from any MAC address</li> <li>• <i>dstmac</i> — Valid destination MAC address.</li> <li>• <i>dstmacmask</i> — Valid MAC address bitmask for the destination MAC address.</li> <li>• <i>bpd</i> — Bridge protocol data unit</li> <li>• <i>ethertypekey</i> — Either a keyword or valid four-digit hexadecimal number. (Range: Supported values are <i>appletalk</i>, <i>arp</i>, <i>ibmsna</i>, <i>ipv4</i>, <i>ipv6</i>, <i>ipx</i>, <i>mplsmcast</i>, <i>mplsucast</i>, <i>Netbios</i>, <i>novell</i>, <i>pppoe</i>, <i>rarp</i>.)</li> <li>• <i>0x0600-0xFFFF</i> — Specify custom EtherType value (hexadecimal range 0x0600-0xFFFF)</li> <li>• <i>vlan eq</i> — VLAN number. (Range 0–4095)</li> <li>• <i>cos</i> — Class of service. (Range 0–7)</li> <li>• <i>secondary-vlan</i> — An outer VLAN tag, if present in the frame</li> </ul>

Command	Purpose
<i>continued</i>	<ul style="list-style-type: none"> <li>• <b>log</b>—Specifies that this rule is to be logged.</li> <li>• <b>time-range</b> <i>time-range-name</i>—Allows imposing time limitation on the ACL rule as defined by the parameter <i>time-range-name</i>. If a time range with the specified name does not exist and the ACL containing this ACL rule is applied to an interface or bound to a VLAN, then the ACL rule is applied immediately. If a time range with specified name exists and the ACL containing this ACL rule is applied to an interface or bound to a VLAN, then the ACL rule is applied when the time-range with specified name becomes active. The ACL rule is removed when the time-range with specified name becomes inactive.</li> <li>• <b>assign-queue</b> <i>queue-id</i>—Specifies the assign-queue, which is the queue identifier to which packets matching this rule are assigned.</li> <li>• <b>{mirror   redirect}</b> <i>unit/slot/port</i>—Specifies the mirror or redirect interface which is the unit/slot/port to which packets matching this rule are copied or forwarded, respectively.</li> <li>• <b>rate-limit</b> <i>rate burst-size</i>—Specifies the allowed rate of traffic as per the configured rate in Kbps, and burst-size in Kbytes. <ul style="list-style-type: none"> <li>– <b>Rate</b> – the committed rate in kilobits per second</li> <li>– <b>Burst-size</b> – the committed burst size in Kilobytes.</li> </ul> </li> </ul>
<b>interface</b> <i>interface</i>	<p>(Optional) Enter interface configuration mode for the specified interface. The <i>interface</i> variable includes the interface type and number, for example <b>tengigabitethernet 1/0/3</b>.</p> <p>A range of interfaces can be specified using the <b>interface range</b> command. For example, <b>interface range tengigabitethernet 1/0/8-12</b> configures interfaces 8, 9, 10, 11, and 12.</p>

Command	Purpose
<code>mac access-group <i>name</i> <i>direction seqnum</i></code>	<p>Bind the specified MAC ACL to an interface.</p> <p><b>NOTE:</b> To apply this ACL to all interfaces, issue the command in Global Configuration mode.</p> <ul style="list-style-type: none"> <li>• <i>name</i> — Access list name. (Range: Valid MAC access-list name up to 31 characters in length)</li> <li>• <i>direction</i> — Direction of the ACL. (Range: In or out. Default is <i>in</i>.)</li> <li>• <i>seqnum</i> — Precedence for this interface and direction. A lower sequence number has higher precedence. Range: 1 – 4294967295. Default is 1.</li> </ul>
CTRL + Z	Exit to Privileged Exec mode.
<code>show mac access-lists [<i>name</i>]</code>	Display all MAC access lists and all of the rules that are defined for the MAC ACL. Use the optional <i>name</i> parameter to identify a specific MAC ACL to display.

## Configuring an IPv6 ACL

Use the following commands to create an IPv6 ACL, configure rules for the ACL, and bind the ACL to an interface.

Command	Purpose
<code>configure</code>	Enter global configuration mode.
<code>ipv6 access-list <i>name</i></code>	Create an extended IPv6 ACL. This command also enters IPv6 Access List Configuration mode. If an IPv6 ACL with this name already exists, this command enters the mode to update the existing ACL.

Command	Purpose
<pre>[sequence-number] {deny   permit} {ipv6- protocol   number   every} {source-ipv6- prefix/prefix-length   any   host source-ipv6- address} [{range {portkey   startport} {portkey   endport}   {eq   neq   lt   gt} {portkey   0-65535}] {destination-ipv6- prefix/prefix-length   any   host destination-ipv6- address} [{range {portkey   startport} {portkey   endport}   {eq   neq   lt   gt} {portkey   0-65535}] [flag [+fin   -fin] [+syn   -syn] [+rst   -rst] [+psh   -psh] [+ack   - ack] [+urg   -urg] [established]] [flow- label value] [icmp-type icmp-type [icmp-code icmp-code]   icmp- message icmp-message] [routing] [fragments] [dscp dscp]] [log] [assign-queue queue-id] [{mirror   redirect} interface] [rate-limit rate burst-size]</pre>	<ul style="list-style-type: none"> <li>• <i>sequence-number</i> — Identifies the order of application of the permit/deny statement. If no sequence number is assigned, permit/deny statements are assigned a sequence number beginning at 1000 and incrementing by 10. Statements are applied in hardware beginning with the lowest sequence number. Sequence numbers are applicable only within an access group; i.e., the ordering applies within the access-group scope. The range for sequence numbers is 1–2147483647.</li> <li>• <b>{deny   permit}</b> — Specifies whether the IP ACL rule permits or denies the matching traffic.</li> <li>• <b>{ipv6-protocol   number   every}</b> — Specifies the protocol to match for the IP ACL rule. <ul style="list-style-type: none"> <li>– IPv4 protocols: <b>icmpv6</b>, <b>ipv6</b>, <b>tcp</b> and <b>udp</b></li> <li>– <b>every</b>: Match any protocol (don't care)</li> </ul> </li> <li>• <i>source-ipv6-prefix/prefixlength   any   host src-ipv6-address</i> — Specifies a source IP address and netmask to match for the IP ACL rule. <ul style="list-style-type: none"> <li>– For IPv6 ACLs, <b>any</b> implies a 0::/128 prefix and a mask of all ones.</li> <li>– Specifying “host X::X” implies a prefix length as “/128” and a mask of 0::/128.</li> </ul> </li> <li>• <b>[{range {portkey   startport} {portkey   endport}   {eq   neq   lt   gt} {portkey   0-65535}]</b> — Specifies the Layer-4 source or destination port match condition for the IP/TCP/UDP ACL rule. A port number, which ranges from 0-65535, can be entered, or a <i>portkey</i>, which can be one of the following keywords: <b>bgp</b>, <b>domain</b>, <b>echo</b>, <b>ftp</b>, <b>ftp-data</b>, <b>http</b>, <b>ntp</b>, <b>pop2</b>, <b>pop3</b>, <b>rip</b>, <b>smtp</b>, <b>snmp</b>, <b>telnet</b>, <b>tftp</b>, <b>telnet</b>, <b>time</b>, <b>who</b>, and <b>www</b>. Each of these keywords translates into its equivalent destination port number. <ul style="list-style-type: none"> <li>– When <b>range</b> is specified, IPv6 ACL rule matches only if the Layer-4 port number falls within the specified port range. The <i>startport</i> and <i>endport</i> parameters identify the first and last ports that are part of the port range. They have values from 0 to 65535. The ending port must have a value equal or greater than the starting port. The starting port, ending port, and all ports in between will be part of the Layer-4 port range.</li> </ul> </li> </ul>



Command	Purpose
(Continued)	<ul style="list-style-type: none"> <li>– When <b>eq</b> is specified, IPv6 ACL rule matches only if the Layer-4 port number is equal to the specified port number or portkey.</li> <li>– When <b>lt</b> is specified, IPv6 ACL rule matches if the Layer-4 destination port number is less than the specified port number or portkey. It is equivalent to specifying the range as 0 to &lt;specified port number – 1&gt;.</li> <li>• <b>destination ipv6 prefix</b> — IPv6 prefix in IPv6 global address format.</li> <li>• <b>flow label value</b> — The value to match in the Flow Label field of the IPv6 header (Range 0–1048575).</li> <li>• <b>dscp dscp</b> — Specifies the TOS for an IPv6 ACL rule depending on a match of DSCP values using the parameter dscp.</li> <li>• <b>log</b> — Specifies that this rule is to be logged.</li> <li>• <b>time-range-name</b> — Specifies the named time range to associate with the ACL rule.</li> <li>• <b>assign-queue queue-id</b> — Specifies particular hardware queue for handling traffic that matches the rule.</li> <li>• <b>mirror interface</b> — Allows the traffic matching this rule to be copied to the specified interface.</li> <li>• <b>redirect interface</b> — This parameter allows the traffic matching this rule to be forwarded to the specified interface.</li> </ul>
<b>interface interface</b>	<p>(Optional) Enter interface configuration mode for the specified interface. The <i>interface</i> variable includes the interface type and number, for example <b>tengigabitethernet 1/0/3</b>.</p> <p>A range of interfaces can be specified using the <b>interface range</b> command. For example, <b>interface range tengigabitethernet 1/0/8-12</b> configures interfaces 8, 9, 10, 11, and 12.</p>

Command	Purpose
<code>ipv6 traffic-filter name direction [sequence seq-num]</code>	<p>Bind the specified IPv6 ACL to an interface.</p> <p><b>NOTE:</b> To apply this ACL to all interfaces, issue the command in Global Configuration mode.</p> <ul style="list-style-type: none"> <li><i>name</i> — Access list name. (Range: Valid IPv6 access-list name up to 31 characters in length)</li> <li><i>direction</i> — Direction of the ACL. (Range: In or out. Default is <i>in</i>.)</li> <li><i>seqnum</i> — Precedence for this interface and direction. A lower sequence number has higher precedence. Range: 1 – 4294967295. Default is 1.</li> </ul>
CTRL + Z	Exit to Privileged Exec mode.
<code>show ipv6 access-lists [name]</code>	Display all IPv6 access lists and all of the rules that are defined for the IPv6 ACL. Use the optional <i>name</i> parameter to identify a specific IPv6 ACL to display.

## Configuring a Time Range

Use the following commands to create a time range and configure time-based entries for the time range.

Command	Purpose
<code>configure</code>	Enter global configuration mode.
<code>time-range name</code>	Create a named time range and enter the Time-Range Configuration mode for the range.
<code>absolute {[start time date] [end time date]}</code>	<p>Configure a nonrecurring time entry for the named time range.</p> <ul style="list-style-type: none"> <li><i>start time date</i> — Time and date the ACL rule starts going into effect. The time is expressed in a 24-hour clock, in the form of hours:minutes. For example, 8:00 is 8:00 am and 20:00 is 8:00 pm. The date is expressed in the format day month year. If no start time and date are specified, the configuration statement is in effect immediately.</li> <li><i>end time date</i> — Time and date the ACL rule is no longer in effect.</li> </ul>

Command	Purpose
<b>periodic</b> { <i>days-of-the-week time</i> } <b>to</b> {[ <i>days-of-the-week</i> ] <i>time</i> }	<p>Configure a recurring time entry for the named time range.</p> <ul style="list-style-type: none"> <li>• <i>days-of-the-week</i> —The first occurrence indicates the starting day(s) the ACL goes into effect. The second occurrence is the ending day(s) when the ACL rule is no longer in effect. If the end <i>days-of-the-week</i> are the same as the start, they can be omitted</li> </ul> <p>This variable can be any single day or combinations of days: <b>Monday, Tuesday, Wednesday, Thursday, Friday, Saturday, Sunday</b>. Other possible values are:</p> <ul style="list-style-type: none"> <li>– <b>daily</b> -- Monday through Sunday</li> <li>– <b>weekdays</b> -- Monday through Friday</li> <li>– <b>weekend</b> -- Saturday and Sunday</li> </ul> <ul style="list-style-type: none"> <li>• <i>time</i> — Time the ACL rule starts going into effect (first occurrence) or ends (second occurrence). The time is expressed in a 24-hour clock, in the form of hours:minutes.</li> </ul>
CTRL + Z	Exit to Privileged Exec mode.
<b>show time-range</b> [ <i>name</i> ]	View information about all configured time ranges, including the absolute/periodic time entries that are defined for each time range. Use the <i>name</i> variable to view information about the specified time range.

# ACL Configuration Examples

This section contains the following examples:

- "Basic Rules" on page 764
- "Internal System ACLs" on page 765
- "Complete ACL Example" on page 766
- "Advanced Examples" on page 770
- "Policy-Based Routing Examples" on page 782



**NOTE:** None of these ACL rules are applicable to the OOB interface.

## Basic Rules

- Inbound rule allowing all packets sequenced after all other rules. It is recommended that the largest possible sequence number be specified with a permit every rule to ensure that it is the last rule processed in the ACL.

```
2147483647 permit every
```

Administrators should be cautious when using the **permit every** rule in an access list, especially when using multiple access lists. All packets match a **permit every** rule and no further processing is done on the packet. This means that a **permit every** match in an access list will skip processing subsequent rules in the current or subsequent access-lists and allow all packets not previously denied by a prior rule.

- Inbound rule to drop all packets:

As the last rule in a list, this rule is redundant as an implicit “deny every” is added after the end of the last access-group configured on an interface.

```
10000 deny every
```

Administrators should be cautious when using the **deny every** rule in an access list, especially when using multiple access lists. When a packet matches a rule, no further processing is done on the packet. This means that a **deny every** match in an access list will skip processing subsequent rules in the current or subsequent access-lists and drop all packets not previously allowed by a prior rule.

- Inbound rule allowing access FROM hosts with IP addresses ranging from 10.0.46.0 to 10.0.47.254:  
`permit ip 10.0.46.0 0.0.1.255 any`
- Inbound rule allowing access TO hosts with IP addresses ranging from 10.0.48.0 to 10.0.49.254:  
`permit ip any 10.0.48.0 0.0.1.255`

As the last rule in an administrator-defined list, the narrower scope of this inbound rule has no effect other than to possibly interfere with switch management access or router operations. The system installs an implicit deny every rule after the end of the last access group bound to an interface:

```
500 deny ip any any
```

## Internal System ACLs

The switch installs a number of internal ACLs to trap packets to the switch CPU for processing. Examples of these types of packets are IEEE 802.1X EAPOL packets, IP source guard packets, LLPF packets, LLDP packets, IEEE 802.1AD packets, etc. These internal ACLs are generally configured at the lowest priority (higher numerically) so that the switch administrator, through the use of ACLs, can override the default switch behavior. An example is an ACL that matches only on the source MAC address. Some of the system rules are installed when the administrator enables specific protocols; other rules are always present and may have their behaviors altered by enabling or disabling protocols, e.g., iSCSI or LLPF. For example, spanning tree BPDUs, LLDP packets, and IEEE 802.1X packets are never forwarded by the switch by default.

## Complete ACL Example

The following example is a complete inbound ACL that allows access for hosts connected to `gil/0/1` with IP address in `10.1.1.x` range to send IP packets to `192.168.0.X` hosts on `gil/0/2`. IP packets not from `10.1.1.x` addresses or not addressed to `192.168.0.x` hosts are dropped. Packets with protocols other than IP, DNS, ARP, or ICMP are dropped. Allowing ICMP supports the `10.1.1.x` hosts in reliably receiving and initiating TCP connections and pinging through the switch. This example also allows ARP and DNS packets to any destination and is suitable for a Layer-2 switch. Both administrator-specified and automatic sequence numbering of the ACLs is demonstrated.

```
console#config
console (config) #mac access-list extended Allow-ARP
console (config-mac-access-list) #permit any any arp
console (config-mac-access-list) #exit

console (config) #ip access-list Allow-10-1-1-x
console (config-ip-acl) #10 permit ip 10.1.1.0 0.0.0.255 any
console (config-ip-acl) #20 permit ip any 192.168.0.0 0.0.0.255
console (config-ip-acl) #30 permit icmp 10.1.1.0 0.0.0.255 any
console (config-ip-acl) #40 permit ip 0.0.0.0 255.255.255.255 any
console (config-ip-acl) #50 permit udp any any eq domain
console (config-ip-acl) #exit

console (config) #interface gil/0/1
console (config-if-gil/0/1) #mac access-group Allow-ARP in 10
console (config-if-gil/0/1) #ip access-group Allow-10-1-1-x in 20
console (config-if-gil/0/1) #exit
```

Another list on the `192.168.0.x` network attached port (`gil/0/2`) is configured for this example. Because the two access lists are complementary/end-to-end, it is necessary to allow ICMP packets to travel between the attached hosts. Specific sequence numbering of the ACLs rules is shown here.

```
console (config) #ip access-list Allow-192-168-0-x
console (config-ip-acl) #10 permit ip 192.168.0.0 0.0.0.255 10.1.1.0
0.0.0.255
console (config-ip-acl) #20 permit icmp 192.168.0.0 0.0.0.255 any
console (config-ip-acl) #30 permit udp any any eq domain
console (config-ip-acl) #exit

console (config) #interface gil/0/2
console (config-if-gil/0/2) #mac access-group Allow-ARP in 10
console (config-if-gil/0/2) #ip access-group Allow-192-168-0-x in 20
```

```
console(config-if-gi1/0/2)#exit
```

Consider the following inbound rules that allow Telnet connections and UDP traffic from the 192.168.0.x network to host 10.1.1.23:

```
ip access-list Host10-1-1-23
! Permit Telnet traffic from 192.168.0.X network to host 10.1.1.23:
permit tcp 192.168.0.0 0.0.0.255 host 10.1.1.23 eq telnet
! Permit TCP traffic from 192.168.0.X network to host 10.1.1.23:
permit tcp 192.168.0.0 0.0.0.255 host 10.1.1.23
! Permit UDP traffic from 192.168.0.X network to host 10.1.1.23
permit udp 192.168.0.0 0.0.0.255 host 10.1.1.23
! Permit IP traffic from 192.168.0.X network to 10.1.1.x network
permit ip 192.168.0.0 0.0.0.255 10.1.1.23 0.0.0.255
```

In the above list, the fourth rule allows all IP packets between the network and host. The narrower scope of the first three rules is redundant, as all IP traffic, including TCP and UDP, is permitted by the fourth rule.

The following list has corrected rules that allow Telnet and UDP packets only and rely on the implicit “deny all” after the end of the last access group to deny other traffic.

```
ip access-list Host10-1-1-23
! Permit Telnet traffic from 192.168.0.X network to host 10.1.1.23
permit tcp 192.168.0.0 0.0.0.255 host 10.1.1.23 eq telnet
! Permit UDP traffic from 192.168.0.X network to host 10.1.1.23
permit udp 192.168.0.0 0.0.0.255 host 10.1.1.23
```

The ACL feature supports TCP and UDP port matching using operators:

```
console(config-ip-acl)#permit tcp 10.1.1.0 0.0.0.255 ?
```

<dstip>	Enter a Destination IP Address.
any	Match any Destination IP Address.
eq	Matches only if port number is equal.
gt	Matches only if port number is greater.
host	Enter a destination host.
lt	Matches only if port number is less.
neq	Matches only if port number is not equal.
range	Specify the range of ports.

The range operator is inclusive of the specified port parameters.

ACLs support TCP flags. If multiple flags are set (+flag) in a single rule, only packets with the all the same flags asserted are matched (logical AND).

Likewise, if multiple flags are cleared (-flag) in a single rule, only packets with the same flags cleared are matched. The established keyword matches TCP

packets with either the RST or ACK bits set (logical OR). Flags that are neither set nor cleared in the rule are not checked in the ACL (don't care or wildcard).

```
console (config) #ip access-list flags-demo
console (config-ip-acl) #permit tcp any any flag ?
```

```
<value>      Enter a TCP Flag (+fin, -fin, +syn, -syn, +rst, -rst,
              +psh, -psh, +ack, -ack, +urg, -urg, established).
              Enter a flag (+|-) only once. Specifying established
              implies specifying either +rst or +ack
established  Match occurs if either RST or ACK bits are set in the
              TCP header (Only for TCP).
```

The following is an example rule to match TCP packets with the PUSH flag asserted AND the RESET flag cleared. The other flags bits are “don't care”:

```
console (config-ip-acl) #permit tcp any any flag -rst +psh
```

ACLs may also contain a number of shorthand qualifiers for protocols and IP, TCP, and UDP port numbers, as shown below. Note that not all of these qualifiers make sense in the context of any given port number; e.g., ftp and ftp-data only make sense in the context of the IP or UDP protocols, while an HTTP port number only makes sense in terms of the TCP or IP protocols. Refer to RFC 1700 or [iana.org/protocols](http://iana.org/protocols) for a list of protocol numbers.

```
console (config-ip-acl) #permit ?

<0-255>      Match the protocol number.
eigrp        Match the EIGRP protocol.
every        Match every packet.
gre          Match the GRE protocol.
icmp         Match the ICMP protocol.
igmp         Match the IGMP protocol.
ip           Match the IP protocol.
ipinip       Match the IPINIP protocol.
ospf         Match the OSPF protocol.
pim          Match the PIM protocol.
sctp         Match the SCTP protocol.
tcp          Match the TCP protocol.
udp          Match the UDP protocol.
```



```
console(config-ip-acl)#permit tcp 10.1.1.0 0.0.0.255 eq ?
```

```
<0-65535> Enter the Layer 4 port number in the range 0 to 65535.  
<portkey> Enter a keyword { domain | echo | ftp | ftp-data |  
http | smtp | snmp | telnet | tftp | www | bgp |  
pop2 | pop3 | ntp | rip | time | who }.
```

To bind an access-list to an interface, use the **access-group** command. The **in** parameter specifies that the ACL is applied to ingress packets. The **out** parameter specifies that the ACL is applied to egress packets not generated by the switch/router. If no **in/out** parameter is specified, the access list default is to apply the ACL to ingress packets.

```
console(config)#interface gi1/0/1  
console(config-if-Gi1/0/1)#ip access-group Host10-1-1-23 in
```

Multiple access lists can be configured on an interface. The processing order is determined by the last parameter on the **access-group** command where the lowest sequence number is processed first, followed by the next higher sequence number, etc.

In this example, access list Host10-1-1-23 is processed first, followed by Host-1-1-21:

```
console(config)#ip access-list Host10-1-1-21  
console(config-ip-acl)#exit  
console(config)#interface gi1/0/1  
console(config-if-Gi1/0/1)#ip access-group Host10-1-1-23 in 2  
console(config-if-Gi1/0/1)#ip access-group Host10-1-1-21 in 1
```

## Advanced Examples

### Configuring a Time-Based ACL

The following example configures an ACL that denies HTTP traffic from 8:00 pm to 12:00 pm and 1:00 pm to 6:00 pm on weekdays and from 8:30 am to 12:30 pm on weekends. The ACL affects all hosts connected to ports that are members of VLAN 100. The ACL permits VLAN 100 members to browse the Internet only during lunch and after hours.

To configure the switch:

- 1 Create a time range called work-hours.

```
console#config  
console(config)#time-range work-hours
```

- 2 Configure an entry for the time range that applies to the morning shift Monday through Friday.

```
console(config-time-range)#periodic weekdays 8:00 to 12:00
```

- 3 Configure an entry for the time range that applies to the afternoon shift Monday through Friday.

```
console(config-time-range)#periodic weekdays 13:00  
to 18:00
```

- 4 Configure an entry for the time range that applies to Saturday and Sunday.

```
console(config-time-range)#periodic weekend 8:30 to 12:30  
console(config-time-range)#exit
```

- 5 Create an ACL named web-limit that denies HTTP traffic during the work-hours time range.

```
console(config)#ip access-list web-limit  
console(config-ip-acl)#deny tcp any any eq http time-range  
work-hours  
console(config-ip-acl)#permit every
```

- 6 Enter interface configuration mode for VLAN 100 and apply the ACL to ingress traffic.

```
console(config)#interface vlan 100  
console(config-if-vlan100)#ip access-group web-limit  
in  
console(config-if-vlan100)#exit  
console(config)#exit
```

- 7 Verify the configuration.

```

console#show ip access-lists web-limit

IP ACL Name: web-limit

Rule Number: 1000
Action..... deny
Match All..... FALSE
Protocol..... 6 (tcp)
Source IP Address..... any
Destination IP Address..... any
Destination Layer 4 Operator..... Equal To
Destination L4 Port Keyword..... 80 (www/http)
ACL Hit Count..... 0

Rule Number: 1010
Action..... permit
Match All..... TRUE
ACL Hit Count..... 1

```

## Denying FTP Traffic

This example filters (drops) ingress FTP setup and data traffic on interfaces `gil/0/24` to `48`. This example is suitable for configuration on a switch or a router where it is desirable to eliminate FTP data traffic on certain interfaces:

```

console#config
console(config)#ip access-list deny-ftp
console(config-ip-acl)#deny tcp any any eq ftp
console(config-ip-access-list)#deny tcp any any eq ftp-data
console(config-ip-access-list)#2147483647 permit every
console(config-ip-access-list)#exit

console(config)#interface range gil/0/24-48
console(config-if)#ip access-group deny-ftp in
console(config-if)#exit

```

## Allow FTP Traffic Only to an FTP Server

This ACL limits traffic from a router to a directly connected FTP server (172.16.0.5) on `gi1/0/11`. Notice that this is an “out” or egress ACL. Traffic to the router from the FTP server is not affected by this rule. Traffic from the router to the FTP server is limited to ICMP and packets destined to the FTP ports. There is no need to add permit rules for all the protocols the router can send to the host (e.g., ARP, ICMP, LLDP, etc.), as internally generated packets are not limited by ACLs. Routing must be enabled to process ARPs or they must be allowed by an explicit rule. We allow ICMP from remote hosts so that the FTP server can receive ICMP feedback from clients utilizing the FTP service. A better implementation would narrow the scope of the ICMP to eliminate ICMP messages not required for the FTP service, e.g., echo, echo-reply, redirect, timestamp, etc.

```
console#config
console (config) #ip access-list allow-ftp-server
console (config-ip-acl) #permit tcp any host 172.16.0.5 eq ftp-data
flag established
console (config-ip-acl) #permit tcp any host 172.16.0.5 eq ftp
console (config-ip-acl) #permit icmp any any
console (config-ip-acl) #exit

console (config) #interface gi1/0/11
console (config-if-gi1/0/11) #ip access-group allow-ftp-server out
console (config-if-gi1/0/11) #exit
```

## Block Incoming Pings

This ingress ACL blocks incoming pings (ICMP echo requests) on interface `Gi1/0/1` directed to hosts reachable from other ports on the switch.

```
console#config
console (config) #ip access-list no-ping
console (config-ip-acl) #deny icmp any any icmp-message echo
console (config-ip-acl) #2147483647 permit every
console (config-ip-acl) #exit

console (config) #interface gi1/0/1
console (config-if-gi1/0/1) #ip access-group no-ping in
console (config-if-gi1/0/1) #exit
```

## Block Incoming Pings and Responses

This example configures an ingress ACL that blocks incoming pings and ping responses. Since packets generated by the CPU are not affected by ACLs, to block pinging from the switch we add a rule to block the ping responses on ingress.

```
console#config
console(config)#ip access-list no-ping
console(config-ip-acl)#deny icmp any any icmp-message echo
console(config-ip-acl)#deny icmp any any icmp-message echo-reply
console(config-ip-acl)#2147483647 permit every
console(config-ip-acl)#exit

console(config)#interface gil/0/1
console(config-if-gil/0/1)#ip access-group no-ping in
console(config-if-gil/0/1)#exit
```

## Block RFC 1918 Addresses

This ingress ACL may be useful on connections to ISPs to block traffic from non-routable addresses.

```
console#config
console(config)#ip access-list no-private-internet
console(config-ip-acl)#deny ip 10.0.0.0 0.255.255.255 any
console(config-ip-acl)#deny ip 192.168.0.0 0.0.255.255 any
console(config-ip-acl)#deny ip 172.16.0.0 0.15.255.255 any
console(config-ip-acl)#2147483647 permit every
console(config-ip-acl)#exit

console(config)#interface port-channel 1
console(config-if-Po1)#ip access-group no-private-internet in
console(config-if-Po1)#exit
```

## Assign Ingress Packets to a CoS Queue

Assign a range of source or destination TCP ports to CoS queue 3 to provide elevated service. Two rules are necessary to handle packets that have source or destination ports outside the range.

```
console#config
console (config) #ip access-list elevated-cos
console (config-ip-acl) #permit tcp any range 49152 65535 any assign-
queue 3
console (config-ip-acl) #permit tcp any any range 49152 65535 assign-
queue 3
console (config-ip-acl) #2147483647 permit every
console (config-ip-acl) #exit

console (config) #ip access-group elevated-cos in 25
```

## Rewrite CoS on Egress (DiffServ)

This DiffServ policy rewrites the CoS value to 4 for all IPv4 packets with a CoS value of 5. An ACL is used to obtain finer-grained match criteria.

```
console#config
console (config) #mac access-list extended IPv4-COS5
console (config-mac-access-list) #permit any any ipv4 cos 5
console (config-mac-access-list) #exit
console (config) #class-map match-all rewrite-cos
console (config-classmap) #match protocol none
console (config-classmap) #match access-group IPv4-COS5
console (config-classmap) #exit

console (config) #policy-map rewrite out
console (config-policy-map) #class rewrite-cos
console (config-policy-classmap) #mark cos 4
console (config-policy-classmap) #exit

console (config-policy-map) #exit

console (config) #interface gil/0/1
console (config-if-gil/0/1) #service-policy out rewrite
console (config-if-gil/0/1) #exit
```

## Schedule Forwarding of Packets to a Different Port

This ACL Layer-2 forwards matching packets to a different port based on a time schedule. This is not equivalent to Policy-Based Forwarding, as the TTL in the packet is not decremented, nor is a new destination MAC address written into the packet. The access-group policy is globally configured on all switch interfaces.

```
console#config
console(config)#time-range work-hours
console(config-time-range)#periodic weekdays 07:30 to 18:00
console(config-time-range)#exit

console(config)#ip access-list redirect-traffic
console(config-ip-acl)#permit ip any 172.16.1.0 255.255.255.0
redirect tel1/0/1 time-range work-hours
console(config-ip-acl)#2147483647 permit every
console(config-ip-acl)#exit

console(config)#ip access-group redirect-traffic in 30
```

## Rate Limit WWW Traffic (DiffServ)

This ingress ACL creates a DiffServ policy to rate-limit WWW packets. Limit and burst values require tuning for local traffic patterns and link speeds. Compare this to the next example.

```
console#config
console(config)#class-map match-all rate-limit-control ipv4
console(config-classmap)#match protocol tcp
console(config-classmap)#match srcl4port www
console(config-classmap)#exit

console(config)#policy-map rate-limit-policy in
console(config-policy-map)#class rate-limit-control
console(config-policy-classmap)#police-simple 9216 128 conform-
action transmit violate-action drop
console(config-policy-classmap)#exit

console(config-policy-map)#exit

console(config)#interface tel1/0/2
console(config-if-Te1/0/2)#service-policy in rate-limit-policy
console(config-if-Te1/0/2)#exit
```

## Rate limit WWW traffic (ACL)

This example creates an ACL to rate-limit WWW traffic ingressing the switch on tel/0/1. Initial and established values require tuning for local traffic patterns and link speeds. Note that this ACL applies to traffic sent to the switch IP address as well as traffic forwarded by the switch (in rule). Permit rules with a rate-limit parameter do not require a following deny rule as matching packets exceeding the rate limit are discarded. Compare this with the example above.

```
console#config
console (config) #ip access-list rate-limit-www
console (config-ip-acl) #permit tcp any any eq www flag established
rate-limit 9216 128
console (config-ip-acl) #permit tcp any any eq www rate-limit 1024 64
console (config-ip-acl) #2147483647 permit every
console (config-ip-acl) #exit

console (config) #interface tel/0/1
console (config-if-Tel/0/1) #ip access-group rate-limit-www in
console (config-if-Tel/0/1) #exit
```

## Rate Limit In-Band Management Traffic

The following is an example of rate limiting in-band management traffic on a Layer-2 switch. The first two rules rate limit Telnet and SSH (22) traffic for established connections. The third and fourth rules set specific limits for inbound Telnet and SSH connection requests (third and fourth rules). Setting the control plane mode on the access group limits the requests to those packets transferred to the CPU and does not affect packets transiting the switching silicon. Likewise, because this is internally an egress ACL, it rate limits packets egressing the silicon to the CPU and does not affect packets that are routed in software due to Layer-3 table lookup failures, nor does it affect packets sent to the CPU via the system rules, as they are applied on ingress.

The established connection rate limit parameters are 1024 Kbits/second and a burst of 128 Kbytes. The non-established rate limits are 12 Kbytes/second with a 2 Kbyte burst.

```
console#config
console (config) #ip access-list rate-limit-inband-mgmt
console (config-ip-acl) #permit tcp any any eq telnet flag
established rate-limit 1024 128
```



```

console(config-ip-acl)#permit tcp any any eq 22 flag established
rate-limit 1024 128
console(config-ip-acl)#permit tcp any any eq telnet rate-limit 12 2
console(config-ip-acl)#permit tcp any any eq 22 rate-limit 12 2
console(config-ip-acl)#2147483647 permit every
console(config-ip-acl)#exit
console(config)#ip access-group rate-limit-inband-mgmt control-
plane

```

The following commands block fragmented traffic from being sent to the CPU:

```

console#config
console(config)#ip access-list no-frag-inband-mgmt
console(config-ip-acl)#deny tcp any any fragments
console(config-ip-acl)#deny udp any any fragments
console(config-ip-acl)#deny ip any any fragments
console(config-ip-acl)#2147483647 permit every
console(config-ip-acl)#exit

console(config)#ip access-group no-frag-inband-mgmt control-plane

```

### Stop Bonjour (mDNS) Traffic

This example drops all traffic destined to 224.0.0.251 on ingress. Packets destined to the reserved multicast address 224.0.0.x are normally forwarded in hardware. This ACL is prioritized over the system rules as it is applied on ingress. This has the effect of stopping all Bonjour (mDNS) traffic from crossing the switch. If it is desired to allow Bonjour traffic in the network, a rate limiter might be more appropriate.

```

console#config
console(config)#ip access-list deny-mdns
console(config-ip-acl)#deny ip any host 224.0.0.251
console(config-ip-acl)#exit
console(config)#ip access-group deny-mdns control-plane

```

## Expedite DSCP(EF) Traffic/Limit Background Traffic

By default (with no CoS or DSCP configuration), packets are assigned to User Priority 1/CoS queue 0 (see the output from `show classofservice trust` and `show classofservice dot1p-mapping`). When incast occurs (multiple ports sending to a single output port at a rate greater than can be accommodated), the switch buffer capacity can be exhausted. When the buffer capacity is exhausted, the switch is unable to perform QoS properly as the decision on whether to expedite a packet is overridden by the availability of a buffer to receive the packet. If no buffer is available, the packet is dropped on ingress.

The following configuration sets the switch to expedite DSCP EF traffic and limits buffering of background traffic in CoS queue 0.

This configuration sets the switch to trust DSCP on ingress, maps DSCP EF to CoS queue 3, and enables WRED on CoS queue 0. Then, green TCP traffic is set to begin random discard at 75% port capacity with a 5% drop probability. Non-TCP traffic is set to tail drop at 100% of port buffer capacity. The other WRED queue parameters (yellow and red traffic) are kept at their default values.

```
console#config
console (config) #classofservice trust ip-dscp
console (config) #classofservice ip-dscp-mapping 46 3
console (config) #cos-queue random-detect 0
console (config) #cos-queue strict 3
console (config) #random-detect queue-parms 0 min-thresh 75 30 20 100
max-thresh 100 90 80 100 drop-prob-scale 5 10 10 100
```

## Configure a VLAN ACL

This example configures a MAC ACL to rate-limit matching traffic. The ACL is configured on the VLAN interface, and multiple ports are made members of the VLAN. As the ACL is the only ACL on the interfaces, a `permit any any` clause is included to allow other traffic to be permitted. Subsequent ACL will never be matched due to this clause.

- 1 Create VLAN 100:

```
console (config) #vlan 100
console (config-vlan100) #exit
```

- 2 Declare a MAC access list with the matching criteria:

```
console (config) #mac access-list extended vlan100
```

- 3** Match source MAC 001E.C9XX.XXXX. Rate limit to 100 Kbps with a burst of 32 Kbytes:

```
console (config-mac-access-list) #permit 001E.C900.0000  
0000.00FF.FFFF any rate-limit 100 32
```

- 4** Let everyone else in:

```
console (config-mac-access-list) #permit any any  
console (config-mac-access-list) #exit
```

- 5** Configure the access group on the VLAN:

```
console (config) #interface vlan 100  
console (config-if-vlan100) #mac access-group vlan100 in 1000  
console (config-if-vlan100) #exit
```

- 6** Assign the VLAN to interfaces:

```
console (config) #interface Gil/0/1  
console (config-if-gil/0/1) #switchport access vlan 100  
console (config-if-gil/0/1) #exit
```

```
console (config) #interface Gil/0/2  
console (config-if-gil/0/2) #switchport access vlan 100  
console (config-if-gil/0/2) #exit
```

```
console (config) #interface Gil/0/3  
console (config-if-gil/0/3) #switchport access vlan 100  
console (config-if-gil/0/3) #exit
```

## A Consolidated DoS Example

This example includes some ACL rules to consider to reduce DoS attacks on the switch. It does not represent a complete DoS suite. A firewall with deep packet inspection capabilities should be used for true DoS protection.



**NOTE:** The rate limits below should be adjusted to match the expected rates of traffic coming to the CPU.

- 1 Configure an IP access list named “squelch-dos attacks”:

```
console#config  
console(config)#ip access-list squelch-dos-attacks
```

- 2 Rate-limit echo requests:

```
console(config-ip-acl)#permit icmp any any icmp-message echo  
rate-limit 32 64
```

- 3 Deny telnet and rate-limit SSH to the CPU:

```
console(config-ip-acl)#deny tcp any any eq telnet flag  
established  
console(config-ip-acl)#permit tcp any any eq 22 flag  
established rate-limit 1024 128  
console(config-ip-acl)#deny tcp any any eq telnet  
console(config-ip-acl)#permit tcp any any eq 22 rate-limit 12 2
```

- 4 Rate limit TCP opens:

```
console(config-ip-acl)#permit tcp any any flag +syn rate-limit  
8 2
```

- 5 Rate limit TCP closes:

```
console(config-ip-acl)#permit tcp any any flag +fin rate-limit  
8 2
```

- 6 Block TCP/UDP/IP frag attacks:

```
console(config-ip-acl)#deny ip any any fragments
```

- 7 Limit SNMP (should set source address to management stations). Must be tuned for SNMP walks. May need to adjust the SNMP client retry count or timeout:

```
console(config-ip-acl)#permit udp any any eq snmp rate-limit  
1024 128
```

- 8 Allow other traffic types to come to CPU:

```
console(config-ip-acl)#permit every  
console(config-ip-acl)#exit
```

```
console (config) #ip access-group squelch-dos-attacks control-plane
```

- 9 Further limit inbound traffic on in-band management ports. Allow only VLAN 99 SSH and TFTP, no telnet, HTTP, HTTPS, or SNMP. The management access list actions are performed by the switch firmware in addition to the access list actions performed by the switching silicon, e.g., squelch-dos-attacks. Note that the switch forces TFTP accesses to use the well-known TFTP port number 69:

```
console (config) #management access-list mgmt-blocks
console (config-ip-acl) #permit vlan 99 service ssh
console (config-ip-acl) #permit vlan 99 service tftp
console (config-ip-acl) #deny vlan 99
console (config-ip-acl) #permit service any
console (config-ip-acl) #exit
```

- 10 Create an in-band Management VLAN (99), assign it to two ports (gil/0/47 and gil/0/48), and add both ACLs and Management ACLs to ALL ports in global config mode.

```
console (config) #vlan 99
console (config-vlan99) #exit
console (config) #interface vlan 99
console (config-if-vlan99) #ip address dhcp
console (config-if-vlan99) #exit
console (config) #interface range gil/0/47-48
console (config-if-Gil/0/47-48) #switchport access vlan 99
console (config-if-Gil/0/47-48) #exit
console (config) #management access-class mgmt-blocks
console (config) #line ssh
console (config-ssh) #login authentication default
console (config-ssh) #exit
console (config) #crypto key generate rsa
console (config) #crypto key generate dsa
console (config) #ip ssh server
```

## Policy-Based Routing Examples

### Route-Map with Scheduled Redirection of RFC 1918 Addresses to a Different Next-Hop

- 1 Create a time range named “work-hours” the from 7:30 AM to 6:00 PM:

```
console#config
console(config)#time-range work-hours
console(config-time-range)#periodic weekdays 07:30 to 18:00
console(config-time-range)#exit
```

- 2 Define an IP ACL named “subnet-172-16” and permit all accesses on the subnet during the work-hours time range:

```
console(config)#ip access-list subnet-172-16
console(config-ip-acl)#permit ip any 172.16.0.0 0.15.255.255
time-range work-hours
console(config-ip-acl)#exit
```

- 3 Define an IP ACL named “subnet-192-168” and permit all accesses on the subnet during the work-hours time range.

```
console(config)#ip access-list subnet-192-168
console(config-ip-acl)#permit ip any 192.168.0.0 0.0.255.255
time-range work-hours
console(config-ip-acl)#exit
```

- 4 Define an IP ACL named “subnet-10-0” and permit all accesses on the subnet during the work-hours time range.

```
console(config)#ip access-list subnet-10-0
console(config-ip-acl)#permit ip any 10.0.0.0 0.255.255.255
time-range work-hours
console(config-ip-acl)#exit
```

- 5 Define a route-map named “redirect-vlan12” that permits routes in the three subnets defined earlier. Specify the next hop addresses for all matching routes.

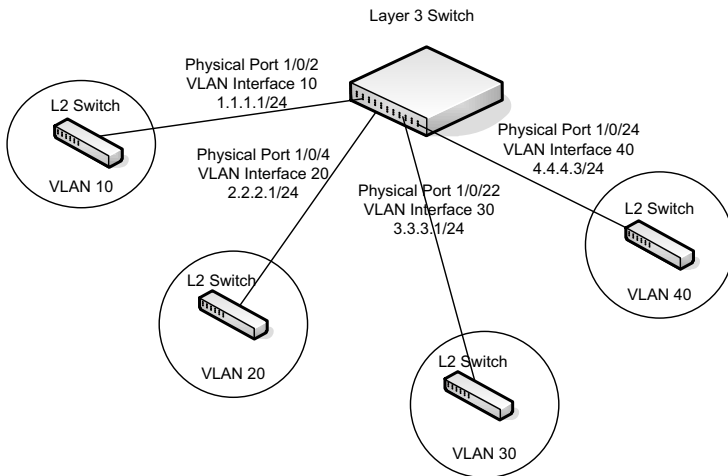
```
console(config)#route-map redirect-vlan12 permit 32
console(config-route-map)#match ip address subnet-172-16
subnet-192-168 subnet-10-0
console(config-route-map)#set ip next-hop 12.1.13.1 12.1.14.1
console(config-route-map)#exit
```

## Complete Example of Policy-Based Routing on VLAN Routing Interfaces

In this example, an Layer-3 router with four VLAN routing interfaces (VLAN 10, VLAN 20, VLAN 30 and VLAN 40) is configured. Each of these interfaces is connected to Layer-2 switches.

Traffic sent to host 2.2.2.2 from host 1.1.1.2 on VLAN interface 10 is normally routed over VLAN interface 20. The steps to override the normal routing decision and policy route traffic from VLAN interface 10 to VLAN interface 30 are described following the figure.

**Figure 19-16. Policy-Based Routing on VLAN Interfaces Example**



- 1 Create VLANs 10, 20, 30 and 40

```
console#config
console (config) #vlan 10,20,30,40
console (config-vlan10,20,30,40) #exit
```

- 2 Add VLAN Membership to Physical Ports. Also, configure the native VLAN on the corresponding interfaces:

```
console (config) #interface gi1/0/2
console (config-if-gi1/0/2) #switchport mode trunk
console (config-if-gi1/0/2) #switchport trunk allowed vlan
remove 1
console (config-if-gi1/0/2) #switchport trunk native vlan 10
```

```

console(config-if-gil/0/2) #exit

console(config) #interface gi 1/0/4
console(config-if-gil/0/4) #switchport mode trunk
console(config-if-gil/0/4) #switchport trunk allowed vlan
remove 1
console(config-if-gil/0/4) #switchport trunk native vlan 20
console(config-if-gil/0/4) #exit

console(config) #interface gil/0/22
console(config-if-gil/0/22) #switchport mode trunk
console(config-if-gil/0/22) #switch trunk allowed vlan remove 1
console(config-if-gil/0/22) #switch trunk native vlan 30
console(config-if-gil/0/22) #exit

console(config) #interface gi 1/0/24
console(config-if-gil/0/24) #switchport mode trunk
console(config-if-gil/0/24) #switchport trunk native vlan 40
console(config-if-gil/0/24) #switchport trunk allowed vlan
remove 1
console(config-if-gil/0/24) #exit

```

### 3 Enable Routing on Each VLAN Interface

```

console(config) #interface vlan 10
console(config-if-vlan10) #ip address 1.1.1.1 255.255.255.0
console(config-if-vlan10) #exit

console(config) #interface vlan 20
console(config-if-vlan20) #ip address 2.2.2.1 255.255.255.0
console(config-if-vlan20) #exit

console(config) #interface vlan 30
console(config-if-vlan30) #ip address 3.3.3.1 255.255.255.0
console(config-if-vlan30) #exit

console(config) #interface vlan 40
console(config-if-vlan40) #ip address 4.4.4.3 255.255.255.0
console(config-if-vlan40) #exit

```

### 4 Enable IP Routing (Global Configuration)

```

console(config) #ip routing

```

In this configuration, traffic from host 1.1.1.2 to host 2.2.2.2 is routed from VLAN routing interface 10 to VLAN routing interface 20 using the directly connected subnets as they appear in the routing table.



**5** Configure Policy Routing. To policy-route such traffic to VLAN routing interface 30, the following additional steps should be performed:

- a** Create an access-list matching all incoming IP traffic from host 1.1.1.1 destined to host 2.2.2.2:

```
console(config)#ip access-list Match-ip-1_1_1_2-to-2_2_2_2
console(config-ip-acl)#permit ip host 1.1.1.2 host 2.2.2.2
console(config-ip-acl)#exit
```

There is no need to add a **permit every** rule, as would be configured in a normal access list, as this ACL will only be used for PBR. The default for PBR is to route non-matching traffic or traffic which is addressed to a non-connected interface normally.

- b** Create a route-map and add match/set rules to the route-map:

```
console(config)#route-map Redirect_to_3_3_3_3 permit 100
console(route-map)#match ip address Match-ip-1_1_1_2-to-2_2_2_2
console(route-map)#set ip next-hop 3.3.3.3
console(route-map)#exit
```

- c** Assign the route-map to VLAN routing interface 10:

```
console(config)#interface vlan 10
console(config-if-vlan10)#ip policy route-map
Redirect_to_3_3_3_3
console(config-if-vlan10)#exit
```

Traffic matching ACL *Match-ip-1\_1\_1\_2-to-2\_2\_2\_2* is now policy-routed to VLAN interface 30 when an interface in VLAN 30 is connected via policy *Redirect\_to\_3\_3\_3\_3*. Counters are incremented in the **show route-map** command indicating that traffic is being policy routed.

```
console(config)#show route-map Redirect_to_3_3_3_3
```

```
route-map "Redirect_to_3_3_3_3" permit 10
```

```
Match clauses:
```

```
ip address (access-lists) : match-subnet-1_1_1_X
```

```
Set clauses:
```

```
ip next-hop 3.3.3.3
```

```
Policy routing matches: 19922869 packets, 1275063872 bytes
```



# VLANs

## Dell EMC Networking N-Series Switches

This chapter describes how to configure VLANs, including port-based VLANs, protocol-based VLANs, double-tagged VLANs, subnet-based VLANs, and Voice VLANs.

The topics covered in this chapter include:

- VLAN Overview
- Default VLAN Behavior
- Configuring VLANs (Web)
- Configuring VLANs (CLI)
- VLAN Configuration Examples

## VLAN Overview

By default, all ports on Dell EMC Networking N-Series switches are in the same broadcast domain (VLAN 1). This means when any host connected to the switch broadcasts traffic, every other device connected to the switch receives that broadcast. All ports in a broadcast domain also forward multicast and unknown unicast traffic to every directly connected device. Large broadcast domains can result in network congestion, and end users might complain that the network is slow. In addition to latency, large broadcast domains are a greater security risk since all hosts receive all broadcasts.

Virtual Local Area Networks (VLANs) allow the administrator to divide a broadcast domain into smaller, logical networks. Like a bridge, a VLAN switch forwards traffic based on the Layer-2 header, which is fast, and like a router, it partitions the network into logical segments, which provides better administration, security, and management of multicast traffic.

Network administrators have many reasons for creating logical divisions within a network, such as department or project membership. Because VLANs enable logical groupings, group members do not need to be physically connected to the same switch or network segment. Some network administrators use VLANs to separate traffic by type so that the time-

sensitive traffic, like voice traffic, has priority over other traffic, such as data. Administrators also use VLANs to protect network resources. Traffic sent by authenticated clients might be assigned to one VLAN, while traffic sent from unauthenticated clients might be assigned to a different VLAN that allows limited network access.

When one host in a VLAN sends a broadcast, the switch forwards traffic only to other members of that VLAN. For traffic to go from a host in one VLAN to a host in a different VLAN, the traffic must be forwarded by a Layer-3 device, such as a router. VLANs work across multiple switches and switch stacks, so there is no requirement for the hosts to be located near each other to participate in the same VLAN.



**NOTE:** Dell EMC Networking N-Series switches support VLAN routing. When you configure VLAN routing, the switch acts as a Layer-3 device and can forward traffic between VLANs. For more information, see "What Are VLAN Routing Interfaces?" on page 1219.

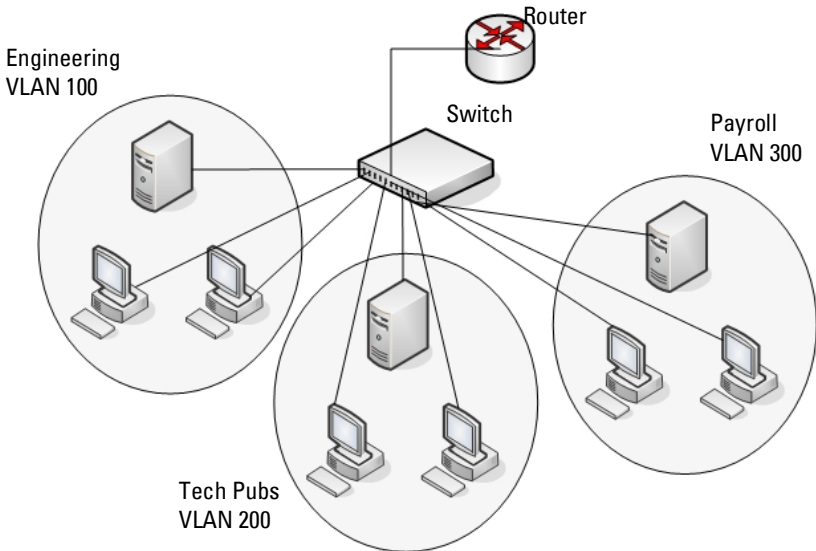
Each VLAN has a unique number, called the VLAN ID. The Dell EMC Networking N-Series switches support a configurable VLAN ID range of 1–4093. A VLAN with VLAN ID 1 is configured on the switch by default. VLAN 1 is named *default*, which cannot be changed. However, names can be associated with any other VLANs that are created.

In a tagged frame, the VLAN is identified by the VLAN ID in the tag. In an untagged frame, the VLAN identifier is the Port VLAN ID (PVID) specified for the port that received the frame. For information about tagged and untagged frames, see "VLAN Tagging" on page 790.

The Dell EMC Networking N-Series switches support adding individual ports and Link Aggregation Groups (LAGs) as VLAN members.

Figure 20-1 shows an example of a network with three VLANs that are department-based. The file server and end stations for the department are all members of the same VLAN.

**Figure 20-1. Simple VLAN Topology**



In this example, each port is manually configured so that the end station attached to the port is a member of the VLAN configured for the port. The VLAN membership for this network is port-based or static.

Dell EMC Networking N-Series switches also support VLAN assignment based on any of the following criteria:

- MAC address of the end station
- IP subnet of the end station
- Protocol of the packet transmitted by the end station

Table 20-1 provides an overview of the types of VLANs that can be used to logically divide the network.

**Table 20-1. VLAN Assignment**

<b>VLAN Assignment</b>	<b>Description</b>
Port-based (Static)	This is the most common way to assign hosts to VLANs. The port where the traffic enters the switch determines the VLAN membership. Trunk ports are automatically members of all VLANs, unless specifically configured otherwise.
IP Subnet	Hosts are assigned to a VLAN based on their IP address. All hosts in the same subnet are members of the same VLAN.
MAC-Based	The MAC address of the device determines the VLAN assignment. This type of VLAN is useful when a host might not always connect to the network through the same port but needs to be on the same VLAN.
Protocol	Protocol-based VLANs were developed to separate traffic based on the Layer-2 EtherType before IP traffic became the de facto standard in the LAN. Use a protocol-based VLAN on networks where you might have a group of hosts that use IPX or another legacy protocol. With protocol-based VLANs, traffic can be separated based on the EtherType value in the frame.
Dynamic	A data VLAN received from a RADIUS server in Access-Accept message may be dynamically created if it does not already exist. The VLAN exists for the duration of the authentication session and is removed when the session terminates, unless converted to a static VLAN. Dynamic VLANs become members of trunk ports.

## **VLAN Tagging**

Dell EMC Networking N-Series switches support IEEE 802.1Q tagging. Ethernet frames on a tagged VLAN have a 4-byte VLAN tag in the header. VLAN tagging is required when a VLAN spans multiple switches, which is why trunk ports transmit and receive only tagged frames.



**NOTE:** A stack of switches behaves as a single switch, so VLAN tagging is not required for packets traversing different stack members.

Tagging may be required when a single port supports multiple devices that are members of different VLANs. For example, a single port might be connected to an IP phone, a PC, and a printer (the PC and printer are connected via ports on the IP phone). IP phones are typically configured to use a tagged VLAN for voice traffic, while the PC and printers typically use the untagged VLAN.

Trunk ports can receive tagged and untagged traffic. Untagged traffic is tagged internally with the native VLAN. Native VLAN traffic received untagged is transmitted untagged on a trunk port.

By default, trunk ports are members of all existing VLANs and will automatically participate in any newly created VLANs. The administrator can restrict the VLAN membership of a trunk port. VLAN membership for tagged frames received on a trunk port is configured separately from the membership of the native VLAN. To configure a trunk port to accept frames only for a single VLAN, both the native VLAN and the tagged VLAN membership settings must be configured. If the native VLAN for a trunk port is deleted, the trunk port drops untagged packets.

Access ports accept untagged traffic and traffic tagged with the access port PVID. Untagged ingress traffic is considered to belong to the VLAN identified by the PVID. If the PVID for an access port is deleted, the PVID is set to VLAN 1.

## **GVRP**

The GARP VLAN Registration Protocol (GVRP) helps to dynamically manage VLAN memberships on trunk ports. When GARP is enabled, switches can dynamically register (and de-register) VLAN membership information with other switches attached to the same segment.

Information about the active VLANs is propagated across all networking switches in the bridged LAN that support GVRP. Ports can be configured to forbid dynamic VLAN assignment through GVRP.

The operation of GVRP relies upon the services provided by the Generic Attribute Registration Protocol (GARP). GVRP can create up to 1024 VLANs. For information about GARP timers, see "What Are GARP and GMRP?" on page 974.

## **Double-VLAN Tagging**

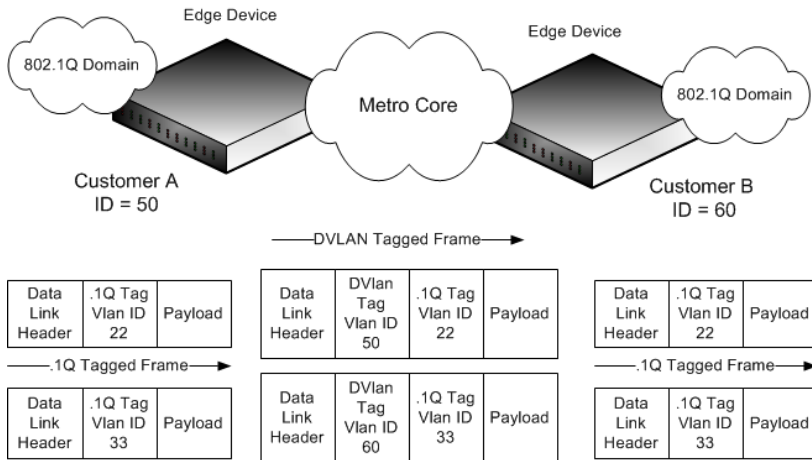
For trunk ports, which are ports that connect one switch to another switch, the Dell EMC Networking N-Series switches support double-VLAN tagging as an option. This feature allows service providers to connect to Virtual Metropolitan Area Networks (VMANs). With double-VLAN tagging, service providers can pass VLAN traffic from one customer domain to another through a metro core in a simple and cost-effective manner. By using an additional tag on the traffic, the switch can differentiate between customers in the MAN while preserving an individual customer's VLAN identification when the traffic enters the customer's 802.1Q domain.

With the introduction of this second tag, customers are no longer required to divide the 4-byte VLAN ID space to send traffic on a Ethernet-based MAN. In short, every frame that is transmitted from an interface has a double-VLAN tag attached, while every packet that is received from an interface has a tag removed (if one or more tags are present).

In Figure 20-2, two customers share the same metro core. The service provider assigns each customer a unique ID so that the provider can distinguish between the two customers and apply different rules to each. When the configurable EtherType is assigned to something different than the 802.1Q (0x8100) EtherType, it allows the traffic to have added security from misconfiguration while exiting the metro core. For example, if the edge device on the other side of the metro core is not stripping the second tag, the packet would never be classified as a 802.1Q tag, so the packet would be dropped rather than forwarded in the incorrect VLAN.



**Figure 20-2. Double VLAN Tagging Network Example**



## Voice VLAN

The Voice VLAN feature enables switch ports to carry voice traffic from IP phones with an administrator-defined priority. When multiple devices, such as a PC and an IP phone, are connected to the same port, the port can be configured to use one VLAN for voice traffic and another VLAN for data traffic. Multiple IP phones per port are supported.

Voice over IP (VoIP) traffic is inherently time-sensitive: for a network to provide acceptable service, low latency is vital. Voice VLAN enables the separation of voice and data traffic coming onto the port and can provide expedited forwarding of Voice VLAN traffic. Untrusted ports rewrite voice packets to use 802.1p priority 5. The voice packets are classified into CoS queue 2. For trusted ports, voice packets are classified into the CoS queue associated with the received 802.1p priority, or DSCP value as configured by the administrator.

A primary benefit of using Voice VLAN is to ensure that the sound quality of an IP phone is safeguarded from interference when the data traffic on the port is high. The switch uses the source MAC address of the traffic traveling through the port to identify the IP phone data flow.

A RADIUS-assigned VLAN may be used to carry voice traffic. The voice VLAN must be preconfigured on the switch. The RADIUS-assigned voice VLAN need not be the same as the voice VLAN configured on the interface. If no voice VLAN is configured on the interface, the RADIUS-assigned voice VLAN is ignored, a log message is generated, and the phone is not authenticated on the network.

The Voice VLAN feature can be enabled on a per-port basis. Voice VLAN supports a configurable voice VLAN DSCP or IEEE 802.1p value. This value is transmitted by LLDP when the LLDPDU is transmitted, if LLDP has been enabled on the port, the DSCP/802.1p value is configured, and the LLDP network policy TLV has not been suppressed for the port. LLDP-MED is enabled by default on all ports.

Voice VLAN is supported on ports configured in access mode or in general mode. Both multi-domain and multi-domain-multi-host authentication is supported on ports configured for Voice VLAN in switchport general or access mode. Only auto mode authentication is supported for Voice VLAN-enabled ports configured in access mode. A single voice device can authenticate into the voice VLAN when the port is configured in access mode. Additional voice device authentications are ignored. Only a single operational voice VLAN is supported on a port at any time. Voice VLAN is not supported on trunk mode ports, although a trunk mode port may be a member of the Voice VLAN.



**NOTE:** Voice VLAN must be configured on general or access mode ports. It is not supported on trunk mode ports.

### Identifying Voice Traffic

Voice VLAN operates in both multi-domain and multi-domain-multi-host host modes. In both modes, voice packets are identified by the VoIP device source MAC address. Both multi-domain and multi-domain-multi-host support a single VoIP device using a single voice VLAN.

Voice VLAN is supported on ports configured in access mode and in general mode. Voice VLAN is not supported on trunk mode ports, although a trunk mode port may be a member of the voice VLAN.

## Authentication of Voice Devices

Switch ports can be configured to use either IEEE 802.1X or MAB authentication. In both cases, the voice device must be authenticated into the configured voice VLAN by the RADIUS server sending an Access-Accept message indicating the device is a voice device. If the **switchport voice vlan override-authentication** option is configured, any device may access the voice VLAN regardless of the 802.1X port authentication state.

Some VoIP phones contain full support for IEEE 802.1X. For each VoIP device to authenticate independently of the data device, configure the port in access or general mode, add the voice VLAN to the port and configure the port to use multi-domain or multi-domain-multi-host authentication. With both types of authentication, voice packets are identified by the MAC address of the phone. The RADIUS server must be configured to enable Voice VLAN by sending the vendor proprietary VSA `device-traffic-class=voice` in the RADIUS Access-Accept message. Use the **no switchport voice vlan override-authentication** command to allow the VoIP device access to the voice VLAN using 802.1X. A voice VLAN identified in the RADIUS Access-Accept is ignored by the switch if a voice VLAN is not configured on the interface. The RADIUS-assigned voice VLAN need not be the same as the configured voice VLAN.

Authentication of a VoIP device via 802.1X is supported on ports configured in general or access mode. If Voice VLAN is enabled and configured on a port, and a device is configured to authenticate via RADIUS, and the RADIUS server identifies the device as an IP phone, the device is allowed access to the configured or RADIUS-assigned voice VLAN. Only a single device may authenticate into the voice VLAN.

When 802.1X authenticates a device onto the voice VLAN, the device is also allowed access over the data VLAN for thirty seconds after authentication. This allows the device to learn the voice VLAN ID via non-standard mechanisms such as HTTP or TFTP.

Many VoIP phone receive their VLAN information from LLDP-MED or CDP. The switch can automatically direct the VoIP traffic to the voice VLAN without manual configuration of the phone. Configure the port in access or general mode, add the voice VLAN to the port and configure the port to use 802.1X auto mode (port-based authentication) and override authentication for the voice VLAN. The first data device will be authenticated using 802.1X

and the voice devices have access to the voice VLAN regardless of authentication state. The phone must tag the packets with the voice VLAN sent via LLDP-MED/CDP when the port is configured in access mode.

The switch identifies the device as a VoIP phone by one of the following protocols:

- Cisco Discovery Protocol (CDP) or Industry Standard Discovery Protocol (ISDP) for Cisco VoIP phones
- DHCP vendor-specific option 176 for Avaya VoIP phones
- LLDP-MED for many VoIP phones
- For ports configured for 802.1X or MAB authentication, an Access-Accept received from the AAA service with a vendor-proprietary VSA device-traffic-class = voice identifies the device as a VoIP device.
- DHCP/ISDP/CDP/LLDP information is not used to identify VoIP devices for assignment to the voice VLAN.



**NOTE:** By default, ISDP is enabled globally and per-interface on the switch. LLDP-MED is enabled on each interface by default. Port-based authentication using 802.1X is disabled on each port by default.

## QoS and Voice VLAN

The switch can be configured to support Voice VLAN on a port that is connected to a VoIP phone. Both of the following methods separate the voice traffic and the data traffic in order to provide better service to the voice traffic.

- When a VLAN is associated with a Voice VLAN-enabled port without a configured 802.1p priority, then the VLAN ID information is passed onto the VoIP phone using the LLDP-MED or CDP protocols. It is recommended that both CDP and LLDP-MED be enabled for maximum device interoperability. In either case, the voice data coming from the VoIP phone is tagged with the exchanged VLAN ID (if configured). Untagged data arriving on the switch is processed on the default or dynamically assigned PVID of the port. As a result, both kinds of traffic may be separated by operator configuration in order to provide better service to the voice traffic. Traffic on the voice VLAN can be assigned to a specific CoS queue or otherwise given priority using the normal policy configuration mechanisms.<sup>1</sup>

- When an 802.1p priority is associated with a voice VLAN, then the priority information is passed onto the VoIP phone using the LLDP-MED or CDP protocol, along with the voice VLAN ID, if any. With this method, the voice data coming from the VoIP phone is tagged with VLAN 0 (or the configured voice VLAN) and with the configured priority; regular data arriving on the switch is given the default priority of the port, and the voice traffic is received with the operator-configured priority from the IP phone.

By default, the switch is configured to trust the 802.1p priority for traffic received from any device, including IP phones. If the port is untrusted, voice traffic is remarked to CoS priority 5 and is classified into CoS queue 2. If trust mode is enabled, voice packets are not remarked and are classified per the switch configuration. Voice traffic is identified by the IP phone's MAC address when Voice VLAN is configured. This helps to ensure that voice traffic is resilient in the presence of other devices on the network such as a desktop computer.

Voice VLAN is incompatible with Auto-VoIP. Disable Auto-VoIP before enabling Voice VLAN.

### **Voice VLAN and LLDP-MED**

The interactions with LLDP-MED are important for Voice VLAN:

- LLDP-MED notifies the Voice VLAN component of the presence and absence of a VoIP phone on the network.
- The Voice VLAN component interacts with LLDP-MED for applying VLAN ID, priority, and tag information to the VoIP phone traffic.

### **Critical Voice VLAN**

Dell EMC Networking switches support critical voice VLAN. Re-authenticating voice devices remain authenticated in the voice VLAN when critical voice VLAN is enabled and no authentication server is reachable. Voice devices will be re-authenticated when a RADIUS server is reachable. MAB device re-authentication is suppressed when critical voice VLAN is enabled and no RADIUS server is reachable.

1. Voice VLAN information is transmitted to the phone via CDP in the Appliance VLAN TLV. The configured or default priority/DSCP is sent to the phone via CDP in the Class of Service (CoS) TLV. Port trust configuration is sent in the CDP Extended Trust TLV if the port is untrusted. Voice VLAN information is transmitted to the phone via LLDP-MED in the Network Policy TLV (Application Type Voice, Tagged Yes, ...).

If no RADIUS server is reachable, newly authenticating voice devices, i.e., devices just powered on or connected to the network, are denied access to the Voice VLAN. The phone will be authenticated and allowed access to the Voice VLAN when a RADIUS server becomes reachable. Configuring a RADIUS server with a deadtime of 0 (default) effectively disables features such as critical Voice VLAN as the configured server is always marked live.

Use the **authentication event server dead action authorize voice** command to enable critical Voice VLAN treatment on an interface. A non-zero dead time must be configured on all RADIUS servers for the servers to be marked dead so a device can be placed into the critical Voice VLAN.

Critical Voice VLAN is also supported for 802.1X unaware clients by using MAB. Additionally, the **switchport voice vlan override-authentication** command may be used to configure 802.1X unaware IP phones in 802.1X port based mode.

### **Voice VLAN Restrictions**

The switch enforces the following restrictions regarding Voice VLAN:

- Multiple VLANs may be configured as voice VLANs on the switch, but only one voice VLAN may be configured on any given interface.
- A voice VLAN may not be configured as a PVID. The switch enforces this restriction by not configuring the voice VLAN if the VLAN is the PVID of any port, or by failing the PVID assignment if the VLAN is a voice VLAN. This prevents operator misconfiguration which allows DoS attacks on the data VLAN to disrupt voice traffic.
- A voice VLAN may not be configured as the unauthenticated VLAN and vice-versa. This prevents operator misconfiguration which allows DoS attacks on the unauthenticated VLAN to disrupt the voice traffic.
- A voice VLAN may not be configured as the guest VLAN and vice-versa. This prevents operator misconfiguration which allows DoS attacks on the guest VLAN to disrupt the voice traffic.
- A voice VLAN may not be configured as a private VLAN host port. This prevents interference between the internal Private VLAN and Voice VLAN treatment of packets.

## Private VLANs

Private VLANs partition a standard VLAN domain into two or more subdomains. Each subdomain is defined by a primary VLAN and a secondary VLAN. The primary VLAN ID is the same for all subdomains that belong to a particular private VLAN instance. The secondary VLAN ID differentiates the subdomains from each other and provides Layer-2 isolation between ports on the same private VLAN.

The following types of VLANs can be configured in a private VLAN:

- **Primary VLAN**—Forwards the traffic from the promiscuous ports to isolated ports, community ports and other promiscuous ports in the same private VLAN. Only one primary VLAN can be configured per private VLAN. All ports within a private VLAN share the same primary VLAN.
- **Isolated VLAN**—A secondary VLAN. It carries traffic from isolated ports to promiscuous ports. Only one isolated VLAN can be configured per private VLAN. A trunk mode port may be configured as a private VLAN isolated port. These ports can carry the traffic of several secondary VLANs along with non-private VLAN traffic.
- **Community VLAN**—A secondary VLAN. It forwards traffic between ports which belong to the same community and to the promiscuous ports. There can be multiple community VLANs per private VLAN.

A port may be designated as one of the following types in a private VLAN:

- **Promiscuous port**—A port associated with a primary VLAN that is able to communicate with all interfaces in the private VLAN, including other promiscuous ports, community ports and isolated ports. A trunk mode port may be configured as promiscuous and may carry the traffic of several primary VLANs along with traffic from non-private VLANs.
- **Host port**—A port associated with a secondary VLAN that can either communicate with the promiscuous ports in the VLAN and with other ports in the same community (if the secondary VLAN is a community VLAN) or can communicate only with the promiscuous ports (if the secondary VLAN is an isolated VLAN).

Private VLANs may be configured across a stack and on physical and port-channel interfaces.

### Private VLAN Usage Scenarios

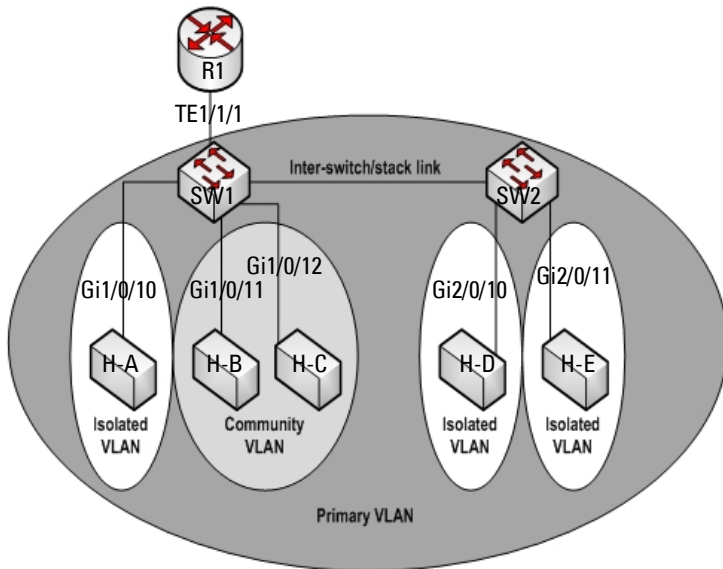
Private VLANs are typically implemented in a DMZ for security reasons. Servers in a DMZ are generally not allowed to communicate with each other but they must communicate to a router, through which they are connected to the users. Such servers are connected to host ports, and the routers are attached to promiscuous ports. Then, if one of the servers is compromised, the intruder cannot use it to attack another server in the same network segment.

The same traffic isolation can be achieved by assigning each port with a different VLAN, allocating an IP subnet for each VLAN, and enabling Layer-3 routing between them. In a private VLAN domain, on the other hand, all members can share the common address space of a single subnet, which is associated with a primary VLAN. So, the advantage of the private VLANs feature is that it reduces the number of consumed VLANs, improves IP addressing space utilization, and helps to reduce the need to deploy Layer-3 routing.

Figure 20-3 shows an example Private VLAN scenario, in which five hosts (H-A through H-E) are connected to a stack of switches (SW1, SW2). The switch stack is connected to router R1. Port references shown are with reference to the stack.



**Figure 20-3. Private VLAN Domain**



### Promiscuous Ports

An endpoint connected to a promiscuous port is allowed to communicate with any endpoint within the private VLAN. Multiple promiscuous ports can be defined for a single private VLAN domain.

In the configuration shown in Figure 20-3, the port connected from SW1 to R1 (TE1/1/1) is configured as a promiscuous port. It is possible to configure a port-channel as a promiscuous port in order to provide a level of redundancy on the private VLAN uplink.

### Isolated Ports

An endpoint connected to an isolated port is allowed to communicate with endpoints connected to promiscuous ports only. Endpoints connected to adjacent isolated ports cannot communicate with each other.

## Community Ports

An endpoint connected to a community port is allowed to communicate with the endpoints within a community and can also communicate with any configured promiscuous port. The endpoints that belong to one community cannot communicate with endpoints that belong to a different community, or with endpoints connected to isolated ports.

## Private VLAN Operation in the Switch Stack and Inter-switch Environment

The Private VLAN feature is supported in a stacked switch environment. The stack links are transparent to the configured VLANs; thus, there is no need for special private VLAN configuration beyond what would be configured for a single switch. Any private VLAN port can reside on any stack member.

To enable private VLAN operation across multiple switches that are not stacked, trunk ports must be configured between the switches to transport the private VLANs. The trunk ports must be configured with the promiscuous, isolated, and community VLANs. Trunk ports must also be configured on all devices separating the switches.

In regular VLANs, ports in the same VLAN switch traffic at Layer 2. However, for a private VLAN, the promiscuous port forwards received traffic to secondary ports in the VLAN (isolated and community). Community ports forward received traffic to the promiscuous ports and other community ports using the same secondary VLAN. Isolated ports transmit received traffic to the promiscuous ports only.

The ports to which the broadcast traffic is forwarded depend on the type of port on which the traffic was received. If the received port is a host port, traffic is broadcast to all promiscuous and trunk ports. If the received port is a community port, the broadcast traffic is forwarded to all promiscuous, trunk, and community ports in the same secondary VLAN. A promiscuous port broadcasts traffic to other promiscuous ports, isolated ports, and community ports.

**Table 20-2. Forwarding Rules for Traffic in Primary VLAN**

From	To				
	promiscuous	community 1	community 2	isolated	stack (trunk)
promiscuous	allow	allow	allow	allow	allow
community 1	N/A	N/A	N/A	N/A	N/A
community 2	N/A	N/A	N/A	N/A	N/A
isolated	N/A	N/A	N/A	N/A	N/A
stack (trunk)	allow	allow	allow	allow	allow

**Table 20-3. Forwarding Rules for Traffic in Community 1 VLAN**

From	To				
	promiscuous	community 1	community 2	isolated	stack (trunk)
promiscuous	N/A	N/A	N/A	N/A	N/A
community 1	allow	allow	deny	deny	allow
community 2	N/A	N/A	N/A	N/A	N/A
isolated	N/A	N/A	N/A	N/A	N/A
stack (trunk)	allow	allow	deny	deny	allow

**Table 20-4. Forwarding Rules for Traffic in Isolated VLAN**

From	To				
	promiscuous	community 1	community 2	isolated	stack (trunk)
promiscuous	N/A	N/A	N/A	N/A	N/A
community 1	N/A	N/A	N/A	N/A	N/A
community 2	N/A	N/A	N/A	N/A	N/A
isolated	allow	deny	deny	deny	allow
stack (trunk)	allow	deny	deny	deny	Allow

## Limitations and Recommendations

- Only a single isolated VLAN can be associated with a primary VLAN. Multiple community VLANs can be associated with a primary VLAN.
- Do not configure access ports using the VLANs participating in any of the private VLANs.
- Multiple primary VLANs may be configured. Each primary VLAN must be unique and each defines a separate private VLAN domain. The operator must take care to use only the secondary VLANs associated with the primary VLAN of a domain.
- Private VLANs cannot be enabled on a preconfigured interface. The interface must physically exist in the switch.
- Secondary (community and isolated) VLANs are associated to the same multiple spanning tree instance as the primary VLAN.
- GVRP/MVRP cannot be enabled after the private VLAN is configured. The administrator will need to disable both before configuring the private VLAN.
- DHCP snooping can be configured on the primary VLAN. If it is enabled for a secondary VLAN, the configuration does not take effect if a primary VLAN is already configured.
- If IP source guard is enabled on private VLAN ports, then DHCP snooping must be enabled on the primary VLAN.
- Do not configure private VLAN ports on interfaces configured for Voice VLAN.
- If static MAC addresses are added for the host port, the same static MAC address entry must be added to the associated primary VLAN. This does not need to be replicated for dynamic MAC addresses.
- A private VLAN cannot be enabled on a management VLAN.
- A private VLAN cannot be enabled on the default VLAN.
- VLAN routing can be enabled on private VLANs. It is not very useful to enable routing on secondary VLANs, as the access to them is restricted. However, primary VLANs can be enabled for routing.
- It is recommended that the private VLAN IDs be removed from the trunk ports connected to devices that do not participate in the private VLAN traffic.

### **Private VLAN Configuration Example**

See "Configuring a Private VLAN" on page 855.

### **Additional VLAN Features**

The Dell EMC Networking N-Series switches also support the following VLANs and VLAN-related features:

- VLAN routing interfaces — See "Routing Interfaces" on page 1219.
- Guest VLAN — See "Port and System Security" on page 705.

## Default VLAN Behavior

One VLAN is configured on the Dell EMC Networking N-Series switches by default. The VLAN ID is 1, and all ports are included in the VLAN as access ports, which are untagged. This means when a device connects to any port on the switch, the port forwards the packets without inserting a VLAN tag. If a device sends a tagged frame to a port with a VLAN ID other than 1, the frame is dropped. Since all ports are members of this VLAN, all ports are in the same broadcast domain and receive all broadcast and multicast traffic received on any port.

MAC address learning occurs on a per-VLAN basis. Dell EMC Networking switches implement independent VLAN Learning (IVL) per IEEE 802.1Q. Packets are forwarded to the port that is a member of the source VLAN where the destination MAC address has been learned and is flooded to all ports in the VLAN otherwise. A unicast MAC address may be associated only with a single port within a VLAN.

When a new VLAN is created, all trunk ports are members of the VLAN by default. The configurable VLAN range is 2–4093. VLANs 4094 and 4095 are reserved for internal system use.

Ports in trunk and access mode have the default behavior shown in Table 17-2 and cannot be configured with different tagging or ingress filtering values. When adding a VLAN to a port in general mode, the VLAN has the behavior shown in Table 20-5.

**Table 20-5. General Mode Default Settings**


Feature	Default Value
Frames accepted	Untagged Incoming untagged frames are classified into the VLAN whose VLAN ID is the currently configured PVID.
Frames sent	Untagged
Ingress Filtering	On
PVID	1

Table 20-6 shows the default values or maximum values for VLAN features.

**Table 20-6. Additional VLAN Default and Maximum Values**

<b>Feature</b>	<b>Value</b>
Default VLAN	VLAN 1
VLAN Name	No VLAN name is configured except for VLAN 1, whose name “default” cannot be changed.
VLAN Range	2–4093
Switchport mode	Access
Double-VLAN tagging	Disabled If double-VLAN tagging is enabled, the default EtherType value is 802.1Q
Maximum number of configurable MAC-to-VLAN bindings	128
Maximum number of configurable IP Subnet-to-VLAN bindings	64
GVRP	Disabled If GVRP is enabled, the default per-port parameters are: <ul style="list-style-type: none"> <li>• GVRP State: Disabled</li> <li>• Dynamic VLAN Creation: Enabled</li> <li>• GVRP Registration: Enabled</li> </ul>
Number of dynamic VLANs that can be assigned through GVRP	1024
Voice VLAN	Disabled
Voice VLAN DSCP value	46
Voice VLAN authentication mode	Auto

## Configuring VLANs (Web)

This section provides information about the OpenManage Switch Administrator pages for configuring and monitoring VLANs on Dell EMC Networking Series switches. For details about the fields on a page, click  at the top of the Dell EMC OpenManage Switch Administrator web page.

### VLAN Membership

Use the **VLAN Membership** page to create VLANs and define VLAN groups stored in the VLAN membership table.

To display the **VLAN Membership** page, click **Switching** → **VLAN** → **VLAN Membership** in the navigation panel.

The **VLAN Membership** tables display which Ports and LAGs are members of the VLAN, and whether they're tagged (T), untagged (U), or forbidden (F). The tables have two rows: **Static** and **Current**. Only the **Static** row is configurable. The **Current** row is updated either dynamically through GVRP or when the **Static** row is changed and **Apply** is clicked.

There are two tables on the page:

- **Ports** — Displays and assigns VLAN membership to ports. To assign membership, click in **Static** for a specific port. The available options depend on the port mode. See Table 20-7 for definitions.
- **LAGs** — Displays and assigns VLAN membership to LAGs. To assign membership, click in **Static** for a specific LAG. The available options depend on the port mode. See Table 20-7 for definitions.

**Table 20-7. VLAN Port Membership Definitions**

Port Control	Definition
T	Tagged: the interface is a member of a VLAN. All packets forwarded by the interface in this VLAN are tagged. The packets contain VLAN information.
U	Untagged: the interface is a VLAN member. Packets forwarded by the interface in this VLAN are untagged.

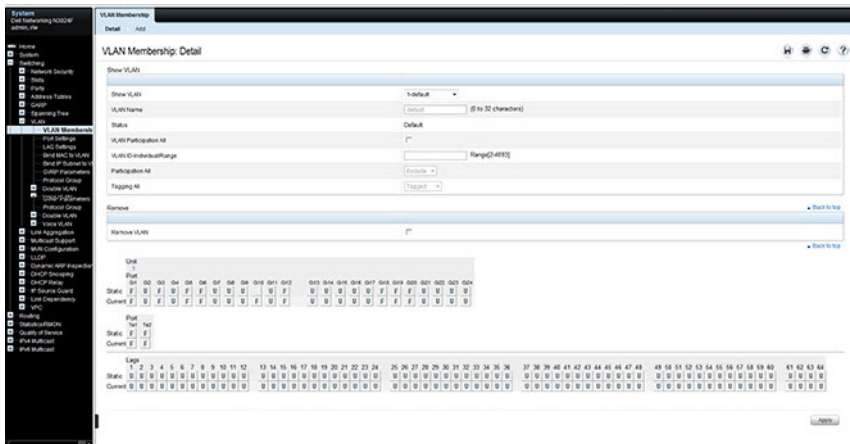


**Table 20-7. VLAN Port Membership Definitions**

Port Control	Definition
F	Forbidden: indicates that the interface is forbidden from becoming a member of the VLAN. This setting is primarily for GVRP, which enables dynamic VLAN assignment.
Blank	Blank: the interface is not a VLAN member. Packets in this VLAN are not forwarded on this interface.

To perform additional port configuration, such as making the port a trunk port, use the **Port Settings** page.

**Figure 20-4. VLAN Membership**



### Adding a VLAN

To create a VLAN:

- 1 Open the **VLAN Membership** page.
- 2 Click **Add** to display the **Add VLAN** page.
- 3 Specify a VLAN ID and a VLAN name.

**Figure 20-5. Add VLAN**



- 4 Click **Apply**.

### **Configuring Ports as VLAN Members**

To add member ports to a VLAN:

- 1 Open the **VLAN Membership** page.
- 2 From the **Show VLAN** menu, select the VLAN to which you want to assign ports.
- 3 In the **Static** row of the **VLAN Membership** table, click the blank field to assign the port as an untagged member.

Figure 20-6 shows Gigabit Ethernet ports 8–10 being added to VLAN 300.

**Figure 20-6. Add Ports to VLAN**

The screenshot shows the 'VLAN Membership' configuration page with the 'Add' tab selected. The page title is 'VLAN Membership: Detail'. Under the 'Show VLAN' section, the 'Show VLAN' dropdown is set to '300-Admin', 'VLAN Name' is 'Admin', 'Status' is 'Static', 'VLAN Participation All' is unchecked, 'VLAN ID-IndividualRange' is empty with a range of [2-4093], 'Participation All' is 'Exclude', and 'Tagging All' is 'Tagged'. Under the 'Remove' section, 'Remove VLAN' is unchecked. Below this is a table for 'Unit 1' showing port membership for various ports. Ports Gi8, Gi9, and Gi10 are circled in red, indicating they are currently 'U' (Unassociated) and need to be added to the VLAN. Other ports are either 'F' (Associated) or empty.

Unit 1	
Port	
Gi1	
Gi2	
Gi3	
Gi4	
Gi5	
Gi6	
Gi7	
Gi8	U
Gi9	U
Gi10	U
Gi11	
Gi12	
Gi13	
Gi14	
Gi15	
Gi16	
Gi17	
Gi18	
Gi19	
Gi20	
Gi21	
Gi22	
Gi23	
Gi24	
Static	F
Current	F

Port	
Te1	
Te2	
Static	F
Current	F

- 4 Click **Apply**.
- 5 Verify that the ports have been added to the VLAN.

In Figure 20-7, the presence of the letter **U** in the **Current** row indicates that the port is an untagged member of the VLAN.

**Figure 20-7. Add Ports to VLAN**

The screenshot shows the 'VLAN Membership' configuration page for a VLAN named '300-Admin'. The 'VLAN Name' is 'Admin' and the status is 'Static'. The 'Participation All' is set to 'Exclude' and 'Tagging All' is set to 'Tagged'. Below the configuration fields, there is a 'Remove' section with a 'Remove VLAN' checkbox. The main part of the page is a table showing the membership status for various ports across different units.

Unit	Port																								
	G01	G02	G03	G04	G05	G06	G07	G08	G09	G10	G11	G12	G13	G14	G15	G16	G17	G18	G19	G20	G21	G22	G23	G24	
Static	F		F		F		F		F		F									F		F		F	
Current	F		F		F		F		U		U		F							F		F		F	

Below the main table, there is a section for 'Port' configuration for 'Te1' and 'Te2'.

Port	Te1	Te2
Static	F	F
Current	F	F

## VLAN Port Settings

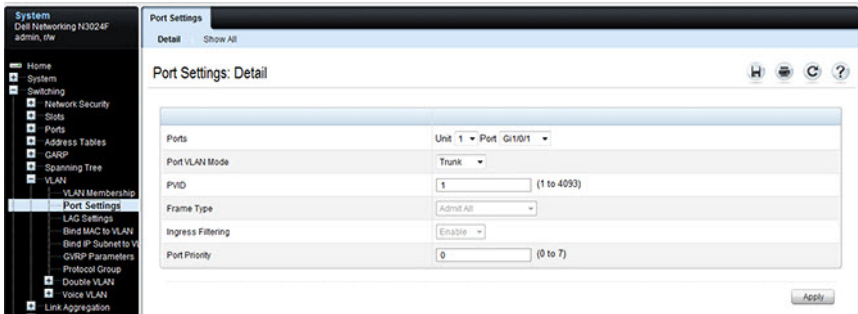
Use the **VLAN Port Settings** page to add ports to an existing VLAN and to configure settings for the port. If you select Trunk or Access as the **Port VLAN Mode**, some of the fields are not configurable because of the requirements for that mode.



**NOTE:** Ports can be added to a VLAN through the table on the **VLAN Membership** page or through the **PVID** field on the **Port Settings** page. The PVID is the VLAN that untagged received packets are assigned to. To include a general-mode port in multiple VLANs, use the **VLAN Membership** page.

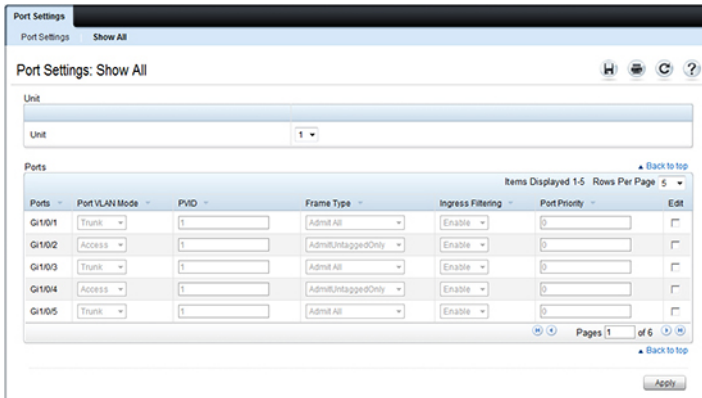
To display the **Port Settings** page, click **Switching** → **VLAN** → **Port Settings** in the navigation panel.

**Figure 20-8. VLAN Port Settings**



From the **Port Settings** page, click **Show All** to see the current VLAN settings for all ports. To change the settings for one or more ports, click the **Edit** option for a port and select or enter new values.

**Figure 20-9. VLAN Settings for All Ports**

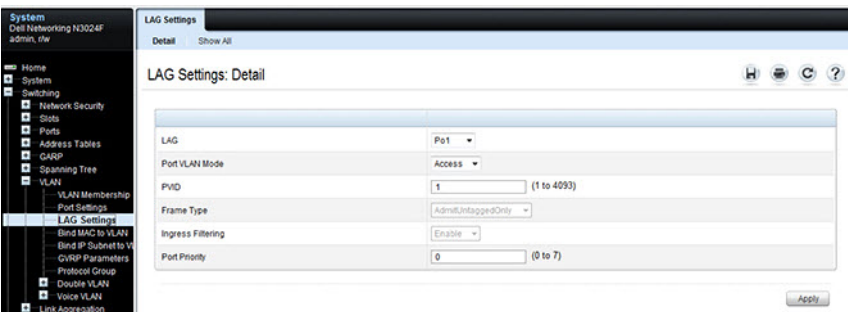


## VLAN LAG Settings

Use the VLAN LAG Settings page to map a LAG to a VLAN and to configure specific VLAN settings for the LAG.

To display the LAG Settings page, click **Switching** → **VLAN** → **LAG Settings** in the navigation panel.

**Figure 20-10. VLAN LAG Settings**



From the LAG Settings page, click **Show All** to see the current VLAN settings for all LAGs. To change the settings for one or more LAGs, click the **Edit** option for a port and select or enter new values.

Figure 20-11. VLAN LAG Table

The screenshot shows the 'LAG Settings' configuration page. At the top, there are tabs for 'Detail' and 'Show All'. Below the tabs, the page title is 'LAG Settings: Show All'. There are three icons: a home icon, a refresh icon, and a help icon. The main content is a table with the following columns: Port, Port VLAN Mode, PVID, Frame Type, Ingress Filtering, Port Priority, and Edit. The table contains five rows, one for each port (Po1 to Po5). Each row has a dropdown menu for 'Port VLAN Mode' (set to 'Access'), a text input field for 'PVID' (set to '1'), a dropdown menu for 'Frame Type' (set to 'AdmitUntaggedOnly'), a dropdown menu for 'Ingress Filtering' (set to 'Enable'), a text input field for 'Port Priority' (set to '0'), and an 'Edit' checkbox.

Port	Port VLAN Mode	PVID	Frame Type	Ingress Filtering	Port Priority	Edit
Po1	Access	1	AdmitUntaggedOnly	Enable	0	<input type="checkbox"/>
Po2	Access	1	AdmitUntaggedOnly	Enable	0	<input type="checkbox"/>
Po3	Access	1	AdmitUntaggedOnly	Enable	0	<input type="checkbox"/>
Po4	Access	1	AdmitUntaggedOnly	Enable	0	<input type="checkbox"/>
Po5	Access	1	AdmitUntaggedOnly	Enable	0	<input type="checkbox"/>

Items Displayed 1-5 Rows Per Page 5

Pages 1 of 26

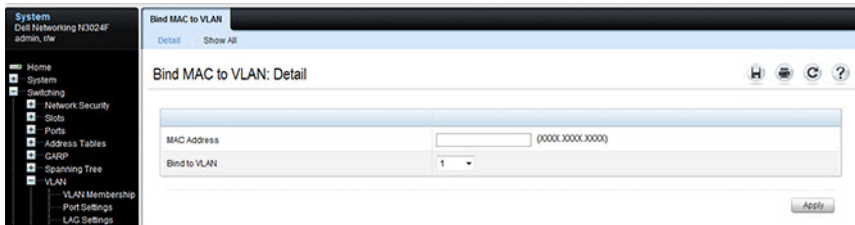
Apply

## Bind MAC to VLAN

Use the **Bind MAC to VLAN** page to map a MAC address to a VLAN. After the source MAC address and the VLAN ID are specified, the MAC to VLAN configurations are shared across all ports of the switch. The MAC to VLAN table supports up to 128 entries.

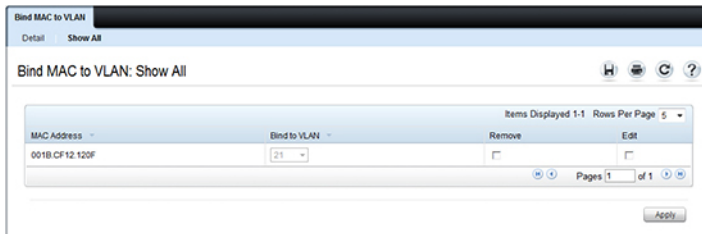
To display the **Bind MAC to VLAN** page, click **Switching** → **VLAN** → **Bind MAC to VLAN** in the navigation panel.

**Figure 20-12. Bind MAC to VLAN**



From the **Bind MAC to VLAN** page, click **Show All** to see the MAC addresses that are mapped to VLANs. From this page, settings can be changed for one or more entries or entries can be removed.

**Figure 20-13. MAC-VLAN Bind Table**



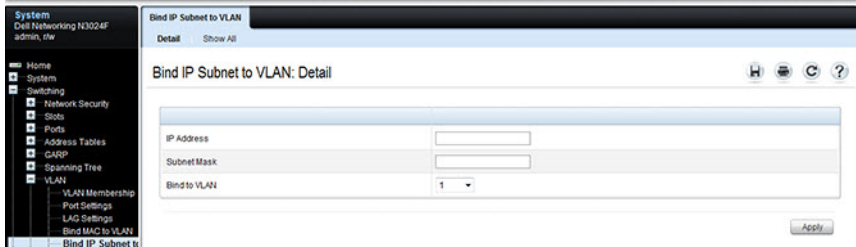
## Bind IP Subnet to VLAN

Use the **Bind IP Subnet to VLAN** page to assign an IP Subnet to a VLAN. The IP Subnet to VLAN configurations are shared across all ports of the switch. There can be up to 128 entries configured in this table.



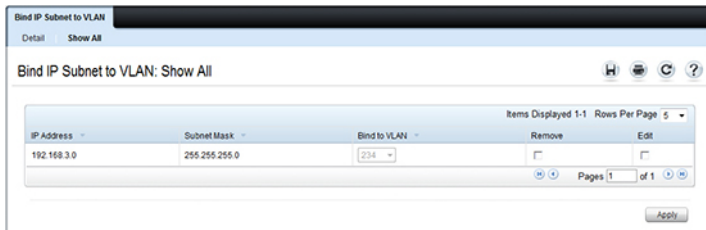
To display the **Bind IP Subnet to VLAN** page, click **Switching** → **VLAN** → **Bind IP Subnet to VLAN** in the navigation panel.

**Figure 20-14. Bind IP Subnet to VLAN**



From the **Bind IP Subnet to VLAN** page, click **Show All** to see the IP subnets that are mapped to VLANs. From this page, settings can be changed for one or more entries or entries can be removed.

**Figure 20-15. Subnet-VLAN Bind Table**

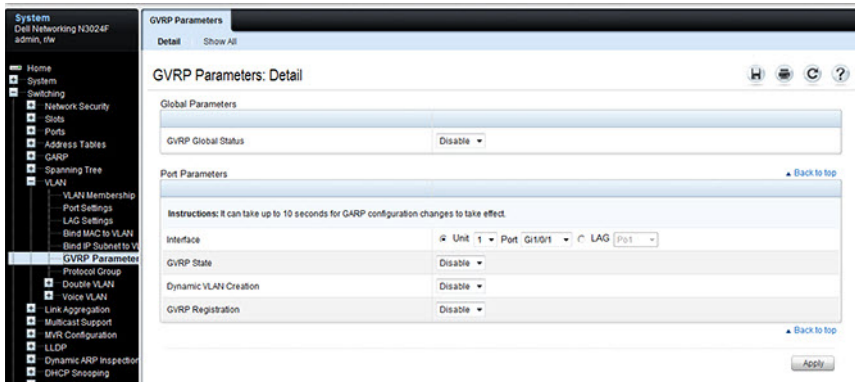


## GVRP Parameters

Use the **GVRP Parameters** page to enable GVRP globally and configure the port settings.

To display the **GVRP Parameters** page, click **Switching** → **VLAN** → **GVRP Parameters** in the navigation panel.

**Figure 20-16. GVRP Parameters**



From the **GVRP Parameters** page, click **Show All** to see the GVRP configuration for all ports. From this page, settings can be changed for one or more entries.



**NOTE:** Per-port and per-LAG GVRP Statistics are available from the Statistics/RMON page. For more information, see "Monitoring Switch Traffic" on page 603.

**Figure 20-17. GVRP Port Parameters Table**

**GVRP Parameters** Detail Show All

---

**GVRP Parameters: Show All** 🏠 🔄 🕒 ?

Unit

Unit 1 ▾

Copy Parameters ▶ Back to top

Copy Parameters From Unit 1 ▾ Port Gi10/1 ▾ LAG Po1 ▾

Ports ▶ Back to top

Items Displayed 1-5 Rows Per Page 5 ▾

▲	Interface ▾	GVRP State ▾	Dynamic VLAN Creation ▾	GVRP Registration ▾	Copy To	Edit
1	Gi10/1	Disable ▾	Disable ▾	Disable ▾	<input type="checkbox"/>	<input type="checkbox"/>
2	Gi10/2	Disable ▾	Disable ▾	Disable ▾	<input type="checkbox"/>	<input type="checkbox"/>
3	Gi10/3	Disable ▾	Disable ▾	Disable ▾	<input type="checkbox"/>	<input type="checkbox"/>
4	Gi10/4	Disable ▾	Disable ▾	Disable ▾	<input type="checkbox"/>	<input type="checkbox"/>
5	Gi10/5	Disable ▾	Disable ▾	Disable ▾	<input type="checkbox"/>	<input type="checkbox"/>

▶ ◀ Pages 1 of 6 ▶ ◀

LAGs ▶ Back to top

Items Displayed 1-5 Rows Per Page 5 ▾

▲	LAGs ▾	GVRP State ▾	Dynamic VLAN Creation ▾	GVRP Registration ▾	Copy To	Edit
1	Po1	Disable ▾	Disable ▾	Disable ▾	<input type="checkbox"/>	<input type="checkbox"/>
2	Po2	Disable ▾	Disable ▾	Disable ▾	<input type="checkbox"/>	<input type="checkbox"/>
3	Po3	Disable ▾	Disable ▾	Disable ▾	<input type="checkbox"/>	<input type="checkbox"/>
4	Po4	Disable ▾	Disable ▾	Disable ▾	<input type="checkbox"/>	<input type="checkbox"/>
5	Po5	Disable ▾	Disable ▾	Disable ▾	<input type="checkbox"/>	<input type="checkbox"/>

▶ ◀ Pages 1 of 26 ▶ ◀

▶ Back to top

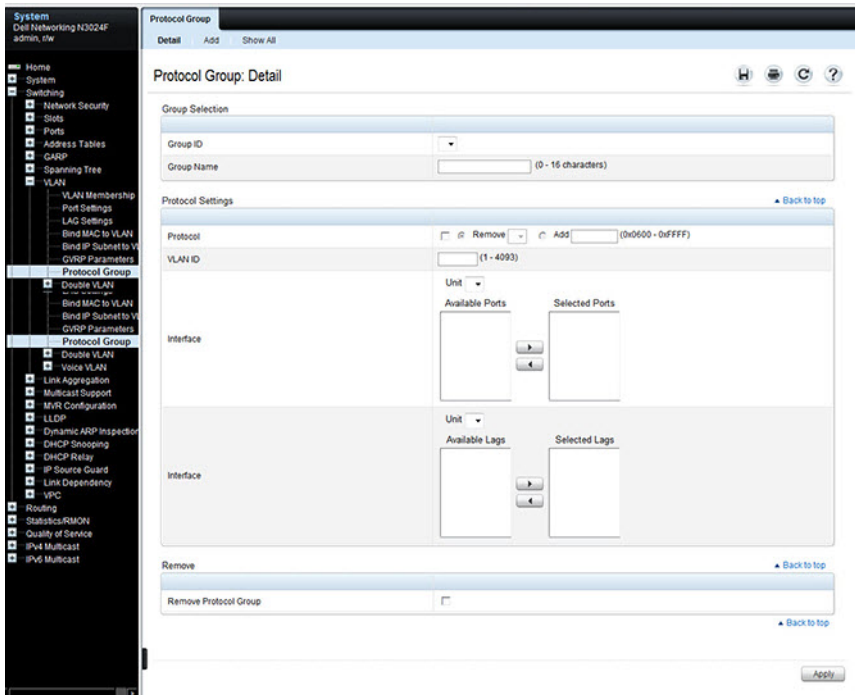
## Protocol Group

Use the **Protocol Group** page to configure which EtherTypes go to which VLANs, and then enable certain ports to use these settings. Protocol-based VLANs are most often used in situations where network segments contain hosts running multiple protocols.

Protocol-based VLANs are not compatible with STP-PV/RSTP-PV. Ensure that the spanning tree protocol is set to something other than one of the per-VLAN protocols.

To display the **Protocol Group** page, click **Switching** → **VLAN** → **Protocol Group** in the navigation panel.

**Figure 20-18. Protocol Group**

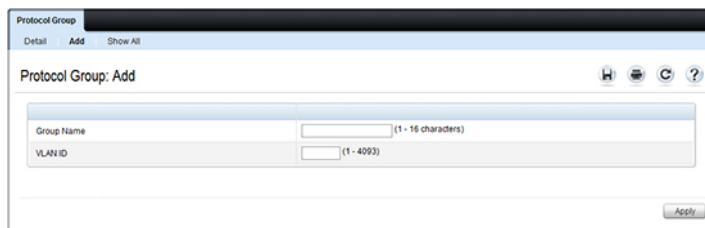


## Adding a Protocol Group

To add a protocol group:

- 1 Open the **Protocol Group** page.
- 2 Click **Add** to display the **Add Protocol Group** page.
- 3 Create a name for the group and associate a VLAN with the group.

**Figure 20-19. Add Protocol Group**

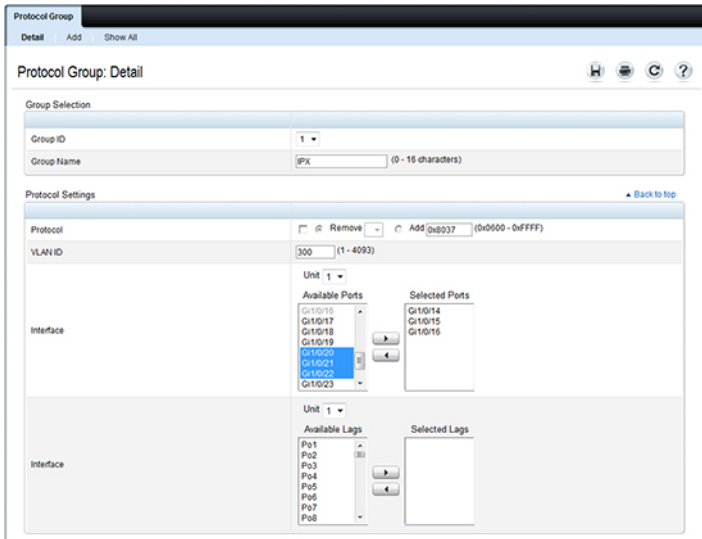


The screenshot shows a web interface for adding a protocol group. At the top, there's a navigation bar with 'Detail', 'Add', and 'Show All' options. Below that, the page title is 'Protocol Group: Add'. There are two input fields: 'Group Name' with a character limit of '(1 - 16 characters)' and 'VLAN ID' with a character limit of '(1 - 4093)'. An 'Apply' button is located at the bottom right of the form area.

- 4 Click **Apply**.
- 5 Click **Protocol Group** to return to the main **Protocol Group** page.
- 6 From the **Group ID** field, select the group to configure.
- 7 In the **Protocol Settings** table, select the protocol and interfaces to associate with the protocol-based VLAN.

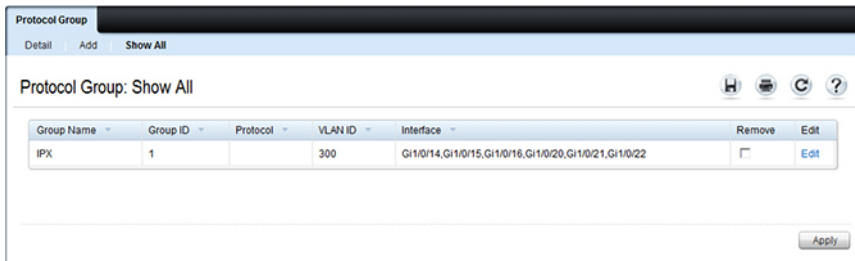
In Figure 20-20, the Protocol Group 1 (named IPX) is associated with the IPX protocol and ports 14–16. Ports 20–22 are selected in **Available Ports** list. After clicking the right arrow, they will be added to the **Selected Ports** list.

**Figure 20-20. Configure Protocol Group**



- 8 Click Apply.
- 9 Click Show All to see the protocol-based VLANs and their members.

**Figure 20-21. Protocol Group Table**

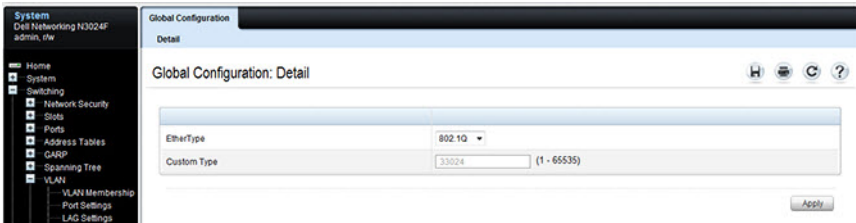


## Double VLAN Global Configuration

Use the Double VLAN Global Configuration page to specify the value of the EtherType field in the first EtherType/tag pair of the double-tagged frame.

To display the Double VLAN Global Configuration page, click **Switching** → **VLAN** → **Double VLAN** → **Global Configuration** in the navigation panel.

**Figure 20-22. Double VLAN Global Configuration**

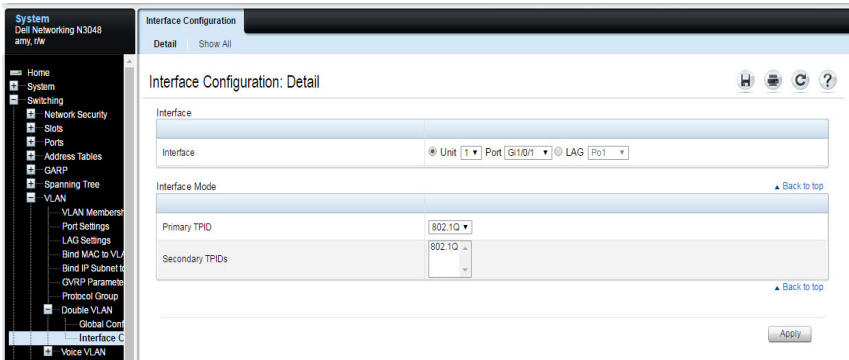


## Double VLAN Interface Configuration

Use the **Double VLAN Interface Configuration** page to specify the value of the **EtherType** field in the first EtherType/tag pair of the double-tagged frame.

To display the **Double VLAN Interface Configuration** page, click **Switching** → **VLAN** → **Double VLAN** → **Interface Configuration** in the navigation panel.

**Figure 20-23. Double VLAN Interface Configuration**



To view a summary of the double VLAN configuration for all interfaces and to edit settings for one or more interfaces, click **Show All**.



**Figure 20-24. Double VLAN Port Parameter Table**

The screenshot displays a network configuration web interface. On the left is a navigation tree with categories like System, Switching, and VLAN. The main content area is titled 'Interface Configuration: Show All' and contains two tables.

**Unit Configuration:**

Unit:

**Interfaces Table:**

▲	Interface	Interface Mode	Primary TPID	Configured Secondary TPIDs
1	Gi1/0/1	Disable	802.1Q	
2	Gi1/0/2	Disable	802.1Q	
3	Gi1/0/3	Disable	802.1Q	
4	Gi1/0/4	Disable	802.1Q	
5	Gi1/0/5	Disable	802.1Q	

Items Displayed 1-5 Rows Per Page 5

Pages 1 of 10

**LAGs Table:**

▲	LAGs	Interface Mode	Primary TPID	Configured Secondary TPIDs
1	Po1	Disable	802.1Q	
2	Po2	Disable	802.1Q	
3	Po3	Disable	802.1Q	
4	Po4	Disable	802.1Q	
5	Po5	Disable	802.1Q	

Items Displayed 1-5 Rows Per Page 5

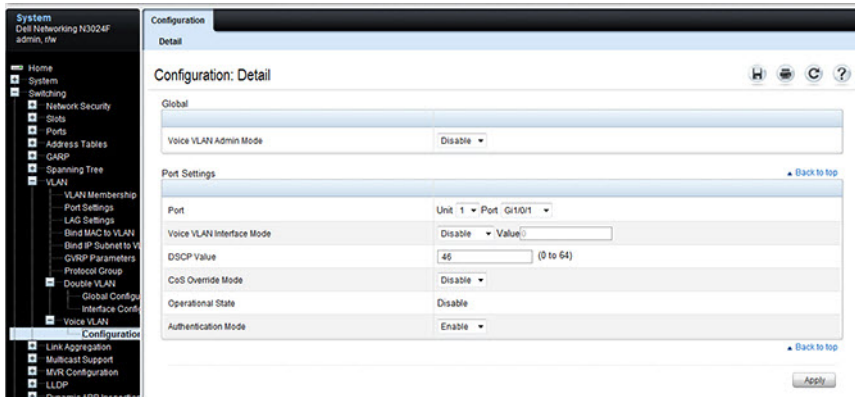
Pages 1 of 26

## Voice VLAN

Use the Voice VLAN Configuration page to configure and view Voice VLAN settings that apply to the entire system and to specific interfaces.

To display the page, click **Switching** → **VLAN** → **Voice VLAN** → **Configuration** in the navigation panel.

**Figure 20-25. Voice VLAN Configuration**



**NOTE:** IEEE 802.1X must be enabled on the switch before you disable IP phone authentication. IP phone authentication can be disabled in order to allow VoIP phones that do not support authentication to send and receive traffic on the Voice VLAN.

## Configuring VLANs (CLI)

This section provides information about the commands you use to create and configure VLANs. For more information about the commands, see the *Dell EMC Networking N1100-ON, N1500, N2000, N2100-ON, N2200-ON, N3000E-ON, N3100-ON, and N3200-ON Series Switches CLI Reference Guide* at [www.dell.com/support](http://www.dell.com/support).

### Creating a VLAN

Use the following commands to configure a VLAN and associate a name with the VLAN.

Command	Purpose
<code>configure</code>	Enter global configuration mode.
<code>vlan <i>vlan-list</i></code>	Create a new VLAN or a range of VLANs and enter the interface configuration mode for the specified VLAN or VLANs. <ul style="list-style-type: none"><li><i>vlan-list</i> — A list of one or more valid VLAN IDs to be added. List separate, non-consecutive VLAN IDs separated by commas (without spaces); use a hyphen to designate a range of IDs. (Range: 2–4093)</li></ul>
<code>name <i>string</i></code>	Add a name to the specified VLAN. <i>string</i> — Comment or description to help identify a specific VLAN (Range: 1–32 characters).
CTRL + Z	Exit to Privileged Exec mode.
<code>show vlan [<i>vlan-id</i>   name <i>vlan-name</i>]</code>	Display VLAN information. <ul style="list-style-type: none"><li><i>vlan-id</i> — A valid VLAN ID. (Range: 1–4093)</li><li><i>vlan-name</i> — A valid VLAN name string. (Range: 1–32 characters)</li></ul>

## Configuring VLAN Settings for a LAG

The VLAN mode and memberships settings you configure for a port are also valid for a LAG (port-channel). Use the following commands to configure the VLAN mode for a LAG. Once the switchport mode settings are specified for a LAG, other VLAN memberships settings can be specified that are valid for the switchport mode.

Command	Purpose
<code>configure</code>	Enter global configuration mode.
<code>interface port-channel channel-id</code>	Enter interface configuration mode for the specified interface.  <i>channel-id</i> — Specific port-channel. (The range is platform specific). A range of LAGs can be specified using the <code>interface range port-channel</code> command. For example, <code>interface range port-channel 4-8</code> .
<code>switchport mode [access general trunk]</code>	Configure the interface as an untagged Layer-2 VLAN interface.
<code>CTRL + Z</code>	Exit to Privileged Exec mode.
<code>show interfaces switchport port-channel channel-id</code>	Display information about the VLAN settings configured for the specified LAG.

## Configuring Double VLAN Tagging

Dell EMC Networking N-Series switches use switchport dot1q-tunnel mode to configure an interface as a customer edge (CE) interface. The dot1q-tunnel mode is an overlay on switchport access mode. In particular, configuring the access mode PVID sets the outer dot1q-tunnel VLAN ID. Changing the switchport mode on a CE port to access, general, or trunk, effectively disables tunneling on the interface.

CE interfaces can be physical ports or port-channels. Untagged frames received on the CE interface are processed as if they belong to the PVID and are transmitted out the service provider (SP) interface with a single VLAN tag (presuming that the destination MAC address has been learned on the SP interface). Tagged frames received on the CE interface are transmitted out the service provider (SP) interface with an outer tag containing the access mode native VLAN ID and the inner tag as received on the CE interface.

CE interfaces **MUST** be configured in dot1q-tunnel mode with the PVID configured with the outer tag (native) VLAN ID for the associated service provider (SP) interface. Configure the outer VLAN ID using the **switchport access vlan** command. All MAC address learning and forwarding occurs on the outer VLAN tag MAC addresses. The VLAN ID must be common to both the SP port and the CE ports.

The service provider interface **MUST** be configured for egress tagging (trunk or general mode) with a native VLAN identical to the PVID of the associated CE ports. SP interfaces **SHOULD** be configured with a single outer VLAN ID. Be aware that a trunk mode port accepts untagged packets on the native VLAN and be a member of any existing or newly created VLANs by default.

It is not possible to configure an inner VLAN TPID value. The inner VLAN TPID value is always 802.1Q (0x8100). Up to four unique outer TPIDs may be configured in the system. An outer TPID/EtherType (other than 802.1Q) must be configured in Global Configuration mode prior to configuration on an interface. The outer TPID/EtherType must be configured on the interface prior to putting the interface into tunnel mode.

Multiple groups of associated CE and SP ports can be defined by configuring the groups with unique VLAN IDs. An outer TPID/EtherType (other than 802.1Q) must be configured in Global Configuration mode prior to configuration on an interface. The outer TPID/EtherType must be configured on the interface prior to putting the interface into tunnel mode.

DVLAN CE interfaces must be configured for tagging (dot1q-tunnel mode) for double tags to be observed on frames egressing the service provider (SP) interface. The DVLAN SP interface should be configured to accept tagged frames for the DVLAN or outer VLAN (trunk or general mode). Ensure that the native (access mode) VLAN on the customer edge (CE) port is set to the DVLAN ID. MAC address learning on DVLAN enabled ports occurs on the DVLAN CE port's native VLAN.

If it is desirable to restrict propagation of spanning tree topology changes from CE interfaces into the service provider network, enable **spanning-tree tenguard** on the CE interfaces. Optionally, use the **spanning-tree guard root** on CE ports to eliminate the possibility that a CE interface becomes a root port. Be aware that root guard may cause spanning-tree to stop forwarding if a superior BPDU is received on the interface.

Perform the following steps to configure an interface as a CE interface. The DVLAN VLAN must also be configured on an interface with tagging enabled (trunk or general mode), and the native VLAN must be set to the DVLAN VLAN identifier.. That interface will act as the SP interface. It is advisable to restrict the allowed VLAN on the SP interface to the DVLAN VLAN only.

<b>Command</b>	<b>Purpose</b>
<code>configure</code>	Enter global configuration mode.
<code>vlan 100</code>	Create the DVLAN (outer) VLAN.
<code>exit</code>	Exit VLAN configuration mode
<code>switchport dot1q ethertype vman</code>	Define the VMAN EtherType for use on the CE port.
<code>interface <i>interface-id</i></code>	Enter interface configuration mode for the specified CE interface. The <i>interface-id</i> variable includes the interface type and number, for example <b>tengigabitethernet 1/0/3</b> .  A range of interfaces can be specified using the <b>interface range</b> command. For example, <b>interface range tengigabitethernet 1/0/8-12</b> configures interfaces 8, 9, 10, 11, and 12.
<code>switchport mode dot1q- tunnel</code>	Configure the interface as a CE tunnel port.
<code>switchport access vlan 100</code>	Configure the DVLAN VLAN

Command	Purpose
<code>spanning-tree guard root</code>	(Optional) Disable the ability of the CE port to become spanning tree root.
<code>spanning-tree tcnguard</code>	(Optional) Ignore topology changes received from CE ports.
<code>exit</code>	Exit to global configuration mode
<code>CTRL + Z</code>	Exit to Privileged Exec mode.
<code>show dot1q-tunnel</code>	Display all interfaces enabled for Double VLAN Tunneling
<code>show dot1q-tunnel interface {interface-id   all}</code>	Display detailed information about Double VLAN Tunneling for the specified interface or all interfaces.
<code>show switchport ether-type [interface interface-id   all]</code>	Display the configured EtherType for each interface.

Beginning in global configuration mode, perform the following steps to configure the SP port using the VMAN (0x88A8) outer tag. In this configuration, packets received on CE ports will have the VMAN tag pushed onto the frame before being transmitted out the SP interface. Packets received on the SP interface will have the VMAN tag stripped before forwarding to the CE interface.

Command	Purpose
<code>switchport dot1q ether-type {vman   custom 0-65535} [primary-tpid]</code>	Configure the EtherType to use for an SP interface using one of the previously configured EtherTypes. <ul style="list-style-type: none"> <li><b>vman</b> — Configures the EtherType as 0x88A8.</li> <li><b>custom</b> — Configure a custom EtherType for the DVLAN tunnel. The value must be 0–65535.</li> <li><b>primary-tpid</b> — Configure the primary (outer) TPID. Up to four unique outer VLAN tag TPIDs may be configured.</li> </ul>
<code>interface interface-id</code>	Enter interface configuration mode for the SP uplink port.
<code>switchport mode trunk</code>	Configure the interface in trunk mode.

<b>Command</b>	<b>Purpose</b>
<code>switchport trunk allowed vlan 100</code>	Only allow VLAN 100 packets on the interface.
<code>switchport trunk native vlan 100</code>	Configure untagged packets to be members of VLAN 100.

## Configuring MAC-Based VLANs

Use the following commands to associate a MAC address with a configured VLAN. The VLAN does not need to be configured on the system to associate a MAC address with it. However, the associated VLAN must be configured on a port in order for the system to map packets matching the MAC address to the associated VLAN and to learn the associated MAC address on the associated VLAN so that packets addressed to the associated MAC address are forwarded properly. Up to 256 VLAN to MAC address associations can be created. VLAN associations operate on untagged packets on access and trunk ports. Tagged traffic is associated with the VLAN identified in the VLAN tag.

<b>Command</b>	<b>Purpose</b>
<code>configure</code>	Enter global configuration mode.
<code>interface gi1/0/3</code>	Enter Interface Config mode for port gi1/0/3.
<code>switchport mode trunk</code>	Configure gi1/0/3 as a trunk port associated with the selected VLAN ID.  Note that the native VLAN for gi1/0/3 is still VLAN 1. Untagged traffic with the associated MAC address is learned on the associated VLAN ID, not VLAN 1.
<code>exit</code>	Exit to Global Config mode.
<code>interface gi1/0/4</code>	Enter Interface Config mode for port gi1/0/4.
<code>switchport access vlan vlanid</code>	Configure gi1/0/4 as an access port.  The PVID for Gi1/0/4 is the associated VLAN ID. It will receive the MAC associated traffic.
<code>exit</code>	Exit to Global Config mode.
<code>vlan vlanid</code>	Enter VLAN configuration mode.



---

<b>Command</b>	<b>Purpose</b>
<code>vlan association mac mac-address</code>	Associate a MAC address with a VLAN. <ul style="list-style-type: none"><li>• <i>mac-address</i> — MAC address to associate. (Range: Any MAC address in the format xxxx.xxxx.xxxx or xx:xx:xx:xx:xx:xx)</li></ul>
CTRL + Z	Exit to Privileged Exec mode.
<code>show vlan association mac [mac-address]</code>	Display the VLAN associated with a specific configured MAC address. If no MAC address is specified, the VLAN associations of all the configured MAC addresses are displayed.

---

## Configuring IP-Based VLANs

Use the following commands to associate an IP subnet with a configured VLAN. The VLAN does not need to be configured on the system to associate an IP subnet with it. However, the subnet VLAN must be configured on a port in order for the system to map packets matching the IP address to the subnet VLAN and to learn the associated MAC address on the subnet VLAN so that packets addressed to the associated IP address are forwarded properly. Up to 256 VLAN-to-IP address associations can be created.

It is not necessary to assign IP addresses to VLANs in order to utilize subnet associations. Untagged packets are switched into the subnet VLAN using the defined subnet address and from the IP subnet VLAN using the learned MAC addresses.

VLAN associations operate on untagged packets on access and trunk ports. Tagged traffic is associated with the VLAN identified in the VLAN tag.

Command	Purpose
<code>configure</code>	Enter global configuration mode.
<code>vlan <i>vlanid</i></code>	Enter VLAN configuration mode.
<code>vlan association subnet <i>ip-address subnet-mask</i></code>	Associate an IP subnet with a VLAN. <ul style="list-style-type: none"><li>• <i>ip-address</i> — Source IP address. (Range: Any valid IP address)</li><li>• <i>subnet-mask</i> — Subnet mask. (Range: Any valid subnet mask)</li></ul>
<code>exit</code>	Exit to Global Config mode.
<code>interface gi1/0/3</code>	Enter Interface Config mode for gi1/0/3.
<code>switchport mode trunk</code>	Configure gi1/0/3 as a trunk member of the subnet VLAN. The Native VLAN is 1 but the port is a member of the subnet VLAN.
<code>exit</code>	Exit to Global Config mode.
<code>interface gi1/0/4</code>	Enter Interface Config mode for gi1/0/4.
<code>switchport mode access</code>	Configure gi1/0/4 as an access port.
<code>switchport access vlan <i>vlanid</i></code>	Specify the subnet VLAN ID of which gi1/0/4 is an access port member.

---

<b>Command</b>	<b>Purpose</b>
exit	Exit to Global Config mode.
CTRL + Z	Exit to Privileged Exec mode.
<b>show vlan association subnet</b> [ <i>ip-address ip- mask</i> ]	Display the VLAN associated with a specific configured IP-Address and netmask. If no IP Address and net mask are specified, the VLAN associations of all the configured IP-subnets are displayed.

---

## Configuring a Protocol-Based VLAN

Use the following commands to create and name a protocol group, and associate VLANs with the protocol group. When you create a protocol group, the switch automatically assigns it a unique group ID number. The group ID is used for both configuration and script generation to identify the group in subsequent commands.

A protocol group may have more than one interface associated with it, but each interface and protocol combination can be associated with one group only. If adding an interface to a group causes any conflicts with protocols currently associated with the group, adding the interface(s) to the group fails and no interfaces are added to the group. Ensure that the referenced VLAN is created prior to the creation of the protocol-based group except when GVRP is expected to create the VLAN.

VLAN associations operate on untagged packets on access and trunk ports. Tagged traffic is associated with the VLAN identified in the VLAN tag.

Command	Purpose
<code>configure</code>	Enter Global Config mode.
<code>vlan protocol group <i>groupid</i></code>	Create a new protocol group.
<code>vlan protocol group name <i>groupid name-string</i></code>	Name the protocol group.
<code>exit</code>	Exit to Global Config mode.
<code>interface gi1/0/3</code>	Enter Interface Config mode for gi1/0/3.
<code>switchport mode trunk</code>	Configure Gi1/0/3 as a trunk member of the associated VLAN.  The Native VLAN is 1 but the port is member of the protocol VLAN.
<code>exit</code>	Exit to Global Config mode.
<code>interface gi1/0/4</code>	Enter Interface Config mode for gi1/0/4.
<code>switchport mode access</code>	Configure gi1/0/4 as an access port.
<code>switchport access vlan <i>vlanid</i></code>	Specify the subnet VLAN ID of which gi1/0/4 is an access port member.

<b>Command</b>	<b>Purpose</b>
<b>exit</b>	Exit to Global Config Mode
<b>show port protocol all</b>	Obtain the group ID for the newly configured group.
<b>configure</b>	Enter global configuration mode.
<b>vlan protocol group add</b> <i>protocol groupid</i> <i>ethertype protocol</i>	<p>Add any EtherType protocol to the protocol-based VLAN groups identified by <i>groupid</i>. A group may have more than one protocol associated with it. Each interface and protocol combination can be associated with one group only. If adding a protocol to a group causes any conflicts with interfaces currently associated with the group, this command fails and the protocol is not added to the group.</p> <ul style="list-style-type: none"> <li>• <i>groupid</i> — The protocol-based VLAN group ID.</li> <li>• <i>protocol</i> — The IANA assigned Ethernet protocol number of the protocol to be added. The protocol number can be any number in the range 0x0600-0xffff.</li> </ul>
<b>protocol vlan group all</b> <i>groupid</i>	<p>(Optional) Add all physical interfaces to the protocol-based group identified by <i>groupid</i>. Individual interfaces can be added to the protocol-based group as shown in the next two commands.</p> <p><i>groupid</i> — The protocol-based VLAN group ID.</p>
<b>interface</b> <i>interface-id</i>	<p>Enter interface configuration mode for the specified interface.</p> <p><i>interface-id</i> — Specific interface type and number, such as <i>gi1/0/8</i>.</p>
<b>protocol vlan group</b> <i>groupid</i>	<p>Add the physical unit/port interface to the protocol-based group identified by <i>groupid</i>.</p> <p><i>groupid</i> — The protocol-based VLAN group ID.</p>
<b>exit</b>	Exit to global configuration mode.
<b>vlan</b> <i>vlanid</i>	Enter VLAN configuration mode.

<b>Command</b>	<b>Purpose</b>
<code>protocol group <i>groupid</i> <i>vlanid</i></code>	<p>Attach a VLAN ID to the protocol-based group identified by <i>groupid</i>. A group may only be associated with one VLAN at a time. However, the VLAN association can be changed.</p> <ul style="list-style-type: none"> <li>• <i>groupid</i>— The protocol-based VLAN group ID, which is automatically generated when you create a protocol-based VLAN group with the <code>vlan protocol group</code> command. To see the group ID associated with the name of a protocol group, use the <code>show port protocol all</code> command.</li> <li>• <i>vlanid</i>— A valid VLAN ID.</li> </ul>
CTRL + Z	Exit to Privileged Exec mode.
<code>show port protocol [all   <i>groupid</i>]</code>	Display the Protocol-Based VLAN information for either the entire system or for the indicated group.

## Configuring GVRP

Use the following commands to enable GVRP on the switch and on an interface, and to configure various GVRP settings.

Command	Purpose
<code>configure</code>	Enter global configuration mode.
<code>gvrp enable</code>	Enable GVRP on the switch.
<code>interface <i>interface-id</i></code>	Enter interface configuration mode for the specified port or LAG. The <i>interface-id</i> parameter includes the interface type and number, for example <code>tengigabitethernet 1/0/3</code> or <code>port-channel 3</code> .  A range of interfaces can be specified using the <code>interface range</code> command. For example, <code>interface range tengigabitethernet 1/0/8-12</code> configures interfaces 8, 9, 10, 11, and 12.
<code>gvrp enable</code>	Enable GVRP on the interface.
<code>switchport general forbidden vlan {add <i>vlan-list</i>   remove <i>vlan-list</i>}</code>  —or—	(Optional) Forbids dynamically adding the VLANs specified by the <code>remove</code> parameter to a port. To revert to allowing the addition of specific VLANs to the port, use the <code>add</code> parameter of this command.
<code>switchport trunk allowed vlan {add <i>vlan-list</i>   remove <i>vlan-list</i>}</code>	<code>add <i>vlan-list</i></code> — List of valid VLAN IDs to remove from the forbidden list. Separate nonconsecutive VLAN IDs with a comma and no spaces. Use a hyphen to designate a range of IDs.  <code>remove <i>vlan-list</i></code> — List of valid VLAN IDs to add to the forbidden list. Separate nonconsecutive VLAN IDs with a comma and no spaces. Use a hyphen to designate a range of IDs.
<code>gvrp registration-forbid</code>	(Optional) Deregister all VLANs on a port and prevent any dynamic registration on the port.
<code>gvrp vlan-creation-forbid</code>	(Optional) Disable dynamic VLAN creation.
<code>exit</code>	Exit to global configuration mode.

<b>Command</b>	<b>Purpose</b>
<code>vlan makestatic <i>vlan-id</i></code>	(Optional) Change a dynamically created VLAN (one that is created by GVRP registration) to a static VLAN (one that is permanently configured and defined).  <i>vlan-id</i> — Valid vlan ID. Range is 2-4093.
CTRL + Z	Exit to Privileged Exec mode.
<code>show gvrp configuration</code>	Display GVRP configuration information. Timer values are displayed. Other data shows whether GVRP is enabled and which ports are running GVRP.
<code>show vlan</code>	Display the VLAN configuration, including the VLAN configuration type and the associated ports.



## Configuring Voice VLANs

Use the following commands to enable the Voice VLAN feature on the switch and on an interface.

Command	Purpose
<code>configure</code>	Enter global configuration mode.
<code>switchport voice vlan</code>	Enable the Voice VLAN capability on the switch.
<code>interface <i>interface</i></code>	Enter interface configuration mode for the specified interface. <i>interface</i> — Specific interface, such as <code>gi1/0/8</code> . A range of interfaces can be specified using the <code>interface range</code> command. For example, <code>interface range gi1/0/8-12</code> enters Interface Configuration mode for ports 8–12.

Command	Purpose
<pre>switchport voice vlan {vlanid   dot1p priority   none   untagged   data priority {trust   untrust}   override- authentication  dscp value}</pre>	<p>Enable the Voice VLAN capability on the interface.</p> <ul style="list-style-type: none"> <li>• <i>vlanid</i>—The Voice VLAN ID. This VLAN ID is sent to IP phones via LLDP. If the phone authenticates using RADIUS, this VLAN ID must match the RADIUS Voice VLAN. The phone must be configured to accept the Voice VLAN configuration from LLDP.</li> <li>• <i>priority</i>—The IEEE 802.1p priority sent to the IP phone on the port via LLDP. The switch must be configured locally to give packets using the transmitted priority the appropriate QoS. The phone must be configured to accept the 802.1p priority configuration from LLDP.</li> <li>• <b>none</b>—Allow the phone to use its own configuration. The administrator must configure the switch appropriately to give voice packets the required QoS.</li> <li>• <b>untagged</b>—Configure the port to accept untagged voice packets.</li> <li>• <b>trust</b>—Trust the dot1p priority or DSCP values contained in Voice VLAN or priority tagged packets.</li> <li>• <b>untrust</b>—Do not trust the dot1p priority or DSCP values contained in packets arriving on the Voice VLAN.</li> <li>• <b>override-authentication</b> — Use this parameter to allow voice traffic on an 802.1x unauthorized port. Use the <b>no</b> form of the command to prevent voice traffic on an 802.1x unauthorized port.</li> <li>• <b>dscp value</b>—The DSCP value (Range: 0–64). This value is transmitted to the IP phone via LLDP. The switch must be configured locally to give packets using the transmitted DSCP value the appropriate QoS.</li> </ul>
CTRL + Z	Exit to Privileged Exec mode.
<pre>show voice vlan [interface {interface  all}]</pre>	Display Voice VLAN configuration information for the switch, for the specified interface, or for all interfaces.

## Configuring a Voice VLAN (Extended Example)

The commands in this example create a VLAN for voice traffic with a VLAN ID of 25 using an IP phone that does not support 802.1X authentication. Port gi1/0/10 is set to an 802.1Q VLAN. Next, Voice VLAN is enabled on the port with the Voice VLAN ID set to 25. Finally, Voice VLAN authentication is disabled on port gi1/0/10 because the phone connected to that port does not support 802.1X authentication. All other devices connected to the port are required to use 802.1X authentication for network access. For more information about 802.1X authentication, see "Port and System Security" on page 705.

This example shows the configuration for a switch with a directly connected IP phones and multiple other data devices. The interior of the network will still require configuration of QoS on the selected Voice VLAN in order to ensure service.



**NOTE:** In an environment where the IP phone uses LLDP-MED to obtain configuration information, an additional step to enable LLDP-MED on the interface would be required by issuing the `lldp med` command in Interface Configuration mode.

To configure the switch:

- 1 Create the Voice VLAN.

```
console#configure
console (config) #vlan 25
console (config-vlan25) #exit
```

- 2 Enable the Voice VLAN feature on the switch.

```
console (config) #switchport voice vlan
```

- 3 Configure port 10 to be in general mode.

```
console (config) #interface gi1/0/10
console (config-if-Gi1/0/10) #switchport mode general
```

- 4 Enable multi-host authentication on the port. The authentication server will need to be configured with the MAC address of the IP phone. See "Configuration Example—MAB Client" on page 305 for information on how to configure the phone MAC address for 802.1X. Multi-host authentication allows multiple devices to be independently authenticated on a port.

```
console(config-if-Gil/0/10)#authentication port-control auto
console(config-if-Gil/0/10)#authentication host-mode multi-
host
```

- 5 Enable the Voice VLAN feature on the interface

```
console(config-if-Gil/0/10)#switchport voice vlan 25
```

- 6 Disable authentication for the Voice VLAN on the port. This step is required only if the voice phone does not support port-based authentication. MAB is not enabled on this port as other devices such as a PC will still authenticate using 802.1X.

```
console(config-if-Gil/0/10)#switchport voice vlan override-
authentication
```

- 7 Exit to Privileged Exec mode.

```
console(config-if-Gil/0/10)#<CTRL+Z>
```

- 8 View the Voice VLAN settings for port 10.

```
console#show voice vlan interface gil/0/10
```

```
Interface..... Gil/0/10
Voice VLAN Interface Mode..... Enabled
Voice VLAN ID..... 25
Voice VLAN COS Override..... False
Voice VLAN DSCP Value..... 46
Voice VLAN Port Status..... Disabled
Voice VLAN Authentication..... Disabled
```

## Enterprise Voice VLAN Configuration With QoS

In this example, Voice VLAN traffic is transmitted and received tagged on VLAN 25 using IEEE 802.1p user priority 5. Background traffic is carried on the default VLAN. The 802.1p user priority 5 tagged packets are mapped onto internal CoS queue 2. CoS queue 2 is additionally configured as strict priority to ensure that the latency-sensitive voice traffic is transmitted first. This is to help overcome the quantization effect of IP traffic, where the first voice sample in an IP packet is typically delayed 10 or 20 ms while the voice samples are collected. A rate-limiting ACL is applied to ensure that 802.1p priority 5 packets are limited in their ability to disrupt lower-priority traffic via a denial-of-service attack.

To configure the switch on the IP phone facing interface:

- 1 Create the Voice VLAN.

```
console#configure  
console (config) #vlan 25  
console (config-vlan25) #exit
```

- 2 Globally enable the Voice VLAN feature on the switch.

```
console (config) #switchport voice vlan
```

- 3 Configure a rate-limiting ACL to ensure that the Voice VLAN does not present a denial-of-service threat. A G.711 voice stream generates 64 Kbps, which translates to 80 bytes of uncompressed voice every 10 ms. Overhead adds 40 bytes, so the phone will generate 100 to 120 byte packets every second per voice stream, or about 96 Kbps. The rate limit below will permit a single voice stream.

```
console (config) #mac access-list extended dot1p-limit  
console (config-mac-access-list) #permit any any cos 5 rate-  
limit 100 64  
console (config-mac-access-list) #permit any any  
console (config-mac-access-list) #exit
```

- 4 Configure port 10 to be in access mode. These ports use the default 802.1X auto mode authentication. Only one IP phone per port may authenticate into the Voice VLAN. By default, access mode ports use VLAN 1 for the data VLAN.

```
console (config) #interface gi1/0/10  
console (config-if-Gi1/0/10) #switchport mode access
```

- 5 Configure the switch to tell the IP phone to use VLAN 25 for voice traffic, and to tag the voice packets with 802.1p priority 5. By default, priority 5 is mapped into CoS queue 2. The RADIUS server must also be configured to identify the phone as a voice device and to send the Voice VLAN in the RADIUS Access-Accept.

```
console (config-if-Gi1/0/10) #switchport voice vlan 25  
console (config-if-Gi1/0/10) #switchport voice vlan dot1p 5
```

- 6 Enable IEEE 802.1p trust mode for the Voice VLAN-tagged packets. The 802.1p priority in the tagged voice packets will be honored.

```
console (config-if-Gi1/0/10) #switchport voice vlan priority  
extend trust
```

- 7 Configure internal CoS queue 2 as strict priority to ensure that egressing voice traffic is transmitted first on this interface. This reduces latency for transmitted voice traffic.

```
console (config-if-Gi1/0/10) #cos-queue strict 2
```

- 8 Map 802.1p priority 5 onto internal CoS queue 2. This is the switch default mapping. It is expected that the IP phones will use priority 5 in transmitted voice packets.

```
console(config-if-Gil/0/10) #classofservice dot1p-mapping 5 2
```

- 9 Rate limit incoming IEEE 802.1p priority 5 traffic

```
console(config-if-Gil/0/10) #mac access-group dot1p-5-limit in
```

Steps 6–8 are required to be configured on all ports that carry voice traffic end-to-end, including the switch ports connected to other switches and the ports on other switches that will carry voice traffic. It may be desirable to configure steps 6–8 globally.

Step 9 should be configured on all ports connected to IP phones if using strict priority or perhaps on all host facing ports if IP phones are moved frequently. Do not configure steps 3 or 9 on inter-switch connections as they will be used to aggregate voice traffic.

When configuring an MLAG for transport of Voice VLAN traffic, remember to configure steps 6-8 on the corresponding MLAG/Voice VLAN and both ends of the MLAG peer link (or configure them globally on both peers and the partner switches).

### Assign CoS for Voice Packets

The following example configures Voice VLAN to assign voice packets to a CoS queue, and to process the received packets on CoS queue 2. In this case, the port is configured in port-based authentication mode.

- 1 Create the Voice VLAN.

```
console(config) #vlan 25
console(config-vlan25) #exit
```

- 2 Enable Voice VLAN globally.

```
console(config) #switchport voice vlan
```

- 3 Enable voice vlan on an interface.

```
console(config) #interface gil/0/10
console(config-if-Gil/0/10) #switchport voice vlan 25
```

- 4 Configure the switch to assign voice VLAN tagged packets to CoS queue 2. Transmit the Voice VLAN priority to the phone using LLDP.

```
console(config-if-Gil/0/10) #no switchport voice vlan priority
extend trust
```

```
console (config-if-Gi1/0/10)#switchport voice vlan dot1p
priority 4
```

### Assign CoS for Voice Packets via Policy

The following example configures a DiffServ policy that remarks the CoS value in voice packets and assigns the voice packets to an internal queue for expedited service. The policy can be assigned to an interface using the `service-policy` command.

- 1 Create the Voice VLAN in Global Configuration mode.

```
vlan 100
exit
```

- 2 Create a class map that matches the Voice VLAN.

```
class-map match-all voice-map
match vlan 100
exit
```

- 3 Create an ingress policy that assigns the voice packets to internal queue 2 and remarks the packets with CoS value 5.

See the `show classofservice` command for the CoS to internal queue mappings.

```
policy-map voice-policy in
class voice-map
assign-queue 2
mark cos 5
exit
```

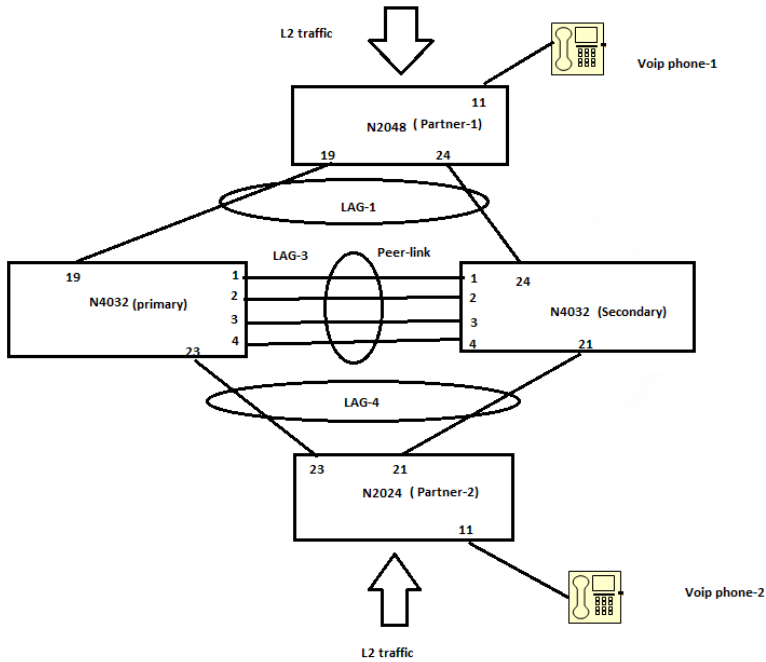
- 4 Assign the policy to an interface and enable Voice VLAN on the interface.

```
interface gi1/0/48
switchport voice vlan 100
service-policy in voice-vlan
exit
```

### MLAG with RPVST and Voice VLAN

Figure 20-26 describes the reference topology. It is presumed that a call manager of some type is connected to the network in the Voice VLAN.

**Figure 20-26. Network Topology for LAG with RPVST and Voice VLAN**



**MLAG Primary Peer Configuration**

- 1 Configure the MLAG primary switch.

Keepalives are disabled on the peer links (optional). The four peer-links are placed in port-channel 3. Port-channel 1 is the northbound (partner 1) MLAG interface in VPC 1 and port-channel 4 is the southbound (partner 2) interface in VPC 4. Finally, VPC is enabled and the VPC domain is set to 1.

```

console#config
console(config)#interface Te1/0/1
console(config-if-Te1/0/1)#channel-group 3 mode active
console(config-if-Te1/0/1)#no keepalive
console(config-if-Te1/0/1)#exit

console(config)#interface Te1/0/2
    
```



```

console (config-if-Te1/0/2) #channel-group 3 mode active
console (config-if-Te1/0/2) #no keepalive
console (config-if-Te1/0/2) #exit

console (config) #interface Te1/0/3
console (config-if-Te1/0/3) #channel-group 3 mode active
console (config-if-Te1/0/3) #no keepalive
console (config-if-Te1/0/3) #exit

console (config) #interface Te1/0/4
console (config-if-Te1/0/4) #channel-group 3 mode active
console (config-if-Te1/0/4) #no keepalive
console (config-if-Te1/0/4) #exit

console (config) #interface Te1/0/19
console (config-if-Te1/0/19) #channel-group 1 mode active
console (config-if-Te1/0/19) #no keepalive
console (config-if-Te1/0/19) #exit

console (config) #interface Te1/0/23
console (config-if-Te1/0/23) #channel-group 4 mode active
console (config-if-Te1/0/23) #no keepalive
console (config-if-Te1/0/23) #exit

console (config) #interface port-channel 1
console (config-if-Po1) #vpc 1
console (config-if-Po1) #switchport mode trunk
console (config-if-Po1) #exit

console (config) #interface port-channel 3
console (config-if-Po3) #vpc peer-link
console (config-if-Po3) #switchport mode trunk
console (config-if-Po3) #exit

console (config) #interface port-channel 4
console (config-if-Po4) #vpc 4
console (config-if-Po4) #switchport mode trunk
console (config-if-Po4) #exit

console (config) #feature vpc
console (config) #vpc domain 1
console (config-vpc 1) #peer-keepalive enable
console (config-vpc 1) #exit

```

## 2 Disable loop protect on all interfaces.

```

console (config) #interface range tengigabitethernet all

```

```
console(config-if) #no keepalive
console(config-if) #exit
```

- 3 Configure spanning-tree mode as RPVST.

```
console(config) #spanning-tree mode rapid-pvst
```

- 4 Create VLAN-2 for voice traffic.

```
console(config) #vlan 2
console(config) #exit
```

- 5 Enable Voice VLAN globally.

```
console(config) #voice vlan
```

- 6 Configure CoS queue 2 as strict. By default, the VoIP phone sends voice traffic with 802.1p priority 5, which is mapped to CoS queue 2 by default.

```
console(config) #cos-queue strict 2
```

## MLAG Secondary Peer Device Configuration

- 1 Configure the secondary MLAG peer device. The peer links, up links, and down links correspond to those configured on the primary MLAG peer.

```
console#config
console(config) #interface Te1/0/1
console(config-if-Te1/0/1) #channel-group 3 mode active
console(config-if-Te1/0/1) #exit
```

```
console(config) #interface Te1/0/2
console(config-if-Te1/0/2) #channel-group 3 mode active
console(config-if-Te1/0/2) #no keepalive
console(config-if-Te1/0/2) #exit
```

```
console(config) #interface Te1/0/3
console(config-if-Te1/0/3) #channel-group 3 mode active
console(config-if-Te1/0/3) #no keepalive
console(config-if-Te1/0/3) #exit
```

```
console(config) #interface Te1/0/4
console(config-if-Te1/0/4) #channel-group 3 mode active
console(config-if-Te1/0/4) #no keepalive
console(config-if-Te1/0/4) #exit
```

```
console(config) #interface Te1/0/21
console(config-if-Te1/0/21) #channel-group 4 mode active
console(config-if-Te1/0/21) #no keepalive
console(config-if-Te1/0/21) #exit
```

```
console (config) #interface Te1/0/24  
console (config-if-Te1/0/24) #channel-group 1 mode active  
console (config-if-Te1/0/24) #no keepalive  
console (config-if-Te1/0/24) #exit
```

```
console (config) #interface port-channel 1  
console (config-if-Po1) #vpc 1  
console (config-if-Po1) #switchport mode trunk  
console (config-if-Po1) #exit
```

```
console (config) #interface port-channel 3  
console (config-if-Po3) #vpc peer-link  
console (config-if-Po3) #switchport mode trunk  
console (config-if-Po3) #exit
```

```
console (config) #interface port-channel 4  
console (config-if-Po4) #vpc 4  
console (config-if-Po4) #switchport mode trunk  
console (config-if-Po4) #exit
```

```
console (config) #feature vpc  
console (config) #vpc domain 1  
console (config-vpc 1) #peer-keepalive enable  
console (config-vpc 1) #exit
```

- 2 Disable loop protect feature on all the interfaces.

```
console (config) #interface range tengigabitethernet all  
console (config-if) #no keepalive  
console (config-if) #exit
```

- 3 Configure spanning-tree mode as RPVST.

```
console (config) #spanning-tree mode rapid-pvst
```

- 4 Create VLAN 2 for voice traffic. This configuration must be identical on both MLAG peers.

```
console (config) #vlan 2  
console (config-vlan-2) #exit
```

- 5 Enable Voice VLAN globally.

```
console (config) #voice vlan
```

- 6 Configure egress queue 2 as strict. By default, the VoIP phone sends voice traffic with 802.1p priority 5, which is mapped to egress queue 2 by default. This configuration must be identical on both MLAG peers.

```
console (config) #cos-queue strict 2
```

## MLAG Partner Switch Configuration

- 1 Configure partner switch 1 with a port-channel connected to the MLAG aware switches.

```
console#config
console (config) #interface Gi1/0/19
console (config-if-Gi1/0/19) #channel-group 1 mode active
console (config-if-Gi1/0/19) #no keepalive
console (config-if-Gi1/0/19) #exit

console (config) #interface Gi1/0/24
console (config-if-Gi1/0/24) #channel-group 1 mode active
console (config-if-Gi1/0/24) #no keepalive
console (config-if-Gi1/0/24) #exit

console (config) #interface port-channel 1
console (config-if-Po1) #switchport mode trunk
console (config-if-Po1) #exit
```

- 2 Disable the loop protect feature on all the interfaces (optional).

```
console (config) #interface range gigabitethernet all
console (config-if) #no keepalive
console (config-if) #exit
```

- 3 Configure spanning-tree mode as RPVST.

```
console (config) #spanning-tree mode rapid-pvst
```

- 4 Create VLAN-2 for voice traffic. This configuration must be the same as on the MLAG aware switches.

```
console (config) #vlan 2
console (config-vlan-2) #exit
```

- 5 Enable Voice VLAN globally.

```
console (config) #voice vlan
```

- 6 Configure the VoIP phone connected port. The Voice VLAN assignment must be the same on all switches.

```
console (config) #interface Gi2/0/11
console (config-if-Gi2/0/11) #switchport mode access
console (config-if-Gi2/0/11) #voice vlan 2
console (config-if-Gi2/0/11) #exit
```

- 7 Configure egress queue 2 as strict. By default, the VoIP phone sends voice traffic with 802.1p priority 5, which is mapped to egress queue 2 by default.

```
console (config) #cos-queue strict 2
```

- 8 Configure an ACL to rate-limit the voice traffic in case of DoS attacks and apply the ACL on the phone-connected interfaces. The administrator should consider whether to apply this configuration on all perimeter ports.

```
console (config) #mac access-list extended dot1p-5-limit
console (config-mac-access-list) #1000 permit any any cos 5
console (config-mac-access-list) #rate-limit 1024 128
console (config-mac-access-list) #1010 permit any any
console (config-mac-access-list) #exit
```

```
console (config) #interface Gi2/0/11
console (config-if-Gi2/0/11) #mac access-group dot1p-5-limit in
1
console (config-if-Gi2/0/11) #exit
```

## Non-MLAG aware device-2 (Partner-2)

- 1 Configure partner-2 with the following configuration. This configuration is highly similar to the partner 1 configuration.

```
console#config
console (config) #interface Gi1/0/21
console (config-if-Gi2/0/21) #channel-group 4 mode active
console (config-if-Gi2/0/21) #no keepalive
console (config-if-Gi2/0/21) #exit
```

```
console (config) #interface Gi1/0/23
console (config-if-Gi1/0/23) #channel-group 4 mode active
console (config-if-Gi1/0/23) #no keepalive
console (config-if-Gi1/0/23) #exit
```

```
console (config) #interface port-channel 4
console (config-if-Po4) #switchport mode trunk
console (config-if-Po4) #exit
```

- 2 Disable loop protect on all the interfaces (optional).

```
console (config) #interface range gigabitethernet all
console (config-if) #no keepalive
console (config-if) #exit
```

- 3 Configure spanning-tree mode as RPVST.

```
console (config) #spanning-tree mode rapid-pvst
```

- 4 Create VLAN 2 for voice traffic. All switches must be configured identically for the Voice VLAN.

```
console(config)#vlan 2
console(config-vlan-2)#exit
```

- 5 Enable Voice VLAN globally.

```
console(config)#voice vlan
```

- 6 Configure the VoIP phone connected port as follows:

```
console(config)#interface Gi2/0/11
console(config-if-Gi2/0/11)#switchport mode access
console(config-if-Gi2/0/11)#voice vlan 2
console(config-if-Gi2/0/11)#exit
```

- 7 Configure CoS queue 2 as strict. By default, the VoIP phone sends voice traffic with 802.1p priority 5, which is mapped to egress queue 2 by default.

```
console(config)#cos-queue strict 2
```

- 8 Configure an ACL to rate-limit the voice traffic in case of DoS attacks and apply the ACL on the port-channel interfaces. The administrator should consider applying this configuration to all perimeter ports.

```
console(config)#mac access-list extended dot1p-5-limit
console(config-mac-access-list)#1000 permit any any cos 5
console(config-mac-access-list)#rate-limit 1024 128
console(config-mac-access-list)#1010 permit any any
console(config-mac-access-list)#exit
```

```
console(config)#interface Gi2/0/11
console(config-if-Gi2/0/11)#mac access-group dot1p-5-limit in
100
console(config-if-Gi2/0/11)#exit
```



**NOTE:** Spanning-tree status is shown accurately on the MLAG primary switch and on the partner switches. On the MLAG secondary switch, interfaces may show as spanning-tree disabled, but will remain in and are shown in the forwarding state.

## Assigning an 802.1p Priority to VLAN Traffic

The following example assigns all traffic on VLAN 25 to internal CoS queue 4. This might be useful when assigning voice traffic a higher priority than normal data traffic. Note that CoS queue 4 shares scheduling with the other CoS queues, albeit more frequently than the lower-number CoS queues.

To ensure that CoS queue 4 packets are always transmitted first, CoS queue 4 could be made a strict-priority queue. In this case, it would be prudent to rate limit CoS queue 4 traffic.

- 1 Create an access list that permits all traffic and assign it to CoS queue 4.

```
console#config
console (config) #ip access-list voice-vlan
console (config-ip-acl) #permit every assign-queue 4
console (config-ip-acl) #exit
```

- 2 Assign the access list to VLAN 25. The access-group is given sequence number 100.

```
console (config) #interface vlan 25
console (config-if-vlan25) #ip access-group voice-vlan in 100
console (config-if-vlan25) #exit
```

## Configuring a Private VLAN

- 1 Configure the VLANs and their roles. This example configures VLAN 100 as the primary VLAN, secondary VLAN 101 as the community VLAN and secondary VLANs 102 and 103 as the isolated VLANs:

```
switch#configure
switch (config) #vlan 100
switch (config-vlan-100) #private-vlan primary
switch (config-vlan-100) #exit
switch (config) #vlan 101
switch (config-vlan-101) #private-vlan community
switch (config-vlan-101) #exit
switch (config) #vlan 102
switch (config-vlan-102) #private-vlan isolated
switch (config-vlan-102) #exit
switch (config) #vlan 103
switch (config-vlan-103) #private-vlan isolated
switch (config-vlan-103) #exit
```

- 2 Associate the community and isolated VLANs with the primary VLAN.

```
switch (config) #vlan 100
switch (config-vlan-100) #private-vlan association 101-102
switch (config-vlan-100) #exit
```

This completes the configuration of the private VLAN. The only remaining step is to assign the ports to the private VLAN.

- 3 Assign the router connected port to the primary VLAN:

```

console(config)#interface tel1/1/1
console(config-if-Tel/1/1)#switchport mode private-vlan
promiscuous
console(config-if-Tel/1/1)#switchport private-vlan mapping 100
101-102
console(config-if-Tel/1/1)#exit

```

4 Assign the community VLAN ports:

```

console(config)#interface gil0/11
console(config-if-Gil/0/11)#switchport mode private-vlan host
console(config-if-Gil/0/11)#switchport private-vlan host-
association 100 101
console(config-if-Gil/0/11)#interface gil0/12
console(config-if-Gil/0/12)#switchport mode private-vlan host
console(config-if-Gil/0/12)#switchport private-vlan host-
association 100 101

```

5 Assign the isolated VLAN ports:

```

console(config)#interface gil0/10
console(config-if-Gil/0/10)#switchport mode private-vlan host
console(config-if-Gil/0/10)#switchport private-vlan host-
association 100 102
console(config-if-Gil/0/10)#interface gi2/0/10
console(config-if-Gi2/0/10)#switchport mode private-vlan host
console(config-if-Gi2/0/10)#switchport private-vlan host-
association 100 102
console(config-if-Gi2/0/10)#interface gi2/0/11
console(config-if-Gi2/0/11)#switchport mode private-vlan host
console(config-if-Gi2/0/11)#switchport private-vlan host-
association 100 102

```

6 Show the configuration:

```

console(config)#show vlan private-vlan type

```

```

VLAN Type
----
100 primary
101 community
102 isolated
103 isolated

```

```

console#show vlan private-vlan

```

Primary VLAN	Secondary VLAN	Type	Ports
100	102	Isolated	Tel/1/1,Gil/0/10,Gi2/0/10-11
100	101	Community	Tel/1/1,Gil/0/11-12
	103	Isolated	



```
console (config) #show vlan
```

VLAN	Name	Ports	Type
1	default	Pol-128, Gi1/0/1-10, Gi1/0/13-24	Default
100	VLAN0100	Tel1/1/1, Gi1/0/11-12	Static
101	VLAN0101	Gi1/0/11	Static
102	VLAN0102	Gi1/0/12	Static

## Configuring Inter-Switch Private VLANs

This is an example of configuring transport of private VLANs across multiple switches using a trunk port. Configuration of the private VLAN on other ports is included for clarity. Tel1/0/2 is the trunk port between the switches, VLAN 2 is the primary VLAN, VLAN 3 is the community VLAN, and VLAN 4 is the isolated VLAN.

```
=====
! Create the VLANs
vlan 2-4
exit
! Make VLAN 2 primary and associate it to VLANs 3 and 4
vlan 2
private-vlan primary
private-vlan association 3-4
exit
! Make VLAN 3 the community VLAN
vlan 3
private-vlan community
exit
! Make VLAN 4 the isolated VLAN
vlan 4
private-vlan isolated
exit
!
interface Tel1/0/2
switchport mode trunk
! This is an optional step to restrict the traffic on the trunk
to just the private VLAN.
! By default, all VLANs are members of a trunk port.
switchport trunk allowed vlan 2-4
```

# VLAN Configuration Examples

This section contains the following examples:

- Configuring VLANs Using the Dell EMC OpenManage Switch Administrator
- Configuring VLANs Using the CLI
- Configuring a Voice VLAN (Extended Example)



**NOTE:** For an example that shows how to use a RADIUS server to provide VLAN information, see "Controlling Authentication-Based VLAN Assignment" on page 384. For an example that shows how to allow the switch to dynamically create RADIUS-assigned VLANs, see "Allowing Dynamic Creation of RADIUS-Assigned VLANs" on page 388.

## Configuring VLANs Using the Dell EMC OpenManage Switch Administrator

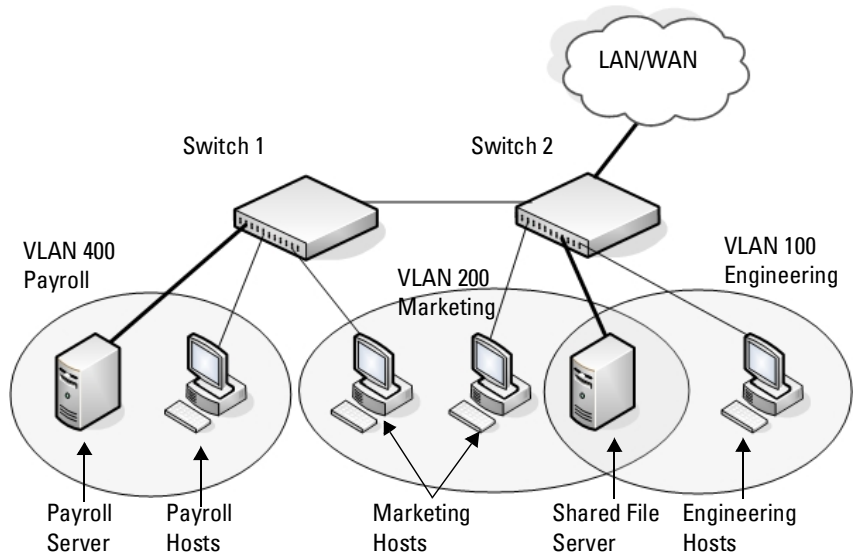
This example assumes that network administrator wants to create the VLANs in Table 20-8:

**Table 20-8. Example VLANs**

VLAN ID	VLAN Name	VLAN Type	Purpose
100	Engineering	Port-based	All employees in the Engineering department use this VLAN. Confining this department's traffic to a single VLAN helps reduce the amount of traffic in the broadcast domain, which increases bandwidth.
200	Marketing	Port-based	All employees in the Marketing department use this VLAN.
300	Sales	MAC-based	The sales staff works remotely but occasionally comes to the office. Since these employees do not have assigned work areas, they typically plug their laptops into a network port in an available cubicle, office, or conference room.
400	Payroll	Port-based	The payroll department has sensitive traffic and needs its own VLAN to help keep that traffic private.

Figure 20-27 shows the network topology for this example. As the figure shows, there are two switches, two file servers, and many hosts. One switch has an uplink port that connects it to a Layer-3 device and the rest of the corporate network.

**Figure 20-27. Network Topology for Port-Based VLAN Configuration**



The network in Figure 20-27 has the following characteristics:

- Each connection to a host represents multiple ports and hosts.
- The Payroll and File servers are connected to the switches through a LAG.
- Some of the Marketing hosts connect to Switch 1, and some connect to Switch 2.
- The Engineering and Marketing departments share the same file server.
- Because security is a concern for the Payroll VLAN, the ports and LAG that are members of this VLAN will accept and transmit only traffic tagged with VLAN 400.
- The Sales staff might connect to a port on Switch 1 or Switch 2.

Table 20-9 shows the port assignments on the switches.

**Table 20-9. Switch Port Connections**

Port/LAG	Function
<b>Switch 1</b>	
1	Connects to Switch 2
2–15	Host ports for Payroll
16–20	Host ports for Marketing
LAG1 (ports 21–24)	Connects to Payroll server
<b>Switch 2</b>	
1	Connects to Switch 1
2–10	Host ports for Marketing
11–30	Host ports for Engineering
LAG1 (ports 35–39)	Connects to file server
LAG2 (ports 40–44)	Uplink to router.

This example shows how to perform the configuration by using the web-based interface.

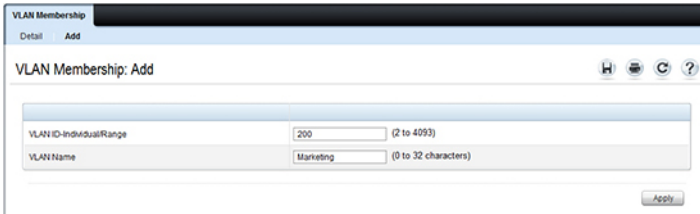
### **Configure the VLANs and Ports on Switch 1**

Use the following steps to configure the VLANs and ports on Switch 1. None of the hosts that connect to Switch 1 use the Engineering VLAN (VLAN 100), so it is not necessary to create it on that switch.

To configure Switch 1:

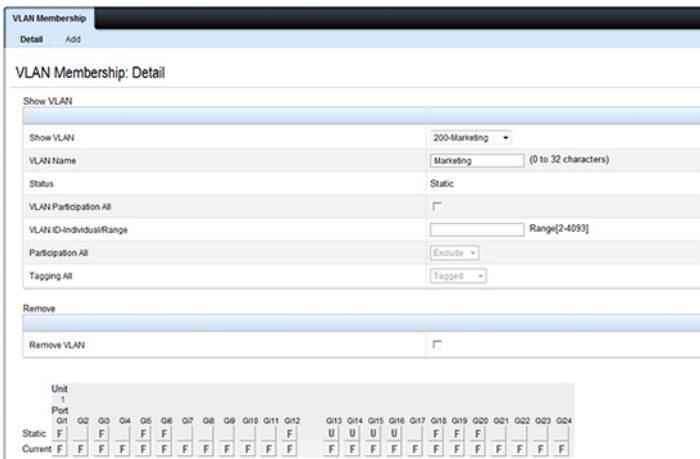
- 1** Create the Marketing, Sales, and Payroll VLANs.
  - a** From the **Switching** → **VLAN** → **VLAN Membership** page, click **Add**.
  - b** In the **VLAN ID** field, enter 200.
  - c** In the **VLAN Name** field, enter Marketing.
  - d** Click **Apply**.

**Figure 20-28. Add VLANs**



- e Repeat steps b–d to create VLANs 300 (Sales) and 400 (Payroll).
- 2 Assign ports 16–20 to the Marketing VLAN.
  - a From the **Switching** → **VLAN** → **VLAN Membership** page, select 200-Marketing from the **Show VLAN** field.
  - b In the **Static** row, click the space for ports 16–20 so the U (untagged) displays for each port.

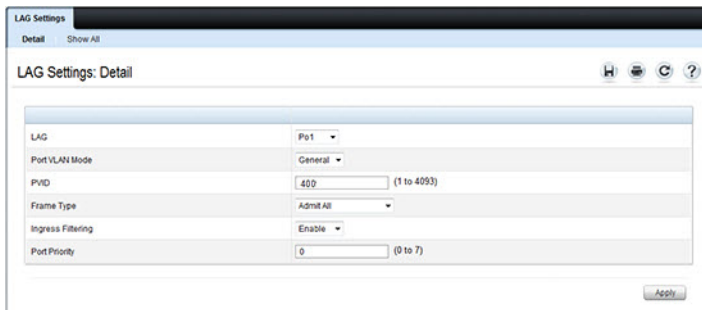
**Figure 20-29. VLAN Membership - VLAN 200**



- 3 Click **Apply**.
- 4 Assign ports 2–15 and LAG1 to the Payroll VLAN.

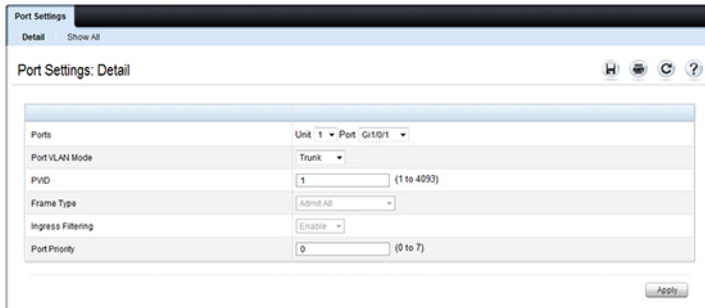
- a From the **Switching** → **VLAN** → **VLAN Membership** page, select 400-Payroll from the Show VLAN field.
  - b In the Static row, click the space for ports 2–15 and LAG 1 so the U (untagged) displays for each port, and then click **Apply**.
5. Configure LAG 1 to be in general mode and specify that the LAG will accept tagged or untagged frames, but that untagged frames will be transmitted tagged with PVID 400.
- a From the **Switching** → **VLAN** → **LAG Settings** page, make sure Po1 is selected.
  - b Configure the following settings:
    - Port VLAN Mode — General
    - PVID — 400
    - Frame Type — AdmitAll
  - c Click **Apply**.

**Figure 20-30. LAG Settings**



- 6 Configure port 1 as a trunk port.
- a From the **Switching** → **VLAN** → **Port Settings** page, make sure port Gi1/0/1 is selected.
  - b From the **Port VLAN Mode** field, select Trunk.
  - c Click **Apply**.

**Figure 20-31. Trunk Port Configuration**



- 7 From the **Switching** → **VLAN** → **VLAN Membership** page, verify that port 1 is marked as a tagged member (T) for each VLAN.

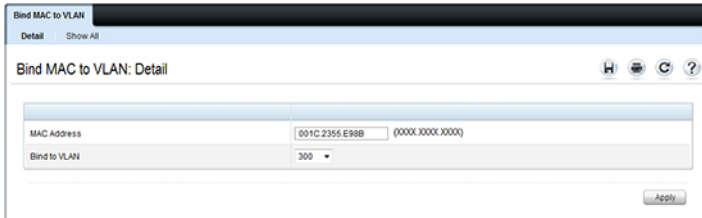
Figure 20-32 shows VLAN 200, in which port 1 is a tagged member, and ports 13–16 are untagged members.

**Figure 20-32. Trunk Port Configuration**

Unit		1																							
Port		G1/0/1																							
Static	Current	G1	G2	G3	G4	G5	G6	G7	G8	G9	G10	G11	G12	G13	G14	G15	G16	G17	G18	G19	G20	G21	G22	G23	G24
T	F	F	F	F	F	F	F	F	F	F	F	F	F	U	U	U	U	F	F	F	F	F	F	F	F

- 8 Configure the MAC-based VLAN information.
  - a Go to the **Switching** → **VLAN** → **Bind MAC to VLAN** page.
  - b In the **MAC Address** field, enter a valid MAC address, for example 00:1C:23:55:E9:8B.
  - c In the **Bind to VLAN** field, enter 300, which is the Sales VLAN ID.
  - d Click **Apply**.

**Figure 20-33. Trunk Port Configuration**



- e Repeat steps b–d to add additional MAC address-to-VLAN information for the Sales department.
- 9 To save the configuration so that it persists across a system reset, use the following steps:
  - a Go to the **System** → **File Management Copy Files** page
  - b Select Copy Configuration and ensure that Running Config is the source and Startup Config is the destination.
  - c Click **Apply**.

**Configure the VLANs and Ports on Switch 2**

Use the following steps to configure the VLANs and ports on Switch 2. Many of the procedures in this section are the same as procedures used to configure Switch 1. For more information about specific procedures, see the details and figures in the previous section.

To configure Switch 2:

- 1. Create the Engineering, Marketing, Sales, and Payroll VLANs.

Although the Payroll hosts do not connect to this switch, traffic from the Payroll department must use Switch 2 to reach the rest of the network and Internet through the uplink port. For that reason, Switch 2 must be aware of VLAN 400 so that traffic is not rejected by the trunk port.
- 2. Configure LAG 1 as a general port so that it can be a member of multiple VLANs.
  - a. From the **Switching** → **VLAN** → **LAG Settings** page, make sure Po1 is selected.
  - b. From the **Port VLAN Mode** field, select General.



- c.** Click **Apply**.
- 3.** Configure port 1 as a trunk port.
- 4.** Configure LAG2 as a trunk port.
- 5.** Assign ports 2–10 to VLAN 200 as untagged (U) members.
- 6.** Assign ports 11–30 to VLAN 100 as untagged (U) members.
- 7.** Assign LAG1 to VLAN 100 and 200 as a tagged (T) member.
- 8.** Assign port 1 and LAG2 to VLAN 100, VLAN 200, VLAN 300, and VLAN 400 as a tagged (T) member.
- 9.** Configure the MAC-based VLAN information.
- 10.** If desired, copy the running configuration to the startup configuration.

## Configuring VLANs Using the CLI

This example shows how to perform the same configuration by using CLI commands.

### Configure the VLANs and Ports on Switch 1

Use the following steps to configure the VLANs and ports on Switch 1. None of the hosts that connect to Switch 1 use the Engineering VLAN (VLAN 100), so it is not necessary to create it on that switch.

To configure Switch 1:

1. Create VLANs 200 (Marketing), 300 (Sales), and 400 (Payroll), and associate the VLAN ID with the appropriate name.

```
console#configure
console(config)#vlan 200
console(config-vlan200)#name Marketing
console(config-vlan200)#exit
console(config)#vlan 300
console(config-vlan300)#name Sales
console(config-vlan300)#exit
console(config)#vlan 400
console(config-vlan400)#name Payroll
console(config-vlan400)#exit
```

2. Assign ports 16–20 to the Marketing VLAN.

```
console(config)#interface range tengigabitEthernet 1/0/16-20
console(config-if)#switchport mode access
console(config-if)#switchport access vlan 200
console(config-if)#exit
```

3. Assign ports 2–15 to the Payroll VLAN

```
console(config)#interface range tengigabitEthernet 1/0/2-15
console(config-if)#switchport mode access
console(config-if)#switchport access vlan 400
console(config-if)#exit
```

4. Assign LAG1 to the Payroll VLAN and specify that frames will always be transmitted untagged with a VLAN ID of 400. By default, all VLANs are members of a trunk port. VLAN 200 and 300 frames will be transmitted tagged. This port is removed from VLAN 1 membership.

```
console (config) #interface port-channel 1
console (config-if-Po1) #switchport mode trunk
console (config-if-Po1) #switchport trunk native vlan 400
console (config-if-Po1) #exit
```

5. Configure port 1 as a trunk port and add VLAN 200, VLAN 300, and VLAN 400 as members. All VLANs are added to trunk ports by default, including those created after the trunk port has been created. VLAN 200, 300, and 400 frames are transmitted tagged. Native VLAN 1 is still configured on this port.

```
console (config) #interface tengigabitEthernet 1/0/1
console (config-if-Te1/0/1) #switchport mode trunk
console (config-if-Te1/0/1) #exit
```

6. Configure the MAC-based VLAN information.

The following commands show how to associate a system with a MAC address of 00:1C:23:55:E9:8B with VLAN 300. Repeat the **vlan association mac** command to associate additional MAC addresses with VLAN 300.

```
console (config) #vlan 300
console (config-vlan10) #vlan association mac 00:1C:23:55:E9:8B
console (config-vlan10) #exit
console (config) #exit
```

7. To save the configuration so that it persists across a system reset, use the following command:

```
console#copy running-config startup-config
```

**8.** View the VLAN settings.

```
console#show vlan
```

VLAN	Name	Ports	Type
1	Default	Po1-12, Tel/0/2-15, Default Tel/0/21-24 Tel/12	
200	Marketing	Tel/0/1, Tel/0/16-20	Static
300	Sales	Tel/0/1	Static
400	Payroll	Tel/0/1-15	Static

**9.** View the VLAN membership information for a port.

```
console(config-vlan100)#show interfaces switchport Te1/0/1
Port: Te1/0/1
VLAN Membership Mode: Trunk Mode
Access Mode VLAN: 1 (default)
General Mode PVID: 1 (default)
General Mode Ingress Filtering: Enabled
General Mode Acceptable Frame Type: Admit All
General Mode Dynamically Added VLANs:
General Mode Untagged VLANs: 1
General Mode Tagged VLANs:
General Mode Forbidden VLANs:
Trunking Mode Native VLAN: 1 (default)
Trunking Mode Native VLAN Tagging: Disabled
Trunking Mode VLANs Enabled: All
Private VLAN Host Association: none
Private VLAN Mapping:
Private VLAN Operational Bindings:
Default Priority: 0
Protected: Disabled
```

## Configure the VLANs and Ports on Switch 2

Use the following steps to configure the VLANs and ports on Switch 2. Many of the procedures in this section are the same as procedures used to configure Switch 1. For more information about specific procedures, see the details and figures in the previous section.

To configure Switch 2:

1. Create the Engineering, Marketing, Sales, and Payroll VLANs.  
Although the Payroll hosts do not connect to this switch, traffic from the Payroll department must use Switch 2 to reach the rest of the network and Internet through the uplink port. For that reason, Switch 2 must be aware of VLAN 400 so that traffic is not rejected by the trunk port.
2. Configure ports 2-10 as access ports and add VLAN 200 to the ports.
3. Configure ports 11-30 as access ports and add VLAN 100 to the ports.
4. Configure LAG 1 as a general port so that it can be a member of multiple untagged VLANs and add VLAN 100 and VLAN 200 to the LAG.
5. Configure port 1 and LAG 2 trunk ports and add VLAN 100, VLAN 200, VLAN 300, and VLAN 400 to the port and LAG.
6. Configure the MAC-based VLAN information.
7. If desired, copy the running configuration to the startup configuration.
8. View VLAN information for the switch and ports.



# Spanning Tree Protocol

## Dell EMC Networking N-Series Switches

This chapter describes how to configure the Spanning Tree Protocol (STP) settings on the switch.

The topics covered in this chapter include:

- STP Overview
- RSTP-PV
- Default STP Values
- Configuring Spanning Tree (Web)
- Configuring Spanning Tree (CLI)
- STP Configuration Examples

## STP Overview

STP is a Layer-2 protocol that provides a tree topology for switches on a bridged LAN. STP allows a network to have redundant paths without the risk of network loops. STP uses the spanning tree algorithm to provide a single path between end stations on a network.

Dell EMC Networking N-Series switches support Classic STP, Multiple STP, and Rapid STP over point-to-point full-duplex links. Half-duplex associated states are not supported in Dell EMC Networking spanning-tree. Dell EMC Networking spanning tree presumes that all links are full-duplex and acts accordingly.

### What Are Classic STP, Multiple STP, and Rapid STP?

Classic STP provides a single path between end stations, avoiding and eliminating loops.

Multiple Spanning Tree Protocol (MSTP) supports multiple instances of Spanning Tree to efficiently channel VLAN traffic over different interfaces. Each instance of the Spanning Tree behaves in the manner specified in IEEE 802.1w, Rapid Spanning Tree (RSTP), with slight modifications in the working but not the end effect (chief among the effects, is the rapid

transitioning of the port to Forwarding). The difference between RSTP and the traditional STP (IEEE 802.1d) is the ability to recognize full-duplex connectivity and ports which are connected to end stations, resulting in rapid transitioning of the port to the Forwarding state and the suppression of Topology Change Notifications.

MSTP is compatible with both RSTP and STP. It behaves appropriately when connected to STP and RSTP bridges. A MSTP bridge can be configured to behave entirely as a RSTP bridge or a STP bridge.

### **How Does STP Work?**

The switches (bridges) that participate in the spanning tree elect a switch to be the root bridge for the spanning tree. The root bridge is the switch with the lowest bridge ID, which is computed from the unique identifier of the bridge and its configurable priority number. When two switches have an equal bridge priority, the switch with the lowest MAC address becomes the root bridge.

After the root bridge is elected, each switch finds the lowest-cost path to the root bridge. The port that connects the switch to the lowest-cost path is the root port on the switch. The switches in the spanning tree also determine which ports have the lowest-path cost for each segment. These ports are the designated ports. Only the root ports and designated ports are placed in a forwarding state to send and receive traffic. All other ports are put into a blocked state to prevent redundant paths that might cause loops. Both internal and external path costs can be configured. For STP, RSTP, and the MSTP CIST, only the external path costs are utilized in the lowest path cost calculation. The internal path cost is used by the MST instances.

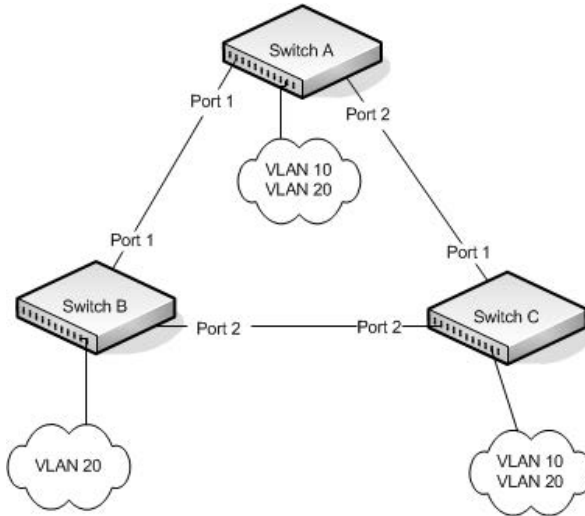
To determine the root path costs and maintain topology information, switches that participate in the spanning tree use Bridge Protocol Data Units (BPDUs) to exchange information.



## How Does MSTP Operate in the Network?

In the following diagram of a small 802.1d bridged network, STP is necessary to create an environment with full connectivity and without loops.

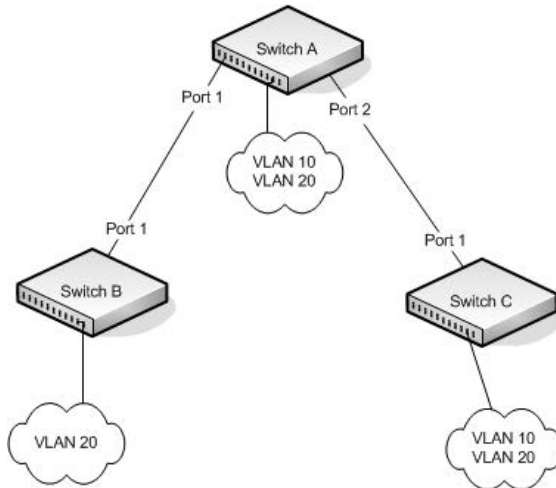
**Figure 21-1. Small Bridged Network**



Assume that Switch A is elected to be the Root Bridge, and Port 1 on Switch B and Switch C are calculated to be the root ports for those bridges, Port 2 on Switch B and Switch C would be placed into the Blocking state. This creates a loop-free topology. End stations in VLAN 10 can talk to other devices in VLAN 10, and end stations in VLAN 20 have a single path to communicate with other VLAN 20 devices.

Figure 21-2 shows the logical single STP network topology.

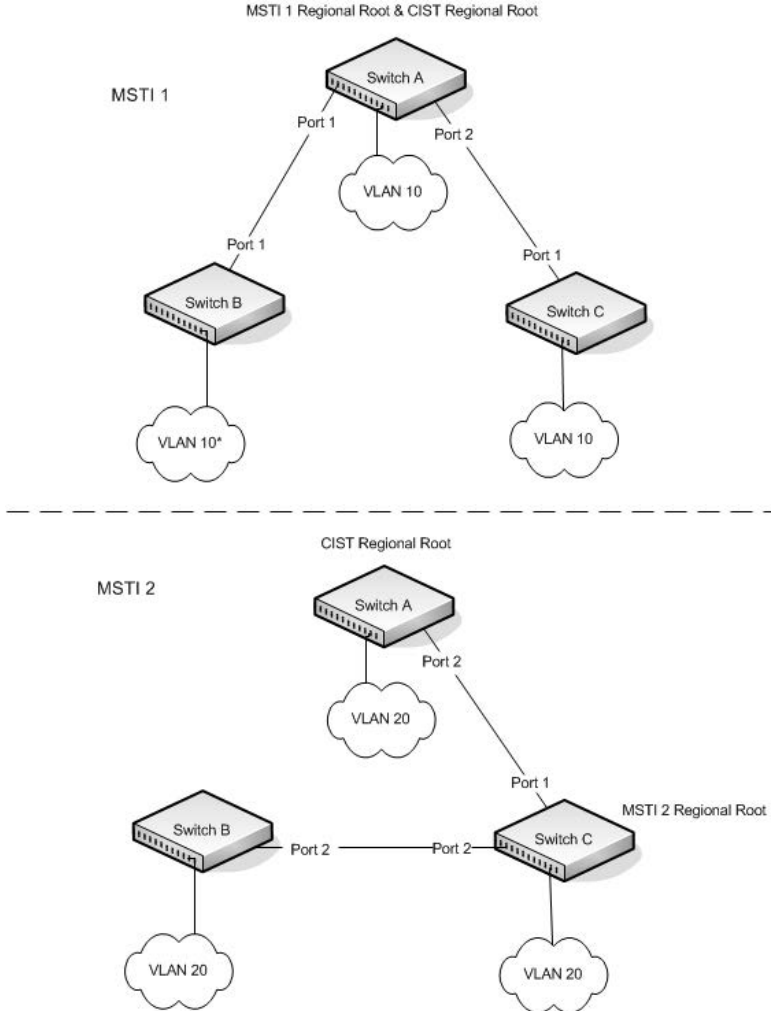
**Figure 21-2. Single STP Topology**



For VLAN 10 this single STP topology is fine and presents no limitations or inefficiencies. On the other hand, VLAN 20's traffic pattern is inefficient. All frames from Switch B will have to traverse a path through Switch A before arriving at Switch C. If the Port 2 on Switch B and Switch C could be used, these inefficiencies could be eliminated. MSTP does just that, by allowing the configuration of MSTIs based upon a VLAN or groups of VLANs. In this simple case, VLAN 10 could be associated with Multiple Spanning Tree Instance (MSTI)1 with an active topology similar to Figure 21-2 and VLAN 20 could be associated with MSTI 2 where Port 1 on both Switch A and Switch B begin discarding and all others forwarding. This simple modification creates an active topology with a better distribution of network traffic and an increase in available bandwidth.

The logical representation of the MSTP environment for these three switches is shown in Figure 21-3.

**Figure 21-3. Logical MSTP Environment**



In order for MSTP to correctly establish the different MSTIs as above, some additional changes are required. For example, the configuration would have to be the same on each and every bridge. That means that Switch B would have to add VLAN 10 to its list of supported VLANs (shown in Figure 21-3 with a \*). This is necessary with MSTP to allow the formation of Regions made up of all switches that exchange the same MST Configuration Identifier. It is within only these MST Regions that multiple instances can exist. It will also allow the election of Regional Root Bridges for each instance. One common and internal spanning tree (CIST) Regional Root for the CIST and an MSTI Regional Root Bridge per instance will enable the possibility of alternate paths through each Region. Above Switch A is elected as both the MSTI 1 Regional Root and the CIST Regional Root Bridge, and after adjusting the Bridge Priority on Switch C in MSTI 2, it would be elected as the MSTI 2 Regional Root.

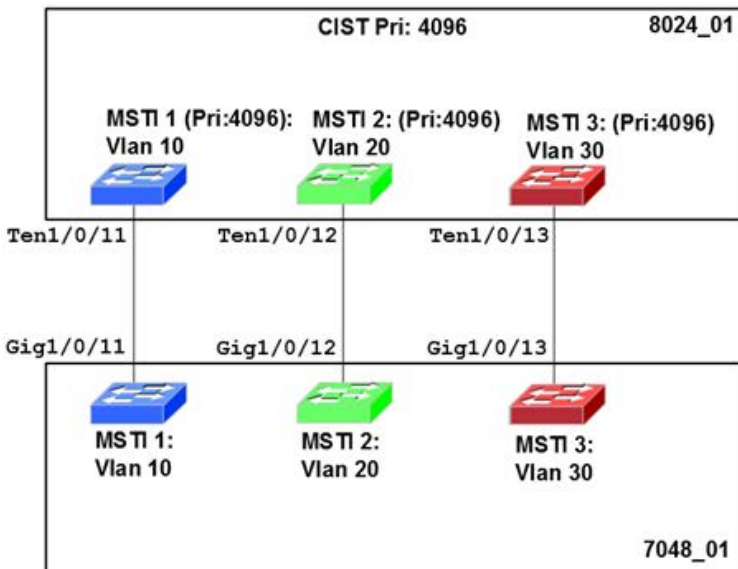
To further illustrate the full connectivity in an MSTP active topology, the following rules apply:

- 1** Each Bridge or LAN is in only one Region.
- 2** Every frame is associated with only one VID.
- 3** Frames are allocated either to the IST or MSTI within any given Region.
- 4** The internal spanning tree (IST) and each MSTI provides full and simple connectivity between all LANs and Bridges in a Region.
- 5** All Bridges within a Region reach a consistent agreement as to which ports interconnect that Region to a different Region and label those as Boundary Ports.
- 6** At the Boundary Ports, frames allocated to the CIST or MSTIs are forwarded or not forwarded alike.
- 7** The CIST provides full and simple connectivity between all LANs and Bridges in the network.

## MSTP with Multiple Forwarding Paths

Consider the physical topology shown in Figure 21-4. It might be assumed that MSTI 2 and MSTI 3 would follow the most direct path for VLANs 20 and 30. However, using the default path costs, this is not the case. MSTI operates without considering the VLAN membership of the ports. This results in unexpected behavior if the active topology of an MSTI depends on a port that is not a member of the VLAN assigned to the MSTI and the port is selected as root port. In this configuration, port TE1/0/11 is selected as the root port and ports TE1/0/12 and TE1/0/13 are blocked. To resolve the issue, set the port path cost of the directly connected links to allow the MSTIs to connect directly.

**Figure 21-4. MSTP with Multiple Forwarding Paths**



## **MSTP and VLAN IDs**

MSTP allows VLAN 4094 to be configured in the MD5 digest of an MSTI region for compatibility purposes. However, the switch reserves VLAN 4094 internally for use in stacking and will drop received packets tagged with VLAN 4094.

## **What are the Optional STP Features?**

The Dell EMC Networking N-Series switches support the following optional STP features:

- BPDU flooding
- PortFast
- BPDU filtering
- Root guard
- Loop guard
- BPDU protection

## **BPDU Flooding**

The BPDU flooding feature determines the behavior of the switch when it receives a BPDU on a port that is disabled for spanning tree. If BPDU flooding is configured, the switch will flood the received BPDU to all the ports on the switch which are similarly disabled for spanning tree.

## **Port Fast**

The PortFast feature reduces the STP convergence time by allowing edge ports that are connected to end devices (such as a desktop computer, printer, or file server) to transition to the forwarding state without going through the listening and learning states.

## **BPDU Filtering**

Ports that have the PortFast feature enabled continue to transmit BPDUs. The BPDU filtering feature prevents PortFast-enabled ports from sending BPDUs.

If BPDU filtering is configured globally on the switch, the feature is automatically enabled on all operational PortFast-enabled ports. These ports are typically connected to hosts that drop BPDUs. However, if an operational edge port receives a BPDU, the BPDU filtering feature disables PortFast and allows the port to participate in the spanning tree calculation.

Enabling BPDU filtering on a specific port prevents the port from sending BPDUs and allows the port to drop any BPDUs it receives.

### **Root Guard**

Root guard is another way of controlling the spanning-tree topology other than setting the bridge priority or path costs. Root guard ensures that a port does not become a root port or a blocked port. When a switch is elected as the root bridge, all ports are assigned roles as designated ports unless two or more ports of the root bridge are connected in a loop. If the switch receives a superior STP BPDU on a root-guard enabled port, the root guard feature moves the port to a root-inconsistent spanning-tree state. No traffic is forwarded across the port, but it continues to receive BPDUs, discards received traffic, and is included in the active topology. Essentially, this is equivalent to the IEEE 802.1D listening state. By not transitioning the port on which the superior BPDU has been received to the forwarding state (designated role), root guard helps maintain the existing spanning-tree topology.

When the STP mode is configured as MSTP, the port may be a designated port in one MSTI and an alternate port in the CIST, etc. Root guard is a per port (not a per port instance command) configuration, so all the MSTP instances this port participates in should not be expected to take on a root role.

### **Loop Guard**

Loop guard protects a network from forwarding loops induced by BPDU packet loss. The reasons for failing to receive packets are numerous, including heavy traffic, software problems, incorrect configuration, and unidirectional link failure. When a non-designated port no longer receives BPDUs, the spanning tree algorithm considers the link to be loop free and transitions the link from blocking to forwarding. Once in the forwarding state, the link may create a loop in the network.

Enabling loop guard prevents such accidental loops. When a port is no longer receiving BPDUs and the max age timer expires, the port is moved to a *loop-inconsistent blocking state*. In the loop-inconsistent blocking state, traffic is not forwarded so the port behaves as if it is in the blocking state; that is, it discards received traffic, does not learn MAC addresses, and is not part of the active topology. The port will remain in this state until it receives a BPDU. It will then transition through the normal spanning tree states based on the information in the received BPDU.



**NOTE:** Loop Guard should be configured only on non-designated ports. These include ports in alternate or backup roles. Root ports and designated ports should not have loop guard enabled so that they can forward traffic.

### **BPDU Protection**

When the switch is used as an access-layer device, most ports function as edge ports that connect to a device such as a desktop computer or file server. The port has a single, direct connection and is configured as an edge port to implement the fast transition to a forwarding state. When the port receives a BPDU packet, the system sets it to non-edge port and recalculates the spanning tree, which causes network topology flapping. In normal cases, these ports do not receive any BPDU packets. However, someone may forge BPDU to maliciously attack the switch and cause network flapping.

BPDU protection can be enabled in RSTP to prevent such attacks. When BPDU protection is enabled, the switch disables an access port that has received a BPDU and notifies the network manager about it.

## **RSTP-PV**

Dell EMC Networking N-Series switches support both Rapid Spanning Tree Per VLAN (RSTP-PV) and Spanning Tree Per VLAN (STP-PV) with a high degree of interoperability with other vendor implementations, such as Cisco's PVST+ and RPVST+. RSTP-PV is the IEEE 802.1w (RSTP) standard implemented per VLAN. A single instance of rapid spanning tree (RSTP) runs on each configured VLAN. Each RSTP instance on a VLAN has a root switch. The RSTP-PV protocol state machine, port roles, port states, and timers are similar to those defined for RSTP. RSTP-PV embeds the DRC and IndirectLink Fast Rapid Convergence (IRC) features, which cannot be disabled.



STP-PV is the IEEE 802.1s (STP) standard implemented per VLAN. The STP-PV-related state machine, roles, and timers are similar to those defined for STP. STP-PV does not have the DirectLink Rapid Convergence (DRC) or IndirectLink Rapid Convergence (IRC) features enabled by default. These features can be enabled by the switch administrator. STP-PV/RSTP-PV are not compatible with protocol-based VLANs. Ensure that ports enabled for per-VLAN spanning tree are not configured for protocol-based VLAN capability.

The switch spanning tree configuration is global in nature. Enabling RSTP-PV disables other spanning tree modes on the switch. The switch cannot operate with some ports configured to operate in standard spanning tree mode and others to operate in RSTP-PV mode. However, RSTP-PV has fallback modes for compatibility with standards-based versions of spanning tree.

**Access Ports**—For an access port, normal IEEE BPDUs will be received and sent, though STP-PV or RSTP-PV is enabled on the switch. BPDUs received on the access port will be associated with the CST instance.

**Trunk Ports**—If the native VLAN on an IEEE 802.1Q trunk is VLAN 1:

- VLAN 1 STP BPDUs are sent to the IEEE STP MAC address (0180.c200.0000), untagged.
- VLAN 1 STP BPDUs are also sent to the SSTP MAC address, untagged.
- Non-VLAN 1 STP BPDUs are sent to the SSTP MAC address (also called the Shared Spanning Tree Protocol [SSTP] MAC address, 0100.0ccc.cccd), tagged with a corresponding IEEE 802.1Q VLAN tag.

If the native VLAN on an IEEE 802.1Q trunk is not VLAN 1:

- VLAN 1 STP BPDUs are sent to the SSTP MAC address, tagged with a corresponding IEEE 802.1Q VLAN tag.
- VLAN 1 STP BPDUs are also sent to the IEEE STP MAC address on the Native VLAN of the IEEE 802.1Q trunk, untagged.
- Non-VLAN 1 STP BPDUs are sent to the SSTP MAC address, tagged with a corresponding IEEE 802.1Q VLAN tag.

## DirectLink Rapid Convergence

The DirectLink Rapid Convergence (DRC) feature is designed for an access-layer switch that has redundant blocked uplinks. It operates on ports blocked by spanning tree. DRC can be configured for the entire switch; it cannot be enabled for individual VLANs.

The DRC feature is based on the concept of an uplink group. An uplink group consists of all the ports that provide a path to the root bridge (the root port and any blocked ports). If the root port fails, the blocked port with next lowest cost from the uplink group is selected and immediately put in the forwarding state without going through the standard spanning tree listening and learning states.

To accelerate convergence time once DRC has switched over to a new root port, STP-PV transmits dummy packets out the new root port, with the source MAC addresses taken from its forwarding table. The destination address is an SSTP MAC address that ensures that the packet is flooded on the whole network. The packets update the forwarding tables on the other upstream switches. The rate at which the dummy multicasts are sent can be configured by the administrator. RSTP-PV has a different mechanism adopted from IEEE 802.1w that handles the update of the forwarding database and the fast transition to a new uplink. DRC can be enabled on RSTP-PV enabled switches but has no effect.

DRC is disabled when the administrator modifies the spanning-tree priority of a VLAN and is re-enabled only when the default priority is restored.

### DRC and Link Up Events

In the event of failure of the primary uplink, a replacement uplink is immediately selected from the uplink group and put into the forwarding state. If another port is enabled that, in accordance with STP rules, should become the primary uplink (root port), the switch delays migrating to the new port for twice the forwarding delay. The purpose of this delay is two-fold:

- **Stability**—If the primary uplink is flapping, reenabling the link immediately can introduce additional instability into the network.
- **Reduced Traffic Loss**—DRC moves a port into the forwarding state as soon as it is up, but the connected port obeys the usual STP rules; i.e. it goes through the listening and learning stages, which take 15 seconds each

by default. Delaying the switchover allows the connected port to go through the listening and learning states while the switch is still transmitting packets on the original uplink.

The optimal behavior is to keep the current uplink active and hold the new port in the blocked state for twice the forwarding delay.

## IndirectLink Rapid Convergence Feature

To handle indirect link failure, the STP standard requires that a switch passively wait for “max\_age” seconds once a topology change has been detected. IndirectLink Rapid Convergence (IRC) handles these failures in two phases:

- Rapid detection of an indirect link failure. Tracking the inferior BPDUs that a designated bridge detects when it transmits a direct link failure indicates that a failure has occurred elsewhere in the network.
- Performing an immediate check if the BPDU information stored on a port is still valid. This is implemented with a new protocol data unit (PDU) and the Root Link Query message (RLQ).

Receiving an inferior BPDU on a port from the designated bridge indicates that one of the following has occurred on the designated bridge:

- The path to the root has been lost and the switch starts to advertise a root with a numerically higher bridge ID (worse root) than the local switch.
- The path cost to the root has increased above the path cost of the local switch.

IEEE 802.1s behavior is to ignore inferior BPDUs. IRC retains the inferior BPDUs sent by the designated bridge and processes them to determine if a failure has occurred on the path to the root. In this case, it must age-out at least one port. This process occurs only in the case that a bridge in the network detects a direct link failure.

The switch tracks inferior BPDUs sent by the designated bridge only, since this is the BPDU that is stored for the port. If, for instance, a newly inserted bridge starts to send inferior BPDUs, it does not start the IRC feature.

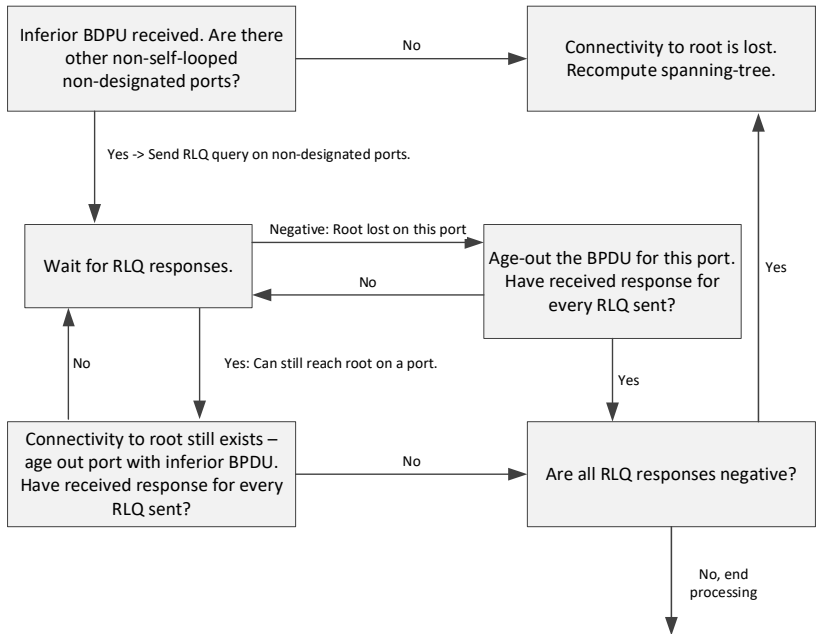
Similar to DRC, the IEEE 802.1w standard incorporated the IRDC feature. RSTP-PV enabled switches allow IRC to be enabled or disabled, but ignore the setting as the RSTP-PV state machines already implement IRC.

### Reacting to Indirect Link Failures

When an inferior BPDU is received on a non-designated port, phase 2 of IRC processing starts. An RLQ PDU is transmitted on all non-designated ports except the port where the inferior BPDU was received and self-looped ports. This action is intended to verify that the switch can still receive from the root

on ports that should have a path to the root. The port where the switch received the inferior BPDU is excluded because it already failed; self-looped and designated ports are eliminated as they do not have a path to the root.

**Figure 21-5. IRC Flow**



Upon receiving a negative RLQ response on a port, the port has lost connection to the root and the switch ages-out its BPDU. If all other non-designated ports received a negative answer, the switch has lost the root and restarts the STP calculation.

If the response confirms the switch can still access the root bridge via a particular port, it immediately ages-out the port on which the inferior BPDU was received.

If the switch only received responses with a root different from the original root, it has lost the root port and restarts the STP calculation immediately.

## Interoperability Between STP-PV and RSTP-PV Modes

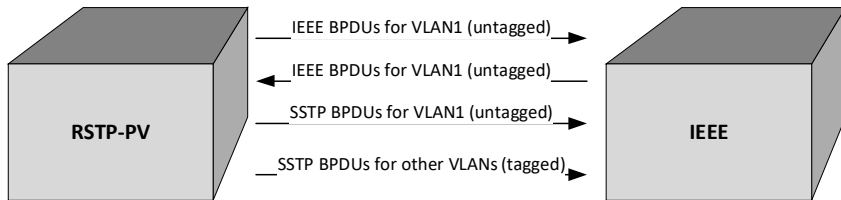
STP-PV is derived from 802.1D and RSTP-PV is derived from 802.1w. The fallback mechanism is the same as between a standard 802.1D switch and a standard 802.1w switch. When a lower protocol version BPDU is received on a switch that runs a higher protocol version, the latter falls back to the lower version after its migration delay timer expires.

For example, an RSTP-PV switch, when connected to STP-PV switch, falls back to the STP-PV protocol after the migration delay timer expires.

## Interoperability With IEEE Spanning Tree Protocols

When a switch configured with RSTP-PV receives IEEE standard RSTP BPDUs on a port, it responds with two versions of BPDUs on the port: SSTP formatted BPDUs and IEEE standard STP BPDUs. The IEEE standard BPDUs are processed by the peer switch running MSTP/RSTP, and the SSTP format BPDUs are flooded across the MSTP/RSTP domain.

**Figure 21-6. RSTP-PV and IEEE Spanning Tree Interoperability**



## Common Spanning Tree

There are differences between the ways that MSTP and RSTP-PV map spanning tree instances to VLANs: RSTP-PV creates a spanning tree instance for each VLAN, and MSTP maps one or more VLANs to each MST instance. Where an RSTP-PV region is connected to an MSTP region, the set of RSTP-PV instances does not generally match the set of MST instances. Therefore, the RSTP-PV region and the MSTP region communicate with each other on a single common spanning tree instance.

For the MSTP region, the MSTP instance communicates to the RSTP-PV region using the CIST. For the RSTP-PV region, switches use the VLAN 1 RSTP-PV instance as the common spanning tree. On the link between the

RSTP-PV region and the MSTP region, the RSTP-PV switch sends VLAN1 BPDUs in IEEE standard format, so they can be interpreted by the MSTP peers. Similarly, the RSTP-PV switch processes incoming MSTP BPDUs as though they were BPDUs for the VLAN 1 RSTP-PV instance.

If the RSTP-PV switch ports connected to the MSTP switches are configured with a native VLAN, the RSTP-PV switches are able to detect IEEE standard format BPDUs arriving from peer switches, incorporate them into the common spanning tree that operates in the native VLAN (VLAN 1), and transmit untagged STP or RSTP packets to the STP/RSTP peers, in addition to the SSTP format BPDUs.

### **SSTP BPDUs Flooding Across MST (CST) Regions**

In addition to the IEEE standard RSTP or STP BPDUs that the RSTP-PV switch sends to the MSTP (or RSTP or STP) region, the switch sends SSTP format BPDUs for VLAN 1 untagged. The MSTP switch does not interpret the SSTP BPDUs as standard BPDUs because they do not use the standard destination MAC address, so it makes no spanning tree decisions based on them. Instead, it floods the SSTP BPDUs over all ports in the corresponding VLAN. These SSTP BPDUs may be multicast over the MSTP region to other RSTP-PV switches, which use them to maintain the VLAN 1 spanning tree topology across the MSTP (non-RSTP-PV) switches.

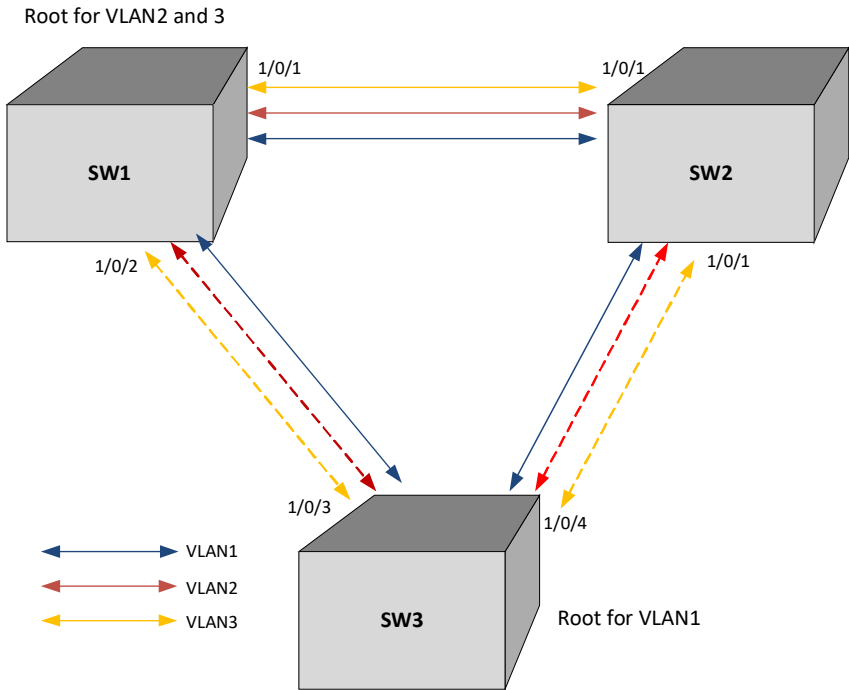
The RSTP-PV switches also send SSTP format BPDUs for the other (non-VLAN 1) RSTP-PV instances into the MSTP region, tagged with the VID of their associated VLANs. These SSTP packets are also be multicast by the switches in the MSTP region, and will reach any other RSTP-PV regions connected to the MSTP region. The switches in the remote RSTP-PV regions receive and process them as normal RSTP-PV BPDUs. Thus, RSTP-PV instances are transparently expanded across the MSTP region and their spanning trees span the MSTP region. For RSTP-PV, the MSTP region is treated as a single hub.

### **Interoperability with RSTP**

In Figure 21-7:

- SW1 and SW2 are Dell EMC Networking N-Series switches running RSTP-PV with default bridge priority 32768.
- SW3 is a Dell EMC Networking N-Series switch running RSTP with default bridge priority 32768.

**Figure 21-7. RSTP-PV and RSTP Interoperability**



SW3 sends IEEE STP BPDUs to the IEEE multicast MAC address as untagged frames. These BPDUs are processed by the VLAN 1 STP instance on the RSTP-PV switch as part of the VLAN 1 STP instance.

The RSTP-PV side sends IEEE STP BPDUs corresponding to the VLAN 1 STP to the IEEE MAC address as untagged frames across the link. At the same time, SSTP BPDUs are sent as untagged frames. IEEE switches simply flood the SSTP BPDUs throughout VLAN 1. This facilitates RSTP-PV connectivity in case there are other RSTP-PV switches connected to the IEEE STP domain.

For non-native VLANs (VLANs 2–4093), the RSTP-PV switch sends SSTP BPDUs, tagged with their VLAN number. The VLAN STP instances are multicast across the RSTP region, as if it were a hub switch.



The VLAN 1 STP instance of SW1 and SW2 are joined with the STP instance running in SW3. VLANs 2 and 3 consider the path across SW3 as another segment linking SW1 and SW2, and their SSTP information is multicast across SW3.

The bridge priority of SW1 and SW2 for VLAN1 instance is 32769 (bridge priority + VLAN identifier).

The bridge priority of SW3 is 32768, per the IEEE 802.w standard.

SW3 is selected as Root Bridge for the VLAN1 instance that is CST, and SW1 is selected as Root Bridge for VLAN2 and VLAN3 (based on the low MAC address of SW1).

### **Interoperability with MSTP**

RSTP-PV runs an individual RSTP instance for each VLAN. MSTP maps VLANs to MSTIs, so one-to-one mapping between VLAN and STP instance is not possible.

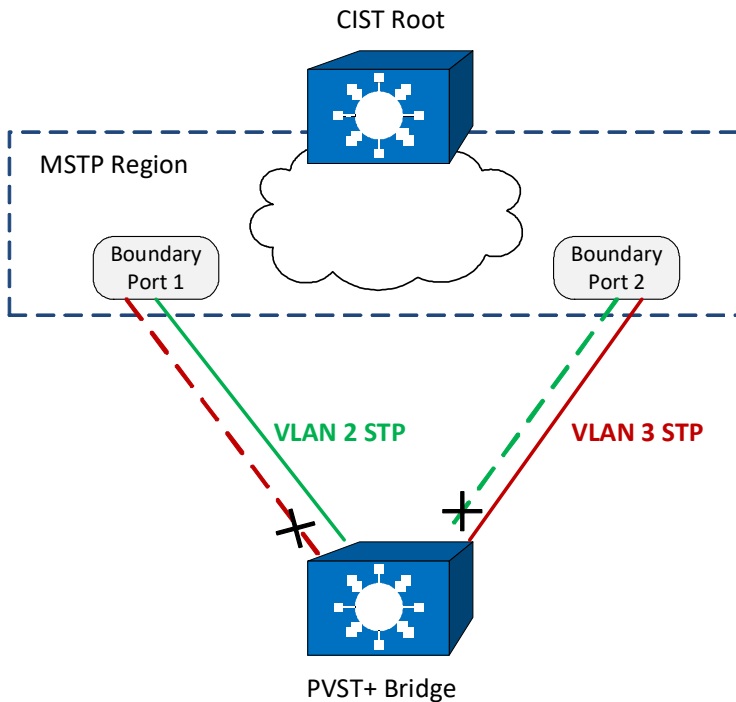
MSTP runs multiple MSTIs inside a region and maps them to the CIST on the border ports. The interoperability model must ensure that internal MSTIs are aware of changes to any of the RSTP-PV trees. Therefore, the simplest way to ensure the correct behavior is to join ALL RSTP-PV trees to the CST.

Connecting RSTP-PV trees to the CST ensures that changes in any of the RSTP-PV STP instances will affect the CST and all MSTIs. This approach ensures that no changes go unnoticed and no black holes occur in a single VLAN. As with IEEE STP, every tree in the RSTP-PV domain views the MSTP regions as virtual bridges with multiple boundary ports. A topology change in any of the RSTP-PV spanning trees will affect the CST and propagate through every MSTI instance in all MSTP regions. This behavior, consequently, makes the MSTP topology less stable.

The MSTP implementation simulates RSTP-PV by replicating CIST BPDUs on the link facing the RSTP-PV domain and sending those BPDUs on ALL VLANs active on the trunk. The MSTP switch processes IEEE STP VLAN 1 BPDUs received from the RSTP-PV domain using the CIST instance. The RSTP-PV+ domain interprets the MSTP domain as an RSTP-PV bridge with all per-VLAN instances claiming the CIST Root as the root of their individual spanning tree. For the common STP Root elected between MSTP and RSTP-PV, two options are possible:

- The MSTP domain contains the root bridge for ALL VLANs. This implies that the CIST Root Bridge ID is configured to be better than any RSTP-PV STP root Bridge ID. If there is only one MSTP region connected to the RSTP-PV domain, then all boundary ports on the virtual-bridge will be unblocked and used by RSTP-PV. This is the only supported topology, as the administrator can manipulate uplink costs on the RSTP-PV side and obtain optimal traffic engineering results. In Figure 21-8, VLANs 2 and 3 have their STP costs configured to select different uplinks connected to the MSTP region's boundary ports. Since the CIST Root is inside the MSTP region, both boundary ports are non-blocking designated and the load balancing scheme operates as expected.

**Figure 21-8. MSTP and RSTP-PV Interoperability**



- The alternative is that the RSTP-PV domain contains the root bridges for ALL VLANs. This is only true if all RSTP-PV root bridges' Bridge IDs for all VLANs are better than the MSTP CIST Root Bridge ID. This is not a supported topology, because all MSTIs map to CIST on the border link, and it is not possible to load-balance the MSTIs as they enter the RSTP-PV domain.

The Dell EMC Networking RSTP-PV implementation does not support the second option. The MSTP domain must contain the bridge with the best Bridge ID to ensure that the CIST Root is also the root for all RSTP-PV trees. In any other case, the MSTP border switch will place the ports that receive superior BPDUs from the RSTP-PV region in the root-inconsistent state. To resolve this issue, ensure that the RSTP-PV domain does not have any bridges with Bridge IDs better than the CIST Root Bridge ID.

### **Native VLAN Inconsistent State**

This occurs if a trunk port receives an untagged SSTP BPDU with a VLAN type, length, value (TLV) that does not match the VLAN where the BPDU was received. In this case, the port transitions to the blocked state.

### **Configuration Examples**

See "RSTP-PV Access Switch Configuration Example" on page 918.

## Default STP Values


Spanning tree is globally enabled on the switch and on all ports and LAGs.

Table 21-1 summarizes the default values for STP.

**Table 21-1. STP Defaults**

Parameter	Default Value
Enable state	Enabled (globally and on all ports)
Spanning tree mode	RSTP (Classic STP, STP-PV, RSTP-PV and MSTP are disabled)
Switch priority	32768
BPDU flooding	Disabled
PortFast mode	Disabled
PortFast BPDU filter	Disabled
Loop guard	Disabled
BPDU protection	Disabled
Spanning tree port priority	128
Maximum-aging time	20 seconds
Forward-delay time	15 seconds
Maximum hops	20
Spanning tree transmit hold count	6
MSTP region name	MAC address of switch
MSTP included VLANs	1

## Configuring Spanning Tree (Web)

This section provides information about the OpenManage Switch Administrator pages for configuring and monitoring STP settings on Dell EMC Networking N1100-ON, N1500, N2000, N2100-ON, N2200-ON, and N3100-ON Series switches. For details about the fields on a page, click  at the top of the Dell EMC OpenManage Switch Administrator web page.

### STP Global Settings

The **STP Global Settings** page contains fields for enabling STP on the switch.

To display the **STP Global Settings** page, click **Switching** → **Spanning Tree** → **Global Settings** in the navigation panel.

**Figure 21-9. Spanning Tree Global Settings**

**System**  
Dell Networking N3048  
any, 11w

**Global Settings**  
Detail

Global Settings: Detail

Global Settings

Spanning Tree Status	Enable
STP Operation Mode	Rapid STP
BPDU Flooding	Disable
Port Fast	<input type="checkbox"/>
Port Fast BPDU Filter	Disable
Loop Guard	Disable
BPDU Protection	Disable

Bridge Settings [Back to top](#)

Priority	32768 (0 to 61440)
Bridge Address	001E.C9DE.B207
Max Age	20 (6 to 40 seconds)
Forward Delay	15 (4 to 30 seconds)
Maximum Hops	20 (6 to 40)
Spanning Tree Tx Hold Count	6 (1 to 10 seconds)

Designated Root Status [Back to top](#)

Root Bridge Priority	32768
Root Bridge Address	001E.C9DE.B207
Root Port	This switch is the root.
Root Path Cost	0
Topology Changes Count	0
Last Topology Change	0 day 3 hr 35 min 53 sec

[Apply](#)

## STP Port Settings

Use the STP Port Settings page to assign STP properties to individual ports. To display the STP Port Settings page, click **Switching** → **Spanning Tree** → **STP Port Settings** in the navigation panel.

**Figure 21-10. STP Port Settings**

The screenshot shows the 'STP Port Settings' configuration page. On the left is a navigation tree with 'STP Port Settings' selected. The main area displays a table of settings for a selected port (Unit 1, Port Gi1/0/1).

STP Port Settings: Detail	
Select a Port	Unit <b>1</b> Port <b>Gi1/0/1</b>
STP	<b>Enable</b>
Port Fast	<input type="checkbox"/>
Port State	Disabled
STP Root Guard	<b>Disable</b>
Role	Disabled
Speed	Auto
Path Cost	<input type="text" value="0"/> (0 to 200000000)
Priority	<input type="text" value="128"/> (0 to 240)
External Path Cost	<input type="text" value="0"/> (0 to 200000000)
Loop Guard	<b>Disable</b>
TCN Guard	<b>Disable</b>
Auto Edge	<b>Enable</b>
Port Fast BPDU Filter	<b>Disable</b>
Designated Bridge Priority	32768
Designated Bridge Address	001E.C9DE.B207
Designated Port ID	00:00
Designated Cost	0
LAG	None

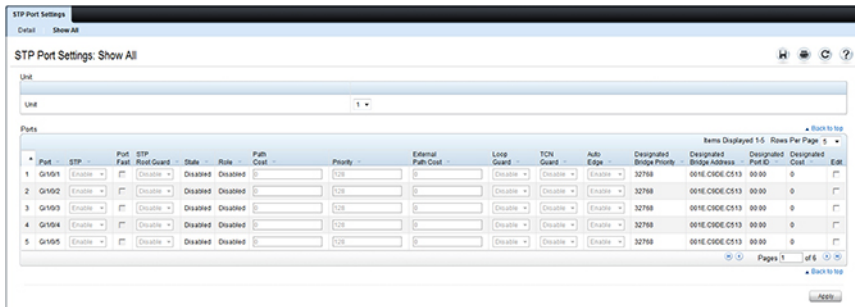
Apply

## Configuring STP Settings for Multiple Ports

To configure STP settings for multiple ports:

- 1 Open the **STP Port Settings** page.
- 2 Click **Show All** to display the **STP Port Table**.

**Figure 21-11. Configure STP Port Settings**



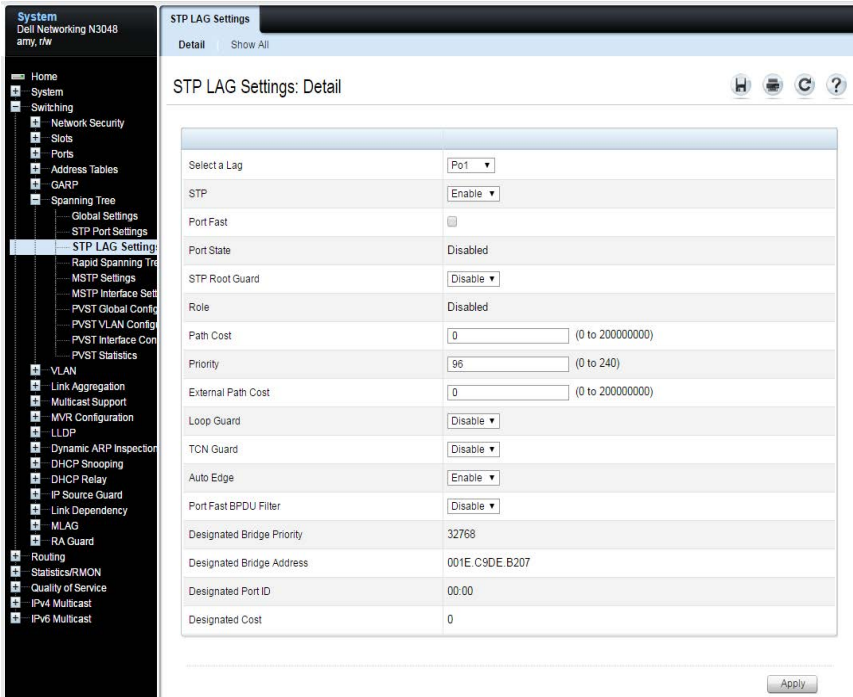
- 3 For each port to configure, select the check box in the **Edit** column in the row associated with the port.
- 4 Select the desired settings.
- 5 Click **Apply**.



## STP LAG Settings

Use the STP LAG Settings page to assign STP aggregating ports parameters. To display the STP LAG Settings page, click **Switching** → **Spanning Tree** → **STP LAG Settings** in the navigation panel.

**Figure 21-12. STP LAG Settings**

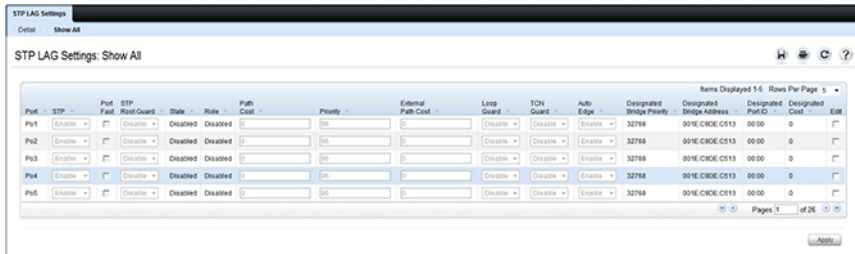


### Configuring STP Settings for Multiple LAGs

To configure STP settings on multiple LAGs:

- 1 Open the STP LAG Settings page.
- 2 Click Show All to display the STP LAG Table.

**Figure 21-13. Configure STP LAG Settings**



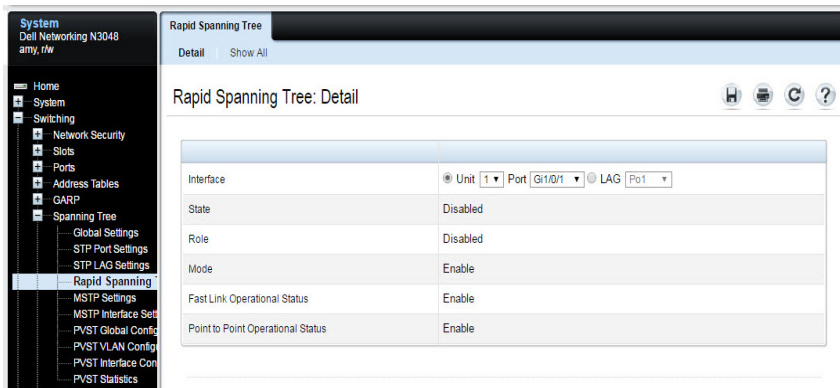
- 3 For each LAG to configure, select the check box in the **Edit** column in the row associated with the LAG.
- 4 Select the desired settings.
- 5 Click **Apply**.

## Rapid Spanning Tree

Rapid Spanning Tree Protocol (RSTP) detects and uses network topologies that allow a faster convergence of the spanning tree without creating forwarding loops.

To display the **Rapid Spanning Tree** page, click **Switching** → **Spanning Tree** → **Rapid Spanning Tree** in the navigation panel.

**Figure 21-14. Rapid Spanning Tree**



To view RSTP Settings for all interfaces, click the Show All link. The Rapid Spanning Tree Table displays.

**Figure 21-15. RSTP Settings**

The screenshot shows the 'Rapid Spanning Tree: Show All' configuration page. It includes a 'Unit' dropdown menu set to '1'. Below are two tables: 'Interfaces' and 'LAGs'. Both tables have columns for ID, Name, Role, Fast Link Operational Status, and Point to Point Operational Status. The 'Interfaces' table lists Gi1/0/1 through Gi1/0/5, all with 'Disabled' roles and 'Enable' operational statuses. The 'LAGs' table lists Po1 through Po5, all with 'Disabled' roles and 'Enable' operational statuses. Navigation controls like 'Back to top', 'Items Displayed', and 'Rows Per Page' are visible for both tables.

Rapid Spanning Tree: Show All				
Unit: 1				
Interfaces				
ID	Interface	Role	Fast Link Operational Status	Point to Point Operational Status
1	Gi1/0/1	Disabled	Enable	Enable
2	Gi1/0/2	Disabled	Enable	Enable
3	Gi1/0/3	Disabled	Enable	Enable
4	Gi1/0/4	Disabled	Enable	Enable
5	Gi1/0/5	Disabled	Enable	Enable
LAGs				
ID	LAGs	Role	Fast Link Operational Status	Point to Point Operational Status
1	Po1	Disabled	Enable	Enable
2	Po2	Disabled	Enable	Enable
3	Po3	Disabled	Enable	Enable
4	Po4	Disabled	Enable	Enable
5	Po5	Disabled	Enable	Enable

## MSTP Settings

The Multiple Spanning Tree Protocol (MSTP) supports multiple instances of Spanning Tree to efficiently channel VLAN traffic over different interfaces. MSTP is compatible with both RSTP and STP; a MSTP bridge can be configured to behave entirely as a RSTP bridge or a STP bridge.

To display the MSTP Settings page, click **Switching** → **Spanning Tree** → **MSTP Settings** in the navigation panel.

**Figure 21-16. MSTP Settings**

The screenshot shows the MSTP Settings configuration page. On the left is a navigation tree with the following items: Home, System, Switching, Network Security, Slots, Ports, Address Tables, GARP, Spanning Tree (expanded), Global Settings, STP Port Settings, STP LAG Settings, Rapid Spanning Tree, **MSTP Settings** (selected), MSTP Interface Settings, PVST Global Config, PVST VLAN Config, PVST Interface Config, PVST Statistics, VLAN, Link Aggregation, Multicast Support, MVR Configuration, LLDP, Dynamic ARP Inspection, DHCP Snooping, DHCP Relay, IP Source Guard, Link Dependency, MLAG, RA Guard, Routing, Statistics/RMON, Quality of Service, IPv4 Multicast, and IPv6 Multicast.

The main content area is titled "MSTP Settings: Detail" and contains two sections:

- Global Settings:**

Region Name	<input type="text" value="00:1E:C9:DE:B2:07"/> (1 to 32 characters)
Revision	<input type="text" value="0"/> (0 to 65535)
Instance ID	80:00:00:1E:C9:DE:B2:07
- Instance Settings:** (with a "Back to top" link)

Instance ID	<input type="text" value="1"/>
Included VLANs	<input type="text" value="1, 2, 3, 4, 5"/>
Priority	<input type="text" value="0"/> (0 to 61440)
BridgeID	001E.C9DE.B207
Root BridgeID	
Root Port	
Root Path Cost	

(with a "Back to top" link)

An "Apply" button is located at the bottom right of the configuration area.

## Viewing and Modifying the Instance ID for Multiple VLANs

To configure MSTP settings for multiple VLANs:

- 1 Open the MSTP Settings page.
- 2 Click Show All to display the MSTP Settings Table.

**Figure 21-17. Configure MSTP Settings**

The screenshot shows the 'MSTP Settings' configuration page. At the top, there are tabs for 'Detail' and 'Show All'. Below the tabs, the page title is 'MSTP Settings: Show All'. There are icons for home, refresh, and help. A table is displayed with the following columns: 'VLAN', 'Instance ID (1-4094)', and 'Edit'. The table contains five rows for VLANs 1, 10, 11, 21, and 41. Each row has an input field for the Instance ID and a checkbox in the Edit column. At the bottom right of the table, there is a pagination control showing 'Pages 1 of 4' and an 'Apply' button.

VLAN	Instance ID (1-4094)	Edit
1	<input type="text"/>	<input type="checkbox"/>
10	<input type="text"/>	<input type="checkbox"/>
11	<input type="text"/>	<input type="checkbox"/>
21	<input type="text"/>	<input type="checkbox"/>
41	<input type="text"/>	<input type="checkbox"/>

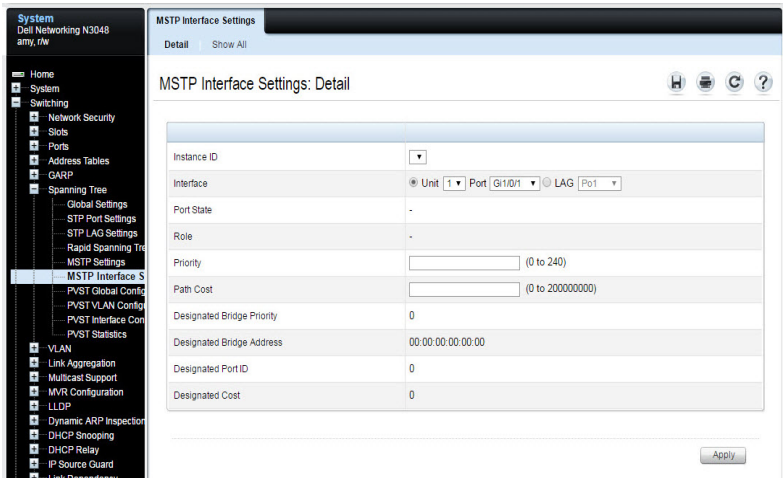
- 3 For each Instance ID to modify, select the check box in the **Edit** column in the row associated with the VLAN.
- 4 Update the **Instance ID** settings for the selected VLANs.
- 5 Click **Apply**.

## MSTP Interface Settings

Use the MSTP Interface Settings page to assign MSTP settings to specific interfaces.

To display the MSTP Interface Settings page, click **Switching** → **Spanning Tree** → **MSTP Interface Settings** in the navigation panel.

**Figure 21-18. MSTP Interface Settings**



### Configuring MSTP Settings for Multiple Interfaces

To configure MSTP settings for multiple interfaces:

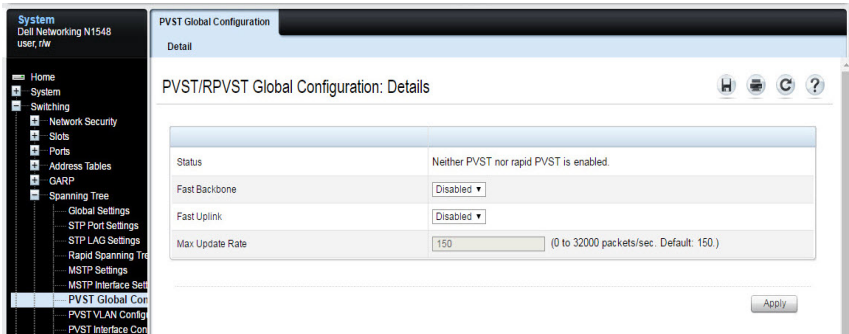
- 1 Open the **MSTP Interface Settings** page.
- 2 Click **Show All** to display the **MSTP Interface Table**.
- 3 For each interface to configure, select the check box in the **Edit** column in the row associated with the interface.
- 4 Update the desired settings.
- 5 Click **Apply**.

## PVST/RPVST Global Configuration

Use the **PVST/RPVST Global Configuration** page to enable or disable the global per-VLAN spanning tree (PVST) and per-VLAN rapid spanning tree (RPVST) features on the switch.

To display the **PVST/RPVST Global Configuration** page, click **Switching** → **Spanning Tree** → **PVST Global Configuration** in the navigation panel.

**Figure 21-19. PVST/RPVST Global Configuration**

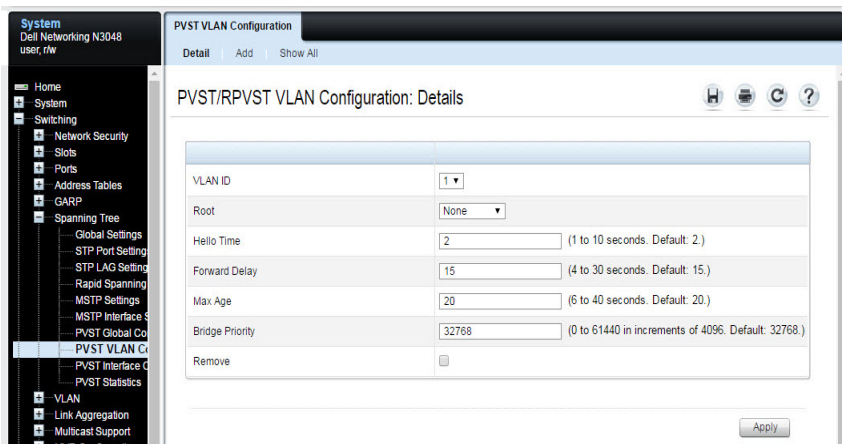


## PVST/RPVST VLAN Configuration

Use the **PVST/RPVST VLAN Configuration** page to configure the PVST/RPVST settings for VLANs that are enabled for PVST/RPVST.

To display the **PVST/RPVST VLAN Configuration** page, click **Switching** → **Spanning Tree** → **PVST VLAN Configuration** in the navigation panel.

**Figure 21-20. PVST/RPVST VLAN Configuration**



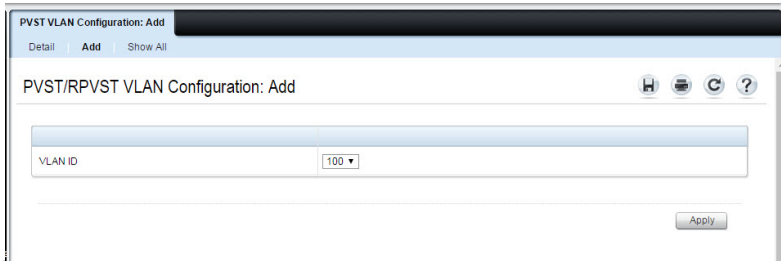
### Enabling a VLAN for PVST/RPVST

To enable PVST/RPVST on a VLAN:

- 1 Open the **PVST/RPVST VLAN Configuration** page.
- 2 Click **Add** to display the **PVST/RPVST VLAN Configuration: Add** page.
- 3 From the **VLAN ID** menu, select the VLAN on which to enable PVST/RPVST.



**Figure 21-21. PVST/RPVST VLAN Configuration: Add**



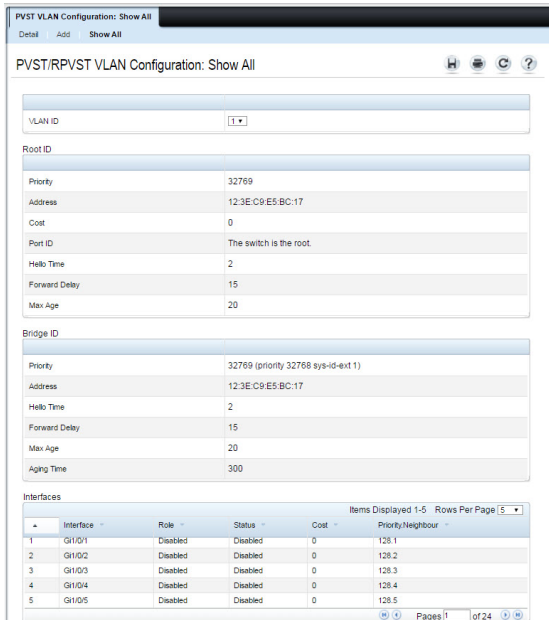
Only VLANs with the PVST/RPVST feature disabled appear in the list.

- 4 Click Apply.

### Viewing VLAN PVST/RPVST Settings

To view PVST/RPVST settings for each VLAN, click the **Show All** link. The **PVST/RPVST VLAN Configuration: Show All** page displays.

**Figure 21-22. PVST/RPVST VLAN Configuration: Show All**

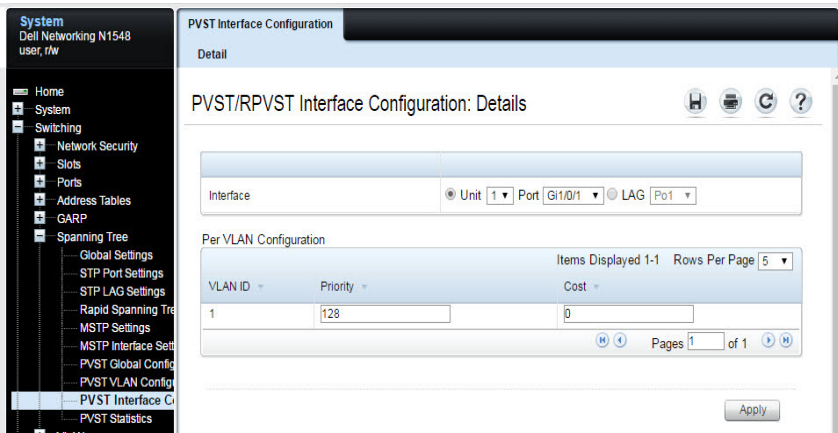


## PVST/RPVST Interface Configuration

Use the **PVST/RPVST Interface Configuration** page to configure the PVST/RPVST settings for an interface.

To display the **PVST/RPVST Interface Configuration** page, click **Switching** → **Spanning Tree** → **PVST Interface Configuration** in the navigation panel.

**Figure 21-23. PVST/RPVST Interface Configuration**



## PVST/RPVST Statistics

Use the PVST/RPVST Statistics page to configure the PVST/RPVST settings for an interface.

To display the PVST/RPVST Statistics page, click **Switching** → **Spanning Tree** → **PVST Statistics** in the navigation panel.

**Figure 21-24. PVST/RPVST Statistics**

The screenshot displays the PVST/RPVST Statistics page in a network management interface. The page is titled "PVST Statistics" and "Detail". The main content area is titled "PVST/RPVST Statistics: Details" and contains two tables of statistics.

**Fast Backbone**

Transitions via Fast Backbone	0
Inferior BPDUs received	0
RLQ Request PDUs Received	0
RLQ Response PDUs Received	0
RLQ Request PDUs Sent	0
RLQ Response PDUs Sent	0

**Fast Uplink**

Fast Uplink Transitions	0
Proxy Multicast Addresses Transmitted	0

# Configuring Spanning Tree (CLI)

This section provides information about the commands used for configuring STP settings on the switch. For more information about the commands, see the *Dell EMC Networking N1100-ON, N1500, N2000, N2100-ON, N2200-ON, N3000E-ON, N3100-ON, and N3200-ON Series Switches CLI Reference Guide* at [www.dell.com/support](http://www.dell.com/support).

## Configuring Global STP Bridge Settings

Use the following commands to configure the global STP settings for the switch, such as the priority and timers.

Command	Purpose
<code>configure</code>	Enter global configuration mode.
<code>spanning-tree</code>	Enable spanning tree on the switch.
<code>spanning tree mode {stp   rstp   mst   pvst   rapid-pvst}</code>	Specify which spanning tree mode to use on the switch.
<code>spanning-tree priority <i>priority</i></code>	Specify the priority of the bridge. (Range: 0–61440). The switch with the lowest priority value is elected as the root switch.
<code>spanning-tree max-age <i>seconds</i></code>	Specify the switch maximum age time, which indicates the amount of time in seconds a bridge waits before implementing a topological change. Valid values are from (6 to 40) seconds.
<code>spanning-tree forward-time <i>seconds</i></code>	Specify the switch forward delay time, which indicates the amount of time in seconds a bridge remains in a listening and learning state before forwarding packets. Valid values are from (4 to 30) seconds.
<code>spanning-tree max-hops <i>hops</i></code>	Configure the maximum number of hops for the Spanning tree. Valid values are from (6 to 40).
<code>spanning-tree transmit hold-count [<i>value</i>]</code>	Set the maximum number of BPDUs that a bridge is allowed to send within a hello time window (2 seconds). The range for <i>value</i> is 1–10.
<code>CTRL + Z</code>	Exit to Privileged Exec mode.

Command	Purpose
<code>show spanning-tree [detail [active   blockedports   instance <i>instance-id</i>]]</code>	View information about spanning tree and the spanning tree configuration on the switch.

## Configuring Optional STP Features

Use the following commands to configure the optional STP features on the switch or on specific interfaces.

Command	Purpose
<code>configure</code>	Enter global configuration mode.
<code>spanning-tree bpdulayer flooding</code>	Allow the flooding of BPDUs received on non-spanning-tree ports to all other non-spanning-tree ports.
<code>spanning-tree portfast default</code>	Enable PortFast on all switch ports.
<code>spanning-tree portfast bpdudfilter default</code>	Prevent ports configured in PortFast mode from sending BPDUs.
<code>spanning-tree loopguard default</code>	Enable loop guard on all ports.
<code>spanning-tree bpduguard protection</code>	Enable BPDU protection on the switch.
<code>interface <i>interface</i></code>	Enter interface configuration mode for the specified interface. The <i>interface</i> variable includes the interface type and number, for example <code>tengigabitethernet 1/0/3</code> or <code>port-channel 4</code> .  A range of interfaces can be specified using the <b>interface range</b> command. For example, <code>interface range tengigabitethernet 1/0/8-12</code> configures interfaces 8, 9, 10, 11, and 12. The <b>range</b> keyword is also valid for LAGs (port-channels).
<code>spanning-tree autoportfast</code>	Set the port to auto portfast mode. This enables the port to become a portfast port if it does not see any BPDUs for 3 seconds.

Command	Purpose
<code>spanning-tree guard {root   loop   none}</code>	Enable loop guard or root guard (or disable both) on the interface.
<code>spanning-tree tcn guard</code>	Prevent the port from propagating topology change notifications.
CTRL + Z	Exit to Privileged Exec mode.
<code>show spanning-tree summary</code>	View various spanning tree settings and parameters for the switch.

## Configuring STP Interface Settings

Use the following commands to configure the STP settings for a specific interface.

Command	Purpose
<code>configure</code>	Enter global configuration mode.
<code>interface <i>interface</i></code>	Enter interface configuration mode for the specified interface. The <i>interface</i> variable includes the interface type and number, for example <code>tengigabitethernet 1/0/3</code> or <code>port-channel 4</code> .  A range of interfaces can be specified using the <code>interface range</code> command. For example, <code>interface range tengigabitethernet 1/0/8-12</code> configures interfaces 8, 9, 10, 11, and 12. The <code>range</code> keyword is also valid for LAGs (port-channels).
<code>spanning-tree disable</code>	Disable spanning tree on the port.
<code>spanning-tree port-priority <i>priority</i></code>	Specify the priority of the port.  The priority value is used to determine which ports are put in the forwarding state and which ports are put in the blocking state. A port with a lower priority value is more likely to be put into a forwarding state.
<code>spanning-tree cost <i>cost</i></code>	Specify the spanning tree path cost for the port. The default port cost is 0, which signifies that the cost is automatically calculated based on port speed.
CTRL + Z	Exit to Privileged Exec mode.

Command	Purpose
<code>show spanning-tree interface</code>	View spanning tree configuration information for the specified port or LAG (port-channel).

## Configuring MSTP Switch Settings

Use the following commands to configure MSTP settings for the switch.

Command	Purpose
<code>configure</code>	Enter global configuration mode.
<code>spanning-tree mst configuration</code>	Enable configuring an MST region by entering the multiple spanning tree (MST) mode.
<code>name string</code>	Define the MST configuration name. This step is required to establish an MST domain.
<code>revision version</code>	Identify the MST configuration revision number.
<code>instance instance-id {add   remove} vlan vlan-list</code>	Map VLANs to an MST instance. <ul style="list-style-type: none"> <li><i>vlan-list</i> — One or more VLANs to be added to the existing MST instance. To specify a range of VLANs, use a hyphen. To specify a series of VLANs, use a comma. (Range: 1-4093)</li> </ul>
<code>exit</code>	Return to global configuration mode.
<code>spanning-tree mst instance-id priority priority</code>	Set the switch priority for the specified spanning tree instance. <ul style="list-style-type: none"> <li><i>instance-id</i> — ID of the spanning tree instance. (Range: 1-4094)</li> <li><i>priority</i> — Sets the switch priority for the specified spanning tree instance. This setting affects the likelihood that the switch is selected as the root switch. A lower value increases the probability that the switch is selected as the root switch. (Range: 0-61440)</li> </ul>
<code>CTRL + Z</code>	Exit to Privileged Exec mode.
<code>show spanning-tree mst-configuration</code>	View multiple spanning tree configuration information.
<code>show spanning-tree instance instance-id</code>	View information about the specified MSTI.

## Configuring MSTP Interface Settings

Use the following commands to configure MSTP settings for the switch.

Command	Purpose
<code>configure</code>	Enter global configuration mode.
<code>interface <i>interface</i></code>	<p>Enter interface configuration mode for the specified interface. The <i>interface</i> variable includes the interface type and number, for example <code>tengigabitethernet 1/0/3</code> or <code>port-channel 4</code>.</p> <p>A range of interfaces can be specified using the <code>interface range</code> command. For example, <code>interface range tengigabitethernet 1/0/8-12</code> configures interfaces 8, 9, 10, 11, and 12. The <code>range</code> keyword is also valid for LAGs (port-channels).</p>
<code>spanning-tree mst 0 cost <i>cost</i></code>	Set the external cost for the common spanning tree. (Range: 0–200000000)
<code>spanning-tree mst <i>instance-id</i> cost <i>cost</i></code>	<p>Configure the path cost for MST calculations. If a loop occurs, the spanning tree considers path cost when selecting an interface to put in the forwarding state.</p> <ul style="list-style-type: none"><li>• <i>instance-ID</i> — ID of the spanning -tree instance. (Range: 1-4094)</li><li>• <i>cost</i> — The port path cost. (Range: 0–200,000,000)</li></ul>
<code>spanning-tree mst <i>instance-id</i> port-priority <i>priority</i></code>	<p>Specify the priority of the port.</p> <p>The priority value is used to determine which ports are put in the forwarding state and which ports are put in the blocking state. A port with a lower priority value is more likely to be put into a forwarding state.</p> <ul style="list-style-type: none"><li>• <i>instance-ID</i> — ID of the spanning tree instance. (Range: 1-4094)</li><li>• <i>priority</i> — The port priority. (Range: 0–240 in multiples of 16)</li></ul>
<code>CTRL + Z</code>	Exit to Privileged Exec mode.
<code>show spanning-tree <i>interface</i> <i>instance</i> <i>instance-id</i></code>	View MST configuration information for the specified port or LAG (port-channel) and instance.



## STP Configuration Examples

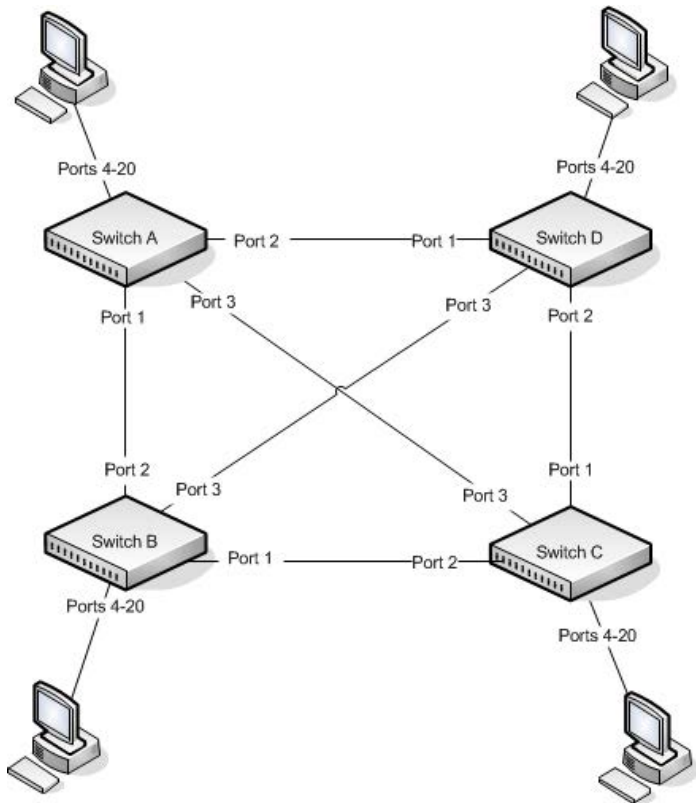
This section contains the following examples:

- STP Configuration Example
- MSTP Configuration Example
- RSTP-PV Access Switch Configuration Example

### STP Configuration Example

This example shows a LAN with four switches. On each switch, ports 1, 2, and 3 connect to other switches, and ports 4–20 connect to hosts (in Figure 21-25, each PC represents 17 host systems).

**Figure 21-25. STP Example Network Diagram**



Of the four switches in Figure 21-25, the administrator decides that Switch A is the most centrally located in the network and is the least likely to be moved or redeployed. For these reasons, the administrator selects it as the root bridge for the spanning tree. The administrator configures Switch A with the highest priority and uses the default priority values for Switch B, Switch C, and Switch D.

For all switches, the administrator also configures ports 4–17 in Port Fast mode because these ports are connected to hosts and can transition directly to the Forwarding state to speed up the connection time between the hosts and the network.

The administrator also configures Port Fast BPDU filtering and Loop Guard to extend STP's capability to prevent network loops. For all other STP settings, the administrator uses the default STP values.

To configure the switch:

- 1 Connect to Switch A and configure the priority to be higher (a lower value) than the other switches, which use the default value of 32768.

```
console#config  
console (config) #spanning-tree priority 8192
```

- 2 Configure ports 4–20 to be in Port Fast mode.

```
console (config) #interface range gi1/0/4-20  
console (config-if) #spanning-tree portfast  
console (config-if) #exit
```

- 3 Enable Loop Guard on ports 1–3 to help prevent network loops that might be caused if a port quits receiving BPDUs.

```
console (config) #interface range gi1/0/1-3  
console (config-if) #spanning-tree guard loop  
console (config-if) #exit
```

- 4 Enable Port Fast BPDU Filter. This feature is configured globally, but it affects only Port Fast-enabled access ports.

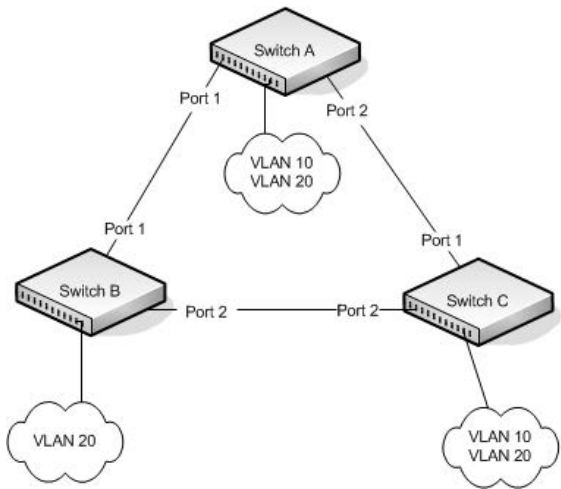
```
console (config) #spanning-tree portfast bpdupfilter default
```

- 5 Repeat [step 2](#) through [step 4](#) on Switch B, Switch C, and Switch D to complete the configuration.

## MSTP Configuration Example

This example shows how to configure IEEE 802.1s Multiple Spanning Tree (MST) protocol on the switches shown in Figure 21-26.

**Figure 21-26. MSTP Configuration Example**



To make multiple switches be part of the same MSTP region, make sure the STP operational mode for all switches is MSTP. Also, make sure the MST region name and revision level are the same for all switches in the region.

To configure the switches:

- 1 Create VLAN 10 (Switch A and Switch B) and VLAN 20 (all switches).



**NOTE:** Even Switch B does not have any ports that are members of VLAN 10, this VLAN must be created to allow the formation of MST regions made up of all bridges that exchange the same MST Configuration Identifier. It is only within these MST Regions that multiple instances can exist.

```
console#configure
console(config)#vlan 10,20
console(config-vlan10,20)#exit
console(config-vlan)#exit
```

- 2 Set the STP operational mode to MSTP.

```
console(config)#spanning-tree mode mst
```

- 3 Create MST instance 10 and associate it to VLAN 10.

```
console(config)#spanning-tree mst configuration
console(config-mst)#instance 10 add vlan 10
```

- 4 Create MST instances 20 and associate it to VLAN 20.

```
console (config-mst) #instance 20 add vlan 20
```

- 5 Change the region name and revision number so that all the bridges that want to be part of the same region can form the region. This step is required for MST to operate properly.

```
console (config-mst) #name dell
console (config-mst) #revision 0
console (config-mst) #exit
```

- 6 (Switch A only) Configure Switch A to be the root bridge of the spanning tree (CIST Regional Root) by configuring a higher root bridge priority.

```
console (config) #spanning-tree priority 8192
```

- 7 (Switch A only) Make Switch A the Regional Root for MSTI 1 by configuring a higher priority for MST ID 10.

```
console (config) #spanning-tree mst 10 priority 12288
```

- 8 (Switch A only) Change the priority of MST ID 20 to ensure Switch C is the Regional Root bridge for this MSTI.

```
console (config) #spanning-tree mst 20 priority 61440
console (config) #spanning-tree priority 8192
```

- 9 (Switch C only) Change the priority of port 1 to force it to be the root port for MST 20.

```
console (config) #interface gi1/0/1
console (config-if-Gi1/0/1) #spanning-tree mst 20 port-priority
64
console (config-if-Gi1/0/1) #exit
```

## RSTP-PV Access Switch Configuration Example

In this configuration, all 1G ports are presumed to be connected to host machines, and the two 10G uplink ports are connected to an aggregation-layer switch with a total Layer-2 network diameter of 4. The aggregation-layer switch can be a single switch or multiple switches, running either RSTP-PV or MSTP. For fastest convergence during failover scenarios, it is recommended that the uplink switches be configured in RSTP-PV mode.

Three VLANs are configured in addition to VLAN 1. Te1/0/1 is configured to be the primary uplink port and Te1/0/2 is configured to be the backup uplink.

- 1 Configure VLANs 2 through 4 and return to Global Config mode.

```
console#configure
console(config)#vlan 2-4
console(config-vlan2-4)#exit
```

- 2 Enable RSTP-PV.

```
console(config)#spanning-tree mode rapid-pvst
```

- 3 Configure for a maximum network diameter of 4.

```
console(config)#spanning-tree vlan 1-4 max-age 16
```

- 4 Configure access and trunk ports

```
console(config)#interface range gi1/0/1-48
console(config-if)#switchport mode access
console(config-if)#exit
console(config)#interface range te1/0/1-2
console(config-if)#switchport mode trunk
console(config-if)#exit
```

- 5 Configure interface te1/0/1 as the preferred uplink.

```
console(config)#interface te1/0/1
console(config-if)#spanning-tree port-priority 112
console(config-if)#exit
```

- 6 Assign ports to VLANs.

```
console(config)#interface range gi1/0/1-12
console(config-if)#switchport access vlan 1
console(config-if)#exit
console(config)#interface range gi1/0/13-24
console(config-if)#switchport access vlan 2
console(config-if)#exit
console(config)#interface range gi1/0/25-36
console(config-if)#switchport access vlan 3
console(config-if)#exit
```

```
console (config) #interface range gi1/0/37-48  
console (config-if) #switchport access vlan 4  
console (config-if) #exit
```

## RSTP-PV Aggregation-Layer Switch Configuration Example

In this configuration example, two aggregation-layer switches are configured. Ports 1–4 are configured in a LAG connecting the two aggregation-layer switches. Ports 12–24 are configured as down-links to 12 access-layer switches configured as in the previous example. Down-links to the access-layer switches have physical diversity; there is one downlink to each of the 12 access-layer switches from each of the paired aggregation-layer switches.

The uplink ports to the network core are configured as LAGs to provide link redundancy. It is presumed that the core links connect to a router running RSTP-PV. The configuration for the two aggregation-layer switches is identical, except for the diversity configuration noted below.

For forwarding diversity, the even numbered switch is made the root for the even-numbered VLANs. The odd numbered switch is made the root for the odd-numbered VLANs.

- 1 Create VLANs 2 through 4:

```
console#configure
console(config)#vlan 2-4
console(config-vlan2-4)#exit
```

- 2 Enable RSTP-PV:

```
console(config)#spanning-tree mode rapid-pvst
```

- 3 Configure for a max network diameter of 4:

```
console(config)#spanning-tree vlan 1-4 max-age 16
```

- 4 Configure one downlink trunk port per downlink switch:

```
console(config)#interface range tel1/0/12-24
console(config-if-Tel1/0/12-24)#switchport mode trunk
exit
```

- 5 Configure forwarding diversity for the even numbered switches:

```
console(config)#spanning-tree vlan 2,4 root primary
console(config)#spanning-tree vlan 1,3 root secondary
```

- 6 Configure forwarding diversity for the odd numbered switches:

```
console(config)#spanning-tree vlan 1,3 root primary
console(config)#spanning-tree vlan 2,4 root secondary
```

- 7 Configure two uplink ports per uplink switch:

```
console(config)#interface range fo1/0/1-2
console(config-if-fo1/0/1-2)#channel-group 1 mode active
console(config-if-fo1/0/1-2)#exit
```



**8** Configure peer switch links:

```
console (config) #interface range tel/0/1-4
console (config-if-tel/0/1-4) #channel-group 2 mode active
console (config-if-tel/0/1-4) #exit
```

**9** Configure the uplinks into a port channel:

```
console (config) #interface port-channel 1
console (config-if-port-channel 1) #switchport mode trunk
console (config-if-port-channel 1) #exit
```

**10** Configure the peer links into a port channel and prefer to go to the core router or access switches directly, i.e. block the peer link unless it is needed:

```
console (config) #interface port-channel 1
console (config-if-port-channel 1) #switchport mode trunk
console (config-if-port-channel 1) #spanning-tree port-priority
144
console (config-if-port-channel 1) #exit
```



# Discovering Network Devices

## Dell EMC Networking N-Series Switches

This chapter describes the Industry Standard Discovery Protocol (ISDP) feature and the Link Layer Discovery Protocol (LLDP) feature, including LLDP for Media Endpoint Devices (LLDP-MED).

The topics covered in this chapter include:

- Device Discovery Overview
- Default ISDP and LLDP Values
- Default IPDT Values
- Configuring ISDP and LLDP (CLI)
- Device Discovery Configuration Examples

## Device Discovery Overview

The switch software includes support for several device discovery protocols: ISDP, IPDT, and LLDP. These protocols allow the switch to broadcast information about itself and to learn information about neighboring devices.

### What Is ISDP?

The Industry Standard Discovery Protocol (ISDP) is a proprietary Layer-2 network protocol that inter-operates with Cisco devices running the Cisco Discovery Protocol (CDP). ISDP is used to share information between neighboring devices. The switch software participates in the CDP protocol and is able to both discover and be discovered by other CDP-supporting devices.

### What is IPDT?

IP Device Tracking maintains a list of attached hosts IPv4 address and MAC bindings. IPDT does not track IPv6 hosts. IPDT obtains information about attached devices from the DHCP snooping bindings table and by snooping

ARP traffic. Periodically, IPDT sends an ARP request to each attached host. This enables IPDT to track the state of the host more accurately than DHCP snooping.

## **What is LLDP?**

LLDP is a standardized discovery protocol defined by IEEE 802.1AB. It allows stations residing on an 802 LAN to advertise major capabilities physical descriptions, and management information to physically adjacent devices allowing a network management system (NMS) to access and display this information.

LLDP is a one-way protocol; there are no request/response sequences. Information is advertised by stations implementing the transmit function, and is received and processed by stations implementing the receive function. The transmit and receive functions can be enabled/disabled separately on each switch port.

## **What is LLDP-MED?**

LLDP-MED is an extension of the LLDP standard. LLDP-MED uses LLDP's organizationally-specific Type- Length-Value (TLV) extensions and defines new TLVs that make it easier for a VoIP deployment in a wired or wireless LAN/MAN environment. It also makes mandatory a few optional TLVs from LLDP and recommends not transmitting some TLVs.

The TLVs only communicate information; these TLVs do not automatically translate into configuration. An external application may query the MED MIB and take management actions in configuring functionality.

## **Why are Device Discovery Protocols Needed?**

The device discovery protocols are used primarily in conjunction with network management tools to provide information about network topology and configuration, and to help troubleshoot problems that occur on the network. The discovery protocols can also facilitate inventory management within a company.

LLDP and the LLDP-MED extension are vendor-neutral discovery protocols that can discover devices made by numerous vendors. LLDP-MED is intended to be used on ports that connect to VoIP phones. Additional applications for LLDP-MED include Power over Ethernet management.

ISDP interoperates with the Cisco-proprietary CDP protocol and is most effective in an environment that contains many Cisco devices.

IPDT is used to track the state of the attached hosts and maintain up-to-date MAC/IPv4 address bindings. The MAC/IPv4 bindings are used to populate the RADIUS Framed-IP-Address attribute transmitted in RADIUS Access-Request packets and to update the source IP address in Dynamic ACLs.

IPDT does not send ARP probes for entries already present in the ARP table until they age out and ARP packets are exchanged. When IPDT is enabled for the first time, it may take up to 20 minutes (or the configured ARP timeout) for the IPDT table to populate.

## Default ISDP and LLDP Values

ISDP and LLDP are globally enabled on the switch and enabled on all ports by default. By default, the switch transmits and receives LLDP information on all ports. LLDP-MED is enabled on all ports by default. The switch sends LLDP frames using destination MAC address 01:80:c2:00:00:0e and EtherType 0x88CC. The switch recognizes LLDP frames addressed to MAC addresses 01:80:c2:00:00:0e, 01:80:c2:00:00:00, 01:80:c2:00:00:03, and EtherType 0x88CC. Frames addressed to other group MAC addresses are discarded.

Table 22-1 summarizes the default values for ISDP.

**Table 22-1. ISDP Defaults**

Parameter	Default Value
ISDP Mode	Enabled (globally and on all ports)
ISDPv2 Mode	Enabled (globally and on all ports)
Message Interval	30 seconds
Hold Time Interval	180 seconds
Device ID	none
Device ID Format Capability	Serial Number, Host Name
Device ID Format	Host Name

Table 22-2 summarizes the default values for LLDP.

**Table 22-2. LLDP Defaults**

<b>Parameter</b>	<b>Default Value</b>
Transmit Mode	Enabled on all ports
Receive Mode	Enabled on all ports
Transmit Interval	30 seconds
Hold Multiplier	4
Reinitialization Delay	2 seconds
Notification Interval	5 seconds
Transmit Management Information	Disabled
Notification Mode	Disabled
Included TLVs	0 — Port Description 1 — System Name 4 — Port PVID or Native VLAN

Table 22-3 summarizes the default values for LLDP-MED.

**Table 22-3. LLDP-MED Defaults**

<b>Parameter</b>	<b>Default Value</b>
LLDP-MED Mode	Enabled on all ports
Config Notification Mode	Disabled on all ports
Transmit TLVs	0 — Port Description 1 — System Name 2 — Extended PSE 3 — Extended PD


## **Default IPDT Values**

Table 22-4 summarizes the default values for IPDT.

**Table 22-4. IPDT Defaults**

<b>Parameter</b>	<b>Default Value</b>
IPDT Mode	Disabled
ARP Probes	Enabled
Probe Interval	30 seconds
Probe Count	3 missed probes
Probe Delay	30 seconds
Probe Source IP	0.0.0.0
Device Maximum	Unlimited

## **Configuring ISDP and LLDP (Web)**

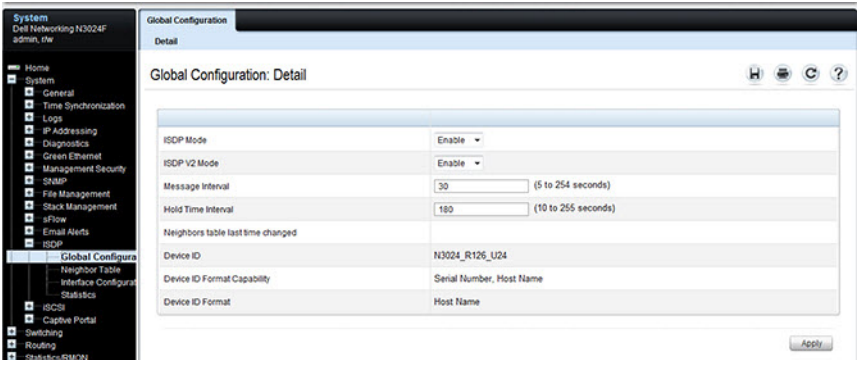
This section provides information about the OpenManage Switch Administrator pages for configuring and monitoring ISDP and LLDP/LLDP-MED on Dell EMC Networking N-Series switches. For details about the fields on a page, click  at the top of the Dell EMC OpenManage Switch Administrator web page.

### **ISDP Global Configuration**

The **ISDP Global Configuration** page enables configuring the ISDP settings for the switch, such as the administrative mode.

To access the **ISDP Global Configuration** page, click **System** → **ISDP** → **Global Configuration** in the navigation panel.

**Figure 22-1. ISDP Global Configuration**



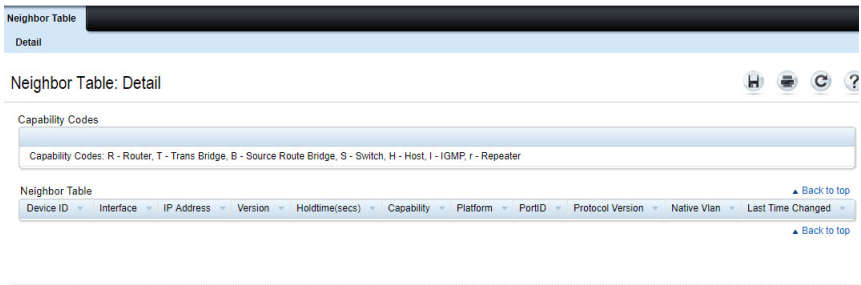


## ISDP Neighbor Table

The **ISDP Neighbor Table** page enables viewing information about other devices the switch has discovered through the ISDP.

To access the **ISDP Neighbor Table** page, click **System** → **ISDP** → **Neighbor Table** in the navigation panel.

**Figure 22-2. ISDP Neighbor Table**



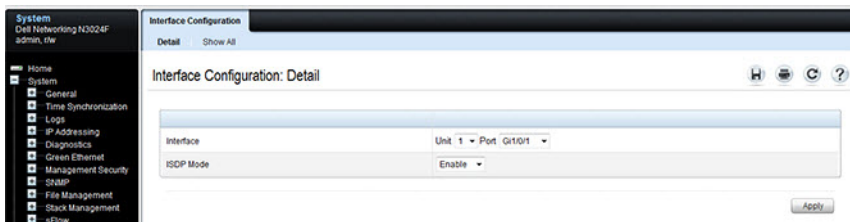
## ISDP Interface Configuration

The **ISDP Interface Configuration** page enables configuring the ISDP settings for each interface.

If ISDP is enabled on an interface, it must also be enabled globally in order for the interface to transmit ISDP packets. If the ISDP mode on the ISDP Global Configuration page is disabled, the interface will not transmit ISDP packets, regardless of the mode configured on the interface.

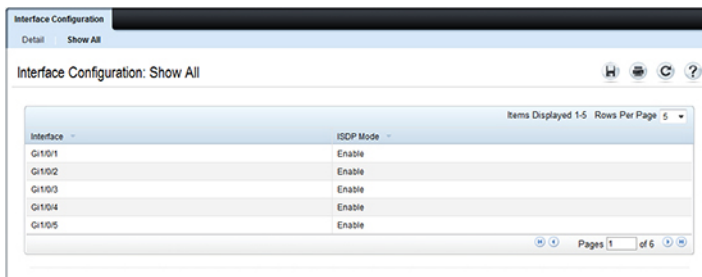
To access the **ISDP Interface Configuration** page, click **System** → **ISDP** → **Interface Configuration** in the navigation panel.

**Figure 22-3. ISDP Interface Configuration**



To view the ISDP mode for multiple interfaces, click **Show All**.

**Figure 22-4. ISDP Interface Summary**



## ISDP Statistics

The ISDP Statistics page enables viewing information about the ISDP packets sent and received by the switch.

To access the ISDP Statistics page, click **System** → **ISDP** → **Statistics** in the navigation panel.

**Figure 22-5. ISDP Statistics**

The screenshot shows the 'Statistics: Detail' page for ISDP. The table below lists various statistics, all of which are currently at 0. A 'Clear' button is located at the bottom right of the table.

Statistic	Value
Packets Received	0
Packets Transmitted	0
ISDPv1 Packets Received	0
ISDPv1 Packets Transmitted	0
ISDPv2 Packets Received	0
ISDPv2 Packets Transmitted	0
Bad Header	0
Checksum Error	0
Transmission Failure	0
Invalid Format Packets Received	0
Table Full	0
ISDP IP Address Table Full	0

## LLDP Configuration

Use the **LLDP Configuration** page to specify LLDP parameters. Parameters that affect the entire system as well as those for a specific interface can be specified here.

To display the **LLDP Configuration** page, click **Switching** → **LLDP** → **Configuration** in the navigation panel.

**Figure 22-6. LLDP Configuration**

The screenshot shows the LLDP Configuration page with two main sections: Global Settings and Port Settings.

**Global Settings**

Transmit Interval	<input type="text" value="30"/>	(5 to 32768 seconds)
Hold Multiplier	<input type="text" value="4"/>	(2 to 10)
Re-Initialization Delay	<input type="text" value="2"/>	(1 to 10 seconds)
Notification Interval	<input type="text" value="5"/>	(5 to 3600 seconds)

**Port Settings**

Interface	Unit <input type="text" value="1"/> Port <input type="text" value="Gi1/0/1"/>
Transmit Mode	<input type="text" value="Enable"/>
Receive Mode	<input type="text" value="Enable"/>
Notification Mode	<input type="text" value="Disable"/>
Included TLVs	<input checked="" type="checkbox"/> System Name <input type="checkbox"/> System Description <input type="checkbox"/> System Capabilities <input checked="" type="checkbox"/> Port Description <input checked="" type="checkbox"/> Port Vlan <input type="checkbox"/> Management Address

To view the **LLDP Interface Settings Table**, click **Show All**. The **LLDP Interface Settings Table** page enables viewing and editing information about the LLDP settings for multiple interfaces.

**Figure 22-7. LLDP Interface Settings Table**

Configuration: Show All

Unit: 1

Copy Parameters: Copy Parameters From, Unit: 1, Port: Gi1/0/1

											Items Displayed 1-5	Rows Per Page 5
▲	Port	Transmit	Receive	Notify	System Name	System Description	System Capabilities	Port Description	Management Address	Port Vlan	Copy To	Edit
1	Gi1/0/1	Enable	Enable	Disable	☑	☐	☐	☑	☐	☑	☐	☐
2	Gi1/0/2	Enable	Enable	Disable	☑	☐	☐	☑	☐	☑	☐	☐
3	Gi1/0/3	Enable	Enable	Disable	☑	☐	☐	☑	☐	☑	☐	☐
4	Gi1/0/4	Enable	Enable	Disable	☑	☐	☐	☑	☐	☑	☐	☐
5	Gi1/0/5	Enable	Enable	Disable	☑	☐	☐	☑	☐	☑	☐	☐

Pages 1 of 8

## LLDP Statistics

Use the LLDP Statistics page to view LLDP-related statistics.

To display the **LLDP Statistics** page, click **Switching** → **LLDP** → **Statistics** in the navigation panel.

**Figure 22-8. LLDP Statistics**

The screenshot displays the LLDP Statistics page in a network management interface. The left sidebar shows the navigation menu with 'LLDP' expanded to 'Statistics'. The main content area is titled 'Statistics: Detail' and contains two sections: 'LLDP Updates' and 'LLDP Interface Statistics'.

**LLDP Updates**

Unit	Value
Unit	1
Last Update	0 Days 00 00 00
Total Inserts	0
Total Deletes	0
Total Drops	0
Total Apocuts	0

**LLDP Interface Statistics**

Interface	Transmit Total	Receive Total	Discards	Errors	Ageouts	TLV Discards	TLV Unknowns
Gi1/0/1	0	0	0	0	0	0	0
Gi1/0/2	0	0	0	0	0	0	0
Gi1/0/3	0	0	0	0	0	0	0
Gi1/0/4	0	0	0	0	0	0	0
Gi1/0/5	0	0	0	0	0	0	0

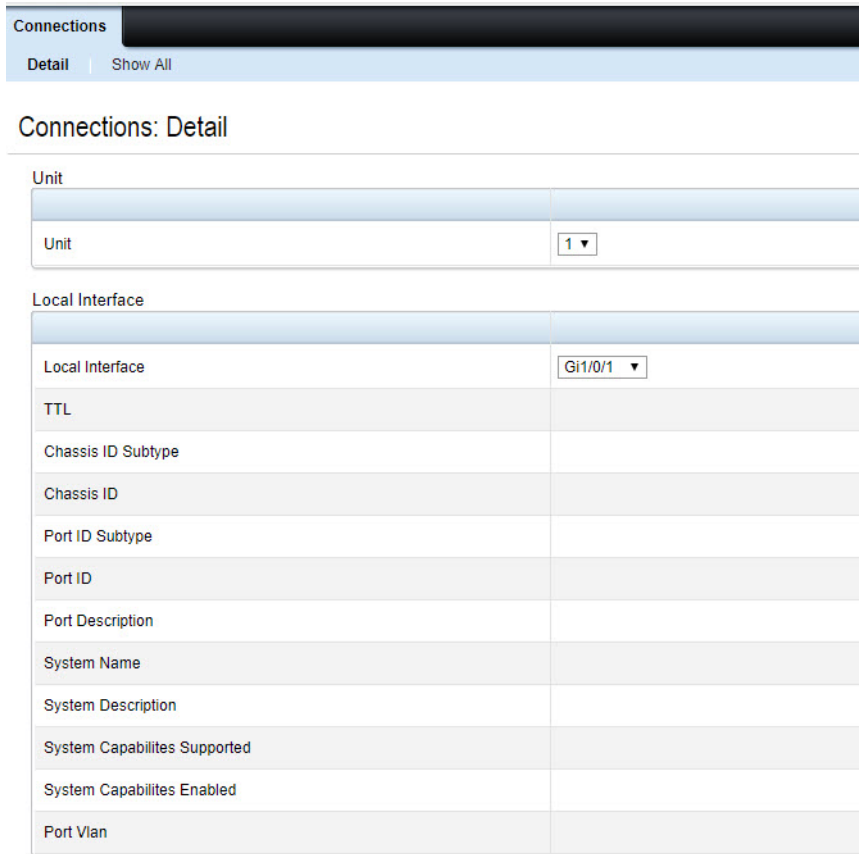
The interface includes a 'Clear' button at the bottom right and a 'Back to top' link in the top right corner of the main content area.

## LLDP Connections

Use the **LLDP Connections** page to view the list of ports with LLDP enabled. Basic connection details are displayed.

To display the **LLDP Connections** page, click **Switching** → **LLDP** → **Connections** in the navigation panel.

**Figure 22-9.** LLDP Connections



The screenshot shows the 'Connections: Detail' page. At the top, there is a navigation bar with 'Connections' and 'Detail' tabs. Below the navigation bar, the page title is 'Connections: Detail'. The main content area contains a table with the following fields:

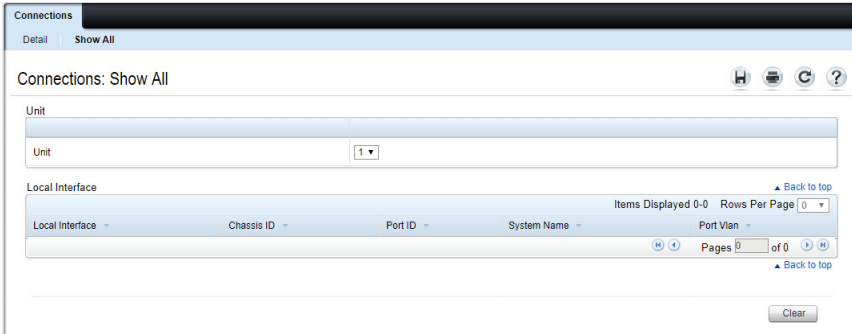
Unit	
Unit	1 ▼

Local Interface	
Local Interface	Gi1/0/1 ▼
TTL	
Chassis ID Subtype	
Chassis ID	
Port ID Subtype	
Port ID	
Port Description	
System Name	
System Description	
System Capabilites Supported	
System Capabilites Enabled	
Port Vlan	

To view additional information about a device connected to a port that has been discovered through LLDP, click the port number in the Local Interface table (it is a hyperlink), or click **Details** and select the port with the connected device.

**Figure 22-10. LLDP Connection Detail**

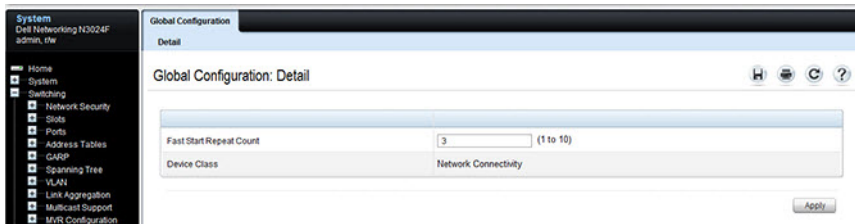


## LLDP-MED Global Configuration

Use the LLDP-MED Global Configuration page to change or view the LLDP-MED parameters that affect the entire system.

To display the LLDP-MED Global Configuration page, click **Switching LLDP** → **LLDP-MED** → **Global Configuration** in the navigation panel.

**Figure 22-11. LLDP-MED Global Configuration**



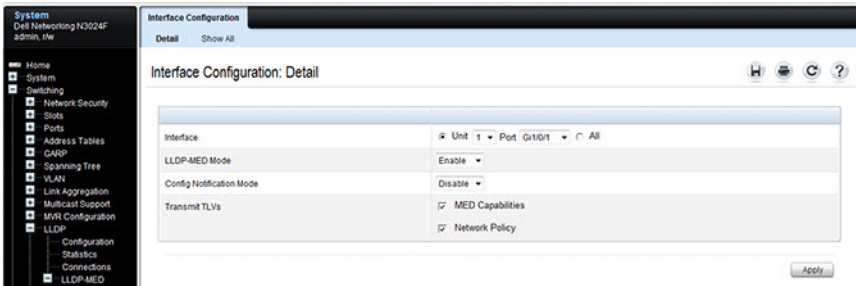


## LLDP-MED Interface Configuration

Use the **LLDP-MED Interface Configuration** page to specify LLDP-MED parameters that affect a specific interface.

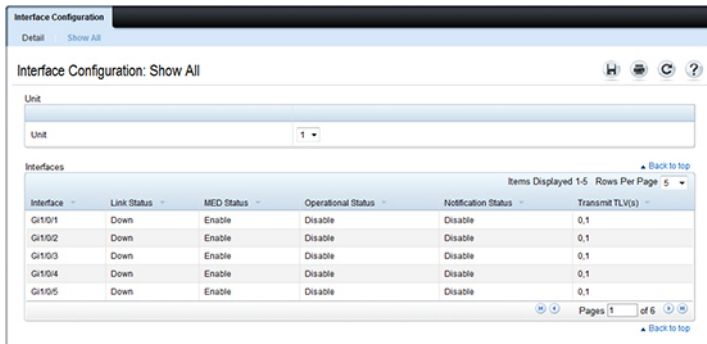
To display the **LLDP-MED Interface Configuration** page, click **Switching** → **LLDP** → **LLDP-MED** → **Interface Configuration** in the navigation panel.

**Figure 22-12. LLDP-MED Interface Configuration**



To view the **LLDP-MED Interface Summary** table, click **Show All**.

**Figure 22-13. LLDP-MED Interface Summary**

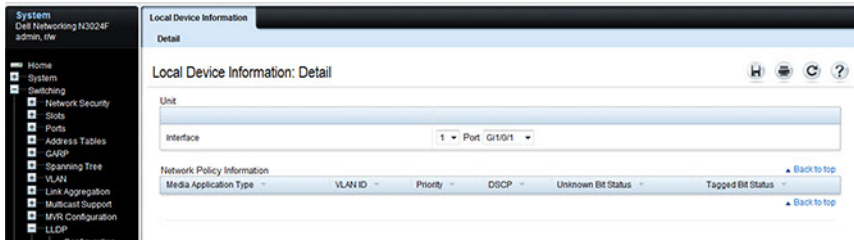


## LLDP-MED Local Device Information

Use the LLDP-MED Local Device Information page to view the advertised LLDP local data for each port.

To display the LLDP-MED Local Device Information page, click **Switching** → **LLDP** → **LLDP-MED** → **Local Device Information** in the navigation panel.

**Figure 22-14.** LLDP-MED Local Device Information

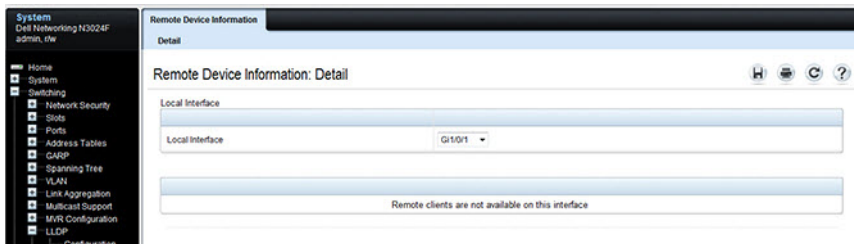


## LLDP-MED Remote Device Information

Use the LLDP-MED Remote Device Information page to view the advertised LLDP data advertised by remote devices.

To display the LLDP-MED Remote Device Information page, click **Switching** → **LLDP** → **LLDP-MED** → **Remote Device Information** in the navigation panel.

**Figure 22-15.** LLDP-MED Remote Device Information



## Configuring ISDP and LLDP (CLI)

This section provides information about the commands you use to manage and view the device discovery protocol features on the switch. For more information about these commands, see the *Dell EMC Networking N1100-ON, N1500, N2000, N2100-ON, N2200-ON, N3000E-ON, N3100-ON, and N3200-ON Series Switches CLI Reference Guide* at [www.dell.com/support](http://www.dell.com/support).

### Configuring Global ISDP Settings

Use the following commands to configure ISDP settings that affect the entire switch.

Command	Purpose
<code>configure</code>	Enter Global Configuration mode.
<code>isdp enable</code>	Administratively enable ISDP on the switch.
<code>isdp advertise-v2</code>	Allow the switch to send ISDPv2 packets.
<code>isdp holdtime <i>time</i></code>	Specify the number of seconds the device that receives ISDP packets from the switch should store information sent in the ISDP packet before discarding it.
<code>isdp timer <i>time</i></code>	Specify the number of seconds to wait between sending new ISDP packets.
<code>exit</code>	Exit to Privileged Exec mode.
<code>show isdp</code>	View global ISDP settings.

## Enabling ISDP on a Port

Use the following commands to enable ISDP on a port.

Command	Purpose
<code>configure</code>	Enter Global Configuration mode.
<code>interface <i>interface</i></code>	Enter interface configuration mode for the specified interface.
<code>isdp enable</code>	Administratively enable ISDP on the switch.
<code>exit</code>	Exit to Global Config mode.
<code>exit</code>	Exit to Privileged Exec mode.
<code>show isdp interface all</code>	View the ISDP mode on all interfaces.

## Viewing and Clearing ISDP Information

Use the following commands to view and clear the contents of the ISDP table and to view and clear ISDP statistics.

Command	Purpose
<code>show isdp entry {all   <i>deviceid</i>}</code>	View information about all entries or a specific entry in the ISDP table.
<code>show isdp neighbors</code>	View the neighboring devices discovered through ISDP.
<code>clear isdp table</code>	Clear all entries, including discovered neighbors, from the ISDP table.
<code>show isdp traffic</code>	View ISDP statistics.
<code>clear isdp counters</code>	Reset all ISDP statistics to zero.

## Configuring Global LLDP Settings

Use the following commands to configure LLDP settings that affect the entire switch.

Command	Purpose
<code>configure</code>	Enter Global Configuration mode.
<code>lldp notification-interval interval</code>	Specify how often, in seconds, the switch should send remote data change notifications.
<code>lldp timers [interval transmit-interval] [hold hold-value] [reinit reinit-delay]</code>	Configure the timing for local data transmission on ports enabled for LLDP. <ul style="list-style-type: none"><li>• <i>transmit-interval</i> — The interval in seconds at which to transmit local data LLDP PDUs. (Range: 5–32768 seconds)</li><li>• <i>hold-value</i> — Multiplier on the transmit interval used to set the TTL in local data LLDP PDUs. (Range: 2–10)</li><li>• <i>reinit-delay</i> — The delay in seconds before re-initialization. (Range: 1–10 seconds)</li></ul>
<code>exit</code>	Exit to Privileged Exec mode.
<code>show lldp</code>	View global LLDP settings.

## Configuring Port-based LLDP Settings

Use the following commands to configure per-port LLDP settings.

Command	Purpose
<code>configure</code>	Enter Global Configuration mode.
<code>interface interface</code>	Enter interface configuration mode for the specified Ethernet interface.
<code>lldp transmit</code>	Enable the LLDP advertise (transmit) capability.
<code>lldp receive</code>	Enable the LLDP receive capability so that the switch can receive LLDP Protocol Data Units (LLDP PDUs) from other devices.
<code>lldp notification</code>	Enable remote data change notifications on the interface.

<b>Command</b>	<b>Purpose</b>
<code>lldp tlv-select</code> <code>[management</code> <code>address][port-</code> <code>description][portvlan]</code> <code>[system-</code> <code>capabilities][system-</code> <code>description][system-</code> <code>name]</code>	Specify which optional type-length-value settings (TLVs) in the 802.1AB basic management set will be transmitted in the LLDP PDUs. <ul style="list-style-type: none"> <li>• <code>management-address</code>—Include the LLDP management address TLV.</li> <li>• <code>port-description</code>—Include the LLDP port description TLV.</li> <li>• <code>port-vlan</code>—Include the LLDP port VLAN TLV.</li> <li>• <code>system-capabilities</code>—Include the LLDP system capabilities TLV.</li> <li>• <code>system-description</code>—Include the LLDP system description TLV.</li> <li>• <code>system-name</code>—Include the LLDP system name TLV.</li> </ul>
<code>exit</code>	Exit to Global Config mode.
<code>exit</code>	Exit to Privileged Exec mode.
<code>show lldp interface all</code>	View LLDP settings for all interfaces.

## Viewing and Clearing LLDP Information

Use the following commands to view transmitted and received LLDP information and to view and clear LLDP statistics.

<b>Command</b>	<b>Purpose</b>
<code>show lldp local-device</code> <code>{all   interface   detail</code> <code>interface}</code>	View LLDP information advertised by all ports or the specified port. Include the keyword <code>detail</code> to see additional information.
<code>show lldp remote-device</code> <code>{all   interface   detail</code> <code>interface}</code>	View LLDP information received by all ports or by the specified port. Include the keyword <code>detail</code> to see additional information.
<code>clear lldp remote-data</code>	Delete all LLDP information from the remote data table.
<code>show lldp statistics</code> <code>{interface   all}</code>	View LLDP traffic statistics.
<code>clear lldp statistics</code>	Reset the LLDP statistics counters to zero.

## Configuring LLDP-MED Settings

Use the following commands to configure LLDP-MED settings that affect the entire switch.

Command	Purpose
<code>configure</code>	Enter Global Configuration mode.
<code>lldp med faststartrepeatcount count</code>	Specifies the number of LLDP PDUs that will be transmitted when the protocol is enabled.
<code>interface interface</code>	Enter interface configuration mode for the specified Ethernet interface.
<code>lldp med</code>	Enable LLDP-MED on the interface. (Enabled by default)
<code>lldp med confignotification</code>	Allow the port to send topology change notifications.
<code>lldp med transmit-tlv [capabilities] [network-policy]</code>	Specify which optional TLVs in the LLDP MED set are transmitted in the LLDP PDUs. (Enabled by default)
<code>exit</code>	Exit to Global Config mode.
<code>exit</code>	Exit to Privileged Exec mode.
<code>show lldp med</code>	View global LLDP-MED settings.
<code>show lldp med interface {all   interface}</code>	View LLDP-MED settings for all ports or for the specified port.

## Viewing LLDP-MED Information

Use the following commands to view information about the LLDP-MED Protocol Data Units (PDUs) that are sent and have been received.

Command	Purpose
<code>show lldp med local-device detail <i>interface</i></code>	View LLDP information advertised by the specified port.
<code>show lldp remote-device {all   <i>interface</i>   detail <i>interface</i>}</code>	View LLDP-MED information received by all ports or by the specified port. Include the keyword <code>detail</code> to see additional information.

## Device Discovery Configuration Examples

This section contains the following examples:

- Configuring ISDP
- Configuring LLDP

### Configuring ISDP

This example shows how to configure ISDP settings on the switch.

To configure the switch:

- 1 Specify the number of seconds that a remote device should keep the ISDP information sent by the switch before discarding it.

```
console#configure
console(config)#isdpr holdtime 60
```

- 2 Specify how often, in seconds, the ISDP-enabled ports should transmit information.

```
console(config)#isdpr timer 45
```

- 3 Enable ISDP on interface `1/0/3`.

```
console(config)#interface tengigabitEthernet1/0/3
console(config-if-Tel1/0/3)#isdpr enable
```

- 4 Exit to Privileged Exec mode and view the LLDP settings for the switch and for interface `1/0/3`.

```
console(config-if-Tel1/0/3)# <CTRL + Z>
console#show isdpr
Timer.....45
```



```

Hold Time.....60
Version 2 Advertisements.....Enabled
Neighbors table time since last change...00 days 00:00:00
Device ID.....none
Device ID format capability.....Serial Number, Host Name
Device ID format.....Serial Number

```

```

console#show isdp interface te1/0/3

```

```

Interface      Mode
-----
Tel1/0/3      Enabled

```

## Configuring LLDP

This example shows how to configure LLDP settings for the switch and to allow 10-Gigabit Ethernet port 1/0/3 to transmit all LLDP information available.

To configure the switch:

- 1 Configure the transmission interval, hold multiplier, and reinitialization delay for LLDP PDUs sent from the switch.

```

console#configure
console (config) #lldp timers interval 60 hold 5 reinit 3

```

- 2 Enable port 1/0/3 to transmit and receive LLDP PDUs.

```

console (config) #interface TengigabitEthernet1/0/3
console (config-if-Te1/0/3) #lldp transmit
console (config-if-Te1/0/3) #lldp receive

```

- 3 Enable port 1/0/3 to transmit management address information in the LLDP PDUs and to send topology change notifications if a device is added or removed from the port.

```

console (config-if-Te1/0/3) #lldp transmit-mgmt
console (config-if-Te1/0/3) #lldp notification

```

- 4 Specify the TLV information to be included in the LLDP PDUs transmitted from port 1/0/3.

```

console (config-if-Te1/0/3) #lldp tlv-select sys-name sys-desc
sys-cap port-desc

```

- 5 Set the port description to be transmitted in LLDP PDUs.

```

console (config-if-Te1/0/3) #description "Test Lab Port"

```

- 6 Exit to Privileged Exec mode.

```

console (config-if-Te1/0/3) # <CTRL + Z>

```

**7** View global LLDP settings on the switch.

```
console#show lldp

LLDP Global Configuration

Transmit Interval..... 60 seconds
Transmit Hold Multiplier..... 5
Reinit Delay..... 3 seconds
Notification Interval..... 5 seconds
```

**8** View summary information about the LLDP configuration on port 1/0/1.

```
console#show lldp interface te1/0/1

LLDP Interface Configuration

Interface Link Transmit Receive Notify TLVs
-----
Te1/0/1 Down Enabled Enabled Disabled 0,1,4

TLV Codes: 0- Port Description, 1- System Name, 2- System
Description, 3- System Capabilities, 4- Port VLAN,5-Management
Address
```

**9** View detailed information about the LLDP configuration on port 1/0/1.

```
console#show lldp local-device detail te1/0/1

LLDP Local Device Detail

Interface: Te1/0/1

Chassis ID Subtype: MAC Address
Chassis ID: 20:04:0F:01:23:30
Port ID Subtype: Interface Name
Port ID: Te1/0/1
Port VLAN: 1
System Name:
System Description: Dell EMC Networking N3024EP-ON, D.5.23.1,
Linux 3.6.5-e3cd5a07
Port Description: Test Lab Port
System Capabilities Supported: bridge, router
System Capabilities Enabled: bridge, router
Management Address:
    Type: IPv4
    Address: 10.0.0.2
```

## Configuring IPDT

This example shows how to configure IPDT for operation on the switch.

- 1 Enable DHCP snooping and IPDT. IPDT relies on DHCP snooping and ARP probes to populate its bindings table. The DHCP server is reachable from interface Tel/0/1.

```
console#configure
console(config)#ip dhcp snooping
console(config)#ip dhcp snooping vlan 1
console(config)#interface tel/0/1
console(config-if-Tel/0/1)#ip dhcp snooping trust
console(config-if-Tel/0/1)#exit
console(config)#ip device tracking
```

- 2 Optionally configure ARP probes (default enabled)

```
console(config)#ip device tracking probe
```

- 3 Optionally configure the missed probe count to transition an entry to INACTIVE. Here, 5 consecutive missed probes are required.

```
console(config)#ip device tracking probe count 5
```

- 4 Optionally configure the probe interval. Here, the probe interval is 60 seconds.

```
console(config)#ip device tracking probe interval
60
```

- 5 Optionally configure the ARP source IP address for a host with address 10.5.5.20.

```
console(config)#ip device tracking probe auto-
source fallback 0.0.0.1 255.255.255.0 override
```

- 6 Optionally configure an 11-second delay for sending the first probe after link up event.

```
console(config)#ip device tracking probe delay 11
```

- 7 Optionally disable IPDT on an interface by setting the maximum host count to 0.

```
console(config)#interface tel/0/1
console(config-if-Tel/0/1)#ip device tracking
maximum 0
```



# Port-Based Traffic Control

## Dell EMC Networking N-Series Switches

This chapter describes how to configure features that provide traffic control through filtering the type of traffic or limiting the speed or amount of traffic on a per-port basis. The features this section describes includes flow control, storm control, protected ports, and Link Local Protocol Filtering (LLPF), which is also known as Cisco Protocol Filtering.

The topics covered in this chapter include:

- Port-Based Traffic Control Overview
- Default Port-Based Traffic Control Values
- Configuring Port-Based Traffic Control (Web)
- Configuring Port-Based Traffic Control (CLI)
- Port-Based Traffic Control Configuration Example

## Port-Based Traffic Control Overview

Table 23-1 provides a summary of the features this chapter describes.

**Table 23-1. Port-Based Traffic Control Features**

Feature	Description
Flow control	Allows traffic transmission between a switch port and another Ethernet device to be paused for a specified period of time when congestion occurs.
Storm control	Limits the amount of broadcast, unknown Layer-2 unicast, and multicast frames accepted and forwarded by the switch.
Protected ports	Prevents traffic from flowing between members of the same protected port group.
Error recovery	Automatically brings up interfaces that have been diagnostically disabled.
Loop protection	Disables ports that are looped.

**Table 23-1. Port-Based Traffic Control Features**

<b>Feature</b>	<b>Description</b>
LLPF	Filters proprietary protocols that should not normally be relayed by a bridge.

### **What is Flow Control?**

IEEE 802.3 Annex 31B flow control allows nodes that transmit at slower speeds to communicate with higher speed switches by requesting that the higher speed switch refrain from sending packets. Transmissions are temporarily halted to prevent buffer overflows. Enabling the flow control feature allows Dell EMC Networking N-Series switches to process pause frames received from connected devices. Dell EMC Networking N-Series switches do not transmit pause frames.

Flow control is supported only on ports that are configured for full-duplex mode of operation.

### **What is Storm Control?**

A LAN storm is the result of an excessive number of broadcast, multicast, or unknown unicast messages simultaneously transmitted across a network by a single port. Forwarded message responses can overload network resources and cause network congestion.

The storm control feature allows the switch to measure the incoming broadcast, multicast, and/or unknown unicast packet rate per port and discard packets when the rate exceeds the defined threshold. Optionally, the system can issue a log message and a trap, or it can shut down (diagnostically disable) the port. Storm control is enabled per interface, by defining the packet type and the rate at which the packets are transmitted. For each type of traffic (broadcast, multicast, or unknown unicast) a threshold level can be configured, which is expressed as a percentage of the total available bandwidth on the port. If the ingress rate of that type of packet is greater than the configured threshold level the port drops the excess traffic until the ingress rate for the packet type falls below the threshold.

When configuring the limit in terms of link bandwidth, the actual rate of ingress traffic required to activate storm-control is based on the size of incoming packets, and a hard-coded average packet size of 512 bytes is used to calculate a packet-per-second (pps) rate, as the forwarding-plane requires

PPS versus an absolute rate in Kbps. For example, if the configured limit is 10% on a 1 Gbps link, this is converted to ~25000 PPS, and this PPS limit is set in the hardware.

## **What are Protected Ports?**

The switch supports up to three separate groups of protected ports. Traffic can flow between protected ports belonging to different groups, but not within the same group.

A port can belong to only one protected port group. You must remove an interface from one group before adding it to another group.

Port protection occurs within a single switch. Protected port configuration does not affect traffic between ports on two different switches. No traffic forwarding is possible between two protected ports.

When an interface is enabled for routing (via the **interface vlan** command), the port will no longer be operationally enabled as a protected port on the interface. If the interface is part of a LAG or is a probe port, the feature is disabled for the port.

## **What is Error Recovery?**

The error recovery feature enables the administrator to configure the switch to automatically bring interfaces that have been diagnostically disabled back into service automatically. The administrator may configure the causes for which error recovery will bring an interface back into service and may also configure the time interval over which error recovery is attempted. If an interface brought back into service by the error recovery mechanism has a subsequent failure, it will again be diagnostically disabled.

## **What is Link Local Protocol Filtering?**

The Link Local Protocol Filtering (LLPF) feature can help troubleshoot network problems that occur when a network includes proprietary protocols running on standards-based switches. LLPF allows Dell EMC Networking N-Series switches to filter out various Cisco proprietary protocol data units (PDUs) and/or ISDP packets if problems occur with these protocols running on standards-based switches. If certain protocol PDUs cause unexpected results, LLPF can be enabled to prevent those PDUs from being processed by the switch.

The LLPF feature can be configured per-port to block any combination (or all) of the following PDUs:

- Industry Standard Discovery Protocol (ISDP)
- VLAN Trunking Protocol (VTP)
- Dynamic Trunking Protocol (DTP)
- UniDirectional Link Detection (UDLD)
- Port Aggregation Protocol (PAgP)
- Shared Spanning Tree Protocol (SSTP)

Access Control Lists (ACLs) and LLPF can exist on the same interface. However, the ACL rules override the LLPF rules when there is a conflict. Similarly, DiffServ and LLPF can both be enabled on an interface, but DiffServ rules override LLPF rules when there is a conflict.

If Industry Standard Discovery Protocol (ISDP) is enabled on an interface, and the LLPF feature on an interface is enabled and configured to drop ISDP PDUs, the ISDP configuration overrides the LLPF configuration, and the ISDP PDUs are allowed on the interface.



## What is Loop Protection?

Dell EMC Networking implements a subset of the Configuration Testing Protocol (CTP) for the detection of network loops. The Configuration Testing Protocol is part of the original Ethernet specification. It does not appear in the IEEE 802 standard.

The Dell EMC implementation of the Loop Protocol unicasts a CTP reply packet with the following field settings:

Source MAC Address:	switch L3 MAC address
Destination MAC Address:	switch L3 MAC address
Ether Type:	0x9000 (LOOP)
Skip Count:	0
Functions:	Reply
Receipt Number:	0
Data:	0

If any interface receives CTP packets with the switch's MAC address as the source and the number of such packets received is in excess of the configured limit, the interface is error-disabled with a Loop Protection cause. The default limit is three packets received. Since all switch ports share the same MAC address, multiple ports may be disabled by a network loop. Disabled ports may be configured to be brought back into service by the Error Recovery feature.

The switch never sends a response to received CTP packets. The switch may flood the first few CTP packets it receives until a MAC address entry is placed in the CAM.

The CTP protocol operates on physical Ethernet interfaces only. It does not operate over Link Aggregation Groups.

The CTP protocol does not operate over the out-of-band interface.

The CTP protocol is disabled on all physical Ethernet interfaces by default. CTP packet reception is not blocked by spanning tree. CTP should be enabled only on interfaces that are not running spanning-tree as it may disable spanning-tree designated (blocked) ports.


# Default Port-Based Traffic Control Values

Table 23-2 lists the default values for the port-based traffic control features that this chapter describes.

**Table 23-2. Default Port-Based Traffic Control Values**

<b>Feature</b>	<b>Default</b>
Flow control	Enabled
Storm control	Disabled
Protected ports	None
LLPF	UDLD is blocked by default. No other protocols are blocked

# Configuring Port-Based Traffic Control (Web)

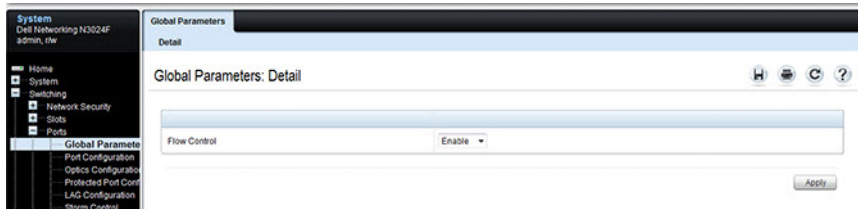
This section provides information about the OpenManage Switch Administrator pages to use to control port-based traffic on Dell EMC Networking N-Series switches. For details about the fields on a page, click  at the top of the Dell EMC OpenManage Switch Administrator web page.

## Flow Control (Global Port Parameters)

Use the **Global Parameters** page for ports to enable or disable flow control support on the switch.

To display the **Global Parameters** page, click **Switching** → **Ports** → **Global Parameters** in the navigation menu.

**Figure 23-1. Global Port Parameters**

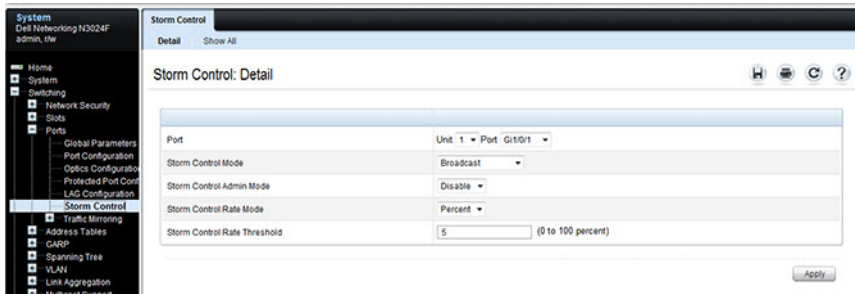


## Storm Control

Use the **Storm Control** page to enable and configure the storm control feature.

To display the **Storm Control** interface, click **Switching** → **Ports** → **Storm Control** in the navigation menu.

**Figure 23-2. Storm Control**



### Configuring Storm Control Settings on Multiple Ports

To configure storm control on multiple ports:

- 1 Open the **Storm Control** page.
- 2 Click **Show All** to display the **Storm Control Settings Table**.
- 3 In the **Ports** list, select the check box in the **Edit** column for the port to configure.
- 4 Select the desired storm control settings.

**Figure 23-3. Storm Control**

Storm Control

Detail Show All

Storm Control: Show All

Unit

Unit 1

Ports

Items Displayed 1-5 Rows Per Page 5

Port	Broadcast Control Mode	Broadcast Rate Mode	Broadcast Rate Threshold	Multicast Control Mode	Multicast Rate Mode	Multicast Rate Threshold	Unicast Control Mode	Unicast Rate Mode	Unicast Rate Threshold	Edit
Gi1/01	Disable	Percent	5	Disable	Percent	5	Disable	Percent	5	
Gi1/02	Disable	Percent	5	Disable	Percent	5	Disable	Percent	5	
Gi1/03	Disable	Percent	5	Disable	Percent	5	Disable	Percent	5	
Gi1/04	Disable	Percent	5	Disable	Percent	5	Disable	Percent	5	
Gi1/05	Disable	Percent	5	Disable	Percent	5	Disable	Percent	5	

Pages 1 of 6

Apply

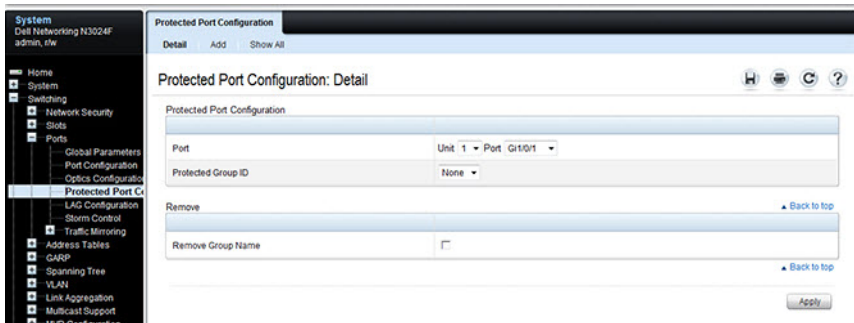
**5** Click Apply.

## Protected Port Configuration

Use the **Protected Port Configuration** page to prevent ports in the same protected ports group from being able to see each other's traffic.

To display the **Protected Port Configuration** page, click **Switching** → **Ports** → **Protected Port Configuration** in the navigation menu.

**Figure 23-4. Protected Port Configuration**

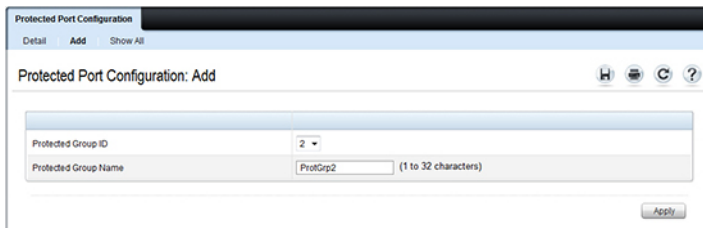


### Configuring Protected Ports

To configure protected ports:

- 1 Open the **Protected Ports** page.
- 2 Click **Add** to display the **Add Protected Group** page.
- 3 Select a group (0–2).
- 4 Specify a name for the group.

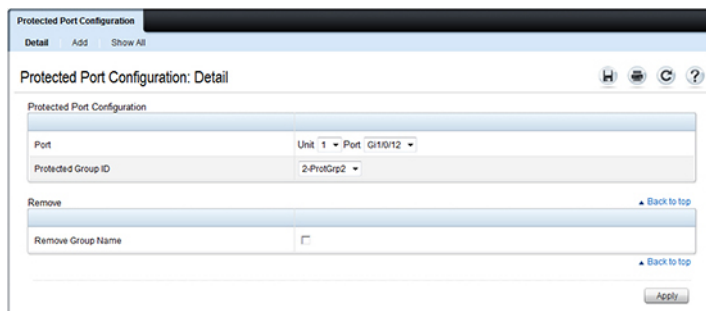
**Figure 23-5. Add Protected Ports Group**



- 5 Click **Apply**.

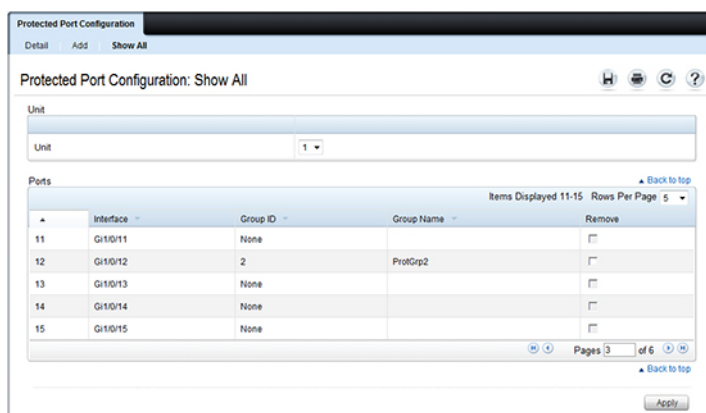
- 6 Click **Protected Port Configuration** to return to the main page.
- 7 Select the port to add to the group.
- 8 Select the protected port group ID.

**Figure 23-6. Add Protected Ports**



- 9 Click **Apply**.
- 10 To view protected port group membership information, click **Show All**.

**Figure 23-7. View Protected Port Information**



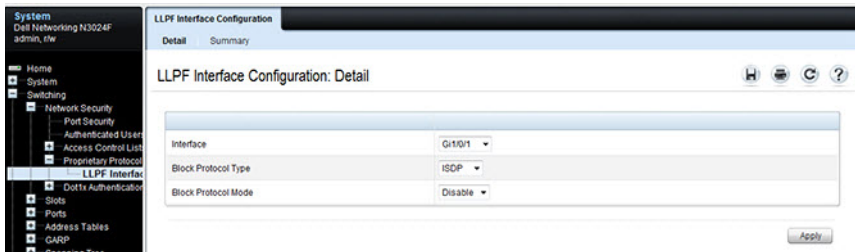
- 11 To remove a port from a protected port group, select the **Remove** check box associated with the port and click **Apply**.

## LLPF Configuration

Use the **LLPF Interface Configuration** page to filter out various proprietary protocol data units (PDUs) and/or ISDP if problems occur with these protocols running on standards-based switches.

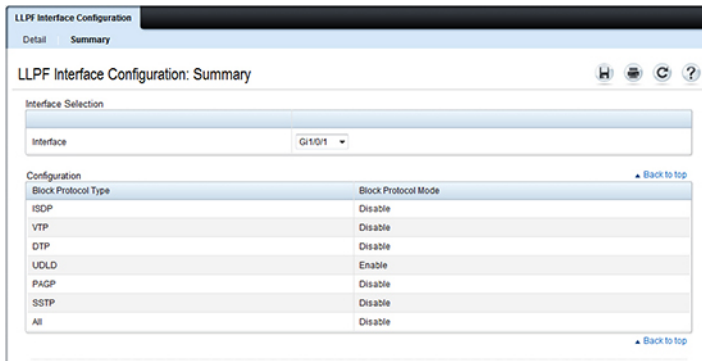
To display the **LLPF Interface Configuration** page, click **Switching** → **Network Security** → **Proprietary Protocol Filtering** → **LLPF Interface Configuration** the navigation menu.

**Figure 23-8. LLPF Interface Configuration**



To view the protocol types that have been blocked for an interface, click **Show All**.

**Figure 23-9. LLPF Filtering Summary**





# Configuring Port-Based Traffic Control (CLI)

This section provides information about the commands used for configuring port-based traffic control settings. For more information about the commands, see the *Dell EMC Networking N1100-ON, N1500, N2000, N2100-ON, N2200-ON, N3000E-ON, N3100-ON, and N3200-ON Series Switches CLI Reference Guide* at [www.dell.com/support](http://www.dell.com/support).

## Configuring Flow Control and Storm Control

Use the following commands to configure the flow control and storm control features.

Command	Purpose
<code>configure</code>	Enter global configuration mode.
<code>flowcontrol receive on</code>	Globally enable flow control. (Enabled by default)
<code>interface interface</code>	Enter interface configuration mode for the specified interface. The <i>interface</i> variable includes the interface type and number, for example <code>tengigabitethernet 1/0/3</code> .  A range of interfaces can be specified using the <b>interface range</b> command. For example, <b>interface range tengigabitethernet 1/0/8-12</b> configures interfaces 8, 9, 10, 11, and 12.
<code>storm-control broadcast [level rate]</code>	Enable broadcast storm recovery mode on the interface and (optionally) set the threshold.  <i>rate</i> — threshold as percentage of port speed. The percentage is converted to a PacketsPerSecond value based on a 512 byte average packet size.
<code>storm-control multicast [level rate]</code>	Enable multicast storm recovery mode on the interface and (optionally) set the threshold.  <i>rate</i> — threshold as percentage of port speed. The percentage is converted to a PacketsPerSecond value based on a 512 byte average packet size.

Command	Purpose
<b>storm-control unicast</b> [ <i>level rate</i> ]	Enable unknown unicast storm recovery mode on the interface and (optionally) set the threshold.  <i>rate</i> — threshold as percentage of port speed. The percentage is converted to a PacketsPerSecond value based on a 512 byte average packet size.
CTRL + Z	Exit to Privileged Exec mode.
<b>show interfaces detail</b> <i>interface</i>	Display detailed information about the specified interface, including the flow control status.
<b>show storm-control</b>	View whether 802.3x flow control is enabled on the switch.
<b>show storm-control</b> [ <i>interface   all</i> ]	View storm control settings for all interfaces or the specified interface.

## Configuring Protected Ports

Use the following commands to add a name to a protected port group and add ports to the group.

Command	Purpose
<b>configure</b>	Enter global configuration mode.
<b>switchport protected</b> <i>groupid</i> [ <i>name name</i> ]	Specify a name for one of the three protected port groups. <ul style="list-style-type: none"> <li><i>groupid</i> — Identifies which group the port is to be protected in. (Range: 0-2)</li> <li><i>name</i> — Name of the group. (Range: 0-32 characters)</li> </ul>
<b>interface</b> <i>interface</i>	Enter interface configuration mode for the specified interface. The <i>interface</i> variable includes the interface type and number, for example <b>tengigabitethernet 1/0/3</b> .
<b>switchport protected</b> <i>groupid</i>	Add the interface to the specified protected port group.
CTRL + Z	Exit to Privileged Exec mode.
<b>show switchport</b> <b>protected</b>	View protected group and port information.

## Configuring LLPF

**NOTE:** LLPF is not supported on the N1500 Series switches.

Use the following commands to configure LLPF settings. Most of these protocols (other than CDP and UDLD) are obsolete and may cause excessive CPU usage.

Command	Purpose
<code>configure</code>	Enter global configuration mode.
<code>interface <i>interface</i></code>	Enter interface configuration mode for the specified interface. The <i>interface</i> variable includes the interface type and number, for example <code>tengigabitethernet 1/0/3</code> .  A range of interfaces can be specified using the <b>interface range</b> command. For example, <b>interface range tengigabitethernet 1/0/8-12</b> configures interfaces 8, 9, 10, 11, and 12.
<code>service-acl input</code> { <code>blockcdp</code>   <code>blockvtp</code>   <code>blockdtp</code>   <code>blockudld</code>   <code>blockpagp</code>   <code>blocksstp</code>   <code>blockall</code> }	Use the appropriate keyword, or combination of keywords to block any (or all) of the following PDUs on the interface: <ul style="list-style-type: none"><li>• CDP — Cisco Discovery Protocol</li><li>• VTP — VLAN Trunking Protocol</li><li>• DTP — Dynamic Trunking Protocol</li><li>• UDLD — Unidirectional Link Detection</li><li>• PAgP — Port Aggregation Protocol</li><li>• SSTP — Secure Socket Tunneling Protocol</li><li>• All</li></ul>
<code>CTRL + Z</code>	Exit to Privileged Exec mode.
<code>show service-acl</code> <code>interface {<i>interface</i>  </code> <code>all}</code>	View information about the blocked PDUs on the specified interface or all interfaces.

# Port-Based Traffic Control Configuration Example

The commands in this example configure storm control, LLPF, and protected port settings for various interfaces on the switch.

The storm control configuration in this example sets thresholds on the switch so that if broadcast traffic occupies more than 10% on the bandwidth on any physical port, the interface blocks the broadcast traffic until the measured amount of this traffic drops below the threshold.

The LLPF configuration in this example disables all PAgP and VTP PDUs from being forwarded on any switch port or LAG.

The protected port configuration in this example prevents the clients connected to ports 3, 4, and 9 from being able to communicate with each other.

When an interface is enabled for routing (via the **interface vlan** command), the port will no longer be operationally enabled as a protected port on the interface. If the interface is part of a LAG or is a probe port, the feature is disabled for the port.

To configure the switch:

- 1 Configure storm control for broadcast traffic on all physical interfaces.  

```
console(config)#interface range te1/0/1-24  
console(config-if)#storm-control broadcast level 10
```
- 2 Configure LLPF to block PAgP and VTP PDUs on all physical interfaces.  

```
console(config-if)#service-acl blockpagp blockvtp  
console(config-if)#exit
```
- 3 Specify a name for protected port group 0.  

```
console(config)#protected 0 name clients
```
- 4 Add the ports to the protected port group.  

```
console(config)#interface te1/0/3  
console(config-if-Tel/0/3)#switchport protected 0  
console(config-if-Tel/0/3)#exit  
console(config)#interface te1/0/4  
console(config-if-Tel/0/4)#switchport protected 0  
console(config-if-Tel/0/4)#exit  
console(config)#interface te1/0/9  
console(config-if-Tel/0/9)#switchport protected 0  
console(config-if-Tel/0/9)#exit  
console(config)#exit
```

**5** Verify the configuration.

```
console#show storm-control tel1/0/1
```

Intf	Bcast Mode	Bcast Level	Mcast Mode	Mcast Level	Ucast Mode	Ucast Level
Tel1/0/1	Enable	10	Enable	5	Disable	5

```
console#show service-acl interface tel1/0/1
```

Protocol	Mode
CDP	Disabled
VTP	Enabled
DTP	Disabled
UDLD	Disabled
PAGP	Enabled
SSTP	Disabled
ALL	Disabled

```
console#show switchport protected 0
```

```
Name..... "clients"
```

```
Member Ports: Tel1/0/1, Tel1/0/2, Tel1/0/3, Tel1/0/4, Tel1/0/9
```



# Layer-2 Multicast Features

## Dell EMC Networking N-Series Switches

This chapter describes the Layer-2 (L2) multicast features on the Dell EMC Networking N-Series switches. The features this chapter describes include bridge multicast flooding and forwarding, Internet Group Management Protocol (IGMP) snooping, Multicast Listener Discovery (MLD) snooping, and Multicast VLAN Registration (MVR).

The topics covered in this chapter include:

- L2 Multicast Overview
- Snooping Switch Restrictions
- Default L2 Multicast Values
- Configuring L2 Multicast Features (Web)
- Configuring L2 Multicast Features (CLI)
- Case Study on a Real-World Network Topology

## L2 Multicast Overview

Multicast traffic is traffic from one source that has multiple destinations. The L2 multicast features on the switch help control network flooding of Ethernet multicast and IP multicast traffic by keeping track of multicast group membership. It is essential that a multicast router be connected to a Dell EMC Networking Layer-2 multicast switch for IGMP/MLD snooping to operate properly. The presence of a multicast router allows the snooping switch to relay IGMP reports to the router and to forward multicast data sources to the multicast router as well as restrict flooding of multicast sources in a VLAN.

### Multicast Flooding and Forwarding

Flooding behavior is to send incoming multicast packets to all ports in the VLAN other than the ingress port. Forwarding behavior is to send incoming multicast packets to selected ports in the VLAN. Forwarding behavior is

desirable as it reduces the network load by sending packets only to other hosts/switches/routers that have indicated an interest in receiving the multicast.

If L2 snooping is not enabled, multicast packets are flooded in the ingress VLAN.

## **What Are the Multicast Bridging Features?**

The Dell EMC Networking N-Series switches support multicast forwarding and multicast flooding. For multicast traffic, the switch uses a database called the Layer-2 Multicast Forwarding Database (MFDB) to make forwarding decisions for packets that arrive with a multicast destination MAC address. By limiting multicasts to only certain ports in the switch, traffic is prevented from going to parts of the network where that traffic is unnecessary.

When a packet enters the switch, the destination MAC address is combined with the VLAN ID, and a search is performed in the Layer-2 MFDB. If no match is found, then the packet is flooded. If a match is found, then the packet is forwarded only to the ports that are members of that multicast group within the VLAN.

Multicast traffic destined to well-known (reserved) multicast IP addresses (control plane traffic) is always flooded to all ports in the VLAN. The well-known IP multicast addresses are 224.0.0.x for IPv4 and FF0x:: for IPv6.

By default IGMP/MLD snooping is enabled and multicast data traffic is flooded to all ports in the VLAN if no multicast router ports have been identified. Once a multicast router port is identified, multicast data traffic is forwarded to the multicast router ports. The MFDB is populated by snooping the membership reports sent to the multicast routers. This causes multicast data traffic to be forwarded to any hosts joining the multicast group. Enabling multicast routing on the switch internally enables an mrouter port, and snooping will forward multicast to hosts joining the group instead of flooding it in the VLAN.

It is possible to statically define an mrouter port. This causes IGMP/MLD snooping to forward multicast data traffic to hosts from which it has received membership reports. This behavior exists even if the mrouter port is not enabled.



## What Is L2 Multicast Traffic?

L3 IP multicast traffic is traffic that is destined to a host group. Host groups are identified by class D IPv4 addresses, which range from 224.0.1.0 to 239.255.255.255, or by FF0x:: or FF3x:: IPv6 addresses. In contrast to L3 multicast traffic, Layer-2 multicast traffic is identified by the MAC address, i.e., the range 01:00:5e:00:00:00 to 01:00:5e:7f:ff:ff:ff for IPv4 multicast traffic or 33:33:xx:xx:xx:xx for IPv6 multicast traffic.

When a packet with a broadcast or multicast destination MAC address is received, the switch will flood a copy into each of the remaining network segments in accordance with the IEEE MAC Bridge standard. Eventually, the packet is made accessible to all nodes connected to the network.

This approach works well for broadcast packets that are intended to be seen or processed by all connected nodes. In the case of multicast packets, however, this approach could lead to less efficient use of network bandwidth, particularly when the packet is intended for only a small number of nodes. Packets will be flooded into network segments where no node has any interest in receiving the packet.

## What Is IGMP Snooping?

IGMP snooping allows the switch to snoop on IGMP exchanges between hosts and multicast routers and perform multicast forwarding within a VLAN. The IGMP snooping feature complies with RFC 4541. When a switch “sees” an IGMP report from a host for a given multicast address, the switch adds the host's interface/VLAN to the L2 multicast group forwarding table and floods the report to all ports in the VLAN. When the switch sees a leave message for the group, it removes the host interface/VLAN from the L2 multicast group forwarding table.

IGMP snooping learns about multicast routers by listening for the following messages:

- An IGMP query packet.
- PIMv1 (IGMP type 0x14) packets with destination IP address 224.0.0.13.
- DVMRP (IGMP type 0x13) packets with destination IP address 224.0.0.4.
- PIMv2 (IP protocol type 0x67) packets with destination IP address 224.0.0.13.

Group addresses that fall into the reserved range 224.0.0.x are never pruned by IGMP snooping—they are always flooded to all ports in the VLAN. Note that this flooding is based on the IP address, not the corresponding 01-00-5e-00-00-xx MAC address.

When a multicast router is discovered (or locally configured on the switch), its interface is added to the interface distribution list for all multicast groups in the VLAN. If a switch is connected to a multicast source and no client, the switch filters the traffic from that group to all interfaces in the VLAN. If the switch sees an IGMP join from a host in the same VLAN, then it forwards the traffic to the host. Likewise, if the switch sees a multicast router in the VLAN, it forwards the group to the multicast router and does not flood in the VLAN. If snooping is disabled, the switch always floods multicast data and control plane packets in the VLAN.

A multicast router can also be statically configured, either by configuring a port as a static L2 mrouter port in the VLAN, or by enabling L3 multicast routing in the switch. If a port is configured as a static L2 mrouter port, IGMP snooping forwards multicast data plane packets in the VLAN regardless of the interface state of the port.

By default, dynamically discovered multicast routers are aged out every five minutes. The user can control whether or not multicast routers age out. If all multicast routers age out, the switch floods the VLAN with any received multicast groups.

Multicast routers send an IGMP query every 60 seconds. This query is intercepted by the switch and forwarded to all ports in the VLAN. All hosts that are members of the group answer that query. The switch intercepts the replies and forwards only one report per group from all of the received responses.

In summary:

- IGMP snooping controls the flooding/forwarding behavior for multicast groups. Multicast data is flooded in the VLAN until a multicast router port is identified.
- IGMP snooping is enabled by default
- IGMP snooping forwards multicast sources to multicast routers by default
- Reserved multicast IP addresses (224.0.0.x) are always flooded to all ports in the VLAN

- Unregistered multicast traffic may be flooded in the VLAN by a user configuration option.



**NOTE:** It is strongly recommended that operators enable MLD snooping if IGMP snooping is enabled and vice-versa. This is because both IGMP snooping and MLD snooping utilize the same forwarding table. Not enabling both may cause unwanted pruning of protocol packets utilized by other protocols, e.g. OSPFv3.



**NOTE:** IGMP snooping (and IGMP querier) validates IGMP packets. As part of the validation, IGMP checks for the router alert option. If other devices in the network do not send IGMP packets with the router alert option, IGMP snooping (and snooping querier) will discard the packet. Use the **no ip igmp snooping router-alert-check** command to disable checking for the router alert option.

### IGMP Snooping Querier

When PIM and IGMP are enabled in a network with IP multicast routing, the IP multicast router acts as the IGMP querier. However, if the IP-multicast traffic in a VLAN needs to be Layer-2 switched only, an IP-multicast router is not required. The IGMP snooping querier can perform the role of generating IGMP queries that would normally be performed by the multicast router.



**NOTE:** Without an IP-multicast router on a VLAN, you must configure another switch as the IGMP querier so that it can send queries.

When IGMP snooping querier is enabled, the querier switch sends out periodic IGMP queries that trigger IGMP report messages from the hosts that want to receive IP multicast traffic. The IGMP snooping feature listens to these IGMP reports to identify multicast router ports. If there is another querier in the network and the local querier is in election mode, then the querier with the lower IP address is elected and the other querier stops querying. If the local querier is not in election mode and another querier is detected, the local querier stops querying.

### What Is MLD Snooping?

In IPv4, Layer-2 switches use IGMP snooping to limit the flooding of multicast traffic by dynamically configuring the multicast forwarding database so that multicast data traffic is forwarded to only those ports

associated with a multicast router or host that has indicated an interest in receiving a particular multicast group. In IPv6, MLD snooping performs a similar function.

With MLD snooping, IPv6 multicast data is selectively forwarded to a list of ports that want to receive the data instead of being flooded to all ports in a VLAN. This list is constructed in the MFDB by snooping IPv6 multicast control packets. MLD snooping floods multicast data packets until a multicast router port has been identified. MLD snooping forwards unregistered multicast data packets to IPv6 multicast routers. MLD snooping discovers multicast routers by listening for MLD queries and populates the MFDB.

MLD Snooping learns of multicast routers by listening for the following packets:

- MLD query packets
- PIMv2 hello packets with destination IP address as FF02::D

Dynamically learned multicast routers are timed out after an administrator-configurable period of time.

MLD is a protocol used by IPv6 multicast routers to discover the presence of multicast listeners (nodes wishing to receive IPv6 multicast packets) on its directly-attached links and to discover which multicast packets are of interest to neighboring nodes. MLD is derived from ICMP; MLD version 1 (MLDv1) is equivalent to IGMPv2, and MLD version 2 (MLDv2) is equivalent to IGMPv3. MLD is a subprotocol of Internet Control Message Protocol version 6 (ICMPv6), and MLD messages are a subset of ICMPv6 messages.

A multicast router can also be statically configured, either by configuring a port as a static L2 mrouter port in the VLAN, or by enabling L3 multicast routing in the switch. If a port is configured as a static L2 mrouter port, IGMP/MLD snooping forwards packets regardless of the interface state of the port.

The switch snoops both MLDv1 and MLDv2 protocol packets and forwards IPv6 multicast data based on destination IPv6 multicast MAC addresses (33:33:.). The switch floods multicast control plane traffic addressed to the permanently assigned (well-known) multicast address FF0x::/8 to all ports in the VLAN, except for MLD packets, which are handled according the MLD snooping rules.



**NOTE:** It is strongly recommended that users enable IGMP snooping if MLD snooping is enabled and vice-versa. This is because both IGMP snooping and MLD snooping utilize the same forwarding table, and not enabling both may cause unwanted pruning of protocol packets utilized by other protocols, e.g. OSPFv2.

## What Is Multicast VLAN Registration?

IGMP snooping helps limit multicast traffic when member ports are in the same VLAN; however, when ports belong to different VLANs, a copy of the multicast stream is sent to each VLAN that has member ports in the multicast group. MVR eliminates the need to duplicate the multicast traffic when multicast group member ports belong to different VLANs.

MVR uses a dedicated multicast VLAN to forward multicast traffic over the L2 network. Only one MVLAN can be configured per switch, and it is used only for certain multicast traffic, such as traffic from an IPTV application, to avoid duplication of multicast streams for clients in different VLANs. Clients can dynamically join or leave the multicast VLAN without interfering with their membership in other VLANs.

MVR, like IGMP snooping, allows a Layer-2 switch to listen to IGMP messages to learn about multicast group membership.

There are two types of MVR ports: source and receiver.

- Source port is the port where multicast traffic is flowing to. It has to be the member of so called multicast VLAN.
- Receiver port is the port where listening host is connected to the switch. It can be the member of any VLAN, except multicast VLAN.

There are two configured learning modes of the MVR operation: dynamic and compatible.

- In the dynamic mode MVR learns existent multicast groups by parsing the IGMP queries from router on source ports and forwarding the IGMP joins from the hosts to the router.
- In the compatible mode MVR does not learn multicast groups, but they have to be configured by administrator and protocol does not forward joins from the hosts to the router. To work in this mode the IGMP router has to be configured to transmit required multicast streams to the network with the MVR switch.

## Enabling MVR and IGMP Snooping on the Same Interface

MVR and IGMP snooping operate independently and can both be enabled on an interface. When both MVR and IGMP snooping are enabled, MVR listens to the IGMP join and report messages for static multicast group information, and IGMP snooping manages dynamic multicast groups.

## When Are Layer-3 Multicast Features Required?

In addition to L2 multicast features, the switch supports IPv4 and IPv6 multicast features. You configure the IPv4/IPv6 multicast features if the switch functions as a multicast router that can route multicast traffic between VLAN routing interfaces. In this case, you must enable a multicast routing protocol on the switch, such as PIM-SM. For information about Layer-3 multicast features, see "IPv4 and IPv6 Multicast" on page 1601.

If the switch functions as a multicast router, it is possible to enable IGMP so that IGMP forwards multicast traffic for directly connected hosts between VLANs. It is recommended that IGMP snooping and MLD snooping be enabled in L3 multicast routed networks, as this allows the switch to limit multicast flooding in multi-access routed VLANs based as controlled by IGMP snooping.



**NOTE:** If MVR is enabled, IP Multicast should be disabled. Multicast routing and MVR cannot coexist on a switch.

For information about configuring Dell EMC Networking N3000-ON and N3200-ON switches as a multicast router that also performs IGMP snooping, see "Configuring Multicast VLAN Routing With IGMP and PIM-SM" on page 1681.

## What Are GARP and GMRP?

Generic Attribute Registration Protocol (GARP) is a general-purpose protocol that registers any network connectivity or membership-style information. GARP defines a set of switches interested in a given network attribute, such as VLAN ID or multicast address.

Dell EMC Networking N-Series switches can use GARP functionality for two applications:

- GARP VLAN Registration Protocol (GVRP) to help dynamically manage VLAN memberships on trunk ports.

- GARP Multicast Registration Protocol (GMRP) to help control the flooding of multicast traffic by keeping track of group membership information.

GVRP and GMRP use the same set of GARP Timers to specify the amount of time to wait before transmitting various GARP messages.

GMRP is similar to IGMP snooping in its purpose, but IGMP snooping is more widely used. GMRP must be running on both the host and the switch to function properly and IGMP/MLD snooping must be disabled on the switch, as IGMP snooping and GMRP cannot simultaneously operate within the same VLAN.

# Snooping Switch Restrictions

## MAC Address-Based Multicast Group

The L2 multicast forwarding table consists of the Multicast group MAC address filtering entries. For IPv4 multicast groups, 16 IP multicast group addresses map to the same multicast MAC address. For example, 224.1.1.1 and 225.1.1.1 map to the MAC address 01:00:5E:01:01:01, and IP addresses in the range [224-239].3.3.3 map to 01:00:5E:03:03:03. As a result, if a host requests 225.1.1.1, then it might receive the multicast traffic of group 226.1.1.1 as well.

## Topologies Where the Multicast Source Is Not Directly Connected to the Querier

If the multicast source is not directly connected to a multicast querier, the multicast stream is forwarded to any router ports on the switch (within the VLAN). Because multicast router queries are flooded to all ports in the VLAN, intermediate IGMP snooping switches will receive the multicast stream from the multicast source and forward it to the multicast router.

## Using Static Multicast MAC Configuration

If configuring static multicast MAC group addresses on a port in a VLAN, it is necessary to configure all ports in the VLAN over which it is desired that the group traffic flow (both host and router) on all switches. IGMP snooping does not dynamically add ports to a VLAN for a multicast group when a static entry is configured for that group in the VLAN. This restriction applies to both multicast router-connected ports and host-connected ports.

## IGMP Snooping and GMRP

IGMP snooping and GMRP are not compatible. Only one of IGMP snooping or GMRP should be configured to filter multicast groups for any VLAN. Simultaneous operation of GMRP and IMGP snooping is not supported and will lead to undesirable results, such as flooding in the VLAN due to the inability to identify multicast router ports.



## Default L2 Multicast Values

Details about the L2 multicast are in Table 24-1.


**Table 24-1. L2 Multicast Defaults**

<b>Parameter</b>	<b>Default Value</b>
IGMP Snooping mode	Enabled
MLD Snooping mode	Enabled
Bridge multicast group	None configured
IGMP/MLD snooping	Enabled on all VLANs
IGMP/MLD snooping auto-learn	Disabled
IGMP/MLD snooping host timeout	260 seconds
IGMP/MLD snooping multicast router timeout	300 seconds
IGMP/MLD snooping leave timeout	10 seconds
IGMP snooping querier	Disabled
IGMP version	v2
MLD version	v1
IGMP/MLD snooping querier query interval	60 seconds
IGMP/MLD snooping querier expiry interval	125/60 seconds
IGMP/MLD snooping VLAN querier	Disabled
VLAN querier election participate mode	Disabled
Snooping Querier VLAN Address	0.0.0.0
MVR running	Disabled
MVR multicast VLAN	1
MVR max multicast groups	64
MVR Global query response time	5 tenths of a second
MVR Mode	Compatible
GARP Leave Timer	60 centiseconds

**Table 24-1. L2 Multicast Defaults (Continued)**

<b>Parameter</b>	<b>Default Value</b>
GARP Leave All Timer	1000 centiseconds
GARP Join Timer	20 centiseconds
GMRP	Disabled globally and per-interface

# Configuring L2 Multicast Features (Web)

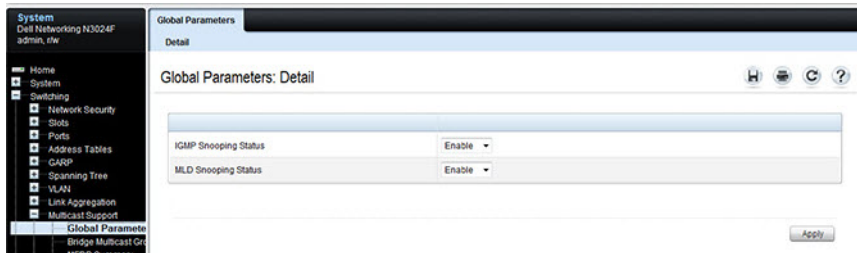
This section provides information about the OpenManage Switch Administrator pages for configuring and monitoring L2 multicast features on Dell EMC Networking N-Series switches. For details about the fields on a page, click  at the top of the Dell EMC OpenManage Switch Administrator web page.

## Multicast Global Parameters

Use the **Multicast Global Parameters** page to enable or disable IGMP snooping, or MLD snooping on the switch.

To display the **Multicast Global Parameters** page, click **Switching** → **Multicast Support** → **Global Parameters** in the navigation menu.

**Figure 24-1. Multicast Global Parameters**



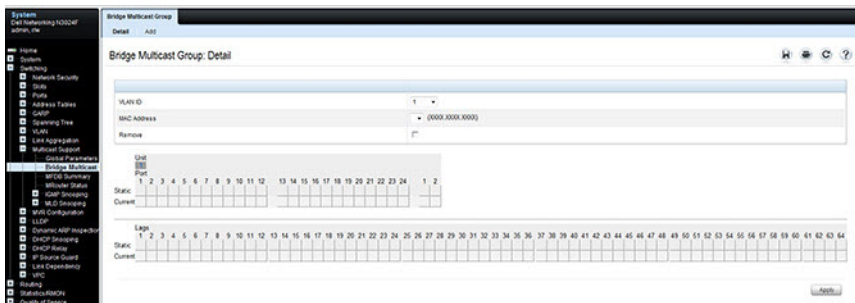
**NOTE:** It is strongly recommended that users enable IGMP snooping if MLD snooping is enabled and vice-versa. This is because both IGMP snooping and MLD snooping utilize the same forwarding table, and not enabling both may cause unwanted pruning of protocol packets utilized by other protocols, e.g. OSPFv2.

## Bridge Multicast Group

Use the **Bridge Multicast Group** page to create new multicast service groups or to modify ports and LAGs assigned to existing multicast service groups. Attached interfaces display in the Port and LAG tables and reflect the manner in which each is joined to the Multicast group.

To display the **Bridge Multicast Group** page, click **Switching** → **Multicast Support** → **Bridge Multicast Group** in the navigation menu.

**Figure 24-2. Bridge Multicast Group**



### Understanding the Port and LAG Member Tables

The **Bridge Multicast Group** tables display which Ports and LAGs are members of the multicast group, and whether they're static (S), dynamic (D), or forbidden (F). The tables have two rows: **Static** and **Current**. Only the **Static** row is accessible from this page. The **Current** row is updated when the **Static** row is changed and **Apply** is clicked.

The **Bridge Multicast Group** page contains two editable tables:

- **Unit and Ports** — Displays and assigns multicast group membership to ports. To assign membership, click in **Static** for a specific port. Each click toggles between S, F, and blank. See Table 24-2 for definitions.
- **LAGs** — Displays and assigns multicast group membership to LAGs. To assign membership, click in **Static** for a specific LAG. Each click toggles between S, F, and blank. See Table 24-2 for definitions.

Table 24-2 contains definitions for port/LAG IGMP management settings.

**Table 24-2. Port/LAG IGMP Management Settings**

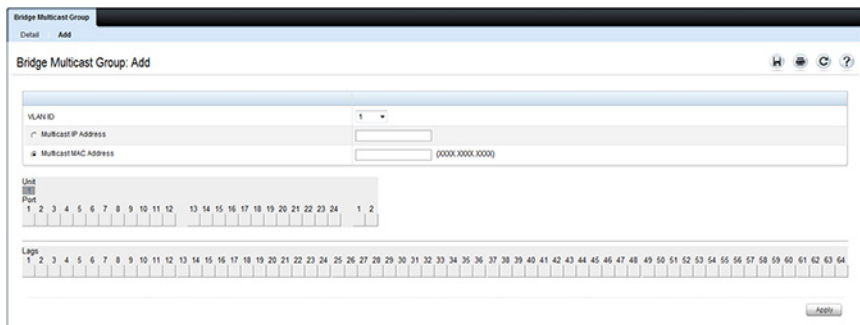
Port Control	Definition
D	Dynamic: Indicates that the port/LAG was dynamically joined to the Multicast group (displays in the <i>Current</i> row).
S	Static: Attaches the port to the Multicast group as a static member in the <i>Static</i> row. Displays in the <i>Current</i> row once <b>Apply</b> is clicked.
F	Forbidden: Indicates that the port/LAG is forbidden entry into the Multicast group in the <i>Static</i> row. Displays in the <i>Current</i> row once <b>Apply</b> is clicked.
Blank	Blank: Indicates that the port is not attached to a Multicast group.

### Adding and Configuring Bridge Multicast Address Groups

To configure a bridge multicast group:

- 1 From the **Bridge Multicast Group** page, click **Add**.  
The **Add Bridge Multicast Group** page displays.

**Figure 24-3. Add Bridge Multicast Group**



- 2 Select the ID of the VLAN to add to the multicast group or to modify membership for an existing group.
- 3 For a new group, specify the multicast group IP or MAC address associated with the selected VLAN.

- 4 In the **Bridge Multicast Group** tables, assign a setting by clicking in the **Static** row for a specific port/LAG. Each click toggles between S, F, and blank. (not a member).
- 5 Click **Apply**.  
The bridge multicast address is assigned to the multicast group, ports/LAGs are assigned to the group (with the **Current** rows being updated with the **Static** settings), and the switch is updated.

### **Removing a Bridge Multicast Group**

To delete a bridge multicast group:

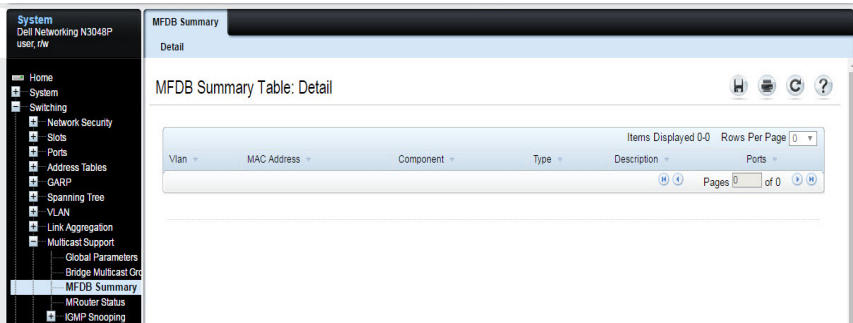
- 1 Open the **Bridge Multicast Group** page.
- 2 Select the **VLAN ID** associated with the bridge multicast group to be removed from the drop-down menu.  
The **Bridge Multicast Address** and the assigned ports/LAGs display.
- 3 Check the **Remove** check box.
- 4 Click **Apply**.  
The selected bridge multicast group is removed, and the device is updated.

## MFDB Summary

Use the MFDB Summary page to view all entries in the multicast forwarding database.

To access this page, click **Switching** → **Multicast Support** → **MFDB Summary** in the navigation panel.

**Figure 24-4. MFDB Summary**

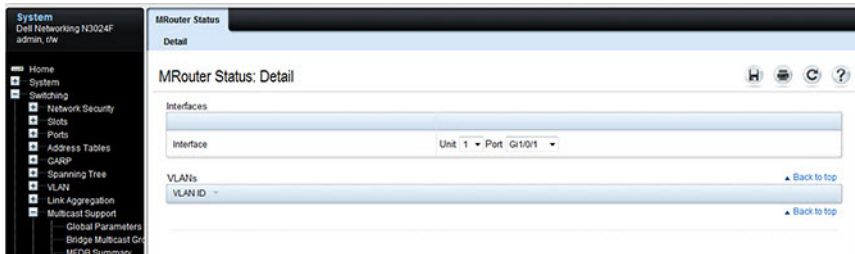


## MRouter Status

Use the **MRouter Status** page to display the status of dynamically learned multicast router interfaces.

To access this page, click **Switching** → **Multicast Support** → **MRouter Status** in the navigation panel.

**Figure 24-5. MRouter Status**



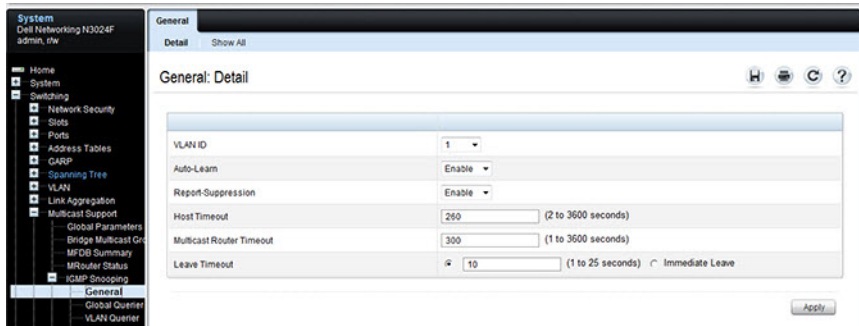


## General IGMP Snooping

Use the **General IGMP snooping** page to configure IGMP snooping settings on specific VLANs.

To display the **General IGMP snooping** page, click **Switching** → **Multicast Support** → **IGMP Snooping** → **General** in the navigation menu.

**Figure 24-6. General IGMP Snooping**

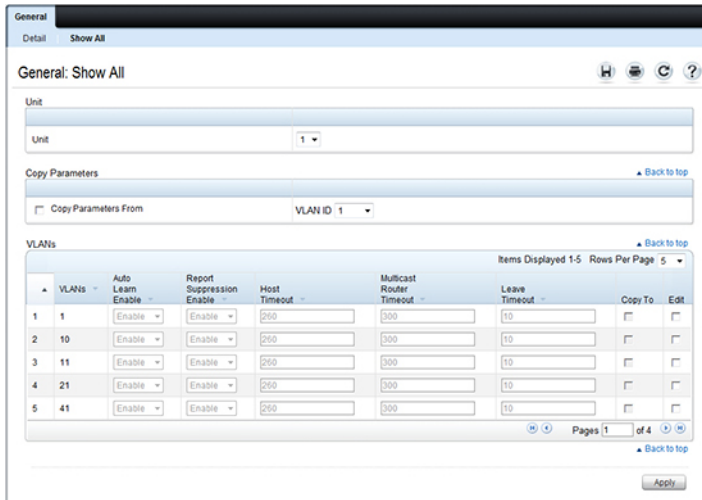


## Modifying IGMP Snooping Settings for VLANs

To modify the IGMP snooping settings:

- 1 From the **General IGMP snooping** page, click **Show All**.  
The **IGMP Snooping Table** displays.
- 2 Select the **Edit** checkbox for each VLAN to modify.  
In Figure 24-7, 2 and 3 are to be modified.

**Figure 24-7. Edit IGMP Snooping Settings**



- 3 Edit the IGMP snooping fields as needed.
- 4 Click **Apply**.  
The IGMP snooping settings are modified, and the device is updated.

### **Copying IGMP Snooping Settings to Multiple VLANs**

To copy IGMP snooping settings:

- 1 From the **General IGMP snooping** page, click **Show All**.  
The **IGMP Snooping Table** displays.
- 2 Select the **Copy Parameters From** checkbox.
- 3 Select a VLAN to use as the source of the desired parameters.
- 4 Select the **Copy To** checkbox for the VLANs that these parameters will be copied to.

In Figure 24-8, the settings for VLAN 21 will be copied to ports 3 and 5.

**Figure 24-8. Copy IGMP Snooping Settings**

General: Show All

Unit: 1

Copy Parameters From: VLAN ID 21

VLANs	Auto Learn Enable	Report Suppression Enable	Host Timeout	Multicast Router Timeout	Leave Timeout	Copy To	Edit
1	Enable	Enable	260	300	10	<input type="checkbox"/>	<input type="checkbox"/>
2	Enable	Enable	260	300	10	<input type="checkbox"/>	<input type="checkbox"/>
3	Enable	Enable	260	300	10	<input checked="" type="checkbox"/>	<input type="checkbox"/>
4	Enable	Enable	260	300	10	<input type="checkbox"/>	<input type="checkbox"/>
5	Enable	Enable	260	300	10	<input checked="" type="checkbox"/>	<input type="checkbox"/>

Pages 1 of 4

Apply

**5** Click Apply.

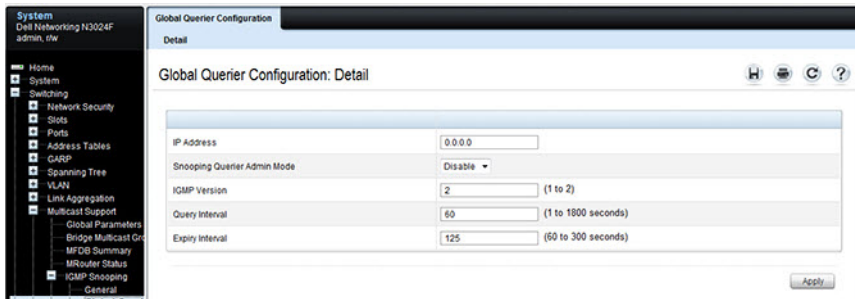
The IGMP snooping settings are modified, and the device is updated.

## Global Querier Configuration

Use the **Global Querier Configuration** page to configure IGMP snooping querier settings, such as the IP address to use as the source in periodic IGMP queries when no source address has been configured on the VLAN.

To display the **Global Querier Configuration** page, click **Switching** → **Multicast Support** → **IGMP Snooping** → **Global Querier Configuration** in the navigation menu.

**Figure 24-9. Global Querier Configuration**

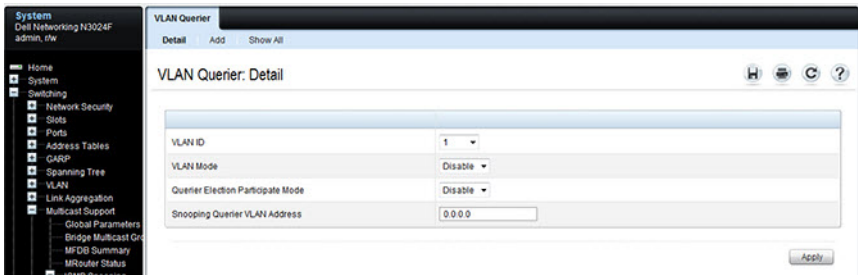


## VLAN Querier

Use the **VLAN Querier** page to specify the IGMP snooping querier settings for individual VLANs.

To display the **VLAN Querier** page, click **Switching** → **Multicast Support** → **IGMP Snooping** → **VLAN Querier** in the navigation menu.

**Figure 24-10. VLAN Querier**



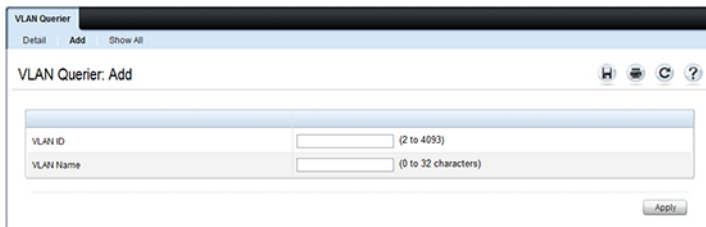
### Adding a New VLAN and Configuring its VLAN Querier Settings

To configure a VLAN querier:

- 1 From the **VLAN Querier** page, click **Add**.

The page refreshes, and the **Add VLAN** page displays.

**Figure 24-11. Add VLAN Querier**



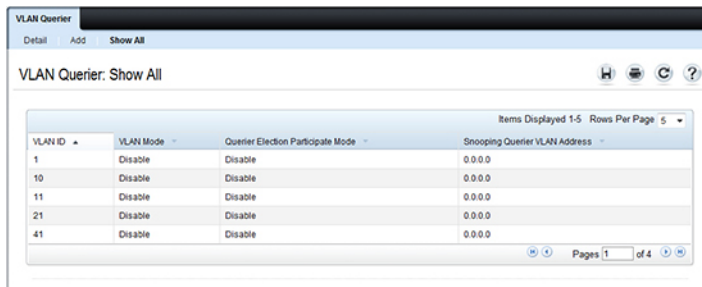
- 2 Enter the VLAN ID and, if desired, an optional VLAN name.
- 3 Return to the **VLAN Querier** page and select the new VLAN from the **VLAN ID** menu.
- 4 Specify the VLAN querier settings.

5 Click Apply.

The VLAN Querier settings are modified, and the device is updated.

To view a summary of the IGMP snooping VLAN querier settings for all VLANs on the switch, click **Show All**.

**Figure 24-12. Add VLAN Querier**



The screenshot shows the 'VLAN Querier' configuration page. At the top, there are tabs for 'Detail', 'Add', and 'Show All'. Below the tabs, the page title is 'VLAN Querier: Show All'. There are three icons: a home icon, a refresh icon, and a help icon. Below the icons, there is a table with the following columns: 'VLAN ID', 'VLAN Mode', 'Querier Election Participate Mode', and 'Snooping Querier VLAN Address'. The table contains five rows of data. At the bottom right of the table, there is a pagination control showing 'Pages 1 of 4'.

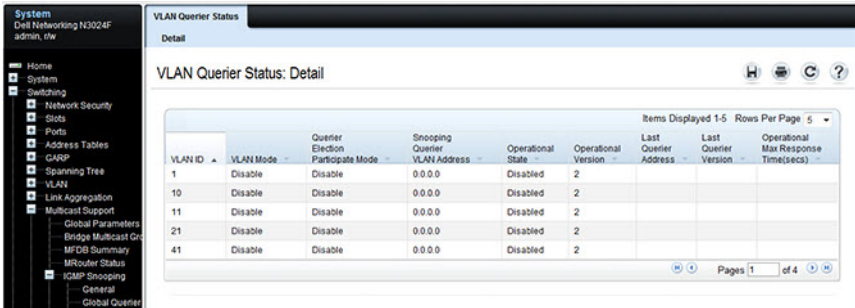
VLAN ID	VLAN Mode	Querier Election Participate Mode	Snooping Querier VLAN Address
1	Disable	Disable	0.0.0
10	Disable	Disable	0.0.0
11	Disable	Disable	0.0.0
21	Disable	Disable	0.0.0
41	Disable	Disable	0.0.0

## VLAN Querier Status

Use the **VLAN Querier Status** page to view the IGMP snooping querier settings for individual VLANs.

To display the **VLAN Querier Status** page, click **Switching** → **Multicast Support** → **IGMP Snooping** → **VLAN Querier Status** in the navigation menu.

**Figure 24-13. IGMP Snooping VLAN Querier Status**



The screenshot displays the 'VLAN Querier Status: Detail' page. The left sidebar shows the navigation menu with 'IGMP Snooping' selected. The main content area contains a table with the following data:

VLAN ID	VLAN Mode	Querier Election Participate Mode	Snooping Querier VLAN Address	Operational State	Operational Version	Last Querier Address	Last Querier Version	Operational Max Response Time (secs)
1	Disable	Disable	0.0.0.0	Disabled	2			
10	Disable	Disable	0.0.0.0	Disabled	2			
11	Disable	Disable	0.0.0.0	Disabled	2			
21	Disable	Disable	0.0.0.0	Disabled	2			
41	Disable	Disable	0.0.0.0	Disabled	2			

## MFDB IGMP Snooping Table

Use the **MFDB IGMP Snooping Table** page to view the multicast forwarding database (MFDB) IGMP Snooping Table and Forbidden Ports settings for individual VLANs.

To display the **MFDB IGMP Snooping Table** page, click **Switching** → **Multicast Support** → **IGMP Snooping** → **MFDB IGMP Snooping Table** in the navigation menu.

**Figure 24-14. MFDB IGMP Snooping Table**



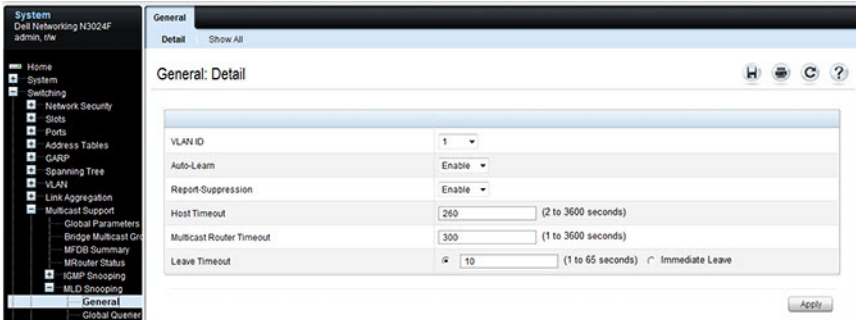


## MLD Snooping General

Use the MLD Snooping **General** page to add MLD members.

To access this page, click **Switching** → **Multicast Support** → **MLD Snooping** → **General** in the navigation panel.

**Figure 24-15. MLD Snooping General**



### Modifying MLD Snooping Settings for VLANs

To configure MLD snooping:

- 1 From the **General** MLD snooping page, click **Show All**.  
The MLD Snooping Table displays.

**Figure 24-16. MLD Snooping Table**

The screenshot shows a web-based configuration interface for MLD Snooping. At the top, there are tabs for 'General' and 'Detail', with 'Show All' selected. Below this, the 'General: Show All' section includes a 'Unit' dropdown menu set to '1'. A 'Copy Parameters' section has a checkbox and a 'VLAN ID 1' dropdown. The main 'VLANs' section contains a table with 5 rows and 8 columns. The columns are: 'VLANs', 'Auto Learn Enable', 'Report Suppression Enable', 'Host Timeout', 'Multicast Router Timeout', 'Leave Timeout', 'Copy To', and 'Edit'. Each row represents a VLAN with its ID and corresponding settings. The 'Auto Learn Enable' and 'Report Suppression Enable' columns contain 'Enable' dropdown menus. The 'Host Timeout', 'Multicast Router Timeout', and 'Leave Timeout' columns contain text input fields with values 250, 300, and 10 respectively. The 'Copy To' and 'Edit' columns contain checkboxes. At the bottom right of the table, there are navigation controls: 'Items Displayed 1-5', 'Rows Per Page 5', and 'Pages 1 of 4'. An 'Apply' button is located at the bottom center.

VLANs	Auto Learn Enable	Report Suppression Enable	Host Timeout	Multicast Router Timeout	Leave Timeout	Copy To	Edit
1	Enable	Enable	250	300	10	<input type="checkbox"/>	<input type="checkbox"/>
2	Enable	Enable	250	300	10	<input type="checkbox"/>	<input type="checkbox"/>
3	Enable	Enable	250	300	10	<input type="checkbox"/>	<input type="checkbox"/>
4	Enable	Enable	250	300	10	<input type="checkbox"/>	<input type="checkbox"/>
5	Enable	Enable	250	300	10	<input type="checkbox"/>	<input type="checkbox"/>

- 2 Select the **Edit** checkbox for each VLAN to modify.
- 3 Edit the MLD snooping fields as needed.
- 4 Click **Apply**.

The MLD snooping settings are modified, and the device is updated.

## Copying MLD Snooping Settings to VLANs

To copy MLD snooping settings:

- 1 From the **General MLD snooping** page, click **Show All**.  
The **MLD Snooping Table** displays.
- 2 Select the **Copy Parameters From** checkbox.
- 3 Select a VLAN to use as the source of the desired parameters.
- 4 Select the **Copy To** checkbox for the VLANs that these parameters will be copied to.
- 5 Click **Apply**.

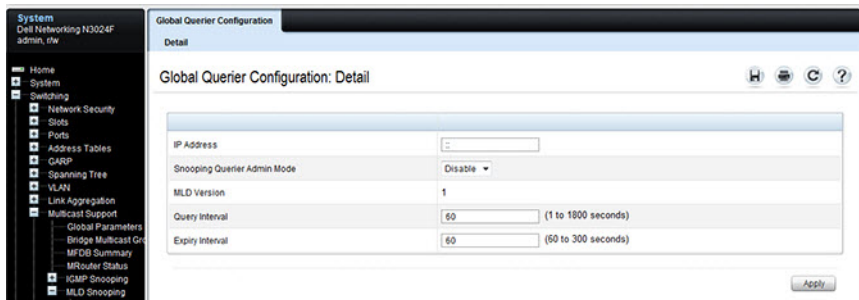
The MLD snooping settings are modified, and the device is updated.

## MLD Snooping Global Querier Configuration

Use the **MLD Snooping Global Querier Configuration** page to configure the parameters for the MLD snooping querier.

To display the **Global Querier Configuration** page, click **Switching** → **Multicast Support** → **MLD Snooping** → **Global Querier Configuration** in the navigation menu.

**Figure 24-17. MLD Snooping Global Querier Configuration**

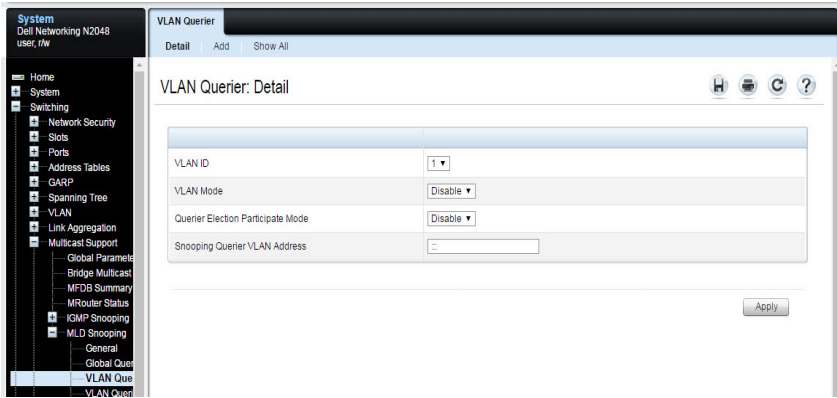


## MLD Snooping VLAN Querier

Use the MLD Snooping VLAN Querier page to specify the MLD snooping querier settings for individual VLANs.

To display the MLD Snooping VLAN Querier page, click **Switching** → **Multicast Support** → **MLD Snooping** → **VLAN Querier** in the navigation menu.

**Figure 24-18. MLD Snooping VLAN Querier**



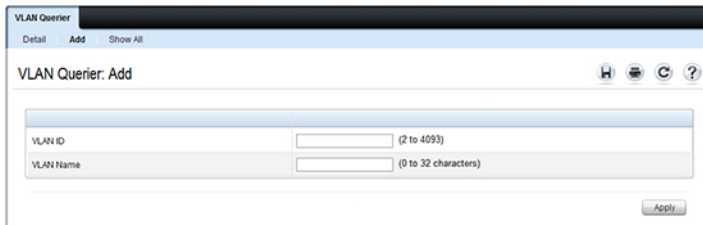
## Adding a New VLAN and Configuring its MLD Snooping VLAN Querier Settings

To configure an MLD snooping VLAN querier:

- 1 From the VLAN Querier page, click **Add**.

The page refreshes, and the **Add VLAN** page displays.

**Figure 24-19. Add MLD Snooping VLAN Querier**



- 2 Enter the VLAN ID and, if desired, an optional VLAN name.
- 3 Return to the **VLAN Querier** page and select the new VLAN from the **VLAN ID** menu.
- 4 Specify the VLAN querier settings.
- 5 Click **Apply**.

The VLAN Querier settings are modified, and the device is updated.

To view a summary of the IGMP snooping VLAN querier settings for all VLANs on the switch, click **Show All**.

**Figure 24-20. Add VLAN Querier**

The screenshot shows the 'VLAN Querier' configuration page with the 'Show All' view selected. The table displays the following data:

VLAN ID	VLAN Mode	Querier Election Participate Mode	Snooping Querier VLAN Address
1	Disable	Disable	::
10	Disable	Disable	::
11	Disable	Disable	::
21	Disable	Disable	::
41	Disable	Disable	::

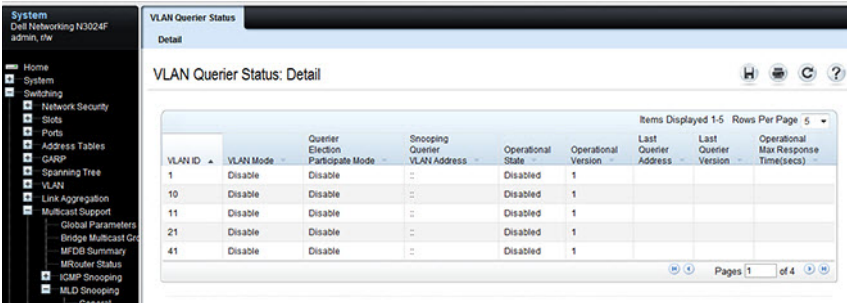
Additional interface details include: 'Items Displayed 1-5', 'Rows Per Page 5', and 'Pages 1 of 4'.

## MLD Snooping VLAN Querier Status

Use the **VLAN Querier Status** page to view the MLD snooping querier settings for individual VLANs.

To display the **VLAN Querier Status** page, click **Switching** → **Multicast Support** → **MLD Snooping** → **VLAN Querier Status** in the navigation menu.

**Figure 24-21. MLD Snooping VLAN Querier Status**



VLAN Querier Status

Detail

VLAN Querier Status: Detail

VLAN ID	VLAN Mode	Querier Election Participate Mode	Snooping Querier VLAN Address	Operational State	Operational Version	Last Querier Address	Last Querier Version	Operational Max Response Time(sec)
1	Disable	Disable	::	Disabled	1			
10	Disable	Disable	::	Disabled	1			
11	Disable	Disable	::	Disabled	1			
21	Disable	Disable	::	Disabled	1			
41	Disable	Disable	::	Disabled	1			

Items Displayed 1-5 Rows Per Page 5

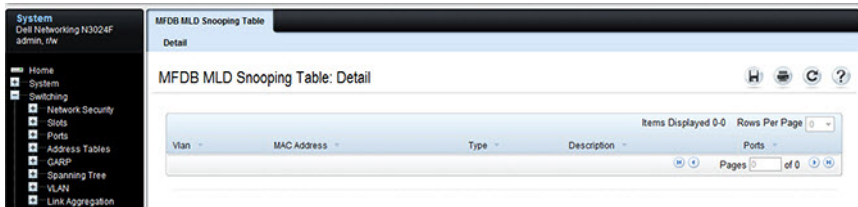
Pages 1 of 4

## MFDB MLD Snooping Table

Use the MFDB MLD Snooping Table page to view the MFDB MLD snooping table settings for individual VLANs.

To display the MFDB MLD Snooping Table page, click **Switching** → **Multicast Support** → **MLD Snooping** → **MFDB MLD Snooping Table** in the navigation menu.

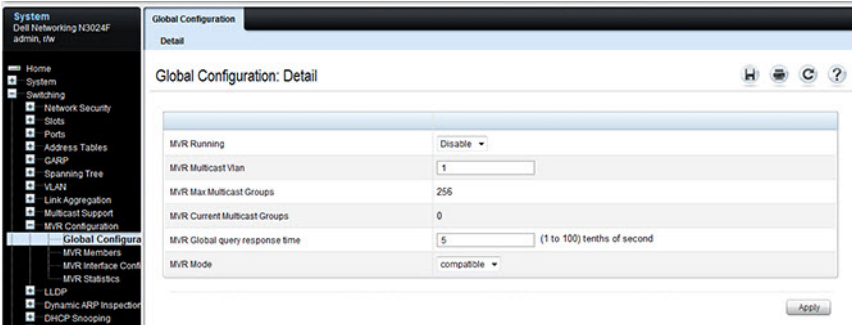
**Figure 24-22. MFDB MLD Snooping Table**



## MVR Global Configuration

Use the MVR Global Configuration page to enable the MVR feature and configure global parameters. To display the MVR Global Configuration page, click Switching → MVR Configuration → Global Configuration in the navigation panel.

Figure 24-23. MVR Global Configuration

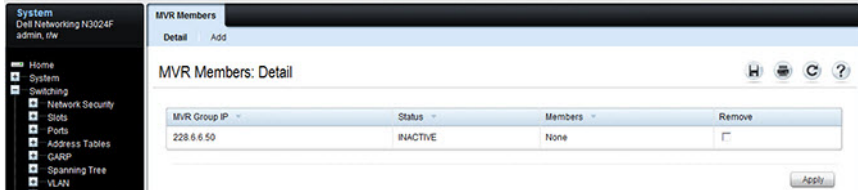




## MVR Members

Use the MVR Members page to view and configure MVR group members. To display the MVR Members page, click **Switching** → **MVR Configuration** → **MVR Members** in the navigation panel.

**Figure 24-24. MVR Members**



## Adding an MVR Membership Group

To add an MVR membership group:

- 1 From the MVR Membership page, click **Add**.  
The MVR Add Group page displays.

**Figure 24-25. MVR Member Group**

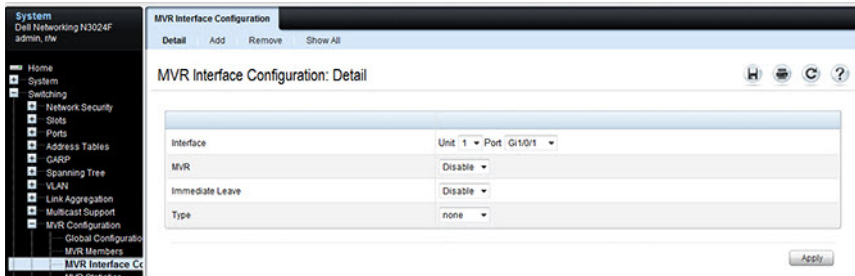


- 2 Specify the MVR group IP multicast address.
- 3 Click **Apply**.

## MVR Interface Configuration

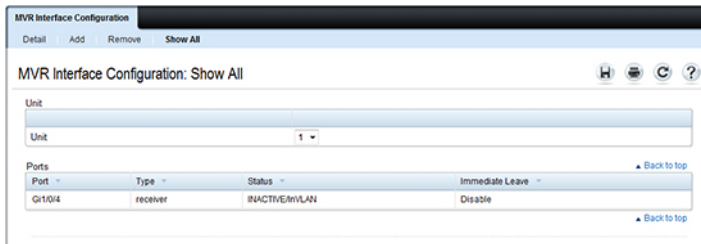
Use the MVR Interface Configuration page to enable MVR on a port, configure its MVR settings, and add the port to an MVR group. To display the MVR Interface Configuration page, click **Switching** → **MVR Configuration** → **MVR Interface Configuration** in the navigation panel.

**Figure 24-26. MVR Interface Configuration**



To view a summary of the MVR interface configuration, click Show All.

**Figure 24-27. MVR Interface Summary**

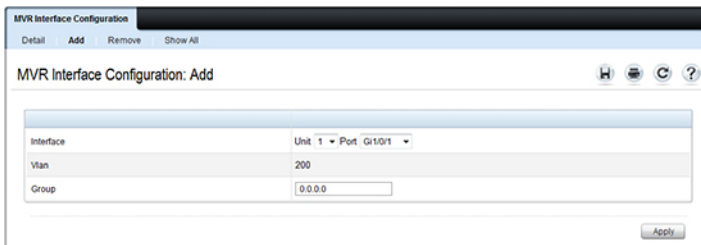


### Adding an Interface to an MVR Group

To add an interface to an MVR group:

- 1 From the MVR Interface page, click Add.

**Figure 24-28. MVR - Add to Group**



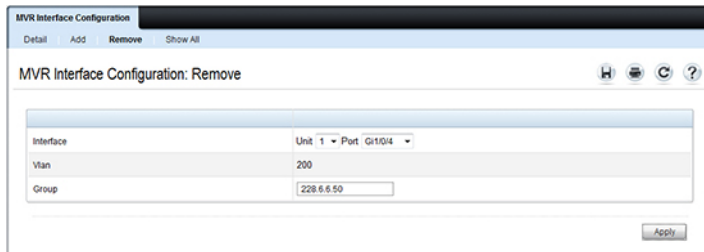
- 2 Select the interface to add to the MVR group.
- 3 Specify the MVR group IP multicast address.
- 4 Click Apply.

### Removing an Interface from an MVR Group

To remove an interface from an MVR group:

- 1 From the MVR Interface page, click **Remove**.

**Figure 24-29. MVR - Remove from Group**

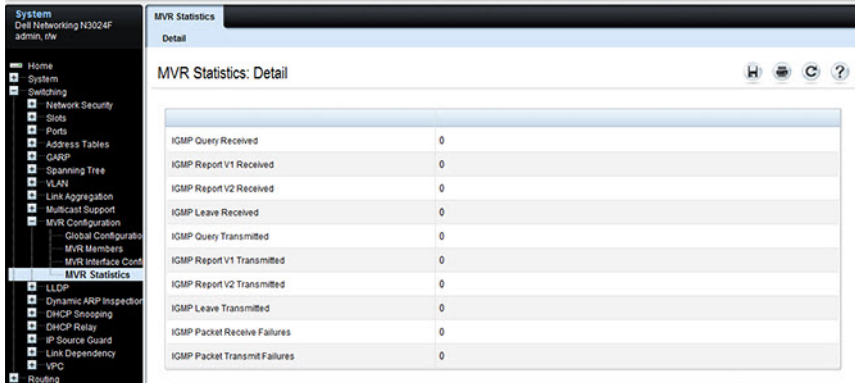


- 2 Select the interface to remove from an MVR group.
- 3 Specify the IP multicast address of the MVR group.
- 4 Click Apply.

## MVR Statistics

Use the MVR Statistics page to view MVR statistics on the switch. To display the MVR Statistics page, click **Switching MVR Configuration → MVR Statistics** in the navigation panel.

**Figure 24-30. MVR Statistics**

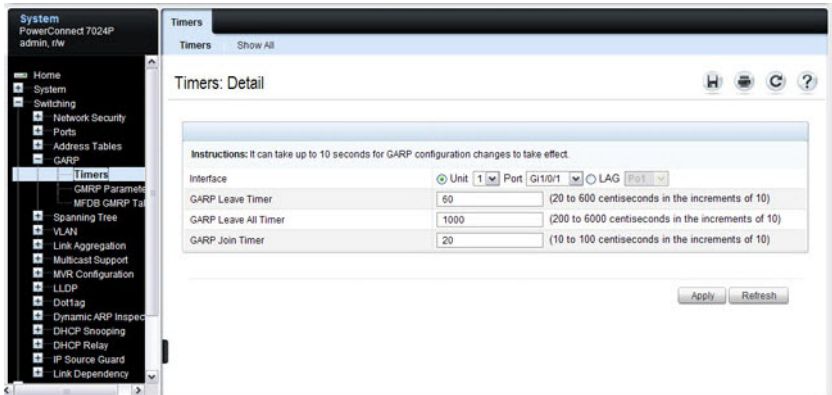


## GARP Timers

The **Timers** page contains fields for setting the GARP timers used by GVRP and GMRP on the switch.

To display the **Timers** page, click **Switching** → **GARP** → **Timers** in the navigation panel.

**Figure 24-31. GARP Timers**



### Configuring GARP Timer Settings for Multiple Ports

To configure GARP timers on multiple ports:

- 1 Open the **Timers** page.
- 2 Click **Show All** to display the **GARP Timers Table**.

**Figure 24-32. Garp Timers Table**

The screenshot shows the 'Timers' configuration page. The 'Unit' is set to 1. The 'Copy Parameters From' section shows 'Unit 1', 'Port Gi1/0/1', and 'LAG Po1'. There are two tables: 'Ports' and 'LAGs'. Both tables have columns for Interface, GARP Leave Timer, GARP Leave All Timer, GARP Join Timer, Copy To, and Edit. The 'Ports' table shows 5 rows (Gi1/0/1 to Gi1/0/5) with timer values of 50, 1000, and 20. The 'LAGs' table shows 5 rows (Po1 to Po5) with timer values of 50, 1000, and 20. An 'Apply' button is at the bottom right.

- 3 For each port or LAG to configure, select the check box in the Edit column in the row associated with the port.
- 4 Specify the desired timer values.
- 5 Click Apply.

## Copying GARP Timer Settings From One Port to Others

To copy GARP timer settings:

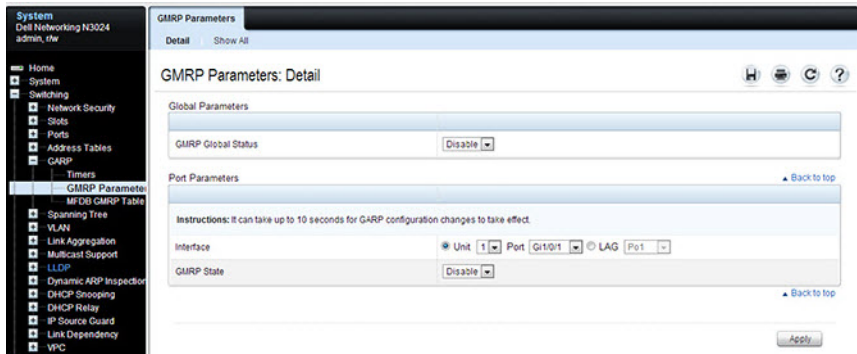
- 1 Select the **Copy Parameters From** check box, and select the port or LAG with the settings to apply to other ports or LAGs.
- 2 In the Ports or LAGs list, select the check box(es) in the **Copy To** column that will have the same settings as the port selected in the **Copy Parameters From** field.
- 3 Click **Apply** to copy the settings.

## GMRP Parameters

Use the **GMRP Parameters** page to configure the administrative mode of GMRP on the switch and on each port or LAG.

To display the **GMRP Parameters** page, click **Switching** → **GARP** → **GMRP Parameters** in the navigation panel.

**Figure 24-33. GMRP Parameters**



## Configuring GMRP Parameters on Multiple Ports

To configure GMRP settings:

- 1 Open the **GMRP Parameters** page.
- 2 Click **Show All** to display the **GMRP Port Configuration Table**.

**Figure 24-34. GMRP Port Configuration Table**

GMRP Parameters

Detail Show All

GMRP Parameters: Show All

Unit Selection

Unit

Copy Parameters [Back to top](#)

Copy Parameters From  Unit  Port   LAG

Port Settings [Back to top](#)

Items Displayed 1-5 Rows Per Page 5

Port	GMRP State	Copy To	Edit
Gi1/0/1	<input type="text" value="Disable"/>	<input type="checkbox"/>	<input type="checkbox"/>
Gi1/0/2	<input type="text" value="Disable"/>	<input type="checkbox"/>	<input type="checkbox"/>
Gi1/0/3	<input type="text" value="Disable"/>	<input type="checkbox"/>	<input type="checkbox"/>
Gi1/0/4	<input type="text" value="Disable"/>	<input type="checkbox"/>	<input type="checkbox"/>
Gi1/0/5	<input type="text" value="Disable"/>	<input type="checkbox"/>	<input type="checkbox"/>

Pages 1 of 6

LAG Settings [Back to top](#)

Items Displayed 1-5 Rows Per Page 5

LAG	GMRP State	Copy To	Edit
Po1	<input type="text" value="Disable"/>	<input type="checkbox"/>	<input type="checkbox"/>
Po2	<input type="text" value="Disable"/>	<input type="checkbox"/>	<input type="checkbox"/>
Po3	<input type="text" value="Disable"/>	<input type="checkbox"/>	<input type="checkbox"/>

- 3 For each port or LAG to configure, select the check box in the **Edit** column in the row associated with the port.
- 4 Specify the desired timer values.
- 5 Click **Apply**.



## Copying Settings From One Port or LAG to Others

To copy GMRP settings:

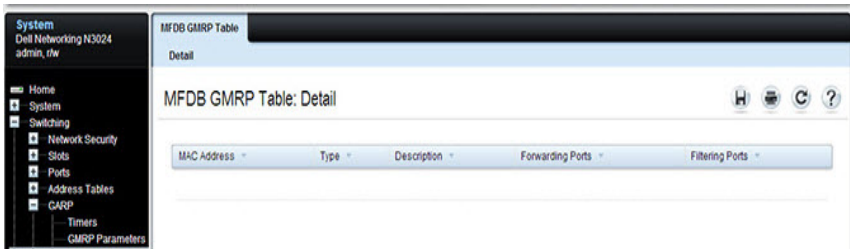
- 1 Select the **Copy Parameters From** check box, and select the port or LAG with the settings to apply to other ports or LAGs.
- 2 In the Ports or LAGs list, select the check box(es) in the **Copy To** column that will have the same settings as the port selected in the **Copy Parameters From** field.
- 3 Click **Apply** to copy the settings.

## MFDB GMRP Table

Use the **MFDB GMRP Table** page to view all of the entries in the Multicast Forwarding Database that were created for the GMRP

To display the **MFDB GMRP Table** page, click **Switching** → **GARP** → **MFDB GMRP Table** in the navigation panel.

**Figure 24-35. MFDB GMRP Table**



# Configuring L2 Multicast Features (CLI)

This section provides information about the commands used for configuring L2 multicast settings on the switch. For more information about the commands, see the *Dell EMC Networking N1100-ON, N1500, N2000, N2100-ON, N2200-ON, N3000E-ON, N3100-ON, and N3200-ON Series Switches CLI Reference Guide* at [www.dell.com/support](http://www.dell.com/support).

## Configuring Layer-2 Multicasting

Use the following commands to configure MAC address table features.

Command	Purpose
<code>configure</code>	Enter global configuration mode.
<code>mac address-table static</code> <code>{ mac-multicast-address</code> <code>  ip-multicast-address }</code> <code>vlan vlan-id interface</code> <code>interface-id</code>	Register a MAC-layer Multicast address in the bridge table. <ul style="list-style-type: none"><li>• <i>mac-multicast-address</i> — MAC multicast address in the format xxxx.xxxx.xxxx or xx:xx:xx:xx:xx:xx.</li><li>• <i>ip-multicast-address</i> — An IP multicast address</li><li>• <i>interface-id</i> — A physical interface or port-channel.</li></ul>
<code>mac address-table</code> <code>multicast forbidden</code> <code>address vlan vlan-id</code> <code>{ mac-multicast-address</code> <code>  ip-multicast-address }</code> <code>{ add   remove }</code> <code>interface interface-list</code>	Forbid adding a specific Multicast address to specific ports. <ul style="list-style-type: none"><li>• <i>mac-multicast-address</i> — MAC multicast address in the format xxxx.xxxx.xxxx or xx:xx:xx:xx:xx:xx.</li><li>• <i>ip-multicast-address</i> — IP multicast address.</li><li>• <b>add</b> — Adds ports to the group. If no option is specified, this is the default option.</li><li>• <b>remove</b> — Removes ports from the group.</li><li>• <i>interface-list</i> — Specifies the interface type (<b>port-channel</b>, <b>gigabitethernet</b>, <b>tengigabitethernet</b>) and number. Separate nonconsecutive interfaces with a comma and no spaces; use a hyphen to designate a range of ports.</li></ul>
<code>exit</code>	Exit to Privileged Exec mode.

Command	Purpose
<code>show mac address-table multicast [vlan <i>vlan-id</i>] [address <i>mac-multicast-address</i>   <i>ip-multicast-address</i>] [format ip   mac]</code>	View entries in the multicast MAC address table. The <code>show mac address-table multicast</code> command shows only multicast addresses. Multicast address are shown along with unicast addresses if the multicast keyword is not used.

## Configuring IGMP Snooping on VLANs

Use the following commands to configure IGMP snooping settings on VLANs. Ensure that an interface in the VLAN is either connected to a multicast router or is configured as an mrouter port. IGMP snooping floods all multicast packets in a VLAN until a multicast router has been identified.

Command	Purpose
<code>configure</code>	Enter global configuration mode.
<code>ip igmp snooping</code>	Enable IGMP snooping globally (default).
<code>ip igmp snooping vlan <i>vlan-id</i></code>	Enable IGMP snooping on the specified VLAN.
<code>ip igmp snooping vlan <i>vlan-id</i> groupmembership-interval <i>seconds</i></code>	Specify the host time-out value for the specified VLAN. If an IGMP report for a multicast group is not received in the number of seconds specified by the <i>seconds</i> value, this port is deleted from the VLAN member list of that multicast group. This command also enables IGMP snooping on the VLAN.
<code>ip igmp snooping vlan <i>vlan-id</i> last-member-query-interval <i>seconds</i></code>	Specify the leave time-out value for the VLAN. If an IGMP report for a multicast group is not received within the number of seconds configured with this command after an IGMP leave was received from a specific interface, the current port is deleted from the VLAN member list of that multicast group.
<code>ip igmp snooping vlan <i>vlan-id</i> immediate-leave</code>	Enables IGMP snooping immediate-leave mode on the specified VLAN. Enabling immediate-leave allows the switch to immediately remove the Layer-2 LAN interface from its forwarding table entry upon receiving an IGMP leave message for that multicast group without first sending out MAC-based general queries to the interface.

<b>Command</b>	<b>Purpose</b>
<code>ip igmp snooping vlan <i>vlan-id</i> mrcrtexpiretime <i>seconds</i></code>	Specify the multicast router time-out value for to associate with a VLAN. This command sets the number of seconds to wait to age out an automatically-learned multicast router port.
<code>interface <i>teX/Y/Z</i> switchport mode trunk ip igmp snooping vlan <i>vlan-id</i> mrouter</code>	Identify an interface as an mrouter interface. IGMP snooping floods all multicast in the VLAN until an mrouter has either been detected or configured.
<code>CTRL + Z</code>	Exit to Privileged Exec mode.
<code>show ip igmp snooping groups</code>	Shows IGMP snooping configuration on all VLANs.
<code>show ip igmp snooping vlan <i>vlan-id</i></code>	View the IGMP snooping settings on the VLAN.

## Configuring IGMP Snooping Querier

Use the following commands to configure IGMP snooping querier settings on the switch and on VLANs.

<b>Command</b>	<b>Purpose</b>
<code>configure</code>	Enter global configuration mode.
<code>ip igmp snooping querier [vlan <i>vlan-id</i>] [<i>address</i> <i>ip-address</i>]</code>	Enable the IGMP snooping querier on the switch or on the VLAN specified with the <i>vlan-id</i> parameter.  Use the optional <i>ip-address</i> parameter to specify the IP address that the snooping querier switch should use as the source address when generating periodic queries.
<code>ip igmp snooping querier query-interval <i>interval- count</i></code>	Set the IGMP snooping querier query interval time, which is the amount of time in seconds that the switch waits before sending another periodic query. The range is 1–1800 seconds.
<code>ip igmp snooping querier timer expiry <i>seconds</i></code>	Set the IGMP snooping querier timer expiration period. This is the time period, in seconds, that the switch remains in non-querier mode after it has discovered that there is a multicast querier in the network.

Command	Purpose
<code>ip igmp snooping querier version <i>version</i></code>	Set the IGMP version of the query that the switch sends periodically. The <i>version</i> range is 1–2.
<code>ip igmp snooping querier <i>vlan-id</i></code>	Enable the IGMP snooping querier on the specified VLAN.
<code>ip igmp snooping querier election participate <i>vlan-id</i></code>	Allow the IGMP snooping querier to participate in the querier election process when it discovers the presence of another querier in the VLAN. When this mode is enabled, if the snooping querier finds that the other querier source address is more than the snooping querier address, it stops sending periodic queries. If the snooping querier wins the election, then it continues sending periodic queries and the other querier ceases sending queries. Use of election mode is not recommended when multicast routers are present in the network.
CTRL + Z	Exit to Privileged Exec mode.
<code>show ip igmp snooping querier [detail  vlan <i>vlan-id</i>]</code>	View IGMP snooping querier settings configured on the switch, on all VLANs, or on the specified VLAN.

## Configuring MLD Snooping on VLANs

Use the following commands to configure MLD snooping settings on VLANs.

Command	Purpose
<code>configure</code>	Enter global configuration mode.
<code>ipv6 mld snooping</code>	Enable MLD snooping globally (default).
<code>ipv6 mld snooping vlan <i>vlan-id</i></code>	Enable MLD snooping on the specified VLAN.
<code>ipv6 mld snooping vlan <i>vlan-id</i> groupmembership-interval <i>seconds</i></code>	Specify the host time-out value for the specified VLAN. If an MLD report for a multicast group is not received in the number of seconds specified by the <i>seconds</i> value, this VLAN is deleted from the member list of that multicast group.

Command	Purpose
<code>ipv6 mld snooping <i>vlan-id</i> last-listener-query-interval <i>seconds</i></code>	Specify the leave time-out value for the VLAN. If an MLD report for a multicast group is not received within the number of seconds configured with this command after an MLD leave was received from a specific interface, the current port is deleted from the VLAN member list of that multicast group.
<code>ipv6 mld snooping <i>vlan-id</i> immediate-leave</code>	Enables MLD snooping immediate-leave mode on the specified VLAN. Enabling immediate-leave allows the switch to immediately remove the Layer-2 LAN interface from its forwarding table entry upon receiving an MLD leave message for that multicast group without first sending out MAC-based general queries to the interface.
<code>ipv6 mld snooping <i>vlan-id</i> mrcrtexpiretime <i>seconds</i></code>	Specify the multicast router time-out value for to associate with a VLAN. This command sets the number of seconds to wait to age out an automatically-learned multicast router port.
CTRL + Z	Exit to Privileged Exec mode.
<code>show ipv6 mld snooping <i>vlan-id</i></code>	View the MLD snooping settings on the VLAN.

## Configuring MLD Snooping Querier

Use the following commands to configure MLD snooping querier settings on the switch and on VLANs.

Command	Purpose
<code>configure</code>	Enter global configuration mode.
<code>ipv6 mld snooping querier</code>	Enable the MLD snooping querier on the switch.
<code>ipv6 mld snooping querier <i>vlan-id</i> [<i>address ipv6-address</i>]</code>	Enable the MLD snooping querier on VLAN specified with the <i>vlan-id</i> parameter. Use the optional <i>ip-address</i> parameter to specify the IP address that the snooping querier switch should use as the source address when generating periodic queries.

<b>Command</b>	<b>Purpose</b>
<pre>ipv6 mld snooping querier election participate <i>vlan-id</i></pre>	<p>Allow the MLD snooping querier to participate in the querier election process when it discovers the presence of another querier in the VLAN. When this mode is enabled, if the snooping querier finds that the other querier source address is more than the snooping querier address, it stops sending periodic queries. If the snooping querier wins the election, then it continues sending periodic queries. Use of election mode is not recommended when multicast routers are present in the network.</p>
<pre>exit</pre>	<p>Exit to Global Configuration mode.</p>
<pre>ipv6 mld snooping querier address <i>ipv6-address</i></pre>	<p>Specify the IP address that the snooping querier switch should use as the source address when generating periodic queries.</p>
<pre>ipv6 mld snooping querier query-interval <i>interval-count</i></pre>	<p>Set the MLD snooping querier query interval time, which is the amount of time in seconds that the switch waits before sending another periodic query. The range is 1–1800 seconds.</p>
<pre>ipv6 mld snooping querier timer expiry <i>seconds</i></pre>	<p>Set the MLD snooping querier timer expiration period. This is the time period, in seconds, that the switch remains in non-querier mode after it has discovered that there is a multicast querier in the network.</p>
<pre>exit</pre>	<p>Exit to Privileged Exec mode.</p>
<pre>show ipv6 mld snooping querier [<i>detail</i>  <i>vlan</i> <i>vlan-id</i>]</pre>	<p>View MLD snooping querier settings configured on the switch, on all VLANs, or on the specified VLAN.</p>

## Configuring MVR

Use the following commands to configure MVR features on the switch.

<b>Command</b>	<b>Purpose</b>
<pre>configure</pre>	<p>Enter global configuration mode.</p>
<pre>mvr</pre>	<p>Enable MVR on the switch.</p>
<pre>mvr vlan <i>vlan-id</i></pre>	<p>Set the VLAN to use as the multicast VLAN for MVR.</p>

Command	Purpose
<code>mvr querytime <i>time</i></code>	Set the MVR query response time. The value for <i>time</i> is in units of tenths of a second. This is the time to wait for a response to the query sent after receiving a leave message and before removing the port from the group.
<code>mvr mode {compatible   dynamic}</code>	Specify the MVR mode of operation.
<code>mvr group <i>mcast-address</i> [<i>groups</i>]</code>	Add an MVR membership group. <ul style="list-style-type: none"> <li>• <i>mcast-address</i>—The group IP multicast address</li> <li>• <i>groups</i>—Specifies the number of contiguous groups</li> </ul>
<code>interface <i>interface</i></code>	Enter interface configuration mode for the specified port. The <i>interface</i> variable includes the interface type and number, for example <code>tengigabitethernet 1/0/3</code> .  A range of ports can be specified using the <code>interface range</code> command. For example, <code>interface range tengigabitethernet 1/0/8-12</code> configures interfaces 8, 9, 10, 11, and 12.
<code>mvr</code>	Enable MVR on the port.
<code>mvr immediate</code>	Enable MVR immediate leave mode on the port.
<code>mvr type {source   receiver}</code>	Specify the MVR port type.
<code>mvr vlan <i>vlan-id</i> group <i>mcast-address</i></code>	Allow the port to participate in the specified MVR group. The <i>vlan-id</i> parameter is the ID of the MVR multicast VLAN.
<code>CTRL + Z</code>	Exit to Privileged Exec mode.
<code>show mvr</code>	View information about the administrative mode of MVR.
<code>show mvr members</code>	View information about MVR groups and their members.
<code>show mvr interface <i>interface</i></code>	View information about the MVR configuration for a specific port.
<code>show mvr traffic</code>	View information about IGMP traffic in the MVR table.



## Configuring GARP Timers and GMRP

Use the following commands to configure the GARP timers and to control the administrative mode GMRP on the switch and per-interface.

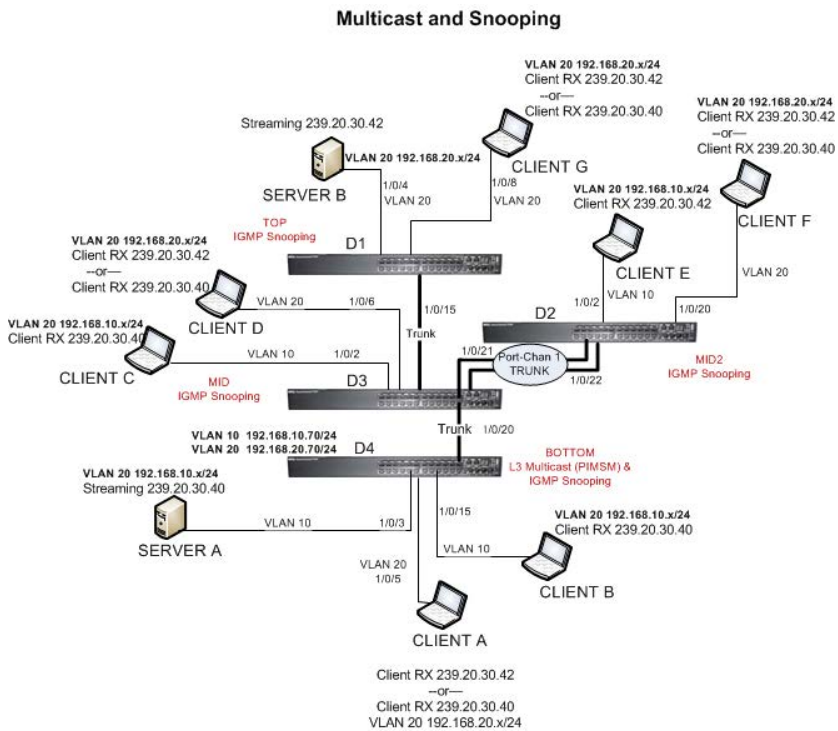
Command	Purpose
<code>configure</code>	Enter global configuration mode.
<code>gmrp enable</code>	Enable GMRP globally on the switch.
<code>interface <i>interface</i></code>	Enter interface configuration mode for the specified port or LAG. The <i>interface</i> variable includes the interface type and number, for example <code>tengigabitethernet 1/0/3</code> . For a LAG, the interface type is <code>port-channel</code> .  A range of ports can be specified using the <code>interface range</code> command. For example, <code>interface range tengigabitethernet 1/0/8-12</code> configures interfaces 8, 9, 10, 11, and 12.
<code>garp timer {join   leave   leaveall} <i>timer_value</i></code>	Adjust the GARP application join, leave, and leaveall GARP timer values  The <i>timer_value</i> variable is in centiseconds. The range is 10-100 for <code>join</code> , 20-600 for <code>leave</code> , and 200-6000 for <code>leaveall</code> .
<code>gmrp enable</code>	Enable GMRP on the interface or range of interfaces.
<code>exit</code>	Exit to Global Config mode.
<code>exit</code>	Exit to Privileged Exec mode.
<code>show gmrp configuration</code>	View the administrative status of GMRP on the switch and all interfaces.

# Case Study on a Real-World Network Topology

## Multicast Snooping Case Study

Figure 24-36 shows the topology that the scenarios in this case study use.

**Figure 24-36. Case Study Topology**



The topology in Figure 24-36 includes the following elements:

- Snooping Switches: D1, D2, D3 with IGMP snooping enabled on VLANs 10, 20
- Multicast Router: D4 with PIM-SM enabled on VLANs 10, 20
- Multicast Listeners: Client A-G
- Multicast Sources: Server A – 239.20.30.40, Server B – 239.20.30.42

- Subnets: VLAN 10 – 192.168.10.x, VLAN 20 – 192.168.20.x
- Mrouter ports: D3 – 1/0/20, D2 – PortChannell, D1 – 1/0/15

### **Snooping Within a Subnet**

In the example network topology, the multicast source and listeners are in the same subnet VLAN 20 – 192.168.20.x/24. D4 sends periodic queries on VLAN 10 and 20, and these queries are forwarded to D1, D2, and D3 via trunk links. Snooping switches D1, D2, and D3 flood these queries in VLANs 10 and 20 to clients G, F, and D, respectively.

#### ***Multicast Source and Listener directly connected to a snooping switch:***

##### ***Server B → Client G***

- 1 Client G sends a report for 239.20.30.42.
- 2 The report is forwarded to multicast router D4 via D1 – 1/0/15 and D3 – 1/0/20.
- 3 A forwarding entry is created by D1 for VLAN 20, 239.20.30.42 – 1/0/8, 1/0/15.
- 4 Client G receives the multicast stream from Server B.
- 5 D3 receives the multicast stream and it is forwarded to D4 because D4 is a multicast router.
- 6 Client D sends a report for 239.20.30.42.
- 7 The report is forwarded to multicast router D4 via D3 – 1/0/20.
- 8 A forwarding entry is created by D3 for VLAN 20, 239.20.30.42 – 1/0/6, 1/0/20.
- 9 Client D receives the multicast stream from Server B.
- 10 Client F does not receive the multicast stream because it did not respond to queries from D4.

#### ***Multicast Source and Listener connected by intermediate snooping switches:***

##### ***Server B → Client D***

- 1 Client D sends a report for 239.20.30.42.
- 2 The report is forwarded to multicast router D4 via D3 – 1/0/20.
- 3 A forwarding entry is created by D3 for VLAN20, 239.20.30.42 – 1/0/6, 1/0/20.

- 4 Client D will receive the multicast stream from Server B because it is forwarded by D1 to D3 and then to D4 because D4 is a multicast router. Because the multicast stream is present on D3, a L2 forwarding entry is created on D3, where 239.20.30.42 is not a registered group.
- 5 Client F does not receive the multicast stream because it did not respond to queries from D4.

### **Snooping Switch Interaction with a Multicast Router**

In the example network topology, consider Client B and Server A. Both are in the same subnet VLAN10 – 192.168.10.70/24. Server A is a source for multicast stream 239.20.30.40. D4 sends periodic queries on VLAN 10 and VLAN 20, and these queries reach D1, D2, and D3 via trunk links, which in turn forward them in VLAN 10 and VLAN 20 to reach their respective attached clients. PIM-SM is enabled on router D4, and IGMP snooping is enabled on D1, D2, and D3.

#### ***Multicast Source and Listener directly connected to Multicast Router on the same routing VLAN: Server A → Client B***

- 1 Because multicast routing is enabled on D4 VLAN 10, an IP multicast table entry is created to include D4 – 1/0/15, D4 – 1/0/20 as part of the L2 forwarding list members.
- 2 Client B sends a report for 239.20.30.40.
- 3 The IP multicast table entry is modified to include only D4 – 1/0/15 as the L2 forwarding list member. IGMP snooping creates an L2 forwarding entry for Client B.
- 4 Client B receives multicast data.
- 5 The multicast stream is not forwarded to D3 on trunk link 1/0/20 because no other clients requested this data.

#### ***Multicast Source directly connected to Multicast Router, and Listener connected to a different routing VLAN via intermediate snooping switches: Server A → Client F***

Clients A, D and F are in the same subnet VLAN20 - 192.168.20.70/24. Server A is in a different subnet VLAN10 – 192.168.10.70/24.

- 1 Client F sends a report for 239.20.30.40.

- 2 A multicast forwarding entry is created on D2 VLAN20, 239.20.30.40 – 1/0/20, PortChannel1.
- 3 The Client F report message is forwarded to D3-PortChannel1 (multicast router attached port).
- 4 A multicast forwarding entry is created on D3 VLAN 20, 239.20.30.40 – PortChannel1, 1/0/20.
- 5 The Client F report message is forwarded to D4 via D3 – 1/0/20 (multicast router attached port).
- 6 An IP multicast routing entry is created on D4 VLAN 10 – VLAN 20 with the Layer-3 outgoing port list as VLAN 20 – 1/0/20.
- 7 The multicast stream is routed to D3.
- 8 The multicast stream is forwarded to listener Client F using forwarding entries created on D3 and D2.
- 9 Clients A and D do not receive the Server A multicast stream because they did not send a report.

***Multicast Source connected to Multicast Router via intermediate snooping switches, and Listener directly connected to multicast router in a different routing interface: Server B → Client B***

Server A and Clients B, C, and E are on the same subnet VLAN10 – 192.168.10.70/24. Server B is in a different subnet VLAN20 – 192.168.20.70/24.

- 1 Client B sends a report for 239.20.30.42.
- 2 Multicast Router D4 learns group 239.20.30.42.
- 3 The administrator creates a static multicast forwarding entry on D1 VLAN 20, 239.20.30.42 – 1/0/15 and on D3 VLAN 20, 239.20.30.42 – 1/0/20.
- 4 The multicast stream from Server B reaches D4 via trunk links because it is a statically registered group on D1 and D3. D4 is a multicast router.
- 5 An IP multicast routing entry is created on D4 VLAN 20 – VLAN 10 with the Layer-3 outgoing port list as VLAN 10 – 1/0/15.
- 6 Client B receives multicast data from Server B.
- 7 Server A and Clients C and E do not receive Server B data because no report messages were sent requesting Server B traffic.

***Multicast Source and Listener connected to Multicast Router via intermediate snooping switches and are part of different routing VLANs: Server B → Client E***

Clients E, B, and C are on the same subnet VLAN10 – 192.168.10.70/24.  
Server B is in a different subnet VLAN20 – 192.168.20.70/24.

- 1** Client E sends a report for 239.20.30.42.
- 2** A multicast forwarding entry is created on D2 VLAN10, 239.20.30.42 – 1/0/2, PortChannel 1.
- 3** The report from Client E is forwarded to D3 via D2 – PortChannel 1.
- 4** A multicast forwarding entry is created on D3 VLAN10, 239.20.30.42 – PortChannel 1, 1/0/20.
- 5** The report from Client E is forwarded to D4 via D3 – 1/0/20.
- 6** Multicast Router D4 learns group 239.20.30.42.
- 7** The multicast stream from Server B reaches D4 via trunk links because it is a multicast router.
- 8** An IP multicast routing entry is created on D4 VLAN 20 – VLAN 10 with the Layer-3 outgoing port list as VLAN 10 – 1/0/20.
- 9** Client E receives multicast data from Server B.
- 10** Clients B and C do not receive Server B data because no report messages were sent requesting Server B traffic.

# Connectivity Fault Management

## Dell EMC Networking N1500/N2200/N3200 Switches

This chapter describes how to configure the Connectivity Fault Management feature, which is specified in IEEE 802.1ag (*IEEE Standard for Local and Metropolitan Area Networks Virtual Bridged Local Area Networks Amendment 5: Connectivity Fault Management*). This protocol, also known as Dot1ag, enables the detection and isolation of connectivity faults at the service level for traffic that is bridged over a metropolitan Ethernet LAN.

The topics covered in this chapter include:

- Dot1ag Overview
- Default Dot1ag Values
- Configuring Dot1ag (Web)
- Configuring Dot1ag (CLI)
- Dot1ag Configuration Example

## Dot1ag Overview

With the emergence of Ethernet as a Metropolitan and Wide-Area Networking technology, different operators often work together to provide end-to-end services to enterprise customers. This has driven the need of a new set of OAM (Operations, Administration, and Maintenance) Protocols.

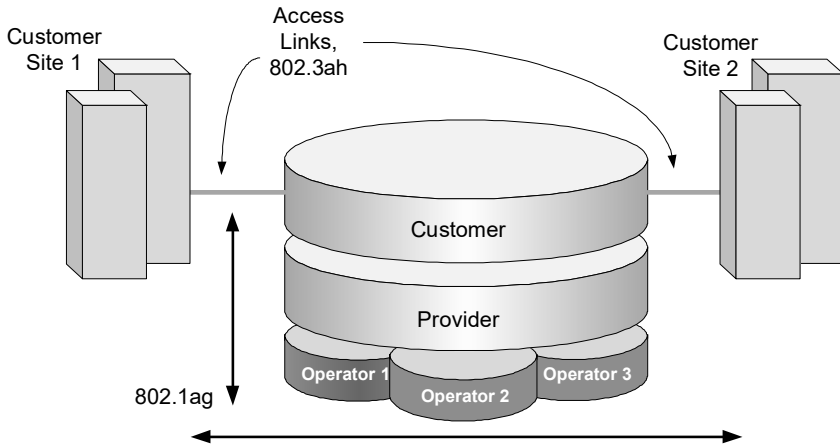
Service-Level Connectivity Fault Management (CFM) is the OAM protocol provision for end-to-end service-layer instances in carrier networks. CFM provides mechanisms to support the administrator in performing connectivity checks, fault detection, fault verification and isolation, and fault notification per service in the network domain of interest. Unlike Ethernet OAM (IEEE 802.3ah), where the faults are detected and notified on a single point-to-point IEEE Std. 802.3 LAN, Dot1ag addresses fault diagnosis at the service layer across networks comprising multiple LANs, including LANs other than 802.3 media.

## How Does Dot1ag Work Across a Carrier Network?

A typical metropolitan area network comprises operator, service provider, and customer networks. To suit this business model, CFM relies on a functional model of hierarchical maintenance domains (MDs). These domains are assigned a unique MD level. There is a maximum of 8 levels, which can be nested but cannot overlap. Each organization can have its own maintenance domain. The MD level limits administrator access to the appropriate domain. The MD level limits administrator access to the appropriate domain.

Figure 25-1 depicts three domains: the customer subscribes to the services of a provider, who, in turn, subscribes to the services of two operators. This scenario is a likely one, since no operator has complete coverage of a large region. A service instance would span the provider network covering one or more operators. Every domain has its own network management system. Dot1ag defines OAM services that operate across these domains (the vertical arrow) and within them (the horizontal arrow)

**Figure 25-1. Organization of Domains**



Entities at different levels have different responsibilities. For example, the lower level (operator) overlooks a subset of the network in detail and provides information about its status to its higher levels such as the provider level). Higher levels have a broader, but less detailed, view of the network. As a result, a provider could include multiple operators, provided that the domains



never intersect. The operator transparently passes frames from the customer and provider, and the customer does not see the operator frames. Multiple levels within a domain (say, operator) are supported for flexibility.

## What Entities Make Up a Maintenance Domain?

Dot1ag defines three primary entities that make up the maintenance domain: Maintenance End Points (MEPs), Maintenance Intermediate Points (MIPs), and Maintenance Associations (MAs).

### MEPs, and MIPs

MEPs and MIPs are software or sometimes hardware per-service entities where CFM functionalities are present.

- MEPs define the boundary of a maintenance domain. They initiate and respond to CFM messages. MEPs prevent the leaking of CFM messages between domains (for example, among operators or between operators and customers). Each MEP has a configurable unique identifier (MEPID) in a maintenance domain.

MEPs periodically issue Continuity Check Messages (CCM) to discover each other and issue SNMP traps to report connectivity losses or malformed or incorrect CCMs.

A MEP can be defined as “down MEP” or an “up MEP”. A down MEPs reside in a bridge that transmits CFM PDUs towards, and receives them from, the direction of the LAN. An up MEP resides in a bridge that transmits CFM PDUs towards, and receives them from, the direction of the Bridge Relay Entity.

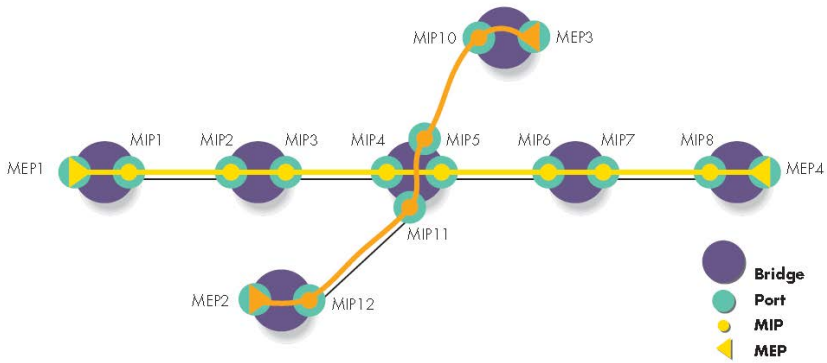


**NOTE:** An entity at the boundary of maintenance domain that offers connectivity and other services to systems outside the domain is referred to as a Domain Service Access Point (DoSAP). A MEP is a type of DoSAP whose services relate to connectivity fault management.

- MIPs are entities within a domain that enable the outer domain to achieve end-to-end connectivity checks. MIPs passively receive CFM messages and respond back to the originating MEP.

Figure 25-2 depicts two MEPs and the MIPs that connect them in a maintenance domain.

**Figure 25-2. Maintenance Endpoints and Intermediate Points**



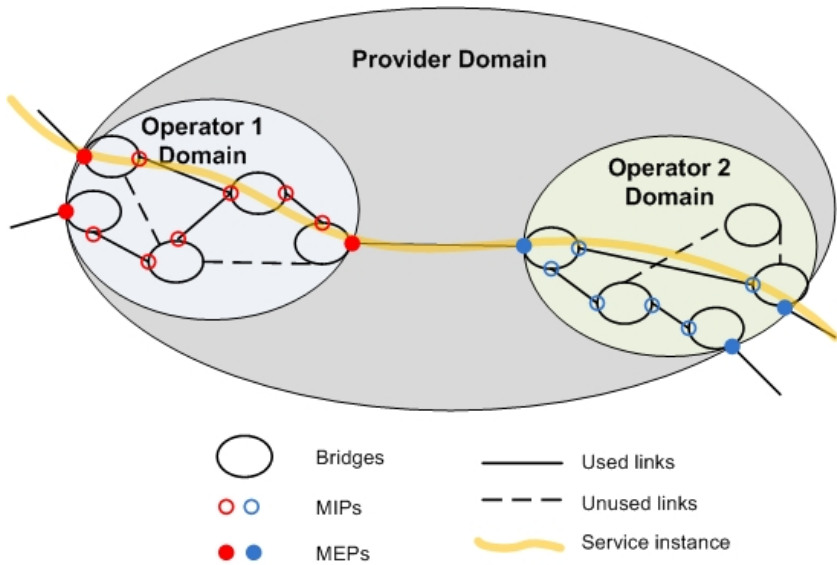
### Maintenance Associations

An MA is a logical connection between one or more MEPs that enables monitoring a particular service instance. Each MA is associated with a unique SVLAN ID. An MA is identified by a maintenance association ID. All MEPs in the MA are assigned the maintenance identifier (MAID) for the association.

An MD consists of one or more MAs at the same domain level.

Figure 25-3 depicts one provider-level domain and two operator-level domains. Dot1ag operation for a service instance is indicated by the path that traverses the different domains to provide the end-to-end connectivity fault management for the service.

**Figure 25-3. Provider View for Service Level OAM**



### **What is the Administrator's Role?**

On the switch, the administrator configures the customer-level maintenance domains, associations, and endpoints used to participate in Dot1ag services with other switches connected through the provider network. The Administrator can also use utilities to troubleshoot connectivity faults when reported via SNMP traps. All the domains within the customer domain should use different domain levels.

### **Configuration Tasks**

The administrator defines the maintenance domains by configuring the domain level (from 0–7) and a name. For each domain, the administrator defines maintenance associations that are specified by a SVLAN ID and an MA name. Then the administrator defines the switch ports that serve as MEPs for a service instance and as MIPs within a domain.

## Troubleshooting Tasks

In the event of a connectivity loss between MEPs, the administrator can perform path discovery, similar to traceroute, from one MEP to any MEP or MIP in a maintenance domain using Link Trace Messages (LTMs). The connectivity loss is narrowed down using path discovery and is verified using Loop-back Messages (LBMs), which are similar to ping operations in IP networks.

## Default Dot1ag Values

Dot1ag service are disabled by default and no maintenance domains, associations, or endpoints are configured by default.

Table 25-1 shows the global default values for Dot1ag.

**Table 25-1. Dot1ag Global Defaults**

Parameter	Default Value
CFM Admin Mode	Disabled
Archive Hold Time	600 seconds

When you configure an association between a VLAN and a maintenance domain, the following default value applies:

**Table 25-2. MA Configuration Defaults**


Parameter	Default Value
Continuity Check Message (CCM) Interval	1 second

When you associate endpoints with SVLAN IDs, the following default values apply and are configurable:

**Table 25-3. MEP Configuration Defaults**

Parameter	Default Value
MEP Active	False
Continuity Check Interval (CCI) Enabled	True

## Configuring Dot1ag (Web)

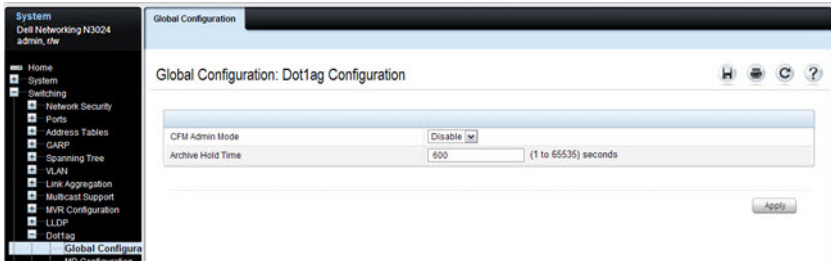
This section provides information about the OpenManage Switch Administrator pages for configuring and monitoring Dot1ag features on a Dell EMC Networking N4000 switch. For details about the fields on a page, click  at the top of the Dell EMC OpenManage Switch Administrator web page.

### Dot1ag Global Configuration

Use the **Global Configuration** page to enable and disable the Dot1ag admin mode and to configure the time after which inactive RMEP messages are removed from the MEP database.

To display the page, click **Switching** → **Dot1ag** → **Global Configuration** in the tree view.

**Figure 25-4. Dot1ag Global Configuration**

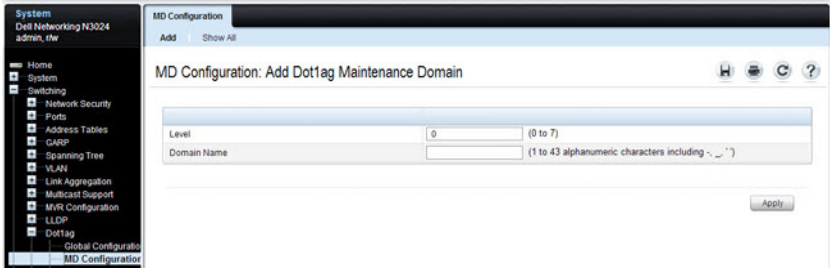


### Dot1ag MD Configuration

Use the **MD Configuration** page to configure maintenance domain levels and names.

To display the page, click **Switching** → **Dot1ag** → **MD Configuration** in the tree view.

**Figure 25-5. Dot1ag MD Configuration**

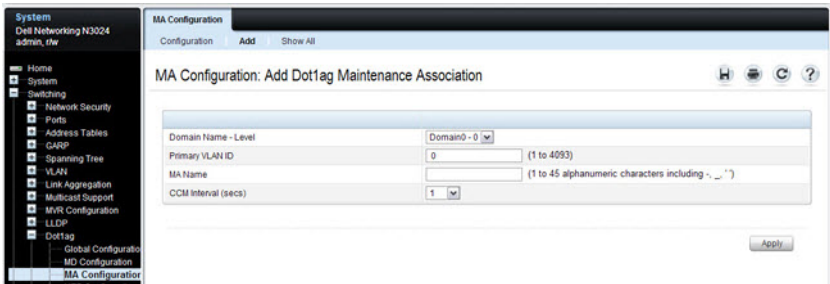


### Dot1ag MA Configuration

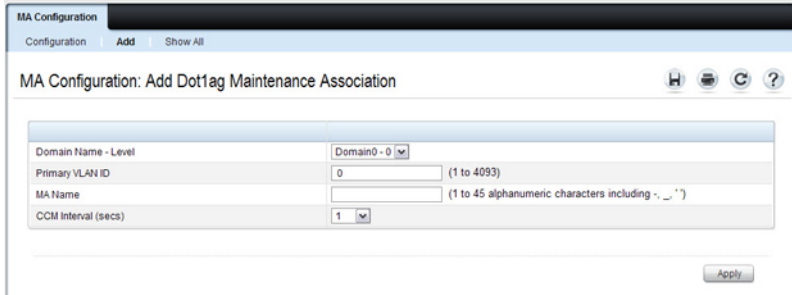
Use the MA Configuration page to associate a maintenance domain level with one or more VLAN ID, provide a name for each maintenance association (MA), and to set the interval between continuity check messages sent by MEPs for the MA.

To display the page, click **Switching** → **Dot1ag** → **MA Configuration** in the tree view.

**Figure 25-6. Dot1ag MA Configuration**



To add an MA, click the **Add** link at the top of the page.

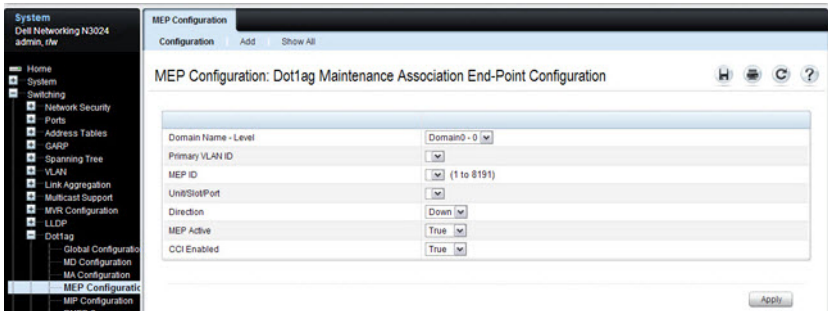


## Dot1ag MEP Configuration

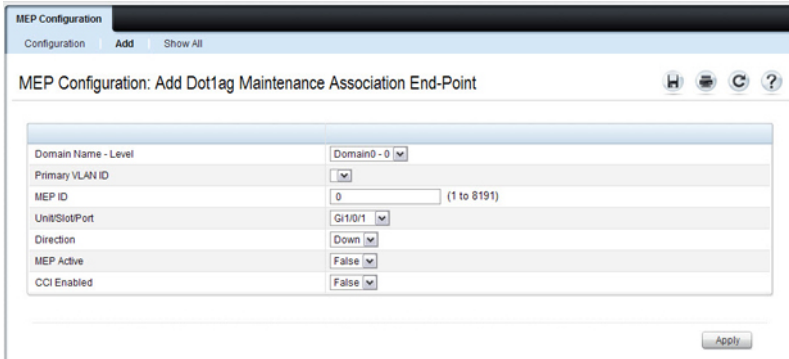
Use the MEP Configuration page to define switch ports as Management End Points. MEPs are configured per domain and per VLAN.

To display the page, click **Switching** → **Dot1ag** → **MEP Configuration** in the tree view.

**Figure 25-7. Dot1ag MEP Configuration**



To add a MEP, click the **Add** link at the top of the page. A VLAN must be associated with the selected domain before you configure a MEP to be used within an MA (see the [MA Configuration](#) page).

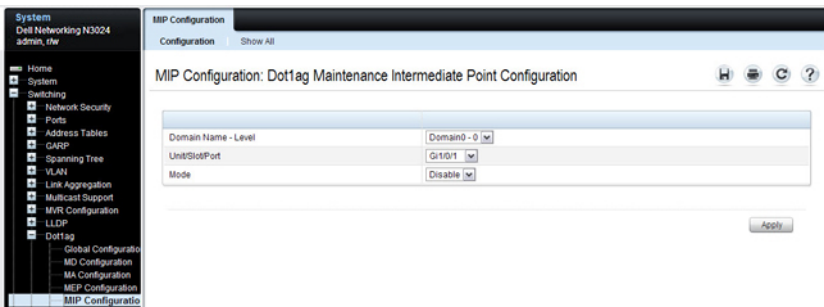


### Dot1ag MIP Configuration

Use the [MIP Configuration](#) page to define a switch port as an intermediate bridge for a selected domain.

To display the page, click **Switching** → **Dot1ag** → **MIP Configuration** in the tree view.

**Figure 25-8. Dot1ag MIP Configuration**



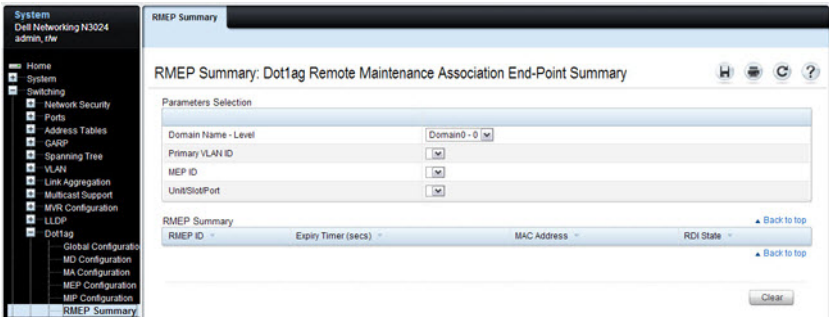


## Dot1ag RMEP Summary

Use the **RMEP Summary** page to view information on remote MEPs that the switch has learned through CFM PDU exchanges with MEPs on the switch.

To display the page, click **Switching** → **Dot1ag** → **RMEP Summary** in the tree view.

**Figure 25-9. Dot1ag RMEP Summary**

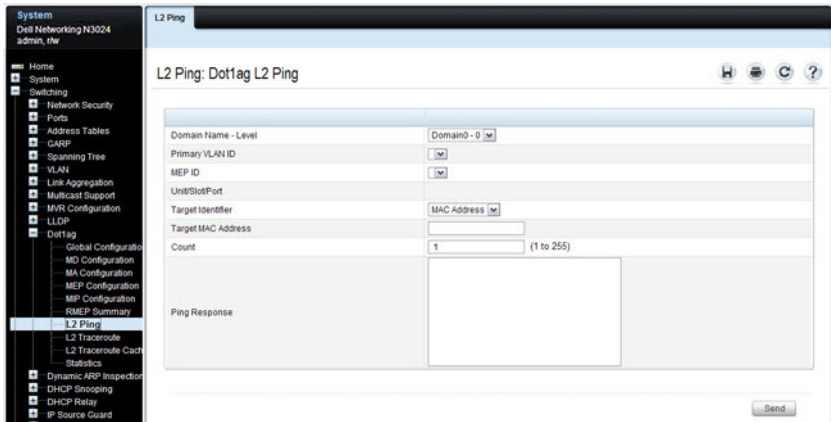


## Dot1ag L2 Ping

Use the **L2 Ping** page to generate a loopback message from a specified MEP. The MEP can be identified by the MEP ID or by its MAC address.

To display the page, click **Switching** → **Dot1ag** → **L2 Ping** in the tree view.

**Figure 25-10. Dot1ag L2 Ping**

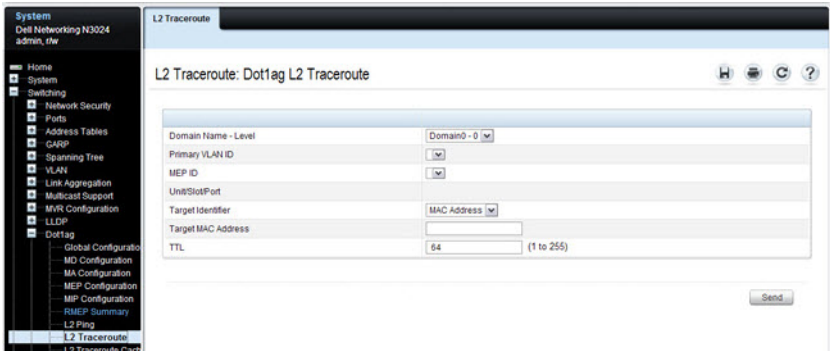


## Dot1ag L2 Traceroute

Use the **L2 Traceroute** page to generate a Link Trace message from a specified MEP. The MEP can be specified by the MAC address, or by the remote MEP ID.

To display the page, click **Switching** → **Dot1ag** → **L2 Traceroute** in the tree view.

**Figure 25-11. Dot1ag L2 Traceroute**

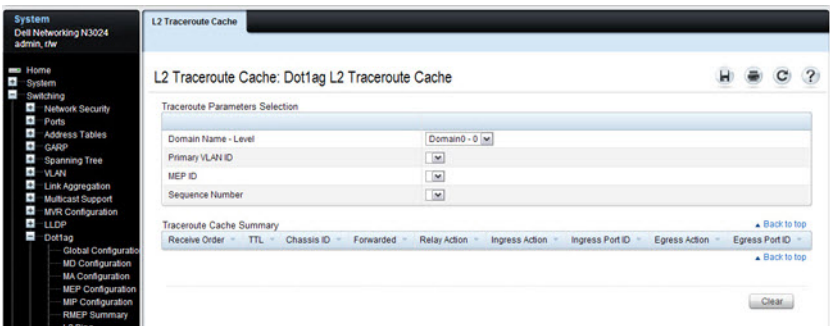


## Dot1ag L2 Traceroute Cache

Use the **L2 Traceroute Cache** page to view link traces retained in the link trace database.

To display the page, click **Switching** → **Dot1ag** → **L2 Traceroute Cache** in the tree view.

**Figure 25-12. Dot1ag L2 Traceroute Cache**



## Dot1ag Statistics

Use the **Statistics** page to view Dot1ag information for a selected domain and VLAN ID.

To display the page, click **Switching** → **Dot1ag** → **Statistics** in the tree view.

**Figure 25-13. Dot1ag Statistics**

The screenshot shows the Dell Networking N3024 configuration interface. The left sidebar contains a navigation tree with the following items: Home, System, Switching, Network Security, Ports, Address Tables, GARP, Spanning Tree, VLAN, Link Aggregation, Multicast Support, MVR Configuration, LLDP, and Dot1ag. Under Dot1ag, there are sub-items: Global Configuration, MD Configuration, MA Configuration, MEP Configuration, MP Configuration, RMEP Summary, L2 Ping, L2 Traceroute, L2 Traceroute Cache, Statistics, and Dynamic ARP Inspection. The 'Statistics' item is selected. The main content area displays the 'Statistics: Dot1ag Statistics' page. The page title is 'Statistics: Dot1ag Statistics'. There are three icons (Home, Refresh, Help) in the top right corner. The page contains a table with the following data:

Domain Name - Level	Domain0 - 0
Primary VLAN ID	
MEP ID	
Uni/Slot/Port	
Out-of-sequence CCMs received	
CCMs transmitted	
In-order Loopback Replies received	
Out-of-order Loopback Replies received	
Bad MSDU Loopback Replies received	
Loopback Replies transmitted	
Unexpected LTRs received	

## Configuring Dot1ag (CLI)

This section provides information about the commands used for configuring Dot1ag settings on the switch. For more information about the commands, see the *Dell EMC Networking N1100-ON, N1500, N2000, N2100-ON, N2200-ON, N3000E-ON, N3100-ON, and N3200-ON Series Switches CLI Reference Guide* at [www.dell.com/support](http://www.dell.com/support).

### Configuring Dot1ag Global Settings and Creating Domains

Use the following commands to configure CFM settings and to view global status and domain information.

CLI Command	Description
<code>configure</code>	Enter global configuration mode.
<code>ethernet cfm enable</code>	Enables connectivity fault management services.
<code>ethernet cfm mep archive-hold-time <i>time</i></code>	Set the time interval (range: 1–65535 seconds) after which inactive RMEPs are removed.
<code>ethernet cfm cc level <i>level</i> vlan <i>vlan-id</i> interval {1   10   60   600}</code>	Configure the Continuity Check Message (CCM) transmit interval for the specified VLAN.
<code>ethernet cfm domain <i>name</i> level <i>level</i></code>	Create a maintenance domain (MD) by assigning a name and level (0–7), and enter Maintenance Domain Config mode for that MD.
<code>service <i>name</i> vlan <i>vlan-id</i></code>	Create a maintenance association (MA) within the current MD by associating it with a VLAN and naming the association (as a service instance).
<code>exit</code>	Exit to privileged Exec Mode
<code>show ethernet cfm domain brief</code>	Display the configured parameters in the Maintenance Domain.

## Configuring MEP Information

Use the following commands to configure the mode and view related settings.

CLI Command	Description
<code>configure</code>	Enter global configuration mode.
<code>interface <i>interface</i></code>	Enter Interface Config mode for the specified interface, where <i>interface</i> is replaced by <b>gigabitethernet <i>unit/slot/port</i></b> , or <b>tengigabitethernet <i>unit/slot/port</i></b> .
<code>ethernet cfm mep enable level <i>level</i> vlan <i>vlan-id</i> mpid <i>mep-id</i></code>	Define the port as a maintenance endpoint (MEP) and associate it with an SVLAN in a domain. When the MEP is enabled, it will generate CCM messages.
<code>ethernet cfm mep level <i>level</i> direction {up   down} mpid <i>mep-id</i> vlan <i>vlan-id</i></code>	Enable a MEP at the specified level and direction.
<code>ethernet cfm mep active</code>	Set the administrative state of the MEP to active.
<code>ethernet cfm mip level <i>level</i></code>	Create a MIP at the specified level on the interface.
<code>exit</code>	Exit to privileged Exec Mode
<code>show ethernet cfm maintenance-points</code>	Add the keywords <b>local domain</b> , <b>local interface</b> , <b>local level</b> , <b>remote domain</b> , or <b>remote level</b> to show information on local or remote endpoints.
<code>show ethernet cfm statistics</code>	Display statistics per MEP.

## Dot1ag Ping and Traceroute

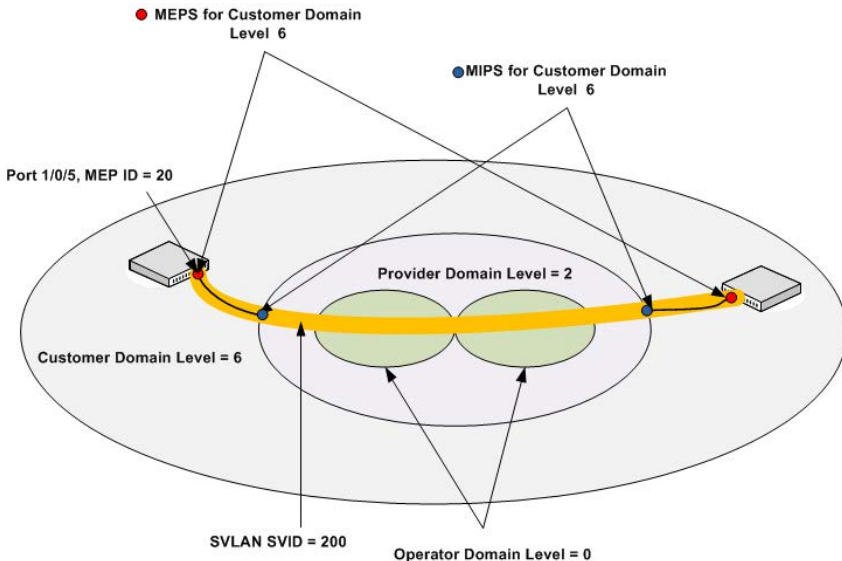
Use the following commands to help identify and troubleshoot Ethernet CFM settings.

CLI Command	Description
<code>ping ethernet cfm mac <i>mac-addr</i></code>	Generate a loopback message from the MEP with the specified MAC address.
<code>ping ethernet cfm remote-mpid <i>mep-id</i></code>	Generate a loopback message from the MEP with the specified MEP ID.
<code>traceroute ethernet cfm mac <i>mac-addr</i></code>	Generate a Link Trace message from the MEP with the specified MAC address.
<code>traceroute ethernet cfm remote-mpid <i>mep-id</i></code>	Generate a Link Trace message from the MEP with the specified MEP ID.
<code>show ethernet cfm traceroute-cache</code>	Show the link trace database.

# Dot1ag Configuration Example

In the following example, the switch at the customer site is part of a Metro Ethernet network that is bridged to remote sites through a provider network. A service VLAN (SVID 200) identifies a particular set of customer traffic on the provider network.

**Figure 25-14. Dot1ag Configuration for a Metro Ethernet Customer Network**



To configure the switch:

- 1 Enable CFM globally on the switch, and then create a level-6 management domain named CustDom for end-to-end CFM on the Metro Ethernet network. VLAN 200 is associated with this domain.

```
console#config
console(config)#ethernet cfm enable
console(config)#ethernet cfm domain CustDom level 6
console(config-cfm-mdomain)#service vlan vlan 200
console(config-cfm-mdomain)#exit
```



- 2 Configure port 1/0/5 as an MEP for service VLAN 200 so that the port can exchange CFM PDUs with its counterpart MEPs on the customer network. The port is first configured as a MEP with MEP ID 20 on domain level 6 for VLAN 200. Then the port is enabled and activated as a MEP.

```
console(config)#interface gigabitethernet 1/0/5
console(config-if-Gi1/0/5)#ethernet cfm mep level 6 direction
down mpid 20 vlan 200
console(config-if-Gi1/0/5)#ethernet cfm mep enabled level 6
vlan 200 mpid 20
console(config-if-Gi1/0/5)#ethernet cfm mep active level 6
vlan 200 mpid 20
console(config-if-Gi1/0/5)#exit
```

- 3 On an intermediate switch, configure the MIP for the customer domain and enable CFM services on the CustDom domain to include local network devices.



# Ethernet Ring Protection

## Dell EMC Networking N1500, N2100, N2200, N3200 Series Switches

Ethernet Ring Protection (ERP) is a highly reliable and stable protection switching mechanism Ethernet layer network rings. Ethernet rings allow a wide-range of economical multipoint connectivity topologies due to their reduced number of links. The Ethernet Ring Protection feature is based on the ITU-T G.8032 (08/15), Corrigendum 1 (08/17) standard. Ethernet Ring Protection Switching defines Ring Automatic Protection Switching (R-APS) Protocol Data Units (PDUs) and protection switching mechanisms. The Ethernet Ring Protection feature is supported on all Ethernet port types on the supported platforms.

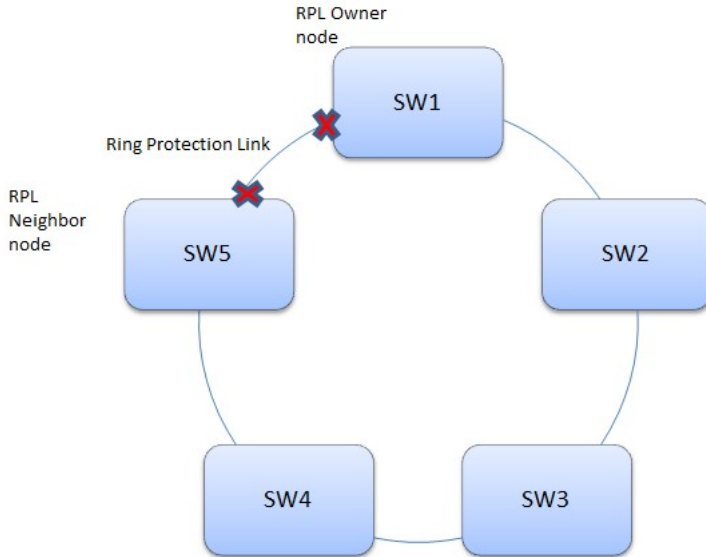
Ethernet Ring Protection does not support Non-Stop Forwarding. Stack failover is destructive to the ring, even when operating on stack units that are not rebooted during the stack failover.

The N1500, N2100, and N3200 Series switches do not support hardware-based Connectivity Fault Management. The lowest configurable value for the Continuity Check Message interval is one second on the N1500, N2100, and N3200. Therefore, ERP failover on the N1500, N2100, and N3200 platforms is on the order of multiple seconds.

Each node in the ring connects to the ring via two ports, known as ring links. These are often referred to as the East and West ring links respectively. Each ring link is bounded by two neighbors (Ethernet ring nodes). The minimum number of ring nodes in a ring is two. At any time, traffic may flow through all but one of the ring links which ensures a loop free ring. This particular link is known as the Ring Protection Link (RPL). Under normal conditions, the RPL is blocked (not used for data traffic). One end of the RPL is designated as the owner, and the other end of the link is designated as the neighbor.

Ring links may be configured as part of a port-channel or M-LAG and may participate in an L2 (spanning-tree network) or an L3 (routed) network.

**Figure 26-1. Ethernet Ring Protection**



The ring protection architecture uses the R-APS protocol to coordinate ring protection actions within an Ethernet ring. When a failure is detected on a ring port, the node detecting the failure will generate an R-APS Signal Fail (SF) message along both the directions. This message notifies the other ring nodes of the failure and causes a protection switch to occur. The RPL nodes (owner and neighbor) unblock the RPL link.

When the failed link is restored, the nodes adjacent to the restored link send R-APS No Request (NR) messages. Upon receiving this message, the RPL owner blocks the RPL port and sends an R-APS No Request, RPL blocked (NR, RB) message. This will cause all nodes other than RPL owner in the ring to unblock all blocked ports.

Ethernet Ring Protection supports the following topologies:

- Single ring
- Shared ring node: A single node would participate in two physical rings and bridge between them.
- Multi-ring (sub-ring without R-APS virtual channel)

# Ethernet Ring Protection Switching Port Role

Ethernet Ring Protection Switching (ERPS) defines three port roles: the RPL owner port, the RPL neighbor port, and the Normal port.

Under normal conditions, the RPL is blocked (not used for data traffic), thus preventing loops. The ports at each end of the RPL are called *RPL owner* and *RPL neighbor*.

## RPL Owner Port

It is the RPL owner that provides the main control for protection switching. The owner generates R-APS No Request RPL-Blocked (NR, RB) messages continuously and is in charge of the RPL's blocking and forwarding states. Under normal operation, when there are no failures, the RPL owner generates R-APS (NR, RB) messages. It periodically sends these, every five seconds, over both of its ring ports. These messages indicate which of its ring ports is being blocked.

## RPL Neighbor Port

The port adjacent to the RPL owner is the RPL neighbor port. Both the RPL owner port and the RPL neighbor ports are blocked in normal situations to prevent loops. Under the Signal Fail condition, both the RPL owner and neighbor ports are unblocked. Configuration of a RPL neighbor port is optional.

## Normal Port

A normal port monitors the status of the directly connected ring link and sends R-APS PDUs to notify the other ports of its link status changes.

## R-APS Channel

R-APS messages require a separate ring-wide VLAN known as the R-APS VLAN or R-APS Channel. Each ERP instance uses an R-APS VLAN for sending and receiving R-APS messages.

The function of the R-APS VLAN is to support a path for monitoring the ring and maintaining its operational functions. R-APS VLAN must have all ERP ring ports as members. Nodes receiving the R-APS message must send a copy

to the ERP control process for local processing and also forward the received R-APS to the next node if the next hop port is not blocked. When a node receives its own generated R-APS message, it drops the R-APS message.

The node that actually generates the R-APS messages will always send messages over both of its ring ports regardless of whether or not the R-APS channels are blocked on its ring ports. Similarly, R-APS messages will be received and processed regardless of whether or not the R-APS channel is being blocked on its ring ports.

## Traffic Channel

Each Ethernet Ring Protection (ERP) instance is responsible for protecting one or more VLANs (known as traffic channels) that transport traffic over the physical ring. All the nodes in the ring are required to have the same protected VLANs. The traffic channel should have the ERP ring ports as members.

Each traffic channel and each R-APS channel on the ring port are managed by the Ethernet Ring Protection control process (ERP control process) of only one Ethernet ring. The R-APS channel and traffic channel must be mapped to an ERP instance.

## Ring Scope

A ring may be configured per port or per VLAN. In a per port ring, there is only one instance and, by default, all the VLANs that are participating in both the ring ports are protected. In the per VLAN ring, multiple instances may be configured and the administrator can define the protected VLANs for each instance.

## Ethernet Ring Protection Port Status

On an ERP ring, a ring port has a status of:

- Forwarding (unblocked): forwards data traffic and transmits and receives R-APS PDUs.
- Discarding (blocked): only transmits and receives R-APS PDUs.

# Ethernet Ring Protection Timers

The following timers are used by the ERP control process to reduce protection switching occurrences.

## Hold-off

When a link failure or defect occurs, the event will not be reported immediately to protection switching if the configured hold-off timer value is non-zero. Instead, the hold-off timer will be started. Upon the expiry of the hold-off timer, the ERP control process checks whether a defect still exists along the trail that started the timer. If it does, the defect will be reported to protection switching. This is used by the underlying Ethernet layer to filter out intermittent link faults.

## Wait-to-Restore

When the fault condition is cleared, the traffic channel reverts after the expiry of a Wait-to-Restore (WTR) timer when a fault condition is not active. This timer is used to avoid toggling protection states in case of intermittent defects. This timer is only used by the RPL owner when in revertive operation.

## Guard Timer

The guard timer prevents ring nodes from acting upon outdated R-APS messages and prevents the possibility of forming a closed loop. This is used by all nodes when a clearing condition occurs. This is the amount of time that an ERP control process discards R-APS messages before being allowed to process them.

It is used when a link is recovered, yet at the same time older messages are still propagating around the ring with failure indications. The guard timer is used whenever a ring node receives an indication that a local switching request has cleared (such as, local clear SF, Clear).

## Wait-to-Block

The Wait-to-block (WTB) timer is used when issuing clearing of Forced Switch (FS) or Manual Switch (MS) commands. It is only used by the RPL owner in a revertive operation before blocking RPL. This timer value is five seconds longer than the guard timer and is not configurable.

# Revertive and Non-Revertive Operation Modes

ERP defines two operation modes: Revertive and Non-Revertive.

## Revertive

In revertive mode, when failures in the link are removed, the traffic channel is restored to the working transport entity and RPL is blocked. When revertive operations are used, the ring will not revert back immediately. Reversion does not start until the Wait-To-Restore (WTR) timer has expired.

## Non-Revertive

In non-revertive mode, RPL is continued to be used by traffic channel, even after a failure condition has been resolved.

# ERPS Subrings

Ethernet Ring Protection also supports interconnection of multiple rings. Interconnection of two rings means that two rings might share the same link or share the same node.

**Figure 26-2. Sub-Ring with VC and without VC**

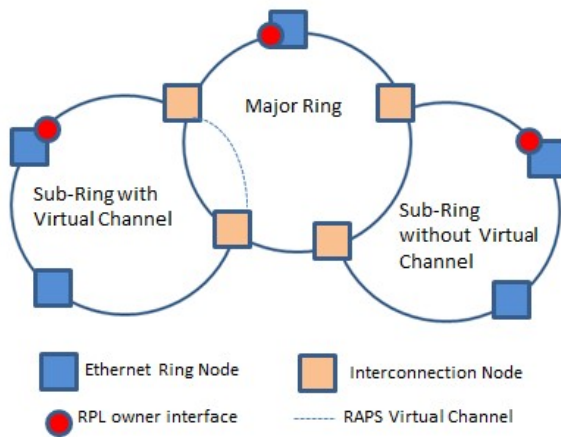




Figure 26-2 shows a multi-ring topology. Here the major ring is fully formed, while the sub-ring connects to the major ring at interconnection nodes. The sub-ring is not fully formed, it is a partial ring in the shape of *C* and it does not control the link on the major ring. Below are the two implementation options for R-APS control channel of the sub-ring.

### **Without R-APS Virtual Channel**

R-APS PDU's processing on the sub-ring terminates at the interconnection nodes. The RPL blocks data traffic but not R-APS PDUs in sub-ring.

### **With R-APS Virtual Channel**

Here R-APS PDU's in sub-rings are transmitted to the major ring through interconnected nodes. R-APS channel blocking is the same as that of the major ring. The RPL of the sub-ring blocks both R-APS PDU's and data traffic. This configuration is not supported.

## **Topology Change Notification**

The topology change propagation process generates a signal to notify the ring nodes of a major ring attached to a sub-ring about topology changes on the sub-ring. This exists only on the ERP instance of sub-ring interconnection nodes.

Once the major ring ERP instance is notified of the TCN by the sub-ring ERP instance, the major ring instance will send out an R-APS message with a special Flush Event sub-code. This message will go around the major ring causing all the other ERP instances in the major ring to perform an FDB flush. After that, MAC re-learning will occur and traffic along the protected data VLANs can flow properly.

## **Protection Switching Triggers**

Protection switching algorithm are triggered when:

- Initiated by manual command (for example, manual switch or forced switch), if there are no requests with higher priority being in effect.
- A *Signal Fail* condition is reported on one of the ring links. Signal Failure can be determined by CCM defects or a link down event.

- The incoming R-APS message requests a protection switch.

## Ring Failure Detection

Protection switching on the ring node occurs when a Continuity Check Message (CCM) fault is reported on one of the ring links or when a physical layer failure condition is reported to the ERP control process.

The Ethernet layer connectivity of ring links is periodically monitored using down Maintenance Entity Endpoints (MEPs). OAM reports a CCM fault when it does not receive the expected CCM for 3.5 times the configured CCM interval. When OAM detects the failure, it signals the ERP control process to initiate the protection switchover.

The ring node detecting the failure will block that port for its protected VLANs and generate an R-APS (SF) message. It will send this R-APS (SF) message out both of its ring ports. The R-APS is first sent as a burst of three R-APS messages and then continues to send this message every five seconds until the Signal Fail (SF) condition recovers.

When the R-APS message is received at the RPL owner and the RPL neighbor, this indicates that there is a block somewhere else in the ring, and this allows the RPL owner and RPL neighbor to unblock their RPL. The RPL owner also notes that the Node ID and BPR received in the R-APS message is not that of itself and its RPL. At this point, the ring has completed the protection switchover.

## Ring Protection Example

The following example configures a single node. The 20 ms hold off timer provides some hysteresis for transient failures. Only one instance is configured. The ring is revertive by default. The RAPS channel uses VLAN 100. VLANs 101-103 are used for data traffic. The CCM configuration is not shown here, however, this example monitors level 7 CCMs.

```
console (config)#vlan 100-103
console (config-vlan100-103)#exit
console (config)#interface te1/0/1
console (config-if-Te1/0/1)#switchport mode trunk
console (config-if-Te1/0/1)#interface te1/0/2
console (config-if-Te1/0/2)#switchport mode trunk
console (config-if-Te1/0/2)#exit
```

```
console (config)# ethernet ring g8032 Ring1
console (config-erp-ring1)#timer hold-off 20
console (config-erp-ring1)#port0 interface tel/0/1
console (config-erp-ring1)#port1 interface tel/0/2
console (config-erp-ring1)#instance 1
console (config-erp-inst-1)#rpl port1 owner
console (config-erp-inst-1)#aps-channel
console (config-erp-inst-1-aps)#level 7
console (config-erp-inst-1-aps)#raps-vlan 100
```



# Snooping and Inspecting Traffic

## Dell EMC Networking N-Series Switches

This chapter describes Dynamic Host Configuration Protocol (DHCP) Snooping, IP Source Guard (IPSG), and Dynamic ARP Inspection (DAI), which are Layer-2 security features that examine traffic to help prevent accidental and malicious attacks on the switch or network.

The topics covered in this chapter include:

- Traffic Snooping and Inspection Overview
- Default Traffic Snooping and Inspection Values
- Configuring Traffic Snooping and Inspection (Web)
- Configuring Traffic Snooping and Inspection (CLI)
- Traffic Snooping and Inspection Configuration Examples

## Traffic Snooping and Inspection Overview

DHCP Snooping is a security feature that monitors DHCP messages between a DHCP client and DHCP server to filter harmful DHCP messages and to build a bindings database. The IPSG and DAI features use the DHCP Snooping bindings database to help enforce switch and network security.

IP Source Guard allows the switch to drop incoming packets that do not match a binding in the bindings database. Dynamic ARP Inspection allows the switch to drop ARP packets whose sender MAC address and sender IP address do not match an entry in the DHCP snooping bindings database.

DHCP Snooping and IPSG are supported for both IPv4 and IPv6. DAI is supported for IPv4 only, as IPv6 does not use ARP.

## What Is DHCP Snooping?

Dynamic Host Configuration Protocol (DHCP) Snooping is a security feature that monitors DHCP messages between a DHCP client and DHCP server to accomplish the following tasks:

- Ensure that only authorized DHCP clients are able to utilize the network.
- Designate which ports are connected to trusted DHCP servers and drop DHCP messages from servers connected to untrusted ports
- Build an authorized DHCP client bindings database with entries that consist of the following information:
  - MAC address
  - IP address
  - VLAN ID
  - Client port
  - Type (static or dynamic)
  - Lease time

Entries in the bindings database are considered to be authorized network clients. DHCP clients can exchange messages with DHCP servers connected via trusted ports. DHCP client messages are never forwarded to untrusted ports.

DHCP snooping can be enabled on VLANs, and the trust status (trusted or untrusted) is specified on individual physical ports or LAGS that are members of the VLAN. When a port or LAG is configured as untrusted, it could potentially be used to launch a network attack. DHCP snooping protects against attacks on untrusted ports. DHCP servers must be reached through trusted ports. DHCP clients are configured on untrusted ports.

DHCP snooping enforces the following security rules:

- DHCP packets from a DHCP server (DHCP OFFER, DHCP ACK, DHCP NAK, DHCP RELEASE QUERY) are dropped if they are received on an untrusted port and a warning level message is logged if invalid DHCP packet logging is enabled. DHCP client originated messages are never forwarded over untrusted ports.
- DHCP RELEASE and DHCP DECLINE messages are dropped if the MAC addresses are found in the snooping database, but the binding's interface is other than the interface where the message was received.

- On untrusted DHCP client interfaces, the switch may be configured to drop DHCP packets with a source MAC address that does not match the client hardware address.

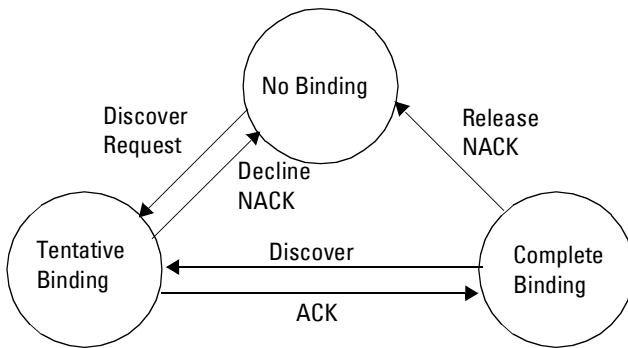
### **How Is the DHCP Snooping Bindings Database Populated?**

The DHCP snooping application uses DHCP messages to build and maintain the binding's database. DHCP snooping creates a tentative binding from DHCP DISCOVER and REQUEST messages. Tentative bindings tie a client to a port (the port where the DHCP client message was received). Tentative bindings are completed when DHCP snooping learns the client's IP address from a DHCP ACK message on a trusted port. DHCP snooping removes bindings in response to DECLINE, RELEASE, and NACK messages. The DHCP snooping application ignores the ACK messages as a reply to the DHCP Inform messages received on trusted ports. Static bindings can also be entered into the binding database.

When a switch learns of new bindings or loses bindings, the switch immediately updates the entries in the database. The switch also updates the entries in the binding file. The frequency at which the file is updated is based on a configurable delay, and the updates are batched. If the switch is rebooted, the bindings file is used to populate the running-config with the DHCP bindings.

If the absolute lease time of the snooping database entry expires, that entry is removed. Make sure the system time is consistent across the reboots. Otherwise, the snooping entries will not expire properly. If a host sends a DHCP release while the switch is rebooting, when the switch receives the DHCP discovery or request, the client's binding goes to the tentative binding as shown in Figure 27-1.

**Figure 27-1. DHCP Binding**



The binding database includes data for clients only on untrusted ports.

### **DHCP Snooping and VLANs**

DHCP snooping forwards valid DHCP client messages received on non-routing VLANs. The message is forwarded on all trusted interfaces in the VLAN.

DHCP snooping can be configured on switching VLANs and routing VLANs. When a DHCP packet is received on a routing VLAN, the DHCP snooping application applies its filtering rules and updates the bindings database. If a client message passes filtering rules, the message is placed into the software forwarding path where it may be processed by the DHCP relay agent, the local DHCP server, or forwarded as an IP packet.

### **DHCP Snooping Logging and Rate Limits**

The DHCP snooping application processes incoming DHCP messages. For DHCPRELEASE and DHCPDECLINE messages, the application compares the receive interface and VLAN with the client interface and VLAN in the bindings database. If the interfaces do not match, the application logs the event and drops the message. For valid client messages, DHCP snooping compares the source MAC address to the DHCP client hardware address. When there is a mismatch, DHCP snooping drops the packet and generates a log message if logging of invalid packets is enabled.



If DHCP relay co-exists with DHCP snooping, DHCP client messages are sent to DHCP relay for further processing.

To prevent DHCP packets from being used as a DoS attack when DHCP snooping is enabled, the snooping application enforces a rate limit for DHCP packets received on interfaces. DHCP rate limiting can be configured on both trusted and untrusted interfaces. DHCP snooping monitors the receive rate on each interface separately. If the receive rate exceeds a configurable limit, DHCP snooping diagnostically disables the interface. Administrative intervention is necessary to enable the port, either by using the **no shutdown** command in Interface Config mode or on the **Switching → Ports → Port Configuration** page. Use the **ip dhcp snooping limit none** command to disable diagnostic disabling of the port due to DHCP snooping.

## What Is IP Source Guard?

IPSG is a security feature that filters IP packets based on source ID. This feature helps protect the network from attacks that use IP address spoofing to compromise or overwhelm the network.

The source ID may be either the source IP address or a {source IP address, source MAC address} pair. The following can be configured:

- Whether enforcement includes the source MAC address
- Static authorized source IDs

The DHCP snooping bindings database and static IPSG entries identify authorized source IDs. IPSG can be enabled on physical and LAG ports.

If you enable IPSG on a port where DHCP snooping is disabled or where DHCP snooping is enabled but the port is trusted, all IP traffic received on that port is dropped depending on the admin-configured IPSG entries.

## IPSG and Port Security

IPSG interacts with port security, also known as port MAC locking, (see "Port Security" on page 705) to enforce the source MAC address. Port security controls source MAC address learning in the Layer-2 forwarding database (MAC address table). When a frame is received with a previously unlearned source MAC address, port security queries the IPSG feature to determine whether the MAC address belongs to a valid binding.

If IPSG is disabled on the ingress port, IPSG replies that the MAC is valid. If IPSG is enabled on the ingress port, IPSG checks the bindings database. If the MAC address is in the bindings database and the binding matches the VLAN the frame was received on, IPSG replies that the MAC is valid. If the MAC is not in the bindings database, IPSG informs port security that the frame is a security violation.

In the case of an IPSG violation, port security takes whatever action it normally takes upon receipt of an unauthorized frame. Port security limits the number of MAC addresses to a configured maximum. If the limit  $n$  is less than the number of stations  $m$  in the bindings database, port security allows only  $n$  stations to use the port. If  $n > m$ , port security allows only the stations in the bindings database. For information about configuring the Port Security feature, see "Port and System Security" on page 705.

## What is Dynamic ARP Inspection?

**NOTE:** Dynamic ARP Inspection (DAI) is not supported on the N1100 Series switches.

Dynamic ARP Inspection (DAI) is a security feature that rejects invalid and malicious ARP packets. DAI prevents a class of man-in-the-middle attacks where an unfriendly station intercepts traffic for other stations by poisoning the ARP caches of its unsuspecting neighbors. The malicious attacker sends ARP requests or responses mapping another station's IP address to its own MAC address.

When DAI is enabled, the switch drops ARP packets whose sender MAC address and sender IP address do not match an entry in the DHCP snooping bindings database. Additional ARP packet validation can optionally be configured.

When DAI is enabled on a VLAN, DAI is enabled on the interfaces (physical ports or LAGs) that are members of that VLAN. Individual interfaces are configured as trusted or untrusted. The trust configuration for DAI is independent of the trust configuration for DHCP snooping.

### Optional DAI Features

If the network administrator has configured the option, DAI verifies that the sender MAC address equals the source MAC address in the Ethernet header. There is a configurable option to verify that the target MAC address equals the destination MAC address in the Ethernet header. This check applies only to ARP responses, since the target MAC address is unspecified in ARP requests. IP address checking can also be enabled. When this option is enabled, DAI drops ARP packets with an invalid IP address. The following IP addresses are considered invalid:

- 0.0.0.0
- 255.255.255.255
- all IP multicast addresses
- all class E addresses (240.0.0.0/4)
- loopback addresses (in the range 127.0.0.0/8)

DAI can also be configured to rate-limit ARP requests on untrusted interfaces. If the configured rate is exceeded, DAI diagnostically disables the port on which the rate limit was exceeded. Use the **no shutdown** command to

re-enable the port. DAI rate limiting cannot be enabled on trusted interfaces. Use the `no ip arp inspection limit` command to disable diagnostic disabling of untrusted ports due to DAI.

### Why Is Traffic Snooping and Inspection Necessary?

DHCP Snooping, IPSPG, and DAI are security features that can help protect the switch and the network against various types of accidental or malicious attacks. It might be a good idea to enable these features on ports that provide network access to hosts that are in physically unsecured locations or if network users connect nonstandard hosts to the network.

For example, if an employee unknowingly connects a workstation to the network that has a DHCP server, and the DHCP server is enabled, hosts that attempt to acquire network information from the legitimate network DHCP server might obtain incorrect information from the rogue DHCP server. However, if the workstation with the rogue DHCP server is connected to a port that is configured as untrusted and is a member of a DHCP Snooping-enabled VLAN, the port discards the DHCP server messages.

## Default Traffic Snooping and Inspection Values

DHCP snooping is disabled globally and on all VLANs by default. Ports are untrusted by default.


**Table 27-1. Traffic Snooping Defaults**

Parameter	Default Value
DHCP snooping mode	Disabled
DHCP snooping VLAN mode	Disabled on all VLANs
Interface trust state	Disabled (untrusted)
DHCP logging invalid packets	Disabled
DHCP snooping rate limit	None
DHCP snooping burst interval	None
DHCP snooping binding database storage	Local
DHCP snooping binding database write delay	300 seconds

**Table 27-1. Traffic Snooping Defaults (Continued)**

<b>Parameter</b>	<b>Default Value</b>
Static DHCP bindings	None configured
IPSG mode	Disabled on all interfaces
IPSG port security	Disabled on all interfaces
Static IPSG bindings	None configured
DAI validate source MAC	Disabled
DAI validate destination MAC	Disabled
DAI validate IP	Disabled
DAI trust state	Disabled (untrusted)
DAI rate limit	15 packets per second
DAI burst interval	1 second
DAI mode	Disabled on all VLANs
DAI logging invalid packets	Disabled
DAI ARP ACL	None configured
DAI Static flag	Disabled (validation by ARP ACL and DHCP snooping binding database)

# Configuring Traffic Snooping and Inspection (Web)

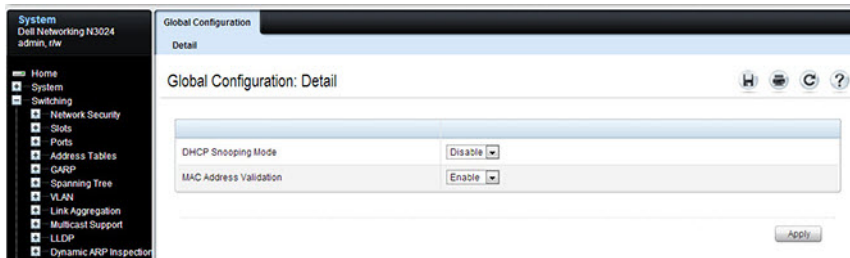
This section provides information about the OpenManage Switch Administrator pages for configuring and monitoring DHCP snooping, IPSPG, and DAI features on Dell EMC Networking N-Series switches. For details about the fields on a page, click  at the top of the Dell EMC OpenManage Switch Administrator web page.

## DHCP Snooping Configuration

Use the **DHCP Snooping Configuration** page to control the DHCP Snooping mode on the switch and to specify whether the sender MAC Address for DHCP Snooping must be validated.

To access the **DHCP Snooping Configuration** page, click **Switching** → **DHCP Snooping** → **Global Configuration** in the navigation panel.

**Figure 27-2. DHCP Snooping Configuration**

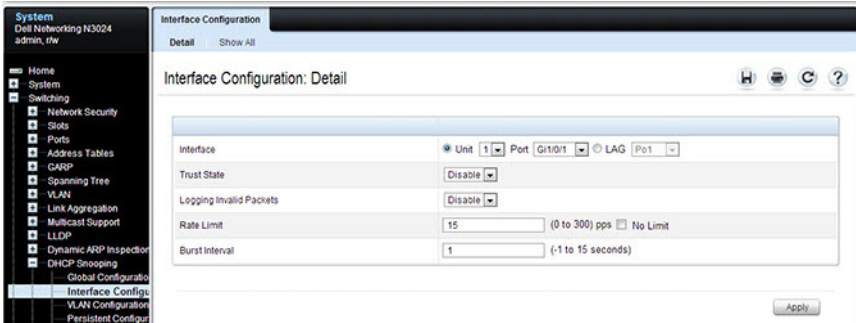


## DHCP Snooping Interface Configuration

Use the DHCP Snooping Interface Configuration page to configure the DHCP Snooping settings on individual ports and LAGs.

To access the DHCP Snooping Interface Configuration page, click Switching → DHCP Snooping → Interface Configuration in the navigation panel.

**Figure 27-3. DHCP Snooping Interface Configuration**



To view a summary of the DHCP snooping configuration for all interfaces, click **Show All**.

**Figure 27-4. DHCP Snooping Interface Configuration Summary**

Interface Configuration

Detail Show All

Interface Configuration: Show All

Unit

Unit 1

Ports [Back to top](#)

Interface	Trust State	Logging Invalid Packets	Rate Limit (0 to 300) pps	Burst Interval (1 to 15 seconds)
Gi1/0/1	Disable	Disable	15	1
Gi1/0/2	Disable	Disable	15	1
Gi1/0/3	Disable	Disable	15	1
Gi1/0/4	Disable	Disable	15	1
Gi1/0/5	Disable	Disable	15	1

Items Displayed 1-5 Rows Per Page 5 Pages 1 of 6

LAGs [Back to top](#)

LAGs	Trust State	Logging Invalid Packets	Rate Limit (0 to 300) pps	Burst Interval (1 to 15 seconds)
Po1	Disable	Disable	15	1
Po2	Disable	Disable	15	1
Po3	Disable	Disable	15	1
Po4	Disable	Disable	15	1
Po5	Disable	Disable	15	1

Items Displayed 1-5 Rows Per Page 5 Pages 1 of 26 [Back to top](#)

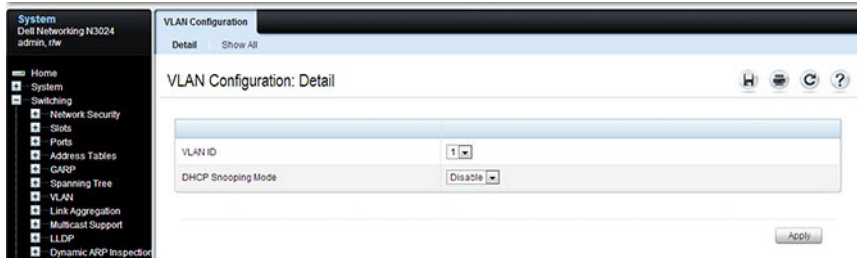


## DHCP Snooping VLAN Configuration

Use the DHCP Snooping VLAN Configuration page to control the DHCP snooping mode on each VLAN.

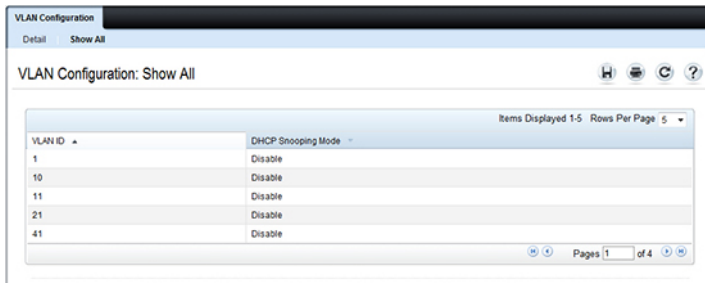
To access the DHCP Snooping VLAN Configuration page, click **Switching** → **DHCP Snooping** → **VLAN Configuration** in the navigation panel.

**Figure 27-5. DHCP Snooping VLAN Configuration**



To view a summary of the DHCP snooping status for all VLANs, click **Show All**.

**Figure 27-6. DHCP Snooping VLAN Configuration Summary**

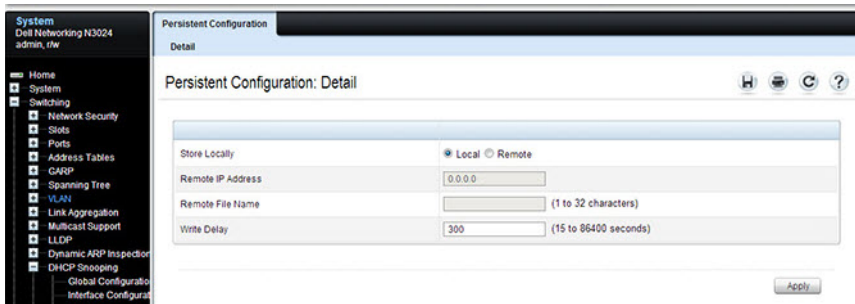


## DHCP Snooping Persistent Configuration

Use the DHCP Snooping Persistent Configuration page to configure the persistent location of the DHCP snooping database. The bindings database can be stored locally on the switch or on a remote system somewhere else in the network. The switch must be able to reach the IP address of the remote system to send bindings to a remote database.

To access the DHCP Snooping Persistent Configuration page, click Switching → DHCP Snooping → Persistent Configuration in the navigation panel.

Figure 27-7. DHCP Snooping Persistent Configuration

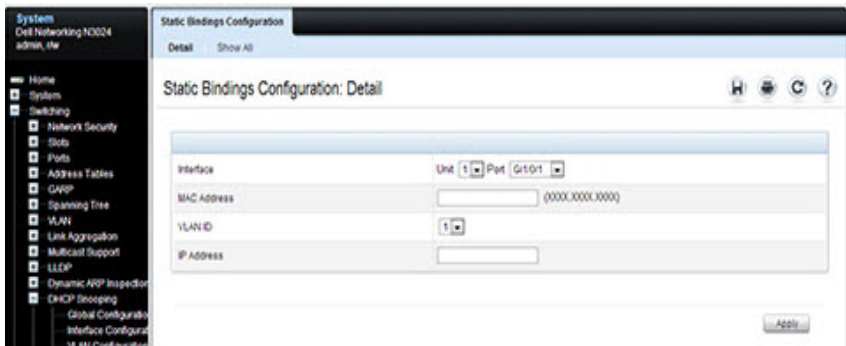


## DHCP Snooping Static Bindings Configuration

Use the DHCP Snooping Static Bindings Configuration page to add static DHCP bindings to the binding database.

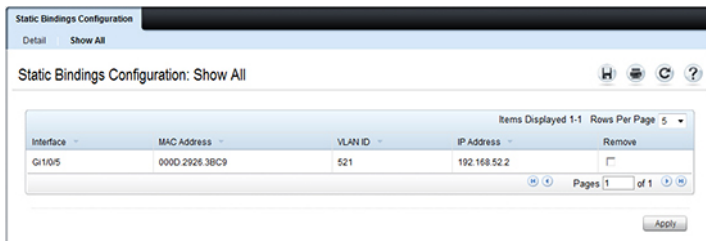
To access the DHCP Snooping Static Bindings Configuration page, click **Switching** → **DHCP Snooping** → **Static Bindings Configuration** in the navigation panel.

**Figure 27-8. DHCP Snooping Static Bindings Configuration**



To view a summary of the DHCP snooping status for all VLANs, click **Show All**.

**Figure 27-9. DHCP Snooping Static Bindings Summary**



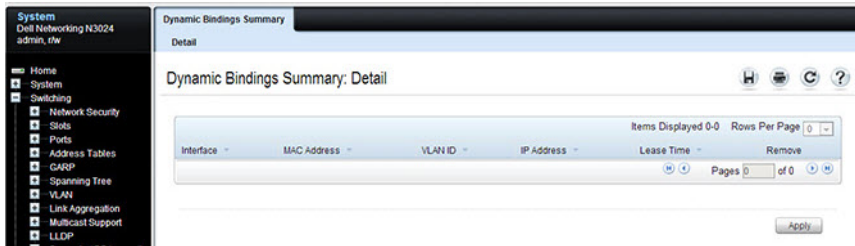
To remove a static binding, select the **Remove** checkbox associated with the binding and click **Apply**.

## DHCP Snooping Dynamic Bindings Summary

The DHCP Snooping Dynamic Bindings Summary lists all the DHCP snooping dynamic binding entries learned on the switch ports.

To access the DHCP Snooping Dynamic Bindings Summary page, click **Switching** → **DHCP Snooping** → **Dynamic Bindings Summary** in the navigation panel.

**Figure 27-10. DHCP Snooping Dynamic Bindings Summary**

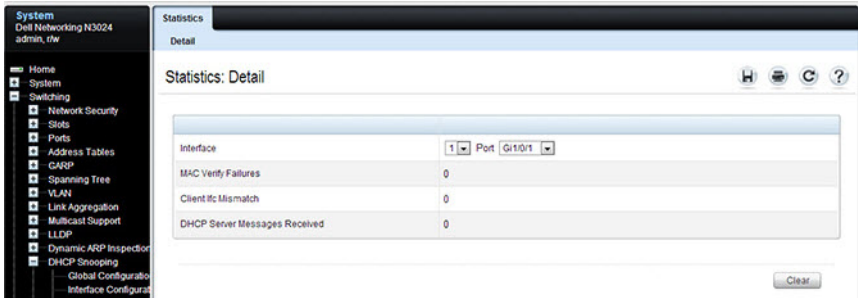


## DHCP Snooping Statistics

The DHCP Snooping Statistics page displays DHCP snooping interface statistics.

To access the DHCP Snooping Statistics page, click **Switching** → **DHCP Snooping** → **Statistics** in the navigation panel.

**Figure 27-11. DHCP Snooping Statistics**

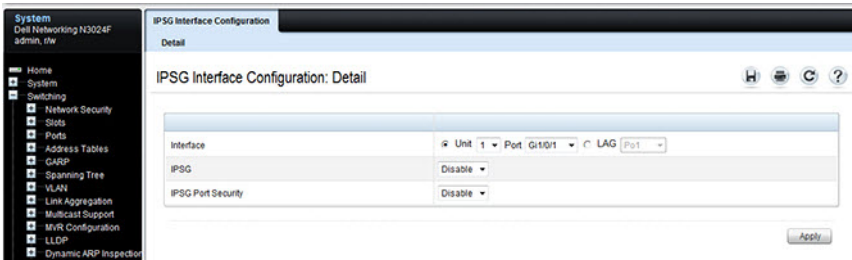


## IPSG Interface Configuration

Use the **IPSG Interface Configuration** page to configure IPSG on an interface.

To access the **IPSG Interface Configuration** page, click **Switching** → **IP Source Guard** → **IPSG Interface Configuration** in the navigation panel.

**Figure 27-12. IPSG Interface Configuration**

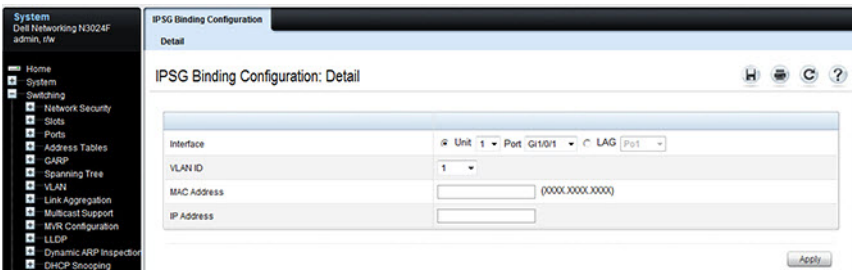


## IPSG Binding Configuration

Use the **IPSG Binding Configuration** page displays DHCP snooping interface statistics.

To access the **IPSG Binding Configuration** page, click **Switching** → **IP Source Guard** → **IPSG Binding Configuration** in the navigation panel.

**Figure 27-13. IPSG Binding Configuration**



## IPSG Binding Summary

The **IPSG Binding Summary** page displays the IPSG Static binding list and IPSG dynamic binding list (the static bindings configured in Binding configuration page).

To access the **IPSG Binding Summary** page, click **Switching** → **IP Source Guard** → **IPSG Binding Summary** in the navigation panel.

**Figure 27-14. IPSG Binding Summary**

The screenshot displays the 'IPSG Binding Summary: Detail' page. On the left is a navigation tree with 'IPSG Binding Summary' selected. The main content area is divided into two sections:

- IPSG Static Binding List:** A table with columns: Interface, VLAN ID, MAC Address, IP Address, Filter Type, and Remove. It shows 0 items displayed.
- IPSG Dynamic Binding List:** A table with columns: Interface, VLAN ID, MAC Address, IP Address, and Filter Type. It shows 1 item displayed.

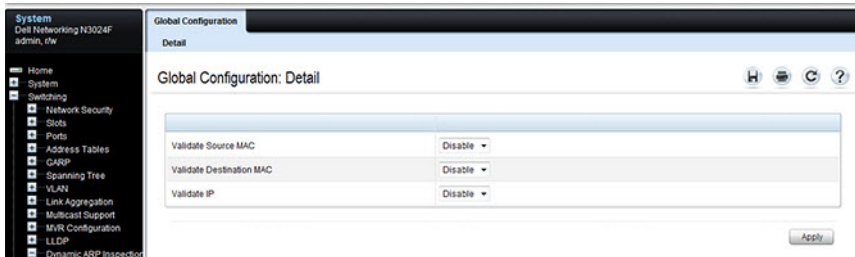
Interface	VLAN ID	MAC Address	IP Address	Filter Type
Gi10/5	521	000D.2926.3BC9	192.168.52.2	FALSE

## DAI Global Configuration

Use the DAI Configuration page to configure global DAI settings.

To display the DAI Configuration page, click **Switching** → **Dynamic ARP Inspection** → **Global Configuration** in the navigation panel.

**Figure 27-15. Dynamic ARP Inspection Global Configuration**



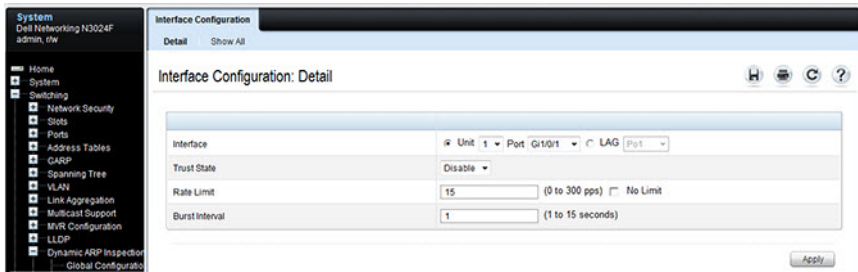


## DAI Interface Configuration

Use the **DAI Interface Configuration** page to select the DAI Interface for which information is to be displayed or configured.

To display the **DAI Interface Configuration** page, click **Switching** → **Dynamic ARP Inspection** → **Interface Configuration** in the navigation panel.

**Figure 27-16. Dynamic ARP Inspection Interface Configuration**



To view a summary of the DAI status for all interfaces, click **Show All**.

**Figure 27-17. DAI Interface Configuration Summary**

Interface Configuration Summary

Unit

Unit: 1

Ports

Port	Trust State	Rate Limit	Burst Interval
Gi1/0/1	Disable	15	1
Gi1/0/2	Disable	15	1
Gi1/0/3	Disable	15	1
Gi1/0/4	Disable	15	1
Gi1/0/5	Disable	15	1

LAGs

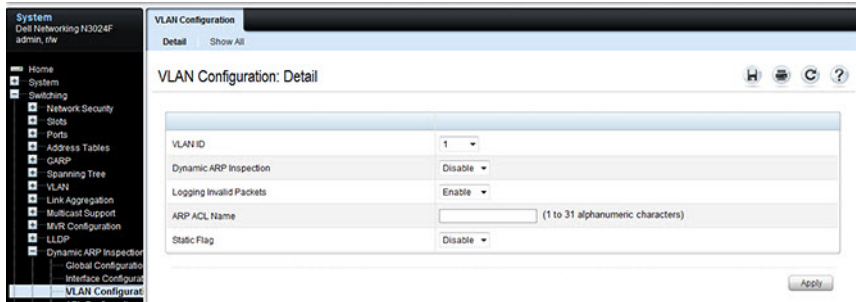
LAGs	Trust State	Rate Limit	Burst Interval
Po1	Disable	15	1
Po2	Disable	15	1
Po3	Disable	15	1
Po4	Disable	15	1
Po5	Disable	15	1

## DAI VLAN Configuration

Use the DAI VLAN Configuration page to select the VLANs for which information is to be displayed or configured.

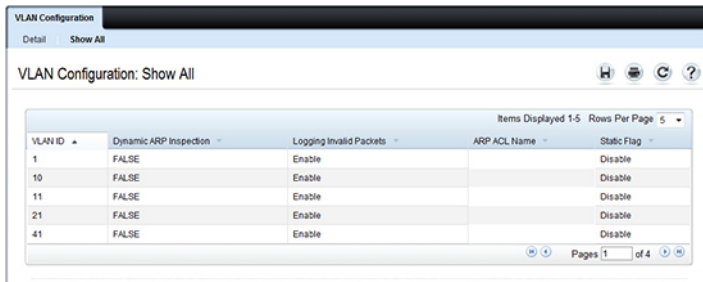
To display the DAI VLAN Configuration page, click **Switching** → **Dynamic ARP Inspection** → **VLAN Configuration** in the navigation panel.

**Figure 27-18. Dynamic ARP Inspection VLAN Configuration**



To view a summary of the DAI status for all VLANs, click **Show All**.

**Figure 27-19. Dynamic ARP Inspection VLAN Configuration Summary**

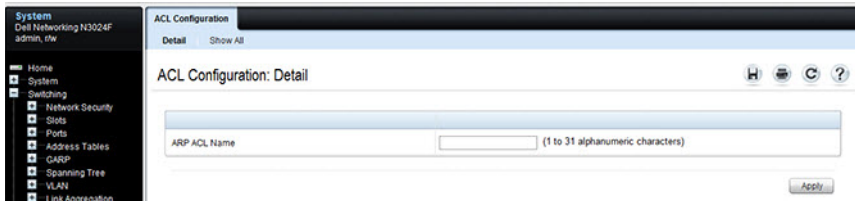


## DAI ACL Configuration

Use the DAI ACL Configuration page to add or remove ARP ACLs.

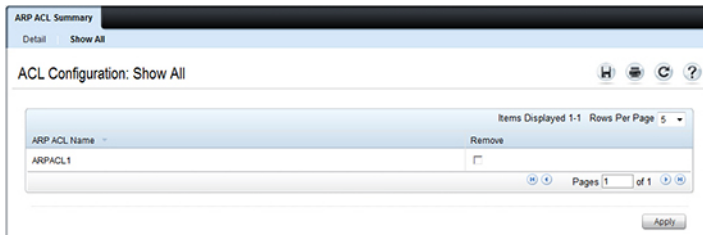
To display the DAI ACL Configuration page, click **Switching** → **Dynamic ARP Inspection** → **ACL Configuration** in the navigation panel.

**Figure 27-20. Dynamic ARP Inspection ACL Configuration**



To view a summary of the ARP ACLs that have been created, click **Show All**.

**Figure 27-21. Dynamic ARP Inspection ACL Summary**



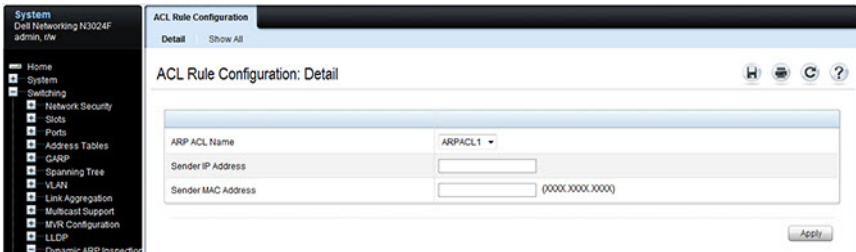
To remove an ARP ACL, select the **Remove** checkbox associated with the ACL and click **Apply**.

## DAI ACL Rule Configuration

Use the DAI ARP ACL Rule Configuration page to add or remove DAI ARP ACL Rules.

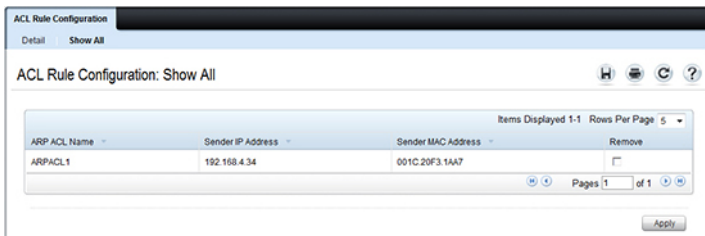
To display the DAI ARP ACL Rule Configuration page, click **Switching** → **Dynamic ARP Inspection** → **ACL Rule Configuration** in the navigation panel.

**Figure 27-22. Dynamic ARP Inspection Rule Configuration**



To view a summary of the ARP ACL rules that have been created, click **Show All**.

**Figure 27-23. Dynamic ARP Inspection ACL Rule Summary**



To remove an ARP ACL rule, select the **Remove** checkbox associated with the rule and click **Apply**.

## DAI Statistics

Use the **DAI Statistics** page to display the statistics per VLAN.

To display the **DAI Statistics** page, click **Switching** → **Dynamic ARP Inspection** → **Statistics** in the navigation panel.

Figure 27-24. Dynamic ARP Inspection Statistics

The screenshot displays a network management console with a sidebar menu on the left and a main content area on the right. The sidebar menu includes categories like System, Switching, Network Security, Ports, Address Tables, GARP, Spanning Tree, VLAN, Link Aggregation, Multicast Support, MVR Configuration, LLDP, Dynamic ARP Inspection, and Statistics. The 'Statistics' menu item is highlighted. The main content area shows the 'Statistics: Detail' page for VLAN 1. A table lists various statistics, all of which are currently at zero.

Statistic	Value
VLAN ID	1
DHCP Drops	0
ACL Drops	0
DHCP Permits	0
ACL Permits	0
Bad Source MAC	0
Bad Dest MAC	0
Invalid IP	0
Forwarded	0
Dropped	0

# Configuring Traffic Snooping and Inspection (CLI)

This section provides information about the commands used for configuring DHCP snooping, IPSPG, and DAI settings on the switch. For more information about the commands, see the *Dell EMC Networking N1100-ON, N1500, N2000, N2100-ON, N2200-ON, N3000E-ON, N3100-ON, and N3200-ON Series Switches CLI Reference Guide* at [www.dell.com/support](http://www.dell.com/support).

## Configuring DHCP Snooping

Use the following commands to configure and view DHCP snooping settings.

Command	Purpose
<code>configure</code>	Enter global configuration mode.
<code>ip dhcp snooping</code>	Enable DHCP snooping on the switch.
<code>ipv6 dhcp snooping</code>	Enable IPv6 DHCP snooping on the switch.
<code>ip dhcp snooping verify mac-address</code>	Enable the verification of the source MAC address with the client MAC address in the received DHCP message.
<code>ip dhcp snooping log-invalid</code>	Enable the logging of DHCP messages filtered by the DHCP Snooping application.
<code>ip dhcp snooping binding mac-address vlan vlan-id ip-address interface interface</code>	Configure a static binding in the DHCP snooping static bindings database. <ul style="list-style-type: none"><li>• <i>mac-address</i>—The client's MAC address.</li><li>• <i>vlan-id</i>—The number of the VLAN the client is authorized to use.</li><li>• <i>ip-address</i>—The IP address of the client.</li><li>• <i>interface</i>—The interface on which the client is authorized. The form is unit/port.</li></ul>
<code>ip dhcp snooping database {local   tftp://hostIP/filename}</code>	Configure the persistent storage location of the DHCP snooping database. <ul style="list-style-type: none"><li>• <i>hostIP</i>—The IP address of the remote host.</li><li>• <i>filename</i>—The name of the file for the database on the remote host.</li></ul>

Command	Purpose
<code>ip dhcp snooping database write-delay seconds</code>	Configure the interval, in seconds, at which the DHCP Snooping database will be stored in persistent storage. The number of seconds can range from 15–86400.
<code>interface interface</code>	Enter interface configuration mode for the specified port or LAG. The <i>interface</i> variable includes the interface type and number, for example <code>tengigabitethernet 1/0/3</code> . For a LAG, the interface type is <code>port-channel</code> .  A range of ports can be specified using the <code>interface range</code> command. For example, <code>interface range tengigabitethernet 1/0/8-12</code> configures interfaces 8, 9, 10, 11, and 12.
<code>ip dhcp snooping limit rate rate [burst interval seconds]</code>	Configure the maximum rate of DHCP messages allowed on the switch at any given time. <ul style="list-style-type: none"> <li>• <i>rate</i>—The maximum number of packets per second allowed (Range: 0–300 pps).</li> <li>• <i>seconds</i>—The time allowed for a burst (Range: 1–15 seconds).</li> </ul>
<code>ip dhcp snooping trust</code>	Configure the interface (or range of interfaces) as a trusted port. DHCP server messages are not filtered on trusted ports.
<code>exit</code>	Exit to Global Configuration mode.
<code>CTRL + Z</code>	Exit to Privileged Exec mode.
<code>show ip dhcp snooping [interfaces]</code>	View the DHCP snooping global and per port configuration.
<code>show ip dhcp snooping binding [{static   dynamic}] [interface port] [vlan vlan-id]</code>	View the entries in the DHCP snooping bindings database.
<code>show ip dhcp snooping database</code>	View information about the persistent database configuration.
<code>show ip dhcp snooping statistics</code>	View the DHCP snooping statistics.
<code>clear ip dhcp snooping statistics</code>	Reset the DHCP snooping statistics to zero.



Command	Purpose
clear ip dhcp snooping bindings	Clear the DHCP snooping bindings for an interface.

## Configuring IP Source Guard

Use the following commands to configure IPSG settings on the switch.

Command	Purpose
configure	Enter global configuration mode.
interface <i>interface</i>	Enter interface configuration mode for the specified port or LAG. The <i>interface</i> variable includes the interface type and number, for example <b>tengigabitethernet 1/0/3</b> . For a LAG, the interface type is <b>port-channel</b> .  A range of ports can be specified using the <b>interface range</b> command. For example, <b>interface range tengigabitethernet 1/0/8-12</b> configures interfaces 8, 9, 10, 11, and 12.
ip verify source [ <b>port-security</b> ] and ipv6 verify source [ <b>port-security</b> ]	Enable IPSG on the port or LAG to prevent packet forwarding if the source IP address in the packet is not in the DHCP snooping binding database. Use the optional <b>port-security</b> keyword to also prevent packet forwarding if the sender MAC address is not in forwarding database table or the DHCP snooping binding database.  <b>NOTE:</b> To enforce filtering based on the source MAC address, port security must also be enabled on the interface by using the <b>port security</b> command in Interface Configuration mode.
exit	Exit to Global Config mode.
ip verify binding <i>mac_addr</i> vlan <i>vlan_id</i> <i>ipaddr</i> interface <i>interface</i> and ipv6 verify binding <i>mac_addr</i> vlan <i>vlan_id</i> <i>ipaddr</i> interface <i>interface</i>	Configure a static binding for IPSG.
exit	Exit to Privileged Exec mode.

Command	Purpose
<code>show ip verify interface <i>interface</i></code>	View IPSPG parameters for a specific port or LAG. The <i>interface</i> parameter includes the interface type (gigabitethernet, tengigabitethernet, or port-channel) and number.
<code>show ip verify source [interface <i>interface</i>]</code>	View IPSPG bindings configured on the switch or on a specific port or LAG.
<code>show ip source binding</code>	View IPSPG bindings.

## Configuring Dynamic ARP Inspection

Use the following commands to configure DAI settings on the switch.

Command	Purpose
<code>configure</code>	Enter global configuration mode.
<code>ip arp inspection vlan <i>vlan-list</i> [logging]</code>	Enable Dynamic ARP Inspection on a single VLAN or a range of VLANs. Use the <b>logging</b> keyword to enable logging of invalid packets.
<code>ip arp inspection validate {[src-mac] [dst-mac] [ip]}</code>	<p>Enable additional validation checks like source MAC address validation, destination MAC address validation, or IP address validation on the received ARP packets.</p> <p>Each command overrides the configuration of the previous command. For example, if a command enables source MAC address and destination validations and a second command enables IP address validation only, the source MAC address and destination MAC address validations are disabled as a result of the second command.</p> <ul style="list-style-type: none"> <li>• <b>src-mac</b>—For validating the source MAC address of an ARP packet.</li> <li>• <b>dst-mac</b>—For validating the destination MAC address of an ARP packet.</li> <li>• <b>ip</b>—For validating the IP address of an ARP packet.</li> </ul>
<code>arp access-list <i>acl-name</i></code>	Create an ARP ACL with the specified name (1–31 characters) and enter ARP Access-list Configuration mode for the ACL.

Command	Purpose
<code>remark <i>string</i></code>	Configure a remark for the ACL.
<code>permit ip host <i>sender-ip</i> mac host <i>sender-mac</i></code>	Configure a rule for a valid IP address and MAC address combination used in ARP packet validation. <ul style="list-style-type: none"> <li>• <i>sender-ip</i>— Valid IP address used by a host.</li> <li>• <i>sender-mac</i>—Valid MAC address in combination with the above <i>sender-ip</i> used by a host.</li> </ul>
<code>exit</code>	Exit to Global Config mode.
<code>ip arp inspection filter <i>acl-name</i> vlan <i>vlan-list</i> [<i>static</i>]</code>	Configure the ARP ACL to be used for a single VLAN or a range of VLANs to filter invalid ARP packets.  Use the <b>static</b> keyword to indicate that packets that do not match a permit statement are dropped without consulting the DHCP snooping bindings.
<code>interface <i>interface</i></code>	Enter interface configuration mode for the specified port or LAG. The <i>interface</i> variable includes the interface type and number, for example <b>tengigabitethernet 1/0/3</b> . For a LAG, the interface type is <b>port-channel</b> .  A range of ports can be specified using the <b>interface range</b> command. For example, <b>interface range tengigabitethernet 1/0/8-12</b> configures interfaces 8, 9, 10, 11, and 12.
<code>ip arp inspection limit {<i>none</i>   <i>rate pps</i> [<i>burst</i> <i>interval seconds</i> ]}</code>	Configure the rate limit and burst interval values for an interface. Use the keyword <b>none</b> to specify that the interface is not rate limited for Dynamic ARP Inspection. <ul style="list-style-type: none"> <li>• <b>none</b> — To set no rate limit.</li> <li>• <i>pps</i> — Packets per second (Range: 0–300).</li> <li>• <i>seconds</i> — The number of seconds (Range: 1–15).</li> </ul>
<code>ip arp inspection trust</code>	Specify that the interface as trusted for Dynamic ARP Inspection.
<code>CTRL + Z</code>	Exit to Privileged Exec mode.
<code>show ip arp inspection interfaces [<i>interface</i>]</code>	View the Dynamic ARP Inspection configuration on all the DAI-enabled interfaces or for the specified interface.

<b>Command</b>	<b>Purpose</b>
<b>show ip arp inspection</b> vlan [ <i>vlan-list</i> ]	View the Dynamic ARP Inspection configuration on the specified VLAN(s).  This command also displays the global configuration values for source MAC validation, destination MAC validation and invalid IP validation.
<b>show ip arp inspection</b> <b>statistics</b> [vlan <i>vlan-list</i> ]	View the statistics of the ARP packets processed by Dynamic ARP Inspection for the switch or for the specified VLAN(s).
<b>show arp access-list</b> [ <i>acl-name</i> ]	View all configured ARP ACL and their rules, or use the ACL name to view information about that ARP ACL only.
<b>clear ip arp inspection</b> <b>statistics</b>	Clear the ARP inspection counters.

# Traffic Snooping and Inspection Configuration Examples

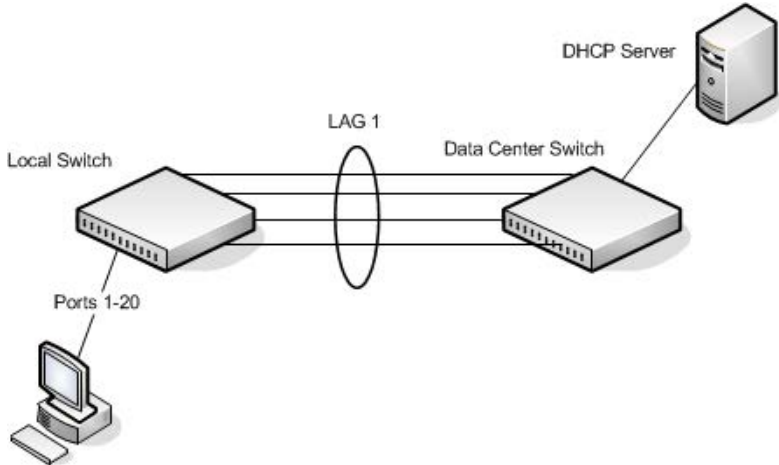
This section contains the following examples:

- Configuring DHCP Snooping
- Configuring IPSC

## Configuring DHCP Snooping

In this example, DHCP snooping is enabled on VLAN 100. Ports 1-20 connect end users to the network and are members of VLAN 100. These ports are configured to limit the maximum number of DHCP packets with a rate limit of 100 packets per second. LAG 1, which is also a member of VLAN 100 and contains ports 21-24, is the trunk port that connects the switch to the data center, so it is configured as a trusted port.

**Figure 27-25. DHCP Snooping Configuration Topology**



The commands in this example also enforce rate limiting and remote storage of the bindings database. The switch has a limited amount of storage space in NVRAM and flash memory, so the administrator specifies that the DHCP snooping bindings database is stored on an external TFTP server.

To configure the switch:

- 1 Enable DHCP snooping on VLAN 100.

```
console#config  
console(config)#ip dhcp snooping vlan 100
```

- 2 Configure LAG 1, which includes ports 21-24, as a trusted port. All other interfaces are untrusted by default.

```
console(config)#interface port-channel 1  
console(config-if-Pol)#ip dhcp snooping trust  
console(config-if-Pol)#exit
```

- 3 Enter interface configuration mode for all untrusted interfaces (ports 1-20) and limit the number of DHCP packets that an interface can receive to 100 packets per second. LAG 1 is a trusted port and keeps the default value for rate limiting (unlimited).

```
console(config)#interface range gi1/0/1-20  
console(config-if)#ip dhcp snooping limit rate 100  
console(config-if)#exit
```

- 4 Specify that the DHCP snooping database is to be stored remotely in a file called dsDb.txt on a TFTP server with an IP address of 10.131.11.1.

```
console(config)#ip dhcp snooping database  
tftp://10.131.11.1/dsDb.txt
```

- 5 Enable DHCP snooping for the switch

```
console(config)#ip dhcp snooping
```

- 6 View DHCP snooping information.

```
console#show ip dhcp snooping
```

```
DHCP snooping is Enabled  
DHCP snooping source MAC verification is disabled  
DHCP snooping is enabled on the following VLANs:  
100
```

```
Interface      Trusted      Log Invalid Pkts  
-----
```

## Configuring IPSG

This example builds on the previous example and uses the same topology shown in Figure 27-25. In this configuration example, IP source guard is enabled on ports 1-20. DHCP snooping must also be enabled on these ports. Additionally, because the ports use IP source guard with source IP and MAC address filtering, port security must be enabled on the ports as well.

To configure the switch:

- 1 Enter interface configuration mode for the host ports and enable IPSG.

```
console (config) #interface range gi1/0/1-20
console (config-if) #ip verify source port-security
```

- 2 View IPSG information.

```
console (config-if) #show ip verify source
```

Interface	Filter Type	IP Address	MAC Address	VLAN
Gi1/0/1	ip-mac	192.168.3.45	00:1C:23:55:D4:8E	100
Gi1/0/2	ip-mac	192.168.3.40	00:1C:23:12:44:B6	100
Gi1/0/3	ip-mac	192.168.3.33	00:1C:23:AA:B8:01	100
Gi1/0/4	ip-mac	192.168.3.18	00:1C:23:67:D3:CC	100
Gi1/0/5	ip-mac	192.168.3.49	00:1C:23:55:1B:6E	100

--More-- or (q)uit





# Link Aggregation

## Dell EMC Networking N-Series Switches

This chapter describes how to create and configure link aggregation groups (LAGs), which are also known as port-channels.

The topics covered in this chapter include:

- Link Aggregation
- Multi-Switch LAG (MLAG)
- Configuring Link Aggregation (Web)
- Configuring Link Aggregation (CLI)

## Link Aggregation

### Overview

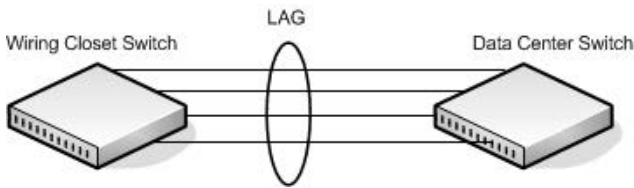
Link Aggregation allows one or more full-duplex Ethernet links of the same speed to be aggregated together to form a LAG. This allows the switch to treat the LAG as if it is a single link. The Dell EMC Networking N-Series switches support industry-standard LAGs that adhere to the IEEE 802.3ad specification.

Assignment of interfaces to LAGs is based on a system limit of 144 interfaces assigned to LAGs, a maximum of 72 dynamic LAGs (or 128 static LAGs) and a maximum of 8 interfaces per LAG. For example, 72 dynamic LAGs may be assigned 2 interfaces each, or 18 dynamic or static LAGs may be assigned 8 interfaces each. Alternatively, 128 interfaces can be assigned to 128 static LAGs with each LAG containing a single port.

Each LAG can consist of up to eight Ethernet ports (for the Dell EMC Networking N-Series switches). When eight Gigabit Ethernet ports are configured as a LAG, the maximum bandwidth for the single, logical interface is 8 Gbps, and when eight 10 Gbps ports are configured as a LAG, the maximum bandwidth for the single, logical interface is 80 Gbps.

Figure 28-1 shows an example of a switch in the wiring closet connected to a switch in the data center by a LAG that consists of four physical 10 Gbps links. The LAG provides full-duplex bandwidth of 40 Gbps between the two switches.

**Figure 28-1. LAG Configuration**



LAGs can be configured on stand-alone or stacked switches. In a stack of switches, the LAG can consist of ports on a single unit or across multiple stack members. When a LAG members span different units across a stack, and a unit fails, the remaining LAG members on the functional units continue to handle traffic for the LAG.

### **Why Are Link Aggregation Groups Necessary?**

The primary purpose of LAGs is to increase the overall bandwidth between two switches. This is accomplished by effectively aggregating multiple ports together that act as a single, logical connection between the two switches.

LAGs also provide redundancy. If a link fails, traffic is automatically redistributed across the remaining links.

### **What Is the Difference Between Static and Dynamic Link Aggregation?**

Link aggregation can be configured as either dynamic or static. Dynamic configuration is supported using the IEEE 802.3ad standard, which is known as Link Aggregation Control Protocol (LACP). Static configuration is used when connecting a Dell EMC Networking N-Series switch to an external Gigabit Ethernet switch that does not support LACP.

One advantage of LACP is that the protocol enables the switch to confirm that the external switch is also configured for link aggregation. When using static configuration, a cabling or configuration mistake involving the Dell EMC Networking N-Series switch or the external switch could go undetected

and thus cause undesirable network behavior. Both static and dynamic LAGs (via LACP) can detect physical link failures within the LAG and continue forwarding traffic through the other connected links within that same LAG. LACP can also detect switch or port failures that do not result in loss of link. This provides a more resilient LAG. Best practices suggest using dynamic link aggregation instead of static link aggregation. When a port is added to a LAG as a static member, it neither transmits nor receives LACP PDUs.

### **What is LAG Hashing?**

Dell EMC Networking N-Series switches support configuration of hashing algorithms for each LAG interface. The hashing algorithm is used to distribute traffic load among the physical ports of the LAG while preserving the per-flow packet order. Enhanced hashing mode is the recommended and default hashing mode for Dell EMC Networking N-Series switches.

The hashing algorithm uses various packet attributes to determine the outgoing physical port.

The switch supports the following set of packet attributes to be used for hash computation:

- Source MAC, VLAN, EtherType, source module, and incoming port.
- Destination MAC, VLAN, EtherType, source module, and incoming port.
- Source IP and Source TCP/UDP port numbers.
- Destination IP and Destination TCP/UDP port numbers.
- Source/Destination MAC, VLAN, EtherType, source module, and incoming port.
- Source/Destination IP and Source/Destination TCP/UDP port numbers.
- Enhanced hashing mode

Enhanced hashing mode has following advantages:

- MODULO-N operation based on the number of ports in the LAG.
- Packet attributes selection based on the packet type. For Layer-2 packets, Source and Destination MAC address plus physical source port are used for hash computation. For IP packets, Source IP, Destination IP address, TCP/UDP ports, and physical source port are used.
- Non-Unicast traffic and Unicast traffic is hashed using a common hash algorithm.

- Excellent load balancing performance.

### **How Do LAGs Interact with Other Features?**

From a system perspective, a LAG is treated just as a physical port, with the same configuration parameters for administrative enable/disable, spanning tree port priority, path cost as may be for any other physical port.

### ***VLAN***

When members are added to a LAG, they are removed from all existing VLAN membership. When members are removed from a LAG they are added back to the VLANs that they were previously members of as per the configuration file. Note that a port's VLAN membership can still be configured when it's a member of a LAG. However this configuration is only actually applied when the port leaves the LAG.

The LAG interface can be a member of a VLAN complying with IEEE 802.1Q.

### ***STP***

Spanning tree does not maintain state for members of a LAG, but does maintain state for the LAG interface. As far as STP is concerned, members of a LAG do not have individual link state. (Internally, the STP state of the LAG interface is replicated for the member links.)

When members are deleted from a LAG they become normal links, and spanning tree maintains their individual link state information.

### ***Statistics***

Statistics are collected for LAGs in the same manner as they are collected for the physical ports, in addition to the statistics collected for individual members as per the 802.3ad MIB statistics.

### **LAG Configuration Guidelines**

Ports to be aggregated must be configured so that they are compatible with the link aggregation feature and with the partner switch to which they connect.

Ports to be added to a LAG must meet the following requirements:

- Interface must be a physical Ethernet link.

- Each member of the LAG must be running at the same speed and must be in full-duplex mode.
- The port cannot be a mirrored port

The following are the interface restrictions

- The configured speed of a LAG member cannot be changed.
- An interface can be a member of only one LAG.


## Default Link Aggregation Values

The LAGs on the switch are created by default, but no ports are members. Table 28-1 summarizes the default values for the Link Aggregation.

**Table 28-1. Link Aggregation Table Defaults**

Parameter	Default Value
LACP system priority	1
LACP port priority	1
LACP timeout	Long
LAG hash algorithm type	Enhanced (7) for N2000, N2100-ON, N3000-ON, N3100-ON, and N3200-ON Series Switches: Source/Destination MAC, VLAN, EtherType, source MODID/port (5) for N1100-ON and N1500 Series switches.

# Configuring Link Aggregation (Web)

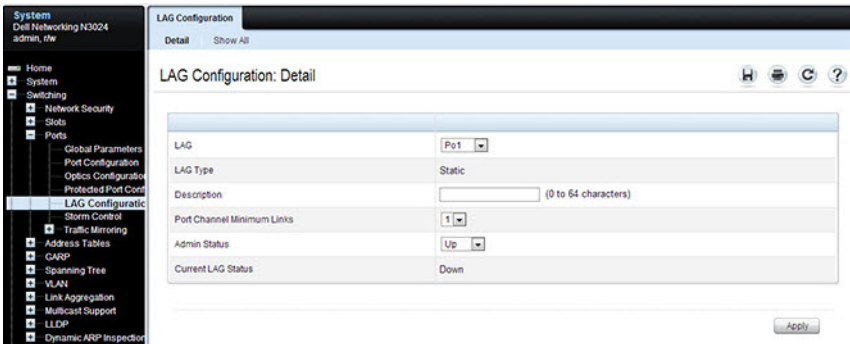
This section provides information about the OpenManage Switch Administrator pages for configuring and monitoring LAGs on Dell EMC Networking N-Series Series switches. For details about the fields on a page, click  at the top of the Dell EMC OpenManage Switch Administrator web page.

## LAG Configuration

Use the **LAG Configuration** page to set the name and administrative status (up/down) of a LAG.

To display the **LAG Configuration** page, click **Switching** → **Ports** → **LAG Configuration** in the navigation panel.

**Figure 28-2. LAG Configuration**



To view or edit settings for multiple LAGs, click **Show All**.

The screenshot shows a web-based configuration interface for LAGs. At the top, there is a 'LAG Configuration' header with a 'Show All' button. Below this is a table titled 'LAG Configuration: LAG Configuration Table'. The table has columns for LAG, Description, Port Channel Minimum Links, LAG Type, Admin Status, Current Status, and Edit. There are five rows of data, each representing a LAG (Po1 to Po5). The table is paginated, showing 'Items Displayed 1-5' and 'Rows Per Page 5'. At the bottom right of the table area, there is an 'Apply' button.

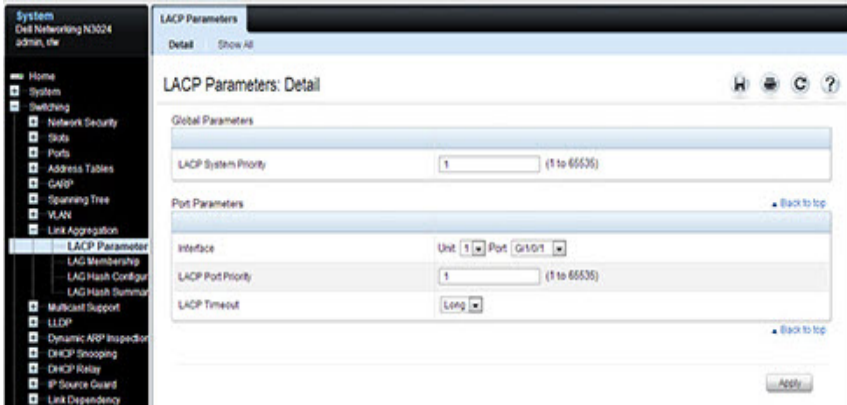
LAG	Description (0 to 64 characters)	Port Channel Minimum Links	LAG Type	Admin Status	Current Status	Edit
Po1		1	Static	Up	Down	<input type="checkbox"/>
Po2		1	Static	Up	Down	<input type="checkbox"/>
Po3		1	Static	Up	Down	<input type="checkbox"/>
Po4		1	Static	Up	Down	<input type="checkbox"/>
Po5		1	Static	Up	Down	<input type="checkbox"/>

### LACP Parameters

Dynamic link aggregation is initiated and maintained by the periodic exchanges of LACP PDUs. Use the **LACP Parameters** page to configure LACP LAGs.

To display the **LACP Parameters** page, click **Switching** → **Link Aggregation** → **LACP Parameters** in the navigation panel.

**Figure 28-3. LACP Parameters**



***Configuring LACP Parameters for Multiple Ports***

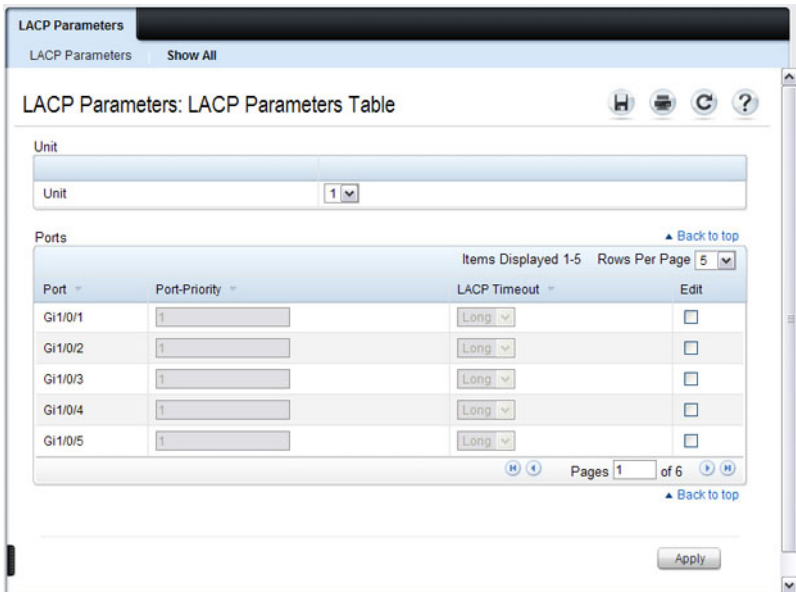
To configure LACP settings:

- 1 Open the LACP Parameters page.
- 2 Click Show All.

The LACP Parameters Table page displays.



**Figure 28-4. LACP Parameters Table**



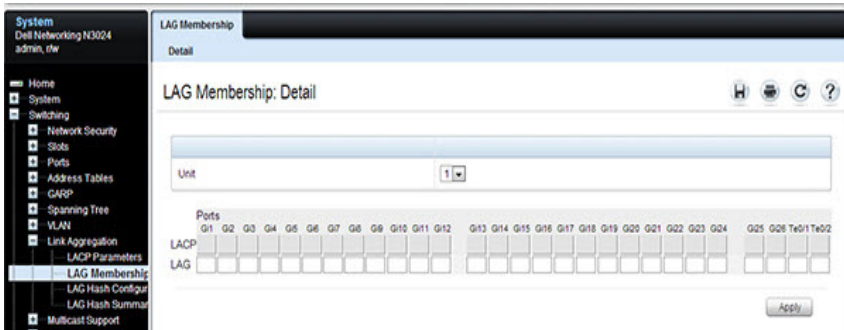
- 3 Select the **Edit** check box associated with each port to configure.
- 4 Specify the LACP port priority and LACP timeout for each port.
- 5 Click **Apply**.

### **LAG Membership**

Your switch supports 48 LAGs per system, and eight ports per LAG. Use the **LAG Membership** page to assign ports to static and dynamic LAGs.

To display the **LAG Membership** page, click **Switching** → **Link Aggregation** → **LAG Membership** in the navigation panel.

**Figure 28-5. LAG Membership**



**Adding a Port to a Static LAG**

To add a static LAG member:

- 1 Open the **LAG Membership** page.
- 2 Click in the **LAG** row on the desired port and enter the number of the LAG to which the port should be added. For example, the following figure shows ports Gi1-Gi4 being added to LAG 1, and ports Gi5-Gi8 being added to LAG 2.

	Ports											
	Gi1	Gi2	Gi3	Gi4	Gi5	Gi6	Gi7	Gi8	Gi9	Gi10	Gi11	Gi12
LACP												
LAG	1	1	1	1	2	2	2	2				

- 3 Click **Apply**.  
The port is assigned to the selected LAG, and the device is updated.

**Adding a LAG Port to a Dynamic LAG by Using LACP**

To add a dynamic LAG member:

- 1 Open the **LAG Membership** page.
- 2 Click in the **LACP** row to toggle the desired LAG port to **L**.

**NOTE:** The port must be assigned to a LAG before it can be aggregated using LACP.

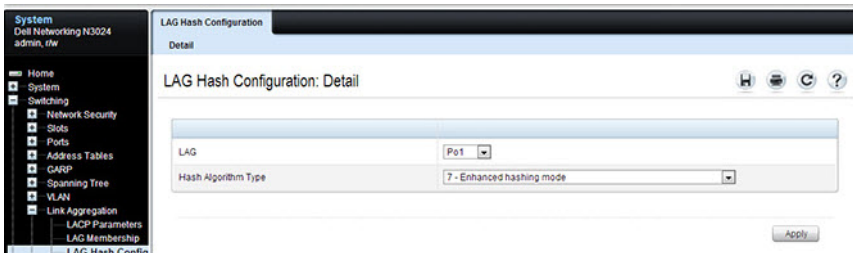
- 3 Click **Apply**.  
The LAG port is added as a dynamic LAG member to the selected LAG.

## LAG Hash Configuration

Use the **LAG Hash Configuration** page to set the traffic distribution mode on the LAG. The hash type can be set for each LAG.

To display the **LAG Hash Configuration** page, click **Switching** → **Link Aggregation** → **LAG Hash Configuration** in the navigation panel.

**Figure 28-6. LAG Hash Configuration**

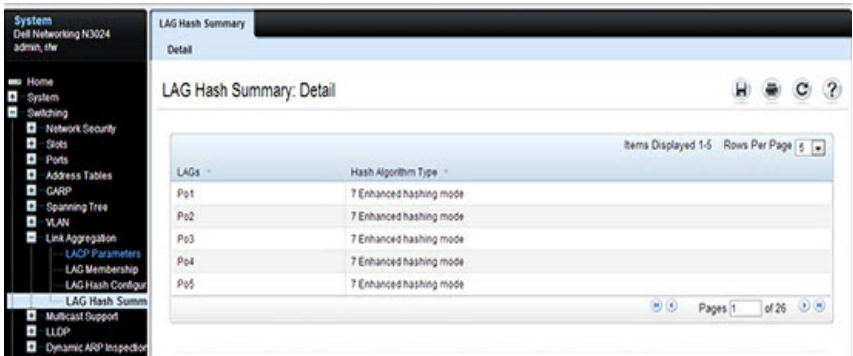


## LAG Hash Summary

The **LAG Hash Summary** page lists the channels on the system and their assigned hash algorithm type.

To display the **LAG Hash Summary** page, click **Switching** → **Link Aggregation** → **LAG Hash Summary** in the navigation panel.

**Figure 28-7. LAG Hash Summary**



# Configuring Link Aggregation (CLI)

This section provides information about the commands used for configuring link aggregation settings on the switch. For more information about the commands, see the *Dell EMC Networking N1100-ON, N1500, N2000, N2100-ON, N2200-ON, N3000E-ON, N3100-ON, and N3200-ON Series Switches CLI Reference Guide* at [www.dell.com/support](http://www.dell.com/support).

## Configuring LAG Characteristics

Use the following commands to configure a few of the available LAG characteristics. Many of the commands described in "Configuring Port Characteristics (CLI)" on page 694 are also applicable to LAGs.

Command	Purpose
<code>configure</code>	Enter global configuration mode.
<code>interface interface</code>	Enter interface configuration mode for the specified LAG. The <i>interface</i> variable includes the interface type, which is <code>port-channel</code> , and the LAG number, for example <code>interface port-channel 3</code> .  A range of LAGs can be specified using the <code>interface range port-channel</code> command. For example, <code>interface range port-channel 3-6</code> configures LAGs 3, 4, 5 and 6.
<code>description description</code>	Configure a description for the LAG or range of LAGs
<code>port-channel min-links minimum</code>	Set the minimum number of links that must be up in order for the port-channel interface to be declared up.
<code>exit</code>	Exit to Global Config mode.
<code>CTRL + Z</code>	Exit to Privileged Exec mode.
<code>show interfaces description port-channel port-channel number</code>	View the configured description for the specified LAG.
<code>show interfaces port-channel [port-channel number]</code>	View LAG information for the specified LAG or for all LAGs.

## Configuring Link Aggregation Groups

Use the following commands to add ports as LAG members and to configure the LAG hashing mode.

Command	Purpose
<code>configure</code>	Enter global configuration mode.
<code>interface <i>interface</i></code>	Enter interface configuration mode for the specified port. The <i>interface</i> variable includes the interface type and number, for example <code>interface tengigabitethernet 1/0/3</code> .  A range of ports can be specified using the <code>interface range</code> command. For example, <code>interface range tengigabitethernet 1/0/8-12</code> configures interfaces 8, 9, 10, 11 and 12.
<code>channel-group <i>port-channel-number</i> mode {on   active}</code>	Add the port(s) to the LAG specified with the <i>port-channel-number</i> value. Use the <code>active</code> keyword to add the port(s) as dynamic members, or use <code>on</code> to specify that the LAG membership is static. <ul style="list-style-type: none"><li>• <i>port-channel-number</i> — Number of a valid port-channel for the current port to join.</li><li>• <code>on</code> — Forces the port to join a channel without LACP (static LAG).</li><li>• <code>active</code> — Forces the port to join a channel with LACP (dynamic LAG).</li></ul>
<code>exit</code>	Exit to Global Config mode.
<code>interface port-channel <i>number</i></code>	Enter interface configuration mode for the specified LAG. A range of LAGs to configure can be specified using the <code>interface range port-channel</code> command. For example, <code>interface range port-channel 1-3,10</code> configures LAGs 1, 2, 3 and 10.

<b>Command</b>	<b>Purpose</b>
<code>hashing-mode mode</code>	<p>Set the hashing algorithm on the LAG.</p> <p>The <i>mode</i> value is a number from 1 to 7. The numbers correspond to the following algorithms:</p> <ul style="list-style-type: none"> <li>• 1 — Source MAC, VLAN, EtherType, source module, and port ID</li> <li>• 2 — Destination MAC, VLAN, EtherType, source module, and port ID</li> <li>• 3 — Source IP and source TCP/UDP port</li> <li>• 4 — Destination IP and destination TCP/UDP port</li> <li>• 5 — Source/destination MAC, VLAN, EtherType, and source MODID/port</li> <li>• 6 — Source/destination IP and source/destination TCP/UDP port</li> <li>• 7 — Enhanced hashing mode</li> </ul>
<code>CTRL + Z</code>	Exit to Privileged Exec mode.
<code>show interfaces port-channel [port-channel number]</code>	View LAG information for the specified LAG or for all LAGs.
<code>show statistics port-channel port-channel-number</code>	View interface statistics for the specified LAG.

### Configuring LACP Parameters

Use the following commands to configure system and per-port LACP parameters.

<b>Command</b>	<b>Purpose</b>
<code>configure</code>	Enter global configuration mode.
<code>lACP system-priority value</code>	Set the Link Aggregation Control Protocol priority for the switch. the priority value range is 1–65535.

<b>Command</b>	<b>Purpose</b>
<code>interface gi1/0/1</code>	Enter physical interface configuration mode for a member of the desired LAG.  A range of physical interfaces can be specified using the <b>interface range</b> command. For example, <b>interface range gi1-3,10</b> configures Gigabit Ethernet interfaces 1, 2, 3, and 10.
<code>lacp port-priority <i>value</i></code>	Set the Link Aggregation Control Protocol priority for the port or range of ports. The priority value range is 1–65535.
<code>lacp timeout {long   short}</code>	Specify whether to wait a long or short time between LACP PDU transmissions.
<code>exit</code>	Exit to Privileged Exec mode.
<code>show lacp <i>interface</i></code>	View LACP parameters for an Ethernet interface or a LAG. The <i>interface</i> parameter includes the interface type ( <b>gigabitethernet</b> , <b>tengigabitethernet</b> , or <b>forty-gigabitethernet</b> ) and number.

## Link Aggregation Configuration Examples

This section contains the following examples:

- Configuring Dynamic LAGs
- Configuring Static LAGs



**NOTE:** The examples in this section show the configuration of only one switch. Because LAGs involve physical links between two switches, the LAG settings and member ports must be configured on both switches.

### Configuring Dynamic LAGs

The commands in this example show how to configure a static LAG on a switch. The LAG number is 1, and the member ports are 1, 2, 3, 6, and 7.

To configure the switch:

- 1 Enter interface configuration mode for the ports that are to be configured as LAG members.

```
console(config)#interface range te1/0/1-3,te1/0/6-7
```

- 2 Add the ports to LAG 2 with LACP.

```
console(config-if)#channel-group 1 mode active
```



### 3 View information about LAG 1.

```
console#show interfaces po1
```

```
Channel  Ports          Ch-Type  Hash Type  Min-links  Local Prf
-----  -
Po1      Active:         Dynamic  7          1          Disabled
        Tel/0/1
        Inactive:
        Tel/0/2,
        Tel/0/3,
        Tel/0/6,
        Tel/0/7

Hash Algorithm Type
1 - Source MAC, VLAN, EtherType, source module and port Id
2 - Destination MAC, VLAN, EtherType, source module and port Id
3 - Source IP and source TCP/UDP port
4 - Destination IP and destination TCP/UDP port
5 - Source/Destination MAC, VLAN, EtherType, source MODID/port
6 - Source/Destination IP and source/destination TCP/UDP port
7 - Enhanced hashing mode
```

### Configuring Static LAGs

The commands in this example show how to configure a static LAG on a switch. The LAG number is 2, and the member ports are 10, 11, 14, and 17.

To configure the switch:

- 1 Enter interface configuration mode for the ports that are to be configured as LAG members.

```
console (config)#interface range te1/0/10-12,te1/0/14,te1/0/17
```

- 2 Add the ports to LAG 2 without LACP.

```
console (config-if)#channel-group 2 mode on
```

### 3 View information about LAG 2.

```
console#show interfaces po2
```

```
Channel  Ports          Ch-Type  Hash Type  Min-links  Local Prf
-----  -
Po1      Active:         Static   7          1          Disabled
        Tel1/0/1
        Inactive:
        Tel1/0/2,
        Tel1/0/3,
        Tel1/0/6,
        Tel1/0/7
```

Hash Algorithm Type

- 1 - Source MAC, VLAN, EtherType, source module and port Id
- 2 - Destination MAC, VLAN, EtherType, source module and port Id
- 3 - Source IP and source TCP/UDP port
- 4 - Destination IP and destination TCP/UDP port
- 5 - Source/Destination MAC, VLAN, EtherType, source MODID/port
- 6 - Source/Destination IP and source/destination TCP/UDP port
- 7 - Enhanced hashing mode

# Multi-Switch LAG (MLAG)



**NOTE:** This feature is not available on the Dell EMC Networking N1100-ON, N1500 Series switch.

## Overview

In a typical Layer-2 network, the Spanning Tree Protocol (STP) is deployed to avoid packet storms due to loops in the network. To perform this function, STP sets ports into either a forwarding state or a blocking state. Ports in the blocking state do not carry traffic. In the case of a topology change, STP re-converges to a new loop-free network and updates the port states. STP is relatively successful mitigating packet storms in the network, but redundant links in the network are blocked from carrying traffic by the spanning tree protocol.

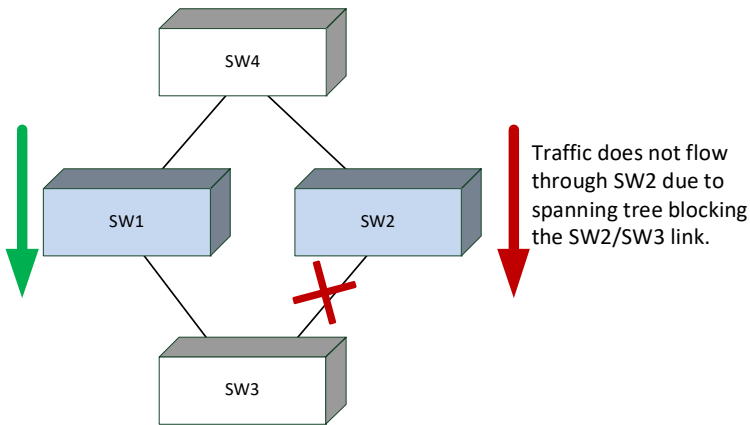
In some network deployments, redundant links between two switches are bundled together in a Link Aggregation Group (LAG) and appear as a single link in the spanning tree topology. The advantage is that all LAG member links can be in the forwarding state and a link failure can be recovered in milliseconds. This allows the bandwidth on the redundant links to be utilized. However, LAGs are limited to connecting multiple links between two partner switches, which leaves the switch as a single point of failure in the topology.

Dell EMC Networking MLAG extends the LAG bandwidth advantage across multiple Dell EMC Networking N-Series switches connected to a LAG partner device. The LAG partner device is unaware that it is connected over a LAG to two peer Dell EMC Networking N-Series switches; instead, the two switches appear as a single switch with a single MAC address to the partner. All links can carry data traffic across a physically diverse topology and in the case of a link or switch failure, traffic can continue to flow with minimal disruption.

## Deployment Scenarios

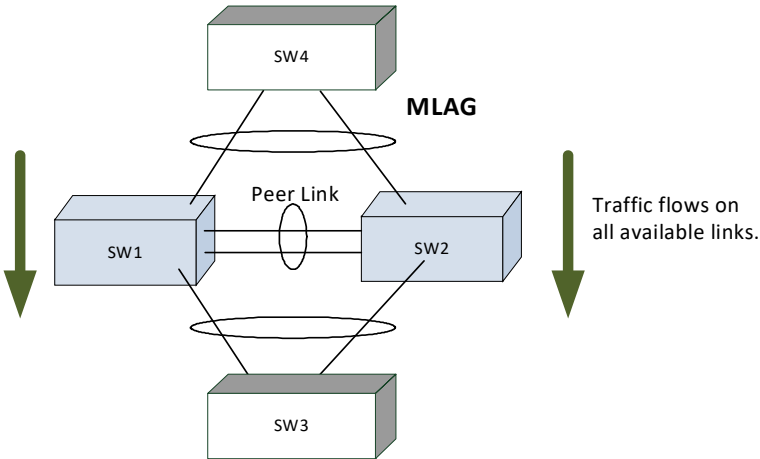
MLAG is intended to support higher bandwidth utilization in scenarios where a redundant Layer-2 network is desired. In such scenarios the effects of STP on link utilization are profound. Large percentages of links do not carry data because they are blocked and only a single path through the network carries traffic.

**Figure 28-8. STP Blocking**



MLAG reduces some of the bandwidth shortcomings of STP in a Layer-2 network. It provides a reduced convergence period when a port-channel link goes down and provides more bandwidth because all links can forward traffic. In the figure below, if SW1 and SW2 form an MLAG with SW3 and SW4, none of the links are blocked, which means traffic can flow over both links from SW4 through to SW1 and SW2 over both links from SW1 and SW2 to SW3.

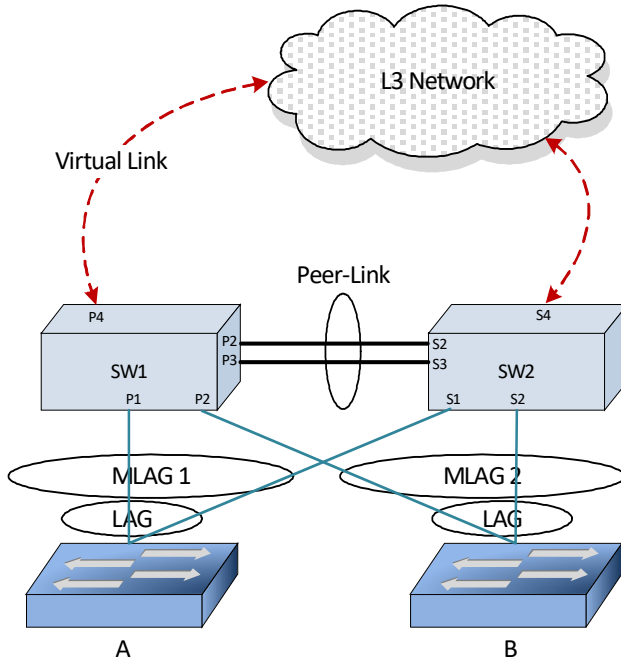
**Figure 28-9. MLAG in a Layer-2 Network**



## Definitions

Refer to Figure 28-10 for the definitions that follow.

**Figure 28-10. MLAG Components**



**MLAG switches:** MLAG aware switches running Dell EMC Networking Series switch firmware. No more than two MLAG aware switches can pair to form one end of the LAG. Stacked switches do not support MLAGs. In the above figure, SW1 and SW2 are MLAG peer switches. These two switches form a single logical end point for the MLAG from the perspective of switch A.

**MLAG interfaces:** MLAG functionality is a property of port-channels. Port-channels configured as MLAGs are called MLAG interfaces. Administrators can configure multiple instances of MLAG interfaces on the peer MLAG

switches. Port-channel limitations and capabilities like min-links and maximum number of ports supported per LAG also apply to MLAG interfaces.

**MLAG member ports:** Ports on the peer MLAG switches that are part of the MLAG interface (P1 on SW1 and S1 on SW2).

**Non-redundant ports:** Ports on either of the peer switches that are not part of the MLAG (ports P4 and S4). MLAG interfaces and non-redundant ports cannot be members of the same VLAN, i.e. a VLAN may contain MLAG interfaces or a VLAN may contain non-redundant ports, but not both. To attach a host or switch to a non-redundant port, configure the port to be a member of the non-MLAG VLANs. This port is not part of the MLAG and is not considered an MLAG partner. Packets on non-MLAG VLANs are never passed over the peer link.

**MLAG peer-link:** A link between the two MLAG peer switches (ports P2,P3,S2,S3). Only one peer-link can be configured per device. The peer-link is crucial for the operation of the MLAG component. A port-channel must be configured as the peer-link. All VLANs configured on MLAG interfaces must be configured on the peer-link as well.

**MLAG Dual Control Plane Detection link:** A virtual link that is used to advertise the Dual Control Plane Detection Protocol (DCPDP) packets between the two MLAG switches (ports P4, S4). DCPDP is optional but should be used with caution. The protocol is used as a secondary means of detecting the presence of the peer switch in the network. The DCPDP protocol must not be configured on MLAG interfaces.

## Configuration Consistency

The administrator must ensure that the neighboring devices connected to MLAG switches perceive the two switches as a single spanning tree and Link Aggregation Control Protocol (LACP) entity. To achieve this end, the following configuration settings must be identical for MLAG links on the MLAG peer switches:

- 1 Link aggregation
  - Hashing mode
  - Minimum links
  - Static/dynamic LAG

- LACP parameters
  - Actor parameters
  - Admin key
  - Collector max-delay
  - Partner parameters

## 2 STP

The default STP mode for Dell EMC Networking N-Series switches is RSTP. VLANs cannot be configured to contain both MLAG ports and non-MLAG (non-redundant) ports. RSTP, MSTP, and STP-PV/RSTP-PV are supported with MLAG. The following STP configuration parameters must be the identical on both MLAG peers.

- Spanning-tree version (RSTP, MSTP, or RSTP-PV)
- Bpdufilter
- Bpduflood
- Auto-edge
- TCN-guard
- Cost
- Edgeport
- STP Version
- MSTP or RSTP-PV VLAN configuration
- MST instance configuration (MST instance ID/port priority/port cost/mode) if MSTP is configured
- Root guard
- Loop guard

## 3 Port-channel interface

The following port-channel attributes must be identical for MLAG port-channels:

- Port-channel mode
- Link speed
- Duplex mode



- MTU
- Bandwidth
- VLAN configuration

The administrator should also ensure that the following are identical before enabling MLAG:

- FDB entry aging timers
- Static MAC entries.
- ACL configuration

#### **4** Interface Configuration

- PFC configuration
- CoS queue assignments

#### **5** VLAN configuration in an L2 topology

- MLAG VLANs must span the MLAG topology and be configured on both MLAG peers. This means that every MLAG VLAN must connect to two partner LAGs.
- VLAN termination of an MLAG VLAN on an MLAG peer is not supported.

#### **6** Switch firmware versions

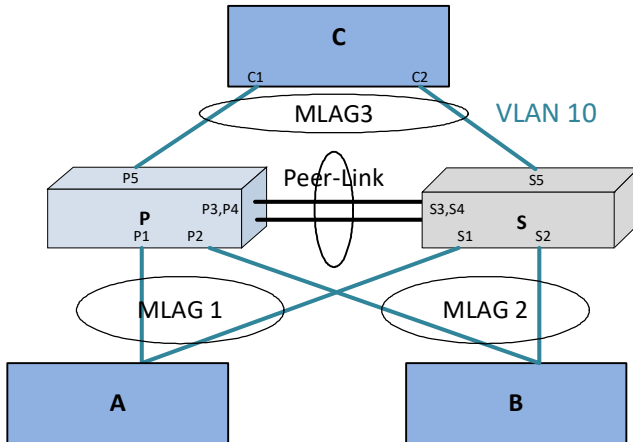
Except during firmware upgrade, the peer switch firmware versions must be identical, as subtle differences between versions may cause instability.

The administrator must ensure that the above configuration items are configured identically on the MLAG interfaces on both of the MLAG peers before enabling the MLAG feature. If the configuration settings are not in sync, the MLAG behavior is undefined. Once the above configuration is in place and consistent, the two switches will form an MLAG that operates in the desired manner. The MLAG may form even if the configuration is not consistent, however, it may not operate consistently in all situations.

## Operation in the Network

Below is a sample MLAG topology and discussion:

**Figure 28-11. Example MLAG Topology**



In Figure 28-11:

- 1 VLAN 10 spans the MLAG network.
- 2 P and S are MLAG-aware peer devices. P stands for primary and S stands for secondary. The roles are elected after the DUTs exchange keep-alive messages. The two devices are connected with a peer-link {P3/P4-S3/S4}. Ports P1, S1 are members of MLAG1 and ports P2, S2 are members of MLAG2.
- 3 A port-channel must be configured as the peer-link. In Figure 28-11, P3, P4 and S3, S4 are the port-channel ports that form the peer-link.
- 4 MLAG devices select the roles based on keep-alive messages that run over the peer-link.
- 5 A, B, and C are MLAG-unaware devices.
- 6 A, B, and C are partner devices that form an MLAG with P and S. On A, B, and C, the aggregation is a regular LAG.
- 7 MLAG links are shown in blue.

Supported topologies and the way traffic is handled in these topologies is explained in the following sections.

The MLAG component uses the keep-alive protocol to select a primary and a secondary device. The primary switch owns the MLAG member ports on the secondary device. It handles the control plane functionality of supported protocols for the MLAG member ports on the secondary.

### **Peer-Link**

The peer-link is a crucial for MLAG operation. The peer-link must be configured on a port-channel interface. Only one peer-link aggregation group is allowed per peer switch and this peer-link is shared by all instances of MLAG running on the two peer switches.

The peer-link is used for the following purposes:

- To transport keep-alive messages to the peer.
- To sync FDB entries learned on MLAG interfaces between the two MLAG peer switches.
- To forward STP BPDUs and LACPDU received on secondary MLAG member ports to the primary MLAG switch.
- To send interface events related to MLAG interface and member ports that occur on the secondary switch to the primary switch.
- To transfer MLAG control information between the primary and secondary MLAG switches.
- To support a redundant forwarding plane in the case that all member ports of an MLAG interface are down on an MLAG peer. In this case, traffic received on the peer switch destined to the MLAG peer with the downed ports is sent over the peer-link to the peer MLAG switch for forwarding to the partner switch.

The peer-link is not utilized for partner traffic unless all LAG links connected to an MLAG partner on a single MLAG peer are disrupted. It is strongly recommended that the MLAG peer LAG consist of multiple physical links with sufficient bandwidth to carry all traffic expected to be carried by either of the MLAG peers.

The MLAG component internally configures filters so that traffic ingressing a peer-link is blocked from egress on the peer MLAG switch. The filters are modified when there is a failure of all the MLAG member interfaces on an

MLAG switch and traffic must egress through selected ports on the MLAG peer. These filters block incoming traffic on all VLANs configured on the peer link, not just those configured as part of an MLAG. Therefore, there is no connectivity between non-redundant ports across the peer-link.

### **Control Plane Election in MLAG Switches**

The MLAG component uses the keep-alive protocol running on the peer link to select a primary and a secondary switch. The keep-alive protocol is mandatory. The selection of the primary switch is non-preemptive and is not configurable.

Once elected, the primary switch owns the MLAG member ports on the secondary device. It handles the control plane functionality of supported protocols for the MLAG member ports on the secondary switch. Protocol status is not sent from the primary to the secondary switch. Always use the management interface on the primary switch to examine MLAG status.

### **Peer-Link Keep-alive Protocol**

MLAG peers exchange keep-alive packets over the peer-link. The keep-alive protocol is Layer-2-based. Keep-alive messages are used for electing roles and to inform the MLAG peer that the MLAG switch is alive and functioning properly. The keep-alive protocol sends messages with an Ether-type of 0x88E8 addressed to destination MAC 01:00:B5:00:00:00.

### **Dual Control Plane Detection Protocol**

The MLAG component may optionally run the Dual Control Plane Detection Protocol (DCPDP) to detect the presence of the peer switch independently of the keep-alive protocol running on the peer link.

The Dual Control Plane Detection Protocol is a UDP-based Layer-3 protocol. DCPDP may be configured on a routed VLAN that does not contain any MLAG port-channel interfaces. When enabled, the DCPDP sends an Layer-3 control plane detection message to the peer once every second. The message is unidirectional and contains the senders MAC address in the payload. The state of the primary and secondary MLAG switches is maintained on both MLAG peers.

DCPDP runs over an IP interface when enabled.

## **DCPDP and Peer Link Failures**

DCPDP is intended to provide a secondary layer of protection against peer link failures. If the peer-link goes down while the DCPDP protocol is enabled and remains up, the MLAG links on the MLAG secondary peer are disabled. The primary switch continues to forward traffic and, if LACP is enabled, send LACPDU's using the system MAC of the MLAG. Spanning tree reconvergence on the partner devices is avoided.

In the case where there are no keep-alive messages detected from the peer and DCPDP is disabled, but both peer units remain up, two primary switches result, each with the MLAG system MAC address, and each operating over its part of the former MLAG. In this situation, the selection of dynamic or static LAGs determines the MLAG behavior.

On a peer-link failure with DCPDP disabled and the MLAG configured with dynamic LAGs to the partners, traffic forwarding continues through the primary MLAG switch. The secondary switch brings down the MLAG interfaces and brings them up with a new (different from the primary) MLAG system ID. LACP running on the partner device detects that the links in the port-channel connected to the secondary MLAG switch are sending LACPDU's with a different system ID and does not bring up the links connected to secondary MLAG peer. This behavior reduces or eliminates spanning tree reconvergence due to the MLAG switches sending BPDUs with different bridge IDs to the partner switch.

On a peer-link failure with DCPDP disabled and the MLAG configured with static LAGs to the partners, traffic forwarding continues through both the primary and secondary MLAG switches. Spanning tree sends BPDUs with different bridge IDs to the partner switch, resulting in serial spanning tree reconvergence. For this reason, dynamic MLAGs are strongly recommended.

## **MLAG and Redundant Peer Links**

A redundant peer link is a link other than the peer link between the MLAG peer switches. Typically, these links cause a loop in the network and may cause the peer link to become blocked by spanning-tree. Dell EMC Networking can support traffic flow over redundant links with some additional configuration. Multiple spanning tree must be configured, the redundant link must be assigned a VLAN that is NOT in the MLAG domain (but can be configured on the peer link), and the VLAN assigned to the redundant link must be

configured in a unique MST instance not shared with the MLAG domain. If the VLAN assigned to the redundant link is also configured on the peer link, traffic on that VLAN is blocked by MLAG.

To configure the redundant link to be the forwarding for the redundant MST instance, the link cost needs to be reduced in order to be the root port. However, with MLAG, even changing the cost of the redundant port will not make the desired port as root port, as the MLAG peer link cost is internally set to 0 for all instances. Also it is not permitted by spanning-tree to set a link cost to 0. The lowest possible value allowed is 1. The spanning tree cost of the peer link is set to 0 with a specific intent—to ensure that the peer link is always elected as the designated /root forwarding port in the case of any redundant links between the primary and secondary switches. It is not possible to configure a non-peer-link/redundant port cost lower than the peer-link cost. The alternative is to configure the priority of the bridge (which is currently a non-root bridge) for the desired MST instance and increase the internal cost of the peer link interface for that same instance on the bridge (which is originally the root bridge) so that the port becomes designated forwarding instead of root forwarding. An example configuration is given later in this chapter.

## Layer-2 Configuration Steps

This section describes how to configure two MLAG peers in a basic Layer-2 switching configuration with the default spanning-tree configuration.

- 1 Enable MLAG globally and create the MLAG VLANs:

```
console#config
console (config) #feature vpc
console (config) #vlan 10-17
console (config-vlan10-17) #exit
```

- 2 Configure the keep-alive protocol:

- a Configure the device priority using the **role** command, if desired. This should be configured differently for each of the MLAG peers.
- b Configure the VPC domain ID and also configure the local priority, if desired. The VPC domain ID is not important except that it **MUST** be the same as the MLAG peer and **SHOULD** be different than any other MLAG partner. The MLAG system MAC address may optionally be configured in the step.

```
console (config) #vpc domain 1
```

```
console(config-vpc 1)#role 10
console(config-vpc 1)#exit
```

Modifications to priority and timeout interval are effective only before the keep-alive protocol is enabled. Once enabled, MLAG switches contest in an election to select the primary and secondary switch. The election is non-preemptive.

If configured, the system virtual MAC address **MUST** be the same on both of the MLAG peers.

### 3 Configure the peer-link. On each MLAG peer:

- Configure a port-channel as the peer-link for the MLAG devices. It is recommended that the administrator use dynamic LAGs as port-channels.
- It is strongly recommended that the MLAG peer LAG consist of multiple physical links with sufficient bandwidth to carry all MLAG traffic expected to be carried by either MLAG peer.
- Enable trunking on the peer-link. Remove any non-MLAG VLANs from the peer-link trunk port. VLANs cannot be configured to contain both MLAG ports and non-MLAG (non-redundant) ports.
- Ensure that the peer-link has a native VLAN configured.
- Optionally, configure UDLD on the peer-link to detect and shut down unidirectional links. UDLD should be used on any fiber ports, as fiber ports can operate in a unidirectional mode.
- Associate the port-channel with physical links.

```
console(config)#interface port-channel 1
console(config-if-Po1)#description "MLAG-Peer-Link"
console(config-if-Po1)#switchport mode trunk
console(config-if-Po1)#vpc peer-link
console(config-if-Po1)#exit
console(config)#interface range te1/0/1-2
console(config-if)#channel-group 1 mode active
console(config-if)#description "MLAG-Peer-Link"
console(config-if)#udld enable
console(config-if)#udld port aggressive
console(config-if)#exit
```

When the peer-link is configured, the MLAG component disables MAC learning on the port-channel configured as the peer-link.

#### 4 Configure DCPDP (optional):

- a Configure a VLAN routing interface and assign a local IP address (different from the peer address).
- b Configure the peer-switch IP address (the destination IP address)
- c If needed, configure the UDP port number to send and receive the protocol messages.
- d Configure the source IP address
- e Enable the protocol. The protocol starts running if MLAG is globally enabled.

```
console(config)#vlan 100
console(config-vlan100)#exit
console(config)#interface vlan 100
console(config-if-vlan100)#ip address 192.168.0.2
255.255.255.0
console(config-if-vlan100)#exit
console(config)#vpc domain 1
console(config-vpc 1)#peer-keepalive destination
192.168.0.1 source 192.168.0.2
console(config-vpc 1)#peer detection enable
console(config-vpc 1)#exit
```

#### 5 Configure the MLAG partner interfaces:

Configure a port-channel as an MLAG interface and assign to a VPC. Each MLAG must have a unique VPC ID and the VPC configuration must be identical on both switches. The port-channels on the MLAG peer must be assigned to the same VPC ID. However, the member ports for the port-channel may be different. The administrator must ensure that the port-channel configuration on both the switches is in sync before enabling MLAG. After the MLAG interfaces are enabled, the MLAG interfaces are operationally disabled for a brief period while the MLAG component exchanges information regarding the port members that constitute the port-channel on each device. Once this information is populated on both devices, the MLAG interfaces are operationally enabled and traffic forwarding on MLAG interfaces is allowed.

The secondary switch forwards all BPDUs/LACPDU's received on the port members of the MLAG interface to the primary switch over the peer-link. Events related to MLAG interface and their port members are forwarded



to the primary switch for handling. FDB entries learned on MLAG interfaces are synced between the two devices.

```
console (config) #interface range gil/0/1-4
console (config-if) #channel-group 2 mode active
console (config-if) #exit
console (config) #interface range gil/0/5-8
console (config-if) #channel-group 3 mode active
console (config-if) #exit
console (config) #interface port-channel 2
console (config-if-Po2) #switchport mode trunk
console (config-if-Po2) #vpc 1
console (config-if-Po2) #exit
console (config) #interface port-channel 3
console (config-if-Po3) #switchport mode trunk
console (config-if-Po3) #vpc 2
console (config-if-Po3) #exit
```

## Switch Firmware Upgrade Procedure

MLAG supports minimally intrusive firmware upgrade of the MLAG peer switches. In most cases, protocols with retransmission capability, e.g., TCP, will experience a limited interruption of service. Network operators must ensure that the aggregate bandwidth in use on the MLAG can be supported on a single MLAG peer.

During the upgrade, traffic that is forwarded to an MLAG switch during reboot will fail over to the MLAG peer. The traffic disruption is limited to the time required for devices dual attached to the VPC device pair to detect the link-down and link-up events and to rehash the traffic.

Use the **show vpc brief** command to determine which switch is the primary switch. This procedure upgrades the primary switch first, followed by the standby switch. Following this order reduces the reconvergence time to the minimum.

### Upgrade Steps

- 1 Download the new code and activate it on both the Primary (VP) and Secondary (VS) MLAG peer switches.
- 2 Enable DCPDP (if disabled) on both the switches and save the running-config.

- 3 Reboot the primary VPC device (VP). During the reboot, devices that are dual attached to the VPC MLAG pair detect the link loss and start forwarding the traffic towards the secondary VPC switch (VS).
- 4 While the VPC primary switch (VP) reboots, the secondary switch (VS) becomes the primary and forwards the traffic.
- 5 After the primary switch (VP) reboot is complete, it assumes the role of the secondary switch. Devices dual attached to the VPC device pair detect link up and may start forwarding traffic to switch VP.
- 6 Reboot the current VPC primary switch (VS). During reboot, devices that are dual attached to the VPC device pair detect the link loss and start forwarding the traffic towards the secondary VPC switch (VP).
- 7 After switch VS reboot is complete, it assumes the role of the secondary switch. Switches dual attached to the VPC device pair detect link up and may start forwarding traffic to device VS.

At this point, the switch firmware is upgraded and the MLAG is fully functional.

## Static Routing on MLAG Interfaces

MLAG interfaces can be enabled as Layer-3 VLANs; that is, they can be assigned IP addresses. There is no support for routing protocols such as OSPF, RIP, etc. on MLAG interfaces. VRRP can be configured on these routing interfaces to provide Virtual IP/Virtual MAC redundancy. Routing is supported only on the edge of the MLAG towards the partner network, in support of implementing a subnet per VLAN towards which the partner network can route. The interior MLAG VLANs, and especially the MLAG peer links, must be configured for switching and must span the MLAG topology.

## MLAGs and Routing

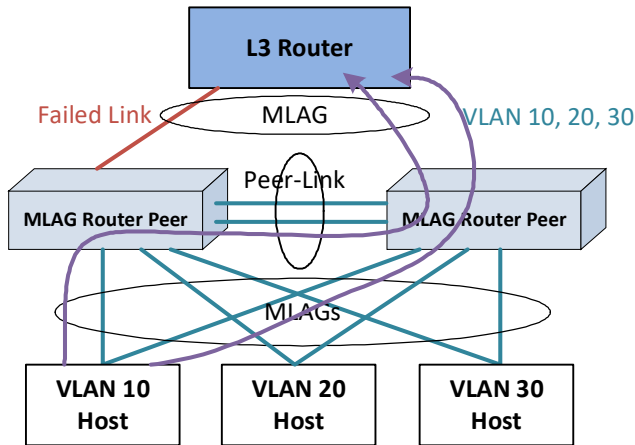
MLAG is supported as a replacement for spanning tree in Layer-2 switched network topologies. When connecting to routed networks, the links/VLANs on the router must be part of the MLAG domain, and the links/VLANs leading to the rest of the Layer-2 network or to Layer-3 hosts must be part of the MLAG domain for the MLAG feature to automatically utilize the peer-link to forward packets around failures. MLAG VLANs may have IP addresses

assigned, but MLAG VLANs cannot be used to route across MLAG or non-redundant VLANs, as the MLAG feature does not correlate failures in one VLAN with another VLAN to unblock packets crossing the MLAG peer-link.

### **Recommended Layer-3 Connectivity**

The topology shown in Figure 28-12 uses the MLAG switches as Layer-2 switches. All VLANs traverse the MLAG topology from the top switches/routers to the bottom switches/routers. The LAGs for each VLAN host are in a separate VPC. The router sees the port-channel as a single logical interface with multiple VLANs. This topology is highly recommended as it utilizes MLAG in the scenario for which it was intended (redundant full-bandwidth replacement for spanning tree) and allows the MLAG peers to detect failures and unblock the appropriate VLANs on the peer link so that traffic flow can continue unimpeded.

**Figure 28-12. Recommended Layer-3 Connectivity**

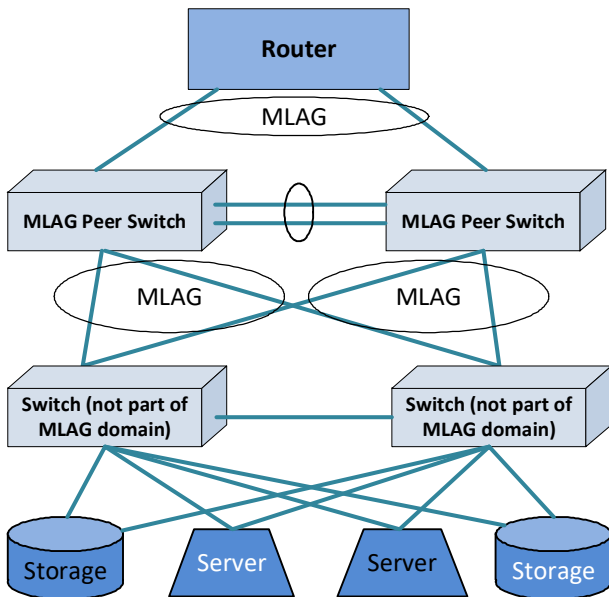


### Alternative Recommended Layer-3 Connectivity

The loop-free topology shown in Figure 28-13 uses the MLAG switches as Layer-2 switches in an EOR role. The single VLAN traverses the MLAG topology from the top router to the bottom storage and servers. Multiple VLANs in different VPCs may be used to isolate clusters of storage/servers from each other. This topology is highly recommended, as it utilizes MLAG in the scenario for which it was intended (redundant full-bandwidth replacement for spanning tree in a fully Layer-2 topology) and allows the MLAG peers to detect failures and unblock the appropriate VLANs on the peer link so that traffic flow can continue unimpeded.

The lower pair of switches connects clusters of storage and servers in a TOR role in support of devices that do not support link aggregation. Switching between the storage and the servers within the rack proceeds in the normal manner and remains isolated on the lower switch pair that is not part of the MLAG domain. Traffic entering or exiting the rack proceeds over the EOR MLAG.

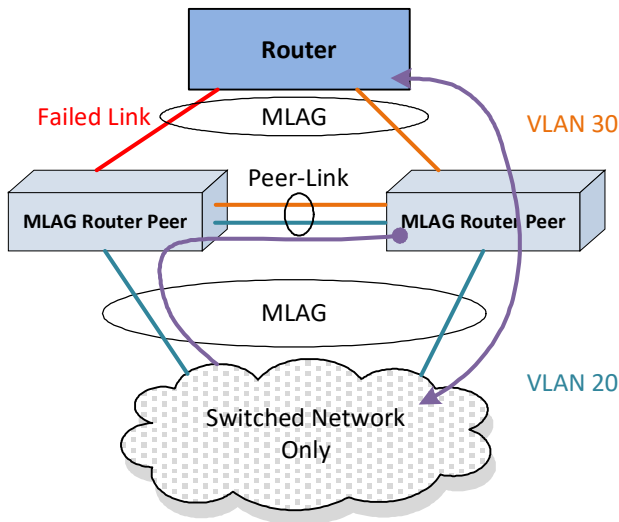
Figure 28-13. Alternative Recommended Layer-3 Connectivity



### **Layer-3 VLAN Termination on MLAG Not Supported**

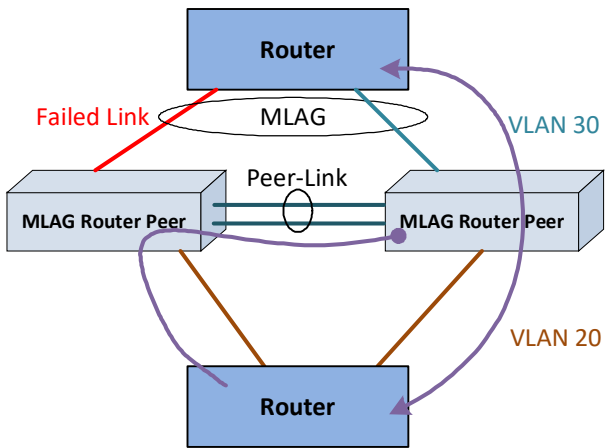
In the “two-armed” fully routed scenario shown in Figure 28-14, both the routed network and the switched network are in the MLAG. Switched traffic to and from the upstream network is automatically unblocked over the peer-link when an MLAG link fails. But, because the failed link is part of a Layer-3 port-channel (with a unique VLAN), the peer-link does not automatically unblock the downstream routed VLANs (which are not correlated with the upstream MLAG VLANs) across the peer link. Specifically, MLAG does not correlate the failure in VLAN 30 with VLAN 20. This leads to a black hole. Adding a backup routed link solves the black hole issue, but it also makes the MLAG solution unnecessary. Layer-3-routed VLAN termination on the MLAG peers is not supported—VLANs must extend across the MLAG peers to two MLAG partners.

**Figure 28-14. Layer-3 VLAN Termination on MLAG, Example 1**



In the scenario shown in Figure 28-15 (similar to the previous scenario), the downstream router is not configured with port-channel and uses ECMP or some other load sharing scheme to send packets to routed MLAG peers. MLAG cannot react appropriately to a link failure on the upstream router because the VLANs are routed across the MLAG peers. MLAG cannot logically connect the failure on VLAN 30 with non-redundant VLAN 20. Consequently, MLAG does not unblock VLAN 20 from traversing the peer link. The downstream router continues to send packets on VLAN 20 to the MLAG peer with the failed link. But because routed VLAN 20 is not part of the MLAG, packets remain blocked when transiting the MLAG peer link. Layer-3 routed VLANs termination on the MLAG peers is not supported—VLANs must extend across the MLAG peers.

**Figure 28-15. Layer-3 VLAN Termination on MLAG, Example 2**



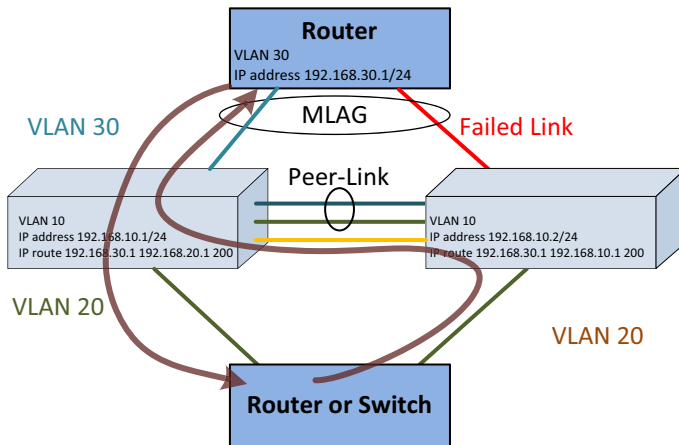
**Degenerate Routing Topology**

In a “one-armed” topology, the MLAG is partnered with a single router or switch. The router is configured with a LAG toward the MLAG peer switches and has an IP address configured on the router LAG. The peer switches may be configured with VRRP and have IP addresses assigned to both the routed VLANs. If a multi-tier MLAG topology is used below the MLAG peers, these switches must not have Layer-3 port-channels configured as part of the MLAG. An additional backup routed link between the MLAG peers is

required to handle the case where a link from the router to one of the MLAG peers fails. Static routes must be added to the primary and secondary MLAG peers to route traffic addressed to the connected router across the backup routed link in the case of a failure of an MLAG link to the router.

This is not a recommended topology, as the same scenario can be achieved without the use of MLAG by simply configuring the middle switches as routers and using ECMP to load-balance across the links to the redundant router pair. In this type of solution, MLAG adds no value, as the redundancy is provided by Layer-3 routing, not by the MLAG.

**Figure 28-16. Degenerate Routing Topology**



In the one-armed scenario in Figure 28-16, the MLAG cannot associate the failure of the VLAN 30 link with VLAN 20. Traffic from the routed or switched network towards the upstream router is routed over the backup router link when the MLAG link fails solely based on the routing configuration. Traffic from the upstream router on VLAN 30 to the switched/routed network is handled by the MLAG failover scenario and is switched across the peer-link on VLAN 30, but it could just as easily be handled by Layer-3 routing.

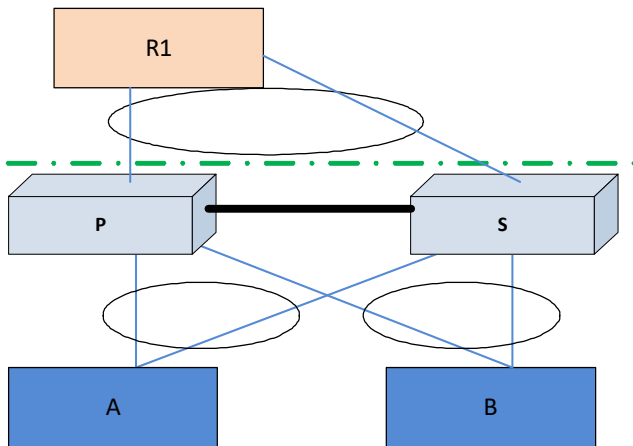
### Virtual Router Redundancy Protocol

If VRRP is enabled on a VLAN that has an MLAG port as its member, both VRRP routers become VRRP primaries operationally in the VLAN. This is to allow load balancing of the northbound Layer-3 traffic on the MLAG.

Since the peer-link is a member of the same routing VLANs as all MLAGs, both the primary and secondary MLAG routers see VRRP advertisements sent by the other router. The internal switch packet filters are modified to drop VRRP advertisement packets if they are received on a VLAN that has an MLAG as its member. This ensures that both MLAG devices become VRRP primaries.

Consider the scenario in Figure 28-17.

**Figure 28-17. MLAG with VRRP**



When Layer-3 data is received by the MLAG primary switch destined to A, P would trigger an ARP request to learn A's MAC address. In this case, the ARP request originated by P would have its interface MAC address as the source MAC address (MAC-P, for example) and interface IP address as the source IP address. If the ARP reply from A, with destination MAC address as MAC-P, is hashed to S, the packet will be forwarded by S to P over the peer-link so that P can learn A's MAC address. **This requires that the virtual IP address of the VRRP "routers" be different from the physical IP of either of the MLAG peers.** This is to ensure that packets generated by either of the MLAG peers is



transmitted with the source MAC address as the physical MAC address and not the virtual MAC address. In the example in Figure 28-17, if the virtual MAC address is used as the source MAC address in the ARP from P to A, then S will consume the packet, as it is operationally a VRRP primary too. The packet is forwarded to P if the physical MAC address is used.

Note that the VLANs connecting A and B to the MLAG peers are extended to R1. P and S do not actually route packets. Within the MLAG domain, packets are switched only.

### **Caveats and Limitations**

Traffic to and from non-redundant ports is filtered and never crosses the MLAG peer-link, and such ports/VLANs need to obtain connectivity via an alternative other than the MLAG-connected ports/VLANs.

To achieve east-west traffic, the administrator can connect an additional interface between the primary and secondary MLAG switches with spanning tree disabled on that link. The administrator must configure the interface to be a member of the required non-MLAG VLANs. The administrator should ensure that there are no loops with this connection.

The MLAG peer link does not become operational until both MLAG peers establish communication, and are configured with the same domain identifier and the same virtual MLAG MAC address. MLAG partner links remain disabled until the MLAG peers establish connectivity. Shutting down an MLAG peer and rebooting the other peer will result in the MLAG partner links remaining disabled until the MLAG peer that was shut down is re-enabled.

Port-channel numbers within a VPC must be identical on the MLAG peers. The associated physical interfaces in the port-channels need not be the same.

It is a requirement of a port-channel that the link members operate at the same duplex and speed settings. In addition, copper ports have larger latencies than fiber ports. If fiber and copper ports are aggregated together, packets sent over the fiber ports would arrive significantly sooner at the destination than packets sent over the copper ports. This can cause significant issues in the receiving device, as it would be required to buffer a potentially large number of frames. Devices unable to buffer the requisite number of frames will show excessive frame discard.

Routing is not supported across multiple MLAGs (i.e., in two-tier topology). This is a fundamental limitation of MLAG, which is intended as a replacement for other, less efficient Layer-2 topologies. Should a multi-tier Layer-3 topology be desired, other well established and well understood techniques, such as ECMP and redundant router pairs, will allow a Layer-3 routed network to utilize bandwidth efficiently. Layer-3 routing is capable of routing packets around failed links and failed routers.

Spanning tree (and LACP) PDUs are proxied from the secondary MLAG peer to the MLAG primary switch. This implies that at least two spanning tree roots will exist in the MLAG network: the root bridge for the MLAG member ports/VLANs on the primary switch and the root bridge for the non-redundant ports/VLANs that are not part of the MLAG.

The peer link requires a native VLAN to be configured. This is a limitation of the peer-link keep alive protocol.

On primary switch failover, the secondary switch flushes the FDB MAC addresses and uses the system virtual MAC address in spanning tree BPDUs and in the LACP actor ID. This avoids rebuilding the link aggregation group followed by spanning tree reconvergence.

MLAG-supported protocols are active only on the MLAG primary switch. The protocols are proxied from the secondary peer switch to the primary switch. The primary switch receives state information from the secondary peer switch and programs the secondary peer hardware. It does not send protocol state information to the secondary peer. This leads to a number of seemingly inconsistent behaviors if these facts are ignored:

- MLAG port-channel state is maintained on the primary peer only. The MLAG secondary peer has accurate state for the member links, but not for an MLAG port-channel. The operator can shut down a MLAG port-channel only from the primary MLAG peer.
- Shutting down a MLAG port-channel on the primary peer shuts down the port-channel on both the primary and secondary MLAG peers.
- Shutting down a MLAG port-channel on the secondary MLAG peer has no effect. The operator can shut down the individual links instead.
- The spanning tree status is only shown correctly on the primary MLAG peer for the redundant links and associated VLANs. The spanning-tree state on the secondary switch is accurate only for the non-redundant links and associated VLANs.

- On a failover from the primary MLAG peer to the secondary MLAG peer, the ports are made members of the secondary MLAG peer switch's spanning tree and spanning tree reconvergence may occur.. The forwarding database and ARP cache are flushed and relearned.
- MLAG (VPC) status only shows correctly on the primary MLAG peer and does not show correctly on the secondary MLAG peer. Status is not forwarded from the primary MLAG peer to the secondary MLAG peer.
- If it is desired to run a redundant link between the MLAG peers, Multiple Spanning Tree must be used, a separate VLAN must be configured for the redundant link which cannot be configured on the peer link, and the VLAN must be assigned to a unique MST instance not used by any MLAG VLAN.

The Dell EMC Networking MLAG solution is not peer-compatible with other vendor's multichassis LAG solutions. Dell EMC Networking N-Series switches configured for MLAG cannot peer with another vendor switch.

IGMP/MLD snooping is not supported on MLAG-enabled switches. Disable IGMP/MLD snooping before enabling MLAG.

MLAG interfaces and non-redundant ports cannot be members of the same VLAN; i.e., a VLAN may contain MLAG interfaces or a VLAN may contain non-redundant ports, but not both.

The Dell EMC Networking MLAG solution supports MSTP, RSTP, and RSTP-PV spanning tree modes. Spanning tree may also be disabled on the MLAG peers, although this may lead to a network loop. If MSTP is configured, the MSTP domain MUST be named or the peer-link will remain blocked.

Only two switches are supported as MLAG peers. These switches may not be stacked with other switches.

The MLAG peer switches synchronize the state of spanning tree, the Layer-2 forwarding cache, and other protocols to support reduced convergence times during MLAG link and MLAG switch failures. The synchronized state is only available on the MLAG primary switch. Table 28-1 indicates which switch features synchronize their state across the MLAG peers.

- An N/A entry indicates that state synchronization is not required (usually for a link local protocol) and the feature can be configured on an MLAG VLAN or MLAG-associated links. In some cases, it may be necessary to configure an N/A feature identically on the MLAG peer switches for it to

work properly; e.g., port mirroring for an MLAG link must be configured on both MLAG peer switches to capture the conversation from the MLAG partner switch.

- A Yes entry indicates that the feature may be configured on an MLAG VLAN and will synchronize state across the MLAG peers. The configuration for features marked Yes must be identical on both switches. MLAG does not synchronize configuration with the MLAG peer.
- A No entry indicates that the switch feature does not synchronize state across the MLAG peers and the feature may not be configured on an MLAG VLAN.

**Table 28-2. MLAG State Synchronization Per Feature**

<b>Components</b>	<b>MLAG State Synchronization Support</b>
DOT1Q	Yes
Protocol Based VLANs/802.1v	No
GARP	No
GVRP	No
GMRP	No
DOT1P	No
Unauthenticated VLAN	No
Voice VLAN	No
Guest VLAN	No
MAC Authentication Bypass	No
Broadcast Storm Recovery	No
DOT3AD	Yes
LAG Hashing	Yes
Port Mirroring	N/A
MAC Filter	N/A
MFDB	No
IGMP/MLD Snooping	No
DOT1Qbb	No

**Table 28-2. MLAG State Synchronization Per Feature (Continued)**

<b>Components</b>	<b>MLAG State Synchronization Support</b>
DOT1S	Yes
Loop Guard	No
FDB	Yes
MACLOCK	No
DVLAN	No
DOT1AB	No
IP Subnet-based VLANs	N/A
MACVLAN	N/A
Protected Port	No
DHCP Snooping	No
IP Source Guard	No
Dynamic ARP Inspection	No
Auto-Negotiation	N/A
L2-Relay	No
MRP	No
MMRP	No
MVRP	No
DOT1AS	No
802.1qav	No
ACL	N/A
DiffServ	N/A
CoS	N/A
ACL Logging	N/A
Flow-based port mirroring	N/A
VOIP	No
iSCSI	No
DOT1AD	No

**Table 28-2. MLAG State Synchronization Per Feature (Continued)**

<b>Components</b>	<b>MLAG State Synchronization Support</b>
DOT3AH	No
DCBX	N/A
ETS	N/A
FIP Snooping	No
MVRP	No
Management ACL	No
UDLD	N/A
Private VLAN	No
LLPF	No
Port Aggregator	No
EAV	No
MSRP	No
MVR	No
Class-Based VLAN	No
DHCP Filtering	No
EASY_ACL	No
Media VLAN	No
PBVLAN	No
VLAN-Rate Limit	No
Flow Control	N/A
LLDP	N/A
Jumbo Frames	N/A

## Basic Configuration Example

This example shows the configuration of the two MLAG peers and a single MLAG partner in the simplest possible configuration. No MLAG peer priorities are configured, nor is UDLD enabled on the peer-link. DCPDP is not enabled. The default spanning tree configuration is used and spanning-tree is disabled on the peer link. A system MAC address is assigned to both MLAG peers. The system virtual MAC address is used in the spanning-tree BPDUs and LACPDUs.

### MLAG Peer A

Current Configuration:

- System Description “Dell EMC Networking N3024F, 6.0.0.0, Linux 3.6.5-858bcf6e”
- System Software Version 6.0.0.0

```
console#configure
console(config)#vlan 10
console(config-vlan10)#exit
console(config)#hostname "MLAG-Peer-A"
MLAG-Peer-A(config)#slot 1/0 2      ! Dell EMC Networking N3024F
MLAG-Peer-A(config)#stack
MLAG-Peer-A(config-stack)#member 1 2      ! N3024F
MLAG-Peer-A(config-stack)#exit

MLAG-Peer-A(config)#interface Gi1/0/23
MLAG-Peer-A(config-if-Gi1/0/23)#channel-group 2 mode active
MLAG-Peer-A(config-if-Gi1/0/23)#description "MLAG-Partner-Link"
MLAG-Peer-A(config-if-Gi1/0/23)#exit

MLAG-Peer-A(config)#interface Te1/0/1
MLAG-Peer-A(config-if-Te1/0/1)#channel-group 1 mode active
MLAG-Peer-A(config-if-Te1/0/1)#description "MLAG-Peer-Link"
MLAG-Peer-A(config-if-Te1/0/1)#exit

MLAG-Peer-A(config)#interface port-channel 1
MLAG-Peer-A(config-if-Po1)#description "MLAG-Peer-Link"
MLAG-Peer-A(config-if-Po1)#switchport mode trunk
MLAG-Peer-A(config-if-Po1)#vpc peer-link
MLAG-Peer-A(config-if-Po1)#exit

MLAG-Peer-A(config)#interface port-channel 2
MLAG-Peer-A(config-if-Po2)#switchport mode trunk
MLAG-Peer-A(config-if-Po2)#switchport trunk native vlan 10
```

```
MLAG-Peer-A(config-if-Po2)#vpc 1
MLAG-Peer-A(config-if-Po2)#exit

MLAG-Peer-A(config)#snmp-server engineid local
800002a203001ec9dec52b
MLAG-Peer-A(config)#snmp-server agent boot count 2
MLAG-Peer-A(config)#feature vpc
MLAG-Peer-A(config)#vpc domain 3
MLAG-Peer-A(config-vpc 3)#system-mac 0011.2233.4455
MLAG-Peer-A(config-vpc 3)#peer-keepalive enable
MLAG-Peer-A(config-vpc 3)#exit
MLAG-Peer-A(config)#exit
```



## MLAG Peer B

### Current Configuration:

- System Description “Dell EMC Networking N3024F, 6.0.0.0, Linux 3.6.5-858bcf6e”
- System Software Version 6.0.0.0

```
console#configure
console(config)#vlan 10
console(config-vlan10)#exit
console(config)#hostname "MLAG-Peer-B"
MLAG-Peer-B(config)#slot 1/0 2      ! Dell EMC Networking N3024F
MLAG-Peer-B(config-stack)#stack
MLAG-Peer-B(config-stack)#member 1 2      ! N3024F
MLAG-Peer-B(config-stack)#exit

MLAG-Peer-B(config)#interface Gi1/0/23
MLAG-Peer-B(config-if-Gi1/0/23)#channel-group 2 mode active
MLAG-Peer-B(config-if-Gi1/0/23)#description "MLAG-Partner-Link"
MLAG-Peer-B(config-if-Gi1/0/23)#exit

MLAG-Peer-B(config)#interface Te1/0/1
MLAG-Peer-B(config-if-Te1/0/1)#channel-group 1 mode active
MLAG-Peer-B(config-if-Te1/0/1)#description "MLAG-Peer-Link"
MLAG-Peer-B(config-if-Te1/0/1)#exit

MLAG-Peer-B(config)#interface port-channel 1
MLAG-Peer-B(config-if-Po1)#description "MLAG-Peer-Link"
MLAG-Peer-B(config-if-Po1)#switchport mode trunk
MLAG-Peer-B(config-if-Po1)#vpc peer-link
MLAG-Peer-B(config-if-Po1)#exit

MLAG-Peer-B(config)#interface port-channel 2
MLAG-Peer-B(config-if-Po2)#switchport mode trunk
MLAG-Peer-B(config-if-Po2)#switchport trunk native vlan 10
MLAG-Peer-B(config-if-Po2)#vpc 1
MLAG-Peer-B(config-if-Po2)#exit

MLAG-Peer-B(config)#snmp-server engineid local
800002a203001ec9dec513
MLAG-Peer-B(config)#snmp-server agent boot count 3
MLAG-Peer-B(config)#feature vpc
MLAG-Peer-B(config)#vpc domain 3
MLAG-Peer-B(config-vpc 3)#system-mac 0011.2233.4455
MLAG-Peer-B(config-vpc 3)#peer-keepalive enable
MLAG-Peer-B(config-vpc 3)#exit
```

```
MLAG-Peer-B (config) #exit
```

## MLAG Partner

Current Configuration:

- System Description “Dell EMC Networking N2048, 6.0.0.0, Linux 3.6.5-858bcf6e”
- System Software Version 6.0.0.0

```
console#configure
console (config) #hostname "LAG-SW"
LAG-SW(config) #slot 1/0 5      ! Dell EMC Networking N2048
LAG-SW(config) #stack
LAG-SW(config-stack) #member 1 8      ! N2048
LAG-SW(config-stack) #exit

LAG-SW(config) #interface vlan 1
LAG-SW(config-if-vlan1) #ip address dhcp
LAG-SW(config-if-vlan1) #exit

LAG-SW(config) #interface Gi1/0/1
LAG-SW(config-if-Gi1/0/1) #channel-group 1 mode active
LAG-SW(config-if-Gi1/0/1) #exit

LAG-SW(config) #interface Gi1/0/2
LAG-SW(config-if-Gi1/0/2) #channel-group 1 mode active
LAG-SW(config-if-Gi1/0/2) #exit

LAG-SW(config) #interface port-channel 1
LAG-SW(config-if-Po1) #switchport mode trunk
LAG-SW(config-if-Po1) #exit

LAG-SW(config) #snmp-server engineid local 800002a203001ec9deb777
LAG-SW(config) #snmp-server agent boot count 3
LAG-SW(config) #exit
```

## Status Reporting

The status outputs of the various VPC commands are self-explanatory. Both the configured and operational status is shown in the outputs. Additional commands are shown below that may be useful in troubleshooting MLAG configuration or operational issues. All of the commands below are run on the MLAG primary switch except as noted otherwise.

```
MLAG-Peer-A(config) #show vpc brief
```

```
VPC admin status..... Enabled
Keep-alive admin status..... Enabled
VPC operational status..... Enabled
Self role..... Primary
Peer role..... Secondary
Peer detection admin status..... Disabled
```

```
Peer-Link details
```

```
-----
```

```
Interface..... Po1
Peer-link admin status..... Enabled
Peer-link STP admin status..... Disabled
Configured VLANs..... 1,10
Egress tagged VLANs..... 10
```

```
VPC Details
```

```
-----
```

```
Number of VPCs configured..... 1
Number of VPCs operational..... 1
```

```
VPC id# 1
```

```
-----
```

```
Interface..... Po2
Configured VLANs..... 1,10
VPC interface state..... Active
```

```
Local Members      Status
```

```
-----
```

```
Gil/0/23          Up
```

```
Peer Members      Status
```

```
-----
```

```
Gil/0/23          Up
```

LAG-SW(config)#show vpc role

Self  
----

Keep-alive admin status..... Disabled  
Keep-alive operational status..... Disabled  
Priority..... 100  
System MAC address..... 001E.C9DE.B777  
Time-out..... 5  
VPC admin status..... Disabled  
VPC role..... None

Peer  
----

Priority..... 0  
VPC role..... None  
System MAC address..... 0000.0000.0000

LAG-SW(config)#show vpc peer-keepalive

Peer IP address..... 0.0.0.0  
Source IP address..... 0.0.0.0  
UDP port..... 50000  
Peer detection..... Disabled  
Peer detection operational status..... Down  
Peer is detected..... False

MLAG-Peer-A(config)#show interfaces status pol

Port Description  
Channel -----

Pol MLAG-Peer-Link

Operational State..... Up  
Admin Mode..... Enabled  
Port Channel Flap Count..... 1

Member Ports	Device/Timeout	Port Speed	Port Active	Flap Count
Tel/0/1	actor/long partner/long	10000	True	1

MLAG-Peer-A (config) #show interfaces status po2

```
Port      Description
Channel
-----
Po2

Operational State..... Up
Admin Mode..... Enabled
Port Channel Flap Count..... 0

Member      Device/      Port      Port      Flap
Ports      Timeout      Speed      Active      Count
-----
Gi1/0/23   actor/long   1000      True       0
           partner/long
```

MLAG-Peer-A (config) #show interfaces utilization po1

```
Port      Load      Rx bits/s      Rx packets/s      Tx bits/s      Tx packets/s
Channel Interval
-----
Po1       300       792             1                 1192           2
```

MLAG-Peer-A (config) #show vpc role

```
Self
----

Keep-alive admin status..... Enabled
Keep-alive operational status..... Enabled
Priority..... 100
System MAC address..... 001E.C9DE.C52B
Timeout..... 5
VPC state..... Primary
VPC role..... Primary

Peer
----

Priority..... 100
VPC role..... Secondary
System MAC address..... 001E.C9dE.C513
```

MLAG-Peer-B#show vpc statistics peer-link

```
Peer link control messages transmitted..... 95
Peer link control messages Tx errors..... 0
Peer link control messages Tx timeout..... 0
Peer link control messages ACK transmitted.... 37
Peer link control messages ACK Tx errors..... 0
Peer link control messages received..... 37
Peer link data messages transmitted..... 777
Peer link data messages Tx errors..... 0
Peer link data messages Tx timeout..... 0
Peer link data messages received..... 878
Peer link BPDU's transmitted to peer..... 2
Peer link BPDU's Tx errors..... 0
Peer link BPDU's received from peer..... 11
Peer link BPDU's Rx errors..... 0
Peer link LACPDU's transmitted to peer..... 775
Peer link LACPDU's Tx errors..... 0
Peer link LACPDU's received from peer..... 867
Peer link LACPDU's Rx errors..... 0
```

MLAG-Peer-B#show vpc statistics peer-keepalive

```
Total transmitted..... 15545
Tx successful..... 15545
Tx errors..... 0
Total received..... 15542
Rx successful..... 15542
Rx Errors..... 0
Timeout counter..... 0
```

## A Complete MLAG Example

The following example configures eight VLANs (10–17) across two VPCs. VPC 1 is connected to a Dell EMC Networking N2048 over two links (gi1/0/23-24) over port-channel 2 on each MLAG peer. Interfaces Te1/0/1-2 on each MLAG peer connect to each other on port-channel 1 utilizing LACP. UDLD is enabled on the two MLAG peer-links and the timers are configured to the minimum values. DCPDP is enabled on VLAN 100 (interface gi1/0/8 on each MLAG peer). VLAN 100 is excluded from any MLAG interface, including the peer-link.

VPC 2 is connected to a legacy Cisco 3750 over port-channel 3 on each MLAG peer, and is also running LACP. The Cisco configuration is shown for completeness.

Spanning tree instance 0 is configured for VLAN 1. Spanning tree instance 1 is configured for VLANs 10–17. Spanning-tree instance 2 carries VLAN 100 traffic on a redundant link between the two MLAG peers. The Cisco 3750 acts as the root bridge for the topology.

To support the redundant link using VLAN 200 running in MST instance 2 across gi1/0/8, configure the peer link with a high path cost for instance 2 on the primary switch to discourage forwarding across the peer link. Likewise, on the MLAG secondary switch, set the bridge priority to 0 for instance 2 to encourage the secondary switch to select the root path. Be sure to name the MST domain.

### MLAG Peer A Configuration

Current Configuration:

- System Description “Dell EMC Networking N3024F, 6.0.0.0, Linux 3.6.5-858bcf6e”
- System Software Version 6.0.0.0

```
console#configure
console(config)#vlan 10-17,100
console(config-vlan10-17)#exit

console(config)#hostname "MLAG-Peer-A"
MLAG-Peer-A(config)#slot 1/0 2      ! Dell EMC Networking N3024F
MLAG-Peer-A(config-stack)#stack
MLAG-Peer-A(config-stack)#member 1 2      ! N3024F
MLAG-Peer-A(config-stack)#exit
MLAG-Peer-A(config)#interface vlan 100
```

```
MLAG-Peer-A(config-if-vlan100)#ip address 192.168.0.1 255.255.255.0
MLAG-Peer-A(config-if-vlan100)#exit
```

```
MLAG-Peer-A(config)#spanning-tree mode mst
MLAG-Peer-A(config)#spanning-tree mst configuration
MLAG-Peer-A(config-mst)#instance 1 add vlan 10-17
MLAG-Peer-A(config-mst)#name "MLAG-A"
MLAG-Peer-A(config-mst)#revision 0
MLAG-Peer-A(config-mst)#instance 2 add vlan 100
MLAG-Peer-A(config-mst)#exit
```

```
MLAG-Peer-A(config)#udld enable
MLAG-Peer-A(config)#udld message time 7
MLAG-Peer-A(config)#udld timeout interval 9
```

```
MLAG-Peer-A(config)#interface Gil/0/1
MLAG-Peer-A(config-if-Gil/0/1)#channel-group 3 mode active
MLAG-Peer-A(config-if-Gil/0/1)#description "Old-Iron-Partner-Link"
MLAG-Peer-A(config-if-Gil/0/1)#exit
```

```
MLAG-Peer-A(config)#interface Gil/0/8
MLAG-Peer-A(config-if-Gil/0/8)#switchport access vlan 100
MLAG-Peer-A(config-if-Gil/0/8)#exit
```

```
MLAG-Peer-A(config)#interface Gil/0/23
MLAG-Peer-A(config-if-Gil/0/23)#channel-group 2 mode active
MLAG-Peer-A(config-if-Gil/0/23)#description "MLAG-Partner-Link"
MLAG-Peer-A(config-if-Gil/0/23)#exit
```

```
MLAG-Peer-A(config)#interface Gil/0/24
MLAG-Peer-A(config-if-Gil/0/24)#channel-group 2 mode active
MLAG-Peer-A(config-if-Gil/0/24)#description "MLAG-Partner-Link"
MLAG-Peer-A(config-if-Gil/0/24)#exit
```

```
MLAG-Peer-A(config)#interface Tel/0/1
MLAG-Peer-A(config-if-Tel/0/1)#channel-group 1 mode active
MLAG-Peer-A(config-if-Tel/0/1)#description "MLAG-Peer-Link"
MLAG-Peer-A(config-if-Tel/0/1)#udld enable
MLAG-Peer-A(config-if-Tel/0/1)#udld port aggressive
MLAG-Peer-A(config-if-Tel/0/1)#exit
```

```
MLAG-Peer-A(config)#interface Tel/0/2
MLAG-Peer-A(config-if-Tel/0/2)#channel-group 1 mode active
MLAG-Peer-A(config-if-Tel/0/2)#description "MLAG-Peer-Link"
MLAG-Peer-A(config-if-Tel/0/2)#udld enable
MLAG-Peer-A(config-if-Tel/0/2)#udld port aggressive
```



```

MLAG-Peer-A(config-if-Tel/0/2)#exit

MLAG-Peer-A(config)#interface port-channel 1
MLAG-Peer-A(config-if-Po1)#description "MLAG-Peer-Link"
MLAG-Peer-A(config-if-Po1)#switchport mode trunk
MLAG-Peer-A(config-if-Po1)#switchport trunk allowed vlan 1-99,101-4093
MLAG-Peer-A(config-if-Po1)#vpc peer-link
MLAG-Peer-A(config-if-Po1)#spanning-tree mst 2 cost 50000
MLAG-Peer-A(config-if-Po1)#exit

MLAG-Peer-A(config)#interface port-channel 2
MLAG-Peer-A(config-if-Po2)#switchport mode trunk
MLAG-Peer-A(config-if-Po2)#switchport trunk allowed vlan 1-99,101-4093
MLAG-Peer-A(config-if-Po2)#vpc 1
MLAG-Peer-A(config-if-Po2)#exit

MLAG-Peer-A(config)#interface port-channel 3
MLAG-Peer-A(config-if-Po3)#description "Old-Iron-Partner-Link"
MLAG-Peer-A(config-if-Po3)#switchport mode trunk
MLAG-Peer-A(config-if-Po3)#switchport trunk allowed vlan 1-99,101-4093
MLAG-Peer-A(config-if-Po3)#vpc 2
MLAG-Peer-A(config-if-Po3)#exit

MLAG-Peer-A(config)#snmp-server engineid local
800002a203001ec9dec52b
MLAG-Peer-A(config)#snmp-server agent boot count 2
MLAG-Peer-A(config)#feature vpc
MLAG-Peer-A(config)#vpc domain 1
MLAG-Peer-A(config-vpc 1)#peer-keepalive enable
MLAG-Peer-A(config-vpc 1)#peer-keepalive destination 192.168.0.2
source 192.168.0.1
MLAG-Peer-A(config-vpc 1)#peer detection enable
MLAG-Peer-A(config-vpc 1)#exit
MLAG-Peer-A(config)#exit

```

## MLAG Peer B Configuration

Current Configuration:

- System Description “Dell EMC Networking N3024F, 6.0.0.0, Linux 3.6.5-858bcf6e”
- System Software Version 6.0.0.0

```
console#configure
console (config) #vlan 10-17,100
console (config-vlan10-17) #exit

console (config) #hostname "MLAG-Peer-B"
MLAG-Peer-B (config) #slot 1/0 2      ! Dell EMC Networking N3024F
MLAG-Peer-B (config-stack) #stack
MLAG-Peer-B (config-stack) #member 1 2    ! N3024F
MLAG-Peer-B (config-stack) #exit

MLAG-Peer-B (config) #interface vlan 100
MLAG-Peer-B (config-if-vlan100) #ip address 192.168.0.2 255.255.255.0
MLAG-Peer-B (config-if-vlan100) #exit

MLAG-Peer-B (config) #spanning-tree mode mst
MLAG-Peer-B (config) #spanning-tree mst configuration
MLAG-Peer-B (config-mst) #instance 1 add vlan 10-17
MLAG-Peer-B (config-mst) #spanning-tree mst 2 priority 0
MLAG-Peer-B (config-mst) #name "MLAG-A"
MLAG-Peer-B (config-mst) #revision 0
MLAG-Peer-B (config-mst) #instance 2 add vlan 100
MLAG-Peer-B (config-mst) #exit

MLAG-Peer-B (config) #udld enable
MLAG-Peer-B (config) #udld message time 7
MLAG-Peer-B (config) #udld timeout interval 9

MLAG-Peer-B (config) #interface Gil/0/1
MLAG-Peer-B (config-if-Gil/0/1) #channel-group 3 mode active
MLAG-Peer-B (config-if-Gil/0/1) #description "Old-Iron-Partner-Link"
MLAG-Peer-B (config-if-Gil/0/1) #exit

MLAG-Peer-B (config) #interface Gil/0/8
MLAG-Peer-B (config-if-Gil/0/8) #switchport access vlan 100
MLAG-Peer-B (config-if-Gil/0/8) #exit

MLAG-Peer-B (config) #interface Gil/0/23
MLAG-Peer-B (config-if-Gil/0/23) #channel-group 2 mode active
```

```
MLAG-Peer-B (config-if-Gil/0/23) #description "MLAG-Partner-Link"  
MLAG-Peer-B (config-if-Gil/0/23) #exit
```

```
MLAG-Peer-B (config) #interface Gil/0/24  
MLAG-Peer-B (config-if-Gil/0/24) #channel-group 2 mode active  
MLAG-Peer-B (config-if-Gil/0/24) #description "MLAG-Partner-Link"  
MLAG-Peer-B (config-if-Gil/0/24) #exit
```

```
MLAG-Peer-B (config) #interface Tel/0/1  
MLAG-Peer-B (config-if-Tel/0/1) #channel-group 1 mode active  
MLAG-Peer-B (config-if-Tel/0/1) #description "MLAG-Peer-Link"  
MLAG-Peer-B (config-if-Tel/0/1) #udld enable  
MLAG-Peer-B (config-if-Tel/0/1) #udld port aggressive  
MLAG-Peer-B (config-if-Tel/0/1) #exit
```

```
MLAG-Peer-B (config) #interface Tel/0/2  
MLAG-Peer-B (config-if-Tel/0/2) #channel-group 1 mode active  
MLAG-Peer-B (config-if-Tel/0/2) #description "MLAG-Peer-Link"  
MLAG-Peer-B (config-if-Tel/0/2) #udld enable  
MLAG-Peer-B (config-if-Tel/0/2) #udld port aggressive  
MLAG-Peer-B (config-if-Tel/0/2) #exit
```

```
MLAG-Peer-B (config) #interface port-channel 1  
MLAG-Peer-B (config-if-Po1) #description "MLAG-Peer-Link"  
MLAG-Peer-B (config-if-Po1) #switchport mode trunk  
MLAG-Peer-B (config-if-Po1) #switchport trunk allowed vlan 1-99,101-  
4093  
MLAG-Peer-B (config-if-Po1) #vpc peer-link  
MLAG-Peer-B (config-if-Po1) #exit
```

```
MLAG-Peer-B (config) #interface port-channel 2  
MLAG-Peer-B (config-if-Po2) #switchport mode trunk  
MLAG-Peer-B (config-if-Po2) #switchport trunk allowed vlan 1-99,101-  
4093  
MLAG-Peer-B (config-if-Po2) #vpc 1  
MLAG-Peer-B (config-if-Po2) #exit
```

```
MLAG-Peer-B (config) #interface port-channel 3  
MLAG-Peer-B (config-if-Po3) #description "Old-Iron-Partner-Link"  
MLAG-Peer-B (config-if-Po3) #switchport mode trunk  
MLAG-Peer-B (config-if-Po3) #switchport trunk allowed vlan 1-99,101-  
4093  
MLAG-Peer-B (config-if-Po3) #vpc 2  
MLAG-Peer-B (config-if-Po3) #exit
```

```

MLAG-Peer-B(config)#snmp-server engineid local
800002a203001ec9dec513
MLAG-Peer-B(config)#snmp-server agent boot count 3
MLAG-Peer-B(config)#feature vpc
MLAG-Peer-B(config)#vpc domain 1
MLAG-Peer-B(config-vpc 1)#peer-keepalive enable
MLAG-Peer-B(config-vpc 1)#peer-keepalive destination 192.168.0.1
source 192.168.0.2
MLAG-Peer-B(config-vpc 1)#peer detection enable
MLAG-Peer-B(config-vpc 1)#exit
MLAG-Peer-B(config)#exit

```

## MLAG Partner Configuration

Current Configuration:

- System Description “Dell EMC Networking N2048, 6.0.0.0, Linux 3.6.5-858bcf6e”
- System Software Version 6.0.0.0

```

console#configure
console(config)#hostname "LAG-SW"
LAG-SW(config)#slot 1/0 5      ! Dell EMC Networking N2048
LAG-SW(config-stack)#stack
LAG-SW(config-stack)#member 1 8      ! N2048
LAG-SW(config-stack)#exit

LAG-SW(config)#interface vlan 1
LAG-SW(config-if-vlan1)#ip address dhcp
LAG-SW(config-if-vlan1)#exit

LAG-SW(config)#spanning-tree mode mst
LAG-SW(config)#spanning-tree mst configuration
LAG-SW(config-mst)#instance 1 add vlan 10-17
LAG-SW(config-mst)#name MLAG-A
LAG-SW(config-mst)#revision 0
LAG-SW(config-mst)#exit

LAG-SW(config)#interface Gi1/0/1
LAG-SW(config-if-Gi1/0/1)#channel-group 1 mode active
LAG-SW(config-if-Gi1/0/1)#exit

LAG-SW(config)#interface Gi1/0/2
LAG-SW(config-if-Gi1/0/2)#channel-group 1 mode active
LAG-SW(config-if-Gi1/0/2)#exit

LAG-SW(config)#interface Gi1/0/3

```

```

LAG-SW(config-if-Gil/0/3)#channel-group 1 mode active
LAG-SW(config-if-Gil/0/3)#exit

LAG-SW(config)#interface Gi1/0/4
LAG-SW(config-if-Gil/0/4)#channel-group 1 mode active
LAG-SW(config-if-Gil/0/4)#exit

LAG-SW(config)#interface port-channel 1
LAG-SW(config-if-Po1)#switchport mode trunk
LAG-SW(config-if-Po1)#exit

LAG-SW(config)#snmp-server engineid local 800002a203001ec9deb777
LAG-SW(config)#snmp-server agent boot count 3
LAG-SW(config)#exit

```

### **Cisco 3750 MLAG Partner Configuration**

Current configuration: 1913 bytes

- version 12.2
- no service pad
- service timestamps debug datetime msec
- service timestamps log datetime msec
- no service password-encryption
- service unsupported-transceiver

```

config
hostname Switch

boot-start-marker
boot-end-marker

no aaa new-model
switch 1 provision ws-c3750g-24ts
system mtu routing 1500
ip subnet-zero

spanning-tree mode mst
spanning-tree extend system-id

spanning-tree mst configuration
  instance 1 vlan 10-17
  name MLAG-A
  revision 0

```

```
vlan internal allocation policy ascending
interface Port-channel1
  switchport trunk encapsulation dot1q
  switchport mode trunk
interface GigabitEthernet1/0/1
interface GigabitEthernet1/0/2
interface GigabitEthernet1/0/3
interface GigabitEthernet1/0/4
interface GigabitEthernet1/0/5
interface GigabitEthernet1/0/6
interface GigabitEthernet1/0/7
interface GigabitEthernet1/0/8
interface GigabitEthernet1/0/9
interface GigabitEthernet1/0/10
interface GigabitEthernet1/0/11
interface GigabitEthernet1/0/12
interface GigabitEthernet1/0/13
interface GigabitEthernet1/0/14
interface GigabitEthernet1/0/15
interface GigabitEthernet1/0/16
interface GigabitEthernet1/0/17
interface GigabitEthernet1/0/18
interface GigabitEthernet1/0/19
interface GigabitEthernet1/0/20
interface GigabitEthernet1/0/21
interface GigabitEthernet1/0/22
interface GigabitEthernet1/0/23
interface GigabitEthernet1/0/24
interface GigabitEthernet1/0/25

  description "MLAG-Peer-Link"
  switchport trunk encapsulation dot1q
  switchport mode trunk
  channel-group 1 mode active

interface GigabitEthernet1/0/26
  description "MLAG-Peer-Link"
  switchport trunk encapsulation dot1q
  switchport mode trunk
  channel-group 1 mode active

interface GigabitEthernet1/0/27
interface GigabitEthernet1/0/28
interface Vlan1
  no ip address
```

```
ip classless
ip http server
ip http secure-server

control-plane

line con 0
line vty 5 15

end
```

## Status Reporting

The following shows the status of various components of the switches in the above configuration. The switch prompts identify the switch on which the status is shown. To obtain accurate status, the commands below are run on the primary MLAG switch unless noted otherwise.

### Spanning Tree Status

```
Old-Iron-3750#show spanning-tree
```

```
MST0
```

```
Spanning tree enabled protocol mstp
Root ID    Priority    32768
           Address    0013.c4bd.f080
           This bridge is the root
           Hello Time 2 sec Max Age 20 sec Forward Delay 15 sec
```

```
Bridge ID  Priority    32768 (priority 32768 sys-id-ext 0)
           Address    0013.c4bd.f080
           Hello Time 2 sec Max Age 20 sec Forward Delay 15 sec
```

Interface	Role	Sts	Cost	Prio.Nbr	Type
-----	-----	-----	-----	-----	-----
Pol	Desg	FWD	10000	128.488	P2p Bound(STP)

```
MST1
```

```
Spanning tree enabled protocol mstp
Root ID    Priority    32769
           Address    0013.c4bd.f080
           This bridge is the root
           Hello Time 2 sec Max Age 20 sec Forward Delay 15 sec
```

```
Bridge ID  Priority    32769 (priority 32768 sys-id-ext 1)
           Address    0013.c4bd.f080
           Hello Time 2 sec Max Age 20 sec Forward Delay 15 sec
```

Interface	Role	Sts	Cost	Prio.Nbr	Type
-----	-----	-----	-----	-----	-----
Pol	Desg	FWD	10000	128.488	P2p Bound(STP)



LAG-SW#show spanning-tree

Spanning tree Enabled BPDU flooding Disabled Portfast BPDU filtering Disabled mode mst  
CST Regional Root: 80:00:00:1E:C9:DE:B7:77  
Regional Root Path Cost: 0

##### MST 0 Vlan Mapped: 1  
ROOT ID

Priority 32768  
Address 0013.C4BD.F080  
Path Cost 5000  
Root Port Po1  
Hello Time 2 Sec Max Age 20 sec Forward Delay 15 sec  
Bridge Max Hops 20

Bridge ID

Priority 32768  
Address 001E.C9DE.B777  
Hello Time 2 Sec Max Age 20 sec Forward Delay 15 sec

TxHoldCount 6 sec

Name	State	Prio.Nbr	Cost	Sts	Role	RestrictedPort
Gi1/0/1	Enabled	128.1	0	DIS	Disb	No
Gi1/0/2	Enabled	128.2	0	DIS	Disb	No
Gi1/0/3	Enabled	128.3	0	DIS	Disb	No
Gi1/0/4	Enabled	128.4	0	DIS	Disb	No
Gi1/0/5	Enabled	128.5	0	DIS	Disb	No
Gi1/0/6	Enabled	128.6	0	DIS	Disb	No
Gi1/0/7	Enabled	128.7	0	DIS	Disb	No
Gi1/0/8	Enabled	128.8	0	DIS	Disb	No
Gi1/0/9	Enabled	128.9	0	DIS	Disb	No
Gi1/0/10	Enabled	128.10	0	DIS	Disb	No
Gi1/0/11	Enabled	128.11	0	DIS	Disb	No
Gi1/0/12	Enabled	128.12	0	DIS	Disb	No
Gi1/0/13	Enabled	128.13	0	DIS	Disb	No
Gi1/0/14	Enabled	128.14	0	DIS	Disb	No
Gi1/0/15	Enabled	128.15	0	DIS	Disb	No
Gi1/0/16	Enabled	128.16	0	DIS	Disb	No
Gi1/0/17	Enabled	128.17	0	DIS	Disb	No
Gi1/0/18	Enabled	128.18	0	DIS	Disb	No
Gi1/0/19	Enabled	128.19	0	DIS	Disb	No
Gi1/0/20	Enabled	128.20	0	DIS	Disb	No
Gi1/0/21	Enabled	128.21	0	DIS	Disb	No
Gi1/0/22	Enabled	128.22	0	DIS	Disb	No
Gi1/0/23	Enabled	128.23	0	DIS	Disb	No

Gil/0/24	Enabled	128.24	0	DIS	Disb	No
Gil/0/25	Enabled	128.25	0	DIS	Disb	No
Gil/0/26	Enabled	128.26	0	DIS	Disb	No
Gil/0/27	Enabled	128.27	0	DIS	Disb	No
Gil/0/28	Enabled	128.28	0	DIS	Disb	No
Gil/0/29	Enabled	128.29	0	DIS	Disb	No
Gil/0/30	Enabled	128.30	0	DIS	Disb	No
Gil/0/31	Enabled	128.31	0	DIS	Disb	No
Gil/0/32	Enabled	128.32	0	DIS	Disb	No
Gil/0/33	Enabled	128.33	0	DIS	Disb	No
Gil/0/34	Enabled	128.34	0	DIS	Disb	No
Gil/0/35	Enabled	128.35	0	DIS	Disb	No
Gil/0/36	Enabled	128.36	0	DIS	Disb	No
Gil/0/37	Enabled	128.37	0	DIS	Disb	No
Gil/0/38	Enabled	128.38	0	DIS	Disb	No
Gil/0/39	Enabled	128.39	0	DIS	Disb	No
Gil/0/40	Enabled	128.40	0	DIS	Disb	No
Gil/0/41	Enabled	128.41	0	DIS	Disb	No
Gil/0/42	Enabled	128.42	0	DIS	Disb	No
Gil/0/43	Enabled	128.43	0	DIS	Disb	No
Gil/0/44	Enabled	128.44	0	DIS	Disb	No
Gil/0/45	Enabled	128.45	0	DIS	Disb	No
Gil/0/46	Enabled	128.46	0	DIS	Disb	No
Gil/0/47	Enabled	128.47	0	DIS	Disb	No
Gil/0/48	Enabled	128.48	0	DIS	Disb	No
Tel/0/1	Enabled	128.49	0	DIS	Disb	No
Tel/0/2	Enabled	128.50	0	DIS	Disb	No
Twl/0/1	Enabled	128.51	0	DIS	Disb	No
Twl/0/2	Enabled	128.52	0	DIS	Disb	No
Po1	Enabled	96.650	5000	FWD	Root	No
Po2	Enabled	96.651	0	DIS	Disb	No
Po3	Enabled	96.652	0	DIS	Disb	No
Po4	Enabled	96.653	0	DIS	Disb	No
Po5	Enabled	96.654	0	DIS	Disb	No
Po6	Enabled	96.655	0	DIS	Disb	No
Po7	Enabled	96.656	0	DIS	Disb	No
Po8	Enabled	96.657	0	DIS	Disb	No
Po9	Enabled	96.658	0	DIS	Disb	No
Po10	Enabled	96.659	0	DIS	Disb	No
Po11	Enabled	96.660	0	DIS	Disb	No
Po12	Enabled	96.661	0	DIS	Disb	No
Po13	Enabled	96.662	0	DIS	Disb	No
Po14	Enabled	96.663	0	DIS	Disb	No
Po15	Enabled	96.664	0	DIS	Disb	No
Po16	Enabled	96.665	0	DIS	Disb	No
Po17	Enabled	96.666	0	DIS	Disb	No

Po18	Enabled	96.667	0	DIS	Disb	No
Po19	Enabled	96.668	0	DIS	Disb	No
Po20	Enabled	96.669	0	DIS	Disb	No
Po21	Enabled	96.670	0	DIS	Disb	No
Po22	Enabled	96.671	0	DIS	Disb	No
Po23	Enabled	96.672	0	DIS	Disb	No
Po24	Enabled	96.673	0	DIS	Disb	No
Po25	Enabled	96.674	0	DIS	Disb	No
Po26	Enabled	96.675	0	DIS	Disb	No
Po27	Enabled	96.676	0	DIS	Disb	No
Po28	Enabled	96.677	0	DIS	Disb	No
Po29	Enabled	96.678	0	DIS	Disb	No
Po30	Enabled	96.679	0	DIS	Disb	No
Po31	Enabled	96.680	0	DIS	Disb	No
Po32	Enabled	96.681	0	DIS	Disb	No
Po33	Enabled	96.682	0	DIS	Disb	No
Po34	Enabled	96.683	0	DIS	Disb	No
Po35	Enabled	96.684	0	DIS	Disb	No
Po36	Enabled	96.685	0	DIS	Disb	No
Po37	Enabled	96.686	0	DIS	Disb	No
Po38	Enabled	96.687	0	DIS	Disb	No
Po39	Enabled	96.688	0	DIS	Disb	No
Po40	Enabled	96.689	0	DIS	Disb	No
Po41	Enabled	96.690	0	DIS	Disb	No
Po42	Enabled	96.691	0	DIS	Disb	No
Po43	Enabled	96.692	0	DIS	Disb	No

**MLAG-Peer-A#show spanning-tree**

Spanning tree Enabled BPDU flooding Disabled Portfast BPDU filtering Disabled mode mst

CST Regional Root: 80:00:00:13:C4:BD:F0:80

Regional Root Path Cost: 200

##### MST 0 Vlan Mapped: 1, 100

ROOT ID

Priority	32768
Address	0013.C4BD.F080
Path Cost	0
Root Port	Po3
Hello Time 2 Sec Max Age 20 sec Forward Delay 15 sec	
Bridge Max Hops 20	

Bridge ID

Priority	32768
Address	001E.C9DE.C52B

Hello Time 2 Sec Max Age 20 sec Forward Delay 15 sec  
 TxHoldCount 6 sec

Name	State	Prio.Nbr	Cost	Sts	Role	RestrictedPort
Gil/0/1	Enabled	128.1	0	DIS	Disb	No
Gil/0/2	Enabled	128.2	0	DIS	Disb	No
Gil/0/3	Enabled	128.3	0	DIS	Disb	No
Gil/0/4	Enabled	128.4	0	DIS	Disb	No
Gil/0/5	Enabled	128.5	0	DIS	Disb	No
Gil/0/6	Enabled	128.6	0	DIS	Disb	No
Gil/0/7	Enabled	128.7	0	DIS	Disb	No
Gil/0/8	Enabled	128.8	20000	FWD	Desg	No
Gil/0/9	Enabled	128.9	0	DIS	Disb	No
Gil/0/10	Enabled	128.10	0	DIS	Disb	No
Gil/0/11	Enabled	128.11	0	DIS	Disb	No
Gil/0/12	Enabled	128.12	0	DIS	Disb	No
Gil/0/13	Enabled	128.13	0	DIS	Disb	No
Gil/0/14	Enabled	128.14	0	DIS	Disb	No
Gil/0/15	Enabled	128.15	0	DIS	Disb	No
Gil/0/16	Enabled	128.16	0	DIS	Disb	No
Gil/0/17	Enabled	128.17	0	DIS	Disb	No
Gil/0/18	Enabled	128.18	0	DIS	Disb	No
Gil/0/19	Enabled	128.19	0	DIS	Disb	No
Gil/0/20	Enabled	128.20	0	DIS	Disb	No
Gil/0/21	Enabled	128.21	0	DIS	Disb	No
Gil/0/22	Enabled	128.22	0	DIS	Disb	No
Gil/0/23	Enabled	128.23	0	DIS	Disb	No
Gil/0/24	Enabled	128.24	0	DIS	Disb	No
Tel/0/1	Enabled	128.25	0	DIS	Disb	No
Tel/0/2	Enabled	128.26	0	DIS	Disb	No
Tw1/0/1	Enabled	128.27	0	DIS	Disb	No
Tw1/0/2	Enabled	128.28	0	DIS	Disb	No
Po1	Disabled	96.650	0	FWD	Disb	No
Po2	Enabled	96.651	5000	FWD	Desg	No
Po3	Enabled	96.652	200	FWD	Root	No
Po4	Enabled	96.653	0	DIS	Disb	No

## **MLAG Status**

MLAG-Peer-A#show vpc brief

VPC config Mode..... Enabled  
Keepalive config mode..... Enabled  
VPC operational Mode..... Enabled  
Self Role..... Primary  
Peer Role..... Secondary  
Peer detection..... Peer detected, VPC  
Operational

Peer-Link details

-----

Interface..... Po1  
Peer link status..... UP  
Peer-link STP Mode..... Enabled  
Configured Vlans.....  
1,10,11,12,13,14,15,16,17  
Egress tagging.....  
10,11,12,13,14,15,16,17

VPC Details

-----

Number of VPCs configured..... 2  
Number of VPCs operational..... 2

VPC id# 1

-----

Interface..... Po2  
Configured Vlans.....  
1,10,11,12,13,14,15,16,17  
VPC Interface State..... Active

Local MemberPorts	Status
-----	-----
Gi1/0/23	UP
Gi1/0/24	UP

Peer MemberPorts	Status
-----	-----
Gi1/0/23	UP
Gi1/0/24	UP

```
VPC id# 2
-----
Interface..... Po3
Configured Vlans.....
1,10,11,12,13,14,15,16,17
VPC Interface State..... Active
```

MLAG-Peer-A#**show vpc 1**

```
VPC id# 1
-----
Config mode..... Enabled
Operational mode..... Enabled
Port channel..... Po2
```

Local MemberPorts	Status
-----	-----
Gil/0/23	UP
Gil/0/24	UP

Peer MemberPorts	Status
-----	-----
Gil/0/23	UP
Gil/0/24	UP

MLAG-Peer-A#**show vpc 2**

```
VPC id# 2
-----
Config mode..... Enabled
Operational mode..... Enabled
Port channel..... Po3
```

Local MemberPorts	Status
-----	-----
Gil/0/1	UP

Peer MemberPorts	Status
-----	-----
Gil/0/1	UP

**MLAG-Peer-A#show vpc peer-keepalive**

```
Peer IP address..... 192.168.0.2
Source IP address..... 192.168.0.1
UDP port..... 50000
Peer detection..... Enabled
Peer detection operational status..... Up
Peer is detected..... TRUE
```

**MLAG-Peer-A#show vpc statistics peer-keepalive**

```
Total transmitted..... 20908
Tx successful..... 20908
Tx errors..... 0
Total received..... 20835
Rx successful..... 20835
Rx Errors..... 0
Timeout counter..... 1
```

**MLAG-Peer-A#show vpc statistics peer-link**

```
Peer link control messages transmitted..... 75
Peer link control messages Tx errors..... 0
Peer link control messages Tx timeout..... 0
Peer link control messages ACK transmitted..... 119
Peer link control messages ACK Tx errors..... 0
Peer link control messages received..... 119
Peer link data messages transmitted..... 1294
Peer link data messages Tx errors..... 0
Peer link data messages Tx timeout..... 0
Peer link data messages received..... 1886
Peer link BPDU's transmitted to peer..... 11
Peer link BPDU's Tx errors..... 0
Peer link BPDU's received from peer..... 751
Peer link BPDU's Rx errors..... 0
Peer link LACPDU's transmitted to peer..... 1283
Peer link LACPDU's Tx errors..... 0
Peer link LACPDU's received from peer..... 1135
Peer link LACPDU's Rx errors..... 0
```





# MAC Addressing and Forwarding

## Dell EMC Networking N-Series Switches

Dell EMC Networking N-Series switches implement a MAC Learning Bridge in compliance with IEEE 802.1Q. The N-Series switches implement independent VLAN learning (IVL). Dynamically learned MAC addresses are used to filter the set of ports on which a frame is forwarded within a VLAN; that is, the destination MAC address and ingress VLAN for a frame entering the switch are looked up in the MAC address table and if a match is found, the frame is forwarded out the matching port(s). If no match is found, the frame is flooded out all ports in the VLAN except for the ingress port.

This chapter describes the Layer-2 MAC address table the switch uses to forward L2 frames between ports.

The topics covered in this chapter include:

- MAC Address Table Overview
- Default MAC Address Table Values
- Managing the MAC Address Table (Web)
- Managing the MAC Address Table (CLI)

## MAC Address Table Overview

The MAC address table keeps track of the MAC addresses that are associated with each port to allow the switch to forward unicast traffic through the appropriate port. This table is sometimes called the bridge table or the forwarding database.

### How Is the Address Table Populated?

The MAC address table can contain two types of addresses:

- **Static:** The address has been manually configured and does not age out.
- **Dynamic:** The address has been automatically learned by the switch and will age out if no frames with the learned MAC address (and VLAN) have been forwarded by the switch during the aging time interval.

Static addresses are configured by the administrator and added to the table. Dynamic addresses are learned by examining information in the Ethernet frame.

When a frame arrives on a port, the switch looks at the frame header to learn the source MAC address of the frame, then adds the address, VLAN ID, and the ingress port to the MAC address table. The address table is constantly updated as new addresses are learned, and unused addresses age out.

A frame that has a destination MAC address that matches an entry in the table is forwarded immediately to the associated port(s) within the same VLAN.

### **What Information Is in the MAC Address Table?**

Each entry in the address table, whether it is static or dynamic, includes the MAC address, the VLAN ID associated with the MAC address, and the interface on which the address was learned or configured.

Each port can maintain multiple MAC addresses, and a single MAC address can be associated with multiple VLANs.

### **How Is the MAC Address Table Maintained Across a Stack?**

The MAC address table is synchronized across all stack members. When a member joins the stack, its previous MAC address table is overwritten by the table maintained by the stack.


## **Default MAC Address Table Values**

Table 29-1 summarizes the default values for the MAC address table.

**Table 29-1. MAC Address Table Defaults**

<b>Parameter</b>	<b>Default Value</b>
Aging time	300 seconds
Dynamic addresses	Enabled (automatically learned)
Static addresses	None configured

# Managing the MAC Address Table (Web)

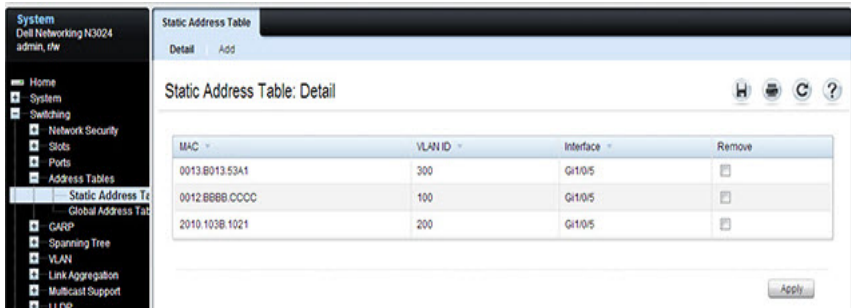
This section provides information about the OpenManage Switch Administrator pages to use to manage the MAC address table on Dell EMC Networking N-Series switches. For details about the fields on a page, click  at the top of the Dell EMC OpenManage Switch Administrator web page.

## Static Address Table

Use the **Static Address Table** page to view MAC addresses that have been manually added to the MAC address table and to configure static MAC addresses.

To display the **Static Address Table** page, click **Switching** → **Address Tables** → **Static Address Table** in the navigation panel.

**Figure 29-1. Static Address Table**



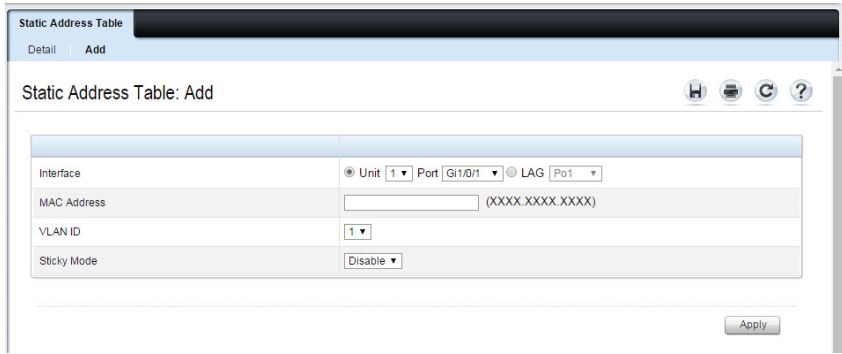
## Adding a Static MAC Address

To add a static MAC address:

- 1 Open the **Static MAC Address** page.
- 2 Click **Add**.

The **Add Static MAC Address** page displays.

**Figure 29-2. Adding Static MAC Address**



- 3 Select the interface to associate with the static address.
- 4 Specify the MAC address and an associated VLAN ID.
- 5 Click **Apply**.

The new static address is added to the **Static MAC Address Table**, and the device is updated.

## Global Address Table

The **Global Address Table** page contains fields for querying information in the MAC address table, including the interface type, MAC addresses, VLAN, and table sorting key. Packets forwarded to an address stored in the address table are forwarded directly to those ports.

The **Global Address Table** also contains information about the type of MAC address, i.e. Static, Learned, or Other.

To display the **Global Address Table**, click **Switching** → **Address Tables** → **Global Address Table** in the navigation panel.

**Figure 29-3. Global Address Table**

The screenshot shows the 'Global Address Table: Detail' configuration page. The left sidebar contains a navigation menu with the following items: Home, System, Switching, Network Security, Slots, Ports, Address Tables, Static Address Table, Global Address Table (selected), GARP, Spanning Tree, VLAN, Link Aggregation, Multicast Support, LLDP, Dynamic ARP Inspector, DHCP Snooping, DHCP Relay, IP Source Guard, Link Dependency, VPC, Routing, Statistics/RMON, Quality of Service, IPv4 Multicast, and IPv6 Multicast.

The main content area is titled 'Global Address Table: Detail' and includes the following sections:

- Dynamic Table Settings:** Contains instructions to change settings and click 'Apply'. It features an 'Address Aging' field set to '300' (with a range of 10 - 1000000 seconds) and a 'Clear Table' checkbox.
- Query Selection:** Contains instructions to change query selection and click 'Query'. It includes a 'Query By' section with checkboxes for 'Interface', 'MAC Address', and 'VLAN ID'. The 'Interface' section has radio buttons for 'Unit' (selected) and 'LAG', with dropdown menus for 'Gi1/0/1' and 'Po1'. The 'MAC Address' field contains '0000.0000.0000'. The 'VLAN ID' field contains '(1-4093)'.
- Current Address Table:** Contains instructions to change the table and click 'Back to top'. It displays a table with columns for 'VLAN ID', 'MAC Address', 'Type', and 'Interface'. The table shows four entries: VLAN 1 (MAC 001E.C9DE.B122, Type Other, Interface V11), VLAN 100 (MAC 0012.BBBB.CCCC, Type Static, Interface Gi1/0/5), VLAN 200 (MAC 2010.103B.1021, Type Static, Interface Gi1/0/5), and VLAN 300 (MAC 0013.B013.53A1, Type Static, Interface Gi1/0/5). Below the table is a pagination control showing 'Items Displayed 1-4' and 'Rows Per Page 5', with 'Pages 1 of 1'.

# Managing the MAC Address Table (CLI)

This section provides information about the commands you use to manage the MAC address table on the switch. For more information about the commands, see the *Dell EMC Networking N1100-ON, N1500, N2000, N2100-ON, N2200-ON, N3000E-ON, N3100-ON, and N3200-ON Series Switches CLI Reference Guide* at [www.dell.com/support](http://www.dell.com/support).

## Managing the MAC Address Table

Use the following commands to add a static MAC address to the table, control the aging time for dynamic addresses, and view entries in the MAC address table.

Command	Purpose
<code>configure</code>	Enter global configuration mode.
<code>mac address-table static mac-address vlan vlan-id interface interface</code>	Add a static MAC source address to the MAC address table. <ul style="list-style-type: none"><li>• <i>mac-address</i> — A valid MAC address</li><li>• <i>vlan-id</i> — A valid VLAN.</li><li>• <i>interface</i> — A valid port or LAG, including the interface type and number.</li></ul>
<code>mac address-table aging-time {0   10-1000000}</code>	Specify the number of seconds that must pass before an unused dynamically-learned MAC address is removed from the MAC address table. A value of 0 disables the aging time for the MAC address table.
<code>exit</code>	Exit to Privileged Exec mode.
<code>show mac address-table [static   dynamic]</code>	View information about the entries in the MAC address table. Use the keywords <b>static</b> or <b>dynamic</b> to specify the address type to view.  For dynamic entries, the <b>clear mac address-table</b> command can be used to remove entries from the table.

<b>Command</b>	<b>Purpose</b>
<code>show mac address-table</code> { <code>vlan <i>vlan</i></code>   <code>interface</code> <code>interface</code> [ <code>vlan <i>vlan-id</i></code> ]}	View information about the MAC addresses that have been configured or learned on the switch, a specific VLAN, or an interface (Ethernet port or LAG/port-channel).
<code>show mac address-table</code> <code>count</code> [{ <code>vlan <i>vlan-id</i></code>   <code>interface <i>interface</i></code> }]	View information about the number of addresses that have been configured or learned on the switch, a specific VLAN, or an interface (Ethernet port or LAG/port-channel).

## MAC Notification

When enabled, the MAC notification feature notifies one or more MAC address records that are either learned or aged out. Each record carries information about the MAC address, VLAN, port, and whether it is learned or aged out. To prevent frequent notifications, administrators can configure the interval, and a notification with one or more records is sent only after an interval time elapses from the previous notification. If there are no records to be notified, an empty notification is not sent.

For the administrator's ease to look up the last few notifications sent out, the records are also copied into the history table and a CLI command will display the records from the history table. In addition to the record information, a timestamp of when the notification is sent out is also displayed.

A station move or MAC move is considered to be a MAC address removed on one port and added on another port. The move thus contributes to two records.

Configuration allows the following:

- Admin enable and disable of the feature globally.
- Trap enable and disable. When disabled records are added to the history table, but notifications are not sent out.
- Interval between notifications.
- History size.

For more information, refer to the MAC Notification commands in the *Dell EMC Networking N1100-ON, N1500, N2000, N2100-ON, N2200-ON, N3000E-ON, N3100-ON, and N3200-ON Series Switches CLI Reference Guide*.



# DHCP Server Settings

## Dell EMC Networking N2000, N2100-ON, N2200-ON, N3000E-ON, and N3100-ON Series Switches

This chapter describes how to configure the switch to dynamically assign network information to hosts by using the Dynamic Host Configuration Protocol (DHCP).



**NOTE:** The DHCP server is not available on the Dell EMC Networking N1500 Series switch.

The topics covered in this chapter include:

- DHCP Overview
- Default DHCP Server Values
- Default DHCP Server Values
- Configuring the DHCP Server (Web)
- Configuring the DHCP Server (CLI)
- DHCP Server Configuration Examples

## DHCP Overview

DHCP is generally used between clients and servers for the purpose of assigning IP addresses, gateways, and other network settings such as DNS and SNTP server information.

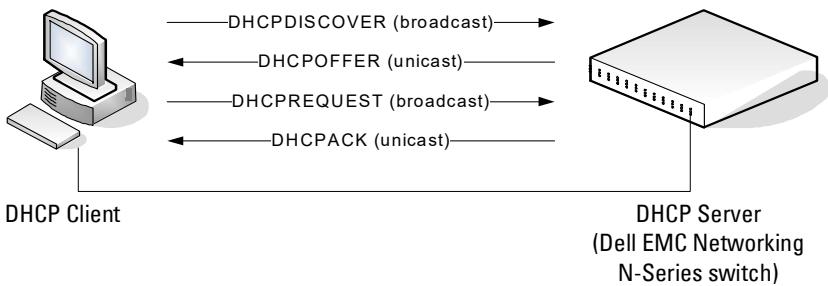
DHCP Snooping is a security feature that monitors DHCP messages between a DHCP client and DHCP server. It filters harmful DHCP messages and builds a bindings database of (MAC address, IP address, VLAN ID, port) tuples that are specified as authorized. DHCP snooping can be enabled globally and on specific VLANs. For information about DHCP Snooping, see "Snooping and Inspecting Traffic" on page 1053.

Dell EMC Networking N-Series switches support a DHCP client for obtaining the switch address from the network, an IPv4 DHCP server for serving IPv4 addresses to DHCP clients in the network, Layer-2 and Layer-3 DHCP relay for relaying IPv4 address assignments from network-based DHCP servers to clients in the same or different subnets, and DHCP snooping for protecting the switch and DHCP clients from certain security risks.

### How Does DHCP Work?

When a host connects to the network, the host's DHCP client broadcasts a message requesting information from any DHCP server that receives the broadcast. One or more DHCP servers respond to the request. The response includes the requested information, such as the IP address, subnet mask, and default gateway IP address. The client accepts an offer from one of the servers, and the server sends an acknowledgment to the client to confirm the transaction.

**Figure 30-1. Message Exchange Between DHCP Client and Server**



The DHCP server maintains one or more set of IP addresses the and other configuration information available, by request, to DHCP clients. Each set of information is known as an address pool.

After a client leases an IP address from the DHCP server, the server adds an entry to its database. The entry is called a binding.

## What are DHCP Options?

DHCP options are collections of data with type codes that indicate how the options should be used. Options can specify information that is required for the DHCP protocol, IP stack configuration parameters for the client, information allowing the client to rendezvous with DHCP servers, and so on.

When a client broadcasts a request for information, the request includes the option codes that correspond to the information the client wants the DHCP server to supply. The Web pages and CLI commands to configure DHCP server settings include many predefined options for the information that is most commonly requested by DHCP clients. For example, DHCP client discover requests typically include options for the IP address (option 50), subnet mask (option 1), default gateway (option 3), and DNS server (option 6). These options are predefined.

For options that are not predefined, the option code can be entered and the data type can be specified, along with the data that the switch should include in DHCP offers. RFC2132 specifies many of the DHCP options. Additional options are described in later RFCs.

## What Additional DHCP Features Does the Switch Support?

The switch software includes a DHCP client that can request network information from a DHCP server on the network during the initial system configuration process. For information about enabling the DHCP client, see "Setting the IP Address and Other Basic Network Information" on page 227.

If the switch is functioning as a Layer-3 device, the Layer-3 DHCP Relay Agent (IP Helper) can relay DHCP messages between DHCP clients and DHCP servers that are located in different IP subnets.

The DHCP L2 relay feature permits L3 relay agent functionality in Layer-2 switched networks. The switch supports L2 DHCP relay configuration on individual ports, link aggregation groups (LAGs) and VLANs. For information about Layer-2 and Layer-3 DHCP Relay, see "Layer-2 and Layer-3 Relay Features" on page 1235.

Additionally, the switch may be configured to perform DHCP validation as protection against spoofed DHCP Release messages. For further information, see Section 33, "Layer-2 and Layer-3 Relay Features" on page 1235


## Default DHCP Server Values

By default, the DHCP server is disabled, and no address pools are configured. You must create at least one address pool and enable the DHCP server to allow the switch to dynamically assign network information to hosts with DHCP clients that broadcast requests.

The DHCP server can lease a maximum of 256 addresses.

The Dell EMC Networking DHCP server does not offer infinite leases. The maximum lease time offered is 60 days, which corresponds to an infinite setting in the UI.

# Configuring the DHCP Server (Web)

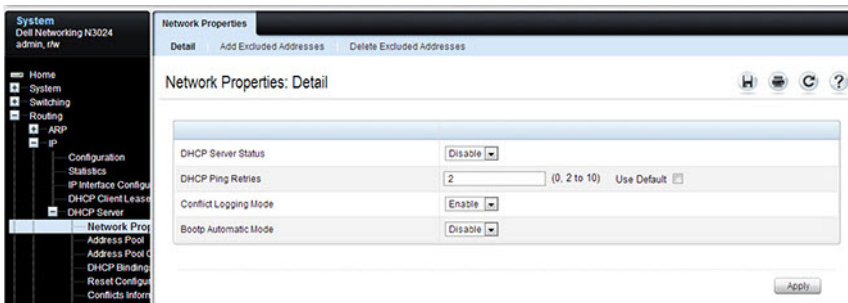
This section provides information about the OpenManage Switch Administrator pages for configuring and monitoring the DHCP server on a Dell EMC Networking N-Series switch. For details about the fields on a page, click  at the top of the Dell EMC OpenManage Switch Administrator web page.

## DHCP Server Network Properties

Use the **Network Properties** page to define global DHCP server settings and to configure addresses that are not included in any address pools.

To display the **Network Properties** page, click **Routing** → **IP** → **DHCP Server** → **Network Properties** in the navigation panel.

**Figure 30-2. DHCP Server Network Properties**



## Adding Excluded Addresses

To exclude an address:

- 1 Open the **Network Properties** page.
- 2 Click **Add Excluded Addresses** to display the **Add Excluded Addresses** page.
- 3 In the **From** field, enter the first IP address to exclude from any configured address pool.
- 4 If the address in the **From** field is the only address to exclude, or if the excluded addresses are non-contiguous, leave the **To** field as the default value of 0.0.0.0. Otherwise, enter the last IP address to excluded from a contiguous range of IP addresses.

In Figure 30-3, the **From** field contains the IP address 192.168.2.1, and the **To** field contains the IP address 192.168.2.5. This means that the following IP addresses are not available for lease:

- 192.168.2.1
- 192.168.2.2
- 192.168.2.3
- 192.168.2.4
- 192.168.2.5

**Figure 30-3. Add Excluded Addresses**

The screenshot shows a web-based interface for configuring network properties. The main title is "Network Properties: Add Excluded Addresses". Below the title, there are three tabs: "Network Properties", "Add Excluded Addresses" (which is selected), and "Delete Excluded Addresses". The interface contains two input fields: "From" with the value "192.168.2.1" and "To" with the value "192.168.2.5". A small text note next to the "To" field explains the format: "(a.b.c.d to Exclude address range or 0.0.0.0 to exclude single address)". At the bottom right, there is an "Apply" button. The interface also includes standard utility icons like Home, Print, Refresh, and Help.

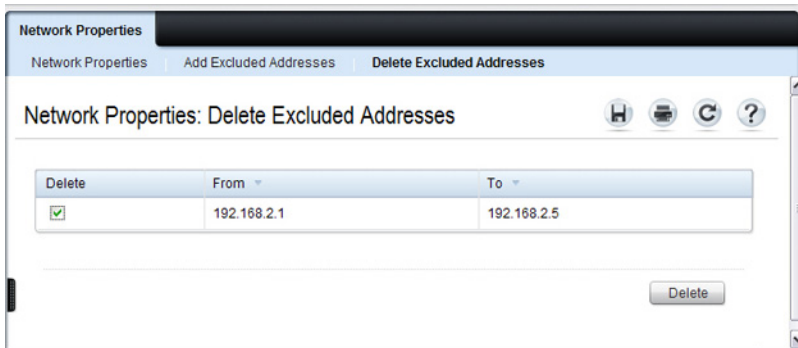
- 5 Click **Apply**.

## Deleting Excluded Addresses

To remove an excluded address:

- 1 Open the **Network Properties** page.
- 2 Click **Delete Excluded Addresses** to display the **Delete Excluded Addresses** page.
- 3 Select the check box next to the address or address range to delete.

**Figure 30-4. Delete Excluded Addresses**



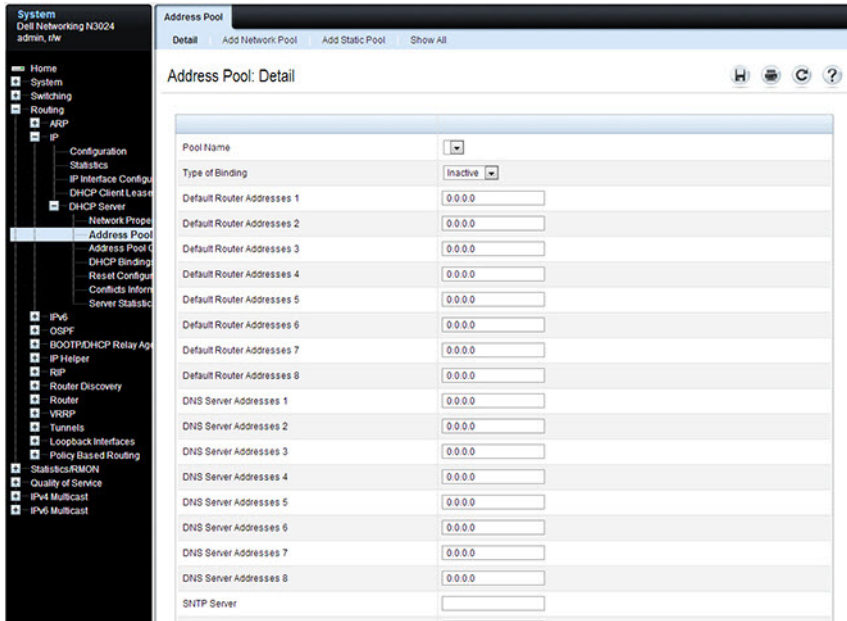
- 4 Click **Apply**.

## Address Pool

Use the **Address Pool** page to create the pools of IP addresses and other network information that can be assigned by the server.

To display the **Address Pool** page, click **Routing** → **IP** → **DHCP Server** → **Address Pool** in the navigation panel.

**Figure 30-5. Address Pool**



### Adding a Network Pool

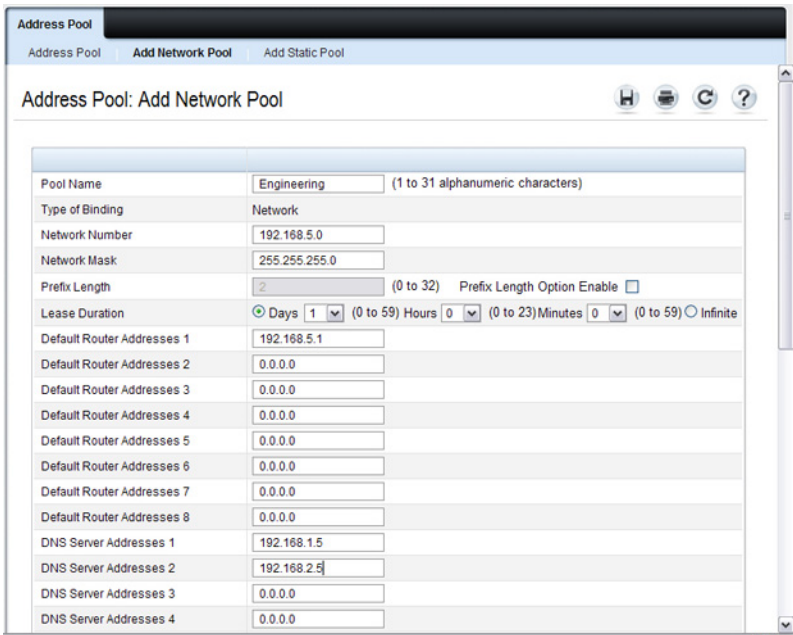
To create and configure a network pool:

- 1 Open the **Address Pool** page.
- 2 Click **Add Network Pool** to display the **Add Network Pool** page.
- 3 Assign a name to the pool and complete the desired fields.

In Figure 30-6, the network pool name is **Engineering**, and the address pool contains all IP addresses in the 192.168.5.0 subnet, which means a client that receives an address from the DHCP server might lease an address in the range of 192.168.5.1 to 192.168.5.254.




**Figure 30-6. Add Network Pool**



Pool Name	Engineering	(1 to 31 alphanumeric characters)
Type of Binding	Network	
Network Number	192.168.5.0	
Network Mask	255.255.255.0	
Prefix Length	2	(0 to 32) Prefix Length Option Enable <input type="checkbox"/>
Lease Duration	Days 1 (0 to 59) Hours 0 (0 to 23) Minutes 0 (0 to 59) Infinite	
Default Router Addresses 1	192.168.5.1	
Default Router Addresses 2	0.0.0.0	
Default Router Addresses 3	0.0.0.0	
Default Router Addresses 4	0.0.0.0	
Default Router Addresses 5	0.0.0.0	
Default Router Addresses 6	0.0.0.0	
Default Router Addresses 7	0.0.0.0	
Default Router Addresses 8	0.0.0.0	
DNS Server Addresses 1	192.168.1.5	
DNS Server Addresses 2	192.168.2.5	
DNS Server Addresses 3	0.0.0.0	
DNS Server Addresses 4	0.0.0.0	

The Engineering pool also configures clients to use 192.168.5.1 as the default gateway IP address and 192.168.1.5 and 192.168.2.5 as the primary and secondary DNS servers.

 **NOTE:** The IP address 192.168.5.1 should be added to the global list of excluded addresses so that it is not leased to a client.

4 Click Apply.

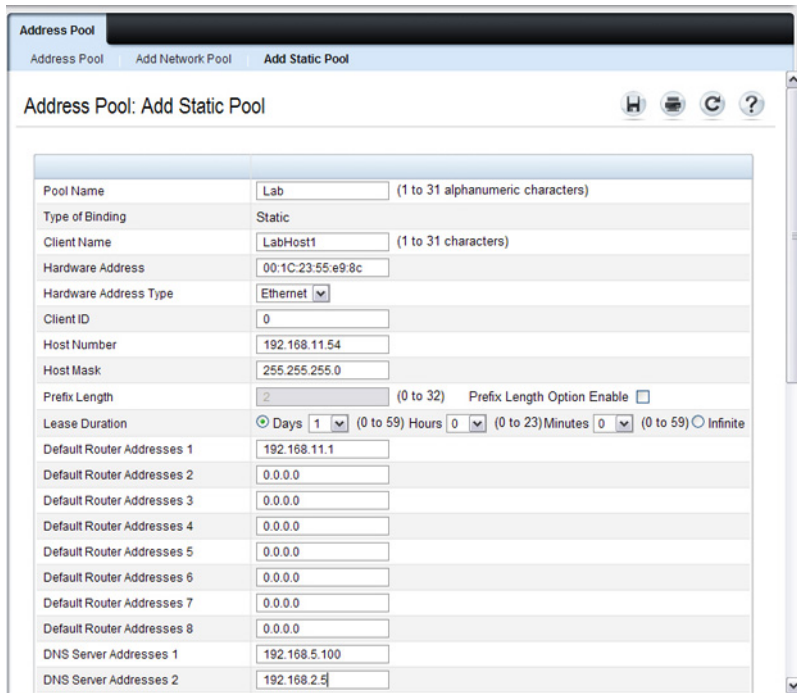
### Adding a Static Pool

To create and configure a static pool of IP addresses:

- 1 Open the Address Pool page.
- 2 Click Add Static Pool to display the Add Static Pool page.
- 3 Assign a name to the pool and complete the desired fields.

In Figure 30-7, the Static pool name is Lab, and the name of the client in the pool is LabHost1. The client's MAC address is mapped to the IP address 192.168.11.54, the default gateway is 192.168.11.1, and the DNS servers the client will use have IP addresses of 192.168.5.100 and 192.168.2.5.

**Figure 30-7. Add Static Pool**



Pool Name	Lab	(1 to 31 alphanumeric characters)
Type of Binding	Static	
Client Name	LabHost1	(1 to 31 characters)
Hardware Address	00:1C:23:55:e9:8c	
Hardware Address Type	Ethernet	
Client ID	0	
Host Number	192.168.11.54	
Host Mask	255.255.255.0	
Prefix Length	2	(0 to 32) Prefix Length Option Enable <input type="checkbox"/>
Lease Duration	Days 1	(0 to 59) Hours 0 (0 to 23) Minutes 0 (0 to 59) <input type="radio"/> Infinite
Default Router Addresses 1	192.168.11.1	
Default Router Addresses 2	0.0.0.0	
Default Router Addresses 3	0.0.0.0	
Default Router Addresses 4	0.0.0.0	
Default Router Addresses 5	0.0.0.0	
Default Router Addresses 6	0.0.0.0	
Default Router Addresses 7	0.0.0.0	
Default Router Addresses 8	0.0.0.0	
DNS Server Addresses 1	192.168.5.100	
DNS Server Addresses 2	192.168.2.5	

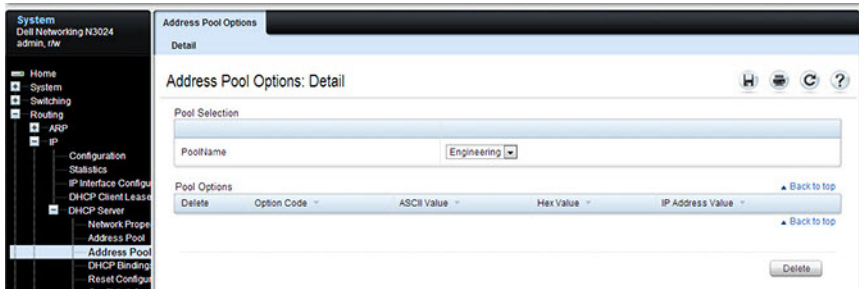
**4** Click Apply.

## Address Pool Options

Use the **Address Pool Options** page to view manually configured options. Options can be defined when an address pool is created or can be added to existing address pools.

To display the **Address Pool Options** page, click **Routing** → **IP** → **DHCP Server** → **Address Pool Options** in the navigation panel.

**Figure 30-8. Address Pool Options**



### Defining DHCP Options

To configure DHCP options:

- 1 Open the **Address Pool** page.
- 2 Select the **Add Options** check box.
- 3 Select the check box that corresponds to the value type (ASCII, Hexadecimal, or IP address).
- 4 Specify the value(s) in the corresponding field.

Figure 30-9 shows an example of adding the SMTP server IP address. The option code for the SMTP server is 69, and the IP address of the SMTP server is 192.168.10.15.

**Figure 30-9. Add DHCP Option**

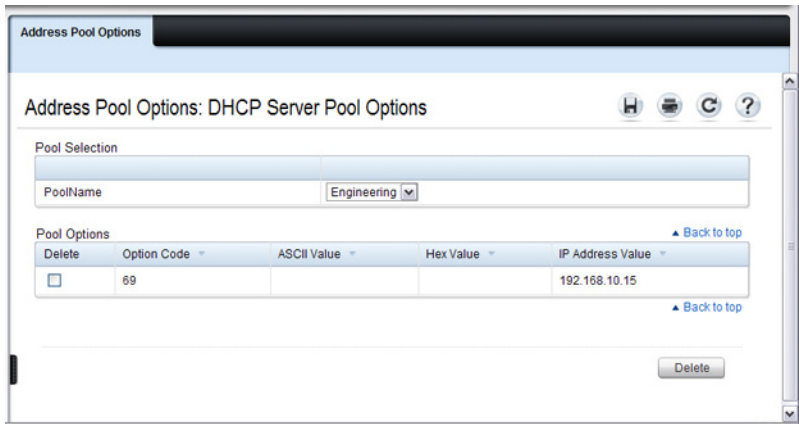
The screenshot shows a web-based configuration interface for an 'Address Pool'. The window has three tabs: 'Address Pool', 'Add Network Pool', and 'Add Static Pool'. The 'Address Pool' tab is active. The form contains the following fields and values:

Field	Value
NetBIOS Name Server Addresses 8	0.0.0.0
NetBIOS Node Type	b-node Broadcast
Next Server Address	0.0.0.0
Domain Name	test.dell.com
Boot File	
Add Option	<input checked="" type="checkbox"/>
Option Code	69
<input type="checkbox"/> ASCII Value	
<input type="checkbox"/> Hex Value	
<input checked="" type="checkbox"/> IP Address Value	
IP Address Value 1	192.168.10.15
IP Address Value 2	0.0.0.0
IP Address Value 3	0.0.0.0
IP Address Value 4	0.0.0.0
IP Address Value 5	0.0.0.0
IP Address Value 6	0.0.0.0
IP Address Value 7	0.0.0.0
IP Address Value 8	0.0.0.0

At the bottom right of the window, there are two buttons: 'Delete' and 'Apply'.

- 5 Click **Apply**.
- 6 To verify that the option has been added to the address pool, open the **Address Pool Options** page.

**Figure 30-10. View Address Pool Options**

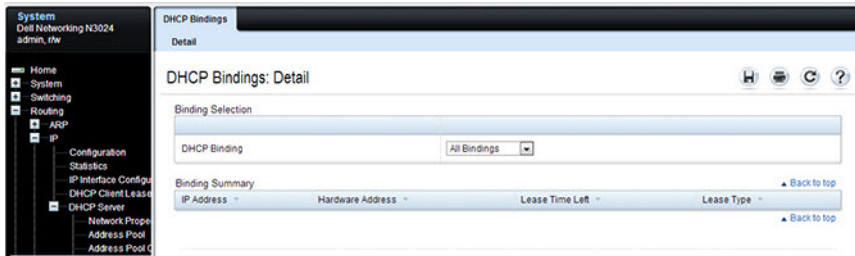


## DHCP Bindings

Use the **DHCP Bindings** page to view information about the clients that have leased IP addresses from the DHCP server.

To display the **DHCP Bindings** page, click **Routing** → **IP** → **DHCP Server** → **DHCP Bindings** in the navigation panel.

**Figure 30-11. DHCP Bindings**

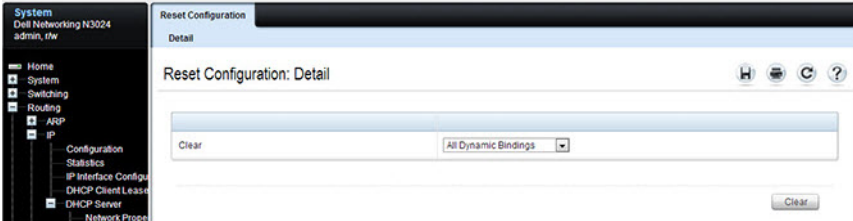


## DHCP Server Reset Configuration

Use the **Reset Configuration** page to clear the client bindings for one or more clients. Bindings can also be reset for clients that have leased an IP address that is already in use on the network.

To display the **Reset Configuration** page, click **Routing** → **IP** → **DHCP Server** → **Reset Configuration** in the navigation panel.

**Figure 30-12. Reset DHCP Bindings**

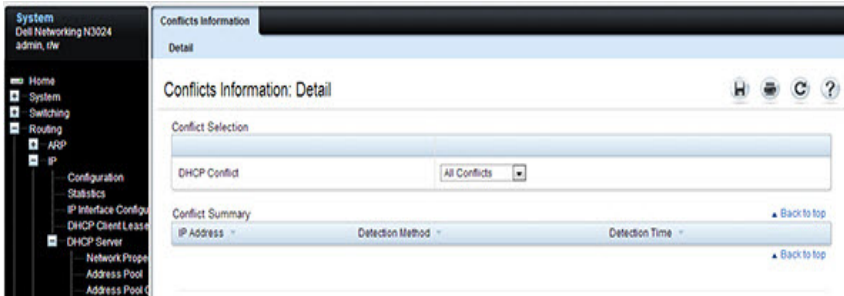


### DHCP Server Conflicts Information

Use the **Conflicts Information** page to view information about clients that have leased an IP address that is already in use on the network.

To display the **Conflicts Information** page, click **Routing** → **IP** → **DHCP Server** → **Conflicts Information** in the navigation panel.

**Figure 30-13. DHCP Server Conflicts Information**



## DHCP Server Statistics

Use the **Server Statistics** page to view general DHCP server statistics, messages received from DHCP clients, and messages sent to DHCP clients.

To display the **Server Statistics** page, click **Routing** → **IP** → **DHCP Server** → **Server Statistics** in the navigation panel.

**Figure 30-14. DHCP Server Statistics**

The screenshot shows the DHCP Server Statistics page in a network management interface. The left navigation pane is expanded to show the path: **System** → **Routing** → **IP** → **DHCP Server** → **Server Statistics**. The main content area is titled "Server Statistics: Detail" and contains three tables:

- General Statistics:**

Automatic Bindings	0
Expired Bindings	0
Malformed Messages	0
- Messages Received:**

DHCPDISCOVER	0
DHCPREQUEST	0
DHCPDECLINE	0
DHCPRELEASE	0
DHCPINFORM	0
- Messages Sent:**

DHCPOFFER	0
DHCPACK	0
DHCPNAK	0

Each table has a "Back to top" link. A "Clear" button is located at the bottom right of the page.

# Configuring the DHCP Server (CLI)

This section provides information about the commands used for configuring and monitoring the DHCP server and address pools. For more information about the commands, see the *Dell EMC Networking N1100-ON, N1500, N2000, N2100-ON, N2200-ON, N3000E-ON, N3100-ON, and N3200-ON Series Switches CLI Reference Guide* at [www.dell.com/support](http://www.dell.com/support).

## Configuring Global DHCP Server Settings

Use the following commands to configure settings for the DHCP server.

Command	Purpose
<code>configure</code>	Enter Global Configuration mode.
<code>service dhcp</code>	Enable the DHCP server.
<code>ip dhcp ping packets</code>	Specify the number, in a range from 2-10, of packets a DHCP server sends to a pool address as part of a ping operation.
<code>ip dhcp conflict logging</code>	Enable conflict logging on DHCP server
<code>ip dhcp bootp automatic</code>	Enable the allocation of the addresses to the BootP client.
<code>ip dhcp excluded-address <i>lowaddress</i> [<i>highaddress</i>]</code>	Specify the IP addresses that a DHCP server should not assign to DHCP clients. A single IP address can be specified, or a contiguous range can be specified by using both the low-address and high-address variables.
<code>exit</code>	Exit to Privileged Exec mode.
<code>show ip dhcp global configuration</code>	Verify the global DHCP server configuration.



## Configuring a Dynamic Address Pool

Use the following commands to create an address pool with network information that is dynamically assigned to hosts with DHCP clients that request the information.

Command	Purpose
<code>configure</code>	Enter Global Configuration mode.
<code>ip dhcp pool name</code>	Create a DHCP address pool and enters DHCP pool configuration mode.
<code>network network-ip [mask   prefixlength]</code>	Configure the subnet number and mask for a DHCP address pool. Clients requesting an IP address can be assigned any non-excluded IP address within this network.
<code>lease {days[hours][minutes]   infinite}</code>	Specify the duration of the lease for an IP address that is assigned from a DHCP server to a DHCP client. <ul style="list-style-type: none"><li>• <i>days</i>— Days the lease is valid (Range 0–59, Default is 1). The hours and minutes can optionally be specified after the days.</li><li>• <i>infinite</i> — 60-day lease. The Dell EMC Networking DHCP server does not offer infinite leases. A setting of infinite corresponds to 60 days.</li></ul>
<code>default-router address1 [address2....address8]</code>	Specify the list of default gateway IP addresses to be assigned to the DHCP client.
<code>dns-server address1 [address2....address8]</code>	Specify the list of DNS server IP addresses to be assigned to the DHCP client.
<code>domain-name domain</code>	Specify the domain name for a DHCP client.
<code>option code {ascii string   hex string1 [string2...string8]   ip address1 [address2...address8]}</code>	Manually configure DHCP options.
<code>CTRL + Z</code>	Exit to Privileged Exec mode.
<code>show ip dhcp pool configuration {name   all}</code>	View the settings for the specified address pool or for all configured address pools.

## Configuring a Static Address Pool

Use the following commands to create a static address pool and specify the network information for the pool. The network information configured in the static address pool is assigned only to the host with the hardware address or client identifier that matches the information configured in the static pool.

Command	Purpose
<code>configure</code>	Enter Global Configuration mode.
<code>ip dhcp pool <i>name</i></code>	Create a DHCP address pool and enters DHCP pool configuration mode.
<code>client-name <i>name</i></code>	Specify the DHCP client name.
<code>hardware-address <i>mac</i> [<i>type</i>]</code>	Specify the hardware address of the client in the static pool. <ul style="list-style-type: none"><li>• <i>mac</i>—MAC address of the hardware platform of the client.</li><li>• <i>type</i> — Indicates the protocol of the hardware platform. It is 1 for Ethernet and 6 for IEEE 802.</li></ul>
<code>client-identifier <i>uniqueidentifier</i></code>	Specify the unique identifier for a DHCP client. The unique-identifier is a valid notation in hexadecimal format.  In some systems, such as Microsoft DHCP clients, the client identifier is required instead of hardware addresses. The unique-identifier is a concatenation of the media type and the MAC address. For example, the Microsoft client identifier for Ethernet address c819.2488.f177 is 01c8.1924.88f1.77 where 01 represents the Ethernet media type.
<code>host <i>address</i> [<i>mask</i>   <i>prefix-length</i>]</code>	Specify the IP address and (optionally) network mask for a manual binding to a DHCP client.

<b>Command</b>	<b>Purpose</b>
<code>lease</code> { <i>days</i> [ <i>hours</i> ][ <i>minutes</i> ]   <i>infinite</i> }	Specify the duration of the lease for an IP address that is assigned from a DHCP server to a DHCP client. <ul style="list-style-type: none"> <li>• <i>days</i>— Days the lease is valid (Range 0–59, Default is 1). The hours and minutes can optionally be specified after the days.</li> <li>• <i>infinite</i> — 60 day lease. The Dell EMC Networking DHCP server does not offer infinite leases. A setting of infinite corresponds to 60 days.</li> </ul>
<code>default-router</code> <i>address1</i> [ <i>address2</i> .... <i>address8</i> ]	Specify the list of default gateway IP addresses to be assigned to the DHCP client.
<code>dns-server</code> <i>address1</i> [ <i>address2</i> .... <i>address8</i> ]	Specify the list of DNS server IP addresses to be assigned to the DHCP client.
<code>domain-name</code> <i>domain</i>	Specify the domain name for a DHCP client.
<code>option</code> <i>code</i> { <i>ascii string</i>   <i>hex string1</i> [ <i>string2</i> .... <i>string8</i> ]   <i>ip</i> <i>address1</i> [ <i>address2</i> .... <i>address8</i> ]}	Manually configure DHCP options.
CTRL + Z	Exit to Privileged Exec mode.
<code>show ip dhcp pool</code> <code>configuration</code> { <i>name</i>   <i>all</i> }	View the settings for the specified address pool or for all configured address pools.

## Monitoring DHCP Server Information

Use the following commands to view bindings, conflicts, and statistics, and to clear the information.

<b>Command</b>	<b>Purpose</b>
<code>show ip dhcp binding</code> [ <i>address</i> ]	View the current binding information in the DHCP server database. Specify the IP address to view a specific binding.
<code>clear ip dhcp binding</code> { <i>address</i>   *}	Delete an automatic address binding from the DHCP server database. Use * to clear all bindings.
<code>show ip dhcp conflict</code> [ <i>address</i> ]	View the current binding conflicts in the DHCP server database. Specify the IP address to view a specific conflict.

Command	Purpose
<code>clear ip dhcp conflict {address   *}</code>	Clear an address conflict from the DHCP Server database. Use * to clear all conflicts.
<code>show ip dhcp server statistics</code>	View DHCP server statistics.
<code>clear ip dhcp server statistics</code>	Reset all DHCP server statistics to zero.

## DHCP Server Configuration Examples

This section contains the following examples:

- Configuring a Dynamic Address Pool
- Configuring a Static Address Pool

### Configuring a Dynamic Address Pool

The commands in this example create an address pool that dynamically assigns network information to hosts with DHCP clients that broadcast DHCP messages. The hosts are assigned an IP address from the 192.168.5.0 network. The IP addresses 192.168.5.1–192.168.5.20, and 192.168.5.100 are excluded from the address pool.

To configure the switch:

- 1 Enable the DHCP service and create an address pool named “Engineering”, and then enter into DHCP pool configuration mode for the pool.

```
console#configure
console(config)#service dhcp
console(config)#ip dhcp pool Engineering
```

- 2 Specify the IP addresses that are available in the pool.

```
console(config-dhcp-pool)#network 192.168.5.0 255.255.255.0
```

- 3 Specify the IP address to use as the default gateway.

```
console(config-dhcp-pool)#default-router 192.168.5.1
```

- 4 Specify the primary and secondary DNS servers the hosts will use.

```
console(config-dhcp-pool)#dns-server 192.168.5.10
console(config-dhcp-pool)#dns-server 192.168.5.11
```

- 5 Specify the domain name to be assigned to clients that lease an address from this pool.

```
console(config-dhcp-pool)#domain-name engineering.dell.com
console(config-dhcp-pool)#exit
```

- 6 In Global Configuration mode, add the addresses to exclude from the pool. Clients will not be assigned these IP addresses.

```
console(config)#ip dhcp excluded-address 192.168.5.1
192.168.5.20
console(config)#ip dhcp excluded-address 192.168.5.100
```

- 7 Enable the DHCP server on the switch.

```
console(config)#service dhcp
console(config)#exit
```

- 8 View DHCP server settings.

```
console#show ip dhcp global configuration

Service DHCP.....Enable
Number of Ping Packets.....2
Excluded Address.....192.168.2.1 to 192.168.2.20
                        1.2.2.2 to 1.5.5.5
                        192.168.5.1 to 192.168.5.20
                        192.168.5.100 to 192.168.5.100
Conflict Logging.....Enable
Bootp Automatic.....Disable
```

- 9 View information about all configured address pools.

```
console#show ip dhcp pool configuration all

Pool: Engineering
Pool Type..... Network
Network..... 192.168.5.0 255.255.255.0
Lease Time..... 1 days 0 hrs 0 mins
DNS Servers..... 192.168.5.11
Default Routers..... 192.168.5.1
Domain Name..... engineering.dell.com
```

## Configuring a Static Address Pool

The commands in this example create an address pool that assigns the address 192.168.2.10 to the host with a MAC address of 00:1C:23:55:E9:F3. When this hosts sends a DHCP message requesting network information, the switch will offer the information configured in this example, which includes a custom DHCP option to assign the SMTP server IP address.

To configure the switch:

- 1 Enable the DHCP service and create an address pool named “Tyler PC”, and then enter into DHCP pool configuration mode for the pool.

```
console#configure
console(config)#service dhcp
console(config)#ip dhcp pool "Tyler PC"
```

- 2 Specify the IP addresses that are available in the pool.

```
console(config-dhcp-pool)#hardware-address 00:1C:23:55:E9:F3
```

- 3 Specify the IP address and subnet mask to assign to the client.

```
console(config-dhcp-pool)#host 192.168.2.10 255.255.255.0
```

- 4 Specify the IP address to use as the default gateway.

```
console(config-dhcp-pool)#default-router 192.168.2.1
```

- 5 Specify the primary and secondary DNS servers the hosts will use.

```
console(config-dhcp-pool)#dns-server 192.168.2.100
console(config-dhcp-pool)#dns-server 192.168.5.101
```

- 6 Specify the domain name to be assigned to clients that lease an address from this pool.

```
console(config-dhcp-pool)#domain-name executive.dell.com
```

- 7 Specify the option that configures the SMTP server IP address to the host.

```
console(config-dhcp-pool)#option 69 ip 192.168.1.33
console(config-dhcp-pool)#exit
```

- 8 View information about the static address pool.

```
console#show ip dhcp pool configuration "Tyler PC"

Pool: Tyler PC
Pool Type.....Static
Client Name.....TylerPC
Hardware Address..... 00:1c:23:55:e9:f3
Hardware Address Type.....ethernet
Host..... 192.168.2.10 255.255.255.0
```

```
Lease Time..... 1 days 0 hrs 0 mins
DNS Servers..... 192.168.2.101
Default Routers..... 192.168.2.1
Domain Name..... executive.dell.com
Option..... 69 ip 192.168.1.33
```





# IP Routing

## Dell EMC Networking N1500, N2000, N2100-ON, N2200-ON, N3000-ON, N3100-ON, N3200-ON Series Switches



**NOTE:** Dell EMC Networking N1100-ON Series switches do not support IP routing.

This chapter describes how to configure routing on the switch, including global routing settings, Address Resolution Protocol (ARP), router discovery, and static routes.

The topics covered in this chapter include:

- IP Routing Overview
- Default IP Routing Values
- IP Path MTU and Path MTU Discovery
- ARP Table
- Configuring IP Routing Features (Web)
- Configuring IP Routing Features (CLI)
- IP Routing Configuration Example
- Wake-on-LAN

## IP Routing Overview

The Dell EMC Networking N-Series switches are multilayer switches that support static and dynamic routing. Table 31-1 describes some of the general routing features that can be configured on the switch.

**Table 31-1. IP Routing Features**

Feature	Description
ICMP message control	The type of ICMP messages that the switch responds to, as well as the rate limit and burst size, are configurable.

**Table 31-1. IP Routing Features (Continued)**

<b>Feature</b>	<b>Description</b>
Default gateway	The switch supports a single default gateway. A manually configured default gateway is more preferable than a default gateway learned from a DHCP server.
ARP table	The switch maintains an ARP table that maps an IP address to a MAC address. Static ARP entries can be created in the table and various ARP table settings can be managed, such as the aging time of dynamically-learned entries.
ICMP Router Discovery Protocol (IRDP)	Hosts can use IRDP to identify operational routers on the subnet. Routers periodically advertise their IP addresses. Hosts listen for these advertisements and discover the IP addresses of neighboring routers.
Routing table entries	The following route types can be configured in the routing table: <ul style="list-style-type: none"><li>• <b>Default:</b> The default route is the route the switch will use to send a packet if the routing table does not contain a longer matching prefix for the packet's destination.</li><li>• <b>Static:</b> A static route is a route that you manually add to the routing table.</li><li>• <b>Static Reject:</b> Packets that match a reject route are discarded instead of forwarded. The router may send an ICMP Destination Unreachable message.</li></ul>
Route preferences	The common routing table collects static, local, and dynamic (routing protocol) routes. When there is more than one route to the same destination prefix, the routing table selects the route with the best (lowest) route preference.

# Default IP Routing Values

Table 31-2 shows the default values for the IP routing features this chapter describes.

**Table 31-2. IP Routing Defaults**

<b>Parameter</b>	<b>Default Value</b>
Default Time to Live	64
Routing Mode	Disabled globally and on each interface
ICMP Echo Replies	Enabled
ICMP Redirects	Enabled
ICMP Rate Limit Interval	1000 milliseconds
ICMP Rate Limit Burst Size	100
Maximum Next Hops	4
Global Default Gateway	None
Dynamic ARP Entry Age Time	1200 seconds
Automatic Renewal of Dynamic ARP Entries	Enabled
ARP Response Timeout	1 second
ARP Retries	4
IRDP Advertise Mode	Disabled
IRDP Advertise Address	224.0.0.1
IRDP Maximum Advertise Interval	600 seconds
IRDP Minimum Advertise Interval	450 seconds
IRDP Advertise Lifetime	1800 seconds
IRDP Preference Level	0

**Table 31-2. IP Routing Defaults (Continued)**

<b>Parameter</b>	<b>Default Value</b>
Route Preference Values	Preference values are as follows: <ul style="list-style-type: none"><li>• Local—0</li><li>• Static—1</li><li>• OSPF Intra—110</li><li>• OSPF Inter—110</li><li>• OSPF External—110</li><li>• RIP—120</li></ul>

## IP Path MTU and Path MTU Discovery

The IP stack maintains an IP MTU for each route in its routing table. Conceptually, the route’s path MTU defaults to the IP MTU of the outgoing interface. The IP MTU of an interface is set automatically based upon the switch MTU. If the switch receives an ICMPv4 Fragmentation Needed or ICMPv6 Packet Too Big message, the IP stack sets the corresponding route’s path MTU to the value in the ICMP message as long as it is less than the switch MTU minus the Ethernet frame header length.

RFC 1191 explains how a router can initiate IPv4 path MTU discovery. The basic idea is that the router sends IPv4 packets with the “don’t fragment” bit set. The router initially assumes that the path MTU is equal to the IP MTU of the outgoing interface. If the packet is too big to reach its destination without fragmentation, a router in the path will return a packet too big message. The originator reduces its estimate of the path MTU and continues the process until packets reach the final destination.


Path MTU discovery is required for IPv6. In IPv6, only the originator is allowed to fragment. Any packet too large to reach its destination triggers a packet too big message, updating the IP stack’s path MTU for the destination.

## ARP Table

The router maintains an ARP table that associates a MAC address (Link layer address) and outgoing port with an IP address and VLAN (Network layer address). The ARP table is dynamically updated with the station MAC address and outgoing port information for directly attached subnets. ARP entries are associated with the VLAN (subnet) on which the IP address or route is known. The router broadcasts an ARP request in the associated VLAN for any unknown MAC address to which it needs to route packets. The router also refreshes an ARP entry by sending an ARP request before a dynamically learned ARP entry times out and updates the ARP table if a response is received. Host or VM movement within the same VLAN (Layer-2 topology change) does not trigger an ARP refresh. Only if the ARP entry is timed out or the port associated with the ARP entry goes down does the ARP entry get refreshed.

If the traffic to a host is bidirectional, it will result in the host ARP entry pointing to the new port. Any gratuitous ARP request sent by a host or VM results in an ARP entry update (including a change in the MAC address and outgoing port).

# Configuring IP Routing Features (Web)

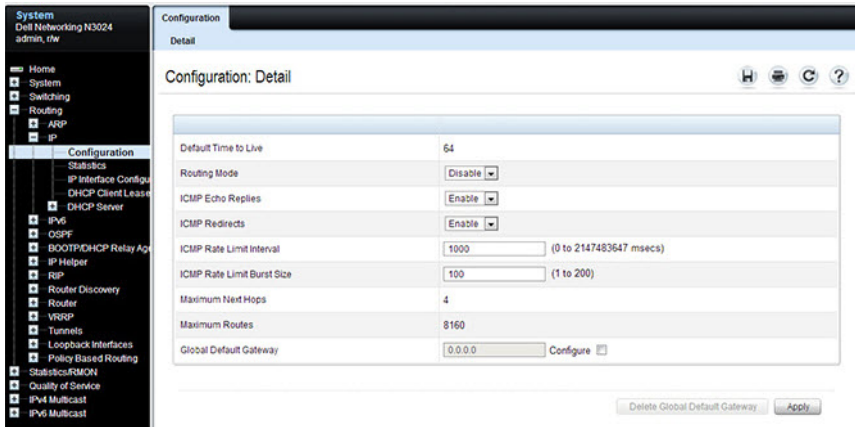
This section provides information about the OpenManage Switch Administrator pages for configuring and monitoring IPv4 routing features on Dell EMC Networking N-Series switches. For details about the fields on a page, click  at the top of the Dell EMC OpenManage Switch Administrator web page.

## IP Configuration

Use the **Configuration** page to configure routing parameters for the switch as opposed to an interface. The IP configuration settings allow you to enable or disable the generation of various types of ICMP messages.

To display the page, click **Routing** → **IP** → **Configuration** in the navigation panel.

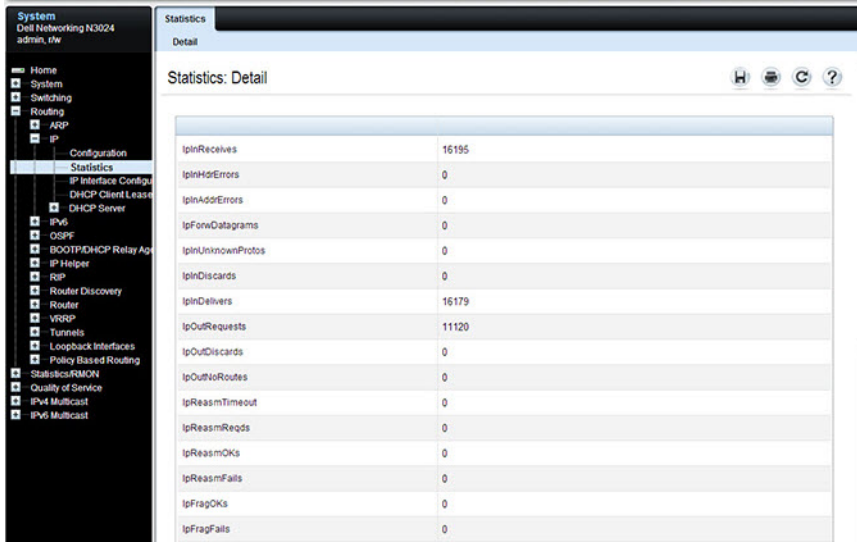
**Figure 31-1. IP Configuration**



## IP Statistics

The IP statistics reported on the **Statistics** page are as specified in RFC 1213. To display the page, click **Routing** → **IP** → **Statistics** in the navigation panel.

**Figure 31-2. IP Statistics**



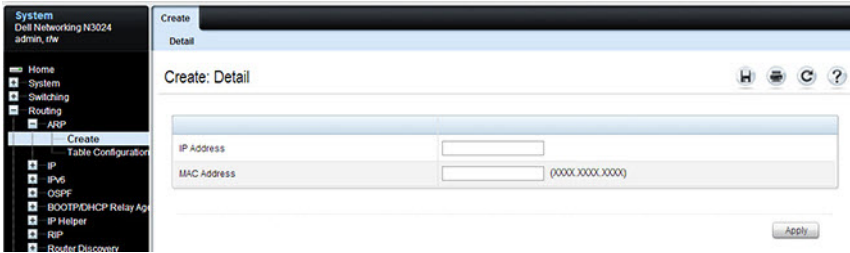
Statistics: Detail	
IpinReceives	16195
IpinHdrErrors	0
IpinAddrErrors	0
IpinFwdDatagrams	0
IpinUnknownProts	0
IpinDiscards	0
IpinDelivers	16179
IpOutRequests	11120
IpOutDiscards	0
IpOutNoRoutes	0
IpReasmTimeout	0
IpReasmReqds	0
IpReasmOKs	0
IpReasmFails	0
IpFragOKs	0
IpFragFails	0

## ARP Create

Use the Create page to add a static ARP entry to the Address Resolution Protocol table.

To display the page, click **Routing** → **ARP** → **Create** in the navigation panel.

**Figure 31-3. ARP Create**





## ARP Table Configuration

Use the **Table Configuration** page to change the configuration parameters for the Address Resolution Protocol Table. This page can also display the contents of the table.

To display the page, click **Routing** → **ARP** → **Table Configuration** in the navigation panel.

**Figure 31-4. ARP Table Configuration**

The screenshot shows the 'Table Configuration' page for ARP. The left navigation pane is open to 'Routing' > 'ARP' > 'Table Configuration'. The main content area is titled 'Table Configuration: Detail' and contains the following configuration parameters:

Parameter	Value	Range/Options
Age Time	1200	(15 to 21600 seconds)
Response Time	1	(1 to 10 seconds)
Retries	4	(0 to 10)
Cache Size	4096	(384 to 4096)
Dynamic Renew	Disable	Dropdown menu
Total Entry Count	0	
Peak Total Entries	0	
Active Static Entries	0	
Configured Static Entries	0	
Maximum Static Entries	128	
Remove From Table	None	Dropdown menu
Remove IP Address		Text input field

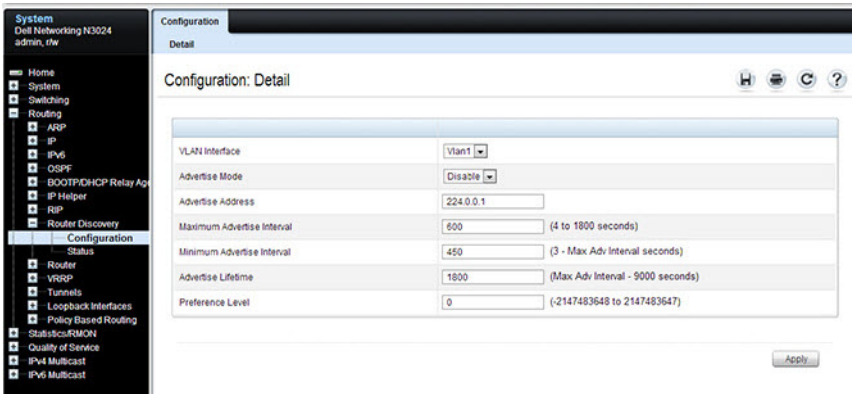
Below the configuration parameters is a 'Summary' section with a table header and navigation controls. The table header includes columns for IP Address, MAC Address, Interface, Type, and Age. The navigation controls show 'Items Displayed 0-0', 'Rows Per Page 0', and 'Pages 0 of 0'. An 'Apply' button is located at the bottom right of the page.

## Router Discovery Configuration

Use the Configuration page to enter or change router discovery parameters.

To display the page, click **Routing** → **Router Discovery** → **Configuration** in the navigation panel.

**Figure 31-5. Router Discovery Configuration**



## Router Discovery Status

Use the **Status** page to display router discovery data for each interface.

To display the page, click **Routing** → **Router Discovery** → **Status** in the navigation panel.

**Figure 31-6. Router Discovery Status**

System  
Dell Networking N3024  
admin, r/w

Home  
System  
Switching  
Routing  
ARP  
IP  
IPV6  
OSPF  
BOOTP/DHCP Relay Agent  
IP Helper  
RIP  
Router Discovery  
Configuration  
Status

Status  
Detail

Status: Detail

Items Displayed 1-1 Rows Per Page 5

VLAN Interface	Advertise Mode	Advertise Address	Maximum Advertise Interval (secs)	Minimum Advertise Interval (secs)	Advertise Lifetime (secs)	Preference Level
Vlan1	Disable	224.0.0.1	600	450	1800	0

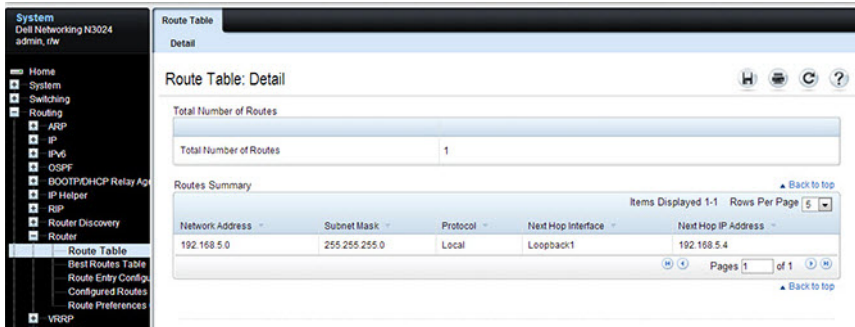
Pages 1 of 1

## Route Table

Use the **Route Table** page to display the contents of the routing table.

To display the page, click **Routing** → **Router** → **Route Table** in the navigation panel.

**Figure 31-7. Route Table**



## Best Routes Table

Use the **Best Routes Table** page to display the best routes from the routing table.

To display the page, click **Routing** → **Router** → **Best Routes Table** in the navigation panel.

**Figure 31-8. Best Routes Table**

The screenshot shows a web-based network management interface. On the left is a navigation tree with the following items: System, Switching, Routing, ARP, IP, IPv6, OSPF, BOOTP/DHCP Relay Agent, IP Helper, RIP, Router Discovery, Router, Route Table, Best Routes Table (highlighted), Route Entry Configuration, Configured Routes, Route Preferences, and VRRP. The main content area is titled "Best Routes Table: Detail" and contains the following information:

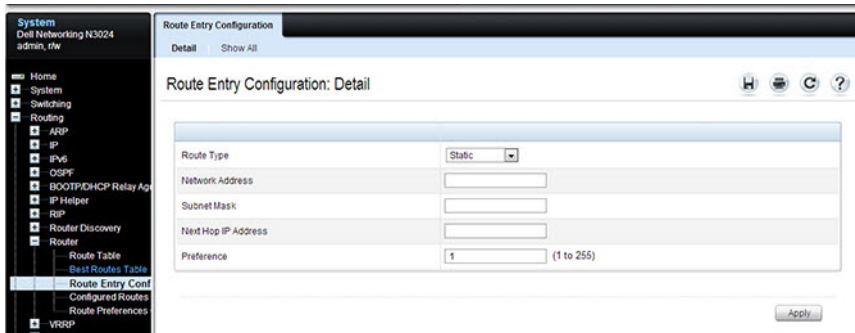
- Total Number of Routes:** A summary box showing "Total Number of Routes" with the value "1".
- Routes Summary:** A table with columns: Network Address, Subnet Mask, Protocol, Next Hop Interface, and Next Hop IP Address. It displays one route: 192.168.5.0, 255.255.255.0, Local, Loopback1, 192.168.5.4.
- Page Navigation:** "Items Displayed 1-1", "Rows Per Page 5", and "Pages 1 of 1".

## Route Entry Configuration

Use the **Route Entry Configuration** page to add new and configure router routes.

To display the page, click **Routing** → **Router** → **Route Entry Configuration** in the navigation panel.

**Figure 31-9. Route Entry Configuration**

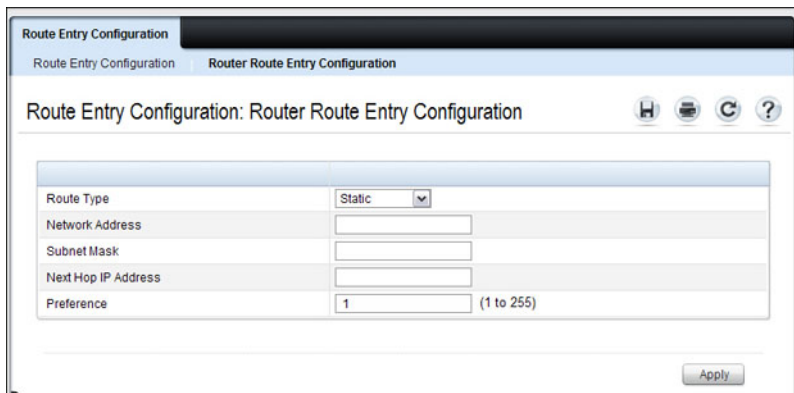


### Adding a Route and Configuring Route Preference

To configure routing table entries:

- 1 Open the **Route Entry Configuration** page.

**Figure 31-10. Router Route Entry and Preference Configuration**



- 2** Next to **Route Type**, use the drop-down box to add a **Default**, **Static**, or **Static Reject** route.

The fields to configure are different for each route type.

- **Default** — Enter the default gateway address in the **Next Hop IP Address** field.
- **Static** — Enter values for **Network Address**, **Subnet Mask**, **Next Hop IP Address**, and **Preference**.
- **Static Reject** — Enter values for **Network Address**, **Subnet Mask**, and **Preference**.

- 3** Click **Apply**.

The new route is added to the routing table.

## Configured Routes

Use the **Configured Routes** page to display the routes that have been manually configured.



**NOTE:** For a static reject route, the next hop interface value is Null0. Packets to the network address specified in static reject routes are intentionally dropped.

To display the page, click **Routing** → **Router** → **Configured Routes** in the navigation panel.

**Figure 31-11. Configured Routes**

The screenshot shows the 'Configured Routes' page in a network management interface. The left sidebar contains a navigation tree with 'Routing' expanded to 'Router' and 'Configured Routes' selected. The main content area displays a table of configured routes. The table has columns for Network Address, Subnet Mask, Next Hop IP, Next Hop Interface, Preference, and Remove. A single route is listed with the following details:

Network Address	Subnet Mask	Next Hop IP	Next Hop Interface	Preference	Remove
192.168.5.0	255.255.255.0	192.168.6.4	Unresolved	2	<input type="checkbox"/>

Below the table, there are navigation controls for 'Items Displayed 1-1', 'Rows Per Page 5', and 'Pages 1 of 1'. An 'Apply' button is located at the bottom right of the table area.

To remove a configured route, select the check box in the **Remove** column of the route to delete, and click **Apply**.



## Route Preferences Configuration

Use the **Route Preferences Configuration** page to configure the default preference for each protocol (for example 60 for static routes). These values are arbitrary values that range from 1 to 255, and are independent of route metrics. Most routing protocols use a route metric to determine the shortest path known to the protocol, independent of any other protocol.

To display the page, click **Routing** → **Router** → **Route Preferences Configuration** in the navigation panel.

**Figure 31-12. Router Route Preferences Configuration**

The screenshot displays the 'Route Preferences Configuration: Detail' page. The left navigation panel shows the following structure:

- System
- System
- Switching
- Routing
  - ARSP
  - IP
  - IPv6
  - OSPF
  - BOOTP/DHCP Relay Agent
  - IP Helper
  - RIP
  - Router Discovery
  - Router
    - Route Table
    - Best Routes Table
    - Route Entry Configuration
    - Configured Routes
  - Route Preference
  - VRRP
  - Tunnels
  - Loopback Interfaces

The main content area shows the following table:

Protocol	Preference Value	Range
Local	0	
Static	<input type="text" value="1"/>	(1 to 255)
OSPF Intra	<input type="text" value="110"/>	(1 to 255)
OSPF Inter	<input type="text" value="110"/>	(1 to 255)
OSPF External	<input type="text" value="110"/>	(1 to 255)
RIP	<input type="text" value="120"/>	(1 to 255)

An 'Apply' button is located at the bottom right of the configuration area.

## Configuring IP Routing Features (CLI)

This section provides information about the commands used for configuring IPv4 routing on the switch. For more information about the commands, see the *Dell EMC Networking N1100-ON, N1500, N2000, N2100-ON, N2200-ON, N3000E-ON, N3100-ON, and N3200-ON Series Switches CLI Reference Guide* at [www.dell.com/support](http://www.dell.com/support).

### Configuring Global IP Routing Settings

Use the following commands to configure various global IP routing settings for the switch.

Command	Purpose
<code>configure</code>	Enter global configuration mode.
<code>ip routing</code>	Globally enable IPv4 routing on the switch.
<code>ip icmp echo-reply</code>	Allow the switch to generate ICMP Echo Reply messages.
<code>ip icmp error-interval burst-interval [burst- size]</code>	Limit the rate at which IPv4 ICMP error messages are sent. <ul style="list-style-type: none"><li>• <i>burst-interval</i> — How often the token bucket is initialized (Range: 0–2147483647 milliseconds).</li><li>• <i>burst-size</i> — The maximum number of messages that can be sent during a burst interval (Range: 1–200).</li></ul>
<code>ip redirects</code>	Allow the switch to generate ICMP Redirect messages.
<code>ip default-gateway ip- address</code>	Configure the global default gateway for the switch. The gateway configured here takes precedence over a default gateway assigned by a network DHCP server.
<code>exit</code>	Exit to Privileged Exec mode.
<code>show ip brief</code>	View the global IP settings for the switch.

## Configuring ARP Settings

Use the following commands to configure static ARP entries in the ARP cache and to specify the settings for the ARP cache.

Command	Purpose
<code>configure</code>	Enter global configuration mode.
<code>arp ip-address hardware-address</code>	Create a static ARP entry in the ARP table. <ul style="list-style-type: none"><li>• <i>ip-address</i> — IP address of a device on a subnet attached to an existing routing interface.</li><li>• <i>hardware-address</i> — A unicast MAC address for that device.</li></ul>
<code>arp timeout seconds</code>	Configure the ARP entry ageout time.
<code>arp resptime seconds</code>	Configure the ARP request response timeout.
<code>arp retries integer</code>	Configure the ARP count of maximum requests for retries. The range is 1–10.
<code>arp cachesize integer</code>	Configure the maximum number of entries in the ARP cache.
<code>arp dynamicrenew</code>	Allow the ARP component to automatically renew dynamic ARP entries when they age out.
<code>exit</code>	Exit to Privileged Exec mode.
<code>show arp [brief]</code>	View the user-configured (static) ARP entries. The static entries display regardless of whether they are reachable over an interface. Use the <b>brief</b> keyword to view only the ARP table settings.
<code>clear arp-cache [gateway]</code>	Remove all dynamic ARP entries from the ARP cache. Include the keyword <b>gateway</b> to remove gateway entries as well.
<code>clear arp-cache management</code>	Remove all dynamic ARP entries from the ARP cache that were learned on the management interface.
<code>arp purge ip-address</code>	Remove the specified IP address from the ARP cache. This command removes dynamic and gateway ARP entries only.

## Configuring Router Discovery (IRDP)

Use the following commands to configure IRDP settings.

Command	Purpose
<code>configure</code>	Enter global configuration mode.
<code>interface <i>interface</i></code>	Enter interface configuration mode for the specified VLAN routing interface. The <i>interface</i> variable includes the interface type ( <b>vlan</b> ) and number, for example <b>vlan 100</b> .
<code>ip irdp</code>	Enable IRDP on the interface.
<code>ip irdp address <i>ip-address</i></code>	Configure the address that the interface uses to send the router discovery advertisements.  The allowed addresses are 224.0.0.1 (all-hosts IP multicast address) or 255.255.255.255 (limited broadcast address)
<code>ip irdp holdtime <i>seconds</i></code>	Configure the value of the holdtime field of the router advertisement sent from this interface.
<code>ip irdp maxadvertinterval <i>seconds</i></code>	Configure the maximum time allowed between sending router advertisements from the interface.
<code>ip irdp minadvertinterval <i>seconds</i></code>	Configure the minimum time allowed between sending router advertisements from the interface.
<code>ip irdp preference <i>integer</i></code>	Configure the preference of the address as a default router address relative to other router addresses on the same subnet.
<code>exit</code>	Exit to Global Config mode.
<code>exit</code>	Exit to Privileged Exec mode.
<code>show ip irdp [vlan <i>vlan-id</i>]</code>	View the router discovery information for all interfaces, or for a specified interface.

## Configuring Route Table Entries and Route Preferences

Use the following commands to configure IRDP settings.

Command	Purpose
<code>configure</code>	Enter global configuration mode.
<code>ip route default nextHopIp[preference ]</code>	Configure the default route. <ul style="list-style-type: none"><li>• <i>nextHopIp</i>— IP address of the next hop router.</li><li>• <i>preference</i> — Specifies the preference value (administrative distance) of an individual static route. (Range: 1-255)</li></ul>
<code>ip route network-address {subnetmask   prefix length } {nextHopIp   Null0   vlan vlan-id} [preference   name text]</code>	Configure a static route. Use the keyword <b>null</b> instead of the next hop router IP address to configure a static reject route. <ul style="list-style-type: none"><li>• <i>network-address</i> — IP address of destination network.</li><li>• <i>subnet-mask</i> — Subnet mask of destination interface.</li><li>• <i>prefix-length</i> — Length of prefix. Must be preceded with a forward slash (/). (Range: 0-32 bits)</li><li>• <i>nextHopIp</i> — IP address of the next hop router. A VLAN next hop is only used with IP unnumbered interfaces or a VRF.</li><li>• <b>Null0</b> — Specifies that the route is a static reject route.</li><li>• <i>preference</i> — Specifies the preference value (administrative distance) of an individual static route. (Range: 1-255)</li></ul>
<code>ip route distance integer</code>	Set the default distance (preference) for static routes. Lower route preference values are preferred when determining the best route. The range is 1-255.
<code>exit</code>	Exit to Privileged Exec mode.

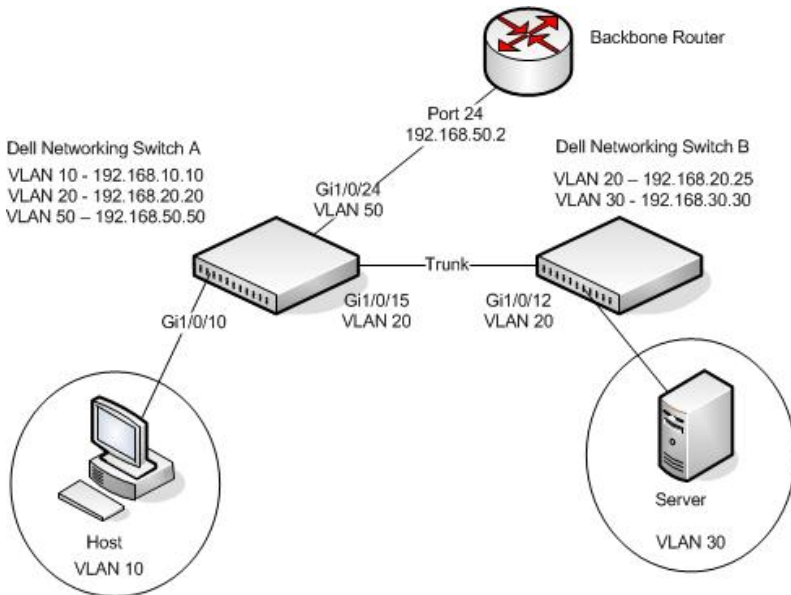
<b>Command</b>	<b>Purpose</b>
<code>show ip route</code> [ <i>ip-address</i> [ <i>mask</i>   <i>prefix-length</i> ]	View the routing table. <ul style="list-style-type: none"> <li>• <i>ip-address</i> — Specifies the network for which the route is to be displayed and displays the best matching best-route for the address.</li> <li>• <i>mask</i> — Subnet mask of the IP address.</li> <li>• <i>prefix-length</i> — Length of prefix, in bits. Must be preceded with a forward slash ('/'). (Range: 0-32 bits)</li> </ul>
<code>show ip route summary</code>	View summary information about the routing table.
<code>show ip protocols</code>	View the parameters and current state of the active routing protocols.
<code>show ip route preferences</code>	View detailed information about the route preferences.

# IP Routing Configuration Example

In this example, the Dell EMC Networking N-Series switches are Layer-3 switches with VLAN routing interfaces. VLAN routing is configured on Dell EMC Networking N-Series Switch A and Dell EMC Networking N-Series Switch B. This allows the host in VLAN 10 to communicate with the server in VLAN 30. A static route to the VLAN 30 subnet is configured on Switch A. Additionally, a default route is configured on Switch A so that all traffic with an unknown destination is sent to the backbone router through port 24, which is a member of VLAN 50. A default route is configured on Dell EMC Networking N-Series switch B to use Switch A as the default gateway. The hosts use the IP address of the VLAN routing interface as their default gateway.

This example assumes that all Layer-2 VLAN information, such as VLAN creation and port membership, has been configured.

**Figure 31-13. IP Routing Example Topology**



## Configuring Dell EMC Networking N-Series Switch A

To configure Switch A.

- 1 Enable routing on the switch.

```
console#configure  
console (config) #ip routing
```

- 2 Assign an IP address to VLAN 10. This command also enables IP routing on the VLAN.

```
console (config) #interface vlan 10  
console (config-if-vlan10) #ip address 192.168.10.10  
255.255.255.0  
console (config-if-vlan10) #exit
```

- 3 Assign an IP address to VLAN 20.

```
console#configure  
console (config) #interface vlan 20  
console (config-if-vlan20) #ip address 192.168.20.20  
255.255.255.0  
console (config-if-vlan20) #exit
```

- 4 Assign an IP address to VLAN 50.

```
console#configure  
console (config) #interface vlan 50  
console (config-if-vlan50) #ip address 192.168.50.50  
255.255.255.0  
console (config-if-vlan50) #exit
```

- 5 Configure a static route to the network that VLAN 30 is in, using the IP address of the VLAN 20 interface on Switch B as the next hop address.

```
console (config) #ip route 192.168.30.0 255.255.255.0  
192.168.20.25
```

- 6 Configure the backbone router interface as the default gateway.

```
console (config) #ip route default 192.168.50.2
```



## Configuring Dell EMC Networking N-Series Switch B

To configure Switch B:

- 1 Enable routing on the switch.

```
console#configure  
console (config) #ip routing
```

- 2 Assign an IP address to VLAN 20. This command also enables IP routing on the VLAN.

```
console#configure  
console (config) #interface vlan 20  
console (config-if-vlan20) #ip address 192.168.20.25  
255.255.255.0  
console (config-if-vlan20) #exit
```

- 3 Assign an IP address to VLAN 30. This command also enables IP routing on the VLAN.

```
console#configure  
console (config) #interface vlan 30  
console (config-if-vlan30) #ip address 192.168.30.30  
255.255.255.0  
console (config-if-vlan30) #exit
```

- 4 Configure the VLAN 20 routing interface on Switch A as the default gateway so that any traffic with an unknown destination is sent to Switch A for forwarding.

```
console (config) #ip route default 192.168.20.20
```

## Wake-on-LAN

The Wake-on-LAN (WoL) feature allows dormant PCs to be powered when the switch receives a specific Ethernet frame, known as the *magic packet*. The magic packets to wake devices are originated in the network. The switch needs to:

- Support passing this packet to the destination.
- Process net-directed broadcast packets.

Refer to the `ip directed-broadcast` command in the *Dell EMC Networking N1100-ON, N1500, N2000, N2100-ON, N2200-ON, N3000E-ON, N3100-ON, and N3200-ON Series Switches CLI Reference Guide*.

When a host that uses WoL is attached through an 802.1X port and the host powers off, the 802.1X port becomes unauthorized. The port can only receive and send EAPOL packets, and WoL magic packets cannot reach the host. When the switch uses 802.1X authentication with WoL, configure forwarding traffic to the unauthorized 802.1x ports, including magic packets using the command `authentication control-direction`. Refer to the *Dell EMC Networking N1100-ON, N1500, N2000, N2100-ON, N2200-ON, N3000E-ON, N3100-ON, and N3200-ON Series Switches CLI Reference Guide* for more details. While the port is unauthorized and the *control direction in* is configured, the switch continues to block ingress traffic. The host can receive packets but cannot send packets to other devices in the network.

# Routing Interfaces

## **Dell EMC Networking N1500, N2000, N2100-ON, N2200-ON, N3000E-ON, N3100-ON, N3200-ON Series Switches**

This chapter describes the routing (Layer-3) interfaces the Dell EMC Networking N-Series switches support, which includes VLAN routing interfaces, loopback interfaces, and tunnel interfaces.

The topics covered in this chapter are:

- Routing Interface Overview
- Default Routing Interface Values
- Configuring Routing Interfaces (Web)
- Configuring Routing Interfaces (CLI)

For information about configuring IPv6 characteristics on routing interfaces, see "IPv6 Routing" on page 1483.

For configuration examples that configure VLAN routing interfaces, see "IP Routing Configuration Example" on page 1215 in the IP Routing chapter. For a configuration example that includes tunnel and loopback interface creation, see "Interconnecting an IPv4 Backbone and Local IPv6 Network" on page 1339.

## **Routing Interface Overview**

Routing interfaces are logical interfaces that can be configured with an IP address. Routing interfaces provide a means of transmitting IP packets between subnets on the network.

### **What Are VLAN Routing Interfaces?**

VLANs divide a single physical network (broadcast domain) into separate logical networks. To forward traffic across VLAN boundaries, a Layer-3 device, such as router, is required. Dell EMC Networking N-Series switches can act as Layer-3 devices when you configure VLAN routing interfaces. VLAN routing

interfaces make it possible to transmit traffic between VLANs while still containing broadcast traffic within VLAN boundaries. The configuration of VLAN routing interfaces makes inter-VLAN routing possible.

For each VLAN routing interface a static IP address can be assigned, or a network DHCP server can assign a dynamic IP address.

When a port is enabled for bridging (Layer-2 switching) rather than routing, which is the default, all normal bridge processing is performed for an inbound packet, which is then associated with a VLAN. Its MAC Destination Address (MAC DA) and VLAN ID are used to search the MAC address table. If routing is enabled for the VLAN, and the MAC DA of an inbound unicast packet is that of the internal router interface, the packet is routed. An inbound multicast packet is forwarded to all ports in the VLAN, plus the internal bridge-router interface, if it was received on a routed VLAN.

Since a port can be configured to belong to more than one VLAN, VLAN routing might be enabled for all of the VLANs on the port or for only some of the VLANs on the port. VLAN Routing can be used to allow more than one physical port to reside on the same subnet. It could also be used when a VLAN spans multiple physical networks, or when additional segmentation or security is required.

## What Are Loopback Interfaces?

A loopback interface is a logical interface that is always up and, because it cannot go down, allows the switch to have a stable IP address that other network devices and protocols can use to reach the switch. The loopback can provide the source address for sent packets.



**NOTE:** In this context, loopback interfaces should not be confused with the loopback IP address, usually 127.0.0.1, assigned to a host for handling self-routed packets.

The loopback interface does not behave like a network switching port. Specifically, there are no neighbors on a loopback interface; it is a pseudo-device for assigning local addresses so that the other Layer-3 devices can communicate with the switch by using the loopback IP address. The loopback interface is always up and can receive traffic from any of the existing active interfaces. Thus, given reachability from a remote client, the address of the loopback can be used to communicate with the switch through various

services such as Telnet and SSH. In this way, the IP address on a loopback behaves identically to any of the local addresses of the VLAN routing interfaces in terms of the processing of incoming packets.

## **What Are Tunnel Interfaces?**

Tunnels are a mechanism for transporting a packet across a network so that it can be evaluated at a remote location or *tunnel endpoint*. The tunnel, effectively, hides the packet from the network used to transport the packet to the endpoint. This allows for the transmission of packets that the transport network cannot process directly, such as in one of the following cases:

- The packet protocol is not supported.
- The packet is in an incompatible addressing space.
- The packet is encrypted.

Dell EMC Networking N-Series switches support tunnels to encapsulate IPv6 traffic in IPv4 tunnels to provide functionality to facilitate the transition of IPv4 networks to IPv6 networks.

The switch supports two types of tunnels: configured (6-in-4) and automatic (6-to-4). Configured tunnels have an explicit configured endpoint and are considered to be point-to-point interfaces. Automatic tunnels determine the endpoint of the tunnel from the destination address of packets routed into the tunnel. These tunnels correspond to Non-Broadcast Multi-Access (NBMA) interfaces. A configured tunnel interface has a single tunnel associated with it, while an automatic tunnel interface has an infinite number of tunnels (limited only by the address encoding scheme).

Because tunnels are used as logical interfaces, static routes can be defined that reference the tunnels. Additionally, dynamic routing can be configured to use the tunnels.

## Why Are Routing Interfaces Needed?

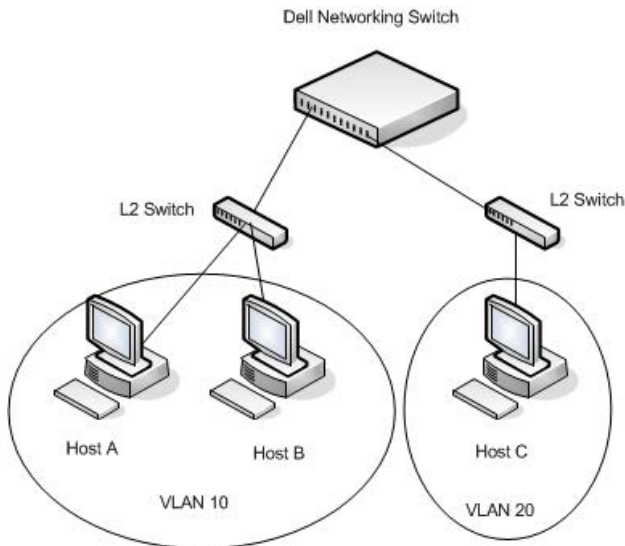
The routing interfaces this chapter describes have very different applications and uses, as this section describes. If you use the switch as a Layer-2 device that handles switching only, routing interface configuration is not required. When the switch is used as a Layer-2 device, it typically connects to an external Layer-3 device that handles the routing functions.

### VLAN Routing

VLAN routing is required when the switch is used as a Layer-3 device. VLAN routing must be configured to allow the switch to forward IP traffic between subnets and allow hosts in different networks to communicate.

In Figure 32-1 the Dell EMC Networking N-Series switch is configured as a Layer-3 device and performs the routing functions for hosts connected to the Layer-2 switches. For Host A to communicate with Host B, no routing is necessary. These hosts are in the same VLAN. However, for Host A in VLAN 10 to communicate with Host C in VLAN 20, the Dell EMC Networking N-Series switch must perform inter-VLAN routing.

**Figure 32-1. Inter-VLAN Routing**



### **Loopback Interfaces**

When packets are sent to the loopback IP address, the network should be able to deliver the packets as long as any physical interface on the switch is up. There are many cases where you need to send traffic to a switch, such as in switch management. The loopback interface IP address is a good choice for communicating with the switch in these cases because the loopback interface cannot go down when the switch is powered on and operational.

### **Tunnel Interface**

Tunnels can be used in networks that support both IPv6 and IPv4. The tunnel allows non-contiguous IPv6 networks to be connected over an IPv4 infrastructure.

# Default Routing Interface Values

By default, no routing interfaces are configured.

When you create a VLAN, no IP address is configured, and DHCP is disabled. After you configure an IP address on a VLAN or loopback interface, the VLAN interface is available for Layer-3 routing (if enabled) and is capable of resolved ARPs and responding to pings, and the interface has the default configuration shown in Table 32-1.

Most interface configuration parameters are not applicable to loopback interfaces, so the default values cannot be changed. However, when a loopback interface is created, the default values are similar to those of VLAN routing interfaces, as Table 32-1 shows.

**Table 32-1. VLAN Routing Interface and Loopback Interface Defaults**

Parameter	Default Value
Forward Net Directed Broadcasts	Disabled
Encapsulation Type	Ethernet (N/A for loopbacks)
Proxy Arp	Enabled
Local Proxy Arp	Disabled
IP MTU	1500
Bandwidth	Not configured.
Destination Unreachables	Enabled
ICMP Redirects	Enabled


When you create a tunnel, it has the default values shown in Table 32-2

**Table 32-2. Tunnel Interface Defaults**

Parameter	Default Value
Tunnel mode	6-in-4 configured
Link Local Only Mode	Disabled
Source address	None
Destination address	0.0.0.0



# Configuring Routing Interfaces (Web)

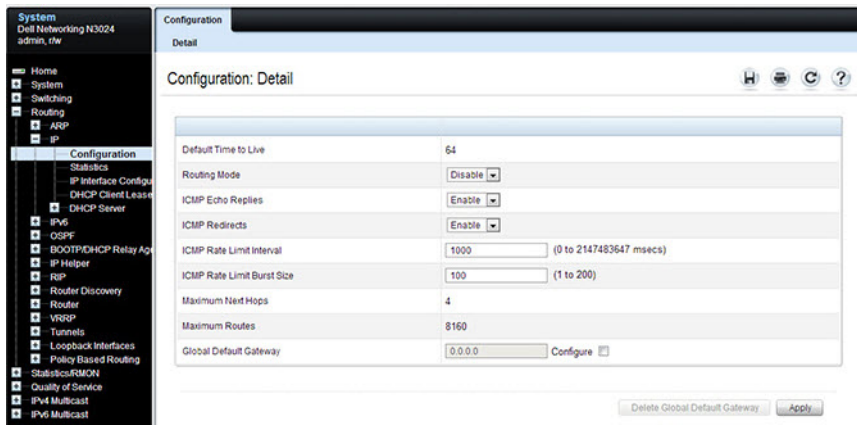
This section provides information about the OpenManage Switch Administrator pages for configuring and monitoring VLAN routing interfaces, loopback interfaces, and tunnels on Dell EMC Networking N-Series switches. For details about the fields on a page, click  at the top of the Dell EMC OpenManage Switch Administrator web page.

## IP Interface Configuration

Use the **IP Interface Configuration** page to update IP interface data for this switch. The IP interface configuration includes the ability to configure the bandwidth, Destination Unreachable messages, and ICMP Redirect messages.

To display the page, click **Routing** → **IP** → **IP Interface Configuration** in the navigation panel.

**Figure 32-2. IP Interface Configuration**

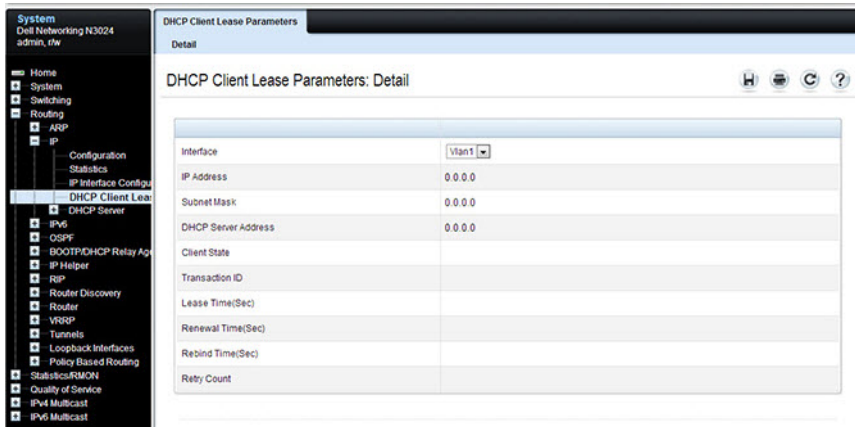


## DHCP Lease Parameters

Use the **DHCP Lease Parameters** page to view information about the network information automatically assigned to an interface by the DHCP server.

To display the page, click **Routing** → **IP** → **DHCP Lease Parameters** in the navigation panel.

**Figure 32-3. DHCP Lease Parameters**

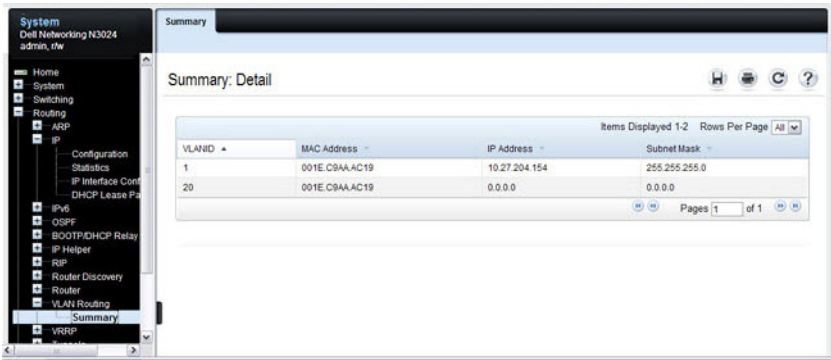


## VLAN Routing Summary

Use the **VLAN Routing Summary** page to view summary information about VLAN routing interfaces configured on the switch.

To display the page, click **Routing** → **VLAN Routing** → **Summary** in the navigation panel.

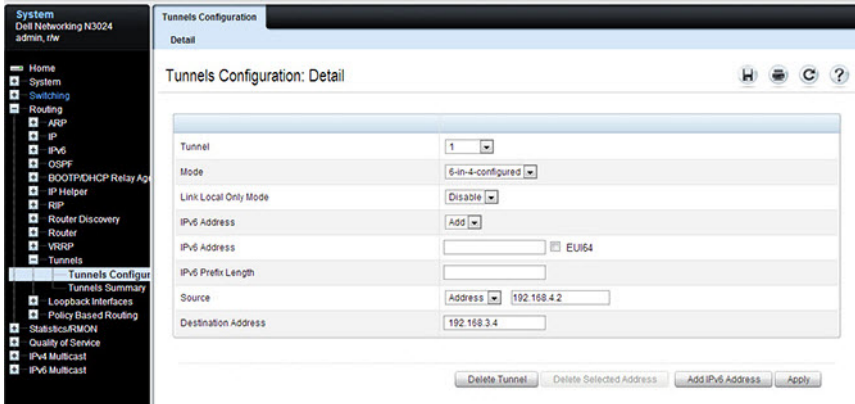
**Figure 32-4. VLAN Routing Summary**



## Tunnel Configuration

Use the Tunnels Configuration page to create, configure, or delete a tunnel. To display the page, click **Routing** → **Tunnels** → **Configuration** in the navigation panel.

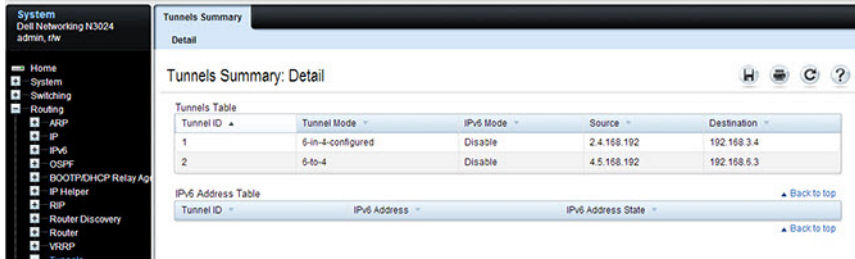
**Figure 32-5. Tunnel Configuration**



## Tunnels Summary

Use the **Tunnels Summary** page to display a summary of configured tunnels. To display the page, click **Routing** → **Tunnels** → **Summary** in the navigation panel.

**Figure 32-6. Tunnels Summary**

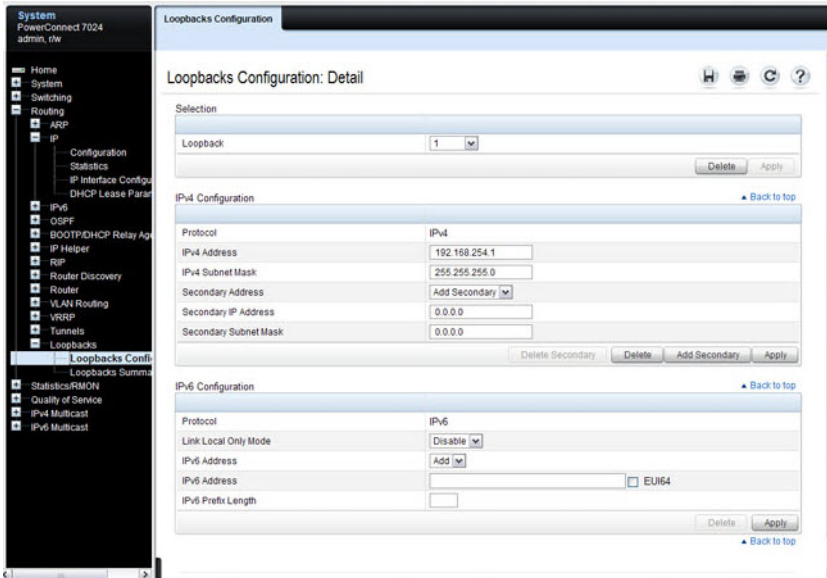


## Loopbacks Configuration

Use the **Loopbacks Configuration** page to create, configure, or remove loopback interfaces. A secondary address for a loopback can also be set up or deleted.

To display the page, click **Routing** → **Loopback Interfaces** → **Loopback Interfaces Configuration** in the navigation panel.

**Figure 32-7. Loopback Configuration**

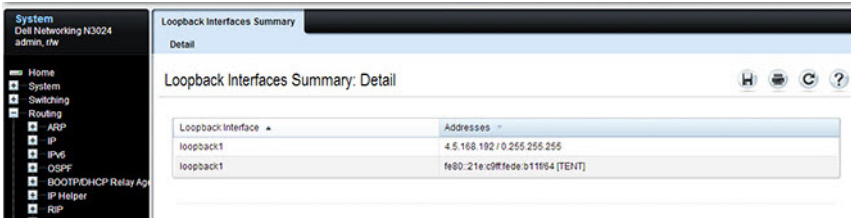


## Loopbacks Summary

Use the **Loopbacks Summary** page to display a summary of configured loopback interfaces on the switch.

To display the page, click **Routing** → **Loopback Interfaces** → **Loopback Interfaces Summary** in the navigation panel.

**Figure 32-8. Loopbacks Summary**



# Configuring Routing Interfaces (CLI)

This section provides information about the commands used for configuring VLAN routing interfaces, loopbacks, and tunnels on the switch. For more information about the commands, see the *Dell EMC Networking N1100-ON, N1500, N2000, N2100-ON, N2200-ON, N3000E-ON, N3100-ON, and N3200-ON Series Switches CLI Reference Guide* at [www.dell.com/support](http://www.dell.com/support).

## Configuring VLAN Routing Interfaces (IPv4)

Use the following commands to configure a VLAN as a routing interface and set the IP configuration parameters.

Command	Purpose
<code>configure</code>	Enter Global Configuration mode.
<code>interface vlan <i>vlan-id</i></code>	Enter Interface Configuration mode for the specified VLAN.
<code>ip address {dhcp   none   <i>ip_address subnet_mask</i> [secondary]}</code>	Configure the IP address. Use the <code>dhcp</code> keyword to enable the DHCP client and obtain an IP address from a network DHCP server. Use <code>none</code> to release the address obtained from the DHCP server. Use <code>ip_address</code> and <code>subnet_mask</code> to assign a static IP address. For a static address, use the <code>secondary</code> keyword to specify that the address is a secondary IP address.
<code>ip netdirbcast</code>	Enable the forwarding of network-directed broadcasts.
<code>encapsulation {ethernet   snap}</code>	Configure the link-layer encapsulation type for the packet. Routed frames are always ethernet encapsulated when a frame is routed to a VLAN.
<code>ip proxy-arp</code>	Enable proxy ARP on the interface. Without proxy ARP, the switch responds to an ARP request only if the target IP address is an address configured on the interface where the ARP request arrived. This command is not available in interface range mode.
<code>ip local-proxy-arp</code>	Enable local proxy ARP on the interface to allow the switch to respond to ARP requests for hosts on the same subnet as the ARP source.

<b>Command</b>	<b>Purpose</b>
<code>bandwidth <i>size</i></code>	Set the configured bandwidth on this interface to communicate the speed of the interface to higher level protocols. OSPF uses the bandwidth value to compute link cost. The range is 1–10000000.
<code>ip unreachable</code>	Allow the switch to send ICMP Destination Unreachable messages in response to packets received on the interface.
<code>ip redirects</code>	Allow the switch to send ICMP Redirect messages in response to packets received on the interface.
<code>exit</code>	Exit to Global Config mode.
<code>ip default-gateway <i>ip_address</i></code>	Configure the default gateway. All switch interfaces use the same default gateway.
<code>exit</code>	Exit to Privileged Exec mode.
<code>show dhcp lease [<i>interface</i> <i>interface</i>]</code>	View information about the DHCP leases acquired for all interfaces or for the specified VLAN interface.  For a VLAN, the <i>interface</i> parameter is <code>vlan</code> followed by the VLAN ID, with or without a space, for example <code>vlan10</code> .
<code>show ip interface vlan <i>vlan-id</i></code>	View the IP interface configuration information for the specified routing VLAN.



## Configuring Loopback Interfaces

Use the following commands to configure a loopback interface.

Command	Purpose
<code>configure</code>	Enter Global Configuration mode.
<code>interface loopback loopback-id</code>	Create the loopback interface and enter Interface Configuration mode for the specified loopback interface.
<code>ip address ip_address subnet_mask [secondary]</code>	Configure a static IP address and subnet mask. Use the <b>secondary</b> keyword to specify that the address is a secondary IP address.
<code>CTRL + Z</code>	Exit to Privileged Exec mode.
<code>show ip interface loopback loopback-id</code>	View interface configuration information for the specified loopback interface.

## Configuring Tunnels

Use the following commands to configure a loopback interface.



**NOTE:** For information about configuring the IPv6 interface characteristics for a tunnel, see "IPv6 Routing" on page 1483.

Command	Purpose
<code>configure</code>	Enter Global Configuration mode.
<code>interface tunnel <i>tunnel-id</i></code>	Create the tunnel interface and enter Interface Configuration mode for the specified tunnel.
<code>tunnel mode ipv6ip [6to4]</code>	Specify the mode of the tunnel. If you use the <b>6to4</b> keyword, the tunnel is an automatic tunnel. If you omit the keyword, the tunnel is a point-to-point (configured) tunnel.
<code>ipv6 enable</code>	Enable IPv6 on this interface using the Link Local address.
<code>tunnel source {<i>ipv4addr</i>   vlan <i>vlan-id</i>}</code>	Specify the source transport address of the tunnel, either, which can be an IPv4 address or a VLAN routing interface.
<code>tunnel destination <i>ipv4addr</i></code>	Specify the destination transport IPv4 address of the tunnel.
<code>CTRL + Z</code>	Exit to Privileged Exec mode.
<code>show interfaces tunnel [<i>tunnel-id</i>]</code>	View configuration information for all tunnels or for the specified tunnel.

# Layer-2 and Layer-3 Relay Features

## Dell EMC Networking N-Series Switches

 **NOTE:** Dell EMC Networking N1100-0N Series switches do not support the L3 relay feature.

This chapter describes how to configure the Layer-2 (L2) DHCP relay, Layer-3 (L3) DHCP relay, and IP Helper features on Dell EMC Networking N-Series switches.

The topics covered in this chapter include:

- L2 and L3 Relay Overview
- Default L2/L3 Relay Values
- Configuring L2 and L3 Relay Features (Web)
- Configuring L2 and L3 Relay Features (CLI)
- Relay Agent Configuration Example

## L2 and L3 Relay Overview

When a DHCP client and server are in the same IP subnet, they can directly connect to exchange IP address requests and replies. However, buying and maintaining a DHCP server on each subnet can be expensive and is often impractical. The IP Helper/DHCP Relay features on the Dell EMC Networking N-Series switches can help enable communication between DHCP clients and DHCP servers that reside in different subnets. Configuring L3 DHCP relay also enables the bootstrap protocol (BOOTP) relay.

### What Is L2 DHCP Relay?

In Layer-2 switched networks, hosts (DHCP clients) may be connected directly to a switch which is connected to a router configured as a DHCP relay agent, or they may be connected directly to a DHCP server (unusual). In this instance, some of the client device information required by the DHCP server may not be included in the DHCP packets sent by the DHCP client. An L2

relay agent can be used to add the information that the DHCP server needs to perform its role in address and configuration and assignment. The information added by the L2 relay agent can include location and identification information that can assist the DHCP server in applying policies such as service offerings or address assignment.

Before it relays DHCP requests from clients, the switch can add a Circuit ID and a Remote ID. These IDs provide information about the circuit and port number connected to the client. This information is added as suboptions in the DHCP Option 82 packets as defined in sections 3.1 and 3.2 of RFC3046. The switch removes this option from packets that it relays from L3 Relay agents/DHCP servers to clients.

These sub-options may be used by the DHCP server to affect how it treats the client and also may be used by the relay agent to limit broadcast replies to the specific circuit or attachment point of the client.

### **Enabling L2 Relay on VLANs**

L2 DHCP relay can be enabled on a particular VLAN. The VLAN is identified by a service VLAN ID (S-VID), which a service provider uses to identify a customer's traffic while traversing the provider network to multiple remote sites. The switch uses the VLAN membership of the switch port client (the customer VLAN ID, or C-VID) to perform a lookup a corresponding S-VID.

If the S-VID is enabled for DHCP Relay, then the packet can be forwarded. If the C-VID does not correspond to an S-VID that is enabled for DHCP Relay, then the switch will not relay the DHCP request packet.

### **How is DHCP Option 82 Used?**

The Dell EMC Networking Operating System supports insertion of DHCP Option 82 information into DHCP messages relayed to DHCP servers. The Dell EMC Networking N-Series switch can be configured to insert either the Circuit ID or the Remote ID or both. When enabled, the Circuit ID contains the port identifier over which the DHCP request was received. The Remote ID is configurable by the administrator on a per-switch basis.

Consider a network with multiple DHCP servers, where the administrator wishes to serve addresses from a specific server based on the switch and port to which the user station is connected. User traffic is served on VLAN 10 or 20.

The administrator globally enables DHCP relay and configures DHCP relay on the end-user ports of each switch as follows:

```
console(config)#dhcp l2relay
console(config)#interface range gi1/0/1-24
console(config-if)#dhcp l2relay
console(config-if)#exit
```

Then, the administrator configures the remote-id and circuit-id:

```
console(config)#dhcp l2relay circuit-id vlan 10,20
console(config)#dhcp l2relay remote-id "Switch A" vlan 10,20
```

Finally, the administrator configures the uplink for DHCP relay and sets the interface to trust Option 82 information received on the interface:

```
console(config)#dhcp l2relay
console(config)#interface te1/0/1
console(config-if)#dhcp l2relay
console(config-if)#dhcp l2relay trust
console(config-if)#exit
```

The administrator is using a Microsoft DHCP server. Microsoft DHCP servers do not have native support for DHCP Option 82, but it can be added using the DhcpServerCalloutEntry API to retrieve the information via the DhcpHandleOptionsHook configured on the switches. Adding Option 82 support enables choosing whether or not a particular DHCP server should respond to the DHCP request, and whether it should only respond to requests from a particular switch (as identified by the remote-id) and port (as identified by the circuit-id). For further information and an example, follow this web link:

<http://blogs.technet.com/b/teamdhcp/archive/2009/07/06/dhcp-server-callout-api-usage.aspx>

For Linux-based systems, which natively support option 82, a configuration to serve two private pools (Pool1 and Pool2) and one public pool of DHCP addresses based upon the remote-id and circuit-id might look like the following:

dhcpd.conf file:

```
class "Pool1" {
    match option agent.remote-id;
    match option agent.circuit-id;
}
```

```

subclass "Pool1" "Switch A" "Gi1/0/1";
subclass "Pool1" "Switch A" "Gi1/0/2";
subclass "Pool1" "Switch A" "Gi1/0/3";

class "Pool2" {
    match option agent.remote-id;
    match option agent.circuit-id;
}

subclass "Pool2" "Switch B" "Gi1/0/1";
subclass "Pool2" "Switch B" "Gi1/0/2";
subclass "Pool2" "Switch B" "Gi1/0/3";

shared-network Public {

    subnet 10.1.222.0 netmask 255.255.254.0 {
        pool {
            deny members of "Pool1";
            deny members of "Pool2";
            option routers 10.1.222.1;
            option subnet-mask 255.255.254.0;
            option domain-name-servers 10.1.218.3, 10.1.219.3;
            range dynamic-bootp 10.1.222.3 10.1.222.254;
            range dynamic-bootp 10.1.223.3 10.1.223.254;
            default-lease-time 21600;
            max-lease-time 43200;
        }
    }
    subnet 10.2.109.192 netmask 255.255.255.224 {
        pool {
            allow members of "Pool1";
            range 10.2.109.194 10.2.109.222;
            option routers 10.2.109.193;
            option subnet-mask 255.255.255.224;
            option domain-name-servers 10.1.218.3,10.1.219.3;
            default-lease-time 21600;
            max-lease-time 43200;
        }
    }
    subnet 10.2.109.224 netmask 255.255.255.224 {
        pool {
            allow members of "Pool2";
            range 10.2.109.226 10.2.109.254;
            option routers 10.2.109.225;
            option subnet-mask 255.255.255.224;
        }
    }
}

```

```
option domain-name-servers 10.1.218.3,10.1.219.3;
default-lease-time 21600;
max-lease-time 43200;
}
}
}
}
```

## What Is L3 DHCP Relay?

Network infrastructure devices can be used to relay packets between a DHCP client and server on different subnets. Such a device, a Layer-3 relay agent, is often a router or L3 switch. The L3 relay agent must have an IP interface on the client subnets and, if it does not have an IP interface on the server's subnet, it should be able to route traffic toward the server's subnet.

The Dell EMC Networking DHCP Relay Agent enables DHCP clients and servers to exchange DHCP messages across different subnets. The relay agent receives the requests from the clients, and checks the valid hops and *giaddr* fields in the DHCP request. If the number of hops is greater than the configured number, the agent discards the packet. If the *giaddr* field is zero, the agent must fill in this field with the IP address of the interface on which the request was received. The agent unicasts the valid packets to all configured DHCP servers. Each server responds with a unicast BOOTREPLY addressed to the relay agent closest to the client as indicated by *giaddr* field. Upon reception of the BOOTREPLY from the server, the agent forwards this reply as broadcast or unicast on the interface where the BOOTREQUEST arrived. This interface can be identified by the *giaddr* field or option 82.

The Dell EMC Networking N-Series switch DHCP component also supports DHCP relay agent options to identify the client interface. If configured, the relay agent inserts these options when forwarding the request to the server and removes them when sending the reply to the clients.

If an interface has more than one IP address, the relay agent uses the primary IP address configured as its relay agent IP address.

## What Is the IP Helper Feature?

The IP Helper feature provides the ability for a router to unicast-forward configured UDP broadcast packets to a particular IP address (including DHCP packets). This allows applications to reach servers on non-local subnets. This is possible even when the application is designed to assume a server is always on a local subnet or when the application uses broadcast packets to reach the server (with the limited broadcast address 255.255.255.255, or a network directed broadcast address). When configured for DHCP, the IP Helper performs the function of a DHCP L3 Relay agent.

Relay entries may be configured globally and on routing interfaces. Each relay entry maps an ingress interface and destination UDP port number to a single IPv4 address (the helper address). Multiple relay entries may be configured for the same interface and UDP port, in which case the relay agent relays matching packets to each server address. Interface configuration takes priority over global configuration. If the destination UDP port for a packet matches any entry on the ingress interface, the packet is handled according to the interface configuration. If the packet does not match any entry on the ingress interface, the packet is handled according to the global IP helper configuration.

Discard relay entries may also be configured. Discard entries are used to discard packets received on a specific interface when those packets would otherwise be relayed according to a global relay entry. Discard relay entries may be configured on interfaces, but are not configured globally.

Additionally, the administrator can configure which UDP ports are forwarded. Certain UDP port numbers can be selected from the web interface or specified by name in the CLI, but a relay entry can also be configured with any UDP port number. It is possible to configure relay entries that do not specify a destination UDP port. The relay agent assumes that these entries match packets with the UDP destination ports listed in Table 33-1 (the list of default ports).



**Table 33-1. Default Ports - UDP Port Numbers Implied By Wildcard**

<b>Protocol</b>	<b>UDP Port Number</b>
IEN-116 Name Service	42
DNS	53
NetBIOS Name Server	137
NetBIOS Datagram Server	138
TACACS Server	49
Time Service	37
DHCP	67
Trivial File Transfer Protocol	69

The system limits the total number of relay entries to four times the maximum number of routing interfaces (512 relay entries). There is no individual limit to the number of relay entries on an individual interface, and no individual limit to the number of servers for a given {interface, UDP port} pair. The system limit applies in these cases.

Certain configurable DHCP relay options do not apply to relay of other protocols. You may optionally set a maximum hop count or minimum wait time using the `bootpdhcprelay maxhopcount` and `bootpdhcprelay minwaittime` commands.

The relay agent relays DHCP packets in both directions. It relays broadcast packets from the client to one or more DHCP servers, and relays packets to the client that the DHCP server unicasts back to the relay agent. For other protocols, the relay agent only relays broadcast packets from the client to the server. Packets from the server back to the client are assumed to be unicast directly to the client. Because there is no relay in the return direction for protocols other than DHCP, the relay agent retains the source IP address from the original client packet. The relay agent uses a local IP address as the source IP address of relayed DHCP client packets.

When a switch receives a broadcast UDP packet on a routing interface, the relay agent verifies that the interface is configured to relay to the destination UDP port. If so, the relay agent unicasts the packet to the configured server IP

addresses. Otherwise, the relay agent verifies that there is a global configuration for the destination UDP port. If so, the relay agent unicasts the packet to the configured server IP addresses. Otherwise the packet is not relayed.



**NOTE:** If the packet matches a discard relay entry on the ingress interface, the packet is not forwarded, regardless of the global configuration.

The relay agent relays packets that meet only the following conditions:

- The destination MAC address must be the all-ones broadcast address (FF:FF:FF:FF:FF:FF).
- The destination IP address must be the limited broadcast address (255.255.255.255) or a directed broadcast address for the receive interface.
- The IP time-to-live (TTL) must be greater than 1.
- The protocol field in the IP header must be UDP (17).
- The destination UDP port must match a configured relay entry.

Table 33-2 shows the most common protocols and their UDP port numbers and names that are relayed.

**Table 33-2. UDP Port Allocations**

<b>UDP Port Number</b>	<b>Acronym</b>	<b>Application</b>
7	Echo	Echo
11	SysStat	Active User
15	NetStat	NetStat
17	Quote	Quote of the day
19	CHARGEN	Character Generator
20	FTP-data	FTP Data
21	FTP	FTP
37	Time	Time
42	NAMESERVER	Host Name Server
43	NICNAME	Who is
53	DOMAIN	Domain Name Server
69	TFTP	Trivial File Transfer
111	SUNRPC	Sun Microsystems Rpc
123	NTP	Network Time
137	NetBiosNameService	NT Server to Station Connections
138	NetBiosDatagramService	NT Server to Station Connections
139	NetBios	SessionServiceNT Server to Station Connections
161	SNMP	Simple Network Management
162	SNMP-trap	Simple Network Management Traps
513	who	Unix Rwho Daemon
514	SYSLOG	System Log
525	timed	Time Daemon


## Default L2/L3 Relay Values

By default L2 DHCP relay is disabled. L3 relay (UDP) is enabled, but no UDP destination ports or server addresses are defined on the switch or on any interfaces.

**Table 33-3. L2/L3 Relay Defaults**

Parameter	Default Value
<b>L2 DHCP Relay</b>	
Admin Mode	Disabled globally and on all interfaces and VLANs
Trust Mode	Disabled on all interfaces
Circuit ID	Disabled on all VLANs
Remote ID	None configured
<b>L3 DHCP Relay</b>	
UDP Relay Mode (IP Helper)	Enabled
Hop Count	4
Minimum Wait Time	0 seconds
Circuit ID Option Mode	Disabled
Circuit ID Check Mode	Enabled
Information Option-Insert	Disabled on all VLAN interfaces
Information Check-Reply	Enabled on all VLAN interfaces

# Configuring L2 and L3 Relay Features (Web)

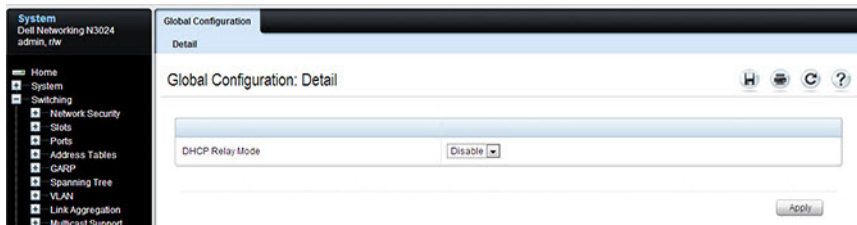
This section provides information about the OpenManage Switch Administrator pages for configuring and monitoring L2 and L3 relay features on Dell EMC Networking N-Series switches. For details about the fields on a page, click  at the top of the Dell EMC OpenManage Switch Administrator web page.

## L2 DHCP Relay Global Configuration

Use this page to enable or disable the switch to act as a DHCP Relay agent. This functionality must also be enabled on each port you want this service to operate on (see "L2 DHCP Relay Interface Configuration" on page 1246). The switch can also be configured to relay requests only when the VLAN of the requesting client corresponds to a service provider's VLAN ID that has been enabled with the L2 DHCP relay functionality (see "L2 DHCP Relay VLAN Configuration" on page 1249).


To access this page, click **Switching** → **DHCP Relay** → **Global Configuration** in the navigation panel.

**Figure 33-1. DHCP Relay Global Configuration**



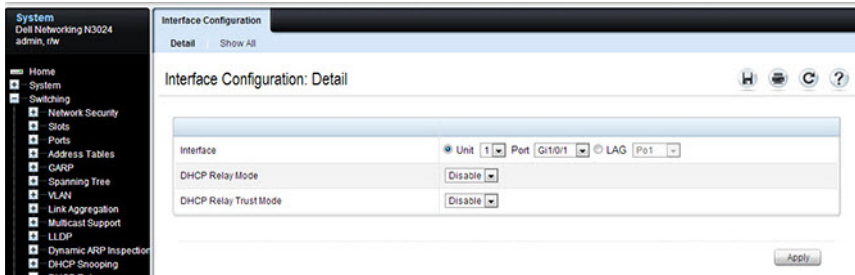
## L2 DHCP Relay Interface Configuration

Use this page to enable L2 DHCP relay on individual ports.

 **NOTE:** L2 DHCP relay must also be enabled globally on the switch.

To access this page, click **Switching** → **DHCP Relay** → **Interface Configuration** in the navigation panel.

**Figure 33-2. DHCP Relay Interface Configuration**



To view a summary of the L2 DHCP relay configuration on all ports and LAGS, click **Show All**.

**Figure 33-3. DHCP Relay Interface Summary**

Interface Configuration

Interface Configuration Show All

### Interface Configuration: Interface Summary

Unit

Unit

Interfaces ▲ Back to top

Items Displayed 1-5 Rows Per Page

Interface	DHCP Relay Mode	DHCP Relay Trust Mode
Gi1/0/1	Disable	Disable
Gi1/0/2	Disable	Disable
Gi1/0/3	Disable	Disable
Gi1/0/4	Disable	Disable
Gi1/0/5	Disable	Disable

Pages  of 6

LAGs ▲ Back to top

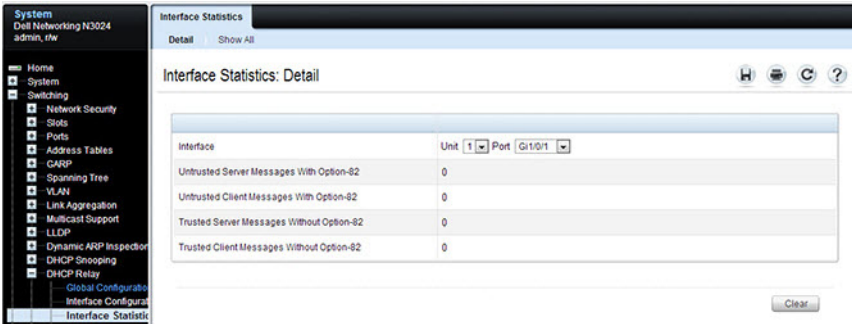
Items Displayed 1-5 Rows Per Page

LAGs	DHCP Relay Mode	DHCP Relay Trust Mode
Po1	Disable	Disable
Po2	Disable	Disable

## L2 DHCP Relay Interface Statistics

Use this page to display statistics on DHCP Relay requests received on a selected port. To access this page, click **Switching** → **DHCP Relay** → **Interface Statistics** in the navigation panel.

**Figure 33-4. DHCP Relay Interface Statistics**



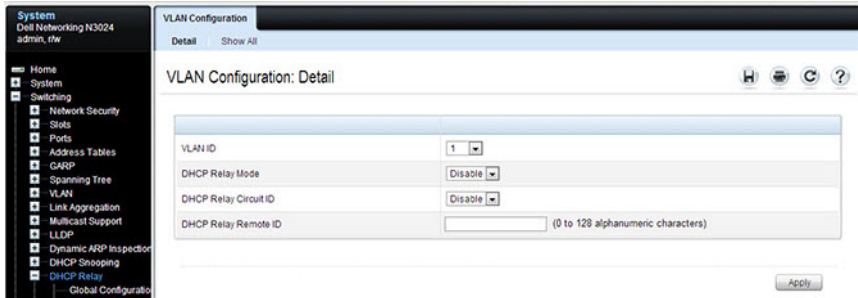


## L2 DHCP Relay VLAN Configuration

Use this page to enable and configure DHCP Relay on specific VLANs.

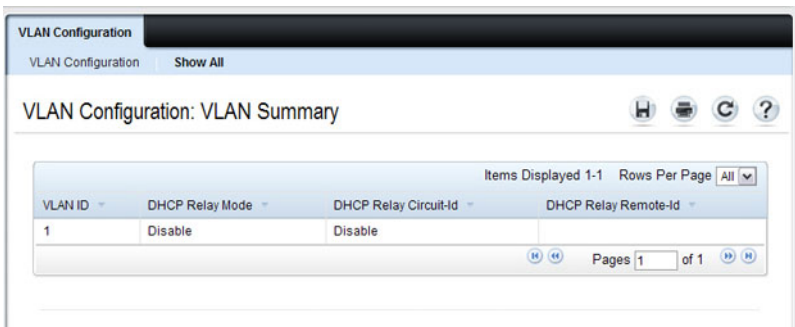
To access this page, click **Switching** → **DHCP Relay** → **VLAN Configuration** in the navigation panel.

**Figure 33-5. DHCP Relay VLAN Configuration**



To view a summary of the L2 DHCP relay configuration on all VLANs, click **Show All**.

**Figure 33-6. DHCP Relay VLAN Summary**

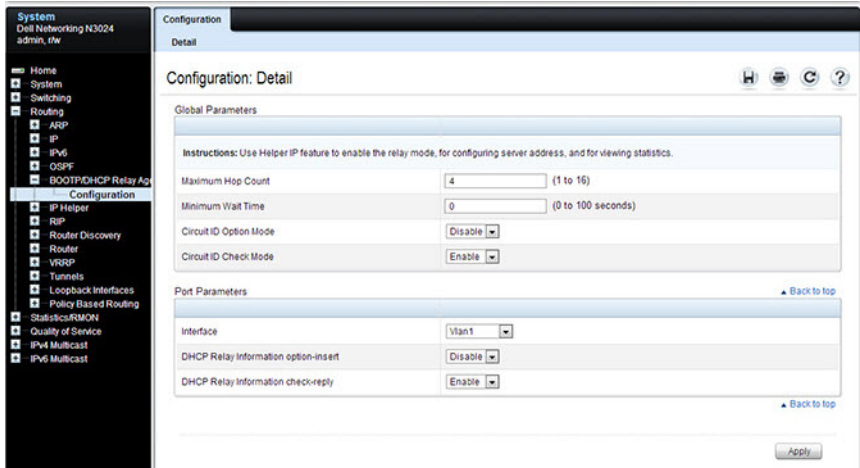


## DHCP Relay Agent Configuration

Use the **Configuration** page to configure and display a DHCP relay agent.

To display the page, click **Routing** → **BOOTP/DHCP Relay Agent** → **Configuration** in the navigation panel.

**Figure 33-7. DHCP Relay Agent Configuration**



## IP Helper (L3 DHCP Relay) Global Configuration

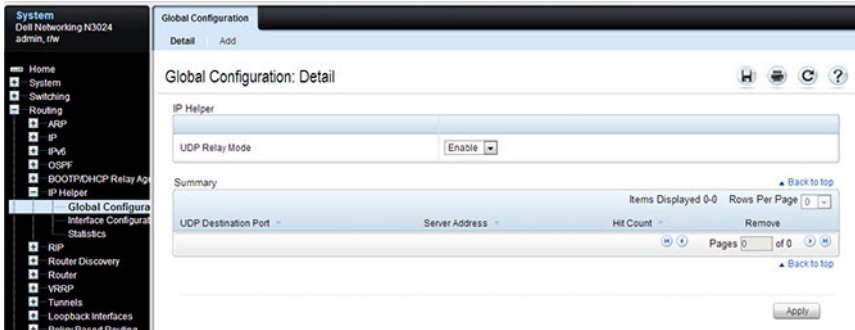


**NOTE:** The IP Helper feature is not supported on the Dell EMC Networking N1100-ON Series switches.

Use the **Global Configuration** page to add, show, or delete UDP Relay and Helper IP configuration

To display the page, click **Routing** → **IP Helper** → **Global Configuration** in the navigation panel.

**Figure 33-8. IP Helper Global Configuration**

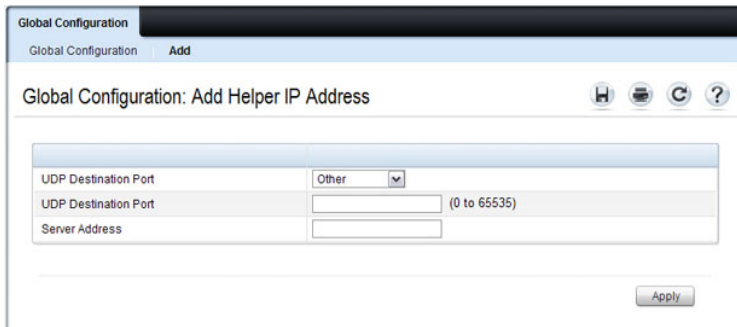


### Adding an IP Helper Entry

To configure an IP helper entry:

1. Open the IP Helper **Global Configuration** page.
2. Click **Add** to display the **Add Helper IP Address** page:

**Figure 33-9. Add Helper IP Address**



3. Select a UDP Destination port name from the menu or enter the UDP Destination Port ID. Select the Default Set to configure for the relay entry for the default set of protocols.



**NOTE:** If the DefaultSet option is specified, the device by default forwards UDP Broadcast packets for the following services: IEN-116 Name Service (port 42), DNS (port 53), NetBIOS Name Server (port 137), NetBIOS Datagram Server (port 138), TACACS Server (Port 49), and Time Service (port 37).

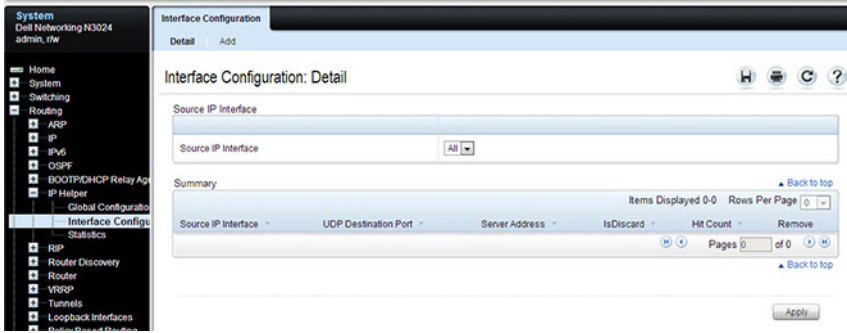
4. Enter the IP address of the server to which the packets with the given UDP Destination Port will be relayed.
5. Click **Apply**.  
The UDP/Helper Relay is added and the device is updated.

## IP Helper (L3 DHCP Relay) Interface Configuration

Use the **Interface Configuration** page to add, show, or delete UDP Relay and Helper IP configuration for a specific interface.

To display the page, click **Routing** → **IP Helper** → **Interface Configuration** in the navigation panel.

**Figure 33-10. IP Helper Interface Configuration**

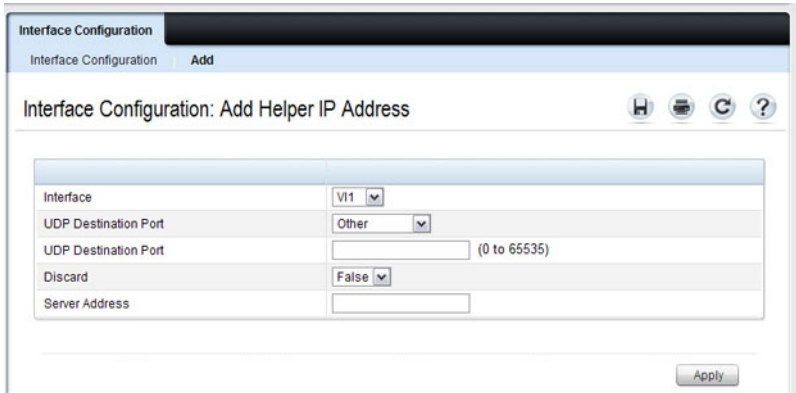


### Adding an IP Helper Entry to an Interface

To add an IP helper entry to an interface:

1. Open the IP Helper **Interface Configuration** page.
2. Click **Add** to display the **Add IP Helper Address** page:

**Figure 33-11. Add Helper IP Address**



3. Select the interface to use for the relay.
4. Select a UDP Destination port name from the menu or enter the UDP Destination Port ID. Select the Default Set to configure for the relay entry for the default set of protocols.



**NOTE:** If the DefaultSet option is specified, the device by default forwards UDP Broadcast packets for the following services: IEN-116 Name Service (port 42), DNS (port 53), NetBIOS Name Server (port 137), NetBIOS Datagram Server (port 138), TACACS Server (Port 49), and Time Service (port 37).

5. Choose whether to discard (True) or keep (False) packets arriving on the given interface with the given destination UDP port.
6. Enter the IP address of the server to which the packets with the given UDP Destination Port will be relayed.
7. Click **Apply**.

The UDP/Helper Relay is added to the interface and the device is updated.

## IP Helper Statistics

Use the **Statistics** page to view UDP Relay Statistics for the switch.

To display the page, click **Routing** → **IP Helper** → **Statistics** in the navigation panel.

**Figure 33-12. IP Helper Statistics**

The screenshot shows a network management interface. On the left is a navigation tree with the following structure:

- System
  - System
  - Switching
  - Routing
    - ARP
    - IP
    - IPv6
    - OSPF
    - BOOTP/DHCP Relay Agent
    - IP Helper
      - Global Configuration
      - Interface Configuration
    - Statistics (highlighted)
    - RIP
    - Router Discovery
    - Router
    - VRMP
    - Tunnels
    - Loopback Interfaces
    - Policy Based Routing
  - Statistics/RMON
  - Quality of Service
  - IPv4 Multicast
  - IPv6 Multicast

The main content area is titled "Statistics: Detail" and contains a table with the following data:

DHCP Client Messages Received	0
DHCP Client Messages Relayed	0
DHCP Server Messages Received	0
DHCP Server Messages Relayed	0
UDP Client Messages Received	0
UDP Client Messages Relayed	0
DHCP Client Messages Hop Count Exceeded Max	0
DHCP Packets Received Too Early	0
Received DHCP Client Messages With Giaddr As Local Address	0
UDP Packets With Expired TTL	0
UDP Packets Discarded	0

A "Clear" button is located at the bottom right of the table area.

# Configuring L2 and L3 Relay Features (CLI)

This section provides information about the commands used for configuring L2 and L3 relay features on the switch. For more information about the commands, see the *Dell EMC Networking N1100-ON, N1500, N2000, N2100-ON, N2200-ON, N3000E-ON, N3100-ON, and N3200-ON Series Switches CLI Reference Guide* at [www.dell.com/support](http://www.dell.com/support).

## Configuring L2 DHCP Relay

Use the following commands to configure switch and interface L2 DHCP relay settings.


Command	Purpose
<code>configure</code>	Enter global configuration mode.
<code>dhcp l2relay</code>	Globally enable L2 DHCP relay on the switch
<code>interface interface</code>	Enter interface configuration mode for the specified port or LAG. The <i>interface</i> variable includes the interface type and number, for example <code>tengigabitethernet 1/0/3</code> . For a LAG, the interface type is <code>port-channel</code> .  A range of ports can be specified using the <code>interface range</code> command. For example, <code>interface range tengigabitethernet 1/0/8-12</code> configures interfaces 8, 9, 10, 11, and 12.
<code>dhcp l2relay</code>	Enable L2 DHCP relay on the port(s) or LAG(s).
<code>dhcp l2relay trust</code>	Configure the interface(s) to mandate Option-82 on receiving DHCP packets.
<code>exit</code>	Exit to Global Configuration mode.
<code>dhcp l2relay vlan vlan-list</code>	Enable the L2 DHCP Relay agent for a set of VLANs. All DHCP packets which arrive on interfaces in the configured VLAN are subject to L2 Relay processing.
<code>dhcp l2relay circuit-id vlan vlan-list</code>	Enable setting the DHCP Option 82 Circuit ID for a VLAN. When enabled, the interface number is added as the Circuit ID in DHCP option 82.



<b>Command</b>	<b>Purpose</b>
<b>dhcp l2relay remote-id</b> <i>remoteId</i> vlan <i>vlan-list</i>	Enable setting the DHCP Option 82 Remote ID for a VLAN. When enabled, the supplied string is used for the Remote ID in DHCP Option 82.  The <i>remoteId</i> variable is a string to be used as the remote ID in the Option 82 (Range: 1 - 128 characters).
<b>exit</b>	Exit to Privileged Exec mode.
<b>show dhcp l2relay all</b>	View L2 DHCP relay settings on the switch.
<b>show dhcp l2relay</b> <b>interface</b> [ <b>all</b>   <i>interface</i> ]	View L2 DHCP relay settings for all interfaces or for the specified interface.
<b>show dhcp l2relay vlan</b> <i>vlan-list</i>	View L2 DHCP relay settings for the specified VLAN
<b>show dhcp l2relay stats</b> <b>interface</b> [ <b>all</b>   <i>interface</i> ]	View the number of DHCP packets processed and relayed by the L2 relay agent. To reset the statistics to 0, use the <b>clear dhcp l2relay statistics interface</b> [ <b>all</b>   <i>interface</i> ] command.
<b>show dhcp l2relay agent-</b> <b>option</b> vlan <i>vlan-id</i>	View the DHCP L2 Relay Option-82 configuration for the specified VLAN.
<b>show dhcp l2relay</b> <b>circuit-id</b> vlan <i>vlan-id</i>	View the DHCP L2 Relay circuit ID configuration for the specified VLAN.
<b>show dhcp l2relay</b> <b>remote-id</b> vlan <i>vlan-id</i>	View the DHCP L2 Relay remote ID configuration for the specified VLAN.

## Configuring L3 Relay (IP Helper) Settings

Use the following commands to configure switch and interface L3 DHCP relay and IP helper settings.

 **NOTE:** The IP Helper feature is not supported on the Dell EMC Networking N1100-ON Series switches.

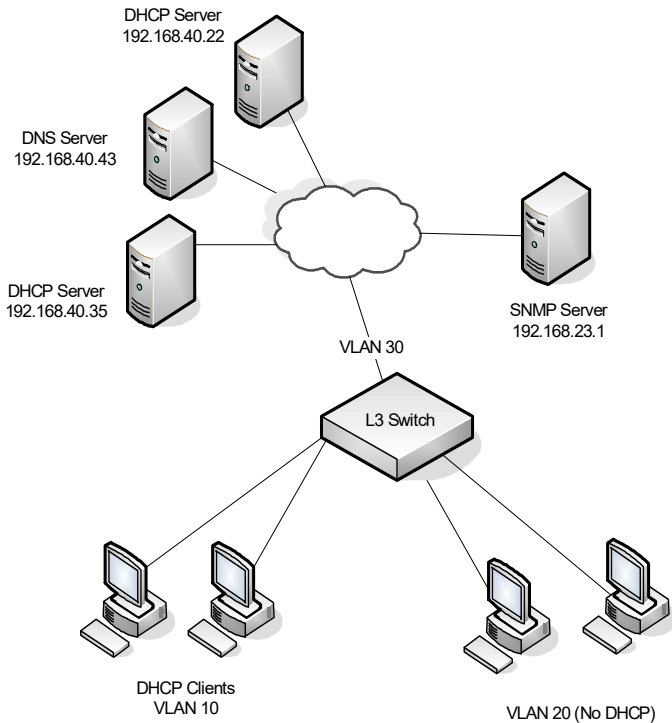
Command	Purpose
<code>configure</code>	Enter global configuration mode.
<code>ip helper enable</code>	Use this command to enable the IP helper feature. It is enabled by default.
<code>ip helper-address server-address [dest-udp-port   dhcp   domain   isakmp   mobile-ip   nameserver   netbios-dgm   netbios-ns   ntp   pim-auto-rp   rip   tacacs   tftp   time]</code>	<p>Configure the relay of certain UDP broadcast packets received on any interface. Specify the one of the protocols defined in the command or the UDP port number.</p> <ul style="list-style-type: none"><li><code>server-address</code> — The IPv4 unicast or directed broadcast address to which relayed UDP broadcast packets are sent. The server address cannot be an IP address configured on any interface of the local router.</li><li><code>dest-udp-port</code> — A destination UDP port number from 1 to 65535.</li></ul>
<code>interface vlan vlan-id</code>	<p>Enter interface configuration mode for the specified VLAN routing interface.</p> <p>A range of VLAN routing interfaces can be specified using the <code>interface range vlan</code> command. For example, <code>interface range vlan 10,20,30</code> configures VLAN interfaces 10, 20, and 30.</p> <p><b>NOTE:</b> All VLANs must be configured as VLAN routing interfaces.</p>

Command	Purpose
<b>ip helper-address</b> { <i>server-address</i>   discard} [ <i>dest-udp-port</i>   dhcp   domain   isakmp   mobile-ip   nameserver   netbios- dgm   netbios-ns   ntp   pim-auto-rp   rip   tacacs   tftp   time]	Configure the relay of certain UDP broadcast packets received on the VLAN routing interface(s). This command takes precedence over an ip helper-address command given in global configuration mode.  Specify the one of the protocols defined in the command or the UDP port number. <ul style="list-style-type: none"> <li>• <i>server-address</i> — The IPv4 unicast or directed broadcast address to which relayed UDP broadcast packets are sent. The server address cannot be an IP address configured on any interface of the local router.</li> <li>• <i>dest-udp-port</i> — A destination UDP port number from 1 to 65535.</li> </ul>
<b>exit</b>	Exit to Global Config mode.
<b>exit</b>	Exit to Privileged Exec mode.
<b>show ip helper-address</b> [ <i>vrf vrf-name</i> ][ <i>vlan vlan-</i> <i>id</i> ]	View IP helper (L3 relay) settings for all interfaces or for the specified VLAN routing interface.
<b>show ip helper</b> [ <i>vrf vrf-</i> <i>name</i> ] <b>statistics</b>	View the number of DHCP and other UDP packets processed and relayed by the UDP relay agent. To reset the statistics to 0, use the <b>clear ip helper statistics</b> command.

# Relay Agent Configuration Example

The example in this section shows how to configure the L3 relay agent (IP helper) to relay and discard various protocols.

**Figure 33-13. L3 Relay Network Diagram**



This example assumes that multiple VLAN routing interfaces have been created, and configured with IP addresses.

To configure the switch:

- 1 Relay DHCP packets received on VLAN 10 to 192.168.40.35  

```
console#config  
console(config)#interface vlan 10  
console(config-if-vlan10)#ip helper-address 192.168.40.35 dhcp
```
- 2 Relay DNS packets received on VLAN 10 to 192.168.40.43

```
console(config-if-vlan10)#ip helper-address 192.168.40.35
domain
console(config-if-vlan10)#exit
```

- 3** Relay SNMP traps (port 162) received on VLAN 20 to 192.168.23.1

```
console(config)#interface vlan 20
console(config-if-vlan20)#ip helper-address 192.168.23.1 162
```

- 4** The clients on VLAN 20 have statically-configured network information, so the switch is configured to drop DHCP packets received on VLAN 20

```
console(config-if-vlan20)#ip helper-address discard dhcp
console(config-if-vlan20)#exit
```

- 5** DHCP packets received from clients in any VLAN other than VLAN 10 and VLAN 20 are relayed to 192.168.40.22.



**NOTE:** The following command is issued in Global Configuration mode, so it applies to all interfaces except VLAN 10 and VLAN 20. IP helper commands issued in Interface Configuration mode override the commands issued in Global Configuration Mode.

```
console(config)#ip helper-address 192.168.40.22 dhcp
```

- 6** Verify the configuration.

```
console#show ip helper-address
```

IP helper is enabled

I/F	UDP Port	Discard	Hit Count	Server Address
----	-----	-----	-----	-----
Vl10	domain	No	0	192.168.40.43
Vl10	dhcp	No	0	192.168.40.35
Vl20	dhcp	Yes	0	
Vl20	162	No	0	192.168.23.1
Any	dhcp	No	0	192.168.40.22



# OSPF and OSPFv3

## Dell EMC Networking N2000, N2100-ON, N2200-ON, N3000E-ON, N3100-ON, N3200-ON Series Switches

This chapter describes how to configure Open Shortest Path First (OSPF) and OSPFv3. OSPF is a dynamic routing protocol for IPv4 networks, and OSPFv3 is used to route traffic in IPv6 networks. The protocols are configured separately within the software, but their functionality is largely similar for IPv4 and IPv6 networks.



**NOTE:** In this chapter references to OSPF apply to OSPFv2 and OSPFv3 unless otherwise noted.



**NOTE:** Dell EMC Networking N1100-ON/N1500 Series switches do not support OSPF.



**NOTE:** Dell EMC Networking N2000/N2100-ON Series switches do not support OSPFv3.

The topics covered in this chapter include:

- OSPF Overview
- OSPF Feature Details
- Default OSPF Values
- Configuring OSPF Features (Web)
- Configuring OSPFv3 Features (Web)
- Configuring OSPF Features (CLI)
- Configuring OSPFv3 Features (CLI)
- OSPF Configuration Examples
- Configuring OSPF VRFs

## OSPF Overview

OSPF is an Interior Gateway Protocol (IGP) that performs dynamic routing within a network. Dell EMC Networking N-Series switches support two dynamic routing protocols: OSPF and Routing Information Protocol (RIP).

Unlike RIP, OSPF is a link-state protocol. Larger networks typically use the OSPF protocol instead of RIP.

### What Are OSPF Areas and Other OSPF Topology Features?

The top level of the hierarchy of an OSPF network is known as an OSPF domain. The domain can be divided into areas. Routers within an area must share detailed information on the topology of their area, but require less detailed information about the topology of other areas. Separating a network into areas enables limiting the amount of route information communicated throughout the network.

Areas are identified by a numeric ID in IP address format n.n.n.n (note, however, that these are not used as actual IP addresses). For simplicity, the area can be configured and referred to in normal integer notation. For example, Area 20 is identified as 0.0.0.20 and Area 256 as 0.0.1.0. The area identified as 0.0.0.0 is referred to as Area 0 and is considered the OSPF backbone. All other OSPF areas in the network must connect to Area 0 directly or through a virtual link. The backbone area is responsible for distributing routing information between non-backbone areas.

A virtual link can be used to connect an area to Area 0 when a direct link is not possible. A virtual link traverses an area between the remote area and Area 0.

A stub area is an area that does not accept external LSAs (LSAs generated by redistributing routes) that were learned from a protocol other than OSPF or were statically configured. These routes typically send traffic outside the AS. Therefore, routes from a stub area to locations outside the AS use the default gateway. A virtual link cannot be configured across a stub area. A Not So Stubby Area can import limited external routes only from a connected ASBR.



## What Are OSPF Routers and LSAs?

When a Dell EMC Networking N-Series switch is configured to use OSPF for dynamic routing, it is considered to be an OSPF router. OSPF routers keep track of the state of the various links they send data to. Routers exchange OSPF link state advertisements (LSAs) with other routers. External LSAs provide information on static routes or routes learned from other routing protocols.

OSPF defines various router types:

- Backbone routers have an interface in Area 0.
- Area border routers (ABRs) have interfaces in multiple areas.
- Internal routers have all their interfaces in a single OSPF area.
- Autonomous system boundary routers (ASBRs) redistribute routes from other protocols and originate external LSAs.

## How Are Routes Selected?

OSPF determines the best route using the route metric and the type of the OSPF route. The following order is used for choosing a route if more than one type of route exists:

- 1 Intra-area (the destination prefix is in the same area as the router computing the route)
- 2 Inter-area (the destination is not in the same area as the router computing the route)
- 3 External Type 1 (Preferred)
- 4 External Type 2 (Default)

## How Are OSPF and OSPFv3 Different?

OSPFv3 is the Open Shortest Path First routing protocol for IPv6. It is similar to OSPFv2 in its concept of a link state database, intra/inter area, and AS external routes and virtual links. It differs from its IPv4 counterpart in a number of respects. Peering is done through link-local addresses, the protocol is link rather than network centric, and addressing semantics have been moved to leaf LSAs.

# OSPF Feature Details

This section provides details on the following OSPF features:

- Stub Router
- Static Area Range Cost
- LSA Pacing
- LSA Pacing

## Stub Router

RFC 3137 introduced stub router behavior to OSPFv2. As a stub, a router can inform other routers that it is not available to forward data packets. This can be useful if OSPF has run out of resources (for example, memory) to compute a complete routing table, or to avoid routing transients as OSPF learns its neighbors and a complete set of routes at startup. Thus, OSPF can enter stub router mode either automatically (as a result of a resource condition) or by configuration.

When OSPF enters stub router mode, it re-originates its router LSAs and sets the metric on each of its non-stub links to the maximum value, 0xFFFF. Whenever OSPF originates a router LSA while in stub router mode, it sets the metrics in this way. Stub router mode is global and applies to router LSAs for all areas. Other routers prefer alternate paths that avoid the stub router; however, if no alternate path is available, another router may compute a transit route through a stub router. Because the stub router does not adjust the metric for stub links in its router LSA, routes to destinations on these networks are unaffected. Thus, stub router mode does not affect management connections to the router, even if the router and management station depend on OSPF routes to communicate with each other.

The feature supports two modes of operation. The network administrator can put OSPF in stub router mode. OSPF remains in stub router mode until the network administrator takes OSPF out of stub router mode. Alternatively, the network administrator can configure OSPF to start in stub router mode for a configurable period of time after the router boots up. On a stack, the startup period also applies when a unit takes over as the management unit. The `clear ip ospf stub-router` command also restarts OSPF in stub router mode if the mode was entered due to exceeding resource limitations. OSPF does not

begin in stub router mode when OSPF is globally enabled. If the operator wants to avoid routing transients when he enables or configures OSPF, he can manually set OSPF in stub router mode.

If OSPF is in startup stub router mode and encounters a resource limitation that would normally cause OSPF to become a stub router, OSPF cancels the timer to exit startup stub router and remains in stub router mode until the network administrator takes action.

The network administrator can optionally configure OSPF to override the metric in summary LSAs while in stub router mode. The option applies to both type 3 and type 4 summary LSAs.

When a router is in stub router mode, all its virtual links are down. This is because the cost to the virtual neighbor is guaranteed to be greater than or equal to 0xFFFF. RFC 2328 section 15 states that:

“...a virtual link whose underlying path has cost greater than hexadecimal 0xffff (the maximum size of an interface cost in a router-LSA) should be considered non-operational.”

To configure a router for stub router mode, use the **max-metric router-lsa** command in Global Router Configuration mode. The following example sets the router to start in stub router mode on a restart and remain in stub router mode for 5 minutes:

```
ABR-R0 (config) #router ospf  
ABR-R0 (config-router) #max-metric router-lsa on-startup 300
```

The following example sets the router to advertise the metric in type 3 and type 4 summary LSAs as 32768 for 5 minutes after a restart, after which time the router will exit stub router mode and advertise the full set of LSAs:

```
ABR-R0 (config) #router ospf  
ABR-R0 (config-router) #max-metric router-lsa on-startup 300 summary-lsa 32768
```

The following example causes the router to exit stub router mode, whether entered automatically due to resource constraints or due to configuration by the operator. Virtual links are enabled when the router exits stub router mode.

```
ABR-R0 (config) #router ospf  
ABR-R0 (config-router) #no max-metric router-lsa
```

## Static Area Range Cost

This feature allows a network operator to configure a fixed OSPF cost that is always advertised when an area range is active. This feature applies to both OSPFv2 and OSPFv3.

An OSPF domain can be divided into areas to limit the processing required on each router. Area Border Routers (ABRs) advertise reachability across area boundaries. It is common to summarize the set of prefixes that an ABR advertises across an area boundary. RFC 2328 specifies that when an ABR originates a type 3 LSA for an active area range, the cost in the LSA is set to “the largest cost of any of the component networks.” Thus, when an area's topology changes in a way that increases the largest cost, the type 3 LSA must be re-originated. In some cases, advertising the change in cost may be less important than preventing the topology change from propagating outside the area (thus causing routers in other areas to process and flood a changed LSA and rerun their routing table calculations). For this reason, it is common to give the network administrator the option of configuring the cost for an area range. When a static cost is configured, the cost advertised in the type 3 LSA does not depend on the cost of the component networks. Thus, topology changes within an area do not propagate outside the area, resulting in greater stability within the OSPF domain.

Dell EMC Networking N-Series switches also use area ranges to summarize type 7 LSAs when they are translated to type 5 LSAs. The cost option may be configured on area ranges used for type 7 to type 5 translation.

If an area range is configured for type 3 summarization and the static cost is set to the maximum value, 16,777,215, the range is not advertised. Setting this static cost is equivalent to configuring a range with the not-advertise option. A summary LSA with this metric (LSInfinity) cannot be advertised, according to RFC 2328 section 12.4.3. This behavior is consistent with the industry standard.

If an area range is configured for type 7 to type 5 translation, a type 5 LSA is sent if the metric is set to 16,777,215; however, other routers will not compute a route from a type 5 LSA with this metric.

See "Configuring the Static Area Range Cost" on page 1342 for a configuration example.

## LSA Pacing

OSPF refreshes each self-originated LSA every 30 minutes. Because a router tends to originate many LSAs at the same time, either at startup or when adjacencies are formed or when routes are first learned, LSA refreshes tend to be grouped. Further, Area Border Routers (ABRs) attached to the same area tend to originate summary LSAs into the area at the same time. This behavior leads to periodic bursts of LS Update packets. Update bursts can lead to high CPU utilization, packet loss, and retransmission, if a receiver cannot absorb all packets in a burst. These losses occur primarily in two places: 1) at the Class of Service (CoS) queue where the hardware queues packets to the CPU, and 2) when a message buffer is allocated for an incoming packet.

This feature makes changes to OSPFv2 to improve the efficiency of LSA flooding, with the expectation that the improvements will greatly reduce or eliminate the packet drops caused by bursts in OSPF control packets. The changes are as follows:

- Introduce LSA transmit pacing, limiting the rate of LS Update packets that OSPF can send
- Introduce LSA refresh groups, so that OSPF efficiently bundles LSAs into LS Update packets when periodically refreshing self-originated LSAs

To configure LSA transmit pacing, use the `timers pacing flood` command in router config mode:

```
ABR-R0 (config) #router ospf
ABR-R0 (config-router) #timers pacing flood 50
```

This will cause LSA Update packets to be sent at no less than a 50 millisecond interval.

When OSPF refreshes LSAs, it considers all self-originated LSAs whose age is from 1800 to 1800 plus the pacing group size. Grouping LSAs for refresh allows OSPF to combine refreshed LSAs into a minimal number of LS Update packets. Minimizing the number of Update packets makes LSA distribution more efficient. To configure an LSA Refresh window, use the `timers pacing lsa-group` command in router-config mode:

```
ABR-R0 (config) #router ospf
ABR-R0 (config-router) #timers pacing lsa-group 300
```

This sets the LSA Refresh window to 2100 seconds or about 35 minutes.

## Flood Blocking

OSPF is a link state routing protocol. Routers describe their local environment in Link State Advertisements (LSAs), which are distributed throughout an area or OSPF domain. Through this process, each router learns enough information to compute a set of routes consistent with the routes computed by all other routers.

Normally, OSPF floods an LSA on all interfaces within the LSA's flooding scope. Flooding ensures that all routers receive all LSAs. A router normally receives a duplicate copy of each LSA once on each interface in the LSA's flooding scope. The duplicate deliveries make OSPF LSA distribution robust, but in highly interconnected networks, can cause a lot of buffer and CPU usage. Buffer and CPU use can be reduced by selectively blocking LSA flooding on some interfaces, while ensuring that LSAs are flooded on enough interfaces to guarantee delivery of all LSAs to all routers. When enabling flood blocking, the network administrator must ensure there is sufficient LSA flooding even when there are router and link failures.

This feature enables a network administrator to disable LSA flooding on an interface. Flood blocking only affects flooding of LSAs with area or AS (i.e., domain-wide) scope. Such LSAs are expected to be flooded to neighbors on other, unblocked interfaces, and eventually reach neighbors on blocked interfaces. An LSA with interface flooding scope cannot be blocked; there is no other way for interface-scope LSAs to reach neighbors on the blocked interface. Allowing interface-scope LSAs on blocked interfaces allows graceful restart to work, even if the restarting router has neighbors on flood blocked interfaces.

When an interface is blocked, LSAs with area or AS scope are not sent to any neighbor on that interface. When flood blocking is enabled, OSPF does not advertise any LSAs with area or AS scope in its database description packets sent to neighbors on a blocked interface. When OSPF receives an LSA from a neighbor and the local database copy is newer than the received LSA, OSPF normally sends the newer LSA directly to the neighbor. If the neighbor is on a blocked interface, OSPF neither acknowledges the LSA nor sends the newer LSA. Instead, OSPF expects that the neighbor will receive the newer LSA indirectly.

Flooding is enabled by default.

Flood blocking cannot be enabled on virtual interfaces. While the feature could be allowed on virtual interfaces, it is less likely to be used on a virtual interface, since virtual interfaces are created specifically to allow flooding between two backbone routers. So the option of flood blocking on virtual interfaces is not supported.

See "Configuring Flood Blocking" on page 1347 for a configuration example.

## MTU

OSPF database description packets announce the IP MTU of the interface where they are transmitted. Two routers form an OSPF adjacency only if their IP MTUs are the same. If OSPF receives a database description packet whose IP MTU is larger than the local IP MTU, it drops the packet. Adjacencies in this situation remain in Exchange Start state. A log message identifies the IP MTU mismatch:

```
<11> JAN 01 00:00:51 192.168.75.1-1 OSPF[175099648]:  
spnbo.c(672) 12 %% Dropping a DD packet received on interface  
0/1. DD MTU is 2000. Local MTU is 1500.
```

The administrator can configure OSPF to ignore MTU mismatches using the `ip ospf mtu-ignore` command. Configuring one end of an OSPF-enabled link to ignore an MTU mismatch can cause issues when the DD or LSA packets are dropped on the end of the link with the smaller MTU.

OSPF does not provide a way to fragment protocol packets. Larger OSPF networks, e.g. those with more than ~100 OSPF links require a larger IP MTU in order to transmit/receive the LSA update. Use the `system jumbo mtu` command to configure an MTU sufficiently large to contain the largest expected LSA packet.

## OSPFv3 MIB Support

Dell EMC Networking firmware supports the RFC 5643 MIB. However, the following objects from RFC 5643 are not supported:

- Any MIB index using InstId
- ospfv3StubRouterAdvertisement
- ospfv3DiscontinuityTime
- ospfv3RestartTime
- Ospf3AreaEntry

- ospfv3AreaNssaTranslatorEvents
- ospfv3AreaTEEnabled
- OspfV3HostEntry
- OspfV3IfEntry
- ospfv3IfDemandNbrProbe
- ospfv3IfDemandNbrProbeRetransLimit
- ospfv3IfDemandNbrProbeInterval
- ospfv3VirtIfLinkScopeLsaCount
- ospfv3VirtIfLinkLsaCksumSum
- OspfV3CfgNbrEntry
- OspfV3AreaAggregateEntry
- ospfv3VirtLinkLsdbTable
- ospfv3NssaTranslatorStatusChange
- ospfv3RestartStatusChange
- ospfv3NbrRestartHelperStatusChange
- ospfv3VirtNbrRestartHelperStatusChange

## Default OSPF Values

OSPF is globally enabled by default. To make it operational on the router, you must configure a router ID and enable OSPF on at least one interface.

Table 34-1 shows the global default values for OSPF and OSPFv3.

**Table 34-1. OSPF/OSPFv3 Global Defaults**

Parameter	Default Value
Router ID	None
Admin Mode	Enabled
RFC 1583 Compatibility	Enabled (OSPFv2 only)
ABR Status	Enabled
Opaque LSA Status	Enabled (OSPFv2 only)
Exit Overflow Interval	Not configured



**Table 34-1. OSPF/OSPFv3 Global Defaults**


<b>Parameter</b>	<b>Default Value</b>
SPF Delay Time	5 (OSPFv2 only)
SPF Hold Time	10 (OSPFv2 only)
External LSDB Limit	None
Default Metric	Not configured
Maximum Paths	4
AutoCost Reference Bandwidth	100 Mbps
Default Passive Setting	Disabled
Default Information Originate	Disabled
Non-Stop Forwarding (NSF) Support	Disabled

Table 34-2 shows the per-interface default values for OSPF and OSPFv3.

**Table 34-2. OSPF Per-Interface Defaults**

<b>Parameter</b>	<b>Default Value</b>
Admin Mode	Disabled
Advertise Secondaries	Enabled (OSPFv2 only)
Router Priority	1
Retransmit Interval	5 seconds
Hello Interval	10 seconds
Dead Interval	40 seconds
LSA Ack Interval	1 second
Interface Delay Interval	1 second
MTU Ignore	Disabled
Passive Mode	Disabled
Network Type	Broadcast
Authentication Type	None (OSPFv2 only)
Metric Cost	Not configured

# Configuring OSPF Features (Web)

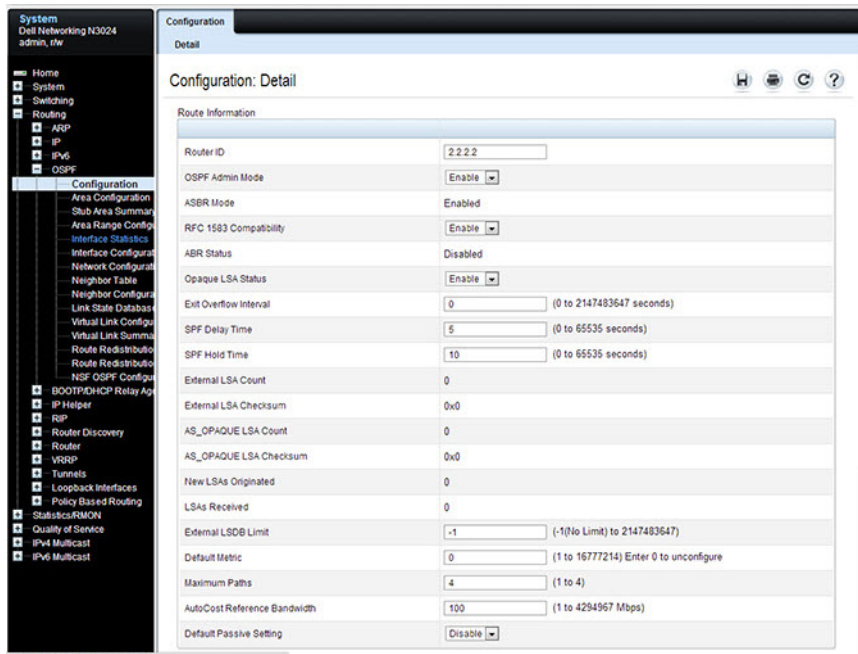
This section provides information about the OpenManage Switch Administrator pages for configuring and monitoring OSPF features on Dell EMC Networking N-Series switches. For details about the fields on a page, click  at the top of the Dell EMC OpenManage Switch Administrator web page.

## OSPF Configuration

Use the **Configuration** page to enable OSPF on a router and to configure the related OSPF settings.

To display the page, click **Routing** → **OSPF** → **Configuration** in the navigation panel.

**Figure 34-1. OSPF Configuration**

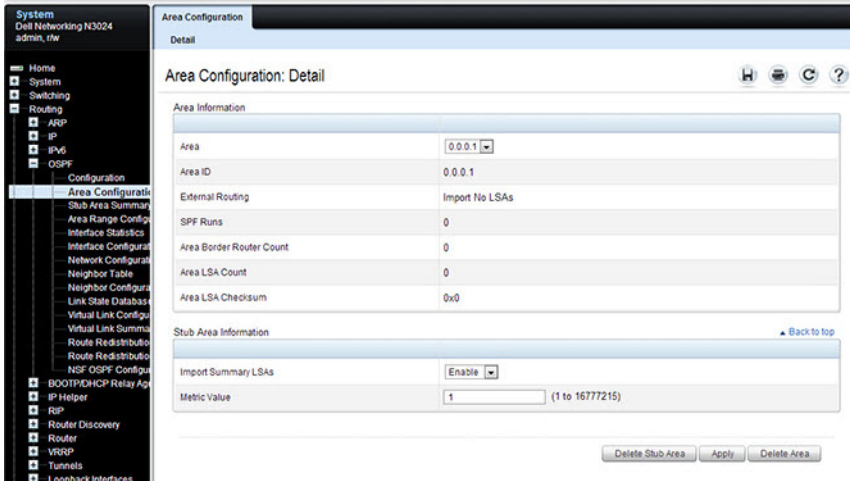


## OSPF Area Configuration

The **Area Configuration** page lets you create a Stub area configuration and NSSA once you've enabled OSPF on an interface through **Routing** → **OSPF** → **Interface Configuration**. At least one router must have OSPF enabled for this web page to display.

To display the page, click **Routing** → **OSPF** → **Area Configuration** in the navigation panel. If a Stub Area has been created, the fields in the Stub Area Information are available. If a NSSA has been created, the fields in the NSSA Area Information are available.

**Figure 34-2. OSPF Area Configuration**



## Configuring an OSPF Stub Area

To configure the area as an OSPF stub area, click **Create Stub Area**. The page refreshes, and displays additional fields that are specific to the stub area.

**Figure 34-3. OSPF Stub Area Configuration**

The screenshot shows a web-based configuration interface for OSPF. The title bar reads "Area Configuration". Below it, the main heading is "Area Configuration: Detail". There are three icons in the top right: a home icon, a refresh icon, and a help icon. The interface is divided into two main sections: "Area Information" and "Stub Area Information".

**Area Information**

Area	0.0.0.2
Area ID	0.0.0.2
External Routing	Import No LSAs
SPF Runs	0
Area Border Router Count	0
Area LSA Count	1
Area LSA Checksum	0x127E

**Stub Area Information** [Back to top](#)

Import Summary LSAs	Enable
Type of Service	Normal
Metric Value	1 (1 to 16777215)

At the bottom right, there are three buttons: "Delete Stub Area", "Apply", and "Delete Area".

Use the **Delete Stub Area** button to remove the stub area.

## Configuring an OSPF Not-So-Stubby Area

To configure the area as an OSPF not-so-stubby area (NSSA), click **NSSA Create**. The page refreshes, and displays additional fields that are specific to the NSSA.

**Figure 34-4. OSPF NSSA Configuration**

The screenshot shows the 'Area Configuration: Detail' page. It is divided into two main sections: 'Area Information' and 'NSSA Area Information'. The 'Area Information' section includes fields for Area (0.0.0.1), Area ID (0.0.0.1), External Routing (Import NSSAs), SPF Runs (0), Area Border Router Count (0), Area LSA Count (0), and Area LSA Checksum (0x0). The 'NSSA Area Information' section includes fields for Import Summary LSAs (Enable), Originate Default Route (False), Metric Value (10), Metric Type (Non-Comparable Cost), Translator Role (Candidate), Translator Stability Interval (40), No-Redistribute Mode (Disable), and Translator State (Disabled). At the bottom right, there are three buttons: 'NSSA Delete', 'Apply', and 'Delete Area'. There are also 'Back to top' links in the NSSA Area Information section.

Area Information	
Area	0.0.0.1
Area ID	0.0.0.1
External Routing	Import NSSAs
SPF Runs	0
Area Border Router Count	0
Area LSA Count	0
Area LSA Checksum	0x0

NSSA Area Information	
Import Summary LSAs	Enable
Originate Default Route	False
Metric Value	10 (1 to 16777214)
Metric Type	Non-Comparable Cost
Translator Role	Candidate
Translator Stability Interval	40 (0 to 3600)
No-Redistribute Mode	Disable
Translator State	Disabled

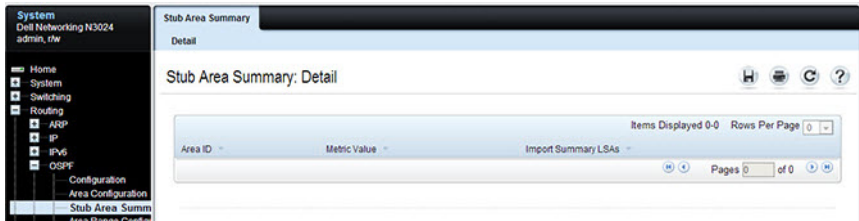
Use the **NSSA Delete** button to remove the NSSA area.

## OSPF Stub Area Summary

The **Stub Area Summary** page displays OSPF stub area detail.

To display the page, click **Routing** → **OSPF** → **Stub Area Summary** in the navigation panel.

**Figure 34-5. OSPF Stub Area Summary**

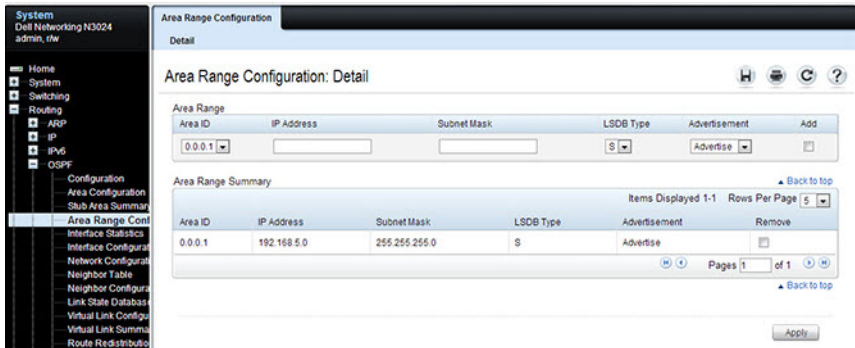


## OSPF Area Range Configuration

Use the Area Range Configuration page to configure and display an area range for a specified NSSA.

To display the page, click **Routing** → **OSPF** → **Area Range Configuration** in the navigation panel.

**Figure 34-6. OSPF Area Range Configuration**



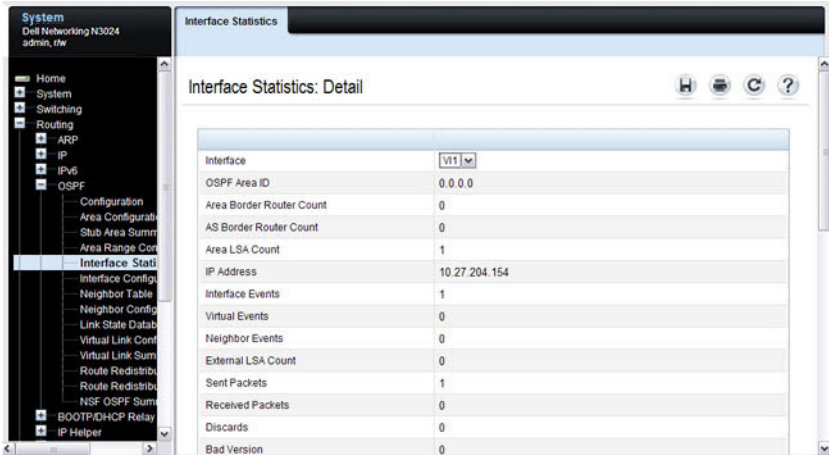


## OSPF Interface Statistics

Use the **Interface Statistics** page to display statistics for the selected interface. The information is displayed only if OSPF is enabled.

To display the page, click **Routing** → **OSPF** → **Interface Statistics** in the navigation panel.

**Figure 34-7. OSPF Interface Statistics**



The screenshot shows the 'Interface Statistics: Detail' page. The interface includes a navigation sidebar on the left and a main content area on the right. The main content area displays a table of statistics for the selected interface, V11.

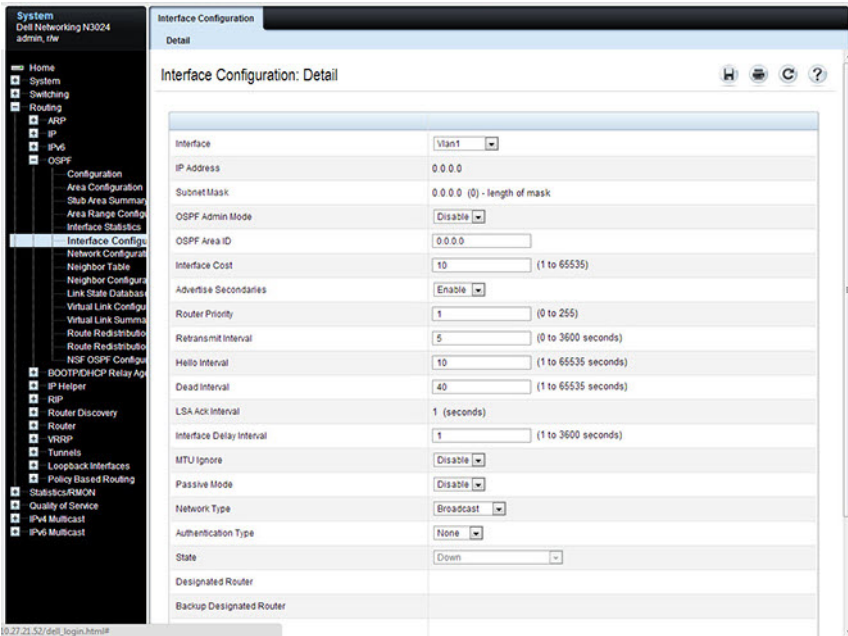
Interface	V11
OSPF Area ID	0.0.0.0
Area Border Router Count	0
AS Border Router Count	0
Area LSA Count	1
IP Address	10.27.204.154
Interface Events	1
Virtual Events	0
Neighbor Events	0
External LSA Count	0
Sent Packets	1
Received Packets	0
Discards	0
Bad Version	0

## OSPF Interface Configuration

Use the Interface Configuration page to configure an OSPF interface.

To display the page, click **Routing** → **OSPF** → **Interface Configuration** in the navigation panel.

**Figure 34-8. OSPF Interface Configuration**

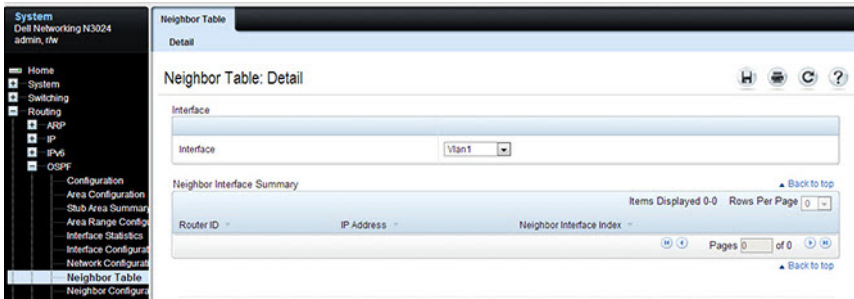


## OSPF Neighbor Table

Use the **Neighbor Table** page to display the OSPF neighbor table list. When a particular neighbor ID is specified, detailed information about a neighbor is given. The information below is only displayed if OSPF is enabled.

To display the page, click **Routing** → **OSPF** → **Neighbor Table** in the navigation panel.

**Figure 34-9. OSPF Neighbor Table**

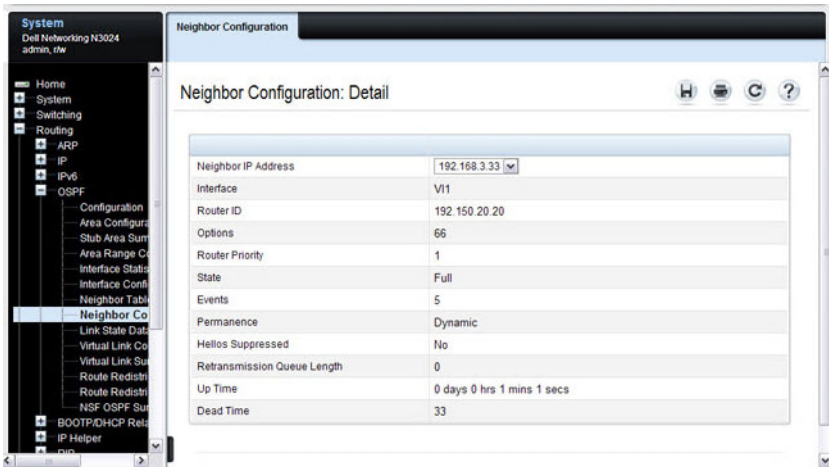


## OSPF Neighbor Configuration

Use the **Neighbor Configuration** page to display the OSPF neighbor configuration for a selected neighbor ID. When a particular neighbor ID is specified, detailed information about a neighbor is given. The information below is only displayed if OSPF is enabled and the interface has a neighbor. The IP address is the IP address of the neighbor.

To display the page, click **Routing** → **OSPF** → **Neighbor Configuration** in the navigation panel.

**Figure 34-10. OSPF Neighbor Configuration**



## OSPF Link State Database

Use the **Link State Database** page to display OSPF link state, external LSDB table, and AS opaque LSDB table information.

To display the page, click **Routing** → **OSPF** → **Link State Database** in the navigation panel.

**Figure 34-11. OSPF Link State Database**

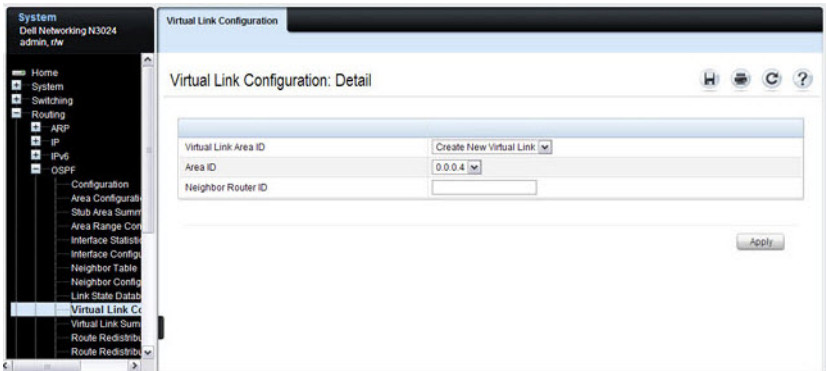
The screenshot shows a network management interface with a navigation panel on the left and a main content area on the right. The navigation panel includes sections for Home, System, Switching, Routing, IP, IPv6, and OSPF. The OSPF section is expanded, showing options like Configuration, Area Configuration, Sub Area Summary, Area Range Config, Interface Statistics, Interface Configurati, Network Configurati, Neighbor Table, Neighbor Configurati, Link State Databa, Virtual Link Configurati, Virtual Link Summar, Route Redistributio, Route Redistributio, NSF OSPF Configurati, BOOTP/DHCP Relay Ag, IP Helper, RIP, and Router Discovery. The main content area is titled "Link State Database" and "Detail". It contains three tables: "Link State Database", "External LSDB Table", and "AS Opaque LSDB Table". Each table has a header with columns for Router ID, Area ID, LSA Type, LS ID, Age, Sequence, and Checksum. The "Link State Database" table shows one entry with Router ID 2.2.2.2, Area ID 0.0.0.1, LSA Type Router Links, LS ID 2.2.2.2, Age 36, Sequence 0x80000002, and Checksum 0x351. The "External LSDB Table" and "AS Opaque LSDB Table" are currently empty. Each table has a "Back to top" link and a "Pages" indicator.

## OSPF Virtual Link Configuration

Use the **Virtual Link Configuration** page to create or configure virtual interface information for a specific area and neighbor. A valid OSPF area must be configured before this page can be displayed.

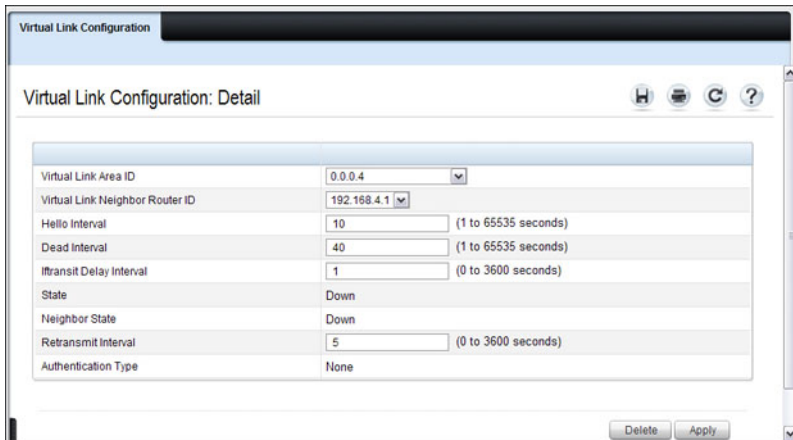
To display the page, click **Routing** → **OSPF** → **Virtual Link Configuration** in the navigation panel.

**Figure 34-12. OSPF Virtual Link Creation**



After you create a virtual link, additional fields display, as the Figure 34-13 shows.

**Figure 34-13. OSPF Virtual Link Configuration**



## OSPF Virtual Link Summary

Use the **Virtual Link Summary** page to display all of the configured virtual links.

To display the page, click **Routing** → **OSPF** → **Virtual Link Summary** in the navigation panel.

**Figure 34-14. OSPF Virtual Link Summary**

Virtual Link Summary: Detail

Area ID	Neighbor Router ID	Hello Interval(secs)	Dead Interval(secs)	Retransmit Interval(secs)	Transit Delay Interval (secs)
0.0.0.6	192.150.20.20	10	40	5	1

Items Displayed 1-1 Rows Per Page All

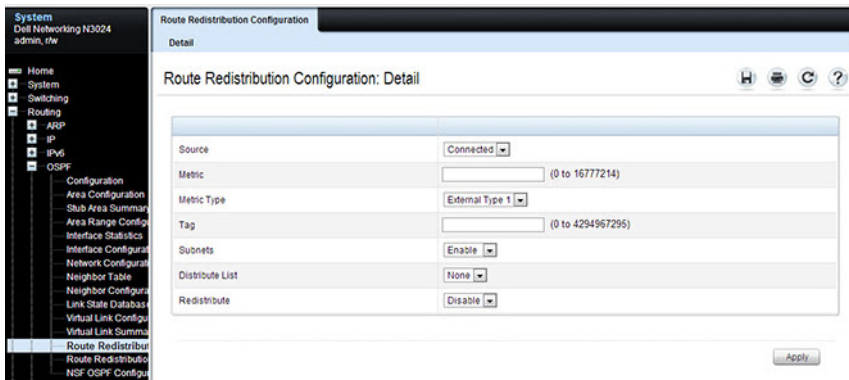
Pages 1 of 1

## OSPF Route Redistribution Configuration

Use the **Route Redistribution Configuration** page to configure redistribution in OSPF for routes learned through various protocols. Routes learned from all available protocols, or from selected protocols, can be redistributed.

To display the page, click **Routing** → **OSPF** → **Route Redistribution Configuration** in the navigation panel.

**Figure 34-15. OSPF Route Redistribution Configuration**



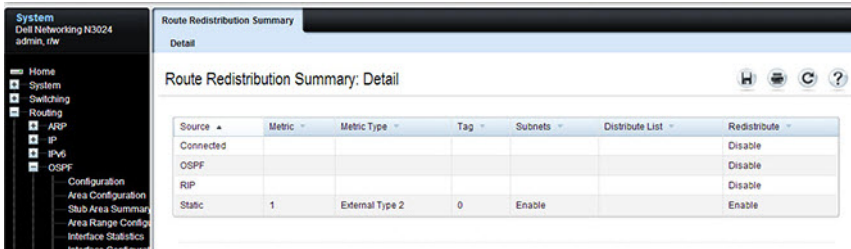


## OSPF Route Redistribution Summary

Use the **Route Redistribution Summary** page to display OSPF Route Redistribution configurations.

To display the page, click **Routing** → **OSPF** → **Route Redistribution Summary** in the navigation panel.

**Figure 34-16. OSPF Route Redistribution Summary**



System  
Dell Networking N3024  
admin, r/w

Route Redistribution Summary  
Detail

Route Redistribution Summary: Detail

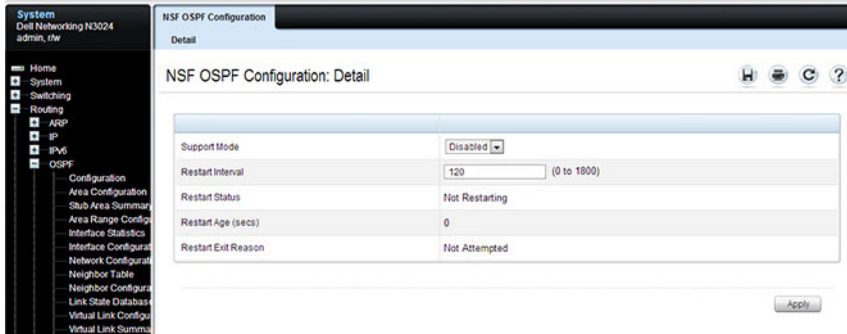
Source	Metric	Metric Type	Tag	Subnets	Distribute List	Redistribute
Connected						Disable
OSPF						Disable
RIP						Disable
Static	1	External Type 2	0	Enable		Enable

## NSF OSPF Configuration


Use the **NSF OSPF Configuration** page to configure the non-stop forwarding (NSF) support mode and to view NSF summary information for the OSPF feature. NSF is a feature used in switch stacks to maintain switching and routing functions in the event of a stack unit failure. For information about NSF, see "What is Nonstop Forwarding?" on page 262 in the Stacking chapter.

To display the page, click **Routing** → **OSPF** → **NSF OSPF Configuration** in the navigation panel.

**Figure 34-17. NSF OSPF Configuration**



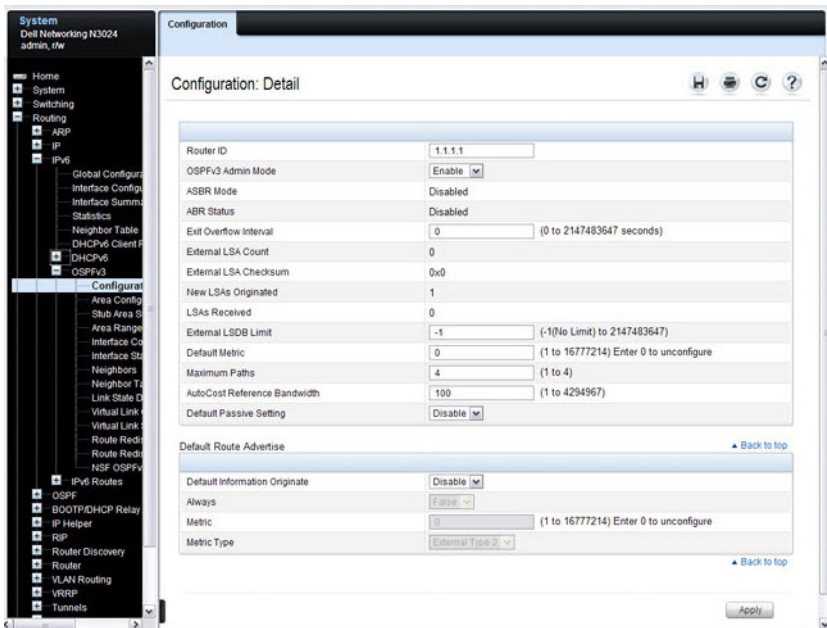
# Configuring OSPFv3 Features (Web)

This section provides information about the OpenManage Switch Administrator pages for configuring and monitoring OSPFv3 features on Dell EMC Networking N-Series switches. For details about the fields on a page, click  at the top of the Dell EMC OpenManage Switch Administrator web page.

## OSPFv3 Configuration

Use the Configuration page to activate and configure OSPFv3 for a switch. To display the page, click IPv6 → OSPFv3 → Configuration in the navigation panel.

Figure 34-18. OSPFv3 Configuration

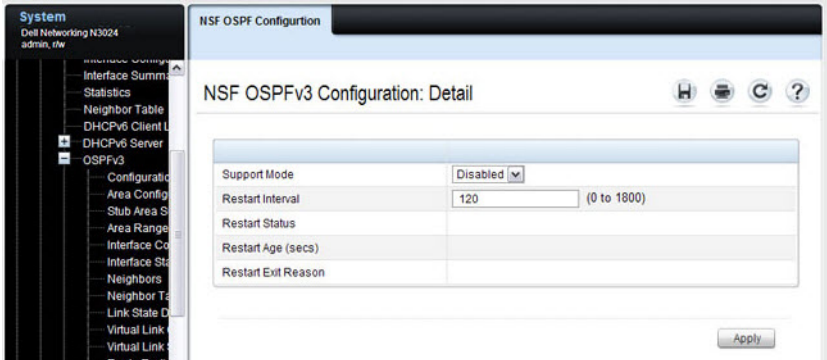


## OSPFv3 Area Configuration

Use the Area Configuration page to create and configure an OSPFv3 area.

To display the page, click IPv6 → OSPFv3 → Area Configuration in the navigation panel.

**Figure 34-19. OSPFv3 Area Configuration**



## Configuring an OSPFv3 Stub Area

To configure the area as an OSPFv3 stub area, click **Create Stub Area**. The page refreshes, and displays additional fields that are specific to the stub area.

**Figure 34-20. OSPFv3 Stub Area Configuration**

Area Configuration	
Area ID	0.0.0.1
External Routing	Import No LSAs
SPF Runs	0
Area Border Router Count	0
Area LSA Count	0
Area LSA Checksum	0x0

Stub Area Information	
Import Summary LSAs	Enable
Metric Value	1 (1 to 16777215)

Buttons: Delete Stub Area, Apply, Delete Area

Use the **Delete Stub Area** button to remove the stub area.

## Configuring an OSPFv3 Not-So-Stubby Area

To configure the area as an OSPFv3 not-so-stubby area (NSSA), click **Create NSSA**. The page refreshes, and displays additional fields that are specific to the NSSA.

**Figure 34-21. OSPFv3 NSSA Configuration**

The screenshot shows the 'Area Configuration: Detail' window. It is divided into two main sections: 'Area Configuration' and 'NSSA Specific Information'. The 'Area Configuration' section includes fields for Area ID (0.0.0.2), External Routing (Import NSSAs), SPF Runs (0), Area Border Router Count (0), Area LSA Count (0), and Area LSA Checksum (0x0). The 'NSSA Specific Information' section includes fields for Import Summary LSAs (Enable), Default Information Originate (False), Default Metric (10), Default Metric Type (Non-Comparable Cost), Translator Role (Candidate), Translator Stability Interval (40), No-Redistribute Mode (Disable), and Translator State (Disabled). At the bottom right, there are three buttons: 'Delete NSSA', 'Apply', and 'Delete Area'.

Area Configuration	
Area ID	0.0.0.2
External Routing	Import NSSAs
SPF Runs	0
Area Border Router Count	0
Area LSA Count	0
Area LSA Checksum	0x0

NSSA Specific Information	
Import Summary LSAs	Enable
Default Information Originate	False
Default Metric	10 (1 to 16777214)
Default Metric Type	Non-Comparable Cost
Translator Role	Candidate
Translator Stability Interval	40 (0 to 3600)
No-Redistribute Mode	Disable
Translator State	Disabled

Buttons: Delete NSSA, Apply, Delete Area

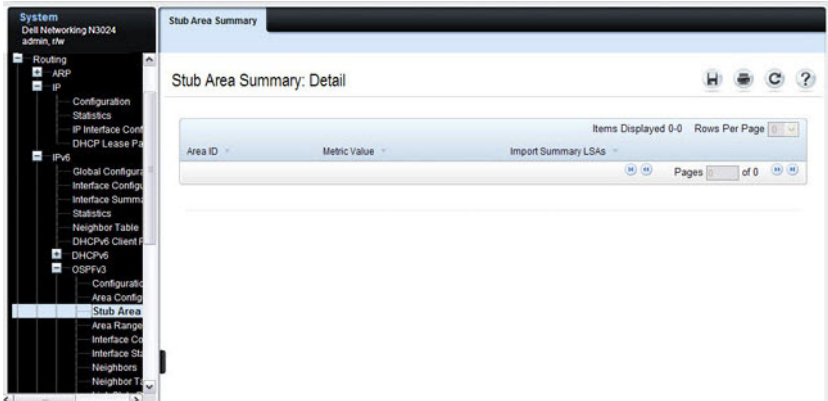
Use the **Delete NSSA** button to remove the NSSA area.

## OSPFv3 Stub Area Summary

Use the **Stub Area Summary** page to display OSPFv3 stub area detail.

To display the page, click **IPv6** → **OSPFv3** → **Stub Area Summary** in the navigation panel.

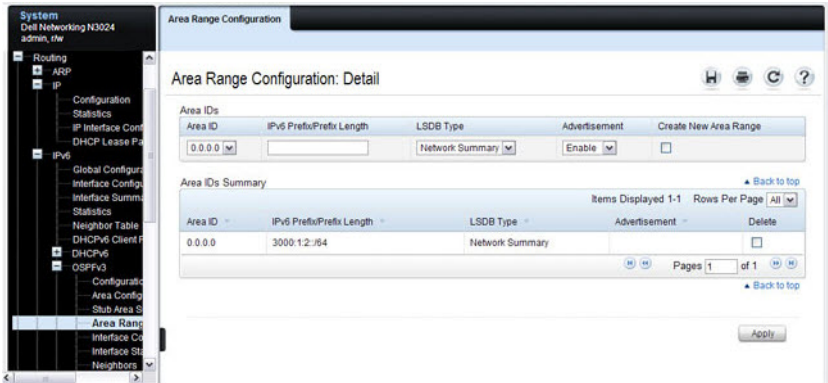
**Figure 34-22. OSPFv3 Stub Area Summary**



## OSPFv3 Area Range Configuration

Use the Area Range Configuration page to configure OSPFv3 area ranges. To display the page, click IPv6 → OSPFv3 → Area Range Configuration in the navigation panel.

Figure 34-23. OSPFv3 Area Range Configuration



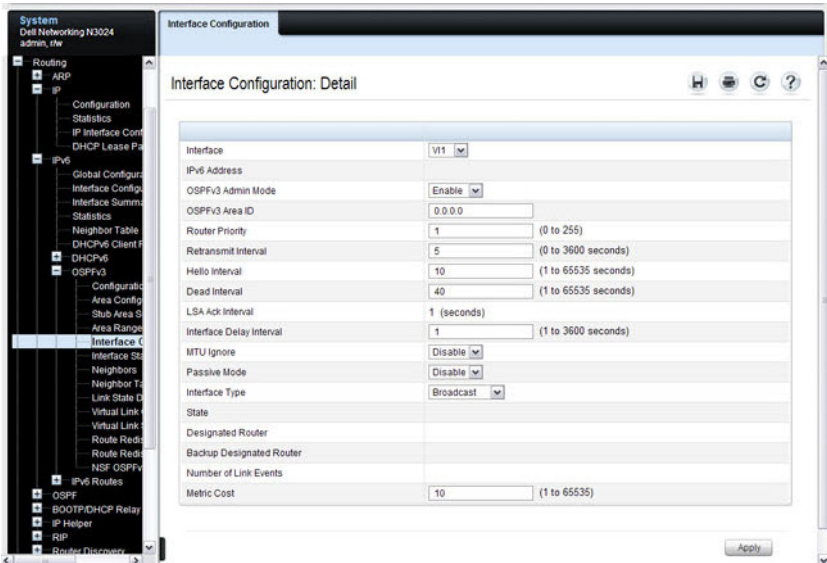


## OSPFv3 Interface Configuration

Use the **Interface Configuration** page to create and configure OSPFv3 interfaces.

To display the page, click **IPv6** → **OSPFv3** → **Interface Configuration** in the navigation panel.

**Figure 34-24. OSPFv3 Interface Configuration**

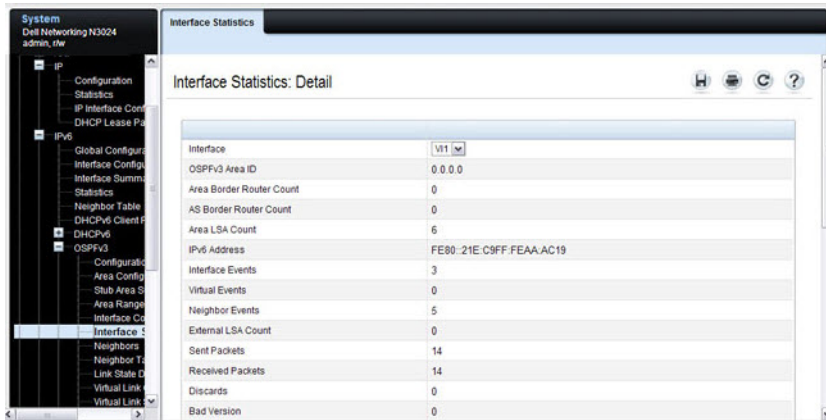


## OSPFv3 Interface Statistics

Use the **Interface Statistics** page to display OSPFv3 interface statistics. Information is only displayed if OSPF is enabled.

To display the page, click **IPv6** → **OSPFv3** → **Interface Statistics** in the navigation panel.

**Figure 34-25. OSPFv3 Interface Statistics**



## OSPFv3 Neighbors

Use the **Neighbors** page to display the OSPF neighbor configuration for a selected neighbor ID. When a particular neighbor ID is specified, detailed information about that neighbor is given. Neighbor information only displays if OSPF is enabled and the interface has a neighbor. The IP address is the IP address of the neighbor.

To display the page, click **IPv6** → **OSPFv3** → **Neighbors** in the navigation panel.

**Figure 34-26. OSPFv3 Neighbors**

The screenshot shows a network management interface with a navigation tree on the left and a main configuration area on the right. The navigation tree includes categories like IP, IPv6, and OSPFv3, with 'Neighbors' selected under OSPFv3. The main area is titled 'Neighbors: Detail' and contains a table of configuration parameters for a specific neighbor.

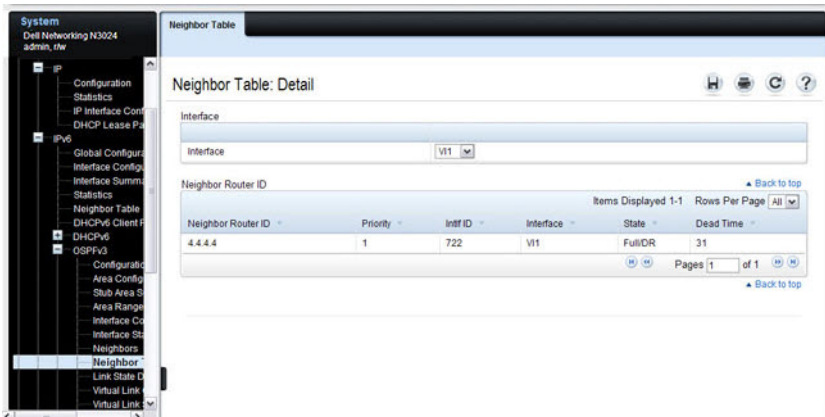
Parameter	Value
VLAN	V11
Neighbor Router ID	4.4.4.4
Area ID	0.0.0.0
Options	19
Router Priority	1
Dead Timer Due	38 (seconds)
State	Full/DR
Events	6
Retransmission Queue Length	0

## OSPFv3 Neighbor Table

Use the Neighbor Table page to display the OSPF neighbor table list. When a particular neighbor ID is specified, detailed information about a neighbor is given. The neighbor table is only displayed if OSPF is enabled.

To display the page, click IPv6 → OSPFv3 → Neighbor Table in the navigation panel.

Figure 34-27. OSPFv3 Neighbor Table



## OSPFv3 Link State Database

Use the **Link State Database** page to display the link state and external LSA databases. The OSPFv3 **Link State Database** page has been updated to display external LSDB table information in addition to OSPFv3 link state information.

To display the page, click **IPv6** → **OSPFv3** → **Link State Database** in the navigation panel.

**Figure 34-28. OSPFv3 Link State Database**

The screenshot displays the OSPFv3 Link State Database configuration page. The left navigation pane shows the path: System > IPv6 > OSPFv3 > Link State Database. The main content area is titled "Link State Database: Detail" and contains two tables.

**Link State Database**

Adv. Router	Area ID	LSA Type	Link ID	Age	Sequence	Checksum	Options	Rtr Opt
3.3.3.3	0.0.0.0	Router Links	0	846	0x80000006	0x3C0F	V5E-R-	---
4.4.4.4	0.0.0.0	Router Links	0	857	0x80000002	0xCB88	V5E-R-	---
4.4.4.4	0.0.0.0	Network Links	722	857	0x80000001	0x84A3	V5E-R-	---
3.3.3.3	0.0.0.0	Link	722	904	0x80000001	0x5D9E	V5E-R-	---
4.4.4.4	0.0.0.0	Link	722	893	0x80000001	0xB939	V5E-R-	---

Items Displayed 1-5 Rows Per Page 5

Pages 1 of 2

**External LSA Database**

Adv. Router	LSA Type	Link ID	Age	Sequence	Checksum
-------------	----------	---------	-----	----------	----------

Items Displayed 0-0 Rows Per Page 0

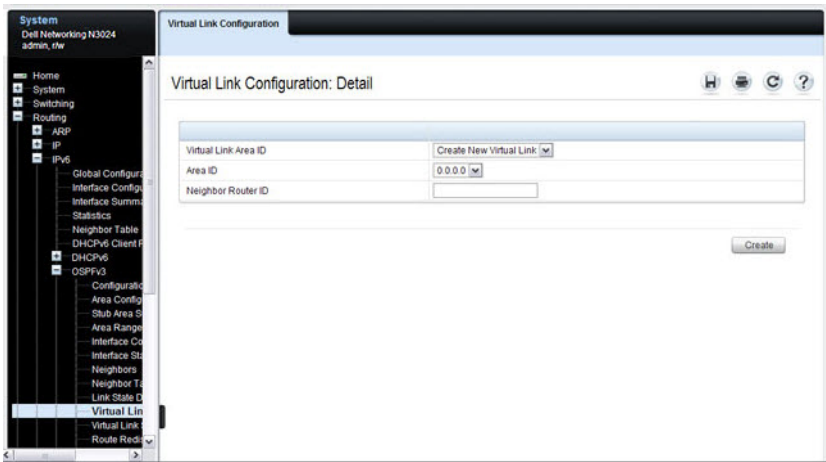
Pages 0 of 0

## OSPFv3 Virtual Link Configuration

Use the **Virtual Link Configuration** page to define a new or configure an existing virtual link. To display this page, a valid OSPFv3 area must be defined through the OSPFv3 Area Configuration page.

To display the page, click **IPv6** → **OSPFv3** → **Virtual Link Configuration** in the navigation panel.

**Figure 34-29. OSPFv3 Virtual Link Configuration**



After you create a virtual link, additional fields display, as the Figure 34-30 shows.

**Figure 34-30. OSPFv3 Virtual Link Configuration**

Virtual Link Configuration: Detail

Virtual Link Area ID	0.0.0.5	
Virtual Link Neighbor Router ID	4.4.4.4	
Hello Interval	10	(1 to 65535 seconds)
Dead Interval	40	(1 to 65535 seconds)
Interface Delay Interval	1	(0 to 3600 seconds)
State	Down	
Neighbor State	Down	
Retransmit Interval	5	(0 to 3600 seconds)
Metric	0	
Delete	<input type="checkbox"/>	

Apply

## OSPFv3 Virtual Link Summary

Use the **Virtual Link Summary** page to display virtual link data by Area ID and Neighbor Router ID.

To display the page, click **IPv6** → **OSPFv3** → **Virtual Link Summary** in the navigation panel.

**Figure 34-31. OSPFv3 Virtual Link Summary**

Virtual Link Summary: Detail

Items Displayed 1-1 Rows Per Page All

Area ID	Neighbor Router ID	Hello Interval(secs)	Dead Interval(secs)	Retransmit Interval (secs)	Interface Delay Interval (secs)
0.0.0.5	4.4.4.4	10	40	5	1

Pages 1 of 1

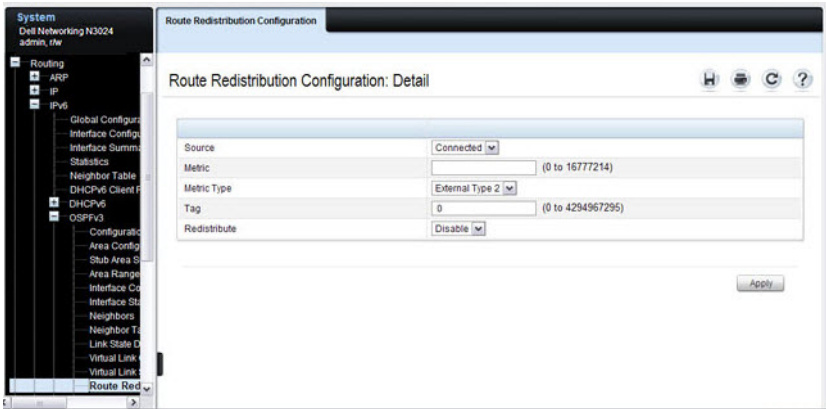


## OSPFv3 Route Redistribution Configuration

Use the **Route Redistribution Configuration** page to configure route redistribution.

To display the page, click **IPv6** → **OSPFv3** → **Route Redistribution Configuration** in the navigation panel.

**Figure 34-32. OSPFv3 Route Redistribution Configuration**

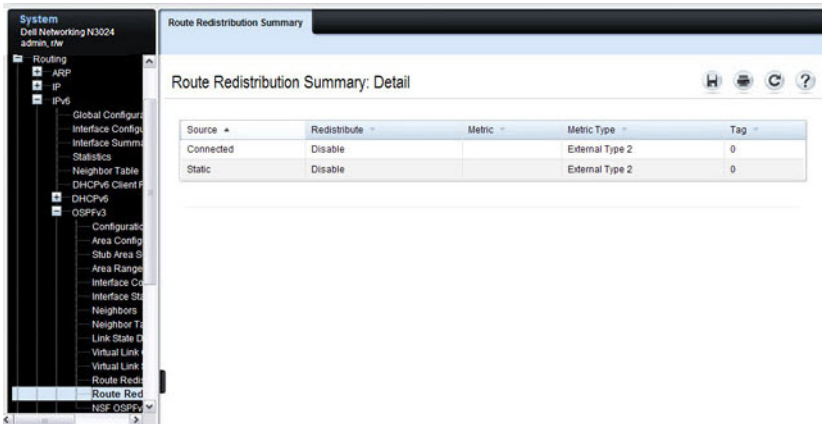


## OSPFv3 Route Redistribution Summary

Use the **Route Redistribution Summary** page to display route redistribution settings by source.

To display the page, click **IPv6** → **OSPFv3** → **Route Redistribution Summary** in the navigation panel.

**Figure 34-33. OSPFv3 Route Redistribution Summary**

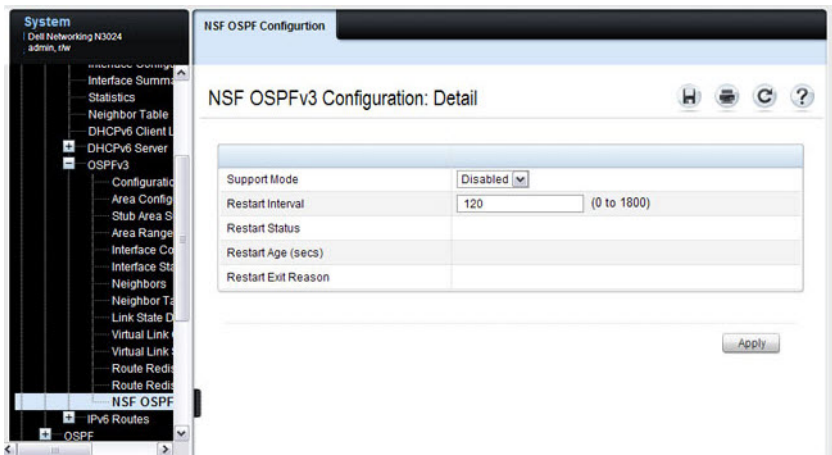


## NSF OSPFv3 Configuration

Use the NSF OSPFv3 Configuration page to configure the non-stop forwarding (NSF) support mode and to view NSF summary information for the OSPFv3 feature. NSF is a feature used in switch stacks to maintain switching and routing functions in the event of a stack unit failure. For information about NSF, see "What is Nonstop Forwarding?" on page 262 in the Stacking chapter.

To display the page, click **Routing** → **OSPFv3** → **NSF OSPFv3 Configuration** in the navigation panel.

**Figure 34-34. NSF OSPFv3 Configuration**



# Configuring OSPF Features (CLI)

This section provides information about the commands used for configuring and viewing OSPF settings on the switch. This section does not describe all available **show** commands. For more information about all available OSPF commands, see the *Dell EMC Networking N1100-ON, N1500, N2000, N2100-ON, N2200-ON, N3000E-ON, N3100-ON, and N3200-ON Series Switches CLI Reference Guide* at [www.dell.com/support](http://www.dell.com/support).

## Configuring Global OSPF Settings

Use the following commands to configure various global OSPF settings for the switch.

Command	Purpose
<code>configure</code>	Enter global configuration mode.
<code>router ospf</code>	Enter OSPF configuration mode.
<code>router-id ip-address</code>	Set the 4-digit dotted-decimal number that uniquely identifies the router.
<code>auto-cost reference-bandwidth ref_bw</code>	Set the reference bandwidth used in the formula to compute link cost for an interface: $\text{link cost} = \frac{\text{ref\_bw}}{\text{interface bandwidth}}$ The <code>ref_bw</code> variable is the reference bandwidth in Mbps (Range: 1–4294967).
<code>capability opaque</code>	Allow OSPF to store and flood opaque LSAs. An opaque LSA is used for flooding user defined information within an OSPF router domain.
<code>compatible rfc1583</code>	(Optional) Enable compatibility with RFC 1583. If all OSPF routers in the routing domain are capable of operating according to RFC 2328, OSPF 1583 compatibility mode should be disabled.

Command	Purpose
<b>default-information originate</b> [always] [metric <i>metric-value</i> ] [metric-type <i>type-value</i> ]	Control the advertisement of default routes. <ul style="list-style-type: none"> <li>• <b>always</b> — Normally, OSPF originates a default route only if a default route is redistributed into OSPF (and default-information originate is configured). When the always option is configured, OSPF originates a default route, even if no default route is redistributed.</li> <li>• <i>metric-value</i> — The metric (or preference) value of the default route. (Range: 1–16777214)</li> <li>• <i>type-value</i> — The value is either 1 or 2: External type-1 route or External type-2 route.</li> </ul>
<b>default-metric</b> <i>metric-value</i>	Set a default for the metric of distributed routes (Range: 1–16777214).
<b>distance ospf</b> {external   inter-area   intra-area } <i>distance</i>	Set the preference values of OSPF route types in the router.  The range for the <i>distance</i> variable is 1–255. Lower route preference values are preferred when determining the best route.
<b>enable</b>	Enable OSPF.
<b>exit-overflow-interval</b> <i>seconds</i>	Specify the exit overflow interval for OSPF as defined in RFC 1765.  The interval is the number of seconds after entering overflow state that a router will wait before attempting to leave the overflow state. (Range: 0–2147483647)
<b>external-lsdb-limit</b> <i>limit</i>	Configure the external LSDB limit for OSPF as defined in RFC 1765. If the value is –1, then there is no limit.  The <i>limit</i> variable is the maximum number of non-default AS external-LSAs allowed in the router's link-state database. (Range: 1 to 2147483647)
<b>maximum-paths</b> <i>integer</i>	Set the number of paths that OSPF can report for a given destination (Range: 1–4). <b>Note:</b> The upper limit of this command depends on the selected SDM template. Use <b>show sdm prefer</b> command to display the upper limit of ECMP next hops.

<b>Command</b>	<b>Purpose</b>
<code>passive-interface default</code>	Configure OSPF interfaces as passive by default. This command overrides any interface-level passive mode settings. OSPF does not form adjacencies on passive interfaces but does advertise attached networks as stub networks.
<code>timers spf <i>delay-time</i> <i>hold-time</i></code>	Specify the SPF delay and hold time. <ul style="list-style-type: none"> <li>• <i>delay-time</i> — SPF delay time. (Range: 0–65535 seconds)</li> <li>• <i>hold-time</i> — SPF hold time. (Range: 0–65535 seconds)</li> </ul>
<code>exit</code>	Exit to Global Configuration mode.
<code>exit</code>	Exit to Privileged Exec mode.
<code>show ip ospf</code>	View OSPF global configuration and status.
<code>show ip ospf statistics</code>	View OSPF routing table calculation statistics.
<code>clear ip ospf [<i>{configuration  </i> <i>redistribution   counters</i> <i>  neighbor [interface vlan</i> <i>vlan-id [neighbor-id]]</i>}]</code>	Reset specific OSPF states. If no parameters are specified, OSPF is disabled and then re-enabled.

## Configuring OSPF Interface Settings

Use the following commands to configure per-interface OSPF settings.

Command	Purpose
<code>configure</code>	Enter global configuration mode.
<code>interface vlan <i>vlan-id</i></code>	Enter Interface Configuration mode for the specified VLAN.
<code>ip ospf area <i>area-id</i> [secondaries none]</code>	<p>Enables OSPFv2 on the interface and sets the area ID of an interface. This command supersedes the effects of network area command.</p> <p>The <i>area-id</i> variable is the ID of the area (Range: IP address or decimal from 0 –4294967295)</p> <p>Use the <b>secondaries none</b> keyword to prevent the interface from advertising its secondary addresses into the OSPFv2 domain.</p>
<code>ip ospf priority <i>number-value</i></code>	<p>Set the OSPF priority for the interface. The <i>number-value</i> variable specifies the priority of an interface (Range: 0 to 255).</p> <p>The default priority is 1, which is the highest router priority. A value of 0 indicates that the router is not eligible to become the designated router on this network.</p>
<code>ip ospf retransmit-interval <i>seconds</i></code>	<p>Set the OSPF retransmit interval for the interface.</p> <p>The <i>seconds</i> variable is the number of seconds between link-state advertisements for adjacencies belonging to this router interface.</p> <p>This value is also used when retransmitting database descriptions and link-state request packets. Valid values range from 0 to 3600 seconds (1 hour).</p>
<code>ip ospf hello-interval <i>seconds</i></code>	<p>Set the OSPF hello interval for the interface. This parameter must be the same for all routers attached to a network.</p> <p>The <i>seconds</i> variable indicates the number of seconds to wait before sending Hello packets from the interface. (Range: 1–65535).</p>

Command	Purpose
<code>ip ospf dead-interval</code> <i>seconds</i>	<p>Set the OSPF dead interval for the interface.</p> <p>The <i>seconds</i> variable indicates the number of seconds a router waits to see a neighbor router's Hello packets before declaring that the router is down (Range: 1–65535).</p> <p>This parameter must be the same for all routers attached to a network. This value should be some multiple of the Hello Interval.</p>
<code>ip ospf transmit-delay</code> <i>seconds</i>	<p>Set the OSPF Transit Delay for the interface.</p> <p>The <i>seconds</i> variable sets the estimated number of seconds it takes to transmit a link state update packet over this interface. (Range: 1–3600 seconds)</p>
<code>ip ospf mtu-ignore</code>	<p>Disable OSPF MTU mismatch detection on the received database description.</p>
<code>ip ospf network</code> { <code>broadcast</code>   <code>point-to-point</code> }	<p>Set the OSPF network type on the interface to broadcast or point-to-point. OSPF selects a designated router and originates network LSAs only for broadcast networks. No more than two OSPF routers may be present on a point-to-point link.</p>
<code>ip ospf authentication</code> { <code>none</code>   { <code>simple</code> <i>key</i> }   { <code>encrypt</code> <i>key</i> <i>key-id</i> }}	<p>Set the OSPF Authentication Type and Key for the specified interface.</p> <ul style="list-style-type: none"> <li>• <code>encrypt</code> — MD5 encrypted authentication key.</li> <li>• <i>key</i> — Authentication key for the specified interface. (Range: 8 bytes or less if the authentication type is <code>simple</code> and 16 bytes or less if the type is <code>encrypt</code>.)</li> <li>• <i>key-id</i> — Authentication key identifier for the authentication type <code>encrypt</code>. (Range: 0–25)</li> </ul>
<code>ip ospf cost</code> <i>interface-cost</i>	<p>Set the metric cost of the interface.</p> <p>The <i>interface-cost</i> variable specifies the cost (link-state metric) of the OSPF interface. (Range: 1–65535)</p>
<code>bandwidth</code> <i>bw</i>	<p>Set the interface bandwidth used in the formula to compute link cost for an interface:</p> $\text{link cost} = \text{ref\_bw} \div \text{interface bandwidth}$ <p>The <i>bw</i> variable is the interface bandwidth (Range: 1–10000000 Kbps).</p>



<b>Command</b>	<b>Purpose</b>
<code>exit</code>	Exit to Global Configuration Mode
<code>router ospf</code>	Enter OSPF configuration mode.
<code>passive-interface vlan vlan-id</code>	Make an interface passive to prevent OSPF from forming an adjacency on an interface. OSPF advertises networks attached to passive interfaces as stub networks.
<code>network ip-address wildcard-mask area area- id</code>	Enable OSPFv2 on interfaces whose primary IP address matches this command, and make the interface a member of the specified area. <ul style="list-style-type: none"> <li>• <i>ip-address</i> — Base IPv4 address of the network area.</li> <li>• <i>wildcard-mask</i> — The network mask indicating the subnet.</li> <li>• <i>area-id</i> — The ID of the area (Range: IP address or decimal from 0–4294967295).</li> </ul>
<code>exit</code>	Exit to Global Config mode.
<code>exit</code>	Exit to Privileged Exec mode.
<code>show ip ospf interface [vlan vlan-id]</code>	View summary information for all OSPF interfaces configured on the switch or for the specified routing interface.
<code>show ip ospf interface stats vlan vlan-id</code>	View per-interface OSPF statistics.

## Configuring Stub Areas and NSSAs

Use the following commands to configure OSPF stub areas and NSSAs.

<b>Command</b>	<b>Purpose</b>
<code>configure</code>	Enter global configuration mode.
<code>router ospf</code>	Enter OSPF configuration mode.
<code>area area-id stub</code>	Create a stub area for the specified area ID.
<code>area area-id stub no- summary</code>	Prevent Summary LSAs from being advertised into the stub area. This command creates a totally stubby area when used in conjunction with the previous command.

<b>Command</b>	<b>Purpose</b>
<code>area <i>area-id</i> default-cost <i>integer</i></code>	Configure the metric value (default cost) for the type 3 summary LSA sent into the stub area. Range: 1–16777215)
<code>area <i>area-id</i> nssa</code>	Create an NSSA for the specified area ID.
<code>area <i>area-id</i> nssa no-summary</code>	Configure the NSSA so that summary LSAs are not advertised into the NSSA.
<code>area <i>area-id</i> nssa translator-role {always   candidate}</code>	Configure the translator role of the NSSA. <ul style="list-style-type: none"> <li>• <b>always</b> — The router assumes the role of the translator when it becomes a border router.</li> <li>• <b>candidate</b> — The router can participate in the translator election process when it attains border router status.</li> </ul>
<code>area <i>area-id</i> nssa translator-stab-intv <i>integer</i></code>	Configure the translator stability interval of the NSSA. The <i>integer</i> variable is the period of time that an elected translator continues to perform its duties after it determines that its translator status has been deposed by another router. (Range: 0–3600)
<code>area <i>area-id</i> nssa default-information-originate [<i>metric</i> <i>metric-value</i>] [<i>metric-type</i> <i>metric-type-value</i>]</code>	Configure the metric value and type for the default route advertised into the NSSA. The metric type can be comparable ( <i>nssa-external</i> 1) or non-comparable ( <i>nssa-external</i> 2).
<code>area <i>area-id</i> nssa no-redistribution</code>	Prevent learned external routes from being redistributed to the NSSA.
<code>exit</code>	Exit to Global Config mode.
<code>exit</code>	Exit to Privileged Exec mode.
<code>show ip ospf area <i>area-id</i></code>	View the configuration and status of an OSPF area.

## Configuring Virtual Links

Use the following commands to configure OSPF Virtual Links.

Command	Purpose
<code>configure</code>	Enter global configuration mode.
<code>router ospf</code>	Enter OSPF configuration mode.
<code>area <i>area-id</i> virtual-link <i>neighbor-id</i></code>	Create the OSPF virtual interface for the specified area-id and neighbor router. The <i>neighbor-id</i> variable is the IP address of the neighboring router.
<code>area <i>area-id</i> virtual-link <i>router-id</i> [authentication [message-digest   null]] [[authentication-key <i>key</i>]   [message-digest-key <i>key-id</i> md5 <i>key</i>]]</code>	Create the OSPF virtual interface for the specified area-id and neighbor router.  Use the optional parameters to configure authentication for the virtual link. If the area has not been previously created, it is created by this command. If the area already exists, the virtual-link information is added or modified. <ul style="list-style-type: none"><li>• <b>authentication</b>—Specifies authentication type.</li><li>• <b>message-digest</b>—Specifies that message-digest authentication is used.</li><li>• <b>null</b>—No authentication is used. Overrides password or message-digest authentication if configured for the area.</li><li>• <b>md5</b>—Use MD5 Encryption for an OSPF Virtual Link</li><li>• <b>key</b>—Authentication key for the specified interface. (Range: 8 bytes or less if the authentication type is simple and 16 bytes or less if the type is encrypt.)</li><li>• <b>key-id</b>—Authentication key identifier for the authentication type encrypt. (Range: 0-255)</li></ul>
<code>area <i>area-id</i> virtual-link <i>neighbor-id</i> retransmit-interval <i>seconds</i></code>	Set the OSPF retransmit interval for the virtual link interface.  The <i>seconds</i> variable is the number of seconds to wait between retransmitting LSAs if no acknowledgement is received. (Range: 0–3600)

<b>Command</b>	<b>Purpose</b>
<b>area <i>area-id</i> virtual-link neighbor-id hello-interval seconds</b>	Set the OSPF hello interval for the virtual link. The <i>seconds</i> variable indicates the number of seconds to wait before sending Hello packets from the virtual interface. (Range: 1–65535).
<b>area <i>area-id</i> virtual-link neighbor-id dead-interval seconds</b>	Set the OSPF dead interval for the virtual link. The <i>seconds</i> variable indicates the number of seconds to wait before the virtual interface is assumed to be dead. (Range: 1–65535)
<b>area <i>area-id</i> virtual-link neighbor-id transmit- delay seconds</b>	Set the OSPF Transit Delay for the interface. The <i>seconds</i> variable is the number of seconds to increment the age of the LSA before sending, based on the estimated time it takes to transmit from the interface. (Range: 0–3600)
<b>exit</b>	Exit to Global Config mode.
<b>exit</b>	Exit to Privileged Exec mode.
<b>show ip ospf virtual-link brief</b>	View summary information about all virtual links configured on the switch.

## Configuring OSPF Area Range Settings

Use the following commands to configure an OSPF area range.

Command	Purpose
configure	Enter global configuration mode.
router ospf	Enter OSPF configuration mode.
area <i>area-id</i> range <i>ip-address mask</i> {summarylink   nssaexternallink} [advertise  not-advertise]	Configure a summary prefix for routes learned in a given area. <ul style="list-style-type: none"><li>• <i>area-id</i> — Identifies the OSPF NSSA to configure. (Range: IP address or decimal from 0–4294967295)</li><li>• <i>ip-address</i> — IP address.</li><li>• <i>subnet-mask</i> — Subnet mask associated with IP address.</li><li>• <i>summarylink</i> — Specifies a summary link LSDB type.</li><li>• <i>nssaexternallink</i> — Specifies an NSSA external link LSDB type.</li><li>• <i>advertise</i> — Advertisement of the area range.</li><li>• <i>not-advertise</i> — Suppresses advertisement of the area range.</li></ul>
exit	Exit to Global Config mode.
exit	Exit to Privileged Exec mode.
show ip ospf range <i>area-id</i>	View information about the area ranges for the specified <i>area-id</i> .

## Configuring OSPF Route Redistribution Settings

Use the following commands to configure OSPF route redistribution settings.

Command	Purpose
configure	Enter global configuration mode.
router ospf	Enter OSPF configuration mode.

Command	Purpose
<b>distribute-list</b> <i>accesslistname</i> out { <b>bgp</b>   <b>rip</b>   <b>static</b>   <b>connected</b> }	<p>Specify the access list to filter routes received from the source protocol. The ACL must already exist on the switch. For information about the commands used for configuring ACLs, see "Configuring ACLs (CLI)" on page 749.</p> <ul style="list-style-type: none"> <li>• <i>accesslistname</i> — The name used to identify an existing ACL.</li> <li>• <b>bgp</b> — Apply the specified access list when BGP is the source protocol.</li> <li>• <b>rip</b> — Apply the specified access list when RIP is the source protocol.</li> <li>• <b>static</b> — Apply the specified access list when packets come through the static route.</li> <li>• <b>connected</b> — Apply the specified access list when packets come from a directly connected route.</li> </ul>
<b>redistribute</b> { <b>bgp</b>   <b>rip</b>   <b>static</b>   <b>connected</b> } [ <i>metric integer</i> ] [ <i>metric-</i> <i>type</i> {1   2}] [ <i>tag integer</i> ] [ <i>subnets</i> ]	<p>Configure OSPF to allow redistribution of routes from the specified source protocol/routers.</p> <ul style="list-style-type: none"> <li>• <b>bgp</b> — Specifies BGP as the source protocol.</li> <li>• <b>rip</b> — Specifies RIP as the source protocol.</li> <li>• <b>static</b> — Specifies that the source is a static route.</li> <li>• <b>connected</b> — Specifies that the source is a directly connected route.</li> <li>• <i>metric</i> — Specifies the metric to use when redistributing the route. (Range: 0–16777214)</li> <li>• <b>metric-type 1</b> — Type 1 external route.</li> <li>• <b>metric-type 2</b> — Type 2 external route.</li> <li>• <i>tag</i> — Value attached to each external route. (Range: 0–4294967295)</li> <li>• <b>subnets</b>—Unless this keyword is configured, OSPF distributes only class A, class B, and class C prefixes.</li> </ul>
<b>exit</b>	Exit to Global Config mode.
<b>exit</b>	Exit to Privileged Exec mode.

Command	Purpose
show ip ospf	View OSPF configuration and status information, including route distribution information.

## Configuring NSF Settings for OSPF

Use the following commands to configure the non-stop forwarding settings for OSPF.

Command	Purpose
configure	Enter global configuration mode.
router ospf	Enter OSPF configuration mode.
nsf [ietf] helper strict-lsa-checking	Require that an OSPF helpful neighbor exit helper mode whenever a topology change occurs. Use the <b>ietf</b> keyword to distinguish the IETF standard implementation of graceful restart from other implementations.
nsf [ietf] restart-interval <i>seconds</i>	Configure the length of the grace period on the restarting router.  The <i>seconds</i> keyword is the number of seconds that the restarting router asks its neighbors to wait before exiting helper mode. The restarting router includes the restart interval in its grace LSAs (range 1–1800 seconds)
nsf helper [planned-only]	Allow OSPF to act as a helpful neighbor for a restarting router. Include the <b>planned-only</b> keyword to indicate that OSPF should only help a restarting router performing a planned restart.
nsf [ietf] [planned-only]	Enable a graceful restart of OSPF. <ul style="list-style-type: none"> <li><b>ietf</b> — This keyword is used to distinguish the IETF standard implementation of graceful restart from other implementations. Since the IETF implementation is the only one supported, this keyword is optional.</li> <li><b>planned-only</b> — This keyword indicates that OSPF should only perform a graceful restart when the restart is planned (i.e., when the restart is a result of the initiate failover command).</li> </ul>

# Configuring OSPFv3 Features (CLI)

This section provides information about the commands used for configuring OSPFv3 settings on the switch. For more information about the commands and about additional `show` commands, see the *Dell EMC Networking N1100-ON, N1500, N2000, N2100-ON, N2200-ON, N3000E-ON, N3100-ON, and N3200-ON Series Switches CLI Reference Guide* at [www.dell.com/support](http://www.dell.com/support).

## Configuring Global OSPFv3 Settings

Use the following commands to configure various global OSPFv3 settings for the switch.

Command	Purpose
<code>configure</code>	Enter global configuration mode.
<code>ipv6 router ospf</code>	Enter OSPFv3 configuration mode.
<code>router-id ip-address</code>	Set the 4-digit dotted-decimal number that uniquely identifies the router.
<code>auto-cost reference-bandwidth ref_bw</code>	Set the reference bandwidth used in the formula to compute link cost for an interface: $\text{link cost} = \text{ref\_bw} \div \text{interface bandwidth}$ The <code>ref_bw</code> variable is the reference bandwidth in Mbps (Range: 1–4294967).
<code>default-information originate [always] [metric metric-value] [metric-type type-value]</code>	Control the advertisement of default routes. <ul style="list-style-type: none"><li>• <code>always</code> — Normally, OSPFv3 originates a default route only if a default route is redistributed into OSPFv3 (and <code>default-information originate</code> is configured). When the <code>always</code> option is configured, OSPFv3 originates a default route, even if no default route is redistributed.</li><li>• <code>metric-value</code> — The metric (or preference) value of the default route. (Range: 1–16777214)</li><li>• <code>type-value</code> — The value is either 1 or 2: External type-1 route or External type-2 route.</li></ul>
<code>default-metric metric-value</code>	Set a default for the metric of distributed routes. (Range: 1–16777214).



Command	Purpose
<code>distance ospf {external   inter-area   intra-area } distance</code>	Set the preference values of OSPFv3 route types in the router.  The range for the <i>distance</i> variable is 1–255. Lower route preference values are preferred when determining the best route.
<code>enable</code>	Enable OSPFv3.
<code>exit-overflow-interval seconds</code>	Specify the exit overflow interval for OSPFv3 as defined in RFC 1765.  The interval is the number of seconds after entering overflow state that a router will wait before attempting to leave the overflow state. (Range: 0–2147483647)
<code>external-lsdb-limit limit</code>	Configure the external LSDB limit for OSPFv3 as defined in RFC 1765. If the value is -1, then there is no limit.  The <i>limit</i> variable is the maximum number of non-default AS external-LSAs allowed in the router's link-state database. (Range: -1 to 2147483647)
<code>maximum-paths maxpaths</code>	Set the number of paths that OSPFv3 can report for a given destination. (Range: 1–4.) <b>Note:</b> The upper limit of this command depends on the selected SDM template. Use the <code>show sdm prefer</code> command to display the maximum ECMP next hops limit.
<code>passive-interface default</code>	Configure OSPFv3 interfaces as passive by default. This command overrides any interface-level passive mode settings.  OSPFv3 does not form adjacencies on passive interfaces but does advertise attached networks as stub networks.
<code>exit</code>	Exit to Global Configuration mode.
<code>exit</code>	Exit to Privileged Exec mode.
<code>show ipv6 ospf</code>	View OSPFv3 global configuration and status.
<code>clear ipv6 ospf [{configuration   redistribution   counters   neighbor [interface vlan <i>vlan-id</i> [neighbor-id]]}]</code>	Reset specific OSPFv3 states. If no parameters are specified, OSPFv3 is disabled and then re-enabled.

## Configuring OSPFv3 Interface Settings

Use the following commands to configure per-interface OSPFv3 settings.

Command	Purpose
<code>configure</code>	Enter global configuration mode.
<code>interface vlan <i>vlan-id</i></code>	Enter Interface Configuration mode for the specified VLAN.
<code>ipv6 ospf areaid <i>area-id</i></code>	Enables OSPFv3 on the interface and sets the area ID of an interface. This command supersedes the effects of network area command.  The <i>area-id</i> variable is the ID of the area (Range: IP address or decimal from 0 –4294967295)
<code>ipv6 ospf priority <i>number-value</i></code>	Set the OSPFv3 priority for the interface. The <i>number-value</i> variable specifies the priority of an interface (Range: 0 to 255).  The default priority is 1, which is the highest router priority. A value of 0 indicates that the router is not eligible to become the designated router on this network.
<code>ipv6 ospf retransmit-interval <i>seconds</i></code>	Set the OSPFv3 retransmit interval for the interface.  The <i>seconds</i> variable is the number of seconds between link-state advertisements for adjacencies belonging to this router interface.  This value is also used when retransmitting database descriptions and link-state request packets. Valid values range from 0 to 3600 seconds (1 hour).
<code>ipv6 ospf hello-interval <i>seconds</i></code>	Set the OSPFv3 hello interval for the interface. This parameter must be the same for all routers attached to a network.  The <i>seconds</i> variable indicates the number of seconds to wait before sending Hello packets from the interface. (Range: 1–65535).

Command	Purpose
<code>ipv6 ospf dead-interval</code> <i>seconds</i>	Set the OSPFv3 dead interval for the interface.  The <i>seconds</i> variable indicates the number of seconds a router waits to see a neighbor router's Hello packets before declaring that the router is down (Range: 1–65535).  This parameter must be the same for all routers attached to a network. This value should be some multiple of the Hello Interval.
<code>ipv6 ospf transmit-delay</code> <i>seconds</i>	Set the OSPFv3 Transit Delay for the interface.  The <i>seconds</i> variable sets the estimated number of seconds it takes to transmit a link state update packet over this interface. (Range: 1–3600 seconds)
<code>ipv6 ospf mtu-ignore</code>	Disable OSPFv3 MTU mismatch detection on received database description packets.
<code>ipv6 ospf network</code> { <code>broadcast</code>   <code>point-to-point</code> }	Set the OSPFv3 network type on the interface to broadcast or point-to-point. OSPFv3 selects a designated router and originates network LSAs only for broadcast networks. No more than two OSPFv3 routers may be present on a point-to-point link.
<code>ipv6 ospf cost</code> <i>interface-cost</i>	Set the metric cost of the interface.  The <i>interface-cost</i> variable specifies the cost (link-state metric) of the OSPFv3 interface. (Range: 1–65535)
<code>bandwidth</code> <i>bw</i>	Set the interface bandwidth used in the formula to compute link cost for an interface:  link cost = ref_bw ÷ interface bandwidth  The <i>bw</i> variable is the interface bandwidth (Range: 1–10000000 Kbps).
<code>exit</code>	Exit to Global Configuration Mode
<code>ipv6 router ospf</code>	Enter OSPFv3 configuration mode.
<code>passive-interface</code> { <code>vlan</code> <i>vlan-id</i>   <code>tunnel</code> <i>tunnel-id</i> }	Make an interface passive to prevent OSPFv3 from forming an adjacency on an interface. OSPFv3 advertises networks attached to passive interfaces as stub networks.
<code>exit</code>	Exit to Global Config mode.
<code>exit</code>	Exit to Privileged Exec mode.

<b>Command</b>	<b>Purpose</b>
<code>show ipv6 ospf interface</code> [ <i>interface-type interface-number</i> ]	View summary information for all OSPFv3 interfaces configured on the switch or for the specified routing interface.
<code>show ipv6 ospf interface stats</code> <i>interface-type interface-number</i>	View per-interface OSPFv3 statistics.

## Configuring Stub Areas and NSSAs

Use the following commands to configure OSPFv3 stub areas and NSSAs.

<b>Command</b>	<b>Purpose</b>
<code>configure</code>	Enter global configuration mode.
<code>ipv6 router ospf</code>	Enter OSPFv3 configuration mode.
<code>area <i>area-id</i> stub</code>	Create a stub area for the specified area ID.
<code>area <i>area-id</i> stub no-summary</code>	Prevent Summary LSAs from being advertised into the stub area. This command creates a totally stubby area when used in conjunction with the previous command.
<code>area <i>area-id</i> default-cost</code> <i>cost</i>	Configure the metric value (default cost) for the type 3 summary LSA sent into the stub area. Range: 1–16777215)

Command	Purpose
<pre>area <i>area-id</i> nssa [no- redistribution] [default- information-originate [metric <i>metric-value</i>] [metric-type <i>metric-type- value</i>] [no-summary] [translator-role <i>role</i>] [translator-stab-intv interval]</pre>	<p>Create and configure an NSSA for the specified area ID.</p> <ul style="list-style-type: none"> <li>• <i>metric-value</i>—Specifies the metric of the default route advertised to the NSSA. (Range: 1–16777214)</li> <li>• <i>metric-type-value</i>—The metric type can be one of the following : <ul style="list-style-type: none"> <li>• A metric type of nssa-external 1 (comparable)</li> <li>• A metric type of nssa-external 2 (non-comparable)</li> </ul> </li> <li>• <b>no-summary</b>—Summary LSAs are not advertised into the NSSA</li> <li>• <b>role</b>—The translator role where <i>role</i> is one of the following : <ul style="list-style-type: none"> <li>• <b>always</b>—The router assumes the role of the translator when it becomes a border router.</li> <li>• <b>candidate</b>—The router to participate in the translator election process when it attains border router status.</li> <li>• <b>interval</b>—The period of time that an elected translator continues to perform its duties after it determines that its translator status has been deposed by another router. (Range: 0–3600)</li> </ul> </li> </ul>
<pre>area <i>area-id</i> nssa no-redistribution</pre>	Prevent learned external routes from being redistributed to the NSSA.
<pre>exit</pre>	Exit to Global Config mode.
<pre>exit</pre>	Exit to Privileged Exec mode.
<pre>show ipv6 ospf area <i>area- id</i></pre>	Show configuration and status of an OSPF area.

## Configuring Virtual Links

Use the following commands to configure OSPFv3 Virtual Links.

Command	Purpose
<code>configure</code>	Enter global configuration mode.
<code>ipv6 router ospf</code>	Enter OSPFv3 configuration mode.
<code>area area-id virtual-link neighbor-id</code>	Create the OSPFv3 virtual interface for the specified <i>area-id</i> and neighbor router. The <i>neighbor-id</i> variable is the IP address of the neighboring router.
<code>area area-id virtual-link neighbor-id retransmit-interval seconds</code>	Set the OSPFv3 retransmit interval for the virtual link interface. The <i>seconds</i> variable is the number of seconds to wait between retransmitting LSAs if no acknowledgement is received. (Range: 0–3600)
<code>area area-id virtual-link neighbor-id hello-interval seconds</code>	Set the OSPFv3 hello interval for the virtual link. The <i>seconds</i> variable indicates the number of seconds to wait before sending Hello packets from the virtual interface. (Range: 1–65535).
<code>area area-id virtual-link neighbor-id dead-interval seconds</code>	Set the OSPFv3 dead interval for the virtual link. The <i>seconds</i> variable indicates the number of seconds to wait before the virtual interface is assumed to be dead. (Range: 1–65535)
<code>area area-id virtual-link neighbor-id transmit-delay seconds</code>	Set the OSPFv3 Transit Delay for the interface. The <i>seconds</i> variable is the number of seconds to increment the age of the LSA before sending, based on the estimated time it takes to transmit from the interface. (Range: 0–3600)
<code>exit</code>	Exit to Global Config mode.
<code>exit</code>	Exit to Privileged Exec mode.
<code>show ipv6 ospf virtual-link brief</code>	View summary information about all virtual links configured on the switch.

## Configuring an OSPFv3 Area Range

Use the following commands to configure an OSPFv3 area range.

Command	Purpose
<code>configure</code>	Enter global configuration mode.
<code>ipv6 router ospf</code>	Enter OSPFv3 configuration mode.
<code>area area-id range ipv6-prefix/prefix-length {summarylink   nssaexternallink} [advertise   not-advertise]</code>	Configure a summary prefix for routes learned in a given area. <ul style="list-style-type: none"><li>• <i>area-id</i> — Identifies the OSPFv3 NSSA to configure. (Range: IP address or decimal from 0–4294967295)</li><li>• <i>ipv6-prefix/prefix-length</i> — IPv6 address and prefix length.</li><li>• <i>summarylink</i> — Specifies a summary link LSDB type.</li><li>• <i>nssaexternallink</i> — Specifies an NSSA external link LSDB type.</li><li>• <i>advertise</i> — Advertisement of the area range.</li><li>• <i>not-advertise</i> — Suppresses advertisement of the area range.</li></ul>
<code>exit</code>	Exit to Global Config mode.
<code>exit</code>	Exit to Privileged Exec mode.
<code>show ipv6 ospf range area-id</code>	View information about the area ranges for the specified area-id.

## Configuring OSPFv3 Route Redistribution Settings

Use the following commands to configure OSPFv3 route redistribution settings.

Command	Purpose
<code>configure</code>	Enter global configuration mode.
<code>ipv6 router ospf</code>	Enter OSPFv3 configuration mode.
<code>redistribute {bgp   static   connected} [metric <i>metric</i>] [metric-type {1   2}] [tag <i>tag</i>]</code>	Configure OSPFv3 to allow redistribution of routes from the specified source protocol/routers. <ul style="list-style-type: none"><li>• <b>bgp</b> — Specifies BGP as the source protocol.</li><li>• <b>static</b> — Specifies that the source is a static route.</li><li>• <b>connected</b> — Specifies that the source is a directly connected route.</li><li>• <i>metric</i> — Specifies the metric to use when redistributing the route. (Range: 0–16777214)</li><li>• <b>metric-type 1</b> — Type 1 external route.</li><li>• <b>metric-type 2</b> — Type 2 external route.</li><li>• <i>tag</i> — Value attached to each external route, which might be used to communicate information between ASBRs. (Range: 0–4294967295)</li></ul>
<code>exit</code>	Exit to Global Config mode.
<code>exit</code>	Exit to Privileged Exec mode.
<code>show ipv6 ospf</code>	View OSPFv3 configuration and status information, including information about redistributed routes.



## Configuring NSF Settings for OSPFv3

Use the following commands to configure the non-stop forwarding settings for OSPFv3.

Command	Purpose
<code>configure</code>	Enter global configuration mode.
<code>ipv6 router ospf</code>	Enter OSPFv3 configuration mode.
<code>nsf [ietf] helper strict-lsa-checking</code>	Require that an OSPFv3 helpful neighbor exit helper mode whenever a topology change occurs. Use the <code>ietf</code> keyword to distinguish the IETF standard implementation of graceful restart from other implementations.
<code>nsf [ietf] restart-interval seconds</code>	Configure the length of the grace period on the restarting router.  The <code>seconds</code> keyword is the number of seconds that the restarting router asks its neighbors to wait before exiting helper mode. The restarting router includes the restart interval in its grace LSAs (range 1–1800 seconds)
<code>nsf helper [planned-only]</code>	Allow OSPFv3 to act as a helpful neighbor for a restarting router. Include the <code>planned-only</code> keyword to indicate that OSPFv3 should only help a restarting router performing a planned restart.
<code>nsf [ietf] [planned-only]</code>	Enable a graceful restart of OSPFv3. <ul style="list-style-type: none"><li>• <code>ietf</code> — This keyword is used to distinguish the IETF standard implementation of graceful restart from other implementations. Since the IETF implementation is the only one supported, this keyword is optional.</li><li>• <code>planned-only</code> — This keyword indicates that OSPF should only perform a graceful restart when the restart is planned (i.e., when the restart is a result of the <code>initiate failover</code> command).</li></ul>

# OSPF Configuration Examples

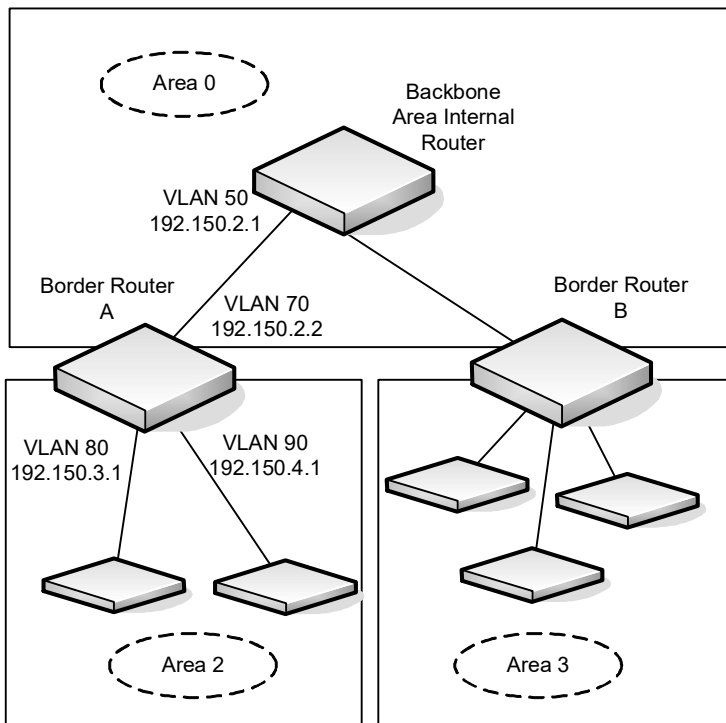
This section contains the following examples:

- Configuring an OSPF Border Router and Setting Interface Costs
- Configuring Stub and NSSA Areas for OSPF and OSPFv3
- Configuring a Virtual Link for OSPF and OSPFv3

## Configuring an OSPF Border Router and Setting Interface Costs

This example shows how to configure the Dell EMC Networking N-Series switch as an OSPF border router. The commands in this example configure the areas and interfaces on Border Router A shown in Figure 34-35.

**Figure 34-35. OSPF Area Border Router**



To Configure Border Router A:

- 1 Enable routing on the switch.

```
console#configure  
console (config) #ip routing
```

- 2 Create VLANs 70, 80, and 90 and assign them to interfaces.

```
console (config) #vlan 70,80,90  
console (config-vlan70,80,90) #interface gi1/0/1  
console (config-if-Gi1/0/1) #switchport access vlan 70  
console (config-if-Gi1/0/1) #interface gi1/0/2  
console (config-if-Gi1/0/2) #switchport access vlan 80  
console (config-if-Gi1/0/1) #interface gi1/0/3  
console (config-if-Gi1/0/2) #switchport access vlan 90
```

- 3 Assign IP addresses for VLANs 70, 80 and 90.

```
console (config) #interface vlan 70  
console (config-if-vlan70) #ip address 192.150.2.2 255.255.255.0  
console (config-if-vlan70) #exit
```

```
console (config) #interface vlan 80  
console (config-if-vlan80) #ip address 192.150.3.1 255.255.255.0  
console (config-if-vlan80) #exit
```

```
console (config) #interface vlan 90  
console (config-if-vlan90) #ip address 192.150.4.1 255.255.255.0  
console (config-if-vlan90) #exit
```

- 4 Enable OSPF on the switch and specify a router ID.

```
console (config) #router ospf  
console (config-router) #router-id 192.150.9.9  
console (config-router) #exit
```

## 5 Configure the OSPF area ID, priority, and cost for each interface.



**NOTE:** OSPF is globally enabled by default. To make it operational on the router, you configure OSPF for particular interfaces and identify which area the interface is associated with.

```
console(config)#interface vlan 70
console(config-if-vlan70)#ip ospf area 0.0.0.0
console(config-if-vlan70)#ip ospf priority 128
console(config-if-vlan70)#ip ospf cost 32
console(config-if-vlan70)#exit
```

```
console(config)#interface vlan 80
console(config-if-vlan80)#ip ospf area 0.0.0.2
console(config-if-vlan80)#ip ospf priority 255
console(config-if-vlan80)#ip ospf cost 64
console(config-if-vlan80)#exit
```

```
console(config)#interface vlan 90
console(config-if-vlan90)#ip ospf area 0.0.0.2
console(config-if-vlan90)#ip ospf priority 255
console(config-if-vlan90)#ip ospf cost 64
console(config-if-vlan90)#exit
```

## Configuring Stub and NSSA Areas for OSPF and OSPFv3

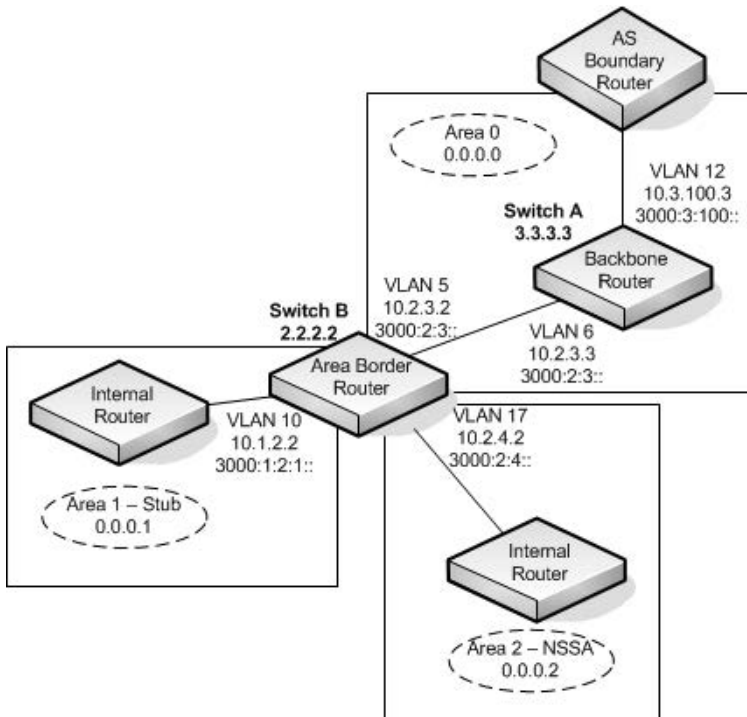
In this example, Area 0 connects directly to two other areas: Area 1 is defined as a stub area and Area 2 is defined as an NSSA area.



**NOTE:** OSPFv2 and OSPFv3 can operate concurrently on a network and on the same interfaces (although they do not interact). This example configures both protocols simultaneously.

Figure 34-36 illustrates this example OSPF configuration.

**Figure 34-36. OSPF Configuration—Stub Area and NSSA Area**



Switch A is a backbone router. It links to an ASBR (not defined here) that routes traffic outside the AS.

To configure Switch A:

- 1 Globally enable IPv6 and IPv4 routing:

```
console#configure
console(config)#ipv6 unicast-routing
console(config)#ip routing
```

- 2 Create VLANs 6 and 12 and assign them to interfaces.

```
console(config)#vlan 6,12
console(config-vlan6,12)#interface gil/0/1
console(config-if-Gil/0/1)#switchport access vlan 6
console(config-if-Gil/0/1)#interface gil/0/2
console(config-if-Gil/0/2)#switchport access vlan 12
```

- 3 Configure IP and IPv6 addresses on VLAN routing interface 6.

```
console(config-if)#interface vlan 6
console(config-if-vlan6)#ip address 10.2.3.3 255.255.255.0
console(config-if-vlan6)#ipv6 address 3000:2:3::/64 eui64
```

- 4 Associate the interface with area 0.0.0.0 and enable OSPFv3.

```
console(config-if-vlan6)#ip ospf area 0.0.0.0
console(config-if-vlan6)#ipv6 ospf
console(config-if-vlan6)#exit
```

- 5 Configure IP and IPv6 addresses on VLAN routing interface 12.

```
console(config)#interface vlan 12
console(config-if-vlan12)#ip address 10.3.100.3 255.255.255.0
console(config-if-vlan12)#ipv6 address 3000:3:100::/64 eui64
```

- 6 Associate the interface with area 0.0.0.0 and enable OSPFv3.

```
console(config-if-vlan12)#ip ospf area 0.0.0.0
console(config-if-vlan12)#ipv6 ospf
console(config-if-vlan12)#exit
```

- 7 Define the OSPF and OSPFv3 router IDs for the switch:

```
console(config)#ipv6 router ospf
console(config-rtr)#router-id 3.3.3.3
console(config-rtr)#exit

console(config)#router ospf
console(config-router)#router-id 3.3.3.3
console(config-router)#exit
```

Switch B is a ABR that connects Area 0 to Areas 1 and 2.

To configure Switch B:

- 1 Configure IPv6 and IPv4 routing. The static routes are included for illustration only. Redistributed static routes, like routes distributed from other protocols, are not injected into stub areas such as Area 1:

```
console#configure
console (config) #ipv6 unicast-routing

console (config) #ipv6 route 3000:44:44::/64
3000:2:3::210:18ff:fe82:c14
console (config) #ip route 10.23.67.0 255.255.255.0 10.2.3.3
```

- 2 Create VLANs 5, 10, and 17.

```
console (config) #vlan 5,10,17
console (config-vlan5,10,17) #interface gil/0/1
console (config-if-Gil/0/1) #switchport access vlan 5
console (config-if-Gil/0/1) #interface gil/0/2
console (config-if-Gil/0/2) #switchport access vlan 10
console (config-if-Gil/0/1) #interface gil/0/3
console (config-if-Gil/0/2) #switchport access vlan 17
```

- 3 On VLANs 5, 10, and 17, configure IPv4 and IPv6 addresses and enable OSPFv3. For IPv6, associate VLAN 5 with Area 0, VLAN 10 with Area 1, and VLAN 17 with Area 2.

```
console (config) #interface vlan 5
console (config-if-vlan5) #ip address 10.2.3.2 255.255.255.0
console (config-if-vlan5) #ipv6 address 3000:2:3::/64 eui64
console (config-if-vlan5) #ipv6 ospf
console (config-if-vlan5) #ipv6 ospf areaid 0
console (config-if-vlan5) #exit
console (config) #interface vlan 10
console (config-if-vlan10) #ip address 10.1.2.2 255.255.255.0
console (config-if-vlan10) #ipv6 address 3000:1:2::/64 eui64
console (config-if-vlan10) #ipv6 ospf
console (config-if-vlan10) #ipv6 ospf areaid 1
console (config-if-vlan10) #exit
console (config) #interface vlan 17
console (config-if-vlan17) #ip address 10.2.4.2 255.255.255.0
console (config-if-vlan17) #ipv6 address 3000:2:4::/64 eui64
console (config-if-vlan17) #ipv6 ospf
console (config-if-vlan17) #ipv6 ospf areaid 2
console (config-if-vlan17) #exit
```

- 4 For IPv4: Configure the router ID, define an OSPF router, define Area 1 as a stub, and define Area 2 as an NSSA.

```

console (config) #router ospf
console (config-router) #router-id 2.2.2.2
console (config-router) #area 0.0.0.1 stub
console (config-router) #area 0.0.0.1 stub no-summary
console (config-router) #area 0.0.0.2 nssa

```

- 5 For IPv4: Enable OSPF for IPv4 on VLANs 10, 5, and 17 by globally defining the range of IP addresses associated with each interface, and then associating those ranges with Areas 1, 0, and 2, respectively.

```

console (config-router) #network 10.1.2.0 0.0.0.255 area 0.0.0.1
console (config-router) #network 10.2.3.0 0.0.0.255 area 0.0.0.0
console (config-router) #network 10.2.4.0 0.0.0.255 area 0.0.0.2

```

- 6 For IPv4: Configure a metric cost to associate with static routes when they are redistributed via OSPF:

```

console (config-router) #redistribute static metric 1 subnets
console (config-router) #exit

```

- 7 For IPv6: Define an OSPF router. Define Area 1 as a stub and area 2 as a Not-So-Stubby-Area (NSSA). Configure a metric cost to associate with static routes when they are redistributed via OSPF:

```

console (config) #ipv6 router ospf
console (config-rtr) #router-id 2.2.2.2
console (config-rtr) #area 0.0.0.1 stub
console (config-rtr) #area 0.0.0.1 stub no-summary
console (config-rtr) #area 0.0.0.2 nssa
console (config-rtr) #redistribute static metric 105 metric-type
1
console (config-rtr) #exit

```

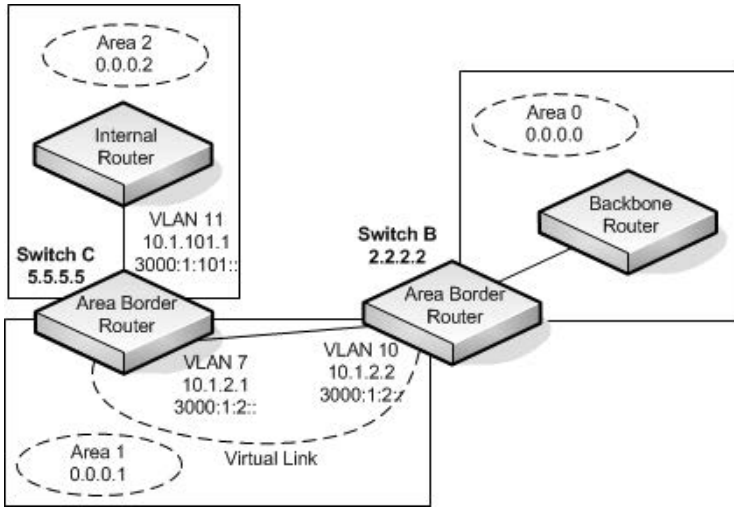
### Configuring a Virtual Link for OSPF and OSPFv3

In this example, Area 0 connects directly to Area 1. A virtual link is defined that traverses Area 1 and connects to Area 2. This example assumes other OSPF settings, such as area and interface configuration, have already been configured.

Figure 34-37 illustrates the relevant components in this example OSPF configuration.



**Figure 34-37. OSPF Configuration—Virtual Link**



Switch B is an ABR that directly connects Area 0 to Area 1. Note that in the previous example, Switch B connected to a stub area and an NSSA. Virtual links cannot be created across stub areas or NSSAs.

The following commands define a virtual link that traverses Area 1 to Switch C (5.5.5.5).

To configure Switch B:

- 1 Configure the virtual link to Switch C for IPv4.

```
console#configure
console (config) #router ospf
console (config-router) #area 0.0.0.1 virtual-link 5.5.5.5
console (config-router) #exit
```

- 2 Configure the virtual link to Switch C for IPv6.

```
console#configure
console (config) #ipv6 router ospf
console (config-rtr) #area 0.0.0.1 virtual-link 5.5.5.5
console (config-rtr) #exit
```

Switch C is a ABR that enables a virtual link from the remote Area 2 in the AS to Area 0. The following commands define a virtual link that traverses Area 1 to Switch B (2.2.2.2).

To configure Switch C:

- 1 For IPv4, assign the router ID, create the virtual link to Switch B, and associate the VLAN routing interfaces with the appropriate areas.

```
console(config)#router ospf  
console(config-router)#area 0.0.0.1 virtual-link 2.2.2.2  
console(config-router)#exit
```

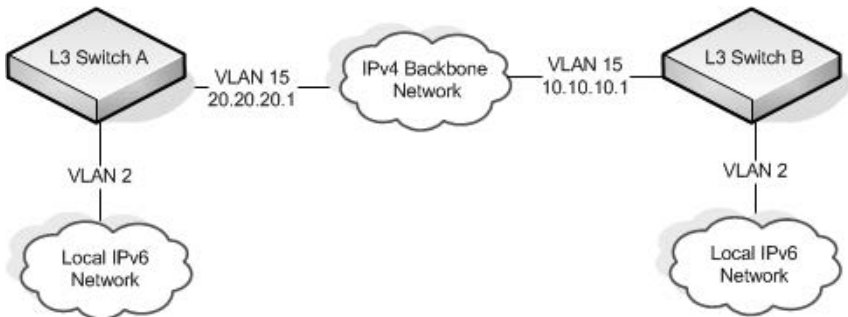
- 2 For IPv6, assign the router ID and create the virtual link to Switch B.

```
console(config)#ipv6 router ospf  
console(config-rtr)#area 0.0.0.1 virtual-link 2.2.2.2  
console(config-rtr)#exit
```

## Interconnecting an IPv4 Backbone and Local IPv6 Network

In Figure 34-38, two Dell EMC Networking L3 switches are connected as shown in the diagram. The VLAN 15 routing interface on both switches connects to an IPv4 backbone network where OSPF is used as the dynamic routing protocol to exchange IPv4 routes. OSPF allows device 1 and device 2 to learn routes to each other (from the 20.20.20.x network to the 10.10.10.x network and vice versa). The VLAN 2 routing interface on both devices connects to the local IPv6 network. OSPFv3 is used to exchange IPv6 routes between the two devices. The tunnel interface allows data to be transported between the two remote IPv6 networks over the IPv4 network.

**Figure 34-38. IPv4 and IPv6 Interconnection Example**



To configure Switch A:

- 1 Create the VLANs.

```
console (config) #vlan 2,15
console (config-vlan70,80,90) #interface te1/0/1
console (config-if-Te1/0/1) #switchport mode trunk
console (config-if-Te1/0/1) #interface gi1/0/1
console (config-if-Gi1/0/1) #switchport access vlan 2
```

- 2 Enable IPv4 and IPv6 routing on the switch.

```
console (config) #ip routing
console (config) #ipv6 unicast-routing
```

- 3 Set the OSPF router ID.

```
console (config) #router ospf
console (config-router) #router-id 1.1.1.1
console (config-router) #exit
```

**4** Set the OSPFv3 router ID.

```
console(config)#ipv6 router ospf  
console(config-rtr)#router-id 1.1.1.1  
console(config-rtr)#exit
```

**5** Configure the IPv4 address and OSPF area for VLAN 15.

```
console(config)#interface vlan 15  
console(config-if-vlan15)#ip address 20.20.20.1 255.255.255.0  
console(config-if-vlan15)#ip ospf area 0.0.0.0  
console(config-if-vlan15)#exit
```

**6** Configure the IPv6 address and OSPFv3 information for VLAN 2.

```
console(config)#interface vlan 2  
console(config-if-vlan2)#ipv6 address 2020:1::1/64  
console(config-if-vlan2)#ipv6 ospf  
console(config-if-vlan2)#ipv6 ospf network point-to-point  
console(config-if-vlan2)#exit
```

**7** Configure the tunnel.

```
console(config)#interface tunnel 0  
console(config-if-tunnel0)#ipv6 address 2001::1/64  
console(config-if-tunnel0)#tunnel mode ipv6ip  
console(config-if-tunnel0)#tunnel source 20.20.20.1  
console(config-if-tunnel0)#tunnel destination 10.10.10.1  
console(config-if-tunnel0)#ipv6 ospf  
console(config-if-tunnel0)#ipv6 ospf network point-to-point  
console(config-if-tunnel0)#exit
```

**8** Configure the loopback interface. The switch uses the loopback IP address as the OSPF and OSPFv3 router ID.

```
console(config)#interface loopback 0  
console(config-if-loopback0)#ip address 1.1.1.1 255.255.255.0  
console(config-if-loopback0)#exit  
console(config)#exit
```

To configure Switch B:

**1** Create the VLANs.

```
console (config) #vlan 2,15
console (config-vlan70,80,90) #interface tel1/0/1
console (config-if-Tel1/0/1) #switchport mode trunk
console (config-if-Tel1/0/1) #interface gil1/0/1
console (config-if-Gil1/0/1) #switchport access vlan 2
```

**2** Enable IPv4 and IPv6 routing on the switch.

```
console (config) #ip routing
console (config) #ipv6 unicast-routing
```

**3** Set the OSPF router ID.

```
console (config) #router ospf
console (config-router) #router-id 2.2.2.2
console (config-router) #exit
```

**4** Set the OSPFv3 router ID.

```
console (config) #ipv6 router ospf
console (config-rtr) #router-id 2.2.2.2
console (config-rtr) #exit
```

**5** Configure the IPv4 address and OSPF area for VLAN 15.

```
console (config) #interface vlan 15
console (config-if-vlan15) #ip address 10.10.10.1 255.255.255.0
console (config-if-vlan15) #ip ospf area 0.0.0.0
console (config-if-vlan15) #exit
```

**6** Configure the IPv6 address and OSPFv3 information for VLAN 2.

```
console (config) #interface vlan 2
console (config-if-vlan2) #ipv6 address 2020:2::2/64
console (config-if-vlan2) #ipv6 ospf
console (config-if-vlan2) #ipv6 ospf network point-to-point
console (config-if-vlan2) #exit
```

**7** Configure the tunnel.

```
console (config) #interface tunnel 0
console (config-if-tunnel0) #ipv6 address 2001::2/64
console (config-if-tunnel0) #tunnel mode ipv6ip
console (config-if-tunnel0) #tunnel source 10.10.10.1
console (config-if-tunnel0) #tunnel destination 20.20.20.1
console (config-if-tunnel0) #ipv6 ospf
console (config-if-tunnel0) #ipv6 ospf network point-to-point
console (config-if-tunnel0) #exit
```

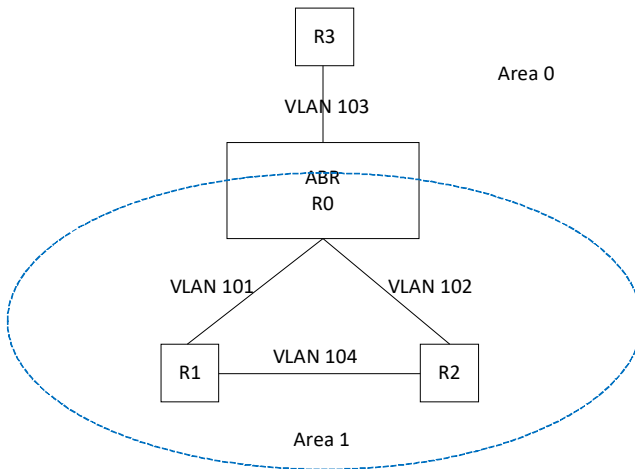
- 8 Configure the loopback interface. The switch uses the loopback IP address as the OSPF and OSPFv3 router ID.

```
console(config)#interface loopback 0
console(config-if-loopback0)#ip address 2.2.2.2 255.255.255.0
console(config-if-loopback0)#exit
console(config)#exit
```

## Configuring the Static Area Range Cost

Figure 34-39 shows a topology for the configuration that follows.

**Figure 34-39. Static Area Range Cost Example Topology**



- 1 Configure R0.

```
terminal length 0
config
hostname ABR-R0
line console
exec-timeout 0
exit
vlan 101-103
exit
ip routing
router ospf
router-id 10.10.10.10
```

```

network 172.20.0.0 0.0.255.255 area 0
network 172.21.0.0 0.0.255.255 area 1
area 1 range 172.21.0.0 255.255.0.0 summarylink
timers spf 3 5
exit
interface vlan 101
ip address 172.21.1.10 255.255.255.0
ip ospf hello-interval 1
ip ospf dead-interval 4
ip ospf network point-to-point
exit
interface tel/0/21
switchport mode trunk
description "R1"
exit
interface vlan 102
ip address 172.21.2.10 255.255.255.0
ip ospf hello-interval 1
ip ospf dead-interval 4
ip ospf network point-to-point
exit
interface tel/0/22
description "R2"
switchport mode trunk
exit
interface vlan 103
ip address 172.20.1.10 255.255.255.0
ip ospf hello-interval 1
ip ospf dead-interval 4
ip ospf network point-to-point
exit
interface tel/0/23
switchport mode trunk
description "R3"
exit
exit

```

## 2 Configure R1.

```

terminal length 0
config
hostname R1
line console
exec-timeout 0
exit
vlan 101,104
exit

```

```

ip routing
router ospf
router-id 1.1.1.1
network 172.21.0.0 0.0.255.255 area 1
timers spf 3 5
exit
interface vlan 101
ip address 172.21.1.1 255.255.255.0
ip ospf hello-interval 1
ip ospf dead-interval 4
ip ospf network point-to-point
exit
interface tel/0/21
switchport mode trunk
exit
interface vlan 104
ip address 172.21.3.1 255.255.255.0
ip ospf hello-interval 1
ip ospf dead-interval 4
ip ospf network point-to-point
exit
interface tel/0/22
switchport mode trunk
exit
interface loopback 0
ip address 172.21.254.1 255.255.255.255
exit
exit

```

### 3 Configure R2.

```

terminal length 0
config
ip routing
router ospf
router-id 2.2.2.2
network 172.21.0.0 0.0.255.255 area 1
timers spf 3 5
exit
vlan 102,104
exit
interface vlan 102
ip address 172.21.2.2 255.255.255.0
ip ospf hello-interval 1
ip ospf dead-interval 4
ip ospf network point-to-point
exit

```



```
interface tel/0/21
switchport mode trunk
exit
interface vlan 104
ip address 172.21.3.2 255.255.255.0
ip ospf hello-interval 1
ip ospf dead-interval 4
ip ospf network point-to-point
exit
interface tel/0/22
switchport mode trunk
exit
interface loopback 0
ip address 172.21.254.2 255.255.255.255
exit
exit
```

#### 4 R3 config:

```
terminal length 0
config
ip routing
router ospf
router-id 3.3.3.3
network 172.21.0.0 0.0.255.255 area 0
timers spf 3 5
exit
vlan 103
exit
interface vlan 103
ip address 172.21.1.1 255.255.255.0
ip ospf hello-interval 1
ip ospf dead-interval 4
ip ospf network point-to-point
exit
interface tel/0/21
switchport mode trunk
exit
interface loopback 0
ip address 172.21.254.2 255.255.255.255
exit
exit
```

## Discussion

With no area range cost specified, the range uses auto cost:

```
(ABR-R0) #show ip ospf range 1
```

Prefix	Subnet Mask	Type	Action	Cost	Active
172.21.0.0	255.255.0.0	S	Advertise	Auto	Y

```
(ABR-R0) #show ip ospf database summary
```

```
Network Summary States (Area 0.0.0.0)
LS Age: 644
LS options: (E-Bit)
LS Type: Network Summary LSA
LS Id: 172.21.0.0 (network prefix)
Advertising Router: 10.10.10.10
LS Seq Number: 0x80000002
Checksum: 0x8ee1
Length: 28
Network Mask: 255.255.0.0
Metric: 2
```

Min—The cost can be set to 0, the minimum value. OSPF re-advertises the summary LSA with a metric of 0:

```
(ABR-R0) (config-router)#area 1 range 172.21.0.0 255.255.0.0 summarylink
advertise cost ?
```

```
<0-16777215> Set area range cost
```

```
(ABR-R0) (config-router)#area 1 range 172.21.0.0 255.255.0.0
summarylink advertise cost 0
```

```
(ABR-R0) #show ip ospf range 1
```

Prefix	Subnet Mask	Type	Action	Cost	Active
172.21.0.0	255.255.0.0	S	Advertise	0	Y

```
(ABR-R0) #show ip ospf 0 database summary
```

```
Network Summary States (Area 0.0.0.0)
LS Age: 49
LS options: (E-Bit)
LS Type: Network Summary LSA
LS Id: 172.21.0.0 (network prefix)
Advertising Router: 10.10.10.10
```

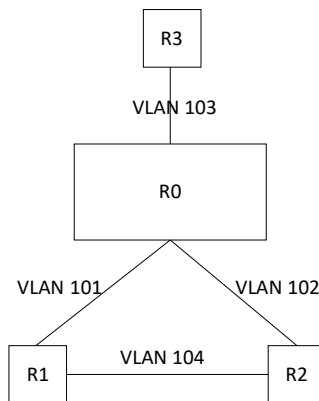
```
LS Seq Number: 0x80000003
Checksum: 0x78f8
Length: 28
Network Mask: 255.255.0.0
Metric: 0
```

The cost can be set to the maximum value, 16,777,215, which is LSIInfinity. Since OSPF cannot send a type 3 summary LSA with this metric (according to RFC 2328), the summary LSA is flushed. The individual routes are not re-advertised.

## Configuring Flood Blocking

Figure 34-40 shows an example topology for flood blocking. The configuration follows.

**Figure 34-40. Flood Blocking Topology**



### 1 Configure R0:

```
terminal length 0
config
hostname R0
line console
exec-timeout 0
exit
vlan 101-103
exit
ip routing
router ospf
```

```

router-id 10.10.10.10
network 172.20.0.0 0.0.255.255 area 0
network 172.21.0.0 0.0.255.255 area 0
timers spf 3 5
exit
interface vlan 101
ip address 172.21.1.10 255.255.255.0
ip ospf hello-interval 1
ip ospf dead-interval 4
ip ospf network point-to-point
exit
interface tel1/0/21
switchport mode trunk
description "R1"
exit
interface vlan 102
ip address 172.21.2.10 255.255.255.0
ip ospf hello-interval 1
ip ospf dead-interval 4
ip ospf network point-to-point
exit
interface tel1/0/22
description "R2"
switchport mode trunk
exit
interface vlan 103
ip address 172.20.1.10 255.255.255.0
ip ospf hello-interval 1
ip ospf dead-interval 4
ip ospf network point-to-point
exit
interface tel1/0/23
switchport mode trunk
description "R3"
exit
exit

```

## 2 Configure R1:

```

terminal length 0
config
hostname R1
line console
exec-timeout 0
exit
vlan 101,104

```

```

exit
ip routing
router ospf
router-id 1.1.1.1
network 172.21.0.0 0.0.255.255 area 0
timers spf 3 5
exit
interface vlan 101
ip address 172.21.1.1 255.255.255.0
ip ospf hello-interval 1
ip ospf dead-interval 4
ip ospf network point-to-point
exit
interface tel0/21
switchport mode trunk
exit
interface vlan 104
ip address 172.21.3.1 255.255.255.0
ip ospf hello-interval 1
ip ospf dead-interval 4
ip ospf network point-to-point
exit
interface tel0/22
switchport mode trunk
exit
interface loopback 0
ip address 172.21.254.1 255.255.255.255
exit
exit

```

### 3 Configure R2:

```

terminal length 0
config
ip routing
router ospf
router-id 2.2.2.2
network 172.21.0.0 0.0.255.255 area 0
timers spf 3 5
exit
vlan 102,104
exit
interface vlan 102
ip address 172.21.2.2 255.255.255.0
ip ospf hello-interval 1
ip ospf dead-interval 4

```

```
ip ospf network point-to-point
exit
interface te1/0/21
switchport mode trunk
exit
interface vlan 104
ip address 172.21.3.2 255.255.255.0
ip ospf hello-interval 1
ip ospf dead-interval 4
ip ospf network point-to-point
exit
interface te1/0/22
switchport mode trunk
exit
interface loopback 0
ip address 172.21.254.2 255.255.255.255
exit
exit
```

#### 4 Configure R3:

```
terminal length 0
config
ip routing
router ospf
router-id 3.3.3.3
network 172.21.0.0 0.0.255.255 area 0
timers spf 3 5
exit
vlan 103
exit
interface vlan 103
ip address 172.21.1.1 255.255.255.0
ip ospf hello-interval 1
ip ospf dead-interval 4
ip ospf network point-to-point
exit
interface te1/0/21
switchport mode trunk
exit
interface loopback 0
ip address 172.21.254.2 255.255.255.255
exit
exit
```

## Discussion

With flood blocking disabled on all interfaces, sending a T3 summary LSA from R3 to R0 will cause R0 to forward the LSA on its interface to R1. Enabling flood blocking on R0's interface to R1 will inhibit this behavior.

```
(R0) (config-if-vlan101)ip ospf database-filter all out
```

A trace on the R3-R0 link shows that the LSA is actually flooded from R1 to R0, since R1 received the LSA via R2. Even though R1 does not receive this LSA directly from R0, it still correctly computes the route through the R0:

```
(R1) #show ip route  
console#show ip route
```

```
Route Codes: R - RIP Derived, O - OSPF Derived, C - Connected, S - Static  
             B - BGP Derived, E - Externally Derived, IA - OSPF Inter Area  
             E1 - OSPF External Type 1, E2 - OSPF External Type 2  
             N1 - OSPF NSSA External Type 1, N2 - OSPF NSSA External Type 2
```

```
O IA 100.0.0.0/24 [110/2] via 172.21.1.10, 00h:01m:35s, 0/25
```

OSPF also blocks external LSAs on the blocked interface. Stopping and restarting R3's OSPF protocol causes R3 to re-originate its router LSA. R0 does not send R3's router LSA on the blocked interface.

With flood blocking enabled on the R0 interface, if the link from R0 to R1 bounces, R0 Database Description packets do not include any LSAs. However, database synchronization still occurs (through R2) and R1 computes the correct routes after the link is restored.

## Configuring OSPF VRFs

Dell EMC Networking VRF is an implementation of Virtual Routing and Forwarding (VRF) for OSPF for IPv4 networks. Virtual Routing and Forwarding allows multiple independent instances for the forwarding plane to exist simultaneously. Refer to "VRF" on page 1355 for more information.

VRF configuration follows the same steps as configuration for the default routing instance with two additional steps: creating the VRF instance and associating VLANs to the instance. Existing commands which have been enabled for VRF accept an additional VRF instance identifier (name). VRF names can be up to 32 characters in length. If a VRF instance identifier is not used in the command, it applies to the global routing instance by default.

Follow the steps below to create a VRF and enable OSPF routing in the VRF:

First, create the VLAN instances associated to the VRF. It is recommended that a VLAN numbering scheme be developed to allow for future growth and to assist in the easy recognition of which VLANs are associated to which VRFs.

In global config mode, create the pool of VLANs:

```
console#configure terminal
console (config) #vlan 100-109
console (config-vlan100-109) #exit
```

Assign the VLAN to an interface:

```
console (config) #interface gil/0/1
console (config-if-Gil/0/1) #switchport access vlan 100
console (config-if-Gil/0/1) #exit
```

Create the VRF and enable routing:

```
console (config) #ip vrf red
console (config-vrf-red) #ip routing
console (config-vrf-red) #exit
```

Assign IP addresses to the interfaces:

```
console (config) #interface vlan 100
```



```
console(config-if-vlan100)#ip address 192.168.0.1 /24
```

Put the VLAN interface into the VRF:

```
console(config-if-vlan100)#ip vrf forwarding red
console(config-if-vlan100)#exit
```

Routing interface moved from Default router instance to red router instance.

Enable OSPF on the VRF, assign a network and enable OSPF for the VRF:

```
console(config)#router ospf vrf red
console(Config-router-vrf-red)#network 192.168.0.0 0.0.0.255 area 0
console(Config-router-vrf-red)#router-id 192.168.0.253
console(Config-router-vrf-red)#redistribute connected
console(Config-router-vrf-red)#enable
console(Config-router-vrf-red)#exit

console(config)#show ip ospf vrf red
```

```
Router ID..... 192.168.0.253
OSPF Admin Mode..... Enable
RFC 1583 Compatibility..... Enable
External LSDB Limit..... No Limit
Exit Overflow Interval..... 0
Spf Delay Time..... 5 seconds
Spf Hold Time..... 10 seconds
Flood Pacing Interval..... 33 ms
LSA Refresh Group Pacing Time..... 60 seconds
Opaque capability..... Enable
AutoCost Ref BW..... 100 Mbps
Default Passive Setting..... Disabled
Maximum Paths..... 16
Default Metric..... Not configured
Stub Router Configuration..... None
Summary LSA Metric Override..... Disabled

Default Route Advertise..... Disabled
Always..... False
Metric..... Not configured
Metric Type..... External Type 2
```

```

Number of Active Areas..... 0 (0 normal, 0
stub, 0 nssa)
ABR Status..... Disable
ASBR Status..... Disable
Stub Router Status..... Inactive
External LSDB Overflow..... False
External LSA Count..... 0
External LSA Checksum..... 0
AS_OPAQUE LSA Count..... 0
AS_OPAQUE LSA Checksum..... 0
New LSAs Originated..... 0
LSAs Received..... 0
LSA Count..... 0
Maximum Number of LSAs..... 66408
LSA High Water Mark..... 0
AS Scope LSA Flood List Length..... 0
Retransmit List Entries..... 0
Maximum Number of Retransmit Entries..... 265632
Retransmit Entries High Water Mark..... 0

NSF Support..... Disabled
NSF Restart Interval..... 120 seconds
NSF Restart Status..... Not Restarting
NSF Restart Age..... 0 seconds
NSF Restart Exit Reason..... Not attempted
NSF Helper Support..... Always
NSF Helper Strict LSA Checking..... Enabled

```

# VRF

## Dell EMC Networking N3000E-ON, N3100-ON, N3200-ON Series Switches



**NOTE:** This feature is not available on Dell EMC Networking N1100-ON, N1500, N2000, N2100-ON, or N2200-ON Series switches.

Virtual Routing and Forwarding (VRF) allows multiple independent instances of the forwarding plane to exist simultaneously. (The terms VRF, VRF instance, and virtual forwarding instance all refer to the same thing.) VRF allows the administrator to segment the network without incurring the costs of multiple routers. Each VRF instance operates as an independent VPN. The IP addresses assigned to each VPN may overlap. Static route leaking to and from the global instance is supported. Configuration of static route leaking among non-default VRFs results in undefined behavior.

VRF-associated VLANs may not overlap with other VRF instances.

VRF is supported on Dell EMC Networking N3000-ON, N3100-ON, and N3200-ON Series switches. In addition to the default global instances, the following number of VRFs are supported.

The following capabilities are supported for VRFs:

- Static routing (including route leaking)
- OSPF
- OSPFv3
- ARP
- Ping
- VRRP
- Trace route
- DHCP relay (IP helper)
- NDP
- Loopback
- BFD

## Sample Configuration

As a quick reference, the following is a sample configuration.

```
!create VRF
console(config)#ip vrf vrf1
console(config-vrf-vrf1)#exit

!Configure the routing interface in desired VRF instance
console(config)#interface vlan 10
console(config-if-vlan10)#ip vrf forwarding vrf1
```

Routing interface moved from Default router instance to vrf1 router instance.

```
!configure the interface
console(config-if-vlan10)#ipv6 address 1001::10/64
console(config-if-vlan10)#ipv6 enable
console(config-if-vlan10)#ipv6 ospf
console(config-if-vlan10)#ipv6 ospf area 0.0.0.0
console(config-if-vlan10)#exit
```

```
!Enable ipv6 routing in the VR instance
console(config)#ip vrf vrf1
console(config-vrf-vrf1)#ipv6 unicast-routing
console(config-vrf-vrf1)#exit
```

```
!Configure OSPFv3 router
console(config)#ipv6 router ospf vrf "vrf1"
console(Config-console6-vrf-vrf1)#router-id 229.1.3.96
console(Config-console6-vrf-vrf1)#enable
console(Config-console6-vrf-vrf1)#exit
console(Config)#
```

## VRF Resource Sharing

Hardware resources such as routes and ARP entries are shared between VRFs. If a VRF allocates the maximum routes supported by the system, no VRF will be able to add a new route.

### VRF ARP Entries

There is no support to reserve ARP entries per VRF instance as the system purges the least recently used ARP entry automatically. The maximum number of static ARP entries is enforced on a per VR instance basis.

## VRF Route Entries

Routes are shared among the VR instances. The number of routes supported can never exceed the platform supported number. Initially, the number of “free” routes is the platform supported maximum. “Free” routes are available for any VR to use.

Two schemes are imposed on sharing of routes between the VR instances: Reservation and Restriction. The administrator can use the **maximum routes** command to reserve a number of routes for a VRF or to restrict the maximum number of routes available to a VR instance.

Reserved routes are deducted from the “free” routes available in the system. In-use routes are also deducted from the “free” routes available in the system. The dynamic number of routes available to be allocated to a VRF instance is the lower of the number of “free” routes available in the system and the administrator-configured maximum routes.

The system-wide limit on static route entries is enforced on a per-VR-instance basis. That is, each VRF may allocate the system limit of static routes.

VRF configuration follows the same steps as configuration for the default routing instance with two additional steps: creating the VRF instance and associating VLANs to the instance. Existing commands which have been enabled for VRF accept an additional VRF instance identifier (name). VRF names can be up to 32 characters in length. If a VRF instance identifier is not used in the command, it applies to the global routing instance by default.

Follow the steps below to create a VRF and enable OSPF routing in the VRF:

First, create the VLAN instances associated to the VRF. It is recommended that a VLAN numbering scheme be developed to allow for future growth and to assist in the easy recognition of which VLANs are associated to which VRFs.

- 1 In global config mode, create the pool of VLANs:

```
console#config
console (config) #vlan 100-109
console (config-vlan100-109) #exit
```

- 2 Assign the VLAN to an interface:

```
console (config) #interface g1/0/1
console (config-if-G1/0/1) #switchport access vlan 100
console (config-if-G1/0/1) #exit
```

### 3 Create the VRF and enable routing:

```
console(config)#ip vrf red
console(config-vrf-red)#ip routing
console(config-vrf-red)#exit
```

### 4 Assign IP addresses to the interfaces:

```
console(config)#interface vlan 100
console(config-if-vlan100)#ip address 192.168.0.1 /24
```

### 5 Put the VLAN interface into the VRF:

```
console(config-if-vlan100)#ip vrf forwarding red
```

Routing interface moved from Default router instance to red router instance.

```
console(config-if-vlan100)#exit
```

### 6 Enable OSPF on the VRF, assign a network and enable OSPF for the VRF:

```
console(config)#router ospf vrf red
console(Config-router-vrf-red)#network 192.168.0.0
0.0.0.255 area 0
console(Config-router-vrf-red)#router-id 192.168.0.253
console(Config-router-vrf-red)#redistribute connected
console(Config-router-vrf-red)#enable
console(Config-router-vrf-red)#exit
```

Use the `show ip ospf vrf` command to view the configuration of the VRF:

```
console(config)#show ip ospf vrf red
```

```
Router ID..... 192.168.0.253
OSPF Admin Mode..... Enable
RFC 1583 Compatibility..... Enable
External LSDB Limit..... No Limit
Exit Overflow Interval..... 0
Spf Delay Time..... 5 seconds
Spf Hold Time..... 10 seconds
Flood Pacing Interval..... 33 ms
LSA Refresh Group Pacing Time..... 60 seconds
Opaque capability..... Enable
AutoCost Ref BW..... 100 Mbps
Default Passive Setting..... Disabled
Maximum Paths..... 16
Default Metric..... Not configured
Stub Router Configuration..... None
Summary LSA Metric Override..... Disabled
```

```

Default Route Advertise..... Disabled
Always..... False
Metric..... Not configured
Metric Type..... External Type 2

Number of Active Areas..... 0 (0 normal, 0
stub, 0 nssa)
ABR Status..... Disable
ASBR Status..... Disable
Stub Router Status..... Inactive
External LSDB Overflow..... False
External LSA Count..... 0
External LSA Checksum..... 0
AS_OPAQUE LSA Count..... 0
AS_OPAQUE LSA Checksum..... 0
New LSAs Originated..... 0
LSAs Received..... 0
LSA Count..... 0
Maximum Number of LSAs..... 66408
LSA High Water Mark..... 0
AS Scope LSA Flood List Length..... 0
Retransmit List Entries..... 0
Maximum Number of Retransmit Entries..... 265632
Retransmit Entries High Water Mark..... 0

NSF Support..... Disabled
NSF Restart Interval..... 120 seconds
NSF Restart Status..... Not Restarting
NSF Restart Age..... 0 seconds
NSF Restart Exit Reason..... Not attempted
NSF Helper Support..... Always
NSF Helper Strict LSA Checking..... Enabled

```





# RIP

## Dell EMC Networking N2000, N2100-ON, N2200-ON, N3000E-ON, N3100-ON, and N3200-ON Series Switches



**NOTE:** Dell EMC Networking N1100-ON/N1500 Series switches do not support RIP.

This chapter describes how to configure Routing Information Protocol (RIP) on the switch. RIP is a dynamic routing protocol for IPv4 networks.

The topics covered in this chapter include:

- RIP Overview
- Default RIP Values
- Configuring RIP Features (Web)
- Configuring RIP Features (CLI)
- RIP Configuration Example

## RIP Overview

RIP is an Interior Gateway Protocol (IGP) that performs dynamic routing within a network. Dell EMC Networking N-Series switches support two dynamic routing protocols: OSPF and Routing Information Protocol (RIP).

Unlike OSPF, RIP is a distance-vector protocol and uses UDP broadcasts to maintain topology information and hop counts to determine the best route to transmit IP traffic. RIP is best suited for small, homogenous networks.

### How Does RIP Determine Route Information?

The routing information is propagated in RIP update packets that are sent out both periodically and in the event of a network topology change. On receipt of a RIP update, depending on whether the specified route exists or does not exist in the route table, the router may modify, delete or add the route to its route table.

RIP uses hop count, which is the number of routers an IP packet must pass through, to calculate the best route for a packet. A route with a low hop count is preferred over a route with a higher hop count. A directly-connected route has a hop-count of 0. With RIP, the maximum number of hops from source to destination is 15. Packets with a hop count greater than 15 are dropped because the destination network is considered unreachable.

### **What Is Split Horizon?**

RIP uses a technique called split horizon to avoid problems caused by including routes in updates sent to the router from which the route was originally learned. With simple split horizon, a route is not included in updates sent on the interface on which it was learned. In split horizon with poison reverse, a route is included in updates sent on the interface where it was learned, but the metric is set to infinity.

### **What RIP Versions Are Supported?**

There are two versions of RIP:

- RIP-1 defined in RFC 1058
  - Routes are specified by IP destination network and hop count
  - The routing table is broadcast to all stations on the attached network
- RIP-2 defined in RFC 1723
  - Route specification is extended to include subnet mask and gateway
  - The routing table is sent to a multicast address, reducing network traffic
  - An authentication method is used for security

The Dell EMC Networking N-Series switches support both versions of RIP. You may configure a given port:

- To receive packets in either or both formats
- To transmit packets formatted for RIP-1 or RIP-2 or to send RIP-2 packets to the RIP-1 broadcast address
- To prevent any RIP packets from being received
- To prevent any RIP packets from being transmitted

## Default RIP Values

RIP is globally enabled by default. To make it operational on the router, you configure and enable RIP for particular VLAN routing interfaces.

Table 36-1 shows the global default values for RIP.

**Table 36-1. RIP Global Defaults**


Parameter	Default Value
Admin Mode	Enabled
Split Horizon Mode	Simple
Auto Summary Mode	Disabled
Host Routes Accept Mode	Enabled
Default Information Originate	Disabled
Default Metric	None configured
Route Redistribution	Disabled for all sources.

Table 36-2 shows the per-interface default values for RIP.

**Table 36-2. RIP Per-Interface Defaults**

Parameter	Default Value
Admin Mode	Disabled
Send Version	RIPv2
Receive Version	Both
Authentication Type	None

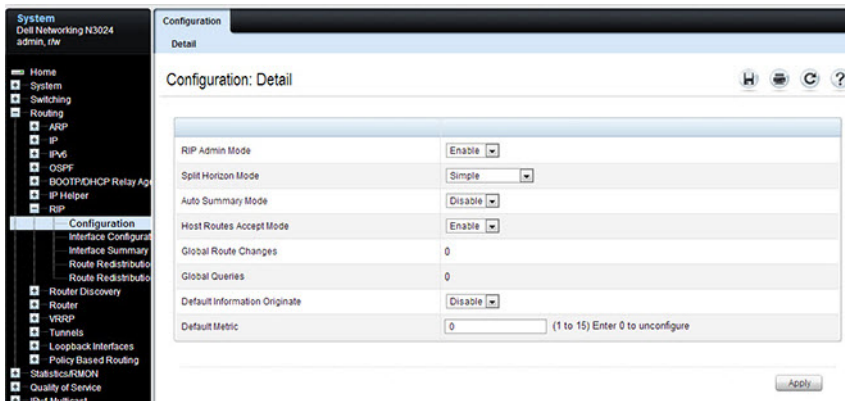
# Configuring RIP Features (Web)

This section provides information about the OpenManage Switch Administrator pages for configuring and monitoring RIP features on Dell EMC Networking N2000, N2100-ON, N2200-ON, N3100-ON, and N3200-ON. For details about the fields on a page, click  at the top of the Dell EMC OpenManage Switch Administrator web page.

## RIP Configuration

Use the **Configuration** page to enable and configure or disable RIP in Global mode. To display the page, click **Routing** → **RIP** → **Configuration** in the navigation panel.

**Figure 36-1. RIP Configuration**

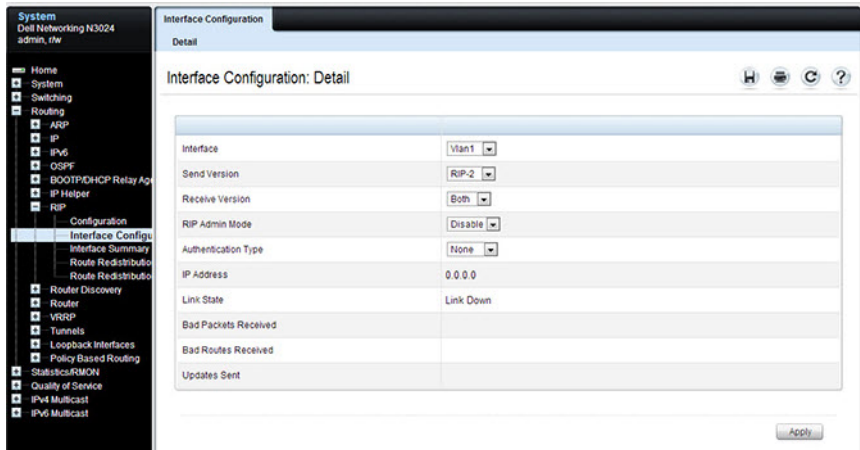


## RIP Interface Configuration

Use the **Interface Configuration** page to enable and configure or to disable RIP on a specific interface.

To display the page, click **Routing** → **RIP** → **Interface Configuration** in the navigation panel.

**Figure 36-2. RIP Interface Configuration**

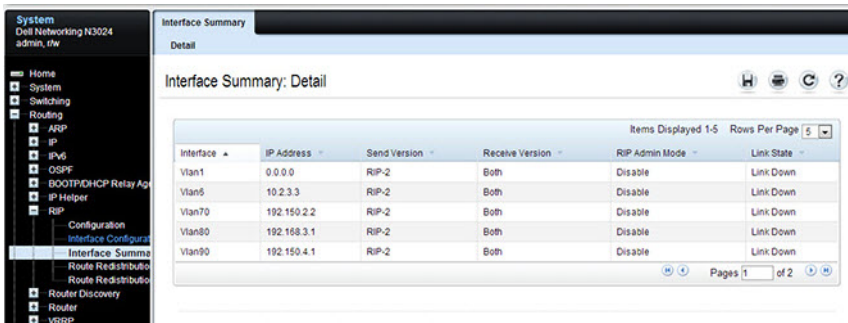


## RIP Interface Summary

Use the **Interface Summary** page to display RIP configuration status on an interface.

To display the page, click **Routing** → **RIP** → **Interface Summary** in the navigation panel.

**Figure 36-3. RIP Interface Summary**



## RIP Route Redistribution Configuration

Use the **Route Redistribution Configuration** page to configure the RIP Route Redistribution parameters. The allowable values for each field are displayed next to the field. If any invalid values are entered, an alert message is displayed with the list of all the valid values.

To display the page, click **Routing** → **RIP** → **Route Redistribution Configuration** in the navigation panel.

**Figure 36-4. RIP Route Redistribution Configuration**

The screenshot shows the 'Route Redistribution Configuration: Detail' page. The left sidebar contains a navigation menu with the following items: Home, System, Switching, Routing, ARP, IP, IPv6, OSPF, BOOTP/DHCP Relay Agent, IP Helper, RIP, Configuration, Interface Configuration, Interface Summary, Route Redistribution (highlighted), and Router Discovery. The main content area displays the following configuration fields:

Source	Connected
Metric	0 (1 to 15) Enter 0 to unconfigure
Distribute List	None
Redistribute	Disable

An 'Apply' button is located at the bottom right of the configuration area.



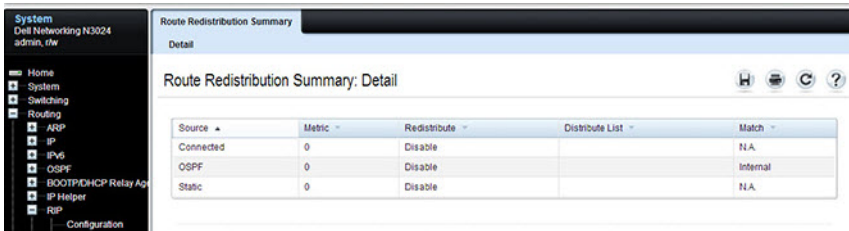
**NOTE:** Static reject routes are not redistributed by RIP. For a static reject route, the next hop interface value is Null0. Packets to the network address specified in static reject routes are intentionally dropped.

## RIP Route Redistribution Summary

Use the **Route Redistribution Summary** page to display Route Redistribution configurations.

To display the page, click **Routing** → **RIP** → **Route Redistribution Summary** in the navigation panel.

**Figure 36-5. RIP Route Redistribution Summary**



The screenshot shows the 'Route Redistribution Summary: Detail' page. The table below displays the configuration for route redistribution:

Source	Metric	Redistribute	Distribute List	Match
Connected	0	Disable		N.A.
OSPF	0	Disable		Internal
Static	0	Disable		N.A.



# Configuring RIP Features (CLI)

This section provides information about the commands used for configuring RIP settings on the switch. For more information about the commands, refer to the Dell EMC Networking N2000, N2100-ON, N2200-ON, N3100-ON, and N3200-ON Series Switches CLI Reference Guide at [www.dell.com/support](http://www.dell.com/support).

## Configuring Global RIP Settings

Use the following commands to configure various global RIP settings for the switch.



**NOTE:** RIP is enabled by default. The Global RIP Settings are optional.

Command	Purpose
<code>configure</code>	Enter global configuration mode.
<code>router rip</code>	Enter RIP configuration mode.
<code>split-horizon {none   simple   poison}</code>	Set the RIP split horizon mode. <ul style="list-style-type: none"><li>• <b>none</b> — RIP does not use split horizon to avoid routing loops.</li><li>• <b>simple</b> — RIP uses split horizon to avoid routing loops.</li><li>• <b>poison</b> — RIP uses split horizon with poison reverse (increases routing packet update size).</li></ul>
<code>auto-summary</code>	Enable the RIP auto-summarization mode.
<code>no hostroutesaccept</code>	Prevent the switch from accepting host routes.
<code>default-information originate</code>	Control the advertisement of default routes.
<code>default-metric <i>metric-value</i></code>	Set a default for the metric of distributed routes. The <i>metric-value</i> variable is the metric (or preference) value of the default route. (Range: 1–15)
<code>enable</code>	Reset the default administrative mode of RIP in the router (active)
CTRL + Z	Exit to Privileged Exec mode.

Command	Purpose
show ip rip	View various RIP settings for the switch.

## Configuring RIP Interface Settings

Use the following commands to configure per-interface RIP settings.

Command	Purpose
configure	Enter global configuration mode.
interface vlan <i>vlan-id</i>	Enter Interface Configuration mode for the specified VLAN.
ip rip	Enable RIP on the interface.
ip rip send version {rip1 rip1c   rip2   none}	Configure the interface to allow RIP control packets of the specified version(s) to be sent.
ip rip receive version {rip1   rip2   both   none}	Configure the interface to allow RIP control packets of the specified version(s) to be received.
ip rip authentication {none   {simple <i>key</i> }   {encrypt <i>key key-id</i> }	<p>set the RIP Version 2 Authentication Type and Key for the interface.</p> <ul style="list-style-type: none"> <li>• <i>key</i> — Authentication key for the specified interface. (Range: 16 bytes or less)</li> <li>• <b>encrypt</b> — Specifies the Ethernet unit/port of the interface to view information.</li> <li>• <i>key-id</i> — Authentication key identifier for authentication type encrypt. (Range: 0-255)</li> </ul>
exit	Exit to Global Configuration Mode
exit	Exit to Privileged Exec mode.
show ip rip interface vlan <i>vlan-id</i>	View RIP configuration information for the specified routing interface.
show ip rip interface brief	View summary information about the RIP configuration on all interfaces.

## Configuring Route Redistribution Settings

Use the following commands to configure an OSPF area range and to configure route redistribution settings.

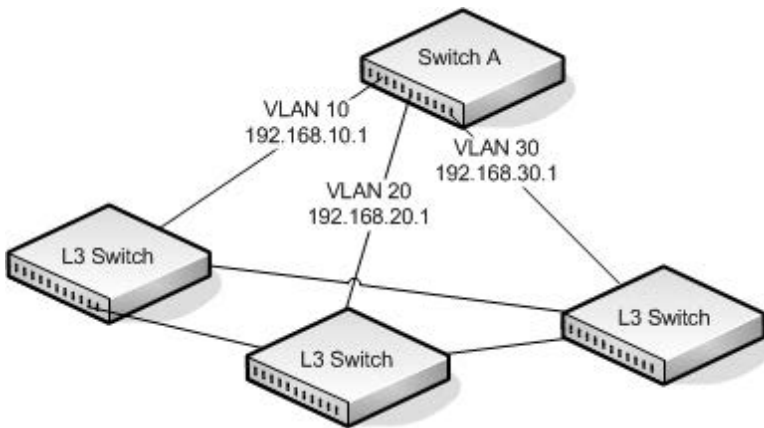
Command	Purpose
<code>configure</code>	Enter global configuration mode.
<code>router rip</code>	Enter RIP configuration mode.
<code>distribute-list accesslistname out {bgp   ospf   static   connected}</code>	<p>Specify the access list to filter routes received from the source protocol. The ACL must already exist on the switch. For information about the commands used for configuring ACLs, see "Configuring ACLs (CLI)" on page 749.</p> <ul style="list-style-type: none"><li>• <i>accesslistname</i> — The name used to identify an existing ACL.</li><li>• <b>bgp</b> — Apply the specified access list when BGP is the source protocol. Distribution into RIP from BGP is not recommended.</li><li>• <b>ospf</b> — Apply the specified access list when OSPF is the source protocol.</li><li>• <b>static</b> — Apply the specified access list when packets come through the static route.</li><li>• <b>connected</b> — Apply the specified access list when packets come from a directly connected route.</li></ul>
<code>redistribute {bgp   ospf   static   connected} [metric integer]</code>	<p>Configure RIP to allow redistribution of routes from the specified source protocol/routers.</p> <ul style="list-style-type: none"><li>• <b>bgp</b> — Specifies BGP as the source protocol.</li><li>• <b>ospf</b> — Specifies OSPF as the source protocol.</li><li>• <b>static</b> — Specifies that the source is a static route.</li><li>• <b>connected</b> — Specifies that the source is a directly connected route.</li><li>• <i>metric</i> — Specifies the metric to use when redistributing the route. Range: 1-15.</li></ul>

<b>Command</b>	<b>Purpose</b>
<b>redistribute ospf</b> [metric <i>metric</i> ] [match [internal] [external 1] [external 2] [nssa-external 1] [nssa-external 2]]	<p>Configure RIP to redistribute routes from OSPF.</p> <ul style="list-style-type: none"> <li>• <b>ospf</b>— Specifies OSPF as the source protocol.</li> <li>• <b>metric</b> — Specifies the metric to use when redistributing the route. Range: 1-15.</li> <li>• <b>internal</b> — Adds internal matches to any match types presently being redistributed.</li> <li>• <b>external 1</b> — Adds routes imported into OSPF as Type-1 external routes into any match types presently being redistributed.</li> <li>• <b>external 2</b> — Adds routes imported into OSPF as Type-2 external routes into any match types presently being redistributed.</li> <li>• <b>nssa-external 1</b> — Adds routes imported into OSPF as NSSA Type-1 external routes into any match types presently being redistributed.</li> <li>• <b>nssa-external 2</b> — Adds routes imported into OSPF as NSSA Type-2 external routes into any match types presently being redistributed.</li> </ul>
<b>redistribute bgp</b> [metric <i>metric</i> ]	<p>Configure RIP to redistribute routes from BGP (not recommended as the default metric from BGP is 15) .</p> <ul style="list-style-type: none"> <li>• <b>metric</b> — Specifies the metric to use when redistributing the route. Range: 1-15. The value 15 indicates an infinite or unreachable value.</li> </ul>
<b>distance rip</b> <i>integer</i>	<p>Set the route preference value of RIP in the router (Range 1-255). Lower route preference values are preferred over higher values when determining the best route.</p>
<b>exit</b>	<p>Exit to Global Config mode.</p>
<b>exit</b>	<p>Exit to Privileged Exec mode.</p>
<b>show ip rip</b>	<p>View information about the RIP route distribution configuration.</p>

# RIP Configuration Example

This example includes four Dell EMC Networking N-Series switches that use RIP to determine network topology and route information. The commands in this example configure Switch A shown in Figure 36-6.

**Figure 36-6. RIP Network Diagram**



To configure the switch:

- 1 Enable routing on the switch

```
console#config  
console (config) #ip routing
```

- 2 Create VLANs 10, 20, and 30.

```
console (config) #vlan 10,20,30  
console (config-vlan10,20,30) #interface gi1/0/1  
console (config-if-Gi1/0/1) #switchport access vlan 10  
console (config-if-Gi1/0/1) #interface gi1/0/2  
console (config-if-Gi1/0/2) #switchport access vlan 20  
console (config-if-Gi1/0/2) #interface gi1/0/3  
console (config-if-Gi1/0/3) #switchport access vlan 30
```

- 3 Assign an IP address and enable RIP on each interface. Additionally, the commands specify that each interface can receive both RIP-1 and RIP-2 frames but send only RIP-2 formatted frames.

```
console (config) #interface vlan 10
```

```
console(config-if-vlan10)#ip address 192.168.10.1 255.255.255.0
console(config-if-vlan10)#ip rip
console(config-if-vlan10)#ip rip receive version both
console(config-if-vlan10)#ip rip send version rip2
console(config-if-vlan10)#exit
```

```
console(config)#interface vlan 20
console(config-if-vlan20)#ip address 192.168.20.1 255.255.255.0
console(config-if-vlan20)#ip rip
console(config-if-vlan20)#ip rip receive version both
console(config-if-vlan20)#ip rip send version rip2
console(config-if-vlan20)#exit
```

```
console(config)#interface vlan 30
console(config-if-vlan30)#ip address 192.168.30.1 255.255.255.0
console(config-if-vlan30)#ip rip
console(config-if-vlan30)#ip rip receive version both
console(config-if-vlan30)#ip rip send version rip2
console(config-if-vlan30)#exit
```

#### 4 Enable auto summarization of subprefixes when crossing classful boundaries.

```
console(config)#router rip
console(config-router)#auto-summary
console(config-router)#exit
console(config)#exit
```

#### 5 Verify the configuration

```
console#show ip rip
```

```
RIP Admin Mode..... Enable
Split Horizon Mode..... Simple
Auto Summary Mode..... Enable
Host Routes Accept Mode..... Enable
Global route changes..... 0
Global queries..... 0
```

```
Default Metric..... Not configured
Default Route Advertise..... 0
```

```
console#show ip rip interface brief
```

Interface	IP Address	Send Version	Receive Version	RIP Mode	Link State
-----	-----	-----	-----	-----	-----
V11	0.0.0.0	RIP-2	RIP-2	Disable	Down
V110	192.168.10.1	RIP-2	Both	Enable	Down
V120	192.168.10.1	RIP-2	Both	Enable	Down
V130	192.168.10.1	RIP-2	Both	Disable	Down





# VRRP

## Dell EMC Networking N-Series Switches

This chapter describes how to configure Virtual Routing Redundancy Protocol (VRRP) on the switch. VRRP can help create redundancy on networks in which end-stations are statically configured with the default gateway IP address.

The topics covered in this chapter include:

- VRRP Overview
- Default VRRP Values
- Configuring VRRP Features (Web)
- Configuring VRRP Features (CLI)
- VRRP Configuration Example

## VRRP Overview

The Virtual Router Redundancy (VRRP) protocol is designed to handle default router (L3 switch) failures by providing a scheme to dynamically elect a backup router. VRRP can help minimize black hole periods due to the failure of the default gateway router during which all traffic directed towards it is lost until the failure is detected.

Both the VRRPv2 (RFC 3768) and VRRPv3 (RFC 5798) protocols are supported. VRRPv2 supports IPv4 addressing. VRRPv3 supports both IPv4 and IPv6 addressing. VRRPv2 is not compatible with VRRPv3 and either VRRPv2 or VRRPv3 may be enabled on the switch.

### How Does VRRP Work?

VRRP eliminates the single point of failure associated with static default routes by enabling a backup router to take over from a primary router without affecting the end stations using the route. The end stations will use a virtual IP address that will be recognized by the backup router if the primary router fails. Participating routers use an election protocol to determine which router is the primary router at any given time. A maximum of 50 virtual routers may

be configured. A given port may appear as more than one virtual router to the network, also, more than one port on a switch may be configured as a virtual router.

With VRRP, a virtual router is associated with one or more IP addresses that serve as default gateways. In the event that the VRRP router controlling these IP addresses (formally known as the primary) fails, the group of IP addresses and the default forwarding role is taken over by a Backup VRRP router.

### **What Is the VRRP Router Priority?**

The VRRP router priority is a value from 1–255 that determines which router is the primary. The greater the number, the higher the priority. If the virtual IP address is the IP address of a VLAN routing interface on one of the routers in the VRRP group, the router with IP address that is the same as the virtual IP address is the interface owner and automatically has a priority of 255. By default, this router is the VRRP primary in the group.

If no router in the group owns the VRRP virtual IP address, the router with the highest configured priority is the VRRP primary. If multiple routers have the same priority, the router with the highest IP address becomes the VRRP primary.

If the VRRP primary fails, other members of the VRRP group will elect a primary based on the configured router priority values. For example, router A is the interface owner and primary, and it has a priority of 255. Router B is configured with a priority of 200, and Router C is configured with a priority of 190. If Router A fails, Router B assumes the role of VRRP primary because it has a higher priority.

### **What Is VRRP Preemption?**

If preempt mode is enabled and a router with a higher priority joins the VRRP group, it takes over the VRRP primary role if the current VRRP primary is not the owner of the virtual IP address. The preemption delay controls how long to wait to determine whether a higher priority Backup router preempts a lower priority primary. In certain cases, for example, during periods of network congestion, a backup router might fail to receive advertisements from the primary. This could cause members in the VRRP group to change their states frequently, i.e. flap. The problem can be resolved by setting the VRRP preemption delay timer to a non-zero value.

## What Is VRRP Accept Mode?

The accept mode allows the switch to respond to pings (ICMP Echo Requests) sent to the VRRP virtual IP address. The VRRP specification (RFC 3768 and RFC 5798) indicates that a router may accept IP packets sent to the virtual router IP address only if the router is the address owner. In practice, this restriction makes it more difficult to troubleshoot network connectivity problems. When a host cannot communicate, it is common to ping the host's default gateway to determine whether the problem is in the first hop of the path to the destination. When the default gateway is a virtual router that does not respond to pings, this troubleshooting technique is unavailable. In the Dell EMC Networking N-Series switch VRRP feature, Accept Mode can be enabled to allow the system to respond to pings that are sent to the virtual IP address.

This capability adds support for responding to pings, but does not allow the VRRP primary to accept other types of packets. The VRRP primary responds to both fragmented and un-fragmented ICMP Echo Request packets. The VRRP primary responds to Echo Requests sent to the virtual router's primary address or any of its secondary addresses.

Members of the virtual router who are in backup state discard ping packets destined to VRRP addresses, just as they discard any Ethernet frame sent to a VRRP MAC address.

When the VRRP primary responds with an Echo Reply, the source IPv4 address is the VRRP address and source MAC address is the virtual router's MAC address.

## What Are VRRP Route and Interface Tracking?

The VRRP Route/Interface Tracking feature extends VRRP capability to allow tracking of specific routes and interface IP states within the router that can alter the priority level of a virtual router for a VRRP group.

VRRP interface tracking monitors a specific interface IP state within the router. Depending on the state of the tracked interface, the feature can alter the VRRP priority level of a virtual router for a VRRP group.



**NOTE:** An exception to the priority level change is that if the VRRP group is the IP address owner, its priority is fixed at 255 and cannot be reduced through the tracking process.

With standard VRRP, the backup router takes over only if the router goes down. With VRRP interface tracking, if a tracked interface goes down on the VRRP primary, the priority decrement value is subtracted from the router priority. If the primary router priority becomes less than the priority on the backup router, the backup router takes over. If the tracked interface becomes up, the value of the priority decrement is added to the current router priority. If the resulting priority is more than the backup router priority, the original VRRP primary resumes control.

VRRP route tracking monitors the reachability of an IP route. A tracked route is considered up when a routing table entry exists for the route and the route is accessible. When the tracked route is removed from the routing table, the priority of the VRRP router will be reduced by the priority decrement value. When the tracked route is added to the routing table, the priority will be incremented by the same.

### **VRRP and OSPF Interoperability**

On the VRRP standby, OSPF selects an interface as the source address for establishing an OSPF adjacency. On the VRRP primary, OSPF selects the VRRP group virtual address as the source address for OSPF packets. After failover, the new standby selects a new IP address from an interface. This address fails OSPF adjacency checks and an adjacency may not form.


## Default VRRP Values

Table 37-1 shows the global default values for VRRP.

**Table 37-1. VRRP Defaults**

<b>Parameter</b>	<b>Default Value</b>
Admin Mode	Disabled
Virtual Router ID (VRID)	None (Range 1-255)
Preempt Mode	Enabled
Preempt Delay	0 Seconds
Learn Advertisement Timer Interval	Enabled
Accept Mode	Disabled
Priority	100
Advertisement Interval	1
Authentication	None
Route Tracking	No routes tracked
Interface Tracking	No interfaces tracked

# Configuring VRRP Features (Web)

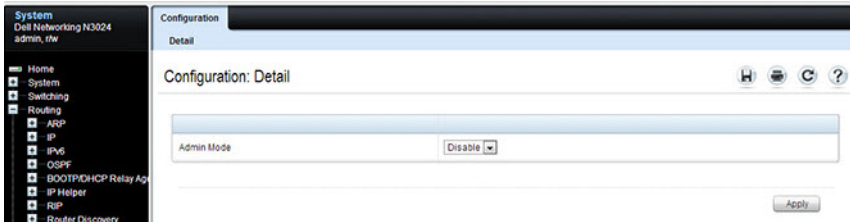
This section provides information about the VRRP pages for configuring and monitoring VRRP features on Dell EMC Networking N1100-ON, N1500, N2000, N2100-ON, N2200-ON, N3100-ON, and N3200-ON Series switches. For details about the fields on a page, click  at the top of the Dell EMC VRRP Configuration web page.

## VRRP Configuration

Use the **Configuration** page to enable or disable the administrative status of a virtual router.

To display the page, click **Routing** → **VRRP** → **Configuration** in the navigation panel.

**Figure 37-1. VRRP Configuration**



## VRRP Virtual Router Status

Use the **Router Status** page to display virtual router status.

To display the page, click **Routing** → **VRRP** → **Router Status** in the navigation panel.

**Figure 37-2. Virtual Router Status**

Router Status

Router Status: Detail

VLAN ID	Description	Priority	Mode	Delay	Internal	Advertisement Interval (secs)	Virtual IP Address	Interface IP Address	Owner	VMAC Address	Auth Type	State	Status	Secondary IP Address
1110	External Network	100	Enable	10	Enable	1	192.168.10.10	192.168.10.1	FR-ISE	0000.0E00.0101	None	Instance	Active	0.0.0.0

## VRRP Virtual Router Statistics

Use the Router Statistics page to display statistics for a specified virtual router.

To display the page, click **Routing** → **VRRP** → **Router Statistics** in the navigation panel.

**Figure 37-3. Virtual Router Statistics**

The screenshot shows the 'Router Statistics' page in a network management interface. The left sidebar contains a navigation tree with the following items: System, Switching, Routing, ARP, IP, IPv6, OSPF, BOOTP/DHCP Relay Agent, IP Helper, RIP, Router Discovery, Router, VLAN Routing, VRRP (with sub-items: Configuration, Router Status, Router Statistics), Router Configuration (with sub-items: Configuration, Route Tracking, Interface Tracking), Tunnels, Loopbacks, Statistics/RMON, Quality of Service, IPv4 Multicast, and IPv6 Multicast. The 'Router Statistics' item is selected and highlighted.

The main content area is titled 'Router Statistics: Detail' and contains a table of statistics for a VRRP instance. The table has two columns: the first column lists the error type, and the second column shows the count. The 'Up Time' row shows the duration of the instance's operation.

Router Checksum Errors	0
Router Version Errors	0
Router VRID Errors	0
VLAN ID	V110
VRID	1
Up Time	0 days, 0 hours, 0 minutes, 0 secs
State Transitioned To Master	0
Advertisement Received	0
Advertisement Interval Errors	0
Authentication Failure	0
IP TTL Errors	0
Zero Priority Packets Received	0
Zero Priority Packets Sent	0
Invalid Type Packets Received	0
Address List Errors	0
Invalid Authentication Type	0
Authentication Type Mismatch	0
Packet Length Errors	0



## VRRP Router Configuration

Use the Configuration page to configure a virtual router.

To display the page, click **Routing** → **VRRP** → **Router Configuration** → **Configuration** in the navigation panel.

**Figure 37-4. VRRP Router Configuration**

Field	Value
VRID and Interface	10-Vlan10
VRID	10
Interface	Vlan10
Description	master (max 80 alpha characters)
Pre-empt Mode	Enable
Pre-empt Delay	0 (0-3600) seconds
Timers Learn Mode	Disable
Accept Mode	Disable
Configured Priority	100 (1 to 254)
Priority	255
Advertisement Interval	1 (1 to 255) seconds
Interface IP Address	192.168.10.1
Primary IP Address	192.168.10.1
Secondary Address	Create
Secondary IP Address	
Authentication Type	0 - None
Authentication Data	(1 to 8 characters)
Status	Inactive

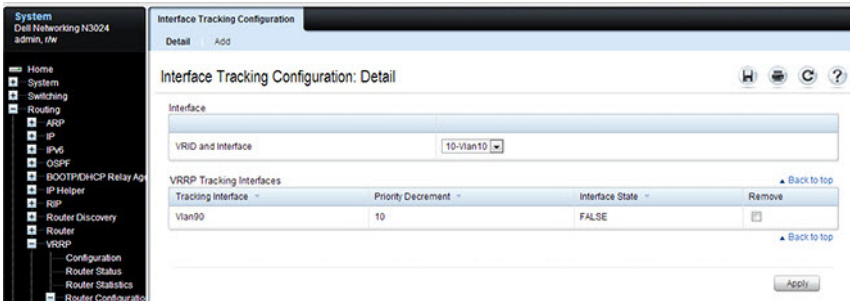
Buttons: Add Secondary, Delete Secondary, Delete, Apply

## VRRP Route Tracking Configuration

Use the **Route Tracking Configuration** page to view routes that are tracked by VRRP and to add new tracked routes.

To display the page, click **Routing** → **VRRP** → **Router Configuration** → **Route Tracking Configuration** in the navigation panel.

**Figure 37-5. VRRP Route Tracking Configuration**

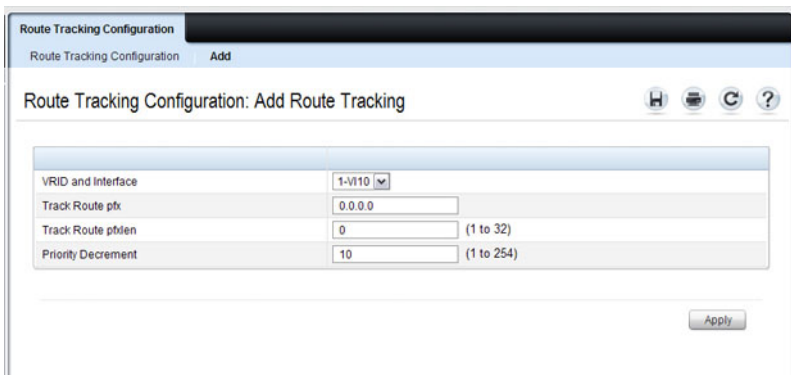


## Configuring VRRP Route Tracking

To configure VRRP route tracking:

- 1 From the **Route Tracking Configuration** page, click **Add**.  
The **Add Route Tracking** page displays.

**Figure 37-6. Add Route Tracking**



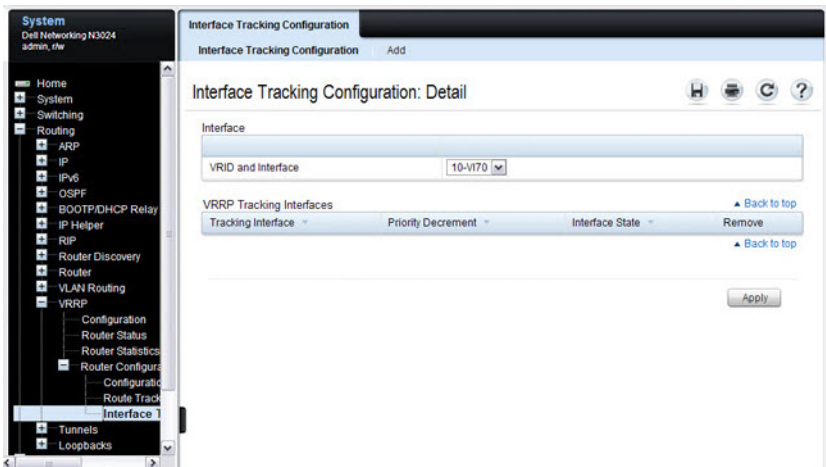
- 2 Select the virtual router ID and VLAN routing interface that will track the route.
- 3 Specify the destination network address (track route prefix) for the route to track. Use dotted decimal format, for example 192.168.10.0.
- 4 Specify the prefix length for the tracked route.
- 5 Specify a value for the **Priority Decrement** to define the amount that the router priority will be decreased when a tracked route becomes unreachable.
6. Click **Apply** to update the switch.

## VRRP Interface Tracking Configuration

Use the **Interface Tracking Configuration** page to view interfaces that are tracked by VRRP and to add new tracked interfaces.

To display the page, click **Routing** → **VRRP** → **Router Configuration** → **Interface Tracking Configuration** in the navigation panel.

**Figure 37-7. VRRP Interface Tracking Configuration**



### Configuring VRRP Interface Tracking

To configure VRRP interface tracking:

- 1 From the **Interface Tracking Configuration** page, click **Add**.

The **Add Interface Tracking** page displays.

**Figure 37-8. VRRP Interface Tracking Configuration**

The screenshot shows a web-based configuration interface for VRRP. The title bar reads 'Interface Tracking Configuration' and 'Add'. The main heading is 'Interface Tracking Configuration: Add Interface Tracking'. The form contains three rows of configuration options:

VRID and Interface	1-V110
Track Interface	V120
Priority Decrement	10 (1 to 254)

An 'Apply' button is positioned at the bottom right of the form area.

- 2 Select the virtual router ID and VLAN routing interface that will track the interface.
- 3 Specify the interface to track.
- 4 Specify a value for the **Priority Decrement** to define the amount that the router priority will be decreased when a tracked interface goes down.
5. Click **Apply** to update the switch.

# Configuring VRRP Features (CLI)

This section provides information about the commands used for configuring VRRP settings on the switch. For more information about the commands, see the *Dell EMC Networking N1100-ON, N1500, N2000, N2100-ON, N2200-ON, N3000E-ON, N3100-ON, and N3200-ON Series Switches CLI Reference Guide* at [www.dell.com/support](http://www.dell.com/support).

## Configuring VRRP Settings

Use the following commands to configure switch and interface VRRP settings. This set of commands also describes how to configure VRRP interface and route tracking.

Command	Purpose
<code>configure</code>	Enter global configuration mode.
<code>ip vrrp</code>	Enable the administrative mode of VRRP for the router (L3 switch).
<code>interface vlan <i>vlan-id</i></code>	Enter Interface Configuration mode for the specified VLAN.
<code>vrrp <i>vr-id</i></code>	Allow the interface to create in the VRRP group specified by the <i>vr-id</i> parameter, which is a number from 1–255.
<code>vrrp <i>vr-id</i> description</code>	(Optional) Create a text description that identifies the VRRP group.
<code>vrrp <i>vr-id</i> preempt [delay <i>seconds</i>]</code>	Enable the preemption mode value for the virtual router configured on a specified interface.  A preempt delay can optionally be configured. A preempt delay is the number of seconds the VRRP router waits before the VRRP router sends an advertisement to claim primary ownership.
<code>vrrp <i>vr-id</i> accept-mode</code>	Allow the VRRP primary to accept ping packets sent to one of the virtual router's IP addresses.
<code>vrrp <i>vr-id</i> priority <i>priority</i></code>	Set the priority value for the virtual router configured on the interface.
<code>vrrp <i>vr-id</i> ip <i>ip-address</i> [secondary]</code>	Set the virtual router IP address value for an interface.

Command	Purpose
<code>vrrp <i>vr-id</i> timers {<b>learn</b>   <b>advertise</b> <i>seconds</i>}</code>	<p>Configure the VRRP timer settings.</p> <p>Use the keyword <b>learn</b> to enable VRRP to learn the advertisement timer interval of the primary router.</p> <p>Use the keyword <b>advertise</b> to set the frequency, in seconds, that an interface on the specified virtual router sends a virtual router advertisement.</p>
<code>vrrp <i>vr-id</i> authentication {<b>none</b>   <b>simple</b> <i>key</i>}</code>	<p>Set the authorization details value for the virtual router configured on a specified interface.</p> <ul style="list-style-type: none"> <li>• <i>vr-id</i> — The virtual router identifier. (Range: 1-255)</li> <li>• <b>none</b> — Indicates authentication type is none.</li> <li>• <b>simple</b> — Authentication type is a simple text password.</li> <li>• <i>key</i> — The key for simple authentication. (Range: String values)</li> </ul>
<code>vrrp <i>vr-id</i> mode</code>	<p>Enable the virtual router configured on an interface, which starts the virtual router.</p>
<code>vrrp <i>vr-id</i> track interface <b>vlan</b> <i>vlan-id</i> [<b>decrement</b> <i>priority</i>]</code>	<p>Specify an interface the virtual router (<i>vr-id</i>) on the interface will track. If the interface goes down, the virtual router priority is decreased by the amount specified by the <i>priority</i> value.</p>
<code>vrrp <i>vr-id</i> track ip route <i>ip-address/prefix-length</i> [<b>decrement</b> <i>priority</i>]</code>	<p>Specify a route that the virtual router (<i>vr-id</i>) on the interface will track. If the route to the destination network specified by the <i>ip-address/prefix-length</i> variable is removed from the routing table, the virtual router priority is decreased by the amount specified by the <i>priority</i> value.</p>
CTRL + Z	<p>Exit to Privileged Exec mode.</p>
<code>show vrrp [<i>vr-id</i>]</code>	<p>View settings for all VRRP groups or for the specified VRRP group for the switch.</p>
<code>show vrrp brief</code>	<p>View a summary of interfaces configured to participate in VRRP groups.</p>
<code>show vrrp interface {<b>brief</b>   <b>vlan</b> <i>vlan-id</i> [<b>stats</b>]}</code>	<p>View information about VRRP settings configured on all interfaces or on the specified interface. If you specify an interface, use the keyword <b>stats</b> to view VRRP statistics for the interface.</p>

# VRRP Configuration Example

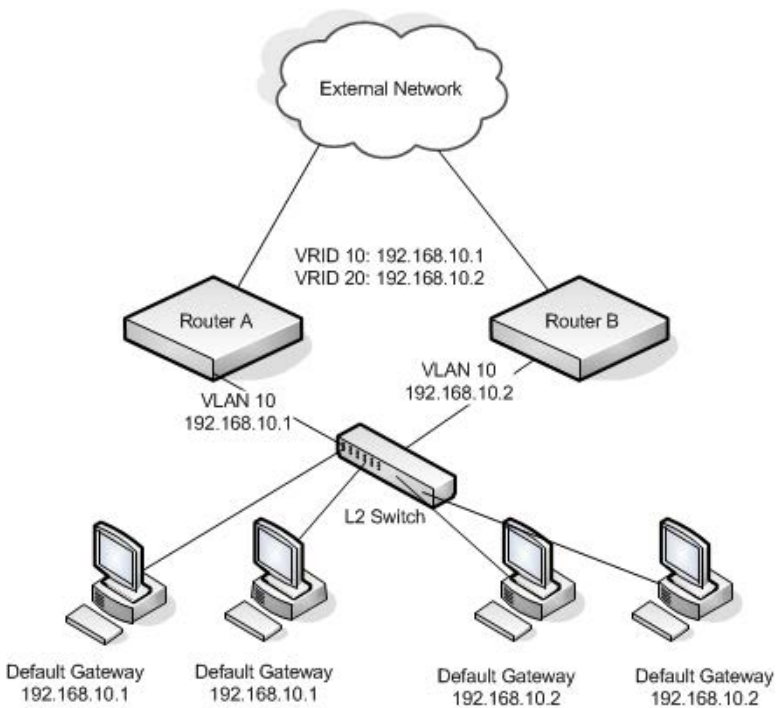
This section contains the following VRRP examples:

- VRRP with Load Sharing
- Troubleshooting VRRP
- VRRP with Route and Interface Tracking
- Configuring VRRP in a VRF

## VRRP with Load Sharing

In Figure 37-9, two L3 Dell EMC Networking N-Series switches are performing the routing for network clients. Router A is the default gateway for some clients, and Router B is the default gateway for other clients.

**Figure 37-9. VRRP with Load Sharing Network Diagram**





This example configures two VRRP groups on each router. Router A is the VRRP primary for the VRRP group with VRID 10 and the backup for VRID 20. Router B is the VRRP primary for VRID 20 and the backup for VRID 10. If Router A fails, Router B will become the primary of VRID 10 and will use the virtual IP address 192.168.10.1. Traffic from the clients configured to use Router A as the default gateway will be handled by Router B.

To configure Router A:

- 1 Enable routing for the switch.

```
console#config  
console (config) #ip routing
```

- 2 Create and configure the VLAN routing interface to use as the default gateway for network clients. This example assumes all other routing interfaces, such as the interface to the external network, have been configured.

```
console (config) #interface vlan 10  
console (config-if-vlan10) #ip address 192.168.10.1 255.255.255.0  
console (config-if-vlan10) #exit
```

- 3 Enable VRRP for the switch.

```
console (config) #ip vrrp
```

- 4 Assign a virtual router ID to the VLAN routing interface for the first VRRP group.

```
console (config) #interface vlan 10  
console (config-if-vlan10) #vrrp 10
```

- 5 Specify the IP address that the virtual router function will use. This router is the virtual IP address owner (because the routing interface has the same IP address as the virtual IP address for the VRRP group), so the priority value is 255.

```
console (config-if-vlan10) #vrrp 10 ip 192.168.10.1
```

- 6 Configure an optional description to help identify the VRRP group.

```
console (config-if-vlan10) #vrrp 10 description primary
```

- 7 Assign a virtual router ID to the VLAN routing interface for the second VRRP group.

```
console (config-if-vlan10) #vrrp 20
```

- 8 Specify the IP address that the virtual router function will use.

```
console (config-if-vlan10) #vrrp 20 ip 192.168.10.2
```

- 9 Configure an optional description to help identify the VRRP group.

```
console(config-if-vlan10) #vrrp 20 description backup
```

- 10 Enable the VRRP groups on the interface.

```
console(config-if-vlan10) #vrrp 10 mode
console(config-if-vlan10) #vrrp 20 mode
console(config-if-vlan10) #exit
console(config) #exit
```

The only difference between the Router A and Router B configurations is the IP address assigned to VLAN 10. On Router B, the IP address of VLAN 10 is 192.168.10.2. Because this is also the actual IP address of VRID 20, Router B is the interface owner and VRRP primary of VRRP group 20.

To configure Router B:

- 1 Enable routing for the switch.

```
console#config
console(config) #ip routing
```

- 2 Create and configure the VLAN routing interface to use as the default gateway for network clients. This example assumes all other routing interfaces, such as the interface to the external network, have been configured.

```
console(config) #interface vlan 10
console(config-if-vlan10) #ip address 192.168.10.2 255.255.255.0
console(config-if-vlan10) #exit
```

- 3 Enable VRRP for the switch.

```
console(config) #ip vrrp
```

- 4 Assign a virtual router ID to the VLAN routing interface for the first VRRP group.

```
console(config) #interface vlan 10
console(config-if-vlan10) #vrrp 10
```

- 5 Specify the IP address that the virtual router function will use.

```
console(config-if-vlan10) #vrrp 10 ip 192.168.10.2
```

- 6 Configure an optional description to help identify the VRRP group.

```
console(config-if-vlan10) #vrrp 10 description primary
```

- 7 Assign a virtual router ID to the VLAN routing interface for the second VRRP group.

```
console(config-if-vlan10) #vrrp 20
```

- 8 Specify the IP address that the virtual router function will use.

The router is the virtual IP address owner of this address, so the priority value is 255 by default.

```
console(config-if-vlan10)#vrrp 20 ip 192.168.10.1
```

- 9 Configure an optional description to help identify the VRRP group.

```
console(config-if-vlan10)#vrrp 20 description backup
```

- 10 Enable the VRRP groups on the interface.

```
console(config-if-vlan10)#vrrp 10 mode
```

```
console(config-if-vlan10)#vrrp 20 mode
```

```
console(config-if-vlan10)#exit
```

```
console(config)#exit
```

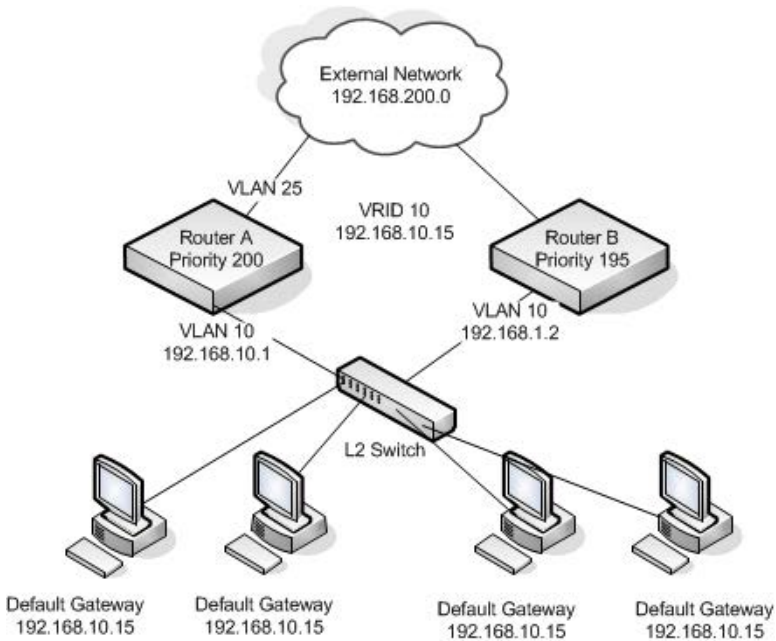
## Troubleshooting VRRP

When configuring VRRP, ensure that the Layer-2 network facing the VRRP router is up. The VRRP peers will show as being in the “Primary” or “Initializing” state until the Layer 2 network is operational. Check the spanning-tree state on any routed links. Routed links must show as forwarding. Disable spanning tree on the routed links if necessary to prevent spanning tree from blocking routed links.

## VRRP with Route and Interface Tracking

In Figure 37-10, the VRRP priorities are configured so that Router A is the VRRP primary, and Router B is the VRRP backup. Router A forwards IP traffic from clients to the external network through the VLAN 25 routing interface. The clients are configured to use the virtual IP address 192.168.10.15 as the default gateway.

**Figure 37-10. VRRP with Tracking Network Diagram**



Without VRRP interface or route tracking, if something happened to VLAN 25 or the route to the external network, as long as Router A remains up, it will continue to be the VRRP primary even though traffic from the clients does not have a path to the external network. However, if the interface and/or route tracking features are configured, Router A can decrease its priority value when the problems occur so that Router B becomes the primary.

To configure Router A:

- 1 Enable routing for the switch.

```
console#config  
console (config) #ip routing
```

- 2 Create and configure the VLAN routing interface to use as the default gateway for network clients. This example assumes all other routing interfaces, such as the interface to the external network, have been configured.

```
console (config) #interface vlan 10  
console (config-if-vlan10) #ip address 192.168.10.1 255.255.255.0  
console (config-if-vlan10) #exit
```

- 3 Enable VRRP for the switch.

```
console (config) #ip vrrp
```

- 4 Assign a virtual router ID to the VLAN routing interface for the VRRP group.

```
console (config) #interface vlan 10  
console (config-if-vlan10) #vrrp 10
```

- 5 Specify the IP address that the virtual router function will use.

```
console (config-if-vlan10) #vrrp 10 ip 192.168.10.15
```

- 6 Configure the router priority.

```
console (config-if-vlan10) #vrrp 10 priority 200
```

- 7 Enable preempt mode so that the router can regain its position as VRRP primary if its priority is greater than the priority of the backup router.

```
console (config-if-vlan10) #vrrp 10 preempt
```

- 8 Enable the VRRP groups on the interface.

```
console (config-if-vlan10) #vrrp 10 mode  
console (config-if-vlan10) #exit
```

- 9 Track the routing interface VLAN 25 on VRID 10 so that if it goes down, the priority of VRID 10 on Router A is decreased by 10, which is the default decrement priority value.

```
console (config-if-vlan10) #vrrp 10 track interface vlan 25
```

- 10 Track the route to the 192.168.200.0 network. If it becomes unavailable, the priority of VRID 10 on Router A is decreased by 10, which is the default decrement priority value.

```
console(config-if-vlan10)#vrrp 10 track ip route 192.168.200.0/24
console(config-if-vlan10)#exit
```

Router B is the backup router for VRID 10. The configured priority is 195. If the VLAN 25 routing interface or route to the external network on Router A go down, the priority of Router A will become 190 (or 180, if both the interface and router are down). Because the configured priority of Router B is greater than the actual priority of Router A, Router B will become the primary for VRID 10. When VLAN 25 and the route to the external network are back up, the priority of Router A returns to 200, and it resumes its role as VRRP primary.

To configure Router B:

- 1 Enable routing for the switch.

```
console#config
console(config)#ip routing
```

- 2 Create and configure the VLAN routing interface to use as the default gateway for network clients. This example assumes all other routing interfaces, such as the interface to the external network, have been configured.

```
console(config)#interface vlan 10
console(config-if-vlan10)#ip address 192.168.10.2 255.255.255.0
console(config-if-vlan10)#exit
```

- 3 Enable VRRP for the switch.

```
console(config)#ip vrrp
```

- 4 Assign a virtual router ID to the VLAN routing interface for the VRRP group.

```
console(config)#interface vlan 10
console(config-if-vlan10)#vrrp 10
```

- 5 Specify the IP address that the virtual router function will use.

```
console(config-if-vlan10)#vrrp 10 ip 192.168.10.15
```

- 6 Configure the router priority.

```
console(config-if-vlan10)#vrrp 10 priority 195
```

- 7 Enable preempt mode so that the router can regain its position as VRRP primary if its priority is greater than the priority of the backup router.

```
console(config-if-vlan10)#vrrp 10 preempt
```

- 8 Enable the VRRP groups on the interface.

```
console(config-if-vlan10)#vrrp 10 mode
console(config-if-vlan10)#exit
console(config)#exit
```

## Configuring VRRP in a VRF

In this example, a VRRP primary is configured in VRF red-1. Interface gil/0/1 on each of the VRRP peers is connected to the other switch. The configuration steps are as follows:

- 1 Create the VRRP VLAN:

```
console#config
console(config)#vlan 10
console(config-vlan10)#exit
```

- 2 Create a VRF and enable routing:

```
console(config)#ip vrf red-1
console(config-vrf-red-1)#ip routing
console(config-vrf-red-1)#exit
```

- 3 Enable ip routing globally:

```
console(config)#ip routing
```

- 4 Enable VRRP globally:

```
console(config)#ip vrrp
```

- 5 Configure a VLAN interface:

```
console(config)#interface vlan 10
```

- 6 Make the VRF a member of the VLAN:

```
console(config-if-vlan10)#ip vrf forwarding red-1
```

- 7 Add an IP address to the VLAN to make it a routing VLAN:

```
console(config-if-vlan10)#ip address 129.168.0.1 255.255.255.0
```

- 8 Create a VRRP instance:

```
console(config-if-vlan10)#vrrp 1
```

- 9 Set the VRRP virtual address:

```
console(config-if-vlan10)#vrrp 1 ip 129.168.0.100
```

- 10 Set the VRRP priority and accept pings:

```
console(config-if-vlan10)#vrrp 1 priority 1
console(config-if-vlan10)#vrrp 1 accept-mode
console(config-if-vlan10)#exit
```

- 11 Configure the physical interface as a VLAN 10 member:

```
console(config)#interface Gi1/0/1
console(config-if-Gi1/0/1)#switchport access vlan 10
console(config-if-Gi1/0/1)#exit
```

The following steps provide configure the companion VRRP peer:

- 1 Create a VLAN:

```
console#configure
console(config)#vlan 10
console(config-vlan)#exit
```

- 2 Create a VRF and enable routing:

```
console(config)#ip vrf red-1
console(config-ip-vrf-red-1)#ip routing
console(config-ip-vrf-red-1)#exit
```

- 3 Enable ip routing globally:

```
console(config)#ip routing
```

- 4 Enable VRRP globally:

```
console(config)#ip vrrp
```

- 5 Configure a VLAN interface:

```
console(config)#interface vlan 10
```

- 6 Make the VRF a member of the VLAN:

```
console(config-if-vlan10)#ip vrf forwarding red-1
```

- 7 Add an IP address to the VLAN:

```
console(config-if-vlan10)#ip address 129.168.0.2 255.255.255.0
```

- 8 Create a VRRP instance:

```
console(config-if-vlan10)#vrrp 1
```

- 9 Set the VRRP virtual address:

```
console(config-if-vlan10)#vrrp 1 ip 129.168.0.100
```

- 10 Set the VRRP priority to indicate the other router is the VRRP primary and to accept pings:



```
console(config-if-vlan10)#vrrp 1 priority 2  
console(config-if-vlan10)#vrrp 1 accept-mode  
console(config-if-vlan10)#exit
```

**11** Configure the physical interface as a VLAN 10 member:

```
console(config)#interface Gi1/0/1  
console(config-if-Gi1/0/1)#switchport access vlan 10  
console(config-if-Gi1/0/1)#exit
```

For VRRP to become active, other interfaces need to be enabled for VLAN 10 such that the VRRP peers are able to establish connectivity to each other over those interfaces as well as over Gi1/0/1.



# BGP

## Dell EMC Networking N3000E-ON, N3100-ON, and N3200-ON Series Switches



**NOTE:** This feature is not available on Dell EMC Networking N1100-ON, N1500, N2000, N2100-ON and N2200-ON Series switches.

Border Gateway Protocol (BGP) is a standardized exterior gateway path-vector or distance-vector protocol. BGP makes routing decisions based upon paths and network policies configured by the administrator.

This chapter includes the following topics:

- Overview
- BGP Operations
- BGP Limitations
- BGP Configuration Examples

The following terms and acronyms are used in this chapter.

**Table 38-1. BGP-Related Terms**

<b>Term</b>	<b>Definition</b>
Accept-RIB-In	The collection of routing information that has passed inbound policy and been accepted as candidate BGP routes.
Adj-RIB-In	The collection of routing information received from peers
Adj-RIB-Out	The collection of routing information sent to peers
AS	Autonomous System
ASN	Autonomous System Number
BGP	Border Gateway Protocol
eBGP	Exterior Border Gateway Protocol
iBGP	Interior Border Gateway Protocol
MED	Multi Exit Discriminator

**Table 38-1. BGP-Related Terms**

<b>Term</b>	<b>Definition</b>
RIB	Routing Information Base
RTO	Routing Table Object. The common routing table, or "RIB," which collects routes from all sources (local, static, dynamic) and determines the most preferred route to each destination.
TCP	Transmission Control Protocol

## Overview

BGP operates by establishing adjacencies (connections) with other BGP peers (routers). BGP peers are configured manually. A BGP speaker (peer) sends a keep-alive message every 30 seconds to the BGP peer to maintain the connections. BGP uses TCP as its transport protocol.

BGP speakers distribute routing information via Network Layer Reachability Information (NLRI) Updates. Normally, Dell EMC Networking BGP distributes routes learned from interior sources only to exterior peers and distributes routes learned from exterior sources to all peers.

Dell EMC Networking BGP supports filtering of learned routes using route-maps for both the in and out directions.

Dell EMC Networking BGP supports IPv4 and IPv6 unicast routes only. Both IPv4 and IPv6 peering are supported. IPv4 routes may be carried over IPv4 peering sessions. IPv6 routes may be carried over IPv4 or IPv6 peering sessions.

The only optional parameters recognized in an OPEN message are the Capabilities option (RFC 5492) and the multiprotocol capabilities option (RFC 4760). The RFC 4271 deprecated Authentication Information option is not supported. If a neighbor includes the deprecated authentication parameter in its OPEN message, Dell EMC Networking BGP rejects the OPEN and will not form an adjacency.

Dell EMC Networking BGP allows the network operator to configure a maximum number of prefixes accepted from a peer. The limit defaults to the maximum number of routes that can be installed in the routing table. When the limit is reached, by default, BGP shuts down the peer. BGP may be configured to instead discard new address prefixes but not terminate the peer (RFC 4271 section 6.7).

Dell EMC Networking BGP supports the following RFCs in whole or in part as indicated:

- RFC 1997 – BGP Communities Attribute
- RFC 2385 – Protection of BGP Sessions via the TCP MD5 Signature Option
- RFC 2545 – Use of BGP-4 Multiprotocol Extensions for IPv6 Inter-Domain Routing
- RFC 2918 – Route Refresh Capability for BGP-4
- RFC 4271 – A Border Gateway Protocol 4 (BGP-4)
- RFC 4273 – Definitions of Managed Objects for BGP-4
- RFC 4456 – BGP Route Reflection: An Alternative to Full Mesh Internal BGP (IBGP)
- RFC 4486 – Sub-codes for BGP Cease Notification Message
- RFC 4724 – Graceful Restart Mechanism for BGP
- RFC 4760 – Multiprotocol Extensions for BGP-4
- RFC 5492 – Capabilities Advertisement with BGP-4
- RFC 5668 – 4 Octet AS Specific BGP Extended Community
- RFC 6793 – BGP Support for Four-Octet Autonomous System (AS) Number Space

Dell EMC Networking BGP supports both IPv4 and IPv6 peering sessions and supports both IPv4 and IPv6 routes (RFC 4760 and RFC 2545). IPv6 peering sessions support IPv6 routes only, but IPv4 addresses may be embedded within IPv6 routes.

TCP MD5 authentication is supported, however, RFC 5295 is not supported. Dell EMC Networking BGP also supports a private MIB with information regarding:

- Internal BGP message queue status
- Transmit and receive message counters
- Decision process statistics
- Per-peer message and prefix counters

Dell EMC Networking BGP supports configuration via the CLI only.

Routing must be enabled to enable Dell EMC Networking BGP. Both the AS number and the router ID are required to be configured. Enabling of BGP is automatic when the AS number and router ID are configured. The **no enable** command may be used to temporarily disable BGP without removing the BGP configuration.

## Autonomous Systems

Dell EMC Networking BGP supports both exterior routing (eBGP) between autonomous systems (inter-AS) and interior routing within an AS (iBGP). Dell EMC Networking BGP is suitable for use in enterprise and data center deployments. Dell EMC Networking switches do not have sufficient capacity to hold a full Internet routing table.

Dell EMC Networking supports BGP version 4 with both 2-byte and 4-byte Autonomous System Numbers (ASN). An autonomous system number is a globally unique identifier for a group of IP networks that has a single, clearly defined external routing policy.

## Graceful Restart

BGP supports graceful restart per RFC 4724. When configured in graceful restart aware mode, the router saves the route table contents prior to an operator-initiated restart.

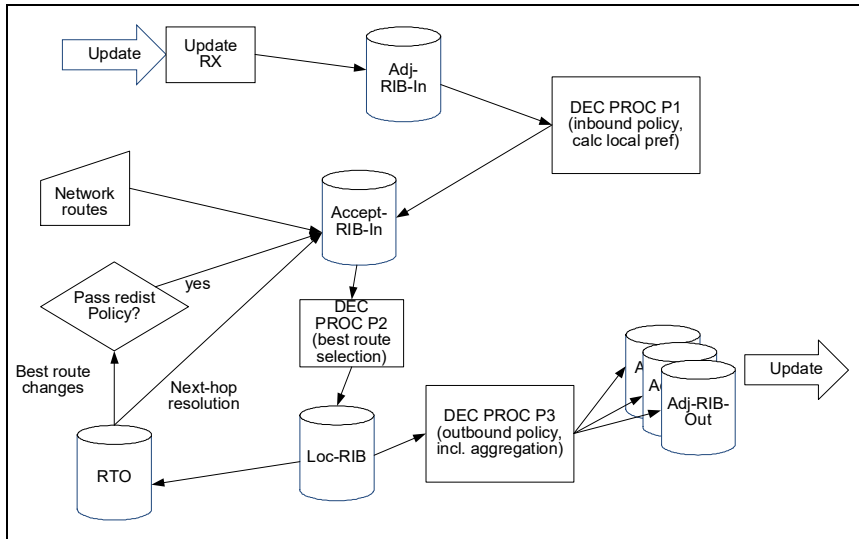
# BGP Operations

## Decision Process Overview

The BGP decision process is logic that applies inbound policy to routing information from peers, computes routes, and advertises routes to peers. Figure 38-1 shows an overview of the decision process. BGP parses incoming UPDATE messages, storing routing information in Adj RIB-In. Phase 1 of the decision process applies inbound policy to routes in Adj RIB In. Routes that pass inbound policy are copied to Accept-RIB-In and LOCAL\_PREF is set. BGP uses the routing table to resolve a BGP next hop to a local next hop. Locally originated routes (those configured with the **network** command or redistributed from another protocol) go directly to Accept-RIB-In. Phase 2 of the decision process selects the best route to each destination in Accept-RIB-In. Each best route is stored in the local RIB and given to RTO. Phase 3 of the

decision process applies outbound policy to routes in the local RIB and determines the status of aggregate routes. Active aggregates and individual routes that pass outbound policy are placed in an Adj-RIB-Out specific to each update group, and UPDATE messages are sent to communicate the routes to neighbors.

**Figure 38-1. BGP Decision Process**



### BGP Route Selection

Dell EMC Networking BGP uses the following route selection rules in order from 1 to N:

- 1 Prefer the route with the higher local preference
- 2 Prefer a locally-originated route over a non-locally originated route
- 3 Prefer the route with the shorter AS Path
- 4 Prefer the route with the lower ORIGIN. IGP is better than EGP is better than INCOMPLETE.

- 5 Prefer the route with the lower MED. By default, MEDs are compared for routes from any AS, but a configuration option limits comparison of MEDs to the same AS. A route with no MED is considered to have a MED of 0.
- 6 Prefer an eBGP route to an iBGP route
- 7 Prefer the route with the lower IGP cost to the BGP NEXT HOP
- 8 Prefer the route learned from the peer with the lower router ID
- 9 Prefer the route learned from the peer with the lower peer IP address

### Limiting Phase 2 CPU Usage

In a network with a large number of prefixes, phase 2 of the decision process can consume a significant amount of time. If the BGP hold timers are configured to be shorter than the duration of the decision process, the timers can expire causing a loss of adjacency. If the decision process runs frequently, it may consume significant CPU resources, starving other processes. Two mechanisms mitigate these potential issues. First, a hold timer prevents phase 2 from running too often. The hold time is explained in more detail in the next paragraph. Second, phase 2 is limited to running no more than approximately one second without yielding to other tasks.

When an event triggers phase 2, a short delay (usually 100 ms) is imposed before the decision process runs. This delay allows other RIB changes to complete before computing new routes. When the trigger occurs, if the decision process was previously run within the hold time, the next decision process is scheduled to run after the hold time expires. The initial hold time is one second. Each time one or more new triggers occur while the hold timer is running, the hold timer is doubled, up to a maximum of 4 seconds. When the hold timer expires without BGP receiving a new phase 2 trigger, the hold time is reset to the minimum hold time.

### Path Attributes

Dell EMC Networking supports all path attributes described in RFC 4271.

Dell EMC Networking BGP sets the ORIGIN path attribute to IGP for routes originated through the **network** command and to INCOMPLETE for routes originated through route redistribution. Dell EMC Networking BGP never sets the ORIGIN path attribute to EGP.



Dell EMC Networking BGP sets the AS\_PATH path attribute in compliance with RFC 4271. Dell EMC Networking BGP does require that paths from external peers include the configured AS number of the peer as the first AS in the path. Dell EMC Networking BGP enforces a configurable limit to the length of the AS\_PATH attribute in received paths. Paths that exceed the limit are discarded.

Dell EMC Networking BGP offers a configuration option (**neighbor next-hop-self**) to set the NEXT\_HOP attribute to a local IP address when sending an UPDATE message to an internal peer. Otherwise, Dell EMC Networking BGP follows the guidance in RFC 4271 when sending to internal peers. When sending an UPDATE message to an external peer, Dell EMC Networking BGP retains the NEXT\_HOP address if it is an address on the subnet used to connect the peers but is not the peer's IP address. Otherwise, Dell EMC Networking BGP sets the NEXT\_HOP path attribute to the local IP address on the interface to the peer. Dell EMC Networking BGP does not support “first party” next hop. Dell EMC Networking does not allow the network operator to disable third party next hop. Dell EMC Networking does not support multihop EBGp. (RFC 4271 section 5.1.3)

The Multi Exit Discriminator (MED) attribute is sent to external peers when advertising routes that originate within the local AS. The MED value may be configured for redistributed routes, either using the **metric** option on the redistribution command or by configuring a **default-metric**. If the MED is not configured for a redistributed route, the route is advertised without a MED attribute. Routes originated through the **network** command set the MED to the metric of the IGP route to the same network. The MED may also be set on locally-originated routes using a route map. The MED for non-locally-originated routes is propagated to internal peers. By default, MEDs are only compared when two routes are received from external peers in the same AS. There is a configuration option to force BGP to compare MEDs for paths received from different autonomous systems.

When BGP receives an UPDATE message from an external peer, it assigns a local preference value during phase 1 of the decision process. Local preference is set to a fixed, configured value which is the same for all paths received from all neighbors. This value is attached to the path in the LOCAL\_PREF path attribute when the path is advertised to internal peers. The configured default local preference is assigned to all locally-originated routes and to the paths for all active aggregate addresses. LOCAL\_PREF can be configured to different values on different routers to influence the exit point from the AS

that other routers select for each destination. An inbound route map can override the default local preference. LOCAL\_PREF is never included in paths sent to external peers. If the user changes the default local preference while BGP is running, BGP automatically initiates an immediate soft inbound reset for all external peers, updates the local preference for all locally-originated routes, and re-computes routes.

For each aggregate address configured, the network administrator may specify whether to advertise an AS\_SET of the AS numbers in the paths from which the aggregate was formed. When the aggregate is advertised with an empty AS Path, the ATOMIC\_AGGREGATE path attribute is attached to the path. In either case, the AGGREGATOR path attribute is attached.

## BGP Finite State Machine (FSM)

Dell EMC Networking BGP supports all mandatory FSM session attributes and the following optional session attributes (RFC 4271 section 8):

- **AllowAutomaticStart**—Connections are automatically restarted after an error closes a connection. An adjacency to an external peer in the IDLE state is automatically started if the routing interface to that peer comes up. An adjacency to an internal peer in the IDLE state is automatically started when the peer's IP address becomes reachable.
- **AllowAutomaticStop**—When a neighbor sends more prefixes than the configured limit, the connection may be automatically shut down, depending on configuration. **AutoStop** is also used for fast fallover. When the routing interface to an external peer goes down, the peering session is automatically stopped. Similarly, if an internal peer becomes unreachable, the peering session is automatically stopped.
- **CollisionDetectEstablishedState**—When an OPEN message is received on a TCP connection and the adjacency using that connection has already reached ESTABLISHED state, the adjacency is cleared. If an OPEN message is received on a different TCP connection than the one used to reach ESTABLISHED state, the new TCP connection is cleared and the adjacency remains up.
- **DampPeerOscillations**—An idle hold time is enforced between automatic restarts. The length of the idle time depends on the reason the adjacency entered the idle state.
- **IdleHoldTime/IdleHoldTimer**—After an error clears a connection or a TCP connection fails, Dell EMC Networking BGP waits before attempting to reestablish the adjacency. The waiting time varies depending on the event. When a TCP connection fails, BGP waits 30 to 60 seconds. When a NOTIFICATION is received, BGP waits 1 to 2 seconds. Other events trigger a wait of 10 to 20 seconds. The delay time is not configurable.
- **SendNOTIFICATIONWithoutOPEN**—Dell EMC Networking will accept a NOTIFICATION packet from a peer that has not first sent an OPEN packet. Dell EMC Networking will not send a NOTIFICATION without first sending an OPEN.

None of the optional session attributes are configurable.

Dell EMC Networking BGP supports manual start and stop events. A manual start event occurs when the user first configures a peer (**neighbor remote-as**) or administratively enables a peer (**no neighbor shutdown**). A manual stop event occurs when the user administratively disables a neighbor (**neighbor shutdown**).

Of the optional events in RFC 4271 section 8.1.2 - 8.1.5, the following events are supported:

- AutomaticStart\_with\_DampPeerOscillations (Event 6)
- AutomaticStop (Event 8)
- IdleHoldTimer\_Expires (Event 13)

When an attempt to establish an adjacency fails, Dell EMC Networking puts the adjacency in the IDLE state and starts the idle hold timer. When the idle hold timer expires, Dell EMC Networking moves the adjacency to the CONNECT state and initiates a new TCP connection. If the neighbor does not respond to the connection request, Dell EMC Networking retries three times. The first retry is done after the configured retry interval. Each subsequent retry doubles the previous retry interval. So by default, the TCP connection is retried after 2, 4, and 8 seconds. Configuring the initial retry interval to a large value can prevent retries. The TCP stack times out a connection attempt in 20 seconds (after retransmitting the SYN segment according to normal retransmit procedures), sends a TCP reset, and notifies the application of the connection failure. The connection failure resets the BGP connect retry timer, puts the adjacency in IDLE state, and starts the idle hold timer.

Dell EMC Networking BGP allows multiple BGP sessions between the same two routers. However, each session must be established between different pairs of IP addresses.

Dell EMC Networking BGP includes two capabilities in every OPEN message it sends. The first is the Route Refresh capability described in RFC 2918. The second is the multiprotocol capability described in RFC 4760. Dell EMC Networking always advertises the IPv4/unicast AFI/SAFI pair. If the user has activated IPv6 for the peer, the OPEN also includes the IPv6/unicast pair. Even though Dell EMC Networking BGP does not support any AFI/SAFI pairs other than IPv4/unicast when IPv6 is not enabled, Dell EMC Networking advertises the multiprotocol capability with IPv4/unicast because some other implementations appear to require this in order to establish an adjacency.

## Detecting Loss of Adjacency

Dell EMC Networking optionally drops an adjacency with an external peer when the routing interface to that peer goes down. This behavior can be enabled globally or on specific interfaces using the **bgp fast-external-fallover** and **ip bgp fast-external-fallover** commands. BGP accomplishes this behavior by listening to router events. When BGP gets a routing interface down event, BGP drops the adjacency with all external peers whose IPv4 address is in one of the subnets on the failed interface. Both **fast-external-fallover** and **fast-internal-fallover** are enabled by default.

Dell EMC Networking also offers an option to quickly detect loss of reachability to internal peers, and drop the BGP adjacency when such a loss occurs. Because internal peers are often not on a local subnet (and an internal peer can be reached through multiple local interfaces), BGP cannot determine internal peer reachability based on local link state. Instead, when this feature is enabled, BGP registers for address resolution changes for each internal peer's IPv4 address. When a peer's address becomes unreachable (i.e., the route table manager deletes the route to the peer and no non-default route to the peer remains), BGP drops the adjacency to the peer. BGP considers an internal peer to be unreachable if the only route to the peer is a default route. This feature can be enabled or disabled globally for all internal peers using **bgp fast-internal-fallover**. Because internal peers are not associated with a single interface, there is no interface configuration option.

When fast fallover is disabled for a peer, the adjacency remains in the ESTABLISHED state until the hold timer expires. When connectivity to the peer is lost, the BGP Next Hop for routes learned from affected peers becomes unreachable. This change makes the routes unusable, and BGP immediately removes them from the routing table. So even without the fast fallover behavior enabled, the routing table reacts quickly to changes in local interface state. However, when the adjacency remains in ESTABLISHED state even though the neighbor is unreachable, BGP cannot send UPDATE messages to the neighbor. If the link is restored before the dead interval expires, there is no event to cause BGP to resend the failed UPDATES. Because BGP does not periodically refresh routing state, and the loss of UPDATES is permanent. To avoid this situation, when an UPDATE message fails to be sent to any member of an outbound update group, BGP reschedules the update send process to resend the data. Thus, having a neighbor in an ESTABLISHED but unreachable state causes duplicate data to be sent to other members of the update group. With fast fallover enabled,

the adjacency to the unreachable neighbor is no longer ESTABLISHED, and if an UPDATE is sent to the neighbor's update group, BGP does not try to send to the failed neighbor. When the failed adjacency is reestablished, BGP resends all routing information to the neighbor.

Both internal and external fallover should happen within a second of the loss of reachability. Enabling fast fallover should relax the need to set a short hold time and send KEEPALIVE messages rapidly.

## Authentication

RFC 4271 requires support for TCP MD5 authentication as specified in RFC 2385. Dell EMC Networking supports TCP MD5 authentication. The network administrator may optionally enable TCP MD5 for a specific peering session by configuring a password on each end of the connection.

Because of concerns about the increasing vulnerability of MD5, the IETF has recently obsoleted RFC 2385, replacing it with more robust mechanisms specified in RFC 5925, *The TCP Authentication Option*. In spite of this, support for TCP MD5 has some near-term value: it allows interoperability with other implementations that do not yet support RFC 5925. Dell EMC Networking BGP does not support for RFC 5925.

## Outbound Update Groups

To reduce the memory required for the Adj-RIB-Out and to reduce the processing required by the phase 3 decision process, BGP sorts peers into update groups. Every peer in an update group has the same configured (or default) value for `minRouteAdvertisementInterval` and the same set of outbound policies. Each update group contains only internal or external peers. Thus, the same information is advertised to every peer in the update group and may be advertised at the same time. A single advertised path list (Adj-RIB-Out) is retained for each update group. A single UPDATE message is constructed and a copy sent to each peer in the update group. When a peer in the ESTABLISHED state moves from one update group to another because of a configuration change, BGP withdraws all prefixes previously advertised to the peer and advertises to the peer the Adj-RIB-Out of the new update group.

BGP maintains separate update groups for IPv4 and IPv6. If IPv6 is active for a peer with an IPv4 address, the peer is in both an IPv4 update group and in an IPv6 update group. A neighbor may be in an IPv6 update group for an IPv4

peer session (if the network administrator activates IPv6 on the peer session) and in an IPv6 update group for an IPv6 peer session. Such a configuration is probably a misconfiguration. BGP will send IPv6 NLRI to the neighbor twice. BGP assigns peers to update groups automatically. The Dell EMC Networking UI has no configuration associated with update groups and the UI does report update group membership.

## **Removing Private AS Numbers**

An organization may use private AS numbers internally. Private ASNs must be removed from routes to destinations within an AS before the routes are advertised in order to avoid conflicts with other networks also using overlapping private ASNs. Dell EMC Networking BGP may be configured to remove private AS numbers from the AS\_PATH attribute of paths advertised to external peers as an outbound policy.

Two-byte ASNs in the range from 64,512 to 65,535 are removed when this option is enabled. The administrator may optionally configure BGP to replace private ASNs with the local AS number. The replace option maintains the original length of an AS path, which can be important when the AS path length is used in route selection. The option to remove or replace private ASNs can be configured independently for each address family (IPv4 or IPv6).

## **Templates**

Dell EMC Networking BGP supports configuration of neighbor parameters in named peer templates. A template defines a set of peer parameters. Multiple peers can inherit parameters from a template, eliminating the need to repeat common configuration for every peer. A neighbor can inherit from a single template. BGP accepts configuration of up to 32 templates.

Neighbor configuration parameters can be divided into two groups, session parameters and policy parameters. Session parameters apply to the peering session. Session parameters include configuration options such as keep-alive and hold timers. Policy parameters are specific to the routes for an address family (e.g., IPv4 and IPv6), such as the maximum number of routes accepted from a peer or prefix lists used to filter routes received from or sent to a peer. Peer templates allow both session parameters and policies to be configured within the same template. With a template, policy parameters are configured for a specific address family.

Session parameters that may be configured in a template are as follows:

**Table 38-2. Configurable Session Parameters in BGP Peer Templates**

<b>Parameter</b>	<b>Description</b>
allowas-in	Configure to accept routes with my ASN in the as-path.
connect-retry-interval	Configure the connection retry interval for the peer.
description	Configure a description for the peer.
ebgp-multihop	Configure to allow non-directly-connected eBGP neighbors.
fall-over	Configure fast fall-over.
local-as	Configure local-as.
password	Configure a TCP password.
remote-as	Configure remote-as.
rfc5549-support	Configure support of RFC 5549.
shutdown	Configure the administrative status.
timers	Configure keepalive and hold time.
update-source	Configure a source address.

Policy parameters that may be configured per address family within a template are as follows:

**Table 38-3. Session Parameters in BGP Peer Templates—Configurable Per-Address Family**

<b>Parameter</b>	<b>Description</b>
advertisement-interval	Configure the BGP advertisement interval for the peer.
default-originate	Configure this peer to generate a default route.
filter-list	Configure filter lists for the peer.
maximum-prefix	Configure the maximum number of prefixes learned from the peer.
next-hop-self	Configure the router as next hop.
prefix-list	Configure prefix lists for the peer.



**Table 38-3. Session Parameters in BGP Peer Templates—Configurable Per-Address Family**

Parameter	Description
remove-private-as	Remove private ASNs from AS_PATH when sending to inheriting peers.
route-map	Configure a route map for the peer.
route-reflector-client	Configure a peer as a route reflector client.
send-community	Configure this peer to send BGP communities.

## Resolving Interface Routes

In Dell EMC Networking, the next hop of a route is always a set of next-hop IP addresses. Dell EMC Networking does not support routes whose next hop is simply an interface. Thus, the second route resolvability condition in RFC 4271 section 9.1.2.1 does not apply.

## Originating BGP Routes

A router running Dell EMC Networking BGP can originate a BGP route through route redistribution and through configuration (the **network** command). Attributes of locally-originated routes may be set through a route map. Locally-originated BGP routes are sent to both internal and external peers unless filtered by outbound policy.

Locally-originated routes are added to Accept-RIB-In. Phase 2 of the decision process considers locally-originated routes along with routes received from peers when selecting the best BGP route to each destination.

BGP can be configured to originate the same prefix through a network command and through redistribution. Dell EMC Networking BGP creates a different path for each if the path attributes differ. BGP only advertises the prefix with the preferred path.

RFC 4271 section 9.2.1.2 specifies “a minimum amount of time that must elapse between successive advertisements of UPDATE messages that report changes within the advertising BGP speaker's own autonomous systems” and refers to this as `minASOriginationInterval`. RFC 4271 section 10 suggests a default of 15 seconds. Dell EMC Networking BGP does not enforce `minASOriginationInterval`, but relies on `minRouteAdvertisementInterval`, which is applied to all advertisements, to dampen flaps of locally-originated

routes. Delay and hold timers limit how often phase 2 of the decision process runs. This phase 2 dampening limits route origination, as does IP event dampening when interface flaps would otherwise cause rapid origination.

BGP originates a default route to all neighbors if the **default-information originate** command is given and the default route is among the routes BGP redistributes. Because this default origination depends on redistribution, BGP normally only originates a default if a default is in the routing table. The **always** option can be configured to relax this requirement. If the routing table does not contain a default route, but the network administrator wants BGP to originate a default route, the administrator can configure a static default route. To prevent the static default route from affecting the local router's forwarding, the default route can be given a preference of 255 (ip route 0.0.0.0 0.0.0.0 next-hop 255) or it can be configured as a reject route (ip route 0.0.0.0 0.0.0.0 Null0).

BGP can also originate a default to a specific neighbor using **neighbor default-originate**. This form of default origination does not install a default route in the BGP routing table (it will not appear in **show ip bgp**), nor does it install a default route in the Adj-RIB-Out for the update group of peers so configured (it will not appear in **show ip bgp neighbor advertised-routes**). A neighbor specific default has no MED and the Origin is IGP. A neighbor-specific default is only advertised if the Adj-RIB-Out does not include a default learned by other means, either from **default-information originate** or a default learned from a peer. This type of default origination is not conditioned on the presence of a default route in the routing table.

## Equal Cost Multipath (ECMP)

By default, Dell EMC Networking BGP selects a single next hop for each BGP route. Dell EMC Networking BGP can be configured to install BGP routes with up to 16 next hops in the common routing table (RTO). The network administrator can independently configure the maximum number of next hops for routes through internal and external peers.

Paths can be used to form an ECMP route when they are both internal or both external, the resolved next hop is different, and the following attributes are the same:

- local preference
- AS path length

- origin
- MED
- IGP distance to the BGP next hop

Dell EMC Networking BGP does not require ECMP next hops to be in a common AS. This behavior is enabled by default. To disable this behavior, use the **no bgp always-compare-med** command.

When advertising to neighbors, BGP always advertises the single best path to each destination prefix, even if BGP has an ECMP route to a destination.



**NOTE:** The maximum ECMP width is limited by the chosen SDM template. All Dell EMC Networking N3000-ON, N3100-ON, and N3200-ON Series switches can support 16-wide ECMP when using a non-default SDM template.

## BGP Next-Hop Resolution

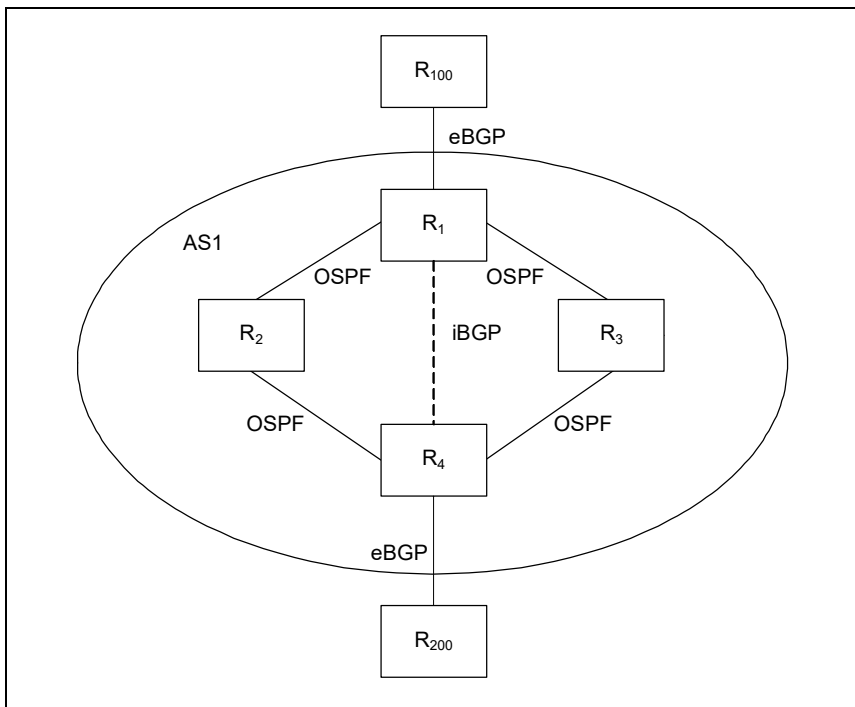
BGP UPDATE messages specify a NEXT\_HOP attribute for each prefix. The NEXT\_HOP attribute may be on an attached subnet for the receiver when the UPDATE is received from an external peer. But the NEXT\_HOP on routes from internal peers or a multihop external peer is not always on a local subnet. Thus, BGP has to resolve the BGP NEXT\_HOP to one or more local next hops (similar to how a router resolves a tunnel endpoint to a local next hop). BGP resolves a remote NEXT\_HOP by asking RTO for the longest prefix match. As the routing table changes, the resolution for a NEXT\_HOP may change. BGP registers each remote BGP NEXT\_HOP with RTO for next hop resolution changes.

When RTO notifies BGP of a next hop resolution change, BGP finds all the paths whose BGP NEXT\_HOP is the IP address whose resolution changed and updates the immediate next hops for each path. A next hop resolution change triggers phase 2 of the decision process for the affected prefixes.

Dell EMC Networking allows up to 512 addresses to be registered for next-hop resolution changes. This should be sufficient for BGP. The number of addresses BGP needs to track is limited to the number of external peers to the router's autonomous system (not just the external peers for the router itself) or, if routers are configured to advertise themselves as the next hop (next-hop-self), to the number of internal peers.

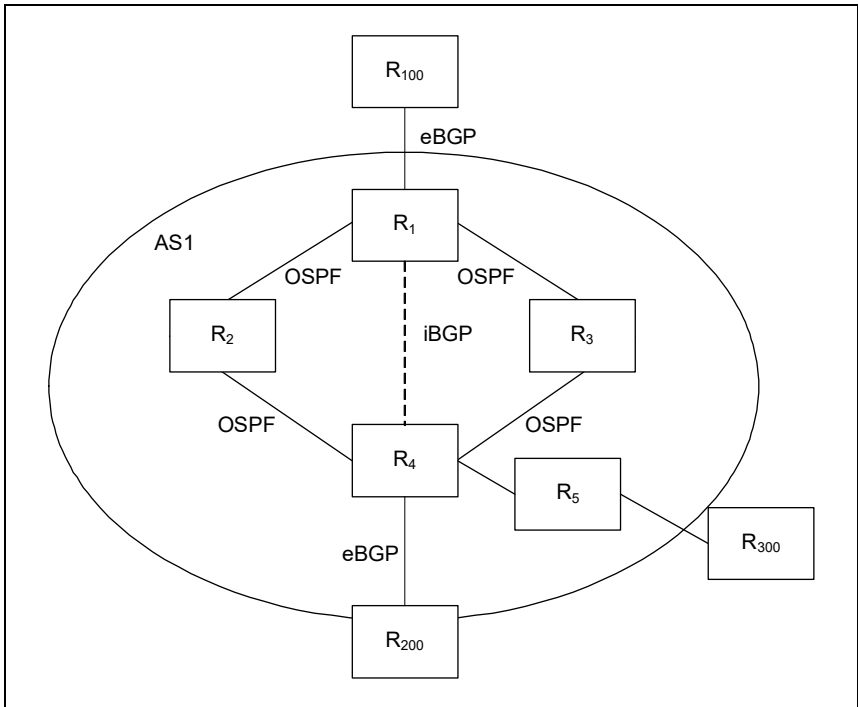
A BGP NEXT\_HOP can resolve to an ECMP IGP route. When BGP is configured to allow ECMP iBGP routes, the BGP NEXT\_HOP resolves to multiple next hops. BGP retains up to the number of resolved next hops allowed for an iBGP route. For example, in Figure 38-2, R4 receives an iBGP route from internal peer R1. The BGP NEXT\_HOP of this path resolves to an ECMP OSPF route through R2 and R3. If BGP is configured on R4 to allow ECMP iBGP routes, then R4 will resolve the path's BGP NEXT\_HOP to a pair of next hops through R2 and R3.

**Figure 38-2. ECMP NEXT\_HOP Resolution**



When iBGP paths are combined into an ECMP route, their next-hop sets are merged to form the set of next hops for the route. For example, in Figure 38-3, if R4 learns another route via R5 and R300 with the same destination as the route in the previous example, and the path from R300 is equivalent to the path through R100, then R4 will install a route using R2, R3, and R5 as next hops.

**Figure 38-3. Combining iBGP Routes**



## Address Aggregation

Dell EMC Networking BGP supports address aggregation. The network administrator can configure up to 128 aggregate addresses. BGP compares active prefixes in the local RIB to the set of aggregate addresses. To be considered a match for an aggregate address, a prefix must be more specific (i.e., have a longer prefix length) than the aggregate address. A prefix whose prefix length equals the length of the aggregate address is not considered for aggregation. If one or more prefixes fall within an aggregate, the aggregate is considered active. A prefix must be used for forwarding to be considered for inclusion in an aggregate address (unless it is a locally-originated prefix). Aggregate addresses may overlap (for example, 10.1.0.0/16 and 10.0.0.0/8). A prefix that matches overlapping aggregates is considered to match only the aggregate with the longest mask. When an aggregate address becomes active (that is, when the first contained route is matched to the aggregate), BGP

adds a discard route to RTO with prefix and network mask equal to those defined for the aggregate address. Aggregate addresses apply to both locally-originated routes and routes learned from peers.

Address aggregation is done prior to application of outbound policy. Thus, an active aggregate may be advertised to a neighbor, even if the outbound policy to the neighbor filters all of the aggregate's more specific routes (but permits the aggregate itself).

An aggregate address is advertised with a set of path attributes derived from the best paths for each NLRI included in the aggregate. Path attributes of the aggregate are formed as follows:

- If one or more aggregated routes have ORIGIN set to INCOMPLETE, the aggregate path sets ORIGIN to INCOMPLETE. Otherwise, if one or more routes has an ORIGIN set to EGP, the aggregate path sets the ORIGIN to EGP. Otherwise, the ORIGIN is set to IGP in the aggregate path.
- The local preference is set to the default local preference configured on the router that creates the aggregate. (Of course, if the aggregate is advertised to an external peer, the local preference is not included.)
- The NEXT\_HOP is not imported from the aggregated routes. It is always set to the local IPv4 address of the TCP connection to the peer.
- If the **as-set** option is configured for an aggregate, then the aggregate is advertised with a non-empty AS\_PATH. If the AS\_PATH of all contained routes is the same, then the AS\_PATH of the aggregate is the AS\_PATH of the contained routes. Otherwise, if the contained routes have different AS\_PATHs, the AS\_PATH attribute includes an AS\_SET with each of the AS numbers listed in the AS\_PATHs of the aggregated routes. If the **as-set** option is not configured, the aggregate is advertised with an empty AS\_PATH.
- If BGP is configured to aggregate routes with different MEDs, no MED is included in the path for the aggregate. Otherwise, if the **as-set** option is not configured the aggregate MED is set to the MED for the aggregated routes. If the **as-set** option is configured and the first segment in the AS Path is an AS SET, then no MED is advertised.
- If the **as-set** option is configured, the aggregate's path does not include the ATOMIC\_AGGREGATE attribute. Otherwise, it does.
- The AGGREGATOR attribute is always included.

- If the individual routes have communities and the aggregate does not have the `ATOMIC_AGGREGATE` attribute set, the aggregate is advertised with the union of the communities from the individual routes. If the aggregate carries the `ATOMIC_AGGREGATE` attribute, the aggregate is advertised with no communities.

Dell EMC Networking BGP never aggregates paths with unknown attributes. By default, Dell EMC Networking BGP does not aggregate paths with different MEDs, but there is a configuration option to allow this.

## Routing Policy

Route maps are used to implement redistribution policy, i.e., they are used to filter routes and change route attributes. Route maps may be applied in the inbound direction (before the P2 decision process) or in the outbound direction (after best route selection but before redistribution to peer routers). In either direction, the list of configured route maps is processed in order of increasing sequence number.

Match clauses in a route map are processed as a logical AND, i.e., all match clauses in a route-map must match for the route to be processed. If a route matches all relevant match clauses in a route map, the route is permitted or denied and route-map list processing ceases for that route. (Some match clauses are irrelevant to routing policy, e.g., match length). ACLs are not supported for matching prefixes when filtering routes. Use the `ip prefix-list` command instead. Matching on AS numbers, community, or extended communities is also supported.

In processing the list of route maps, each route map is processed individually. When a match occurs, if the route is permitted, the set clauses are processed and list processing ceases. If the route is denied, no set clauses are processed and list processing ceases. If no match occurs, list processing continues with the next highest numbered route map.

Unlike PBR, routing policy route maps implement an implicit deny at the end of the last route map that filters out all routes. Routes that do not match any match clause reach the end of the route map list and are removed.

An empty route map has a defined action. An deny route map with no match clause matches all routes and does not perform any set actions since the action is deny. Processing of the route-map list ceases. An empty permit route map permits all routes, performs any set clauses, and stops processing of the route-map list since it matched a route.

## Inbound Policy

An inbound policy is a policy applied to UPDATE messages received from peers. Dell EMC Networking BGP supports the following inbound policies which are matched against incoming route updates in the order below:

- A global prefix filter that applies to all neighbors (**distribute-list in**)
- A per-neighbor AS path filter (**neighbor filter-list in**)
- A prefix filter that applies to a specific neighbor (**neighbor prefix-list in**)
- A per-neighbor route map (**neighbor route-map in**)

These policy mechanisms determine whether to accept or reject routes received from neighbors. A route map may also change the attributes of received routes.

Within a route map, match terms are considered in the following order:

- AS path list
- Prefix list
- Community list

When processing list terms, a match for any term indicates a match and processing stops.

## Outbound Policy

An outbound policy is a policy applied to BGP's best routes (those in the local RIB and active aggregates) and determines which routes are advertised to each peer. The route map option may also change the attributes advertised to a peer. Dell EMC Networking BGP supports the following outbound policies which are matched against outgoing routes in the order below:

- A per-neighbor AS path filter (**neighbor filter-list out**)
- A prefix filter that applies to all neighbors (**distribute-list out**)
- A prefix filter that applies to a specific neighbor (**neighbor prefix-list out**)
- A per-neighbor route map (**neighbor route-map out**)

Within a route map, match terms are considered in the following order:

- AS path list
- Prefix list
- Community list



When processing list terms, a match for any term indicates a match and processing stops.

## **Routing Policy Changes**

When the user makes a routing policy configuration change, Dell EMC Networking BGP automatically applies the new policy. Like any other configuration change, routing policy changes are immediately saved in the running configuration, as soon as the user enters the command.

Even though policy configuration changes are committed to the running configuration immediately, they do not take operational effect until three minutes after the last configuration change. The delay allows the user time to make other configuration changes or correct any mistakes before the change takes effect. If another event, such as receipt of an UPDATE message or a neighbor established event triggers the decision process while waiting for the three minutes to expire, then the decision process runs at the time of the event using the old policy configuration. To immediately apply policy changes, the **clear ip bgp** command can be issued to trigger an immediate soft reset.

In response to a change to an outbound policy, BGP recomputes update group membership and advertises updates to the affected peer to reflect the change in policy.

In response to a change of an inbound policy, BGP schedules phase 1 of the decision process. If the policy change is neighbor-specific, phase 1 only re-evaluates routes received from that neighbor. If the change is global, phase 1 re-evaluates all routes. If an affected neighbor supports Route Refresh, BGP sends a ROUTE REFRESH message to the neighbor, and applies the new policy to the UPDATE messages received in response. If a neighbor does not support Route Refresh, BGP applies the new policy to path information previously received from the neighbor. As with outbound policy, inbound policy changes are immediately committed to the running configuration but do not take effect for three minutes. The soft reset is deferred for three minutes to allow configuration changes to be finalized before they are applied. The **clear ip bgp** command can be issued to trigger an immediate soft reset, if desired.

At startup, when the saved configuration is applied, there could potentially be a lot of churn to outbound update groups and filtering of routing information. This startup churn is avoided by keeping BGP globally disabled until after the entire configuration is applied and the status of all routing interfaces is known.

## **BGP Timers**

Dell EMC Networking BGP supports the five mandatory timers described in RFC 4271 section 10. Dell EMC Networking BGP employs the optional IdleHoldTimer, but does not support a DelayOpenTimer.

When Dell EMC Networking BGP initiates a TCP connection to a peer, it starts a retry timer (ConnectRetryTimer from RFC 4271). If the connection is not established before the retry timer expires, BGP initiates a new TCP connection attempt. Up to 3 retries are attempted with an exponential back-off of the retry time. The initial retry time is configurable per neighbor.

The IDLE hold timer runs when a peer has automatically transitioned to the IDLE state. When the IDLE hold timer expires, BGP attempts to form an adjacency. The IDLE hold time is jittered to avoid synchronization of retries. The idle hold time varies depending on the event that triggered the transition to IDLE.

Dell EMC Networking BGP starts hold and keep-alive timers for each peer. When BGP establishes an adjacency, the neighbors agree to use the minimum hold time configured on either neighbor. BGP sends KEEPALIVE messages at either 1/3 of the negotiated hold time or the configured keepalive interval, whichever is more frequent. Keepalive times are jittered.

RFC 4271 section 9.2.1.1 specifies a “minimum amount of time that must elapse between an advertisement and/or withdrawal of routes to a particular destination by a BGP speaker to a peer.” In Dell EMC Networking BGP, this advertisement interval is configurable independently for each peer, defaulting to 30 seconds for external peers and 5 seconds for internal peers. The advertisement interval may be configured to 0. Dell EMC Networking BGP enforces the advertisement interval by limiting how often phase 3 of the decision process can run for each outbound update group. The advertisement interval is applied to withdrawals as well as active advertisements.

## Communities

Dell EMC Networking BGP supports BGP standard communities as defined in RFC 1997. Dell EMC Networking supports community lists for matching routes based on community, and supports matching and setting communities in route maps. Dell EMC Networking BGP recognizes and honors the following well-known communities (RFC 1997):

- `NO_EXPORT`—A route carrying this community is not advertised to external peers.
- `NO_ADVERTISE`—A route carrying this community is not advertised to any peer.
- `NO_EXPORT_SUBCONFED`—A route carrying this community is not advertised to external peers.

If Dell EMC Networking receives an UPDATE message with more than 512 communities, a NOTIFICATION message is returned to the sender with error UPDATE message/attribute length error.

## Routing Table Overflow

### BGP Routing Table

Device configuration errors and other network transients can cause temporary or sustained spikes in the BGP routing table size. To protect the router from allocating too much memory in these scenarios, Dell EMC Networking BGP limits the BGP routing table size. The limit is set to the number of routes supported by the routing table (RTO). BGP imposes separate limits for each address family it supports. Once the BGP routing table is full, new routes computed in phase 2 of the decision process are not added to RTO and are not used for forwarding, but are advertised to neighbors. When the BGP routing table becomes full, a log message is written to the log warning the administrator. While BGP remains in this state, it periodically writes a log message that states the number of NLRI routes that could not be added to the routing table.

BGP automatically recovers from a temporary spike in BGP routes above this limit. When BGP cannot add a route to the BGP routing table, it sets the phase 2 pending flag on that NLRI in the Accept RIB. While there are NLRI

in this state, BGP periodically checks if there is space available in the BGP routing table, and if so, runs phase 2. When space becomes available in the BGP routing table, these routes are added.

### **RTO Full Condition**

If BGP computes a new route but the routing table does not accept the route because it is full, BGP flags the route as one not added to RTO. BGP periodically tries to add these routes to RTO. BGP will continue to advertise the best routes to neighbors, even if they are not added to RTO. The only necessary condition for forwarding a route to the neighbor is that the route is the best route in the BGP database. When used in conjunction with VRFs, this rule may make routing black holes likely unless the network capacity is planned correctly.

### **Route Reflection**

Dell EMC Networking BGP can be configured as a route reflector as described in RFC 4456. Like any BGP implementation, Dell EMC Networking BGP can also act as a route reflector client. Route reflection eliminates the need to configure a full mesh of iBGP peering sessions. As its name implies, this feature allows a router to reflect a route received from an internal peer to another internal peer. Under conventional BGP rules, a router can only send routes learned from an external peer or routes locally originated to an internal peer. A route reflector will advertise routes learned from an iBGP speaker designated as a route reflector client to other iBGP speakers.

The administrator can configure an internal BGP peer to be a route reflector client. Alternatively, the administrator can configure a peer template to make any inheriting peers route reflector clients. The client status of a peer can be configured independently for IPv4 and IPv6.

A cluster may have multiple route reflectors. Route reflectors within the same cluster are configured with a cluster ID. When a route reflector reflects a route, it prepends its cluster ID to a list of cluster IDs in the `CLUSTER_LIST` attribute.

RFC 4456 notes that:

"...when a RR reflects a route, it SHOULD NOT modify the following path attributes: `NEXT_HOP`, `AS_PATH`, `LOCAL_PREF`, and `MED`. Their modification could potentially result in routing loops."

For this reason, if a route reflector client has an outbound neighbor route-map configured, the set statements in the route map are ignored.

## **VRF Support**

Dell EMC Networking switches that support BGP and VRFs also support BGP in conjunction with OSPF or statically routed VRFs. When configured in a VRF, the single instance of BGP runs independent sessions to neighbors in the VRF and forwards independently.

## **BGP Neighbor Configuration**

Dell EMC Networking BGP supports configuration of eBGP neighbors that are not directly connected using the **ebgp-multihop** parameter to the **neighbor** command. Multi-hop is supported only for eBGP configurations where the neighbor has a different AS number. Dell EMC Networking iBGP requires neighbors to be directly connected.

Dell EMC Networking BGP also supports auto-detection of a neighbor's IPv6 link local address. The BGP neighbor must be directly connected and the link must be configured to use IPv6 addressing.

## **Extended Communities**

Dell EMC Networking BGP supports standard extended communities as defined in RFC 4360. Dell EMC Networking BGP supports extended community lists for matching routes based on the extended community and supports matching and setting of extended communities in route maps. It also supports selective export and import of routes using export and import maps.

The extended community attribute provides a mechanism for labeling routes carried in BGP-4. These labels are then used to control the distribution of routes among VRFs. The extended community attribute is sent by BGP when configured in the default VRF only, i.e., as part of an MP-BGP configuration.

A BGP NLRI can carry both standard and extended community attributes and it can also carry multiple community attributes through the use of the additive keyword in the case of standard communities, and through the use of route-maps when exporting the VRF routes in the case of extended communities.

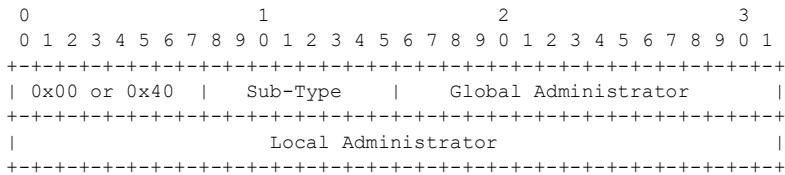
## Extended Community Attribute Structure

Each Extended Community attribute has a community type code of 16 and is encoded into an 8-octet value. The first 2 octets are the attribute type and the remaining 6 octets contain the value of attribute. The values from 0 through 0x7FFF are assigned by IANA and values from 0x8000 through 0xFFFF are vendor-specific.

The Extended Community attribute may be represented in multiple ways but Dell EMC Networking supports only the following two formats:

### *Two-octet AS specific Extended Community*

This is an extended type with Type Field composed of 2 octets and Value Field composed of 6 octets.



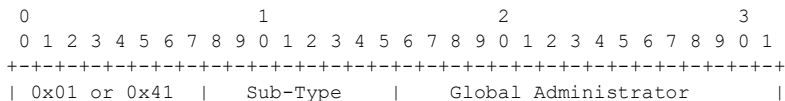
The value of the high-order octet of this extended type is either 0x00 or 0x40. The low-order octet of this extended type is used to indicate sub-types.

The Value Field consists of two sub-fields:

- Global Administrator sub-field: 2 octets  
This sub-field contains an Autonomous System number assigned by IANA.
- Local Administrator sub-field: 4 octets  
The organization identified by Autonomous System number in the Global Administrator sub-field can encode any information in this sub-field. The format and meaning of the value encoded in this sub-field should be defined by the sub-type of the community.

### *IPv4 address specific Extended Community*

This is an extended type with Type Field composed of 2 octets and Value Field composed of 6 octets.



```

+-----+-----+-----+-----+-----+-----+-----+-----+-----+-----+
| Global Administrator (cont.) | Local Administrator |
+-----+-----+-----+-----+-----+-----+-----+-----+-----+-----+

```

The value of the high-order octet of this extended type is either 0x01 or 0x41. The low-order octet of this extended type is used to indicate sub-types.

The Value field consists of two sub-fields:

- Global Administrator sub-field: 4 octets  
This sub-field contains an IPv4 unicast address assigned by one of the Internet registries.
- Local Administrator sub-field: 2 octets  
The organization that has been assigned the IPv4 address in the Global Administrator sub-field can encode any information in this sub-field. The format and meaning of this value encoded in this sub-field should be defined by the sub-type of the community.

### **Types of Extended Communities**

Dell EMC Networking BGP recognizes and honors the following well-known extended community attributes from RFC 4360:

- Route target community
- Route origin community

#### ***Route Target Community***

The Route Target Community identifies one or more routers that may receive a set of routes (attached with this community) carried by BGP. This community is transitive across the Autonomous System boundary.

The value of the high-order octet of the Type field for the Route Target Community can be 0x00, 0x01 or 0x02. The value of the low-order octet (Sub-type) of the Type field for this community is 0x02 (if represented in Two-octet AS specific format) and 0x102 (if represented in IPv4 address specific format).

Possible uses of the Route Target Community attribute are described in the following sections.

### ***Route Origin Community Attribute***

The Route Origin Community attribute identifies one or more routers that advertise routes via BGP. The attribute is transitive across Autonomous System boundaries.

The Route Origin Community attribute is used to prevent routing loops when BGP speakers are multi-homed to another site and that site uses the AS-Override feature. This Route Origin Community attribute identifies the site from where the routes are originated so that they are not re-distributed back to the originating site.

The value of the high-order octet of the Type field for the Route Origin Community can be 0x00, 0x01, or 0x02. The value of the low-order octet (Sub-type) of the Type field for this community is 0x03 (if represented in Two-octet AS specific format) and 0x103 (if represented in IPv4 address specific format).

### **VPNv4/VRF Route Distribution via MP-BGP**

Some administrators may choose to use BGP to redistribute VPN routes. Each VRF has its own independent address space; meaning that the same address/net mask can be used in any number of VRFs, where in each VRF the address, in fact, identifies a different system. But a BGP speaker can only install and distribute one route for a specific address prefix. If multiple overlapping routes are received by BGP, only the last received route is installed in any particular per-site VRF route table. Dell EMC Networking allows BGP to install and distribute multiple overlapping routes to a single IP address prefix in different VRFs. This is achieved by the use of a new VPNv4 address family as discussed below. It is recommended that the administrator use a policy to determine which sites can advertise and install routes.

### **VPNv4 Address Family**

MP-BGP allows BGP to carry routes from different address families. To allow BGP to install and distribute overlapping address routes, each address/route must be made unique. To achieve this, a new VPNv4 address family is introduced. A VPN-IPv4 address is a 12-byte quantity, beginning with an 8-byte Route Distinguisher (RD) followed by a 4-byte IPv4 address. The RD attribute follows the same structuring mechanism as described in the 'Extended Community structure' above.



If two VRFs use the same IPv4 address prefix, the router translates these into unique VPN-IPv4 address prefixes by prepending the RD (configured per VRF) to the address. The purpose of the RD is to allow the router to install unique routes with an identical IPv4 address prefix. The structuring of the RD provides no semantics. When BGP compares two such addresses, it ignores the RD structure completely and compares it as a 12-byte entity. It is recommended that each VPN within a site utilize a unique RD.

A router may be configured to associate routes that belong to a particular VRF with a particular RD. When BGP redistributes these routes, BGP prepends the configured RD value to the route and re-distributes them as VPNv4 routes. The router that receives these VPNv4 routes installs them into the global BGP table along with the RD. If two routes have the same address prefix but different RD values, only the last route is installed to the RTO table of the router that imports the route and the rest are overwritten.

Dell EMC Networking BGP doesn't advertise routes in the traditional IPv4 NLRI format when a neighbor is activated in VPNv4 address family mode.

## **Controlling Route Distribution**

This section describes the methods by which VPNv4 route redistribution may be controlled.

### ***The Route Target Attribute (RT)***

A Route Target attribute identifies a set of VRFs belonging to a VPN. Every VRF is associated with one or more "Route Target" attributes that define the VPNs to which it belongs. Route targets are advertised using the VPNv4 address family.

When a VPNv4 route is advertised by a router, the "Route Target" attributes are carried in the BGP advertisement as attributes of the route.

An MP-BGP router that receives a VPNv4 route compares it with the Import Route Target attributes configured for one or multiple VRFs and depending on the match installs the route into the matching VRF table. When a BGP router advertises a route to a BGP neighbor, it attaches one or more Export Route Target attributes to the route (as configured for that VRF).

The Export Route Target attributes and the Import Route Target attributes are distinct sets and may or may not be the same in a VRF.

A BGP route can only have one RD but can have multiple Route Targets.

A VRF may be configured to associate all the routes that belong to the VRF with a particular Route Target attribute. Dell EMC Networking allows a finer selection of routes with the use of Export and Import maps. Export and Import maps provides greater flexibility to the administrator where she can associate some routes of a VRF with a particular Route Target attribute and some other routes with a different Route Target attribute.

The Route Target attribute assists in configuring selective route leaking among VRFs using Multi-protocol BGP. Essentially, route leaking between VRFs within a single router can be achieved with just the import and export Route Target statements.

Dell EMC Networking allows configuring Route Target attributes in VRF mode, using IP Extended community lists in association with inbound/outbound Route maps.

### **Behavior of VPNv4 Route Leaking into a VRF with Identical Prefixes & RTs**

In this scenario, multiple routes with identical prefix/RTs but different RDs are advertised to a VPNv4 peer from a single router. The standard decision process rules handle the cases when receiving identical prefix/RTs with the same RD or with different RDs from different routers. On the receiving VPNv4 router, the decision process picks the best route from the identical prefix/neighbor combination routes as follows:

- 1 If the next hops of the prefixes are the same, the first received MP-NLRI/route is imported into the VRFs with a matching import statement. In the case of an update, the first received MP-NLRI/route is maintained and is not replaced, even if the next hop is different.
- 2 If the next hops of the prefixes are different, the prefix with the highest RD value is imported into the VRF.

The decision to use the highest RD is arbitrary; however, the scenario where routes with identical prefix/RT pairs are configured in different VRFs on a single router is almost certainly a misconfiguration.

### **How the VPNv4 NLRI Is Carried in BGP**

The BGP Multiprotocol Extensions are used to encode the NLRI. If the Address Family Identifier (AFI) field is set to 1, and the Subsequent Address Family Identifier (SAFI) field is set to 128, the NLRI is a VPNv4 address. AFI 1 is used since the network layer protocol associated with the NLRI is still IP.

In order for two BGP speakers to exchange labeled VPN-IPv4 NLRI, they must use the BGP Capabilities Advertisement (in the OPEN message) to ensure that they both are capable of properly processing VPN-IPv4 NLRI. This is done by using capability code 1 (multiprotocol BGP), with an AFI of 1 and an SAFI of 128.

The VPNv4 NLRI is encoded as specified in the above sections, where the prefix consists of an 8-byte RD followed by an IPv4 prefix.

### **The Site of Origin Attribute (SOO)**

A VPNv4 route may optionally carry a Site of Origin attribute that uniquely identifies a site (a topologically associated set of routers with mutual IP connectivity). This attribute identifies the corresponding route as having come from one of the site members.

The SOO attribute is used in the identification and prevention of routing loops. The SOO attribute is an extended community attribute used to identify routes that have originated from a site so that the re-advertisement of that prefix back to the source site can be prevented, thereby helping to eliminate routing loops.

Site of Origin is one of the attributes a router assigns to a prefix prior to redistributing any VPNv4 prefixes. All prefixes learned from a particular site must be assigned the same site of origin attribute, even if the site is multiply connected to a single router external to the site or is connected to multiple routers external to the site.

Dell EMC Networking allows configuration of the SOO attribute using IP Extended community lists in association with inbound/outbound route maps.

### **IPv6**

Dell EMC Networking supports both IPv4 and IPv6 peering sessions. IPv4 routes are advertised on IPv4 peer sessions. Dell EMC Networking does not support advertisement of IPv4 routes over IPv6 peer sessions. IPv6 routes can be advertised over either type of peer session as described in RFC 4760 and RFC 2545. The user must explicitly activate IPv6 route advertisement on either type of peer session. When IPv6 is enabled, the OPEN message includes the IPv6/unicast AFI/SAFI pair in the multiprotocol capability option.

IPv6 prefixes can be originated through route redistribution or a **network** command. Both can be configured with a route map to set path attributes. BGP can also originate an IPv6 default route. Default-origination can be neighbor-specific. IPv6 routes can be filtered using prefix lists, route maps with community lists, and using AS path access lists. BGP can compute IPv6 routes with up to 16 ECMP next hops.

### **IPv6 Peering Using A Link Local Address**

Link local addresses are one class of IPv6 address that can be used as a BGP peer address. Allowing link local addresses to be used as peer addresses introduces some complications. These are discussed here:

First, consider whether it even makes sense to use a link local address as a peer address. As its name implies, a link local address has link scope; it is only valid on a single link. This characteristic implies that a BGP peer identified by a link local address must be attached to a local link (i.e., shares a Layer-2 broadcast domain with the router where the peer is configured). This restriction is typically met for external peers (with the exception of external peers configured with `ebgp-multihop`). Internal peers are typically not on a local link. Even when two BGP speakers share a common link, a loopback address is often assigned as the peer address to avoid tying the fate of the adjacency to a single link or interface. However, it is possible to configure internal peers using an IPv6 address configured on the link that connects them.

Another feature of link local addresses that makes them less than ideal for BGP peering is that they are auto-generated, typically from the local MAC address. Because each BGP peer is configured with a specific IP address, the peer address must be known at configuration time. This is in contrast to OSPFv3 adjacencies, where neighbor addresses are learned dynamically. If the peer's MAC address changes (for example, if a router fails and is replaced with new hardware), the link local address may change and the BGP configuration will need to be updated. Dell EMC Networking allows discovery of BGP peers using link-local addresses through the configuration of listen ranges.

To use link local addresses for eBGP peers, an administrator must use the `next-hop-self` option. Normally, when a BGP speaker forwards an external route to internal peers, it retains the BGP `NEXT_HOP`. If the `NEXT_HOP` is a link local address, internal peers will be unable to resolve it and thus not be able to use these routes. The router must therefore be configured to change

the NEXT\_HOP to one of its own global addresses before forwarding routes from an external peer with a link local address (or the implementation must do this automatically).

A primary consideration in using link-local addresses is the user interface. With IPv4 addresses and global IPv6 addresses, the user interface simply identifies the neighbor by IP address:

```
router bgp 1
  neighbor 10.1.1.1 remote-as 100
  neighbor 10.1.1.1 advertisement-interval 10
  neighbor 2001:db8::1 remote-as 200
  neighbor 2001:db8::1 advertisement-interval 20
```

Because two neighbors on different links may have the same link local address, the address itself may not uniquely identify a neighbor, nor does the link local address identify the interface where control packets should be sent to the neighbor. The interface must also be specified.

Dell EMC Networking uses the same MAC address for all routing interfaces on a router and, thus, has the same link local address on each interface. If a user were to try to configure two parallel adjacencies between two Dell EMC Networking routers and wanted to use link local peering, the peers would have the same link local address.

Dell EMC Networking BGP uses the **interface** parameter to the neighbor command to identify a unique auto-configured link local address as shown in the following examples:

```
router bgp 1
  neighbor fe80::1 interface vlan 10 remote-as 100
  neighbor fe80::1 interface vlan 10 advertisement-interval 10
  neighbor fe80::1 interface vlan 20 remote-as 200
```

### **BGP Dynamic Neighbor Peering**

This capability allows peering with BGP neighbors to be dynamically established when BGP connection requests are received from a configured IP address range. Dynamic neighbor peering avoids the need for explicit configuration of the neighbor by the administrator when it is acceptable to establish peering with a neighbor irrespective of their specific IP address. This capability is especially useful when deploying BGP in data centers where

configuration of the specific neighbors is time-consuming and error-prone, and where security concerns are lessened due to the closed nature of the network.

Configuration includes the address range on which to listen and, optionally, a peer template from which the neighbor's properties may be inherited.

Because Dell EMC Networking routing is configured on routed VLANs, it is required that dynamic neighbor peering never be configured on a multi-access VLAN. Only a single interface may be a member of a VLAN on which dynamic neighbor peering is configured. Dynamic neighbor configuration on multi-access VLANs is not supported and the behavior is undefined.

The number of configurable listen address ranges in the system is limited to 10. The number of dynamic neighbors sessions established as a result of this feature is limited to the total number of neighbor sessions supported in the system. Listen ranges may be configured for both IPv4 and IPv6 addresses.

The following example configures an interface with a BGP listen range:

- 1 Create VLAN 200 and set the switch hostname:

```
console#configure
console(config)#vlan 200
console(config-vlan200)#exit
console(config)#hostname "R3"
R3(config)#no ip domain-lookup
```

- 2 Enable IPv4 routing.

```
R3(config)#ip routing
```

- 3 Configure a loopback for the local router.

```
R3(config)#interface loopback 0
R3(config-if-loopback0)#ip address 11.11.11.11 255.255.255.255
R3(config-if-loopback0)#exit
```

- 4 Configure a routed interface to the peer.

```
R3(config)#interface vlan 200
R3(config-if-vlan200)#ip address 192.168.100.11 255.255.255.0
R3(config-if-vlan200)#exit
```

- 5 Assign the routed interface to a physical interface.

```
R3(config)#interface Gi1/0/16
R3(config-if-Gi1/0/16)#switchport access vlan 200
R3(config-if-Gi1/0/16)#exit
```

- 6 Configure the local BGP speaker.

```
R3 (config) #router bgp 5500
R3 (config-router) #bgp log-neighbor-changes
```

**7** The router ID is required.

```
R3 (config-router) #bgp router-id 11.11.11.11
```

**8** Set the listen range to the local routed interface subnet and use template T1.

```
R3 (config-router) #bgp listen range 192.168.100.0/24 inherit peer T1
```

**9** Configure template T1 to indicate an IGP peer.

```
R3 (config-router) #template peer T1
R3 (config-router-tmp) #remote-as 5500
R3 (config-router-tmp) #exit
R3 (config-router) #exit
R3 (config) #exit
```

**10** Display the dynamic neighbors.

```
R3#show ip bgp listen range
```

```
Listen Range ..... 192.168.100.0/24
Inherited Template ..... T1
```

Member	ASN	State
192.168.100.10	5500	ESTABLISHED

### IPv6 Source Address Selection

When BGP initiates a TCP connection to a peer, it selects a source IPv6 address. When the user has configured a source interface (using neighbor update-source), the source address is taken from this interface. When the peer's IPv6 address is a link local address, the local interface used to reach the peer is configured (in neighbor remote-as) and the source address is taken from this interface.

If the neighbor address is a link local address, BGP selects a link local address as the source address. Otherwise, BGP selects a local address in the same subnet as the neighbor's address. If no such address is found, BGP selects the first active global IPv6 address on the source interface.

## **Network Address of Next Hop**

When advertising IPv6 routes, the *Network Address of Next Hop* field in MP\_REACH\_NLRI is set according to RFC 2545. Under conditions specified in this RFC, both a global and a link local next-hop address may be included. The primary purpose of the global address is an address that can be re-advertised to internal peers. The primary purpose of the link local address is for use as the next hop of routes.

We expect interfaces to external peers will normally have both a link local and a global IPv6 address. Both addresses are included in the *Network Address of Next Hop* field when sending MP\_REACH\_NLRI to the peer. Normally, internal peers are not on a common subnet (even when they are, peering is normally to addresses on loopback interfaces) and the *Network Address of Next Hop* field includes only a global address. Even when the peer address of an internal peer is on a local link, Dell EMC Networking BGP only advertises a global next-hop IPv6 address.

## **Identifying Local IPv6 Addresses**

In some situations, a router sets the next-hop addresses to addresses configured on one of its own interfaces. When local IPv6 addresses are needed, Dell EMC Networking BGP uses IPv6 addresses on the local end of the TCP connection to the peer. If the peering session uses IPv4, BGP finds IPv6 addresses on the same routing interface as the IPv4 address that terminates the TCP connection. If there are multiple global addresses on the interface, BGP uses the first one (essentially, a random choice). If the set of IPv6 addresses on the interface changes, BGP may alter its choice of local IPv6 addresses.

## **Using Policy to Specify Next Hop**

The network administrator can override the normal rules for selecting a next hop address by configuring IPv6 next hops with outbound policy (a neighbor-specific route map with a **set ipv6 next-hop** term). When configuring an IPv6 next hop, the network administrator should ensure the neighbor can reach the next-hop address. For example, a link local next-hop address should not be configured to an internal peer not on a local link. Using per-neighbor outbound policy to set the IPv6 next hop has the disadvantage of putting each neighbor in a different outbound update group, thus losing the efficiency advantages of sharing an Adj-RIB-Out and of building an UPDATE message once and sending it to many peers.



Alternatively, the network administrator can configure inbound policy on the receiver to set IPv6 next hops.

## BGP Limitations

Dell EMC Networking BGP does not support configuration via the Web interface. Dell EMC Networking supports the following RFCs with the exceptions listed in Table 38-4:

**Table 38-4. BGP Limitations**

Description	Source	Compliance
A BGP speaker MUST be able to support the disabling advertisement of third party NEXT_HOP attributes in order to handle imperfectly bridged media.	RFC 4271 section 5.1.3	No configuration option is available
The parameter MinASOriginationIntervalTimer determines the minimum amount of time that must elapse between successive advertisements of UPDATE messages that report changes within the advertising BGP speaker's own autonomous systems.	RFC 4271 section 9.2.1.2	No. Dell EMC Networking does not enforce a MinASOrigination Interval
BGP can be configured to remove or replace private ASNs from the AS_PATH attribute of paths advertised to external peers	Dell EMC Networking requirement	Yes
The option to remove or replace private ASNs can be configured independently for each address family	Dell EMC Networking requirement	Yes
ASNs in the range from 64512 to 65535 are removed when this option is enabled	Dell EMC Networking requirement	Yes

**Table 38-4. BGP Limitations (Continued)**

Description	Source	Compliance
Dell EMC Networking BGP can only be configured through the CLI. SNMP support is limited to the standard MIB, which primarily provides status reporting, and a proprietary MIB which provides additional status variables. Configuration through SNMP is not supported.	Dell EMC Networking requirement	–
BGP may learn the maximum number of routes supported by each Dell EMC Networking N-Series switch.	Dell EMC Networking requirement	–

# BGP Configuration Examples

This section includes the following configuration examples:

- Enabling BGP
- BGP Example
- Network Example
- BGP Redistribution of OSPF Example
- Configuring the Multi-Exit Discriminator in BGP Advertised Routes
- Configuring Communities in BGP
- Configuring a Route Reflector
- Campus Network MP-BGP and OSPF Configuration
- Configuring MP-eBGP and Extended Communities

## Enabling BGP

The following are rules to remember when enabling BGP:

- IP routing must be enabled in order to enable BGP:

```
console(config)#router bgp 4545
```

```
IP routing is not enabled. Enable IP routing or IPv6 routing
before configuring BGP.
```

```
console(config)#ip routing
console(config)#router bgp 4545
```

- The AS number is required when configuring BGP and will place the user into configuration mode for that BGP ASN. The router-id is required as the IPv4 address for BGP to use. The router-id may be the same as a loopback address.

```
console(config-router)#bgp router-id 1.1.1.1
```

- BGP ASN is enabled by default when both the AS number and router-id are configured
- The BGP configuration mode **no enable** command is not shown in the running config unless both the AS number and router-id are configured.

BGP is now enabled in this example.

## BGP Example

This example configures iBGP between two routers using the same AS and each using their own loopback address as update-source.

### Router A Configuration

On a router, a loopback interface is created and assigned an IP address. The router ID is assigned (the same IPv4 address as the loopback interface) and the IPv4 address of the neighbor (Router B IP address) is assigned. Finally, the neighbor's update source is assigned to the local loopback interface. This ensures that the adjacency will remain up, helping to avoid reconvergence events.

```
console (config) #ip routing
console (config) #interface lo1
console (config-if-loopback1) #ip address 1.1.1.1 /31
console (config-if-loopback1) #exit

console (config) #router bgp 65001
console (config-router) #bgp router-id 1.1.1.1
console (config-router) #neighbor 1.1.1.3 remote-as 65001
console (config-router) #neighbor 1.1.1.3 update-source loopback 1
```

### Router B Configuration

Router B is the mirror image of the Router A configuration shown above. The steps are the same except the IP address of the local router and the neighbor are reversed from the configuration above.

```
console (config) #ip routing
console (config) #interface lo1
console (config-if-loopback1) #ip address 1.1.1.3 /31
console (config-if-loopback1) #exit

console (config) #router bgp 65001
console (config-router) #bgp router-id 1.1.1.3
console (config-router) #neighbor 1.1.1.1 remote-as 65001
console (config-router) #neighbor 1.1.1.1 update-source loopback 1
```

## Network Example

The following configuration uses the network command to inject received iBGP routes into the BGP routing table. The network mask allows subnetting and super-netting. An alternative to the **network** command is to use the **redistribute** command.

Interface Gi1/0/1 is configured as a member of VLAN 10, VLAN 10 is assigned an IP address, IP routing is enabled, and BGP router 65001 is created with a router ID of 129.168.1.254. A static subnet route 129.168.0.X is created for VLAN 10. An iBGP neighbor 129.168.0.254 is configured and the network 129.168.x.X is configured to super-net the 129.168.0.x advertisement. The neighbor state is configured to follow loopback 0.

```
console#configure
console(config)#vlan 10
console(config-vlan)#exit
console(config)#interface gi1/0/1
console(config-if-Gi1/0/1)#switchport access vlan 10
console(config-if-Gi1/0/1)#exit

console(config)#interface vlan 10
console(config-if-vlan10)#ip address 129.168.10.2 /24
console(config-if-vlan10)#exit

console(config)#int loopback 0
console(config-if-loopback0)#ip address 129.168.1.254 /24
console(config-if-loopback0)#exit

console(config)#ip routing
console(config)#router bgp 65001
console(config-router)#bgp router-id 129.168.1.254
console(config-router)#neighbor 129.168.0.254 remote-as 65001
console(config-router)#neighbor 129.168.0.254 update-source
loopback 0
console(config-router)#network 129.168.0.0 mask 255.255.0.0
console(config-router)#exit
```

## BGP Redistribution of OSPF Example

The following configuration uses the redistribute command to inject received eBGP routes into the BGP routing table.

Interface Tel/0/1 is configured in trunk mode with a native VLAN 10 and VLAN 10 is assigned an IP address with a /30 subnet. BGP fast fallover is enabled for VLAN 10.

IP routing is enabled and a default route is configured that points to the neighbor router. BGP router 3434 is created with a router ID of 172.16.64.1. An eBGP neighbor 216.31.219.19 is configured. Private AS numbers are stripped before distribution to this neighbor.

The router is configured to redistribute static and OSPF type 1 & type 2 external routes. Internal and connected routes are not redistributed. An alternative to the redistribute command is to use the network command.

```
console#configure
console (config) #vlan 10
console (config-vlan) #exit

console (config) #interface tel/0/1
console (config-if-tel/0/1) #switchport mode trunk
console (config-if-tel/0/1) #switchport trunk native vlan 10
console (config-if-tel/0/1) #exit

console (config) #ip routing
console (config) #interface vlan 10
console (config-if-vlan10) #ip address 172.16.65.1 /30
console (config-if-vlan10) #ip bgp fast-external-fallover permit
console (config-if-vlan10) #exit

console (config) #ip route 0.0.0.0 0.0.0.0 172.16.65.2 name 'Default-Route'
console (config) #router bgp 3434
console (config-router) #bgp router-id 172.16.64.1
console (config-router) #neighbor 216.31.219.19 remote-as 1402
console (config-router) #neighbor 216.31.219.19 remove-private-as
console (config-router) #redistribute static
console (config-router) #redistribute ospf match external 1
console (config-router) #redistribute ospf match external 2
console (config-router) #exit
```

## Configuring the Multi-Exit Discriminator in BGP Advertised Routes

The following example configures an egress routing policy that sets the metric for matching routes. In the example, VLAN 10 is created, followed by an access list matching directly connected source address 5.5.5.x for which the metric will be injected into the advertised routes.

A route map “Inject-MED” is created. This route map sets the match criteria as ACL MED-Hosts and configures the metric for matching routes to be 100.

Interface Gil/0/1 is configured as a member of VLAN 10, VLAN 10 is assigned an IP address, IP routing is enabled, and BGP router 65001 is created with a router ID of 129.168.1.254. A static subnet route 129.168.0.X is created for VLAN 10. An iBGP neighbor 129.168.0.254 is configured and the network 129.168.x.X is configured to inject the metric of 100 into routes matching the prefix-list MED-Hosts. All other routes are permitted using the default metric.

```
console#configure
console(config)#vlan 10
console(config-vlan)#exit

console(config)#ip prefix-list MED-Hosts seq 10 permit 5.5.5.0
255.255.255.0
console(config)#ip bgp-community new-format
console(config)#route-map "Inject-MED" permit 100
console(route-map)#match ip address prefix-list MED-Hosts
console(route-map)#set metric 100
console(route-map)#exit

console(config)#route-map "Inject-MED" permit 200
console(route-map)#exit

console(config)#interface gil/0/1
console(config-if-Gil/0/1)#switchport access vlan 10
console(config-if-Gil/0/1)#exit

console(config)#interface vlan 10
console(config-if-vlan10)#ip address 129.168.10.2 /24
console(config-if-vlan10)#exit

console(config)#ip routing
console(config)#ip route 129.168.0.0 255.255.255.0 129.168.10.1
vlan 10
console(config)#router bgp 65001
console(config-router)#bgp router-id 129.168.1.254
```

```
console(config-router)#neighbor 129.168.0.254 remote-as 65001
console(config-router)#network 129.168.0.0 mask 255.255.0.0 route-
map Inject-MED
console(config-router)#redistribute connected
console(config-router)#exit
```

## Configuring Communities in BGP

The following example configures an egress routing policy that sets the community attribute for matching routes. In the example, VLAN 10 is created, followed by an access list Comm-Hosts matching directly connected source address 5.5.5.x for which the community attribute will be injected into the advertised routes.

A route map “Subnet-5-5-5” is created. This route map sets the match criteria as ACL Comm-Hosts and configures the community attribute 65001:300 for the matching routes.

Interface Gi1/0/1 is configured as a member of VLAN 10, VLAN 10 is assigned an IP address, IP routing is enabled, and BGP router 65001 is created with a router ID of 129.168.1.254. An iBGP neighbor 129.168.0.254 with a remote AS of 65001 is configured (this is an iBGP configuration). BGP is configured to send the community attribute and to use the Subnet-5-5-5 match criteria as an egress policy.

```
console#configure
console(config)#vlan 10
console(config-vlan)#exit

console(config)#ip prefix-list Comm-Hosts seq 10 permit 5.5.5.0
255.255.255.0
console(config)#ip bgp-community new-format
console(config)#route-map "Subnet-5-5-5" permit 100
console(route-map)#match ip address prefix-list Comm-Hosts
console(route-map)#set community 65001:300 additive
console(route-map)#exit

console(config)#interface gil/0/1
console(config-if-Gi1/0/1)#switchport access vlan 10
console(config-if-Gi1/0/1)#exit

console(config)#interface vlan 10
console(config-if-vlan10)#ip address 129.168.10.2 /24
console(config-if-vlan10)#exit

console(config)#int loopback 0
```



```

console(config-if-loopback0)#ip address 129.168.1.254 /24
console(config-if-loopback0)#exit

console(config)#ip routing
console(config)#router bgp 65001
console(config-router)#bgp router-id 129.168.1.254
console(config-router)#neighbor 129.168.0.254 remote-as 65001
console(config-router)#neighbor 129.168.0.254 send-community
console(config-router)#neighbor 129.168.0.254 route-map Subnet-5-5-5 out
console(config-router)#redistribute connected
console(config-router)#exit

```

## Configuring a Route Reflector

The following example configures an iBGP speaker as a route reflector. Each iBGP neighbor will have its routes reflected to other iBGP neighbors. In this example, only a single neighbor is configured.

- 1 Interface Gi1/0/1 is configured as a member of VLAN 10:

```

console#configure
console(config)#vlan 10
console(config-vlan10)#interface gi1/0/1
console(config-if-Gi1/0/1)#switchport access vlan 10

```

- 2 VLAN 10 is assigned an IP address:

```

console(config-if-Gi1/0/1)#interface vlan 10
console(config-if-vlan10)#ip address 129.168.10.2 /24

```

- 3 Loopback 0 is assigned an IP address. The iBGP peer will be configured to follow the loopback state in a later step:

```

console(config-if-vlan10)#interface loopback 0
console(config-if-loopback0)#ip address 129.168.1.254 /24
console(config-if-loopback0)#exit

```

- 4 IP routing is enabled:

```

console(config)#ip routing

```

- 5 BGP router 65001 is created with a router ID of 129.168.1.254:

```

console(config)#router bgp 65001
console(config-router)#bgp router-id 129.168.1.254

```

- 6 iBGP neighbor 129.168.0.254 is configured as a neighbor following the loopback 0 state:

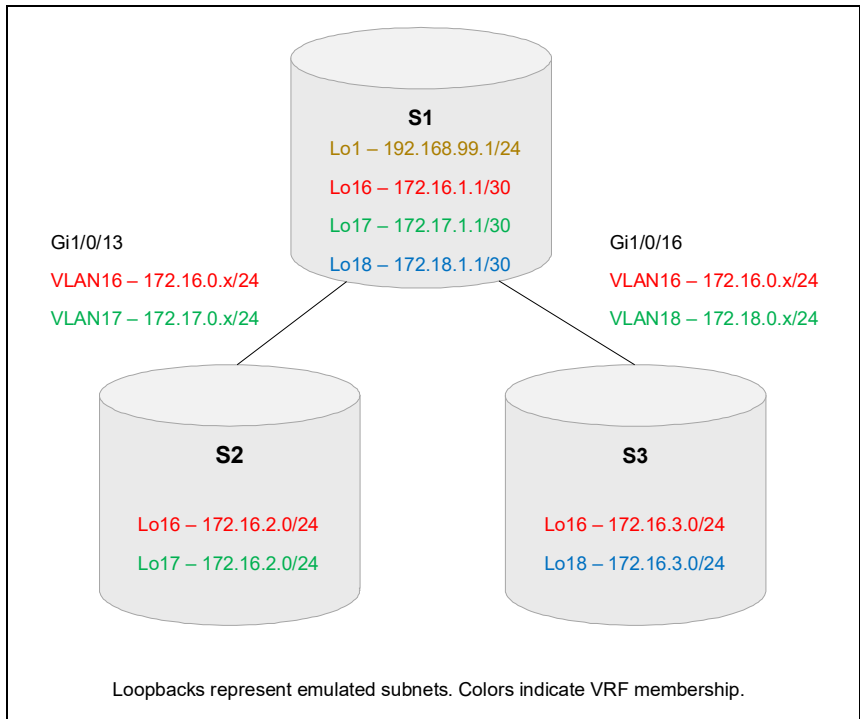
This iBGP neighbor is designated a route reflector client. Other iBGP neighbors can be configured as route reflector clients in order to reduce the explosion of neighbor configuration required to implement a full mesh iBGP network.

```
console(config-router)#neighbor 129.168.0.254 remote-as 65001
console(config-router)#neighbor 129.168.0.254 update-source
loopback 0
console(config-router)#neighbor 129.168.0.254 route-reflector-
client
console(config-router)#exit
```

## Campus Network MP-BGP and OSPF Configuration

Consider the topology below, which is a subset of what might be found on a small campus. This network services three customers (Red, Green, and Blue). The Internet connection to the outside world is hosted in router S1. Router S2 hosts the Red and Green network. Router S3 hosts the Red and Blue network. A common service is supplied over the 192.168.99.1/24 network.

**Figure 38-4. Campus Network MP-BGP and OSPF Configuration**



The IPv4 prefixes are assigned as follows:

- Red: 172.16.0.0/16
- Green: 172.17.0.0/16
- Blue: 172.18.0.0/16
- VoIP Services: 192.168.99.0/24

Four VRFs are created on S1. Each VRF is assigned a unique route distinguisher (RD). The RDs utilized here are taken from the private ASN address space. Three of the VRFs are assigned to the Red, Green, and Blue networks and the last VRF is utilized for the common service. We use a loopback on S1 to emulate the common service network instead of a VLAN and physical interface. The VRF configuration on the loopback is identical to the case of a VLAN and physical interface. Interfaces need not be assigned to a VRF before configuring the IP address. IP addresses are migrated when an interface is assigned to a VRF.

VRF Blue will not participate in the common service; however VRFs Red and Green will participate. Route target import and export statements set the appropriate distribution of routes.

- 1 Create VLANs for the VRFs.

```
console#configure
console(config)#vlan 16-18
console(config-vlan)#exit
```

- 2 Set the hostname.

```
console(config)#hostname "S1"
```

- 3 Set a loopback for the common service. This could be replaced with a VLAN and physical interface.

```
S1(config)#interface loopback 1
S1(config-if-loopback1)#ip vrf forwarding Shared
S1(config-if-loopback1)#ip address 192.168.99.1 255.255.255.0
S1(config-if-loopback1)#exit
```

- 4 Create VRF Blue.

```
S1(config)#ip vrf Blue
S1(config-ip-vrf-Blue)#rd 65000:3
S1(config-ip-vrf-Blue)#exit
```

- 5 Create VRF Green, import the common service, and export the Green network.

```
S1(config)#ip vrf Green
S1(config-ip-vrf-Green)#rd 65000:2
S1(config-ip-vrf-Green)#route-target export 65000:2
S1(config-ip-vrf-Green)#route-target import 65000:99
S1(config-ip-vrf-Green)#exit
```

- 6 Create VRF Red, import the common service, and export the Red network.

```
S1 (config) #ip vrf Red
S1 (config-ip-vrf-Red) #rd 65000:1
S1 (config-ip-vrf-Red) #route-target export 65000:1
S1 (config-ip-vrf-Red) #route-target import 65000:99
S1 (config-ip-vrf-Red) #exit
```

- 7 Create VRF Shared, import the Red and Green network, and export the common service.

```
S1 (config) #ip vrf Shared
S1 (config-vrf-Shared) #rd 65000:99
S1 (config-vrf-Shared) #route-target import 65000:1
S1 (config-vrf-Shared) #route-target import 65000:2
S1 (config-vrf-Shared) #route-target export 65000:99
S1 (config-vrf-Shared) #exit
S1 (config) #no ip domain-lookup
```

- 8 Enable IPv4 routing.

```
S1 (config) #ip routing
```

- 9 Set a loopback for Red network interface access. This could be replaced with a VLAN and physical interface.

```
S1 (config) #interface loopback 16
S1 (config-if-loopback16) #ip vrf forwarding Red
S1 (config-if-loopback16) #ip address 172.16.1.1 255.255.255.252
S1 (config-if-loopback16) #exit
```

- 10 Set a loopback for Green network interface access. This could be replaced with a VLAN and physical interface.

```
S1 (config) #interface loopback 17
S1 (config-if-loopback17) #ip vrf forwarding Green
S1 (config-if-loopback17) #ip address 172.17.1.1 255.255.255.252
S1 (config-if-loopback17) #exit
```

- 11 Set a loopback for Blue network interface access. This could be replaced with a VLAN and physical interface.

```
S1 (config) #interface loopback 18
S1 (config-if-loopback18) #ip vrf forwarding Blue
S1 (config-if-loopback18) #ip address 172.18.1.1 255.255.255.252
S1 (config-if-loopback18) #exit
```

**12** Associate the Red VRF with a VLAN routed interface.

```
S1(config)#interface vlan 16
S1(config-if-vlan16)#ip vrf forwarding Red
S1(config-if-vlan16)#ip address 172.16.0.1 255.255.255.0
S1(config-if-vlan16)#exit
```

**13** Associate the Green VRF with a VLAN routed interface.

```
S1(config)#interface vlan 17
S1(config-if-vlan17)#ip vrf forwarding Green
S1(config-if-vlan17)#ip address 172.17.0.1 255.255.255.0
S1(config-if-vlan17)#exit
```

**14** Associate the Blue VRF with a VLAN routed interface.

```
S1(config)#interface vlan 18
S1(config-if-vlan18)#ip vrf forwarding Blue
S1(config-if-vlan18)#ip address 172.18.0.1 255.255.255.0
S1(config-if-vlan18)#exit
```

We can display the VRF associated RDs and interfaces as follows:

```
S1(config)#show ip vrf
```

```
Number of VRFs..... 4
```

Name	Identifier	Route Distinguisher
Blue	1	65000:3
Green	2	65000:2
Red	3	65000:1
Shared	4	65000:99

```
S1(config)#show ip vrf interface
```

VRF Name	Interface	State	IP Address	IP Mask	Method
Blue	Vl18	Up	172.18.0.1	255.255.255.0	Manual
Blue	Lo18	Up	172.18.1.1	255.255.255.252	Manual
Green	Vl17	Up	172.17.0.1	255.255.255.0	Manual
Green	Lo17	Up	172.17.1.1	255.255.255.252	Manual
Red	Vl16	Up	172.16.0.1	255.255.255.0	Manual
Red	Lo16	Up	172.16.1.1	255.255.255.252	Manual
Shared	Lo1	Up	192.168.99.1	255.255.255.0	Manual

Next, configure OSPF to exchange routes with the other routers. OSPF runs in the VRFs and area 0 is used within each VRF. Each VRF is configured to redistribute BGP subnets advertised by S1.

**1** Configure router Blue.

```
S1 (config) #router ospf vrf "Blue"
```

**2** A router ID is required.

```
S1 (config-router-vrf-Blue) #router-id 172.18.0.1
```

**3** Configure network as 'don't care'. A non-zero IP address is required.

```
S1 (config-router-vrf-Blue) #network 172.18.0.0 255.255.255.255  
area 0
```

**4** Redistribute BGP subnets.

```
S1 (config-router-vrf-Blue) #redistribute bgp subnets  
S1 (config-router-vrf-Blue) #exit
```

**5** VRF Green and Red are nearly identical to VRF Blue.

```
S1 (config) #router ospf vrf "Green"
```

```
S1 (config-router-vrf-Green) #router-id 172.17.0.1
```

```
S1 (config-router-vrf-Green) #network 172.17.0.0 255.255.255.255  
area 0
```

```
S1 (config-router-vrf-Green) #redistribute bgp subnets  
S1 (config-router-vrf-Green) #exit
```

```
S1 (config) #router ospf vrf "Red"
```

```
S1 (config-router-vrf-Red) #router-id 172.16.0.1
```

```
S1 (config-router-vrf-Red) #network 172.16.0.0 255.255.255.255  
area 0
```

```
S1 (config-router-vrf-Red) #redistribute bgp subnets  
S1 (config-router-vrf-Red) #exit
```

Next, assign the VRF associated VLANs to the interfaces connected to the rest of the Red, Green, and Blue networks:

- 1 Configure the S1-S2 trunk.

```
S1 (config) #interface Gi1/0/13
S1 (config-if-Gi1/0/13) #switchport mode trunk
S1 (config-if-Gi1/0/13) #switchport trunk allowed vlan 1,16-17
S1 (config-if-Gi1/0/13) #exit
```

- 2 Configure the S1-S3 trunk.

```
S1 (config) #interface Gi1/0/16
S1 (config-if-Gi1/0/16) #switchport mode trunk
S1 (config-if-Gi1/0/16) #switchport trunk allowed vlan 1,16-18
S1 (config-if-Gi1/0/16) #exit
```

Routers S2 and S3 require VRFs to be created and OSPF to be configured. The RDs must match the RDs configured for the VRFs on S1.

- 1 Configure S2.

```
console#configure
console (config) #vlan 16-17
console (config-vlan) #exit
```

- 2 Set the hostname.

```
console (config) #hostname "S2"
```

- 3 Create VRF Green. Same RD as on S1.

```
S2 (config) #ip vrf Green
S2 (config-vrf-Green) #rd 65000:2
S2 (config-vrf-Green) #exit
```

- 4 Create VRF Red. Same RD as on S1.

```
S2 (config) #ip vrf Red
S2 (config-vrf-Red) #rd 65000:1
S2 (config-vrf-Red) #exit
S2 (config) #no ip domain-lookup
```

- 5 Enable IP routing.

```
S2 (config) #ip routing
```

- 6 Emulate a network in the Red VRF. The loopback subnet can be replaced with a VLAN-routed interface.

```
S2 (config) #interface loopback 16
S2 (config-if-loopback16) #ip vrf forwarding Red
S2 (config-if-loopback16) #ip address 172.16.2.1 255.255.255.0
S2 (config-if-loopback16) #exit
```



- 7 Emulate a network in the Green VRF. The loopback network can be replaced with a VLAN-routed interface.

```
S2 (config)#interface loopback 17
S2 (config-if-loopback17)#ip vrf forwarding Green
S2 (config-if-loopback17)#ip address 172.17.2.1 255.255.255.0
S2 (config-if-loopback17)#exit
```

- 8 Create a VLAN routed interface to router S1 for VRF Red.

```
S2 (config)#interface vlan 16
S2 (config-if-vlan16)#ip vrf forwarding Red
S2 (config-if-vlan16)#ip address 172.16.0.2 255.255.255.0
S2 (config-if-vlan16)#exit
```

- 9 Create a VLAN routed interface to router S1 for VRF Green.

```
S2 (config)#interface vlan 17
S2 (config-if-vlan17)#ip vrf forwarding Green
S2 (config-if-vlan17)#ip address 172.17.0.2 255.255.255.0
S2 (config-if-vlan17)#exit
```

- 10 Assign VLANs to a trunk.

```
S2 (config)#interface Gi1/0/13
S2 (config-if-Gi1/0/13)#switchport mode trunk
S2 (config-if-Gi1/0/13)#switchport trunk allowed vlan 1,16-17
S2 (config-if-Gi1/0/13)#exit
```

S3 is configured almost identically to S2 with the exception that VRF Green is not configured on S2.

- 1 Create VLANs and configure the hostname for S3.

```
console#configure
console (config)#vlan 16,18
console (config-vlan)#exit
console (config)#hostname "S3"
```

- 2 Configure VRF Blue. Same RD as on S1 and S2.

```
S3 (config)#ip vrf Blue
S3 (config-vrf-Blue)#rd 65000:3
S3 (config-vrf-Blue)#exit
```

- 3 Configure VRF Red. Same RD as on S1 and S2.

```
S3 (config)#ip vrf Red
S3 (config-vrf-Red)#rd 65000:1
S3 (config-vrf-Red)#exit
S3 (config)#no ip domain-lookup
```

#### 4 Enable routing.

```
S3(config)#ip routing
```

#### 5 Emulate the Red network using a loopback.

```
S3(config)#interface loopback 16  
S3(config-if-loopback16)#ip vrf forwarding Red  
S3(config-if-loopback16)#ip address 172.16.3.1 255.255.255.0  
S3(config-if-loopback16)#exit
```

#### 6 Emulate the Blue network using a loopback.

```
S3(config)#interface loopback 18  
S3(config-if-loopback18)#ip vrf forwarding Blue  
S3(config-if-loopback18)#ip address 172.18.3.1 255.255.255.0  
S3(config-if-loopback18)#exit
```

#### 7 Assign VLANs to the VRFs.

```
S3(config)#interface vlan 16  
S3(config-if-vlan16)#ip vrf forwarding Red  
S3(config-if-vlan16)#ip address 172.16.0.3 255.255.255.0  
S3(config-if-vlan16)#exit
```

```
S3(config)#interface vlan 18  
S3(config-if-vlan18)#ip vrf forwarding Blue  
S3(config-if-vlan18)#ip address 172.18.0.3 255.255.255.0  
S3(config-if-vlan18)#exit
```

#### 8 Assign the VLANs to a physical interface.

```
S3(config)#interface Gi1/0/16  
S3(config-if-Gi1/0/16)#switchport mode trunk  
S3(config-if-Gi1/0/16)#switchport trunk allowed vlan 1,16,18  
S3(config-if-Gi1/0/16)#exit
```

This is a very simple OSPF configuration for each of the routers. In this case, a loopback is used to emulate an OSPF connected interface. If an actual VLAN-routed interface is used, declare it a passive interface in the OSPF configuration.

For router S2, VRF Green and Red are configured.

- 1 Create an OSPF instance for VRF Green

```
S2 (config) #router ospf vrf "Green"
```

- 2 Router ID is required.

```
S2 (config-router-vrf-Green) #router-id 172.17.0.99
```

- 3 Network is all 'don't care'.

```
S2 (config-router-vrf-Green) #network 172.17.0.0 255.255.255.255  
area 0
```

- 4 Redistribute connected routes to S1.

```
S2 (config-router-vrf-Green) #redistribute connected  
S2 (config-router-vrf-Green) #exit
```

- 5 Create an OSPF instance for VRF Red.

```
S2 (config) #router ospf vrf "Red"
```

- 6 Router ID is required.

```
S2 (config-router-vrf-Red) #router-id 172.16.0.99
```

- 7 Network is all 'don't care'.

```
S2 (config-router-vrf-Red) #network 172.16.0.0 255.255.255.255  
area 0
```

- 8 Redistribute connected routes.

```
S2 (config-router-vrf-Red) #redistribute connected  
S2 (config-router-vrf-Red) #exit
```

- 9 Allow both VRF Red and Green access to router S1 over a physical interface.

```
S2 (config) #interface Gi1/0/13  
S2 (config-if-Gi1/0/16) #switchport mode trunk  
S2 (config-if-Gi1/0/16) #switchport trunk allowed vlan 1,16-17  
S2 (config-if-Gi1/0/16) #exit
```

OSPF on S3 is configured similarly to S2 with VRF Red and Blue:

- 1 Create OSPF sessions in each VRF. Assign area 0. Router ID assignment is required.

```
S3(config)#router ospf vrf "Blue"
S3(config-router-vrf-Blue)#router-id 172.18.0.99
S3(config-router-vrf-Blue)#network 172.18.0.0 255.255.255.255
area 0
S3(config-router-vrf-Blue)#exit
```

```
S3(config)#router ospf vrf "Red"
S3(config-router-vrf-Red)#router-id 172.16.0.98
S3(config-router-vrf-Red)#network 172.16.0.0 255.255.255.255
area 0
S3(config-router-vrf-Red)#exit
```

- 2 Assign the VLANs to the physical interface connected to S1.

```
S3(config)#interface Gi1/0/16
S3(config-if-Gi1/0/16)#switchport mode trunk
S3(config-if-Gi1/0/16)#switchport trunk allowed vlan 1,16,18
S3(config-if-Gi1/0/16)#exit
```

Examine the OSPF adjacencies on router S1. Every router is connected to every other router.

```
S1#show ip ospf neighbor vrf Red
```

Router ID	Priority	IP Address	Interface	State	Dead Time
172.16.0.99	1	172.16.0.2	Vl16	Full/BACKUP-DR	37
172.16.0.98	1	172.16.0.3	Vl16	Full/BACKUP-DR	33

```
S1#show ip ospf neighbor vrf Green
```

Router ID	Priority	IP Address	Interface	State	Dead Time
172.17.0.99	1	172.17.0.2	Vl17	Full/BACKUP-DR	33

```
S1#show ip ospf neighbor vrf Blue
```

Router ID	Priority	IP Address	Interface	State	Dead Time
172.18.0.99	1	172.18.0.3	Vl18	Full/BACKUP-DR	35

The VRFs should all have full connectivity.

```
S1#show ip route vrf Red
```

```
Route Codes: R - RIP Derived, O - OSPF Derived, C - Connected, K - Kernel S - Static
              B - BGP Derived, E - Externally Derived, IA - OSPF Inter Area
              E1 - OSPF External Type 1, E2 - OSPF External Type 2
              N1 - OSPF NSSA External Type 1, N2 - OSPF NSSA External Type 2
              S U - Unnumbered Peer, L - Leaked Route
```

```
* Indicates the best (lowest metric) route for the subnet.
```

```
No default gateway is configured.
```

```
C      *172.16.0.0/24 [0/0] directly connected, V116
C      *172.16.1.0/30 [0/0] directly connected, Lo16
O      *172.16.2.0/24 [110/11] via 172.16.0.2, V116
O      *172.16.3.0/24 [110/11] via 172.16.0.3, V116
```

```
S1#show ip route vrf Green
```

```
Route Codes: R - RIP Derived, O - OSPF Derived, C - Connected, K - Kernel S - Static
              B - BGP Derived, E - Externally Derived, IA - OSPF Inter Area
              E1 - OSPF External Type 1, E2 - OSPF External Type 2
              N1 - OSPF NSSA External Type 1, N2 - OSPF NSSA External Type 2
              S U - Unnumbered Peer, L - Leaked Route
```

```
* Indicates the best (lowest metric) route for the subnet.
```

```
No default gateway is configured.
```

```
C      *172.17.0.0/24 [0/0] directly connected, V117
C      *172.17.1.0/30 [0/0] directly connected, Lo17
O      *172.17.2.0/24 [110/11] via 172.17.0.2, V117
```

```
S1#show ip route vrf Blue
```

```
Route Codes: R - RIP Derived, O - OSPF Derived, C - Connected, K - Kernel S - Static
              B - BGP Derived, E - Externally Derived, IA - OSPF Inter Area
              E1 - OSPF External Type 1, E2 - OSPF External Type 2
              N1 - OSPF NSSA External Type 1, N2 - OSPF NSSA External Type 2
              S U - Unnumbered Peer, L - Leaked Route
```

```
* Indicates the best (lowest metric) route for the subnet.
```

```
No default gateway is configured.
```

```
C      *172.18.0.0/24 [0/0] directly connected, V118
C      *172.18.1.0/30 [0/0] directly connected, Lo18
O      *172.18.3.0/24 [110/11] via 172.18.0.3, V118
```

To provision MPBGP to distribute routes for the shared service, on S1 configure a loopback to emulate the common service network:

- 1 Set a loopback for the BGP router.

```
S1(config)#interface loopback 0  
S1(config-if-loopback0)#ip address 192.0.2.1 255.255.255.255  
S1(config-if-loopback0)#exit
```

Next, configure a BGP router and allow route redistribution to occur. Configuration of the router ID is required.

- 2 Configure a BGP router.

```
S1(config)#router bgp 65000  
S1(config-router)#bgp log-neighbor-changes  
S1(config-router)#bgp router-id 192.0.2.1
```

- 3 Add the Blue VRF address family and allow redistribution of OSPF and connected origin routes.

```
S1(config-router)#address-family ipv4 vrf Blue  
S1(config-router-af)#redistribute connected  
S1(config-router-af)#redistribute ospf  
S1(config-router-af)#exit
```

- 4 Add the Green VRF address family and allow redistribution of OSPF and connected origin routes.

```
S1(config-router)#address-family ipv4 vrf Green  
S1(config-router-af)#redistribute connected  
S1(config-router-af)#redistribute ospf  
S1(config-router)#exit
```

- 5 Add the Red VRF address family and allow redistribution of OSPF and connected origin routes.

```
S1(config-router)#address-family ipv4 vrf Red  
S1(config-router-af)#redistribute connected  
S1(config-router-af)#redistribute ospf  
S1(config-router-af)#exit
```

- 6 Add the Shared VRF and allow redistribution of OSPF and connected origin routes.

```
S1(config-router)#address-family ipv4 vrf Shared  
S1(config-router-af)#redistribute connected  
S1(config-router-af)#redistribute ospf  
S1(config-router-af)#exit  
S1(config-router)#exit
```

Verify that BGP maintains routes for each of the VRFs. The common service VRF "Shared" is exported via the route-target 65000:99 and imported into the Red and Green VRFs.

```
S1(config-router)#show ip bgp vpnv4 all
```

```
BGP table version is 0, local router ID is 192.0.2.1
Status codes: s suppressed, * valid, > best, i - internal
Origin codes: i - IGP, e - EGP, ? - incomplete
```

Network	Next Hop	Metric	LocPref	Path
Route Distinguisher : 65000:3 for VRF Blue				
*>i 172.18.0.0/24	::			
	0.0.0.0		100	?
*>i 172.18.1.0/30	::			
	0.0.0.0		100	?
*>i 172.18.3.0/24	172.18.0.3		100	?
Route Distinguisher : 65000:2 for VRF Green				
*>i 172.17.0.0/24	::			
	0.0.0.0		100	?
*>i 172.17.1.0/30	::			
	0.0.0.0		100	?
*>i 172.17.2.0/24	172.17.0.2		100	?
*>i 192.168.99.0/24	::			
	0.0.0.0		100	?
Route Distinguisher : 65000:1 for VRF Red				
*>i 172.16.0.0/24	::			
	0.0.0.0		100	?
*>i 172.16.1.0/30	::			
	0.0.0.0		100	?
*>i 172.16.2.0/24	172.16.0.2		100	?
*>i 172.16.3.0/24	172.16.0.3		100	?
*>i 192.168.99.0/24	::			
	0.0.0.0		100	?
Route Distinguisher : 65000:99 for VRF Shared				
*>i 172.16.0.0/24	::			
	0.0.0.0		100	?
*>i 172.17.0.0/24	::			
	0.0.0.0		100	?
*>i 172.16.1.0/30	::			
	0.0.0.0		100	?
*>i 172.17.1.0/30	::			
	0.0.0.0		100	?
*>i 172.16.2.0/24	172.16.0.2		100	?
*>i 172.17.2.0/24	172.17.0.2		100	?
*>i 172.16.3.0/24	172.16.0.3		100	?
*>i 192.168.99.0/24	::			
	0.0.0.0		100	?

The best routes are placed into the route table in each of the VRFs. VRF Blue does not import or export any routes and does not have access to the common services.

**S1#show ip route vrf Shared**

Route Codes: R - RIP Derived, O - OSPF Derived, C - Connected, K - Kernel S - Static  
B - BGP Derived, E - Externally Derived, IA - OSPF Inter Area  
E1 - OSPF External Type 1, E2 - OSPF External Type 2  
N1 - OSPF NSSA External Type 1, N2 - OSPF NSSA External Type 2  
S U - Unnumbered Peer, L - Leaked Route

\* Indicates the best (lowest metric) route for the subnet.

No default gateway is configured.

```
L *172.16.0.0/24 [200/0] via 0.0.0.0, V116
L *172.16.1.0/30 [200/0] via 0.0.0.0, Lo16
L *172.16.2.0/24 [200/0] via 172.16.0.2, V116
L *172.16.3.0/24 [200/0] via 172.16.0.3, V116
L *172.17.0.0/24 [200/0] via 0.0.0.0, V117
L *172.17.1.0/30 [200/0] via 0.0.0.0, Lo17
L *172.17.2.0/24 [200/0] via 172.17.0.2, V117
C *192.168.99.0/24 [0/0] directly connected, Lo1
```

**S1#show ip route vrf Red**

Route Codes: R - RIP Derived, O - OSPF Derived, C - Connected, K - Kernel S - Static  
B - BGP Derived, E - Externally Derived, IA - OSPF Inter Area  
E1 - OSPF External Type 1, E2 - OSPF External Type 2  
N1 - OSPF NSSA External Type 1, N2 - OSPF NSSA External Type 2  
S U - Unnumbered Peer, L - Leaked Route

\* Indicates the best (lowest metric) route for the subnet.

No default gateway is configured.

```
C *172.16.0.0/24 [0/0] directly connected, V116
C *172.16.1.0/30 [0/0] directly connected, Lo16
O *172.16.2.0/24 [110/11] via 172.16.0.2, V116
O *172.16.3.0/24 [110/11] via 172.16.0.3, V116
L *192.168.99.0/24 [200/0] via 0.0.0.0, Lo1
```

**S1#show ip route vrf Green**

Route Codes: R - RIP Derived, O - OSPF Derived, C - Connected, K - Kernel S - Static  
B - BGP Derived, E - Externally Derived, IA - OSPF Inter Area  
E1 - OSPF External Type 1, E2 - OSPF External Type 2  
N1 - OSPF NSSA External Type 1, N2 - OSPF NSSA External Type 2  
S U - Unnumbered Peer, L - Leaked Route

\* Indicates the best (lowest metric) route for the subnet.

No default gateway is configured.

```
C *172.17.0.0/24 [0/0] directly connected, V117
C *172.17.1.0/30 [0/0] directly connected, Lo17
O *172.17.2.0/24 [110/11] via 172.17.0.2, V117
L *192.168.99.0/24 [200/0] via 0.0.0.0, Lo1
```



S1#show ip route vrf Blue

Route Codes: R - RIP Derived, O - OSPF Derived, C - Connected, K - Kernel S - Static  
B - BGP Derived, E - Externally Derived, IA - OSPF Inter Area  
E1 - OSPF External Type 1, E2 - OSPF External Type 2  
N1 - OSPF NSSA External Type 1, N2 - OSPF NSSA External Type 2  
S U - Unnumbered Peer, L - Leaked Route

\* Indicates the best (lowest metric) route for the subnet.

No default gateway is configured.

```
C *172.18.0.0/24 [0/0] directly connected, V118
C *172.18.1.0/30 [0/0] directly connected, Lo18
O *172.18.3.0/24 [110/11] via 172.18.0.3, V118
```

The routes are propagated via OSPF to the S2 and S3 routers.

S2#show ip route vrf Red

Route Codes: R - RIP Derived, O - OSPF Derived, C - Connected, K - Kernel S - Static  
B - BGP Derived, E - Externally Derived, IA - OSPF Inter Area  
E1 - OSPF External Type 1, E2 - OSPF External Type 2  
N1 - OSPF NSSA External Type 1, N2 - OSPF NSSA External Type 2  
S U - Unnumbered Peer, L - Leaked Route

\* Indicates the best (lowest metric) route for the subnet.

No default gateway is configured.

```
C *172.16.0.0/24 [0/0] directly connected, V116
O *172.16.1.0/30 [110/11] via 172.16.0.1, V116
C *172.16.2.0/24 [0/0] directly connected, Lo16
O *172.16.3.0/24 [110/11] via 172.16.0.3, V116
O E2 *192.168.99.0/24 [110/1] via 172.16.0.1, V116
```

S2#show ip route vrf Green

Route Codes: R - RIP Derived, O - OSPF Derived, C - Connected, K - Kernel S - Static  
B - BGP Derived, E - Externally Derived, IA - OSPF Inter Area  
E1 - OSPF External Type 1, E2 - OSPF External Type 2  
N1 - OSPF NSSA External Type 1, N2 - OSPF NSSA External Type 2  
S U - Unnumbered Peer, L - Leaked Route

\* Indicates the best (lowest metric) route for the subnet.

No default gateway is configured.

```
C *172.17.0.0/24 [0/0] directly connected, V117
O *172.17.1.0/30 [110/11] via 172.17.0.1, V117
C *172.17.2.0/24 [0/0] directly connected, Lo17
O E2 *192.168.99.0/24 [110/1] via 172.17.0.1, V117
```

S3#show ip route vrf Red

Route Codes: R - RIP Derived, O - OSPF Derived, C - Connected, K - Kernel S - Static  
B - BGP Derived, E - Externally Derived, IA - OSPF Inter Area  
E1 - OSPF External Type 1, E2 - OSPF External Type 2  
N1 - OSPF NSSA External Type 1, N2 - OSPF NSSA External Type 2  
S U - Unnumbered Peer, L - Leaked Route

\* Indicates the best (lowest metric) route for the subnet.

No default gateway is configured.

```
C      *172.16.0.0/24 [0/0] directly connected,    V116
O      *172.16.1.0/30 [110/11] via 172.16.0.1,    V116
O      *172.16.2.0/24 [110/11] via 172.16.0.2,    V116
C      *172.16.3.0/24 [0/0] directly connected,    Lo16
O E2   *192.168.99.0/24 [110/1] via 172.16.0.1,    V116
```

S3#show ip route vrf Blue

Route Codes: R - RIP Derived, O - OSPF Derived, C - Connected, K - Kernel S - Static  
B - BGP Derived, E - Externally Derived, IA - OSPF Inter Area  
E1 - OSPF External Type 1, E2 - OSPF External Type 2  
N1 - OSPF NSSA External Type 1, N2 - OSPF NSSA External Type 2  
S U - Unnumbered Peer, L - Leaked Route

\* Indicates the best (lowest metric) route for the subnet.

No default gateway is configured.

```
C      *172.18.0.0/24 [0/0] directly connected,    V118
O      *172.18.1.0/30 [110/11] via 172.18.0.1,    V118
C      *172.18.3.0/24 [0/0] directly connected,    Lo18
```

## Configuring MP-eBGP and Extended Communities

In this configuration, router R1 is connected to router R2 (via VLAN 100 on Gi1/0/13) and router R3 (via VLAN 200 in Gi1/0/16). Router R1 (AS 5500) and R2 (AS 6500) communicate via MP-eBGP. Router R1 and R3 are both in AS 5500 and for an iBGP relationship. R3's purpose in this configuration is to show that routes received from R2 are redistributed within the IGP and to inject routes into the IGP.

### Router R1 Configuration

Router R1 does not have any VRFs and does not send the extended community attribute.

- 1 Create two VLANs for connection to R2 (VLAN 100) and R3 (VLAN 200).

```
console#configure
console (config) #vlan 100,200
console (config-vlan) #exit
console (config) #hostname "R1"
```

- 2 Disable domain lookup and enable IP routing.

```
R1 (config) #no ip domain-lookup
R1 (config) #ip routing
```

- 3 Create a loopback for the router ID.

```
R1 (config) #interface loopback 0
R1 (config-if-loopback0) #ip address 10.10.10.10 255.255.255.255
R1 (config-if-loopback0) #exit
```

- 4 Configure the two IP routing VLANs for the connections to R1 and R2.

```
R1 (config) #interface vlan 100
R1 (config-if-vlan100) #ip address 172.16.10.1 255.255.255.0
R1 (config-if-vlan100) #exit
```

```
R1 (config) #interface vlan 200
R1 (config-if-vlan200) #ip address 192.168.100.10 255.255.255.0
R1 (config-if-vlan200) #exit
```

- 5 Assign the R1 physical interface.

```
R1 (config) #interface Gi1/0/13
R1 (config-if-Gi1/0/13) #switchport access vlan 100
R1 (config-if-Gi1/0/13) #exit
```

- 6 Assign the R2 physical interface.

```
R1 (config) #interface Gi1/0/16
```

```
R1(config-if-Gil/0/16)#switchport access vlan 200
R1(config-if-Gil/0/16)#exit
```

- 7 Configure the BGP router.

```
R1(config)#router bgp 5500
R1(config-router)#bgp log-neighbor-changes
```

- 8 Configure the router ID.

```
R1(config-router)#bgp router-id 10.10.10.10
```

- 9 This router advertises the 192.168.100.0/24 network.

```
R1(config-router)#network 192.168.100.0 mask 255.255.255.0
```

- 10 Redistribute connected routes (10.10.10.10/32).

```
R1(config-router)#redistribute connected
```

- 11 Configure the R2 neighbor.

```
R1(config-router)#neighbor 172.16.10.2 remote-as 6500
```

- 12 Configure the R1 neighbor.

```
R1(config-router)#neighbor 192.168.100.11 remote-as 5500
R1(config-router)#address-family vpnv4 unicast
R1(config-router-af)#exit
R1(config-router)#exit
```

## Router R2 Configuration

Router R2 has a VRF WAN with route distinguisher 2020:1. This attribute is sent in the UPDATE message in the MP\_REACH\_NLRI path attribute. Router R2 exhibits an MP-BGP capability toward router R1. The administrator for R2 can implement route maps to control distribution of VRF route information to R1 by matching on the extended community attribute.

- 1 Configure a VLAN for the R1 neighbor.

```
console#configure
console(config)#vlan 100
console(config-vlan100)#exit
console(config)#hostname "R2"
```

- 2 Create a VRF.

```
R2(config)#ip vrf WAN
R2(config-vrf-WAN)#rd 2020:1
R2(config-vrf-WAN)#route-target export 2020:1
R2(config-vrf-WAN)#route-target import 2020:1
R2(config-vrf-WAN)#exit
```

- 3** Disable domain lookup and enable IP routing.

```
R2 (config) #no ip domain-lookup
R2 (config) #ip routing
```

- 4** Create a loopback for the BGP router.

```
R2 (config) #interface loopback 0
R2 (config-if-loopback0) #ip address 20.20.20.20 255.255.255.255
R2 (config-if-loopback0) #exit
```

- 5** Create a loopback to emulate a subnet in the VRF. This could be assigned to a real VLAN.

```
R2 (config) #interface loopback 1
R2 (config-if-loopback1) #ip vrf forwarding WAN
R2 (config-if-loopback1) #ip address 30.30.30.30 255.255.255.0
R2 (config-if-loopback1) #exit
```

- 6** VLAN 100 is connected to R1.

```
R2 (config) #interface vlan 100
R2 (config-if-vlan100) #ip address 172.16.10.2 255.255.255.0
R2 (config-if-vlan100) #exit
```

- 7** Assign the physical connection to R1.

```
R2 (config) #interface Gi1/0/13
R2 (config-if-Gi1/0/13) #switchport access vlan 100
R2 (config-if-Gi1/0/13) #exit
```

- 8** Configure a BGP router with as 6500.

```
R2 (config) #router bgp 6500
R2 (config-router) #bgp log-neighbor-changes
```

- 9** Use the loopback for the router ID. The router ID is required.

```
R2 (config-router) #bgp router-id 20.20.20.20
```

- 10** Redistribute connected subnets.

```
R2 (config-router) #redistribute connected
```

- 11** R1 is an eBGP connection.

```
R2 (config-router) #neighbor 172.16.10.1 remote-as 5500
R2 (config-router) #neighbor 172.16.10.1 send-community
```

- 12** Advertise the IPv4 routes in VRF WAN (20.20.20.20/32 and 172.16.10.0/24).

```
R2 (config-router) #address-family ipv4 vrf WAN
R2 (config-router-af) #neighbor 172.16.10.1 remote-as 5500
R2 (config-router-af) #redistribute connected
```

```
R2(config-router-af) #redistribute static
R2(config-router-af) #exit
```

- 13 Advertise the VPNv4 routes (30.30.30.0/24). These routes are transmitted with the extended community attribute (2020:1).

```
R2(config-router) #address-family vpnv4 unicast
R2(config-router-af) #neighbor 172.16.10.1 send-community both
R2(config-router-af) #neighbor 172.16.10.1 activate
R2(config-router-af) #exit
R2(config-router) #exit
R2(config) #exit
```

### Router R3 Configuration

- 1 Configure a VLAN for connection to R1.

```
console#configure
console(config) #vlan 200
console(config-vlan200) #exit
console(config) #hostname "R3"
```

- 2 Create a loopback for the BGP router ID.

```
R3(config) #interface loopback 0
R3(config-if-loopback0) #ip address 11.11.11.11 255.255.255.255
R3(config-if-loopback0) #exit
```

- 3 Disable domain lookup.

```
R3(config) #no ip domain-lookup
```

- 4 Create a routed VLAN for connection to R1.

```
R3(config) #interface vlan 200
R3(config-if-vlan200) #ip address 192.168.100.11 255.255.255.0
R3(config-if-vlan200) #exit
```

- 5 Attach a physical interface to the VLAN.

```
R3(config) #interface Gi1/0/16
R3(config-if-Gi1/0/16) #switchport access vlan 200
R3(config-if-Gi1/0/16) #exit
```

- 6 Create an iBGP router.

```
R3(config) #router bgp 6500
R3(config-router) #bgp log-neighbor-changes
```

- 7 Setting the router ID is mandatory.

```
R3(config-router) #bgp router-id 11.11.11.11
```

- 8 Identify the BGP neighbor.

```
R3(config-router)#neighbor 192.168.100.10 remote-as 5500
```

## 9 Redistribute connected and static routes.

```
R3(config-router)#redistribute connected
R3(config-router)#redistribute static
R3(config-router)#exit
R3(config)#exit
R3#exit
```

## Discussion

Verify that the routes on R2 are being distributed to R1 and R3. This shows the R2 BGP and routing tables.

```
R2#show ip route vrf WAN
```

```
Route Codes: R - RIP Derived, O - OSPF Derived, C - Connected, K - Kernel S - Static
              B - BGP Derived, E - Externally Derived, IA - OSPF Inter Area
              E1 - OSPF External Type 1, E2 - OSPF External Type 2
              N1 - OSPF NSSA External Type 1, N2 - OSPF NSSA External Type 2
              S U - Unnumbered Peer, L - Leaked Route
```

\* Indicates the best (lowest metric) route for the subnet.

No default gateway is configured.

```
C      *30.30.30.0/24 [0/0] directly connected,   Lo1
```

```
R2#show ip bgp vpnv4 all
```

```
BGP table version is 24, local router ID is 20.20.20.20
Status codes: s suppressed, * valid, > best, i - internal
Origin codes: i - IGP, e - EGP, ? - incomplete
```

Network	Next Hop	Metric	LocPref	Path
-----				
Route Distinguisher : 2020:1 for VRF WAN				
*>i 30.30.30.0/24	::			
	0.0.0.0		100	?

R2 shows routes from R1 and R3 in the IPv4 address family.

```
R2#show ip route
```

```
Route Codes: R - RIP Derived, O - OSPF Derived, C - Connected, K - Kernel S - Static
              B - BGP Derived, E - Externally Derived, IA - OSPF Inter Area
              E1 - OSPF External Type 1, E2 - OSPF External Type 2
              N1 - OSPF NSSA External Type 1, N2 - OSPF NSSA External Type 2
              S U - Unnumbered Peer, L - Leaked Route
```

\* Indicates the best (lowest metric) route for the subnet.

No default gateway is configured.

```
B      *10.10.10.10/32 [20/0] via 172.16.10.1,    V1100
B      *11.11.11.11/32 [20/0] via 172.16.10.1,    V1100
C      *20.20.20.20/32 [0/0] directly connected,   Lo0
C      *172.16.10.0/24 [0/0] directly connected,   V1100
```

```
B *192.168.100.0/24 [20/0] via 172.16.10.1, V1100
```

This is the resulting R1 routing table.

```
R1#show ip route
```

```
Route Codes: R - RIP Derived, O - OSPF Derived, C - Connected, K - Kernel S - Static  
B - BGP Derived, E - Externally Derived, IA - OSPF Inter Area  
E1 - OSPF External Type 1, E2 - OSPF External Type 2  
N1 - OSPF NSSA External Type 1, N2 - OSPF NSSA External Type 2  
S U - Unnumbered Peer, L - Leaked Route
```

```
* Indicates the best (lowest metric) route for the subnet.
```

```
No default gateway is configured.
```

```
C *10.10.10.10/32 [0/0] directly connected, Lo0  
B *11.11.11.11/32 [200/0] via 192.168.100.11, V1200  
B *20.20.20.20/32 [20/0] via 172.16.10.2, V1100  
C *172.16.10.0/24 [0/0] directly connected, V1100  
B *30.30.30.30/32 [20/0] via 172.16.10.2, V1100  
  
C *192.168.100.0/24 [0/0] directly connected, V1200
```

This is the resulting R3 routing table.

```
R3#show ip route
```

```
Route Codes: R - RIP Derived, O - OSPF Derived, C - Connected, K - Kernel S - Static  
B - BGP Derived, E - Externally Derived, IA - OSPF Inter Area  
E1 - OSPF External Type 1, E2 - OSPF External Type 2  
N1 - OSPF NSSA External Type 1, N2 - OSPF NSSA External Type 2  
S U - Unnumbered Peer, L - Leaked Route
```

```
* Indicates the best (lowest metric) route for the subnet.
```

```
No default gateway is configured.
```

```
B *10.10.10.10/32 [200/0] via 192.168.100.10, V1200  
C *11.11.11.11/32 [0/0] directly connected, Lo0  
B *20.20.20.20/32 [200/0] via 192.168.100.10, V1200  
B *172.16.10.0/24 [200/0] via 192.168.100.10, V1200  
B *30.30.30.30/24 [200/0] via 192.168.100.10, V1200  
C *192.168.100.0/24 [0/0] directly connected, V1200
```

On R1, the result of the routing decision process can be shown for routes coming from R2. Use the **received-routes** option to display routes received from R2.

```
R1#show ip bgp neighbors 172.16.10.2 received-routes
```

```
Local router ID is 10.10.10.10  
Origin codes: i - IGP, e - EGP, ? - incomplete
```

Network	Next Hop	Metric	LocPref	Path	Origin
172.16.10.0/24	172.16.10.2			6500	?



```

20.20.20.20/32      172.16.10.2      6500      ?
30.30.30.0/24     172.16.10.2      6500      ?

```

Use the **routes** option to display routes received from R2.

```
R1#show ip bgp neighbors 172.16.10.2 routes
```

```

Local router ID is 10.10.10.10
Origin codes: i - IGP, e - EGP, ? - incomplete

```

Network	Next Hop	Metric	LocPref	Path	Origin
172.16.10.0/24	172.16.10.2			6500	?
20.20.20.20/32	172.16.10.2			6500	?
30.30.30.0/24	172.16.10.2			6500	?

Use the **rejected-routes** option to display routes received from R2 which are not matched by a policy.

```
R1#show ip bgp neighbors 172.16.10.2 rejected-routes
```

```

Local router ID is 10.10.10.10
Origin codes: i - IGP, e - EGP, ? - incomplete

```

Network	Next Hop	Metric	LocPref	Path	Origin
---------	----------	--------	---------	------	--------



# Bidirectional Forwarding Detection

## Dell EMC Networking N3000E-ON, N3100-ON, and N3200-ON Series Switches



**NOTE:** This feature is not available on Dell EMC Networking N1100-ON, N1500, N2000, N2100-ON and N2200X-ON Series switches.

Bidirectional Forwarding Detection (BFD) provides a lightweight fast failure detection mechanism to verify bidirectional connectivity between forwarding engines, which may be a single hop or multiple hops away from each other.

The topics covered in this chapter include:

- Overview
- BFD Operational Modes
- Limitations
- BFD Example

## Overview

BFD only supports notification of failures to the BGP and OSPF protocols. The BFD protocol is designed to work over any underlying transmission mechanism and protocol layer with a wide range of detection times, especially in scenarios where fast failure detection is required in the data plane level for multiple concurrent sessions. For example, the BGP keepalive timer is 60 seconds and the hold timer is 180 seconds. A typical BFD session might use a 200-millisecond `min_rx` interval with a multiplier of 5. This means that BGP would detect a connectivity failure in 180 seconds, whereas BFD would report the same failure in slightly more than one second.

In Dell EMC Networking N-Series switches, BFD is presented as a service that reports on the session status to its client applications.

BFD uses a simple 'hello' mechanism that is similar to the neighbor detection components of some well-known protocols. It establishes an operational session between a pair of network devices to verify a two-way communication path between them and serves information regarding the connectivity status

to the applications. The pair of devices transmits BFD packets between them periodically and, if one stops receiving peer packets within the detection time limit, it considers the bidirectional path to have failed. It then notifies the application protocol of this failure.

BFD allows each device to estimate how quickly it can send and receive BFD packets to agree with its neighbor upon how fast detection of failure may be performed.

BFD operates between two devices on top of any underlying data protocol (network layer, link layer, tunnels, etc.) as payload of any encapsulating protocol appropriate for the transmission medium. The Dell EMC Networking implementation of BFD works with IP networks (v4 and v6) and supports IPv4/v6 address-based encapsulations.

BFD is standardized in RFC 5880.

## **BFD Operational Modes**

BFD implements two main operational modes, as well as an additional capability that may be used in combination with either of the two modes. The two modes are Asynchronous mode and Demand mode, and the additional capability is the Echo function.

### **Asynchronous Mode**

This is the nominal operating mode for BFD. In this mode, the pair of devices periodically sends BFD control packets to one another and, if a consecutive number of those packets are not received by the other device, the session is declared down.

The asynchronous mode is advantageous as it requires half the number of packets to achieve a particular detection time as does to the echo function.

### **Demand Mode**

In demand mode, it is assumed that a device has an independent way of verifying that it has connectivity to the other system. Once a BFD session is established, a demand mode device may ask the other to stop sending BFD control packets, except when the device needs to verify the connectivity

explicitly. In this case, a short sequence of BFD Control packets, known as the Poll Sequence, is exchanged to ascertain the connectivity. Demand mode may operate independently in either direction.

Demand mode is advantageous in cases when the overhead of a periodic protocol appears burdensome on a device, e.g., a router with a large number of BFD sessions running.

Dell EMC Networking BFD does not support demand mode.

## Echo Function

Echo mode is an auxiliary operation that may be used with either BFD mode. When the echo function is active, a stream of BFD echo packets is transmitted in such a way that the other system loops them back through its forwarding path. If a configured number of consecutive packets of the echoed data stream are not received, the session is declared to be down. Since the echo function is handling the task of neighbor detection, the rate of periodic transmission of BFD control packets may be reduced (in the case of asynchronous mode) or eliminated completely (in the case of demand mode).

The echo function has the advantage of testing the forwarding path on the remote system. This may reduce round-trip jitter and, thus, allow more aggressive detection times, and can potentially catch some classes of failure that might not otherwise be detected.

## Limitations

- Dell EMC Networking BFD does not support demand mode.
- Dell EMC Networking BFD does not support authentication.
- The BFD feature provides notification to BGP or OSPF when an interface is detected to not be in a forwarding state. No other protocols are supported for notification.
- BFD is supported in the default VRF only.
- BFD should be configured on routed interfaces only. BFD should not be configured mirrored ports or on interfaces enabled for IEEE 802.1x.
- BFD is supported across link aggregation groups, but does not detect individual LAG member link failure.
- BFD does not operate on the out-of-band interface.

## BFD Example

This example configures BFD for a BGP peer session. BFD is only supported in conjunction with BGP. The BGP configuration is taken from BGP Redistribution of OSPF Example in the BGP Configuration Examples section and is not explained further here. The fast-external-fallover is not enabled in this example, as BFD will provide failure detection.

- 1 Enable the BFD feature. This step is mandatory before configuring or enabling BFD:

```
console#config
console(config)#feature bfd
console(config)#interface tel1/0/1
console(config-if-Tel1/0/1)#switchport mode trunk
console(config-if-Tel1/0/1)#switchport trunk native vlan 100
console(config-if-Tel1/0/1)#exit
```

```
console(config)#ip routing
```

- 2 Configure a VLAN routing interface and enable notification to BGP on routing connectivity failure.

(Optional) Configure BFD sessions parameter on the BGP peer link.

BFD echo mode is enabled first. Then the BFD control packet interval is set to 1 second. This configuration will send echo packets every 100 ms. If three consecutive control or echo packets are missed, the interface is declared down. BGP fast external failover is disabled on the peer interface as BFD will notify BGP if the routing peer is not reachable:

```
console(config)#vlan 10
console(config-vlan10)#exit
```

```
console(config)#interface vlan 10
console(config-if-vlan10)#ip address 172.16.65.1 /30
console(config-if-vlan10)#ip bgp fast-external-fallover deny
console(config-if-vlan10)#bfd echo
console(config-if-vlan10)#exit
```

```
console(config)#bfd slow-timer 1000
console(config)#ip routing
console(config)#ip route 0.0.0.0 0.0.0.0 172.16.65.2 name
'Default-Route'
console(config)#router bgp 3434
console(config-router)#bgp router-id 172.16.64.1
```

```
console(config-router)#neighbor 216.31.219.19 remote-as 200
console(config-router)#redistribute static
console(config-router)#redistribute ospf match external 1
console(config-router)#redistribute ospf match external 2
```

**3** Enable a BFD session on the BGP peer link:

```
console(config-router)#neighbor 216.31.219.19 fall-over bfd
console(config-router)#exit
```





# Unicast Reverse Path Forwarding

## Dell EMC Networking N3000-ON, N3100-ON, and N3200-ON Series Switches

The Unicast Reverse Path Forwarding (uRPF) feature verifies that an incoming packet has a path that is consistent with the local routing table. It does so by doing a reverse check—that is, the source IP address look up is done in the routing table and the reachability of the path determines if the packet is forwarded or dropped.

An interface may be configured for uRPF source path validation in one of two modes: loose or strict.

- In loose mode, a packet is considered valid if there is a path to the source IP address on any interface.
- Strict mode considers a packet valid only if the path to the source IP address is the interface on which the packet was received.

If the path is valid, the packet is forwarded. If the path is invalid, the uRPF counters are incremented and the packet is discarded.

Dell EMC uRPF also supports the allow-default option (refer to RFC 3704). The allow-default option, when used with loose mode, considers the default route in the routing table if the specified prefix is not found. A packet is considered valid when the IP address is not found in the routing table, but a default route is present. This option is generally used on upstream interfaces.

The allow-default option, when used with strict mode, considers a packet as valid only if the packet arrives on the interface(s) where the default route is learned.

uRPF validation is not performed for the following:

- 1 Packets where the destination IP address is not a unicast address. This applies to both IPv4 and IPv6 addresses.
- 2 Packets where the source IP address is a link-local IPv6 address.
- 3 BOOTP/DHCP packets (SIP is 0.0.0.0 and DIP is FF.FF.FF.FF).

uRPF validation may be enabled for VLAN routing interfaces and 6to4 tunnels. uRPF validation operates on both IPv4 and IPv6 packets. For ECMP routes, only loose mode validation is performed.

Strict uRPF validation is useful only in networks with symmetric paths where IP datagrams to the destination and from the destination traverse the same routing interfaces. If the network has asymmetric paths then strict uRPF validation will always fail. In networks with asymmetric paths, the administrator can use the uRPF validation to verify that the IP datagram sender is on a valid subnet.

Strict uRPF validation should not be used on internal interfaces as these are likely to have routing asymmetry.

Ingress ACLs and uRPF validation can operate simultaneously. The uRPF validation failures have a higher priority than any ACL permit rule.

For example, when there is a rule in the ACL to permit a packet based on certain criteria, but the source IP address is not found in the routing table, a uRPF validation failure will drop the packet even when the ACL rule results in a match.

## Limitations

uRPF validation requires that the routing table be used for both source and destination IP addresses. Enabling uRPF effectively reduces the routing table capacity by one half. The existing route failure mechanism will display and log any routes that are in the RTO but fail to be added to the hardware route table.

Enabling or disabling uRPF at the global configuration level causes the switch to disable and re-enable routing.

uRPF dropped packet counters are supported per physical interface. The counter indicates the sum of IPv4 and IPv6 uRPF dropped packets. There is no hardware support for per-VLAN or global uRPF drop counters.

# IPv6 Routing

## Dell EMC Networking N3000E-ON, N3100-ON, and N3200-ON Series Switches



**NOTE:** This feature is not available on Dell EMC Networking N1100-ON, N1500, N2000, N2100-ON, and N2200-ON Series switches.

This chapter describes how to configure general IPv6 routing information on the switch, including global routing settings and IPv6 static routes. The topics covered in this chapter include:

- IPv6 Routing Overview
- Default IPv6 Routing Values
- Configuring IPv6 Routing Features (Web)
- Configuring IPv6 Routing Features (CLI)
- IPv6 Static Reject and Discard Routes
- IPv6 Router Advertisement Guard

The Dell EMC Networking N-Series switches support additional features to help manage IPv6 networks, including OSPFv3, DHCPv6, and IPv6 multicast. For information about OSPFv3, see "OSPF and OSPFv3" on page 1263. For information about DHCPv6, see "DHCPv6 Server Settings" on page 1511. For information about IPv6 multicast, see "IPv4 and IPv6 Multicast" on page 1601.

For configuration examples that include IPv6 interface configuration, see "OSPF Configuration Examples" on page 1330

## IPv6 Routing Overview

IPv6 is the next generation of the Internet Protocol. With 128-bit addresses, versus 32-bit addresses for IPv4, IPv6 solves the address depletion issues seen with IPv4 and removes the requirement for Network Address Translation (NAT), which is used in IPv4 networks to reduce the number of globally unique IP addresses required for a given network.

On the Dell EMC Networking N3000-ON, N3100-ON, and N3200-ON Series switches, IPv6 coexists with IPv4. As with IPv4, IPv6 routing can be enabled on loopback and VLAN interfaces. Each L3 routing interface can be used for IPv4, IPv6, or both. IP protocols running over L3 (for example, UDP and TCP) are common to both IPv4 and IPv6.

## **How Does IPv6 Compare with IPv4?**

There are many conceptual similarities between IPv4 and IPv6 network operation. Addresses still have a network prefix portion (network) and a device interface specific portion (host). While the length of the network portion is still variable, most users have standardized on using a network prefix length of 64 bits. This leaves 64 bits for the interface specific portion, called an Interface ID in IPv6. Depending upon the underlying link addressing, the Interface ID can be automatically computed from the link (e.g., MAC address). Such an automatically computed Interface ID is called an EUI-64 identifier, which is the interface MAC address with ff:fe inserted in the middle.

IPv6 packets on the network are of an entirely different format than traditional IPv4 packets and are also encapsulated in a different EtherType (0x86DD rather than 0x0800 which is used with IPv4). The details for encapsulating IPv6 in Ethernet frames are described in RFC2462.

Unlike IPv4, IPv6 does not have broadcasts. There are two types of IPv6 addresses — unicast and multicast. Unicast addresses allow direct one-to-one communication between two hosts, whereas multicast addresses allow one-to-many communication. Multicast addresses are used as destinations only. Unicast addresses will have 00 through fe in the most significant octets and multicast addresses will have ff in the most significant octets.

## **How Are IPv6 Interfaces Configured?**

The basic IPv6 protocol specifies two classes of PDU options, both of which are supported: hop-by-hop options and destination. Although new options may be defined in the future, the following are currently supported: routing (for source routing), fragment, router alert, and pad. IPv6 jumbograms (RFC 2675) are not supported. In IPv6, only source nodes fragment. ICMPv6 support of path MTU discovery is therefore supported. IPv6 forwarded or routed packets are never fragmented by the switch. IPv6 flow labels are ignored.

Neighbor Discovery (ND) protocol is the IPv6 replacement for Address Resolution Protocol (ARP) in IPv4. The IPv6 Neighbor Discovery protocol is described in detail in RFC7048. Dell EMC Networking IPv6 supports neighbor advertise and solicit, duplicate address detection, and unreachability detection. Router advertisement is part of the Neighbor Discovery process and is required for IPv6. As part of router advertisement, Dell EMC Networking N-Series switch software supports stateless auto configuration of end nodes. The switch supports both EUI-64 interface identifiers and manually configured interface IDs.

For ICMPv6, error PDU generation is supported, as are path MTU, echo, and redirect.

While optional in IPv4, router advertisement is mandatory in IPv6. Router advertisements specify the network prefix(es) on a link which can be used by receiving hosts, in conjunction with an EUI-64 identifier, to autoconfigure a host's address. Routers have their network prefixes configured and may use EUI-64 or manually configured interface IDs. In addition to a single global address and a single unique local address in the fc00::/7 range, each IPv6 interface also has an autoconfigured "link-local" address, which is:

- fe80::/10, with the EUI-64 address in the least significant bits.
- Reachable only on the local VLAN — link-local addresses are never routed.
- Not globally unique

Next hop addresses computed by routing protocols are usually link-local addresses.

During the period of transitioning the Internet to IPv6, a global IPv6 Internet backbone may not be available. One transition mechanism is to tunnel IPv6 packets inside IPv4 to reach remote IPv6 islands. When a packet is sent over such a link, it is encapsulated in IPv4 in order to traverse an IPv4 network and has the IPv4 headers removed at the other end of the tunnel.

# Default IPv6 Routing Values

IPv6 is disabled by default on the switch and on all interfaces.

Table 41-1 shows the default values for the IP routing features this chapter describes.

**Table 41-1. IPv6 Routing Defaults**

Parameter	Default Value
IPv6 Unicast Routing Mode	Disabled
IPv6 Hop Limit	Unconfigured
ICMPv6 Rate Limit Error Interval	1000 milliseconds
ICMPv6 Rate Limit Burst Size	100
Interface IPv6 Mode	Disabled
IPv6 Router Route Preferences	Local—0 Static—1 OSPFv3 Intra—110 OSPFv3 Inter—110 OSPFv3 External—110 RIP—120 IBGP—200 EBGP—20 Local BGP—200
IPv6 Router Advertisement Guard	Disabled

Table 41-2 shows the default IPv6 interface values after a VLAN routing interface has been created.


**Table 41-2. IPv6 Interface Defaults**

Parameter	Default Value
IPv6 Mode	Disabled
DHCPv6 Client Mode	Disabled
Stateless Address AutoConfig Mode	Disabled

**Table 41-2. IPv6 Interface Defaults (Continued)**

<b>Parameter</b>	<b>Default Value</b>
Routing Mode	Enabled
Interface Maximum Transmit Unit	1500
Router Duplicate Address Detection Transmits	1
Router Advertisement NS Interval	Not configured
Router Lifetime Interval	1800 seconds
Router Advertisement Reachable Time	0 seconds
Router Advertisement Interval	600 seconds
Router Advertisement Managed Config Flag	Disabled
Router Advertisement Other Config Flag	Disabled
Router Advertisement Suppress Flag	Disabled
IPv6 Destination Unreachables	Enabled

# Configuring IPv6 Routing Features (Web)

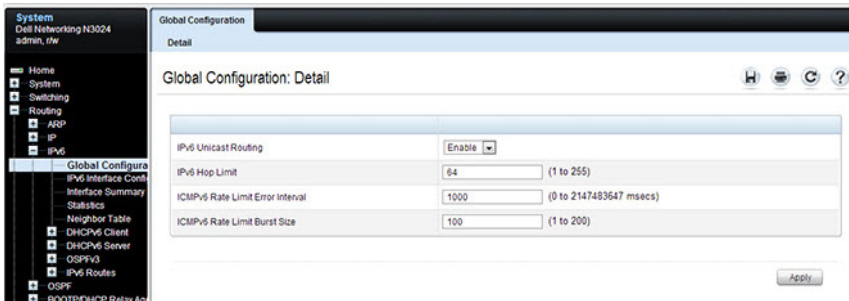
This section provides information about the OpenManage Switch Administrator pages for configuring and monitoring IPv6 unicast routing features on a Dell EMC Networking N3000-ON, N3100-ON, and N3200-ON Series switch. For details about the fields on a page, click  at the top of the Dell EMC OpenManage Switch Administrator web page.

## Global Configuration

Use the **Global Configuration** page to enable IPv6 forwarding on the router, enable the forwarding of IPv6 unicast datagrams, and configure global IPv6 settings.

To display the page, click **Routing** → **IPv6** → **Global Configuration** in the navigation panel.

**Figure 41-1. IPv6 Global Configuration**





## Interface Configuration

Use the **Interface Configuration** page to configure IPv6 interface parameters. This page has been updated to include the IPv6 Destination Unreachables field.

To display the page, click **Routing** → **IPv6** → **Interface Configuration** in the navigation panel.

**Figure 41-2. IPv6 Interface Configuration**

The screenshot displays the 'IPv6 Interface Configuration: Detail' page. The left sidebar shows a navigation tree with 'IPv6' expanded to 'IPv6 Interface Configuration'. The main content area contains the following configuration details:

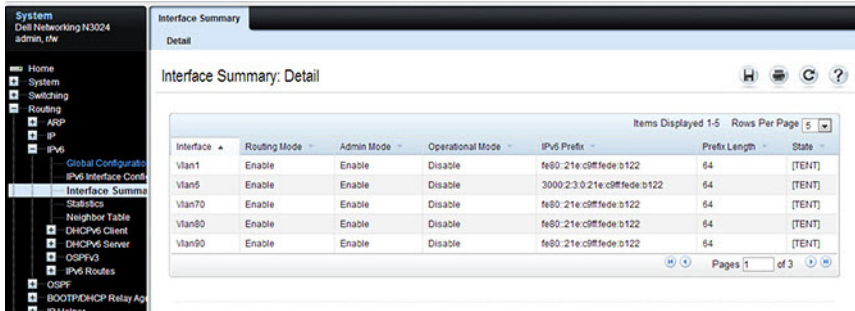
Field	Value	Notes
Interface	Vlan1	
DHCPv6 Client Mode	Disable	
Stateless Address AutoConfig Mode	Disable	
IPv6 Prefix	fe80::21e:cfff:ede:b122:b14	
Current State by Prefix	[TENT]	
Routing Mode	Enable	
IPv6 Enable Mode	Disable	
IPv6 Operational Mode	Disable	
Interface Maximum Transmit Unit	1500	(1280 to 1500). Enter 0 to accept the default.
Router Duplicate Address Detection Transmits	1	(0 to 600)
Router Advertisement NS Interval	0	(1000 to 4294967295 milliseconds) Enter 0 to unconfigure
Router Lifetime Interval	1800	(0 to 9000 seconds)
Router Advertisement Reachable Time	0	(0 to 3600000 milliseconds)
Router Max Advertisement Interval	600	(4 to 1800 seconds)
Router Min Advertisement Interval	200	(3 - (0.75 * Router Max Advertisement Interval))
Router Advertisement Managed Config Flag	Disable	
Router Advertisement Other Config Flag	Disable	
Router Advertisement Suppress Flag	Disable	

## Interface Summary

Use the **Interface Summary** page to display settings for all IPv6 interfaces.

To display the page, click **Routing** → **IPv6** → **Interface Summary** in the navigation panel.

**Figure 41-3. IPv6 Interface Summary**



## IPv6 Statistics

Use the IPv6 Statistics page to display IPv6 traffic statistics for one or all interfaces.

To display the page, click **Routing** → **IPv6** → **IPv6 Statistics** in the navigation panel.

**Figure 41-4. IPv6 Statistics**

The screenshot displays the IPv6 Statistics page. The left navigation pane shows the following structure:

- System
- System
- Switching
- Routing
  - ARP
  - IP
  - IPv6
    - Global Configuration
    - IPv6 Interface Config
    - Interface Summary
    - Statistics**
    - Neighbor Table
    - DHCPv6 Client
    - DHCPv6 Server
    - OSPFv3
    - IPv6 Routes
  - OSPF
  - OSPFv3/DHCP Relay Agent
  - IP Helper
  - RIP
  - Router Discovery
  - Router
  - VRRP
  - Tunnels
  - Loopback Interfaces
  - Policy Based Routing
  - Statistics/RMON
  - Quality of Service
  - IPv4 Multicast
  - IPv6 Multicast

The main content area is titled "Statistics: Detail" and includes a dropdown menu for "Interface" set to "Vlan1". Below this is a table of IPv6 statistics:

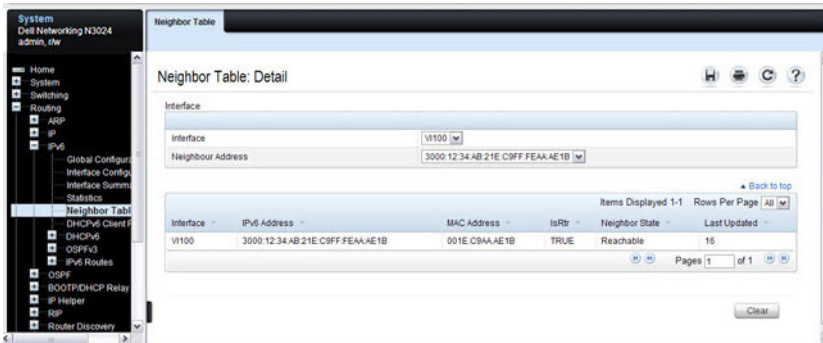
IPv6 Statistics		<a href="#">Back to top</a>
Total Datagrams Received	0	
Received Datagrams Locally Delivered	0	
Received Datagrams Discarded Due To Header Errors	0	
Received Datagrams Discarded Due To MTU	0	
Received Datagrams Discarded Due To No Route	0	
Received Datagrams With Unknown Protocol	0	
Received Datagrams Discarded Due To Invalid Address	0	
Received Datagrams Discarded Due To Truncated Data	0	
Received Datagrams Discarded Other	0	
Received Datagrams Reassembly Required	0	
Datagrams Successfully Reassembled	0	
Datagrams Failed To Reassemble	0	
Datagrams Forwarded	0	
Datagrams Locally Transmitted	0	
Datagrams Transmit Failed	0	
Datagrams Successfully Fragmented	0	

## IPv6 Neighbor Table

Use the IPv6 Neighbor Table page to display IPv6 neighbor details for a specified interface.

To display the page, click IPv6 → IPv6 Neighbor Table in the navigation panel.

Figure 41-5. IPv6 Neighbor Table



## DHCPv6 Client Parameters

Use the **DHCPv6 Client Parameters** page to view information about the network information automatically assigned to an interface by the DHCPv6 server. This page displays information only if the DHCPv6 client has been enabled on an IPv6 routing interface.

To display the page, click **Routing** → **IPv6** → **DHCPv6 Client** → **Lease Parameters** in the navigation panel.

**Figure 41-6. DHCPv6 Lease Parameters**

The screenshot shows a network management interface with a navigation tree on the left and a main configuration area on the right. The navigation tree includes sections for System, Home, System, Switching, Routing, ARP, IP, IPv6, and DHCPv6 Client. The DHCPv6 Client section is expanded to show Lease Parameters. The main area displays the 'Lease Parameters: Detail' page for the 'Vlan1' interface. The page contains a table with the following parameters:

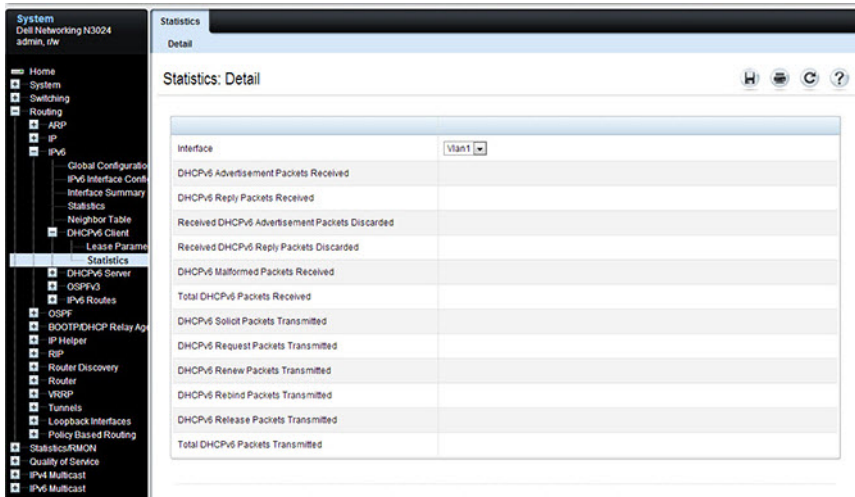
Parameter	Value
Interface	Vlan1
Client State	
Server DUID	
T1 Time (Sec)	
T2 Time (Sec)	
Interface IAD	
Prefix	
Prefix Length	
Prefer LifeTime (Sec)	
Valid LifeTime (Sec)	
Renew Time (Sec)	
Expiry Time (Sec)	

## DHCPv6 Client Statistics

Use the DHCPv6 Client Statistics page to view information about DHCPv6 packets received and transmitted on a DHCPv6 client interface.

To display the page, click **Routing** → **IPv6** → **DHCPv6 Client** → **Statistics** in the navigation panel.

**Figure 41-7. DHCPv6 Client Statistics**

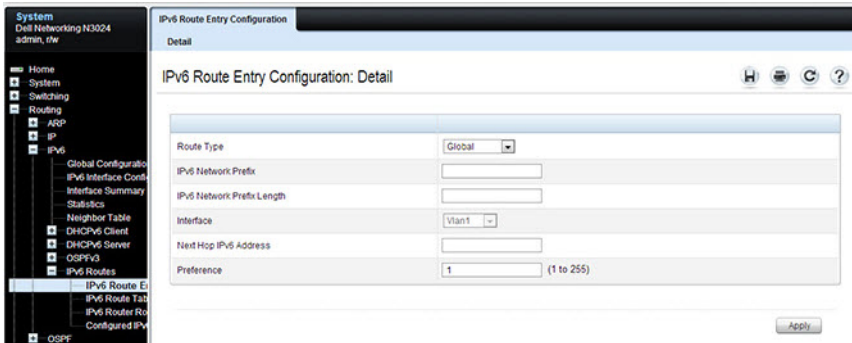


## IPv6 Router Entry Configuration

Use the IPv6 Route Entry Configuration page to configure information for IPv6 routes.

To display the page, click **Routing** → **IPv6** → **IPv6 Routes** → **IPv6 Route Entry Configuration** in the navigation panel.

**Figure 41-8. IPv6 Route Entry Configuration**



## IPv6 Route Table

Use the **IPv6 Route Table** page to display all active IPv6 routes and their settings.

To display the page, click **Routing** → **IPv6** → **IPv6 Routes** → **IPv6 Route Table** in the navigation panel.

**Figure 41-9. IPv6 Route Table**

The screenshot shows a network management interface for a Dell Networking N3048 switch. The left navigation pane is expanded to 'IPv6' > 'IPv6 Routes' > 'IPv6 Route Table'. The main content area is titled 'IPv6 Route Table: Detail'. It includes a 'Routes Displayed' section with a dropdown menu set to 'All Routes' and a 'Number of Routes' field showing '2'. Below this is a table titled 'IPv6 Route Table' with columns for IPv6 Prefix, IPv6 Prefix Length, Protocol, Next Hop Interface, and Next Hop IP Address. The table contains two entries: 2a00:1450:8003::/64 (Connected, Loopback1) and 2a0b:1450::/32 (Connected, Loopback0). The interface also features a 'Pages 1 of 1' indicator and a 'Back to top' link.

IPv6 Prefix	IPv6 Prefix Length	Protocol	Next Hop Interface	Next Hop IP Address
2a00:1450:8003::	64	Connected	Loopback1	::
2a0b:1450::	32	Connected	Loopback0	::

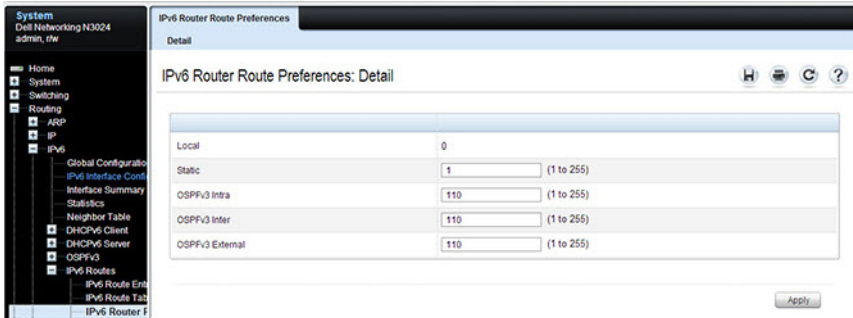


## IPv6 Route Preferences

Use the **IPv6 Route Preferences** page to configure the default preference for each protocol. These values are arbitrary values in the range of 1 to 255 and are independent of route metrics. Most routing protocols use a route metric to determine the shortest path known to the protocol, independent of any other protocol. The best route to a destination is chosen by selecting the route with the lowest preference value. When there are multiple routes to a destination, the preference values are used to determine the preferred route. If there is still a tie, the route with the best route metric is chosen. To avoid problems with mismatched metrics, you must configure different preference values for each of the protocols.


To display the page, click **Routing** → **IPv6** → **IPv6 Routes** → **IPv6 Route Preferences** in the navigation panel.

**Figure 41-10. IPv6 Route Preferences**



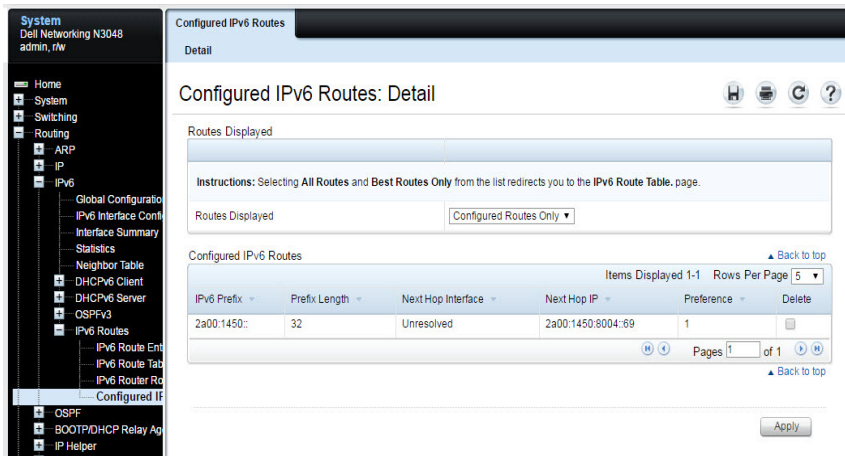
## Configured IPv6 Routes

Use the Configured IPv6 Routes page to display selected IPv6 routes.

 **NOTE:** For a static reject route, the next hop interface value is Null0. Packets to the network address specified in static reject routes are intentionally dropped.

To display the page, click **Routing** → **IPv6** → **IPv6 Routes** → **Configured IPv6 Routes** in the navigation panel.

**Figure 41-11. Configured IPv6 Routes**



The screenshot shows the 'Configured IPv6 Routes: Detail' page. The navigation sidebar on the left includes 'System', 'Switching', 'Routing', 'IPv6', and 'Configured IPv6 Routes'. The main content area displays a table of routes. The table has the following data:

IPv6 Prefix	Prefix Length	Next-Hop Interface	Next-Hop IP	Preference	Delete
2a00:1450::	32	Unresolved	2a00:1450:8004:69	1	<input type="checkbox"/>

To remove a configured route, select the check box in the **Delete** column of the route to remove, and click **Apply**.

# Configuring IPv6 Routing Features (CLI)

This section provides information about the commands used for configuring IPv6 routing on the switch. For more information about the commands, see the *Dell EMC Networking N1100-ON, N1500, N2000, N2100-ON, N2200-ON, N3000E-ON, N3100-ON, and N3200-ON Series Switches CLI Reference Guide* at [www.dell.com/support](http://www.dell.com/support).

## Configuring Global IP Routing Settings

Use the following commands to configure various global IP routing settings for the switch.

Command	Purpose
<code>configure</code>	Enter global configuration mode.
<code>sdm prefer dual-ipv4-and-ipv6 default</code>	Select a Switch Database Management (SDM) template to enable support for both IPv4 and IPv6. Changing the SDM template requires a system reload.
<code>ipv6 unicast-routing</code>	Globally enable IPv6 routing on the switch.
<code>ipv6 hop-limit <i>limit</i></code>	Set the TTL value for the router. The valid range is 0 to 255.
<code>ipv6 icmp error-interval <i>burst-interval</i> [<i>burst-size</i>]</code>	Limit the rate at which IPv4 ICMP error messages are sent. <ul style="list-style-type: none"><li>• <i>burst-interval</i> — How often the token bucket is initialized (Range: 0–2147483647 milliseconds).</li><li>• <i>burst-size</i> — The maximum number of messages that can be sent during a burst interval (Range: 1–200).</li></ul>
<code>exit</code>	Exit to Privileged Exec mode.

## Configuring IPv6 Interface Settings

Use the following commands to configure IPv6 settings for VLAN, tunnel, or loopback interfaces.

Command	Purpose
<code>configure</code>	Enter Global Configuration mode.
<code>interface {vlan   tunnel   loopback} interface-id</code>	Enter Interface Configuration mode for the specified VLAN, tunnel, or loopback interface.
<code>ipv6 enable</code>	Enable IPv6 on the interface. Configuring an IPv6 address will automatically enable IPv6 on the interface.
<code>ipv6 address {autoconfig   dhcp   prefix/prefix-length [eui64]}</code>	<p>Configure the IPv6 address and network prefix length. Setting an IPv6 address enables IPv6 on the interface. The <b>ipv6 enable command</b> can be used to enable IPv6 on the interface without setting an address.</p> <p>Link-local, multicast, IPv4-compatible, and IPv4-mapped addresses are not allowed to be configured. Multiple globally unique unicast addresses (2001::/23) with non-overlapping subnets and one unique local (fc00::/7) address may be configured in addition to the link local address.</p> <p>Include the <b>EUI-64</b> keyword to have the system add the 64-bit interface ID to the address. You must use a network prefix length of 64 in this case.</p> <p>For VLAN interfaces, use the <b>dhcp</b> keyword to enable the DHCPv6 client and obtain an IP address from a network DHCPv6 server.</p>
<code>ipv6 traffic-filter ACL name</code>	Add an access-list filter to this interface.
<code>ipv6 unreachable</code>	(VLAN interfaces only) Allow the interface to send ICMPv6 Destination Unreachable messages. The <b>no ipv6 unreachable</b> command suppresses the ICMPv6 unreachable messages for this interface.
<code>exit</code>	Exit the interface configuration mode.

## Configuring IPv6 Neighbor Discovery

Use the following commands to configure IPv6 Neighbor Discovery settings.

Command	Purpose
<code>ipv6 nd prefix</code> <i>prefix/prefix-length</i> [ <i>{valid-lifetime</i> <i>infinite}</i> <i>{preferred-lifetime</i> <i>infinite}</i> ] [ <i>no-autoconfig</i> ] [ <i>off-link</i> ]	Configure parameters associated with network prefixes that the router advertises in its Neighbor Discovery advertisements. <ul style="list-style-type: none"><li>• <i>ipv6-prefix</i>—IPv6 network prefix.</li><li>• <i>prefix-length</i>—IPv6 network prefix length.</li><li>• <i>valid-lifetime</i>—Valid lifetime of the router in seconds. (Range: 0–4294967295 seconds.)</li><li>• <i>infinite</i>—Indicates lifetime value is infinite.</li><li>• <i>preferred-lifetime</i>—Preferred-lifetime of the router in seconds. (Range: 0–4294967295 seconds.)</li><li>• <i>no-autoconfig</i>—Do not use the prefix for auto configuration.</li><li>• <i>off-link</i>—Do not use the prefix for onlink determination.</li></ul>
<code>ipv6 nd ra-interval</code> <i>maximum minimum</i>	Set the transmission interval between router Neighbor Discovery advertisements. <ul style="list-style-type: none"><li>• <i>maximum</i> — The maximum interval duration (Range: 4–1800 seconds).</li><li>• <i>minimum</i> — The minimum interval duration (Range: 3 – (0.75 * maximum) seconds).</li></ul>
<code>ipv6 nd ra-lifetime</code> <i>seconds</i>	Set the value that is placed in the Router Lifetime field of the router Neighbor Discovery advertisements sent from the interface. <p>The <i>seconds</i> value must be zero, or it must be an integer between the value of the router advertisement transmission interval and 9000 seconds. A value of zero means this router is not to be used as the default router. (Range: 0-9000).</p>
<code>ipv6 nd suppress-ra</code>	Suppress router advertisement transmission on an interface.
<code>ipv6 nd dad attempts</code> <i>value</i>	Set the number of duplicate address detection probes transmitted while doing Neighbor Discovery. <p>The range for <i>value</i> is 0–600.</p>

<b>Command</b>	<b>Purpose</b>
<code>ipv6 nd ns-interval</code> <i>milliseconds</i>	Set the interval between router advertisements for advertised neighbor solicitations. The range is 1000 to 4294967295 milliseconds.
<code>ipv6 nd other-config-flag</code>	Set the <i>other stateful configuration</i> flag in router advertisements sent from the interface.
<code>ipv6 nd managed-config-flag</code>	Set the <i>managed address configuration</i> flag in router advertisements. When the value is true, end nodes use DHCPv6. When the value is false, end nodes automatically configure addresses.
<code>ipv6 nd reachable-time</code> <i>milliseconds</i>	Set the router advertisement time to consider a neighbor reachable after neighbor discovery confirmation.

## Configuring IPv6 Route Table Entries and Route Preferences

Use the following commands to configure IPv6 Static Routes.

Command	Purpose
<code>configure</code>	Enter global configuration mode.
<code>ipv6 route ipv6-prefix/prefix-length {next-hop-address   interface-type interface-number} [preference] [track &lt;object-number&gt;]</code>	<p>Configure a static route. Use the keyword <b>null</b> instead of the next hop router IP address to configure a static reject route.</p> <ul style="list-style-type: none"><li>• <i>prefix/prefix-length</i>—The IPv6 network prefix and prefix length that is the destination of the static route. Use the <code>::/0</code> form (unspecified address and zero length prefix) to specify a default route.</li><li>• <i>interface-type interface-number</i>—Must be specified when using a link-local address as the next hop. The interface-type can be <b>Null0</b>, <b>vlan</b> or <b>tunnel</b>.</li><li>• <i>next-hop-address</i> —The IPv6 address of the next hop that can be used to reach the specified network. A link-local next hop address must have a prefix length of 128. The next hop address cannot be an unspecified address (all zeros), a multicast address, or a loopback address. If a link local next hop address is specified, the interface (VLAN or tunnel), must also be specified.</li><li>• <i>preference</i>—Also known as Administrative Distance, a metric the router uses to compare this route with routes from other route sources that have the same network prefix. (Range: 1-255). Lower values have precedence over higher values. The default preference for static routes is 1. Routes with a preference of 255 are considered as “disabled” and will not be used for forwarding. Routes with a preference metric of 254 are used by the local router but will never be advertised to other neighboring routers.</li><li>• <i>track &lt;object-number&gt;</i>—The optional IP SLA tracking object identifier (Range 1 to 128).</li></ul>
<code>ipv6 route ipv6-prefix/prefix-length null [preference]</code>	Configure a static reject route. IPv6 packets matching the reject route will be silently discarded.

---

<b>Command</b>	<b>Purpose</b>
<code>ipv6 route distance</code> <i>integer</i>	Set the default distance (preference) for static IPv6 routes. Lower route preference values are preferred when determining the best route. The default distance (preference) for static routes is 1.
<code>exit</code>	Exit to Global Config mode.

---



## IPv6 Show Commands

Use the following commands in Privileged Exec mode to view IPv6 configuration status and related data.

Command	Purpose
<code>show sdm prefer</code>	Show the currently active SDM template.
<code>show sdm prefer dual-ipv4-and-ipv6 default</code>	Show parameters for the SDM template.
<code>show ipv6 dhcp interface vlan <i>vlan-id</i></code>	View information about the DHCPv6 lease acquired by the specified interface.
<code>show ipv6 interface {vlan   tunnel   loopback} <i>interface-id</i></code>	View the IP interface configuration information for the specified IPv6 routing interface.
<code>show ipv6 brief</code>	View the global IPv6 settings for the switch.
<code>show ipv6 route [<i>ipv6-address</i>   <i>ipv6-prefix/prefix-length</i>   <i>protocol</i>   <i>interface-type interface-number</i>] [<b>best</b>]</code>	View the routing table. <ul style="list-style-type: none"><li>• <i>ipv6-address</i>—Specifies an IPv6 address for which the best-matching route would be displayed.</li><li>• <i>protocol</i>—Specifies the protocol that installed the routes. Is one of the following keywords: connected, ospf, static.</li><li>• <i>ipv6-prefix/prefix-length</i>—Specifies an IPv6 network for which the matching route would be displayed.</li><li>• <i>interface-type interface-number</i>—Valid IPv6 interface. Specifies that the routes with next-hops on the selected interface be displayed.</li><li>• <b>best</b>—Specifies that only the best routes are displayed. If the connected keyword is selected for protocol, the best option is not available because there are no best or non-best connected routes.</li></ul>
<code>show ipv6 route summary</code>	View summary information about the IPv6 routing table.
<code>show ipv6 route preferences</code>	View detailed information about the IPv6 route preferences.

## IPv6 Static Reject and Discard Routes

A static configured route with a next-hop of “null” causes any packet matching the route to disappear or vanish from the network. This type of route is called a “Discard” route if the router returns an ICMP “network-unreachable” message, or is called a “Reject” route if no ICMP message is returned. The Dell EMC Networking N-Series switches support “Reject” routes, where any packets matching the route network prefix silently disappear.

A common use of a Reject route is to quickly discard packets that cannot be delivered because a valid route to the destination is not known. Without the Reject route, these undeliverable packets will continue to circulate through the network, following the default routes, until their TTL expires. Forwarding packets that cannot be delivered wastes bandwidth, particularly on expensive WAN connections. The Reject route will also suppress a type of “Denial of Service” (DoS) attack where an internal host sends large numbers of packets to unknown destinations, causing congestion of the WAN links.

- `ipv6 route ::/0 null 254`

Use this in all routers except the ones with direct Internet connectivity. Routers with direct Internet connectivity should advertise a default route. The effect of this route is that when a router does not have connectivity to the Internet, the router will quickly discard packets that it cannot deliver.

If the router learns a default route from another router, the learned route will have a lower distance metric and therefore a higher preference. Routes that are more specific (have more bits in the prefix) will have precedence over less specific routes. This will cause packets destined for non-existent networks to be quickly discarded. Also, because of the high distance metric (254), this route will never be advertised to any neighbor routers.

- `ipv6 route fc00::/7 null 254`

This route covers the entire ULA (IPv6 private) address space. If you have networks configured in this address space, you will have more specific routes for those networks. The more specific routes (more bits of prefix) will have precedence over this route. Any destinations in this range not known via another, more specific route do not exist. The effect is that packets destined for private networks that do not exist in your network will be quickly discarded instead of being forwarded to the default route.

- `ipv6 route 2001::/16 null 254`  
`ipv6 route 2002::/16 null 254`

These address ranges are reserved and not reachable in the Internet. If for some reason you have local networks in this range, a more specific route will have precedence.

Another use for the Reject route is to prevent internal hosts from communication with specific addresses or ranges of addresses. The effect is the same as an outgoing access-list with a “deny” statement. A route is generally more efficient than an access-list that performs the same function. If you need more fine-grained filtering, such as protocols or port numbers, use the access-list instead.

## IPv6 Router Advertisement Guard

Dell EMC Networking N-Series switches support IPv6 Router Advertisement Guard (RA-Guard) to protect against attacks via rogue Router Advertisements in accordance with RFC 6105. Dell EMC Networking RA-Guard supports Stateless RA-Guard, where the administrator can configure the interface to allow received router advertisements and router redirect message to be processed/forwarded or dropped.

By default, RA-Guard is not enabled on any interfaces. RA-Guard is enabled/disabled on physical interfaces or port-channels. RA-Guard does not require IPv6 routing to be enabled. This allows VLANs to span interfaces connected to routers and hosts, while allowing configuration such that router advertisements or redirect messages received from connected hosts are dropped (L2 configuration). L3 configuration of RA-Guard on IPv6 routing interfaces is also supported.

Dell EMC Networking supports a single unnamed RA-Guard policy that blocks all incoming IPv6 router advertisements and IPv6 router redirect messages. The single unnamed policy is preconfigured and may not be renamed or removed.

The following example configures the unnamed RA-Guard policy to drop all RA advertisements and router redirect messages on host connected routed interface Gi1/0/1. In the example, routed VLAN 10 is isolated to physical interface Gi1/0/1 connected to a host. IPv6 routing is enabled on VLAN 10 and IPv6 unicast routing is enabled globally. Interface gi1/0/1 is placed into

access mode, meaning untagged incoming and outgoing packets are processed on VLAN 10. RA-Guard is enabled on interface Gil/0/1 and then the configuration is verified with the show command.

```
console (config) #vlan 10
console (config-vlan10) #exit
console (config) #interface vlan 10
console (config-if-vlan10) #ipv6 enable
console (config-if-vlan10) #exit
console (config) #ipv6 unicast-routing
console (config) #interface gil/0/1
console (config-if-Gil/0/1) #switchport mode access
console (config-if-Gil/0/1) #switchport access vlan 10
console (config-if-Gil/0/1) #exit
console (config) #interface gil/0/1
console (config-if-Gil/0/1) #ipv6 nd raguard attach-policy
console (config-if-Gil/0/1) #show ipv6 nd raguard policy
```

Ipv6 RA-Guard Configured Interfaces

Interface	Role
-----	-----
Gil/0/1	Host

The following example configures the unnamed RA-Guard policy to drop all RA advertisements and router redirect messages on host connected interface Gil/0/1. In the example, switched VLAN 10 spans physical interface Gil/0/1 connected to a host as well as interface Tel/0/1 connected to a router. Interface gil/0/1 is placed into access mode, meaning untagged incoming and outgoing packets are processed on VLAN 10. RA-Guard is enabled on interface Gil/0/1 and then the configuration is verified with the show command.

```
console (config) #vlan 10
console (config-vlan10) #exit
console (config) #interface gil/0/1
console (config-if-Gil/0/1) #switchport mode access
console (config-if-Gil/0/1) #switchport access vlan 10
console (config-if-Gil/0/1) #exit
console (config) #interface tel/0/1
console (config-if-Tel/0/1) #switchport mode trunk
console (config-if-Tel/0/1) #exit
console (config) #interface gil/0/1
```

```
console(config-if-Gi1/0/1)#ipv6 nd rguard attach-policy  
console(config-if-Gi1/0/1)#show ipv6 nd rguard policy
```

Ipv6 RA-Guard Configured Interfaces

Interface	Role
-----	-----
Gi1/0/1	Host



# DHCPv6 Server Settings

## Dell EMC Networking N2000, N2100-ON, N3000E-ON, N3100-ON, and N3200-ON Series Switches



**NOTE:** The DHCPv6 Server is not available on the Dell EMC Networking N1100-ON, and N1500 Series switches.

This chapter describes how to configure the switch to dynamically assign network information to IPv6 hosts by using the Dynamic Host Configuration Protocol for IPv6 (DHCPv6).

The topics covered in this chapter include:

- DHCPv6 Overview
- Default DHCPv6 Server and Relay Values
- Configuring the DHCPv6 Server and Relay (Web)
- Configuring the DHCPv6 Server and Relay (CLI)
- DHCPv6 Configuration Examples

## DHCPv6 Overview

DHCP is a protocol that is generally used between clients and servers for the purpose of assigning IP addresses, gateways, and other networking definitions such as Domain Name System (DNS) and Network Time Protocol (NTP) parameters. However, IPv6 natively provides IP address auto configuration through IPv6 Neighbor Discovery Protocol (NDP) and through the use of Router Advertisement messages. Thus, the role of DHCPv6 within the network is different than that of DHCPv4 because DHCPv6 is not the primary source for IP address assignment.

DHCPv6 server and client interactions are described by RFC 3315. There are many similarities between DHCPv6 and DHCPv4 interactions and options, but there are enough differences in the messages and option definitions that there is no DHCPv4 to DHCPv6 migration or interoperability.

## What Is a DHCPv6 Pool?

DHCPv6 pools are used to specify information for DHCPv6 server to distribute to DHCPv6 clients. These pools are shared between multiple interfaces over which DHCPv6 server capabilities are configured.

## What Is a Stateless Server?

DHCPv6 incorporates the notion of the *stateless* server, where DHCPv6 is not used for IP address assignment to a client; rather, it provides other networking information such as DNS or NTP information. The stateless server behavior is described by RFC 3736, which simply contains descriptions of the portions of RFC 3315 that are necessary for stateless server behavior. In order for a router to drive a DHCPv6 client to utilize stateless DHCPv6, the *other stateful configuration* option must be configured for neighbor discovery on the corresponding IPv6 router interface. This, in turn, causes DHCPv6 clients to send the DHCPv6 Information Request message in response. A DHCPv6 server then responds by providing only networking definitions such as DNS domain name and server definitions, NTP server definitions, or SIP definitions.

## What Is the DHCPv6 Relay Agent Information Option?

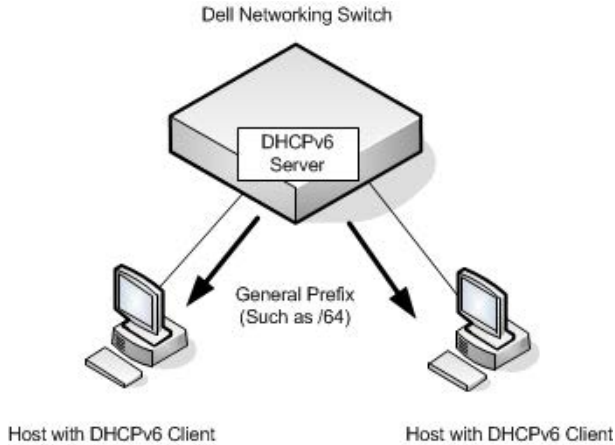
The DHCPv6 Relay Agent Information Option allows for various sub-options to be attached to messages that are being relayed by the local router to a DHCPv6 server. The DHCPv6+ server may in turn use this information in determining an address to assign to a DHCPv6 client. RFC 3315 also describes DHCPv6 Relay Agent interactions, which are very much like DHCPv4 Relay Agents. Additionally, there is a DHCPv6 Relay Agent Option described in RFC 4649, which employs very similar capabilities as those described by the DHCPv4 Relay Agent Option in RFC 2132.

## What Is a Prefix Delegation?

With the larger address space inherent to IPv6, addresses within a network can be allocated more effectively in a hierarchical fashion. DHCPv6 introduces the notion of prefix delegation as described in RFC 3633 as a way for routers to centralize and delegate IP address assignment. Figure 42-1 depicts a typical network scenario where prefix delegation is used.



**Figure 42-1. DHCPv6 Prefix Delegation Scenario**




In Figure 42-1, the Dell EMC Networking switch acts as the Prefix Delegation (PD) server and defines one or more *general* prefixes to allocate and assign addresses to hosts that may be utilizing IPv6 auto-address configuration or acting as DHCPv6 clients.

DHCPv6 clients may request multiple IPv6 prefixes. Also, DHCPv6 clients may request specific IPv6 prefixes. If the configured DHCPv6 pool contains the specific prefix that a DHCPv6 client requests, then that prefix will be delegated to the client. Otherwise, the first available IPv6 prefix within the configured pool will be delegated to the client.

## Default DHCPv6 Server and Relay Values

By default, the DHCPv6 server is disabled, and no address pools are configured. VLAN routing interfaces are not configured to perform DHCPv6 server or DHCPv6 relay functions.

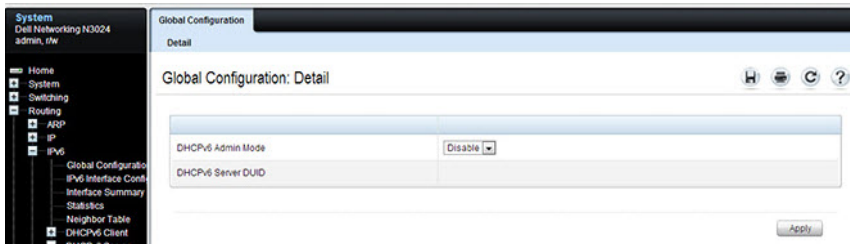
# Configuring the DHCPv6 Server and Relay (Web)

This section provides information about the OpenManage Switch Administrator pages for configuring and monitoring the DHCPv6 server on a Dell EMC Networking N2000, N2100-ON, N3000-ON, N3100-ON, and N3200-ON Series switch. For details about the fields on a page, click  at the top of the Dell EMC OpenManage Switch Administrator web page.

## DHCPv6 Global Configuration

Use the **Global Configuration** page to configure DHCPv6 global parameters. To display the page, click **Routing** → **IPv6** → **DHCPv6 Server** → **Global Configuration** in the navigation panel.

**Figure 42-2. DHCPv6 Global Configuration**

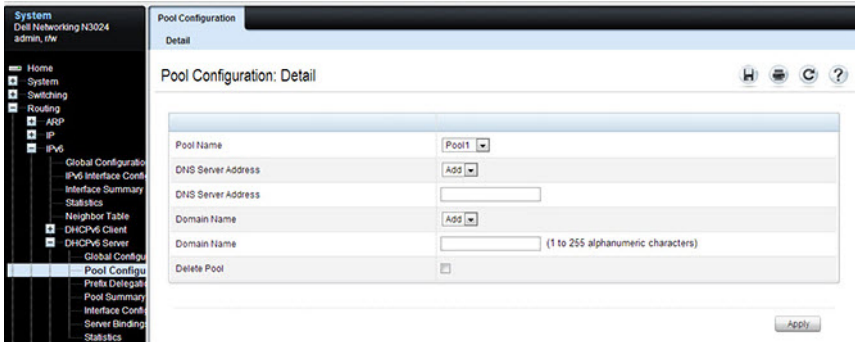


## DHCPv6 Pool Configuration

Use the **Pool Configuration** page to set up a pool of DHCPv6 parameters for DHCPv6 clients. The pool is identified with a pool name and contains IPv6 addresses and domain names of DNS servers.

To display the page, click **Routing** → **IPv6** → **DHCPv6** → **Pool Configuration** in the navigation panel. Figure 42-3 shows the page when no pools have been created. After a pool has been created, additional fields display.

**Figure 42-3. Pool Configuration**

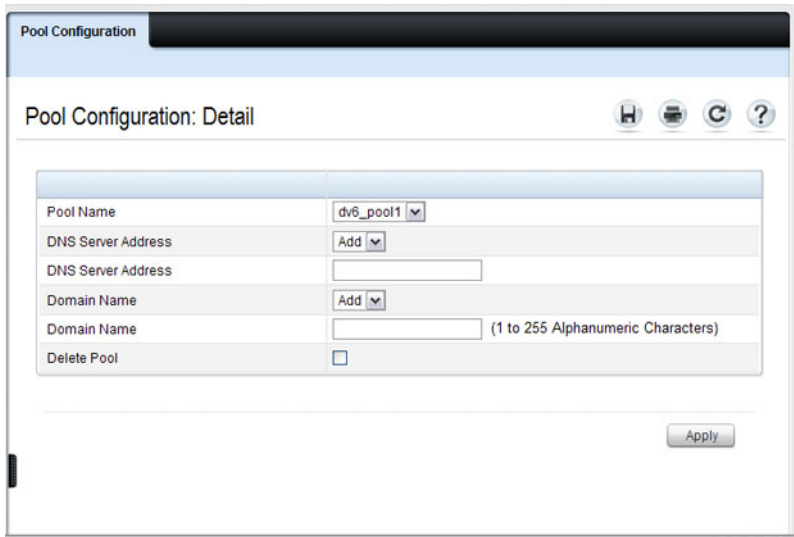


### Configuring a DHCPv6 Pool

To configure the pool:

- 1 Open the **Pool Configuration** page.
- 2 Select **Create** from the **Pool Name** menu and type a name in the **Pool Name** text box.
- 3 Click **Apply**.

**Figure 42-4. Pool Configuration**



- 4 From the **DNS Server Address** menu, select an existing DNS Server Address to associate with this pool, or select **Add** and specify a new server to add.
- 5 From the **Domain Name** menu, select an existing domain name to associate with this pool, or select **Add** and specify a new domain name.
- 6 Click **Apply**.

## Prefix Delegation Configuration

Use the **Prefix Delegation Configuration** page to configure a delegated prefix for a pool. At least one pool must be created using DHCPv6 Pool Configuration before a delegated prefix can be configured.

To display the page, click **Routing** → **IPv6** → **DHCPv6** → **Prefix Delegation Configuration** in the navigation panel.

**Figure 42-5. Prefix Delegation Configuration**

System  
Dell Networking N3024  
admin, fw

Prefix Delegation Configuration  
Detail

Prefix Delegation Configuration: Detail

Pool Name	<input type="text" value="Pool1"/>
Delegated Prefix	<input type="text"/>
Prefix Length	<input type="text"/>
Client DUID	<input type="text"/>
Client Name	<input type="text" value=""/> (0 to 31 characters)
Valid Lifetime	<input type="text" value="604800"/> (0 to 4294967295 secs)
Prefer Lifetime	<input type="text" value="2592000"/> (0 to 4294967295 secs)

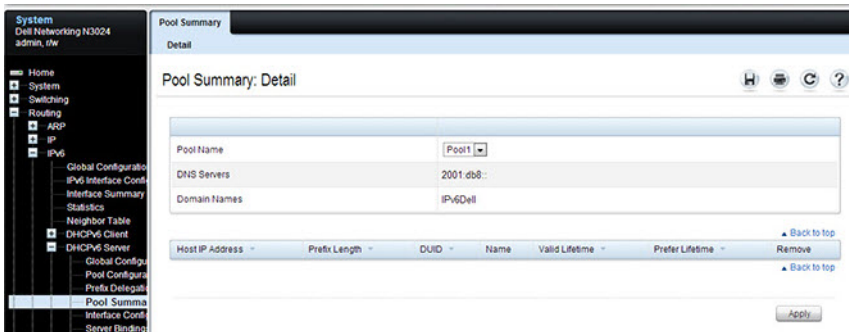
Apply

## DHCPv6 Pool Summary

Use the **Pool Summary** page to display settings for all DHCPv6 Pools. At least one pool must be created using DHCPv6 Pool Configuration before the Pool Summary displays.

To display the page, click **Routing** → **IPv6** → **DHCPv6** → **Pool Summary** in the navigation panel.

**Figure 42-6. Pool Summary**



## DHCPv6 Interface Configuration

Use the DHCPv6 Interface Configuration page to configure a DHCPv6 interface.

To display the page, click **Routing** → **IPv6** → **DHCPv6** → **Interface Configuration** in the navigation panel. The fields that display on the page depend on the selected interface mode.

**Figure 42-7. DHCPv6 Interface Configuration**

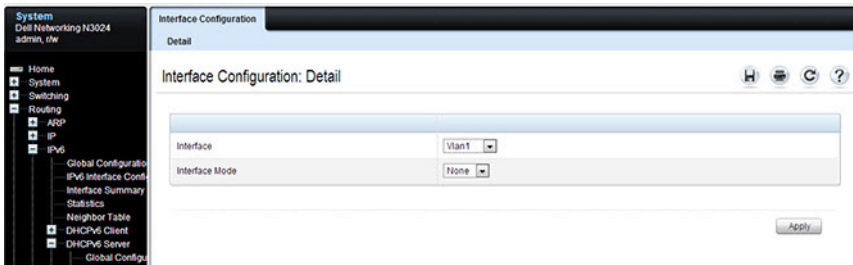


Figure 42-8 shows the screen when the selected interface mode is Server.

**Figure 42-8. DHCPv6 Interface Configuration - Server Mode**

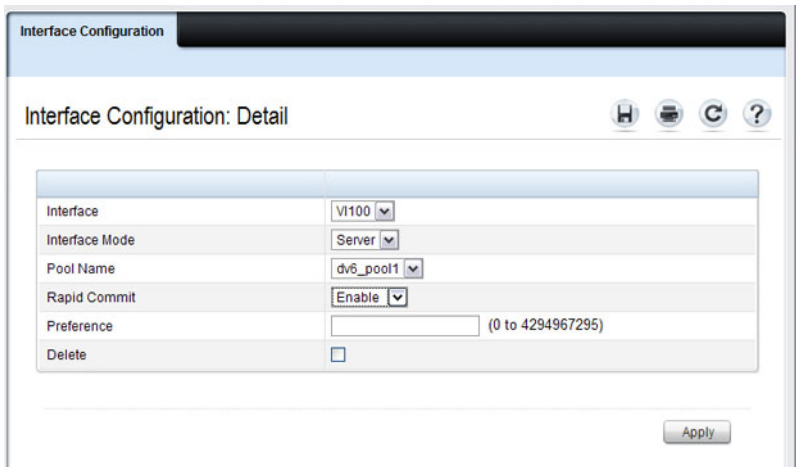
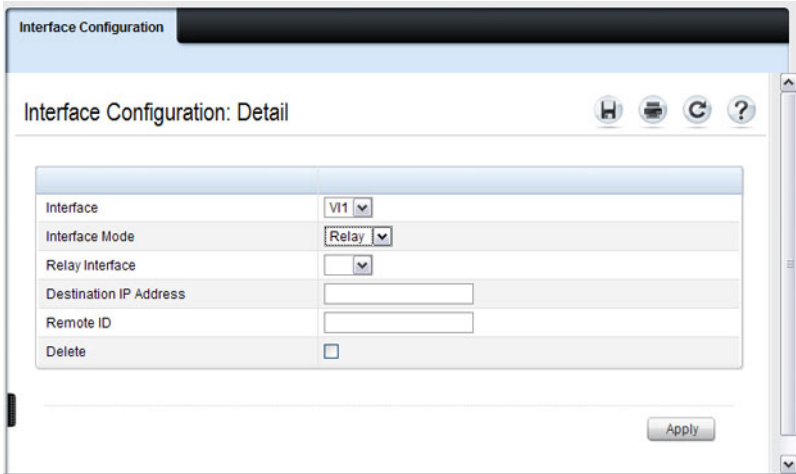


Figure 42-9 shows the screen when the selected interface mode is Relay.

**Figure 42-9. DHCPv6 Interface Configuration - Relay Mode**



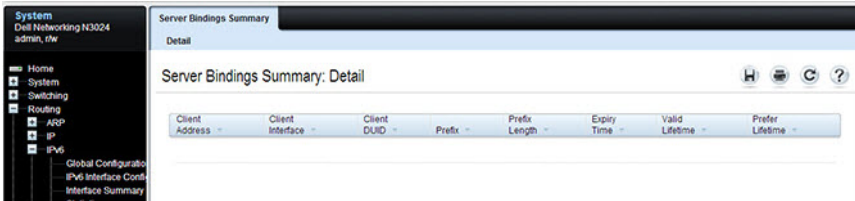


## DHCPv6 Server Bindings Summary

Use the Server Bindings Summary page to display all DHCPv6 server bindings.

To display the page, click **Routing** → **IPv6** → **DHCPv6** → **Bindings Summary** in the navigation panel.

**Figure 42-10. Server Bindings Summary**



## DHCPv6 Statistics

Use the DHCPv6 Statistics page to display DHCPv6 statistics for one or all interfaces.

To display the page, click **Routing** → **IPv6** → **DHCPv6** → **Statistics** in the navigation panel.

**Figure 42-11. DHCPv6 Statistics**

The screenshot shows a network management interface. On the left is a navigation tree with the following structure:

- System
- System
- Switching
- Routing
  - ARP
  - IP
    - IPv6
      - Global Configuration
      - IPv6 Interface Config
      - Interface Summary
      - Statistics
      - Neighbor Table
      - DHCPv6 Client
      - DHCPv6 Server
        - Global Configuration
        - Pool Configuration
        - Prefix Delegation
        - Pool Summary
        - Interface Configuration
        - Server Binding
        - Statistics

- OSPFV3
- IPv6 Routes
- OSPF
- BOOTP/DHCP Relay Agent
- IP Helper
- RIP
- Router Discovery
- Router
- VRRP
- Tunnels
- Loopback Interfaces
- Policy Based Routing
- Status/MON
- Quality of Service
- IPv4 Multicast
- IPv6 Multicast

The main content area is titled "Statistics: Detail" and shows a dropdown menu for "Interface" set to "vlan1". Below this are two sections: "Messages Received" and "Messages Sent".

**Messages Received**

Message Type	Count
DHCPv6 Solicit Packets Received	0
DHCPv6 Request Packets Received	0
DHCPv6 Confirm Packets Received	0
DHCPv6 Renew Packets Received	0
DHCPv6 Rebind Packets Received	0
DHCPv6 Release Packets Received	0
DHCPv6 Decline Packets Received	0
DHCPv6 Inform Packets Received	0
DHCPv6 Relay-forward Packets Received	0
DHCPv6 Relay-reply Packets Received	0
DHCPv6 Malformed Packets Received	0
Received DHCPv6 Packets Discarded	0
Total DHCPv6 Packets Received	0

**Messages Sent**

Message Type	Count
DHCPv6 Advertisement Packets Transmitted	0

## Configuring the DHCPv6 Server and Relay (CLI)

This section provides information about the commands used for configuring and monitoring the DHCP server and address pools. For more information about the commands, see the *Dell EMC Networking N1100-ON, N1500, N2000, N2100-ON, N2200-ON, N3000E-ON, N3100-ON, and N3200-ON Series Switches CLI Reference Guide* at [www.dell.com/support](http://www.dell.com/support).

### Configuring Global DHCP Server and Relay Agent Settings

Use the following commands to configure settings for the DHCPv6 server.

Command	Purpose
<code>configure</code>	Enter Global Configuration mode.
<code>service dhcpv6</code>	Enable the DHCPv6 server.
<code>ipv6 dhcp relay-agent-info-opt <i>option</i></code>	Configure a number to represent the DHCPv6 Relay Agent Information Option. The <i>option</i> parameter is an integer from 54–65535.
<code>ipv6 dhcp relay-agent-info-remote-id-subopt <i>suboption</i></code>	Configure a number to represent the DHCPv6 remote-ID sub-option. The <i>suboption</i> parameter is an integer from 1–65535.
<code>exit</code>	Exit to Privileged Exec mode.
<code>show ipv6 dhcp</code>	Verify the global DHCPv6 server configuration.

### Configuring a DHCPv6 Pool for Stateless Server Support

Use the following commands to create a pool and configure pool parameters for DHCPv6 clients that obtain IPv6 network information dynamically.

Command	Purpose
<code>configure</code>	Enter Global Configuration mode.
<code>ipv6 dhcp pool <i>name</i></code>	Create a DHCPv6 pool and enter DHCPv6 pool configuration mode.
<code>dns-server <i>ipv6-address</i></code>	Set up to eight IPv6 DNS server addresses to provide to a DHCPv6 client by the DHCPv6 server.

Command	Purpose
<code>domain-name</code> <i>domain</i>	Set up to five DNS domain names to provide to a DHCPv6 client by the DHCPv6 server.
CTRL + Z	Exit to Privileged Exec mode.
<code>show ipv6 dhcp pool</code> <i>[name]</i>	View the settings for all DHCPv6 pools or for the specified pool.

## Configuring a DHCPv6 Pool for Specific Hosts

Use the following commands to create a pool and/or configure pool parameters for specific DHCPv6 clients.

Command	Purpose
<code>configure</code>	Enter Global Configuration mode.
<code>ipv6 dhcp pool</code> <i>name</i>	Create a DHCPv6 pool and enter DHCPv6 pool configuration mode.
<code>prefix-delegation</code> <i>ipv6-prefix/prefix-length</i> <i>client-DUID</i> [ <i>name</i> <i>hostname</i> ] [ <i>valid-lifetime</i>   <i>infinite</i> ] [ <i>preferred-lifetime</i> { <i>preferred-lifetime</i>   <i>infinite</i> }]	Define an IPv6 prefixes within a pool for distributing to specific DHCPv6 Prefix delegation clients. <ul style="list-style-type: none"> <li>• <i>prefix/prefix-length</i>—Delegated IPv6 prefix.</li> <li>• <i>client-DUID</i>—DHCP Unique Identifier for the client (e.g. 00:01:00:09:f8:79:4e:00:04:76:73:43:76).</li> <li>• <i>hostname</i>—Client hostname used for logging and tracing. (Range: 0-31 characters.) The command allows spaces in the host name.</li> <li>• <i>valid-lifetime</i>—Valid lifetime for delegated prefix. (Range: 0-4294967295 seconds) or use the keyword <i>infinite</i>.</li> <li>• <i>preferred-lifetime</i>—Preferred lifetime for delegated prefix. (Range: 0-4294967295 seconds) or use the keyword <i>infinite</i>.</li> </ul>
CTRL + Z	Exit to Privileged Exec mode.
<code>show ipv6 dhcp pool</code>	View information about the DHCPv6 pools configured on the switch.

## Configuring DHCPv6 Interface Information

Use the following commands to configure an interface as a DHCPv6 server or a DHCPv6 relay agent. The server and relay functionality are mutually exclusive. In other words, a VLAN routing interface may be configured as a DHCPv6 server or a DHCPv6 relay agent, but not both.

Configuring an interface in DHCP relay mode overwrites DHCP server mode and vice-versa. An IP interface configured in relay mode cannot be configured as a DHCP client (ip address dhcp).

Up to 10 relay destinations may be configured per interface. If a destination relay address has global scope, then the interface option (option 18) is not required. If the destination relay address scope is link local (FE80::) or multicast (FF00::/8), then the destination interface option (option 18) must be configured.

If no relay destination is configured, then a relay interface must be configured and the DHCPV6-ALLAGENTS multicast address (such as, FF02::1:2) is used to relay DHCPv6 messages to the relay server.

Command	Purpose
<code>configure</code>	Enter Global Configuration mode.
<code>service dhcp</code>	Enable the IPv6 DHCP service.
<code>interface {tunnel <i>tunnel-id</i>   vlan <i>vlan-id</i>}</code>	Enter interface configuration mode for a tunnel or VLAN routing interface to configure as a DHCPv6 relay agent.

Command	Purpose
<code>ipv6 dhcp relay</code> <code>{destination relay-address [interface vlan <i>vlan-id</i>]   interface vlan <i>vlan-id</i>   remote-id {duid-<i>ifid</i>   user-defined-string}}</code>	Configure the interface for DHCPv6 relay functionality. <ul style="list-style-type: none"> <li>• <b>destination</b> — Keyword that sets the relay server IPv6 address.</li> <li>• <b>relay-address</b> — An IPv6 address of a DHCPv6 relay server.</li> <li>• <b>interface</b> — Sets the relay server interface.</li> <li>• <b>vlan-id</b> — A valid VLAN ID.</li> <li>• <b>remote-id {duid-<i>ifid</i>   user-defined-string}</b> — The Relay Agent Information Option “remote ID” sub-option to be added to relayed messages. This can either be the special keyword <i>duid-<i>ifid</i></i>, which causes the “remote ID” to be derived from the DHCPv6 server DUID and the relay interface number, or it can be specified as a user-defined string.</li> </ul>
<code>exit</code>	Exit to Global Configuration Mode
<code>interface {tunnel <i>tunnel-id</i>   vlan <i>vlan-id</i>}</code>	Enter interface configuration mode for a tunnel or VLAN routing interface to configure with DHCPv6 server functionality.
<code>ipv6 dhcp server <i>pool-name</i> [rapid-commit] [preference <i>pref-value</i>]</code>	Configure DHCPv6 server functionality on the interface. <ul style="list-style-type: none"> <li>• <b>pool-name</b> — The name of the DHCPv6 pool containing stateless and/or prefix delegation parameters</li> <li>• <b>rapid-commit</b> — Is an option that allows for an abbreviated exchange between the client and server.</li> <li>• <b>pref-value</b> — Preference value—used by clients to determine preference between multiple DHCPv6 servers. (Range: 0-4294967295)</li> </ul>
<code>CTRL + Z</code>	Exit to Privileged Exec Mode.
<code>show ipv6 dhcp interface [tunnel <i>tunnel-id</i>   vlan <i>vlan-id</i>]</code>	View DHCPv6 information for all interfaces or for the specified interface.

## Monitoring DHCPv6 Information

Use the following commands to view bindings, and statistics, and to clear the information.

---

<b>Command</b>	<b>Purpose</b>
<code>show ipv6 dhcp binding</code> [ <i>address</i> ]	View the current binding information in the DHCP server database. Specify the IP address to view a specific binding.
<code>show ipv6 dhcp statistics</code>	View DHCPv6 server and relay agent statistics.
<code>clear ipv6 dhcp statistics</code>	Reset all DHCPv6 server and relay agent statistics to zero.

---

# DHCPv6 Configuration Examples

This section contains the following examples:

- Configuring a DHCPv6 Stateless Server
- Configuring the DHCPv6 Server for Prefix Delegation
- Configuring an Interface as a DHCPv6 Relay Agent

## Configuring a DHCPv6 Stateless Server

This example configures a DHCPv6 pool that will provide information for the DHCPv6 server to distribute to DHCPv6 clients that are members of VLAN 100. To define stateless information for the DHCPv6 server to distribute, multiple DNS domain names and DNS server addresses are defined within the pool.

VLAN routing interface 100 is configured as a DHCPv6 server. Setting NDP on the interface to send the other-config-flag option allows the interface to prompt DHCPv6 clients to request only stateless server information.

To configure the switch:

- 1 Enable the DHCPv6 feature.

```
console#configure
console(config)#service dhcpv6
```

- 2 Create the DHCPv6 pool and configure stateless information.

```
console(config)#ipv6 dhcp pool my-pool
console(config-dhcp6s-pool)#domain-name pengo.dell.com
console(config-dhcp6s-pool)#domain-name dell.com
console(config-dhcp6s-pool)#dns-server 2001:DB8:A328:22C::1
console(config-dhcp6s-pool)#dns-server 2001:DB8:A328:22C::2
```

- 3 Configure VLAN 100 as a routing interface and assign a globally unique IPv6 address.

```
console(config)#interface vlan 100
console(config-if-vlan100)#ipv6 address
2001:DB8:A328:34B::11/32
```

- 4 Configure the DHCPv6 server functionality on VLAN 100. Clients can use the preference value to determine which DHCPv6 server to use when multiple servers exist.

```
console(config-if-vlan100)#ipv6 dhcp server my-pool preference
10
```



```
console (config-if-vlan100) #ipv6 nd other-config-flag
console (config-if-vlan100) #exit
```

## Configuring the DHCPv6 Server for Prefix Delegation

In this example, VLAN routing interface 200 is configured to delegate specific prefixes to certain DHCPv6 clients. The prefix-to-DUID mapping is defined within the DHCPv6 pool.

To configure the switch:

- 1 Create the DHCPv6 pool and specify the domain name and DNS server information.

```
console (config) #ipv6 dhcp pool my-pool2
console (config-dhcp6s-pool) #domain-name dell.com
console (config-dhcp6s-pool) #dns-server 2001:DB8:A328:22C::1
```

- 2 Specify the prefix delegations for specific clients. The first two commands provide multiple prefixes to the same client.

```
console (config-dhcp6s-pool) #prefix-delegation
2001:DB8:1000::/32 00:01:00:09:f8:79:4e:00:04:76:73:43:76
valid-lifetime 600 preferred-lifetime 400
```

```
console (config-dhcp6s-pool) #prefix-delegation
2001:DB8:1001::/32 00:01:00:09:f8:79:4e:00:04:76:73:43:76
valid-lifetime 600 preferred-lifetime 400
```

```
console (config-dhcp6s-pool) #prefix-delegation
2001:DB8:1002::/32 00:01:00:09:f8:79:4e:00:04:76:73:43:76
valid-lifetime 600 preferred-lifetime 400
```

```
console (config-dhcp6s-pool) #exit
```

- 3 Configure the DHCPv6 server functionality on VLAN 200 and specify the pool to use for DHCPv6 clients.

```
console (config) #interface vlan 200
console (config-if-vlan200) #ipv6 dhcp server my-pool2
preference 20
```

## Configuring an Interface as a DHCPv6 Relay Agent

This example configures a VLAN routing interface as a DHCPv6 Relay. The command defines the destination address of the relay server and the interface used for reachability to the relay server.

To configure the switch:

- 1 Create VLAN 300 and define its IPv6 address.

```
console(config)#interface vlan 300  
console(config-if-vlan300)#ipv6 address 2001:DB8:03a::14/64
```

- 2 Configure the interface as a DHCPv6 relay agent and specify the IPv6 address of the relay server. The command also specifies that the route to the server is through the VLAN 100 routing interface.

```
console(config-if-vlan300)#ipv6 dhcp relay destination  
FE80::250:A2FF:FEBF:A056 interface vlan 100  
console(config-if-vlan300)#exit  
console(config)#exit
```

- 3 View the DHCPv6 configuration for VLAN 300.

```
console#show ipv6 dhcp interface vlan 300  
  
IPv6 Interface.....Vl300  
Mode.....Relay  
Relay Address.....FE80::250:A2FF:FEBF:A056  
Relay Interface Number.....Vl100  
Relay Remote ID.....  
Option Flags.....
```

# Differentiated Services

## Dell EMC Networking N-Series Switches

This chapter describes how to configure the Differentiated Services (DiffServ) feature. DiffServ enables traffic to be classified into streams and given certain QoS treatment in accordance with defined per-hop behaviors.

The topics covered in this chapter include:

- DiffServ Overview
- Class-Map Processing
- Configuring DiffServ (Web)
- Configuring DiffServ (CLI)
- DiffServ Configuration Examples

## DiffServ Overview

Standard IP-based networks are designed to provide “best effort” data delivery service. Best effort service implies that the network delivers the data in a timely fashion, although there is no guarantee that it will. During times of congestion, packets may be delayed, sent sporadically, or dropped. For typical Internet applications, such as email and file transfer, a slight degradation in service is acceptable and in many cases unnoticeable. Conversely, any degradation of service has undesirable effects on applications with strict timing requirements, such as voice or multimedia.

## How Does DiffServ Functionality Vary Based on the Role of the Switch?

How you configure DiffServ support in Dell EMC Networking N-Series switch software varies depending on the role of the switch in your network:

- **Edge device:** An edge device handles ingress traffic, flowing towards the core of the network, and egress traffic, flowing away from the core. An edge device separates inbound traffic into a small set of traffic classes, and is responsible for determining a packet's classification. Classification is primarily based on the contents of the Layer-3 and Layer-4 headers, and is recorded in the Differentiated Services Code Point (DSCP) added to a packet's IP header.
- **Interior node:** A switch in the core of the network is responsible for forwarding packets, rather than for classifying them. It decodes the DSCP in an incoming packet, and provides buffering and forwarding services using the appropriate queue management algorithms.

Before configuring DiffServ on Dell EMC Networking N-Series switches, you must determine the QoS requirements for the network as a whole. The requirements are expressed in terms of rules, which are used to classify inbound or outbound traffic on a particular interface.

## What Are the Elements of DiffServ Configuration?

During configuration, you define DiffServ rules in terms of classes, policies, and services:

- **Class:** A class consists of a set of rules that identify which packets belong to the class. Inbound traffic is separated into traffic classes based on Layer-2, Layer-3, and Layer-4 header data. The class type **All** is supported; this specifies that every match criterion defined for the class must be true for a match to occur. Additionally, the class type **Any** is supported; this specifies that if any match criteria defined for the class is true, a match will occur.
- **Policy:** A policy defines the QoS attributes for one or more traffic classes. An attribute identifies the action taken when a packet matches a class rule. An example of an attribute is to mark a packet. The switch supports the ability to assign traffic classes to output CoS queues, and to mirror incoming packets in a traffic stream to a specific egress interface (physical port or LAG).

Dell EMC Networking N-Series switch software supports the **Traffic Conditioning Policy** type which is associated with an inbound traffic class and specifies the actions to be performed on packets meeting the class rules:

- Marking the packet with a given DSCP, IP precedence, or CoS value. Traffic to be processed by the DiffServ feature requires an IP header if the system uses IP Precedence or IP DSCP marking.
- Policing packets by dropping or re-marking those that exceed the class's assigned data rate.
- Counting the traffic within the class.
- **Service:** Assigns a policy to an interface for inbound traffic.



**NOTE:** An 802.1X authenticator or RADIUS server can be used to dynamically assign DiffServ policy to ports when a host connects to a port and authenticates by using 802.1X. For more information, see "How Does the Authentication Server Assign DiffServ Policy or ACLs?" on page 366

## Class-Map Processing

An incoming packet is matched against the criteria in the *match* terms specified in each class-map in a DiffServ policy. The *match* terms (clauses) may refer to one or more MAC, IPv4, and IPv6 access-groups. Use the **match protocol** command to select the type of access-group. Multiple access-group match terms are allowed in a class-map if the match criteria is match-all, each access-group consisting of a list of permit and deny statements. A single access-group is allowed if the match criteria is match-any.

If the built-in class-map match criteria are utilized, an access-group match may not be included in the class-map. Likewise, if an access-group match is specified, the built-in match criteria may not be included.

Conceptually, class-map ACL processing proceeds by attempting to match each of the ACLs listed in the class-map match clauses, in order. If an ACL does not match, processing moves to the next ACL, in order, until an ACL matches, or the ACL list is exhausted. If there are more match terms in the class-map, processing proceeds with the next match term, in the order specified. In reality, all rule matches in an access-group are attempted in

parallel at once, and the priority of the ACL is used to implement the conceptual match process. There are no counters instantiated for ACLs referred to by a class-map.

An ACL that is used in a class-map *match* term itself has one or more permit and/or deny rules. The incoming packet is matched sequentially against the permit rules in each ACL in the match list, in order, and a match/no match decision is reached. If a permit rule in an ACL in the list matches, the ACL match criteria is met and no further match processing takes place in the class-map. If a deny rule in an access-group in the list matches, the ACL no match criteria is met and no further match processing takes place.

ACLs in an access-group referred to in a class map do not have counters enabled. The hit counts will always be zero.

If none of the rules in an access-group matches, the packet match is attempted against the next access-group in the class-map match list. Once a match has occurred, if the decision reached in the above step is match, then DiffServ executes the action specified in the set term(s) of the DiffServ policy.

If the decision reached in the above step is no match, then DiffServ does not apply any action that is specified in set term(s) in the policy-map statement. The processing logic terminates, and the packet goes through the standard destination-based switching logic.

The switch supports either access-group match criteria or regular DiffServ match criteria in a policy map, but not both. If match criteria other than a match access-group are configured in a policy, configuration of access-group match criteria is rejected and vice-versa.

## Default DiffServ Values

Table 43-1 shows the global default values for DiffServ.


**Table 43-1. DiffServ Global Defaults**

Parameter	Default Value
DiffServ	Enabled
Classes	None configured
Policies	None configured

**Table 43-1. DiffServ Global Defaults**

Parameter	Default Value
Services	None configured

## Configuring DiffServ (Web)

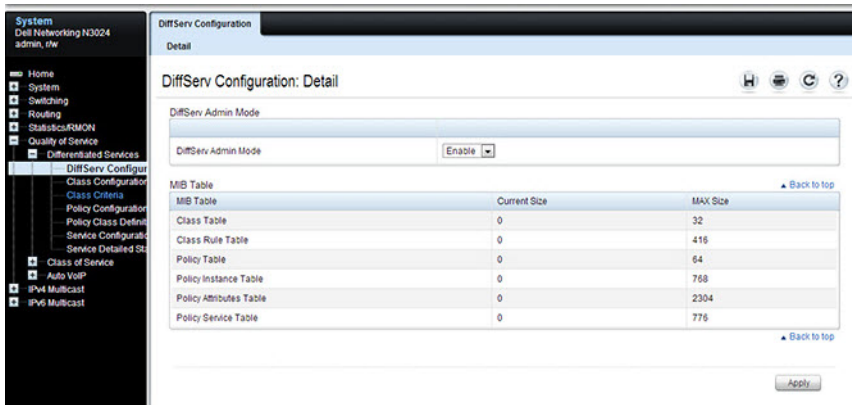
This section provides information about the OpenManage Switch Administrator pages for configuring and monitoring DiffServ features on Dell EMC Networking N1100-ON, N1500, N2000, N2100-ON, N2200-ON, N3000-ON, N3100-ON, and N3200-ON Series switches. For details about the fields on a page, click  at the top of the Dell EMC OpenManage Switch Administrator web page.

### DiffServ Configuration

Use the DiffServ Configuration page to display the DiffServ administrative mode setting as well as the current and maximum number of rows in each of the main DiffServ private MIB tables.

To display the page, click **Quality of Service** → **Differentiated Services** → **DiffServ Configuration** in the navigation panel.

**Figure 43-1. DiffServ Configuration**

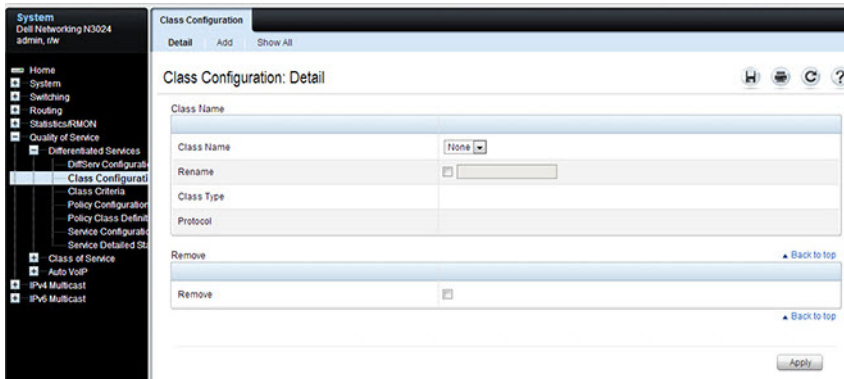


## Class Configuration

Use the DiffServ Class Configuration page to add a new DiffServ class name, or to rename or delete an existing class.

To display the page, click **Quality of Service** → **Differentiated Services** → **Class Configuration** in the navigation panel.

**Figure 43-2. DiffServ Class Configuration**

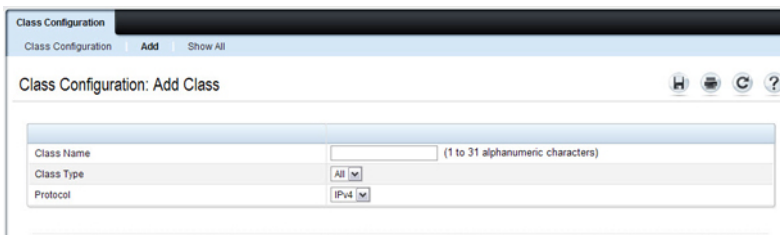


### Adding a DiffServ Class

To add a DiffServ class:

- 1 From the DiffServ Class Configuration page, click **Add** to display the Add Class page.

**Figure 43-3. Add DiffServ Class**



- 2 Enter a name for the class and select the protocol to use for class match criteria.



- 3 Click **Apply** to add the new class.
- 4 To view a summary of the classes configured on the switch, click **Show All**.

**Figure 43-4. View DiffServ Class Summary**

▲	Class Name ▼	Class Type ▼	Reference Class ▼	Protocol ▼
1	ds_class1	All		IPv4
2	ds_class2	All	ds_class1	IPv4

## Class Criteria

Use the **DiffServ Class Criteria** page to define the criteria to associate with a DiffServ class. As packets are received, these DiffServ classes are used to identify packets.

To display the page, click **Quality of Service** → **Differentiated Services** → **Class Criteria** in the navigation panel.

**Figure 43-5. DiffServ Class Criteria**

The screenshot displays the 'Class Criteria: Detail' configuration page. The left sidebar shows a navigation tree with the following structure:

- System
  - Diff Networking N3024
  - admin, rw
  - Home
  - System
  - Switching
  - Routing
  - Statistics/RMON
  - Quality of Service
    - Differentiated Services
      - DiffServ Configurati...
      - Class Configurati...
      - Class Criteria
      - Policy Configurati...
      - Policy Class Defini...
      - Service Configurati...
      - Service Detailed St...
    - Class of Service
    - Auto VoIP
  - IPv4 Multicast
    - Policy Configurati...
    - Policy Class Defini...
    - Service Configurati...
    - Service Detailed St...
  - Class of Service
  - Auto VoIP
  - IPv4 Multicast
    - Service Configurati...
    - Service Detailed St...
  - Class of Service
  - Auto VoIP
  - IPv4 Multicast
  - IPv6 Multicast

The main configuration area is titled 'Class Criteria: Detail' and contains the following sections:

- Class:**
  - Class Name: None
  - Class Type: (empty)
- Match Attributes:**
  - Source IP Address:  [ ] Subnet Mask: [ ]
  - Destination IP Address:  [ ] Subnet Mask: [ ]
  - Source L4 Port:   Select From List [ ]  Match to Port [ ] (0 - 65535)
  - Destination L4 Port:   Select From List [ ]  Match to Port [ ] (0 - 65535)
  - Protocol:   Select From List [ ]  Match to Protocol ID [ ] (0 - 255)
  - EtherType:   Select From List [ ]  Match to Value [ ] (0600 - FFFF)
  - Class of Service:  [ ] (0 - 7)
  - Source MAC Address:  [ ] (0000.XXXX.XXXX) Source MAC Mask: [ ] (0000.XXXX.XXXX)
  - Destination MAC Address:  [ ] (0000.XXXX.XXXX) Destination MAC Mask: [ ] (0000.XXXX.XXXX)
  - VLAN ID:  [ ] (1 - 4095)
  - Reference Class:  Add DiffServ Class [ ]
- Service Type:**
  - IP DSCP:   Select From List [ ]  Match to Value [ ] (0 - 63)
  - IP Precedence:  [ ] (0 - 7)
  - IP TOS Bits:  [ ] (00 - FF) IP TOS Mask: [ ] (00 - FF)
- Match:**
  - Match Every:

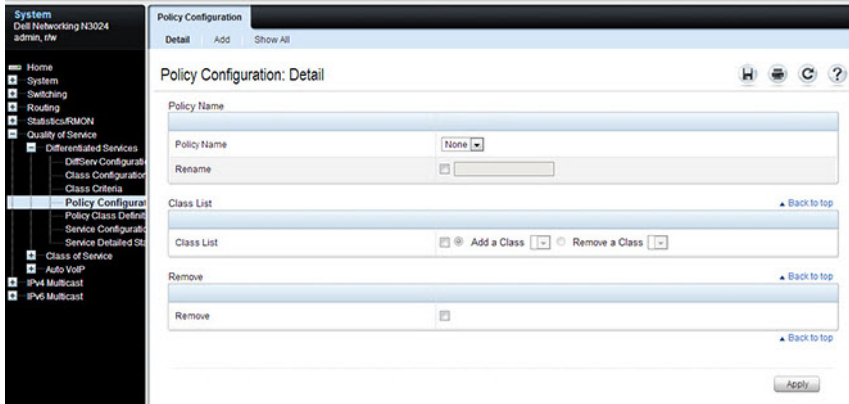
An 'Apply' button is located at the bottom right of the configuration area.

## Policy Configuration

Use the **DiffServ Policy Configuration** page to associate a collection of classes with one or more policy statements.

To display the page, click **Quality of Service** → **Differentiated Services** → **Policy Configuration** in the navigation panel.

**Figure 43-6. DiffServ Policy Configuration**



### Adding a New Policy Name

To add a policy:

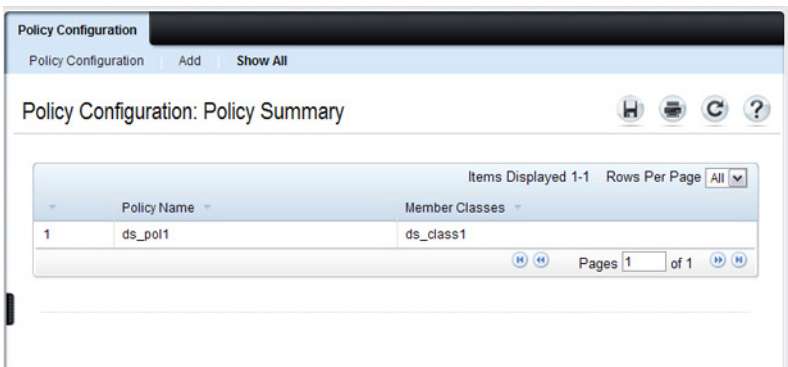
- 1 From the DiffServ Policy Configuration page, click **Add** to display the **Add Policy** page.

**Figure 43-7. Add DiffServ Policy**



- 2 Enter the new **Policy Name**.
- 3 Click **Apply** to save the new policy.
- 4 To view a summary of the policies configured on the switch, click **Show All**.

**Figure 43-8. View DiffServ Policies**



## Policy Class Definition

Use the **DiffServ Policy Class Definition** page to associate a class to a policy, and to define attributes for that policy-class instance.

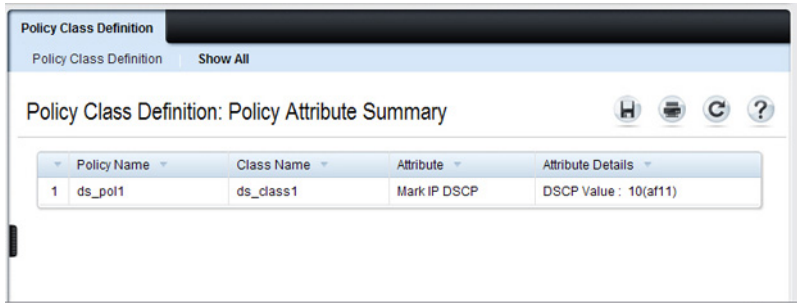
To display the page, click **Quality of Service** → **Differentiated Services** → **Policy Class Definition** in the navigation panel.

**Figure 43-9. DiffServ Policy Class Definition**

The screenshot displays the 'Policy Class Definition: Detail' configuration page. On the left is a navigation tree with 'Policy Class Definition' highlighted. The main area has a 'Policy' section with 'Policy Name' set to 'None' and 'Member Classes' as an empty list. Below is the 'Attributes' section, which includes an instruction: 'Instructions: Selecting Marking or Policing from the Traffic Conditioning list redirects you to the associated configuration page.' The attributes are: 'Drop Packets' (checked), 'Assign Queue' (checked, value 0-5), 'Traffic Conditioning' (checked, value 'Configured: None'), 'Redirect Interface' (checked, 'Unit 1 Port Gi1/0/1'), and 'Flow Based Mirroring' (checked, 'Unit 1 Port Gi1/0/1'). An 'Apply' button is located at the bottom right of the page.

To view a summary of the policy attributes, click **Show All**.

**Figure 43-10. Policy Class Definition**



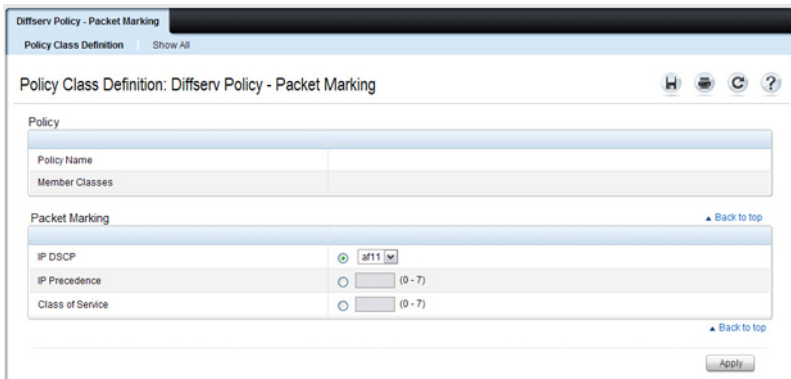
**Packet Marking Traffic Condition**

Follow these steps to have packets that match the class criteria for this policy marked with a marked with either an IP DSCP, IP precedence, or CoS value:

- 1 Select Marking from the **Traffic Conditioning** drop-down menu on the **DiffServ Policy Class Definition** page.

The **Packet Marking** page displays.

**Figure 43-11. Policy Class Definition - Attributes**



- 2 Select **IP DSCP**, **IP Precedence**, or **Class of Service** to mark for this policy-class.
- 3 Select or enter a value for this field.
- 4 Click **Apply** to define the policy-class.

## Policing Traffic Condition

Follow these steps to perform policing on the packets that match this policy class:

- 1 Select **Policing** from the **Traffic Conditioning** drop-down menu on the **DiffServ Policy Class Definition** page to display the **DiffServ Policy - Policing** page.

**Figure 43-12. Policy Class Definition - Policing**

Policing	
Policy Name	
Class Name	
Policing Style	Police Simple
Color Mode	Color Blind
Conform Action Selector	Send
Violate Action	Drop

The **DiffServ Policy - Policing** page displays the **Policy Name**, **Class Name**, and **Policing Style**.

Select a value for the following fields:

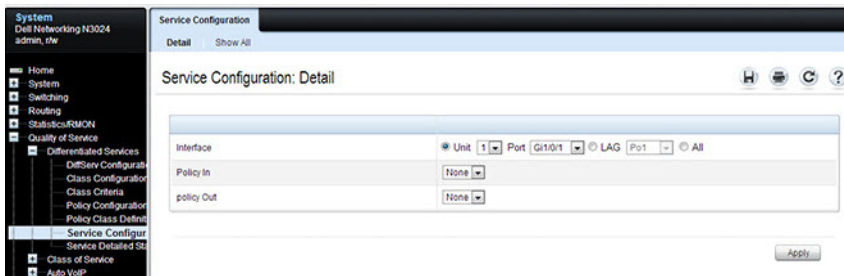
- **Color Mode** — The type of color policing used: Color Blind or Color Aware.
  - **Conform Action Selector** — The action taken on packets that are considered conforming (below the police rate). Options are Send, Drop, Mark CoS, Mark IP DSCP, Mark IP Precedence.
  - **Violate Action** — The action taken on packets that are considered non-conforming (above the police rate). Options are Send, Drop, Mark CoS, Mark IP DSCP, Mark IP Precedence.
- 2 Click **Apply**.

The policy-class is defined, and the device is updated.

## Service Configuration

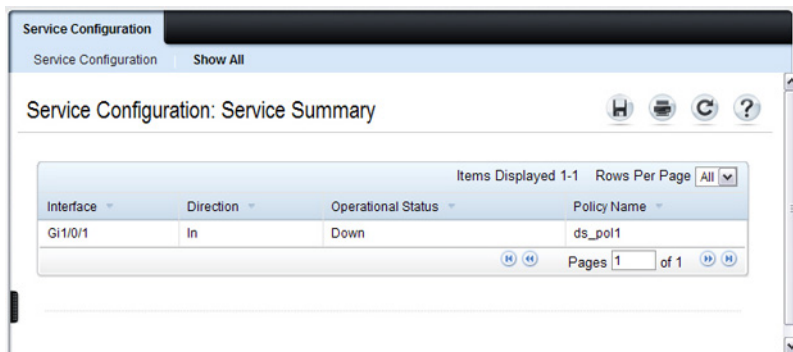
Use the DiffServ Service Configuration page to activate a policy on a port. To display the page, click **Quality of Service** → **Differentiated Services** → **Service Configuration** in the navigation panel.

**Figure 43-13. DiffServ Service Configuration**



To view a summary of the services configured on the switch, click **Show All**.

**Figure 43-14. DiffServ Service Summary**



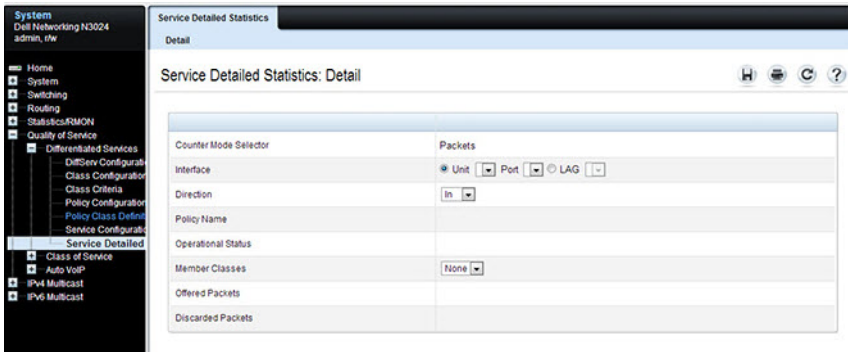


## Service Detailed Statistics

Use the DiffServ Service Detailed Statistics page to display packet details for a particular port and class.

To display the page, click **Quality of Service** → **Differentiated Services** → **Service Detailed Statistics** in the navigation panel.

**Figure 43-15. DiffServ Service Detailed Statistics**

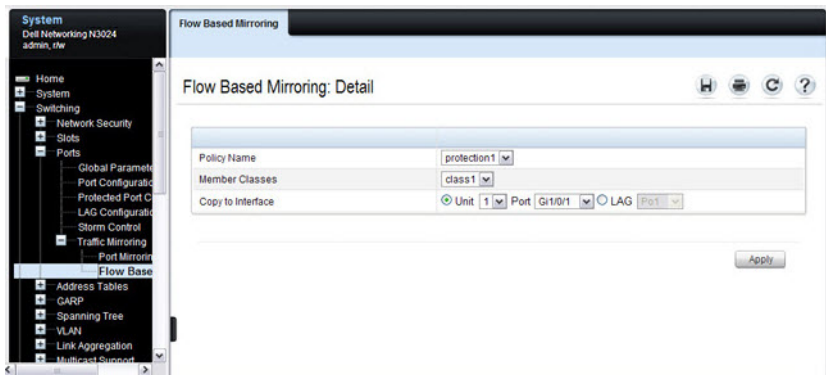


## Flow-Based Mirroring

Use the **Flow-Based Mirroring** page to create a mirroring session in which the traffic that matches the specified policy and member class is mirrored to a destination port.

To display the **Flow-Based Mirroring** page, click **Switching** → **Ports** → **Traffic Mirroring** → **Flow-Based Mirroring** in the navigation panel.

**Figure 43-16. Flow-Based Mirroring**



## Configuring DiffServ (CLI)

This section provides information about the commands used for configuring DiffServ settings on the switch. For more information about the commands, see the *Dell EMC Networking N1100-ON, N1500, N2000, N2100-ON, N2200-ON, N3000E-ON, N3100-ON, and N3200-ON Series Switches CLI Reference Guide* at [www.dell.com/support](http://www.dell.com/support).

### DiffServ Configuration (Global)

Use the following commands to configure the global DiffServ mode and view related settings.

CLI Command	Description
<code>configure</code>	Enter global configuration mode.
<code>diffserv</code>	Set the DiffServ operational mode to active.
<code>exit</code>	Exit to Privileged Exec mode.
<code>show diffserv</code>	Display the DiffServ general information, which includes the current administrative mode setting as well as the current and maximum number of DiffServ components.

## DiffServ Class Configuration for IPv4

Use the following commands to configure DiffServ classes for IPv4 and view related information.

CLI Command	Description
configure	Enter global configuration mode.
class-map [match-all   match-any] <i>class-map-name</i>	Define a new DiffServ class and enter Class-Map Configuration mode for the specified class.  The <b>match-all</b> parameter indicates that all match criteria must match.  The <b>match-any</b> parameter indicates that at least one match criteria must match.  <b>NOTE:</b> To enter Class-Map Configuration mode for a class that has already been created, use the <b>class-map <i>class-map-name</i></b> command.
match access-group <i>group-name</i>	Configure a match condition using an IPv4 ACL. Only the permit/deny conditions are used to match packets. Any ACL actions are ignored. A permit clause that matches the packet indicates a match condition for the class-map. A deny clause that matches the packet indicates a no match condition for the class-map.
match [all   any]	Configure the match condition for the class-map. Match all indicates that all match criteria must match. Match any indicates that at least one match criteria must match. This configuration does not affect the processing of access-groups.
match class-map	Add to the specified class definition the set of match conditions defined for another class.
match dstip	Add to the specified class definition a match condition based on the destination IP address of a packet.
match dstl4port	Add to the specified class definition a match condition based on the destination Layer-4 port of a packet using a single keyword, or a numeric notation.

CLI Command	Description
match ip dscp	Add to the specified class definition a match condition based on the value of the IP DiffServ Code Point (DSCP) field in a packet.
match ip precedence	Add to the specified class definition a match condition based on the value of the IP.
match ip tos	Add to the specified class definition a match condition based on the value of the IP TOS field in a packet.
match srcip	Add to the specified class definition a match condition based on the source IP address of a packet.
match src4port	Add to the specified class definition a match condition based on the source Layer-4 port of a packet using a single keyword, a numeric notation, or a numeric range notation.

## DiffServ Class Configuration for IPv6

Use the following commands to configure DiffServ classes for IPv6 and view related information.

CLI Command	Description
configure	Enter global configuration mode.
class-map [match-any   match-all] <i>class-map-name</i>	Define a new DiffServ class.
match protocol ipv6	Configure the type of ACL match.
match access-group <i>group-name</i>	Configure a match condition using an IPv6 ACL. Only the permit/deny conditions are used to match packets. Any ACL actions are ignored. A permit clause that matches the packet indicates a match condition for the class-map. A deny clause that matches the packet indicates a no match condition for the class-map.

<b>CLI Command</b>	<b>Description</b>
<code>match [any]</code>	Configure the match condition for the class-map. Match any indicates that at least one match criteria must match. This configuration does not affect the processing of access-groups.
<code>match class-map</code>	Add to the specified class definition, the set of match conditions defined for another class.
<code>match dstip6</code>	Add to the specified class definition a match condition based on the destination IPv6 address of a packet.
<code>match dstl4port</code>	Add to the specified class definition a match condition based on the destination Layer-4 port of a packet using a single keyword, or a numeric notation.
<code>match ip6flowlbl</code>	Add to the specified class definition a match condition based on the IPv6 flow label of a packet.
<code>match ip dscp</code>	Add to the specified class definition a match condition based on the value of the IP DiffServ Code Point (DSCP) field in a packet.
<code>match srcip6</code>	Add to the specified class definition a match condition based on the source IPv6 address of a packet.
<code>match srcl4port</code>	Add to the specified class definition a match condition based on the source Layer-4 port of a packet using a single keyword, a numeric notation, or a numeric range notation.

## DiffServ Protocol Matching

DiffServ may be configured to match on protocols other than IPv4 or IPv6. Use the following commands to specify L2 or other match criteria.

CLI Command	Description
<code>match cos</code>	Add to the specified class definition, a match condition for the Class of Service value.
<code>match destination-address mac</code>	Add to the specified class definition, a match condition based on the destination MAC address of a packet.
<code>match ethertype <i>ethertype</i></code>	Add to the specified class definition, a match condition based on the value of the EtherType.
<code>match protocol {arp icmp igmp ip ipv6 tcp  udp gre icmp-v6 <i>identifier</i>  none}</code>	Specify the L3 protocol on which to match. ARP, IP, IPv6 and identifier are EtherType only matches. ICMP, IGMP, TCP, UDP, GRE, and ICMP-V6 also match on the IPv4 protocol or IPv6 Next Header. The none keyword removes the EtherType and associated protocol match criteria.
<code>match source-address mac</code>	Add to the specified class definition a match condition based on the source MAC address of the packet.
<code>match secondary-cos</code>	Configure a match condition based on a secondary CoS value.
<code>match secondary-vlan</code>	Configure a match condition based on a secondary VLAN value.
<code>match vlan</code>	Add to the specified class definition a match condition based on the value of the Layer-2 VLAN Identifier field.

## DiffServ Policy Creation

Use the following commands to configure DiffServ policies and view related information.

CLI Command	Description
configure	Enter global configuration mode.
policy-map <i>policy-name</i> in	Create a new DiffServ policy for ingress traffic and enter Policy Map Configuration mode for the policy.
exit	Exit to Privilege Exec mode.
show policy-map	Displays all configuration information for the specified policy.
show policy-map <i>interface</i> in	Displays policy-oriented statistics information for the specified interface.

## Simple DiffServ Policy Attributes Configuration

Beginning in Privilege Exec mode, use the following commands to configure policy attributes and view related information. Information regarding configuration of single-rate three color meters (srTCM) and two-rate three color meters (trTCM) can be found in "WRED" on page 1563.

CLI Command	Description
configure	Enter global configuration mode.
policy-map <i>policy-map-name</i>	Enter Policy Map Configuration mode for the specified policy.
class <i>class-name</i>	Create an instance of a class definition within the specified policy for the purpose of defining treatment of the traffic class through subsequent policy attribute statements. Also enters Policy-Class-Map Configuration mode for the policy-class-map instance. The class-map must exist.
assign-queue <i>queue-id</i>	Modify the queue ID (range: 0–6) to which the associated traffic stream is assigned.



CLI Command	Description
<pre>police-simple {<i>datarate</i> <i>burstsize</i> conform-action {drop   set-cos-transmit <i>cos</i>   set-prec-transmit <i>cos</i>   set- dscp-transmit <i>dscpval</i>   transmit} [<i>violate-action</i> {drop   set-cos-transmit <i>cos</i>   set-prec-transmit <i>cos</i>   set- dscp-transmit <i>dscpval</i>   transmit}]}</pre>	<p>Establish the traffic policing style for the specified class. The simple form of the police command uses a single data rate and burst size, resulting in two outcomes: conform and nonconform.</p> <ul style="list-style-type: none"> <li>• <i>datarate</i> — Data rate in kilobits per second (kbps). (Range: 1–4294967295)</li> <li>• <i>burstsize</i> — Burst size in Kbps (Range: 1–128)</li> <li>• <b>conform action</b> — Indicates what happens when the packet is conforming to the policing rule: it could be dropped, it could have its CoS modified, it could have its IP precedence modified, or it could have its DSCP modified. The same actions are available for packets that do not conform to the policing rule.</li> <li>• <i>cos</i> — Class of Service value. (Range: 0–7)</li> <li>• <i>dscpval</i> — DSCP value. (Range: 0–63 or a keyword from this list, af11, af12, af13, af21, af22, af23, af31, af32, af33, af41, af42, af43, be, cs0, cs1, cs2, cs3, cs4, cs5, cs6, cs7, ef)</li> </ul>
<pre>conform-color <i>class-map-name</i> [<i>exceed-color class-map-name</i>]</pre>	<p>Specify the color class for color-aware policing.</p> <p>The action for the policy-class-map instance must be set to <b>police-simple</b> before issuing the <b>conform-color</b> command.</p>
<pre>drop</pre>	<p>Specify that all matching packets for the associated traffic stream are to be dropped.</p>
<pre>mark cos <i>cos-value</i></pre>	<p>Mark all packets for the associated traffic stream with the specified class of service value (range: 0–7) in the priority field of the 802.1p header.</p>
<pre>mark ip-dscp <i>dscp-value</i></pre>	<p>Mark all packets for the associated traffic stream with the specified IP DSCP value.</p>
<pre>mark ip-precedence <i>value</i></pre>	<p>Mark all packets for the associated traffic stream with the specified IP precedence value (range: 0–7).</p>

<b>CLI Command</b>	<b>Description</b>
<code>mirror <i>interface</i>   redirect <i>interface</i></code>	Use <b>mirror</b> to mirror all packets for the associated traffic stream that matches the defined class to the specified destination port or LAG.  Use <b>redirect</b> to specify that all incoming packets for the associated traffic stream are redirected to the specified destination port or LAG.
<code>exit</code>	Exit to Policy-Map Config mode.
<code>exit</code>	Exit to Global Config mode.
<code>exit</code>	Exit to Privilege Exec mode.
<code>show policy-map <i>policy-map-name</i></code>	Displays configuration information for the specified policy.

## DiffServ Service Configuration

Beginning Privilege Exec mode, use the following commands to associate a policy with an interface and view related information.

CLI Command	Description
<code>configure</code>	Enter Global Configuration mode.
<code>interface interface-idd</code>	Enter interface configuration mode for the desired interface.
<code>service-policy {in   out} <i>policy-map-name</i></code>	Attach a policy to an interface in the inbound or outbound direction.  This command can be used in either Global Configuration mode (for all system interfaces) or Interface Configuration mode (for a specific interface).
<code>exit</code>	Exit to Privilege Exec mode.
<code>show diffserv service brief [in   out]</code>	Display all interfaces in the system to which a DiffServ policy has been attached.
<code>show diffserv service interface <i>interface</i> {in   out}</code>	Display policy service information for the specified interface, where <i>interface</i> is replaced by <b>gigabitethernet</b> <i>unit/slot/port</i> , <b>tengigabitethernet</b> <i>unit/slot/port</i> , or <b>port-channel</b> <i>port-channel number</i> .
<code>show service-policy {in   out}</code>	Display a summary of policy-oriented statistics information for all interfaces.

# DiffServ Configuration Examples

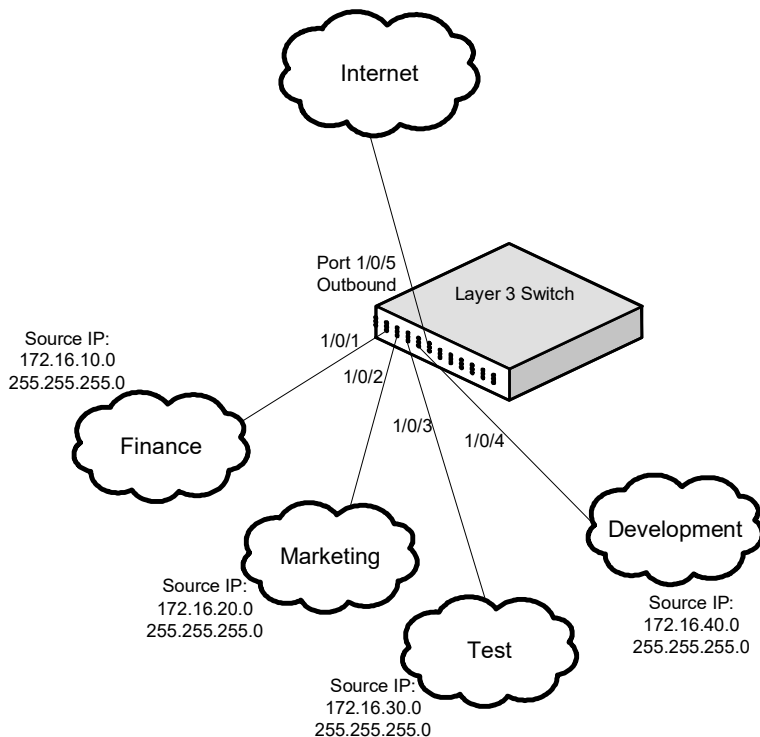
This section contains the following examples:

- Providing Subnets Equal Access to External Network
- DiffServ for VoIP

## Providing Subnets Equal Access to External Network

This example shows how a network administrator can provide equal access to the Internet (or other external network) to different departments within a company. Each of four departments has its own Class B subnet that is allocated 25% of the available bandwidth on the port accessing the Internet.

**Figure 43-17. DiffServ Internet Access Example Network Diagram**



The following commands show how to configure the DiffServ example depicted in Figure 43-17.

- 1 Enable DiffServ operation for the switch.

```
console#config
console (config) #diffserv
```

- 2 Create a DiffServ class of type *all* for each of the departments, and name them. Also, define the match criteria—Source IP address—for the new classes.

```
console (config) #class-map match-all finance_dept
console (config-classmap) #match srcip 172.16.10.0 255.255.255.0
console (config-classmap) #exit
```

```
console (config) #class-map match-all marketing_dept
console (config-classmap) #match srcip 172.16.20.0 255.255.255.0
console (config-classmap) #exit
```

```
console (config) #class-map match-all test_dept
console (config-classmap) #match srcip 172.16.30.0 255.255.255.0
console (config-classmap) #exit
```

```
console (config) #class-map match-all development_dept
console (config-classmap) #match srcip 172.16.40.0 255.255.255.0
console (config-classmap) #exit
```

- 3 Create a DiffServ policy for inbound traffic named *internet\_access*, adding the previously created department classes as instances within this policy. This policy uses the assign-queue attribute to put each department's traffic on a different egress queue. This is how the DiffServ inbound policy connects to the CoS queue settings established below.

```
console (config) #policy-map internet_access in
console (config-policy-map) #class finance_dept
console (config-policy-classmap) #assign-queue 1
console (config-policy-classmap) #exit
```

```
console (config-policy-map) #class marketing_dept
console (config-policy-classmap) #assign-queue 2
console (config-policy-classmap) #exit
```

```
console (config-policy-map) #class test_dept
console (config-policy-classmap) #assign-queue 3
console (config-policy-classmap) #exit
```

```

console(config-policy-map) #class development_dept
console(config-policy-classmap) #assign-queue 4
console(config-policy-classmap) #exit
console(config-policy-map) #exit

```

- 4 Attach the defined policy to 10-Gigabit Ethernet interfaces 1/0/1 through 1/0/4 in the inbound direction

```

console(config) #interface tengigabitethernet 1/0/1
console(config-if-Tel/0/1) #service-policy in internet_access
console(config-if-Tel/0/1) #exit

```

```

console(config) #interface tengigabitethernet 1/0/2
console(config-if-Tel/0/2) #service-policy in internet_access
console(config-if-Tel/0/2) #exit

```

```

console(config) #interface tengigabitethernet 1/0/3
console(config-if-Tel/0/3) #service-policy in internet_access
console(config-if-Tel/0/3) #exit

```

```

console(config) #interface tengigabitethernet 1/0/4
console(config-if-Tel/0/4) #service-policy in internet_access
console(config-if-Tel/0/4) #exit

```

- 5 Set the CoS queue configuration for the (presumed) egress 10-Gigabit Ethernet interface 1/0/1 such that each of queues 1, 2, 3 and 4 get a minimum guaranteed bandwidth of 25%. All queues for this interface use weighted round robin scheduling by default. The DiffServ inbound policy designates that these queues are to be used for the departmental traffic through the assign-queue attribute. It is presumed that the switch will forward this traffic to 10-Gigabit Ethernet interface 1/0/1 based on a normal destination address lookup for internet traffic.

```

console(config) #interface tengigabitethernet 1/0/5
console(config-if-Tel/0/5) #cos-queue min-bandwidth 0 25 25 25 25 0 0
console(config-if-Tel/0/5) #exit
console(config) #exit

```

## Configuring DiffServ Policy Using ACLs

The following example configures a single trTCM policer for two subnets. Traffic for the two subnets is policed together as an aggregate.

First, configure two access lists (ten-one-subnet and ten-two-subnet) to match the first 16 bits of the source address.

```

ip access-list ten-one-subnet
1000 permit ip 10.1.0.0 0.0.255.255 any
exit
ip access-list ten-two-subnet
1000 permit ip 10.2.0.0 0.0.255.255 any
exit

```

Create a class map (ten-subnet) using the match-any attribute to allow matching of both access-lists. The choice of using one access list with multiple permit clauses is also possible.

```

class-map match-any ten-subnet
match access-group name ten-one-subnet
match access-group name ten-two-subnet
exit

```

Create a policy map (p1) and include the matching class. Multiple class and action pairs may be configured in a policy map. Each is processed in order.

```

policy-map p1 in
class ten-subnet

```

Configure the action for the matching packets. Matching packets are assigned to CoS queue 2.

```

assign-queue 2

```

Additionally, matching traffic is policed with a two-rate three-color meter. The first rate is 1000 Kbps with a burst size of 64 kilobits. Conforming traffic (traffic received at a rate less than 1000 Kbps and burst less than 64 kilobits) is marked green and transmitted with a DSCP value of 26.

The second rate is set to 5000 Kbps and a burst size of 128 kilobits. Traffic that exceeds the first rate/burst size but not the second rate/burst size is marked yellow and transmitted with a DSCP value of 10.

Traffic that exceeds the second rate is dropped.

```

police-two-rate 1000 64 5000 128 conform-action set-dscp-
transmit af31 exceed-action
set-dscp-transmit af11 violate-action drop

exit
exit

```

Enable WRED discard for CoS queue 2. Use the **random-detect queue-parms** command to set the thresholds for random discard of the green and yellow marked packets for CoS queue 2 in the event of congestion.

```
cos-queue random-detect 2
```

Apply the policy to an interface. Incoming traffic on this interface will be matched against the policy. Matching packets will be assigned to CoS queue 2 and policed per the above.

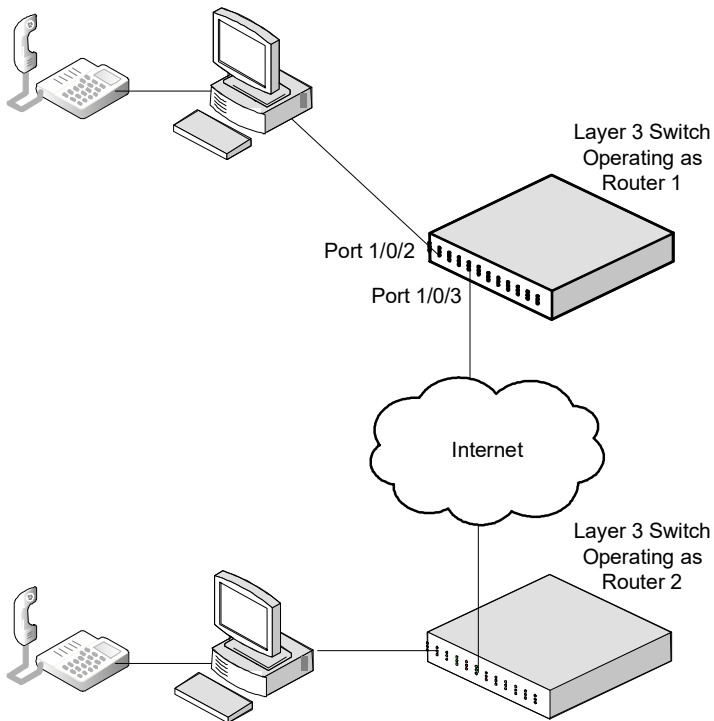
```
interface Te1/0/1
service-policy in p1
exit
```

## **DiffServ for VoIP**

One of the most valuable uses of DiffServ is to support Voice over IP (VoIP). VoIP traffic is inherently time-sensitive: for a network to provide acceptable service, a guaranteed transmission rate is vital. This example shows one way to provide the necessary quality of service: how to set up a class for UDP traffic, have that traffic marked on the inbound side, and then expedite the traffic on the outbound side. The configuration script is for Router 1 in the accompanying diagram: a similar script should be applied to Router 2.



**Figure 43-18. DiffServ VoIP Example Network Diagram**



The following commands show how to configure the DiffServ example depicted in Figure 43-18.

- 1 Set queue 6 on all ports to use strict priority mode. This queue shall be used for all VoIP packets. Activate DiffServ for the switch.

```
console#config  
console (config) #cos-queue strict 6  
console (config) #diffserv
```

- 2 Create a DiffServ classifier named *class\_voip* and define a single match criterion to detect UDP packets. The class type *match-all* indicates that all match criteria defined for the class must be satisfied in order for a packet to be considered a match.

```
console (config) #class-map match-all class_voip
console (config-classmap) #match protocol udp
console (config-classmap) #exit
```

- 3 Create a second DiffServ classifier named *class\_ef* and define a single match criterion to detect a DiffServ code point (DSCP) of EF (expedited forwarding). This handles incoming traffic that was previously marked as expedited elsewhere in the network.

```
console (config) #class-map match-all class_ef
console (config-classmap) #match ip dscp ef
console (config-classmap) #exit
```

- 4 Create a DiffServ policy for inbound traffic named *pol\_voip*, then add the previously created classes 'class\_ef' and 'class\_voip' as instances within this policy. This policy handles incoming packets already marked with a DSCP value of EF (per class\_ef definition), or marks UDP packets (per the class\_voip definition) with a DSCP value of EF. In each case, the matching packets are assigned internally to use queue 6 of the egress port to which they are forwarded.

```
console (config) #policy-map pol_voip in
console (config-policy-map) #class class_ef
console (config-policy-classmap) #assign-queue 6
console (config-policy-classmap) #exit
```

```
console (config-policy-map) #class class_voip
console (config-policy-classmap) #mark ip-dscp ef
console (config-policy-classmap) #assign-queue 6
console (config-policy-classmap) #exit
console (config-policy-map) #exit
```

- 5 Attach the defined policy to an inbound service interface.

```
console (config) #interface tengigabitethernet 1/0/1
console (config-if-Tel1/0/1) #service-policy in pol_voip
console (config-if-Tel1/0/1) #exit
console (config) #exit
```

# WRED



**NOTE:** WRED is not supported on the Dell EMC Networking N1500 Series switch.

## WRED Processing

Traffic ingressing the switch can be assigned to one of four drop probabilities based on a set of matching criteria. There are three drop probabilities for TCP traffic (green, yellow, and red) and one drop probability for non-TCP traffic (all colors). Users may configure the congestion thresholds at which packets queued for transmission are dropped for each color.

WRED is intended to provide early feedback to protocols (e.g., TCP) that depend on packet drop to adjust their transmission rate. WRED packet drops only occur when the system is congested within the ranges specified. If congestion exceeds the upper limit, packets will be dropped at the rate of traffic ingressing the system, e.g., 100%. If the congestion is less than the lower limit, no packets will be dropped.

## WRED Drop Probabilities

Between the minimum and maximum thresholds, the drop probability is divided into eight discrete levels of increasing probability of packet drop. The levels are as follows:

- 0 – 6.25% of maximum drop probability
- 1 – 18.75% of maximum drop probability
- 2 – 30.25% of maximum drop probability
- 3 – 43.75% of maximum drop probability
- 4 – 56.25% of maximum drop probability
- 5 – 68.75% of maximum drop probability
- 6 – 81.25% of maximum drop probability
- 7 – 92.75% of maximum drop probability

As an example, with a drop probability of 50%, a minimum threshold of 10% and a maximum threshold of 90%, the drop probability from 10% to 20% congestion is 3.125%, from 21% to 30% congestion is 9.375%.

## Exponential Weighting Constant

The degree of congestion is determined by sampling the egress queue depth and calculating an average queue size. The exponential weighting constant smooths the result of the average queue depth calculation by the function:

$$\text{average depth} = (\text{previous queue depth} * (1 - 1/2^n)) + (\text{current queue depth} * 1/2^n)$$

The average queue depth is used to select the drop probability for packets queued for egress. Because the instantaneous queue depth fluctuates rapidly, larger values of the weighting constant will cause the average queue depth value to respond to changes more slowly than smaller values.

## WRED Color-Aware Processing

Packets may be assigned to different colors using an ingress policing policy. Each color has a different profile of WRED drop probabilities. This capability allows the operator to configure different WRED drop policies based on the incoming packet's CoS, secondary CoS, IP DSCP, or IP precedence values.

To assign a color to incoming packets, define a class map with the desired matching criteria, assign the class map to a policy map, and set a metering rule in the policy map. Dell EMC Networking switches implement three policing meters: a simple two-color meter, a single-rate three-color meter, and a two-rate three-color meter.

Each of these may be configured in color-aware or color-blind mode.

The **conform-color** command is used to enable color-aware mode. If the **conform-color** command is not used, packets are processed in color-blind mode. Color-blind mode means that all packets are initially colored green and are assigned their final color by the meter. Color-aware mode means that packets are pre-colored prior to entering the meter that assigns the final packet color. Packets that match the conform-color class are pre-colored green.

Packets that match the exceed color class are pre-colored yellow. Packets that do not match the conform color or exceed color class are pre-colored red, that is, they will always have a final color of red and will be processed accordingly.

- Packets that are pre-colored green and exceed the CIR will be colored yellow. Those that exceed the PIR will be colored red.

- Packets that are pre-colored yellow and exceed the PIR will be colored red. This does not apply to the simple algorithm since there is no yellow pre-coloring.
- Packets that are pre-colored red remain colored red.

Refer to RFC 2697 and RFC 2698 for further detail on color-aware and color-blind processing.

## **Simple Meter Implementation**

The simple algorithm meters a traffic stream and colors packets red or green according to two parameters, the Committed Information Rate (CIR) and the Committed Burst Size (CBS). If the CIR is violated, the offending packets are colored red, otherwise, they are colored green.

In color-aware mode, packets may also be pre-colored red based on user-defined criteria. Packets that are pre-colored red are considered for discard as if the simple rate meter had colored them red as a result of exceeding the meter. Pre-colored packets may not be re-colored to green by the meter.

It is recommended that the CBS parameter be set to the largest IP packet size that can be legally transported.

## **Single Rate Meter Implementation**

The police-one-rate algorithm implements a single-rate Three Color Marker (srTCM) per RFC 2697. The srTCM algorithm is useful in situations where the length of the burst is the distinguishing factor for determining service eligibility and the peak rate is not considered. A srTCM meters a traffic stream per the Committed Burst Size (CBS) and Excess Burst Size (EBS) parameters and colors packets according to the Committed Information Rate (CIR), the CBS and the EBS. At least one of the CBS or EBS must be greater than 0. It is recommended that when the CBS or EBS parameters are larger than 0, they be configured to be greater than or equal to the largest IP packet size that can be legally transported. In color-blind mode, a packet is colored green if it does not exceed the CBS, yellows if it exceeds the CBS but not the EBS, and red if it exceeds both.

In color-aware mode, packets may be pre-colored yellow or red based on user-defined criteria prior to being processed by the meter. Packets that are pre-colored yellow or red are considered for discard as if the meter had colored

them as a result of exceeding the meter. Pre-colored packets are not re-colored to green or yellow by the meter. Yellow packets may be colored red as a result of exceeding the meter.

Refer to RFC 2697 for further details.

## **Two-Rate Meter Implementation**

The police-two-rate algorithm implements a two-rate Three-Color Marker (trTCM) per RFC 2698. The trTCM algorithm is useful in situations where a peak rate needs to be enforced separately from a committed rate. A trTCM meters a traffic stream per the Committed Burst Size (CBS) and Peak Burst Size (PBS) parameters and colors packets according to the Committed Information Rate (CIR) and the Peak Information Rate (PIR). The PIR must be greater than or equal to the CIR. The PBS must be greater than or equal to the CBS. It is recommended that the CBS parameter be set to the largest IP packet size that can be legally transported. In color-blind mode, a packet is colored red if it exceeds the PIR, yellow if it exceeds the CIR, and green if it exceeds neither.

In color-aware mode, packets may be pre-colored yellow or red based on user-defined criteria prior to being processed by the meter. Packets that are pre-colored yellow or red are considered for discard as if the meter had colored them as a result of exceeding the meter. Pre-colored packets are not re-colored to green or yellow by the meter. Yellow packets may be colored red as a result of exceeding the meter.

Refer to RFC 2698 for further details.

# Class-of-Service

## Dell EMC Networking N-Series Switches

This chapter describes how to configure the Class-of-Service (CoS) feature. The CoS queuing feature lets you directly configure certain aspects of switch queuing. This provides the desired QoS behavior for different types of network traffic when the complexities of DiffServ are not required. The priority of a packet arriving at an interface can be used to steer the packet to the appropriate outbound CoS queue through a mapping table. CoS queue characteristics that affect queue mapping, such as minimum guaranteed bandwidth, transmission rate shaping, etc., are user-configurable at the queue (or port) level.

The topics covered in this chapter include:

- CoS Overview
- Default CoS Values
- Configuring CoS (Web)
- Configuring CoS (CLI)
- CoS Configuration Example

## CoS Overview

The CoS feature lets you give preferential treatment to certain types of traffic over others. To set up this preferential treatment, configure the ingress ports, the egress ports, and individual queues on the egress ports to provide customization that suits your environment.

The level of service is determined by the egress port queue to which the traffic is assigned. When traffic is queued for transmission, the rate at which it is serviced depends on how the queue is configured and possibly the amount of traffic present in other queues for that port.

Some traffic is classified for service (i.e., packet marking) before it arrives at the switch. If you decide to use these classifications, this traffic can be mapped to egress queues by setting up a CoS Mapping table.

Each ingress port on the switch has a default priority value (set by configuring VLAN Port Priority in the Switching sub-menu) that determines the egress queue its traffic gets forwarded to. Packets that arrive without a VLAN user priority, or packets from ports you've identified as "untrusted," get forwarded according to this default.

## **What Are Trusted and Untrusted Port Modes?**

Ports can be configured in "trusted" mode or "untrusted" mode with respect to ingress traffic.

### **Ports in Trusted Mode**

When a port is configured in trusted mode, the system accepts at face value a priority designation encoded within packets arriving on the port. Ports can be configured to trust priority designations based on one of the following fields in the packet header:

- 802.1 Priority: values 0–7
- IP DSCP: values 0–63

A mapping table associates the designated field values in the incoming packet headers with a traffic class priority (actually a CoS traffic queue).

### **Ports in Untrusted Mode**

If you configure an ingress port in untrusted mode, the system ignores any priority designations encoded in incoming packets, and instead sends the packets to a traffic queue based on the ingress port's default priority.

## **How Is Traffic Shaping Used on Egress Traffic?**

For unit/slot/port interfaces, a traffic shaping rate can be specified for the port (in Kbps) for egress traffic. The traffic shaping rate specifies an upper limit of the transmission bandwidth used. Once the traffic shaping rate has been reached, frames that exceeded the limit remain queued for transmission until the next scheduling slot.



## How Are Traffic Queues Configured?

The switch CoS queues may be configured to selectively service packets queued for transmission in a pre-defined manner when an interface is congested. If an interface is not congested, packets are transmitted in FIFO order. The switch supports 7 queues. By default, the switch selects packets in higher numbered queues more often than lower numbered queues while still ensuring fairness as described below. It is recommended that administrators utilize the lower numbered queues (0-3) to provide services as control plane protocols are internally mapped onto the higher numbered queues (4-7).

For each queue, the following can be specified:

- Minimum bandwidth guarantee—A percentage of the port's maximum negotiated bandwidth reserved for the queue. Unreserved bandwidth can be utilized by all queues, including strict priority queues. If the sum of the minimum bandwidth is 100%, then there is no unreserved bandwidth and no sharing of bandwidth is possible. This type of configuration will override the strict priority configuration when congestion is present.
- Scheduler type—strict/weighted:
  - Strict priority scheduling gives an absolute priority based on CoS queue number, with traffic in the highest numbered queue sent first, then the next lowest numbered queue, and so on. Weighted queues are serviced after all strict priority queues have been serviced.
  - Weighted scheduling selects packets for transmission with a fixed weighting equal to the CoS queue number plus one. The weighted scheduler measures bandwidth based upon bytes vs. packet counts, offering a better granularity of scheduling. For example, if CoS queues 0, 1, and 2 have an equal offered load toward a congested output port, CoS queue 2 will receive approximately  $\frac{3}{6}$  of the bandwidth, CoS queue 1 will receive approximately  $\frac{2}{6}$  of the bandwidth, and CoS queue 0 will receive approximately  $\frac{1}{6}$  of the bandwidth.

The minimum bandwidth setting can be used to override the strict priority and weighted settings. The highest numbered strict priority queue will receive no more bandwidth than 100 percent minus the sum of the minimum bandwidths percentages assigned to the other queues. If used, it is recommended that minimum bandwidth percentages only be high enough to ensure a minimum level of service for any queue; i.e., the sum of the minimum bandwidth percentages is a small fraction of 100%. This ensures

that the system can respond to bursts in traffic. Setting the minimum bandwidth percentages such that they sum to 100% effectively sets the scheduler such that sharing of bandwidth is disabled, and all queues, including strict priority queues, are serviced according to their minimum bandwidth configuration during congestion.

## **Which Queue Management Methods Are Supported?**

The switch supports the following methods, configurable per-interface-queue, for determining which packets are dropped when the queue is full:

- Taildrop—Any packet forwarded to a full queue is dropped regardless of its priority.
- Weighted Random Early Detection (WRED)—Drops packets queued for transmission on an interface selectively based their drop precedence level. For each of four drop precedence levels on each WRED-enabled interface queue, the following parameters can be configured:
  - Minimum Threshold: A percentage of the interface queue size below which no packets of the selected drop precedence level are dropped.
  - Maximum Threshold: A percentage of the interface queue size above which all packets of the selected drop precedence level are dropped.
  - Drop Probability: When the queue depth is between the minimum and maximum thresholds, this value provides a scaling factor for increasing the number of packets of the selected drop precedence level that are dropped as the queue depth increases. The drop probability supports configuration in the range of 0 to 10%, and the discrete values 25%, 50%, and 75%. Values not listed are truncated to the next lower value in hardware.

The minimum and maximum WRED thresholds should be calculated to give a reasonable amount of buffering to TCP flows given the switch buffer capacity. WRED thresholds are applied individually to each physical interface. For the Dell EMC Networking N1500, N2000, N2100-ON, N2200-ON, N3000-ON, N3100-ON, and N3200-ON Series switches, a threshold of 100% corresponds to a buffer occupancy of 295428 bytes queued for transmission on an interface.

- Simple Random Early Detection (SRED)—Drops packets queued for transmission on an interface selectively based their drop precedence level. For each of three drop precedence levels on each SRED-enabled interface queue, the following parameters can be configured:
  - Minimum Threshold: A percentage of the interface queue size below which no packets of the selected drop precedence level are dropped.
  - Drop Probability: When the queue depth exceeds the minimum thresholds, this value provides a scaling factor for determining the percentage of congested packets that are dropped.



**NOTE:** SRED is only supported on the Dell EMC Networking N1500 Series switch.

## CoS Queue Usage

CoS queue 7 is reserved by the system and is not assignable. It is generally recommended that the administrator utilize CoS queues 0 to 3, as CoS queues 4-6 may be used by the system for other types of system traffic, for example, routing protocol PDU handling.

## Default CoS Values

Table 44-1 shows the global default values for CoS.


**Table 44-1. CoS Global Defaults**

Parameter	Default Value
Trust Mode	802.1p User Priority
802.1p CoS value to queue mapping	802.1p User Priority Queue
	0, 3 1
	1, 2 0
	4, 5 2
	6, 7 3

**Table 44-1. CoS Global Defaults**

<b>Parameter</b>	<b>Default Value</b>	
IP DSCP value to queue mapping	<b>IP DSCP</b>	<b>Queue</b>
	0–7, 24–31	1
	8–23	0
	32–47	2
	48–63	3
Interface Shaping Rate	0 Kbps	
Minimum Bandwidth	0%	
Scheduler Type	Weighted	
Queue Management Type	Taildrop	
Drop Precedence Level	1	
WRED Decay Exponent	9	
WRED Minimum Threshold	40	
WRED Green Minimum Threshold	40	
WRED Yellow Minimum Threshold	30	
WRED Red Minimum Threshold	20	
WRED Non-TCP Minimum Threshold	100	
WRED Green Maximum Threshold	100	
WRED Yellow Maximum Threshold	90	
WRED Red Maximum Threshold	80	
WRED Non-TCP Maximum Threshold	100	
WRED Drop Probability Scale	10	

# Configuring CoS (Web)

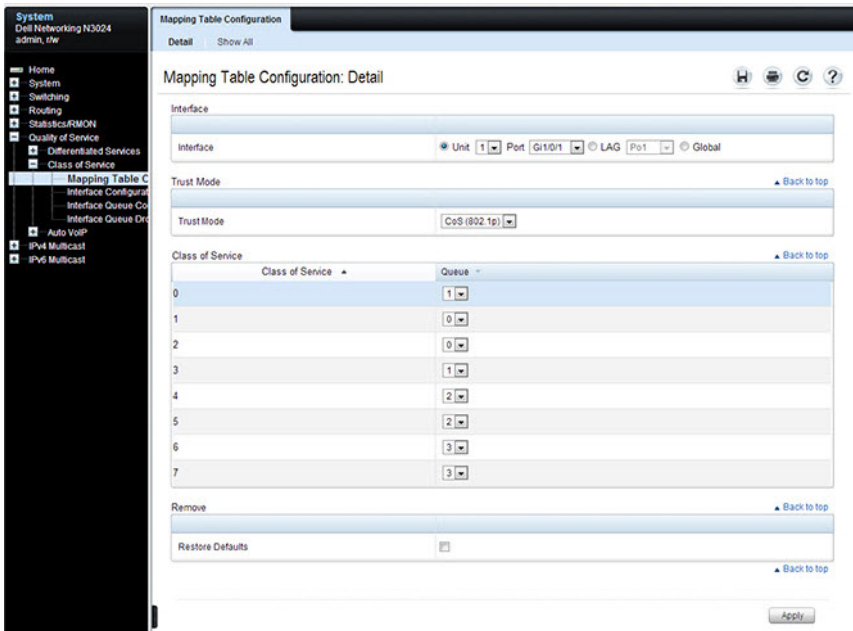
This section provides information about the OpenManage Switch Administrator pages for configuring and monitoring CoS features on Dell EMC Networking N1100-ON, N1500, N2000, N2100-ON, N2200-ON, N3100-ON, and N3200-ON Series switches. For details about the fields on a page, click  at the top of the Dell EMC OpenManage Switch Administrator web page.

## Mapping Table Configuration

Use the Mapping Table Configuration page to define how class of service is assigned to a packet.

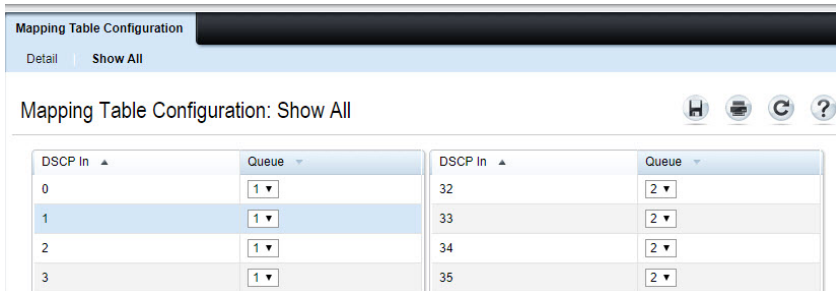
To display the page, click **Quality of Service** → **Class of Service** → **Mapping Table Configuration** in the navigation panel. CoS(802.1P) is the default mode, so this is the page that displays when Mapping Table Configuration is selected from the Class of Service menu page.

**Figure 44-1. Mapping Table Configuration — CoS (802.1P)**



To display the **Queue Mapping Table** for the selected Trust Mode, click the **Show All** link at the top of the page. The following figure shows the queue mapping table when CoS (802.1p) is selected as the Trust Mode.

**Figure 44-2. DSCP Queue Mapping Table**



The screenshot shows a web interface titled "Mapping Table Configuration" with a "Show All" link. Below the title, there are navigation icons for home, print, refresh, and help. The main content area displays "Mapping Table Configuration: Show All" and contains two tables side-by-side. Each table has a "DSCP In" column and a "Queue" column. The first table lists DSCP values 0, 1, 2, and 3, all mapped to Queue 1. The second table lists DSCP values 32, 33, 34, and 35, all mapped to Queue 2.

DSCP In	Queue
0	1
1	1
2	1
3	1

DSCP In	Queue
32	2
33	2
34	2
35	2

## Interface Configuration

Use the **Interface Configuration** page to define the interface shaping rate for egress packets on an interface and the decay exponent for WRED queues defined on the interface.

Each interface CoS parameter can be configured globally or per-port. A global configuration change is applied to all interfaces in the system.

To display the Interface Configuration page, click **Quality of Service** → **Class of Service** → **Interface Configuration** in the navigation panel.

**Figure 44-3. Interface Configuration**

The screenshot displays the 'Interface Configuration: Detail' page. At the top, there is a navigation bar with 'Interface Configuration' and 'Detail' tabs. Below this, the page title 'Interface Configuration: Detail' is shown alongside icons for home, print, refresh, and help. The main content area is titled 'Interface Configuration' and contains a table with the following rows:

Interface	<input checked="" type="radio"/> Unit <input type="text" value="1"/> <input type="text" value="Port Gi1/0/1"/> <input type="radio"/> LAG <input type="text" value="Po1"/> <input type="radio"/> Global
Interface Shaping Rate	<input type="text" value=""/> (64 to 4294967295 Kbps)
WRED Decay Exponent	<input type="text" value="9"/> (0 to 15)

Below the table, there is a 'Remove' section with a 'Restore To Defaults' checkbox and a 'Back to top' link. At the bottom right, there is an 'Apply' button.

## Interface Queue Configuration

Use the **Interface Queue Configuration** page to configure egress queues on interfaces. The settings you configure control the amount of bandwidth the queue uses, the scheduling method, and the queue management method.

The configuration process is simplified by allowing each CoS queue parameter to be configured globally or per-port. A global configuration change is applied to the same queue ID on all ports in the system.

To display the **Interface Queue Configuration** page, click **Quality of Service** → **Class of Service** → **Interface Queue Configuration** in the navigation panel.

**Figure 44-4. Interface Queue Configuration**

The screenshot shows the 'Interface Queue Configuration: Detail' page. At the top, there is a navigation bar with 'Interface Queue Configuration' and 'Detail | Show All'. Below this, the page title 'Interface Queue Configuration: Detail' is displayed with icons for home, print, refresh, and help. The main configuration area is titled 'Interface Queue Configuration' and contains the following fields:

Interface	<input checked="" type="radio"/> Unit <input type="radio"/> Port <input type="radio"/> LAG <input type="radio"/> Global
Queue ID	0
Minimum Bandwidth	0 (0 to 100 in increments of 1)
Scheduler Type	Weighted
Queue Management Type	taildrop

Below the configuration fields, there is a 'Remove' section with a 'Back to top' link. A 'Restore To Defaults' checkbox is present and unchecked. Another 'Back to top' link is located at the bottom right of the configuration area. An 'Apply' button is located at the bottom center of the page.



To access the **Interface Queue Status** page, click the **Show All** link at the top of the page.

The screenshot shows the 'Interface Queue Configuration' page. At the top, there is a navigation bar with 'Interface Queue Configuration' and a 'Show All' link. Below this is the page title 'Interface Queue Configuration: Interface Queue Status' and several utility icons (Home, Print, Refresh, Help). The main content area is divided into two sections: 'Interfaces' and 'Queue Management'. The 'Interfaces' section has a search bar with filters for 'Unit' (set to 1), 'Port' (set to Gi1/0/1), 'LAG' (set to Po1), and 'Global'. The 'Queue Management' section contains a table with the following data:

Queue ID	Minimum Bandwidth	Scheduler Type	Queue Management Type
0	0	Weighted	TailDrop
1	0	Weighted	TailDrop
2	0	Weighted	TailDrop
3	0	Weighted	TailDrop
4	0	Weighted	TailDrop
5	0	Weighted	TailDrop
6	0	Weighted	TailDrop

There are 'Back to top' links at the top right and bottom right of the table area.

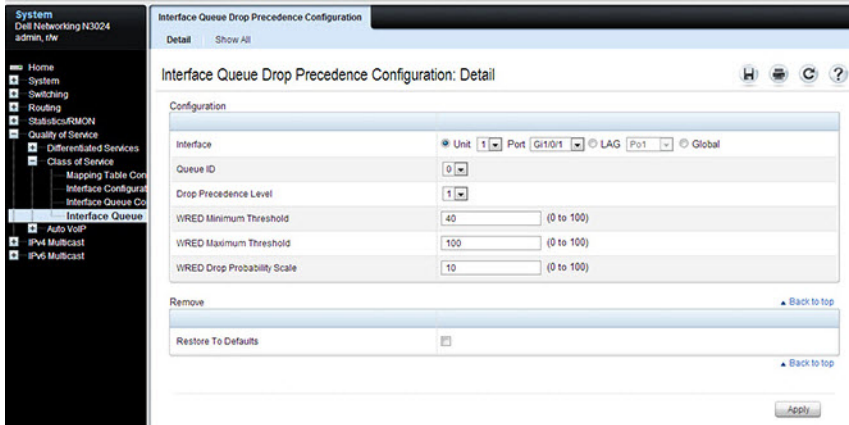
## Interface Queue Drop Precedence Configuration

Use the **Interface Queue Drop Precedence Configuration** page to configure thresholds and scaling values for each of four drop precedence levels on a WRED-enabled interface queue. The settings you configure control the minimum and maximum thresholds and a drop probability scaling factor for the selected drop precedence level.

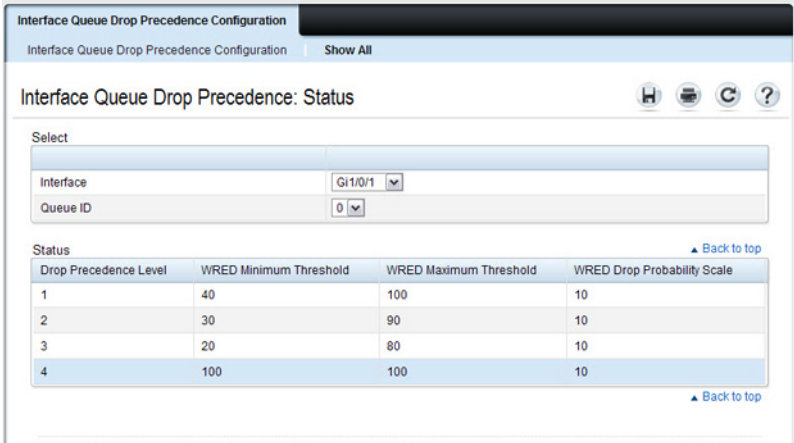
These parameters can be applied to each drop precedence level on a per-interface-queue basis, or can be set globally for the same drop precedence level and queue ID on all interfaces.

To display the **Interface Queue Drop Precedence Configuration** page, click **Quality of Service** → **Class of Service** → **Interface Queue Drop Precedence Configuration** in the navigation panel.

**Figure 44-5. Interface Queue Drop Precedence Configuration**



To access the Interface Queue Drop Precedence Status page, click the Show All link at the top of the page.



## Configuring CoS (CLI)

This section provides information about the commands used for configuring CoS settings on the switch. For more information about the commands, see the *Dell EMC Networking N1100-ON, N1500, N2000, N2100-ON, N2200-ON, N3000E-ON, N3100-ON, and N3200-ON Series Switches CLI Reference Guide* at [www.dell.com/support](http://www.dell.com/support).

The interface mode commands shown in this section may also be used in Global Configuration mode to configure CoS for all interfaces. Interface mode configuration overrides the global configuration for the specified interfaces.

### Mapping Table Configuration

Use the following commands to configure the CoS mapping tables.

CLI Command	Description
<code>configure</code>	Enter Global Configuration mode.
<code>interface <i>interface</i></code>	Enter Interface Configuration mode, where <i>interface</i> is replaced by <code>gigabitethernet unit/slot/port</code> , <code>tengigabitethernet unit/slot/port</code> , or <code>port-channel port-channel number</code> .
<code>classofservice dot1p-mapping <i>priority</i></code>	Map an 802.1p user priority to an internal traffic class (CoS queue) for a switch. This command can also be used in Global Configuration mode to configure the same mappings on all interfaces.
<code>classofservice trust {dot1p   ip-dscp   untrusted}</code>	Set the class of service trust mode of an interface.
<code>exit</code>	Exit to Global Config mode.
<code>exit</code>	Exit to Privilege Exec mode.
<code>show classofservice dot1p-mapping</code>	Display the current Dot1p (802.1p) priority mapping to internal traffic classes for a specific interface.

CLI Command	Description
show classofservice ip-dscp-mapping	Display the current IP DSCP mapping to internal traffic classes for a specific interface.
show classofservice trust	Display the current trust mode setting for a specific interface.

## CoS Interface Configuration Commands

Use the following commands to configure the traffic shaping and WRED exponent values for an interface.

CLI Command	Description
configure	Enter Global Configuration mode.
interface <i>interface</i>	Enter Interface Configuration mode, where <i>interface</i> is replaced by <b>gigabitethernet</b> <i>unit/slot/port</i> , <b>tengigabitethernet</b> <i>unit/slot/port</i> , or <b>port-channel</b> <i>port-channel number</i> .
traffic-shape <i>bw</i> kbps	Sets the upper limit on how much traffic can leave a port. The <i>bw</i> variable represents the shaping bandwidth value from 64 to 4294967295 kbps.
random-detect exponential-weighting-constant <i>exponent</i>	Configure the WRED decay exponent (range: 0–15) for the interface. The weighting constant exponent determines how much of the previous average queue length sample is added to the current average queue length. A value of 0 indicates that no weight is given to the previous sample and only the instantaneous rate is used. A value of 1 indicates that 1/2 of the difference between the instantaneous value and the previous value is added to the current value; a value of 2 implies that 1/4 of the difference is added, 3 implies 1/8 of the difference is added, etc.

## Interface Queue Configuration

Use the following commands to configure and view CoS interface queue settings.

CLI Command	Description
<code>configure</code>	Enter Global Configuration mode.
<code>interface <i>interface</i></code>	Enter Interface Configuration mode, where <i>interface</i> is replaced by <code>gigabitethernet <i>unit/slot/port</i></code> , <code>tengigabitethernet <i>unit/slot/port.</i></code> , or <code>port-channel <i>port-channel number</i></code> .
<code>cos-queue min-bandwidth <i>bw</i></code>	Specify the minimum transmission bandwidth (range: 0-100% in 1% increments) for each interface queue. The sum of the configured minimum bandwidths should be less than 100% to allow for buffering of bursty traffic.
<code>cos-queue strict <i>queue-id</i></code>	Activate the strict priority scheduler mode for each specified queue. The <i>queue-id</i> value ranges from 0 to 6.
<code>cos-queue random-detect <i>queue-id</i></code>	Set the queue management type for the specified queue to WRED. The <code>no</code> version of this command resets the value to taildrop.
<code>exit</code>	Exit to Global Config mode.
<code>exit</code>	Exit to Privilege Exec mode.
<code>show interfaces cos-queue</code>	Display the class-of-service queue configuration for a specified interface or all interfaces.

## Configuring Interface Queue Drop Probability

Use the following commands to configure characteristics of the drop probability and view related settings. The drop probability supports configuration in the range of 0 to 10%, and the discrete values 25%, 50%, and 75%. Values not listed are truncated to the next lower value in hardware.

Not all switches support all colors (or non-TCP thresholds) or thresholds. Drop probability settings also vary among the switch families. The **ecn** parameter is not supported on the N1500 Series switches. Refer to the *CLI Reference Guide* for further details.

CLI Command	Description
<code>configure</code>	Enter Global Configuration mode.
<code>interface <i>interface</i></code>	Enter Interface Configuration mode, where <i>interface</i> is replaced by <b>gigabitethernet</b> <i>unit/slot/port</i> , <b>tengigabitethernet</b> <i>unit/slot/port</i> , or <b>port-channel</b> <i>port-channel number</i> .
<code>random-detect queue-pams queue-id [<i>queue-id...</i>] min- thresh <i>min1 min2 min3 min4</i> max-thresh <i>max1 max2 max3</i> max4 drop-prob-scale <i>prob1</i> <i>prob2 prob3 prob4</i> [<i>ecn</i>]</code>	Configure the maximum and minimum thresholds for one or more queue IDs on a WRED-enabled interface queue.  This command can also be used in Global Configuration mode to configure the same parameters for one or more queues on all interfaces.
<code>exit</code>	Exit to Global Config mode.
<code>exit</code>	Exit to Privilege Exec mode.
<code>show interfaces random-detect</code>	Display WRED parameters for an interface or all interfaces.

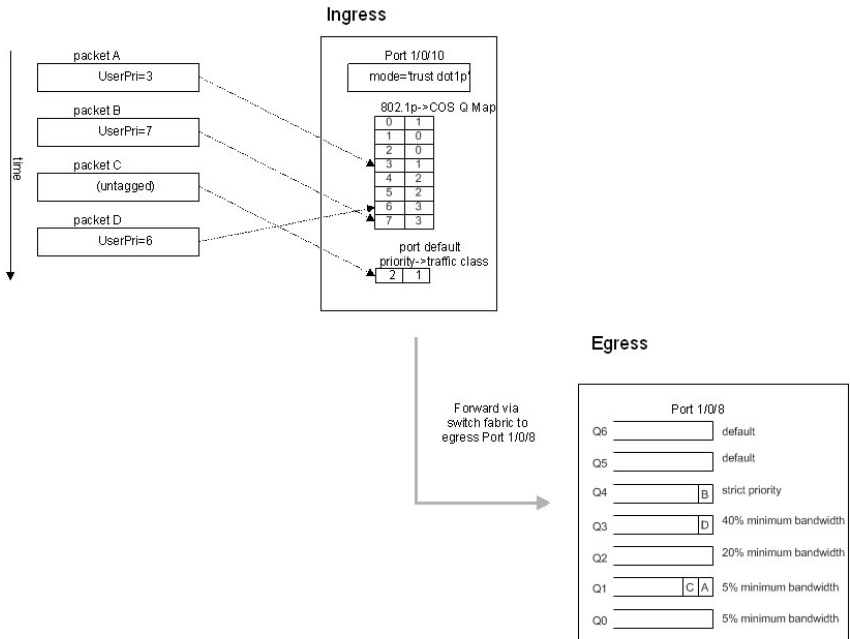
# CoS Configuration Example

Figure 44-6 illustrates the network operation as it relates to CoS mapping and queue configuration.

Four packets arrive at the ingress port te1/0/10 in the order A, B, C, and D. port te1/0/10 is configured to trust the 802.1p field of the packet, which serves to direct packets A, B, and D to their respective queues on the egress port. These three packets utilize the 802.1p to CoS Mapping Table for port te1/0/10.

In this example, the 802.1p user priority 3 is configured to send the packet to queue 3 instead of the default queue 2. Since packet C does not contain a VLAN tag, the 802.1p user priority does not exist, so port te1/0/10 relies on its default port priority (2) to direct packet C to egress queue 0.

**Figure 44-6. CoS Mapping and Queue Configuration**



Packet Transmission order: B, A, D, C

Continuing this example, the egress port `te1/0/8` is configured for strict priority on queue 4, and a weighted scheduling scheme is configured for queues 3-0. Assuming queue 3 has a higher minimum bandwidth than queue 1 (relative bandwidth values are shown as a percentage, with 0% indicating the bandwidth is shared according to the default weighting), the queue service order, when congested, is 4 followed by 3 followed by 1. Assuming each queue transmits all packets shown in the diagram, the packet transmission order as seen on the network out of port `te1/0/8` is B, D, A, C. Thus, packet B, with its strict priority scheduling, is transmitted ahead of the other packets at the egress port.

The following commands configure port 10 (ingress interface) and port 8 (egress interface).

- 1 Configure the Trust mode for port 10.

```
console#config
console(config)#interface tengigabitethernet 1/0/10
console(config-if-Te1/0/10)#classofservice trust dot1p
```

- 2 For port 10, configure the 802.1p user priority 7 to send the packet to queue 4 instead of the default queue (queue 3).

```
console(config-if-Te1/0/10)#classofservice dot1p-mapping 7 4
```

- 3 For port 10, specify that untagged VLAN packets should have a default priority of 2, which maps to queue 0.

```
console(config-if-Te1/0/10)#vlan priority 2
console(config-if-Te1/0/10)#exit
```

- 4 For port 8, the egress port, configure a weighted scheduling scheme for queues 3-0.

```
console(config)#interface tengigabitethernet 1/0/8
console(config-if-Te1/0/8)#cos-queue min-bandwidth 5 5 20 40 0 0 0 0
```

- 5 Configure port 8 to have strict priority on queue 4:

```
console(config-if-Te1/0/8)#cos-queue strict 4
```

To configure the CoS queues for lossless traffic when transporting iSCSI traffic, set the lossless traffic class to have a one-to-one mapping with the priority value. The following example illustrates how to change the dot1p mapping from the switch defaults to support lossless<sup>1</sup> transport of frames on CoS queue 4, with a 50% minimum bandwidth guarantee. Lossless traffic

1. Lossless behavior is guaranteed only when configured in conjunction with a congestion control mechanism such as PFC.



classes generally use the default WRR scheduling mode as opposed to strict priority, to avoid starving other traffic. For example, the following commands assign 802.1p user priority 4 to CoS queue 4 and reserves 50% of the scheduler time slices to CoS queue 4. This implies that, when the switch is congested, the scheduler will service CoS queue 4 fifty percent of the time to the exclusion of all other CoS queues, including higher-priority CoS queues.

```
classofservice dot1p-mapping 4 4  
cos-queue min-bandwidth 0 0 0 0 50 0 0
```

## Explicit Congestion Notification

Explicit Congestion Notification (ECN) is defined in RFC 3168.

Conventional TCP networks signal congestion by dropping packets. A Random Early Discard scheme provides earlier notification than tail drop. ECN marks congested packets that would otherwise have been dropped and expects a ECN capable receiver to signal congestion back to the transmitter without the need to retransmit the packet that would have been dropped. For TCP, this means that the TCP receiver signals a reduced window size to the transmitter but does not request retransmission of the CE marked packet.

ECN uses the two least significant bits of DiffServ field (TOS octet in IPv4 / Traffic Class octet in IPv6) and codes them as follows:

00: Non ECN-Capable Transport – Non-ECT

10: ECN Capable Transport – ECT(0)

01: ECN Capable Transport – ECT(1)

11: Congestion Encountered – CE

ECN capable hosts communicate support for ECN via two flags in the TCP header:

- ECN-Echo (ECE)
- Congestion Window Reduced (CWR)

Dell EMC Networking WRED considers packets for early discard only when the number of packets queued for transmission on a port exceeds the relevant minimum WRED threshold. Four thresholds are available for configuration. The green, yellow, and red thresholds operate on TCP packets. The fourth threshold operates on non-TCP packets.

When ECN is enabled and congestion is experienced, packets that are marked ECN-capable, are queued for transmission, and are randomly selected for discard by WRED are instead marked CE and are transmitted rather than dropped. This includes packets that exceed the WRED upper threshold. If the switch experiences severe congestion (no buffers available), then packets are discarded.

Dell EMC Networking implements ECN capability as part of the WRED configuration process. Eligible packets are marked by hardware based upon the WRED configuration. Switches that do not support WRED (for

example, N1500 series) cannot support ECN. The network operator can configure any CoS queue to operate in ECN marking mode and can configure different discard thresholds for each color.

## Enabling ECN in Microsoft Windows

On many current Windows implementations, ECN capability is enabled via the **netsh** command as follows:

```
netsh int tcp set global ecncapability=enabled
```

The capability can be verified with the command **netsh int tcp show global**.

An example is shown below:

```
C:\Users\jmclendo>Netsh int tcp set global ecncapability=enabled
Ok.
C:\Users\jmclendo>netsh int tcp show global
Querying active state...
```

```
TCP Global Parameters
-----
Receive-Side Scaling State      : enabled
Chimney Offload State          : automatic
NetDMA State                    : enabled
Direct Cache Access (DCA)      : disabled
Receive Window Auto-Tuning Level : normal
Add-On Congestion Control Provider : none
ECN Capability                  : enabled
RFC 1323 Timestamps           : disabled
```

In Windows Server 2012, DCTCP is self-activating based on the RTT of TCP packets. No user management is required. Use the PowerShell cmdlet **Get-NetTcpConnection** to verify DCTCP operation.

## Example 1: SLA Configuration

The following example configures a simple meter and a trTCM meter in support of a network SLA. The SLA classes are separated by CoS class as described in the comments.

- 1 Define a class-map so that all traffic will be in the set of traffic “cos-any”.

```
console#config
console (config) #class-map match-all cos-any ipv4
console (config-classmap) #match any
console (config-classmap) #exit
```

- 2 Define a class-map such that all traffic with a CoS value of 1 will be in the set of traffic “cos1.” We will use this as a conform color class map. Conform-color class maps must be one of cos, secondary cos, dscp, or ip precedence.

```
console (config) #class-map match-all cos1 ipv4
console (config-classmap) #match cos 1
console (config-classmap) #exit
```

- 3 Define a class-map such that all IPv4 traffic with a CoS value of 0 will be in the set of traffic “cos0.” We will use this as a conform-color class map. Conform-color class maps must be one of cos, secondary cos, dscp, or ip precedence.

```
console (config) #class-map match-all cos0 ipv4
console (config-classmap) #match cos 0
console (config-classmap) #exit
```

- 4 Define a class-map such that all TCP will be in the set of traffic “TCP.” We will use this as a base color class for metering traffic.

```
console (config) #class-map match-all tcp ipv4
console (config-classmap) #match protocol tcp
console (config-classmap) #exit
```

- 5 Define a policy-map to include packets matching class cos-any (IPv4). Ingress IPv4 traffic arriving at a port participating in this policy will be assigned red or green coloring based on the metering.

```
console (config) #policy-map simple-policy in
console (config-policy-map) #class cos-any
```

- 6 Create a simple policer in color blind mode. Packets below the committed information rate (CIR) or committed burst size (CBS) are assigned drop precedence green. Packets that exceed the CIR (in Kbps) or CBS (in Kbytes) are colored red. Both the conform and violate actions are set to transmit as WRED is used to drop packets when congested.

```
console (config-policy-classmap) #police-simple 1000000 64  
conform-action transmit violate-action transmit  
console (config-policy-classmap) #exit  
console (config-policy-map) #exit
```

- 7 Define a policy-map in color aware mode matching class cos-any (IPv4). Ingress IPv4 traffic arriving at a port participating in this policy will be assigned green, yellow, or red coloring based on the meter.

```
console (config) #policy-map two-rate-policy in  
console (config-policy-map) #class tcp
```

- 8 Create a two-rate policer per RFC 2698. The CIR value is 800 Kbps and the CBS is set to 96 Kbytes. The PIR is set to 950 Kbps and the PBS is set to 128 Kbytes.

Color-aware processing is enabled via the **conform-color** command; i.e., any packets not in CoS 0 or CoS 1 are pre-colored “red.” Packets in CoS 0 are pre-colored yellow. Packets in CoS 1 are pre-colored green. Pre-coloring gives greater bandwidth to CoS 1 packets as they are initially subject to the CIR/CBS limits. Packets in CoS 0 are subject to the PIR limits. Based on the CIR/CBS, the PIR/PBS, and the conform, exceed, and violate actions specified below:

- TCP packets with rates less than or equal to the CIR/CBS in class CoS 1 are conforming to the rate (green).
- These packets will be dropped randomly at an increasing rate between 0 and 3% when the outgoing interface is congested between 80 and 100%.
- TCP packets with rates above the CIR/CBS and less than or equal to PIR/PBS in either class CoS 1 or class CoS 2 are policed as exceeding the CIR (yellow). These packets will be dropped randomly at an increasing rate between 0 and 5% when the outgoing interface is congested between 70 and 100%.

- TCP packets with rates higher than the PIR/PBS or which belong to neither class CoS 1 or class CoS 2 violate the rate (red). These packets will be dropped randomly at an increasing rate between 0 and 10% when the outgoing interface is congested between 50 and 100%.
- Non-TCP packets in CoS queue 0 or 1 will be dropped randomly at an increasing rate between 0 and 15% when the outgoing interface is congested between 50 and 100%.

```
console(config-policy-classmap)#police-two-rate 800 96 950 128
conform-action transmit exceed-action transmit violate-action
transmit
console(config-policy-classmap)#conform-color cos1 exceed-
color cos0
console(config-policy-classmap)#exit
console(config-policy-map)#exit
```

- 9** Enable WRED drop on traffic classes 0 and 1.

```
console(config)#cos-queue random-detect 0 1
```

- 10** Set the exponential-weighting-constant. The exponential weighting constant smooths the result of the average queue depth calculation by the following function:

*average depth = (previous queue depth \* (1-1/2<sup>n</sup>)) + (current queue depth \* 1/2<sup>n</sup>).*

The average depth is used in calculating the amount of congestion on a queue. Because the instantaneous queue depth fluctuates rapidly, larger values of the weighting constant cause the average queue depth value to respond to changes more slowly than smaller values.

```
console(config)#random-detect exponential-weighting-constant 4
```

- 11** Configure the queue parameters for traffic class 0 and 1. We set the minimum threshold and maximum thresholds to 80–100% for green traffic, 70–100% for yellow traffic, and 50–100% for red traffic. Non-TCP traffic drops in the 50–100% congestion range. Green traffic is dropped at a very low rate to slowly close the TCP window. Yellow and red traffic are dropped more aggressively.

```
console(config)#random-detect queue-parms 0 1 min-thresh 80 70
50 50 max-thresh 100 100 100 100 drop-prob-scale 3 5 10 15
```

- 12** Assign the color policies to ports. The metering policies are applied on ingress ports.

```
console (config) #interface Te1/0/22
console (config-if-Te1/0/22) #service-policy in simple-policy
console (config-if-Te1/0/22) #exit
console (config) #interface Te1/0/23
console (config-if-Te1/0/23) #service-policy in two-rate-policy
console (config-if-Te1/0/23) #exit
```

## Example 2: Long-Lived Congestion

The following example enables WRED discard for non-color-aware traffic. Since a color-aware policer is not enabled, all traffic is treated as if it were colored “green.” This means that only the “green” TCP and non-TCP WRED thresholds are active. Since the default CoS queue is 1, this example is suitable as a starting point for configuring WRED on a switch using the default settings. Packets will be randomly dropped on an egress port when the port becomes congested above the minimum threshold.

If many (more than  $\frac{1}{4}$ ) of the ports are becoming congested, then there is a chance that the switch buffer capacity will be exceeded and the switch will revert to tail-drop behavior. It is appropriate to lower the minimum threshold when many ports are becoming congested and to raise the minimum threshold when only one or two ports are becoming congested. Use the `show interfaces traffic` command to display interface congestion.

- 1 Configure the green thresholds for TCP traffic on CoS queue 1. Other thresholds are kept at their default values. The minimum threshold of 150% and maximum threshold of 200% with a drop probability of 2% are a good starting point for tuning the WRED parameters for an enterprise storage network that exhibits long term congestion on a few ports. Non-TCP traffic is configured for tail-drop at the 100% threshold. No color-aware processing is configured.

```
console(config)#random-detect queue-parms 1 min-thresh 150 30  
20 100 max-thresh 200 90 80 100 drop-prob-scale 2 10 10 100
```

- 2 Enable WRED on cos-queue 1 (the default cos queue for packets marked user priority 0).

```
console(config)#cos-queue random-detect 1
```

## Example 3: Data Center TCP (DCTCP) Configuration

This example globally configures a Dell EMC Networking N2000/N3000E-ON Series switch to utilize ECN marking of green packets queued for egress on CoS queues 0 and 1 using the DCTCP threshold as it appears in “DCTCP: Efficient Packet Transport for the Commoditized Data Center” Alizadeh, Greenberg, Maltz, Padhye, Patel, Prabhakar, Sengupta, and Sridharan, 2010.



**NOTE:** Data center TCP requires changes to the TCP stack on both ends of the connection. Reno TCP stacks do not always respond well to DCTCP settings.



In the first line of the configuration below, the first integer after the `min-thresh` keyword configures green-colored Congestion Enabled TCP packets in CoS queues 0 and 1 that exceed the WRED threshold (13% or ~38 Kbytes) to mark packets as Congestion Experienced. The first integer after the `max-thresh` parameter configures the upper threshold for green-colored TCP packets to the same value as the `min-thresh` threshold. This causes the switch to mark all ECN-capable queued packets as Congestion Experienced when the threshold is reached or exceeded. TCP packets without ECN capability bits set are dropped according to the normal WRED processing when the threshold is exceeded. Packets on other CoS queues are handled in the standard manner, i.e., tail-dropped when insufficient buffer is available. Yellow and red packet configuration (second and third threshold parameters) is kept at the defaults, as no metering to reclassify packets from green to yellow or red is present. The last threshold parameter configures non-TCP packets in CoS queues 0 and 1 to be processed with the WRED defaults. The `ecn` keyword enables ECN marking of ECN-capable packets on CoS queues 0 and 1. The weighting constant is set to 0 in the second line of the configuration, as described in the DCTCP paper cited above. Finally, CoS queues 0 and 1 are configured for WRED in the last line of the configuration.

```
console(config)#random-detect queue-parms 0 1 min-thresh 13 30 20  
100 max-thresh 13 90 80 100 drop-prob-scale 100 10 10 10 ecn  
console(config)#random-detect exponential-weighting-constant 0  
console(config)#cos-queue random-detect 0 1
```



# Auto VoIP

## **Dell EMC Networking N1500, N2000, N2100-ON, N2200-ON, N3000E-ON, N3100-ON, and N3200-ON Series Switches**

Voice over Internet Protocol (VoIP) allows you to make telephone calls using a computer network over a data network like the Internet. With the increased prominence of delay-sensitive applications (voice, video, and other multimedia applications) deployed in networks today, proper QoS configuration will ensure high-quality application performance. The Auto VoIP feature is intended to provide an easy classification mechanism for voice packets so that they can be prioritized above data packets in order to provide better QoS. Because Auto VoIP supports a limited number of sessions, Voice VLAN is the preferred solution for enterprises wishing to deploy a scalable voice service. Voice VLAN and Auto VoIP are incompatible. Only one of Voice VLAN or Auto VoIP should be enabled in the switch.

The topics covered in this chapter include:

- Auto VoIP Overview
- Default Auto VoIP Values
- Configuring Auto VoIP (Web)
- Configuring Auto VoIP (CLI)

## **Auto VoIP Overview**

The Auto VoIP feature explicitly matches VoIP streams in Ethernet switches and provides them with a better class of service than ordinary traffic. If you enable the Auto VoIP feature on an interface, the interface scans incoming traffic for the following call-control protocols:

- Session Initiation Protocol (SIP)
- H.323
- Skinny Client Control Protocol (SCCP)

When a call-control protocol is detected the switch assigns the traffic in that session to the highest CoS queue, which is generally used for time-sensitive traffic.

Auto VoIP supports a limited number of active sessions since it makes use of the switch CPU to classify traffic. It is preferable to use the Voice VLAN feature in larger enterprise environments as it uses the switching silicon to classify voice traffic onto a VLAN.

Auto VoIP is incompatible with Voice VLAN and should not be enabled on switches on which Voice VLAN is enabled.

### How Does Auto VoIP Use ACLs?

Auto VoIP utilizes ACL lists from the global system pool. ACL lists allocated by Auto VoIP reduce the total number of ACLs available for use by the network operator. Enabling Auto VoIP uses one ACL list (slice) to monitor for VoIP sessions. Each monitored VoIP session utilizes two rules from an additional ACL list. This means that the maximum number of ACL lists (slices) allocated by Auto VoIP is two.


## Default Auto VoIP Values

Table 45-1 shows the global default value for Auto VoIP.

**Table 45-1. Auto VoIP Global Defaults**

Parameter	Default Value
Auto VoIP	Disabled

# Configuring Auto VoIP (Web)

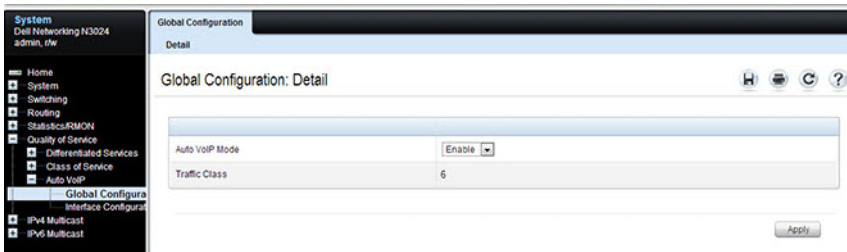
This section provides information about the OpenManage Switch Administrator pages for configuring and monitoring Auto VoIP features on Dell EMC Networking N-Series switches. For details about the fields on a page, click  at the top of the Dell EMC OpenManage Switch Administrator web page.

## Auto VoIP Global Configuration

Use the **Global Configuration** page to enable or disable Auto VoIP on all interfaces.

To display the **Auto VoIP Global Configuration** page, click **Quality of Service** → **Auto VoIP** → **Global Configuration** in the navigation menu.

**Figure 45-1. Auto VoIP Global Configuration**

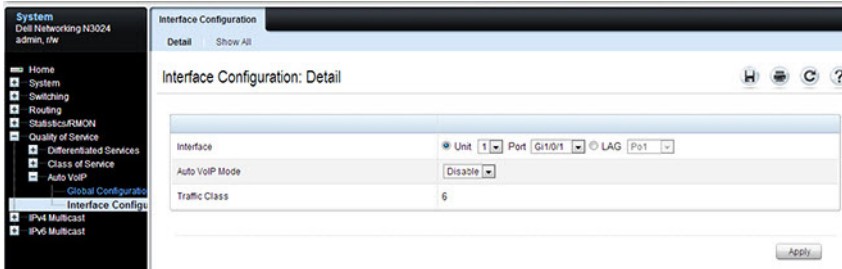


## Auto VoIP Interface Configuration

Use the **Interface Configuration** page to enable or disable Auto VoIP on a particular interface.

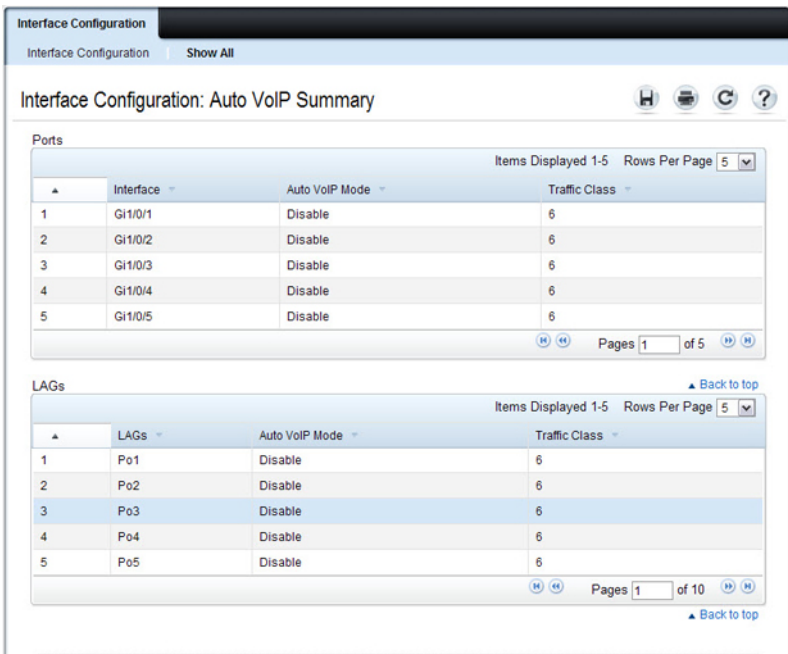
To display the **Interface Configuration** page, click **Quality of Service** → **Auto VoIP** → **Interface Configuration** in the navigation menu.

**Figure 45-2. Auto VoIP Interface Configuration**



To display summary Auto VoIP configuration information for all interfaces, click the **Show All** link at the top of the page.

**Figure 45-3. Auto VoIP**



## Configuring Auto VoIP (CLI)

This section provides information about the commands used for configuring Auto VoIP settings on the switch. For more information about the commands, see the *Dell EMC Networking N1100-ON, N1500, N2000, N2100-ON, N2200-ON, N3000E-ON, N3100-ON, and N3200-ON Series Switches CLI Reference Guide* at [www.dell.com/support](http://www.dell.com/support).

### Mapping Table Configuration

Use the following commands to enable Auto VoIP and view its configuration.

CLI Command	Description
<code>configure</code>	Enter Global Configuration mode.
<code>switchport voice detect auto</code>	Enable the VoIP Profile on all the interfaces of the switch. The same command can be entered in Interface Configuration mode to enable it on a specific interface.
<code>exit</code>	Exit to Global Configuration Exec mode.
<code>exit</code>	Exit to Privilege Exec mode.
<code>show switchport voice</code>	Show the status of Auto VoIP on all interfaces or on an interface, if one is specified.





# IPv4 and IPv6 Multicast

## Dell EMC Networking N3000E-ON, N3100-ON, and N3200-ON Series Switches



**NOTE:** This feature is available only on Dell EMC Networking N3000-ON, N3100-ON, and N3200-ON Series switches.

This chapter describes how to configure and monitor Layer-3 (L3) multicast features for IPv4 and IPv6, including global IP and IPv6 multicast features as well as multicast protocols, including IGMP, DVMRP, and PIM for IPv4 and MLD and PIM for IPv6.

The topics covered in this chapter include:

- L3 Multicast Overview
- Default L3 Multicast Values
- Configuring General IPv4 Multicast Features (Web)
- Configuring IPv6 Multicast Features (Web)
- Configuring IGMP and IGMP Proxy (Web)
- Configuring MLD and MLD Proxy (Web)
- Configuring PIM for IPv4 and IPv6 (Web)
- Configuring DVMRP (Web)
- Configuring L3 Multicast Features (CLI)
- L3 Multicast Configuration Examples

## L3 Multicast Overview

IP Multicasting enables a network host (or multiple hosts) to send an IP datagram to multiple destinations simultaneously. The initiating host sends each multicast datagram only once to a destination multicast group address, and multicast routers forward the datagram only to hosts who are members of the multicast group. Multicast enables efficient use of network bandwidth because each multicast datagram needs to be transmitted only once on each network link, regardless of the number of destination hosts. Multicasting contrasts with IP unicasting, which sends a separate datagram to each

recipient host. The IP routing protocols can route multicast traffic, but the IP multicast protocols handle the multicast traffic more efficiently with better use of network bandwidth.

Applications that often send multicast traffic include video or audio conferencing, Whiteboard tools, stock distribution tickers, and IP-based television (IP/TV).

### **What Is IP Multicast Traffic?**

IP multicast traffic is traffic that is destined to a host group. Host groups are identified by class D IP addresses, which range from 224.0.0.0 to 239.255.255.255. When a packet with a broadcast or multicast destination IP address is received, the switch will forward a copy into each of the remaining network segments in accordance with the IEEE MAC Bridge standard. Eventually, the packet is made accessible to all nodes connected to the network.

This approach works well for broadcast packets that are intended to be seen or processed by all connected nodes. In the case of multicast packets, however, this approach could lead to less efficient use of network bandwidth, particularly when the packet is intended for only a small number of nodes. Packets will be flooded into network segments where no node has any interest in receiving the packet. The L3 multicast features on the switch help to ensure that only the hosts in the multicast group receive the multicast traffic for that group.

Multicast applications send one copy of a packet, and address it to a group of receivers (Multicast Group Address) rather than to a single receiver (unicast address). Multicast depends on the network to forward the packets to only those networks and hosts that need to receive them.

### **Multicast Addressing**

IPv4 multicast addresses in the range 224.0.0.X are reserved link local addresses used for control plane traffic. Packets sent to these addresses are always flooded to all ports. Do not use these addresses for multicast data traffic. Because there is a 32:1 overlap in the IPv4 multicast address range, any address in the range 224–239.0.0.x and 224–239.128.0.0 should never be used for multicast data traffic.

239.0.0.0/8 is the locally scoped IPv4 multicast address range. Use addresses from this block for local/intra-domain multicast data traffic. See RFC 2365 for further information

233.0.0.0/8 is the GLOP IPv4 public address range and is suitable for inter-domain multicast data traffic. See RFC 2770 for further information.

232.0.0.0/8 is the PIM-SSM IPv4 public address space and is suitable for inter-domain data traffic. See RFC 4608 for further information.

ffx5::/16 is the IPv6 site-local scope multicast address space and is suitable for intra-domain IPv6 multicast data traffic.

ffx8::/16 is the IPv6 Organization-local scope multicast address space and is suitable for intra-domain data traffic that may be sent over a VPN. These addresses are not valid in the public Internet.

ffxe::/16 is the IPv6 Global scope multicast address space and is suitable for inter-domain data traffic. These addresses are valid in the public Internet.

## What Multicast Protocols Does the Switch Support?

Multicast protocols are used to deliver multicast packets from one source to multiple receivers. Table 46-1 summarizes the multicast protocols that the switch supports.

**Table 46-1. Multicast Protocol Support Summary**

Protocol	IPv4 or IPv6	For Communication Between
IGMP	IPv4	Host-to-L3 switch/router
IGMP Proxy	IPv4	Host-to-L3 switch/router
MLD	IPv6	Host-to-L3 switch/router
MLD Proxy	IPv6	Host-to-L3 switch/router
PIM-SM	IPv4 and IPv6	L3-switch/router-to-L3 switch/router
PIM-DM	IPv4 and IPv6	L3-switch/router-to-L3 switch/router
DVMRP	IPv4	L3-switch/router-to-L3 switch/router

## What Are the Multicast Protocol Roles?

Hosts must have a way to identify their interest in joining any particular multicast group, and routers must have a way to collect and maintain group memberships. These functions are handled by the IGMP protocol in IPv4. In the IPv6 domain, multicast routers use the Multicast Listener Discover (MLD) protocol to maintain group membership information.

Multicast routers must also be able to construct a multicast distribution tree that enables forwarding multicast datagrams only on the links that are required to reach a destination group member. Protocols such as DVMRP, and PIM handle this function.

IGMP and MLD are multicast group discovery protocols that are used between the clients and the local multicast router. PIM-SM, PIM-DM, and DVMRP are multicast routing protocols that are used across different subnets, usually between the local multicast router and remote multicast router.

## When Is L3 Multicast Required on the Switch?

Use the IPv4/IPv6 multicast feature on Dell EMC Networking N-Series switches to route multicast traffic between VLANs on the switch. If all hosts connected to the switch are on the same subnet, there is no need to configure the IPv4/IPv6 multicast feature. If the switch does not require L3 routing, IGMP snooping or MLD snooping can be used to manage port-based multicast group membership. For more information, see "What Is IGMP Snooping?" on page 969 and "What Is MLD Snooping?" on page 971. If the local network does not have a multicast router, the switch can be configured to act as the IGMP querier. For more information, see "IGMP Snooping Querier" on page 971.

If the switch is configured as an L3 switch and handles inter-VLAN routing through static routes, OSPF, or RIP, and multicast traffic is transmitted within the network, enabling and configuring L3 multicast routing on the switch is recommended.

By default, multicast packets locally routed into a VLAN by the router are flooded to all ports in the VLAN. Multicast packets ingressing a port that is a member of a routed VLAN are flooded to all ports in the VLAN other than the receiving port. Although IGMP/MLD snooping can be used to mitigate this behavior, it is strongly recommended that multicast routed VLANs only

contain two ports, one on each connecting switch. A VLAN carrying multicast traffic should never traverse a multicast router, as ingress multicast traffic is Layer-2-switched across the VLAN, defeating the purpose of the multicast router.

### **Determining Which Multicast Protocols to Enable**

IGMP is required on any multicast router that serves IPv4 hosts. IGMP is not required on inter-router links. MLD is required on any router that serves IPv6 hosts. MLD is not required on inter-router links. PIM-DM, PIM-SM, and DVMRP are multicast routing protocols that help determine the best route for IP (PIM and DVMRP) and IPv6 (PIM) multicast traffic.

IGMP is automatically enabled whenever an IPv4 multicast routing protocol is enabled that requires it, i.e., PIM-SM, PIM-DM, and DVMRP via the CLI. Likewise, MLD is automatically enabled whenever an IPv6 multicast routing protocol is enabled that requires it (PIM-SM and PIM-DM) via the CLI. IGMP and MLD may not be separately enabled or disabled via the CLI. They may be separately enabled/disabled via the web.

For more information about when to use PIM-DM, see "Using PIM-DM as the Multicast Routing Protocol" on page 1618. For more information about when to use PIM-SM, see "Using PIM-SM as the Multicast Routing Protocol" on page 1608. For more information about when to configure DVMRP, see "Using DVMRP as the Multicast Routing Protocol" on page 1619.

### **What Is the Multicast Routing Table?**

Multicast capable/enabled routers forward multicast packets based on the routes in the Multicast Routing Information Base (MRIB). These routes are created in the MRIB during the process of building multicast distribution trees by the Multicast Protocols running on the router. Different IP Multicast routing protocols use different techniques to construct these multicast distribution trees.

## What Is IGMP?

The Internet Group Management Protocol (IGMP) is used by IPv4 systems (hosts, L3 switches, and routers) to report their IP multicast group memberships to any neighboring multicast routers. The Dell EMC Networking N-Series switch performs the multicast router role of the IGMP protocol, which means it collects the membership information needed by the active multicast routing protocol. IGMP is automatically enabled when PIM or DVMRP are enabled via the CLI.

Dell EMC Networking N3000-ON, N3100-ON, and N3200-ON Series switches also support IGMP Version 3. Version 3 adds support for source filtering, which is the ability for a system to report interest in receiving packets only from specific source addresses, as required to support Source-Specific Multicast [SSM], or from all but specific source addresses, sent to a particular multicast address. Version 3 is designed to be interoperable with Versions 1 and 2.

## Understanding IGMP Proxy

IGMP proxy enables a multicast router to learn multicast group membership information and forward multicast packets based upon the group membership information. The IGMP Proxy is capable of functioning only in certain topologies that do not require Multicast Routing Protocols (i.e., DVMRP, PIM-DM, and PIM-SM) and have a tree-like topology, as there is no support for features like reverse path forwarding (RPF) to correct packet route loops.

The proxy contains many downstream interfaces and a unique upstream interface explicitly configured. It performs the host side of the IGMP protocol on its upstream interface and the router side of the IGMP protocol on its downstream interfaces.

The IGMP proxy offers a mechanism for multicast forwarding based only on IGMP membership information. The router must decide about forwarding packets on each of its interfaces based on the IGMP membership information. The proxy creates the forwarding entries based on the membership information and adds it to the multicast forwarding cache (MFC) in order not to make the forwarding decision for subsequent multicast packets with same combination of source and group.

## What Is MLD?

Multicast Listener Discovery (MLD) protocol enables IPv6 routers to discover the presence of multicast listeners, the hosts that wish to receive the multicast data packets, on its directly-attached interfaces. The protocol specifically discovers which multicast addresses are of interest to its neighboring nodes and provides this information to the active multicast routing protocol that makes decisions on the flow of multicast data packets. MLD is automatically enabled whenever IPv6 PIM is enabled on IPv6 interfaces via the CLI.

The Multicast router sends General Queries periodically to request multicast address listeners information from systems on an attached network. These queries are used to build and refresh the multicast address listener state on attached networks. Multicast listeners respond to these queries by reporting their multicast addresses listener state and their desired set of sources with Current-State Multicast address Records in the MLD2 Membership Reports. The Multicast router also processes unsolicited Filter-Mode-Change records and Source-List-Change Records from systems that want to indicate interest in receiving or not receiving traffic from particular sources.

The Dell EMC Networking implementation of MLD v2 supports the multicast router portion of the protocol (i.e., not the listener portion). It is backward-compatible with MLD v1.

## What Is PIM?

The Protocol Independent Multicast protocol is a simple, protocol-independent multicast routing protocol. PIM uses an existing unicast routing table and a Join/Prune/Graft mechanism to build a tree. Dell EMC Networking N-Series switches support two types of PIM: sparse mode (PIM-SM) and dense mode (PIM-DM).

PIM-SM is most effective in networks with a sparse population of multicast receivers. In contrast, PIM-DM is most effective in networks with densely populated multicast receivers. In other words, PIM-DM can be used if the majority of network hosts request to receive a multicast stream, while PIM-SM might be a better choice in networks in which a small percentage of network hosts, located throughout the network, wish to receive the multicast stream.

## Using PIM-SM as the Multicast Routing Protocol

PIM-SM is used to efficiently route multicast traffic to multicast groups that may span wide area networks and where bandwidth is constrained. PIM-SM uses shared trees by default and implements source-based trees for efficiency. PIM-SM assumes that no hosts want the multicast traffic unless they specifically ask for it. It initially creates a shared distribution tree centered on a defined “rendezvous point” (RP) through which source traffic is relayed to the ultimate receiver. Multicast traffic sources first send the multicast data to the RP, which in turn sends the data down the shared tree to the receivers. Shared trees centered on an RP do not necessarily provide the shortest or most optimal path. In such cases, a Dell EMC Networking PIM-SM router adjacent to the host switches to the shortest path upon seeing the very first multicast data packet.

Many IP multicast applications, such as those that handle real-time dissemination of financial information, require high performance. Multicast group membership management (IGMP), unicast routing protocols (OSPF, RIP), and multicast routing protocols are all required to enable end-to-end multicast capabilities. The RP is a critical function for PIM-SM deployments. RP redundancy is always recommended. In a shared-tree model, multicast traffic from the multicast source is routed via the RP. If the RP goes down, the multicast receivers do not receive traffic until the RP comes up again. In general, more than one RP is configured (for a group range) to provide RP redundancy. The PIM-SM router acting as a BSR advertises the list of candidate RPs to all the PIM routers in the network. Each PIM router then runs the RP selection algorithm to determine an RP for the given group range. All the interested PIMSM routers then initiate re-reception of traffic through this new RP, and the multicast traffic is rerouted via the new RP. This is to provide high availability to the multicast applications and help ensure that the multicast traffic is recovered quickly in such scenarios.

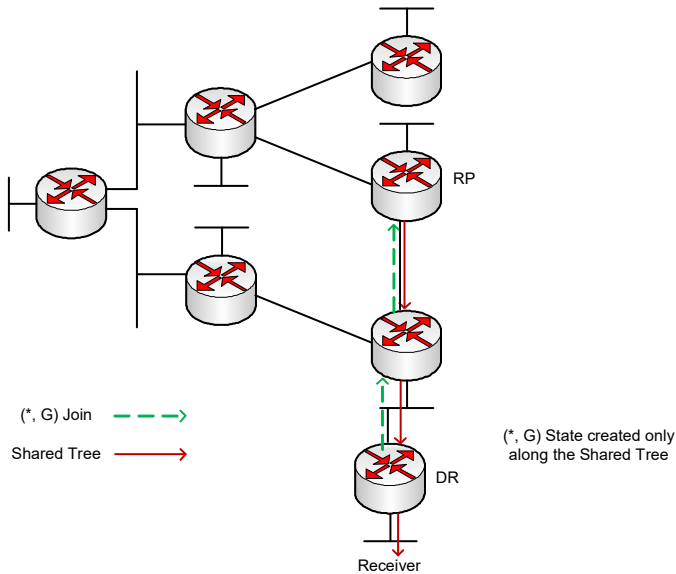


## PIM-SM Protocol Operation

This section describes the workings of PIM-SM protocol per RFC 4601. The protocol operates essentially in three phases, as explained in the following sections.

### Phase-1: RP Tree

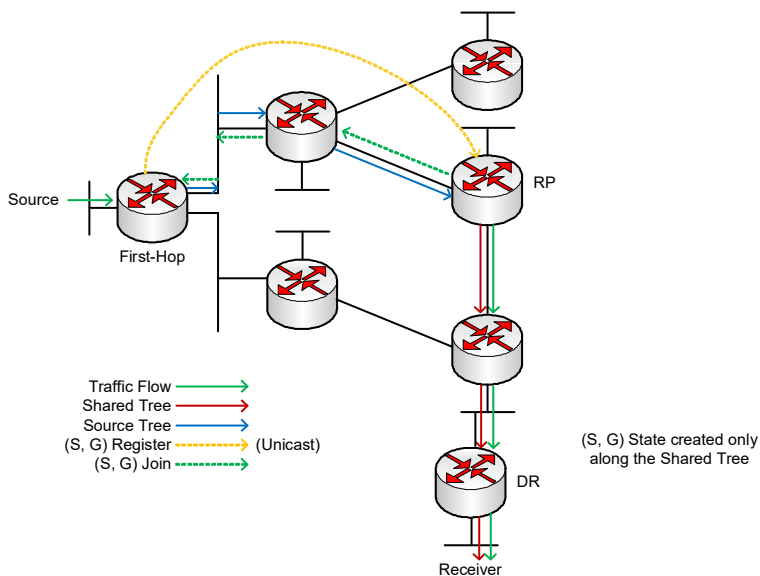
Figure 46-1. PIM-SM Shared Tree Join



- In this example, an active receiver (attached to leaf router at the bottom of the drawing) has joined multicast group “G”.
- The leaf router (labeled DR above) knows the IP address of the Rendezvous Point (RP) for group G and sends a (\*, G) Join for this group towards the RP.
- This (\*, G) Join travels hop-by-hop to the RP, building a branch of the Shared Tree that extends from the RP to the last-hop router directly connected to the receiver.
- At this point, group “G” traffic can flow down the Shared Tree to the receiver.

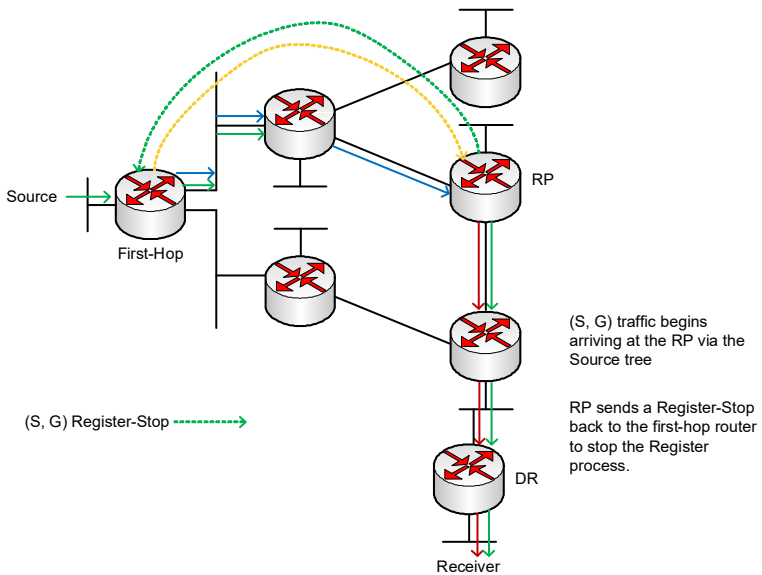
## Phase-2: Register Stop

Figure 46-2. PIM-SM Sender Registration—Part1



- As soon as an active source for group G sends a packet, the designated router (DR) that is attached to this source is responsible for “Registering” this source with the RP and requesting the RP to build a tree back to that router.
- To do this, the source router encapsulates the multicast data from the source in a special PIM-SM message, called the Register message, and unicasts that data to the RP.
- When the RP receives the Register message, it does two things:
  - It de-encapsulates the multicast data packet inside of the Register message and forwards it down the Shared Tree.
  - The RP sends a source group (S, G) Join back towards the source to create a branch of an (S, G) Shortest-Path Tree (SPT). This results in the (S, G) state being created in the entire router path along the SPT, including the RP.

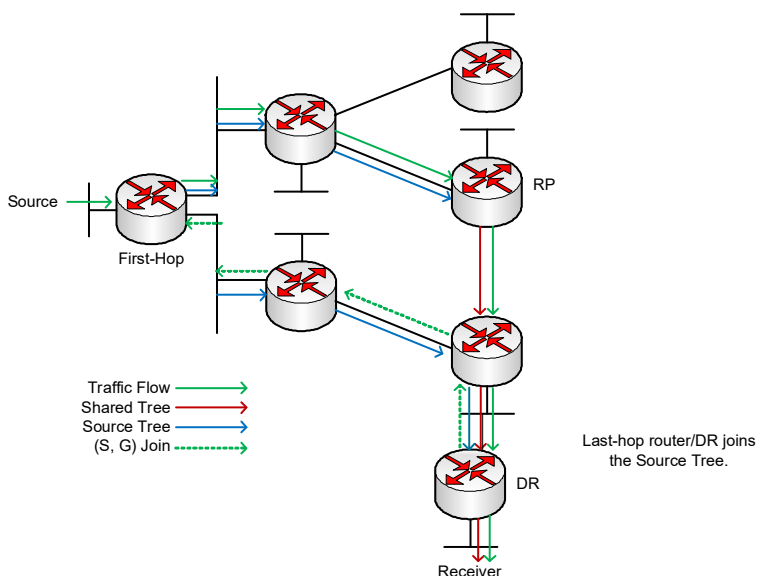
**Figure 46-3. PIM-SM Sender Registration—Part 2**



- As soon as the SPT is built from the Source router to the RP, multicast traffic begins to flow unencapsulated from source S to the RP.
- Once this is complete, the RP Router will send a “Register Stop” message to the first-hop router to tell it to stop sending the encapsulated data to the RP.

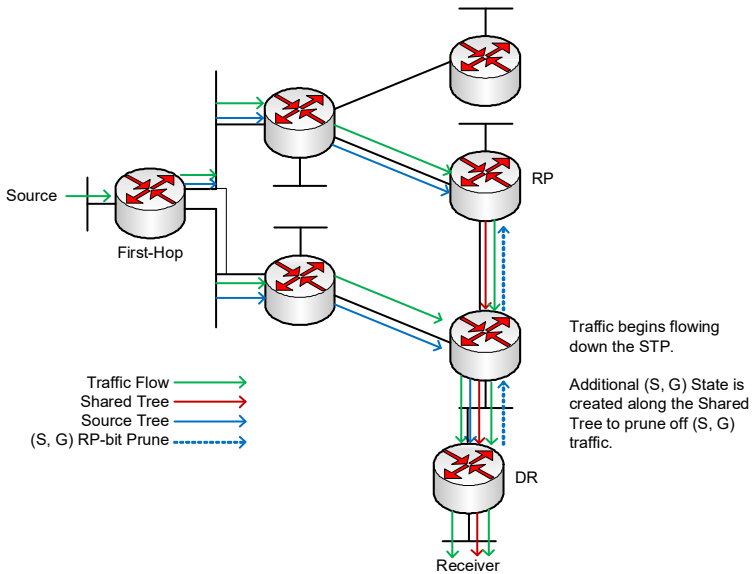
### Phase 3: Shortest Path Tree

Figure 46-4. PIM-SM SPT—Part 1



- PIM-SM has the capability for last-hop routers (i.e., routers with directly connected group members) to switch to the Shortest-Path Tree and bypass the RP. This switchover is based upon an implementation-specific function called `SwitchToSptDesired(S,G)` in the standard and generally takes a number of seconds to switch to the SPT.
- In the above example, the last-hop router (at the bottom of the drawing) sends an (S, G) Join message toward the source to join the SPT and bypass the RP.
- This (S, G) Join messages travels hop-by-hop to the first-hop router (i.e., the router connected directly to the source), thereby creating another branch of the SPT. This also creates (S, G) state in all the routers along this branch of the SPT.

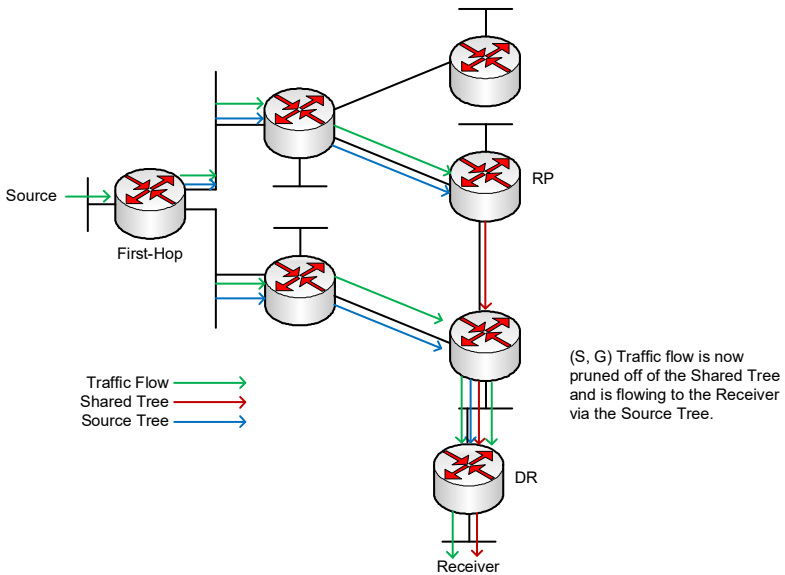
**Figure 46-5. PIM-SM SPT—Part 2**



- Finally, special (S, G) RP-bit Prune messages are sent up the Shared Tree to prune off this (S, G) traffic.

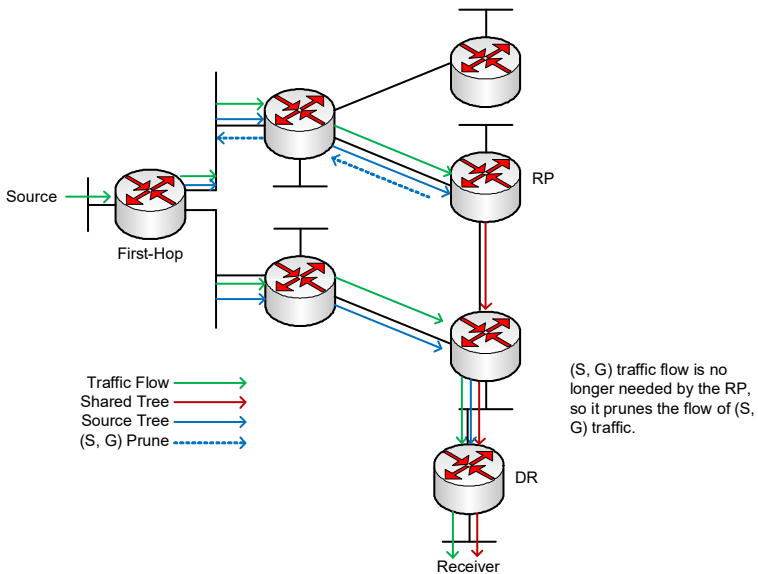
If this were not done, (S, G) traffic would continue flowing down the Shared Tree resulting in duplicate (S, G) packets arriving at the receiver.

**Figure 46-6. PIM-SM SPT—Part 3**




- At this point, (S, G) traffic is now flowing directly from the first-hop router to the last-hop router and from there to the receiver.

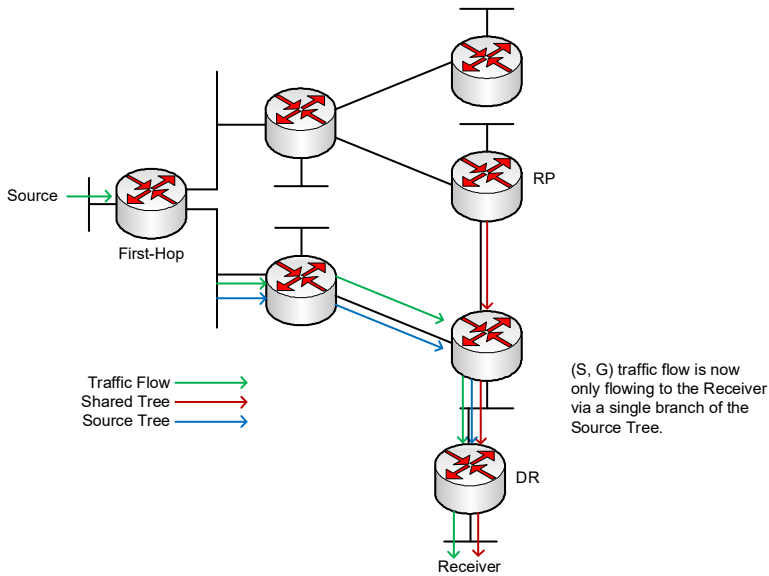
Figure 46-7. PIM-SM SPT—Part 4



- At this point, the RP no longer needs the flow of (S, G) traffic since all branches of the Shared Tree (in this case there is only one) have pruned off the flow of (S, G) traffic.
- As a result, the RP will send (S, G) Prunes back toward the source to shut off the flow of the now unnecessary (S, G) traffic to the RP.

 **NOTE:** This will occur if the RP has received an (S, G) RP-bit Prune on all interfaces on the Shared Tree.

**Figure 46-8. PIM-SM SPT—Part 5**



- As a result of the SPT-Switchover, (S, G) traffic is now flowing only from the first-hop router to the last-hop router and from there to the receiver. Notice that traffic is no longer flowing to the RP.

The PIM standard requires support for multi-hop RP in that a router running PIM can act as an RP even if it is multiple router hops away from the multicast source. This requires that the first-hop router perform encapsulation of the multicast data and forward it as unicast toward the RP. In practice, this encapsulation is almost always performed in software due to the complexity of the operation. Likewise, the RP must perform de-encapsulation and forwarding of the multicast packets in software. This creates a performance problem in that it limits the number of packets that can be processed and places a high load on the CPUs in the first hop and RP routers, which can then adversely affect other router functions.

### ***Dell EMC Networking Optimizations to PIM-SM***

Dell EMC Networking N-Series switches perform the following optimizations to reduce the impact of multicast encapsulation/de-encapsulation and provide a higher level of multicast performance in the network.



- Limiting the number of packets sent to the RP by the first-hop router. When a multicast data source (S) starts sending data destined for a multicast group (G), the first-hop router receives these packets and traps them to its local CPU. A Dell EMC Networking first-hop router immediately blocks further data packets in the stream and prevents them from reaching the CPU. The first-hop router then unicast-encapsulates the first received data packet in the form of a PIM Register message and software forwards it to the RP.

When a Dell EMC Networking first-hop router subsequently receives the PIM Join from the RP, the block is replaced with a regular multicast forwarding entry so that subsequent data packets are forwarded in the hardware.

If the initial Register message(s) does not reach the RP, or the PIM Join sent in response does not reach the first-hop router, then the data stream would never get forwarded. To solve this, the negative entry is timed out and removed after 3 seconds so that the process can be repeated until it succeeds.

- In Phase 3—Shortest Path Tree, the last-hop router initiates a switchover to the SPT tree by sending a PIM (S,G) Join message towards the source as soon as it receives the first data packet via the (\*,G) shared tree. Per the standard, this function is used to detect suboptimal routing of multicast traffic. Dell EMC Networking multicast eliminates the SwitchToSptDesired(S,G) function and performs as if the SwitchToSptDesired(S,G) function always returns “true” as soon as it receives the first multicast packet instead of waiting for 30 seconds.
- Dell EMC Networking RPs do not wait to receive the native multicast data but immediately respond to the PIM (S,G) Join by sending a 'Register Stop' message to the source's first-hop router to inform it that it can stop sending the encapsulated Register messages. This removes the load from the CPU of the first-hop router and the RP, as they no longer need to encapsulate and de-encapsulate register messages with multicast data.

These optimizations significantly reduce the load on first-hop routers and RPs to encapsulate/de-encapsulate PIM register messages and their associated multicast data. In addition, the switchover to the SPT is initiated immediately upon the first multicast packet reaching the last-hop router. This

leads to significantly faster response times for receiving the full multicast stream directly from the first-hop router (as opposed to the typical bandwidth-limited stream traversing the RP).

### **Using PIM-DM as the Multicast Routing Protocol**

Unlike PIM-SM, PIM-DM creates source-based shortest-path distribution trees that make use of reverse-path forwarding (RPF). PIM-DM assumes that when a sender starts sending data, all downstream routers and hosts want to receive a multicast datagram. PIM-DM initially floods multicast traffic throughout the network. Routers that do not have any downstream neighbors prune back the unwanted traffic. In addition to PRUNE messages, PIM-DM makes use of graft and assert messages. Graft messages are used whenever a new host wants to join the group. Assert messages are used to shutoff duplicate flows on the same multi-access network.

There are two versions of PIM-DM. Version 2 does not use the IGMP message; instead, it uses a message that is encapsulated in an IP packet, with protocol number 103. In Version 2, a Hello message is introduced in place of a query message.

PIM-DM is appropriate for:

- Densely distributed receivers
- Few senders-to-many receivers (due to frequent flooding)
- High volume of multicast traffic
- Constant stream of traffic

To minimize the repeated flooding of datagrams and subsequent pruning associated with a particular source-group (S,G) pair, PIM-DM uses a State Refresh message. This message is sent by the router(s) directly connected to the source and is propagated throughout the network. When received by a router on its RPF interface, the State Refresh message causes an existing prune state to be refreshed. State Refresh messages are generated periodically by the router directly attached to the source.

### **What Is DVMRP?**

DVMRP is an interior gateway protocol that is suitable for routing multicast traffic within an autonomous system (AS). DVMRP should not be used between different autonomous systems due to limitations with hop count and scalability.



**NOTE:** In addition to DVMRP, the switch supports the Protocol-Independent Multicast (PIM) sparse-mode (PIM-SM) and dense-mode (PIM-DM) routing protocol. Only one multicast routing protocol can be operational on the switch at any time. If you enable DVMRP, PIM must be disabled. Similarly, if PIM is enabled, DVMRP must be disabled.

DVMRP exchanges probe packets with all its DVMRP-enabled routers, it establishes two-way neighboring relationships, and it builds a neighbor table. DVMRP exchanges report packets and creates a unicast topology table, with which it builds the multicast routing table. This table is used to route the multicast packets. Since every DVMRP router uses the same unicast routing protocol, routing loops are avoided.

### **Understanding DVMRP Multicast Packet Routing**

DVMRP is based on RIP; it forwards multicast datagrams to other routers in the AS and constructs a forwarding table based on information it learns in response. More specifically, it uses this sequence.

- A new multicast packet is forwarded to the entire multicast network, with respect to the time-to-live (TTL) of the packet.
- The TTL restricts the area to be flooded by the message.
- All routers that do not have members on directly-attached subnetworks send back *Prune messages* to the upstream router.
- The branches that transmit a prune message are deleted from the delivery tree.
- The delivery tree which is spanning to all the members in the multicast group, is constructed in the form of a DVMRP forwarding table.

### **Using DVMRP as the Multicast Routing Protocol**

DVMRP is used to communicate multicast information between L3 switches or routers. If a Dell EMC Networking N3000-ON, N3100-ON, or N3200-ON Series switch handles inter-VLAN routing for IP traffic, including IP multicast traffic, a multicast routing protocol might be required on the switch.

DVMRP is best suited for small networks where the majority of hosts request a given multicast traffic stream. DVMRP is similar to PIM-DM in that it floods multicast packets throughout the network and prunes branches where the multicast traffic is not desired. DVMRP was developed before PIM-DM, and it has several limitations that do not exist with PIM-DM.

You might use DVMRP as the multicast routing protocol if it has already been widely deployed within the network.

### **Microsoft Network Load Balancing**

Dell EMC Networking N-Series switches support Microsoft Network Load Balancing (NLB) in unicast mode only. When using Microsoft NLB, ensure that the Cluster Operation Mode is configured to the default value of Unicast.

## Default L3 Multicast Values

IP and IPv6 multicast is disabled by default. Table 46-2 shows the default values for L3 multicast and the multicast protocols.


**Table 46-2. L3 Multicast Defaults**

Parameter	Default Value
<b>IPv4 Multicast Defaults</b>	
L3 Multicast Admin Mode	Disabled
Maximum Multicast Routing Table Entries	2048 (1536 IPv4/512 IPv6) Switch sizes are as follows: Dell EMC Networking N3000-ON/N3100-ON/N3200-ON Series—1536 IPv4 / 512 IPv6
Static Multicast Routes	None configured
Interface TTL Threshold	1
<b>IGMP Defaults</b>	
IGMP Admin Mode	Disabled globally and on all interfaces
IGMP Version	v3
IGMP Robustness	2
IGMP Query Interval	125 seconds
IGMP Query Max Response Time	100 seconds
IGMP Startup Query Interval	31 seconds
IGMP Startup Query Count	2
IGMP Last Member Query Interval	1 second
IGMP Last Member Query Count	2
IGMP Proxy Interface Mode	Disabled
IGMP Proxy Unsolicited Report Interval	1 second
<b>MLD Defaults</b>	
MLD Admin Mode	Disabled globally and on all interfaces
MLD Version	v2

**Table 46-2. L3 Multicast Defaults (Continued)**

<b>Parameter</b>	<b>Default Value</b>
MLD Query Interval	125 seconds
MLD Query Max Response Time	10,000 milliseconds
MLD Last Member Query Interval	1000 milliseconds
MLD Last Member Query Count	2
MLD Proxy Interface Mode	Disabled
MLD Proxy Unsolicited Report Interval	1 second
<b>PIM Defaults</b>	
PIM Protocol	Disabled globally and on all interfaces
PIM Hello Interval	30 seconds (when enabled on an interface)
PIM-SM Join/Prune Interval	60 seconds (when enabled on an interface)
PIM-SM BSR Border	Disabled
PIM-SM DR Priority	1 (when enabled on an interface)
PIM Candidate Rendezvous Points (RPs)	None configured
PIM Static RP	None configured
PIM Source-Specific Multicast (SSM) Range	None configured. Default SSM group address is 232.0.0.0/8 for IPv4 multicast and ff3x::/32 for IPv6 multicast.
PIM BSR Candidate Hash Mask Length	30 (IPv4) 126 (IPv6)
PIM BSR Candidate Priority	0
<b>DVMRP Defaults</b>	
DVMRP Admin Mode	Disabled globally and on all interfaces
DVMRP Version	3
DVMRP Interface Metric	1

# Configuring General IPv4 Multicast Features (Web)

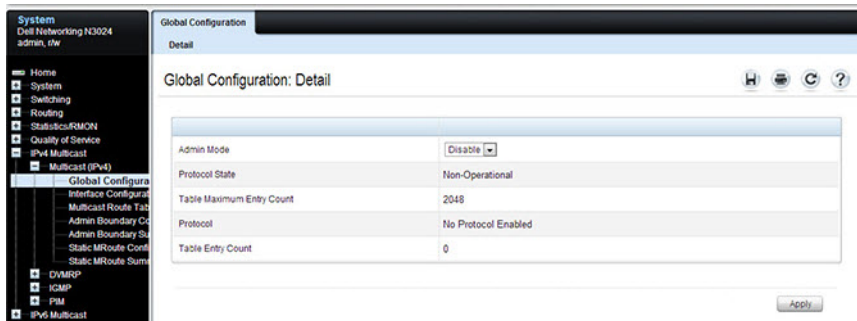
This section provides information about the OpenManage Switch Administrator pages for configuring and monitoring the L3 multicast features that are not protocol-specific on Dell EMC Networking N3000-ON, N3100-ON, and N3200-ON Series switches. For details about the fields on a page, click  at the top of the Dell EMC OpenManage Switch Administrator web page.

## Multicast Global Configuration

Use the **Global Configuration** page to configure the administrative status of Multicast Forwarding in the router, and to display global multicast parameters.

To display the page, click **IPv4 Multicast** → **Multicast** → **Global Configuration** in the navigation panel.

**Figure 46-9. Multicast Global Configuration**

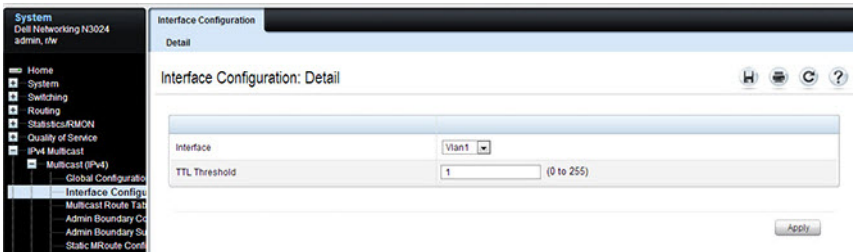


## Multicast Interface Configuration

Use the **Interface Configuration** page to configure the TTL threshold of a multicast interface. At least one VLAN routing interface must be configured on the switch before fields display on this page.

To display the page, click **IPv4 Multicast** → **Multicast** → **Interface Configuration** in the navigation panel.

**Figure 46-10. Multicast Interface Configuration**



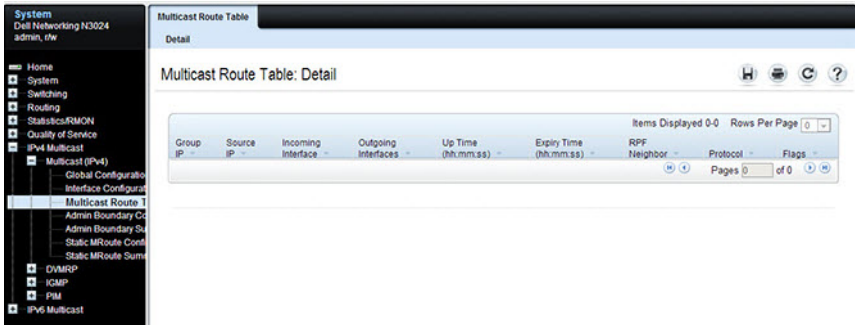


## Multicast Route Table

Use the **Route Table** page to view information about the multicast routes in the IPv4 multicast routing table.

To display the page, click **IPv4 Multicast** → **Multicast** → **Multicast Route Table** Multicast Route Table

**Figure 46-11. Multicast Route Table**

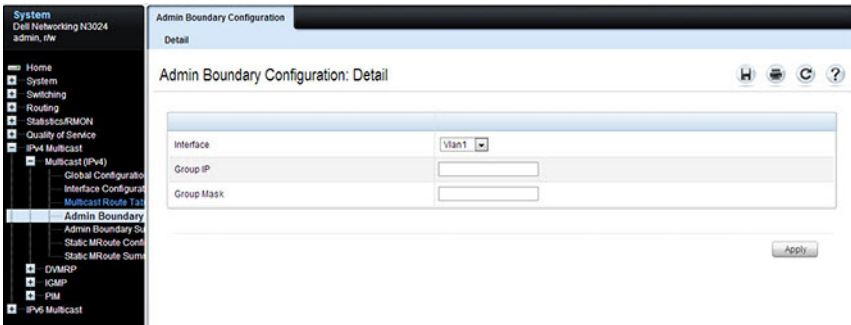


## Multicast Admin Boundary Configuration

The definition of an administratively scoped boundary is a way to stop the ingress and egress of multicast traffic for a given range of multicast addresses on a given routing interface. Use the **Admin Boundary Configuration** page to configure a new or existing administratively scoped boundary. To see this page, you must have configured a valid routing interface and multicast.

To display the page, click **IPv4 Multicast** → **Multicast** → **Admin Boundary Configuration** in the navigation panel.

**Figure 46-12. Multicast Admin Boundary Configuration**

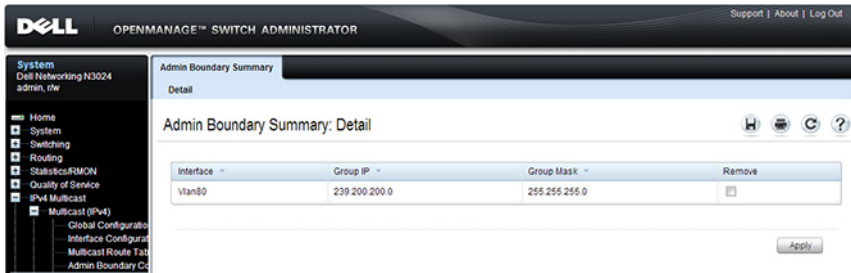


## Multicast Admin Boundary Summary

Use the Admin Boundary Summary page to display existing administratively scoped boundaries.

To display the page, click IPv4 Multicast → Multicast → Admin Boundary Summary in the navigation panel.

Figure 46-13. Multicast Admin Boundary Summary

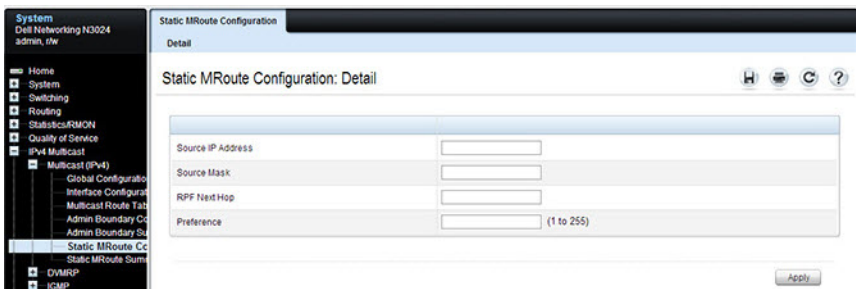


## Multicast Static MRoute Configuration

Use the Static MRoute Configuration page to configure a new static entry in the Mroute table or to modify an existing entry.

To display the page, click IPv4 Multicast → Multicast → Static MRoute Configuration in the navigation panel.

Figure 46-14. Multicast Static MRoute Configuration

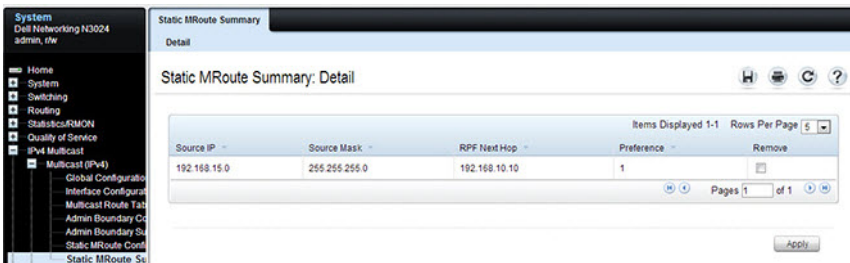


## Multicast Static MRoute Summary


Use the Static MRoute Summary page to display static routes and their configurations.

To display the page, click IPv4 Multicast → Multicast → Static MRoute Summary in the navigation panel.

Figure 46-15. Multicast Static MRoute Summary



# Configuring IPv6 Multicast Features (Web)

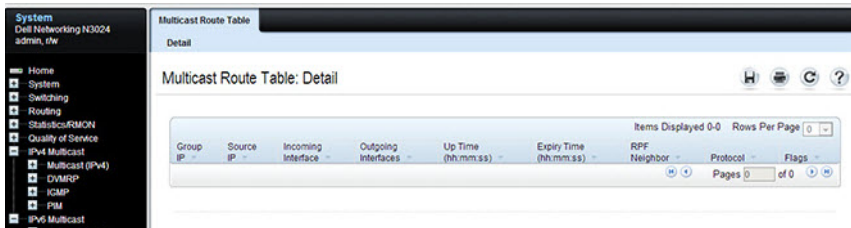
This section provides information about the OpenManage Switch Administrator pages for configuring and monitoring the IPv6 multicast features that are not protocol-specific on Dell EMC Networking N3000-ON, N3100-ON, and N3200-ON Series switches. For details about the fields on a page, click  at the top of the Dell EMC OpenManage Switch Administrator web page.

## IPv6 Multicast Route Table

Use the **Multicast Route Table** page to view information about the multicast routes in the IPv6 multicast routing table.


To display the page, click **IPv6 Multicast** → **Multicast** → **Multicast Route Table**.

**Figure 46-16. IPv6 Multicast Route Table**



The screenshot displays the 'Multicast Route Table: Detail' page. The left sidebar shows the navigation menu with 'IPv6 Multicast' selected. The main content area features a table with the following columns: Group, Source, Incoming Interface, Outgoing Interfaces, Up Time (hh:mm:ss), Expiry Time (hh:mm:ss), RPF Neighbor, Protocol, and Flags. The table is currently empty, and the page includes navigation controls like 'Items Displayed 0-0', 'Rows Per Page', and 'Pages 0 of 0'.

# Configuring IGMP and IGMP Proxy (Web)

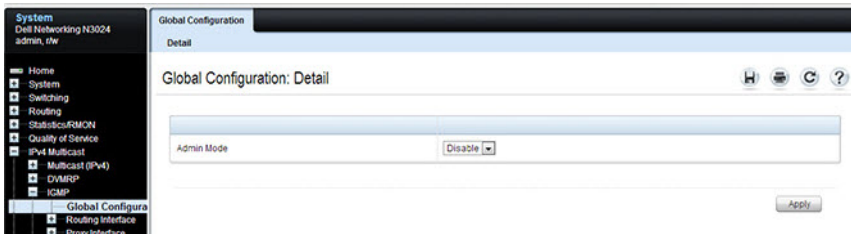
This section provides information about the OpenManage Switch Administrator pages for configuring and monitoring the IGMP and IGMP proxy features on Dell EMC Networking N3000-ON, N3100-ON, and N3200-ON Series switches. For details about the fields on a page, click  at the top of the Dell EMC OpenManage Switch Administrator web page.

## IGMP Global Configuration

Use the **Global Configuration** page to set IGMP on the system to active or inactive.

To display the page, click **IPv4 Multicast** → **IGMP** → **Global Configuration** in the navigation panel.

**Figure 46-17. IGMP Global Configuration**



## IGMP Interface Configuration

Use the **Interface Configuration** page to configure and/or display router interface parameters. At least one valid routing interface must be configured before this page can be accessed to configure IP Multicast IGMP.

To display the page, click **IPv4 Multicast** → **IGMP** → **Routing Interface** → **Interface Configuration** in the navigation panel.

**Figure 46-18. IGMP Interface Configuration**

The screenshot displays the 'Interface Configuration: Detail' page for 'Vlan1'. The configuration parameters are as follows:

Parameter	Value	Range
Interface	Vlan1	
Interface Mode	Disable	
Version	IPv3	
Robustness	2	(1 to 255)
Query Interval	125	(1 to 3600 seconds)
Query Max Response Time	10	(0 to 25 seconds)
Startup Query Interval	31	(1 to 300 seconds)
Startup Query Count	2	(1 to 20)
Last Member Query Interval	10	(0 to 255 1/10th of a second)
Last Member Query Count	2	(1 to 20)

An 'Apply' button is located at the bottom right of the configuration area.

## IGMP Interface Summary

Use the **Interface Summary** page to display IGMP routing parameters and data. You must configure at least one IGMP router interface to access this page.

To display the page, click **IPv4 Multicast** → **IGMP** → **Routing Interface** → **Interface Summary** in the navigation panel.

**Figure 46-19. IGMP Interface Summary**

The screenshot shows the 'Interface Summary: Detail' page for interface 'Vlan1'. The left sidebar navigation tree includes: System, Switching, Routing, Statistics/RMON, Quality of Service, IPv4 Multicast, IGMP, Global Configuration, Routing Interface, Interface Config, Interface Summary (selected), Cache Information, Source List Info, Proxy Interface, PIM, IPv6 Multicast, Multicast (IPv6), Multicast Route Table, MLD, and PIM.

**Interface Parameters**

Interface Mode	Disable
Operational Mode	Non-Operational
Version	V3
Query Interval	125 (1 to 3600 seconds)
Query Max Response Time	10 (0 to 25 seconds)
Robustness	2
Startup Query Interval	31 (1 to 300 seconds)
Startup Query Count	2
Last Member Query Interval	10 (0 to 255 1/10th of a second)
Last Member Query Count	2

**Interface Statistics**

Querier	
Querier Status	
Querier Up Time	(hh:mm:ss)
Querier Expiry Time	(hh:mm:ss)

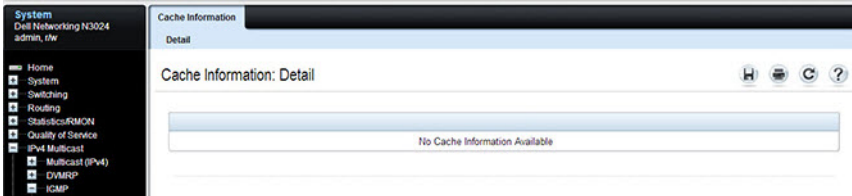
## IGMP Cache Information

Use the **Cache Information** page to display cache parameters and data for an IP multicast group address. Group membership reports must have been received on the selected interface for data to display on the page.

To display the page, click **IPv4 Multicast** → **IGMP** → **Routing Interface** → **Cache Information** in the navigation panel.



**Figure 46-20. IGMP Cache Information**

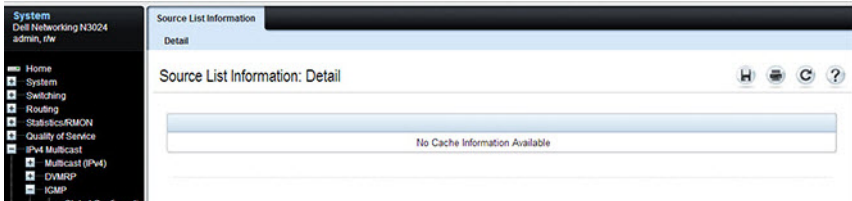


## IGMP Interface Source List Information

Use the **Source List Information** page to display detailed membership information for an interface. Group membership reports must have been received on the selected interface for data to display information.

To display the page, click **IPv4 Multicast** → **IGMP** → **Routing Interface** → **Source List Information** in the navigation panel.

**Figure 46-21. IGMP Interface Source List Information**



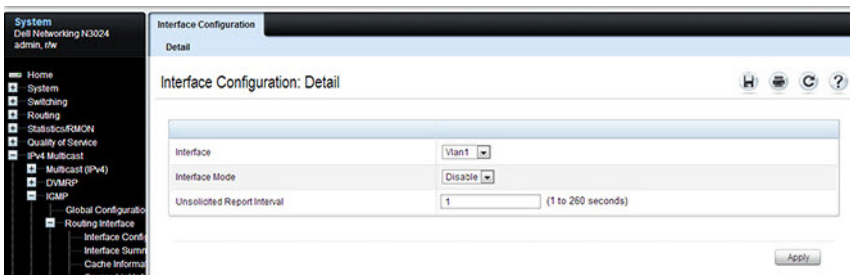
## IGMP Proxy Interface Configuration

The IGMP Proxy is used by IGMP Router (IPv4 system) to enable the system to issue IGMP host messages on behalf of hosts that the system discovered through standard IGMP router interfaces. Thus, this feature acts as proxy to all hosts residing on its router interfaces.

Use the **Interface Configuration** page to configure IGMP proxy for a VLAN interface. You must have configured at least one VLAN routing interface before configuring or displaying data for an IGMP proxy interface, and it should not be an IGMP routing interface.

To display the page, click **IPv4 Multicast** → **IGMP** → **Proxy Interface** → **Interface Configuration** in the navigation panel.

**Figure 46-22. IGMP Proxy Interface Configuration**



## IGMP Proxy Configuration Summary

Use the Configuration Summary page to display proxy interface configurations by interface. You must have configured at least one VLAN routing interface configured before data displays on this page.

To display the page, click **IPv4 Multicast** → **IGMP** → **Proxy Interface** → **Configuration Summary** in the navigation panel.

**Figure 46-23. IGMP Proxy Configuration Summary**

The screenshot shows a network management interface with a navigation tree on the left and a configuration summary page on the right. The navigation tree includes categories like System, Switching, Routing, and IPv4 Multicast. The configuration summary page is titled 'Configuration Summary: Detail' and shows the following data:

Interface Parameters	
Interface	vlan6
IP Address	10.2.3.3
Subnet Mask	255.255.255.0
Admin Mode	Enable
Operational Mode	Disable
Number of Groups	
Version	V3
Unsolicited Report Interval	1 (1 to 260 seconds)
Version 1 Querier Timeout	
Version 2 Querier Timeout	
Proxy Start Frequency	

IGMPv1 Statistics	
Queries Received	
Reports Received	
Reports Sent	

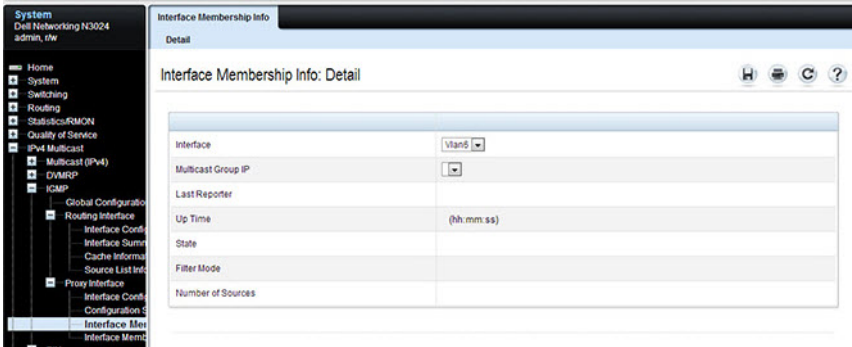
IGMPv2 Statistics	

## IGMP Proxy Interface Membership Info

Use the **Interface Membership Info** page to display interface membership data for a specific IP multicast group address. At least one VLAN routing interface must be configured for this page to display interface membership information, and it should not be an IGMP routing interface. Also, if no group membership reports have been received on the selected interface, no data displays on this page.

To display the page, click **IPv4 Multicast** → **IGMP** → **Proxy Interface** → **Interface Membership Info** in the navigation panel.

**Figure 46-24. IGMP Proxy Interface Membership Info**

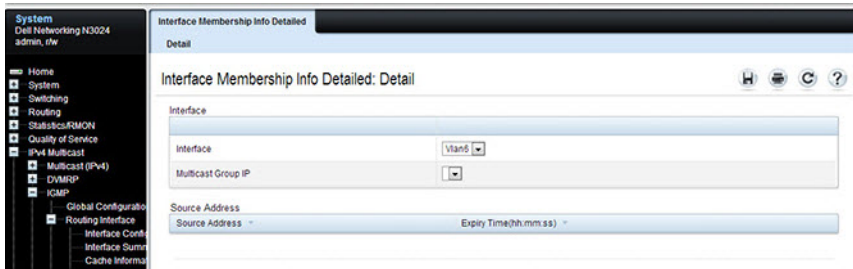


## Detailed IGMP Proxy Interface Membership Information


Use the **Interface Membership Info Detailed** page to display detailed interface membership data. At least one VLAN routing interface must be configured before detailed interface membership information can be displayed, and it should not be an IGMP routing interface. Also, if no group membership reports have been received on the selected interface, then no data can be displayed.

To display the page, click **IPv4 Multicast** → **IGMP** → **Proxy Interface** → **Interface Membership Info Detailed** in the navigation panel.

**Figure 46-25. IGMP Proxy Interface Membership Info Detailed**



# Configuring MLD and MLD Proxy (Web)

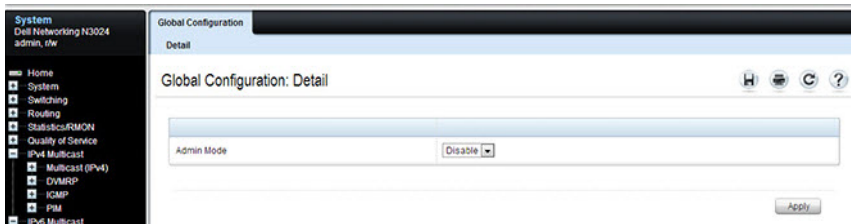
This section provides information about the OpenManage Switch Administrator pages for configuring and monitoring the MLD and MLD proxy features on Dell EMC Networking N3000-ON, N3100-ON, and N3200-ON Series switches. For details about the fields on a page, click  at the top of the Dell EMC OpenManage Switch Administrator web page.

## MLD Global Configuration

Use the **Global Configuration** page to administratively enable and disable the MLD service.

To display the page, click **IPv6 Multicast** → **MLD** → **Global Configuration** in the navigation panel.

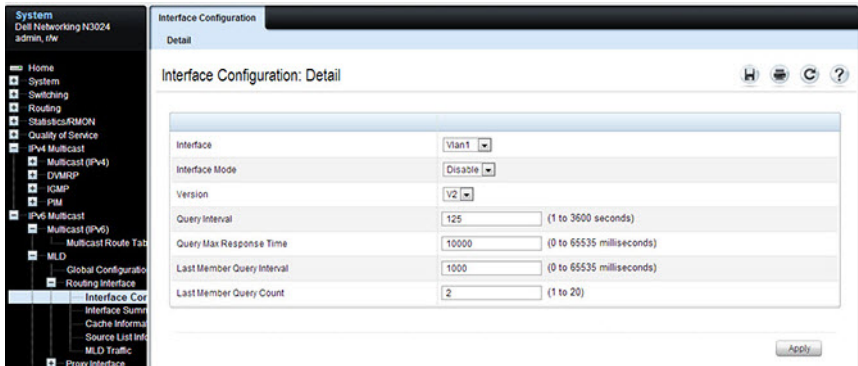
**Figure 46-26. MLD Global Configuration**



## MLD Routing Interface Configuration

Use the **Interface Configuration** page to enable selected IPv6 router interfaces to discover the presence of multicast listeners, the nodes who wish to receive the multicast data packets, on its directly attached interfaces. To access this page, click **IPv6 Multicast** → **MLD** → **Routing Interface Interface Configuration** in the navigation panel.

**Figure 46-27. MLD Routing Interface Configuration**



## MLD Routing Interface Summary

Use the **Interface Summary** page to display information and statistics on a selected MLD-enabled interface. You must configure at least one IGMP VLAN routing interface to access this page.

To access this page, click **IPv6 Multicast** → **MLD** → **Routing Interface** → **Interface Summary** in the navigation panel.

**Figure 46-28. MLD Routing Interface Summary**

The screenshot displays the 'Interface Summary: Detail' page for interface 'Vlan1'. The left sidebar shows the navigation tree with 'Interface Summary' selected. The main content area is divided into two sections: 'Interface Parameters' and 'Interface Statistics'.

**Interface Parameters**

Global Admin Mode	Disable
Interface Mode	Disable
Operational Mode	Not In Service
Version	V2
Query Interval	125 (1 to 3600 seconds)
Query Max Response Time	10000 (0 to 65535 milliseconds)
Robustness	2
Startup Query Interval	31 (1 to 300 seconds)
Startup Query Count	2
Last Member Query Interval	1000 (0 to 65535 milliseconds)
Last Member Query Count	2

**Interface Statistics**

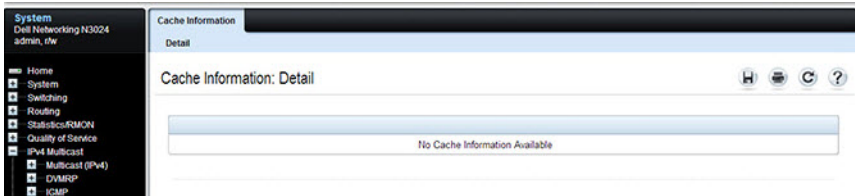
Querier Status	
Querier	
Querier Up Time	(hh:mm:ss)

## MLD Routing Interface Cache Information

The **Interface Cache Information** page displays cache parameters and data for an IP multicast group address that has been reported to operational MLD routing interfaces. You must configure at least one MLD VLAN routing interface to access this page. Also, group membership reports must have been received on the selected interface in order for data to be displayed here. To access this page, click **IPv6 Multicast** → **MLD** → **Routing Interface** → **Cache Information** in the navigation panel.



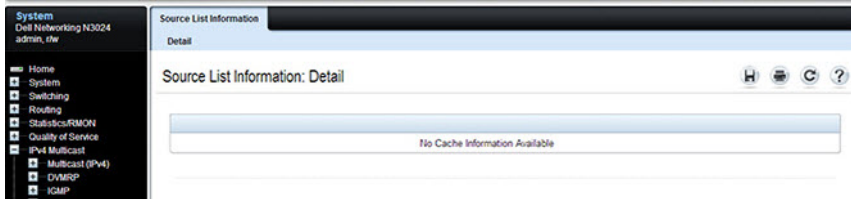
**Figure 46-29. MLD Routing Interface Cache Information**



## MLD Routing Interface Source List Information

The **Interface Source List Information** page displays detailed membership information for an interface. You must configure at least one MLD VLAN routing interface to access this page. Also, group membership reports must have been received on the selected interface in order for data to be displayed here. To access this page, click **IPv6 Multicast** → **MLD** → **Routing Interface** → **Source List Information** in the navigation panel.

**Figure 46-30. MLD Routing Interface Source List Information**

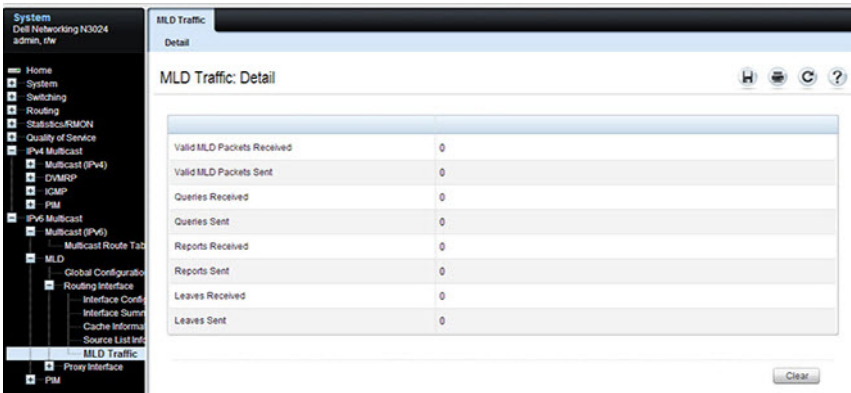


## MLD Traffic

The MLD Traffic page displays summary statistics on the MLD messages sent to and from the router.

To access this page, click **IPv6 Multicast** → **MLD** → **Routing Interface** → **MLD Traffic** in the navigation panel.

**Figure 46-31. MLD Traffic**

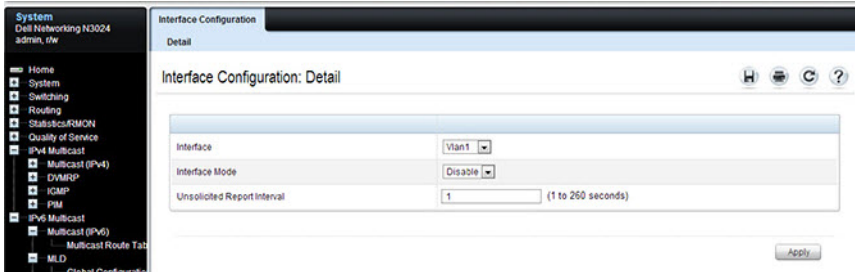


## MLD Proxy Configuration

When you configure an interface in MLD proxy mode, it acts as a proxy multicast host that sends MLD membership reports on one VLAN interface for MLD Membership reports received on all other MLD-enabled VLAN routing interfaces.

Use the **Interface Configuration** page to enable and disable ports as MLD proxy interfaces. To display this page, click **IPv6 Multicast** → **MLD** → **Proxy Interface** → **Interface Configuration** in the navigation panel.

**Figure 46-32. MLD Proxy Interface Configuration**



## MLD Proxy Configuration Summary

Use the Configuration Summary page to view configuration and statistics on MLD proxy-enabled interfaces. To display this page, click **IPv6 Multicast** → **MLD** → **Proxy Interface** → **Configuration Summary** in the navigation panel.

**Figure 46-33. MLD Proxy Configuration Summary**

The screenshot displays the 'Configuration Summary: Detail' page for the 'Vlan5' interface. The left sidebar shows the navigation tree with 'MLD Proxy Interface Configuration' selected. The main content area is divided into two sections: 'Interface Parameters' and 'MLDv1 Statistics'.

**Interface Parameters:**

Interface	Vlan5
IPv6 Address	fe80::21e:c9f:fede:b122
Prefix Length	64
Admin Mode	Enable
Operational Mode	Disable
Number of Multicast Groups	
Version	V2
Unsolicted Report Interval	1 (1 to 260 seconds)
Version 1 Querier Timeout	(hh:mm:ss)
Proxy Start Frequency	

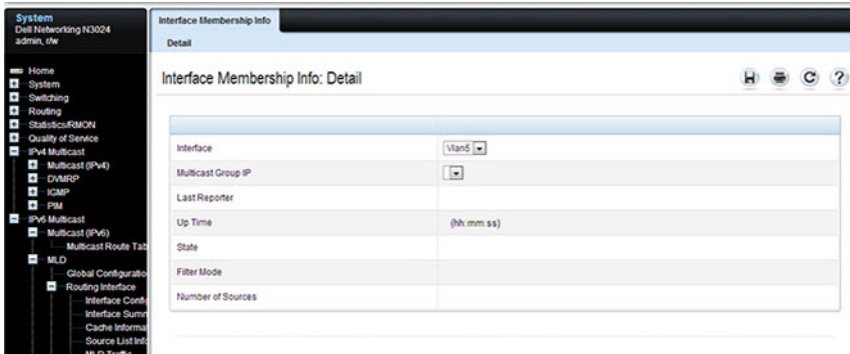
**MLDv1 Statistics:**

Queries Received	
Reports Received	
Reports Sent	
Leaves Received	
Leaves Sent	

## MLD Proxy Interface Membership Information

The **Interface Membership Information** page lists each IP multicast group for which the MLD proxy interface has received membership reports. To display this page, click **IPv6 Multicast** → **MLD** → **Proxy interface** → **Interface Membership Info** in the navigation panel.

**Figure 46-34. Interface Membership Information**



Interface Membership Info

Detail

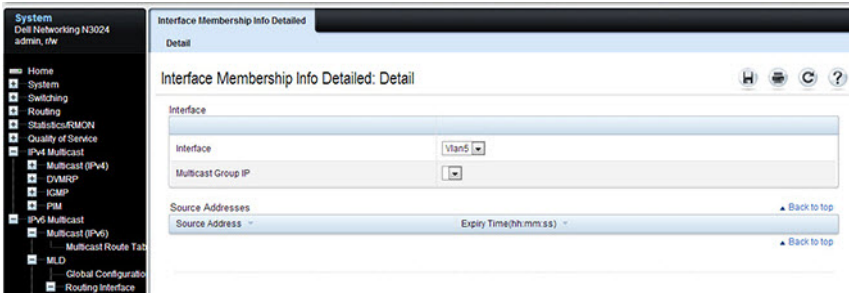
Interface Membership Info: Detail

Interface	Vlan5
Multicast Group IP	
Last Reporter	
Up Time	(hh:mm:ss)
State	
Filter Mode	
Number of Sources	


## Detailed MLD Proxy Interface Membership Information

The **Interface Membership Information Detailed** page provides additional information about the IP multicast groups for which the MLD proxy interface has received membership reports. To display this page, click **IPv6 Multicast** → **MLD** → **Proxy Interface** → **Interface Membership Info Detailed** in the navigation panel.

**Figure 46-35. Interface Membership Information—Detailed**



## Configuring PIM for IPv4 and IPv6 (Web)

This section provides information about the OpenManage Switch Administrator pages for configuring and monitoring PIM-SM and PIM-DM for IPv4 and IPv6 multicast routing on Dell EMC Networking N3000-ON, N3100-ON, and N3200-ON Series switches. For details about the fields on a page, click  at the top of the Dell EMC OpenManage Switch Administrator web page.



**NOTE:** The OpenManage Switch Administrator pages to configure IPv4 multicast routing and IPv6 multicast routing is very similar. The figures in this section show the IPv4 multicast configuration pages. To configure IPv6 multicast with PIM, use the pages available from the IPv6 Multicast → PIM menu.

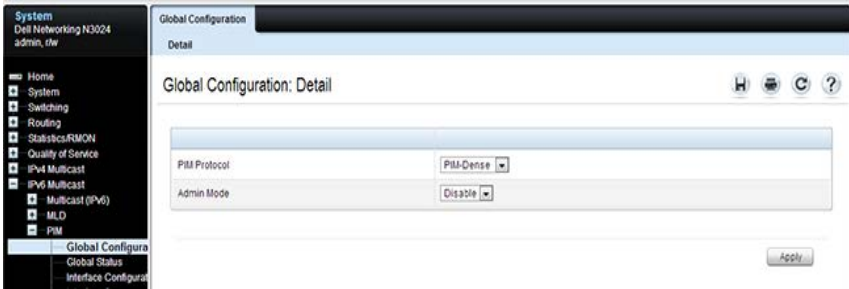
### PIM Global Configuration

Use the **Global Configuration** page to configure the administrative status of PIM-DM or PIM-SM on the switch. It is strongly recommended that IGMP be enabled on any switch on which IPv4 PIM is enabled and MLD be enabled on any switch for which IPv6 PIM is enabled. This ensures that the multicast router behaves as expected.

The CLI behavior is different than the web interface. Enabling PIM on an IPv4 interface via the CLI automatically enables IGMP on the interface. Likewise, enabling PIM on an IPv6 interface via the CLI automatically enables MLD on the interface.

To display the page, click **IPv4 Multicast → PIM → Global Configuration** or **IPv6 Multicast → PIM → Global Configuration** in the navigation panel.

**Figure 46-36. PIM-DM Global Configuration**



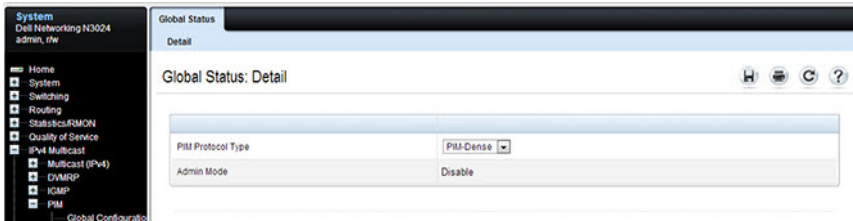


## PIM Global Status

Use the **Global Status** page to view the administrative status of PIM-DM or PIM-SM on the switch.

To display the page, click **IPv4 Multicast** → **PIM** → **Global Status** or **IPv6 Multicast** → **PIM** → **Global Status** in the navigation panel.

**Figure 46-37. PIM Global Status**

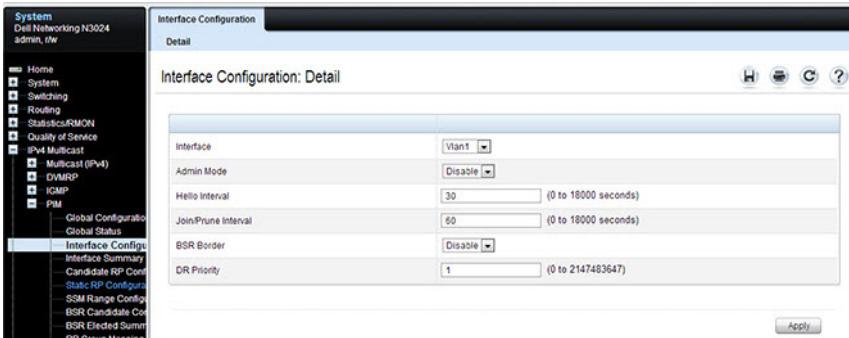


## PIM Interface Configuration

Use the **Interface Configuration** page to configure specific VLAN routing interfaces with PIM.

To display the page, click **IPv4 Multicast** → **PIM** → **Interface Configuration** or **IPv6 Multicast** → **PIM** → **Interface Configuration** in the navigation panel.

**Figure 46-38. PIM Interface Configuration**



## PIM Interface Summary

Use the **Interface Summary** page to display a PIM-enabled VLAN routing interface and its settings.

To display the page, click **IPv4 Multicast** → **PIM** → **Interface Summary** or **IPv6 Multicast** → **PIM** → **Interface Summary** in the navigation panel.

**Figure 46-39. PIM Interface Summary**

The screenshot shows the 'Interface Summary: Detail' page for a PIM-enabled interface. The left sidebar contains a navigation tree with the following structure:

- System  
Dell Networking N3024  
admin, f/w
- Home
- System
- Switching
- Routing
- Statistics/RMON
- Quality of Service
- IPv4 Multicast
  - Multicast (IPv4)
  - DVMRP
  - ICMP
  - PIM
    - Global Configuration
    - Global Status
    - Interface Configuration
    - Interface Summary
    - Candidate (P) Config
    - Static RP Configuration
    - SSM Range Configuration
    - BSR Candidate Configuration
    - BSR Elected Summary
    - RP Group Mapping
- IPv6 Multicast
  - Multicast (IPv6)
  - MLD
  - PIM

The main content area is titled 'Interface Summary: Detail' and includes the following sections:

- Interface:** A dropdown menu showing 'Vlan1'.
- Interface Parameters:** A table with the following data:

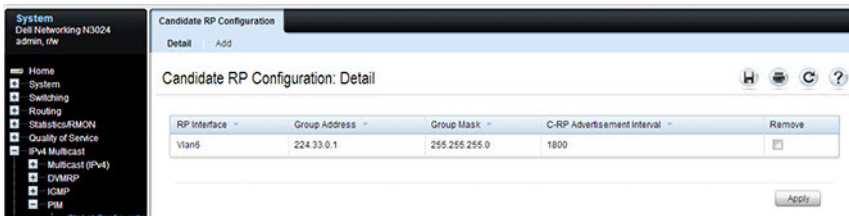
Parameter	Value
Admin Mode	Disable
Protocol State	Non-Operational
IP Address	0.0.0.0
Hello Interval	30 (0 to 18000 seconds)
JoinPrune Interval	60 (0 to 18000 seconds)
DR Priority	1
BSR Border	Disable
Designated Router	
- Interface Neighbors:** A section with a 'Neighbor Count' field.
- Summary:** A table with columns for 'Neighbor IP', 'Up Time(hh:mm:ss)', and 'Expiry Time(hh:mm:ss)'. It includes pagination controls: 'Items Displayed 0-0', 'Rows Per Page 0', and 'Pages 0 of 0'.

## Candidate RP Configuration

The Candidate RP is configured on the **Add Candidate RP** page. Use the **Candidate RP Configuration** page to display and delete the configured rendezvous points (RPs) for each port using PIM.

To access the page, click **IPv4 Multicast** → **PIM** → **Candidate RP Configuration** or **IPv6 Multicast** → **PIM** → **Candidate RP Configuration**.

**Figure 46-40. Candidate RP Configuration**



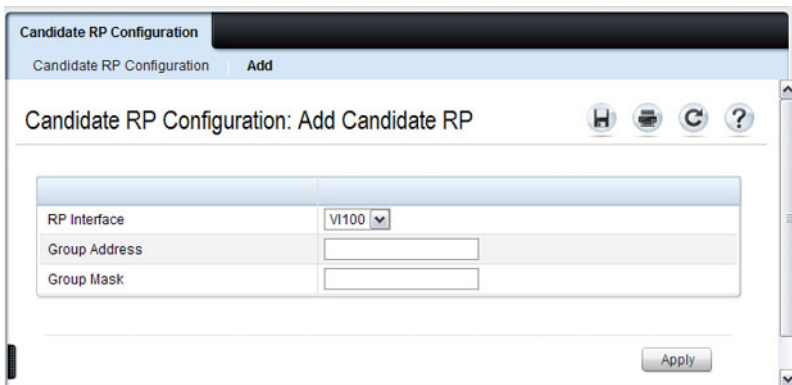
### Adding a Candidate RP

To add PIM Candidate rendezvous points (RPs) for each IP multicast group:

- 1 Open the **Candidate RP Configuration** page.
- 2 Click **Add**.

The **Add Candidate RP** page displays.

**Figure 46-41. Add Candidate RP**



- 3** Select the VLAN interface for which the Candidate RP is to be configured.
- 4** Enter the group address transmitted in Candidate-RP-Advertisements.
- 5** Enter the prefix length transmitted in Candidate-RP-Advertisements to fully identify the scope of the group which the router supports if elected as a Rendezvous Point.
- 6** Click **Apply Changes**.

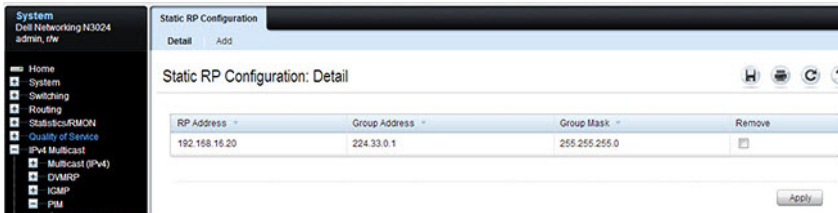
The new Candidate RP is added, and the device is updated.

## Static RP Configuration

Use the **Static RP Configuration** page to display or remove the configured RP. The page also allows adding new static RPs by clicking the **Add** button. Only one RP address can be used at a time within a PIM domain. If the PIM domain uses the BSR to dynamically learn the RP, configuring a static RP is not required. However, the static RP can be configured to override any dynamically learned RP from the BSR.

To access the page, click **IPv4 Multicast** → **PIM** → **Static RP Configuration** or **IPv6 Multicast** → **PIM** → **Static RP Configuration**.

**Figure 46-42. Static RP Configuration**



### Adding a Static RP

To add a static RP for the PIM router.

- 1 Open the **Static RP Configuration** page.
- 2 Click **Add**.

The **Add Static RP** page displays.

**Figure 46-43. Add Static RP**

The screenshot shows a web browser window titled "Static RP Configuration" with a sub-tab "Add". The main heading is "Static RP Configuration: Add Static RP". Below the heading are four utility icons: Home, Print, Refresh, and Help. The configuration area contains a table with four rows: "RP Address", "Group Address", "Group Mask", and "Override". Each of the first three rows has a text input field to its right. The "Override" row has a checkbox to its right. At the bottom right of the form is an "Apply" button.

RP Address	<input type="text"/>
Group Address	<input type="text"/>
Group Mask	<input type="text"/>
Override	<input type="checkbox"/>

Apply

- 3** Enter the IP address of the RP for the group range.
- 4** Enter the group address of the RP.
- 5** Enter the group mask of the RP.
- 6** Check the **Override** option to configure the static RP to override the dynamic (candidate) RPs learned for same group ranges.
- 7** Click **Apply**.

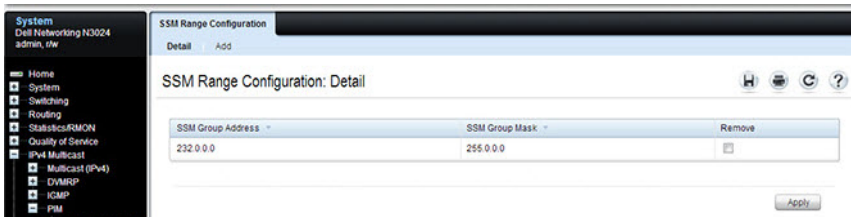
The new Static RP is added, and the device is updated.

## SSM Range Configuration

Use this page to display or remove the Source Specific Multicast (SSM) group IP address and group mask for the PIM router.

To display the page, click **IPv4 Multicast** → **PIM** → **SSM Range Configuration** or **IPv6 Multicast** → **PIM** → **SSM Range Configuration**.

**Figure 46-44. SSM Range Configuration**



### Adding an SSM Range

To add the Source-Specific Multicast (SSM) Group IP Address and Group Mask (IPv4) or Prefix Length (IPv6) for the PIM router:

- 1 Open the **SSM Range Configuration** page.
- 2 Click **Add**.

The **Add SSM Range** page displays.



**Figure 46-45. Add SSM Range**

The screenshot shows a configuration window titled "SSM Range Configuration" with a subtitle "SSM Range Configuration Add". The main heading is "SSM Range Configuration: Add SSM Range". There are three input fields: "SSM Group Address", "SSM Group Mask", and "Add Default SSM Range" (a checkbox). An "Apply" button is located at the bottom right of the form area.

- 3** Click the Add Default SSM Range check box to add the default SSM Range. The default SSM Range is 232.0.0.0/8 for IPv4 multicast and ff3x::/32 for IPv6 multicast.
- 4** Enter the SSM Group IP Address.
- 5** Enter the SSM Group Mask (IPv4) or SSM Prefix Length (IPv6).
- 6** Click **Apply**.

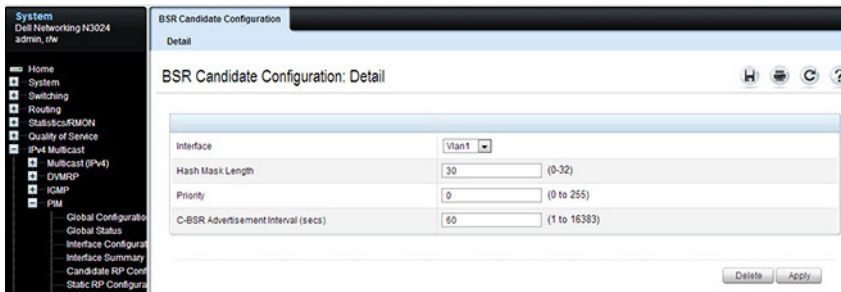
The new SSM Range is added, and the device is updated.

## BSR Candidate Configuration

Use this page to configure information to be used if the interface is selected as a bootstrap router.

To display the page, click IPv4 Multicast → PIM → BSR Candidate Configuration or IPv6 Multicast → PIM → BSR Candidate Configuration.

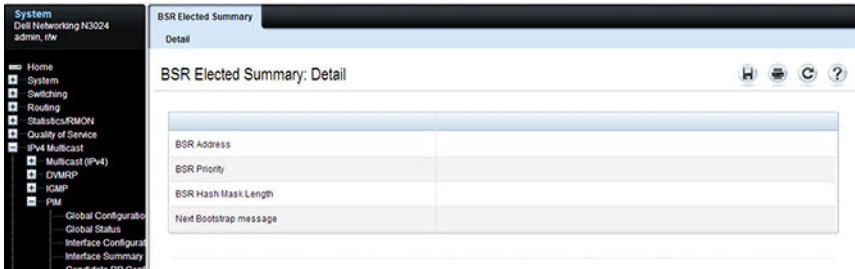
Figure 46-46. BSR Candidate Configuration




## BSR Candidate Summary

Use this page to display information about the configured BSR candidates. To display this page, click **IPv4 Multicast** → **PIM** → **BSR Candidate Summary** or **IPv6 Multicast** → **PIM** → **BSR Elected Summary**.

**Figure 46-47. BSR Elected Summary**



# Configuring DVMRP (Web)

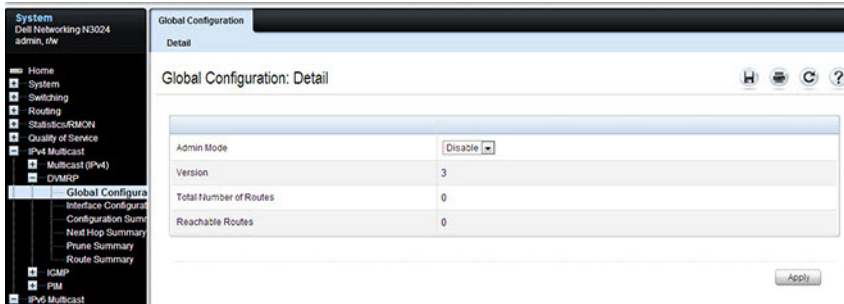
This section provides information about the OpenManage Switch Administrator pages for configuring and monitoring DVMRP on Dell EMC Networking N3000-ON, N3100-ON, and N3200-ON Series switches. For details about the fields on a page, click  at the top of the Dell EMC OpenManage Switch Administrator web page.

## DVMRP Global Configuration

Use the **Global Configuration** page to configure global DVMRP settings. It is strongly recommended that IGMP be enabled on any switch on which DVMRP is enabled. The use cases for enabling DVMRP without IGMP are few, and enabling IGMP ensures that the multicast router behaves as expected.

To display the page, click **IPv4 Multicast** → **DVMRP** → **Global Configuration** in the navigation panel.

**Figure 46-48. DVMRP Global Configuration**

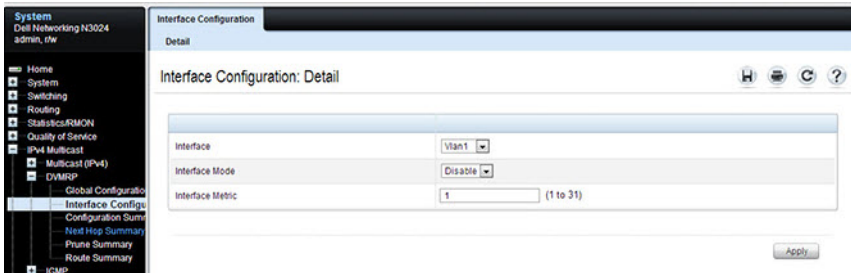


## DVMRP Interface Configuration

Use the **Interface Configuration** page to configure a DVMRP VLAN routing interface. You must configure at least one router interface before you configure a DVMRP interface. Otherwise you see a message telling you that no router interfaces are available, and the configuration screen is not displayed. It is strongly recommended that IGMP be enabled on any interface on which DVMRP is enabled. This ensures that the multicast router behaves as expected.

To display the page, click **IPv4 Multicast** → **DVMRP** → **Interface Configuration** in the navigation panel.

**Figure 46-49. DVMRP Interface Configuration**



## DVMRP Configuration Summary

Use the **Configuration Summary** page to display the DVMRP configuration and data for a selected interface. At least one VLAN routing interface must be configured before data can be displayed for a DVMRP interface. Otherwise, a message displays that no VLAN router interfaces are available, and the configuration summary screen is not displayed.

To display the page, click **IPv4 Multicast** → **DVMRP** → **Configuration Summary** in the navigation panel.

**Figure 46-50. DVMRP Configuration Summary**

The screenshot shows a network management interface with a navigation tree on the left and a main content area on the right. The navigation tree includes sections for System, Switching, Routing, Statistics/RMON, Quality of Service, IPv4 Multicast, and IPv6 Multicast. Under IPv4 Multicast, the DVMRP section is expanded, showing options for Global Configuration, Interface Configuration, Configuration Summary, Next Hop Summary, Prune Summary, and Route Summary. The main content area is titled 'Configuration Summary: Detail' and contains the following sections:

- Interface:** A dropdown menu showing 'Vlan1'.
- Interface Parameters:** A table with the following data:

Interface Mode	Disable
Protocol State	Non-Operational
Local Address	0.0.0.0
Interface Metric	1
- Interface Statistics:** A table with the following data:

Generation ID	
Received Bad Packets	0
Received Bad Routes	0
Sent Routes	0
- Neighbor Parameters:** A table with the following data:

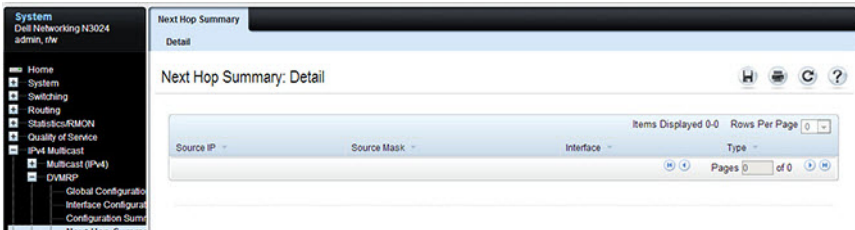
Neighbor IP	[Dropdown]
State	
Neighbor Uptime	

## DVMRP Next Hop Summary

Use the Next Hop Summary page to display the next hop summary by Source IP.

To display the page, click IPv4 Multicast → DVMRP → Next Hop Summary in the navigation panel.

**Figure 46-51. DVMRP Next Hop Summary**

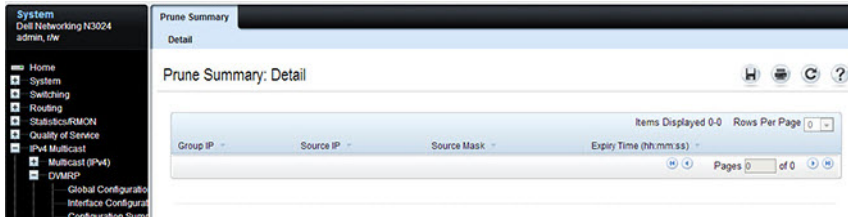


## DVMRP Prune Summary

Use the **Prune Summary** page to display the prune summary by Group IP.

To display the page, click **IPv4 Multicast** → **DVMRP** → **Prune Summary** in the navigation panel.

**Figure 46-52. DVMRP Prune Summary**

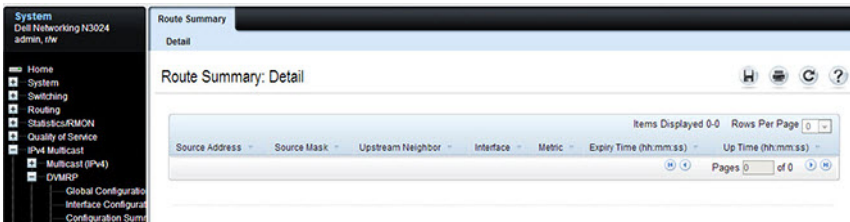


## DVMRP Route Summary

Use the **Route Summary** page to display the DVMRP route summary.

To display the page, click **IPv4 Multicast** → **DVMRP** → **Route Summary** in the navigation panel.

**Figure 46-53. DVMRP Route Summary**





# Configuring L3 Multicast Features (CLI)

This section provides information about the commands used for configuring general IPv4 multicast settings on the switch. For more information about the commands, see the *Dell EMC Networking N1100-ON, N1500, N2000, N2100-ON, N2200-ON, N3000E-ON, N3100-ON, and N3200-ON Series Switches CLI Reference Guide* at [www.dell.com/support](http://www.dell.com/support).

## Configuring and Viewing IPv4 Multicast Information

Use the following commands to enable IPv4 multicast on the switch and to view and configure other general multicast settings.

Command	Purpose
<code>configure</code>	Enter global configuration mode.
<code>ip multicast-routing</code>	Enable IPv4/IPv6 multicast on the switch.
<code>ip pim sparse-mode</code>	Enable PIM/IGMP/MLD. Multicast routing is not operationally enabled until IGMP or MLD is enabled.
<code>ip mroute source-address mask rpf-address preference</code>	Create a static multicast route for a source range. <ul style="list-style-type: none"><li>• <i>source-address</i> — The IP address of the multicast data source.</li><li>• <i>mask</i> — The IP subnet mask of the multicast data source.</li><li>• <i>rpf-address</i> — The IP address of the next hop towards the source.</li><li>• <i>preference</i> — The cost of the route (Range: 1–255).</li></ul>
<code>interface vlan vlan-id</code>	Enter Interface Configuration mode for the specified VLAN.
<code>ip mcast boundary groupipaddr mask</code>	Add an administrative scope multicast boundary specified by the multicast group IP address ( <i>groupipaddr</i> ) and group IP subnet mask ( <i>mask</i> ) for which this multicast administrative boundary is applicable. <p>The group IP address valid range is 239.0.0.0 to 239.255.255.255.</p>

<b>Command</b>	<b>Purpose</b>
<code>ip multicast ttl-threshold <i>ttlvalue</i></code>	Apply a Time to Live (TTL) value to the VLAN interface. The <i>ttlvalue</i> is the TTL threshold which is applied to the multicast data packets forwarded through the interface.
<code>exit</code>	Exit to Global Config mode.
<code>exit</code>	Exit to Privileged Exec mode.
<code>show ip multicast</code>	View system-wide multicast information.
<code>show ip mcast boundary {vlan <i>vlan-id</i>   all}</code>	View all the configured administrative scoped multicast boundaries.
<code>show ip mcast mroute {detail   summary}</code>	View a summary or all the details of the multicast table.
<code>show mac address-table multicast [count]</code>	View information about the entries in the multicast address table.
<code>show ip mcast mroute group <i>groupipaddr</i> {detail   summary}</code>	View the multicast configuration settings such as flags, timer settings, incoming and outgoing interfaces, RPF neighboring routers, and expiration times of all the entries in the multicast mroute table containing the <i>groupipaddr</i> value.
<code>show ip mcast mroute source <i>sourceipaddr</i> {summary   <i>groupipaddr</i>}</code>	View the multicast configuration settings such as flags, timer settings, incoming and outgoing interfaces, RPF neighboring routers, and expiration times of all the entries in the multicast mroute table containing the <i>sourceipaddr</i> or <i>sourceipaddr   groupipaddr</i> pair value(s).
<code>show ip mcast mroute static [<i>sourceipaddr</i>]</code>	View all the static routes configured in the static mcast table if it is specified or display the static route associated with the particular <i>sourceipaddr</i> .

## Configuring and Viewing IPv6 Multicast Route Information

Use the following commands to configure static IPv6 multicast routes on the switch and to view IPv6 multicast table information.

Command	Purpose
<code>configure</code>	Enter global configuration mode.
<code>ip multicast-routing</code>	Enable IPv4/IPv6 multicast routing.
<code>ip pim sparse-mode</code>	Enable PIM/IGMP. Multicast routing is not operationally enabled until IGMP or MLD is enabled.
<code>ipv6 mroute source-address/prefix-length rpf-address [interface vlan-id] preference</code>	Create a static multicast route for a source range. <ul style="list-style-type: none"><li>• <i>source-address/prefix-length</i> — The IPv6 address of the multicast data source.</li><li>• <i>rpf-address</i> — The IPv6 address of the next hop towards the source.</li><li>• <i>vlan-id</i>— If the <i>rpf-address</i> is a link-local address then the VLAN interface must also be specified. If the <i>rpf-address</i> is a global address, then specifying the VLAN interface is not required.</li><li>• <i>preference</i> — The cost of the route (Range: 1–255).</li></ul>
<code>exit</code>	Exit to Privileged Exec mode.
<code>show ipv6 mroute {detail   summary}</code>	View a summary or all the details of the multicast table.
<code>show ipv6 mroute group groupipaddr {detail   summary}</code>	View the multicast configuration settings such as flags, timer settings, incoming and outgoing interfaces, RPF neighboring routers, and expiration times of all the entries in the multicast mroute table containing the <i>groupipaddr</i> value.
<code>show ipv6 mroute source sourceipaddr {summary   groupipaddr}</code>	View the multicast configuration settings such as flags, timer settings, incoming and outgoing interfaces, RPF neighboring routers, and expiration times of all the entries in the multicast mroute table containing the <i>sourceipaddr</i> or <i>sourceipaddr   groupipaddr</i> pair value(s).
<code>show ipv6 mroute static [sourceipaddr]</code>	View all the static routes configured in the static mcast table if it is specified or display the static route associated with the particular <i>sourceipaddr</i> .

## Configuring and Viewing IGMP

Use the following commands to configure IGMP on the switch and on VLAN routing interfaces and to view IGMP information.

Command	Purpose
<code>configure</code>	Enter global configuration mode.
<code>ip multicast-routing</code>	Enable IPv4/IPv6 multicast routing.
<code>ip pim sparse-mode</code>	Enable PIM/IGMP on the switch. IGMP is implicitly enabled with PIM.
<code>interface vlan <i>vlan-id</i></code>	Enter Interface Configuration mode for the specified VLAN.
<code>ip igmp version <i>version</i></code>	Set the version of IGMP for an interface. The <i>version</i> variable can be 1, 2, or 3.
<code>ip igmp robustness <i>robustness</i></code>	Configure the robustness that allows tuning of the interface, that is, tuning for the expected packet loss on a subnet. If a subnet is expected to have significant loss, the robustness variable may be increased for the interface. The range for <i>robustness</i> is 1–255.
<code>ip igmp query-interval <i>seconds</i></code>	Configure the query interval for the specified interface. The query interval determines how fast IGMP Host-Query packets are transmitted on this interface. The range for <i>seconds</i> is 0–3600 seconds.
<code>ip igmp query-max-response-time <i>seconds</i></code>	Configure the maximum response time interval for the specified interface. It is the maximum query response time advertised in IGMPv2 queries on this interface. The range for <i>seconds</i> is 0–25 seconds.
<code>ip igmp startup-query-interval <i>seconds</i></code>	Set the interval between general queries sent at startup on the interface. The range for <i>seconds</i> is 0–300 seconds.
<code>ip igmp startup-query-count <i>count</i></code>	Set the number of queries sent out on startup—at intervals equal to the startup query interval for the interface. The range for <i>count</i> is 1–20.

<b>Command</b>	<b>Purpose</b>
<code>ip igmp last-member-query-interval <i>tenths</i></code>	Configure the Maximum Response Time inserted in Group-Specific Queries which are sent in response to Leave Group messages.  The range is 0–255 tenths of a second.
<code>ip igmp last-member-query-count <i>count</i></code>	Set the number of Group-Specific Queries sent before the router assumes that there are no local members on the interface.  The range for <i>count</i> is 1–20.
<code>CTRL + Z</code>	Exit to Privileged Exec mode.
<code>show ip igmp</code>	View system-wide IGMP information.
<code>show ip igmp interface [vlan <i>vlan-id</i>]</code>	View IGMP information for all interfaces or for the specified interface.
<code>show ip igmp interface stats [vlan <i>vlan-id</i>]</code>	View IGMP statistics for all interfaces or for the specified interface.
<code>show ip igmp groups [vlan <i>vlan-id</i>]</code>	View the registered multicast groups on the interface.
<code>show ip igmp membership</code>	View the list of interfaces that have registered in any multicast group.

## Configuring and Viewing IGMP Proxy

Use the following commands to configure the upstream VLAN routing interface as an IGMP proxy. The IGMP proxy issues host messages on behalf of the hosts that have been discovered on IGMP-enabled interfaces. The upstream interface is the interface closest to the root multicast router, which should be running IGMP.



**NOTE:** Configure only the upstream interface as the IGMP proxy. IGMP should be enabled on all downstream interfaces. IP routing and IP multicast must be enabled on the switch for the IGMP proxy feature to operate.

Command	Purpose
<code>configure</code>	Enter global configuration mode.
<code>interface vlan <i>vlan-id</i></code>	Enter Interface Configuration mode for the specified VLAN.
<code>ip igmp proxy-service</code>	Configure the interface as an IGMP proxy interface.
<code>ip igmp proxy-service reset-status</code>	(Optional) Reset the host interface status parameters of the IGMP Proxy.
<code>ip igmp proxy-service unsolicited-rprt-interval <i>seconds</i></code>	Configure the unsolicited report interval for the IGMP proxy interface. The range for <i>seconds</i> is 0–260 seconds.
<code>CTRL + Z</code>	Exit to Privileged Exec mode.
<code>show ip igmp proxy-service</code>	View a summary of the host interface status parameters.
<code>show ip igmp proxy-service interface</code>	View a detailed list of the host interface status parameters. This command displays information only when IGMP Proxy is operational.
<code>show ip igmp proxy-service groups</code>	View a table of information about multicast groups that IGMP Proxy reported. This command displays information only when IGMP Proxy is operational.

## Configuring and Viewing MLD

Use the following commands to configure MLD on the switch and on VLAN routing interfaces and to view IGMP information.

Command	Purpose
<code>configure</code>	Enter global configuration mode.
<code>ip multicast-routing</code>	Enable IPv4/IPv6 multicast routing.
<code>ipv6 pim sparse-mode</code>	Enable PIM/MLD on the switch.
<code>interface vlan <i>vlan-id</i></code>	Enter Interface Configuration mode for the specified VLAN.
<code>ipv6 mld version <i>version</i></code>	Set the version of MLD for an interface. The <i>version</i> variable can be 1 or 2.
<code>ipv6 mld query-interval <i>seconds</i></code>	Configure the query interval for the specified interface. The query interval determines how fast MLD Host-Query packets are transmitted on this interface. The range for <i>seconds</i> is 0–3600 seconds.
<code>ipv6 mld query-max-response-time <i>seconds</i></code>	Configure the maximum response time interval for the specified interface. It is the maximum query response time advertised in MLD queries on this interface. The range for <i>seconds</i> is 0–25 seconds.
<code>ipv6 mld last-member-query-interval <i>tenthsseconds</i></code>	Set the last member query interval for the MLD interface, which is the value of the maximum response time parameter in the group-specific queries sent out of this interface. The range is 0–65535 milliseconds.
<code>ipv6 mld last-member-query-count <i>count</i></code>	Set the number of listener-specific queries sent before the router assumes that there are no local members on the interface. The range for <i>count</i> is 1–20.
<code>CTRL + Z</code>	Exit to Privileged Exec mode.
<code>show ipv6 mld interface [<i>vlan vlan-id</i>]</code>	View MLD information for all interfaces or for the specified interface.

Command	Purpose
show ipv6 mld interface stats [vlan <i>vlan-id</i> ]	View MLD statistics for all interfaces or for the specified interface.
show ipv6 mld groups [interface vlan <i>vlan-id</i> ]	View the registered multicast groups on the interface.
show ipv6 mld membership	View the list of interfaces that have registered in any multicast group.

## Configuring and Viewing MLD Proxy

Use the following commands to configure the upstream VLAN routing interface as an MLD proxy. The MLD proxy issues host messages on behalf of the hosts that have been discovered on the downstream MLD-enabled interfaces. The upstream interface is the interface closest to the root multicast router, which should be running IGMP.



**NOTE:** Configure only the upstream interface as the MLD proxy. MLD should be enabled on all downstream interfaces. IPv6 routing must be enabled on the switch for the MLD proxy feature to operate.

Command	Purpose
configure	Enter global configuration mode.
interface vlan <i>vlan-id</i>	Enter Interface Configuration mode for the specified VLAN.
ipv6 mld host-proxy	Configure the interface as an MLD proxy interface.
ipv6 mld host-proxy reset-status	(Optional) Reset the host interface status parameters of the MLD Proxy.
ipv6 mld host-proxy unsolicit- rprt-interval <i>seconds</i>	Configure the unsolicited report interval for the MLD proxy interface.  The range for <i>seconds</i> is 0–260 seconds.
CTRL + Z	Exit to Privileged Exec mode.
show ipv6 mld host-proxy	View a summary of the host interface status parameters.



<b>Command</b>	<b>Purpose</b>
<code>show ipv6 mld host-proxy interface</code>	View a detailed list of the host interface status parameters. This command displays information only when MLD Proxy is operational.
<code>show ipv6 mld host-proxy groups</code>	View a table of information about multicast groups that MLD Proxy reported. This command displays information only when MLD Proxy is operational.

## Configuring and Viewing PIM-DM for IPv4 Multicast Routing

Use the following commands to configure PIM-DM for IPv4 multicast routing on the switch and on VLAN routing interfaces and to view PIM-DM information.

<b>Command</b>	<b>Purpose</b>
<code>configure</code>	Enter global configuration mode.
<code>ip routing</code>	Enable IP routing. Routing is required for PIM to calculate where to prune the multicast trees.
<code>ip pim dense-mode</code>	Enable PIM-DM on the switch. This also enables IGMP globally.
<code>ip multicast-routing</code>	Enable IPv4/IPv6 multicast routing.
<code>interface vlan <i>vlan-id</i></code>	Enter Interface Configuration mode for the specified VLAN.
<code>ip pim</code>	Enable PIM on the interface. This also enables IGMP on the interface.
<code>ip pim hello-interval <i>seconds</i></code>	Specify the number of seconds (range: 0–65535) to wait between sending PIM hello messages on the interface.
<code>exit</code>	Exit to Privileged Exec mode.
<code>show ip pim</code>	View system-wide PIM information.
<code>show ip pim interface vlan <i>vlan-id</i></code>	View the PIM-DM information for the specified interface.
<code>show ip pim neighbor [interface vlan <i>vlan-id</i>   all]</code>	View a summary or all the details of the multicast table.

## Configuring and Viewing PIM-DM for IPv6 Multicast Routing

Use the following commands to configure PIM-DM for IPv6 multicast routing on the switch and on VLAN routing interfaces and to view PIM-DM information.

Command	Purpose
<code>configure</code>	Enter global configuration mode.
<code>ipv6 unicast-routing</code>	Enable IPv6 routing. IPv6 routing is required for the operation of PIM.
<code>ipv6 pim dense-mode</code>	Enable PIM-DM on the switch. Enabling IPv6 PIM enables MLD.
<code>ip multicast-routing</code>	Enable IPv6/IPv6 multicast routing.
<code>interface vlan <i>vlan-id</i></code>	Enter Interface Configuration mode for the specified VLAN.
<code>ipv6 pim</code>	Enable PIM on the VLAN interface. This command also enables MLD on the interface.
<code>ipv6 enable</code>	Enable IPv6 on the VLAN.
<code>ipv6 pim hello-interval <i>seconds</i></code>	Specify the number of seconds (range: 0–65535) to wait between sending PIM hello messages on the interface.
<code>exit</code>	Exit to Privileged Exec mode.
<code>show ipv6 pim</code>	View system-wide PIM information.
<code>show ipv6 pim interface vlan <i>vlan-id</i></code>	View the PIM information for the specified interface.
<code>show ipv6 pim neighbor [interface vlan <i>vlan-id</i>   all]</code>	View a summary or all the details of the multicast table.

## Configuring and Viewing PIM-SM for IPv4 Multicast Routing

Use the following commands to configure PIM-SM for IPv4 multicast routing on the switch and on VLAN routing interfaces and to view PIM-SM information.

Command	Purpose
<code>configure</code>	Enter global configuration mode.
<code>ip routing</code>	Enable IP routing. Routing is required for PIM operation.
<code>ip pim sparse-mode</code>	Enable PIM-SM as the multicast routing protocol on the switch. This command also enables IGMP.
<code>ip multicast-routing</code>	Enable IPv4/IPv6 multicast routing.
<code>ip pim bsr-candidate vlan vlan-id hash-mask-length [priority] [interval interval]</code>	Configure the switch to announce its candidacy as a bootstrap router (BSR). <ul style="list-style-type: none"><li>• <i>vlan-id</i> — A valid VLAN ID.</li><li>• <i>hash-mask-length</i> — The length of a mask that is to be ANDed with the group address before the hash function is called. All groups with the same seed hash correspond to the same RP. For example, if this value is 24, only the first 24 bits of the group addresses matter. This allows you to get one RP for multiple groups. (Range 0–32 bits).</li><li>• <i>priority</i> — The priority of the candidate BSR. The BSR with the higher priority is preferred. If the priority values are the same, the router with the higher IP address is the BSR. (Range 0–255).</li><li>• <i>interval</i> — (Optional) Indicates the BSR candidate advertisement interval. The range is from 1 to 16383 seconds. The default value is 60 seconds.</li></ul>

Command	Purpose
<code>ip pim rp-candidate vlan <i>vlan-id</i> group-address <i>group-address</i> group-mask [<i>interval interval</i>]</code>	<p>Configure the router to advertise itself to the BSR router as a PIM candidate Rendezvous Point (RP) for a specific multicast group range.</p> <ul style="list-style-type: none"> <li>• <i>vlan-id</i> — A valid VLAN ID.</li> <li>• <i>group-address</i> — Group IP address supported by RP.</li> <li>• <i>group-mask</i> — Group subnet mask for group address.</li> <li>• <i>interval</i> — (Optional) Indicates the RP candidate advertisement interval. The range is from 1 to 16383 seconds. The default value is 60 seconds.</li> </ul>
<code>ip pim rp-address <i>rp-address</i> group-address <i>group-address</i> group-mask [<i>override</i>]</code>	<p>(Optional) Statically configure the RP address for one or more multicast groups. Only one RP address can be used at a time within a PIM domain</p> <p>The optional keyword <b>override</b> indicates that if there is a conflict, the RP configured with this command prevails over the RP learned by BSR.</p>
<code>interface vlan <i>vlan-id</i></code>	Enter VLAN Interface Configuration mode for the specified VLAN.
<code>ip pim</code>	Enable PIM/IGMP on the VLAN interface.
<code>ip pim hello-interval <i>seconds</i></code>	Specify the number of seconds (range: 0–65535) to wait between sending PIM hello messages on the interface.
<code>ip pim bsr-border</code>	Prevent bootstrap router (BSR) messages from being sent or received through the interface.
<code>ip pim dr-priority <i>priority</i></code>	Set the priority value for which a router is elected as the designated router (DR). The election priority range is 0–2147483647.
<code>ip pim join-prune-interval <i>interval</i></code>	Configure the interface join/prune interval for the PIM-SM router. The interval range is 0–18000 seconds.
<code>exit</code>	Exit to Global Config mode.
<code>exit</code>	Exit to Privileged Exec mode.
<code>show ip pim</code>	View system-wide PIM information.

<b>Command</b>	<b>Purpose</b>
<code>show ip pim interface vlan <i>vlan-id</i></code>	View the PIM information for the specified interface.
<code>show ip pim neighbor [interface vlan <i>vlan-id</i>   all]</code>	View a summary or all the details of the multicast table.
<code>show ip pim rp-hash <i>groupaddr</i></code>	View the RP router being selected for the specified multicast group address from the set of active RP routers. The RP router for the group is selected by using a hash algorithm.
<code>show ip pim bsr-router [candidate   elected]</code>	View the bootstrap router (BSR) information.
<code>show ip pim rp mapping</code>	View group-to-RP mappings of which the router is aware (either configured or learned from the BSR)

## Configuring and Viewing PIM-SM for IPv6 Multicast Routing

Use the following commands to configure PIM-SM for IPv6 multicast routing on the switch and on VLAN routing interfaces and to view PIM-SM information.

<b>Command</b>	<b>Purpose</b>
<code>configure</code>	Enter global configuration mode.
<code>ip routing</code>	Enable IP routing. Routing is required for PIM operation.
<code>ipv6 unicast-routing</code>	Enable IPv6 routing. IPv6 routing is required for IPv6 PIM.
<code>ipv6 pim sparse-mode</code>	Enable PIM-SM as the multicast routing protocol on the switch. This also enables MLD.
<code>ip multicast-routing</code>	Enable IPv4/IPv6 multicast.

Command	Purpose
<pre>ipv6 pim bsr-candidate vlan vlan-id hash-mask-length [<i>priority</i>] [<i>interval interval</i>]</pre>	<p>Configure the switch to announce its candidacy as a bootstrap router (BSR)</p> <ul style="list-style-type: none"> <li>• <i>vlan-id</i> — A valid VLAN ID.</li> <li>• <i>hash-mask-length</i> — The length of a mask that is to be ANDed with the group address before the hash function is called. All groups with the same seed hash correspond to the same RP. For example, if this value is 24, only the first 24 bits of the group addresses matter. This allows you to get one RP for multiple groups. (Range 0–32 bits).</li> <li>• <i>priority</i> — The priority of the candidate BSR. The BSR with the higher priority is preferred. If the priority values are the same, the router with the higher IPv6 address is the BSR. (Range 0–255).</li> <li>• <i>interval</i> — (Optional) Indicates the BSR candidate advertisement interval. The range is from 1 to 16383 seconds. The default value is 60 seconds.</li> </ul>
<pre>ipv6 pim rp-candidate vlan vlan-id group-address/prefix- length [<i>interval interval</i>]</pre>	<p>Configure the router to advertise itself to the BSR router as a PIM candidate Rendezvous Point (RP) for a specific multicast group range.</p> <ul style="list-style-type: none"> <li>• <i>vlan-id</i> — A valid VLAN ID.</li> <li>• <i>group-address/prefix-length</i> — Group IPv6 address and prefix length supported by RP.</li> <li>• <i>interval</i> — (Optional) Indicates the RP candidate advertisement interval. The range is from 1 to 16383 seconds. The default value is 60 seconds.</li> </ul>
<pre>ipv6 pim rp-address rp- address group-address/prefix- length [<i>override</i>]</pre>	<p>(Optional) Statically configure the RP address for one or more multicast groups. Only one RP address can be used at a time within a PIM domain</p> <p>The optional keyword <b>override</b> indicates that if there is a conflict, the RP configured with this command prevails over the RP learned by BSR.</p>
<pre>interface vlan <i>vlan-id</i></pre>	<p>Enter VLAN Interface Configuration mode for the specified VLAN.</p>
<pre>ipv6 pim</pre>	<p>Enable PIM/MLD on the VLAN.</p>

<b>Command</b>	<b>Purpose</b>
<code>ipv6 enable</code>	Enable IPv6 on the VLAN.
<code>ipv6 pim hello-interval <i>seconds</i></code>	Specify the number of seconds (range: 0–65535) to wait between sending PIM hello messages on the interface.
<code>ipv6 pim bsr-border</code>	Prevent bootstrap router (BSR) messages from being sent or received through the interface.
<code>ipv6 pim dr-priority <i>priority</i></code>	Set the priority value for which a router is elected as the designated router (DR). The election priority range is 0–2147483647.
<code>ipv6 pim join-prune-interval <i>interval</i></code>	Configure the interface join/prune interval for the PIM-SM router. The interval range is 0–18000 seconds.
<code>exit</code>	Exit to Global Config mode.
<code>exit</code>	Exit to Privileged Exec mode.
<code>show ipv6 pim</code>	View system-wide PIM information.
<code>show ipv6 pim interface vlan <i>vlan-id</i></code>	View the PIM information for the specified interface.
<code>show ipv6 pim neighbor [interface vlan <i>vlan-id</i>   all]</code>	View a summary or all the details of the multicast table.
<code>show ipv6 pim rp-hash <i>groupaddr</i></code>	View the RP router being selected for the specified multicast group address from the set of active RP routers. The RP router for the group is selected by using a hash algorithm.
<code>show ipv6 pim bsr-router</code>	View the bootstrap router (BSR) information.
<code>show ipv6 pim rp mapping</code>	View group-to-RP mappings of which the router is aware (either configured or learned from the BSR)

## Configuring and Viewing DVMRP Information

Use the following commands to configure DVMRP on the switch and on VLAN routing interfaces and to view DVMRP information.

Command	Purpose
<code>configure</code>	Enter global configuration mode.
<code>ip dvmrp</code>	Enable DVMRP on the switch. This command also enables IGMP.
<code>ip routing</code>	Enable IP routing on the switch. IP routing is required for DVMRP.
<code>ip multicast-routing</code>	Enable IP multicast.
<code>interface vlan <i>vlan-id</i></code>	Enter VLAN Interface Configuration mode for the specified VLAN routing interface.
<code>ip dvmrp</code>	Enable DVMRP/IGMP on the interface.
<code>ip dvmrp metric <i>metric</i></code>	Configure the metric (range: 1–31) for an interface. This value is used in the DVMRP messages as the cost to reach this network.
<code>exit</code>	Exit to Privileged Exec mode.
<code>show ip dvmrp interface vlan <i>vlan-id</i>]</code>	View the multicast information for the specified interface.
<code>show ip dvmrp neighbor</code>	View neighbor information for DVMRP.
<code>show ip dvmrp nexthop</code>	View the next hop information on outgoing interfaces for routing multicast datagrams.
<code>show ip dvmrp prune</code>	View the table that lists the router's upstream prune information
<code>show ip dvmrp route</code>	View the multicast routing information for DVMRP.



## L3 Multicast Configuration Examples

This section contains the following configuration examples:

- Configuring Multicast VLAN Routing With IGMP and PIM-SM
- Configuring DVMRP

### Configuring Multicast VLAN Routing With IGMP and PIM-SM

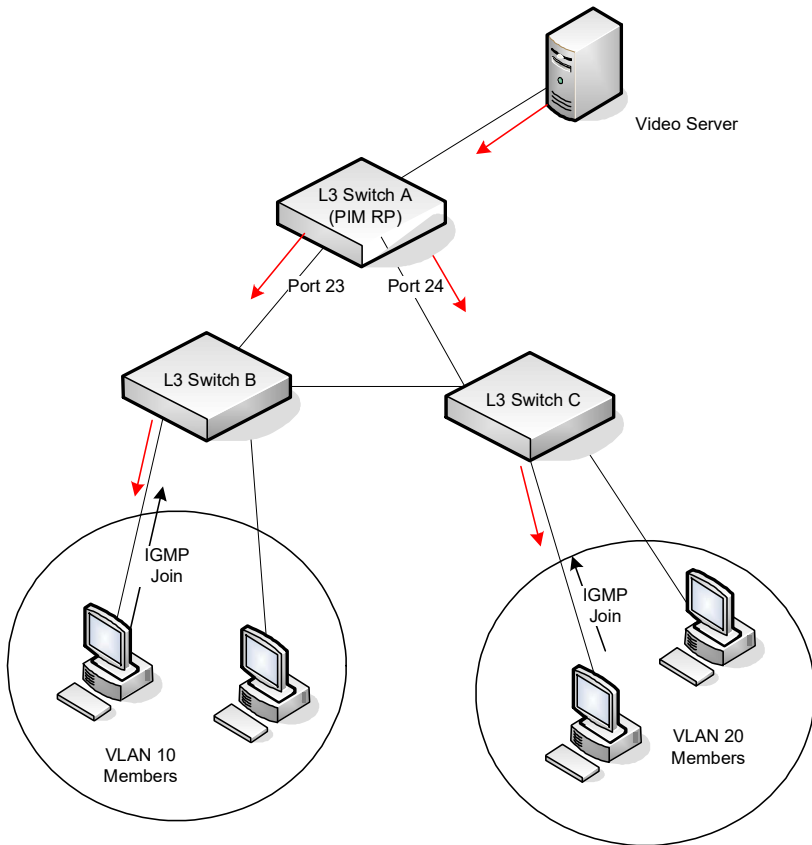
This example describes how to configure a Dell EMC Networking N-Series switch with two VLAN routing interfaces that route IP multicast traffic between the VLANs. PIM and IGMP are enabled on the switch and interfaces to manage the multicast routing. VLAN 10 is statically configured as the RP for the multicast group.



**NOTE:** PIM does not require OSPF specifically; static routing or RIP could also be configured for unicast routing.

The configuration in this example takes place on L3 switch A shown in Figure 46-54. The red arrows indicate the path that multicast traffic takes. L3 Switch A is configured as the RP for the PIM domain, so it is in charge of sending the multicast stream to L3 Switch B and L3 Switch C, and these switches forward the multicast data to the hosts that have requested to receive the data.

**Figure 46-54. IPv4 Multicast VLAN Routing**



In addition to multicast configuration, this example includes commands to configure STP and OSPF on L3 Switch A. STP is configured on the ports that connects the switch to other switches. OSPF is configured to route unicast traffic between the VLANs and PIM is enabled to route multicast traffic between the two VLANs. Since IGMP snooping is enabled by default on all VLANs, no commands to enable it appear in the example below.

To configure Switch A:

- 1 Create the two VLANs.

```
console#configure
console (config) #vlan 10,20
console (config-vlan10,20) #exit
```

- 2 Configure port 23 and 24 as trunk ports.

```
console (config) #interface tel/0/23
console (config-if-Tel1/0/23) #switchport mode trunk
console (config-if-Tel1/0/23) #switchport trunk allowed vlan remove 10
console (config-if-Tel1/0/23) #exit
```

```
console (config) #interface tel/0/24
console (config-if-Tel1/0/24) #switchport mode trunk
console (config-if-Tel1/0/24) #switchport trunk allowed vlan remove 20
console (config-if-Tel1/0/24) #exit
```

- 3 Enable routing on the switch and configure the OSPF router ID.

```
console (config) #ip routing
console (config) #router ospf
console (config-router) #router-id 3.3.1.1
console (config-router) #exit
```

- 4 Configure VLAN 10 as a VLAN routing interface and specify the OSPF area. When you assign an IP address to the VLAN, routing is automatically enabled.

```
console (config) #interface vlan 10
console (config-if-vlan10) #ip address 192.168.10.4 255.255.255.0
console (config-if-vlan10) #ip ospf area 0
```

- 5 Enable IGMPv2 and PIM-SM on the VLAN routing interface.

```
console (config-if-vlan10) #ip igmp version 2
console (config-if-vlan10) #ip pim
console (config-if-vlan10) #exit
```

- 6 Configure VLAN 20 as a VLAN routing interface and specify the OSPF area.

```
console (config) #interface vlan 20
console (config-if-vlan20) #ip address 192.168.20.4 255.255.255.0
console (config-if-vlan20) #ip ospf area 0
```

- 7 Enable IGMPv2 and PIM-SM on the VLAN routing interface.

```
console (config-if-vlan10) #ip igmp version 2
console (config-if-vlan20) #ip pim
console (config-if-vlan20) #exit
```

- 8 Globally enable IP multicast, ICMP, and PIM-SM on the switch.

```
console(config) #ip multicast-routing  
console(config) #ip pim sparse-mode
```

- 9 Configure VLAN 10 as the RP and specify the range of multicast groups for PIM-SM to control. The 239.9.x.x address is chosen as it is a locally administered address that maps to MAC addresses that do not conflict with control plane protocols.

```
console(config) #ip pim rp-address 192.168.10.4 239.9.0.0 255.255.0.0
```

## Configuring DVMRP

The following example configures two DVMRP interfaces on the switch to enable inter-VLAN multicast routing.

To configure the switch:

- 1 Globally enable IP routing and IP multicast.

```
console#configure  
console (config) #ip routing  
console (config) #ip multicast-routing
```

- 2 Globally enable DVMRP and IGMP so that this L3 switch can manage group membership information for its directly-connected hosts. Enabling IGMP is not required if there are no directly-connected hosts; however, it is recommended that it be enabled to ensure correct operation of multicast routing.

```
console (config) #ip dvmrp
```

- 3 Enable DVMRP and IGMP on VLAN routing interfaces 10 and 20.

```
console (config) #interface vlan 10  
console (config-if-vlan10) #ip address 192.168.10.1 255.255.255.0  
console (config-if-vlan10) #ip dvmrp  
console (config-if-vlan10) #exit
```

```
console (config) #interface vlan 20  
console (config-if-vlan20) #ip address 192.168.20.1 255.255.255.0  
console (config-if-vlan20) #ip dvmrp  
console (config-if-vlan20) #exit
```



# Multiple Registration Protocol

## Dell EMC Networking N3000E-ON, N3100-ON, and N3200-ON Series Switches



**NOTE:** Support for MMRP/MVRP is available on the N3000E-ON, N3100-ON, and N3200-ON models when utilizing the Advanced firmware.

### Overview

Multiple Registration Protocol (MRP) is a suite of protocols for reserving resources in the network to facilitate configuration of the network. MRP uses the following protocols:

- Multiple VLAN Registration Protocol (MVRP)—Replaces the role of CVRP in dynamic VLAN creation. MVRP propagates dynamic VLAN information to participating bridges. The participating bridges register (or withdraw) VLAN ID registrations for propagation of AVB streams. If a VLAN ID is dynamically registered on a bridge port, the bridge forwards frames for that VLAN ID on the port.
- Multiple MAC Registration Protocol—Replaces the role of GMRP in dynamic (M)FDB entry creation. MMRP propagates the association of a MAC address (associated with an AVB stream) to a VLAN. This helps to determine to what part of a network a given MAC address needs to be transmitted. If a MAC address is registered on a bridge port by MMRP, the bridge forwards frames addressed to that MAC address on the port.

MMRP and MVRP share a common framework that provides services to the individual protocols. The common framework is the Multiple Registration Protocol (MRP). MRP allows participants in an MRP application to register attributes with other participants in a Bridged LAN. Each MRP participant maintains:

- Registrar and Applicant state machine for each attribute of interest
- LeaveAll and PeriodicTransmission state machine support for the participant

MRP propagates the attribute registrations throughout the AVB network. AVB network participants are aware of all other participants and their attribute registrations. VLAN bridges that do not support MRP forward received MRPDUs on all ports that are in forwarding state.

MRP implements as many MRP Attribute Protocol (MAP) contexts as there are MSTP instances. Within each MAP context, one participant is created for each bridge port and for each MRP application (MMRP, MSRP or MVRP). The AVB protocol family implements the following attributes:

<b>Protocol</b>	<b>Attribute</b>
MVRP	A VLAN identifier
MMRP	A VLAN MAC address association

## **MVRP**

MVRP provides a mechanism for the declaration of dynamic registration of VLANs and propagation of VLAN information over a bridged network. The propagation of VLAN information via MRP allows MVRP-aware devices to dynamically establish and update the set of VLANs that are active on network devices and the ports through which those devices can be reached.

With MVRP both end stations and bridges may issue and revoke VLAN membership declarations. The effect of issuing such declaration is that each MVRP Participant that receives the declaration will create or update a dynamic VLAN Registration entry in the Filtering Database to indicate whether that VLAN is registered on the reception Port.

The MVRP protocol serves end stations that want to exchange data across the network with the specific VID. MVRP guarantees that the required VID will be present on all MVRP-aware devices on the path from one station to another without any manual configuration required. An MVRP request from a device (end station or bridge) means that the device wants to receive traffic on the requested VID. If the data flow is bidirectional, then each end station desiring the flow must issue the same MVRP request.

Receiving the MVRP request for a specific VID on a port of the bridge implies:

- The requested VLAN is dynamically added to the bridge's Dynamic VLAN Registration Entries table.



- The port where the request is received is dynamically added to the set of ports that participate in the requested VLAN.
- For a bridge, the MVRP request is propagated to all other ports that are in the forwarding state in at least one instance of a Multiple Spanning Tree context.

The port of a bridge that receives an MVRP request converts the Join Request into a Join Indication, and an MVRP attribute is registered on these ports. On receipt of a Join Indication, MVRP creates the requested VLAN and adds the ingress port as a member of the newly created VLAN. Also, the Join Indication calls the MAP function to propagate the attribute to all other MVRP-enabled ports in the same MAP context.

Declarations are “alive” while at least one registration exists. Registrations can be purged by LeaveTimer if no MVRPDUs with confirmation are received within the LeaveTimer value after LeaveAll timer expiration, or by receiving an MSRPDU with the Leave event. The LeaveAll timer is running constantly. The purging time is variable and depends on when the LeaveAll timer expires after traffic has been stopped. The possible range is [LeaveTimerValue, LeaveTimerValue + LeaveAllTimerValue \* 1.5].

## MMRP

MMRP allows hosts and bridges to dynamically register and de-register multicast group membership or individual MAC addresses with bridges attached to the network. MMRP propagates that information across all the bridges that support Extended Filtering Services in the network. The MAC address attributes registered, deregistered, and disseminated via MMRP can apply to a group MAC address or individual MAC addresses. The exchange of multicast group membership information can result in the creation or updating of the MAC Address Registration Entries in the Filtering Database to indicate the ports and VLAN IDs on which the multicast groups have been registered.

Operationally, MMRP defines a sub-tree of the active spanning tree as a result of the creation of MAC Address Registration Entries in the filtering databases of the bridges. End stations may also make use of the group membership information registered via MMRP to keep track of the groups for which active members currently exist and the service requirements of upstream devices.

This allows end stations that are sources of frames destined for a Group to suppress the transmission of such frames if their registered Group membership and Group service requirement information indicates that there are no valid recipients of those frames reachable via the networks to which they are attached.

This end system behavior (known as source pruning) allows MAC service users transmitting MAC frames destined for a number of groups to avoid unnecessary flooding of traffic in the local network when there are no group members registered to receive traffic.

## MRP Configuration Example

The following example configures an MRP switch.

- 1 Create VLAN 2. This VLAN is used to carry the MSRP traffic.

```
console#config
console (config) #vlan 2
console (config-vlan2) #exit
```

- 2 Configure two CoS queues for minimum latency, with CoS queue 3 receiving a guarantee of 10% of the scheduler and CoS queue 4 receiving a guarantee of 15% of the scheduler.

```
console (config) #cos-queue min-bandwidth 0 0 0 10 15 0 0
```

- 3 Configure CoS queues 3 and 4 as strict priority queues. This means that CoS queue 4 packets will be scheduled for transmission first, with up to 15% of the scheduler slots. CoS queue 3 packets will be scheduled next, with up to 10% of the scheduler slots, and then all other packets will be scheduled fairly with the remaining scheduler slots.

```
console (config) #cos-queue strict 3 4
```

- 4 Configure interfaces Te1/0/1-4 as trunk ports and enable them for MVRP and MMRP.

```
console (config) #interface range Te1/0/1-4
console (config-if) #switchport mode trunk
console (config-if) #mvrp
console (config-if) #mmrp
console (config-if) #exit
```

- 5 Globally enable MVRP and MMRP and enable the periodic state machines to purge registrations periodically.

```
console (config) #mvrp global
```

```
console (config) #mvrp periodic state machine
console (config) #mmrp global
console (config) #mmrp periodic state machine
```

- 6** Use commands such as the following, among others, to verify the configuration and operation of the various protocols.

```
console#show mrp interface summary
```

Intf	JoinTimer	LeaveTimer	LeaveAllTimer
Tel/0/1	20	300	2000
Tel/0/2	20	300	2000
Tel/0/3	20	300	2000
Tel/0/4	20	300	2000
Tel/0/5	20	300	2000
Tel/0/6	20	300	2000



# OpenFlow

**Dell EMC Networking N2000, N2100-ON, N2200-ON, N3000E-ON, N3100-ON, and N3200-ON Series Switches**

## Dell EMC Networking OpenFlow Hybrid Overview

The following acronyms are used in this chapter.

**Table 48-1. OpenFlow Acronyms**

Acronym	Definition
ICAP	Ingress Content Aware Processor. This is a hardware flow matching table. The term ICAP is used synonymously with IFP.
IFP	Ingress Field Processor. The IFP is a hardware flow matching table.
OVS	Open vSwitch
VCAP	VLAN Content Aware Processor. This is a hardware flow matching table. The term VCAP is used synonymously with VFP.
VFP	VLAN Field Processor. The VFP is a hardware flow matching table.

The Dell EMC Networking OpenFlow Hybrid feature implements a true OpenFlow hybrid model as opposed to a 'ships-in-the-night' model. Packets may be forwarded normally via bridging or routing for interfaces that do not have flows installed. On interfaces with flows installed, packet forwarding proceeds normally (except as noted herein) for non-matching flows. Dell EMC Networking OpenFlow Hybrid enables the switch to be managed by a centralized OpenFlow Controller using the OpenFlow protocol. Dell EMC Networking OpenFlow Hybrid is not supported in stacking deployments. Remove all stack members prior to enabling Dell EMC Networking OpenFlow Hybrid.

Dell EMC Networking partially supports the OpenFlow 1.0 and OpenFlow 1.3 standards. The Dell EMC Networking OpenFlow Hybrid switch contains OpenFlow agent version 2.3.0 from the Open vSwitch (OVS) project. The Open vSwitch code is licensed under the Apache 2 license. The OpenFlow agent has been validated with the Helium release of OpenDaylight (ODL).

The OpenFlow 1.0 standard supports a single-table data forwarding path. Dell EMC Networking switches support Open Vswitch proprietary extensions to enable the OpenFlow controller access to multiple forwarding tables.

The OpenFlow 1.3 standard enables a multi-table data forwarding path. Dell EMC Networking switches, however, support a single-table OpenFlow 1.3 data forwarding path.

The Dell EMC Networking OpenFlow feature has the following major functions:

- 1 Enabling Dell EMC Networking OpenFlow Hybrid.
- 2 Deploying OpenFlow Configuration.
- 3 Interacting with the OpenFlow Controllers.
- 4 Deploying OpenFlow Controller Flows.
- 5 Collecting Port and Queue Status and Statistics.
- 6 Supporting OpenFlow Controller Group tables

## **Enable Dell EMC Networking OpenFlow Hybrid**

The OpenFlow feature can be enabled and disabled by the network administrator. Although Dell EMC Networking OpenFlow Hybrid may be administratively enabled, it is not operational until the switch has an IP address.

The OpenFlow feature can be administratively disabled at any time. After administratively disabling the feature, the network administrator must wait until the OpenFlow Feature is operationally disabled before re-enabling the feature.

The administrator can allow the switch to automatically assign an IP address to OpenFlow or to specifically select which address should be used. The administrator can also direct the OpenFlow feature to always use the out-of-band interface.

If the address is assigned automatically and the interface with the assigned address goes down, the switch selects another active interface if one is available. Dell EMC Networking OpenFlow Hybrid becomes operationally disabled and re-enabled when a new IP address is selected. If the address is assigned statically, the OpenFlow feature comes up only when a switch interface with the matching IP address becomes active.

Automatic IP address selection is done in the following order of preference.

- 1** Loopback interfaces.
- 2** Routing interfaces.
- 3** Out-of-band interface.

Dell EMC Networking switches support IPv4 addresses for connecting to the OpenFlow controller. IPv6 addresses are not supported.

If IP routing is enabled, the out-of-band interface cannot be used as the OpenFlow interface.

Once the OpenFlow IP address is selected, it is used until the interface goes down or the OpenFlow feature is disabled or, in case of automatic address selection, a more preferred interface becomes available.

If the out-of-band interface is manually selected as the OpenFlow IP address, the Open Flow feature becomes enabled immediately, even if there is no IP address assigned to the interface.

The selected IP address is used as the endpoint of the IP connections to the OpenFlow controllers.

When the OpenFlow feature is operationally disabled, the switch drops connections with the OpenFlow Controllers. The switch also purges all flows programmed by the controllers.

If the administrator changes the OpenFlow variant while the OpenFlow feature is enabled, the switch automatically disables and re-enables OpenFlow. This causes all flows to be deleted and connections to the controllers to be dropped.

If the administrator changes the default hardware table for OpenFlow 1.0 and the switch is currently operating in OpenFlow 1.0 variant, the OpenFlow feature is automatically disabled and re-enabled.

## Interaction with OpenFlow Controllers

Dell EMC Networking OpenFlow Hybrid implements a subset of the OpenFlow 1.0 protocol and a subset of the OpenFlow 1.3 protocol. Dell EMC Networking OpenFlow Hybrid also implements certain enhancements to the OpenFlow protocol to optimize it for the Data Center environment and to make it compatible with Open vSwitch. Dell EMC Networking OpenFlow Hybrid interacts with any OpenFlow controller that supports OpenFlow 1.0 or the OpenFlow 1.3 standards.

This section covers the following topics:

- "Dell EMC Networking OpenFlow Hybrid Principles of Operation" on page 1696
- "OpenFlow 1.0 Supported Flow Match Criteria, Actions and Status" on page 1698
- "Port Configuration, Status and Statistics" on page 1724
- "Queue Configuration and Status" on page 1725
- "Queue Configuration and Status" on page 1725
- Dell EMC Networking OpenFlow Hybrid Supported OpenFlow messages and options.

### Dell EMC Networking OpenFlow Hybrid Principles of Operation

The Dell EMC Networking OpenFlow Hybrid OpenFlow implementation is targeted for the data center market as opposed to the education market. As a consequence of this design decision, some aspects of the OpenFlow 1.0/1.3 specifications are not supported, while extra features are added to enhance the data center networking environment.

Key limitations are:

- A single bridge instance.
- A limited subset of supported flow actions.

The Dell EMC Networking OpenFlow Hybrid implements the following behaviors:

- 1 The switch behaves as an OpenFlow-Enabled Hybrid switch. This means that the switch can forward OpenFlow and normal Layer-2 and Layer-3 traffic on the same ports and the same VLANs at the same time. When the controller adds flows, the ports mentioned in the match criteria or egress



actions are automatically assumed to be OpenFlow ports, so the switch disables ingress and egress filtering on those ports and allows the ports to receive and transmit traffic for any VLAN. This change in the ingress and egress filtering behavior may affect how the switch handles the non-OpenFlow traffic on those ports.

- 2** The switch supports only one bridge instance.
- 3** In OpenFlow 1.0 mode, the switch supports several backup OpenFlow controllers. The backup controllers can exchange hello messages with the switch, but cannot add flows or monitor switch status. A vendor message is defined to allow a backup controller become a primary controller. In the OpenFlow 1.3 mode several OpenFlow controllers can manage the switch at the same time.
- 4** In the OpenFlow 1.0 mode, the switch supports multiple hardware tables to which flows are added. The switch advertises to the controller as having multiple tables. The multi-table support in OpenFlow 1.0 is weak because it does not allow the OpenFlow controller to specify the table to add the flow to. Dell EMC Networking OpenFlow Hybrid extends the OpenFlow 1.0 protocol to specify the table number into which the flow is inserted by using the most significant byte of the command field in the OFPT\_FLOW\_MOD message. "OpenFlow 1.0 Supported Flow Match Criteria, Actions and Status" on page 1698 defines which flows are added to which hardware tables.
- 5** In OpenFlow 1.3 mode, the switch supports only one hardware table.
- 6** When operating in the OpenFlow 1.3 mode, the switch supports the group table. See "Group Table" on page 1719 for more information.
- 7** The switch does not support the OpenFlow 1.0 emergency flow table.
- 8** The switch does not support forwarding packets in software. If a flow cannot be added to the hardware, the switch generates an error message.
- 9** The switch does not support adding flow match criteria and forwarding actions for ports that are not currently present in the system. However, if ports are removed after the flow is installed, then the flow is updated with the correct port forwarding rules. If the match port is not present on the switch, the switch holds the flow in a software table and applies the flow to the hardware when the port becomes available. If the port for a forwarding action is not present on the switch, the switch adds the flow without the

missing port and modifies the flow when the port becomes available. This behavior can cause a flow to be added with no egress ports, which causes packets matching the flow to be dropped.

- 10 When the switch loses connection to the OpenFlow controller it continues to forward traffic using the flows previously programmed by the controller. When the switch reconnects to the controller, it keeps using the previously programmed flows until the OpenFlow controller tells it otherwise.
- 11 At boot time, when the switch does not have any flows, it forwards traffic normally using the Layer-2/Layer-3 forwarding rules.
- 12 The switch supports sending data packets to the controller. However, the controller must explicitly install a flow to forward packets to the controller. Packets that do not match any flow entries are forwarded normally using the Layer-2 or Layer-3 logic.
- 13 The switch supports the ability for the controller to inject packets into the network via the switch. This means that the controller can inject packets into the network.
- 14 The switch supports only a limited set of flow match criteria and actions. See "OpenFlow 1.0 Supported Flow Match Criteria, Actions and Status" on page 1698.
- 15 The switch supports flows for physical ports and LAGs. These ports can be used as destinations and match criteria. Status and statistics are reported for these ports.
- 16 The switch supports eight CoS queues per physical port. Redirection to queues is supported only for the OpenFlow 1.3 protocol. Queue status reporting is supported.
- 17 The switch supports flow aging. The switch checks the flow install time and idle time every 30 seconds. If either of the timers exceeds the configured values for the flow, the switch deletes the flow. For hardware tables that do not support flow statistics, the switch does not support the idle timeout.

### **OpenFlow 1.0 Supported Flow Match Criteria, Actions and Status**

The Dell EMC Networking OpenFlow Hybrid switch supports a limited set of match criteria and actions. This section defines which match criteria and flow actions are supported in each hardware table.

Dell EMC Networking OpenFlow Hybrid adds flows into one of the following hardware tables: the VLAN Field Processor or the Ingress Field Processor. The Ingress Field Processor is subdivided into two different hardware tables: the "MAC Forwarding Table" and the "OpenFlow 1.0 Rule Table". The hardware table to which the flow is added depends on the flow table identifier specified in the OFPT\_FLOW\_MOD message.

The flows are added, modified, and removed using the OFPT\_FLOW\_MOD message. The OFPT\_FLOW\_MOD message is handled by the Open vSwitch layer and the resulting flow modification commands are passed to Dell EMC Networking OpenFlow Hybrid using the ofproto\_class interface.

Dell EMC Networking OpenFlow Hybrid enables the OpenFlow 1.0 Controller to add flows to different tables by making use of the most significant byte in the command field in the OFPT\_FLOW\_MOD message. If this byte is 0, the flow is added to the default table configured by the administrator. If the byte is not zero, the flow is added to the flow table specified in Table 48-2.

The following table identifiers are mapped to the listed hardware tables. The table identifiers are not contiguous because some identifiers are reserved for future enhancements. The supported hardware table IDs, sizes, and descriptions are accessible through the switch user interface.

**Table 48-2. Flow Table Identifiers**

<b>ID</b>	<b>Usage</b>	<b>Description</b>
0	User-Configured table.	This table ID in the OFPT_FLOW_MOD messages indicates that the rule should be added to the default table configured by the administrator. The standard OpenFlow 1.0 controllers always send 0 to the switch. Table 0 is not reported in the OFPST_TABLE message.
1–3	Reserved	Unused.
4	Source MAC VLAN Assignment	This table is in the VLAN Field Processor.
5–23	Reserved	Unused.
24	OpenFlow 1.0 Rule Table	IFP table containing OpenFlow 1.0 rules.

**Table 48-2. Flow Table Identifiers (Continued)**

<b>ID</b>	<b>Usage</b>	<b>Description</b>
25	MAC Forwarding Table	IFP table containing multicast and unicast DA-MAC-based forwarding rules.
26–31	Reserved	Unused
32–255	Unsupported	The enhanced OpenFlow 1.0 protocol only supports table IDs 0 to 31.

When using multiple hardware tables, it is possible to set up the hardware so that, for example, the MAC Forwarding Table and OpenFlow 1.0 Rule Table match the same packet. If the packet matches multiple slices in the IFP, the hardware performs all non-conflicting actions on the packet. For example, the OpenFlow 1.0 Rule Table may set the packet priority and the MAC Forwarding Table may direct the packet to a specific output port.

If the packet actions conflict, the egress action is not predictable. The controller-based applications should take care not to insert flow with conflicting actions.

If the packet matches an IFP rule installed by a different component, such as QoS, any conflicting actions are generally resolved in favor of the other component. The IFP slices allocated to the OpenFlow component have the lowest priority except for the system rules. The OpenFlow actions override actions installed by the system rules.

Although the OpenFlow IFP slices are lower priority than IFP slices used by other Dell EMC Networking OpenFlow Hybrid components, the IFP itself is positioned in the ingress pipeline after the forwarding database and the routing tables. This means that IFP rules inserted by the OpenFlow feature can affect switching and routing decisions.

VFP-based flows also may affect switching decisions and alter switching protocols behavior by changing MAC addresses or/and VLAN IDs.

To avoid interfering with non-OpenFlow traffic, the rules should be qualified with a VLAN ID reserved for the OpenFlow traffic. The Dell EMC Networking OpenFlow Hybrid switch does not enforce any specific VLAN IDs and also accepts wildcard VLAN IDs, so it is up to the OpenFlow Controller to configure the switch correctly.

Refer to "Limitations, Restrictions, and Assumptions" on page 1736 for the list of known interferences.

This section includes the following topics:

- "OpenFlow 1.0 Rule Table" on page 1701
- "Source MAC VLAN Assignment Table" on page 1707
- "MAC Forwarding Table" on page 1708
- "Flow Addition and Modification Error Messages" on page 1711
- "Flow Status and Statistics" on page 1712

### ***OpenFlow 1.0 Rule Table***

The OpenFlow 1.0 rule table implements many of the OpenFlow match criteria and actions defined in the OpenFlow 1.0 standard.

The table is implemented in the Ingress Field Processor using slices configured in the intra-slice double-wide mode. This means that the number of rules in each IFP slice is divided in half to provide the necessary rule width.

The following sections describe the match criteria and actions supported by the OpenFlow 1.0 table.

- OpenFlow 1.0 Match Criteria

Table 48-3 defines the OpenFlow 1.0 match criteria supported by Dell EMC Networking OpenFlow Hybrid. The fields in the table correspond to the fields defined in Table 3 in the OpenFlow 1.0 Switch Specification.

In summary, the Dell EMC Networking OpenFlow Hybrid switch supports matching on all fields specified in the OpenFlow 1.0 standard except the IP address fields in ARP frames and the ARP op-code.

If the switch is configured to operate as a router, then for IPv4 packets, the hardware matches the packet fields only if the packet can be forwarded by the hardware. Packets with IP header errors and packets with options in the IP header are sent to the switch protocol stack and cannot be intercepted by the OpenFlow controller.

If the switch is not a router and is only performing Layer-2 switching, then it ignores IPv4 header errors and applies the match rules to all IPv4 packets.

All fields in this table can be wild-carded.

**Table 48-3. Supported OpenFlow Match Criteria**

<b>Match Field</b>	<b>Description</b>
Ingress Port	Physical port or LAG.
Ethernet Source Address	The 6-byte source MAC.
Ethernet Destination Address	The 6-byte destination MAC.
Ethernet Type	The EtherType in Ethernet V2 tagged and untagged packets.
VLAN ID	The VLAN Identifier field in the VLAN header. The valid range for the VLAN ID is 1 to 4094. Note that all packets are classified into a VLAN when they are processed by the OpenFlow 1.0 classifier. The packets that entered the switch without a tag are assigned a VLAN either by the ingress port PVID or by the Source MAC VLAN Assignment Table. Thus 0xFFFF, a special VLAN designator indicating that the entry should match untagged traffic, cannot be used as a match criteria for this field.
VLAN Priority	The VLAN Priority field in the VLAN header. The valid range for the VLAN Priority is 0 to 7. Note that all packets are tagged in the system when they are processed by the OpenFlow 1.0 classifier. The packets that entered the switch without a tag are assigned a default port priority configured for the port.
IP Source Address	<p>The 4-byte IP source address in IPv4 packets. Only packets with EtherType 0x0800 can match to the IP Source Address field. The OpenFlow controller is not required to explicitly set up the Ethernet Type match field. The Ethernet Type field may be wildcarded and the switch can still match IPv4 packets.</p> <p>The switch supports subnet masking for the IP Source Address.</p> <p>The Source IP Address matching within ARP packets is not supported.</p>

**Table 48-3. Supported OpenFlow Match Criteria (Continued)**

<b>Match Field</b>	<b>Description</b>
IP Destination Address	<p>The 4-byte IP destination address in IPv4 packets. Only packets with EtherType 0x0800 can match to the IP Destination Address field. The OpenFlow controller is not required to explicitly set up the Ethernet Type match field. The Ethernet Type field may be wildcarded and the switch can still match IPv4 packets.</p> <p>The switch supports subnet masking for the IP Destination Address.</p> <p>The Destination IP Address matching within ARP packets is not supported.</p>
IP Protocol	<p>1-byte IP Protocol field in the IPv4 packets. The hardware matches this field only against IPv4 packets.</p> <p>The protocol field in ARP packets is not supported.</p>
IP ToS	<p>The most significant 6-bits of the Type of Service byte. The value is actually interpreted as the DiffServ Codepoint.</p> <p>Only IPv4 frames can match this classifier.</p>
Transport Source Port / ICMP Type	<p>Source IP port for TCP and UDP IPv4 packets or ICMP Type.</p> <p>To correctly match on the ICMP type, the controller must set the IP Protocol value to ICMP (1). The IP Protocol can be wildcarded for matching on the IP Port number</p>
Transport Destination Port / ICMP Code	<p>The destination IP port for TCP and UDP IPv4 packets or ICMP code.</p> <p>To correctly match on the ICMP code, the Controller must set the IP Protocol to ICMP (1). The IP Protocol can be wildcarded for matching on the IP port number.</p>

- OpenFlow 1.0 Actions

The switch supports single-port and multi-port forwarding actions as well as some optional packet modifications actions.

Table 48-4 defines the supported and unsupported forwarding actions.

**Table 48-4. Supported/Unsupported OpenFlow Forwarding Actions**

Forwarding Action	Description
Forward—Physical Port	The switch can redirect traffic to one or more ports. A valid port can be a physical port or a LAG. When redirecting traffic to multiple ports, a combination of physical ports and LAGs can be specified in the actions.
Forward—CONTROLLER	Send packet to the OpenFlow controller. The "CONTROLLER" reserved port can also be used with switch port numbers. The flow must not include any packet modification actions.
Forward—ALL	Not Supported.  This is a "Required" action for OpenFlow, however it is not practical on a VLAN-enabled switch.
Forward—LOCAL	Not Supported.  This is a "Required" action, but does not make sense on an OpenFlow-Enabled switch. The packets are sent to the switch CPU only when directed by its bridging or routing protocol stack.
Forward—TABLE	Not Applicable.  The action is defined only for packet-out messages.
Forward—IN_PORT	Not Supported.  This is a "Required" action, but is not supported because this action is too dangerous on switches in production network.



**Table 48-4. Supported/Unsupported OpenFlow Forwarding Actions (Continued)**

<b>Forwarding Action</b>	<b>Description</b>
Forward— NORMAL	<p>This is a supported forwarding action. "NORMAL" reserved port can be either the only action in the list, or can be specified along with the "CONTROLLER" port. No packet modifications are allowed when this action is specified.</p> <p>The packet is forwarded according to normal Layer-2 or Layer-3 tables.</p> <p>There are two use cases identified for this action:</p> <ul style="list-style-type: none"><li>• An access list, where traffic matching the rule is allowed while traffic not matching the rule is dropped.</li><li>• A statistics monitor, enabling the OpenFlow controller to collect byte and packet counters for the matching traffic.</li></ul>
Forward— FLOOD	<p>Not Supported.</p> <p>This is an "Optional" action and is not supported.</p>
Enqueue	<p>Not Supported.</p> <p>This is an "Optional" action and is not supported. The egress queue is selected based on the packet 802.1p priority and the switch configuration.</p>
Drop	<p>Packets matching the flow with this action are dropped. When this action is specified, it must be the only action in the action list.</p>

**Table 48-4. Supported/Unsupported OpenFlow Forwarding Actions (Continued)**

<b>Forwarding Action</b>	<b>Description</b>
Modify Field	<p>The switch supports modifying certain fields in the packet. The feature can be used to give higher priority to certain packets by modifying the 802.1p and DSCP fields. The feature can also be used to implement policy based routing.</p> <p>The packet modifications can be made to the single-port and multi-port flows. If multiple egress ports are specified in the flow then all of the packet modification actions must precede the port forwarding actions. All ports in a multi-port flow perform the same packet modifications. Dell EMC Networking OpenFlow Hybrid does not support modifying packets differently for different ports. This action is only supported for table 4 and 24.</p> <p>The field modification is supported for the following fields:</p> <ul style="list-style-type: none"><li>• Set VLAN ID</li><li>• Set VLAN Priority</li><li>• Modify Source MAC Address</li><li>• Modify Destination MAC Address</li><li>• Modify IPv4 ToS bits</li></ul> <p>If the flow has a modify VLAN action and does not specify a tagged matched criterion, the flow is rejected.</p> <p>The packet actions may appear in any order, but must precede any forwarding actions. Also, each type of packet modification action must appear only one time in the flow.</p> <p>The remaining OpenFlow 1.0 packet modification actions are not supported. The unsupported actions are:</p> <ul style="list-style-type: none"><li>• Strip VLAN Header.</li><li>• Modify IPv4 Source Address</li><li>• Modify IPv4 Destination address.</li><li>• Modify Transport Source Port.</li><li>• Modify Transport Destination Port.</li></ul>

### **Source MAC VLAN Assignment Table**

The Source MAC VLAN Assignment table matches on SA MAC, VLAN, and Input Port. Dell EMC Networking OpenFlow Hybrid checks the 'wildcards' field in the `ofp_match` structure and returns an error if any of the bits other than `OFPPFW_IN_PORT`, `OFPPFW_DL_VLAN`, or `OFPPFW_DL_SRC` are set to 0. If the OpenFlow Controller specifies an unsupported action, the switch rejects the flow with an error.

**Table 48-5. Source MAC VLAN Assignment Table Match Criteria**

<b>Name</b>	<b>Description</b>	<b>Match Criteria/Actions</b>
Phase-1-Untagged-MAC	Assign a VLAN to the station. The flow is added to the VFP. Only one untagged VLAN may be used per port.	<code>dl_vlan</code> — 0xFFFF — Special VLAN designator indicating that entry should match untagged traffic. <code>in_port</code> — Valid physical or LAG port number on the switch. <code>dl_src</code> — Source MAC. Action type — <code>OFPAT_SET_VLAN_VID</code> VLAN — Valid VLAN ID.
Phase-1-MAC	Assign a VLAN to the station. The flow is added to the VFP.	<code>dl_vlan</code> — Valid VLAN ID. <code>in_port</code> — Valid physical or LAG port number on the switch. <code>dl_src</code> — Source MAC. Action type — <code>OFPAT_SET_VLAN_VID</code> VLAN — Valid VLAN ID.
Phase-1-Drop	Drop packets that don't match more specific VFP rules.	<code>dl_vlan</code> — Wildcard. <code>in_port</code> — Valid physical or LAG port number on the switch. <code>dl_src</code> — Wildcard No Actions (Packet is Dropped)

### MAC Forwarding Table

The MAC Forwarding table matches on DA MAC, SA MAC, VLAN, and Input Port. Dell EMC Networking OpenFlow Hybrid checks the 'wildcards' field in the `ofp_match` structure and returns an error if any of the bits other than `OFFFW_IN_PORT`, `OFFFW_DL_VLAN`, `OFFFW_DL_SRC`, or `OFFFW_DL_DST` are set to 0. `0xFFFF`, a special VLAN designator indicating that entry should match untagged traffic, cannot be used as a match criteria for VLAN ID field `dl_vlan`.

**Table 48-6. MAC Forwarding Table Match Criteria**

Name	Description	Match Criteria/Actions
Local — MAC	Entry used for sending traffic between local ports.	<code>dl_vlan</code> — Valid VLAN ID <code>dl_dst</code> — Non-multicast destination MAC address. <code>in_port</code> — Wildcard <code>dl_src</code> — Wildcard Action Type — <code>OFFPAT_OUTPUT</code> <code>port</code> — Valid physical port or LAG. <code>max_len</code> — Ignored
Local — Broadcast	Match on Broadcast packets sent by the local ports.	<code>dl_vlan</code> — Valid VLAN ID <code>dl_dst</code> — <code>ff:ff:ff:ff:ff:ff</code> <code>in_port</code> — Valid physical port or LAG. <code>dl_src</code> — Wildcard Action Type — <code>OFFPAT_OUTPUT</code> (Can be repeated) <ul style="list-style-type: none"> <li>• <code>port</code> — Valid physical port or LAG.</li> <li>• <code>max_len</code> — Ignored</li> </ul>

**Table 48-6. MAC Forwarding Table Match Criteria (Continued)**

Name	Description	Match Criteria/Actions
Local — Multicast	Match on any MAC address with the multicast bit enabled. All other bits in the destination MAC are implicitly masked.	dl_vlan — Valid VLAN ID dl_dst — 01:00:00:00:00:00 — Special MAC address in_port — Valid Physical Port or LAG. dl_src — Wildcard Action Type — OFPAT_OUTPUT (Can be repeated) <ul style="list-style-type: none"> <li>• port — Valid physical port or LAG.</li> <li>• max_len — Ignored</li> </ul>
Local — Default	Match traffic arriving on local port and a specific VLAN.	dl_vlan — Valid VLAN ID in_port — Valid Physical Port or LAG. dl_dst — Wildcard dl_src — Wildcard Action Type — OFPAT_OUTPUT (Can be repeated) <ul style="list-style-type: none"> <li>• port — Valid physical port or LAG.</li> <li>• max_len — Ignored</li> </ul>
Layer-2-Match	This flow matches all Layer-2 fields required for a learning bridge.	dl_dst — Non-Multicast destination MAC address. dl_src — Source MAC Address. dl_vlan — VLAN ID in_port — Ingress physical port or LAG. Action Type OFPAT_OUTPUT <ul style="list-style-type: none"> <li>• port — Valid physical port or LAG.</li> <li>• max_len — Ignored</li> </ul>

**Table 48-6. MAC Forwarding Table Match Criteria (Continued)**

<b>Name</b>	<b>Description</b>	<b>Match Criteria/Actions</b>
Controller — VLAN	Match traffic for a specific VLAN and send the packet to the OpenFlow Controller.	dl_vlan — Valid VLAN ID dl_dst — Wildcard in_port — Wildcard dl_src — Wildcard Action Type — OFPAT_OUTPUT (Can be specified only one time) <ul style="list-style-type: none"><li>• port — OFPP_CONTROLLER (0xffffd)</li><li>• max_len — An integer from 0 to 9216.</li></ul>

### **Flow Addition and Modification Error Messages**

If the switch detects a problem with a newly added flow, or is unable to add or modify a flow due to lack of hardware resources, the switch generates an error message in response to the `ofproto_class Flow Put` function and generates a syslog message with a text string representing the error type.

Table 48-7 lists the syslog messages that can be generated by the switch in response to the flow modification requests. The syslog notification level for all these message is 3-Warning.

**Table 48-7. Syslog Messages in Response to Flow Modification Requests**

<b>ASCII Text</b>	<b>Description</b>
Unexpected 'wildcards' value <hex-value>.	The wildcards field contains bits that are set to 0 for match criteria unsupported by the switch.
Unsupported Match Criteria	The match criteria do not correspond to any supported pattern defined in "OpenFlow 1.0 Rule Table" on page 1701, "Source MAC VLAN Assignment Table" on page 1707, and "MAC Forwarding Table" on page 1708.
Unsupported Match Port <hex-value>.	The match criteria port is not wild-carded and not in the range from 0-0xff00 or 0xffc0.
Invalid Match VLAN <hex-value>.	The VLAN is not in the range from 1 to 4094 or special untagged VLAN 0xFFFF.
Unable to add the flow to the hardware, xid - <hex-value>, table = <integer>.	Hardware does not have enough room to add this flow.
Unsupported Flow Actions, xid - <hex-value>	One or more actions for the flow type corresponding to the match criteria are not supported. The supported actions are defined in "OpenFlow 1.0 Supported Flow Match Criteria, Actions and Status" on page 1698.
Invalid Output Port <hex-value>.	The output port number is not in the range 0-0xff00.

### ***Flow Status and Statistics***

The OpenFlow Controller uses the `OFPT_STATS_REQUEST` message with the type `OFPT_FLOW` to request flow status and statistics. The switch supports all flow match criteria in the `OFPT_STATS_REQUEST` defined by the OpenFlow 1.0 standard.

The switch supports packet and byte counters for the OpenFlow 1.0 Rule Table and the MAC Forwarding Table.

The `OFPT_STATS_REPLY` message includes the flow match criteria and actions.

### **OpenFlow 1.3 Flow Match Criteria and Actions**

The Policy ACL Flow Table supports wide, multi-field matching. Most fields can be wildcard matched, and relative priority must be specified in all flow entries. The Policy ACL Flow Table has actions to redirect packets to different destination groups. It can be used to output copies of packets (for example, ARP packets or BPDU frames) to the Controller.

The Policy ACL Flow Table is organized into mutually exclusive logical sub-tables. Flow entries in the IPv6 logical tables match only packets that require matching on IPv6 header fields. The non-IPv6 logical table matches any packet that does not require matching on IPv6 header fields. Following the OpenFlow single-entry match semantics, since the Policy ACL Flow Table is considered a single table, a packet can match at most one rule in the entire table.

Flow entries must conform to match field prerequisite requirements defined in the OpenFlow specification or in this document. In other words, if a prerequisite field is identified for a particular match field, it must be explicitly provided. For example, to match a TCP source port, the IP protocol must be 4 (TCP) and the EtherType must be 0x0800 (IPv4) or 0x86dd (IPv6).

The default on table miss is to do nothing. The packet will be forwarded using the output or group in the action set, if any. If the action set does not have a group or output action the packet is dropped.



### **Flow Match Fields**

The available match fields for Policy ACL Flow Table flow entry types are as described in the following tables.

**Table 48-8. Policy ACL Flow Table Layer 2 Match Fields**

<b>Field</b>	<b>Bits</b>	<b>Maskable</b>	<b>Optional</b>	<b>Description or Prerequisite</b>
IN_PORT	32	No	Yes	Physical or logical ingress port.
ETH_SRC	48	Yes	Yes	Ethernet source MAC
ETH_DST	48	Yes	Yes	Ethernet destination MAC
ETH_TYPE	16	No	Yes	Any value except 0x86dd. Explicit prerequisite must be 0x800 if IP fields are to be matched.
VLAN_VID	16	Yes	Yes	VLAN ID. Cannot be masked for a VLAN bridging rule that redirects to a different L2 output group. Only applicable to VLAN flow entry types.
VLAN_PCP	3	No	Yes	802.1p priority field from VLAN tag. Always has a value, will be zero if packet did not have a VLAN tag.

**Table 48-9. Policy ACL Flow Table IPv4 Match Fields**

<b>Field</b>	<b>Bits</b>	<b>Maskable</b>	<b>Optional</b>	<b>Description or Prerequisite</b>
IN_PORT	32	No	Yes	Physical or logical ingress port.
ETH_SRC	48	Yes	Yes	Ethernet source MAC
ETH_DST	48	Yes	Yes	Ethernet destination MAC
ETH_TYPE	16	No	Yes	Any value except 0x86dd. Explicit prerequisite must be 0x800 if IP fields are to be matched.
VLAN_VID	16	Yes	Yes	VLAN ID. Cannot be masked for a VLAN bridging rule that redirects to a different L2 output group. Only applicable to VLAN flow entry types.

**Table 48-9. Policy ACL Flow Table IPv4 Match Fields (Continued)**

<b>Field</b>	<b>Bits</b>	<b>Maskable</b>	<b>Optional</b>	<b>Description or Prerequisite</b>
VLAN_PCP	3	No	Yes	802.1p priority field from VLAN tag. Always has a value, will be zero if packet did not have a VLAN tag.
IPV4_SRC	32	Yes	Yes	Matches SIP if EtherType = 0x0800
IPV4_DST	32	Yes	Yes	Matches DIP if EtherType = 0x0800
IP_PROTO	8	No	Yes	IP protocol field from IP header if EtherType = 0x0800
IP_DSCP	6	No	Yes	Bits 0 through 5 of the IP ToS Field as defined in RFC 2474 if EtherType = 0x0800
IP_ECN	2	No	Yes	Bits 6 through 7 of the IP ToS Field as defined in RFC 3168 if EtherType = 0x0800
TCP_SRC	16	No	Yes	If EtherType = 0x0800 and IP_PROTO = 6
UDP_SRC	16	No	Yes	If EtherType = 0x0800 and IP_PROTO = 17
SCTP_SRC	16	No	Yes	If EtherType = 0x0800 and IP_PROTO = 132
ICMPV4_TYPE	8	No	Yes	If EtherType = 0x0800 and IP_PROTO = 1
TCP_DST	16	No	Yes	If EtherType = 0x0800 and IP_PROTO = 6
UDP_DST	16	No	Yes	If EtherType = 0x0800 and IP_PROTO = 17
SCTP_DST	16	No	Yes	If EtherType = 0x0800 and IP_PROTO = 132
ICMPv4_CODE	8	No	Yes	If EtherType = 0x0800 and IP_PROTO = 1

**Table 48-10. Policy ACL Flow Table IPv6 Match Fields**

<b>Field</b>	<b>Bits</b>	<b>Maskable</b>	<b>Optional</b>	<b>Description</b>
IN_PORT	32	No	Yes	Physical or logical ingress port.
ETH_SRC	48	Yes	Yes	Ethernet source MAC
ETH_DST	48	Yes	Yes	Ethernet destination MAC
ETH_TYPE	16	No	Yes	Must be 0x86dd
VLAN_VID	16	Yes	Yes	VLAN ID. Cannot be masked for a VLAN bridging rule that redirects to a different L2 output group. Only applicable to VLAN flow entry types.
VLAN_PCP	3	No	Yes	802.1p priority field from VLAN tag. Always has a value, will be zero if packet did not have a VLAN tag.
IPV6_SRC	128	Yes	Yes	Matches IPv6 SIP
IPV6_DST	128	Yes	Yes	Matches IPv6 DIP
IP_PROTO	8	No	Yes	Matches IPv6 Next header
IPV6_FLABEL	20	No	Yes	Matches IPv6 flow label
IP_DSCP	6	No	Yes	Bits 0 through 5 of the IP ToS Field as defined in RFC 2474 if EtherType = 0x86dd
IP_ECN	2	No	Yes	Bits 6 through 7 of the IP ToS Field as defined in RFC 3168 if EtherType = 0x86dd
TCP_SRC	16	No	Yes	If EtherType = 0x86dd and IP_PROTO = 6
UDP_SRC	16	No	Yes	If EtherType = 0x86dd and IP_PROTO = 17
SCTP_SRC	16	No	Yes	If EtherType = 0x86dd and IP_PROTO = 132
ICMPV6_TYPE	8	No	Yes	If EtherType = 0x86dd and IP_PROTO = 58

**Table 48-10. Policy ACL Flow Table IPv6 Match Fields (Continued)**

Field	Bits	Maskable	Optional	Description
TCP_DST	16	No	Yes	If EtherType = 0x86dd 00 and IP_PROTO = 6
UDP_DST	16	No	Yes	If EtherType = 0x86dd and IP_PROTO = 17
SCTP_DST	16	No	Yes	If EtherType = 0x86dd and IP_PROTO = 132
ICMPv6_COD E	8	No	Yes	If EtherType = 0x86dd and IP_PROTO = 58

**Notes:**

The following table lists OpenFlow 1.3 match criteria that are NOT supported.

**Table 48-11. Match Criteria Not Supported**

Field	Description
IN_PHY_PORT	Switch physical input port.
METADATA	Metadata passed between tables.
MPLS_LABEL	MPLS label.
MPLS_TC	MPLS TC.
MPLS_BOS	MPLS BoS bit.
PBB_ISID	PBB I-SID.
TUNNEL_ID	Logical Port Metadata.
ARP_OP	ARP opcode.
ARP_SPA	ARP source IPv4 address.
ARP_TPA	ARP target IPv4 address.
ARP_SHA	ARP source hardware address.
ARP_THA	ARP target hardware address.
IPV6_ND_TARGET	Target address for ND.
IPV6_ND_SLL	Source link-layer for ND.

**Table 48-11. Match Criteria Not Supported (Continued)**

Field	Description
IPV6_ND_TLL	Target link-layer for ND.
IPV6_EXTHDR	IPv6 Extension Header pseudo-field

**Action Set Actions**

The Policy ACL Flow Table action set supports the actions listed in Table 48-12.

**Table 48-12. Policy ACL Flow Table Flow Entry Action Set**

Name	Argument	Description
Group	Group	<p>Sets output group entry for processing the packet after this table. Group must exist, be consistent with the type of rule and packet, and can be any of: L3 Unicast, L3 Multicast, or L3 ECMP; must respect VLAN ID naming conventions.</p> <p>Specifies the group to which to send this packet. Egress ports can be specified explicitly via groups. This action can be specified at the same time as the "Output" action only if the output port is CONTROLLER.</p>
Output	ifNum	<p>Specifies a port to which to send the packet.</p> <p>Possible values for this action are any valid switch port numbers and the reserved ports "NORMAL" and "CONTROLLER". "NORMAL" reserved port can be either the only action in the list, or specified along with "CONTROLLER" port. "CONTROLLER" reserved port can also be used with switch port numbers.</p>
Drop	–	The packet is dropped
Set Field	–	Support marking DSCP field in IPv4 and IPv6 packets.
Set Field	–	Support marking 802.1p priority in the VLAN tag.

### **Counters and Flow Expiration**

The Policy ACL Flow Table counters are listed in Table 48-13.

**Table 48-13. Policy ACL Flow Table Counters**

<b>Name</b>	<b>Bits</b>	<b>Type</b>	<b>Description</b>
Active Entries	32	Table	Reference count of number of active entries in the table.
Duration (sec)	32	Per-entry	Seconds since this flow entry was installed
Received Packets	64	Per-entry	Number of packets that hit this flow entry.
Received Bytes	64	Per-entry	Number of bytes that hit this flow entry.

Policy ACL Flow Table expiry provisions are shown in Table 48-14. Each flow entry can have its own timeout values.

**Table 48-14. Policy ACL Flow Table Expiry**

<b>Name</b>	<b>Bits</b>	<b>Description</b>
Hard Timeout	32	Number of seconds after which flow entry is removed. Optional, entry does not age out if zero or not specified.
Idle Timeout	32	Number of seconds of inactivity, after which a flow entry is removed. Optional, entry does not age out if zero or not specified.

## Group Table

The group abstraction enables OpenFlow to represent a set of ports as a single entity for forwarding packets. Different types of groups are provided, to represent different abstractions such as multicasting or multipathing. Each group is composed of a set group buckets, and each group bucket contains the set of actions to be applied before forwarding to the port. Groups buckets can also forward to other groups, enabling groups to be chained together.

- Group indirection to represent a set of ports.
- Group table with three types of groups:
  - All — used for multicast and flooding
  - Select — used for multipath
  - Indirect — simple indirection
- Group action to direct a flow to a group.
- Group buckets contains actions related to the individual port

A group table consists of group entries. The ability for a flow entry to point to a group enables OpenFlow to represent additional methods of forwarding (e.g., select and all).

Each group entry is identified by its group identifier and contains:

- group identifier: a 32 bit unsigned integer uniquely identifying the group on the OpenFlow switch.
- group type: to determine group semantics.
- counters: updated when packets are processed by a group.
- action buckets: an ordered list of action buckets, where each action bucket contains a set of actions to execute and associated parameters. The actions in a bucket are always applied as an action set.

Dell EMC Networking OpenFlow Hybrid does not assign any special meaning to the group ID. The OpenFlow controller is free to use any valid group identifier. Dell EMC Networking OpenFlow Hybrid determines the type of hardware group to create based on the group type passed from the OpenFlow controller.

- The “Indirect” group type simply creates a next-hop. (L3 Unicast group entry)

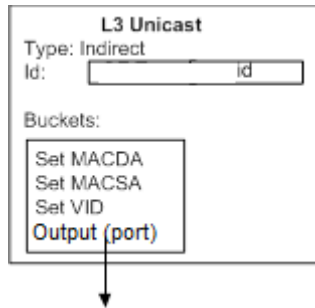
- The “All” group type creates an IPMC replication group that points to one or more next hops. Depending on the SA/DA/VLAN modifications actions, the next hops may be added to the IPMC group as routed or switches. (L3 Multicast group entry)
- The “Select” group type creates an ECMP group object which points to one or more next hops. (L3 ECMP group entry)
- The OpenFlow fast failover group type is unsupported.

The following sections provide additional details on each of these group types.

**Indirect (L3 Unicast) Group Type**

Indirect Group type (L3 Unicast Group) is used to supply the routing next hop and output interface for packet forwarding. To properly route a packet from the Policy ACL Flow Table, the forwarding flow entry must reference an L3 Unicast Group entry.

**Figure 48-1. Indirect Group (L3 Unicast Group) Entry Usage**



All packets must have a VLAN tag.

- Action Buckets

The single action bucket is as shown in Table 48-15.

**Table 48-15. Unicast Bucket Actions**

Field	Argument	Description
Output	Port	Physical output port. Required



**Table 48-15. Unicast Bucket Actions (Continued)**

Field	Argument	Description
Set Field	MAC_DST	Write the next hop destination MAC. Optional.
Set Field	MAC_SRC	Write the source MAC corresponding to the L3 output interface. Optional.
Set Field	VLAN-id	Write the VLAN ID corresponding to the L3 output interface. Optional.

- Counters

The L3 Unicast group entry counters are as shown in Table 48-16.

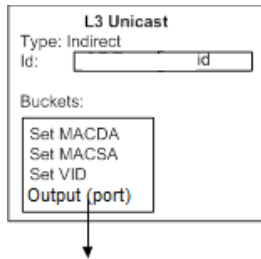
**Table 48-16. L3 Unicast Group Entry Counters**

Name	Bits	Type	Description
Reference Count	32	Per-entry	Number of group entities currently referencing this group entry.
Duration (sec)	32	Per-entry	Seconds since this group entry was installed

### All (L3 Multicast) Group Type

L3 Multicast group entries are of OpenFlow ALL type. The action buckets describe the interfaces to which multicast packet replicas are forwarded. Figure 48-2 illustrates L3 Multicast group entries.

Figure 48-2. L3 Multicast Group Entry Usage




IP multicast packets are forwarded differently depending on whether they are switched or routed. Packets must be switched in the VLAN in which they came, and cannot be output to IN\_PORT.

- Action Buckets

The action buckets contain the values shown in Table 48-17.

Table 48-17. L3 Multicast Bucket Actions

Field	Argument	Description
Set Field	Output Port	Write the L3 output interface. Required.
Set Field	MAC_DST	Write the next hop destination MAC. Optional.
Set Field	MAC_SRC	Write the source MAC corresponding to the L3 output interface. Optional.
Set Field	VLAN-id	Write the VLAN id corresponding to the L3 output interface. Optional.

 **NOTE:** For replication of non-IP packets, all of (MAC-Src, MAC-dest, VLAN-ID) action bucket fields are to be left empty.

For replication of IP packets, at least one of (MAC-Src, MAC-dest and VLAN-ID) should be valid.

L2 multicast is supported. It is done using IPMC L2 replication when all of (MAC-Src, MAC-dest, VLAN-ID) action bucket fields are left empty. So an "All (L3 Multicast) Group" can have a mix of buckets — few with L3 replication and few with L2 replication. To use the L2 multicast, the user should not qualify the IP fields in flow match criteria.

- Counters

The L3 Multicast group entry counters are as shown in Table 48-18.

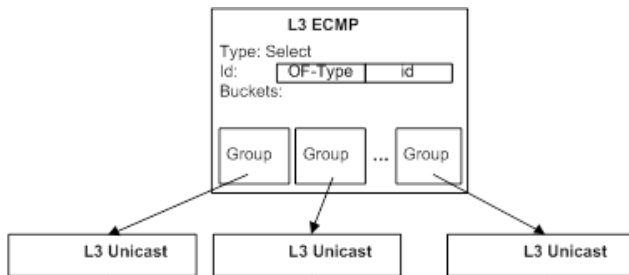
**Table 48-18. L3 Multicast Group Entry Counters**

Name	Bits	Type	Description
Reference Count	32	Per-entry	Number of group entities currently referencing this group entry.
Duration (sec)	32	Per-entry	Seconds since this group entry was installed

**Select (L3 ECMP) Group Type**

L3 ECMP group entries are of OpenFlow type SELECT. For IP routing the action buckets reference the L3 Unicast group entries that are members of the multipath group for ECMP forwarding. Figure 48-3 illustrates this L3 ECMP Group entry usage.

**Figure 48-3. L3 ECMP Group Entry Usage**



An L3 ECMP Group entry can also be used in a Provider Edge Router.

An L3 ECMP Group entry can be specified as a routing target instead of an L3 Unicast Group entry. Selection of an action bucket for forwarding a particular packet is hardware specific.

- Action Buckets

The action buckets contain the single value listed in Table 48-19.

**Table 48-19. L3 ECMP Group Entry Bucket Actions**

Field	Argument	Description
Group	Group-id	May chain to an L3 Unicast Group.

- Counters

The L3 ECMP group entry counters are as shown in Table 48-20.

**Table 48-20. L3 ECMP Group Entry Counters**

Name	Bits	Type	Description
Reference Count	32	Per-entry	Number of group entities currently referencing this group entry.
Duration (sec)	32	Per-entry	Seconds since this group entry was installed.

**Fast Failover**

Fast Failover is not supported

**Port Configuration, Status and Statistics**

The Dell EMC Networking OpenFlow Hybrid switch does not support any port configuration commands. The OFPT\_PORT\_MOD messages from the OpenFlow controller do not modify the port configuration.

The Dell EMC Networking OpenFlow Hybrid switch reports port creation, removal, and status changes to the controller using the OFPT\_PORT\_STATUS message. The message is sent for physical ports and LAGs. All three reason codes, OFPPR\_ADD, OFPPR\_DELETE, and OFPPR\_MODIFY, are supported for all port types.

The only trigger for the OFPPR\_MODIFY reason code is a link status change for the port.

The desc field in the message contains port information. This field of type ofp\_port contains the following elements:

- 1** port\_no — Set to the MIB-2 ifIndex field for the port.
- 2** hw\_addr — All ports in the switch have the same MAC address. The switch reports the lowest MAC assigned to the unit. This address is typically printed on the MAC address label on the switch.
- 3** name — A unit/slot/port designation for physical ports and LAGs. The LAGs are also identified with the symbolic name lag-<n>.
- 4** config — Always set to 0.
- 5** state — The OFPPS\_LINK\_DOWN is set according to the link state for physical ports and LAGs. The remaining bits are always 0.
- 6** curr, advertised, supported, peer — These parameters are set to 0.
- 7** curr\_speed – Current port bitrate in kbps.max\_speed—Max port bitrate in kbps

The Dell EMC Networking OpenFlow Hybrid switch reports port statistics in response to the OFPT\_STATS\_REQUEST message with type OFPST\_PORT. The port statistics are reported using the structure of type ofp\_port\_stats. The packet and byte counters are reported for all interface types. The only supported error counters are rx\_errors and tx\_errors. The remaining error counters are always reported as 0xffffffffffff.

### **Queue Configuration and Status**

The Dell EMC Networking OpenFlow Hybrid switch supports eight queues for each physical port. The LAGs report aggregate statistics for member ports. The port queues are automatically created by the switch for each physical port.

The port queues are prioritized, with queue 7 having the highest priority. The traffic statistics reported for the port queues include OpenFlow traffic and non-OpenFlow traffic.

The OpenFlow Controller retrieves the list of port queues using the OFPT\_QUEUE\_GET\_CONFIG\_REQUEST message. Only physical ports and LAGs can be specified in the message.

The queue configuration reply message of type `ofp_queue_get_config_reply` includes an array of `ofp_packet_queue` structures. For each interface, the queues are numbered 0 to 7, with queue 7 representing the highest priority queue.

The port queues do not have any queue properties.

The OpenFlow Controller requests queue statistics using the `OFPT_STATS_REQUEST` message with type `OFPST_QUEUE`. Dell EMC Networking OpenFlow Hybrid reports the `tx_bytes`, `tx_packets`, and `tx_errors` statistics for each queue.

## **Deploy OpenFlow Controller Flows**

This section describes OpenFlow flow management within Dell EMC Networking OpenFlow Hybrid enabled switches.

### **Dell EMC Networking OpenFlow Hybrid Flow Database Organization and Manipulation**

Dell EMC Networking OpenFlow Hybrid supports multiple hardware flow tables, allowing the OpenFlow controller to specify into which table the flow should be added.

In some cases, the flows added by the OpenFlow Controller cannot be installed in the hardware even though the hardware has space available in its flow table. For example, this can happen if an interface specified in the flow match criteria has not been created yet in the driver. Similarly, the flows can be removed from the hardware when interfaces specified in the match criteria are removed. For example, in a modular system, a port card may be unplugged, causing the interfaces to go away.

When the OpenFlow protocol adds a flow to the Dell EMC Networking OpenFlow Hybrid flow database, the flow is not immediately added to the hardware. The flow additions to the hardware are done by a separate task. Therefore, the OpenFlow Controller can add multiple flows very quickly without blocking, while waiting for flows to be added to the hardware.

Similarly, when the OpenFlow protocol removes flows from the Dell EMC Networking OpenFlow Hybrid flow database, the flows are marked for deletion, but are removed from the hardware by a separate task. This enables the OpenFlow controller to not block while waiting for flows to be removed from the hardware.

To accommodate the scenario where the Flow Controller removes many flows and quickly adds many new flows, the OpenFlow flow database is twice the size of the hardware database. The extra headroom provides enough space to buffer the new flows before the old flows are removed from the hardware.

If the OpenFlow Controller adds a flow with the same match criteria as an existing flow, Dell EMC Networking OpenFlow Hybrid treats the new flow as a flow modification action. The old flow is deleted from the hardware and the new flow is added to the hardware.

If a flow cannot be added to the hardware because the hardware reports that it is out of space, Dell EMC Networking OpenFlow Hybrid sends a message to the OpenFlow controller indicating that the flow addition failed and removes the flow from the software table.

Each time the switch fails to add a flow to the hardware, it sends a syslog message indicating the flow `XID`.

The switch cannot always accommodate a flow in the hardware because the hardware space is shared between different flow types and is shared with other Dell EMC Networking OpenFlow Hybrid components, and because the hardware usage depends on the flow match criteria.

An example of resource sharing among different flow types is the OpenFlow 1.0 Rule Table (24) and MAC Forwarding Table (25) that share IFP resources. Different flow types may require a different number of IFP slices. VFP-based flows (Source MAC VLAN Assignment (4)) have no common resources with IFP-based flows.

An example of resource sharing between components is the IFP. Both the QoS component and the OpenFlow component use IFP resources. The system does not reserve space in the IFP, but instead allocates resources as they are requested by the application.

The flow match criteria can affect hardware usage in a couple of ways. For entries that are added to the IFP or the VFP, the hardware table usage on multi-ASIC switches depends on the port match criteria in the flow. If the flow matches a physical port, the flow is inserted only into the IFP/VFP on the ASIC where the physical port is located. If the flow does not match a specific physical port, the flow is inserted in all ASICs. Since many flows use the ingress port as a match criterion, the overall flow table capacity depends on how the flows are distributed across the multiple ASICs.

## Interaction between Flows and VLANs

The OpenFlow Controller can add flows for any VLAN ID. The VLANs for which flows are added are created in the Dell EMC Networking OpenFlow Hybrid VLAN database as dynamic VLANs if they are not already configured on the switch. Learning is enabled on the dynamic VLAN. The switch never adds ports to OpenFlow dynamic VLANs, but instead disables ingress and egress filtering on the ports on which the OpenFlow flows are installed. This allows the OpenFlow traffic to be received and transmitted on those ports. The OpenFlow flows can also be added for VLANs that are statically created in the VLAN database. However, if the administrator removes a static VLAN with installed flows, then the traffic for those flows may not be forwarded correctly. The administrator should remove all flows on a static VLAN before deleting that VLAN.

VLANs dynamically created with the flows are not deleted when the flows are deleted. Dynamic VLANs are deleted only when the OpenFlow feature is disabled.

If the network administrator does not wish to mix OpenFlow and non-OpenFlow traffic on the same VLANs, then it is up to the administrator to ensure that the OpenFlow Controller is configured such that it does not add flows on VLANs used for non-OpenFlow traffic.

Since OpenFlow VLANs are created in hardware without any port members, the ports on which the OpenFlow traffic enters and exits the switch must disable egress filtering. Dell EMC Networking OpenFlow Hybrid determines which ports are used for OpenFlow by examining the ingress port for flows with non-wildcard port match criteria and port numbers specified in the OFPAT\_OUTPUT action. Once ingress/egress filtering is disabled, it is re-enabled only when the OpenFlow feature is disabled or the port is removed from the switch. Even if a flow previously using the port is removed and there are no other flows using the port, ingress/egress filtering remains disabled on that port.

Normally, traffic forwarded to ports with egress filtering disabled is always tagged. However the administrator may want to attach untagged clients to some of the ports. If the egress VLAN is explicitly created by the network administrator and the port is participating in the VLAN as untagged, then the switch settings take precedence over flow rules and traffic is transmitted untagged.



For the switch to receive the untagged traffic and map it to the appropriate VLAN, the OpenFlow controller can install a flow that maps the incoming MAC address to the VLAN. This is done with the flow type "Phase-1-Untagged-MAC" and action `OFFPAT_SET_VLAN_ID` (see "Source MAC VLAN Assignment Table" on page 1707).

For the switch to transmit untagged traffic on the port for the untagged VLAN, the switch uses the VLAN translation table to configure the traffic that matches the VLAN and egress port to be sent untagged.

The switch strips the tag on the VLAN specified in the `OFFPAT_SET_VLAN_ID` action for Phase-1-Untagged-MAC flows that use the magic VLAN ID `0xFFFF` as a match criterion.

The pure OpenFlow 1.0 Controllers and the OpenFlow 1.3 controllers do not support Phase-1 flows. If such controllers are used in the network, then to map untagged ingress traffic to a specific VLAN on a specific port, the network administrator must configure the PVID for that port. To send traffic without tags, the network administrator must statically create the VLANs with untagged port members.

### **Interaction between Flows and Interfaces**

Dell EMC Networking OpenFlow Hybrid supports flows on physical ports and LAGs. For a flow to be installed in the hardware, the hardware must know about the interface. Ports that are members of link-up LAGs cannot be match ports or egress ports for flows. When a port becomes a LAG member, it becomes unknown to the OpenFlow application.

If a physical port is enabled for port-based routing, the port becomes unknown to the OpenFlow controller.

The OpenFlow Controller can install flows only on ports that are physically present. The OpenFlow Controller cannot install flows on preconfigured ports that are not physically present. It is possible, however, that the interface goes away after the flow is installed in the hardware. A race condition is also possible where a new flow is added while the port is physically present, but the port disappears before the switch has a chance to add the flow to the hardware.

If an unknown interface is used in the match criteria for a new flow, the flow is held in the application table until the interface is attached. Dell EMC Networking OpenFlow Hybrid does not generate any error for the flow. Once the interface is attached, the flow is added to the hardware.

If the flow is already installed and the interface in the match criteria goes away, the flow is removed from the hardware. Dell EMC Networking OpenFlow Hybrid keeps the flow in the application table and reinserts it into the hardware when the interface becomes attached again.

If an interface specified in the action list for the new flow is not attached, the flow is added to the hardware. If the missing interface is the only egress interface for the flow, the flow is configured to drop matching packets. If the missing interface is one of several egress interfaces, it is simply excluded from the egress interface list.

The OpenFlow application monitors for interface creation and removal events and modifies the flows as needed.

### **Flow Status and Statistics Collection**

The OpenFlow Controller can ask the switch to send it the list of flows that match certain criteria. The switch sends the matching flows with one or more messages.

Flows support packet and byte counters. The switch polls the hardware counters periodically and stores the counter values in the application table. When sending messages to the controller, the switch retrieves the counter values from the application table. The switch does not read the hardware counters when sending flow statistics to the controller.

To avoid performance problems, the counter collection is rate-limited. The switch polls counters for 100 flows every 10 seconds. This means that if the flow table has one to 100 entries, the counters are updated every 10 seconds for all flows. If the flow table has 3000 entries, the counters are updated every 300 seconds for all flows.

The statistics poll rate and the number of flows per poll cycle are porting parameters that can be tuned as needed. When the switch is busy manipulating flows, the statistics update may take longer.

If a flow is removed from the hardware, the packet counters are reported as 0. If the flow is added back to the hardware, the counters start counting from 0.

## **Collect Port and Queue Status and Statistics**

The OpenFlow Controller can collect status and statistics for ports and queues. When ports are created, Dell EMC Networking OpenFlow Hybrid sends an OFPT\_PORT\_STATUS message to the OpenFlow Controller. The status message is triggered by creation of entries in the Physical Port Table. The same tables are used for reporting port status information.

The port status is updated by a separate task that periodically polls the status for all physical ports. To avoid performance issues, the statistics are polled every 10 seconds for a maximum of 100 interfaces. For physical ports, the switch also reads the queue statistics for all eight queues at the same time as it reads the port statistics.

The LAG statistics are reported as a sum of statistics for all active LAG member ports. This implies that when a port is removed from the LAG, the statistics counters for the LAG go down. Also, when all ports are removed from a LAG, the LAG statistics are reported as 0.

## **Usage Scenarios**

The OpenFlow feature is mainly targeted for deployment in a data center network where devices located in different parts of the network require Layer-2 connectivity.

The OpenFlow feature enables customers to avoid scaling problems and loops associated with the Layer-2 network.

The OpenFlow feature can also be used in a research environment, but there are two limitations that may make the "research" use case less attractive. First, there is only one OpenFlow instance, meaning that concurrent experiments are not supported at the switch level. Second, the OpenFlow controller has complete access to all ports and VLANs; therefore, using the switch for mixed production and experimental traffic is not advisable.

## **Eligible Interfaces**

The OpenFlow application affects traffic forwarding on physical ports and LAGs.

## OpenFlow Hybrid

The operation of the OpenFlow switch in a network largely depends on the functionality of the OpenFlow controller. The OpenFlow feature is a powerful tool that enables the OpenFlow controller to forward packets in the network without regard to the Layer-2 forwarding database and the IPv4 routing tables.

Refer to the OpenFlow Controller documentation to understand how the switch behaves in the customer network.

The one legacy networking rule the switch enforces is that the switch does not forward packets over ports that are in spanning-tree blocking state for the egress VLAN, even if the OpenFlow Controller has configured a rule to do so.

## Example Configuration

This example configures the switch to operate with OpenFlow version 1.3 and to connect to the controller at IP address 1.2.3.4 on port 3435 with no security.

```
console (config) #vlan 10
console (config-vlan10) #interface vlan 10
console (config-if-vlan10) #ip address 1.2.3.1 255.255.0.0
console (config-if-vlan10) #interface gi1/0/1
console (config-if-Gi1/0/1) #switchport mode access
console (config-if-Gi1/0/1) #switchport access vlan 10
console (config-if-Gi1/0/1) #exit
console (config) #openflow
```

WARNING! OpenFlow does not operate on stack members. Enable OpenFlow on stand-alone switches only.

```
console (config-of-switch) #controller ipv4 1.2.3.4 port 3435
security none
console (config-of-switch) #protocol-version 1.3
console (config-of-switch) #mode auto
```

## Interaction with Other Switch Functions

The Dell EMC Networking OpenFlow Hybrid component interacts with multiple Dell EMC Networking switch components by either communicating with these components or sharing common resources with the components. The following sections describe these interactions.

### OpenSSL

The OpenFlow component establishes SSL connections to the OpenFlow controllers and OpenFlow Managers. The total number of switch-initiated connection depends on the number of configured controllers and managers and can be in the order of 10 to 20 connections.

The OpenFlow component always initiates the SSL connections and does not accept SSL connections.

The OpenFlow component makes use of certificate-based authentication, mutual authentication, and encryption.

### IP Stack

The OpenFlow component uses the IP stack for initiating SSL connections and TCP connections. The administrator can configure whether to connect to the OpenFlow Controllers using TCP or SSL. The administrator can also configure the IP port number to use for the connections. By default, the IP ports are 6632 and 6633.

For debugging, the switch accepts TCP connections to ports 6632 and 6633 when passive mode is enabled. Passive connection mode can be enabled using the command `openflow passive-mode` in Global Config mode.

### VLANs

The OpenFlow component dynamically creates VLANs that it detects in the flow match criteria or the flow VLAN modification action.

## **LAGs**

When physical ports become LAG members, the flows installed by the OpenFlow Controller on these ports are removed from the hardware and the flows that are installed for the LAG are activated for the new LAG member port. The reverse action takes place when the ports are removed from the LAG.

## **Ports**

The OpenFlow component installs flows in the hardware and removes flows from the hardware as ports become attached and detached or join and leave the LAG.

When flows referencing a specific port in the match criteria or output actions are added to the hardware, the OpenFlow component operationally disables ingress filtering on the port.

Ingress filtering is re-enabled on those ports when flows are removed or aged-out.

## **Network Interface ARP Table**

In some cases, the OpenFlow component may trigger ARP resolution for a specific IP address.

## **Routing Interface ARP Table**

In some cases, the OpenFlow component may trigger ARP resolution for a specific IP address.

## **QoS**

The QoS component does not interact with OpenFlow directly, but it shares the ingress field processor and VLAN field processor hardware resources with the OpenFlow component.

The QoS component gracefully handles an out-of-resource condition and ensures that flows installed by the QoS component have precedence over the OpenFlow flows when the actions are in conflict.

## **IP Routing, IP Multicast, and Layer-2 Multicast**

The OpenFlow component uses the same hardware resources as the routing and IP multicast components. Namely, the OpenFlow component uses the Next-Hop entries and Multicast Group entries in the hardware.

The routing and multicast Dell EMC Networking OpenFlow Hybrid feature gracefully handles the out-of-resources errors.

## **Port Mirroring**

The OpenFlow component is not active on probe ports. OpenFlow configuration is retained but not operational when a port is set as a probe port.

## **LLDP and Voice VLAN**

The LLDP and Voice VLAN features do not interact with OpenFlow directly. The ODL controller proactively installs the flow to redirect all the incoming LLDP traffic to the controller. Then, it sends LLDP packet to the switch and installs the flows to flood all the incoming traffic to all the physical ports on the switch and to the ODL controller. As all the switches in the controller's network have the rule to redirect the LLDP traffic to the controller, the controller is able to build the network topology. To allow the switch to process incoming LLDP traffic and the ODL controller to build the topology, an overriding flow with "NORMAL" and "CONTROLLER" actions should be installed manually.

# Limitations, Restrictions, and Assumptions

The following OpenFlow features are not supported:

- 1 Flow installation in the MAC Forwarding table.
- 2 Uplink Rate Limiting, including the flow installation in the Uplink Rate Limiter Table, traffic rate control, the rate limiter table, and the rate limiter statistics.
- 3 OpenFlow functionality currently interoperates with the Open vSwitch command line utility ovs-ofctl 2.3.0. Higher versions may have interoperability issues.

## List of OpenFlow—Dell EMC Networking Component Interferences

**Table 48-21. OpenFlow-Dell EMC Networking Component Interferences**

<b>Component</b>	<b>Behavior</b>
DAI	If DAI is configured along with a MAC-address modification flow, DAI operates on the modified MAC address instead of original MAC address.
Static MAC filter	OpenFlow flow forwarding takes precedence over static MAC filtering. Traffic is forwarded according to flow rule.



## OpenFlow Configuration Example

This example enables OpenFlow 1.3 on the switch and configures a connection to a controller at IPv4 address 172.16.0.3 over TCP port 3435 using no encryption on the out-of-band interface. This example presumes the out-of-band interface has obtained an IP address on the 172.16.0.X subnet.

```
console(config)#openflow
```

WARNING! OpenFlow does not operate on stack members. Enable OpenFlow on stand-alone switches only.

```
console(config-of-switch)#protocol-version 1.3
```

```
console(config-of-switch)#controller ipv4 172.16.0.3 port 3435  
security none
```



# Dell EMC Networking Python Support

Dell EMC Networking switches support installation and execution of Python applications. Python applications that are to be executed on the switch must be developed and tested offline to the maximum degree possible. The switch does not offer interactive shell access for development of Python scripts, nor does the Dell EMC Networking switch come with all of the normal Python “batteries included” modules. A list of the included packages is in the example below. Output from Python scripts is sent to the serial console, so a serial connection is mandatory when developing scripts.

Input from the console is not supported, e.g. `raw_input()` is not supported. This means that interactive Python applications are not suitable for use in the switch environment.

An example Python script that prints some useful information is shown below. Explanation of Python syntax is beyond the scope of this document. Refer to the 3.7 version of Python documentation available elsewhere.

```
#!/usr/bin/env python
import sys
print "Hello World!\n"
print (sys.version)
help('modules')
```

To execute this script on the switch, save the lines above in a file named "app". Package the app script using the following commands on a Linux system. The package may be a gzipped tarball with a .tgz or .tar.gz extension. It is required that the permissions be set on the app file prior to packaging; i.e., user read, write, and execute must be set. Group and other permissions need not be set. Application names can be a maximum of 15 characters.

```
/home/jmclendo/tftboot>chmod u+rx app
/home/jmclendo/tftboot>tar czf app.tgz app
```

Copy the resulting file to the switch using the **copy** command with the **application** keyword. The application may be a single script, or it may be a collection of scripts in a compressed or uncompressed tarball. Applications are copied to the user-apps directory. If a single file is downloaded, the destination file name is the same as the source file name (if the optional destination file name is not given). If a tarball is downloaded, the original file names within the archive are retained. The tarball is deleted after extraction.

```
console#copy tftp://10.27.9.99/jmclendo/app.tgz application
```

```
Transfer Mode..... TFTP
Server IP Address..... 10.27.9.99
Source File Path..... jmclendo/
Source Filename..... app.tgz
Data Type..... Application
Downloads application file
```

```
Management access will be blocked for the duration of the transfer
Are you sure you want to start? (y/n) y
```

```
File transfer in progress. Management access will be blocked for
the duration of the transfer. please wait...
```

```
215 bytes transferred
```

```
Application file download completed successfully.
```

Use the **dir** command to see the application. Applications reside in the user-apps subdirectory.

```
console#dir user-apps
```

```
Attr Size(bytes)          Creation Time           Name
drwx           224 Jan 01 1970 00:24:56 .
drwx          2824 Jan 01 1970 00:00:55 ..
-rwx           94 Nov 24 2015 15:56:30 app
```

```
Total Size: 216555520
Bytes Used: 3142
Bytes Free: 216552378
```

Install the application using the **application install** command in Global Configuration mode.

```
console#conf
```

```
console(config)#application install app
console(config)#show application
```

OpEN application table contains 2 entries.

Name	StartOnBoot	AutoRestart	CPU Sharing	Max Memory
SupportAssist	Yes	Yes	0	0
app	No	No	0	0



**CAUTION:** The application install command has an **auto-restart** parameter. Do NOT use this parameter while debugging or on any short-lived application. The switch does NOT limit restarts and attempts to restart a failed application immediately. Installing a failing or short-lived application with auto-restart enabled will result in a switch that:

- cannot perform normal protocol operations at its advertised level.
- is difficult to access via the console.

The **auto-restart** parameter is recommended only for well-tested, stable applications.

Execute the application in Privileged Exec mode using the **application start** command and examine the results on the serial console.

```
console(config)#exit
console#application start app
```

Application started.

```
console##Hello World!
```

```
Python 2.7.10 (default, Feb 12 2021, 13:03:25)
[GCC 4.9.4] on linux2
```

Please wait a moment while I gather a list of all available modules...

```
BaseHTTPServer      audioop              io                   rfc822
Bastion              base64               itertools           rlcompleter
CGIHTTPServer       bdb                  json                 robotparser
ConfigParser        binascii             keyword             runpy
Cookie               binhex               libopenclt          sched
DocXMLRPCServer     bisect               libospf              select
HTMLParser          bsddb                libpam               sets
MimeWriter          cPickle              libping              sgmlib
```

OpEN	cProfile	libproc_libs	sha
OpENUtil	cStringIO	librpcclt	shelve
OpEN_py	calendar	libsock_agent	shlex
Queue	cgi	libsshcompat	shutil
SimpleHTTPServer	cgith	libsshppam	signal
SimpleXMLRPCServer	chunk	libtraceroute	site
SocketServer	cmath	libvr_agent	smtpd
StringIO	cmd	libvrf_init	smtplib
UserDict	code	libz	sndhdr
UserList	codecs	linecache	socket
UserString	codeop	locale	spwd
_LWPCookieJar	collections	logging	sre
_MozillaCookieJar	colorsys	macpath	sre_compile
_OpEN	commands	macurl2path	sre_constants
_builtin__	compileall	mailbox	sre_parse
_future__	compiler	mailcap	ssl
_abcoll	contextlib	markupbase	stat
_ast	cookieclic	marshal	statvfs
_bisect	copy	math	string
_codecs	copy_reg	md5	stringold
_codecs_cn	crypt	mhlib	stringprep
_codecs_hk	csv	mimetools	strop
_codecs_iso2022	curses	mimetypes	struct
_codecs_jp	datetime	mimify	subprocess
_codecs_kr	dbhash	mmap	sunau
_codecs_tw	decimal	modulefinder	sunaudio
_collections	difflib	multifile	symbol
_csv	dircache	multiprocessing	symtable
_ctypes	dis	mutex	sys
_ctypes_test	distutils	netrc	sysconfig
_elementtree	doctest	new	syslog
_functools	dumbdbm	ntplib	tabnanny
_heapq	dummy_thread	ntpath	tarfile
_hotshot	dummy_threading	nturl2path	telnetlib
_io	email	numbers	tempfile
_json	encodings	opcode	termios
_locale	errno	operator	textwrap
_lsprof	exceptions	optparse	this
_md5	fcntl	os	thread
_multibytecodec	filecmp	os2emxpath	threading
_multiprocessing	fileinput	parser	time
_osx_support	fnmatch	pdb	timeit
_pyio	formatter	pickle	toaiff
_random	fpformat	pickletools	token
_sha	fractions	pipes	tokenize
_sha256	ftplib	pkgutil	trace

_sha512	functools	platform	traceback
_socket	future_builtins	plistlib	tty
_sre	gc	popen2	types
_ssl	genericpath	poplib	unicodedata
_strptime	getopt	posix	urllib
_struct	getpass	posixfile	urllib2
_symtable	gettext	posixpath	urlparse
_sysconfigdata	glob	pprint	user
_testcapi	grp	profile	uu
_threading_local	gzip	pstats	uuid
_warnings	hashlib	pty	warnings
_weakref	heapq	pwd	wave
_weakrefset	hmac	py_compile	weakref
abc	hotshot	pyclbr	webbrowser
aifc	htmlentitydefs	pydoc	whichdb
antigravity	httplib	pydoc_data	wsgiref
anydbm	httplib	pyexpat	xdrlib
argparse	ihooks	quopri	xml
array	imaplib	random	xmllib
ast	imgchr	re	xmlrpclib
asynchat	imp	repr	xxsubtype
asyncore	importlib	requests	zipfile
atexit	imputil	resource	zipimport
audiodev	inspect	rexec	zlib

Enter any module name to get more help. Or, type "modules spam" to search for modules whose descriptions contain the word "spam".

Note that the output of print statements only appears on the serial console.

One possible use for a Python script embedded on the switch is to perform configuration tasks. Such a Python script might use the telnetlib package to telnet into the switch console and perform some configuration. The following script provides the basic framework for a local telnet session to the switch console. The switch must be configured with an "admin" user, and telnet access must be allowed or this code will fail. Readers should look at the numerous articles on the Web for an explanation of the following Python code.

```
#!/usr/bin/env python
import telnetlib
import os
import re
import time
import string
```

```

import sys

HOST = '127.0.0.1'
PORT = 23
LOGIN_STRING = "Login:"
PASSWORD_STRING = "Password:"
TERMINAL_LEN_ZERO = "terminal length 0\n"
TERMINAL_MONITOR = "terminal monitor\n"
ENABLE_STRING = "enable\n"
CONFIG_STRING = "configure\n"

USERNAME = 'admin'
PASSWORD = 'password'
ENABLE_PASSWORD = ''
TIMEOUT = 3

def do_terminal_settings(tn):
    tn.write(TERMINAL_MONITOR)
    tn.read_until("#")
    tn.write(TERMINAL_LEN_ZERO)
    tn.read_until("#")

def do_login(tn):
    print "TN object created\n"
    tn.read_until(LOGIN_STRING, TIMEOUT)
    print "Read Login Prompt\n"
    tn.write(USERNAME + "\n")
    tn.read_until(PASSWORD_STRING, TIMEOUT)
    print "Read Password Prompt\n"
    tn.write(PASSWORD + "\n")
    tn.read_until(">", TIMEOUT)
    print "Received Exec Prompt\n"
    tn.write(ENABLE_STRING)
    tn.read_until("#", TIMEOUT)
    print "Received Enable Prompt\n"

def do_config(tn):
    tn.write(CONFIG_STRING)
    tn.read_until("#", TIMEOUT)
    print "Received Config Prompt\n"
    tn.write("ip routing\n");
    print "Enabled ip routing\n"
    tn.write("exit\n");
    tn.read_until("#")

```



```
def main():
    telnet = telnetlib.Telnet(HOST, PORT)
    do_login(telnet)
    do_terminal_settings(telnet)
    do_config(telnet)
    telnet.close()
    sys.exit(0)

main()
```



# Appendix

The topics covered in this appendix include:

- Feature Limits and Platform Constants
- System Process Definitions
- SupportAssist

## Feature Limits and Platform Constants

Table A-1 lists the feature limits and Table A-2 lists the platform constants for the Dell EMC Networking N-Series switches.

Certain platform constants may be adjusted by selecting a different SDM template. For example, the Dell EMC Networking N3000E-ON Series switches support 16-wide ECMP using a non-default template.

The limits listed here are the maximum possible configuration. It may not be possible to configure the maximum possible configuration. This may be due to hash collisions in certain tables such as the MAC address or ARP tables or because an optimization reserves additional space in a table (ACLs). Other limits are enforced by the switch firmware and may be larger than what the underlying hardware can support, such as ACLs or Voice VLAN sessions.

**Table A-1. Feature Limits**

Feature	N1100-ON Series	N1500 Series	N2000/ N2100-ON/ N2200-ON Series	N3000E-ON/ N3100-ON/ N3200-ON Series
<b>Switching features</b>				
Spanning Tree				
MST Instances	31	31	15	15
RPVST VLANs	64	64	64	64
RPVST VLANs * Interfaces	1024	1024	1024	1024
Port Mirroring				

**Table A-1. Feature Limits (Continued)**

<b>Feature</b>	<b>N1100-ON Series</b>	<b>N1500 Series</b>	<b>N2000/ N2100- ON/N2200- ON Series</b>	<b>N3000E-ON/ N3100-ON/N3200- ON Series</b>
Number of monitor sessions	1	1	4	4
Max source ports in a session	192	192	424	624
<b>RMON 1, 2, 3, 9</b>				
Max Ether Stats entries	762	762	762	762
Max History entries	270	270	270	270
Max buckets per History entry	50	50	50	50
Max Alarm entries	32	32	32	32
Max Event entries	32	32	32	32
Max Log entries per Event entry	100	100	100	100
Management ACL (MACAL) Max Rules	64	64	64	64
Cut-through mode threshold (bytes)	–	–	–	–
<b>VPC</b>				
Max Number of VPCs	–	–	64	64
Max Member ports per VPC	–	–	8	8
DCPDP UDP Port Number	–	–	50000	50000
<b>Routing features</b>				
IP Helper Max entries	–	64	64	512
VRF Max instances	–	–	–	12
Route Maps Max	–	–	–	64
Route Map Max Statements	–	–	–	32
BFD Max Sessions	–	–	–	96
<b>Metro Ethernet features</b>				
802.lag				

**Table A-1. Feature Limits (Continued)**

<b>Feature</b>	<b>N1100-ON Series</b>	<b>N1500 Series</b>	<b>N2000/ N2100- ON/N2200- ON Series</b>	<b>N3000E-ON/ N3100-ON/N3200- ON Series</b>
Max number of domains	–	–	–	–
Max number of MAs per domain	–	–	–	–
Max number of MAs	–	–	–	–
Max number of RMEPs	–	–	–	–
Max number LTR entries	–	–	–	–
<b>Management features</b>				
HTTP Max Sessions	16	16	16	16
SSL/HTTPS Max Sessions	16	16	16	16
Maximum number of remote Telnet connections	4	4	4	4
Maximum number of remote SSH connections	5	5	5	5
<b>User management features</b>				
User ID configuration				
Max number of configured users	8	8	8	8
Max user name length	64	64	64	64
Max password length	64	64	64	64
Max number of IAS users (internal user database)	100	100	100	100
Authentication login list				
Max Count	5	5	5	5
Max methods per list	6	6	6	6
Max name length	15	15	15	15
Authentication Enable lists				
Max Count	5	5	5	5

**Table A-1. Feature Limits (Continued)**

<b>Feature</b>	<b>N1100-ON Series</b>	<b>N1500 Series</b>	<b>N2000/ N2100- ON/N2200- ON Series</b>	<b>N3000E-ON/ N3100-ON/N3200- ON Series</b>
Max methods per list	6	6	6	6
Max name length	15	15	15	15
Authentication HTTP lists				
Max Count	1	1	1	1
Max methods per list	6	6	6	6
Max name length	15	15	15	15
Authentication HTTPS lists				
Max Count	1	1	1	1
Max methods per list	6	6	6	6
Max name length	15	15	15	15
Authentication Dot1x lists				
Max Count	1	1	1	1
Max methods per list	6	6	6	6
Max name length	15	15	15	15
Authorization Exec lists				
Max Count	5	5	5	5
Max methods per list	4	4	4	4
Max name length	20	20	20	20
Authorization command lists				
Max count	5	5	5	5
Max methods per list	4	4	4	4
Max name length	20	20	20	20
Accounting Exec lists				
Max count	5	5	5	5
Max methods per list	2	2	2	2

**Table A-1. Feature Limits (Continued)**

<b>Feature</b>	<b>N1100-ON Series</b>	<b>N1500 Series</b>	<b>N2000/ N2100- ON/N2200- ON Series</b>	<b>N3000E-ON/ N3100-ON/N3200- ON Series</b>
Max name length	15	15	15	15
Accounting commands lists				
Max count	5	5	5	5
Max methods per list	1	1	1	1
Max name length	15	15	15	15
Login History	50	50	50	50
<b>Stacking features</b>				
Max physical units per stack	4	4	8/12	12
Max physical slots per unit	1	1	3	3
Max physical ports per slot	52	52	52	52
Max physical ports per unit	56	56	56	56
Max physical ports per stack	224	224	424/636	448/672
Max active stack ports per unit	4	4	2	2

**Table A-2. Platform Constants**

<b>Feature</b>	<b>N1100-ON Series</b>	<b>N1500 Series</b>	<b>N2000/ N2100-ON/N2200- ON Series</b>	<b>N3000E-ON/ N3100- ON/N3200- ON Series</b>
MAC addresses assigned per system	4	4	4	4
Reference CPU	ARM Cortex A9	ARM Cortex A9	ARM Cortex A9 Dual Core (Intel Atom N2200)	ARM Cortex A9 Dual Core (Intel Atom N32xx)

**Table A-2. Platform Constants (Continued)**

<b>Feature</b>	<b>N1100-ON Series</b>	<b>N1500 Series</b>	<b>N2000/ N2100-ON/N2200- ON Series</b>	<b>N3000E-ON/ N3100- ON/N3200- ON Series</b>
Reference CPU speed	1 GHz	1 GHz/1 GHz dual core	1 GHz/1 GHz/1.5 GHz	1 GHz/1.2 GHz/1.5 GHz
Reference RAM	1 Gbyte	1 Gbyte/2 Gbyte	1 Gbyte	2 Gbyte/4 Gbyte
Reference Flash	32 Mbyte	32 Mbyte	512 Mbyte/4096 Mbyte	1 Gbyte/4 Gbyte
Number of MAC addresses supported	16384	16384	24576	32768
Maximum Agetime in seconds	1000000	1000000	1000000	1000000
Number of VLANs	512	512	4096	4096
Maximum VLAN ID	4093	4093	4093	4093
Number of 802.1p traffic classes	7	7	7	7
IEEE 802.1X				
Number of 802.1X clients per stack	1152	1152	1696/1696/2496	2496
Number of 802.1X clients per port	32	32	64	64
Number of LAGs (max. LAGs/ports/ max dynamic LAG ports per system)	64/8/ 144	64/8/ 144	128/8/ 144	128/8/ 144
Link Dependency Max Groups	24	24	72	72
Number of MAC-based VLANs supported	256	256	256	256



**Table A-2. Platform Constants (Continued)**

<b>Feature</b>	<b>N1100-ON Series</b>	<b>N1500 Series</b>	<b>N2000/ N2100-ON/N2200- ON Series</b>	<b>N3000E-ON/ N3100- ON/N3200- ON Series</b>
Number of network buffers	182	182	182	182
Number of records in log	400	400	400	400
Static filter entries				
Unicast MAC and source port	20	20	20	20
Multicast MAC and source port	20	20	20	20
Multicast MAC and destination port (only)	512	512	1024	1024
Number of subnet-based VLANs supported	128	128	128	128
Protocol-based VLANs				
Max number of groups	128	128	128	128
Max protocols	16	16	16	16
Maximum MFDB entries	512	512	1024	1024
IGMPv3/MLDv2 Snooping limits				
IGMPv3/MLDv2 HW entries when IP Multicast present	–	–	1024	1024
IGMPv3/MLDv2 HW entries when Routing w/o IP Multicast	–	512	4096	4096

**Table A-2. Platform Constants (Continued)**

<b>Feature</b>	<b>N1100-ON Series</b>	<b>N1500 Series</b>	<b>N2000/ N2100-ON/N2200- ON Series</b>	<b>N3000E-ON/ N3100- ON/N3200- ON Series</b>
IGMPv3/MLDv2 HW entries when Switching only	512	512	4096	4096
Jumbo frame support				
Max size supported	9216	9216	9216	9216
Number of IP Source Guard stations	253	253	1020	1020
Number of DHCP snooping bindings	16384	16384	32768	32768
Number of DHCP snooping static entries	128	128	1024	1024
LLDP-MED				
Number of remote nodes	416	416	1296	1296
LLDP Remote Management address buffers	1296	1296	1296	1296
LLDP Unknown TLV address buffers	100	100	100	100
LLDP Organizationally Defined TLV buffers	8424	8424	8424	8424
Port MAC locking				
Dynamic addresses per port	300	300	600	600
Static addresses per port	100	100	100	100
sFlow				

**Table A-2. Platform Constants (Continued)**

<b>Feature</b>	<b>N1100-ON Series</b>	<b>N1500 Series</b>	<b>N2000/ N2100-ON/N2200- ON Series</b>	<b>N3000E-ON/ N3100- ON/N3200- ON Series</b>
Number of samplers	224	224	424/424/636	672
Number of pollers	224	224	424/424/636	672
Number of receivers	8	8	8	8
<b>RADIUS</b>				
Max Authentication servers	8	8	32	32
Max Accounting servers	8	8	32	32
TACACS+ Max servers	5	5	5	5
SNMP Max Servers	255	255	255	255
SNTP Max Servers	12	12	12	12
<b>Number of routes (IPv4/IPv6)</b>				
IPv4 only template	–	510	1024	12254
IPv4/IPv6 template				
IPv4 routes	–	382	256	8158
IPv6 routes	–	64	128	2K
RIP application route scaling	–	256	256	512
OSPF application route scaling	–	–	256	8158
Number of static routes (IPv4/IPv6)	–	256/ 64	256/ 128	1024/ 1024

**Table A-2. Platform Constants (Continued)**

<b>Feature</b>	<b>N1100-ON Series</b>	<b>N1500 Series</b>	<b>N2000/ N2100-ON/N2200- ON Series</b>	<b>N3000E-ON/ N3100- ON/N3200- ON Series</b>
OSPF				
Max OSPFv2 LSAs IPv4-only template	–	–	3272	36962
IPv4/IPv6 template	–	–	3272 (N2200- ON)	24674
OSPFv2 max neighbors	–	–	400	400
Max OSPFv3 LSAs	–	–	824 (N2200-ON)	6344/12488
OSPFv3 max neighbors per interface	–	–	400 (N2200-ON)	400
OSPF Max Areas	–	–	30 (N2200-ON)	30
BGP				
BGP Route Scaling	–	–	–	8158
BGP Peer Scaling	–	–	–	256
Tunnels				
Number of configured v6-over-v4 tunnels	–	–	–	8
Number of automatic (6to4) tunnels	–	–	–	1
Number 6to4 next hops	–	–	–	16
DHCP server				
Max number of pools	–	–	16	16
Total max leases	–	–	256	256
DNS client				
Concurrent requests	16	16	16	16

**Table A-2. Platform Constants (Continued)**

<b>Feature</b>	<b>N1100-ON Series</b>	<b>N1500 Series</b>	<b>N2000/ N2100-ON/N2200- ON Series</b>	<b>N3000E-ON/ N3100- ON/N3200- ON Series</b>
Name server entries	8	8	8	8
Search list entries	6	6	6	6
Static host entries	64	64	64	64
Cache entries	128	128	128	128
Domain search list entries	32	32	32	32
DHCPv6 Server				
Max number of pools	–	–	16	16
DNS domain names within a pool	–	–	5	5
DNS server addresses within a pool	–	–	8	8
Delegated prefix definitions within a pool	–	–	10	10
Number of VLAN routing interfaces	–	128	128	128
Number of ARP entries (Hosts)				
IPv4-only template	–	1000	4096	6144
IPv4/IPv6 template (v4/v6)	–	893/ 510	4096/ 512	4096/ 1024
Static v4 ARP entries	–	128	128	128
Number of ECMP next hops per route	0	0	0	4

**Table A-2. Platform Constants (Continued)**

<b>Feature</b>	<b>N1100-ON Series</b>	<b>N1500 Series</b>	<b>N2000/ N2100-ON/N2200- ON Series</b>	<b>N3000E-ON/ N3100- ON/N3200- ON Series</b>
Number of ECMP groups	0	0	0	64
MLAG				
Maximum MLAGs	–	64	64	64
MRP				
MMRP MACs	–	–	–	64
MVR				
MVR Groups	64	64	64	64
IP Multicast				
Number of IPv4/IPv6 Multicast Forwarding Entries	–	–	–	2048 (1536 IPv4, 512 IPv6)
IGMP Group Memberships per system	–	–	–	2048 each for IPv4 and IPv6
DVMRP Neighbors	–	–	–	256
PIM-DM Neighbors	–	–	–	256
PIM-SM Neighbors	–	–	–	256
PIM-SM Static RP entries	–	–	–	5
PIM-SM Candidate RP Group Range entries	–	–	–	20
PIM-SM SSM range entries	–	–	–	5

**Table A-2. Platform Constants (Continued)**

<b>Feature</b>	<b>N1100-ON Series</b>	<b>N1500 Series</b>	<b>N2000/ N2100-ON/N2200- ON Series</b>	<b>N3000E-ON/ N3100- ON/N3200- ON Series</b>
IGMP Sources processed per group per message	–	–	–	73
Fan Out (max OIFs per group when all groups active)	–	–	–	16
ACL limits				
Maximum number of ACLs (any type)	100	100	100	100
Maximum number of configurable rules per list	1023	1023	1023	1023
Maximum ACL Rules per Interface and Direction (IPv4/L2)	1012 ing 511 egr	1012 ing 511 egr	1023 ing 511 egr	1023 ing 511 egr
Maximum ACL Rules per Interface and Direction (IPv6)	378 ing 253 egr	378 ing 253 egr	1023 ing 509 egr	1023 ing 509 egr
Maximum ACL Rules (system-wide)	3072	3072	3914	3914
Maximum VLAN interfaces with ACLs applied	24	24	24	24
Maximum ACL Logging Rules (system-wide)	128	128	128	128
ARP ACL rules	20	20	20	20
CoS Device Characteristics				

**Table A-2. Platform Constants (Continued)**

<b>Feature</b>	<b>N1100-ON Series</b>	<b>N1500 Series</b>	<b>N2000/ N2100-ON/N2200- ON Series</b>	<b>N3000E-ON/ N3100- ON/N3200- ON Series</b>
Configurable Queues per port (stacking /nonstacking)	7	7	7	7
Configurable Drop Precedence levels	3	3	3	3
DiffServ Device Limits				
Number of queues (stacking/nonstacking )	7	7	7	7
Max Rules per Class	6	13	26	26
Max Instances per Policy	12	12	12	12
Max Attributes per Instance	3	3	3	3
Max Service Interfaces	288	800	800	800
Max table entries				
Class Table	32	32	32	32
Class Rule Table	192	416	416	416
Policy Table	64	64	64	64
Policy Instance Table	768	768	768	768
Policy Attribute Table	2304	2304	2304	2304
Datacenter Device Limits				



**Table A-2. Platform Constants (Continued)**

<b>Feature</b>	<b>N1100-ON Series</b>	<b>N1500 Series</b>	<b>N2000/ N2100-ON/N2200- ON Series</b>	<b>N3000E-ON/ N3100- ON/N3200- ON Series</b>
PFC number of lossless priorities	–	–	–	–
ETS number of traffic class groups	–	–	–	–
AutoVoIP number of voice calls	–	16	16	16
Voice VLAN number of devices	192	192	424	672

# System Process Definitions

The following process/thread definitions are intended to assist the end user in troubleshooting switch issues. Only the most often seen threads/processes are listed here. Other processes or threads may be seen occasionally but are not a cause for concern.

**Table A-3. System Process Definitions**

Name	Task Summary
aclClusterTask	ACL tasks
aclEventTask	
aclLogTask	
ARP Timer	ARP tasks
autoInstTask	Auto Install task - USB, etc.
bcmATP-RX	BCM system task: Acknowledged Transport Protocol
bcmATP-TX	
bcmCNTR.0	BCM system task: SDK Statistics collection
bcmDISC	BCM system task: SDK Discovery task
bcmDPC	BCM system task: SDK DPC task
bcmL2X.0	BCM system task: SDK L2 SOC shadow table maintenance
bcmLINK.0	BCM system task: SDK Physical link status monitor
bcmNHOP	BCM system task: SDK transport Next Hop task
bcmRLINK	BCM system task: SDK Remote registration last
bcmRPC	BCM system task: SDK Remote registration last
bcmRX	BCM system task: SDK Control plane packet receiver/dispatcher
bcmTUNQ	BCM system task: SDK transport queueing task
bcmTX	BCM system task: SDK Control plane packet transmitter
bcmXGS3AsyncTask	BCM system task: SDK XGX3 hw task
BootP	Boot Loader

**Table A-3. System Process Definitions (Continued)**

<b>Name</b>	<b>Task Summary</b>
boxs Req	Box Services Request (temperature, power, fan)
boxs Resp	Box Services Response (temperature, power, fan)
boxs Timer	Box Services Response (temperature, power, fan)
cdaFftpTask	Code Distribution Administrator FTP task
cdaStatusTask	Code Distribution Administrator Status task
cdaUpdateTask	Code Distribution Administrator Update task
cliWebIORedirectTask	CLI Web IO Redirection Task
cmgrInsertTask	Card Manager Insertion Handler
cmgrTask	Card Manager Status (built-in and plug-in card configuration processing)
Cnfrgr_Thread	Configurator (startup manager)
CP Wired If	Captive Portal
cpuUtilMonitorTask	CPU Utilities monitor
DapiDebugTask	Device API debug processing
DHCP Server Processing Task	DHCP Tasks
DHCP snoop	
dhcpsPingTask	
DHCPv4 Client Task	
DHCPv6 Client Task	
DHCPv6 Server Task	
dnsRxTask	DNS tasks
dnsTask	
dosTask	Denial of Service task
dot1qTask	VLAN routing task

**Table A-3. System Process Definitions (Continued)**

<b>Name</b>	<b>Task Summary</b>
Dot1s transport task dot1s_helper_task dot1s_task dot1s_timer_task	Spanning Tree tasks
dot1xTask dot1xTimerTask	802.1x authentication tasks
dot3ad_core_task dot3ad_core_ac_task dot3ad_helper_task dot3ad_timer_task	Link aggregation tasks
dtlAddrTask dtlTask	Device Transform Layer - Silicon Integration Layer
dvmrpMapTask	DVMRP Mapping Layer
Dynamic ARP Inspection	Dynamic ARP Inspection task
EDB	Entity MIB Processing task
EDB Trap	Entity MIB Trap task
emWeb	UI processing task
envMonTask	Environment Monitor (fans, power supplies, temperature, ...)
fdbTask	Forwarding Data Base Manager
fftpTask	FTP processing
gcecp_t	GARP Central Control Point task (dot 1d)

**Table A-3. System Process Definitions (Continued)**

<b>Name</b>	<b>Task Summary</b>
hapiBpduTxTask	High Level API - SDK Integration Layer
hapiL2AsyncTask	
hapiL2FlushTask	
hapiL3AsyncTask	
hapiLinkStatusTask	
hapiMcAsyncTask	
hapiRxTask	
hapiTxTask	
hpcBroadRpcTask	SDK Remote messaging task.
ip6MapExceptionDataTask	IP Stack
ip6MapLocalDataTask	
ip6MapNbrDiscTask	
ip6MapProcessingTask	
ip6MapRadvdTask	
ipcom_sysl	
IpHelperTask	
ipMapForwardingTask	
ipMapProcessingTask	
ipnetd	
iscsiTask	ISCSI task
isdpTask	ISDP task
lldpTask	LLDP task
LOG	System LOG processing
LOGC	System LOG processing
MAC Age Task	MAC address table aging
MAC Send Task	MAC address table learning
macalTask	Management ACL packet processing

**Table A-3. System Process Definitions (Continued)**

<b>Name</b>	<b>Task Summary</b>
mcastMapTask	Multicast Mapping Tasks
mgmdMapTask	
mvrTask	MVR Message Handler
nim_t	Network Interface Manager
osapiMonTask	System Task Monitor
osapiTimer	Application timer service
osapiWdTask	Hardware watchdog timer service
OSPF mapping Task	OSPF tasks
OSPF Proto	
OSPFV3 mapping Task	
OSPFV3 recvmg Task	
OSPFv3 Proto	
pimdMapTask	PIMDM task
pimsmMapTask	PIMSM task
pingAsync	Ping response processing
pktRcvrTask	Multicast control plane packet receiver/dispatch
pmlTask	Port MAC Locking management task
portAggTask	Port Aggregator task
radius_rx_task	RADIUS server tasks
radius_task	
ripMapProcessingTask	RIP Mapping layer
RLIM cnfgr task	VRRP configuration
RLIM task	VRRP message processing
RMONTask	RMON Statistics Collection
serialInput	Serial Input task
sFlowTask	sFlow task
SimAddrConflictTask	System Interface Manager Address Conflict Task

**Table A-3. System Process Definitions (Continued)**

<b>Name</b>	<b>Task Summary</b>
simPts_task	System Interface Manager (time zone, system name, service port config, file transfers, ...)
SNMPCTTask	SNMP Tasks
SNMPSaveCfgTask	
SNMPTask	
SNMPTrapTask	
snoopTask	IGMP/MLD Snooping packet processing
SNTTP	SNTTP tasks
SNTPC	
spmTask	Stack port manager - stacking control plane packet processing
sshdEvTask	SSH task
sslTask	SSL task
Stk Mgr Task	Stack Manager Task
tacacs_rx_task	TACACS tasks
tacacs_task	
tArpCallback	ARP tasks
tArpReissue	
tArpTimerExp	ARP Timer Expiry
tCpktSvc	NSF Processing
tCptvPrtl	Captive portal control plane processing
tDhcp6sTask	DHCP Tasks
tDhcpsTask	
tEmWeb	Web page server
TimeRange Processing Task	ACL Time Ranges
tIomEvtMon	CMC Communication
tL7Timer0	System Timer
tLogTask	System LOG processing

**Table A-3. System Process Definitions (Continued)**

<b>Name</b>	<b>Task Summary</b>
TransferTask	TFTP Processing
trapTask	Trap handler
tRipTask	RIP Routing
tRtrDiscProcessingTask	Router Discovery packet processing
usbFlashDriveTask	USB Flash driver processing
umCfgUpdateTask	Stack Management: Unit Manager tasks
umWorkerTask	
unitMgrTask	
USL Worker Task	USL Message processing (primarily MAC address table CLI commands)
UtilTask	Mgmt. UI login/logout processing
voipTask	Voice Over IP
VRRPdaemon	VRRP task

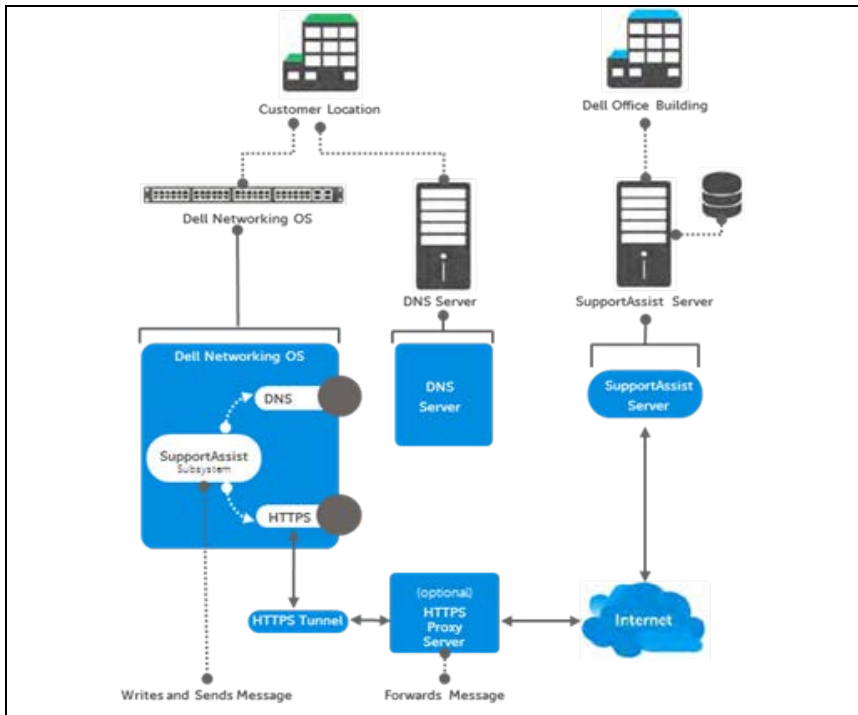


# SupportAssist

SupportAssist sends troubleshooting data securely to Dell. SupportAssist in this Dell EMC Networking OS release does not support automated email notification at the time of hardware fault alert, automatic case creation, automatic part dispatch, or reports. SupportAssist requires Dell EMC Networking OS 6.3 or later and the SupportAssist Package to be installed on the Dell EMC Networking device.

SupportAssist is enabled by default on all Dell EMC Networking switches. To disable SupportAssist, enter the command `eula-consent support-assist reject` in Global Configuration mode and then save the configuration.

**Figure A-1. SupportAssist**



SupportAssist operates by periodically reporting switch identity (service tag and serial number), configuration, logs, status, and diagnostic information to an external SupportAssist server operated by Dell, Inc. Information is logged periodically on the SupportAssist server.

It is recommended that Dell EMC Networking customers utilizing SupportAssist configure the appropriate contact information using the **contact-person** and **contact-company** commands in Support-Assist Configuration mode.

The SupportAssist EULA is printed here:

I accept the terms of the license agreement. You can reject the license agreement by configuring this command 'eula-consent support-assist reject'.

By installing SupportAssist, you allow Dell to save your contact information (e.g. name, phone number and/or email address) which would be used to provide technical support for your Dell products and services. Dell may use the information for providing recommendations to improve your IT infrastructure.

SupportAssist also collects and stores machine diagnostic information, which may include but is not limited to configuration information, user supplied contact information, names of data volumes, IP addresses, access control lists, diagnostics & performance information, network configuration information, host/server configuration & performance information and related data (Collected Data) and transmits this information to Dell. By downloading SupportAssist and agreeing to be bound by these terms and the Dell end user license agreement, available at: <http://www.dell.com/aeula>, you agree to allow Dell to provide remote monitoring services of your IT environment and you give Dell the right to collect the Collected Data in accordance with Dell's Privacy Policy, available at: <http://www.dell.com/privacypolicycountryspecific>, in order to enable the performance of all of the various functions of SupportAssist during your entitlement to receive related repair services from Dell. You further agree to allow Dell to transmit and store the Collected Data from SupportAssist in accordance with these terms. You agree that the provision of SupportAssist may involve international transfers of data from you to Dell and/or to Dell's affiliates, subcontractors or business partners. When making such transfers, Dell shall ensure appropriate protection is in place to safeguard the Collected Data being transferred in connection with SupportAssist. If you are downloading SupportAssist on behalf

of a company or other legal entity, you are further certifying to Dell that you have appropriate authority to provide this consent on behalf of that entity. If you do not consent to the collection, transmission and/or use of the Collected Data, you may not download, install or otherwise use SupportAssist.



# Index

## Numerics

802.x - see IEEE802.x for all related standards

## A

AAA, 291

access lines, 295

access profiles, 67

accounting, 352

ACLs

Auto-VoIP usage, 1596

binding configuration, 746

CLI configuration, 749

configuration steps, 724

counters, 715

defined, 713

examples, 764

iSCSI usage, 665

limitations, 719

logging, 718

preventing false matches, 724

supported types, 72

time based, 72

web-based configuration, 735

ACLs. See also IP ACL, IPv6 ACL, and MAC ACL.

active images, 562

address table. See MAC address table.

administrative profiles, 341

RADIUS authorization, 343

TACACS+ authorization, 349

ARP, 99

dynamic ARP inspection, 73

ARP table

configuring (CLI), 1211

configuring (web), 1201

authentication, 297

examples, 314

profiles, 67

tiered, 298

authentication host modes, 357

authentication key, SNMP, 485

Authentication Manager, 298

authentication server, diffserv

filter assignments, 389

authorization, 340

administrative profiles, 341

examples, 342

RADIUS, 343

auto configuration

auto save, 594

CLI configuration, 598

defaults, 596

defined, 583

DHCP, 600

- configuration file, 591
- image, 590
- IP address, obtaining, 588
- example, 599
- files, managing, 594
- IP address lookup, 585
- MAC address lookup, 585
- setup file, 587
- stopping, 594
- using a USB device, 599
- web-based configuration, 597
- auto image download
  - DHCP, 600
  - USB, 599
- auto install. See auto configuration.
- auto save feature, 594
- auto VoIP, 1595
  - and ACLs, 1596
  - CLI configuration, 1599
  - defaults, 1596
  - understanding, 1595
  - web-based configuration, 1597
- auto-negotiation, 89
- auto-provisioning, iSCSI, 666
- AVB
  - configuration, 1690
  - overview, 1687

## B

- back pressure, 89
- banner, CLI, 507

## BFD

- example, 1478
- limitations, 1477
- modes, 1476
- overview, 1475

## BGP, 100

- address aggregation, 1421
- adjacency detection, 1413
- communities, 1427, 1448
- configuration, 1443
- decision process overview, 1406
- ECMP paths, 1418
- finite state machine, 1411
- inbound and outbound
  - policies, 1424
- IPv4 and IPv6 peering
  - sessions, 1435
- limitations, 1441
- next hops, 1419
- OSPF route redistribution, 1446
- overview, 1403
- peer templates, 1415
- private AS numbers, 1415
- route reflection, 1428, 1449
- routes, 1417
- routing table, 1427
- supported path attributes, 1408
- TCP MD5 authentication, 1414
- timers, 1426

## BOOTP/DHCP relay agent, 101

## BPDU

- filtering, 96, 878
- flooding, 878
- guard, 96
- protection, 880

- bridge multicast group table, 980
- bridge table, 1161
- broadcast storm control. See storm control.

## C

- cable test, 433, 445
  - and green mode, 445, 681
- captive portal, 70
  - CLI configuration, 418
  - client management, 423
  - configuring, 424
  - customizing pages, 396
  - defaults, 400
  - defined, 392
  - dependencies, 394
  - design considerations, 395
  - example, 424
  - localization, 397
  - understanding, 392, 396
  - user logout mode, 397
  - users, RADIUS server, 410
  - web-based configuration, 402
- cards
  - configuration, 492
  - supported, 494
- CDP, interoperability through ISDP, 63
- certificates, 556
- CFM, 1023, 1044
- checkpointing, 263

- Cisco protocol filtering, 92

## CLI

- accessing the switch, 215
- banner, 471
- banner, configuring, 507
- command completion, 220
- command modes, 217
- command prompt, 472
- error messages, 221
- negating commands, 220

- clock, system, 483

- command modes, CLI, 217

- commands
  - abbreviated, 220
  - entering, 219
  - history buffer, 221

- Compellent storage arrays, 666

- configuration
  - saving, 560

- configuration file
  - defined, 555
  - DHCP auto configuration, 591
  - downloading, 558
  - editing, 558
  - SNMP, 560
  - USB auto configuration, 586
  - USB device, 581

- configuration scripts, 558, 579

- connectivity fault management.
  - See IEEE 802.lag.

- console port
  - connecting to, 215
  - description

- N1500, 121
- N2000, 131
- N3000E-ON, 160
- copy, files, 568
- CoS
  - CLI configuration, 1579
  - configuration example, 1583
  - defaults, 1571
  - defined, 1567
  - iSCSI and, 664
  - queue management
    - methods, 1570
  - traffic queues, 1569
  - traffic shaping, 1568
  - trusted mode ports, 1568
  - untrusted mode ports, 1568
  - web-based configuration, 1573

## D

- DAI
  - defaults, 1060
  - optional features, 1059
  - purpose, 1060
  - understanding, 1059
- data center
  - DHCP snooping and, 1085
  - NSF and, 283
  - SDM template, 473
- date, setting, 503
- daylight saving time, 472
- DCBx, 92
- default gateway,
  - configuring, 229, 237
- default VLAN, 245
  - DHCP client, 242
  - IP address configuration, 234
- denial of service, 68, 712
- device discovery protocols, 924
- device view, 212
- DHCP, 1169
  - adding a pool, 1176
  - understanding, 1169
- DHCP auto configuration
  - dependencies, 595
  - enabling, 600
  - monitoring, 594
  - process, 588
- DHCP client, 1171
  - default VLAN, 242
  - OOB port, 242
- DHCP relay, 92, 101, 1171
  - CLI configuration, 1256
  - defaults, 1244
  - example, 1260
  - layer 2, 1235
  - layer 3, 1235
  - understanding, 1235
  - VLAN, 1236
  - web-based configuration, 1245
- DHCP server, 59
  - address pool configuration, 1188
  - CLI configuration, 1184
  - defaults, 1172
  - examples, 1188



- leases, 243
- options, 1171
- web-based configuration, 1173
- DHCP snooping, 73, 1171
  - bindings database, 1055
  - defaults, 1060
  - example, 1085
  - logging, 1056
  - purpose, 1060
  - understanding, 1054
  - VLANs, 1056
- DHCPv6, 1511
  - client, 1493-1494
  - defined, 103
  - examples, 1528
  - pool, 1512
  - pool configuration for stateless server support, 1523
  - prefix delegation, 1512
  - relay agent, configuring, 1529
  - relay agent, understanding, 1512
  - stateless server
    - configuring, 1528
  - stateless server,
    - understanding, 1512
  - understanding, 1511
- DHCPv6 relay
  - CLI configuration, 1523
  - defaults, 1513
  - web-based configuration, 1514
- DHCPv6 server
  - CLI configuration, 1523
  - defaults, 1513
  - prefix delegation, 1529
  - web-based configuration, 1514
- DiffServ, 104
  - 802.1X and, 366
  - CLI configuration, 1547
  - defaults, 1533
  - elements, 1532
  - example, 1556
  - RADIUS and, 366
  - switch roles and, 1532
  - understanding, 1531
  - VoIP, 1560
  - web-based configuration, 1535
- discovery, device, 923
- document conventions, 54
- domain name server, 238
- domain name, default, 239
- Dot1. see IEEE802.1X
- double-VLAN tagging, 792
- downloading files, 564
- DSCP value and iSCSI, 665
- dual images, 60
- dual IPv4 and IPv6 template, 473
- duplex mode, 121, 130, 159
- DVMRP, 107
  - configuring, 1680
  - defaults, 1621
  - example, 1685
  - understanding, 1618
  - web-based configuration, 1660
  - when to use, 1619
- dynamic ARP inspection - see DAI

- dynamic LAGs, 1104
- dynamic VLAN creation, 388

## **E**

- EAP statistics, 621
- eBGP, 1406
- ECMP
  - with BGP, 1418
- email alerting, 468
  - log messages, 463
  - statistics, 456
- enable authentication, 297
- Energy Detect mode, 74, 674
- Energy Efficient Ethernet, 74
- energy savings, port, 674
- EqualLogic and iSCSI, 666
- error messages, CLI, 221
- error-disabled state, 69
- Etherlike statistics, 619
- EtherType numbers,
  - common, 725
- exec authorization, 340
- expansion slots, 477

## **F**

- failover, stacking, 65, 263
- false matches, ACL, 724

- FCoE
  - configuring CoS queues for, 1584

- file management, 61
  - CLI, 569
  - considerations, 557
  - copying, 568
  - purpose, 553
  - supported protocols, 556
  - web-based, 561

- file system, 561

- files
  - and stacking, 560
  - downloading to the switch, 557
  - types, 551
  - uploading from the switch, 557

- filter assignments,
  - authentication server, 389

- filter, DiffServ, 366

- finite state machine
  - BGP attributes, 1411

- firmware
  - managing, 557
  - updating the stack, 261
  - upgrade example, 576

- firmware synchronization,
  - stacking, 261

- flow control
  - configuring, 961
  - default, 954
  - port-based, 955
  - understanding, 950

- flow-based mirroring, 1546

forwarding database, 1161  
and port security, 1058

## **G**

GARP, 94, 974  
general mode  
switchport configuration, 703  
GMRP, 974  
green Ethernet, 674, 680  
green features, 74  
guest VLAN, 363, 387  
GVRP, 94, 791  
statistics, 620

## **H**

head of line blocking  
prevention, 88  
health, system, 442  
help, accessing web-based, 219  
hierarchical authentication, 298  
host name, 471  
host name mapping, 228

## **I**

IAS  
database, 373  
understanding, 366  
users, 379

iBGP, 1406, 1420, 1445  
icons, web-based interface, 211

identification

asset tag, 471  
system contact, 471  
system location, 471  
system name, 471

IDSP

defaults, 925

IEEE 802.1ag

administrator, 1027  
carrier network, 1024, 1045  
configuration (CLI), 1037  
configuration (web), 1029  
defaults, 1028  
defining domains and ports, 1027  
example, 1040  
MEPs and MIPs, 1025  
troubleshooting tasks, 1028  
understanding, 1023, 1044

IEEE 802.1d, 95

IEEE 802.1p

see CoS queuing

IEEE 802.1Q, 94

IEEE 802.1X, 70

authentication, 71  
configuring, 379  
defined, 355  
DiffServ and, 366  
monitor mode, 71, 364, 376  
port authentication, 374  
port states, 356  
RADIUS-assigned VLANs, 378

- reauthenticating ports, 370
- VLAN assignment, 360
- IEEE 802.1x
  - authentication, 297
- IEEE 802.3x. See flow control.
- IGMP, 107
  - configuration, 1668
  - defaults, 1621
  - understanding, 1606
  - web-based configuration, 1630
- IGMP proxy, 107, 1606
  - CLI-based configuration, 1670
  - web-based configuration, 1630
- IGMP snooping, 105
  - defaults, 977
  - querier, 106
  - querier, defined, 971
  - understanding, 969
- image
  - activating, 570
  - auto configuration, 590
  - auto install, 587
  - considerations, 557
  - defined, 551
  - downloading, 570
  - management, CLI, 569
  - management, web-based, 561
  - purpose, 553
- in-band management, 229
- interface, 1219
  - loopback, 1220
  - OOB, 233
  - routing, 1219
    - CLI configuration, 1231
    - web configuration, 1225
  - routing defaults, 1224
  - supported types, 678
  - tunnel, 1221
- Interface Configuration
  - mode, 678
- internal authentication server,
  - see IAS
- IP ACL
  - configuration, 735
  - defined, 716
- IP address
  - configuring, 229
  - default, 232
  - default VLAN, 235, 245
  - OOB port, 244
- IP helper, 101, 1240
- IP multicast traffic
  - layer 2, 969
  - layer 3, 1602
- IP protocol numbers,
  - common, 725
- IP routing
  - CLI configuration, 1210
  - defaults, 1195
  - example, 1215
  - understanding, 1193
  - web-based configuration, 1198
- IP source guard, 73
- IPSG
  - example, 1087
  - port security and, 1058

- purpose, 1060
    - understanding, 1058
  - IPv4 and IPv6 networks,
    - interconnecting, 1339
  - IPv4 multicast
    - web-based configuration, 1623
  - IPv4 routing template, 473
  - IPv6
    - ACL configuration, 743
    - compared to IPv4, 1484
    - DHCP client, 1493-1494
    - DHCPv6, 103
    - interface configuration, 1484
    - management, 60
    - OSPFv3, 103
    - routes, 103
    - static reject and discard
      - routes, 1506
    - tunnel, 102
  - IPv6 multicast
    - CLI configuration, 1667
    - web-based configuration, 1629
  - IPv6 routing
    - CLI configuration, 1499
    - defaults, 1486
    - features, 103
    - understanding, 1483
    - web-based configuration, 1488
  - IRDP, configuring, 1212
  - iSCSI
    - ACL usage, 665
    - assigning flows, 664
    - CLI configuration, 669
    - Compellent storage arrays
      - and, 666
    - CoS and, 664
    - defaults, 667
    - Dell EqualLogic arrays and, 666
    - examples, 670
    - flow detection, 664
    - information tracking, 665
    - servers and a disk array, 670
    - understanding, 663
    - using, 663
    - web-based configuration, 668
  - ISDP
    - CDP and, 63
    - CLI configuration, 939
    - configuring, 940
    - enabling, 940
    - example, 944
    - understanding, 923
    - web-based configuration, 926
- J**
- jumbo frames, 88
- L**
- LACP, 98
    - adding a LAG port, 1098
    - CLI configuration, 1102
    - web-based configuration, 1096
  - LAG
    - CLI configuration, 1100
    - defaults, 1093

- examples, 1104
  - guidelines, configuration, 1092
  - hashing, 1091
  - interaction with other
    - features, 1092
  - LACP, 98
  - MLAG, 98
  - purpose, 1090
  - static and dynamic, 1090
  - statistics, 635
  - STP and, 1092
  - threshold, minimum links, 1100
  - understanding, 1089
  - web-based configuration, 1094
- languages, captive portal, 397
- LED**
- 100/1000/10000Base-T port, 124, 134, 165, 175
  - SFP port, 124, 134, 165, 175
  - system, 114, 125, 135, 144, 155, 166, 177, 196
- link aggregation group. See LAG.
- link dependencies
- CLI configuration, 696-697
  - creating, 687
  - example, 699
  - group configuration, 699
  - scenarios, 677
  - understanding, 676
  - web configuration, 687
- link local protocol filtering, see LLPF
- LLDP**
- CLI configuration, 939
  - defaults, 925
  - example, 945
  - understanding, 924
  - web-based configuration, 926
- LLDP-MED**
- configuring, 943
  - understanding, 924
  - viewing information, 944
  - voice VLANs and, 797
- LLPF**
- defaults, 954
  - example, 964
  - understanding, 951
- localization, captive portal, 397
- locating the switch, 213
- locator LED
- enabling, 213, 458
- log messages, 59
- log server, remote, 451
- logging
- ACL, 718
  - CLI configuration, 458
  - considerations, 438
  - defaults, 439
  - destination for log messages, 434
  - example, 465
  - file, 450
  - log message format, 436
  - operation logs, 435
  - severity levels, 435
  - system startup logs, 435
  - trap log, 533
  - web-based configuration, 440

- loopback interface, 102
  - configuring, 1233
  - purpose, 1223
  - understanding, 1220
- low-power idle, 680
- LSA, OSPF, 1265

## **M**

- MAC ACL
  - understanding, 715
- MAC address table
  - and port security, 1058
  - contents, 1162
  - defaults, 1162
  - defined, 1161
  - dynamic, 1165
  - managing, CLI, 1166
  - populating, 1161
  - stacking, 1162
  - web-based management, 1163
- MAC multicast support, 105
- MAC port locking, 707
- MAC-based VLAN, 790
- mail server
  - adding, 454
  - configuring, 462
  - email alert, 453
- management
  - access control using
    - TACACS+, 312
  - in-band and out-of-band, 229
  - MD5, 476
  - MDI/MDIX, auto, 88
  - MEP, configuring, 1038
  - MIB, SNMP, 513
  - Microsoft Network Load Balancing, 1620
  - mirror, ACL, 718
  - mirroring, flow-based, 1546
  - MLAG, 98, 1107
  - MLD, 108
    - configuring, 1671
    - defaults, 1621
    - understanding, 1607
    - web-based configuration, 1638
  - MLD proxy
    - configuring, 1672
  - MLD snooping, 106
    - defaults, 977, 1060
    - understanding, 971
    - VLAN configuration, 1013
  - MMRP, 1689
  - monitor mode, IEEE 802.1X, 364
  - monitoring system
    - information, 433
  - MSTP
    - example, 915
    - operation in the network, 873
    - support, 95
    - understanding, 871
  - MTU

- configuring, 695
- management interface, 231
- Multicast
  - L3 IPv4 configuration, 1665
- multicast
  - DVMRP, 107
  - IGMP, 107
  - IGMP proxy, 107
  - IGMP snooping, 105
  - IPv6, 1629
  - layer 2, 105
    - configuring (CLI), 1010
    - configuring (web), 979
    - defaults, 977
    - understanding, 967
    - when to use, 974
  - layer 3, 107
    - configuring (CLI), 1665
    - configuring general features (web), 1623
    - defaults, 1621
    - examples, 1681
    - understanding, 1601
    - when to use, 1604
  - MAC layer, 105
  - MLD snooping, 106
  - protocols
    - roles, 1604
    - supported, 1603
  - VLAN Routing with IGMP and PIM-SM, 1681
- multicast bridging, 968, 1010
- multicast routing table, 1605
- multicast snooping, 1018

- multicast VLAN
  - registration, 106, 973
  - adding an interface, 1002
- Multiple MAC Registration Protocol, 1687
- Multiple VLAN Registration Protocol, 1687-1688

## **N**

- N1500 hardware
  - back panel, 123
  - LEDs, 124
  - power consumption for PoE switches, 127
- N2000 hardware
  - back panel, 132
  - front panel, 128
  - LEDs, 112, 134, 141, 153, 188
  - power consumption for PoE switches, 137
- N3000 hardware
  - front panel, 157
- N3000E-ON hardware
  - back panel, 163
  - LEDs, 165
  - power consumption for PoE switches, 170
- network information
  - CLI configuration, 242
  - default, 232
  - defined, 227
  - example, 248
  - purpose, 228



- web-based configuration, 233
- nonstop forwarding, see NSF

## NSF

- DHCP snooping and, 285
- in the data center, 283
- network design
  - considerations, 266
- routed access and, 288
- the storage access network and, 286
- understanding, 262
- VoIP and, 284

## O

- OAM, 1023, 1044

- ONIE, 139

- OOB port, 233

- DHCP client, 242

- OpenManage Switch

- Administrator, about, 207

- optical transceiver
  - diagnostics, 446

- OSPF, 100

- areas, 1264
- border router, 1330
- CLI configuration, 1308
- defaults, 1272
- difference from OSPFv3, 1265
- examples, 1330
- flood blocking, 1270, 1347
- LSA pacing, 1269
- NSSA, 1333

- static area range cost, 1268, 1342
- stub area, 1333
- stub routers, 1266
- topology, 1264
- trap flags, 531
- understanding, 1264
- web-based configuration, 1275

- OSPFv3, 103

- CLI configuration, 1320
- difference from OSPF, 1265
- global settings, 1320
- interface settings, 1322
- NSSA, 1333
- stub area, 1333
- trap flags, 532
- web-based configuration, 1291

- out-of-band management, 229

- OOB port IP address, 244

## P

- password

- protecting management
  - access, 67
- strong, 67

- PIM

- defaults, 1621
- IPv4 web-based
  - configuration, 1647
- IPv6 web-based
  - configuration, 1647
- SSM range, 1656
- understanding, 1607

- PIM-DM

- configuring for IPv4 multicast, 1673
  - configuring for IPv6 multicast, 1674
  - using, 1618
- PIM-SM
  - configuring for IPv4 multicast, 1675
  - configuring for IPv6 multicast, 1677
  - using, 1608
- plug-in modules
  - configuring, 477
- PoE+, 81, 505
- port
  - access control, 371
  - characteristics, 673
    - CLI configuration, 694
    - web-based configuration, 684
  - configuration examples, 698
  - configuring multiple, 685
  - defaults, 682
  - defined, 673
  - device view features, 212
  - locking, 707
  - power saving, 680
  - protected, 73, 958, 962
  - statistics, 634
  - traffic control, 949
  - USB
    - N1500, 122
    - N2000, 131
    - N3000E-ON, 161
- port control, 371
- port fast, STP, 878
- port LEDs
  - N1500, 124
  - N2000, 112, 134, 142, 153, 191
  - N3000E-ON, 165
- port mirroring, 90
  - configuring, 636
  - mode, enabling, 609
  - understanding, 607
- port protection
  - diagnostically disabled state, 69
- port security
  - configuring, 710
  - MAC-based port locking, 72
- port-based flow control, 955
- port-based traffic control, 949
  - CLI configuration, 961
  - web-based configuration, 955
- port-based VLAN, 790
- port-channel. See LAG.
- power consumption
  - N1500 PoE switches, 127
  - N2000 PoE switches, 137
  - N3000E-ON PoE switches, 170
- power utilization reporting, 75
- power, per-port saving
  - modes, 680
- private VLAN edge, 73
- private VLANs, 799, 855
- protected port
  - defined, 951

- example, 964
- protocol filtering, Cisco, 92
- protocol-based VLAN, 790

## **Q**

- QoS
  - diffserv, 104
- queues, CoS, 1569

## **R**

- RADIUS, 68
  - authentication example, 323
  - authorization, 343
  - COA configuration example, 347
  - configuration example, 326
  - DiffServ and, 366
  - for management access control, 307
  - supported attributes, 309
  - understanding, 307
- RAM log, 448
- real-time clock, 472
- redirect, ACL, 717
- relay agent
  - DHCP, 1235
- relay agent, DHCPv6, 1512
- remote logging, 461
- RIP, 101
  - CLI configuration, 1369
  - defaults, 1363

- determining route information, 1361
- example, 1373
- supported versions, 1362
- understanding, 1361
- web-based configuration, 1364

- RMON, 63
  - CLI management, 638
  - defaults, 613
  - example, 651
  - understanding, 606
  - web-based configuration, 614

- route reflection, 1449
  - BGP, 1428

- router discovery, 101, 1212

- router, OSPF, 1265

- routes
  - IPv4, 1208
  - IPv6, 1498
  - selecting, 1265

- routing
  - defaults (IPv4), 1195
  - defaults (IPv6), 1486
  - example, 1215
  - IPv4, CLI configuration, 1210
  - IPv4, web-based configuration, 1198
  - IPv6, CLI configuration, 1499
  - IPv6, web-based configuration, 1488
  - understanding, 1193

- routing interfaces
  - CLI configuration, 1231
  - defaults, 1224

- understanding, 1219
- using, 1222
- web-based configuration, 1225

- routing table, 101
  - best routes, 1205
  - configuring, 1213
  - IPv6, 1503, 1505

- RSPAN, 90, 607

- RSTP
  - understanding, 871

- RSTP-PV, 880

- running-config, saving, 560

## S

- save, system settings, 560

- SDM template, 61
  - configuration guidelines, 476
  - managing, 501
  - understanding, 473

- security
  - port-based
    - CLI configuration, 374
    - defaults, 367, 707
    - examples, 379
    - web-based
      - configuration, 368

- setup file format, auto
  - configuration, 587

- sFlow, 62
  - CLI management, 638
  - defaults, 613
  - example, 649

- understanding, 603
- web-based management, 614

- SFP port LEDs
  - N1500, 124
  - N2000, 134
  - N3000E-ON, 165, 175

- SFTP, managing files, 574

- slots, 477

- SNMP
  - CLI configuration, 535
  - defaults, 515
  - examples, 544
  - MIB, 513
  - purpose, 515
  - traps, 514
  - understanding, 513
  - uploading files, 560
  - web-based configuration, 517

- SNMPv1 example, 544

- SNMPv2 example, 544

- SNMPv3
  - engine ID, 535
  - example, 546

- SNTTP
  - authentication, 501
  - authentication key, 485
  - example, 510
  - server, 501
  - server configuration, 487
  - understanding, 476

- software image, 551

- spanning tree. See STP.

- split horizon, 1362
- SSH, 68
  - associating a user with an SSH key, 338
  - files, 556
  - public key authentication
    - example, 329
- SSL, 68
  - files, 556
- SSM range, 1656
- stacking
  - adding a switch, 259
  - CLI configuration, 276
  - defaults, 266
  - defined, 253
  - design consideration, 265
  - failover, 65
    - example, 279
    - initiating, 263
  - features, 63
  - file management, 560
  - firmware synchronization, 261
  - firmware update, 261
  - MAC address table, 1162
  - MAC addresses, 265
  - NSF and, 65
  - NSF usage scenario, 279
  - preconfiguration, 281
  - purpose, 266
  - removing a switch, 260
  - standby, 261
  - web-based configuration, 268
- static reject route, 1194
- statistics
  - Etherlike, 619
  - IPv6, 1491
- storage arrays and iSCSI, 666
- storage arrays, Compellent, 666
- storm control
  - configuring, 961
  - default, 954
  - example, 964
  - understanding, 950
- STP
  - classic, 871
  - CLI configuration, 908
  - defaults, 892
  - defined, 871
  - examples, 913
  - LAGs and, 1092
  - loop guard, 879
  - MSTP, 95
  - optional features, 878
  - port fast, 878
  - port settings, 95
  - root guard, 879
  - RSTP, 95
  - understanding, 872
  - web-based configuration, 893
- STP-PV, 880
- subnet mask, configuring, 229
- subnet-based VLAN, 790
- summer time, 472
- switchport modes, VLAN, 681
- switchport statistics, web
  - view, 624

- system health, monitoring, 440
- system information
  - CLI configuration, 499
  - default, 477
  - defined, 471
  - example, 507
  - purpose, 472
  - web-based configuration, 478
- system time, 476

## T

- TACACS+, 67
  - authentication, 328
  - authorization, 348-349
  - management access control, 312
  - supported attributes, 314
  - understanding, 312
- tagging, VLAN, 790
- Telnet
  - configuration options, 68
  - connecting to the switch, 216
- TFTP, image download, 570
- tiered authentication, 298
- time
  - management, 58
  - setting in system, 512
  - time zone, 491
- time domain reflectometry, 445
- time range, 762
- time-based ACLs, 718
- traffic

- monitoring, 603
- snooping, 1053
- traffic class queue, 664
- traffic control
  - port based, 949
- traffic inspection, 1053
- traps
  - OSPF, 531
- trunk mode
  - configuration, 700
- trunk port
  - and 802.1X authentication, 387, 389
- tunnels, 102
  - interfaces, 1221

## U

- UDP relay, 1240
- uploading files, 566
- USB auto configuration
  - example, 599
  - files, 584-585
  - understanding, 584
- USB flash drive, example, 581
- USB port
  - N1500, 122
  - N2000, 131
  - N3000E-ON, 161
- user security model, SNMP, 514
- users

- authenticated, 371
- captive portal, 408
- IAS database, 366

USM, 514

## V

ventilation system

- N1500, 123
- N2000, 133
- N3000E-ON, 165

virtual link, OSPF, 1336

VLAN, 1092

- authenticated and unauthenticated, 361
- CLI configuration, 827
- defaults, 806
- defining membership, 808
- double, 94
- double-VLAN tagging, 792
- dynamic, 362
- dynamically created, 388
- example, 866
- guest, 94, 363, 387-388
- IP subnet-based, 93
- MAC-based, 93, 790
- port-based, 93, 790
- private, 799, 855
- protocol-based, 93, 790
- RADIUS-assigned, 388
- routing, 99
- routing interfaces, 1219, 1231
- static, 790
- support, 93

- switchport modes, 681
- trunk port, 700
- understanding, 787
- voice, 94, 796
- voice traffic, 794
- voice, example, 843
- voice, understanding, 793
- web-based configuration, 808

VLAN priority tag and iSCSI, 665

VLAN routing, 1219, 1222

VLAN tagging, 790

voice traffic, identifying, 794

voice VLAN, 796

- and LLDP-MED, 797
- example, 843
- understanding, 793

VoIP, 104

- Auto VoIP, 1595
- with DiffServ, 1560

VRF, 100, 1357

- configuration example, 1357
- overview, 1355
- sharing routes and ARP entries, 1356

VRRP, 102

- accept mode, 1379
- CLI configuration, 1390
- defaults, 1381
- example, 1392
- interface tracking, 1379
- load sharing example, 1392
- preemption, 1378
- route and interface tracking







Printed in the U.S.A.

[www.dell.com](http://www.dell.com) | [support.dell.com](http://support.dell.com)

