

Dell PowerEdge Configuration Guide for the M I/O Aggregator

9.14.1.5

Notes, cautions, and warnings

 **NOTE:** A NOTE indicates important information that helps you make better use of your product.

 **CAUTION:** A CAUTION indicates either potential damage to hardware or loss of data and tells you how to avoid the problem.

 **WARNING:** A WARNING indicates a potential for property damage, personal injury, or death.

Chapter 1: About this Guide	13
Audience.....	13
Conventions.....	13
Information Symbols.....	13
Related Documents.....	14
Chapter 2: Before You Start	15
Operational Modes.....	15
Default Settings.....	16
Other Auto-Configured Settings.....	16
Data Center Bridging Support.....	17
FCoE Connectivity and FIP Snooping	17
iSCSI Operation.....	17
Link Aggregation	17
Link Tracking.....	18
Configuring VLANs.....	18
Uplink LAG.....	18
Server-Facing LAGs.....	18
Where to Go From Here	18
Deploying FN I/O Module.....	19
Configuration Examples.....	19
Ensuring the FN IOM system is in Standalone Mode.....	21
Configure Interfaces and Port Channel.....	21
Verifying the Configurations.....	22
Chapter 3: Configuration Fundamentals	23
Accessing the Command Line.....	23
CLI Modes.....	24
Navigating CLI Modes.....	24
The do Command.....	25
Undoing Commands.....	25
Obtaining Help.....	26
Entering and Editing Commands.....	26
Command History.....	27
Filtering show Command Outputs.....	27
Multiple Users in Configuration Mode.....	28
Configuring a Unique Host Name on the System.....	29
Enabling Secured CLI Mode.....	29
Viewing the Reason for Last System Reboot.....	29
Chapter 4: Configuration Cloning	30
Cloning Configuration Output Status.....	30
Chapter 5: Data Center Bridging (DCB)	33

Ethernet Enhancements in Data Center Bridging.....	33
Priority-Based Flow Control.....	34
Enhanced Transmission Selection.....	35
Data Center Bridging Exchange Protocol (DCBx).....	36
Data Center Bridging in a Traffic Flow.....	37
Enabling Data Center Bridging.....	37
Configuring DCB Maps and its Attributes.....	38
Data Center Bridging: Default Configuration.....	40
Data Center Bridging: Auto-DCB-Enable Mode.....	40
Configuring Priority-Based Flow Control.....	42
How Priority-Based Flow Control is Implemented.....	44
Configuring Enhanced Transmission Selection.....	44
How Enhanced Transmission Selection is Implemented.....	44
ETS Operation with DCBx.....	45
Hierarchical Scheduling in ETS Output Policies.....	45
DCBx Operation.....	46
DCBx Operation.....	46
DCBx Port Roles.....	46
DCB Configuration Exchange.....	47
Configuration Source Election.....	48
Propagation of DCB Information.....	48
Auto-Detection of the DCBx Version.....	48
DCBx Example.....	49
DCBx Prerequisites and Restrictions.....	50
DCBx Error Messages.....	50
Debugging DCBx on an Interface.....	50
Verifying the DCB Configuration.....	51
QoS dot1p Traffic Classification and Queue Assignment.....	60
Troubleshooting PFC, ETS, and DCBx Operation.....	60
Configuring the Dynamic Buffer Method.....	61
Chapter 6: Dynamic Host Configuration Protocol (DHCP).....	63
Assigning an IP Address using DHCP.....	63
Debugging DHCP Client Operation.....	65
DHCP Client.....	66
How DHCP Client is Implemented.....	67
DHCP Client on a Management Interface.....	67
DHCP Client on a VLAN.....	68
DHCP Packet Format and Options.....	68
Option 82.....	69
Releasing and Renewing DHCP-based IP Addresses.....	69
Viewing DHCP Statistics and Lease Information.....	70
Chapter 7: FIP Snooping.....	71
Fibre Channel over Ethernet.....	71
Ensuring Robustness in a Converged Ethernet Network.....	71
FIP Snooping on Ethernet Bridges.....	72
How FIP Snooping is Implemented.....	74
FIP Snooping on VLANs.....	74

FC-MAP Value	74
Bridge-to-FCF Links	74
Impact on other Software Features	74
FIP Snooping Prerequisites	75
FIP Snooping Restrictions.....	75
Configuring FIP Snooping.....	75
Displaying FIP Snooping Information.....	76
FIP Snooping Example.....	81
Debugging FIP Snooping.....	82
Chapter 8: Internet Group Management Protocol (IGMP)	83
IGMP Overview.....	83
IGMP Version 2.....	83
Joining a Multicast Group.....	84
Leaving a Multicast Group.....	84
IGMP Version 3.....	84
Joining and Filtering Groups and Sources.....	85
Leaving and Staying in Groups.....	86
IGMP Snooping.....	86
How IGMP Snooping is Implemented on an Aggregator.....	86
Disabling Multicast Flooding.....	86
Displaying IGMP Information.....	87
Chapter 9: Interfaces	89
Interface Auto-Configuration.....	90
Interface Types.....	90
Viewing Interface Information	90
Disabling and Re-enabling a Physical Interface.....	92
Layer 2 Mode.....	92
Management Interfaces	93
Accessing an Aggregator	93
Configuring a Management Interface.....	93
Configuring a Static Route for a Management Interface.....	94
VLAN Membership.....	94
Default VLAN	94
Port-Based VLANs	95
VLANs and Port Tagging.....	95
Configuring VLAN Membership.....	95
Displaying VLAN Membership	96
Adding an Interface to a Tagged VLAN	96
Adding an Interface to an Untagged VLAN	97
VLAN Configuration on Physical Ports and Port-Channels.....	97
Port Channel Interfaces	99
Port Channel Definitions and Standards	99
Port Channel Benefits.....	99
Port Channel Implementation.....	99
1GbE and 10GbE Interfaces in Port Channels	100
Uplink Port Channel: VLAN Membership	100
Server-Facing Port Channel: VLAN Membership	100

Displaying Port Channel Information	100
Interface Range	102
Bulk Configuration Examples	102
Monitor and Maintain Interfaces.....	103
Maintenance Using TDR.....	104
Configuring wavelength for 10–Gigabit SFP+ optics.....	104
Flow Control Using Ethernet Pause Frames	105
Enabling Pause Frames.....	105
MTU Size.....	106
Setting the Speed and Duplex Mode of Ethernet Interfaces.....	107
Auto-Negotiation on Ethernet Interfaces.....	108
Setting Auto-Negotiation Options.....	109
Viewing Interface Information	110
Clearing Interface Counters.....	111
Enabling the Management Address TLV on All Interfaces of an Aggregator.....	112
Enhanced Validation of Interface Ranges.....	112
Enhanced Control of Remote Fault Indication Processing.....	112
Chapter 10: iSCSI Optimization	113
iSCSI Optimization Overview.....	113
Monitoring iSCSI Traffic Flows.....	114
Information Monitored in iSCSI Traffic Flows.....	114
Detection and Auto configuration for Dell EqualLogic Arrays.....	115
iSCSI Optimization: Operation.....	115
Displaying iSCSI Optimization Information.....	115
Chapter 11: Isolated Networks for Aggregators	117
Configuring and Verifying Isolated Network Settings.....	117
Chapter 12: Link Aggregation	118
How the LACP is Implemented on an Aggregator.....	118
Uplink LAG.....	119
Server-Facing LAGs.....	119
LACP Modes.....	119
Auto-Configured LACP Timeout.....	119
LACP Example.....	120
Link Aggregation Control Protocol (LACP).....	120
Configuration Tasks for Port Channel Interfaces.....	121
Creating a Port Channel.....	121
Adding a Physical Interface to a Port Channel.....	121
Reassigning an Interface to a New Port Channel.....	123
Configuring the Minimum Oper Up Links in a Port Channel.....	123
Configuring VLAN Tags for Member Interfaces.....	124
Deleting or Disabling a Port Channel.....	124
Configuring Auto LAG.....	124
Configuring the Minimum Number of Links to be Up for Uplink LAGs to be Active.....	126
Optimizing Traffic Disruption Over LAG Interfaces On IOA Switches in VLT Mode.....	127
Preserving LAG and Port Channel Settings in Nonvolatile Storage.....	127
Enabling LACP link-fallback.....	127

Enabling the Verification of Member Links Utilization in a LAG Bundle.....	128
Monitoring the Member Links of a LAG Bundle.....	128
Verifying LACP Operation and LAG Configuration.....	129
Multiple Uplink LAGs.....	132
Multiple Uplink LAGs with 10G Member Ports.....	132
Multiple Uplink LAGs with 40G Member Ports.....	134
Chapter 13: Layer 2.....	136
Managing the MAC Address Table.....	136
Clearing the MAC Address Entries.....	136
Displaying the MAC Address Table.....	137
Network Interface Controller (NIC) Teaming.....	137
MAC Address Station Move.....	138
MAC Move Optimization.....	139
Chapter 14: Link Layer Discovery Protocol (LLDP).....	140
Protocol Data Units.....	140
Configure LLDP.....	141
CONFIGURATION versus INTERFACE Configurations.....	142
Enabling LLDP.....	143
Disabling and Undoing LLDP.....	143
Advertising TLVs.....	143
Optional TLVs.....	144
Management TLVs.....	144
IEEE Organizationally Specific TLVs.....	144
LLDP-MED Capabilities TLV.....	146
LLDP-MED Network Policies TLV.....	146
Extended Power via MDI TLV.....	147
LLDP Operation.....	148
Storing and Viewing Unrecognized LLDP TLVs.....	148
Viewing the LLDP Configuration.....	149
Viewing Information Advertised by Adjacent LLDP Agents.....	150
Configuring LLDPDU Intervals.....	151
Configuring a Time to Live.....	151
Clearing LLDP Counters.....	152
Debugging LLDP.....	152
Relevant Management Objects.....	153
Chapter 15: Object Tracking.....	158
Object Tracking Overview.....	158
Track Layer 2 Interfaces.....	159
Track Layer 3 Interfaces.....	159
Track IPv4 and IPv6 Routes.....	159
Set Tracking Delays.....	160
VRRP Object Tracking.....	160
Object Tracking Configuration.....	160
Tracking a Layer 2 Interface.....	160
Tracking a Layer 3 Interface.....	161
Track an IPv4/IPv6 Route.....	162

Displaying Tracked Objects.....	163
Chapter 16: Port Monitoring.....	165
Configuring Port Monitoring.....	165
Important Points to Remember.....	166
Port Monitoring.....	167
Chapter 17: Security.....	169
Understanding Banner Settings.....	169
Accessing the I/O Aggregator Using the CMC Console Only.....	169
AAA Authentication.....	170
Configuration Task List for AAA Authentication.....	170
AAA Authorization.....	173
Privilege Levels Overview.....	173
Configuration Task List for Privilege Levels.....	173
RADIUS.....	176
RADIUS Authentication.....	177
Configuration Task List for RADIUS.....	178
TACACS+.....	180
Configuration Task List for TACACS+.....	180
TACACS+ Remote Authentication.....	181
Enabling SCP and SSH.....	182
Using SCP with SSH to Copy a Software Image.....	183
Secure Shell Authentication.....	184
Troubleshooting SSH.....	186
Telnet.....	186
VTY Line and Access-Class Configuration.....	187
VTY Line Local Authentication and Authorization.....	187
VTY Line Remote Authentication and Authorization.....	188
VTY MAC-SA Filter Support.....	188
Dell EMC Networking OS Security Hardening.....	188
Dell EMC Networking OS Image Verification.....	188
Startup Configuration Verification.....	189
Configuring the root User Password.....	190
Enabling User Lockout for Failed Login Attempts.....	191
Chapter 18: Simple Network Management Protocol (SNMP).....	192
Implementation Information.....	193
Configuring the Simple Network Management Protocol.....	193
Important Points to Remember.....	193
Setting up SNMP.....	193
Creating a Community.....	193
Setting Up User-Based Security (SNMPv3).....	194
Subscribing to Managed Object Value Updates using SNMP.....	195
Enabling a Subset of SNMP Traps.....	195
Reading Managed Object Values.....	197
Displaying the Ports in a VLAN using SNMP.....	198
Fetching Dynamic MAC Entries using SNMP.....	199
Deriving Interface Indices.....	200

MIB Support to Display Reason for Last System Reboot.....	201
Viewing the Reason for Last System Reboot Using SNMP.....	201
MIB Support to Display Egress Queue Statistics.....	201
Monitoring BGP sessions via SNMP.....	202
Monitor Port-Channels.....	203
Entity MIBS.....	205
SNMP Traps for Link Status.....	206
Standard VLAN MIB.....	206
MIB Support to Display the Available Memory Size on Flash.....	208
Viewing the Available Flash Memory Size.....	208
MIB Support to Display the Software Core Files Generated by the System.....	208
Viewing the Software Core Files Generated by the System.....	209
MIB Support to Display the Available Partitions on Flash.....	209
Viewing the Available Partitions on Flash.....	209
MIB Support to Display Egress Queue Statistics.....	210
MIB Support to Display Egress Queue Statistics.....	211
Viewing the ECMP Group Count Information.....	211
MIB Support for entAliasMappingTable	214
Viewing the entAliasMappingTable MIB.....	214
MIB Support for LAG.....	215
Viewing the LAG MIB.....	216
MIB Support to Display Unrecognized LLDP TLVs.....	216
MIB Support to Display Reserved Unrecognized LLDP TLVs.....	216
MIB Support to Display Organizational Specific Unrecognized LLDP TLVs.....	217
Transceiver Monitoring.....	218
Chapter 19: Stacking.....	220
Stacking Aggregators.....	220
Stack Management Roles.....	221
Stack Master Election.....	222
Failover Roles.....	222
MAC Addressing.....	222
Stacking LAG.....	222
Stacking VLANs.....	223
Stacking Port Numbers.....	224
Stacking in PMUX Mode.....	224
Configuring a Switch Stack.....	225
Stacking Prerequisites.....	225
Master Selection Criteria.....	225
Configuring Priority and stack-group.....	226
Cabling Stacked Switches.....	226
Accessing the CLI.....	227
Configuring and Bringing Up a Stack.....	227
Adding a Stack Unit.....	228
Resetting a Unit on a Stack.....	228
Removing an Aggregator from a Stack and Restoring Quad Mode.....	228
Configuring the Uplink Speed of Interfaces as 40 Gigabit Ethernet.....	229
Merging Two Operational Stacks.....	230
Verifying a Stack Configuration.....	230
Using Show Commands.....	231

Troubleshooting a Switch Stack.....	232
Failure Scenarios.....	234
Upgrading a Switch Stack.....	236
Upgrading a Single Stack Unit.....	237
Chapter 20: Storm Control.....	238
Configure Storm Control.....	238
Configuring Storm Control from CONFIGURATION Mode.....	238
Configuring Storm Control from INTERFACE Mode.....	239
Chapter 21: Broadcast Storm Control.....	240
Disabling Broadcast Storm Control.....	240
Displaying Broadcast-Storm Control Status.....	240
Configuring Storm Control.....	240
Chapter 22: SupportAssist.....	241
Configuring SupportAssist Using a Configuration Wizard.....	241
Configuring SupportAssist Manually.....	242
Configuring SupportAssist Activity.....	243
Configuring SupportAssist Company.....	245
Configuring SupportAssist Person.....	245
Configuring SupportAssist Server.....	246
Viewing SupportAssist Configuration.....	247
Chapter 23: System Time and Date.....	249
Setting the Time for the Software Clock.....	249
Setting the Timezone.....	249
Setting Daylight Savings Time.....	250
Setting Daylight Saving Time Once.....	250
Setting Recurring Daylight Saving Time.....	250
Configuring the Offset-Threshold for NTP Audit Log.....	251
Configuring NTP control key password.....	252
Chapter 24: Uplink Failure Detection (UFD).....	253
Feature Description.....	253
How Uplink Failure Detection Works.....	254
UFD and NIC Teaming.....	255
Important Points to Remember.....	256
Uplink Failure Detection (SMUX mode).....	256
Configuring Uplink Failure Detection (PMUX mode).....	257
Clearing a UFD-Disabled Interface (in PMUX mode).....	258
Displaying Uplink Failure Detection.....	259
Sample Configuration: Uplink Failure Detection.....	261
Chapter 25: PMUX Mode of the IO Aggregator.....	263
I/O Aggregator (IOA) Programmable MUX (PMUX) Mode.....	263
Configuring and Changing to PMUX Mode.....	263
Configuring the Commands without a Separate User Account.....	264
Virtual Link Trunking (VLT).....	264

Overview.....	264
Setting up VLT.....	265
Virtual Link Trunking (VLT) in PMUX Mode.....	266
VLT Terminology.....	268
Configure Virtual Link Trunking.....	269
Verifying a VLT Configuration.....	272
Additional VLT Sample Configurations.....	275
Troubleshooting VLT.....	275
Chapter 26: FC Flex IO Modules.....	277
FC Flex IO Modules.....	277
Understanding and Working of the FC Flex IO Modules.....	277
FC Flex IO Modules Overview.....	277
FC Flex IO Module Capabilities and Operations.....	278
Guidelines for Working with FC Flex IO Modules.....	279
Processing of Data Traffic.....	280
Installing and Configuring the Switch.....	281
Interconnectivity of FC Flex IO Modules with Cisco MDS Switches.....	283
Fibre Channel over Ethernet for FC Flex IO Modules.....	284
Chapter 27: FC FLEXIO FPORT.....	286
FC FLEXIO FPORT.....	286
Configuring Switch Mode to FCF Port Mode.....	286
Name Server.....	287
FCoE Maps.....	287
Creating an FCoE Map.....	288
Zoning.....	289
Creating Zone and Adding Members.....	289
Creating Zone Alias and Adding Members.....	289
Creating Zonesets.....	290
Activating a Zoneset.....	290
Displaying the Fabric Parameters.....	290
Chapter 28: NPIV Proxy Gateway.....	294
NPIV Proxy Gateway Configuration.....	294
NPIV Proxy Gateway Operations and Capabilities.....	294
NPIV Proxy Gateway Operation	294
NPIV Proxy Gateway: Protocol Services.....	295
NPIV Proxy Gateway Functionality.....	295
NPIV Proxy Gateway: Terms and Definitions.....	295
Configuring an NPIV Proxy Gateway.....	297
Enabling Fibre Channel Capability on the Switch.....	298
Creating a DCB Map	298
Applying a DCB Map on Server-facing Ethernet Ports	299
Creating an FCoE VLAN.....	299
Creating an FCoE Map	300
Applying an FCoE Map on Server-facing Ethernet Ports.....	300
Applying an FCoE Map on Fabric-facing FC Ports.....	301
Sample Configuration.....	302

Displaying NPIV Proxy Gateway Information.....	302
show interfaces status Command Example.....	303
show fcoe-map Command Examples	304
show qos dcb-map Command Examples	304
show npiv devices brief Command Example.....	305
show npiv devices Command Example	306
show fc switch Command Example	307
Chapter 29: Upgrade Procedures.....	308
Chapter 30: Debugging and Diagnostics.....	309
Debugging Aggregator Operation.....	309
All interfaces on the Aggregator are operationally down.....	309
Broadcast, unknown multicast, and DLF packets switched at a very low rate.....	310
Flooded packets on all VLANs are received on a server.....	310
Software show Commands.....	311
Offline Diagnostics.....	312
Important Points to Remember.....	313
Running Offline Diagnostics.....	313
Trace Logs.....	314
Auto Save on Crash or Rollover.....	314
Using the Show Hardware Commands.....	314
Environmental Monitoring.....	315
Recognize an Over-Temperature Condition.....	316
Troubleshoot an Over-Temperature Condition.....	317
Recognize an Under-Voltage Condition.....	317
Troubleshoot an Under-Voltage Condition.....	318
Buffer Tuning.....	318
Deciding to Tune Buffers.....	319
Sample Buffer Profile Configuration.....	322
Troubleshooting Packet Loss.....	322
Displaying Drop Counters.....	323
Dataplane Statistics.....	324
Displaying Stack Port Statistics.....	325
Enabling Buffer Statistics Tracking	325
Restoring the Factory Default Settings.....	327
Chapter 31: Standards Compliance.....	329
IEEE Compliance.....	329
RFC and I-D Compliance.....	329
General Internet Protocols.....	330
General IPv4 Protocols.....	330
Network Management.....	331
MIB Location.....	333

About this Guide

This guide describes the supported protocols and software features, and provides configuration instructions and examples, for the Dell Networking M I/O Aggregator running Dell Networking OS version 9.7(0.0).

The M I/O Aggregator is installed in a Dell PowerEdge M I/O Aggregator. For information about how to install and perform the initial switch configuration, refer to the *Getting Started Guides* on the Dell Support website at <http://www.dell.com/support/manuals>

Though this guide contains information about protocols, it is not intended to be a complete reference. This guide is a reference for configuring protocols on Dell Networking systems. For complete information about protocols, refer to other documentation, including IETF requests for comment (RFCs). The instructions in this guide cite relevant RFCs, and Standards Compliance contains a complete list of the supported RFCs and management information base files (MIBs).

 **NOTE:** You can perform some of the configuration tasks described in this document by using either the Dell command line or the chassis management controller (CMC) graphical interface. Tasks supported by the CMC interface are shown with the CMC icon: CMC

Topics:

- [Audience](#)
- [Conventions](#)
- [Information Symbols](#)
- [Related Documents](#)

Audience

This document is intended for system administrators who are responsible for configuring and maintaining networks and assumes knowledge in Layer 2 and Layer 3 networking technologies.

Conventions

This guide uses the following conventions to describe command syntax.

Keyword	Keywords are in Courier (a monospaced font) and must be entered in the CLI as listed.
<i>parameter</i>	Parameters are in italics and require a number or word to be entered in the CLI.
{X}	Keywords and parameters within braces must be entered in the CLI.
[X]	Keywords and parameters within brackets are optional.
x y	Keywords and parameters separated by a bar require you to choose one option.
x y	Keywords and parameters separated by a double bar allows you to choose any or all of the options.

Information Symbols

This book uses the following information symbols.

 **NOTE:** The Note icon signals important operational information.

 **CAUTION:** The Caution icon signals information about situations that could result in equipment damage or loss of data.

 **NOTE:** The Warning icon signals information about hardware handling that could result in injury.

* (Exception). This symbol is a note associated with additional text on the page that is marked with an asterisk.

Related Documents

For more information about the Dell PowerEdge M I/O Aggregator MXL 10/40GbE Switch IO Module, refer to the following documents:

- *Dell Networking OS Command Line Reference Guide for the M I/O Aggregator*
- *Dell Networking OS Getting Started Guide for the M I/O Aggregator*
- *Release Notes for the M I/O Aggregator*

Before You Start

To install the Aggregator in a Dell PowerEdge M1000e Enclosure, use the instructions in the Dell PowerEdge M I/O Aggregator Getting Started Guide that is shipped with the product. The I/O Aggregator (also known as Aggregator) installs with zero-touch configuration. After you power it on, an Aggregator boots up with default settings and auto-configures with software features enabled. This chapter describes the default settings and software features that are automatically configured at startup. To reconfigure the Aggregator for customized network operation, use the tasks described in the other chapters.

Topics:

- [Operational Modes](#)
- [Default Settings](#)
- [Other Auto-Configured Settings](#)
- [Data Center Bridging Support](#)
- [FCoE Connectivity and FIP Snooping](#)
- [iSCSI Operation](#)
- [Link Aggregation](#)
- [Link Tracking](#)
- [Configuring VLANs](#)
- [Where to Go From Here](#)
- [Deploying FN I/O Module](#)

Operational Modes

IOA supports four operational modes. Select the operational mode that meets your deployment needs. To enable a new operational mode, reload the switch.

Standalone mode

stack-unit *unit* iom-mode standalone

CONFIGURATION mode

```
Dell(conf)#stack-unit 0 iom-mode standalone
```

This mode is the default mode for IOA. It is a fully automated zero-touch mode that allows you to configure VLAN memberships. (Supported in CMC)

VLT mode

stack-unit *unit* iom-mode vlt

CONFIGURATION mode

```
Dell(conf)#stack-unit 0 iom-mode vlt
```

Select this mode to multihomed server interfaces to different IOA modules. This mode is a low-touch mode where all configuration except VLAN membership is automated. To enable VLAN, configure the VLANs at the server port level. In this mode, port 9 link, which is associated with LAG-127, is dedicated to VLT interconnect.

Programmable MUX mode

stack-unit *unit* iom-mode programmable-mux

CONFIGURATION mode

```
Dell(conf)#stack-unit 0 iom-mode programmable-mux
```

Select this mode to configure PMUX mode CLI commands.

For more information on the PMUX mode, see [PMUX Mode of the IO Aggregator](#).

Stacking mode

stack-unit unit iom-mode stack

CONFIGURATION mode

```
Dell(conf)#stack-unit 0 iom-mode stack
```

Select this mode to configure Stacking mode CLI commands.

For more information on the Stacking mode, see [Stacking](#).

Default Settings

The I/O Aggregator provides zero-touch configuration with the following default configuration settings:

- default user name (**root**)
- password (**calvin**)
- VLAN (vlan1) and IP address for in-band management (**DHCP**)
- IP address for out-of-band (OOB) management (**DHCP**)
- read-only SNMP community name (**public**)
- broadcast storm control (**enabled in Standalone mode and disabled in VLT mode**)
- IGMP multicast flooding (**enabled**)
- VLAN configuration (**in Standalone mode, all ports belong to all VLANs**)

You can change any of these default settings using the CLI. Refer to the appropriate chapter for details.

i **NOTE:** You can also change many of the default settings using the chassis management controller (CMC) interface. For information about how to access the CMC to configure the aggregator, refer to the *Dell Chassis Management Controller (CMC) User's Guide* on the Dell Support website at <http://support.dell.com/>

Other Auto-Configured Settings

After the Aggregator powers on, it auto-configures and is operational with software features enabled, including:

- Ports: Ports are administratively up and auto-configured to operate as hybrid ports to transmit tagged and untagged VLAN traffic.

Ports 1 to 32 are internal server-facing ports, which can operate in 10GbE mode. Ports 33 to 56 are external ports auto-configured to operate by default as follows:

- The base-module ports operate in standalone 4x10GbE mode. You can configure these ports to operate in 40GbE stacking mode. When configured for stacking, you cannot use 40GbE base-module ports for uplinks.
- Ports on the 2-Port 40-GbE QSFP+ module operate only in 4x10GbE mode. You cannot use them for stacking.
- Ports on the 4-Port 10-GbE SFP+ and 4-Port 10GBASE-T modules operate only in 10GbE mode.

For more information about how ports are numbered, refer to [Port Numbering](#).

- Link aggregation: All uplink ports are configured in a single LAG (LAG 128).
- VLANs: All ports are configured as members of all (4094) VLANs. All VLANs are up and can send or receive layer 2 traffic. For more information, refer to [VLAN Membership](#).
- Data center bridging capability exchange protocol (DCBx): Server-facing ports auto-configure in auto-downstream port roles; uplink ports auto-configure in auto-upstream port roles.
- Fibre Channel over Ethernet (FCoE) connectivity and FCoE initiation protocol (FIP) snooping: The uplink port channel (LAG 128) is enabled to operate in Fibre channel forwarder (FCF) port mode.
- Link layer discovery protocol (LLDP): Enabled on all ports to advertise management TLV and system name with neighboring devices.
- Internet small computer system interface (iSCSI) optimization.

- Internet group management protocol (IGMP) snooping.
- Jumbo frames: Ports are set to a maximum MTU of 12,000 bytes by default.
- Link tracking: Uplink-state group 1 is automatically configured. In uplink state-group 1, server-facing ports auto-configure as downstream interfaces; the uplink port-channel (LAG 128) auto-configures as an upstream interface. Server-facing links are auto-configured to be brought up only if the uplink port-channel is up.
- In VLT mode, port 9 is automatically configured as VLT interconnect ports. VLT domain configuration is automatic. This includes peer-link, configured MAC, backup link and setting every port channel as VLT port-channel.

Data Center Bridging Support

To eliminate packet loss and provision links with required bandwidth, Data Center Bridging (DCB) enhancements for data center networks are supported.

The aggregator provides zero-touch configuration for DCB. The aggregator auto-configures DCBx port roles as follows:

- Server-facing ports are configured as auto-downstream interfaces.
- Uplink ports are configured as auto-upstream interfaces.

In operation, DCBx auto-configures uplink ports to match the DCB configuration in the ToR switches to which they connect.

The Aggregator supports DCB only in standalone mode.

FCoE Connectivity and FIP Snooping

Many data centers use Fiber Channel (FC) in storage area networks (SANs). Fiber Channel over Ethernet (FCoE) encapsulates Fiber Channel frames over Ethernet networks.

On an Aggregator, the internal ports support FCoE connectivity and connects to the converged network adapter (CNA) in servers. FCoE allows Fiber Channel to use 10-Gigabit Ethernet networks while preserving the Fiber Channel protocol.

The Aggregator also provides zero-touch configuration for FCoE connectivity. The Aggregator auto-configures to match the FCoE settings used in the switches to which it connects through its uplink ports.

FIP snooping is automatically configured on an Aggregator. The auto-configured port channel (LAG 128) operates in FCF port mode.

iSCSI Operation

Support for iSCSI traffic is turned on by default when the Aggregator powers up. No configuration is required.

When an aggregator powers up, it monitors known TCP ports for iSCSI storage devices on all interfaces. When a session is detected, an entry is created and monitored as long as the session is active.

The Aggregator also detects iSCSI storage devices on all interfaces and autoconfigures to optimize performance. Performance optimization operations, such as Jumbo frame size support and disabling storm control on interfaces connected to an iSCSI equallogic (EQL) storage device, are applied automatically.

Link Aggregation

All uplink ports are configured in a single LAG (LAG 128). Server-facing ports are auto-configured as part of link aggregation groups if the corresponding server is configured for LACP-based network interface controller (NIC) teaming. Static LAGs are not supported.

 **NOTE:** The recommended LACP timeout is Long-Timeout mode.

Link Tracking

By default, all server-facing ports are tracked by the operational status of the uplink LAG. If the uplink LAG goes down, the aggregator loses its connectivity and is no longer operational; all server-facing ports are brought down after the specified defer-timer interval, which is 10 seconds by default. If you have configured VLAN, you can reduce the defer time by changing the defer-timer value or remove it by using the `no defer-timer` command.

NOTE: If installed servers do not have connectivity to a switch, check the Link Status LED of uplink ports on the aggregator. If all LEDs are on, to ensure the LACP is correctly configured, check the LACP configuration on the ToR switch that is connected to the aggregator .

Configuring VLANs

By default, in Standalone mode, all aggregator ports belong to all 4094 VLANs and are members of untagged VLAN 1. To configure only the required VLANs on a port, use the CLI or CMC interface.

You can configure VLANs only on server ports. The uplink LAG will automatically get the VLANs, based on the server ports VLAN configuration.

When you configure VLANs on server-facing interfaces (ports from 1 to 32), you can assign VLANs to a port or a range of ports by entering the `vlan tagged` or `vlan untagged` commands in Interface Configuration mode; for example:

```
Dell(conf)# interface range tengigabitethernet 0/2 - 4
Dell(conf-if-range-te-0/2-4)# vlan tagged 5,7,10-12
Dell(conf-if-range-te-0/2-4)# vlan untagged 3
```

Uplink LAG

The tagged VLAN membership of the uplink LAG is automatically configured based on the VLAN configuration of all server-facing ports (ports from 1 to 32).

The untagged VLAN used for the uplink LAG is always the default VLAN.

Server-Facing LAGs

The tagged VLAN membership of a server-facing LAG is automatically configured based on the server-facing ports that are members of the LAG.

The untagged VLAN of a server-facing LAG is configured based on the untagged VLAN to which the lowest numbered server-facing port in the LAG belongs.

NOTE: Dell Networking recommends configuring the same VLAN membership on all LAG member ports.

Where to Go From Here

You can customize the Aggregator for use in your data center network as necessary. To perform additional switch configuration, do one of the following:

- For remote out-of-band management, enter the OOB management interface IP address into a Telnet or SSH client and log in to the switch using the user ID and password to access the CLI.
- For local management using the CLI, use the attached console connection.
- For remote in-band management from a network management station, enter the IP address of the default VLAN and log in to the switch to access the CLI.

In case of a Dell upgrade, you can check to see that an Aggregator is running the latest Dell version by entering the `show version` command. To download Dell version, go to <http://support.dell.com>

For detailed information about how to reconfigure specific software settings, refer to the appropriate chapter.

Deploying FN I/O Module

This section provides design and configuration guidance for deploying the Dell PowerEdge FN I/O Module (FN IOM).

By default the FN IOM is in Standalone Mode. It consists of the following default settings:

Mode	Default Settings
Chassis Management Controller Configuration	Yes
Stacking and VLT	Disabled
Data Center Bridging Exchange Protocol (DCBx)	Enabled
FIP Snooping Bridge (FSB)	Enabled on FN 410S & FN 410T; Disabled on FN 2210S
NPIV Proxy Gateway Mode (NPG)	Enabled in FN 2210S; Disabled on FN 410S & FN 410T
iSCSI Optimization	Enabled
Broadcast Storm Control	Enabled
Internet Group Management Protocol (IGMP) Flood Restrict	Enabled
Network Time Protocol (NTP)	Enabled
Enable and Disable ports	All port enabled by default. Disable ports through Command Line Interface
Uplink Failure Detection (UFD)	Enabled
TACACS+/RADIUS (AAA Auth/Acct; Auth coming up)	Disabled
DHCP	Enabled n client only mode
Internet Group Management Protocol (IGMP) v2 & v3	Enabled
Auto LACP LAG	Enabled on all ports (Uplink created by default based on LACP PDU)
All VLANS	Available on all server and uplink ports

Configuration Examples

Following are the configuration examples for common upstream switches. To establish a functional uplink and bring the network ports on PowerEdge FC-Series servers up (FC830, FC630, FC430, FC 620, and FC420) use the following steps:

1. Ensure that the FN IOM system is in Standalone Mode.
2. Create a LACP LAG on the upstream top of rack switch.

3. Verify the connection.

By default the network ports on the PowerEdge FC-Series servers installed in the FX2 chassis is down, until the uplink port channel is operational on the FN IOM system. It is due to an Uplink Failure Detection, by that when upstream connectivity fails; the FN IOM disables the downstream links.

You can disable the UFD on a preconfigured FN IOM using the following commands:

```
Dell#configure
Dell(conf)#uplink-state-group 1
Dell(conf-uplink-state-group-1)#no enable

Dell#show uplink-state-group
Uplink State Group: 1    Status: Disabled, Down
```

To re-enable UFD, use the following commands:

```
Dell#configure
Dell(conf)#uplink-state-group 1
Dell(conf-uplink-state-group-1)#enable

Dell#show uplink-state-group
Uplink State Group: 1    Status: Enabled, Up
```

Sample FN IOM commands and outputs

In the following, port channel 128 is up. The port channel consists of ports TenGigabitEthernet 0/11 and TenGigabitEthernet 0/12.

```
Dell#show interfaces port-channel 128
Port-channel 128 is up, line protocol is up
Created by LACP protocol
Hardware address is f8:b1:56:6e:fc:59, Current address is f8:b1:56:6e:fc:59
Interface index is 1258356736
Minimum number of links to bring Port-channel up is 1
Internet address is not set
Mode of IPv4 Address Assignment : NONE
DHCP Client-ID :f8b1566efc59
MTU 12000 bytes, IP MTU 11982 bytes
LineSpeed 20000 Mbit
Members in this channel:  Te 0/11(U) Te 0/12(U)
ARP type: ARPA, ARP Timeout 04:00:00
Queueing strategy: fifo
Input Statistics:
  194 packets, 26975 bytes
  40 64-byte pkts, 47 over 64-byte pkts, 83 over 127-byte pkts
  24 over 255-byte pkts, 0 over 511-byte pkts, 0 over 1023-byte pkts
  160 Multicasts, 34 Broadcasts, 0 Unicasts
  0 runts, 0 giants, 0 throttles
  0 CRC, 0 overrun, 0 discarded
Output Statistics:
  1619 packets, 212604 bytes, 0 underruns
  0 64-byte pkts, 201 over 64-byte pkts, 1376 over 127-byte pkts
  42 over 255-byte pkts, 0 over 511-byte pkts, 0 over 1023-byte pkts
  1531 Multicasts, 88 Broadcasts, 0 Unicasts
  0 throttles, 0 discarded, 0 collisions, 0 wredrops
Rate info (interval 299 seconds):
  Input 00.00 Mbits/sec,          0 packets/sec, 0.00% of line-rate
  Output 00.00 Mbits/sec,         1 packets/sec, 0.00% of line-rate
Time since last interface status change: 00:13:45
```

In the following, port channel 128 is down. As a result, the downstream ports (TenGigabitEthernet 0/1 – 8) are disabled by UFD.

```
Dell#show interfaces tengigabitethernet 0/1
TenGigabitEthernet 0/1 is up, line protocol is down(error-disabled[UFD])
Hardware is DellEth, address is f8:b1:56:6e:fc:59
  Current address is f8:b1:56:6e:fc:59
Server Port AdminState is N/A
Pluggable media not present
Interface index is 1048580
Internet address is not set
Mode of IPv4 Address Assignment : NONE
```

```

DHCP Client-ID :f8b1566efc59
MTU 12000 bytes, IP MTU 11982 bytes
LineSpeed auto
Flowcontrol rx off tx off
ARP type: ARPA, ARP Timeout 04:00:00
Last clearing of "show interface" counters 01:26:42
Queueing strategy: fifo
Input Statistics:
  941 packets, 98777 bytes
  83 64-byte pkts, 591 over 64-byte pkts, 267 over 127-byte pkts
  0 over 255-byte pkts, 0 over 511-byte pkts, 0 over 1023-byte pkts
  694 Multicasts, 247 Broadcasts, 0 Unicasts
  0 runts, 0 giants, 0 throttles
  0 CRC, 0 overrun, 0 discarded
Output Statistics:
  1474 packets, 238933 bytes, 0 underruns
  0 64-byte pkts, 204 over 64-byte pkts, 1071 over 127-byte pkts
  175 over 255-byte pkts, 24 over 511-byte pkts, 0 over 1023-byte pkts
  1198 Multicasts, 276 Broadcasts, 0 Unicasts
  0 throttles, 0 discarded, 0 collisions, 0 wredrops
Rate info (interval 299 seconds):
  Input 00.00 Mbits/sec,          0 packets/sec, 0.00% of line-rate
  Output 00.00 Mbits/sec,        0 packets/sec, 0.00% of line-rate
Time since last interface status change: 00:00:17

```

NOTE: For more information on Uplink Failure Detection and all other configuration settings, see the [Uplink Failure Detection \(UFD\)](#) chapter.

Ensuring the FN IOM system is in Standalone Mode

To ensure that the FN IOM is in Standalone Mode, use the `show system stack-unit 0 iom-mode` command.

```

Dell#show system stack-unit 0 iom-mode
Unit      Boot-Mode          Next-Boot
-----
0         standalone

```

If the FN IOM system is not in the Standalone Mode, reset the system to its factory default state. To reset the system, use the `restore factory-defaults stack-unit 0 clear-all` command. It brings the system in standalone (preconfigured) mode and sets all configuration settings to a known state.

```

Dell#restore factory-defaults stack-unit 0 clear-all
Proceed with factory settings? Confirm [yes/no]:y

```

Configure Interfaces and Port Channel

This section provides the commands for configuring port channels on common upstream switches that are connected to the FN IOM system.

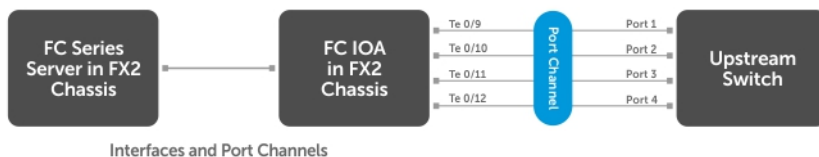

The previous illustration is applicable to the FN 410S and FN 410T servers. If you are using the FN 2210S server in its default configuration, you can only use the TenGigabitethernet 0/11 and TenGigabitethernet 0/12 in the uplink port channel. Ports TenGigabitethernet 0/9 and TenGigabitethernet 0/10 are Fibre Channel ports.

By default on the FN IOM, the external Ethernet ports are preconfigured in port channel 128 with LACP enabled. Port channel 128 is in hybrid (trunk) mode.

To bring up the downstream (server) ports on the FN IOM, port channel 128 must be up. When the Port channel 128 is up, it is connected to a configured port channel on an upstream switch. To enable the Port channel 128, connect any combination of the FN IOM's external Ethernet ports (ports TenGigabitEthernet 0/9-12) to the upstream switch. The port channel may have a minimum of one and a maximum of four links.

Following example configures a port channel on an upstream switch:

- No configuration is required on the FN IOM system. All configurations are done on the upstream switch.
- In the example, four interfaces are configured in the port channel. Configure as many interfaces as you have connected. Change the port numbers to match your switch.
- Any valid ID number can be used for the port channel number on the upstream switch.

```
Dell(conf)#interface range tengigabitethernet 0/1-4
Dell(conf-if-te-0/1)#no shut
Dell(conf-if-te-0/1)#port-channel-protocol lacp
Dell(conf-if-te-0/1-lacp)#port-channel 128 mode active

Dell(conf)#interface port-channel 128
Dell(conf-if-po-128)#portmode hybrid
Dell(conf-if-po-128)#switchport
Dell(conf-if-po-128)#no shut
```

Verifying the Configurations

When the port channel of the upstream switch is configured, the port channel on the FN IOM is up. A series of messages is logged on the system indicating port channel 128 and the ports connected to the servers downstream are up.

```
Changed interface state to up: Po 128

Downstream interface cleared from UFD error-disabled: Te 0/1
Downstream interface cleared from UFD error-disabled: Te 0/2
Downstream interface cleared from UFD error-disabled: Te 0/3
...etc.
```

To verify the status, run the following commands:

```
Dell#show interfaces port-channel 128
Port-channel 128 is up, line protocol is up
```

```
Dell#show uplink-state-group
Uplink State Group: 1    Status: Enabled, Up
```

Configuration Fundamentals

The Dell Networking Operating System (OS) command line interface (CLI) is a text-based interface you can use to configure interfaces and protocols.

The CLI is structured in modes for security and management purposes. Different sets of commands are available in each mode, and you can limit user access to modes using privilege levels.

In Dell Networking OS, after you enable a command, it is entered into the running configuration file. You can view the current configuration for the whole system or for a particular CLI mode. To save the current configuration, copy the running configuration to another location. For more information, refer to [Save the Running-Configuration](#).

NOTE: You can use the chassis management controller (CMC) out-of-band management interface to access and manage an Aggregator using the Dell Networking OS command-line reference. For more information about how to access the CMC to configure an Aggregator, refer to the [Dell Chassis Management Controller \(CMC\) User's Guide](#) on the Dell Support website at <http://support.dell.com/support/edocs/systems/pem/en/index.htm>.

NOTE: You can also perform some of the configurations using the Web GUI - Dell Blade IO Manager. For more information, see the [Dell Blade IO Manager Online Help](#).

Topics:

- [Accessing the Command Line](#)
- [CLI Modes](#)
- [The do Command](#)
- [Undoing Commands](#)
- [Obtaining Help](#)
- [Entering and Editing Commands](#)
- [Command History](#)
- [Filtering show Command Outputs](#)
- [Multiple Users in Configuration Mode](#)
- [Configuring a Unique Host Name on the System](#)
- [Enabling Secured CLI Mode](#)
- [Viewing the Reason for Last System Reboot](#)

Accessing the Command Line

Access the command line through a serial console port or a Telnet session (Logging into the System using Telnet). When the system successfully boots, enter the command line in EXEC mode.

Logging into the System using Telnet

```
telnet 172.31.1.53
Trying 172.31.1.53...
Connected to 172.31.1.53.
Escape character is '^]'.
Login: username
Password:
Dell>
```

CLI Modes

Different sets of commands are available in each mode.

A command found in one mode cannot be executed from another mode (except for EXEC mode commands with a preceding `do` command (refer to the `do` Command section).

The Dell Networking OS CLI is divided into three major mode levels:

- EXEC mode is the default mode and has a privilege level of 1, which is the most restricted level. Only a limited selection of commands is available, notably the `show` commands, which allow you to view system information.
- EXEC Privilege mode has commands to view configurations, clear counters, manage configuration files, run diagnostics, and enable or disable debug operations. The privilege level is 15, which is unrestricted. You can configure a password for this mode.
- CONFIGURATION mode allows you to configure security features, time settings, set logging and SNMP functions, configure static ARP and MAC addresses, and set line cards on the system.

Beneath CONFIGURATION mode are submodes that apply to interfaces, protocols, and features. The following example shows the submode command structure. Two sub-CONFIGURATION modes are important when configuring the chassis for the first time:

- INTERFACE submode is the mode in which you configure Layer 2 protocols and IP services specific to an interface. An interface can be physical (10 Gigabit Ethernet) or logical (Null, port channel, or virtual local area network [VLAN]).
- LINE submode is the mode in which you to configure the console and virtual terminal lines.

NOTE: At any time, entering a question mark (?) displays the available command options. For example, when you are in CONFIGURATION mode, entering the question mark first lists all available commands, including the possible submodes.

The CLI modes are:

```
EXEC
  EXEC Privilege
    CONFIGURATION
      INTERFACE
        10 GIGABIT ETHERNET
        INTERFACE RANGE
        MANAGEMENT ETHERNET
      LINE
        CONSOLE
        VIRTUAL TERMINAL
          MONITOR SESSION
```

Navigating CLI Modes

The Dell prompt changes to indicate the CLI mode.

The following table lists the CLI mode, its prompt, and information about how to access and exit the CLI mode. Move linearly through the command modes, except for the `end` command which takes you directly to EXEC Privilege mode and the `exit` command which moves you up one command mode level.

NOTE: Sub-CONFIGURATION modes all have the letters “conf” in the prompt with more modifiers to identify the mode and slot/port information.

Table 1. Dell Command Modes

CLI Command Mode	Prompt	Access Command
EXEC	Dell>	Access the router through the console or Telnet.
EXEC Privilege	Dell#	<ul style="list-style-type: none">• From EXEC mode, enter the <code>enable</code> command.• From any other mode, use the <code>end</code> command.

Table 1. Dell Command Modes (continued)

CLI Command Mode	Prompt	Access Command
CONFIGURATION	Dell (conf) #	<ul style="list-style-type: none">From EXEC privilege mode, enter the <code>configure</code> command.From every mode except EXEC and EXEC Privilege, enter the <code>exit</code> command.
 NOTE: Access all of the following modes from CONFIGURATION mode.		
10 Gigabit Ethernet Interface	Dell (conf-if-te-0/1) #	<code>interface</code> (INTERFACE modes)
Interface Range	Dell (conf-if-range) #	<code>interface</code> (INTERFACE modes)
Management Ethernet Interface	Dell (conf-if-ma-0/0) #	<code>interface</code> (INTERFACE modes)
MONITOR SESSION	Dell (conf-mon-sess) #	<code>monitor session</code>
CONSOLE	Dell (config-line-console) #	<code>line</code> (LINE Modes)
VIRTUAL TERMINAL	Dell (config-line-vty) #	<code>line</code> (LINE Modes)

The following example shows how to change the command mode from CONFIGURATION mode to INTERFACE configuration mode.

Example of Changing Command Modes

```
Dell(conf)#interface tengigabitethernet 0/2
Dell(conf-if-te-0/2) #
```

The do Command

You can enter an EXEC mode command from any CONFIGURATION mode (CONFIGURATION, INTERFACE, and so on.) without having to return to EXEC mode by preceding the EXEC mode command with the `do` command.

The following example shows the output of the `do` command.

```
Dell(conf)#do show system brief
Stack MAC : 00:01:e8:00:ab:03
-- Stack Info --
Slot UnitType          Status          ReqTyp          CurTyp          Version          Ports
-----
0      Member            not present
1      Management        online          I/O-Aggregator I/O-Aggregator  8-3-17-38
56
2      Member            not present
3      Member            not present
4      Member            not present
5      Member            not present

Dell(conf) #
```

Undoing Commands

When you enter a command, the command line is added to the running configuration file (running-config).

To disable a command and remove it from the running-config, enter the `no` command, then the original command. For example, to delete an IP address configured on an interface, use the `no ip address ip-address` command.

 **NOTE:** Use the help or ? command as described in [Obtaining Help](#).

Example of Viewing Disabled Commands

```
Dell(conf)# interface managementethernet 0/0
Dell(conf-if-ma-0/0)# ip address 192.168.5.6/16
Dell(conf-if-ma-0/0)#
Dell(conf-if-ma-0/0)#
Dell(conf-if-ma-0/0)#show config
!
interface ManagementEthernet 0/0
ip address 192.168.5.6/16
no shutdown
Dell(conf-if-ma-0/0)#
Dell(conf-if-ma-0/0)# no ip address
Dell(conf-if-ma-0/0)#
Dell(conf-if-ma-0/0)# show config
!
interface ManagementEthernet 0/0
no ip address
no shutdown
Dell(conf-if-ma-0/0)#
```

Obtaining Help

Obtain a list of keywords and a brief functional description of those keywords at any CLI mode using the ? or help command:

- To list the keywords available in the current mode, enter ? at the prompt or after a keyword.
- Enter ? after a prompt lists all of the available keywords. The output of this command is the same for the help command.

```
Dell#?
start          Start Shell
capture        Capture Packet
cd             Change current directory
clear          Reset functions
clock          Manage the system clock
configure      Configuring from terminal
copy           Copy from one file to another
--More--
```

- Enter ? after a partial keyword lists all of the keywords that begin with the specified letters.

```
Dell(conf)#cl?
clock
Dell(conf)#cl
```

- Enter [space]? after a keyword lists all of the keywords that can follow the specified keyword.

```
Dell(conf)#clock ?
summer-time    Configure summer (daylight savings) time
timezone       Configure time zone
Dell(conf)#clock
```

Entering and Editing Commands

Notes for entering commands.

- The CLI is not case-sensitive.
- You can enter partial CLI keywords.
 - Enter the minimum number of letters to uniquely identify a command. For example, you cannot enter c1 as a partial keyword because both the c1ock and c1ass-map commands begin with the letters “cl.” You can enter c1o, however, as a partial keyword because only one command begins with those three letters.
- The TAB key auto-completes keywords in commands. Enter the minimum number of letters to uniquely identify a command.
- The UP and DOWN arrow keys display previously entered commands (refer to [Command History](#)).
- The BACKSPACE and DELETE keys erase the previous letter.

- Key combinations are available to move quickly across the command line. The following table describes these short-cut key combinations.

Short-Cut Key Action Combination

CNTL-A	Moves the cursor to the beginning of the command line.
CNTL-B	Moves the cursor back one character.
CNTL-D	Deletes character at cursor.
CNTL-E	Moves the cursor to the end of the line.
CNTL-F	Moves the cursor forward one character.
CNTL-I	Completes a keyword.
CNTL-K	Deletes all characters from the cursor to the end of the command line.
CNTL-L	Re-enters the previous command.
CNTL-N	Return to more recent commands in the history buffer after recalling commands with CTRL-P or the UP arrow key.
CNTL-P	Recalls commands, beginning with the last command.
CNTL-U	Deletes the line.
CNTL-W	Deletes the previous word.
CNTL-X	Deletes the line.
CNTL-Z	Ends continuous scrolling of command outputs.
Esc B	Moves the cursor back one word.
Esc F	Moves the cursor forward one word.
Esc D	Deletes all characters from the cursor to the end of the word.

Command History

Dell Networking OS maintains a history of previously-entered commands for each mode. For example:

- When you are in EXEC mode, the UP and DOWN arrow keys display the previously-entered EXEC mode commands.
- When you are in CONFIGURATION mode, the UP or DOWN arrows keys recall the previously-entered CONFIGURATION mode commands.

Filtering show Command Outputs

Filter the output of a `show` command to display specific information by adding `| [except | find | grep | no-more | save] specified_text` after the command.

The variable `specified_text` is the text for which you are filtering and it IS case sensitive unless you use the `ignore-case` sub-option.

Starting with Dell Networking OS version 7.8.1.0, the `grep` command accepts an `ignore-case` sub-option that forces the search to case-insensitive. For example, the commands:

- `show run | grep Ethernet` returns a search result with instances containing a capitalized "Ethernet," such as `interface TenGigabitEthernet 0/1`.
- `show run | grep ethernet` does not return that search result because it only searches for instances containing a non-capitalized "ethernet."
- `show run | grep Ethernet ignore-case` returns instances containing both "Ethernet" and "ethernet."

The `grep` command displays only the lines containing specified text. The following example shows this command used in combination with the `show linecard all` command.

```
Dell(conf)#do show stack-unit all stack-ports all pfc details | grep 0
stack unit 0 stack-port all
  0 Pause Tx pkts, 0 Pause Rx pkts
  0 Pause Tx pkts, 0 Pause Rx pkts
  0 Pause Tx pkts, 0 Pause Rx pkts
  0 Pause Tx pkts, 0 Pause Rx pkts
  0 Pause Tx pkts, 0 Pause Rx pkts
  0 Pause Tx pkts, 0 Pause Rx pkts
```

NOTE: Dell accepts a space or no space before and after the pipe. To filter a phrase with spaces, underscores, or ranges, enclose the phrase with double quotation marks.

The `except` keyword displays text that does not match the specified text. The following example shows this command used in combination with the `show linecard all` command.

Example of the `except` Keyword

```
Dell(conf)#do show stack-unit all stack-ports all pfc details | except 0

Admin mode is On
Admin is enabled
Local is enabled
Link Delay 65535 pause quantum
Dell(conf)#
```

The `find` keyword displays the output of the `show` command beginning from the first occurrence of specified text. The following example shows this command used in combination with the `show linecard all` command.

Example of the `find` Keyword

```
Dell(conf)#do show stack-unit all stack-ports all pfc details | find 0
stack unit 0 stack-port all
  Admin mode is On
  Admin is enabled
  Local is enabled
  Link Delay 65535 pause quantum
  0 Pause Tx pkts, 0 Pause Rx pkts
Dell(conf)#
```

The `no-more` command displays the output all at once rather than one screen at a time. This is similar to the `terminal length` command except that the `no-more` option affects the output of the specified command only.

The `save` command copies the output to a file for future reference.

NOTE: You can filter a single command output multiple times. The `save` option must be the last option entered. For example: `Dell# command | grep regular-expression | except regular-expression | grep other-regular-expression | find regular-expression | save.`

Multiple Users in Configuration Mode

Dell notifies all users when there are multiple users logged in to CONFIGURATION mode.

A warning message indicates the username, type of connection (console or VTY), and in the case of a VTY connection, the IP address of the terminal on which the connection was established. For example:

- On the system that telnets into the switch, this message appears:

```
% Warning: The following users are currently configuring the system:
User "<username>" on line console0
```

- On the system that is connected over the console, this message appears:

```
% Warning: User "<username>" on line vty0 "10.11.130.2" is in configuration mode
```

If either of these messages appears, Dell Networking recommends coordinating with the users listed in the message so that you do not unintentionally overwrite each other's configuration changes.

Configuring a Unique Host Name on the System

While you can manually configure a host name for the system, you can also configure the system to have a unique host name. The unique host name is a combination of the platform type and the serial number of the system. The unique host name appears in the command prompt. The running configuration gets updated with the `feature unique-name` command. It also overwrites any existing host name configured on the system using the `hostname` command.

To create a unique host name, use the following command.

- Create a unique host name.
CONFIGURATION mode
`feature unique-name`

```
Dell(conf)#feature unique-name
FN2210STW000000000022(conf)#
```

```
FN2210STW000000000022(conf)#no feature unique-name
Dell(conf)#
```

Enabling Secured CLI Mode

The secured CLI mode prevents the users from enhancing the permissions or promoting the privilege levels.

- Enter the following command to enable the secured CLI mode:
CONFIGURATION Mode
`secure-cli enable`

After entering the command, save the running-configuration. Once you save the running-configuration, the secured CLI mode is enabled.

If you do not want to enter the secured mode, do not save the running-configuration. Once saved, to disable the secured CLI mode, you need to manually edit the startup-configuration file and reboot the system.

Viewing the Reason for Last System Reboot

You can view the reason for the last system reboot. To view the reason for the last system reboot, follow this procedure:

- Use the following command to view the reason for the last system reboot:

```
EXEC or EXEC Privilege mode
show reset-reason [stack-unit {unit-number | all}]
```

Enter the `stack-unit` keyword and the stack unit number to view the reason for the last system reboot for that stack unit.

Enter the `stack-unit` keyword and the keyword `all` to view the reason for the last system reboot of all stack units in the stack.

```
DellEMC#show reset-reason
Cause      : Reset by User through CLI command
Reset Time: 11/05/2017-08:36
```

```
DellEMC# show reset-reason stack-unit 1
Cause      : Reset by User through CLI command
Reset Time: 11/05/2017-08:36
```

Configuration Cloning

Configuration Cloning enables you to clone the configuration from one aggregator to one or more aggregators. You can identify the source aggregator where running configuration is check-pointed, extracted and downloaded to the target aggregator for further use. The target aggregator checks the compatibilities of the cloning file based on the version, mode and optional modules. The target aggregator further takes care of the conflicting configurations and appropriately proceeds with the application of the cloning configuration. Select the source or target aggregator and run the CLI commands to achieve the cloning operation and verify the CLI output to check the status of the command execution. By default, the aggregator is enabled with SCP server, so that you can make necessary transfers of cloning configuration file. You can also confirm the configuration status of server using the `show ip ssh` command before proceeding to file transfer. The aggregator takes care of the conflicting configurations between the source aggregator and target aggregator and appropriately informs you to perform the necessary action.

To configure a cloning operation on an aggregator, follow these general configuration steps:

1. Create the cloning configuration in the source aggregator.

```
clone-config create [file-name filename][output xml]
```

```
Dell#clone-config create filename standalone_combo_card
SUCCESS:Cloning configuration created successfully(13)
Dell#
```

2. Check the cloning configuration file compatibility with the current configurations on the target aggregator. The command expects the file specified in the command to be already present in local file system (flash:).

```
clone-config check [file-name filename][output xml]
```

```
WARNING:Release Patch version mismatch(20);
Release time mismatch(21);
Release size mismatch(22);
FC ports have to be reconfigured to Ethernet ports.(28)
NumRebootsRequired : 1
```

3. Add the command usage in the target aggregator.

```
clone-config apply [file-name filename][output xml]
```

```
Dell#clone-config apply filename standalone_combo_card
Jul 23 15:08:11: %STKUNIT0-M:CP %CFGCLONING-1-CFGCLONING_INFO_RELOAD: Reloading
device to apply cloning configuration
Jul 23 15:08:11: %STKUNIT0-M:CP %CHMGR-5-RELOAD: User request to reload the chassis
```

By default, if the filename is not specified in CLI, the file used for the cloning operation is `cloning-config`.

Topics:

- [Cloning Configuration Output Status](#)

Cloning Configuration Output Status

If you specify the XML option in the CLI, the output of the CLI commands is displayed in XML format.

The output includes the following parameters:

- Cloning state displays one of the following status:
 - Success
 - Warning
 - Failure

- Cloning detailed status displays a string that gives detailed description of cloning status. When multiple error or warning messages are present, the status is separated by the ; delimiter.
- Cloning status codes are useful when there are multiple warning or failure messages. Each warning or failure message is given a code number; this status can list the message codes that can be decoded when the cloning status string could not accommodate all the errors and warnings.
- Number of Reboots count the number of reboots required to complete the cloning operation. The reboot details can be displayed only when the clonability check is done.

Table 2. Cloning Status

Cloning state (captured in command output)	Cloning status (captured in command output)	Applicability
Success	Cloning file successfully created	Source
Success	Cloning file compatibility passed	Target
Success	Target IOA is up and running with cloning config.	Target
Failure	Failed to create running-configuration	Source
Failure	Failed to extract release information	Source
Failure	Failed to extract platform information	Source
Failure	Release version info missing in header	Target
Failure	Platform info missing in header	Target
Failure	IOM — mode info missing in header	Target
Failure	Cloning header missing	Target
Failure	Release version mismatch	Target
Failure	Card type mismatch	Target
Failure	Optional -module mismatch at slot <>	Target
Failure	IOM-mode mismatch	Target
Failure	The specified file doesn't exist to check compatibility	Target
Failure	The specified file cannot be applied as it 'failed' compatibility check.	Target
Failure	The specified file has not completed for compatibility check.	Target
Warning	Uplink bandwidth mismatch	Target
Warning	BMP is disabled to complete cloning operation.	Target
Warning	IOM modes are changed from <> to <> to complete cloning operation.	Target
Warning	Minor release version mismatch	Target

If the compatibility check passes through, the target aggregator strips the cloning header and proceeds to parsing actual configuration in the cloning-file. It goes through the configuration one by one and checks if any command or feature requires

in reboot. A counter is maintained to inform the user about number of reboots required to make the target aggregator up and running with the cloning file. The counter is incremented for the first instance that would require reboot. The counter is incremented only when a conflicted or dependent instance is encountered. The counter is not incremented for the cases which are mutually exclusive.

The current list identifies all command that requires reboot to take into effect.

Table 3. Command List — Reboot

Command	Comments
Upgrade system stack-unit <>	Action command, are not present in xxxx- config file
DCB enable autodetect on-next-reload	Comes into picture after subsequent reload
stack-unit stack-number priority 1-14	Stacking specific. Stack config cloning is not supported.
stack-unit stack-number stack-group <>	Stacking specific. Stack config cloning is not supported.
Stack-unit <> renumber <>	
Restore factory defaults	Action command, not present in xxxxx-config file.
Reset stack-unit	Stacking specific
Power-cycle stack-unit <>	Action command, not present in xxxxx-config file.
Global buffer profile	
Cam-acl	Not present in STOMP UI

Clonability Configuration apply command

Based on the status of `check` command on the target aggregator, you can proceed or abort the operation. When the clonability check results in *Failure*, the `clone config apply` is automatically aborted. If clonability check results in *Success*, the `Apply` command proceeds further without any intervention. If the **Check** results in *Warnings*, you are prompted to proceed or abort.

When the cloning configuration is getting committed, no new cloning checks are entertained until the target aggregator device is up and running with the applied clone configuration. A log is generated once the target aggregator is running completely with the cloned configuration.

Data Center Bridging (DCB)

On an I/O Aggregator, data center bridging (DCB) features are auto-configured in standalone mode. You can display information on DCB operation by using **show** commands.

 **NOTE:** DCB features are not supported on an Aggregator in stacking mode.

Supported Modes

Standalone, Stacking, PMUX, VLT

Topics:

- [Ethernet Enhancements in Data Center Bridging](#)
- [Enabling Data Center Bridging](#)
- [Data Center Bridging: Default Configuration](#)
- [Data Center Bridging: Auto-DCB-Enable Mode](#)
- [Configuring Priority-Based Flow Control](#)
- [Configuring Enhanced Transmission Selection](#)
- [Hierarchical Scheduling in ETS Output Policies](#)
- [DCBx Operation](#)
- [Verifying the DCB Configuration](#)
- [QoS dot1p Traffic Classification and Queue Assignment](#)
- [Troubleshooting PFC, ETS, and DCBx Operation](#)
- [Configuring the Dynamic Buffer Method](#)

Ethernet Enhancements in Data Center Bridging

The following section describes DCB.

- The device supports the following DCB features:
 - Data center bridging exchange protocol (DCBx)
 - Priority-based flow control (PFC)
 - Enhanced transmission selection (ETS)

DCB refers to a set of IEEE Ethernet enhancements that provide data centers with a single, robust, converged network to support multiple traffic types, including local area network (LAN), server, and storage traffic. Through network consolidation, DCB results in reduced operational cost, simplified management, and easy scalability by avoiding the need to deploy separate application-specific networks.

For example, instead of deploying an Ethernet network for LAN traffic, additional storage area networks (SANs) to ensure lossless fibre-channel traffic, and a separate InfiniBand network for high-performance inter-processor computing within server clusters, only one DCB-enabled network is required in a data center. The Dell Networking switches that support a unified fabric and consolidate multiple network infrastructures use a single input/output (I/O) device called a converged network adapter (CNA).

A CNA is a computer input/output device that combines the functionality of a host bus adapter (HBA) with a network interface controller (NIC). Multiple adapters on different devices for several traffic types are no longer required.

Data center bridging satisfies the needs of the following types of data center traffic in a unified fabric:

- LAN traffic consists of a large number of flows that are generally insensitive to latency requirements, while certain applications, such as streaming video, are more sensitive to latency. Ethernet functions as a best-effort network that may drop packets in case of network congestion. IP networks rely on transport protocols (for example, TCP) for reliable data transmission with the associated cost of greater processing overhead and performance impact.

- Storage traffic based on Fibre Channel media uses the SCSI protocol for data transfer. This traffic typically consists of large data packets with a payload of 2K bytes that cannot recover from frame loss. To successfully transport storage traffic, data center Ethernet must provide no-drop service with lossless links.
- Servers use InterProcess Communication (IPC) traffic within high-performance computing clusters to share information. Server traffic is extremely sensitive to latency requirements.

To ensure lossless delivery and latency-sensitive scheduling of storage and service traffic and I/O convergence of LAN, storage, and server traffic over a unified fabric, IEEE data center bridging adds the following extensions to a classical Ethernet network:

- 802.1Qbb - Priority-based Flow Control (PFC)
- 802.1Qaz - Enhanced Transmission Selection (ETS)
- 802.1Qau - Congestion Notification
- Data Center Bridging Exchange (DCBx) protocol

NOTE: In Dell Networking OS version 9.4.0.x, only the PFC, ETS, and DCBx features are supported in data center bridging.

Priority-Based Flow Control

In a data center network, priority-based flow control (PFC) manages large bursts of one traffic type in multiprotocol links so that it does not affect other traffic types and no frames are lost due to congestion.

When PFC detects congestion on a queue for a specified priority, it sends a pause frame for the 802.1p priority traffic to the transmitting device. In this way, PFC ensures that large amounts of queued LAN traffic do not cause storage traffic to be dropped, and that storage traffic does not result in high latency for high-performance computing (HPC) traffic between servers.

PFC enhances the existing 802.3x pause and 802.1p priority capabilities to enable flow control based on 802.1p priorities (classes of service). Instead of stopping all traffic on a link (as performed by the traditional Ethernet pause mechanism), PFC pauses traffic on a link according to the 802.1p priority set on a traffic type. You can create lossless flows for storage and server traffic while allowing for loss in case of LAN traffic congestion on the same physical interface.

The following illustration shows how PFC handles traffic congestion by pausing the transmission of incoming traffic with dot1p priority 3.

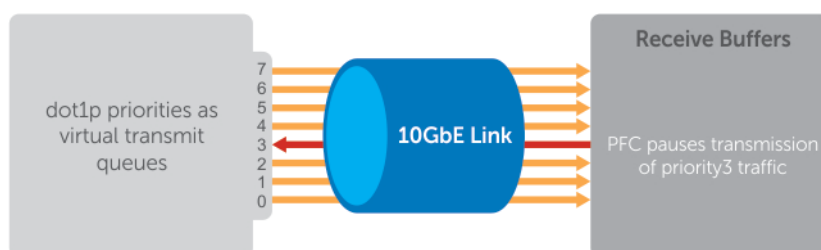

Figure 1. Priority-Based Flow Control

In the system, PFC is implemented as follows:

- PFC is supported on specified 802.1p priority traffic (dot1p 0 to 7) and is configured per interface. However, only two lossless queues are supported on an interface: one for Fibre Channel over Ethernet (FCoE) converged traffic and one for Internet Small Computer System Interface (iSCSI) storage traffic. Configure the same lossless queues on all ports.
- A dynamic threshold handles intermittent traffic bursts and varies based on the number of PFC priorities contending for buffers, while a static threshold places an upper limit on the transmit time of a queue after receiving a message to pause a specified priority. PFC traffic is paused only after surpassing both static and dynamic thresholds for the priority specified for the port.
- By default, PFC is enabled when you enabled DCB. When you enable DCB globally, you cannot simultaneously enable TX and RX on the interface for flow control and link-level flow control is disabled.
- Buffer space is allocated and de-allocated only when you configure a PFC priority on the port.
- PFC delay constraints place an upper limit on the transmit time of a queue after receiving a message to pause a specified priority.
- By default, PFC is enabled on an interface with no dot1p priorities configured. You can configure the PFC priorities if the switch negotiates with a remote peer using DCBX. During DCBX negotiation with a remote peer:

- DCBx communicates with the remote peer by link layer discovery protocol (LLDP) type, length, value (TLV) to determine current policies, such as PFC support and enhanced transmission selection (ETS) BW allocation.
- If the negotiation succeeds and the port is in DCBX Willing mode to receive a peer configuration, PFC parameters from the peer are used to configured PFC priorities on the port. If you enable the link-level flow control mechanism on the interface, DCBX negotiation with a peer is not performed.
- If the negotiation fails and PFC is enabled on the port, any user-configured PFC input policies are applied. If no PFC dcb-map has been previously applied, the PFC default setting is used (no priorities configured). If you do not enable PFC on an interface, you can enable the 802.3x link-level pause function. By default, the link-level pause is disabled, when you disable DCBx and PFC. If no PFC dcb-map has been applied on the interface, the default PFC settings are used.
- PFC supports buffering to receive data that continues to arrive on an interface while the remote system reacts to the PFC operation.
- PFC uses the DCB MIB IEEE802.1azd2.5 and the PFC MIB IEEE802.1bb-d2.2.

If DCBx negotiation is not successful (for example, due to a version or TLV mismatch), DCBx is disabled and you cannot enable PFC or ETS.

Enhanced Transmission Selection

Enhanced transmission selection (ETS) supports optimized bandwidth allocation between traffic types in multiprotocol (Ethernet, FCoE, SCSI) links.

ETS allows you to divide traffic according to its 802.1p priority into different priority groups (traffic classes) and configure bandwidth allocation and queue scheduling for each group to ensure that each traffic type is correctly prioritized and receives its required bandwidth. For example, you can prioritize low-latency storage or server cluster traffic in a traffic class to receive more bandwidth and restrict best-effort LAN traffic assigned to a different traffic class.

Although you can configure strict-priority queue scheduling for a priority group, ETS introduces flexibility that allows the bandwidth allocated to each priority group to be dynamically managed according to the amount of LAN, storage, and server traffic in a flow. Unused bandwidth is dynamically allocated to prioritized priority groups. Traffic is queued according to its 802.1p priority assignment, while flexible bandwidth allocation and the configured queue-scheduling for a priority group is supported.

The following figure shows how ETS allows you to allocate bandwidth when different traffic types are classed according to 802.1p priority and mapped to priority groups.

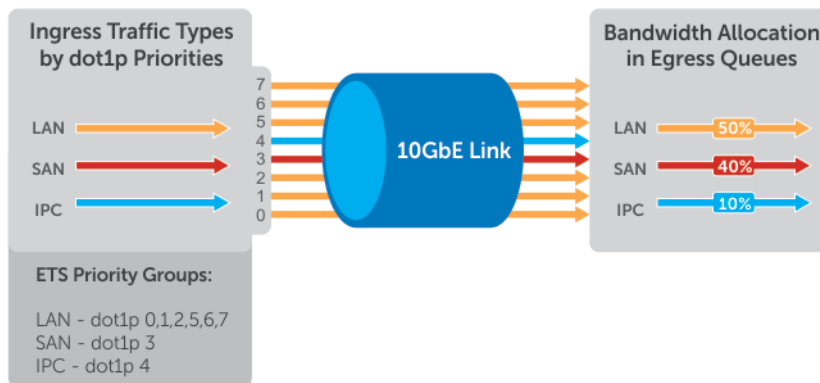

Figure 2. Enhanced Transmission Selection

The following table lists the traffic groupings ETS uses to select multiprotocol traffic for transmission.

Table 4. ETS Traffic Groupings

Traffic Groupings	Description
Priority group	A group of 802.1p priorities used for bandwidth allocation and queue scheduling. All 802.1p priority traffic in a group must have the same traffic handling requirements for latency and frame loss.

Table 4. ETS Traffic Groupings (continued)

Traffic Groupings	Description
Group ID	A 4-bit identifier assigned to each priority group. The range is from 0 to 7.
Group bandwidth	Percentage of available bandwidth allocated to a priority group.
Group transmission selection algorithm (TSA)	Type of queue scheduling a priority group uses.

In the Dell Networking OS, ETS is implemented as follows:

- ETS supports groups of 802.1p priorities that have:
 - PFC enabled or disabled
 - No bandwidth limit or no ETS processing
- Bandwidth allocated by the ETS algorithm is made available after strict-priority groups are serviced. If a priority group does not use its allocated bandwidth, the unused bandwidth is made available to other priority groups so that the sum of the bandwidth use is 100%. If priority group bandwidth use exceeds 100%, all configured priority group bandwidth is decremented based on the configured percentage ratio until all priority group bandwidth use is 100%. If priority group bandwidth usage is less than or equal to 100% and any default priority groups exist, a minimum of 1% bandwidth use is assigned by decreasing 1% of bandwidth from the other priority groups until priority group bandwidth use is 100%.
- For ETS traffic selection, an algorithm is applied to priority groups using:
 - Strict priority shaping
 - ETS shaping
 - (Credit-based shaping is not supported)
- ETS uses the DCB MIB IEEE 802.1azd2.5.

Data Center Bridging Exchange Protocol (DCBx)

The data center bridging exchange (DCBx) protocol is disabled by default on any switch on which PFC or ETS are enabled.

DCBx allows a switch to automatically discover DCB-enabled peers and exchange configuration information. PFC and ETS use DCBx to exchange and negotiate parameters with peer devices. DCBx capabilities include:

- Discovery of DCB capabilities on peer-device connections.
- Determination of possible mismatch in DCB configuration on a peer link.
- Configuration of a peer device over a DCB link.

DCBx requires the link layer discovery protocol (LLDP) to provide the path to exchange DCB parameters with peer devices. Exchanged parameters are sent in organizationally specific TLVs in LLDP data units. For more information, refer to [Link Layer Discovery Protocol \(LLDP\)](#). The following LLDP TLVs are supported for DCB parameter exchange:

PFC parameters PFC Configuration TLV and Application Priority Configuration TLV.

ETS parameters ETS Configuration TLV and ETS Recommendation TLV.

Data Center Bridging in a Traffic Flow

The following figure shows how DCB handles a traffic flow on an interface.

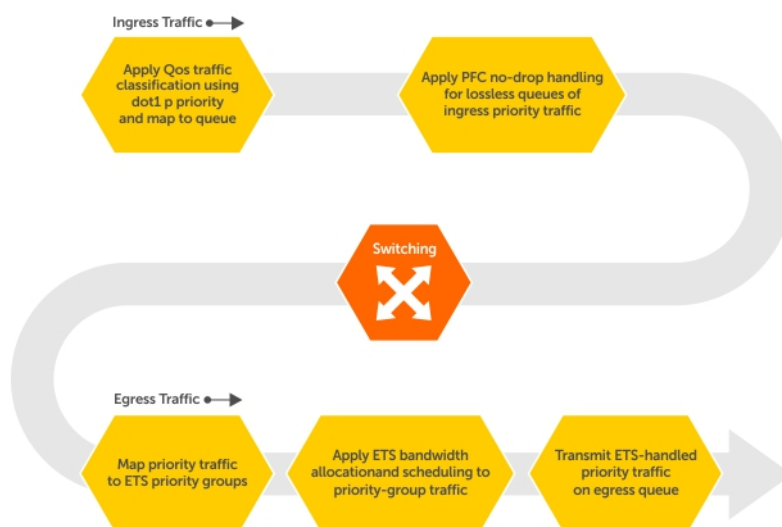

Figure 3. DCB PFC and ETS Traffic Handling

Enabling Data Center Bridging

DCB is automatically configured when you configure FCoE or iSCSI optimization.

Data center bridging supports converged enhanced Ethernet (CEE) in a data center network. DCB is disabled by default. It must be enabled to support CEE.

- Priority-based flow control
- Enhanced transmission selection
- Data center bridging exchange protocol
- FCoE initialization protocol (FIP) snooping

DCB processes virtual local area network (VLAN)-tagged packets and dot1p priority values. Untagged packets are treated with a dot1p priority of 0.

For DCB to operate effectively, you can classify ingress traffic according to its dot1p priority so that it maps to different data queues. The dot1p-queue assignments used are shown in the following table.

To enable DCB, enable either the iSCSI optimization configuration or the FCoE configuration. For information to configure iSCSI optimization, refer to [iSCSI Optimization](#). For information to configure FCoE, refer to [Fibre Channel over Ethernet](#).

To enable DCB with PFC buffers on a switch, enter the following commands, save the configuration, and reboot the system to allow the changes to take effect.

1. Enable DCB.
CONFIGURATION mode
`dcb enable`
2. Set PFC buffering on the DCB stack unit.
CONFIGURATION mode
`dcb stack-unit all pfc-buffering pfc-ports 64 pfc-queues 2`

NOTE: To save the pfc buffering configuration changes, save the configuration and reboot the system.

NOTE: Dell Networking OS Behavior: DCB is not supported if you enable link-level flow control on one or more interfaces. For more information, refer to [Flow Control Using Ethernet Pause Frames](#).

Configuring DCB Maps and its Attributes

This topic contains the following sections that describe how to configure a DCB map, apply the configured DCB map to a port, configure PFC without a DCB map, and configure lossless queues.

DCB Map: Configuration Procedure

A DCB map consists of PFC and ETS parameters. By default, PFC is not enabled on any 802.1p priority and ETS allocates equal bandwidth to each priority. To configure user-defined PFC and ETS settings, you must create a DCB map.

1. Enter global configuration mode to create a DCB map or edit PFC and ETS settings.

```
CONFIGURATION mode
```

```
dcb-map name
```

2. Configure the PFC setting (on or off) and the ETS bandwidth percentage allocated to traffic in each priority group, or whether the priority group traffic should be handled with strict priority scheduling. You can enable PFC on a maximum of two priority queues on an interface. Enabling PFC for dot1p priorities makes the corresponding port queue lossless. The sum of all allocated bandwidth percentages in all groups in the DCB map must be 100%. Strict-priority traffic is serviced first. Afterwards, bandwidth allocated to other priority groups is made available and allocated according to the specified percentages. If a priority group does not use its allocated bandwidth, the unused bandwidth is made available to other priority groups.

```
DCB MAP mode
```

```
priority-group group_num {bandwidth percentage | strict-priority} pfc {on | off}
```

Example: **priority-group 0 bandwidth 60 pfc off priority-group 1 bandwidth 20 pfc on priority-group 2 bandwidth 20 pfc on priority-group 4 strict-priority pfc off**

Repeat this step to configure PFC and ETS traffic handling for each priority group.

3. Specify the dot1p priority-to-priority group mapping for each priority. Priority-group range: 0 to 7. All priorities that map to the same queue must be in the same priority group.

```
DCB MAP mode
```

```
priority-pgid dot1p0_group_num dot1p1_group_num dot1p2_group_num dot1p3_group_num  
dot1p4_group_num dot1p5_group_num dot1p6_group_num dot1p7_group_num
```

Leave a space between each priority group number. For example: **priority-pgid 0 0 0 1 2 4 4 4** in which priority group 0 maps to dot1p priorities 0, 1, and 2; priority group 1 maps to dot1p priority 3; priority group 2 maps to dot1p priority 4; priority group 4 maps to dot1p priorities 5, 6, and 7.

Important Points to Remember

- If you remove a dot1p priority-to-priority group mapping from a DCB map (`no priority pgid` command), the PFC and ETS parameters revert to their default values on the interfaces on which the DCB map is applied. By default, PFC is not applied on specific 802.1p priorities; ETS assigns equal bandwidth to each 802.1p priority.

As a result, PFC and lossless port queues are disabled on 802.1p priorities, and all priorities are mapped to the same priority queue and equally share the port bandwidth.

- To change the ETS bandwidth allocation configured for a priority group in a DCB map, do not modify the existing DCB map configuration. Instead, first create a new DCB map with the desired PFC and ETS settings, and apply the new map to the interfaces to override the previous DCB map settings. Then, delete the original dot1p priority-priority group mapping.

If you delete the dot1p priority-priority group mapping (`no priority pgid` command) before you apply the new DCB map, the default PFC and ETS parameters are applied on the interfaces. This change may create a DCB mismatch with peer DCB devices and interrupt network operation.

Applying a DCB Map on a Port

When you apply a DCB map with PFC enabled on an S6000 interface, a memory buffer for PFC-enabled priority traffic is automatically allocated. The buffer size is allocated according to the number of PFC-enabled priorities in the assigned map.

To apply a DCB map to an Ethernet port, follow these steps:

1. Enter interface configuration mode on an Ethernet port.

```
CONFIGURATION mode
```

```
interface {tengigabitEthernet slot/port | fortygigabitEthernet slot/port
```

2. Apply the DCB map on the Ethernet port to configure it with the PFC and ETS settings in the map; for example:

```
INTERFACE mode
```

```
dcb-map name
```

You cannot apply a DCB map on an interface that has been already configured for PFC using the `pfc priority` command or which is already configured for lossless queues (`pfc no-drop queues` command).

```
Dell# interface tengigabitEthernet 0/0  
Dell(config-if-te-0/0) # dcb-map SAN_A_dcb_map1
```

Repeat Steps 1 and 2 to apply a DCB map to more than one port.

Configuring PFC without a DCB Map

In a network topology that uses the default ETS bandwidth allocation (assigns equal bandwidth to each priority), you can also enable PFC for specific dot1p-priorities on individual interfaces without using a DCB map. This type of DCB configuration is useful on interfaces that require PFC for lossless traffic, but do not transmit converged Ethernet traffic.

1. Enter interface configuration mode on an Ethernet port.

```
CONFIGURATION mode
```

```
interface {tengigabitEthernet slot/port | fortygigabitEthernet slot/port}
```

2. Enable PFC on specified priorities. Range: 0-7. Default: None.

```
INTERFACE mode
```

```
pfc priority priority-range
```

Maximum number of lossless queues supported on an Ethernet port: 2.

Separate priority values with a comma. Specify a priority range with a dash, for example: `pfc priority 3,5-7`

You cannot configure PFC using the `pfc priority` command on an interface on which a DCB map has been applied or which is already configured for lossless queues (`pfc no-drop queues` command).

Configuring Lossless Queues

DCB also supports the manual configuration of lossless queues on an interface after you disable PFC mode in a DCB map and apply the map on the interface. The configuration of no-drop queues provides flexibility for ports on which PFC is not needed, but lossless traffic should egress from the interface.

Lossless traffic egresses out the no-drop queues. Ingress 802.1p traffic from PFC-enabled peers is automatically mapped to the no-drop egress queues.

When configuring lossless queues on a port interface, consider the following points:

- By default, no lossless queues are configured on a port.
- A limit of two lossless queues are supported on a port. If the number of lossless queues configured exceeds the maximum supported limit per port (two), an error message is displayed. You must re-configure the value to a smaller number of queues.
- If you configure lossless queues on an interface that already has a DCB map with PFC enabled (**pfc on**), an error message is displayed.

1. Enter INTERFACE Configuration mode.

```
CONFIGURATION mode
```

```
interface {tengigabitEthernet slot/port | fortygigabitEthernet slot/port}
```

2. Open a DCB map and enter DCB map configuration mode.

```
INTERFACE mode
dcb-map name
```

3. Disable PFC.

```
DCB MAP mode
no pfc mode on
```

4. Return to interface configuration mode.

```
DCB MAP mode
exit
```

5. Apply the DCB map, created to disable the PFC operation, on the interface.

```
INTERFACE mode
dcb-map {name | default}
```

6. Configure the port queues that still function as no-drop queues for lossless traffic. Range: 0-3. Separate queue values with a comma; specify a priority range with a dash; for example: pfc no-drop queues 1,3 or pfc no-drop queues 2-3 Default: No lossless queues are configured.

```
INTERFACE mode
pfc no-drop queues queue-range
```

The maximum number of lossless queues globally supported on a port is 2.

You cannot configure PFC no-drop queues on an interface on which a DCB map with PFC enabled has been applied, or which is already configured for PFC using the `pfc priority` command.

Data Center Bridging: Default Configuration

Before you configure PFC and ETS on a switch see the priority group setting taken into account the following default settings:

DCB is enabled.

PFC and ETS are globally enabled by default.

The default dot1p priority-queue assignments are applied as follows:

```
Dell(conf)#do show qos dot1p-queue-mapping
Dot1p Priority : 0 1 2 3 4 5 6 7
Queue : 0 0 0 1 2 3 3 3
Dell(conf)#
```

 **NOTE:** In Dell Networking OS we support 4 data queues.

PFC is not applied on specific dot1p priorities.

ETS: Equal bandwidth is assigned to each port queue and each dot1p priority in a priority group.

Data Center Bridging: Auto-DCB-Enable Mode

On an Aggregator in standalone or VLT modes, the default mode of operation for data center bridging on Ethernet ports is auto-DCB-enable mode. In this mode, Aggregator ports detect whether peer devices support CEE or not, and enable ETS and PFC or link-level flow control accordingly:

- Interfaces come up with DCB disabled and link-level flow control enabled to control data transmission between the Aggregator and other network devices (see Flow Control Using Ethernet Pause Frames). When DCB is disabled on an interface, PFC, and ETS are also disabled.
- When DCBx protocol packets are received, interfaces automatically enable DCB and disable link-level flow control.

DCB is required for PFC, ETS, DCBx, and FCoE initialization protocol (FIP) snooping to operate.

 **NOTE:** Normally, interfaces do not flap when DCB is automatically enabled.

DCB processes VLAN-tagged packets and dot1p priority values. Untagged packets are treated with a dot1p priority of 0.

For DCB to operate effectively, ingress traffic is classified according to its dot1p priority so that it maps to different data queues. The dot1p-queue assignments used on an Aggregator are shown in Table 6-1 in `dcb enable auto-detect on-next-reload` Command Example QoS dot1p Traffic Classification and Queue Assignment.

When DCB is Disabled (Default) By default, Aggregator interfaces operate with DCB disabled and link-level flow control enabled. When an interface comes up, it is automatically configured with:

- Flow control enabled on input interfaces.
- A DCB-MAP policy is applied with PFC disabled.

The following example shows a default interface configuration with DCB disabled and link-level flow control enabled.

show interfaces Command Example: DCB disabled and Flow Control enabled

```
Dell#show running-config interface te 0/4
!
interface TenGigabitEthernet 0/4
  mtu 12000
  portmode hybrid
  switchport
  auto vlan
  flowcontrol rx on tx off
  dcb-map DCB_MAP_PFC_OFF
!
  protocol lldp
    advertise management-tlv management-address system-name
    dcbx port-role auto-downstream
  no shutdown
Dell#
```

When DCB is Enabled When an interface receives a DCBx protocol packet, it automatically enables DCB and disables link-level flow control. The `dcb-map` and flow control configurations are removed as shown in the following example.

show interfaces Command Example: DCB enabled and Flow Control disabled

```
Dell#show running-config interface te 0/3
!
interface TenGigabitEthernet 0/3
  mtu 12000
  portmode hybrid
  switchport
  auto vlan
!
  protocol lldp
    advertise management-tlv management-address system-name
    dcbx port-role auto-downstream
  no shutdown
Dell#
```

When no DCBx TLVs are received on a DCB-enabled interface for 180 seconds, DCB is automatically disabled and flow control is re-enabled.

Lossless Traffic Handling In auto-DCB-enable mode, Aggregator ports operate with the auto-detection of DCBx traffic. At any moment, some ports may operate with link-level flow control while others operate with DCB-based PFC enabled.

As a result, lossless traffic is ensured only if traffic ingresses on a PFC-enabled port and egresses on another PFC-enabled port.

Lossless traffic is not guaranteed when it is transmitted on a PFC-enabled port and received on a link-level flow control-enabled port, or transmitted on a link-level flow control-enabled port and received on a PFC-enabled port.

Enabling DCB on Next Reload To configure the Aggregator so that all interfaces come up with DCB enabled and flow control disabled, use the `dcb enable on-next-reload` command. Internal PFC buffers are automatically configured.

1. Globally enable DCB on all interfaces after next switch reload.

```
CONFIGURATION mode
dcb enable on-next-reload
```

To reconfigure the Aggregator so that all interfaces come up with DCB disabled and link-level flow control enabled, use the `no dcb enable on-next-reload` command. PFC buffer memory is automatically freed.

Enabling Auto-DCB-Enable Mode on Next Reload To configure the Aggregator so that all interfaces come up in auto-DCB-enable mode with DCB disabled and flow control enabled, use the `dcb enable aut-detect on-next-reload` command.

1. Globally enable auto-detection of DCBx and auto-enabling of DCB on all interfaces after switch reload.

```
CONFIGURATION mode
dcb enable auto-detect on-next-reload
```

Enabling DCB To configure the Aggregator so that all interfaces are DCB enabled and flow control disabled, use the `dcb enable` command.

Disabling DCB To configure the Aggregator so that all interfaces are DCB disabled and flow control enabled, use the `no dcb enable` command.

dcb enable auto-detect on-next-reload Command Example

```
Dell#dcb enable auto-detect on-next-reload
```

Configuring Priority-Based Flow Control

PFC provides a flow control mechanism based on the 802.1p priorities in converged Ethernet traffic received on an interface and is enabled by default when you enable DCB.

As an enhancement to the existing Ethernet pause mechanism, PFC stops traffic transmission for specified priorities (Class of Service (CoS) values) without impacting other priority classes. Different traffic types are assigned to different priority classes.

When traffic congestion occurs, PFC sends a pause frame to a peer device with the CoS priority values of the traffic that is to be stopped. Data Center Bridging Exchange protocol (DCBx) provides the link-level exchange of PFC parameters between peer devices. PFC allows network administrators to create zero-loss links for Storage Area Network (SAN) traffic that requires no-drop service, while retaining packet-drop congestion management for Local Area Network (LAN) traffic.

To ensure complete no-drop service, apply the same DCB input policy with the same pause time and dot1p priorities on all PFC-enabled peer interfaces.

To configure PFC and apply a PFC input policy to an interface, follow these steps.

1. Create a DCB input policy to apply pause or flow control for specified priorities using a configured delay time.

```
CONFIGURATION mode
dcb-input policy-name
The maximum is 32 alphanumeric characters.
```

2. Configure the link delay used to pause specified priority traffic.

```
DCB INPUT POLICY mode
pfc link-delay value
One quantum is equal to a 512-bit transmission.
The range (in quanta) is from 712 to 65535.
The default is 45556 quantum in link delay.
```

3. Configure the CoS traffic to be stopped for the specified delay.

```
DCB INPUT POLICY mode
pfc priority priority-range
Enter the 802.1p values of the frames to be paused.
The range is from 0 to 7.
The default is none.
```

Maximum number of loss less queues supported on the switch: 2.

Separate priority values with a comma. Specify a priority range with a dash, for example: `pfc priority 1,3,5-7`.

4. Enable the PFC configuration on the port so that the priorities are included in DCBx negotiation with peer PFC devices.

```
DCB INPUT POLICY mode
```

```
pfc mode on
```

The default is PFC mode is **on**.

5. (Optional) Enter a text description of the input policy.

```
DCB INPUT POLICY mode
```

```
description text
```

The maximum is 32 characters.

6. Exit DCB input policy configuration mode.

```
DCB INPUT POLICY mode
```

```
exit
```

7. Enter interface configuration mode.

```
CONFIGURATION mode
```

```
interface type slot/port
```

8. Apply the input policy with the PFC configuration to an ingress interface.

```
INTERFACE mode
```

```
dcb-policy input policy-name
```

9. Repeat Steps 1 to 8 on all PFC-enabled peer interfaces to ensure lossless traffic service.

Dell Networking OS Behavior: As soon as you apply a DCB policy with PFC enabled on an interface, DCBx starts exchanging information with PFC-enabled peers. The IEEE802.1Qbb, CEE, and CIN versions of PFC Type, Length, Value (TLV) are supported. DCBx also validates PFC configurations that are received in TLVs from peer devices.

By applying a DCB input policy with PFC enabled, you enable PFC operation on ingress port traffic. To achieve complete lossless handling of traffic, also enable PFC on all DCB egress ports or configure the dot1p priority-queue assignment of PFC priorities to lossless queues.

To remove a DCB input policy, including the PFC configuration it contains, use the `no dcb-input policy-name` command in INTERFACE Configuration mode. To disable PFC operation on an interface, use the `no pfc mode on` command in DCB Input Policy Configuration mode. PFC is enabled and disabled as the global DCB operation is enabled (`dcb enable`) or disabled (`no dcb enable`).

You can enable any number of 802.1p priorities for PFC. Queues to which PFC priority traffic is mapped are lossless by default. Traffic may be interrupted due to an interface flap (going down and coming up) when you reconfigure the lossless queues for no-drop priorities in a PFC input policy and reapply the policy to an interface.

To apply PFC, a PFC peer must support the configured priority traffic (as detected by DCBx).

To honor a PFC pause frame multiplied by the number of PFC-enabled ingress ports, the minimum link delay must be greater than the round-trip transmission time the peer requires.

If you apply an input policy with PFC disabled (`no pfc mode on`):

- You can enable link-level flow control on the interface. To delete the input policy, first disable link-level flow control. PFC is then automatically enabled on the interface because an interface is by default PFC-enabled.
- PFC still allows you to configure lossless queues on a port to ensure no-drop handling of lossless traffic.

 **NOTE:** You cannot enable PFC and link-level flow control at the same time on an interface.

When you apply an input policy to an interface, an error message displays if:

- The PFC dot1p priorities result in more than two lossless port queues globally on the switch.
- Link-level flow control is already enabled. You cannot enable PFC and link-level flow control at the same time on an interface.
- In a switch stack, configure all stacked ports with the same PFC configuration.

A DCB input policy for PFC applied to an interface may become invalid if you reconfigure dot1p-queue mapping. This situation occurs when the new dot1p-queue assignment exceeds the maximum number (2) of lossless queues supported globally on the switch. In this case, all PFC configurations received from PFC-enabled peers are removed and resynchronized with the peer devices.

Traffic may be interrupted when you reconfigure PFC no-drop priorities in an input policy or reapply the policy to an interface.

How Priority-Based Flow Control is Implemented

Priority-based flow control provides a flow control mechanism based on the 802.1p priorities in converged Ethernet traffic received on an interface and is enabled by default. As an enhancement to the existing Ethernet pause mechanism, PFC stops traffic transmission for specified priorities (CoS values) without impacting other priority classes. Different traffic types are assigned to different priority classes.

When traffic congestion occurs, PFC sends a pause frame to a peer device with the CoS priority values of the traffic that needs to be stopped. DCBx provides the link-level exchange of PFC parameters between peer devices. PFC creates zero-loss links for SAN traffic that requires no-drop service, while at the same time retaining packet-drop congestion management for LAN traffic.

PFC is implemented on an Aggregator as follows:

- If DCB is enabled, as soon as a dcb-map with PFC is applied on an interface, DCBx starts exchanging information with PFC-enabled peers. The IEEE802.1Qbb, CEE and CIN versions of PFC TLV are supported. DCBx also validates PFC configurations received in TLVs from peer devices.
- To achieve complete lossless handling of traffic, enable PFC operation on ingress port traffic and on all DCB egress port traffic.
- All 802.1p priorities are enabled for PFC. Queues to which PFC priority traffic is mapped are lossless by default. Traffic may be interrupted due to an interface flap (going down and coming up).
- For PFC to be applied on an Aggregator port, the auto-configured priority traffic must be supported by a PFC peer (as detected by DCBx).
- A dcb-map for PFC applied to an interface may become invalid if dot1p-queue mapping is reconfigured. This situation occurs when the new dot1p-queue assignment exceeds the maximum number (2) of lossless queues supported globally on the switch. In this case, all PFC configurations received from PFC-enabled peers are removed and re-synchronized with the peer devices.
- Dell Networking OS does not support MACsec Bypass Capability (MBC).

Configuring Enhanced Transmission Selection

ETS provides a way to optimize bandwidth allocation to outbound 802.1p classes of converged Ethernet traffic.

Different traffic types have different service needs. Using ETS, you can create groups within an 802.1p priority class to configure different treatment for traffic with different bandwidth, latency, and best-effort needs.

For example, storage traffic is sensitive to frame loss; interprocess communication (IPC) traffic is latency-sensitive. ETS allows different traffic types to coexist without interruption in the same converged link by:

- Allocating a guaranteed share of bandwidth to each priority group.
- Allowing each group to exceed its minimum guaranteed bandwidth if another group is not fully using its allotted bandwidth.

To configure ETS and apply an ETS output policy to an interface, you must:

1. Create a Quality of Service (QoS) output policy with ETS scheduling and bandwidth allocation settings.
2. Create a priority group of 802.1p traffic classes.
3. Configure a DCB output policy in which you associate a priority group with a QoS ETS output policy.
4. Apply the DCB output policy to an interface.

How Enhanced Transmission Selection is Implemented

Enhanced transmission selection (ETS) provides a way to optimize bandwidth allocation to outbound 802.1p classes of converged Ethernet traffic. Different traffic types have different service needs. Using ETS, groups within an 802.1p priority class are auto-configured to provide different treatment for traffic with different bandwidth, latency, and best-effort needs.

For example, storage traffic is sensitive to frame loss; interprocess communication (IPC) traffic is latency-sensitive. ETS allows different traffic types to coexist without interruption in the same converged link.

 **NOTE:** The IEEE 802.1Qaz, CEE, and CIN versions of ETS are supported.

ETS is implemented on an Aggregator as follows:

- Traffic in priority groups is assigned to strict-queue or WERR scheduling in a dcb-map and is managed using the ETS bandwidth-assignment algorithm. Dell Networking OS de-queues all frames of strict-priority traffic before servicing any other queues. A queue with strict-priority traffic can starve other queues in the same port.
- ETS-assigned bandwidth allocation and scheduling apply only to data queues, not to control queues.

- Dell Networking OS supports hierarchical scheduling on an interface. Dell Networking OS control traffic is redirected to control queues as higher priority traffic with strict priority scheduling. After control queues drain out, the remaining data traffic is scheduled to queues according to the bandwidth and scheduler configuration in the dcb-map. The available bandwidth calculated by the ETS algorithm is equal to the link bandwidth after scheduling non-ETS higher-priority traffic.
- By default, equal bandwidth is assigned to each port queue and each dot1p priority in a priority group.
- By default, equal bandwidth is assigned to each priority group in the dcb-map applied to an egress port. The sum of auto-configured bandwidth allocation to dot1p priority traffic in all ETS priority groups is 100%.
- dot1p priority traffic on the switch is scheduled according to the default dot1p-queue mapping. dot1p priorities within the same queue should have the same traffic properties and scheduling method.
- A priority group consists of 802.1p priority values that are grouped together for similar bandwidth allocation and scheduling, and that share the same latency and loss requirements. All 802.1p priorities mapped to the same queue should be in the same priority group.
 - By default:
 - All 802.1p priorities are grouped in priority group 0.
 - 100% of the port bandwidth is assigned to priority group 0. The complete bandwidth is equally assigned to each priority class so that each class has 12 to 13%.
 - The maximum number of priority groups supported in ETS output policies on an interface is equal to the number of data queues (4) on the port. The 802.1p priorities in a priority group can map to multiple queues.
- A dcb-map is created to associate a priority group with a dcb-map with scheduling and bandwidth configuration, and applied on egress ports.
 - The ETS configuration associated with 802.1p priority traffic in a dcb-map is used in DCBx negotiation with ETS peers.
 - When a dcb-map is applied to an interface, ETS-configured scheduling and bandwidth allocation take precedence over any auto-configured settings in the QoS output policies.
 - ETS is enabled by default with the default ETS configuration applied (all dot1p priorities in the same group with equal bandwidth allocation).

ETS Operation with DCBx

In DCBx negotiation with peer ETS devices, ETS configuration is handled as follows:

- ETS TLVs are supported in DCBx versions CIN, CEE, and IEEE2.5.
- ETS operational parameters are determined by the DCBx port-role configurations.
- ETS configurations received from TLVs from a peer are validated.
- In case of a hardware limitation or TLV error, the DCBx operation on an ETS port goes down.
- ETS operates with legacy DCBx versions as follows:
 - In the CEE version, the priority group/traffic class group (TCG) ID 15 represents a non-ETS priority group. Any priority group configured with a scheduler type is treated as a strict-priority group and is given the priority-group (TCG) ID 15.
 - The CIN version supports two types of strict-priority scheduling:
 - Group strict priority: Allows a single priority flow in a priority group to increase its bandwidth usage to the bandwidth total of the priority group. A single flow in a group can use all the bandwidth allocated to the group.
 - Link strict priority: Allows a flow in any priority group to increase to the maximum link bandwidth.

CIN supports only the default dot1p priority-queue assignment in a priority group.

Hierarchical Scheduling in ETS Output Policies

ETS supports up to three levels of hierarchical scheduling.

For example, you can apply ETS output policies with the following configurations:

- Priority group 1** Assigns traffic to one priority queue with 20% of the link bandwidth and strict-priority scheduling.
- Priority group 2** Assigns traffic to one priority queue with 30% of the link bandwidth.
- Priority group 3** Assigns traffic to two priority queues with 50% of the link bandwidth and strict-priority scheduling.

In this example, the configured ETS bandwidth allocation and scheduler behavior is as follows:

- Unused bandwidth usage:** Normally, if there is no traffic or unused bandwidth for a priority group, the bandwidth allocated to the group is distributed to the other priority groups according to the bandwidth percentage allocated to each group. However, when three priority groups with different bandwidth allocations are used on an interface:

- If priority group 3 has free bandwidth, it is distributed as follows: 20% of the free bandwidth to priority group 1 and 30% of the free bandwidth to priority group 2.
- If priority group 1 or 2 has free bandwidth, (20 + 30)% of the free bandwidth is distributed to priority group 3. Priority groups 1 and 2 retain whatever free bandwidth remains up to the (20+ 30)%.

Strict-priority groups:

If two priority groups have strict-priority scheduling, traffic assigned from the priority group with the higher priority-queue number is scheduled first. However, when three priority groups are used and two groups have strict-priority scheduling (such as groups 1 and 3 in the example), the strict priority group whose traffic is mapped to one queue takes precedence over the strict priority group whose traffic is mapped to two queues.

Therefore, in this example, scheduling traffic to priority group 1 (mapped to one strict-priority queue) takes precedence over scheduling traffic to priority group 3 (mapped to two strict-priority queues).

DCBx Operation

The data center bridging exchange protocol (DCBx) is used by DCB devices to exchange configuration information with directly connected peers using the link layer discovery protocol (LLDP) protocol. DCBx can detect the misconfiguration of a peer DCB device, and optionally, configure peer DCB devices with DCB feature settings to ensure consistent operation in a data center network.

DCBx is a prerequisite for using DCB features, such as priority-based flow control (PFC) and enhanced traffic selection (ETS), to exchange link-level configurations in a converged Ethernet environment. DCBx is also deployed in topologies that support lossless operation for FCoE or iSCSI traffic. In these scenarios, all network devices are DCBx-enabled (DCBx is enabled end-to-end).

The following versions of DCBx are supported on an Aggregator: CIN, CEE, and IEEE2.5.

DCBx requires the LLDP to be enabled on all DCB devices.

DCBx Operation

DCBx performs the following operations:

- Discovers DCB configuration (such as PFC and ETS) in a peer device.
- Detects DCB mis-configuration in a peer device; that is, when DCB features are not compatibly configured on a peer device and the local switch. Mis-configuration detection is feature-specific because some DCB features support asymmetric configuration.
- Reconfigures a peer device with the DCB configuration from its configuration source if the peer device is willing to accept configuration.
- Accepts the DCB configuration from a peer if a DCBx port is in “willing” mode to accept a peer’s DCB settings and then internally propagates the received DCB configuration to its peer ports.

DCBx Port Roles

The following DCBx port roles are auto-configured on an Aggregator to propagate DCB configurations learned from peer DCBx devices internally to other switch ports:

Auto-upstream

The port advertises its own configuration to DCBx peers and receives its configuration from DCBx peers (ToR or FCF device). The port also propagates its configuration to other ports on the switch.

The first auto-upstream that is capable of receiving a peer configuration is elected as the *configuration source*. The elected configuration source then internally propagates the configuration to other auto-upstream and auto-downstream ports. A port that receives an internally propagated configuration overwrites its local configuration with the new parameter values.

When an auto-upstream port (besides the configuration source) receives and overwrites its configuration with internally propagated information, one of the following actions is taken:

- If the peer configuration received is compatible with the internally propagated port configuration, the link with the DCBx peer is enabled.

- If the received peer configuration is not compatible with the currently configured port configuration, the link with the DCBx peer port is disabled and a syslog message for an incompatible configuration is generated. The network administrator must then reconfigure the peer device so that it advertises a compatible DCB configuration.

The configuration received from a DCBx peer or from an internally propagated configuration is not stored in the switch's running configuration.

On a DCBx port in an auto-upstream role, the PFC and application priority TLVs are enabled. ETS recommend TLVs are disabled and ETS configuration TLVs are enabled.

Auto-downstream

The port advertises its own configuration to DCBx peers but is *not willing* to receive remote peer configuration. The port always accepts internally propagated configurations from a configuration source. An auto-downstream port that receives an internally propagated configuration overwrites its local configuration with the new parameter values.

When an auto-downstream port receives and overwrites its configuration with internally propagated information, one of the following actions is taken:

- If the peer configuration received is compatible with the internally propagated port configuration, the link with the DCBx peer is enabled.
- If the received peer configuration is not compatible with the currently configured port configuration, the link with the DCBx peer port is disabled and a syslog message for an incompatible configuration is generated. The network administrator must then reconfigure the peer device so that it advertises a compatible DCB configuration.

The internally propagated configuration is not stored in the switch's running configuration. On a DCBx port in an auto-downstream role, all PFC, application priority, ETS recommend, and ETS configuration TLVs are enabled.

Default DCBx port role: Uplink ports are auto-configured in an auto-upstream role. Server-facing ports are auto-configured in an auto-downstream role.

NOTE: You can change the port roles only in the PMUX mode. Use the following command to change the port roles:

```
dcbx port-role {auto-downstream | auto-upstream | config-source | manual}
```

manual is the default port role.

NOTE: On a DCBx port, application priority TLV advertisements are handled as follows:

- The application priority TLV is transmitted only if the priorities in the advertisement match the configured PFC priorities on the port.
- On auto-upstream and auto-downstream ports:
 - If a configuration source is elected, the ports send an application priority TLV based on the application priority TLV received on the configuration-source port. When an application priority TLV is received on the configuration-source port, the auto-upstream and auto-downstream ports use the internally propagated PFC priorities to match against the received application priority. Otherwise, these ports use their locally configured PFC priorities in application priority TLVs.
 - If no configuration source is configured, auto-upstream and auto-downstream ports check to see that the locally configured PFC priorities match the priorities in a received application priority TLV.
- On manual ports, an application priority TLV is advertised only if the priorities in the TLV match the PFC priorities configured on the port.

DCB Configuration Exchange

On an Aggregator, the DCBx protocol supports the exchange and propagation of configuration information for the following DCB features.

- Enhanced transmission selection (ETS)
- Priority-based flow control (PFC)

DCBx uses the following methods to exchange DCB configuration parameters:

- Asymmetric** DCB parameters are exchanged between a DCBx-enabled port and a peer port without requiring that a peer port and the local port use the same configured values for the configurations to be compatible. For example, ETS uses an asymmetric exchange of parameters between DCBx peers.
- Symmetric** DCB parameters are exchanged between a DCBx-enabled port and a peer port but requires that each configured parameter value be the same for the configurations in order to be compatible. For example, PFC uses an symmetric exchange of parameters between DCBx peers.

Configuration Source Election

When an auto-upstream or auto-downstream port receives a DCB configuration from a peer, the port first checks to see if there is an active configuration source on the switch.

- If a configuration source already exists, the received peer configuration is checked against the local port configuration. If the received configuration is compatible, the DCBx marks the port as DCBx-enabled. If the configuration received from the peer is not compatible, a warning message is logged and the DCBx frame error counter is incremented. Although DCBx is operationally disabled, the port keeps the peer link up and continues to exchange DCBx packets. If a compatible peer configuration is later received, DCBx is enabled on the port.
- If there is no configuration source, a port may elect itself as the configuration source. A port may become the configuration source if the following conditions exist:
 - No other port is the configuration source.
 - The port role is auto-upstream.
 - The port is enabled with link up and DCBx enabled.
 - The port has performed a DCBx exchange with a DCBx peer.
 - The switch is capable of supporting the received DCB configuration values through either a symmetric or asymmetric parameter exchange.

A newly elected configuration source propagates configuration changes received from a peer to the other auto-configuration ports. Ports receiving auto-configuration information from the configuration source ignore their current settings and use the configuration source information.

Propagation of DCB Information

When an auto-upstream or auto-downstream port receives a DCB configuration from a peer, the port acts as a DCBx client and checks if a DCBx configuration source exists on the switch.

- If a configuration source is found, the received configuration is checked against the currently configured values that are internally propagated by the configuration source. If the local configuration is compatible with the received configuration, the port is enabled for DCBx operation and synchronization.
- If the configuration received from the peer is not compatible with the internally propagated configuration used by the configuration source, the port is disabled as a client for DCBx operation and synchronization and a syslog error message is generated. The port keeps the peer link up and continues to exchange DCBx packets. If a compatible configuration is later received from the peer, the port is enabled for DCBx operation.

i **NOTE:** When a configuration source is elected, all auto-upstream ports other than the configuration source are marked as *willing disabled*. The internally propagated DCB configuration is refreshed on all auto-configuration ports and each port may begin configuration negotiation with a DCBx peer again.

Auto-Detection of the DCBx Version

The Aggregator operates in auto-detection mode so that a DCBx port automatically detects the DCBx version on a peer port. Legacy CIN and CEE versions are supported in addition to the standard IEEE version 2.5 DCBx.

A DCBx port detects a peer version after receiving a valid frame for that version. The local DCBx port reconfigures to operate with the peer version and maintains the peer version on the link until one of the following conditions occurs:

- The switch reboots.
- The link is reset (goes down and up).
- The peer times out.
- Multiple peers are detected on the link.

DCBx operations on a port are performed according to the auto-configured DCBx version, including fast and slow transmit timers and message formats. If a DCBx frame with a different version is received, a syslog message is generated and the peer version is recorded in the peer status table. If the frame cannot be processed, it is discarded and the discard counter is incremented.

DCBx Example

The following figure shows how DCBx is used on an Aggregator installed in a Dell PowerEdge M I/O Aggregator chassis in which servers are also installed.

The external 40GbE ports on the base module (ports 33 and 37) of two switches are used for uplinks configured as DCBx auto-upstream ports. The Aggregator is connected to third-party, top-of-rack (ToR) switches through 40GbE uplinks. The ToR switches are part of a Fibre Channel storage network.

The internal ports (ports 1-32) connected to the 10GbE backplane are configured as auto-downstream ports.

On the Aggregator, PFC and ETS use DCBx to exchange link-level configuration with DCBx peer devices.

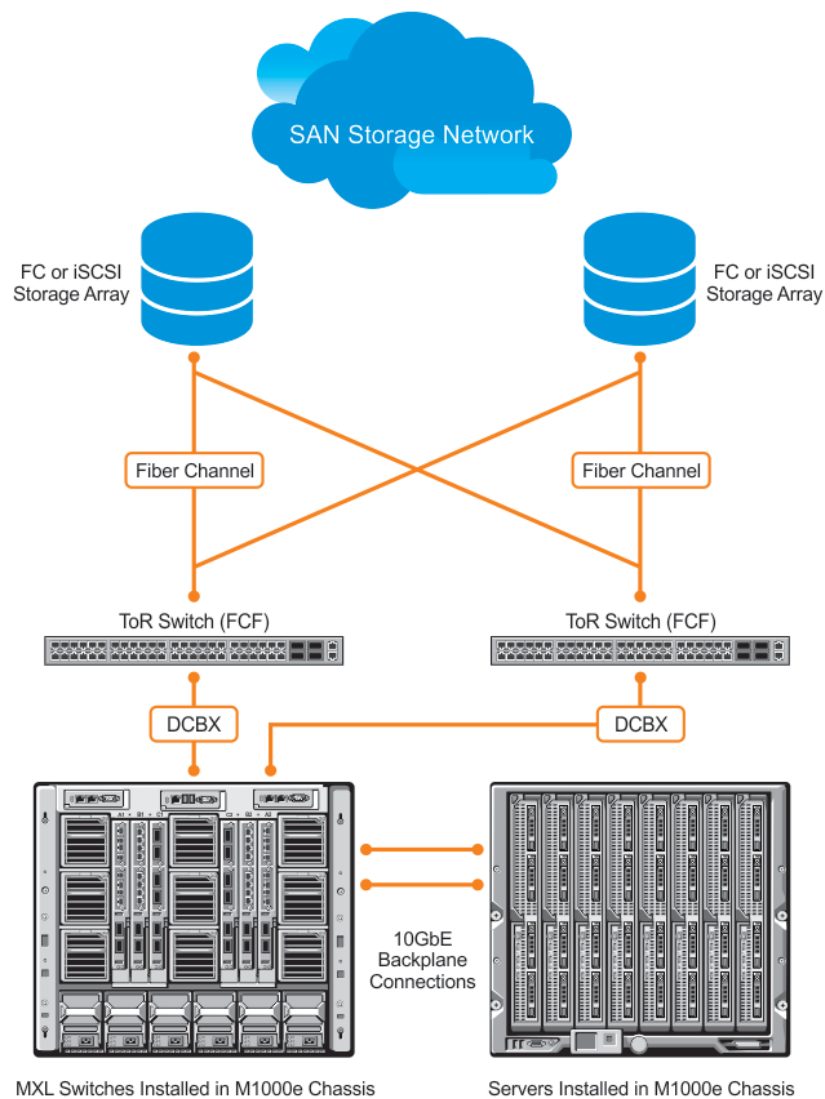

Figure 4. DCBx Sample Topology

DCBx Prerequisites and Restrictions

The following prerequisites and restrictions apply when you configure DCBx operation on a port:

- DCBx requires LLDP in both send (TX) and receive (RX) modes to be enabled on a port interface. If multiple DCBx peer ports are detected on a local DCBx interface, LLDP is shut down.
- The CIN version of DCBx supports only PFC, ETS, and FCOE; it does not support iSCSI, backward congestion management (BCN), logical link down (LLD), and network interface virtualization (NIV).

DCBx Error Messages

The following syslog messages appear when an error in DCBx operation occurs.

```
LLDP_MULTIPLE_PEER_DETECTED: DCBx is operationally disabled after detecting more than one DCBx peer on the port interface.
```

```
LLDP_PEER_AGE_OUT: DCBx is disabled as a result of LLDP timing out on a DCBx peer interface.
```

```
DSM_DCBx_PEER_VERSION_CONFLICT: A local port expected to receive the IEEE, CIN, or CEE version in a DCBx TLV from a remote peer but received a different, conflicting DCBx version.
```

```
DSM_DCBx_PFC_PARAMETERS_MATCH and DSM_DCBx_PFC_PARAMETERS_MISMATCH: A local DCBx port received a compatible (match) or incompatible (mismatch) PFC configuration from a peer.
```

```
DSM_DCBx_ETS_PARAMETERS_MATCH and DSM_DCBx_ETS_PARAMETERS_MISMATCH: A local DCBx port received a compatible (match) or incompatible (mismatch) ETS configuration from a peer.
```

```
LLDP_UNRECOGNISED_DCBx_TLV_RECEIVED: A local DCBx port received an unrecognized DCBx TLV from a peer.
```

Debugging DCBx on an Interface

To enable DCBx debug traces for all or a specific control paths, use the following command.

- Enable DCBx debugging.
EXEC PRIVILEGE mode
`debug dcbx {all | auto-detect-timer | config-exchng | fail | mgmt | resource | sem | tlv}`
 - `all`: enables all DCBx debugging operations.
 - `auto-detect-timer`: enables traces for DCBx auto-detect timers.
 - `config-exchng`: enables traces for DCBx configuration exchanges.
 - `fail`: enables traces for DCBx failures.
 - `mgmt`: enables traces for DCBx management frames.
 - `resource`: enables traces for DCBx system resource frames.
 - `sem`: enables traces for the DCBx state machine.
 - `tlv`: enables traces for DCBx TLVs.

Verifying the DCB Configuration

To display DCB configurations, use the following `show` commands.

Table 5. Displaying DCB Configurations

Command	Output
<code>show qos dot1p-queue mapping</code>	Displays the current 802.1p priority-queue mapping.
<code>show qos dcb-map map-name</code>	Displays the DCB parameters configured in a specified DCB map.
<code>show dcb [stack-unit unit-number]</code>	Displays the data center bridging status, number of PFC-enabled ports, and number of PFC-enabled queues. On the master switch in a stack, you can specify a stack-unit number. The range is from 0 to 5.
<code>show interface port-type slot/port pfc statistics</code>	Displays counters for the PFC frames received and transmitted (by dot1p priority class) on an interface.
<code>show interface port-type slot/port pfc {summary detail}</code>	Displays the PFC configuration applied to ingress traffic on an interface, including priorities and link delay. To clear PFC TLV counters, use the <code>clear pfc counters {stack-unit unit-number tengigabitethernet slot/port}</code> command.
<code>show interface port-type slot/port ets {summary detail}</code>	Displays the ETS configuration applied to egress traffic on an interface, including priority groups with priorities and bandwidth allocation. To clear ETS TLV counters, enter the <code>clear ets counters stack-unit unit-number</code> command.

Example of the `show qos dot1p-queue-mapping` Command

```
Dell#show qos dot1p-queue-mapping
Dot1p Priority : 0 1 2 3 4 5 6 7
Queue         : 0 0 0 1 2 3 3 3
Dell#
```

Example of the `show qos dcb-map map-name` Command

```
Dell#show qos dcb-map dcbmap2
State      :Complete
PfcMode:ON
-----
PG:0 TSA:ETS BW:50 PFC:OFF
Priorities:0 1 2 4 5 6 7

PG:1 TSA:ETS BW:50 PFC:ON
Priorities:3
Dell#
```

Example of the `show dcb` Command

```
Dell# show dcb
stack-unit 0 port-set 0
DCB Status           : Enabled
PFC Queue Count      : 2
Total Buffer[lossy + lossless] (in KB) : 3822
PFC Total Buffer (in KB) : 1912
PFC Shared Buffer (in KB) : 832
PFC Available Buffer (in KB) : 1080
```

Example of the show interface pfc statistics Command

```
Dell#show interfaces tengigabitethernet 0/3 pfc statistics
Interface TenGigabitEthernet 0/3

Priority Rx XOFF Frames Rx Total Frames Tx Total Frames
-----
0          0          0          0          0
1          0          0          0          0
2          0          0          0          0
3          0          0          0          0
4          0          0          0          0
5          0          0          0          0
6          0          0          0          0
7          0          0          0          0
```

Example of the show interfaces pfc summary Command

```
Dell# show interfaces tengigabitethernet 0/4 pfc summary
Interface TenGigabitEthernet 0/4
  Admin mode is on
  Admin is enabled
  Remote is enabled, Priority list is 4
  Remote Willing Status is enabled
  Local is enabled
  Oper status is Recommended
  PFC DCBx Oper status is Up
  State Machine Type is Feature
  TLV Tx Status is enabled
  PFC Link Delay 45556 pause quantams
  Application Priority TLV Parameters :
-----
  FCOE TLV Tx Status is disabled
  ISCSI TLV Tx Status is disabled
  Local FCOE PriorityMap is 0x8
  Local ISCSI PriorityMap is 0x10
  Remote FCOE PriorityMap is 0x8
  Remote ISCSI PriorityMap is 0x8

Dell# show interfaces tengigabitethernet 0/4 pfc detail
Interface TenGigabitEthernet 0/4
  Admin mode is on
  Admin is enabled
  Remote is enabled
  Remote Willing Status is enabled
  Local is enabled
  Oper status is recommended
  PFC DCBx Oper status is Up
  State Machine Type is Feature
  TLV Tx Status is enabled
  PFC Link Delay 45556 pause quanta
  Application Priority TLV Parameters :
-----
  FCOE TLV Tx Status is disabled
  ISCSI TLV Tx Status is disabled
  Local FCOE PriorityMap is 0x8
  Local ISCSI PriorityMap is 0x10
  Remote FCOE PriorityMap is 0x8
  Remote ISCSI PriorityMap is 0x8

0 Input TLV pkts, 1 Output TLV pkts, 0 Error pkts, 0 Pause Tx pkts, 0 Pause Rx pkts
2 Input Appln Priority TLV pkts, 0 Output Appln Priority TLV pkts, 0 Error Appln
Priority TLV Pkts
```

The following table describes the show interface pfc summary command fields.

Fields	Description
Interface	Interface type with stack-unit and port number.

Fields	Description
Admin mode is on; Admin is enabled	PFC Admin mode is on or off with a list of the configured PFC priorities . When PFC admin mode is on, PFC advertisements are enabled to be sent and received from peers; received PFC configuration takes effect. The admin operational status for a DCBx exchange of PFC configuration is enabled or disabled.
Remote is enabled; Priority list Remote Willing Status is enabled	Operational status (enabled or disabled) of peer device for DCBx exchange of PFC configuration with a list of the configured PFC priorities. Willing status of peer device for DCBx exchange (Willing bit received in PFC TLV): enabled or disabled.
Local is enabled	DCBx operational status (enabled or disabled) with a list of the configured PFC priorities.
Operational status (local port)	Port state for current operational PFC configuration: <ul style="list-style-type: none"> • Init: Local PFC configuration parameters were exchanged with peer. • Recommend: Remote PFC configuration parameters were received from peer. • Internally propagated: PFC configuration parameters were received from configuration source.
PFC DCBx Oper status	Operational status for exchange of PFC configuration on local port: match (up) or mismatch (down).
State Machine Type	Type of state machine used for DCBx exchanges of PFC parameters: <ul style="list-style-type: none"> • Feature: for legacy DCBx versions • Symmetric: for an IEEE version
TLV Tx Status	Status of PFC TLV advertisements: enabled or disabled.
PFC Link Delay	Link delay (in quanta) used to pause specified priority traffic.
Application Priority TLV: FCOE TLV Tx Status	Status of FCoE advertisements in application priority TLVs from local DCBx port: enabled or disabled.
Application Priority TLV: ISCSI TLV Tx Status	Status of ISCSI advertisements in application priority TLVs from local DCBx port: enabled or disabled.
Application Priority TLV: Local FCOE Priority Map	Priority bitmap used by local DCBx port in FCoE advertisements in application priority TLVs.
Application Priority TLV: Local ISCSI Priority Map	Priority bitmap used by local DCBx port in ISCSI advertisements in application priority TLVs.
Application Priority TLV: Remote FCOE Priority Map	Priority bitmap received from the remote DCBx port in FCoE advertisements in application priority TLVs.
Application Priority TLV: Remote ISCSI Priority Map	Priority bitmap received from the remote DCBx port in iSCSI advertisements in application priority TLVs.
PFC TLV Statistics: Input TLV pkts	Number of PFC TLVs received.
PFC TLV Statistics: Output TLV pkts	Number of PFC TLVs transmitted.

Fields	Description
PFC TLV Statistics: Error pkts	Number of PFC error packets received.
PFC TLV Statistics: Pause Tx pkts	Number of PFC pause frames transmitted.
PFC TLV Statistics: Pause Rx pkts	Number of PFC pause frames received.
Input Appln Priority TLV pkts	Number of Application Priority TLVs received.
Output Appln Priority TLV pkts	Number of Application Priority TLVs transmitted.
Error Appln Priority TLV pkts	Number of Application Priority error packets received.

Example of the show interface ets summary Command

```
Dell# show interfaces te 0/0 ets summary
Interface TenGigabitEthernet 0/0
Max Supported TC Groups is 4
Number of Traffic Classes is 8
Admin mode is on
Admin Parameters :
-----
Admin is enabled
TC-grp      Priority#      Bandwidth      TSA
0           0,1,2,3,4,5,6,7  100%           ETS
1           0%              ETS
2           0%              ETS
3           0%              ETS
4           0%              ETS
5           0%              ETS
6           0%              ETS
7           0%              ETS

Priority#    Bandwidth    TSA
0           13%          ETS
1           13%          ETS
2           13%          ETS
3           13%          ETS
4           12%          ETS
5           12%          ETS
6           12%          ETS
7           12%          ETS

Remote Parameters:
-----
Remote is disabled

Local Parameters :
-----
Local is enabled
TC-grp      Priority#      Bandwidth      TSA
0           0,1,2,3,4,5,6,7  100%           ETS
1           0%              ETS
2           0%              ETS
3           0%              ETS
4           0%              ETS
5           0%              ETS
6           0%              ETS
7           0%              ETS

Priority#    Bandwidth    TSA
0           13%          ETS
1           13%          ETS
```

```

2          13%      ETS
3          13%      ETS
4          12%      ETS
5          12%      ETS
6          12%      ETS
7          12%      ETS
Oper status is init
Conf TLV Tx Status is disabled
Traffic Class TLV Tx Status is disabled

```

Example of the show interface ets detail Command

```

Dell# show interfaces tengigabitethernet 0/4 ets detail
Interface TenGigabitEthernet 0/4
Max Supported TC Groups is 4
Number of Traffic Classes is 8
Admin mode is on
Admin Parameters :
-----
Admin is enabled
TC-grp    Priority#    Bandwidth    TSA
0         0,1,2,3,4,5,6,7  100%         ETS
1         0%              ETS
2         0%              ETS
3         0%              ETS
4         0%              ETS
5         0%              ETS
6         0%              ETS
7         0%              ETS

Remote Parameters:
-----
Remote is disabled

Local Parameters :
-----
Local is enabled
PG-grp    Priority#    Bandwidth    TSA
0         0,1,2,3,4,5,6,7  100%         ETS
1         0%              ETS
2         0%              ETS
3         0%              ETS
4         0%              ETS
5         0%              ETS
6         0%              ETS
7         0%              ETS

Oper status is init
ETS DCBX Oper status is Down
State Machine Type is Asymmetric
Conf TLV Tx Status is enabled
Reco TLV Tx Status is enabled

0 Input Conf TLV Pkts, 0 Output Conf TLV Pkts, 0 Error Conf TLV Pkts
0 Input Reco TLV Pkts, 0 Output Reco TLV Pkts, 0 Error Reco TLV Pkts

```

The following table describes the show interface ets detail command fields.

Field	Description
Interface	Interface type with stack-unit and port number.
Max Supported TC Group	Maximum number of priority groups supported.
Number of Traffic Classes	Number of 802.1p priorities currently configured.
Admin mode	ETS mode: on or off.

Field	Description
	When on, the scheduling and bandwidth allocation configured in an ETS output policy or received in a DCBx TLV from a peer can take effect on an interface.
Admin Parameters	ETS configuration on local port, including priority groups, assigned dot1p priorities, and bandwidth allocation.
Remote Parameters	ETS configuration on remote peer port, including Admin mode (enabled if a valid TLV was received or disabled), priority groups, assigned dot1p priorities, and bandwidth allocation. If the ETS Admin mode is enabled on the remote port for DCBx exchange, the Willing bit received in ETS TLVs from the remote peer is included.
Local Parameters	ETS configuration on local port, including Admin mode (enabled when a valid TLV is received from a peer), priority groups, assigned dot1p priorities, and bandwidth allocation.
Operational status (local port)	Port state for current operational ETS configuration: <ul style="list-style-type: none"> • Init: Local ETS configuration parameters were exchanged with peer. • Recommend: Remote ETS configuration parameters were received from peer. • Internally propagated: ETS configuration parameters were received from configuration source.
ETS DCBx Oper status	Operational status of ETS configuration on local port: match or mismatch.
State Machine Type	Type of state machine used for DCBx exchanges of ETS parameters: <ul style="list-style-type: none"> • Feature: for legacy DCBx versions • Asymmetric: for an IEEE version
Conf TLV Tx Status	Status of ETS Configuration TLV advertisements: enabled or disabled.
Reco TLV Tx Status	Status of ETS Recommendation TLV advertisements: enabled or disabled.
Input Conf TLV pktsOutput Conf TLV pktsError Conf TLV pkts	Number of ETS Configuration TLVs received and transmitted, and number of ETS Error Configuration TLVs received.
Input Reco TLV pktsOutput Reco TLV pktsError Reco TLV pkts	Number of ETS Recommendation TLVs received and transmitted, and number of ETS Error Recommendation TLVs received.

Example of the show stack-unit all stack-ports all pfc details Command

```
Dell# show stack-unit all stack-ports all pfc details

stack unit 0 stack-port all
  Admin mode is On
  Admin is enabled, Priority list is 4-5
  Local is enabled, Priority list is 4-5
  Link Delay 45556 pause quantum
  0 Pause Tx pkts, 0 Pause Rx pkts

stack unit 1 stack-port all
  Admin mode is On
  Admin is enabled, Priority list is 4-5
  Local is enabled, Priority list is 4-5
  Link Delay 45556 pause quantum
  0 Pause Tx pkts, 0 Pause Rx pkts
```

Example of the show stack-unit all stack-ports all ets details Command

```
Dell# show stack-unit all stack-ports all ets details
Stack unit 0 stack port all
Max Supported TC Groups is 4
Number of Traffic Classes is 1

Admin mode is on
```

Admin Parameters:

```
-----  
Admin is enabled  
TC-grp      Priority#      Bandwidth      TSA  
-----  
0           0,1,2,3,4,5,6,7  100%           ETS  
1           -                -              -  
2           -                -              -  
3           -                -              -  
4           -                -              -  
5           -                -              -  
6           -                -              -  
7           -                -              -  
8           -                -              -
```

Stack unit 1 stack port all
Max Supported TC Groups is 4
Number of Traffic Classes is 1
Admin mode is on
Admin Parameters:

```
-----  
Admin is enabled  
TC-grp      Priority#      Bandwidth      TSA  
-----  
0           0,1,2,3,4,5,6,7  100%           ETS  
1           -                -              -  
2           -                -              -  
3           -                -              -  
4           -                -              -  
5           -                -              -  
6           -                -              -  
7           -                -              -  
8           -                -              -
```

Example of the show interface DCBx detail Command

```
Dell# show interface tengigabitethernet 0/4 dcbx detail  
Dell#show interface te 0/4 dcbx detail  
  
E-ETS Configuration TLV enabled           e-ETS Configuration TLV disabled  
R-ETS Recommendation TLV enabled          r-ETS Recommendation TLV disabled  
P-PFC Configuration TLV enabled           p-PFC Configuration TLV disabled  
F-Application priority for FCOE enabled    f-Application Priority for FCOE disabled  
I-Application priority for iSCSI enabled    i-Application Priority for iSCSI disabled  
-----  
  
Interface TenGigabitEthernet 0/4  
  Remote Mac Address 00:00:00:00:00:11  
  Port Role is Auto-Upstream  
  DCBX Operational Status is Enabled  
  Is Configuration Source? TRUE  
  
Local DCBX Compatibility mode is CEE  
  Local DCBX Configured mode is CEE  
  Peer Operating version is CEE  
  Local DCBX TLVs Transmitted: ErPfi  
  
Local DCBX Status  
-----  
  DCBX Operational Version is 0  
  DCBX Max Version Supported is 0  
  Sequence Number: 2  
  Acknowledgment Number: 2  
  Protocol State: In-Sync  
  
Peer DCBX Status:  
-----  
  DCBX Operational Version is 0  
  DCBX Max Version Supported is 255  
  Sequence Number: 2  
  Acknowledgment Number: 2  
  2 Input PFC TLV pkts, 3 Output PFC TLV pkts, 0 Error PFC pkts, 0 PFC Pause Tx pkts,  
  0 Pause Rx pkts
```

```

2 Input PG TLV Pkts, 3 Output PG TLV Pkts, 0 Error PG TLV Pkts
2 Input Appln Priority TLV pkts, 0 Output Appln Priority TLV pkts, 0 Error Appln Priority
TLV Pkts
Total DCBX Frames transmitted 27
Total DCBX Frames received 6
Total DCBX Frame errors 0
Total DCBX Frames unrecognized 0

```

The following table describes the `show interface DCBx detail` command fields.

Field	Description
Interface	Interface type with chassis slot and port number.
Port-Role	Configured DCBx port role: auto-upstream or auto-downstream.
DCBx Operational Status	Operational status (enabled or disabled) used to elect a configuration source and internally propagate a DCB configuration. The DCBx operational status is the combination of PFC and ETS operational status.
Configuration Source	Specifies whether the port serves as the DCBx configuration source on the switch: true (yes) or false (no).
Local DCBx Compatibility mode	DCBx version accepted in a DCB configuration as compatible. In auto-upstream mode, a port can only receive a DCBx version supported on the remote peer.
Local DCBx Configured mode	DCBx version configured on the port: CEE, CIN, IEEE v2.5, or Auto (port auto-configures to use the DCBx version received from a peer).
Peer Operating version	DCBx version that the peer uses to exchange DCB parameters.
Local DCBx TLVs Transmitted	Transmission status (enabled or disabled) of advertised DCB TLVs (see TLV code at the top of the show command output).
Local DCBx Status: DCBx Operational Version	DCBx version advertised in Control TLVs.
Local DCBx Status: DCBx Max Version Supported	Highest DCBx version supported in Control TLVs.
Local DCBx Status: Sequence Number	Sequence number transmitted in Control TLVs.
Local DCBx Status: Acknowledgment Number	Acknowledgement number transmitted in Control TLVs.
Local DCBx Status: Protocol State	Current operational state of DCBx protocol: ACK or IN-SYNC.
Peer DCBx Status: DCBx Operational Version	DCBx version advertised in Control TLVs received from peer device.
Peer DCBx Status: DCBx Max Version Supported	Highest DCBx version supported in Control TLVs received from peer device.
Peer DCBx Status: Sequence Number	Sequence number transmitted in Control TLVs received from peer device.

Field	Description
Peer DCBx Status: Acknowledgment Number	Acknowledgement number transmitted in Control TLVs received from peer device.
Total DCBx Frames transmitted	Number of DCBx frames sent from local port.
Total DCBx Frames received	Number of DCBx frames received from remote peer port.
Total DCBx Frame errors	Number of DCBx frames with errors received.
Total DCBx Frames unrecognized	Number of unrecognizable DCBx frames received.
PFC TLV Statistics: Input PFC TLV pkts	Number of PFC TLVs received.
PFC TLV Statistics: Output PFC TLV pkts	Number of PFC TLVs transmitted.
PFC TLV Statistics: Error PFC pkts	Number of PFC error packets received.
PFC TLV Statistics: PFC Pause Tx pkts	Number of PFC pause frames transmitted.
PFC TLV Statistics: PFC Pause Rx pkts	Number of PFC pause frames received.
PG TLV Statistics: Input PG TLV Pkts	Number of PG TLVs received.
PG TLV Statistics: Output PG TLV Pkts	Number of PG TLVs transmitted.
PG TLV Statistics: Error PG TLV Pkts	Number of PG error packets received.
Application Priority TLV Statistics: Input Appln Priority TLV pkts	Number of Application TLVs received.
Application Priority TLV Statistics: Output Appln Priority TLV pkts	Number of Application TLVs transmitted.
Application Priority TLV Statistics: Error	Number of Application TLV error packets received.

Field	Description
-------	-------------

Appln Priority
TLV Pkts

QoS dot1p Traffic Classification and Queue Assignment

DCB supports PFC, ETS, and DCBx to handle converged Ethernet traffic that is assigned to an egress queue according to the following QoS methods:

Honor dot1p	dot1p priorities in ingress traffic are used at the port or global switch level.
Layer 2 class maps	dot1p priorities are used to classify traffic in a class map and apply a service policy to an ingress port to map traffic to egress queues.

NOTE: Dell Networking does not recommend mapping all ingress traffic to a single queue when using PFC and ETS. However, Dell Networking does recommend using Ingress traffic classification using the `service-class dynamic dot1p` command (honor dot1p) on all DCB-enabled interfaces. If you use L2 class maps to map dot1p priority traffic to egress queues, take into account the default dot1p-queue assignments in the following table and the maximum number of two lossless queues supported on a port.

Although the system allows you to change the default dot1p priority-queue assignments, DCB policies applied to an interface may become invalid if you reconfigure dot1p-queue mapping. If the configured dcb-map remains valid, the change in the dot1p-queue assignment is allowed. For DCB ETS enabled interfaces, traffic destined to queue that is not mapped to any dot1p priority are dropped.

dot1p Value in the Incoming Frame

dot1p Value	Egress Queue Assignment
0	0
1	0
2	0
3	1
4	2
5	3
6	3
7	3

Troubleshooting PFC, ETS, and DCBx Operation

In the `show interfaces pfc | ets | dcbx` output, the DCBx operational status may be down for any of the reasons described in the following table.

When DCBx is down, the following values display in the `show` output field for DCBx Oper status:

- PFC DCBx Oper status: Down
- ETS DCBx Oper status: Down
- DCBx Oper status: Disabled.

Reason	Description
--------	-------------

Port Shutdown	Port is shut down. All other reasons for DCBx inoperation, if any, are ignored.
----------------------	---

Reason	Description
LLDP Rx/Tx is disabled	LLDP is disabled (Admin Mode set to rx or tx only) globally or on the interface.
Waiting for Peer	Waiting for peer or detected peer connection has aged out.
Multiple Peer Detected	Multiple peer connections detected on the interface.
Version Conflict	DCBx version on peer version is different than the local or globally configured DCBx version.
Config-source Down	Although DCBx parameters match in auto-upstream or auto-downstream port, the configuration source (elected dynamically or CLI-configured) is down.
Unrecognized TLV received	Invalid TLV length TLV has been received. In the case of an invalid PFC or ETS TLV, the error displays in the <code>show interfaces pfc ets</code> output. The <code>show interfaces dcbx</code> output displays PFC or ETS as down.
Admin Mode OFF (Local)	Local Admin Mode is disabled.
Admin Mode OFF (Remote)	Remote Admin Mode is disabled.
Waiting for ACK from Peer	For a legacy DCBx version, a peer has not acknowledged the reception of a sent packet. This reason displays only when a remote peer is willing to receive a DCB configuration.
Error Bit set	For a legacy DCBx version, a peer has sent packets with an error bit set. This reason displays only when a remote peer is willing to receive a DCB configuration.
Enabled with ETS Mismatch (show interfaces dcbx output)	DCBx is enabled but an ETS validation failure error has occurred.
PFC is down (show interfaces pfc output)	One of the following PFC-specific errors has occurred: <ul style="list-style-type: none"> • No MBC support. • Configured PFC priorities exceed maximum PFC capability limit. • New dot1p-to-queue mapping violates the allowed system limit for PFC Enable status per priority
ETS is down (show interfaces ets output)	One of the following ETS-specific errors occurred in ETS validation: <ul style="list-style-type: none"> • Unsupported PGID • A priority group exceeds the maximum number of supported priorities. • COSQ is mapped to more than one priority group. • COSQ is mapped to more than one priority group. - Invalid or unsupported transmission selection algorithm (TSA). • Bandwidth is configured for an unconfigured priority group. • Total ETS bandwidth mapped in priority groups is not equal to 100%. • Priorities mapped to a queue use different TSAs. • Total bandwidth assigned to priorities in one or more priority groups is not equal to 100%. Or one of the following ETS failure errors occurred: <ul style="list-style-type: none"> • Incompatible priority group ID (PGID). • Incompatible bandwidth (BW) allocation. • Incompatible TSA. • Incompatible TC BW. • Incompatible TC TSA.

Configuring the Dynamic Buffer Method

To configure the dynamic buffer capability, perform the following steps:

1. Enable the DCB application. By default, DCB is enabled and link-level flow control is disabled on all interfaces.
CONFIGURATION mode

```
S6000-109-Dell (conf) #dcb enable
```

2. Configure the shared PFC buffer size and the total buffer size. A maximum of 4 lossless queues are supported.

```
CONFIGURATION mode
```

```
S6000-109-Dell (conf) #dcb pfc-shared-buffer-size 4000
```

```
S6000-109-Dell (conf) #dcb pfc-total-buffer-size 5000
```

3. Configure the number of PFC queues.

```
CONFIGURATION mode
```

```
Dell (conf) #dcb enable pfc-queues 4
```

The number of ports supported based on lossless queues configured will depend on the buffer.

For each priority, you can specify the shared buffer threshold limit, the ingress buffer size, buffer limit for pausing the acceptance of packets, and the buffer offset limit for resuming the acceptance of received packets.

4. Configure the profile name for the DCB buffer threshold

```
CONFIGURATION mode
```

```
Dell (conf) #dcb-buffer-threshold test
```

5. DCB-BUFFER-THRESHOLD mode

```
Dell (conf-dcb-buffer-thr) # priority 0 buffer-size 52 pause-threshold 16 resume-offset 10  
shared-threshold-weight 7
```

6. Assign the DCB policy to the DCB buffer threshold profile on stack ports.

```
CONFIGURATION mode
```

```
Dell (conf) # dcb-policy buffer-threshold stack-unit all stack-ports all test
```

7. Assign the DCB policy to the DCB buffer threshold profile on interfaces. This setting takes precedence over the default buffer-threshold setting.

```
INTERFACE mode (conf-if-te)
```

```
Dell (conf-if-te-0/0) #dcb-policy buffer-threshold test
```

8. Create a QoS policy buffer and enter the QoS Policy Buffer Configuration mode to configure the no-drop queues, ingress buffer size, buffer limit for pausing, and buffer offset limit for resuming.

```
CONFIGURATION mode
```

```
Dell (conf) # qos-policy-buffer test
```

```
Dell (conf-qos-policy-buffer) #queue 0 pause no-drop buffer-size 128000 pause-threshold  
103360 resume-threshold 83520
```

```
Dell (conf-qos-policy-buffer) # queue 4 pause no-drop buffer-size 128000 pause-threshold  
103360 resume-threshold 83520
```

Dynamic Host Configuration Protocol (DHCP)

The Aggregator is auto-configured to operate as a dynamic host configuration protocol (DHCP) client. The DHCP server, DHCP relay agent, and secure DHCP features are not supported. The DHCP is an application layer protocol that dynamically assigns IP addresses and other configuration parameters to network end-stations (hosts) based on configuration policies determined by network administrators.

DHCP relieves network administrators of manually configuring hosts, which can be a tedious and error-prone process when hosts often join, leave, and change locations on the network and it reclaims IP addresses that are no longer in use to prevent address exhaustion.

DHCP is based on a client-server model. A host discovers the DHCP server and requests an IP address, and the server either leases or permanently assigns one. There are three types of devices that are involved in DHCP negotiation:

DHCP Server	This is a network device offering configuration parameters to the client.
DHCP Client	This is a network device requesting configuration parameters from the server.
Relay Agent	This is an intermediary network device that passes DHCP messages between the client and server when the server is not on the same subnet as the host.

 **NOTE:** The DHCP server and relay agent features are not supported on an Aggregator.

Supported Modes

Stacking, PMUX, Standalone, VLT

Topics:

- [Assigning an IP Address using DHCP](#)
- [Debugging DHCP Client Operation](#)
- [DHCP Client](#)
- [How DHCP Client is Implemented](#)
- [DHCP Client on a Management Interface](#)
- [DHCP Client on a VLAN](#)
- [DHCP Packet Format and Options](#)
- [Option 82](#)
- [Releasing and Renewing DHCP-based IP Addresses](#)
- [Viewing DHCP Statistics and Lease Information](#)

Assigning an IP Address using DHCP

The following section describes DHCP and the client in a network.

When a client joins a network:

1. The client initially broadcasts a **DHCPDISCOVER** message on the subnet to discover available DHCP servers. This message includes the parameters that the client requires and might include suggested values for those parameters.
2. Servers unicast or broadcast a **DHCPOFFER** message in response to the DHCPDISCOVER that offers to the client values for the requested parameters. Multiple servers might respond to a single DHCPDISCOVER; the client might wait a period of time and then act on the most preferred offer.
3. The client broadcasts a **DHCPREQUEST** message in response to the offer, requesting the offered values.

- After receiving a DHCPREQUEST, the server binds the clients' unique identifier (the hardware address plus IP address) to the accepted configuration parameters and stores the data in a database called a *binding table*. The server then broadcasts a **DHCPACK** message, which signals to the client that it may begin using the assigned parameters.

There are additional messages that are used in case the DHCP negotiation deviates from the process previously described and shown in the illustration below.

- DHCPDECLINE** A client sends this message to the server in response to a DHCPACK if the configuration parameters are unacceptable; for example, if the offered address is already in use. In this case, the client starts the configuration process over by sending a DHCPDISCOVER.
- DHCPINFORM** A client uses this message to request configuration parameters when it assigned an IP address manually rather than with DHCP. The server responds by unicast.
- DHCPNAK** A server sends this message to the client if it is not able to fulfill a DHCPREQUEST; for example, if the requested address is already in use. In this case, the client starts the configuration process over by sending a DHCPDISCOVER.
- DHCPRELEASE** A DHCP client sends this message when it is stopped forcefully to return its IP address to the server.

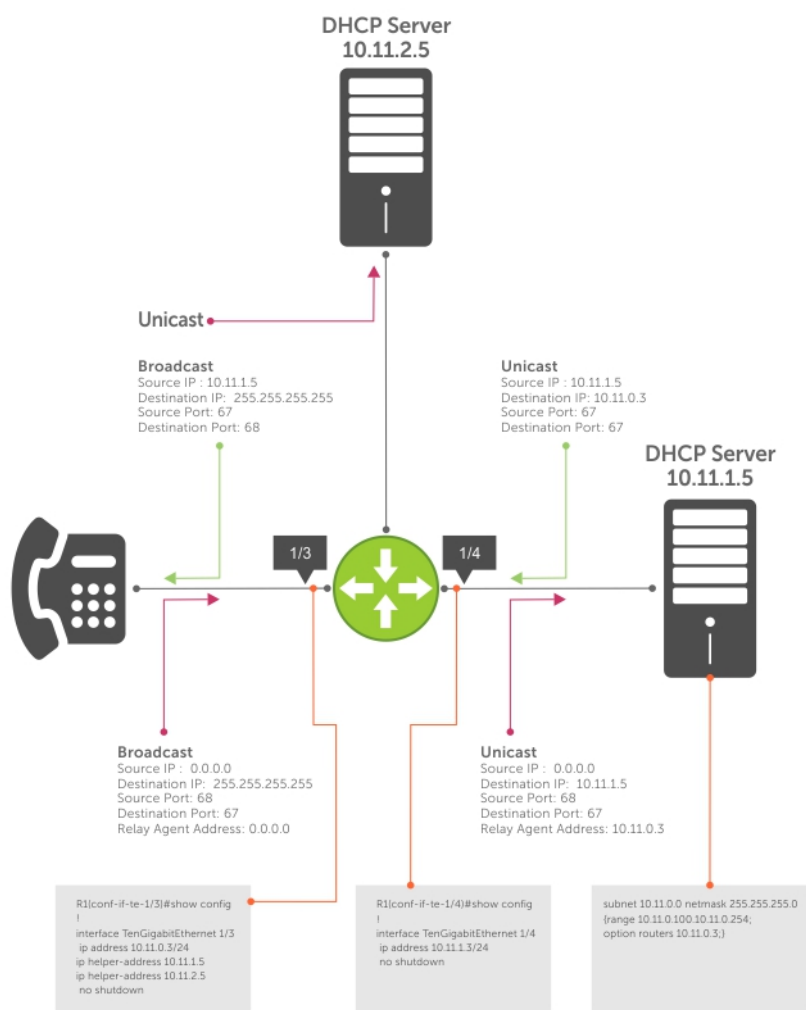

Figure 5. Assigning Network Parameters using DHCP

Dell Networking OS Behavior: DHCP is implemented in Dell Networking OS based on RFC 2131 and 3046.

Debugging DHCP Client Operation

To enable debug messages for DHCP client operation, enter the following **debug** commands:

- Enable the display of log messages for all DHCP packets sent and received on DHCP client interfaces.
EXEC Privilege
`[no] debug ip dhcp client packets [interface type slot/port]`
- Enable the display of log messages for the following events on DHCP client interfaces: IP address acquisition, IP address release, Renewal of IP address and lease time, and Release of an IP address.
EXEC Privilege
`[no] debug ip dhcp client events [interface type slot/port]`

The following example shows the packet- and event-level debug messages displayed for the packet transmissions and state transitions on a DHCP client interface.

DHCP Client: Debug Messages Logged during DHCP Client Enabling/Disabling

```
Dell (conf-if-Ma-0/0)# ip address dhcp
1w2d23h: %STKUNIT0-M:CP %DHCLIENT-5-DHCLIENT-LOG: DHCLIENT_DBG_EVT: Interface Ma 0/0
:DHCP ENABLE
CMD
Received in state START
1w2d23h: %STKUNIT0-M:CP %DHCLIENT-5-DHCLIENT-LOG: DHCLIENT_DBG_EVT: Interface Ma 0/0
:Transitioned
to state SELECTING
1w2d23h: %STKUNIT0-M:CP %DHCLIENT-5-DHCLIENT-LOG: DHCLIENT_DBG_PKT: DHCP DISCOVER sent
in
Interface
Ma 0/0
1w2d23h: %STKUNIT0-M:CP %DHCLIENT-5-DHCLIENT-LOG: DHCLIENT_DBG_PKT: Received DHCP OFFER
packet in
Interface Ma 0/0 with Lease-ip:10.16.134.250, Mask:255.255.0.0, Server-Id:10.16.134.249
1w2d23h: %STKUNIT0-M:CP %DHCLIENT-5-DHCLIENT-LOG: DHCLIENT_DBG_EVT: Interface Ma 0/0
:Transitioned
to state REQUESTING
1w2d23h: %STKUNIT0-M:CP %DHCLIENT-5-DHCLIENT-LOG: DHCLIENT_DBG_PKT:DHCP REQUEST sent in
Interface
Ma 0/0
1w2d23h: %STKUNIT0-M:CP %DHCLIENT-5-DHCLIENT-LOG: DHCLIENT_DBG_PKT:Received DHCPACK
packet in
Interface
Ma 0/0 with Lease-IP:10.16.134.250, Mask:255.255.0.0,DHCP REQUEST sent in Interface Ma
0/0
1w2d23h: %STKUNIT0-M:CP %DHCLIENT-5-DHCLIENT-LOG: DHCLIENT_DBG_EVT: Interface Ma 0/0
:Transitioned
to state BOUND

Dell(conf-if-ma-0/0)# no ip address
Dell(conf-if-ma-0/0)#1w2d23h: %STKUNIT0-M:CP %DHCLIENT-5-DHCLIENT-LOG: DHCLIENT_DBG_EVT:
Interface
Ma 0/0 :DHCP DISABLE CMD Received in state SELECTING
1w2d23h: %STKUNIT0-M:CP %DHCLIENT-5-DHCLIENT-LOG: DHCLIENT_DBG_EVT: Interface Ma 0/0
:Transitioned
to state START
1w2d23h: %STKUNIT0-M:CP %DHCLIENT-5-DHCLIENT-LOG: DHCLIENT_DBG_EVT: Interface Ma 0/0
:DHCP DISABLED
CMD
sent to FTOS in state START

Dell# release dhcp int Ma 0/0
Dell#1w2d23h: %STKUNIT0-M:CP %DHCLIENT-5-DHCLIENT-LOG: DHCLIENT_DBG_EVT: Interface Ma
0/0 :DHCP
RELEASE
CMD Received in state BOUND
```

```

1w2d23h: %STKUNIT0-M:CP %DHCLIENT-5-DHCLIENT-LOG: DHCLIENT_DBG_PKT: DHCP RELEASE sent in
Interface
Ma 0/0
1w2d23h: %STKUNIT0-M:CP %DHCLIENT-5-DHCLIENT-LOG: DHCLIENT_DBG_EVT: Interface Ma 0/0
:Transitioned
to state STOPPED
1w2d23h: %STKUNIT0-M:CP %DHCLIENT-5-DHCLIENT-LOG: DHCLIENT_DBG_EVT: Interface Ma 0/0
:DHCP IP
RELEASED
CMD sent to FTOS in state STOPPED

Dell# renew dhcp int Ma 0/0
Dell#1w2d23h: %STKUNIT0-M:CP %DHCLIENT-5-DHCLIENT-LOG: DHCLIENT_DBG_EVT: Interface Ma
0/0 :DHCP
RENEW
CMD Received in state STOPPED
1w2d23h: %STKUNIT0-M:CP %DHCLIENT-5-DHCLIENT-LOG: DHCLIENT_DBG_EVT: Interface Ma 0/0
:Transitioned
to state SELECTING
1w2d23h: %STKUNIT0-M:CP %DHCLIENT-5-DHCLIENT-LOG: DHCLIENT_DBG_PKT: DHCP DISCOVER sent
in Interface
Ma 0/0
1w2d23h: %STKUNIT0-M:CP %DHCLIENT-5-DHCLIENT-LOG: DHCLIENT_DBG_PKT: Received DHCP OFFER
packet in
Interface Ma 0/0 with Lease-Ip:10.16.134.250, Mask:255.255.0.0, Server-Id:10.16.134.249

```

The following example shows the packet- and event-level debug messages displayed for the packet transmissions and state transitions on a DHCP client interface when you release and renew a DHCP client.

DHCP Client: Debug Messages Logged during DHCP Client Release/Renew

```

Dell# release dhcp interface managementethernet 0/0
May 27 15:55:22: %STKUNIT0-M:CP %DHCLIENT-5-DHCLIENT-LOG: DHCLIENT_DBG_EVT: Interface Ma
0/0 :
DHCP RELEASE CMD Received in state BOUND
May 27 15:55:22: %STKUNIT0-M:CP %DHCLIENT-5-DHCLIENT-LOG: DHCLIENT_DBG_PKT:
DHCP RELEASE sent in Interface Ma 0/0
May 27 15:55:22: %STKUNIT0-M:CP %DHCLIENT-5-DHCLIENT-LOG: DHCLIENT_DBG_EVT: Interface Ma
0/0 :
Transitioned to state STOPPED
May 27 15:55:22: %STKUNIT0-M:CP %DHCLIENT-5-DHCLIENT-LOG: DHCLIENT_DBG_EVT: Interface Ma
0/0 :
DHCP IP RELEASED CMD sent to FTOS in state STOPPED

Dell# renew dhcp interface tengigabitethernet 0/1
Dell#May 27 15:55:28: %STKUNIT0-M:CP %DHCLIENT-5-DHCLIENT-LOG: DHCLIENT_DBG_EVT:
Interface Ma 0/0 :
DHCP RENEW CMD Received in state STOPPED
May 27 15:55:31: %STKUNIT0-M:CP %DHCLIENT-5-DHCLIENT-LOG: DHCLIENT_DBG_EVT: Interface Ma
0/0 :
Transitioned to state SELECTING
May 27 15:55:31: %STKUNIT0-M:CP %DHCLIENT-5-DHCLIENT-LOG: DHCLIENT_DBG_PKT:
DHCP DISCOVER sent in Interface Ma 0/0
May 27 15:55:31: %STKUNIT0-M:CP %DHCLIENT-5-DHCLIENT-LOG: DHCLIENT_DBG_PKT:
Received DHCP OFFER packet in Interface Ma 0/0 with Lease-Ip:10.16.134.250,
Mask:255.255.0.0, Server-Id:10.16.134.249

```

DHCP Client

An Aggregator is auto-configured to operate as a DHCP client. The DHCP client functionality is enabled only on the default VLAN and the management interface.

A DHCP client is a network device that requests an IP address and configuration parameters from a DHCP server. On an Aggregator, the DHCP client functionality is implemented as follows:

- The public out-of-band management (OOB) interface and default VLAN 1 are configured, by default, as a DHCP client to acquire a dynamic IP address from a DHCP server.

You can override the DHCP-assigned address on the OOB management interface by manually configuring an IP address using the CLI or CMC interface. If no user-configured IP address exists for the OOB interface exists and if the OOB IP address is not in the startup configuration, the Aggregator will automatically obtain it using DHCP.

You can also manually configure an IP address for the VLAN 1 default management interface using the CLI. If no user-configured IP address exists for the default VLAN management interface exists and if the default VLAN IP address is not in the startup configuration, the Aggregator will automatically obtain it using DHCP.

- The default VLAN 1 with all ports configured as members is the only L3 interface on the Aggregator. When the default management VLAN has a DHCP-assigned address and you reconfigure the default VLAN ID number, the Aggregator:
 - Sends a DHCP release to the DHCP server to release the IP address.
 - Sends a DHCP request to obtain a new IP address. The IP address assigned by the DHCP server is used for the new default management VLAN.

How DHCP Client is Implemented

The Aggregator is enabled by default to receive DHCP server-assigned dynamic IP addresses on an interface. This setting persists after a switch reboot. If you enter the `shutdown` command on the interface, DHCP transactions are stopped and the dynamically-acquired IP address is saved. Use the `show interface type slot/port` command to display the dynamic IP address and DHCP as the mode of IP address assignment. If you later enter the `no shutdown` command and the lease timer for the dynamic IP address has expired, the IP address is unconfigured and the interface tries to acquire a new dynamic address from DHCP server.

If you later enter the `no shutdown` command and the lease timer for the dynamic IP address has expired, the IP address is released.

When you enter the `release dhcp` command, although the IP address that was dynamically-acquired from a DHCP server is released from an interface, the ability to acquire a new DHCP server-assigned address remains in the running configuration for the interface. To acquire a new IP address, enter either the `renew dhcp` command at the EXEC privilege level or the `ip address dhcp` command at the interface configuration level.

If you enter `renew dhcp` command on an interface already configured with a dynamic IP address, the lease time of the dynamically acquired IP address is renewed.

NOTE: To verify the currently configured dynamic IP address on an interface, enter the `show ip dhcp lease` command. The `show running-configuration` command output only displays `ip address dhcp`; the currently assigned dynamic IP address is not displayed.

DHCP Client on a Management Interface

These conditions apply when you enable a management interface to operate as a DHCP client.

- The management default route is added with the gateway as the router IP address received in the DHCP ACK packet. It is required to send and receive traffic to and from other subnets on the external network. The route is added irrespective of whether the DHCP client and server are on same or different subnets. The management default route is deleted if the management IP address is released like other DHCP client management routes.
- `ip route for 0.0.0.0` takes precedence if it is present or added later.
- Management routes added by a DHCP client display with Route Source as **DHCP** in the `show ip management route` and `show ip management-route dynamic` command output.
- Management routes added by DHCP are automatically reinstalled if you configure a static IP route with the `ip route` command that replaces a management route added by the DHCP client. If you remove the statically configured IP route using the `no ip route` command, the management route is reinstalled. Manually delete management routes added by the DHCP client.
- To reinstall management routes added by the DHCP client that is removed or replaced by the same statically configured management routes, release the DHCP IP address and renew it on the management interface.
- Management routes added by the DHCP client have higher precedence over the same statically configured management route. Static routes are not removed from the running configuration if a dynamically acquired management route added by the DHCP client overwrites a static management route.
- Management routes added by the DHCP client are not added to the running configuration.

NOTE: Management routes added by the DHCP client include the specific routes to reach a DHCP server in a different subnet and the management route.

DHCP Client on a VLAN

The following conditions apply on a VLAN that operates as a DHCP client:

- The default VLAN 1 with all ports auto-configured as members is the only L3 interface on the Aggregator.
- When the default management VLAN has a DHCP-assigned address and you reconfigure the default VLAN ID number, the Aggregator:
 - Sends a DHCP release to the DHCP server to release the IP address.
 - Sends a DHCP request to obtain a new IP address. The IP address assigned by the DHCP server is used for the new default management VLAN.

DHCP Packet Format and Options

DHCP uses the user datagram protocol (UDP) as its transport protocol.

The server listens on port 67 and transmits to port 68; the client listens on port 68 and transmits to port 67. The configuration parameters are carried as options in the DHCP packet in Type, Length, Value (TLV) format; many options are specified in RFC 2132. To limit the number of parameters that servers must provide, hosts specify the parameters that they require, and the server sends only those parameters. Some common options are shown in the following illustration.

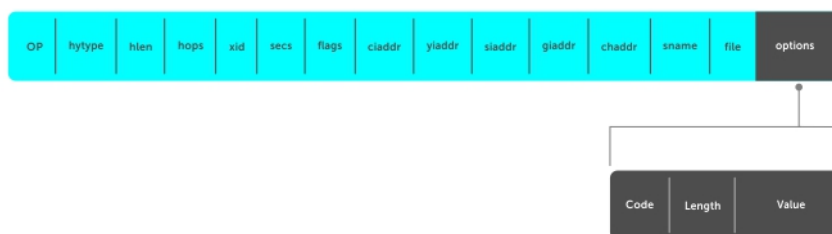

Figure 6. DHCP packet Format

The following table lists common DHCP options.

Option	Number and Description
Subnet Mask	Option 1 Specifies the client's subnet mask.
Router	Option 3 Specifies the router IP addresses that may serve as the client's default gateway.
Domain Name Server	Option 6 Specifies the domain name servers (DNSs) that are available to the client.
Domain Name	Option 15 Specifies the domain name that clients should use when resolving hostnames via DNS.
IP Address Lease Time	Option 51 Specifies the amount of time that the client is allowed to use an assigned IP address.
DHCP Message Type	Option 53 <ul style="list-style-type: none"> • 1: DHCPDISCOVER • 2: DHCPOFFER • 3: DHCPREQUEST • 4: DHCPDECLINE • 5: DHCPACK • 6: DHCPNACK • 7: DHCPRELEASE

Option	Number and Description
	<ul style="list-style-type: none"> 8: DHCPINFORM
Parameter Request List	Option 55 Clients use this option to tell the server which parameters it requires. It is a series of octets where each octet is DHCP option code.
Renewal Time	Option 58 Specifies the amount of time after the IP address is granted that the client attempts to renew its lease with the <i>original</i> server.
Rebinding Time	Option 59 Specifies the amount of time after the IP address is granted that the client attempts to renew its lease with <i>any</i> server, if the original server does not respond.
End	Option 255 Signals the last option in the DHCP packet.

Option 82

RFC 3046 (the relay agent information option, or Option 82) is used for class-based IP address assignment.

The code for the relay agent information option is 82, and is comprised of two sub-options, circuit ID and remote ID.

Circuit ID	This is the interface on which the client-originated message is received.
Remote ID	This identifies the host from which the message is received. The value of this sub-option is the MAC address of the relay agent that adds Option 82.

The DHCP relay agent inserts Option 82 before forwarding DHCP packets to the server. The server can use this information to:

- track the number of address requests per relay agent. Restricting the number of addresses available per relay agent can harden a server against address exhaustion attacks.
- associate client MAC addresses with a relay agent to prevent offering an IP address to a client spoofing the same MAC address on a different relay agent.
- assign IP addresses according to the relay agent. This prevents generating DHCP offers in response to requests from an unauthorized relay agent.

The server echoes the option back to the relay agent in its response, and the relay agent can use the information in the option to forward a reply out the interface on which the request was received rather than flooding it on the entire VLAN.

The relay agent strips Option 82 from DHCP responses before forwarding them to the client.

To insert Option 82 into DHCP packets, follow this step.

- Insert Option 82 into DHCP packets.
CONFIGURATION mode

```
int ma 0/0
ip add dhcp relay information-option remote-id
```

For routers between the relay agent and the DHCP server, enter the `trust-downstream` option.

Releasing and Renewing DHCP-based IP Addresses

On an Aggregator configured as a DHCP client, you can release a dynamically-assigned IP address without removing the DHCP client operation on the interface.

To manually acquire a new IP address from the DHCP server, use the following command.

- Release a dynamically-acquired IP address while retaining the DHCP client configuration on the interface.
EXEC Privilege mode

```
release dhcp interface type slot/port
```

- Acquire a new IP address with renewed lease time from a DHCP server.

```
EXEC Privilege mode
```

```
renew dhcp interface type slot/port
```

Viewing DHCP Statistics and Lease Information

To display DHCP client information, enter the following **show** commands:

- Display statistics about DHCP client interfaces.

```
EXEC Privilege
```

```
show ip dhcp client statistics interface type slot/port
```

- Clear DHCP client statistics on a specified or on all interfaces.

```
EXEC Privilege
```

```
clear ip dhcp client statistics {all | interface type slot/port}
```

- Display lease information about the dynamic IP address currently assigned to a DHCP client interface.

```
EXEC Privilege
```

```
show ip dhcp lease [interface type slot/port]
```

View the statistics about DHCP client interfaces with the **show ip dhcp client statistics** command and the lease information about the dynamic IP address currently assigned to a DHCP client interface with the **show ip dhcp lease** command.

Example of the show ip dhcp client statistics Command

```
Dell#show ip dhcp client statistics interface managementethernet 0/0
Interface Name          Ma 0/0
Message                 Received
DHCPPOFFER              0
DHCPACK                  0
DHCPNAK                  0
Message                 Sent
DHCPDISCOVER            1626
DHCPREQUEST              0
DHCPDECLINE              0
DHCPRELEASE              0
DHCPREBIND               0
DHCPRENEW                0
DHCPINFORM               0
Dell#
```

Example of the show ip dhcp lease Command

```
Dell# show ip dhcp
Interface  Lease-IP  Def-Router  ServerId  State  Lease Obtnd At  Lease Expires At
=====  =====  =====  =====  =====  =====
Ma 0/0
0.0.0.0/0 0.0.0.0   0.0.0.0    INIT     -----NA-----  ----NA----

Vl 1     10.1.1.254/24 0.0.0.0    10.1.1.1  BOUND  08-26-2011 04:33:39  08-27-2011 04:33:39

Renew Time          Rebind Time
=====
-----NA-----   -----NA-----

08-26-2011 16:21:50  08-27-2011 01:33:39
```

FIP Snooping

This chapter describes about the FIP snooping concepts and configuration procedures.

Supported Modes

Standalone, PMUX, VLT

Topics:

- [Fibre Channel over Ethernet](#)
- [Ensuring Robustness in a Converged Ethernet Network](#)
- [FIP Snooping on Ethernet Bridges](#)
- [How FIP Snooping is Implemented](#)
- [Configuring FIP Snooping](#)
- [Displaying FIP Snooping Information](#)
- [FIP Snooping Example](#)
- [Debugging FIP Snooping](#)

Fibre Channel over Ethernet

Fibre Channel over Ethernet (FCoE) provides a converged Ethernet network that allows the combination of storage-area network (SAN) and LAN traffic on a Layer 2 link by encapsulating Fibre Channel data into Ethernet frames.

FCoE works with Ethernet enhancements provided in data center bridging (DCB) to support lossless (no-drop) SAN and LAN traffic. In addition, DCB provides flexible bandwidth sharing for different traffic types, such as LAN and SAN, according to 802.1p priority classes of service. For more information, refer to the Data Center Bridging (DCB) chapter.

Ensuring Robustness in a Converged Ethernet Network

Fibre Channel networks used for SAN traffic employ switches that operate as trusted devices. End devices log into the switch to which they are attached in order to communicate with the other end devices attached to the Fibre Channel network. Because Fibre Channel links are point-to-point, a Fibre Channel switch controls all storage traffic that an end device sends and receives over the network. As a result, the switch can enforce zoning configurations, ensure that end devices use their assigned addresses, and secure the network from unauthorized access and denial-of-service attacks.

To ensure similar Fibre Channel robustness and security with FCoE in an Ethernet cloud network, the Fibre Channel over Ethernet initialization protocol (FIP) establishes virtual point-to-point links between FCoE end-devices (server ENodes and target storage devices) and FCoE forwarders (FCFs) over transit FCoE-enabled bridges.

Ethernet bridges commonly provide access control list (ACLs) that can emulate a point-to-point link by providing the traffic enforcement required to create a Fibre Channel-level of robustness. In addition, FIP serves as a Layer 2 protocol to:

- Operate between FCoE end-devices and FCFs over intermediate Ethernet bridges to prevent unauthorized access to the network and achieve the required security.
- Allow transit Ethernet bridges to efficiently monitor FIP frames passing between FCoE end-devices and an FCF, and use the FIP snooping data to dynamically configure ACLs on the bridge to only permit traffic authorized by the FCF.

FIP enables FCoE devices to discover one another, initialize and maintain virtual links over an Ethernet network, and access storage devices in a storage area network. FIP satisfies the Fibre Channel requirement for point-to-point connections by creating a unique virtual link for each connection between an FCoE end-device and an FCF via a transit switch.

FIP provides a functionality for discovering and logging in to an FCF. After discovering and logging in, FIP allows FCoE traffic to be sent and received between FCoE end-devices (ENodes) and the FCF. FIP uses its own EtherType and frame format. The below illustration about FIP discovery, depicts the communication that occurs between an ENode server and an FCoE switch (FCF).

FIP performs the following functions:

- FIP virtual local area network (VLAN) discovery: FCoE devices (ENodes) discover the FCoE VLANs on which to transmit and receive FIP and FCoE traffic.
- FIP discovery: FCoE end-devices and FCFs are automatically discovered.
- Initialization: FCoE devices perform fabric login (FLOGI) and fabric discovery (FDISC) to create a virtual link with an FCoE switch.
- Maintenance: A valid virtual link between an FCoE device and an FCoE switch is maintained and the link termination logout (LOGO) functions properly.

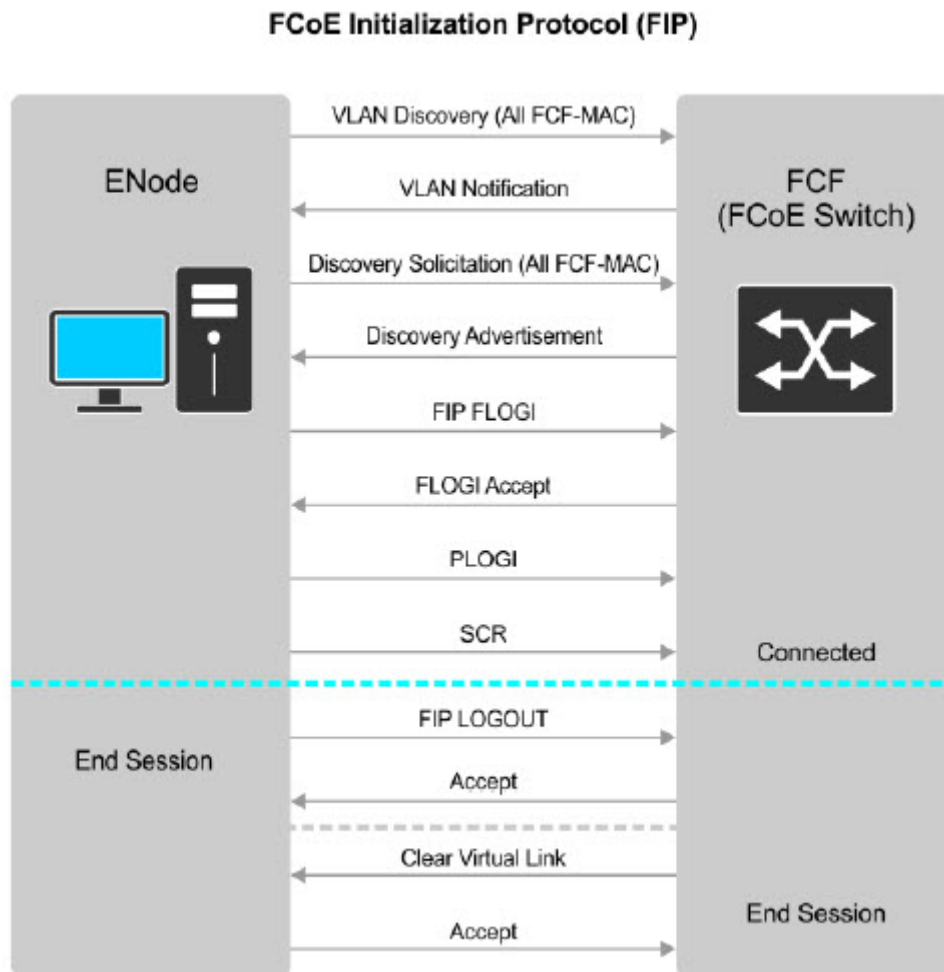

Figure 7. FIP Discovery and Login between an ENode and an FCF

FIP Snooping on Ethernet Bridges

In a converged Ethernet network, intermediate Ethernet bridges can snoop on FIP packets during the login process on an FCF. Then, using ACLs, a transit bridge can permit only authorized FCoE traffic to be transmitted between an FCoE end-device and an FCF. An Ethernet bridge that provides these functions is called a FIP snooping bridge (FSB).

On a FIP snooping bridge, ACLs are created dynamically as FIP login frames are processed. The ACLs are installed on switch ports configured for the following port modes:

- ENode mode for server-facing ports
- FCF mode for a trusted port directly connected to an FCF

You must enable FIP snooping on an Aggregator and configure the FIP snooping parameters. When you enable FIP snooping, all ports on the switch by default become ENode ports.

Dynamic ACL generation on an Aggregator operating as a FIP snooping bridge functions as follows:

- Global ACLs are applied on server-facing ENode ports.
- Port-based ACLs are applied on ports directly connected to an FCF and on server-facing ENode ports.
- Port-based ACLs take precedence over global ACLs.
- FCoE-generated ACLs take precedence over user-configured ACLs. A user-configured ACL entry cannot deny FCoE and FIP snooping frames.

The below illustration depicts an Aggregator used as a FIP snooping bridge in a converged Ethernet network. The ToR switch operates as an FCF for FCoE traffic. Converged LAN and SAN traffic is transmitted between the ToR switch and an Aggregator. The Aggregator operates as a lossless FIP snooping bridge to transparently forward FCoE frames between the ENode servers and the FCF switch.

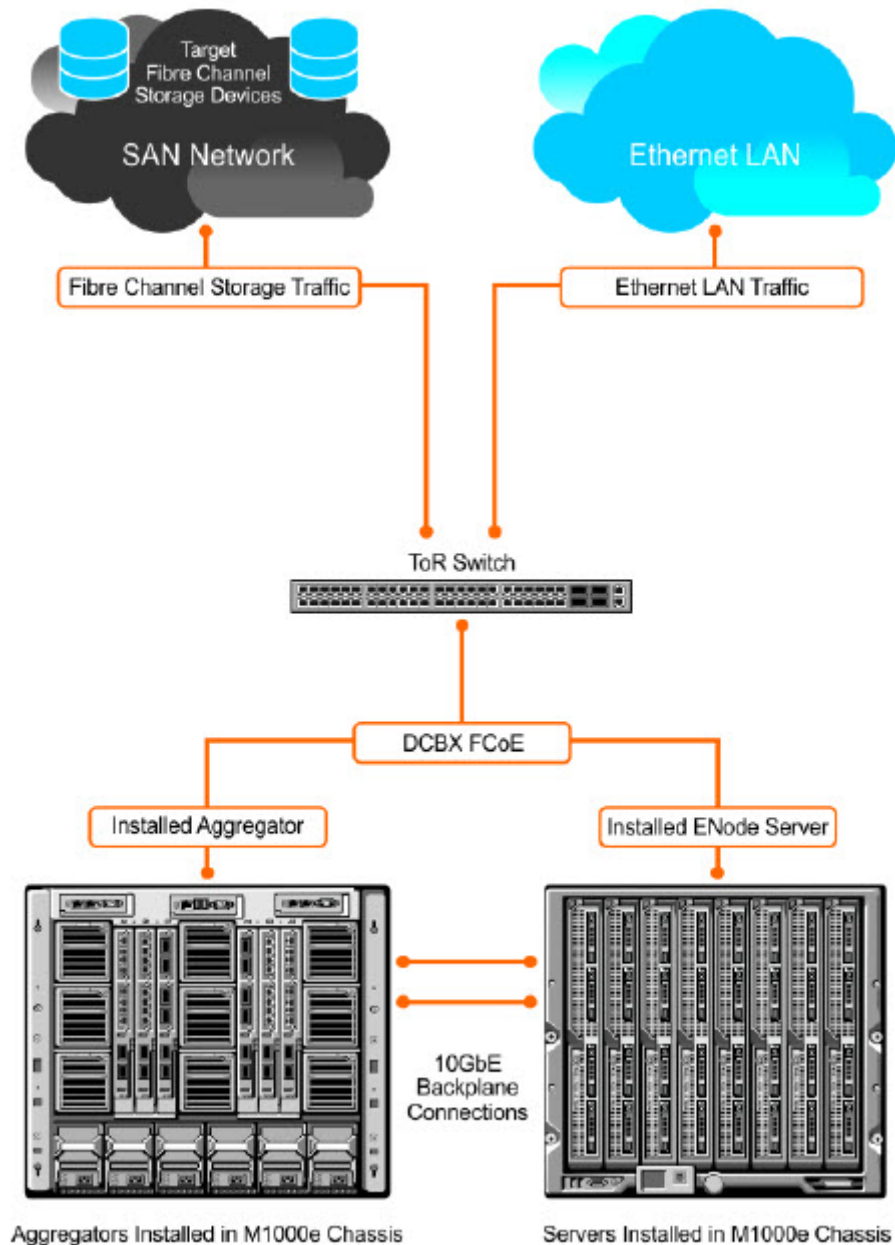

Figure 8. FIP Snooping on an Aggregator

The following sections describes how to configure the FIP snooping feature on a switch that functions as a FIP snooping bridge so that it can perform the following functions:

- Performs FIP snooping (allowing and parsing FIP frames) globally on all VLANs or on a per-VLAN basis.
- Set the FCoE MAC address prefix (FC-MAP) value used by an FCF to assign a MAC address to an ECoE end-device (server ENode or storage device) after a server successfully logs in.
- Set the FCF mode to provide additional port security on ports that are directly connected to an FCF.
- Check FIP snooping-enabled VLANs to ensure that they are operationally active.
- Process FIP VLAN discovery requests and responses, advertisements, solicitations, FLOGI/FDISC requests and responses, FLOGO requests and responses, keep-alive packets, and clear virtual-link messages.

How FIP Snooping is Implemented

As soon as the Aggregator is activated in an M1000e chassis as a switch-bridge, existing VLAN-specific and FIP snooping auto-configurations are applied. The Aggregator snoops FIP packets on VLANs enabled for FIP snooping and allows legitimate sessions. By default, all FCoE and FIP frames are dropped unless specifically permitted by existing FIP snooping-generated ACLs.

FIP Snooping on VLANs

FIP snooping is enabled globally on an Aggregator on all VLANs:

- FIP frames are allowed to pass through the switch on the enabled VLANs and are processed to generate FIP snooping ACLs.
- FCoE traffic is allowed on VLANs only after a successful virtual-link initialization (fabric login FLOGI) between an ENode and an FCF. All other FCoE traffic is dropped.
- At least one interface is auto-configured for FCF (FIP snooping bridge — FCF) mode on a FIP snooping-enabled VLAN. Multiple FCF trusted interfaces are auto-configured in a VLAN.
- A maximum of eight VLANs are supported for FIP snooping on an Aggregator. FIP snooping processes FIP packets in traffic only from the first eight incoming VLANs.

FC-MAP Value

The FC-MAP value that is applied globally by the Aggregator on all FCoE VLANs to authorize FCoE traffic is auto-configured.

The FC-MAP value is used to check the FC-MAP value for the MAC address assigned to ENodes in incoming FCoE frames. If the FC-MAP values does not match, FCoE frames are dropped. A session between an ENode and an FCF is established by the switch —bridge only when the FC-MAP value on the FCF matches the FC-MAP value on the FIP snooping bridge.

Bridge-to-FCF Links

A port directly connected to an FCF is auto-configured in FCF mode. Initially, all FCoE traffic is blocked; only FIP frames are allowed to pass.

FCoE traffic is allowed on the port only after a successful FLOGI request/response and confirmed use of the configured FC-MAP value for the VLAN.

Impact on other Software Features

FIP snooping affects other software features on an Aggregator as follows:

- MAC address learning: MAC address learning is not performed on FIP and FCoE frames, which are denied by ACLs dynamically created by FIP snooping in server-facing ports in ENode mode.
- MTU auto-configuration: MTU size is set to mini-jumbo (2500 bytes) when a port is in Switchport mode, the FIP snooping feature is enabled on the switch, and the FIP snooping is enabled on all or individual VLANs.
- Link aggregation group (LAG): FIP snooping is supported on port channels on ports on which PFC mode is on (PFC is operationally up).

FIP Snooping Prerequisites

On an Aggregator, FIP snooping requires the following conditions:

- A FIP snooping bridge requires DCBX and PFC to be enabled on the switch for lossless Ethernet connections (refer to **Data Center Bridging (DCB)**). Dell recommends that you also enable ETS; ETS is recommended but not required. DCBX and PFC mode are auto-configured on Aggregator ports and FIP snooping is operational on the port. If the PFC parameters in a DCBX exchange with a peer are not synchronized, FIP and FCoE frames are dropped on the port.
- VLAN membership:
 - The Aggregator auto-configures the VLANs which handle FCoE traffic. You can reconfigure VLAN membership on a port (`vlan tagged` command).
 - Each FIP snooping port is auto-configured to operate in Hybrid mode so that it accepts both tagged and untagged VLAN frames.
 - Tagged VLAN membership is auto-configured on each FIP snooping port that sends and receives FCoE traffic and has links with an FCF, ENode server or another FIP snooping bridge.
 - The default VLAN membership of the port should continue to operate with untagged frames. FIP snooping is not supported on a port that is configured for non-default untagged VLAN membership.

FIP Snooping Restrictions

The following restrictions apply to FIP snooping on an Aggregator:

- The maximum number of FCoE VLANs supported on the Aggregator is eight.
- The maximum number of FIP snooping sessions supported per ENode server is 32. To increase the maximum number of sessions to 64, use the `fip-snooping max-sessions-per-enodemac` command. This is configurable only in PMUX mode.
- In a full FCoE N port ID virtualization (NPIV) configuration, 16 sessions (one FLOGI + 15 NPIV sessions) are supported per ENode. In an FCoE NPV configuration, only one session is supported per ENode.
- The maximum number of FCFs supported per FIP snooping-enabled VLAN is 12.
- Links to other FIP snooping bridges on a FIP snooping-enabled port (bridge-to-bridge links) are not supported on the Aggregator.

Configuring FIP Snooping

FIP snooping is auto-configured on an Aggregator in standalone mode. You can display information on FIP snooping operation and statistics by entering `show` commands. You can enable FIP snooping globally on all FCoE VLANs on a switch or on an individual FCoE VLAN.

By default, FIP snooping is disabled.

To enable FCoE transit on the switch and configure the FCoE transit parameters on ports, follow these steps.

1. Enable the FCoE transit feature on a switch.
CONFIGURATION mode.
`feature fip-snooping`
2. Enable FIP snooping on all VLANs or on a specified VLAN.
CONFIGURATION mode or VLAN INTERFACE mode.
`fip-snooping enable`
By default, FIP snooping is disabled on all VLANs.
3. Configure the FC-MAP value used by FIP snooping on all VLANs.
CONFIGURATION VLAN or INTERFACE mode
`fip-snooping fc-map fc-map-value`
The default is 0x0EFC00.
The valid values are from 0EFC00 to 0EFCFF.
4. Enter interface configuration mode to configure the port for FIP snooping links.
CONFIGURATION mode
`interface port-type slot/port`

By default, a port is configured for bridge-to-ENode links.

5. Configure the port for bridge-to-FCF links.

INTERFACE or CONFIGURATION mode

```
fip-snooping port-mode fcf
```

NOTE: All these configurations are available only in PMUX mode.

NOTE: To disable the FIP snooping feature or FIP snooping on VLANs, use the `no` version of a command; for example, `no feature fip-snooping` or `no fip-snooping enable`.

Displaying FIP Snooping Information

Use the `show` commands from the table below, to display information on FIP snooping.

Table 6. Displaying FIP Snooping Information

Command	Output
<code>show fip-snooping sessions [interface vlan <i>vlan-id</i>]</code>	Displays information on FIP-snooped sessions on all VLANs or a specified VLAN, including the ENode interface and MAC address, the FCF interface and MAC address, VLAN ID, FCoE MAC address and FCoE session ID number (FC-ID), worldwide node name (WWNN) and the worldwide port name (WWPN). Information on NPIV sessions is also displayed.
<code>show fip-snooping config</code>	Displays the FIP snooping status and configured FC-MAP values.
<code>show fip-snooping enode [<i>enode-mac-address</i>]</code>	Displays information on the ENodes in FIP-snooped sessions, including the ENode interface and MAC address, FCF MAC address, VLAN ID and FC-ID.
<code>show fip-snooping fcf [<i>fcf-mac-address</i>]</code>	Displays information on the FCFs in FIP-snooped sessions, including the FCF interface and MAC address, FCF interface, VLAN ID, FC-MAP value, FKA advertisement period, and number of ENodes connected.
<code>clear fip-snooping database interface vlan <i>vlan-id</i> {<i>fcoe-mac-address</i> <i>enode-mac-address</i> <i>fcf-mac-address</i>}</code>	Clears FIP snooping information on a VLAN for a specified FCoE MAC address, ENode MAC address, or FCF MAC address, and removes the corresponding ACLs generated by FIP snooping.
<code>show fip-snooping statistics [interface vlan <i>vlan-id</i> interface <i>port-type</i> <i>port/slot</i> interface <i>port-channel</i> <i>port-channel-number</i>]</code>	Displays statistics on the FIP packets snooped on all interfaces, including VLANs, physical ports, and port channels.
<code>clear fip-snooping statistics [interface vlan <i>vlan-id</i> interface <i>port-type</i> <i>port/slot</i> interface <i>port-channel</i> <i>port-channel-number</i>]</code>	Clears the statistics on the FIP packets snooped on all VLANs, a specified VLAN, or a specified port interface.
<code>show fip-snooping system</code>	Display information on the status of FIP snooping on the switch (enabled or disabled), including the number of FCoE VLANs, FCFs, ENodes, and currently active sessions.
<code>show fip-snooping vlan</code>	Display information on the FCoE VLANs on which FIP snooping is enabled.

show fip-snooping sessions **Command Example**

```
Dell#show fip-snooping sessions
Enode MAC          Enode Intf      FCF MAC          FCF Intf      VLAN
aa:bb:cc:00:00:00 Te 0/42         aa:bb:cd:00:00:00 Te 0/43        100
aa:bb:cc:00:00:00 Te 0/42         aa:bb:cd:00:00:00 Te 0/43        100
aa:bb:cc:00:00:00 Te 0/42         aa:bb:cd:00:00:00 Te 0/43        100
aa:bb:cc:00:00:00 Te 0/42         aa:bb:cd:00:00:00 Te 0/43        100
aa:bb:cc:00:00:00 Te 0/42         aa:bb:cd:00:00:00 Te 0/43        100

FCoE MAC          FC-ID          Port WWPN          Port WWNN
0e:fc:00:01:00:01 01:00:01      31:00:0e:fc:00:00:00:00 21:00:0e:fc:00:00:00:00
0e:fc:00:01:00:02 01:00:02      41:00:0e:fc:00:00:00:00 21:00:0e:fc:00:00:00:00
0e:fc:00:01:00:03 01:00:03      41:00:0e:fc:00:00:00:01 21:00:0e:fc:00:00:00:00
0e:fc:00:01:00:04 01:00:04      41:00:0e:fc:00:00:00:02 21:00:0e:fc:00:00:00:00
0e:fc:00:01:00:05 01:00:05      41:00:0e:fc:00:00:00:03 21:00:0e:fc:00:00:00:00
```

show fip-snooping sessions **Command Description**

Field	Description
ENode MAC	MAC address of the ENode.
ENode Interface	Slot/ port number of the interface connected to the ENode.
FCF MAC	MAC address of the FCF.
FCF Interface	Slot/ port number of the interface to which the FCF is connected.
VLAN	VLAN ID number used by the session.
FCoE MAC	MAC address of the FCoE session assigned by the FCF.
FC-ID	Fibre Channel ID assigned by the FCF.
Port WWPN	Worldwide port name of the CNA port.
Port WWNN	Worldwide node name of the CNA port.

show fip-snooping config **Command Example**

```
Dell# show fip-snooping config
FIP Snooping Feature enabled Status: Enabled
FIP Snooping Global enabled Status: Enabled
Global FC-MAP Value: 0X0EFC00

FIP Snooping enabled VLANs
VLAN      Enabled      FC-MAP
-----
100      TRUE          0X0EFC00
```

show fip-snooping enode **Command Example**

```
Dell# show fip-snooping enode
Enode MAC          Enode Interface  FCF MAC          VLAN      FC-ID
-----
d4:ae:52:1b:e3:cd Te 0/11         54:7f:ee:37:34:40 100      62:00:11
```

show fip-snooping enode **Command Description**

Field	Description
ENode MAC	MAC address of the ENode.
ENode Interface	Slot/ port number of the interface connected to the ENode.
FCF MAC	MAC address of the FCF.
VLAN	VLAN ID number used by the session.
FC-ID	Fibre Channel session ID assigned by the FCF.

show fip-snooping fcf **Command Example**

```
Dell# show fip-snooping fcf
FCF MAC          FCF Interface      VLAN      FC-MAP      FKA_ADV_PERIOD  No. of
Enodes
-----
54:7f:ee:37:34:40 Po 22             100      0e:fc:00    4000           2
```

show fip-snooping fcf **Command Description**

Field	Description
FCF MAC	MAC address of the FCF.
FCF Interface	Slot/port number of the interface to which the FCF is connected.
VLAN	VLAN ID number used by the session.
FC-MAP	FC-Map value advertised by the FCF.
ENode Interface	Slot/ number of the interface connected to the ENode.
FKA_ADV_PERIOD	Period of time (in milliseconds) during which FIP keep-alive advertisements are transmitted.
No of ENodes	Number of ENodes connected to the FCF.
FC-ID	Fibre Channel session ID assigned by the FCF.

show fip-snooping statistics (VLAN and port) **Command Example**

```
Dell# show fip-snooping statistics interface vlan 100
Number of Vlan Requests           :0
Number of Vlan Notifications      :0
Number of Multicast Discovery Solicits :2
Number of Unicast Discovery Solicits :0
Number of FLOGI                   :2
Number of FDISC                   :16
Number of FLOGO                   :0
Number of Enode Keep Alive        :9021
Number of VN Port Keep Alive      :3349
Number of Multicast Discovery Advertisement :4437
Number of Unicast Discovery Advertisement :2
Number of FLOGI Accepts           :2
Number of FLOGI Rejects           :0
Number of FDISC Accepts           :16
Number of FDISC Rejects           :0
Number of FLOGO Accepts           :0
Number of FLOGO Rejects           :0
Number of CVL                     :0
Number of FCF Discovery Timeouts   :0
Number of VN Port Session Timeouts :0
Number of Session failures due to Hardware Config :0
Dell(conf)#

Dell# show fip-snooping statistics int tengigabitethernet 0/11
Number of Vlan Requests           :1
Number of Vlan Notifications      :0
Number of Multicast Discovery Solicits :1
Number of Unicast Discovery Solicits :0
Number of FLOGI                   :1
Number of FDISC                   :16
Number of FLOGO                   :0
Number of Enode Keep Alive        :4416
Number of VN Port Keep Alive      :3136
Number of Multicast Discovery Advertisement :0
Number of Unicast Discovery Advertisement :0
Number of FLOGI Accepts           :0
Number of FLOGI Rejects           :0
Number of FDISC Accepts           :0
Number of FDISC Rejects           :0
Number of FLOGO Accepts           :0
```

```

Number of FLOGO Rejects           :0
Number of CVL                     :0
Number of FCF Discovery Timeouts  :0
Number of VN Port Session Timeouts :0
Number of Session failures due to Hardware Config :0

```

show fip-snooping statistics (port channel) Command Example

```

Dell# show fip-snooping statistics interface port-channel 22
Number of Vlan Requests           :0
Number of Vlan Notifications      :2
Number of Multicast Discovery Solicits :0
Number of Unicast Discovery Solicits :0
Number of FLOGI                   :0
Number of FDISC                   :0
Number of FLOGO                    :0
Number of Enode Keep Alive        :0
Number of VN Port Keep Alive      :0
Number of Multicast Discovery Advertisement :4451
Number of Unicast Discovery Advertisement :2
Number of FLOGI Accepts           :2
Number of FLOGI Rejects           :0
Number of FDISC Accepts           :16
Number of FDISC Rejects           :0
Number of FLOGO Accepts           :0
Number of FLOGO Rejects           :0
Number of CVL                     :0
Number of FCF Discovery Timeouts  :0
Number of VN Port Session Timeouts :0
Number of Session failures due to Hardware Config :0

```

show fip-snooping statistics Command Description

Field	Description
Number of Vlan Requests	Number of FIP-snooped VLAN request frames received on the interface.
Number of VLAN Notifications	Number of FIP-snooped VLAN notification frames received on the interface.
Number of Multicast Discovery Solicits	Number of FIP-snooped multicast discovery solicit frames received on the interface.
Number of Unicast Discovery Solicits	Number of FIP-snooped unicast discovery solicit frames received on the interface.
Number of FLOGI	Number of FIP-snooped FLOGI request frames received on the interface.
Number of FDISC	Number of FIP-snooped FDISC request frames received on the interface.
Number of FLOGO	Number of FIP-snooped FLOGO frames received on the interface.
Number of ENode Keep Alives	Number of FIP-snooped ENode keep-alive frames received on the interface.
Number of VN Port Keep Alives	Number of FIP-snooped VN port keep-alive frames received on the interface.
Number of Multicast Discovery Advertisements	Number of FIP-snooped multicast discovery advertisements received on the interface.
Number of Unicast	Number of FIP-snooped unicast discovery advertisements received on the interface.

Field	Description
Discovery Advertisements	
Number of FLOGI Accepts	Number of FIP FLOGI accept frames received on the interface.
Number of FLOGI Rejects	Number of FIP FLOGI reject frames received on the interface.
Number of FDISC Accepts	Number of FIP FDISC accept frames received on the interface.
Number of FDISC Rejects	Number of FIP FDISC reject frames received on the interface.
Number of FLOGO Accepts	Number of FIP FLOGO accept frames received on the interface.
Number of FLOGO Rejects	Number of FIP FLOGO reject frames received on the interface.
Number of CVLs	Number of FIP clear virtual link frames received on the interface.
Number of FCF Discovery Timeouts	Number of FCF discovery timeouts that occurred on the interface.
Number of VN Port Session Timeouts	Number of VN port session timeouts that occurred on the interface.
Number of Session failures due to Hardware Config	Number of session failures due to hardware configuration that occurred on the interface.

show fip-snooping system **Command Example**

```
Dell# show fip-snooping system
Global Mode           : Enabled
FCOE VLAN List (Operational) : 1, 100
FCFs                  : 1
Enodes                : 2
Sessions              : 17
```

 **NOTE:** NPIV sessions are included in the number of FIP-snooped sessions displayed.

show fip-snooping vlan **Command Example**

```
Dell# show fip-snooping vlan
* = Default VLAN

VLAN    FC-MAP      FCFs    Enodes    Sessions
----    -
*1      -            -       -         -
100     0X0EFC00    1       2         17
```

 **NOTE:** NPIV sessions are included in the number of FIP-snooped sessions displayed.

FIP Snooping Example

The below illustration shows an Aggregator used as a FIP snooping bridge for FCoE traffic between an ENode (server blade) and an FCF (ToR switch). The ToR switch operates as an FCF and FCoE gateway.

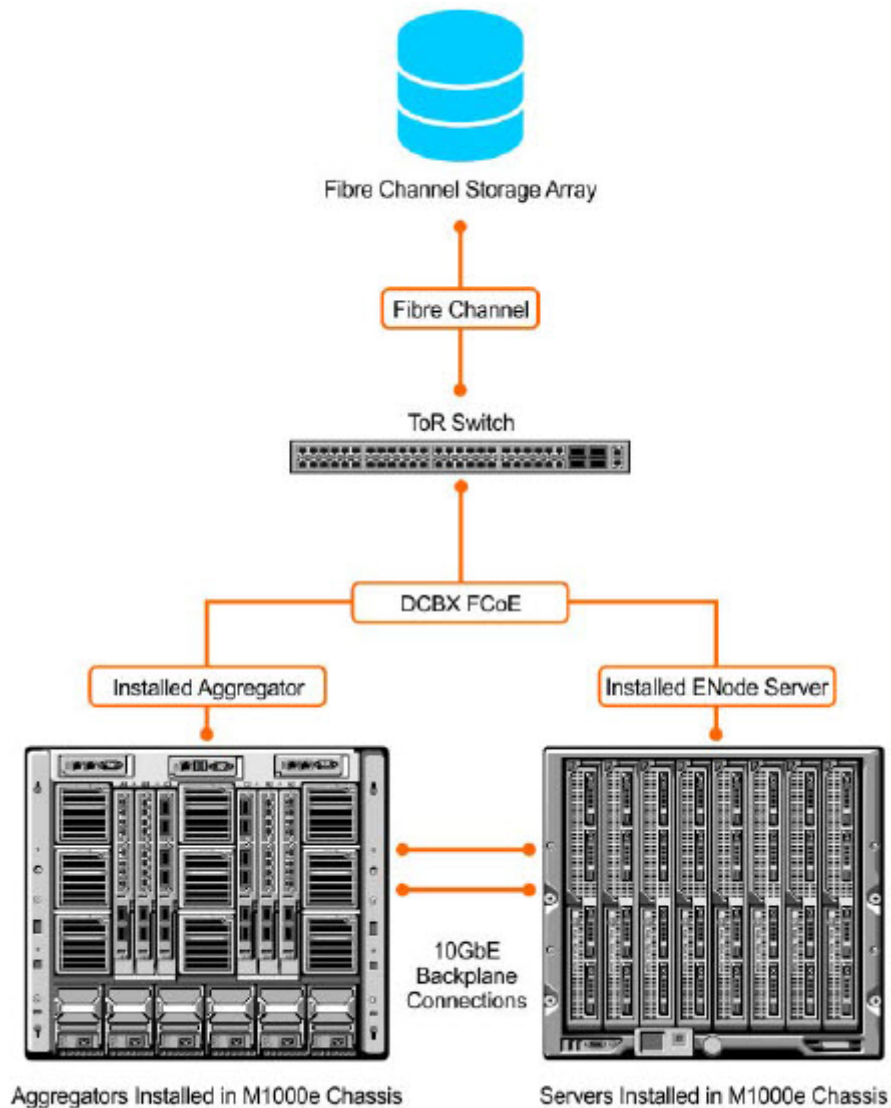

Figure 9. FIP Snooping on an Aggregator

In the above figure, DCBX and PFC are enabled on the Aggregator (FIP snooping bridge) and on the FCF ToR switch. On the FIP snooping bridge, DCBX is configured as follows:

- A server-facing port is configured for DCBX in an auto-downstream role.
- An FCF-facing port is configured for DCBX in an auto-upstream or configuration-source role.

The DCBX configuration on the FCF-facing port is detected by the server-facing port and the DCB PFC configuration on both ports is synchronized. For more information about how to configure DCBX and PFC on a port, refer to [FIP Snooping](#)

After FIP packets are exchanged between the ENode and the switch, a FIP snooping session is established. ACLS are dynamically generated for FIP snooping on the FIP snooping bridge/switch.

Debugging FIP Snooping

To enable debug messages for FIP snooping events, enter the `debug fip-snooping` command..

1. Enable FIP snooping debugging on for all or a specified event type, where:

- `all` enables all debugging options.
- `acl` enables debugging only for ACL-specific events.
- `error` enables debugging only for error conditions.
- `ifm` enables debugging only for IFM events.
- `info` enables debugging only for information events.
- `ipc` enables debugging only for IPC events.
- `rx` enables debugging only for incoming packet traffic.

EXEC PRIVILEGE mode

```
debug fip-snooping [all | acl | error | ifm | info | ipc | rx]
```

To turn off debugging event messages, enter the `no debug fip-snooping` command.

Internet Group Management Protocol (IGMP)

On an Aggregator, IGMP snooping is auto-configured. You can display information on IGMP by using `show ip igmp` command.

Multicast is based on identifying many hosts by a single destination IP address. Hosts represented by the same IP address are a multicast group. The internet group management protocol (IGMP) is a Layer 3 multicast protocol that hosts use to join or leave a multicast group. Multicast routing protocols (such as protocol-independent multicast [PIM]) use the information in IGMP messages to discover which groups are active and to populate the multicast routing table.

This chapter contains the following sections:

- [IGMP Overview](#)
- [IGMP Snooping](#)

Topics:

- [IGMP Overview](#)
- [IGMP Version 2](#)
- [IGMP Version 3](#)
- [Joining and Filtering Groups and Sources](#)
- [Leaving and Staying in Groups](#)
- [IGMP Snooping](#)
- [How IGMP Snooping is Implemented on an Aggregator](#)
- [Disabling Multicast Flooding](#)
- [Displaying IGMP Information](#)

IGMP Overview

IGMP has three versions. Version 3 obsoletes and is backwards-compatible with version 2; version 2 obsoletes version 1.

IGMP Version 2

IGMP version 2 improves upon version 1 by specifying IGMP Leave messages, which allows hosts to notify routers that they no longer care about traffic for a particular group. Leave messages reduce the amount of time that the router takes to stop forwarding traffic for a group to a subnet (leave latency) after the last host leaves the group. In version 1 hosts quietly leave groups, and the router waits for a query response timer several times the value of the query interval to expire before it stops forwarding traffic.

To receive multicast traffic from a particular source, a host must join the multicast group to which the source is sending traffic. A host that is a member of a group is called a “receiver.” A host may join many groups, and may join or leave any group at any time. A host joins and leaves a multicast group by sending an IGMP message to its IGMP querier. The querier is the router that surveys a subnet for multicast receivers and processes survey responses to populate the multicast routing table.

IGMP messages are encapsulated in IP packets which is as illustrated below:

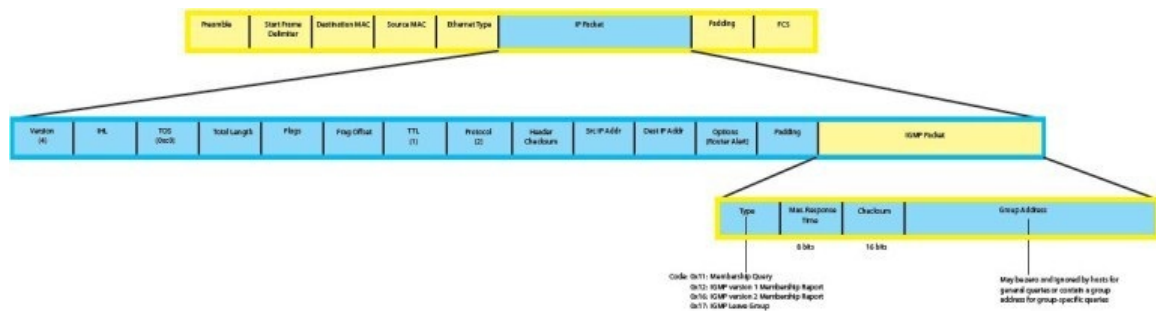

Figure 10. IGMP Version 2 Packet Format

Joining a Multicast Group

There are two ways that a host may join a multicast group: it may respond to a general query from its querier, or it may send an unsolicited report to its querier.

- Responding to an IGMP Query.
 - One router on a subnet is elected as the querier. The querier periodically multicasts (to all-multicast-systems address 224.0.0.1) a general query to all hosts on the subnet.
 - A host that wants to join a multicast group responds with an IGMP membership report that contains the multicast address of the group it wants to join (the packet is addressed to the same group). If multiple hosts want to join the same multicast group, only the report from the first host to respond reaches the querier, and the remaining hosts suppress their responses (for how the delay timer mechanism works, refer to [IGMP Snooping](#)).
 - The querier receives the report for a group and adds the group to the list of multicast groups associated with its outgoing port to the subnet. Multicast traffic for the group is then forwarded to that subnet.
- Sending an Unsolicited IGMP Report.
 - A host does not have to wait for a general query to join a group. It may send an unsolicited IGMP membership report, also called an IGMP Join message, to the querier.

Leaving a Multicast Group

- A host sends a membership report of type 0x17 (IGMP Leave message) to the all routers multicast address 224.0.0.2 when it no longer cares about multicast traffic for a particular group.
- The querier sends a group-specific query to determine whether there are any remaining hosts in the group. There must be at least one receiver in a group on a subnet for a router to forward multicast traffic for that group to the subnet.
- Any remaining hosts respond to the query according to the delay timer mechanism (refer to [IGMP Snooping](#)). If no hosts respond (because there are none remaining in the group), the querier waits a specified period and sends another query. If it still receives no response, the querier removes the group from the list associated with forwarding port and stops forwarding traffic for that group to the subnet.

IGMP Version 3

Conceptually, IGMP version 3 behaves the same as version 2. However, there are differences:

- Version 3 adds the ability to filter by multicast source, which helps the multicast routing protocols avoid forwarding traffic to subnets where there are no interested receivers.
- To enable filtering, routers must keep track of more state information, that is, the list of sources that must be filtered. An additional query type, the group-and-source-specific query, keeps track of state changes, while the group-specific and general queries still refresh existing state.
- Reporting is more efficient and robust. Hosts do not suppress query responses (non-suppression helps track state and enables the immediate-leave and IGMP snooping features), state-change reports are retransmitted to insure delivery, and a single membership report bundles multiple statements from a single host, rather than sending an individual packet for each statement.

To accommodate these protocol enhancements, the IGMP version 3 packet structure is different from version 2. Queries (shown below in query packet format) are still sent to the all-systems address 224.0.0.1, but reports (shown below in report packet format) are sent to all the IGMP version 3 — capable multicast routers address 224.0.0.22.

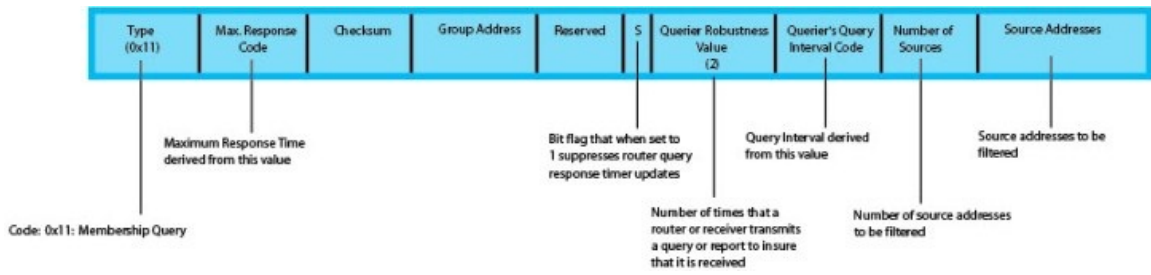

Figure 11. IGMP version 3 Membership Query Packet Format

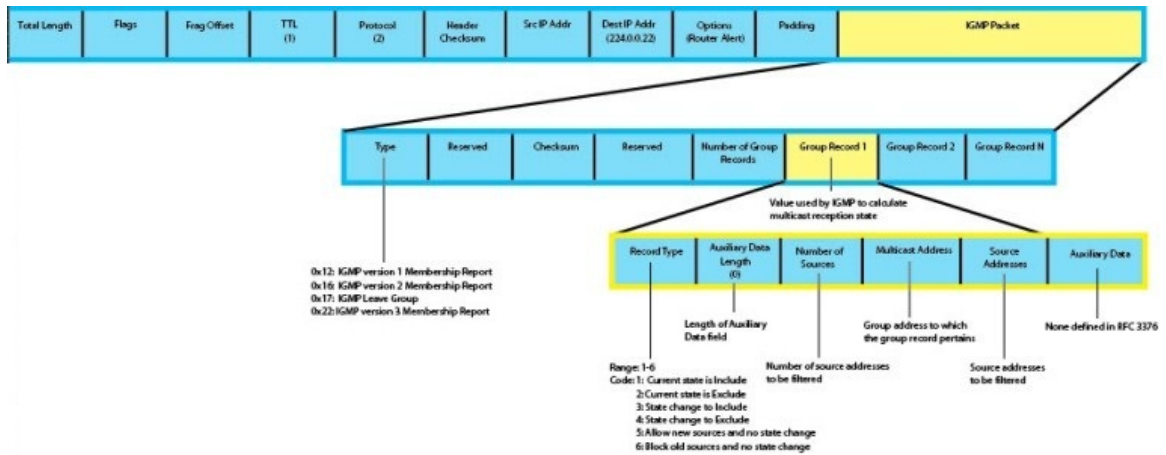

Figure 12. IGMP version 3 Membership Report Packet Format

Joining and Filtering Groups and Sources

The below illustration shows how multicast routers maintain the group and source information from unsolicited reports.

- The first unsolicited report from the host indicates that it wants to receive traffic for group 224.1.1.1.
- The host's second report indicates that it is only interested in traffic from group 224.1.1.1, source 10.11.1.1. Include messages prevent traffic from all other sources in the group from reaching the subnet, so before recording this request, the querier sends a group-and-source query to verify that there are no hosts interested in any other sources. The multicast router must satisfy all hosts if they have conflicting requests. For example, if another host on the subnet is interested in traffic from 10.11.1.3, the router cannot record the include request. There are no other interested hosts, so the request is recorded. At this point, the multicast routing protocol prunes the tree to all but the specified sources.
- The host's third message indicates that it is only interested in traffic from sources 10.11.1.1 and 10.11.1.2. Because this request again prevents all other sources from reaching the subnet, the router sends another group-and-source query so that it can satisfy all other hosts. There are no other interested hosts, so the request is recorded.

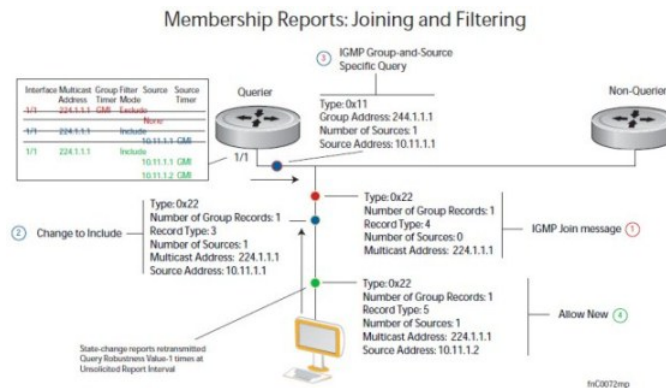

Figure 13. IGMP Membership Reports: Joining and Filtering

Leaving and Staying in Groups

The below illustration shows how multicast routers track and refreshes the state change in response to group-and-specific and general queries.

- Host 1 sends a message indicating it is leaving group 224.1.1.1 and that the included filter for 10.11.1.1 and 10.11.1.2 are no longer necessary.
- The querier, before making any state changes, sends a group-and-source query to see if any other host is interested in these two sources; queries for state-changes are retransmitted multiple times. If any are interested, they respond with their current state information and the querier refreshes the relevant state information.
- Separately in the below figure, the querier sends a general query to 224.0.0.1.
- Host 2 responds to the periodic general query so the querier refreshes the state information for that group.

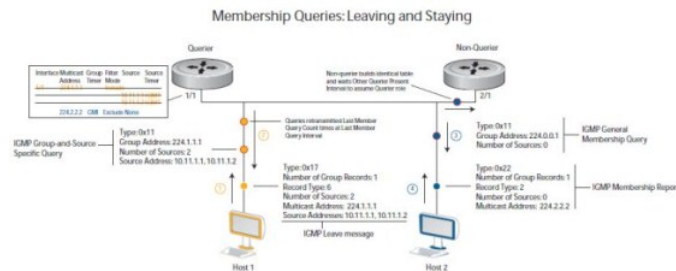

Figure 14. IGMP Membership Queries: Leaving and Staying in Groups

IGMP Snooping

IGMP snooping is auto-configured on an Aggregator.

Multicast packets are addressed with multicast MAC addresses, which represents a group of devices rather than one unique device. Switches forward multicast frames out of all ports in a VLAN by default, even if there are only a small number of interested hosts, resulting in a waste of bandwidth. IGMP snooping enables switches to use information in IGMP packets to generate a forwarding table that associate ports with multicast groups, so that the received multicast frames are forwarded only to interested receivers.

How IGMP Snooping is Implemented on an Aggregator

- IGMP snooping is enabled by default on the switch.
- Dell Networking OS supports version 1, version 2 and version 3 hosts.
- Dell Networking OS — IGMP snooping is based on the IP multicast address (not on the Layer 2 multicast MAC address). IGMP snooping entries are stored in the Layer 3 flow table instead of in the Layer 2 forwarding information base (FIB).
- Dell Networking OS — IGMP snooping is based on draft-ietf-magma-snoop-10.
- A maximum of 2k groups and 4k virtual local area networks (VLAN) are supported.
- IGMP snooping is not supported on the default VLAN interface.
- Flooding of unregistered multicast traffic is enabled by default.
- Queries are not accepted from the server side ports and are only accepted from the uplink LAG.
- Reports and Leaves are flooded by default to the uplink LAG irrespective of whether it is an mrouter port or not.

Disabling Multicast Flooding

If the switch receives a multicast packet that has an IP address of a group it has not learned (unregistered frame), the switch floods that packet out of all ports on the VLAN. To disable multicast flooding on all VLAN ports, enter the **no ip igmp snooping flood** command in global configuration mode.

When multicast flooding is disabled, unregistered multicast data traffic is forwarded to only multicast router ports on all VLANs. If there is no multicast router port in a VLAN, unregistered multicast data traffic is dropped.

Displaying IGMP Information

Use the show commands from the below table, to display information on IGMP. If you specify a group address or interface:

- Enter a group address in dotted decimal format; for example, 225.0.0.0.
- Enter an interface in one of the following formats: `tengigabitethernet slot/port`, `port-channel port-channel-number`, or `vlan vlan-number`.

Displaying IGMP Information

Command	Output
<pre>show ip igmp snooping groups [group- address [detail] detail interface [group- address [detail]]</pre>	Displays information on IGMP groups.
<pre>show ip igmp snooping interface [interface]</pre>	Displays IGMP information on IGMP-enabled interfaces.
<pre>show ip igmp snooping mrouter [vlan vlan-number]</pre>	Displays information on IGMP-enabled multicast router (mrouter) interfaces.
<pre>clear ip igmp snooping groups [group- address interface]</pre>	Clears IGMP information for group addresses and IGMP-enabled interfaces.

show ip igmp snooping groups **Command Example**

```
Dell# show ip igmp snooping groups
Total Number of Groups: 2
IGMP Connected Group Membership
Group Address      Interface      Mode          Uptime        Expires        Last Reporter
226.0.0.1          Vlan 1500     INCLUDE       00:00:19     Never          1.1.1.2
226.0.0.1          Vlan 1600     INCLUDE       00:00:02     Never          1.1.1.2
Dell#show ip igmp snooping groups detail

Interface          Vlan 1500
Group              226.0.0.1
Uptime             00:00:21
Expires            Never
Router mode        INCLUDE
Last reporter      1.1.1.2
Last reporter mode INCLUDE
Last report received IS_INCL
Group source list
Source address      Uptime          Expires
1.1.1.2             00:00:21        00:01:48
  Member Ports: Po 1

Interface          Vlan 1600
Group              226.0.0.1
Uptime             00:00:04
Expires            Never
Router mode        INCLUDE
```

```
Last reporter      1.1.1.2
Last reporter mode INCLUDE
Last report received IS_INCL
Group source list
Source address          Uptime      Expires
1.1.1.2                00:00:04   00:02:05
  Member Ports: Po 1
Dell#
```

show ip igmp snooping interface **Command Example**

```
Dell# show ip igmp snooping interface

Vlan 2 is up, line protocol is down
  Inbound IGMP access group is not set
  Interface IGMP group join rate limit is not set
  IGMP snooping is enabled on interface
  IGMP Snooping query interval is 60 seconds
  IGMP Snooping querier timeout is 125 seconds
  IGMP Snooping last member query response interval is 1000 ms
  IGMP snooping fast-leave is disabled on this interface
  IGMP snooping querier is disabled on this interface
Vlan 3 is up, line protocol is down
  Inbound IGMP access group is not set
  Interface IGMP group join rate limit is not set
  IGMP snooping is enabled on interface
  IGMP Snooping query interval is 60 seconds
  IGMP Snooping querier timeout is 125 seconds
  IGMP Snooping last member query response interval is 1000 ms
  IGMP snooping fast-leave is disabled on this interface
  IGMP snooping querier is disabled on this interface
--More--
```

show ip igmp snooping mrouter **Command Example**

```
Dell# show ip igmp snooping mrouter
Interface Router Ports
Vlan 1000 Po 128
Dell#
```

Interfaces

This chapter describes 100/1000/10000 Mbps Ethernet, 10 Gigabit Ethernet, and 40 Gigabit Ethernet interface types, both physical and logical, and how to configure them with the Dell Networking Operating Software (OS).

Basic Interface Configuration

- Interface Auto-Configuration
- Interface Types
- Viewing Interface Information
- Disabling and Re-enabling a Physical Interface
- Layer 2 Mode
- Management Interfaces
- VLAN Membership
- Port Channel Interfaces

Advanced Interface Configuration

- Monitor and Maintain Interfaces
- Flow Control Using Ethernet Pause Frames
- MTU Size
- Auto-Negotiation on Ethernet Interfaces
- Viewing Interface Information

NOTE: You can also perform some of the configurations using the Web GUI - Dell Blade IO Manager. For more information, see the Dell Blade IO Manager Online Help.

Topics:

- Interface Auto-Configuration
- Interface Types
- Viewing Interface Information
- Disabling and Re-enabling a Physical Interface
- Layer 2 Mode
- Management Interfaces
- VLAN Membership
- Port Channel Interfaces
- Interface Range
- Monitor and Maintain Interfaces
- Configuring wavelength for 10-Gigabit SFP+ optics
- Flow Control Using Ethernet Pause Frames
- Enabling Pause Frames
- MTU Size
- Setting the Speed and Duplex Mode of Ethernet Interfaces
- Auto-Negotiation on Ethernet Interfaces
- Viewing Interface Information
- Enabling the Management Address TLV on All Interfaces of an Aggregator
- Enhanced Validation of Interface Ranges
- Enhanced Control of Remote Fault Indication Processing

Interface Auto-Configuration

An Aggregator auto-configures interfaces as follows:

- All interfaces operate as layer 2 interfaces at 10GbE in standalone mode. FlexIO module interfaces support only uplink connections. You can only use the 40GbE ports on the base module for stacking.
 - By default, the two fixed 40GbE ports on the base module operate in 4x10GbE mode with breakout cables and support up to eight 10GbE uplinks. You can configure the base-module ports as 40GbE links for stacking.
 - The interfaces on a 40GbE QSFP+ FlexIO module auto-configure to support only 10GbE SFP+connections using 4x10GbE breakout cables.
- All 10GbE uplink interfaces belong to the same 10GbE link aggregation group (LAG).
 - The tagged Virtual Local Area Network (VLAN) membership of the uplink LAG is automatically configured based on the VLAN configuration of all server-facing ports (ports 1 to 32). The untagged VLAN used for the uplink LAG is always the default VLAN 1.
 - The tagged VLAN membership of a server-facing LAG is automatically configured based on the server-facing ports that are members of the LAG. The untagged VLAN of a server-facing LAG is auto-configured based on the untagged VLAN to which the lowest numbered server-facing port in the LAG belongs.
- All interfaces are auto-configured as members of all (4094) VLANs and untagged VLAN 1. All VLANs are up and can send or receive layer 2 traffic. You can use the Command Line Interface (CLI) or CMC interface to configure only the required VLANs on a port interface.
- Aggregator ports are numbered 1 to 56. Ports 1 to 32 are internal server-facing interfaces. Ports 33 to 56 are external ports numbered from the bottom to the top of the Aggregator.

Interface Types

The following interface types are supported on an Aggregator.

Table 7. Interface Types

Interface Type	Supported Modes	Default Mode	Requires Creation	Default State
Physical	L2	10GbE uplink	No	No Shutdown (enabled)
Management	L3	L3	No	No Shutdown (enabled)
Port Channel	L2	L2	No	L2 - No Shutdown (enabled)
Default VLAN	L2 and L3	L2 and L3 (VLAN 1)	No	L2 - No Shutdown (enabled)L3 - No Shutdown (enabled)
Non-default VLANs (VLANs 2 - 4094)	L2 and L3	L2 and L3	Yes	L2 - No Shutdown (enabled)L3 - No Shutdown (enabled)

Viewing Interface Information

To view interface status and auto-configured parameters use show commands.

The `show interfaces` command in EXEC mode lists all configurable interfaces on the chassis and has options to display the interface status, IP and MAC addresses, and multiple counters for the amount and type of traffic passing through the interface. If you configure a port channel interface, the `show interfaces` command lists the interfaces configured in the port channel.

NOTE: To end output from the system, such as the output from the `show interfaces` command, enter CTRL+C and the Dell Networking Operating System (OS) returns to the command prompt.

NOTE: The CLI output may be incorrectly displayed as 0 (zero) for the Rx/Tx power values. Perform a simple network management protocol (SNMP) query to obtain the correct power information.

The following example shows the configuration and status information for one interface.

```
Dell#show interface tengig 1/16
TenGigabitEthernet 1/16 is up, line protocol is up
Hardware is DellForce10Eth, address is 00:01:e8:00:ab:01
  Current address is 00:01:e8:00:ab:01
Server Port AdminState is Up
Pluggable media not present
Interface index is 71635713
Internet address is not set
Mode of IP Address Assignment : NONE
DHCP Client-ID :tenG2730001e800ab01
MTU 12000 bytes, IP MTU 11982 bytes
LineSpeed 1000 Mbit
Flowcontrol rx off tx off
ARP type: ARPA, ARP Timeout 04:00:00
Last clearing of "show interface" counters 11:04:02
Queueing strategy: fifo
Input Statistics:
  0 packets, 0 bytes
  0 64-byte pkts, 0 over 64-byte pkts, 0 over 127-byte pkts
  0 over 255-byte pkts, 0 over 511-byte pkts, 0 over 1023-byte pkts
  0 Multicasts, 0 Broadcasts
  0 runts, 0 giants, 0 throttles
  0 CRC, 0 overrun, 0 discarded
Output Statistics:
  14856 packets, 2349010 bytes, 0 underruns
  0 64-byte pkts, 4357 over 64-byte pkts, 8323 over 127-byte pkts
  2176 over 255-byte pkts, 0 over 511-byte pkts, 0 over 1023-byte pkts
  12551 Multicasts, 2305 Broadcasts, 0 Unicasts
  0 throttles, 0 discarded, 0 collisions, 0 wredrops
Rate info (interval 299 seconds):
  Input 00.00 Mbits/sec,          0 packets/sec, 0.00% of line-rate
  Output 00.00 Mbits/sec,        0 packets/sec, 0.00% of line-rate
Time since last interface status change: 11:01:23
```

To view only configured interfaces use the `show interfaces configured` command in EXEC Privilege mode.

To determine which physical interfaces are available, use the `show running-config` command in EXEC mode. This command displays all physical interfaces available on the switch, which is as shown in the following example.

```
Dell#show running config
Current Configuration ...
! Version E8-3-17-38
! Last configuration change at Tue Jul 24 20:48:55 2012 by default
!
boot system stack-unit 1 primary tftp://10.11.9.21/dv-m1000e-2-b2
boot system stack-unit 1 default system: A:
boot system gateway 10.11.209.62
!
redundancy auto-synchronize full
!
service timestamps log datetime
!
hostname FTOS
!
username root password 7 d7acc8aldcd4f698 privilege 15
mac-address-table aging-time 300
!
stack-unit 1 provision I/O-Aggregator
!
stack-unit 1 port 33 portmode quad
!
stack-unit 1 port 37 portmode quad
--More--
```

Disabling and Re-enabling a Physical Interface

By default, all port interfaces on an Aggregator are operationally enabled (no shutdown) to send and receive Layer 2 traffic. You can reconfigure a physical interface to shut it down by entering the `shutdown` command. To re-enable the interface, enter the `no shutdown` command.

1. Enter the keyword `interface` followed by the type of interface and slot/port information:
 - For a 10GbE interface, enter the keyword `TenGigabitEthernet` followed by the *slot/port* numbers; for example, **`interface tengigabitethernet 0/5`**.
 - For the management interface on a stack-unit, enter the keyword `ManagementEthernet` followed by the *slot/port* numbers; for example, **`interface managementethernet 0/0`**.

```
CONFIGURATION mode
interface interface
```

2. Enter the shutdown command to disable the interface.

```
INTERFACE mode
shutdown
```

To confirm that the interface is enabled, use the `show config` command in INTERFACE mode.

To leave INTERFACE mode, use the `exit` command or `end` command.

You cannot delete a physical interface.

The management IP address on the D-fabric provides a dedicated management access to the system.

The switch interfaces support Layer 2 traffic over the 10-Gigabit Ethernet interfaces. These interfaces can also become part of virtual interfaces such as VLANs or port channels.

For more information about VLANs, refer to [VLANs and Port Tagging](#). For more information about port channels, refer to [Port Channel Interfaces](#).

Dell Networking OS Behavior: The Aggregator uses a single MAC address for all physical interfaces.

Layer 2 Mode

On an Aggregator, physical interfaces, port channels, and VLANs auto-configure to operate in Layer 2 mode. Following example demonstrates about the basic configurations found in Layer 2 interface.

 **NOTE:** Layer 3 (Network) mode is not supported on Aggregator physical interfaces, port channels and VLANs. Only management interfaces operate in Layer 3 mode.

```
Dell(conf-if-te-0/1)#show config
!
interface TenGigabitEthernet 0/1
  mtu 12000
  portmode hybrid
  switchport
  auto vlan
!
protocol lldp
  advertise management-tlv system-name
  dcbx port-role auto-downstream
no shutdown
Dell(conf-if-te-0/1)#
```

To view the interfaces in Layer 2 mode, use the `show interfaces switchport` command in EXEC mode.

Management Interfaces

An Aggregator auto-configures with a DHCP-based IP address for in-band management on VLAN 1 and remote out-of-band (OOB) management.

The Aggregator management interface has both a public IP and private IP address on the internal Fabric D interface. The public IP address is exposed to the outside world for WebGUI configurations/WSMAN and other proprietary traffic. You can statically configure the public IP address or obtain the IP address dynamically using the dynamic host configuration protocol (DHCP).

Accessing an Aggregator

You can access the Aggregator using:

- Internal RS-232 using the chassis management controller (CMC). Telnet into CMC and do a connect —b switch-id to get console access to the corresponding Aggregator.
- External serial port with a universal serial bus (USB) connector (front panel): connect using the Aggregator front panel USB serial line to get console access (Labeled as USB B).
- Telnet/ssh using the public IP interface on the fabric D interface.
- CMC through the private IP interface on the fabric D interface.

The Aggregator supports the management ethernet interface as well as the standard interface on any front-end port. You can use either method to connect to the system.

Configuring a Management Interface

On the Aggregator, the dedicated management interface provides management access to the system. You can configure this interface with Dell Networking OS, but the configuration options on this interface are limited. You cannot configure gateway addresses and IP addresses if it appears in the main routing table of Dell Networking OS. In addition, the proxy address resolution protocol (ARP) is not supported on this interface.

For additional management access, the Aggregator supports the default VLAN (VLAN 1) L3 interface in addition to the public fabric D management interface. You can assign the IP address for the VLAN 1 default management interface using the setup wizard or through the CLI.

If you do not configure the default VLAN 1 in the startup configuration using the wizard or CLI, by default, the VLAN 1 management interface gets its IP address using DHCP.

To configure a management interface, use the following command in CONFIGURATION mode:

1. Enter the slot and the port (0). Slot range: 0-0.

```
CONFIGURATION mode
interface Managementethernet interface
```

To configure an IP address on a management interface, use either of the following commands in MANAGEMENT INTERFACE mode:

1. Configure an IP address and mask on the interface.
 - *ip-address mask*: enter an address in dotted-decimal format (A.B.C.D), the mask must be in /prefix format (/x)

```
INTERFACE mode
ip address ip-address mask
```

2. Acquire an IP address from the DHCP server.

```
INTERFACE mode
ip address dhcp
```

To access the management interface from another LAN, you must configure the management route command to point to the management interface.

There is only one management interface for the whole stack.

To display the routing table for a given port, use the `show ip route` command from EXEC Privilege mode.

Configuring a Static Route for a Management Interface

When an IP address used by a protocol and a static management route exists for the sample prefix, the protocol route takes precedence over the static management route.

To configure a static route for the management port, use the following command in CONFIGURATION mode:

1. Assign a static route to point to the management interface or forwarding router.

CONFIGURATION mode

```
management route ip-address mask {forwarding-router-address | ManagementEthernet slot/  
port}
```

To view the configured static routes for the management port, use the `show ip management-route` command in EXEC privilege mode.

```
Dell#show ip management-route all  
  
Destination          Gateway              State  
-----  
1.1.1.0/24           172.31.1.250        Active  
172.16.1.0/24        172.31.1.250        Active  
172.31.1.0/24        ManagementEthernet 1/0 Connected  
  
Dell#
```

VLAN Membership

A virtual LAN (VLANs) is a logical broadcast domain or logical grouping of interfaces in a LAN in which all data received is kept locally and broadcast to all members of the group. In Layer 2 mode, VLANs move traffic at wire speed and can span multiple devices. Dell Networking OS supports up to 4093 port-based VLANs and one default VLAN, as specified in IEEE 802.1Q.

VLAN provide the following benefits:

- Improved security because you can isolate groups of users into different VLANs.
- Ability to create one VLAN across multiple devices.

On an Aggregator in standalone mode, all ports are configured by default as members of all (4094) VLANs, including the default VLAN. All VLANs operate in Layer 2 mode. You can reconfigure the VLAN membership for individual ports by using the `vlan tagged` or `vlan untagged` commands in INTERFACE configuration mode (Configuring VLAN Membership). Physical Interfaces and port channels can be members of VLANs.

NOTE: You can assign a static IP address to default VLAN 1 using the `ip address` command. To assign a different VLAN ID to the default VLAN, use the `default vlan-id vlan-id` command.

Following table lists out the VLAN defaults in Dell Networking OS:

Table 8. VLAN Defaults

Feature	Default
Mode	Layer 2 (no IP address is assigned)
Default VLAN ID	VLAN 1

Default VLAN

When an Aggregator boots up, all interfaces are up in Layer 2 mode and placed in the default VLAN as untagged interfaces. Only untagged interfaces can belong to the default VLAN.

By default, VLAN 1 is the default VLAN. To change the default VLAN ID, use the `default vlan-id <1-4094>` command in CONFIGURATION mode. You cannot delete the default VLAN.

Port-Based VLANs

Port-based VLANs are a broadcast domain defined by different ports or interfaces. In Dell Networking OS, a port-based VLAN can contain interfaces from different stack units within the chassis. Dell Networking OS supports 4094 port-based VLANs.

Port-based VLANs offer increased security for traffic, conserve bandwidth, and allow switch segmentation. Interfaces in different VLANs do not communicate with each other, adding some security to the traffic on those interfaces. Different VLANs can communicate between each other by means of IP routing. Because traffic is only broadcast or flooded to the interfaces within a VLAN, the VLAN conserves bandwidth. Finally, you can have multiple VLANs configured on one switch, thus segmenting the device

Interfaces within a port-based VLAN must be in Layer 2 mode and can be tagged or untagged in the VLAN ID.

VLANs and Port Tagging

To add an interface to a VLAN, it must be in Layer 2 mode. After you place an interface in Layer 2 mode, it is automatically placed in the default VLAN. Dell Networking OS supports IEEE 802.1Q tagging at the interface level to filter traffic. When you enable tagging, a tag header is added to the frame after the destination and source MAC addresses. The information that is preserved as the frame moves through the network. The below figure shows the structure of a frame with a tag header. The VLAN ID is inserted in the tag header.

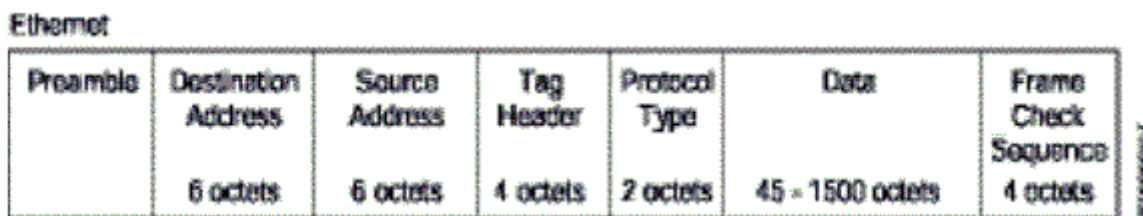

Figure 15. Tagged Frame Format

The tag header contains some key information used by Dell Networking OS:

- The VLAN protocol identifier identifies the frame as tagged according to the IEEE 802.1Q specifications (2 bytes).
- Tag control information (TCI) includes the VLAN ID (2 bytes total). The VLAN ID can have 4,096 values, but two are reserved.

NOTE: The insertion of the tag header into the Ethernet frame increases the size of the frame to more than the 1518 bytes specified in the IEEE 802.3 standard. Some devices that are not compliant with IEEE 802.3 may not support the larger frame size.

Information contained in the tag header allows the system to prioritize traffic and to forward information to ports associated with a specific VLAN ID. Tagged interfaces can belong to multiple VLANs, while untagged interfaces can belong only to one VLAN.

Configuring VLAN Membership

By default, all Aggregator ports are member of all (4094) VLANs, including the default untagged VLAN 1. You can use the CLI or CMC interface to reconfigure VLANs only on server-facing interfaces (1–32) so that an interface has membership only in specified VLANs.

To assign an Aggregator interface in Layer 2 mode to a specified group of VLANs, use the `vlan tagged` and `vlan untagged` commands. To view which interfaces are tagged or untagged and to which VLAN they belong, use the `show vlan` command (Displaying VLAN Membership).

To reconfigure an interface as a member of only specified tagged VLANs, enter the `vlan tagged` command in INTERFACE mode:

1. Add the interface as a tagged member of one or more VLANs.

INTERFACE mode

```
vlan tagged {vlan-id | vlan-range}
```

vlan-id specifies a tagged VLAN number. Range: 2-4094

vlan-range specifies a range of tagged VLANs. Separate VLAN IDs with a comma; specify a VLAN range with a dash; for example, **vlan tagged 3,5-7**.

To reconfigure an interface as a member of only specified untagged VLANs, enter the `vlan untagged` command in INTERFACE mode:

1. Add the interface as an untagged member of one or more VLANs.

INTERFACE mode

```
vlan untagged {vlan-id | vlan-range}
```

vlan-id specifies an untagged VLAN number. Range: 2-4094

vlan-range specifies a range of untagged VLANs. Separate VLAN IDs with a comma; specify a VLAN range with a dash; for example, **vlan tagged 3,5-7**.

When you delete a VLAN (using the `no vlan vlan-id` command), any interfaces assigned to the VLAN are assigned to the default VLAN as untagged interfaces.

If you configure additional VLAN membership and save it to the startup configuration, the new VLAN configuration is activated following a system reboot.

Dell Networking OS Behavior:When two or more server-facing ports with VLAN membership are configured in a LAG based on the NIC teaming configuration in connected servers learned via LACP, the resulting LAG is a tagged member of all the configured VLANs and an untagged member of the VLAN to which the port with the lowest port ID belongs. For example, if port 0/3 is an untagged member of VLAN 2 and port 0/4 is an untagged member of VLAN 3, the resulting LAG consisting of the two ports is an untagged member of VLAN 2 and a tagged member of VLAN 3.

Displaying VLAN Membership

To view the configured VLANs, enter the `show vlan` command in EXEC privilege mode:

```
Dell#show vlan

Codes: * - Default VLAN, G - GVRP VLANs, R - Remote Port Mirroring VLANs, P - Primary, C
-
Community, I - Isolated
Q: U - Untagged, T - Tagged
  x - Dot1x untagged, X - Dot1x tagged
  G - GVRP tagged, M - Vlan-stack, H - VSN tagged
  i - Internal untagged, I - Internal tagged, v - VLT untagged, V - VLT tagged

  NUM      Status      Description                               Q Ports
  *  1       Inactive
  *  20      Active
                                     U Po32 ()
                                     U Te 0/3,5,13,53-56
  1002     Active
                                     T Te 0/3,13,55-56
Dell#
```

NOTE: A VLAN is active only if the VLAN contains interfaces and those interfaces are operationally up. In the above example, VLAN 1 is inactive because it does not contain any interfaces. The other VLANs listed contain enabled interfaces and are active. In a VLAN, the `shutdown` command stops Layer 3 (routed) traffic only. Layer 2 traffic continues to pass through the VLAN. If the VLAN is not a routed VLAN (that is, configured with an IP address), the `shutdown` command has no affect on VLAN traffic.

Adding an Interface to a Tagged VLAN

The following example shows you how to add a tagged interface (Tel/7) to a VLAN (VLAN 2).

Enter the `vlan tagged` command to add interface Te 1/7 to VLAN 2, which is as shown below. Enter the `show vlan` command to verify that interface Te 1/7 is a tagged member of VLAN 2..

```
Dell(conf-if-te-1/7)# vlan tagged 2
Dell(conf-if-te-1/7)# exit
Dell(conf)# exit
Dell# show vlan id 2
```



```
Codes: * - Default VLAN, G - GVRP VLANs, R - Remote Port Mirroring VLANs, P - Primary, C
- Community,
I - Isolated
Q: U - Untagged, T - Tagged
    x - Dot1x untagged, X - Dot1x tagged
    G - GVRP tagged, M - Vlan-stack, H - VSN tagged
    i - Internal untagged, I - Internal tagged, v - VLT untagged, V - VLT tagged, C - CMC
tagged
```

NUM	Status	Description	Q Ports
2	Active		U Po1(Te 0/7,18) T Po128(Te 0/50-51) T Te 1/7

```
Dell(conf-if-te-1/7)
```

Except for hybrid ports, only a tagged interface can be a member of multiple VLANs. You can assign hybrid ports to two VLANs if the port is untagged in one VLAN and tagged in all others.

NOTE: When you remove a tagged interface from a VLAN (using the `no vlan tagged` command), it remains tagged only if it is a tagged interface in another VLAN. If you remove the tagged interface from the only VLAN to which it belongs, the interface is placed in the default VLAN as an untagged interface.

Adding an Interface to an Untagged VLAN

To move an untagged interfaces from the default VLAN to another VLAN, use the `vlan untagged` command as shown in the below figure.

```
Dell(conf)# interface tengigabit 0/16
Dell(conf-if-te-0/16)# vlan untagged 4
Dell(conf-if-te-0/16)# exit
Dell(conf)# exit
Dell#00:23:49: %STKUNIT0-M:CP %SYS-5-CONFIG_I: Configured from console
```

```
Dell# show vlan id 4
```

```
Codes: * - Default VLAN, G - GVRP VLANs, R - Remote Port Mirroring VLANs, P - Primary,
C - Community, I - Isolated
Q: U - Untagged, T - Tagged
    x - Dot1x untagged, X - Dot1x tagged
    G - GVRP tagged, M - Vlan-stack, H - VSN tagged
    i - Internal untagged, I - Internal tagged, v - VLT untagged, V - VLT tagged, C - CMC
tagged
```

NUM	Status	Description	Q Ports
4	Active		U Po1(Te 0/16) T Po128(Te 0/33,39,51,56) T Te 0/1-15,17-32

```
Dell#
```

VLAN Configuration on Physical Ports and Port-Channels

Unlike other Dell Networking OS platforms, IOA allows VLAN configurations on port and port-channel levels. This allows you to assign VLANs to a port/port-channel.

NOTE: In PMUX mode, in order to avoid loops, only disjoint VLANs are allowed between the uplink ports/uplink LAGs and uplink-to-uplink switching is disabled.

1. Initialize the port with configurations such as `admin up`, `portmode`, and `switchport`.

```
Dell#configure
Dell(conf)#int tengigabitethernet 0/1
Dell(conf-if-te-0/1)#no shutdown
Dell(conf-if-te-0/1)#portmode hybrid
Dell(conf-if-te-0/1)#switchport
```

2. Configure the tagged VLANs 10 through 15 and untagged VLAN 20 on this port.

```
Dell(conf-if-te-0/1)#vlan tagged 10-15
Dell(conf-if-te-0/1)#vlan untagged 20
Dell(conf-if-te-0/1)#
```

3. Show the running configurations on this port.

```
Dell(conf-if-te-0/1)#show config
!
interface TenGigabitEthernet 0/1
portmode hybrid
switchport
vlan tagged 10-15
vlan untagged 20
no shutdown
Dell(conf-if-te-0/1)#end
Dell#
```

4. Initialize the port-channel with configurations such as admin up, portmode, and switchport.

```
Dell#configure
Dell(conf)#int port-channel 128
Dell(conf-if-po-128)#portmode hybrid
Dell(conf-if-po-128)#switchport
```

5. Configure the tagged VLANs 10 through 15 and untagged VLAN 20 on this port-channel.

```
Dell(conf-if-po-128)#vlan tagged 10-15
Dell(conf-if-po-128)#
Dell(conf-if-po-128)#vlan untagged 20
```

6. Show the running configurations on this port-channel.

```
Dell(conf-if-po-128)#show config
!
interface Port-channel 128
portmode hybrid
switchport
vlan tagged 10-15
vlan untagged 20
shutdown
Dell(conf-if-po-128)#end
Dell#
```

7. Show the VLAN configurations.

```
Dell#show vlan
Codes: * - Default VLAN, G - GVRP VLANs, R - Remote Port
Mirroring VLANs, P - Primary, C - Community, I - Isolated
       O - Openflow
Q: U - Untagged, T - Tagged
    x - Dot1x untagged, X - Dot1x tagged
    o - OpenFlow untagged, O - OpenFlow tagged
    G - GVRP tagged, M - Vlan-stack, H - VSN tagged
    i - Internal untagged, I - Internal tagged, v - VLT
untagged, V - VLT tagged

  NUM      Status      Description      Q      Ports
*  1        Active
  10        Active          T Po128(Te 0/4-5)
                        T Te 0/1
  11        Active          T Po128(Te 0/4-5)
  12        Active          T Po128(Te 0/4-5)
                        T Te 0/1
  13        Active          T Po128(Te 0/4-5)
                        T Te 0/1
  14        Active          T Po128(Te 0/4-5)
```

```

15      Active      T Te 0/1
          T Po128 (Te 0/4-5)
20      Active      T Te 0/1
          U Po128 (Te 0/4-5)
          U Te 0/1
Dell#

```

You can remove the inactive VLANs that have no member ports using the following command:

```

Dell#configure
Dell(conf)#no interface vlan vlan-id

```

vlan-id — Inactive VLAN with no member ports

You can remove the tagged VLANs using the `no vlan tagged vlan-range` command. You can remove the untagged VLANs using the `no vlan untagged` command in the physical port/port-channel.

Port Channel Interfaces

On an Aggregator, port channels are auto-configured as follows:

- All 10GbE uplink interfaces (ports 33 to 56) are auto-configured to belong to the same 10GbE port channel (LAG 128).
- Server-facing interfaces (ports 1 to 32) auto-configure in LAGs (1 to 127) according to the NIC teaming configuration on the connected servers.

Port channel interfaces support link aggregation, as described in IEEE Standard 802.3ad. .

 **NOTE:** A port channel may also be referred to as a *link aggregation group* (LAG).

Port Channel Definitions and Standards

Link aggregation is defined by IEEE 802.3ad as a method of grouping multiple physical interfaces into a single logical interface—a link aggregation group (LAG) or port channel. A LAG is “a group of links that appear to a MAC client as if they were a single link” according to IEEE 802.3ad. In Dell Networking OS, a LAG is referred to as a port channel interface.

A port channel provides redundancy by aggregating physical interfaces into one logical interface. If one physical interface goes down in the port channel, another physical interface carries the traffic.

Port Channel Benefits

A port channel interface provides many benefits, including easy management, link redundancy, and sharing.

Port channels are transparent to network configurations and can be modified and managed as one interface.

With this feature, you can create larger-capacity interfaces by utilizing a group of lower-speed links. For example, you can build a 40-Gigabit interface by aggregating four 10-Gigabit Ethernet interfaces together. If one of the four interfaces fails, traffic is redistributed across the three remaining interfaces.

Port Channel Implementation

An Aggregator supports only port channels that are dynamically configured using the link aggregation control protocol (LACP). For more information, refer to Link Aggregation. Statically-configured port channels are not supported.

The table below lists out the number of port channels per platform.

Table 9. Number of Port Channels

Platform	Port-channels	Members/Channel
M IO Aggregator	128	16

As soon as a port channel is auto-configured, the Dell Networking OS treats it like a physical interface. For example, IEEE 802.1Q tagging is maintained while the physical interface is in the port channel.

Member ports of a LAG are added and programmed into hardware in a predictable order based on the port ID, instead of in the order in which the ports come up. With this implementation, load balancing yields predictable results across switch resets and chassis reloads.

A physical interface can belong to only one port channel at a time.

Each port channel must contain interfaces of the same interface type/speed.

Port channels can contain a mix of 1000 or 10000 Mbps Ethernet interfaces. The interface speed (100, 1000, or 10000 Mbps) used by the port channel is determined by the first port channel member that is physically up. Dell Networking OS disables the interfaces that do not match the interface speed set by the first channel member. That first interface may be the first interface that is physically brought up or was physically operating when interfaces were added to the port channel. For example, if the first operational interface in the port channel is a TenGigabit Ethernet interface, all interfaces at 1000 Mbps are kept up, and all 100/1000/10000 interfaces that are not set to 1000 Mbps speed or auto negotiate are disabled.

1GbE and 10GbE Interfaces in Port Channels

When both Gigabit and TenGigabitEthernet interfaces are added to a port channel, the interfaces must share a common speed. When interfaces have a configured speed different from the port channel speed, the software disables those interfaces.

The common speed is determined when the port channel is first enabled. At that time, the software checks the first interface listed in the port channel configuration. If that interface is enabled, its speed configuration becomes the common speed of the port channel. If the other interfaces configured in that port channel are configured with a different speed, Dell Networking OS disables them.

For example, if four interfaces (TenGig 0/1, 0/2, 0/3 and 0/4) in which TenGig 0/1 and TenGig 0/2 are set to speed 1000 Mb/s and the TenGig 0/3 and TenGig 0/4 are set to 10000 Mb/s, with all interfaces enabled, and you add them to a port channel by entering `channel-member tengigabitethernet 0/1-4` while in port channel interface mode, and the Dell Networking OS determines if the first interface specified (TenGig 0/0) is up. After it is up, the common speed of the port channel is 1000 Mb/s. Dell Networking OS disables those interfaces configured with speed 10000 Mb/s or whose speed is 10000 Mb/s as a result of auto-negotiation.

In this example, you can change the common speed of the port channel by changing its configuration so the first enabled interface referenced in the configuration is a 1000 Mb/s speed interface. You can also change the common speed of the port channel by setting the speed of the TenGig 0/1 interface to 1000 Mb/s.

Uplink Port Channel: VLAN Membership

The tagged VLAN membership of the uplink LAG is automatically configured based on the VLAN configuration of all server-facing ports (ports 1 to 32).

The untagged VLAN used for the uplink LAG is always the default VLAN 1.

Server-Facing Port Channel: VLAN Membership

The tagged VLAN membership of a server-facing LAG is automatically configured based on the server-facing ports that are members of the LAG.

The untagged VLAN of a server-facing LAG is auto-configured based on the untagged VLAN to which the lowest numbered server-facing port in the LAG belongs.

Displaying Port Channel Information

To view the port channel's status and channel members in a tabular format, use the `show interfaces port-channel brief` command in EXEC Privilege mode.

```
Dell#show int port brief
Codes: L - LACP Port-channel
```

LAG	Mode	Status	Uptime	Ports
-----	------	--------	--------	-------

```
1      L2 down          00:00:00      Te 0/16      (Down)
Dell#
```

To display detailed information on a port channel, enter the show interfaces port-channel command in EXEC Privilege mode. The below example shows the port channel's mode (L2 for Layer 2, L3 for Layer 3, and L2L3 for a Layer 2 port channel assigned to a routed VLAN), the status, and the number of interfaces belonging to the port channel.

In this example, the Port-channel 1 is a dynamically created port channel based on the NIC teaming configuration in connected servers learned via LACP. Also, the Port-channel 128 is the default port channel to which all the uplink ports are assigned by default.

```
Dell#show interface port-channel
Port-channel 1 is up, line protocol is up
Created by LACP protocol
Hardware address is 00:1e:c9:f1:03:58, Current address is 00:1e:c9:f1:03:58
Interface index is 1107755009
Minimum number of links to bring Port-channel up is 1
Internet address is not set
Mode of IP Address Assignment : NONE
DHCP Client-ID :lag1001ec9f10358
MTU 12000 bytes, IP MTU 11982 bytes
LineSpeed 50000 Mbit
Members in this channel:  Te 1/2(U) Te 1/3(U) Te 1/4(U) Te 1/5(U) Te 1/7(U)
ARP type: ARPA, ARP Timeout 04:00:00
Last clearing of "show interface" counters 00:13:56
Queueing strategy: fifo
Input Statistics:
  836 packets, 108679 bytes
  412 64-byte pkts, 157 over 64-byte pkts, 135 over 127-byte pkts
  132 over 255-byte pkts, 0 over 511-byte pkts, 0 over 1023-byte pkts
  836 Multicasts, 0 Broadcasts
  0 runts, 0 giants, 0 throttles, 0 CRC, 0 overrun, 0 discarded
Output Statistics:
  9127965 packets, 3157378990 bytes, 0 underruns
  0 64-byte pkts, 133 over 64-byte pkts, 3980 over 127-byte pkts
  9123852 over 255-byte pkts, 0 over 511-byte pkts, 0 over 1023-byte pkts
  4113 Multicasts, 9123852 Broadcasts, 0 Unicasts
  0 throttles, 0 discarded, 0 collisions, 0 wredrops
Rate info (interval 299 seconds):
  Input 00.00 Mbits/sec,          1 packets/sec, 0.00% of line-rate
  Output 34.00 Mbits/sec,       12318 packets/sec, 0.07% of line-rate
Time since last interface status change: 00:13:49
```

```
Port-channel 128 is up, line protocol is up
Created by LACP protocol
Hardware address is 00:1e:c9:f1:03:58, Current address is 00:1e:c9:f1:03:58
Interface index is 1107755136
Minimum number of links to bring Port-channel up is 1
Internet address is not set
Mode of IP Address Assignment : NONE
DHCP Client-ID :lag128001ec9f10358
MTU 12000 bytes, IP MTU 11982 bytes
LineSpeed 10000 Mbit
Members in this channel:  Te 1/49(U)
ARP type: ARPA, ARP Timeout 04:00:00
Last clearing of "show interface" counters 00:14:06
Queueing strategy: fifo
Input Statistics:
  476 packets, 33180 bytes
  414 64-byte pkts, 33 over 64-byte pkts, 29 over 127-byte pkts
  0 over 255-byte pkts, 0 over 511-byte pkts, 0 over 1023-byte pkts
  476 Multicasts, 0 Broadcasts
  0 runts, 0 giants, 0 throttles, 0 CRC, 0 overrun, 0 discarded
Output Statistics:
  9124688 packets, 3156959396 bytes, 0 underruns
  0 64-byte pkts, 30 over 64-byte pkts, 804 over 127-byte pkts
  9123854 over 255-byte pkts, 0 over 511-byte pkts, 0 over 1023-byte pkts
  834 Multicasts, 9123854 Broadcasts, 0 Unicasts
  0 throttles, 0 discarded, 0 collisions, 0 wredrops
Rate info (interval 299 seconds):
  Input 00.00 Mbits/sec,          1 packets/sec, 0.00% of line-rate
```

```
Output 34.00 Mbits/sec,      12314 packets/sec, 0.36% of line-rate
Time since last interface status change: 00:13:57
```

Interface Range

An interface range is a set of interfaces to which other commands may be applied, and may be created if there is at least one valid interface within the range. Bulk configuration excludes from configuring any non-existing interfaces from an interface range. A default VLAN may be configured only if the interface range being configured consists of only VLAN ports.

The `interface range` command allows you to create an interface range allowing other commands to be applied to that range of interfaces.

The interface range prompt offers the interface (with slot and port information) for valid interfaces. The maximum size of an interface range prompt is 32. If the prompt size exceeds this maximum, it displays (...) at the end of the output.

NOTE: Non-existing interfaces are excluded from interface range prompt.

NOTE: When creating an interface range, interfaces appear in the order they were entered and are not sorted.

To display all interfaces that have been validated under the interface range context, use the `show range` in Interface Range mode.

To display the running configuration only for interfaces that are part of interface range, use the `show configuration` command in Interface Range mode.

You can avoid specifying spaces between the range of interfaces, separated by commas, that you configure by using the `interface range` command. For example, if you enter a list of interface ranges, such as `interface range fo 2/0-1,te 10/0,gi 3/0,fa 0/0`, this configuration is considered valid. The comma-separated list is not required to be separated by spaces in between the ranges. You can associate multicast MAC or hardware addresses to an interface range and VLANs by using the `mac-address-table static multicast-mac-address vlan vlan-id output-range interface` command.

Bulk Configuration Examples

The following are examples of using the interface range command for bulk configuration:

- [Create a Single-Range](#)
- [Create a Multiple-Range](#)
- [Exclude a Smaller Port Range](#)
- [Overlap Port Ranges](#)
- [Commas](#)

Create a Single-Range

Creating a Single-Range Bulk Configuration

```
Dell(conf)# interface range tengigabitethernet 0/1 - 23
Dell(conf-if-range-te-0/1-23)# no shutdown
Dell(conf-if-range-te-0/1-23)#
```

Create a Multiple-Range

Creating a Multiple-Range Prompt

```
Dell(conf)#interface range tengigabitethernet 0/5 - 10 , tengigabitethernet 0/1 , vlan 1
Dell(conf-if-range-te-0/5-10,te-0/1,vl-1)#
```

Exclude a Smaller Port Range

If the interface range has multiple port ranges, the smaller port range is excluded from the prompt.

Interface Range Prompt Excluding a Smaller Port Range

```
Dell(conf)#interface range tengigabitethernet 2/0 - 23 , tengigab 2/1 - 10
Dell(conf-if-range-te-2/0-23) #
```

Overlap Port Ranges

If overlapping port ranges are specified, the port range is extended to the smallest start port number and largest end port number.

Interface Range Prompt Including Overlapping Port Ranges

```
Dell(conf)#inte ra tengig 2/1 - 11 , tengig 2/1 - 23
Dell(conf-if-range-te-2/1-23) #
```

Commas

The example below shows how to use commas to add different interface types to the range, enabling all Ten Gigabit Ethernet interfaces in the range 0/1 to 0/23 and both Ten Gigabit Ethernet interfaces 1/1 and 1/2.

Multiple-Range Bulk Configuration Gigabit Ethernet and Ten-Gigabit Ethernet

```
Dell(conf-if)# interface range tengigabitethernet 0/1 - 23, tengigabitethernet 1/1 - 2
Dell(conf-if-range-te-0/1-23) # no shutdown
Dell(conf-if-range-te-0/1-23) #
```

Monitor and Maintain Interfaces

You can display interface statistics with the `monitor interface` command. This command displays an ongoing list of the interface status (up/down), number of packets, traffic statistics, and so on.

1. View interface statistics. Enter the type of interface and slot/port information:

- For a 10GbE interface, enter the keyword `TenGigabitEthernet` followed by the *slot/port* numbers; for example, **interface tengigabitethernet 0/7**.

EXEC Privilege mode

```
monitor interface interface
```

The information displays in a continuous run, refreshes every two seconds by default (Refer `monitor interface` command example below). Use the following keys to manage the output.

- m – Change mode
- c – Clear screen
- l – Page up
- a – Page down
- T – Increase refresh interval (by 1 second)
- t – Decrease refresh interval (by 1 second)
- q – Quit

monitor interface command example

```
Dell#monitor interface tengig 0/1

Dell Networking OS uptime is 1 day(s), 4 hour(s), 31 minute(s)
Monitor time: 00:00:00 Refresh Intvl.: 2s
```

```
Interface: Te 0/1, Disabled, Link is Down, Linespeed is 1000 Mbit
```

```
Traffic statistics:           Current           Rate           Delta
  Input bytes:                0             0 Bps          0
  Output bytes:               0             0 Bps          0
  Input packets:              0             0 pps          0
  Output packets:             0             0 pps          0
    64B packets:              0             0 pps          0
  Over 64B packets:           0             0 pps          0
  Over 127B packets:          0             0 pps          0
  Over 255B packets:          0             0 pps          0
  Over 511B packets:          0             0 pps          0
  Over 1023B packets:         0             0 pps          0
Error statistics:
  Input underruns:            0             0 pps          0
  Input giants:               0             0 pps          0
  Input throttles:           0             0 pps          0
  Input CRC:                  0             0 pps          0
  Input IP checksum:          0             0 pps          0
  Input overrun:              0             0 pps          0
  Output underruns:           0             0 pps          0
  Output throttles:          0             0 pps          0

  m - Change mode             c - Clear screen
  l - Page up                  a - Page down
  T - Increase refresh interval t - Decrease refresh interval
  q - Quit
```

Maintenance Using TDR

The time domain reflectometer (TDR) is supported on all Dell Networking switch/routers. TDR is an assistance tool to resolve link issues that helps detect obvious open or short conditions within any of the four copper pairs. TDR sends a signal onto the physical cable and examines the reflection of the signal that returns. By examining the reflection, TDR is able to indicate whether there is a cable fault (when the cable is broken, becomes unterminated, or if a transceiver is unplugged).

TDR is useful for troubleshooting an interface that is not establishing a link, that is, when the link is flapping or not coming up. Do not use TDR on an interface that is passing traffic. When a TDR test is run on a physical cable, it is important to shut down the port on the far end of the cable. Otherwise, it may lead to incorrect test results.

 **NOTE:** TDR is an intrusive test. Do not run TDR on a link that is up and passing traffic.

To test the condition of cables on 100/1000/10000 BASE-T modules, follow the below steps using the `tdr-cable-test` command.

1. To test for cable faults on the TenGigabitEthernet cable.
 - Between two ports, you must not start the test on both ends of the cable.
 - Enable the interface before starting the test.
 - The port must be enabled to run the test or the test prints an error message.

```
EXEC Privilege mode
```

```
tdr-cable-test tengigabitethernet <slot>/<port>
```

2. Displays TDR test results.

```
EXEC Privilege mode
```

```
show tdr tengigabitethernet <slot>/<port>
```

Configuring wavelength for 10–Gigabit SFP+ optics

You can set the wavelength for tunable 10–Gigabit SFP+ optics using the `wavelength` command. To set the wavelength, follow these steps:

- Enter the interface mode and set the wavelength.

INTERFACE mode

```
wavelength 1529.0
```

The wavelength range is from 1528.3 nm to 1568.77nm.

- Verify configuration changes.

INTERFACE mode

```
show config
```

Flow Control Using Ethernet Pause Frames

An Aggregator auto-configures to operate in auto-DCB-enable mode (Refer to Data Center Bridging: Auto-DCB-Enable Mode). In this mode, Aggregator ports detect whether peer devices support converged enhanced Ethernet (CEE) or not, and enable DCBX and PFC or link-level flow control accordingly:

- Interfaces come up with DCB disabled and link-level flow control enabled to control data transmission between the Aggregator and other network devices.
- When DCB is disabled on an interface, PFC, ETS, and DCBX are also disabled.
- When DCBX protocol packets are received, interfaces automatically enable DCB and disable link level flow control.
- DCB is required for PFC, ETS, DCBX, and FCoE initialization protocol (FIP) snooping to operate.

Link-level flow control uses Ethernet pause frames to signal the other end of the connection to pause data transmission for a certain amount of time as specified in the frame. Ethernet pause frames allow for a temporary stop in data transmission. A situation may arise where a sending device may transmit data faster than a destination device can accept it. The destination sends a pause frame back to the source, stopping the sender's transmission for a period of time.

The globally assigned 48-bit Multicast address 01-80-C2-00-00-01 is used to send and receive pause frames. To allow full duplex flow control, stations implementing the pause operation instruct the MAC to enable reception of frames with a destination address equal to this multicast address.

The pause frame is defined by IEEE 802.3x and uses MAC Control frames to carry the pause commands. Ethernet pause frames are supported on full duplex only. The only configuration applicable to half duplex ports is rx off tx off.

Note that if a port is over-subscribed, Ethernet Pause Frame flow control does not ensure no loss behavior.

The following error message appears when trying to enable flow control when half duplex is already configured:

```
Can't configure flowcontrol when half duplex is configure, config ignored.
```

The following error message appears when trying to enable half duplex and flow control configuration is on:

```
Can't configure half duplex when flowcontrol is on, config ignored.
```

Enabling Pause Frames

Enable Ethernet pause frames flow control on all ports on a chassis. If not, the system may exhibit unpredictable behavior.

i **NOTE:** If you disable `rx flow control`, Dell Networking recommends rebooting the system.

The flow control sender and receiver must be on the same port-pipe. Flow control is not supported across different port-pipes. (also refer to [iSCSI Optimization: Operation](#)).

i **NOTE:** After you disable DCB, if link-level flow control is not automatically enabled on an interface, to enable flow control, manually shut down the interface (`shutdown` command) and re-enable it (`no shutdown` command).

To enable pause frames, use the following command.

- Control how the system responds to and generates 802.3x pause frames on 10 and 40 Gig ports.

INTERFACE mode

```
flowcontrol rx [off | on] tx [off | on] [negotiate]
```

- rx on: enter the keywords `rx on` to process the received flow control frames on this port.
- rx off: enter the keywords `rx off` to ignore the received flow control frames on this port.

- `tx on`: enter the keywords `tx on` to send control frames from this port to the connected device when a higher rate of traffic is received.
- `tx off`: enter the keywords `tx off` so that flow control frames are not sent from this port to the connected device when a higher rate of traffic is received.
- `negotiate`: enable pause-negotiation with the egress port of the peer device. If the `negotiate` command is not used, pause-negotiation is disabled.

 **NOTE:** The default is `rx off`.

MTU Size

The Aggregator auto-configures interfaces to use a maximum MTU size of 12,000 bytes.

If a packet includes a Layer 2 header, the difference in bytes between the link MTU and IP MTU must be enough to include the Layer 2 header. For example, for VLAN packets, if the MTU is 1400, the link MTU must be no less than 1422.

`1400-byte IP MTU + 22-byte VLAN Tag = 1422-byte link MTU`

The MTU range is 592-12000, with a default of 1554.

The table below lists out the various Layer 2 overheads found in Dell Networking OS and the number of bytes.

Table 10. Difference between Link MTU and IP MTU

Layer 2 Overhead	Difference between Link MTU and IP MTU
Ethernet (untagged)	18 bytes
VLAN Tag	22 bytes
Untagged Packet with VLAN-Stack Header	22 bytes
Tagged Packet with VLAN-Stack Header	26 bytes

Link MTU and IP MTU considerations for port channels and VLANs are as follows.

Port Channels:

- All members must have the same link MTU value and the same IP MTU value.
- The port channel link MTU and IP MTU must be less than or equal to the link MTU and IP MTU values configured on the channel members.

For example, if the members have a link MTU of 2100 and an IP MTU 2000, the port channel's MTU values cannot be higher than 2100 for link MTU or 2000 bytes for IP MTU.

VLANs:

- All members of a VLAN must have the same IP MTU value.
- Members can have different link MTU values. Tagged members must have a link MTU 4 bytes higher than untagged members to account for the packet tag.
- The VLAN link MTU and IP MTU must be less than or equal to the link MTU and IP MTU values configured on the VLAN members.

For example, the VLAN contains tagged members with a link MTU of 1522 and an IP MTU of 1500 and untagged members with a link MTU of 1518 and an IP MTU of 1500. The VLAN's Link MTU cannot be higher than 1518 bytes and its IP MTU cannot be higher than 1500 bytes.

Setting the Speed and Duplex Mode of Ethernet Interfaces

To discover whether the remote and local interface requires manual speed synchronization, and to manually synchronize them if necessary, use the following command sequence.

1. Determine the local interface status. Refer to the following example.

```
EXEC Privilege mode
show interfaces [interface] status
```

2. Determine the remote interface status.

```
EXEC mode or EXEC Privilege mode
[Use the command on the remote system that is equivalent to the first command.]
```

3. Access CONFIGURATION mode.

```
EXEC Privilege mode
config
```

4. Access the port.

```
CONFIGURATION mode
interface interface slot/port
```

5. Set the local port speed.

```
INTERFACE mode
speed {100 | 1000 | 10000 | auto}
```

NOTE: If you use an active optical cable (AOC), you can convert the QSFP+ port to a 10 Gigabit SFP+ port or 1 Gigabit SFP port. You can use the `speed` command to enable the required speed.

6. Optionally, set full- or half-duplex.

```
INTERFACE mode
duplex {half | full}
```

7. Disable auto-negotiation on the port.

```
INTERFACE mode
no negotiation auto
If the speed was set to 1000, do not disable auto-negotiation.
```

8. Verify configuration changes.

```
INTERFACE mode
show config
```

NOTE: The `show interfaces status` command displays link status, but not administrative status. For both link and administrative status, use the `show ip interface [interface | brief] [configuration]` command.

```
Dell#show interfaces status
Port Description Status Speed Duplex Vlan
Te 0/1          Down   Auto  Auto  --
Te 0/2          Down   Auto  Auto  --
Te 0/3          Down   Auto  Auto  --
Te 0/4          Down   Auto  Auto  --
Te 0/5          Down   Auto  Auto  --
Te 0/6          Down   Auto  Auto  --
Te 0/7          Down   Auto  Auto  --
Te 0/8          Down   Auto  Auto  --
Te 0/9          Down   Auto  Auto  --
Te 0/10         Down   Auto  Auto  --
Te 0/11         Down   Auto  Auto  --
Te 0/12         Down   Auto  Auto  --
Te 0/13         Down   Auto  Auto  --
[output omitted]
```

In the previous example, several ports display “Auto” in the Speed field, including port 0/1. In the following example, the speed of port 0/1 is set to 100Mb and then its auto-negotiation is disabled.

```
Dell#configure
Dell(config)#interface tengig 0/1
Dell(conf-if-te-0/1)#speed 100
Dell(conf-if-te-0/1)#duplex full
Dell(conf-if-te-0/1)#no negotiation auto
Dell(conf-if-te-0/1)#show config
!
interface TenGigabitEthernet 0/1
no ip address
speed 100
duplex full
no shutdown
```

Auto-Negotiation on Ethernet Interfaces

Setting Speed and Duplex Mode of Ethernet Interfaces

By default, auto-negotiation of speed and duplex mode is enabled on 1GbE and 10GbE Ethernet interfaces on an Aggregator.

The local interface and the directly connected remote interface must have the same setting. Auto-negotiation is the easiest way to accomplish these settings, as long as the remote interface is capable of auto-negotiation.

NOTE: As a best practice, Dell Networking recommends keeping auto-negotiation enabled. Auto-negotiation should only be disabled on switch ports that attach to devices not capable of supporting negotiation or where connectivity issues arise from interoperability issues.

For 100/1000/10000 Ethernet interfaces, the negotiation auto command is tied to the speed command. Auto-negotiation is always enabled when the speed command is set to 1000 or auto. In Dell Networking OS, the speed 1000 command is an exact equivalent of speed auto 1000 in IOS.

To discover whether the remote and local interface require manual speed synchronization, and to manually synchronize them if necessary, follow these steps.

1. Determine the local interface status.
EXEC Privilege mode
`show interfaces [interface] status`
2. Determine the remote interface status.
EXEC mode
EXEC Privilege mode
[Use the command on the remote system that is equivalent to the above command.]
3. Access CONFIGURATION mode.
EXEC Privilege mode
`config`
4. Access the port.
CONFIGURATION mode
`interface interface slot/port`
5. Set the local port speed.
INTERFACE mode
`speed {100 | 1000 | 10000 | auto}`
6. Optionally, set full- or half-duplex.
INTERFACE mode
`duplex {half | full}`
7. Disable auto-negotiation on the port. If the speed is set to 1000, you do not need to disable auto-negotiation.

```
INTERFACE mode
no negotiation auto
```

8. Verify configuration changes.

```
INTERFACE mode
show config
```

NOTE: The `show interfaces status` command displays link status, but not administrative status. For link and administrative status, use the `show ip interface [interface | brief] [configuration]` command.

`show interface status` Command Example:

```
Dell#show interfaces status
Port      Description  Status Speed      Duplex Vlan
Te 0/1    Down        Auto   Auto      Auto   --
Te 0/2    Down        Auto   Auto      Auto   --
Te 0/3    Down        Auto   Auto      Auto   --
Te 0/4    Down        Auto   Auto      Auto   --
Te 0/5    Down        Auto   Auto      Auto   --
Te 0/6    Down        Auto   Auto      Auto   --
Te 0/7    Down        Auto   Auto      Auto   --
Te 0/8    Down        Auto   Auto      Auto   --
Te 0/9    Down        Auto   Auto      Auto   --
Te 0/10   Down        Auto   Auto      Auto   --
Te 0/11   Down        Auto   Auto      Auto   --
Te 0/12   Down        Auto   Auto      Auto   --
Te 0/13   Down        Auto   Auto      Auto   --
[output omitted]
```

In the above example, several ports display “Auto” in the speed field, including port 0/1. Now, in the below example, the speed of port 0/1 is set to 100 Mb and then its auto-negotiation is disabled.

Setting Port Speed Example

```
Dell#configure
Dell(conf)#interface tengig 0/1
Dell(conf-if-te-0/1)#speed 1000

Dell(conf-if-te-0/1)#no negotiation auto
Dell(conf-if-te-0/1)#show config
!
interface TenGigabitEthernet 0/1
no ip address
speed 1000
duplex full
no shutdown
```

Setting Auto-Negotiation Options

The `negotiation auto` command provides a mode option for configuring an individual port to forced master/forced slave after you enable auto-negotiation.

CAUTION: Ensure that only one end of the node is configured as forced-master and the other is configured as forced-slave. If both are configured the same (that is, both as forced-master or both as forced-slave), the `show interface` command flaps between an auto-neg-error and forced-master/slave states.

Table 11. Auto-Negotiation, Speed, and Duplex Settings on Different Optics

Command	Mode	10GbaseT module	10G SFP+ optics	1G SFP optics	Copper SFP - 1000baseT	Comments
speed 100	interface-config mode	Supported	Not supported(Error message is thrown)	Not supported(Error message is thrown) (% Error: Speed 100 not supported on	% Error: Speed 100 not supported on this interface,	

Table 11. Auto-Negotiation, Speed, and Duplex Settings on Different Optics (continued)

			(% Error: Speed 100 not supported on this interface, config ignored Te 0/49)	this interface, config ignored Te 0/49)		
speed auto	interface-config mode	Supported	Not supported	Not supported	Not supported	Error messages not thrown wherever it says not supported
speed 1000	interface-config mode	Supported	Supported	Supported	Supported	
speed 10000	interface-config mode	Supported	Supported	Not Supported	Not supported	Error messages not thrown wherever it says not supported
negotiation auto	interface-config mode	Supported	Not supported(S hould some error message be thrown?)	Not supported	Not supported	Error messages not thrown wherever it says not supported
duplex half	interface-config mode	Supported	CLI not available	CLI not available	Invalid Input error- CLI not available	
duplex full	interface-config mode	Supported	CLI not available	CLI not available	Invalid Input error-CLI not available	

Setting Auto-Negotiation Options:

```

Dell(conf)# int tengig 0/1
Dell(conf-if-te-0/1)#neg auto
Dell(conf-if-autoneg)# ?

end                Exit from configuration mode
exit               Exit from autoneg configuration mode
mode              Specify autoneg mode
no                Negate a command or set its defaults
show              Show autoneg configuration information
Dell(conf-if-autoneg)#mode ?
forced-master     Force port to master mode
forced-slave      Force port to slave mode
Dell(conf-if-autoneg)#
    
```

Viewing Interface Information

Displaying Non-Default Configurations.

The show [ip | running-config] interfaces configured command allows you to display only interfaces that have non-default configurations are displayed.

The below example illustrates the possible show commands that have the available configured keyword.

```
Dell#show interfaces configured
Dell#show interfaces tengigabitEthernet 0 configured
Dell#show ip interface configured
Dell#show ip interface tengigabitEthernet 1 configured
Dell#show ip interface brief configured
Dell#show running-config interfaces configured
Dell#show running-config interface tengigabitEthernet 1 configured
```

In EXEC mode, `show interfaces switchport` command displays only interfaces in Layer 2 mode and their relevant configuration information. The `show interfaces switchport` command displays the interface, whether the interface supports IEEE 802.1Q tagging or not, and the VLANs to which the interface belongs.

`show interfaces switchport` Command Example:

```
Dell#show interfaces switchport
Name: TenGigabitEthernet 13/0
802.1QTagged: True
Vlan membership:
Vlan    2

Name: TenGigabitEthernet 13/1
802.1QTagged: True
Vlan membership:
Vlan    2

Name: TenGigabitEthernet 13/2
802.1QTagged: True
Vlan membership:
Vlan    2

Name: TenGigabitEthernet 13/3
802.1QTagged: True
Vlan membership:
Vlan    2
--More--
```

Clearing Interface Counters

The counters in the `show interfaces` command are reset by the `clear counters` command. This command does not clear the counters captured by any SNMP program.

To clear the counters, use the following command in EXEC Privilege mode:

1. Clear the counters used in the show interface commands for all VLANs, and physical interfaces or selected ones.

Without an interface specified, the command clears all interface counters.

- (OPTIONAL) Enter the following interface keywords and slot/port or number information:
- For a Port Channel interface, enter the keyword `port-channel` followed by a number from 1 to 128.
- For a 10-Gigabit Ethernet interface, enter the keyword **TenGigabitEthernet** followed by the slot/port numbers.
- For a VLAN, enter the keyword **vlan** followed by a number from 1 to 4094.

EXEC Privilege mode

```
clear counters [interface]
```

When you enter this command, you must confirm that you want Dell Networking OS to clear the interface counters for the interface (refer to the below clearing interface example).

Clearing an Interface:

```
Dell#clear counters tengig 0/0
Clear counters on TenGigabitEthernet 0/0 [confirm]
Dell#
```

Enabling the Management Address TLV on All Interfaces of an Aggregator

The management address TLV, which is an optional TLV of type 8, denotes the network address of the management interface, and is supported by the Dell Networking OS. It is advertised on all the interfaces on an I/O Aggregator in the Link Layer Discovery Protocol (LLDP) data units. You can use the `show running-configuration` command to verify that this TLV is advertised on all the configured interfaces and the `show lldp neighbors detail` command to view the value of this TLV.

Enhanced Validation of Interface Ranges

You can avoid specifying spaces between the range of interfaces, separated by commas, that you configure by using the `interface range` command. For example, if you enter a list of interface ranges, such as `interface range fo2/0-1,te 10/0,gi 3/0,fa 0/0`, this configuration is considered valid. The comma-separated list is not required to be separated by spaces in between the ranges. You can associate multicast MAC or hardware addresses to an interface range and VLANs by using the `mac-address-table static multicast-mac-address vlan vlan-id output-range interface` command.

Enhanced Control of Remote Fault Indication Processing

By default, the M I/O Aggregator module processes RFI errors transmitted by remote peers and brings down the interface when an RFI error is detected.

You must enter the interface configuration mode before configuring Remote Fault Indication (RFI).

You can use the following CLI commands to enable or disable processing of received RFI events:

```
Dell(conf-if-te-1/3)#remote-fault-signaling rx ?
on Enable
off Disable
```

The default is "remote-fault-signaling rx on".

iSCSI Optimization

An Aggregator enables internet small computer system interface (iSCSI) optimization with default iSCSI parameter settings (Default iSCSI Optimization Values) and is auto-provisioned to support:

[iSCSI Optimization: Operation](#)

To display information on iSCSI configuration and sessions, use `show` commands.

iSCSI optimization enables quality-of-service (QoS) treatment for iSCSI traffic.

Supported Modes

Stacking, VLT

Topics:

- [iSCSI Optimization Overview](#)
- [Monitoring iSCSI Traffic Flows](#)
- [Information Monitored in iSCSI Traffic Flows](#)
- [Detection and Auto configuration for Dell EqualLogic Arrays](#)
- [iSCSI Optimization: Operation](#)
- [Displaying iSCSI Optimization Information](#)

iSCSI Optimization Overview

iSCSI is a TCP/IP-based protocol for establishing and managing connections between IP-based storage devices and initiators in a storage area network (SAN).

iSCSI optimization enables the network switch to auto-detect Dell's iSCSI storage arrays and triggers self-configuration of several key network configurations that enables optimization of the network for better storage traffic throughput.

iSCSI optimization provides a means of monitoring iSCSI sessions and applying QoS policies on iSCSI traffic. When enabled, iSCSI optimization allows a switch to monitor (snoop) the establishment and termination of iSCSI connections. The switch uses the snooped information to detect iSCSI sessions and connections established through the switch.

iSCSI optimization allows you to reduce deployment time and management complexity in data centers. In a data center network, Dell EqualLogic and Compellent iSCSI storage arrays are connected to a converged Ethernet network using the data center bridging exchange protocol (DCBx) through stacked and/or non-stacked Ethernet switches.

iSCSI session monitoring over virtual link trunking (VLT) synchronizes the iSCSI session information between the VLT peers, allowing session information to be available in both VLT peers.

iSCSI optimization functions as follows:

- Auto-detection of EqualLogic storage arrays — the switch detects any active EqualLogic array directly attached to its ports.
- Manual configuration to detect Compellent storage arrays where auto-detection is not supported.
- Automatic configuration of switch ports after detection of storage arrays.
- If you configured flow-control, iSCSI uses the current configuration. If you did not configure flow-control, iSCSI auto-configures flow control.
- iSCSI monitoring sessions — the switch monitors and tracks active iSCSI sessions in connections on the switch, including port information and iSCSI session information.
- iSCSI QoS — A user-configured iSCSI class of service (CoS) profile is applied to all iSCSI traffic. Classifier rules are used to direct the iSCSI data traffic to queues that can be given preferential QoS treatment over other data passing through the switch. Preferential treatment helps to avoid session interruptions during times of congestion that would otherwise cause dropped iSCSI packets.
- iSCSI DCBx TLVs are supported.

NOTE: After a switch is reloaded, powercycled, or upgraded, any information exchanged during the initial handshake is not available. If the switch establishes communication after reloading, it detects that a session was in progress but could not obtain complete information for it. Any incomplete information is not available in the show commands.

NOTE: After a switch is reloaded, powercycled, or upgraded, the system may display the `ACL_AGENT-3-
ISCSI_OPT_MAX_SESS_LIMIT_REACHED: Monitored iSCSI sessions reached maximum limit` log message. This cannot be inferred as the maximum supported iSCSI sessions are reached. Also, number of iSCSI sessions displayed on the system may show any number equal to or less than the maximum.

The following figure shows iSCSI optimization between servers in an M1000e enclosure and a storage array in which an Aggregator connects installed servers (iSCSI initiators) to a storage array (iSCSI targets) in a SAN network. iSCSI optimization running on the Aggregator is configured to use dot1p priority-queue assignments to ensure that iSCSI traffic in these sessions receives priority treatment when forwarded on Aggregator hardware.

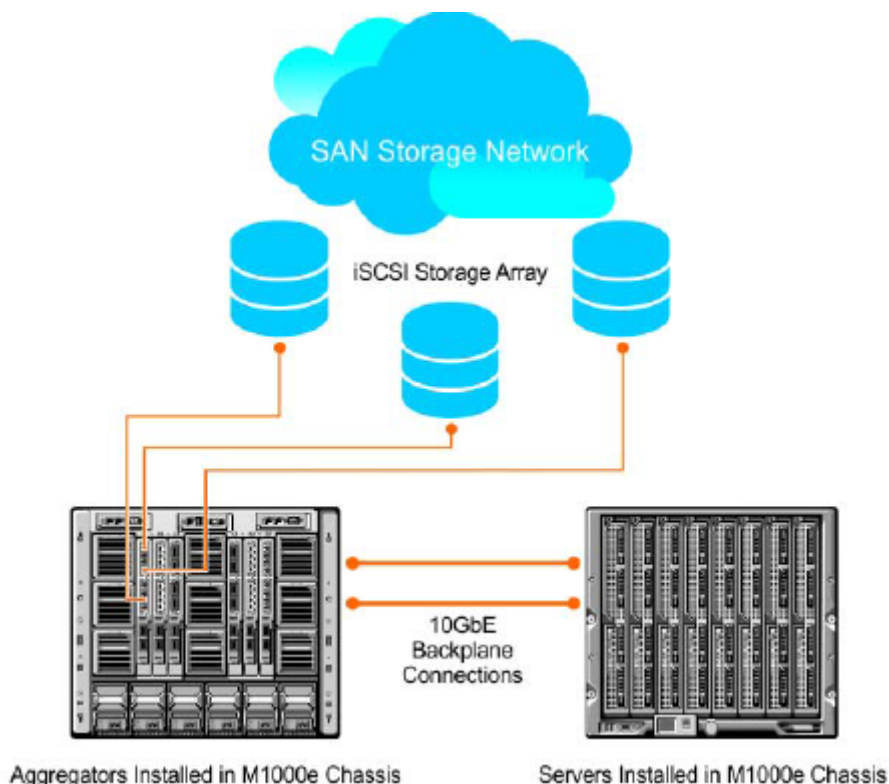

Figure 16. iSCSI Optimization Example

Monitoring iSCSI Traffic Flows

The switch snoops iSCSI session-establishment and termination packets by installing classifier rules that trap iSCSI protocol packets to the CPU for examination.

Devices that initiate iSCSI sessions usually use well-known TCP ports 3260 or 860 to contact targets. When you enable iSCSI optimization, by default the switch identifies IP packets to or from these ports as iSCSI traffic.

You can configure the switch to monitor traffic for additional port numbers or a combination of port number and target IP address, and you can remove the well-known port numbers from monitoring.

Information Monitored in iSCSI Traffic Flows

iSCSI optimization examines the following data in packets and uses the data to track the session and create the classifier entries that enable QoS treatment:

- Initiator's IP Address
- Target's IP Address

- ISID (Initiator defined session identifier)
- Initiator's IQN (iSCSI qualified name)
- Target's IQN
- Initiator's TCP Port
- Target's TCP Port

If no iSCSI traffic is detected for a session during a user-configurable aging period, the session data clears.

Detection and Auto configuration for Dell EqualLogic Arrays

The iSCSI optimization feature includes auto-provisioning support with the ability to detect directly connected Dell EqualLogic storage arrays and automatically reconfigure the switch to enhance storage traffic flows.

An Aggregator uses the link layer discovery protocol (LLDP) to discover Dell EqualLogic devices on the network. LLDP is enabled by default. For more information about LLDP, refer to [Link Layer Discovery Protocol \(LLDP\)](#)

The following message displays the first time a Dell EqualLogic array is detected and describes the configuration change that are automatically performed:

```
%STKUNIT0-M:CP %IFMGR-5-IFM_ISCSI_AUTO_CONFIG: This switch is being configured for optimal conditions to support iSCSI traffic which will cause some automatic configuration to occur including jumbo frames and flow-control on all ports; no storm control to be enabled on the port of detection.
```

The following syslog message is generated the first time an EqualLogic array is detected:

```
%STKUNIT0-M:CP %LLDP-5-LLDP_EQL_DETECTED: EqualLogic Storage Array detected on interface Te 1/43
```

- At the first detection of an EqualLogic array, a maximum transmission unit (MTU) of 12000 is enabled on all ports and port-channels (if it has not already been enabled).
- Unicast storm control is disabled on the interface identified by LLDP.

iSCSI Optimization: Operation

When the Aggregator auto-configures with iSCSI enabled, the following occurs:

- Link-level flow control is enabled on PFC disabled interfaces.
- iSCSI session snooping is enabled.
- iSCSI LLDP monitoring starts to automatically detect EqualLogic arrays.

iSCSI optimization requires LLDP to be enabled. LLDP is enabled by default when an Aggregator auto-configures.

The following message displays when you enable iSCSI on a switch and describes the configuration changes that are automatically performed:

```
%STKUNIT0-M:CP %IFMGR-5-IFM_ISCSI_ENABLE: iSCSI has been enabled causing flow control to be enabled on all interfaces. EQL detection and enabling iscsi profile-compellent on an interface may cause some automatic configurations to occur like jumbo frames on all ports and no storm control and spanning tree port-fast on the port of detection.
```

Displaying iSCSI Optimization Information

To display information on iSCSI optimization, use the show commands detailed in the below table:

Table 12. Displaying iSCSI Optimization Information

Command	Output
---------	--------

Table 12. Displaying iSCSI Optimization Information (continued)

show iscsi	Displays the currently configured iSCSI settings.
show iscsi sessions	Displays information on active iSCSI sessions on the switch that have been established since the last reload.
show iscsi sessions detailed [session isid]	Displays detailed information on active iSCSI sessions on the switch. To display detailed information on specified iSCSI session, enter the session's iSCSI ID.
show run iscsi	Displays all globally-configured non-default iSCSI settings in the current Dell Networking OS session.

show iscsi Command Example

```
Dell# show iscsi
iSCSI is enabled
iSCSI session monitoring is enabled
iSCSI COS : dot1p is 4 no-remark
Session aging time: 10
Maximum number of connections is 256
-----
iSCSI Targets and TCP Ports:
-----
TCP Port Target IP Address
3260
860
```

show iscsi sessions Command Example

```
Dell# show iscsi sessions
Session 0:
-----
Target: iqn.2001-05.com.equallogic:0-8a0906-0e70c2002-10a0018426a48c94-iom010
Initiator: iqn.1991-05.com.microsoft:win-x918v27yajg
ISID: 400001370000
Session 1:
-----
Target: iqn.2001-05.com.equallogic:0-8a0906-0f60c2002-0360018428d48c94-iom011
Initiator: iqn.1991-05.com.microsoft:win-x918v27yajg
ISID: 400001370000.
```

show iscsi sessions detailed Command Example

```
Dell# show iscsi sessions detailed
Session 0 :
-----
Target:iqn.2010-11.com.ixia:ixload:iscsi-TG1
Initiator:iqn.2010-11.com.ixia.ixload:initiator-iscsi-2c
Up Time:00:00:01:28(DD:HH:MM:SS)
Time for aging out:00:00:09:34(DD:HH:MM:SS)
ISID:806978696102
Initiator Initiator Target Target Connection
IP Address TCP Port IP Address TCPPort ID
10.10.0.44 33345 10.10.0.101 3260 0
Session 1 :
-----
Target:iqn.2010-11.com.ixia:ixload:iscsi-TG1
Initiator:iqn.2010-11.com.ixia.ixload:initiator-iscsi-35
Up Time:00:00:01:22(DD:HH:MM:SS)
Time for aging out:00:00:09:31(DD:HH:MM:SS)
ISID:806978696102
Initiator Initiator Target Target Connection ID
IP Address TCP Port IP Address TCPPort
10.10.0.53 33432 10.10.0.101 3260 0
```

Isolated Networks for Aggregators

An Isolated Network is an environment in which servers can only communicate with the uplink interfaces and not with each other even though they are part of same VLAN. If the servers in the same chassis need to communicate with each other, it requires a non-isolated network connectivity between them or it needs to be routed in the TOR.

Isolated Networks can be enabled on per VLAN basis. If a VLAN is set to be isolated, all the packets of originating from the server ports for that VLAN (Isolated Network) will be redirected to uplink LAG, including the packets destined for the server ports on the same blade.

ToR applies required ACLs and other necessary actions before sending the packet to destination. If the packet is destined to server on the same IOA blade, it is routed back on the uplink lag where it was received. Traffic that hits at the uplink ports are regularly switched based on the L2 MAC lookup. Unknown Unicast and Multicast packets from Uplink Port towards server port on an isolated network enabled VLAN, is dropped.

The isolated network feature is supported only in the standalone mode.

Isolated network is currently not supported in the following modes:

- VLT mode
- Stacking mode
- PMUX mode

 **NOTE:** Isolated Networks is not enabled for FCOE VLANs and on default VLAN. It can be managed via CLI or AFM. For more information, refer to AFM user manual.

Topics:

- [Configuring and Verifying Isolated Network Settings](#)

Configuring and Verifying Isolated Network Settings

Enable the isolated-network functionality for a particular VLAN or a set of VLANs using below command:

```
Dell(conf)#io-aggregator isolated-network vlan <vlan-range>
```

To disable the isolated-network functionality, use the no form of command.

```
Dell(conf)#no io-aggregator isolated-network vlan <vlan-range>
```

To display the VLANs that are configured to be part of an isolated network on the Aggregator, use the below command.

```
Dell#show io-aggregator isolated-networks
Isolated Network Enabled VLANs : 5-10
```

Link Aggregation

Unlike IOA Automated modes (Standalone and VLT modes), the IOA Programmable MUX (PMUX) can support multiple uplink LAGs. You can provision multiple uplink LAGs. The I/O Aggregator auto-configures with link aggregation groups (LAGs) as follows:

- All uplink ports are automatically configured in a single port channel (LAG 128).
- Server-facing LAGs are automatically configured if you configure server for link aggregation control protocol (LACP)-based NIC teaming (Network Interface Controller (NIC) Teaming).

No manual configuration is required to configure Aggregator ports in the uplink or a server-facing LAG.

NOTE: Static LAGs are not supported on the SMUX Aggregator.

NOTE: In order to avoid loops, only disjoint VLANs are allowed between the uplink ports/uplink LAGs and uplink-to-uplink switching is disabled.

Supported Modes

Standalone, VLT, PMUX, Stacking

Topics:

- [How the LACP is Implemented on an Aggregator](#)
- [LACP Example](#)
- [Link Aggregation Control Protocol \(LACP\)](#)
- [Configuring Auto LAG](#)
- [Configuring the Minimum Number of Links to be Up for Uplink LAGs to be Active](#)
- [Optimizing Traffic Disruption Over LAG Interfaces On IOA Switches in VLT Mode](#)
- [Preserving LAG and Port Channel Settings in Nonvolatile Storage](#)
- [Enabling LACP link-fallback](#)
- [Enabling the Verification of Member Links Utilization in a LAG Bundle](#)
- [Monitoring the Member Links of a LAG Bundle](#)
- [Verifying LACP Operation and LAG Configuration](#)
- [Multiple Uplink LAGs](#)
- [Multiple Uplink LAGs with 10G Member Ports](#)
- [Multiple Uplink LAGs with 40G Member Ports](#)

How the LACP is Implemented on an Aggregator

The LACP provides a means for two systems (also called partner systems) to exchange information through dynamic negotiations to aggregate two or more ports with common physical characteristics to form a link aggregation group.

NOTE: A link aggregation group is referred to as a *port channel* by the Dell Networking OS.

A LAG provides both load-sharing and port redundancy across stack units. An Aggregator supports LACP for auto-configuring dynamic LAGs. Use CLI commands to display LACP information, clear port-channel counters, and debug LACP operation for auto-configured LAG on an Aggregator.

The Dell Networking OS implementation of LACP is based on the standards specified in the IEEE 802.3: "Carrier sense multiple access with collision detection (CSMA/CD) access method and physical layer specifications."

LACP functions by constantly exchanging custom MAC protocol data units (PDUs) across local area network (LAN) Ethernet links. The protocol packets are only exchanged between ports that you configure as LACP-capable.

NOTE: In Standalone, VLT, and Stacking modes, you can configure a maximum of 16 members in port-channel 128. In PMUX mode, you can have multiple port-channels with up to 16 members per channel.

Uplink LAG

When the Aggregator power is on, all uplink ports are configured in a single LAG (LAG 128).

Server-Facing LAGs

Server-facing ports are configured as individual ports by default. If you configure a server NIC in standalone, stacking, or VLT mode for LACP-based NIC teaming, server-facing ports are automatically configured as part of dynamic LAGs. The LAG range 1 to 127 is reserved for server-facing LAGs.

After the Aggregator receives LACPDU from server-facing ports, the information embedded in the LACPDU (remote-system ID and port key) is used to form a server-facing LAG. The LAG/port-channel number is assigned based on the first available number in the range from 1 to 127. For each unique remote system-id and port-key combination, a new LAG is formed and the port automatically becomes a member of the LAG.

All ports with the same combination of system ID and port key automatically become members of the same LAG. Ports are automatically removed from the LAG if the NIC teaming configuration on a server-facing port changes or if the port goes operationally down. Also, a server-facing LAG is removed when the last port member is removed from the LAG.

The benefit of supporting a dynamic LAG is that the Aggregator's server-facing ports can toggle between participating in the LAG or acting as individual ports based on the dynamic information exchanged with a server NIC. LACP supports the exchange of messages on a link to allow their LACP instances to:

- Reach agreement on the identity of the LAG to which the link belongs.
- Attach the link to that LAG.
- Enable the transmission and reception functions in an orderly manner.
- Detach the link from the LAG if one of the partner stops responding.

LACP Modes

The Aggregator supports only LACP active mode as the default mode of operation. In active mode, a port interface is considered to be not part of a LAG but rather in an active negotiating state.

A port in active mode automatically initiates negotiations with other ports by sending LACP packets. If you configure server-facing ports for LACP-based NIC teaming, LACP negotiations take place to aggregate the port in a dynamic LAG. If you do not configure server-facing ports for LACP-based NIC teaming, a port is treated as an individual port in active negotiating state.

Auto-Configured LACP Timeout

LACP PDUs are exchanged between port channel (LAG) interfaces to maintain LACP sessions. LACP PDUs are transmitted at a slow or fast transmission rate, depending on the LACP timeout value configured on the partner system.

The timeout value is the amount of time that a LAG interface waits for a PDU from the partner system before bringing the LACP session down. The default timeout is long-timeout (30 seconds) and is not user-configurable on the Aggregator.

LACP Example

The below illustration shows how the LACP operates in an Aggregator stack by auto-configuring the uplink LAG 128 for the connection to a top of rack (ToR) switch and a server-facing LAG for the connection to an installed server that you configured for LACP-based NIC teaming.

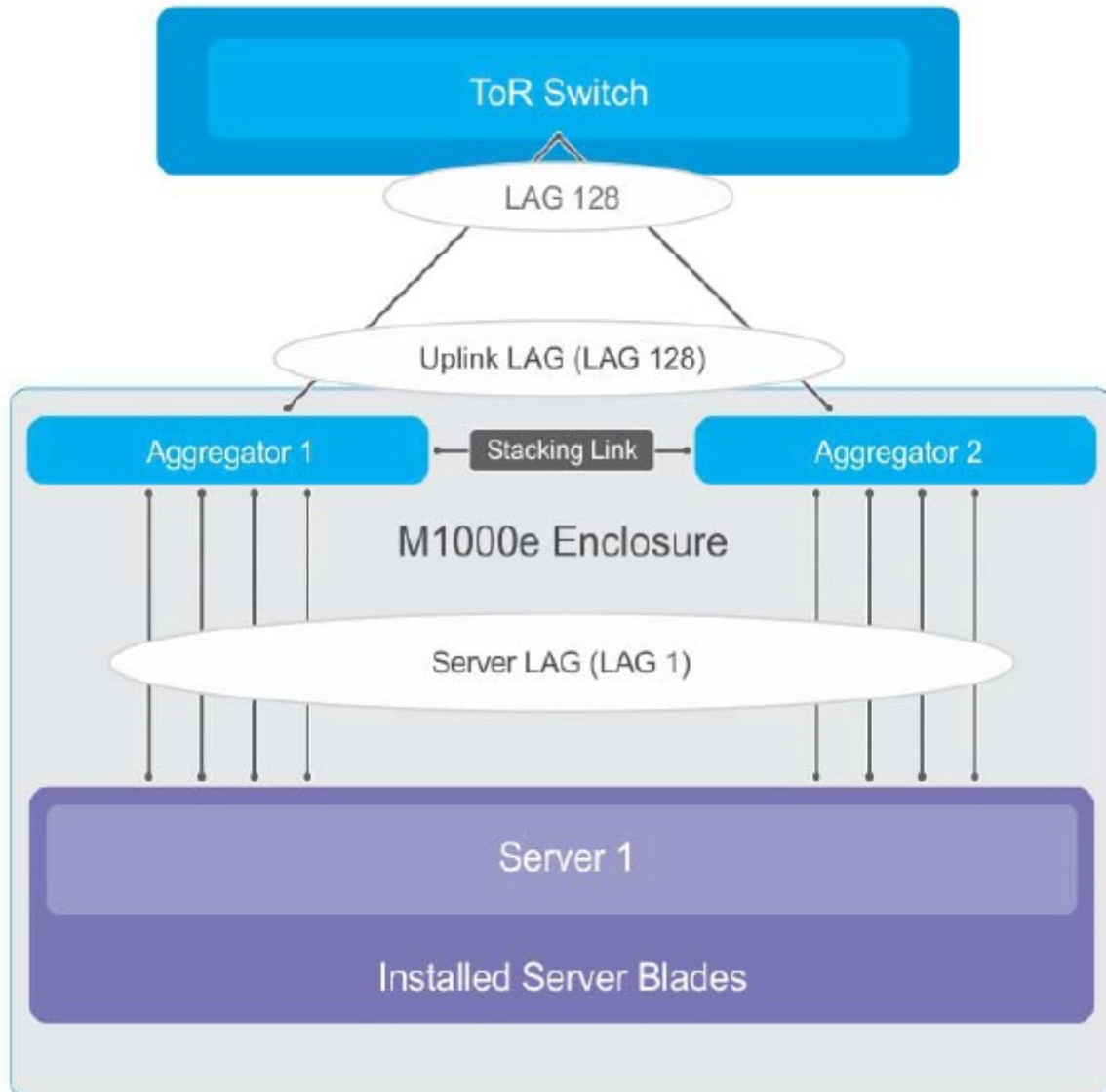

Figure 17. LACP Operation on an Aggregator

Link Aggregation Control Protocol (LACP)

The commands for Dell Networks's implementation of the link aggregation control protocol (LACP) for creating dynamic link aggregation groups (LAGs) — known as port-channels in the Dell Networking OS — are provided in the following sections.

NOTE: For static LAG commands, refer to the [Interfaces](#) chapter), based on the standards specified in the IEEE 802.3 Carrier sense multiple access with collision detection (CSMA/CD) access method and physical layer specifications.

Configuration Tasks for Port Channel Interfaces

To configure a port channel (LAG), use the commands similar to those found in physical interfaces. By default, no port channels are configured in the startup configuration. In VLT mode, port channel configurations are allowed in the startup configuration.

These are the mandatory and optional configuration tasks:

- [Creating a Port Channel](#) (mandatory)
- [Adding a Physical Interface to a Port Channel](#) (mandatory)
- [Reassigning an Interface to a New Port Channel](#) (optional)
- [Configuring the Minimum Oper Up Links in a Port Channel](#) (optional)
- [Configuring VLAN Tags for Member Interfaces](#) (optional)
- [Deleting or Disabling a Port Channel](#) (optional)

Creating a Port Channel

You can create up to 128 port channels with eight port members per group on the Aggregator.

To configure a port channel, use the following commands.

1. Create a port channel.
CONFIGURATION mode

```
interface port-channel id-number
```
2. Ensure that the port channel is active.
INTERFACE PORT-CHANNEL mode

```
no shutdown
```

After you enable the port channel, you can place it in Layer 2 mode. To configure an IP address to place the port channel in Layer 2 mode, use the `switchport` command.

You can configure a port channel as you would a physical interface by enabling or configuring protocols or assigning access control lists.

Adding a Physical Interface to a Port Channel

The physical interfaces in a port channel can be on any line card in the chassis, but must be the same physical type.

NOTE: Port channels can contain a mix of Gigabit Ethernet and 10/100/1000 Ethernet interfaces, but Dell Networking OS disables the interfaces that are not the same speed of the first channel member in the port channel.

You can add any physical interface to a port channel if the interface configuration is minimal. You can configure only the following commands on an interface if it is a member of a port channel:

- `description`
- `shutdown/no shutdown`
- `mtu`
- `ip mtu` (if the interface is on a Jumbo-enabled by default)

NOTE:

A logical port channel interface cannot have flow control. Flow control can only be present on the physical interfaces if they are part of a port channel.

To view the interface's configuration, enter INTERFACE mode for that interface and use the `show config` command or from EXEC Privilege mode, use the `show running-config interface interface` command.

When an interface is added to a port channel, Dell Networking OS recalculates the hash algorithm.

To add a physical interface to a port, use the following commands.

1. Add the interface to a port channel.
INTERFACE PORT-CHANNEL mode

```
channel-member interface
```

This command is applicable only in PMUX mode.

The *interface* variable is the physical interface type and slot/port information.

2. Double check that the interface was added to the port channel.

```
INTERFACE PORT-CHANNEL mode
show config
```

To view the port channel's status and channel members in a tabular format, use the `show interfaces port-channel brief` command in EXEC Privilege mode, as shown in the following example.

Example of the `show interfaces port-channel brief` Command

```
Dell#show int port brief

LAG Mode Status Uptime   Ports
1 L2      up      00:06:03 Te 0/7 (Up) *
                Te 0/8 (Up)
2 L2      up      00:06:03 Te 0/9 (Up) *
                Te 0/10 (Up)
                Te 0/11 (Up)

Dell#
```

The following example shows the port channel's mode (L2 for Layer 2 and L3 for Layer 3 and L2L3 for a Layer 2-port channel assigned to a routed VLAN), the status, and the number of interfaces belonging to the port channel.

Example of the `show interface port-channel` Command

```
Dell>show interface port-channel 20
Port-channel 20 is up, line protocol is up
Hardware address is 00:01:e8:01:46:fa
Internet address is 1.1.120.1/24
MTU 1554 bytes, IP MTU 1500 bytes
LineSpeed 2000 Mbit
Members in this channel: Gi 9/10 Gi 9/17
ARP type: ARPA, ARP timeout 04:00:00
Last clearing of "show interface" counters 00:00:00
Queueing strategy: fifo
 1212627 packets input, 1539872850 bytes
  Input 1212448 IP Packets, 0 Vlans 0 MPLS
  4857 64-byte pkts, 17570 over 64-byte pkts, 35209 over 127-byte pkts
  69164 over 255-byte pkts, 143346 over 511-byte pkts, 942523 over 1023-byte pkts
  Received 0 input symbol errors, 0 runts, 0 giants, 0 throttles
  42 CRC, 0 IP Checksum, 0 overrun, 0 discarded
  2456590833 packets output, 203958235255 bytes, 0 underruns
  Output 1640 Multicasts, 56612 Broadcasts, 2456532581 Unicasts
  2456590654 IP Packets, 0 Vlans, 0 MPLS
  0 throttles, 0 discarded
Rate info (interval 5 minutes):
  Input 00.01Mbits/sec, 2 packets/sec
  Output 81.60Mbits/sec, 133658 packets/sec
Time since last interface status change: 04:31:57

Dell>
```

When more than one interface is added to a Layer 2-port channel, Dell Networking OS selects one of the active interfaces in the port channel to be the primary port. The primary port replies to flooding and sends protocol data units (PDUs). An asterisk in the `show interfaces port-channel brief` command indicates the primary port.

As soon as a physical interface is added to a port channel, the properties of the port channel determine the properties of the physical interface. The configuration and status of the port channel are also applied to the physical interfaces within the port channel. For example, if the port channel is in Layer 2 mode, you cannot add an IP address or a static MAC address to an interface that is part of that port channel.

Example of Error Due to an Attempt to Configure an Interface that is Part of a Port Channel

```
Dell(conf)#int port-channel 128
Dell(conf-if-po-128)#show config
!
interface Port-channel 128
mtu 12000
portmode hybrid
switchport
```

```
fip-snooping port-mode fcf
no shutdown
link-bundle-monitor enable
Dell(conf-if-po-128)#
```

Reassigning an Interface to a New Port Channel

An interface can be a member of only one port channel. If the interface is a member of a port channel, remove it from the first port channel and then add it to the second port channel.

Each time you add or remove a channel member from a port channel, Dell Networking OS recalculates the hash algorithm for the port channel.

To reassign an interface to a new port channel, use the following commands.

1. Remove the interface from the first port channel.

```
INTERFACE PORT-CHANNEL mode
no channel-member interface
```

2. Change to the second port channel INTERFACE mode.

```
INTERFACE PORT-CHANNEL mode
interface port-channel id number
```

This command is applicable only in PMUX mode.

3. Add the interface to the second port channel.

```
INTERFACE PORT-CHANNEL mode
channel-member interface
```

The following example shows moving the TenGigabitEthernet 0/8 interface from port channel 4 to port channel 3.

```
Dell(conf-if-po-4)#show config
!
interface Port-channel 4
channel-member TenGigabitEthernet 0/8
no shutdown
Dell(conf-if-po-4)#no chann tengi 0/8
Dell(conf-if-po-4)#int port 3
Dell(conf-if-po-3)#channel tengi 0/8
Dell(conf-if-po-3)#sho conf
!
interface Port-channel 3
channel-member TenGigabitEthernet 0/8
shutdown
Dell(conf-if-po-3)#
```

Configuring the Minimum Oper Up Links in a Port Channel

You can configure the minimum links in a port channel (LAG) that must be in “oper up” status to consider the port channel to be in “oper up” status.

To set the “oper up” status of your links, use the following command.

- Enter the number of links in a LAG that must be in “oper up” status.

```
INTERFACE mode
minimum-links number
```

The default is **1**.

Example of Configuring the Minimum Oper Up Links in a Port Channel

```
DellEMC#config t
DellEMC(conf)#int po 1
DellEMC(conf-if-po-1)#minimum-links 5
DellEMC(conf-if-po-1)#
```

Configuring VLAN Tags for Member Interfaces

To configure and verify VLAN tags for individual members of a port channel, perform the following:

1. Configure VLAN membership on individual ports

INTERFACE mode

```
Dell(conf-if-te-0/2)#vlan tagged 2,3-4
```

2. Use the `switchport` command in INTERFACE mode to enable Layer 2 data transmissions through an individual interface

INTERFACE mode

```
Dell(conf-if-te-0/2)#switchport
```

This `switchport` configuration is allowed only in PMUX mode. In all other modes, it is automatically configured.

3. Verify the manually configured VLAN membership (**show interfaces switchport interface** command).

EXEC mode

```
Dell(conf)# interface tengigabitethernet 0/1
Dell(conf-if-te-0/1)#switchport
Dell(conf-if-te-0/1)# vlan tagged 2-5,100,4010
Dell#show interfaces switchport te 0/1

Codes:  U - Untagged, T - Tagged
         x - Dot1x untagged, X - Dot1x tagged
         G - GVRP tagged, M - Trunk, H - VSN tagged
         i - Internal untagged, I - Internal tagged, v - VLT untagged, V - VLT tagged

Name: TenGigabitEthernet 0/1
802.1QTagged: True
Vlan membership:
Q      Vlans
T      2-5,100,4010

Dell#
```

Deleting or Disabling a Port Channel

To delete or disable a port channel, use the following commands.

- Delete a port channel.

CONFIGURATION mode

```
no interface portchannel channel-number
```

- Disable a port channel.

```
shutdown
```

When you disable a port channel, all interfaces within the port channel are operationally down also.

Configuring Auto LAG

You can enable or disable auto LAG on the server-facing interfaces. By default, auto LAG is enabled. This functionality is supported on the Aggregator in Standalone, Stacking, and VLT modes.

To configure auto LAG, use the following commands:

1. Enable the auto LAG on all the server ports.

CONFIGURATION mode

```
io-aggregator auto-lag enable
```

```
Dell(config)# io-aggregator auto-lag enable
```

To disable the auto LAG on all the server ports, use the `no io-aggregator auto-lag enable` command. When disabled, all the server ports associated in a LAG are removed and the LAG itself gets removed. Any LACPDU received on the server ports are discarded.

In VLT mode, the global auto LAG is automatically synced to the peer VLT through ICL message.

2. Enable the auto LAG on a specific server port.

Interface Configuration mode

```
auto-lag enable
```

```
Dell(conf-if-te-0/1)# auto-lag enable
```

To disable the auto LAG, use the `no auto-lag enable` command. When disabled, the server port is removed from the LAG and if the server port is the last member of the LAG, the LAG itself gets removed. Any LACPDUs received on the server port are discarded.

In VLT mode, the interface level auto LAG configuration is not synced to the peer. Only the global auto LAG is synced to the peer.

3. View the auto LAG configurations.

EXEC mode

```
show io-aggregator auto-lag status
```

```
Dell# show io-aggregator auto-lag status
Auto LAG creation on server port(s) is enabled
```

For the interface level auto LAG configurations, use the `show interface` command.

```
Dell(conf-if-te-0/1)#no auto-lag enable
Dell(conf-if-te-0/1)#
Dell(conf-if-te-0/1)#do show interface tengigabitethernet 0/1
TenGigabitEthernet 0/1 is up, line protocol is down(error-disabled[UFD])
Hardware is Delleth, address is f8:b1:56:07:1d:8e
    Current address is f8:b1:56:07:1d:8e
Server Port AdminState is Up
Pluggable media not present
Interface index is 15274753
Internet address is not set
Mode of IPv4 Address Assignment : NONE
DHCP Client-ID :f8b156071d8e
MTU 12000 bytes, IP MTU 11982 bytes
LineSpeed auto
Auto-lag is disabled
Flowcontrol rx on tx off
ARP type: ARPA, ARP Timeout 04:00:00
Last clearing of "show interface" counters 00:12:53
Queueing strategy: fifo
Input Statistics:
    0 packets, 0 bytes
    0 64-byte pkts, 0 over 64-byte pkts, 0 over 127-byte pkts
    0 over 255-byte pkts, 0 over 511-byte pkts, 0 over 1023-byte pkts
    0 Multicasts, 0 Broadcasts
    0 runts, 0 giants, 0 throttles
    0 CRC, 0 overrun, 0 discarded
Output Statistics:
    0 packets, 0 bytes, 0 underruns
    0 64-byte pkts, 0 over 64-byte pkts, 0 over 127-byte pkts
    0 over 255-byte pkts, 0 over 511-byte pkts, 0 over 1023-byte pkts
    0 Multicasts, 0 Broadcasts, 0 Unicasts
    0 throttles, 0 discarded, 0 collisions, 0 wredrops
Rate info (interval 299 seconds):
    Input 00.00 Mbits/sec,          0 packets/sec, 0.00% of line-rate
    Output 00.00 Mbits/sec,        0 packets/sec, 0.00% of line-rate
Time since last interface status change: 00:11:36

Dell(conf-if-te-0/1)#
```

Sample Configuration

```
Dell# config terminal
Dell(conf)# no io-aggregator auto-lag enable
Dell(conf)# end
Dell# show io-aggregator auto-lag status

Auto LAG creation on server port(s) is disabled

Dell#

Dell# config terminal
Dell(config)# interface tengigabitethernet 0/1
Dell(config-if-te-0/1)# no auto-lag enable
Dell(config-if-te-0/1)# show config
!
interface TenGigabitEthernet 0/1
mtu 12000
portmode hybrid
switchport
no auto-lag enable
!
protocol lldp
  advertise management-tlv management-address system-name
  dcbx port-role auto-downstream
  no shutdown
Dell#
```

Configuring the Minimum Number of Links to be Up for Uplink LAGs to be Active

You can activate the LAG bundle for uplink interfaces or ports (the uplink port-channel is LAG 128) on the I/O Aggregator only when a minimum number of member interfaces of the LAG bundle is up. For example, based on your network deployment, you may want the uplink LAG bundle to be activated only if a certain number of member interface links is also in the up state. If you enable this setting, the uplink LAG bundle is brought up only when the specified minimum number of links are up and the LAG bundle is moved to the down state when the number of active links in the LAG becomes less than the specified number of interfaces. By default, the uplink LAG 128 interface is activated when at least one member interface is up.

To configure the minimum number of member links that must be up for a LAG bundle to be fully up, perform the following steps:

Specify the minimum number of member interfaces of the uplink LAG 128 bundle that must be up for the LAG bundle to be brought up. The default minimum number of member links that must be active for the uplink LAG to be active is 1. Enter the `minimum-links number` command in the Port Channel Interface 128 Configuration mode to specify this value.

```
Dell(conf)#interface port-channel 128
Dell(conf-if-po-128)#minimum-links 4
```

Use the `show interfaces port-channel` command to view information regarding the configured LAG or port channel settings. The **Minimum number of links to bring Port-channel up is** field in the output of this command displays the configured number of active links for the LAG to be enabled.

```
Dell#show interfaces port-channel 128
Port-channel 128 is up, line protocol is down(minimum links not up)
Created by LACP protocol
Hardware address is 00:01:02:03:04:05, Current address is 00:01:02:03:04:05
Interface index is 1107492992
Minimum number of links to bring Port-channel up is 4
Internet address is not set
Mode of IPv4 Address Assignment : NONE
DHCP Client-ID :000102030405
MTU 12000 bytes, IP MTU 11982 bytes
LineSpeed auto
Members in this channel:
ARP type: ARPA, ARP Timeout 04:00:00
Last clearing of "show interface" counters 05:22:24
Queueing strategy: fifo
Input Statistics:
```

```

0 packets, 0 bytes
0 64-byte pkts, 0 over 64-byte pkts, 0 over 127-byte pkts
0 over 255-byte pkts, 0 over 511-byte pkts, 0 over 1023-byte pkts
0 Multicasts, 0 Broadcasts
0 runts, 0 giants, 0 throttles
0 CRC, 0 overrun, 0 discarded
Output Statistics:
0 packets, 0 bytes, 0 underruns
0 64-byte pkts, 0 over 64-byte pkts, 0 over 127-byte pkts
0 over 255-byte pkts, 0 over 511-byte pkts, 0 over 1023-byte pkts
0 Multicasts, 0 Broadcasts, 0 Unicasts
0 throttles, 0 discarded, 0 collisions, 0 wredrops
Rate info (interval 299 seconds):
Input 00.00 Mbits/sec,          0 packets/sec, 0.00% of line-rate
Output 00.00 Mbits/sec,        0 packets/sec, 0.00% of line-rate
Time since last interface status change: 05:22:28

```

Optimizing Traffic Disruption Over LAG Interfaces On IOA Switches in VLT Mode

When you use the `write memory` command while an Aggregator operates in VLT mode, the VLT LAG configurations are saved in nonvolatile storage (NVS).

By restoring the settings saved in NVS, the VLT ports come up quicker on the primary VLT node and traffic disruption is reduced. The delay in restoring the VLT LAG parameters is reduced (90 seconds by default) on the secondary VLT peer node before it becomes operational. This makes sure that the configuration settings of the primary VLT node are synchronized with the secondary VLT peer node before the secondary VLT mode is up. The traffic outage is less than 200 milliseconds during the restart or switchover of the VLT peer nodes from primary to secondary.

Preserving LAG and Port Channel Settings in Nonvolatile Storage

Use the `write memory` command on an I/O Aggregator, which operates in either standalone or PMUX modes, to save the LAG port channel configuration parameters. This behavior enables the port channels to be brought up because the configured interface attributes are available in the system database during the booting of the device. With the reduction in time for the port channels to become active after the switch is booted, the loss in the number of packets that are serviced by these interfaces is minimized.

Enabling LACP link-fallback

By default, the `lacp link-fallback member-independent port-channel 128` command is enabled on the Standalone, VLT, and Stacking mode. To disable the LACP link-fallback, use the `no lacp link-fallback member-independent port-channel 128` command.

The following log message is displayed when LACP link fallback is elected:

```

Feb 26 15:53:32: %STKUNIT0-M:CP IFMGR-5-NO_LACP_PDU_RECEIVED_FROM_PEER: Connectivity to
PEER is restricted because LACP PDU's are not received. Verify the LACP configurations
on PEER to bring up the Uplink LAG to attain better bandwidth

```

```

May 12 16:31:22: %STKUNIT1-M:CP %IFMGR-5-LACP_LINK_FALLBACK_ELECTED: Te 1/11 : Elected
LACP Fallback Link

```

The following log message is displayed when LACP link-fallback is removed:

```
Feb 26 15:53:32: %STKUNIT0-M:CP %SMUX-5-SMUX_LACP_PDU_RECEIVED_FROM_PEER: LACP PDU received from PEER and connectivity to PEER will be restored to Uplink Port-channel 128.
```

```
May 12 16:30:21: %STKUNIT1-M:CP %IFMGR-5-LACP_LINK_FALLBACK_REVERTED: Te 1/11 : Reverted LACP Fallback link
```

Enabling the Verification of Member Links Utilization in a LAG Bundle

To examine the working efficiency of the LAG bundle interfaces, perform the following steps:

1. The functionality to detect the working efficiency of the LAG bundle interfaces is automatically activated on all the port channels, except the port channel that is configured as a VLT interconnect link, during the booting of the switch.
2. Use the `show link-bundle-distribution port-channel interface-number` command to display the traffic handling and utilization of the member interfaces of the port channel. The following sample output is displayed when you enter this show command.

EXEC

```
Dell#show link-bundle-distribution port-channel
```

```
Dell#show link-bundle-distribution port-channel 1
Link-bundle trigger threshold - 60

LAG bundle - 1      Utilization[In Percent] - 0      Alarm State - Inactive

Interface          Line Protocol  Utilization[In Percent]
Te 0/5             Up             0
Te 0/7             Up             0
```

Monitoring the Member Links of a LAG Bundle

You can examine and view the operating efficiency and the traffic-handling capacity of member interfaces of a LAG or port channel bundle. This method of analyzing and tracking the number of packets processed by the member interfaces helps you manage and distribute the packets that are handled by the LAG bundle. The functionality to detect the working efficiency of the LAG bundle interfaces is automatically activated on all the port channels, except the port channel that is configured as a VLT interconnect link, during the booting of the switch. This functionality is supported on I/O Aggregators in PMUX, Standalone, and VLT modes. By default, this capability is enabled on all of the port channels set up on the switch.

You can use the `show link-bundle-distribution port-channel interface-number` command to display the traffic-handling and utilization of the member interfaces of the port channel. The following table describes the output fields of this show command.

Table 13. Output Field Descriptions for show link-bundle-distribution port-channel Command

Field	Description
Link-bundle trigger threshold	Threshold value that is the checkpoint, exceeding which the link bundle is marked as being overutilized and alarm is generated
LAG bundle number	Number of the LAG bundle
Utilization (In Percent)	Traffic usage in percentage of the packets processed by the port channel
Alarm State	Indicates whether an alarm is generated if over-utilization of the port channel occurred. The value, Active, is displayed for this field.

Table 13. Output Field Descriptions for show link-bundle-distribution port-channel Command (continued)

Field	Description
Interface	Slot and port number, and the type of the member interface of the port channel
Line Protocol	Indicates whether the interface is administratively up or down
Utilization (In Percent)	Traffic usage in percentage of the packets processed by the particular member interface

You can also use the `show running-configuration interface port-channel` command in EXEC Privilege mode to view whether the mechanism to evaluate the utilization of the member interfaces of the LAG bundle is enabled. The following sample output illustrates the portion of this show command:

```
Dell#show running-config int port-channel 1
!
interface Port-channel 1
 mtu 12000
 portmode hybrid
 switchport
 vlt-peer-lag port-channel 1
 no shutdown
 link-bundle-monitor enable
```

Verifying LACP Operation and LAG Configuration

To verify the operational status and configuration of a dynamically created LAG, and LACP operation on a LAG on an Aggregator, enter the `show interfaces port-channel port-channel-number` and `show lacp port-channel-number` commands.

The show outputs in this section for uplink LAG 128 and server-facing LAG 1 refer to the *LACP Operation on an Aggregator* figure

```
show interfaces port-channel 128
```

Command Example

```
Dell# show interfaces port-channel 128

Port-channel 128 is up, line protocol is up
Created by LACP protocol
Hardware address is 00:01:e8:e1:e1:c1, Current address is 00:01:e8:e1:e1:c1
Interface index is 1107755136
Minimum number of links to bring Port-channel up is 1
Internet address is not set
Mode of IP Address Assignment : NONE
DHCP Client-ID :lag1280001e8e1e1c1
MTU 12000 bytes, IP MTU 11982 bytes
LineSpeed 40000 Mbit
Members in this channel:  Te 0/41(U) Te 0/42(U) Te 0/43(U) Te 0/44(U)
ARP type: ARPA, ARP Timeout 04:00:00
Last clearing of "show interface" counters 00:11:50
Queueing strategy: fifo
Input Statistics:
  182 packets, 17408 bytes
  92 64-byte pkts, 0 over 64-byte pkts, 90 over 127-byte pkts
  0 over 255-byte pkts, 0 over 511-byte pkts, 0 over 1023-byte pkts
  182 Multicasts, 0 Broadcasts
  0 runts, 0 giants, 0 throttles
  0 CRC, 0 overrun, 0 discarded
Output Statistics:
  2999 packets, 383916 bytes, 0 underruns
  5 64-byte pkts, 214 over 64-byte pkts, 2727 over 127-byte pkts
  53 over 255-byte pkts, 0 over 511-byte pkts, 0 over 1023-byte pkts
  2904 Multicasts, 95 Broadcasts, 0 Unicasts
  0 throttles, 0 discarded, 0 collisions, 0 wredrops
Rate info (interval 299 seconds):
```

```
Input 00.00 Mbits/sec,          0 packets/sec, 0.00% of line-rate
Output 00.00 Mbits/sec,        4 packets/sec, 0.00% of line-rate
Time since last interface status change: 00:11:42
```

show lacp 128 **Command Example**

```
Dell# show lacp 128

Port-channel 128 admin up, oper up, mode lacp
Actor System ID: Priority 32768, Address 0001.e8e1.e1c3
Partner System ID: Priority 32768, Address 0001.e88b.253d
Actor Admin Key 128, Oper Key 128, Partner Oper Key 128, VLT Peer Oper Key 128
LACP LAG 128 is an aggregatable link
LACP LAG 128 is a normal LAG

A - Active LACP, B - Passive LACP, C - Short Timeout, D - Long Timeout
E - Aggregatable Link, F - Individual Link, G - IN_SYNC, H - OUT_OF_SYNC
I - Collection enabled, J - Collection disabled, K - Distribution enabled
L - Distribution disabled, M - Partner Defaulted, N - Partner Non-defaulted,
O - Receiver is in expired state, P - Receiver is not in expired state

Port Te 0/41 is enabled, LACP is enabled and mode is lacp
Port State: Bundle
  Actor Admin: State ADEHJLMP Key 128 Priority 32768
    Oper: State ADEGIKNP Key 128 Priority 32768
  Partner Admin: State BDFHJLMP Key 0 Priority 0
    Oper: State ACEGIKNP Key 128 Priority 32768

Port Te 0/42 is enabled, LACP is enabled and mode is lacp
Port State: Bundle
  Actor Admin: State ADEHJLMP Key 128 Priority 32768
    Oper: State ADEGIKNP Key 128 Priority 32768
  Partner Admin: State BDFHJLMP Key 0 Priority 0
    Oper: State ACEGIKNP Key 128 Priority 32768

Port Te 0/43 is enabled, LACP is enabled and mode is lacp
Port State: Bundle
  Actor Admin: State ADEHJLMP Key 128 Priority 32768
    Oper: State ADEGIKNP Key 128 Priority 32768
  Partner Admin: State BDFHJLMP Key 0 Priority 0
    Oper: State ACEGIKNP Key 128 Priority 32768

Port Te 0/44 is enabled, LACP is enabled and mode is lacp
Port State: Bundle
  Actor Admin: State ADEHJLMP Key 128 Priority 32768
    Oper: State ADEGIKNP Key 128 Priority 32768
  Partner Admin: State BDFHJLMP Key 0 Priority 0
    Oper: State ACEGIKNP Key 128 Priority 32768

Port Te 0/45 is disabled, LACP is disabled and mode is lacp
Port State: Bundle
  Actor Admin: State ADEHJLMP Key 128 Priority 32768
    Oper: State ADEHJLMP Key 128 Priority 32768
  Partner is not present

Port Te 0/46 is disabled, LACP is disabled and mode is lacp
Port State: Bundle
  Actor Admin: State ADEHJLMP Key 128 Priority 32768
    Oper: State ADEHJLMP Key 128 Priority 32768
  Partner is not present

Port Te 0/47 is disabled, LACP is disabled and mode is lacp
Port State: Bundle
  Actor Admin: State ADEHJLMP Key 128 Priority 32768
    Oper: State ADEHJLMP Key 128 Priority 32768
  Partner is not present

Port Te 0/48 is disabled, LACP is disabled and mode is lacp
Port State: Bundle
  Actor Admin: State ADEHJLMP Key 128 Priority 32768
    Oper: State ADEHJLMP Key 128 Priority 32768
  Partner is not present

Port Te 0/49 is disabled, LACP is disabled and mode is lacp
```

```

Port State: Bundle
  Actor   Admin: State ADEHJLMP Key 128 Priority 32768
         Oper: State ADEHJLMP Key 128 Priority 32768
  Partner is not present

Port Te 0/50 is disabled, LACP is disabled and mode is lacp
Port State: Bundle
  Actor   Admin: State ADEHJLMP Key 128 Priority 32768
         Oper: State ADEHJLMP Key 128 Priority 32768
  Partner is not present

Port Te 0/51 is disabled, LACP is disabled and mode is lacp
Port State: Bundle
  Actor   Admin: State ADEHJLMP Key 128 Priority 32768
         Oper: State ADEHJLMP Key 128 Priority 32768
  Partner is not present

Port Te 0/52 is disabled, LACP is disabled and mode is lacp
Port State: Bundle
  Actor   Admin: State ADEHJLMP Key 128 Priority 32768
         Oper: State ADEHJLMP Key 128 Priority 32768
  Partner is not present

Port Te 0/53 is disabled, LACP is disabled and mode is lacp
Port State: Bundle
  Actor   Admin: State ADEHJLMP Key 128 Priority 32768
         Oper: State ADEHJLMP Key 128 Priority 32768
  Partner is not present

Port Te 0/54 is disabled, LACP is disabled and mode is lacp
Port State: Bundle
  Actor   Admin: State ADEHJLMP Key 128 Priority 32768
         Oper: State ADEHJLMP Key 128 Priority 32768
  Partner is not present

Port Te 0/55 is disabled, LACP is disabled and mode is lacp
Port State: Bundle
  Actor   Admin: State ADEHJLMP Key 128 Priority 32768
         Oper: State ADEHJLMP Key 128 Priority 32768
  Partner is not present

Port Te 0/56 is disabled, LACP is disabled and mode is lacp
Port State: Bundle
  Actor   Admin: State ADEHJLMP Key 128 Priority 32768
         Oper: State ADEHJLMP Key 128 Priority 32768
  Partner is not present

```

show interfaces port-channel 1 **Command Example**

```

Dell# show interfaces port-channel 1

Port-channel 1 is up, line protocol is up
Created by LACP protocol
Hardware address is 00:01:e8:e1:e1:c1, Current address is 00:01:e8:e1:e1:c1
Interface index is 1107755009
Minimum number of links to bring Port-channel up is 1
Internet address is not set
Mode of IP Address Assignment : NONE
DHCP Client-ID :lag10001e8e1e1c1
MTU 12000 bytes, IP MTU 11982 bytes
LineSpeed 10000 Mbit
Members in this channel: Te 0/12(U)
ARP type: ARPA, ARP Timeout 04:00:00
Last clearing of "show interface" counters 00:12:41
Queueing strategy: fifo
Input Statistics:
  112 packets, 18161 bytes
  0 64-byte pkts, 46 over 64-byte pkts, 37 over 127-byte pkts
  29 over 255-byte pkts, 0 over 511-byte pkts, 0 over 1023-byte pkts
  59 Multicasts, 53 Broadcasts
  0 runts, 0 giants, 0 throttles
  0 CRC, 0 overrun, 0 discarded
Output Statistics:

```

```

135 packets, 19315 bytes, 0 underruns
0 64-byte pkts, 79 over 64-byte pkts, 32 over 127-byte pkts
24 over 255-byte pkts, 0 over 511-byte pkts, 0 over 1023-byte pkts
93 Multicasts, 42 Broadcasts, 0 Unicasts
0 throttles, 0 discarded, 0 collisions, 0 wredrops
Rate info (interval 299 seconds):
  Input 00.00 Mbits/sec,          0 packets/sec, 0.00% of line-rate
  Output 00.00 Mbits/sec,        0 packets/sec, 0.00% of line-rate
Time since last interface status change: 00:12:38

```

show lacp 1 **Command Example**

```

Dell# show lacp 1

Port-channel 1 admin up, oper up, mode lacp
Actor   System ID: Priority 32768, Address 0001.e8e1.e1c3
Partner System ID: Priority 65535, Address 24b6.fd87.d8ac
Actor Admin Key 1, Oper Key 1, Partner Oper Key 33, VLT Peer Oper Key 1
LACP LAG 1 is an aggregatable link
LACP LAG 1 is a normal LAG

A - Active LACP, B - Passive LACP, C - Short Timeout, D - Long Timeout
E - Aggregatable Link, F - Individual Link, G - IN_SYNC, H - OUT_OF_SYNC
I - Collection enabled, J - Collection disabled, K - Distribution enabled
L - Distribution disabled, M - Partner Defaulted, N - Partner Non-defaulted,
O - Receiver is in expired state, P - Receiver is not in expired state

Port Te 0/12 is enabled, LACP is enabled and mode is lacp
Port State: Bundle
  Actor   Admin: State ADEHJLMP Key 1 Priority 32768
           Oper: State ADEGIKNP Key 1 Priority 32768
  Partner Admin: State BDFHJLMP Key 0 Priority 0
           Oper: State ADEGIKNP Key 33 Priority 255

```

Multiple Uplink LAGs

Unlike IOA Automated modes (Standalone, VLT, and Stacking Modes), the IOA Programmable MUX can support multiple uplink LAGs. You can provision multiple uplink LAGs.

NOTE: In order to avoid loops, only disjoint VLANs are allowed between the uplink ports/uplink LAGs and uplink-to-uplink switching is disabled.

Multiple Uplink LAGs with 10G Member Ports

The following sample commands configure multiple dynamic uplink LAGs with 10G member ports based on LACP.

1. Bring up all the ports.

```

Dell#configure
Dell(conf)#int range tengigabitethernet 0/1 - 56
Dell(conf-if-range-te-0/1-56)#no shutdown

```

2. Associate the member ports into LAG-10 and 11.

```

Dell#configure
Dell(conf)#int range tengigabitethernet 0/41 - 42
Dell(conf-if-range-te-0/41-42)#port-channel-protocol lacp
Dell(conf-if-range-te-0/41-42-lacp)#port-channel 10 mode active
Dell(conf-if-range-te-0/41-42-lacp)#end
Dell#
Dell#configure
Dell(conf)#int tengigabitethernet 0/43
Dell(conf-if-te-0/43)#port-channel-protocol lacp
Dell(conf-if-te-0/43-lacp)#port-channel 11 mode active

```

```
Dell(conf-if-te-0/43-lacp)#end
Dell#
```

3. Show the LAG configurations and operational status.

```
Dell#show interface port-channel brief
Codes: L - LACP Port-channel
       O - OpenFlow Controller Port-channel
LAG Mode Status      Uptime      Ports
L  10  L3    up          00:01:00    Te 0/41    (Up)
                                   Te 0/42    (Up)
L  11  L3    up          00:00:01    Te 0/43    (Up)
Dell#
```

4. Configure the port mode, VLAN, and so forth on the port-channel.

```
Dell#configure
Dell(conf)#int port-channel 10
Dell(conf-if-po-10)#portmode hybrid
Dell(conf-if-po-10)#switchport
Dell(conf-if-po-10)#vlan tagged 1000
Dell(conf-if-po-10)#link-bundle-monitor enable

Dell#configure
Dell(conf)#int port-channel 11
Dell(conf-if-po-11)#portmode hybrid
Dell(conf-if-po-11)#switchport
Dell(conf-if-po-11)#vlan tagged 1000
% Error: Same VLAN cannot be added to more than one uplink port/LAG.
Dell(conf-if-po-11)#vlan tagged 1001
Dell(conf-if-po-11)#link-bundle-monitor enable

Dell#show vlan
Codes: * - Default VLAN, G - GVRP VLANs, R - Remote Port
Mirroring VLANs, P - Primary, C - Community, I - Isolated
       O - Openflow
Q: U - Untagged, T - Tagged
   x - Dot1x untagged, X - Dot1x tagged
   o - OpenFlow untagged, O - OpenFlow tagged
   G - GVRP tagged, M - Vlan-stack, H - VSN tagged
   i - Internal untagged, I - Internal tagged, v - VLT
untagged, V - VLT tagged

NUM      Status      Description      Q      Ports
* 1      Active
          U Po10(Te 0/4-5)
          U Po11(Te 0/6)
1000    Active
          T Po10(Te 0/4-5)
1001    Active
          T Po11(Te 0/6)
Dell#
```

5. Show LAG member ports utilization.

```
Dell#show link-bundle-distribution
Link-bundle trigger threshold - 60
LAG bundle - 10 Utilization[In Percent] - 0 Alarm State - Inactive
Interface      Line Protocol      Utilization[In Percent]
Te 0/41         Up                  0
Te 0/42         Up                  0
LAG bundle - 11 Utilization[In Percent] - 0 Alarm State - Inactive
Interface      Line Protocol      Utilization[In Percent]
Te 0/6         Up                  0
Dell#
```

Multiple Uplink LAGs with 40G Member Ports

By default in IOA, native 40G QSFP+ optional module ports are used in Quad (4x10G) mode, to convert Quad mode to Native 40G mode, refer to the sample configuration. Also note, converting between Quad mode and Native mode, and vice versa, requires that you reload the system for the configuration changes to take effect.

The following sample commands configure multiple dynamic uplink LAGs with 40G member ports based on LACP.

1. Convert the quad mode (4x10G) ports to native 40G mode.

```
Dell#configure
Dell(conf)#no stack-unit 0 port 33 portmode quad
Disabling quad mode on stack-unit 0 port 33 will make interface configs of Te 0/33 Te
0/34 Te 0/35 Te 0/36 obsolete after a save and reload.
[confirm yes/no]:yes
Please save and reset unit 0 for the changes to take effect.

Dell(conf)#no stack-unit 0 port 37 portmode quad
Disabling quad mode on stack-unit 0 port 37 will make interface configs of Te 0/37 Te
0/38 Te 0/39 Te 0/40 obsolete after a save and reload.
[confirm yes/no]:yes
Please save and reset unit 0 for the changes to take effect.

Dell(conf)#no stack-unit 0 port 49 portmode quad
Disabling quad mode on stack-unit 0 port 49 will make interface configs of Te 0/49 Te
0/50 Te 0/51 Te 0/52 obsolete after a save and reload.
[confirm yes/no]:yes
Please save and reset unit 0 for the changes to take effect.

Dell(conf)#no stack-unit 0 port 53 portmode quad
Disabling quad mode on stack-unit 0 port 53 will make interface configs of Te 0/53 Te
0/54 Te 0/55 Te 0/56 obsolete after a save and reload.
[confirm yes/no]:yes
Please save and reset unit 0 for the changes to take effect.
Dell(conf)#
```

2. Save the configuration.

```
Dell#write memory
!
01:05:48: %STKUNIT0-M:CP %FILEMGR-5-FILESAVED: Copied running-config to startup-
config in flash by default
Dell#reload
Proceed with reload [confirm yes/no]: yes
```

3. Configure the port-channel with 40G member ports.

```
Dell#configure
Dell(conf)#interface range fortygige 0/33, fortygige 0/37
Dell(conf-if-range-fo-0/33,fo-0/37)#no shut
Dell(conf-if-range-fo-0/33,fo-0/37)#port-channel-protocol lacp
Dell(conf-if-range-fo-0/33,fo-0/37-lacp)#port-channel 20 mode active
Dell(conf)#

Dell(conf)#int fortygige 0/49
Dell(conf-if-fo-0/49)#port-channel-protocol lacp
Dell(conf-if-fo-0/49-lacp)#port-channel 21 mode active
Dell(conf-if-fo-0/49-lacp)#
Dell(conf-if-fo-0/49)#no shut
```

4. Configure the port mode, VLAN, and so forth on the port-channel.

```
Dell#configure
Dell(conf)#int port-channel 20
Dell(conf-if-po-20)#portmode hybrid
Dell(conf-if-po-20)#switchport
Dell(conf-if-po-20)#no shut
Dell(conf-if-po-20)#ex
Dell(conf)#int port-channel 21
```

```
Dell(conf-if-po-21)#portmode hybrid
Dell(conf-if-po-21)#switchport
Dell(conf-if-po-21)#no shut
Dell(conf-if-po-21)#end
Dell#
```

5. Show the port channel status.

```
Dell#sh int port-channel br
Codes: L - LACP Port-channel
       O - OpenFlow Controller Port-channel

   LAG Mode Status      Uptime      Ports
L  20  L2  up           00:00:53    Fo 0/33 (Up)
                    Fo 0/37 (Up)
L  21  L2  up           00:00:02    Fo 0/49 (Up)
Dell#

Dell(conf)#int port-channel 20
Dell(conf-if-po-20)#vlan tagged 1000
Dell(conf-if-po-20)#

Dell(conf-if-po-21)#vlan tagged 1000
% Error: Same VLAN cannot be added to more than one uplink port/LAG.
Dell(conf-if-po-21)#vlan tagged 1001
Dell(conf-if-po-21)#
```

6. Show the VLAN status.

```
Dell#show vlan
Codes: * - Default VLAN, G - GVRP VLANs, R - Remote Port
Mirroring VLANs, P - Primary, C - Community, I - Isolated
       O - Openflow
Q: U - Untagged, T - Tagged
x - Dot1x untagged, X - Dot1x tagged
o - OpenFlow untagged, O - OpenFlow tagged
G - GVRP tagged, M - Vlan-stack, H - VSN tagged
i - Internal untagged, I - Internal tagged, v - VLT untagged,
V - VLT tagged

  NUM Status Description Q Ports
*   1 Active                U Po20(Fo 0/33,37)
                        U Po21(Fo 0/49)
  1000 Active                T Po20(Fo 0/33,37)
  1001 Active                T Po21(Fo 0/49)
Dell#
```

Layer 2

The Aggregator supports CLI commands to manage the MAC address table:

- [Clearing the MAC Address Entries](#)
- [Displaying the MAC Address Table](#)

The Aggregator auto-configures with support for Network Interface Controller (NIC) Teaming.

NOTE: On an Aggregator, all ports are configured by default as members of all (4094) VLANs, including the default VLAN. All VLANs operate in Layer 2 mode. You can reconfigure the VLAN membership for individual ports by using the `vlan tagged` or `vlan untagged` commands in INTERFACE configuration mode. See [VLAN Membership](#) for more information.

Supported Modes

Standalone, PMUX, VLT, Stacking

NOTE: You can also perform some of the configurations using the Web GUI - Dell Blade IO Manager. For more information, see the Dell Blade IO Manager Online Help.

Topics:

- [Managing the MAC Address Table](#)
- [Network Interface Controller \(NIC\) Teaming](#)

Managing the MAC Address Table

On an Aggregator in VLT and PMUX modes, you can manage the MAC address table by:

- [Clearing the MAC Address Entries](#)
- [Displaying the MAC Address Table](#)

In the Standalone mode, use the `show cam mac stack-unit 0 port-set 0` command to view the mac-addresses.

The Aggregator auto-configures with support for Network Interface Controller (NIC) Teaming.

Clearing the MAC Address Entries

Learned MAC addresses are entered in the table as dynamic entries, which means that they are subject to aging. For any dynamic entry, if no packet arrives on the switch with the MAC address as the source or destination address within the timer period, the address is removed from the table. The default aging time is 1800 seconds in PMUX mode and 300 seconds in Standalone and VLT modes.

You can manually clear the MAC address table of dynamic entries.

To clear a MAC address table, use the following command:

1. Clear a MAC address table of dynamic entries. EXEC Privilege mode

```
clear mac-address-table dynamic {address | all | interfaces | vlan}
```

- `address`: deletes the specified entry.
- `all`: deletes all dynamic entries.
- `interface`: deletes all entries for the specified interface.
- `vlan`: deletes all entries for the specified VLAN.

Displaying the MAC Address Table

To display the MAC address table, use the following command.

- Display the contents of the MAC address table.

EXEC Privilege mode

i **NOTE:** This command is available only in PMUX mode.

```
show mac-address-table [address | aging-time [vlan vlan-id] | count | dynamic | interface  
| static | vlan]
```

- `address`: displays the specified entry.
- `aging-time`: displays the configured aging-time.
- `count`: displays the number of dynamic and static entries for all VLANs, and the total number of entries.
- `dynamic`: displays only dynamic entries.
- `interface`: displays only entries for the specified interface.
- `static`: displays only static entries.
- `vlan`: displays only entries for the specified VLAN.

Network Interface Controller (NIC) Teaming

NIC teaming is a feature that allows multiple network interface cards in a server to be represented by one MAC address and one IP address in order to provide transparent redundancy, balancing, and to fully utilize network adapter resources.

Support for NIC teaming is auto-configured on the Aggregator, including support for:

- [MAC Address Station Move](#)
- [MAC Move Optimization](#)

The below fig shows a topology where two NICs have been teamed together. In this case, if the primary NIC fails, traffic switches to the secondary NIC, because they are represented by the same set of addresses.

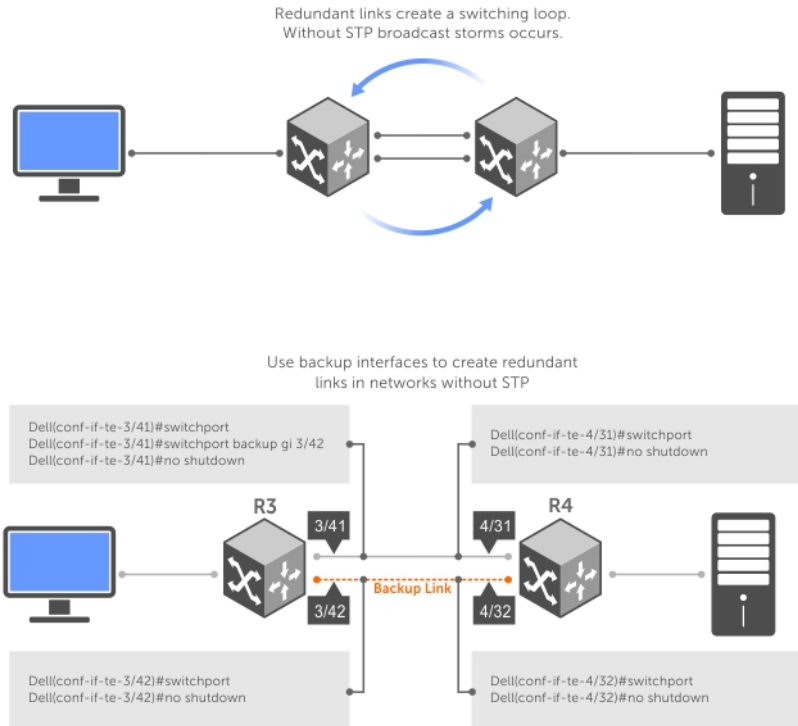

Figure 18. Redundant NOCs with NIC Teaming

MAC Address Station Move

When you use NIC teaming, consider that the server MAC address is originally learned on Port 0/1 of the switch (see figure below). If the NIC fails, the same MAC address is learned on Port 0/5 of the switch. The MAC address is disassociated with one port and re-associated with another in the ARP table; in other words, the ARP entry is “moved”. The Aggregator is auto-configured to support MAC Address station moves.

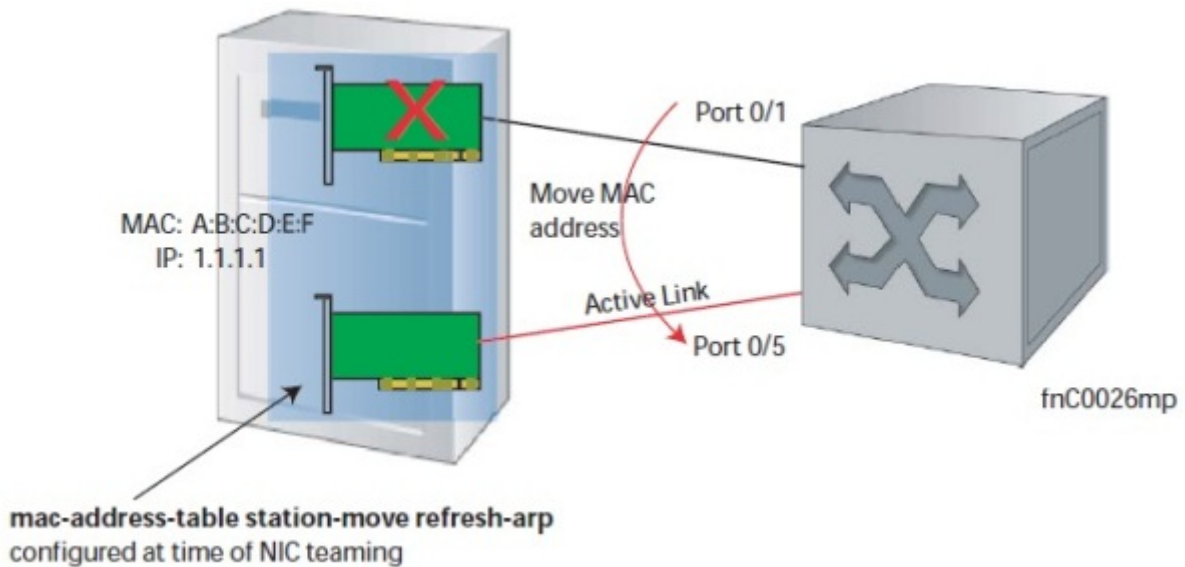

Figure 19. MAC Address Station Move

MAC Move Optimization

Station-move detection takes 5000ms because this is the interval at which the detection algorithm runs.

Link Layer Discovery Protocol (LLDP)

Link layer discovery protocol (LLDP) advertises connectivity and management from the local station to the adjacent stations on an IEEE 802 LAN.

LLDP facilitates multi-vendor interoperability by using standard management tools to discover and make available a physical topology for network management. The Dell Networking operating software implementation of LLDP is based on IEEE standard 801.1ab.

The starting point for using LLDP is invoking LLDP with the protocol lldp command in either CONFIGURATION or INTERFACE mode.

The information LLDP distributes is stored by its recipients in a standard management information base (MIB). You can access the information by a network management system through a management protocol such as simple network management protocol (SNMP).

An Aggregator auto-configures to support the link layer discovery protocol (LLDP) for the auto-discovery of network devices. You can use CLI commands to display acquired LLDP information, clear LLDP counters, and debug LACP operation.

Supported Modes

Standalone, PMUX, VLT, Stacking

Topics:

- [Protocol Data Units](#)
- [Configure LLDP](#)
- [CONFIGURATION versus INTERFACE Configurations](#)
- [Enabling LLDP](#)
- [Advertising TLVs](#)
- [Optional TLVs](#)
- [LLDP Operation](#)
- [Storing and Viewing Unrecognized LLDP TLVs](#)
- [Viewing the LLDP Configuration](#)
- [Viewing Information Advertised by Adjacent LLDP Agents](#)
- [Configuring LLDPDU Intervals](#)
- [Configuring a Time to Live](#)
- [Clearing LLDP Counters](#)
- [Debugging LLDP](#)
- [Relevant Management Objects](#)

Protocol Data Units

Configuration information is exchanged in the form of type, length, value (TLV) segments. The below figure shows the chassis ID TLV.

- **Type** — Indicates the type of field that a part of the message represents.
- **Length** — Indicates the size of the value field (in byte).
- **Value** — Indicates the data for this part of the message.

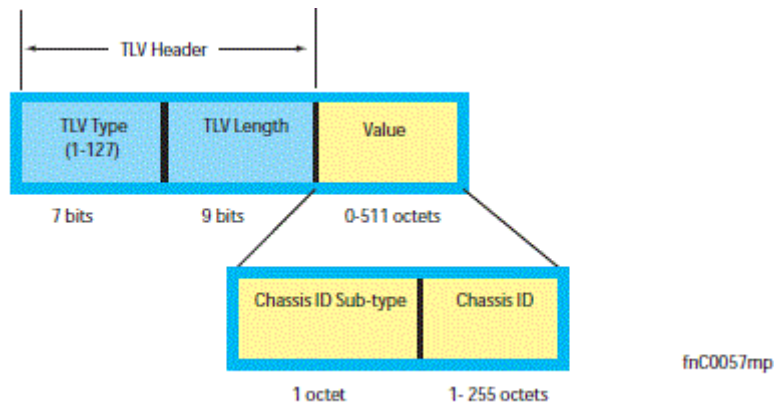

Figure 20. Type, Length, Value (TLV) Segment

TLVs are encapsulated in a frame called an LLDP data unit (LLDPDU), which is transmitted from one LLDP-enabled device to its LLDP-enabled neighbors. LLDP is a one-way protocol. LLDP-enabled devices (LLDP agents) can transmit and/or receive advertisements, but they cannot solicit and do not respond to advertisements.

There are five types of TLVs (as shown in the below table). All types are mandatory in the construction of an LLDPDU except Optional TLVs. You can configure the inclusion of individual Optional TLVs.

Table 14. Type, Length, Value (TLV) Types

Type	TLV	Description
0	End of LLDPDU	Marks the end of an LLDPDU.
1	Chassis ID	The Chassis ID TLV is a mandatory TLV that identifies the chassis containing the IEEE 802 LAN station associated with the transmitting LLDP agent.
2	Port ID	The Port ID TLV is a mandatory TLV that identifies the port component of the MSAP identifier associated with the transmitting LLDP agent.
3	Time to Live	The Time To Live TLV indicates the number of seconds that the recipient LLDP agent considers the information associated with this MSAP identifier to be valid.
—	Optional	Includes sub-types of TLVs that advertise specific configuration information. These sub-types are Management TLVs, IEEE 802.1, IEEE 802.3, and TIA-1057 Organizationally Specific TLVs.

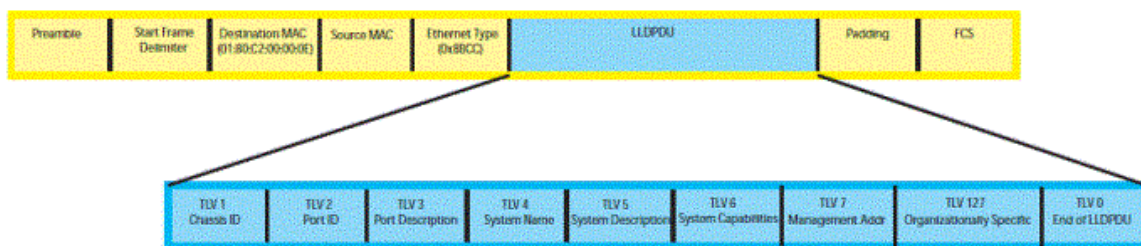

Figure 21. LLDPDU Frame

Configure LLDP

Configuring LLDP is a two-step process.

1. Enable LLDP globally.
2. Advertise TLVs out of an interface.

Related Configuration Tasks

- [Viewing the LLDP Configuration](#)
- [Viewing Information Advertised by Adjacent LLDP Agents](#)
- [Configuring LLDPDU Intervals](#)
- [Configuring a Time to Live](#)
- [Debugging LLDP](#)

Important Points to Remember

- LLDP is enabled by default.
- Dell Networking systems support up to eight neighbors per interface.
- Dell Networking systems support a maximum of 8000 total neighbors per system. If the number of interfaces multiplied by eight exceeds the maximum, the system does not configure more than 8000.
- INTERFACE level configurations override all CONFIGURATION level configurations.
- LLDP is not hitless.

CONFIGURATION versus INTERFACE Configurations

All LLDP configuration commands are available in PROTOCOL LLDP mode, which is a sub-mode of the CONFIGURATION mode and INTERFACE mode.

- Configurations made at the CONFIGURATION level are global; that is, they affect all interfaces on the system.
- Configurations made at the INTERFACE level affect only the specific interface; they override CONFIGURATION level configurations.

Example of the `protocol lldp` Command (CONFIGURATION Level)

```
Dell(conf)#protocol lldp
Dell(conf-lldp)#?
advertise      Advertise TLVs
disable        Disable LLDP protocol globally
end            Exit from configuration mode
exit           Exit from LLDP configuration mode
hello          LLDP hello configuration
mode           LLDP mode configuration (default = rx and tx)
multiplier     LLDP multiplier configuration
no             Negate a command or set its defaults
show          Show LLDP configuration

Dell(conf-lldp)#exit
Dell(conf)#interface tengigabitethernet 0/3
Dell(conf-if-te-0/3)#protocol lldp
Dell(conf-if-te-0/3-lldp)#?
advertise      Advertise TLVs
disable        Disable LLDP protocol on this interface
end            Exit from configuration mode
exit           Exit from LLDP configuration mode
hello          LLDP hello configuration
mode           LLDP mode configuration (default = rx and tx)
multiplier     LLDP multiplier configuration
no             Negate a command or set its defaults
show          Show LLDP configuration
Dell(conf-if-te-0/3-lldp)#
```

Enabling LLDP

LLDP is enabled by default. Enable and disable LLDP globally or per interface. If you enable LLDP globally, all UP interfaces send periodic LLDPDUs.

To enable LLDP, use the following command.

1. Enter Protocol LLDP mode.
CONFIGURATION or INTERFACE mode
`protocol lldp`
2. Enable LLDP.
PROTOCOL LLDP mode
`no disable`

Disabling and Undoing LLDP

To disable or undo LLDP, use the following command.

- Disable LLDP globally or for an interface.
`disable`

To undo an LLDP configuration, precede the relevant command with the keyword `no`.

Advertising TLVs

You can configure the system to advertise TLVs out of all interfaces or out of specific interfaces.

- If you configure the system globally, all interfaces send LLDPDUs with the specified TLVs.
- If you configure an interface, only the interface sends LLDPDUs with the specified TLVs.
- If you configure LLDP both globally and at interface level, the interface level configuration overrides the global configuration.

To advertise TLVs, use the following commands.

1. Enter LLDP mode.
CONFIGURATION or INTERFACE mode
`protocol lldp`
2. Advertise one or more TLVs.
PROTOCOL LLDP mode
`advertise {dcbx-appln-tlv | dcbx-tlv | dot3-tlv | interface-port-desc | management-tlv | med }`

Include the keyword for each TLV you want to advertise.

- For management TLVs: `system-capabilities`, `system-description`.
- For 802.1 TLVs: `port-protocol-vlan-id`, `port-vlan-id`.
- For 802.3 TLVs: `max-frame-size`.
- For TIA-1057 TLVs:
 - `guest-voice`
 - `guest-voice-signaling`
 - `location-identification`
 - `power-via-mdi`
 - `softphone-voice`
 - `streaming-video`
 - `video-conferencing`
 - `video-signaling`
 - `voice`
 - `voice-signaling`

In the following example, LLDP is enabled globally. R1 and R2 are transmitting periodic LLDPDUs that contain management, 802.1, and 802.3 TLVs.

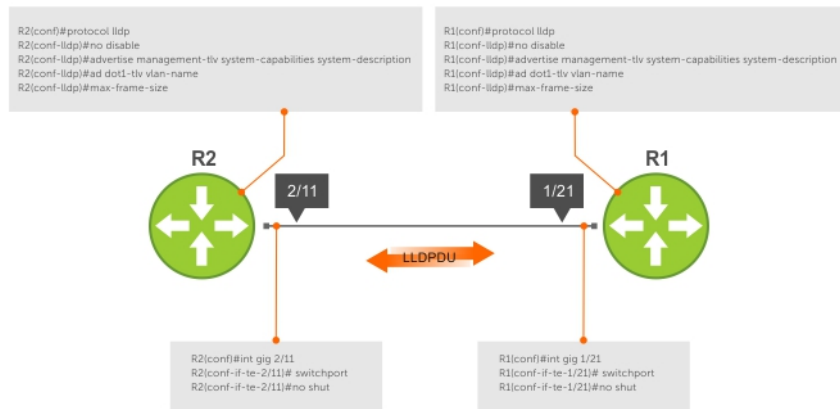

Figure 22. Configuring LLDP

Optional TLVs

The Dell Networking Operating System (OS) supports the following optional TLVs: Management TLVs, IEEE 802.1 and 802.3 organizationally specific TLVs, and TIA-1057 organizationally specific TLVs.

Management TLVs

A management TLV is an optional TLVs sub-type. This kind of TLV contains essential management information about the sender.

Organizationally Specific TLVs

A professional organization or a vendor can define organizationally specific TLVs. They have two mandatory fields (as shown in the following illustration) in addition to the basic TLV fields.

- Organizationally Unique Identifier (OUI)—a unique number assigned by the IEEE to an organization or vendor.
- OUI Sub-type—These sub-types indicate the kind of information in the following data field. The sub-types are determined by the owner of the OUI.



Figure 23. Organizationally Specific TLVs

IEEE Organizationally Specific TLVs

Eight TLV types have been defined by the IEEE 802.1 and 802.3 working groups as a basic part of LLDP; the IEEE OUI is 00-80-C2. You can configure the Dell Networking system to advertise any or all of these TLVs.

Table 15. Optional TLV Types

Type	TLV	Description
Optional TLVs		

Table 15. Optional TLV Types (continued)

Type	TLV	Description
4	Port description	A user-defined alphanumeric string that describes the port. The Dell Networking OS does not currently support this TLV.
5	System name	A user-defined alphanumeric string that identifies the system.
6	System description	A user-defined alphanumeric string that identifies the system.
7	System capabilities	Identifies the chassis as one or more of the following: repeater, bridge, WLAN Access Point, Router, Telephone, DOCSIS cable device, end station only, or other.
8	Management address	Indicates the network address of the management interface. The Dell Networking OS does not currently support this TLV.
IEEE 802.1 Organizationally Specific TLVs		
127	Port-VLAN ID	On Dell Networking systems, indicates the untagged VLAN to which a port belongs.
127	Port and Protocol VLAN ID	On Dell Networking systems, indicates the tagged VLAN to which a port belongs (and the untagged VLAN to which a port belongs if the port is in Hybrid mode).
127	VLAN Name	Indicates the user-defined alphanumeric string that identifies the VLAN.
127	Protocol Identity	Indicates the protocols that the port can process. The Dell Networking OS does not currently support this TLV.
IEEE 802.3 Organizationally Specific TLVs		
127	MAC/PHY Configuration/Status	Indicates the capability and current setting of the duplex status and bit rate, and whether the current settings are the result of auto-negotiation. This TLV is not available in the Dell Networking OS implementation of LLDP, but is available and mandatory (non-configurable) in the LLDP-MED implementation.
127	Power via MDI	Dell Networking supports the LLDP-MED protocol, which recommends that Power via MDI TLV be not implemented, and therefore Dell Networking implements Extended Power via MDI TLV only.
127	Link Aggregation	Indicates whether the link is capable of being aggregated, whether it is currently in a LAG, and the port identification of the LAG. The Dell Networking OS does not currently support this TLV.

Table 15. Optional TLV Types (continued)

Type	TLV	Description
127	Maximum Frame Size	Indicates the maximum frame size capability of the MAC and PHY.

LLDP-MED Capabilities TLV

The LLDP-MED capabilities TLV communicates the types of TLVs that the endpoint device and the network connectivity device support. LLDP-MED network connectivity devices must transmit the Network Policies TLV.

- The value of the LLDP-MED capabilities field in the TLV is a 2-octet bitmap, each bit represents an LLDP-MED capability (as shown in the following table).
- The possible values of the LLDP-MED device type are shown in the following. The Dell Networking system is a network connectivity device, which is Type 4.

When you enable LLDP-MED in Dell Networking OS (using the `advertise med` command), the system begins transmitting this TLV.

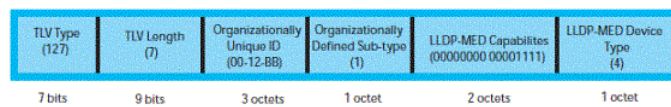

Figure 24. LLDP-MED Capabilities TLV

Table 16. Dell Networking OS LLDP-MED Capabilities

Bit Position	TLV	Dell Networking OS Support
0	LLDP-MED Capabilities	Yes
1	Network Policy	Yes
2	Location Identification	Yes
3	Extended Power via MDI-PSE	Yes
4	Extended Power via MDI-PD	No
5	Inventory	No
6–15	reserved	No

Table 17. LLDP-MED Device Types

Value	Device Type
0	Type Not Defined
1	Endpoint Class 1
2	Endpoint Class 2
3	Endpoint Class 3
4	Network Connectivity
5–255	Reserved

LLDP-MED Network Policies TLV

A network policy in the context of LLDP-MED is a device’s VLAN configuration and associated Layer 2 and Layer 3 configurations.

LLDP-MED network policies TLV include:

- VLAN ID
- VLAN tagged or untagged status

- Layer 2 priority
- DSCP value

An integer represents the application type (the Type integer shown in the following table), which indicates a device function for which a unique network policy is defined. An individual LLDP-MED network policy TLV is generated for each application type that you specify with the CLI (XXAdvertising TLVs).

NOTE: As shown in the following table, signaling is a series of control packets that are exchanged between an endpoint device and a network connectivity device to establish and maintain a connection. These signal packets might require a different network policy than the media packets for which a connection is made. In this case, configure the signaling application.

Table 18. Network Policy Applications

Type	Application	Description
0	Reserved	—
1	Voice	Specify this application type for dedicated IP telephony handsets and other appliances supporting interactive voice services.
2	Voice Signaling	Specify this application type only if voice control packets use a separate network policy than voice data.
3	Guest Voice	Specify this application type for a separate limited voice service for guest users with their own IP telephony handsets and other appliances supporting interactive voice services.
4	Guest Voice Signaling	Specify this application type only if guest voice control packets use a separate network policy than voice data.
5	Softphone Voice	Specify this application type only if guest voice control packets use a separate network policy than voice data.
6	Video Conferencing	Specify this application type for dedicated video conferencing and other similar appliances supporting real-time interactive video.
7	Streaming Video	Specify this application type for dedicated video conferencing and other similar appliances supporting real-time interactive video.
8	Video Signaling	Specify this application type only if video control packets use a separate network policy than video data.
9–255	Reserved	—

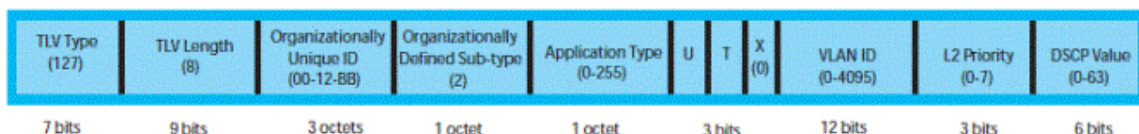

Figure 25. LLDP-MED Policies TLV

Extended Power via MDI TLV

The extended power via MDI TLV enables advanced PoE management between LLDP-MED endpoints and network connectivity devices.

Advertise the extended power via MDI on all ports that are connected to an 802.3af powered, LLDP-MED endpoint device.

- **Power Type** — there are two possible power types: power source entity (PSE) or power device (PD). The Dell Networking system is a PSE, which corresponds to a value of 0, based on the TIA-1057 specification.
- **Power Source** — there are two possible power sources: primary and backup. The Dell Networking system is a primary power source, which corresponds to a value of 1, based on the TIA-1057 specification.

- **Power Priority** — there are three possible priorities: Low, High, and Critical. On Dell Networking systems, the default power priority is **High**, which corresponds to a value of 2 based on the TIA-1057 specification. You can configure a different power priority through the CLI. Dell Networking also honors the power priority value the powered device sends; however, the CLI configuration takes precedence.
- **Power Value** — Dell Networking advertises the maximum amount of power that can be supplied on the port. By default the power is **15.4W**, which corresponds to a power value of 130, based on the TIA-1057 specification. You can advertise a different power value using the `max-milliwatts` option with the `power inline auto | static` command. Dell Networking also honors the power value (power requirement) the powered device sends when the port is configured for `power inline auto`.

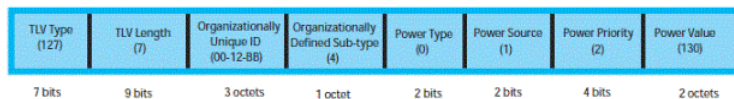

Figure 26. Extended Power via MDI TLV

LLDP Operation

On an Aggregator, LLDP operates as follows:

- LLDP is enabled by default.
- LLDPDUs are transmitted and received by default. LLDPDUs are transmitted periodically. The default interval is 30 seconds.
- LLDPDU information received from a neighbor expires after the default Time to Live (TTL) value: 120 seconds.
- Dell Networking OS supports up to eight neighbors per interface.
- Dell Networking OS supports a maximum of 8000 total neighbors per system. If the number of interfaces multiplied by eight exceeds the maximum, the system does not configure more than 8000.
- LLDP is not hitless.

Storing and Viewing Unrecognized LLDP TLVs

Dell EMC Networking OS provides support to store unrecognized (reserved and organizational specific) LLDP TLVs. Also, support is extended to retrieve the stored unrecognized TLVs using SNMP.

When the incoming TLV from LLDP neighbors is not recognized, the TLV is categorized as unrecognized TLV. The unrecognized TLVs is categorized into two types:

1. Reserved unrecognized LLDP TLV
2. Organizational specific unrecognized LLDP TLV

Reserved Unrecognized LLDP TLVs

The type value for reserved TLV ranging from 9 to 126.

The system processes each LLDP frame to retrieve the type and length, and stores the retrieved data of reserved unrecognized LLDP TLVs in a list. The stored list of unrecognized TLVs is removed when subsequent LLDP neighbor frame is received, neighbor is lost, or neighbor ages out. If there are multiple unrecognized TLVs with the same TLV type, only the information of first unrecognized TLV is stored and the TLV discard counter is incremented for the successive TLVs.

Organizational Specific Unrecognized LLDP TLVs

The type value for organizational specific TLV is 127.

The system processes each LLDP frame to retrieve the OUI, subtype, and data length, and stores the retrieved data of organizational specific unrecognized LLDP TLVs in a list. The stored list of organizational TLVs is removed when the neighbor is lost or neighbor ages out. The software assigns a temporary identification index for each unrecognized organizational specific LLDP TLVs upon receiving more than one TLV with the same OUI and subtype, but with different organizationally defined information strings.

 **NOTE:**

The system increments the TLV discard counter and does not store unrecognized LLDP TLV information in following scenarios:

- If there are multiple TLVs with the same information is received
- If DCBX is down on the receiving interface

The organizational specific TLV list is limited to store 256 entries per neighbor. If TLV entries are more than 256, then the oldest entry (of that neighbor) in the list is replaced. A syslog message appears when the organization specific unrecognized TLV list exceeds more than 205 entries (80 percent of 256) for you to take action. Following shows the syslog message:

```
Nov 14 03:01:53 %STKUNIT2-M:CP %LLDP-5-LLDP_ORG_UNRECOGNISED_TLV_MAX: Received
Organizational Specific unrecognised TLVs exceeds threshold (205) from Remote Chassis
ID: 4c:76:25:f4:ab:00, Remote Port ID: fortyGigE 1/2/8/1 on interface: Te 2/31/1
```

Viewing Unrecognized LLDP TLVs

You can view or retrieve the stored unrecognized (reserved and organizational specific) TLVs using the `show lldp neighbor details` command.

View all the LLDP TLV information including unrecognized TLVs, using the `snmpwalk` and `snmpget` commands.

Viewing the LLDP Configuration

To view the LLDP configuration, use the following command.

- Display the LLDP configuration.
CONFIGURATION or INTERFACE mode
`show config`

Example of Viewing LLDP Global Configurations

```
R1(conf)#protocol lldp
R1(conf-lldp)#show config
!
protocol lldp
  advertise dot3-tlv max-frame-size
  advertise management-tlv system-capabilities system-description
  hello 10
  no disable
R1(conf-lldp)#
```

Example of Viewing LLDP Interface Configurations

```
R1(conf-lldp)#exit
R1(conf)#interface tengigabitethernet 0/3
R1(conf-if-te-0/3)#show config
!
interface tengigabitEthernet 0/3
  switchport
  no shutdown
R1(conf-if-te-0/3)#protocol lldp
R1(conf-if-te-0/3-lldp)#show config
!
  protocol lldp
R1(conf-if-te-0/3-lldp)#
```

Viewing Information Advertised by Adjacent LLDP Agents

To view brief information about adjacent devices or to view all the information that neighbors are advertising, use the following commands.

- Display brief information about adjacent devices.
show lldp neighbors
- Display all of the information that neighbors are advertising.
show lldp neighbors detail

Example of Viewing Brief Information Advertised by Neighbors

```
R1(conf-if-te-1/31-lldp)#end
R1(conf-if-te-1/31)#do show lldp neighbors
Loc PortID Rem Host Name Rem Port Id          Rem Chassis Id
-----
Te 0/2      -                00:00:c9:b1:3b:82  00:00:c9:b1:3b:82
Te 0/3      -                00:00:c9:ad:f6:12  00:00:c9:ad:f6:12
```

Example of Viewing Details Advertised by Neighbors

```
Dell#show lldp neighbors detail
=====
Local Interface Te 0/2 has 1 neighbor
Total Frames Out: 16843
Total Frames In: 17464
Total Neighbor information Age outs: 0
Total Multiple Neighbors Detected: 0
Total Frames Discarded: 0
Total In Error Frames: 0
Total Unrecognized TLVs: 0
Total TLVs Discarded: 0
Next packet will be sent after 16 seconds
The neighbors are given below:
-----

Remote Chassis ID Subtype: Mac address (4)
Remote Chassis ID: 00:00:c9:b1:3b:82
Remote Port Subtype: Mac address (3)
Remote Port ID: 00:00:c9:b1:3b:82
Local Port ID: TenGigabitEthernet 0/2
Locally assigned remote Neighbor Index: 7
Remote TTL: 120
Information valid for next 105 seconds
Time since last information change of this neighbor: 1d21h56m
Remote System Desc: Emulex OneConnect 10Gb Multi function Adapter
Existing System Capabilities: Station only
Enabled System Capabilities: Station only
-----

=====
Local Interface Te 0/3 has 1 neighbor
Total Frames Out: 39165
Total Frames In: 40650
Total Neighbor information Age outs: 0
Total Multiple Neighbors Detected: 0
Total Frames Discarded: 0
Total In Error Frames: 0
Total Unrecognized TLVs: 0
Total TLVs Discarded: 0
Next packet will be sent after 4 seconds
The neighbors are given below:
-----

Remote Chassis ID Subtype: Mac address (4)
Remote Chassis ID: 00:00:c9:ad:f6:12
Remote Port Subtype: Mac address (3)
```

```
Remote Port ID: 00:00:c9:ad:f6:12
Local Port ID: TenGigabitEthernet 0/3
```

Configuring LLDPDU Intervals

LLDPDUs are transmitted periodically; the default interval is **30 seconds**.

To configure LLDPDU intervals, use the following command.

- Configure a non-default transmit interval.
CONFIGURATION mode or INTERFACE mode
hello

```
Dell#conf
Dell(conf)#protocol lldp
Dell(conf-lldp)#show config
!
protocol lldp
Dell(conf-lldp)#hello ?
<5-180>          Hello interval in seconds (default=30)
Dell(conf-lldp)#hello 10
Dell(conf-lldp)#show config
!
protocol lldp
  hello 10
Dell(conf-lldp)#
Dell(conf-lldp)#no hello
Dell(conf-lldp)#show config
!
protocol lldp
Dell(conf-lldp)#
```

Configuring a Time to Live

The information received from a neighbor expires after a specific amount of time (measured in seconds) called a time to live (TTL).

The TTL is the product of the LLDPDU transmit interval (hello) and an integer called a multiplier. The default multiplier is **4**, which results in a default TTL of 120 seconds.

- Adjust the TTL value.
CONFIGURATION mode or INTERFACE mode.
multiplier
- Return to the default multiplier value.
CONFIGURATION mode or INTERFACE mode.
no multiplier

```
R1(conf-lldp)#show config
!
protocol lldp
  advertise dot1-tlv port-protocol-vlan-id port-vlan-id
  advertise dot3-tlv max-frame-size
  advertise management-tlv system-capabilities system-description
  no disable
R1(conf-lldp)#multiplier ?
<2-10>          Multiplier (default=4)
R1(conf-lldp)#multiplier 5
R1(conf-lldp)#show config
!
protocol lldp
  advertise dot1-tlv port-protocol-vlan-id port-vlan-id
  advertise dot3-tlv max-frame-size
  advertise management-tlv system-capabilities system-description
multiplier 5
```

```
no disable
R1(conf-lldp) #no multiplier
R1(conf-lldp) #show config
!
protocol lldp
  advertise dot1-tlv port-protocol-vlan-id port-vlan-id
  advertise dot3-tlv max-frame-size
  advertise management-tlv system-capabilities system-description
no disable
R1(conf-lldp) #
```

Clearing LLDP Counters

You can clear LLDP statistics that are maintained on an Aggregator for LLDP counters for frames transmitted to and received from neighboring devices on all or a specified physical interface.

To clear LLDP counters, enter the `clear lldp counters` command.

1. Clear counters for LLDP frames sent to and received from neighboring devices on all Aggregator interfaces or on a specified interface.

interface specifies a 10GbE uplink port in the format: **tenGigabitEthernet slot/port**.

EXEC Privilege mode

```
clear lldp counters [interface]
```

Debugging LLDP

You can view the TLVs that your system is sending and receiving.

To view the TLVs, use the following commands.

- View a readable version of the TLVs.
`debug lldp brief`
- View a readable version of the TLVs plus a hexadecimal version of the entire LLDPDU.
`debug lldp detail`

```

Dell# debug lldp interface tengigabitethernet 1/2 packet detail tx
Dell#1w1d19h : Transmit timer blew off for local interface Gi 1/2
1w1d19h : Forming LLDP pkt to send out of interface Gi 1/2
1w1d19h : TLV: Chassis ID, Len: 7, Subtype: Mac address (4), Value: 00:01:e8:0d:b6:d6
1w1d19h : TLV: Port ID, Len: 20, Subtype: Interface name (5), Value: TenGigabitEthernet 1/2
1w1d19h : TLV: TTL, Len: 2, Value: 120
1w1d19h : TLV: SYS_DESC, Len: 207, Value: Dell Networks Real Time Operating System Software. Dell
Operating System Version: 1.0. Dell Application Software Version: E_MAIN4.7.5.276. Copyright (c)1999-Build
Time: Fri Oct 26 12:22:22 PDT 2007
1w1d19h : TLV: SYSTEM_CAPAB, Len: 4, Value: Existing: Repeater Bridge Router, Enabled: Repeater Bridge Router
1w1d19h : TLV: ENDOFPDU, Len: 0
1w1d19h : Sending LLDP pkt out of Gi 1/2 of length 270
1w1d19h : Packet dump:
1w1d19h : 01 80 c2 00 00 0e 00 01 e8 0d b7 3b 81 00 00 00
1w1d19h : 88 cc 02 07 04 00 01 e8 0d b6 d6 04 14 05 47 69
1w1d19h : 67 61 62 69 74 45 74 68 65 72 6e 65 74 20 31 2f
1w1d19h : 32 06 02 00 78 0c cf 46 6f 72 63 65 31 30 20 4e
1w1d19h : 65 74 77 6f 72 6b 73 20 52 65 61 6c 20 54 69 6d
1w1d19h : 65 20 4f 70 65 72 61 74 69 6e 67 20 53 79 73 74
1w1d19h : 65 6d 20 53 6f 66 74 77 61 72 65 2e 20 46 6f 72
1w1d19h : 63 65 31 30 20 4f 70 65 72 61 74 69 6e 67 20 53
1w1d19h : 79 73 74 65 6d 20 56 65 72 73 69 6f 6e 3a 20 31
1w1d19h : 2e 30 2e 20 46 6f 72 63 65 31 30 20 41 70 70 6c
1w1d19h : 69 63 61 74 69 6f 6e 20 53 6f 66 74 77 61 72 65
1w1d19h : 20 56 65 72 73 69 6f 6e 3a 20 45 5f 4d 41 49 4e
1w1d19h : 34 2e 37 2e 35 2e 32 37 36 2e 20 43 6f 70 79 72
1w1d19h : 69 67 68 74 20 28 63 29 20 31 39 39 39 2d 42 75
1w1d19h : 69 6c 64 20 54 69 6d 65 3a 20 46 72 69 20 4f 63
1w1d19h : 74 20 32 36 20 31 32 3a 32 32 3a 32 32 20 50 44
1w1d19h : 54 20 32 30 30 37 0e 04 00 16 00 16 00 00
1w1d19h : LLDP frame sent out successfully of Gi 1/2
1w1d19h : Started Transmit timer for Loc interface Gi 1/2 for time 30 sec

```

Figure 27. The debug lldp detail Command — LLDPDU Packet Dissection

Relevant Management Objects

Dell Networkings OS supports all IEEE 802.1AB MIB objects.

The following tables list the objects associated with:

- Received and transmitted TLVs
- LLDP configuration on the local agent
- IEEE 802.1AB Organizationally Specific TLVs
- Received and transmitted LLDP-MED TLVs

Table 19. LLDP Configuration MIB Objects

MIB Object Category	LLDP Variable	LLDP MIB Object	Description
LLDP Configuration	adminStatus	lldpPortConfigAdminStatus	Whether you enable the local LLDP agent for transmit, receive, or both.
	msgTxHold	lldpMessageTxHoldMultiplier	Multiplier value.
	msgTxInterval	lldpMessageTxInterval	Transmit Interval value.
	rxInfoTTL	lldpRxInfoTTL	Time to live for received TLVs.
	txInfoTTL	lldpTxInfoTTL	Time to live for transmitted TLVs.
Basic TLV Selection	mibBasicTLVsTxEnable	lldpPortConfigTLVsTxEnable	Indicates which management TLVs are enabled for system ports.

Table 19. LLDP Configuration MIB Objects (continued)

MIB Object Category	LLDP Variable	LLDP MIB Object	Description
	mibMgmtAddrInstanceTxEnable	IldpManAddrPortsTxEnable	The management addresses defined for the system and the ports through which they are enabled for transmission.
LLDP Statistics	statsAgeoutsTotal	IldpStatsRxPortAgeoutsTotal	Total number of times that a neighbor's information is deleted on the local system due to an rxInfoTTL timer expiration.
	statsFramesDiscardedTotal	IldpStatsRxPortFramesDiscardedTotal	Total number of LLDP frames received then discarded.
	statsFramesInErrorsTotal	IldpStatsRxPortFramesErrors	Total number of LLDP frames received on a port with errors.
	statsFramesInTotal	IldpStatsRxPortFramesTotal	Total number of LLDP frames received through the port.
	statsFramesOutTotal	IldpStatsTxPortFramesTotal	Total number of LLDP frames transmitted through the port.
	statsTLVsDiscardedTotal	IldpStatsRxPortTLVsDiscardedTotal	Total number of TLVs received then discarded.
	statsTLVsUnrecognizedTotal	IldpStatsRxPortTLVsUnrecognizedTotal	Total number of all TLVs the local agent does not recognize.

Table 20. LLDP System MIB Objects

TLV Type	TLV Name	TLV Variable	System	LLDP MIB Object
1	Chassis ID	chassis ID subtype	Local	IldpLocChassisIdSubtype
			Remote	IldpRemChassisIdSubtype
		chassid ID	Local	IldpLocChassisId
			Remote	IldpRemChassisId
2	Port ID	port subtype	Local	IldpLocPortIdSubtype
			Remote	IldpRemPortIdSubtype
		port ID	Local	IldpLocPortId
			Remote	IldpRemPortId
4	Port Description	port description	Local	IldpLocPortDesc
			Remote	IldpRemPortDesc
5	System Name	system name	Local	IldpLocSysName
			Remote	IldpRemSysName
6	System Description	system description	Local	IldpLocSysDesc
			Remote	IldpRemSysDesc
7	System Capabilities	system capabilities	Local	IldpLocSysCapSupported
			Remote	IldpRemSysCapSupported
8	Management Address	enabled capabilities	Local	IldpLocSysCapEnabled
			Remote	IldpRemSysCapEnabled

Table 20. LLDP System MIB Objects (continued)

TLV Type	TLV Name	TLV Variable	System	LLDP MIB Object
		management address length	Local	IldpLocManAddrLen
			Remote	IldpRemManAddrLen
		management address subtype	Local	IldpLocManAddrSubtype
			Remote	IldpRemManAddrSubtype
		management address	Local	IldpLocManAddr
			Remote	IldpRemManAddr
		interface numbering subtype	Local	IldpLocManAddrIfSubtype
			Remote	IldpRemManAddrIfSubtype
		interface number	Local	IldpLocManAddrIfId
			Remote	IldpRemManAddrIfId
		OID	Local	IldpLocManAddrOID
			Remote	IldpRemManAddrOID

Table 21. LLDP 802.1 Organizationally specific TLV MIB Objects

TLV Type	TLV Name	TLV Variable	System	LLDP MIB Object
127	Port-VLAN ID	PVID	Local	IldpXdot1LocPortVlanId
			Remote	IldpXdot1RemPortVlanId
127	Port and Protocol VLAN ID	port and protocol VLAN supported	Local	IldpXdot1LocProtoVlanSupported
			Remote	IldpXdot1RemProtoVlanSupported
		port and protocol VLAN enabled	Local	IldpXdot1LocProtoVlanEnabled
			Remote	IldpXdot1RemProtoVlanEnabled
		PPVID	Local	IldpXdot1LocProtoVlanId
			Remote	IldpXdot1RemProtoVlanId
127	VLAN Name	VID	Local	IldpXdot1LocVlanId
			Remote	IldpXdot1RemVlanId
		VLAN name length	Local	IldpXdot1LocVlanName
			Remote	IldpXdot1RemVlanName
		VLAN name	Local	IldpXdot1LocVlanName
			Remote	IldpXdot1RemVlanName

Table 22. LLDP-MED System MIB Objects

TLV Sub-Type	TLV Name	TLV Variable	System	LLDP-MED MIB Object
1	LLDP-MED Capabilities	LLDP-MED Capabilities	Local	IldpXMedPortCapSupported

Table 22. LLDP-MED System MIB Objects (continued)

TLV Sub-Type	TLV Name	TLV Variable	System	LLDP-MED MIB Object
				IldpXMedPortConfigTLVsTxEnable
			Remote	IldpXMedRemCapSupported IldpXMedRemConfigTLVsTxEnable
		LLDP-MED Class Type	Local	IldpXMedLocDeviceClass
			Remote	IldpXMedRemDeviceClasses
2	Network Policy	Application Type	Local	IldpXMedLocMediaPolicyAppType
			Remote	IldpXMedRemMediaPolicyAppType
		Unknown Policy Flag	Local	IldpXMedLocMediaPolicyUnknown
			Remote	IldpXMedLocMediaPolicyUnknown
		Tagged Flag	Local	IldpXMedLocMediaPolicyTagged
			Remote	IldpXMedLocMediaPolicyTagged
		VLAN ID	Local	IldpXMedLocMediaPolicyVlanID
			Remote	IldpXMedRemMediaPolicyVlanID
		L2 Priority	Local	IldpXMedLocMediaPolicyPriority
			Remote	IldpXMedRemMediaPolicyPriority
		DSCP Value	Local	IldpXMedLocMediaPolicyDscp
			Remote	IldpXMedRemMediaPolicyDscp
3	Location Identifier	Location Data Format	Local	IldpXMedLocLocationSubtype
			Remote	IldpXMedRemLocationSubtype
		Location ID Data	Local	IldpXMedLocLocationInfo
			Remote	IldpXMedRemLocationInfo
4	Extended Power via MDI	Power Device Type	Local	IldpXMedLocXPoEDeviceType
			Remote	IldpXMedRemXPoEDeviceType

Table 22. LLDP-MED System MIB Objects (continued)

TLV Sub-Type	TLV Name	TLV Variable	System	LLDP-MED MIB Object
		Power Source	Local	IldpXMedLocXPoEPSEPowerSource IldpXMedLocXPoEPDPowerSource
			Remote	IldpXMedRemXPoEPSEPowerSource IldpXMedRemXPoEPDPowerSource
		Power Priority	Local	IldpXMedLocXPoEPDPowerPriority IldpXMedLocXPoEPSEPortPDPriority
			Remote	IldpXMedRemXPoEPSEPowerPriority IldpXMedRemXPoEPDPowerPriority
		Power Value	Local	IldpXMedLocXPoEPSEPortPowerAv IldpXMedLocXPoEPDPowerReq
			Remote	IldpXMedRemXPoEPSEPowerAv IldpXMedRemXPoEPDPowerReq

Object Tracking

IPv4 or IPv6 object tracking is available on Dell Networking OS.

Object tracking allows the Dell Networking OS client processes, such as virtual router redundancy protocol (VRRP), to monitor tracked objects (for example, interface or link status) and take appropriate action when the state of an object changes.

i **NOTE:** In Dell Networking OS release version 9.7(0.0), object tracking is supported only on VRRP.

Topics:

- [Object Tracking Overview](#)
- [Object Tracking Configuration](#)
- [Displaying Tracked Objects](#)

Object Tracking Overview

Object tracking allows you to define objects of interest, monitor their state, and report to a client when a change in an object's state occurs.

The following tracked objects are supported:

- Link status of Layer 2 interfaces
- Routing status of Layer 3 interfaces (IPv4 and IPv6)
- Reachability of IP hosts
- Reachability of IPv4 and IPv6 routes
- Metric thresholds of IPv4 and IPv6 routes
- Tracking of IP Hosts

In future releases, environmental alarms and available free memory will be supported. You can configure client applications, such as VRRP, to receive a notification when the state of a tracked object changes.

The following example shows how object tracking is performed. Router A and Router B are both connected to the internet via interfaces running OSPF. Both routers belong to a VRRP group with a virtual router at 10.0.0.1 on the local area network (LAN) side. Neither Router A nor Router B is the owner of the group. Although Router A and Router B use the same default VRRP priority (100), Router B would normally become the master for the VRRP group because it has a higher IP address.

You can create a tracked object to monitor the metric of the default route 0.0.0.0/0. After you configure the default route as a tracked object, you can configure the VRRP group to track the state of the route. In this way, the VRRP priority of the router with the better metric automatically becomes master of the VRRP group. Later, if network conditions change and the cost of the default route in each router changes, the mastership of the VRRP group is automatically reassigned to the router with the better metric.

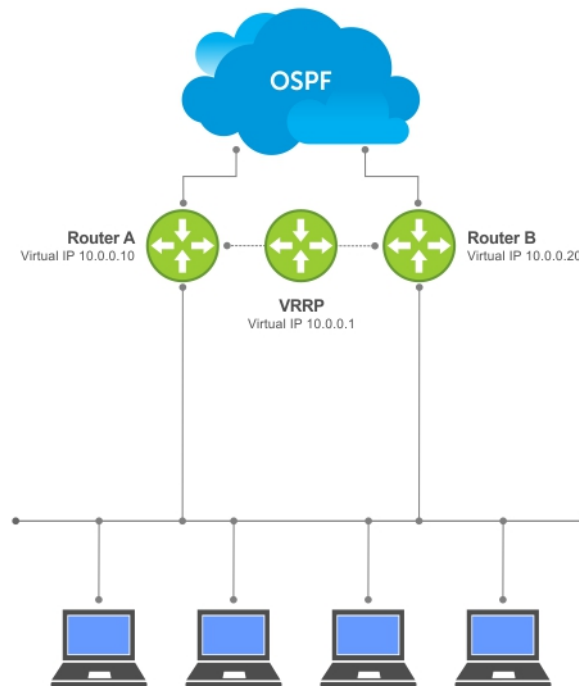

Figure 28. Object Tracking Example

When you configure a tracked object, such as an IPv4/IPv6 a route or interface, you specify an object number to identify the object. Optionally, you can also specify:

- UP and DOWN thresholds used to report changes in a route metric.
- A time delay before changes in a tracked object's state are reported to a client.

Track Layer 2 Interfaces

You can create an object to track the line-protocol state of a Layer 2 interface. In this type of object tracking, the link-level operational status (UP or DOWN) of the interface is monitored.

When the link-level status goes down, the tracked resource status is considered to be DOWN; if the link-level status goes up, the tracked resource status is considered to be UP. For logical interfaces, such as port-channels or virtual local area networks (VLANs), the link-protocol status is considered to be UP if any physical interface under the logical interface is UP.

Track Layer 3 Interfaces

You can create an object that tracks the Layer 3 state (IPv4 or IPv6 routing status) of an interface.

- The Layer 3 status of an interface is UP only if the Layer 2 status of the interface is UP and the interface has a valid IP address.
- The Layer 3 status of an interface goes DOWN when its Layer 2 status goes down or the IP address is removed from the routing table.

Track IPv4 and IPv6 Routes

You can create an object that tracks an IPv4 or IPv6 route entry in the routing table.

Specify a tracked route by its IPv4 or IPv6 address and prefix-length. Optionally specify a tracked route by a virtual routing and forwarding (VRF) instance name if the route to be tracked is part of a VRF. The next-hop address is not part of the definition of the tracked object.

A tracked route matches a route in the routing table only if the exact address and prefix length match an entry in the routing table. For example, when configured as a tracked route, 10.0.0.0/24 does not match the routing table entry 10.0.0.0/8. If no route-table entry has the exact address and prefix length, the tracked route is considered to be DOWN.

In addition to the entry of a route in the routing table, you can configure how the status of a route is tracked in either the following ways:

- By the reachability of the route's next-hop router.
- By comparing the UP or DOWN threshold for a route's metric with current entries in the route table.

Set Tracking Delays

You can configure an optional UP and/or DOWN timer for each tracked object to set the time delay before a change in the state of a tracked object is communicated to clients. The configured time delay starts when the state changes from UP to DOWN or the opposite way.

If the state of an object changes back to its former UP/DOWN state before the timer expires, the timer is cancelled and the client is not notified. If the timer expires and an object's state has changed, a notification is sent to the client. For example, if the DOWN timer is running when an interface goes down and comes back up, the DOWN timer is cancelled and the client is not notified of the event.

If you do not configure a delay, a notification is sent when a change in the state of a tracked object is detected. The time delay in communicating a state change is specified in seconds.

VRRP Object Tracking

As a client, VRRP can track up to 20 objects (including route entries, and Layer 2 and Layer 3 interfaces) in addition to the 12 tracked interfaces supported for each VRRP group.

You can assign a unique priority-cost value from 1 to 254 to each tracked VRRP object or group interface. The priority cost is subtracted from the VRRP group priority if a tracked VRRP object is in a DOWN state. If a VRRP group router acts as owner-master, the run-time VRRP group priority remains fixed at 255 and changes in the state of a tracked object have no effect.

 **NOTE:** In VRRP object tracking, the sum of the priority costs for all tracked objects and interfaces cannot equal or exceed the priority of the VRRP group.

Object Tracking Configuration

You can configure three types of object tracking for a client.

- [Track Layer 2 Interfaces](#)
- [Track Layer 3 Interfaces](#)
- [Track an IPv4/IPv6 Route](#)

For a complete listing of all commands related to object tracking, refer to the *Dell Networking OS Command Line Interface Reference Guide*.

Tracking a Layer 2 Interface

You can create an object that tracks the line-protocol state of a Layer 2 interface and monitors its operational status (UP or DOWN).

You can track the status of any of the following Layer 2 interfaces:

- 1 Gigabit Ethernet: Enter `gigabitethernet slot/port` in the `track interface interface` command (see Step 1).
- 10 Gigabit Ethernet: Enter `tengigabitethernet slot/port`.
- Port channel: Enter `port-channel number`, where valid port-channel numbers are from 1 to 128:
- VLAN: Enter `vlan vlan-id`, where valid VLAN IDs are from 1 to 4094

A line-protocol object only tracks the link-level (UP/DOWN) status of a specified interface. When the link-level status goes down, the tracked object status is DOWN; if the link-level status is up, the tracked object status is UP.

To remove object tracking on a Layer 2 interface, use the `no track object-id` command.

To configure object tracking on the status of a Layer 2 interface, use the following commands.

1. Configure object tracking on the line-protocol state of a Layer 2 interface.

CONFIGURATION mode

```
track object-id interface interface line-protocol
```

Valid object IDs are from 1 to 65535.

2. (Optional) Configure the time delay used before communicating a change in the status of a tracked interface.

OBJECT TRACKING mode

```
delay {[up seconds] [down seconds]}
```

Valid delay times are from 0 to 180 seconds.

The default is **0**.

3. (Optional) Identify the tracked object with a text description.

OBJECT TRACKING mode

```
description text
```

The text string can be up to 80 characters.

4. (Optional) Display the tracking configuration and the tracked object's status.

EXEC Privilege mode

```
show track object-id
```

```
Dell(conf)#track 100 interface tengigabitethernet 7/1 line-protocol
Dell(conf-track-100)#delay up 20
Dell(conf-track-100)#description San Jose data center
Dell(conf-track-100)#end
Dell#show track 100
```

```
Track 100
  Interface TenGigabitEthernet 7/1 line-protocol
  Description: San Jose data center
```

Tracking a Layer 3 Interface

You can create an object that tracks the routing status of an IPv4 or IPv6 Layer 3 interface.

You can track the routing status of any of the following Layer 3 interfaces:

- For a 10-Gigabit Ethernet interface, enter the keyword `TenGigabitEthernet` then the slot/port information.
- For a port channel interface, enter the keywords `port-channel` then a number.
- For a VLAN interface, enter the keyword `vlan` then a number from 1 to 4094.

For an IPv4 interface, a routing object only tracks the UP/DOWN status of the specified IPv4 interface (the `track interface ip-routing` command).

- The status of an IPv4 interface is UP only if the Layer 2 status of the interface is UP and the interface has a valid IP address.
- The Layer 3 status of an IPv4 interface goes DOWN when its Layer 2 status goes down (for a Layer 3 VLAN, all VLAN ports must be down) or the IP address is removed from the routing table.

For an IPv6 interface, a routing object only tracks the UP/DOWN status of the specified IPv6 interface (the `track interface ipv6-routing` command).

- The status of an IPv6 interface is UP only if the Layer 2 status of the interface is UP and the interface has a valid IPv6 address.
- The Layer 3 status of an IPv6 interface goes DOWN when its Layer 2 status goes down (for a Layer 3 VLAN, all VLAN ports must be down) or the IPv6 address is removed from the routing table.

To remove object tracking on a Layer 3 IPv4/IPv6 interface, use the `no track object-id` command.

To configure object tracking on the routing status of a Layer 3 interface, use the following commands.

1. Configure object tracking on the routing status of an IPv4 or IPv6 interface.

CONFIGURATION mode

```
track object-id interface interface {ip routing | ipv6 routing}
```

Valid object IDs are from 1 to 65535.

- (Optional) Configure the time delay used before communicating a change in the status of a tracked interface.

OBJECT TRACKING mode

```
delay {[up seconds] [down seconds]}
```

Valid delay times are from 0 to 180 seconds.

The default is **0**.

- (Optional) Identify the tracked object with a text description.

OBJECT TRACKING mode

```
description text
```

The text string can be up to 80 characters.

- (Optional) Display the tracking configuration and the tracked object's status.

EXEC Privilege mode

```
show track object-id
```

Examples of Configuring Object Tracking for an IPv4 or IPv6 Interface

The following is an example of configuring object tracking for an IPv4 interface:

```
Dell(conf)#track 101 interface tengigabitethernet 7/2 ip routing
Dell(conf-track-101)#delay up 20
Dell(conf-track-101)#description NYC metro
Dell(conf-track-101)#end
Dell#show track 101
```

```
Track 101
  Interface TenGigabitEthernet 7/2 ip routing
  Description: NYC metro
```

The following is an example of configuring object tracking for an IPv6 interface:

Examples of Configuring Object Tracking for an IPv4 or IPv6 Interface

```
Dell(conf)#track 103 interface tengigabitethernet 7/11 ipv6
routing
Dell(conf-track-103)#description Austin access point
Dell(conf-track-103)#end
Dell#show track 103
```

```
Track 103
  Interface TenGigabitEthernet 7/11 ipv6 routing
  Description: Austin access point
```

Track an IPv4/IPv6 Route

You can create an object that tracks the reachability or metric of an IPv4 or IPv6 route.

You specify the route to be tracked by its address and prefix-length values. Optionally, for an IPv4 route, you can enter a VRF instance name if the route is part of a VPN routing and forwarding (VRF) table. The next-hop address is not part of the definition of a tracked IPv4/IPv6 route.

In order for a route's reachability or metric to be tracked, the route must appear as an entry in the routing table. A tracked route is considered to match an entry in the routing table only if the exact IPv4 or IPv6 address and prefix length match an entry in the table. For example, when configured as a tracked route, 10.0.0.0/24 does not match the routing table entry 10.0.0.0/8. Similarly, for an IPv6 address, 3333:100:200:300:400::/80 does not match routing table entry 3333:100:200:300::/64. If no route-table entry has the exact IPv4/IPv6 address and prefix length, the tracked route is considered to be DOWN.

In addition to the entry of a route in the routing table, you can configure the UP/DOWN state of a tracked route to be determined in the following ways:

- By the reachability of the route's next-hop router.

The UP/DOWN state of the route is determined by the entry of the next-hop address in the ARP cache. A tracked route is considered to be reachable if there is an ARP cache entry for the route's next-hop address. If the next-hop address in the

ARP cache ages out for a route tracked for its reachability, an attempt is made to regenerate the ARP cache entry to see if the next-hop address appears before considering the route DOWN.

- By comparing the threshold for a route's metric with current entries in the route table.

The UP/DOWN state of the tracked route is determined by the threshold for the current value of the route metric in the routing table.

To provide a common tracking interface for different clients, route metrics are scaled in the range from 0 to 255, where 0 is connected and 255 is inaccessible. The scaled metric value communicated to a client always considers a lower value to have priority over a higher value. The resulting scaled value is compared against the configured threshold values to determine the state of a tracked route as follows:

- If the scaled metric for a route entry is less than or equal to the UP threshold, the state of a route is UP.
- If the scaled metric for a route is greater than or equal to the DOWN threshold or the route is not entered in the routing table, the state of a route is DOWN.

The UP and DOWN thresholds are user-configurable for each tracked route. The default UP threshold is **254**; the default DOWN threshold is **255**. The notification of a change in the state of a tracked object is sent when a metric value crosses a configured threshold.

The tracking process uses a protocol-specific resolution value to convert the actual metric in the routing table to a scaled metric in the range from 0 to 255. The resolution value is user-configurable and calculates the scaled metric by dividing a route's cost by the resolution value set for the route type:

- For ISIS, you can set the resolution in the range from 1 to 1000, where the default is **10**.
- For OSPF, you can set the resolution in the range from 1 to 1592, where the default is **1**.
- The resolution value used to map static routes is not configurable. By default, Dell Networking OS assigns a metric of 0 to static routes.
- The resolution value used to map RIP routes is not configurable. The RIP hop-count is automatically multiplied by 16 to scale it. For example, a RIP metric of 16 (unreachable) scales to 256, which considers a route to be DOWN.

Displaying Tracked Objects

To display the currently configured objects used to track Layer 2 and Layer 3 interfaces, and IPv4 and IPv6 routes, use the following `show` commands.

To display the configuration and status of currently tracked Layer 2 or Layer 3 interfaces, IPv4 or IPv6 routes, use the `show track` command. You can also display the currently configured per-protocol resolution values used to scale route metrics when tracking metric thresholds.

- Display the configuration and status of currently tracked Layer 2 or Layer 3 interfaces, IPv4 or IPv6 routes instance.
`show track [object-id [brief] | interface [brief] | ip route [brief] | resolution | brief]`
- Use the `show running-config track` command to display the tracking configuration of a specified object or all objects that are currently configured on the router.

```
show running-config track [object-id]
```

Examples of Viewing Tracked Objects

```
Dell#show track

Track 1
  IP route 23.0.0.0/8 reachability
  Reachability is Down (route not in route table)
  2 changes, last change 00:16:08
  Tracked by:

Track 2
  IPv6 route 2040::/64 metric threshold
  Metric threshold is Up (STATIC/0/0)
  5 changes, last change 00:02:16
  Metric threshold down 255 up 254
  First-hop interface is TenGigabitEthernet 1/2
  Tracked by:
    VRRP TenGigabitEthernet 2/30 IPv6 VRID 1

Track 3
```

```
IPv6 route 2050::/64 reachability
Reachability is Up (STATIC)
 5 changes, last change 00:02:16
First-hop interface is TenGigabitEthernet 1/2
Tracked by:
  VRRP TenGigabitEthernet 2/30 IPv6 VRID 1

Track 4
Interface TenGigabitEthernet 1/4 ip routing
IP routing is Up
 3 changes, last change 00:03:30
Tracked by:
```

Example of the show track brief Command

```
Router# show track brief

ResId  Resource                Parameter
State  LastChange
1      IP route reachability      10.16.0.0/16
```

Example of the show track resolution Command

```
Dell#show track resolution

IP Route Resolution
  ISIS      1
  OSPF      1

IPv6 Route Resolution
  ISIS      1
```

Port Monitoring

The Aggregator supports user-configured port monitoring. See [Configuring Port Monitoring](#) for the configuration commands to use.

Port monitoring copies all incoming or outgoing packets on one port and forwards (mirrors) them to another port. The source port is the monitored port (MD) and the destination port is the monitoring port (MG).

Supported Modes

Standalone, PMUX, VLT, Stacking, and Full-Switch

Topics:

- [Configuring Port Monitoring](#)
- [Important Points to Remember](#)
- [Port Monitoring](#)

Configuring Port Monitoring

To configure port monitoring, use the following commands.

1. Verify that the intended monitoring port has no configuration other than no shutdown, as shown in the following example.

```
EXEC Privilege mode
show interface
```

2. Create a monitoring session using the command `monitor session` from CONFIGURATION mode, as shown in the following example.

```
CONFIGURATION mode
monitor session
```

3. Specify the source and destination port and direction of traffic, as shown in the following example.

```
MONITOR SESSION mode
source
```

NOTE: By default, all uplink ports are assigned to port-channel (LAG) 128 and the destination port in a port monitoring session must be an uplink port. When you configure the destination port using the `source` command, the destination port is removed from LAG 128. To display the uplink ports currently assigned to LAG 128, enter the `show lag 128` command.

To display information on currently configured port-monitoring sessions, use the `show monitor session` command from EXEC Privilege mode.

```
Dell(conf)# monitor session 0
Dell(conf-mon-sess-0)# source tengig 1/1 dest tengig 1/42 direction rx
Dell(conf-mon-sess-0)#exit
Dell(conf)# do show monitor session 0
SessionID Source      Destination      Direction      Mode      Type
-----
0      TenGig 1/1      TenGig 1/42      rx      interface  Port-based
Dell(conf)#
```

In the following example, the host and server are exchanging traffic which passes through the uplink interface 1/1. Port 1/1 is the monitored port and port 1/42 is the destination port, which is configured to only monitor traffic received on `tengigabitethernet 1/1` (host-originated traffic).

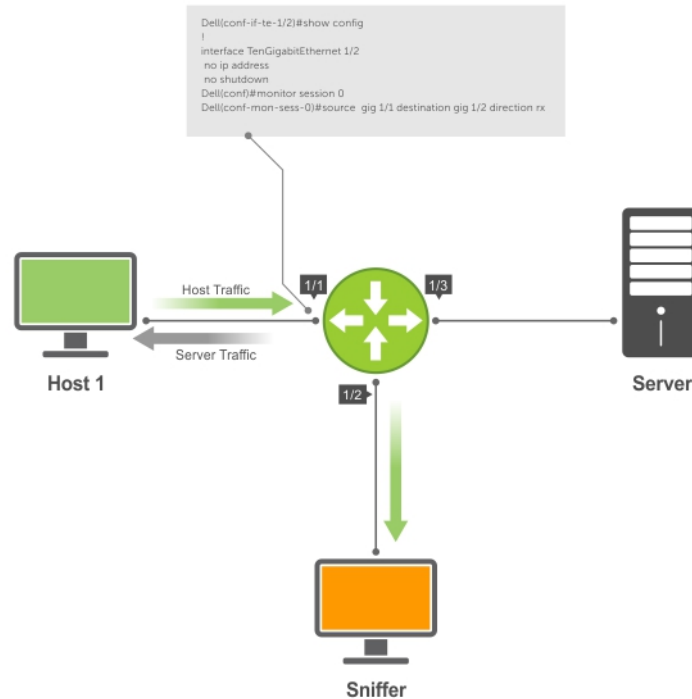

Figure 29. Port Monitoring Example

Important Points to Remember

- Port monitoring is supported on physical ports only; virtual local area network (VLAN) and port-channel interfaces do not support port monitoring.
- The monitored (the source, [MD]) and monitoring ports (the destination, [MG]) must be on the same switch.
- The monitored (source) interface must be a server-facing interface in the format *slot/port*, where the valid slot numbers are 0 or 1 and server-facing port numbers are from 1 to 32.
- The destination interface must be an uplink port (ports 33 to 56).
- In general, a monitoring port should have `no ip address` and `no shutdown` as the only configuration; the Dell Networking OS permits a limited set of commands for monitoring ports. You can display these commands using the `?` command.
- A monitoring port may not be a member of a VLAN.
- There may only be one destination port in a monitoring session.
- A source port (MD) can only be monitored by one destination port (MG). If you try to assign a monitored port to more than one monitoring port, the following message displays:

```

Dell(conf)#mon ses 1
Dell(conf-mon-sess-1)#source tengig 0/1 destination tengig 0/33 direction both
Dell(conf-mon-sess-1)#do show monitor session

SessionID   Source          Destination      Direction        Mode          Type
-----
          1   TenGig 0/1     TenGig 0/33     both             interface     Port-based

Dell(conf-mon-sess-1)#mon ses 2
Dell(conf-mon-sess-2)#source tengig 0/1 destination tengig 0/33 direction both
% Error: MD port is already being monitored.

```

NOTE: There is no limit to the number of monitoring sessions per system, provided that there are only four destination ports per port-pipe. If each monitoring session has a unique destination port, the maximum number of session is four per port-pipe.

Port Monitoring

The Aggregator supports multiple source-destination statements in a monitor session, but there may only be one destination port in a monitoring session.

There may only be one destination port in a monitoring session (% Error: Only one MG port is allowed in a session.).

The number of source ports the Dell Networking OS allows within a port-pipe is equal to the number of physical ports in the port-pipe (n). Multiple source ports may have up to four different destination ports (Exceeding max MG ports for this MD port pipe.).

In the following examples, ports 0/13, 0/14, 0/15, and 0/16 all belong to the same port-pipe. These ports mirror traffic to four different destinations (0/33, 0/34, 0/35, and 0/37). Another source port from the same port-pipe (for example, 0/17) does not support a new destination (for example, 0/4). If you attempt to configure another destination, an error message is displayed: % Error: Exceeding max MG ports for this MD port pipe. However, you can configure another monitoring session that uses one of previously configured destination ports.

Example of Number of Monitoring Ports

```
Dell#show mon session
SessionID  Source      Destination  Direction Mode      Type
-----
0          TenGig 0/13 TenGig 0/33   rx      interface Port-based
10         TenGig 0/14 TenGig 0/34   rx      interface Port-based
20         TenGig 0/15 TenGig 0/35   rx      interface Port-based
30         TenGig 0/16 TenGig 0/37   rx      interface Port-based
Dell(conf)# monitor session 300
Dell(conf-mon-sess-300)# source tengig 0/17 destination tengig 0/40 direction tx
% Error: Exceeding max MG ports for this MD port pipe.
Dell(conf-mon-sess-300)#
Dell(conf-mon-sess-300)# source tengig 0/17 destination tengig 0/33 direction tx
Dell(conf-mon-sess-300)# do show monitor session
SessionID  Source      Destination  Direction Mode      Type
-----
0          TenGig 0/13 TenGig 0/33   rx      interface Port-based
10         TenGig 0/14 TenGig 0/34   rx      interface Port-based
20         TenGig 0/15 TenGig 0/35   rx      interface Port-based
30         TenGig 0/16 TenGig 0/37   rx      interface Port-based
300        TenGig 0/17 TenGig 0/33   tx      interface Port-based
Dell(conf-mon-sess-300)#
```

The following example shows ports 0/25 and 0/26 that belong to port pipe 1 with a maximum of four destination ports.

Example of Number of Monitoring Ports

```
Dell(conf-mon-sess-300)#do show mon session
SessionID  Source      Destination  Direction Mode      Type
-----
0          TenGig 0/13 TenGig 0/33   rx      interface Port-based
10         TenGig 0/14 TenGig 0/34   rx      interface Port-based
20         TenGig 0/15 TenGig 0/35   rx      interface Port-based
30         TenGig 0/16 TenGig 0/37   rx      interface Port-based
100        TenGig 0/25 TenGig 0/38   tx      interface Port-based
110        TenGig 0/26 TenGig 0/39   tx      interface Port-based
300        TenGig 0/17 TenGig 0/33   tx      interface Port-based
Dell(conf-mon-sess-300)#
```

In the example below, 0/25 and 0/26 belong to Port-pipe 1. This port-pipe has the same restriction of only four destination ports, new or used.

Example of Viewing a Monitoring Session

```
Dell(conf-mon-sess-300)#do show mon session
SessionID  Source      Destination  Direction Mode      Type
-----
0          TenGig 0/13 TenGig 0/1    rx      interface Port-based
10         TenGig 0/14 TenGig 0/2    rx      interface Port-based
20         TenGig 0/15 TenGig 0/3    rx      interface Port-based
30         TenGig 0/16 TenGig 0/37   rx      interface Port-based
```

```
100    TenGig 0/25 TenGig 0/38 tx    interface Port-based
110    TenGig 0/26 TenGig 0/39 tx    interface Port-based
300    TenGig 0/17 TenGig 0/1  tx    interface Port-based
Dell(conf-mon-sess-300)#
```

A source port may only be monitored by one destination port (% Error: Exceeding max MG ports for this MD port pipe.), but a destination port may monitor more than one source port.

Dell Networking OS Behavior: All monitored frames are tagged if the configured monitoring direction is transmit (TX), regardless of whether the monitored port (MD) is a Layer 2 or Layer 3 port.

- If the MD port is a Layer 2 port, the frames are tagged with the VLAN ID of the VLAN to which the MD belongs.
- If the MD port is a Layer 3 port, the frames are tagged with VLAN ID 4095.
- If the MD port is in a Layer 3 VLAN, the frames are tagged with the respective Layer 3 VLAN ID.

For example, in the configuration *source tengig 1/1 destination tengig 1/41 direction tx*, if the source port 1/1 is an untagged member of any VLAN, all monitored frames that the destination port 1/41 receives are tagged with the VLAN ID of the source port.

Security

The Aggregator provides many security features.

This chapter describes several ways to provide access security to the Dell Networking system.

For details about all the commands described in this chapter, see the *Security* chapter in the *Dell PowerEdge Command Line Reference Guide for the M I/O Aggregator*.

Supported Modes

Standalone, PMUX, VLT, Stacking

 **NOTE:** You can also perform some of the configurations using the Web GUI - Dell Blade IO Manager. For more information, see the Dell Blade IO Manager Online Help.

Topics:

- [Understanding Banner Settings](#)
- [Accessing the I/O Aggregator Using the CMC Console Only](#)
- [AAA Authentication](#)
- [AAA Authorization](#)
- [RADIUS](#)
- [TACACS+](#)
- [Enabling SCP and SSH](#)
- [Telnet](#)
- [VTY Line and Access-Class Configuration](#)
- [Dell EMC Networking OS Security Hardening](#)

Understanding Banner Settings

This functionality is supported on the Aggregator.

A banner is a note that is displayed when you log in to the system, depending on the privilege level and the command mode into which the you log in. You can specify different banners to be displayed as the message-of-the-day (MOTD), as the opening quote in EXEC mode, or as the beginning message in EXEC Privilege mode. Setting up a banner enables you to display any important information or group-level notification that needs to be communicated to all the users of the system.

A login banner message is displayed only in EXEC Privilege mode after entering the enable command followed by the password. These banners are not displayed to users in EXEC mode. When you connect to a system, the message-of-the-day (MOTD) banner is displayed first, followed by the login banner and prompts. After you log in to the system with valid authentication credentials, the EXEC banner is shown.

You can use the MOTD banner to alert users of critical upcoming events so that they can plan and schedule their accessibility to the device. You can modify the banner messages depending on the requirements or conditions.

Accessing the I/O Aggregator Using the CMC Console Only

This functionality is supported on the Aggregator.

You can enable the option to access and administer an Aggregator only using the chassis management controller (CMC) interface, and prevent the usage of the CLI interface of the device to configure and monitor settings. You can configure the restrict-access session command to disable access of the Aggregator using a Telnet or SSH session; the device is accessible

only using the CMC GUI. You can use the no version of this command to reactivate the Telnet or SSH session capability for the device. Use the show restrict-access command to view whether the access to a device using Telnet or SSH is disabled or not.

AAA Authentication

Dell EMC Networking OS supports a distributed client/server system implemented through authentication, authorization, and accounting (AAA) to help secure networks against unauthorized access.

In the Dell EMC Networking implementation, the Dell EMC Networking system acts as a RADIUS or TACACS+ client and sends authentication requests to a central remote authentication dial-in service (RADIUS) or Terminal access controller access control system plus (TACACS+) server that contains all user authentication and network service access information.

Dell EMC Networking uses local usernames/passwords (stored on the Dell EMC Networking system) or AAA for login authentication. With AAA, you can specify the security protocol or mechanism for different login methods and different users. In Dell EMC Networking OS, AAA uses a list of authentication methods, called method lists, to define the types of authentication and the sequence in which they are applied. You can define a method list or use the default method list. User-defined method lists take precedence over the default method list.

NOTE: If a console user logs in with RADIUS authentication, the privilege level is applied from the RADIUS server if the privilege level is configured for that user in RADIUS, whether you configure RADIUS authorization.

Configuration Task List for AAA Authentication

The following sections provide the configuration tasks.

- [Configure Login Authentication for Terminal Lines](#)
- [Configuring AAA Authentication Login Methods](#)
- [Enabling AAA Authentication](#)
- [Enabling AAA Authentication - RADIUS](#)

For a complete list of all commands related to login authentication, refer to the *Security* chapter in the *Dell Networking OS Command Reference Guide*.

Configure Login Authentication for Terminal Lines

You can assign up to five authentication methods to a method list. Dell EMC Networking OS evaluates the methods in the order in which you enter them in each list.

If the first method list does not respond or returns an error, Dell EMC Networking OS applies the next method list until the user either passes or fails the authentication. If the user fails a method list, Dell EMC Networking OS does not apply the next method list.

Configuring AAA Authentication Login Methods

To configure an authentication method and method list, use the following commands.

Dell Networking OS Behavior: If you use a method list on the console port in which RADIUS or TACACS is the last authentication method, and the server is not reachable, Dell Networking OS allows access even though the username and password credentials cannot be verified. Only the console port behaves this way, and does so to ensure that users are not locked out of the system if network-wide issue prevents access to these servers.

1. Define an authentication method-list (*method-list-name*) or specify the default.

CONFIGURATION mode

```
aaa authentication login {method-list-name | default} method1 [... method4]
```

The default method-list is applied to all terminal lines.

Possible methods are:

- **enable:** use the password you defined using the enable sha256-password, enable secret, or enable password command in CONFIGURATION mode. In general, the enable secret command overrules the enable password command. If you configure the enable sha256-password command, it overrules both the enable secret and enable password commands.

- `line`: use the password you defined using the `password` command in LINE mode.
- `local`: use the username/password database defined in the local configuration.
- `none`: no authentication.
- `radius`: use the RADIUS servers configured with the `radius-server host` command.
- `tacacs+`: use the TACACS+ servers configured with the `tacacs-server host` command.

2. Enter LINE mode.

CONFIGURATION mode

```
line {aux 0 | console 0 | vty number [... end-number]}
```

3. Assign a `method-list-name` or the default list to the terminal line.

LINE mode

```
login authentication {method-list-name | default}
```

To view the configuration, use the `show config` command in LINE mode or the `show running-config` in EXEC Privilege mode.

 **NOTE:** Dell Networking recommends using the `none` method only as a backup. This method does not authenticate users. The `none` and `enable` methods do not work with secure shell (SSH).

You can create multiple method lists and assign them to different terminal lines.

Enabling AAA Authentication

To enable AAA authentication, use the following command.

- Enable AAA authentication.

CONFIGURATION mode

```
aaa authentication enable {method-list-name | default} method1 [... method4]
```

- `default`: uses the listed authentication methods that follow this argument as the default list of methods when a user logs in.
- `method-list-name`: character string used to name the list of enable authentication methods activated when a user logs in.
- `method1 [... method4]`: any of the following: RADIUS, TACACS, enable, line, none.

If you do not set the default list, only the local enable is checked. This setting has the same effect as issuing an `aaa authentication enable default enable` command.

Enabling AAA Authentication — RADIUS

To enable authentication from the RADIUS server, and use TACACS as a backup, use the following commands.

1. Enable RADIUS and set up TACACS as backup.

CONFIGURATION mode

```
aaa authentication enable default radius tacacs
```

2. Establish a host address and password.

CONFIGURATION mode

```
radius-server host x.x.x.x key some-password
```

3. Establish a host address and password.

CONFIGURATION mode

```
tacacs-server host x.x.x.x key some-password
```

To get enable authentication from the RADIUS server and use TACACS as a backup, issue the following commands.

Example of Enabling Authentication from the RADIUS Server

```
Dell(config)# aaa authentication enable default radius tacacs
Radius and TACACS server has to be properly setup for this.
Dell(config)# radius-server host x.x.x.x key <some-password>
Dell(config)# tacacs-server host x.x.x.x key <some-password>
```

To use local authentication for `enable secret` on the console, while using remote authentication on VTY lines, issue the following commands.

Example of Enabling Local Authentication for the Console and Remote Authentication for VTY Lines

```
Dell(config)# aaa authentication enable mymethodlist radius tacacs
Dell(config)# line vty 0 9
Dell(config-line-vty)# enable authentication mymethodlist
```

Server-Side Configuration

- **TACACS+** — When using TACACS+, Dell Networking OS sends an initial packet with service type `SVC_ENABLE`, and then sends a second packet with just the password. The TACACS server must have an entry for username `$enable$`.
- **RADIUS** — When using RADIUS authentication, Dell Networking OS sends an authentication packet with the following:

```
Username: $enab15$
Password: <password-entered-by-user>
```

Therefore, the RADIUS server must have an entry for this username.

Configuring Re-Authentication

Starting from Dell EMC Networking OS 9.11(0.0), the system enables re-authentication of user whenever there is a change in the authenticators.

The change in authentication happens when:

- Add or remove an authentication server (RADIUS/TACACS+)
- Modify an AAA authentication/authorization list
- Change to role-only (RBAC) mode

The re-authentication is also applicable for authenticated 802.1x devices. When there is a change in the authentication servers, the supplicants connected to all the ports are forced to re-authenticate.

1. Enable the re-authentication mode.

```
CONFIGURATION mode
aaa reauthentication enable
```

2. You are prompted to force the users to re-authenticate while adding or removing a RADIUS/TACACS+ server.

```
CONFIGURATION mode
aaa authentication login method-list-name
```

Example:

```
DellEMC(config)#aaa authentication login vty_auth_list radius
Force all logged-in users to re-authenticate (y/n)?
```

3. You are prompted to force the users to re-authenticate whenever there is a change in the RADIUS server list..

```
CONFIGURATION mode
radius-server host IP Address
```

Example:

```
DellEMC(config)#radius-server host 192.100.0.12
Force all logged-in users to re-authenticate (y/n)?
```

```
DellEMC(config)#no radius-server host 192.100.0.12
Force all logged-in users to re-authenticate (y/n)?
```

AAA Authorization

The Dell Networking OS enables AAA new-model by default.

You can set authorization to be either `local` or `remote`. Different combinations of authentication and authorization yield different results. By default, the system sets both to **local**.

Privilege Levels Overview

Limiting access to the system is one method of protecting the system and your network. However, at times, you might need to allow others access to the router and you can limit that access to a subset of commands. In the Dell Networking OS, you can configure a privilege level for users who need limited access to the system.

Every command in the Dell Networking OS is assigned a privilege level of 0, 1, or 15. You can configure up to 16 privilege levels. The Dell Networking OS is pre-configured with three privilege levels and you can configure 13 more. The three pre-configured levels are:

- **Privilege level 1** — is the default level for EXEC mode. At this level, you can interact with the router, for example, view some `show` commands and Telnet and ping to test connectivity, but you cannot configure the router. This level is often called the “user” level. One of the commands available in Privilege level 1 is the `enable` command, which you can use to enter a specific privilege level.
- **Privilege level 0** — contains only the `end`, `enable`, and `disable` commands.
- **Privilege level 15** — the default level for the `enable` command, is the highest level. In this level you can access any command in the Dell Networking OS.

Privilege levels 2 through 14 are not configured and you can customize them for different users and access.

After you configure other privilege levels, enter those levels by adding the level parameter after the `enable` command or by configuring a user name or password that corresponds to the privilege level. For more information about configuring user names, refer to [Configuring a Username and Password](#).

By default, commands are assigned to different privilege levels. You can access those commands only if you have access to that privilege level. For example, to reach the `protocol spanning-tree` command, log in to the router, enter the `enable` command for privilege level 15 (this privilege level is the default level for the command) and then enter CONFIGURATION mode.

You can configure passwords to control access to the box and assign different privilege levels to users. The Dell Networking OS supports the use of passwords when you log in to the system and when you enter the `enable` command. If you move between privilege levels, you are prompted for a password if you move to a higher privilege level.

Configuration Task List for Privilege Levels

The following list has the configuration tasks for privilege levels and passwords.

- [Configuring a Username and Password](#) (mandatory)
- [Configuring the Enable Password Command](#) (mandatory)
- [Configuring Custom Privilege Levels](#) (mandatory)
- [Specifying LINE Mode Password and Privilege](#) (optional)
- [Enabling and Disabling Privilege Levels](#) (optional)

For a complete listing of all commands related to privilege levels and passwords, refer to the *Security* chapter in the *Dell Networking OS Command Reference Guide*.

Configuring a Username and Password

In the Dell Networking OS, you can assign a specific username to limit user access to the system.

To configure a username and password, use the following command.

- Assign a user name and password.

```
CONFIGURATION mode
```

```
username name [access-class access-list-name] [nopassword | password [encryption-type] password] [privilege level] [secret]
```

Configure the optional and required parameters:

- o *name*: Enter a text string up to 63 characters long.
- o *access-class access-list-name*: Restrict access by access-class.
- o *nopassword*: Require password for the user to login.
- o *encryption-type*: Enter 0 for plain text or 7 for encrypted text.
- o *password*: Enter a string. Specify the password for the user.
- o *privilege level*: The range is from 0 to 15.
- o *secret*: Specify the secret for the user.

To view username, use the `show users` command in EXEC Privilege mode.

Configuring the Enable Password Command

To configure the Dell Networking OS, use the `enable` command to enter EXEC Privilege level 15. After entering the command, the system requests that you enter a password.

Privilege levels are not assigned to passwords, rather passwords are assigned to a privilege level. You can always change a password for any privilege level. To change to a different privilege level, enter the `enable` command, then the privilege level. If you do not enter a privilege level, the default level **15** is assumed.

To configure a password for a specific privilege level, use the following command.

- Configure a password for a privilege level.

CONFIGURATION mode

```
enable password [level level] [encryption-mode] password
```

Configure the optional and required parameters:

- o *level level*: Specify a level from 0 to 15. Level 15 includes all levels.
- o *encryption-type*: Enter 0 for plain text or 7 for encrypted text.
- o *password*: Enter a string.

To change only the password for the `enable` command, configure only the *password* parameter.

To view the configuration for the `enable secret` command, use the `show running-config` command in EXEC Privilege mode.

In custom-configured privilege levels, the `enable` command is always available. No matter what privilege level you entered, you can enter the `enable 15` command to access and configure all CLIs.

Configuring Custom Privilege Levels

In addition to assigning privilege levels to the user, you can configure the privilege levels of commands so that they are visible in different privilege levels.

Within the Dell Networking OS, commands have certain privilege levels. With the `privilege` command, you can change the default level or you can reset their privilege level back to the default. Assign the launch keyword (for example, `configure`) for the keyword's command mode.

To assign commands and passwords to a custom privilege level, use the following commands. You must be in privilege level 15.

1. Assign a user name and password.

CONFIGURATION mode

```
username name [access-class access-list-name] [privilege level] [nopassword | password
[encryption-type] password] [secret]
```

Configure the optional and required parameters:

- *name*: enter a text string (up to 63 characters).
- *access-class access-list-name*: enter the name of a configured IP ACL.
- *privilege level*: the range is from 0 to 15.
- *nopassword*: do not require the user to enter a password.
- *encryption-type*: enter 0 for plain text or 7 for encrypted text.
- *password*: enter a text string.
- *secret*: specify the secret for the user.

2. Configure a password for privilege level.

CONFIGURATION mode

```
enable password [level level] [encryption-mode] password
```

Configure the optional and required parameters:

- *level level*: specify a level from 0 to 15. Level 15 includes all levels.
- *encryption-type*: enter 0 for plain text or 7 for encrypted text.
- *password*: enter a text string up to 32 characters long.

To change only the password for the `enable` command, configure only the `password` parameter.

3. Configure level and commands for a mode or reset a command's level.

CONFIGURATION mode

```
privilege mode {level level command | reset command}
```

Configure the following required and optional parameters:

- *mode*: enter a keyword for the modes (`exec`, `configure`, `interface`, `line`, `route-map`, or `router`)
- *level level*: the range is from 0 to 15. Levels 0, 1, and 15 are pre-configured. Levels 2 to 14 are available for custom configuration.
- *command*: an Dell CLI keyword (up to five keywords allowed).
- *reset*: return the command to its default privilege mode.

To view the configuration, use the `show running-config` command in EXEC Privilege mode.

The following example shows a configuration to allow a user *john* to view only EXEC mode commands and all `snmp-server` commands. Because the `snmp-server` commands are *enable* level commands and, by default, found in CONFIGURATION mode, also assign the launch command for CONFIGURATION mode, `configure`, to the same privilege level as the `snmp-server` commands.

Line 1: The user *john* is assigned privilege level 8 and assigned a password.

Line 2: All other users are assigned a password to access privilege level 8.

Line 3: The `configure` command is assigned to privilege level 8 because it needs to reach CONFIGURATION mode where the `snmp-server` commands are located.

Line 4: The `snmp-server` commands, in CONFIGURATION mode, are assigned to privilege level 8.

Example of Configuring a Custom Privilege Level

```
Dell (conf) #username john privilege 8 password john
Dell (conf) #enable password level 8 notjohn
Dell (conf) #privilege exec level 8 configure
Dell (conf) #privilege config level 8 snmp-server
Dell (conf) #end
Dell#show running-config
Current Configuration ...
!
hostname FTOS
!
enable password level 8 notjohn
enable password FTOS
!
username admin password 0 admin
username john password 0 john privilege 8
!
```

The following example shows the Telnet session for user *john*. The `show privilege` command output confirms that *john* is in privilege level 8. In EXEC Privilege mode, *john* can access only the commands listed. In CONFIGURATION mode, *john* can access only the `snmp-server` commands.

Example of Privilege Level Login and Available Commands

```
apollo% telnet 172.31.1.53
Trying 172.31.1.53...
Connected to 172.31.1.53.
Escape character is '^]'.
Login: john
Password:
Dell#show priv
Current privilege level is 8
```

```

Dell#?
configure      Configuring from terminal
disable        Turn off privileged commands
enable         Turn on privileged commands
exit           Exit from the EXEC
no             Negate a command
show           Show running system information
terminal       Set terminal line parameters
traceroute     Trace route to destination
Dell#confi
Dell(conf)#?
end            Exit from Configuration mode

```

Specifying LINE Mode Password and Privilege

You can specify a password authentication of all users on different terminal lines.

The user's privilege level is the same as the privilege level assigned to the terminal line, unless a more specific privilege level is assigned to the user.

To specify a password for the terminal line, use the following commands.

- Configure a custom privilege level for the terminal lines.
 LINE mode
`privilege level level`
 - `level level`: The range is from 0 to 15. Levels 0, 1, and 15 are pre-configured. Levels 2 to 14 are available for custom configuration.
- Specify either a plain text or encrypted password.
 LINE mode
`password [encryption-type] password`
 Configure the following optional and required parameters:
 - `encryption-type`: Enter 0 for plain text or 7 for encrypted text.
 - `password`: Enter a text string up to 25 characters long.

To view the password configured for a terminal, use the `show config` command in LINE mode.

Enabling and Disabling Privilege Levels

To enable and disable privilege levels, use the following commands.

- Set a user's security level.
 EXEC Privilege mode
`enable or enable privilege-level`
 If you do not enter a privilege level, the system sets it to 15 by default.
- Move to a lower privilege level.
 EXEC Privilege mode
`disable level-number`
 - `level-number`: The level-number you wish to set.
 If you enter `disable` without a level-number, your security level is 1.

RADIUS

Remote authentication dial-in user service (RADIUS) is a distributed client/server protocol.

This protocol transmits authentication, authorization, and configuration information between a central RADIUS server and a RADIUS client (the Dell EMC Networking system). The system sends user information to the RADIUS server and requests authentication of the user and password. The RADIUS server returns one of the following responses:

- **Access-Accept** — the RADIUS server authenticates the user.

- **Access-Reject** — the RADIUS server does not authenticate the user.

If an error occurs in the transmission or reception of RADIUS packets, you can view the error by enabling the `debug radius` command.

Transactions between the RADIUS server and the client are encrypted (the users' passwords are not sent in plain text). RADIUS uses UDP as the transport protocol between the RADIUS server host and the client.

For more information about RADIUS, refer to RFC 2865, *Remote Authentication Dial-in User Service*.

RADIUS Authentication

Dell EMC Networking OS supports RADIUS for user authentication (text password) at login and can be specified as one of the login authentication methods in the `aaa authentication login` command.

When configuring AAA authorization, you can configure to limit the attributes of services available to a user. When you enable authorization, the network access server uses configuration information from the user profile to issue the user's session. The user's access is limited based on the configuration attributes. RADIUS exec-authorization stores a user-shell profile and that is applied during user login. You may name the relevant named-lists with either a unique name or the default name. When you enable authorization by the RADIUS server, the server returns the following information to the client:

- [Idle Time](#)
- [ACL Configuration Information](#)
- [Auto-Command](#)
- [Privilege Levels](#)

After gaining authorization for the first time, you may configure these attributes.

 **NOTE:** RADIUS authentication/authorization is done for every login. There is no difference between first-time login and subsequent logins.

Idle Time

Every session line has its own idle-time. If the idle-time value is not changed, the default value of **30 minutes** is used.

RADIUS specifies idle-time allow for a user during a session before timeout. When a user logs in, the lower of the two idle-time values (configured or default) is used. The idle-time value is updated if both of the following happens:

- The administrator changes the idle-time of the line on which the user has logged in.
- The idle-time is lower than the RADIUS-returned idle-time.

ACL Configuration Information

The RADIUS server can specify an ACL. If an ACL is configured on the RADIUS server, and if that ACL is present, the user may be allowed access based on that ACL.

If the ACL is absent, authorization fails, and a message is logged indicating this.

RADIUS can specify an ACL for the user if both of the following are true:

- If an ACL is absent.
- If there is a very long delay for an entry, or a denied entry because of an ACL, and a message is logged.

 **NOTE:** The ACL name must be a string. Only standard ACLs in authorization (both RADIUS and TACACS) are supported. Authorization is denied in cases using Extended ACLs.

Auto-Command

You can configure the system through the RADIUS server to automatically execute a command when you connect to a specific line.

The `auto-command` command is executed when the user is authenticated and before the prompt appears to the user.

- Automatically execute a command.

```
auto-command
```

Privilege Levels

Through the RADIUS server, you can configure a privilege level for the user to enter into when they connect to a session.

This value is configured on the client system.

- Set a privilege level.
`privilege level`

Configuration Task List for RADIUS

To authenticate users using RADIUS, you must specify at least one RADIUS server so that the system can communicate with and configure RADIUS as one of your authentication methods.

The following list includes the configuration tasks for RADIUS.

- [Defining a AAA Method List to be Used for RADIUS](#) (mandatory)
- [Applying the Method List to Terminal Lines](#) (mandatory except when using default lists)
- [Specifying a RADIUS Server Host](#) (mandatory)
- [Setting Global Communication Parameters for all RADIUS Server Hosts](#) (optional)
- [Monitoring RADIUS](#) (optional)

For a complete listing of all Dell EMC Networking OS commands related to RADIUS, refer to the *Security* chapter in the *Dell EMC Networking OS Command Reference Guide*.

i **NOTE:** RADIUS authentication and authorization are done in a single step. Hence, authorization cannot be used independent of authentication. However, if you have configured RADIUS authorization and have not configured authentication, a message is logged stating this. During authorization, the next method in the list (if present) is used, or if another method is not present, an error is reported.

To view the configuration, use the `show config` in LINE mode or the `show running-config` command in EXEC Privilege mode.

Defining a AAA Method List to be Used for RADIUS

To configure RADIUS to authenticate or authorize users on the system, create a AAA method list.

Default method lists do not need to be explicitly applied to the line, so they are not mandatory.

To create a method list, use the following commands.

- Enter a text string (up to 16 characters long) as the name of the method list you wish to use with the RADIUS authentication method.
CONFIGURATION mode
`aaa authentication login method-list-name radius`
- Create a method list with RADIUS and TACACS+ as authorization methods.
CONFIGURATION mode
`aaa authorization exec {method-list-name | default} radius tacacs+`
Typical order of methods: RADIUS, TACACS+, Local, None.
If RADIUS denies authorization, the session ends (RADIUS must not be the last method specified).

Applying the Method List to Terminal Lines

To enable RADIUS AAA login authentication for a method list, apply it to a terminal line.

To configure a terminal line for RADIUS authentication and authorization, use the following commands.

- Enter LINE mode.
CONFIGURATION mode
`line {aux 0 | console 0 | vty number [end-number]}`
- Enable AAA login authentication for the specified RADIUS method list.
LINE mode

```
login authentication {method-list-name | default}
```

This procedure is mandatory if you are not using default lists.

- To use the method list.

```
CONFIGURATION mode
```

```
authorization exec methodlist
```

Specifying a RADIUS Server Host

When configuring a RADIUS server host, you can set different communication parameters, such as the UDP port, the key password, the number of retries, and the timeout.

To specify a RADIUS server host and configure its communication parameters, use the following command.

- Enter the host name or IP address of the RADIUS server host.

```
CONFIGURATION mode
```

```
radius-server host {hostname | ip-address} [auth-port port-number] [retransmit retries] [timeout seconds] [key [encryption-type] key]
```

Configure the optional communication parameters for the specific host:

- `auth-port port-number`: the range is from 0 to 65535. Enter a UDP port number. The default is **1812**.
- `retransmit retries`: the range is from 0 to 100. Default is **3**.
- `timeout seconds`: the range is from 0 to 1000. Default is **5 seconds**.
- `key [encryption-type] key`: enter 0 for plain text or 7 for encrypted text, and a string for the key. The key can be up to 42 characters long. This key must match the key configured on the RADIUS server host.

If you do not configure these optional parameters, the global default values for all RADIUS host are applied.

To specify multiple RADIUS server hosts, configure the `radius-server host` command multiple times. If you configure multiple RADIUS server hosts, Dell EMC Networking OS attempts to connect with them in the order in which they were configured. When Dell EMC Networking OS attempts to authenticate a user, the software connects with the RADIUS server hosts one at a time, until a RADIUS server host responds with an accept or reject response.

If you want to change an optional parameter setting for a specific host, use the `radius-server host` command. To change the global communication settings to all RADIUS server hosts, refer to [Setting Global Communication Parameters for all RADIUS Server Hosts](#).

To view the RADIUS configuration, use the `show running-config radius` command in EXEC Privilege mode.

To delete a RADIUS server host, use the `no radius-server host {hostname | ip-address}` command.

Setting Global Communication Parameters for all RADIUS Server Hosts

You can configure global communication parameters (`auth-port`, `key`, `retransmit`, and `timeout` parameters) and specific host communication parameters on the same system.

However, if you configure both global and specific host parameters, the specific host parameters override the global parameters for that RADIUS server host.

To set global communication parameters for all RADIUS server hosts, use the following commands.

- Set a time interval after which a RADIUS host server is declared dead.

```
CONFIGURATION mode
```

```
radius-server deadtime seconds
```

- `seconds`: the range is from 0 to 2147483647. The default is **0 seconds**.

- Configure a key for all RADIUS communications between the system and RADIUS server hosts.

```
CONFIGURATION mode
```

```
radius-server key [encryption-type] key
```

- `encryption-type`: enter 7 to encrypt the password. Enter 0 to keep the password as plain text.
- `key`: enter a string. The key can be up to 42 characters long. You cannot use spaces in the key.

- Configure the number of times Dell EMC Networking OS retransmits RADIUS requests.

```
CONFIGURATION mode
```

```
radius-server retransmit retries
```

- *retries*: the range is from 0 to 100. Default is **3 retries**.

- Configure the time interval the system waits for a RADIUS server host response.

CONFIGURATION mode

```
radius-server timeout seconds
```

- *seconds*: the range is from 0 to 1000. Default is **5 seconds**.

To view the configuration of RADIUS communication parameters, use the `show running-config` command in EXEC Privilege mode.

Monitoring RADIUS

To view information on RADIUS transactions, use the following command.

- View RADIUS transactions to troubleshoot problems.

EXEC Privilege mode

```
debug radius
```

TACACS+

Dell EMC Networking OS supports terminal access controller access control system (TACACS+ client, including support for login authentication).

Configuration Task List for TACACS+

The following list includes the configuration task for TACACS+ functions.

- [Choosing TACACS+ as the Authentication Method](#)
- [Monitoring TACACS+](#)
- [TACACS+ Remote Authentication](#)
- [Specifying a TACACS+ Server Host](#)

For a complete listing of all commands related to TACACS+, refer to the *Security* chapter in the *Dell EMC Networking OS Command Reference Guide*.

Choosing TACACS+ as the Authentication Method

One of the login authentication methods available is TACACS+ and the user's name and password are sent for authentication to the TACACS hosts specified.

To use TACACS+ to authenticate users, specify at least one TACACS+ server for the system to communicate with and configure TACACS+ as one of your authentication methods.

To select TACACS+ as the login authentication method, use the following commands.

1. Configure a TACACS+ server host.

CONFIGURATION mode

```
tacacs-server host {ip-address | host}
```

Enter the IP address or host name of the TACACS+ server.

Use this command multiple times to configure multiple TACACS+ server hosts.

2. Enter a text string (up to 16 characters long) as the name of the method list you wish to use with the TACAS+ authentication method.

CONFIGURATION mode

```
aaa authentication login {method-list-name | default} tacacs+ [...method3]
```

The TACACS+ method must not be the last method specified.

3. Enter LINE mode.

CONFIGURATION mode

```
line {aux 0 | console 0 | vty number [end-number]}
```

4. Assign the *method-list* to the terminal line.

LINE mode

```
login authentication {method-list-name | default}
```

To view the configuration, use the `show config` in LINE mode or the `show running-config tacacs+` command in EXEC Privilege mode.

If authentication fails using the primary method, Dell EMC Networking OS employs the second method (or third method, if necessary) automatically. The fallback to the second method would happen only if the authentication failure is due to a non-reachable server or invalid TACACS server key. The fallback would not occur if the authentication failure is due to invalid credentials. For example, if the TACACS+ server is reachable, but the server key is invalid, Dell EMC Networking OS proceeds to the next authentication method. In the following example, the TACACS+ is incorrect, but the user is still authenticated by the secondary method.

First bold line: Server key purposely changed to incorrect value.

Second bold line: User authenticated using the secondary method.

```
DelleMC(conf)#
DelleMC(conf)#do show run aaa
!
aaa authentication enable default tacacs+ enable
aaa authentication enable LOCAL enable tacacs+
aaa authentication login default tacacs+ local
aaa authentication login LOCAL local tacacs+
aaa authorization exec default tacacs+ none
aaa authorization commands 1 default tacacs+ none
aaa authorization commands 15 default tacacs+ none
aaa accounting exec default start-stop tacacs+
aaa accounting commands 1 default start-stop tacacs+
aaa accounting commands 15 default start-stop tacacs+
DelleMC(conf)#
DelleMC(conf)#do show run tacacs+
!
tacacs-server key 7 d05206c308f4d35b
tacacs-server host 10.10.10.10 timeout 1
```

Monitoring TACACS+

To view information on TACACS+ transactions, use the following command.

- View TACACS+ transactions to troubleshoot problems.

EXEC Privilege mode

```
debug tacacs+
```

TACACS+ Remote Authentication

The system takes the access class from the TACACS+ server. Access class is the class of service that restricts Telnet access and packet sizes.

If you have configured remote authorization, the system ignores the access class you have configured for the VTY line and gets this access class information from the TACACS+ server. The system must know the username and password of the incoming user before it can fetch the access class from the server. A user, therefore, at least sees the login prompt. If the access class denies the connection, the system closes the Telnet session immediately. The following example demonstrates how to configure the access-class from a TACACS+ server. This configuration ignores the configured access-class on the VTY line. If you have configured a deny10 ACL on the TACACS+ server, the system downloads it and applies it. If the user is found to be coming from the 10.0.0.0 subnet, the system also immediately closes the Telnet connection. Note, that no matter where the user is coming from, they see the login prompt.

When configuring a TACACS+ server host, you can set different communication parameters, such as the key password.

Example of Specifying a TACACS+ Server Host

```
DellEMC(conf)#
DellEMC(conf)#aaa authentication login tacacsmethod tacacs+
DellEMC(conf)#aaa authentication exec tacacsauthorization tacacs+
DellEMC(conf)#tacacs-server host 25.1.1.2 key Force
DellEMC(conf)#
DellEMC(conf)#line vty 0 9
DellEMC(config-line-vty)#login authentication tacacsmethod
DellEMC(config-line-vty)#end
```

Specifying a TACACS+ Server Host

To specify a TACACS+ server host and configure its communication parameters, use the following command.

- Enter the host name or IP address of the TACACS+ server host.

CONFIGURATION mode

```
tacacs-server host {hostname | ip-address} [port port-number] [timeout seconds] [key key]
```

Configure the optional communication parameters for the specific host:

- `port port-number`: the range is from 0 to 65535. Enter a TCP port number. The default is **49**.
- `timeout seconds`: the range is from 0 to 1000. Default is **10 seconds**.
- `key key`: enter a string for the key. The key can be up to 42 characters long. This key must match a key configured on the TACACS+ server host. This parameter must be the last parameter you configure.

If you do not configure these optional parameters, the default global values are applied.

To specify multiple TACACS+ server hosts, configure the `tacacs-server host` command multiple times. If you configure multiple TACACS+ server hosts, Dell EMC Networking OS attempts to connect with them in the order in which they were configured.

To view the TACACS+ configuration, use the `show running-config tacacs+` command in EXEC Privilege mode.

To delete a TACACS+ server host, use the `no tacacs-server host {hostname | ip-address}` command.

```
freebsd2# telnet 2200:2200:2200:2200:2200::2202
Trying 2200:2200:2200:2200:2200::2202...
Connected to 2200:2200:2200:2200:2200::2202.
Escape character is '^]'.
Login: admin
Password:
DellEMC#
```

Enabling SCP and SSH

Secure shell (SSH) is a protocol for secure remote login and other secure network services over an insecure network. Dell EMC Networking OS is compatible with SSH versions 2, in both the client and server modes. SSH sessions are encrypted and use authentication. SSH is enabled by default.

For details about the command syntax, refer to the *Security* chapter in the *Dell EMC Networking OS Command Line Interface Reference Guide*.

Dell EMC Networking OS SCP, which is a remote file copy program that works with SSH.

i **NOTE:** The Windows-based WinSCP client software is not supported for secure copying between a PC and a Dell EMC Networking OS-based system. Unix-based SCP client software is supported.

To use the SSH client, use the following command.

- Open an SSH connection and specify the hostname, username, port number, encryption cipher, HMAC algorithm and version of the SSH client.

EXEC Privilege mode

```
ssh {hostname} [-l username | -p port-number | -v 2] [-c encryption cipher | -m HMAC algorithm]
```

`hostname` is the IP address or host name of the remote device. Enter an IPv4 or IPv6 address in dotted decimal format (A.B.C.D).

- SSH V2 is enabled by default on all the modes.
- Display SSH connection information.

EXEC Privilege mode

```
show ip ssh
```

The following example uses the `ip ssh server version 2` command to enable SSH version 2 and the `show ip ssh` command to confirm the setting.

```
DellEMC(conf)#ip ssh server version 2
DellEMC(conf)#do show ip ssh
SSH server          : enabled.
SSH server version  : v2.
SSH server vrf      : default.
SSH server ciphers  : 3des-cbc,aes128-cbc,aes192-cbc,aes256-cbc,aes128-ctr,aes192-ctr,aes256-ctr.
SSH server macs     : hmac-md5,hmac-md5-96,hmac-sha1,hmac-sha1-96,hmac-sha2-256,hmac-sha2-256-96.
SSH server kex algorithms : diffie-hellman-group-exchange-sha1,diffie-hellman-group1-sha1,diffie-hellman-group14-sha1.
Password Authentication : enabled.
Hostbased Authentication : disabled.
RSA Authentication    : disabled.
Vty Encryption HMAC Remote IP
DellEMC(conf)#
```

To disable SSH server functions, use the `no ip ssh server enable` command.

Using SCP with SSH to Copy a Software Image

To use secure copy (SCP) to copy a software image through an SSH connection from one switch to another, use the following commands.

1. On Switch 1, set the SSH port number (port 22 by default).

```
CONFIGURATION MODE
```

```
ip ssh server port number
```

2. On Switch 1, enable SSH.

```
CONFIGURATION MODE
```

```
copy ssh server enable
```

3. On Switch 2, invoke SCP.

```
CONFIGURATION MODE
```

```
copy scp: flash:
```

4. On Switch 2, in response to prompts, enter the path to the desired file and enter the port number specified in Step 1.

```
EXEC Privilege Mode
```

5. On the chassis, invoke SCP.

```
CONFIGURATION mode
```

```
copy scp: flash:
```

The following example shows the use of SCP and SSH to copy a software image from one switch running SSH server on UDP port 99 to the local switch.

Other SSH related command include:

- `crypto key generate` : generate keys for the SSH server.
- `debug ip ssh` : enables collecting SSH debug information.
- `ip scp topdir` : identify a location for files used in secure copy transfer.
- `ip ssh authentication-retries` : configure the maximum number of attempts that should be used to authenticate a user.
- `ip ssh connection-rate-limit` : configure the maximum number of incoming SSH connections per minute.
- `ip ssh hostbased-authentication enable` : enable host-based authentication for the SSHv2 server.

- `ip ssh password-authentication enable` : enable password authentication for the SSH server.
- `ip ssh pub-key-file` : specify the file the host-based authentication uses.
- `ip ssh rhostsfile` : specify the rhost file the host-based authorization uses.
- `ip ssh rsa-authentication enable` : enable RSA authentication for the SSHv2 server.
- `ip ssh rsa-authentication` : add keys for the RSA authentication.
- `show crypto` : display the public part of the SSH host-keys.
- `show ip ssh client-pub-keys` : display the client public keys used in host-based authentication.
- `show ip ssh rsa-authentication` : display the authorized-keys for the RSA authentication.

```
DellEMC#copy scp: flash:
Address or name of remote host []: 10.10.10.1
Port number of the server [22]: 99
Source file name []: test.cfg
User name to login remote host: admin
Password to login remote host:
```

Secure Shell Authentication

Secure Shell (SSH) is enabled by default using the SSH Password Authentication method.

Enabling SSH Authentication by Password

Authenticate an SSH client by prompting for a password when attempting to connect to the Dell EMC Networking system. This setup is the simplest method of authentication and uses SSH version 2.

To enable SSH password authentication, use the following command.

- Enable SSH password authentication.

```
CONFIGURATION mode
ip ssh password-authentication enable
```

To view your SSH configuration, use the `show ip ssh` command from EXEC Privilege mode.

```
DellEMC(conf)#ip ssh server enable
DellEMC(conf)#ip ssh password-authentication enable
DellEMC# show ip ssh
SSH server          : enabled.
SSH server version  : v2.
SSH server vrf      : default.
SSH server ciphers  : 3des-cbc,aes128-cbc,aes192-cbc,aes256-cbc,aes128-ctr,aes192-ctr,aes256-ctr.
SSH server macs     : hmac-md5,hmac-md5-96,hmac-sha1,hmac-sha1-96,hmac-sha2-256,hmac-sha2-256-96.
SSH server kex algorithms : diffie-hellman-group-exchange-sha1,diffie-hellman-group1-sha1,diffie-hellman-group14-sha1.
Password Authentication : enabled.
Hostbased Authentication : disabled.
RSA Authentication    : disabled.
Vty          Encryption          HMAC          Remote IP
```

Using RSA Authentication of SSH

The following procedure authenticates an SSH client based on an RSA key using RSA authentication. This method uses SSH version 2.

1. On the SSH client (Unix machine), generate an RSA key, as shown in the following example.
2. Copy the public key `id_rsa.pub` to the Dell EMC Networking system.
3. Disable password authentication if enabled.

```
CONFIGURATION mode
no ip ssh password-authentication enable
```

4. Enable RSA authentication in SSH.

CONFIGURATION Mode

```
ip ssh rsa-authentication enable
```

5. Install user's public key for RSA authentication in SSH.

EXEC Privilege Mode

```
ip ssh rsa-authentication username username my-authorized-keys flash://public_key
```

If you provide the username, the Dell EMC Networking OS installs the public key for that specific user. In case, no user is associated with the current logged-in session, the system displays the following error message.

NOTE: If no user is associated with the current logged-in session, the system displays the following error message. %
Error: No username set for this term.

```
admin@Unix_client#ssh-keygen -t rsa
Generating public/private rsa key pair.
Enter file in which to save the key (/home/admin/.ssh/id_rsa):
/home/admin/.ssh/id_rsa already exists.
Overwrite (y/n)? y
Enter passphrase (empty for no passphrase):
Enter same passphrase again:
Your identification has been saved in /home/admin/.ssh/id_rsa.
Your public key has been saved in /home/admin/.ssh/id_rsa.pub.
```

Configuring Host-Based SSH Authentication

Authenticate a particular host. This method uses SSH version 2.

To configure host-based authentication, use the following commands.

1. Configure RSA Authentication. Refer to [Using RSA Authentication of SSH](#).
2. Create *shosts* by copying the public RSA key to the file *shosts* in the directory *.ssh*, and write the IP address of the host to the file.

```
cp /etc/ssh/ssh_host_rsa_key.pub /.ssh/shosts
```

Refer to the first example.

3. Create a list of IP addresses and usernames that are permitted to SSH in a file called *rhosts*.
Refer to the second example.

4. Copy the file *shosts* and *rhosts* to the Dell EMC Networking system.
5. Disable password authentication and RSA authentication, if configured

CONFIGURATION mode or EXEC Privilege mode

```
no ip ssh password-authentication or no ip ssh rsa-authentication
```

6. Enable host-based authentication.

CONFIGURATION mode

```
ip ssh hostbased-authentication enable
```

7. Bind *shosts* and *rhosts* to host-based authentication.

CONFIGURATION mode

```
ip ssh pub-key-file flash://filename or ip ssh rhostsfile flash://filename
```

The following example shows creating *shosts*.

```
admin@Unix_client# cd /etc/ssh

admin@Unix_client# ls
moduli      sshd_config  ssh_host_dsa_key.pub  ssh_host_key.pub
ssh_host_rsa_key.pub  ssh_config  ssh_host_dsa_key  ssh_host_key
ssh_host_rsa_key

admin@Unix_client# cat ssh_host_rsa_key.pub

ssh-rsa AAAAB3NzaC1yc2EAAAABIwAAAIEA8K7jLZRVfjgHJzUOmXxuIbZx/
AyWhVgJDQh39k8v3e8eQvLnHBIsqIL8jVylQHhUeb7GaD1JVEDAMz30myqQbJgXBBRTWgBpLWwL/
doyUXFufjiL9YmoVTkbKcFmxJEMke3JyHanEi7hg34LChjk9hL1by8cYZP2kYS2lnSyQWk=
```

```

admin@Unix_client# ls
id_rsa id_rsa.pub shosts
admin@Unix_client# cat shosts
10.16.127.201, ssh-rsa AAAAB3NzaC1yc2EAAAABIwAAAIEA8K7jLZRVfjgHJzUOmXxuIbZx/AyW
hVgJDQh39k8v3e8eQvLnHBIsqIL8jVy1QHhUeb7GaDlJVEDAMz30myqQbJgXBBRTWgBpLWwL/
doyUXFufjiL9YmoVTkbKcFmxJEMkE3JyHanEi7hg34LChjk9hL1by8cYZP2kYS2lnSyQWk=

```

The following example shows creating *rhosts*.

```

admin@Unix_client# ls
id_rsa id_rsa.pub rhosts shosts
admin@Unix_client# cat rhosts
10.16.127.201 admin

```

Using Client-Based SSH Authentication

To SSH from the chassis to the SSH client, use the following command.

If the SSH port is a non-default value, use the `ip ssh server port number` command to change the default port number. You may only change the port number when SSH is disabled. Then use the `-p` option with the `ssh` command.

- SSH from the chassis to the SSH client.

```
ssh ip_address
```

```

DellEMC#ssh 10.16.127.201 ?
-c          Encryption cipher to use (for v2 clients only)
-l          User name option
-m          HMAC algorithm to use (for v2 clients only)
-p          SSH server port option (default 22)
-v          SSH protocol version

```

Troubleshooting SSH

To troubleshoot SSH, use the following information.

You may not bind *id_rsa.pub* to RSA authentication while logged in via the console. In this case, this message displays: `%Error: No username set for this term.`

Enable host-based authentication on the server (Dell EMC Networking system) and the client (Unix machine). The following message appears if you attempt to log in via SSH and host-based is disabled on the client. In this case, verify that host-based authentication is set to “Yes” in the *file ssh_config* (root permission is required to edit this file): `permission denied (host based)`.

If the IP address in the RSA key does not match the IP address from which you attempt to log in, the following message appears. In this case, verify that the name and IP address of the client is contained in the *file /etc/hosts*: `RSA Authentication Error.`

Telnet

To use Telnet with SSH, first enable SSH, as previously described.

By default, the Telnet daemon is enabled. If you want to disable the Telnet daemon, use the following command, or disable Telnet in the startup config. To enable or disable the Telnet daemon, use the `[no] ip telnet server enable` command.

Example of Using Telnet for Remote Login

```

DellEMC(conf)#ip telnet server enable
DellEMC(conf)#no ip telnet server enable

```

VTY Line and Access-Class Configuration

Various methods are available to restrict VTY access in . These depend on which authentication scheme you use — line, local, or remote.

Table 23. VTY Access

Authentication Method	VTY access-class support?	Username access-class support?	Remote authorization support?
Line	YES	NO	NO
Local	NO	YES	NO
TACACS+	YES	NO	YES (with version 5.2.1.0 and later)
RADIUS	YES	NO	YES (with version 6.1.1.0 and later)

provides several ways to configure access classes for VTY lines, including:

- [VTY Line Local Authentication and Authorization](#)
- [VTY Line Remote Authentication and Authorization](#)

VTY Line Local Authentication and Authorization

retrieves the access class from the local database.

To use this feature:

1. Create a username.
2. Enter a password.
3. Assign an access class.
4. Enter a privilege level.

You can assign line authentication on a per-VTY basis; it is a simple password authentication, using an access-class as authorization.

Configure local authentication globally and configure access classes on a per-user basis.

can assign different access classes to different users by username. Until users attempt to log in, does not know if they will be assigned a VTY line. This means that incoming users always see a login prompt even if you have excluded them from the VTY line with a deny-all access class. After users identify themselves, retrieves the access class from the local database and applies it. (then can close the connection if a user is denied access.)

NOTE: If a VTY user logs in with RADIUS authentication, the privilege level is applied from the RADIUS server only if you configure RADIUS authentication.

The following example shows how to allow or deny a Telnet connection to a user. Users see a login prompt even if they cannot log in. No access class is configured for the VTY line. It defaults from the local database.

Example of Configuring VTY Authorization Based on Access Class Retrieved from a Local Database (Per User)

```
DellEMC(conf)#user gooduser password abc privilege 10 access-class permitall
DellEMC(conf)#user baduser password abc privilege 10 access-class denyall
DellEMC(conf)#
DellEMC(conf)#aaa authentication login localmethod local
DellEMC(conf)#
DellEMC(conf)#line vty 0 9
DellEMC(config-line-vty)#login authentication localmethod
DellEMC(config-line-vty)#end
```

VTY Line Remote Authentication and Authorization

retrieves the access class from the VTY line.

The takes the access class from the VTY line and applies it to ALL users. does not need to know the identity of the incoming user and can immediately apply the access class. If the authentication method is RADIUS, TACACS+, or line, and you have configured an access class for the VTY line, immediately applies it. If the access-class is set to deny all or deny for the incoming subnet, closes the connection without displaying the login prompt. The following example shows how to deny incoming connections from subnet 10.0.0.0 without displaying a login prompt. The example uses TACACS+ as the authentication mechanism.

Example of Configuring VTY Authorization Based on Access Class Retrieved from the Line (Per Network Address)

```
DellEMC(conf)#ip access-list standard deny10
DellEMC(conf-ext-nacl)#permit 10.0.0.0/8
DellEMC(conf-ext-nacl)#deny any
DellEMC(conf)#
DellEMC(conf)#aaa authentication login tacacsmethod tacacs+
DellEMC(conf)#tacacs-server host 256.1.1.2 key Force10
DellEMC(conf)#
DellEMC(conf)#line vty 0 9
DellEMC(config-line-vty)#login authentication tacacsmethod
DellEMC(config-line-vty)#
DellEMC(config-line-vty)#access-class deny10
DellEMC(config-line-vty)#end
(same applies for radius and line authentication)
```

VTY MAC-SA Filter Support

supports MAC access lists which permit or deny users based on their source MAC address.

With this approach, you can implement a security policy based on the source MAC address.

To apply a MAC ACL on a VTY line, use the same `access-class` command as IP ACLs.

The following example shows how to deny incoming connections from subnet 10.0.0.0 without displaying a login prompt.

Example of Configuring VTY Authorization Based on MAC ACL for the Line (Per MAC Address)

```
DellEMC(conf)#mac access-list standard sourcemac
DellEMC(config-std-mac)#permit 00:00:5e:00:01:01
DellEMC(config-std-mac)#deny any
DellEMC(conf)#
DellEMC(conf)#line vty 0 9
DellEMC(config-line-vty)#access-class sourcemac
DellEMC(config-line-vty)#end
```

Dell EMC Networking OS Security Hardening

The security of a network consists of multiple factors. Apart from access to the device, best practices, and implementing various security features, security also lies with the integrity of the device. If the software itself is compromised, all of the aforementioned methods become ineffective.

The Dell EMC Networking OS is enhanced verify whether the OS image and the startup configuration file are altered before loading. This section explains how to configure OS image and startup configuration verification.

Dell EMC Networking OS Image Verification

Dell EMC Networking OS comes with the OS image verification and the startup configuration verification features. When enabled, these features check the integrity of The OS image and the startup configuration that the system uses while the system reboots and loads only if they are intact.

Important Points to Remember

- The OS image verification feature is disabled by default on the Dell EMC Networking OS.
- The OS image verification feature is supported for images stored in the local system only.
- The OS image verification feature is not supported when the fastboot or the warmboot features are enabled on the system.
- If OS image verification fails after a reload, the system does not load the startup configuration. The System displays an appropriate error message until the `no verified boot` command is used on the system.
- After you enable The OS image verification feature, the system prompts you to enter The OS image hash when you upgrade the Dell EMC Networking OS to a later version. The system checks if your hash matches with The OS image hash only after reloading.
- After enabling The OS image verification feature, use the `verified boot hash` command to verify and store the hash value. If you don't store the hash value, you cannot reboot the device until you verify The OS image hash.

Enabling and Configuring OS Image Hash Verification

To enable and configure Dell EMC Networking OS image hash verification, follow these steps:

1. Enable the OS image hash verification feature.

```
CONFIGURATION mode
verified boot
```

2. Verify the hash checksum of the current OS image file on the local file system.

```
EXEC Privilege
verified boot hash system-image {A: | B:} hash-value
```

You can get the hash value for your hashing algorithm from the Dell EMC iSupport page. You can use the MD5, SHA1, or SHA256 hash and the Dell EMC Networking OS automatically detects the type of hash.

NOTE: The `verified boot hash` command is only applicable for OS images in the local file system.

3. Save the configuration.

```
EXEC Privilege
copy running-configuration startup-configuration
```

After enabling and configuring OS image hash verification, the device verifies the hash checksum of the OS boot image during every reload.

```
DellEMC# verified boot hash system-image A: 619A8C1B7A2BC9692A221E2151B9DA9E
```

Image Verification for Subsequent OS Upgrades

After enabling OS image hash verification, for subsequent Dell EMC Networking OS upgrades, you must enter the hash checksum of the new OS image file. To enter the hash checksum during upgrade, follow these steps:

- Use the following command to upgrade the Dell EMC Networking OS and enter the hash value when prompted.

```
EXEC Privilege
upgrade system
```

```
DellEMC# upgrade system tftp://10.16.127.35/FTOS-SE-9.11.0.1 A:
Hash Value: e42e2548783c2d5db239ea2fa9de4232
!!!!!!!!!!!!!!!!!!!!..
```

Startup Configuration Verification

Dell EMC Networking OS comes with startup configuration verification feature. When enabled, it checks the integrity of the startup configuration that the system uses while the system reboots and loads only if it is intact.

Important Points to Remember

- The startup configuration verification feature is disabled by default on the Dell EMC Networking OS.
- The feature is supported for startup configuration files stored in the local system only.
- The feature is not supported when the fastboot or the warmboot features are enabled on the system.
- If the startup configuration verification fails after a reload, the system does not load your startup configuration.
- After enabling the startup configuration verification feature, use the `verified boot hash` command to verify and store the hash value. If you don't store the hash value, you cannot reboot the device until you verify the image hash.
- If OS image verification fails, the system does not load your startup configuration and displays an error message until you remove the `verified boot` command from the configuration.

Dell EMC Networking OS Behavior after System Power-Cycle

If the system reboots due reasons such as power-cycle, the current startup configuration may be different than the one you verified the hash using the `verified boot hash` command. When the system comes up, the system may use the last-verified startup configuration.

Dell EMC Networking recommends backing up the startup configuration to a safe location after you use the `verified boot hash` command. When the startup configuration verification fails, you can restore it from the backup.

The system continues to display a message stating that startup configuration verification failed. You can disable the startup configuration feature either by disabling startup configuration verification or save the running configuration to the startup configuration and update the hash for the startup configuration.

Enabling and Configuring Startup Configuration Hash Verification

To enable and configure startup configuration hash verification, follow these steps:

1. Enable the startup configuration hash verification feature.
CONFIGURATION mode
`verified startup-config`
2. Generate the hash checksum for your startup configuration file.
EXEC Privilege
`generate hash {md5 | sha1 | sha256} {flash://filename | startup-config}`
3. Verify the hash checksum of the current startup configuration on the local file system.
EXEC Privilege
`verified boot hash startup-config hash-value`

 **NOTE:** The `verified boot hash` command is only applicable for the startup configuration file in the local file system.

After enabling and configuring startup configuration verification, the device verifies the hash checksum of the startup configuration during every reload.

```
DellEMC# verified boot hash startup-config 619A8C1B7A2BC9692A221E2151B9DA9E
```

Configuring the root User Password

For added security, you can change the root user password.

If you configure the `secure-cli` command on the system, the Dell EMC Networking OS resets any previously-configured root access password without displaying any warning message. With the `secure-cli` command enabled on the system, the CONFIGURATION mode does not display the `root access password` option.

To change the default root user password, follow these steps:

- Change the default root user password.
CONFIGURATION mode
`root-access password [encryption-type] root-password`

Enter an encryption type for the root password.

- o 0 directs the system to store the password as clear text.
- o 7 directs the system to store the password with a dynamic salt.
- o 9 directs the system to encrypt the clear text password and store the encrypted password in an inaccessible location.

When you configure the root access password, ensure that your password meets the following criteria:

- o A minimum of eight characters in length
- o A minimum of one lower case letter (a to z)
- o A minimum of one upper case letter (A to Z)
- o A minimum of one numeric character (0 to 9)
- o A minimum of one special character including a space (" !"#\$\$%&'()*+,-./:;<=>?@[\\]^_`{|}~")

```
DellEMC)# show running-config | g root
root-access password 7 f4dc0cb9787722dd1084d17f417f164cc7f730d4f03d4f0215294cbd899614e3
```

Enabling User Lockout for Failed Login Attempts

You can configure the system to lock out local users for a specific period for unsuccessful login attempts.

This feature enhances the security of the switch by locking out the local user account if there are more number of unsuccessful login attempts than what is configured using the *max-retry* parameter. To enable the user lock out feature, use the following commands:

Enable the user lockout feature.

CONFIGURATION

```
password-attributes user-lockout-period minutes
```

Enter the duration in minutes.

Simple Network Management Protocol (SNMP)

Network management stations use SNMP to retrieve or alter management data from network elements. A datum of management information is called a managed object; the value of a managed object can be static or variable. Network elements store managed objects in a database called a management information base (MIB).

MIBs are hierarchically structured and use object identifiers to address managed objects, but managed objects also have a textual name called an *object descriptor*.

i **NOTE:** An I/O Aggregator supports standard and private SNMP MIBs, including Get operations in supported MIBs.

i **NOTE:** The system does not support SNMPv3 traps in PMUX mode.

Supported Modes

Standalone, PMUX, VLT, Stacking

Topics:

- [Implementation Information](#)
- [Configuring the Simple Network Management Protocol](#)
- [Setting Up User-Based Security \(SNMPv3\)](#)
- [Subscribing to Managed Object Value Updates using SNMP](#)
- [Enabling a Subset of SNMP Traps](#)
- [Reading Managed Object Values](#)
- [Displaying the Ports in a VLAN using SNMP](#)
- [Fetching Dynamic MAC Entries using SNMP](#)
- [Deriving Interface Indices](#)
- [MIB Support to Display Reason for Last System Reboot](#)
- [MIB Support to Display Egress Queue Statistics](#)
- [Monitoring BGP sessions via SNMP](#)
- [Monitor Port-Channels](#)
- [Entity MIBs](#)
- [SNMP Traps for Link Status](#)
- [Standard VLAN MIB](#)
- [MIB Support to Display the Available Memory Size on Flash](#)
- [MIB Support to Display the Software Core Files Generated by the System](#)
- [MIB Support to Display the Available Partitions on Flash](#)
- [MIB Support to Display Egress Queue Statistics](#)
- [MIB Support to Display Egress Queue Statistics](#)
- [MIB Support for entAliasMappingTable](#)
- [MIB Support for LAG](#)
- [MIB Support to Display Unrecognized LLDP TLVs](#)
- [Transceiver Monitoring](#)

Implementation Information

The Dell Networking OS supports SNMP version 1 as defined by RFC 1155, 1157, and 1212, SNMP version 2c as defined by RFC 1901.

Configuring the Simple Network Management Protocol

NOTE: The configurations in this chapter use a UNIX environment with net-snmp version 5.4. This is only one of many RFC-compliant SNMP utilities you can use to manage the Aggregator using SNMP. Also, these configurations use SNMP version 2c.

Configuring SNMP version 1 or version 2 requires only a single step:

1. Create a community.

NOTE: IOA supports only Read-only mode.

Important Points to Remember

- Typically, 5-second timeout and 3-second retry values on an SNMP server are sufficient for both local area network (LAN) and wide area network (WAN) applications. If you experience a timeout with these values, increase the timeout value to greater than 3 seconds, and increase the retry value to greater than 2 seconds on your SNMP server.

Setting up SNMP

Dell Networking OS supports SNMP version 1 and version 2 which are community-based security models. The primary difference between the two versions is that version 2 supports two additional protocol operations (informs operation and **snmpgetbulk** query) and one additional object (counter64 object).

Creating a Community

For SNMPv1 and SNMPv2, create a community to enable the community-based security in the Dell Networking OS.

The management station generates requests to either retrieve or alter the value of a management object and is called the *SNMP manager*. A network element that processes SNMP requests is called an *SNMP agent*. An *SNMP community* is a group of SNMP agents and managers that are allowed to interact. Communities are necessary to secure communication between SNMP managers and agents; SNMP agents do not respond to requests from management stations that are not part of the community.

The Dell Networking OS enables SNMP automatically when you create an SNMP community and displays the following message. You must specify whether members of the community may retrieve values in Read-Only mode. Read-write access is not supported.

```
22:31:23: %RPM1-P:CP %SNMP-6-SNMP_WARM_START: Agent Initialized - SNMP WARM_START.
```

To create an SNMP community:

- Choose a name for the community.
CONFIGURATION mode
`snmp-server community name ro`

To view your SNMP configuration, use the `show running-config snmp` command from EXEC Privilege mode.

```
Dell(conf)#snmp-server community my-snmp-community ro
22:31:23: %RPM1-P:CP %SNMP-6-SNMP_WARM_START: Agent Initialized - SNMP WARM_START.
Dell#show running-config snmp
!
```

```
snmp-server community mycommunity ro
Dell#
```

Setting Up User-Based Security (SNMPv3)

When setting up SNMPv3, you can set users up with one of the following three types of configuration for SNMP read/write operations.

Users are typically associated to an SNMP group with permissions provided, such as OID view.

- **noauth** — no password or privacy. Select this option to set up a user with no password or privacy privileges. This setting is the basic configuration. Users must have a group and profile that do not require password privileges.
- **auth** — password privileges. Select this option to set up a user with password authentication.
- **priv** — password and privacy privileges. Select this option to set up a user with password and privacy privileges.

To set up user-based security (SNMPv3), use the following commands.

i **NOTE:** SNMPv3 is supported only in PMUX mode.

- Configure the user with view privileges only (no password or privacy privileges).

CONFIGURATION mode

```
snmp-server user name group-name 3 noauth
```

- Configure an SNMP group with view privileges only (no password or privacy privileges).

CONFIGURATION mode

```
snmp-server group group-name 3 noauth auth read name write name
```

- Configure an SNMPv3 view.

CONFIGURATION mode

```
snmp-server view view-name oid-tree {included | excluded}
```

i **NOTE:** To give a user read and write view privileges, repeat this step for each privilege type.

- Configure the user with an authorization password (password privileges only).

CONFIGURATION mode

```
snmp-server user name group-name 3 noauth auth md5 auth-password
```

- Configure an SNMP group (password privileges only).

CONFIGURATION mode

```
snmp-server group groupname {oid-tree} auth read name write name
```

- Configure an SNMPv3 view.

CONFIGURATION mode

```
snmp-server view view-name 3 noauth {included | excluded}
```

i **NOTE:** To give a user read and write privileges, repeat this step for each privilege type.

- Configure an SNMP group (with password or privacy privileges).

CONFIGURATION mode

```
snmp-server group group-name {oid-tree} priv read name write name
```

- Configure the user with a secure authorization password and privacy password.

CONFIGURATION mode

```
snmp-server user name group-name {oid-tree} auth md5 auth-password priv des56 priv password
```

- Configure an SNMPv3 view.

CONFIGURATION mode

```
snmp-server view view-name oid-tree {included | excluded}
```

```
Dell(conf)#snmp-server host 1.1.1.1 traps {oid tree} version 3 ?
auth          Use the SNMPv3 authNoPriv Security Level
noauth       Use the SNMPv3 noAuthNoPriv Security Level
priv         Use the SNMPv3 authPriv Security Level
```

```
Dell(conf)#snmp-server host 1.1.1.1 traps {oid tree} version 3 noauth ?
WORD          SNMPv3 user name
```

Subscribing to Managed Object Value Updates using SNMP

By default, the Dell Networking system displays some unsolicited SNMP messages (traps) upon certain events and conditions. You can also configure the system to send the traps to a management station. Traps cannot be saved on the system.

Dell Networking OS supports the following three sets of traps:

- **RFC 1157-defined traps** — coldStart, warmStart, linkDown, linkUp, authenticationFailure, and egpNeighborLoss.
- **Force10 enterpriseSpecific environment traps** — fan, supply, and temperature.
- **Force10 enterpriseSpecific protocol traps** — bgp, ecfm, stp, and xstp.

To configure the system to send SNMP notifications, use the following commands.

1. Configure the Dell Networking system to send notifications to an SNMP server.

CONFIGURATION mode

```
snmp-server host ip-address [traps | informs] [version 1 | 2c | 3] [community-string]
```

To send trap messages, enter the keyword `traps`.

To send informational messages, enter the keyword `informs`.

To send the SNMP version to use for notification messages, enter the keyword `version`.

To identify the SNMPv1 community string, enter the name of the `community-string`.

2. Specify which traps the Dell Networking system sends to the trap receiver.

CONFIGURATION mode

```
snmp-server enable traps
```

Enable all Dell Networking enterprise-specific and RFC-defined traps using the `snmp-server enable traps` command from CONFIGURATION mode.

Enable all of the RFC-defined traps using the `snmp-server enable traps snmp` command from CONFIGURATION mode.

3. Specify the interfaces out of which Dell Networking OS sends SNMP traps.

CONFIGURATION mode

```
snmp-server trap-source
```

The following example lists the RFC-defined SNMP traps and the command used to enable each. The `coldStart` and `warmStart` traps are enabled using a single command.

```
snmp authentication      SNMP_AUTH_FAIL:SNMP Authentication failed.Request with invalid
community string.
snmp coldstart           SNMP_COLD_START: Agent Initialized - SNMP COLD_START.
                        SNMP_WARM_START:Agent Initialized - SNMP WARM_START.
snmp linkdown            PORT_LINKDN:changed interface state to down:%d
snmp linkup              PORT_LINKUP:changed interface state to up:%d
```

Enabling a Subset of SNMP Traps

You can enable a subset of Dell Networking enterprise-specific SNMP traps using one of the following listed command options.

To enable a subset of Dell Networking enterprise-specific SNMP traps, use the following command.

- Enable a subset of SNMP traps.
`snmp-server enable traps`



NOTE: The `envmon` option enables all environment traps including those traps that are enabled with the `envmon supply`, `envmon temperature`, and `envmon fan` options.

envmon

```
CARD_SHUTDOWN: %sLine card %d down - %s
CARD_DOWN: %sLine card %d down - %s
LINECARDUP: %sLine card %d is up
CARD_MISMATCH: Mismatch: line card %d is type %s - type %s required.
RPM_STATE: RPM1 is in Active State
RPM_STATE: RPM0 is in Standby State
RPM_DOWN: RPM 0 down - hard reset
RPM_DOWN: RPM 0 down - card removed
HOT_FAILOVER: RPM Failover Completed
SFM_DISCOVERY: Found SFM 1
SFM_REMOVE: Removed SFM 1
MAJOR_SFM: Major alarm: Switch fabric down
MAJOR_SFM_CLR: Major alarm cleared: Switch fabric up
MINOR_SFM: Minor alarm: No working standby SFM
MINOR_SFM_CLR: Minor alarm cleared: Working standby SFM present
TASK_SUSPENDED: SUSPENDED - svce:%d - inst:%d - task:%s
RPM0-P:CP %CHMGR-2-CARD_PARITY_ERR
ABNORMAL_TASK_TERMINATION: CRASH - task:%s %s
CPU_THRESHOLD: Cpu %s usage above threshold. Cpu5SecUsage (%d)
CPU_THRESHOLD_CLR: Cpu %s usage drops below threshold. Cpu5SecUsage (%d)
MEM_THRESHOLD: Memory %s usage above threshold. MemUsage (%d)
MEM_THRESHOLD_CLR: Memory %s usage drops below threshold. MemUsage (%d)
DETECT_STN_MOVE: Station Move threshold exceeded for Mac %s in vlan %d
CAM-UTILIZATION: Enable SNMP envmon CAM utilization traps.
```

envmon supply

```
PEM_PRBLM: Major alarm: problem with power entry module %s
PEM_OK: Major alarm cleared: power entry module %s is good
MAJOR_PS: Major alarm: insufficient power %s
MAJOR_PS_CLR: major alarm cleared: sufficient power
MINOR_PS: Minor alarm: power supply non-redundant
MINOR_PS_CLR: Minor alarm cleared: power supply redundant
```

envmon temperature

```
MINOR_TEMP: Minor alarm: chassis temperature
MINOR_TEMP_CLR: Minor alarm cleared: chassis temperature normal (%s %d
temperature is within threshold of %dC)
MAJOR_TEMP: Major alarm: chassis temperature high (%s temperature reaches or
exceeds threshold of %dC)
MAJOR_TEMP_CLR: Major alarm cleared: chassis temperature lower (%s %d
temperature is within threshold of %dC)
```

envmon fan

```
FAN_TRAY_BAD: Major alarm: fantray %d is missing or down
FAN_TRAY_OK: Major alarm cleared: fan tray %d present
FAN_BAD: Minor alarm: some fans in fan tray %d are down
FAN_OK: Minor alarm cleared: all fans in fan tray %d are good
```

vlt

```
Enable VLT traps.
```

vrrp

```
Enable VRRP state change traps
```

xstp

```
%SPANMGR-5-STP_NEW_ROOT: New Spanning Tree Root, Bridge ID Priority 32768,
Address 0001.e801.fc35.
%SPANMGR-5-STP_TOPOLOGY_CHANGE: Bridge port TenGigabitEthernet 1/8 transitioned
from Forwarding to Blocking state.
%SPANMGR-5-MSTP_NEW_ROOT_BRIDGE: Elected root bridge for instance 0.
%SPANMGR-5-MSTP_NEW_ROOT_PORT: MSTP root changed to port Te 1/8 for instance
0. My Bridge ID: 40960:0001.e801.fc35 Old Root: 40960:0001.e801.fc35 New Root:
32768:00d0.038a.2c01.
%SPANMGR-5-MSTP_TOPOLOGY_CHANGE: Topology change BridgeAddr: 0001.e801.fc35 Mstp
Instance Id 0 port Te 1/8 transitioned from forwarding to discarding state.
```

ecfm

```
%ECFM-5-ECFM_XCON_ALARM: Cross connect fault detected by MEP 1 in Domain
customer1 at Level 7 VLAN 1000
%ECFM-5-ECFM_ERROR_ALARM: Error CCM Defect detected by MEP 1 in Domain customer1
at Level 7 VLAN 1000
%ECFM-5-ECFM_MAC_STATUS_ALARM: MAC Status Defect detected by MEP 1 in Domain
provider at Level 4 VLAN 3000
%ECFM-5-ECFM_REMOTE_ALARM: Remote CCM Defect detected by MEP 3 in Domain
customer1 at Level 7 VLAN 1000
%ECFM-5-ECFM_RDI_ALARM: RDI Defect detected by MEP 3 in Domain customer1 at
Level 7 VLAN 1000
```

entity

```
Enable entity change traps
Trap SNMPv2-MIB::sysUpTime.0 = Timeticks: (1487406) 4:07:54.06,
SNMPv2-MIB::snmpTrapOID.0 = OID: SNMPv2-SMI::mib-2.47.2.0.1,
SNMPv2-SMI::enterprises.6027.3.6.1.1.2.0 = INTEGER: 4
Trap SNMPv2-MIB::sysUpTime.0 = Timeticks: (1488564) 4:08:05.64,
SNMPv2-MIB::snmpTrapOID.0 = OID: SNMPv2-SMI::mib-2.47.2.0.1,
SNMPv2-SMI::enterprises.6027.3.6.1.1.2.0 = INTEGER: 5
Trap SNMPv2-MIB::sysUpTime.0 = Timeticks: (1489064) 4:08:10.64,
SNMPv2-MIB::snmpTrapOID.0 = OID: SNMPv2-SMI::mib-2.47.2.0.1,
SNMPv2-SMI::enterprises.6027.3.6.1.1.2.0 = INTEGER: 6
Trap SNMPv2-MIB::sysUpTime.0 = Timeticks: (1489568)
4:08:15.68,SNMPv2-MIB::snmpTrapOID.0 = OID: SNMPv2-SMI::mib-2.47.2.0.1,
SNMPv2-SMI::enterprises.6027.3.6.1.1.2.0 = INTEGER: 7
```

<cr>

```
SNMP Copy Config Command Completed
%RPM0-P:CP %SNMP-4-RMON_RISING_THRESHOLD: STACKUNIT0 rising threshold alarm from
SNMP OID <oid>
%RPM0-P:CP %SNMP-4-RMON_FALLING_THRESHOLD: STACKUNIT0 falling threshold alarm from
SNMP OID <oid>
%RPM0-P:CP %SNMP-4-RMON_HC_RISING_THRESHOLD: STACKUNIT0 high-capacity rising threshold
alarm from SNMP OID <oid>
```

Reading Managed Object Values

You may only retrieve (read) managed object values if your management station is a member of the same community as the SNMP agent.

Dell Networking supports RFC 4001, *Textual Conventions for Internet Work Addresses* that defines values representing a type of internet address. These values display for ipAddressTable objects using the `snmpwalk` command.

There are several UNIX SNMP commands that read data.

- Read the value of a single managed object.
`snmpget -v version -c community agent-ip {identifier.instance | descriptor.instance}`
- Read the value of the managed object directly below the specified object.
`snmpgetnext -v version -c community agent-ip {identifier.instance | descriptor.instance}`
- Read the value of many objects at once.
`snmpwalk -v version -c community agent-ip {identifier.instance | descriptor.instance}`

In the following example, the value “4” displays in the OID before the IP address for IPv4. For an IPv6 IP address, a value of “16” displays.

Example of Reading the Value of a Managed Object

```
> snmpget -v 2c -c mycommunity 10.11.131.161 sysUpTime.0
DISMAN-EVENT-MIB::sysUpTimeInstance = Timeticks: (32852616) 3 days, 19:15:26.16
> snmpget -v 2c -c mycommunity 10.11.131.161 .1.3.6.1.2.1.1.3.0
DISMAN-EVENT-MIB::sysUpTimeInstance = Timeticks: (32856932) 3 days, 19:16:09.32
```

Example of Reading the Value of the Next Managed Object

```
> snmpgetnext -v 2c -c mycommunity 10.11.131.161 .1.3.6.1.2.1.1.3.0
SNMPv2-MIB::sysContact.0 = STRING:
```

```
> snmpgetnext -v 2c -c mycommunity 10.11.131.161 sysContact.0
SNMPv2-MIB::sysName.0 = STRING:
```

Example of Reading the Value of Many Managed Objects at Once

```
> snmpwalk -v 2c -c mycommunity 10.16.130.148 .1.3.6.1.2.1.1
SNMPv2-MIB::sysDescr.0 = STRING: Dell Networking OS
Operating System Version: 1.0
Application Software Version: E8-3-17-46
Series: I/O-Aggregator
Copyright (c) 1999-2012 by Dell Inc. All Rights Reserved.
Build Time: Sat Jul 28 03:20:24 PDT 2012
SNMPv2-MIB::sysObjectID.0 = OID: SNMPv2-SMI::enterprises.6027.1.4.2
DISMAN-EVENT-MIB::sysUpTimeInstance = Timeticks: (77916) 0:12:59.16
SNMPv2-MIB::sysContact.0 = STRING:
SNMPv2-MIB::sysName.0 = STRING: FTOS
SNMPv2-MIB::sysLocation.0 = STRING:
SNMPv2-MIB::sysServices.0 = INTEGER: 4
```

Displaying the Ports in a VLAN using SNMP

Dell Networking OS identifies VLAN interfaces using an interface index number that is displayed in the output of the `show interface vlan` command.

Example of Identifying the VLAN Interface Index Number

```
Dell(conf)#do show interface vlan 10
Vlan 10 is down, line protocol is down
Address is 00:01:e8:cc:cc:ce, Current address is 00:01:e8:cc:cc:ce
Interface index is 1107787786
Internet address is not set
MTU 1554 bytes, IP MTU 1500 bytes
LineSpeed auto
ARP type: ARPA, ARP Timeout 04:00:00
Last clearing of "show interface" counters 00:12:42
Queueing strategy: fifo
Time since last interface status change: 00:12:42
```

To display the ports in a VLAN, send an `snmpget` request for the object `dot1qStaticEgressPorts` using the interface index as the instance number, as shown in the following example.

Example of Viewing the Ports in a VLAN in SNMP

```
> snmpget -v2c -c mycommunity 10.11.131.185 .1.3.6.1.2.1.17.7.1.4.3.1.2.1107787786
SNMPv2-SMI::mib-2.17.7.1.4.3.1.2.1107787786 = Hex-STRING:
00 00 00 00 00 00 00 00 00 00 00 00 00 00 00 00 00 00
00 00 00 00 00 00 00 00 00 00 00 00 00 00 00 00 00 00
00 00 00 00 00 00 00 00 00 00 00 00 00 00 00 00 00 00
```

The table that the Dell Networking system sends in response to the `snmpget` request is a table that contains hexadecimal (hex) pairs, each pair representing a group of eight ports.

- Seven hex pairs represent a stack unit. Seven pairs accommodate the greatest number of ports available on an Aggregator, 56 ports. The last stack unit is assigned eight pairs, the eight pair is unused.

The first hex pair, 00 in the previous example, represents ports 1 to 7 in Stack Unit 0. The next pair to the right represents ports 8 to 15. To resolve the hex pair into a representation of the individual ports, convert the hex pair to binary. Consider the first hex pair 00, which resolves to 0000 0000 in binary:

- Each position in the 8-character string is for one port, starting with Port 1 at the left end of the string, and ending with Port 8 at the right end. A 0 indicates that the port is not a member of the VLAN; a 1 indicates VLAN membership.

All hex pairs are 00, indicating that no ports are assigned to VLAN 10. In the following example, Port 0/2 is added to VLAN 10 as untagged; the first hex pair changes from 00 to 04.

Example of Viewing VLAN Ports Using SNMP (Port Assigned)

```
[Dell Networking system output]
R5(conf)#do show vlan id 10
```

```
Codes: * - Default VLAN, G - GVRP VLANs
Q: U - Untagged, T - Tagged
  x - Dot1x untagged, X - Dot1x tagged
  G - GVRP tagged, M - Vlan-stack
```

```
NUM Status Description Q Ports
10 Inactive U Tengig 0/2
```

[Unix system output]

```
> snmpget -v2c -c mycommunity 10.11.131.185 .1.3.6.1.2.1.17.7.1.4.3.1.2.1107787786
SNMPv2-SMI::mib-2.17.7.1.4.3.1.2.1107787786 = Hex-STRING: 40 00 00 00 00 00 00 00 00 00
00
00 00 00 00 00
00 00 00 00 00 00 00 00 00 00 00 00 00 00 00 00
00 00 00 00 00 00 00 00 00 00 00 00 00 00 00
00 00 00 00 00 00 00 00
```

The value 40 is in the first set of 7 hex pairs, indicating that these ports are in Stack Unit 0. The hex value 40 is 0100 0000 in binary. As described, the left-most position in the string represents Port 1. The next position from the left represents Port 2 and has a value of 1, indicating that Port 0/2 is in VLAN 10. The remaining positions are 0, so those ports are not in the VLAN.

Fetching Dynamic MAC Entries using SNMP

The Aggregator supports the RFC 1493 dot1d table for the default VLAN and the dot1q table for all other VLANs.

- NOTE:** The table contains none of the other information provided by the show vlan command, such as port speed or whether the ports are tagged or untagged.
- NOTE:** The 802.1q Q-BRIDGE MIB defines VLANs regarding 802.1d, as 802.1d itself does not define them. As a switchport must belong a VLAN (the default VLAN or a configured VLAN), all MAC address learned on a switchport are associated with a VLAN. For this reason, the Q-Bridge MIB is used for MAC address query. Moreover, specific to MAC address query, the MAC address indexes dot1dTpFdbTable only for a single forwarding database, while dot1qTpFdbTable has two indices — VLAN ID and MAC address — to allow for multiple forwarding databases and considering that the same MAC address is learned on multiple VLANs. The VLAN ID is added as the first index so that MAC addresses are read by the VLAN, sorted lexicographically. The MAC address is part of the OID instance, so in this case, lexicographic order is according to the most significant octet.

Table 24. MIB Objects for Fetching Dynamic MAC Entries in the Forwarding Database

MIB Object	OID	MIB	Description
dot1dTpFdbTable	.1.3.6.1.2.1.17.4.3	Q-BRIDGE MIB	List the learned unicast MAC addresses on the default VLAN.
dot1qTpFdbTable	.1.3.6.1.2.1.17.7.1.2. 2	Q-BRIDGE MIB	List the learned unicast MAC addresses on non-default VLANs.
dot3aCurAggFdb Table	.1.3.6.1.4.1.6027.3.2. 1.1.5	F10-LINK-AGGREGATION - MIB	List the learned MAC addresses of aggregated links (LAG).

In the following example, R1 has one dynamic MAC address, learned off of port TenGigabitEthernet 0/7, which is a member of the default VLAN, VLAN 1. The SNMP walk returns the values for dot1dTpFdbAddress, dot1dTpFdbPort, and dot1dTpFdbStatus.

Each object is comprised of an OID concatenated with an instance number. In the case of these objects, the instance number is the decimal equivalent of the MAC address; derive the instance number by converting each hex pair to its decimal equivalent. For example, the decimal equivalent of E8 is 232, and so the instance number for MAC address 00:01:e8:06:95:ac is 0.1.232.6.149.172.

The value of dot1dTpFdbPort is the port number of the port off which the system learns the MAC address. In this case, of TenGigabitEthernet 0/7, the manager returns the integer 118.

Example of Fetching Dynamic MAC Addresses on the Default VLAN

```
-----MAC Addresses on Dell Networking
System-----
Dell#show mac-address-table
VlanId  Mac Address      Type      Interface  State
1       00:01:e8:06:95:ac  Dynamic   Tengig 0/7  Active
-----Query from Management Station-----
>snmpwalk -v 2c -c techpubs 10.11.131.162 .1.3.6.1.2.1.17.4.3.1
SNMPv2-SMI::mib-2.17.4.3.1.1.0.1.232.6.149.172 = Hex-STRING: 00 01 E8 06 95 AC
```

Example of Fetching Dynamic MAC Addresses on a Non-default VLANs

In the following example, TenGigabitEthernet 0/7 is moved to VLAN 1000, a non-default VLAN. To fetch the MAC addresses learned on non-default VLANs, use the object dot1qTpFdbTable. The instance number is the VLAN number concatenated with the decimal conversion of the MAC address.

```
-----MAC Addresses on Dell Networking
System-----
Dell#show mac-address-table
VlanId  Mac Address      Type      Interface  State
1000    00:01:e8:06:95:ac  Dynamic   Tengig 0/7  Active
-----Query from Management Station-----
>snmpwalk -v 2c -c techpubs 10.11.131.162 .1.3.6.1.2.1.17.7.1.2.2.1
```

Example of Fetching MAC Addresses Learned on a Port-Channel

Use dot3aCurAggFdbTable to fetch the learned MAC address of a port-channel. The instance number is the decimal conversion of the MAC address concatenated with the port-channel number.

```
-----MAC Addresses on Dell Networking
System-----
Dell(conf)#do show mac-address-table
VlanId  Mac Address      Type      Interface  State
1000    00:01:e8:06:95:ac  Dynamic   Po 1       Active
-----Query from Management Station-----
>snmpwalk -v 2c -c techpubs 10.11.131.162 .1.3.6.1.4.1.6027.3.2.1.1.5
SNMPv2-SMI::enterprises.6027.3.2.1.1.5.1.1.1000.0.1.232.6.149.172.1 = INTEGER: 1000
SNMPv2-SMI::enterprises.6027.3.2.1.1.5.1.2.1000.0.1.232.6.149.172.1 = Hex-STRING: 00 01
E8
06 95 AC
SNMPv2-SMI::enterprises.6027.3.2.1.1.5.1.3.1000.0.1.232.6.149.172.1 = INTEGER: 1
SNMPv2-SMI::enterprises.6027.3.2.1.1.5.1.4.1000.0.1.232.6.149.172.1 = INTEGER: 1
```

Deriving Interface Indices

The Dell Networking OS assigns an interface number to each (configured or unconfigured) physical and logical interface. Display the interface index number using the `show interface` command from EXEC Privilege mode, as shown in the following example.

The interface index is a binary number with bits that indicate the slot number, port number, interface type, and card type of the interface. The Dell Networking OS converts this binary index number to decimal, and displays it in the output of the `show interface` command.

Starting from the least significant bit (LSB):

- the first 14 bits represent the card type
- the next 4 bits represent the interface type
- the next 7 bits represent the port number
- the next 5 bits represent the slot number
- the next 1 bit is 0 for a physical interface and 1 for a logical interface
- the next 1 bit is unused

For example, the index 44634369 is 10101010010001000100000001 in binary. The binary interface index for TenGigabitEthernet 0/41 of an Aggregator. Notice that the physical/logical bit and the final, unused bit are not given. The interface is physical, so this must be represented by a 0 bit, and the unused bit is always 0. These two bits are not given because they are the most significant bits, and leading zeros are often omitted.

For interface indexing, slot and port numbering begins with binary one. If the Dell Networking system begins slot and port numbering from 0, binary 1 represents slot and port 0. In S4810, the first interface is 0/0, but in the Aggregator the first interface is 0/1. Hence, in the Aggregator 0/0s Ifindex is unused and Ifindex creation logic is not changed. Because Zero is reserved for logical interfaces, it starts from 1. For the first interface, port number is set to 1. Adding it causes an increment by 1 for the next interfaces, so it only starts from 2. Therefore, the port number is set to 42 for 0/41.

```
Dell#show interface tengig 1/21
TenGigabitEthernet 1/21 is up, line protocol is up
Hardware is Dell Force10Eth, address is 00:01:e8:0d:b7:4e
  Current address is 00:01:e8:0d:b7:4e
Interface index is 72925242
[output omitted]
```

MIB Support to Display Reason for Last System Reboot

Dell EMC Networking provides MIB objects to display the reason for the last system reboot. The dellNetProcessorResetReason object contains the reason for the last system reboot. The following table lists the related MIB objects.

Table 25. MIB Objects for Displaying Reason for Last System Reboot

MIB Object	OID	Description
dellNetProcessorResetReason	1.3.6.1.4.1.6027.3.26.1.4.3.1.7	This is the table that contains the reason for last system reboot.
dellNetProcessorResetTime	1.3.6.1.4.1.6027.3.26.1.4.3.1.8	This is the table that contains the timestamp.

Viewing the Reason for Last System Reboot Using SNMP

- To view the reason for last system reboot using SNMP, you can use any one of the applicable SNMP commands:

The following example shows a sample output of the `snmpwalk` command to view the last reset reason.

```
[DellEMC ~]$ snmpwalk -c public -v 2c 10.16.133.172 1.3.6.1.4.1.6027.3.26.1.4.3.1.7
DELL-NETWORKING-CHASSIS-MIB::dellNetProcessorResetReason.stack.1.1 = STRING: Reboot
by Software
DELL-NETWORKING-CHASSIS-MIB::dellNetProcessorResetReason.stack.2.1 = STRING: Reboot
by Software
DELL-NETWORKING-CHASSIS-MIB::dellNetProcessorResetReason.stack.3.1 = STRING: Cold
Reset
[DellEMC ~]$
[DellEMC ~]$ snmpwalk -c public -v 2c 10.16.133.172 1.3.6.1.4.1.6027.3.26.1.4.3.1.8
DELL-NETWORKING-CHASSIS-MIB::dellNetProcessorResetTime.stack.1.1 = STRING:
2017-11-1,5:43:44.0
DELL-NETWORKING-CHASSIS-MIB::dellNetProcessorResetTime.stack.2.1 = STRING:
2017-11-1,5:43:44.0
DELL-NETWORKING-CHASSIS-MIB::dellNetProcessorResetTime.stack.3.1 = STRING:
```

MIB Support to Display Egress Queue Statistics

Dell Networking OS provides MIB objects to display the information of the packets transmitted or dropped per unicast or multicast egress queue. The following table lists the related MIB objects:

Table 26. MIB Objects to display egress queue statistics

MIB Object	OID	Description
dellNetFpEgrQTxPacketsRate	1.3.6.1.4.1.6027.3.27.1.20.1.6	Rate of Packets transmitted per Unicast/Multicast Egress queue.

Table 26. MIB Objects to display egress queue statistics (continued)

MIB Object	OID	Description
dellNetFpEgrQTxBytesRate	1.3.6.1.4.1.6027.3.27.1.20.1.7	Rate of Bytes transmitted per Unicast/Multicast Egress queue.
dellNetFpEgrQDroppedPacketsRate	1.3.6.1.4.1.6027.3.27.1.20.1.8	Rate of Packets dropped per Unicast/Multicast Egress queue.
dellNetFpEgrQDroppedBytesRate	1.3.6.1.4.1.6027.3.27.1.20.1.9	Rate of Bytes dropped per Unicast/Multicast Egress queue.

Monitoring BGP sessions via SNMP

This section covers the monitoring of BGP sessions using SNMP.

BGP SNMP support for non-default VRF uses a SNMP context to distinguish multiple BGP VRF instances within a single BGP process. SNMP context is a repository of management information that can be accessed through the SNMP agent. SNMP supports multiple contexts in a device. SNMPv3 has a context name field in its PDU, which automatically allows the context name field to be mapped to a particular VRF instance without having to be mapped to a community map. SNMPv2c context has to be mapped to a community map. A new CLI command, `snmp context`, under BGP context, has been introduced to perform this function.

To map the context to a VRF instance for SNMPv2c, follow these steps:

1. Create a community and map a VRF to it. Create a context and map the context and community, to a community map.
 - `sho run snmp`
 - `snmp-server community public ro`
 - `snmp-server community public ro`
 - `snmp-server community vrf1 ro`
 - `snmp-server community vrf2 ro`
 - `snmp-server context context1`
 - `snmp-server context context2`
 - `snmp mib community-map vrf1 context context1`
 - `snmp mib community-map vrf1 context context2`
2. Configure `snmp context` under the VRF instances.
 - `sho run bgp`
 - `router bgp 100`
 - `address-family ipv4 vrf vrf1`
 - `snmp context context1`
 - `neighbor 20.1.1.1 remote-as 200`
 - `neighbor 20.1.1.1 no shutdown`
 - `exit-address-family`
 - `address-family ipv4 vrf vrf2`
 - `snmp context context2`
 - `timers bgp 30 90`
 - `neighbor 30.1.1.1 remote-as 200`
 - `neighbor 30.1.1.1 no shutdown`
 - `exit-address-family`

To map the context to a VRF instance for SNMPv3, follow these steps:

1. Create a community and map a VRF to it. Create a context and map the context and community, to a community map.
 - `snmp-server community public ro`
 - `snmp-server community VRF1 ro`
 - `snmp-server community VRF2 ro`
 - `snmp-server context cx1`
 - `snmp-server context cx2`
 - `snmp-server group admingroup 3 auth read readview write writeview`
 - `snmp-server group admingroup 3 auth read readview context cx1`
 - `snmp-server group admingroup 3 auth read readview context cx2`

- snmp-server user admin admingroup 3 auth md5 helloworld
- snmp mib community-map VRF1 context cx1
- snmp mib community-map VRF2 context cx2
- snmp-server view readview .1 included
- snmp-server view writeview .1 included

2. Configure `snmp context` under the VRF instances.

- `sho run bgp`
- `router bgp 100`
- `address-family ipv4 vrf vrf1`
- `snmp context context1`
- `neighbor 20.1.1.1 remote-as 200`
- `neighbor 20.1.1.1 no shutdown`
- `exit-address-family`
- `address-family ipv4 vrf vrf2`
- `snmp context context2`
- `timers bgp 30 90`
- `neighbor 30.1.1.1 remote-as 200`
- `neighbor 30.1.1.1 no shutdown`
- `exit-address-family`

Example of SNMP Walk Output for BGP timer configured for vrf1 (SNMPv2c)

```
snmpwalk -v 2c -c vrf1 10.16.131.125 1.3.6.1.4.1.6027.20.1.2.3
SNMPv2-SMI::enterprises.6027.20.1.2.3.1.1.1.0.1.20.1.1.2.1.20.1.1.1 = Gauge32: 950
SNMPv2-SMI::enterprises.6027.20.1.2.3.1.1.2.0.1.20.1.1.2.1.20.1.1.1 = Gauge32: 14
SNMPv2-SMI::enterprises.6027.20.1.2.3.2.1.1.0.1.20.1.1.2.1.20.1.1.1 = Gauge32: 60
SNMPv2-SMI::enterprises.6027.20.1.2.3.2.1.2.0.1.20.1.1.2.1.20.1.1.1 = Gauge32: 180
SNMPv2-SMI::enterprises.6027.20.1.2.3.2.1.3.0.1.20.1.1.2.1.20.1.1.1 = Gauge32: 60
SNMPv2-SMI::enterprises.6027.20.1.2.3.2.1.4.0.1.20.1.1.2.1.20.1.1.1 = Gauge32: 30
SNMPv2-SMI::enterprises.6027.20.1.2.3.2.1.5.0.1.20.1.1.2.1.20.1.1.1 = Gauge32: 30
SNMPv2-SMI::enterprises.6027.20.1.2.3.3.1.1.0.1.20.1.1.2.1.20.1.1.1 = Gauge32: 180
SNMPv2-SMI::enterprises.6027.20.1.2.3.3.1.2.0.1.20.1.1.2.1.20.1.1.1 = Gauge32: 60
```

Example of SNMP Walk Output for BGP timer configured for vrf2 (SNMPv2c)

```
snmpwalk -v 2c -c vrf2 10.16.131.125 1.3.6.1.4.1.6027.20.1.2.3
SNMPv2-SMI::enterprises.6027.20.1.2.3.1.1.1.0.1.30.1.1.2.1.30.1.1.1 = Gauge32: 950
SNMPv2-SMI::enterprises.6027.20.1.2.3.1.1.2.0.1.30.1.1.2.1.30.1.1.1 = Gauge32: 14
SNMPv2-SMI::enterprises.6027.20.1.2.3.2.1.1.0.1.30.1.1.2.1.30.1.1.1 = Gauge32: 60
SNMPv2-SMI::enterprises.6027.20.1.2.3.2.1.2.0.1.30.1.1.2.1.30.1.1.1 = Gauge32: 90
SNMPv2-SMI::enterprises.6027.20.1.2.3.2.1.3.0.1.30.1.1.2.1.30.1.1.1 = Gauge32: 30
SNMPv2-SMI::enterprises.6027.20.1.2.3.2.1.4.0.1.30.1.1.2.1.30.1.1.1 = Gauge32: 30
SNMPv2-SMI::enterprises.6027.20.1.2.3.2.1.5.0.1.30.1.1.2.1.30.1.1.1 = Gauge32: 30
SNMPv2-SMI::enterprises.6027.20.1.2.3.3.1.1.0.1.30.1.1.2.1.30.1.1.1 = Gauge32: 90
SNMPv2-SMI::enterprises.6027.20.1.2.3.3.1.2.0.1.30.1.1.2.1.30.1.1.1 = Gauge32: 30
```

Example of SNMP Walk Output for BGP timer (SNMPv3)

```
snmpwalk -v 3 -a md5 -A helloworld -l authNoPriv -n cx1 -u admin 10.16.143.179
1.3.6.1.4.1.6027.20.1.3.6.1.4
SNMPv2-SMI::enterprises.6027.20.1.3.6.1.4.2963474636.0.1 = Gauge32: 200
SNMPv2-SMI::enterprises.6027.20.1.3.6.1.4.2963475124.0.1 = Gauge32: 100
```

Monitor Port-Channels

To check the status of a Layer 2 port-channel, use `f10LinkAggMib (.1.3.6.1.4.1.6027.3.2)`. In the following example, Po 1 is a switchport and Po 2 is in Layer 3 mode.

NOTE: The interface index does not change if the interface reloads or fails over. If the unit is renumbered (for any reason) the interface index changes during a reload.

Example of SNMP Trap for Monitored Port-Channels

```
[senthilnathan@lithium ~]$ snmpwalk -v 2c -c public 10.11.1.1 .1.3.6.1.4.1.6027.3.2.1.1
SNMPv2-SMI::enterprises.6027.3.2.1.1.1.1.1.1 = INTEGER: 1
SNMPv2-SMI::enterprises.6027.3.2.1.1.1.1.1.2 = INTEGER: 2
SNMPv2-SMI::enterprises.6027.3.2.1.1.1.1.1.2.1 = Hex-STRING: 00 01 E8 13 A5 C7
SNMPv2-SMI::enterprises.6027.3.2.1.1.1.1.1.2.2 = Hex-STRING: 00 01 E8 13 A5 C8
SNMPv2-SMI::enterprises.6027.3.2.1.1.1.1.1.3.1 = INTEGER: 1107755009
SNMPv2-SMI::enterprises.6027.3.2.1.1.1.1.1.3.2 = INTEGER: 1107755010
SNMPv2-SMI::enterprises.6027.3.2.1.1.1.1.1.4.1 = INTEGER: 1
SNMPv2-SMI::enterprises.6027.3.2.1.1.1.1.1.4.2 = INTEGER: 1
SNMPv2-SMI::enterprises.6027.3.2.1.1.1.1.1.5.1 = Hex-STRING: 00 00
SNMPv2-SMI::enterprises.6027.3.2.1.1.1.1.1.5.2 = Hex-STRING: 00 00
SNMPv2-SMI::enterprises.6027.3.2.1.1.1.1.1.6.1 = STRING: "Tengig 0/4 " << Channel member for
Po1
SNMPv2-SMI::enterprises.6027.3.2.1.1.1.1.1.6.2 = STRING: "Tengig 0/5 " << Channel member for
Po2
dot3aCommonAggFdbIndex
SNMPv2-SMI::enterprises.6027.3.2.1.1.6.1.1.1107755009.1 = INTEGER: 1107755009
dot3aCommonAggFdbVlanId
SNMPv2-SMI::enterprises.6027.3.2.1.1.6.1.2.1107755009.1 = INTEGER: 1
dot3aCommonAggFdbTagConfig
SNMPv2-SMI::enterprises.6027.3.2.1.1.6.1.3.1107755009.1 = INTEGER: 2 (Tagged 1 or Untagged 2)
dot3aCommonAggFdbStatus
SNMPv2-SMI::enterprises.6027.3.2.1.1.6.1.4.1107755009.1 = INTEGER: 1 << Status active, 2 -
status inactive
```

If you learn the MAC address for the LAG, the LAG status also displays.

```
dot3aCurAggVlanId
SNMPv2-SMI::enterprises.6027.3.2.1.1.4.1.1.1.1.0.0.0.0.0.1.1 = INTEGER: 1
dot3aCurAggMacAddr
SNMPv2-SMI::enterprises.6027.3.2.1.1.4.1.2.1.0.0.0.0.0.1.1 = Hex-STRING: 00 00 00 00 00
01
dot3aCurAggIndex
SNMPv2-SMI::enterprises.6027.3.2.1.1.4.1.3.1.0.0.0.0.0.1.1 = INTEGER: 1
dot3aCurAggStatus
SNMPv2-SMI::enterprises.6027.3.2.1.1.4.1.4.1.0.0.0.0.0.1.1 = INTEGER: 1 << Status active, 2 -
status
inactive
```

For L3 LAG, you do not have this support.

```
SNMPv2-MIB::sysUpTime.0 = Timeticks: (8500842) 23:36:48.42
SNMPv2-MIB::snmpTrapOID.0 = OID: IF-MIB::linkDown
IF-MIB::ifIndex.33865785 = INTEGER: 33865785
SNMPv2-SMI::enterprises.6027.3.1.1.4.1.2 = STRING: "OSTATE_DN: Changed interface state
to down: Tengig 0/1"
2010-02-10 14:22:39 10.16.130.4 [10.16.130.4]:
SNMPv2-MIB::sysUpTime.0 = Timeticks: (8500842) 23:36:48.42
SNMPv2-MIB::snmpTrapOID.0 = OID: IF-MIB::linkDown
IF-MIB::ifIndex.1107755009 = INTEGER: 1107755009
SNMPv2-SMI::enterprises.6027.3.1.1.4.1.2 = STRING: "OSTATE_DN: Changed interface state to
down: Po 1"
2010-02-10 14:22:40 10.16.130.4 [10.16.130.4]:
SNMPv2-MIB::sysUpTime.0 = Timeticks: (8500932) 23:36:49.32 SNMPv2-MIB::snmpTrapOID.0 =
OID:
IF-MIB::linkUp IF-MIB::ifIndex.33865785 = INTEGER: 33865785 SNMPv2-
SMI::enterprises.6027.3.1.1.4.1.2 =
STRING: "OSTATE UP: Changed interface state to up: Tengig 0/1"
2010-02-10 14:22:40 10.16.130.4 [10.16.130.4]:
SNMPv2-MIB::sysUpTime.0 = Timeticks: (8500934) 23:36:49.34 SNMPv2-MIB::snmpTrapOID.0 =
OID:
IF-MIB::linkUp IF-MIB::ifIndex.1107755009 = INTEGER: 1107755009
SNMPv2-SMI::enterprises.6027.3.1.1.4.1.2 = STRING: "OSTATE_UP: Changed interface state to up:
Po 1"
```

Entity MIBS

The Entity MIB provides a mechanism for presenting hierarchies of physical entities using SNMP tables. The Entity MIB contains the following groups, which describe the physical elements and logical elements of a managed system. The following tables are implemented for the Aggregator.

- **Physical Entity:** A physical entity or physical component represents an identifiable physical resource within a managed system. Zero or more logical entities may utilize a physical resource at any given time. Determining which physical components are represented by an agent in the EntPhysicalTable is an implementation-specific matter. Typically, physical resources (for example, communications ports, backplanes, sensors, daughter-cards, power supplies, and the overall chassis), which you can manage via functions associated with one or more logical entities, are included in the MIB.
- **Containment Tree:** Each physical component may be modeled as contained within another physical component. A containment-tree is the conceptual sequence of *entPhysicalIndex* values that uniquely specifies the exact physical location of a physical component within the managed system. It is generated by following and recording each *entPhysicalContainedIn* instance up the tree towards the root, until a value of zero indicating no further containment is found.

Example of Sample Entity MIBS outputs

```
Dell#show inventory optional-module
Unit Slot Expected Inserted Next Boot Status/Power(On/Off)
-----
1 0 SFP+ SFP+ AUTO Good/On
1 1 QSFP+ QSFP+ AUTO Good/On
* - Mismatch
Dell#
The status of the MIBS is as follows:
$ snmpwalk -c public -v 2c 10.16.130.148 1.3.6.1.2.1.47.1.1.1.2
SNMPv2-SMI::mib-2.47.1.1.1.1.2.1 = ""
SNMPv2-SMI::mib-2.47.1.1.1.1.2.2 = STRING: "PowerConnect I/O-Aggregator"
SNMPv2-SMI::mib-2.47.1.1.1.1.2.3 = STRING: "Module 0"
SNMPv2-SMI::mib-2.47.1.1.1.1.2.4 = STRING: "Unit: 0 Port 1 10G Level"
SNMPv2-SMI::mib-2.47.1.1.1.1.2.5 = STRING: "Unit: 0 Port 2 10G Level"
SNMPv2-SMI::mib-2.47.1.1.1.1.2.6 = STRING: "Unit: 0 Port 3 10G Level"
SNMPv2-SMI::mib-2.47.1.1.1.1.2.7 = STRING: "Unit: 0 Port 4 10G Level"
SNMPv2-SMI::mib-2.47.1.1.1.1.2.8 = STRING: "Unit: 0 Port 5 10G Level"
SNMPv2-SMI::mib-2.47.1.1.1.1.2.9 = STRING: "Unit: 0 Port 6 10G Level"
SNMPv2-SMI::mib-2.47.1.1.1.1.2.10 = STRING: "Unit: 0 Port 7 10G Level"
SNMPv2-SMI::mib-2.47.1.1.1.1.2.11 = STRING: "Unit: 0 Port 8 10G Level"
SNMPv2-SMI::mib-2.47.1.1.1.1.2.12 = STRING: "Unit: 0 Port 9 10G Level"
SNMPv2-SMI::mib-2.47.1.1.1.1.2.13 = STRING: "Unit: 0 Port 10 10G Level"
SNMPv2-SMI::mib-2.47.1.1.1.1.2.14 = STRING: "Unit: 0 Port 11 10G Level"
SNMPv2-SMI::mib-2.47.1.1.1.1.2.15 = STRING: "Unit: 0 Port 12 10G Level"
SNMPv2-SMI::mib-2.47.1.1.1.1.2.16 = STRING: "Unit: 0 Port 13 10G Level"
SNMPv2-SMI::mib-2.47.1.1.1.1.2.17 = STRING: "Unit: 0 Port 14 10G Level"
SNMPv2-SMI::mib-2.47.1.1.1.1.2.18 = STRING: "Unit: 0 Port 15 10G Level"
SNMPv2-SMI::mib-2.47.1.1.1.1.2.19 = STRING: "Unit: 0 Port 16 10G Level"
SNMPv2-SMI::mib-2.47.1.1.1.1.2.20 = STRING: "Unit: 0 Port 17 10G Level"
SNMPv2-SMI::mib-2.47.1.1.1.1.2.21 = STRING: "Unit: 0 Port 18 10G Level"
SNMPv2-SMI::mib-2.47.1.1.1.1.2.22 = STRING: "Unit: 0 Port 19 10G Level"
SNMPv2-SMI::mib-2.47.1.1.1.1.2.23 = STRING: "Unit: 0 Port 20 10G Level"
SNMPv2-SMI::mib-2.47.1.1.1.1.2.24 = STRING: "Unit: 0 Port 21 10G Level"
SNMPv2-SMI::mib-2.47.1.1.1.1.2.25 = STRING: "Unit: 0 Port 22 10G Level"
SNMPv2-SMI::mib-2.47.1.1.1.1.2.26 = STRING: "Unit: 0 Port 23 10G Level"
SNMPv2-SMI::mib-2.47.1.1.1.1.2.27 = STRING: "Unit: 0 Port 24 10G Level"
SNMPv2-SMI::mib-2.47.1.1.1.1.2.28 = STRING: "Unit: 0 Port 25 10G Level"
SNMPv2-SMI::mib-2.47.1.1.1.1.2.29 = STRING: "Unit: 0 Port 26 10G Level"
SNMPv2-SMI::mib-2.47.1.1.1.1.2.30 = STRING: "Unit: 0 Port 27 10G Level"
SNMPv2-SMI::mib-2.47.1.1.1.1.2.31 = STRING: "Unit: 0 Port 28 10G Level"
SNMPv2-SMI::mib-2.47.1.1.1.1.2.32 = STRING: "Unit: 0 Port 29 10G Level"
SNMPv2-SMI::mib-2.47.1.1.1.1.2.33 = STRING: "Unit: 0 Port 30 10G Level"
SNMPv2-SMI::mib-2.47.1.1.1.1.2.34 = STRING: "Unit: 0 Port 31 10G Level"
SNMPv2-SMI::mib-2.47.1.1.1.1.2.35 = STRING: "Unit: 0 Port 32 10G Level"
SNMPv2-SMI::mib-2.47.1.1.1.1.2.36 = STRING: "40G QSFP+ port"
SNMPv2-SMI::mib-2.47.1.1.1.1.2.37 = STRING: "Unit: 0 Port 33 40G Level"
SNMPv2-SMI::mib-2.47.1.1.1.1.2.41 = STRING: "40G QSFP+ port"
SNMPv2-SMI::mib-2.47.1.1.1.1.2.42 = STRING: "Unit: 0 Port 37 40G Level"
SNMPv2-SMI::mib-2.47.1.1.1.1.2.46 = STRING: "Optional module 0"
```

```

SNMPv2-SMI::mib-2.47.1.1.1.1.2.56 = STRING: "Optional module 1"
SNMPv2-SMI::mib-2.47.1.1.1.1.2.57 = STRING: "4-port 10GE 10BASE-T (XL) "
SNMPv2-SMI::mib-2.47.1.1.1.1.2.58 = STRING: "Unit: 0 Port 49 10G Level"
SNMPv2-SMI::mib-2.47.1.1.1.1.2.59 = STRING: "Unit: 0 Port 50 10G Level"
SNMPv2-SMI::mib-2.47.1.1.1.1.2.60 = STRING: "Unit: 0 Port 51 10G Level"
SNMPv2-SMI::mib-2.47.1.1.1.1.2.61 = STRING: "Unit: 0 Port 52 10G Level"
SNMPv2-SMI::mib-2.47.1.1.1.1.2.66 = STRING: "PowerConnect I/O-Aggregator"
SNMPv2-SMI::mib-2.47.1.1.1.1.2.67 = STRING: "Module 0"
SNMPv2-SMI::mib-2.47.1.1.1.1.2.68 = STRING: "Unit: 1 Port 1 10G Level"
SNMPv2-SMI::mib-2.47.1.1.1.1.2.69 = STRING: "Unit: 1 Port 2 10G Level"
SNMPv2-SMI::mib-2.47.1.1.1.1.2.70 = STRING: "Unit: 1 Port 3 10G Level"
SNMPv2-SMI::mib-2.47.1.1.1.1.2.71 = STRING: "Unit: 1 Port 4 10G Level"
SNMPv2-SMI::mib-2.47.1.1.1.1.2.72 = STRING: "Unit: 1 Port 5 10G Level"
SNMPv2-SMI::mib-2.47.1.1.1.1.2.73 = STRING: "Unit: 1 Port 6 10G Level"
SNMPv2-SMI::mib-2.47.1.1.1.1.2.74 = STRING: "Unit: 1 Port 7 10G Level"
SNMPv2-SMI::mib-2.47.1.1.1.1.2.75 = STRING: "Unit: 1 Port 8 10G Level"
SNMPv2-SMI::mib-2.47.1.1.1.1.2.76 = STRING: "Unit: 1 Port 9 10G Level"
SNMPv2-SMI::mib-2.47.1.1.1.1.2.77 = STRING: "Unit: 1 Port 10 10G Level"
SNMPv2-SMI::mib-2.47.1.1.1.1.2.78 = STRING: "Unit: 1 Port 11 10G Level"
SNMPv2-SMI::mib-2.47.1.1.1.1.2.79 = STRING: "Unit: 1 Port 12 10G Level"
SNMPv2-SMI::mib-2.47.1.1.1.1.2.80 = STRING: "Unit: 1 Port 13 10G Level"
SNMPv2-SMI::mib-2.47.1.1.1.1.2.81 = STRING: "Unit: 1 Port 14 10G Level"
SNMPv2-SMI::mib-2.47.1.1.1.1.2.82 = STRING: "Unit: 1 Port 15 10G Level"
SNMPv2-SMI::mib-2.47.1.1.1.1.2.83 = STRING: "Unit: 1 Port 16 10G Level"
SNMPv2-SMI::mib-2.47.1.1.1.1.2.84 = STRING: "Unit: 1 Port 17 10G Level"
SNMPv2-SMI::mib-2.47.1.1.1.1.2.85 = STRING: "Unit: 1 Port 18 10G Level"
SNMPv2-SMI::mib-2.47.1.1.1.1.2.86 = STRING: "Unit: 1 Port 19 10G Level"
SNMPv2-SMI::mib-2.47.1.1.1.1.2.87 = STRING: "Unit: 1 Port 20 10G Level"
SNMPv2-SMI::mib-2.47.1.1.1.1.2.88 = STRING: "Unit: 1 Port 21 10G Level"
SNMPv2-SMI::mib-2.47.1.1.1.1.2.89 = STRING: "Unit: 1 Port 22 10G Level"
SNMPv2-SMI::mib-2.47.1.1.1.1.2.90 = STRING: "Unit: 1 Port 23 10G Level"
SNMPv2-SMI::mib-2.47.1.1.1.1.2.91 = STRING: "Unit: 1 Port 24 10G Level"
SNMPv2-SMI::mib-2.47.1.1.1.1.2.92 = STRING: "Unit: 1 Port 25 10G Level"
SNMPv2-SMI::mib-2.47.1.1.1.1.2.93 = STRING: "Unit: 1 Port 26 10G Level"
SNMPv2-SMI::mib-2.47.1.1.1.1.2.94 = STRING: "Unit: 1 Port 27 10G Level"
SNMPv2-SMI::mib-2.47.1.1.1.1.2.95 = STRING: "Unit: 1 Port 28 10G Level"
SNMPv2-SMI::mib-2.47.1.1.1.1.2.96 = STRING: "Unit: 1 Port 29 10G Level"
SNMPv2-SMI::mib-2.47.1.1.1.1.2.97 = STRING: "Unit: 1 Port 30 10G Level"
SNMPv2-SMI::mib-2.47.1.1.1.1.2.98 = STRING: "Unit: 1 Port 31 10G Level"
SNMPv2-SMI::mib-2.47.1.1.1.1.2.99 = STRING: "Unit: 1 Port 32 10G Level"
SNMPv2-SMI::mib-2.47.1.1.1.1.2.100 = STRING: "40G QSFP+ port"
SNMPv2-SMI::mib-2.47.1.1.1.1.2.101 = STRING: "Unit: 1 Port 33 40G Level"
SNMPv2-SMI::mib-2.47.1.1.1.1.2.105 = STRING: "40G QSFP+ port"
SNMPv2-SMI::mib-2.47.1.1.1.1.2.106 = STRING: "Unit: 1 Port 37 40G Level"
SNMPv2-SMI::mib-2.47.1.1.1.1.2.110 = STRING: "Optional module 0"
SNMPv2-SMI::mib-2.47.1.1.1.1.2.111 = STRING: "4-port 10GE SFP+ (XL) "
SNMPv2-SMI::mib-2.47.1.1.1.1.2.112 = STRING: "Unit: 1 Port 41 10G Level"
SNMPv2-SMI::mib-2.47.1.1.1.1.2.113 = STRING: "Unit: 1 Port 42 10G Level"
SNMPv2-SMI::mib-2.47.1.1.1.1.2.114 = STRING: "Unit: 1 Port 43 10G Level"
SNMPv2-SMI::mib-2.47.1.1.1.1.2.115 = STRING: "Unit: 1 Port 44 10G Level"
SNMPv2-SMI::mib-2.47.1.1.1.1.2.120 = STRING: "Optional module 1"

```

SNMP Traps for Link Status

To enable SNMP traps for link status changes, use the `snmp-server enable traps snmp linkdown linkup` command.

Standard VLAN MIB

When the Aggregator is in Standalone mode, where all the 4000 VLANs are part of all server side interfaces as well as the single uplink LAG, it takes a long time (30 seconds or more) for external management entities to discover the entire VLAN membership table of all the ports. Support for current status OID in the standard VLAN MIB is expected to simplify and speed up this process. This OID provides 4000 VLAN entries with port membership bit map for each VLAN and reduces the scan for (4000 X Number of ports) to 4000.

Enhancements

1. The `dot1qVlanCurrentEgressPorts` MIB attribute has been enhanced to support logical LAG interfaces.
2. Current status OID in standard VLAN MIB is accessible over SNMP.
3. The bitmap supports 42 bytes for physical ports and 16 bytes for the LAG interfaces (up to a maximum of 128 LAG interfaces).
4. A 59 byte buffer bitmap is supported and in that bitmap:
 - First 42 bytes represent the physical ports.
 - Next 16 bytes represent logical ports 1-128.
 - An additional 1 byte is reserved for future.

Fetching the Switchport Configuration and the Logical Interface Configuration

Important Points to Remember

- The SNMP should be configured in the chassis and the chassis management interface should be up with the IP address.
- If a port is configured in a VLAN, the respective bit for that port will be set to 1 in the specific VLAN.
- In the aggregator, all the server ports and uplink LAG 128 will be in switchport. Hence, the respective bits are set to 1.

The following output is for the default VLAN.

Example of `dot1qVlanCurrentUntaggedPorts` output

```
snmpwalk -Os -c public -v 1 10.16.151.151 1.3.6.1.2.1.17.7.1.4.2.1.5
mib-2.17.7.1.4.2.1.5.0.1107525633 = Hex-STRING: FF FF FF FF 00 00 00 00 00 00 00 00 00 00 00 00
00 00 00 00 00 00 00 00 00 00 00 00 00 00 00 00
00 00 00 00 00 00 00 00 00 00 00 00 00 00 00 00
00 00 00 00 00 00 00 00 00 00 01 00
```

The last byte is free byte . The bit for LAGs starts from 43 byte. If server LAG 1 is created with server ports Te 0/6 and Te 0/7, the respective bit for the ports are unset and the bit for LAG 1 is set in default VLAN. The corresponding output will be as follows:

```
snmpwalk -Os -c public -v 1 10.16.151.151 1.3.6.1.2.1.17.7.1.4.2.1.5
mib-2.17.7.1.4.2.1.5.0.1107525633 = Hex-STRING: F9 FF FF FF 00 00 00 00 00 00 00 00 00 00 00 00
00 00 00 00 00 00 00 00 00 00 00 00 00 00 00 00
00 00 00 00 00 00 00 00 00 00 80 00 00 00 00 00
00 00 00 00 00 00 00 00 00 00 01 00
```

In the above example, the 43rd byte is set to 80. The 43rd byte is for LAG IDs from 1 to 8. But, only one LAG po 1 is set as switch port. Hence, the binary bits will be 10000000. If this converted to Hexadecimal, the value will be 80. Similarly, the first byte for Te 0/1 to Te 0/8 server ports, as the 6th and 7th byte is removed from switch port, the respective bits are set to 0. In binary, the value is 11111001 and the corresponding hex decimal value is F9.

In standalone mode, there are 4000 VLANs, by default. The SNMP output will display for all 4000 VLANs. To view a particular VLAN, issue the `snmp query` with VLAN interface ID.

```
Dell#show interface vlan 1010 | grep "Interface index"
Interface index is 1107526642
```

Use the output of the above command in the snmp query.

```
snmpwalk -Os -c public -v 1 10.16.151.151 1.3.6.1.2.1.17.7.1.4.2.1.4.0.1107526642
mib-2.17.7.1.4.2.1.4.0.1107526642 = Hex-STRING: F9 FF FF FF 00 00 00 00 00 00 00 00 00 00 00 00
00 00 00 00 00 00 00 00 00 00 00 00 00 00 00 00
00 00 00 00 00 00 00 00 00 00 80 00 00 00 00 00
00 00 00 00 00 00 00 00 00 00 01 00
```

MIB Support to Display the Available Memory Size on Flash

Dell Networking provides more MIB objects to display the available memory size on flash memory. The following table lists the MIB object that contains the available memory size on flash memory.

Table 27. MIB Objects for Displaying the Available Memory Size on Flash via SNMP

MIB Object	OID	Description
chStackUnitFlashUsageUtil	1.3.6.1.4.1.6027.3.19.1.2.8.1.6	Contains flash memory usage in percentage.

The chStackUnitUtilTable MIB table contains the chStackUnitFlashUsageUtil MIB object which contains the flash memory usage percent.

Viewing the Available Flash Memory Size

- To view the available flash memory using SNMP, use the following command.

```
snmpget -v2c -c public 192.168.60.120 .1.3.6.1.4.1.6027.3.10.1.2.9.1.6.1
```

```
enterprises.6027.3.10.1.2.9.1.5.1 = Gauge32: 24
```

The output above displays that 24% of the flash memory is used.

MIB Support to Display the Software Core Files Generated by the System

Dell Networking provides MIB objects to display the software core files generated by the system. The chSysSwCoresTable contains the list of software core files generated by the system. The following table lists the related MIB objects.

Table 28. MIB Objects for Displaying the Software Core Files Generated by the System

MIB Object	OID	Description
chSysSwCoresTable	1.3.6.1.4.1.6027.3.19.1.2.9	This is the table that contains the list of software core files generated by the system.
chSysCoresEntry	1.3.6.1.4.1.6027.3.19.1.2.9.1	Entry number.
chSysCoresInstance	1.3.6.1.4.1.6027.3.19.1.2.9.1.1	Stores the indexed information about the available software core files.
chSysCoresFileName	1.3.6.1.4.1.6027.3.19.1.2.9.1.2	Contains the core file names and the file paths.
chSysCoresTimeCreated	1.3.6.1.4.1.6027.3.19.1.2.9.1.3	Contains the time at which core files are created.
chSysCoresStackUnitNumber	1.3.6.1.4.1.6027.3.19.1.2.9.1.4	Contains information that includes which stack unit or processor the core file was originated from.
chSysCoresProcess	1.3.6.1.4.1.6027.3.19.1.2.9.1.5	Contains information that includes the process names that generated each core file.

Viewing the Software Core Files Generated by the System

- To view the viewing the software core files generated by the system, use the following command.

```
snmpwalk -v2c -c public 192.168.60.120 .1.3.6.1.4.1.6027.3.10.1.2.10
```

```
enterprises.6027.3.10.1.2.10.1.1.1.1 = 1
enterprises.6027.3.10.1.2.10.1.1.1.2 = 2
enterprises.6027.3.10.1.2.10.1.1.1.3 = 3
enterprises.6027.3.10.1.2.10.1.1.2.1 = 1
enterprises.6027.3.10.1.2.10.1.2.1.1 = "/CORE_DUMP_DIR/flashmntr.core.gz"
enterprises.6027.3.10.1.2.10.1.2.1.2 = "/CORE_DUMP_DIR/FTP_STK_MEMBER/
f10cp_l2mgr_131108080758_Stk1.acore.gz"
enterprises.6027.3.10.1.2.10.1.2.1.3 = "/CORE_DUMP_DIR/FTP_STK_MEMBER/
f10cp_vrrp_140522124357_Stk1.acore.gz"
enterprises.6027.3.10.1.2.10.1.2.2.1 =
"/CORE_DUMP_DIR/FTP_STK_MEMBER/f10cp_sysd_140617134445_Stk0.acore.gz"
enterprises.6027.3.10.1.2.10.1.3.1.1 = "Fri Mar 14 11:51:46 2014"
enterprises.6027.3.10.1.2.10.1.3.1.2 = "Fri Nov 8 08:11:16 2013"
enterprises.6027.3.10.1.2.10.1.3.1.3 = "Fri May 23 05:05:16 2014"
enterprises.6027.3.10.1.2.10.1.3.2.1 = "Tue Jun 17 14:19:26 2014"
enterprises.6027.3.10.1.2.10.1.4.1.1 = 0
enterprises.6027.3.10.1.2.10.1.4.1.2 = 1
enterprises.6027.3.10.1.2.10.1.4.1.3 = 1
enterprises.6027.3.10.1.2.10.1.4.2.1 = 0
enterprises.6027.3.10.1.2.10.1.5.1.1 = "flashmntr"
enterprises.6027.3.10.1.2.10.1.5.1.2 = "l2mgr"
enterprises.6027.3.10.1.2.10.1.5.1.3 = "vrrp" Hex: 76 72 72 70
enterprises.6027.3.10.1.2.10.1.5.2.1 = "sysd" Hex: 73 79 73 64
```

The output above displays that the software core files generated by the system.

MIB Support to Display the Available Partitions on Flash

Dell EMC Networking provides MIB objects to display the information of various partitions such as /flash, /tmp, /usr/pkg, and /f10/ConfD. The dellNetFlashStorageTable table contains the list of all partitions on disk. The following table lists the related MIB objects:

Table 29. MIB Objects to Display the Available Partitions on Flash

MIB Object	OID	Description
dellNetFlashPartitionNumber	1.3.6.1.4.1.6027.3.26.1.4.8.1.1	Index for the table.
dellNetFlashPartitionName	1.3.6.1.4.1.6027.3.26.1.4.8.1.2	Contains partition name and complete path.
dellNetFlashPartitionSize	1.3.6.1.4.1.6027.3.26.1.4.8.1.3	Contains the partition size.
dellNetFlashPartitionUsed	1.3.6.1.4.1.6027.3.26.1.4.8.1.4	Contains the amount of space used by the files on the partition.
dellNetFlashPartitionFree	1.3.6.1.4.1.6027.3.26.1.4.8.1.5	Contains the amount of free space available on the partition.
dellNetFlashPartitionMountPoint	1.3.6.1.4.1.6027.3.26.1.4.8.1.6	Symbolic or Alias name for the partition.

Viewing the Available Partitions on Flash

- To view the available partitions on flash using SNMP, use the following command:

```
snmpwalk -v 2c -c public -On 10.16.150.97 1.3.6.1.4.1.6027.3.26.1.4.8
```

```
.1.3.6.1.4.1.6027.3.26.1.4.8.1.2.1 = STRING: "tmpfs"
.1.3.6.1.4.1.6027.3.26.1.4.8.1.2.2 = STRING: "/dev/wd0i"
.1.3.6.1.4.1.6027.3.26.1.4.8.1.2.3 = STRING: "mfs:477"
.1.3.6.1.4.1.6027.3.26.1.4.8.1.2.4 = STRING: "/dev/wd0e"
.1.3.6.1.4.1.6027.3.26.1.4.8.1.3.1 = INTEGER: 40960
.1.3.6.1.4.1.6027.3.26.1.4.8.1.3.2 = INTEGER: 4128782
.1.3.6.1.4.1.6027.3.26.1.4.8.1.3.3 = INTEGER: 148847
.1.3.6.1.4.1.6027.3.26.1.4.8.1.3.4 = INTEGER: 4186108
.1.3.6.1.4.1.6027.3.26.1.4.8.1.4.1 = INTEGER: 28
.1.3.6.1.4.1.6027.3.26.1.4.8.1.4.2 = INTEGER: 28
.1.3.6.1.4.1.6027.3.26.1.4.8.1.4.3 = INTEGER: 2537
.1.3.6.1.4.1.6027.3.26.1.4.8.1.4.4 = INTEGER: 76200
.1.3.6.1.4.1.6027.3.26.1.4.8.1.5.1 = INTEGER: 40932
.1.3.6.1.4.1.6027.3.26.1.4.8.1.5.2 = INTEGER: 3922316
.1.3.6.1.4.1.6027.3.26.1.4.8.1.5.3 = INTEGER: 138868
.1.3.6.1.4.1.6027.3.26.1.4.8.1.5.4 = INTEGER: 4109908
.1.3.6.1.4.1.6027.3.26.1.4.8.1.6.1 = STRING: "/tmp"
.1.3.6.1.4.1.6027.3.26.1.4.8.1.6.2 = STRING: "/usr/pkg"
.1.3.6.1.4.1.6027.3.26.1.4.8.1.6.3 = STRING: "/f10/ConfD/db"
.1.3.6.1.4.1.6027.3.26.1.4.8.1.6.4 = STRING: "/f10/flash"
```

- If Smart Script is installed on the system, the log also shows the phone home partition.

```
snmpwalk -v 2c -c public -On 10.16.151.161 1.3.6.1.4.1.6027.3.26.1.4.8
.1.3.6.1.4.1.6027.3.26.1.4.8.1.2.1 = STRING: "/dev/ld0g"
.1.3.6.1.4.1.6027.3.26.1.4.8.1.2.2 = STRING: "mfs:332"
.1.3.6.1.4.1.6027.3.26.1.4.8.1.2.3 = STRING: "mfs:398"
.1.3.6.1.4.1.6027.3.26.1.4.8.1.2.4 = STRING: "/dev/ld0h"
.1.3.6.1.4.1.6027.3.26.1.4.8.1.2.5 = STRING: "tmpfs"
.1.3.6.1.4.1.6027.3.26.1.4.8.1.3.1 = INTEGER: 4624894
.1.3.6.1.4.1.6027.3.26.1.4.8.1.3.2 = INTEGER: 59503
.1.3.6.1.4.1.6027.3.26.1.4.8.1.3.3 = INTEGER: 148847
.1.3.6.1.4.1.6027.3.26.1.4.8.1.3.4 = INTEGER: 2008708
.1.3.6.1.4.1.6027.3.26.1.4.8.1.3.5 = INTEGER: 51200
.1.3.6.1.4.1.6027.3.26.1.4.8.1.4.1 = INTEGER: 521636
.1.3.6.1.4.1.6027.3.26.1.4.8.1.4.2 = INTEGER: 1
.1.3.6.1.4.1.6027.3.26.1.4.8.1.4.3 = INTEGER: 2545
.1.3.6.1.4.1.6027.3.26.1.4.8.1.4.4 = INTEGER: 400528
.1.3.6.1.4.1.6027.3.26.1.4.8.1.4.5 = INTEGER: 60
.1.3.6.1.4.1.6027.3.26.1.4.8.1.5.1 = INTEGER: 3872014
.1.3.6.1.4.1.6027.3.26.1.4.8.1.5.2 = INTEGER: 56527
.1.3.6.1.4.1.6027.3.26.1.4.8.1.5.3 = INTEGER: 138860
.1.3.6.1.4.1.6027.3.26.1.4.8.1.5.4 = INTEGER: 1608180
.1.3.6.1.4.1.6027.3.26.1.4.8.1.5.5 = INTEGER: 51140
.1.3.6.1.4.1.6027.3.26.1.4.8.1.6.1 = STRING: "/usr/pkg"
.1.3.6.1.4.1.6027.3.26.1.4.8.1.6.2 = STRING: "/tmpimg"
.1.3.6.1.4.1.6027.3.26.1.4.8.1.6.3 = STRING: "/f10/ConfD/db"
.1.3.6.1.4.1.6027.3.26.1.4.8.1.6.4 = STRING: "/f10/flash"
.1.3.6.1.4.1.6027.3.26.1.4.8.1.6.5 = STRING: "/f10/phonehome"
```

MIB Support to Display Egress Queue Statistics

Dell Networking OS provides MIB objects to display the information of the packets transmitted or dropped per unicast or multicast egress queue. The following table lists the related MIB objects:

Table 30. MIB Objects to display egress queue statistics

MIB Object	OID	Description
dellNetFpEgrQTxPacketsRate	1.3.6.1.4.1.6027.3.27.1.20.1.6	Rate of Packets transmitted per Unicast/Multicast Egress queue.
dellNetFpEgrQTxBytesRate	1.3.6.1.4.1.6027.3.27.1.20.1.7	Rate of Bytes transmitted per Unicast/Multicast Egress queue.

Table 30. MIB Objects to display egress queue statistics (continued)

MIB Object	OID	Description
dellNetFpEgrQDroppedPacketsRate	1.3.6.1.4.1.6027.3.27.1.20.1.8	Rate of Packets dropped per Unicast/Multicast Egress queue.
dellNetFpEgrQDroppedBytesRate	1.3.6.1.4.1.6027.3.27.1.20.1.9	Rate of Bytes dropped per Unicast/Multicast Egress queue.

MIB Support to Display Egress Queue Statistics

Dell Networking OS provides MIB objects to display the information of the ECMP group count information. The following table lists the related MIB objects:

Table 31. MIB Objects to display ECMP Group Count

MIB Object	OID	Description
dellNetInetCidrECMPGrpMax	1.3.6.1.4.1.6027.3.9.1.6	Total CAM for ECMP group.
dellNetInetCidrECMPGrpUsed	1.3.6.1.4.1.6027.3.9.1.7	Used CAM for ECMP group.
dellNetInetCidrECMPGrpAvl	1.3.6.1.4.1.6027.3.9.1.8	Available CAM for ECMP group.

Viewing the ECMP Group Count Information

- To view the ECMP group count information generated by the system, use the following command.

```
snmpwalk -c public -v 2c 10.16.151.191 1.3.6.1.4.1.6027.3.9
```

```
SNMPv2-SMI::enterprises.6027.3.9.1.1.1.2.1.1 = Counter64: 79
SNMPv2-SMI::enterprises.6027.3.9.1.1.1.2.1.2 = Counter64: 1
SNMPv2-SMI::enterprises.6027.3.9.1.3.0 = Gauge32: 18
SNMPv2-SMI::enterprises.6027.3.9.1.4.0 = Gauge32: 1
SNMPv2-SMI::enterprises.6027.3.9.1.5.1.8.1.1.4.10.1.1.0.24.0.0.0.0 = INTEGER: 2098693
SNMPv2-SMI::enterprises.6027.3.9.1.5.1.8.1.1.4.10.1.1.1.32.1.4.10.1.1.1.1.4.10.1.1.1
= INTEGER: 2098693
SNMPv2-
SMI::enterprises.6027.3.9.1.5.1.8.1.1.4.10.1.1.2.32.1.4.127.0.0.1.1.4.127.0.0.1 =
INTEGER: 0
SNMPv2-SMI::enterprises.6027.3.9.1.5.1.8.1.1.4.20.1.1.0.24.0.0.0.0 = INTEGER:
1258296320
SNMPv2-SMI::enterprises.6027.3.9.1.5.1.8.1.1.4.20.1.1.1.32.1.4.20.1.1.1.1.4.20.1.1.1
= INTEGER: 1258296320
SNMPv2-
SMI::enterprises.6027.3.9.1.5.1.8.1.1.4.20.1.1.2.32.1.4.127.0.0.1.1.4.127.0.0.1 =
INTEGER: 0
SNMPv2-SMI::enterprises.6027.3.9.1.5.1.8.1.1.4.30.1.1.0.24.0.0.0.0 = INTEGER:
1275078656
SNMPv2-SMI::enterprises.6027.3.9.1.5.1.8.1.1.4.30.1.1.1.32.1.4.30.1.1.1.1.4.30.1.1.1
= INTEGER: 1275078656
SNMPv2-
SMI::enterprises.6027.3.9.1.5.1.8.1.1.4.30.1.1.2.32.1.4.127.0.0.1.1.4.127.0.0.1 =
INTEGER: 0
SNMPv2-SMI::enterprises.6027.3.9.1.5.1.8.1.1.4.70.70.70.0.24.0.0.0.0 = INTEGER:
2097157
SNMPv2-
SMI::enterprises.6027.3.9.1.5.1.8.1.1.4.70.70.70.1.32.1.4.127.0.0.1.1.4.127.0.0.1 =
INTEGER: 0
SNMPv2-
SMI::enterprises.6027.3.9.1.5.1.8.1.1.4.70.70.70.2.32.1.4.70.70.70.2.1.4.70.70.70.2 =
INTEGER: 2097157
SNMPv2-
SMI::enterprises.6027.3.9.1.5.1.8.1.1.4.80.80.80.0.24.1.4.10.1.1.1.1.4.10.1.1.1 =
INTEGER: 2098693
SNMPv2-
SMI::enterprises.6027.3.9.1.5.1.8.1.1.4.80.80.80.0.24.1.4.20.1.1.1.1.4.20.1.1.1 =
```

```

INTEGER: 1258296320
SNMPv2-
SMI::enterprises.6027.3.9.1.5.1.8.1.1.4.80.80.80.0.24.1.4.30.1.1.1.1.4.30.1.1.1 =
INTEGER: 1275078656
SNMPv2-SMI::enterprises.6027.3.9.1.5.1.8.1.1.4.90.90.90.0.24.0.0.0.0 = INTEGER:
2097157
SNMPv2-
SMI::enterprises.6027.3.9.1.5.1.8.1.1.4.90.90.90.1.32.1.4.127.0.0.1.1.4.127.0.0.1 =
INTEGER: 0
SNMPv2-
SMI::enterprises.6027.3.9.1.5.1.8.1.1.4.90.90.90.2.32.1.4.90.90.90.2.1.4.90.90.90.2 =
INTEGER: 2097157
SNMPv2-
SMI::enterprises.6027.3.9.1.5.1.8.1.1.4.100.100.100.0.24.1.4.10.1.1.1.1.4.10.1.1.1 =
INTEGER: 2098693
SNMPv2-
SMI::enterprises.6027.3.9.1.5.1.8.1.1.4.100.100.100.0.24.1.4.20.1.1.1.1.4.20.1.1.1 =
INTEGER: 1258296320
SNMPv2-
SMI::enterprises.6027.3.9.1.5.1.8.1.1.4.100.100.100.0.24.1.4.30.1.1.1.1.4.30.1.1.1 =
INTEGER: 1275078656
SNMPv2-SMI::enterprises.6027.3.9.1.5.1.9.1.1.4.10.1.1.0.24.0.0.0.0 = ""
SNMPv2-SMI::enterprises.6027.3.9.1.5.1.9.1.1.4.10.1.1.1.32.1.4.10.1.1.1.1.4.10.1.1.1
= Hex-STRING: 4C 76 25 F4 AB 02
SNMPv2-
SMI::enterprises.6027.3.9.1.5.1.9.1.1.4.10.1.1.2.32.1.4.127.0.0.1.1.4.127.0.0.1 = ""
SNMPv2-SMI::enterprises.6027.3.9.1.5.1.9.1.1.4.20.1.1.0.24.0.0.0.0 = ""
SNMPv2-SMI::enterprises.6027.3.9.1.5.1.9.1.1.4.20.1.1.1.32.1.4.20.1.1.1.1.4.20.1.1.1
= Hex-STRING: 4C 76 25 F4 AB 02
SNMPv2-
SMI::enterprises.6027.3.9.1.5.1.9.1.1.4.20.1.1.2.32.1.4.127.0.0.1.1.4.127.0.0.1 = ""
SNMPv2-SMI::enterprises.6027.3.9.1.5.1.9.1.1.4.30.1.1.0.24.0.0.0.0 = ""
SNMPv2-SMI::enterprises.6027.3.9.1.5.1.9.1.1.4.30.1.1.1.32.1.4.30.1.1.1.1.4.30.1.1.1
= Hex-STRING: 4C 76 25 F4 AB 02
SNMPv2-
SMI::enterprises.6027.3.9.1.5.1.9.1.1.4.30.1.1.2.32.1.4.127.0.0.1.1.4.127.0.0.1 = ""
SNMPv2-SMI::enterprises.6027.3.9.1.5.1.9.1.1.4.70.70.70.0.24.0.0.0.0 = ""
SNMPv2-
SMI::enterprises.6027.3.9.1.5.1.9.1.1.4.70.70.70.1.32.1.4.127.0.0.1.1.4.127.0.0.1 = ""
SNMPv2-
SMI::enterprises.6027.3.9.1.5.1.9.1.1.4.70.70.70.2.32.1.4.70.70.70.2.1.4.70.70.70.2 =
Hex-STRING: 00 00 F4 FD 2C EF
SNMPv2-
SMI::enterprises.6027.3.9.1.5.1.9.1.1.4.80.80.80.0.24.1.4.10.1.1.1.1.4.10.1.1.1 = Hex-
STRING: 4C 76 25 F4 AB 02
SNMPv2-
SMI::enterprises.6027.3.9.1.5.1.9.1.1.4.80.80.80.0.24.1.4.20.1.1.1.1.4.20.1.1.1 = Hex-
STRING: 4C 76 25 F4 AB 02
SNMPv2-
SMI::enterprises.6027.3.9.1.5.1.9.1.1.4.80.80.80.0.24.1.4.30.1.1.1.1.4.30.1.1.1 = Hex-
STRING: 4C 76 25 F4 AB 02
SNMPv2-SMI::enterprises.6027.3.9.1.5.1.9.1.1.4.90.90.90.0.24.0.0.0.0 = ""
SNMPv2-
SMI::enterprises.6027.3.9.1.5.1.9.1.1.4.90.90.90.1.32.1.4.127.0.0.1.1.4.127.0.0.1 = ""
SNMPv2-
SMI::enterprises.6027.3.9.1.5.1.9.1.1.4.90.90.90.2.32.1.4.90.90.90.2.1.4.90.90.90.2 =
Hex-STRING: 00 00 DA FE 04 0B
SNMPv2-
SMI::enterprises.6027.3.9.1.5.1.9.1.1.4.100.100.100.0.24.1.4.10.1.1.1.1.4.10.1.1.1 =
Hex-STRING: 4C 76 25 F4 AB 02
SNMPv2-
SMI::enterprises.6027.3.9.1.5.1.9.1.1.4.100.100.100.0.24.1.4.20.1.1.1.1.4.20.1.1.1 =
Hex-STRING: 4C 76 25 F4 AB 02
SNMPv2-
SMI::enterprises.6027.3.9.1.5.1.9.1.1.4.100.100.100.0.24.1.4.30.1.1.1.1.4.30.1.1.1 =
Hex-STRING: 4C 76 25 F4 AB 02
SNMPv2-SMI::enterprises.6027.3.9.1.5.1.10.1.1.4.10.1.1.0.24.0.0.0.0 = STRING: "CP"
SNMPv2-SMI::enterprises.6027.3.9.1.5.1.10.1.1.4.10.1.1.1.32.1.4.10.1.1.1.1.4.10.1.1.1
= STRING: "Fo 1/4/1"
SNMPv2-
SMI::enterprises.6027.3.9.1.5.1.10.1.1.4.10.1.1.2.32.1.4.127.0.0.1.1.4.127.0.0.1 =
STRING: "CP"
SNMPv2-SMI::enterprises.6027.3.9.1.5.1.10.1.1.4.20.1.1.0.24.0.0.0.0 = STRING: "CP"

```

```

SNMPv2-SMI::enterprises.6027.3.9.1.5.1.10.1.1.4.20.1.1.1.32.1.4.20.1.1.1.1.4.20.1.1.1
= STRING: "Po 10"
SNMPv2-
SMI::enterprises.6027.3.9.1.5.1.10.1.1.4.20.1.1.2.32.1.4.127.0.0.1.1.4.127.0.0.1 =
STRING: "CP"
SNMPv2-SMI::enterprises.6027.3.9.1.5.1.10.1.1.4.30.1.1.0.24.0.0.0.0 = STRING: "CP"
SNMPv2-SMI::enterprises.6027.3.9.1.5.1.10.1.1.4.30.1.1.1.32.1.4.30.1.1.1.1.4.30.1.1.1
= STRING: "Po 20"
SNMPv2-
SMI::enterprises.6027.3.9.1.5.1.10.1.1.4.30.1.1.2.32.1.4.127.0.0.1.1.4.127.0.0.1 =
STRING: "CP"
SNMPv2-SMI::enterprises.6027.3.9.1.5.1.10.1.1.4.70.70.70.0.24.0.0.0.0 = STRING: "CP"
SNMPv2-
SMI::enterprises.6027.3.9.1.5.1.10.1.1.4.70.70.70.1.32.1.4.127.0.0.1.1.4.127.0.0.1 =
STRING: "CP"
SNMPv2-
SMI::enterprises.6027.3.9.1.5.1.10.1.1.4.70.70.70.2.32.1.4.70.70.70.2.1.4.70.70.70.2
= STRING: "Fo 1/1/1"
SNMPv2-
SMI::enterprises.6027.3.9.1.5.1.10.1.1.4.80.80.80.0.24.1.4.10.1.1.1.1.4.10.1.1.1 =
STRING: "Fo 1/4/1"
SNMPv2-
SMI::enterprises.6027.3.9.1.5.1.10.1.1.4.80.80.80.0.24.1.4.20.1.1.1.1.4.20.1.1.1 =
STRING: "Po 10"
SNMPv2-
SMI::enterprises.6027.3.9.1.5.1.10.1.1.4.80.80.80.0.24.1.4.30.1.1.1.1.4.30.1.1.1 =
STRING: "Po 20"
SNMPv2-SMI::enterprises.6027.3.9.1.5.1.10.1.1.4.90.90.90.0.24.0.0.0.0 = STRING: "CP"
SNMPv2-
SMI::enterprises.6027.3.9.1.5.1.10.1.1.4.90.90.90.1.32.1.4.127.0.0.1.1.4.127.0.0.1 =
STRING: "CP"
SNMPv2-
SMI::enterprises.6027.3.9.1.5.1.10.1.1.4.90.90.90.2.32.1.4.90.90.90.2.1.4.90.90.90.2
= STRING: "Fo 1/1/1"
SNMPv2-
SMI::enterprises.6027.3.9.1.5.1.10.1.1.4.100.100.100.0.24.1.4.10.1.1.1.1.4.10.1.1.1 =
STRING: "Fo 1/4/1"
SNMPv2-
SMI::enterprises.6027.3.9.1.5.1.10.1.1.4.100.100.100.0.24.1.4.20.1.1.1.1.4.20.1.1.1 =
STRING: "Po 10"
SNMPv2-
SMI::enterprises.6027.3.9.1.5.1.10.1.1.4.100.100.100.0.24.1.4.30.1.1.1.1.4.30.1.1.1 =
STRING: "Po 20"
SNMPv2-SMI::enterprises.6027.3.9.1.5.1.11.1.1.4.10.1.1.0.24.0.0.0.0 = Gauge32: 0
SNMPv2-SMI::enterprises.6027.3.9.1.5.1.11.1.1.4.10.1.1.1.32.1.4.10.1.1.1.1.4.10.1.1.1
= Gauge32: 0
SNMPv2-
SMI::enterprises.6027.3.9.1.5.1.11.1.1.4.10.1.1.2.32.1.4.127.0.0.1.1.4.127.0.0.1 =
Gauge32: 0
SNMPv2-SMI::enterprises.6027.3.9.1.5.1.11.1.1.4.20.1.1.0.24.0.0.0.0 = Gauge32: 0
SNMPv2-SMI::enterprises.6027.3.9.1.5.1.11.1.1.4.20.1.1.1.32.1.4.20.1.1.1.1.4.20.1.1.1
= Gauge32: 0
SNMPv2-
SMI::enterprises.6027.3.9.1.5.1.11.1.1.4.20.1.1.2.32.1.4.127.0.0.1.1.4.127.0.0.1 =
Gauge32: 0
SNMPv2-SMI::enterprises.6027.3.9.1.5.1.11.1.1.4.30.1.1.0.24.0.0.0.0 = Gauge32: 0
SNMPv2-SMI::enterprises.6027.3.9.1.5.1.11.1.1.4.30.1.1.1.32.1.4.30.1.1.1.1.4.30.1.1.1
= Gauge32: 0
SNMPv2-
SMI::enterprises.6027.3.9.1.5.1.11.1.1.4.30.1.1.2.32.1.4.127.0.0.1.1.4.127.0.0.1 =
Gauge32: 0
SNMPv2-SMI::enterprises.6027.3.9.1.5.1.11.1.1.4.70.70.70.0.24.0.0.0.0 = Gauge32: 0
SNMPv2-
SMI::enterprises.6027.3.9.1.5.1.11.1.1.4.70.70.70.1.32.1.4.127.0.0.1.1.4.127.0.0.1 =
Gauge32: 0
SNMPv2-
SMI::enterprises.6027.3.9.1.5.1.11.1.1.4.70.70.70.2.32.1.4.70.70.70.2.1.4.70.70.70.2
= Gauge32: 0
SNMPv2-
SMI::enterprises.6027.3.9.1.5.1.11.1.1.4.80.80.80.0.24.1.4.10.1.1.1.1.4.10.1.1.1 =
Gauge32: 0
SNMPv2-
SMI::enterprises.6027.3.9.1.5.1.11.1.1.4.80.80.80.0.24.1.4.20.1.1.1.1.4.20.1.1.1 =

```

```

Gauge32: 0
SNMPv2-
SMI::enterprises.6027.3.9.1.5.1.11.1.1.4.80.80.80.0.24.1.4.30.1.1.1.1.4.30.1.1.1 =
Gauge32: 0
SNMPv2-SMI::enterprises.6027.3.9.1.5.1.11.1.1.4.90.90.90.0.24.0.0.0.0 = Gauge32: 0
SNMPv2-
SMI::enterprises.6027.3.9.1.5.1.11.1.1.4.90.90.90.1.32.1.4.127.0.0.1.1.4.127.0.0.1 =
Gauge32: 0
SNMPv2-
SMI::enterprises.6027.3.9.1.5.1.11.1.1.4.90.90.90.2.32.1.4.90.90.90.2.1.4.90.90.90.2
= Gauge32: 0
SNMPv2-
SMI::enterprises.6027.3.9.1.5.1.11.1.1.4.100.100.100.0.24.1.4.10.1.1.1.1.4.10.1.1.1 =
Gauge32: 0
SNMPv2-
SMI::enterprises.6027.3.9.1.5.1.11.1.1.4.100.100.100.0.24.1.4.20.1.1.1.1.4.20.1.1.1 =
Gauge32: 0
SNMPv2-
SMI::enterprises.6027.3.9.1.5.1.11.1.1.4.100.100.100.0.24.1.4.30.1.1.1.1.4.30.1.1.1 =
Gauge32: 0
SNMPv2-SMI::enterprises.6027.3.9.1.6.0 = Gauge32: 2048
SNMPv2-SMI::enterprises.6027.3.9.1.7.0 = Gauge32: 1
SNMPv2-SMI::enterprises.6027.3.9.1.8.0 = Gauge32: 2047

```

MIB Support for entAliasMappingTable

Dell EMC Networking provides a method to map the physical interface to its corresponding `ifindex` value. The `entAliasMappingTable` table contains zero or more rows, representing the logical entity mapping and physical component to external MIB identifiers. The following table lists the related MIB objects:

Table 32. MIB Objects for entAliasMappingTable

MIB Object	OID	Description
entAliasMappingTable	1.3.6.1.2.1.47.1.3.2	Contains information about entAliasMapping table.
entAliasMappingEntry	1.3.6.1.2.1.47.1.3.2.1	Contains information about a particular logical entity.
entAliasLogicalIndexOrZero	1.3.6.1.2.1.47.1.3.2.1.1	Contains a non-zero value and identifies the logical entity named by the same value of entLogicalIndex.
entAliasMappingIdentifier	1.3.6.1.2.1.47.1.3.2.1.2	Identifies a particular conceptual row associated with the indicated entPhysicalIndex and entLogicalIndex pair.

Viewing the entAliasMappingTable MIB

- To view the `entAliasMappingTable` generated by the system, use the following command.

```
snmpwalk -v 2c -c public -On 10.16.150.97 1.3.6.1.2.1.47.1.3.2.1
```

```

.1.3.6.1.2.1.47.1.3.2.1.2.5.0 = OID: .1.3.6.1.2.1.2.2.1.1.2097157
.1.3.6.1.2.1.47.1.3.2.1.2.9.0 = OID: .1.3.6.1.2.1.2.2.1.1.2097669
.1.3.6.1.2.1.47.1.3.2.1.2.13.0 = OID: .1.3.6.1.2.1.2.2.1.1.2098181
.1.3.6.1.2.1.47.1.3.2.1.2.17.0 = OID: .1.3.6.1.2.1.2.2.1.1.2098693
.1.3.6.1.2.1.47.1.3.2.1.2.21.0 = OID: .1.3.6.1.2.1.2.2.1.1.2099205
.1.3.6.1.2.1.47.1.3.2.1.2.25.0 = OID: .1.3.6.1.2.1.2.2.1.1.2099717
.1.3.6.1.2.1.47.1.3.2.1.2.29.0 = OID: .1.3.6.1.2.1.2.2.1.1.2100228
.1.3.6.1.2.1.47.1.3.2.1.2.30.0 = OID: .1.3.6.1.2.1.2.2.1.1.2100356
.1.3.6.1.2.1.47.1.3.2.1.2.31.0 = OID: .1.3.6.1.2.1.2.2.1.1.2100484

```

MIB Support for LAG

Dell EMC Networking provides a method to retrieve the configured LACP information (Actor and Partner). Actor (local interface) is to designate the parameters and flags pertaining to the sending node, while the term Partner (remote interface) is to designate the sending node's view of its peer parameters and flags. LACP provides a standardized means for exchanging information, with partner systems, to form a link aggregation group (LAG). The following table lists the related MIB objects:

Table 33. MIB Objects for LAG

MIB Object	OID	Description
lagMIB	1.2.840.10006.300.43	Contains information about link aggregation module for managing 802.3ad.
lagMIBObjects	1.2.840.10006.300.43.1	
dot3adAgg	1.2.840.10006.300.43.1.1	
dot3adAggTable	1.2.840.10006.300.43.1.1.1	Contains information about every Aggregator that is associated with a system.
dot3adAggEntry	1.2.840.10006.300.43.1.1.1.1	Contains a list of Aggregator parameters and indexed by the <code>ifIndex</code> of the Aggregator.
dot3adAggMACAddress	1.2.840.10006.300.43.1.1.1.1.1	Contains a six octet read-only value carrying the individual MAC address assigned to the Aggregator.
dot3adAggActorSystemPriority	1.2.840.10006.300.43.1.1.1.1.2	Contains a two octet read-write value indicating the priority value associated with the Actor's system ID.
dot3adAggActorSystemID	1.2.840.10006.300.43.1.1.1.1.3	Contains a six octet read-write MAC address value used as a unique identifier for the system that contains the Aggregator.
dot3adAggAggregateOrIndividual	1.2.840.10006.300.43.1.1.1.1.4	Contains a read-only boolean value (True or False) indicating whether the Aggregator represents an Aggregate or an Individual link.
dot3adAggActorAdminKey	1.2.840.10006.300.43.1.1.1.1.5	Contains a 16-bit read-write value which is the current administrative key.
dot3adAggActorOperKey	1.2.840.10006.300.43.1.1.1.1.6	Contains a 16-bit read-write value which is the operational key.
dot3adAggPartnerSystemID	1.2.840.10006.300.43.1.1.1.1.7	Contains a six octet read-only MAC address value consisting of an unique identifier for the current Protocol partner of the Aggregator.
dot3adAggPartnerSystemPriority	1.2.840.10006.300.43.1.1.1.1.8	Contains a two octet read-only value that indicates the priority value associated with the Partner's system ID.
dot3adAggPartnerOperKey	1.2.840.10006.300.43.1.1.1.1.9	Contains the current operational value of the key for the Aggregator's current protocol partner.
dot3adAggCollectorMaxDelay	1.2.840.10006.300.43.1.1.1.1.10	Contains a 16-bit read-write attribute defining the maximum delay, in tens of microseconds, that may be imposed by the frame collector between receiving a frame from an Aggregator Parser, and

Table 34. MIB Objects for Displaying Reserved Unrecognized LLDP TLVs (continued)

MIB Object	OID	Description
lldpRemUnknownTLVInfo	1.0.8802.1.1.2.1.4.3.1.2	Contains value extracted from the value field of the TLV.

Viewing the Details of Reserved Unrecognized LLDP TLVs

- To view the information of reserved unrecognized LLDP TLVs using SNMP, use the following commands.

```
snmpwalk -v2c -c mycommunity 10.16.150.83 1.0.8802.1.1.2.1.4
```

```
iso.0.8802.1.1.2.1.4.1.1.6.0.2113029.2 = INTEGER: 5
iso.0.8802.1.1.2.1.4.1.1.6.0.3161092.6 = INTEGER: 5
iso.0.8802.1.1.2.1.4.1.1.6.0.3161605.2 = INTEGER: 5
iso.0.8802.1.1.2.1.4.1.1.6.0.4209668.6 = INTEGER: 5
iso.0.8802.1.1.2.1.4.1.1.6.0.4210181.2 = INTEGER: 5
iso.0.8802.1.1.2.1.4.1.1.6.0.9437185.2 = INTEGER: 5
iso.0.8802.1.1.2.1.4.1.1.7.0.2113029.2 = STRING: "fortyGigE 1/50"
iso.0.8802.1.1.2.1.4.1.1.7.0.3161092.6 = STRING: "TenGigabitEthernet 0/39"
iso.0.8802.1.1.2.1.4.1.1.7.0.3161605.2 = STRING: "fortyGigE 1/49"
iso.0.8802.1.1.2.1.4.1.1.7.0.4209668.6 = STRING: "TenGigabitEthernet 0/40"
iso.0.8802.1.1.2.1.4.1.1.7.0.4210181.2 = STRING: "fortyGigE 1/51"
iso.0.8802.1.1.2.1.4.1.1.7.0.9437185.2 = STRING: "GigabitEthernet 1/12"
iso.0.8802.1.1.2.1.4.1.1.12.0.9437185.2 = Hex-STRING: 00
iso.0.8802.1.1.2.1.4.3.1.2.0.3161092.6.9 = STRING: "Dell"
iso.0.8802.1.1.2.1.4.3.1.2.0.3161092.6.10 = STRING: "Dell"
iso.0.8802.1.1.2.1.4.3.1.2.0.4209668.6.9 = STRING: "Dell"
iso.0.8802.1.1.2.1.4.3.1.2.0.4209668.6.10 = STRING: "Dell"
```

```
snmpget -v2c -c public 10.16.150.83 1.0.8802.1.1.2.1.4.3.1.2.0.4209668.6.9
```

```
iso.0.8802.1.1.2.1.4.3.1.2.0.4209668.6.9 = STRING: "Dell"
```

MIB Support to Display Organizational Specific Unrecognized LLDP TLVs

The `lldpRemOrgDefInfoTable` contains organizationally defined information that is not recognized by the local neighbor. The following table lists the related MIB objects:

Table 35. MIB Objects for Displaying Organizational Specific Unrecognized LLDP TLVs

MIB Object	OID	Description
lldpRemOrgDefInfoTable	1.0.8802.1.1.2.1.4.4	This table contains organizationally defined information that is not recognized by the local neighbor.
lldpRemOrgDefInfoEntry	1.0.8802.1.1.2.1.4.4.1	Contains information about the unrecognized organizationally defined information advertised by the remote system.
lldpRemOrgDefInfoOUI	1.0.8802.1.1.2.1.4.4.1.1	Contains OUI of the information received from the remote system.
lldpRemOrgDefInfoSubtype	1.0.8802.1.1.2.1.4.4.1.2	Contains integer value used to identify the subtype of the organizationally defined information received from the remote system.
lldpRemOrgDefInfoIndex	1.0.8802.1.1.2.1.4.4.1.3	Contains the object represents an arbitrary local integer value used by

Table 35. MIB Objects for Displaying Organizational Specific Unrecognized LLDP TLVs (continued)

MIB Object	OID	Description
		this neighbor to identify a particular unrecognized organizationally defined information instance.
lldpRemOrgDefInfo	1.0.8802.1.1.2.1.4.4.1.4	Contains the string value used to identify the organizationally defined information of the remote system.

Viewing the Details of Organizational Specific Unrecognized LLDP TLVs

- To view the information of organizational specific unrecognized LLDP TLVs using SNMP, use the following commands.

```
snmpwalk -v2c -c public 10.16.150.83 1.0.8802.1.1.2.1.4.4.1.4
```

```
iso.0.8802.1.1.2.1.4.4.1.4.0.3161092.1.0.1.102.1.133 = STRING: "Dell"
iso.0.8802.1.1.2.1.4.4.1.4.0.3161092.1.0.1.102.2.134 = STRING: "Dell"
iso.0.8802.1.1.2.1.4.4.1.4.0.3161092.1.0.1.102.3.135 = STRING: "Dell"
iso.0.8802.1.1.2.1.4.4.1.4.0.3161092.1.0.1.102.4.136 = STRING: "Dell"
iso.0.8802.1.1.2.1.4.4.1.4.0.3161092.1.0.1.102.5.137 = STRING: "Dell"
```

```
snmpget -v2c -c public 10.16.150.102 1.0.8802.1.1.2.1.4.4.1.4.0.1048580.2.0.1.232.16.1
```

```
iso.0.8802.1.1.2.1.4.4.1.4.0.1048580.2.0.1.232.16.1 = STRING: "A"
```

Transceiver Monitoring

To retrieve and display the transceiver related parameters you can perform a `snmpwalk` transceiver table OID to retrieve transceiver details as per the MIB. This enables transceiver monitoring and identification of potential issues related to the transceivers on a switch.

- Ensure that SNMP is enabled on the device before running a query to retrieve the transceiver information.
- If Tx/Rx power, temperature, current, or voltage is not supported on optics, `snmp walk` returns a null ("") value.
- If optics are not inserted in a port, empty string is displayed.

Example of SNMP Output for Transceiver Monitoring

```
Dell $ snmpwalk -v1 -c public 10.16.150.210 1.3.6.1.4.1.6027.3.11.1.3.1.1 | grep 2106373
SNMPv2-SMI::enterprises.6027.3.11.1.3.1.1.1.2113540 = STRING: "stack-unit-1
fixedmodule-5 port-1"
SNMPv2-SMI::enterprises.6027.3.11.1.3.1.1.2.2113540 = STRING: "Te 1/5/1"
SNMPv2-SMI::enterprises.6027.3.11.1.3.1.1.3.2113540 = INTEGER: 1
SNMPv2-SMI::enterprises.6027.3.11.1.3.1.1.4.2113540 = STRING: "10GBASE-SR"
SNMPv2-SMI::enterprises.6027.3.11.1.3.1.1.5.2113540 = STRING: "FINISAR CORP."
SNMPv2-SMI::enterprises.6027.3.11.1.3.1.1.6.2113540 = STRING: "FTLX8571D3BCL-FC"
SNMPv2-SMI::enterprises.6027.3.11.1.3.1.1.7.2113540 = STRING: "AL20L80"
SNMPv2-SMI::enterprises.6027.3.11.1.3.1.1.8.2113540 = STRING: "-2.293689"
SNMPv2-SMI::enterprises.6027.3.11.1.3.1.1.9.2113540 = ""
SNMPv2-SMI::enterprises.6027.3.11.1.3.1.1.10.2113540 = ""
SNMPv2-SMI::enterprises.6027.3.11.1.3.1.1.11.2113540 = ""
SNMPv2-SMI::enterprises.6027.3.11.1.3.1.1.12.2113540 = STRING: "-1.615917"
SNMPv2-SMI::enterprises.6027.3.11.1.3.1.1.13.2113540 = ""
SNMPv2-SMI::enterprises.6027.3.11.1.3.1.1.14.2113540 = ""
SNMPv2-SMI::enterprises.6027.3.11.1.3.1.1.15.2113540 = ""
SNMPv2-SMI::enterprises.6027.3.11.1.3.1.1.16.2113540 = STRING: "29.109375"
SNMPv2-SMI::enterprises.6027.3.11.1.3.1.1.17.2113540 = STRING: "3.286000"
SNMPv2-SMI::enterprises.6027.3.11.1.3.1.1.18.2113540 = STRING: "7.530000"
SNMPv2-SMI::enterprises.6027.3.11.1.3.1.1.19.2113540 = ""
SNMPv2-SMI::enterprises.6027.3.11.1.3.1.1.20.2113540 = ""
SNMPv2-SMI::enterprises.6027.3.11.1.3.1.1.21.2113540 = ""
```

Table 36. SNMP OIDs for Transceiver Monitoring

Field (OID)	Description
SNMPv2-SMI::enterprises.6027.3.11.1.3.1.1.1	Device Name
SNMPv2-SMI::enterprises.6027.3.11.1.3.1.1.2	Port
SNMPv2-SMI::enterprises.6027.3.11.1.3.1.1.3	Optics Present
SNMPv2-SMI::enterprises.6027.3.11.1.3.1.1.4	Optics Type
SNMPv2-SMI::enterprises.6027.3.11.1.3.1.1.5	Vendor Name
SNMPv2-SMI::enterprises.6027.3.11.1.3.1.1.6	Part Number
SNMPv2-SMI::enterprises.6027.3.11.1.3.1.1.7	Serial Number
SNMPv2-SMI::enterprises.6027.3.11.1.3.1.1.8	Transmit Power Lane1
SNMPv2-SMI::enterprises.6027.3.11.1.3.1.1.9	Transmit Power Lane2
SNMPv2-SMI::enterprises.6027.3.11.1.3.1.1.10	Transmit Power Lane3
SNMPv2-SMI::enterprises.6027.3.11.1.3.1.1.11	Transmit Power Lane4
SNMPv2-SMI::enterprises.6027.3.11.1.3.1.1.12	Receive Power Lane1
SNMPv2-SMI::enterprises.6027.3.11.1.3.1.1.13	Receive Power Lane2
SNMPv2-SMI::enterprises.6027.3.11.1.3.1.1.14	Receive Power Lane3
SNMPv2-SMI::enterprises.6027.3.11.1.3.1.1.15	Receive Power Lane4
SNMPv2-SMI::enterprises.6027.3.11.1.3.1.1.16	Temperature
SNMPv2-SMI::enterprises.6027.3.11.1.3.1.1.17	Voltage
SNMPv2-SMI::enterprises.6027.3.11.1.3.1.1.18	Transmit Bias Current Lane1
SNMPv2-SMI::enterprises.6027.3.11.1.3.1.1.19	Transmit Bias Current Lane2
SNMPv2-SMI::enterprises.6027.3.11.1.3.1.1.20	Transmit Bias Current Lane3
SNMPv2-SMI::enterprises.6027.3.11.1.3.1.1.21	Transmit Bias Current Lane4

Stacking

An Aggregator auto-configures to operate in standalone mode. To use an Aggregator in a stack, you must manually configure it using the CLI to operate in stacking mode.

In automated Stack mode, the base module 40GbE ports (33 and 37) operate as stack links and it is fixed.

In Programmable MUX (PMUX) mode, you can select either the base or optional modules (ports 33 — 56). An Aggregator supports a maximum of six stacking units.

Stacking provides a single point of management for high availability and higher throughput.

NOTE: Internal ports cannot be used for stacking.

NOTE: Prior to configuring the stack-group, ensure that the stacking ports are connected and in 40G native mode.

Supported Modes

PMUX, Stacking

Topics:

- [Stacking Aggregators](#)
- [Stacking Port Numbers](#)
- [Stacking in PMUX Mode](#)
- [Configuring a Switch Stack](#)
- [Configuring the Uplink Speed of Interfaces as 40 Gigabit Ethernet](#)
- [Merging Two Operational Stacks](#)
- [Verifying a Stack Configuration](#)
- [Troubleshooting a Switch Stack](#)
- [Upgrading a Switch Stack](#)
- [Upgrading a Single Stack Unit](#)

Stacking Aggregators

A stack of Aggregators operates as a virtual chassis with management units (primary and standby) and member units. The Dell Networking operating software elects a primary (master) and secondary (standby) management unit. The forwarding database resides on the master switch; the standby unit maintains a synchronized local copy. Each unit in the stack makes forwarding decisions based on their local copy.

The following example shows how you can stack two Aggregators. The Aggregators are connected to operate as a single stack in a ring topology using only the 40GbE ports on the base modules.

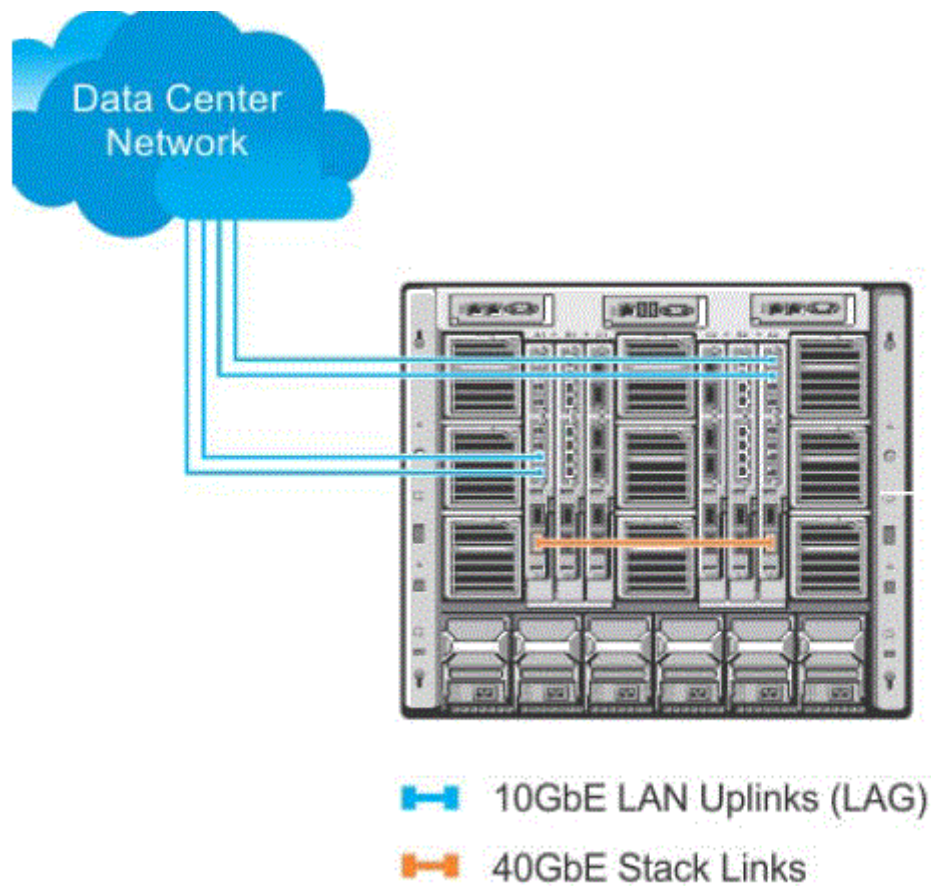

Figure 30. A Two-Aggregator Stack

Stack Management Roles

The stack elects the management units for the stack management.

- **Stack master** — primary management unit
- **Standby** — secondary management unit

The master holds the control plane and the other units maintain a local copy of the forwarding databases. From Stack master you can configure:

- System-level features that apply to all stack members
- Interface-level features for each stack member

The master synchronizes the following information with the standby unit:

- Stack unit topology
- Stack running configuration (which includes LACP, SNMP, etc.)
- Logs

The master switch maintains stack operation with minimal impact in the event of:

- Switch failure
- Inter-switch stacking link failure
- Switch insertion
- Switch removal

If the master switch goes off line, the standby replaces it as the new master.

NOTE: For the Aggregator, the entire stack has only one management IP address.

Stack Master Election

The stack elects a master and standby unit at bootup time based on MAC address. The unit with the higher MAC value becomes master.

To view which switch is the stack master, enter the `show system` command. The following example shows sample output from an established stack.

A change in the stack master occurs when:

- You power down the stack master or bring the master switch offline.
- A failover of the master switch occurs.
- You disconnect the master switch from the stack.

NOTE: When a stack reloads and all the units come up at the same time; for example, when all units boot up from flash, all units participate in the election and the master and standby are chosen based on the priority on the MAC address. When the units do not boot up at the same time, such as when some units are powered down just after reloading and powered up later to join the stack, they do not participate in the election process, even though the units that boot up late may have a higher priority configured. This happens because the master and standby have already been elected, hence the unit that boots up late joins only as a member. Also, when an up and running standalone unit or stack is merged with another stack, based on election, the losing stack reloads and the master unit of the winning stack becomes the master of the merged stack. To ensure a fully synchronised bootup, it is possible to reset individual units to force them to give up the management role; or reload the whole stack from the command line interface (CLI).

Example of Viewing Stack Members

```
Dell# show system brief
Stack MAC : 00:1e:c9:f1:00:9b
-- Stack Info --
Unit  UnitType  Status  ReqTyp          CurTyp          Version  Ports
-----
0      Management  online  I/O-Aggregator I/O-Aggregator 8-3-17-46  56
1      Standby     online  I/O-Aggregator I/O-Aggregator 8-3-17-46  56
2      Member      not present
3      Member      not present
4      Member      not present
5      Member      not present
Dell#
```

Failover Roles

If the stack master fails (for example, powered off), it is removed from the stack topology. The standby unit detects the loss of peering communication and takes ownership of the stack management, switching from standby to master. The lack of a standby unit triggers an election within the remaining units for a standby role.

After the former master switch recovers, despite having a higher priority or MAC address, it does not recover its master role but instead takes the next available role.

MAC Addressing

All port interfaces in the stack use the MAC address of the management interface on the master switch. The MAC address of the chassis in which the master Aggregator is installed is used as the stack MAC address.

The stack continues to use the master's chassis MAC address even after a failover. The MAC address is not refreshed until the stack is reloaded and a different unit becomes the stack master.

Stacking LAG

When you use multiple links between stack units, Dell Networking Operating System automatically bundles them in a stacking link aggregation group (LAG) to provide aggregated throughput and redundancy. The stacking LAG is established automatically and transparently by operating system (without user configuration) after peering is detected and behaves as follows:

- The stacking LAG dynamically aggregates; it can lose link members or gain new links.
- Shortest path selection inside the stack: if multiple paths exist between two units in the stack, the shortest path is used.

Stacking VLANs

When you configure an Aggregator to operate in stacking mode (Configuring and Bringing Up a Stack), VLANs are reconfigured as follows:

- If an Aggregator port belonged to all 4094 VLANs in standalone mode (default), all VLAN membership is removed and the port is assigned only to default VLAN 1. You must configure additional VLAN membership as necessary.
- If you had manually configured an Aggregator port to belong to one or more VLANs (non-default) in standalone mode, the VLAN configuration is retained in stacking mode only on the master switch.

When you reconfigure an Aggregator from stacking to standalone mode:

- Aggregator ports that you manually configured for VLAN membership in stacking mode retain their VLAN configuration in standalone mode.
- To restore the default auto-VLAN mode of operation (in which all ports are members of all 4094 VLANs) on a port, enter the `auto vlan` command; for example:

```
Dell(conf)# interface tengigabitethernet 0/2
Dell(conf-if-te-0/2)# auto vlan
```

Stacking Port Numbers

By default, each Aggregator in Standalone mode is numbered stack-unit 0. Stack-unit numbers are assigned to member switches when the stack comes up. The following example shows the numbers of the 40GbE stacking ports on an Aggregator.

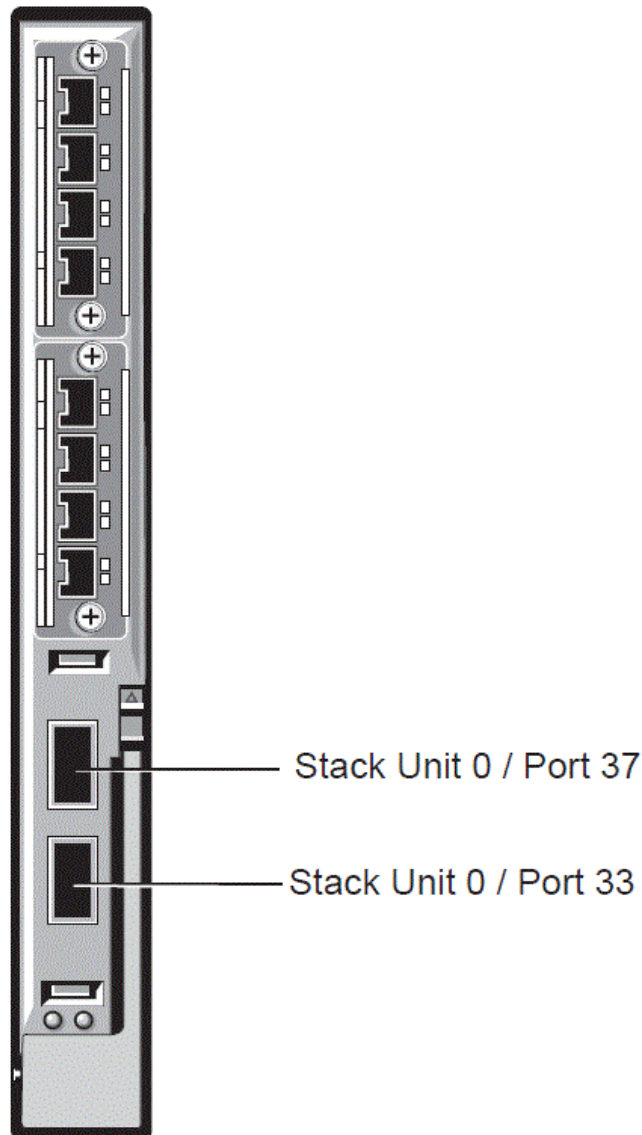

Figure 31. Stack Groups on an Aggregator

Stacking in PMUX Mode

PMUX stacking allows the stacking of two or more IOA units. This allows grouping of multiple units for high availability. IOA supports a maximum of six stacking units.

NOTE: Prior to configuring the stack-group, ensure the stacking ports are connected and in 40G native mode.

1. Configure stack groups on all stack units.

```
Dell#  
Dell#configure  
Dell(conf)#stack-unit 0 stack-group 0  
Dell(conf)#00:37:46: %STKUNIT0-M:CP %IFMGR-6-STACK_PORTS_ADDED: Ports Fo 0/33 have  
been configured as stacking ports. Please save and reset stack-unit 0 for config to  
take effect
```



```
Dell(conf)#stack-unit 0 stack-group 1
Dell(conf)#00:37:57: %STKUNIT0-M:CP %IFMGR-6-STACK_PORTS_ADDED: Ports Fo 0/37 have
been configured as stacking ports. Please save and reset stack-unit 0 for config to
take effect

Dell(conf)#end
Dell#00:38:16: %STKUNIT0-M:CP %SYS-5-CONFIG_I: Configured from console
```

2. Reload the stack units.

```
Dell#reload
Proceed with reload [confirm yes/no]: yes
```

3. Show the units stacking status.

```
Dell#show system brief
Stack MAC : 00:01:e8:e1:e1:c3
Reload-Type : normal-reload [Next boot : normal-reload]
-- Stack Info --
Unit UnitType Status ReqTyp CurTyp
Version Ports
-----
0 Management online I/O-Aggregator I/O-
Aggregator <<release version>> 56
1 Standby online I/O-Aggregator I/O-
Aggregator <<release version>> 56
2 Member not present
3 Member not present
4 Member not present
5 Member not present
Dell#
```

Configuring a Switch Stack

To configure and bring up a switch stack, follow these steps:

1. Connect the 40GbE ports on the base module of two Aggregators using 40G direct attach or QSFP fibre cables.
2. Configure each Aggregator to operate in stacking mode.
3. Reload each Aggregator, one after the other in quick succession.

Stacking Prerequisites

Before you cable and configure a stack of MXL 10/40GbE switches, review the following prerequisites.

- All Aggregators in the stack must be powered up with the initial or startup configuration before you attach the cables.
- All stacked Aggregators must run the same Dell Networking OS version. The minimum Dell networking OS version required is 8.3.17.0. To check the version that a switch is running, use the `show version` command. To download a Dell Networking OS version, go to <http://support.dell.com>.
- Stacking is supported only with other Aggregators. A maximum of six Aggregators are supported in a single stack. You cannot stack the Aggregator with MXL 10/40GbE Switches or another type of switch.
- A maximum of four stack groups (40GbE ports) is supported on a stacked Aggregator.
- Interconnect the stack units by following the instructions in [Cabling Stacked Switches](#).
- You cannot stack a Standalone IOA and a PMUX.

Master Selection Criteria

A Master is elected or re-elected based on the following considerations, in order:

1. The switch with the highest priority at boot time.
2. The switch with the highest MAC address at boot time.

3. A unit is selected as Standby by the administrator, and a fail over action is manually initiated or occurs due to a Master unit failure.

No record of previous stack mastership is kept when a stack loses power. As it reboots, the election process will once again determine the Master and Standby switches. As long as the priority has not changed on any members, the stack will retain the same Master and Standby.

NOTE: Each stack members' role (including the Master and Standby) can be defined by the user at any time by setting the priority.

If the entire stack is powered OFF and ON again, the unit that was the Master before the reboot will remain the Master after the stack resumes operation. However, when a stack is powered on, all members are in **sleep** mode for 5 seconds while waiting on the previous Master to join the stack. If the previous Master fails to join within 5 seconds, the remaining members (including the Standby) elect a new Master.

Configuring Priority and stack-group

Perform the following steps to configure the priorities and stack-groups for each of the switches.

1. Set the priorities for the stack-unit.

CONFIGURATION mode

```
stack-unit unit-number priority 1-14
```

```
Dell(conf)# stack-unit 0 priority 12
```

Setting the priority will determine which switch will become the management (Master) switch. The switch with the highest priority number is elected Master. The default priority is 0.

NOTE: It is best practice to assign priority values to all switches before stacking them in order to acquire and retain complete control over each units role in the stack.

2. Configure the stack-group for each stack-unit.

CONFIGURATION mode

```
stack-unit unit-no stack-group stack-group-id
```

```
Dell(conf)# stack-unit 0 stack-group 0
Dell (conf)#02:26:05: %STKUNIT0-M:CP %IFMGR-6-STACK_PORTS_ADDED:
Ports Fo 0/33 have been configured as stacking ports.
Please save and reload for config to take effect
```

Stack-groups are easier to think of simply as stack ports. For example, using the `stack-group 0` command simply turns the lower port (port 9) into a stacking port. Similarly, `stack-group 1`, `stack-group 2` and `stack-group 3` commands correspond to ports 10, 11 and 12 respectively.

NOTE: Stack-group is supported only in PMUX mode.

3. Continue to run the `stack-unit 0 stack-group <0-3>` command to add additional stack ports to the switch, using the stack-group mapping.

Cabling Stacked Switches

Before you configure MXL switches in a stack, connect the 40G direct attach or QSFP cables and transceivers to connect 40GbE ports on two Aggregators in the same or different chassis.

Cabling Restrictions

The following restrictions apply when setting up a stack of Aggregators:

- Only daisy-chain or ring topologies are supported; star and full mesh topologies are not supported.
- Stacking is supported only on 40GbE links by connecting 40GbE ports on the base module. Stacking is not supported on 10GbE ports or 4x10GbE ports.
- Use only QSFP transceivers and QSFP or direct attach cables (purchased separately) to connect stacking ports.

Cabling Redundancy

Connect the units in a stack with two or more stacking cables to avoid a stacking port or cable failure. Removing one of the stacked cables between two stacked units does not trigger a reset.

Cabling Procedure

The following cabling procedure uses the stacking topology shown earlier in this chapter.

To connect the cabling:

1. Connect a 40GbE base port on the first Aggregator to a 40GbE base port on another Aggregator in the same chassis.
2. Connect a 40GbE base port on the second Aggregator to a 40GbE port on the first Aggregator.

The resulting ring topology allows the entire stack to function as a single switch with resilient fail-over capabilities. If you do not connect the last switch to the first switch (Step 4), the stack operates in a daisy chain topology with less resiliency. Any failure in a non-edge stack unit causes a split stack.

Accessing the CLI

To configure a stack, you must access the stack master in one of the following ways.

- For remote out-of-band management (OOB), enter the OOB management interface IP address into a Telnet or secure shell (SSH) client and log in to the switch using the user ID and password to access the CLI.
- For local management, use the attached console connection to the master switch to log in to the CLI. Console access to the stack CLI is available on the master only.
- For remote in-band management from a network management station, enter the virtual local area network (VLAN) IP address of the management port and log in to the switch to access the CLI.

Configuring and Bringing Up a Stack

After you attach the 40G QSFP or direct attach cables in a stack of Aggregators, to bring up the stack, follow these steps.

i **NOTE:** The procedure uses command examples for the stacking topology shown previously in this chapter.

1. Set up a connection to the CLI on an Aggregator as described in [Accessing the CLI](#).
2. Log on to the CLI and enter Global Configuration mode.
Login: username
Password: *****
Dell> enable
Dell# configure
3. Configure the Aggregator to operate in stacking mode.
CONFIGURATION mode
stack-unit 0 iom-mode stack
4. Repeat Steps 1 to 3 on the second Aggregator in the stack.
5. Log on to the CLI and reboot each switch, one after another, in as short a time as possible.
EXEC PRIVILEGE mode
reload

i **NOTE:** If the stacked switches all reboot at approximately the same time, the switch with the highest MAC address is automatically elected as the master switch. The switch with the next highest MAC address is elected as standby. As each switch joins the stack, it is assigned the lowest available stack-unit number from 0 to 5. The default configuration of each stacked switch is stored in the running configuration of the stack. The stack-unit ID numbers are retained after future stack reloads.

To verify the stack-unit number assigned to each switch in the stack, use the `show system brief` command.

Adding a Stack Unit

You can add a new unit to an existing stack both when the unit has no stacking ports (stack groups) configured and when the unit already has stacking ports configured. If the units to be added to the stack have been previously used, they are assigned the smallest available unit ID in the stack.

To add a standalone Aggregator to a stack, follow these steps:

1. Power on the switch.
2. Attach QSFP or direct attach cables to connect 40GbE ports on the switch to one or more switches in the stack.
3. Log on to the CLI and enter global configuration mode.
Login: username
Password: *****
Dell> enable
Dell# configure
4. Configure the Aggregator to operate in stacking mode.
CONFIGURATION mode
stack-unit 0 iom-mode
stack
5. Reload the switch. Dell Operating System automatically assigns a number to the new unit and adds it as member switch in the stack. The new unit synchronizes its running and startup configurations with the stack.
EXEC Privilege mode
reload

If an Aggregator is already configured to operate in stacking mode, simply attach QSFP or direct attach cables to connect 40GbE ports on the base module of each stacked Aggregator. The new unit synchronizes its running and startup configurations with the stack.

Dell Networking OS Behavior: When you add a new Aggregator to a stack:

- If the new unit has been configured with a stack number that is already assigned to a stack member, the stack avoids a numbering conflict by assigning the new switch the first available stack number.
- If the stack has been provisioned for the stack number that is assigned to the new unit, the pre-configured provisioning must match the switch type. If there is a conflict between the provisioned switch type and the new unit, a mismatch error message is displayed.

Resetting a Unit on a Stack

Use the following `reset` commands to reload any of the member units or the standby in a stack. If you try to reset the stack master, the following error message is displayed:

```
% Error: Reset of master unit is not allowed.
```

To reset a unit on a stack, use the following commands:

- Reload a stack-unit from the master switch.
EXEC Privilege mode
reset stack-unit *unit-number*
- Reset a stack-unit when the unit is in a problem state.
EXEC Privilege mode
reset stack-unit *unit-number* {hard}

Removing an Aggregator from a Stack and Restoring Quad Mode

To remove an Aggregator from a stack and return the 40GbE stacking ports to 4x10GbE quad mode follow the below steps:

1. Disconnect the stacking cables from the unit. The unit can be powered on or off and can be online or offline.

2. Log on to the CLI and enter Global Configuration mode.

```

Login: username
Password: *****
Dell> enable
Dell# configure

```

3. Configure the Aggregator to operate in standalone mode.

```

stack-unit 0 iom-mode standalone
CONFIGURATION

```

4. Log on to the CLI and reboot each switch, one after another, in as short a time as possible.

```

reload
EXEC PRIVILEGE

```

When the reload completes, the base-module ports comes up in 4x10GbE (quad) mode. The switch functions in standalone mode but retains the running and startup configuration that was last synchronized by the master switch while it operated as a stack unit.

Configuring the Uplink Speed of Interfaces as 40 Gigabit Ethernet

You can configure the I/O Aggregator switch in standalone, VLT, and stack modes to operate with an uplink speed of 40 Gigabit Ethernet per second. You can use the chassis management controller (CMC) interface to access the switch and specify the 40 GbE QSFP+ module ports to function in 40 GbE mode after the subsequent reload operation. By default, these QSFP+ modules function in 10GbE mode.

When you configure the native mode to be 40 GbE, the CMC sends a notification to the Aggregator to set the default internal working of all of the ports to be 40 GbE after the switch reloads. After you set this configuration, you must enter the `reload` command (not pressing the Reset button, which causes the factory default settings to be applied when the device comes up online) from the CMC for the uplink speed to be effective.

This functionality to set the uplink speed is available from the CLI or the CMC interface when the Aggregator functions as a simple MUX or a VLT node, with all of the uplink interfaces configured to be member links in the same LAG bundle. You cannot configure the uplink speed to be set as 40 GbE if the Aggregator functions in programmable MUX mode with multiple uplink LAG interfaces or in stacking mode. This is because CMC is not involved with the configuration of parameters when the Aggregator operates in either of these modes, with the uplink interfaces being part of different LAG bundles.

After you restart the Aggregator, the 4-Port 10 GbE Ethernet modules or the 40GbE QSFP+ port that is split into four 10GbE SFP+ ports cannot be configured to be part of the same uplink LAG bundle that is set up with the uplink speed of 40 GbE. In such a condition, you can perform a hot-swap of the 4-port 10 GbE Flex IO modules with a 2-port 40 GbE Flex IO module, which causes the module to become a part of the LAG bundle that is set up with 40 GbE as the uplink speed without another reboot. The Aggregator supports native 40 GbE mode for QSFP ports only in simple MUX mode and stacking mode of operation. In stacking mode, the base 40 GbE module ports are used for stacking and native 40 GbE uplink speed is enabled for only the QSFP+ ports on the optional 2-Port 40-Gigabit Ethernet QSFP+ FlexIO modules.

The following table describes the various speeds in different Aggregator modes. If a 4x10G SFP+ or a 4x10BASE-T module is plugged in and 40 GbE mode is configured, it is in error-disabled state.

Table 37. Speeds in Different Aggregator Modes

Module Type	Standalone 10G mode	Standalone 40G Mode	Stacking 10G Mode	Stacking 40G mode	VLT 10G Mode	VLT 40G Mode
Base module	10G	40G	40G (HiGig)	40G (HiGig)	40G (Native)	40G (Native)
Optional module (2 40GbE)	10G	40G	10G	40G	10G	40G
Optional modules (4 10GbE)	10G	Error	10G	Error	10G	Error

Table 37. Speeds in Different Aggregator Modes (continued)

Module Type	Standalone 10G mode	Standalone 40G Mode	Stacking 10G Mode	Stacking 40G mode	VLT 10G Mode	VLT 40G Mode
FC module	10G	10G	10G	10G	10G	10G

To configure the uplink speed of the member interfaces in a LAG bundle to be 40 GbE Ethernet per second for the Aggregator that operates in standalone, stacking, or VLT mode, perform the following steps:

Specify the uplink speed as 40 GbE. By default, the uplink speed of the LAG bundle is set as 10 GbE. You cannot configure the uplink speed if the Aggregator operates in programmable MUX mode. The `stack-unit unit-number iom-mode [stack | standalone | vlt] 40G` command is available in the CMC interface and the CLI interface.

CONFIGURATION

```
stack-unit unit-number iom-mode [stack | standalone | vlt] 40G
```

You can use the `show system stack-unit unit-number iom-uplink-speed` command to view the uplink speed of the LAG bundles configured on the Flex IO modules installed on the Aggregator. The value under the **Boot-speed** field in the output of the `show system stack-unit` command indicates the uplink speed that is currently effective on the LAG bundles, whereas the value under the **Next-Boot** field indicates the uplink speed that is applicable for the LAG bundle after the next reboot of the switch. Depending on the uplink speed configured, the fan-out setting is designed accordingly during the booting of the switch.

The following example displays the output of the `show system stack-unit unit-number iom-uplink-speed` command with the **Boot-speed** field contained in it:

```
Dell# show system stack-unit 0 iom-uplink-speed
Unit      Boot-speed                Next-Boot
-----
0         10G                       40G
```

Merging Two Operational Stacks

The recommended procedure for merging two operational stacks is as follows:

1. Always power off all units in one stack before connecting to another stack.
2. Add the units as a group by unplugging one stacking cable in the operational stack and physically connecting all unpowered units.
3. Completely cable the stacking connections, making sure the redundant link is also in place.

Two operational stacks can also be merged by reconnecting stack cables without powering down units in either stack. Connecting a powered-up standalone unit to an existing stack leads to same behavior as when merging two operational stacks. In such cases, Manager re-election is done and the Manager with the higher MAC address wins the election. The losing stack manager resets itself and all its member units. After the reset, all the losing stack members join the winning stack to form a single stack. The winning stack remains functional through the merge process. If the stack merge is performed in this way, then it is strongly recommended that the user set the admin management preference of the desired winner stack manager to a higher value than the stack manager that should lose the election.

NOTE: In case of a stack, when one unit member resets and joins the stack, momentary drops will be observed, which is recovered after few seconds.

Verifying a Stack Configuration

The following lists the status of a stacked switch according to the color of the System Status light emitting diodes (LEDs) on its front panel.

- Blue indicates the switch is operating as the stack master or as a standalone unit.
- Off indicates the switch is a member or standby unit.
- Amber indicates the switch is booting or a failure condition has occurred.

Using Show Commands

To display information on the stack configuration, use the `show` commands on the master switch.

- Displays stacking roles (master, standby, and member units) and the stack MAC address.
`show system [brief]`
- Displays the FlexIO modules currently installed in expansion slots 0 and 1 on a switch and the expected module logically provisioned for the slot.
`show inventory optional-module`
- Displays the stack groups allocated on a stacked switch. The range is from 0 to 5.
`show system stack-unit unit-number stack-group configured`
- Displays the port numbers that correspond to the stack groups on a switch. The valid stack-unit numbers are from 0 to 5.
`show system stack-unit unit-number stack-group`
- Displays the type of stack topology (ring or daisy chain) with a list of all stacked ports, port status, link speed, and peer stack-unit connection.
`show system stack-ports [status | topology]`

Example of the `show system brief` Command

```
Dell# show system brief
StStack MAC : 00:1e:c9:f1:00:9b
-- Stack Info --
Unit UnitType   Status      ReqTyp          CurTyp          Version        Ports
-----
0  Management  online      I/O-Aggregator I/O-Aggregator 8-3-17-46     56
1  Standby     online      I/O-Aggregator I/O-Aggregator 8-3-17-46     56
2  Member      not present
3  Member      not present
4  Member      not present
5  Member      not present
```

Example of the `show system` Command

```
Dell# show system
Stack MAC : 00:1e:c9:f1:00:9b
Reload Type : normal-reload [Next boot : normal-reload]
-- Unit 0 --
Unit Type : Management Unit
Status : online
Next Boot : online
Required Type : I/O-Aggregator - 34-port GE/TE (XL)
Current Type : I/O-Aggregator - 34-port GE/TE (XL)
Master priority : 0
Hardware Rev :
Num Ports : 56
Up Time : 2 hr, 41 min
FTOS Version : 8-3-17-46
Jumbo Capable : yes
POE Capable : no
Burned In MAC : 00:1e:c9:f1:00:9b
No Of MACs : 3
-- Unit 1 --
Unit Type : Standby Unit
Status : online
Next Boot : online
Required Type : I/O-Aggregator - 34-port GE/TE (XL)
Current Type : I/O-Aggregator - 34-port GE/TE (XL)
Master priority : 0
Hardware Rev :
Num Ports : 56
Up Time : 2 hr, 27 min
FTOS Version : 8-3-17-46
Jumbo Capable : yes
POE Capable : no
Burned In MAC : 00:1e:c9:f1:04:82
No Of MACs : 3
-- Unit 2 --
Unit Type : Member Unit
```

```
Status : not present
Required Type :
```

Example of the show inventory optional-module Command

```
Dell# show inventory optional-module

Unit Slot Expected Inserted Next Boot Power
-----
0     0     SFP+     SFP+     AUTO     Good
0     1     QSFP+    QSFP+    AUTO     Good
* - Mismatch
```

Example of the show system stack-unit stack-group configured Command

```
Dell# show system stack-unit 1 stack-group configured
Configured stack groups in stack-unit 1
-----
0
1
4
5
```

Example of the show system stack-unit stack-group Command

```
Dell#show system stack-unit 1 stack-group
Stack group   Ports
-----
0             0/33
1             0/37
2             0/41
3             0/45
4             0/49
5             0/53
Dell#
```

Example of the show system stack-ports (ring) Command

```
Dell# show system stack-ports
Topology: Ring
Interface Connection Link Speed Admin Link Trunk
              (Gb/s)  Status Status Group
0/33          1/33      40      up    up
0/37          1/37      40      up    up
1/33          0/33      40      up    up
1/37          0/37      40      up    up
```

Example of the show system stack-ports (daisy chain) Command

```
Dell# show system stack-ports
Topology: Daisy Chain
Interface Connection Link Speed Admin Link Trunk
              (Gb/s)  Status Status Group
0/33          40      up    down
0/37          1/37      40      up    up
1/33          40      up    down
1/37          0/37      40      up    up
```

Troubleshooting a Switch Stack

To perform troubleshooting operations on a switch stack, use the following commands on the master switch.

1. Displays the status of stacked ports on stack units.

```
show system stack-ports
```

2. Displays the master standby unit status, failover configuration, and result of the last master-standby synchronization; allows you to verify the readiness for a stack failover.

```
show redundancy
```

3. Displays input and output flow statistics on a stacked port.

```
show hardware stack-unit unit-number stack-port port-number
```

4. Clears statistics on the specified stack unit. The valid stack-unit numbers are from 0 to 5.

```
clear hardware stack-unit unit-number counters
```

5. Displays the current operational mode of the Aggregator (standalone or stacking) and the mode in which the Aggregator will operate at the next reload.

```
show system stack-unit unit-number iom-mode
```

Example of the show system stack-ports Command

```
Dell# show system stack-ports
Topology: Ring

Interface Connection Link Speed Admin Link Trunk
          (Gb/s)      Status Status Group
0/33      1/33      40      up      up
0/37      1/37      40      up      up
1/33      0/33      40      up      up
1/37      0/37      40      up      up
```

Example of the show redundancy Command

```
Dell#show redundancy

-- Stack-unit Status --
-----
Mgmt ID:                0
Stack-unit ID:          0
Stack-unit Redundancy Role: Primary
Stack-unit State:       Active (Indicates Master Unit.)
Stack-unit SW Version:  E8-3-16-46
Link to Peer:           Up

-- PEER Stack-unit Status --
-----
Stack-unit State:       Standby (Indicates Standby Unit.)
Peer stack-unit ID:    1
Stack-unit SW Version: E8-3-16-46

-- Stack-unit Redundancy Configuration --
-----
Primary Stack-unit:    mgmt-id 0
Auto Data Sync:       Full
Failover Type:        Hot (Failover Failover type with redundancy.)
force-failover
Auto reboot Stack-unit: Enabled
Auto failover limit:  3 times in 60 minutes

-- Stack-unit Failover Record --
-----
Failover Count:       0
Last failover timestamp: None
Last failover Reason: None
Last failover type:   None

-- Last Data Block Sync Record: --
-----
Stack Unit Config:    succeeded Sep 03 1993 09:36:52
Start-up Config:     succeeded Sep 03 1993 09:36:52 (Latest sync of config.)
Runtime Event Log:   succeeded Sep 03 1993 09:36:52
Running Config:      succeeded Sep 03 1993 09:36:52
ACL Mgr:             succeeded Sep 03 1993 09:36:52
LACP: no block sync done
STP: no block sync done
SPAN: no block sync done
```

Example of the show hardware stack-unit port-stack Command

```
Dell# show hardware stack-unit 1 stack-port 53
Input Statistics:
 7934 packets, 1049269 bytes
 0 64-byte pkts, 7793 over 64-byte pkts, 100 over 127-byte pkts
 0 over 255-byte pkts, 7 over 511-byte pkts, 34 over 1023-byte pkts
 70 Multicasts, 0 Broadcasts
 0 runts, 0 giants, 0 throttles
 0 CRC, 0 overrun, 0 discarded
Output Statistics:
 438 packets, 270449 bytes, 0 underruns
 0 64-byte pkts, 57 over 64-byte pkts, 181 over 127-byte pkts
 54 over 255-byte pkts, 0 over 511-byte pkts, 146 over 1023-byte pkts
 72 Multicasts, 0 Broadcasts, 221 Unicasts
 0 throttles, 0 discarded, 0 collisions, 0 wredDrops
Rate info (interval 45 seconds):
 Input 00.00 Mbits/sec,    0 packets/sec, 0.00% of line-rate
 Output 00.00 Mbits/sec,    0 packets/sec, 0.00% of line-rate
```

Failure Scenarios

The following sections describe some of the common fault conditions that can happen in a switch stack and how they are resolved.

Stack Member Fails

- **Problem:** A unit that is not the stack master fails in an operational stack.
- **Resolution:** If a stack member fails in a daisy chain topology, a split stack occurs. If a member unit fails in a ring topology, traffic is re-routed over existing stack links.

The following syslog messages are generated when a member unit fails:

```
Dell#May 31 01:46:17: %STKUNIT3-M:CP %IPC-2-STATUS: target stack unit 4 not responding
May 31 01:46:17: %STKUNIT3-M:CP %CHMGR-2-STACKUNIT_DOWN: Major alarm: Stack unit 4 down
- IPC
timeout

Dell#May 31 01:46:17: %STKUNIT3-M:CP %IFMGR-1-DEL_PORT: Removed port: Te 4/1-32,41-48,
Fo 4/
49,53

Dell#May 31 01:46:18: %STKUNIT5-S:CP %IFMGR-1-DEL_PORT: Removed port: Te 4/1-32,41-48,
Fo 4/
49,53
```

Unplugged Stacking Cable

- **Problem:** A stacking cable is unplugged from a member switch. The stack loses half of its bandwidth from the disconnected switch.
- **Resolution:** Intra-stack traffic is re-routed on a another link using the redundant stacking port on the switch. A recalculation of control plane and data plane connections is performed.

Master Switch Fails

- **Problem:** The master switch fails due to a hardware fault, software crash, or power loss.
- **Resolution:** A failover procedure begins:
 1. Keep-alive messages from the Aggregator master switch time out after 60 seconds and the switch is removed from the stack.
 2. The standby switch takes the master role. Data traffic on the new master switch is uninterrupted. Protocol traffic is managed by the control plane.

- A member switch is elected as the new standby. Data traffic on the new standby is uninterrupted. The control plane prepares for operation in Warm Standby mode.

Stack-Link Flapping Error

Problem/Resolution: Stacked Aggregators monitor their own stack ports and disable any stack port that flaps five times within 10 seconds. If the stacking ports that flap are on the master or standby, KERN-2-INT error messages note the units

To re-enable a downed stacking port, power cycle the stacked switch on which the port is installed.

The following is an example of the stack-link flapping error message.

```
-----MANAGEMENT
UNIT-----
Error: Stack Port 49 has flapped 5 times within 10 seconds. Shutting down this stack port now.
Error: Please check the stack cable/module and power-cycle the stack.
10:55:20: %STKUNIT1-M:CP %KERN-2-INT: Error: Stack Port 50 has flapped 5 times within 10
seconds. Shutting down this stack port now.
10:55:20: %STKUNIT1-M:CP %KERN-2-INT: Error: Please check the stack cable/module and
power-cycle the stack.
-----STANDBY
UNIT-----
10:55:18: %STKUNIT1-M:CP %KERN-2-INT: Error: Stack Port 50 has flapped 5 times within 10
seconds. Shutting down this stack port now.
10:55:18: %STKUNIT1-M:CP %KERN-2-INT: Error: Please check the stack cable/module
and power-cycle the stack.
```

Master Switch Recovers from Failure

- Problem:** The master switch recovers from a failure after a reboot and rejoins the stack as the standby unit or member unit. Protocol and control plane recovery requires time before the switch is fully online.
- Resolution:** When the entire stack is reloaded, the recovered master switch becomes the master unit of the stack.

Stack Unit in Card-Problem State Due to Incorrect Dell Networking OS Version

- Problem:** A stack unit enters a Card-Problem state because the switch has a different Dell Networking OS version than the master unit. The switch does not come online as a stack unit.
- Resolution:** To restore a stack unit with an incorrect Dell Networking OS version as a member unit, disconnect the stacking cables on the switch and install the correct Dell Networking OS version. Then add the switch to the stack as described in [Adding a Stack Unit](#). To verify that the problem has been resolved and the stacked switch is back online, use the `show system brief` command.

```
Dell#show system brief
Stack MAC : 00:1e:c9:f1:00:9b
-- Stack Info --
Unit UnitType  Status          ReqTyp          CurTyp          Version  Ports
-----
0  Management online          I/O-Aggregator I/O-Aggregator 8-3-17-46  56
1  Standby   card problem I/O-Aggregator unknown          56
2  Member   not present
3  Member   not present
4  Member   not present
5  Member   not present
```

Card Problem — Resolved

```
Dell#show system brief
Stack MAC : 00:1e:c9:f1:04:82
-- Stack Info --
Unit UnitType  Status          ReqTyp          CurTyp          Version  Ports
-----
0  Management online          I/O-Aggregator I/O-Aggregator 8-3-17-52  56
1  Standby   online       I/O-Aggregator I/O-Aggregator 8-3-17-52  56
2  Member   not present
```

```
3 Member not present
4 Member not present
5 Member not present
```

Stack Unit in Card-Problem State Due to Configuration Mismatch

- **Problem:** A stack unit enters a Card-Problem state because there is a configuration mismatch between the logical provisioning stored for the stack-unit number on the master switch and the newly added unit with the same number.
- **Resolution:** From the master switch, reload the stack by entering the `reload` command in EXEC Privilege mode. When the stack comes up, the card problem will be resolved.

Upgrading a Switch Stack

To upgrade all switches in a stack with the same Dell Networking OS version, follow these steps.

1. Copy the new Dell Networking OS image to a network server.
2. Download the Dell Networking OS image by accessing an interactive CLI that requests the server IP address and image filename, and prompts you to upgrade all member stack units.
EXEC Privilege mode

```
upgrade system { flash: | ftp: | scp: | tftp: | usbflash: } partition
```

Specify the system partition on the master switch into which you want to copy the Dell Networking OS image. The system then prompts you to upgrade all member units with the new Dell Networking OS version.
The valid values are a: and b:.
3. Reboot all stack units to load the Dell Networking OS image from the same partition on all switches in the stack.
CONFIGURATION mode

```
boot system stack-unit all primary system partition
```
4. Save the configuration.
EXEC Privilege

```
write memory
```
5. Reload the stack unit to activate the new Dell Networking OS version.
CONFIGURATION mode

```
reload
```

The following example shows how to upgrade all switches in a stack, including the master switch.

```
Dell# upgrade system ftp: A:
Address or name of remote host []: 10.11.200.241
Source file name []: //FTOS-XL-8.3.17.0.bin
User name to login remote host: ftp
Password to login remote host:
!!!!!!!!!!!!!!!!!!!!!!!!!!!!!!!!!!!!!!!!!!!!!!!!!!!!!!!!!!!!!!!!!!!!!!!!!!!!
Erasing IOM Primary Image, please wait
.!.....
.....Writing.....
.....
31972272 bytes successfully copied
System image upgrade completed successfully.
Upgrade system image for all stack-units [yes/no]: yes
!!!!!!!!!!!!!!!!!!!!!!!!!!!!!!!!!!!!!!!!!!!!!!!!!!!!!!!!!!!!!!!!!!!!!!!!!!!!
!!!!!!!!!!!!!!
!
Image upgraded to all
Dell# configure
Dell(conf)# boot system stack-unit all primary system: A:
Dell(conf)# end
Dell# write memory
Jan 3 14:01:48: %STKUNIT0-M:CP %FILEMGR-5-FILESAVED: Copied running-config to startup-
config
in flash by default
```

```
Synchronizing data to peer Stack-unit
!!!!
Dell# reload
Proceed with reload [confirm yes/no]: yes
```

Upgrading a Single Stack Unit

Upgrading a single stacked switch is necessary when the unit was disabled due to an incorrect Dell Networking OS version. This procedure upgrades the image in the boot partition of the member unit from the corresponding partition in the master unit.

To upgrade an individual stack unit with a new Dell Networking OS version, follow the below steps:

1. Download the Dell Networking OS image from the master's boot partition to the member unit, and upgrade the relevant boot partition in the single stack-member unit.

```
EXEC Privilege mode
upgrade system stack-unit unit-number partition
```

2. Reboot the stack unit from the master switch to load the Dell Networking OS image from the same partition.

```
CONFIGURATION mode
boot system stack-unit unit-number primary system partition
```

3. Save the configuration.

```
EXEC Privilege mode
write memory
```

4. Reset the stack unit to activate the new Dell Networking OS version.

```
EXEC Privilege mode
power-cycle stack-unit unit-number
```

The following example shows how to upgrade an individual stack unit.

```
Dell# upgrade system stack-unit 1 A:
!!!!!!!!!!!!!!!!!!!!!!!!!!!!!!!!!!!!!!!!!!!!!!!!!!!!!!!!!!!!!!!!!!!!!!!!!!!!!!!!!!!!!!!!!!!!!!!!!!!!!!!!!!!!!!!!!!!!!!!!
!!!!!!!!!!!!!!!!!!!!!!!!!!!!!!!!!!!!!!!!!!!!!!!!!!!!!!!!!!!!!!!!!!!!!!!!!!!!!!!!!!!!!!!!!!!!!!!!!!!!!!!!!!!!!!!!!!!!!!!!
!!!!!!!!!!!!!!!!!!!!!!!!!!!!!!!!!!!!!!!!!!!!!!!!!!!!!!!!!!!!!!!!!!!!!!!!!!!!!!!!!!!!!!!!!!!!!!!!!!!!!!!!!!!!!!!!!!!!!!!!
!!!!!!!!!!!!!!!!!!!!!!!!!!!!!!!!!!!!!!!!!!!!!!!!!!!!!!!!!!!!!!!!!!!!!!!!!!!!!!!!!!!!!!!!!!!!!!!!!!!!!!!!!!!!!!!!!!!!!!!!
!!!!!!!!!!!!!!!!!!!!!!!!!!!!!!!!!!!!!!!!!!!!!!!!!!!!!!!!!!!!!!!!!!!!!!!!!!!!!!!!!!!!!!!!!!!!!!!!!!!!!!!!!!!!!!!!!!!!!!!!
!!!!!!!!!!!!!!!!!!!!!!!!!!!!!!!!!!!!!!!!!!!!!!!!!!!!!!!!!!!!!!!!!!!!!!!!!!!!!!!!!!!!!!!!!!!!!!!!!!!!!!!!!!!!!!!!!!!!!!!!
!!!!!!!!!!!!!!!!!!!!!!!!!!!!!!!!!!!!!!!!!!!!!!!!!!!!!!!!!!!!!!!!!!!!!!!!!!!!!!!!!!!!!!!!!!!!!!!!!!!!!!!!!!!!!!!!!!!!!!!!
!!!!!!!!!!!!!!!!!!!!!!!!!!!!!!!!!!!!!!!!!!!!!!!!!!!!!!!!!!!!!!!!!!!!!!!!!!!!!!!!!!!!!!!!!!!!!!!!!!!!!!!!!!!!!!!!!!!!!!!!
!!!!!!!!!!!!!!!!!!!!!!!!!!!!!!!!!!!!!!!!!!!!!!!!!!!!!!!!!!!!!!!!!!!!!!!!!!!!!!!!!!!!!!!!!!!!!!!!!!!!!!!!!!!!!!!!!!!!!!!!
Image upgraded to Stack unit 1
Dell# configure
Dell(conf)# boot system stack-unit 1 primary system: A:
Dell(conf)# end
Dell#Jan 3 14:27:00: %STKUNIT0-M:CP %SYS-5-CONFIG_I: Configured from console
Dell# write memory
Jan 3 14:27:10: %STKUNIT0-M:CP %FILEMGR-5-FILESAVED: Copied running-config to startup-
config in flash
by default
Synchronizing data to peer Stack-unit
!!!!
....
Dell# power-cycle stack-unit 1
Proceed with power-cycle? Confirm [yes/no]:yes
```

Storm Control

The storm control feature allows you to control unknown-unicast, multicast, and broadcast control traffic on Layer 2 and Layer 3 physical interfaces.

Dell Networking OS Behavior: The Dell Networking OS supports broadcast control (the `storm-control broadcast` command) for Layer 2 and Layer 3 traffic. The minimum number of packets per second (PPS) that storm control can limit is two.

To view the storm control broadcast configuration show `storm-control broadcast | multicast | unknown-unicast | pfc-llfc [interface]` command.

EXEC Privilege

To view the storm control multicast configuration, use the `show storm-control multicast [interface]` command.

EXEC Privilege

Example:

```
Dell#show storm-control multicast Tengigabitethernet 1/1
Multicast storm control configuration
Interface  Direction      Packets/Second
-----
Te 1/1      Ingress          5
Dell#
```

To display the storm control unknown-unicast configuration, use the `show storm-control unknown-unicast [interface]` command.

EXEC Privilege

Topics:

- [Configure Storm Control](#)

Configure Storm Control

Storm control is supported in INTERFACE mode and CONFIGURATION mode.

Configuring Storm Control from CONFIGURATION Mode

To configure storm control from CONFIGURATION mode, use the following command.

You can configure storm control for ingress traffic in CONFIGURATION mode. Do not apply per-virtual local area network (per-VLAN) quality of service (QoS) on an interface that you have enabled storm-control (either on an interface or globally).

- Configure storm control.
CONFIGURATION mode
- Configure the packets per second of broadcast traffic allowed in the network.
CONFIGURATION mode
`storm-control broadcast packets_per_second in`
- Configure the packets per second (pps) of multicast traffic allowed on C-Series and S-Series networks only.
CONFIGURATION mode
`storm-control multicast packets_per_second in`
- Configure the packets per second of unknown-unicast traffic allowed in or out of the network.

CONFIGURATION mode

```
storm-control unknown-unicast [packets_per_second in]
```

Configuring Storm Control from INTERFACE Mode

To configure storm control, use the following command.

You can only configure storm control for ingress traffic in INTERFACE mode. If you configure storm control from both INTERFACE and CONFIGURATION mode, the INTERFACE mode configurations override the CONFIGURATION mode configurations.

- Configure storm control.

INTERFACE mode

- Configure the percentage of broadcast traffic allowed on an interface (ingress only).

INTERFACE mode

```
storm-control broadcast packets_per_second in
```

- Configure the percentage of multicast traffic allowed on C-Series or S-Series interface (ingress only) network only.

INTERFACE mode

```
storm-control multicast packets_per_second in
```

- Shut down the port if it receives the PFC/LLFC packets more than the configured rate.

INTERFACE mode

```
storm-control pfc-llfc pps in shutdown
```

 **NOTE:** PFC/LLFC storm control enabled interface disables the interfaces if it receives continuous PFC/LLFC packets. It can be a result of a faulty NIC/Switch that sends spurious PFC/LLFC packets.

Broadcast Storm Control

On the Aggregator, the broadcast storm control feature is enabled by default on all ports, and disabled on a port when an iSCSI storage device is detected. Broadcast storm control is re-enabled as soon as the connection with an iSCSI device ends.

Broadcast traffic on Layer 2 interfaces is limited or suppressed during a broadcast storm. You can view the status of a broadcast-storm control operation by using the `show io-aggregator broadcast storm-control status` command. You can disable broadcast storm control by using the `no io-aggregator broadcast storm-control` command.

Dell Networking OS Behavior: If broadcast traffic exceeds 1000 Mbps, the Aggregator limits it to 1000 Mbps per port-pipe.

Supported Modes

Standalone, PMUX, VLT, Stacking

Topics:

- [Disabling Broadcast Storm Control](#)
- [Displaying Broadcast-Storm Control Status](#)
- [Configuring Storm Control](#)

Disabling Broadcast Storm Control

To disable broadcast storm control on an Aggregator, use the `no io-aggregator broadcast storm-control` command from CONFIGURATION mode.

To re-enable broadcast storm control, enter the `io-aggregator broadcast storm-control` command.

Displaying Broadcast-Storm Control Status

To display the status of a current storm control operation, use the `show io-aggregator broadcast storm-control status` command from EXEC Privilege mode.

Configuring Storm Control

The following configurations are available only in PMUX mode.

1. To configure the percentage of broadcast traffic allowed on an interface, use the `storm-control broadcast [packets_per_second in]` command from INTERFACE mode.
2. To configure the percentage of multicast traffic allowed on an interface, use the `storm-control multicast [packets_per_second in]` command from INTERFACE mode.
3. To configure the percentage of unknown-unicast traffic allowed on an interface, use the `storm-control unknown-unicast [packets_per_second in]` command from INTERFACE mode.

SupportAssist

SupportAssist sends troubleshooting data securely to Dell. SupportAssist in this Dell EMC Networking OS release does not support automated email notification at the time of hardware fault alert, automatic case creation, automatic part dispatch, or reports. SupportAssist requires Dell EMC Networking OS 9.9(0.0) and SmartScripts 9.7 or later to be installed on the Dell EMC Networking device. For more information on SmartScripts, see *Dell EMC Networking Open Automation guide*.

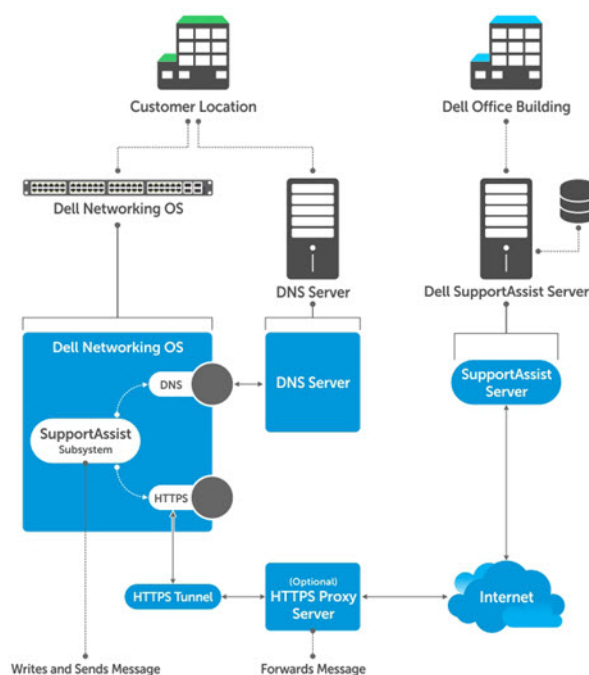

Figure 32. SupportAssist

NOTE: SupportAssist is enabled by default on the system. To disable SupportAssist, enter the `eula-consent support-assist reject` command in Global Configuration mode and save the configuration.

Topics:

- [Configuring SupportAssist Using a Configuration Wizard](#)
- [Configuring SupportAssist Manually](#)
- [Configuring SupportAssist Activity](#)
- [Configuring SupportAssist Company](#)
- [Configuring SupportAssist Person](#)
- [Configuring SupportAssist Server](#)
- [Viewing SupportAssist Configuration](#)

Configuring SupportAssist Using a Configuration Wizard

You are guided through a series of queries to configure SupportAssist. The generated commands are added to the running configuration, including the DNS resolve commands, if configured.

This command starts the configuration wizard for the SupportAssist. At any time, you can exit by entering `Ctrl-C`. If necessary, you can skip some data entry.

Enable the SupportAssist service.

CONFIGURATION mode

support-assist activate

```
DellEMC(conf)#support-assist activate
```

This command guides you through steps to configure SupportAssist.

Configuring SupportAssist Manually

To manually configure SupportAssist service, use the following commands.

1. Accept the end-user license agreement (EULA).

CONFIGURATION mode

```
eula-consent {support-assist} {accept | reject}
```

i **NOTE:** Once accepted, you do not have to accept the EULA again.

```
DellEMC(conf)# eula-consent support-assist accept
I accept the terms of the license agreement. You can reject
the license agreement by configuring this command
'eula-consent support-assist reject'.
```

By installing SupportAssist, you allow Dell to save your contact information (e.g. name, phone number and/or email address) which would be used to provide technical support for your Dell products and services. Dell may use the information for providing recommendations to improve your IT infrastructure.

Dell SupportAssist also collects and stores machine diagnostic information, which may include but is not limited to configuration information, user supplied contact information, names of data volumes, IP addresses, access control lists, diagnostics & performance information, network configuration information, host/server configuration & performance information and related data ("Collected Data") and transmits this information to Dell. By downloading SupportAssist and agreeing to be bound by these terms and the Dell end user license agreement, available at: www.dell.com/aeula, you agree to allow Dell to provide remote monitoring services of your IT environment and you give Dell the right to collect the Collected Data in accordance with Dells Privacy Policy, available at: www.dell.com/privacypolicycountryspecific, in order to enable the performance of all of the various functions of SupportAssist during your entitlement to receive related repair services from Dell,. You further agree to allow Dell to transmit and store the Collected Data from SupportAssist in accordance with these terms. You agree that the provision of SupportAssist may involve international transfers of data from you to Dell and/or to Dells affiliates, subcontractors or business partners. When making such transfers, Dell shall ensure appropriate protection is in place to safeguard the Collected Data being transferred in connection with SupportAssist. If you are downloading SupportAssist on behalf of a company or other legal entity, you are further certifying to Dell that you have appropriate authority to provide this consent on behalf of that entity. If you do not consent to the collection, transmission and/or use of the Collected Data, you may not download, install or otherwise use SupportAssist.

i **NOTE:** This step is not mandatory and you can configure SupportAssist manually without performing this step. Even before you accept or reject the EULA, the configuration data is sent to the default centrally deployed SupportAssist Server. If you reject the EULA, the configuration data is not transmitted to the SupportAssist server.

2. Move to the SupportAssist Configuration mode.

To manually configure SupportAssist, use the following command.

CONFIGURATION mode

```
support-assist
```

```
DellEMC (conf) #support-assist  
DellEMC (conf-supportassist) #
```

3. (Optional) Configure the contact information for the company.

```
SUPPORTASSIST mode
```

```
contact-company name {company-name} [company-next-name] ... [company-next-name]
```

```
DellEMC (conf) #support-assist  
DellEMC (conf-supportassist) #contact-company name test  
DellEMC (conf-supportassist-cmpy-test) #
```

4. (Optional) Configure the contact name for an individual.

```
SUPPORTASSIST mode
```

```
contact-person [first <first-name>] last <last-name>
```

```
DellEMC (conf) #support-assist  
DellEMC (conf-supportassist) #contact-person first john last doe  
DellEMC (conf-supportassist-pers-john_doe) #
```

5. (Optional) Configure the name of the custom server and move to SupportAssist Server mode.

```
SUPPORTASSIST mode
```

```
server server-name
```

```
DellEMC (conf) #support-assist  
DellEMC (conf-supportassist) #server default  
DellEMC (conf-supportassist-serv-default) #
```

You can configure a maximum of two servers:

- default server
- custom user configured server

6. Enable all activities and servers for the SupportAssist service.

```
SUPPORTASSIST mode
```

```
enable all
```

```
DellEMC (conf) #support-assist  
DellEMC (conf-supportassist) #enable all
```

7. Trigger an activity event immediately.

```
EXEC Privilege mode
```

```
support-assist activity {full-transfer | core-transfer} start now
```

```
DellEMC#support-assist activity full-transfer start now
```

```
DellEMC#support-assist activity core-transfer start now
```

Configuring SupportAssist Activity

SupportAssist Activity mode allows you to configure and view the action-manifest file for a specific activity.

To configure SupportAssist activity, use the following commands.

1. Move to the SupportAssist Activity mode for an activity. Allows you to configure customized details for a specific activity.

```
SUPPORTASSIST mode
```

```
[no] activity {full-transfer|core-transfer|event-transfer}
```

```
DellEMC(conf-supportassist)#activity full-transfer  
DellEMC(conf-supportassist-act-full-transfer)#
```

```
DellEMC(conf-supportassist)#activity core-transfer  
DellEMC(conf-supportassist-act-core-transfer)#
```

```
DellEMC(conf-supportassist)#activity event-transfer  
DellEMC(conf-supportassist-act-event-transfer)#
```

2. Copy an action-manifest file for an activity to the system.

SUPPORTASSIST ACTIVITY mode

```
action-manifest get tftp | ftp | flash <file-specification> <local-file-name>
```

```
DellEMC(conf-supportassist-act-full-transfer)#action-manifest get tftp://10.0.0.1/  
test file  
DellEMC(conf-supportassist-act-full-transfer)#
```

```
DellEMC(conf-supportassist-act-event-transfer)#action-manifest get tftp://10.0.0.1/  
test file  
DellEMC(conf-supportassist-act-event-transfer)#
```

3. Configure the action-manifest to use for a specific activity.

SUPPORTASSIST ACTIVITY mode

```
[no] action-manifest install {default | <local-file-name>}
```

```
DellEMC(conf-supportassist-act-full-transfer)#action-manifest install  
custom_file1.json  
DellEMC(conf-supportassist-act-full-transfer)#
```

```
DellEMC(conf-supportassist-act-event-transfer)#action-manifest install  
custom_event_file1.json  
DellEMC(conf-supportassist-act-event-transfer)#
```

4. View the list of action-manifest for a specific activity.

SUPPORTASSIST ACTIVITY mode

```
action-manifest show {all}
```

```
DellEMC(conf-supportassist-act-full-transfer)#action-manifest show all  
custom_file1.json  
DellEMC(conf-supportassist-act-full-transfer)#
```

```
DellEMC(conf-supportassist-act-event-transfer)#action-manifest show all  
custom_event_file1.json [installed]  
DellEMC(conf-supportassist-act-event-transfer)#
```

5. Remove the action-manifest file for an activity.

SUPPORTASSIST ACTIVITY mode

```
action-manifest remove <local-file-name>
```

```
DellEMC(conf-supportassist-act-full-transfer)#action-manifest remove custom_file1.json  
DellEMC(conf-supportassist-act-full-transfer)#
```

```
DellEMC(conf-supportassist-act-event-transfer)#action-manifest remove  
custom_event_file1.json  
DellEMC(conf-supportassist-act-event-transfer)#
```

6. Enable a specific SupportAssist activity.

By default, the full transfer includes the core files. When you disable the core transfer activity, the full transfer excludes the core files.

SUPPORTASSIST ACTIVITY mode

[no] enable

```
DellEMC (conf-supportassist-act-full-transfer) #enable
DellEMC (conf-supportassist-act-full-transfer) #
```

```
DellEMC (conf-supportassist-act-core-transfer) #enable
DellEMC (conf-supportassist-act-core-transfer) #
```

```
DellEMC (conf-supportassist-act-event-transfer) #enable
DellEMC (conf-supportassist-act-event-transfer) #
```

Configuring SupportAssist Company

SupportAssist Company mode allows you to configure name, address and territory information of the company. SupportAssist Company configurations are optional for the SupportAssist service.

To configure SupportAssist company, use the following commands.

1. Configure the contact information for the company.

SUPPORTASSIST mode

[no] contact-company name {*company-name*}[*company-next-name*] ... [*company-next-name*]

```
DellEMC (conf-supportassist) #contact-company name test
DellEMC (conf-supportassist-cmpy-test) #
```

2. Configure the address information for the company.

SUPPORTASSIST COMPANY mode

[no] address [*city company-city*] [{*province | region | state*} *name*] [*country company-country*] [{*postalcode | zipcode*} *company-code*]

```
DellEMC (conf-supportassist-cmpy-test) #address city MyCity state MyState country
MyCountry
DellEMC (conf-supportassist-cmpy-test) #
```

3. Configure the street address information for the company.

SUPPORTASSIST COMPANY mode

[no] street-address {*address1*}[*address2*]...[*address8*]

```
DellEMC (conf-supportassist-cmpy-test) #street-address 123 Main Street
DellEMC (conf-supportassist-cmpy-test) #
```

4. Configure the territory and set the coverage for the company site.

SUPPORTASSIST COMPANY mode

[no] territory *company-territory*

```
DellEMC (conf-supportassist-cmpy-test) #territory IN
DellEMC (conf-supportassist-cmpy-test) #
```

Configuring SupportAssist Person

SupportAssist Person mode allows you to configure name, email addresses, phone, method and time zone for contacting the person. SupportAssist Person configurations are optional for the SupportAssist service.

To configure SupportAssist person, use the following commands.

1. Configure the contact name for an individual.

SUPPORTASSIST mode

```
[no] contact-person [first <first-name>] last <last-name>
```

```
DellEMC(conf-supportassist)#contact-person first john last doe  
DellEMC(conf-supportassist-pers-john_doe)#
```

2. Configure the email addresses to reach the contact person.

```
SUPPORTASSIST PERSON mode
```

```
[no] email-address primary email-address [alternate email-address]
```

```
DellEMC(conf-supportassist-pers-john_doe)#email-address primary jdoe@mycompany.com  
DellEMC(conf-supportassist-pers-john_doe)#
```

3. Configure phone numbers of the contact person.

```
SUPPORTASSIST PERSON mode
```

```
[no] phone primary phone [alternate phone]
```

```
DellEMC(conf-supportassist-pers-john_doe)#phone primary +919999999999  
DellEMC(conf-supportassist-pers-john_doe)#
```

4. Configure the preferred method for contacting the person.

```
SUPPORTASSIST PERSON mode
```

```
preferred-method {email | no-contact | phone}
```

```
DellEMC(conf-supportassist-pers-john_doe)#preferred-method email  
DellEMC(conf-supportassist-pers-john_doe)#
```

5. Configure the time frame for contacting the person.

```
SUPPORTASSIST PERSON mode
```

```
[no] time-zone zone +-HH:MM[start-time HH:MM] [end-time HH:MM]
```

```
DellEMC(conf-supportassist-pers-john_doe)#time-zone zone +01:24 start-time 12:00 end-  
time 23:00  
DellEMC(conf-supportassist-pers-john_doe)#
```

Configuring SupportAssist Server

SupportAssist Server mode allows you to configure server name and the means of reaching the server. By default, a SupportAssist server URL has been configured on the device. Configuring a URL to reach the SupportAssist remote server should be done only under the direction of Dell SupportChange.

To configure SupportAssist server, use the following commands.

1. Configure the name of the remote SupportAssist Server and move to SupportAssist Server mode.

```
SUPPORTASSIST mode
```

```
[no] server server-name
```

```
DellEMC(conf-supportassist)#server default  
DellEMC(conf-supportassist-serv-default)#
```

2. Configure a proxy for reaching the SupportAssist remote server.

```
SUPPORTASSIST SERVER mode
```

```
[no] proxy-ip-address {ipv4-address | ipv6-address}port port-number [ username userid  
password [encryption-type] password ]
```

```
DellEMC(conf-supportassist-serv-default)#proxy-ip-address 10.0.0.1 port 1024 username  
test password 0 test1  
DellEMC(conf-supportassist-serv-default)#
```

3. Enable communication with the SupportAssist server.

```
SUPPORTASSIST SERVER mode
```

```
[no] enable
```

```
DellEMC (conf-supportassist-serv-default) #enable  
DellEMC (conf-supportassist-serv-default) #
```

4. Configure the URL to reach the SupportAssist remote server.

```
SUPPORTASSIST SERVER mode
```

```
[no] url uniform-resource-locator
```

```
DellEMC (conf-supportassist-serv-default) #url https://192.168.1.1/index.htm  
DellEMC (conf-supportassist-serv-default) #
```

Viewing SupportAssist Configuration

To view the SupportAssist configurations, use the following commands:

1. Display information on the SupportAssist feature status including any activities, status of communication, last time communication sent, and so on.

```
EXEC Privilege mode
```

```
show support-assist status
```

```
DellEMC#show support-assist status  
SupportAssist Service: Installed  
EULA: Accepted  
Server: default  
  Enabled: Yes  
  URL: https://stor.g3.ph.dell.com  
Server: Dell  
  Enabled: Yes  
  URL: http://1.1.1.1:1337  
Service status: Enabled
```

Activity	State	Last Start	Last Success
core-transfer	Success	Feb 15 2016 09:43:41 IST	Feb 15 2016 09:43:56 IST
event-transfer IST	Success	Feb 15 2016 09:47:43 IST	Feb 15 2016 09:48:21
full-transfer	Success	Feb 15 2016 09:36:12 IST	Feb 15 2016 09:38:27 IST

```
DellEMC#
```

2. Display the current configuration and changes from the default values.

```
EXEC Privilege mode
```

```
show running-config support-assist
```

```
DellEMC# show running-config support-assist  
!  
support-assist  
enable all  
!  
activity event-transfer  
  enable  
  action-manifest install default  
!  
activity core-transfer  
  enable  
!  
contact-company name Dell  
  street-address F lane , Sector 30  
  address city Brussels state HeadState country Belgium postalcode S328J3  
!  
contact-person first Fred last Nash  
  email-address primary des@sed.com alternate sed@dol.com  
  phone primary 123422 alternate 8395729  
  preferred-method email  
  time-zone zone +05:30 start-time 12:23 end-time 15:23
```

```
!  
server Dell  
  enable  
  url http://1.1.1.1:1337  
DellEMC#
```

3. Display the EULA for the feature.

EXEC Privilege mode

```
show eula-consent {support-assist | other feature}
```

```
DellEMC#show eula-consent support-assist
```

```
SupportAssist EULA has been: Accepted
```

```
Additional information about the SupportAssist EULA is as follows:
```

By installing SupportAssist, you allow Dell to save your contact information (e.g. name, phone number and/or email address) which would be used to provide technical support for your Dell products and services. Dell may use the information for providing recommendations to improve your IT infrastructure.

Dell SupportAssist also collects and stores machine diagnostic information, which may include but is not limited to configuration information, user supplied contact information, names of data volumes, IP addresses, access control lists, diagnostics & performance information, network configuration information, host/server configuration & performance information and related data (Collected Data) and transmits this information to Dell. By downloading SupportAssist and agreeing to be bound by these terms and the Dell end user license agreement, available at: www.dell.com/aeula, you agree to allow Dell to provide remote monitoring services of your IT environment and you give Dell the right to collect the Collected Data in accordance with Dells Privacy Policy, available at: www.dell.com/privacypolicycountryspecific, in order to enable the performance of all of the various functions of SupportAssist during your entitlement to receive related repair services from Dell,. You further agree to allow Dell to transmit and store the Collected Data from SupportAssist in accordance with these terms. You agree that the provision of SupportAssist may involve international transfers of data from you to Dell and/or to Dells affiliates, subcontractors or business partners. When making such transfers, Dell shall ensure appropriate protection is in place to safeguard the Collected Data being transferred in connection with SupportAssist. If you are downloading SupportAssist on behalf of a company or other legal entity, you are further certifying to Dell that you have appropriate authority to provide this consent on behalf of that entity. If you do not consent to the collection, transmission and/or use of the Collected Data, you may not download, install or otherwise use SupportAssist.

System Time and Date

The Aggregator auto-configures the hardware and software clocks with the current time and date. If necessary, you can manually set and maintain the system time and date using the CLI commands described in this chapter.

- Setting the Time for the Software Clock
- Setting the Time Zone
- Setting Daylight Savings Time

Supported Modes

Standalone, PMUX, VLT, Stacking

Topics:

- [Setting the Time for the Software Clock](#)
- [Setting the Timezone](#)
- [Setting Daylight Savings Time](#)
- [Configuring the Offset-Threshold for NTP Audit Log](#)
- [Configuring NTP control key password](#)

Setting the Time for the Software Clock

You can change the order of the `month` and `day` parameters to enter the time and date as *time day month year*. You cannot delete the software clock.

The software clock runs only when the software is up. The clock restarts, based on the hardware clock, when the switch reboots.

To set the software clock, use the following command.

- Set the system software clock to the current time and date.
EXEC Privilege mode
`clock set time month day year`
 - *time*: Enter the time in hours:minutes:seconds. For the hour variable, use the 24-hour format; for example, 17:15:00 is 5:15 pm.
 - *month*: Enter the name of one of the 12 months in English. You can enter the name of a day to change the order of the display to *time day month year*.
 - *day*: Enter the number of the day. The range is from 1 to 31. You can enter the name of a month to change the order of the display to *time day month year*.
 - *year*: Enter a four-digit number as the year. The range is from 1993 to 2035.

```
Dell#clock set 12:11:00 21 may 2012  
Dell#
```

Setting the Timezone

Universal time coordinated (UTC) is the time standard based on the International Atomic Time standard, commonly known as Greenwich Mean time. When determining system time, you must include the differentiator between the UTC and your local timezone. For example, San Jose, CA is the Pacific Timezone with a UTC offset of -8.

To set the clock timezone, use the following command.

- Set the clock to the appropriate timezone.

CONFIGURATION mode

```
clock timezone timezone-name offset
```

- *timezone-name*: Enter the name of the timezone. Do not use spaces.
- *offset*: Enter one of the following:
 - a number from 1 to 23 as the number of hours in addition to UTC for the timezone.
 - a minus sign (-) then a number from 1 to 23 as the number of hours.

```
Dell#conf
Dell(conf)#clock timezone Pacific -8
Dell#
```

Setting Daylight Savings Time

Dell Networking OS supports setting the system to daylight savings time once or on a recurring basis every year.

Setting Daylight Saving Time Once

Set a date (and time zone) on which to convert the switch to daylight saving time on a one-time basis.

To set the clock for daylight savings time once, use the following command.

- Set the clock to the appropriate timezone and daylight saving time.

CONFIGURATION mode

```
clock summer-time time-zone date start-month start-day start-year start-time end-month
end-day end-year end-time [offset]
```

- *time-zone*: Enter the three-letter name for the time zone. This name displays in the show clock output.
- *start-month*: Enter the name of one of the 12 months in English. You can enter the name of a day to change the order of the display to *time day month year*.
- *start-day*: enter the number of the day. The range is from 1 to 31. You can enter the name of a month to change the order of the display to *time day month year*.
- *start-year*: enter a four-digit number as the year. The range is from 1993 to 2035.
- *start-time*: enter the time in hours:minutes. For the hour variable, use the 24-hour format; example, 17:15 is 5:15 pm.
- *end-month*: enter the name of one of the 12 months in English. You can enter the name of a day to change the order of the display to *time day month year*.
- *end-day*: enter the number of the day. The range is from 1 to 31. You can enter the name of a month to change the order of the display to *time day month year*.
- *end-year*: enter a four-digit number as the year. The range is from 1993 to 2035.
- *end-time*: enter the time in hours:minutes. For the hour variable, use the 24-hour format; example, 17:15 is 5:15 pm.
- *offset*: (OPTIONAL) enter the number of minutes to add during the summer-time period. The range is from 1 to 1440. The default is **60 minutes**.

```
Dell(conf)#clock summer-time pacific date Mar 14 2012 00:00 Nov 7 2012 00:00
Dell(conf)#
```

Setting Recurring Daylight Saving Time

Set a date (and time zone) on which to convert the switch to daylight saving time on a specific day every year.

If you have already set daylight saving for a one-time setting, you can set that date and time as the recurring setting with the `clock summer-time time-zone recurring` command.

To set a recurring daylight saving time, use the following command.

- Set the clock to the appropriate timezone and adjust to daylight saving time every year.

CONFIGURATION mode

`clock summer-time time-zone recurring start-week start-day start-month start-time end-week end-day end-month end-time [offset]`

- o `time-zone`: Enter the three-letter name for the time zone. This name displays in the show clock output.
- o `start-week`: (OPTIONAL) Enter one of the following as the week that daylight saving begins and then enter values for `start-day` through `end-time`:
 - `week-number`: Enter a number from 1 to 4 as the number of the week in the month to start daylight saving time.
 - `first`: Enter the keyword `first` to start daylight savings time in the first week of the month.
 - `last`: Enter the keyword `last` to start daylight saving time in the last week of the month.
- o `start-month`: Enter the name of one of the 12 months in English. You can enter the name of a day to change the order of the display to `time day month year`.
- o `start-day`: Enter the number of the day. The range is from 1 to 31. You can enter the name of a month to change the order of the display to `time day month year`.
- o `start-year`: Enter a four-digit number as the year. The range is from 1993 to 2035.
- o `start-time`: Enter the time in hours:minutes. For the hour variable, use the 24-hour format; example, 17:15 is 5:15 pm.
- o `end-week`: If you entered a start-week, enter the one of the following as the week that daylight saving ends:
 - `week-number`: Enter a number from 1 to 4 as the number of the week in the month to end daylight saving time.
 - `first`: Enter the keyword `first` to end daylight saving time in the first week of the month.
 - `last`: Enter the keyword `last` to end daylight saving time in the last week of the month.
- o `end-month`: Enter the name of one of the 12 months in English. You can enter the name of a day to change the order of the display to `time day month year`.
- o `end-day`: Enter the number of the day. The range is from 1 to 31. You can enter the name of a month to change the order of the display to `time day month year`.
- o `end-year`: Enter a four-digit number as the year. The range is from 1993 to 2035.
- o `end-time`: Enter the time in hours:minutes. For the hour variable, use the 24-hour format; example, 17:15 is 5:15 pm.
- o `offset`: (OPTIONAL) Enter the number of minutes to add during the summer-time period. The range is from 1 to 1440. The default is **60 minutes**.

Example of the `clock summer-time recurring` Command

```
Dell(conf)#clock summer-time pacific recurring Mar 14 2012 00:00 Nov 7 2012 00:00
Dell(conf)#
```

 **NOTE:** If you enter <CR> after entering the `recurring` command parameter, and you have already set a one-time daylight saving time/date, the system uses that time and date as the recurring setting.

Example of Clock Summer-Time Recurring Parameters

```
Dell(conf)#clock summer-time pacific recurring ?
<1-4>      Week number to start
first      Week number to start
last       Week number to start
<cr>
Dell(conf)#clock summer-time pacific recurring
Dell(conf)#
```

Configuring the Offset-Threshold for NTP Audit Log

You can configure the system to send an audit log message to a syslog server if the time difference from the NTP server is greater than a threshold value (offset-threshold). However, time synchronization still occurs. To configure the offset-threshold, follow this procedure.

- Specify the threshold time interval before which the system generates an NTP audit log message if the system time deviates from the NTP server.

CONFIGURATION mode

```
ntp offset-threshold threshold-value
```

The range for `threshold-value` is from 0 to 999.

```
Dell(conf)#ntp offset-threshold 9
```

Configuring NTP control key password

The Network Time Protocol daemon (NTPD) design uses NTPQ to configure NTPD. NTP control key supports encrypted and unencrypted password options. The `ntp control-key-passwd` command authenticates NTPQ packets. The default control-key-passwd authenticates the NTPQ packets until the user changes the control-key using the `ntp control-key-passwd` command.

To configure NTP control key password, use the following command.

Configure NTP control key password.

CONFIGURATION mode

```
ntp control-key-passwd [encryption-type] password
```

Uplink Failure Detection (UFD)

Supported Modes

Standalone, PMUX, VLT, Stacking

Topics:

- [Feature Description](#)
- [How Uplink Failure Detection Works](#)
- [UFD and NIC Teaming](#)
- [Important Points to Remember](#)
- [Uplink Failure Detection \(SMUX mode\)](#)
- [Configuring Uplink Failure Detection \(PMUX mode\)](#)
- [Clearing a UFD-Disabled Interface \(in PMUX mode\)](#)
- [Displaying Uplink Failure Detection](#)
- [Sample Configuration: Uplink Failure Detection](#)

Feature Description

UFD provides detection of the loss of upstream connectivity and, if used with network interface controller (NIC) teaming, automatic recovery from a failed link.

A switch provides upstream connectivity for devices, such as servers. If a switch loses its upstream connectivity, downstream devices also lose their connectivity. However, the devices do not receive a direct indication that upstream connectivity is lost because connectivity to the switch is still operational.

UFD allows a switch to associate downstream interfaces with upstream interfaces. When upstream connectivity fails, the switch disables the downstream links. Failures on the downstream links allow downstream devices to recognize the loss of upstream connectivity.

For example, as shown in the following illustration, Switches S1 and S2 both have upstream connectivity to Router R1 and downstream connectivity to the server. UFD operation is shown in Steps A through C:

- In Step A, the server configuration uses the connection to S1 as the primary path. Network traffic flows from the server to S1 and then upstream to R1.
- In Step B, the upstream link between S1 and R1 fails. The server continues to use the link to S1 for its network traffic, but the traffic is not successfully switched through S1 because the upstream link is down.
- In Step C, UFD on S1 disables the link to the server. The server then stops using the link to S1 and switches to using its link to S2 to send traffic upstream to R1.

 **NOTE:** In Standalone and VLT modes, the UFD group number is 1 by default and cannot be changed.

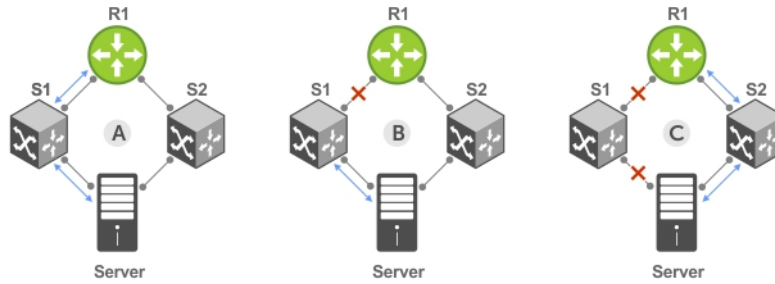

- A. Switches 1 and 2 have upstream and downstream connections to Router1 and Server via primary Links.
- B. Upstream link between Switch1 and Router1 fails. Downstream link to Server stays up temporarily.
- C. Switch1 disables downstream link to Server. Server starts to connect with Router1 using backup link to Switch2; Switch2 starts to use the backup link to Router1.

Figure 33. Uplink Failure Detection

How Uplink Failure Detection Works

UFD creates an association between upstream and downstream interfaces. The association of uplink and downlink interfaces is called an *uplink-state group*.

An interface in an uplink-state group can be a physical interface or a port-channel (LAG) aggregation of physical interfaces.

An enabled uplink-state group tracks the state of all assigned upstream interfaces. Failure on an upstream interface results in the automatic disabling of downstream interfaces in the uplink-state group. As a result, downstream devices can execute the protection or recovery procedures they have in place to establish alternate connectivity paths, as shown in the following illustration.

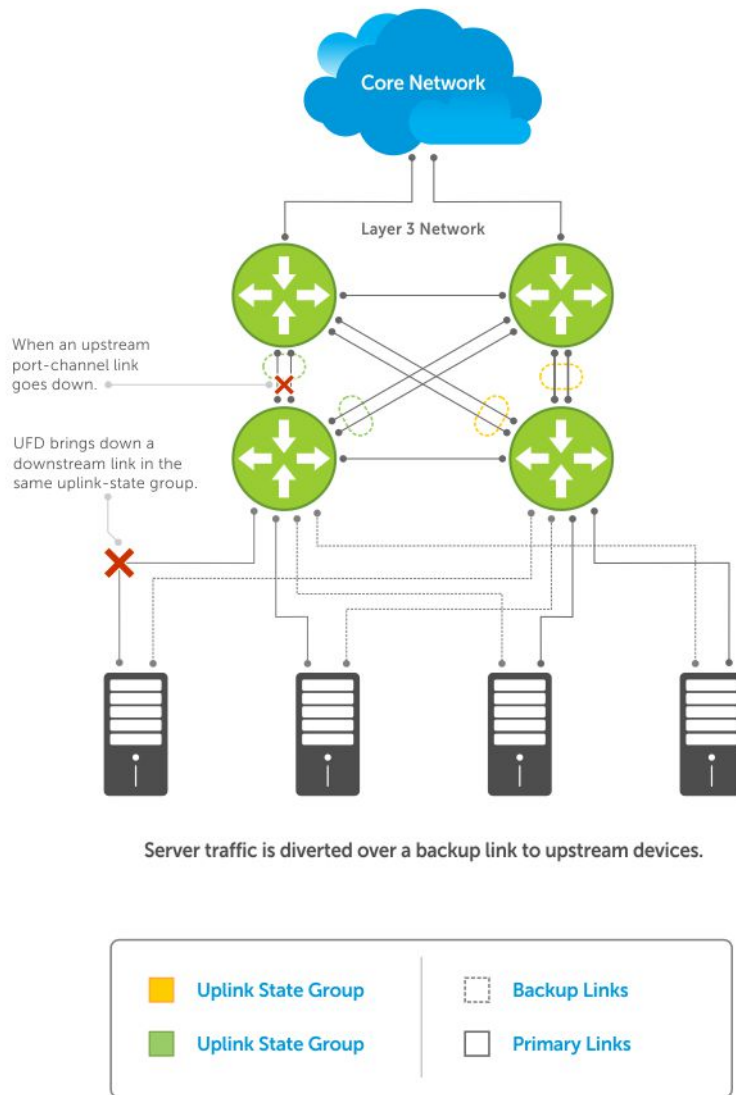

Figure 34. Uplink Failure Detection Example

If only one of the upstream interfaces in an uplink-state group goes down, a specified number of downstream ports associated with the upstream interface are put into a Link-Down state. You can configure this number and is calculated by the ratio of the upstream port bandwidth to the downstream port bandwidth in the same uplink-state group. This calculation ensures that there is no traffic drops due to insufficient bandwidth on the upstream links to the routers/switches.

By default, if all upstream interfaces in an uplink-state group go down, all downstream interfaces in the same uplink-state group are put into a Link-Down state.

Using UFD, you can configure the automatic recovery of downstream ports in an uplink-state group when the link status of an upstream port changes. The tracking of upstream link status does not have a major impact on central processing unit (CPU) usage.

UFD and NIC Teaming

To implement a rapid failover solution, you can use uplink failure detection on a switch with network adapter teaming on a server.

For more information, refer to [Network Interface Controller \(NIC\) Teaming](#).

For example, as shown previously, the switch/ router with UFD detects the uplink failure and automatically disables the associated downstream link port to the server. To continue to transmit traffic upstream, the server with NIC teaming detects the disabled link and automatically switches over to the backup link in order to continue to transmit traffic upstream.

Important Points to Remember

When you configure UFD, the following conditions apply.

- You can configure up to 16 uplink-state groups. By default, no uplink state groups are created in PMUX mode and uplink state group 1 is created in Standalone and VLT modes.
 - An uplink-state group is considered to be operationally *up* if it has at least one upstream interface in the Link-Up state.
 - An uplink-state group is considered to be operationally *down* if it has no upstream interfaces in the Link-Up state. No uplink-state tracking is performed when a group is disabled or in an Operationally Down state.
- You can assign physical port or port-channel interfaces to an uplink-state group in PMUX mode.
 - You can assign an interface to only one uplink-state group. Configure each interface assigned to an uplink-state group as either an upstream or downstream interface, but not both.
 - You can assign individual member ports of a port channel to the group. An uplink-state group can contain either the member ports of a port channel or the port channel itself, but not both.
 - If you assign a port channel as an upstream interface, the port channel interface enters a Link-Down state when the number of port-channel member interfaces in a Link-Up state drops below the configured `minimum number of members` parameter.
- If one of the upstream interfaces in an uplink-state group goes down, either a user-configurable set of downstream ports or all the downstream ports in the group are put in an Operationally Down state with an UFD Disabled error. The order in which downstream ports are disabled is from the lowest numbered port to the highest.
 - If one of the upstream interfaces in an uplink-state group that was down comes up, the set of UFD-disabled downstream ports (which were previously disabled due to this upstream port going down) is brought up and the UFD Disabled error is cleared.
- If you disable an uplink-state group, the downstream interfaces are not disabled regardless of the state of the upstream interfaces.
 - If an uplink-state group has no upstream interfaces assigned, you cannot disable downstream interfaces when an upstream link goes down.
- To enable the debug messages for events related to a specified uplink-state group or all groups, use the `debug uplink-state-group [group-id]` command, where the `group-id` is from 1 to 16.
 - To turn off debugging event messages, use the `no debug uplink-state-group [group-id]` command.
 - For an example of debug log message, refer to [Clearing a UFD-Disabled Interface](#).

Uplink Failure Detection (SMUX mode)

In Standalone or VLT modes, by default, all the server-facing ports are tracked by the operational status of the uplink LAG. If the uplink LAG goes down, the aggregator loses its connectivity and is no longer operational. All the server-facing ports are brought down after the specified `defer-timer` interval, which is 10 seconds by default. If you have configured VLAN, you can reduce the defer time by changing the `defer-timer` value or remove it by using the `no defer-timer` command.

1. View the Uplink status group.

EXEC Privilege mode

```
show uplink-state-group
```

```
Dell#show uplink-state-group
Uplink State Group: 1    Status: Enabled, Down
```

2. Enable the uplink group tracking.

UPLINK-STATE-GROUP mode

```
enable
```

```
Dell(conf)#uplink-state-group 1
Dell(conf-uplink-state-group-1)#enable
```

To disable the uplink group tracking, use the `no enable` command.

3. Change the default timer.

UPLINK-STATE-GROUP mode

```
defer-timer seconds
```

```
Dell(conf)#uplink-state-group 1
Dell(conf-uplink-state-group-1)#defer-timer 20
Dell(conf-uplink-state-group-1)#show config
!
uplink-state-group 1
downstream TenGigabitEthernet 0/1-32
upstream Port-channel 128
defer-timer 20
```

Configuring Uplink Failure Detection (PMUX mode)

To configure UFD, use the following commands.

1. Create an uplink-state group and enable the tracking of upstream links on the switch/router.

CONFIGURATION mode

```
uplink-state-group group-id
```

- *group-id*: values are from 1 to 16.

To delete an uplink-state group, use the `no uplink-state-group group-id` command.

2. Assign a port or port-channel to the uplink-state group as an upstream or downstream interface.

UPLINK-STATE-GROUP mode

```
{upstream | downstream} interface
```

For interface, enter one of the following interface types:

- 10 Gigabit Ethernet: enter `tengigabitethernet {slot/port | slot/port-range}`
- 40 Gigabit Ethernet: enter `fortygigabitethernet {slot/port | slot/port-range}`
- Port channel: enter `port-channel {1-512 | port-channel-range}`

Where *port-range* and *port-channel-range* specify a range of ports separated by a dash (-) and/or individual ports/port channels in any order; for example:

```
upstream gigabitethernet 1/1-2,5,9,11-12
downstream port-channel 1-3,5
```

- A comma is required to separate each port and port-range entry.

To delete an interface from the group, use the `no {upstream | downstream} interface` command.

3. (Optional) Configure the number of downstream links in the uplink-state group that will be disabled (Oper Down state) if one upstream link in the group goes down.

UPLINK-STATE-GROUP mode

```
downstream disable links {number | all}
```

- *number*: specifies the number of downstream links to be brought down. The range is from 1 to 1024.
- *all*: brings down all downstream links in the group.

The default is no downstream links are disabled when an upstream link goes down.

To revert to the default setting, use the `no downstream disable links` command.

4. (Optional) Enable auto-recovery so that UFD-disabled downstream ports in the uplink-state group come up when a disabled upstream port in the group comes back up.

UPLINK-STATE-GROUP mode

```
downstream auto-recover
```

The default is auto-recovery of UFD-disabled downstream ports is enabled.

To disable auto-recovery, use the `no downstream auto-recover` command.

- Specify the time (in seconds) to wait for the upstream port channel (LAG 128) to come back up before server ports are brought down.

```
UPLINK-STATE-GROUP mode
defer-timer seconds
```

NOTE: This command is available in Standalone and VLT modes only.

The range is from 1 to 120.

- (Optional) Enter a text description of the uplink-state group.

```
UPLINK-STATE-GROUP mode
description text
```

The maximum length is 80 alphanumeric characters.

- (Optional) Disable upstream-link tracking without deleting the uplink-state group.

```
UPLINK-STATE-GROUP mode
no enable
```

The default is upstream-link tracking is automatically enabled in an uplink-state group.

To re-enable upstream-link tracking, use the `enable` command.

Clearing a UFD-Disabled Interface (in PMUX mode)

You can manually bring up a downstream interface in an uplink-state group that UFD disabled and is in a UFD-Disabled Error state.

To re-enable one or more disabled downstream interfaces and clear the UFD-Disabled Error state, use the following command.

- Re-enable a downstream interface on the switch/router that is in a UFD-Disabled Error State so that it can send and receive traffic.

```
EXEC mode
```

```
clear ufd-disable {interface interface | uplink-state-group group-id}
```

For *interface*, enter one of the following interface types:

- 10 Gigabit Ethernet: enter `tengigabitethernet {slot/port | slot/port-range}`
- 40 Gigabit Ethernet: enter `fortygigabitethernet {slot/port | slot/port-range}`
- Port channel: enter `port-channel {1-512 | port-channel-range}`

- Where *port-range* and *port-channel-range* specify a range of ports separated by a dash (-) and/or individual ports/port channels in any order; for example:

```
tengigabitethernet 1/1-2,5,9,11-12
port-channel 1-3,5
```

- A comma is required to separate each port and port-range entry.

```
clear ufd-disable {interface interface | uplink-state-group group-id}; re-enables all UFD-
disabled downstream interfaces in the group. The range is from 1 to 16.
```

The following example message shows the Syslog messages that display when you clear the UFD-Disabled state from all disabled downstream interfaces in an uplink-state group by using the `clear ufd-disable uplink-state-group group-id` command. All downstream interfaces return to an operationally up state.

```
00:10:12: %STKUNIT0-M:CP %IFMGR-5-ASTATE_DN: Changed interface Admin state to down: Te
0/1
00:10:12: %STKUNIT0-M:CP %IFMGR-5-ASTATE_DN: Changed interface Admin state to down: Te
0/2
00:10:12: %STKUNIT0-M:CP %IFMGR-5-ASTATE_DN: Changed interface Admin state to down: Te
0/3
00:10:12: %STKUNIT0-M:CP %IFMGR-5-OSTATE_DN: Changed interface state to down: Te 0/1
00:10:12: %STKUNIT0-M:CP %IFMGR-5-OSTATE_DN: Changed interface state to down: Te 0/2
00:10:12: %STKUNIT0-M:CP %IFMGR-5-OSTATE_DN: Changed interface state to down: Te 0/3
00:10:13: %STKUNIT0-M:CP %IFMGR-5-OSTATE_DN: Changed uplink state group state to down:
Group
3
00:10:13: %STKUNIT0-M:CP %IFMGR-5-OSTATE_DN: Downstream interface set to UFD error-
```

```

disabled:
Te 0/4
00:10:13: %STKUNIT0-M:CP %IFMGR-5-OSTATE_DN: Downstream interface set to UFD error-
disabled:
Te 0/5
00:10:13: %STKUNIT0-M:CP %IFMGR-5-OSTATE_DN: Downstream interface set to UFD error-
disabled:
Te 0/6
00:10:13: %STKUNIT0-M:CP %IFMGR-5-OSTATE_DN: Changed interface state to down: Te 0/4
00:10:13: %STKUNIT0-M:CP %IFMGR-5-OSTATE_DN: Changed interface state to down: Te 0/5
00:10:13: %STKUNIT0-M:CP %IFMGR-5-OSTATE_DN: Changed interface state to down: Te 0/6

Dell(conf-if-range-te-0/1-3)#do clear ufd-disable uplink-state-group 3

00:11:50: %STKUNIT0-M:CP %IFMGR-5-OSTATE_UP: Downstream interface cleared from UFD
error-disabled: Te 0/4
00:11:51: %STKUNIT0-M:CP %IFMGR-5-OSTATE_UP: Downstream interface cleared from UFD
error-disabled: Te 0/5
00:11:51: %STKUNIT0-M:CP %IFMGR-5-OSTATE_UP: Downstream interface cleared from UFD
error-disabled: Te 0/6
00:11:51: %STKUNIT0-M:CP %IFMGR-5-OSTATE_UP: Changed interface state to up: Te 0/4
00:11:51: %STKUNIT0-M:CP %IFMGR-5-OSTATE_UP: Changed interface state to up: Te 0/5
00:11:51: %STKUNIT0-M:CP %IFMGR-5-OSTATE_UP: Changed interface state to up: Te 0/6

```

Displaying Uplink Failure Detection

To display information on the UFD feature, use any of the following commands.

- Display status information on a specified uplink-state group or all groups.

EXEC mode

```
show uplink-state-group [group-id] [detail]
```

- *group-id*: The values are 1 to 16.
- *detail*: displays additional status information on the upstream and downstream interfaces in each group.

- Display the current status of a port or port-channel interface assigned to an uplink-state group.

EXEC mode

```
show interfaces interface
```

interface specifies one of the following interface types:

- 10 Gigabit Ethernet: enter `tengigabitethernet slot/port`.
- 40 Gigabit Ethernet: enter `fortygigabitethernet slot/port`.
- Port channel: enter `port-channel {1-512}`.

If a downstream interface in an uplink-state group is disabled (Oper Down state) by uplink-state tracking because an upstream port is down, the message `error-disabled[UFD]` displays in the output.

- Display the current configuration of all uplink-state groups or a specified group.

EXEC mode or UPLINK-STATE-GROUP mode

(For EXEC mode) `show running-config uplink-state-group [group-id]`

(For UPLINK-STATE-GROUP mode) `show configuration`

- *group-id*: The values are from 1 to 16.

Example of Viewing Uplink State Group Status (S50)

```

Dell# show uplink-state-group

Uplink State Group: 1 Status: Enabled, Up
Uplink State Group: 3 Status: Enabled, Up
Uplink State Group: 5 Status: Enabled, Down
Uplink State Group: 6 Status: Enabled, Up
Uplink State Group: 7 Status: Enabled, Up
Uplink State Group: 16 Status: Disabled, Up

```

Dell# show uplink-state-group 16

```
Uplink State Group: 16 Status: Disabled, Up
```

Dell#show uplink-state-group detail

```
(Up): Interface up (Dwn): Interface down (Dis): Interface disabled

Uplink State Group      : 1 Status: Enabled, Up
Upstream Interfaces     :
Downstream Interfaces   :

Uplink State Group      : 3 Status: Enabled, Up
Upstream Interfaces     : Tengig 0/46(Up) Tengig 0/47(Up)
Downstream Interfaces   : Te 13/0(Up) Te 13/1(Up) Te 13/3(Up) Te 13/5(Up) Te 13/6(Up)

Uplink State Group      : 5 Status: Enabled, Down
Upstream Interfaces     : Tengig 0/0(Dwn) Tengig 0/3(Dwn) Tengig 0/5(Dwn)
Downstream Interfaces   : Te 13/2(Dis) Te 13/4(Dis) Te 13/11(Dis) Te 13/12(Dis) Te
13/13(Dis)
Te 13/14(Dis) Te 13/15(Dis)

Uplink State Group      : 6 Status: Enabled, Up
Upstream Interfaces     :
Downstream Interfaces   :

Uplink State Group      : 7 Status: Enabled, Up
Upstream Interfaces     :
Downstream Interfaces   :

Uplink State Group      : 16 Status: Disabled, Up
Upstream Interfaces     : Tengig 0/41(Dwn) Po 8(Dwn)
Downstream Interfaces   : Tengig 0/40(Dwn)
```

Example of Viewing Interface Status with UFD Information (S50)

Dell#show interfaces gigabitethernet 7/45

```
TenGigabitEthernet 7/45 is up, line protocol is down (error-disabled[UFD])
Hardware is Force10Eth, address is 00:01:e8:32:7a:47
Current address is 00:01:e8:32:7a:47
Interface index is 280544512
Internet address is not set
MTU 1554 bytes, IP MTU 1500 bytes
LineSpeed 1000 Mbit, Mode auto
Flowcontrol rx off tx off
ARP type: ARPA, ARP Timeout 04:00:00
Last clearing of "show interface" counters 00:25:46
Queueing strategy: fifo
Input Statistics:
  0 packets, 0 bytes
  0 64-byte pkts, 0 over 64-byte pkts, 0 over 127-byte pkts
  0 over 255-byte pkts, 0 over 511-byte pkts, 0 over 1023-byte pkts
  0 Multicasts, 0 Broadcasts
  0 runts, 0 giants, 0 throttles
  0 CRC, 0 overrun, 0 discarded
Output Statistics:
  0 packets, 0 bytes, 0 underruns
  0 64-byte pkts, 0 over 64-byte pkts, 0 over 127-byte pkts
  0 over 255-byte pkts, 0 over 511-byte pkts, 0 over 1023-byte pkts
  0 Multicasts, 0 Broadcasts, 0 Unicasts
  0 throttles, 0 discarded, 0 collisions
Rate info (interval 299 seconds):
  Input 00.00 Mbits/sec, 0 packets/sec, 0.00% of line-rate
  Output 00.00 Mbits/sec, 0 packets/sec, 0.00% of line-rate
Time since last interface status change: 00:01:23
```

Examples of Viewing UFD Output

```
Dell#show running-config uplink-state-group
!
uplink-state-group 1
no enable
downstream TenGigabitEthernet 0/0
```

```
upstream TenGigabitEthernet 0/1
Dell#
```

```
Dell(conf-uplink-state-group-16)# show configuration
!
uplink-state-group 16
no enable
description test
downstream disable links all
downstream TenGigabitEthernet 0/40
upstream TenGigabitEthernet 0/41
upstream Port-channel 8
```

Sample Configuration: Uplink Failure Detection

The following example shows a sample configuration of UFD on a switch/router in which you configure as follows.

- Configure uplink-state group 3.
- Add downstream links GigabitEthernet 0/1, 0/2, 0/5, 0/9, 0/11, and 0/12.
- Configure two downstream links to be disabled if an upstream link fails.
- Add upstream links GigabitEthernet 0/3 and 0/4.
- Add a text description for the group.
- Verify the configuration with various show commands.

Example of Configuring UFD

```
Dell(conf)#uplink-state-group 3
Dell(conf-uplink-state-group-3)#

00:23:52: %STKUNIT0-M:CP %IFMGR-5-ASTATE_UP: Changed uplink state group Admin state to
up:
Group 3

Dell(conf-uplink-state-group-3)#downstream tengigabitethernet 0/1-2,5,9,11-12
Dell(conf-uplink-state-group-3)#downstream disable links 2
Dell(conf-uplink-state-group-3)#upstream tengigabitethernet 0/3-4
Dell(conf-uplink-state-group-3)#description Testing UFD feature
Dell(conf-uplink-state-group-3)#show config
!
uplink-state-group 3
description Testing UFD feature
downstream disable links 2
downstream TenGigabitEthernet 0/1-2,5,9,11-12
upstream TenGigabitEthernet 0/3-4

Dell#show running-config uplink-state-group
!
uplink-state-group 3
description Testing UFD feature
downstream disable links 2
downstream TenGigabitEthernet 0/1-2,5,9,11-12
upstream TenGigabitEthernet 0/3-4

Dell#show uplink-state-group 3

Uplink State Group: 3 Status: Enabled, Up

Dell#show uplink-state-group detail

(Up): Interface up (Dwn): Interface down (Dis): Interface disabled

Uplink State Group      : 3 Status: Enabled, Up
Upstream Interfaces     : Te 0/3(Up) Te 0/4(Up)
Downstream Interfaces   : Te 0/1(Up) Te 0/2(Up) Te 0/5(Up) Te 0/9(Up) Te 0/11(Up)
                        : Te 0/12(Up)

< After a single uplink port fails >
```

```
Dell#show uplink-state-group detail
```

```
(Up): Interface up (Dwn): Interface down (Dis): Interface disabled
```

```
Uplink State Group      : 3 Status: Enabled, Up  
Upstream Interfaces     : Te 0/3(Dwn) Te 0/4(Up)  
Downstream Interfaces   : Te 0/1(Dis) Te 0/2(Dis) Te 0/5(Up) Te 0/9(Up) Te 0/11(Up)  
                        Te 0/12(Up)
```

PMUX Mode of the IO Aggregator

This chapter provides an overview of the PMUX mode.

Topics:

- I/O Aggregator (IOA) Programmable MUX (PMUX) Mode
- Configuring and Changing to PMUX Mode
- Configuring the Commands without a Separate User Account
- Virtual Link Trunking (VLT)

I/O Aggregator (IOA) Programmable MUX (PMUX) Mode

IOA PMUX is a mode that provides flexibility of operation with added configurability. This involves creating multiple LAGs, configuring VLANs on uplinks and the server side, configuring data center bridging (DCB) parameters, and so forth.

By default, IOA starts up in IOA Standalone mode. You can change to PMUX mode by executing the following commands and then reloading the IOA. After the IOA reboots, the IOA operates in PMUX mode. PMUX mode supports both stacking and VLT operations.

Configuring and Changing to PMUX Mode

After the IOA is operational in the default Standalone mode:

1. Connect the terminal to the console port on the IOA to access the CLI and enter the following commands:

```

Login: username
Password: *****
Dell> enable
Dell#
Dell#show system stack-unit 0 iom-mode
Unit Boot-Mode Next-Boot
-----
0 standalone standalone
Dell#

```

2. Change IOA mode to PMUX mode.

```
Dell(conf)# stack-unit 0 iom-mode programmable-mux
```

Where `stack-unit 0` defines the default stack-unit number.

3. Delete the startup configuration file.

```
Dell# delete startup-config
```

4. Reboot the IOA by entering the `reload` command.

```
Dell# reload
```

5. Repeat the above steps for each member of the IOA in PMUX mode.

After system is up, you can see the PMUX mode status:

```

Dell#sh system stack-unit 0 iom-mode
Unit          Boot-Mode          Next-Boot

```

```
-----  
0          programmable-mux          programmable-mux  
Dell#
```

The IOA is now ready for PMUX operations.

Configuring the Commands without a Separate User Account

Starting with Dell Networking OS version 9.3(0.0), you can configure the PMUX mode CLI commands without having to configure a new, separate user profile. The user profile you defined to access and log in to the switch is sufficient to configure the PMUX mode commands.

The IOA PMUX Mode CLI Commands section lists the PMUX mode CLI commands that you can now configure without a separate user account.

Virtual Link Trunking (VLT)

VLT allows physical links between two chassis to appear as a single virtual link to the network core. VLT eliminates the requirement for Spanning Tree protocols by allowing link aggregation group (LAG) terminations on two separate distribution or core switches, and by supporting a loop-free topology. VLT provides Layer 2 multipathing, creating redundancy through increased bandwidth and enabling multiple parallel paths between nodes and load-balancing traffic where alternative paths exist.

i **NOTE:** When you launch the VLT link, the VLT peer-ship is not established if any of the following is **TRUE**:

- The VLT System-MAC configured on both the VLT peers do not match.
- The VLT Unit-Id configured on both the VLT peers are identical.
- The VLT System-MAC or Unit-Id is configured only on one of the VLT peers.
- The VLT domain ID is not the same on both peers.

If the VLT peer-ship is already established, changing the System-MAC or Unit-Id does not cause VLT peer-ship to go down.

Also, if the VLT peer-ship is already established and the VLT Unit-Id or System-MAC are configured on both peers, then changing the CLI configurations on the VLT Unit-Id or System-MAC is rejected if any of the following become **TRUE**:

- After making the CLI configuration change, the VLT Unit-Id becomes identical on both peers.
- After making the CLI configuration change, the VLT System-MAC do not match on both peers.

When the VLT peer-ship is already established, you can remove the VLT Unit-Id or System-MAC configuration from either or both peers. However, removing configuration settings can cause the VLT ports to go down if you configure the Unit-Id or System-MAC on only one of the VLT peers.

Overview

VLT allows physical links between two chassis to appear as a single virtual link to the network core or other switches such as Edge, Access, or top-of-rack (ToR).

VLT reduces the role of spanning tree protocols (STPs) by allowing link aggregation group (LAG) terminations on two separate distribution or core switches, and by supporting a loop-free topology. (To prevent the initial loop that may occur prior to VLT being established, use a spanning tree protocol.)

VLT provides Layer 2 multipathing, creating redundancy through increased bandwidth, enabling multiple parallel paths between nodes and load-balancing traffic where alternative paths exist.

Virtual link trunking offers the following benefits:

- Allows a single device to use a LAG across two upstream devices.
- Eliminates STP-blocked ports.
- Provides a loop-free topology.
- Uses all available uplink bandwidth.

- Provides fast convergence if either the link or a device fails.
- Optimized forwarding with virtual router redundancy protocol (VRRP).
- Provides link-level resiliency.
- Assures high availability.

CAUTION: Dell Networking does not recommend enabling Stacking and VLT simultaneously. If you enable both features at the same time, unexpected behavior occurs.

As shown in the following example, VLT presents a single logical Layer 2 domain from the perspective of attached devices that have a virtual link trunk terminating on separate chassis in the VLT domain. However, the two VLT chassis are independent Layer2/Layer3 (L2/L3) switches for devices in the upstream network. L2/L3 control plane protocols and system management features function normally in VLT mode. Features such as VRRP and internet group management protocol (IGMP) snooping require state information coordinating between the two VLT chassis. IGMP and VLT configurations must be identical on both sides of the trunk to ensure the same behavior on both sides.

Setting up VLT

The following figure shows the sample VLT topology.

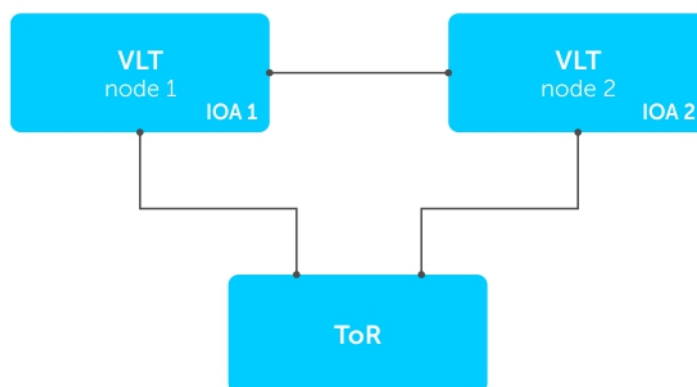

Figure 35. Sample VLT Topology

Ports 33 and 37 are used as ICL links and these two 40G ports are connected back to back between the two Aggregators. In PMUX VLT, you can choose any uplink ports for configuring VLT.

NOTE: Ensure the connectivity to ToR from each Aggregator.

To enable VLT and verify the configuration, follow these steps.

1. Enable VLT in node 1 and 2.

```

stack-unit unit iom-mode vlt
CONFIGURATION mode
Dell(conf)#stack-unit 0 iom-mode vlt
  
```

2. Verify the VLT configurations.

```

show interface port-channel brief
EXEC mode
  
```

```

Dell# show interfaces port brief
Codes: L - LACP Port-channel
  
```

```
O - OpenFlow Controller Port-channel
```

LAG	Mode	Status	Uptime	Ports	
127	L2	up	00:18:22	Fo 0/33	(Up) <<<<<<<<<<ICL LAG
				Fo 0/37	(Up)
L 128	L2	up	00:00:00	Fo 0/41	(Up) <<<<<<<<<<Uplink LAG

Virtual Link Trunking (VLT) in PMUX Mode

VLT allows the physical links between two devices (known as VLT nodes or peers) within a VLT domain to be considered a single logical link to connected external devices.

For VLT operations, use the following configurations on both the primary and secondary VLT. Ensure the VLTi links are connected and administratively up. VLTi connects the VLT peers for VLT data exchange.

1. Configure VLTi.

```
Dell#configure
Dell(conf)#int port-channel 127
Dell(conf-if-po-127)# channel-member fortygige 0/33,37
Dell(conf-if-po-127)# no shutdown
Dell(conf-if-po-127)# end
```

2. Configure the VLT domain.

```
Dell#configure
Dell(conf)#vlt domain 1
Dell(conf-vlt-domain)# peer-link port-channel 127
-> VLT peer destination
Dell(conf-vlt-domain)# back-up destination 169.254.31.23
Dell(conf-vlt-domain)#system-mac mac-address
00:01:09:06:06:06
-> unit-id 0 - VLT Primary, unit-id 1 - VLT Secondary
Dell(conf-vlt-domain)# unit-id 0
Dell(conf-vlt-domain)#end
```

3. Configure the VLT port channel. In the following example, the local and remote VLT port-channels are the same but you can also use different VLT port-channels.

```
Dell#configure
Dell(conf)#int port-channel 128
Dell(conf-if-po-128)# portmode hybrid
Dell(conf-if-po-128)# switchport
Dell(conf-if-po-128)# vlt-peer-lag port-channel 128
Dell(conf-if-po-128)# link-bundle-monitor enable
Dell(conf-if-po-128)# no shutdown
Dell(conf-if-po-128)# end
```

4. Show the VLT peer status.

```
Dell#show vlt br
VLT Domain Brief
-----
Domain ID                : 1
Role                     : Secondary
Role Priority             : 32768
ICL Link Status          : Up
HeartBeat Status        : Up
VLT Peer Status         : Up
Version                  : 6(3)
Local System MAC address : 00:01:e8:8a:e9:91
Remote System MAC address : 00:01:e8:8a:e9:76
Remote system version    : 6(3)
Delay-Restore timer      : 90 seconds
Delay-Restore Abort Threshold : 60 seconds
```

```

Peer-Routing : Disabled
Peer-Routing-Timeout timer : 0 seconds
Multicast peer-routing timeout : 150 seconds
Dell#

```

5. Configure the secondary VLT.

NOTE: Repeat steps from 1 through 4 on the secondary VLT, ensuring you use the different backup destination and unit-id.

```

Dell#show vlt br
VLT Domain Brief
-----
Domain ID : 1
Role : Secondary
Role Priority : 32768
ICL Link Status : Up
HeartBeat Status : Up
VLT Peer Status : Up
Version : 6(3)
Local System MAC address : 00:01:e8:8a:e9:91
Remote System MAC address : 00:01:e8:8a:e9:76
Remote system version : 6(3)
Delay-Restore timer : 90 seconds

Delay-Restore Abort Threshold : 60 seconds
Peer-Routing : Disabled
Peer-Routing-Timeout timer : 0 seconds
Multicast peer-routing timeout : 150 seconds
Dell#

```

```

Dell#show vlt detail
Local LAG Id Peer LAG Id Local Status Peer Status
Active VLANs
-----
128 128 UP UP 1
Dell#

```

6. Show the running configurations on this port-channel.

```

Dell(conf-if-po-128)#show config
!
interface Port-channel 128
portmode hybrid
switchport
vlan tagged 10-15
vlan untagged 20
shutdown
Dell(conf-if-po-128)#end
Dell#

```

7. Show the VLAN configurations.

```

Dell#show vlan
Codes: * - Default VLAN, G - GVRP VLANs, R - Remote Port Mirroring VLANs, P -
Primary, C - Community, I - Isolated
O - Openflow
Q: U - Untagged, T - Tagged
x - Dot1x untagged, X - Dot1x tagged
o - OpenFlow untagged, O - OpenFlow tagged
G - GVRP tagged, M - Vlan-stack, H - VSN tagged
i - Internal untagged, I - Internal tagged, v - VLT untagged, V - VLT tagged
NUM Status Description Q Ports
* 1 Active U Te 0/33
10 Active T Po128(Te 0/41-42)
T Te 0/1
11 Active T Po128(Te 0/41-42)
T Te 0/1
12 Active T Po128(Te 0/41-42)
T Te 0/1

```

```

13 Active          T Po128 (Te 0/41-42)
                   T Te 0/1
14 Active          T Po128 (Te 0/41-42)
                   T Te 0/1
15 Active          T Po128 (Te 0/41-42)
                   T Te 0/1
20 Active          U Po128 (Te 0/41-42)
                   U Te 0/1
Dell

```

You can remove the inactive VLANs that have no member ports using the following command:

```

Dell#configure
Dell(conf)#no interface vlan <vlan-id>

```

->vlan-id - Inactive VLAN with no member ports

You can remove the tagged VLANs using the `no vlan tagged <VLAN-RANGE>` command. You can remove the untagged VLANs using the `no vlan untagged` command in the physical port/port-channel.

VLT Terminology

The following are key VLT terms.

- **Virtual link trunk (VLT)** — The combined port channel between an attached device and the VLT peer switches.
- **VLT backup link** — The backup link monitors the connectivity between the VLT peer switches. The backup link sends configurable, periodic keep alive messages between the VLT peer switches.
- **VLT interconnect (VLTi)** — The link used to synchronize states between the VLT peer switches. Both ends must be on 10G or 40G interfaces.
- **VLT domain** — This domain includes both the VLT peer devices, VLT interconnect, and all of the port channels in the VLT connected to the attached devices. It is also associated to the configuration mode that you must use to assign VLT global parameters.
- **VLT peer device** — One of a pair of devices that are connected with the special port channel known as the VLT interconnect (VLTi).
- **Enhanced VLT (eVLT)** — Combining two VLT domains. eVLT can operate in layer 2 and layer 3 modes. eVLT is also known as mVLT.

VLT peer switches have independent management planes. A VLT interconnect between the VLT chassis maintains synchronization of L2/L3 control planes across the two VLT peer switches. The VLT interconnect uses 10G or 40G user ports on the chassis.

A separate backup link maintains heartbeat messages across an out-of-band (OOB) management network. The backup link ensures that node failure conditions are correctly detected and are not confused with failures of the VLT interconnect. VLT ensures that local traffic on a chassis does not traverse the VLTi and takes the shortest path to the destination via directly attached links.

The following is a summary of VLT and its functions:

- End devices (such as switches, servers, and so on) connected to a VLT domain consider the two VLT peers as a single logical switch.
- Although VLT does not require spanning tree protocols, Dell EMC Networking recommends enabling RSTP before configuring VLT to avoid possible loops from forming due to incorrect configuration.
- You can connect two VLT domains to create an eVLT topology.
- You can use eVLT as layer 2.
- Peer routing enables one VLT node to act as the default gateway for its VLT peer within a VLT domain.
- With peer routing, you need not use VRRP.
- You can use routing protocols in a VLT domain or between VLT domains (eVLT).
- VLT Proxy Gateway enables one VLT domain to act as the default gateway for its peer VLT domain in an eVLT topology.

Configure Virtual Link Trunking

VLT requires that you enable the feature and then configure the same VLT domain, backup link, and VLT interconnect on both peer switches.

Important Points to Remember

- VLT port channel interfaces must be switch ports.
- Dell Networking strongly recommends that the VLTi (VLT interconnect) be a static LAG and that you disable LACP on the VLTi.
- If the `lACP-ungroup` feature is not supported on the ToR, reboot the VLT peers one at a time. After rebooting, verify that VLTi (ICL) is active before attempting DHCP connectivity.

Configuration Notes

When you configure VLT, the following conditions apply.

- VLT domain
 - A VLT domain supports two chassis members, which appear as a single logical device to network access devices connected to VLT ports through a port channel.
 - A VLT domain consists of the two core chassis, the interconnect trunk, backup link, and the LAG members connected to attached devices.
 - Each VLT domain has a unique MAC address that you create or VLT creates automatically.
 - ARP tables are synchronized between the VLT peer nodes.
 - VLT peer switches operate as separate chassis with independent control and data planes for devices attached on non-VLT ports.
 - One chassis in the VLT domain is assigned a primary role; the other chassis takes the secondary role. The primary and secondary roles are required for scenarios when connectivity between the chassis is lost. VLT assigns the primary chassis role according to the lowest MAC address. You can configure the primary role.
 - In a VLT domain, the peer switches must run the same Dell Networking OS software version.
 - Separately configure each VLT peer switch with the same VLT domain ID and the VLT version. If the system detects mismatches between VLT peer switches in the VLT domain ID or VLT version, the VLT Interconnect (VLTi) does not activate. To find the reason for the VLTi being down, use the `show vlt statistics` command to verify that there are mismatch errors, then use the `show vlt brief` command on each VLT peer to view the VLT version on the peer switch. If the VLT version is more than one release different from the current version in use, the VLTi does not activate.
 - The chassis members in a VLT domain support connection to orphan hosts and switches that are not connected to both switches in the VLT core.
- VLT interconnect (VLTi)
 - The VLT interconnect supports a maximum of two 10G ports.
 - In VLT mode, port 33 and 37 are dedicated to VLT interconnect ports.
 - A VLT interconnect over 1G ports is *not* supported.
 - The port channel must be in Default mode (not Switchport mode) to have VLTi recognize it.
 - The system automatically includes the required VLANs in VLTi. You do not need to manually select VLANs.
 - VLT peer switches operate as separate chassis with independent control and data planes for devices attached to non-VLT ports.
 - Port-channel link aggregation (LAG) across the ports in the VLT interconnect is required; individual ports are not supported. Dell Networking strongly recommends configuring a static LAG for VLTi.
 - The VLT interconnect synchronizes L2 and L3 control-plane information across the two chassis.
 - The VLT interconnect is used for data traffic only when there is a link failure that requires using VLTi in order for data packets to reach their final destination.
 - Unknown, multicast, and broadcast traffic can be flooded across the VLT interconnect.
 - MAC addresses for VLANs configured across VLT peer chassis are synchronized over the VLT interconnect on an egress port such as a VLT LAG. MAC addresses are the same on both VLT peer nodes.
 - ARP entries configured across the VLTi are the same on both VLT peer nodes.
 - If you shut down the port channel used in the VLT interconnect on a peer switch in a VLT domain in which you did not configure a backup link, the switch's role displays in the `show vlt brief` command output as Primary instead of Standalone.
 - When you change the default VLAN ID on a VLT peer switch, the VLT interconnect may flap.

- In a VLT domain, the following software features are supported on VLTi: link layer discovery protocol (LLDP), flow control, port monitoring, jumbo frames, and data center bridging (DCB).
- When you enable the VLTi link, the link between the VLT peer switches is established if the following configured information is true on both peer switches:
 - the VLT system MAC address matches.
 - the VLT unit-id is not identical.
- **NOTE:** If you configure the VLT system MAC address or VLT unit-id on only one of the VLT peer switches, the link between the VLT peer switches is not established. Each VLT peer switch must be correctly configured to establish the link between the peers.
- If the link between the VLT peer switches is established, changing the VLT system MAC address or the VLT unit-id causes the link between the VLT peer switches to become disabled. However, removing the VLT system MAC address or the VLT unit-id may disable the VLT ports if you happen to configure the unit ID or system MAC address on only one VLT peer at any time.
- If the link between VLT peer switches is established, any change to the VLT system MAC address or unit-id fails if the changes made create a mismatch by causing the VLT unit-ID to be the same on both peers and/or the VLT system MAC address does not match on both peers.
- If you replace a VLT peer node, preconfigure the switch with the VLT system MAC address, unit-id, and other VLT parameters before connecting it to the existing VLT peer switch using the VLTi connection.
- VLT backup link
 - In the backup link between peer switches, heartbeat messages are exchanged between the two chassis for health checks. The default time interval between heartbeat messages over the backup link is 1 second. You can configure this interval. The range is from 1 to 5 seconds. DSCP marking on heartbeat messages is CS6.
 - In order that the chassis backup link does not share the same physical path as the interconnect trunk, Dell Networking recommends using the management ports on the chassis and traverse an out-of-band management network. The backup link can use user ports, but not the same ports the interconnect trunk uses.
 - The chassis backup link does not carry control plane information or data traffic. Its use is restricted to health checks only.
- Virtual link trunks (VLTs) between access devices and VLT peer switches
 - To connect servers and access switches with VLT peer switches, you use a VLT port channel, as shown in [Overview](#).
 - The discovery protocol running between VLT peers automatically generates the ID number of the port channel that connects an access device and a VLT switch. The discovery protocol uses LACP properties to identify connectivity to a common client device and automatically generates a VLT number for port channels on VLT peers that connects to the device. The discovery protocol requires that an attached device always runs LACP over the port-channel interface.
 - VLT provides a loop-free topology for port channels with endpoints on different chassis in the VLT domain.
 - VLT uses shortest path routing so that traffic destined to hosts via directly attached links on a chassis does not traverse the chassis-interconnect link.
 - VLT allows multiple active parallel paths from access switches to VLT chassis.
 - VLT supports port-channel links with LACP between access switches and VLT peer switches. Dell Networking recommends using static port channels on VLTi.
 - If VLTi connectivity with a peer is lost but the VLT backup connectivity indicates that the peer is still alive, the VLT ports on the Secondary peer are orphaned and are shut down.
- Software features supported on VLT port-channels
 - For information about configuring IGMP Snooping in a VLT domain, refer to [VLT and IGMP Snooping](#).
 - All system management protocols are supported on VLT ports, including SNMP, RMON, AAA, ACL, DNS, FTP, SSH, Syslog, NTP, RADIUS, SCP, TACACS+, Telnet, and LLDP.
 - Enable Layer 3 VLAN connectivity VLT peers by configuring a VLAN network interface for the same VLAN on both switches.
 - Dell Networking does not recommend enabling peer-routing if the CAM is full. To enable peer-routing, a minimum of two local DA spaces for wild card functionality are required.
- Software features supported on VLT physical ports
 - In a VLT domain, the following software features are supported on VLT physical ports: 802.1p, LLDP, flow control, port monitoring, and jumbo frames.
- Software features not supported with VLT
 - In a VLT domain, the following software features are supported on non-VLT ports: 802.1x, , DHCP snooping, FRRP, IPv6 dynamic routing.
- Failure scenarios
 - On a link failover, when a VLT port channel fails, the traffic destined for that VLT port channel is redirected to the VLTi to avoid flooding.
 - When a VLT switch determines that a VLT port channel has failed (and that no other local port channels are available), the peer with the failed port channel notifies the remote peer that it no longer has an active port channel for a link. The

remote peer then enables data forwarding across the interconnect trunk for packets that would otherwise have been forwarded over the failed port channel. This mechanism ensures reachability and provides loop management. If the VLT interconnect fails, the VLT software on the primary switch checks the status of the remote peer using the backup link. If the remote peer is up, the secondary switch disables all VLT ports on its device to prevent loops.

- If all ports in the VLT interconnect fail, or if the messaging infrastructure fails to communicate across the interconnect trunk, the VLT management system uses the backup link interface to determine whether the failure is a link-level failure or whether the remote peer has failed entirely. If the remote peer is still alive (heartbeat messages are still being received), the VLT secondary switch disables its VLT port channels. If keepalive messages from the peer are not being received, the peer continues to forward traffic, assuming that it is the last device available in the network. In either case, after recovery of the peer link or reestablishment of message forwarding across the interconnect trunk, the two VLT peers resynchronize any MAC addresses learned while communication was interrupted and the VLT system continues normal data forwarding.
- If the primary chassis fails, the secondary chassis takes on the operational role of the primary.
- The SNMP MIB reports VLT statistics.

Primary and Secondary VLT Peers

Primary and Secondary VLT Peers are supported on the Aggregator.

To prevent issues when connectivity between peers is lost, you can designate Primary and Secondary roles for VLT peers. You can elect or configure the Primary Peer. By default, the peer with the lowest MAC address is selected as the Primary Peer.

If the VLTi link fails, the status of the remote VLT Primary Peer is checked using the backup link. If the remote VLT Primary Peer is available, the Secondary Peer disables all VLT ports to prevent loops.

If all ports in the VLTi link fail or if the communication between VLTi links fails, VLT checks the backup link to determine the cause of the failure. If the failed peer can still transmit heartbeat messages, the Secondary Peer disables all VLT member ports and any Layer 3 interfaces attached to the VLAN associated with the VLT domain. If heartbeat messages are not received, the Secondary Peer forwards traffic assuming the role of the Primary Peer. If the original Primary Peer is restored, the VLT peer reassigned as the Primary Peer retains this role and the other peer must be reassigned as a Secondary Peer. Peer role changes are reported as SNMP traps.

VLT Bandwidth Monitoring

When bandwidth usage of the VLTi (ICL) exceeds 80%, a syslog error message (shown in the following message) and an SNMP trap are generated.

```
%STKUNIT0-M:CP %VLTMGR-6-VLT-LAG-ICL: Overall Bandwidth utilization of VLT-ICL-LAG (port-channel 25) crosses threshold. Bandwidth usage (80 )
```

When the bandwidth usage drops below the 80% threshold, the system generates another syslog message (shown in the following message) and an SNMP trap.

```
%STKUNIT0-M:CP %VLTMGR-6-VLT-LAG-ICL: Overall Bandwidth utilization of VLT-ICL-LAG (port-channel 25) reaches below threshold. Bandwidth usage (74 )VLT show remote port channel status
```

VLT and Stacking

You cannot enable stacking with VLT.

If you enable stacking on a unit on which you want to enable VLT, you must first remove the unit from the existing stack. After you remove the unit, you can configure VLT on the unit.

VLT and IGMP Snooping

When configuring IGMP Snooping with VLT, ensure the configurations on both sides of the VLT trunk are identical to get the same behavior on both sides of the trunk.

When you configure IGMP snooping on a VLT node, the dynamically learned groups and multicast router ports are automatically learned on the VLT peer node.

VLT Port Delayed Restoration

When a VLT node boots up, if the VLT ports have been previously saved in the start-up configuration, they are not immediately enabled.

To ensure MAC and ARP entries from the VLT per node are downloaded to the newly enabled VLT node, the system allows time for the VLT ports on the new node to be enabled and begin receiving traffic.

The `delay-restore` feature waits for all saved configurations to be applied, then starts a configurable timer. After the timer expires, the VLT ports are enabled one-by-one in a controlled manner. The delay between bringing up each VLT port-channel is proportional to the number of physical members in the port-channel. The default is 90 seconds.

If you enable IGMP snooping, IGMP queries are also sent out on the VLT ports at this time allowing any receivers to respond to the queries and update the multicast table on the new node.

This delay in bringing up the VLT ports also applies when the VLTi link recovers from a failure that caused the VLT ports on the secondary VLT peer node to be disabled.

VLT Routing

VLT routing is supported on the Aggregator.

Layer 2 protocols from the ToR to the server are intra-rack and inter-rack. No spanning tree is required, but interoperability with spanning trees at the aggregation layer is supported. Communication is active-active, with no blocked links. MAC tables are synchronized between VLT nodes for bridging and you can enable IGMP snooping.

Spanned VLANs

Any VLAN configured on both VLT peer nodes is referred to as a Spanned VLAN. The VLT Interconnect (VLTi) port is automatically added as a member of the Spanned VLAN. As a result, any adjacent router connected to at least one VLT node on a Spanned VLAN subnet is directly reachable from both VLT peer nodes at the routing level.

Non-VLT ARP Sync

In the Dell Networking OS version 9.2(0.0), ARP entries (including ND entries) learned on other ports are synced with the VLT peer to support station move scenarios.

Prior to Dell Networking OS version 9.2.(0.0), only ARP entries learned on VLT ports were synced between peers.

Additionally, ARP entries resulting from station movements from VLT to non-VLT ports or to different non-VLT ports are learned on the non-VLT port and synced with the peer node. The peer node is updated to use the new non-VLT port.

 **NOTE:** ARP entries learned on non-VLT, non-spanned VLANs are not synced with VLT peers.

Verifying a VLT Configuration

To monitor the operation or verify the configuration of a VLT domain, use any of the following `show` commands on the primary and secondary VLT switches.

- Display information on backup link operation.
EXEC mode
`show vlt backup-link`
- Display general status information about VLT domains currently configured on the switch.
EXEC mode
`show vlt brief`
- Display detailed information about the VLT-domain configuration, including local and peer port-channel IDs, local VLT switch status, and number of active VLANs on each port channel.
EXEC mode
`show vlt detail`
- Display the VLT peer status, role of the local VLT switch, VLT system MAC address and system priority, and the MAC address and priority of the locally-attached VLT device.

EXEC mode

```
show vlt role
```

- Display the current configuration of all VLT domains or a specified group on the switch.

EXEC mode

```
show running-config vlt
```

- Display statistics on VLT operation.

EXEC mode

```
show vlt statistics
```

- Display the current status of a port or port-channel interface used in the VLT domain.

EXEC mode

```
show interfaces interface
```

o *interface*: specify one of the following interface types:

- Fast Ethernet: enter `fastethernet slot/port`.
- 1-Gigabit Ethernet: enter `gigabitethernet slot/port`.
- 10-Gigabit Ethernet: enter `tengigabitethernet slot/port`.
- Port channel: enter `port-channel {1-128}`.

Example of the `show vlt backup-link` Command

```
Dell_VLTpeer1# show vlt backup-link

VLT Backup Link
-----
Destination:          10.11.200.18
Peer HeartBeat status: Up
HeartBeat Timer Interval: 1
HeartBeat Timeout:    3
UDP Port:             34998
HeartBeat Messages Sent: 1026
HeartBeat Messages Received: 1025

Dell_VLTpeer2# show vlt backup-link

VLT Backup Link
-----
Destination:          10.11.200.20
Peer HeartBeat status: Up
HeartBeat Timer Interval: 1
HeartBeat Timeout:    3
UDP Port:             34998
HeartBeat Messages Sent: 1030
HeartBeat Messages Received: 1014
```

Example of the `show vlt brief` Command

```
Dell#show vlt br
VLT Domain Brief
-----
Domain ID                : 1
Role                     : Secondary
Role Priority             : 32768
ICL Link Status          : Up
HeartBeat Status         : Up
VLT Peer Status         : Up
Version                  : 6(3)
Local System MAC address : 00:01:e8:8a:e9:91
Remote System MAC address : 00:01:e8:8a:e9:76
Remote system version    : 6(3)
Delay-Restore timer      : 90 seconds

Delay-Restore Abort Threshold : 60 seconds
Peer-Routing               : Disabled
Peer-Routing-Timeout timer  : 0 seconds
Multicast peer-routing timeout : 150 seconds
```

```
Dell#
```

Example of the show vlt detail Command

```
Dell_VLTpeer1# show vlt detail
```

Local LAG Id	Peer LAG Id	Local Status	Peer Status	Active VLANs
100	100	UP	UP	10, 20, 30
127	2	UP	UP	20, 30

```
Dell_VLTpeer2# show vlt detail
```

Local LAG Id	Peer LAG Id	Local Status	Peer Status	Active VLANs
2	127	UP	UP	20, 30
100	100	UP	UP	10, 20, 30

Example of the show vlt role Command

```
Dell_VLTpeer1# show vlt role
```

```
VLT Role
-----
VLT Role: Primary
System MAC address: 00:01:e8:8a:df:bc
System Role Priority: 32768
Local System MAC address: 00:01:e8:8a:df:bc
Local System Role Priority: 32768
```

```
Dell_VLTpeer2# show vlt role
```

```
VLT Role
-----
VLT Role: Secondary
System MAC address: 00:01:e8:8a:df:bc
System Role Priority: 32768
Local System MAC address: 00:01:e8:8a:df:e6
Local System Role Priority: 32768
```

Example of the show running-config vlt Command

```
Dell_VLTpeer1# show running-config vlt
!
vlt domain 30
 peer-link port-channel 60
 back-up destination 10.11.200.18
```

```
Dell_VLTpeer2# show running-config vlt
!
vlt domain 30
 peer-link port-channel 60
 back-up destination 10.11.200.20
```

Example of the show vlt statistics Command

```
Dell_VLTpeer1# show vlt statistics
```

```
VLT Statistics
-----
HeartBeat Messages Sent: 987
HeartBeat Messages Received: 986
ICL Hello's Sent: 148
ICL Hello's Received: 98
```

```
Dell_VLTpeer2# show vlt statistics
```

```
VLT Statistics
-----
HeartBeat Messages Sent: 994
```

```
HeartBeat Messages Received: 978
ICL Hello's Sent: 89
ICL Hello's Received: 89
```

Additional VLT Sample Configurations

To configure VLT, configure a backup link and interconnect trunk, create a VLT domain, configure a backup link and interconnect trunk, and connect the peer switches in a VLT domain to an attached access device (switch or server).

Review the following examples of VLT configurations.

Configuring Virtual Link Trunking (VLT Peer 1)

Enable VLT and create a VLT domain with a backup-link and interconnect trunk (VLTi).

```
Dell_VLTpeer1(conf)#vlt domain 999
Dell_VLTpeer1(conf-vlt-domain)#peer-link port-channel 100
Dell_VLTpeer1(conf-vlt-domain)#back-up destination 10.11.206.35
Dell_VLTpeer1(conf-vlt-domain)#exit
```

Configure the backup link.

Configure the VLT interconnect (VLTi).

Configure the port channel to an attached device.

Verify that the port channels used in the VLT domain are assigned to the same VLAN.

Configuring Virtual Link Trunking (VLT Peer 2)

Enable VLT and create a VLT domain with a backup-link VLT interconnect (VLTi).

```
Dell_VLTpeer2(conf)#vlt domain 999
Dell_VLTpeer2(conf-vlt-domain)#peer-link port-channel 100
Dell_VLTpeer2(conf-vlt-domain)#back-up destination 10.11.206.23
Dell_VLTpeer2(conf-vlt-domain)#exit
```

Configure the backup link.

Configure the VLT interconnect (VLTi).

Configure the port channel to an attached device.

Verify that the port channels used in the VLT domain are assigned to the same VLAN.

Verifying a Port-Channel Connection to a VLT Domain (From an Attached Access Switch)

On an access device, verify the port-channel connection to a VLT domain.

Troubleshooting VLT

To help troubleshoot different VLT issues that may occur, use the following information.

 **NOTE:** For information on VLT Failure mode timing and its impact, contact your Dell Networking representative.

Table 38. Troubleshooting VLT

Description	Behavior at Peer Up	Behavior During Run Time	Action to Take
Bandwidth monitoring	A syslog error message and an SNMP trap is generated when the VLTi bandwidth usage goes above the 80% threshold and when it drops below 80%.	A syslog error message and an SNMP trap is generated when the VLTi bandwidth usage goes above its threshold.	Depending on the traffic that is received, the traffic can be offloaded inVLTi.
Domain ID mismatch	The VLT peer does not boot up. The VLTi is forced to a down state.	The VLT peer does not boot up. The VLTi is forced to a down state.	Verify the domain ID matches on both VLT peers.

Table 38. Troubleshooting VLT (continued)

Description	Behavior at Peer Up	Behavior During Run Time	Action to Take
	A syslog error message and an SNMP trap are generated.	A syslog error message and an SNMP trap are generated.	
Dell Networking OS Version mismatch	A syslog error message is generated.	A syslog error message is generated.	Follow the correct upgrade procedure for the unit with the mismatched Dell Networking OS version.
Remote VLT port channel status	N/A	N/A	Use the <code>show vlt detail</code> and <code>show vlt brief</code> commands to view the VLT port channel status information.
System MAC mismatch	A syslog error message and an SNMP trap are generated.	A syslog error message and an SNMP trap are generated.	Verify that the unit ID of VLT peers is not the same on both units and that the MAC address is the same on both units.
Unit ID mismatch	The VLT peer does not boot up. The VLTi is forced to a down state. A syslog error message is generated.	The VLT peer does not boot up. The VLTi is forced to a down state. A syslog error message is generated.	Verify the unit ID is correct on both VLT peers. Unit ID numbers must be sequential on peer units; for example, if Peer 1 is unit ID "0", Peer 2 unit ID must be "1".
Version ID mismatch	A syslog error message and an SNMP trap are generated.	A syslog error message and an SNMP trap are generated.	Verify the Dell Networking OS software versions on the VLT peers is compatible. For more information, refer to the <i>Release Notes</i> for this release.
VLT LAG ID is not configured on one VLT peer	A syslog error message is generated. The peer with the VLT configured remains active.	A syslog error message is generated. The peer with the VLT configured remains active.	Verify the VLT LAG ID is configured correctly on both VLT peers.
VLT LAG ID mismatch	The VLT port channel is brought down. A syslog error message is generated.	The VLT port channel is brought down. A syslog error message is generated.	Perform a mismatch check after the VLT peer is established.

FC Flex IO Modules

This part provides a generic, broad-level description of the operations, capabilities, and configuration commands of the Fiber Channel (FC) Flex IO module.

Topics:

- [FC Flex IO Modules](#)
- [Understanding and Working of the FC Flex IO Modules](#)
- [Fibre Channel over Ethernet for FC Flex IO Modules](#)

FC Flex IO Modules

This part provides a generic, broad-level description of the operations, capabilities, and configuration commands of the Fiber Channel (FC) Flex IO module.

Understanding and Working of the FC Flex IO Modules

This chapter provides a generic, broad-level description of the operations and functionality of the Fiber Channel (FC) Flex IO module, and contains the following sections:

- [FC Flex IO Modules Overview](#)
- [FC Flex IO Module Capabilities and Operations](#)
- [Guidelines for Working with FC Flex IO Modules](#)
- [Processing of Data Traffic](#)
- [Installing and Configuring the Switch](#)
- [Interconnectivity of FC Flex IO Modules with Cisco MDS Switches](#)

FC Flex IO Modules Overview

The Fibre Channel (FC) Flex IO module is supported on I/O Aggregator (IOA). The IOA switch installed with the FC Flex IO module functions as a top-of-rack edge switch that supports converged enhanced Ethernet (CEE) traffic — Fibre Channel over Ethernet (FCoE) for storage, Interprocess Communication (IPC) for servers, and Ethernet local area network (LAN) (IP cloud) for data — as well as FC links to one or more storage area network (SAN) fabrics. Although the IOA can act as a FIP snooping bridge (FSB) to provide FCoE transit switch capabilities, the salient and significant advantage of deploying the FC Flex IO module is to enable more streamlined and cohesive FCoE N-port identifier virtualization (NPIV) proxy gateway functionalities. The NPIV proxy gateway (NPG) provides FCoE-FC bridging behavior.

The FC Flex IO module offers a rich, comprehensive set of FCoE functionalities on the M1000e chassis by splitting the Ethernet and Fibre Channel (FC) traffic at the edge of the chassis. The FC switches that are connected directly to the FC Flex IO module provide Fibre Channel capabilities because the FC Flex IO module does not support full fabric functionalities. With the separation of Ethernet and FC packets performed at the edge of the chassis itself, you can use the IOA that contains an FC Flex IO module to connect to a SAN environment without the need for a separate ToR switch to operate as NPIV proxy gateways. The IOA can function in NPIV proxy gateway mode when an FC Flex IO module is present or in the FIP snooping bridge (FSB) mode when all the ports are Ethernet ports.

The FC Flex IO module uses the same baseboard hardware of the IOA and the M1000e chassis. You can insert the FC Flex IO module into any of the optional module slots of the IOA and it provides four FC ports per module. If you insert only one FC Flex IO module, four ports are supported; if you insert two FC Flex IO modules, eight ports are supported.

By installing an FC Flex IO module, you can enable the IOA to directly connect to an existing FC SAN network. The FC Flex IO module uses the existing slots on the IOA and provides four or eight FC ports up to speed of 8 GbE per second. You can connect all of the FC ports to the same FC SAN fabric to yield FC bandwidth of up to 64GB. It is possible to connect some of the ports to a different FC SAN fabric to provide access to multiple fabric devices.

In a typical Fibre Channel storage network topology, separate network interface cards (NICs) and host bus adapters (HBAs) on each server (two each for redundancy purposes) are connected to LAN and SAN networks respectively. These deployments typically include a ToR SAN switch in addition to a ToR LAN switch. By employing converged network adapters (CNAs) that the FC Flex IO module supports, CNAs are used to transmit FCoE traffic from the server instead of separate NIC and HBA devices. In such a scenario, you can determine whether the FC or SAN packets and the Ethernet or LAN packets must be split within the chassis or by using a ToR switch to perform this splitting.

If you want to segregate the LAN and SAN traffic within the chassis, you can employ switches such as the Dell M8428-k Converged 10GbE Switch or FC-only switches such as the Dell M5424 switch module. You can also use the S5000 Switch as a ToR switch to separate the LAN and SAN traffic at the ToR. By using the FC Flex IO module, you can optimally and effectively split the LAN and SAN traffic at the edge of the blade chassis itself. You can deploy the FC Flex IO module can be deployed in the enterprise and data center switching networks to leverage and derive the advantages of a converged Ethernet network.

The FC Flex IO module is not an FCF switch, but it offers FCoE capabilities from the server to the IOA, and native FC capability in the uplink direction to the SAN switches. Although the FC Flex IO module does not support all of the FCF characteristics, such as full-blown name services or zone parameters, it presents the most flexible solution in interoperating with third-party switches that enable the splitting of LAN and SAN traffic. With the IOA being well-established systems in the switch domain, you can install the FC Flex IO module to enhance and increase the converged Ethernet network performance and behavior. With the FC Flex IO module, the IOA provide thirty-two 1GbE or 10 GbE server-facing ports and the option to add two FC Flex IO modules that offer up to 8 8Gb Fibre Channel ports for uplink traffic in addition to the fixed two 40GbE ports on the IOA.

i NOTE: When an FC Flex IO module is inserted into an I/O Aggregator and the FC ports are in the operationally up state, you can configure the port speed of these FC ports as 2 Gbps, 4 Gbps, or 8 Gbps. In the chassis management controller (CMC) GUI, the FC port link speed is always shown as 10 Gbps, regardless of whether the port speed configured is 2 Gbps, 4 Gbps, or 8 Gbps.

You can configure one of the following upstream (fabric-facing) FC ports:

- Two 40GbE and eight 8GB FC ports
- Four 40GbE and four 8GB FC ports
- Two 40GbE, four 10GbE, and four 8GB FC ports
- Two 40GbE, four 10GBASE-T, and four 8GB FC ports

FC Flex IO Module Capabilities and Operations

The FC Flex IO module has the following characteristics:

- You can install one or two FC Flex IO modules on the I/O Aggregator. Each module supports four FC ports.
- Each port can operate in 2Gbps, 4Gbps, or 8Gbps of Fibre Channel speed.
- All ports on an FC Flex IO module can function in the NPIV mode that enables connectivity to FC switches or directors, and also to multiple SAN topologies.
- It automatically senses the current speed when the port link is up. Valid link speeds are 2 Gbps, 4 Gbps, and 8 Gbps.
- By default, the FC ports are configured to operate in N-port mode to connect to an F port on an FC switch in a fabric. You can apply only one FCoE map on an FC port. An N-Port is a port on the node of an FC device and is called a node port.
- There should a maximum of 64 server fabric login (FLOGI) requests or fabric discovery (FDISC) requests per server MAC address before forwarded by the FC Flex IO module to the FC core switch. Without user configuration, only 32 server login sessions are permitted for each server MAC address. To increase the total number of sessions to 64, use the `max sessions` command.
- A distance of up to 300 meters is supported at 8 Gbps for Fibre Channel traffic.
- Multiple domains are supported in an NPIV proxy gateway (NPG).
- If the switch contains FC Flex IO module, you cannot create a stack and a log message states that `%Error: cannot configure stack group when FC module is enabled`. Similarly, FC Flex IO modules do not function when you insert them into a stack of I/O Aggregator switches.

Guidelines for Working with FC Flex IO Modules

The following guidelines apply to the FC Flex IO module:

- All the ports of FC Flex IO modules operate in FC mode, and do not support Ethernet mode.
- FC Flex IO modules are not supported in the chassis management controller (CMC) GUI.
- The only supported FCoE functionality is NPIV proxy gateway. Configure the other FCoE services, such as name server, zone server, and login server on an external FC switch.
- FC Flex IOM module is a field-replaceable unit (FRU). Its memory type is electrically erasable programmable read-only memory (EEPROM), which enables it to save manufacturing information, such as the serial number. It is hot-swappable, assuming that the module that is removed is replaced by the same type of module in that same slot.
- The FC Flex IO does not have persistent storage for any runtime configuration. All the persistent storage for runtime configuration is on the I/O Aggregator baseboard.
- With both FC Flex IO modules present in the I/O Aggregator switches, the power supply requirement and maximum thermal output are the same as these parameters needed for the M1000 chassis.
- Each port on the FC Flex IO module contains status indicators to denote the link status and transmission activity. For traffic that is being transmitted, the port LED shows a blinking green light. The Link LED displays solid green when a proper link with the peer is established. If there is no connectivity, the LEDs are not lit
- The I/O Aggregator switches continue to operate in FCoE Gateway mode even if connectivity to a ToR switch does not exist.
- The I/O Aggregator examines whether the FC Flex IO module is inserted into the switch. When the FC Flex IO module is present during the boot process, the switch runs in FCoE NPIV gateway mode by default.
- When an FC Flex IO module is present in the I/O Aggregator, the software autoconfigures the DCB settings on the ports that support DCB and does not retrieve these settings from the ToR switch.
- Active fabric manager (AFM) is compatible with FC Flex IO modules.
- All SNMP MIBs that are supported for I/O Aggregator switches apply equally for FC Flex IO modules. The interface MIB indicates the FC interface when you install the FC flex IO module. The interface MIB statistical counters compute and display the FC interface metrics.
- When the Dell Networking OS sends FC frames (the initial FLOGI or FLOGO messages), or converts FLOGI to FDISC messages or processes any internally generated FC frames, the software computes and verifies the FC cyclic redundancy check (CRC) value before sending the frame to FC ports.
- Fabric worldwide name (WWN) verification is available for eight FC ports. Single-switching WWN capability is provided when the switch operates in NPIV mode.
- With FC Flex IO modules, you can connect the IOA in Simple MUX mode to a single fabric.
- With FC Flex IO modules on an IOA, the FC port speed is set to auto. The following parameters are automatically configured on the ENode facing and FC ports
- Description: SAN_FABRIC
- Fabric-id: 1002
- Fcoe-vlan: 1002
- Fc-map: 0x0efc00
- Fcf-priority: 128
- Fka-adv-period: 8000mSec
- Keepalive: enable
- Vlan priority: 3
- On an IOA, the FCoE virtual local area network (VLAN) is automatically configured.
- With FC Flex IO modules on an IOA, the following DCB maps are applied on all of the ENode facing ports.
- dcb-map: SAN_DCB_MAP

- priority-group 0 bandwidth 30 pfc off
- priority-group 1 bandwidth 30 pfc off
- priority-group 2 bandwidth 40 pfc on
- priority-pgid 0 0 0 2 1 0 0 0
- On I/O Aggregators, uplink failure detection (UFD) is disabled if FC Flex IO module is present to allow server ports to communicate with the FC fabric even when the Ethernet upstream ports are not operationally up.
- Ensure that the NPIV functionality is enabled on the upstream switches that operate as FC switches or FCoE forwarders (FCF) before you connect the FC port of the I/O Aggregator to these upstream switches.
- While storage traffic traverses through FC Flex IO modules and the Ethernet uplink port-channel status changes (with DCB enabled on an adjacent switch), FCoE traffic is disrupted. This problem does not occur if Ethernet traffic is not involved and only FCoE traffic is transmitted. Also, if DCB on the ToR switch is disabled, traffic disruption does not occur.

Port Numbering for FC Flex IO Modules

Even-numbered ports are at the bottom of the I/O panel and for modules odd-numbered ports are at the top of the I/O panel. When installed in a PowerEdge M1000e Enclosure, the I/O Aggregator ports are numbered 33 to 56 from the bottom to the top of the switch. The following port numbering convention applies to the FC Flex IO module:

- In expansion slot 0, the ports are numbered 41 to 44.
- In expansion slot 1, the ports are numbered 49 to 52.

Installing the Optics

The following optical ports are supported on the FC Flex IO module using one of the supported breakout cables:

- 4G or 8G Fibre Channel small form-factor pluggable plus (SFP+) optics module and LC connectors over a distance of 150 meters.
- 4G or 8G Fibre Channel SFP+ optics module and LC connectors over a distance of 4 km.

CAUTION:

Electrostatic discharge (ESD) damage can occur if the components are mishandled. Always wear an ESD-preventive wrist or heel ground strap when handling the FC Flex IO module and its components.

 **WARNING: When working with optical fibres, follow all the warning labels and always wear eye protection. Never look directly into the end of a terminated or unterminated fibre or connector as it may cause eye damage.**

1. • Position the optic so it is in the correct position. The optic has a key that prevents it from being inserted incorrectly.
 - Insert the optic into the port until it gently snaps into place.

NOTE:

1. When you cable the ports, be sure not to interfere with the airflow from the small vent holes above and below the ports.

Processing of Data Traffic

The Dell Networking OS determines the module type that is plugged into the slot. Based on the module type, the software performs the appropriate tasks. The FC Flex IO module encapsulates and decapsulates the FCoE frames. The module directly switches any non-FCoE or non-FIP traffic, and only FCoE frames are processed and transmitted out of the Ethernet network.

When the external device sends FCoE data frames to the switch that contains the FC Flex IO module, the destination MAC address represents one of the Ethernet MAC addresses assigned to FC ports. Based on the destination address, the FCoE header is removed from the incoming packet and the FC frame is transmitted out of the FC port. The flow control mechanism is performed using per-priority flow control to ensure that frame loss does not occur owing to congestion of frames.

Operation of the FIP Application

The NPIV proxy gateway terminates the FIP sessions and responds to FIP messages. The FIP packets are intercepted by the FC Flex IO module and sent to the Dell Networking OS for further analysis. The FIP application responds to the FIP VLAN discovery request from the host based on the configured FCoE VLANs. For every ENode and VN_Port that is logged in, the FIP application responds to keepalive messages for the virtual channel. If the FC link becomes inactive or a logging off of the switch occurs, the FIP engine sends clear virtual link (CVL) messages to the host. The FIP application also responds to solicited advertisements from the end-device. In addition, the FIP application periodically sends advertisement packets to the end-devices for each FCF that is part of the NPIV proxy gateway.

If FC Flex IO modules are installed, the I/O Aggregator does not perform FIP snooping because the FIP frames are terminated on the switch for NPIV operations.

On the Aggregator, if the FC module is present, the uplink ports are not automatically set up as FCF or bridge ports. The FC Flex module cannot function as both an NPIV proxy gateway and a FIP snooping bridge at the same time.

Operation of the NPIV Proxy Gateway

The NPIV application on the FC Flex IO module manages the FC functionalities configured in Dell Networking OS. After the FC link comes up, the gateway sends the initial FLOGI request to the connected switch using the switch and port WWN methods. After a successful login, the NPIV gateway sends a notification to inform the CNA that the FCF is available to log in. The source address of the FIP advertisement and FIP discovery advertisement response contain the MAC address of the FC Flex IO module port. Depending on the number of login sessions on a particular FCF, the NPIV gateway can load-balance the login sessions from ENodes.

The NPIV application performs the FLOGI to FDISC conversion and sends the new FC frame on the associated FC ports. After the external switch responds to the FLOGI request, the NPIV gateway establishes the NPIV session and sends the frame to the FIP application. The FIP application establishes virtual links to convert FCoE FLOGI accept messages into FIP FLOGI accept messages. The corresponding ACL for the accept message is then applied. If a FIP timeout from ENode or VN_PORT occurs, the NPIV application performs the FC fabric logout to the external FC switch. The NPIV application manages the sessions between the FCoE and the FC domain.

Installing and Configuring the Switch

After you unpack the I/O Aggregator, refer to the flow chart in the following figure for an overview of the steps you must follow to install the blade and perform the initial configuration.

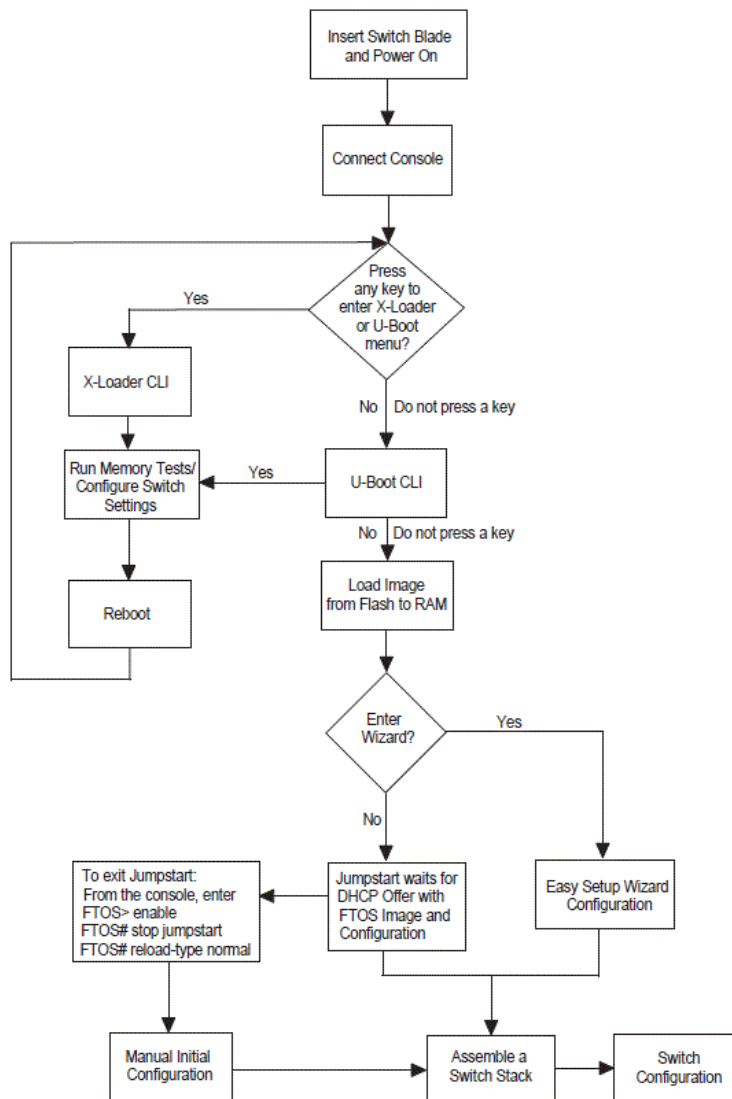

Figure 36. Installing and Configuring Flowchart for FC Flex IO Modules

To see if a switch is running the latest Dell Networking OS version, use the `show version` command. To download a Dell Networking OS version, go to <http://support.dell.com>.

Installation

Site Preparation

Before installing the switch or switches, make sure that the chosen installation location meets the following site requirements:

- **Clearance** — There is adequate front and rear clearance for operator access. Allow clearance for cabling, power connections, and ventilation.
- **Cabling** — The cabling is routed to avoid sources of electrical noise such as radio transmitters, broadcast amplifiers, power lines, and fluorescent lighting fixtures.
- **Ambient Temperature** — The ambient switch operating temperature range is 10° to 35°C (50° to 95°F).
 1. Decrease the maximum temperature by 1°C (1.8°F) per 300 m (985 ft.) above 900 m (2955 ft.).
 2. **Relative Humidity** — The operating relative humidity is 8 percent to 85 percent (non-condensing) with a maximum humidity gradation of 10 percent per hour.

Unpacking the Switch

Package Contents

When unpacking each switch, make sure that the following items are included:

- One Dell Networking I/O Aggregator module
- One USB type A-to-DB-9 female cable
- Getting Started Guide
- Safety and Regulatory Information
- Warranty and Support Information
- Software License Agreement

Unpacking Steps

1. Before unpacking the switch, inspect the container and immediately report any evidence of damage.
2. Place the container on a clean, flat surface and cut all straps securing the container.
3. Open the container or remove the container top.
4. Carefully remove the switch from the container and place it on a secure and clean surface.
5. Remove all packing material.
6. Inspect the product and accessories for damage.

After you insert a Flex IO module into an empty slot, you must reload the I/O Aggregator for the module. If you remove an installed module and insert a different module type, an error message displays to remind you that the slot is configured for a different type of Flex IO module. You must reload the switch to make the Flex IO module operational.

Interconnectivity of FC Flex IO Modules with Cisco MDS Switches

In a network topology that contains Cisco MDS switches, FC Flex IO modules that are plugged into the I/O Aggregator switches enable interoperability for a robust, effective deployment of the NPIV proxy gateway and FCoE-FC bridging behavior. In an environment that contains FC Flex IO modules and Cisco MDS switches, perform the following steps:

- Insert the FC Flex IO module into any of the optional module slots of the I/O Aggregator Switch and reload the switch.
- When the device is reloaded, NPIV mode is automatically enabled.
- Configure the NPIV-related commands on I/O Aggregator.

After you perform the preceding procedure, the following operations take place:

- A physical link is established between the FC Flex I/O module and the Cisco MDS switch.
- The FC Flex I/O module sends a proxy FLOGI request to the upstream F_Port of the FC switch or the MDS switch. The F_port accepts the proxy FLOGI request for the FC Flex IO virtual N_Port. The converged network adapters (CNAs) are brought online and the FIP application is run.
- Discovery of the VLAN and FCF MAC addresses is completed.
- The CNA sends a FIP fabric login (FLOGI) request to the FC Flex IO module, which converts FLOGI to FDISC messages or processes any internally generated FC frames and sends these messages to the SAN environment.
- When the FC fabric discovery (FDISC) accept message is received from the SAN side, the FC Flex IO module converts the FDISC message again into an FLOGI accept message and transmits it to the CNA.
- Internal tables of the switch are then programmed to enable the gateway device to forward FCoE traffic directly back and forth between the devices.
- The FC Flex IO module sends an FC or FCoE registered state change notification (RSCN) message to the upstream or downstream devices whenever an error occurs in the appropriate direction.
- An F_Port is a port on an FC switch that connects to an N_Port of an FC device and is called a fabric port.

By default, the NPIV functionality is disabled on the Cisco MDS switch; enable this capability before you connect the FC port of the I/O Aggregator to these upstream switches.

Data Center Bridging, Fibre Channel over Ethernet, and NPIV Proxy Gateway features are supported on the FC Flex IO modules. For detailed information about these applications and their working, see the corresponding chapters for these applications in this manual.

The following figures illustrate two deployment scenarios of configuring FC Flex IO modules:

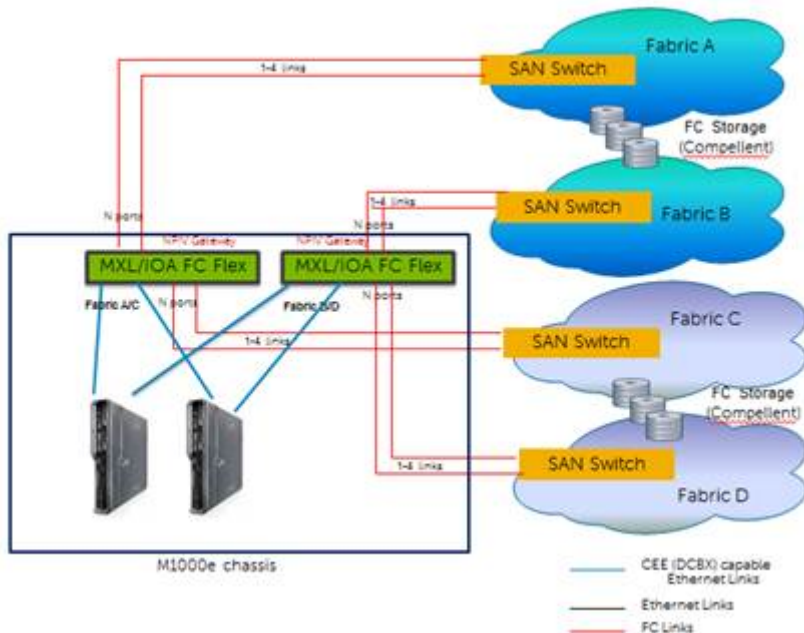

Figure 37. Case 1: Deployment Scenario of Configuring FC Flex IO Modules

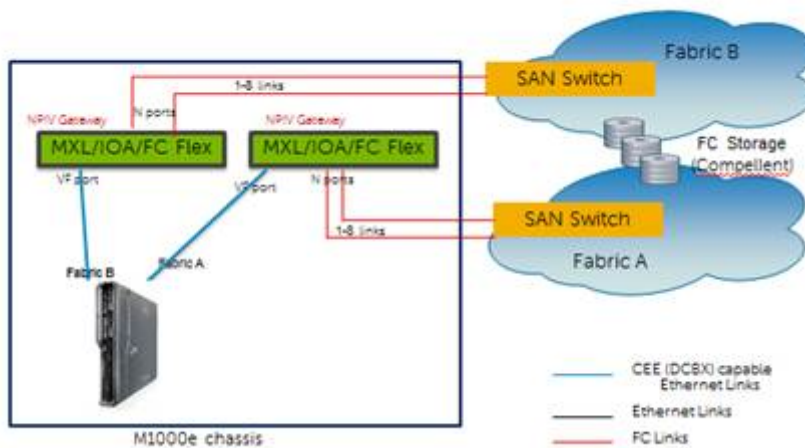

Figure 38. Case 2: Deployment Scenario of Configuring FC Flex IO Modules

Fibre Channel over Ethernet for FC Flex IO Modules

FCoE provides a converged Ethernet network that allows the combination of storage-area network (SAN) and LAN traffic on a Layer 2 link by encapsulating Fibre Channel data into Ethernet frames.

The Fibre Channel (FC) Flex IO module is supported on Dell Networking Operating System (OS) I/O Aggregator (IOA). The IOA switch installed with the FC Flex IO module functions as a top-of-rack edge switch that supports converged enhanced Ethernet (CEE) traffic — Fibre channel over Ethernet (FCoE) for storage, Interprocess Communication (IPC) for servers, and Ethernet local area network (LAN) (IP cloud) for data — as well as FC links to one or more storage area network (SAN) fabrics.

FCoE works with the Ethernet enhancements provided in Data Center Bridging (DCB) to support lossless (no-drop) SAN and LAN traffic. In addition, DCB provides flexible bandwidth sharing for different traffic types, such as LAN and SAN, according to 802.1p priority classes of service. DCBx should be enabled on the system before the FIP snooping feature is enabled.

All of the commands that are supported for FCoE on the I/O Aggregator apply to the FC Flex IO modules. Similarly, all of the configuration procedures and the settings that are applicable for FCoE on the I/O Aggregator are valid for the FC Flex IO modules.

FC FLEXIO FPORT

FC FlexIO FPort is now supported on the Dell Networking OS.

Topics:

- [FC FLEXIO FPORT](#)
- [Configuring Switch Mode to FCF Port Mode](#)
- [Name Server](#)
- [FCoE Maps](#)
- [Creating an FCoE Map](#)
- [Zoning](#)
- [Creating Zone and Adding Members](#)
- [Creating Zone Alias and Adding Members](#)
- [Creating Zonesets](#)
- [Activating a Zoneset](#)
- [Displaying the Fabric Parameters](#)

FC FLEXIO FPORT

The switch is a blade switch which is plugged into the Dell M1000 Blade server chassis. The blade module contains two slots for pluggable flexible module. With single FC Flex IO module, 4 ports are supported, whereas 8 ports are supported with both FC Flex IO modules. Each port can operate in 2G, 4G or 8G Fiber Channel speed. The topology-wise, FC Flex IOM is directly connected to a FC Storage. In the following topology, the FC flex IOM model offers local connectivity without a SAN switch or fabric.

Configuring Switch Mode to FCF Port Mode

To configure switch mode to Fabric services, use the following commands.

1. Configure Switch mode to FCF Port.

```
CONFIGURATION mode
feature fc fport domain id 2
```

 **NOTE:** Enable `remote-fault-signaling rx off` command in FCF FPort mode on interfaces connected to the Compellent and MDF storage devices.

2. Create an FCoE map with the parameters used in the communication between servers and a SAN fabric.

```
CONFIGURATION mode
fcoe-map map-name
```

3. Configure the association between the dedicated VLAN used to carry FCoE traffic between servers and a SAN, and the fabric where the desired storage arrays are installed.

```
FCOE MAP mode
fabric-id fabric-num vlan vlan-id
```

4. Configure the FCoE mapped address prefix (FC-MAP) value which is used to identify FCoE traffic transmitted on the FCoE VLAN for the specified fabric.

```
FCOE MAP mode
fc-map fc-map-value
```

5. Configure the SAN fabric to which the FC port connects by entering the name of the FCoE map applied to the interface.

```
INTERFACE mode
```

```
fcoe-map <fcoe-map-name> {tengigabitEthernet slot/port | fortygigabitEthernet slot/port}
```

The FCoE map contains FCoE and FC parameter settings (refer to [FCoE Maps](#)). Manually apply the `fcoe-map` to any Ethernet ports used for FCoE.

Name Server

Each participant in the FC environment has a unique ID, which is called the World Wide Name (WWN). This WWN is a 64-bit address.

A Fibre Channel fabric uses another addressing scheme to address the ports in the switched fabric. Each port in the switched fabric is assigned a 24-bit address by the FC switch. When the device logs into the switch fabric on a specific port with its WWN, the switch assigns the port address to that port, and the switch also maintains the correlation between the port address and the WWN address of the device on that port. This function of the switch is implemented by using a name server, a database of objects in which the fabric attached device registers its values.

FC-ID: 24-bit port address. Consists of three parts:

- **Domain:** Address of the switch itself. There are only 239 addresses available for switches in your SAN environment.
- **Area:** Identifies a group of F_Ports. Each group of ports has a different area number, even if there is only one port in the group.
- **Port:** Provides 256 addresses for identifying attached N_Ports and NL_Ports.

The following sequence explains the operation for the attached N_Port:

- N_Port sends a Fabric Login (FLOGI) as it requests a unique 24-bit address from the Fabric Login Server.
- N_Port sends FLOGI to address 0xFFFFFE. Upon success, it obtains a valid address (FCID).
- N_Port sends a Port Login (PLOGI) to inform the Fabric Name Server of its personality and capabilities, this includes WWNN, WWPN.
- N_Port sends PLOGI to address 0xFFFFFC to register this address with the name server.

Command	Description
<code>show fc ns switch</code>	Display all the devices in name server database of the switch.
<code>show fc ns switch brief</code>	Displays the local name server entries — brief version.

The following configurations are applicable only after configuring the switch mode to FCF Port mode using the `feature fc fport domain id 2` command. When you set Switch mode to FCF Port mode, any previously configured `fcoe-map` is removed.

FCoE Maps

To identify the SAN fabric to which FCoE storage traffic is sent, use an FCoE map.

Using an FCoE map, an NPG operates as an FCoE-FC bridge between an FC SAN and FCoE network by providing FCoE-enabled servers and switches with the necessary parameters to log in to a SAN fabric.

An FCoE map applies the following parameters on server-facing Ethernet and fabric-facing FC ports:

- The dedicated FCoE VLAN used to transport FCoE storage traffic.
- The FC-MAP value used to generate a fabric-provided MAC address.
- The association between the FCoE VLAN ID and FC fabric ID where the desired storage arrays are installed. Each Fibre Channel fabric serves as an isolated SAN topology within the same physical network.
- A server uses the priority to select an upstream FCoE forwarder (FCF priority).
- FIP keepalive (FKA) advertisement timeout.

 **NOTE:** In each FCoE map, the fabric ID, FC-MAP value, and FCoE VLAN must be unique. To access one SAN fabric, use one FCoE map.

When you configure an M I/O Aggregator as an NPG, FCoE transit with FIP snooping is automatically enabled and configured using the parameters in the FCoE map applied to server-facing Ethernet and fabric-facing FC interfaces.

After you apply an FCoE map on an FC port, when you enable the port (using the `no shutdown` command), the NPG starts sending FIP multicast advertisements on behalf of the FC port to downstream servers to advertise the availability of a new FCF

port on the FCoE VLAN. The FIP advertisement also contains a keepalive message to maintain connectivity between a SAN fabric and downstream servers.

After removing and reapplying the fabric map or after modifying the FCoE map, the Fiber Channel (FC) devices do not re-login. To mitigate this issue, you must first run the shut command and then the no shutdown command on each member interface after you alter the FCOE map.

Creating an FCoE Map

An FCoE map consists of the following elements.

- An association between the dedicated VLAN used to carry FCoE traffic and SAN fabric where the storage arrays are installed. Use a separate FCoE VLAN for each fabric to which FCoE traffic is forwarded. Any non-FCoE traffic sent on a dedicated FCoE VLAN is dropped.
- The FC-MAP value used to generate the fabric-provided MAC address (FPMA). The server uses the FPMA to transmit FCoE traffic to the fabric. You can associate an FC-MAP with only one FCoE VLAN and vice versa.
- FCF priority: a CNA server uses the priority to select an upstream FCoE forwarder (FCF).
- FIP keepalive (FKA) advertisement timeout.

The values for the FCoE VLAN, fabric ID, and FC-MAP must be unique. Apply an FCoE map on downstream server-facing Ethernet ports and upstream fabric-facing Fibre Channel ports.

1. Create an FCoE map which contains parameters used in the communication between servers and a SAN fabric.

CONFIGURATION mode

```
fcoe-map map-name
```

2. Configure the association between the dedicated VLAN and the fabric where the desired storage arrays are installed.

FCoE MAP mode

```
fabric-id fabric-num vlan vlan-id
```

The fabric and VLAN ID numbers must be the same.

The fabric and VLAN ID range is from 2 to 4094.

For example:

```
fabric id 10 vlan 10
```

3. Add a text description of the settings in the FCoE map.

FCoE MAP mode

```
description text
```

The maximum is 32 characters.

4. Specify the FC-MAP value used to generate a fabric-provided MAC address, which is required to send FCoE traffic from a server on the FCoE VLAN to the FC fabric specified in Step 2.

FCoE MAP mode

```
fc-map fc-map-value
```

You must enter a unique MAC address prefix as the FC-MAP value for each fabric.

The range is from 0EFC00 to 0EFCFF.

The default is none.

5. Configure the priority used by a server CNA to select the FCF for a fabric login (FLOGI).

FCoE MAP mode

```
fcf-priority priority
```

The range is from 1 to 255.

The default is **128**.

6. Enable the monitoring FIP keep-alive messages (if it is disabled) to detect if other FCoE devices are reachable.

FCoE MAP mode

```
keepalive
```

The default is FIP keep-alive monitoring is enabled.

7. Configure the time interval (in seconds) used to transmit FIP keepalive advertisements.

FCoE MAP mode

```
fka-adv-period seconds
```

The range is from 8 to 90 seconds.

The default is **8 seconds**.

Zoning

The zoning configurations are supported for Fabric FCF Port mode operation on the MXL.

In FCF Port mode, the `fcoe-map fabric map-name` has the default Zone mode set to deny. This setting denies all the fabric connections unless included in an active zoneset. To change this setting, use the `default-zone-allow` command. Changing this setting to all allows all the fabric connections without zoning.

Zoning is a mechanism to ensure only the nodes that are part of a zone can communicate with each other. Zoning prevents unauthorized access of storage assets. A zone consists of members which are nodes that the adapter address, fabric address, interface, or alias specifies. S5000 supports using World Wide Port Name (WWPN), Fibre Channel ID (FC-ID), or alias as members of a zone.

- WWPN: End device's port WWN name.
- FC-ID: Switch assigned 24-bit device FC address.
- Alias: User-defined name of a zone member.

 **NOTE:** The M I/O Aggregator does not support using WWNN or Domain/Port as members of a zone.

Creating Zone and Adding Members

To create a zone and add members to the zone, use the following commands.

1. Create a zone.

```
CONFIGURATION mode
```

```
fc zone zonename
```

2. Add members to a zone.

```
ZONE CONFIGURATION mode
```

```
member word
```

The member can be WWPN (00:00:00:00:00:00:00:00), port ID (000000), or alias name (word).

```
Dell(conf)#fc zone z1
Dell(conf-fc-zone-z1)#member 11:11:11:11:11:11:11:11
Dell(conf-fc-zone-z1)#member 020202
Dell(conf-fc-zone-z1)#exit
```

Creating Zone Alias and Adding Members

To create a zone alias and add devices to the alias, follow these steps.

1. Create a zone alias name.

```
CONFIGURATION mode
```

```
fc alias ZoneAliasName
```

2. Add devices to an alias.

```
ALIAS CONFIGURATION mode
```

```
member word
```

The member can be WWPN (00:00:00:00:00:00:00:00), port ID (000000), or alias name (word).

```
Dell(conf)#fc alias all
Dell(conf-fc-alias-all)#member 030303
Dell(conf-fc-alias-all)#exit
Dell(conf)#fc zone z1
```

```
Dell(conf-fc-zone-z1)#member all
Dell(conf-fc-zone-z1)#exit
```

Creating Zonesets

A zoneset is a grouping or configuration of zones.

To create a zoneset and zones into the zoneset, use the following steps.

1. Create a zoneset.

```
CONFIGURATION mode
fc zoneset zoneset_name
```

2. Add zones into a zoneset.

```
ZONESET CONFIGURATION mode
member zonename
```

```
Dell(conf)#fc zoneset z1
Dell(conf-fc-zoneset-z1)#member z1
Dell(conf-fc-zoneset-z1)#
Dell(conf-fc-zoneset-z1)#exit
Dell(conf-fc-zoneset-z1)#
```

Activating a Zoneset

Activating a zoneset makes the zones within it effective.

On a switch, only one zoneset can be active. Any changes in an activated zoneset do not take effect until it is re-activated.

By default, the fcoe-map fabric map-namedoes not have any active zonesets.

1. Enter enter the fc-fabric command in fcoe-map to active or de-activate the zoneset.

```
Dell(conf-fcoe-map)#fc-fabric
```

Example:

```
Dell(conf)#fcoe-map map
Dell(conf-fcoe-map)#fc-fabric
Dell(conf-fmap-map-fcfabric)#active-zoneset set
Dell(conf-fmap-map-fcfabric)#no active-zoneset?
active-zoneset
Dell(conf-fmap-map-fcfabric)#no active-zoneset ?
<cr>
Dell(conf-fmap-map-fcfabric)#no active-zoneset
```

2. View the active zoneset.

```
show fc zoneset active
```

Displaying the Fabric Parameters

To display information on switch-wide and interface-specific fabric parameters, use the show commands in the following table.

Examples of these show commands follow this table.

Command	Description
show config	Displays the fabric parameters.
show fcoe-map	Displays the fcoe-map.
show fc ns switch	Display all the devices in name server database of the switch.

Command	Description
show fc ns switch brief	Display all the devices in name server database of the switch - brief version.
show fc zoneset	Displays the zoneset.
show fc zoneset active	Displays the active zoneset.
show fc zone	Displays the configured zone.
show fc alias	Displays the configured alias.
show fc switch	Displays the FC Switch mode and world wide name.

Example of the show config Command

```
Dell(conf-fcoe-SAN_FABRIC)#show config
!
fcoe-map SAN_FABRIC
  description SAN_FABRIC
  fc-map 0efc00
  fabric-id 1002 vlan 1002
!
fc-fabric
  default-zone-allow all
Dell(conf-fcoe-SAN_FABRIC)#
```

Example of the show fcoe-map Command

```
Dell(conf)#do show fcoe-map

Fabric Name          map

Fabric Type          Fport
Fabric Id            1002
Vlan Id              1002
Vlan priority        3
FC-MAP               0efc00
FKA-ADV-Period       8
Fcf Priority          128
Config-State         ACTIVE
Oper-State           UP
=====
Switch Config Parameters
=====
DomainID             2
=====
Switch Zoning Parameters
=====
Default Zone Mode:   Deny
Active Zoneset:      set
=====
Members
Fc 0/41
Te 0/29
=====
=====
```

Example of the show fc ns switch Command

```
Dell(conf)#do show fc ns sw

Total number of devices = 1

Switch Name          28:4e:55:4c:4c:29:00:00
Domain Id            2
Switch Port          4
FC-Id                02:04:03
Port Name            20:01:d4:ae:52:44:37:b2
```

```

Node Name                20:00:d4:ae:52:44:37:b2
Class of Service         8
Symbolic Port Name       Broadcom Port0 pWWN 20:01:d4:ae:52:44:37:b2
Symbolic Node Name       Broadcom BCM57810 FCoE 7.6.3.0 7.6.59.0 WIN-KBFI7FJ2FUH
Port Type                 N_Port

```

Example of the show fc ns switch brief Command

```

Dell#show fc ns switch brief
Total number of devices = 1
Intf#  Domain  FC-ID      Enode-WWPN          Enode-WWNN
Fc 0/3  1          01:35:00  10:00:8c:7c:ff:17:f8:01  20:00:8c:7c:ff:17:f8:01
Dell#

```

Example of the show fc zoneset Command

```

Dell#show fc zoneset
ZoneSetName ZoneName ZoneMember
=====
fcoe_srv_fc_tgt
      brcd_sanb
            brcd_cna1_wwpn1
            sanb_p2tgt1_wwpn

Active Zoneset: fcoe_srv_fc_tgt
ZoneName ZoneMember
=====
brcd_sanb
      10:00:8c:7c:ff:21:5f:8d
      20:02:00:11:0d:03:00:00
Dell#

```

Example of the show fc zoneset active Command

```

Dell#show fc zoneset active
Active Zoneset: fcoe_srv_fc_tgt
ZoneName ZoneMember
=====
brcd_sanb
      10:00:8c:7c:ff:21:5f:8d
      20:02:00:11:0d:03:00:00
Dell#

```

Example of the show fc zone Command

```

Dell#show fc zone
ZoneName ZoneMember
=====
brcd_sanb
      brcd_cna1_wwpn1
      sanb_p2tgt1_wwpn
Dell#

```

Example of the show fc alias Command

```

Dell(conf)#do show fc alias

ZoneAliasName          ZoneMember
=====
test
                                20:02:d4:ae:52:44:38:4f
                                20:34:78:2b:cb:6f:65:57

```

Example of the show fc switch Command

```

Dell(conf)#do show fc switch
Switch Mode : FPORT

```

```
Switch WWN : 10:00:aa:00:00:00:00:ac  
Dell(conf)#
```

NPIV Proxy Gateway

The N-port identifier virtualization (NPIV) Proxy Gateway (NPG) feature provides FCoE-FC bridging capability on the Aggregator, allowing server CNAs to communicate with SAN fabrics over the Aggregator.

Supported Modes

PMUX

Topics:

- [NPIV Proxy Gateway Configuration](#)
- [NPIV Proxy Gateway Operations and Capabilities](#)
- [Configuring an NPIV Proxy Gateway](#)
- [Displaying NPIV Proxy Gateway Information](#)

NPIV Proxy Gateway Configuration

The Aggregator switches function as a top-of-rack edge switch that supports Converged Enhanced Ethernet (CEE) traffic — Fibre Channel over Ethernet (FCoE) for storage, Interprocess Communication (IPC) for servers, and Ethernet local area network (LAN) (IP cloud) for data — as well as FC links to one or more storage area network (SAN) fabrics.

The NPG provides FCoE-FC bridging capability on the Aggregator.

This chapter describes how to configure and use an NPIV proxy gateway on the Aggregator in a SAN.

NPIV Proxy Gateway Operations and Capabilities

Benefits of an NPIV Proxy Gateway

The Aggregator functions as a top-of-rack edge switch that supports CEE traffic — FCoE for storage, IPC for servers, and Ethernet LAN (IP cloud) for data — as well as FC links to one or more SAN fabrics.

Using an NPG helps resolve the following problems in a storage area network:

- Fibre Channel storage networks typically consist of servers connected to edge switches, which are connected to SAN core switches. As the SAN grows, it is necessary to add more ports and SAN switches. This results in an increase in the required domain IDs, which may surpass the upper limit of 239 domain IDs supported in the SAN network. An NPG avoids the need for additional domain IDs because it is deployed outside the SAN and uses the domain IDs of core switches in its FCoE links.
- With the introduction of 10GbE links, FCoE is being implemented for server connections to optimize performance. However, a SAN traditionally uses Fibre Channel to transmit storage traffic. FCoE servers require an efficient and scalable bridging feature to access FC storage arrays, which an NPG provides.

NPIV Proxy Gateway Operation

Consider a sample scenario of NPG operation. An FX2 server chassis configured as an NPG does not join a SAN fabric, but functions as an FCoE-FC bridge that forwards storage traffic between servers and core SAN switches. The core switches forward SAN traffic to and from FC storage arrays.

An FX2 chassis FC port is configured as an N (node) port that logs in to an F (fabric) port on the upstream FC core switch and creates a channel for N-port identifier virtualization. NPIV allows multiple N-port fabric logins at the same time on a single, physical Fibre Channel link.

Converged Network Adapter (CNA) ports on servers connect to the FX2 chassis Ten-Gigabit Ethernet ports and log in to an upstream FC core switch through the N port. Server fabric login (FLOGI) requests are converted into fabric discovery (FDISC) requests before being forwarded to the FC core switch.

Servers use CNA ports to connect over FCoE to an Ethernet port in ENode mode on the NPIV proxy gateway. FCoE transit with FIP snooping is automatically enabled and configured on the FX2 gateway to prevent unauthorized access and data transmission to the SAN network. FIP is used by server CNAs to discover an FCoE switch operating as an FCoE forwarder (FCF).

The NPIV proxy gateway aggregates multiple locally connected server CNA ports into one or more upstream N port links, conserving the number of ports required on an upstream FC core switch while providing an FCoE-to-FC bridging functionality. The upstream N ports on an FX2 can connect to the same or multiple fabrics.

Using an FCoE map applied to downstream (server-facing) Ethernet ports and upstream (fabric-facing) FC ports, you can configure the association between a SAN fabric and the FCoE VLAN that connects servers over the NPIV proxy gateway to FC switches in the fabric. An FCoE map virtualizes the upstream SAN fabric as an FCF to downstream CNA ports on FCoE-enabled servers as follows:

- As soon as an FC N port comes online (`no shutdown` command), the NPG starts sending FIP multicast advertisements, which contain the fabric name derived from the 64-bit worldwide name (WWN) of the principal SAN switch. (The principal switch in a fabric is the FC switch with the lowest domain ID.)
- When you apply the FCoE map to a server-facing Ethernet port in ENode mode, ACLs are automatically configured to allow only FCoE traffic from servers that perform a successful FLOGI on the FC switch. All other traffic on the VLAN is denied.

You can specify one or more upstream N ports in an FCoE map. The FCoE map also contains the VLAN ID of the dedicated VLAN used to transmit FCoE traffic between the SAN fabric and servers.

NPIV Proxy Gateway: Protocol Services

The Aggregator with the NPG provides the following protocol services:

- Fibre Channel service to create N ports and log in to an upstream FC switch.
- FCoE service to perform:
 - Virtualization of FC N ports on an NPG so that they appear as FCoE FCFs to downstream servers.
 - NPIV service to perform the association and aggregation of FCoE servers to upstream F ports on core switches (through N ports on the NPG). Conversion of server FLOGIs and FDISCs, which are received over the Aggregator with the ENode ports, are converted into FDISCs addressed to the upstream F ports on core switches.

NPIV Proxy Gateway Functionality

The Aggregator with the NPG provides the following functionality in a storage area network:

- FIP Snooping bridge that provides security for FCoE traffic using ACLs.
- FCoE gateway that provides FCoE-to-FC bridging. N-port virtualization using FCoE maps exposes upstream F ports as FCF ports to downstream server-facing ENode ports on the NPG.

NPIV Proxy Gateway: Terms and Definitions

The following table describes the terms used in an NPG configuration on the Aggregator.

Table 39. Aggregator with the NPIV Proxy Gateway: Terms and Definitions

Term	Description
FC port	Fibre Channel port on the Aggregator that operates in autosensing, 2, 4, or 8-Gigabit mode. On an NPIV proxy gateway, an FC port can be used as a downlink for a server connection and an uplink for a fabric connection.
F port	Port mode of an FC port connected to an end node (N) port on an Aggregator with the NPIV proxy gateway.

Table 39. Aggregator with the NPIV Proxy Gateway: Terms and Definitions (continued)

Term	Description
N port	Port mode of an Aggregator with the FC port that connects to an F port on an FC switch in a SAN fabric. On an Aggregator with the NPIV proxy gateway, an N port also functions as a proxy for multiple server CNA-port connections.
ENode port	Port mode of a server-facing Aggregator with the Ethernet port that provides access to FCF functionality on a fabric.
CNA port	N-port functionality on an FCoE-enabled server port. A converged network adapter (CNA) can use one or more Ethernet ports. CNAs can encapsulate Fibre Channel frames in Ethernet for FCoE transport and de-encapsulate Fibre Channel frames from FCoE to native Fibre Channel.
DCB map	Template used to configure DCB parameters, including priority-based flow control (PFC) and enhanced transmission selection (ETS), on CEE ports.
Fibre Channel fabric	Network of Fibre Channel devices and storage arrays that inter-operate and communicate.
FCF	Fibre Channel forwarder: FCoE-enabled switch that can forward FC traffic to both downstream FCoE and upstream FC devices. An NPIV proxy gateway functions as an FCF to export upstream F port configurations to downstream server CNA ports.
FC-MAP	FCoE MAC-address prefix — The unique 24-bit MAC address prefix in FCoE packets used to generate a fabric-provided MAC address (FPMA). The FPMA is required to send FCoE packets from a server to a SAN fabric.
FCoE map	Template used to configure FCoE and FC parameters on Ethernet and FC ports in a converged fabric.
FCoE VLAN	VLAN dedicated to carrying only FCoE traffic between server CNA ports and a SAN fabric. (FCoE traffic must travel in a VLAN.) When you apply an FCoE map on a port, FCoE is enabled on the port. All non-FCoE traffic is dropped on an FCoE VLAN.
FIP	FCoE Initialization Protocol: Layer 2 protocol for endpoint discovery, fabric login, and fabric association. FIP is used by server CNAs to discover an upstream FCoE switch operating as an FCF. FIP keepalive messages maintain the connection between an FCoE initiator and an FCF.
NPIV	N-port identifier virtualization: The capability to map multiple FCoE links from downstream ports to a single upstream FC link.
principal switch	The switch in a fabric with the lowest domain number. The principal switch accesses the master name database and the zone/zone set database.

DCB Maps

A Data Center Bridging (DCB) map is used to configure DCB functionality, such as PFC and ETS, on the Aggregator with the Ethernet ports that support CEE traffic and are DCBx-enabled, by default.

By default, no PFC and ETS settings in a DCB map are applied to the Aggregator with the Ethernet ports when they are enabled. On an Aggregator with the NPG, you must configure PFC and ETS parameters in a DCB map and then apply the map to server-facing Ethernet ports.

FCoE Maps

An FCoE map is used to identify the SAN fabric to which FCoE storage traffic is sent. Using an FCoE map, an Aggregator with the NPG operates as an FCoE-FC bridge between an FC SAN and FCoE network by providing FCoE-enabled servers and switches with the necessary parameters to log in to a SAN fabric.

An FCoE map applies the following parameters on server-facing Ethernet and fabric-facing FC ports on the Aggregator:

- The dedicated FCoE VLAN used to transport FCoE storage traffic.

- The FC-MAP value used to generate a fabric-provided MAC address.
- The association between the FCoE VLAN ID and FC fabric ID where the desired storage arrays are installed. Each Fibre Channel fabric serves as an isolated SAN topology within the same physical network.
- The priority used by a server to select an upstream FCoE forwarder (FCF priority).
- FIP keepalive (FKA) advertisement timeout.

NOTE:

In each FCoE map, the fabric ID, FC-MAP value, and FCoE VLAN must be unique. Use one FCoE map to access one SAN fabric. You cannot use the same FCoE map to access different fabrics.

When you configure an Aggregator with the NPG, FCoE transit with FIP snooping is automatically enabled and configured using the parameters in the FCoE map applied to server-facing Ethernet and fabric-facing FC interfaces.

After you apply an FCoE map on an FC port, when you enable the port (`no shutdown`), the NPG starts sending FIP multicast advertisements on behalf of the FC port to downstream servers in order to advertise the availability of a new FCF port on the FCoE VLAN. The FIP advertisement also contains a keepalive message to maintain connectivity between a SAN fabric and downstream servers.

Configuring an NPIV Proxy Gateway

Prerequisite: Before you configure an NPIV proxy gateway (NPG) on an Aggregator, ensure that the following features are enabled.

- DCB is enabled by default on the Aggregator.
- Autonegotiated DCBx is enabled for converged traffic by default with the Ethernet ports on all Aggregators.
- FCoE transit with FIP snooping is automatically enabled when you configure Fibre Channel on the Aggregator.

To configure an NPG operation on an Aggregator, follow these general configuration steps:

1. Enabling Fibre Channel Capability on the Switch
2. Creating a DCB map
3. Applying a DCB map on server-facing Ethernet ports
4. Creating an FCoE VLAN
5. Creating an FCoE map
6. Applying an FCoE map on server-facing Ethernet ports
7. Applying an FCoE Map on fabric-facing FC ports

NOTE: All these configurations are available only in PMUX mode and you cannot perform these configurations in Standalone mode.

Default Configurations in Standalone mode

By default, the following configurations are set in Standalone mode:

1. All the FC port are applied with the default FCoE map.
2. All the 10G server facing ports with the DCBX frames will have the default FCoE map and default DCB map assigned, and without the DCBX frames, `DCB_MAP_PFC_OFF` will be applied.

Default DCB map

```
Dell(conf)#do show qos dcb-map SAN_DCB_MAP
```

```
-----
State      :Complete
PfcMode:ON
-----
PG:0 TSA:ETS  BW:30  PFC:OFF
Priorities:0 1 2 5 6 7

PG:1 TSA:ETS  BW:30  PFC:OFF
Priorities:4

PG:2 TSA:ETS  BW:40  PFC:ON
Priorities:3
```

Default FCoE map

```
Dell(conf)#do show fcoe-map

Fabric Name      SAN FABRIC
Fabric Id       1002
Vlan Id         1002
Vlan priority    3
FC-MAP          0efc00
FKA-ADV-Period  8
Fcf Priority     128
Config-State    ACTIVE
Oper-State      UP
Members
Fc 0/9
Te 0/4
```

DCB_MAP_PFC_OFF

```
Dell(conf)#do show qos dcb-map DCB_MAP_PFC_OFF
-----

State      :In-Progress
PfcMode:OFF
-----

Dell(conf)#
```

Enabling Fibre Channel Capability on the Switch

Enable the Fibre Channel capability on an Aggregator that you want to configure as an NPG for the Fibre Channel protocol. When you enable Fibre Channel capability, FCoE transit with FIP snooping is automatically enabled on all VLANs on the switch, using the default FCoE transit settings.

1. Enable the Fibre Channel capability on an Aggregator for the Fibre Channel protocol.

```
CONFIGURATION mode
feature fc
```

Creating a DCB Map

Configure the priority-based flow control (PFC) and enhanced traffic selection (ETS) settings in a DCB map before you apply them on downstream server-facing ports on an Aggregator.

1. Create a DCB map to specify PFC and ETS settings for groups of dot1p priorities.

```
CONFIGURATION mode
dcb-map name
```

2. Configure the PFC setting (on or off) and the ETS bandwidth percentage allocated to traffic in each priority group. Configure whether the priority group traffic should be handled with strict-priority scheduling. The sum of all allocated bandwidth percentages must be 100 percent. Strict-priority traffic is serviced first. Afterward, bandwidth allocated to other priority groups is made available and allocated according to the specified percentages. If a priority group does not use its allocated bandwidth, the unused bandwidth is made available to other priority groups.

Restriction: You can enable PFC on a maximum of two priority queues.

```
Repeat this step to configure PFC and ETS traffic handling for each priority group, for example:
priority-group 0 bandwidth 60 pfc off
priority-group 1 bandwidth 20 pfc on
priority-group 2 bandwidth 20 pfc on
priority-group 4 strict-priority pfc off
```

```
DCB MAP mode
```

```
priority-group group_num {bandwidth percentage | strict-priority} pfc {on | off}
```

3. Specify the priority group ID number to handle VLAN traffic for each dot1p class-of-service: 0 through 7. Leave a space between each priority group number. For example, `priority-pgid 0 0 0 1 2 4 4 4` where dot1p priorities 0, 1, and

2 are mapped to priority group 0; dot1p priority 3 is mapped to priority group 1; dot1p priority 4 is mapped to priority group 2; dot1p priorities 5, 6, and 7 are mapped to priority group 4.

All priorities that map to the same egress queue must be in the same priority group.

DCB MAP mode

```
priority-pgid dot1p0_group_num dot1p1_group_num dot1p2_group_num dot1p3_group_num
dot1p4_group_num dot1p5_group_num dot1p6_group_num dot1p7_group_num
```

Important Points to Remember

- If you remove a dot1p priority-to-priority group mapping from a DCB map (`no priority pgid` command), the PFC and ETS parameters revert to their default values on the interfaces on which the DCB map is applied. By default, PFC is not applied on specific 802.1p priorities; ETS assigns equal bandwidth to each 802.1p priority.
As a result, PFC and lossless port queues are disabled on 802.1p priorities, and all priorities are mapped to the same priority queue and equally share port bandwidth.
- To change the ETS bandwidth allocation configured for a priority group in a DCB map, do not modify the existing DCB map configuration. Instead, create a new DCB map with the desired PFC and ETS settings, and apply the new map to the interfaces to override the previous DCB map settings. Then, delete the original dot1p priority-to-priority group mapping.
- If you delete the dot1p priority-to-priority group mapping (`no priority pgid` command) before you apply the new DCB map, the default PFC and ETS parameters are applied on the interfaces. This change may create a DCB mismatch with peer DCB devices and interrupt the network operation.

Applying a DCB Map on Server-facing Ethernet Ports

You can apply a DCB map only on a physical Ethernet interface and can apply only one DCB map per interface.

1. Enter CONFIGURATION mode on a server-facing port or port channel to apply a DCB map.

You cannot apply a DCB map on a port channel. However, you can apply a DCB map on the ports that are members of the port channel.

CONFIGURATION mode

```
interface {tengigabitEthernet slot/port }
```

2. Apply the DCB map on an Ethernet port or port channel. The port is configured with the PFC and ETS settings in the DCB map.

Repeat this step to apply a DCB map to more than one port or port channel.

INTERFACE mode

```
dcb-map name
```

```
Dell# interface tengigabitEthernet 0/0
Dell(config-if-te-0/0)# dcb-map SAN_DCB1
```

Creating an FCoE VLAN

Create a dedicated VLAN to send and receive Fibre Channel traffic over FCoE links between servers and a fabric over an NPG. The NPG receives FCoE traffic and forwards decapsulated FC frames over FC links to SAN switches in a specified fabric.

1. Create the dedicated VLAN for FCoE traffic. Range: 2–4094.

VLAN 1002 is commonly used to transmit FCoE traffic.

CONFIGURATION mode

```
interface vlan vlan-id
```

When you apply an FCoE map to an Ethernet port, the port is automatically configured as a tagged member of the FCoE VLAN.

Creating an FCoE Map

An FCoE map consists of:

- An association between the dedicated VLAN, used to carry FCoE traffic, and the SAN fabric where the storage arrays are installed. Use a separate FCoE VLAN for each fabric to which the FCoE traffic is forwarded. Any non-FCoE traffic sent on a dedicated FCoE VLAN is dropped.
- The FC-MAP value, used to generate the fabric-provided MAC address (FPMA). The FPMA is used by servers to transmit FCoE traffic to the fabric. You can associate an FC-MAP with only one FCoE VLAN and conversely, associate an FCoE VLAN with only one FC-MAP.
- FCF priority, the priority used by a server CNA to select an upstream FCoE forwarder (FCF).
- FIP keepalive (FKA) advertisement timeout.

The values for the FCoE VLAN, fabric ID and FC-MAP must be unique. Apply an FCoE map on downstream server-facing Ethernet ports and upstream fabric-facing Fibre Channel ports.

1. Create an FCoE map that contains parameters used in the communication between servers and a SAN fabric.

CONFIGURATION mode

```
fcoe-map map-name
```

2. Configure the association between the dedicated VLAN and the fabric where the desired storage arrays are installed. The fabric and VLAN ID numbers must be the same. Fabric and VLAN ID range: 2–4094.

For example: `fabric id 10 vlan 10`

FCoE MAP mode

```
fabric-id fabric-num vlan vlan-id
```

3. Add a text description of the settings in the FCoE map. Maximum: 32 characters.

FCoE MAP mode

```
description text
```

4. Specify the FC-MAP value used to generate a fabric-provided MAC address, which is required to send FCoE traffic from a server on the FCoE VLAN to the FC fabric specified in Step 2. Enter a unique MAC address prefix as the FC-MAP value for each fabric. Range: 0EFC00–0EFCFF. Default: None.

FCoE MAP mode

```
fc-map fc-map-value
```

5. Configure the priority used by a server CNA to select the FCF for a fabric login (FLOGI). Range: 1–255. Default: 128.

FCoE MAP mode

```
fcf-priority priority
```

6. Enable the monitoring FIP keepalive messages (if it is disabled) to detect if other FCoE devices are reachable. Default: FIP keepalive monitoring is enabled.

FCoE MAP mode

```
keepalive
```

7. Configure the time interval (in seconds) used to transmit FIP keepalive advertisements. Range: 8–90 seconds. Default: 8 seconds.

FCoE MAP mode

```
fka-adv-period seconds
```

Applying an FCoE Map on Server-facing Ethernet Ports

You can apply multiple FCoE maps on an Ethernet port or port channel. When you apply an FCoE map on a server-facing port or port channel:

- The port is configured to operate in hybrid mode (accept both tagged and untagged VLAN frames).
- The associated FCoE VLAN is enabled on the port or port channel.

When you enable a server-facing Ethernet port, the servers respond to the FIP advertisements by performing FLOGIs on upstream virtualized FCF ports. The NPG forwards the FLOGIs as FDISC messages to a SAN switch.

1. Configure a server-facing Ethernet port or port channel with an FCoE map.

CONFIGURATION mode

```
interface {tengigabitEthernet slot/port | port-channel num}
```

2. Apply the FCoE/FC configuration in an FCoE map on the Ethernet port. Repeat this step to apply an FCoE map to more than one port.

INTERFACE or INTERFACE PORT_CHANNEL mode

```
fcoe-map map-name
```

```
Dell# interface tengigabitEthernet 0/0
Dell(config-if-te-0/0)# fcoe-map SAN_FABRIC_A
Dell# interface port-channel 3
Dell(config-if-te-0/0)# dcb-map SAN_DCB1
Dell(config-if-po-3)# fcoe-map SAN_FABRIC_A
Dell# interface fortygigabitEthernet 0/48
Dell(config-if-fo-0/0)# fcoe-map SAN_FABRIC_A
```

3. Enable the port for FCoE transmission using the map settings.

INTERFACE mode

```
no shutdown
```

Applying an FCoE Map on Fabric-facing FC Ports

The Aggregator, with the FC ports, are configured by default to operate in N port mode to connect to an F port on an FC switch in a fabric. You can apply only one FCoE map on an FC port.

When you apply an FCoE map on a fabric-facing FC port, the FC port becomes part of the FCoE fabric, whose settings in the FCoE map are configured on the port and exported to downstream server CNA ports.

Each Aggregator, with the FC port, is associated with an Ethernet MAC address (FCF MAC address). When you enable a fabric-facing FC port, the FCoE map applied to the port starts sending FIP multicast advertisements using the parameters in the FCoE map over server-facing Ethernet ports. A server sees the FC port, with its applied FCoE map, as an FCF port.

1. Configure a fabric-facing FC port.

CONFIGURATION mode

```
interface fibrechannel slot/port
```

2. Apply the FCoE and FC fabric configurations in an FCoE map to the port. Repeat this step to apply an FCoE map to more than one FC port.

INTERFACE FIBRE_CHANNEL mode

```
fabric map-name
```

```
Dell# interface fi 0/9
Dell(config-if-fc-0/9)# fabric SAN_FABRIC_A
```

3. Enable the port for FC transmission.

INTERFACE FIBRE_CHANNEL mode

```
no shutdown
```

Important Points to Remember

You can apply a DCB or FCoE map to a range of Ethernet or Fibre Channel interfaces by using the `interface range` command; for example:

Enter the keywords `interface range` followed by an interface type and port range. A port range must contain spaces before and after the dash. Separate each interface type and port range with a space, comma, and space as shown in the preceding examples.

Sample Configuration

1. Configure a DCB map with PFC and ETS settings:

```
Dell(config)# dcb-map SAN_DCB_MAP
Dell(config-dcbx-name)# priority-group 0 bandwidth 60 pfc off
Dell(config-dcbx-name)# priority-group 1 bandwidth 20 pfc on
Dell(config-dcbx-name)# priority-group 2 bandwidth 20 pfc on
Dell(config-dcbx-name)# priority-group 4 strict-priority pfc off
Dell(conf-dcbx-name)# priority-pgid 0 0 0 1 2 4 4 4
```

2. Apply the DCB map on a downstream (server-facing) Ethernet port:

```
Dell(config-if-te-0/0)#dcb-map SAN_DCB_MAP
```

3. Create the dedicated VLAN to be used for FCoE traffic:

```
Dell(conf)#interface vlan 1002
```

4. Configure an FCoE map to be applied on downstream (server-facing) Ethernet and upstream (core-facing) FC ports:

```
Dell(config)# fcoe-map SAN_FABRIC_A
Dell(config-fcoe-name)# fabric-id 1002 vlan 1002
Dell(config-fcoe-name)# description "SAN_FABRIC_A"
Dell(config-fcoe-name)# fc-map 0efc00
Dell(config-fcoe-name)# keepalive
Dell(config-fcoe-name)# fcf-priority 128
Dell(config-fcoe-name)# fka-adv-period 8
```

5. Enable an upstream FC port:

```
Dell(config-if-fc-0)# no shutdown
```

6. Enable a downstream Ethernet port:

```
Dell(conf-if-te-0)# no shutdown
```

Displaying NPIV Proxy Gateway Information

To display information on the NPG operation, use the show commands in the following table:

Table 40. Displaying NPIV Proxy Gateway Information

Command	Description
<code>show interfaces status</code>	Displays the operational status of Ethernet and Fibre Channel interfaces on the Aggregator with the NPG.  NOTE: Although the show interface status command displays the Fiber Channel (FC) interfaces with the abbreviated label of 'Fc' in the output, if you attempt to specify a FC interface by using the <code>interface fc</code> command in the CLI interface, an error message is displayed. You must configure FC interfaces by using the <code>interface fi</code> command in CONFIGURATION mode.
<code>show fcoe-map [brief map-name]</code>	Displays the Fibre Channel and FCoE configuration parameters in FCoE maps. Enter the brief keyword to display an overview of currently configured FCoE maps.

Table 40. Displaying NPIV Proxy Gateway Information (continued)

Command	Description
	Enter the name of an FCoE map to display the FC and FCoE parameters configured in the map to be applied on the Aggregator with the FC ports.
<code>show qos dcb-map map-name</code>	Displays configuration parameters in a specified DCB map.
<code>show npiv devices [brief]</code>	Displays information on FCoE and FC devices currently logged in to the NPG.
<code>show fc switch</code>	Displays the FC mode of operation and worldwide node (WWN) name of an Aggregator.

show interfaces status Command Example

```
Dell# show interfaces status
Port      Description      Status  Speed      Duplex  Vlan
Te 0/1    Up              10000  Mbit Full  1-4094
Te 0/2    Down           Auto    Auto    1-1001,1003-4094
Te 0/3    Up              10000  Mbit Full  1-1001,1003-4094
Te 0/4    Down           Auto    Auto    1-1001,1003-4094
Te 0/5    Up              10000  Mbit Full  1-4094
Te 0/6    Up              10000  Mbit Full  1-4094
Te 0/7    Up              10000  Mbit Full  1-4094
Te 0/8 toB300 Down         Auto    Auto    1-1001,1003-4094
Fc 0/9    Up              8000   Mbit Full  --
Fc 0/10   Up              8000   Mbit Full  --
Te 0/11   Down           Auto    Auto    --
Te 0/12   Down           Auto    Auto    --
```

Table 41. show interfaces status Field Descriptions

Field	Description
Port	Server-facing 10GbE Ethernet (Te), or fabric-facing Fibre Channel (FC) port with <i>slot/port</i> information.
Description	Text description of port.
Status	Operational status of port: Ethernet ports - up (transmitting FCoE and LAN storage traffic) or down (not transmitting traffic). Fibre Channel ports - up (link is up and transmitting FC traffic) or down (link is down and not transmitting FC traffic), link-wait (link is up and waiting for FLOGI to complete on peer SW port), or removed (port has been shut down).
Speed	Transmission speed (in Megabits per second) of Ethernet and FC ports, including auto-negotiated speed (Auto).
Duplex	Data transmission mode: Full (allows communication in both directions at the same time), Half (allows communication in both directions but not at the same time), Auto (auto-negotiated transmission).
VLAN	VLAN IDs of the VLANs in which the port is a member.

show fcoe-map Command Examples

```
Dell# show fcoe-map brief
Fabric-Name   Fabric-Id       Vlan-Id  FC-MAP    FCF-Priority  Config-State  Oper-State
fid_1003     1003           1003     0efc03    128           ACTIVE        UP
fid_1004     1004           1004     0efc04    128           ACTIVE        DOWN

Dell# show fcoe-map fid_1003

Fabric Name       fid_1003
Fabric Id         1003
Vlan Id           1003
Vlan priority     3
FC-MAP            0efc03
FKA-ADV-Period   8
Fcf Priority      128
Config-State     ACTIVE
Oper-State       UP
Members
Fc 0/9
Te 0/11 Te 0/12
```

Table 42. show fcoe-map Field Descriptions

Field	Description
Fabric-Name	Name of a SAN fabric.
Fabric ID	The ID number of the SAN fabric to which FC traffic is forwarded.
VLAN ID	The dedicated VLAN used to transport FCoE storage traffic between servers and a fabric over the NPG. The configured VLAN ID must be the same as the fabric ID.
VLAN priority	FCoE traffic uses VLAN priority 3. This setting is not user-configurable.
FC-MAP	FCoE MAC-address prefix value - The unique 24-bit MAC address prefix that identifies a fabric.
FKA-ADV-period	Time interval (in seconds) used to transmit FIP keepalive advertisements.
FCF Priority	The priority used by a server to select an upstream FCoE forwarder.
Config-State	Indicates whether the configured FCoE and FC parameters in the FCoE map are valid: Active (all mandatory FCoE and FC parameters are correctly configured) or Incomplete (either the FC-MAP value, fabric ID, or VLAN ID are not correctly configured).
Oper-State	Operational status of the link to the fabric: up (link is up and transmitting FC traffic), down (link is down and not transmitting FC traffic), link-wait (link is up and waiting for FLOGI to complete on peer FC port), or removed (port has been shut down).
Members	Aggregator with the FC ports, which are members of the dedicated FCoE VLAN that carries storage traffic to the specified fabric.

show qos dcb-map Command Examples

```
Dell# show qos dcb-map dcbmap2

State      :Complete
PfcMode:ON
-----
PG:0 TSA:ETS BW:50 PFC:OFF
```



```
Priorities:0 1 2 4 5 6 7
```

```
PG:1 TSA:ETS BW:50 PFC:ON  
Priorities:3
```

Table 43. show qos dcb-map Field Descriptions

Field	Description
State	Complete: All mandatory DCB parameters are correctly configured. In progress: The DCB map configuration is not complete. Some mandatory parameters are not configured.
PFC Mode	PFC configuration in the DCB map: On (enabled) or Off.
PG	Priority group configured in the DCB map.
TSA	Transmission scheduling algorithm used in the DCB map: Enhanced Transmission Selection (ETS).
BW	Percentage of bandwidth allocated to the priority group.
PFC	PFC setting for the priority group: On (enabled) or Off.
Priorities	802.1p priorities configured in the priority group.

show npiv devices brief Command Example

```
Dell# show npiv devices brief
```

```
Total NPIV Devices = 2
```

```
-----  
-----  
ENode-Intf      ENode-WWPN          FCoE-Vlan  Fabric-Intf      Fabric-Map  
LoginMethod     Status  
-----  
-----  
Te 0/11         20:01:00:10:18:f1:94:20  1003      Fc 0/9          fid_1003  
FLOGI          LOGGED_IN  
Te 0/12         10:00:00:00:c9:d9:9c:cb  1003      Fc 0/10         fid_1003  
FDISC          LOGGED_IN
```

Table 44. show npiv devices brief Field Descriptions

Field	Description
Total NPIV Devices	Number of downstream ENodes connected to a fabric over the Aggregator with the NPG.
ENode-Intf	Aggregator with the Ethernet interface (<i>slot/port</i>) to which a server CNA is connected.
ENode-WWPN	Worldwide port name (WWPN) of a server CNA port.
FCoE-Vlan	VLAN ID of the dedicated VLAN used to transmit FCoE traffic to and from the fabric.
Fabric-Intf	Fabric-facing Fibre Channel port (<i>slot/port</i>) on which FC traffic is transmitted to the specified fabric.

Table 44. show npiv devices brief Field Descriptions (continued)

Field	Description
Fabric-Map	Name of the FCoE map containing the FCoE/FC configuration parameters for the server CNA-fabric connection.
Login Method	Method used by the server CNA to log in to the fabric; for example: FLOGI - ENode logged in using a fabric login (FLOGI). FDISC - ENode logged in using a fabric discovery (FDISC).
Status	Operational status of the link between a server CNA port and a SAN fabric: Logged In - Server has logged in to the fabric and is able to transmit FCoE traffic.

show npiv devices Command Example

```
Dell# show npiv devices
ENode[0]:
ENode MAC      : 00:10:18:f1:94:21
ENode Intf     : Te 0/11
FCF MAC        : 5c:f9:dd:ef:10:c8
Fabric Intf    : Fc 0/9
FCoE Vlan      : 1003
Fabric Map     : fid_1003
ENode WWPN     : 20:01:00:10:18:f1:94:20
ENode WWNN     : 20:00:00:10:18:f1:94:21
FCoE MAC       : 0e:fc:03:01:02:01
FC-ID          : 01:02:01
LoginMethod    : FLOGI
Secs           : 5593
Status         : LOGGED_IN

ENode[1]:
ENode MAC      : 00:10:18:f1:94:22
ENode Intf     : Te 0/12
FCF MAC        : 5c:f9:dd:ef:10:c9
Fabric Intf    : Fc 0/10
FCoE Vlan      : 1003
Fabric Map     : fid_1003
ENode WWPN     : 10:00:00:00:c9:d9:9c:cb
ENode WWNN     : 10:00:00:00:c9:d9:9c:cd
FCoE MAC       : 0e:fc:03:01:02:02
FC-ID          : 01:02:01
LoginMethod    : FDISC
Secs           : 5593
Status         : LOGGED_IN
```

Table 45. show npiv devices Field Descriptions

Field	Description
ENode [number]	Server CNA that has successfully logged in to a fabric over an Aggregator with the Ethernet port in ENode mode.
Enode MAC	MAC address of a server CNA port.
Enode Intf	Port number of a server-facing Ethernet port operating in ENode mode.
FCF MAC	Fibre Channel forwarder MAC: MAC address of Aggregator with the FCF interface.
Fabric Intf	Fabric-facing Aggregator with the Fibre Channel port (<i>slot/port</i>) on which FCoE traffic is transmitted to the specified fabric.

Table 45. show npiv devices Field Descriptions (continued)

Field	Description
FCoE VLAN	ID of the dedicated VLAN used to transmit FCoE traffic from a server CNA to a fabric and configured on both the server-facing Aggregator with the server CNA port.
Fabric Map	Name of the FCoE map containing the FCoE/FC configuration parameters for the server CNA-fabric connection.
Enode WWPN	Worldwide port name of the server CNA port.
Enode WWNN	Worldwide node name of the server CNA.
FCoE MAC	Fabric-provided MAC address (FPMA). The FPMA consists of the FC-MAP value in the FCoE map and the FC-ID provided by the fabric after a successful FLOGI. In the FPMA, the most significant bytes are the FC-MAP; the least significant bytes are the FC-ID.
FC-ID	FC port ID provided by the fabric.
LoginMethod	Method used by the server CNA to log in to the fabric; for example, FLOGI or FDISC.
Secs	Number of seconds that the fabric connection is up.
State	Status of the fabric connection: logged in.

show fc switch Command Example

```
Dell# show fc switch
Switch Mode : NPG
Switch WWN  : 10:00:5c:f9:dd:ef:10:c0
Dell#
```

Table 46. show fc switch Command Description

Field	Description
Switch Mode	Fibre Channel mode of operation of an Aggregator. Default: NPG (configured as an NPIV proxy gateway).
Switch WWN	Factory-assigned worldwide node (WWN) name of the Aggregator. The Aggregator WWN name is not user-configurable.

Upgrade Procedures

To find the upgrade procedures, go to the *Dell Networking OS Release Notes* for your system type to see all the requirements needed to upgrade to the desired Dell Networking OS version. To upgrade your system type, follow the procedures in the *Dell Networking OS Release Notes*.

Get Help with Upgrades

Direct any questions or concerns about the Dell Networking OS upgrade procedures to the Dell Technical Support Center. You can reach Technical Support:

- On the web: <http://support.dell.com/>
- By email: Dell-Force10_Technical_Support@Dell.com
- By phone: US and Canada: 866.965.5800, International: 408.965.5800.

Debugging and Diagnostics

This chapter contains the following sections:

- Debugging Aggregator Operation
- Software Show Commands
- Offline Diagnostics
- Trace Logs
- Show Hardware Commands

Supported Modes

Standalone, PMUX, VLT

Topics:

- [Debugging Aggregator Operation](#)
- [Software show Commands](#)
- [Offline Diagnostics](#)
- [Trace Logs](#)
- [Using the Show Hardware Commands](#)
- [Environmental Monitoring](#)
- [Buffer Tuning](#)
- [Troubleshooting Packet Loss](#)
- [Enabling Buffer Statistics Tracking](#)
- [Restoring the Factory Default Settings](#)

Debugging Aggregator Operation

This section describes common troubleshooting procedures to use for error conditions that may arise during Aggregator operation.

All interfaces on the Aggregator are operationally down

This section describes how you can troubleshoot the scenario in which all the interfaces are down.

Symptom: All Aggregator interfaces are down.

Resolution: Ensure the port channel 128 is up and that the Aggregator-facing port channel on the top-of-rack switch is correctly configured.

Steps to Take:

1. Verify that uplink port-channel 128 is up (show interfaces port-channel 128 brief command) and display the status of member ports (show uplink-state-group 1 detail command).

```
Dell#show interfaces port-channel 128 brief
Codes: L - LACP Port-channel

   LAG  Mode  Status      Uptime      Ports
L   128  L2L3  up          17:36:24    Te 0/33    (Up)
                   Te 0/35    (Up)
                   Te 0/36    (Up)
                   Te 0/39    (Up)
                   Te 0/51    (Up)
```

```
Te 0/53 (Up)
Te 0/54 (Up)
Te 0/56 (Up)
```

```
Dell#show uplink-state-group 1 detail
```

```
(Up): Interface up (Dwn): Interface down (Dis): Interface disabled
```

```
Uplink State Group : 1 Status: Enabled, Up
Defer Timer : 10 sec
Upstream Interfaces : Po 128 (Up)
Downstream Interfaces : Te 0/1 (Up) Te 0/2 (Up) Te 0/3 (Dwn) Te 0/4 (Dwn) Te 0/5 (Up)
Te 0/6 (Dwn) Te 0/7 (Dwn) Te 0/8 (Up) Te 0/9 (Up) Te 0/10 (Up)
Te 0/11 (Dwn) Te 0/12 (Dwn) Te 0/13 (Up) Te 0/14 (Dwn) Te
0/15 (Up)
Te 0/16 (Up) Te 0/17 (Dwn) Te 0/18 (Dwn) Te 0/19 (Dwn) Te
0/20 (Dwn)
Te 0/21 (Dwn) Te 0/22 (Dwn) Te 0/23 (Dwn) Te 0/24 (Dwn) Te
0/25 (Dwn)
Te 0/26 (Dwn) Te 0/27 (Dwn) Te 0/28 (Dwn) Te 0/29 (Dwn) Te
0/30 (Dwn)
Te 0/31 (Dwn) Te 0/32 (Dwn)
```

2. Verify that the downstream port channel in the top-of-rack switch that connect to the Aggregator is configured correctly.

Broadcast, unknown multicast, and DLF packets switched at a very low rate

Symptom: Broadcast, unknown multicast, and DLF packets are switched at a very low rate.

By default, broadcast storm control is enabled on an Aggregator and rate limits the transmission of broadcast, unknown multicast, and DLF packets to 1Gbps. This default behavior is designed to avoid unnecessarily flooding these packets on all (4094) VLANs on all Aggregator interfaces (default configuration).

Resolution: Disable broadcast storm control globally on the Aggregator.

Steps to Take:

1. Display the current status of broadcast storm control on the Aggregator (show io-aggregator broadcast storm-control status command).

```
Dell#show io-aggregator broadcast storm-control status
Storm-Control Enabled
Broadcast Traffic limited to 1000 Mbps
```

2. Disable broadcast storm control (no io-aggregator broadcast storm-control command) and re-display its status.

```
Dell#config terminal
Dell(conf)#no io-aggregator broadcast storm-control
Dell(conf)#end
Dell#show io-aggregator broadcast storm-control status
Storm-Control Disabled
```

Flooded packets on all VLANs are received on a server

Symptom: All packets flooded on all VLANs on an Aggregator are received on a server, even if the server is configured as a member of only a subset of VLANs. This behavior happens because all Aggregator ports are, by default, members of all (4094) VLANs.

Resolution: Configure a port that is connected to the server with restricted VLAN membership.

Steps to Take:

1. Display the current port mode for Aggregator L2 interfaces (show interfaces switchport interface command)..

```
Dell#show interfaces switchport tengigabitethernet 0/1

Codes:  U - Untagged, T - Tagged
        x - Dot1x untagged, X - Dot1x tagged
        G - GVRP tagged, M - Trunk, H - VSN tagged
        i - Internal untagged, I - Internal tagged, v - VLT untagged, V - VLT tagged

Name: TenGigabitEthernet 0/1
802.1QTagged: Hybrid
SMUX port mode: Auto VLANs enabled
Vlan membership:
Q      Vlans
U      1
T      2-4094

Native VlanId: 1
```

2. Assign the port to a specified group of VLANs (vlan tagged command) and re-display the port mode status..

```
Dell(conf)#interface tengigabitethernet 0/1
Dell(conf-if-te-0/1)#vlan tagged 2-5,100,4010
Dell(conf-if-te-0/1)#

Dell#show interfaces switchport tengigabitethernet 0/1

Codes:  U - Untagged, T - Tagged
        x - Dot1x untagged, X - Dot1x tagged
        G - GVRP tagged, M - Trunk, H - VSN tagged
        i - Internal untagged, I - Internal tagged, v - VLT untagged, V - VLT tagged

Name: TenGigabitEthernet 0/1
802.1QTagged: Hybrid
SMUX port mode: Admin VLANs enabled
Vlan membership:
Q      Vlans
U      1
T      2-5,100,4010

Native VlanId: 1
```

Software show Commands

Use the show version and show system stack-unit 0 commands as a part of troubleshooting an Aggregator’s software configuration in a standalone or stacking scenario.

Table 47. Software show Commands

Command	Description
show version	Display the current version of Dell Networking OS software running on an Aggregator.
show system stack-unit 0	Display software configuration on an Aggregator in stacking mode.

show version Command Example

```
Dell#show version
Dell Real Time Operating System Software
Dell Operating System Version: 1.0
Dell Force10 Application Software Version: E8-3-17-24
Copyright (c) 1999-2014 by Dell Inc. All Rights Reserved.
Build Time: Thu Jul 5 11:20:28 PDT 2012
Build Path: /sites/sjc/work/build/buildSpaces/build05/E8-3-17/SW/SRC/Cp_src/Tacacs
st-sjc-m1000e-3-72 uptime is 17 hour(s), 1 minute(s)
```

System Type: I/O-Aggregator

Control Processor: MIPS RMI XLP with 2147483648 bytes of memory.

256M bytes of boot flash memory.

1 34-port GE/TE (XL)

56 Ten GigabitEthernet/IEEE 802.3 interface(s)

Dell#

show system stack-unit 0 Command Example

```
Dell#show system stack-unit 0 | no-more

-- Unit 0 --
Unit Type           : Management Unit
Status              : online
Next Boot           : online

Required Type : I/O-Aggregator - 34-port GE/TE (XL)
Current Type  : I/O-Aggregator - 34-port GE/TE (XL)
Master priority : 0
Hardware Rev  :
Num Ports    : 56
Up Time      : 17 hr, 8 min
FTOS Version : 8-3-17-15
Jumbo Capable : yes
POE Capable  : no
Boot Flash   : A: 4.0.1.0 [booted] B: 4.0.1.0bt
Boot Selector : 4.0.0.0
Memory Size  : 2147483648 bytes
Temperature  : 64C
Voltage      : ok
Switch Power : GOOD
Product Name : I/O Aggregator
Mfg By       : DELL
Mfg Date     : 2012-05-01
Serial Number : TW282921F00038
Part Number  : ONVH81
Piece Part ID : TW-ONVH81-28292-1F0-0038
PPID Revision :
Service Tag  : N/A
Expr Svc Code : N/A
PSOC FW Rev  : 0xb
ICT Test Date : 0-0-0
ICT Test Info : 0x0
Max Power Req : 31488
Fabric Type   : 0x3
Fabric Maj Ver : 0x1
Fabric Min Ver : 0x0
SW Manageability: 0x4
HW Manageability: 0x1
Max Boot Time : 3 minutes
Link Tuning   : unsupported
Auto Reboot   : enabled
Burned In MAC : 00:1e:c9:f1:03:42
No Of MACs   : 3
Dell#
```

Offline Diagnostics

The offline diagnostics test suite is useful for isolating faults and debugging hardware.

The diagnostics tests are grouped into three levels:

- **Level 0** — Level 0 diagnostics check for the presence of various components and perform essential path verifications. In addition, Level 0 diagnostics verify the identification registers of the components on the board.
- **Level 1** — A smaller set of diagnostic tests. Level 1 diagnostics perform status, self-test, access, and read-write tests for all the components on the board and test their registers for appropriate values. In addition, Level 1 diagnostics perform extensive tests on memory devices (for example, SDRAM, flash, NVRAM, EEPROM) wherever possible.

- **Level 2** — The full set of diagnostic tests. Level 2 diagnostics are used primarily for on-board MAC level, Physical level, external Loopback tests, and more extensive component diagnostics. Various components on the board are put into Loopback mode and test packets are transmitted through those components. These diagnostics also perform snake tests using virtual local area network (VLAN) configurations.

NOTE: Diagnostic is not allowed in Stacking mode, including member stacking. Avoid stacking before executing the diagnostic tests in the chassis.

Important Points to Remember

- You can only perform offline diagnostics on an offline standalone unit. You cannot perform diagnostics if the ports are configured in a stacking group. Remove the port(s) from the stacking group before executing the diagnostic test.
- Diagnostics only test connectivity, not the entire data path.
- Diagnostic results are stored on the flash of the unit on which you performed the diagnostics.
- When offline diagnostics are complete, the unit or stack member reboots automatically.

Running Offline Diagnostics

To run offline diagnostics, use the following commands.

For more information, refer to the examples following the steps.

1. Place the unit in the offline state.

```
EXEC Privilege mode
offline stack-unit
```

You cannot enter this command on a MASTER or Standby stack unit.

NOTE: The system reboots when the offline diagnostics complete. This is an automatic process. The following warning message appears when you implement the `offline stack-unit` command:

```
Warning - offline of unit will bring down all the protocols and
the unit will be operationally down, except for running Diagnostics.
Please make sure that stacking/fanout not configured for Diagnostics execution.
Also reboot/online command is necessary for normal operation after the offline
command is issued.
Proceed with Offline [confirm yes/no]:
```

```
Dell#offline stack-unit 0
Warning - offline of unit will bring down all the protocols and
the unit will be operationally down, except for running Diagnostics.
Please make sure that stacking/fanout not configured for Diagnostics execution.
Also reboot/online command is necessary for normal operation after the offline
command is issued.
Proceed with Offline [confirm yes/no]:yes
Dell#
```

2. Confirm the offline status.

```
EXEC Privilege mode
show system brief
```

```
Dell#show system brief

Stack MAC : 00:1e:c9:de:03:7b

-- Stack Info --
Unit  UnitType   Status           ReqTyp           CurTyp           Version         Ports
-----
0     Member        not present
1     Management    online           I/O-Aggregator  I/O-Aggregator  8-3-17-38      56
2     Member        not present
3     Member        not present
4     Member        not present
5     Member        not present
```

Trace Logs

In addition to the syslog buffer, the Dell Networking OS buffers trace messages which are continuously written by various software tasks to report hardware and software events and status information.

Each trace message provides the date, time, and name of the Dell Networking OS process. All messages are stored in a ring buffer. You can save the messages to a file either manually or automatically after failover.

Auto Save on Crash or Rollover

Exception information for MASTER or standby units is stored in the `flash://TRACE_LOG_DIR` directory. This directory contains files that save trace information when there has been a task crash or timeout.

- On a MASTER unit, you can reach the `TRACE_LOG_DIR` files by FTP or by using the `show file` command from the `flash://TRACE_LOG_DIR` directory.
- On a Standby unit, you can reach the `TRACE_LOG_DIR` files only by using the `show file` command from the `flash://TRACE_LOG_DIR` directory.

NOTE: Non-management member units do not support this functionality.

Example of the `dir flash:` Command

```
Dell#dir flash://TRACE_LOG_DIR
Directory of flash://TRACE_LOG_DIR
 1 drwx   4096 Jan 17 2011 15:02:16 +00:00 .
 2 drwx   4096 Jan 01 1980 00:00:00 +00:00 ..
 3 -rwx 100583 Feb 11 2011 20:41:36 +00:00 failure_trace0_RPM0_CP

flash: 2143281152 bytes total (2069291008 bytes free)
```

Using the Show Hardware Commands

The `show hardware` command tree consists of commands used with the Aggregator switch.

These commands display information from a hardware sub-component and from hardware-based feature tables.

NOTE: Use the `show hardware` commands only under the guidance of the Dell Technical Assistance Center.

- View internal interface status of the stack-unit CPU port which connects to the external management interface.
EXEC Privilege mode
`show hardware stack-unit {0-5} cpu management statistics`
- View driver-level statistics for the data-plane port on the CPU for the specified stack-unit.
EXEC Privilege mode
`show hardware stack-unit {0-5} cpu data-plane statistics`
This view provides insight into the packet types entering the CPU to see whether CPU-bound traffic is internal (IPC traffic) or network control traffic, which the CPU must process.
- View the modular packet buffers details per stack unit and the mode of allocation.
EXEC Privilege mode
`show hardware stack-unit {0-5} buffer total-buffer`
- View the modular packet buffers details per unit and the mode of allocation.
EXEC Privilege mode
`show hardware stack-unit {0-5} buffer unit {0-1} total-buffer`
- View the forwarding plane statistics containing the packet buffer usage per port per stack unit.
EXEC Privilege mode

```
show hardware stack-unit {0-5} buffer unit {0-1} port {1-64 | all} buffer-info
```

- View the forwarding plane statistics containing the packet buffer statistics per COS per port.

EXEC Privilege mode

```
show hardware stack-unit {0-5} buffer unit {0-1} port {1-64} queue {0-14 | all} buffer-info
```

- View input and output statistics on the party bus, which carries inter-process communication traffic between CPUs.

EXEC Privilege mode

```
show hardware stack-unit {0-5} cpu party-bus statistics
```

- View the ingress and egress internal packet-drop counters, MAC counters drop, and FP packet drops for the stack unit on per port basis.

EXEC Privilege mode

```
show hardware stack-unit {0-5} drops unit {0-0} port {33-56}
```

This view helps identifying the stack unit/port pipe/port that may experience internal drops.

- View the input and output statistics for a stack-port interface.

EXEC Privilege mode

```
show hardware stack-unit {0-5} stack-port {33-56}
```

- View the counters in the field processors of the stack unit.

EXEC Privilege mode

```
show hardware stack-unit {0-5} unit {0-0} counters
```

- View the details of the FP Devices and Hi gig ports on the stack-unit.

EXEC Privilege mode

```
show hardware stack-unit {0-5} unit {0-0} details
```

- Execute a specified bShell command from the CLI without going into the bShell.

EXEC Privilege mode

```
show hardware stack-unit {0-5} unit {0-0} execute-shell-cmd {command}
```

- View the Multicast IPMC replication table from the bShell.

EXEC Privilege mode

```
show hardware stack-unit {0-5} unit {0-0} ipmc-replication
```

- View the internal statistics for each port-pipe (unit) on per port basis.

EXEC Privilege mode

```
show hardware stack-unit {0-5} unit {0-0} port-stats [detail]
```

- View the stack-unit internal registers for each port-pipe.

EXEC Privilege mode

```
show hardware stack-unit {0-5} unit {0-0} register
```

- View the tables from the bShell through the CLI without going into the bShell.

EXEC Privilege mode

```
show hardware stack-unit {0-5} unit {0-0} table-dump {table name}
```

Environmental Monitoring

Aggregator components use environmental monitoring hardware to detect transmit power readings, receive power readings, and temperature updates.

To receive periodic power updates, you must enable the following command.

- Enable environmental monitoring.

```
enable optic-info-update interval
```

```
Dell#show int ten 0/49 transceiver
SFP is present
SFP 49 Serial Base ID fields
SFP 49 Id = 0x03
SFP 49 Ext Id = 0x04
SFP 49 Connector = 0x07
```

```

SFP 49 Transceiver Code      = 0x00 0x00 0x00 0x01 0x20 0x40 0x0c 0x01
SFP 49 Encoding              = 0x01
SFP 49 BR Nominal            = 0x0c
SFP 49 Length(9um) Km       = 0x00
SFP 49 Length(9um) 100m     = 0x00
SFP 49 Length(50um) 10m    = 0x37
SFP 49 Length(62.5um) 10m  = 0x1e
SFP 49 Length(Copper) 10m  = 0x00
SFP 49 Vendor Rev           =
SFP 49 Laser Wavelength     = 850 nm
SFP 49 CheckCodeBase        = 0x78
SFP 49 Serial Extended ID fields
SFP 49 Options               = 0x00 0x12
SFP 49 BR max                = 0
SFP 49 BR min                = 0
SFP 49 Vendor SN            = P11C0B0
SFP 49 Datecode              = 020919
SFP 49 CheckCodeExt         = 0xb6

```

SFP 49 Diagnostic Information

```

=====
SFP 49 Rx Power measurement type      = Average
=====
SFP 49 Temp High Alarm threshold      = 100.000C
SFP 49 Voltage High Alarm threshold  = 5.000V
SFP 49 Bias High Alarm threshold     = 100.000mA
SFP 49 TX Power High Alarm threshold = 5.000mW
SFP 49 RX Power High Alarm threshold = 5.000mW
SFP 49 Temp Low Alarm threshold      = -50.000C
SFP 49 Voltage Low Alarm threshold   = 0.000V
SFP 49 Bias Low Alarm threshold      = 0.000mA
SFP 49 TX Power Low Alarm threshold  = 0.000mW
SFP 49 RX Power Low Alarm threshold  = 0.000mW
=====
SFP 49 Temp High Warning threshold   = 100.000C
SFP 49 Voltage High Warning threshold = 5.000V
SFP 49 Bias High Warning threshold   = 100.000mA
SFP 49 TX Power High Warning threshold = 5.000mW
SFP 49 RX Power High Warning threshold = 5.000mW
SFP 49 Temp Low Warning threshold    = -50.000C
SFP 49 Voltage Low Warning threshold = 0.000V
SFP 49 Bias Low Warning threshold    = 0.000mA
SFP 49 TX Power Low Warning threshold = 0.000mW
SFP 49 RX Power Low Warning threshold = 0.000mW
=====
SFP 49 Temperature                   = 40.844C
SFP 49 Voltage                       = 3.169V
SFP 49 Tx Bias Current                = 0.000mA
SFP 49 Tx Power                      = 0.000mW
SFP 49 Rx Power                      = 0.227mW
=====
SFP 49 Data Ready state Bar          = False
SFP 49 Rx LOS state                  = False
SFP 49 Tx Fault state                = False

```

Recognize an Over-Temperature Condition

An overtemperature condition occurs, for one of two reasons: the card genuinely is too hot or a sensor has malfunctioned.

Inspect cards adjacent to the one reporting the condition to discover the cause.

- If directly adjacent cards are not normal temperature, suspect a genuine overheating condition.
- If directly adjacent cards are normal temperature, suspect a faulty sensor.

When the system detects a genuine over-temperature condition, it powers off the card. To recognize this condition, look for the following system messages:

```

CHMGR-2-MAJOR_TEMP: Major alarm: chassis temperature high (temperature reaches or
exceeds threshold of
[value]C)

```

```
CHMGR-2-TEMP_SHUTDOWN_WARN: WARNING! temperature is [value]C; approaching shutdown threshold of [value]C
```

To view the programmed alarm thresholds levels, including the shutdown value, use the `show alarms threshold` command.

NOTE: When the ingress air temperature exceeds 61°C, the Status LED turns Amber and a major alarm is triggered.

Example of the `show alarms threshold` Command

```
Dell#show alarms threshold

-- Temperature Limits (deg C) --
-----
Unit0      Ingress-Air Off   Ingress-Air   Major Off    Major   Shutdown
Dell#      58                61            84           86       90
```

Troubleshoot an Over-Temperature Condition

To troubleshoot an over-temperature condition, use the following information.

1. Use the `show environment` commands to monitor the temperature levels.
2. Check air flow through the system. Ensure that the air ducts are clean and that all fans are working correctly.
3. After the software has determined that the temperature levels are within normal limits, you can re-power the card safely. To bring back the line card online, use the `power-on` command in EXEC mode.

In addition, Dell Networking requires that you install blanks in all slots without a line card to control airflow for adequate system cooling.

NOTE: Exercise care when removing a card; if it has exceeded the major or shutdown thresholds, the card could be hot to the touch.

Example of the `show environment` Command

```
Dell#show environment

-- Unit Environment Status --
Unit  Status      Temp  Voltage      TempStatus
-----
* 0   online       59C   ok           2

* Management Unit

-- Thermal Sensor Readings (deg C) --
Unit  Sensor0  Sensor1  Sensor2
-----
0     55       45       58

Dell#
```

Recognize an Under-Voltage Condition

If the system detects an under-voltage condition, it sends an alarm.

To recognize this condition, look for the following system message: `%CHMGR-1-CARD_SHUTDOWN: Major alarm: Line card 2 down - auto-shutdown due to under voltage.`

This message indicates that the specified card is not receiving enough power. In response, the system first shuts down Power over Ethernet (PoE).

Troubleshoot an Under-Voltage Condition

To troubleshoot an under-voltage condition, check that the correct number of power supplies are installed and their Status light emitting diodes (LEDs) are lit.

The following table lists information for SNMP traps and OIDs, which provide information about environmental monitoring hardware and hardware components.

Table 48. SNMP Traps and OIDs

OID String	OID Name	Description
Receiving Power		
.1.3.6.1.4.1.6027.3.10.1.2.5.1.6	chSysPortXfpRecvPower	OID displays the receiving power of the connected optics.
Transmitting power		
.1.3.6.1.4.1.6027.3.10.1.2.5.1.8	chSysPortXfpTxPower	OID displays the transmitting power of the connected optics.
Temperature		
.1.3.6.1.4.1.6027.3.10.1.2.5.1.7	chSysPortXfpRecvTemp	OID displays the temperature of the connected optics. i NOTE: These OIDs only generate if you enable the <code>enable optic-info-update-interval is enabled</code> command.
Hardware MIB Buffer Statistics		
.1.3.6.1.4.1.6027.3.27.1.4	dellNetFpPacketBufferTable	View the modular packet buffers details per stack unit and the mode of allocation.
.1.3.6.1.4.1.6027.3.27.1.5	dellNetFpStatsPerPortTable	View the forwarding plane statistics containing the packet buffer usage per port per stack unit.
.1.3.6.1.4.1.6027.3.27.1.6	dellNetFpStatsPerCOSTable	View the forwarding plane statistics containing the packet buffer statistics per COS per port.

Buffer Tuning

Buffer tuning allows you to modify the way your switch allocates buffers from its available memory and helps prevent packet drops during a temporary burst of traffic.

The application-specific integrated circuit (ASICs) implement the key functions of queuing, feature lookups, and forwarding lookups in hardware.

Forwarding processor (FP) ASICs provide Ethernet MAC functions, queueing, and buffering, as well as store feature and forwarding tables for hardware-based lookup and forwarding decisions. 1G and 10G interfaces use different FPs.

You can tune buffers at three locations

1. CSF — Output queues going from the CSF.
2. FP Uplink — Output queues going from the FP to the CSF IDP links.
3. Front-End Link — Output queues going from the FP to the front-end PHY.

All ports support eight queues, four for data traffic and four for control traffic. All eight queues are tunable.

Physical memory is organized into cells of 128 bytes. The cells are organized into two buffer pools — the dedicated buffer and the dynamic buffer.

- **Dedicated buffer** — this pool is reserved memory that other interfaces cannot use on the same ASIC or by other queues on the same interface. This buffer is always allocated, and no dynamic re-carving takes place based on changes in interface

status. Dedicated buffers introduce a trade-off. They provide each interface with a guaranteed minimum buffer to prevent an overused and congested interface from starving all other interfaces. However, this minimum guarantee means that the buffer manager does not reallocate the buffer to an adjacent congested interface, which means that in some cases, memory is under-used.

- **Dynamic buffer** — this pool is shared memory that is allocated as needed, up to a configured limit. Using dynamic buffers provides the benefit of statistical buffer sharing. An interface requests dynamic buffers when its dedicated buffer pool is exhausted. The buffer manager grants the request based on three conditions:
 - The number of used and available dynamic buffers.
 - The maximum number of cells that an interface can occupy.
 - Available packet pointers (2k per interface). Each packet is managed in the buffer using a unique packet pointer. Thus, each interface can manage up to 2k packets.

You can configure dynamic buffers per port on both 1G and 10G FPs and per queue on CSFs. By default, the FP dynamic buffer allocation is 10 times oversubscribed. For the 48-port 1G card:

- Dynamic Pool= Total Available Pool(16384 cells) — Total Dedicated Pool = 5904 cells
- Oversubscription ratio = 10
- Dynamic Cell Limit Per port = $59040/29 = 2036$ cells

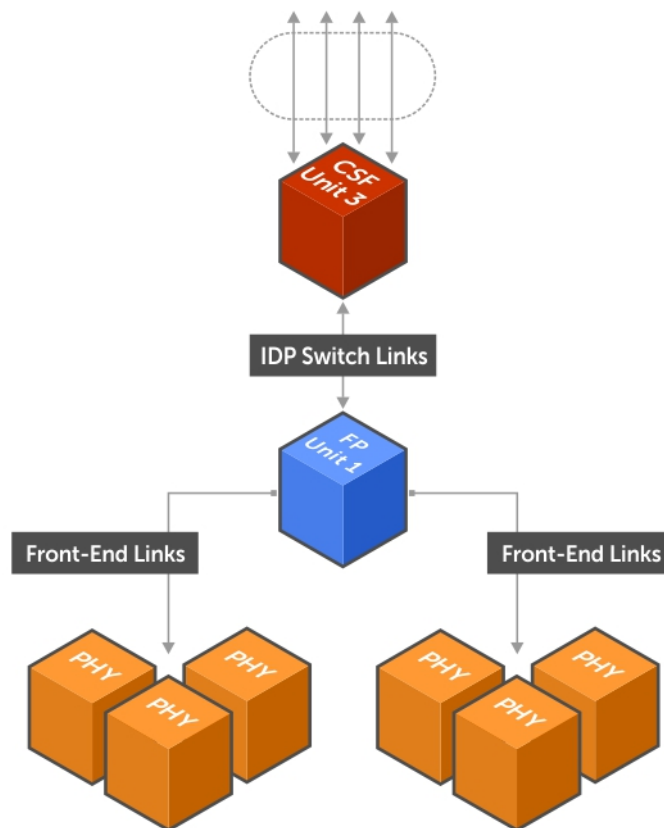

Figure 39. Buffer Tuning Points

Deciding to Tune Buffers

Dell Networking recommends exercising caution when configuring any non-default buffer settings, as tuning can significantly affect system performance. The default values work for most cases.

As a guideline, consider tuning buffers if traffic is bursty (and coming from several interfaces). In this case:

- Reduce the dedicated buffer on all queues/interfaces.
- Increase the dynamic buffer on all interfaces.
- Increase the cell pointers on a queue that you are expecting will receive the largest number of packets.

To define, change, and apply buffers, use the following commands.

- Define a buffer profile for the FP queues.

CONFIGURATION mode

```
buffer-profile fp fsqueue
```

- Define a buffer profile for the CSF queues.

CONFIGURATION mode

```
buffer-profile csf csqueue
```

- Change the dedicated buffers on a physical 1G interface.

BUFFER PROFILE mode

```
buffer dedicated
```

- Change the maximum number of dynamic buffers an interface can request.

BUFFER PROFILE mode

```
buffer dynamic
```

- Change the number of packet-pointers per queue.

BUFFER PROFILE mode

```
buffer packet-pointers
```

- Apply the buffer profile to a CSF to FP link.

CONFIGURATION mode

```
buffer csf linecard
```

Dell Networking OS Behavior: If you attempt to apply a buffer profile to a non-existent port-pipe, the system displays the following message: %DIFFSERV-2-DSA_BUFF_CARVING_INVALID_PORT_SET: Invalid FP port-set 2 for linecard 2. Valid range of port-set is <0-1>. However, the configuration still appears in the running-config.

Configuration changes take effect immediately and appear in the running configuration. Because under normal conditions all ports do not require the maximum allocation, the configured dynamic allocations can exceed the actual amount of available memory; this allocation is called oversubscription. If you choose to oversubscribe the dynamic allocation, a burst of traffic on one interface might prevent other interfaces from receiving the configured dynamic allocation, which causes packet loss.

You cannot allocate more than the available memory for the dedicated buffers. If the system determines that the sum of the configured dedicated buffers allocated to the queues is more than the total available memory, the configuration is rejected, returning a syslog message similar to the following: 00:04:20: %S50N:0 %DIFFSERV-2-DSA_DEVICE_BUFFER_UNAVAILABLE: Unable to allocate dedicated buffers for stack-unit 0, port pipe 0, egress port 25 due to unavailability of cells.

Dell Networking OS Behavior: When you remove a buffer-profile using the `no buffer-profile [fp | csf]` command from CONFIGURATION mode, the buffer-profile name still appears in the output of the `show buffer-profile [detail | summary]` command. After a stack unit reset, the buffer profile correctly returns to the default values, but the profile name remains. Remove it from the `show buffer-profile [detail | summary]` command output by entering `no buffer [fp-uplink |csf] stack-unit port-set buffer-policy` from CONFIGURATION mode and `no buffer-policy` from INTERFACE mode.

To display the allocations for any buffer profile, use the `show` commands.

To display the default buffer profile, use the `show buffer-profile {summary | detail}` command from EXEC Privilege mode.

Example of Viewing the Default Buffer Profile

```
Dell#show buffer-profile detail interface tengigabitethernet 0/1
Interface tengig 0/1
Buffer-profile -
Dynamic buffer 194.88 (Kilobytes)
Queue# Dedicated Buffer   Buffer Packets
      (Kilobytes)
0      2.50                256
1      2.50                256
2      2.50                256
3      2.50                256
4      9.38                256
5      9.38                256
6      9.38                256
7      9.38                256
```

Example of Viewing the Buffer Profile Allocations

```
Dell#show running-config interface tengigabitethernet 2/0 !
interface TenGigabitEthernet 2/0
no ip address
mtu 9252
switchport
no shutdown
buffer-policy myfsbufferprofile
```

Example of Viewing the Buffer Profile (Interface)

```
Dell#show buffer-profile detail int gi 0/10
Interface Gi 0/10
Buffer-profile fsqueue-fp
Dynamic buffer 1256.00 (Kilobytes)
Queue# Dedicated Buffer Buffer Packets
      (Kilobytes)
0      3.00          256
1      3.00          256
2      3.00          256
3      3.00          256
4      3.00          256
5      3.00          256
6      3.00          256
7      3.00          256
```

Example of Viewing the Buffer Profile (Linecard)

```
Dell#show buffer-profile detail fp-uplink stack-unit 0 port-set 0
Linecard 0 Port-set 0
Buffer-profile fsqueue-hig
Dynamic Buffer 1256.00 (Kilobytes)
Queue# Dedicated Buffer Buffer Packets
      (Kilobytes)
0      3.00          256
1      3.00          256
2      3.00          256
3      3.00          256
4      3.00          256
5      3.00          256
6      3.00          256
7      3.00          256
```

Using a Pre-Defined Buffer Profile

The Dell Networking OS provides two pre-defined buffer profiles, one for single-queue (for example, non-quality-of-service [QoS]) applications, and one for four-queue (for example, QoS) applications.

You must reload the system for the global buffer profile to take effect, a message similar to the following displays: % Info: For the global pre-defined buffer profile to take effect, please save the config and reload the system..

Dell Networking OS Behavior: After you configure buffer-profile global 1Q, the message displays during every bootup. Only one reboot is required for the configuration to take effect; afterward you may ignore this bootup message.

Dell Networking OS Behavior: The buffer profile does not returned to the default, 4Q. If you configure 1Q, save the running-config to the startup-config, and then delete the startup-config and reload the chassis. The only way to return to the default buffer profile is to remove the 1Q profile configured and then reload the chassis.

If you have already applied a custom buffer profile on an interface, the buffer-profile global command fails and a message similar to the following displays: % Error: User-defined buffer profile already applied. Failed to apply global pre-defined buffer profile. Please remove all user-defined buffer profiles.

Similarly, when you configure buffer-profile global, you cannot not apply a buffer profile on any single interface. A message similar to the following displays: % Error: Global pre-defined buffer profile already applied. Failed to apply user-defined buffer profile on interface Gi 0/1. Please remove global pre-defined buffer profile.

If the default buffer profile (4Q) is active, the system displays an error message instructing you to remove the default configuration using the `no buffer-profile global` command.

To apply a predefined buffer profile, use the following command.

- Apply one of the pre-defined buffer profiles for all port pipes in the system.

CONFIGURATION mode

```
buffer-profile global [1Q|4Q]
```

Sample Buffer Profile Configuration

The two general types of network environments are sustained data transfers and voice/data.

Dell Networking recommends a single-queue approach for data transfers.

Example of a Single Queue Application with Default Packet Pointers

```
!  
buffer-profile fp fsqueue-fp  
buffer dedicated queue0 3 queue1 3 queue2 3 queue3 3 queue4 3 queue5 3 queue6 3 queue7 3  
buffer dynamic 1256  
!  
buffer-profile fp fsqueue-hig  
buffer dedicated queue0 3 queue1 3 queue2 3 queue3 3 queue4 3 queue5 3 queue6 3 queue7  
3  
buffer dynamic 1256  
!  
buffer fp-uplink stack-unit 0 port-set 0 buffer-policy fsqueue-hig  
buffer fp-uplink stack-unit 0 port-set 1 buffer-policy fsqueue-hig  
!  
Interface range gi 0/1 - 48  
buffer-policy fsqueue-fp  
  
Dell#show run int Tengig 0/10  
!  
interface TenGigabitEthernet 0/10
```

Troubleshooting Packet Loss

The `show hardware stack-unit` command is intended primarily to troubleshoot packet loss.

To troubleshoot packet loss, use the following commands.

- `show hardware stack-unit 0-5 cpu data-plane statistics`
- `show hardware stack-unit 0-5 cpu party-bus statistics`
- `show hardware stack-unit 0-5 drops unit 0-0 port 1-56`
- `show hardware stack-unit 0-5 stack-port 33-56`
- `show hardware stack-unit 0-5 unit 0-0 {counters | details | port-stats [detail] | register | ipmc-replication | table-dump}`:
- `show hardware {layer2| layer3} {eg acl |in acl} stack-unit 0-5 port-set 0-0`
- `show hardware layer3 qos stack-unit 0-5 port-set 0-0`
- `show hardware system-flow layer2 stack-unit 0-5 port-set 0-1 [counters]`
- `show hardware drops interface [range] interface`
- `show hardware stack-unit <id> buffer-stats-snapshot unit <id> resource x`
- `show hardware buffer interface interface{priority-group { id | all } | queue { id| all}] buffer-info`
- `show hardware buffer-stats-snapshot resource interface interface{priority-group { id | all } | queue { ucast{id | all}{ mcast {id | all} | all}`
- `show hardware drops interface interface`
- `clear hardware stack-unit 0-5 counters`
- `clear hardware stack-unit 0-5 unit 0-0 counters`

- clear hardware stack-unit 0-5 cpu data-plane statistics
- clear hardware stack-unit 0-5 cpu party-bus statistics
- clear hardware stack-unit 0-5 stack-port 33-56

Displaying Drop Counters

To display drop counters, use the following commands.

- Identify which stack unit, port pipe, and port is experiencing internal drops.

```
show hardware stack-unit 0-11 drops [unit 0 [port 0-63]]
```
- Display drop counters.

```
show hardware stack-unit drops unit port
```
- Identify which interface is experiencing internal drops.

```
show hardware drops interface interface
```

```
Dell#show hardware stack-unit 0 drops
UNIT No: 0
Total Ingress Drops :0
Total IngMac Drops :0
Total Mmu Drops :0
Total EgMac Drops :0
Total Egress Drops :0
UNIT No: 1
Total Ingress Drops :0
Total IngMac Drops :0
Total Mmu Drops :0
Total EgMac Drops :0
Total Egress Drops :0

Dell#show hardware stack-unit 0 drops unit 0
Port# :Ingress Drops :IngMac Drops :Total Mmu Drops :EgMac Drops :Egress
Drops
1 0 0 0 0 0
2 0 0 0 0 0
3 0 0 0 0 0
4 0 0 0 0 0
5 0 0 0 0 0
6 0 0 0 0 0
7 0 0 0 0 0
8 0 0 0 0 0
```

Example of show hardware drops interface *interface*

```
Dell#show hardware drops interface tengigabitethernet 2/1

Drops in Interface Te 2/1:
--- Ingress Drops ---
Ingress Drops : 0
IBP CBP Full Drops : 0
PortSTPnotFwd Drops : 0
IPv4 L3 Discards : 0
Policy Discards : 0
Packets dropped by FP : 0
(L2+L3) Drops : 0
Port bitmap zero Drops : 0
Rx VLAN Drops : 0
--- Ingress MAC counters---
Ingress FCSDrops : 0
Ingress MTUExceeds : 0
--- MMU Drops ---
Ingress MMU Drops : 0
HOL DROPS (TOTAL) : 0
HOL DROPS on COS0 : 0
HOL DROPS on COS1 : 0
HOL DROPS on COS2 : 0
HOL DROPS on COS3 : 0
HOL DROPS on COS4 : 0
HOL DROPS on COS5 : 0
```

```

HOL DROPS on COS6           : 0
HOL DROPS on COS7           : 0
HOL DROPS on COS8           : 0
HOL DROPS on COS9           : 0
HOL DROPS on COS10          : 0
HOL DROPS on COS11          : 0
HOL DROPS on COS12          : 0
HOL DROPS on COS13          : 0
HOL DROPS on COS14          : 0
HOL DROPS on COS15          : 0
HOL DROPS on COS16          : 0
HOL DROPS on COS17          : 0
TxPurge CellErr             : 0
Aged Drops                   : 0
  --- Egress MAC counters---
Egress FCS Drops             : 0
  --- Egress FORWARD PROCESSOR Drops ---
IPv4 L3UC Aged & Drops       : 0
TTL Threshold Drops         : 0
INVALID VLAN CNTR Drops     : 0
L2MC Drops                   : 0
PKT Drops of ANY Conditions  : 0
Hg MacUnderflow              : 0
TX Err PKT Counter           : 0
  --- Error counters---
Internal Mac Transmit Errors : 0
Unknown Opcodes              : 0
Internal Mac Receive Errors  : 0

```

Dataplane Statistics

The `show hardware stack-unit cpu data-plane statistics` command provides insight into the packet types coming to the CPU.

The command output in the following example has been augmented, providing detailed RX/ TX packet statistics on a per-queue basis. The objective is to see whether CPU-bound traffic is internal (so-called *party bus* or IPC traffic) or network control traffic, which the CPU must process.

Example of Viewing Dataplane Statistics

```

Dell#show hardware stack-unit 2 cpu data-plane statistics

bc pci driver statistics for device:
rxHandle           :0
noMhdr             :0
noMbuf             :0
noClus             :0
recvd              :0
dropped            :0
recvToNet          :0
rxError            :0
rxDatapathErr     :0
rxPkt(COS0)        :0
rxPkt(COS1)        :0
rxPkt(COS2)        :0
rxPkt(COS3)        :0
rxPkt(COS4)        :0
rxPkt(COS5)        :0
rxPkt(COS6)        :0
rxPkt(COS7)        :0
rxPkt(UNIT0)       :0
rxPkt(UNIT1)       :0
rxPkt(UNIT2)       :0
rxPkt(UNIT3)       :0
transmitted        :0
txRequested        :0
noTxDesc           :0
txError            :0
txReqTooLarge      :0
txInternalError    :0

```

```

txDatapathErr      :0
txPkt(COS0)       :0
txPkt(COS1)       :0
txPkt(COS2)       :0
txPkt(COS3)       :0
txPkt(COS4)       :0
txPkt(COS5)       :0
txPkt(COS6)       :0
txPkt(COS7)       :0
txPkt(UNIT0)      :0

```

The `show hardware stack-unit cpu party-bus statistics` command displays input and output statistics on the party bus, which carries inter-process communication traffic between CPUs

Example of Viewing Party Bus Statistics

```

Dell#show hardware stack-unit 2 cpu party-bus statistics
Input Statistics:
 27550 packets, 2559298 bytes
 0 dropped, 0 errors
Output Statistics:
1649566 packets, 1935316203 bytes
 0 errors

```

Displaying Stack Port Statistics

The `show hardware stack-unit stack-port` command displays input and output statistics for a stack-port interface.

Example of Viewing Stack Unit Statistics

```

Dell#show hardware stack-unit 2 stack-port 49
Input Statistics:
 27629 packets, 3411731 bytes
 0 64-byte pkts, 27271 over 64-byte pkts, 207 over 127-byte pkts
 17 over 255-byte pkts, 56 over 511-byte pkts, 78 over 1023-byte pkts
 0 Multicasts, 5 Broadcasts
 0 runts, 0 giants, 0 throttles
 0 CRC, 0 overrun, 0 discarded
Output Statistics:
1649714 packets, 1948622676 bytes, 0 underruns
 0 64-byte pkts, 27234 over 64-byte pkts, 107970 over 127-byte pkts
 34 over 255-byte pkts, 504838 over 511-byte pkts, 1009638 over 1023-byte pkts
 0 Multicasts, 0 Broadcasts, 1649714 Unicasts
 0 throttles, 0 discarded, 0 collisions
Rate info (interval 45 seconds):
 Input 00.00 Mbits/sec, 2 packets/sec, 0.00% of line-rate
 Output 00.06 Mbits/sec, 8 packets/sec, 0.00% of line-rate
Dell#

```

Enabling Buffer Statistics Tracking

You can enable the tracking of statistical values of buffer spaces at a global level. The buffer statistics tracking utility operates in the max use count mode that enables the collection of maximum values of counters.

To configure the buffer statistics tracking utility, perform the following step:

1. Enable the buffer statistics tracking utility and enter the Buffer Statistics Snapshot configuration mode.

```

CONFIGURATION mode
Dell(conf)#buffer-stats-snapshot
Dell(conf)#no disable

```

You must enable this utility to be able to configure the parameters for buffer statistics tracking. By default, buffer statistics tracking is disabled.

2. Enable the buffer statistics tracking utility and enter the Buffer Statistics Snapshot configuration mode.

CONFIGURATION mode

```
Dell (conf) #buffer-stats-snapshot
```

```
Dell (conf) #no disable
```

You must enable this utility to be able to configure the parameters for buffer statistics tracking. By default, buffer statistics tracking is disabled.

3. To view the buffer statistics tracking resource information depending on the type of buffer information, such as device-level details, queue-based snapshots, or priority group-level snapshot in the egress and ingress direction of traffic, use `show hardware stack-unit <id> buffer-stats-snapshot unit <id> resource x`

EXEC/EXEC Privilege mode

```
Dell#show hardware stack-unit 1 buffer-stats-snapshot unit 3 resource interface all
queue mcast 3
Unit 1 unit: 3 port: 1 (interface Fo 1/144)
-----
Q# TYPE      Q#      TOTAL BUFFERED CELLS
-----
MCAST      3        0

Unit 1 unit: 3 port: 5 (interface Fo 1/148)
-----
Q# TYPE      Q#      TOTAL BUFFERED CELLS
-----
MCAST      3        0

Unit 1 unit: 3 port: 9 (interface Fo 1/152)
-----
Q# TYPE      Q#      TOTAL BUFFERED CELLS
-----
MCAST      3        0

Unit 1 unit: 3 port: 13 (interface Fo 1/156)
-----
Q# TYPE      Q#      TOTAL BUFFERED CELLS
-----
MCAST      3        0

Unit 1 unit: 3 port: 17 (interface Fo 1/160)
-----
Q# TYPE      Q#      TOTAL BUFFERED CELLS
-----
MCAST      3        0

Unit 1 unit: 3 port: 21 (interface Fo 1/164)
-----
Q# TYPE      Q#      TOTAL BUFFERED CELLS
-----
MCAST      3        0

Unit 1 unit: 3 port: 25 (interface Fo 1/168)
-----
Q# TYPE      Q#      TOTAL BUFFERED CELLS
-----
MCAST      3        0

Unit 1 unit: 3 port: 29 (interface Fo 1/172)
-----
Q# TYPE      Q#      TOTAL BUFFERED CELLS
-----
MCAST      3        0

Unit 1 unit: 3 port: 33 (interface Fo 1/176)
-----
Q# TYPE      Q#      TOTAL BUFFERED CELLS
-----
MCAST      3        0

Unit 1 unit: 3 port: 37 (interface Fo 1/180)
-----
```

Q#	TYPE	Q#	TOTAL BUFFERED CELLS
----	------	----	----------------------

- Use `show hardware buffer-stats-snapshot resource interface interface{priority-group { id | all } | queue { ucast{id | all}{ mcast {id | all} | all}}` to view buffer statistics tracking resource information for a specific interface.

EXEC/EXEC Privilege mode

```
Dell# show hardware buffer-stats-snapshot resource interface fortyGigE 0/0 queue all
Unit 0 unit: 0 port: 1 (interface Fo 0/0)
-----
Q# TYPE      Q#      TOTAL BUFFERED CELLS
-----
UCAST      0        0
UCAST      1        0
UCAST      2        0
UCAST      3        0
UCAST      4        0
UCAST      5        0
UCAST      6        0
UCAST      7        0
UCAST      8        0
UCAST      9        0
UCAST     10        0
UCAST     11        0
MCAST      0        0
MCAST      1        0
MCAST      2        0
MCAST      3        0
MCAST      4        0
MCAST      5        0
MCAST      6        0
MCAST      7        0
MCAST      8        0
```

Restoring the Factory Default Settings

Restoring factory defaults deletes the existing NVRAM settings, startup configuration and all configured settings such as stacking or fanout.

To restore the factory default settings, use the `restore factory-defaults stack-unit {0-5 | all} {clear-all | nvram}` command in EXEC Privilege mode.

 **CAUTION: There is no undo for this command.**

Important Points to Remember

- When you restore all the units in a stack, all units in the stack are placed into stand-alone mode.
- When you restore a single unit in a stack, only that unit is placed in stand-alone mode. No other units in the stack are affected.
- When you restore the units in stand-alone mode, the units remain in stand-alone mode after the restoration.
- After the restore is complete, the units power cycle immediately.

The following example shows the using the `restore factory-defaults` command to restore the Factory Default Settings.

Restoring the Factory Default Settings

```
Dell#restore factory-defaults stack-unit 0 nvram
*****
* Warning - Restoring factory defaults will delete the existing          *
* persistent settings (stacking, fanout, etc.)                          *
* After restoration the unit(s) will be powercycled immediately.        *
* Proceed with caution !                                                 *
***** Proceed with
```

```
factory
settings? Confirm [yes/no]:yes
-- Restore status -- Unit    Nvram    Config
-----
0      Success

Power-cycling the unit(s).
....
```

Standards Compliance

This chapter describes standards compliance for Dell Networking products.

i NOTE: Unless noted, when a standard cited here is listed as supported by the Dell Networking Operating System (OS), the system also supports predecessor standards. One way to search for predecessor standards is to use the <http://tools.ietf.org/> website. Click "Browse and search IETF documents," enter an RFC number, and inspect the top of the resulting document for obsolescence citations to related RFCs.

Topics:

- [IEEE Compliance](#)
- [RFC and I-D Compliance](#)
- [MIB Location](#)

IEEE Compliance

The following is a list of IEEE compliance.

802.1AB	LLDP
802.1D	Bridging
802.1p	L2 Prioritization
802.1Q	VLAN Tagging, Double VLAN Tagging, GVRP
802.3ac	Frame Extensions for VLAN Tagging
802.3ad	Link Aggregation with LACP
802.3ae	10 Gigabit Ethernet (10GBASE-W, 10GBASE-X)
802.3ak	10 Gigabit Ethernet (10GBASE-CX4)
802.3i	Ethernet (10BASE-T)
802.3u	Fast Ethernet (100BASE-FX, 100BASE-TX)
802.3x	Flow Control
802.1Qaz	Enhanced Transmission Selection
802.1Qbb	Priority-based Flow Control
ANSI/TIA-1057	LLDP-MED
MTU	12,000 bytes

RFC and I-D Compliance

The Dell Networking OS supports the following standards. The standards are grouped by related protocol. The columns showing support by platform indicate which version of Dell Networking OS first supports the standard.

General Internet Protocols

The following table lists the Dell Networking OS support per platform for general internet protocols.

Table 49. General Internet Protocols

RFC#	Full Name
768	User Datagram Protocol
793	Transmission Control Protocol
854	Telnet Protocol Specification
959	File Transfer Protocol (FTP)
1321	The MD5 Message-Digest Algorithm
1350	The TFTP Protocol (Revision 2)
1661	The Point-to-Point Protocol (PPP)
1989	PPP Link Quality Monitoring
1990	The PPP Multilink Protocol (MP)
1994	PPP Challenge Handshake Authentication Protocol (CHAP)
2474	Definition of the Differentiated Services Field (DS Field) in the IPv4 and IPv6 Headers
2698	A Two Rate Three Color Marker
3164	The BSD syslog Protocol

General IPv4 Protocols

The following table lists the Dell Networking OS support per platform for general IPv4 protocols.

Table 50. General IPv4 Protocols

RFC#	Full Name
791	Internet Protocol
792	Internet Control Message Protocol
826	An Ethernet Address Resolution Protocol
1027	Using ARP to Implement Transparent Subnet Gateways
1035	DOMAIN NAMES - IMPLEMENTATION AND SPECIFICATION (client)
1042	A Standard for the Transmission of IP Datagrams over IEEE 802 Networks
1191	Path MTU Discovery
1305	Network Time Protocol (Version 3) Specification, Implementation and Analysis
1519	Classless Inter-Domain Routing (CIDR): an Address Assignment and Aggregation Strategy
1542	Clarifications and Extensions for the Bootstrap Protocol
1812	Requirements for IP Version 4 Routers
2131	Dynamic Host Configuration Protocol
2338	Virtual Router Redundancy Protocol (VRRP)

Table 50. General IPv4 Protocols (continued)

RFC#	Full Name
3021	Using 31-Bit Prefixes on IPv4 Point-to-Point Links
3046	DHCP Relay Agent Information Option
3069	VLAN Aggregation for Efficient IP Address Allocation
3128	Protection Against a Variant of the Tiny Fragment Attack

Network Management

The following table lists the Dell Networking OS support per platform for network management protocol.

Table 51. Network Management

RFC#	Full Name
1155	Structure and Identification of Management Information for TCP/IP-based Internets
1156	Management Information Base for Network Management of TCP/IP-based internets
1157	A Simple Network Management Protocol (SNMP)
1212	Concise MIB Definitions
1215	A Convention for Defining Traps for use with the SNMP
1493	Definitions of Managed Objects for Bridges [except for the dot1dTpLearnedEntryDiscards object]
1901	Introduction to Community-based SNMPv2
2011	SNMPv2 Management Information Base for the Internet Protocol using SMIv2
2012	SNMPv2 Management Information Base for the Transmission Control Protocol using SMIv2
2013	SNMPv2 Management Information Base for the User Datagram Protocol using SMIv2
2024	Definitions of Managed Objects for Data Link Switching using SMIv2
2096	IP Forwarding Table MIB
2570	Introduction and Applicability Statements for Internet Standard Management Framework
2571	An Architecture for Describing Simple Network Management Protocol (SNMP) Management Frameworks
2572	Message Processing and Dispatching for the Simple Network Management Protocol (SNMP)
2574	User-based Security Model (USM) for version 3 of the Simple Network Management Protocol (SNMPv3)
2575	View-based Access Control Model (VACM) for the Simple Network Management Protocol (SNMP)
2576	Coexistence Between Version 1, Version 2, and Version 3 of the Internet-standard Network Management Framework
2578	Structure of Management Information Version 2 (SMIv2)
2579	Textual Conventions for SMIv2
2580	Conformance Statements for SMIv2
2618	RADIUS Authentication Client MIB, except the following four counters:

Table 51. Network Management (continued)

RFC#	Full Name
	radiusAuthClientInvalidServerAddresses
	radiusAuthClientMalformedAccessResponses
	radiusAuthClientUnknownTypes
	radiusAuthClientPacketsDropped
3635	Definitions of Managed Objects for the Ethernet-like Interface Types
2674	Definitions of Managed Objects for Bridges with Traffic Classes, Multicast Filtering and Virtual LAN Extensions
2787	Definitions of Managed Objects for the Virtual Router Redundancy Protocol
2819	Remote Network Monitoring Management Information Base: Ethernet Statistics Table, Ethernet History Control Table, Ethernet History Table, Alarm Table, Event Table, Log Table
2863	The Interfaces Group MIB
2865	Remote Authentication Dial In User Service (RADIUS)
3273	Remote Network Monitoring Management Information Base for High Capacity Networks (64 bits): Ethernet Statistics High-Capacity Table, Ethernet History High-Capacity Table
3416	Version 2 of the Protocol Operations for the Simple Network Management Protocol (SNMP)
3418	Management Information Base (MIB) for the Simple Network Management Protocol (SNMP)
3434	Remote Monitoring MIB Extensions for High Capacity Alarms, High-Capacity Alarm Table (64 bits)
ANSI/TIA-1057	The LLDP Management Information Base extension module for TIA-TR41.4 Media Endpoint Discovery information
draft-grant-tacacs -02	The TACACS+ Protocol
IEEE 802.1AB	Management Information Base module for LLDP configuration, statistics, local system data and remote systems data components.
IEEE 802.1AB	The LLDP Management Information Base extension module for IEEE 802.1 organizationally defined discovery information. (LLDP DOT1 MIB and LLDP DOT3 MIB)
IEEE 802.1AB	The LLDP Management Information Base extension module for IEEE 802.3 organizationally defined discovery information. (LLDP DOT1 MIB and LLDP DOT3 MIB)
sFlow.org	sFlow Version 5
sFlow.org	sFlow Version 5 MIB
FORCE10-IF-EXTENSION-MIB	Force10 Enterprise IF Extension MIB (extends the Interfaces portion of the MIB-2 (RFC 1213) by providing proprietary SNMP OIDs for other counters displayed in the "show interfaces" output)
FORCE10-LINKAGG-MIB	Force10 Enterprise Link Aggregation MIB
FORCE10-COPY-CONFIG-MIB	Force10 File Copy MIB (supporting SNMP SET operation)
FORCE10-MONMIB	Force10 Monitoring MIB
FORCE10-PRODUCTS-MIB	Force10 Product Object Identifier MIB
FORCE10-SS-CHASSIS-MIB	Force10 S-Series Enterprise Chassis MIB
FORCE10-SMI	Force10 Structure of Management Information

Table 51. Network Management (continued)

RFC#	Full Name
FORCE10-SYSTEM-COMPONENT-MIB	Force10 System Component MIB (enables the user to view CAM usage information)
FORCE10-TC-MIB	Force10 Textual Convention
FORCE10-TRAP-ALARM-MIB	Force10 Trap Alarm MIB
FORCE10-FIPS NOOPING-MIB	Force10 FIP Snooping MIB (Based on T11-FCoE-MIB mentioned in FC-BB-5)
FORCE10-DCB -MIB	Force10 DCB MIB
IEEE 802.1Qaz	Management Information Base extension module for IEEE 802.1 organizationally defined discovery information (LDP-EXT-DOT1-DCBX-MIB)
IEEE 802.1Qbb	Priority-based Flow Control module for managing IEEE 802.1Qbb

MIB Location

You can find Force10 MIBs under the Force10 MIBs subhead on the Documentation page of iSupport:

<https://www.force10networks.com/csportal20/KnowledgeBase/Documentation.aspx>

You also can obtain a list of selected MIBs and their OIDs at the following URL:

https://www.force10networks.com/csportal20/MIBs/MIB_OIDs.aspx

Some pages of iSupport require a login. To request an iSupport account, go to:

<https://www.force10networks.com/CSPortal20/Support/AccountRequest.aspx>

If you have forgotten or lost your account information, contact Dell TAC for assistance.