

Latitude 7212

Rugged Extreme Tablet

Quick Start Guide

Guide de démarrage rapide

Hızlı Başlangıç Kılavuzu

Guia de início rápido

دليل بدء التشغيل السريع



1 Insert uSIM card (optional)

Insérer une carte uSIM (en option)

uSIM kart takın (isteğe bağlı)

Inserir cartão uSIM (opcional)

إدخال بطاقة uSIM (اختياري)

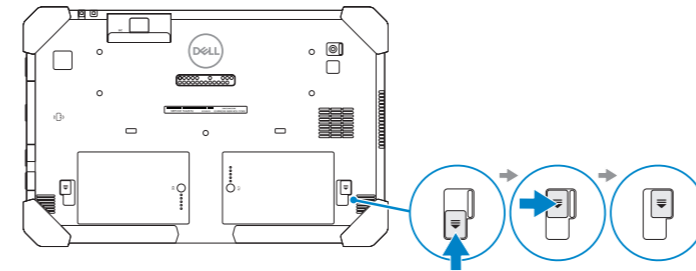
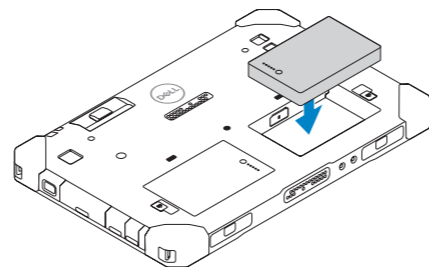
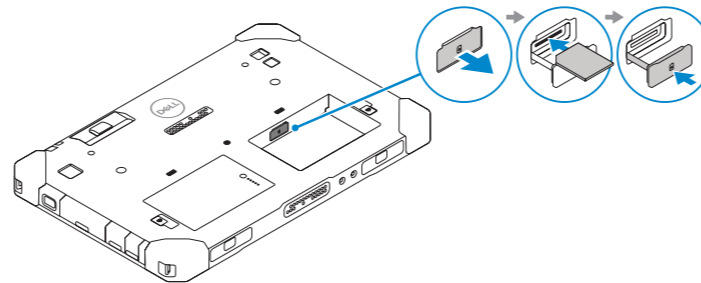
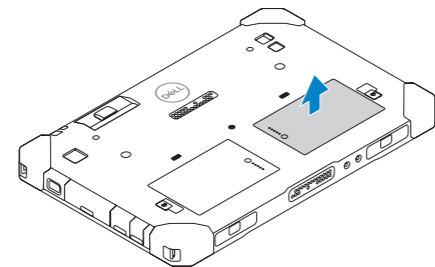
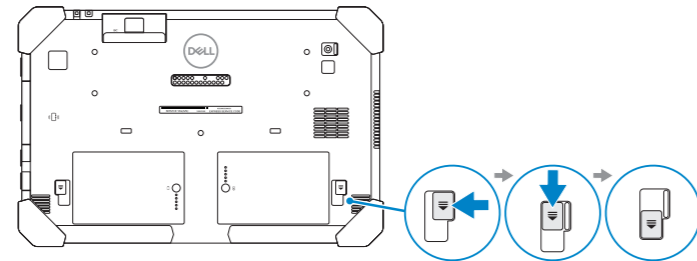

- NOTE:** Make sure the card is correctly aligned and is inserted all the way.
 - REMARQUE :** assurez-vous que la carte est correctement alignée et insérée jusqu'au bout.
 - NOT:** Kartı doğru yere takmaya ve yuvasına tamamen girmiş olmasına dikkat edin.
 - NOTA:** certifique-se de que o cartão está corretamente alinhado e totalmente inserido.
- ملاحظة: تأكد من محاذاة البطاقة بشكل صحيح، وإدخالها عن آخرها.

2 Connect the power adapter and press the power button

Branchez l'adaptateur secteur et appuyez sur le bouton d'alimentation

Güç adaptörünü takıp güç düğmesine basın

Ligar o transformador e premir o botão para ligar/desligar

قم بتوصيل مهبطي التيار والضغظ على زر التشغيل

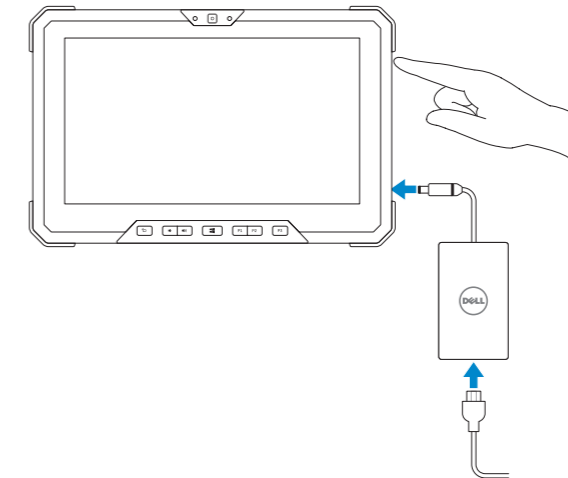

Product support and manuals

Assistance produits et manuels

Ürün desteği ve kılavuzlar

Suporte do produto e manuais

دعم المنتج والأدلة

Dell.com/support

Dell.com/support/manuals

Dell.com/support/windows

Contact Dell

Contacter Dell | Dell'e başvurun

Contactar a Dell | Dell الاتصال بـ

Dell.com/contactdell

Regulatory and safety

Règlementations et sécurité | Mevzuat ve güvenlik

Regulamentos e segurança | ممارسات الأمان والممارسات التنظيمية

Dell.com/regulatory_compliance

Regulatory model

Modèle réglementaire | Yasal model numarası

Modelo regulamentar | الموديل التنظيمي

T03H

Regulatory type

Type réglementaire | Yasal tür

Tipo regulamentar | النوع التنظيمي

T03H002

Computer model

Modèle de l'ordinateur | Bilgisayar modeli

Modelo do computador | طراز جهاز الكمبيوتر

Latitude 7212 Rugged Extreme Tablet

Connection and use of this communications equipment is permitted by the Nigerian Communications Commission



092GJGA00

© 2017 Dell Inc. or its subsidiaries.

© 2017 Microsoft Corporation.

ETC

2017-06

Features

Caractéristiques | Özellikler | Funcionalidades | الميزات

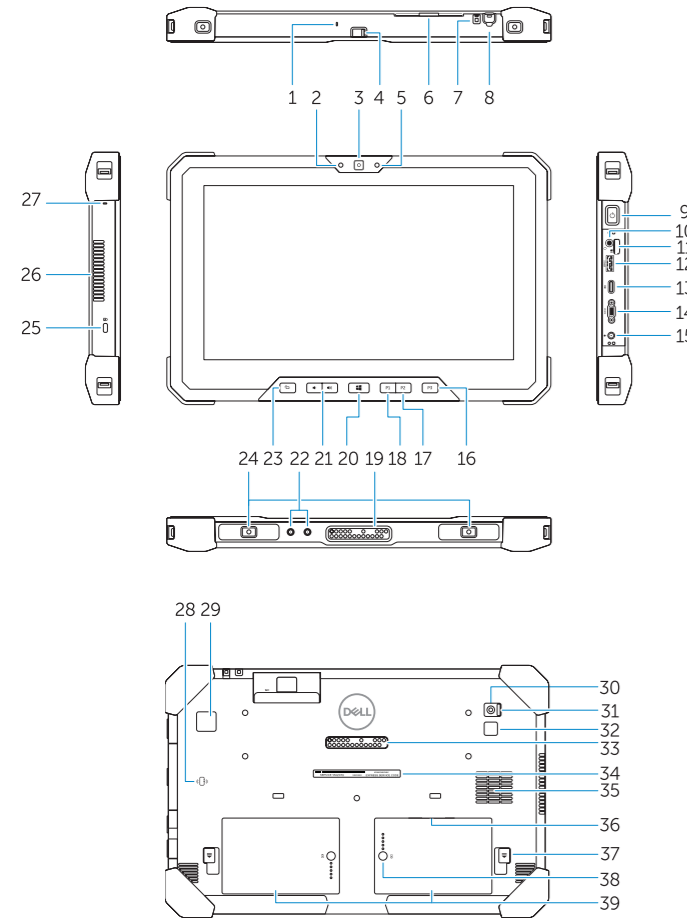

1. Microphone
2. Camera status light
3. Camera
4. Camera shutter switch
5. Ambient light sensor
6. Security card reader
7. Lanyard connector slot for stylus
8. Stylus
9. Power button
10. Headset port
11. microSD card reader
12. USB 3.1 Gen 1 port with PowerShare
13. DisplayPort with PowerShare over USB Type-C
14. Micro serial port
15. Power connector port
16. User programmable button 3*
17. User programmable button 2*
18. User programmable button 1*
19. Docking pogo pins
20. Windows button
21. Volume buttons
22. Radio antennae pass-through connector
23. Screen rotate lock button
24. Dock-guide slots
25. Security cable slot
26. QuadCool vent output
27. Microphone
28. Contactless smart card reader
29. Fingerprint reader
30. Rear camera
31. Camera shutter switch
32. Camera flash lens
33. Expansion module pogo pins
34. Service tag label
35. QuadCool intake vent
36. uSIM card slot (remove battery to access)
37. Battery release latch
38. Battery life meter
39. Battery

NOTE: *To setup and configure Rugged Control Center (RCC) with the tablet, see the documentation available at [Dell.com/support/manuals](https://dell.com/support/manuals)

1. Microphone
2. Voyant d'état de la caméra
3. Caméra
4. Obturateur de l'appareil photo
5. capteur de lumière ambiante
6. Lecteur de carte de sécurité
7. Emplacement du connecteur du cordon pour le stylus
8. Stylet
9. Bouton d'alimentation
10. Port casque
11. Lecteur de carte microSD
12. Port USB 3.1 Gen 1 avec PowerShare
13. DisplayPort avec PowerShare sur USB type-C
14. Port série micro
15. Port du connecteur d'alimentation
16. Touche programmable par l'utilisateur 3*
17. Touche programmable par l'utilisateur 2*
18. Touche programmable par l'utilisateur 1*
19. Broches de connexion Pogo
20. Bouton Windows
21. Boutons de volume
22. Connecteur d'antenne radio en sonde
23. Bouton de verrouillage de la rotation de l'écran
24. Fentes de guidage pour station d'accueil
25. Fente pour câble de sécurité
26. Dispositif de sortie d'air QuadCool
27. Microphone
28. Lecteur de cartes à puce sans contact
29. Lecteur d'empreintes digitales
30. Caméra arrière
31. Obturateur de l'appareil photo
32. Flash de l'appareil photo
33. Broches pogo du module d'extension
34. Étiquette du numéro de série
35. Entrée d'air QuadCool
36. Logement de la carte uSIM (retirer la batterie pour y accéder)
37. Loquet de déverrouillage de batterie
38. Indicateur de batterie
39. Batterie

REMARQUE : *Pour installer et configurer le Rugged Control Center (RCC) avec la tablette, reportez-vous à la documentation disponible sur [Dell.com/support/manuals](https://dell.com/support/manuals)

1. Mikrofon
2. Kamera durum ışığı
3. Kamera
4. Kamera deklanşör düğmesi
5. Ortam ışığı sensörü
6. Güvenlik kartı okuyucu
7. Stylus için halat konektör yuvası
8. Stylus
9. Güç düğmesi
10. Mikrofonlu kulaklık girişi
11. microSD kart okuyucu
12. PowerShare'e sahip USB 3.1 Gen 1 portu
13. USB Tip C üzerinden PowerShare ile DisplayPort
14. Mikro seri bağlantı noktası
15. Güç konektörü bağlantı noktası
16. Kullanıcı programlanabilir düğme 3*
17. Kullanıcı programlanabilir düğme 2*
18. Kullanıcı programlanabilir düğme 1*
19. Pogo yerleştirme pimleri
20. Windows düğmesi
21. Ses düğmeleri
22. Radyo anteni düz geçiş konektörü
23. Ekran döndürme kilidi düğmesi
24. Yerleştirme kılavuzu yuvaları
25. Güvenlik kablosu yuvası
26. QuadCool havalandırma çıkışı
27. Mikrofon
28. Temassız akıllı kart okuyucu
29. Parmak izi okuyucu
30. Arka kamera
31. Kamera deklanşör düğmesi
32. Kamera flaş merceği
33. Geniştirme modülü pogo pim
34. Servis etiketi çıkartması
35. QuadCool havalandırma girişi
36. uSIM kart yuvası (erişim için pili çıkarın)
37. Pili serbest bırakma mandalı
38. Pili ömrü ölçer
39. Pili

NOT: *Tablet ile Dayanıklı Kontrol Merkezi (RCC) kurulumunu yapmak ve ayarlamak için, [Dell.com/support/manuals](https://dell.com/support/manuals) adresindeki belgelere bakın

1. Microfone
2. Luz de estado da câmara
3. Câmara
4. Obturador da câmara
5. Sensor de luz ambiente
6. Leitor de cartão de segurança
7. Ranhura para ligação de caneta
8. Caneta
9. Botão para ligar/desligar
10. Porta de auscultadores
11. Leitor de cartões microSD
12. Porta USB 3.1 Gen 1 com PowerShare
13. DisplayPort com PowerShare via USB tipo C
14. Micro porta série
15. Porta do transformador
16. Botão 3* programável pelo utilizador
17. Botão 2* programável pelo utilizador
18. Botão 1* programável pelo utilizador
19. Pinos pogo para acoplamento
20. Botão do Windows
21. Botões de volume
22. Conector "pass-through" de antena de rádio
23. Botão de bloqueio da rotação do ecrã
24. Slots de guia do dock
25. Ranhura do cabo de segurança
26. Saída de ar QuadCool
27. Microfone
28. Leitor de Smart Card sem contactos
29. Leitor de impressões digitais
30. Câmara posterior
31. Obturador da câmara
32. Lente flash da câmara
33. Pinos tipo "pogo" do módulo de expansão
34. Rótulo da etiqueta de serviço
35. Entrada de ar QuadCool
36. Ranhura para cartão uSIM (remover bateria para aceder)
37. Trava de liberação da bateria
38. Medidor de carga da bateria
39. Bateria

NOTA: *para instalar e configurar o Rugged Control Center (RCC) no tablet, consultar a documentação disponível em [Dell.com/support/manuals](https://dell.com/support/manuals)

1. الميكروفون
2. قارئ البطاقات الذكية دون التلامس
3. قارئ بصمات الأصابع
4. الكاميرا الخلفية
5. مفتاح مصراع الكاميرا
6. عدسة فلاش الكاميرا
7. مسامير بوجو لوحدة التوسيع
8. ملصق علامة الخدمة
9. فتحة سحب تهوية QuadCool
10. فتحة بطاقة uSIM (إزالة البطارية للوصول)
11. قفل تحرير البطارية
12. جهاز قياس عمر البطارية
13. الميكروفون
14. منفذ موصل التيار
15. زر المستخدم 3 القابل للبرمجة*
16. زر المستخدم 2 القابل للبرمجة*
17. زر المستخدم 1 القابل للبرمجة*
18. مسامير بوجو للإرساء
19. أزرار الصوت
20. زر Windows
21. أزرار الصوت
22. موصل تمرير الهوائي اللاسلكي
23. زر قفل تدوير الشاشة
24. فتحات دليل الإرساء
25. فتحة كابل الأمان
26. مخرج فتحة التهوية QuadCool
27. الميكروفون
28. Temassız akıllı kart okuyucu
29. Parmak izi okuyucu
30. Arka kamera
31. Kamera deklanşör düğmesi
32. Kamera flaş merceği
33. Geniştirme modülü pogo pim
34. Servis etiketi çıkartması
35. QuadCool havalandırma girişi
36. uSIM kart yuvası (erişim için pili çıkarın)
37. Pili serbest bırakma mandalı
38. Pili ömrü ölçer
39. Pili

ملاحظة: *الإعداد برنامج Rugged Control Center (المعروف بالاختصار RCC) وتكوينه باستخدام الكمبيوتر اللوحي، راجع الوثائق المتوفرة على موقع dell.com/support/manuals

Removing Battery

Retrait de la batterie | Pili Çıkarma

Remoção da bateria | إزالة البطارية

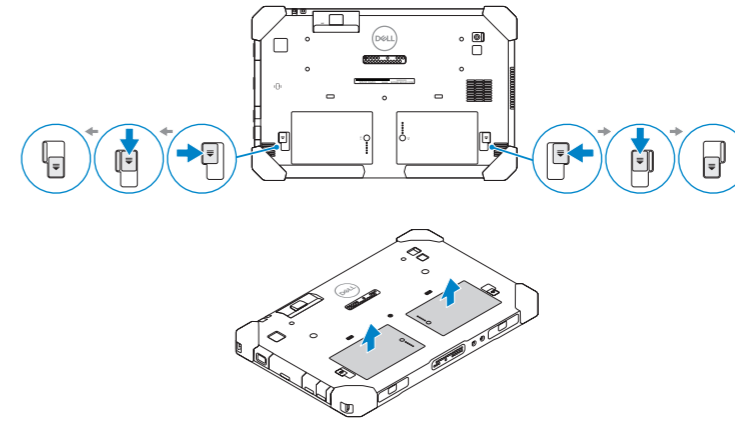

NOTE: The Rugged Control Center software for your Rugged Tablet is available at [Dell.com/support](https://dell.com/support).

REMARQUE : le logiciel Rugged Control Center de votre tablette Rugged est disponible sur le site [Dell.com/support](https://dell.com/support).

NOT: Dayanıklı Tabletiniz için Dayanıklı Kontrol merkezi yazılımını [Dell.com/support](https://dell.com/support) adresinde bulabilirsiniz.

NOTA: o software Rugged Control Center para o tablet Rugged está disponível em [Dell.com/support](https://dell.com/support).

ملاحظة: يتوفر برنامج Rugged Control Center للكمبيوتر اللوحي طراز Rugged على موقع [Dell.com/support](https://dell.com/support).

Tablet Computer Intended Use Orientation:

The tablet computer screen-side held against the user's body is not a Dell-specified usable orientation of a tablet. Please keep the tablet computer's "screen-side" at 15 mm (0.59 inches) or greater distance from the user's body under all circumstances when a transmitter is active. The other 5 sides of the product are a Dell specified usable orientation of a tablet and can be used in close contact to the user's body.

Orientação prevista do tablet:

O ecrã do tablet, encostado ao corpo do utilizador, não é uma orientação especificada pela Dell a usar num tablet. Quando o transmissor estiver ativo, manter sempre o ecrã do tablet a uma distância mínima de 15 mm (0,59 polegadas) do corpo do utilizador. Os restantes 5 lados do tablet são uma orientação especificada pela Dell e podem ser utilizados encostados ao corpo do utilizador.

NOTE: Your Dell Rugged Tablet is designed to prevent damage due to dust or dirt entering the QuadCool intake vent. It is however recommended to keep QuadCool vents clean and unobstructed for optimal performance.

REMARQUE : votre tablette Dell Rugged est conçue pour prévenir les dommages causés par la poussière ou la saleté pénétrant dans l'entrée d'air QuadCool. Pour des performances optimales, il est cependant recommandé de garder les grilles de ventilation QuadCool propres et accessibles.

NOT: Dell Dayanıklı Tabletiniz, toz veya kirlerin QuadCool havalandırma girişine kaçmasını engelleyerek cihaz hasarını önlemek için tasarlanmıştır. Ancak en iyi performans için QuadCool havalandırma girişlerinin temiz tutulması ve havalandırma girişlerinin önüne herhangi bir engel koyulmaması önerilir.

NOTA: o tablet Dell Rugged está concebido para prevenir danos decorrentes da infiltração de poeiras ou sujidade na entrada de ar QuadCool. Assim, recomenda-se a limpeza e desobstrução da entrada/saída de ar QuadCool para obter um ótimo desempenho.

ملاحظة: الكمبيوتر اللوحي طراز Rugged من Dell مصمم لمنع التلف الناتج عن الغبار أو الاتساخ المتسرب إلى فتحة سحب هواء QuadCool. إلا أنه يوصى بالحفاظ على نظافة فتحات QuadCool وعدم انسدادها للحصول على أفضل أداء.