

Dell™ Inspiron™ XPS

Owner's Manual

Model PP09L



www.dell.com | support.dell.com

Notes, Notices, and Cautions



NOTE: A NOTE indicates important information that helps you make better use of your computer.



NOTICE: A NOTICE indicates either potential damage to hardware or loss of data and tells you how to avoid the problem.



CAUTION: A CAUTION indicates a potential for property damage, personal injury, or death.

Abbreviations and Acronyms

For a complete list of abbreviations and acronyms, see the *Dell™ Inspiron™ Help* file. To access the help file, see page 18.

If you purchased a Dell™ n Series computer, any references in this document to Microsoft® Windows® operating systems are not applicable.

Information in this document is subject to change without notice.

© 2004 Dell Inc. All rights reserved.

Reproduction in any manner whatsoever without the written permission of Dell Inc. is strictly forbidden.

Trademarks used in this text: *Dell*, the *DELL* logo, *TrueMobile*, *Dell TravelLite*, *Inspiron*, *Dell Precision*, *Dimension*, *OptiPlex*, *Latitude*, *PowerEdge*, *PowerVault*, *PowerConnect*, *PowerApp*, *DellNet*, *Axim*, and *Dell OpenManage* are trademarks of Dell Inc.; *Intel*, *Pentium*, and *Celeron* are registered trademarks of Intel Corporation; *Microsoft* and *Windows* are registered trademarks of Microsoft Corporation; *Bluetooth* is a trademark owned by Bluetooth SIG and is used by Dell Inc. under license; *EMC* is a registered trademark of EMC Corporation.

Other trademarks and trade names may be used in this document to refer to either the entities claiming the marks and names or their products. Dell Inc. disclaims any proprietary interest in trademarks and trade names other than its own.

Model PP09L

May 2004

P/N M3551

Rev. A02

Contents

CAUTION: Safety Instructions	11
SAFETY: General	11
SAFETY: Power	12
SAFETY: Battery.	12
SAFETY: Air Travel.	12
SAFETY: EMC Instructions	13
When Using Your Computer	13
SAFETY: Ergonomic Computing Habits	14
SAFETY: When Working Inside Your Computer	14
SAFETY: Protecting Against Electrostatic Discharge	14
SAFETY: Battery Disposal	15
Finding Information	17
1 A Tour of Your Computer	
Front View	21
Left Side View	25
Right Side View	26
Back View	27
Bottom View	31
2 Using Your Computer	
Transferring Information to a New Computer	33
Configuring Graphics Cards	34
Settings and Functions	34
Connecting Your Computer to a TV or Audio Device	35
S-Video and Standard Audio.	36
S-Video and S/PDIF Digital Audio	37
Composite Video and Standard Audio	39
Composite Video and S/PDIF Digital Audio	40

Enabling S/PDIF Digital Audio	42
Setting Up the Dolby Headphone	42
Enabling the Display Settings for a TV	43
Connecting Monitors	43
Using CDs and DVDs	45
Copying CDs and DVDs	45
How to Copy a CD or DVD	45
Using Blank CD-Rs, CD-RWs, DVD+Rs, and DVD+RWs	46
Helpful Tips	46
3 Optimizing Performance	
DDR Memory and Processor Front-Side Bus	47
Hyper-Threading	47
4 Using a Battery	
Battery Performance	49
Checking the Battery Charge	50
Dell™ QuickSet Battery Meter	50
Microsoft® Windows® Power Meter	50
Charge Gauge	50
Low-Battery Warning	51
Charging the Battery	51
Removing a Battery	52
Installing a Battery	53
Storing a Battery	53
5 Using the Module Bay	
About the Module Bay	55
Removing and Installing Devices While the Computer Is Turned Off	55
Removing and Installing Devices While the Computer Is Running	56

6 Using the Keyboard and Touch Pad

Numeric Keypad	59
Key Combinations	59
System Functions	59
Battery	59
CD or DVD Tray	59
Display Functions	60
Radios (Including Wireless Networking and PC Cards With Bluetooth® Wireless Technology)	60
Power Management	60
Speaker Functions	60
Microsoft® Windows® Logo Key Functions	61
Touch Pad	62
Customizing the Touch Pad and Track Stick	63
Changing the Track Stick Cap	63

7 Setting Up a Home and Office Network

Connecting to a Network Adapter	65
Network Setup Wizard	66
Connecting to a Wireless Local Area Network	66
Determining Your Network Type	66
Connecting to a Wireless Network in Microsoft® Windows® XP	67
Configuring Security Settings (Optional)	70

8 Solving Problems

Using the Dell Diagnostics	75
When to Use the Dell Diagnostics	75
Error Messages	77
Video and Display Problems	79
If the display is blank	79
If the display is difficult to read	80
If only part of the display is readable	80

Scanner Problems	81
Hard Drive Problems	81
If you have problems with a hard drive	81
PC Card Problems	82
External Keyboard Problems	82
Power Problems	83
Unexpected Characters	84
Touch Pad or Mouse Problems	84
Printer Problems	85
E-Mail Problems	86
Modem and Internet Connection Problems	86
Network Problems	87
General Program Problems	88
A program crashes	88
A program stops responding	88
A solid blue screen appears	88
Error messages appear	88
CD or DVD Problems	89
If you cannot play a CD, CD-RW, or DVD	89
If you cannot eject the CD, CD-RW, or DVD drive tray	89
If you hear an unfamiliar scraping or grinding sound	90
Sound and Speaker Problems	90
If you have a problem with integrated speakers	90
If you have a problem with external speakers	91
E-Mail, Modem, and Internet Problems	92
Resolving Other Technical Problems	93
Drivers	93
What Is a Driver?	93
Identifying Drivers	94
Reinstalling Drivers and Utilities	94
Resolving Software and Hardware Incompatibilities	96

Using Microsoft® Windows® XP System Restore	97
Creating a Restore Point	97
Restoring the Computer to an Earlier Operating State	97
Undoing the Last System Restore	98
Reinstalling Microsoft® Windows® XP	98
Before You Begin	98
Reinstalling Windows XP	99

9 Adding and Replacing Parts

Before You Begin	103
Recommended Tools	103
Shutting Down Your Computer	103
Memory	105
Mini PCI Card	108
Hard Drive	111
Returning a Hard Drive to Dell	112
Subwoofer	113
Keyboard	114
PC Card With Bluetooth® Wireless Technology	116
Modem	117
Removing the Modem	117
Installing the Modem	118
Keyboard Bracket	118
Fans	119
Hinge Covers	121
Display	124
Display Latch	127
Video Card	128
Processor Thermal-Cooling Assembly	129
Removing the Processor Thermal-Cooling Assembly	129
Installing the Processor Thermal-Cooling Assembly	130

Palm Rest	130
Processor Module	132
Removing the Processor Module	132
Installing the Processor Module	133
Flashing the BIOS	134
Reserve Battery	134
System Board	135
Removing the System Board	135
Installing the System Board	137
Speakers	138
Display Latch Release	139
Pin Assignments for I/O Connectors	140
USB Connector	140
Video Connector	140
S-Video TV-Out Connector	141
IEEE 1394 Connector	141
DVI-I Connector	142

10 Appendix

Specifications	143
Using the System Setup Program	149
Overview	149
Viewing the System Setup Screens	150
System Setup Screens	150
Commonly Used Options	150
Enabling the Infrared Sensor	151
Dell Technical Support Policy (U.S. Only)	152
Definition of "Dell-Installed" Software and Peripherals	152
Definition of "Third-Party" Software and Peripherals	152
Contacting Dell	152
Regulatory Notices	170
NOM Information (Mexico Only)	171

Limited Warranties	171
Limited Warranty for Dell-Branded Hardware Products (U.S. Only)	171
Limited Warranty Terms for Dell-Branded Hardware Products (Canada Only).	174
Dell Software and Peripherals (Canada Only)	177
1-Year End-User Manufacturer Guarantee (Latin America and the Caribbean Only)	178
Intel® Warranty Statement for Pentium® and Celeron® Processors Only (U.S. and Canada Only)	180
 Index	 183

CAUTION: Safety Instructions

Use the following safety guidelines to help ensure your own personal safety and to help protect your computer and working environment from potential damage.

SAFETY: General

- Do not attempt to service the computer yourself unless you are a trained service technician. Always follow installation instructions closely.
- If you use an extension power cable with your AC adapter, ensure that the total ampere rating of the products plugged in to the extension power cable does not exceed the ampere rating of the extension cable.
- Do not push objects into air vents or openings of your computer. Doing so can cause fire or electric shock by shorting out interior components.
- Do not store your computer in a low-airflow environment, such as a carrying case or a closed briefcase, while the computer is turned on. Restricting airflow can damage the computer or cause a fire.
- Keep your computer away from radiators and heat sources. Also, do not block cooling vents. Avoid placing loose papers underneath your computer; do not place your computer in a closed-in wall unit or on a bed, sofa, or rug.
- Place the AC adapter in a ventilated area, such as a desk top or on the floor, when you use it to run the computer or to charge the battery. Do not cover the AC adapter with papers or other items that will reduce cooling; also, do not use the AC adapter inside a carrying case.
- The AC adapter may become hot during normal operation of your computer. Use care when handling the adapter during or immediately after operation.
- Do not allow your portable computer to operate with the base resting directly on exposed skin for extended periods of time. The surface temperature of the base will rise during normal operation (particularly when AC power is present). Allowing sustained contact with exposed skin can cause discomfort or, eventually, a burn.
- Do not use your computer in a wet environment, for example, near a bath tub, sink, or swimming pool or in a wet basement.
- If your computer includes an integrated or optional (PC Card) modem, disconnect the modem cable if an electrical storm is approaching to avoid the remote risk of electric shock from lightning via the telephone line.
- To help avoid the potential hazard of electric shock, do not connect or disconnect any cables or perform maintenance or reconfiguration of this product during an electrical storm. Do not use your computer during an electrical storm unless all cables have been disconnected and the computer is operating on battery power.
- If your computer includes a modem, the cable used with the modem should be manufactured with a minimum wire size of 26 American wire gauge (AWG) and an FCC-compliant RJ-11 modular plug.
- Before you open the memory module cover, fan covers, or Mini PCI card cover on the bottom of your computer, disconnect all cables from their electrical outlets and disconnect the telephone cable.
- If your computer has both a *modem* RJ-11 connector and a *network* RJ-45 connector, which look alike, make sure you insert the telephone cable into the RJ-11 connector, not the RJ-45 connector.
- PC Cards may become very warm during normal operation. Use care when removing PC Cards after their continuous operation.
- Before you clean your computer, disconnect the computer from the electrical outlet. Clean your computer with a soft cloth dampened with water. Do not use liquid or aerosol cleaners, which may contain flammable substances.

SAFETY: Power

- Use only the Dell-provided AC adapter approved for use with this computer. Use of another AC adapter may cause a fire or explosion.
- Before you connect the computer to an electrical outlet, check the AC adapter voltage rating to ensure that the required voltage and frequency match the available power source.
- To remove the computer from all power sources, turn the computer off, disconnect the AC adapter from the electrical outlet, and remove any battery installed in the battery bay.
- To help prevent electric shock, plug the AC adapter and device power cables into properly grounded power sources. These power cables may be equipped with 3-prong plugs to provide an earth grounding connection. Do not use adapter plugs or remove the grounding prong from the power cable plug. If you use a power extension cable, use the appropriate type, 2-prong or 3-prong, to mate with the AC adapter power cable.
- Be sure that nothing rests on your AC adapter's power cable and that the cable is not located where it can be tripped over or stepped on.
- If you are using a multiple-outlet power strip, use caution when plugging the AC adapter's power cable into the power strip. Some power strips may allow you to insert the plug incorrectly. Incorrect insertion of the power plug could result in permanent damage to your computer, as well as risk of electric shock and/or fire. Ensure that the ground prong of the power plug is inserted into the mating ground contact of the power strip.

SAFETY: Battery

- Use only Dell™ battery modules that are approved for use with this computer. Use of other types may increase the risk of fire or explosion.
- Do not carry a battery pack in your pocket, purse, or other container where metal objects (such as car keys or paper clips) could short-circuit the battery terminals. The resulting excessive current flow can cause extremely high temperatures and may result in damage to the battery pack or cause fire or burns.
- The battery poses a burn hazard if you handle it improperly. Do not disassemble it. Handle a damaged or leaking battery pack with extreme care. If the battery is damaged, electrolyte may leak from the cells and may cause personal injury.
- Keep the battery away from children.
- Do not store or leave your computer or battery pack near a heat source such as a radiator, fireplace, stove, electric heater, or other heat-generating appliance or otherwise expose it to temperatures in excess of 60°C (140°F). When heated to excessive temperatures, battery cells could explode or vent, posing a risk of fire.
- Do not dispose of your computer's battery in a fire or with normal household waste. Battery cells may explode. Discard a used battery according to the manufacturer's instructions or contact your local waste disposal agency for disposal instructions. Dispose of a spent or damaged battery promptly.

SAFETY: Air Travel

- Certain Federal Aviation Administration regulations and/or airline-specific restrictions may apply to the operation of your Dell computer while you are on board an aircraft. For example, such regulations/restrictions may prohibit the use of any personal electronic device (PED) that has the capacity for intentional transmission of radio frequency or other electromagnetic signals while on an aircraft.
 - In order to best comply with all such restrictions, if your Dell portable computer is equipped with Dell TrueMobile™ or some other wireless communication device, please disable this device before you board the aircraft and follow all instructions provided by airline personnel with regard to such device.

- Additionally, the use of any PED, such as a portable computer, may be prohibited in aircraft during certain critical phases of flight, for example, takeoff and landing. Some airlines may further define the critical flight phase as any time the aircraft is below 3050 m (10,000 ft). Please follow the airline's specific instructions as to when the use of a PED is allowed.

SAFETY: EMC Instructions

Use shielded signal cables to ensure that you maintain the appropriate electromagnetic compatibility (EMC) classification for the intended environment. For parallel printers, a cable is available from Dell. If you prefer, you can order a cable from Dell at its worldwide website at www.dell.com.

Static electricity can harm electronic components inside your computer. To prevent static damage, discharge static electricity from your body before you touch any of your computer's electronic components, such as a memory module. You can do so by touching a connector on the back panel.

WARNING: Handling the cord on this product, or cords associated with accessories sold with this product, will expose you to lead, a chemical known to the State of California to cause birth defects or other reproductive harm. **Wash your hands after handling the cord.**

When Using Your Computer

Observe the following safe-handling guidelines to prevent damage to your computer:

- When setting up the computer for work, place it on a level surface.
- When traveling, do not check the computer as baggage. You can put your computer through an X-ray security machine, but never put your computer through a metal detector. If you have the computer checked by hand, be sure to have a charged battery available in case you are asked to turn on the computer.
- When traveling with the hard drive removed from the computer, wrap the drive in a nonconducting material, such as cloth or paper. If you have the drive checked by hand, be ready to install the drive in the computer. You can put the hard drive through an X-ray security machine, but never put the drive through a metal detector.
- When traveling, do not place the computer in overhead storage compartments where it could slide around. Do not drop your computer or subject it to other mechanical shocks.
- Protect your computer, battery, and hard drive from environmental hazards such as dirt, dust, food, liquids, temperature extremes, and overexposure to sunlight.
- When you move your computer between environments with very different temperature and/or humidity ranges, condensation may form on or within the computer. To avoid damaging the computer, allow sufficient time for the moisture to evaporate before using the computer.



NOTICE: When taking the computer from low-temperature conditions into a warmer environment or from high-temperature conditions into a cooler environment, allow the computer to acclimate to room temperature before turning on power.

- When you disconnect a cable, pull on its connector or on its strain-relief loop, not on the cable itself. As you pull out the connector, keep it evenly aligned to avoid bending any connector pins. Also, before you connect a cable make sure both connectors are correctly oriented and aligned.
- Handle components with care. Hold a component such as a memory module by its edges, not its pins.
- When preparing to remove a memory module from the system board or disconnect a device from the computer, turn off the computer, disconnect the AC adapter cable, remove any battery installed in the battery bay, and then wait 5 seconds before proceeding to help avoid possible damage to the system board.

- Clean the display with a soft, clean cloth and water. Apply the water to the cloth; then stroke the cloth across the display in one direction, moving from the top of the display to the bottom. Remove moisture from the display quickly and keep the display dry. Long-term exposure to moisture can damage the display. *Do not* use a commercial window cleaner to clean your display.
- If your computer gets wet or is damaged, follow the procedures described in your *Product Information Guide*. If, after following these procedures, you confirm that your computer is not operating properly, contact Dell (see page 152 for the appropriate contact information).

SAFETY: Ergonomic Computing Habits



CAUTION: Improper or prolonged keyboard use may result in injury.



CAUTION: Viewing the display or external monitor screen for extended periods of time may result in eye strain.

For comfort and efficiency, observe the ergonomic guidelines in the *Dell™ Inspiron™ Help* file when setting up and using your computer. To access the help file, see page 18.

This portable computer is not designed for continuous operation as office equipment. For extended use in an office, it is recommended that you connect an external keyboard.

SAFETY: When Working Inside Your Computer

Before removing or installing a memory module, Mini PCI card, fan, keyboard, display, reserve battery, or PC Card with Bluetooth® wireless technology, perform the following steps in the sequence indicated.



NOTICE: The only time you should ever access the inside of your computer is when you are installing a memory module, Mini PCI card, fan, keyboard, display, reserve battery, or PC Card with Bluetooth wireless technology.



NOTICE: Wait 5 seconds after turning off the computer before disconnecting a device or removing a memory module, Mini PCI card, fan, keyboard, display, reserve battery, or PC Card with Bluetooth wireless technology to help prevent possible damage to the system board.

- 1 Shut down your computer and turn off any attached devices.
- 2 Disconnect your computer and devices from electrical outlets to reduce the potential for personal injury or shock. Also, disconnect any telephone or telecommunication lines from the computer.
- 3 Remove the main battery from the battery bay.
- 4 Ground yourself by touching any connector on the back panel.
- 5 While you work, periodically touch a connector on the back panel to dissipate any static electricity that might harm internal components.

SAFETY: Protecting Against Electrostatic Discharge

Static electricity can harm electronic components inside your computer. To prevent static damage, discharge static electricity from your body before you touch any of your computer's electronic components, such as a memory module. You can do so by touching any connector on the back panel of the computer.

As you continue to work inside the computer, periodically touch any connector on the back panel of the computer to remove any static charge your body may have accumulated.

You can also take the following steps to prevent damage from electrostatic discharge (ESD):

- When unpacking a static-sensitive component from its shipping carton, do not remove the component from the antistatic packing material until you are ready to install the component. Just before unwrapping the antistatic packaging, be sure to discharge static electricity from your body.

- When transporting a sensitive component, first place it in an antistatic container or packaging.
- Handle all sensitive components in a static-safe area. If possible, use antistatic floor pads and workbench pads.

SAFETY: Battery Disposal



Your computer uses a lithium-ion battery and a coin-cell reserve battery. For instructions about replacing the lithium-ion battery in your computer, see "Removing a Battery" on page 52 and "Installing a Battery" on page 53. The reserve battery is a long-life battery, and it is very possible that you will never need to replace it. However, should you need to replace it, see "Reserve Battery" on page 134 for instructions.

Do not dispose of the battery along with household waste. Contact your local waste disposal agency for the address of the nearest battery deposit site.

Finding Information

What Are You Looking For?

- How to access tutorials and other how-to information
- How to get a copy of my invoice
- How to extend my warranty
- How to access Dell Support on my Microsoft® Windows® desktop (U.S. only)
- Additional documentation, tools, troubleshooting information, and links to online support resources

Find It Here

Dell Solution Center



On your Windows desktop

-
- A diagnostic program for my computer
 - Drivers for my computer
 - My computer documentation
 - My device documentation

Drivers and Utilities CD (also known as the ResourceCD)

Documentation and drivers are already installed on your computer. You can use the CD to reinstall drivers (see page 94 for instructions), run the Dell Diagnostics (see page 75 for instructions), or access your documentation.

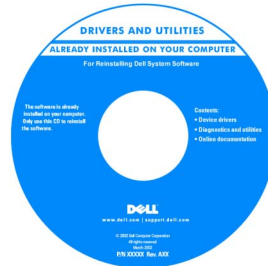

Readme files may be included on your CD to provide last-minute updates about technical changes to your computer or advanced technical-reference material for technicians or experienced users.

-
- How to set up a printer
 - Additional information about setting up my computer
 - How to troubleshoot and solve problems
 - How to remove and install parts
 - Technical specifications
 - How to contact Dell

Owner's Manual

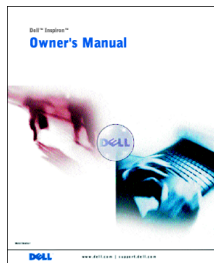

NOTE: This document is available as a PDF at support.dell.com.

What Are You Looking For?

- How to set up my computer

Find It Here

Setup Diagram

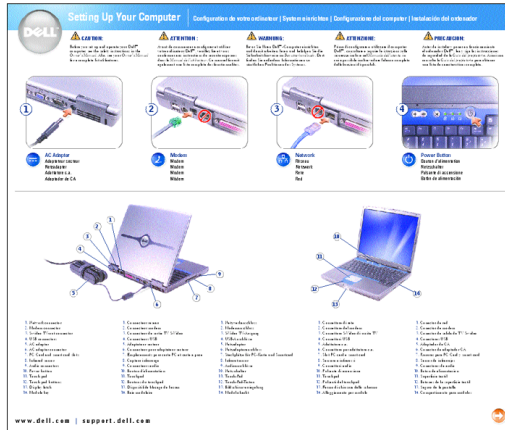

- Tips on using Microsoft® Windows®
 - How to play CDs and DVDs
 - How to use standby mode and hibernate mode
 - How to change my display resolution
 - How to clean my computer
-
- Service Tag and Express Service Code
 - Microsoft Windows License Label

Dell Inspiron Help File

- 1 Click the **Start** button and click **Help and Support**.
- 2 Click **User and system guides** and click **User's guides**.
- 3 Click **Dell Inspiron Help**.

Service Tag and Microsoft Windows License

These labels are located on the bottom of your computer.

- Use the Service Tag to identify your computer when you use support.dell.com or contact technical support.
- Enter the Express Service Code to direct your call when you contact technical support. The Express Service Code may not be available in certain countries.
- Use the number on the Microsoft Windows License Label if you reinstall your operating system.



What Are You Looking For?

- Latest drivers for my computer
- Answers to technical service and support questions
- Online discussions with other users and technical support
- Documentation for my computer

Find It Here

Dell Support Website — support.dell.com

The Dell Support website provides several online tools, including:

- Solutions — Troubleshooting hints and tips, articles from technicians, and online courses
- Community — Online discussion with other Dell customers
- Upgrades — Upgrade information for components, such as memory, the hard drive, and the operating system
- Customer Care — Contact information, order status, warranty, and repair information
- Downloads — Drivers, patches, and software updates
- Reference — Computer documentation, product specifications, and white papers

-
- How to use Windows XP
 - Documentation for my computer
 - Documentation for devices (such as a modem)

Windows Help and Support Center

- 1 Click the **Start** button and click **Help and Support**.
- 2 Type a word or phrase that describes your problem and click the arrow icon.
- 3 Click the topic that describes your problem.
- 4 Follow the instructions on the screen.

-
- How to reinstall my operating system

Operating System CD

The operating system is already installed on your computer. To reinstall your operating system, use the *Operating System* CD. For instructions, see "Reinstalling Microsoft Windows XP" on page 98.

After you reinstall your operating system, use the *Drivers and Utilities* CD to reinstall drivers for the devices that came with your computer. For instructions, see "Reinstalling Drivers and Utilities" on page 94.

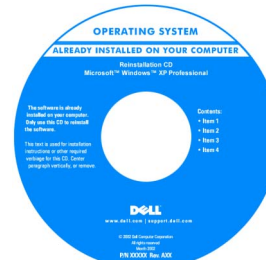

Your operating system product key label is located on your computer.

A Tour of Your Computer

Front View

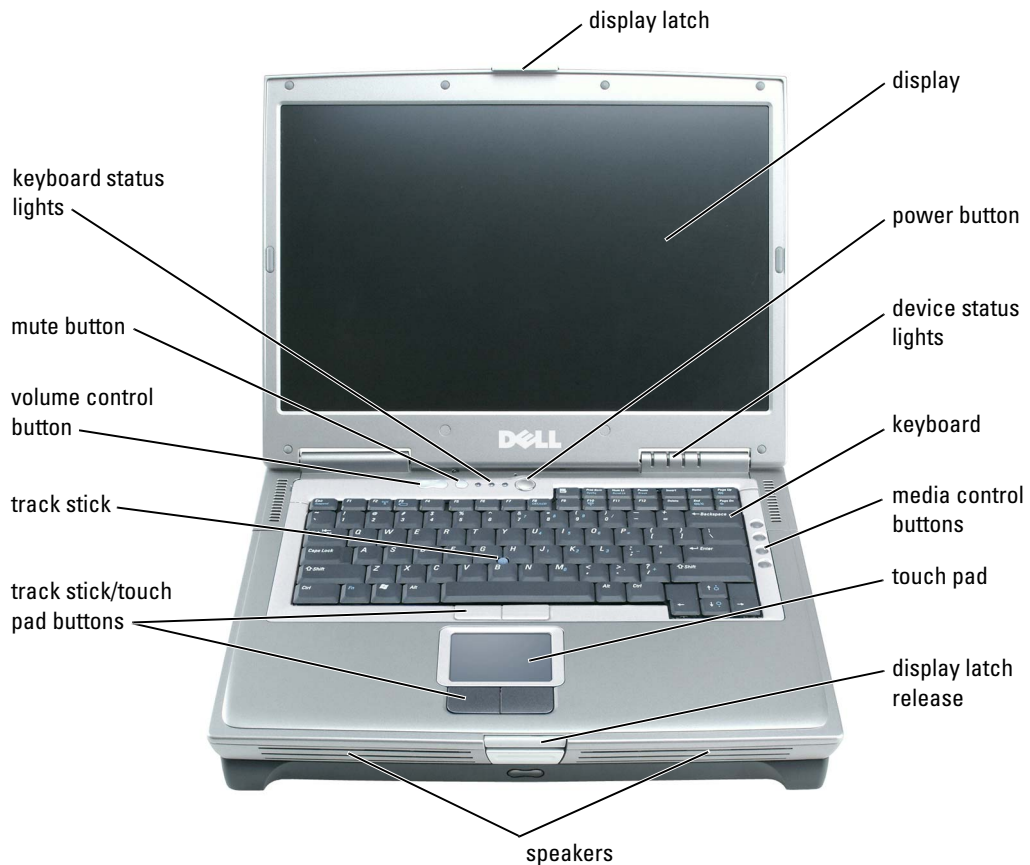

DISPLAY LATCH — Keeps the display closed.





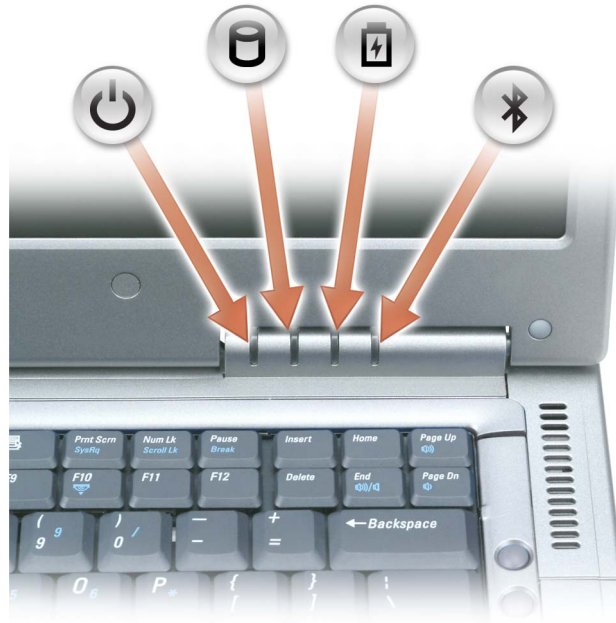

DISPLAY — For more information about your display, see the *Dell Inspiron Help* file. To access the help file, see page 18.

POWER BUTTON — Press the power button to turn on the computer or to enter or exit a power management mode.

➔ **NOTICE:** To avoid losing data when you turn off your computer, shut down your computer through the Start menu instead of pressing the power button.

DEVICE STATUS LIGHTS



-  Turns on when you turn on the computer.
-  Turns on when the computer reads or writes data.
- ➔ **NOTICE:** To avoid loss of data, never turn off the computer while the  light is flashing.
-  Turns on steadily or flashes when the computer is in a power management mode. It also flashes to indicate battery charge status.
-  Turns on when a PC Card with Bluetooth® wireless technology is enabled.
-  **NOTE:** The PC Card with Bluetooth wireless technology is an optional feature, so the  light turns on only if you ordered the card with your computer. For more information, see the Windows Help and Support Center online documentation on PC Cards with Bluetooth wireless technology, or any documentation that came with your device. (To access the Help and Support Center, see page 19.)

To turn off only the functionality of the PC Card with Bluetooth wireless technology, right-click the  icon in the notification area and select **Disable Bluetooth Radio**.

To quickly enable or disable all wireless devices, press <Fn><F2>.

If the computer is connected to an electrical outlet, the  light operates as follows:

- Solid green: The battery is charging.
- Flashing green: The battery is almost fully charged.

If the computer is running on a battery, the  light operates as follows:

- Off: The battery is adequately charged (or the computer is turned off).
- Flashing orange: The battery charge is low.
- Solid orange: The battery charge is critically low.

KEYBOARD — The keyboard includes a numeric keypad as well as the Microsoft® Windows® logo key. For information on supported keyboard shortcuts, see "Key Combinations" on page 59.

MEDIA CONTROL BUTTONS — Control CD and DVD playback.

TOUCH PAD — Touch pad and touch pad buttons provide the functionality of a mouse.

DISPLAY LATCH RELEASE — Press this to release the display latch and open the display.

SPEAKERS — To adjust the volume of the integrated speakers, press the volume control button or speaker-volume key combinations. For more information, see page 60.

TRACK STICK/TOUCH PAD BUTTONS — Track stick and touch pad buttons provide the functionality of a mouse.

TRACK STICK — Track stick and track stick buttons provide the functionality of a mouse.



VOLUME CONTROL BUTTON — Press to adjust the speaker volume.

MUTE BUTTON — Press this button to turn off the speaker sound.

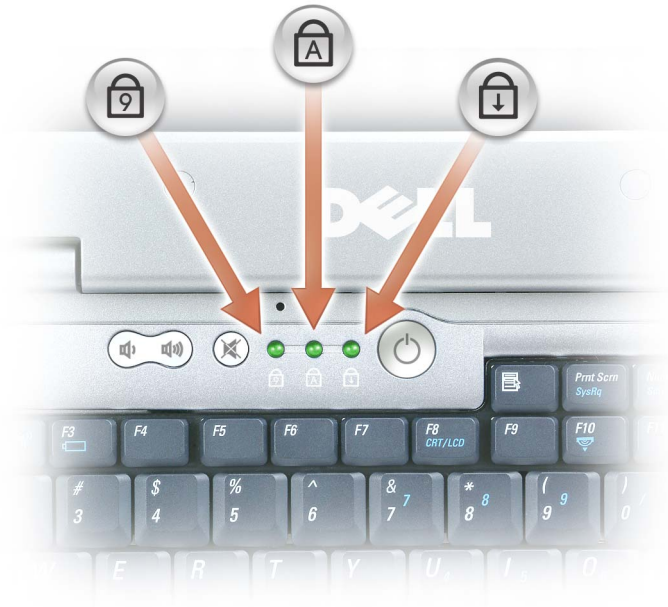
KEYBOARD STATUS LIGHTS



The green lights located above the keyboard indicate the following:

-  Turns on when the numeric keypad is enabled.
-  Turns on when the uppercase letter function is enabled.
-  Turns on when the scroll lock function is enabled.

Left Side View

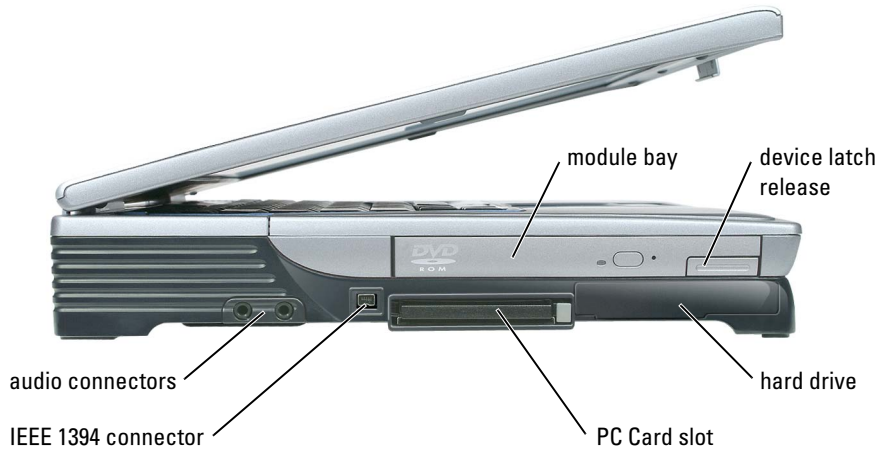

MODULE BAY — You can install devices such as a CD, DVD, or other optical drive in the module bay. For more information, see page 55.

DEVICE LATCH RELEASE — Press to release the device latch.

HARD DRIVE — Stores software and data.

PC CARD SLOT — Supports one PC Card, such as a modem or network adapter. The computer ships with a plastic blank installed in the slot. For more information, see the *Dell™ Inspiron™ Help* file. To access the help file, see page 18.

IEEE 1394 CONNECTOR — Connects devices supporting IEEE 1394 high-speed transfer rates, such as some digital video cameras.

AUDIO CONNECTORS

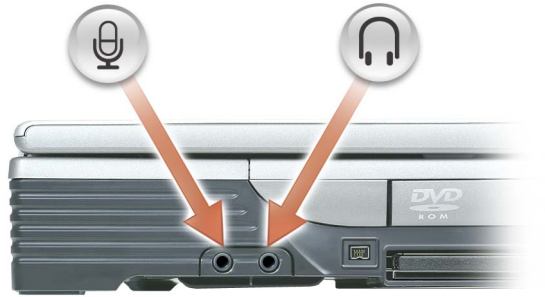

Attach a microphone to the  connector.

Attach headphones or speakers to the  connector.

Right Side View

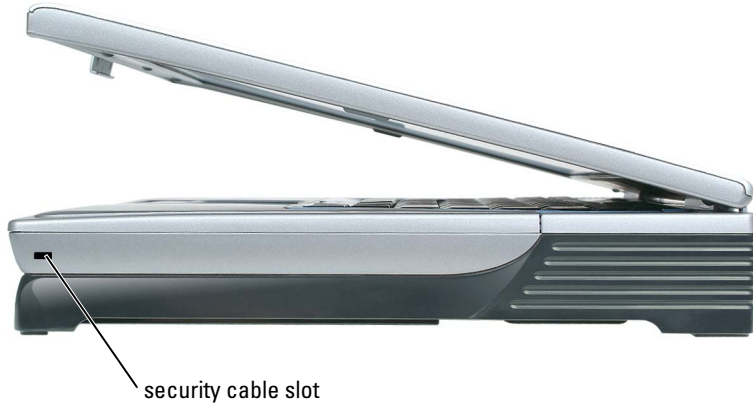

SECURITY CABLE SLOT — Lets you attach a commercially available antitheft device to the computer. For more information, see the instructions included with the device.

 **NOTICE:** Before you buy an antitheft device, ensure that it will work with the security cable slot.



Back View

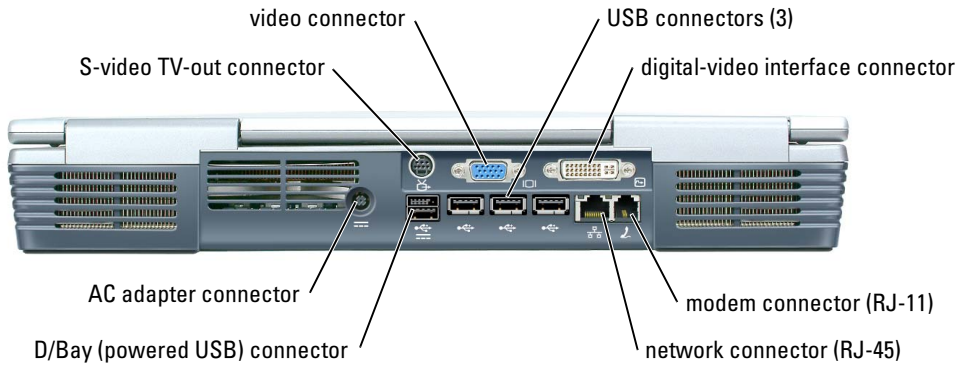

S-VIDEO TV-OUT CONNECTOR



Connects your computer to a TV. Also connects digital audio capable devices using the TV/digital audio adapter cable.

VIDEO CONNECTOR



Connects an external VGA-compatible monitor. For more information, see the *Dell Inspiron Help* file. To access the help file, see page 18.

USB CONNECTORS (3)

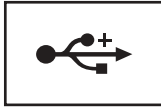

Connect USB devices, such as a mouse, keyboard, or printer. You can also connect the optional floppy drive directly to a USB connector using the optional floppy-drive cable, as shown below.



DIGITAL-VIDEO INTERFACE (DVI) CONNECTOR



Connects an external DVI-compatible monitor. With an adapter cable, you can also connect an external VGA-compatible monitor to the DVI connector.

MODEM CONNECTOR (RJ-11)



To use the internal modem, connect the telephone line to the modem connector.

For additional information on using the modem, see the online modem documentation supplied with your computer.

NETWORK CONNECTOR (RJ-45)

NOTICE: The network connector is slightly larger than the modem connector. To avoid damaging the computer, do not plug a telephone line into the network connector.

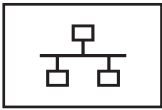

Connects the computer to a network. The green and yellow lights next to the connector indicate activity for both wired and wireless network communications.

For information on using the network adapter, see the online network adapter documentation supplied with your computer.

D/BAY (POWERED USB) CONNECTOR

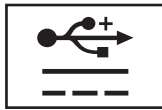

Connects powered USB devices such as a Dell™ D/Bay, which is an external module bay that accommodates an optical drive, floppy drive, or second hard drive; also connects standard USB devices.



AC ADAPTER CONNECTOR — Attaches an AC adapter to the computer.



The AC adapter converts AC power to the DC power required by the computer. You can connect the AC adapter with your computer turned either on or off.



CAUTION: The AC adapter works with electrical outlets worldwide. However, power connectors and power strips vary among countries. Using an incompatible cable or improperly connecting the cable to the power strip or electrical outlet may cause fire or equipment damage.



NOTICE: Do not use an AC adapter rated at less than 150 W with this computer.



NOTICE: When you disconnect the AC adapter cable from the computer, grasp the connector, not the cable itself, and pull firmly but gently to avoid damaging the cable.

Bottom View

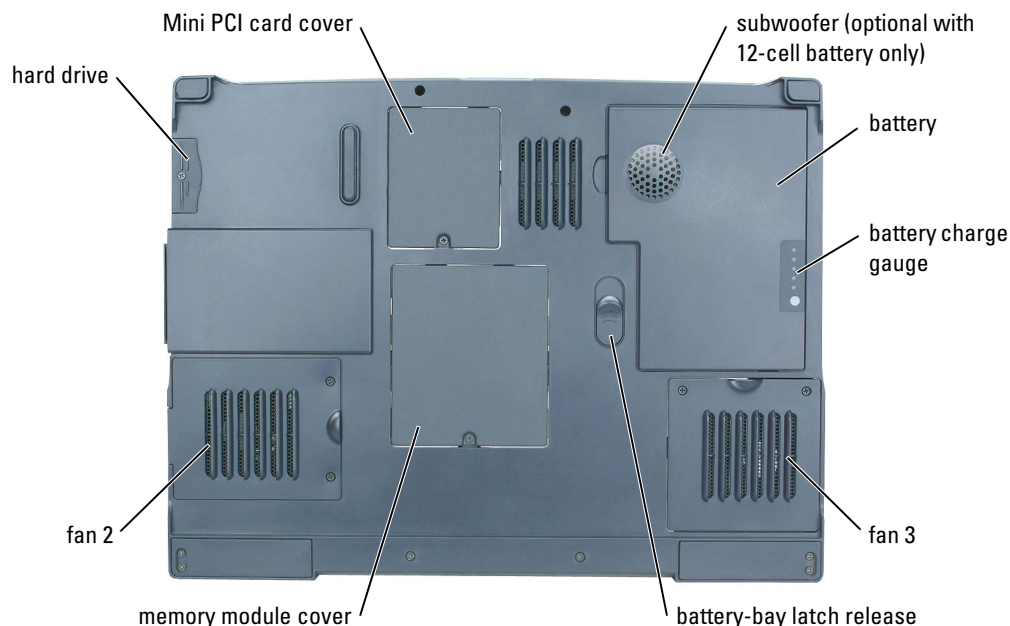

MINI PCI CARD COVER — Covers the compartment that contains the Mini PCI card. See page 108.

SUBWOOFER — An optional component available with the 12-cell battery only. It produces a broader bass output than is provided by the speakers. See page 111.

BATTERY — When a battery is installed, you can use the computer without connecting the computer to an electrical outlet. See page 49.

BATTERY CHARGE GAUGE — Provides information on the battery charge. See page 50.

FAN — The computer uses fans to create airflow through the vents, which prevents the computer from overheating. See page 119.

BATTERY-BAY LATCH RELEASE — Releases the battery from the battery bay. See "Removing a Battery" on page 52.

MEMORY MODULE COVER — Covers the compartment that contains the memory modules. See page 105.

HARD DRIVE — Stores software and data. See page 111.

Using Your Computer

Transferring Information to a New Computer

The Microsoft® Windows® XP operating system provides a Files and Settings Transfer wizard to move data from the source computer to the new computer. You can move data such as:

- E-mails
- Toolbar settings
- Window sizes
- Internet bookmarks

You can transfer the data to the new computer over a network or serial connection, or you can store it on a removable medium, such as a writable CD or floppy disk.

To prepare the new computer for the file transfer:

- 1 Click the **Start** button, point to **All Programs**→**Accessories**→**System Tools**, and then click **Files and Settings Transfer Wizard**.
- 2 When the **Files and Settings Transfer Wizard** welcome screen appears, click **Next**.
- 3 On the **Which computer is this?** screen, click **New Computer** and click **Next**.
- 4 On the **Do you have a Windows XP CD?** screen, click **I will use the wizard from the Windows XP CD** and click **Next**.
- 5 When the **Now go to your old computer** screen appears, go to your source computer. *Do not* click **Next** at this time.

To copy data from the source computer:

- 1 On the old computer, insert the *Windows XP Operating System* CD.
- 2 On the **Welcome to Microsoft Windows XP** screen, click **Perform additional tasks**.
- 3 Under **What do you want to do?**, click **Transfer files and settings**.
- 4 On the **Files and Settings Transfer Wizard** welcome screen, click **Next**.
- 5 On the **Which computer is this?** screen, click **Old Computer** and click **Next**.
- 6 On the **Select a transfer method** screen, click the transfer method you prefer.

- 7 On the **What do you want to transfer?** screen, select the items you want to transfer and click **Next**.

After the information has been copied, the **Completing the Collection Phase** screen appears.

- 8 Click **Finish**.

To transfer data to the new computer:

- 1 On the **Now go to your old computer** screen on the new computer, click **Next**.
- 2 On the **Where are the files and settings?** screen, select the method you chose for transferring your settings and files and click **Next**.

The wizard reads the collected files and settings and applies them to your new computer.

When all of the settings and files have been applied, the **Finished** screen appears.

- 3 Click **Finished** and restart the new computer.

Configuring Graphics Cards

Settings and Functions

Dell configured your graphics card for optimal performance with most games and other video programs. However, some game manufacturers may recommend that you either change a setting or enable or disable a certain function for a game to properly run. You may also want to readjust settings to better fit your gaming style.

Some settings, such as Direct3D or OpenGL, enable you to adjust the card for higher performance or for higher image quality. Other settings, such as contrast or color level, are cosmetic adjustments.

Certain high-end graphics cards are available with TV-out support, which enables you to connect a TV to your computer, in addition to a monitor. A TV-out configuration is ideal for watching movies using an optional DVD player or for giving presentations. For information on connecting a TV to your computer, see page 35.

For information and instructions on adjusting your graphics card's operating mode, settings, and functions:

- 1 Click the **Start** button and click **Help and Support**.
- 2 Click **User and system guides**.
- 3 Locate and click the guide for your graphics card.

Connecting Your Computer to a TV or Audio Device

NOTE: Unless otherwise indicated, some of the video and audio cables required for connecting your computer to a TV may not be included with your computer. Cables may be purchased at most consumer electronics stores.

Your computer has an S-video TV-out connector that, together with the TV/digital audio adapter cable (available from Dell), enables you to connect the computer to a TV and/or stereo audio device. The TV/digital audio adapter cable provides connectors for an S-video cable, a composite video cable, and an S/PDIF digital audio cable.

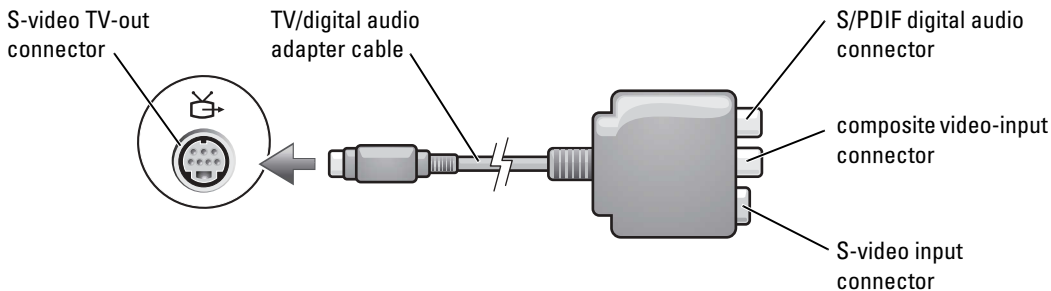

Your TV has either an S-video input connector or a composite video-input connector. Depending on what type of connector is available on your TV, you can use an S-video cable (included with your Dell computer) or a commercially available composite video cable to connect your computer to your TV. For audio devices without support for S/PDIF digital audio, you can use the audio connector on the side of the computer to connect the computer to your audio device.

It is recommended that you connect video and audio cables to your computer in one of the following combinations.

NOTE: See the diagrams at the beginning of each subsection to help you determine which method of connection you should use.

- S-video and standard audio (see page 36)
- S-video and S/PDIF digital audio (see page 37)
- Composite video and standard audio (see page 39)
- Composite video and S/PDIF digital audio (see page 40)

When you finish connecting the video and audio cables between your computer and your TV, you must enable your computer to work with the TV. See "Enabling the Display Settings for a TV" on page 43 to ensure that the computer recognizes and works properly with the TV. Additionally, if you are using S/PDIF digital audio, see "Enabling S/PDIF Digital Audio" on page 42.

S-Video and Standard Audio

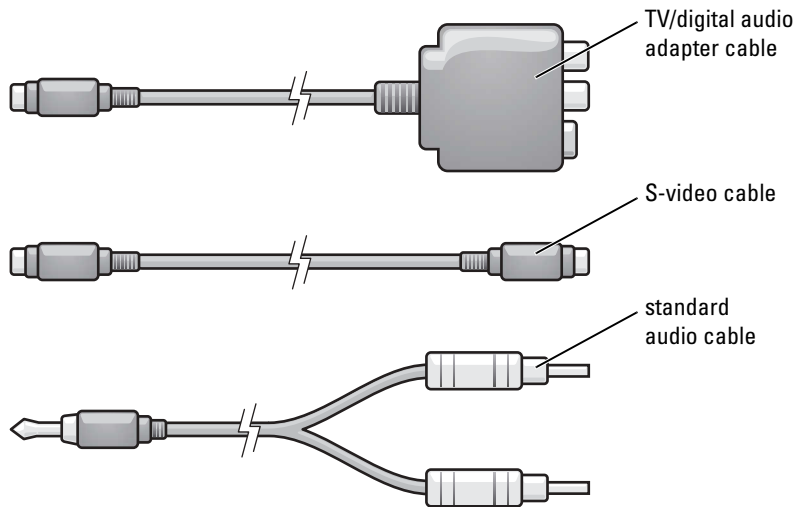
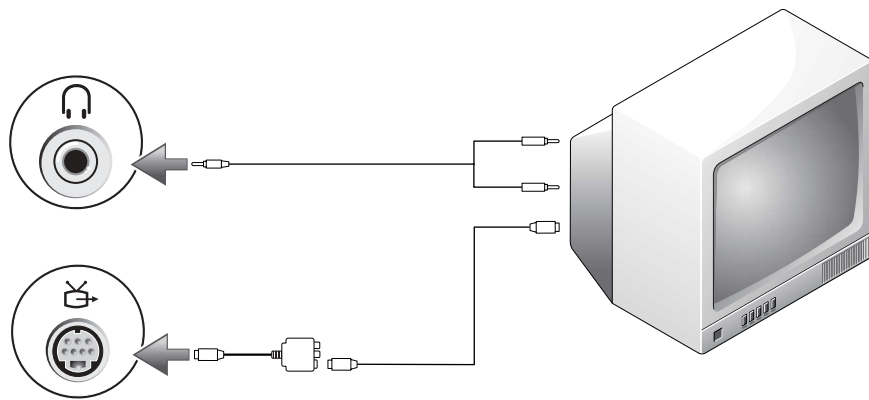

- 1 Turn off the computer and the TV and/or audio device that you want to connect.

NOTE: You can connect an S-video cable directly to the S-video TV-out connector on the computer (without the TV/digital audio adapter cable) if your TV or audio device supports S-video but not S/PDIF digital audio.

- 2 Connect the TV/digital audio adapter cable to the S-video TV-out connector on your computer.

- 3 Plug one end of the S-video cable in to the S-video input connector on the TV/digital audio adapter cable.

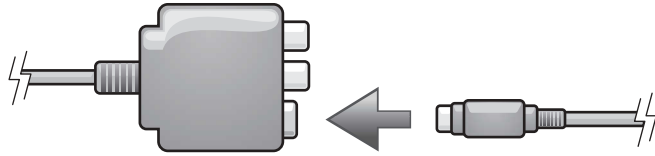

- 4 Plug the other end of the S-video cable in to the S-video input connector on your TV.
- 5 Plug the single-connector end of the audio cable in to the headphone connector on your computer.
- 6 Plug the two RCA connectors on the other end of the audio cable in to the audio input connectors on your TV or other audio device.
- 7 Turn on the TV and any audio device that you connected, and then turn on the computer.
- 8 See "Enabling the Display Settings for a TV" on page 43 to ensure that the computer recognizes and works properly with the TV.

S-Video and S/PDIF Digital Audio

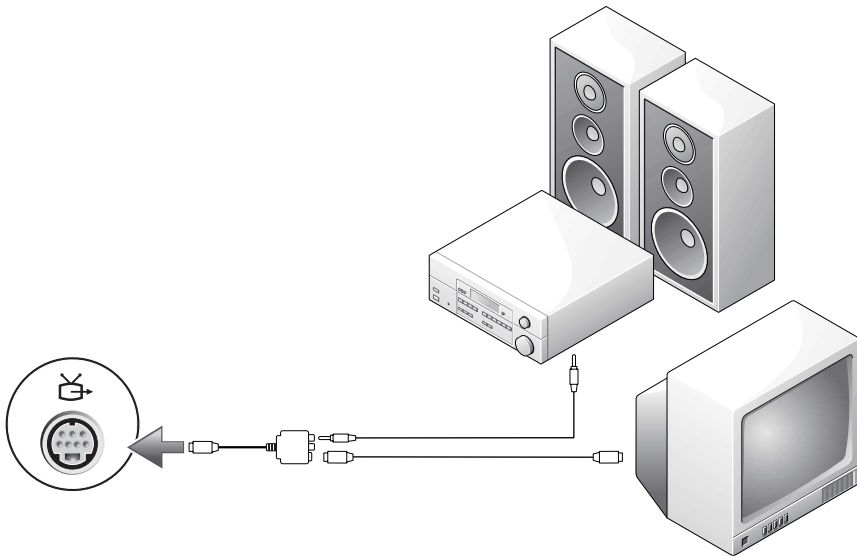

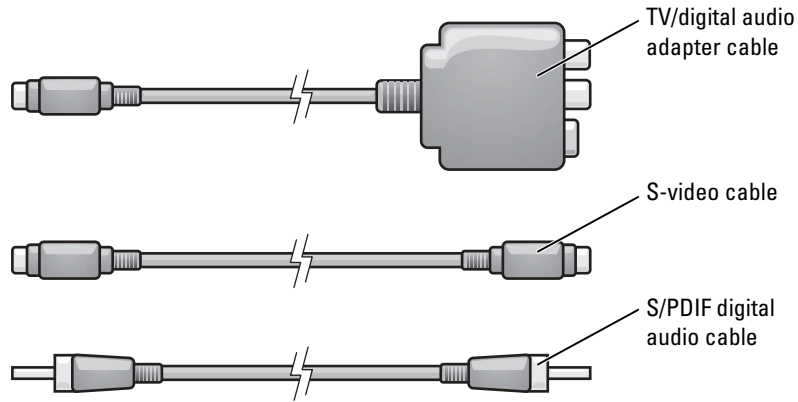

- 1 Turn off the computer and the TV and/or audio device that you want to connect.
- 2 Connect the TV/digital audio adapter cable to the S-video TV-out connector on your computer.
- 3 Plug one end of the S-video cable in to the S-video input connector on the TV/digital audio adapter cable.

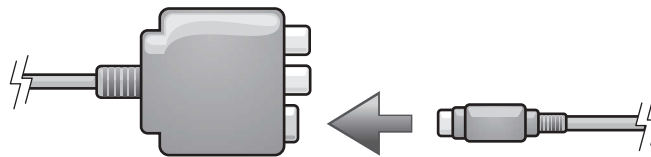

- 4 Plug the other end of the S-video cable in to the S-video input connector on the TV.
- 5 Plug one end of the S/PDIF digital audio cable in to the digital audio connector on the TV/digital audio adapter cable.

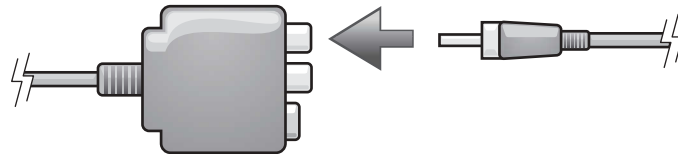

- 6 Plug the other end of the S/PDIF digital audio cable in to the audio input connector on your TV or other audio device.
- 7 Turn on the TV, turn on any audio device that you connected (if applicable), and then turn on the computer.

- 8 See "Enabling the Display Settings for a TV" on page 43 to ensure that the computer recognizes and works properly with the TV.

Composite Video and Standard Audio

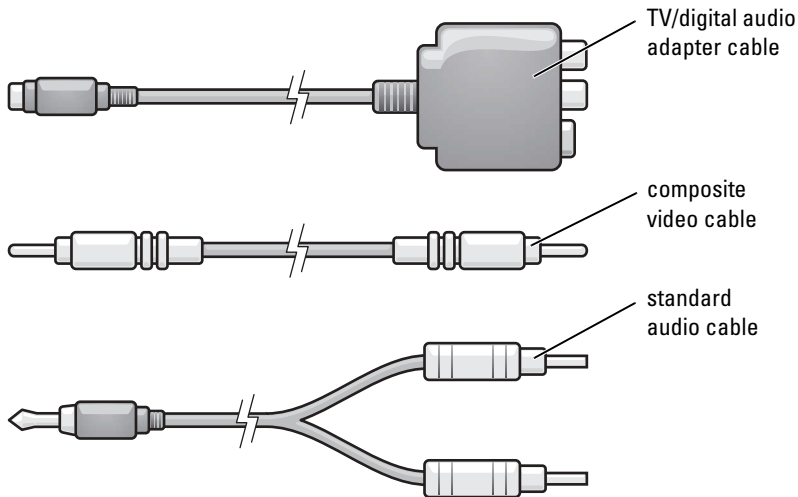
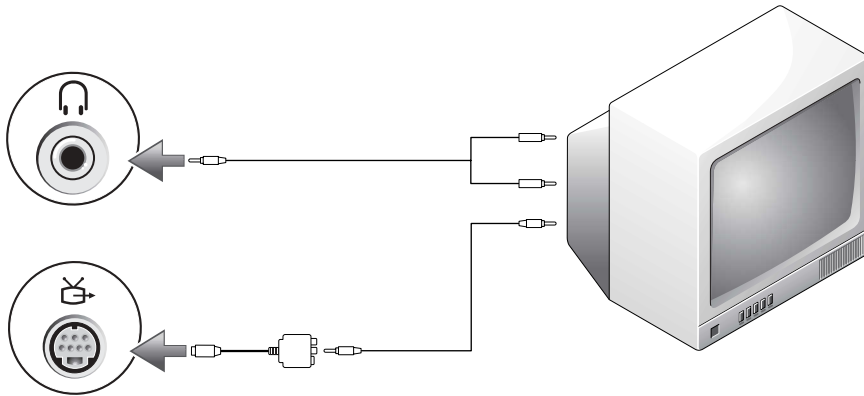

- 1 Turn off the computer and the TV and/or audio device that you want to connect.
- 2 Connect the TV/digital audio adapter cable to the S-video TV-out connector on the computer.

- 3 Plug one end of the composite video cable in to the composite video-input connector on the TV/digital audio adapter cable.

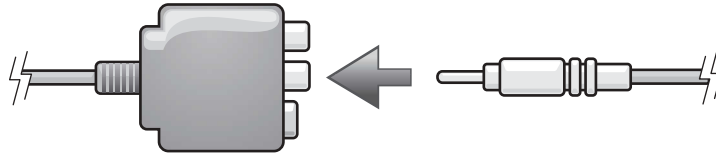

- 4 Plug the other end of the composite video cable in to the composite video-input connector on the TV.
- 5 Plug the single-connector end of the audio cable in to the headphone connector on the computer.
- 6 Plug the two RCA connectors on the other end of the audio cable in to the audio input connectors on your TV or other audio device.
- 7 Turn on the TV, turn on any audio device that you connected (if applicable), and then turn on the computer.
- 8 See "Enabling the Display Settings for a TV" on page 43 to ensure that the computer recognizes and works properly with the TV.

Composite Video and S/PDIF Digital Audio

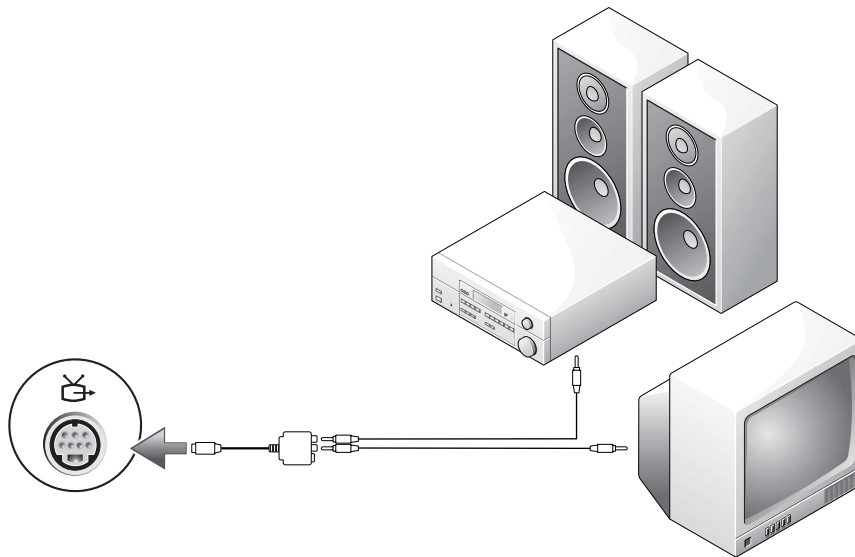

- 1 Turn off the computer and the TV and/or audio device that you want to connect.
- 2 Connect the TV/digital audio adapter cable to the S-video TV-out connector on the computer.
- 3 Plug one end of the composite video cable in to the composite video-input connector on the TV/digital audio adapter cable.

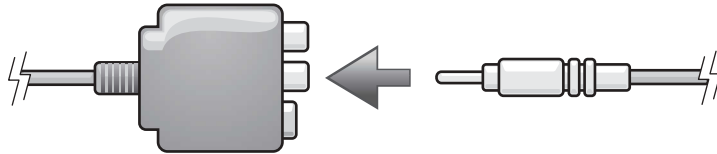

- 4 Plug the other end of the composite video cable in to the composite video-input connector on the TV.
- 5 Plug one end of the S/PDIF digital audio cable in to the S/PDIF audio connector on the TV/digital audio adapter cable.

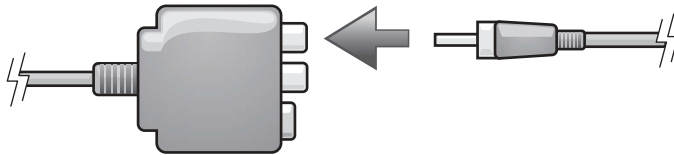

- 6 Plug the other end of the digital audio cable in to the S/PDIF input connector on your TV or other audio device.
- 7 Turn on the TV, turn on any audio device that you connected (if applicable), and then turn on the computer.
- 8 See "Enabling the Display Settings for a TV" on page 43 to ensure that the computer recognizes and works properly with the TV.

Enabling S/PDIF Digital Audio

If your computer has a DVD drive, you can enable Dolby Digital 5.1 audio for DVD playback.

- 1 Double-click the CyberLink PowerDVD icon on the Microsoft® Windows® desktop.

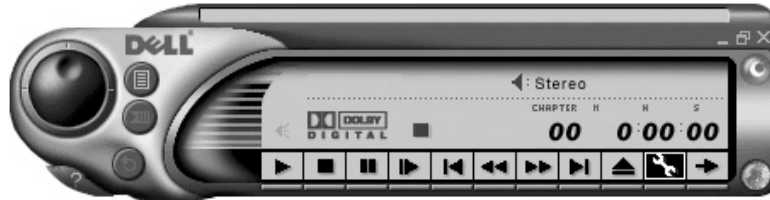

- 2 Insert a DVD into the DVD drive.
If the DVD begins playing, click the stop button.
- 3 Click the properties (wrench) icon.
- 4 Click the **Audio** tab.
- 5 Click **Enable S/PDIF output**.
- 6 Click **Apply**.
- 7 Click **OK**.

Enabling S/PDIF in the Windows Audio Driver

 **NOTE:** Enabling S/PDIF in Windows disables the sound from the headphone connector.

- 1 Double-click the speaker icon in the Windows notification area.
- 2 Click the **Options** menu and then click **Advanced Controls**.
- 3 Click **Advanced**.
- 4 Click **Enable S/PDIF**.
- 5 Click **Close**.
- 6 Click **OK**.

Setting Up the Dolby Headphone

 **NOTE:** The Dolby headphone feature is available only if your computer has a DVD drive.

- 1 Double-click the Cyberlink PowerDVD icon on the Windows desktop.
- 2 Click the **Properties** icon.
- 3 Click the **Dolby Headphone** tab.
- 4 Click **Enable Dolby Headphone**.

 **NOTE:** Icon labels may be visible only when you place the cursor over the icon.

- 5 Select one of the four options to set the level of surround sound effects. **Option 1** is a baseline stereo option and **Options 2, 3, and 4** are surround sound levels.
- 6 Click **Apply**, and then click **OK** to close the **Properties** window.
- 7 Click **Exit**.

Enabling the Display Settings for a TV

Your computer has an ATI video-controller card. To enable the display settings for a TV:

 **NOTE:** See the documentation that came with your TV, and ensure that you properly configure and connect the TV before you enable the display settings.

- 1 Click the **Start** button and click **Control Panel**.
- 2 Click **Appearances and Themes**.
- 3 Under or pick a **Control Panel** icon, click **Display**.
- 4 Click the **Settings** tab and click **Advanced**.
- 5 Click the **Displays** tab.
- 6 Click the upper-left corner of the **TV** button to enable the TV.
- 7 Click **OK**.

Connecting Monitors

 **NOTE:** If you are connecting two monitors that both have VGA connectors, you must have the optional VGA adapter, available from Dell. If you are connecting two flat-panel monitors, at least one of them must have a VGA connector. If you are connecting a television, you may connect only one monitor (VGA or DVI) in addition to the television.

This section provides instructions for connecting and enabling monitors. The instructions tell you how to connect either one or two monitors (each with a VGA connector), one monitor with a VGA connector and/or one monitor with a DVI connector, and one monitor of either type and/or a television.

- 1 Connect the monitor cables to the connectors on the back of the computer.

If you are connecting one VGA monitor, connect it to the VGA (blue) connector on the computer.

If you are connecting one DVI monitor, connect it to the DVI (white) connector on the computer.

If you are connecting two monitors that both have VGA connectors:

- a Connect one of the monitors to the VGA (blue) connector on the computer.
- b Connect the other monitor to the optional VGA adapter and connect the VGA adapter to the DVI (white) connector on the computer.

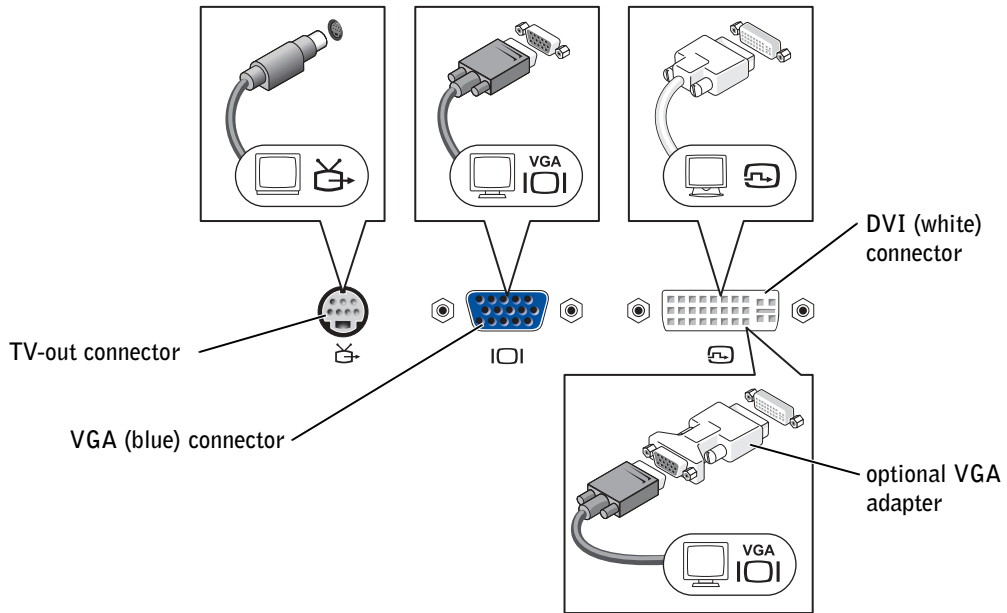

If you are connecting two monitors, and one monitor has a VGA connector and the other monitor has a DVI connector:

- a Connect the VGA connector on the monitor to the VGA (blue) connector on the computer.
- b Connect the DVI connector on the other monitor to the DVI (white) connector on the computer.

 **NOTE:** To connect a television to your computer, you must use the S-video cable included with your computer.

If you are connecting two monitors and one of the monitors is a television:

- a Connect one end of the S-video cable to the TV-out connector on the computer.
- b Connect the other end of the S-video cable to the S-video input connector on your television.
- c Connect the VGA or DVI monitor as described on page 44.

- 2 Enable clone mode or extended desktop mode in the display settings.
 - In clone mode, both monitors display the same image.
 - In extended desktop mode, you can drag objects from one screen to the other, effectively doubling the amount of viewable work space.

For information on changing the display settings for your video card, see the user's guide in the Help and Support Center (click the **Start** button, click **Help and Support**, click **User and system guides**, click **Device guides**, and then click the guide for your video card).

Using CDs and DVDs

For information about using CDs and DVDs in your computer, see the *Dell Inspiron Help* file. To access the help file, see page 18.

Copying CDs and DVDs

 **NOTE:** Ensure that you follow all copyright laws when you create CDs or DVDs.

This section applies only to computers that have a CD-R, CD-RW, DVD+RW, DVD+R, or DVD/CD-RW combo drive.

The following instructions show how to make an exact copy of a CD or DVD. You can also use Sonic RecordNow for other purposes, including creating CDs from audio files on your computer and creating MP3 CDs. For instructions, see the Sonic RecordNow documentation that came with your computer. Open Sonic RecordNow, click the question mark icon in the upper-right corner of the window, and then click **RecordNow Help** or **RecordNow Tutorial**.

How to Copy a CD or DVD

 **NOTE:** If you have a DVD/CD-RW combo drive and you experience recording problems, check for available software patches at the Sonic support website at support.sonic.com.

Currently, there are five DVD writeable disc formats available: DVD+R, DVD+RW, DVD-R, DVD-RW and DVD-RAM. The DVD-writeable drives installed in Dell™ computers will write to DVD+R and DVD+RW media, as well as read DVD-R and DVD-RW media, but the drives will not write to and may not read DVD-RAM media. The commercially available DVD players for home theater systems may or may not read all five formats.

 **NOTE:** Most commercial DVDs have copyright protection and cannot be copied using Sonic RecordNow.

- 1 Click the **Start** button, point to **All Programs**→ **Sonic**→ **RecordNow!**→ **RecordNow!**
- 2 Click either the audio tab or the data tab, depending on the kind of CD or DVD you are planning to copy.
- 3 Click **Exact Copy**.

4 To copy the CD or DVD:

- *If you have one CD or DVD drive*, ensure that the settings are correct and click **Copy**. The computer reads your source CD or DVD and copies it to a temporary folder on your computer hard drive.

When prompted, insert a blank CD or DVD into the CD or DVD drive and click **OK**.

- *If you have two CD or DVD drives*, select the drive into which you have inserted your source CD or DVD and click **Copy**. The computer copies the data on the CD or DVD to the blank CD or DVD.

Once you have finished copying the source CD or DVD, the CD or DVD that you have created automatically ejects.

Using Blank CD-Rs, CD-RWs, DVD+Rs, and DVD+RWs

Your CD-RW drive can write to two different types of recording media—CD-Rs and CD-RWs (including High-Speed CD-RWs). Use blank CD-Rs to record music or permanently store data files. After creating a CD-R, you cannot write to that CD-R again without changing your method of recording (see the Sonic documentation for more information). Use blank CD-RWs to write to CDs or to erase, rewrite, or update data on CDs.

Your DVD writeable drive can write to four different types of recording media—CD-Rs, CD-RWs (including High-Speed CD-RWs), DVD+Rs, and DVD+RWs. Blank DVD+Rs can be used to permanently store large amounts of information. After creating a DVD+R disc, you may not be able write to that disc again, depending on whether or not the disc is "finalized" or "closed" (the final stage of the disc creation process). Use blank DVD+RWs when you will need to erase, rewrite, or update the information on that disc later.

Helpful Tips

- Use Microsoft® Windows® Explorer to drag and drop files to a CD-R or CD-RW only after you start Sonic RecordNow and open a RecordNow project.
- You must use CD-Rs to burn music CDs that you want to play in regular stereos. CD-RWs do not play in most home or car stereos.
- You cannot create audio DVDs with Sonic RecordNow.
- Music MP3 files can be played only on MP3 players or on computers that have MP3 software installed.
- Do not burn a blank CD-R or CD-RW to its maximum capacity; for example, do not copy a 650-MB file to a 650-MB blank CD. The CD-RW drive needs 1 or 2 MB of the blank CD to finalize the recording.
- Use a blank CD-RW to practice CD recording until you are familiar with CD recording techniques. If you make a mistake, you can erase the data on the CD-RW and try again. You can also use blank CD-RWs to test music file projects before you record the project permanently to a blank CD-R.
- See the Sonic support website at support.sonic.com for additional information.

Optimizing Performance

Your Dell™ Inspiron™ computer is equipped with the Intel® 865PE chip set, which is designed to support the Intel Pentium® 4 processor with Hyper-Threading (HT) technology to deliver the highest level of system performance. The Intel 865PE chip set is highly integrated; it provides dual-channel PC3200 memory interfaces and an 8X AGP graphics interface.

DDR Memory and Processor Front-Side Bus

The performance of your computer's DDR memory depends on the type of memory installed and the clock speed of your processor. For your computer, the memory type is PC3200, so for an 800-MHz front-side bus processor, the memory performs at 400 MHz.

Processor Type	Processor Front-Side Bus	Memory Type	DDR Memory Performance
Intel Pentium 4 with Hyper-Threading technology	800-MHz front-side bus	PC3200	400 MHz



NOTE: To get dual-channel memory bandwidth capability, you must always have two memory modules installed and they must be of the same memory capacity.

For information on installing memory, see page 105. For more information on the type of memory supported by your computer, see page 144.

Hyper-Threading

Hyper-Threading is an Intel® technology that can enhance overall computer performance by allowing one physical processor to function as two logical processors, capable of performing certain tasks simultaneously. The Microsoft® Windows® XP operating system is optimized to take advantage of Hyper-Threading technology. While many programs can benefit from Hyper-Threading, some programs have not been optimized for Hyper-Threading and may require an update from the software manufacturer. Contact the software manufacturer for updates and information about using Hyper-Threading with your software.

Using a Battery

Battery Performance

 **CAUTION:** Before you begin this procedure, read the safety instructions at the front of this document (see page 11).

 **NOTE:** Batteries for portable computers are covered only during the initial one-year period of the limited warranty for your computer. For more information about the Dell warranty for your computer, see "Limited Warranties" on page 171 or the separate paper warranty document that shipped with your computer.

For optimal computer performance and to help preserve BIOS settings, operate your Dell™ portable computer with the main battery installed at all times. Use a battery to run the computer when it is not connected to an electrical outlet. One battery is supplied as standard equipment in the battery bay.

Battery operating time varies depending on operating conditions.

Operating time is significantly reduced when you perform operations including, but not limited to, the following:

- Using DVD, DVD+RW, and CD-RW drives.
- Using wireless communications devices, PC Cards, or USB devices.
- Using high-brightness display settings, 3D screen savers, or other power-intensive programs such as 3D games.
- Running the computer in maximum performance mode. (See "Power Management" in the *Dell Inspiron Help* file for more information. To access the help file, see page 18.)

 **NOTE:** It is recommended that you connect your computer to an electrical outlet when writing to a CD or DVD.

You can check the battery charge before or after you insert the battery into the computer. You can also set power management options to alert you when the battery charge is low.

 **CAUTION:** Using an incompatible battery may increase the risk of fire or explosion. Replace the battery only with a compatible battery purchased from Dell. The lithium-ion battery is designed to work with your Dell computer. Do not use a battery from other computers with your computer.

 **CAUTION:** Do not dispose of batteries with household waste. When your battery no longer holds a charge, call your local waste disposal or environmental agency for advice on disposing of a lithium-ion battery. See "Battery Disposal" on page 15.

⚠ CAUTION: Misuse of the battery may increase the risk of fire or chemical burn. Do not puncture, incinerate, disassemble, or expose the battery to temperatures above 65°C (149°F). Keep the battery away from children. Handle damaged or leaking batteries with extreme care. Damaged batteries may leak and cause personal injury or equipment damage.

Checking the Battery Charge

The Dell QuickSet Battery Meter, the Microsoft® Windows® Power Meter window and  icon, the battery charge gauge, and the low-battery warning provide information on the battery charge.

Dell™ QuickSet Battery Meter

If Dell QuickSet is installed, press <Fn><F3> to display the QuickSet Battery Meter.

The **Battery Meter** window displays status, charge level, and charge completion time for the battery in your computer.

The following icons appear in the **Battery Meter** window:



- The computer is running on battery power.
- The battery is discharging or idle.



- The computer is connected to an electrical outlet and running on AC power.
- The battery is charging.



- The computer is connected to an electrical outlet and running on AC power.
 - The battery is discharging, idle, or charging.
-

For more information about QuickSet, right-click the  icon in the taskbar, and click **Help**.

Microsoft® Windows® Power Meter

The Windows Power Meter indicates the remaining battery charge. To check the Power Meter, double-click the  icon on the taskbar. For more information about the **Power Meter** tab, see "Power Management" in the *Dell Inspiron Help* file. To access the help file, see page 18.

If the computer is connected to an electrical outlet, a  icon appears in the taskbar.

Charge Gauge

Press the status button on the battery charge gauge to illuminate the charge-level lights. Each light represents approximately 20 percent of the total battery charge. For example, if the battery has 80 percent of its charge remaining, four of the lights are on. If no lights appear, the battery has no charge.



Low-Battery Warning

➡ NOTICE: To avoid losing or corrupting data, save your work immediately after a low-battery warning. Then connect the computer to an electrical outlet. If the battery runs completely out of power, hibernate mode begins automatically.

A pop-up window warns you when the battery charge is approximately 90 percent depleted. For more information about low-battery alarms, see "Power Management" in the *Dell Inspiron Help* file. To access the help file, see page 18.

Charging the Battery

🔌 NOTE: The AC adapter charges a completely discharged battery in approximately 1.5 hours with the computer turned off. Charge time is longer with the computer turned on. You can leave the battery in the computer as long as you like. The battery's internal circuitry prevents the battery from overcharging.

When you connect the computer to an electrical outlet or install a battery while the computer is connected to an electrical outlet, the computer checks the battery charge and temperature. If necessary, the AC adapter then charges the battery and maintains the battery charge.

If the battery is hot from being used in your computer or being in a hot environment, the battery may not charge when you connect the computer to an electrical outlet.

The battery is too hot to start charging if the  light flashes alternately green and orange. Disconnect the computer from the electrical outlet and allow the computer and the battery to cool to room temperature. Then connect the computer to an electrical outlet to continue charging the battery.

For more information about resolving problems with a battery, see "Power Problems" on page 83.

Removing a Battery

⚠ CAUTION: Before performing these procedures, disconnect all cables from the computer.

- 1 Ensure that the computer is turned off or disconnected from an electrical outlet.
- 2 Slide and hold the battery-bay latch release on the bottom of the computer, and then remove the battery from the bay.



Installing a Battery

- 1 Slide the battery into the bay at a 45-degree angle.
- 2 Press the other side down until the latch release clicks.



Storing a Battery

Remove the battery when you store your computer for an extended period of time. A battery discharges during prolonged storage. After a long storage period, recharge the battery fully before you use it.

Using the Module Bay

About the Module Bay

⚠ CAUTION: Before you begin this procedure, read the safety instructions at the front of this document (see page 11).

You can install devices such as a floppy drive, CD drive, CD-RW drive, DVD drive, CD-RW/DVD drive, DVD+RW, or second hard drive in the module bay.

Your Dell™ Inspiron™ computer ships with a CD, DVD, or other optical drive installed in the module bay.

Removing and Installing Devices While the Computer Is Turned Off

➡ NOTICE: To prevent damage to devices, store them in a safe, dry place when they are not installed in the computer. Avoid pressing down on them or placing heavy objects on top of them.

- 1 Press the device latch release.

The latch release ejects partway.



- 2 Pull the device out of the module bay.



- 3 Push the new device into the bay until it clicks.

Removing and Installing Devices While the Computer Is Running

- 1 Before ejecting the device, double-click the **Safely Remove Hardware** icon on the taskbar, click the device you want to eject, and click **Stop**.

NOTICE: To prevent damage to devices, store them in a safe, dry place when they are not installed in the computer. Avoid pressing down on them or placing heavy objects on top of them.

- 2 Press the device latch release.



- 3 Pull the device out of the module bay.



- 4 Push the new device into the bay until it clicks.
The operating system automatically recognizes the device.
- 5 If necessary, enter your password to unlock your computer.

Using the Keyboard and Touch Pad

Numeric Keypad

The numeric keypad functions like the numeric keypad on an external keyboard. Each key on the keypad has multiple functions. The keypad numbers and symbols are marked in blue on the middle of the keypad keys.

- To type a number or symbol, hold down <Fn> and press the desired key.
- To enable the keypad, press <Num Lk>. The  light indicates that the keypad is active.
- To disable the keypad, press <Num Lk> again.

Key Combinations

System Functions

<Ctrl><Shift><Esc>	Opens the Task Manager window
<Num Lk>	Enables and disables the numeric keypad
<Fn><Num Lk>	Enables and disables the scroll lock function

Battery

<Fn><F3>	Displays the Dell™ QuickSet Battery Meter (see page 50)
----------	---

CD or DVD Tray

<Fn><F10>	Ejects the tray out of the drive if Dell QuickSet is installed
-----------	--

Display Functions

<Fn><F8>	Switches the video image to the next display option
<Fn> and up-arrow key	Increases brightness on the integrated display only (not on an external monitor)
<Fn> and down-arrow key	Decreases brightness on the integrated display only (not on an external monitor)

Radios (Including Wireless Networking and PC Cards With Bluetooth® Wireless Technology)

<Fn><F2>	Enables and disables radios, including wireless networking and the PC Card with Bluetooth wireless technology.
----------	--

Power Management

<Fn><Esc>	Activates a power management mode. You can reprogram this keyboard shortcut to activate a different power management mode using the Advanced tab in the Power Options Properties window. For instructions, see "Power Management" in the <i>Dell Inspiron Help</i> file. To access the help file, see page 18.
-----------	--

Speaker Functions

<Fn><Page Up>	Increases the volume of the integrated speakers and external speakers, if attached
<Fn><Page Dn>	Decreases the volume of the integrated speakers and external speakers, if attached
<Fn><End>	Enables and disables the integrated speakers and external speakers, if attached

Microsoft® Windows® Logo Key Functions

Windows logo key and <m>	Minimizes all open windows
Windows logo key and <Shift><m>	Maximizes all windows
Windows logo key and <e>	Runs Windows Explorer
Windows logo key and <r>	Opens the Run dialog box
Windows logo key and <f>	Opens the Search Results dialog box
Windows logo key and <Ctrl><f>	Opens the Search Results-Computer dialog box (if the computer is connected to a network)
Windows logo key and <Pause>	Opens the System Properties dialog box

To adjust keyboard operation, such as the character repeat rate, open the Control Panel, click **Printers and Other Hardware**, and click **Keyboard**.

Touch Pad

The touch pad detects the pressure and movement of your finger to allow you to move the cursor on the display. Use the touch pad and touch pad buttons as you would use a mouse.



- To move the cursor, lightly slide your finger over the touch pad.
- To select an object, lightly tap once on the surface of the touch pad or use your thumb to press the left touch-pad button.
- To select and move (or drag) an object, position the cursor on the object and tap down-up-down on the touch pad. On the second down motion, leave your finger on the touch pad and move the selected object by sliding your finger over the surface.
- To double-click an object, position the cursor on the object and tap twice on the touch pad or use your thumb to press the left touch-pad button twice.

You can also use the track stick to move the cursor. Press the track stick left, right, up, or down to change the direction of the cursor on the display. Use the track stick and track stick buttons as you would use a mouse.

Customizing the Touch Pad and Track Stick

You can use the **Mouse Properties** window to disable the touch pad and track stick or adjust their settings.

- 1 Click the **Start** button, click **Control Panel**, click **Printers and Other Hardware**, and then click **Mouse**.
- 2 In the **Mouse Properties** window:
 - Click the **Device Select** tab to disable the touch pad and track stick.
 - Click the **Pointer** tab to adjust touch pad and track stick settings.
- 3 Select the desired settings and click **Apply**.
- 4 Click **OK** to save the settings and close the window.

Changing the Track Stick Cap

You can replace your track stick cap if it wears down from prolonged use. You can purchase additional caps by visiting the Dell website at www.dell.com.



- 1 Pull the cap off the track stick.
- 2 Align the new cap over the square track-stick post and gently press the cap down onto the post.
- ➔ **NOTICE:** The track stick can damage the display if it is not properly seated on the post.
- 3 Test the track stick to ensure that the cap is seated properly.

Setting Up a Home and Office Network

Connecting to a Network Adapter

Before you connect your computer to a network, the computer must have a network adapter installed and a network cable connected to it.

To connect a network cable:

- 1 Connect the network cable to the network adapter connector on the back of your computer.

 **NOTE:** Insert the cable until it clicks into place, and then gently pull it to ensure that it is secure.

- 2 Connect the other end of the network cable to a network connection device, such as a network wall jack.

 **NOTE:** Do not use a network cable with a telephone wall jack.



Network Setup Wizard

The Microsoft® Windows® XP operating system provides a Network Setup Wizard to guide you through the process of sharing files, printers, or an Internet connection between computers in a home or small office.

- 1 Click the **Start** button, point to **All Programs**→**Accessories**→**Communications**, and then click **Network Setup Wizard**.
- 2 On the welcome screen, click **Next**.
- 3 Click **Checklist for creating a network**.

 **NOTE:** Selecting the connection method labeled "This computer connects directly to the Internet" enables the integrated firewall provided with Windows XP.

- 4 Complete the checklist and required preparations.
- 5 Return to the Network Setup Wizard and follow the instructions on the screen.

Connecting to a Wireless Local Area Network

 **NOTE:** These networking instructions do not apply to PC Cards with Bluetooth® wireless technology or cellular products.

Determining Your Network Type

 **NOTE:** Most wireless networks are of the infrastructure type.

Wireless networks fall into three categories—infrastructure networks, ad-hoc networks, and home networks. An infrastructure network uses routers or access points to connect several computers. An ad-hoc network does not use routers or access points and consists of computers that broadcast to one another. A home network typically employs high-speed Internet access such as DSL or cable, and an access point or router. For additional assistance with setting up your wireless connection, go to support.dell.com and search for the keyword *wireless setup*.

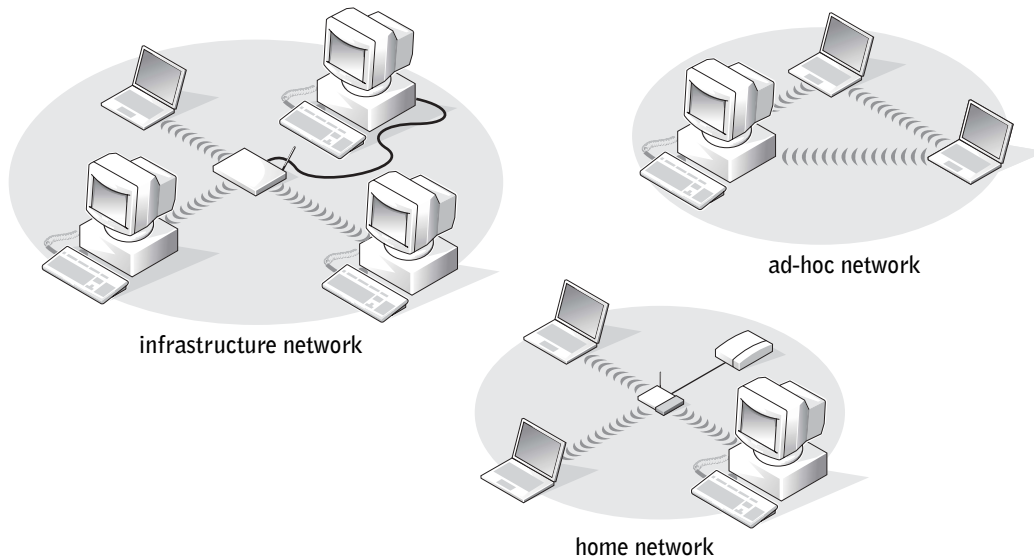

Connecting to a Wireless Network in Microsoft® Windows® XP

Your wireless network card requires specific software and drivers in order to connect to a network. The software is already installed. If the software is removed or corrupted, follow the instructions included in the user's guide for your wireless network card. The user's guide is located on your *Drivers and Utilities* CD (that came with your computer) in the "User's Guides-Network User's Guides" category. The user's guide is also available on the Dell Support website at support.dell.com.

- 1 Click the **Start** button, click **Control Panel**, and then click **Switch to Classic View**.
- 2 Double-click **Network Connections**.
- 3 Click **Wireless Network Connection**.

The **Wireless Network Connection** icon is highlighted.

- 4 Under **Network Tasks** in the left-hand pane, click **Change settings of this connection**.

The **Wireless Network Connection Properties** window appears.

- 5 Click the **Wireless Networks** tab.



NOTE: The names of wireless networks that your computer can detect are listed under **Available Networks**.



- 6 Click Add.
The Wireless network properties window appears.

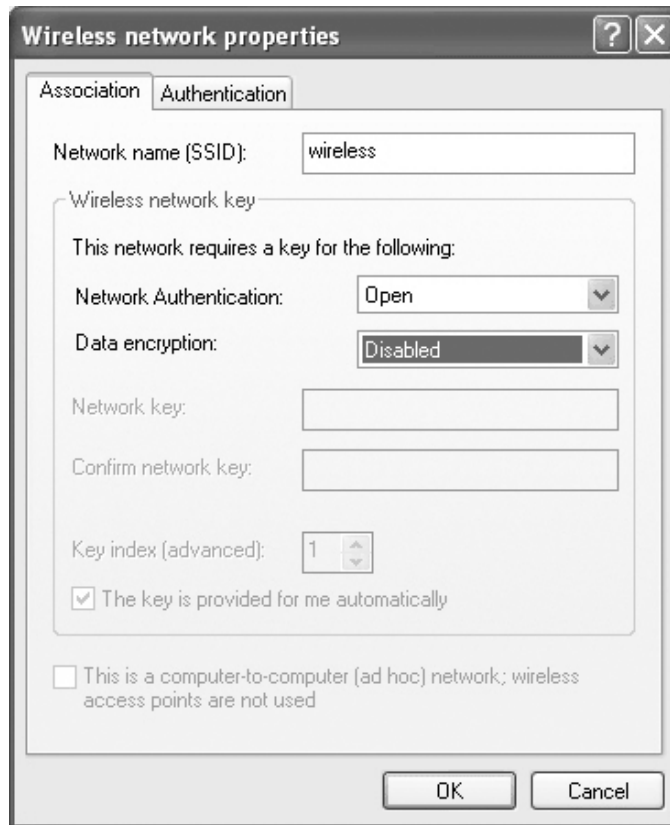

NOTE: If you are using a WPA-protected network, and the **Association** tab does not give you the option to select WPA, download the WPA wireless security update from the Microsoft support site.

7 Enter the name of your network in the **Network name (SSID)** field.

8 *If you do not need to configure security settings, go to step 9.*

If you choose to configure security settings (optional), go to "Configuring Security Settings (Optional)" on page 70.

9 Click **OK**.

Your new network name appears in the **Preferred networks** field, and your network setup is complete.

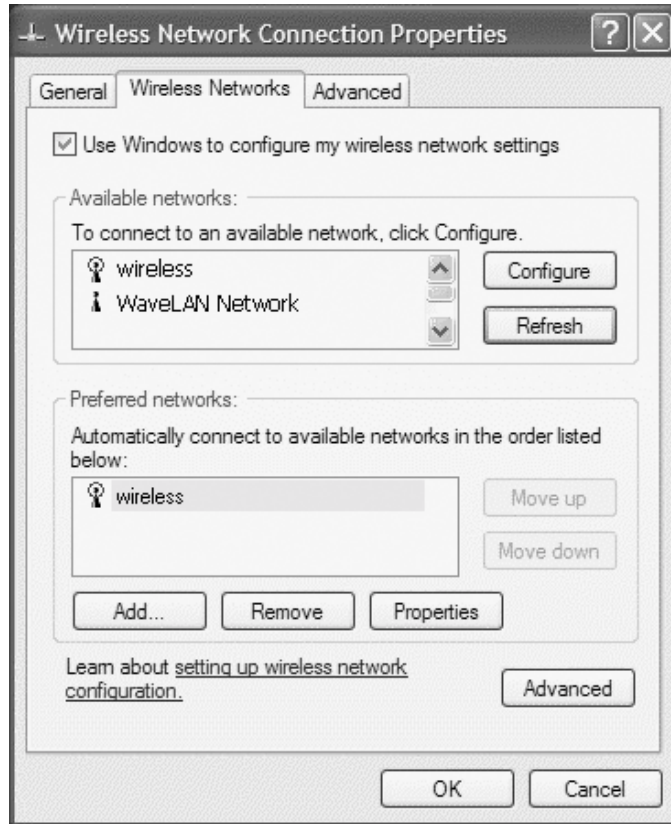

Configuring Security Settings (Optional)

Choose one of the following connection options based on the security settings for your network:

- Connecting to a Network with Wired Equivalent Protocol (WEP) Security Requirements
- Connecting to a Network with Wi-Fi Protected Access (WPA) Security Requirements

 **NOTE:** Network security settings are unique to your network. Dell cannot provide this information.

Connecting to a Network With Wired Equivalent Protocol (WEP) Security Requirements

- 1 In the **Preferred networks** field, click the name of your wireless network.
- 2 Click **Properties**.

- 3 From the **Network Authentication** drop-down menu, select **Open**.

Earlier versions of Dell wireless network software may not contain the drop-down menu. If you are using an earlier version, click to check the **Data encryption (WEP enabled)** check box and go to step 5.

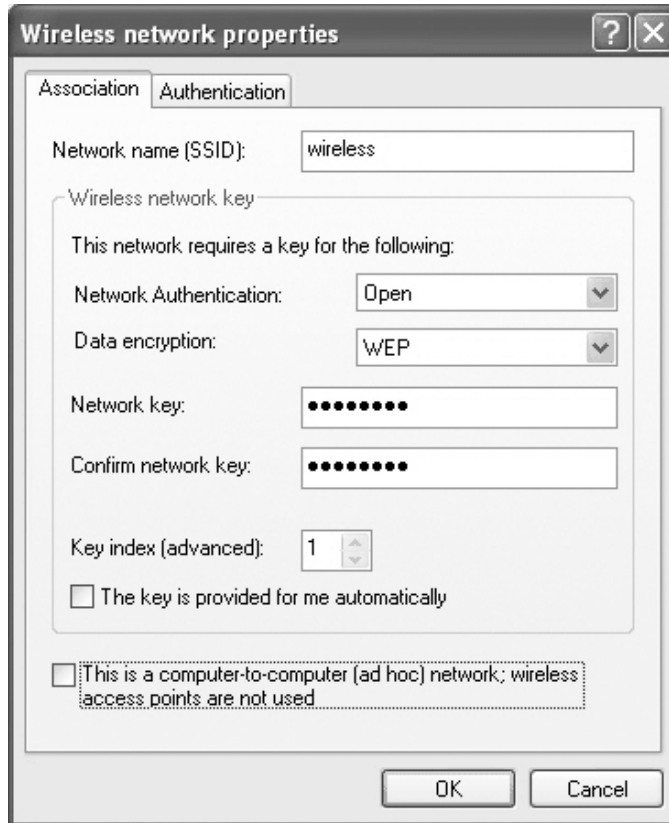

- 4 From the **Data encryption** drop-down menu, select **WEP**.
 - 5 If the wireless network does not require a network key, such as a password, go to step 9.
 - 6 Click to uncheck the **The key is provided for me automatically** check box.
 - 7 Enter the WEP network key in the **Network key** field.
 - 8 Enter the WEP network key again in the **Confirm network key** field.
-  **NOTE:** Your computer can take up to 1 minute to connect to the network.
- 9 Click **OK**.

Your network setup is complete.

Connecting to a Network With Wi-Fi Protected Access (WPA) Security Requirements

The following instructions are basic steps for connecting to a WPA network. If your network requires a user name, password, or domain settings, consult the setup instructions in the user's guide for your wireless network card.

 **NOTE:** WPA protocols require that you know the network authentication and data encryption settings for your wireless network. In addition, your WPA-protected network may require special settings such as a network key, user name, password, and domain name.

- 1 In the **Preferred networks** field, click the name of your wireless network.
- 2 Click **Properties**.
- 3 From the **Network Authentication** drop-down menu, select your network authentication type.

If you are using a WPA-protected network, and the **Association** tab does not give you the option to select WPA, download the WPA wireless security update from the Microsoft support site.

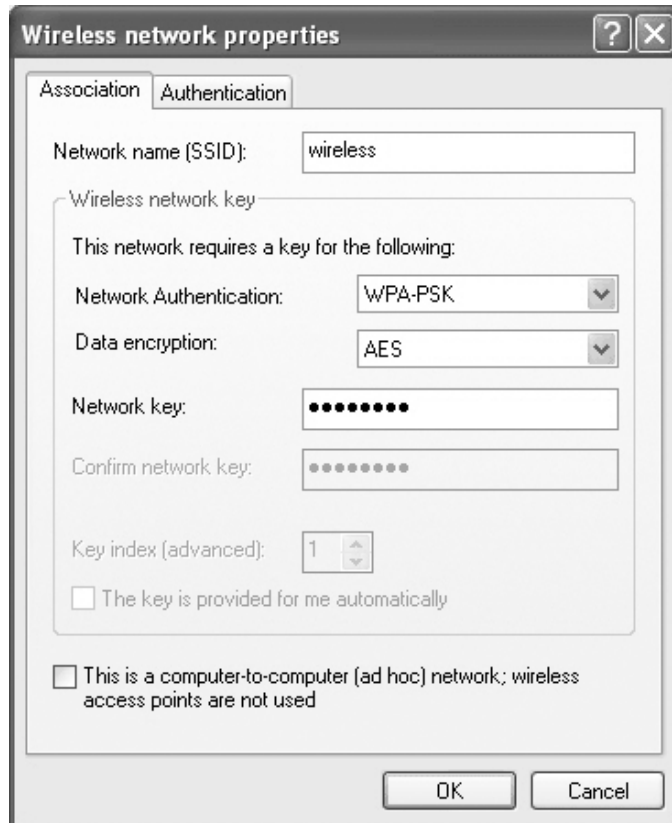

4 From the **Data encryption** drop-down menu, select your data encryption type.

5 If your wireless network requires a key, enter it in the **Network key** field.

 **NOTE:** Your computer can take up to 1 minute to connect to the network.

6 Click **OK**.

Your network setup is complete.

Solving Problems

Using the Dell Diagnostics

 **CAUTION:** Before you begin this procedure, read the safety instructions at the front of this document (see page 11).

When to Use the Dell Diagnostics

If you experience a problem with your computer, perform the checks in this chapter and run the Dell Diagnostics before you contact Dell for technical assistance.

 **NOTICE:** The Dell Diagnostics works only on Dell™ computers.

The Dell Diagnostics is located on a hidden diagnostic utility partition on your hard drive.

 **NOTE:** If your computer cannot display a screen image, contact Dell (see page 152).

- 1 Shut down the computer (see page 103).
- 2 Connect the computer to an electrical outlet.
- 3 Turn on the computer. When the DELL™ logo appears, press <F12> immediately.

 **NOTE:** If you cannot see anything on your display, hold down the mute button and press the computer's power button to begin the Dell Diagnostics. The computer automatically runs the Pre-boot System Assessment.

 **NOTE:** If you see a message stating that no diagnostics utility partition has been found, run the Dell Diagnostics from your *Drivers and Utilities* CD.

If you wait too long and the Microsoft® Windows® logo appears, continue to wait until you see the Windows desktop. Then shut down your computer through the **Start** menu and try again.

- 4 When the boot device list appears, highlight **Diagnostics** and press <Enter>.

The computer runs the Pre-boot System Assessment, a series of initial tests of your system board, keyboard, hard drive, and display.

- During the assessment, answer any questions that appear.
- If a failure is detected, the computer stops and beeps. To stop the assessment and restart the computer, press <n>; to continue to the next test, press <y>; to retest the component that failed, press <r>.

- If failures are detected during the Pre-boot System Assessment, write down the error code(s) and contact Dell (see page 152) before continuing on to the Dell Diagnostics.
 - If the Pre-boot System Assessment completes successfully, you receive the message **Booting Dell Diagnostic Utility Partition. Press any key to continue.**
- 5 Press any key to start the Dell Diagnostics from the diagnostics utility partition on your hard drive.
 - 6 When the Dell Diagnostics Main Menu appears, select the test you want to run, as described in the following section.

Dell Diagnostics Main Menu

- 1 After the Dell Diagnostics loads and the **Main Menu** screen appears, click the button for the option you want to run.

Option	Function
Express Test	Performs a quick test of devices. This test typically takes 10 to 20 minutes and requires no interaction on your part. Run Express Test first to increase the possibility of tracing the problem quickly.
Extended Test	Performs a thorough check of devices. This test typically takes an hour or more and requires you to answer questions periodically.
Custom Test	Tests a specific device. You can customize the tests you want to run.
Symptom Tree	Lists the most common symptoms encountered and allows you to select a test based on the symptom of the problem you are having.

- 2 If a test detects a problem with a device, a message appears with an error code and a description of the problem. Write down the error code and problem description and follow the instructions on the screen.

If you cannot resolve the error condition, contact Dell (see "Contacting Dell" on page 152).

 **NOTE:** The Service Tag for your computer is located at the top of each test screen. If you contact Dell, a technical support representative will ask for your Service Tag.

- 3 If you run a test from the **Custom Test** or **Symptom Tree** option, click the applicable tab described in the following table for more information.

Tab	Function
Results	Displays the results of the test and any error conditions encountered.
Errors	Displays error conditions encountered, error codes, and the problem description.
Help	Describes the test and may indicate requirements for running the test.
Configuration	Displays your hardware configuration for the selected device. The Dell Diagnostics obtains configuration information for all devices from the system setup program, memory, and various internal tests, and it displays the information in the device list in the left pane of the screen. The device list may not display the names of all the components installed on your computer or all devices attached to your computer.
Parameters	Allows you to customize the test by changing the test settings.

- 4 When the tests are complete, close the test screen to return to the **Main Menu** screen. To exit the Dell Diagnostics and restart the computer, close the **Main Menu** screen.

Error Messages

If the message is not listed, see the documentation for the operating system or the program that was running at the time the message appeared.

THE FILE BEING COPIED IS TOO LARGE FOR THE DESTINATION DRIVE — The file that you are trying to copy is too large to fit on the disk, or the disk is too full. Try copying the file to a different disk or use a larger capacity disk.

A FILENAME CANNOT CONTAIN ANY OF THE FOLLOWING CHARACTERS: \ / : * ? " < > | — Do not use these characters in filenames.

INSERT BOOTABLE MEDIA — The operating system is trying to boot to a nonbootable floppy disk or CD. Insert a bootable floppy disk or CD.

NON-SYSTEM DISK OR DISK ERROR — A floppy disk is in the floppy drive. Remove the floppy disk and restart the computer.

NTLDR IS MISSING — Essential system files are missing or corrupt. Use the following instructions to make new copies of the files from your *Operating System CD*:

- 1 Insert the *Operating System CD* and turn on your computer.
- 2 At the **Welcome to Setup** screen, press <r> to choose **Repair using Recovery Console**.
- 3 When prompted for the particular Windows XP installation you want to log onto, press <l>.
- 4 In the next screen you will be prompted to enter the administrator password; enter the password if you have one. If no password is set, press <Enter>.
- 5 When `c:\winnt>` (or `c:\>`) appears, type: `copy x:\i386\ntldr c:\`
- 6 The message `1 file(s) copied` appears.
- 7 Type `copy x:\i386\ntdetect.com c:\` (where x: is the drive letter of your CD drive).
- 8 The message `1 file(s) copied` appears.
- 9 Remove the *Operating System CD* and press <Ctrl><Alt> to shut down and then restart the computer.

NOT ENOUGH MEMORY OR RESOURCES. EXIT SOME PROGRAMS AND TRY AGAIN — You have too many programs open. Close all windows and open the program that you want to use.

OPERATING SYSTEM NOT FOUND — Contact Dell (see page 152).

A REQUIRED .DLL FILE WAS NOT FOUND — The program that you are trying to open is missing an essential file. Remove and then reinstall the program.

- 1 Click the **Start** button.
- 2 Click **Control Panel**.
- 3 Click **Add or Remove Programs**.
- 4 Select the program you want to remove.
- 5 Click **Remove** or **Change/Remove** and follow the prompts on the screen.
- 6 See the program documentation for installation instructions.



X:\ IS NOT ACCESSIBLE. THE DEVICE IS NOT READY — Insert a disk into the drive and try again.

Video and Display Problems

If the display is blank

 **NOTE:** If you are using a program that requires a higher resolution than your computer supports, it is recommended that you attach an external monitor to your computer.

CHECK THE  LIGHT — When the  light is blinking, the computer has power.

- If the  light is blinking, the computer is in standby mode—press the power button to exit standby mode.
- If the  light is off, press the power button.
- If the  light is on, your power management settings may have caused the display to turn off. Try pressing any key or move the cursor to exit standby mode.

CHECK THE BATTERY — If you are using a battery to power your computer, the battery charge may be depleted. Connect the computer to an electrical outlet using the AC adapter, and turn on the computer.

TEST THE ELECTRICAL OUTLET — Ensure that the electrical outlet is working by testing it with another device, such as a lamp.

CHECK THE AC ADAPTER — Check the AC adapter cable connections. If the AC adapter has a light, ensure that it is on.

CONNECT THE COMPUTER DIRECTLY TO AN ELECTRICAL OUTLET — Bypass power protection devices, power strips, and the extension cable to verify that the computer turns on.

ADJUST THE POWER PROPERTIES — Search for the keyword *standby* in the Windows Help and Support Center. To access the Help and Support Center, see page 19.

SWITCH THE VIDEO IMAGE — If your computer is attached to an external monitor, press <Fn><F8> to switch the video image to the display.

If the display is difficult to read

ADJUST THE BRIGHTNESS — See the *Dell Inspiron Help* file for instructions on adjusting the brightness. To access the help file, see page 18.

MOVE YOUR EXTERNAL SUBWOOFER AWAY FROM THE COMPUTER OR MONITOR — If your external speaker system includes a subwoofer, ensure that the subwoofer is at least 60 cm (2 ft) away from the computer or external monitor.

ELIMINATE POSSIBLE INTERFERENCE — Turn off nearby fans, fluorescent lights, halogen lamps, or other appliances.

ROTATE THE COMPUTER TO FACE A DIFFERENT DIRECTION — Eliminate sunlight glare, which can cause poor picture quality.

ADJUST THE WINDOWS DISPLAY SETTINGS

- 1 Click the **Start** button and then click **Control Panel**.
- 2 Click **Appearance and Themes**.
- 3 Click the area you want to change or click the **Display** icon.
- 4 Try different settings for **Color quality** and **Screen resolution**.

SEE "ERROR MESSAGES" — If an error message appears, see "Error Messages" on page 77.

If only part of the display is readable

CONNECT AN EXTERNAL MONITOR

- 1 Turn off your computer and connect an external monitor to the computer.
- 2 Turn on the computer and the monitor and adjust the monitor brightness and contrast controls.

If the external monitor works, the computer display or video controller may be defective. Contact Dell (see page 152).

Scanner Problems

CHECK THE POWER CABLE CONNECTION — Ensure that the scanner power cable is firmly connected to a working electrical power source and that the scanner is turned on.

CHECK THE SCANNER CABLE CONNECTION — Ensure that the scanner cable is firmly connected to the computer and to the scanner.

UNLOCK THE SCANNER — Ensure that your scanner is unlocked if it has a locking tab or button.

REINSTALL THE SCANNER DRIVER — See the scanner documentation for instructions.

Hard Drive Problems



NOTE: For information on saving files to a floppy disk, see the *Dell Inspiron Help* file. To access the help file, see page 18.

If you have problems with a hard drive

ALLOW THE COMPUTER TO COOL BEFORE TURNING IT ON — A hot hard drive may prevent the operating system from starting. Try allowing the computer to return to room temperature before turning it on.

CHECK THE DRIVE FOR ERRORS

- 1 Click the **Start** button and click **My Computer**.
- 2 Right-click the drive letter (local disk) that you want to scan for errors, and then click **Properties**.
- 3 Click the **Tools** tab.
- 4 Under **Error-checking**, click **Check Now**.
- 5 Click **Start**.

PC Card Problems

CHECK THE PC CARD — Ensure that the PC Card is properly inserted into the connector.

ENSURE THAT THE CARD IS RECOGNIZED BY WINDOWS® — Double-click the **Unplug** or **Eject Hardware** icon in the Windows taskbar. Ensure that the card is listed.

IF YOU HAVE PROBLEMS WITH A DELL-PROVIDED PC CARD — Contact Dell (see page 152).

IF YOU HAVE PROBLEMS WITH A PC CARD NOT PROVIDED BY DELL — Contact the PC Card manufacturer.

External Keyboard Problems

 **NOTE:** When you attach an external keyboard, the integrated keyboard remains fully functional.

CHECK THE KEYBOARD CABLE — Shut down the computer (see page 103). Disconnect the keyboard cable and check it for damage.

If you are using a keyboard extension cable, disconnect it and connect the keyboard directly to the computer.

CHECK THE EXTERNAL KEYBOARD

- 1 Turn off the computer, wait 1 minute, and turn it on again.
- 2 Verify that the numbers, capitals, and scroll lock lights on the keyboard blink during the boot routine.
- 3 From the Windows® desktop, click the **Start** button, point to **Programs**, point to **Accessories**, and click **Notepad**.
- 4 Type some characters on the external keyboard and verify that they appear on the display.

If you cannot verify these steps, you may have a defective external keyboard.

TO VERIFY THAT THE PROBLEM IS WITH THE EXTERNAL KEYBOARD, CHECK THE INTEGRATED KEYBOARD

- 1 Turn off the computer.
- 2 Disconnect the external keyboard.
- 3 Turn on the computer.
- 4 From the Windows desktop, click the **Start** button, point to **Programs**, point to **Accessories**, and click **Notepad**.
- 5 Type some characters on the external keyboard and verify that they appear on the display.

If the characters appear now but did not with the external keyboard, you may have a defective external keyboard. Contact Dell (see page 152).

Power Problems



NOTE: See the *Dell Inspiron Help* file for information on standby mode. To access the help file, see page 18.

CHECK THE POWER LIGHT — When the power light is lit or blinking, the computer has power. If the power light is blinking, the computer is in standby mode—press the power button to exit standby mode. If the light is off, press the power button to turn on the computer.

CHARGE THE BATTERY — The battery charge may be depleted.

- 1 Reinstall the battery.
- 2 Use the AC adapter to connect the computer to an electrical outlet.
- 3 Turn on the computer.

CHECK THE BATTERY STATUS LIGHT — If the battery status light flashes orange or is a steady orange the battery charge is low or depleted. Connect the computer to an electrical outlet.

If the battery status light flashes green and orange, the battery is too hot to charge. Turn off the computer, disconnect the computer from the electrical outlet, and then let the battery and computer cool to room temperature.

If the battery status light rapidly flashes orange, the battery may be defective. Contact Dell (see page 152).

TEST THE ELECTRICAL OUTLET — Ensure that the electrical outlet is working by testing it with another device, such as a lamp.

CHECK THE AC ADAPTER — Check the AC adapter cable connections. If the AC adapter has a light, ensure that the light is on.

CONNECT THE COMPUTER DIRECTLY TO AN ELECTRICAL OUTLET — Bypass power protection devices, power strips, and the extension cable to verify that the computer turns on.

ELIMINATE POSSIBLE INTERFERENCE — Turn off nearby fans, fluorescent lights, halogen lamps, or other appliances.

ADJUST THE POWER PROPERTIES — See the *Dell Inspiron Help* file or search for the keyword *standby* in the Windows Help and Support Center. To access help, see page 18.

RESEAT THE MEMORY MODULES — If the computer power light turns on but the display remains blank, reseat the memory modules. (For instructions, see "Memory" on page 105.)

Unexpected Characters

DISABLE THE NUMERIC KEYPAD — Press <Fn><Num Lk> to disable the numeric keypad if numbers are displayed instead of letters. Verify that the numbers lock light is not lit.

Touch Pad or Mouse Problems

CHECK THE TOUCH PAD SETTINGS

- 1 Click the **Start** button, click **Control Panel**, and then click **Printers and Other Hardware**.
- 2 Click **Mouse**.
- 3 Try adjusting the settings.

CHECK THE MOUSE CABLE — Shut down the computer (see page 103). Disconnect the mouse cable and check it for damage. Firmly reconnect the cable. If you are using a mouse extension cable, disconnect it and connect the mouse directly to the computer.

TO VERIFY THAT THE PROBLEM IS WITH THE MOUSE, CHECK THE TOUCH PAD

- 1 Turn off the computer.
- 2 Disconnect the mouse.
- 3 Turn on the computer.
- 4 At the Windows desktop, use the touch pad to move the cursor around, select an icon, and open it.

If the touch pad operates correctly, the mouse may be defective.

REINSTALL THE TOUCH PAD DRIVER — See "Reinstalling Drivers and Utilities" on page 94.

Printer Problems

CHECK THE PRINTER CABLE CONNECTIONS — Ensure that the printer cable is properly connected to the computer.

TEST THE ELECTRICAL OUTLET — Ensure that the electrical outlet is working by testing it with another device, such as a lamp.

ENSURE THAT THE PRINTER IS TURNED ON — See the documentation supplied with the printer.

VERIFY THAT WINDOWS® RECOGNIZES THE PRINTER



- 1 Click the Start button.
- 2 Click Control Panel.
- 3 Click Printers and Other Hardware.
- 4 Click View installed printers or fax printers. If the printer model is listed, right-click the printer icon.
- 5 Click Properties, and then click the Ports tab. Ensure that the Print to the following port(s): setting is USB.

REINSTALL THE PRINTER DRIVER — See the documentation supplied with the printer.

E-Mail Problems

ENSURE THAT YOU ARE CONNECTED TO THE INTERNET — With the Outlook Express e-mail program open, click **File**. If **Work Offline** has a check mark next to it, click the check mark to remove it and connect to the Internet.

Modem and Internet Connection Problems

-  **NOTICE:** Connect the modem to an analog telephone wall jack only. Connecting the modem to a digital telephone network damages the modem.
-  **NOTICE:** Modem and network connectors look similar. Do not plug a telephone line into the network connector.
-  **NOTE:** If you can connect to your Internet service provider (ISP), your modem is functioning properly. If you are sure that your modem is working properly and you still experience problems, contact your ISP.

CHECK THE TELEPHONE WALL JACK — Disconnect the telephone line from the modem and connect it to a telephone. Listen for a dial tone. Ensure that you have touchtone telephone service. Try connecting the modem to a different telephone wall jack.

Slow connection speeds can be caused by telephone noise as well as by telephone line or network conditions. Contact your telephone company or network administrator for more information.

CONNECT THE MODEM CABLE DIRECTLY TO THE TELEPHONE WALL JACK — If you have other telephone devices sharing the line, such as an answering machine, fax machine, surge protector, or line splitter, then bypass them and use the telephone line to connect the modem directly to the telephone wall jack.

CHECK THE CONNECTION — Verify that the telephone line is connected to the modem.

CHECK THE TELEPHONE LINE — Try using a different telephone line. If you are using a line that is 3 m (10 ft) or more in length, try a shorter one.

IRREGULAR DIAL TONE — If you have voice mail service, you might hear an irregular dial tone when you have messages. Contact your telephone company for instructions on restoring a dial tone.

TURN OFF CALL WAITING (CATCH-PHONE) — See your telephone directory for instructions on deactivating this feature. Then adjust the dial-up networking connection properties.

- 1 Click the **Start** button and click **Control Panel**.
- 2 Click **Printers and Other Hardware**, click **Phone and Modem Options**, click the **Dialing Rules** tab, and then click **Edit...**
- 3 In the **Edit Location** window, ensure that **To disable call waiting, dial:** is checked, and then select the proper code as listed in your telephone directory.
- 4 Click **Apply** and click **OK**.
- 5 Close the **Phone and Modems Options** window.
- 6 Close the **Control Panel** window.

VERIFY THAT THE MODEM IS COMMUNICATING WITH WINDOWS

- 1 Click the **Start** button and click **Control Panel**.
- 2 Click **Printers and Other Hardware** and click **Phone and Modem Options**.
- 3 Click the **Modems** tab.
- 4 Click the COM port for your modem.
- 5 Click **Properties**, click the **Diagnostics** tab, and then click **Query Modem** to verify that the modem is communicating with Windows.

If all commands receive responses, the modem is operating properly.

Network Problems

CHECK THE NETWORK CABLE CONNECTOR — Ensure that the network cable connector is firmly connected to the optional connector on the computer and the network wall jack.

CHECK THE NETWORK LIGHTS ON THE NETWORK CONNECTOR —

Green indicates that the network connection is active. If the status light is not green, try replacing the network cable. Amber indicates that the optional network adapter driver is loaded and the adapter is detecting activity.

RESTART THE COMPUTER — Try to log on to the network again.

CONTACT YOUR NETWORK ADMINISTRATOR — Verify that your network settings are correct and that the network is functioning.

General Program Problems

A program crashes

 **NOTE:** Software usually includes installation instructions in its documentation or on a floppy disk or CD.

SEE THE SOFTWARE DOCUMENTATION — Many software manufacturers maintain websites with information that may help you solve the problem. Ensure that you properly installed and configured the program. Reinstall the program if necessary.

A program stops responding

END THE PROGRAM

- 1 Simultaneously press <Ctrl><Shift><Esc>.
- 2 Click the **Applications** tab, and then select the program that is no longer responding.
- 3 Click **End Task**.

A solid blue screen appears

TURN THE COMPUTER OFF — If the computer does not respond to a keystroke or a proper shutdown (see page 103), press the power button until the computer turns off. Press the power button again to restart the computer. The solid blue screen appears because you were not able to perform a proper Windows® shutdown. ScanDisk automatically runs during the start-up process. Follow the instructions on the screen.

Error messages appear

REVIEW "ERROR MESSAGES" — Look up the message and take the appropriate action. See the software documentation.

CD or DVD Problems

If you cannot play a CD, CD-RW, or DVD

 **NOTE:** Because of different worldwide file types, not all DVD titles work in all DVD drives.

High-speed CD drive vibration is normal and may cause noise. This noise does not indicate a defect with the drive or the CD.

ENSURE THAT WINDOWS® RECOGNIZES THE DRIVE — Click the **Start** button and click **My Computer**, or right-click the **Start** button and click **Explorer**. If the drive is not listed, perform a full scan with your antivirus software to check for and remove viruses. Viruses can sometimes prevent Windows from recognizing the drive. Insert a bootable disk and restart the computer. Verify that the  light is blinking, indicating normal operation.

TRY ANOTHER DISC — Insert another disc to eliminate the possibility that the original disc is defective.

ADJUST THE WINDOWS VOLUME CONTROL — Double-click the speaker icon in the lower-right corner of your screen. Ensure that the volume is turned up and that the sound is not muted.

REINSTALL THE DRIVE

- 1 Save and close any open files, exit any open programs, and shut down the computer (see page 103).
- 2 Remove the drive. See "Using the Module Bay" on page 55 for instructions.
- 3 Reinstall the drive.
- 4 Turn on the computer.

CLEAN THE DRIVE OR DISC — See "Cleaning Your Computer" in the *Dell Inspiron Help* file for instructions. To access the help file, see page 18.

If you cannot eject the CD, CD-RW, or DVD drive tray

- 1 Ensure that the computer is turned off.
- 2 Straighten a paper clip and insert one end into the eject hole at the front of the drive; push firmly until the tray is partially ejected.
- 3 Gently pull out the tray until it stops.

If you hear an unfamiliar scraping or grinding sound

- Ensure that the sound is not caused by the program that is running.
- Ensure that the disk or disc is inserted properly.

If the CD-RW drive stops writing

DISABLE STANDBY MODE IN WINDOWS BEFORE WRITING TO A CD-RW —

Search for the keyword *standby* in the Windows Help and Support Center. To access the Help and Support Center, see page 19.

CHANGE THE WRITE SPEED TO A SLOWER RATE — See the help files for your CD creation software.

EXIT ALL OTHER OPEN PROGRAMS — Exiting all other open programs before writing to the CD-RW may alleviate the problem.

Sound and Speaker Problems

If you have a problem with integrated speakers

ADJUST THE WINDOWS® VOLUME CONTROL — Double-click the speaker icon in the lower-right corner of your screen. Ensure that the volume is turned up and that the sound is not muted.

ADJUST THE VOLUME USING KEYBOARD SHORTCUTS — Press <Fn><End> to disable (mute) or re-enable the integrated speakers.

REINSTALL THE SOUND (AUDIO) DRIVER — See "Reinstalling Drivers and Utilities" on page 94.

If you have a problem with external speakers

 **NOTE:** The volume control in some MP3 players overrides the Windows volume setting. If you have been listening to MP3 songs, make sure that you did not turn the player volume down or off.

CHECK THE SPEAKER CABLE CONNECTIONS — See the setup diagram supplied with the speakers.

TEST THE ELECTRICAL OUTLET — Ensure that the electrical outlet is working by testing it with another device, such as a lamp.

ENSURE THAT THE SPEAKERS ARE TURNED ON — See the setup diagram supplied with the speakers.

ADJUST THE WINDOWS VOLUME CONTROL — Double-click the speaker icon in the lower-right corner of your screen. Ensure that the volume is turned up and that the sound is not muted. Adjust the volume, bass, or treble controls to eliminate distortion.

TEST THE SPEAKERS — Plug the speaker audio cable into the line-out connector on the computer. Ensure that the headphone volume control is turned up. Play a music CD.

RUN THE SPEAKER SELF-TEST — Some speaker systems have a self-test button on the subwoofer. See the speaker documentation for self-test instructions.

ELIMINATE POSSIBLE INTERFERENCE — Turn off nearby fans, fluorescent lights, or halogen lamps to check for interference.

REINSTALL THE SOUND (AUDIO) DRIVER — See "Reinstalling Drivers and Utilities" on page 94.

E-Mail, Modem, and Internet Problems



CAUTION: Before you begin any of the procedures in this section, follow the safety instructions in the *Product Information Guide*.



NOTE: Connect the modem to an analog telephone jack only. The modem does not operate while it is connected to a digital telephone network.

CHECK THE MICROSOFT OUTLOOK® EXPRESS SECURITY SETTINGS — If you cannot open your e-mail attachments:

- 1 In Outlook Express, click **Tools**, click **Options**, and then click **Security**.
- 2 Click **Do not allow attachments** to remove the checkmark.

CHECK THE TELEPHONE LINE CONNECTION —

CHECK THE TELEPHONE JACK —

CONNECT THE MODEM DIRECTLY TO THE TELEPHONE WALL JACK —

USE A DIFFERENT TELEPHONE LINE —

- Verify that the telephone line is connected to the jack on the modem. (The jack has either a green label or a connector-shaped icon next to it.)
- Ensure that you hear a click when you insert the telephone line connector into the modem.
- Disconnect the telephone line from the modem and connect it to a telephone. Listen for a dial tone.
- If you have other telephone devices sharing the line, such as an answering machine, fax machine, surge protector, or line splitter, then bypass them and use the telephone to connect the modem directly to the telephone wall jack. If you are using a line that is 3 m (10 ft) or more in length, try a shorter one.

RUN THE MODEM HELPER DIAGNOSTICS — Click the **Start** button, point to **All Programs**, and then click **Modem Helper**. Follow the instructions on the screen to identify and resolve modem problems. (Modem Helper is not available on all computers.)

VERIFY THAT THE MODEM IS COMMUNICATING WITH WINDOWS —

- 1 Click the **Start** button and click **Control Panel**.
 - 2 Click **Printers and Other Hardware**.
 - 3 Click **Phone and Modem Options**.
 - 4 Click the **Modems** tab.
 - 5 Click the COM port for your modem.
 - 6 Click **Properties**, click the **Diagnostics** tab, and then click **Query Modem** to verify that the modem is communicating with Windows.
- If all commands receive responses, the modem is operating properly.

ENSURE THAT YOU ARE CONNECTED TO THE INTERNET — Ensure that you have subscribed to an Internet provider. With the Outlook Express e-mail program open, click **File**. If **Work Offline** has a checkmark next to it, click the checkmark to remove it and connect to the Internet. For help, contact your Internet service provider.

SCAN THE COMPUTER FOR SPYWARE — If you are experiencing slow computer performance, you frequently receive pop-up advertisements, or you are having problems connecting to the Internet, your computer might be infected with spyware. Use an anti-virus program that includes anti-spyware protection (your program may require an upgrade) to scan the computer and remove spyware. For more information, go to support.dell.com and search for the keyword *spyware*.

Resolving Other Technical Problems

GO TO THE DELL SUPPORT WEBSITE — Go to support.dell.com for help with general usage, installation, and troubleshooting questions. See "Dell Technical Support Policy (U.S. Only)" on page 152 for a description of the hardware and software support provided by Dell.

E-MAIL DELL — Go to support.dell.com and then click **E-Mail Dell** in the **Communicate** list. Send an e-mail message to Dell about your problem; you can expect to receive an e-mail message from Dell within hours. See "Dell Technical Support Policy (U.S. Only)" on page 152 for a description of the hardware and software support provided by Dell.

CONTACT DELL — If you cannot solve your problem using the Dell™ support website or e-mail service, call Dell for technical assistance (see page 152). See "Dell Technical Support Policy (U.S. Only)" on page 152 for a description of the hardware and software support provided by Dell.

Drivers

What Is a Driver?

A driver is a program that controls a device such as a printer, mouse, or keyboard. All devices require a driver program. A driver acts like a translator between the device and any other programs that use the device. Each device has its own set of specialized commands that only its driver recognizes.

Dell ships your computer to you with required drivers already installed—no further installation or configuration is needed.

 **NOTICE:** The *Drivers and Utilities* CD may contain drivers for operating systems that are not on your computer. Ensure that you are installing software appropriate for your operating system.

Many drivers, such as the keyboard driver, come with your Microsoft® Windows® operating system. You may need to install drivers if you:

- Upgrade your operating system.
- Reinstall your operating system.
- Connect or install a new device.

Identifying Drivers

If you experience a problem with any device, identify whether the driver is the source of your problem and, if necessary, update the driver.

- 1 Click the **Start** button and click **Control Panel**.
- 2 Under **Pick a Category**, click **Performance and Maintenance**.
- 3 Click **System**.
- 4 In the **System Properties** window, click the **Hardware** tab.
- 5 Click **Device Manager**.
- 6 Scroll down the list to see if any device has an exclamation point (a yellow circle with a [!]) on the device icon.

If an exclamation point is next to the device name, you may need to reinstall the driver or install a new driver as described in the following section.

Reinstalling Drivers and Utilities

 **NOTICE:** The Dell Support website at support.dell.com and your *Drivers and Utilities* CD provide approved drivers for Dell™ computers. If you install drivers obtained from other sources, your computer might not work correctly.

Using Windows XP Device Driver Rollback

If a problem occurs on your computer after you install or update a driver, use Windows XP Device Driver Rollback to replace the driver with the previously installed version.

- 1 Click the **Start** button and click **Control Panel**.
- 2 Under **Pick a Category**, click **Performance and Maintenance**.
- 3 Click **System**.
- 4 In the **System Properties** window, click the **Hardware** tab.
- 5 Click **Device Manager**.
- 6 Right-click the device for which the new driver was installed and click **Properties**.

- 7 Click the **Drivers** tab.
- 8 Click **Roll Back Driver**.

If Device Driver Rollback does not resolve the problem, then use System Restore (see page 97) to return your computer to the operating state that existed before you installed the new driver.

Using the Drivers and Utilities CD

If using Device Driver Rollback or System Restore does not resolve the problem, then reinstall the driver from the *Drivers and Utilities* CD.

- 1 Save and close any open files, and exit any open programs.
- 2 Insert the *Drivers and Utilities* CD.

In most cases, the CD starts running automatically. If it does not, start Windows Explorer, click your CD drive directory to display the CD contents, and then double-click the **autorcd.exe** file. The first time that you run the CD, it might prompt you to install setup files. Click **OK**, and follow the instructions on the screen to continue.

- 3 From the **Language** drop-down menu in the toolbar, select your preferred language for the driver or utility (if available). A welcome screen appears.
- 4 Click **Next**.

The CD automatically scans your hardware to detect drivers and utilities used by your computer.

- 5 After the CD completes the hardware scan, you can also detect other drivers and utilities. Under **Search Criteria**, select the appropriate categories from the **System Model**, **Operating System**, and **Topic** drop-down menus.

A link or links appear(s) for the specific drivers and utilities used by your computer.

- 6 Click the link of a specific driver or utility to display information about the driver or utility that you want to install.
- 7 Click the **Install** button (if present) to begin installing the driver or utility. At the welcome screen, follow the screen prompts to complete the installation.

If no **Install** button is present, automatic installation is not an option. For installation instructions, either see the appropriate instructions in the following sections, or click **Extract**, follow the extracting instructions, and then read the readme file.

If instructed to navigate to the driver files, click the CD directory on the driver information window to display the files associated with that driver.

Manually Reinstalling Drivers



NOTE: If you are reinstalling an infrared sensor driver, you must first enable the infrared sensor (see page 151) in the system setup program before continuing with the driver installation.

- 1 After extracting the driver files to your hard drive as described in the previous section, click the **Start** button and right-click **My Computer**.
- 2 Click **Properties**.
- 3 Click the **Hardware** tab and click **Device Manager**.
- 4 Double-click the type of device for which you are installing the driver (for example, **Modems** or **Infrared devices**).
- 5 Double-click the name of the device for which you are installing the driver.
- 6 Click the **Driver** tab and click **Update Driver**.
- 7 Click **Install from a list or specific location (Advanced)** and click **Next**.
- 8 Click **Browse** and browse to the location to which you previously extracted the driver files.
- 9 When the name of the appropriate driver appears, click **Next**.
- 10 Click **Finish** and restart your computer.

Resolving Software and Hardware Incompatibilities

If a device is either not detected during the operating system setup or is detected but incorrectly configured, you can use Device Manager or the Hardware Troubleshooter to resolve the incompatibility.

To resolve incompatibilities using Device Manager:

- 1 Click the **Start** button and click **Control Panel**.
- 2 Click **Performance and Maintenance** and click **System**.
- 3 Click the **Hardware** tab and click **Device Manager**.
- 4 In the **Device Manager** list, check for devices that are incorrectly configured. Incorrectly configured devices are indicated by a yellow exclamation point (!) or a red x if the device has been disabled.
- 5 Double-click any device marked with an exclamation point to display the **Properties** window. The **Device** status area in the **Properties** window reports the cards or devices that need to be reconfigured.
- 6 Reconfigure the devices or remove the devices from the **Device Manager**. See the documentation that came with the device for information on configuring the device.

To resolve incompatibilities using the Hardware Troubleshooter:

- 1 Click the **Start** button and click **Help and Support**.
- 2 Type `hardware troubleshooter` in the **Search** field and click the arrow to start the search.
- 3 Click **Hardware Troubleshooter** in the **Search Results** list.
- 4 In the **Hardware Troubleshooter** list, click **I need to resolve a hardware conflict on my computer**, and click **Next**.

Using Microsoft® Windows® XP System Restore

The Microsoft Windows XP operating system provides System Restore to allow you to return your computer to an earlier operating state (without affecting data files) if changes to the hardware, software, or other system settings have left the computer in an undesirable operating state. See the Windows Help and Support Center for information on using System Restore. To access the Help and Support Center, see page 19.



NOTICE: Make regular backups of your data files. System Restore does not monitor your data files or recover them.

Creating a Restore Point

- 1 Click the **Start** button and click **Help and Support**.
- 2 Click **System Restore**.
- 3 Follow the instructions on the screen.

Restoring the Computer to an Earlier Operating State

If problems occur after you install a device driver, use Device Driver Rollback (see page 94) to resolve the problem. If that is unsuccessful, then use System Restore.



NOTICE: Before you restore the computer to an earlier operating state, save and close any open files and exit any open programs. Do not alter, open, or delete any files or programs until the system restoration is complete.

- 1 Click the **Start** button, point to **All Programs**→**Accessories**→**System Tools**, and then click **System Restore**.
- 2 Ensure that **Restore my computer to an earlier time** is selected and click **Next**.
- 3 Click a calendar date to which you want to restore your computer.

The **Select a Restore Point** screen provides a calendar that allows you to see and select restore points. All calendar dates with available restore points appear in boldface type.

- 4 Select a restore point and click **Next**.

If a calendar date has only one restore point, then that restore point is automatically selected. If two or more restore points are available, click the restore point that you prefer.

- 5 Click **Next**.

The **Restoration Complete** screen appears after System Restore finishes collecting data and then the computer restarts.

- 6 After the computer restarts, click **OK**.

To change the restore point, you can either repeat the steps using a different restore point, or you can undo the restoration.

Undoing the Last System Restore



NOTICE: Before you undo the last system restore, save and close all open files and exit any open programs. Do not alter, open, or delete any files or programs until the system restoration is complete.

- 1 Click the **Start** button, point to **All Programs**→**Accessories**→**System Tools**, and then click **System Restore**.
- 2 Click **Undo my last restoration** and click **Next**.
- 3 Click **Next**.

The **System Restore** screen appears and the computer restarts.

- 4 After the computer restarts, click **OK**.

Enabling System Restore

If you reinstall Windows XP with less than 200 MB of free hard-disk space available, System Restore is automatically disabled. To see if System Restore is enabled:

- 1 Click the **Start** button and click **Control Panel**.
- 2 Click **Performance and Maintenance**.
- 3 Click **System**.
- 4 Click the **System Restore** tab.
- 5 Ensure that **Turn off System Restore** is unchecked.

Reinstalling Microsoft® Windows® XP

Before You Begin

If you are considering reinstalling the Windows XP operating system to correct a problem with a newly installed driver, first try using Windows XP Device Driver Rollback (see page 94). If Device Driver Rollback does not resolve the problem, then use System Restore (see page 97) to return your operating system to the operating state it was in before you installed the new device driver.

-  **NOTICE:** Before performing the installation, back up all data files on your primary hard drive. For conventional hard drive configurations, the primary hard drive is the first drive detected by the computer.

To reinstall Windows XP, you need the following items:



- Dell™ *Operating System* CD
- Dell *Drivers and Utilities* CD

-  **NOTE:** The *Drivers and Utilities* CD contains drivers that were installed during assembly of the computer. Use the *Drivers and Utilities* CD to load any required drivers.

Reinstalling Windows XP

To reinstall Windows XP, perform all the steps in the following sections in the order in which they are listed.

The reinstallation process can take 1 to 2 hours to complete. After you reinstall the operating system, you must also reinstall the device drivers (see "Reinstalling Drivers and Utilities" on page 94), virus protection program, and other software.

-  **NOTICE:** The *Operating System* CD provides options for reinstalling Windows XP. The options can overwrite files and possibly affect programs installed on your hard drive. Therefore, do not reinstall Windows XP unless a Dell technical support representative instructs you to do so.
-  **NOTICE:** To prevent conflicts with Windows XP, disable any virus protection software installed on your computer before you reinstall Windows XP. See the documentation that came with the software for instructions.

Booting From the Operating System CD

- 1 Save and close any open files and exit any open programs.
- 2 Insert the *Operating System* CD. Click **Exit** if the **Install Windows XP** message appears.
- 3 Restart the computer.
- 4 Press <F12> immediately after the DELL™ logo appears.
If the operating system logo appears, wait until you see the Windows desktop, and then shut down the computer and try again.
- 5 Press the arrow keys to select **CD-ROM**, and press <Enter>.
- 6 When the **Press any key to boot from CD** message appears, press any key.

Windows XP Setup

- 1 When the **Windows XP Setup** screen appears, press <Enter> to select **To set up Windows now**.
- 2 Read the information on the **Microsoft Windows Licensing Agreement** screen, and press <F8> to accept the license agreement.

- 3 If your computer already has Windows XP installed and you want to recover your current Windows XP data, type `r` to select the repair option, and remove the CD.
- 4 If you want to install a new copy of Windows XP, press `<Esc>` to select that option.
- 5 Press `<Enter>` to select the highlighted partition (recommended), and follow the instructions on the screen.

The **Windows XP Setup** screen appears, and the operating system begins to copy files and install the devices. The computer automatically restarts multiple times.

 **NOTICE:** Do not press any key when the following message appears: Press any key to boot from the CD.

 **NOTE:** The time required to complete the setup depends on the size of the hard drive and the speed of your computer.

- 6 When the **Regional and Language Options** screen appears, select the settings for your location and click **Next**.
- 7 Enter your name and organization (optional) in the **Personalize Your Software** screen, and click **Next**.
- 8 *If you are reinstalling Windows XP Home Edition*, at the **What's your computer's name** window, enter a name for your computer (or accept the name provided) and click **Next**.
If you are reinstalling Windows XP Professional, at the **Computer Name and Administrator Password** window, enter a name for your computer (or accept the one provided) and a password, and click **Next**.
- 9 If the **Modem Dialing Information** screen appears, enter the requested information and click **Next**.
- 10 Enter the date, time, and time zone in the **Date and Time Settings** window, and click **Next**.
- 11 If the **Networking Settings** screen appears, click **Typical** and click **Next**.
- 12 If you are reinstalling Windows XP Professional and you are prompted to provide further information regarding your network configuration, enter your selections. If you are unsure of your settings, accept the default selections.

Windows XP installs the operating system components and configures the computer. The computer automatically restarts.

 **NOTICE:** Do not press any key when the following message appears: Press any key to boot from the CD.

- 13 When the **Welcome to Microsoft** screen appears, click **Next**.
- 14 When the **How will this computer connect to the Internet?** message appears, click **Skip**.
- 15 When the **Ready to register with Microsoft?** screen appears, select **No, not at this time** and click **Next**.
- 16 When the **Who will use this computer?** screen appears, you can enter up to five users.

- 17 Click **Next**.
 - 18 Click **Finish** to complete the setup, and remove the CD.
 - 19 Reinstall the appropriate drivers with the *Drivers and Utilities* CD. For instructions, see "Reinstalling Drivers and Utilities" on page 94.
 - 20 Reinstall your virus protection software.
 - 21 Reinstall your programs.
-  **NOTE:** To reinstall and activate your Microsoft Office or Microsoft Works Suite programs, you need the Product Key number located on the back of the Microsoft Office or Microsoft Works Suite CD sleeve.

Adding and Replacing Parts

Before You Begin

This chapter provides procedures for removing and installing the components in your computer. Unless otherwise noted, each procedure assumes that the following conditions exist:

- You have performed the steps in "Shutting Down Your Computer" (see page 103).
- You have read the safety information (see page 11).



NOTE: Unless otherwise noted, each procedure in this chapter assumes that a part can be replaced by performing the removal procedure in the reverse order.

Recommended Tools

The procedures in this chapter may require the following tools:

- Small flat-blade screwdriver
- Phillips screwdriver
- Small plastic scribe
- Flash BIOS update program floppy disk or CD

Shutting Down Your Computer

Use the following safety guidelines to help protect your computer from potential damage and to help ensure your own personal safety.



CAUTION: Before you begin this procedure, read the safety instructions at the front of this document (see page 11).



CAUTION: Handle components and cards with care. Do not touch the components or contacts on a card. Hold a card by its edges or by its metal mounting bracket. Hold a component such as a memory module by its side edges, not by its connector edge.



NOTICE: Only a certified service technician should perform repairs on your computer. Damage due to servicing that is not authorized by Dell is not covered by your warranty.



NOTICE: When you disconnect a cable, pull on its connector or on its strain-relief loop, not on the cable itself. Some cables have a connector with locking tabs; if you are disconnecting this type of cable, press in on the locking tabs before you disconnect the cable. As you pull connectors apart, keep them evenly aligned to avoid bending any connector pins. Also, before you connect a cable, ensure that both connectors are correctly oriented and aligned.

- ➔ **NOTICE:** To avoid damaging the computer, perform the following steps before you begin working inside the computer.
- 1 Ensure that the work surface is flat and clean to prevent the computer cover from being scratched.
 - 2 Shut down the computer (see page 103).
 - 3 Ensure that the computer and any attached devices are turned off. If your computer and attached devices did not automatically turn off when you shut down your computer, press and hold the power button for 4 seconds.
- ➔ **NOTICE:** To disconnect a network cable, first unplug the cable from your computer and then unplug it from the network wall jack.
- 4 Disconnect any telephone or telecommunication lines from the computer.
 - 5 Disconnect your computer and all attached devices from their electrical outlets, and then press the power button to ground the system board.
- ➔ **NOTICE:** To connect a network cable, first plug the cable into the network wall jack and then plug it into the computer.
- 6 Remove any installed PC Cards from the PC Card slot.
 - 7 Close the display and turn the computer upside down on a flat work surface.
- ➔ **NOTICE:** To avoid damaging the system board, you must remove the main battery before you begin working inside the computer.
- 8 Slide and hold the battery-bay latch release on the bottom of the computer, and then remove the battery from the bay.

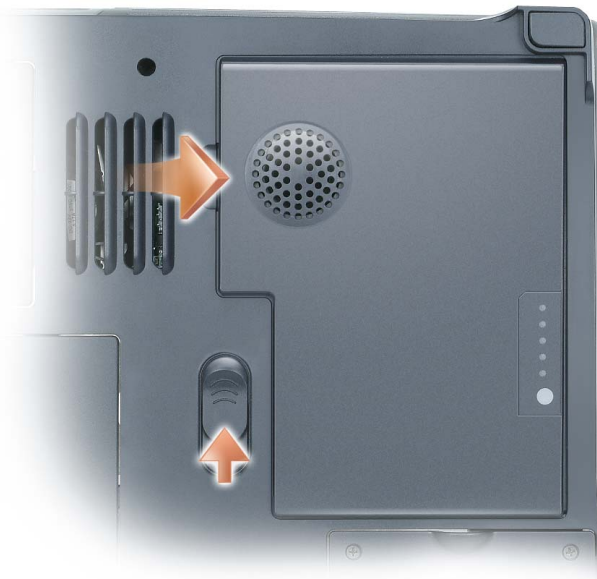

- 9 Remove any installed module from the module bay.
- 10 Remove the hard drive (see page 111).

Memory

You can increase your computer memory by installing memory modules on the system board. See "Specifications" on page 144 for information on the memory supported by your computer. Install only memory modules that are intended for your computer.

CAUTION: Before you begin this procedure, read the safety instructions at the front of this document (see page 11).

NOTICE: To avoid damaging the system board, you must remove the main battery before you begin working inside the computer (see page 52).

NOTE: Memory modules purchased from Dell are covered under your computer warranty.

NOTE: This computer requires matched memory modules and therefore always has two identical memory modules.

- 1 Follow the procedures in "Before You Begin" (see page 103).
- 2 Turn the computer over, unscrew the captive screw labeled "M", and remove the memory module cover.

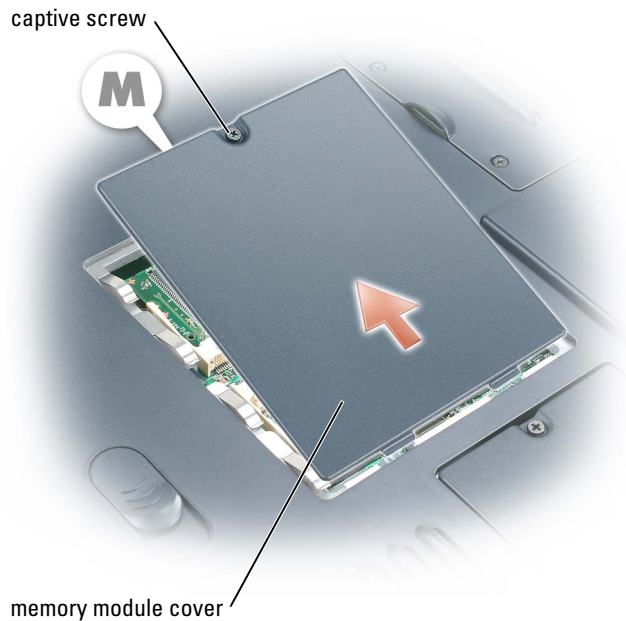

- ➔ **NOTICE:** To prevent damage to the memory module connector, do not use tools to spread the memory-module securing clips.
- 3 If you are replacing a memory module, ground yourself and remove the existing module:
- Use your fingertips to carefully spread apart the securing clips on each end of the memory module connector until the module pops up.
 - Remove the module from the connector at a 45-degree angle.

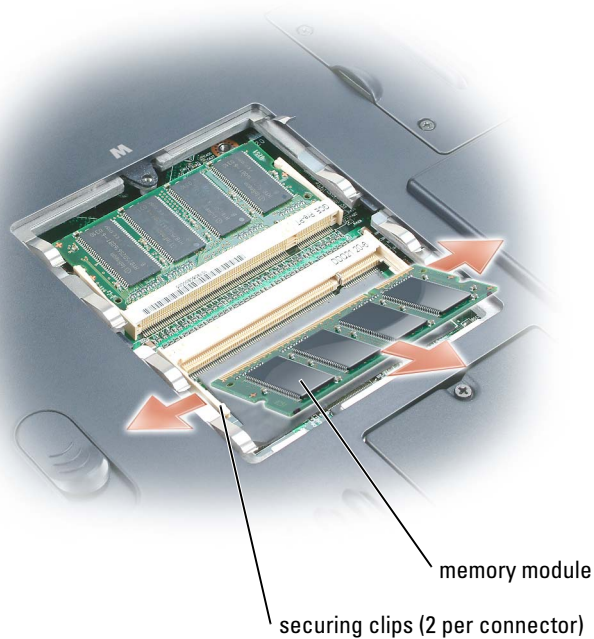

- ➔ **NOTICE:** Ensure that memory modules are installed in both connectors and they are of the same capacity. Insert memory modules at a 45-degree angle to avoid damaging the connector.
- 4 Ground yourself and install the new memory module:
- ✎ **NOTE:** If the memory module is not installed properly, the computer may not boot properly. No error message indicates this failure.
- Align the notch in the module edge connector with the tab in the connector slot.
 - Slide the module firmly into the slot at a 45-degree angle, and rotate the module down until it clicks into place. If you do not feel the click, remove the module and reinstall it.

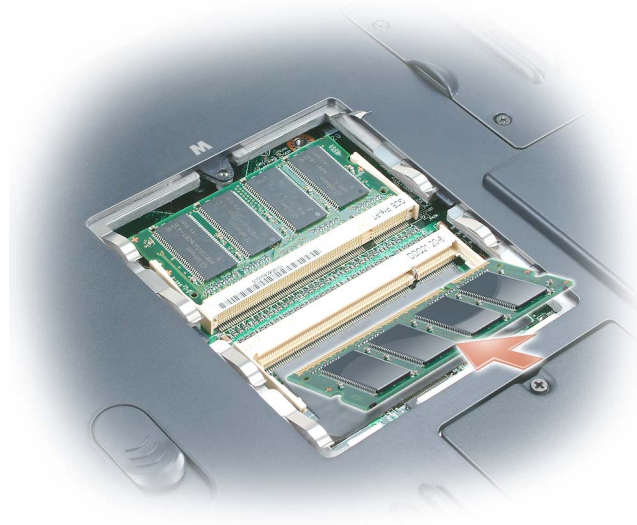

5 Replace the memory module cover.

➔ **NOTICE:** If the cover is difficult to close, remove the module and reinstall it. Forcing the cover to close may damage your computer.





6 Insert the battery into the battery bay, or connect the AC adapter to your computer and an electrical outlet.

7 Turn on the computer.

As the computer boots, it detects the additional memory and automatically updates the system configuration information.

To confirm the amount of memory installed in the computer, click the **Start** button, click **Help and Support**, and then click **Computer Information**.

Mini PCI Card

-  **CAUTION:** FCC rules strictly prohibit users from installing 5-GHz (802.11a, 802.11a/b, 802.11a/b/g) Wireless LAN Mini PCI cards. Under no circumstances should you install such a device. Only trained Dell service personnel are authorized to install a 5-GHz Wireless LAN Mini PCI card.
-  **CAUTION:** If you are removing and/or installing a 2.4-GHz (802.11b, 802.11b/g) Mini PCI card, follow the instructions noted below. Only products approved for use in your portable computer may be installed. Approved Mini PCI cards may be purchased only from Dell.
-  **CAUTION:** Before you begin this procedure, read the safety instructions at the front of this document (see page 11).
-  **NOTICE:** To avoid damaging the system board, you must remove the main battery before you begin working inside the computer (see page 52).
-  **NOTE:** 2.4-GHz Wireless LAN PC Cards may be removed and installed by the user.

If you ordered a Mini PCI card with your computer, the card is already installed.

- 1 Follow the procedures in "Before You Begin" (see page 103).
- 2 Turn the computer over.
- 3 Unscrew the captive screw labeled "C" and remove the Mini PCI card cover.

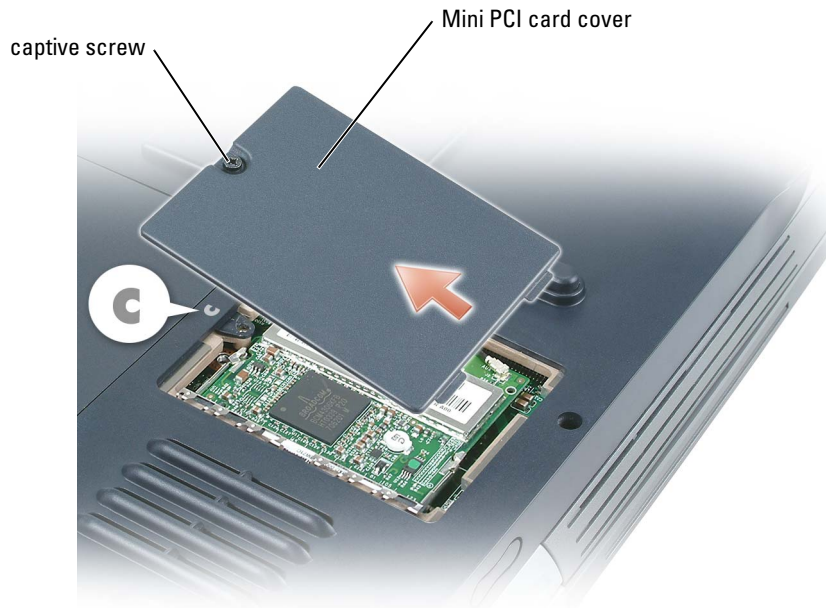

4 If a Mini PCI card is not already installed, go to step 5. If you are replacing a Mini PCI card, first remove the existing card:

a Disconnect the antenna cables from the Mini PCI card.

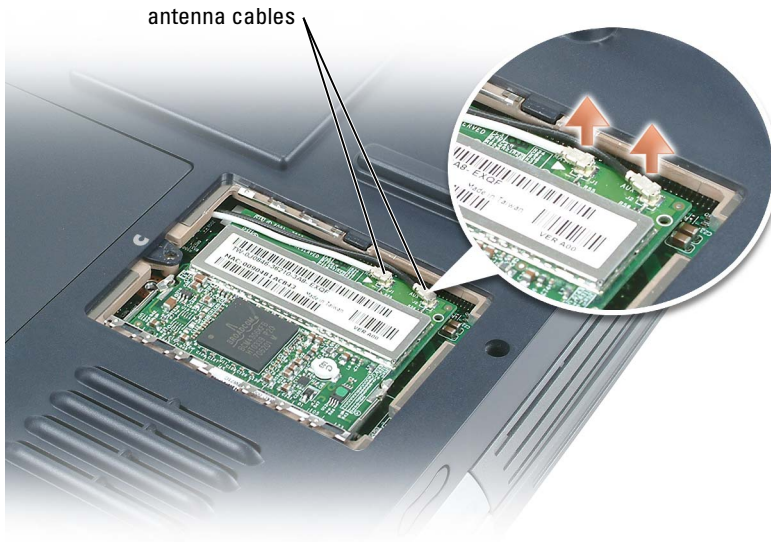

b Release the Mini PCI card by spreading the metal securing tabs until the card pops up slightly.

c Lift the Mini PCI card out of its connector.

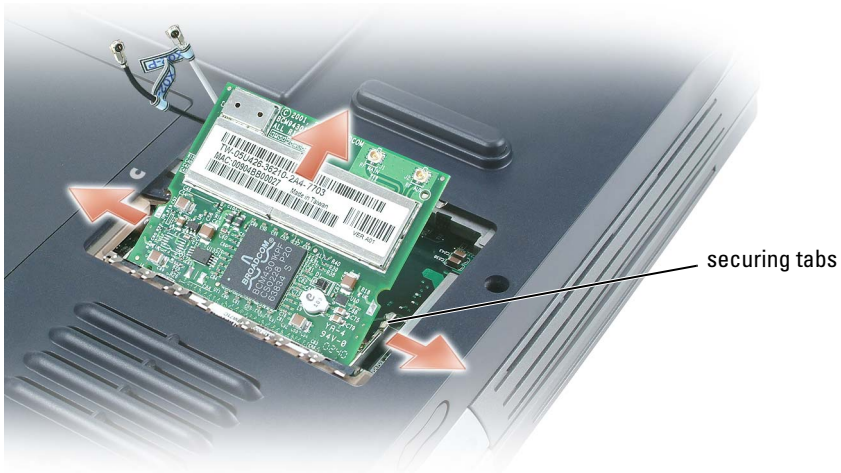

- ➔ **NOTICE:** The connectors are keyed to ensure correct insertion. If you feel resistance, check the connectors and realign the card.
- 5 To install a Mini PCI card, align the card with the connector at a 45-degree angle, and press the card into the connector until it clicks.





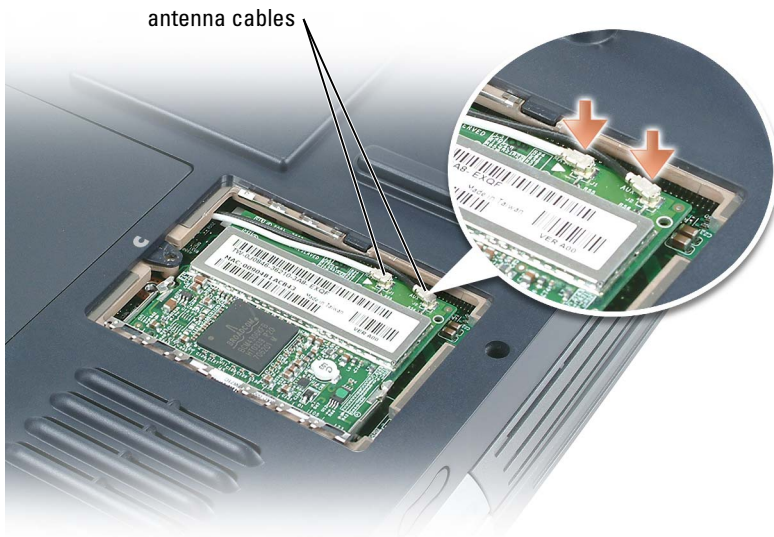



- ➔ **NOTICE:** To avoid damaging the antenna cables or the Mini PCI card, never place the cables under the card.
- 6 Connect the antenna cables to the Mini PCI card.



- 7 Replace the Mini PCI card cover and tighten the captive screw.

Hard Drive

-  **CAUTION:** If you remove the hard drive from the computer when the drive is hot, *do not touch* the metal housing of the hard drive.
-  **CAUTION:** Before you begin this procedure, read the safety instructions at the front of this document (see page 11).
-  **NOTICE:** To avoid damaging the system board, you must remove the main battery before you begin working inside the computer.
-  **NOTICE:** To prevent data loss, turn off your computer before removing the hard drive. Do not remove the hard drive while the computer is on, in standby mode, or in hibernate mode.
-  **NOTICE:** Hard drives are extremely fragile; even a slight bump can damage the drive.
-  **NOTE:** Dell does not guarantee compatibility or provide support for hard drives from sources other than Dell.
-  **NOTE:** You need the *Operating System CD* to install the Microsoft® Windows® operating system. You also need the *Drivers and Utilities CD* for your computer to install the drivers and utilities on the new hard drive.

To replace the hard drive in the hard drive bay:

- 1 Follow the procedures in "Before You Begin" (see page 103).
- 2 Turn the computer over, and remove the hard drive screw.

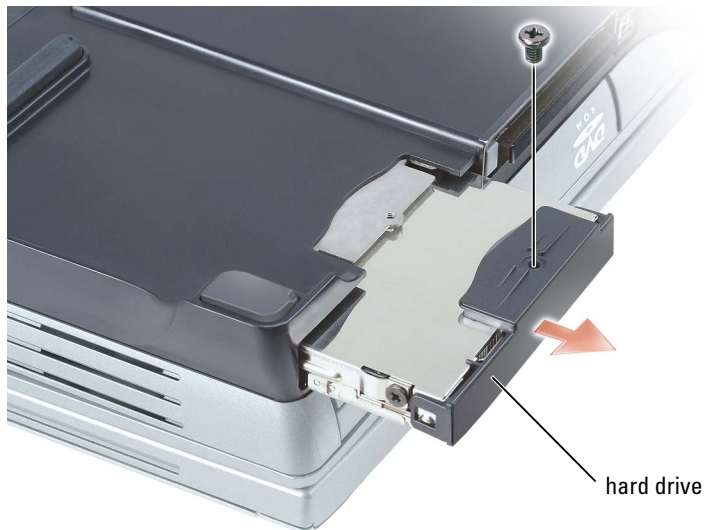

- ➔ **NOTICE:** When the hard drive is not in the computer, store it in protective antistatic packaging. See "Protecting Against Electrostatic Discharge" on page 14.
- 3 Slide the hard drive out of the computer.
 - 4 Remove the new drive from its packaging.
Save the original packaging for storing or shipping the hard drive.
- ➔ **NOTICE:** Use firm and even pressure to slide the drive into place. If you use excessive force, you may damage the connector.
- 5 Slide the drive into the bay until it is fully seated.
 - 6 Replace and tighten the screw.
 - 7 Use the *Operating System* CD to install the operating system for your computer. For instructions, see "Reinstalling Microsoft Windows XP" on page 98.
 - 8 Use the *Drivers and Utilities* CD to install the drivers and utilities for your computer. For instructions, see "Reinstalling Drivers and Utilities" on page 94.

Returning a Hard Drive to Dell

Return your old hard drive to Dell in its original or comparable foam packaging. Otherwise, the hard drive may be damaged in transit.

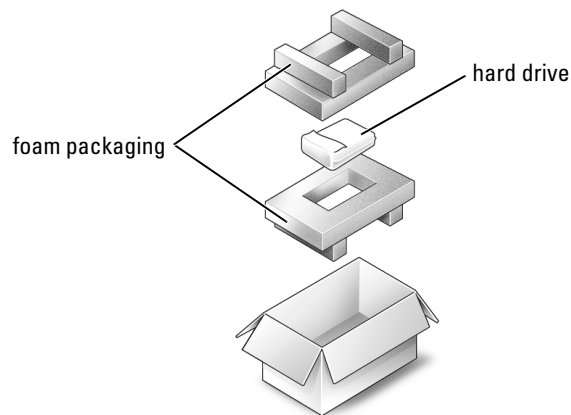

Subwoofer

⚠ CAUTION: Before you begin this procedure, read the safety instructions at the front of this document (see page 11).

➡ NOTICE: To avoid electrostatic discharge, ground yourself by using a wrist grounding strap or by periodically touching a connector on the back panel of the computer.

If you ordered a subwoofer with your computer, it is already installed. To remove and replace a subwoofer:

- 1 Follow the procedures in "Before You Begin" (see page 103).
- 2 Remove the battery (see page 52).
- 3 Remove the subwoofer from the battery:
 - a Disconnect the subwoofer cable.
 - b Apply a small screwdriver or scribe to the notch in the side of the battery, releasing the subwoofer from the compartment in the battery.

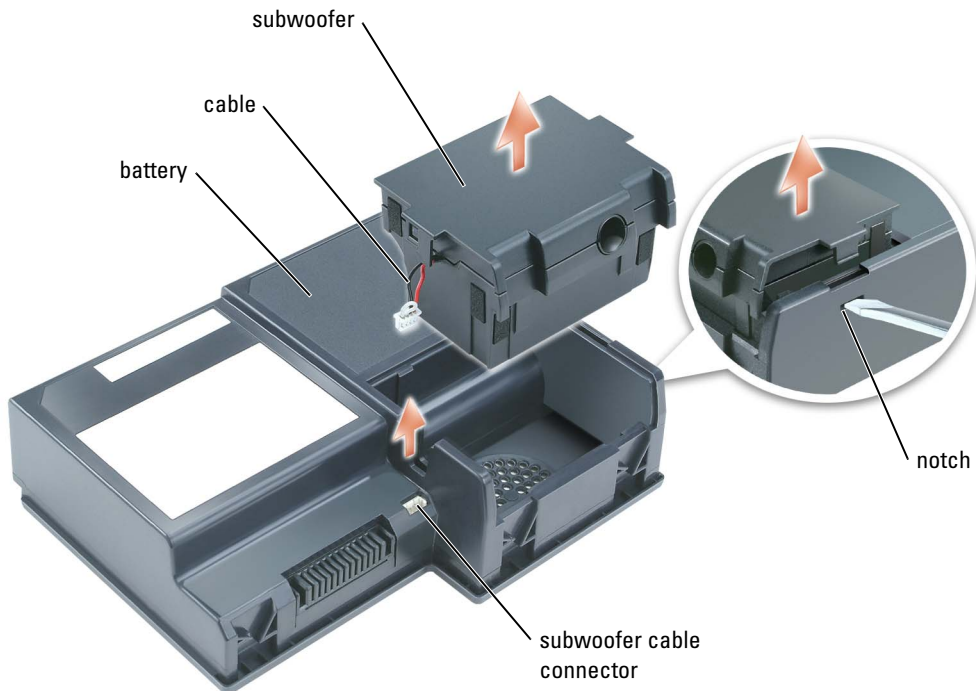

- 4 Insert the subwoofer into the compartment within the battery.

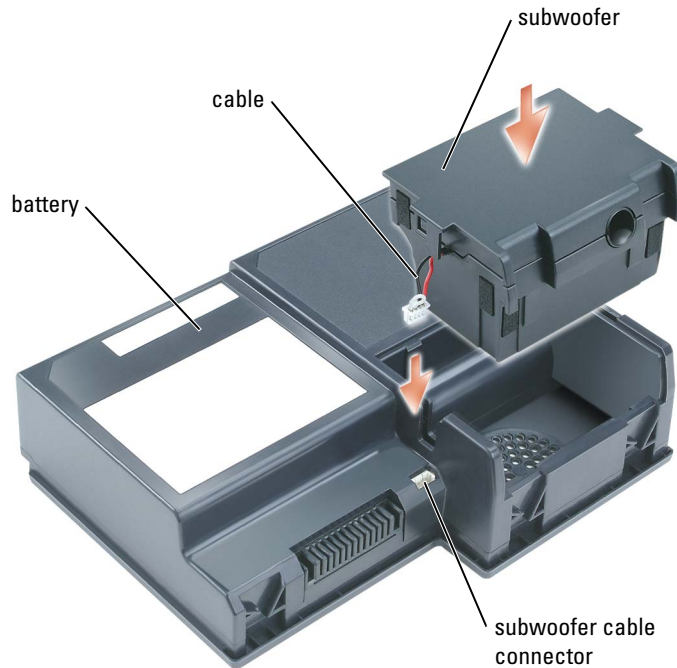

- 5 Connect the cable to the subwoofer connector.
- 6 Replace the battery in the battery bay (see page 53).

Keyboard

⚠ CAUTION: Before you begin this procedure, read the safety instructions at the front of this document (see page 11).

➡ NOTICE: To avoid electrostatic discharge, ground yourself by using a wrist grounding strap or by periodically touching a connector on the back panel of the computer.

➡ NOTICE: To avoid damaging the system board, you must remove the main battery before you begin working inside the computer.

- 1 Follow the procedures in "Before You Begin" (see page 103).
- 2 Remove the center hinge cover (see page 121).

✍ NOTE: You do not need to remove the left and right hinge covers.

3 Remove the keyboard:

- a** Remove the two M2.5 x 3-mm screws across the top of the keyboard.

→ NOTICE: The keycaps on the keyboard are fragile, easily dislodged, and time-consuming to replace. Be careful when removing and handling the keyboard.

- b** Lift up the keyboard and gently slide it toward the display.
- c** Hold the keyboard up and slightly forward to allow access to the keyboard connector.
- d** Pull up on the keyboard connector tab to disconnect the keyboard connector from the system board.



→ NOTICE: To avoid scratching the palm rest when replacing the keyboard, hook the four tabs along the front edge of the keyboard into the palm rest, and then secure the keyboard in place.

PC Card With Bluetooth[®] Wireless Technology

⚠ CAUTION: Before you begin this procedure, read the safety instructions at the front of this document (see page 11).

➡ NOTICE: To avoid electrostatic discharge, ground yourself by using a wrist grounding strap or by periodically touching a connector on the back panel of the computer.

➡ NOTICE: To avoid damaging the system board, you must remove the main battery before you begin working inside the computer.

If you ordered a PC Card with Bluetooth wireless technology with your computer, it is already installed.

- 1 Remove the battery (see page 52).
- 2 Open the card door.
- 3 Using a plastic scribe or screwdriver, gently pry the module from the plastic guide bracket and the compartment so that you can disconnect the card from its cable and remove it from the computer.

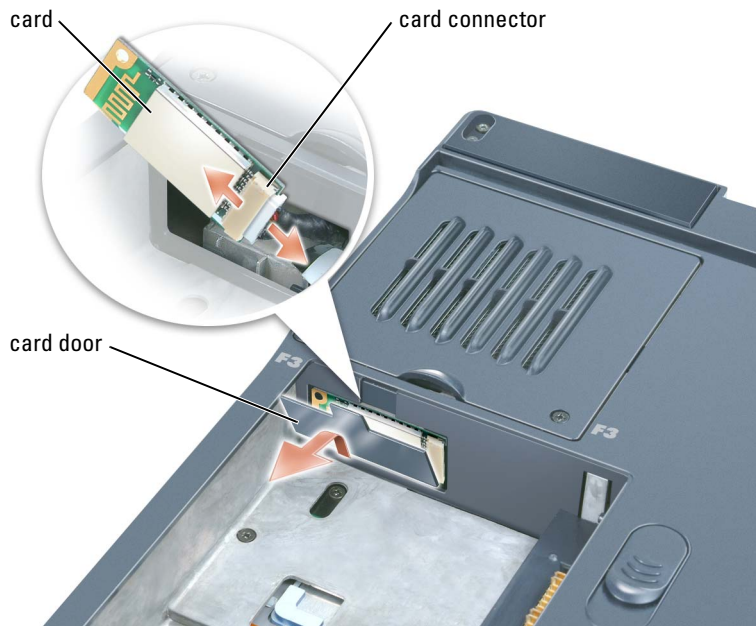

Modem

CAUTION: Before you begin this procedure, read the safety instructions at the front of this document (see page 11).

NOTICE: To avoid electrostatic discharge, ground yourself by using a wrist grounding strap or by periodically touching a connector on the back panel of the computer.

Removing the Modem

- 1 Follow the procedures in "Before You Begin" (see page 103).
- 2 Remove the center hinge cover (see page 121).
- 3 Remove the keyboard (see page 114).
- 4 Remove the M2 x 3-mm screw.

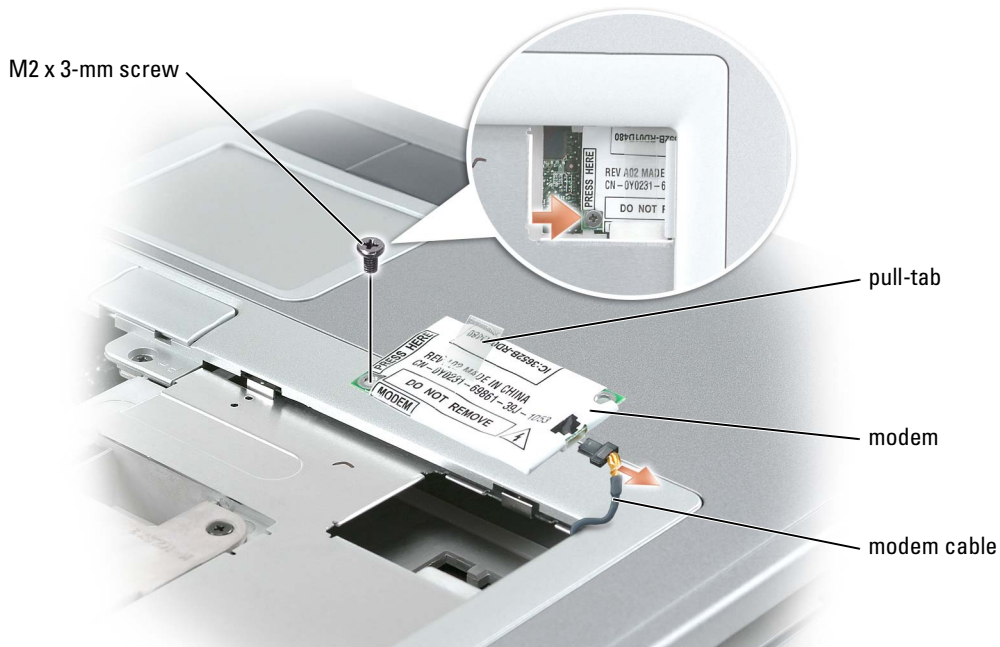



- 5 Pull up on the pull-tab to disconnect the modem from the modem connector on the system board.

NOTICE: Do not disconnect the modem cable from the system board.

- 6 Disconnect the modem cable from the modem.

Installing the Modem

- 1 Connect the modem cable to the modem.
-  **NOTICE:** Ensure that the modem cable is routed correctly when you replace the modem.
-  **NOTICE:** Do not press down on the left side of the modem while installing it.
- 2 Align the connector on the bottom of the modem with the modem connector on the system board, and then press down on the right side of the modem to seat both connectors.
- 3 Replace the M2 x 3-mm screw.

Keyboard Bracket

 **CAUTION:** Before you begin this procedure, read the safety instructions at the front of this document (see page 11).

-  **NOTICE:** To avoid electrostatic discharge, ground yourself by using a wrist grounding strap or by periodically touching a connector on the back panel of the computer.
- 1 Follow the procedures in "Before You Begin" (see page 103).
- 2 Remove the center hinge cover (see page 121).
- 3 Remove the keyboard (see page 114).
- 4 Remove the display (see page 124).
- 5 Remove the palm rest (see page 130).
- 6 Remove the four M2.5 x 6-mm screws.
- 7 Pull up on the pull-tab on the FPC cable connector to disconnect the FPC cable from the keyboard bracket
- 8 Slightly lift up the keyboard bracket, move it approximately one inch toward the back of the computer, and then lift straight up to remove it.

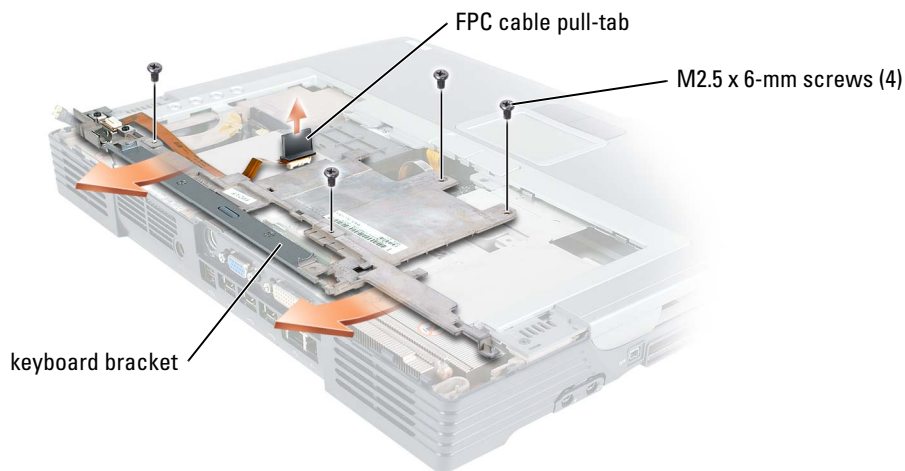

Fans

⚠ CAUTION: Before you begin this procedure, read the safety instructions at the front of this document (see page 11).

➡ NOTICE: To avoid electrostatic discharge, ground yourself by using a wrist grounding strap or by periodically touching a connector on the back panel of the computer.

➡ NOTICE: To avoid damaging the system board, you must remove the main battery before you begin working inside the computer.

The two fans are located on the bottom of the computer, one with screws labeled "F2" (fan 2) and one with screws labeled "F3" (fan 3).

To remove fan 2:

- 1 Follow the procedures in "Before You Begin" (see page 103).
- 2 Turn the computer over.
- 3 Unscrew the two captive screws labeled "F2", lift up the fan cover, and remove it from the computer.

✍ NOTE: This fan cover comes off over the audio connectors.

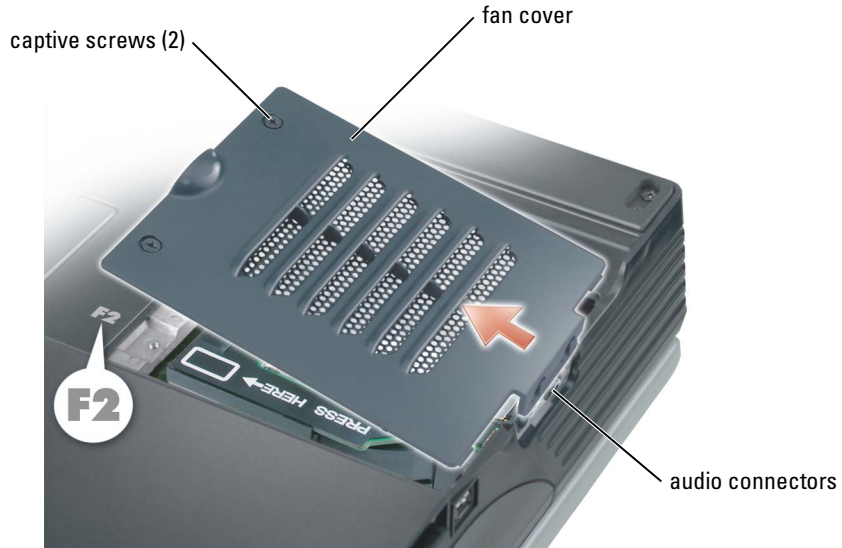

4 Remove the screw on the fan and lift up the fan release lever.

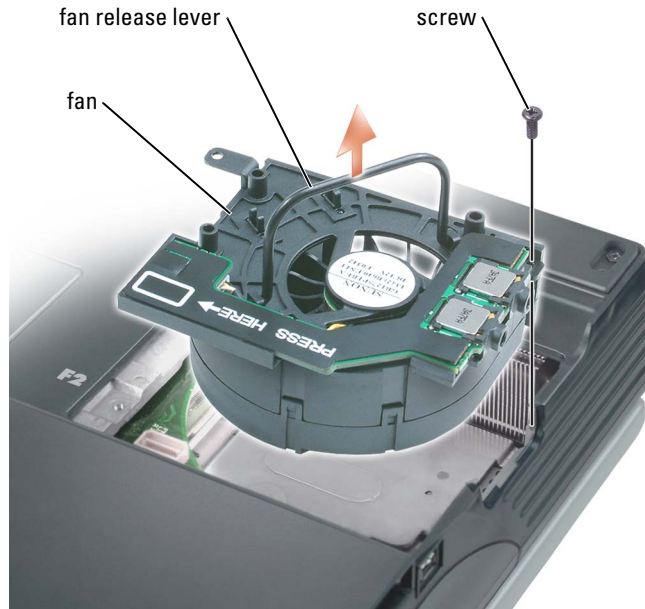

5 Use the fan release lever to lift the fan out of the computer.

When replacing fan 2, press down on the fan surface labeled "Press here" to securely seat the fan in place.

To remove fan 3:

- 1 Unscrew the two captive screws labeled "F3."
- 2 Lift the fan out of the computer.

 **NOTE:** The cover on this fan is not removable. It remains attached to the fan.

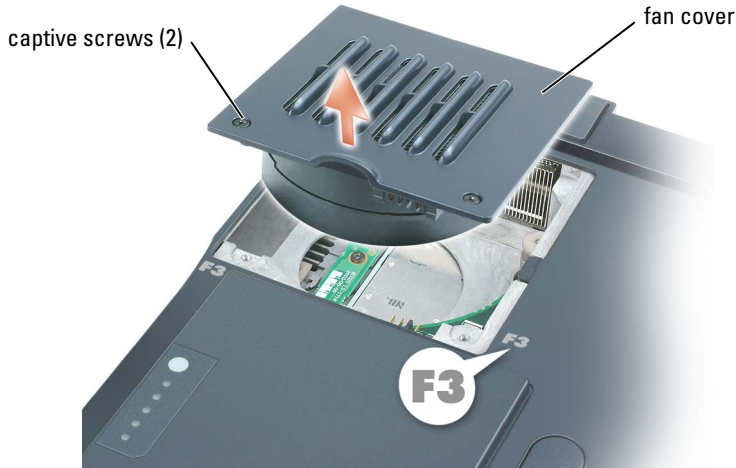

Hinge Covers

 **CAUTION:** Before you begin this procedure, read the safety instructions at the front of this document (see page 11).

 **NOTICE:** To avoid electrostatic discharge, ground yourself by using a wrist grounding strap or by periodically touching a connector on the back panel of the computer.

 **NOTICE:** To avoid damaging the system board, you must remove the main battery before you begin working inside the computer.

- 1 Follow the procedures in "Before You Begin" (see page 103).

 **NOTE:** The hinge cover consists of three separate pieces: the left cover, the right cover, and the center cover. To remove computer components, you must remove all three covers *except* when removing the keyboard or the reserve battery. For these two components, remove only the center cover.

2 Remove the left and right hinge covers:

- a** Open the display.

→ NOTICE: To avoid damaging the cover, do not lift the center hinge cover on both sides simultaneously.

- b** Slide the left and right hinge covers toward the back of the computer and then slide them to the side, away from the computer.



3 Remove the center hinge cover:

- a** Close the display.

- b** Facing the front of the computer, press in on the two hinge cover snaps and pull them up slightly to disengage them.



- c** Open the display all the way (180 degrees) so that it lies flat against your work surface.
- d** Lift the center hinge cover on the right side first just enough to access the flex-cable connector.
- e** Using the pull-tab, disconnect the center-hinge-cover flex cable from the system board connector.

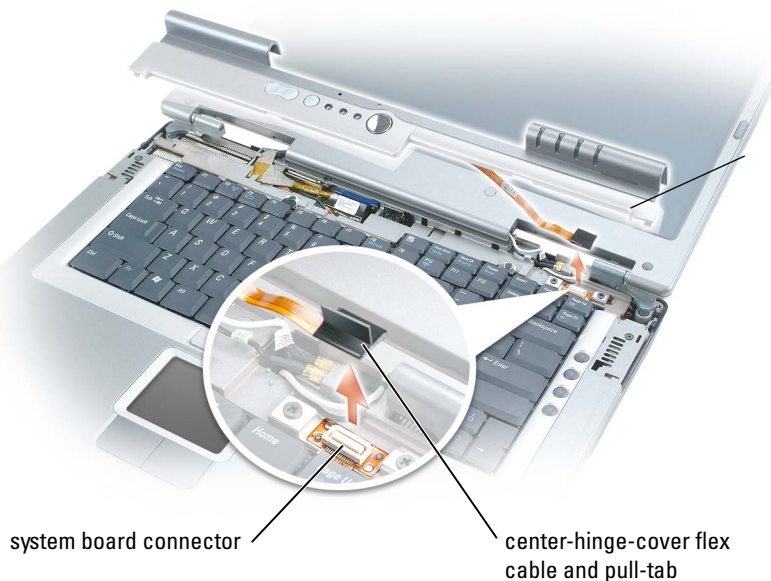

Display

⚠ CAUTION: Before you begin this procedure, read the safety instructions at the front of this document (see page 11).

➡ NOTICE: To avoid electrostatic discharge, ground yourself by using a wrist grounding strap or by periodically touching a connector on the back panel of the computer.

➡ NOTICE: To avoid damaging the system board, you must remove the main battery before you begin working inside the computer.

1 Follow the procedures in "Before You Begin" (see page 103).

➡ NOTICE: Before turning the computer over and removing the screws, ensure that the display is firmly latched closed.

2 Turn the computer over and remove the four screws (two on each side) labeled "D" on the bottom of the computer.

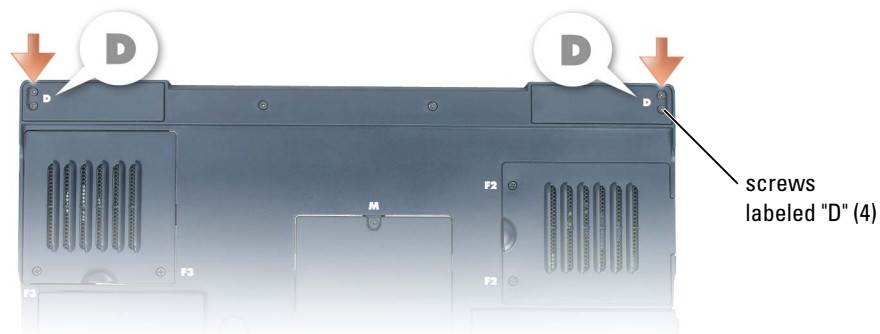

3 Turn the computer right-side up.

4 Remove the left, right, and center hinge covers (see page 121).

5 Disconnect the antenna cables (pull to separate the connectors).

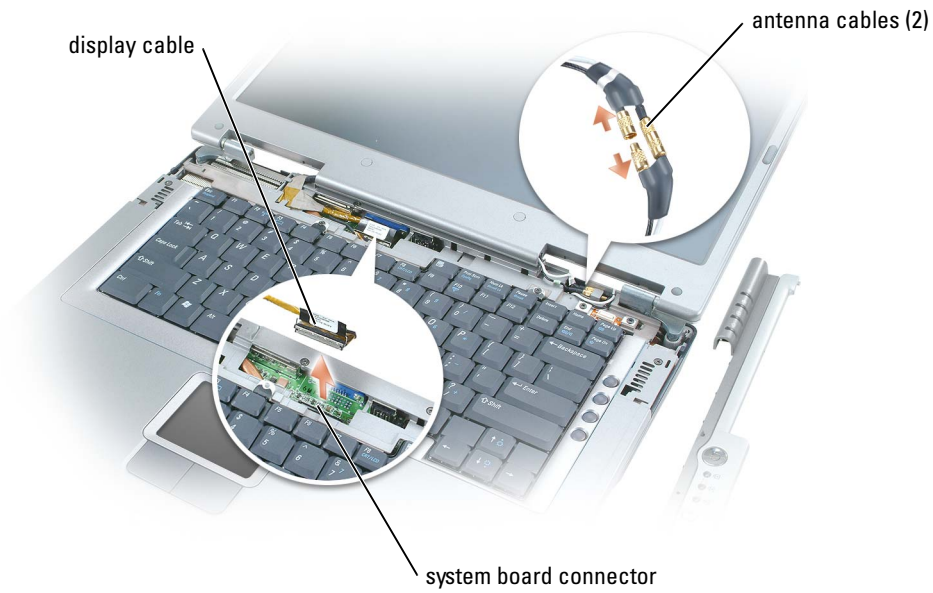

- 6 Disconnect the display cable, using the pull-tab.
- 7 Lift the display out of the computer at a 90-degree angle.

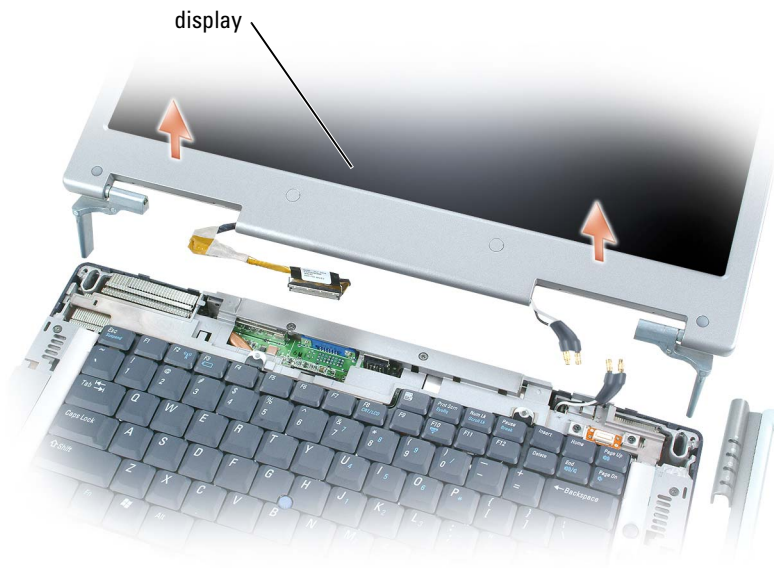

When you replace the display, ensure that the ribbon tape around the display cable is securely tucked underneath the two tabs.

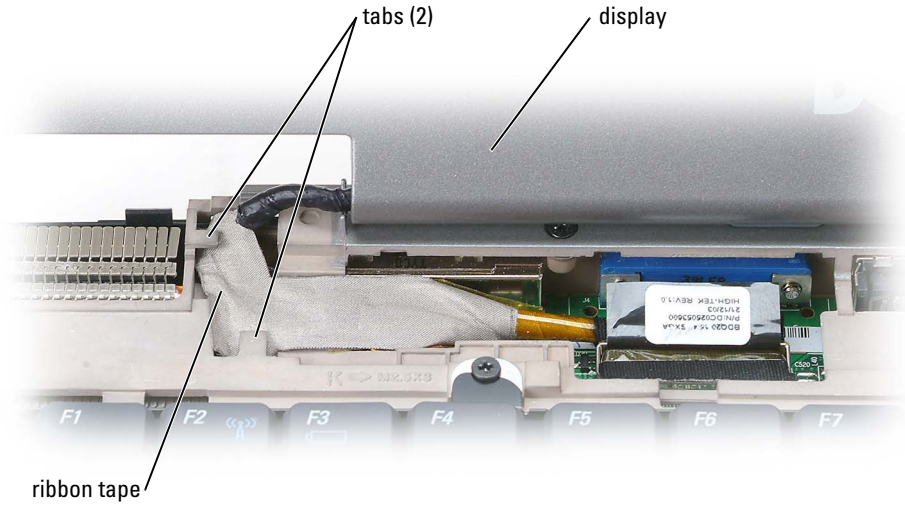

Also, ensure that the antenna cables are not twisted and that they are lying flat in the antenna cable clip.

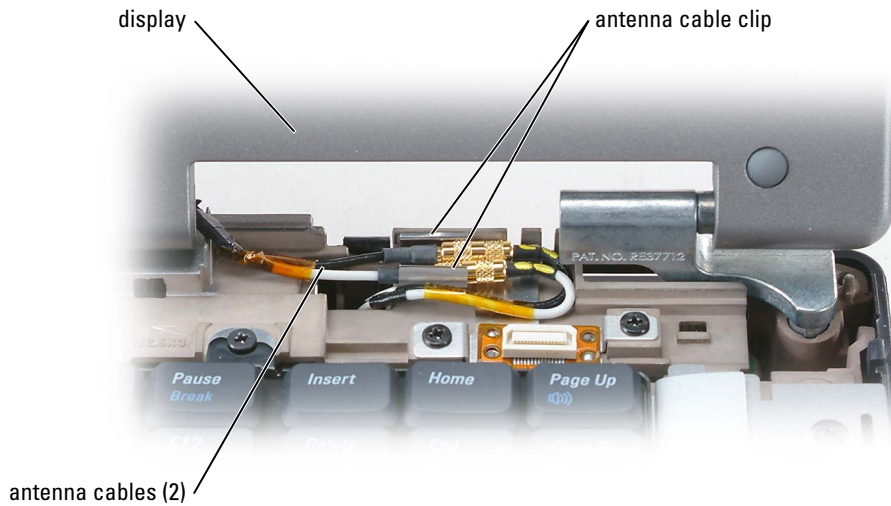

Display Latch

⚠ CAUTION: Before you begin this procedure, read the safety instructions at the front of this document (see page 11).

➡ NOTICE: To avoid electrostatic discharge, ground yourself by using a wrist grounding strap or by periodically touching a connector on the back panel of the computer.

➡ NOTICE: To avoid damaging the system board, you must remove the main battery before you begin working inside the computer.

- 1 Follow the procedures in "Before You Begin" (see page 103).
- 2 Remove the display (see page 124).
- 3 Remove the eight rubber display bumpers.
- 4 Remove the two M2.5 x 6-mm shoulder screws and six M2.5 x 6-mm screws, and remove the display bezel.

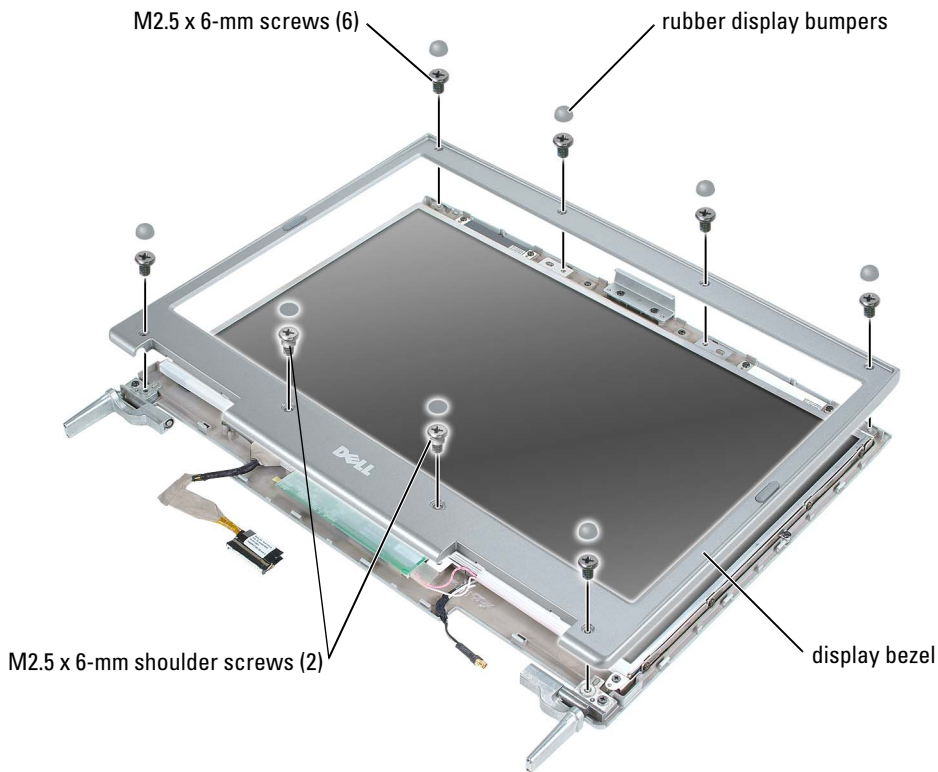

- 5 Remove the two M2 x 4-mm screws and remove the display latch.

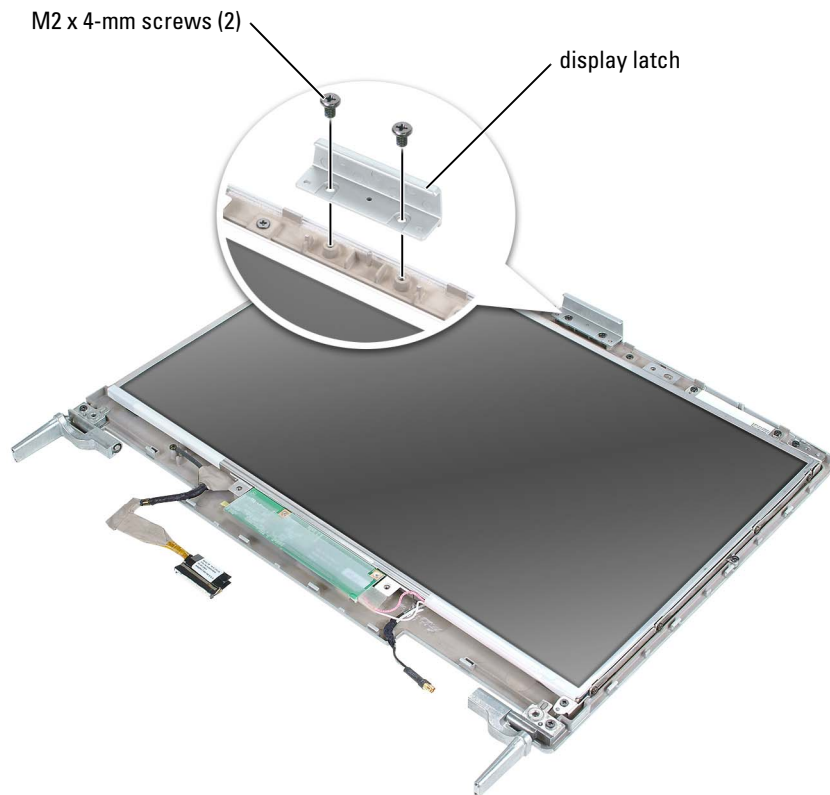

Video Card

⚠ CAUTION: Before you begin this procedure, read the safety instructions at the front of this document (see page 11).

🔄 NOTICE: To avoid electrostatic discharge, ground yourself by using a wrist grounding strap or by periodically touching a connector on the back panel of the computer.

- 1 Follow the procedures in "Before You Begin" (see page 103).
- 2 Remove the center hinge cover (see page 121).
- 3 Remove the keyboard (see page 114).
- 4 Remove the display (see page 124).
- 5 Remove the keyboard bracket (see page 118).
- 6 Remove the four M2.5 x 6-mm screws from the video card.

- Lift up the video card to remove it.
The video-card heat sink is part of the video card assembly.

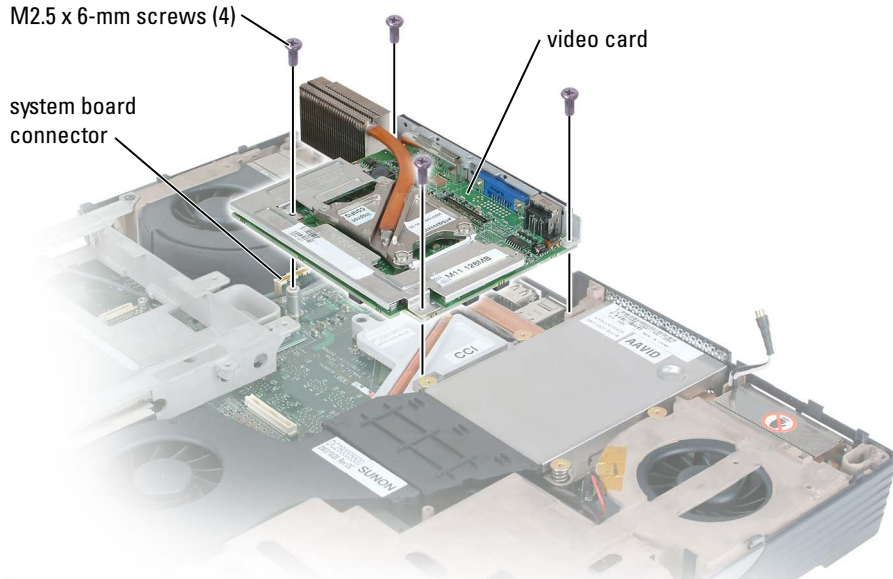

Processor Thermal-Cooling Assembly



CAUTION: Before you begin this procedure, read the safety instructions at the front of this document (see page 11).



NOTICE: To avoid electrostatic discharge, ground yourself by using a wrist grounding strap or by periodically touching a connector on the back panel of the computer.

Removing the Processor Thermal-Cooling Assembly

- Follow the procedures in "Before You Begin" (see page 103).
- Remove the center hinge cover (see page 121).
- Remove the keyboard (see page 114).
- Remove the display (see page 124).
- Remove the keyboard bracket (see page 118).
- Remove the video card (see page 128).
- Loosen in consecutive order the four captive screws, labeled "1" through "4," that secure the processor thermal-cooling assembly to the system board.

- Lift up the processor thermal-cooling assembly and remove it from the system board.

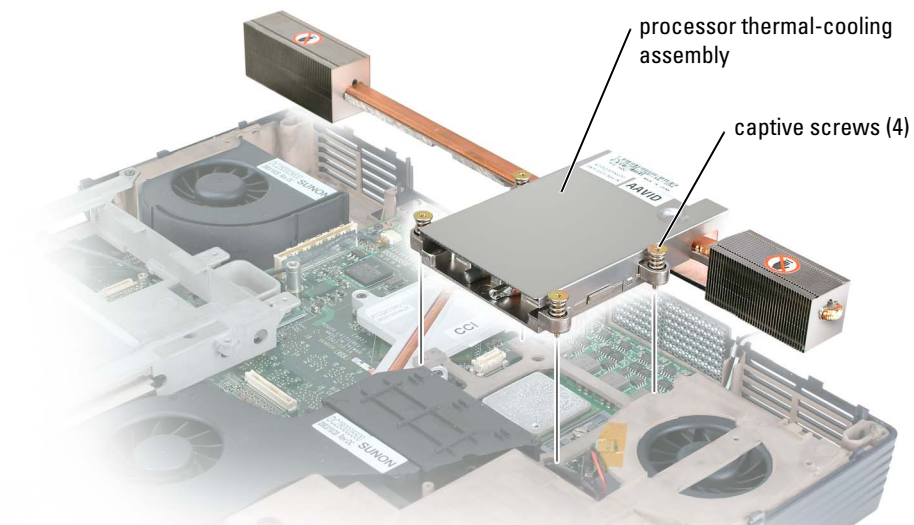

Installing the Processor Thermal-Cooling Assembly

- Place the processor thermal-cooling assembly over the processor.
- Tighten the four captive screws, labeled "1" through "4," in consecutive order.

Palm Rest



CAUTION: Before you begin this procedure, read the safety instructions at the front of this document (see page 11).



NOTICE: To avoid electrostatic discharge, ground yourself by using a wrist grounding strap or by periodically touching a connector on the back panel of the computer.

- Follow the procedures in "Before You Begin" (see page 103).
- Remove the center hinge cover (see page 121).
- Remove the keyboard (see page 114).
- Remove the display (see page 124).
- Remove the keyboard bracket (see page 118).
- Turn over the computer and remove the three M2.5 x 8-mm screws labeled "circle P."

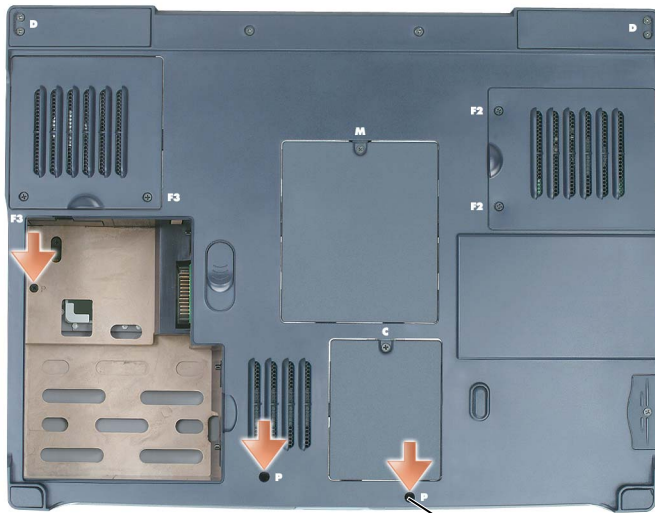

M2.5 x 8-mm screws
labeled "circle P" (3)

- 7 Turn the computer top-side up and remove the four M2.5 x 3-mm screws labeled "circle P."
- 8 Disconnect the touch-pad connector from the system board.
- 9 Slide the palm rest forward and remove it from the computer.

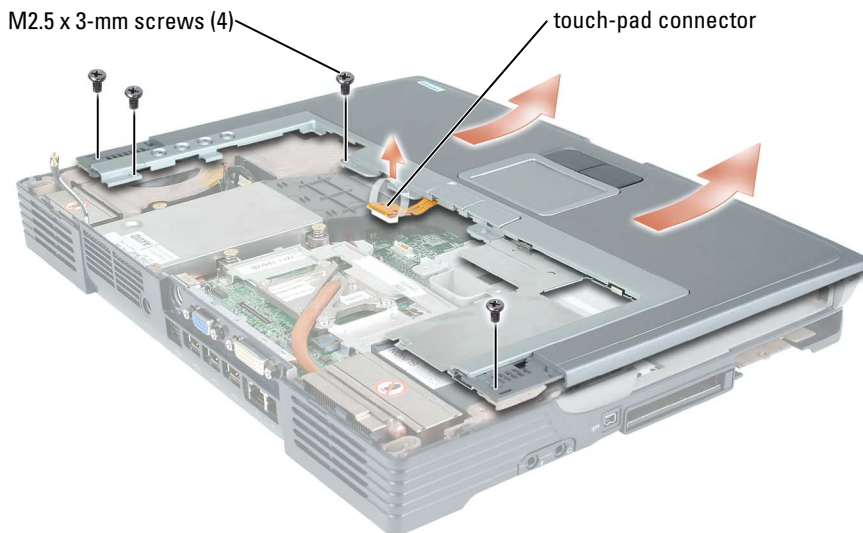

Processor Module

Removing the Processor Module



CAUTION: Before you begin this procedure, read the safety instructions at the front of this document (see page 11).





NOTICE: To avoid electrostatic discharge, ground yourself by using a wrist grounding strap or by periodically touching a connector on the back panel of the computer.





NOTICE: Do not touch the processor die. Press and hold the processor down on the substrate on which the die is mounted while turning the cam screw to prevent intermittent contact between the cam screw and processor.

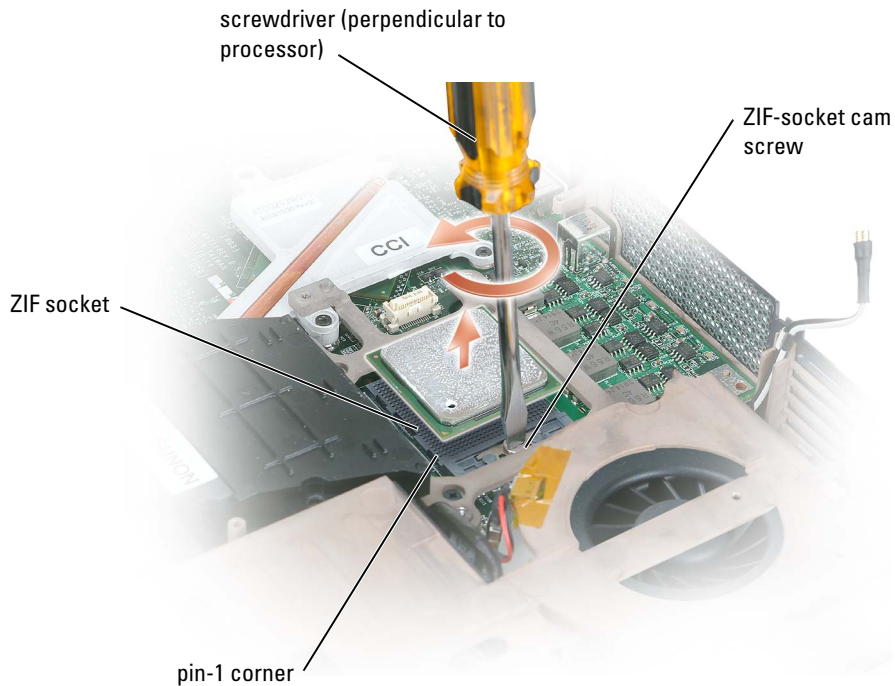

NOTICE: To avoid damage to the processor, hold the screwdriver so that it is perpendicular to the processor when turning the cam screw.

- 1 Follow the instructions in "Before You Begin" on page 103.
- 2 Remove the video card (see page 128).
- 3 Remove the keyboard (see page 114).
- 4 Remove the fan (see page 119).
-  **NOTICE:** To help ensure maximum cooling for the processor, do not touch the heat transfer areas on the processor thermal-cooling assembly. The oils in your skin reduce the heat transfer capability of the thermal pads.
- 5 Remove the processor thermal-cooling assembly.
-  **NOTICE:** When removing the processor module, pull the module straight up. Be careful not to bend the pins on the processor module.
- 6 To loosen the ZIF socket, use a small, flat-blade screwdriver and rotate the ZIF-socket cam screw counterclockwise until it comes to the cam stop.



 **NOTE:** The ZIF-socket cam screw secures the processor to the system board. Take note of the arrow on the ZIF-socket cam screw, which indicates the direction to turn the cam screw.

7 Lift out the processor module.

Installing the Processor Module

 **NOTICE:** Ensure that the cam lock is in the fully open position before seating the processor module. Seating the processor module properly in the ZIF socket does not require force.

 **NOTICE:** A processor module that is not properly seated can result in an intermittent connection or permanent damage to the processor and ZIF socket.

1 Align the pin-1 corner of the processor module with the pin-1 corner of the ZIF socket, and insert the processor module.

 **NOTE:** The pin-1 corner of the processor module has a triangle that aligns with the triangle on the pin-1 corner of the ZIF socket.

-  **NOTICE:** You must position the processor module correctly in the ZIF socket to avoid permanent damage to the module and the socket.

When the processor module is correctly seated, all four corners are aligned at the same height. If one or more corners of the module are higher than the others, the module is not seated correctly.

- 2 Tighten the ZIF socket by turning the cam screw clockwise to secure the processor module to the system board.
- 3 Perform the steps in "Removing the Processor Module" on page 132 in reverse order, beginning with step 5.
- 4 Update the BIOS using the flash BIOS update program floppy disk or CD. For instructions on how to flash the BIOS, see the following section.

Flashing the BIOS

- 1 Ensure that the AC adapter is plugged in and that the main battery is installed properly.
- 2 Insert the flash BIOS update program floppy disk or CD and turn on the computer.
Follow the instructions that appear on the screen. The computer continues to boot and updates the new BIOS. When the update is complete, the computer will automatically reboot.
- 3 Press <F2> during POST to enter the system setup program.
- 4 Press <Alt> and <f> to reset the computer defaults.
- 5 Press <Esc>, select **Save changes and reboot**, and press <Enter> to save configuration changes.
- 6 Remove the flash BIOS update program floppy disk or CD from the drive and restart the computer.

Reserve Battery

-  **CAUTION:** Before you begin this procedure, read the safety instructions at the front of this document (see page 11).

-  **NOTICE:** To avoid electrostatic discharge, ground yourself by using a wrist grounding strap or by periodically touching a connector on the back panel of the computer.

➔ NOTICE: To avoid damaging the system board, you must remove the main battery before you begin working inside the computer.

- 1 Follow the procedures in "Before You Begin" (see page 103).
- 2 Remove the center hinge cover (see page 121).

✍ NOTE: You do not need to remove the left and right hinge covers.

- 3 Remove the keyboard (see page 114).
- 4 Disconnect the reserve battery cable connector from the system board.
- 5 Lift the reserve battery clip slightly to disengage it from the fan chassis.
- 6 Pull the reserve battery together with the clip straight out of the computer base.

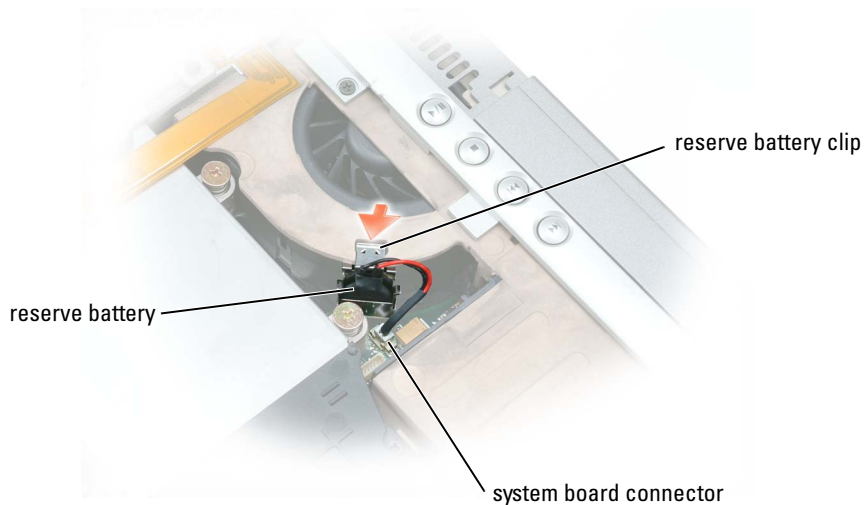

✍ NOTE: Use a scribe to press the reserve battery cable connector into the system board connector when replacing the reserve battery.

System Board

Removing the System Board

⚠ CAUTION: Before you begin this procedure, read the safety instructions at the front of this document (see page 11).

➔ NOTICE: To avoid electrostatic discharge, ground yourself by using a wrist grounding strap or by periodically touching a connector on the back panel of the computer.

The system board's BIOS chip contains the Service Tag, which is also visible on a barcode label on the bottom of the computer. The replacement kit for the system board includes a CD that provides a utility for transferring the Service Tag to the replacement system board.

NOTICE: Disconnect the computer and any attached devices from electrical outlets, and remove any installed batteries.

- 1 Remove the keyboard (see page 114).
- 2 Remove the display (see page 124).
- 3 Remove the palm rest (see page 130).
- 4 Remove the video card (see page 128).
- 5 Remove the processor thermal-cooling assembly (see page 129).
- 6 Remove the processor (see page 132).
- 7 Turn the system over and remove the two M2.5 x 6-mm screws from the system-board bottom assembly.

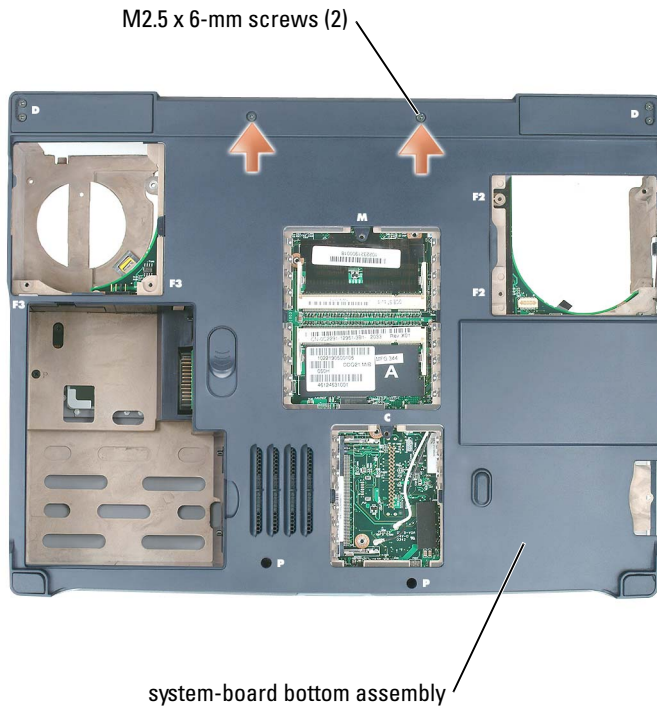

- 8 Turn the system top-side up again, and remove the four M2.5 x 6-mm screws from the system-board top assembly.
- 9 With the front of the computer facing you, lift the system-board top assembly from the right side, swinging it up, then lift the left side and draw the system-board top assembly out of the computer.

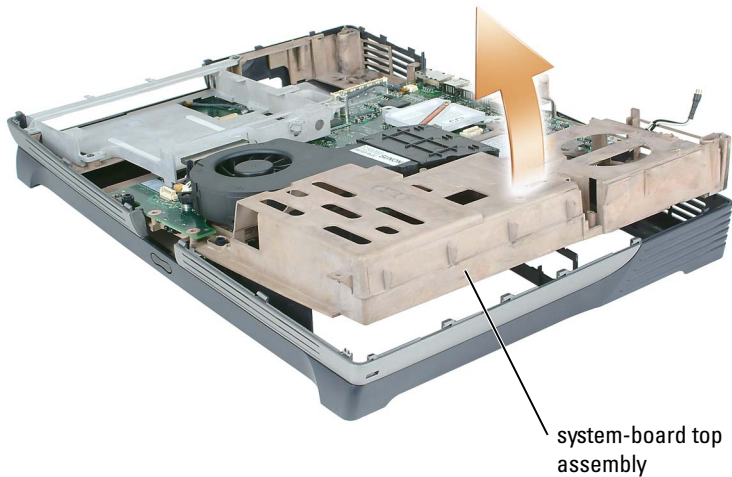

Installing the System Board

- 1 Perform all of the steps in "Removing the System Board" on page 135 in reverse order.
- ➔ **NOTICE:** Before turning on the computer, replace all screws and ensure that no stray screws remain inside the computer. Failure to do so may result in damage to the computer.
- 2 Turn on the computer.
- ✍ **NOTE:** After replacing the system board, you must enter the computer Service Tag sequence into the BIOS of the replacement system board as part of the BIOS update procedure.
- 3 Insert the flash BIOS update program floppy disk or CD that accompanied the replacement system board into the appropriate drive. Follow the instructions that appear on the screen.

Speakers

⚠ CAUTION: Before you begin this procedure, read the safety instructions at the front of this document (see page 11).

➡ NOTICE: To avoid electrostatic discharge, ground yourself by using a wrist grounding strap or by periodically touching a connector on the back panel of the computer.

- 1 Follow the procedures in "Before You Begin" (see page 103).
- 2 Remove the center hinge cover (see page 121).
- 3 Remove the keyboard (see page 114).
- 4 Remove the display (see page 124).
- 5 Remove the palm rest (see page 130).
- 6 Remove the keyboard bracket (see page 118).

➡ NOTICE: Handle the speakers with care to avoid damaging them.

- 7 Remove the three M2.5 x 5-mm screws from the speakers.
- 8 Lift up the speakers.
- 9 Disconnect the speaker connector from the system board connector.

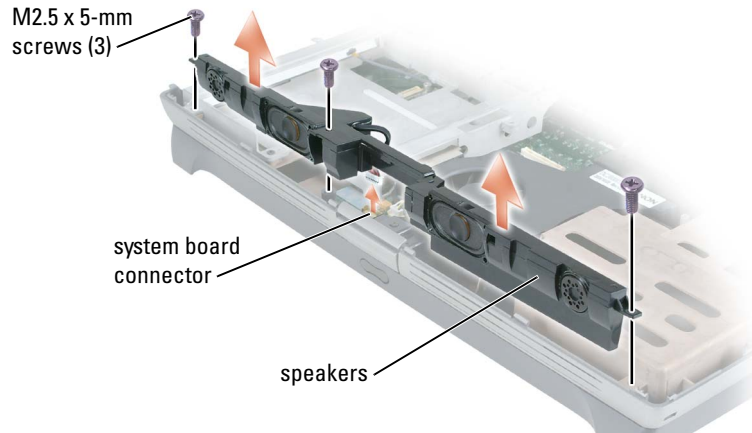

Display Latch Release

⚠ CAUTION: Before you begin this procedure, read the safety instructions at the front of this document (see page 11).

➡ NOTICE: To avoid electrostatic discharge, ground yourself by using a wrist grounding strap or by periodically touching a connector on the back panel of the computer.

- 1 Remove the hard drive (see page 105).
- 2 Remove the keyboard (see page 114).
- 3 Remove the display (see page 124).
- 4 Remove the palm rest (see page 130).
- 5 Remove the system board (see page 135).
- 6 Remove the speakers (see page 138).
- 7 Remove the two M2.5x 6-mm screws on each side of the latch.
- 8 Pull the latch straight up and away from the computer base.

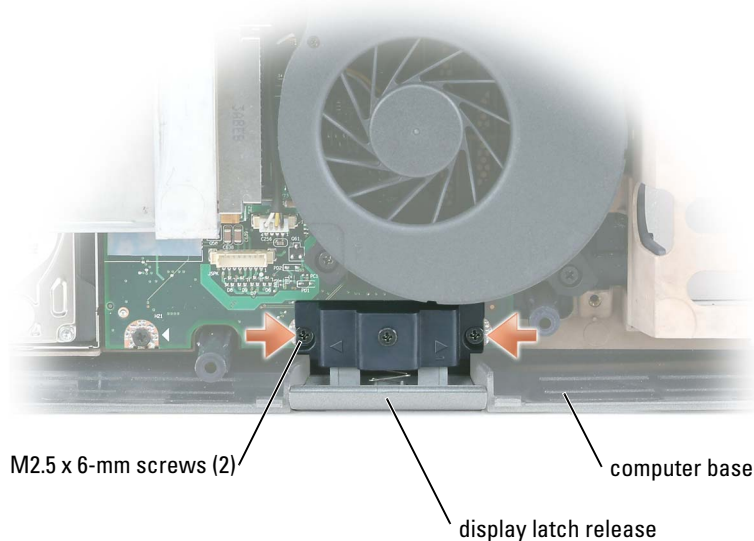

Pin Assignments for I/O Connectors

USB Connector

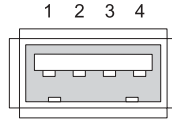

Pin	Signal
1	USB5V+
2	USBP-
3	USBP+
4	GND

Video Connector

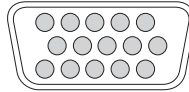

5 ——— 1
10 ——— 6
15 ——— 11

Pin	Signal	Pin	Signal
1	CRT_R	9	5V+
2	CRT_G	10	GND
3	CRT_B	11	MONITOR_DETECT-
4	NC	12	DDC_DATA
5	GND	13	CRT_HS
6	GND	14	CRT_VS
7	GND	15	DDC_CLK
8	GND		

S-Video TV-Out Connector

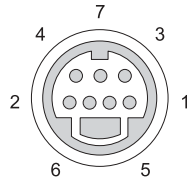

S-Video

Pin	Signal
1	GND
2	GND
3	DLUMA-L
4	DCRMA-L

Composite Video

Pin	Signal
5	NC
6	DCMPS-L
7	GND

IEEE 1394 Connector

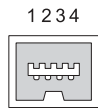

Pin	Signal
1	TPB-
2	TPB+
3	TPA-
4	TPA+

DVI-I Connector

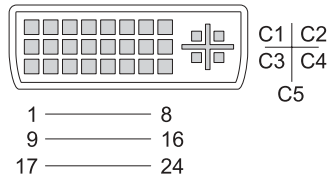

Pin	Signal	Pin	Signal
1	TMDS DATA2-	13	TMDS DATA3+
2	TMDS DATA2+	14	+5V
3	TMDS DATA2/4 SHLD	15	GND (FOR +5V)
4	TMDS DATA4-	16	HOT PLUG DETECT
5	TMDS DATA4+	17	TMDS DATA0-
6	DDC CLK	18	TMDS DATA0+
7	DDC DATA	19	TMDS DATA0/5 SHLD
8	ANALOG VERT SYNC	20	TMDS DATA5-
9	TMDS DATA1-	21	TMDS DATA5+
10	TMDS DATA1+	22	TMDS CLK SHLD
11	TMDS DATA1/3 SHLD	23	TMDS CLK+
12	TMDS DATA3-	24	TMDS CLK-

Pin	Signal
C1	ANALOG RED VID OUT
C2	ANALOG GRN VID OUT
C3	ANALOG BLU VID OUT
C4	ANALOG HOR SYNC
C5	ANALOG COM GND RET

Appendix

Specifications

Processor

Processor type	Intel® Pentium® 4 with Hyper-Threading technology Intel Pentium 4, Extreme Edition, with Hyper-Threading technology
External bus frequency	800 MHz

System Information

System chip set	Intel 865PE
Data bus width	64 bits
DRAM bus width	dual-channel DDR memory, 64 bits per channel
Processor address bus width	32 bits
Flash EPROM	1 MB
Graphics bus	64 bits
PCI bus	32 bits

PC Card

CardBus controller	Texas Instruments PCI 4510
PC Card connector	one (supports one Type I or Type II card)
Cards supported	3.3 V and 5 V
PC Card connector size	68 pins
Data width (maximum)	PCMCIA 16 bits CardBus 32 bits

Memory

Memory module connector	dual-channel DDR, two user-accessible DDR SODIMM connectors, single SODIMM per channel
Memory module capacities	128 MB, 256 MB, 512 MB, and 1024 MB
Memory type	PC3200
Memory configuration support	dual-channel only NOTE: To get dual-channel memory bandwidth capability, both the connectors must contain memory modules and they must be of the same size and configuration.
Minimum memory	256 MB
Maximum memory	2048 MB

Ports and Connectors

Video	15-hole connector
Digital-video interface (DVI-I)	one 24-hole connector
Audio	microphone miniconnector, stereo headphone/speakers miniconnector; S/PDIF connector
USB	three 4-pin USB 2.0-compliant connectors
D/Bay (powered USB) connector	4-pin power supply
IEEE 1394	4-pin mini, nonpowered connector
Infrared	sensor compatible with IrDA Standard 1.1 (Fast IR)
S-video TV-out	7-pin mini-DIN connector (optional S-video to composite video adapter cable)
Mini PCI	Type IIIA Mini PCI card slot
Modem	RJ-11 port
Network adapter	RJ-45 port

Communications

Modem:	
Type	v.92 56K MDC
Controller	softmodem
Interface	internal AC'97 bus

Communications (continued)

Network adapter	10/100/1000 Ethernet LAN on system board
Wireless	internal Mini PCI Wi-Fi wireless support; PC Card with Bluetooth® wireless technology

Video

Video type	64-bit hardware accelerated
Data bus	8X AGP
Video controller	ATI Mobility RADEON 9700
Video memory	64 MB and 128 MB
LCD interface	LVDS
TV support	NTSC or PAL in S-video and composite modes

Audio

Audio type	compatible with Soundblaster and Microsoft® Windows® Sound System
Audio controller	Intel AC'97
Stereo conversion	20-bit (stereo digital-to-analog) 18-bit (stereo analog-to-digital)
Interfaces:	
Internal	AC'97
External	microphone miniconnector, stereo headphones/speakers miniconnector S/PDIF connector
Speaker	two 4-ohm speakers
Internal speaker amplifier	2-W per channel stereo into 4 ohms, two speakers per channel 5-W mono into 8 ohms (for the subwoofer)
Volume controls	key combinations; program menus

Display	
Type (active-matrix TFT)	WUXGA; WSXGA+; WXGA
Dimensions:	
Height	222.5 mm (8.8 inches)
Width	344.5 mm (13.6 inches)
Diagonal	391.2 mm (15.4 inches)
Maximum resolutions	1920 x 1200 (WUXGA); 1680 x 1050 (WSXGA+); 1280 x 800 (WXGA)
Response time (typical)	20-ms rise (maximum), 35-ms fall (maximum)
Refresh rate	60 Hz
Operating angle	0° (closed) to 180°
Viewing angles:	
Horizontal	±55°
Vertical	±48°
Pixel pitch	0.1725 mm (WUXGA) 0.1971 mm (WSXGA+) 0.2588 mm (WXGA)
Power Consumption:	
Panel with backlight (typical)	7.0 W (WUXGA) 6.0 W (WSXGA+) 5.5 W (WXGA)
Controls	brightness can be controlled through key combinations
Keyboard	
Number of keys	87 (U.S. and Canada); 88 (Europe); 91 (Japan)
Layout	QWERTY/AZERTY/Kanji

Touch Pad

X/Y position resolution (graphics table mode)	240 cpi
Size:	
Width	64.9-mm (2.5-inch) sensor-active area
Height	48.9-mm (1.9-inch) rectangle

Track Stick

X/Y position resolution (graphics table mode)	250 count/sec @ 100 gf
Size	protrudes 0.5 mm higher than surrounding keycaps

Battery

Type	12-cell, 95-WHr "smart" lithium ion dual 8-cell, 66-WHr "smart" lithium ion
Dimensions:	
Depth	88.5 mm (3.5 inches)
Height	21.5 mm (0.8 inch)
Width	139.0 mm (5.5 inches)
Weight	12 cell: 0.6 kg (1.4 lb); dual 8 cell: 0.95 kg (2.1 lb)
Voltage	14.8 VDC
Charge time (approximate):	
Computer on	2.5 hours
Computer off	1.5 hours
Operating time	Battery operating time varies depending on operating conditions and can be significantly reduced under certain power-intensive conditions. See "Using a Battery" on page 49 for more information on battery life.
Life span (approximate)	500 discharge/charge cycles

Battery (continued)

Temperature range:

Operating	0° to 35°C (32° to 95°F)
Storage	-40° to 65°C (-40° to 149°F)

AC Adapter

Input voltage	90–264 VAC
Input current (maximum)	2.5 A
Input frequency	47–63 Hz
Output current	9 A (maximum at 4-second pulse); 7.3–8.1 A (continuous)
Output power	150 W NOTICE: Do not use an AC adapter rated at less than 150 W with this computer.
Rated output voltage	19.5 VDC
Dimensions:	
Height	40.0 mm (1.6 inches)
Width	85.0 mm (3.4 inches)
Depth	170.0 mm (6.7 inches)
Weight (with cables)	0.68–1.09 kg (1.5–2.4 lb)
Temperature range:	
Operating	0° to 40°C (32° to 104°F)
Storage	-40° to 70°C (-40° to 158°F)

Physical

Height	50.6 mm (1.9 inches)
Width	358.9 mm (14.1 inches)
Depth	373.7 mm (10.8 inches)
Weight:	
With combo drive	4.0 kg (8.9 lb)
With DVD drive	3.9 kg (8.8 lb)

Environmental

Temperature range:

Operating	0° to 35°C (32° to 95°F)
Storage	-40° to 65°C (-40° to 149°F)

Relative humidity (maximum):

Operating	10% to 90% (noncondensing)
Storage	5% to 95% (noncondensing)

Maximum vibration (using a random-vibration spectrum that simulates user environment):

Operating	0.7 GRMS
Storage	1.3 GRMS

Maximum shock (measured with hard drive in head-parked position and a 2-ms half-sine pulse):

Operating	122 G
Storage	163 G

Altitude (maximum):

Operating	-15.2 to 3048 m (-50 to 10,000 ft)
Storage	-15.2 to 10,668 m (-50 to 35,000 ft)

Using the System Setup Program

Overview

 **NOTE:** Your operating system may automatically configure most of the options available in system setup, thus overriding options that you set through system setup. For more information on configuring features for your operating system, see the Help and Support Center. To access the Help and Support Center, see page 19.

The system setup screens display the current setup information and settings for your computer, such as:

- System configuration
- Boot order
- Boot (start-up) configuration
- Basic device-configuration settings
- System security and hard-drive password settings

-  **NOTICE:** Unless you are an expert computer user or are directed to do so by Dell technical support, do not change the system setup settings. Certain changes might make your computer work incorrectly.

Viewing the System Setup Screens

- 1 Turn on (or restart) your computer.
- 2 When the DELL™ logo appears, press <F2> immediately. If you wait too long and the Windows logo appears, continue to wait until you see the Windows desktop. Then shut down your computer and try again.

System Setup Screens

-  **NOTE:** For information about a specific item on a system setup screen, highlight the item and see the **Help** area on the screen.

On each screen, the system setup options are listed at the left. To the right of each option is the setting or value for that option. You can change settings that appear as white type on the screen. Options or values that you cannot change (because they are determined by the computer) appear less bright.

The upper-right corner of the screen displays help information for the currently highlighted option; the lower-right corner displays information about the computer. System-setup key functions are listed across the bottom of the screen.

Commonly Used Options

Certain options require that you reboot the computer for new settings to take effect.

Changing the Boot Sequence

The *boot sequence*, or *boot order*, tells the computer where to look to find the software needed to start the operating system. You can control the boot sequence and enable/disable devices using the **Boot Order** page of system setup.

-  **NOTE:** To change the boot sequence on a one-time-only basis, see "Performing a One-Time Boot" on page 151.

The **Boot Order** page displays a general list of the bootable devices that may be installed in your computer, including but not limited to the following:

- Diskette Drive
- Modular bay HDD
- Internal HDD
- CD/DVD/CD-RW drive

During the boot routine, the computer starts at the top of the list and scans each enabled device for the operating system start-up files. When the computer finds the files, it stops searching and starts the operating system.

To control the boot devices, select (highlight) a device by pressing the down-arrow or up-arrow key, and then enable or disable the device or change its order in the list.

- To enable or disable a device, highlight the item and press the space bar. Enabled items appear as white and display a small triangle to the left; disabled items appear blue or dimmed without a triangle.
- To reorder a device in the list, highlight the device and then press <u> or <d> (not case-sensitive) to move the highlighted device up or down.

Boot sequence changes take effect as soon as you save the changes and exit system setup.

Performing a One-Time Boot

You can set a one-time-only boot sequence without entering system setup. (You can also use this procedure to boot the Dell Diagnostics on the diagnostics utility partition on your hard drive.)

- 1** Shut down the computer through the **Start** menu.
- 2** Connect the computer to an electrical outlet.
- 3** Turn on the computer. When the DELL logo appears, press <F12> immediately. If you wait too long and the Windows logo appears, continue to wait until you see the Windows desktop. Then shut down your computer and try again.
- 4** When the boot device list appears, highlight the device from which you want to boot and press <Enter>.

The computer boots to the selected device.

The next time you reboot the computer, the previous boot order is restored.

Enabling the Infrared Sensor

- 1** Enter the system setup program:
 - a** Turn on your computer.
 - b** Press <F2> when the Dell™ logo appears to enter the system setup program.
- 2** Press <Alt><p> until you locate **Infrared Data Port** under **Basic Device Configuration**.
- 3** Press the down-arrow key to select the **Infrared Data Port** setting, and press the right-arrow key to change the setting to a COM port.
- 4** Press <Esc> and then click **Yes** to save the changes and exit the system setup program. If you are prompted to restart your computer, click **Yes**.
- 5** Follow the instructions on the screen.
- 6** After the infrared sensor has been enabled, click **Yes** to restart the computer.

After you enable the infrared sensor, you can use it to establish a link to an infrared device. To set up and use an infrared device, see the infrared device documentation and the Microsoft® Windows® XP Help and Support Center. To access the Help and Support Center, see page 19.

Dell Technical Support Policy (U.S. Only)

Technician-assisted technical support requires the cooperation and participation of the customer in the troubleshooting process and provides for restoration of the operating system, software programs, and hardware drivers to the original default configuration as shipped from Dell, as well as the verification of appropriate functionality of the computer and all Dell-installed hardware. In addition to this technician-assisted technical support, online technical support is available at support.dell.com. Additional technical support options may be available for purchase.

Dell provides limited technical support for the computer and any "Dell-installed" software and peripherals¹. Support for third-party software and peripherals is provided by the original manufacturer, including those purchased and/or installed through Dell Software and Peripherals, Readyware, and Custom Factory Integration².

¹ Repair services are provided pursuant to the terms and conditions of your limited warranty and any optional support service contract purchased with the computer.

² All Dell-standard components included in a Custom Factory Integration (CFI) project are covered by the standard Dell limited warranty for your computer. However, Dell also extends a parts replacement program to cover all nonstandard, third-party hardware components integrated through CFI for the duration of the computer's service contract.

Definition of "Dell-Installed" Software and Peripherals

Dell-installed software includes the operating system and some of the software programs that are installed on the computer during the manufacturing process (Microsoft® Office, Norton Antivirus, and so on).

Dell-installed peripherals include any internal expansion cards, or Dell-branded module bay or PC Card accessories. In addition, any Dell-branded monitors, keyboards, mice, speakers, microphones for telephonic modems, port replicators, networking products, and all associated cabling are included.

Definition of "Third-Party" Software and Peripherals

Third-party software and peripherals include any peripheral, accessory, or software program sold by Dell not under the Dell brand (printers, scanners, cameras, games, and so on). Support for all third-party software and peripherals is provided by the original manufacturer of the product.

Contacting Dell

To contact Dell electronically, you can access the following websites:

- www.dell.com
- support.dell.com (technical support)
- premiersupport.dell.com (technical support for educational, government, healthcare, and medium/large business customers, including Premier, Platinum, and Gold customers)

For specific web addresses for your country, find the appropriate country section in the table below.

NOTE: Toll-free numbers are for use within the country for which they are listed.

When you need to contact Dell, use the electronic addresses, telephone numbers, and codes provided in the following table. If you need assistance in determining which codes to use, contact a local or an international operator.

Country (City) International Access Code Country Code City Code	Department Name or Service Area, Website and E-Mail Address	Area Codes, Local Numbers, and Toll-Free Numbers
Anguilla	General Support	toll-free: 800-335-0031
Antigua and Barbuda	General Support	1-800-805-5924
Argentina (Buenos Aires)	Website: www.dell.com.ar	
International Access Code: 00	Tech Support and Customer Care	toll-free: 0-800-444-0733
Country Code: 54	Sales	0-810-444-3355
City Code: 11	Tech Support Fax	11 4515 7139
	Customer Care Fax	11 4515 7138
Aruba	General Support	toll-free: 800-1578
Australia (Sydney)	E-mail (Australia): au_tech_support@dell.com	
International Access Code: 0011	E-mail (New Zealand): nz_tech_support@dell.com	
Country Code: 61	Home and Small Business	1-300-65-55-33
City Code: 2	Government and Business	toll-free: 1-800-633-559
	Preferred Accounts Division (PAD)	toll-free: 1-800-060-889
	Customer Care	toll-free: 1-800-819-339
	Corporate Sales	toll-free: 1-800-808-385
	Transaction Sales	toll-free: 1-800-808-312
	Fax	toll-free: 1-800-818-341

Country (City) International Access Code Country Code City Code	Department Name or Service Area, Website and E-Mail Address	Area Codes, Local Numbers, and Toll-Free Numbers
Austria (Vienna)	Website: support.euro.dell.com	
International Access Code: 900	E-mail: tech_support_central_europe@dell.com	
Country Code: 43	Home/Small Business Sales	0820 240 530 00
City Code: 1	Home/Small Business Fax	0820 240 530 49
	Home/Small Business Customer Care	0820 240 530 14
	Preferred Accounts/Corporate Customer Care	0820 240 530 16
	Home/Small Business Technical Support	0820 240 530 14
	Preferred Accounts/Corporate Technical Support	0660 8779
	Switchboard	0820 240 530 00
Bahamas	General Support	toll-free: 1-866-278-6818
Barbados	General Support	1-800-534-3066
Belgium (Brussels)	Website: support.euro.dell.com	
International Access Code: 00	E-mail: tech_be@dell.com	
Country Code: 32	E-mail for French Speaking Customers: support.euro.dell.com/be/fr/emaildell/	
City Code: 2	Technical Support	02 481 92 88
	Customer Care	02 481 91 19
	Corporate Sales	02 481 91 00
	Fax	02 481 92 99
	Switchboard	02 481 91 00
Bermuda	General Support	1-800-342-0671
Bolivia	General Support	toll-free: 800-10-0238
Brazil	Website: www.dell.com/br	
International Access Code: 00	Customer Support, Technical Support	0800 90 3355
Country Code: 55	Tech Support Fax	51 481 5470
City Code: 51	Customer Care Fax	51 481 5480
	Sales	0800 90 3390
British Virgin Islands	General Support	toll-free: 1-866-278-6820
Brunei	Customer Technical Support (Penang, Malaysia)	604 633 4966
Country Code: 673	Customer Service (Penang, Malaysia)	604 633 4949
	Transaction Sales (Penang, Malaysia)	604 633 4955

Country (City) International Access Code Country Code City Code	Department Name or Service Area, Website and E-Mail Address	Area Codes, Local Numbers, and Toll-Free Numbers
Canada (North York, Ontario) International Access Code: 011	Online Order Status: www.dell.ca/ostatus AutoTech (automated technical support) TechFax Customer Care (Home Sales/Small Business) Customer Care (med./large business, government) Technical Support (Home Sales/Small Business) Technical Support (med./large bus., government) Sales (Home Sales/Small Business) Sales (med./large bus., government) Spare Parts Sales & Extended Service Sales	toll-free: 1-800-247-9362 toll-free: 1-800-950-1329 toll-free: 1-800-847-4096 toll-free: 1-800-326-9463 toll-free: 1-800-847-4096 toll-free: 1-800-387-5757 toll-free: 1-800-387-5752 toll-free: 1-800-387-5755 1 866 440 3355
Cayman Islands	General Support	1-800-805-7541
Chile (Santiago) Country Code: 56 City Code: 2	Sales, Customer Support, and Technical Support	toll-free: 1230-020-4823

Country (City) International Access Code Country Code City Code	Department Name or Service Area, Website and E-Mail Address	Area Codes, Local Numbers, and Toll-Free Numbers
China (Xiamen)	Tech Support website: support.dell.com.cn	
Country Code: 86	Tech Support E-mail: cn_support@dell.com	
City Code: 592	Tech Support Fax	818 1350
	Technical Support (Dimension™ and Inspiron™)	toll-free: 800 858 2969
	Technical Support (OptiPlex™, Latitude™, and Dell Precision™)	toll-free: 800 858 0950
	Technical Support (servers and storage)	toll-free: 800 858 0960
	Technical Support (projectors, PDAs, printers, switches, routers, and so on)	toll-free: 800 858 2920
	Customer Experience	toll-free: 800 858 2060
	Home and Small Business	toll-free: 800 858 2222
	Preferred Accounts Division	toll-free: 800 858 2557
	Large Corporate Accounts GCP	toll-free: 800 858 2055
	Large Corporate Accounts Key Accounts	toll-free: 800 858 2628
	Large Corporate Accounts North	toll-free: 800 858 2999
	Large Corporate Accounts North Government and Education	toll-free: 800 858 2955
	Large Corporate Accounts East	toll-free: 800 858 2020
	Large Corporate Accounts East Government and Education	toll-free: 800 858 2669
	Large Corporate Accounts Queue Team	toll-free: 800 858 2222
	Large Corporate Accounts South	toll-free: 800 858 2355
	Large Corporate Accounts West	toll-free: 800 858 2811
	Large Corporate Accounts Spare Parts	toll-free: 800 858 2621
Colombia	General Support	980-9-15-3978
Costa Rica	General Support	0800-012-0435

Country (City) International Access Code Country Code City Code	Department Name or Service Area, Website and E-Mail Address	Area Codes, Local Numbers, and Toll-Free Numbers
Czech Republic (Prague)	Website: support.euro.dell.com	
International Access Code: 00	E-mail: czech_dell@dell.com	
Country Code: 420	Technical Support	02 2186 27 27
City Code: 2	Customer Care	02 2186 27 11
	Fax	02 2186 27 14
	TechFax	02 2186 27 28
	Switchboard	02 2186 27 11
Denmark (Copenhagen)	Website: support.euro.dell.com	
International Access Code: 00	E-mail Support (portable computers): den_nbk_support@dell.com	
Country Code: 45	E-mail Support (desktop computers): den_support@dell.com	
	E-mail Support (servers): Nordic_server_support@dell.com	
	Technical Support	7023 0182
	Customer Care (Relational)	7023 0184
	Home/Small Business Customer Care	3287 5505
	Switchboard (Relational)	3287 1200
	Fax Switchboard (Relational)	3287 1201
	Switchboard (Home/Small Business)	3287 5000
	Fax Switchboard (Home/Small Business)	3287 5001
Dominica	General Support	toll-free: 1-866-278-6821
Dominican Republic	General Support	1-800-148-0530
Ecuador	General Support	toll-free: 999-119
El Salvador	General Support	01-899-753-0777

Country (City) International Access Code Country Code City Code	Department Name or Service Area, Website and E-Mail Address	Area Codes, Local Numbers, and Toll-Free Numbers
Finland (Helsinki)	Website: support.euro.dell.com	
International Access Code: 990	E-mail: fin_support@dell.com	
Country Code: 358	E-mail Support (servers):	
City Code: 9	Nordic_support@dell.com	
	Technical Support	09 253 313 60
	Technical Support Fax	09 253 313 81
	Relational Customer Care	09 253 313 38
	Home/Small Business Customer Care	09 693 791 94
	Fax	09 253 313 99
	Switchboard	09 253 313 00
France (Paris) (Montpellier)	Website: support.euro.dell.com	
International Access Code: 00	E-mail: support.euro.dell.com/fr/fr/emaildell/	
Country Code: 33	Home and Small Business	
City Codes: (1) (4)	Technical Support	0825 387 270
	Customer Care	0825 823 833
	Switchboard	0825 004 700
	Switchboard (calls from outside of France)	04 99 75 40 00
	Sales	0825 004 700
	Fax	0825 004 701
	Fax (calls from outside of France)	04 99 75 40 01
	Corporate	
	Technical Support	0825 004 719
	Customer Care	0825 338 339
	Switchboard	01 55 94 71 00
	Sales	01 55 94 71 00
	Fax	01 55 94 71 01

Country (City) International Access Code Country Code City Code	Department Name or Service Area, Website and E-Mail Address	Area Codes, Local Numbers, and Toll-Free Numbers
Germany (Langen) International Access Code: 00 Country Code: 49 City Code: 6103	Website: support.euro.dell.com E-mail: tech_support_central_europe@dell.com Technical Support Home/Small Business Customer Care Global Segment Customer Care Preferred Accounts Customer Care Large Accounts Customer Care Public Accounts Customer Care Switchboard	06103 766-7200 0180-5-224400 06103 766-9570 06103 766-9420 06103 766-9560 06103 766-9555 06103 766-7000
Greece International Access Code: 00 Country Code: 30	Website: support.euro.dell.com E-mail: support.euro.dell.com/gr/en/emaildell/ Technical Support Gold Technical Support Switchboard Sales Fax	080044149518 08844140083 2108129800 2108129800 2108129812
Grenada	General Support	toll-free: 1-866-540-3355
Guatemala	General Support	1-800-999-0136
Guyana	General Support	toll-free: 1-877-270-4609
Hong Kong International Access Code: 001 Country Code: 852	Website: support.ap.dell.com E-mail: ap_support@dell.com Technical Support (Dimension™ and Inspiron™) Technical Support (OptiPlex™, Latitude™, and Dell Precision™) Technical Support (PowerApp™, PowerEdge™, PowerConnect™, and PowerVault™) Gold Queue EEC Hotline Customer Advocacy Large Corporate Accounts Global Customer Programs Medium Business Division Home and Small Business Division	2969 3189 2969 3191 2969 3196 2969 3187 3416 0910 3416 0907 3416 0908 3416 0912 2969 3105

Country (City) International Access Code Country Code City Code	Department Name or Service Area, Website and E-Mail Address	Area Codes, Local Numbers, and Toll-Free Numbers
India	Technical Support	1600 33 8045
	Sales	1600 33 8044
Ireland (Cherrywood)	Website: support.euro.dell.com	
International Access Code: 16	E-mail: dell_direct_support@dell.com	
Country Code: 353	Technical Support	1850 543 543
City Code: 1	U.K. Technical Support (dial within U.K. only)	0870 908 0800
	Home User Customer Care	01 204 4014
	Small Business Customer Care	01 204 4014
	U.K. Customer Care (dial within U.K. only)	0870 906 0010
	Corporate Customer Care	1850 200 982
	Corporate Customer Care (dial within U.K. only)	0870 907 4499
	Ireland Sales	01 204 4444
	U.K. Sales (dial within U.K. only)	0870 907 4000
	Fax/SalesFax	01 204 0103
	Switchboard	01 204 4444
Italy (Milan)	Website: support.euro.dell.com	
International Access Code: 00	E-mail: support.euro.dell.com/it/it/emaildell/	
Country Code: 39	Home and Small Business	
City Code: 02	Technical Support	02 577 826 90
	Customer Care	02 696 821 14
	Fax	02 696 821 13
	Switchboard	02 696 821 12
	Corporate	
	Technical Support	02 577 826 90
	Customer Care	02 577 825 55
	Fax	02 575 035 30
	Switchboard	02 577 821
Jamaica	General Support (dial from within Jamaica only)	1-800-682-3639

Country (City) International Access Code Country Code City Code	Department Name or Service Area, Website and E-Mail Address	Area Codes, Local Numbers, and Toll-Free Numbers
Japan (Kawasaki)	Website: support.jp.dell.com	
International Access Code: 001	Technical Support (servers)	toll-free: 0120-198-498
Country Code: 81	Technical Support outside of Japan (servers)	81-44-556-4162
City Code: 44	Technical Support (Dimension™ and Inspiron™)	toll-free: 0120-198-226
	Technical Support outside of Japan (Dimension and Inspiron)	81-44-520-1435
	Technical Support (Dell Precision™, OptiPlex™, and Latitude™)	toll-free: 0120-198-433
	Technical Support outside of Japan (Dell Precision, OptiPlex, and Latitude)	81-44-556-3894
	Technical Support (Axim™)	toll-free: 0120-981-690
	Technical Support outside of Japan (Axim)	81-44-556-3468
	Faxbox Service	044-556-3490
	24-Hour Automated Order Service	044-556-3801
	Customer Care	044-556-4240
	Business Sales Division (up to 400 employees)	044-556-1465
	Preferred Accounts Division Sales (over 400 employees)	044-556-3433
	Large Corporate Accounts Sales (over 3500 employees)	044-556-3430
	Public Sales (government agencies, educational institutions, and medical institutions)	044-556-1469
	Global Segment Japan	044-556-3469
	Individual User	044-556-1760
	Switchboard	044-556-4300
Korea (Seoul)	Technical Support	toll-free: 080-200-3800
International Access Code: 001	Sales	toll-free: 080-200-3600
Country Code: 82	Customer Service (Seoul, Korea)	toll-free: 080-200-3800
City Code: 2	Customer Service (Penang, Malaysia)	604 633 4949
	Fax	2194-6202
	Switchboard	2194-6000

Country (City) International Access Code Country Code City Code	Department Name or Service Area, Website and E-Mail Address	Area Codes, Local Numbers, and Toll-Free Numbers
Latin America	Customer Technical Support (Austin, Texas, U.S.A.)	512 728-4093
	Customer Service (Austin, Texas, U.S.A.)	512 728-3619
	Fax (Technical Support and Customer Service) (Austin, Texas, U.S.A.)	512 728-3883
	Sales (Austin, Texas, U.S.A.)	512 728-4397
	SalesFax (Austin, Texas, U.S.A.)	512 728-4600 or 512 728-3772
Luxembourg	Website: support.euro.dell.com	
International Access Code: 00	E-mail: tech_be@dell.com	
Country Code: 352	Technical Support (Brussels, Belgium)	3420808075
	Home/Small Business Sales (Brussels, Belgium)	toll-free: 080016884
	Corporate Sales (Brussels, Belgium)	02 481 91 00
	Customer Care (Brussels, Belgium)	02 481 91 19
	Fax (Brussels, Belgium)	02 481 92 99
	Switchboard (Brussels, Belgium)	02 481 91 00
Macao	Technical Support	toll-free: 0800 582
Country Code: 853	Customer Service (Penang, Malaysia)	604 633 4949
	Transaction Sales	toll-free: 0800 581
Malaysia (Penang)	Technical Support (Dell Precision, OptiPlex, and Latitude)	toll-free: 1 800 88 0193
International Access Code: 00		
Country Code: 60	Technical Support (Dimension and Inspiron)	toll-free: 1 800 88 1306
City Code: 4	Customer Service	04 633 4949
	Transaction Sales	toll-free: 1 800 888 202
	Corporate Sales	toll-free: 1 800 888 213

Country (City) International Access Code Country Code City Code	Department Name or Service Area, Website and E-Mail Address	Area Codes, Local Numbers, and Toll-Free Numbers
Mexico International Access Code: 00 Country Code: 52	Customer Technical Support Sales Customer Service Main	001-877-384-8979 or 001-877-269-3383 50-81-8800 or 01-800-888-3355 001-877-384-8979 or 001-877-269-3383 50-81-8800 or 01-800-888-3355
Montserrat	General Support	toll-free: 1-866-278-6822
Netherlands Antilles	General Support	001-800-882-1519
Netherlands (Amsterdam) International Access Code: 00 Country Code: 31 City Code: 20	Website: support.euro.dell.com E-mail (Technical Support): (Enterprise): nl_server_support@dell.com (Latitude): nl_latitude_support@dell.com (Inspiron): nl_inspiron_support@dell.com (Dimension): nl_dimension_support@dell.com (OptiPlex): nl_optiplex_support@dell.com (Dell Precision): nl_workstation_support@dell.com	
	Technical Support	020 674 45 00
	Technical Support Fax	020 674 47 66
	Home/Small Business Customer Care	020 674 42 00
	Relational Customer Care	020 674 4325
	Home/Small Business Sales	020 674 55 00
	Relational Sales	020 674 50 00
	Home/Small Business Sales Fax	020 674 47 75
	Relational Sales Fax	020 674 47 50
	Switchboard	020 674 50 00
	Switchboard Fax	020 674 47 50

Country (City) International Access Code Country Code City Code	Department Name or Service Area, Website and E-Mail Address	Area Codes, Local Numbers, and Toll-Free Numbers
New Zealand	E-mail (New Zealand): nz_tech_support@dell.com	
International Access Code: 00	E-mail (Australia): au_tech_support@dell.com	
Country Code: 64	Home and Small Business	0800 446 255
	Government and Business	0800 444 617
	Sales	0800 441 567
	Fax	0800 441 566
Nicaragua	General Support	001-800-220-1006
Norway (Lysaker)	Website: support.euro.dell.com	
International Access Code: 00	E-mail Support (portable computers):	
Country Code: 47	nor_nbk_support@dell.com	
	E-mail Support (desktop computers):	
	nor_support@dell.com	
	E-mail Support (servers):	
	nordic_server_support@dell.com	
	Technical Support	671 16882
	Relational Customer Care	671 17514
	Home/Small Business Customer Care	23162298
	Switchboard	671 16800
	Fax Switchboard	671 16865
Panama	General Support	001-800-507-0962
Peru	General Support	0800-50-669
Poland (Warsaw)	Website: support.euro.dell.com	
International Access Code: 011	E-mail: pl_support_tech@dell.com	
Country Code: 48	Customer Service Phone	57 95 700
City Code: 22	Customer Care	57 95 999
	Sales	57 95 999
	Customer Service Fax	57 95 806
	Reception Desk Fax	57 95 998
	Switchboard	57 95 999

Country (City) International Access Code Country Code City Code	Department Name or Service Area, Website and E-Mail Address	Area Codes, Local Numbers, and Toll-Free Numbers
Portugal	Website: support.euro.dell.com	
International Access Code: 00	E-mail: support.euro.dell.com/pt/en/emailldell/	
Country Code: 351	Technical Support	707200149
	Customer Care	800 300 413
	Sales	800 300 410 or 800 300 411 or 800 300 412 or 21 422 07 10
	Fax	21 424 01 12
Puerto Rico	General Support	1-800-805-7545
St. Kitts and Nevis	General Support	toll-free: 1-877-441-4731
St. Lucia	General Support	1-800-882-1521
St. Vincent and the Grenadines	General Support	toll-free: 1-877-270-4609
Singapore (Singapore)	Technical Support	toll-free: 800 6011 051
International Access Code: 005	Customer Service (Penang, Malaysia)	604 633 4949
Country Code: 65	Transaction Sales	toll-free: 800 6011 054
	Corporate Sales	toll-free: 800 6011 053
South Africa (Johannesburg)	Website: support.euro.dell.com	
International Access Code:	E-mail: dell_za_support@dell.com	
09/091	Technical Support	011 709 7710
Country Code: 27	Customer Care	011 709 7707
City Code: 11	Sales	011 709 7700
	Fax	011 706 0495
	Switchboard	011 709 7700
Southeast Asian and Pacific Countries	Customer Technical Support, Customer Service, and Sales (Penang, Malaysia)	604 633 4810

Country (City) International Access Code Country Code City Code	Department Name or Service Area, Website and E-Mail Address	Area Codes, Local Numbers, and Toll-Free Numbers
Spain (Madrid)	Website: support.euro.dell.com	
International Access Code: 00	E-mail: support.euro.dell.com/es/es/emaildell/	
Country Code: 34	Home and Small Business	
City Code: 91	Technical Support	902 100 130
	Customer Care	902 118 540
	Sales	902 118 541
	Switchboard	902 118 541
	Fax	902 118 539
	Corporate	
	Technical Support	902 100 130
	Customer Care	902 118 546
	Switchboard	91 722 92 00
	Fax	91 722 95 83
Sweden (Upplands Vasby)	Website: support.euro.dell.com	
International Access Code: 00	E-mail: swe_support@dell.com	
Country Code: 46	E-mail Support for Latitude and Inspiron: Swe-nbk_kats@dell.com	
City Code: 8	E-mail Support for OptiPlex: Swe_kats@dell.com	
	E-mail Support for Servers: Nordic_server_support@dell.com	
	Technical Support	08 590 05 199
	Relational Customer Care	08 590 05 642
	Home/Small Business Customer Care	08 587 70 527
	Employee Purchase Program (EPP) Support	20 140 14 44
	Fax Technical Support	08 590 05 594
	Sales	08 590 05 185

Country (City) International Access Code Country Code City Code	Department Name or Service Area, Website and E-Mail Address	Area Codes, Local Numbers, and Toll-Free Numbers
Switzerland (Geneva) International Access Code: 00 Country Code: 41 City Code: 22	Website: support.euro.dell.com E-mail: Tech_support_central_Europe@dell.com E-mail for French-speaking HSB and Corporate Customers: support.euro.dell.com/ch/fr/emaildell/ Technical Support (Home and Small Business) Technical Support (Corporate) Customer Care (Home and Small Business) Customer Care (Corporate) Fax Switchboard	0844 811 411 0844 822 844 0848 802 202 0848 821 721 022 799 01 90 022 799 01 01
Taiwan International Access Code: 002 Country Code: 886	Technical Support (portable and desktop computers) Technical Support (servers) Transaction Sales Corporate Sales	toll-free: 00801 86 1011 toll-free: 0080 60 1256 toll-free: 0080 651 228 toll-free: 0080 651 227
Thailand International Access Code: 001 Country Code: 66	Technical Support Customer Service (Penang, Malaysia) Sales	toll-free: 0880 060 07 604 633 4949 toll-free: 0880 060 09
Trinidad/Tobago	General Support	1-800-805-8035
Turks and Caicos Islands	General Support	toll-free: 1-866-540-3355

Country (City) International Access Code Country Code City Code	Department Name or Service Area, Website and E-Mail Address	Area Codes, Local Numbers, and Toll-Free Numbers
U.K. (Bracknell)	Website: support.euro.dell.com	
International Access Code: 00	Customer Care website: support.euro.dell.com/uk/en/ECare/Form/Home.asp	
Country Code: 44		
City Code: 1344	E-mail: dell_direct_support@dell.com	
	Technical Support (Corporate/Preferred Accounts/PAD [1000+ employees])	0870 908 0500
	Technical Support (direct/PAD and general)	0870 908 0800
	Global Accounts Customer Care	01344 373 186
	Home and Small Business Customer Care	0870 906 0010
	Corporate Customer Care	01344 373 185
	Preferred Accounts (500–5000 employees) Customer Care	0870 906 0010
	Central Government Customer Care	01344 373 193
	Local Government & Education Customer Care	01344 373 199
	Health Customer Care	01344 373 194
	Home and Small Business Sales	0870 907 4000
	Corporate/Public Sector Sales	01344 860 456
	Home and Small Business Fax	0870 907 4006
Uruguay	General Support	toll-free: 000-413-598-2521

Country (City) International Access Code Country Code City Code	Department Name or Service Area, Website and E-Mail Address	Area Codes, Local Numbers, and Toll-Free Numbers
U.S.A. (Austin, Texas)	Automated Order-Status Service	toll-free: 1-800-433-9014
International Access Code: 011 Country Code: 1	AutoTech (portable and desktop computers) Consumer (Home and Home Office) Technical Support Customer Service DellNet™ Service and Support Employee Purchase Program (EPP) Customers Financial Services website: www.dellfinancialservices.com Financial Services (lease/loans) Financial Services (Dell Preferred Accounts [DPA]) Business Customer Service and Technical Support Employee Purchase Program (EPP) Customers Printers and Projectors Technical Support Public (government, education, and healthcare) Customer Service and Technical Support Employee Purchase Program (EPP) Customers Dell Sales Dell Outlet Store (Dell refurbished computers) Software and Peripherals Sales Spare Parts Sales Extended Service and Warranty Sales Fax Dell Services for the Deaf, Hard-of-Hearing, or Speech-Impaired	toll-free: 1-800-247-9362 toll-free: 1-800-624-9896 toll-free: 1-800-624-9897 toll-free: 1-877-Dellnet (1-877-335-5638) toll-free: 1-800-695-8133 toll-free: 1-877-577-3355 toll-free: 1-800-283-2210 toll-free: 1-800-822-8965 toll-free: 1-800-695-8133 toll-free: 1-877-459-7298 toll-free: 1-800-456-3355 toll-free: 1-800-234-1490 toll-free: 1-800-289-3355 or toll-free: 1-800-879-3355 toll-free: 1-888-798-7561 toll-free: 1-800-671-3355 toll-free: 1-800-357-3355 toll-free: 1-800-247-4618 toll-free: 1-800-727-8320 toll-free: 1-877-DELLITY (1-877-335-5889)
U.S. Virgin Islands	General Support	1-877-673-3355
Venezuela	General Support	8001-3605

Regulatory Notices

Electromagnetic Interference (EMI) is any signal or emission, radiated in free space or conducted along power or signal leads, that endangers the functioning of a radio navigation or other safety service or seriously degrades, obstructs, or repeatedly interrupts a licensed radio communications service. Radio communications services include but are not limited to AM/FM commercial broadcast, television, cellular services, radar, air-traffic control, pager, and Personal Communication Services (PCS). These licensed services, along with unintentional radiators such as digital devices, including computers, contribute to the electromagnetic environment.

Electromagnetic Compatibility (EMC) is the ability of items of electronic equipment to function properly together in the electronic environment. While this computer has been designed and determined to be compliant with regulatory agency limits for EMI, there is no guarantee that interference will not occur in a particular installation. If this equipment does cause interference with radio communications services, which can be determined by turning the equipment off and on, you are encouraged to try to correct the interference by one or more of the following measures:

- Reorient the receiving antenna.
- Relocate the computer with respect to the receiver.
- Move the computer away from the receiver.
- Plug the computer into a different outlet so that the computer and the receiver are on different branch circuits.

If necessary, consult a Dell Technical Support representative or an experienced radio/television technician for additional suggestions.

For additional regulatory information, see the *Dell Inspiron Help* file that accompanied your computer. To access the help file, see page 18.

NOM Information (Mexico Only)

The following information is provided on the device(s) described in this document in compliance with the requirements of the official Mexican standards (NOM):

Exporter:	Dell Inc. One Dell Way Round Rock, TX 78682
Importer:	Dell Computer de México, S.A. de C.V. Paseo de la Reforma 2620 - 11° Piso Col. Lomas Altas 11950 México, D.F.
Ship to:	Dell Computer de México, S.A. de C.V. al Cuidado de Kuehne & Nagel de México S. de R.L. Avenida Soles No. 55 Col. Peñon de los Baños 15520 México, D.F.
Model number:	PP09L
Supply voltage:	100–240 VAC
Frequency:	50–60 Hz
Current consumption:	2.5 A
Output voltage:	19.5 V
Output current:	7.7 A

Limited Warranties

Dell-branded hardware products purchased in the U.S. or Canada come with either a 90-day, 1-year, 2-year, 3-year, or 4-year limited warranty. To determine which warranty came with your hardware product(s), see your packing slip or invoice. The following sections describe the limited warranties for the U.S., the limited warranties for Canada, the manufacturer guarantee for Latin America and the Caribbean, and the Intel® Pentium® and Celeron® warranty for the U.S. and Canada.

Limited Warranty for Dell-Branded Hardware Products (U.S. Only)

What is covered by this limited warranty?

This limited warranty covers defects in materials and workmanship in your—our end-user customer's—Dell-branded hardware products, including Dell-branded peripheral products.

What is not covered by this limited warranty?

This limited warranty does not cover:

- Software, including the operating system and software added to the Dell-branded hardware products through our factory-integration system, third-party software, or the reloading of software
- Non-Dell-branded and Solution Provider Direct products and accessories

- Problems that result from:
 - External causes such as accident, abuse, misuse, or problems with electrical power
 - Servicing not authorized by Dell
 - Usage that is not in accordance with product instructions
 - Failure to follow the product instructions or failure to perform preventive maintenance
 - Problems caused by using accessories, parts, or components not supplied by Dell
- Products with missing or altered Service Tags or serial numbers
- Products for which Dell has not received payment

THIS WARRANTY GIVES YOU SPECIFIC LEGAL RIGHTS, AND YOU MAY ALSO HAVE OTHER RIGHTS WHICH VARY FROM STATE TO STATE (OR JURISDICTION TO JURISDICTION). DELL'S RESPONSIBILITY FOR MALFUNCTIONS AND DEFECTS IN HARDWARE IS LIMITED TO REPAIR AND REPLACEMENT AS SET FORTH IN THIS WARRANTY STATEMENT. ALL EXPRESS AND IMPLIED WARRANTIES FOR THE PRODUCT, INCLUDING BUT NOT LIMITED TO ANY IMPLIED WARRANTIES AND CONDITIONS OF MERCHANTABILITY AND FITNESS FOR A PARTICULAR PURPOSE, ARE LIMITED IN TIME TO THE TERM OF THE LIMITED WARRANTY PERIOD REFLECTED ON YOUR PACKING SLIP OR INVOICE. NO WARRANTIES, WHETHER EXPRESS OR IMPLIED, WILL APPLY AFTER THE LIMITED WARRANTY PERIOD HAS EXPIRED. SOME STATES DO NOT ALLOW LIMITATIONS ON HOW LONG AN IMPLIED WARRANTY LASTS, SO THIS LIMITATION MAY NOT APPLY TO YOU.

WE DO NOT ACCEPT LIABILITY BEYOND THE REMEDIES PROVIDED FOR IN THIS LIMITED WARRANTY OR FOR CONSEQUENTIAL OR INCIDENTAL DAMAGES, INCLUDING, WITHOUT LIMITATION, ANY LIABILITY FOR THIRD-PARTY CLAIMS AGAINST YOU FOR DAMAGES, FOR PRODUCTS NOT BEING AVAILABLE FOR USE, OR FOR LOST DATA OR LOST SOFTWARE. OUR LIABILITY WILL BE NO MORE THAN THE AMOUNT YOU PAID FOR THE PRODUCT THAT IS THE SUBJECT OF A CLAIM. THIS IS THE MAXIMUM AMOUNT FOR WHICH WE ARE RESPONSIBLE.

SOME STATES DO NOT ALLOW THE EXCLUSION OR LIMITATION OF INCIDENTAL OR CONSEQUENTIAL DAMAGES, SO THE ABOVE LIMITATION OR EXCLUSION MAY NOT APPLY TO YOU.

How long does this limited warranty last?

This limited warranty lasts for the time period indicated on your packing slip or invoice, except for the following Dell-branded hardware:

- Portable computer batteries carry a 1-year limited warranty.
- Projector lamps carry a 90-day limited warranty.
- Memory carries a lifetime limited warranty.
- Monitors carry the longer of either a 3-year limited warranty or the remainder of the warranty for the Dell computer to which the monitor will be connected.
- Other add-on hardware carries the longer of either a 1-year limited warranty for new parts and a 90-day limited warranty for reconditioned parts or, for both new and reconditioned parts, the remainder of the warranty for the Dell computer on which such parts are installed.

The limited warranty on all Dell-branded products begins on the date of the packing slip or invoice. The warranty period is not extended if we repair or replace a warranted product or any parts. Dell may change the availability of limited warranties, at its discretion, but any changes will not be retroactive.

What do I do if I need warranty service?

Before the warranty expires, please call us at the relevant number listed in the following table. Please also have your Dell Service Tag or order number available.

Individual Home Consumers:	U.S. Only
Technical Support	1-800-624-9896
Customer Service	1-800-624-9897
Individual Home Consumers who purchased through an Employee Purchase Program:	
Technical Support and Customer Service	1-800-822-8965
Home and Small Business Commercial Customers:	
Technical Support and Customer Service	1-800-456-3355
Medium, Large, or Global Commercial Customers, Healthcare Customers, and Value-Added Resellers (VARs):	
Technical Support and Customer Service	1-800-822-8965
Government and Education Customers:	
Technical Support and Customer Service	1-800-234-1490
Dell-Branded Memory	1-888-363-5150

What will Dell do?

During the 90 days of the 90-day limited warranty and the first year of all other limited warranties: During the 90 days of the 90-day limited warranty and the first year of all other limited warranties, we will repair any Dell-branded hardware products returned to us that prove to be defective in materials or workmanship. If we are not able to repair the product, we will replace it with a comparable product that is new or refurbished.

When you contact us, we will issue a Return Material Authorization Number for you to include with your return. You must return the products to us in their original or equivalent packaging, prepay shipping charges, and insure the shipment or accept the risk if the product is lost or damaged in shipment. We will return the repaired or replacement products to you. We will pay to ship the repaired or replaced products to you if you use an address in the United States (excluding Puerto Rico and U.S. possessions and territories). Otherwise, we will ship the product to you freight collect.

If we determine that the product is not covered under this warranty, we will notify you and inform you of service alternatives that are available to you on a fee basis.

NOTE: Before you ship the product(s) to us, make sure to back up the data on the hard drive(s) and any other storage device(s) in the product(s). Remove any confidential, proprietary, or personal information and removable media such as floppy disks, CDs, or PC Cards. We are not responsible for any of your confidential, proprietary, or personal information; lost or corrupted data; or damaged or lost removable media.

During the remaining years: For the remaining period of the limited warranty, we will replace any defective part with new or refurbished parts, if we agree that it needs to be replaced. When you contact us, we will require a valid credit card number at the time you request a replacement part, but we will not charge you for the replacement part as long as you return the original part to us within 30 days after we ship the replacement part to you. If we do not receive the original part within 30 days, we will charge to your credit card the then-current standard price for that part.

We will pay to ship the part to you if you use an address in the United States (excluding Puerto Rico and U.S. possessions and territories). Otherwise, we will ship the part freight collect. We will also include a prepaid shipping container with each replacement part for your use in returning the replaced part to us.

NOTE: Before you replace parts, make sure to back up the data on the hard drive(s) and any other storage device(s) in the product(s). We are not responsible for lost or corrupted data.

What if I purchased a service contract?

If your service contract is with Dell, service will be provided to you under the terms of the service agreement. Please refer to that contract for details on how to obtain service.

If you purchased through us a service contract with one of our third-party service providers, please refer to that contract for details on how to obtain service.

How will you fix my product?

We use new and refurbished parts made by various manufacturers in performing warranty repairs and in building replacement parts and systems. Refurbished parts and systems are parts or systems that have been returned to Dell, some of which were never used by a customer. All parts and systems are inspected and tested for quality. Replacement parts and systems are covered for the remaining period of the limited warranty for the product you bought. Dell owns all parts removed from repaired products.

May I transfer the limited warranty?

Limited warranties on systems may be transferred if the current owner transfers ownership of the system and records the transfer with us. The limited warranty on Dell-branded memory may not be transferred. You may record your transfer by going to Dell's website:

- If you are an Individual Home Consumer, go to www.dell.com/us/en/dhs/topics/sbtopic_015_ccare.htm
- If you are a Home Office, Small, Medium, Large, or Global Commercial Customer, go to www.dell.com/us/en/biz/topics/sbtopic_ccare_nav_015_ccare.htm
- If you are a Government, Education, or Healthcare Customer, or an Individual Home Consumer who purchased through an Employee Purchase Program, go to www.dell.com/us/en/pub/topics/sbtopic_015_ccare.htm

If you do not have Internet access, call your customer care representative or call 1-800-624-9897.

Limited Warranty Terms for Dell-Branded Hardware Products (Canada Only)

What is covered by this limited warranty?

This limited warranty covers defects in materials and workmanship in your—our end-user customer's—Dell-branded hardware products, including Dell-branded peripheral products.

What is not covered by this limited warranty?

This limited warranty does not cover:

- Software, including the operating system and software added to the Dell-branded hardware products through our factory-integration system, or the reloading of the software
- Non-Dell branded and Solution Provider Direct products and accessories

- Problems that result from:
 - External causes such as accident, abuse, misuse, or problems with electrical power
 - Servicing not authorized by Dell
 - Usage that is not in accordance with product instructions
 - Failure to follow the product instructions or failure to perform preventive maintenance
 - Problems caused by using accessories, parts, or components not supplied by Dell
- Products with missing or altered Service Tags or serial numbers
- Products for which Dell has not received payment

THIS WARRANTY GIVES YOU SPECIFIC LEGAL RIGHTS, AND YOU MAY ALSO HAVE OTHER RIGHTS WHICH VARY FROM PROVINCE TO PROVINCE. DELL'S RESPONSIBILITY FOR MALFUNCTIONS AND DEFECTS IN PRODUCT IS LIMITED TO REPAIR AND REPLACEMENT AS SET FORTH IN THIS WARRANTY STATEMENT, FOR THE TERM OF THE WARRANTY PERIOD REFLECTED ON YOUR PACKING SLIP OR INVOICE. EXCEPT FOR THE EXPRESS WARRANTIES CONTAINED IN THIS WARRANTY STATEMENT, DELL DISCLAIMS ALL OTHER WARRANTIES AND CONDITIONS, EXPRESS OR IMPLIED, INCLUDING WITHOUT LIMITATION IMPLIED WARRANTIES AND CONDITIONS OF MERCHANTABILITY AND FITNESS FOR A PARTICULAR PURPOSE, STATUTORY OR OTHERWISE. SOME PROVINCES DO NOT ALLOW THE EXCLUSION OF CERTAIN IMPLIED WARRANTIES OR CONDITIONS, OR LIMITATIONS ON HOW LONG AN IMPLIED WARRANTY OR CONDITION LASTS. THEREFORE, THE FOREGOING EXCLUSIONS AND LIMITATIONS MAY NOT APPLY TO YOU.

WE DO NOT ACCEPT LIABILITY BEYOND THE REMEDIES PROVIDED FOR IN THIS WARRANTY STATEMENT OR FOR SPECIAL, INDIRECT, CONSEQUENTIAL, OR INCIDENTAL DAMAGES, INCLUDING, WITHOUT LIMITATION, ANY LIABILITY FOR THIRD-PARTY CLAIMS AGAINST YOU FOR DAMAGES, FOR PRODUCTS NOT BEING AVAILABLE FOR USE, OR FOR LOST DATA OR LOST SOFTWARE. OUR LIABILITY WILL BE NO MORE THAN THE AMOUNT YOU PAID FOR THE PRODUCT THAT IS THE SUBJECT OF A CLAIM. THIS IS THE MAXIMUM AMOUNT FOR WHICH WE ARE RESPONSIBLE.

SOME PROVINCES DO NOT ALLOW THE EXCLUSION OR LIMITATION OF SPECIAL, INDIRECT, INCIDENTAL, OR CONSEQUENTIAL DAMAGES, SO THE ABOVE LIMITATION OR EXCLUSION MAY NOT APPLY TO YOU.

How long does this limited warranty last?

This limited warranty lasts for the time period indicated on your packing slip or invoice, except that the limited warranty on Dell-branded batteries lasts only 1 year and the limited warranty on the lamps for Dell-branded projectors lasts only 90 days. The limited warranty begins on the date of the packing slip or invoice. The warranty period is not extended if we repair or replace a warranted product or any parts. Dell may change the terms and availability of limited warranties, at its discretion, but any changes will not be retroactive (that is, the warranty terms in place at the time of purchase will apply to your purchase).

What do I do if I need warranty service?

Before the warranty expires, please call us at the relevant number listed in the following table. Please also have your Dell Service Tag or order number available.

Individual Home Consumers; Home Office and Small Business Customers:	Canada Only
Technical Support and Customer Service	1-800-847-4096
Medium, Large, and Global Commercial Customers; Government, Education, and Healthcare Customers; and Value-Added Resellers (VARs):	
Technical Support	1-800-387-5757
Customer Service	1-800-326-9463
Government or Education Customers, or Individual Home Consumers who purchased through an Employee Purchase Program:	
Technical Support	1-800-387-5757
Customer Service	1-800-326-9463 (Extension 8221 for Individual Consumers)
Dell-Branded Memory	1-888-363-5150

What will Dell do?

During the 90 days of the 90-day limited warranty and the first year of all other limited warranties: During the 90 days of the 90-day limited warranty and the first year of all other limited warranties, we will repair any Dell-branded hardware products returned to us that prove to be defective in materials or workmanship. If we are not able to repair the product, we will replace it with a comparable product that is new or refurbished.

When you contact us, we will issue a Return Material Authorization Number for you to include with your return. You must return the products to us in their original or equivalent packaging, prepay shipping charges, and insure the shipment or accept the risk if the product is lost or damaged in shipment. We will return the repaired or replacement products to you. We will pay to ship the repaired or replaced products to you if you use an address in Canada. Otherwise, we will ship the product to you freight collect.

If we determine that the problem is not covered under this warranty, we will notify you and inform you of service alternatives that are available to you on a fee basis.

NOTE: Before you ship the product(s) to us, make sure to back up the data on the hard drive(s) and any other storage device(s) in the product(s). Remove any confidential, proprietary or personal information, removable media, such as floppy disks, CDs, or PC Cards. We are not responsible for any of your confidential, proprietary or personal information; lost or corrupted data; or damaged or lost removable media.

During the remaining years following the first year of all limited warranties: We will replace any defective part with new or refurbished parts, if we agree that it needs to be replaced. When you contact us, we will require a valid credit card number at the time you request a replacement part, but we will not charge you for the replacement part as long as you return the original part to us within 30 days after we ship the replacement part to you. If we do not receive the original part within 30 days, we will charge to your credit card the then-current standard price for that part.

We will pay to ship the part to you if you use an address in Canada. Otherwise, we will ship the part freight collect. We will also include a prepaid shipping container with each replacement part for your use in returning the replaced part to us.

NOTE: Before you replace parts, make sure to back up the data on the hard drive(s) and any other storage device(s) in the product(s). We are not responsible for lost or corrupted data.

What if I purchased a service contract?

If your service contract is with Dell, service will be provided to you under the terms of the service contract. Please refer to that contract for details on how to obtain service. Dell's service contracts can be found online at www.dell.ca or by calling Customer Care at 1-800-847-4096. If you purchased through us a service contract with one of our third-party service providers, please refer to that contract (mailed to you with your packing slip or invoice) for details on how to obtain service.

How will you fix my product?

We use new and refurbished parts made by various manufacturers in performing warranty repairs and in building replacement parts and systems. Refurbished parts and systems are parts or systems that have been returned to Dell, some of which were never used by a customer. All parts and systems are inspected and tested for quality. Replacement parts and systems are covered for the remaining period of the limited warranty for the product you bought. Dell owns all parts removed from repaired products.

May I transfer the limited warranty?

Limited warranties on systems may be transferred if the current owner transfers ownership of the system and records the transfer with us. The limited warranty on Dell-branded memory may not be transferred. You may record your transfer by going to Dell's website:

- For Canada-purchased computers (in-country transfers) and to transfer from one customer to another, go to www.dell.ca/ca/en/gen/topics/segtopic_ccare_nav_013_ccare.htm
- For out-of-country transfers (outside of the original country of purchase), go to www.dell.com/us/en/biz/topics/sbtopic_ccare_nav_016_ccare.htm

If you do not have Internet access, call Dell at 1-800-847-4096 (Home Consumer customers) or 1-800-326-9463 (Corporate Commercial or Government customers).

Dell Software and Peripherals (Canada Only)

Third-Party Software and Peripherals Products

Similar to other resellers of software and peripherals, Dell does not warrant third-party products. Third-party software and peripheral products are covered by the warranties provided by the original manufacturer or publisher only. Third-party manufacturer warranties vary from product to product. Consult your product documentation for specific warranty information. More information may also be available from the manufacturer or publisher.

While Dell offers a wide selection of software and peripheral products, we do not specifically test or guarantee that all of the products we offer work with any or all of the various models of Dell computers, nor do we test or guarantee all of the products we sell on the hundreds of different brands of computers available today. If you have questions about compatibility, we recommend and encourage you to contact the third-party software and peripheral product manufacturer or publisher directly.

Dell-Branded Peripheral Products

Dell does provide a limited warranty for new Dell-branded peripheral products (products for which Dell is listed as the manufacturer) such as monitors, batteries, memory, and projectors. To determine which limited warranty applies to the product you purchased, see the Dell packing slip or invoice and/or the product documentation that accompanied your product. Descriptions of Dell's limited warranties are described in preceding sections.

Return Policy

If you are an end-user customer who bought Dell Software and Peripherals products directly from a Dell company, you may return Dell Software and Peripherals products that are in as-new condition to Dell up to 30 days from the date on the packing slip or invoice for a refund of the product purchase price if already paid. This refund will not include any shipping and handling charges shown on your packing slip or invoice; you are responsible for those.

To return products, you must call Dell Customer Service at 1-800-387-5759 to receive a Credit Return Authorization Number. You must ship the Dell Software and Peripherals products back to Dell in their original manufacturer's packaging (which must be in as-new condition), prepay shipping charges, and insure the shipment or accept the risk of loss or damage during shipment.

To qualify for refund or replacement, returned products must be in as-new condition, software products must be unopened, and all of the manuals, floppy disk(s), CD(s), power cables, and other items included with a product must be returned with it.

1-Year End-User Manufacturer Guarantee (Latin America and the Caribbean Only)

Guarantee

Dell Computer Corporation ("Dell") warrants to the end user in accordance with the following provisions that its branded hardware products, purchased by the end user from a Dell company or an authorized Dell distributor in Latin America or the Caribbean, will be free from defects in materials, workmanship, and design affecting normal use, for a period of 1 year from the original purchase date. Products for which proper claims are made will, at Dell's option, be repaired or replaced at Dell's expense. Dell owns all parts removed from repaired products. Dell uses new and reconditioned parts made by various manufacturers in performing repairs and building replacement products.

Exclusions

This Guarantee does not apply to defects resulting from: improper or inadequate installation, use, or maintenance; actions or modifications by unauthorized third parties or the end user; accidental or willful damage; or normal wear and tear.

Making a Claim

Claims must be made in Latin America or the Caribbean by contacting the Dell point of sale within the guarantee period. The end user must always supply proof of purchase, indicating name and address of the seller, date of purchase, model and serial number, name and address of the customer, and details of symptoms and configuration at the time of malfunction, including peripherals and software used. Otherwise, Dell may refuse the guarantee claim. Upon diagnosis of a warranted defect, Dell will make arrangements and pay for ground freight and insurance to and from Dell's repair/replacement center. The end user must ensure that the defective product is available for collection properly packed in original or equally protective packaging together with the details listed above and the return number provided to the end user by Dell.

Limitation and Statutory Rights

Dell makes no other warranty, guarantee or like statement other than as explicitly stated above, and this Guarantee is given in place of all other guarantees whatsoever, to the fullest extent permitted by law. In the absence of applicable legislation, this Guarantee will be the end user's sole and exclusive remedy against Dell or any of its affiliates, and neither Dell nor any of its affiliates shall be liable for loss of profit or contracts, or any other indirect or consequential loss arising from negligence, breach of contract, or howsoever.

This Guarantee does not impair or affect mandatory statutory rights of the end user against and/or any rights resulting from other contracts concluded by the end user with Dell and/or any other seller.

Dell World Trade LP

One Dell Way, Round Rock, TX 78682, USA

Dell Computadores do Brasil Ltda (CNPJ No. 72.381.189/0001-10)

Avenida Industrial Belgraf, 400
92990-000 - Eldorado do Sul – RS - Brasil

Dell Computer de Chile Ltda

Coyancura 2283, Piso 3- Of.302,
Providencia, Santiago - Chile

Dell Computer de Colombia Corporation

Carrera 7 #115-33 Oficina 603
Bogota, Colombia

Dell Computer de Mexico SA de CV

Paseo de la Reforma 2620 - 11° Piso
Col. Lomas Altas
11950 México, D.F.

Intel® Warranty Statement for Pentium® and Celeron® Processors Only (U.S. and Canada Only)

Intel's Three Year Limited Warranty

Limited Warranty

Intel warrants that its family of Pentium® and Celeron® processors, if properly used and installed, will be free from defects in materials and workmanship and will substantially conform to Intel's publicly available specifications for a period of three (3) years after the date the Pentium or Celeron processor was purchased (whether purchased separately or as part of a computer system).

If the Pentium or Celeron processor, which is the subject of this Limited Warranty, fails during the warranty period for reasons covered by this Limited Warranty, Intel, at its option, will:

- REPAIR the Pentium or Celeron processor by means of hardware and/or software; OR
- REPLACE the Pentium or Celeron processor with another Pentium or Celeron processor; OR
- if Intel is unable to repair or replace the particular Pentium or Celeron processor,
- REFUND the then-current value of the Pentium or Celeron processor.

THIS LIMITED WARRANTY, AND ANY IMPLIED WARRANTIES THAT MAY EXIST UNDER STATE LAW, APPLY ONLY TO THE ORIGINAL PURCHASER OF THE PENTIUM OR CELERON PROCESSOR, OR PENTIUM OR CELERON PROCESSOR-BASED COMPUTER AND LAST ONLY FOR AS LONG AS SUCH PURCHASER CONTINUES TO OWN THE PROCESSOR.

Extent of Limited Warranty

Intel does not warrant that your Pentium or Celeron processor will be free from design defects or errors known as "errata." Current characterized errata are available upon request. This limited warranty is for purchasers in the United States and Canada only. The limited warranty does not cover any costs relating to removal or replacement of any Pentium or Celeron processors that are soldered or otherwise permanently affixed to your system's motherboard.

This limited warranty does not cover damages due to external causes, including accident, problems with electrical power, usage not in accordance with product instructions, misuse, neglect, alteration, repair, improper installation, or improper testing.

How to Obtain Warranty Service

To obtain warranty service for your Pentium or Celeron processor, you may contact your computer system manufacturer in accordance with its instructions, or you may contact Intel.

To request warranty service from Intel, you should call Intel at 1-800-628-8686 during the warranty period during normal business hours (Pacific Time), excluding holidays. Please be prepared to provide:

- (1) your name, address, and telephone numbers;
- (2) proof of purchase;
- (3) this Intel warranty card;
- (4) a description of the computer system including the brand and model; and
- (5) an explanation of the problem.

[Note: The Customer Service Representative may need additional information from you depending on the nature of the problem.]

The replacement processor is warranted under this written warranty and is subject to the same limitations and exclusions for the remainder of the original warranty period or one (1) year, whichever is longer.

WARRANTY LIMITATIONS AND EXCLUSIONS

THESE WARRANTIES REPLACE ALL OTHER WARRANTIES, EXPRESS OR IMPLIED INCLUDING, BUT NOT LIMITED TO, THE IMPLIED WARRANTIES OF MERCHANTABILITY AND FITNESS FOR A PARTICULAR PURPOSE. INTEL MAKES NO EXPRESS WARRANTIES BEYOND THOSE STATED HERE. INTEL DISCLAIMS ALL OTHER WARRANTIES, EXPRESS OR IMPLIED, INCLUDING, WITHOUT LIMITATION, IMPLIED WARRANTIES OF MERCHANTABILITY AND FITNESS FOR A PARTICULAR PURPOSE.

SOME LAWS DO NOT ALLOW THE EXCLUSION OF IMPLIED WARRANTIES SO THIS LIMITATION MAY NOT APPLY TO YOU. IF THESE LAWS APPLY, THEN ALL EXPRESS AND IMPLIED WARRANTIES ARE LIMITED IN DURATION TO THE LIMITED WARRANTY PERIOD. NO WARRANTIES APPLY AFTER THAT PERIOD. SOME LAWS DO NOT ALLOW LIMITATIONS ON HOW LONG AN IMPLIED WARRANTY LASTS, SO THIS LIMITATION MAY NOT APPLY TO YOU.

LIMITATIONS OF LIABILITY

INTEL'S RESPONSIBILITY UNDER THIS, OR ANY OTHER WARRANTY, IMPLIED OR EXPRESS, IS LIMITED TO REPAIR, REPLACEMENT OR REFUND, AS SET FORTH ABOVE. THESE REMEDIES ARE THE SOLE AND EXCLUSIVE REMEDIES FOR ANY BREACH OF WARRANTY. INTEL IS NOT RESPONSIBLE FOR INDIRECT, SPECIAL, INCIDENTAL, OR CONSEQUENTIAL DAMAGES RESULTING FROM ANY BREACH OF WARRANTY OR UNDER ANY OTHER LEGAL THEORY INCLUDING, BUT NOT LIMITED TO, LOST PROFITS, DOWNTIME, GOODWILL, DAMAGE TO OR REPLACEMENT OF EQUIPMENT AND PROPERTY, AND ANY COSTS OF RECOVERING, REPROGRAMMING, OR REPRODUCING ANY PROGRAM OR DATA STORED IN OR USED WITH A SYSTEM CONTAINING YOUR PENTIUM PROCESSOR. SOME JURISDICTIONS DO NOT ALLOW THE EXCLUSION OR LIMITATION OF INCIDENTAL OR CONSEQUENTIAL DAMAGES, SO THE ABOVE LIMITATIONS OR EXCLUSIONS MAY NOT APPLY TO YOU.

THE LIMITED WARRANTY GIVES YOU SPECIFIC LEGAL RIGHTS, AND YOU MAY ALSO HAVE OTHER RIGHTS THAT VARY FROM JURISDICTION TO JURISDICTION.

**Intel Pentium® and Celeron® Processors are backed by a three-year limited warranty.
Please refer to the reverse side of this card for complete warranty details.**

Intel's Commitment to Quality

Intel is committed to producing the highest quality processors available. That's why we have hundreds of people dedicated to continuously improve our design, manufacturing, and testing technology.

We put every one of our Pentium® and Celeron® processors through a rigorous battery of tests during the design and manufacturing processes.

To verify that the new chip will correctly run the software written for Intel Architecture processors, a team of Intel engineers is dedicated to compatibility testing. In a state-of-art lab, this group runs an extensive set of operating systems, applications, network tests and stress tests repeatedly to ensure that the processor is compatible with representative software.

Just as importantly, we work with hardware and software companies in the computer industry to ensure that our processors are compatible with their products.

Additionally, a sampling of Intel processors are subjected to a rigorous "burn-in" test whereby the chip is operated at higher-than-normal temperatures and voltages. During this burn-in period, the processor experiences the equivalent of weeks of normal usage. These units are monitored for failures as part of our ongoing quality assurance process.

As a result, today's microprocessors from Intel are among the most reliable components in computers.

What are "Errata"?

Exhaustive product testing can highlight differences between the actual behavior of the microprocessor and its specifications. Sometimes the discrepancies are caused by a design defect or error, which we call errata. Rigorous validation identifies most errata during the development of the processor, but we do detect additional errata during the life cycle of a microprocessor.

When an erratum is identified, our engineers work to characterize it and find a solution. We work with system designers and software developers to ensure that the discrepancy does not affect their products. If necessary, special software or hardware solutions (sometimes known as "work arounds") are implemented in the system design to prevent computer users from encountering the problem. Errata may then be corrected in future revisions of the microprocessor.

No microprocessor is perfect, and Intel recognizes that some consumers want to know about any errata, whether or not the errata affect them. Intel makes documentation of all characterized Pentium and Celeron processor errata publicly available through our Technical Documentation Service.

At Intel, our goal is to make every computer user satisfied with his or her Pentium or Celeron processor. Should you have any questions, comments or concerns about your Intel microprocessor, please call us at 1-800-628-8686.

©1997, 1998 Intel Corporation. All rights reserved.

Index

A

- audio connectors
 - description, 26
 - system view, 26
- audio device
 - connecting, 35
 - enabling, 42

B

- battery
 - charge gauge, 31, 50
 - charging, 51
 - checking the charge, 50
 - description, 31
 - installing, 53
 - low-battery warning, 51
 - performance, 49
 - power meter, 50
 - removing, 52
 - storing, 53
 - system view, 31
- Bluetooth wireless technology
 - card
 - device status light, 22
 - installing, 116

C

- CD drive
 - fixing problems, 90
 - See* module bay

- CDs, 45
- characters
 - unexpected, 84
- computer
 - crashes, 88
 - restore to previous operating state, 97
 - slow performance, 93
 - specifications, 143
- conflicts
 - software and hardware incompatibilities, 96
- copying CDs
 - general information, 45
 - helpful tips, 46
 - how to copy a CD, 45
- crashes, 88

D

- Dell
 - contacting, 152, 170
 - online support site, 19
- Dell Diagnostics, 75
- Dell support policy, 152
- Device Driver Rollback, 94
- device latch release
 - description, 25
 - system view, 25

- device status lights
 - description, 22
 - system view, 22
- diagnostics, 75
- digital-video interface
 - See* DVI, 28
- display
 - description, 21-22
 - removing, 124
 - system view, 21-22
- display latch
 - description, 21
 - system view, 21
- display settings for a TV
 - enabling in Windows XP, 43
- documentation
 - online, 19
- Dolby headphones
 - setting up, 42
- drivers
 - about, 93
 - identifying, 94
 - reinstalling, 94
- Drivers and Utilities CD, 95
- drives
 - fixing problems, 81
 - See* hard drive, 111
- DVD drive. *See* module bay
- DVDs, 45

DVI monitor connector
description, 28
system view, 28

E

error messages, 77

F

fan
description, 31
replacing, 119
system view, 31

Files and Settings Transfer
Wizard, 33

floppy drive
connecting to a USB
connector, 28
fixing problems, 81
See module bay

H

hard drive
description, 31
fixing problems, 81
replacing, 111
returning to Dell, 112
system view, 31

hardware
conflicts, 96

Hardware Troubleshooter, 96
Help and Support Center, 19
Hyper-Threading
technology, 47

I

IEEE 1394 connector
description, 25
system view, 25
infrared sensor
enabling, 151
installing parts
recommended tools, 103
safety guidelines, 103

K

key combinations, 59
keyboard
description, 23
fixing problems, 82, 84
removing, 114
shortcuts, 59
system view, 23
unexpected characters, 84
keyboard status lights
description, 24
system view, 24
keypad
numeric, 59

L

labels
Microsoft Windows, 18
Service Tag, 18

M

media control buttons
description, 23
system view, 23
memory
adding, 105
removing, 106
memory module cover
description, 31
system view, 31
Microsoft Windows label, 18
Mini PCI card
installing, 108
Mini PCI card cover
description, 31
system view, 31
modem connector
description, 29
system view, 29
module bay
swapping devices while the
computer is running, 56
swapping devices while the
computer is turned off, 55
system view, 25
monitor
connecting a television, 43
connecting two, 43

- mute buttons
 - description, 23
 - system view, 23

N

- network
 - fixing problems, 87
- network connector
 - description, 29
 - system view, 29

O

- operating system
 - reinstalling Windows XP, 98
- optical drive. *See* module bay

P

- PC Card slot
 - description, 25
 - system view, 25
- PC Cards
 - fixing problems, 82
- power
 - fixing problems, 83
- problems
 - slow computer performance, 93
 - spyware, 93
- processor module
 - removing, 132

- processor thermal cooling
 - assembly
 - removing, 129

- programs
 - crashes, 88
 - fixing problems, 88
 - not responding, 88

R

- RAM. *See* memory
- reinstalling
 - drivers, 94
 - Windows XP, 98
- reserve battery
 - replacing, 134

S

- S/PDIF digital audio
 - enabling, 42
- safety instructions, 11
- security cable slot
 - description, 26
 - system view, 26
- Service Tag, 18
- shutting down your computer, 103
- software
 - conflicts, 96
 - fixing problems, 88
 - Hyper-Threading technology, 47

- speakers
 - description, 23
 - system view, 23
- specifications, system, 143
- spyware, 93

- subwoofer
 - description, 31
 - installing, 113
 - system view, 31

- support
 - contacting Dell, 152

- S-video TV-out connector
 - description, 27
 - system view, 27

- system board assembly
 - removing, 132

- system performance
 - Hyper-Threading, 47
 - memory and front-side bus, 47

- System Restore, 97

- system setup program
 - commonly used options, 150
 - purpose, 149
 - screens, 150
 - viewing, 150

T

- technical support
 - contacting Dell, 170
- television
 - connecting to your computer, 43

- thermal cooling assembly
 - removing, 129
- touch pad, 62
 - customizing, 63
 - description, 23
 - system view, 23
- track stick, 62
 - description, 23
 - system view, 23
- troubleshooting
 - blue screen, 88
 - cannot save to floppy disk, 81
 - CD drive problems, 90
 - CD problems, 89
 - Dell Diagnostics, 75
 - Device Driver Rollback, 94
 - DVD problems, 89
 - e-mail problems, 86
 - external keyboard
 - problems, 82
 - hard drive problems, 81
 - hardware and software
 - conflicts, 96
 - Hardware Troubleshooter, 96
 - Help and Support Center, 19
 - Internet connection
 - problems, 86
 - modem problems, 86
 - mouse problems, 84
 - network problems, 87
 - PC Card problems, 82
 - power problems, 83

- troubleshooting (*continued*)
 - printer problems, 85
 - program crash, 88
 - program stopped
 - responding, 88
 - scanner problems, 81
 - speaker problems, 90
 - touch pad problems, 84
 - unexpected characters, 84
 - video and display problems, 79

- TV
 - connecting, 35
 - enabling display settings in Windows XP, 43

U

- USB connectors
 - description, 28
 - system view, 28

V

- video connector
 - description, 28
 - system view, 28
- volume control buttons
 - description, 23
 - system view, 23

W

- warranty, 171
- Windows XP
 - Device Driver Rollback, 94
 - enabling display settings for a TV, 43
 - Hardware Troubleshooter, 96
 - Help and Support Center, 19
 - Hyper-Threading
 - technology, 47
 - reinstalling, 98
 - System Restore, 97
- wireless network
 - changing security settings, 70
 - connecting to, 67
 - type, 66